

Graphs with Non-unique Decomposition and Their Associated Surfaces

Weiwen Gu

Abstract

The ideal (tagged resp.) triangulation of bounded surface with marked points are associated with skew-symmetric (skew-symmetrizable) exchange matrices. An algorithm is established to decompose the graph associated to such matrix. There are finite many graph with non-unique decomposition. We find all such graphs and their decompositions. In addition, we also find the associated ideal (tagged) triangulations to different decompositions.

1 Introduction

Triangulation is a useful tool to study the topology of surfaces. Ideal triangulation of bordered surfaces with marked points is of particular interests in cluster algebra. For example, in [?], the authors construct cluster algebra associated to an ideal triangulation.

Definition 1. We associate to each ideal triangulation T the (generalized) signed adjacency matrix $B = B(T)$ that reflects the combinatorics of T . The rows and columns of $B(T)$ are naturally labeled by the arcs in T . For notational convenience, we arbitrarily label these arcs by the numbers $1, \dots, n$, so that the rows and columns of $B(T)$ are numbered from 1 to n as customary, with the understanding that this numbering of rows and columns is temporary rather than intrinsic. For an arc (labeled) i , let $\pi_T(i)$ denote (the label of) the arc defined as follows: if there is a self-folded ideal triangle in T folded along i , then $\pi_T(i)$ is its remaining side (the enclosing loop); if there is no such triangle, set $\pi_T(i) = i$. For each ideal triangle Δ in T which is not self-folded, define the $n \times n$ integer matrix $B^\Delta = (b_{ij}^\Delta)$ by settings:

$$b_{ij}^\Delta = \begin{cases} 1 & \text{if } \Delta \text{ has sides labeled } \pi_T(i) \text{ and } \pi_T(j) \\ & \text{with } \pi_T(j) \text{ following } \pi_T(i) \text{ in the clockwise order;} \\ -1 & \text{if the same holds, with the counter-clockwise order;} \\ 0 & \text{otherwise.} \end{cases}$$

The matrix $B = B(T) = (b_{ij})$ is then defined by

$$B = \sum_{\Delta} B^\Delta$$

The sum is taken over all ideal triangles \triangle in T which are not self-folded. The $n \times n$ matrix B is skew-symmetric, and all its entries b_{ij} are equal to 0, 1, -1 , 2, or -2 .

A quiver is defined as a finite oriented multi-graph without loops and 2-cycles.

Definition 2. Let G be a quiver, $B(G) = (b_{ij})$ is the skew-symmetric matrix whose rows and columns are labeled by the vertices of G , and whose entry b_{ij} is equal to the number of edges going from i to j minus the number of edges going from j to i .

Definition 3. Suppose B is a signed adjacency matrix associated to an ideal triangulation of a bordered surface with marked points (S, M) , and G is a quiver. If $B(G) = B$, we say G is the *oriented adjacency graph* associated to (S, M) .

The notion of *Block decomposition* plays an important role in determining the mutation class of a quiver. It is proved in [?] that a *quiver* is *block-decomposable* if and only if it is the associated adjacency graph of an ideal triangulations of a bordered surface with marked points. A quiver is a finite oriented multi-graph without loops and 2-cycles. In [?], we provide an algorithm that determines if a given quiver is block decomposable. In addition, we find all connected decomposable graphs with non-unique block-decomposition.

In [?], the authors generalize the property to the graph associated to ideal (tagged) triangulation of bordered surfaces with marked points. A new decomposability called *s-decomposable* is studied. It is proved in the same article that there is a one-to-one correspondence between *s-decomposable* skew-symmetrizable graphs with fixed block decomposition and ideal tagged triangulations of marked bordered surfaces with fixed tuple of conjugate pairs of edges. In [?], we provide a generalized algorithm that determines if a given graph is *s-decomposable*. In addition, we find that only two connected *s-decomposable* graphs that are not block-decomposable have non-unique decomposition.

2 Decomposition Rules and Blocks

For convenience, we denote an edge that connects nodes x, y by \overline{xy} if the orientation of this edge is unknown or irrelevant, \overrightarrow{xy} if the edge is directed from x to y , and \overleftarrow{xy} otherwise.

Definition 4. We recall that a diagram (or graph) is *block-decomposable* (or *decomposable*) if it is obtained by gluing elementary blocks of Table 1 by the following *gluing rules*:

1. Two white nodes of two different blocks can be identified. As a result, the graph becomes a union of two parts; the common node is colored black. A white node can neither be identified to itself nor with another node of the same block.
2. A black node can not be identified with any other node.
3. If two white nodes x, y of one block (endpoints of edge \overleftarrow{xy}) are identified with two white nodes p, q of another block (endpoints of edge \overleftarrow{pq}), x with p , y with q correspondingly, then a multi-edge of weight 2 is formed, and nodes $x = p, y = q$ are black.

4. If two white nodes x, y of one block (endpoints of edge \overleftarrow{xy}) are identified with two white nodes p, q of another block (endpoints of edge \overleftarrow{pq}), x with q, y with p correspondingly, then both edges are removed after gluing, and nodes $x = q, y = p$ are black.

Definition 5. If a graph G can be obtained by gluing both elementary blocks and new blocks in Table 2 by the gluing rules in Definition 4 and the following new rules, we say the graph is *s-decomposable*:

1. If the graph has multiple edges containing n parallel edges, replace the multiple edge by an edge of weight $2n$. For example, if we glue two parallel spikes of the same direction, we get an edge of weight 4 (see Figure 1).

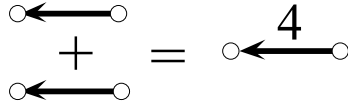

Figure 1: Edge of Weight 4

2. All single edges have weight 1.

Gluing two blocks corresponding to gluing two pieces of triangulations of surfaces: gluing two white nodes means gluing the corresponding sides of the triangulations, (see Figure. 2).

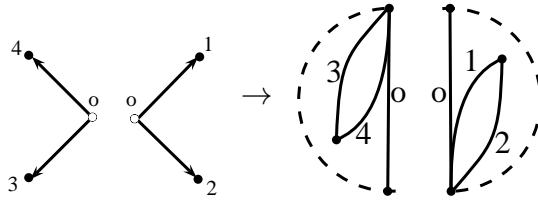

Figure 2: Triangulation Gluing

If a decomposable graph has a white node, we will glue a particular piece surface to that node in the corresponding triangulation to form the boundary, see Figure. 3

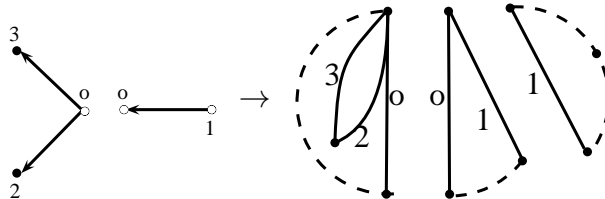

Figure 3: Boundary Gluing

It is shown in [?] that there is a one-to-one correspondence between a decomposition of a graph and an ideal triangulation of a bordered surfaces with marked points. We show in next section that most graphs with non-unique decomposition correspond to unique bordered surfaces.

3 Results

All graphs with non-unique decompositions (s-decompositions) are given in Figure. 78 in [?] and Figure. 4 in [?]. We list all their block decomposition (s-decomposition) and corresponding ideal (tagged) triangulation of surfaces.

Theorem 1. *If G is a decomposable or s-decomposable graph, G is associated to a unique bordered surface unless G is graph 5.*

Elementary Blocks Triangulation

Spike:

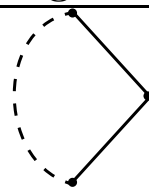

Triangle:

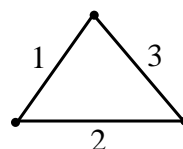
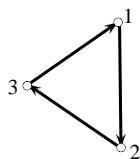

Infork:

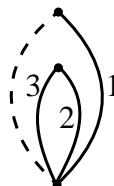
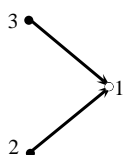

Outfork:

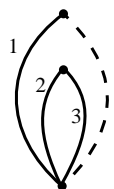
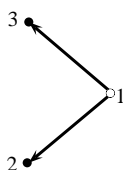

Diamond:

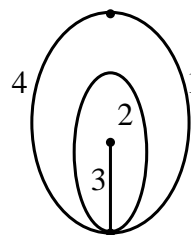
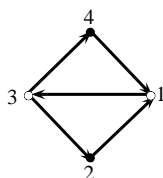

Square:

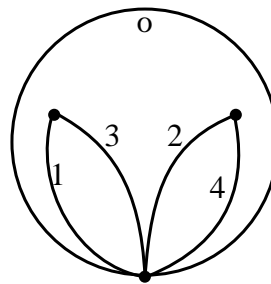
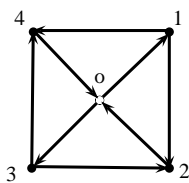
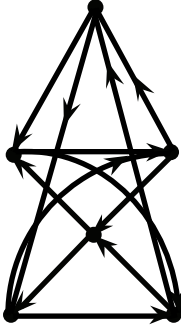
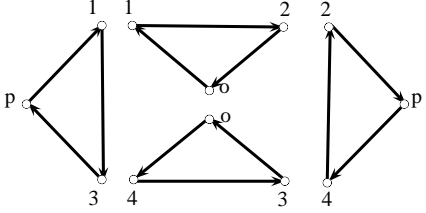
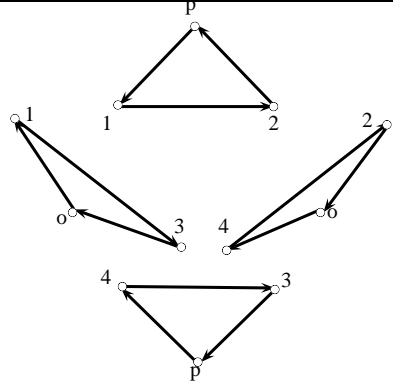
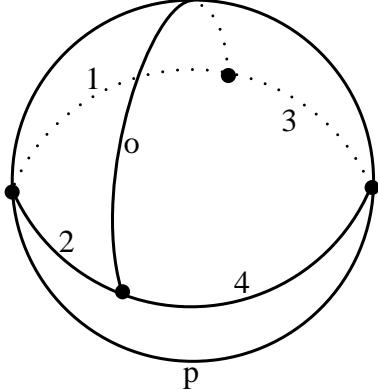
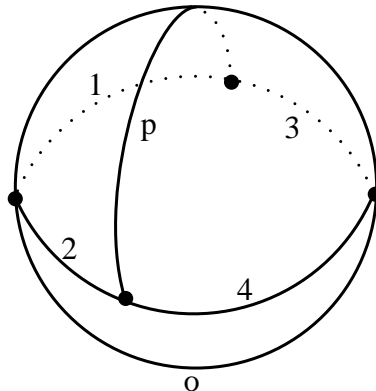

Table 1: Elementary Blocks

Table 2: Blocks of Unfolding

	New Blocks	Unfolding	Triangulation
Ia:			
Ib:			
II:			
IIIa:			
IIIb:			
IV:			
V:			

Graph 1		
Decomposition		
Surfaces		

<p>Graph 2</p>		
<p>Decomposition</p>		
<p>Surfaces</p>		

Graph 3		
Decomposition		
Surfaces		

<p>Graph 4</p>			
<p>Decomposition</p>			
<p>Surfaces</p>			

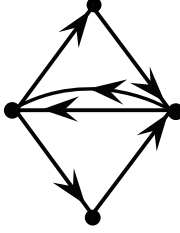
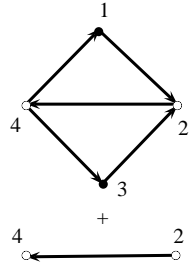
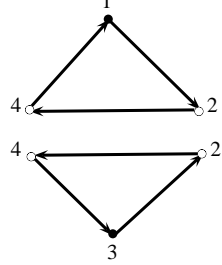
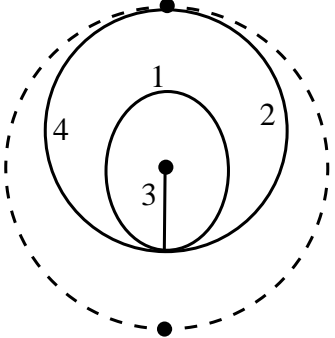
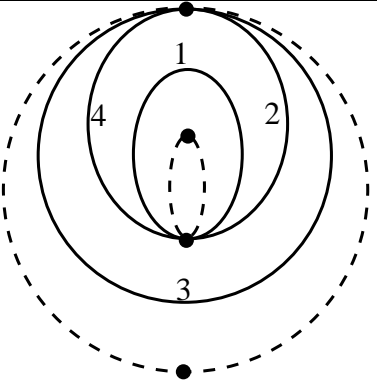
Graph 5		
Decomposition		
Surfaces		

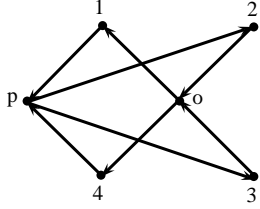
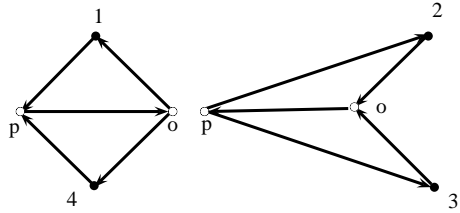
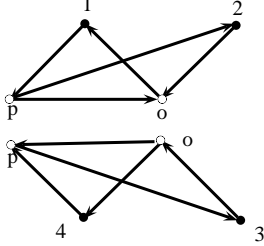
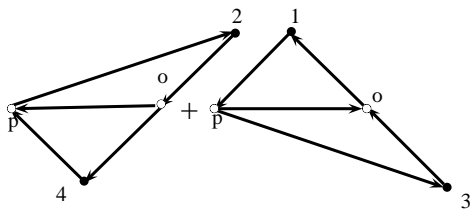
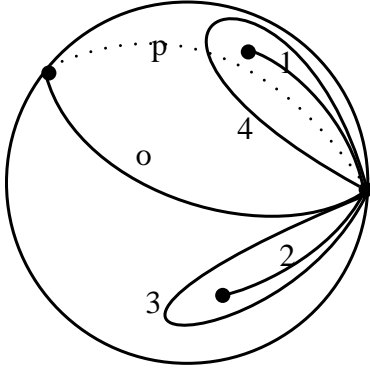
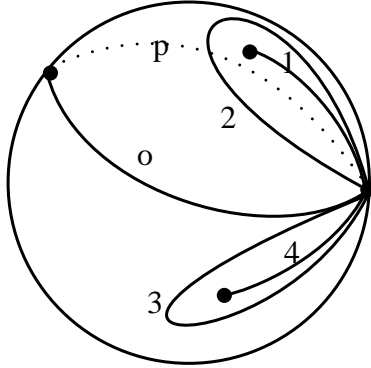
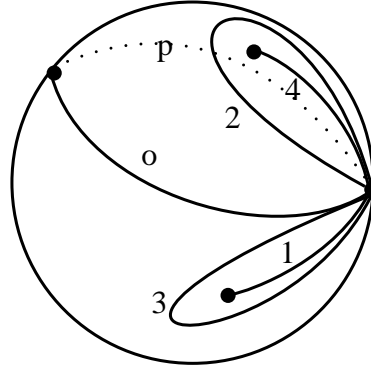
<p>Graph 6</p>			
<p>Decomposition</p>			
<p>Surfaces</p>			

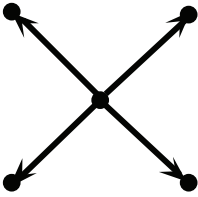
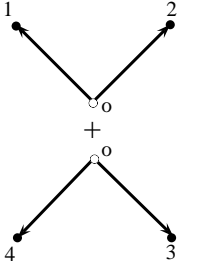
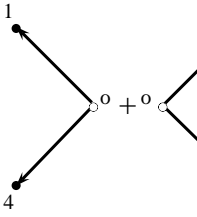
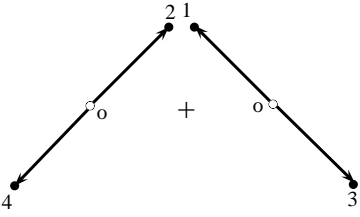
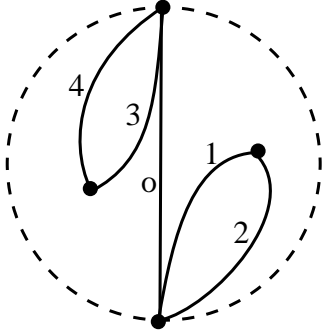
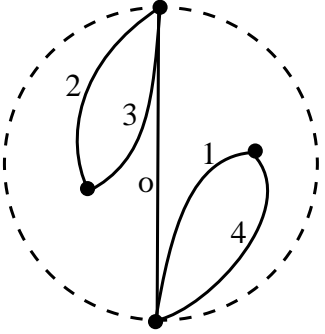
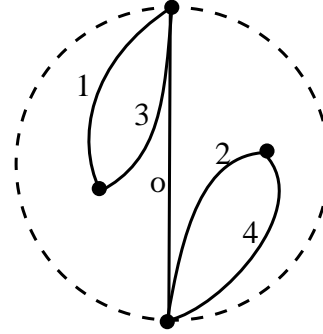
<p>Graph 7</p>			
<p>Decomposition</p>			
<p>Surfaces</p>			

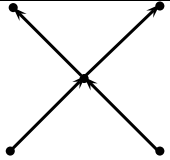
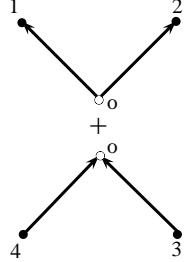
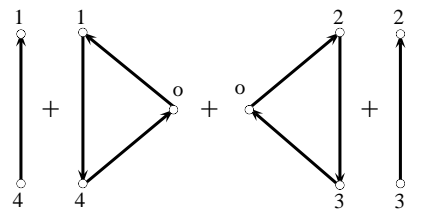
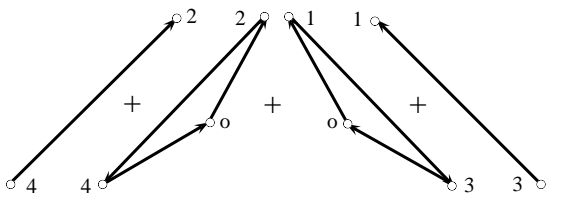
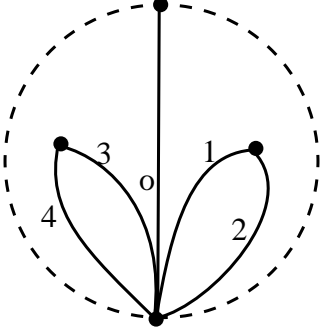
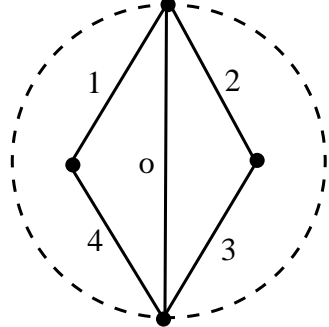
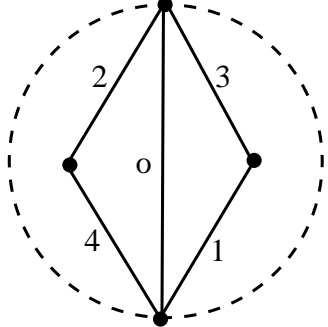
<p>Graph 7'</p>			
<p>Decomposition</p>			
<p>Surfaces</p>			

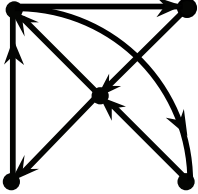
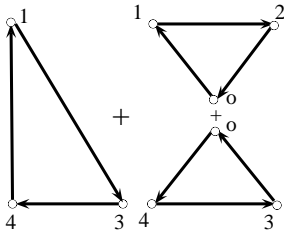
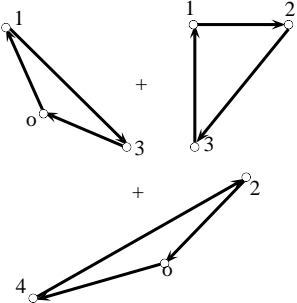
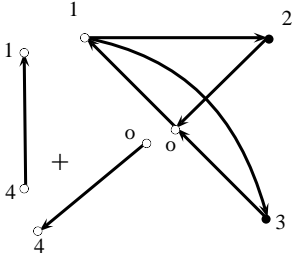
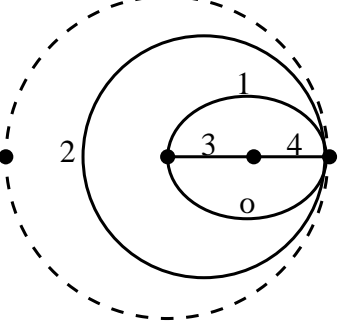
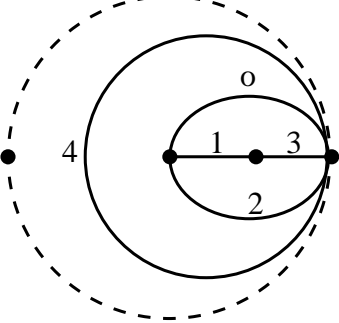
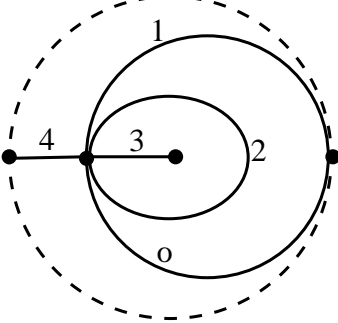
<p>Graph 8</p>			
<p>Decomposition</p>			
<p>Surfaces</p>			

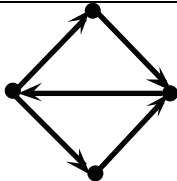
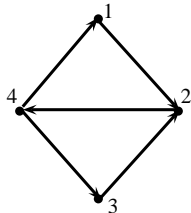
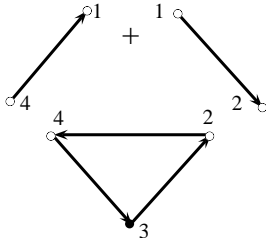
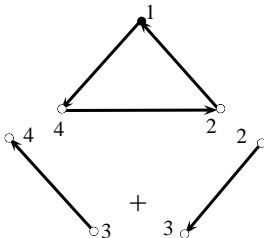
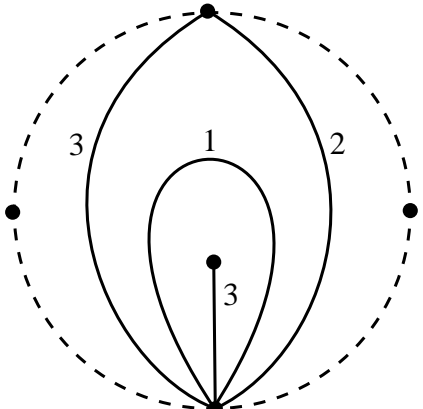
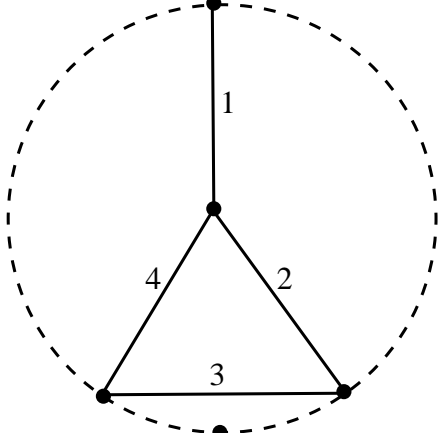
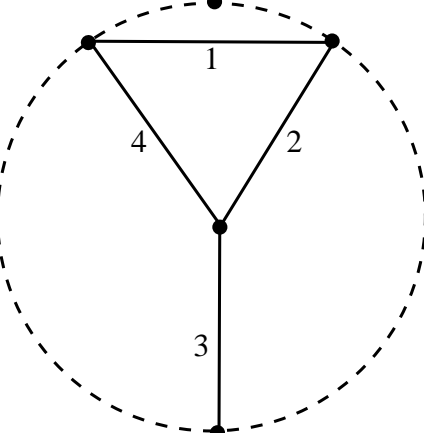
<p>Graph 9</p>			
<p>Decomposition</p>			
<p>Surfaces</p>			

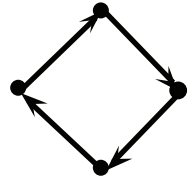
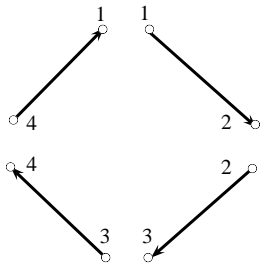
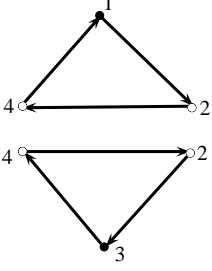
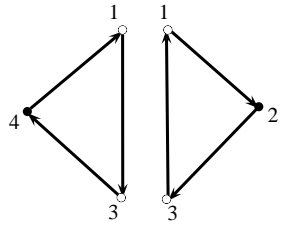
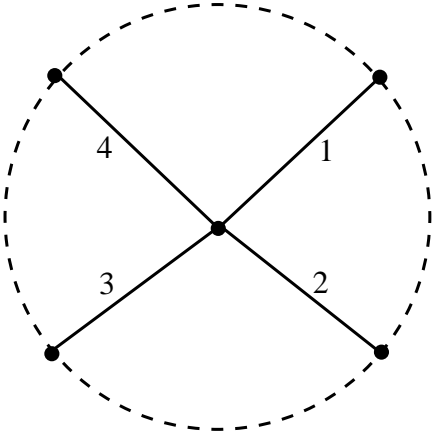
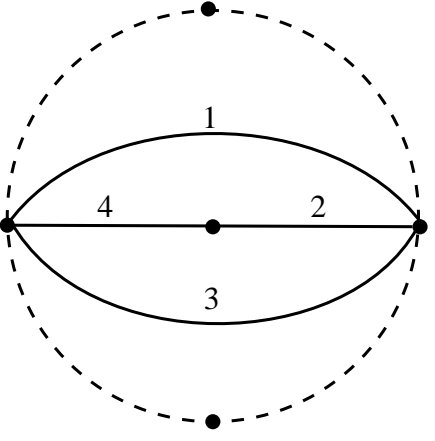
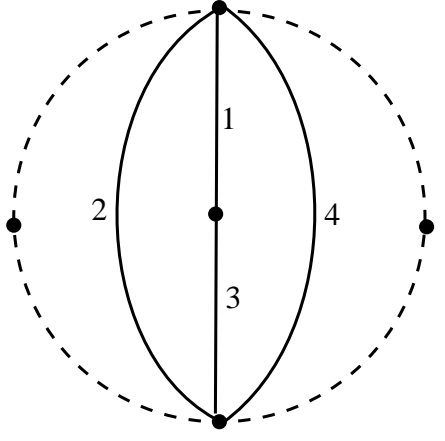
<p>Graph 10</p>			
<p>Decomposition</p>			
<p>Surfaces</p>			

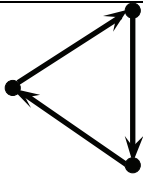
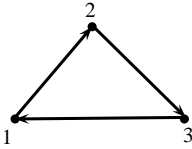
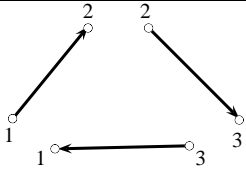
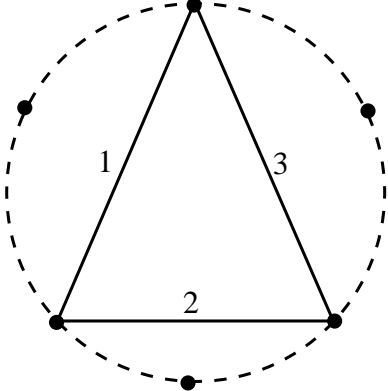
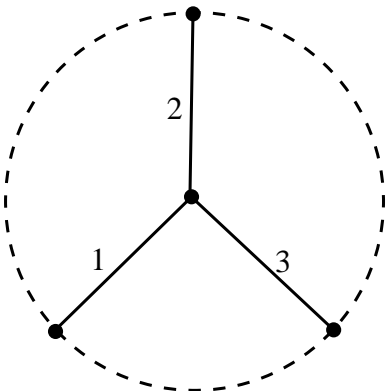
Graph 11		
Decomposition		
Surfaces		

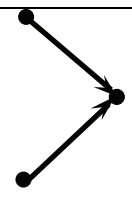
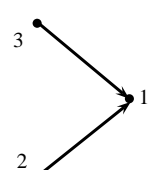
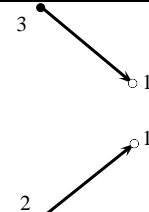
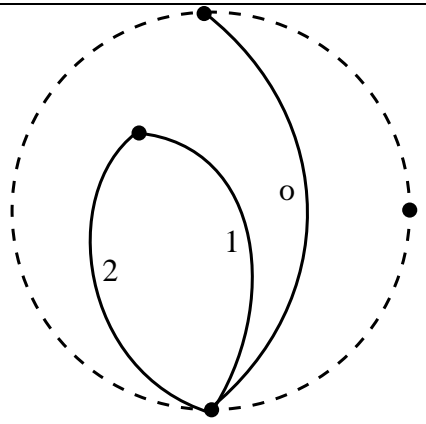
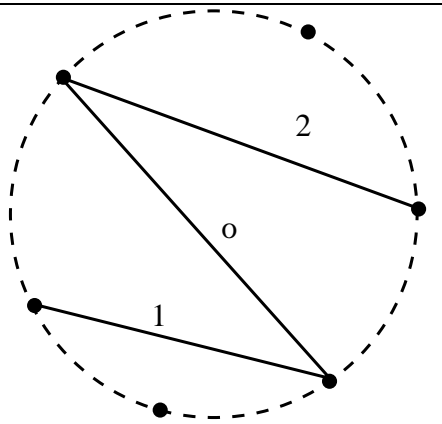
Graph 12		
Decomposition		
Surfaces		

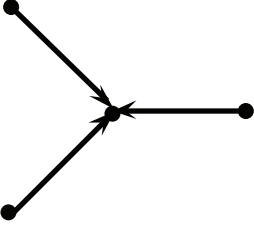
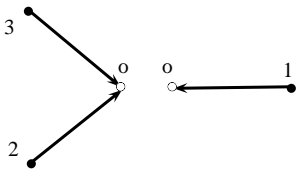
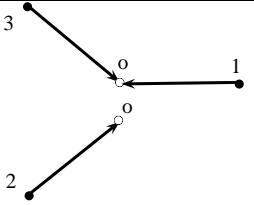
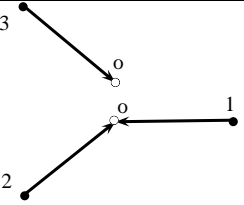
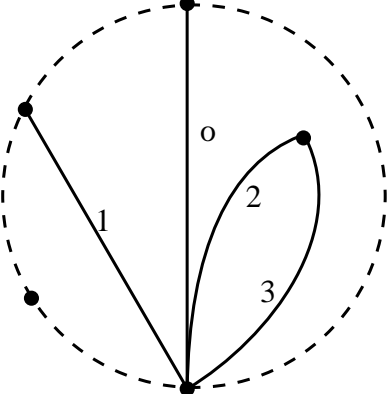
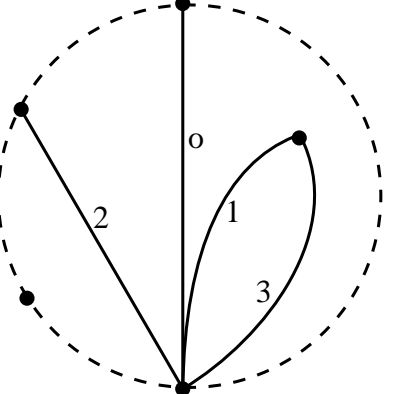
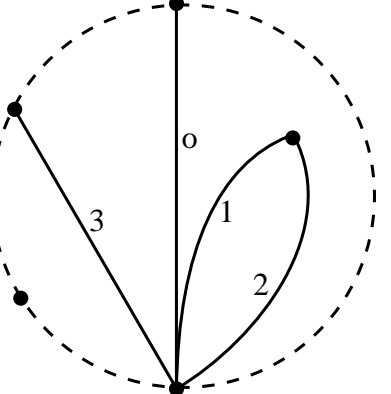
<p>Graph 13</p>			
<p>Decomposition</p>			
<p>Surfaces</p>			

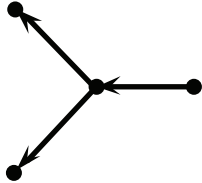
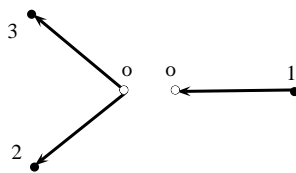
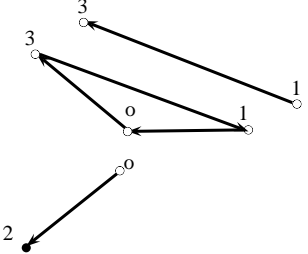
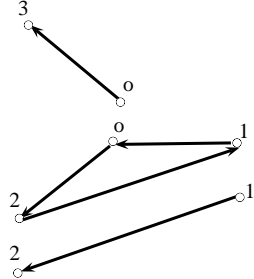
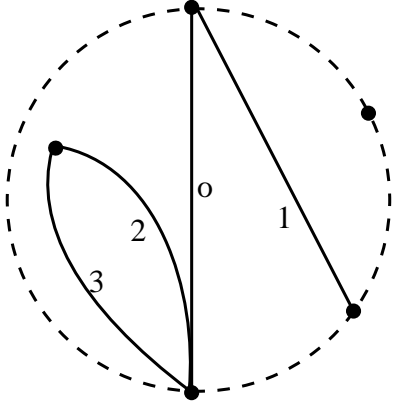
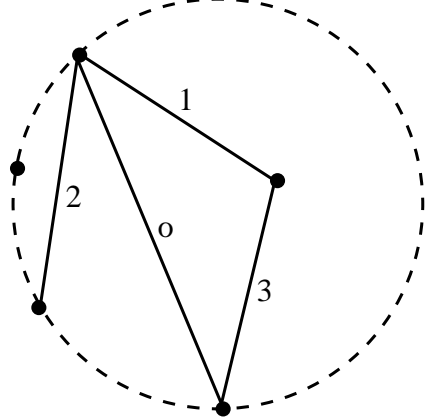
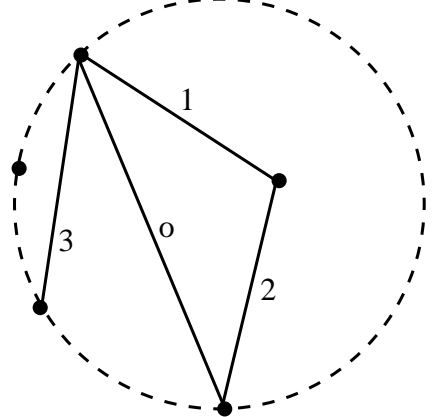
<p>Graph 14</p>			
<p>Decomposition</p>			
<p>Surfaces</p>			

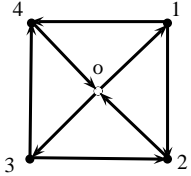
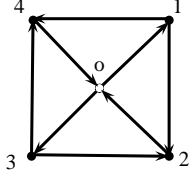
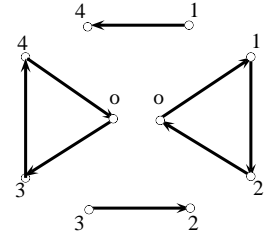
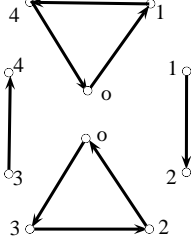
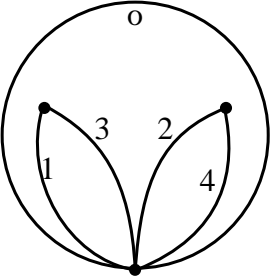
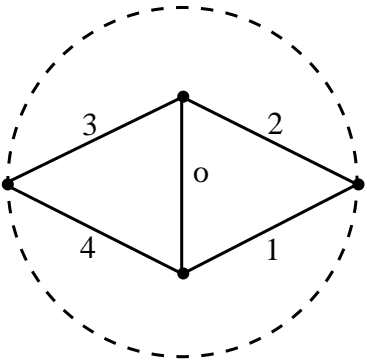
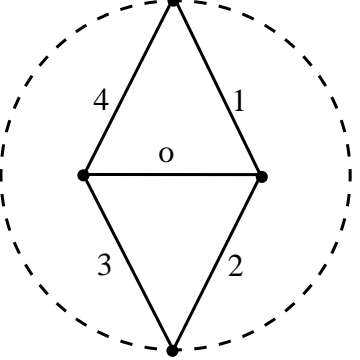
<p>Graph 15</p>			
<p>Decomposition</p>			
<p>Surfaces</p>			

Graph 16		
Decomposition		
Surfaces		

Graph 17		
Decomposition		
Surfaces		