

Formal Specification & Analysis of Autonomous Systems in PrCCSL/Simulink Design Verifier

Eun-Young Kang^{1,2}, Li Huang²

¹PreCISE Research Centre, University of Namur, Belgium

**²School of Data and Computer Science,
Sun Yat-sen University, Guangzhou, China**

eykang@fundp.ac.be

huangl223@mail2.sysu.edu.cn

ABSTRACT

Modeling and analysis of timing constraints is crucial in automotive systems. EAST-ADL is a domain specific architectural language dedicated to safety-critical automotive embedded system design. In most cases, a bounded number of violations of timing constraints in systems would not lead to system failures when the results of the violations are negligible, called Weakly-Hard (WH). We have previously specified EAST-ADL timing constraints in Clock Constraint Specification Language (CCSL) and transformed timed behaviors in CCSL into formal models amenable to model checking. Previous work is extended in this paper by including support for probabilistic analysis of timing constraints in the context of WH: Probabilistic extension of CCSL, called PrCCSL, is defined and the EAST-ADL timing constraints with stochastic properties are specified in PrCCSL. The semantics of the extended constraints in PrCCSL is translated into *Proof Objective Models* that can be verified using SIMULINK DESIGN VERIFIER. Furthermore, a set of mapping rules is proposed to facilitate guarantee of translation. Our approach is demonstrated on an autonomous traffic sign recognition vehicle case study.

Keywords: CPS, EAST-ADL, UPPAAL-SMC, SIMULINK DESIGN VERIFIER, Verification & Validation

Contents

1	Introduction	1
2	Preliminary	3
2.1	Clock Constraint Specification Language (CCSL)	3
2.2	Simulink and SDV	4
3	Running Example: Traffic Sign Recognition Vehicle	5
4	Probabilistic Extension of <i>Relations</i> in CCSL	10
5	Specification of Timing Constraints in PrCCSL	13
6	Translation of CCSL & PrCCSL into SDV	20
6.1	Mapping CCSL Expressions into S/S	20
6.2	Representation of PrCCSL in SDV	22
7	Modeling of AV System and its Environment in S/S	27
8	Experiments: Verification & Validation	30
9	Related work	32
10	Conclusion	33
	References	34

List of Figures

2.1	General verification models in SDV	4
3.1	AV in EAST-ADL augmented with TADL timing constraints (R.ID), specified in PrCCSL (Spec.R.ID)	6
4.1	Example of subclock relation	11
6.1	$h_c = \text{His}(c)$	20
6.2	$res \triangleq \text{PeriodicOn } base \text{ period } p$	21
6.3	$res \triangleq \text{Inf}(c1, c2)$ (rep. $\text{Sup}(c1, c2)$)	21
6.4	$res \triangleq base \text{ DelayFor } d \text{ on } ref$	22
6.5	POM of Probabilistic Subclock	22
6.6	POM of Probabilistic Coincidence and Exclusion	23
6.7	$sup \preceq_p \{inf \text{ DelayFor } 40 \text{ on } ms\}$	24
6.8	POM of Probabilistic Coincidence and Exclusion	24
6.9	$\{signIn \text{ DelayFor } 250 \text{ on } ms\} \preceq_p \{signIn \text{ DelayFor } (Wctrl + Wvd)$ $\text{ on } ms\}$	25
6.10	$\{obstc \text{ DelayFor } 500 \text{ on } ms\} \prec_p veRun$	25
6.11	POM of End-to-End timing constraint	26
7.1	Top-view of AV in S/S	27
7.2	Simulink model of Camera and SignRecognition	28
7.3	Stateflow chart of Controller	28
7.4	Simulink model of VehicleDynamic f_p	29

Chapter 1

Introduction

Software development for Cyber-Physical Systems (CPS) requires both functional and non-functional quality assurance to guarantee that CPS operate in a safety-critical context under timing constraints. Automotive electric/electronic systems are ideal examples of CPS in which the software controllers interact with physical environments. The continuous time behaviors of those systems often rely on complex dynamics as well as on stochastic behaviors. Formal verification and validation (V&V) technologies are indispensable and highly recommended for development of safe and reliable automotive systems [3, 4].

Conventional formal analysis of timing models addresses worst case designs, typically used for hard deadlines in safety critical systems, however, there is great incentive to include “less-than-worst-case” designs with a view to improving efficiency without affecting the quality of timing analysis in the systems. The challenge is the definition of suitable model semantics providing reliable predictions of *system timing*, given the timing of individual components and their compositions. While the standard worst case models are well understood in this respect, the behavior and the expressiveness of “less-than-worst-case” models is far less investigated. In most cases, a bounded number of violations of timing constraints in systems would not lead to system failures when the results of the violations are negligible, called Weakly-Hard (WH) [8, 26]. In this paper, we propose a formal probabilistic modeling and analysis technique by extending the known concept of WH constraints to what is called “typical” worst case model and analysis.

EAST-ADL (Electronics Architecture and Software Technology- Architecture Description Language) [5, 11], aligned with AUTOSAR (Automotive Open System Architecture) standard [1], is the model-based development approach for the architectural modeling of safety-critical automotive embedded systems. A system in EAST-ADL is described by Functional Architectures (FA) at different abstraction levels. The FA are composed of a number of interconnected *function prototypes* (f_p), and the f_p s have ports and connectors for communication. EAST-ADL relies on external tools for the analysis of specifications related to requirements. For example, behavioral description in EAST-ADL is captured in external tools, i.e., SIMULINK/STATEFLOW [30]. The latest release of EAST-ADL has adopted the time

model proposed in the Timing Augmented Description Language (TADL) [9]. TADL expresses and composes the basic timing constraints, i.e., repetition rates, end-to-end delays, and synchronization constraints. The time model of TADL specializes the time model of MARTE, the UML profile for Modeling and Analysis of Real-Time and Embedded systems [27]. MARTE provides CCSL, a time model and a Clock Constraint Specification Language, that supports specification of both logical and dense timing constraints for MARTE models, as well as functional causality constraints [23].

We have previously specified non-functional properties (timing and energy constraints) of automotive systems specified in EAST-ADL and MARTE/CCSL, and proved the correctness of specification by mapping the semantics of the constraints into UPPAAL models for model checking [21]. Previous work is extended in this paper by including support for probabilistic analysis of timing constraints of automotive systems in the context WH: 1. Probabilistic extension of CCSL, called PrCCSL, is defined and the EAST-ADL/TADL timing constraints with stochastic properties are specified in PrCCSL; 2. The semantics of the extended constraints in PrCCSL is translated into verifiable *Proof Objective Models* (POMs) for formal verification using SIMULINK DESIGN VERIFIER (SDV) [2]; 3. A set of mapping rules is proposed to facilitate guarantee of translation. Our approach is demonstrated on an autonomous traffic sign recognition vehicle (AV) case study.

The paper is organized as follows: Sec. 2 presents an overview of CCSL, SIMULINK/STATEFLOW and SDV. The AV is introduced as a running example in Sec. 3. Sec. 4 presents the formal definition of PrCCSL and Sec. 5 demonstrates the specification of EAST-ADL timing constraints in CCSL/PrCCSL. Sec. 6 describes a set of translation patterns from CCSL/PrCCSL to POMs and how our approaches provide support for formal analysis at the design level. The modeling of AV system and its environments in S/S are illustrated in Sec. 7. The applicability of our method is demonstrated by performing verification on the AV case study in Sec. 8. Sec. 9 and Sec. 10 present related work and the conclusion.

Chapter 2

Preliminary

In our framework, we consider a subset of CCSL and its extension with stochastic properties that is sufficient to specify EAST-ADL timing constraints in the context of WH automotive systems. SIMULINK and EMBEDDED MATLAB (EML) are utilized for modeling purposes, and V&V are performed by the SIMULINK built-in verification tool, SIMULINK DESIGN VERIFIER (SDV).

2.1 Clock Constraint Specification Language (CCSL)

CCSL [7, 23] clocks describe events in a system and measure occurrences of the events. The physical time is represented by a dense clock (with a base) and discretized into a logical clock. *idealClock* is a predefined dense clock whose unit is *second*. We define a universal clock *ms* based on *idealClock*: $ms = idealClock \text{ discretizedBy } 0.001$, where *ms* is a periodic clock that ticks every 1 millisecond. A step is a tick of the universal clock. Hence the length of one step is 1 millisecond in this paper.

CCSL provides two types of clock constraints, *relation* and *expression*: A *relation* limits the occurrences among different events/clocks. Let C be a set of clocks, $c1, c2 \in C$, Coincidence relation ($c1 \equiv c2$) specifies that two clocks must tick simultaneously. Precedence relation ($c1 \prec c2$) limits that $c1$ runs faster than $c2$, i.e., $\forall k \in \mathbb{N}^+$, where \mathbb{N}^+ is the set of positive natural numbers, the k^{th} tick of $c1$ must occur prior to the k^{th} tick of $c2$. Causality relation ($c1 \preceq c2$) represents a relaxed version of Precedence, allowing the two clocks to tick at the same time. Subclock ($c1 \subseteq c2$) indicates the relation between two clocks, *superclock* ($c1$) and *subclock* ($c2$), s.t. each tick of the subclock must correspond to a tick of its superclock at the same step. Exclusion ($c1 \# c2$) prevents the instants of two clocks from being coincident. An *expression* derives new clocks from the already defined clocks: *PeriodicOn* builds a new clock found on a *base* clock and a *period* parameter, s.t., the instants of the new clocks are separated by a number of instants of the *base* clock. The number is given as *period*. *DelayFor* results in a clock by delaying the *base* clock for a given number of ticks of a *reference* clock. *Infimum*, denoted *Inf*, is

defined as the slowest clock that is faster than both $c1$ and $c2$. Supremum, denoted Sup , is defined as the fastest clock that is slower than $c1$ and $c2$.

2.2 Simulink and SDV

SIMULINK [30] is a synchronous data flow language, which provides different types of *blocks* for modeling and simulation of dynamic systems and code generation. SIMULINK supports the definition of custom blocks via STATEFLOW diagrams or *user-defined function* blocks written in EML, C, and C++. SDV is a formal verification tool that performs reachability analysis on SIMULINK/STATEFLOW (S/S) model with PROVER plugin. The satisfiability of each reachable state is determined by a SAT solver. A proof objective model is specified in SIMULINK/SDV and illustrated in Fig.2.1. A set of data (predicates) on the input flows of *System* is constrained via «Proof Assumption» blocks during proof construction. A set of proof objectives are constructed via a function F block and the output of F is specified as input to a property P block. P passes its output signal to an «Assertion» block and returns *true* when the predicates set on the input data flows of the outline model are satisfied. Whenever «Assertion» is utilized, SDV verifies whether the specified input data flow is always *true*. Any failed proof attempt ends in the generation of a counterexample representing an execution path to an invalid state. A harness model is generated to analyze the counterexample and refine the model.

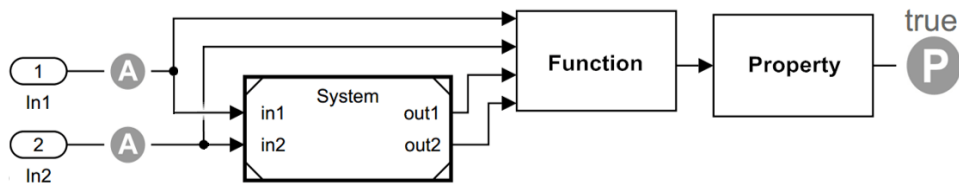

Figure 2.1: General verification models in SDV

Chapter 3

Running Example: Traffic Sign Recognition Vehicle

An autonomous vehicle (AV) [19, 20] application using Traffic Sign Recognition is adopted to illustrate our approach. The AV reads the road signs, e.g., “speed limit” or “right/left turn”, and adjusts speed and movement accordingly. The functionality of AV, augmented with timing constraints and viewed as Functional Design Architecture (FDA) (designFunctionTypes), consists of the following f_p s in Fig.3.1: System function type contains four f_p s, i.e., the Camera captures sign images and relays the images to SignRecognition periodically. Sign Recognition analyzes each frame of the detected images and computes the desired images (sign types). Controller determines how the speed of the vehicle is adjusted based on the sign types and the current speed of the vehicle. VehicleDynamic specifies the kinematics behaviors of the vehicle. Environment function type consists of three f_p s, i.e., the information of traffic signs, random obstacles, and speed changes caused by environmental influences described in TrafficSign, Obstacle, and Speed f_p s respectively.

We consider the Periodic, Execution, End-to-End, Synchronization, Sporadic, and Comparison timing constraints on top of the AV EAST-ADL model, which are sufficient to capture the constraints described in Fig.3.1. Furthermore, we extend EAST-ADL/TADL with an Exclusion timing constraint that integrates relevant concepts from the CCSL constraint, i.e., two events cannot occur simultaneously (R27 – R31).

R1. The camera must capture an image every 50ms. In other words, a Periodic acquisition of Camera must be carried out every 50ms.

R2. The captured image must be recognized by an AV every 200ms, i.e., a Periodic constraint on SignRecognition f_p .

R3. The obstacle must be detected by an AV every 40ms, i.e., the Periodic timing constraint is applied on the input port of Controller.

R4. The speed of AV is updated periodically with the period of 30ms.

R5. The detected image must be computed within [100, 150]ms in order to generate the desired sign type, SignRecognition must complete its execution within [100,

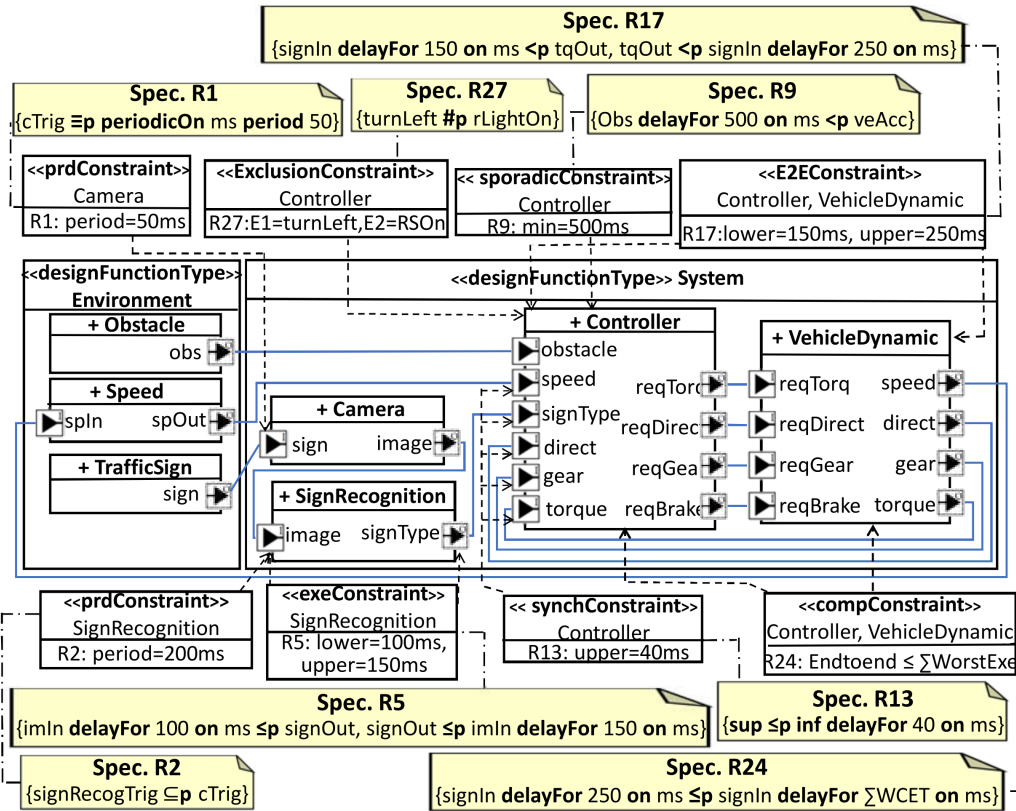

Figure 3.1: AV in EAST-ADL augmented with TADL timing constraints (R.ID), specified in PrCCSL (Spec.R.ID)

150]ms.

R6. Camera sends out captured images within [20, 30]ms to Controller, i.e., the execution time of Camera should be between 20 and 30ms.

R7. If an obstacle is detected, Controller must send out a “brake request” signal to VehicleDynamic in order to stop AV within [100, 150]ms, i.e., the execution time of Controller should be in the range of [100, 150].

R8. After VehicleDynamic receives a command/request from Controller, the speed of AV should be updated within [50, 100]ms, i.e., the Execution timing constraint applied on VehicleDynamic is within [50, 100]ms.

R9. If the mode of AV switches to “emergency stop” due to a certain obstacle, it should not revert back to “automatic running” mode within a specific time period. It is interpreted as a Sporadic constraint, i.e., the mode of AV is changed to Stop because of the encounter with an obstacle, it should not revert back to Run mode within 500ms.

R10. If the mode of AV switches to “emergency stop” due to a certain obstacle, it should not revert back to “accelerate” mode within a specific time period. It is interpreted as a Sporadic constraint, i.e., the mode of AV is changed to Stop because of the encounter with an obstacle, it should not revert back to accelerate mode within 500ms.

R11. If the mode of AV switches to “emergency stop” due to a certain obstacle, it

should not revert back to “turn left” mode within a specific time period. It is interpreted as a *Sporadic* constraint, i.e., the mode of AV is changed to *Stop* because of the encounter with an obstacle, it should not revert back to *turn left* mode within 500ms.

R12. If the mode of AV switches to “emergency stop” due to the certain obstacle, it should not revert back to “turn right” mode within a specific time period. It is interpreted as a *Sporadic* constraint, i.e., the mode of AV is changed to *Stop* because of the encounter with an obstacle, it should not revert back to *turn right* mode within 500ms.

R13. The necessary information from environment must be arrived to *Controller* within 40ms, e.g., all the input signals arriving on the *speed*, *signType*, *direct*, *gear* and *torque* ports of *Controller* must be within a given time window, i.e., the tolerated maximum constraint is 40ms. It is called *Input Synchronization* constraint.

R14. Once the execution of *Controller* is completed, it sends out the computed signals/values to *VehicleDynamic* within 30ms, e.g., all the output signals leaving via *reqTorq*, *reqDirect*, *reqGear*, *reqBrake* ports of *Controller* must be within a given time window, i.e., the tolerated maximum constraint is 30ms. It is called *Output Synchronization* constraint.

R15. The necessary information from *Controller* must be arrived to *VehicleDynamic* within 30ms. The *Input Synchronization* constraint applied on the input ports of *VehicleDynamic* (*reqTorq*, *reqDirect*, *reqGear*, *reqBrake*) should be 30ms.

R16. Once *VehicleDynamic* completes its execution, the information of AV must be updated within 40ms. The *Output Synchronization* constraint applied on the output ports of *VehicleDynamic* (*speed*, *direct*, *gear*, *torque*) should be 40ms.

R17. When a traffic sign is recognized, the speed of AV should be updated within [150, 250]ms. An *End-to-End* constraint on *Controller* and *VehicleDynamic*, i.e., the time interval from the input of *Controller* to the output of *VehicleDynamic* must be within a certain time.

R18. When *Camera* is triggered, the computation of image processing based on the traffic signs captured by *Camera* must be finished within [120, 180]ms, i.e., the *End-to-End* timing constraint applied on *Camera* and *SignRecognition* should be between 120ms and 180ms.

R19. The time interval between *Camera* capturing an image of traffic sign and the status of AV (i.e., speed, direction etc.) being updated according to the recognized sign type should be within [270, 430]ms, *End-to-End* timing constraint measured from the input of *Camera* to the output of *VehicleDynamic* should be between 270 and 430ms.

R20. When a “left turn” sign is recognized, AV must turn left within 500ms, i.e., a *End-to-End* timing constraint applied on the events *DetectLeftSign* and *StartTurn-*

Left is 500ms.

R21. When a “right turn” sign is recognized, AV must turn right within 500ms, i.e., a End-to-End timing constraint applied on the events DetectRightSign and StartTurnRight is 500ms.

R22. When a “stop” sign is recognized, AV must start to brake within 200ms, i.e., a End-to-End timing constraint applied on the events DetectStopSign and StartBrake is 20ms.

R23. When a “stop” sign is recognized, AV must be stop completely within 3000ms, i.e., a End-to-End timing constraint applied on the events DetectStopSign and Stop is 3000ms.

R24 The execution time interval between Controller and VehicleDynamic is less than or equal to the sum of the worst case execution time interval of each f_p .

R25. The execution time interval between Camera and SignRecognition is less than or equal to the sum of the worst case execution time interval of each f_p .

R26. The execution time interval between Camera and VehicleDynamic is less than or equal to the sum of the worst case execution time interval of each f_p .

R27. While AV turns left, the “turning right” mode should not be activated. The events of turning left and right considered as exclusive and specified as an Exclusion constraint.

R28. While AV is braking, the “accelerate” mode should not be activated. The events of braking and accelerating are considered as exclusive and specified as an Exclusion constraint.

R29. When AV is in the “emergency” mode because of encountering an obstacle, “turning left” mode must not be activated, i.e., the events of handling “emergency” and “turning left” are exclusive. It is specified as an Exclusion constraint.

R30. When AV is in the “emergency” mode because of encountering an obstacle, “turning right” mode must not be activated, i.e., the events of handling “emergency” and “turning right” are exclusive. It is specified as an Exclusion constraint.

R31. When AV is in the “emergency” mode because of encountering an obstacle, “accelerating” mode must not be activated, i.e., the events of handling “emergency” and “accelerating” are exclusive. It is specified as an Exclusion constraint.

Delay constraint gives duration bounds (minimum and maximum) between two events *source* and *target*. This is specified using *lower*, *upper* values given as either Execution constraints (R5 – R8) or End-to-End constraints (R17 – R23). Synchronization constraint describes how tightly the occurrences of a group of events follow each other. All events must occur within a sliding window, specified by the *tolerance* attribute, i.e., the maximum time interval allowed between events (R13 – R16). Periodic constraint states that the period of successive occurrences of a single event must have a time interval (R1 – R4). Sporadic constraint states that *events* can arrive at arbitrary points in time, but with defined minimum inter-arrival times between two consecutive occurrences (R9 – R12). Comparison constraint

delimits that two consecutive occurrences of an event should have a minimum inter-arrival time (R24 – R26). Exclusion constraint states that two events must not occur at the same time (R27 – R31). Those timing constraints are formally specified (seen as Spec. R. IDs in Fig.2) using clock *relation* and *expression* in the context of WH then verified utilizing probabilistic analysis techniques that are described further in the following sections.

Chapter 4

Probabilistic Extension of *Relations* in CCSL

To perform the formal specification and probabilistic verification of EAST-ADL timing constraints (R1 – R31 in Sec 3.), CCSL *relations* are augmented with probabilistic properties, called PrCCSL, based on WH [8]. To describe the bound on the number of allowed constraint violations in WH, we extend CCSL *relations* with a probabilistic parameter p , where p is the probability threshold. PrCCSL is satisfied if and only if the probability of *relation* constraint being satisfied is greater than or equal to p .

Definition 1 (PrCCSL) Let $c1, c2$ and \mathcal{M} be two logical clocks and a system model. The probabilistic extension of relation constraints, denoted $c1 \sim_p c2$, is satisfied if the following condition holds:

$$\mathcal{M} \models c1 \sim_p c2 \iff \Pr(c1 \sim c2) \geq p$$

where $\sim \in \{\subseteq, \equiv, \prec, \preceq, \#\}$, $\Pr(c1 \sim c2)$ is the probability of the relation $c1 \sim c2$ being satisfied, and $p \in [0, 1]$ is the probability threshold.

$\Pr(c1 \sim c2)$ is calculated based on clock ticks: $\Pr(c1 \sim c2) = \frac{m}{k}$, where k is the total number of ticks and m is a number of ticks satisfying the clock relation $c1 \sim c2$.

Definition 2 (Tick and History) For $c \in C$, the tick of c is indicated by a function $t_c: \mathbb{N} \rightarrow \{0, 1\}$. For $i \in \mathbb{N}$, $t_c(i)$ is a boolean variable that indicates whether c ticks at the i^{th} step, which is defined as: if c ticks at step i , $t_c(i) = 1$; otherwise $t_c(i) = 0$. The history of c is a function $h_c: \mathbb{N} \rightarrow \mathbb{N}$. $h_c(i)$ that represents the number of ticks of c that have been fired prior to the i^{th} step, which can be defined as: (1) $h_c(0) = 0$; (2) $\forall i \in \mathbb{N}^+, t_c(i) = 0 \implies h_c(i+1) = h_c(i)$; (3) $\forall i \in \mathbb{N}^+, t_c(i) = 1 \implies h_c(i+1) = h_c(i) + 1$.

The five CCSL *relations*, Subclock, Coincidence, Exclusion, Causality and Precedence, are considered and the related probabilistic extensions are defined.

Definition 3 (Probabilistic Subclock) The probability of subclock relation between $c1$ and $c2$, denoted $c1 \subseteq_p c2$, is satisfied if the following conditions hold:

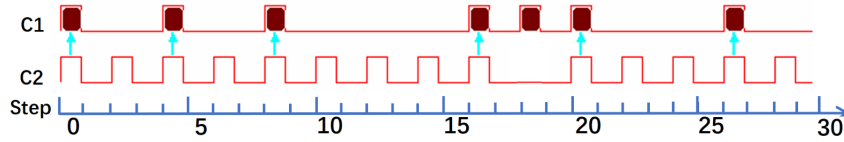

Figure 4.1: Example of subclock relation

$$\mathcal{M} \models c1 \subseteq_p c2 \iff Pr(c1 \subseteq c2) \geq p$$

where $Pr(c1 \subseteq c2) = \frac{m}{k}$, $k = \sum_{i=0}^n t_{c1}(i)$, $m = \sum_{i=0}^n \{t_{c1}(i) \wedge (t_{c1}(i) \implies t_{c2}(i))\}$

n refers to the simulation bound (number of steps of an execution). k is the total number of ticks of the subclock $c1$ during the execution. m is the number of ticks of $c1$ satisfying the subclock relation. A tick of the subclock $c1$ satisfies the relation if at the step it occurs, its superclock $c2$ ticks. An example is shown in Fig. 4.1: among the 30 steps, $c1$ ticks seven times, and six of them (denoted by the arrows) satisfy subclock relation. In this case, $n=30$, $k = 7$ and $m = 6$.

Coincidence relation states that two clocks should tick at the same step. i.e., they are subclocks of each other.

Definition 4 (Probabilistic Coincidence) The probability of coincidence relation between $c1$ and $c2$, denoted $c1 \equiv_p c2$, is satisfied if the following conditions hold:

$$\mathcal{M} \models c1 \equiv_p c2 \iff Pr(c1 \equiv c2) \geq p$$

where $Pr(c1 \equiv c2) = \frac{m}{k}$, $k = \sum_{i=0}^n \{t_{c1}(i) \vee t_{c2}(i)\}$, $m = \sum_{i=0}^n \{t_{c1}(i) \wedge t_{c2}(i)\}$

$Pr(c1 \equiv c2)$ represents the probability of the instants $c1$ that are coincident with the instants of $c2$. Coincidence relation is bidirectional, which means that $c1$ and $c2$ are equivalent in the relation. In this case, k is the total number of steps at which either $c1$ or $c2$ ticks. m is the number of ticks of steps at which coincidence relation is satisfied, i.e., the steps at which both $c1$ and $c2$ tick.

The inverse of coincidence relation, called exclusion, hinders two clocks from ticking simultaneously.

Definition 5 (Probabilistic Exclusion) The probability of exclusion relation between $c1$ and $c2$, denoted $c1 \#_p c2$, is satisfied if the following conditions hold:

$$\mathcal{M} \models c1 \#_p c2 \iff Pr(c1 \# c2) \geq p, \text{ where } Pr(c1 \# c2) = \frac{m}{k},$$

$$k = \sum_{i=0}^n \{t_{c1}(i) \vee t_{c2}(i)\},$$

$$m = \sum_{i=0}^n \{(t_{c1}(i) \wedge \neg t_{c2}(i)) \vee (\neg t_{c1}(i) \wedge t_{c2}(i))\}$$

k is the total number of steps at which either $c1$ or $c2$ ticks. m indicates the number of steps at which exclusion relation is satisfied, i.e., the steps at which only one of the two clocks ticks.

The probabilistic extension of causality and precedence relations are defined based on the history of the clocks. Recall that $h_{c1}(i)$ ($h_{c2}(i)$) indicates how many times $c1$ ($c2$) has ticked before the step i . If the history of $c1$ is greater than the one of $c2$ at the same step, we say that $c1$ runs faster than $c2$ at that step. Causality relation specifies that an event causes another one, i.e., the effect cannot occur if the cause has not.

Definition 6 (Probabilistic Causality) *The probabilistic causality relation between $c1$ and $c2$ ($c1$ is the cause and $c2$ is the effect), denoted, $c1 \preceq_p c2$, is satisfied if the following conditions hold:*

$$\mathcal{M} \models c1 \preceq_p c2 \iff Pr(c1 \preceq c2) \geq p$$

$$\text{where } Pr(c1 \preceq c2) = \frac{m}{k}, \quad k = \sum_{i=0}^n t_{c1}(i), \quad m = \sum_{i=0}^n \{t_{c1}(i) \wedge h_{c1}(i) \geq h_{c2}(i)\}$$

k is the total number of ticks of $c1$. m is the number of ticks of $c1$ satisfying causality relation. A tick of $c1$ satisfies causality relation if $c2$ does not occur prior to $c1$, i.e., the history of $c2$ is less than or equal to the history of $c1$ at the current step.

The strict causality, called precedence, constrains that one clock must always run faster than the other.

Definition 7 (Probabilistic Precedence) *The probabilistic precedence relation between $c1$ and $c2$, denoted, $c1 \prec_p c2$, is satisfied if the following conditions hold:*

$$\mathcal{M} \models c1 \prec_p c2 \iff Pr(c1 \prec c2) \geq p, \quad \text{where}$$

$$Pr(c1 \prec c2) = \frac{m}{k}, \quad k = \sum_{i=0}^n t_{c1}(i),$$

$$m = \sum_{i=0}^n \underbrace{t_{c1}(i) \wedge h_{c1}(i) \geq h_{c2}(i)}_{(1)} \wedge \underbrace{(h_{c1}(i) = h_{c2}(i) \implies \neg t_{c2}(i))}_{(2)}$$

k indicates the total number of ticks of $c1$. m is the number of ticks of $c1$ satisfying precedence and holding the two conditions: (1) the history of $c1$ is greater than or equal to the history of $c2$ at the same step; (2) $c1$ and $c2$ must not be coincident, i.e., when the history of $c1$ and $c2$ are equal, $c2$ must not tick.

Chapter 5

Specification of Timing Constraints in PrCCSL

To describe the property that a timing constraint is satisfied with the probability greater than or equal to a given threshold, CCSL and its extension PrCCSL are employed to capture the semantics of probabilistic timing constraints in the context of WH. Below, we show how EAST-ADL timing constraints, including `Execution`, `Periodic`, `End-to-End`, `Sporadic`, `Synchronization`, `Exclusion` and `Comparison` timing constraints, can be specified in CCSL/PrCCSL. In the system, events are represented as clocks. The ticks of clocks correspond to the occurrences of the events.

Periodic timing constraints (R1 – R4) can be specified using `PeriodicOn` *expression* and probabilistic coincident *relation*. For example, R1 states that the camera must be triggered periodically with a period 50ms. We first construct a periodic clock `prd_50` which ticks every 50 ticks of `ms` (the universal clock). Then the property that the periodic timing constraint is satisfied with probability no less than the threshold p can be interpreted as the probabilistic coincidence *relation* between `cmrTrig` (the event that Camera f_p being triggered) and `prd_50`. The corresponding specification is given below, where \triangleq means “is defined as”:

$$prd_50 \triangleq \text{PeriodicOn } ms \text{ period } 50 \quad (5.1)$$

$$cmrTrig \equiv_p prd_50 \quad (5.2)$$

By combining (1) and (2), we can obtain the the specification of R1:

$$cmrTrig \equiv_p \{\text{PeriodicOn } ms \text{ period } 50\} \quad (5.3)$$

In similar, the CCSL/PrCCSL specification of R3 – R4 can be derived:

$$\mathbf{R3}: obsDetect \equiv_p \{\text{PeriodicOn } ms \text{ period } 40\} \quad (5.4)$$

$$\mathbf{R4}: spUpdate \equiv_p \{\text{PeriodicOn } ms \text{ period } 30\} \quad (5.5)$$

where $signTrig$ is the event/clock that $SignRecognition f_p$ will be triggered, $obsDetect$ represents the event that the object detection is activated by the vehicle and $spU pdate$ denotes the event that the speed is updated (i.e., recieved by $Controller$) from the environment.

Since the *period* attribute of the periodic timing constraint R2 is 200ms, which is a integral multiple of the *period* of R1, R2 can be interpreted as a *subclock* relation, i.e., the event $signTrig$ should be a *subclock* of $cmrTrig$. The specification is given below:

$$signTrig \subseteq_p cmrTrig \quad (5.6)$$

Execution timing constraints (R5 – R8) can be specified using *DelayFor expression* and probabilistic causality *relation*. To specify R5, which states that the $SignRecognition f_p$ must finish execution within [100, 150]ms, i.e., the interval measured from the input event of the f_p (i.e., the event that the image is received by the f_p , denoted $imIn$) to the output event of the f_p (denoted $signOut$) must have a minimum value 100 and a maximum value 150. We divide this property into two sub-properties: R5(1). The time duration between $imIn$ and $signOut$ should be greater than 100ms. R5(2). The time duration between $imIn$ and $signOut$ should be less than 150ms. To specify property R5(1), we first construct a new clock $imIn_dly100$ by delaying $imIn$ (the input event of $SignRecognition$) for 100ms. To check whether R5(1) is satisfied within a probability threshold is to verify whether the probabilistic causality between $imIn_dly100$ and $signOut$ is valid. The specification of R5(1) is given below:

$$imIn_dly100 \triangleq imIn \text{ DelayFor } 100 \text{ on } ms \quad (5.7)$$

$$imIn_dly100 \preceq_p signOut \quad (5.8)$$

By combining (7) and (8), we can obtain the the specification of R5(1):

$$\{imIn \text{ DelayFor } 100 \text{ on } ms\} \preceq_p signOut \quad (5.9)$$

Similarly, to specify property R5(2), a new clock $imIn_dly150$ is generated by delaying $imIn$ for 150 ticks on ms . Afterwards, the property that R5(2) is satisfied with a probability greater than or equal to p relies on whether the probabilistic causality *relation* between $imIn_dly150$ and $signOut$ is satisfied. The specification is illustrated as follows:

$$imIn_dly150 \triangleq imIn \text{ DelayFor } 150 \text{ on } ms \quad (5.10)$$

$$signOut \preceq_p imIn_dly150 \quad (5.11)$$

By combining (10) and (11), we can obtain the the specification of R5(2):

$$signOut \preceq_p \{imIn \text{ DelayFor } 150 \text{ on } ms\} \quad (5.12)$$

Analogously, the CCSL/PrCCSL specification of R6 – R8 can be derived:

$$\begin{aligned} \mathbf{R6} : \{cmrTrig \text{ DelayFor } 20 \text{ on } ms\} \preceq_p cmrOut \\ cmrOut \preceq_p \{cmrTrig \text{ DelayFor } 30 \text{ on } ms\} \end{aligned} \quad (5.13)$$

$$\begin{aligned} \mathbf{R7} : \{ctrlIn \text{ DelayFor } 100 \text{ on } ms\} \preceq_p ctrlOut \\ ctrlOut \preceq_p \{ctrlIn \text{ DelayFor } 150 \text{ on } ms\} \end{aligned} \quad (5.14)$$

$$\begin{aligned} \mathbf{R8} : \{vdIn \text{ DelayFor } 50 \text{ on } ms\} \preceq_p vdOut \\ vdOut \preceq_p \{vdIn \text{ DelayFor } 100 \text{ on } ms\} \end{aligned} \quad (5.15)$$

where *cmrTrig* is the event that the Camera f_p is triggered, *cmrOut* represents the event that the captured image is sent out. *ctrlIn* (*ctrlOut*) represents the input (resp. output) of Controller f_p . *vdIn* (*vdOut*) represents the input (resp. output) of VehicleDynamic f_p .

Sporadic timing constraints (R9 – R12) can be specified using *DelayFor expression* and probabilistic precedence *relation*. For instance, R9 states that there should be a minimum delay between the event *veRun* (the event that the vehicle is in the *Run* mode) and the event *obstc* (the event that the vehicle detects an obstacle), which is specified as 500ms. To specify R9, we first build a new clock *obstc_dly500* by delaying *obstc* for 500 ticks of *ms*. We then check whether the probabilistic precedence relation between *obst_dly500* and *veRun*:

$$obstc_dly500 \triangleq obstc \text{ DelayFor } 500 \text{ on } ms \quad (5.16)$$

$$obstc_dly500 \prec_p veRun \quad (5.17)$$

By combining (16) and (17), we can obtain the the specification of R9:

$$\{obstc \text{ DelayFor } 500 \text{ on } ms\} \prec_p veRun \quad (5.18)$$

Analogously, the CCSL/PrCCSL specification of R10 – R12 can be derived:

$$\mathbf{R10} : \{obstc \text{ DelayFor } 500 \text{ on } ms\} \prec_p veAcc \quad (5.19)$$

$$\mathbf{R11} : \{obstc \text{ DelayFor } 500 \text{ on } ms\} \prec_p tLeft \quad (5.20)$$

$$\mathbf{R12} : \{obstc \text{ DelayFor } 500 \text{ on } ms\} \prec_p tRight \quad (5.21)$$

where *veAcc* is the event/clock that the vehicle is accelerating. *tLeft* and *tRight* represent the event that the vehicle transits from the *emergency* stop mode to *turn left* and *turn right* mode respectively.

Synchronization timing constraints (R13 – R16) can be specified using Infimum and Supremum *expression*, together with probabilistic precedence *relation*. R13 states that the five input events must be detected by Controller within the maximum tolerated time, given as 40ms. The synchronization timing constraint can be interpreted as: the time interval between the earliest/fastest and the latest/slowest event among the five input events, i.e., *speed*, *signType*, *direct*, *gear* and *torque*, must not exceed 40ms. To specify the constraints, Infimum is utilized to express the fastest event (denoted inf_{ctrlIn}) while Supremum is utilized to specify the slowest event sup_{ctrlIn} . sup_{ctrlIn} and inf_{ctrlIn} are defined as:

$$sup_{ctrl} \triangleq \text{Sup}(\text{Sup}(\text{speed}, \text{signType}), \text{Sup}(\text{Sup}(\text{direct}, \text{gear}), \text{toque})) \quad (5.22)$$

$$inf_{ctrl} \triangleq \text{Inf}(\text{Inf}(\text{speed}, \text{signType}), \text{Inf}(\text{Inf}(\text{direct}, \text{gear}), \text{toque})) \quad (5.23)$$

where $\text{Inf}(c1, c2)$ (resp. $\text{Sup}(c1, c2)$) is the Infimum (resp. Supremum) operator returns the slowest (resp. fastest) clock faster (resp. slower) than $c1$ and $c2$. Afterwards, we construct a new clock $inf_{ctrlIn}\text{-dly}40$ that is the inf_{ctrlIn} delayed for 40 ticks of ms , which is defined as:

$$inf_{ctrlIn}\text{-dly}40 \triangleq inf_{ctrlIn} \text{DelayFor } 40 \text{ on } ms \quad (5.24)$$

Therefore, the synchronization constraint R13 can be represented as the probabilistic causality *relation* between sup_{ctrlIn} and $inf_{ctrlIn}\text{-dly}40$, given as the CCSL/PrCCSL expression below:

$$sup_{ctrlIn} \preceq_p inf_{ctrlIn}\text{-dly}40 \quad (5.25)$$

By combining (24) and (25), we can obtain the the specification of R13:

$$sup_{ctrlIn} \preceq_p \{inf_{ctrlIn} \text{DelayFor } 40 \text{ on } ms\} \quad (5.26)$$

In similar, the CCSL/PrCCSL specification of R14 – R16 can be derived. For R14, we first construct the clocks that represent the fastest and slowest output event/clock among the four output events of Controller f_p , i.e., *reqTorq*, *reqDirec*, *reqGear* and *reqBrake*. Then the property that the synchronization constraint is satisfied with a probability greater than or equal to p can be interpreted as a probabilistic causality *relation*:

$$\begin{aligned} \mathbf{R14} : sup_{ctrlOut} &\triangleq \text{Sup}(\text{Sup}(\text{reqTorq}, \text{reqDirec}), \text{Sup}(\text{reqGear}, \text{reqBrake})) \\ inf_{ctrlOut} &\triangleq \text{Inf}(\text{Inf}(\text{reqTorq}, \text{reqDirec}), \text{Inf}(\text{reqGear}, \text{reqBrake})) \\ &sup_{ctrlOut} \preceq_p \{inf_{ctrlOut} \text{DelayFor } 30 \text{ on } ms\} \end{aligned} \quad (5.27)$$

For R15, we first construct the fastest and slowest input event/clock among the four input events of VehicleDynamic , i.e., *reqTorq*, *reqDirec*, *reqGear* and *reqBrake*.

Then the property that the synchronization constraint is satisfied with a probability greater than or equal to p can be interpreted as a probabilistic causality *relation*:

$$\begin{aligned}
 \mathbf{R15} : sup_{vdIn} &\triangleq \text{Sup}(\text{Sup}(reqTorq, reqDirec), \text{Sup}(reqGear, reqBrake)) \\
 inf_{vdIn} &\triangleq \text{Inf}(\text{Inf}(reqTorq, reqDirec), \text{Inf}(reqGear, reqBrake)) \quad (5.28) \\
 sup_{vdIn} &\preceq_p \{inf_{vdIn} \text{DelayFor } 40 \text{ on } ms\}
 \end{aligned}$$

For R16, we first construct the fastest and slowest output event/clock among the four output events of `VehicleDynamic`, i.e., *speed*, *direct*, *torque* and *gear*. Then the property that the synchronization constraint is satisfied with a probability greater than or equal to p can be interpreted as a probabilistic causality *relation*:

$$\begin{aligned}
 \mathbf{R16} : sup_{vdOut} &\triangleq \text{Sup}(\text{Sup}(speed, direct), \text{Sup}(gear, torque)) \\
 inf_{vdOut} &\triangleq \text{Inf}(\text{Inf}(speed, direct), \text{Inf}(gear, torque)) \quad (5.29) \\
 sup_{vdOut} &\preceq_p \{inf_{vdOut} \text{DelayFor } 40 \text{ on } ms\}
 \end{aligned}$$

End-to-End timing constraints (R17 – R23) can be specified using `DelayFor` *expression* and probabilistic precedence *relation*. To specify R17, which limits that the time duration measured from the instant of the occurrence of the event that Controller f_p receive the traffic sign type information (denoted as *signIn*), to the occurrence of event that the speed is sent out from `VehicleDynamic` f_p (denoted as *spOut*) should be between 150 and 250ms. We divide this property into two subproperties: R17(1). The time duration between *signIn* and *spOut* should be larger than 150ms. R17(2). The time duration between *signIn* and *spOut* should be less than 250ms. To specify property R17(1), we first construct a new clock *signIn_dly150* by delaying *signIn* for 150ms. To check whether R17(1) is satisfied within a probability threshold p is to verify whether the probabilistic precedence between *signIn_dly150* and *spOut* is valid. The specification of R17(1) is given below:

$$signIn_dly150 \triangleq signIn \text{DelayFor } 150 \text{ on } ms \quad (5.30)$$

$$signIn_dly150 \prec_p spOut \quad (5.31)$$

By combining (30) and (31), we can obtain the the specification of R17(1):

$$\{signIn \text{DelayFor } 150 \text{ on } ms\} \prec_p spOut \quad (5.32)$$

Similarly, to specify property R17(2), a new clock *signIn_dly250* is generated by delaying *signIn* for 250 ticks of *ms*. Afterwards, the property that R17(2) is satisfied with a probability greater than or equal to p relies on whether the probabilistic precedence *relation* is satisfied. The specification is illustrated as follows:

$$signIn_dly250 \triangleq signIn \text{DelayFor } 250 \text{ on } ms \quad (5.33)$$

$$spOut \prec_p signIn_dly250 \quad (5.34)$$

By combining (33) and (34), we can obtain the the specification of R17(2):

$$spOut \prec_p \{signIn \text{ DelayFor } 250 \text{ on } ms\} \quad (5.35)$$

In similar, the CCSL/PrCCSL specification of R18 – R23 can be derived:

$$\begin{aligned} \mathbf{R18} : \{cmrTrig \text{ DelayFor } 120 \text{ on } ms\} \prec_p signOut \\ signOut \prec_p \{cmrTrig \text{ DelayFor } 180 \text{ on } ms\} \end{aligned} \quad (5.36)$$

$$\begin{aligned} \mathbf{R19} : \{cmrTrig \text{ DelayFor } 270 \text{ on } ms\} \prec_p spOut \\ spOut \prec_p \{cmrTrig \text{ DelayFor } 430 \text{ on } ms\} \end{aligned} \quad (5.37)$$

$$\mathbf{R20} : \{startTurnLeft \prec_p DetectLeftSign \text{ DelayFor } 500 \text{ on } ms\} \quad (5.38)$$

$$\mathbf{R21} : \{startTurnRight \prec_p DetectRightSign \text{ DelayFor } 500 \text{ on } ms\} \quad (5.39)$$

$$\mathbf{R22} : \{startBrake \prec_p DetectStopSign \text{ DelayFor } 500 \text{ on } ms\} \quad (5.40)$$

$$\mathbf{R23} : \{Stop \prec_p DetectStopSign \text{ DelayFor } 3000 \text{ on } ms\} \quad (5.41)$$

Comparison timing constraints (R24 – R26) can be specified using *DelayFor* expression and probabilistic causality relation. R24 states that the execution time interval from Controller to VehicleDynamic should be less than or equal to the sum of the worst case execution time of Controller and VehicleDynamic, denoted as W_{ctrl} and W_{vd} respectively. To specify comparison constraint, we first construct a new clock *signIn_dly250* by delaying *signIn* for 250 ticks of *ms*. Afterwards, we generate another new clock *signIn_dlysw* that is the *signIn* clock delayed for sum of the *worst case execution time* of the two f_p s. The specification is illustrated as follows:

$$signIn_dly250 \triangleq signIn \text{ DelayFor } 250 \text{ on } ms \quad (5.42)$$

$$signIn_dlysw \triangleq signIn \text{ DelayFor } (W_{ctrl} + W_{vd}) \text{ on } ms \quad (5.43)$$

Therefore, the property that the probability of comparison constraint is satisfied should be greater than or equal to the threshold p can be interpreted as a probabilistic causality relation between *signIn_dly250* and *signIn_dlysw*:

$$signIn_dly250 \preceq_p signIn_dlysw \quad (5.44)$$

By combining (42), (43) and (44), we can obtain the the specification of R24:

$$\{signIn \text{ DelayFor } 250 \text{ on } ms\} \preceq_p \{signIn \text{ DelayFor } (W_{ctrl} + W_{vd}) \text{ on } ms\} \quad (5.45)$$

Analogously, the CCSL/PrCCSL specification of R25 and R26 can be derived:

$$\begin{aligned} \mathbf{R25} : \{cmrTrig \text{ DelayFor } 180 \text{ on } ms\} &\preceq_p \\ &\{cmrTrig \text{ DelayFor } (W_{cmr} + W_{sr}) \text{ on } ms\} \end{aligned} \quad (5.46)$$

$$\begin{aligned} \mathbf{R26} : \{cmrTrig \text{ DelayFor } 430 \text{ on } ms\} &\preceq_p \\ &\{cmrTrig \text{ DelayFor } (W_{cmr} + W_{sr} + W_{ctrl} + W_{vd}) \text{ on } ms\} \end{aligned} \quad (5.47)$$

where W_{cmr} and W_{vd} represent the worst case execution time of Camera and SignRecognition respectively.

Exclusion timing constraints (R27 – R31) can be specified using exclusion *relation* directly. R27 states that the two events *turnLeft* (the event that the vehicle is turning left) and *rightOn* (the event that the turn right mode is activated) should be exclusive, which can be expressed as:

$$turnLeft \#_p rightOn \quad (5.48)$$

Analogously, the exclusion timing constraints R28 – R31 can be specified using exclusion *relation*:

$$\mathbf{R27} : turnLeft \#_p rightOn \quad (5.49)$$

$$\mathbf{R28} : veAcc \#_p veBrake \quad (5.50)$$

$$\mathbf{R29} : emgcy \#_p turnLeft \quad (5.51)$$

$$\mathbf{R30} : emgcy \#_p rightOn \quad (5.52)$$

$$\mathbf{R31} : emgcy \#_p veAcc \quad (5.53)$$

where *emgcy* is the event that the vehicle is in the *emergency* mode, *veBrake* and *veAcc* represent the event that the vehicle is braking or accelerating, respectively.

Chapter 6

Translation of CCSL & PrCCSL into SDV

In order to formally prove the EAST-ADL timing constraints (given in Sec. 3) using SIMULINK DESIGN VERIFIER (SDV), we investigate how those constraints, specified in CCSL *expressions* and PrCCSL *relations* (Spec. R.ID in Fig. 3.1), can be translated into *Proof Objective Models* (POM). CCSL *expressions* constructs new clocks and the *relations* between the new clocks are specified using PrCCSL. We first provide strategies that represent CCSL *expressions* in SIMULINK/STATEFLOW (S/S). We then present how the EAST-ADL timing constraints defined in PrCCSL can be translated into the corresponding POMs, which are integrated with the S/S models of CCSL *expressions*, based on the strategies.

6.1 Mapping CCSL Expressions into S/S

We first describe how tick and history of CCSL can be mapped to corresponding S/S models. Using the mapping, we show CCSL *expressions* can be modeled in S/S. A “step” (defined in Sec. 2) is represented as a sample time in SIMULINK and set to 0.001 second. The clock ticks are expressed as boolean variables (1 “ticking” or 0 “non-ticking”) during simulation. The history of clock (expressed as integer) is increased as the clock ticks and interpreted as a function $\text{His}(c)$ in Fig.6.1: Since h_c , the history of clock c , is determined by the value of c at the immediate precedent step, a «Delay» block is employed to delay c by one step. Whenever c ticks at the prior step, «ES» is executed and increases h_c by 1.

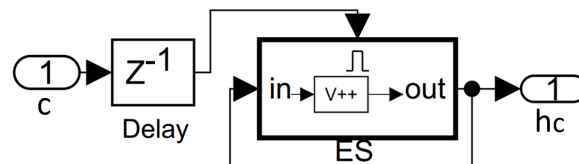

Figure 6.1: $h_c = \text{His}(c)$

Based on the mapping patterns of tick and history, we present how *PeriodicOn*, *DelayFor*, *Infimum* and *Supremum expressions* can be represented as S/S models.

PeriodicOn: $res \triangleq \text{PeriodicOn } base \text{ period } p$, where \triangleq means “is defined as”,

builds a new clock res based on $base$ clock and a $period$ parameter p , i.e., res ticks at every p^{th} tick of $base$. The SIMULINK model of `PeriodicOn` is illustrated in Fig.6.2: When $base$ ticks, the «Matlab Function» (code is shown in the box), embedded in the «ES» subsystem, is triggered and checks if the history of the $base$, $His(base)$, is an integral multiple of p . When $base$ ticks and its history equals to the integral multiple of p , res ticks. The `PeriodicOn` S/S model is employed for the translation of EAST-ADL `Periodic` timing constraint (R1 – R4 in Fig.3.1) into its POM in SDV.

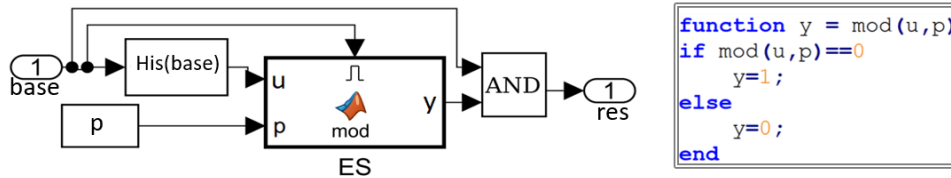

Figure 6.2: $res \triangleq \text{PeriodicOn } base \text{ period } p$

Infimum (resp. Supremum): $res \triangleq \text{Inf}(c1, c2)$ (resp. $\text{Sup}(c1, c2)$), creates a new clock res , which is the slowest (resp. fastest) clock faster (resp. slower) than the two clocks, $c1$ and $c2$. In other words, res ticks at the step whereby the faster (slower) clock between $c1$ and $c2$ ticks. The SIMULINK model of `Infimum` (resp. `Supremum`) is depicted in Fig.6.3. When $c1$ or $c2$ ticks, the `inf` (resp. `sup`) function embedded in «ES» is executed and decides which clock is faster (resp. slower) than the other by comparing the history of $c1$ and $c2$ ($h1$ and $h2$). If the clock (either $c1$ or $c2$) ticking at the current step is the faster (resp. slower) clock, res ticks. The `Infimum` and `Supremum` S/S models are utilized for the translation of EAST-ADL `Synchronization` timing constraint (R13 – R16 in Sec. 3) into POM. **DelayFor:**

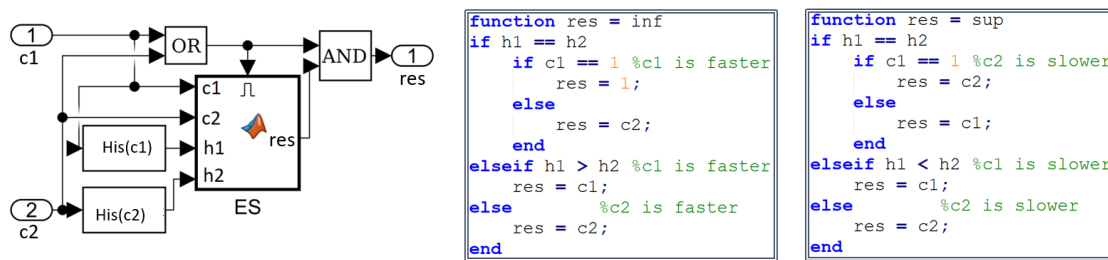

Figure 6.3: $res \triangleq \text{Inf}(c1, c2)$ (resp. $\text{Sup}(c1, c2)$)

$res \triangleq base \text{ DelayFor } d \text{ on } ref$, constructs a new clock res based on $base$ clock and $reference$ clock (ref), i.e., each time $base$ ticks, res ticks at the d^{th} tick of ref . The SIMULINK model of `DelayFor` is shown in Fig. 6.4: A STATEFLOW chart is utilized to observe the ticks of $base$ and ref . A queue, Q , whose enqueue/dequeue operation is implemented in the function `queue`. y indicates whether ref has ticked d times since $base$ ticked. When $base$ ticks ($base == 1$), an element with value d is enqueued, and each time ref ticks, the value of the element is decreased by 1. After d ticks of ref , the element becomes 0 and y becomes true. An «And» block

is applied to delimit that the tick of res must coincide with the tick of ref (i.e., res is a subclock of ref). The DelayFor S/S model is adapted to construct the POM models of EAST-ADL timing requirements R5 – R26 in Sec. 3.

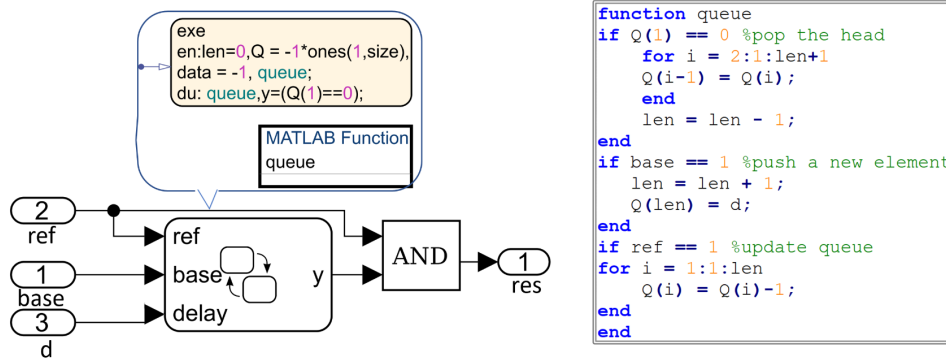

Figure 6.4: $res \triangleq base \text{ DelayFor } d \text{ on } ref$

6.2 Representation of PrCCSL in SDV

We present how the translation of EAST-ADL timing constraints (specified in PrCCSL *relations* and CCSL *expressions*) can be interpreted as POMs in the view point of analysis engine SDV. Recall the definitions of PrCCSL in Sec. 4. A PrCCSL *relation* is valid if the probability of a *relation* ϕ being satisfied is greater than or equal to the given probability threshold p . It can be interpreted as a *Hypothesis Testing* [29]: Decide whether $\mathcal{M} \models \Pr(\phi) \geq p$ (hypothesis H_0) against $\mathcal{M} \models \Pr(\phi) < p$ (alternative hypothesis H_1).

Probabilistic Subclock is employed to specify EAST-ADL Periodic timing constraint, given as $signRecTrig \subseteq_p cTrig$ (Spec. R2 in Fig.3.1). The corresponding POM is shown in Fig.6.5: The STATEFLOW chart *Obs* in Fig.6.5.(b) is utilized for *Hypothesis Testing*, where k is the total number of ticks of $signRecTrig$ (subclock) and m is the number of ticks satisfying the subclock *relation*. Whenever

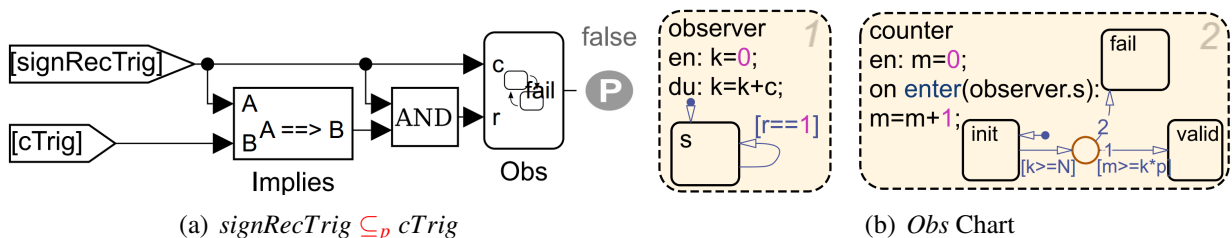

Figure 6.5: POM of Probabilistic Subclock

$signRecTrig$ ticks, k is increased by 1, and if the subclock *relation* holds on that tick (i.e., the condition “ $signRecTrig \implies cTrig$ ” is true), m is increased by 1. When k is increased to the sample size N , the STATEFLOW chart then judges whether the number of “success” ticks of $signRecTrig$ is greater than or equal to “ $p * k$ ” (i.e., whether

$\frac{m}{k} \geq p$ is valid), and it activates either *valid* (“H₀” is accepted) or *fail* state (“H₁” is accepted). A «Proof Objective» block with *false* value is employed to check whether the probabilistic subclock *relation* is satisfied, i.e., the *fail* is never reached. In similar, using the *Obs* chart, other PrCCSL *relations* can be represented as POMs. Further details are given below. **Probabilistic Coincidence** is adapted to specify EAST-ADL Periodic timing constraint, given as $cTrig \equiv_p \{\text{PeriodicOn } ms \text{ period } 50\}$ (Spec. R1 in Fig.3.1). The representative POM is shown in Fig.6.6.(a): A PeriodicOn subsystem (whose internal blocks are shown in Fig.6.2) is utilized to generate a periodic clock *res* that ticks every 50ms. According to Definition 4 in Sec. 4, if either *cTrig* or *res* ticks (“*cTrig* OR *res*” is true), *c* becomes true and *k* is increased by 1. Meanwhile, if *cTrig* and *res* tick simultaneously (“*cTrig* AND *res*” is true), *r* becomes true and *m* is increased by 1. Based on the value of *m* and *k*, *Obs* checks whether the probability of coincidence *relation* being satisfied is greater than or equal to *p* and activates either *valid* or *fail* state. «Proof Objective» block checks whether *fail* state is always inactive, i.e., H₀ is accepted.

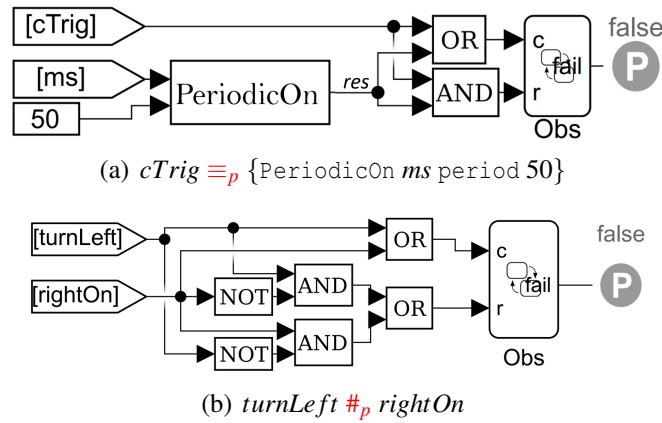

Figure 6.6: POM of Probabilistic Coincidence and Exclusion

Probabilistic Exclusion is utilized to specify EAST-ADL Exclusion timing constraint, given as $turnLeft \#_p rightOn$ (Spec. R27 in Fig.3.1). The corresponding POM is shown in Fig.6.6.(b): *k* is increased by 1 when either *turnLeft* or *rightOn* ticks. If only one of the two clocks ticks at the current step, i.e., *r* (the input of *Obs*) is true, *m* is increased by 1. «Proof Objective» block with *false* value checks whether *fail* state is never reached, i.e., H₀ is accepted.

Probabilistic Causality is employed to specify EAST-ADL Synchronization timing constraint, $sup \preceq_p \{inf \text{ DelayFor } 40 \text{ on } ms\}$ (Spec. R13 in Fig.3.1)), where *sup* (*inf*) is the fastest (slowest) event slower (faster) than the five input events, *speed*, *signType*, *direct*, *gear* and *torque*. *sup* and *inf* are defined as:

$$sup \triangleq \text{Sup}(\text{Sup}(\text{speed}, \text{signType}), \text{Sup}(\text{Sup}(\text{direct}, \text{gear}), \text{torque})) \quad (6.1)$$

$$inf \triangleq \text{Inf}(\text{Inf}(\text{speed}, \text{signType}), \text{Inf}(\text{Inf}(\text{direct}, \text{gear}), \text{torque})) \quad (6.2)$$

The representative POM is illustrated in Fig.6.7: The S/S models of *Inf* and *Sup* (shown in Fig.6.3) are utilized in order to construct *inf* (54) and *sup* (55), modeled as INF and SUP subsystems, respectively. A new clock *dinf* is generated by delaying *inf* for 40 ticks of *ms*, i.e., $dinf \triangleq \{inf \text{ DelayFor } 40 \text{ on } ms\}$, and it is represented by using the S/S model of *DelayFor* (shown in Fig.6.4). Then Probabilistic Causality *relation* between *sup* and *dinf* is checked. According to Definition 6, when *sup* ticks, *k* is increased by 1. At the same step, if the causality *relation* between *sup* and *dinf* is satisfied, i.e., the history of *sup* is greater than or equal to the history of *dinf*, *m* is increased by 1. «Proof Objective» block analyzes if the Probabilistic Causality *relation* is satisfied, i.e., the *fail* state is never activated.

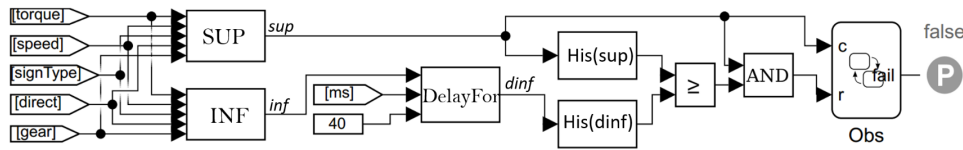
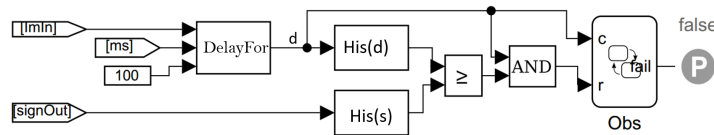
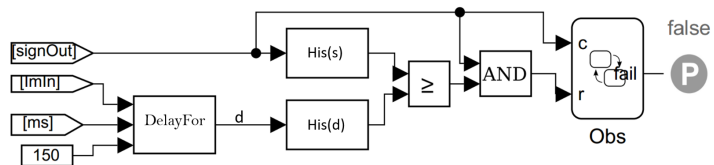

Figure 6.7: $sup \preceq_p \{inf \text{ DelayFor } 40 \text{ on } ms\}$

In Similar, EAST-ADL Execution (R5) can be specified in Probabilistic Causality using *DelayFor* and translated into corresponding POMs. The execution timing constraint R5 can be divided into two sub-properties, given as R5(1) and R5(2) in Sec.5. The POM models of R5(1) and R5(2) are illustrated in Fig.6.8.(a) and Fig.6.8.(b) respectively. Two intermediate clocks are generated by delaying *imIn* for 100 ticks and 150 ticks of *ms* (the output of the *DelayFor* subsystem). Then the execution timing constraints, interpreted as the probabilistic causality *relation*, can be modeled with *Obs* chart.



(a) $\{imIn \text{ DelayFor } 100 \text{ on } ms\} \preceq_p signOut$



(b) $signOut \preceq_{0.95} \{imIn \text{ DelayFor } 150 \text{ on } ms\}$

Figure 6.8: POM of Probabilistic Coincidence and Exclusion

Comparison (R24) timing constraint, specified in Probabilistic Causality and *DelayFor* (see Sec. 5), can be translated into the POMs presented in Fig.6.9. Two intermediate clocks are generated by using the S/S model of *DelayFor*, i.e., *d1* is the *signIn* clock delayed for 250 and *d2* is the clock generated by delaying *signIn* for ($Wctrl + Wvd$) ticks of *ms*. Afterwards, the *Obs* is applied to check whether the

Probabilistic Causality *relation* between $d1$ and $d2$ is satisfied, i.e., whether the history of $d1$ is always greater than or equal to the history of $d2$.

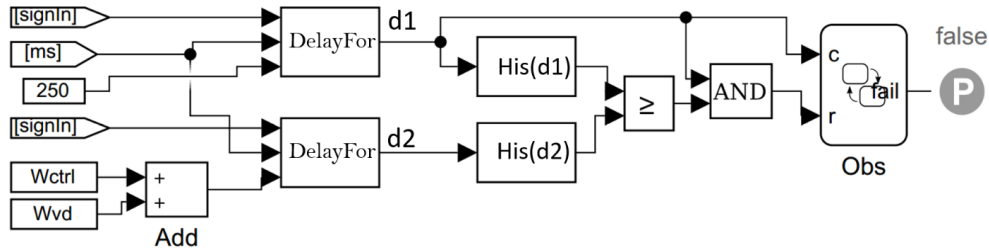

Figure 6.9: $\{signIn\ DelayFor\ 250\ on\ ms\} \prec_p \{signIn\ DelayFor\ (Wctrl + Wvd)\ on\ ms\}$

Probabilistic Precedence is used to specify EAST-ADL Sporadic timing constraint, given as $\{obstc\ DelayFor\ 500\ on\ ms\} \prec_p veRun$ (Spec. R9 in Fig.3.1). The constraint delimits that two events $obstc$ and $veRun$ must have a minimum delay 500ms, and its corresponding POM is illustrated in Fig.6.10: A new clock res is generated by delaying $obstc$ by 500 ticks of ms , i.e., $res \triangleq \{obstc\ DelayFor\ 500\ on\ ms\}$, and it is modeled by using the S/S model of $DelayFor$. Then R9 can be checked by verifying $res \prec_p veRun$. As presented in Fig.6.10, whenever res ticks, c becomes true and k is increased by 1. If the tick of $obstc$ satisfies the precedence *relation*, i.e., the history of res is greater than or equal to the history of $veRun$ (excludes res and $veRun$ are coincident), r becomes true and m is be increased by 1. «Proof Objective» block checks whether Probabilistic Precedence is satisfied, i.e., the *fail* state is never activated.

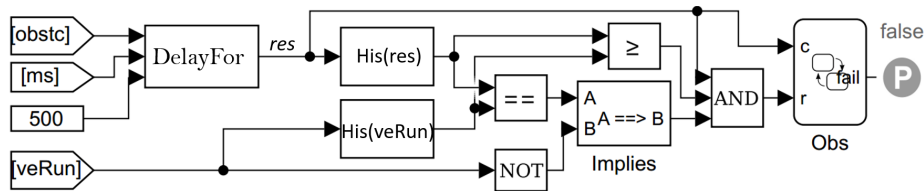
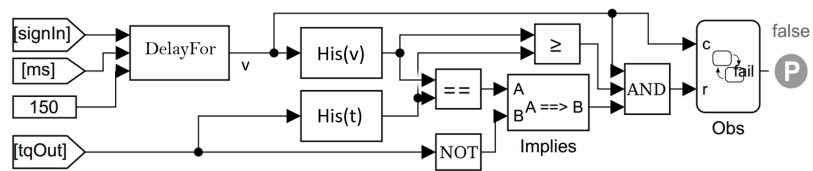
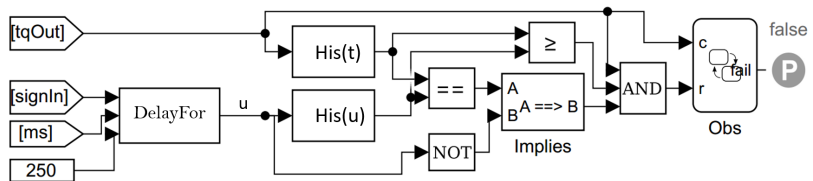

Figure 6.10: $\{obstc\ DelayFor\ 500\ on\ ms\} \prec_p veRun$

Similarly, End-to-End timing constraint (R17) specified in Probabilistic Precedence (see Sec.5) can be translated into its corresponding POM. The constraint R17 can be divided into two sub-properties, R17(1) and R17(2) (see Sec.5). The corresponding POM of R17(1) and R17(2) are presented in Fig.6.11. For R17(1), a new clock v (the output of $DelayFor$ subsystem) is generated by using the S/S model of $DelayFor$ such that the ticks of v is the ticks of $signIn$ delayed for 150 ticks of ms . To check whether R17(1) is satisfied is to verify whether v always precedes $signOut$. For R17(2), a new clock u is constructed by delaying $signIn$ for 250 ticks on ms . The *Obs* chart is then utilized to check whether the Probabilistic Precedence between $signOut$ and u is satisfied.



(a) $\{signIn\ DelayFor\ 150\ on\ ms\} \prec_p tqOut$



(b) $tqOut \prec_p \{signIn\ DelayFor\ 250\ on\ ms\}$

Figure 6.11: POM of End-to-End timing constraint

Chapter 7

Modeling of AV System and its Environment in S/S

We have presented how the EAST-ADL timing constraints, specified in PrCCSL *relations* and CCSL *expressions* are converted to POMs. To enable verification of the timed and stochastic behaviors of AV using SDV, the behaviors of each f_p is described in S/S. The F_{AVSYS} , consisting of a set of S/S is considered the entire behavior model of AV. The top-view architecture of F_{AVSYS} in S/S is shown in Fig.7.1.

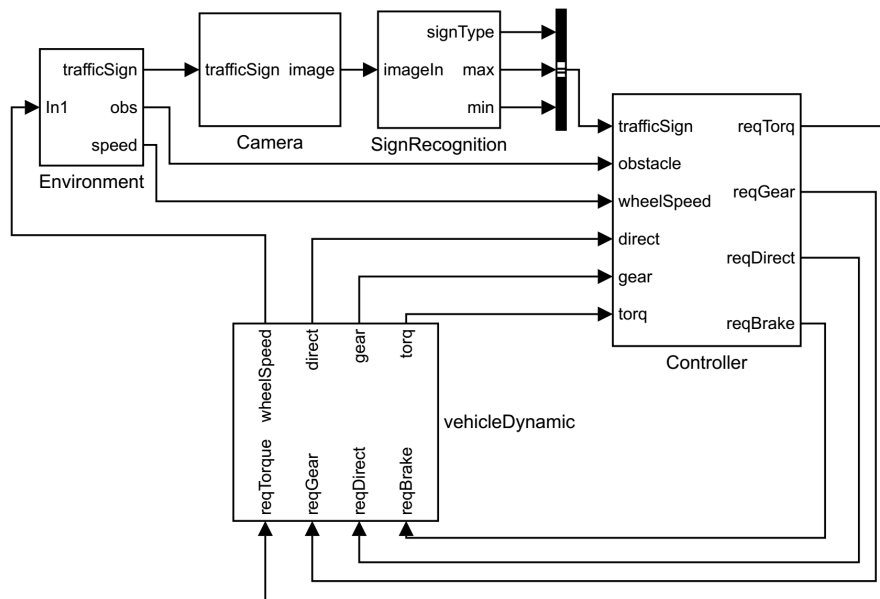

Figure 7.1: Top-view of AV in S/S

Each f_p in EAST-ADL model is modeled in a «Subsystem» with input and output ports for communication with other f_p s. To describe the stochastic environments of AV (modeled in the *Environment* subsystem in Fig.7.1), a pseudo random number generator, *Mersenne Twister* [25] implemented in MATLAB script is employed: 1. The traffic signs (6 types) are randomly recognized by AV and the probability of each sign type occurred is equally set as 16.7%; 2. The probability of AV being obstructed by any obstacles is set to maximum 5%; 3. Since AV runs under different road conditions, speed variation influenced by the conditions ranges within [0, 2] m/s.

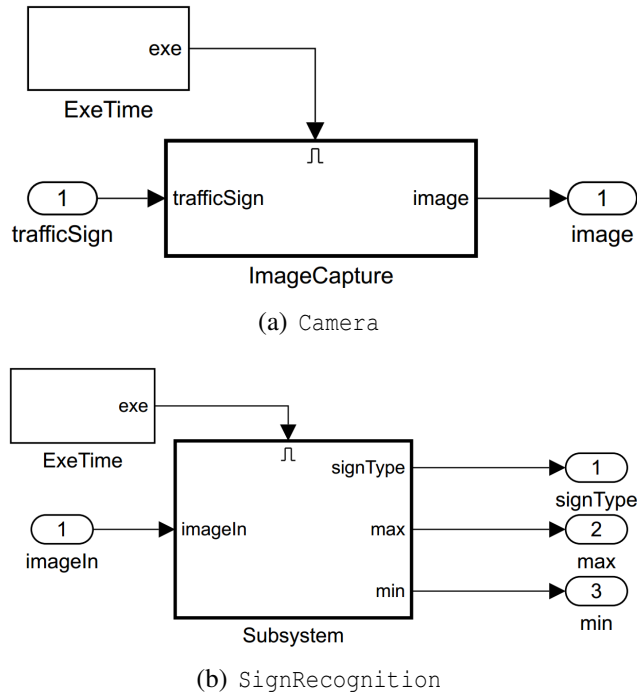

Figure 7.2: Simulink model of Camera and SignRecognition

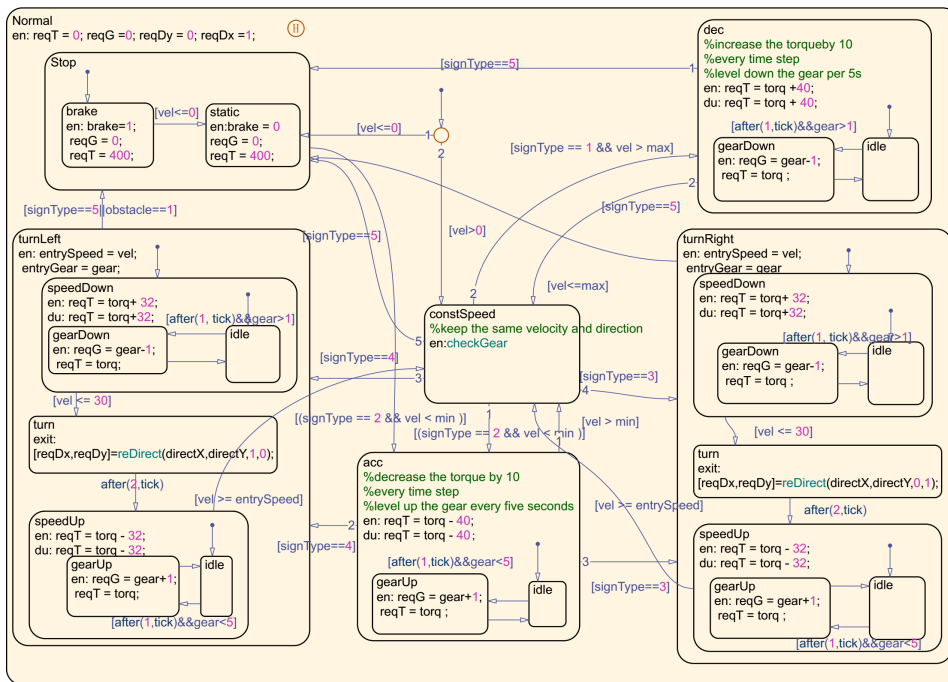
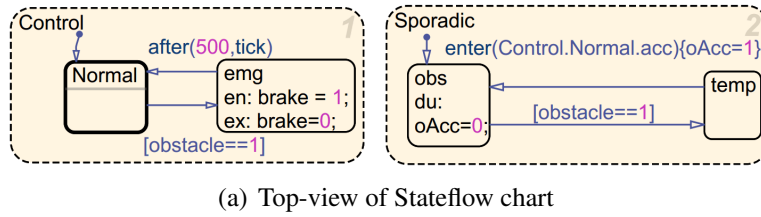

Figure 7.3: Stateflow chart of Controller

The S/S model of Camera and SignRecognition are illustrated in Fig.7.2.(a) and Fig.7.2.(b) respectively. Since Camera and SignRecognition are triggered to execute periodically, *ExeTime* subsystem is utilized to generate a boolean signal that becomes true periodically that can be the trigger signal of the Camera and SignRecognition subsystem. In SignRecognition, the computation of traffic sign type of the detected image is implemented in a «Matlab Function» block.

As shown in Fig.7.3, a Stateflow chart is employed to model the control logic of Controller. Fig.7.3.(a) presents the top-view of the Controller, which consists of two parallel states (in “AND” decomposition), *Control* and *Sporadic*. If the vehicle is in the emergency mode because of encounter of obstacles, *emg* state will be activated. Otherwise the *Normal* state will be activated. There are five substates inside *Normal* states (see Fig.7.3.(b)), i.e., *turnLeft* (the vehicle is turning left), *turnRight* (the vehicle is turning right), *Stop* (the vehicle is braking to stop), *dec* (the vehicle is decelerating) and *acc* (the vehicle is accelerating).

The inner behaviors of VehicleDynamic in S/S is illustrated in Fig.7.4. VehicleDynamic updates the speed and running direction of the vehicle according to the requests/commands of torque, gear and direction from Controller.

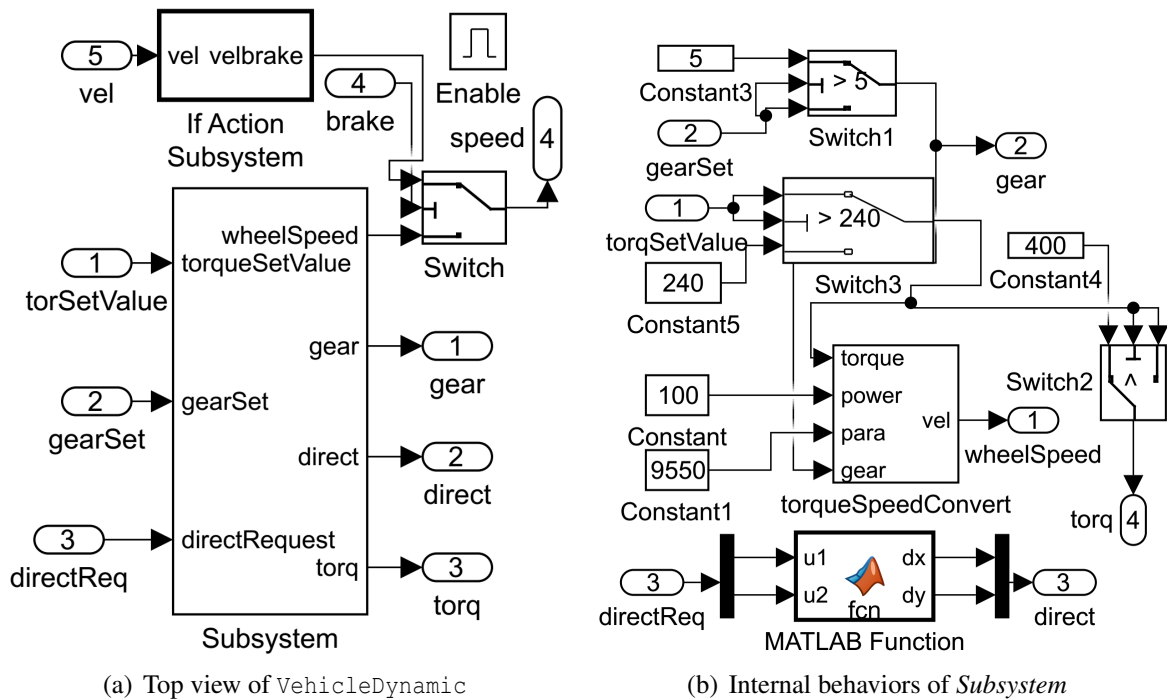

Figure 7.4: Simulink model of VehicleDynamic f_p

Chapter 8

Experiments: Verification & Validation

We have formally specified and analyzed over 30 properties (associated with timing constraints) of the AV system. The properties (given in Sec. 3) are verified using SDV and the results are listed in Table.8.1. The simulation bound and the probability threshold are set to 60000 steps and 95% respectively. Maximum 4 properties per each EAST-ADL timing constraint are verified and all properties are established as valid. For further details regarding the full POMs and S/S models used in the experiment, refer to [6].

Table 8.1: Consolidated Verification Results in SDV

Category	R.ID	Expression	Result	Time (Min)	Mem (Mb)	CPU (%)
Periodic	R1	$cTrig \equiv_{0.95} \{\mathbf{PeriodicOn\ ms\ period\ 50}\}$	valid	6.28	2491	24.7
	R2	$signTrig \equiv_{0.95} \{\mathbf{PeriodicOn\ ms\ period\ 200}\}$	valid	6.36	3920	24.13
	R3	$obsDetect \equiv_{0.95} \{\mathbf{PeriodicOn\ ms\ period\ 40}\}$	valid	6.35	2357	24.7
	R4	$spUpdate \equiv_{0.95} \{\mathbf{PeriodicOn\ ms\ period\ 30}\}$	valid	7	2218	24.01
Execution	R5	$\{imIn\ \mathbf{DelayFor\ 100\ on\ ms}\} \preceq_{0.95} signOut$	valid	38.20	4086	24.73
		$signOut \preceq_{0.95} \{imIn\ \mathbf{DelayFor\ 150\ on\ ms}\}$	valid	33.96	16225	19.90
	R6	$\{cmrTrig\ \mathbf{DelayFor\ 20\ on\ ms}\} \preceq_{0.95} cmrOut$	valid	44:26	14379	18.39
		$cmrOut \preceq_{0.95} \{cmrTrig\ \mathbf{DelayFor\ 30\ on\ ms}\}$	valid	51.15	4428.6	24.89
	R7	$\{ctrlIn\ \mathbf{DelayFor\ 100\ on\ ms}\} \preceq_{0.95} ctrlOut$	valid	62.83	18306	6.09
		$ctrlOut \preceq_{0.95} \{ctrlIn\ \mathbf{DelayFor\ 150\ on\ ms}\}$	valid	63.88	10737	22.04
R8	$\{-vdIn\ \mathbf{DelayFor\ 50\ on\ ms}\} \preceq_{0.95} vdOut$	valid	49.13	17705	6.40	
	$vdOut \preceq_{0.95} \{vdIn\ \mathbf{DelayFor\ 100\ on\ ms}\}$	valid	34.05	18511	6.02	
Sporadic	R9	$\{obstc\ \mathbf{DelayFor\ 500\ on\ ms}\} \prec_{0.95} veRun$	valid	100.5	13961	18.05
	R10	$\{obstc\ \mathbf{DelayFor\ 500\ on\ ms}\} \prec_{0.95} veAcc$	valid	120.45	13873	17.99
	R11	$\{obstc\ \mathbf{DelayFor\ 500\ on\ ms}\} \prec_{0.95} tLeft$	valid	106.89	13775	16.94
	R12	$\{obstc\ \mathbf{DelayFor\ 500\ on\ ms}\} \prec_{0.95} tRight$	valid	143.26	13775	16.07
Synchronization	R13	$supctrlIn \preceq_{0.95} \{infctrlIn\ \mathbf{DelayFor\ 40\ on\ ms}\}$	valid	38.95	14135	16.85
	R14	$supctrlOut \preceq_{0.95} \{infctrlOut\ \mathbf{DelayFor\ 30\ on\ ms}\}$	valid	42.6	20616	18.32
	R15	$supvdIn \preceq_{0.95} \{infvdIn\ \mathbf{DelayFor\ 40\ on\ ms}\}$	valid	66.78	2196	23.36
	R16	$supvdOut \preceq_{0.95} \{infvdOut\ \mathbf{DelayFor\ 40\ on\ ms}\}$	valid	34.6	3164	24.07
End-to-End	R17	$\{signIn\ \mathbf{DelayFor\ 150\ on\ ms}\} \prec_{0.95} tqOut$	valid	35.95	6307	24.31
		$tqOut \prec_{0.95} \{signIn\ \mathbf{DelayFor\ 250\ on\ ms}\}$	valid	24.95	3989	24.07
	R18	$\{cmrTrig\ \mathbf{DelayFor\ 120\ on\ ms}\} \prec_{0.95} signOut$	valid	33.96	6309	24.49
		$signOut \prec_{0.95} \{cmrTrig\ \mathbf{DelayFor\ 180\ on\ ms}\}$	valid	43.02	6308	24.29
	R19	$\{cmrTrig\ \mathbf{DelayFor\ 270\ on\ ms}\} \prec_{0.95} spOut$	valid	132.4	16287	9.53
		$spOut \prec_{0.95} \{cmrTrig\ \mathbf{DelayFor\ 430\ on\ ms}\}$	valid	163.8	16090	24.53
	R20	$startTurnLeft \prec_{0.95} \{\mathbf{DetectLeftSign\ DelayFor\ 500\ on\ ms}\}$	valid	63.2	13052	12.74
	R21	$startTurnRight \prec_{0.95} \{\mathbf{DetectRightSign\ DelayFor\ 500\ on\ ms}\}$	valid	76.5	15132	10.46
R22	$startBrake \prec_{0.95} \{\mathbf{DetectStopSign\ DelayFor\ 500\ on\ ms}\}$	valid	69	15293	9.38	
R23	$Stop \prec_{0.95} \{\mathbf{DetectStopSign\ DelayFor\ 3000\ on\ ms}\}$	valid	95.7	15396	9.38	
Comparison	R24	$\{signIn\ \mathbf{DelayFor\ 250\ on\ ms}\} \preceq_{0.95} \{signIn\ \mathbf{DelayFor\ (Wctrl + Wvd)\ on\ ms}\}$	valid	17.88	6309	24.61
	R25	$\{cmrTrig\ \mathbf{DelayFor\ 180\ on\ ms}\} \preceq_{0.95} \{cmrTrig\ \mathbf{DelayFor\ (Wcmr + Wsr)\ on\ ms}\}$	valid	60.15	6410	24.43
	R26	$\{cmrTrig\ \mathbf{DelayFor\ 430\ on\ ms}\} \preceq_{0.95} \{cmrTrig\ \mathbf{DelayFor\ (Wcmr + Wsr + Wctrl + Wvd)\ on\ ms}\}$	valid	43.33	17370	14.15
Exclusion	R27	$turnLeft \#_{0.95} rightOn$	valid	387.76	20987	8.25
	R28	$veAcc \#_{0.95} veBrake$	valid	360.15	21168	18.15
	R29	$emgcy \#_{0.95} turnLeft$	valid	233.6	22861	11.98
	R30	$emgcy \#_{0.95} turnRight$	valid	498.51	23245	9.97
	R31	$emgcy \#_{0.95} veAcc$	valid	260.96	22257	8.85

Chapter 9

Related work

Considerable research efforts have been devoted to formal analysis of CPS by applying SDV [12, 14], which are however, limited to the functional properties without consideration of non-functional properties, i.e., timing constraints. In the context of EAST-ADL, efforts on the integration of EAST-ADL and formal techniques based on timing constraints were investigated in several works [13, 16, 22, 28], which are however, restricted to the executional aspects of system functions without addressing stochastic behaviors. Kang [21] and Suryadevara [31, 32] defined the execution semantics of both the controller and the environment of industrial systems in CCSL which are given as mapping to UPPAAL models amenable to model checking. In contrast to our current work, those approaches lack precise probabilistic annotations specifying stochastic properties. Zhang [33] transformed CCSL into first order logics that are verifiable using SMT solver. However, this work is limited to functional properties, and no timing constraints are addressed. Though, Kang et al. [15, 18] and Marinescu et al. [24] presented both simulation and model checking approaches of SIMULINK and UPPAAL-SMC on EAST-ADL models, neither formal specification nor verification of extended EAST-ADL timing constraints with probability were conducted. Our approach is a first application on the integration of EAST-ADL and formal V&V techniques based on probabilistic extension of EAST-ADL/TADL constraints using SDV. An earlier study [17, 19, 20] defined a probabilistic extension of EAST-ADL timing constraints and presented model checking approaches on EAST-ADL models, which inspires our current work. Specifically, the techniques provided in this paper define new operators of CCSL with stochastic extensions (PrCCSL) and formally verify the extended EAST-ADL timing constraints of CPS. Du. et al. [10] proposed the use of CCSL with probabilistic logical clocks to enable stochastic analysis of hybrid systems by limiting the possible solutions of clock ticks. Whereas, our work is based on the probabilistic extension of EAST-ADL timing constraints with the focus on probabilistic verification of the extended constraints, particularly, in the context of WH.

Chapter 10

Conclusion

We present an approach to perform probabilistic analysis of EAST-ADL timing constraints in automotive systems at the early design phase: 1. Probabilistic extension of CCSL, called PrCCSL, is defined and the EAST-ADL/TADL timing constraints with stochastic properties are specified in PrCCSL; 2. The semantics of the extended constraints in PrCCSL, captured in SIMULINK/STATEFLOW, is translated into verifiable POMs for formal verification; 3. A set of mapping rules is proposed to facilitate guarantee of translation. Our approach is demonstrated on an autonomous traffic sign recognition vehicle (AV) case study. Although, we have shown that defining and translating a subset of CCSL with probabilistic extension into POMs is sufficient to verify EAST-ADL timing constraints, as ongoing work, advanced techniques covering a full set of CCSL constraints are further studied. Despite the fact that SDV supports probabilistic analysis of the timing constraints of AV, the computational cost of verification in terms of time is rather expensive. Thus, we continuously investigate complexity-reducing design/mapping patterns for CPS to improve effectiveness and scalability of system design and verification.

Acknowledgment

This work is supported by the National Natural Science Foundation of China and International Cooperation & Exchange Program (46000-41030005) within the project EASY.

References

- [1] Automotive open system architecture. <https://www.autosar.org/>
- [2] Simulink Design Verifier. <https://www.mathworks.com/help/sldv>
- [3] IEC 61508: Functional safety of electrical electronic programmable electronic safety related systems. International Organization for Standardization, Geneva (2010)
- [4] ISO 26262-6: Road vehicles functional safety part 6. Product development at the software level. International Organization for Standardization, Geneva (2011)
- [5] MAENAD. <http://www.maenad.eu/> (2011)
- [6] Simulink library of PrCCSL. <https://github.com/huangl223/PrCCSL>
- [7] André, C.: Syntax and semantics of the clock constraint specification language (CCSL). Ph.D. thesis, INRIA (2009)
- [8] Bernat, G., Burns, A., Llamosi, A.: Weakly hard real-time systems. *Transactions on Computers* **50**(4), 308 – 321 (2001)
- [9] Blom, H., Feng, L., Lönn, H., Nordlander, J., Kuntz, S., Lisper, B., Quinton, S., Hanke, M., Peraldi-Frati, M.A., Goknil, A., Deantoni, J., Defo, G.B., Klobedanz, K., Özhan, M., Honcharova, O.: TIMMO-2-USE Timing Model, Tools, Algorithms, Languages, Methodology, Use Cases. Tech. rep., TIMMO-2-USE (2012)
- [10] Du, D., Huang, P., Jiang, K., Mallet, F., Yang, M.: MARTE/pCCSL: Modeling and refining stochastic behaviors of CPSs with probabilistic logical clocks. In: *FACS. LNCS*, pp. 111 – 133. Springer (2016)
- [11] EAST-ADL: EAST-ADL specification v2.1.9. Tech. rep., MAENAD (2011), https://www.maenad.eu/public/EAST-ADL-Specification_M2.1.9.1.pdf
- [12] Gholami, M.R.: Verifying Timed LTL Properties Using Simulink Design Verifier. Ph.D. thesis, École Polytechnique de Montréal (2016)

- [13] Goknil, A., Suryadevara, J., Peraldi-Frati, M.A., Mallet, F.: Analysis support for TADL2 timing constraints on EAST-ADL models. In: ECSA. LNCS, pp. 89 – 105. Springer (2013)
- [14] J-F. Etienne, S. Fechter, E.J.: Using Simulink Design Verifier for proving behavioral properties on a complex safety critical system in the ground transportation domain. *Science of Computer Programming* **77**(10), 1151 – 1177 (2010)
- [15] Kang, E.Y., Chen, J., Ke, L., Chen, S.: Statistical analysis of energy-aware real-time automotive systems in EAST-ADL/Stateflow. In: ICIEA. pp. 1328 – 1333. IEEE (2016)
- [16] Kang, E.Y., Enois, E.P., Marinescu, R., Seceleanu, C., Schobbens, P.Y., Pettersson, P.: A methodology for formal analysis and verification of EAST-ADL models. *Reliability Engineering and System Safety*, pp. 127 – 138 (2013)
- [17] Kang, E.Y., Huang, L., Mu, D.: Formal verification of energy and timed requirements for a cooperative automotive system. In: SAC. pp. 1492 – 1499. ACM (2018)
- [18] Kang, E.Y., Ke, L., Hua, M.Z., Wang, Y.X.: Verifying automotive systems in EAST-ADL/Stateflow using UPPAAL. In: APSEC. pp. 143 – 150. IEEE (2015)
- [19] Kang, E.Y., Mu, D., Huang, L., Lan, Q.: Model-based analysis of timing and energy constraints in an autonomous vehicle system. In: QRS. pp. 525 – 532. IEEE (2017)
- [20] Kang, E.Y., Mu, D., Huang, L., Lan, Q.: Verification and validation of a cyber-physical system in the automotive domain. In: QRS. pp. 326 – 333. IEEE (2017)
- [21] Kang, E.Y., Schobbens, P.Y.: Schedulability analysis support for automotive systems: from requirement to implementation. In: SAC. pp. 1080 – 1085. ACM (2014)
- [22] Kang, E.Y., Schobbens, P.Y., Pettersson, P.: Verifying functional behaviors of automotive products in EAST-ADL2 using UPPAAL-PORT. In: SAFECOMP. LNCS, pp. 243 – 256. Springer (2011)
- [23] Mallet, F., De Simone, R.: Correctness issues on MARTE/CCSL constraints. *Science of Computer Programming* **106**, 78 – 92 (2015)
- [24] Marinescu, R., Kaijser, H., Mikučionis, M., Seceleanu, C., Lönn, H., David, A.: Analyzing industrial architectural models by simulation and model-checking. In: FTSCS. LNCS, pp. 189 – 205. Springer (2014)

- [25] Matsumoto, M., Nishimura, T.: Mersenne Twister: a 623-dimensionally equidistributed uniform pseudo-random number generator. *TOMACS* **8**(1), 3–30 (1998)
- [26] Nicolau, G.B.: Specification and analysis of weakly hard real-time systems. *Transactions on Computers*, pp. 308 – 321 (1988)
- [27] Object Management Group: UML profile for MARTE: Modeling and analysis of real-time embedded systems. Tech. rep. (2011)
- [28] Qureshi, T.N., Chen, D.J., Persson, M., Törngren, M.: Towards the integration of UPPAAL for formal verification of EAST-ADL timing constraint specification. In: *TiMoBD workshop* (2011)
- [29] Reijsbergen, D., Boer, P.T.D., Scheinhardt, W., Haverkort, B.: On hypothesis testing for statistical model checking. *STTT* **17**(4), 377–395 (2015)
- [30] Simulink and Stateflow. <https://www.mathworks.com/products.html>
- [31] Suryadevara, J.: Validating EAST-ADL timing constraints using UPPAAL. In: *SEAA*. pp. 268 – 275. IEEE (2013)
- [32] Suryadevara, J., Seceleanu, C., Mallet, F., Pettersson, P.: Verifying MARTE/CCSL model behaviors using UPPAAL. In: *SEFM. LNCS*, pp. 1 – 15. Springer (2013)
- [33] Zhang, M., Ying, Y.: Towards SMT-based LTL model checking of clock constraint specification language for real-time and embedded systems. *ACM SIGPLAN Notices* **52**(4), 61 – 70 (2017)