

---

# Optimizing Highway Ramp Merge Safety and Efficiency via Spatio-Temporal Cooperative Control and Vehicle-Road Coordination

Ting PENG<sup>1</sup>, Member, IEEE, Xiaoxue XU<sup>2</sup>, YuanLI<sup>3</sup>, Jie WU, Tao LI, Xiang DONG, Yincai CAI and Peng WU

<sup>1-3</sup>Key Laboratory for Special Area Highway Engineering of Ministry of Education, Chang'an University, 71200

Corresponding author: Ting PENG (e-mail: t.peng@ieee.org).

**ABSTRACT** In view of existing automatic driving is difficult to accurately and timely obtain the status and driving intention of other vehicles, and the safety risk and urgency of autonomous vehicles in the absence of collision are evaluated. To ensure safety, road efficiency is improved, and a method of pre-compiling the spatio-temporal trajectory of vehicles is established to eliminate the conflicts between vehicles in advance. According to the vehicle speed difference, vehicle positioning error and clock error, the calculation method of the safe distance under the spatio-time condition is studied. Combined with collision acceleration and urgent acceleration, the evaluation model vehicle conflict risk is constructed. Determine the main line vehicles that may have conflicts with on-ramp vehicles, and then determine the target gap of on-ramp vehicles. Finally, a cooperative control method is established in accordance with the selected target gap, and the selected target gap, and prepare the vehicle travel path in advance. Taking highway ramp merge as an example, the main line priority spatio-temporal cooperative control method is proposed, and its effect is verified by simulation. Using sumo and python co-simulation, the main line traffic of  $800 \text{ veh}\cdot\text{h}^{-1}\cdot\text{lane}^{-1}$ ,  $1200 \text{ veh}\cdot\text{h}^{-1}\cdot\text{lane}^{-1}$ ,  $1800 \text{ veh}\cdot\text{h}^{-1}\cdot\text{lane}^{-1}$  was selected. Ramp flow of  $200 \text{ veh}\cdot\text{h}^{-1}\cdot\text{lane}^{-1}$ ,  $300 \text{ veh}\cdot\text{h}^{-1}\cdot\text{lane}^{-1}$  and  $500 \text{ veh}\cdot\text{h}^{-1}\cdot\text{lane}^{-1}$  were simulated. The analysis results show that the average delay time can be reduced by 97.96%, and the fuel consumption can be reduced by 6.01%, respectively. The main line priority strategy shows higher speed and better synergistic effect, and improves traffic efficiency and safety, showing its advantages in on-ramp merge control.

**INDEX TERMS** Autonomous driving, Spatio-temporal trajectory, Vehicle conflict risk, Ramp merge; Highway

## I. INTRODUCTION

Research on cooperative control strategies in ramp merging areas is a hot topic in the fields of intelligent transportation systems and autonomous driving technology. With the development of vehicle-to-everything (V2X) communication technology and the proliferation of intelligent vehicles, many scholars have investigated cooperative merging strategies for intelligent connected and autonomous vehicles (ICAVs), aiming to enhance traffic efficiency and safety by optimizing vehicle trajectories and merging sequences. In terms of optimization control strategies, most literature adopts optimal control strategies such as Mixed-Integer Nonlinear Programming (MINLP)[1],[2],[3], pseudospectral methods[4], game theory[5],[6],[7],[8],[9], hierarchical control strategies[10],[11],[12],[13],[14],[15],[16],[17], distributed control[15],[18],[19], and centralized control[6],[20],[21] to precisely plan vehicle merging behaviors and trajectories. On the other hand, some studies employ centralized approaches based on game theory[6],[9],[14] to optimize overall fuel consumption and total travel time by formulating fair and comprehensive game rules to enhance traffic efficiency. Additionally, advanced algorithms such as reinforcement learning[5],[23],[24] and Model Predictive Control (MPC) are widely applied for real-time dynamic optimization. In terms of cooperative control, literature commonly utilizes cooperative adaptive cruise control[25] and multi-agent systems to coordinate the merging behaviors of multiple vehicles, thus improving overall traffic flow. Through vehicle-to-everything (V2X) communication technology, real-time information sharing and collaborative decision-making are achieved among vehicles and between vehicles and infrastructure (V2I) and vehicles (V2V). In terms of simulation validation, all methods are evaluated for their effectiveness using different simulation platforms such as SUMO, Simulink,[26] etc., assessing their performance advantages under various traffic volumes and speed conditions. Through the aforementioned optimization control strategies, cooperative control methods, and simulation validation approaches, these studies demonstrate effective means to enhance vehicle merging efficiency and safety in complex traffic environments.

Existing literature has proposed various innovative solutions when studying cooperative control methods in highway ramp merging areas. Among them, some methods employ optimization scheduling techniques, such as dynamic conflict graphs[27],[28],[29],[30],[31], which abstract the merging problem as a graph search problem and achieve optimal solutions through heuristic search strategies to reduce overall travel delays. Additionally, some studies have utilized hierarchical system designs[32],[33],[34],[35], including tactical planning and motion planning models, and improved computational efficiency using algorithms like Monte Carlo tree search to achieve flexible merging positions and a safe and efficient merging process. Furthermore, queue-based networked autonomous vehicle cooperative optimal control

algorithms[36],[37],[38],[39],[40] have been widely discussed. Through distributed cooperative control of multiple local queues, these algorithms transform complex merging problems into one-dimensional queue-following control problems, thereby improving traffic efficiency. These studies comprehensively utilize graph search, game theory, hierarchical system design, and autonomous driving technology, providing diverse and efficient solutions for cooperative control in highway ramp merging areas.

The risk of a collision between two vehicles should not be underestimated. Despite the reduction in some traffic accidents due to autonomous driving, accidents still occur. Therefore, many scholars have assessed the risk of accidents involving autonomous vehicles.

Wang Jie [41] collects the status of autonomous driving vehicles and surrounding vehicles, calculates risk indicators such as speed, acceleration, and headway distance, and assesses the risk level based on road geometry and road surface friction coefficient. Rahman M. S. et al.[42] evaluated the safety of vehicle operation under mixed road conditions with traditional vehicles and autonomous vehicles. They used five alternative safety indicators, including speed standard deviation, exposure time collision time, time integral collision time, exposure time rear-end risk index, and side-swipe collision risk, as safety assessment metrics. Shetty A[43] proposed a risk assessment framework that utilizes human driving data and road test data to provide insights into the safety of autonomous vehicles. Hu W et al.[44] proposed a collision risk assessment framework based on the prediction of trajectories of other vehicles. This framework integrates solutions such as expected path planning of other vehicles, description of uncertainties in the driving process, trajectory changes caused by obstacle intrusion, etc. Han J et al.[45] proposed a novel spatial-temporal risk field (STRF) from the perspective of spatio-temporal coupling. This risk field represents the dynamic driving risk of autonomous vehicles in dynamic traffic.

In summary, current manual and automated driving technologies still struggle to accurately and promptly acquire the status and driving intentions of surrounding vehicles. Despite efforts to maintain appropriate safety distances between vehicles on highway merge zones, a significant number of traffic accidents still occur. Due to the necessity of maintaining safe distances between vehicles, the capacity for road traffic cannot be further increased, posing a formidable barrier to overcoming traffic congestion. The majority of scholars calculate the safety risk of autonomous vehicles based on risk indicators or propose new frameworks or models for real-time risk assessment or risk control. However, in these studies, there is little assessment from scholars regarding the harm and urgency of vehicle collisions.

Based on these, a calculation method of the safe distance between vehicles in the vehicle-road depth cooperation scenario is proposed. Based on the acceleration of the vehicle when the collision occurs, the critical degree of vehicle

collision is quantitatively assessed. A collaborative control method is proposed to pre-compile vehicle trajectories to improve vehicle safety and traffic efficiency in on-ramp confluence area of highway.

## II. Quantitative Evaluation of Vehicle Conflict Risk

### A. Selection of Quantitative Indicators for Conflict Risk

Given the insufficient research in academia on assessing the severity of collision hazards, this paper selects safety distance and conflict urgency as indicators of conflict risk. This selection is based on a series of theoretical foundations and analytical processes, as outlined below:

#### 1) SAFETY DISTANCE

Safety distance refers to the minimum distance [46] that should be maintained to prevent collisions between vehicles. When the distance between vehicles is less than this safety distance, the risk of collision significantly increases. Therefore, safety distance is an important indicator for assessing conflict risk.

#### 2) CONFLICT URGENCY

Collision acceleration reflects the danger of vehicle collisions. When the acceleration is low, it only affects passenger comfort. However, when the acceleration is particularly high, it can directly pose lethal problems to passengers. Therefore, collision acceleration is an important indicator for assessing the danger of conflict occurrence.

Urgent acceleration reflects the urgency of collision occurrence. When the urgent acceleration is high, it indicates that the two vehicles are about to collide.

Neither collision acceleration nor urgent acceleration alone can comprehensively reflect the risk of vehicle collisions. Thus, by multiplying them together, the degree of conflict urgency is obtained. This combined metric can simultaneously reflect the danger and urgency of vehicle collisions. Therefore, conflict urgency is considered an important indicator for quantifying conflict risk.

### B. Deep Cooperative Safety Distance

The safety distance includes three components: the safe distance to be maintained between merging vehicles and mainline vehicles when vehicles enter the mainline, the positioning error of the Global Positioning System (GPS), and the timing synchronization error between autonomous driving vehicles and the national time synchronization center.

When merging in the merging area, it's necessary to maintain a sufficient safety gap between two mainline vehicles to allow the merging vehicle from the entrance ramp to merge safely and smoothly onto the mainline. The minimum required safety gap is twice the safe distance that should be maintained between the preceding and following vehicles, plus the sum of the lengths of the merging vehicle's body. When calculating the safe distance retained for the speed difference and clock precision error, the speeds of the two vehicles are taken as those of the merging vehicle and the mainline vehicle, respectively. The formula for this calculation is:

$$L_{\min.s} = L_v + 2L_{safe} \quad (1)$$

Information:

$L_{\min.s}$ : the minimum safe gap left between the mainline vehicles at the moment when the merging vehicle from the entrance ramp merges into the mainline, m;

$L_v$ : the length of the merging vehicle's body when merging onto the mainline, m;

$L_{safe}$ : the safe gap between the merging vehicle and the mainline vehicle at the moment of merging, m.

### C. The Severity of Conflict

A single indicator, neither collision acceleration nor urgent acceleration, can fully represent the severity of conflict. Hence, multiplying collision acceleration by urgent acceleration yields the severity of collision. The formula for calculation is as follows:

$$J = a \cdot a_p \quad (2)$$

Information

$J$ : the severity of the potential collision between vehicles;

$a$ : the collision acceleration, m/s<sup>2</sup>;

$a_p$ : the urgency acceleration, m/s<sup>2</sup>.

When the collision acceleration is high and the urgency level is also high, the resulting severity of collision for that vehicle is high. However, if the collision acceleration is high but the urgency level is low, or if the collision acceleration is low but the urgency level is high, the resulting severity of collision for that vehicle is not high.

#### 1) COLLISION ACCELERATION

Let the speed difference between two vehicles be denoted as  $\Delta v$ , ranging from 0 to 100 m/s, which corresponds to 0 to 360 km/h, covering almost all possible collision speed ranges. The maximum speed difference occurs when two vehicles collide head-on, where, due to velocity being a vector, the speed difference is the sum of the scalar velocities of the two vehicles.

Let  $k = \frac{m_1}{m_2}$  represent a certain value, and the masses of the two

colliding vehicles be denoted as  $m_1$  and  $m_2$ . The relationship between the masses  $m_1$  and  $m_2$  of the vehicles is denoted as  $m_1 = km_2$ . In this study, the range of  $k$  is from 0.001 to 1000, where values of 0.001 and 1000 represent extreme cases.

Due to the wide range of  $k$ , spanning several orders of magnitude, directly plotting it would result in insignificant distinctions between small values. However, using a logarithmic coordinate axis can address this issue. Additionally, employing a logarithmic coordinate axis facilitates easier observation of patterns and trends across the entire data range. Let  $p = \lg k$  be  $k = 10^p$ , so  $p_{\min} = \lg 10^{-3} = -3$ , and  $p_{\max} = \lg 10^3 = 3$ . Consequently, the range of  $p$  values is from -3 to 3.

In the scenario where a vehicle with mass  $m_1$  is traveling uniformly in a straight line before the collision, with its

coordinate system serving as the reference frame, this implies that the vehicle with mass  $m_1$  is stationary. Meanwhile, another vehicle with mass  $m_2$  is traveling at velocity  $v_2$  towards it, resulting in a collision.

When two vehicles collide, momentum is conserved both before and after the collision, thus satisfying the following equation:

$$m_2 v_2 = (m_1 + m_2) \cdot a \cdot t \quad (3)$$

Information:

$v_2$  :velocity of the vehicle with mass  $m_2$  before the collision, m/s;

$a$  :acceleration generated during the collision of the two vehicles, m/s<sup>2</sup>;

$t$  :duration from the beginning to the end of the collision between the two vehicles, s;

The danger to the vehicles after a collision is related to the collision acceleration that occurs afterward. The smaller the acceleration of the vehicle after the collision, the safer it is, whereas higher acceleration poses greater danger.

Since the reference frame is established based on the vehicle with mass  $m_1$ , which is assumed to be moving uniformly along a straight line, it appears stationary in this frame of reference, with its velocity assumed to be  $v_1 = 0$ . Therefore, when another vehicle with mass  $m_2$  collides with the vehicle of mass  $m_1$ , we only consider the velocity  $v_2$  of the vehicle with mass  $m_2$ .

Hence, the speed difference between the two vehicles is  $|\Delta v| = |v_2 - v_1| = |v_2|$  m/s

Substitute  $|\Delta v| = |v_2|$  and  $m_1 = km_2$  into equation (3), the formula for calculating the average acceleration during the collision is obtained as:

$$a = \frac{|\Delta v|}{(1+k) \cdot t} \quad (4)$$

Where the collision time  $t$  is taken as 0.2 seconds, substituting  $k = 10^p$  into equation(4), the formula for calculating the collision acceleration is obtained as:

$$a = \frac{5|\Delta v|}{1+10^p} \quad (5)$$

In the formula:

$a$  : collision acceleration, m/s<sup>2</sup>;

$|\Delta v|$  : speed difference between the two vehicles, m/s;

$k$  :the ratio of the masses of the two vehicles,  $k = \frac{m_1}{m_2}$  ;

$p$  :take the logarithm of the mass ratio with a base of 10,

$p = \log_{10} k$ .

The acceleration generated during collision depends not only on the mass of the vehicles but also on the difference in their velocities. The abscissa and ordinate represent the velocity difference and the logarithm of the mass ratio, respectively, using

a logarithmic scale of base 10. Since the range of the mass ratio itself spans multiple orders of magnitude, directly plotting it would obscure the differences between small values. Using a logarithmic scale allows us to observe trends across the entire data range more easily. When  $p = 0$ , indicating equal masses for both vehicles,  $m_1 = m_2$ , the acceleration during collision is primarily determined by the velocity difference. As shown in the FIGURE 1 above, a greater velocity difference leads to a higher acceleration during collision, resulting in increased danger to the vehicles.

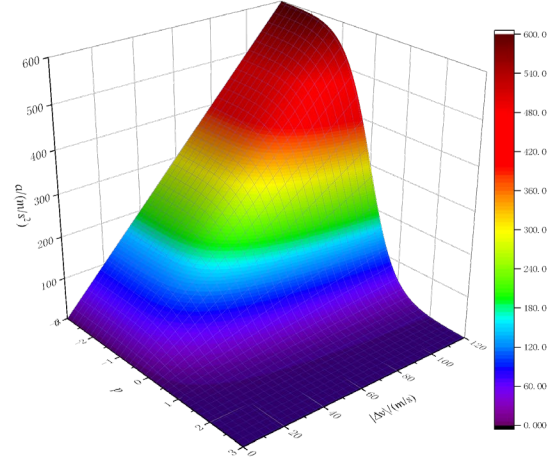

FIGURE 1.The relationship graph among  $a$ ,  $|\Delta v|$ , and  $p$ .

## 2) URGENT ACCELERATION

However, relying solely on the acceleration at the moment of collision may not fully capture the peril of the collision. For instance, if a collision were to occur in the next second, there would be insufficient time to adjust the vehicle's trajectory, resulting in a high level of urgency. Conversely, if the collision were to happen 30 seconds later, there would be less urgency to adjust the vehicle's trajectory. Therefore, urgent acceleration is chosen to represent the urgency of the collision, taking into account the timing of the collision occurrence.

Given that the distance between two cars is  $S$  m and the velocity difference between them is  $\Delta v$ , the acceleration of a car traveling from a higher speed to match the velocity of the preceding car is:6

$$a_p = \frac{v_1^2 - v_2^2}{2S} \quad (6)$$

Information

$a_p$  : urgent acceleration, m/s<sup>2</sup>;

$v_1$  : the speed of the faster vehicle, m/s;

$v_2$  : the speed of the slower vehicle, m/s;

$S$  : the distance between the two vehicles, m.

## III. The Spatio-temporal Coordinated Control of Vehicles in the Merging Area of Ramps

### A. The judgment process for coordinated control

No coordinated control refers to the unrestricted free movement of both mainline and ramp vehicles. In this book, the free movement state of vehicles is defined as follows: mainline vehicles travel at a constant speed of  $v_0$ , while ramp vehicles travel at a constant speed of  $v_{R0}$  on the ramp until the end of the ramp, then accelerate at a rate of  $a_r$  m/s<sup>2</sup> on the acceleration lane to merge directly into the mainline at the same speed as the mainline vehicles.

The initial position of the mainline vehicle is  $x_0$ , and the functional relationship between the mainline vehicle's station number and time is as follows:

$$S_{main} = x_0 + \frac{v_0}{3.6}t \quad (7)$$

The movement of ramp vehicles consists of three stages: the first stage is constant-speed driving, the second stage is uniform acceleration, and the third stage is constant-speed driving.

The first stage involves the vehicle traveling at a constant speed  $v_{R0}$  from its initial station  $r$  until reaching station 0 (the end of the ramp). Let  $t_1 = \frac{|r|}{\frac{v_{R0}}{3.6}}$  denote the time required for the

vehicle to travel at a constant speed from its initial station to station 0. During this time, the functional relationship between the station number of the ramp vehicle and time is given by:

$$S_1(t) = r + \frac{v_{R0}}{3.6}t \quad (0 \leq t < t_1) \quad (8)$$

The second stage involves the vehicle accelerating with acceleration  $a_r$  on the acceleration lane from station 0 until it reaches the same speed as the mainline traffic, then merging directly into the mainline. Let  $t_2 = \frac{v_0 - v_{R0}}{3.6a_r}$  denote the time during

which the ramp vehicle accelerates uniformly. During this time, the functional relationship between the station number of the ramp vehicle and time is given by:

$$S_2(t) = S_1(t_1) + \frac{v_{R0}}{3.6}(t - t_1) + \frac{1}{2}a_r(t - t_1)^2 \quad (t_1 \leq t \leq t_1 + t_2) \quad (9)$$

The third stage involves the ramp vehicle traveling at a constant speed  $v_0$  after merging into the mainline. During this time, the functional relationship between the station number of the ramp vehicle and time is given by:

$$S_3(t) = S_2(t_1 + t_2) + \frac{v_0}{3.6}(t - t_1 - t_2) \quad (t > t_1 + t_2) \quad (10)$$

The functional relationship between the station number of the ramp vehicle and time is expressed as:

$$S_{ramp}(t) = \begin{cases} r + \frac{v_{R0}}{3.6}t, & 0 \leq t < t_1 \\ \frac{v_{R0}}{3.6}(t - t_1) + \frac{1}{2}a_r(t - t_1)^2, & t_1 \leq t \leq t_1 + t_2 \\ S_2(t_1 + t_2) + \frac{v_0}{3.6}(t - t_1 - t_2), & t > t_1 + t_2 \end{cases} \quad (11)$$

In this state of free movement, two main scenarios are likely to occur:

(1) When ramp vehicles can safely merge into the mainline, there is no conflict between ramp vehicles and mainline vehicles, thus no adjustment of vehicles is required. When vehicles can merge into the mainline safely without coordination, it incurs the minimum cost, as no vehicle needs to be adjusted.

(2) When conflicts arise between ramp vehicles and mainline vehicles, coordinated control of both ramp and mainline vehicles is necessary. This paper proposes two methods of coordinated control: mainline priority and ramp priority coordinated control methods. Through these two coordinated control methods, ramp vehicles can safely merge into the mainline. Both of these coordinated control methods incur certain costs when ensuring the safe merging of ramp vehicles into the mainline. These costs may involve sacrificing vehicle travel speed or increasing vehicle fuel consumption.

#### IV. The mainline priority coordinated control method

##### 1) CALCULATING THE SAFE DISTANCE BETWEEN VEHICLES

When the speed of the mainline vehicle is  $v_0$  and the speed of the ramp vehicle is  $v_{R0}$ , even if the ramp vehicle accelerates to match the mainline speed, there is still a speed difference between the mainline and ramp vehicles because the ramp vehicle has both lateral and longitudinal speeds during merging. Assuming the angle of inclination during merging for the ramp vehicle is  $30^\circ$ , the schematic diagram of the merging angle for the ramp vehicle is shown in FIGURE 2. Then, the lateral speed of the ramp vehicle is  $v_{Rx} = v_0 \cos 30^\circ$  km/h. Therefore, there exists a speed difference between the ramp vehicle and the mainline vehicle.

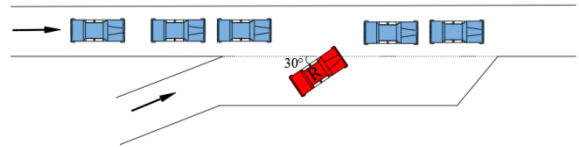

FIGURE 2. The schematic diagram of vehicle merging angle.

Assuming that when the ramp vehicle merges into the mainline, the mainline vehicle in front of the target gap is denoted as X, with its initial station number as  $S_X(t=0) = x$ ; and the mainline vehicle behind the target gap is denoted as Y, with its initial station number as  $S_Y(t=0) = y$ . During merging, the safe distance between the ramp vehicle and the vehicle in front of the target gap should be:

$$L_{r-X} = 2L_1 + \frac{(v_{Rx} - v_X)^2}{254(\phi + \varphi)} \quad (12)$$

During merging, the safe distance between the ramp vehicle and the vehicle behind the target gap should be:13

$$L_{r-Y} = 2L_1 + \frac{(v_{Rx} - v_Y)^2}{254(\phi + \varphi)} \quad (13)$$

Information:



$L_{r-X}$  : The safe distance between the ramp vehicle and the front vehicle of the target gap, m;

$L_{r-Y}$  : The safe distance between the ramp vehicle and the rear vehicle of the target gap, m;

$L_1$  : GPS positioning error, taken as 0.02 meters;

$v_X$  : The driving speed of the front vehicle of the target gap when the ramp vehicle merges into the mainline, km/h;

$v_Y$  : The driving speed of the rear vehicle of the target gap when the ramp vehicle merges into the mainline, km/h;

$v_{Rc}$  : The lateral speed of the ramp vehicle when merging into the mainline, km/h;

$\phi$  : The coefficient of adhesion between the road surface and the tires, taken as 0.40;

$\varphi$  : The coefficient of road resistance, taken as 0.11.

The safe distance between mainline vehicles traveling at the same speed is  $L_{m-m} = 0.04m$ .

When the ramp vehicle merges into the mainline, the minimum gap that needs to be left between two vehicles on the mainline is equal to the length of the ramp vehicle plus the safe distance between the ramp vehicle and the vehicles in front and behind. The calculation formula is as follows:

$$L_{\min s} = L_v + L_{r-X} + L_{r-Y} \quad (14)$$

Information:

$L_{\min s}$  : The minimum gap that should be left between the ramp vehicle and the vehicles in front and behind when the ramp vehicle merges into the mainline, m;

$L_v$  : The length of the vehicle body, taken as 5 meters, m;

$L_{r-X}$  : The safe distance that should be maintained between the ramp vehicle and the vehicle in front of the target gap, m;

$L_{r-Y}$  : The safe distance that should be maintained between the ramp vehicle and the vehicle behind the target gap, m.

## 2) CALCULATING THE SEVERITY OF CONFLICT

When the acceleration is less than 0.3g, passengers are in a relatively comfortable state. Therefore, the threshold for the severity of conflict is set to  $J = (0.3g)^2 = 0.09g^2$  (where  $g = 9.8 \text{ m/s}^2$ ).

## 3) VEHICLE CONFLICT IDENTIFICATION

The time for the ramp vehicle to travel at a constant speed on the ramp is  $t_1$ ,  $t_1 = \frac{|r|}{v_{R0}/3.6}$ , while the time for it to accelerate uniformly

on the acceleration lane is  $t_2$ ,  $t_2 = \frac{v_0 - v_{R0}}{3.6a_r}$ . At the moment it reaches the same speed as the mainline vehicle on the acceleration lane, denoted as time  $t_1 + t_2$ , the ramp vehicle merges into the mainline. At this moment, the position of the ramp vehicle is:

$$S_R(t_1 + t_2) = \frac{v_{R0}t_2}{3.6} + \frac{1}{2}a_r t_2^2 \quad (15)$$

Information:

$S_{ramp}(t_1 + t_2)$  : The milestone position of the ramp vehicle at time  $t_1 + t_2$ , m;

$a_r$  : The acceleration of the ramp vehicle on the acceleration lane,  $\text{m/s}^2$ ;

$t_1$  : The time it takes for the ramp vehicle to travel at a constant speed from the initial milestone to milestone 0, s;

$t_2$  : The time it takes for the ramp vehicle to accelerate from milestone 0 to the point of merging with the mainline vehicle (i.e., where their speeds are the same), s;

The milestone position of the mainline vehicle at time  $t_1 + t_2$  :

$$S_{main}(t_1 + t_2) = x_0 + \frac{v_0}{3.6}(t_1 + t_2) \quad (16)$$

When the milestone positions of the ramp vehicle and the mainline vehicle at time  $t_1 + t_2$  satisfy the following equation(17) a conflict will occur at the merging point:  $S_{main}(t_1 + t_2) - L_v - 0.04 \leq S_R(t_1 + t_2) \leq S_{main}(t_1 + t_2) + L_v + 0.04$  (17)

If there are two mainline vehicles that satisfy this equation, the one with the larger milestone position will be selected as the vehicle conflicting with the ramp vehicle.

## 4) DETERMINE THE TARGET GAP

Select the gap greater than or equal to the minimum acceptable merging gap  $L_{\min s}$  for the ramp vehicle as the target merging gap.

No adjustments are required for the vehicles before and after the selected gap, allowing the ramp vehicle to merge directly.

I Select the gap before or after the mainline vehicle conflicting with the ramp, which is greater than or equal to the minimum acceptable merging gap  $L_{\min s}$ , as the target merging gap for the ramp vehicle.

The gaps between the vehicle that may collide with the ramp vehicle and its preceding and following vehicles are denoted as  $S_{front}$  and  $S_{behind}$ , respectively. After calculating the sizes of these two gaps, they are compared. If both gaps are greater than or equal to the minimum acceptable merging gap for the ramp vehicle, then the larger of the two gaps is chosen as the target merging gap for the ramp vehicle. In case the gaps of the two mainline vehicles are equal, the gap between vehicle A and its preceding vehicle B is selected as the target gap for the ramp vehicle to merge.

When  $S_{front} \geq L_{\min s}$  and  $S_{behind} \geq L_{\min s}$  are valid, if  $S_{front} > S_{behind}$  or  $S_{front} = S_{behind}$ , select the gap between the vehicle that might collide with the ramp vehicle and its preceding vehicle as the target gap. Adjust the ramp vehicle's acceleration to merge into this gap; If  $S_{front} < S_{behind}$ , select the gap between the vehicle that might collide with the ramp vehicle and its following vehicle as the target gap.

II Select the gap greater than or equal to the minimum acceptable merging gap  $L_{\min s}$  for the ramp vehicle outside of the preceding and following vehicles of the mainline vehicle

conflicting with the ramp as the target merging gap for the ramp vehicle.

If the gaps before or after the mainline vehicle conflicting with the ramp are both smaller than the minimum acceptable merging gap  $L_{\min,s}$ , search for a gap closer to the mainline vehicle that is greater than or equal to the minimum acceptable merging gap  $L_{\min,s}$  as the target merging gap for the ramp vehicle.

The ramp vehicle's acceleration and the merging point must both meet the requirements to merge into the selected target gap greater than or equal to the minimum acceptable merging gap  $L_{\min,s}$ . If the ramp vehicle cannot satisfy both of these requirements simultaneously, then select a gap smaller than the minimum acceptable merging gap  $L_{\min,s}$  as the target merging gap for the ramp vehicle.

If the ramp vehicle is accelerating only on the acceleration lane, and given that the length of the acceleration lane is only 200 meters, the condition that the acceleration must satisfy is:

$$a_r \geq \frac{\left(\frac{v_0}{3.6}\right)^2 - \left(\frac{v_{R0}}{3.6}\right)^2}{2S_a} \quad (18)$$

Information:

$a_r$ : The acceleration of the ramp vehicle on the acceleration lane,  $m/s^2$ ;

$v_0$ : The driving speed of the mainline vehicle, km/h;

$v_{R0}$ : The driving speed of the ramp vehicle, km/h;

$S_a$ : The length of the acceleration lane, taken as 200 meters, m;

In addition, to ensure passenger comfort and prevent discomfort caused by excessive acceleration, the maximum acceleration is constrained to not exceed  $6 m/s^2$ . Therefore, the final condition that the acceleration must satisfy is:

$$\frac{\left(\frac{v_0}{3.6}\right)^2 - \left(\frac{v_{R0}}{3.6}\right)^2}{2S_a} \leq a_r \leq 6 \quad (m/s^2) \quad (19)$$

The duration of the first phase during which the ramp vehicle travels at a constant speed is:  $t_1 = \frac{|r|}{v_{R0}/3.6}$ , The duration of

the second phase, during which the vehicle accelerates uniformly, is  $t_2 = \frac{v_0 - v_{R0}}{3.6a_r}$ . Therefore, the requirements for the milepost of the ramp vehicle after the end of the second phase (uniform acceleration) to meet the merging point adjustment are:

$$0 < S_R(t_1 + t_2) = \frac{v_{R0}t_2}{3.6} + \frac{1}{2}a_r t_2^2 < 200 \quad (m) \quad (20)$$

## 5) ESTABLISHING A METHOD FOR MAINLINE PRIORITY COORDINATED CONTROL

(a) Choosing a gap greater than or equal to the minimum acceptable merging gap  $L_{\min,s}$  as the target merging gap for the ramp vehicle to merge into.

In this scenario, the ramp vehicle accelerates to merge into the mainline when its speed matches that of the mainline vehicle. The acceleration of the ramp vehicle needs to be determined by formulating equations based on the driving conditions of the mainline vehicle.

The duration of the first phase during which the ramp vehicle travels at a constant speed is:

$$t_1 = \frac{|r|}{v_{R0}/3.6} \quad (21)$$

The duration of the second phase of uniform acceleration:

$$t_2 = \frac{v_0 - v_{R0}}{3.6a_r} \quad (22)$$

Information:

$t_1$ : The duration of the first phase during which the ramp vehicle travels at a constant speed, s;

$t_2$ : The duration of the second phase during which the ramp vehicle accelerates uniformly, s;

$r$ : The initial milepost of the ramp vehicle, m;

$v_0$ : The driving speed of the mainline vehicle, km/h;

$v_{R0}$ : The driving speed of the ramp vehicle, km/h;

$a_r$ : The adjusted acceleration of the ramp vehicle,  $m/s^2$ ;

I First, select a gap before or after the mainline vehicle conflicting with the ramp that is greater than or equal to the minimum acceptable merging gap  $L_{\min,s}$  as the target merging gap for the ramp vehicle to merge into.

Next, plot the spatio-temporal diagram depicting the changes in milepost over time for 7 mainline vehicles and 1 ramp vehicle. The mainline vehicles are all traveling at a speed of 100 km/h, while the ramp vehicle travels at 60 km/h on the ramp and accelerates at  $2 m/s^2$  on the acceleration lane until merging directly into the mainline when its speed matches that of the mainline vehicles.

Calculate the gaps between the vehicle that may collide with the ramp vehicle and its preceding and following vehicles, denoted as  $S_{front}$  and  $S_{behind}$ , respectively. After calculating the sizes of these two gaps, compare them.

When  $L_{\min,s} \leq S_{behind} \leq S_{front}$  is established, the target gap between the vehicle intending to merge and the vehicle in front of it, which may collide with the merging vehicle, needs to be selected. The acceleration of the merging vehicle's movement should be adjusted to merge into this gap;

When  $L_{\min,s} \leq S_{front} < S_{behind}$  is established, then the gap between the vehicle that is about to collide with the merging vehicle and the vehicle behind it is selected as the target gap;

After selecting the target gap, the vehicle in front of the target gap is considered as the reference vehicle for calculating the merging acceleration of the merging lane. Let the initial station of this vehicle be  $S_X(t=0) = x$ , and the initial station of the merging vehicle be:  $S_R(t=0) = r$ .

Following the adjustment, the time variation for the merging vehicle to accelerate uniformly is as follows:

$$t_2' = \frac{v_0 - v_{R0}}{3.6a_r'} \quad (23)$$

The station location of vehicle X in front of the target gap at time  $t_1 + t_2$  is:

$$S_X(t_1 + t_2) = x + \frac{v_0}{3.6}(t_1 + t_2) \quad (24)$$

The station location of the merging vehicle at time  $t_1 + t_2$  is:

$$S_r'(t_1 + t_2) = \frac{\left(\frac{v_0}{3.6}\right)^2 - \left(\frac{v_{R0}}{3.6}\right)^2}{2a_r'} \quad (25)$$

To ensure the safe merging of the merging vehicle into the selected target gap, the following requirements need to be met:

$$S_X(t_1 + t_2) - L_v - L_{r-X} = S_{ramp}'(t_1 + t_2) \quad (26)$$

By substituting equations (21), (23), (24) and (25) into equation (26), the adjusted acceleration of the merging vehicle can be solved as:

$$a_r' = - \frac{(v_0 - v_{R0})^2}{25.92\left(x + \frac{v_0|r|}{v_{R0}} - L_v - L_{r-X}\right)} \quad (27)$$

Information:

$a_r'$ : Adjust the acceleration of vehicles on the acceleration lane, m/s<sup>2</sup>;

$r$ : Initial station of the ramp vehicle, m;

$b$ : The initial station of mainline vehicle B, m;

$v_0$ : The traveling speed of the mainline vehicle, km/h;

$v_{R0}$ : The traveling speed of the ramp vehicle, km/h;

$L_v$ : Vehicle length, taken as 5 meters, m;

$L_{r-B}$ : The safety distance to be maintained between the ramp vehicle and the mainline vehicle during merging, m;

The time required to travel at a constant speed from the initial station to station 0 is still  $t_1 = \frac{|r|}{v_{R0}/3.6}$ .

The adjusted function representing the relationship between the station number and time for the ramp vehicle in the first phase is:

$$S_1(t) = r + \frac{v_{R0}}{3.6}t \quad (0 \leq t < t_1) \quad (28)$$

The adjustment for the second phase involves the vehicle accelerating from station 0 with an acceleration of  $a_r'$  on the acceleration lane until it matches the mainline speed. Once it reaches the mainline speed, it merges directly onto the mainline.

During this period, the function representing the relationship between the station number and time for the ramp vehicle is:

$$S_2'(t) = \frac{v_{R0}}{3.6}(t - t_1) + \frac{1}{2}a_r'(t - t_1)^2 \quad (t_1 \leq t \leq t_1 + t_2') \quad (29)$$

In the third phase after merging onto the mainline, the ramp vehicle travels at a constant speed of  $v_0$ . During this period, the function representing the relationship between the station number and time for the ramp vehicle is:

$$S_3'(t) = S_2'(t_1 + t_2) + \frac{v_0}{3.6}(t - t_1 - t_2') \quad (t > t_1 + t_2') \quad (30)$$

Therefore, the adjusted function representing the relationship between the station number and time for the entire travel process of the ramp vehicle is:

$$S_r'(t) = \begin{cases} r + \frac{v_{R0}}{3.6}t, & 0 \leq t < t_1 \\ \frac{v_{R0}}{3.6}(t - t_1) + \frac{1}{2}a_r'(t - t_1)^2, & t_1 \leq t \leq t_1 + t_2' \\ S_2'(t_1 + t_2) + \frac{v_0}{3.6}(t - t_1 - t_2'), & t > t_1 + t_2' \end{cases} \quad (31)$$

After comparing before and after, it's apparent that the function relationship between the ramp vehicle's station number and time remains unchanged. However, there are changes in the value of time  $t_2$  and the merging point of the ramp vehicle onto the mainline. This change is due to variations in the acceleration of the ramp vehicle, which directly affect the duration of the acceleration phase. As the ramp vehicle merges onto the mainline after completing acceleration, any changes in acceleration result in alterations in the distance covered during acceleration, thus directly affecting the merging point.

In summary, the gap between the mainline vehicle conflicting with the ramp vehicle and its preceding or following vehicle is chosen as the target gap for the ramp vehicle to merge into. After adjustment, the travel trajectory of the mainline vehicle and the ramp vehicle is as follows:

**Mainline Vehicles:** All mainline vehicles travel at a constant speed of  $v_0$  without adjustments until the merging process is complete;

**Ramp Vehicles:** Ramp vehicles travel at a constant speed of  $v_{R0}$  on the ramp until reaching the end of the ramp (station 0m). From the end of the ramp, they accelerate with an acceleration of  $a_r'$  until they match the speed of the mainline vehicles. They merge onto the mainline at point  $S_{ramp}'(t_1 + t_2)$ , then travel at a constant speed of  $v_0$  on the mainline.



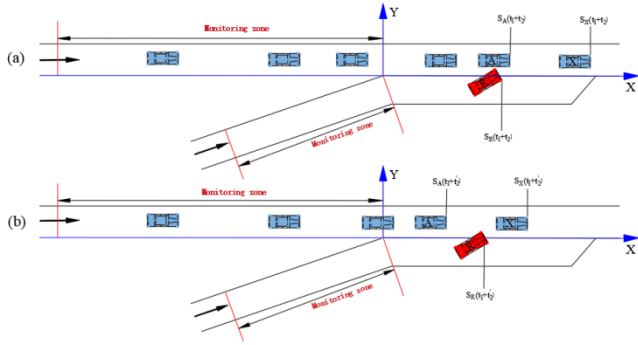

Graph (a) illustrates the schematic diagram of vehicle positions before adjustment, when the ramp vehicle collides with the mainline vehicle; graph (b) represents the schematic diagram of vehicle positions after adjustment, when the ramp vehicle merges onto the mainline.

**FIGURE 3. Schematic diagrams of vehicle positions before and after adjustments.**

Furthermore, the target gap for the ramp vehicle to merge into is selected as the gap between the mainline vehicle conflicting with the ramp vehicle and any vehicles other than its preceding and following vehicles, which is equal to or greater than the minimum mergeable gap for the ramp vehicle.

After selecting the gap, the acceleration after adjustment is calculated using the method described above, following the formula 27. After calculation, the velocity must satisfy the following conditions:

$$\frac{\left(\frac{v_0}{3.6}\right)^2 - \left(\frac{v_{R0}}{3.6}\right)^2}{2S_a} \leq a'_r \leq 6 \text{ (m/s}^2\text{)} \quad (32)$$

Since passengers typically don't feel discomfort when the vehicle's acceleration is equal to or less than  $6 \text{ m/s}^2$ , we'll limit the ramp vehicle's acceleration on the acceleration lane to be less than or equal to  $6 \text{ m/s}^2$ .

After selecting the gap, we calculate the merging point for the ramp vehicle after adjustment, ensuring that it satisfies the following conditions:

$$0 < S_R(t_1 + t_2) = \frac{v_{R0}t_2}{3.6} + \frac{1}{2}a_r t_2^2 < 200\text{m} \quad (33)$$

If the calculated acceleration for the ramp vehicle's travel and the merging point meet the requirements, then the function describing the relationship between the station number and time for the ramp vehicle after adjustment remains the same as equation (31).

If either the calculated acceleration for the ramp vehicle's travel or the merging point does not meet the requirements, then we will not select the gap greater than or equal to the minimum mergeable gap as the target gap. Instead, we will choose a gap smaller than the minimum mergeable gap  $L_{\min,s}$  as the target gap for the ramp vehicle to merge into.

(b) By selecting a gap smaller than the minimum mergeable gap  $L_{\min,s}$  as the target gap for the ramp vehicle to merge into, adjustments to the velocities of the vehicles before and after the target gap are necessary to accommodate the ramp

vehicle's merge. However, it is crucial to determine the ramp vehicle's acceleration and merging point in this scenario.

Before adjustment, the spatio-temporal diagram illustrating the variation of station numbers with respect to time for 7 mainline vehicles and 1 ramp vehicle is depicted in FIGURE 4. The localized enlargement of this diagram is shown in FIGURE 5. In this depiction, the mainline vehicles travel at a speed of  $100 \text{ km/h}$ , while the ramp vehicle travels at  $60 \text{ km/h}$  on the ramp and accelerates at a rate of  $2 \text{ m/s}^2$  on the acceleration lane until merging directly onto the mainline.

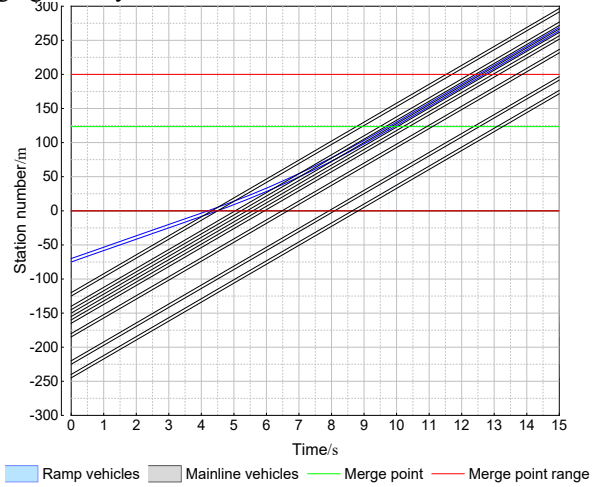

**FIGURE 4. Pre-adjustment spatio-temporal diagram of vehicle collisions.**

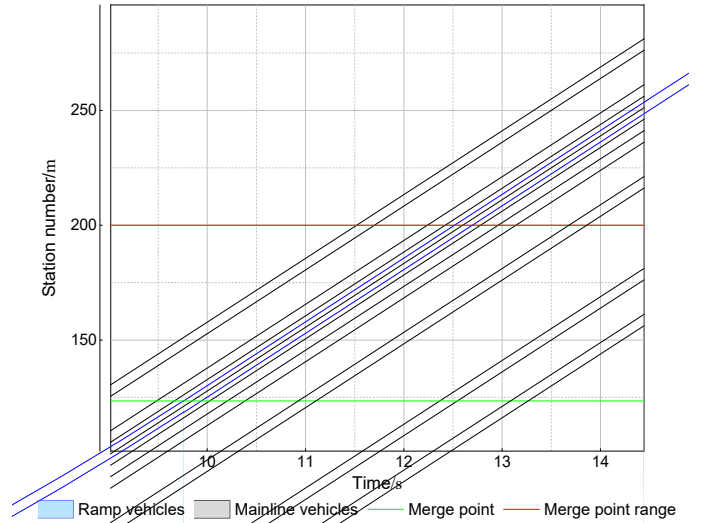

**FIGURE 5. Localized enlargement of the pre-adjustment spatio-temporal diagram of vehicle collisions.**

If either the calculated acceleration for the ramp vehicle's travel or the merging point does not meet the requirements, then we will not select the gap greater than or equal to the minimum mergeable gap as the target gap. Instead, we will choose a gap smaller than the minimum mergeable gap  $L_{\min,s}$ , between the mainline vehicle conflicting with the ramp vehicle and its preceding vehicle, as the target gap for the ramp vehicle to merge into.

Adjustments to the velocities of the mainline vehicles before the target gap are made to create enough space for the ramp vehicle to merge.

Let the initial station number of the mainline vehicle X before the selected target gap be:  $S_X(t=0) = x$ , and let the initial station number of the mainline vehicle Y after the selected target gap be:  $S_Y(t=0) = y$ . The initial station number of the ramp vehicle is  $S_R(t=0) = r$ . The time required for the ramp vehicle

to travel from its initial station to the end of the ramp is  $t_1 = \frac{|r|}{v_{R0}/3.6}$ .

Therefore, at time  $t = t_1$ , the positions of the mainline vehicles X and Y before and after the target gap, respectively, are:

$$S_X(t = t_1) = x + \frac{v_0 t_1}{3.6} = x + \frac{v_0 |r|}{v_{R0}} \quad (34)$$

$$S_Y(t = t_1) = y + \frac{v_0 t_1}{3.6} = y + \frac{v_0 |r|}{v_{R0}} \quad (35)$$

When it is necessary to adjust the velocities of mainline vehicles before and after the target gap to ensure that there is no gap greater than or equal to the minimum mergeable gap on the mainline, the process involves creating space for the ramp vehicle to merge safely into the minimum mergeable gap. Subsequently, based on relevant data, the feasibility of the ramp vehicle merging safely into the gap left by the mainline vehicles before and after the target gap is calculated. The specific approach for the entire process is as follows:

During the adjustment process to create the minimum mergeable gap for the ramp vehicle between the mainline vehicles before and after the target gap, there are three scenarios for the velocity changes of vehicles X and Y:

Scenario 1: Mainline vehicle Y continues to travel at its original speed, while vehicle X accelerates uniformly to create the minimum mergeable gap for the ramp vehicle between the two vehicles.

Scenario 2: Mainline vehicle X continues to travel at its original speed, while vehicle Y decelerates uniformly to create the minimum mergeable gap for the ramp vehicle between the two vehicles.

Scenario 3: Mainline vehicle X accelerates uniformly while vehicle Y decelerates uniformly until the minimum mergeable gap for the ramp vehicle is created between the two vehicles.

Among these three scenarios, Scenario 3 causes the greatest disturbance to the mainline vehicles because both mainline vehicles X and Y need to adjust their speeds. To ensure that vehicles X and Y maintain a safe distance from their preceding and following vehicles during the speed adjustment process, it may be necessary to adjust the vehicles before vehicle X or after vehicle Y. This adjustment could affect the vehicles within a certain range before mainline vehicle X and after mainline vehicle Y. Particularly when the spacing between mainline vehicles and their preceding or following vehicles is small, adjusting the speeds of both vehicles may require further

adjustments to maintain the minimum safe distance between vehicles. Scenario 1 only affects the vehicles before mainline vehicle X, and Scenario 2 only affects the vehicles after mainline vehicle Y. The impact range of these two scenarios is relatively smaller compared to Scenario 3. Although Scenario 2 has a smaller impact range than Scenario 3, when the spacing between the vehicles after mainline vehicle Y is small, the deceleration of vehicle Y can significantly affect the vehicles following it. Therefore, considering the above factors, Scenario 1 is chosen as the adjustment plan for the mainline vehicle speeds. The specific adjustment plan for vehicle X is described in the following text.

The specific process of adjusting vehicle X is as follows: The minimum distance that vehicle X needs to travel forward to create the minimum target mergeable gap is:36

$$\Delta L_X = L_{\min s} - L = L_{\min s} - (x - y - 5) \quad (36)$$

Information:

$\Delta L_X$ : The distance that the vehicle needs to travel forward to create the minimum mergeable gap is, m;

$L_{\min s}$ : The minimum safe gap required for the ramp vehicle to merge into the mainline is, m;

$L$ —The selected target gap length is,  $L = x - y - 5$ , m;

During the process of adjusting the speed of vehicle X to create a mergeable gap for the ramp vehicle, vehicle Y continues to travel forward at a constant speed  $v_0$ . After time  $t_2'$  has elapsed, a mergeable gap is formed between vehicles X and Y for the ramp vehicle. Throughout this process, vehicle Y travels a distance of  $\frac{v_0 t_2'}{3.6}$  m. Vehicle A needs to travel an additional  $\Delta L_X$  m compared to vehicle B. Therefore, the distance that vehicle A needs to travel within this time is  $(\frac{v_0 t_2'}{3.6} + \Delta L_X)$  m. The schematic

diagram of the positions of vehicles X and Y before and after creating the mergeable gap is shown in FIGURE 6 below. .

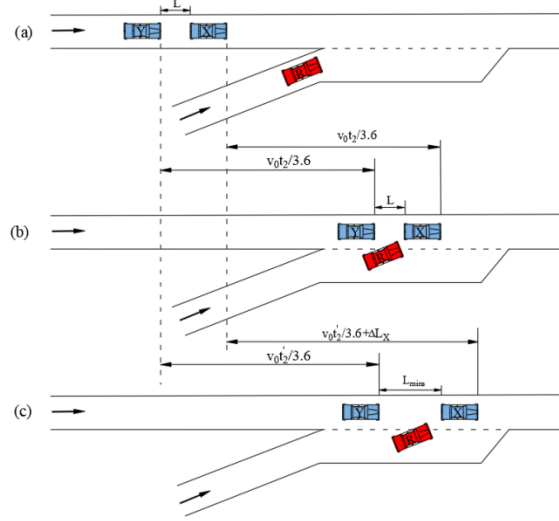

Graph (a) illustrates the schematic diagram of the positions of various vehicles when the ramp vehicle reaches the end of the ramp; graph (b) represents the positions of various vehicles

before the ramp vehicle merges into the mainline; graph (c) shows the positions of various vehicles after the ramp vehicle merges into the mainline.

**FIGURE 6. The schematic diagram of the positions before and after the adjustment of the mainline and ramp vehicles.**

After the adjustment, after  $t'_2$  s, the ramp vehicle accelerates from the marker at 0 meters to the merge point. The acceleration of the ramp vehicle on the acceleration lane after the adjustment is:

$$a'_r = \frac{v_0 - v_{R0}}{3.6t'_2} \quad (37)$$

The position of the merge point for the ramp vehicle at time  $t_1 + t_2$  after the adjustment is:

$$S'_{mr} = \frac{\left(\frac{v_0}{3.6}\right)^2 - \left(\frac{v_{R0}}{3.6}\right)^2}{2a'_r} = \frac{(v_0 + v_{R0}) \cdot t'_2}{7.2} \quad (38)$$

At the merge point, the relationship between the position of the ramp vehicle and the position of the mainline vehicle X ahead of the target gap is:

$$S_X(t = t_1) + \left(\frac{v_0 t'_2}{3.6} + \Delta L_X\right) = S'_{mr} + L_v + L_{r-X} \quad (39)$$

Substitute equations (34) and (37), (38) into equation (39), then solve for the time required to leave the minimum mergeable gap for the ramp vehicle. This time represents the time it takes for the ramp vehicle to accelerate to the same speed as the mainline vehicle, or the time it takes for the ramp vehicle to reach the merge point from the marker at 0 meters. The calculation formula is as follows<sup>40</sup>

$$t'_2 = \frac{7.2(L_v + L_{r-X} - x - \Delta L_X - \frac{v_0 |r|}{v_{R0}})}{v_0 - v_{R0}} \quad (40)$$

Information:

$t'_2$ : The time required to leave the minimum mergeable gap for the ramp vehicle, which is also the time for the ramp vehicle to accelerate, s;

$x$ : Initial stationing of mainline vehicle X before the target gap, m;

$\Delta L_X$ : The minimum distance vehicle X needs to travel forward in order to leave the smallest target merge gap, m;

Therefore, the adjusted function expressing the relationship between the stationing of ramp vehicles and time throughout the entire travel process is:

$$S'_r(t) = \begin{cases} r + \frac{v_{R0}}{3.6}t, & 0 \leq t < t_1 \\ \frac{v_{R0}}{3.6}(t - t_1) + \frac{1}{2}a'_r(t - t_1)^2, & t_1 \leq t \leq t_1 + t'_2 \\ S'_2(t_1 + t_2) + \frac{v_0}{3.6}(t - t_1 - t_2), & t > t_1 + t'_2 \end{cases} \quad (41)$$

In order to minimize the impact of speed adjustments of mainline vehicle X on other vehicles on the mainline, ensuring that the speed of vehicle X remains the same as the original speed after leaving a sufficient safety gap, vehicle X accelerates uniformly for the first half of the entire speed adjustment process and decelerates uniformly for the second half with an acceleration equal to the opposite of the acceleration during acceleration, denoted as  $a_{Xdec} = -a_{Xacc}$ . By following this procedure, the speed of vehicle X before adjusting its speed at the target gap is the same as the speed after forming a mergeable gap on the ramp. Additionally, the absolute values of the acceleration during the first half and the second half of the process are equal, denoted as  $a_{Xdec} = -a_{Xacc}$ . Therefore, the time taken for acceleration  $t_{Xacc}$  and deceleration  $t_{Xdec}$  is the same, both equal to  $\frac{t'_2}{2}$  s. The distance traveled during acceleration and deceleration is also the same, denoted as

$$S_{Xacc} = S_{Xdec} = \frac{S_X}{2} = \frac{v_0 t'_2 / 3.6 + \Delta L_X}{2} \text{ m.}$$

The relationship between distance and time during acceleration is:

$$S_X = \frac{v_0}{3.6} \cdot t'_2 + \Delta L_X \quad (42)$$

The relationship between distance and acceleration during acceleration is:

$$\frac{S_X}{2} = \frac{v_0}{3.6} \cdot \frac{t'_2}{2} + \frac{1}{2} a_{Xacc} \left(\frac{t'_2}{2}\right)^2 \quad (43)$$

Therefore, find the acceleration of the mainline vehicle X traveling with uniform acceleration is:

$$a_{Xacc} = \frac{4\Delta L_X}{(t'_2)^2} \quad (44)$$

Information:

$a_{Xacc}$ : The acceleration of vehicle X when it is about to merge into the target gap before the exit ramp,  $\text{m/s}^2$ ;

$t'_2$ : The total time vehicle X reserves before the target gap to merge into it, s;

$S_X$ : The total distance that mainline vehicle X needs to travel throughout the entire deceleration process, m;

Due to  $a_{Xdec} = -a_{Xacc}$ , therefore:

$$a_{Xdec} = -a_{Xacc} = -\frac{4\Delta L_X}{(t'_2)^2} \quad (45)$$

The calculation formula for the total acceleration time and deceleration time of vehicle X adjusting its speed before the target gap, forming a period during which ramp vehicles can merge into the gap, is equal:

$$t_{Xdec} = t_{Xacc} = \frac{t'_2}{2} \quad (46)$$

Speed of the mainline vehicle after uniform acceleration:47

$$v_t = \frac{v_0}{3.6} + a_{Xacc} \cdot t_{Xacc} \quad (47)$$

In conclusion, the relationship between the station number of the ramp vehicle and time during the entire driving process after adjustment is expressed as a function:

$$S'_R(t) = \begin{cases} r + \frac{v_{R0}}{3.6}t, & 0 \leq t < t_1 \\ \frac{v_{R0}}{3.6}(t-t_1) + \frac{1}{2}a_r(t-t_1)^2, & t_1 \leq t \leq t_1 + t'_2 \\ S'_2(t_1 + t'_2) + \frac{v_0}{3.6}(t-t_1 - t'_2), & t > t_1 + t'_2 \end{cases} \quad (48)$$

The function describing the relationship between the station number of mainline vehicle X before the target gap and time after adjustment throughout the entire driving process is as follows:

$$S'_x(t) = \begin{cases} x + \frac{v_0}{3.6}t, & 0 \leq t < t_1 \\ x + \frac{v_0}{3.6}t_1 + \frac{v_0}{3.6}(t-t_1) + \frac{1}{2}a_{Xacc}(t-t_1)^2, & t_1 \leq t \leq t_1 + \frac{t'_2}{2} \\ x + \frac{v_0}{3.6}t_1 + \frac{v_0 t'_2 / 3.6 + \Delta L_X}{2} + \frac{v_0}{3.6}(t-t_1 - \frac{t'_2}{2}) + \frac{1}{2}a_{Xdec}(t-t_1 - \frac{t'_2}{2})^2, & t_1 + \frac{t'_2}{2} \leq t \leq t_1 + t'_2 \\ x + \frac{v_0}{3.6}t_1 + \frac{v_0 t'_2}{3.6} + \Delta L_X + \frac{v_0}{3.6}(t-t_1 - t'_2), & t > t_1 + t'_2 \end{cases} \quad (49)$$

The function describing the relationship between the station number of mainline vehicle Y before and after adjustment and time remains unchanged throughout the entire driving process after the target gap:

$$S_Y(t) = y + \frac{v_0}{3.6}t \quad (0 \leq t \leq t_1 + t'_2) \quad (50)$$

Using the collaborative control method described above, calculate the acceleration of the ramp vehicles after employing the collaborative method. Also, adjust the vehicles that would collide after merging point. The spatio-temporal diagram of the adjusted vehicles is shown in FIGURE 7, with a zoomed-in view provided in FIGURE 8.

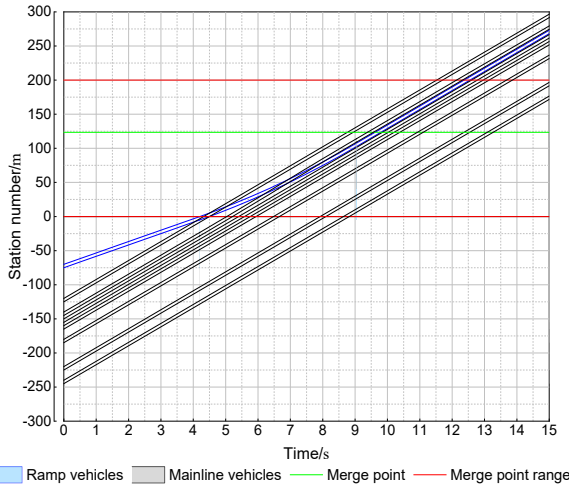

FIGURE 7. The spatio-temporal diagram of the adjusted vehicles.

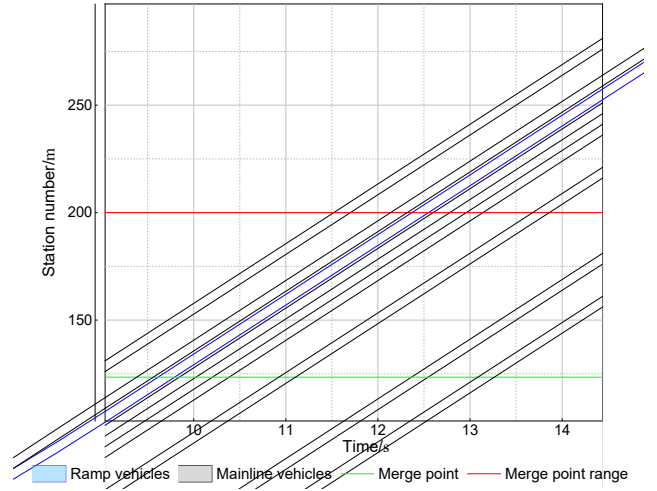

FIGURE 8. A zoomed-in view of the spatio-temporal diagram of the adjusted vehicles.

## V. Simulation and Evaluation

### A. SIMULATION OVERALL FRAMEWORK

Utilizing the programming software Python, the microscopic traffic simulation tool SUMO, and their interaction interface TraCI to implement all modules in the simulation framework. The built simulation overall framework is shown in FIGURE 9. Python mainly implements major algorithm modules such as calculation processing and trajectory generation, as well as metric modules related to energy consumption statistics and vehicle motion analysis. SUMO provides basic modules related to traffic, such as road models, vehicle models, and visualization functions. TraCI enables real-time interaction between Python and SUMO.

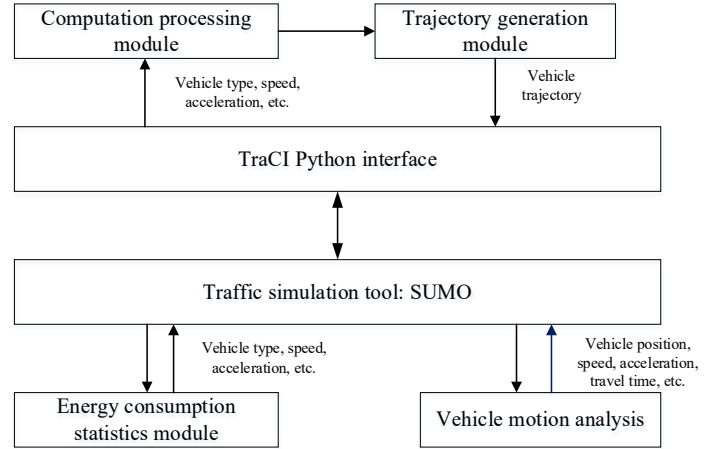

FIGURE 9. Overall simulation framework diagram.

### B. SIMULATION SCENE AND PARAMETER SETTINGS

#### 1) SIMULATION SCENE

The simulation scene selected in this chapter mainly focuses on the outermost lane of the mainline highway in a connected environment and the single-lane entrance section of the ramp. It is assumed that the maximum speed of vehicles on the ramp is 17 m/s, while the speed of vehicles on the mainline varies between 15 and 20 m/s. The acceleration lane length is set to 200 meters.



Since the ratio of the maximum travel speed of mainline vehicles to that of ramp vehicles is approximately 1:3, the detection zones on the mainline and ramp are set to start 130m and 100m upstream from the nose of the ramp, respectively. The length ratio from the start of the detection zone to the nose of the ramp is also set to 1:3.

Simulation is conducted with mainline traffic volumes of 800 veh/h/lane, 1200 veh/h/lane, and 1800 veh/h/lane, and ramp traffic volumes of 200 veh/h/lane, 300 veh/h/lane, and 500 veh/h/lane. Mainline and ramp traffic volumes are randomly paired to form simulation scenarios.

All connected autonomous vehicles are equipped with vehicle-infrastructure cooperative devices, providing functions such as vehicle positioning and real-time communication with the infrastructure. All vehicles in the merging area of the highway ramp obey control and drive according to planned trajectories.

## 2) MODEL AND PARAMETER SETTINGS

Since previous studies have not proposed pre-planned trajectories for vehicles under mainline priority and ramp priority cooperative control methods, two cooperative control methods proposed in this paper are selected for comparison with no cooperative control. The no cooperative control method uses the Krauss car-following model and LC2013 lane-changing model in SUMO. Therefore, the simulation conducted in the SUMO software using the Krauss model as the car-following model and the LC2013 model as the lane-changing decision model will be referred to as the Kraus/LC2013 model in the subsequent text.

## C. ANALYSIS OF COOPERATIVE CONTROL SIMULATION RESULTS

### 1) AVERAGE DELAY TIME

Average delay is a crucial traffic metric, especially when evaluating the effectiveness of highway ramp merging, as it provides key insights into traffic flow and efficiency. It reflects traffic congestion, merging efficiency, traffic safety, and the effectiveness of cooperative control.

In this paper, simulations were conducted with mainline traffic volumes of 800 veh/h/lane, 1200 veh/h/lane, and 1800 veh/h/lane, and ramp traffic volumes of 200 veh/h/lane, 300 veh/h/lane, and 500 veh/h/lane. Three strategies were simulated: mainline priority, ramp priority, and SUMO's own cooperative control. This resulted in nine different traffic flow scenarios with corresponding average delay times, as shown in TABLE1.

The average delay for mainline vehicles is the additional travel time compared to free-flow conditions. Similarly, the average delay for ramp vehicles is the extra travel time compared to free-flow conditions. For mainline vehicles, the free-flow travel time over 800m in the ramp merging area is 40s, while for ramp vehicles, it is 25s over 400m in the merging area.

**TABLE1. Table of average delay times for different mainline traffic volumes.**

Mainline traffic volume (veh/h/lane)	Ramp traffic volume (veh/h/lane)	Mainline average delay time /(s)				
		Krauss /LC2013 model	Mainline priority	Improvement rate/%	Ramp priority	Improvement rate /%
800	200	4.44	0.23	94.82	0.61	86.26
800	300	5.01	0.38	92.42	1.10	78.04
800	500	5.99	0.45	92.49	0.97	83.81
1200	200	7.60	0.26	96.58	0.54	92.89
1200	300	8.55	0.57	93.33	1.19	86.08
1200	500	9.45	0.54	94.29	1.31	86.14
1800	200	15.28	0.54	96.47	0.73	95.22
1800	300	18.04	0.65	96.40	1.24	93.13
1800	500	26.98	0.68	97.48	1.35	95.00

From TABLE1, it can be observed that under the same traffic conditions, the average delay time of mainline vehicles under the mainline priority strategy is always lower than that under the ramp priority strategy. Additionally, under the same traffic volume, the improvement rate of the mainline average delay time under the mainline priority strategy, compared to the Krauss/LC2013 model used in SUMO, is consistently higher than that under the ramp priority strategy. In the simulated traffic volumes, the improvement rate of mainline vehicle average delay under the mainline priority strategy can reach up to 97.48%, while under the ramp priority strategy, it reaches a maximum of 95%. When the mainline traffic volume is fixed, in most cases, with the increase of ramp traffic volume, the average delay of mainline vehicles under both mainline priority and ramp priority strategies will increase, while the improvement rate will decrease. However, in a few cases, with the increase of ramp traffic volume, the average delay of mainline vehicles under the mainline priority strategy may decrease, and the improvement rate will increase accordingly.

**TABLE2. Table of average delay times for different ramp traffic volumes**

Mainline traffic volume (veh/h/lane)	Ramp traffic volume (veh/h/lane)	Ramp average delay time (s)				
		Krauss /LC2013 model	Mainline priority	Improvement rate/%	Ramp priority	Improvement rate /%
800	200	7.35	0.15	97.96	0.46	93.74
800	300	8.62	0.31	96.40	0.43	95.01
800	500	9.65	0.33	96.58	0.37	96.17
1200	200	8.54	0.18	97.89	0.45	94.73
1200	300	9.66	0.34	96.48	0.44	95.45



Mainline traffic volume (veh/h/lane)	Ramp traffic volume (veh/h/lane)	Ramp average delay time (s)				
		Krauss/LC2013 model	Mainline priority	Improvement rate/%	Ramp priority	Improvement rate/%
1200	500	12.29	0.44	96.42	0.67	94.55
1800	200	11.47	0.55	95.20	0.71	93.81
1800	300	16.43	0.66	95.98	0.86	94.77
1800	500	20.42	0.59	97.11	0.85	95.84

From TABLE2, the following conclusions can be drawn regarding the average delay time for different ramp traffic volumes: Under all traffic flow conditions, the average delay time for ramps under the mainline priority strategy is always lower than that under the Krauss/LC2013 model and ramp priority strategy. Additionally, the improvement rate of the mainline priority strategy is higher than that of the ramp priority strategy for different traffic flow volumes, indicating better performance in reducing ramp vehicle delays. Although the average delay time for ramps under the ramp priority strategy is also lower than that under the Krauss/LC2013 model, its improvement rate is consistently lower than that of the mainline priority strategy, indicating that while the ramp priority strategy is effective, its effect is not as significant as that of the mainline priority strategy.

With the increase of mainline and ramp traffic volumes, the average delay time for ramps under the Krauss/LC2013 model significantly increases, indicating that higher traffic pressure leads to longer delays. When the mainline traffic volume is constant, with the increase of ramp traffic volume, the average delay time for ramps under both mainline priority and ramp priority strategies gradually increases, indicating that higher ramp traffic volume leads to increased delay time.

Under conditions of high mainline traffic volume and low ramp traffic volume, the mainline priority strategy can significantly reduce delay time, showing the most pronounced effect. Therefore, the mainline priority strategy performs better than the ramp priority strategy in reducing ramp vehicle delays, especially under conditions of high mainline traffic volume and low ramp traffic volume. With the increase of ramp traffic volume, both strategies show certain trends of increasing delay time and decreasing improvement rate.

In the simulated traffic volumes, the improvement rate of ramp vehicle average delay under the mainline priority strategy can reach up to 97.96%, while under the ramp priority strategy, it reaches a maximum of 96.17%.

The mainline average delay indicates:

(a) Mainline traffic flow status: The average delay on the mainline reflects the smoothness of main road traffic. Higher delays indicate that mainline traffic may be approaching or

exceeding road capacity, resulting in speed reduction and increased travel time.

(b) Merge impact: Increased average delay on the mainline may be caused by ramp merging, especially if the merging design is improper or the merging traffic volume is too high, which may lead to mainline vehicles slowing down or even stopping, thereby increasing delays.

(c) Driving behavior and safety: Higher mainline delays may lead to drivers engaging in aggressive driving behavior to avoid delays, which may increase accident risks. By regularly measuring and analyzing average delays, a better understanding of the performance of specific merge areas can be obtained, and appropriate improvement measures can be formulated to optimize traffic flow, enhance driving experience, and reduce environmental impacts.

## 2) AVERAGE SPEED

Average speed is a key indicator for assessing the efficiency and safety of highway ramp merging. A higher average speed typically indicates smooth merging onto the main road, indicating good traffic flow in the area with no significant congestion. The stability of average speed indicates the predictability and stability of traffic flow, which is crucial for reducing the risk of accidents caused by sudden braking or acceleration. The appropriate average speed also helps reduce speed differentials between vehicles, which is crucial for the safety of merging points; driving too fast may lead to insufficient braking time, while driving too slowly may increase the risk of rear-end collisions. For ramps using cooperative control measures, average speed also reflects the effectiveness of these cooperative measures. Therefore, analyzing average speed is crucial for highway ramp merging.

When analyzing the average speed of highway ramp merging areas, three scenarios are selected: the maximum mainline flow rate (i.e., 1800 veh/h/lane) with ramp flow rates of 200, 300, and 500 veh/h/lane, respectively. If a particular cooperative control method performs better with higher mainline traffic flow, it may perform better with lower mainline traffic flow as well. The average mainline speed is shown in FIGURE 10, and the average ramp speed is shown in FIGURE 11. In both figures:

- (a) represents the scenario with a mainline flow rate of 1800 veh/h/lane and a ramp flow rate of 200 veh/h/lane;
- (b) represents the scenario with a mainline flow rate of 1800 veh/h/lane and a ramp flow rate of 300 veh/h/lane;
- (c) represents the scenario with a mainline flow rate of 1800 veh/h/lane and a ramp flow rate of 500 veh/h/lane.

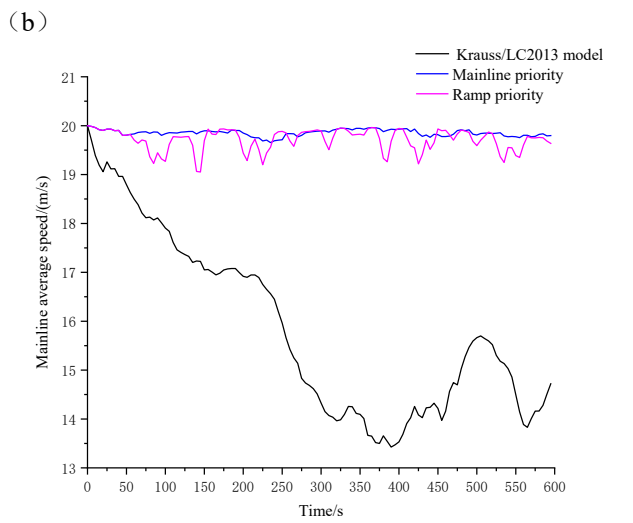
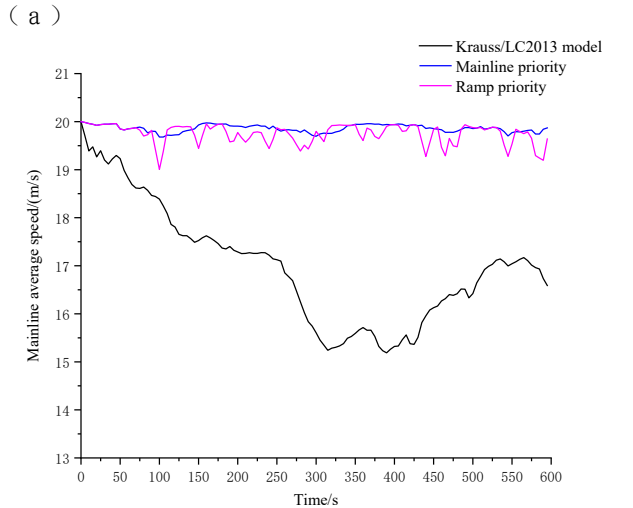
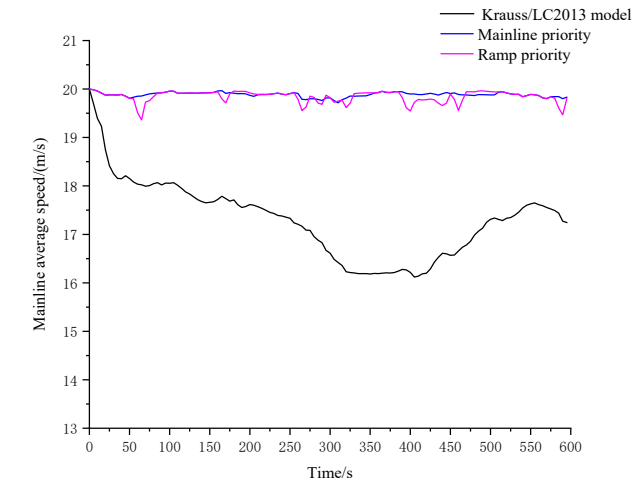

vehicles, thus increasing traffic instability and accident risks. In contrast, both the mainline priority and ramp priority cooperative control strategies showed similar higher average speeds, indicating their superiority in merging efficiency compared to the KRAUSS/LC2013 model. However, the ramp priority strategy exhibited larger speed fluctuations, suggesting that while it facilitated smooth merging for ramp vehicles, it might cause more speed adjustments for mainline vehicles, thereby reducing driving comfort and increasing the probability of traffic conflicts. Therefore, the mainline priority control strategy demonstrated a more balanced performance in reducing speed fluctuations and maintaining traffic stability, providing a better balance between improving efficiency and ensuring safety.

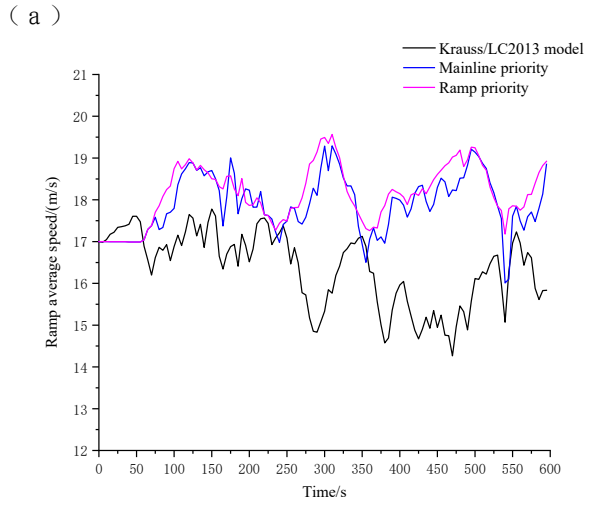
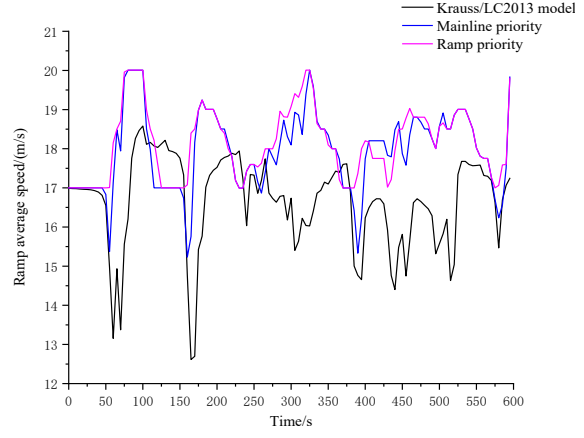

(b)

**FIGURE 10. Mainline average speed.**

From FIGURE 10, it can be observed that in the highway ramp merging under three different traffic flow conditions, the KRAUSS/LC2013 model resulted in the lowest and most fluctuating average speed on the mainline. This indicates that this strategy failed to effectively integrate the flow from the ramp and the mainline, leading to frequent speed adjustments by mainline

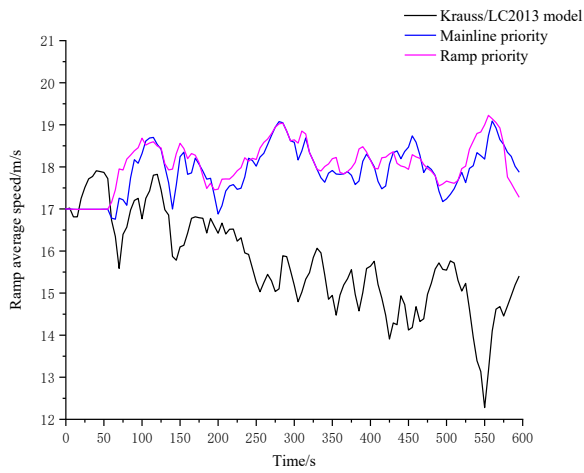

( c )

**FIGURE 11.** Ramp average speed.

From FIGURE 11, it can be observed that in the highway ramp merging under three different traffic flow conditions, we found that the KRAUSS/LC2013 model resulted in the lowest average speed and the largest speed fluctuations for ramp vehicles. This suggests that this strategy may have failed to effectively coordinate traffic between the ramp and the mainline, leading to difficulties in ramp merging and traffic congestion. In contrast, both the mainline priority and ramp priority strategies exhibited similar and relatively stable average speeds and fluctuation ranges, indicating that these two methods were more effective in managing traffic flow and could better balance the needs of the ramp and the mainline, thereby reducing congestion and improving traffic flow efficiency and safety.

In summary, in the highway ramp merging under three different traffic flow conditions, the KRAUSS/LC2013 model showed the lowest average speed and the largest speed fluctuations for ramp vehicles, indicating that this strategy was not effective enough in coordinating traffic between the ramp and the mainline, leading to merging difficulties and increased traffic congestion. While the mainline priority and ramp priority strategies exhibited similar higher average speeds, suggesting their effectiveness in cooperative control, the larger speed fluctuations in the ramp priority strategy indicated that it might cause frequent speed adjustments for mainline traffic, affecting driving comfort and safety. In contrast, the mainline priority strategy optimized traffic stability with smaller speed fluctuations, achieving the best balance between efficiency and safety.

### 3) TOTAL FUEL CONSUMPTION

In this paper, when acceleration is negative,  $f_{accel}$  is automatically set to zero. In the fuel consumption model, setting  $f_{accel}$  to zero when it is negative is mainly because in this case, the vehicle is decelerating or driving downhill, and its fuel consumption is no longer directly driven by acceleration. Firstly, fuel consumption is mainly influenced by the additional energy demand during acceleration, which decreases during deceleration, so the related fuel consumption can be considered zero. Secondly, modern vehicles are often equipped with energy recovery

systems that can recover kinetic energy during deceleration, reducing the overall energy consumption and further reducing the necessity of considering  $f_{accel}$  in this state. In addition, simplifying the model is an important consideration in the modeling process; not calculating  $f_{accel}$  during deceleration can reduce model complexity without significantly affecting the overall accuracy of the model. Finally, in actuality, during vehicle deceleration, fuel consumption is influenced more by factors such as engine braking, air resistance, and rolling resistance, rather than the deceleration action itself. Therefore, this approach reflects both physical reality and provides convenience and accuracy in model development.

Where  $p_0, p_1, p_2, p_3, q_0, q_1, q_2$  are coefficients of the polynomial and are constants. The values of each parameter in the energy consumption model are shown in TABLE3, and the graph of the fuel consumption model with these parameter values is illustrated in FIGURE 12.

**TABLE3.** Parameter values of the energy consumption model.

Parameters	Parameter meanings	Values	Units
$M_v$	Vehicle mass	1200	Kg
$C_D$	Drag coefficient	0.32	\
$\rho_a$	Air density	1.184	Km/m <sup>3</sup>
$A_f$	Vehicle frontal area	2.5	m <sup>2</sup>
$\mu$	Viscosity coefficient	0.015	\
$p_0$	Polynomial coefficient	0.1569	\
$p_1$	Polynomial coefficient	0.0245	\
$p_2$	Polynomial coefficient	$-7.415 \times 10^{-4}$	\
$p_3$	Polynomial coefficient	$5.975 \times 10^{-5}$	\
$q_0$	Polynomial coefficient	0.07224	\
$q_1$	Polynomial coefficient	0.09681	\
$q_2$	Polynomial coefficient	$1.075 \times 10^{-3}$	\

The speed of the vehicle is represented on the x-axis, acceleration on the y-axis, and fuel consumption on the z-axis. The velocity ranges from 0 to 30 m/s, and the acceleration ranges from 0 to 5 m/s<sup>2</sup>. The functional relationship between fuel consumption, velocity, and acceleration:

$$f_{fuel} = 0.1596 + 0.0245v - 7.145 \times 10^{-4}v^2 + 5.975 \times 10^{-5}v^3 + a(0.07224 + 0.09681v + 1.075 \times 10^{-3}v^2)$$

The three-dimensional plot illustrating the relationship between fuel consumption, velocity, and acceleration, based on the aforementioned functional relationship, is shown in FIGURE 12.

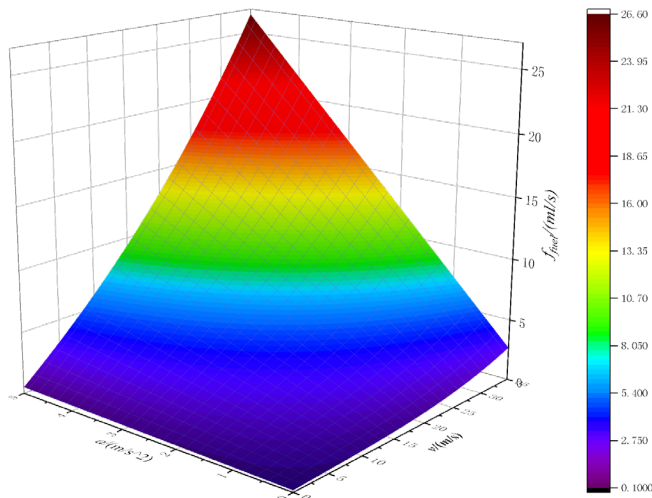

**FIGURE 12.**Fuel consumption model graph.

From FIGURE 12, it can be observed that, in a single dimension, as velocity increases, fuel consumption also increases. Similarly, as acceleration increases, fuel consumption increases as well. When velocity is held constant, higher acceleration results in higher fuel consumption. Likewise, when acceleration is constant, higher velocity leads to higher fuel consumption. If both the acceleration and velocity of the vehicle are relatively high, fuel consumption is expected to be higher, as indicated by the red area in the figure.

In summary, the mainline priority strategy performs better than the merging lane priority strategy in reducing total fuel consumption, especially under moderate traffic flow conditions. With the increase of traffic flow, both the fuel consumption and improvement rates under both strategies show certain trends of change. Under the same traffic flow conditions, the maximum improvement rate of total fuel consumption for the mainline priority strategy can reach 6.01%, while that for the merging lane priority strategy can reach 4.88%.

**TABLE4.** Total fuel consumption under different traffic volume and various coordinated control methods.

Mainline traffic volume (veh/h/lane)	Ramp traffic volume (veh/h/lane)	Krauss /LC 2013 model	Mainline priority/(L)	Improvement rate/%	Ramp priority/(L)	Improvement rate /%
800	200	15.18	15.04	0.92	15.13	0.33
800	300	16.93	16.47	2.72	16.33	3.72
800	500	19.65	18.91	3.77	19.17	2.44
1200	200	20.93	20.62	1.48	20.59	1.62
1200	300	22.36	21.77	2.64	21.48	3.94
1200	500	25.02	24.27	3.00	23.08	4.88
1800	200	28.56	28.49	0.25	27.49	3.75
1800	300	29.91	29.64	0.90	28.86	3.51
1800	500	34.76	32.67	6.01	32.95	5.21

From TABLE4, the following conclusions can be drawn:

1) Mainline priority strategy consistently results in lower total fuel consumption compared to the Krauss/LC2013 model across all traffic volumes, indicating its effectiveness in reducing fuel consumption. Moreover, its improvement rate is higher than that of the ramp priority strategy across different traffic volumes.

2) The ramp priority strategy also exhibits lower total fuel consumption than the Krauss/LC2013 model. Although its improvement rate is not as high as that of the mainline priority strategy, it still demonstrates some optimization effect.

3) With the increase in mainline traffic volume and ramp traffic volume, the total fuel consumption under the Krauss/LC2013 model significantly increases, indicating that higher traffic pressure leads to higher fuel consumption.

4) Under a constant mainline traffic volume, the total fuel consumption gradually increases with an increase in ramp traffic volume for both mainline priority and ramp priority strategies, indicating that higher ramp traffic volume leads to increased fuel consumption. Particularly, under conditions of mainline traffic volume at 1800 veh/h/lane and ramp traffic volume at 500 veh/h/lane, the mainline priority strategy achieves the highest improvement rate of 6.10%, while the ramp priority strategy has an improvement rate of 5.21%. This highlights the significant optimization effect of the mainline priority strategy under high mainline and ramp traffic volumes.

### Conclusion

Key research findings include:

1) The safe distance between vehicles in trajectory spatio-

temporal coordination depends on factors such as speed differences, vehicle positioning errors, and vehicle clock errors. Considering the uncertainty of these factors, a method for calculating the safe distance between vehicles under deep vehicle-road coordination conditions is proposed. The safe distance is the sum of the safety distances required for speed differences and clock precision errors, as well as vehicle positioning errors.

2) Collision acceleration is mainly determined by the speed difference and mass ratio of two vehicles. Based on the scenarios of completely inelastic and completely elastic collisions, a quantitative evaluation model for vehicle collision risk is proposed, analyzing the quantitative relationship between collision risk and vehicle speed difference and mass ratio. A smaller mass ratio and a larger absolute value of speed difference result in higher collision accelerations and greater harm to vehicles.

3) A model is proposed to calculate the urgency of vehicle collisions, represented by urgent acceleration. A higher urgent acceleration indicates a greater speed adjustment required per unit time when adjusting two vehicles to the same speed, reflecting a higher degree of collision urgency. Combining collision acceleration and urgent acceleration, an evaluation model for assessing the urgency of vehicle collisions is constructed. A conflict severity threshold is set, indicating that when the conflict urgency of merge-lane vehicles exceeds this threshold, it signifies a conflict with mainline vehicles, requiring corresponding vehicle coordination control adjustments.

4) Mainline priority coordinated control methods is proposed to pre-plan vehicle trajectories. Firstly, the safe distance between vehicles, as calculated by the proposed formula, is determined. Then, the conflict level of merge-lane vehicles is calculated to identify mainline vehicles that may conflict. Subsequently, the target gap for merge-lane vehicles is determined, and corresponding coordinated control methods are established based on the selected target gap. Vehicle trajectories are pre-planned accordingly, and vehicles can safely merge based on the planned trajectories.

5) In simulations under different traffic flow conditions, it is observed that the uncoordinated control using the Krauss car-following model and the LC2013 lane-changing model in SUMO results in high delays on merge lanes and mainlines, indicating poor merging effects. In contrast, both mainline priority and merge lane priority strategies significantly reduce delays on merge lanes and mainlines, improving merging efficiency and traffic flow stability. Compared to uncoordinated control in SUMO, the mainline priority strategy achieves the highest improvement rates in average delays on mainlines and merge lanes, reaching up to 97.48% and 97.96%, respectively.

6) In simulations under different traffic flow conditions at highway merge areas, uncoordinated control using the Krauss car-following model and the LC2013 lane-changing model in SUMO results in the lowest average speed and the largest speed fluctuations for merge lane vehicles. Conversely, mainline

priority and merge lane priority strategies exhibit higher average speeds and better coordination effects. Among them, the mainline priority strategy performs the best in improving traffic efficiency and safety due to its smaller speed fluctuations, demonstrating its advantages in merge lane control.

7) Under different traffic flow conditions in simulations at highway merge areas, uncoordinated control using the Krauss car-following model and the LC2013 lane-changing model in SUMO leads to the highest total fuel consumption, while mainline priority and merge lane priority strategies result in similar fuel consumption, with mainline priority occasionally slightly higher or lower than merge lane priority. Compared to uncoordinated control in SUMO, the mainline priority strategy achieves the highest improvement rate in total fuel consumption, reaching up to 6.01%, while the merge lane priority strategy achieves a maximum improvement rate of 4.88% under the same traffic flow volume.

## REFERENCES

- [1] CHEN J, ZHOU Y, CHUNG E. An Integrated Approach to Optimal Merging Sequence Generation and Trajectory Planning of Connected Automated Vehicles for Freeway On-Ramp Merging Sections [J]. *IEEE Transactions on Intelligent Transportation Systems*, 2024, 25(2): 1897-912.
- [2] LI S R, WEI C, WANG Y, et al. A Ramp Merging Strategy for Automated Vehicles Considering Vehicle Longitudinal and Latitudinal Dynamics; proceedings of the IEEE 5th International Conference on Intelligent Transportation Engineering (ICITE), Beijing, PEOPLES R CHINA, F Sep 11-13, 2020 [C]. 2020.
- [3] SHI Y J, YU H, GUO Y J, et al. A Collaborative Merging Strategy with Lane Changing in Multilane Freeway On-Ramp Area with V2X Network [J]. *Future Internet*, 2021, 13(5).
- [4] ZHU J, WANG L, TASIC I, et al. Improving Freeway Merging Efficiency via Flow-Level Coordination of Connected and Autonomous Vehicles [J]. *Ieee Transactions on Intelligent Transportation Systems*, 2024.
- [5] LIU J Q, ZHAO W Z, WANG C Y, et al. Interactive on-ramp merging decision-making with motion prediction considering merging motivation [J]. *Proceedings of the Institution of Mechanical Engineers Part D-Journal of Automobile Engineering*, 2023: 09544070231187687.
- [6] [MIN H G, FANG Y K, WANG R M, et al. A Novel On-Ramp Merging Strategy for Connected and Automated Vehicles Based on Game Theory [J]. *Journal of Advanced Transportation*, 2020, 2020.
- [7] WEI C, HE Y H, TIAN H Q, et al. Game Theoretic Merging Behavior Control for Autonomous Vehicle at Highway On-Ramp [J]. *Ieee Transactions on Intelligent Transportation Systems*, 2022, 23(11): 21127-36.
- [8] SHOUCAI J. Research on Vehicle Cooperative Merging Control Method at On-Ramps in the context of Intelligent and Connected Vehicle Infrastructure [D]; Chang'an University, 2021.
- [9] CHEN W H, REN G, CAO Q, et al. A Game-Theory-Based Approach to Modeling Lane-Changing Interactions on Highway On-Ramps: Considering the Bounded Rationality of Drivers [J]. *Mathematics*, 2023, 11(2).
- [10] CHEN N, VAN AREM B, ALKIM T, et al. A Hierarchical Model-Based Optimization Control Approach for Cooperative Merging by Connected Automated Vehicles [J]. *Ieee Transactions on Intelligent Transportation Systems*, 2021, 22(12): 7712-25.
- [11] HU Z Y, HUANG J, YANG Z Y, et al. Embedding Robust Constraint-Following Control in Cooperative On-Ramp Merging [J]. *Ieee Transactions on Vehicular Technology*, 2021, 70(1): 133-45.
- [12] JING S, HUI F, ZHAO X, et al. Integrated Longitudinal and Lateral Hierarchical Control of Cooperative Merging of Connected and Automated Vehicles at On-Ramps [J]. *IEEE Transactions on Intelligent Transportation Systems*, 2022, 23(12): 24248-62.



- [13] JING S C, HUI F, ZHAO X M, et al. Integrated Longitudinal and Lateral Hierarchical Control of Cooperative Merging of Connected and Automated Vehicles at On-Ramps [J]. *Ieee Transactions on Intelligent Transportation Systems*, 2022, 23(12): 24248-62.
- [14] LI D F, PAN H, XIAO Y, et al. Social-Aware Decision Algorithm for On-ramp Merging Based on Level-k Gaming; proceedings of the IEEE 18th International Conference on Automation Science and Engineering (IEEE CASE), Mexico City, MEXICO, F Aug 20-24, 2022 [C]. 2022.
- [15] XUE Y J, ZHANG X K, CUI Z Y, et al. A platoon-based cooperative optimal control for connected autonomous vehicles at highway on-ramps under heavy traffic [J]. *Transportation Research Part C-Emerging Technologies*, 2023, 150.
- [16] YANG W Z, DONG C Y, CHEN X, et al. A cooperative control method for safer on-ramp merging process in heterogeneous traffic flow [J]. *Accident Analysis and Prevention*, 2023, 193.
- [17] YE F, GUO J L, KIM K J, et al. Bi-level Optimal Edge Computing Model for On-ramp Merging in Connected Vehicle Environment; proceedings of the 30th IEEE Intelligent Vehicles Symposium (IV), Paris, FRANCE, F Jun 09-12, 2019 [C]. 2019.
- [18] CHEN T Y, WANG M, GONG S Y, et al. Connected and automated vehicle distributed control for on-ramp merging scenario: A virtual rotation approach [J]. *Transportation Research Part C-Emerging Technologies*, 2021, 133.
- [19] ZHOU S X, ZHUANG W C, YIN G D, et al. Cooperative On-Ramp Merging Control of Connected and Automated Vehicles: Distributed Multi-Agent Deep Reinforcement Learning Approach; proceedings of the IEEE 25th International Conference on Intelligent Transportation Systems (ITSC), Macau, PEOPLES R CHINA, F Oct 08-12, 2022 [C]. 2022.
- [20] LUO X L, LI X F, SHAON M R R, et al. Multi-lane-merging strategy for connected automated vehicles on freeway ramps [J]. *Transportmetrica B-Transport Dynamics*, 2023, 11(1): 127-45.
- [21] MIN H G, FANG Y K, WU X, et al. On-ramp merging strategy for connected and automated vehicles based on complete information static game [J]. *Journal of Traffic and Transportation Engineering-English Edition*, 2021, 8(4): 582-95.
- [22] YANG L, ZHAN J H, SHANG W L, et al. Multi-Lane Coordinated Control Strategy of Connected and Automated Vehicles for On-Ramp Merging Area Based on Cooperative Game [J]. *Ieee Transactions on Intelligent Transportation Systems*, 2023, 24(11): 13448-61.
- [23] BAGWE G, LI J, DENG X H, et al. Poster: Reliable On-Ramp Merging via Multimodal Reinforcement Learning; proceedings of the IEEE/ACM 7th Symposium on Edge Computing (SEC), Seattle, WA, F Dec 05-08, 2022 [C]. 2022.
- [24] KHERROUBI Z, AKNINE S, BACHA R. Novel Decision-Making Strategy for Connected and Autonomous Vehicles in Highway On-Ramp Merging [J]. *IEEE Transactions on Intelligent Transportation Systems*, 2022, 23(8): 12490-502.
- [25] GAO Z B, WU Z Z, HAO W, et al. Optimal Trajectory Planning of Connected and Automated Vehicles at On-Ramp Merging Area [J]. *Ieee Transactions on Intelligent Transportation Systems*, 2022, 23(8): 12675-87.
- [26] WANG Z J, COOK A, SHAO Y L, et al. Cooperative Merging Speed Planning: A Vehicle-Dynamics-Free Method; proceedings of the 34th IEEE Intelligent Vehicles Symposium (IV), Anchorage, AK, F Jun 04-07, 2023 [C]. 2023.
- [27] SHI J, LUO Y G, LI P F, et al. An optimized scheduling method with dynamic conflict graph for connected and automated vehicles at multi-lane on-ramp areas; proceedings of the 34th IEEE Intelligent Vehicles Symposium (IV), Anchorage, AK, F Jun 04-07, 2023 [C]. 2023.
- [28] SHI J, LI K Q, CHEN C Y, et al. Cooperative Merging Strategy in Mixed Traffic Based on Optimal Final-State Phase Diagram With Flexible Highway Merging Points [J]. *Ieee Transactions on Intelligent Transportation Systems*, 2023, 24(10): 11185-97.
- [29] RIOS-TORRES J, MALIKOPOULOS A A. Automated and Cooperative Vehicle Merging at Highway On-Ramps [J]. *Ieee Transactions on Intelligent Transportation Systems*, 2017, 18(4): 780-9.
- [30] HADDE M, MERDRIGNAC P, DUHAMEL S, et al. Security attacks impact for collective perception based road section assistance: A study of a highway on-ramp merging case; proceedings of the 16th IEEE International Wireless Communications and Mobile Computing Conference (IEEE IWCMC), Electr Network, F Jul 27, 2020 [C]. 2020.
- [31] SHEN M H, HU H Y, SUN B H, et al. Heuristics Based Cooperative Planning for Highway On-Ramp Merge; proceedings of the 21st IEEE International Conference on Intelligent Transportation Systems (ITSC), Maui, HI, F Nov 04-07, 2018 [C]. 2018.
- [32] TANG Z X, ZHU H, ZHANG X, et al. A novel hierarchical cooperative merging control model of connected and automated vehicles featuring flexible merging positions in system optimization [J]. *Transportation Research Part C-Emerging Technologies*, 2022, 138.
- [33] CHEN N, VAN AREM B, WANG M. Hierarchical Optimal Maneuver Planning and Trajectory Control at On-Ramps With Multiple Mainstream Lanes [J]. *Ieee Transactions on Intelligent Transportation Systems*, 2022, 23(10): 18889-902.
- [34] XIE Y Z, LU G Y, ZHENG F F, et al. A Hierarchical Approach for Integrating Merging Sequencing and Trajectory Optimization for Connected and Automated Vehicles [J]. *Ieee Transactions on Intelligent Transportation Systems*, 2024.
- [35] ROMANO F, DEL PRETE A, MANSARD N, et al. Prioritized Optimal Control: a Hierarchical Differential Dynamic Programming approach; proceedings of the IEEE International Conference on Robotics and Automation (ICRA), Seattle, WA, F May 26-30, 2015 [C]. 2015.
- [36] WU J X, WANG Y B, ZHANG Z, et al. A Cooperative Merging Control Method for Freeway Ramps in Connected and Autonomous Driving [J]. *Sustainability*, 2022, 14(18): 11120.
- [37] KUMARAVEL S D, MALIKOPOULOS A A, AYYAGARI R, et al. Decentralized Cooperative Merging of Platoons of Connected and Automated Vehicles at Highway On-Ramps; proceedings of the American Control Conference (ACC), Electr Network, F May 25-28, 2021 [C]. 2021.
- [38] BIAN C T, YIN G D, XU L W, et al. Trajectory Planning Algorithm For Merging Control Of Heterogeneous Vehicular Platoon On Curve Road [J]. *Transport*, 2022, 37(4): 279-90.
- [39] LIN J Y, TSAI C C, NGUYEN V L, et al. Coordinated Multi-Platooning Planning for Resolving Sudden Congestion on Multi-Lane Freeways [J]. *Applied Sciences-Basel*, 2022, 12(17): 8622.
- [40] KUMARAVEL S D, MALIKOPOULOS A A, AYYAGARI R. Optimal Coordination of Platoons of Connected and Automated Vehicles at Signal-Free Intersections [J]. *Ieee Transactions on Intelligent Vehicles*, 2022, 7(2): 186-97.
- [41] JIE W. Research on Safety Evaluation of Autonomous Vehicle for Freeway Scene [Z]. Chang'an University. 2023.10.26976/d.cnki.gchau.2023.000299
- [42] RAHMAN M S, ABDEL-ATY M. Longitudinal safety evaluation of connected vehicles' platooning on expressways [J]. *Accident Analysis and Prevention*, 2018, 117: 381-91.
- [43] SHETTY A, TAVAFOGHI H, KURZHANSKIY A, et al. Risk Assessment of Autonomous Vehicles across Diverse Driving Contexts; proceedings of the IEEE Intelligent Transportation Systems Conference (ITSC), Indianapolis, IN, F Sep 19-22, 2021 [C]. 2021.
- [44] HU W, KANG L Y, YU Z G. A Possibilistic Risk Assessment Framework for Unmanned Electric Vehicles With Predict of Uncertainty Traffic [J]. *Frontiers in Energy Research*, 2022, 10.
- [45] HAN J, ZHAO J, ZHU B, et al. Spatial-Temporal Risk Field for Intelligent Connected Vehicle in Dynamic Traffic and Application in Trajectory Planning [J]. *IEEE Transactions on Intelligent Transportation Systems*, 2023, 24(3): 2963-75.
- [46] Xiaoxue XU, Maokai LAI, Haitao ZHANG, et al. Spatio-temporal cooperative control Method of Highway Ramp Merge Based on Vehicle-road Coordination. arXiv preprint arXiv: 2407.03671, 2024



**Ting PENG** is an Associate Professor in the Highway School of Chang'an University. He received his B.S. degree in Highway and Urban Street Engineering from Xi'an Highway University in 1999, his M.S. degree in Road and Railway Engineering from Chang'an University in 2004, and his Ph.D. degree in Computer Science from Xi'an Jiaotong University in 2010. His research interests include infrastructure monitoring, big data mining for engineering, highway assets management systems, and artificial intelligence applications.



**Xiang DONG** is a postgraduate student at the Highway School of Chang'an University. She received her B.S. degree in Transportation Engineering from the City College of Southwest University of Science and Technology in 2022. Her current research interests include intelligent detection technology for infrastructure and engineering data analysis.



**Xiaoxue XU** is a postgraduate student at the Highway School of Chang'an University. She received her B.S. degree in Transportation Engineering from the City College of Southwest University of Science and Technology in 2023. Her current research interests include intelligent detection technology for infrastructure and engineering data analysis.



**Yincan CAI** is a postgraduate student at the Highway School of Chang'an University. His current research interests include intelligent detection technology for infrastructure and engineering data analysis.



**Yuan LI** is a doctor from Xi'an Jiaotong University with a doctorate degree in Mechanics. She is a lecturer at Chang'an University. Her main research interests are multi-scale destruction behavior of solid materials and multi-field coupled mechanics simulation analysis. She has presided over and participated in 4 national fund projects such as National Natural Science Foundation of China, Ministry of Education Foundation and Central University Foundation, and published many academic papers in domestic and foreign journals.



**Peng WU** is a postgraduate student at the Highway School of Chang'an University. He received his B.S. degree in Civil Engineering from Chongqing Jiaotong University in 2022. His current research interests include intelligent detection technology for infrastructure and engineering data analysis.



**Jie WU** is a postgraduate student at the Highway School of Chang'an University. Her current research interests include intelligent detection technology for infrastructure and engineering data analysis.



**Tao LI** is a postgraduate student at the Highway School of Chang'an University. He received his B.S. degree in Transportation Engineering from Guangdong University of Technology University of Science and Technology in 2023. His current research interests include intelligent detection technology for infrastructure and engineering data analysis.