

HERON TRIANGLES WITH CONSTANT AREA AND PERIMETER

N. ANGHEL

Communicated by Lucian Beznea

The paper undertakes a very detailed, very visual, and quite elementary study of the Heron triangles of fixed area and perimeter. It circumvents the traditional approach to Heron triangles based on elliptic curves. Its key focus is on the geometry, calculus, and algebra of the associated area curve. The main result presents a simple sufficient condition for the existence of infinitely many Heron triangles with constant area and perimeter. An application to Diophantine equations is also given.

AMS 2010 Subject Classification: Primary 51M04; Secondary 11G05, 14H50, 14H52.

Key words: Triangle, Area, Perimeter, Moduli space, Heron triangle, Elliptic curve, Lie group, Real affine/projective area curve, Mordell's theorem, Mazur's theorem, Brahmagupta theorem, Diophantine equation.

The last three decades have seen some significant research regarding the number-theoretical properties of the Heron triangles — the Euclidean triangles with integer or rational sides and area [3, 4, 7, 11, 15, 16]. All of them point out to the deep connections between such elementary and simple to state geometric problems and cutting edge research in the analytic number theory and the algebraic geometry of elliptic curves and abelian varieties. As a bi-product, they also produce interesting information about the solutions of some very difficult Diophantine equations.

Of note is the problem of fully characterizing the *congruent numbers*, that is of the integers which can be realized as the areas of right triangles with rational sides [1, 15]. This problem is directly related to the Birch and Swinnerton-Dyer conjecture (one of the six Clay Institute million-dollar-prized Millennium Problems [2]), about a potential zero of a Riemann-Zeta-like function associated to rational elliptic curves.

To reach their respective conclusions the contributions cited above rely almost exclusively on results about the rational elliptic curves, such as the Mordell-Weil or Mazur theorems [14]. In the present work we, instead, insist more on the geometry, calculus, and algebra of the real *area curve* $E_{\bullet}^A(\mathbb{R})$ (see below for the definitions) hosting the Heron triangles, to draw our conclusions,

cf. Theorems 2, 3, and Corollary. Besides being in line with the Manin program [9], this also adds to the interesting approach to Heron triangle problems started by [12], an inspiration for our work.

Lastly, we want to mention that our approach is first and foremost geometric and visual, in the sense that each statement is motivated by a supporting picture. Of course, we also provide analytic proofs or hints for such proofs for our results, sometimes even more than one. Therefore, by and large, our work is accessible to many.

Fix now A , a positive real number, and consider Euclidean triangles with real sides (a, b, c) , $0 < a \leq b \leq c$, $a + b > c$, of area A . By Heron's formula for the area, we have

$$(1) \quad s(s-a)(s-b)(s-c) = A^2, \quad \text{where } s := \frac{a+b+c}{2} \text{ is the semi-perimeter.}$$

Since this study involves only (rational) triangles with constant perimeter, from the very beginning we will scale the sides of the triangles such that the semi-perimeter is equal to 1, i.e., $\frac{a+b+c}{2} = 1$, or $c = 2 - a - b$.

Consequently, (1) becomes

$$(2) \quad \begin{aligned} (1-a)(1-b)(a+b-1) &= A^2, \quad \text{for reals } (a, b), \quad 0 < a \leq b, \\ a + 2b &\leq 2, \quad a + b > 1. \end{aligned}$$

The inequalities in (2) describe the moduli space \mathcal{M} of all triangles of semi-perimeter 1 [8, 13], a plane triangular region with vertices $P(0, 1)$, $Q\left(\frac{1}{2}, \frac{1}{2}\right)$, and $R\left(\frac{2}{3}, \frac{2}{3}\right)$, cf. Figure 1. Let us stress that to each real triangle with sides (a, b, c) ordered increasingly and having semi-perimeter 1 corresponds an unique point (a, b) in the moduli space \mathcal{M} . Also, $0 < a \leq \frac{2}{3}$ and $\frac{1}{2} < b < 1$.

To fully explore the configuration of points (a, b) given by (2) for a fixed A , we define, cf. Figure 2 (see also Theorem 1), the companion real affine and projective curves $E_{\text{aff}}^A(\mathbb{R})$ and $E_{\text{proj}}^A(\mathbb{R})$ by

$$(3) \quad E_{\text{aff}}^A(\mathbb{R}) := \{(x, y) \in \mathbb{R}^2 \mid (x-1)(y-1)(x+y-1) = A^2\},$$

respectively

$$(4) \quad E_{\text{proj}}^A(\mathbb{R}) := \{(x : y : z) \in \mathbb{RP}^2 \mid (x-z)(y-z)(x+y-z) = A^2 z^3\}.$$

In (4), by \mathbb{RP}^2 we denote the real projective plane of all the lines through the origin in \mathbb{R}^3 , i.e., $(\mathbb{R}^3 \setminus \{(0, 0, 0)\}) / \sim$, where $(x, y, z) \sim (tx, ty, tz)$, $(x, y, z) \in \mathbb{R}^3 \setminus \{(0, 0, 0)\}$, $t \in \mathbb{R} \setminus \{0\}$. As it is customary, the equivalence class of (x, y, z) in \mathbb{RP}^2 is denoted by $(x : y : z)$.

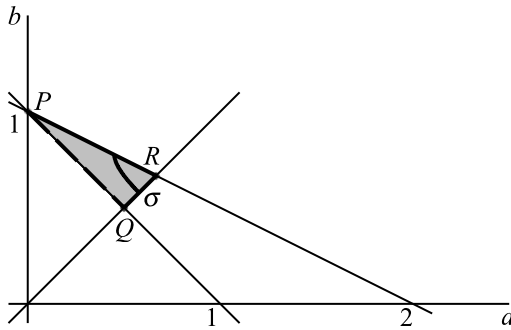

Figure 1: The triangular region PQR (shaded) as the moduli space \mathcal{M} of all real triangles with semi-perimeter 1, and a typical fixed area curve $\sigma = \sigma_A$.

The equation (3) and Figure 2 show that $E_{\text{aff}}^A(\mathbb{R})$ exhibits symmetry with respect to the first bisector $y = x$, vertical symmetry through the line $x + 2y = 2$, and a fortiori horizontal symmetry through the line $2x + y = 2$.

THEOREM 1. a) *Via the identification $\mathbb{R}^2 \ni (x, y) \equiv (x : y : 1) \in \mathbb{RP}^2$, $E_{\text{proj}}^A(\mathbb{R}) = E_{\text{aff}}^A(\mathbb{R}) \cup \{O, \infty, -\infty\}$, where in \mathbb{RP}^2 , $O := (-1 : 1 : 0)$, $\infty := (0 : 1 : 0)$, and $-\infty := (1 : 0 : 0)$.*

b) *$E_{\text{aff}}^A(\mathbb{R}) \cap \mathcal{M}$ is non-empty if and only if $0 < A \leq \frac{1}{3\sqrt{3}}$.*

c) *For $0 < A < \frac{1}{3\sqrt{3}}$, $E_{\text{proj}}^A(\mathbb{R})$ is a compact Lie curve, that is a smooth one-dimensional compact real submanifold of \mathbb{RP}^2 , which is also an abelian group for a smooth operation $+$, given geometrically by Euler’s chord-and-tangent process (cf. Figure 4). The neutral element in this Lie group is the point O defined at a), and opposite (additive inverse) points are symmetric with respect to the projective/affine line $y = x$. In particular, the opposite of ∞ is $-\infty$. Moreover, $E_{\text{proj}}^A(\mathbb{R})$ is isomorphic as a Lie group to $\mathbb{R}/\mathbb{Z} \times \mathbb{Z}/2\mathbb{Z}$.*

Proof. a) Clearly, $E_{\text{proj}}^A(\mathbb{R})$ is well defined. Any point in \mathbb{RP}^2 is uniquely representable as $(x : y : 1)$, or $(u : 1 : 0)$, or $(1 : 0 : 0)$, $x, y, u \in \mathbb{R}$. Those of type $(x : y : 1)$ are in $E_{\text{proj}}^A(\mathbb{R})$ if and only if (x, y) belongs to $E_{\text{aff}}^A(\mathbb{R})$. For $(u : 1 : 0)$ to be in $E_{\text{proj}}^A(\mathbb{R})$ we must have $u(u + 1) = 0$, which yields ∞ and O . Finally, $(1 : 0 : 0) = -\infty$ is also in $E_{\text{proj}}^A(\mathbb{R})$.

b) Let (x, y) be a point in $E_{\text{aff}}^A(\mathbb{R})$ such that $0 < x < 1$. The defining equation (3) gives then

$$(5) \quad y^2 - (2 - x)y + (1 - x) + \frac{A^2}{1 - x} = 0.$$

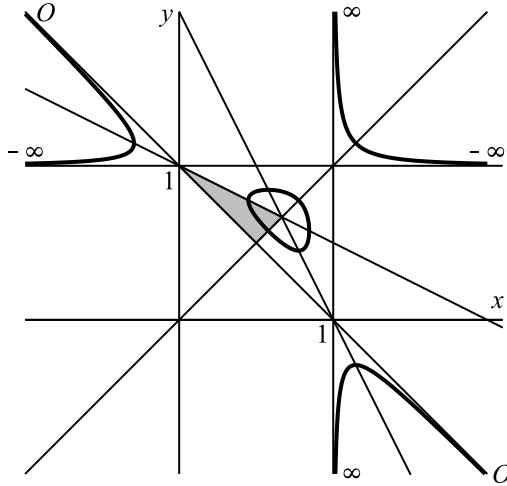

Figure 2: The real affine and projective companion curves $E_{\text{aff}}^A(\mathbb{R})$ and $E_{\text{proj}}^A(\mathbb{R})$, associated to triangles with area A and semi-perimeter 1.

For y to exist as a real root of the quadratic equation (5) it is necessary that

$$(6) \quad x^3 - x^2 + 4A^2 \leq 0.$$

The cubic function $f(t) = t^3 - t^2 + 4A^2$, $0 \leq t \leq 1$, admits the global minimum value of $4\left(A^2 - \frac{1}{27}\right)$, which is attained for $t = 2/3$. Since $f(0) = f(1) = 4A^2 > 0$, for (6) to happen we must have $A \leq \frac{1}{3\sqrt{3}}$.

Conversely, if $0 < A \leq \frac{1}{3\sqrt{3}}$, denoting by τ_A the smallest positive root of the cubic equation $t^3 - t^2 + 4A^2 = 0$ we see that $\left(\tau_A, 1 - \frac{\tau_A}{2}\right) \in E_{\text{aff}}^A(\mathbb{R}) \cap \mathcal{M}$.

c) We must show that $E_{\text{proj}}^A(\mathbb{R})$ is a smooth curve in a neighborhood of each one of its points.

Points in $E_{\text{aff}}^A(\mathbb{R})$ belong to the graphs of the curves

$$(7) \quad y_{\pm}(x) = 1 - \frac{x}{2} \pm \frac{1}{2} \sqrt{\frac{x^3 - x^2 + 4A^2}{x - 1}},$$

which are well defined on the intervals

$$(8) \quad \left(-\infty, \frac{1 - \tau_A - \sqrt{(1 - \tau_A)(1 + 3\tau_A)}}{2} \right] \cup \left[\tau_A, \frac{1 - \tau_A + \sqrt{(1 - \tau_A)(1 + 3\tau_A)}}{2} \right] \cup (1, \infty),$$

where τ_A is, as in *b*), the smallest positive root ($0 < \tau_A \leq 2/3$) of the cubic equation $t^3 - t^2 + 4A^2 = 0$. (A little detective work shows that

$$\frac{1 - \tau_A \pm \sqrt{(1 - \tau_A)(1 + 3\tau_A)}}{2}$$

are the other two real roots of $t^3 - t^2 + 4A^2 = 0$).

By (7) and (8), the smoothness of $E_{\text{proj}}^A(\mathbb{R})$ is guaranteed at all points $(x, y) \in E_{\text{aff}}^A(\mathbb{R})$ with $x \neq \tau_A, \frac{1 - \tau_A \pm \sqrt{(1 - \tau_A)(1 + 3\tau_A)}}{2}$. However, the symmetry of $E_{\text{aff}}^A(\mathbb{R})$ with respect to the line $y = x$ takes care of these points too.

An even better argument is to look at $E_{\text{aff}}^A(\mathbb{R})$ as a level curve (given by (3)), and to check the rank of the gradient of its defining function. The gradient is

$$\langle (y - 1)(2x + y - 2), (x - 1)(x + 2y - 2) \rangle$$

which clearly does not vanish at points $(x, y) \in E_{\text{aff}}^A(\mathbb{R})$.

For the points ∞ and O of $E_{\text{proj}}^A(\mathbb{R})$ smoothness can be checked in a similar fashion, after transferring them in a different coordinate patch of \mathbb{RP}^2 , namely that of type $(x : 1 : z)$, $(x, z) \in \mathbb{R}^2$. There, $E_{\text{proj}}^A(\mathbb{R})$ is given by

$$\{(z, x) \in \mathbb{R}^2 \mid (x - z)(1 - z)(x + 1 - z) = A^2 z^3\},$$

and looks geometrically as in Figure 3. (Notice that ∞ corresponds to $(0, 0)$ and O to $(0, -1)$).

At last, the smoothness of $E_{\text{proj}}^A(\mathbb{R})$ about the point $-\infty$ is resolved by its symmetry with respect to the projective line $y = x$, or by mirroring it in the coordinate patch $(1 : y : z)$ of \mathbb{RP}^2 .

Since $E_{\text{proj}}^A(\mathbb{R})$ is closed in \mathbb{RP}^2 and \mathbb{RP}^2 is compact, $E_{\text{proj}}^A(\mathbb{R})$ is a compact one-dimensional submanifold, therefore a disjoint union of topological circles. Figures 2 ad 3 make it apparent that there are two such circles.

One of them, completely contained in $E_{\text{aff}}^A(\mathbb{R})$, is in fact an *oval* in \mathbb{R}^2 , that is a smooth, strictly convex closed curve. The strict convexity can be proved rigorously by studying the concavity of the functions y_{\pm} given by (7), on the interval

$$\left[\tau_A, \frac{1 - \tau_A + \sqrt{(1 - \tau_A)(1 + 3\tau_A)}}{2} \right],$$

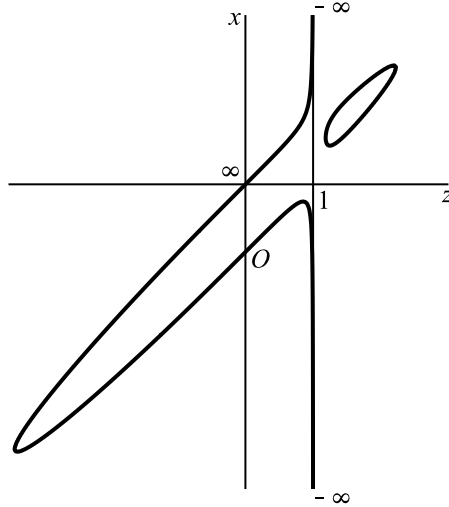

Figure 3: The view of the real projective curve $E_{\text{proj}}^A(\mathbb{R})$ from the coordinate patch $(x : 1 : z)$ of $\mathbb{R}P^2$.

whose graphs make up this oval. Alternatively, one can show that the region $\{(x, y) \in (0, 1) \times (0, 1) | (x - 1)(y - 1)(x + y - 1) \geq A^2\}$ is strictly convex in \mathbb{R}^2 . Notice that this oval contains as a sub-arc the area curve σ_A , which was our primary focus in this study.

Figures 2 and 3 show how the other three connected components of $E_{\text{aff}}^A(\mathbb{R})$ defined by y_{\pm} on the intervals $\left(-\infty, \frac{1 - \tau_A - \sqrt{(1 - \tau_A)(1 + 3\tau_A)}}{2}\right]$ and $(1, \infty)$ link up at O, ∞ , and $-\infty$ to create the second circle.

It remains to elaborate on the abelian group structure of $E_{\text{proj}}^A(\mathbb{R})$, which visually is a result of Euler’s chord-and-tangent process: Given two points P and Q in $E_{\text{proj}}^A(\mathbb{R})$ we want to define $P + Q$. The chord through P and Q , i.e., the projective line determined by these two points in $\mathbb{R}P^2$ intersects $E_{\text{proj}}^A(\mathbb{R})$ in a unique third point, which by definition will be taken to be the opposite, $-(P + Q)$, of $P + Q$. Since the order of points is irrelevant, this operation is commutative. In the model of $E_{\text{proj}}^A(\mathbb{R})$ given by part a) of the theorem we have $P + O = P$ for any $P \in E_{\text{proj}}^A(\mathbb{R})$ (making O the neutral element), $-P = (y : x : 1)$, if $P = (x : y : 1) \in E_{\text{proj}}^A(\mathbb{R})$, and $-(\infty) = -(0 : 1 : 0) = (1 : 0 : 0) = -\infty$. When $P = Q$ the chord in a limiting process becomes a tangent, so we obtain $2P = P + P$. Figure 4 shows few instances of this chord-and-tangent process. The first exemplifies the associativity of the operation $+$, the second the doubling of a point, and the third a remarkable property of

doubling: If $P(a, b)$, $Q(a, 2 - a - b)$ and $R(2 - a - b, b)$ are the points in $E_{\text{aff}}^A(\mathbb{R})$ associated to the ‘sides’ $(a, b, 2 - a - b)$ of a triangle, then $2P + Q + R = O$.

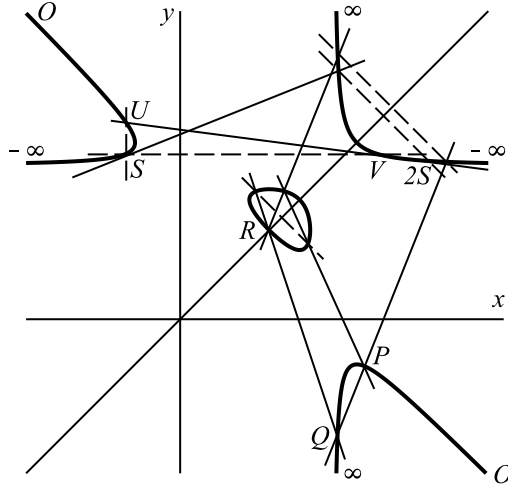

Figure 4: The chord-and-tangent process in $E_{\text{aff}}^A(\mathbb{R})$: $(P+Q)+R = P+(Q+R)$, $S + S = 2S$, and $2S + U + V = O$.

The operation $+$ is smooth because the operation which associates to any two points P and Q from $E_{\text{proj}}^A(\mathbb{R})$, the third point in $E_{\text{proj}}^A(\mathbb{R})$ on the chord/tangent through them, is manifestly so. The formal details, especially the associativity of the operation $+$, are a little elaborate. They involve a lengthy multi-case analysis. We will define carefully here only the operation $+$ in $E_{\text{aff}}^A(\mathbb{R})$ proper, and the doubling of a point in $E_{\text{proj}}^A(\mathbb{R})$.

For the former, take any two points (x_1, y_1) and (x_2, y_2) in $E_{\text{aff}}^A(\mathbb{R})$, having the property that the affine line through them is neither horizontal, nor vertical, nor perpendicular to the first bisector $y = x$. If this line has equation $y = mx + n$, i.e.,

$$(9) \quad m = \frac{y_2 - y_1}{x_2 - x_1}, \quad \text{and} \quad n = \frac{x_2 y_1 - x_1 y_2}{x_2 - x_1},$$

then

$$(10) \quad (x_1, y_1) + (x_2, y_2) := (x_3, y_3) \in E_{\text{aff}}^A(\mathbb{R}),$$

where

$$(11) \quad y_3 = 1 + \frac{1 - n}{m} + \frac{1 - n}{m + 1} - x_1 - x_2, \quad \text{and} \quad x_3 = m y_3 + n.$$

For the latter, define

$$(12) \quad 2O = O, \quad 2(\pm\infty) = \mp\infty,$$

and for any element c in the set $\left\{ \tau_A, \frac{1 - \tau_A \pm \sqrt{(1 - \tau_A)(1 + 3\tau_A)}}{2} \right\}$, τ_A as before, the smallest positive root of the equation $t^3 - t^2 + 4A^2 = 0$, also define

$$(13) \quad 2\left(c, 1 - \frac{c}{2}\right) = -\infty, \quad \text{and} \quad 2\left(1 - \frac{c}{2}, c\right) = \infty.$$

At points (x_1, y_1) in $E_{\text{aff}}^A(\mathbb{R})$ other than those in (13), the tangent line to $E_{\text{aff}}^A(\mathbb{R})$ is $y = mx + n$, where

$$(14) \quad m = -\frac{(1 - y_1)(2 - 2x_1 - y_1)}{(1 - x_1)(2 - x_1 - 2y_1)}, \quad \text{and} \quad n = y_1 - mx_1,$$

and so we define

$$(15) \quad 2(x_1, y_1) := (x_3, y_3) \in E_{\text{aff}}^A(\mathbb{R}),$$

similarly to (10) and (11) above, namely

$$(16) \quad y_3 = 1 + \frac{1 - n}{m} + \frac{1 - n}{m + 1} - 2x_1, \quad \text{and} \quad x_3 = my_3 + n.$$

The formulas (9) through (16) allow for an algebraic verification of the doubling property $2P + Q + R = 0$, alluded to before, if P , Q , and R are associated to the sides of a triangle.

Notice that on the trace of $E_{\text{proj}}^A(\mathbb{R})$ in the coordinate patch $(x : 1 : z)$ of \mathbb{RP}^2 , if P has coordinates (z_1, x_1) and Q has coordinates (z_2, x_2) then $S := P + Q$ will have coordinates $\left(\frac{z_3}{x_3}, \frac{1}{x_3}\right) = \frac{1}{x_3}(z_1, 1)$, where (z_3, x_3) are the coordinates of R , the third point in $E_{\text{proj}}^A(\mathbb{R})$, on the chord through P and Q . A visualization of this fact is given by Figure 5. There, S is constructed geometrically from R in the following way: Let U be the intersection point of the vertical line through R and the line $x = 1$. Let V be the intersection point of the line through R and ∞ , $\infty \equiv (0, 0)$, with the line $x = 1$. Then S is the intersection point of the line through U and ∞ , and the vertical line through V .

The connected component of $E_{\text{proj}}^A(\mathbb{R})$ containing O , a topological circle, is a subgroup. This is supported visually by Figure 2: No line through two points outside the oval intersects the oval. The claim can be made rigorous via the graph description of $E_{\text{aff}}^A(\mathbb{R})$ given by equations (7) and (8). By elementary Lie group theory, this component is isomorphic as a Lie group to \mathbb{R}/\mathbb{Z} . Also, the line through any two points of the oval intersects $E_{\text{proj}}^A(\mathbb{R})$ outside the oval. Therefore, $E_{\text{proj}}^A(\mathbb{R})$ is Lie isomorphic to $\mathbb{R}/\mathbb{Z} \times \mathbb{Z}/2\mathbb{Z}$. The proof of Theorem 1 is complete. \square

The following proposition gives a very useful (geometric and analytic) characterization of the points of order 2, 3, 4, and 6, in $E_{\text{proj}}^A(\mathbb{R})$ and in $E_{\text{aff}}^A(\mathbb{R}) \cap$

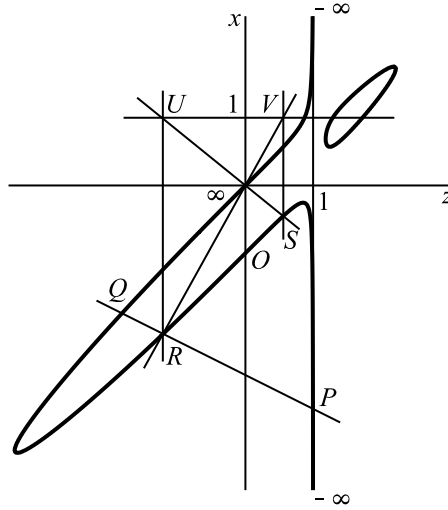

Figure 5: The operation of addition, $P + Q = R$, for the trace of $E^A_{\text{proj}}(\mathbb{R})$ in the coordinate patch $(x : 1 : z)$ of \mathbb{RP}^2 .

\mathcal{M} . It is supported by Figure 6, where the numbers next to the points indicate order. Knowing that $E^A_{\text{proj}}(\mathbb{R}) \sim \mathbb{R}/\mathbb{Z} \times \mathbb{Z}/2\mathbb{Z}$ simplifies the task.

PROPOSITION 1. Fix a real number $0 < A < \frac{1}{3\sqrt{3}}$.

a) There are three points of order 2 in $E^A_{\text{proj}}(\mathbb{R})$. They occur where $E^A_{\text{aff}}(\mathbb{R})$ intersects the first bisector line $y = x$, and so have affine coordinates (τ, τ) , with τ one of the three real roots of the cubic equation $(t - 1)^2(2t - 1) = A^2$. Only one point belongs to $E^A_{\text{aff}}(\mathbb{R}) \cap \mathcal{M}$, namely the bottom point of $E^A_{\text{aff}}(\mathbb{R}) \cap \mathcal{M}$.

b) $\pm\infty$ are the only two points of order 3 in $E^A_{\text{proj}}(\mathbb{R})$. Therefore, none belongs $E^A_{\text{aff}}(\mathbb{R}) \cap \mathcal{M}$.

c) There are four points of order 4 in $E^A_{\text{proj}}(\mathbb{R})$, all in $E^A_{\text{aff}}(\mathbb{R})$ and none in $E^A_{\text{aff}}(\mathbb{R}) \cap \mathcal{M}$. They occur precisely where lines through the point of order 2 not on the oval are tangent to $E^A_{\text{aff}}(\mathbb{R})$. If the point of order 2 has coordinates (σ, σ) , $(\sigma - 1)^2(2\sigma - 1) = A^2$, $\sigma > 1$, then the four points have coordinates (the \pm signs correspond)

$$\left(\frac{1}{2} \left(2 - \sigma \pm \omega - \sqrt{(3\sigma - 2)(1 \mp 2\omega)} \right), \frac{1}{2} \left(2 - \sigma \pm \omega + \sqrt{(3\sigma - 2)(1 \mp 2\omega)} \right) \right),$$

$$\left(\frac{1}{2} \left(2 - \sigma \pm \omega + \sqrt{(3\sigma - 2)(1 \mp 2\omega)} \right), \frac{1}{2} \left(2 - \sigma \pm \omega - \sqrt{(3\sigma - 2)(1 \mp 2\omega)} \right) \right),$$

where $\omega := \sqrt{(3\sigma - 2)(\sigma - 1)}$.

d) There are six points of order 6 in $E_{\text{proj}}^A(\mathbb{R})$, located where the affine lines $x + 2y = 2$ and $2x + y = 2$ intersect $E_{\text{aff}}^A(\mathbb{R})$. The lone point of order 6 in $E_{\text{aff}}^A(\mathbb{R}) \cap \mathcal{M}$ is the top point of $E_{\text{aff}}^A(\mathbb{R}) \cap \mathcal{M}$. The six points have affine coordinates $\left\{ \left(\tau, 1 - \frac{\tau}{2} \right), \left(1 - \frac{\tau}{2}, \tau \right) \right\}$, where τ is a root of the cubic equation $t^3 - t^2 + 4A^2 = 0$.

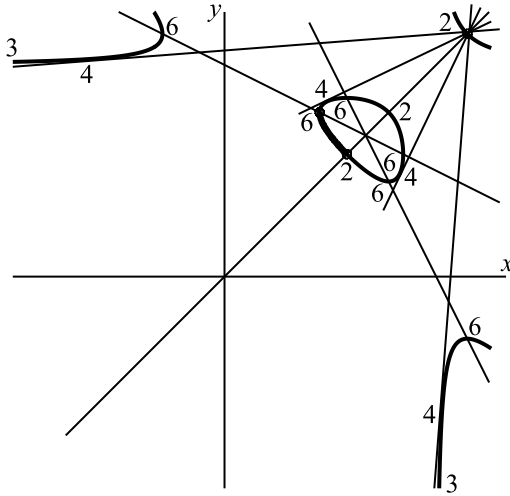

Figure 6: The points of order 2, 3, 4, and 6, in $E_{\text{proj}}^A(\mathbb{R})$.

Proof. It is not hard to see that for a fixed positive integer n , the number of elements of order n in $\mathbb{R}/\mathbb{Z} \times \mathbb{Z}/2\mathbb{Z} \sim E_{\text{proj}}^A(\mathbb{R})$ equals

$$\begin{cases} \phi(n), & \text{if } n \text{ odd,} \\ 2\phi(n), & \text{if } n \text{ even, } n \equiv 0 \pmod{4}, \\ 2\phi(n) + \phi\left(\frac{n}{2}\right), & \text{if } n \text{ even, } n \equiv 2 \pmod{4}, \end{cases}$$

where $\phi(n)$ is Euler’s totient function, which counts the number of positive integers up to n and relatively prime to n .

In particular, for $n = 2, 3, 4$, and 6 , we have, respectively, 3, 2, 4, 6 elements of those orders. Then the content of the lemma will follow from the chord and tangent addition process in $E_{\text{proj}}^A(\mathbb{R})$, cf. Figure 6.

Specifically, in case a) the tangent line to $E_{\text{aff}}^A(\mathbb{R})$ through the indicated points is parallel to the bisector $y = -x$, and so those points have order 2. Case b) is clear, via equation (12). The elaborate formulas in case c) can be

obtained by setting in the equations (9), (10), and (11), $(x_2, y_2) = (\sigma, \sigma)$ and requiring that (x_3, y_3) be equal to (y_1, x_1) . Finally, case d) is equivalent to the content of equation (13), via case b). \square

Now we turn our attention to the study of the Heron triangles. By definition, these are all the triangles with rational sides and rational area, which, without loss of generality, can be assumed to have semi-perimeter 1. The task is equivalent to understanding, for $A \in \mathbb{Q}$, $0 < A < \frac{1}{3\sqrt{3}}$, the set

$$(17) \quad E_{\text{aff}}^A(\mathbb{Q}) := \{(p, q) \in \mathbb{Q}^2 \mid (p-1)(q-1)(p+q-1) = A^2\}.$$

For obvious reasons we want to consider $O, \pm\infty$ as rational points at infinity. Then,

$$(18) \quad E_{\text{proj}}^A(\mathbb{Q}) := E_{\text{aff}}^A(\mathbb{Q}) \cup \{O, \infty, -\infty\}$$

is a subgroup of $E_{\text{proj}}^A(\mathbb{R})$, since the chord-and-tangent process, equations (9) through (16), is clearly \mathbb{Q} -invariant. Our main goal is to find practical ways for deciding which rational numbers A afford infinitely many Heron triangles with area A and semi-perimeter 1. Equivalently, when is $E_{\text{aff}}^A(\mathbb{Q}) \cap \mathcal{M}$ infinite?

The first crucial observation is that $E_{\text{aff}}^A(\mathbb{Q}) \cap \mathcal{M}$ is infinite if and only if $E_{\text{aff}}^A(\mathbb{Q})$ is so. This is a consequence of the fact mentioned before that $E_{\text{aff}}^A(\mathbb{R})$ exhibits symmetry with respect to the first bisector $y = x$, vertical symmetry with respect to the line $x + 2y = 2$, and horizontal symmetry with respect to the line $2x + y = 2$.

LEMMA. *Assume that A is a rational number, $0 < A < \frac{1}{3\sqrt{3}}$. The three cubic equations, $t^3 - t^2 + 4A^2 = 0$, $(t-1)^2(2t-1) = A^2$, and $t^3 - t + 2A = 0$ admit the same number of rational roots. In other words, any one of them possesses a rational root if and only if any other one does so.*

Proof. Notice first that τ is a root of $t^3 - t^2 + 4A^2 = 0$ if and only if $1 - \frac{\tau}{2}$ is a root of $(t-1)^2(2t-1) = A^2$. If τ is a rational root of $t^3 - t^2 + 4A^2 = 0$ then $1 - \tau = \left(\frac{2A}{\tau}\right)^2$, and so $\sqrt{1 - \tau} = \frac{2A}{|\tau|}$ is a rational number. Set now $\alpha := \sqrt{1 - \tau} \in \mathbb{Q}$. Then, $\tau = 1 - \alpha^2$. If $\tau > 0$, then $\alpha = \frac{2A}{1 - \alpha^2}$ shows that α is a rational root of $t^3 - t + 2A = 0$. If $\tau < 0$, then $\alpha = \frac{2A}{\alpha^2 - 1}$, and so $(-\alpha)$ is a rational root of $t^3 - t + 2A = 0$. Conversely, if α is a rational root of $t^3 - t + 2A = 0$ then $\tau := 1 - \alpha^2$ is a rational root of $t^3 - t^2 + 4A^2 = 0$. \square

THEOREM 2. *Assume that $0 < A < \frac{1}{3\sqrt{3}}$ is a rational number such that none of the three real roots of the cubic equation $t^3 - t + 2A = 0$ is a rational number. Then $E_{\text{aff}}^A(\mathbb{Q}) \cap \mathcal{M}$ is either empty or infinite. Equivalently, there are infinitely many Heron triangles with area A and semi-perimeter 1 if and only if there is at least one of them.*

Notice that the theorem gives a practical way of testing whether a given A works. For instance, $A = \frac{1}{6}$ works because $(\frac{1}{2}, \frac{2}{3}) \in E_{\text{aff}}^{1/6}(\mathbb{Q})$, and the equation $t^3 - t + \frac{1}{3} = 0$ does not have any rational roots, by the rational root test. So does $A = \frac{1}{7}$, $E_{\text{aff}}^{1/7}(\mathbb{Q}) \cap \mathcal{M}$ is infinite, and we let the reader find the necessary point. So does $A = \frac{1}{8}$, however $E_{\text{aff}}^{1/8}(\mathbb{Q})$ is empty (see Proposition 3 below). The theorem is inapplicable to $A = \frac{3}{16}$ as $\tau = \frac{1}{2}$ is a rational root.

Proof of Theorem 2. We will give two proofs to this theorem. The first one has the advantage that it is quick, and the second one that it is very elementary.

If there is a point in $E_{\text{aff}}^A(\mathbb{Q}) \cap \mathcal{M}$, we claim that this point cannot have finite order in $E_{\text{proj}}^A(\mathbb{Q})$. Indeed, any finite order element of the oval has *even* order, so the existence of one guarantees the existence of an element of order 2 in $E_{\text{proj}}^A(\mathbb{Q})$. By Proposition 1, a), the above Lemma, and the hypothesis, the three elements of order 2 in $E_{\text{proj}}^A(\mathbb{R})$ cannot belong to $E_{\text{proj}}^A(\mathbb{Q})$, and we are done.

For the second proof we need only the symmetries of $E_{\text{proj}}^A(\mathbb{R})$ and the chord-and-tangent process there. Assume by contradiction that $E_{\text{aff}}^A(\mathbb{Q}) \cap \mathcal{M}$ is non-empty and has only finitely many points, and let P be the point there with the least x -coordinate. Looking at Figure 7, P cannot be T or B , the top and the bottom points of $\sigma_A = E_{\text{aff}}^A(\mathbb{R}) \cap \mathcal{M}$, since they have irrational coordinates, by Proposition 1 and the Lemma. Also, the points B', T' , and R in Figure 7 cannot belong to $E_{\text{aff}}^A(\mathbb{Q})$ for the same reason. There is a bijective correspondence between the real (rational) points X of the oval, belonging to the arc $\overline{P'B'T'P''}$, $X \neq P', X \neq P''$, and the real (rational) points Y of the connected component of $E_{\text{aff}}^A(\mathbb{R})$ situated in the quadrant $\{x > 1, y > 1\}$. The best way to describe this correspondence is by looking at the gray area in Figure 7: To any X it corresponds the point Y on the chord through P and X . Using the symmetries of $E_{\text{aff}}^A(\mathbb{R})$ we realize that there are an odd number of rational points X and an even number of rational points Y , contradiction. \square

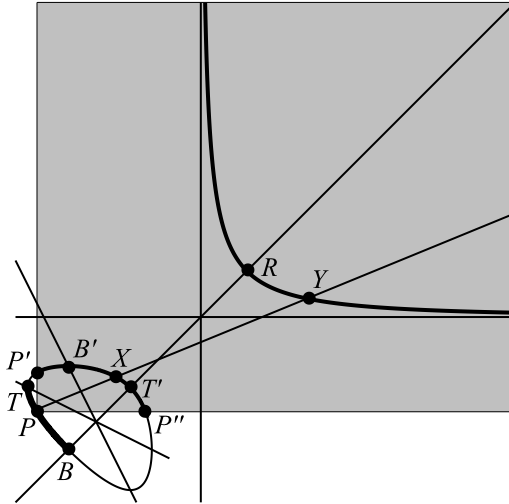

Figure 7: The P -chord bijection $X \mapsto Y$, between the real points of the arc $\overline{P'B'T'P''}$ on the oval and the upper right component of $E_{\text{aff}}^A(\mathbb{R})$, which preserves rational points.

How about a concrete scheme for generating infinitely many Heron triangles with a given area and semi-perimeter 1, if one of them exists? The following, although not the most efficient, will do:

Start with a Heron triangle with sides (a_1, b_1, c_1) , $(a_1, b_1) \equiv P \in E_{\text{aff}}^A(\mathbb{Q}) \cap \mathcal{M}$. Then $(2n - 1)P$, $n \in \mathbb{N}$, belongs to the oval, and has coordinates, say, $(2n - 1)P = (p_n, q_n) \in \mathbb{Q}^2$. Define

$$(19) \quad a_n := \min\{p_n, q_n, 2 - p_n - q_n\}, \quad c_n := \max\{p_n, q_n, 2 - p_n - q_n\}, \\ \text{and} \quad b_n := 2 - a_n - c_n.$$

Then the sequence $(a_n, b_n, c_n)_{n=1}^{\infty}$ gives distinct Heron triangles with the same area and semi-perimeter 1, represented by (a_n, b_n) in the moduli space \mathcal{M} .

Remark. Making use of a very powerful theorem of Mazur [10] about the possible finite orders of rational points of an elliptic curve, the previous theorem can be considerably extended. According to Mazur's theorem, $E_{\text{proj}}^A(\mathbb{R})$, which is an elliptic curve [7], can have rational points of finite order only for orders 1 through 10, and 12. A diligent analysis of the finite order points in $E_{\text{proj}}^A(\mathbb{R}) \sim \mathbb{R}/\mathbb{Z} \times \mathbb{Z}/2\mathbb{Z}$, similar to that in Proposition 1, shows that in $E_{\text{aff}}^A(\mathbb{R}) \cap \mathcal{M}$ there is only one point of each order in the list $\{2, 6, 8, 10, 12\}$, and no others. The points of order 8 and 10 cannot be ratio-

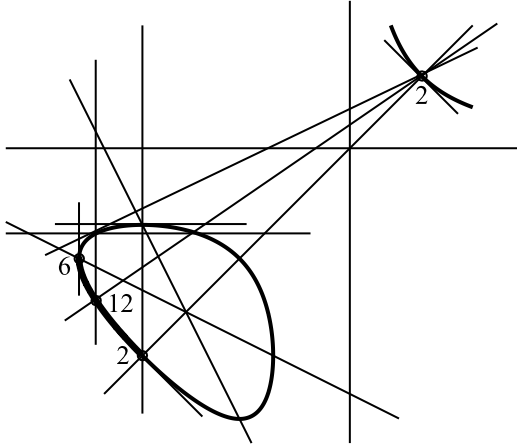

Figure 8: The relative position of the only three (in fact two) possible rational points of finite order in $E_{\text{aff}}^A(\mathbb{R}) \cap \mathcal{M}$.

nal or else $E_{\text{proj}}^A(\mathbb{Q})$ would have elements of order 24, respectively 30, which would contradict Mazur's theorem. It remains to test for rationality the points of order 2, 6, and 12. Their geometric realization and relative location on $E_{\text{aff}}^A(\mathbb{R}) \cap \mathcal{M}$ is shown in Figure 8, where the numbers next to the points indicate, again, order. The points of order 2 and 6 are the bottom, respectively the top, points of $E_{\text{aff}}^A(\mathbb{R}) \cap \mathcal{M}$, corresponding to B and T in Figure 7. They are rational points if and only if τ_2 , the smallest positive root of the equation $t^3 - t + 2A = 0$, respectively τ_3 , the largest (positive) root of the same equation, are rational numbers. The point of order 12 has the following realization: draw the tangent line to the (top of) oval through the point R (of order 2) in Figure 7, and then project the point of tangency vertically onto $E_{\text{aff}}^A(\mathbb{R}) \cap \mathcal{M}$. Therefore, the point of order 12 is rational if and only if the point of tangency, which has order 4, is so. A necessary, however not sufficient, condition for that to happen is that the largest (positive) root σ of the equation $(t - 1)^2(2t - 1) = A^2$ be rational, or equivalently $\sqrt{2\sigma - 1}$ be a rational number. In fact, by Proposition 1, c) the point of order 12 in $E_{\text{aff}}^A(\mathbb{R}) \cap \mathcal{M}$ has real coordinates

$$\left(\frac{1}{2} \left(2 - \sigma + \sqrt{(3\sigma - 2)(\sigma - 1)} - \sqrt{(3\sigma - 2) \left(1 - 2\sqrt{(3\sigma - 2)(\sigma - 1)} \right)} \right), \right. \\ \left. \sigma - \sqrt{(3\sigma - 2)(\sigma - 1)} \right).$$

However, there is no rational number $\sigma > 1$ such that

$$\sqrt{2\sigma - 1}, \sqrt{(3\sigma - 2)(\sigma - 1)}, \text{ and } \sqrt{(3\sigma - 2)(1 - 2\sqrt{(3\sigma - 2)(\sigma - 1)})}$$

are all rational numbers, so the point of order 12 cannot belong to $E_{\text{aff}}^A(\mathbb{Q}) \cap \mathcal{M}$.

In conclusion, no more than two points in $E_{\text{aff}}^A(\mathbb{Q}) \cap \mathcal{M}$ can have finite order.

A refinement of Theorem 2 is then the following:

THEOREM 3. *For any given rational number $0 < A < \frac{1}{3\sqrt{3}}$, depending on the nature of the rational roots of the equation $t^3 - t + 2A = 0$ the following is true about the Heron triangles with area A and semi-perimeter 1:*

a) *If the cubic equation $t^3 - t + 2A = 0$ has no positive rational roots then there are infinitely many Heron triangles with area A and semi-perimeter 1 if and only if there is one of them.*

b) *If only the smallest positive real root of the equation $t^3 - t + 2A = 0$ is a rational number then there are infinitely many Heron triangles with area A and semi-perimeter 1 if and only if there are two such. One of them, an isosceles triangle, always corresponds to B , the bottom point of $E_{\text{aff}}^A(\mathbb{R}) \cap \mathcal{M}$.*

c) *If only the largest (positive) real root of the equation $t^3 - t + 2A = 0$ is a rational number then there are infinitely many Heron triangles with area A and semi-perimeter 1 if and only if there are two such. One of them, an isosceles triangle, always corresponds to T , the top point of $E_{\text{aff}}^A(\mathbb{R}) \cap \mathcal{M}$.*

d) *If both positive roots of the equation $t^3 - t + 2A = 0$ are rational then there are infinitely many Heron triangles with area A and semi-perimeter 1 if and only if there are three of them. Two of them are the only possible isosceles triangles of fixed area and perimeter, and correspond to T and B , the top and bottom points of $E_{\text{aff}}^A(\mathbb{R}) \cap \mathcal{M}$.*

Our next result gives an indirect answer to a very natural question: Which rational numbers $0 < A < \frac{1}{3\sqrt{3}}$ can be the areas of Heron triangles with semi-perimeter 1? This answer will be useful for stating an application of Theorems 2 and 3 to Diophantine equations.

PROPOSITION 2. *For a given rational number $0 < A < \frac{1}{3\sqrt{3}}$ there is a Heron triangle with area A and semi-perimeter 1 if and only if there are positive rational numbers a and s such that*

$$(20) \quad a < \frac{2}{3}, \quad 2a - 1 \leq s^2 \leq 1 - a, \quad \text{and} \quad A = \frac{sa(1-a)}{s^2 + 1 - a}.$$

Then such a triangle has sides $a \leq b \leq c$, where

$$(21) \quad b = \frac{s^2 + (1-a)^2}{s^2 + 1 - a}, \quad \text{and} \quad c = \frac{(s^2 + 1)(1-a)}{s^2 + 1 - a}.$$

Equivalently (Brahmagupta), A is the area of a Heron triangle with semi-perimeter 1 if and only if there exist relatively prime positive integers k, m, n (i.e., their greatest common divisor, $\gcd(k, m, n)$ is 1) such that

$$(22) \quad m \geq n, \quad mn > k^2 \geq \frac{m^2 n}{2m + n}, \quad \text{and} \quad A = \frac{k(mn - k^2)}{mn(m + n)},$$

which yield the Heron triangle with sides

$$(23) \quad a = \frac{mn - k^2}{mn}, \quad b = \frac{n^2 + k^2}{n(m + n)}, \quad \text{and} \quad c = \frac{m^2 + k^2}{m(m + n)}.$$

Proof. For the *only if* part of the proof, let the Heron triangle with area A and semi-perimeter 1 have sides, $0 < a \leq b \leq c$. Since $a + b + c = 2$, we have $3a \leq 2$, or $a \leq \frac{2}{3}$. If $a = \frac{2}{3}$, then $a = b = c = \frac{2}{3}$ and so the triangle is equilateral with irrational area $\frac{1}{3\sqrt{3}}$. Therefore, a is a rational number such that $a < \frac{2}{3}$.

Let us now look at a physical realization of the Heron triangle in an xy -coordinate plane, cf. Figure 8. We will take the vertices of the triangle to be $Y\left(\frac{a}{2}, 0\right)$, $Z\left(-\frac{a}{2}, 0\right)$, and $X(p, q)$, with $p, q > 0$ to be decided by the conditions $XY = b$ and $XZ = c$. Since $b + c = XY + XZ = 2 - a$, X can be viewed as a point on the ellipse with foci at Y and Z , and semi-axes $1 - \frac{a}{2} > \sqrt{1 - a}$.

There is then a real number θ , $0 < \theta < \frac{\pi}{2}$ such that

$$(24) \quad p = \left(1 - \frac{a}{2}\right) \cos \theta, \quad \text{and} \quad q = \sqrt{1 - a} \sin \theta.$$

An easy calculation shows that

$$(25) \quad b = XY = 1 - \frac{a}{2} - \frac{2}{2} \cos \theta, \quad \text{and} \quad c = XZ = 1 - \frac{a}{2} + \frac{a}{2} \cos \theta.$$

Therefore, $\cos \theta$ is a rational number, and so are

$$p = \left(1 - \frac{a}{2}\right) \cos \theta \quad \text{and} \quad q = \sqrt{1 - a} \sin \theta = \frac{2A}{a}.$$

Further, there is $0 < t < 1$ such that $\sin \theta = \frac{2t}{1 + t^2}$ and $\cos \theta = \frac{1 - t^2}{1 + t^2}$, namely $t = \frac{\sin \theta}{1 + \cos \theta}$. Since $t^2 = \frac{1 - \cos \theta}{1 + \cos \theta}$, t^2 is a rational number, and then

$$(26) \quad s := t\sqrt{1 - a} = \frac{\sqrt{1 - a} \sin \theta (1 + t^2)}{2} = \frac{A(1 + t^2)}{a}$$

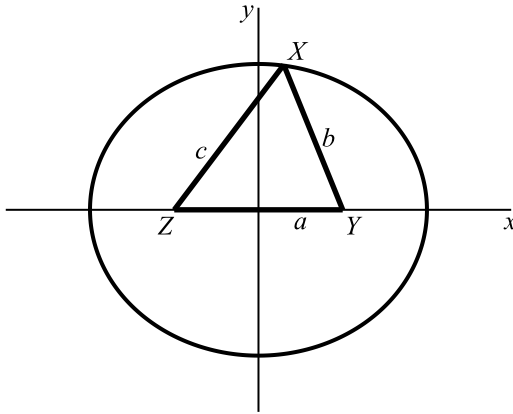

Figure 9: Heron triangle, $\triangle XYZ$, with one vertex, X , on an ellipse whose foci are the other two vertices, Y and Z .

is a positive rational number. Substituting now $t = \frac{s}{\sqrt{1-a}}$ into the equations (24), gives the equations (21). The formula (20) for the area A is already incorporated in (25). Finally, the inequalities (20) involving s^2 are a consequence of $a \leq b \leq c$, via (21).

The *if* part of the proof is a routine verification, based on formulas (20) and (21), that $a \leq b \leq c$, $a+b > c$, $a+b+c = 2$, and $(a-1)(b-1)(a+b-1) = A^2$.

To the end of proving the Brahmagupta formulas (22) and (23), for a and s provided by (20), write s and $\frac{1-a}{s}$ in lowest terms,

$$s = \frac{\alpha}{\beta}, \quad \frac{1-a}{s} = \frac{\gamma}{\delta}, \quad \alpha, \beta, \gamma, \delta \in \mathbb{N}, \quad \gcd(\alpha, \beta) = 1, \quad \gcd(\gamma, \delta) = 1.$$

Setting then

$$(27) \quad k := \frac{\alpha\gamma}{\gcd(\alpha, \gamma)}, \quad m := \frac{\beta\gamma}{\gcd(\alpha, \gamma)}, \quad \text{and} \quad n := \frac{\alpha\delta}{\gcd(\alpha, \gamma)},$$

everything else follows. \square

Not every rational number $0 < A < \frac{1}{3\sqrt{3}}$ can be the area of a Heron triangle with semi-perimeter 1.

PROPOSITION 3. *There are no Heron triangles with area $\frac{1}{8}$ and semi-perimeter 1.*

Proof. By Proposition 2 it suffices to show that the Diophantine equation

$$(28) \quad 8k(mn - k^2) = mn(m + n)$$

has no solutions in positive integers (k, m, n) with $\gcd(k, m, n) = 1$. Suppose a solution exists. Then m and n cannot both be even. If they were, k would be odd, and setting $m = 2m'$, $n = 2n'$, m', n' positive integers, would turn equation (28) into

$$(29) \quad k(4m'n' - k^2) = m'n'(m' + n').$$

However, (29) cannot hold true, as its left-hand-side is an odd number while its right-hand-side is even.

Now, equation (28) can be re-arranged as

$$(30) \quad mn(8k - m - n) = 8k^3,$$

or equivalently, via the substitution $l := 8k - m - n$, as

$$(31) \quad lmn = \left(\frac{l + m + n}{4}\right)^3$$

Since m and n cannot be simultaneously even, in equation (31) the positive integers l , m , and n , are pairwise relatively prime. Therefore l , m , and n must all be perfect cubes, i.e., $l = x^3$, $m = y^3$, and $n = z^3$, with x , y , and z pairwise relatively prime positive integers. Then equation (31) becomes

$$(32) \quad x^3 + y^3 + z^3 = 4xyz$$

Equation (32) belongs to a 1-parameter family of Diophantine equations

$$(33) \quad x^3 + y^3 + z^3 = \lambda xyz, \quad \lambda \in \mathbb{Z},$$

with a long history [6]: Its solutions were studied by Sylvester ($\lambda = -6$), Hurwitz and Mordell ($\lambda = -1, 5$), Sierpinski ($\lambda = 4$), and Cassels ($\lambda = 1$). In 1997 Garaev [6] showed that (33) does not admit any solutions (x, y, z) in positive integers for an infinite family of positive values of λ , including $\lambda = 4$. \square

COROLLARY. *Let s, a be rational numbers, $0 < s < 1$ and*

$0 < a < \max\left\{\frac{s^2 + 1}{2}, 1 - s^2\right\}$. Write $A := \frac{sa(1-a)}{s^2 + 1 - a}$ in lowest terms, $A = \frac{p}{q}$, $p, q \in \mathbb{N}$. Then the Diophantine equation

$$(34) \quad qk(mn - k^2) = pmn(m + n)$$

admits infinitely many solutions (k, m, n) in positive integers, with $\gcd(k, m, n) = 1$.

In particular, for Heron right triangles, $\sqrt{2} - 1 < s < 1$ and $a = 1 - s$, which make $A = \frac{s(1-s)}{1+s}$.

Proof. The corollary is a reformulation of key parts of Theorem 3 and Proposition 2, in such a way that a non-isosceles Heron triangle with area A exists. The Heron right triangle description follows by imposing the condition $a^2 + b^2 = c^2$ on the expressions of b and c given by equation (21), and noticing that there are no Heron isosceles right triangles. \square

Final Remarks. There are many interesting, difficult, questions about the Heron triangles of fixed area and perimeter left unanswered. They all reduce to finding practical ways of deciding which given positive rational numbers A can be the areas of Heron triangles (of semi-perimeter 1). For the interested reader, here are some:

a) For which positive integers $q \geq 6$ are there no Heron triangles with area $\frac{1}{q}$ and semi-perimeter 1? In this paper we realized that 8 is the least q with this property.

b) For which rational numbers $0 < A < \frac{1}{3\sqrt{3}}$ are there exactly two Heron triangles with area A and semi-perimeter 1? With the help of Theorem 3 and Proposition 2 it is not hard to see that such A 's must necessarily be of form

$$(35) \quad A = \frac{\sigma(1 - \sigma^2)(1 - 3\sigma^2)}{(1 + 3\sigma^2)^3}, \quad 0 < \sigma < \frac{2(\sqrt{3} - \sqrt{2})}{3} \text{ rational number.}$$

Could (35) be also sufficient?

c) Is there any concrete area A which affords infinitely many Heron triangles with semi-perimeter 1, *all* describable in parametric form? We are not aware of any, however the best chance for an affirmative answer would seem to have $A = \frac{1}{6}$.

REFERENCES

- [1] J. Coates, *Congruent Numbers*. Proc. Nat. Acad. Sci. **109** (2012), 52, 21182-21183.
- [2] Clay Institute – <http://www.claymath.org/millennium-problems>
- [3] G. Campbell and E. H. Goins, *Heron Triangles, Diophantine Problems and Elliptic Curves*. Preprint.
- [4] A. Dujella and J. C. Peral, *Elliptic Curves Coming From Heron Triangles*. Rocky Mountain J. Math., **44** (2014), 4, 1145-1160.
- [5] N. J. Fine, *On Rational Triangles*. Amer. Math. Monthly **83** (1976), 517-521.
- [6] M. Z. Garaev, *Third-Degree Diophantine Equations*. Proc. Steklov Inst. Math. **218** (1997), 94-103.
- [7] E. H. Goins and D. Maddox, *Heron Triangles via Elliptic Curves*. Rocky Mountain J. Math. **36** (2006), 5, 1511-1526.

- [8] J. Gaspar and O. Neto, *All Triangles at Once*. Amer. Math. Monthly **122** (2015), 982.
- [9] Y. I. Manin, *Rational Points on Algebraic Curves*. 1964 Russ. Math. Surv. **19** (1975), 75-78.
- [10] B. Mazur, *Rational Isogenies of Prime Degree*. Inventiones Math. **44** (1978), 129-162.
- [11] D. J. Rusin, *Rational Triangles with Equal Area*. New York J. Math. **4** (1998), 1-15.
- [12] S. Rosenberg, M. Spillane, and D. B. Wulf, *Heron Triangles and Moduli Spaces*. Math. Teacher, **101** (2008), 9, 656-663.
- [13] I. Stewart, *Why Do All Triangles Form a Triangle?* Amer. Math. Monthly **124**(2017), 1, 70-73.
- [14] J. H. Silverman and J. T. Tate, *Rational Points on Elliptic Curves*. 2nd Ed., UTM Springer, (2015).
- [15] J. B. Tunnell, *A Classical Diophantine Problem and Modular Forms of Weight $\frac{3}{2}$* . Inventiones Math. **72** (1983), 323-334.
- [16] R. van Luijk, *An Elliptic K3 Surface Associated to Heron Triangles*. J. Number Theory **123** (2007), 92-119.

Received January 15, 2019

*University of North Texas
Department of Mathematics
Denton, TX 76203, USA
anghel@unt.edu*