



Ghana e-Waste Country Assessment

SBC e-Waste Africa Project

March 2011



Materials Science & Technology

AUTHORS

Yaw Amoyaw-Osei	- Green Advocacy Ghana
Obed Opoku Agyekum	- Green Advocacy Ghana
John A. Pwamang	- Environmental Protection Agency, Ghana
Esther Mueller	- Empa, Switzerland
Raphael Fasko	- Empa, Switzerland
Mathias Schluep	- Empa, Switzerland

ACKNOWLEDGMENTS

The Ghana e-Waste Country Assessment was developed in the framework of the project entitled "Building local capacity to address the flow of e-wastes and electrical and electronic products destined for reuse in selected African countries and augment the sustainable management of resources through the recovery of materials in e-wastes". The project is funded through the generous support of the European Commission, Norway, the United Kingdom, and the Dutch Recyclers Association (NVMP), together with the support of the Secretariat of the Basel Convention which provided an overall coordination to the project.

Technical support for the preparation of this document was provided by the Swiss Federal Laboratories for Materials Science and Technology (EMPA). Other partners participating in the project include the Basel Convention Coordinating Centre based in Nigeria and the Basel Convention Regional Centre based in Senegal, the Institute for Applied Ecology (the Öko Institut), the European Union Network for the Implementation and Enforcement of Environmental Law (IMPEL), the United Nations Educational, Scientific and Cultural Organization (UNESCO), and the Partnership for Action on Computing Equipment (PACE).

The contents of the Ghana e-Waste Country Assessment are those of the authors and do not necessarily reflect the views or policies of the Secretariat of the Basel Convention, UNEP, or the United Nations, nor are they an official record. Information contained in this document has been compiled from sources believed to be reliable, therefore neither the Secretariat of the Basel Convention, UNEP, nor the United Nations can be responsible for the absolute correctness or sufficiency of such information.

The designations employed and the presentation do not imply the expression of any opinion whatsoever on the part of the Secretariat of the Basel Convention, UNEP, or the United Nations concerning the status and policies of any commercial or legal entity, the legal status of any country, territory or city or its authority, or concerning the delimitation of its frontiers or boundaries."

TABLE OF CONTENTS

AUTHORS	II
ACKNOWLEDGMENTS	II
TABLE OF CONTENTS	III
LIST OF FIGURES	VI
LIST OF TABLES	VII
ABBREVIATIONS	VIII
EXECUTIVE SUMMARY	X
1.0 INTRODUCTION	1
1.1 BACKGROUND.....	1
1.2 PROBLEM IDENTIFICATION	2
1.3 HISTORY OF AGBOGBLOSHIE.....	3
1.4 OBJECTIVES OF THE ASSESSMENT	4
2.0 METHODS	5
2.1 DATA ACQUISITION	5
2.1.1 LITERATURE REVIEW AND STATISTICAL DATA	5
2.1.2 MEETINGS AND WORKSHOPS	5
2.1.3 SURVEYS.....	5
2.1.4 SAMPLING TECHNIQUES	6
2.1.5 FIELD STUDIES	6
2.2 MASSFLOW ASSESSMENTS.....	6
2.2.1 IMPORT AND ASSEMBLY.....	6
2.2.2 CONSUMERS	7
2.2.3 REPAIRERS OF EEE.....	13
2.2.4 COLLECTION OF (W)EEE.....	14
2.2.5 RECYCLING OF WEEE.....	14
2.3 LIMITATIONS OF THE METHODOLOGY USED	14
3.0 SYSTEM DEFINITION	15
3.1 GEOGRAPHICAL SCOPE.....	15
3.2 PRODUCT SCOPE	17
3.3 DEVELOPMENT INDICATORS	17
3.3.1 THE PEOPLE	18
3.3.2 THE ENVIRONMENT	18
3.3.3 THE ECONOMY	18
3.3.4 STATE AND MARKETS	18
3.3.5 SUMMARY	19
4.0 POLICY AND LEGISLATION	20
4.1 WEEE RELATED POLICIES AND LEGISLATION	20
4.2 SPECIFIC WEEE MANAGEMENT LEGISLATION	21
4.3 INSTITUTIONAL FRAMEWORK.....	22
5.0 IMPORTS OF (W)EEE	24
5.1 OVERVIEW OF STAKEHOLDERS	24
5.2 FORMAL BUSINESS IMPORTERS AND DISTRIBUTORS	25
5.2.1 IMPORT PROCEDURE	25
5.2.2 QUALITY OF GOODS	25
5.2.3 SALE LOCATIONS	25

5.2.4	MARKETING STRATEGIES	26
5.3	SMALL SCALE/INFORMAL IMPORTERS AND DISTRIBUTORS.....	26
5.3.1	IMPORT PROCEDURE	27
5.3.2	QUALITY OF GOODS	27
5.3.3	SALE LOCATIONS	27
5.3.4	MARKETING STRATEGIES	27
5.4	PRIVATE IMPORTS	28
5.5	DONATIONS	28
5.6	STATISTICAL DATA	29
5.6.1	CEPS	29
5.6.2	UN COMTRADE	30
6.0	STAKEHOLDER ASSESSMENT	36
6.1	STAKEHOLDER OVERVIEW	36
6.2	ASSEMBLERS.....	36
6.3	CONSUMERS OF EEE	37
6.3.1	CONSUMER STRUCTURE	37
6.3.2	INSTALLED BASE	38
6.3.3	NEW AND SECOND HAND EEE	45
6.3.4	WEEE GENERATION AND STORAGE.....	45
6.3.5	WEEE DISPOSAL.....	48
6.4	COLLECTORS OF WEEE	49
6.4.1	INFORMAL COLLECTION	49
6.4.2	FORMAL COLLECTION	50
6.4.3	DOMESTIC WASTE COLLECTION	50
6.5	REFURBISHERS/REPAIRERS OF EEE	50
6.6	FORMAL WEEE RECYCLERS	53
6.7	INFORMAL WEEE RECYCLERS.....	54
6.8	DOWNSTREAM PROCESSORS OF WEEE	57
6.9	FINAL DISPOSERS OF WEEE	59
6.10	MOST AFFECTED COMMUNITIES	60
6.11	OTHER STAKEHOLDERS.....	61
6.11.1	POLICY MAKERS.....	61
6.11.2	POLICY IMPLEMENTERS.....	61
6.11.3	OTHER CIVIL SOCIETY ORGANIZATIONS AND MEDIA	61
7.0	MASSFLOW ASSESSMENT	62
7.1	MASSFLOW SYSTEM CHART	62
7.2	CURRENT MASSFLOWS	63
7.3	FUTURE MASSFLOW TRENDS.....	64
8.0	IMPACTS	66
8.1	OVERVIEW	66
8.2	SOCIAL AND ECONOMIC IMPACTS	69
8.2.1	IMPACTS ON EMPLOYEES.....	69
8.2.2	IMPACTS ON LOCAL COMMUNITIES.....	69
8.2.3	IMPACTS ON SOCIETY	70
8.3	ENVIRONMENTAL IMPACTS	70
8.3.1	EMISSIONS TO SOIL, AIR AND WATER	70
8.3.2	SOLID WASTE	75
8.3.3	HUMAN HEALTH	76
8.3.4	PRESSURE ON ECOSYSTEMS	77
9.0	CONCLUSION.....	78

10 REFERENCES	81
ANNEXES	83
ANNEX A: QUESTIONNAIRE IMPORTERS / DEALERS	84
ANNEX B: QUESTIONNAIRE HOUSEHOLDS	87
ANNEX C: QUESTIONNAIRE INSTITUTIONS	90
ANNEX D: QUESTIONNAIRES REPAIRERS	92
ANNEX E: PHOTO DOCUMENTATION	95
ANNEX F: WEIGHT, LIFE SPAN AND COMPOSITION OF EQUIPMENT.....	100
ANNEX G: MASSFLOW ASSESSMENT.....	103

LIST OF FIGURES

Figure 3.1	Ghana (Administrative Regions)	15
Figure 3.2	Accra, the national capital and Tema, the industrial city	16
Figure 3.3	Accra with the Location of Agbogbloshie Scrap Yard	17
Figure 5.1	Import of Second Hand EEE- Tracer Products (2006-2009)	1
Figure 5.2	Small Scale/Informal Importers and Distributers	26
Figure 5.3	Import of New and Second Hand EEE for Selected Tracer Products	30
Figure 5.4	Import of New and Second Hand tracer products into Ghana (tons/ year)	31
Figure 5.5	Import of air conditioners from 2003 to 2008 into Ghana	32
Figure 5.6	Map of Supplying Markets of Air Conditioners Imported by Ghana	32
Figure 5.7	Import of computer from 2003 to 2008 into Ghana	33
Figure 5.8	Map of supplying markets of computer imported by Ghana	33
Figure 5.9	Import of refrigerators and freezers from 2003 to 2008 into Ghana.....	34
Figure 5.10	Map of supplying markets of refrigerators and freezers imported by Ghana.....	34
Figure 5.11	Import of televisions from 2003 to 2008 into Ghana	35
Figure 5.12	Map of supplying markets of televisions imported by Ghana	35
Figure 6.1	An Overview of the Assessed Stakeholders	36
Figure 6.2	Installed base of tracer products (units 2009).....	39
Figure 6.3	Installed base of tracer products (tons 2009)	39
Figure 6.4	Mobile Phones in use in Ghana 2004 - 2010 (units, ITU, 2008)	42
Figure 6.5	Import of Computers into Ghana (tons/year)	42
Figure 6.6	Installed Base of Computers (kg/GDP (PPP)).....	43
Figure 6.7	Flows of WEEE Tracer Products from Consumers (tons/year, 2009)	47
Figure 6.8	Informal Collection	49
Figure 6.9	Refurbishers/Repairers of EEE	51
Figure 6.10	Comparison of WEEE thrown away, for repair and not repairable (2009).....	53
Figure 6.11	Formal e-Waste Recycling	54
Figure 6.12	The Agbogbloshie area	55
Figure 6.13	The Agbogbloshie scrap yard	55
Figure 6.14	Informal e-Waste Recycling	56
Figure 6.15	Informal Downstream Processing of Lead	58
Figure 6.16	Final Disposers of WEEE.....	59
Figure 6.17	Odaw Drain and Grazing Land adjacent to Agbogbloshie.....	60
Figure 7.1	Massflow System for EEE in Ghana	62
Figure 7.2	Stocks and Flows for EEE estimated for 2009 (tons)	63
Figure 7.3	Simplified Chart of Stocks and Flows for EEE (2009)	64
Figure 7.4	EEE Imports in Linear and Exponential Trend Lines.....	65
Figure 8.1	Massflow Chart Indicating Hot Spots	66
Figure 8.2	Hot Spots: Dismantlers/Scrap Dealers	67
Figure 8.3	Hot Spots: Informal Dumping	68
Figure 8.4	Hot Spots: Informal Burning during the Day	68
Figure 8.5	Hot Spots: Informal Burning at night	68
Figure 8.6	Principal WEEE Recycling Activities.....	71
Figure 8.7	Emissions from Cable Burning	74
Figure 8.8	Burning of plastics at Agbogbloshie	75
Figure 8.9	Pressure on Ecosystems through waste disposal next to and into the Odaw River	77

LIST OF TABLES

Table 2.1	Estimated Undeclared Private Imports through Kotoka Airport.....	7
Table 2.2	Factors Employed in Calculations	8
Table 2.3	Obsolete Products Going to Storage Annually	8
Table 2.4	Reduction Factor for Equipment per Household in Greater Accra	9
Table 2.5	Income Groups	9
Table 2.6	Reduction Factors for Product Groups.....	10
Table 2.7	Reduction of Likelihood for EEE	10
Table 2.8	Reduction of Likelihood for Mobile Phones	11
Table 3.1	Summary of most important development indicators	19
Table 5.1	Private Imports in Units and Tons (2009).....	28
Table 5.2	CEPS Import Data on New and Second Hand EEE (units, 2006-2009).....	29
Table 5.3	New Imports in % Share of total Imports for Selected Tracer Products.....	30
Table 5.4	New and Second Hand Imports into Ghana (units/ year).....	30
Table 5.5	All of EEE imported into Ghana (tons/ year)	31
Table 6.1	Domestic Assembling of EEE (units).....	37
Table 6.2	Breakdown of Households into Income Groups (GSS, 2008).....	37
Table 6.3	Breakdown of Workforce (Sector % (CIA, 2005))	38
Table 6.4	Breakdown of Institutional Consumers (calculated).....	38
Table 6.5	Installed Base of Tracer Products and Total EEE (units and tons, 2009)	38
Table 6.6	Installed base of households allocated to region categories (tons and kg, 2009).....	40
Table 6.7	Installed base of households allocated to income groups (tons and kg, 2009).....	40
Table 6.8	Installed and Stored base of (W)EEE (tons 2009)	40
Table 6.9	Installed Base of Computers (W)EEE (units 2009)	40
Table 6.10	Penetration rate of EEE tracer in Ghana (2009)	41
Table 6.11	Comparison of end-of-life and Import of computers (units)	43
Table 6.12	Composition breakdown of installed and stored base (tons, 2009)	44
Table 6.13	Purchase of New EEE by Private Consumer (% of all purchases)	45
Table 6.14	Flows of EEE Reaching End-of-Life (tons/year, 2009)	46
Table 6.15	Stored Balance of WEEE (in tons/year, 2009)	46
Table 6.16	Flows of WEEE to Recycling (tons/year, 2009)	46
Table 6.17	Flow of End-of-life Tracer Products from Consumer to Collection (2009)	47
Table 6.18	Flow of End-of-life Tracer Products from Consumer to Collection (2009)	48
Table 6.19	Flow of End-of-life Tracer Products from Consumer to Collection (2009)	48
Table 6.20	Flow of WEEE through Communal Collection (tons/year, 2009)	50
Table 6.21	EEE Taken for Repair (units and tons, 2009)	52
Table 6.22	Total Flow of WEEE to Informal Recycling (tons/year, 2009)	56
Table 6.23	Annual Flow of WEEE in Fractions (tons/year, 2009)	57
Table 8.1	Overview of Results of the Greenpeace Sampling Campaign.....	73
Table 9.1	Recycling Options for different WEEE Dismantling Waste Streams.....	79

ABBREVIATIONS

AMA	Accra Metropolitan Assembly
AU	African Union
CBD	Central Business District
CEPS	Customs, Excise and Preventive Service
CFC	Chlorofluorocarbons
CRT	Cathode Ray Tube
CSR	Corporate Social Responsibilities
CIA	Central Intelligence Agency
CPI	Corruption Perception Index
COHRE	Centre on Housing Rights and Eviction
ECOWAS	Economic Community of West African States
EEE	Electronic and Electric Equipment
EMPA	Swiss Federal Institute of Technology
EPA	Environmental Protection Agency
FAO	Food and Agriculture Organisation
GDHS	Ghana Demographic and Health Survey
GDP	Gross Domestic Product
GESTA	Ghana Electronic Service Technicians Association
GLSS	Ghana Living Standards Survey
GNAT	Ghana National Association of Teachers
GPHA	Ghana Ports and Harbours Authority
GSS	Ghana Statistical Service
HCFC	Hydro Chlorofluorocarbons
HDI	Human Development Index
ICT	Information and Communication Technology
ILO	International Labour Organisation
IRS	Internal Revenue Service
IT	Information Technology
JHS	Junior High School
KLERP	Korle Lagoon Ecological Restoration Project
LCD	Liquid Crystal Display
LMIS	Labour Market Information System
MMDA	Metropolitan/Municipal/District Assembly
NARWOA	National Refrigeration Workshop Owners' Association
NHI	National Health Insurance
NYC	National Youth Council
PACE	Partnership for Action on Computing Equipment
PBDE	Polybrominated Diphenyl Ethers
PC	Personal Computer
PPP	Purchasing Power Parity
PUR	Polyurethane
PVC	Polyvinyl chloride
PWB	Printed Wiring Board
SBC	Secretariat of the Basel Convention
SFO	Serious Fraud Office
SHEP	Self Help Electrification Project
SME	Small and Medium-scale Enterprise
SSNIT	Social Security and National Insurance Trust

TFR	Total Fertility Rate
TEQ	Toxic Equivalent
TEWU	Teacher and Educational Workers Union
TV	Television
UAE	United Arab Emirates
UNDP	United Nation Development Programme
UNEP	United Nation Environment Programme
USD	United States Dollars
VAT	Value Added Tax
WEEE	Waste Electronic and Electric Equipment
WHO	World Health Organisation

EXECUTIVE SUMMARY

The emergence of the digital age has underscored the important role that EEE plays in a nation's socio-economic development, including education, health delivery and communications as well as global connectivity. In 2003 Ghana formulated its policy on Information and Communications Technology (ICT) for accelerated development, with the understanding for instance, that Ghana's accelerated development would not be possible without an ICT-driven development agenda. The demand for EEE in Ghana grows by the day with a corresponding high rate of WEEE generation. Almost all EEE in Ghana is imported mainly from Europe, North America and Asia.

The Ghana e-Waste Country Assessment, comprising Component 1 and 2 of the Secretariat of the Basel Convention e-Waste Africa Project, was undertaken in the Accra – Tema area of Ghana between November 2009 and January 2011. The study subjects included; importers and distributors, assemblers, consumers, collectors, repairers, dismantlers, and recyclers of EEE and the disposal mechanisms available at present. All EEE of the four categories 'large household appliances', 'small household appliances', information and communication technologies' and 'consumer electronics' were included in the study. The findings were then extrapolated to become representative of Ghana as a whole. Sources of data included surveys, CEPS, UN Comtrade, and Statistical Service etc.

The EEE imports into Ghana in 2009 added up to 215'000 tons and a per capita import of 9kg. About 30% comprised of new products and 70% second hand EEE. Around 15% of the second hand imports was estimated to be unsellable (i.e. would not respond to power, broken or outdated), a significant portion of which was destined directly to informal recycling. Another 20% of the imports can be serviced (repaired/refurbished) to get them functioning. Due to high amounts of second hand imports, Ghana has a high availability of second hand EEE that can be purchased at comparatively low prices. This makes these products available for a larger share of the population, compared to other countries, and gives many Ghanaians the possibility to benefit from EEE in their everyday life. On the other hand, second hand products have a shorter lifespan compared to new products, which leads to a higher e-waste generation per year. The equipment that arrives already in broken condition is added to the internally generated WEEE and thus again increases the large amount of e-waste generated.

There is certain awareness on environmental impacts of wrong disposal of WEEE among the consumers, especially within Accra, but due to the lack of environmentally sound disposal options, most obsolete equipment is either given to the informal collectors or stored. Yet, a high proportion of devices becoming obsolete are brought to repair shops instead of immediate disposal. The repairers, having a high success rate in repairing certain EEE, contribute to a significant extension of the lifetime of those devices and therefore to a reduction of the WEEE generated. Of the 280'000 tons of obsolete devices generated in 2009, 57% went to repair, 8% to storage and 34% directly to recycling via the informal collectors. Only 1% was collected via communal collection.

The informal collectors receive money from the informal recyclers for every piece collected or they dismantle the devices themselves and afterwards sell the valuable fractions, they are able to pay the consumers for the WEEE. This makes them able to collect a high share of the WEEE generated in Ghana. For the formal collection that is not able to pay for the e-waste it is difficult to compete against that well established and flexible system.

About 171'000 tons of WEEE from consumers, repair shops and communal collection reached the informal recycling sector in 2009. The material flow to the formal recycling sector accounted for only 0.2%. In the informal recycling sector, WEEE is dismantled and sorted into various valuable and non-valuable fractions. If necessary, equipment (or parts of it) is burnt in order to get more valuable fractions out of it. Valuable fractions, which account for around 42% of the material treated, are then sold to dealers, which again sell the material to local industries or export it. Non-valuable fractions are informally dumped and periodically burnt, in order to reduce the waste volumes on the dump site. During these activities, high amounts of hazardous substances are released, with no thoughts given to the safety of the workers and the protection of the environment. This leads to significant negative impacts on soil, air and water as well as human health. The preliminary estimation of total dioxin (PCDD/F) emissions to air from open cable burning alone in the Greater Accra Region amounts to a source strength of ~3 g / year. This equals to 7.5 – 15 % of European dioxin emissions from industrial waste incineration. Currently there is no infrastructure available for the environmentally sound disposal of the hazardous fraction from WEEE.

Assuming a linear growth, the imports would double by the year 2020. An exponential growth would lead to an increase in imports by a factor 7. Considering the fact, that Ghanaian consumers already possess a large amount of EEE and markets for household appliances and televisions are already saturated to a large extent, an exponential growth of the total imports of EEE seems not very likely. However, exponential growth scenarios for imports of certain ICT -equipment or consumer electronics such as desktops and laptops, mobile phones, mp3-players etc. are still possible. It is therefore assumed, that the future massflow trends lie between a linear and an exponential growth scenario. It can be deduced that future WEEE flows will rise according to the increase of imports and that until 2020, WEEE flows will grow at least by a factor of 2.

The environmental and health menace of WEEE recycling activities can be attributed to the lack of an appropriate framework to regulate importation, and the proper management of disposal. A policy and legislation analysis illustrates that there is currently no specific policy or legislation for WEEE management in place. Regarding the importation of WEEE, Ghana has ratified the Basel Convention on the Control of Transboundary Movements of Hazardous Wastes and their Disposal, which prohibits imports and exports of e-waste. Though, the Convention has not yet been incorporated into local law and therefore has not come into force. There are a number of laws and regulations, such as the Environmental Protection Agency Act, that have some relevance to the control and management of hazardous wastes (including WEEE), but they do not address the dangers posed to humans and the environment from such wastes. Specific regulations on the environmentally sound handling of e-waste and the disposal of hazardous fractions are not available.

As a follow up of this study, a national E-waste strategy to provide policy and management of WEEE direction nationwide has been developed in a separate document. The objectives of the national strategy were the following:

- Establish an institutional framework for collaboration in controlling importation of used EEE;
- Create awareness on the dangers of the current handling process, the new hand-in/take back system and on recycling centres at all levels of governance and the public;
- Develop a policy on general importation and management of (W)EEE and on hazardous substances;
- Adapt a business model (acceptable to the WEEE-scrap Dealers Association) for ease of ownership by the Association eventually;
- Develop a legal framework for EEE importation, introduction of EEE levies, mandatory licensing, EEE management fund and for control of WEEE management.

- Establish a formal and efficient WEEE recycling industry, nation-wide
- Strengthen the capacity of the WEEE-scrap Dealers' Association and the training of the membership in safe and efficient handling and good business practices;
- Establishment of regional associations to ensure national integration in the WEEE recycling industry;
- Develop an enforcement mechanism centred around EPA's Compliance and Enforcement Network (CEN)

1.0 INTRODUCTION

1.1 Background

The demand for electrical and electronic equipment (EEE) in Ghana continues to grow by the day. Household electrical and electronic appliances, IT and telecommunication equipment and consumer electronic goods are in increasing use. The demand for computers and accessories in particular is phenomenal as a result of increasing e-literacy and the common use of these gadgets in most offices, schools and other institutions, in line with current trends in the global electronic and information age. The emergence of the information age has underscored the critical role that information, knowledge and technology can play in a nation's development and for global connectivity. The effective use of information and knowledge is crucial for the rapid economic growth and socio-economic wellbeing of every nation, and the computer is at the heart of all this.

In 2003 Ghana formulated its policy on Information and Communications Technology (ICT) for accelerated development, which represents the country's vision on technology. The premise of the policy is that Ghana's development process can be accelerated through the development and deployment of ICTs. In other words, Ghana's accelerated development within the emerging information and digital age will not be possible without an ICT-driven development agenda.

At the present, most of the electrical and electronic equipment in demand or use are imported into the country, since only an insignificant fraction is assembled locally. The level of demand has led to an alarming influx of EEE into the country, most of which are second-hand equipment. Considerable proportions of these imports are old, near or at end-of-life, with little or no utility value and consigned as waste equipment for disposal within a short time. Unfortunately, no facility exists in Ghana for managing the disposal of such e-waste in an environmentally sound manner, in spite of the existing large stocks and the ever-increasing high rate of generation of the waste. The policy direction on ICT and demands of the current information and digital age are major drivers of high per capita EEE import and use, as well as e-waste generation in Ghana.

To meet these challenges, which are similar in many West African countries, the e-Waste Africa Project was launched in Benin, Ghana, Ivory Coast, Liberia and Nigeria. The project is implemented in the framework the Basel Convention on the Control of Transboundary Movements of Hazardous Wastes and their Disposal and includes a comprehensive programme of activities aiming at enhancing environmental governance of e-wastes and at creating favourable social and economic conditions for partnerships and small businesses in the recycling sector in Africa.

The project is implemented by the Basel Convention Coordinating Centre based in Nigeria and the Basel Convention Regional Centre based in Senegal in cooperation with partners including: EMPA, Öko-Institut, IMPEL, UNESCO and the Partnership for Action on Computing Equipment (PACE).

The e-Waste Africa Project is composed of four components: component 1 is a fact finding study on transboundary movement into several West African countries in particular from European countries, component 2 consists in an e-waste country assessment including a multi-stakeholder process, component 3 is an analysis of the socio-economic functioning and impacts of the informal e-waste sector, and a related feasibility study for international co-operation, and finally component 4 includes an enforcement program on the monitoring and control of transboundary movements and the prevention of illegal traffic.

1.2 Problem Identification

The second-hand EEE import business is a highly booming sector - both formal and informal. The sector enjoys high patronage from all levels of societal spectrum in Ghana. Due to the inability of many Ghanaians to afford brand new products, large consignments of used and old fashioned EEE discarded mainly in Europe and North America are imported. Some of the products such as computers and accessories enjoy a free-import duty regime, thus, further boosting the import trade.

Ghana has an unregulated and unrestricted import regime for second hand EEE. Even in the case of the importation and sale of used air conditioners, refrigerators, refrigerator-freezers and freezers which are prohibited by LI 1932 (2008), there is no enforcement. Any consignment of e-waste could therefore enter the country under the guise of second hand EEE without restriction or detection, at the present. Thus, it is difficult to know about the status of actual WEEE import into Ghana, if any.

In spite of the high rate of e waste generation (from the imports that is consigned for disposal), a significant amount of cannibalization is undertaken by commercial importers. This ensures that a good number of the equipment is salvaged, in order to maximize sale. Though the importation of second hand EEE helps most people to acquire and use these gadgets, the useful lifespan, especially of the rehabilitated equipment rarely goes beyond three years. In effect, most of the second-hand EEE imports end up discarded as waste within a year or two of arrival.

A large number of end-of-life EEE are known to be stored, mostly in houses, institutions/offices and warehouses among others, due to the uncertainty about management of their disposal. A portion is, however, sold to scavengers or get mixed with household wastes, and finally disposed of at refuse dumps. End-of-life equipment from some institutions are disposed of at dump sites or auctioned to scrap dealers, especially when storage capacity is exhausted.

The present situation of second hand EEE imports and the menace of WEEE disposal can be attributed to the lack of an appropriate framework to regulate importation, and the proper management of disposal. The Ghana ICT policy for instance, makes no reference to the concerns about importation of old computers and related EEE, and their effect on health and the environment. It is also silent on the opportunity to collect the wastes, on required national capacity to recycle and proper disposal. Under the circumstance, EEE scrap yards/dump sites are emerging uncontrollably and dangerously in many places.

The Basel Convention on trans-boundary movement of hazardous wastes and their disposal establishes a framework of control on the movements of waste from developed to developing countries, and offers a platform for tackling the menace of 'e-dumping'. Ghana ratified the Convention in 2005, but its provisions are not yet incorporated into a national legislation. The feasible application of the Basel Convention to control EEE imports to Ghana is considered an attractive option. However, any attempt to ban such importations could have adverse implications for Ghana's ICT Policy, and other ramifications. For instance, placing a ban without any special intervention, such as fiscal subsidy to make computers and other EEE affordable, will promote smuggling of the same second-hand goods across the country's borders.

The current situation has led to an important informal industry that recycles or reprocesses e-waste in Ghana (as in other low and middle-income countries), to take advantage of the valuable metals that can be extracted for sale. Unfortunately, as a relatively new industry in Ghana, proper recycling facilities, management systems and industry standards do not exist. The informal recycling business has neither spurred policy-makers on to address the issue. There are no clear and specific national regulations that define, restrict or prohibit hazardous e-waste recycling and set up. As a result, e-waste handlers and recyclers work in appalling conditions, constantly exposing themselves and communities nearby to serious hazards. For example, burning is a

common method used to reduce waste volumes, which is practiced at waste dumps and scrap yards, such as Agbogbloshie. The burning process in particular releases toxic substances into the atmosphere, soils and water bodies with dire health consequences. Some known health problems include acute damage to the lungs, e.g. from inhalation of fumes of heavy metals such as lead and cadmium. Others include mental retardation in case of lead exposure in children, damage to blood cells and the kidney and predisposition to cancers. The menace of e-waste and its burning has grave adverse implications on health and the environment.

The informal nature of the business has prevented workers from learning about the associated risks, in order to organize and seek social protection and benefits to improve working conditions. Given the absence of controls and regulations, it has become an open and ready source of employment and point of entry for economic migrants, usually with no education and employable skills drifting mainly from the northern parts Ghana. Thus, the industry keeps expanding. Unfortunately, the industry even attracts children who also find themselves some work; commonly found scavenging at such sites rather innocently.

1.3 History of Agbogbloshie

The settlement of Agbogbloshie or Old Fadama consists of about 6,000 families or 30,000 people, situated on the left bank of the Odaw River, and in the upper reaches of the Korle Lagoon in Accra. There are at least four different social and economic factors driving the establishment and growth of Agbogbloshie. These include:

- ✚ Spill-over population associated with the size and growth of the adjacent market;
- ✚ Migration from the north of Ghana, as an outcome of tribal conflict;
- ✚ Social downward movement by those forced out of more expensive areas in Accra, partly attributable to the impact of the Structural Adjustment Programme initiated in the early 1980s; and
- ✚ Cheaper settlement area free from bureaucratic constraints and high rentals in recognized formal areas in Accra.

The Agbogbloshie site started as a food stuff market for onions and yam. Over the years it has grown into a slum with people dealing in all kinds of scrap, and a dumping ground for old electrical and electronic products and household waste. The scrap yard has grown steadily into a popular recycling area, where old and discarded EEE could be put to use. Hundreds of tons of e-waste end up there every month as a final resting place, where they are broken apart to salvage copper and other metallic components that can be sold.

The scrap dealers discovering the place as a good location for business started to erect temporary stalls and sheds to house their wares and activities. The National Youth Council (NYC), the custodians of the land was approached by the scrap dealers for a portion of the land as a permanent base for the scrap industry. The dealers later registered with the NYC as the Scrap Dealers' Association of Ghana, and the land was leased to them in 1994. To date Agbogbloshie has become the hub of informal 'recycling' industry in Ghana. Beside this main scrap yard, there are other smaller known scrap yards such as Gallaway, Kokompe and in Ashaiman in the Greater Accra Region. Other much smaller scrap yards keep springing up throughout Accra.

1.4 Objectives of the Assessment

The study consists of two (2) main components. Component 1 is a study on transboundary movement, i.e. imports especially from EU countries. Component 2 is a country assessment of new, used and end-of-life EEE which should contribute to develop environmentally sound management policies and plan. The sub-objectives of the components are provided below.

Component 1 – ‘Transboundary Movement’

- ✚ To check the importation of used and end-of-life EEE into Ghana by land, sea and air, in particular from European countries.
- ✚ To record re-exportation in the sub-region.
- ✚ To improve the level of information available on flows of e-waste and EEE being imported into Ghana.
- ✚ To improve decision making and increase communication between exporting and importing countries.

Component 2 – ‘Country Assessment’

- ✚ To undertake a national assessment of new, used and end-of-life EEE.
- ✚ To assess e-waste management practices in the formal and informal sectors.
- ✚ To describe the legal and regulatory frameworks in place.
- ✚ To assist to develop environmentally sound management policies for nationally generated e-waste.
- ✚ To assess needs towards environmentally sound management.

The study was carried out in close cooperation with the in-depth socioeconomic study of the e-waste sector in Ghana, conducted by Green Advocacy Ghana and Öko-Institut e.V. and commissioned by the Inspectorate of the Ministry of Housing, Spatial Planning and the Environment of the Netherlands (VROM-Inspectorate) and the Dutch e-Waste Compliance Scheme (NVMP). This study was closely linked to component 3 of the Basel Convention e-Waste Africa Project which was carried out in Nigeria. The assessment and results of component 3 can be found in the separate report 'Socio-economic assessment and feasibility study on sustainable e-waste management in Ghana' (Prakash et al. 2010).

2.0 METHODS

2.1 Data Acquisition

Data acquisition methods and sources for the study were involved a variety of means. The key ones included import data from the Customs, Excise and Preventive Service (CEPS), literature review, meetings and workshops of key stakeholders, surveys involving questionnaires and field visits to the places of operation of importers, repairers and other downstream processors. A mass-flow chart was constructed, which also indicated the flow of electrical and electronic goods into the country, and the in-country flow paths until final disposal.

2.1.1 Literature Review and Statistical Data

Guidelines developed by EMPA were used in the study. Similar studies also conducted by EMPA in some other developing countries were useful points of reference. Information from government websites and other sources such as the Ghana Living Standards Survey (GLSS) and data from the Census Secretariat and development partners were used. The Statistical data from the National Census Bureau, Statistical Service and Ministry of Communications, among others, were important information sources relied on to corroborate results from field studies. The HPMP project also served as a basis for estimating the quantity of installed base of electronic equipment in the country.

2.1.2 Meetings and Workshops

A number of meetings were held with the various stakeholders including the Scrap Dealers Association, CEPS, Ghana Ports and Harbours Authority (GPHA) and some government ministries. Meetings with the Scrap Dealers Association was immensely helpful in arranging visits to the dumpsites, identifying scavengers for interviews and in facilitating the observation of recycling practices that take place at the sites. There was a workshop of two working groups drawn from the stakeholders that deliberated on the topics 'Technology and Skill' and 'Marketing, Awareness and Education'. Outputs of the workshop included viable plans and recommendations for effective stakeholder engagement, sampling space expansion and preferred methodology for data analysis, extrapolation and presentation of project results. Thus, the study made good use of the varying expertise among stakeholders, such that, in spite of the informal nature of the sector, the non-availability of well documented and reliable data neither hampered the study nor the credibility of results.

2.1.3 Surveys

The data used for Component 1 was obtained from CEPS and UN Comtrade. The Research Unit of CEPS provided data on the import of EEE into the country for a 4-year period (2006 - 2009), on yearly basis. Information on the export of metal fractions, EEE and others were provided by GPHA.

Data for Component 2 came from surveys (through questionnaire) of the following category of stakeholders: private/household users, corporate/institutional users, repairers/refurbishers and major importers of EEE. Information obtained included knowledge of environmental hazards due to indiscriminate disposal of e-waste, life span of EEE, duration of storage of end-of-life EEE, use of discarded EEE and disposal methods, among others (Annex A, B, C and D). In addition, informal collectors/scavengers, dismantlers, scrap dealers, informal disposers and recyclers were also interviewed (captured in the photo documentation, see Annex E).

2.1.4 Sampling Techniques

Three (3) key sampling techniques - cluster, quota and random sampling outlined below - were used, each of which was applied at various levels in the sampling process.

Cluster Sampling

Cluster sampling was applied at the national level to select the cluster which is representative of the Ghanaian population. Ghana is divided into clusters or regions; and the Greater Accra Region which is highly representative of the Ghanaian population was selected. The choice of the Greater Accra region was because the variation in the Ghanaian population is within the clusters, not between them. This same technique was also used in selecting Accra and Tema as the sample study area.

Quota Sampling

Quota sampling was used at the regional level. Different quotas were assigned both to Accra and Tema depending on the concentration of the population necessary for this study. There were furthermore geographical groupings within the bigger groups of Accra or Tema.

Random Sampling

Random sampling was used at the location level to randomly select samples from the demarcated locations within Accra and Tema. That gave the various categories: scavengers, repairers / refurbishers, dealers, importers and institutions an equal chance of being selected for the study.

2.1.5 Field Studies

Field studies at the scrap yards at Agbogbloshie, Gallaway, Ashaiman, Kokompe, etc. enabled access to first-hand information on e-waste activities. There were similar visits to repairers and importers of EEE. A number of visits were paid also to the main Port at Tema to ascertain operations and possibility of observing the presence of end-of-life EEE imports meant directly for the scrap yard on arrival. The study also included observation of WEEE fractions at some landfills and the recycling practices undertaken (see Photo Documentation, Annex -E).

2.2 Massflow Assessments

The assessment of flow covered generally assemblers, importers (commercial and private), consumers (households and institutions), repairers, collectors and recyclers.

2.2.1 Import and Assembly

2.2.1.1 Assemblers

One main assembler and three others were identified. The numbers of assembled products were estimated from statements made by the main assembler.

2.2.1.2 Private Import

Private importers refer to international travellers who enter the country along with EEE such as laptops, mobile phones and cameras that are not declared at customs and therefore not documented. The number of people arriving at the Kotoka International Airport was obtained from the Ghana Immigration Service Annual Report (GIS, 2008). The percentage of people importing a laptop, mobile phone, camera, DVD, MP3 or game console without declaration was estimated. The factors used for the estimates are provided in the Table 2.1 below.

Table 2.1 Estimated Undeclared Private Imports through Kotoka Airport

Equipment	Passengers Import	Equipment	Passengers Import
Laptop	10%	DVD Player	10%
Mobile Phone	50%	Game Console	10%
Camera	10%	MP3 Player	10%

10% means that percentage of all people arriving at Kotoka import one Laptop. The 50% for mobile phones implies, that probably 10% bring 5 phones or 5% bring 10 phones at once (not that 50% bring one phone).

2.2.1.3 Import

Data from the UN Comtrade database on importation of EEE into Ghana (available for refrigerators, air conditioners, computer/laptops and televisions) for the years 2003 to 2008 was obtained (UN Comtrade, 2010). To extrapolate for the year 2009, which is the one relevant for the massflow assessment, 30% were added. The growth rates of the two preceding years were 37% (2007) and 23% (2008).

The household survey indicated that the four tracer products make up 43.5% of the weight of the total installed base. To extrapolate for the import of all EEE, it was assumed that the proportions between the products are similar for installed base and imports; therefore the ‘missing’ 56.5% were added to make up for the total import of EEE.

The UN Comtrade data base does not differentiate between new and second hand products. Results from the transboundary movement assessment (Chapter 5) and the household survey (Section 6.3) lead to the estimation that new imports account for 30% of the total imports. From interviews with importers, retailers, scrap dealers, CEPS, Port authorities and investigative journalists, the fraction of WEEE arriving with EEE imports was estimated at 15% (Chapter 5).

2.2.2 Consumers

Consumers were split into private, corporate and institutional consumers. The installed base of EEE for each consumer group for all of Ghana was extrapolated from results from the respective surveys. The extrapolation factors below were based on interviews and field experience:

- ✚ To extrapolate for all EEE in each consumer group, a percentage for EEE not covered in the questionnaires was estimated and added (Table 2.2).
- ✚ The stored base of e-waste was calculated as a percentage of the installed base (Table 2.2).
- ✚ To calculate the flow of e-waste out of the stored base, a rate was estimated at which the different consumers clear their stock. For example households clear their stock every 10 years, which implies that 10% of the stock flows out every year (Table 2.2).

Table 2.2 Factors Employed in Calculations

	Added to weight of installed base for EEE not counted	Stored base in % of installed base	WEEE leaving stored base every year
Private	10 %	30 %	10 %
Corporations	20 %	30 %	30 %
Institutions	20 %	30 %	10 %

To calculate the generation of WEEE out of the installed base, lifespan of products were obtained from literature and adjusted to the Ghanaian setting (where necessary) (Annex F). The percentage of yearly generated WEEE out of the installed base, going to storage, was estimated (Table 2.3) based on the assumptions that - scavengers and payment for WEEE is more available in urban areas. Thus, equipment that is more likely to be found in urban settings is less likely to go to storage (e.g. popcorn maker, electric toothbrush) whereas equipment that is also used in rural areas is more likely to be stored (e.g. refrigerator, television). Non-conventional uses of WEEE e.g. obsolete refrigerators used for storage (of items such as utensils) were also taken into account.

Table 2.3 Obsolete Products Going to Storage Annually

Equipment	Obsolete products going to storage annually (%)	Equipment	Obsolete products going to storage annually (%)
Large Household Appliances		Small Household Appliances	
Refrigerator	50%	Iron	40%
Air conditioner	30%	Kettle	40%
Dish washer	30%	Blender	40%
Dryer	30%	Coffee Machines	30%
Electric Heaters	50%	Electric Lawnmower	30%
Grillers	30%	Electric Toothbrushes	10%
Electric/Gas Stoves	40%	Fans	40%
Washing Machines	30%	Hair Dryers	30%
Information & Communication Technologies		Microwaves	30%
Laptops	30%	Mixer	30%
Personal Computers	30%	Popcorn Maker	30%
LCD Monitor	30%	Toaster	30%
CRT Monitor	30%	Vacuum Cleaner	30%
Mobile Phones	10%	Consumer Electronics	
Fax Machine	30%	Television CRT	40%
Phone (Land Line)	20%	Television LCD	30%
Modems	30%	Radio	30%
Printers	30%	Stereo	40%
Scanners	30%	Alarm Clock	10%
Photocopiers	30%	Camera	10%
		DVD Player	40%
		E Instruments	30%
		Game Console	30%
		Mp3 Player	10%
		Projector	30%

Shaded: Tracer Products

The storage balance for the different consumer groups as presented in Table 6.15 indicates the stored base for households is increasing. This is to be expected, due to the lack of recycling/disposal options in most parts of the country. On the other hand, the stored base for enterprises is decreasing. This is also expected, because most of the enterprises with a lot of EEE usage are in urban areas, where money is paid for WEEE by scavengers or dismantlers. Existing stocks are therefore easily cleared. Based on these results, the above assumptions seemed reasonable.

2.2.2.1 Private Consumer

A questionnaire (Annex B) on the installed number of EEE, their condition and age and the disposal practices of the households was administered to 64 households in Accra/Tema (January and February 2010). After a quality check, the responses from 57 households were considered valid. The households were from the following different neighbourhoods of Accra/Tema for representative results:

- ✚Circle/Adabraka
- ✚Tudu/Makola/High Street Areas
- ✚Nima/Kotobabi
- ✚Abeka/Lapaz
- ✚Ashaiman
- ✚Tema Community 1/Manhean
- ✚Sakumono/Spintex
- ✚Madina
- ✚Kaneshie/Dansoman
- ✚Teshie/Nungua/La
- ✚Osu

The survey dealt with the following products:

- ✚ **Large Household Appliances:** air conditioner, dish washer, dryer, electric heater, refrigerator/freezer, griller, electric and gas stove and washing machine.
- ✚ **Small Household Appliances:** blender, coffee machine, electric lawn mower, electric tooth brush, fan, hair dryer, iron, kettle, microwave, mixer, popcorn maker, toaster, vacuum cleaner.
- ✚ **IT and Telecommunication:** fax machine, phone, mobile phone, laptop, PC, LCD and CRT monitor, modem, printer, scanner, and photocopier.
- ✚ **Consumer Equipment:** alarm clock, camera, DVD player, electric instrument, game console, MP3 player, projector, radio, stereo and LCD and CRT TV

It was observed that respondents tended to overstate the number of equipment they have or to understate their income. Both lead to higher numbers on average EEE per household within the income groups. In addition, it was realized that the sample taken was not very representative for Greater Accra. It favoured well educated and technology-inclined people. To make up for the deficiency, the average number of equipment per household was reduced by some percentages (Table 2.4). The reduction factors were greater for product groups that were assumed to have a higher penetration rate in an urban setting.

Table 2.4 Reduction Factor for Equipment per Household in Greater Accra

	Large Household Appliances	Small Household Appliances	IT and Tele-communication	Consumer Equipment
Likelihood reduction	-15%	-15 %	-50 %	-30 %

These adjusted figures were used to extrapolate the results for the whole country. In addition, data on the total number of households from the Ghana Living Standard Survey, 2008 (GSS, 2008) was used for the extrapolation. Since the income groupings for the questionnaire and the GLSS surveys were different (Table 2.5), some adjustments had to be made.

Table 2.5 Income Groups

Income Groups (GLSS, 2008)	
Quintile	Mean monthly household income (GHC)
Lowest	728
Second	1'020
Third	1'098
Fourth	1'263
Highest	1'544

Income Groups (Questionnaire)	
Grouping	Mean monthly household income (GHC)
Low	100 – 199
Low	200 – 499
Low	500 – 999
High	1'000 – 1'999
High	Over 2'000

The first two quintiles (average 874 GHC) were matched with the low-income group (100 - 999 GHC), and the highest quintile was matched with the high-income group (1000 - over 2000 GHC). The average of the low and high-income groups from the household survey was taken to match the third and fourth quintile. Because the survey was undertaken only on households in Accra, the reflected averages of possession of EEE in the different income groups are higher than in other regions of Ghana. This is because the electrification rate (SHEP, 2010), lifestyle and living conditions in Accra differ highly from the rest of the country, especially compared to rural areas (GSS, 2008). To take this into account for the extrapolation, the regions from the Living Standard Survey were divided into three categories:

- 📍 **Urban** with Greater Accra
- 📍 **Medium Urban** with Western, Central, Eastern, Ashanti and Brong Ahafo
- 📍 **Mostly Rural** with Volta, Northern, Upper East and Upper West

The likelihood of a household to possess an electronic good in the same income group was considered to be lower than in Greater Accra depending on the region and the product group. For example, the likelihood that a household from a mostly rural area possesses small household appliances is 70% lower than for a household within the same income group in Greater Accra. The estimated reduction factors are listed in Table 2.6. Different factors were however, used for some individual products as shown in Table 2.7 below.

Table 2.6 Reduction Factors for Product Groups

	Large Household Appliances	Small Household Appliances	IT and Telecommunication	Consumer Equipment
Medium Urban	-50%	-35 %	-85 %	-60 %
Mostly Rural	-70 %	-70 %	-95 %	-90 %

Table 2.7 Reduction of Likelihood for EEE



	Refrigerator/ Freezer	Coffee Machine, Electric Lawnmower and Toothbrush, Microwave, Mixer, Popcorn Maker, Toaster, Vacuum Cleaner	DVD and MP3 Player, Radio, Stereo, TV (CRT)
Medium Urban	-20 %	-70 %	-30 %
Mostly Rural	-30 %	-90 %	-50 %

Mobile phones have become very common in all income groups and regions of Ghana, therefore no general reduction was applied as in Table 2.7, and instead the factors shown in Table 2.8 were used.

Table 2.8 Reduction of Likelihood for Mobile Phones

	Mobile Phone
General Reduction	-0%
Medium Urban	-35%
Mostly Rural	-60%



The likelihood reduction for the purchase of a computer monitor or television is applied as indicated in Table 2.6 and Table 2.7. The likelihood to purchase an LCD product instead of CRT is lower in medium-urban and rural settings than in an urban area, because of lower availability and different lifestyle. The following factors were used:

-  **Medium Urban:** The number of LCD products was reduced by 50 % and reallocated to the corresponding CRT product.
-  **Mostly Rural:** The number of LCD products was reduced by 70 % and reallocated to the corresponding CRT product.

In addition, a strong possibility existed to double count on laptops. A person, who had a laptop provided by the employer, could also count it in the household survey. The same laptop would also be counted in the questionnaire completed by the enterprises. To correct the likelihood of double count, the number of laptops per household was reduced by 70%.

2.2.2.2 Corporate Consumers

A questionnaire (Annex C) on the installed number of EEE and their replacement was completed by 13 enterprises in Accra (April, 2010). For extrapolation purposes two categories were determined:

-  Service Sector
-  Industrial Sector

The workforce of each sector was determined using the total workforce of Ghana as 10.6 million (WDI 2008) split into: 15% employed in the industrial sector and 29% employed in the service sector (CIA 2005). Data on air conditioners and refrigerators for corporate consumers was obtained from the "Hydrochloro-fluorocarbon Management Plan" (UNDP, 2010). The number of the two appliances was lumped together. One third of this figure was allocated to refrigerators and remaining 2/3 to air conditioners.

(a) Service Sector

The averages on EEE per employee from the twelve (12) enterprises sampled were determined. The averages obtained were reduced by 70% because the sampled enterprises were all part of the formal private sector (banks, consulting and a large internet provider). A large proportion of people working in the service sector, operate in an informal setting (e.g. street vendors, petty traders and other small scale businesses), where none or very little EEE is installed. The reduced numbers were multiplied by the total number of people employed in the service sector minus the number of people employed by the government.

(b) Industrial Sector

The numbers of EEE per employee from one (1) enterprise sampled were multiplied by the total number of people employed in the industrial sector.

2.2.2.3 Institutional Consumers

(a) Health Sector

A questionnaire (Annex C) on the installed number of EEE and their replacement was administered in three (3) health institutions (2 clinics and 1 hospital) in Accra in April 2010. For extrapolation purposes three categories were made, based on the available data on the number of health institutions (GHS, 2005):

- ✚ Hospitals and Polyclinics
- ✚ Health Centres
- ✚ Clinics/Maternity Homes

Hospitals and Polyclinics

The number of staff at the hospital sampled was 63, which was assumed to be the average size of hospitals and polyclinics in Ghana. Therefore the number of equipment was multiplied by the total number of hospitals and polyclinics.

Health Centres

The average number of staff of the two (2) health centres/clinics was 79. It was assumed however, that the average size of health centres in Ghana was smaller, and therefore the average number of staff was estimated to be about 26. The averages were divided by 3 and multiplied by the total number of health centres.

Clinics / Maternity Homes

A similar usage of EEE as with health centres was assumed. The average number of staff for a clinic/maternity home was estimated to be 16. Therefore the averages of health centres were divided by 5 and multiplied by the total number of clinics/maternity homes.

Validation of Assumptions and Estimations

The assumed average staff numbers for the institutions were multiplied by the corresponding numbers of government (excluding private) institutions. The outcome was that about 35,400 people were employed in the government health institutions. The number compared well with the figure given by the Ghana Health Service (GHS, 2005), which indicated that 36,000 people were employed.

(b) Educational Sector

A questionnaire (Annex C) on the installed number of EEE and their replacement was completed by eight (8) educational institutions in Accra in April 2010. They comprised three (3) public and one (1) private schools, which have both Primary and Junior High Departments and four (4) higher education institutions. For extrapolation purposes three categories were determined based on the available data on the number of schools (Thompson & Casely-Hayford, 2008; NAB, 2009; Mereku, 2000) as follows:

- ✚ Government primary to senior high schools;
- ✚ Private primary to senior high schools; and
- ✚ Higher education institutions.

Government – Primary to Senior High Schools

The average number of staff of the three (3) schools sampled was 68. It was assumed that the average size of government schools in Ghana was smaller, and therefore estimated to be 9. The averages of equipment were divided by 8 and multiplied by the total number of schools in Ghana.

Private – Primary to Senior High Schools

The number of staff of the schools sampled was 132. It was assumed that the average size of private schools in Ghana was smaller, and therefore estimated to be 13. The averages of equipment were divided by 10 and multiplied by the total number of schools.

Higher Educational Institutions

The average number of staff of the four (4) institutions sampled was 166. It was assumed to be smaller than the average size of higher educational institutions in Ghana. Therefore the averages of equipment were multiplied by 1.5 and also by the total number of schools.

Validation of Assumptions

The assumed average staff numbers for the different school types were multiplied by the corresponding number of schools, resulting in about 250,000 staff in those schools. A study by the Ghana National Association of Teachers (GNAT) and the Teacher and Educational Workers' Union (TEWU) estimates that 190,000 teachers are in the field today. It seems possible to have one supportive staff (e.g. custodian) per four teachers, so the assumptions seem realistic.

(c) Governmental Institutions

A questionnaire (Annex C) on the installed number of EEE and their replacement was completed by 18 government institutions in Accra (April 2010). After a quality check, responses from 15 institutions were considered valid.

The averages of EEE per employee were calculated and reduced by 30% to adjust for the numerous government workers who were not working directly in the ministries in Accra (where the questionnaire was administered). Employees in these areas have very little EEE provided for their work. The adjusted averages were multiplied with the total number of people employed by the government – excluding the health and education sectors (covered by institutional consumers). Data on the total number of government employees was obtained from an interview with the Serious Fraud Office (SFO).

Validation of Assumptions and Estimations

The ratio of computers per employee in the public service calculated was 38.7%. That compared well with 38% for the Ministries and public sector organizations, stated by the National ITC Policy and Plan Development Committee (MoC, 2003).

2.2.3 Repairers of EEE

A questionnaire (Annex D) on the number of repaired EEE and the disposal practices was administered to 28 repairers in Accra/Tema in January and February 2010. The averages of devices successfully repaired per week were multiplied by 52 weeks to obtain yearly figures. Because each repairer only handled a particular set of devices, the averages calculated for the individual devices repaired were based on only one to ten answers from questionnaires. For the extrapolation, the average number of devices repaired per year was multiplied by the number of repairers in Ghana (estimation by the Ghana Electronic Service Technicians Association). Through the household survey it was possible to extrapolate from the devices listed in the question-

naire to all of EEE repaired. With respect to the interviews with the repairers, the percentage of unsuccessful repairs for all of EEE was estimated to be 30%. That allowed for the calculation of the total number of EEE delivered to repairers which were successfully repaired and which became WEEE.

2.2.4 Collection of (W)EEE

From interviews with the communal waste collectors, visit to a landfill and answers on disposal, the fraction of the total generated WEEE that ended up in the formal waste collection was estimated. In the same way the fractions that go from the formal waste collection to the informal recycling or the landfill were estimated.

2.2.5 Recycling of WEEE

The recovery rates with the presently applied technologies for ferrous material, aluminium, copper, gold, silver, palladium and indium (export of high grade PWB) were taken from the findings of the socioeconomic survey of the informal sector (Prakash et al 2010). The fractions mentioned above are either processed in the Ghanaian industry or exported. The remaining fractions are informally dumped or burnt. The volumes for formal recycling were taken from an interview with the City Waste Management Limited.

2.3 Limitations of the Methodology Used

The main limitations of the methodologies used in the study are listed below.

1. The absence of previous detailed studies on the subject to serve as local reference and baseline information for purposes of comparison of methodologies and possible improvement, led to the use of several innovative methodologies.
2. Data from official sources e.g. CEPS on imports (the authorized organization for such information) was found to be doubtful in certain respects, based on the survey findings;
3. The survey was limited to the Accra-Tema area, which has rather unique socio-economic characteristics compared to the rest of the country, e.g. private and institutional consumer surveyed did not appear nationally representative, and in some cases sample spaces, e.g. schools and industry were very limited.
4. The methodology for extrapolation onto the national level made use of a lot of assumptions, correction or reduction factors and adjustments, which potentially could create margins of error.
5. The informal nature of the sector meant very inadequate documentation and ‘fabricated-responses’ from some interviewees, leading to reliance on expert judgment to arrive at most of the conclusions, especially the Massflow Assessment.

3.0 SYSTEM DEFINITION

3.1 Geographical Scope

Ghana is located in West Africa and borders Côte d'Ivoire to the west, Burkina Faso to the north, Togo to the east and the Gulf of Guinea to the south. The word Ghana means "Warrior King" and derives from the ancient Ghana Empire.

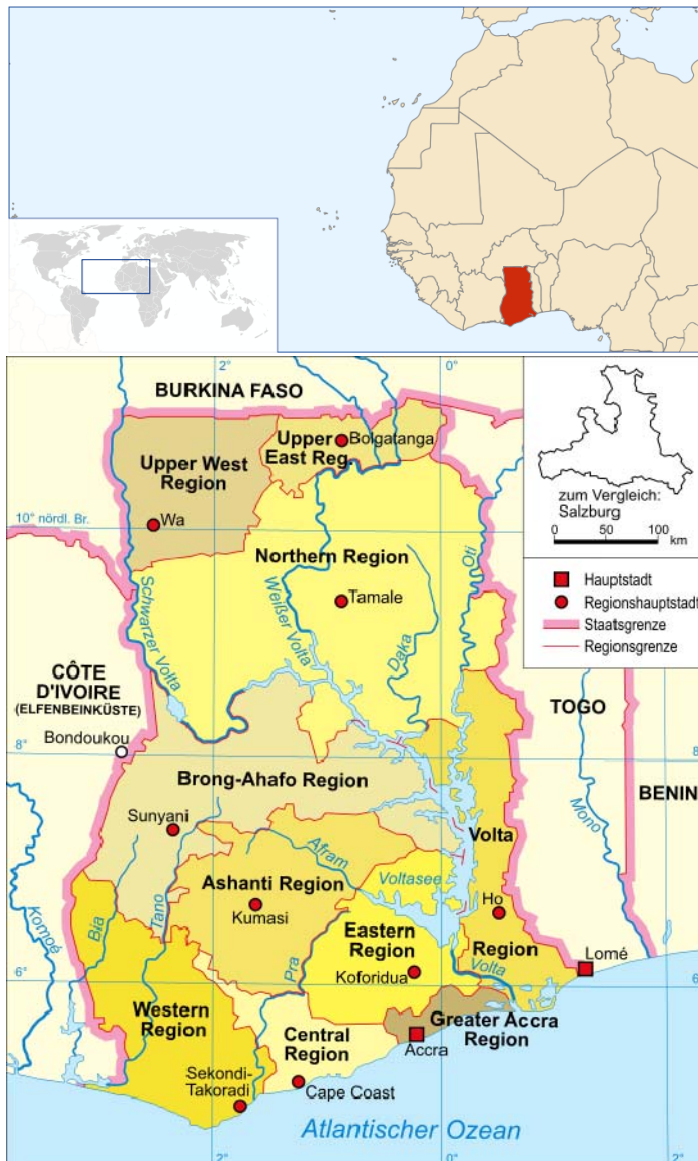

Figure 3.1 Ghana (Administrative Regions)

(Source: Wikipedia)

Ghana was inhabited in pre-colonial times by a number of predominantly Akan Kingdoms, including the Akwamu on the eastern coast, the inland Ashanti Empire and various Fante and non-Akan states, like the Ga and Ewe along the coast and inland. Trade with European states flourished after contact with the Portuguese in the 15th century, and the British established a Crown colony, Gold Coast, in 1874.

The Gold Coast achieved independence from the British in 1957, the first sub-Saharan African nation to do so. The name Ghana was chosen for the new nation to reflect the ancient Empire of Ghana, which once extended throughout much of West Africa. Ghana is a member of many international organizations including the Commonwealth of Nations, the Economic Community of West African States (ECOWAS), the African Union (AU), La Francophonie (Associate Member) and the United Nations (UN). Ghana is the second largest producer of cocoa in the world and is also home to Lake Volta, the largest artificial lake in the world.

Ghana is politically divided into 10 Regions; Eastern, Western, Central, Volta, Ashanti, Brong Ahafo, Northern, Upper East, Upper West and Greater Accra (Figure 3.1). The Greater Accra Region (Figure 3.2) comprises mainly of Accra (the national capital) and Tema (the industrial city) and their suburbs. Accra is the city in Ghana where the most modern and EEE-intensive lifestyle is lived. The seat of government administration and multinational companies as well as many companies in the service sector e.g. banks and insurances have national headquarters in the capital. Tema is the industrial city with an international container port. The Tema port is the main entry point of EEE importation and other goods to Accra and other parts of Ghana. The majority of EEE flows go through the Greater Accra area, where the most significant dumpsites for WEEE are also locate.



Figure 3.2 Accra, the national capital and Tema, the industrial city
 (Source: Google maps)

Of special interest for the study was the area of Agbogbloshie (Figure 3.3) where a large WEEE scrap yard is located; and noted for most of the informal WEEE recycling in Ghana.



Figure 3.3 Accra with the Location of Agbogbloshie Scrap Yard

(Source: Google maps)

3.2 Product Scope

The emphasis of the study was on all new and second hand EEE imported and used in the country by all sectors of the population. The product scope included the following categories and tracer products:

- 🚪 Large household appliances – refrigerators and air conditioners;
- 🚪 Small household appliances – iron and kettle;
- 🚪 Information and communication technologies – personal computers and mobile phones;
- 🚪 Consumer electronics – televisions, radio/HiFi.

3.3 Development Indicators

Development indicators outline the key characteristics of Ghana which are relevant to the study. The level of the country’s development has an influence on the WEEE generation and management. It also provides the basis for comparison with other countries on major indicators of WEEE characteristics, quantities and distribution. The latest available indicators were taken into account.

3.3.1 The People

According to World Development Indicators (WDI) and the African Development Indicators (ADI), Ghana's total population stood at 23.8 million as at the year 2009 (estimate) and the country had a total of 5.5 million households (GSS, 2008). Population density is 102.6 per km². The population growth rate averages 2.1% per annum. General unemployment rate in 2000 was at 10%, while youth unemployment rates were as high as 16%. Urban informal sector employment rates were however 56.5% (WDI, ADI, 2008). Average household sizes stand at 5 persons according to the Ghana Statistical Service. The country's population living below the national poverty line stands at 28.5% as at the year 2008, below \$1 a day 30% and below \$2 a day 54% (WDI, ADI, 2008).

3.3.2 The Environment

Ghana has a total land area of 227'540 km², a predominantly rural population of 49.98% and an urban population of 50.02%. The largest city is Accra, the capital city - has a population size of 2'119'279 inhabitants, while the country's population in urban agglomerations of more than one million stands at 3'764'401 inhabitants (WDI, ADI, 2008). With respect to energy use, the country's GDP per unit of energy use (PPP \$ per kg of oil equivalent) is \$3 (ADI, 2006). Total energy use (kg of oil equivalent per capita) stands at 424kg (ADI, 2006), while Ghana's electrification rate is 67% (SHEP, 2010). The recorded organic water pollutant (BOD) discharges are 15'418 kg per day (ADI, 2003).

3.3.3 The Economy

Ghana has a GDP of current USD 15'618'878'637 according to the World Development Indicators, 2009 while the calculated GDP per capita is USD 655. Based on a Purchasing Power Parity (PPP) conversion factor of 0.69 the GDP (PPP) per capita is USD 1'511 (WDI, 2009). The country has a relatively large labour force of 10.6 million (WDI, 2008), with 56% employed in the agricultural sector, 15% in industry and 29% in the service sector (CIA, 2005). The country's consumer price index (Year 2000 = 100) stands at 251.

3.3.4 State and Markets

In the areas of business and technology use, Ghana recorded a total number of 25'679 Micro, Small, and Medium-Scale Enterprises (WDI, 2004). According to the WDI and ADI, approximately 5.1% of Ghanaian households have a computer, 1.8% of households have access to the internet and 25.5% households have television sets. Out of 1000 Ghanaians, only 6 have fixed telephone lines, 5.8 have computers, 40 are internet users and 500 are mobile phone subscribers. Ghana's tax revenue as a percentage of GDP stands at 22%.

3.3.5 Summary

The Table 3.1 summarizes the most important indicators from the above.

Table 3.1 Summary of most important development indicators

Total population	23.8 million people
Number of households	5.5 million
Household size	5 persons
Population below international poverty line (Population below \$1 per day / population below \$2 per day)	30% / 54%
Electrification rate	65%
Land area	227'540 km ²
Rural population	50%
Urban population	50%
Population in urban agglomerations of more than 1 million	3.7 million people
Gross domestic product (GDP)	15.6 million current US\$
GDP per capita	655 current US\$
GDP (PPP) per capita	1'511 current international \$
Households with television	25%
Fixed telephone lines per 1000 people	6
Personal computers per 1000 people	5.8
Internet users per 1000 people	42
Mobile Phone subscribers per 1000 people	500

(Source: WDI, ADI, CIA)

4.0 POLICY AND LEGISLATION

4.1 WEEE Related Policies and Legislation

(a) The 1992 Constitution of the Republic of Ghana

The 1992 Constitution of Ghana provides the broad basis for the protection of the environment in general. The relevant sections are as follows:

- ✚ Economic Development - Article 36 (9): The State shall take appropriate measures needed to protect and safeguard the national environment for posterity; and shall seek co-operation with other states and bodies for the purposes of protecting the wider international environment for mankind.
- ✚ Economic Development - Article 36 (10): The State shall safeguard the health, safety and welfare of all persons in employment, and shall establish the basis for the full deployment of the creative potential of all Ghanaians.

Duties of a Citizen - Article 41 (k): The exercise and enjoyment of rights and freedoms is inseparable from the performance of duties and obligations, and accordingly, it shall be the duty of every citizen to protect and safeguard the environment.

(b) National Environmental Policy

The National Environmental Action Plan (NEAP), which incorporates the Environmental Policy of Ghana, was published in 1991. The aim of the environmental policy is to improve the surroundings, living conditions and the quality of life both of the present and future generations. The policy requires the State to take appropriate measures to control pollution and the importation and use of potentially toxic substances (which include EEE). The policy among others seeks to:

- ✚ Ensure sound management of natural resources and the environment against harmful impacts and destructive practices;
- ✚ Guide development in accordance with quality requirements to prevent, reduce, and as far as possible, eliminate pollution and nuisances;
- ✚ Integrate environmental considerations at all levels of development; and
- ✚ Seek common solutions to environmental problems in West Africa, Africa and the world at large.

The environmental policy provides broad framework for the control and management of potentially toxic substances, which include releases from uncontrolled management of Electrical and Electronic Wastes in Ghana.

(c) International and Multilateral Environmental Agreements

Ghana has ratified a number of chemical and waste related Multilateral Environmental Agreements (MEAs) and adopted a number of codes and international declarations including the following:

- ✚ The Basel Convention on the Control of Transboundary Movements of Hazardous Wastes and their Disposal;
- ✚ The Vienna Convention on Protection of the Ozone Layer;
- ✚ Montreal Protocol on Control of Substances that Deplete the Ozone Layer;
- ✚ The Rotterdam Convention on the Prior Informed Consent (PIC) Procedure of certain Hazardous Chemicals and Pesticides in International Trade;
- ✚ The Stockholm Convention on Persistent Organic Pollutants;

- ✚ ILO Convention on the Safety of Chemicals at the Workplace;
- ✚ London Amendment of the Montreal Protocol on Substances that Deplete the Ozone Layer;
- ✚ The Johannesburg Plan of Implementation on Environment and Development;
- ✚ The Rio Declaration on Environment and Development - Agenda 21; and
- ✚ The Strategic Approach to International Chemicals Management (SAICM).

Ghana's effort towards the sound management of hazardous substances and wastes has been growing steadily following the UN Conference on Environment and Development in Rio de Janeiro, Brazil, in 1992. Preventing harm to human health and the environment from inputs, products, or wastes containing harmful substances, or that lead to the formation of harmful substances, is an important element of achieving the 2020 goal of the Strategic Approach to International Chemicals Management (SAICM). Electrical and Electronic Wastes (WEEE or e-waste) was nominated as an emerging policy issue at the Second Session of the International Conference on Chemicals Management (ICCM-2) indicating that the fate and sound management of chemicals during the life cycle of electrical and electronic equipment and products constitute important elements of the Strategic Approach to International Chemicals Management (SAICM).

Ghana agreed to the Nairobi Ministerial Declaration on the environmentally sound management of electronic and electrical waste on the occasion of the Eighth meeting of the Conference of the Parties to the Basel Convention and in particular the World forum on e-Waste, which called, inter alia for the promotion of clean technology and green design for EEE, including the phase-out of hazardous substances used in production and included in components and the promotion of product stewardship and extended producers responsibilities in the life-cycle management of electronic and electrical products;

Ghana also shares the views as expressed in the Abuja Platform on e-Waste created during the International Conference on e-Waste Control held in Abuja, Nigeria 20-21 July 2009 regarding the special needs of African countries, including the domestication of the Basel Convention into national laws, the operationalization of the Bamako Convention by the African Union and the African Ministerial Conference on Environment (AMCEN) and to address this issue as one of the strongest emerging environmental issues in Africa.

Ghana appreciates the on-going Secretariat of Basel Convention E-waste Africa Project funded by the European Union (EU), the United Kingdom, Norway and NVMP - the Dutch Recyclers Organization; with the goal of building local capacity to address the flow of e-wastes and electrical and electronic products destined for reuse in selected African countries and augment the sustainable management of resources through the recovery of materials

4.2 Specific WEEE Management Legislation

There are a number of laws and regulations that have some relevance to the control and management of hazardous wastes (including WEEE), but they do not address the dangers posed to humans and the environment from such wastes. The existing law in Ghana that is closely related to WEEE is the Environmental Protection Agency Act, 1994 (Act 490), which established the Environmental Protection Agency, with the mandate to regulate, coordinate and manage the environment. Section 2 of the Act requires the EPA to, among others:

- ✚ Prescribe standards and guidelines relating to the pollution and the discharge of toxic wastes and control of toxic substances;
- ✚ Coordinate activities and control the generation, treatment, storage, transportation and disposal of industrial wastes; and

- ✚ Control the volumes, types, constituents and effects of waste discharges, emissions, deposits or other sources of pollutants and/or substances which are hazardous or potentially dangerous to the quality of life, human health and the environment

Section 10 of the Act establishes the Hazardous Chemicals Committee required to monitor the use of hazardous chemicals by collecting information on the importation, exportation, manufacture, distribution, sale, use and disposal of such chemicals, etc. Although this Act does not make specific reference to WEEE, it provides a framework for the management of hazardous substances. Other related laws in the country with some relevance to WEEE control and management include:

- ✚ The Factories, Offices and Shops Act, 1970 (Act 328) - which seeks to protect the health and safety of workers from the dangers posed by chemicals to employees in the working environment;
- ✚ The Standards Act, 1973 (NRCD 173);
- ✚ The Draft Policy and Bill on Occupational Safety and Health, 2000 - which seeks that measures are instituted to ensure the attainment of optimum health for workers in all occupations in Ghana;
- ✚ The Mercury Act, 1989;
- ✚ Merchant Shipping (Dangerous Goods) Rules, 1974 (LI 971);
- ✚ Customs, Excise and Preventive Service Law, 1992 (PNDCL 330);
- ✚ Local Government Act, 1992 (Act 458);
- ✚ Export and Import Act, 1995 (Act 528); and
- ✚ Environmental Assessment Regulations, 1999 (LI 1652)

On new specific regulation with relevance to EEE and WEEE are the LI 1932 Energy Efficiency (Prohibition of Manufacture, Sale or Importation of Incandescent Filament Lamp, Used Refrigerator, Used Refrigerator-Freezer, Used Freezer and Used Air-Conditioner) Regulations, 2008. They prohibit the importation as well as the sale and distribution of used refrigerators, freezers and air-conditioners. Despite these regulations, there is currently no enforcement.

4.3 Institutional Framework

The institutional framework for the control and management of WEEE in Ghana is provided for by Section 10 of the Environmental Protection Agency Act, 1994 (Act 490), which established the multi-stakeholder Hazardous Chemicals Committee (HCC) – for the management/disposal or destruction of unwanted or obsolete hazardous wastes (Degraded, damaged, expired, and obsolete or otherwise unwanted chemical substances and products including WEEE). The Committee comprises representatives of the following agencies:

- ✚ Environmental Protection Agency (Chair);
- ✚ Ministry of Environment, Science and Technology;
- ✚ Ministry of Trade;
- ✚ Ghana Cocoa Board;
- ✚ Ministry of Health/Ghana Health Services;
- ✚ Ministry of Local Government and Rural Development;
- ✚ Crops Services Directorate of the Ministry of Food and Agriculture (MoFA);
- ✚ Plant Protection and Regulatory Services Directorate of MoFA;

- ✚ Veterinary Services Directorate of MoFA;
- ✚ Ghana Standards Board;
- ✚ Ghana Atomic Energy Commission;
- ✚ Industrial Research Institute (CSIR-IRI)
- ✚ Customs, Excise and Preventive Service;
- ✚ Food and Drugs Board;
- ✚ Universities and Research Institutions;
- ✚ Chemical Society of Ghana; and
- ✚ Environmental Non-Governmental Organisations (NGOs).

The Chemicals Control and Management Centre (CCMC) of the EPA provides secretariat for the Hazardous Chemicals Committee and collects information on all chemicals (industrial chemicals and agrochemicals) imported into the country. The processing of applications for importation of chemicals is supported by documents such as the Material Safety Data Sheets or Technical Dossiers, which provide technical information on the chemicals. The documents may also suggest disposal options of such chemicals as well as information on their toxicity.

The disposal of obsolete or unwanted hazardous chemicals or wastes poses a great challenge for regulatory authorities in Ghana. The disposal of municipal and some types of chemical wastes are essentially carried out at landfill sites, which are not engineered. Incinerators for the disposal of some hazardous wastes are not available in Ghana. The improper disposal of chemical wastes into the environment may also result in long-term exposure of the population to pollutants that cause adverse health effects.

Any organization or individual wishing to dispose of unwanted materials (industrial, commercial or chemical wastes including WEEE) applies to the EPA for both advice and permission. The application is accompanied by the following:

- ✚ A list stating the type(s) of substance(s), their quantities and origin of importation or manufacture;
- ✚ Material Safety Data Sheet (MSDs) or Technical Dossier or Label covering each substance or materials as appropriate;
- ✚ Description of the storage facility where the unwanted substances are stored etc.

Inspectors of the EPA then visit the premises to:

- ✚ Conduct visual inspection of the material to be disposed of to ascertain declared quantity, form, location and packaging;
- ✚ Collect samples of materials for analysis (if necessary); and
- ✚ Request owner of material to provide such additional information as may be necessary for the proper classification of materials.

Based on the available information covering the materials/substances; analysis results and inputs from experts, the inspection team recommends the appropriate mode of disposal/destruction or other measures such as repackaging and safe storage. The nature and characteristics of the wastes determines the suitable handling, destruction and disposal options taking into consideration all existing environmental and legal requirements. The EPA also collaborates with a number of institutions in the destruction and disposal of unwanted materials. Such institutions include Ghana Standards Board, Food and Drugs Board, Municipal and District Waste Management Departments, etc.

5.0 IMPORTS OF (W)EEE

5.1 Overview of Stakeholders

EEE is imported into Ghana from European and North American countries (Figure 5.1), though there is an insignificant local assembly of such equipment. There is a new trend where brand new EEE is also imported from Asia, mainly China and UAE (Dubai). Importers of EEE and retailers who sell directly to consumers are considered as one stakeholder, because many importers also sell their goods directly to consumers.

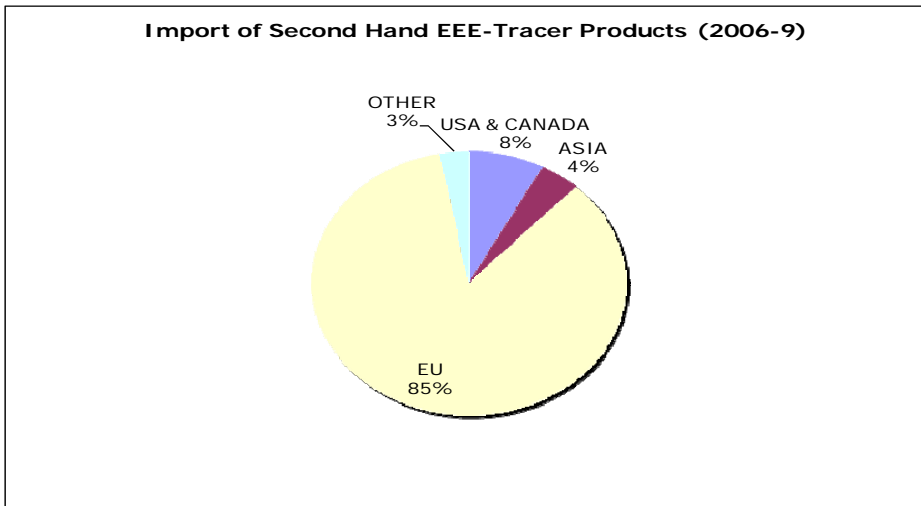

Figure 5.1 Import of Second Hand EEE- Tracer Products (2006-2009)
(Source: CEPS)

There are basically two (2) types of importers in the country; formal business importers and small scale or informal importers. Importers of second hand goods also have repair and refurbishment capacities to handle damaged or outdated equipment. Some importers/retailers use their refurbishment capacities also for promotions (e.g. Setmat Computers and Hanbee Plaza). Customers can bring in old EEE for replacement of non-functioning or outdated parts. Importers/retailers sell EEE and accessories in shops or on the street directly to the general public. It is estimated that there are currently more than 300 importers and distributors of EEE in the country. Most of them are minor dealers and handle only a few hundreds of EEE per year. Some of the major importers/distributors (involved in the survey) are listed below:

- | | |
|--------------------------|---------------------------|
| Adminsco Gh Limited | Aftech Limited |
| Akosah Enterprise | Compu Ghana |
| Coscharis Ghana Limited | Deon 2000 |
| Geoder Ventures | Hanbee Plaza Limited |
| Kwame Matthew Enterprise | Melcom Ghana Limited |
| Mobile Phone People | Next Computers Limited |
| PC Direct | Printcom Resources |
| Qabass Computers | Rainbow Computers Limited |
| Setmat Import & Export | Somovision |
| Tick Tock Ventures | Tomredicta Enterprise |
| Town and City Phones | Zayaa Phones |

There is no association of importers as is the case for repairers or scrap dealers in Ghana.

5.2 Formal Business Importers and Distributors

Formal business importers and distributors are those whose main business is to import on a regular basis. Such importers normally have registered companies and tend to specialize in specific products such as fridges, TVs, PCs, cookers, microwaves, etc.

5.2.1 Import Procedure

The large/formal importers buy directly from the manufacturers of brand new items and also from various sources for second hand EEE e.g. the USA army, federal institutions, private companies as well as locations in Europe; while some are obtained from auction sale. Some of the second hand EEE from countries such as The Netherlands, Germany, UK, Belgium, USA and Canada are tested and arrive with a seal indicating they respond to power.

5.2.2 Quality of Goods

Varying account on the quality of the imported second hand EEE was obtained. The common position however, was that not all goods cost the same as some were in better condition than others, but there is no formal system of grading for the EEE purchased. Estimates from the recorded accounts indicated the following:

- ✚ About 70% of the imports arrive in a working condition;
- ✚ About 20% can be serviced (repaired/refurbished) to get them functioning;
- ✚ About 10% do not function.

The 20% that still can be repaired or refurbished are often old and near at end-of-life devices with lifespans of less than two years. Some of the non-functional 10% is kept in storage and used as spare parts to service other imported EEE. The amounts of waste EEE on the premises of some of the importers and the quantities that find their way to the dump sites, however, create a contrary impression from the figures given above. The percentage of imported EEE that respond to power could be far less than 70%.

5.2.3 Sale Locations

The major importers listed in Section 5.1 are well organized with managed premises and shops/offices managers. Sales of EEE take place in the shops/offices which employ a sizeable number of people. The small scale wayside importers however, make up the majority of the number, although their share of the imports does not necessarily correspond to their numbers. Most of such importers operate from 'containers' (the container used in shipping the items) or kiosks. Most of the businesses are not formally registered and continuity of business is linked to frequency imports. Employees of such importers include the owner/importer and a relative to help in the shop who only takes over when the owner is out for other businesses.

5.2.4 Marketing Strategies

Importers and distributors rely a lot on both the electronic and print media for advertisements on stock and prices. Radio advertisements, flyers, billboards and banners are also used, especially in the business districts of the city.

Patrons of EEE may receive discounts and promotional items such as free pen-drives, set of CD/DVDs or speaker systems for purchases. The distributors of brand new EEE go a step further to conduct raffles which present customers with the opportunity to win ‘fantastic’ prizes. The prizes are most of the time other EEE of lower value in terms of price.

A major importer/distributor like SETMAT Computers has a special scheme whereby customers can trade in their lower grade EEE for a higher/newer version and pay the difference. With respect to Corporate Social Responsibility (CSR), the very large importers/distributors usually support social events, donate to schools or orphanages. Others support radio news broadcast in the local languages for the benefit of the illiterate population. They believe that through such initiatives, they are able to give back to society.

5.3 Small Scale/Informal Importers and Distributors

The second category of importers is mainly people resident in a foreign country who bring a container or two of EEE once in a while. Some become one-time importers, while others wait till they are visiting Ghana again before importing another set of EEE for sale. They do not have any designated business address. In the instance where they do, their shops may either be empty or they may sell other products when the imported EEE is sold out.



Figure 5.2 Small Scale/Informal Importers and Distributors

5.3.1 Import Procedure

The procedure for exporting EEE varies from country to country, but the process is similar for countries such as Germany, UK, The Netherlands, USA, etc. There are state registered companies that sell slightly used, store reject, and sometimes out of use EEE (this could be due to a company replacing some EEE stocks). The Ghanaian businessmen/exporters go to such places and order the types of goods they are interested in. A deposit is made and after a waiting period of between 2 – 4 weeks, the goods are ready. The exporters carry out an inspection of the goods, pack and ship them to Ghana. An importer may follow up to Ghana and stay until the goods are sold or has a relative that attends to the business on his or her behalf.

The importer may normally be domiciled in the country of export and may take months to organize for another shipment. A number of the importers may come together to engage in what is described as ‘house-to-house’ and share the cost of a container as well as the freight.

Another category of informal business involves the purchase of untested EEE (because there is no means of testing) from some importers at the port. Such goods cost only half the price of a tested and working one. After servicing and/or repairs, more than 80% (survey) of the goods will be in a sellable condition. Most dealers who sell along the road in Tema typically fall in this category.

5.3.2 Quality of Goods

The quality of imported EEE purchased at the port is usually of lower quality than those tested in the country export before shipment. Most of the small scale importers do not have formally registered business names. It was estimated as follows:

- ✚ About 60% of the imports arrive in a working condition;
- ✚ About 20% can be serviced (repaired/refurbished) to get them functioning;
- ✚ About 20% do not function and go as waste.

The price of equipment that looks relatively new will be more expensive than those that may not look appealing. Newer models also are more expensive as compared to older ones. Again, the 20% that still can be repaired or refurbished are often old and near at end-of-life devices with lifespans of less than two years. Some of the non-functional 20% is kept in storage and used as spare parts to service other imported EEE.

5.3.3 Sale Locations

Sellers of such EEE can be found in any part of the city, usually by the road side. The informal nature of the business is a telltale sign of where or what the source is.

5.3.4 Marketing Strategies

The marketing strategy is principally the display of the goods in the shop and in stands by the road side. Consumers sometimes buy the goods untested (e.g. irons, mobile phones, or even television sets) even from such dealers.

5.4 Private Imports

A substantial import constituting about 10% of all EEE is done by private individuals, which is usually not captured by the Customs Excise and Preventive Service (CEPS). This is done by individual travellers into the country; both foreign and locals nationals. Small sized EEE such as mobile phones, digital cameras, Ipods/Ipads, laptops, DVD players, MP3s, game consoles, etc. are easily carried on one's body and luggage, thereby evading customs clearance and import data captured. Foreigners visiting the country sometimes leave or sell such EEE to their local hosts or friends. Information from the Ghana Immigration Service indicates that for the year 2009, a total of 500,000 people entered the country through the national airport, 350,000 of who were Ghanaians and the rest other nationals.

Mobile phones are also brought in larger quantities by semi-professional importers. Therefore, the factor for mobile phones was increased to 50%. In total, about 1'300 tons of EEE arrives in the country via this import flow (Table 5.1).

Table 5.1 Private Imports in Units and Tons (2009)

People arriving in Ghana: 525'000			
	Factor	Number of Units	Tons
Laptop	10%	52'500	184
Mobile Phones	50%	262'500	131
Camera	10%	52'500	37
Dvd Player	10%	52'500	263
Game Consol	10%	52'500	630
MP3 Player	10%	52'500	11
Total			1'255

5.5 Donations

There is no import duty paid on computers and accessories. It is a policy decision by the government to ensure that such EEE are made accessible to Ghanaians to help improve the computer literacy rate. Therefore importers only pay Value Added Tax (VAT) and other levies. An importer who is able to prove (by letter from the Ministry of Finance) that the computers and accessories are meant for donation or charity is even exempted from paying VAT. Example of organizations that have taken advantage of the facility includes the Catholic Relief Organization and a few other NGOs.

A suspicion that some private importers under the guise of charity donation could receive EEE from companies/organizations in Europe and North America only to sell them in the country, could not be proven or estimated. A few companies/institutions in Ghana also donate EEE charity to hospitals, schools, etc. Such donations may be new, but more often are old EEE discarded when the organizations change over to more modern equipment.

5.6 Statistical Data

Two types of data were obtained on EEE importation. These were from CEPS and UN Comtrade sources (UN Comtrade 2010)

5.6.1 CEPS

Data from CEPS on the import of new EEE (all products) was obtained for the period 2006 to 2009. The records indicate that for the 4-year period, a total of 3'763'100 units of EEE were imported. The study (survey/interviews conducted), however, showed a higher figure than that provided by CEPS. The CEPS has the singular mandate of registering and receiving customs duty on all EEE (new and used) imported into the country. The registration is done at all the entry points to the country, including sea, air and land ports.

Each importer has to fill out a declaration which serves as the basis for calculating the duty that has to be paid. It was noted that the CEPS processes could possibly be fraught with under declaration or wrongful declaration of imported EEE to reduce duty. There is however, provision for officials of CEPS to cross-check declarations with a database containing information on the shipping manifests, where the accuracy of a declaration was in doubt. Cross-checking however, was rarely done, perhaps, because of inadequate staff. The data obtained (Table 5.2) was therefore considered less accurate in some respects, especially for air conditioners and mobile phones. It was not possible to obtain data directly from the shipping manifest database.

Table 5.2 CEPS Import Data on New and Second Hand EEE (units, 2006-2009)

EEE	2006	2007	2008	2009
Refrigerators	240'000	307'000	340'000	249'000
Air conditioners	2'100	3'400	500	300
Irons	2'400	37'000	32'000	30'000
Kettles	8'400	11'000	23'000	23'000
PCs/Laptops	187'000	125'000	23'000	151'000
Mobile phones	61'000	860'000	175'000	34'000
Television sets	89'000	153'000	139'000	181'000
Stereos/Radios	52'000	79'000	76'000	69'000

The results of the household survey indicated clearly, that the number of air conditioners provided in the CEPS data does not reflect the real level of imports. For mobile phones, about 5.7 million become obsolete every year and need to be replaced through imports, making the CEPS figure a gross under-statement. In this case, the private import is probably also underestimated.

Figure 5.2 shows the trend of imports over the years, based on the CEPS data. It shows strong fluctuations and no clear trend. The data from UN Comtrade (Table 5.4) suggests that these fluctuations come from different declaration practices over the years, because they display a clear trend.

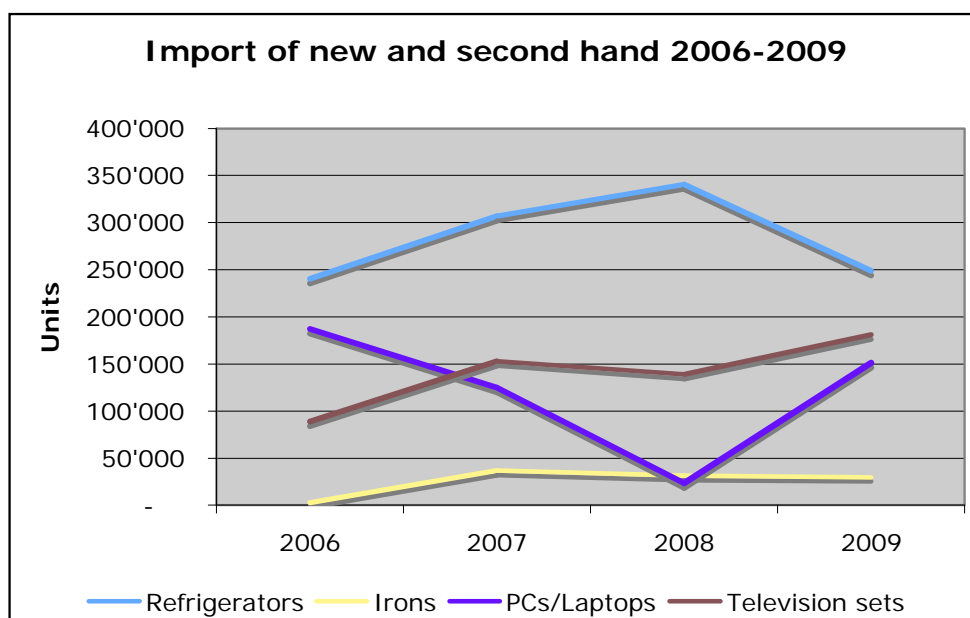

Figure 5.3 Import of New and Second Hand EEE for Selected Tracer Products

Table 5.3 shows the imports of new products as a percentage of the total number of units arriving in Ghana according to the CEPS data as well as the corresponding strong fluctuations over the years. These fluctuations are probably also strongly connected to an inconsistent or wrongful declaration and it is assumed that the true numbers are higher than the ones provided. Data from the household survey indicated a share of over 40% of new equipment in their installed base, however, it is not possible to infer directly from the installed base to imports. Considering both the household survey and the CEPS data, it was estimated that new EEE account for 30% of all EEE imported.

Table 5.3 New Imports in % Share of total Imports for Selected Tracer Products

	2006	2007	2008	2009	Average
Refrigerators	21%	2%	1%	1%	6%
PCs/Laptops	41%	11%	N/A	17%	23%
Television sets	17%	33%	14%	5%	17%
Stereos/Radios	3%	10%	7%	0%	5%

5.6.2 UN Comtrade

The UN Comtrade data base is the International Merchandise Trade Statistics with data reported by the countries to the United Nations Statistic Division. Table 5.4 gives the import numbers in units per year for four tracer products that were clearly identifiable in the database. The numbers for the year 2005 are strongly outside of the trend and are marked in the database as 'in doubt'.

Table 5.4 New and Second Hand Imports into Ghana (units/ year)

	2003	2004	2005*	2006	2007	2008
Refrigerators	330'000	535'000	N/A	427'000	567'000	757'000
Air Conditioners	152'000	246'000	N/A	250'000	541'000	708'000
PCs/Laptops	209'000	275'000	N/A	377'000	487'000	757'000
Televisions	324'000	420'000	N/A	587'000	720'000	627'000

Source: UN Comtrade, *2005: no data available

Figure 5.4 shows the development of the import of the four tracer products over the years in tons per year. The trend shows a clear growth of the import of these tracer products.

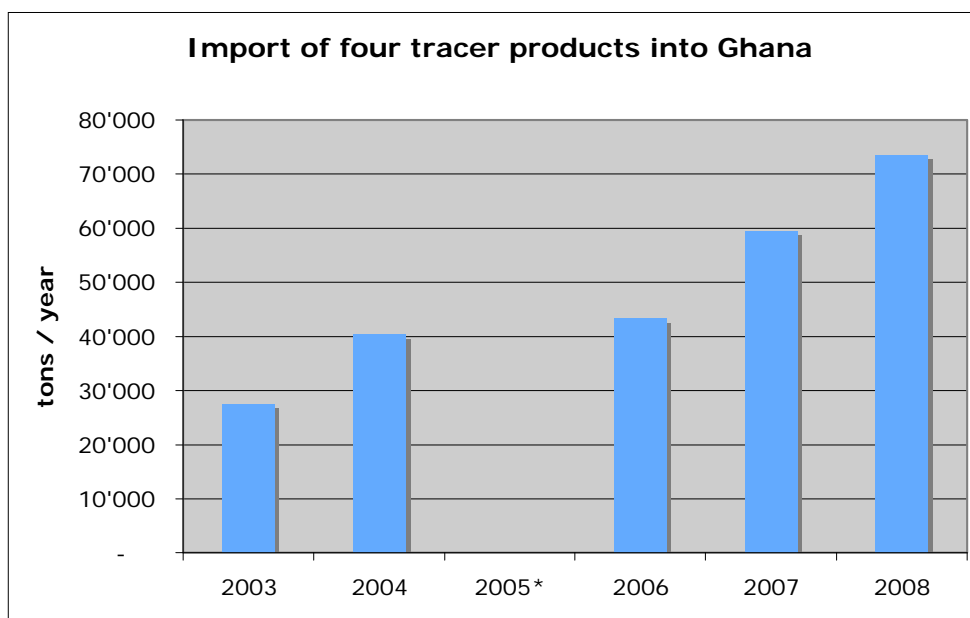

Figure 5.4 Import of New and Second Hand tracer products into Ghana (tons/ year)
 (Source: UN Comtrade. Tracer products: Refrigerator, Air Conditioner, Computer, Television.
 *2005: no data available)

UN Comtrade offers also structural indicators on the consistency of the data. One indicator analyses the discrepancy between imports reported by Ghana and exports to Ghana reported by exporting countries. This indicator is based on the values of the good reported by the two parties. The discrepancy for the four products and the different years is mostly rated high. Ghana declares many times higher values imported than other countries report their exports. Reasons could be that Ghana does not report correctly their imports or that exporting countries often do not report their exports to Ghana, due to the small volumes exported to Ghana. We therefore conclude that also these figures have to be taken as guiding numbers and not precise quantification of imports.

The four tracer products add up to 43.5% of the installed base. This ratio was also taken to extrapolate for the import of all EEE into Ghana as displayed in Table 5.5.

Table 5.5 All of EEE imported into Ghana (tons/ year)

	2003	2004	2005*	2006	2007	2008
All of EEE imported	63'000	93'000	N/A	100'000	137'000	169'000

The following graphs show the imports of the four tracer products air conditioners, computers, refrigerators and freezers as well as television into Ghana according to UN Comtrade data. They display the total quantity as well as the quantities imported from the four (4) main supplying markets. In addition, of each of the four products imported by Ghana, a map of supplying markets is shown.

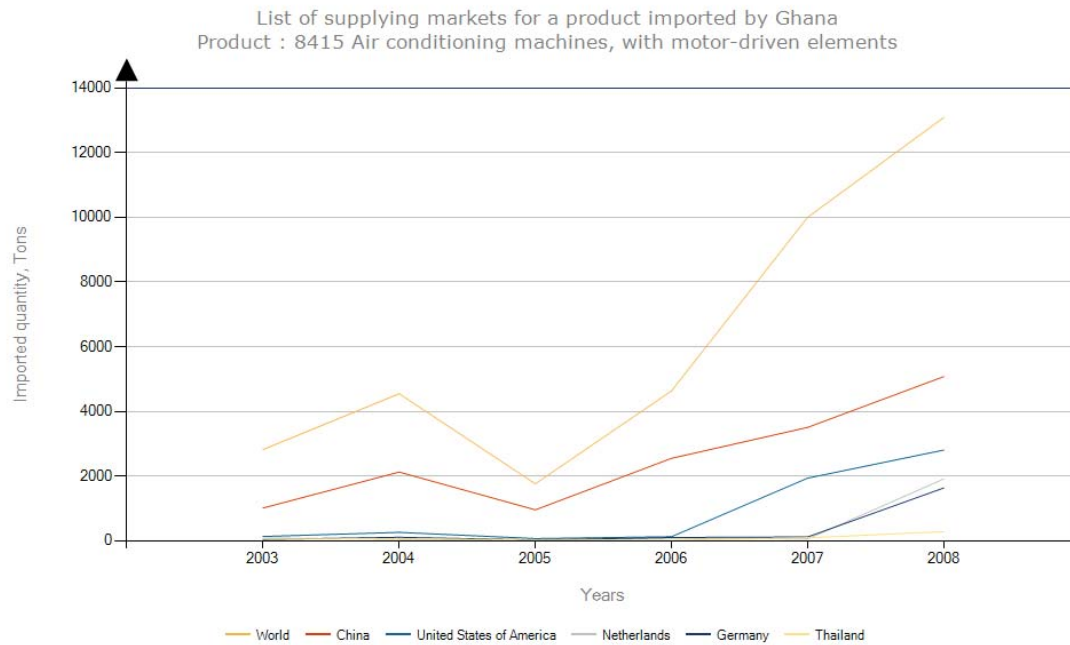

Figure 5.5 Import of air conditioners from 2003 to 2008 into Ghana

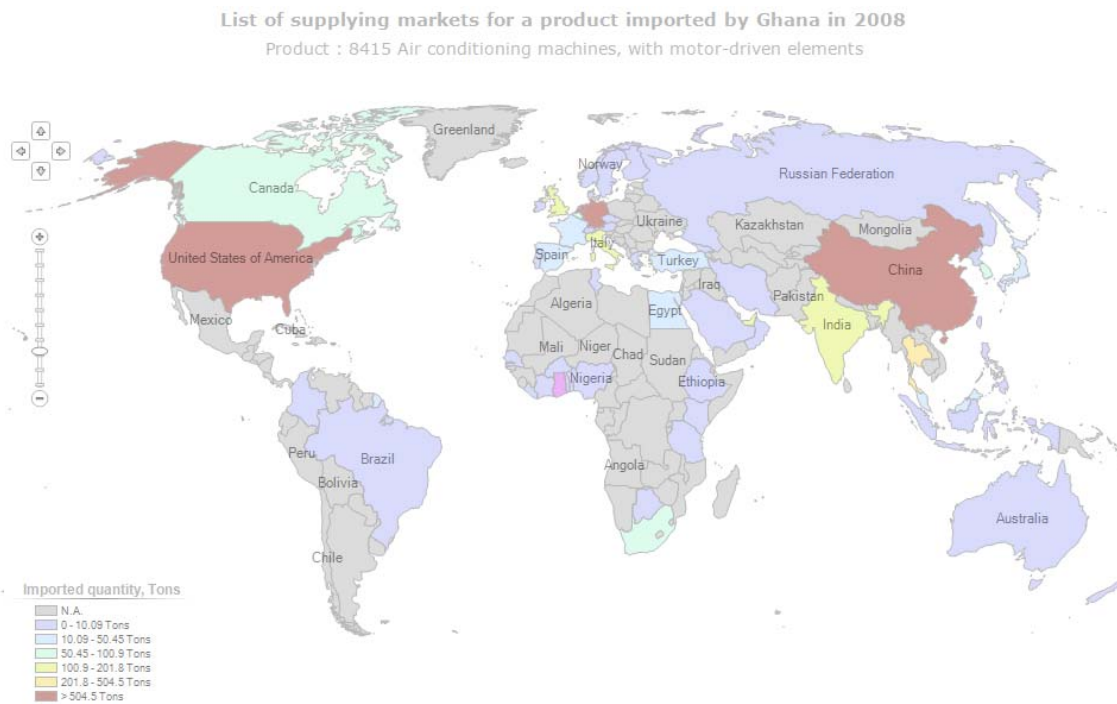

Figure 5.6 Map of Supplying Markets of Air Conditioners Imported by Ghana

List of supplying markets for a product imported by Ghana
 Product : 8471 Automatic data processing machines;optical reader, etc

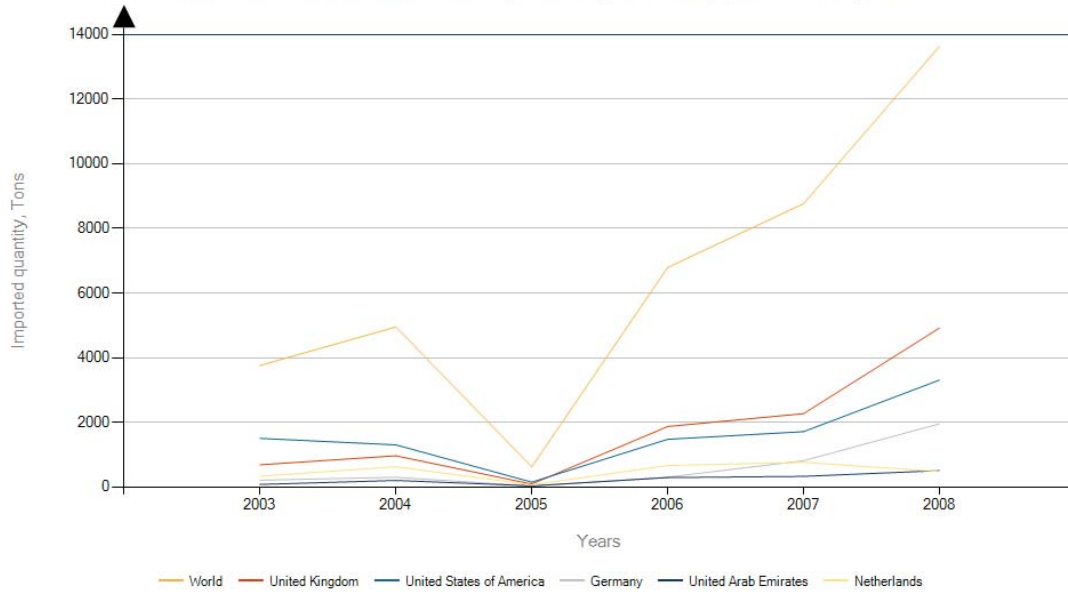

Figure 5.7 Import of computer from 2003 to 2008 into Ghana

List of supplying markets for a product imported by Ghana in 2008
 Product : 8471 Automatic data processing machines;optical reader, etc

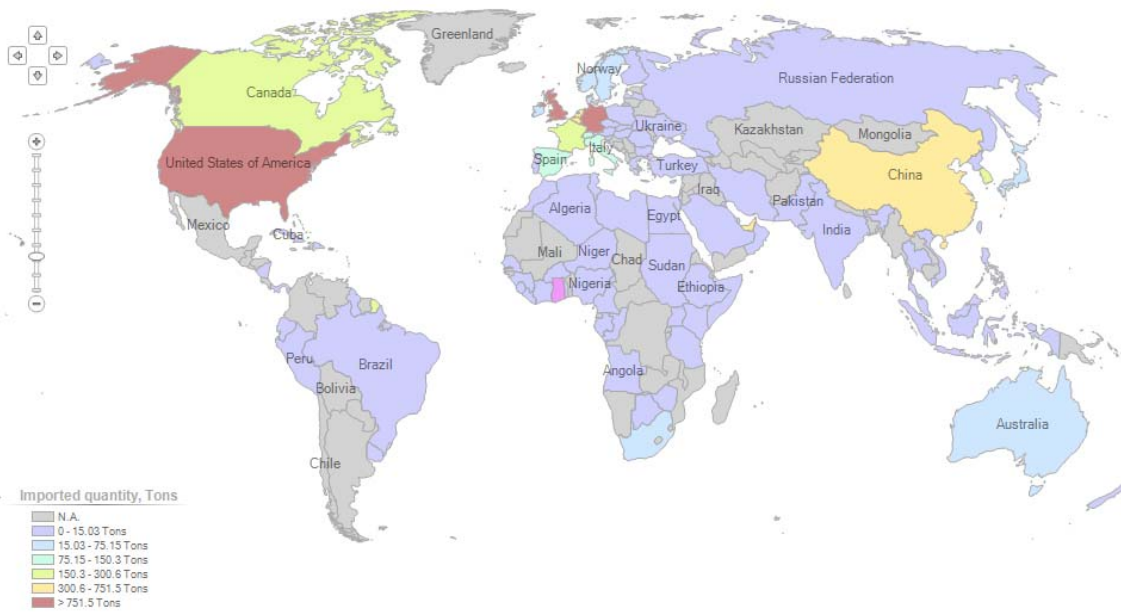

Figure 5.8 Map of supplying markets of computer imported by Ghana

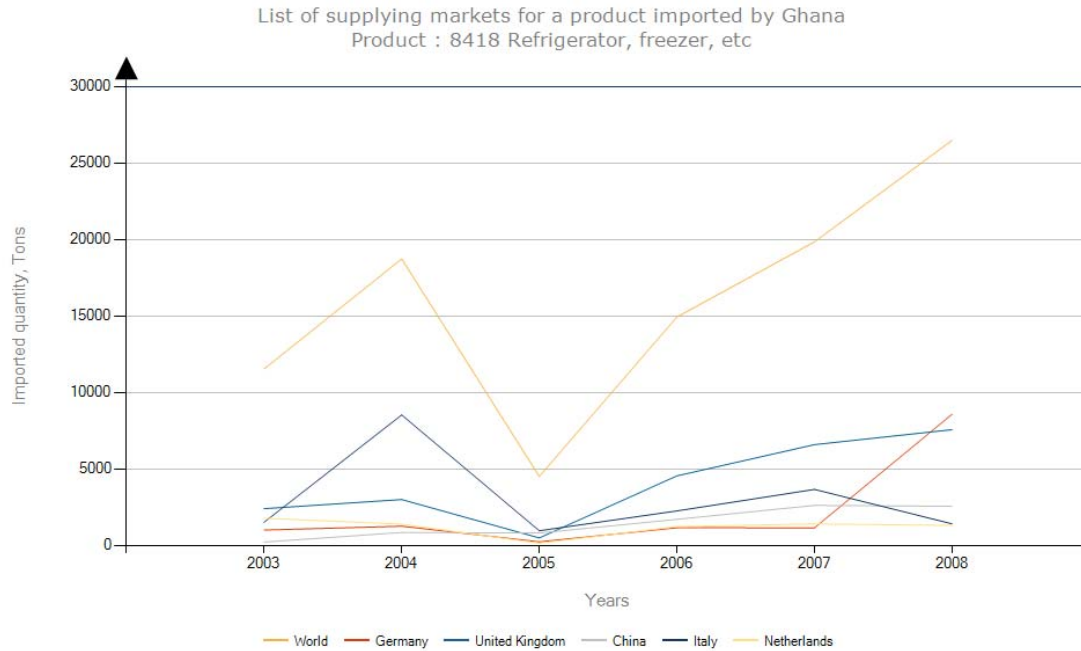

Figure 5.9 Import of refrigerators and freezers from 2003 to 2008 into Ghana

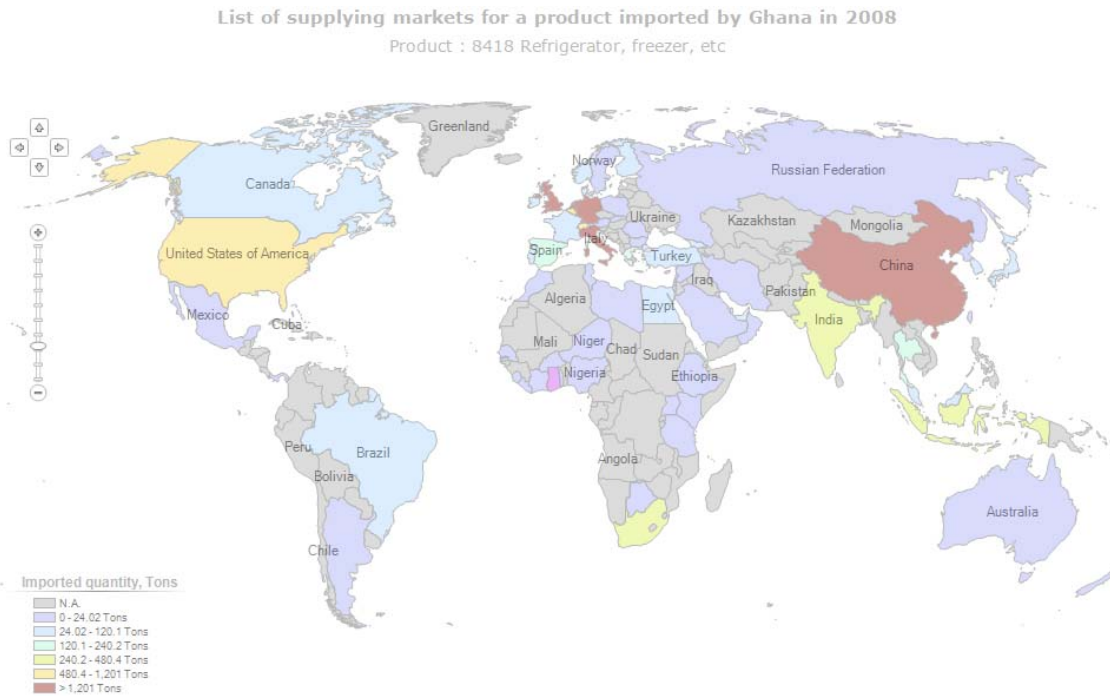

Figure 5.10 Map of supplying markets of refrigerators and freezers imported by Ghana

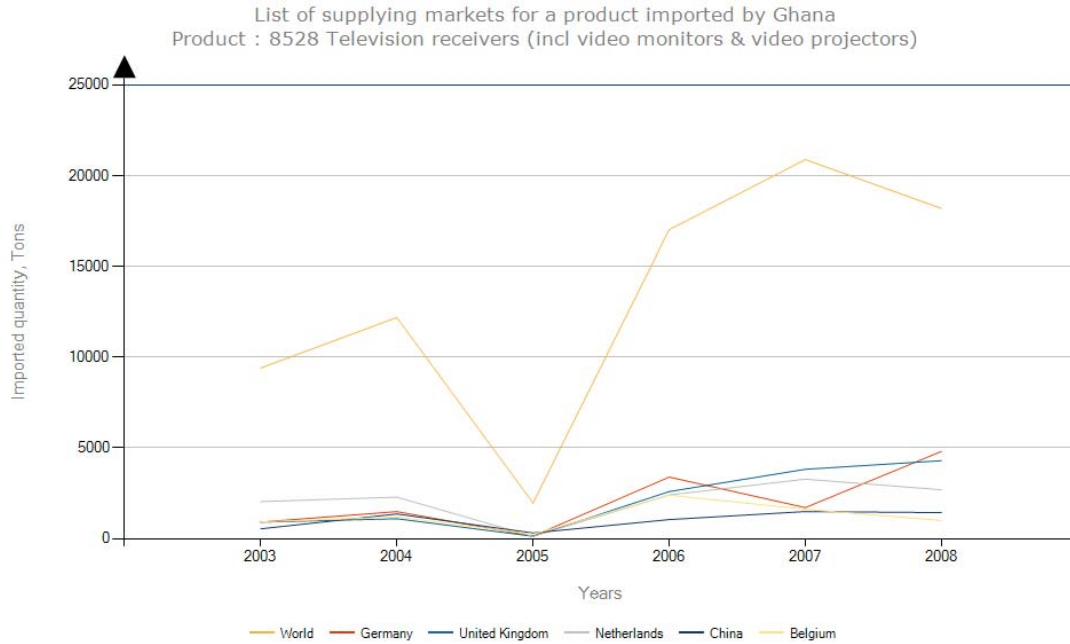

Figure 5.11 Import of televisions from 2003 to 2008 into Ghana

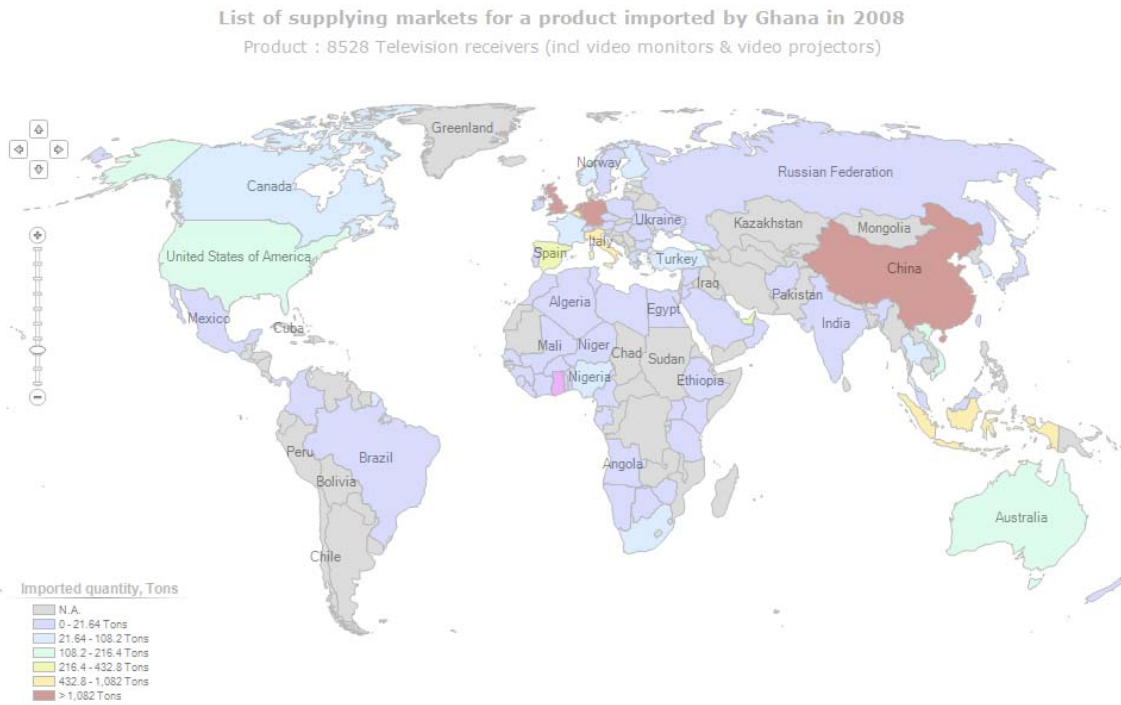

Figure 5.12 Map of supplying markets of televisions imported by Ghana

6.0 STAKEHOLDER ASSESSMENT

6.1 Stakeholder Overview

The stakeholder assessment analysed the various stakeholders involved in the importation, distribution and consumption of EEE and the handling of WEEE. Figure 6.1 gives an overview of how these stakeholders and the massflows they generate are interlinked. Information on Government as a stakeholder is provided in chapter 4 (Policy and Legislation). Importers and retailers are covered in detail in chapter 5 (Imports of (W)EEE).

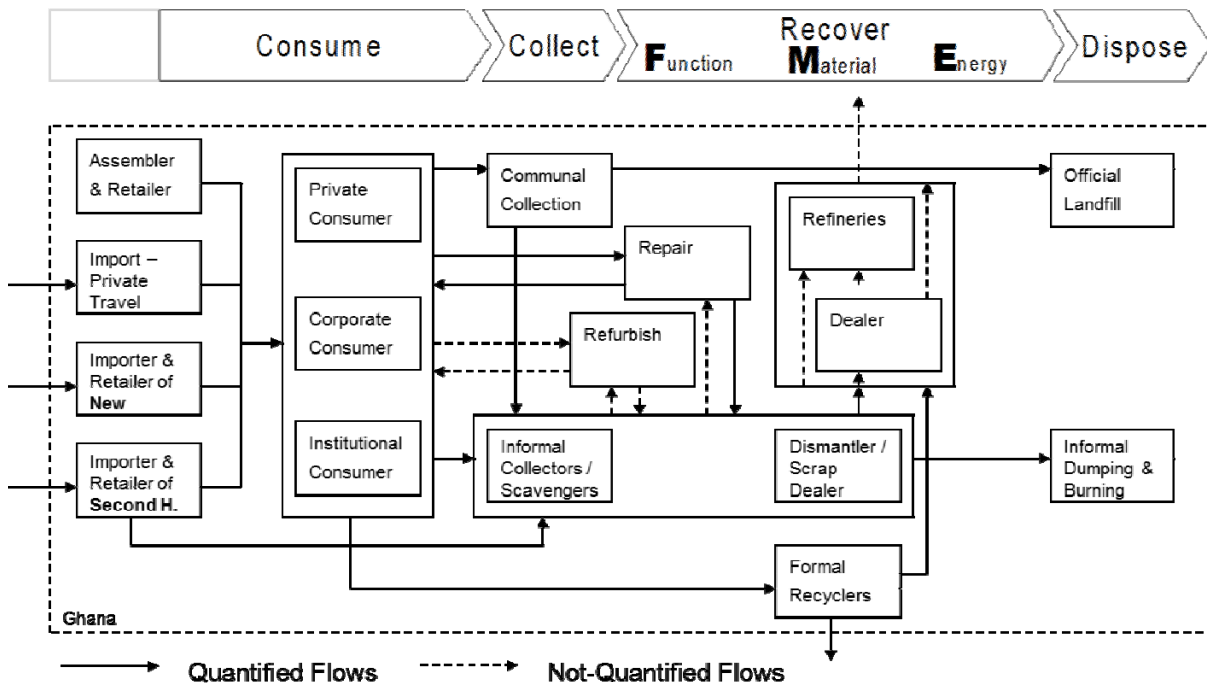

Figure 6.1 An Overview of the Assessed Stakeholders

6.2 Assemblers

Assemblers import parts of EEE and assemble them to fully functioning devices.

The following assemblers were identified:

- 🚧 Omatek Computers Ghana Limited
- 🚧 Zapto Ghana Limited
- 🚧 Topical Business Solutions

There is currently no manufacturer of EEE operating in the country but assembling of EEE, though not on a major scale, is happening in Ghana. The major assembler is Omatek Computers, producing personal computers, laptops, stereo systems and LCD TVs. It has a production capacity of 350 units per day but averages 150 units per day. The company was registered in 2007 but actual production operations started in 2008. The management admits that there are peak seasons when they have to operate a double shift to keep up with the demand and there are low seasons as well when they are not even able to achieve the 150 units of EEE per

day. Table 6.1 shows the breakdown of Omateks production. Some experiments were made with exporting computers to Togo, but were stopped because of the need of French keyboards.

Table 6.1 Domestic Assembling of EEE (units)

EEE	Year	
	2008	2009
PCs/Laptops	36'000	36'000
Television sets	1'200	1'800
Stereos/Radios	2'500	3'200
Total	39'700	41'000

Zapto Limited which is engaged in the production of computers, hi-fi systems and televisions, and Topical Business Solutions have been involved in assembling since May 2010. It can be said that the assembling of EEE in Ghana is just starting and so far there is none or no substantial export of Ghana-assembled EEE.

6.3 Consumers of EEE

Consumers are the general public and any organization that uses EEE and discards (or stores) it as waste once it has reached the end of its useful life. For the study, three types of consumers were differentiated:

- ✚ **Private Consumers** (households);
- ✚ **Corporate Consumers** (service and industrial sectors); and
- ✚ **Institutional Consumers** (government, health and educational sectors)

6.3.1 Consumer Structure

Private Consumer

There are 23.8 million habitants in 5.5 million households in Ghana. Table 6.2 shows the breakdown into urban, medium urban and rural households, as well as their income level.

Table 6.2 Breakdown of Households into Income Groups (GSS, 2008)

Income (GHC)		Urban	Medium Urban	Rural	Total
100-999	= 1 st & 2 nd Quintile	2%	14%	12%	28%
Average in between	= 3 rd & 4 th Quintile	7%	26%	7%	40%
1000 - over 2000	= 5 th Quintile	8%	21%	3%	32%
	Total	17%	61%	22%	100%

Degree of urbanization and income values in Ghana Cedi (GHC)

Corporate Consumer

The workforce in Ghana is given as 10.6 million (WDI, 2008), Table 6.3 gives the breakdown into the different sectors.

Table 6.3 Breakdown of Workforce (Sector % (CIA, 2005))

	Agriculture	Industry	Service	Total
Work force	5'936'000	1'590'000	3'074'000	10'600'000
% Work force	56%	15%	29%	100%

Corporate consumers cover the industrial sector and the service sector minus government, private education and private health service. This also means that NGOs are covered within the corporate and not institutional consumers.

Institutional Consumer

Institutional consumers cover the health service sector (government and private), education (government and private) and the rest of government. Table 6.4 gives a breakdown of the employees in the different categories.

Table 6.4 Breakdown of Institutional Consumers (calculated)

Sector	Work force
Health	66'569
Education	253'871
Government	1'013'502
Total Institutions	1'333'943

6.3.2 Installed Base

From the consumer surveys, the installed base, shown in Table 6.5, was calculated.

Table 6.5 Installed Base of Tracer Products and Total EEE (units and tons, 2009)

Installed Base (units)	Private	Enterprises	Institutions	Total (units)	Total (tons)
Large Household Appliances					
Refrigerator	5'870'000	216'000	129'000	6'215'000	218'000
Air Conditioner	1'644'000	433'000	88'000	2'165'000	40'000
Small Household Appliances					
Iron	4'663'000	0	0	4'663'000	4'700
Kettle	2'911'000	N/A	N/A	2'911'000	2'900
Information & Communication Technologies					
PC	622'000	471'000	367'000	1'460'000	32'000
Laptop	283'000	70'000	97'000	450'000	1'600
Mobile Phone	17'351'000	N/A	N/A	17'351'000	8'700
Consumer Electronics					
Television	4'621'000	22'000	60'000	4'703'000	136'000
Radio & Hi/Fi	6'638'000	33'000	120'000	6'791'000	38'000
Total Tracer				46'709'000	482'000
Total EEE					984'000

Because the different products of EEE vary highly in terms of weight, the picture of the dominant tracers in the installed base is different looking either at units or weight (Figures 6.2 and 6.3).

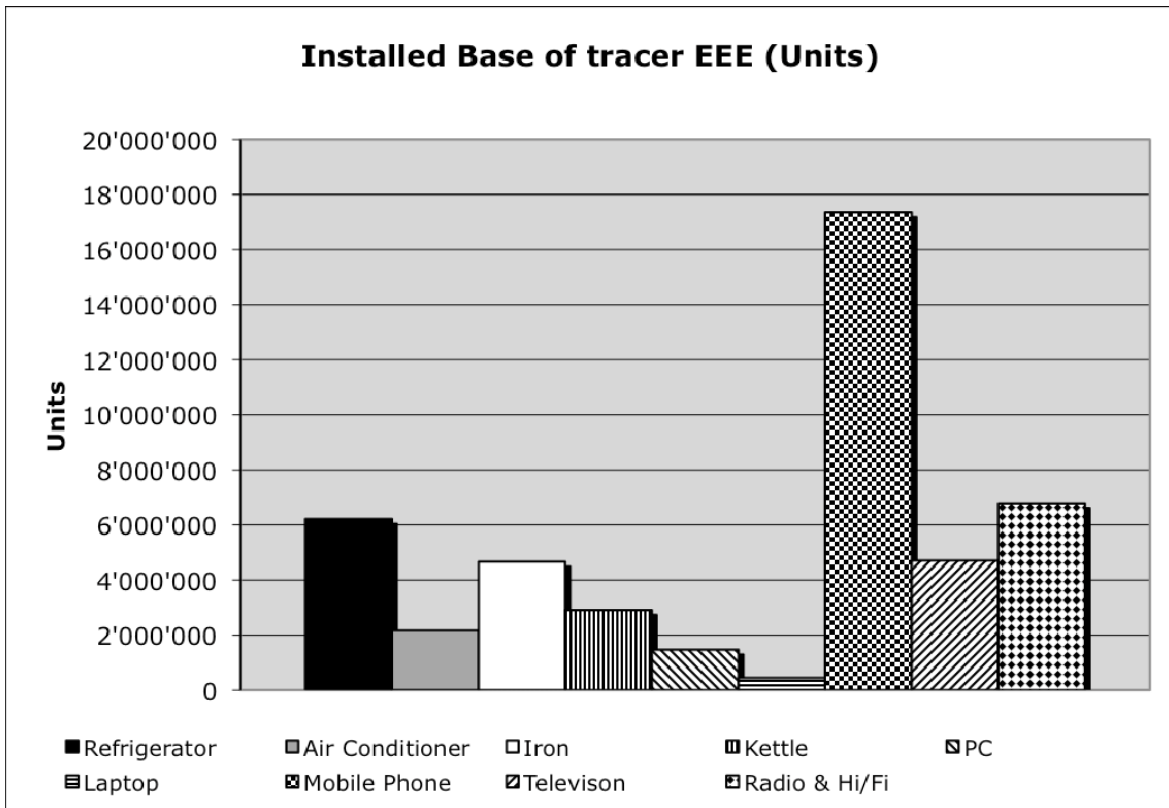

Figure 6.2 Installed base of tracer products (units 2009)

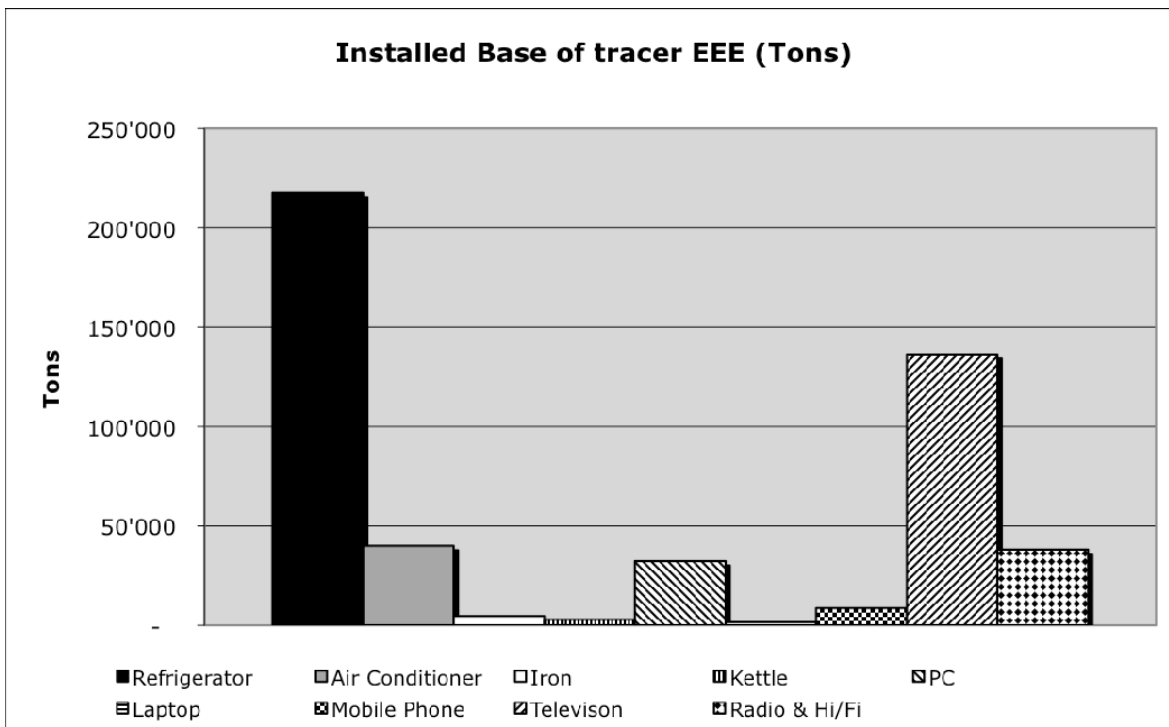

Figure 6.3 Installed base of tracer products (tons 2009)

The allocation of the installed base of households to the region categories 'urban', 'medium urban' and 'mostly rural' leads to the distribution displayed in Table 6.6. Urban regions account for 30% and medium urban regions for almost 60% of the total installed base, whereas mostly rural regions contribute only 13%.

The largest amount of EEE per household or per person is found in urban areas with 288 kg/household and 81 kg/person.

Table 6.6 Installed base of households allocated to region categories (tons and kg, 2009)

	EEE installed (ton)	% EEE (ton)	EEE/household (kg)	EEE/person (kg)
Urban	265'000	29%	288	81
Medium urban	540'000	59%	159	41
Mostly rural	118'000	13%	96	20
All of Ghana	923'000	100%	167	41

Looking at the distribution of the installed base of EEE of households amongst income classes shows that the two higher income groups account for 40% each and the lowest income group for 20% (see Table 6.7). The average amount of EEE in use of a single person from the highest income group is 84 kg, from the lowest income group 20 kg.

Table 6.7 Installed base of households allocated to income groups (tons and kg, 2009)

	EEE installed (ton)	% EEE (ton)	EEE/household (kg)	EEE/person (kg)
1&2 Quintile	183'000	20%	117	20
3&4 Quintile	366'000	40%	166	41
5th Quintile	373'000	40%	211	84
All of Ghana	923'000	100%	167	41

Based on the surveys, the existing stored base of (W)EEE was assumed to be about 30% of the installed base of working equipment for all three consumer groups. The amount of stored (W)EEE is shown in Table 6.8.

Table 6.8 Installed and Stored base of (W)EEE (tons 2009)

	Private	Corporate	Institutional	Total
Installed EEE	923'000	36'000	25'000	984'000
(W)EEE stored	277'000	11'000	7'000	295'000
% of total installed (and stored)	94%	4%	3%	100%

Table 6.8 also shows that 94% of the installed (and stored) EEE tonnage can be found with private consumers. The reason is the high weight per unit of refrigerators and other large household appliances as well as consumer equipment, such as televisions, which are predominantly used by private consumers. The picture is different if one looks at the distribution of units for example of personal computers over the different consumer groups (Table 6.9).

Table 6.9 Installed Base of Computers (W)EEE (units 2009)

	Private	Corporate	Institutional	Total
PC	622'000	471'000	367'000	1'460'000
% of Total PC	43%	32%	25%	100%

Table 6.10 shows the penetration rate of EEE tracers in 2009. Some of these penetration rates may seem rather high. Factors accounting for the high penetration rates in Ghana could be the following:

- ✚ High availability of second hand EEE because of a port on a strong trading route and good business climate (political stability of Ghana);
- ✚ Comparatively low cost because of high availability of second hand EEE;
- ✚ An "ICT for accelerated development" policy (MoC, 2003), since 2003 that includes an action plan for computer literacy of the population and for spreading ICT in the communities; and
- ✚ Strong growth of imports in the last few years (Table 5.5); and
- ✚ Import duty exemption for some EEE types, e.g. computers and accessories.
- ✚ The numbers from the household survey even with the correction factors were rather high.

Table 6.10 Penetration rate of EEE tracer in Ghana (2009)

	Per Capita*	Per Household**
Large Household Appliances		
Refrigerator	26%	113%
Air Conditioner	9%	32%
Small Household Appliances		
Iron	19%	90%
Kettle	12%	56%
Information & Communication Technologies		
Computer	7.6%	17%
Mobile Phone	72%	334%
Consumer Electronics		
Television	20%	89%
Radio & Hi/Fi	28%	128%

* *Equipment installed with all consumers / population (25 million)*

** *Equipment installed ONLY in households / households (5.5 million)*

Comparison between Survey Results and Statistical Data

In order to crosscheck the high penetration rate of mobile phones, a comparison with data from the ITU (ITU, 2008) was made. The 17.3 million mobile phones calculated from the household survey for (the end of) 2009 was within 10% of the extrapolation of the ITU data, and thus seemed to be a reasonable result (Figure 6.4).

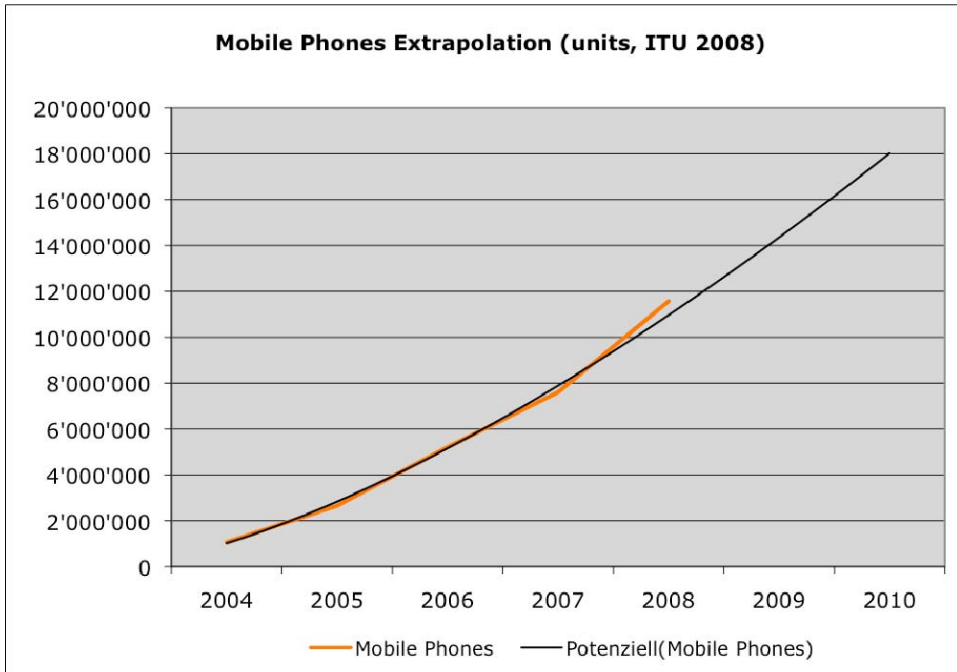

Figure 6.4 Mobile Phones in use in Ghana 2004 - 2010 (units, ITU, 2008)

The penetration rate of computers (PC and laptop) from the different surveys was 7.6 % (1.9 Million units in 2009). By contrast, the penetration rate stated by the ITU (ITU, 2008) was 0.6% (128'000 units in 2005) and the World Bank (WDI, 2008) was 1.1% (250'000 units in 2008). However, the UN Comtrade import data for computers into Ghana (UN Comtrade, 2010) showed more than a tripling of the units imported between 2003 and 2008 (Table 6.5). In 2005, the import data implied over 300'000 units; and in 2008, over 750'000 units imported. These numbers question the penetration rate estimated by ITU and WDI, which would be even lower than the amount of computers imported in the same year.

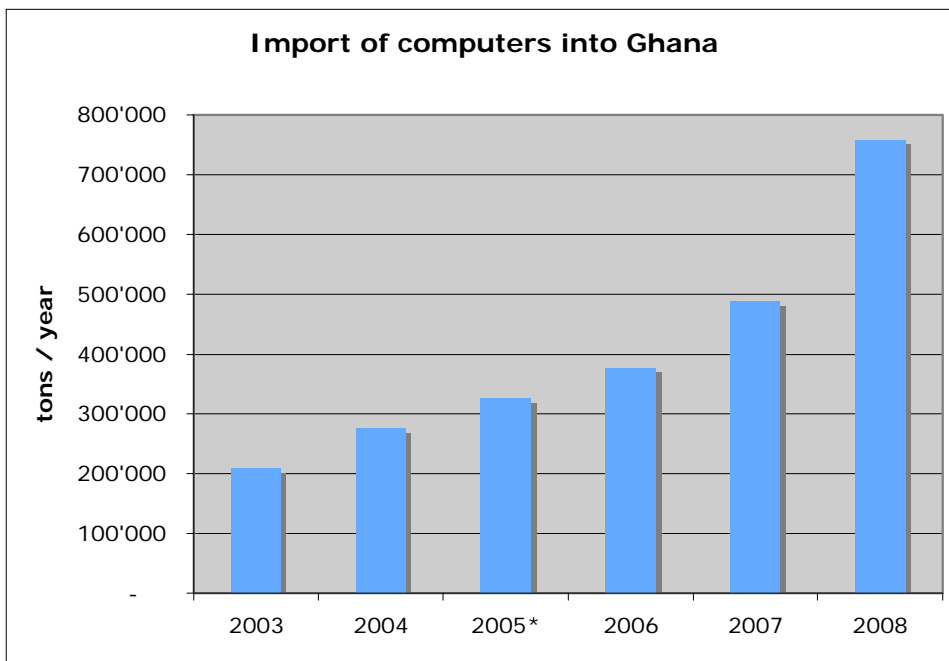

Figure 6.5 Import of Computers into Ghana (tons/year)

(Source: UN Comtrade. * 2005: no data available, average between 2004 and 2006)

The penetration rate can also be compared to results from similar studies in other countries (Schluep et. al, 2009). According to the 2008 Review of Directive 2002/96 on WEEE (UNU, 2008), a good indicator for the comparison of computer penetration rates is kg computers/GDP (PPP). Figure 6.6 indicates that Ghana shows the highest fraction with 0.9 g/GDP (PPP) of all developing and emerging countries compared.

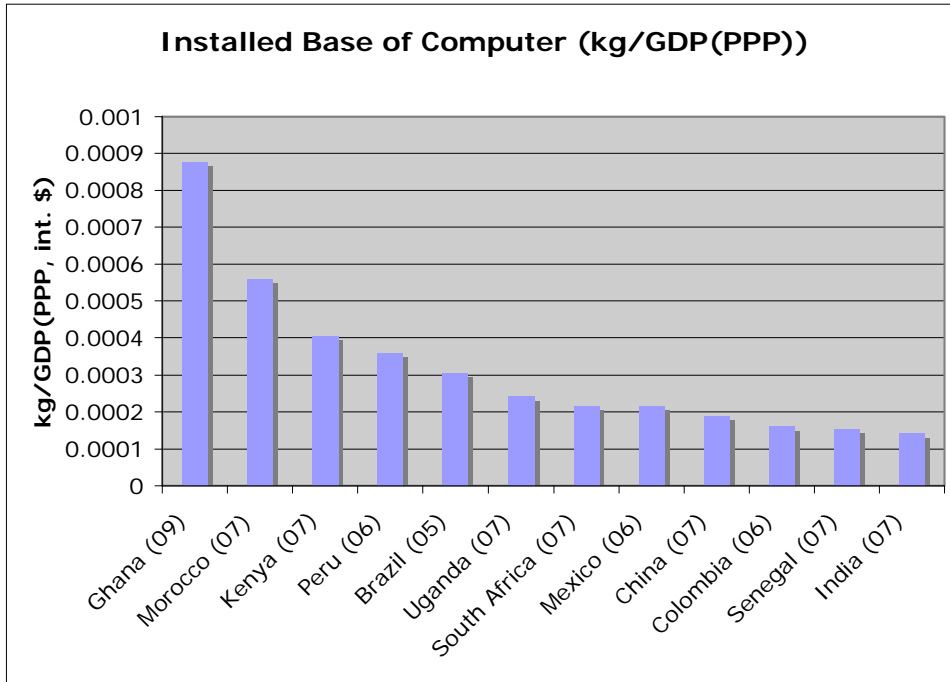

Figure 6.6 Installed Base of Computers (kg/GDP (PPP))

A developing country where a computer boom starts will first show a high kg computer per GDP (PPP). Once the growth flattens and the GDP growth continues, the rate will descend again. That means that a lower kg computer per GDP (PPP) rate is expected for countries that are in later stages of the introduction of computers into the society, as well as countries where no computer boom has started yet. In addition, Ghana has a high availability of second hand EEE that can be purchased at comparatively low prices, due to the high amount of second hand imports. This makes these products available for a larger share of the population, compared to other countries, where mostly new and therefore more expensive products are consumed.

Yet, if the generated WEEE is compared to the imports, a discrepancy can be observed. The installed base of 1.9 million computer resulted in 513'000 units becoming obsolete in 2009. About four (4) years were taken as the average lifespan of desktop computers and laptops in Ghana (Annex F). Hence, the imports of 2005 would have to be of the same size or even higher as the number of end-of-life computers in 2009, which is not the case (Table 6.11).

Table 6.11 Comparison of end-of-life and Import of computers (units)

	Computer
Installed base 2009	1'900'000
End-of-life 2009	513'000
Import 2005*	326'000

* Average between 2004 and 2006

There are three factors that could lead to the discrepancy:

- ✚ The installed base is overestimated;
- ✚ The estimated average lifespan is rather short; and/or
- ✚ The import numbers are under declared.

Imports 2005 do not cover the end-of-life equipment 2009, even if the import data were increased by 30% as done for the mass flow assessment (Section 2.2.1.3). The estimated lifespan for PCs and laptops lie in the range of 20% to 30% of the lifespan applied in other studies. The conclusion was that the real installed base for computer is probably lower than calculated from the household survey, but within the same order of magnitude and definitely higher than ITU and World Bank figures.

Materials contained in the Installed Base

Table 6.12 shows the composition breakdown of the installed and stored base of the consumers, based on the composition data of Mueller and Widmer 2008 (Annex F). There are substantial tonnages of valuables like ferrous metals, aluminium and copper "stored" with consumers. Precious metals such as gold, silver, palladium are stored in smaller amounts. Besides valuable substances, EEE also contains a high amount of hazardous fractions. For example, around 13'000 tons of lead and 84'000 tons of brominated plastics will leave the installed base and storage within the next 5 to 10 years and should be treated in an environmentally sound manner.

Table 6.12 Composition breakdown of installed and stored base (tons, 2009)

Material	Large Household Appliances	Small Household Appliances	ICT and Consumer Electronics	All of EEE
Total Tons	689'000	198'000	446'000	1'333'000
Ferrous metal	296'000	57'000	161'000	514'000
Aluminium	96'000	18'000	22'000	136'000
Copper	83'000	34'000	18'000	135'000
Lead	11'000	1'100	1'300	13'000
Cadmium	10	13	80	103
Mercury	0.3	0.04	0.3	0.6
Gold	0.005	0.001	1.1	1.1
Silver	0.05	0.01	5.4	5.4
Palladium	0.002	0.000	0.3	0.3
Indium	-	-	2.2	2.2
Brominated plastics	2'000	1'500	80'000	84'000
Plastics	131'000	73'000	54'000	258'000
Lead glass	-	-	85'000	85'000
Glass	100	300	1'300	2'000
Other	69'000	14'000	25'000	108'000

Shaded = hazardous or possibly hazardous fractions

6.3.3 New and Second Hand EEE

Most users acquire EEE based on their resources. Therefore the high income earners may prefer to buy new EEE whereas the majority with low income may only be able to afford second hand EEE. Almost all the types of users have both used and new EEE in their stock (Table 6.13).

Table 6.13 Purchase of New EEE by Private Consumer (% of all purchases)

	New Devices / High Income	New Devices/ Low Income	Total Share of New Devices*
Refrigerators	84%	31%	48%
PCs	67%	40%	49%
Laptop	96%	46%	62%
All Computer			53%
Televisions	82%	33%	49%
Radios	80%	50%	60%

* *Weighted average based on the ratio between high and low income households (Section 6.3.1)*

The household survey showed a rate between 50 to 60% of new products purchased (Table 6.13). The number is believed to be rather high, perhaps due to a skew survey towards technology-prone people, even in the low income group. The CEPS import data (Chapter 6) on the same products showed a very strong variation over the years (2006-2009); the averages of the four years range from 5 to 25% of new products imported. In addition, the percentage of newly imported EEE must be lower than the one of the installed base, since new products have a longer lifespan than second hand products and accumulate in the installed base. Field experience suggested that the true number for the installed base must be definitely lower than the survey results. A rate of about 40% of new products is estimated for the installed base with private consumers. Corporate consumers often acquired new equipment, so they were believed to have a higher percentage of new products than private consumers. Estimation for institutional consumer was difficult, because some branches of the government would buy new and behave in a similar way as a corporation, but other institutional consumers were likely to buy second hand or receive EEE donations (e.g. schools).

6.3.4 WEEE Generation and Storage

The generation of WEEE per year depends on the lifespan of the EEE. The lifespan varies strongly between the different products and differs also for new and second hand products. For the massflow assessment, lifespans from literature were taken and adjusted for Ghana, based on results from the surveys and experience. The lifespan for new and second hand was not differentiated, but an average for the new/second hand mix of Ghana taken. The complete list of lifespans used can be found in Annex F.

Based on the estimated lifespans the amount of EEE that reached its end-of-life every year was calculated. There was a total flow of 109'000 tons or about 5 kg per capita of WEEE generated in 2009 in Ghana. However, not all of that WEEE reached the collection and recycling system, since a significant amount of it was stored (Table 6.14).

To estimate the rate of how much of an end-of-life item was stored or went directly into the informal sector, the distribution of the products over the consumer groups and their disposal behaviour were considered (paragraph below). A detailed list on the rates for all products is given in Table 2.3.

Table 6.14 Flows of EEE Reaching End-of-Life (tons/year, 2009)

	Private	Corporate	Institutional	Total
EEE Reaching End-of-life	100'000	5'200	3'800	109'000
WEEE to Storage	38'000	1'600	1'100	40'700
WEEE to Recycling	63'000	3'700	2'600	69'300

Every year new WEEE goes into storage and stored WEEE is disposed of or/and given to scavengers. Private consumers clear their storage in average every ten (10) years. People living in urban areas tend to store their WEEE less, because scavengers roam the streets and offer money for WEEE. Since there is no market available in rural environments, WEEE is stored for a longer time.

Institutional consumers also tend to keep their WEEE for about ten (10) years. As many government bodies are located in Accra, the market for WEEE would be available, however, under the Public Procurement Act (PPA) public institutions can only purchase and dispose of items through competitive bidding. This prevents government departments and agencies from disposing of WEEE as easily as they may want to. Government bodies hope for an environmentally sound disposal option, while they store WEEE until their storage capacity is used up. The WEEE is then auctioned and enters the informal sector. The pioneers in formal recycling, who are at the moment not able to offer payment for WEEE, cannot receive the governmental WEEE because the PPA demands for the maximum value from the 'sale'.

Corporate consumers dispose of stored WEEE on the average every three (3) years. Most corporate consumers are situated in Accra and have easy access to the WEEE market, and are therefore able to generate income from the waste through selling it to scavengers or auctioning it. Some institutions also donate to schools and other less endowed institutions as a Corporate Social Responsibility.

The storage balance in Table 6.15 shows that the stored WEEE is building up with private and institutional consumers and declining with corporate consumers. The availability of payment for WEEE has increased in the last 5 years with the development of a stronger informal recycling sector. It seemed that corporate consumer profit from the situation and are emptying their stock.

Table 6.15 Stored Balance of WEEE (in tons/year, 2009)

	Private	Corporate	Institutional	Total
WEEE to Storage	38'000	1'600	1'100	40'700
Storage to Recycling	28'000	3'300	700	32'000
Storage Balance	10'000	-1'700	400	8'700

Table 6.16 shows the WEEE that flows directly from the consumer and from the storage to the collection and recycling system.

Table 6.16 Flows of WEEE to Recycling (tons/year, 2009)

	Private	Corporate	Institutional	Total
Direct to Recycling	63'000	3'700	2'600	69'300
Storage to Recycling	28'000	3'300	700	32'000
all WEEE to Recycling	91'000	7'000	3'300	101'300

Table 6.17 shows the flow of the end-of-life tracer products from the different consumer groups into the collection system. These numbers include WEEE directly from consumer and WEEE from storage. The total flow of WEEE reaching the collection system amounts to 101'300 tons or around 4.5 kg per capita in 2009. Figure 6.7 shows the breakdown of the WEEE flow from all consumer groups into the different tracer products.

Table 6.17 Flow of End-of-life Tracer Products from Consumer to Collection (2009)

	Private	Corporate	Institutional	Total (units)	Total (tons)
Large Household Appliances					
Refrigerator	421'000	32'000	11'000	464'000	16'000
Air Conditioner	193'000	77'000	10'000	280'000	5'000
Small Household Appliances					
Iron	420'000	0	0	420'000	400
Kettle	337'000	N/A	N/A	337'000	300
Information & Communication Technologies					
PC	106'000	110'000	62'000	279'000	6'000
Laptop	74'000	23'000	26'000	123'000	400
Mobile Phone	5'726'000	N/A	N/A	5'726'000	3'000
Consumer Electronics					
Television	420'000	4'000	6'000	430'000	12'000
Radio & Hi/Fi	471'000	5'000	11'000	488'000	3'000
Total Tracer				8'547'000	46'000
Total WEEE					101'300

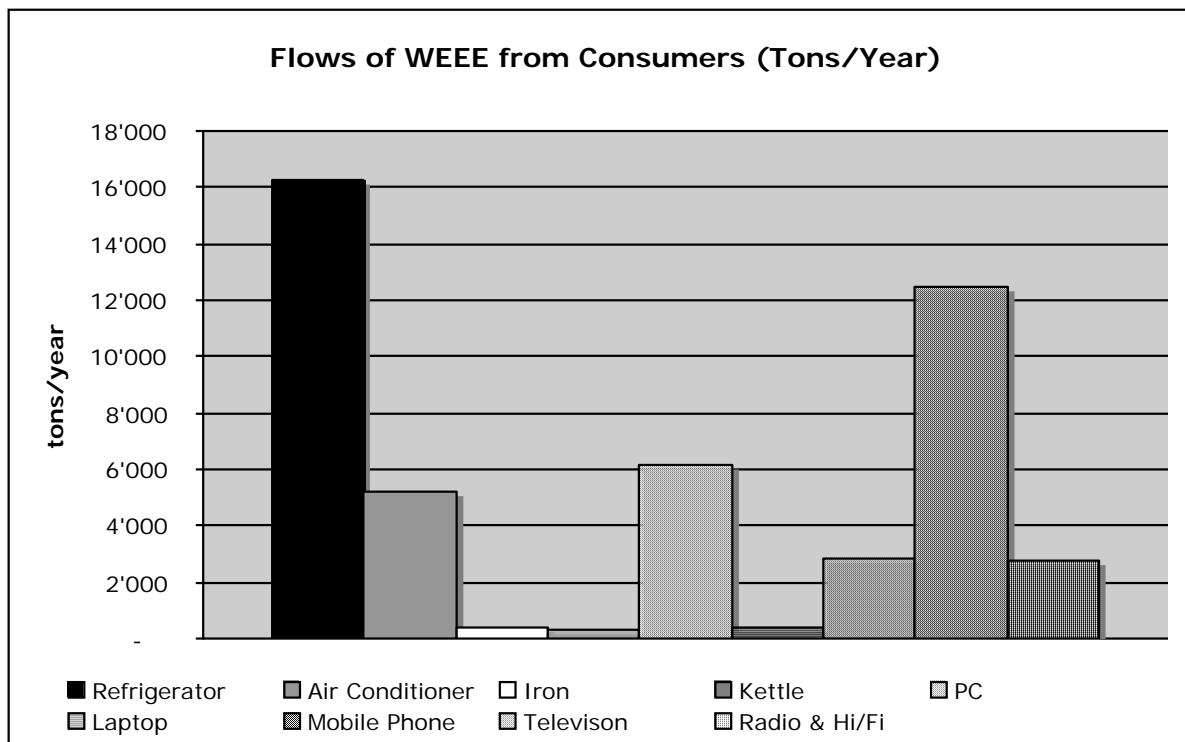

Figure 6.7 Flows of WEEE Tracer Products from Consumers (tons/year, 2009)

The allocation of the WEEE generation of households to the region categories 'urban', 'medium urban' and 'mostly rural' leads to the distribution displayed in Table 6.18. The medium urban category accounted for the most WEEE with 59'000 tons, the urban generated 29'000 tons and the mostly rural not surprisingly contributed the minimum WEEE with 13'000 kg per year. The largest amount of WEEE generation per household or per person is found in urban areas with 31 kg/household and 8.8 kg/person.

Table 6.18 Flow of End-of-life Tracer Products from Consumer to Collection (2009)

	WEEE generated (ton/year)	% WEEE (ton/year)	WEEE/household (kg/year)	WEEE/person (kg/year)
Urban	29'000	29%	31	8.8
Medium urban	59'000	58%	17	4.4
Rural	13'000	13%	11	2.2
All of Ghana	101'000	100%	18	4.5

The WEEE generation of households amongst income classes is shown in Table 6.19. The average amount of WEEE generated by a single person from the highest income group is 9.2 kg, from the lowest income group 2.2 kg.

Table 6.19 Flow of End-of-life Tracer Products from Consumer to Collection (2009)

	WEEE generated (ton/year)	% WEEE (ton/year)	WEEE/household (kg/year)	WEEE/person (kg/year)
1&2 Quintile	20'000	20%	13	2.2
3&4 Quintile	40'000	40%	18	4.5
5th Quintile	41'000	40%	23	9.2
All of Ghana	101'000	100%	18	4.5

6.3.5 WEEE Disposal

The disposal options available to a user at the end of the product life are:

- ✚ Adding it to household waste;
- ✚ Giving away/selling to informal collectors; and
- ✚ Donating to a family member/school/employee.

There was a high awareness about the environmental issues among the respondents. About 78% were aware of the environmental impacts of wrong disposal of WEEE and about 53.5% felt that the best way to dispose of them was to establish a recycling facility.

For end-of-life management, the majority of consumers relied on the informal collectors (92.4%), as compared to only 2.7% that gave their WEEE to formal recyclers and 4.9% who added it to the domestic waste.

In rural areas, disposal options for WEEE are limited and it was assumed that most of the generated WEEE ended up in informal dumpsites. Information on this flow, however, was not collected and therefore it was not accounted for in the massflow assessment.

6.4 Collectors of WEEE

Collectors are people or organizations that transport WEEE from consumers to recyclers or to a disposal site, and include the following:

- ✚ Informal Collectors: mobile and sedentary (located at formal dump site) scavengers
- ✚ Formal Collectors: City Waste Recycling Limited, and small scale businesses
- ✚ Domestic waste collectors: ABC Waste, Zoomlion, Chagnon Limited, etc.

6.4.1 Informal collection

Collection of e-waste is undertaken mainly by the informal collectors, also called scavengers. They are the mainstay of the disposal system of WEEE in Ghana. Young men go from door to door to pick up or buy obsolete EEE, and may travel long distances. They also sift through waste bins, visit landfills and other waste dumping grounds for WEEE. Since they receive money from the informal recyclers for every piece collected or they dismantle the devices themselves and afterwards sell the valuable fractions, they are able to pay the consumers for the WEEE. According to the results of the socioeconomic study (Prakash et al. 2010), scavengers pay the following prices for WEEE:

- ✚ PC: 2 - 5 GHC / piece
- ✚ CRT-TV: 2 - 5 GHC / piece
- ✚ CRT-monitor: 2 - 5 GHC / piece
- ✚ Refrigerator: 3 - 7 GHC / piece



Figure 6.8 Informal Collection

6.4.2 Formal Collection

Formal collection of WEEE is done by small scale formal recyclers. They have arrangements with the generators of WEEE which enables them to pick up for free. City Waste Recycling Limited is the only known formal collector of WEEE even though there are a few other businesses that are yet to start full scale operations. The private formal companies that want to be part of the collection system are faced with a number of challenges, including the capacity to perform door-to-door collection and also the ability to pay consumers competitive price for the WEEE. Consumers are now aware of the income that even WEEE can generate for them. The formal collectors are, however, unable to meet such financial demands as they may have to pay for the disposal of the hazardous components of the waste after retrieval of the valuable fractions. The informal collectors on the other hand do not bother about the hazardous fractions generated and thus are able to pay 'competitive' prices for the WEEE.

6.4.3 Domestic Waste Collection

It was estimated that 5% of WEEE ended up with the communal collection. It was further assumed that 95% of that WEEE entered the informal sector through informal collectors / scavengers who collect them at the official landfill or directly dismantle the WEEE on site (see Table 6.20).

Table 6.20 Flow of WEEE through Communal Collection (tons/year, 2009)

	WEEE
Communal collection	5'000
To informal treatment	4'800
To official landfill	200

6.5 Refurbishers/Repairers of EEE

The refurbishers/repairers render the service of getting non-functioning EEE into functioning and are usually located close to offices and residences to make them accessible to users of EEE to repair faulty gadgets. There are many repair shops in almost all corners of the country. The new trend is the advent of service centres operated by the major dealers in EEE. The following refurbishers/repairers were identified:

- ✚ Adminsco Ghana Ltd, Spintex road
- ✚ Adom Phones, Nungua
- ✚ Compaq Cellular Enterprise, Osu
- ✚ Courage Modern Electrical Works -
- ✚ Gosheen Cell Phones, Osu
- ✚ HANBEE Plaza ring road branch
- ✚ In Jesus Name Phone Shop, Nungua
- ✚ Infinity Ventures
- ✚ Isaac Electricals, Sakumono
- ✚ Joelartech Technology, Nungua.
- ✚ Joephillip and Co., Sakumono
- ✚ Kwame Mathew Co.
- ✚ M & D Phones
- ✚ Macro Ref & Air Con Ltd, Labone
- ✚ New Era Mobile Phone Repair, Nungua
- ✚ Next Computers, La Accra
- ✚ On The Move for Jesus Ent. Darkuman
- ✚ PC Direct - Spintex Road
- ✚ PHONEBOY Ltd. - Teshie Nungua
- ✚ Qabass Computers
- ✚ Rainbow Computers Ltd
- ✚ Adom Buy Phoneless

- ✚ Alhaji Iddrisu Enterprise
- ✚ Ashanti Cool (Comm 2, Tema)
- ✚ Computer Avenue Ashaiman Valco Flats)
- ✚ Cool Age Enterprise, Comm 1, Tema
- ✚ Ebenezer New Generation Electricals & Eng.
- ✚ Godey Elelectricals
- ✚ John Electrical Works (Comm., 7, Tema)
- ✚ Jolash Electrical Store
- ✚ Kingsize Electronic Service (Tema)
- ✚ Media Electronics, Ashaiman
- ✚ One-Man, One Soul (Ashaiman Valco Flats)
- ✚ Otto Electronics
- ✚ Quasco Refrigeration
- ✚ SETCOM Ent (Comm. 8, Tema)
- ✚ SAM & CO, Lapaz
- ✚ Solomon Adu
- ✚ Summit Electronix Works - Osu
- ✚ Tarletech Brothers Co. Ltd
- ✚ Town & City Phones
- ✚ Unlock Pros., - Osu
- ✚ Yungz Ventures - Spintex Road

There is an association of repairers and technicians of EEE known as the Ghana Electronic Service Technicians Association (GESTA), which has countrywide membership. There is also the National Refrigeration Workshop Owners Association (NARWOA) for refrigeration and air condition repairers. GESTA has 500 registered repairers in Accra, and estimates a total of 900 repairers in Greater Accra and also 1200 repairers in the whole country. Out of the number, 800 are involved in general repair (large and small household devices and consumer electronics) and 400 specialized in ICT repair. It is an informal economy and many of them are not registered with the Registrar General’s Department as business entities. They however, pay income taxes to the respective Metropolitan/Municipal/District Assemblies (MMDAs).



Figure 6.9 Refurbishers/Repairers of EEE

Table 6.21 EEE Taken for Repair (units and tons, 2009)

EEE	Units	Tons
Large Household Appliances		
Refrigerator	891'000	31'000
Air Conditioner	371'000	7'000
Small Household Appliances		
Iron	481'000	500
Kettle	208'000	200
Information & Communication Technologies		
PC	193'000	4'500
Laptop	188'000	700
Mobile Phone	894'000	400
Consumer Electronics		
Television	720'000	22'000
Radio & Hi/Fi	954'000	6'000
Total Tracer brought		72'000
Total EEE brought		159'000
Repaired		111'000
Not repairable		48'000

The services of refurbishers/repairers are significant in helping to extend the lifespan of EEE. Such services are rendered to the consumers of EEE who are the owners. Ownership is not transferred and remains with the consumer. EEE that are left at the service centres by consumers and not retrieved after years may also be refurbished and sold into the second hand market, though rare. The repair success rate is about 70% according to the survey. An EEE would last a further year or two after it had been repaired. The amount of equipment brought to repair in 2009 is listed in Table 6.21. The share of equipment brought to repair and the repair success rate depended on the product (Figure 6.10). In total, 159'000 tons of EEE are yearly brought for repair, with 111'000 tons of EEE actually repaired - compared to 109'000 tons of WEEE stored or disposed of as waste.

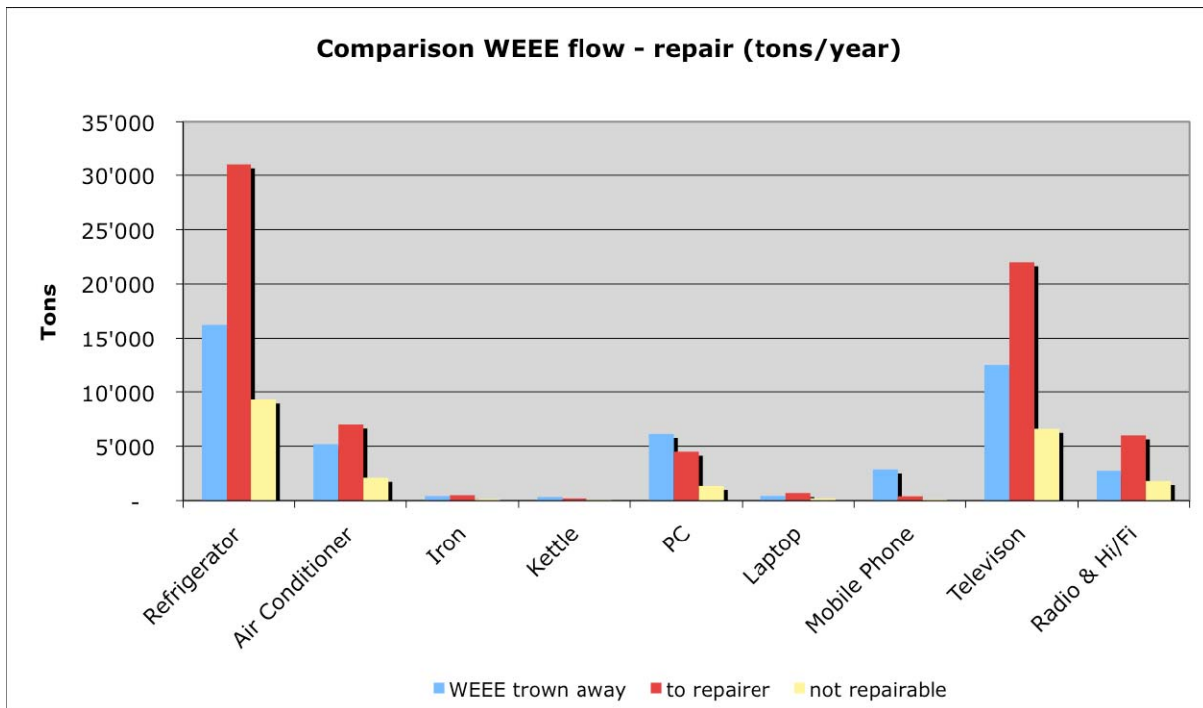

Figure 6.10 Comparison of WEEE thrown away, for repair and not repairable (2009)

6.6 Formal WEEE Recyclers

Formal recyclers are companies or organizations that are in possession of an environmental operation permit, issued by the EPA. They dismantle, separate fractions and recover valuable materials from WEEE, but are also responsible for the environmentally sound treatment of the hazardous fractions. The following formal recyclers were identified:

- ✚ City Waste Management Company Limited
- ✚ Environwise Waste Systems
- ✚ Waste Recycling Ghana Limited

City Waste Recycling Limited is the only formal e-waste recycler in the country. The company has started its first trial with a 20ft container being filled with dismantled and separated WEEE. City Waste Recycling collects WEEE from companies, dismantles it and separates the fractions. Iron, copper and aluminium are sold within Ghana. All other fractions will be exported to a recycling partner in Europe to treat the hazardous fractions, while gaining form the valuable fractions. After the first trial it would be clear if it was feasible to pay companies for picking their WEEE or if a fee has to be collected from the companies. City Waste Management received an environmental permit for their operation from the EPA. Others, such as Environwise Waste Systems are yet to roll out full scale operations while Waste Recycling Ghana Limited is yet to commence WEEE recycling even though it is already processing other non EEE wastes.

It was estimated that in total about 30 tons was handled by formal recyclers in 2009, about 0.2% of all the total WEEE treated by recyclers (formal or informal). About 10 tons of the dismantled WEEE went to Ghanaian downstream processors and the rest was treated abroad.

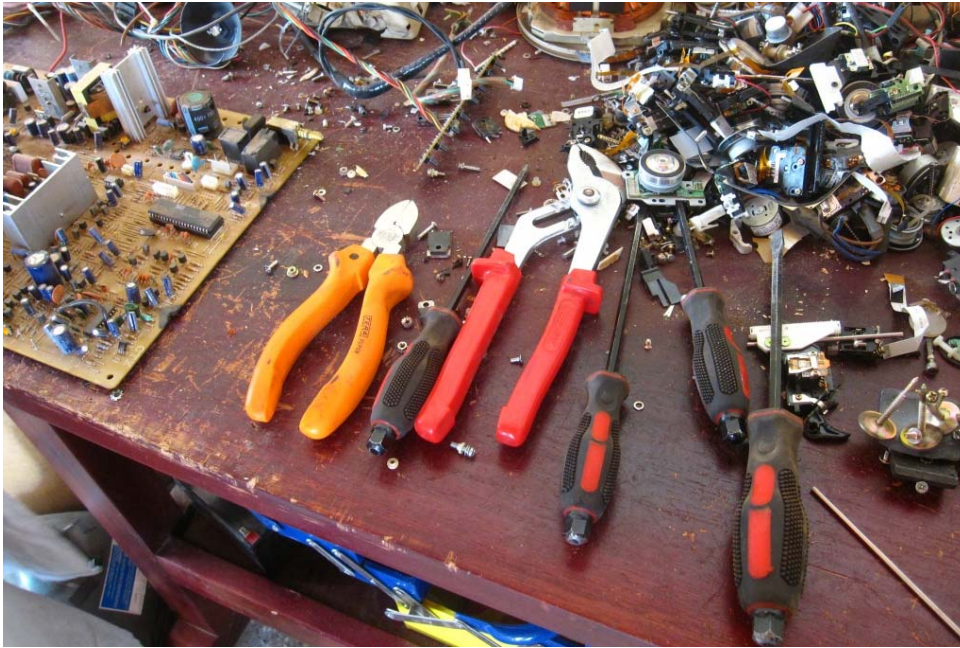

Figure 6.11 Formal e-Waste Recycling

6.7 Informal WEEE Recyclers

Informal recyclers dismantle, separate fractions and recover valuable materials from WEEE, without taking into account the hazardous fractions. Their operation leads to emissions of toxic substances which put their health and the environment at high risk.

Informal waste recycling in Ghana is done by informal scavengers and dismantlers. They operate from different parts of the country, but the hub of the recycling operations is in the Greater Accra Region at the scrap yards at Agbogbloshie as well as at Gallaway and Ashiaman. Figures 6.12 and 6.13 show the Agbogbloshie area, the scrap yard, dump site, the adjacent two markets and residential area where most of the scrap yard workers live.

The main recycling activity is the manual dismantling of all types of waste and scrap and the recovery of copper, iron and aluminium and printed wiring boards. Copper cables are burnt nearby to remove the plastic casings. Insulating foam from obsolete refrigerators, primarily polyurethane and/or old car tyres are the main fuels used to sustain the fires. The monitor screens and other 'non profitable' fractions such as plastic casings of all kinds, keyboards, capacitors, dry batteries, etc. are not recovered and usually dumped and may eventually be burnt. The emissions from the recycling operations lead to negative impacts on the health of the scrap yard workers and the adjacent communities, and the environment (Chapter 8). It was estimated that a total of between 6'300 – 9'600 people work in the informal WEEE sector of the country, with a dependent population of between 121'000 – 201'600 (Prakash et al 2010).



Figure 6.12 The Agbogbloshie area

(Source: Google maps)



Figure 6.13 The Agbogbloshie scrap yard

(Source: Google maps)

Due to the very low educational levels of the WEEE handlers/workers and the high unemployment levels in Ghana (about 45 %), it is not easy for them to get engaged in other forms of employment, more dignified and healthy.

The annual volume of WEEE handled by recyclers was 171'000 tons for 2009, which came directly from consumers, from consumers via communal collection, from consumers through repairers and directly from 'waste' imports (Table 6.22). Almost all of it was handled by the informal recyclers. The negligible share of the formal sector is due to the fact that the sector is just developing, and the consumer desire to earn some money for their WEEE.

Table 6.22 Total Flow of WEEE to Informal Recycling (tons/year, 2009)

	WEEE
From Consumers	96'000
From Communal Collection	5'000
From Repairers	48'000
From Imports	22'000
Total	171'000

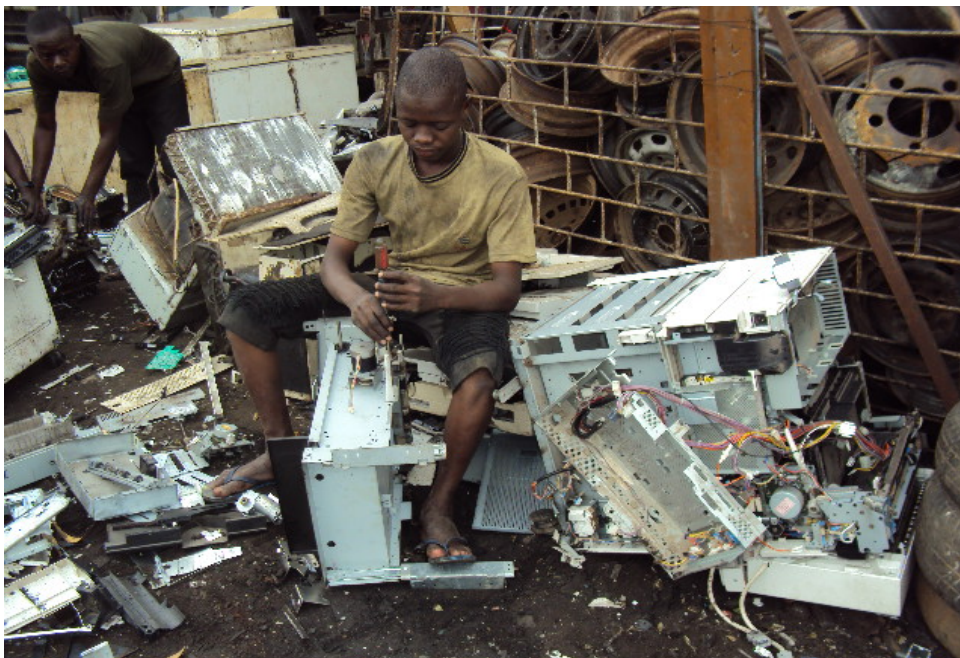

Figure 6.14 Informal e-Waste Recycling

From the findings of the Socioeconomic Survey (Prakash et al. 2010), a recovery rate for ferrous material with the presently applied technology was 95% (about 69'000 tons in 2009), 85% for aluminium and copper (each about 16'000 tons in 2009), and 70% for gold, silver, palladium and indium (export of high grade PWB) was assumed. That would result in a total recovery rate of about 42%. The recovered 72'000 tons of pure fractions were either processed in the Ghanaian industry or exported. The remaining 99'000 tons of hazardous and "unusable" fractions were informally dumped or burnt. Lead, cadmium, mercury, plastics, plastics with brominated flame retardants, leaded glass, and glass among others entered the environment without treatment in significant volumes (Table 6.23).

Table 6.23 Annual Flow of WEEE in Fractions (tons/year, 2009)

Material	Reaching informal sector
Total Tons	171'000
Ferrous metal	65'000
Aluminium	17'000
Copper	17'000
Lead	1'600
Cadmium	11
Mercury	0.06
Gold	0.12
Silver	0.6
Palladium	0.03
Indium	0.2
Brominated plastics	12'000
Plastics	34'000
Lead glass	12'000
Glass	300
Other	13'000

Shaded = hazardous fractions

6.8 Downstream Processors of WEEE

Downstream processors are the industries that buy the fractions (e.g. copper, plastics, precious and non-precious metals) to use in production. The recovered fractions, e.g. ferrous metal, aluminium and copper are mainly sold to industries in Tema or to private businesses for export. Leaching of printed wiring boards is not yet a practice in the WEEE sector of Ghana. Thus the boards are sold as a whole to buyers from China and Nigeria. There is no direct use of monitor cases, except some workers use them as seat. With the exception of lead, which is informally smelted and re-casted into new lead bars (an activity that produced high toxic emissions) directly at the Agbogbloshie scrap yard, there are no downstream processes available to recover hazardous fractions. Most of the hazardous parts are therefore improperly disposed of. Below, some of the downstream processes available in Ghana are listed.



Figure 6.15 Informal Downstream Processing of Lead

Steel Industry

The companies do steel melting and also process scrap steel. The industry could use more scrap than they actually process. Ghana also exports more scrap than it processes in the country. The following steel processing companies were identified:

- ✚ Ferro Fabrics Limited, Tema
- ✚ Tema Steel Limited, Tema
- ✚ Western Steel & Rods Limited, Tema
- ✚ Special Steels Limited, Tema
- ✚ Special Ghana Steel, Tema
- ✚ Wahome Limited, Tema

Aluminum Industry

There are many aluminium smelters operating. The demand is higher than the supply and Aluworks has upped their capacity from 400'000 to 600'000 metric tons / year. There are also many informal aluminium smelting activities in Accra and Tema. Some of the products of this informal sector include coal pots and cooking utensils moulded out of the parts of refrigerator and aluminium scrap. The following main aluminium industries were identified:

- ✚ Aluworks Limited, Tema
- ✚ VALCO, Tema

Copper Industry

There are no copper refineries and smelters in Ghana. But there are some companies that produce wires from imported copper rods. There are however many informal copper smelting operations, mainly for jewellery making. The following wire producing companies were identified:

- ✚ Tropical Cables and Conductors Limited, Tema - Copper wire production;
- ✚ Nexans Metal Cable Limited, Tema - Copper wire production; and
- ✚ Western Wire & Rods Limited, Tema - Aluminium rod and wire production.

6.9 Final Disposers of WEEE

These are organizations or individuals in charge of the final disposal of waste through incineration or land filling. Waste management in Accra is the responsibility of the Accra Metropolitan Assembly (AMA), which has sub-contracted to private companies such as Zoom Lion Ghana Limited, ABC Waste, Chagnon Limited, etc. to undertake the collection in various parts of the city.

Most of the waste generated is disposed of at landfills or dumpsites across the country. The existing landfills are not well-engineered and are largely dump sites where open burning is carried out e.g. at Kpone, Oblogo and Odorkor. There are also no infrastructures for the disposal of hazardous waste and it is all disposed of together with the non-hazardous waste generated. At Agbogbloshie for instance, non-valuable as well as hazardous fractions are disposed of at the adjacent dump site, and accumulated waste get burned to reduce the volume (Chapter 8).



Figure 6.16 Final Disposers of WEEE

6.10 Most Affected Communities

The surrounding suburbs close to the dump site e.g. Accra Central, Ministries area, Korle Bu, Abossey Okai, Kaneshie, Adabraka, Asylum Down and other places are known to be affected by the activities at the Agboglobshie site. Especially the burning operations, which emit toxic fumes into the atmosphere that are carried to these communities, pose a serious health risk. The Light Industrial Area nearby is also severely affected, and several complaints have been made to the Ghana EPA and the AMA. Food sold at the adjoining major market could be contaminated as well as their patrons. The recycling industry has created business opportunities including women catering and food vending, selling of drinks, cigarettes, clothing, push trucks, bicycles, motor bikes, etc. The pollution in the area does not affect only the air, but the land, and nearby Odaw River which receives some amount of the waste, and eventually the Korle Lagoon.

There were reported cases of informal collectors ‘taking’ away supposed waste without the express approval of the owners.



Figure 6.17 Odaw Drain and Grazing Land adjacent to Agboglobshie

6.11 Other Stakeholders

6.11.1 Policy Makers

The main policy making institution on environment and WEEE-related matters is the Ministry of Environment Science and Technology (MEST)

6.11.2 Policy Implementers

The lead policy implementing institutions with respect to environment and WEEE related matters include:

- ✚ Accra Metropolitan Authority (AMA)/ Waste Management Department(WMD)
- ✚ Environmental Protection Agency (EPA)
- ✚ Customs Excise & Preventive Service (CEPS)
- ✚ Ghana Ports & Harbours Authority (GPHA)
- ✚ Ministry of Local Government & Rural Development (MLGRD)

6.11.3 Other Civil Society Organizations and Media

Other relevant civil society organizations and media network include:

- ✚ Ports Environmental Network Africa (PENAf)
- ✚ League of Environmental Journalists
- ✚ Media - TV3 and GTV,

7.0 MASSFLOW ASSESSMENT

7.1 Massflow System Chart

The massflow analysis considered all the pathways of EEE and WEEE between all relevant stakeholders in Ghana. The massflow system chart in Figure 7.1 displays the most important stakeholders and the flows between them.

There is no production of EEE in Ghana, but very limited assembly of imported parts. Imports take place in different ways. These include: private travellers and semi-professional importers using their private luggage through the airport and by container loads of new or second hand EEE through the sea port. There is always a variable fraction of non-functioning EEE and perhaps also actual WEEE mixed with the second hand goods. The non-functioning equipment could reach directly the informal recycling sector (if any). All imported and assembled EEE goes to consumers. There are about five ways non-functioning or outdated equipment is treated by consumers.

- ✚ It is taken for repair, but if unsuccessful (i.e. not repairable) then it goes into the informal recycling.
- ✚ It can be brought for refurbishment, where parts are replaced or are updated and the lifespan is prolonged, while non-usable parts go into the informal recycling.
- ✚ It is mixed with communal waste, where it may be collected at a landfill, with parts separated and informally treated on-site or brought to the informal recycling.
- ✚ It is collected by scavengers and enters the informal recycling sector.
- ✚ It is brought to the formal recycling sector.

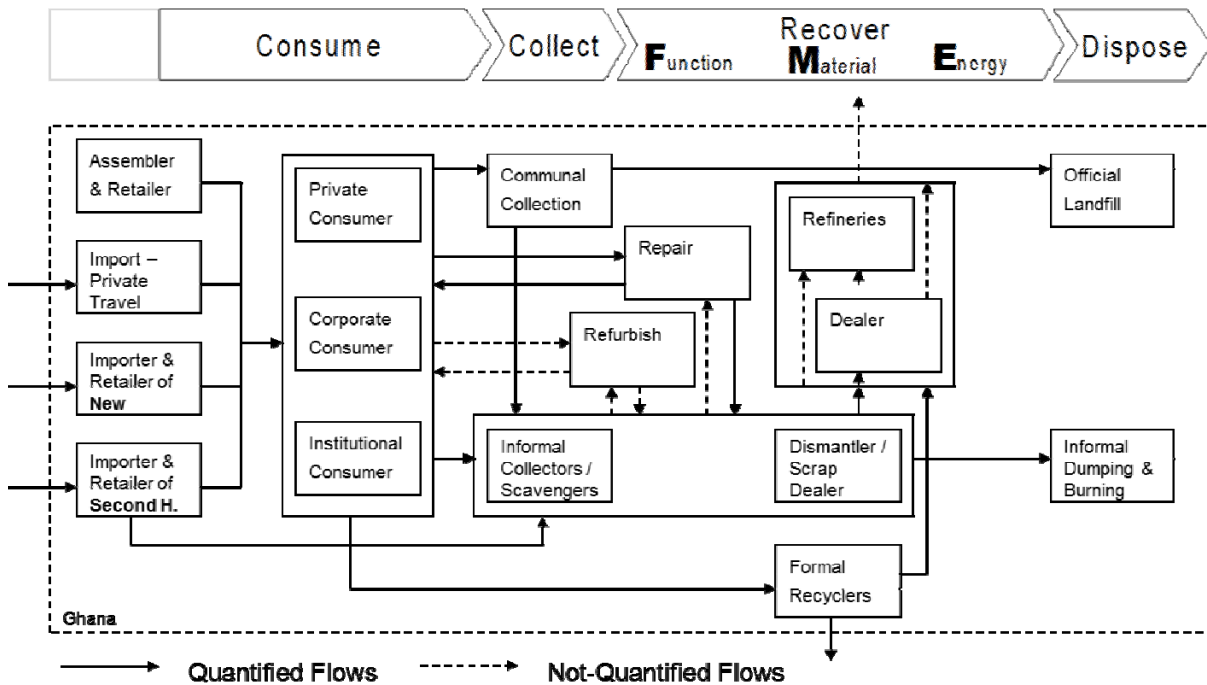

Figure 7.1 Massflow System for EEE in Ghana

7.2 Current Massflows

The massflows are shown in Figure 7.2. All EEE of the four categories - large household appliances, small household appliances, information and communication technology and consumer electronic appliances were taken into account. The flows and stocks were considered in tons and for the year 2009. The figures for the massflow assessment were acquired through the surveys, expert interviews, existing statistical data, observation and extrapolations onto the national level. They summarize all the findings presented in the Stakeholder Assessment (Chapter 5 and 6). The detailed method is presented in Chapter 2 and all detailed numbers in Annex G.

In order to have a better overview of the complex system, a simplified massflow chart was generated, with a focus on imports, consumption and recycling (Figure 7.3).

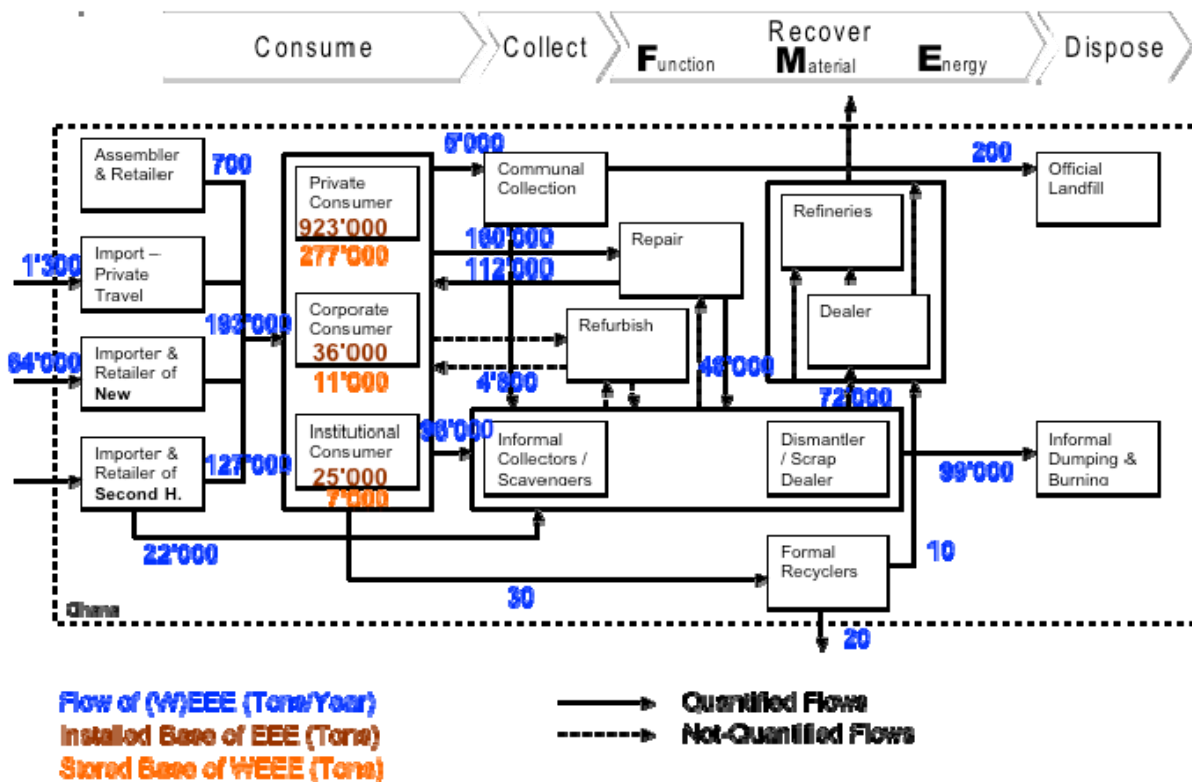

Figure 7.2 Stocks and Flows for EEE estimated for 2009 (tons)

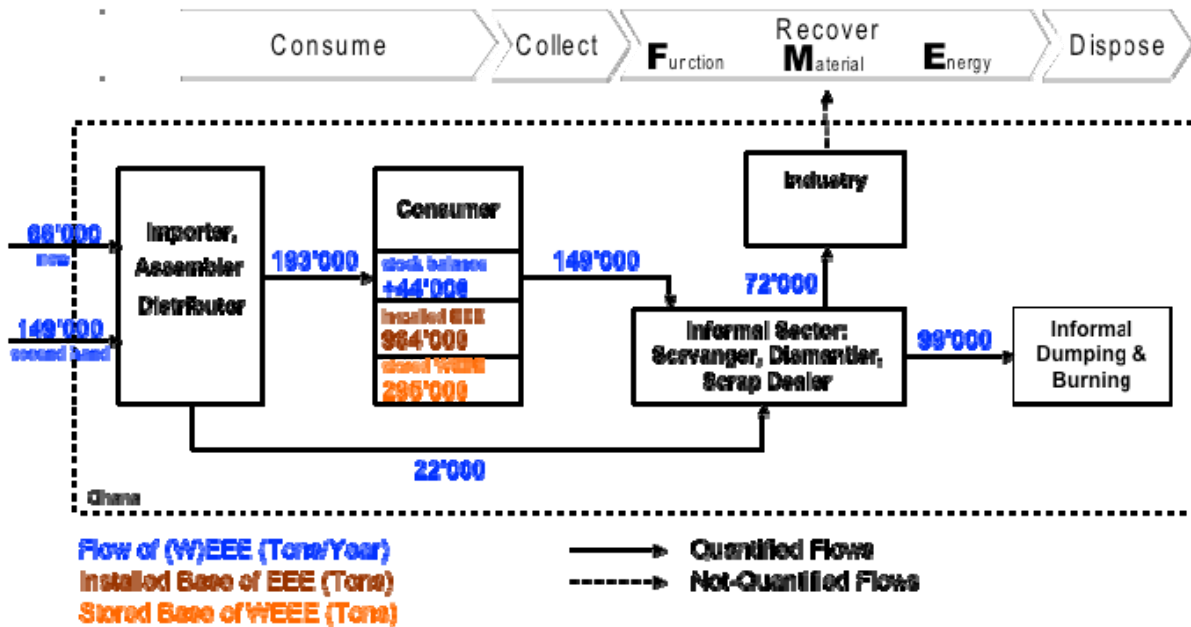

Figure 7.3 Simplified Chart of Stocks and Flows for EEE (2009)

The imports into Ghana in 2009 added up to 215'000 tons of EEE. About 30% comprised of new products and 70% second hand EEE. Around 15% of the second hand imports was estimated to be unsellable (i.e. would not respond to power, broken or outdated), a significant portion of which was destined directly to informal recycling. The consumer built up an installed base of about 984'000 tons of EEE, with more than 90% used by the private consumer. Additional to the devices in use, there were about 295'000 tons of obsolete items stored. The stock was growing by 44'000 tons in 2009.

For obsolete items, five (5) different options existed as described in Section 7.1. Of the 280'000 tons of obsolete devices generated in 2009, 57% went to repair, 8% to storage and 34% directly to recycling. Only 1% was collected via communal collection, and most of the material reached the informal recycling sector through scavengers. The flow of EEE that was refurbished could not be quantified.

About 149'000 tons of WEEE from consumers, repair shops and communal collection reached the informal recycling sector. In addition, 22'000 tons coming directly from the second hand imports was treated. The material flow to the formal recycling sector accounted for only 0.2%. Approximately 42% of the material treated in the informal sector was recovered (mainly metals such as iron, aluminium and copper) and sold to local refineries or exported. About 58% (plastics, glass, hazardous fractions) was dumped and/or burnt at nearby informal dumpsites adjacent to the scrap yards.

7.3 Future Massflow Trends

The EEE sector in Ghana will continue to grow as far as importation is concerned. This is due to policies which are aimed at improving access to ICT knowledge by the average Ghanaian. Policies such as One Laptop per Child, A Computer in Every Home, all help to accentuate the growth of EEE imports.

These policies have also led to an increase in the number of assemblers in the country. Not long ago, Omatek Computers was the only assembler, however, there are many others now. Notable among them are Zepto and Topical Business Solutions. This situation will also add to the number of EEE produced even locally and thus expand the sector.

The average Ghanaian is becoming more sophisticated as compared to 10 years ago (GSS 1998, 2008). People are equating the possession of EEE to good social standing, thus, there are some who consider having a computer in their living room as a prestige and a sign of modernity, even if the equipment never gets to be used. The easy accessibility to such equipment also enhances the demand.

The UN Comtrade import data (Table 5.5) show a clear trend that imports to Ghana have increased between 2003 and 2008 by a factor 2.7. The finding of this study is in line with the general observation by UN Comtrade that imports to Sub-Saharan Africa have increased between 2000 and 2008 by a factor 2 to 3, depending on the country of origin.

In order to estimate the future massflow trends, both a linear and an exponential extrapolation of the UN Comtrade import data for Ghana were prepared (Figure 7.4). The correlation factors both show a high correlation. Assuming a linear growth, the imports would double by the year 2020. An exponential growth would lead to an increase in imports by a factor 7. Considering that Ghanaian consumers already possess a large amount of EEE and markets for household appliances and televisions are already saturated to a large extent, an exponential growth of the total imports of EEE does not seem likely. However, exponential growth scenarios for imports of certain ICT-equipment or consumer electronics such as desktops and laptops, mobile phones, mp3-players, etc. are possible due to the ICT policies described above. It was therefore assumed, that the future massflow trends lie between a linear and an exponential growth scenario.

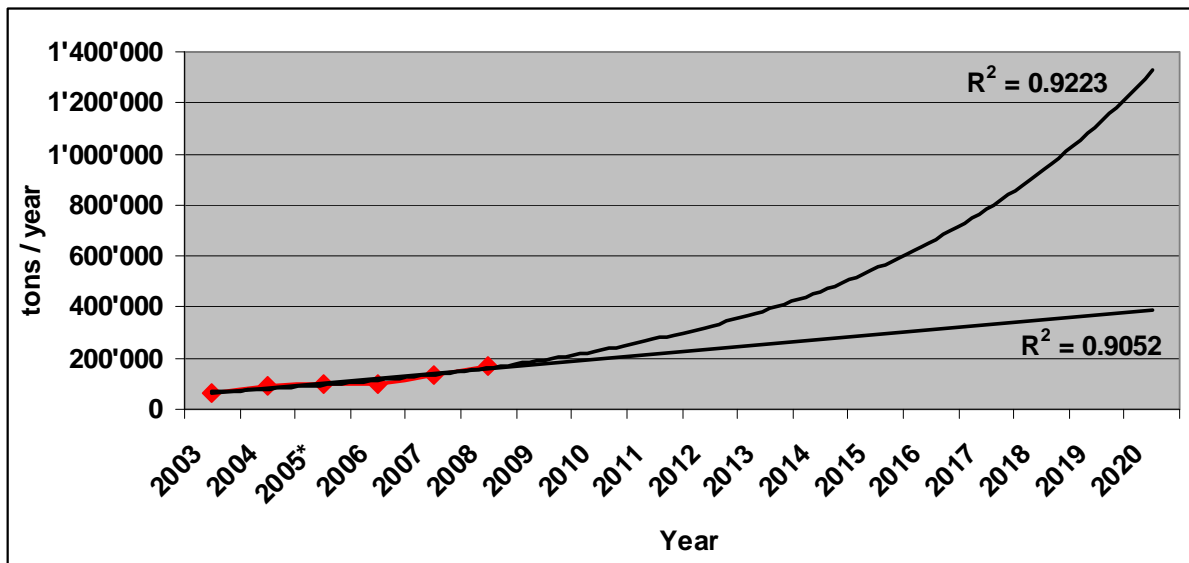

Figure 7.4 EEE Imports in Linear and Exponential Trend Lines

(Source: UN Comtrade. * Average of 2004 and 2006)

Since there were doubts about the reliability of some of the import data, the current WEEE flows were calculated based on the consumer survey. It was therefore difficult to calculate future WEEE flows based on extrapolated import data. Nevertheless, it could be deduced that future WEEE flows will rise according to increase in imports, and that until 2020, WEEE flows will grow at least by a factor of 2.

8.0 IMPACTS

8.1 Overview

The WEEE sector provides thousands of people with jobs and has multi-nationals including Nigerians, Togolese, Indians and Chinese involved, in spite of the health and environmental risks the operations pose. The massflow chart below identifies the various stages of the process which are sources of concern and requiring attention (Figure 8.1).

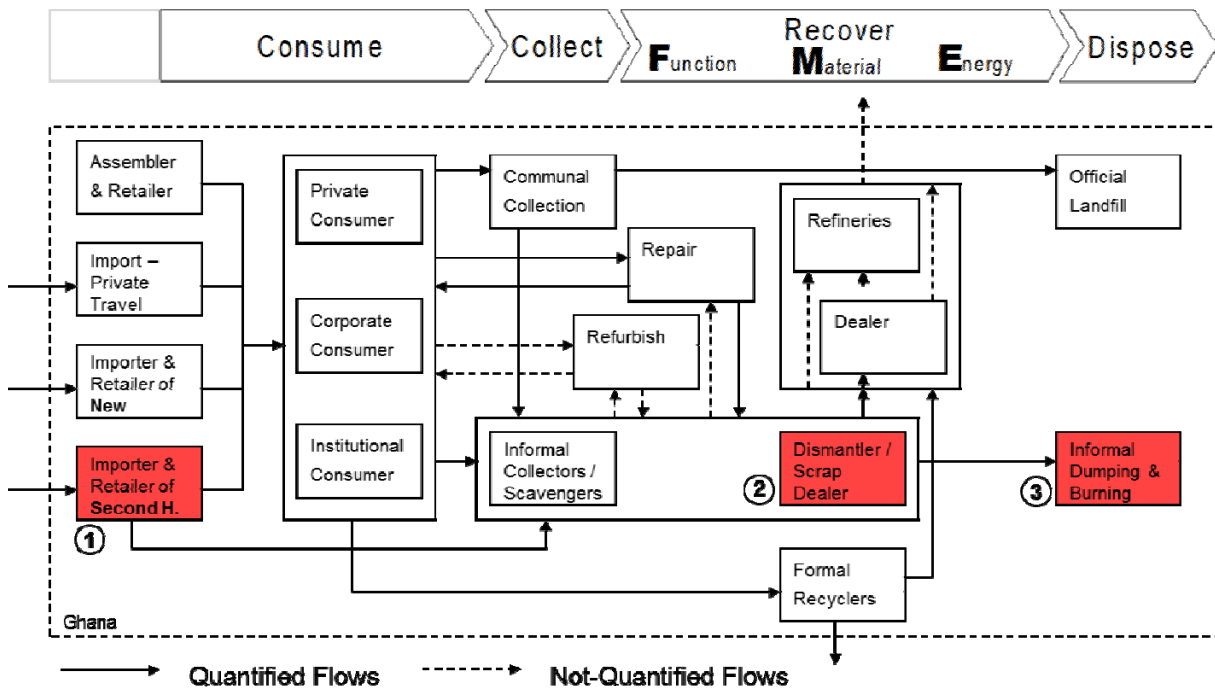

Figure 8.1 Massflow Chart Indicating Hot Spots

The following Hot Spots were identified:

Importers and Retailers of Second Hand EEE

The problems with importers of second hand EEE (imports) were that:

- ✚ About 15 percent of the imported EEE were non-functional, and added to the internally generated WEEE.
- ✚ About 20 percent of the imported EEE has to be repaired or refurbished to get them functioning. It can be assumed that these devices on average have a shorter lifespan compared to new equipment or second hand equipment arriving in working condition and therefore lead to ever increasing large stocks of WEEE in Ghana
- ✚ Some of the imported EEE were not in working condition or outdated, but kept in storage and used as spare parts for refurbishing other defective ones.

Dismantlers/Scrap Dealers

The problems with people dismantling WEEE in informal settings and processes related mainly to the use of crude methods such as the following:

- ✚ The methods used were harmful to the environment and the health of the workers and people living nearby e.g. the open cable burning.
- ✚ Hazardous fractions from WEEE were untreated and openly dumped.
- ✚ The valuable fractions were taken out of the WEEE, and the hazardous fractions left untreated – cherry picking.
- ✚ The cherry picking gave a value to the WEEE (money was paid to the consumers by the scavengers for each piece of WEEE, i.e. consumers expect to receive money for WEEE rather than pay for the disposal).



Figure 8.2 Hot Spots: Dismantlers/Scrap Dealers

Informal Dumping and Burning

WEEE in the hands of informal recyclers poses the following risks:

- ✚ All remaining fractions after salvaging the valuable components are dumped and/or burnt on the dumpsite
- ✚ The dumping and open burning of hazardous fraction has serious consequences on the environment and a threat to public health.



Figure 8.3 Hot Spots: Informal Dumping



Figure 8.4 Hot Spots: Informal Burning during the Day



Figure 8.5 Hot Spots: Informal Burning at night

8.2 Social and Economic Impacts

The following is a brief account from the Socio-economic Assessment (findings of the Component 3), in Prakash et al. 2010.

8.2.1 Impacts on Employees

Employment in the refurbishing and WEEE recycling sector involves exposure to rigorous and insecure working conditions and severe health hazards (Section 8.3.3). Even children, sometimes as young as 5 years old, were observed to be involved in the recovery of materials from WEEE, earning less than US\$ 20 per month. Most of the people employed in the WEEE recycling, aged between 14 to 40 years, worked for 10 to 12 hours a day (i.e. 300 to 360 hours per month). On the other hand, people in the refurbishing sector worked between 8 to 10 hours a day (or 210 to 260 hours per month). Although most of the workers do not have any fixed working time in terms of working hours per day or per week, compared to the formal sector, it could be inferred that WEEE recyclers produce between 108 to 168 overtime hours per month.

Despite the long working hours, most of the people employed in the refurbishing and WEEE recycling sector continue to live in extreme poverty. Monthly incomes of collectors were between US\$ 70 and 140, refurbishers between US\$ 190 and 250, and recyclers US\$ 175 to 285. Expert opinion suggested that these incomes could go lower, in case regular supply or collection of WEEE was hindered. Hence, considering the partial or full dependency of family members – in urban areas of up to 6 people – on such incomes, it could be concluded that most of these workers lived below nationally and internationally defined poverty lines.

This was a significant revelation, especially considering that: (1) people related to refurbishing and WEEE recycling activities belonged to the group of about 11% of the total urban population in Ghana that lived below poverty line; and (2) most of these workers originate from the northern part of the country where majority of the poor lived. Thus, even though engaging in the informal WEEE recycling did not necessarily ensure higher incomes, the workers preferred that sector as they had access to regular income in the form of rapid cash flow – in contrast to agriculture-driven households in northern Ghana.

With the exception of a few workers engaged in some high-end refurbishing/repair/sales business, almost none of the workers employed in refurbishing and WEEE recycling sectors had any kind of employment or social security. All the same, employment turnover in the business was quite high, often ranging between 3 to 7 years, due mainly to low incomes, rigorous working conditions and health hazards.

8.2.2 Impacts on Local Communities

Improper recycling activities of WEEE lead not only to occupational, but also to residential hazards (Chapter 8.3). However, despite all drawbacks of the informal recycling industry, it also opens up opportunities, for example, employment opportunities exist not only for workers from the north of Ghana, but also for other inhabitants of the Agbogbloshie area. While the quality of jobs was doubtful in most of the cases, primarily due to health and environmental concerns, these employment opportunities offered alternatives to agricultural work. There were at least four different socio-economic reasons behind the establishment and growth of Agbogbloshie listed below.

- ✚ Migration from the north, as an outcome of tribal conflict and chronic food insecurity.
- ✚ Social downward movement in accommodation by those forced out of more expensive accommodation in Accra. That was due to the financial impact of the Structural Adjustment Programme initiated in the early 1980s.
- ✚ Spill-over of population associated with the size and growth of the adjacent market.
- ✚ Demand for land by those seeking economic and business opportunities in an area free from the bureaucratic constraints and high rentals that exist in the recognised formal market.

8.2.3 Impacts on Society

The population of collectors and recyclers, who originated mostly from the northern part of the country, was between 4'500 and 6'000 in Accra only, but about 6'300 and 9'600 in the whole country. Additionally, refurbishing of old and second-hand EEE also represented an important economic activity. In Accra, between 10'000 and 15'000 people were employed in the refurbishing sector, while for the whole country the number was between 14'000 and 24'000 people. Thus, in total, the informal refurbishing and WEEE management sector employed between 20'300 to 33'600 people, constituting about 0.19% to 0.32% of the country's total labour force.

Considering a Total Fertility Rate (TFR) of 4.0 (on an average leading to 6 people in a household) for an urban household in Ghana, it can be said that countrywide between 37'800 and 57'600 people are dependent either partially or fully on WEEE collection and recycling activities by the informal sector. Simultaneously, between 84'000 and 144'000 people depended partially or fully on refurbishing activities. In total, in terms of dependence on informal refurbishing and WEEE recycling as a livelihood option, the sector sustained between 121'800 to 201'600 people in Ghana. That represented about 1.04% to 1.72% of the total urban population, or 0.50% to 0.82% of the total population.

Due to the informal nature of refurbishing and WEEE recycling sector, its true value was not reflected in the national GDP. Nevertheless, based on the data on total number of people employed in the refurbishing and WEEE recycling sector and their average salaries, the sector was estimated to contribute between US\$ 105 to 268 million indirectly to the national economy.

8.3 Environmental Impacts

As already illustrated in Figure 8.1, major environmental impacts result mainly from the processes of dismantling, material recovery and final disposal. During collection as well as refurbishment or repair of EEE, negative impacts can hardly occur. An exception could be if refurbishers or repairers dispose of hazardous fractions resulting from their business in an inappropriate way.

8.3.1 Emissions to Soil, Air and Water

8.3.1.1 Literature review

Emissions from informal recycling activities have already been assessed in many studies (Sepúlveda et al. 2009). Figure 8.6 below gives an overview on principal WEEE recycling activities, types of produced emissions/discharges and general environmental pathways.

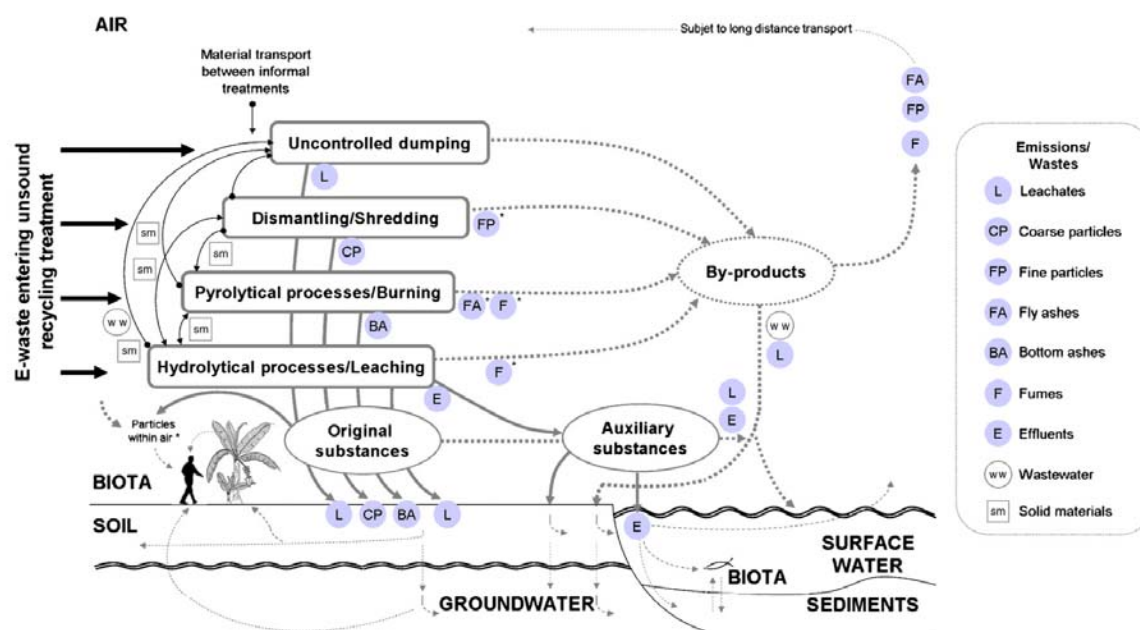

Figure 8.6 Principal WEEE Recycling Activities

Types of produced emissions and general environmental pathways - Ovals: types of substances contained within emissions. Continuous bold lines: fate of original and auxiliary substances. Dotted bold lines: fate of by-products such as dioxins and furans. Black arrows with a bold dot: material transport fluxes between treatments. Fine dashed arrows: general environmental pathways (Sepúlveda et al. 2009)

The recycling activities at Ghanaian scrap yards include mainly dismantling, uncontrolled dumping as well as pyrolytical processes. Hydrolytical processes such as leaching precious metals from printed wiring boards was not observed.

The recycling activities at numerous small workshops within the scrap yard often take place directly on unfortified ground. Harmful substances released during dismantling therefore lead directly to discharges to soil. Within the burning areas, scrap yard workers use numerous temporary fires to burn plastics, mainly from copper cables and wires as well as monitor and TV casings. The burning operations were creating an accumulation of ash and partially burned materials. Insulating foam from dismantled refrigerators, primarily polyurethane, or old car tyres were the main fuels used for the fires, contributing in itself to acute chemical hazards and longer-term contamination at the burning sites. In order to quantify soil and ash as well as sediment contamination in Agbogbloshie and Korforidua, Greenpeace Research Laboratories carried out a small sampling campaign (Bridgen et al. 2008).

The two soils and ashes samples with the highest contamination (GH8002 & 3), taken at burning sites in Agbogbloshie showed copper, lead, tin and zinc concentrations over one hundred times higher than typical background levels. Concentrations of antimony and cadmium exceeded typical background soil levels by around fifty times for antimony and five times for cadmium. The sample taken from an open burning site in Korforidua showed similar metal contents, what could lead to the conclusion that similar materials were burnt (Table 8.1). Two major potential sources of lead from WEEE were electrical solders and the use of lead compounds to stabilise polyvinyl chloride (PVC), a plastic that is widely used as a coating on wires and cables. Compounds of antimony have also been widely used as additives in polymers, principally in flame retardant formulations. Cadmium is used in some contacts, switches and solder joints as well as in rechargeable nickel-cadmium batteries. Lead and cadmium are both highly toxic and can build up in the body following repeated exposures. Antimony compounds have also known toxic properties (Bridgen et al. 2008).

In addition to heavy metals, the samples also contained organic chemicals such as halogenated chemicals (e.g. polybrominated diphenyl ethers (PBDEs), used as flame retardants, especially in monitor and TV casings) and polychlorinated biphenyls (PCBs, often found in old condensers) as well as phthalates (commonly used as plasticizers in flexible PVC). The burning of PVC, in addition to release chemical additives including heavy metals and phthalates, can generate many organic chemicals itself. Dioxins and furans (PCDD/F) are formed as products of incomplete combustion of chlorinated organic materials, including PVC coated wires, with the reaction being catalysed by the presence of metals such as copper. This process can disperse fine ashes containing PCDD/Fs to areas surrounding burning sites, leading to contamination of surface soils and dusts (Bridgen et al. 2008).

The sample from a burning site within the disposal area at Agbogbloshie (GH08004) contained only a fraction of the organic chemicals found in the other samples, and had generally lower levels of metals, other than zinc (Table 8.1). This difference may be due to the more scattered setting of fires within the disposal area, as well the presence of large amounts of other type of wastes in this area, which could lead to the dilution of contaminants arising from e-waste (Bridgen et al. 2008).

Sample GH8005 was taken from an area where CRT-glass is disposed of. It contained some metals at levels above those found in uncontaminated soils, though at lower levels than those recorded in the burning site samples. It was, however, the only sample with yttrium above a typical background level. Yttrium has been used in CRTs in the internal phosphorous coating. It is not toxic, but its presence demonstrates the potential for chemicals within e-waste to become distributed into the environment through disposal (Bridgen et al. 2008).

The Agbogbloshie market is situated on flat ground alongside the Odaw River. During periods of heavy rainfall much of the site becomes flooded and it is likely that surface dusts and soils, along with any chemical contaminant they may contain, are carried into the adjacent, lower-lying lagoons and the Odaw River which ultimately flows into the ocean. The sample of sediment collected from a shallow lagoon located near the WEEE disposal and open burning areas within the Agbogbloshie Market contained a very similar profile of metal concentrations and organic chemicals to those in the more contaminated soil and ash samples (Table 8.1). These similarities suggest the migration of pollutants away from the burning sites into surface waters, probably as a result of heavy rainfall and flooding (Bridgen et al. 2008). Table 8.1 gives an overview of results from the Greenpeace Research Laboratories sampling campaign.

Table 8.1 Overview of Results of the Greenpeace Sampling Campaign

Sample/ Location	GH8001 Soil/ash Burning ar- ea	GH8002 Soil/ash Burning site	GH8003 Soil/ash Burning site	GH8004 Soil/ash Burning + disposal site	GH8005 Soil below broken CRT-glass	GH8006 Sediment
Metal	mg/kg dw	mg/kg dw	mg/kg dw	mg/kg dw	mg/kg dw	mg/kg dw
Antimony	159	286	592	16	8	256
Barium	270	1190	1260	107	114	400
Beryllium	<0.2	0.6	<0.2	0.3	0.4	0.6
Cadmium	3	10	10	<1	<1	6
Copper	14'300	7'240	9'730	119	85	2260
Lead	3'530	4'160	5'510	110	190	1'685
Mercury	0.6	<0.5	<0.5	<0.5	<0.5	<0.5
Tin	123	1'290	1'175	7	16	220
Yttrium	2	8	2	4	33	9
Zinc	382	6'920	18'900	31'300	274	2'425
Organic compound identified	x: yes - :no	x: yes - :no	x: yes - :no	x: yes - :no	x: yes - :no	x: yes - :no
PCBs	-	-	x	-	-	-
PBDEs	x	x	x	-	x	X
Phtalates	x	x	x	-	x	x
Congeners	pg/g TEQ	pg/g TEQ	pg/g TEQ	pg/g TEQ	pg/g TEQ	pg/g TEQ
PCDD/Fs	n.a	n.a	31	n.a.	n.a.	988

Sample GH8001 was taken in Korforidua, samples GH8002 -6 at Agbogbloshie (Bridgen et al. 2008).

8.3.1.2 Estimation of Dioxin Emissions from Cable Burning

The amount of dioxin emissions from cable burning in the Greater Accra Region was estimated by brief surveys conducted at the Agbogbloshie, Gallaway, Kokompe and Ashaiman scrap yards, within the framework of the country assessment (Component 2). At Agbogbloshie, where most WEEE activities take place, the quantities of burnt cables were determined by five surveys of two-hour duration each between March and May 2010. At Gallaway, a single two-hour field survey was carried out, while the amount of burnt copper cables at Kokompe and Ashaiman was determined by interviews.



Figure 8.7 Emissions from Cable Burning

The results of the surveys showed that the burning activities of Gallaway, Kokompe and Ashaiman accounted for about 35% of the activities at Agbogbloshie. In total, around 200 kg of copper cables were burnt within one hour. On the assumption of 10 working hours per day, 6 working days per week and 52 weeks per year, the following results were reached from calculations:

- ✚ ~200 kg burnt cables in one hour; and
- ✚ ~625 tons burnt cables in one year.

About 10 - 20 % of these cables were associated with WEEE, while the rest originated mainly from old vehicles. The composition of cables was assumed to be the following:

- ✚ ~38% plastic = 235 tons / year
- ✚ ~62% copper = 390 tons / year

The estimation of dioxin emissions from open burning of cables was based on the “Standardized Toolkit for Identification and Quantification of Dioxin and Furan Release” (UNEP Chemicals 2005, Edition 2.1) Emissions and calculated as:

$\text{Source Strength (Dioxin emissions per year)} = \text{Emission Factor} \times \text{“Activity Rate”}$

Where:

Emission Factor to Air for Open burning of cable = 5’000 µg TEQ (Toxic Equivalent) /t of material; and “Activity rate” (Greater Accra Region) = 625 tonnes / year

(Note: For the purpose of the Toolkit, there is no difference if concentrations or emission factors are reported in I-TEQ or N-TEQ or WHO-TEQ (for PCDD/PCDF only))

The preliminary estimation of total dioxin (PCDD/F) emissions to air from open cable burning in the Greater Accra Region amounts to a source strength of ~3 g / year.

Compared with the European dioxin air emission inventory for 2005 (EU15 & Norway & Switzerland, Quass et al. 2004) this equals to 0.15 – 0.3 % of total dioxin emissions, 1.5 – 3 % of dioxin emissions from municipal waste incineration or 7.5 – 15 % of dioxin emissions from industrial waste incineration.

This result can be extrapolated to all project countries, assuming as a rough estimate that cable burning is done in the same way in all urban regions in West Africa and the extrapolation can be done along the population numbers. With the estimation that 4 million people live in the Greater Accra Region and about 90 million people in urban regions in the project countries (Nigeria, Benin, Ghana, Côte d'Ivoire, Liberia), the estimation of total dioxin (PCDD/F) emissions to air from open cable burning in the SBC e-waste Africa project countries amounts to a source Strength of ~70 g / year. This equals to approximately 3% –7% of total dioxin emissions to air in Europe.

8.3.2 Solid Waste

WEEE recycling activities in Ghana lead to large quantities of non-recoverable fractions that are not disposed of in an environmentally sound manner. According to the massflow assessment, over 30,000 tons of solid waste such as plastics, CRT-glass, printed circuit boards, batteries and accumulators, condensers as well as other hazardous components were informally dumped in Agbogbloshie or similar dump sites in 2009. Plastics account for over 50% of the non-recoverable fractions. They are piled up on the dump site and occasionally burnt to reduce the volume. The burning usually takes place at night to disguise the black clouds of smoke emerging from these enormous fires. Resulting emissions to air and subsequently also to soil and water through particle deposition are described above.



Figure 8.8 Burning of plastics at Agbogbloshie

CRT-glass amounted to over 30% of the disposed fractions. After removing the plastic casing and the metal-containing fractions from a CRT-monitor or TV, the tube was taken to the dumpsite, where it was crushed to remove the last metal parts. The CRT glass contains large quantities of lead oxide as well as barium oxide

and strontium oxide. These substances are bound in the glass matrix, but crushing and weathering of CRT-glass leads to long term emissions into soil and groundwater, a process that is likely to be accelerated under tropical conditions such as in Ghana. Additionally, when CRT-tubes are broken, the internal phosphorous coating which contains cadmium and other pollutants is partly released as dust, which can lead to emission to soil as well as health problems of the scrap yard workers (Prakash et al. 2010).

Batteries, accumulators, condensers and other hazardous components such as mercury switches or parts containing chlorofluorocarbons (CFCs) and hydro chlorofluorocarbons (HCFCs) accounted for less than 5% each. The disposal path of these hazardous fractions was mainly dumping which would lead to emissions/discharges of cadmium, mercury, lithium, PCB's, CFCs and HCFCs to soil, air and water. One scrap yard worker, for example, explained that condensers were usually thrown into the lagoon. Printed wiring boards added up to a small percentage as well. Usually larger copper and aluminium parts were removed from the boards before dumped or sold. As already stated above, printed wiring boards often contain lead solder which can lead to emissions to soil.

8.3.3 Human Health

Impacts on human health from WEEE recycling activities in Agbogbloshie are currently being investigated in a sampling campaign carried out by the Ghana Health Service, Green Advocacy Ghana, the Blacksmith Institute and the Hunter College as part of the Human and Environmental Exposure Surveys (Ghana e-Waste Project). The study collected blood and urine samples of scrap yard workers as well as Makola market porters as a control group. Results were not available yet.

Many other studies, mainly from India and China were reviewed in (Sepúlveda et al. 2009). Results show that atmospheric pollution due to burning and dismantling activities seems to be the main cause for occupational exposure and contamination of neighbouring communities. Combustion typically generates smaller particles and consequently, fine particulate matter (PM_{2.5}, strongly implicated in pulmonary and cardiovascular disease). Scrap yard workers are also exposed to PBDEs and dioxins which is again a result of atmospheric emissions.

Among the direct and indirect exposed groups to PM_{2.5}, PBDE and dioxins, the more vulnerable are pregnant women and children. Blood lead levels in children of Guiyu, China, for example, were found to exceed the Chinese mean. Many children and adolescents are working in Agbogbloshie and risking negative impacts on their health (Sepúlveda et al. 2009).

Larger coarse dust particles do not usually reach the lungs of humans, but they can irritate the eyes, nose and throat. Metallic dust and dust containing PBDEs can be transported into areas outside the WEEE recycling site. Close to the Agbogbloshie scrap yard, there is an onion market. This is of special concern, since the food market items easily come into contact with contaminated dust. Again, the potential health risk for children is eight times greater compared to adults, and since they might stay at the scrap yard during the day, they become even more easily exposed to metal-laden dust (Sepúlveda et al. 2009).

8.3.4 Pressure on Ecosystems

The heavy metals and organic substances released to the soil and the surface water lead to high pressure on the ecosystem. The Odaw River used to be an important fishing ground for the neighbouring communities. Since the WEEE recycling activities started about ten (10) years ago, the river has become dead. Due to the burning and dumping activities also, most of the vegetation has disappeared.



Figure 8.9 Pressure on Ecosystems through waste disposal next to and into the Odaw River

9.0 CONCLUSION

The WEEE industry in Ghana is a very vibrant one, growing at an amazing rate year after year. There are many people whose very existence bases on the growth of the industry. In the socioeconomic study it was found that the sector is sustaining between 121'800 to 201'600 people in Ghana (Prakash et al.)

Regarding the various stages of the massflow; import, consumption, repair, collection, recycling and disposal, it became clear during the study that the main problems and challenges lie within the import as well as the recycling and disposal stage.

Based on the available import data, it was estimated that up to 70% of all EEE imported are second hand products. A survey among importers concluded that around 60 - 70% of these second hand products arrive in working condition, another 20-30 % can be repaired or refurbished to get them functioning and about 10 - 20% are broken and sent directly to the informal recycling. Due to high amounts of second hand imports, Ghana has a high availability of second hand EEE that can be purchased at comparatively low prices. This makes these products available for a larger share of the population, compared to other countries, and gives many Ghanaians the possibility to benefit from EEE in their everyday life. On the other hand, second hand products have a shorter lifespan compared to new products, which leads to a higher e-waste generation per year. The equipment that arrives already in broken condition is added to the internally generated WEEE and thus again increases the large amount of e-waste generated.

There is certain awareness on environmental impacts of wrong disposal of WEEE among the consumers, especially within Accra, but due to the lack of environmentally sound disposal options, most obsolete equipment is either given to the informal collectors or stored. Yet, a high proportion of devices becoming obsolete are brought to repair shops instead of immediate disposal. The repairers, having a high success rate in repairing certain EEE, contribute to a significant extension of the lifetime of those devices and therefore to a reduction of the WEEE generated.

The informal door-to-door collectors are able to collect a high amount of WEEE generated in Ghana. Since they receive money from the informal recyclers for every piece collected or they dismantle the devices themselves and afterwards sell the valuable fractions, they are able to pay the consumers for the WEEE. For the formal collection that is not able to pay for the e-waste it is difficult to compete against that well established and flexible system.

Within the recycling and disposal stage, WEEE is dismantled and sorted into various valuable and non-valuable fractions. If necessary, equipment (or parts of it) is burnt in order to get more valuable fractions out of it. Valuable fractions are then sold to dealers, which again sell the material to local industries or export it. Non-valuable fractions are informally dumped and periodically burnt, in order to reduce the waste volumes on the dump site. During these activities, high amounts of hazardous substances are released, with no thoughts given to the safety of the workers and the protection of the environment. This leads to significant negative impacts on soil, air and water as well as human health. The preliminary estimation of total dioxin (PCDD/F) emissions to air from open cable burning alone in the Greater Accra Region amounts to a source strength of ~3 g / year. This equals to 7.5 – 15 % of European dioxin emissions from industrial waste incineration.

Currently there is no infrastructure available for the environmentally sound disposal of the hazardous fraction from WEEE. Table 9.1 below presents a summary of recycling options in Ghana for different waste streams generated by WEEE dismantling.

Table 9.1 Recycling Options for different WEEE Dismantling Waste Streams

Material Fraction	Recycling and Disposal in Country	Possible Downstream Partners	Comments
Ferrous metals	yes	Ferro Fabrics Limited, Tema Tema Steel Limited, Tema Western Steel & Rods Limited, Tema Special Steels Limited, Tema Special Ghana Steel, Tema Wahome Limited, Tema	Selling the fraction generates income
Aluminum	yes	Aluworks Limited, Tema VALCO, Tema	Lots of informal smelting on small scale
Copper	partially	Local refineries and individual copper smelters all over town	Informal recycler engage in burning for copper recovery Selling the fraction generates income There is a substantial export volume though local refineries require copper in their operations
Plastic	partially	Waste Recycling Ltd, Export to Europe	Needs investments for upgrading the local recyclers Selling the fraction generates income Plastics with brominated flame retardants should not be recycled but eliminated.
Printed wiring boards (PWB containing precious metals)	no	Not available in Ghana, export to Europe and Asia.	Middle men (scrap dealers) collect from informal collectors and then sell to buyers who are purported to come from Nigeria and China. Leaching is not practiced in Ghana.
CRT tubes (containing lead, beryllium, phosphor, etc.)	no	There is the need for a hazardous waste treatment facility (special incineration or a controlled landfill) which is not available in Ghana. Export to Europe is the best way out presently.	Metal smelters might be able to use CRT glass partially as a substitute for sand as a fluxing material. However the environmental impacts of such a solution would have to be evaluated carefully. A metal smelter might take the tubes for free. Otherwise the tubes need to be exported to specialized recycling companies e.g. in Europe, which is costly.
Hazardous fractions (PCB in capacitors, mercury in backlights, batteries)	no	Needs a hazardous waste treatment facility (special incineration or controlled landfill) which is not available, smaller capacitors and batteries can be left on the PWB when sold to international smelters. Export to Europe	Needs either investment into a local hazardous waste treatment facility or needs to be exported to specialized facilities abroad (e.g. to Europe)

A policy and legislation analysis illustrates that there is currently no specific policy or legislation for WEEE management in place. Regarding the importation of WEEE, Ghana has ratified the Basel Convention on the Control of Transboundary Movements of Hazardous Wastes and their Disposal, which prohibits imports and exports of e-waste in 2005, but its provisions are not yet incorporated into a national legislation.

Concerning the imports of second hand equipment, the energy efficiency regulations, which prohibit the import, sale and distribution of second hand refrigerators, freezers and air conditioners, came into force in 2010, but there is no enforcement. The imports of other second hand equipment, such as computers, televisions etc. are not regulated.

There are a number of laws and regulations, such as the Environmental Protection Agency Act, that have some relevance to the control and management of hazardous wastes (including WEEE), but they do not address the dangers posed to humans and the environment from such wastes. Specific regulations on the environmentally sound handling of e-waste and the disposal of hazardous fractions are not available.

All findings of the Ghana e-Waste Country Assessment were incorporated in the National Strategy document that gives recommendations on the following elements: Policy and Legislation, Business and Financing, Technology & Skills, Monitoring & Control and Marketing, Awareness & Education. The National Strategy also includes a roadmap how to build up a national e-waste management system.

10 REFERENCES

- ADI (2010). African Development Indicators, Open Data by Country. Available at (31.01.2011): <http://data.worldbank.org/data-catalog/africa-development-indicators>
- CIA (2005). Central Intelligence Agency, The World Factbook. Available at (22.9.2010): <https://www.cia.gov/library/publications/the-world-factbook/geos/gh.html>
- Eugster M., R. Hischer, et al. (2007). Key environmental impacts of the Chinese EEE industry - a life cycle assessment study. State Secretariat for Economic Affairs (SECO). St.Gallen / Switzerland; Beijing / China, Swiss Federal Laboratories for Materials Testing and Research (Empa); Tsinghua University China: 90.
- Furniture re-use network (2009). Set of average weights for furniture, appliances and other items.
- GHS (2005). Ghana Health Service: The Health Sector in Ghana, Facts and Figures 2005. Accra.
- GIS (2008). Ghana Immigration Service: Aikins, L. F.; Gyasi, A. A.; Hlorgbey, D. E. K.: Annual Report for 2008, Analysis of Immigration Data. Accra.
- GSS (1998). Ghana Statistical Service: Apphia, Rebecca; et al.: Ghana Living Standard Survey 4, Report of the fourth Round (GLSS 4). Accra.
- GSS (2008). Ghana Statistical Service: Apphia, Rebecca; et al.: Ghana Living Standard Survey, Report of the fifth Round (GLSS 5). Accra.
- GSS (2009). Ghana Statistical Service: Ghana in Figures 2008. Accra.
- HPMP (2010). United Nation Development Program: Hydrochlorofluorocarbon Management Plan (HPMP). Accra. Not published yet.
- Huisman, J., F. Magalini, et al. (2008). 2008 Review of Directive 2002/96 on Waste Electrical and Electronic Equipment (WEEE), Final Report, United Nations University.
- ITU (2008). Information Technology Union, World Telecommunication IICT Indicators Database, Chronological Time Series 1960-2007, 12th Edition 2008, Geneva 2008. Parts also available at: <http://www.itu.int/>
- Kuenzler Bossart & Partner GmbH. (2001). Elektronikschrott in der Schweiz 2001, Bundesamt für Umwelt, Wald und Landschaft, Bern.
- Laffely, J. (2007). Assessing cost implications of applying best e-waste recovery practices in a manual disassembly material recovery facility in Cape Town, South Africa, using process-based cost modelling. Lausanne / St.Gallen, EPF Lausanne / Empa.
- Mereku, D. K. (2000). Demand and Supply of Basic School Teachers in Ghana. National Teacher Education Forum, Winneba.
- MoC, (2003). Ministry of Communication: The Ghana ICT for Accelerated Development (ICT4AD) Policy. Accra.
- Mueller, E. and Widmer, R. (2009). Materialflüsse der elektrischen und elektronischen Geräte in der Schweiz, BAFU, Bern.
- NAB (2009). National Accreditation Board: Accredited Tertiary Institutions, as at December 2009. Accra, 2009. Available at (30.06.2010): <http://nab.gov.gh/nabsite/downloads/2010%20PUBLICATION%20FINAL.pdf>
- Prakash S., Manhart, A., Amoyaw-Osei, Y., Agyekum, O. (2010). Socio-economic assessment and feasibility study on sustainable e-waste management in Ghana. Accra.
- Schluep, M., C. Hagelueken, et al. (2009). Sustainable Innovation and Technology Transfer Industrial Sector Studies: Recycling – From E-Waste to Resources. Nairobi.
- Sépulveda, A., M. Schluep et al. (2010). A review of the environmental fate and effects of hazardous substances released from electrical and electronic equipments during recycling: Examples from China and India. Environmental Impact Assessment Review. Volume 30, Issue 1, Pages 28–41.

SHEP (2010). Self-help Electrification Program: Presentation by Vanderpuye, Henry, Energy Consultant, Ministry of Energy, Ghana, to the Climate Parliament, March 2010. Available at (30.06.2010): <http://www.climateparl.net/cpcontent/pdfs/SHEP%20-%20Ghana's%20Self-help%20Electrification%20Programme.pdf>

SWICO Recycling Guarantee (2006). Activity Report 2005. Zurich, Switzerland, Swiss Association for Information, Communications and Organization Technology (SWICO).

Thompson, N. M. and Casely-Hayford, L. (2008). Associates for Change: RECOUP Working Paper 16, The Financing and Outcome of Education in Ghana. Cambridge.

UN Comtrade (2010). United Nations Commodity Trade Statistics Database, Country List, International Trade Center (ITC) Country Profile, Trade in goods statistics. Available at (22.09.2010): http://www.intracen.org/dbms/country/CA_CtryIndex.Asp?CT=288

WDI (2008). The World Bank, Development Indicators, Open Data by Country. Available at (22.09.2010): <http://data.worldbank.org/country/ghana>

Zumbuehl, D. (2006). Mass flow assessment (MFA) and assessment of recycling strategies for cathode ray tubes (CRTs) for the Cape Metropolitan Area (CMA), South Africa. Zurich / St.Gallen, ETH Zurich / Empa

ANNEXES

Annex A: Questionnaire Importers / Dealers

This survey is being conducted to assess the level of acquisition, use and disposal of e-equipment in Ghana. This is to support the development of acceptable procedures for managing the disposal of e-waste generated in the country in order to avoid environmental and health hazards caused by improper disposal procedures. We would like to assure you that information provided by respondents would be treated with utmost confidentiality. We therefore entreat you to cooperate with the interviewer. Thank you.

Date _____

Interviewer _____

Name of Company _____

Name of Interviewed Person _____

Contact Telephone _____

Email Address _____

1	Yes		No
Are you aware that some hazardous fractions in e-waste need a special treatment in order to be safely disposed of?			
2	Yes	No	Give Details
Do waste collectors come and pick-up e-waste at your door?			
3	Yes /No		
Is the current collection of waste convenient to you? If no, what could be improved?			
4	Yes		No
Do you replace parts of equipment before sale to customers?			
5	Store/Keep	Throw Away	Sell
What do you do to replaced/refurbished part?			
6			
What do you do with the equipment you can't sell anymore?	<ul style="list-style-type: none"> - store - sell - throw them away with general waste - give them to a recycler - donate them to schools, employees, friends, etc. - give them back to the person who sold them to you - other 		

Product							
<i>Large Household Appliances</i>	Number Imported	Country of Import	New	Second Hand	Retail	Wholesale	Remarks/Detail
Air Conditioners							
Dish Washers							
Dryers							
Electric Heaters							
Fridges/Freezers							
Grillers							
Electric Gas Stoves							
Washing Machines							
<i>Small Household Appliances</i>							
Blenders							
Coffee Machines							
Electric Lawn-mowers							
Electric Toothbrushes							
Fans							
Hair Dryers							
Irons							
Kettles							
Microwaves							
Mixers							
Pool Cleaners							
Popcorn Makers							
Toasters							
Vacuum Cleaners							

Product							
<i>IT and Telecommunication Equipment</i>	Number Imported	Country of Import	New	Second Hand	Retail	Wholesale	Remarks/Detail
Fax Machines							
Phones (Lan lines)							
Mobile phones							

Laptops							
PCs							
LCD monitors							
CRT monitors							
Modems							
Printers							
Scanners							
Photocopiers							
<i>Consumer Equipment</i>							
Alarm Clocks							
Cameras							
DVD Players							
Electric Instruments							
Game Consoles							
MP3 Players							
Projectors							
Radios							
Stereos							
TV (CRT)							
TV (Flat panel)							

Annex B: Questionnaire Households

This survey is being conducted to assess the level of acquisition, use and disposal of e-equipment in Ghana. This is to support the development of acceptable procedures for managing the disposal of e-waste generated in the country in order to avoid environmental and health hazards caused by improper disposal procedures. We would like you to assure you that information provided by respondents would be treated with utmost confidentiality. We therefore entreat you to cooperate with the interviewer. Thank you.

Date: _____

Interviewer: _____

Interviewed Person

Name	
Residence	
Telephone	
E-mail	

Introduction:

Questions about awareness and behaviour

1	Yes		No	
Are you aware that some hazardous fractions in e-waste need a special treatment in order to be safely disposed of?				
2	Yes, everything	Yes, but no E-Waste	No	
Do waste collectors come and pick-up waste at your door? Do they take out e-waste too?				
3	Yes /No			
Is the current collection of waste convenient to you? If no, what could be improved?				

Numbers of Electrical and Electronic Equipment in the Household (in use)

Large Household Appliances

Product	Number of Products
Air Conditioners	
Dish Washers	
Dryers	
Electric Heaters	
Fridges/Freezers	
Grillers	
Electric Gas Stoves	
Washing Machines	
Others	

Small Household Appliances

Product	Number of Products
Blenders	
Coffee Machines	
Electric Lawn-mowers	
Electric Toothbrushes	
Fans	
Hair Dryers	
Irons	
Kettles	
Microwaves	
Mixers	
Pool Cleaners	
Popcorn Makers	
Toasters	
Vacuum Cleaners	
Others	

IT and Telecommunication Equipment

Product	Number of Products
Fax Machines	
Phones (Lan lines)	
Mobile phones	
Laptops	
PCs	
LCD monitors	
CRT monitors	
Modems	
Printers	
Scanners	
Photocopiers	
Others	

Consumer Equipment

Product	Number of Products
Alarm Clocks	
Cameras	
DVD Players	
Electric Instruments	
Game Consoles	
MP3 Players	
Projectors	
Radios	
Stereos	
TV (CRT)	
TV (Flat panel)	
Others	

Batteries

Product	Number of Products
Inverters	
Car Batteries	
Dry Cell Batteries	
Others	

Detailed Information about tracing products

Product	In what condition when purchased? new – N Used – U Working – W Broken – B	Number of years used	Number of years stored	In what condition was the product at the end of life? working -W broken - B broken but fixable - F
Fridge				
Washing Machine				
Toaster				
Microwave				
PC(Desktop)				
CRT monitor				
LCD Monitor				
Laptop				
Mobile				
TV (CRT)				
TV (Flat panel)				
Radio				

Disposal of Equipment (please mark with “x”)

Product	Donation	Sold to second hand dealers	Sold to scrap dealers	Disposed with household waste	Put on the street	Dumped somewhere else	Other
Fridge							
Washing Machine							
Toaster							
Microwave							
PC(Desktop)							
CRT monitor							
LCD Monitor							
Laptop							
Mobile							
TV (CRT)							
TV (Flat panel)							
Radio/stereo							

Number of persons in the household

1	2	3-4	5-8	more than 8

Salary per month in the whole household – Ghana Cedis

under 100	100 - 199	200 - 499	500 - 999	1,000 – 1,999	over 2,000

Annex C: Questionnaire Institutions

This survey is being conducted to assess the level of acquisition, use and disposal of e-equipment in Ghana. This is to support the development of acceptable procedures for managing the disposal of e-waste generated in the country in order to avoid environmental and health hazards caused by improper disposal procedures. We would like to assure you that information provided by respondents would be treated with utmost confidentiality. We therefore entreat you to cooperate with the interviewer. Thank you.

Date: _____

Question	Answer	Remarks (please enhance your replies with comments, suggestions, details, etc.)
General		
1. Are you aware of the environmental hazards caused by discarded electronic equipments?	Yes / No	
2. Are you aware that some electronic parts may be profitably recycled?	Yes / No	
3. Are you aware that some hazardous fractions in e-waste need a special treatment in order to be safely disposed of?	Yes / No	
4. Does your company have a policy for the management of e-waste?	Yes / No	
5. If not, does your company plan to adopt a policy of e-waste management?	Yes / No	
Stock and Generation of e-waste		
6. what is the installed base of electric & electronic equipment (in numbers)	<ul style="list-style-type: none"> - Desktop computers..... - Printers..... - Telephones..... - Televisions..... - Refrigerators..... -Scanners -Photocopiers -Laptops - Fax machines..... - Others..... 	
7. How many new e-equipment does your company purchase per year?	<ul style="list-style-type: none"> - Desktop computers..... - Printers..... - Telephones..... - Televisions..... - Refrigerators..... - Scanners -Photocopiers..... -Laptops -Fax machines..... - Others..... 	
8. Where do you purchase your equipment?	<ul style="list-style-type: none"> - retail shop - general distributor - directly from the manufacturer - lease - second hand market - other 	

Question	Answer	Remarks (please enhance your replies with comments, suggestions, details, etc.)
Stock and generation of e-waste (continuation)		
9. What do you do with the equipment you don't use anymore?	<ul style="list-style-type: none"> - store - sell - throw them away with general waste - give them to a recycler - donate them to schools, employees, friends, etc. - give them back to the person who sold them to you - Other... 	
10. Do you keep inventories of the equipment you discard / store?	Yes / No	
End-of-life management of your electric and electronic equipment		
11. Are you aware of what happens to the equipment you have discarded?	Yes / No	
12. Would you be ready to pay for your equipment to be collected and recycled?	Yes / No	
13. If yes, at what conditions? (e.g. pick-up service, guarantee of proper disposal, etc.)		
14. What are to your point of view the most important obstacles to proper recycling of electric and electronic equipment in Ghana?	<ul style="list-style-type: none"> - costs - lack of infrastructure - absence of recycling possibilities - lack of legislation/policy - other 	
15. What should be done to implement proper recycling channels in Ghana?		
Institution information		
16. Name and address of the institution		
17. Details of a contact person		
18. Type of institution	<ul style="list-style-type: none"> - government - private company - NGO - other 	
19. Principal activity of the company		
20. Number of employees		

Annex D: Questionnaires Repairers

This survey is being conducted to assess the level of acquisition, use and disposal of e-equipment in Ghana. This is to support the development of acceptable procedures for managing the disposal of e-waste generated in the country in order to avoid environmental and health hazards caused by improper disposal procedures. We would like to assure you that information provided by respondents would be treated with utmost confidentiality. We therefore entreat you to cooperate with the interviewer. Thank you.

Date _____
 Interviewer _____
 Name of Company (Repairer) _____
 Name of Contact Person _____
 Contact Telephone _____
 Email Address _____

1	Yes	No	
Are you aware that some hazardous fractions in e-waste need a special treatment in order to be safely disposed of?			
2	Yes	No	Give details
Are you aware that some electronic parts may be profitably recycled?			
3	Yes /No		
Do you pay for your e-waste to be collected? Please give details.			
4	Yes	No	
Do waste collectors come and pick-up e-waste at your door?			
5			
What do you normally do to old and unserviceable e-equipment?	1. - store 2. - sell to scrap dealer/ e-waste business 3. - throw them away with general waste 4. - donate them to schools, employees, friends, etc. 5. - give them back to the person who brought them for servicing 6. - other		

Product							
<i>Large Household Appliances</i>	Quantity Repaired	Quantity Not Repaired	Replace Part	Repair	Refurbish	Individuals/ Companies	How Long do you keep before disposal?
Air Conditioners							
Dish Washers							
Dryers							
Electric Heaters							
Fridges/Freezers							
Grillers							
Electric Gas Stoves							
Washing Machines							
<i>Small Household Appliances</i>							
Blenders							
Coffee Machines							
Electric Lawn-mowers							
Electric Toothbrushes							
Fans							
Hair Dryers							
Irons							
Kettles							
Microwaves							
Mixers							
Pool Cleaners							
Popcorn Makers							
Toasters							
Vacuum Cleaners							

Product							
<i>IT and Telecommu- nication Equipment</i>	Quantity Repaired	Quantity Not Re- paired	Replace Part	Repair	Refurbish	Individuals/ Companies	How Long do you keep be- fore dis- posal?
Fax Machines							
Phones (Lan lines)							
Mobile phones							
Laptops							
PCs							
LCD monitors							
CRT monitors							
Modems							
Printers							
Scanners							
Photocopiers							
<i>Consumer Equipment</i>							
Alarm Clocks							
Cameras							
DVD Players							
Electric Instruments							
Game Consoles							
MP3 Players							
Projectors							
Radios							
Stereos							
TV (CRT)							
TV (Flat panel)							

Annex E: Photo Documentation



The two faces of Agbogbloshie - onion market and scrap yard



A Meeting at the Agbogbloshie scrap yard



A stock pile of used System Units on sale



Scrap yard shop selling lead and copper



A scavenger carrying his cables to the burning site



A dismantler hard at work



Informal Dumping and Burning to extract copper



The burning site manned by children



The scrap yard also serving us a refuse dump



Gathering soil samples for heavy metal test at Ag-bogbloshi scrap yard



Electronic cables bundled up and ready to be burnt



Stock pile of old computers and fridges already cannibalized



A stock pile of car batteries to be cannibalized



A large section of the dump site filled with Styrofoam from refrigerators



Iron smelting at the dump site



A small boy carrying an air conditioner filter walking in the scrap yard



The extent of damage to the environment by the scrap dealers



High level consultations at the Ministry of Environment



Mr. Opoku Agyekum giving a presentation on 2nd stakeholder meeting in Accra



Discussions under way at the ministry of Environment



Participants registering for the 2nd Stakeholder meeting in Accra



Participants listening to presentation



Discussions by the Marketing and Awareness Group



Dr. Edith Clarke making a point during the training of field teams



Stakeholder meetings and consultations



GreenAd and EMPA field team who worked on the data collection and analysis



Field team discussing the data acquired



Workshops and Meetings organized

Annex F: Weight, Life Span and Composition of Equipment

Weight and lifetime estimations used for the Ghana massflow assessment

Item	Weight (kg)	Source	Lifetime (Years)	Source
Category 1: Large household appliances				
Refrigerator / Freezer	35	Estimate based on (Huisman, Magalini et al. 2008)	12	Estimate for Ghana setting
Air Conditioner	18.5	(Furniture re-use network, 2009)	8	Estimate for Ghana setting
Dish Washer	50	(Huisman, Magalini et al. 2008)	10	(Huisman, Magalini et al. 2008)
Tumble Dryer	49	(Künzler Bossert & Partner GmbH 2001)	10	(Huisman, Magalini et al. 2008)
Electric Heater	5	(Huisman, Magalini et al. 2008)	20	(Huisman, Magalini et al. 2008)
BBQ / Griller	15	(Furniture re-use network, 2009)	10	Estimate for Ghana setting
Electric/Gas Stove	56	(Furniture re-use network, 2009)	15	Estimate for Ghana setting
Washing machine	65	(Huisman, Magalini et al. 2008)	10	Estimate for Ghana setting
Category 2: Small household appliances				
Iron	1	(Huisman, Magalini et al. 2008)	10	(Huisman, Magalini et al. 2008)
Kettle	1	(Huisman, Magalini et al. 2008)	7	Estimate for Ghana setting
Blender	2	Estimate	5	Estimate for Ghana setting
Coffee Machine	7	Estimate	8	Estimate for Ghana setting
Electric Lawn-mower	13	(Furniture re-use network, 2009)	10	(Huisman, Magalini et al. 2008)
Electric Tooth-brush	0.2	Estimate	4	Estimate for Ghana setting
Fan	10	(Furniture re-use network, 2009)	6	Estimate for Ghana setting
Hair dryer	1	(Huisman, Magalini et al. 2008)	10	(Huisman, Magalini et al. 2008)
Microwave	15	(Huisman, Magalini et al. 2008)	7	(Huisman, Magalini et al. 2008)
Mixer	1	(Huisman, Magalini et al. 2008)	5	(Huisman, Magalini et al. 2008)
Popcorn Maker	2	Estimate	5	Estimate for Ghana setting

Item	Weight (kg)	Source	Lifetime (Years)	Source
Toaster	1	(Huisman, Magalini et al. 2008)	5	(Huisman, Magalini et al. 2008)
Vacuum cleaner	8	(Künzler Bossert & Partner GmbH 2001)	10	(Huisman, Magalini et al. 2008)
Category 3: Information and communication technologies				
Desktop Computer (inkl. mouse and keyboard)	9.9	(Eugster, Hischier et al. 2007)	5	Estimate for Ghana setting
Desktop Computer (as above & Monitors (Ghana lcd/crt mix)	22	Estimate	5	Estimate for Ghana setting
Laptop Computer	3.5	(SWICO Recycling Guarantee 2006) / ecoinvent v2.0	3	Estimate for Ghana setting
CRT Monitor	14.1	(Laffely 2007)/ (Zumbuehl 2006)	5	Estimate for Ghana setting
LCD Monitor	4.7	(SWICO Recycling Guarantee 2006) / ecoinvent v2.0	5	Estimate for Ghana setting
Mobile Phone (inkl. Charger)	0.5	(Furniture re-use network, 2009)	3	Estimate for Ghana setting
Fax Machine	4	Estimate	8	Estimate for Ghana setting
Telephone	1	(Huisman, Magalini et al. 2008)	5	(Huisman, Magalini et al. 2008)
Modem	0.3	Estimate	4	Estimate for Ghana setting
Printer	6.5	(Laffely 2007)/	4	Estimate for Ghana setting
Scanner	7	(Furniture re-use network, 2009)	5	Estimate for Ghana setting
Photocopier	52	(Furniture re-use network, 2009)	10	Estimate for Ghana setting
Category 4: Consumer electronics				
Television (CRT)	31.6	(Zumbuehl 2006)	10	(Huisman, Magalini et al. 2008)
Television LCD)	15	Estimate	10	(Huisman, Magalini et al. 2008)
Television (Ghana CRT/LCD mix)	28	Estimate based on proportion crt / lcd	10	(Huisman, Magalini et al. 2008)
Radio	2	(Huisman, Magalini et al. 2008)	12	Estimate for Ghana setting
Hi-Fi system	10	(Huisman, Magalini et al. 2008)	10	(Huisman, Magalini et al. 2008)
Radio / HiFi	5.6	Estimate based on portion radio / hifi	11	Estimate for Ghana setting

Item	Weight (kg)	Source	Lifetime (Years)	Source
Alarm Clock	0.3	Estimate	5	Estimate for Ghana setting
Camera	0.7	Estimate	5	Estimate for Ghana setting
Video recorder / DVD player	5	(Huisman, Magalini et al. 2008)	5	(Huisman, Magalini et al. 2008)
E-Instrument	7	Estimate	10	Estimate for Ghana setting
Game Console	12	(Furniture re-use network, 2009)	6	Estimate for Ghana setting
MP3 Player	.2	Estimate	3	Estimate for Ghana setting
Projector	5	Estimate	4	Estimate for Ghana setting

Average composition of four different WEEE categories in weight %

Material	Large household appliances	Small household appliances	ICT and consumer electronics	Lighting equipment
Iron	43	29	36	n.a.
Aluminium	14	9.3	5.0	14
Copper	12	17	4.0	0.22
Lead	1.6	0.57	0.29	n.a.
Cadmium	0.014	0.0068	0.018	n.a.
Mercury	3.8E-05	1.8E-05	7.0E-05	0.020
Gold	6.7E-07	6.1E-07	2.4E-04	n.a.
Silver	7.7E-06	7.0E-06	1.2E-03	n.a.
Palladium	3.0E-07	2.4E-07	6.0E-05	n.a.
Indium	0	0	5.0E-04	5.0E-04
Plastics with brominated flame retardants	0.29	0.75	18	3.7
Plastics	19	37	12	n.a.
Lead glass	0	0	19	0
Glass	0.017	0.16	0.30	77
Other	10	6.9	5.7	5.0
Total	100.00	100.00	100.00	100

(Source: Mueller and Widmer, 2009)

Annex G: Massflow Assessment

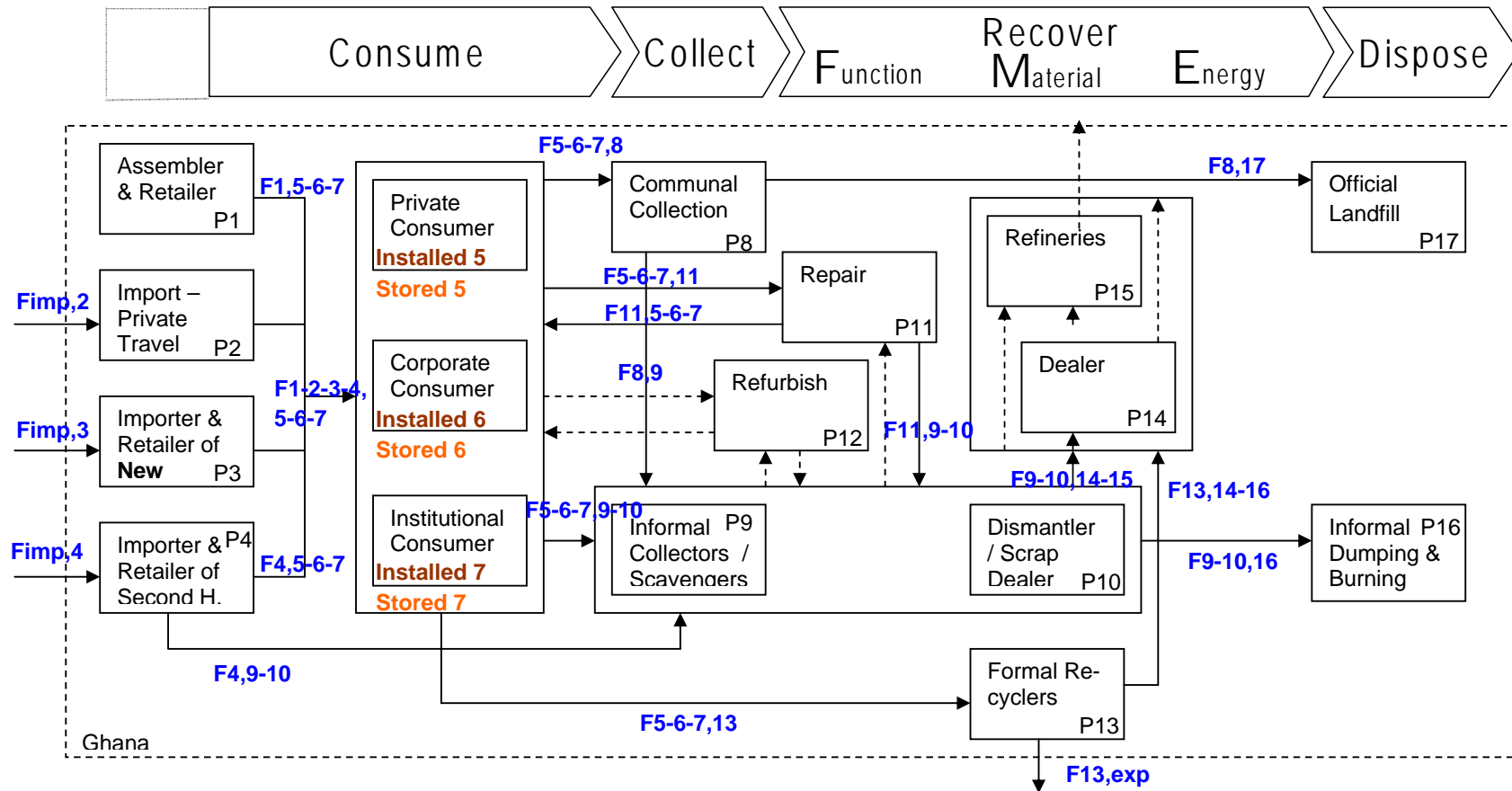

Flow of (W)EEE (Tons/Year)
 Installed Base of EEE (Tons)
 Stored Base of WEEE (Tons)

—————> Quantified Flows
 - - - - -> Not-Quantified Flows

P1 - Assembler & Retailer

Flows	Factor	Nr. of Units	Tons	Source
Fass,1_computer		36'000	648	estimate, 2009 (interview)
Fass,1_television		1'800	52	estimate, 2009 (interview)
Fass,1_radio/hifi		3'200	18	estimate, 2009 (interview)
Fass_all			718	
F1,5-6-7			718	

P2 - Import, Private Travel

Flows	Factor	Nr. of Units	Tons	Source
people arriving in GH	525'000			GIS, 2008
Fimp,2_laptop	10%	52500	184	estimate
Fimp,2_mobile phones inkl. charger	50%	262'500	131	estimate
Fimp,2_camera	10%	52'500	37	estimate
Fimp,2_dvd player	10%	52'500	263	estimate
Fimp,2_game consol	10%	52'500	630	estimate
Fimp,2_mp3 player	10%	52'500	11	estimate
Fimp,2_all			1'255	
F2,5-6-7			1'255	

P3-4 - Import New & Second Hand

Flows		Nr. of Units	Tons	Source
% for underdeclaration added	30%			
Fimp,3-4_refrigerator		983'654	34'428	UN comtrade 2008
Fimp,3-4_aircondition		919'908	17'018	UN comtrade 2008
Fimp,3-4_computer/laptop		984'317	17'718	UN comtrade 2008
Fimp,3-4_television		815'414	23'647	UN comtrade 2008
Fimp,3_sum			92'811	
products are % weight of all	43.5%			
Fimp,3-4_all			213'409	

P3 - Importer & Retailer New

Flows	Factor	Nr. of Units	Tons	Source
% new of all imports	30%			estimate, survey, interview
Fimp,3_refrigerator		295'096	10'328	calculation
Fimp,3_aircondition		275'972	5'105	calculation
Fimp,3_computer/laptops		295'295	5'315	calculation
Fimp,3_television		244'624	7'094	calculation
Fimp,3_sum			27'843	
products are % weight of all	43.5%			
Fimp,3_all			64'023	
F3,5-6-7			64'023	

P4 - Importer & Retailer Second Hand

Flows	Factor	Nr. of Units	Tons	Source
% second hand of all imports	70%			estimate, survey, interview
Fimp,4_refrigerator		688'558	24'100	calculation
Fimp,4_aircondition		643'936	11'913	calculation
Fimp,4_computer/laptops		689'022	12'402	calculation
Fimp,4_television		570'790	16'553	calculation
Fimp,4_sum			64'968	
products are % weight of all	43.5%			
Fimp,4_all			149'386	
% to dump	15%			
F4,5-6-7			126'978	
F4,9-10			22'408	

P1-2-3-4 - Assembly & Imports

Flows	Factor	Nr. of Units	Tons	Source
F1-2-3-4,5-6-7			192'974	

P5 - Private Consumer - Installed Base

Installed Base	Factor	Nr. of Units	Tons	Source
Large Household Appliances				
S5_refrigerator		5'869'567	205'435	GreenAd survey, 2010
S5_aircondition		1'644'118	30'416	GreenAd survey, 2010
S5_dish washer		114'911	5'746	GreenAd survey, 2010
S5_dryer		303'494	14'871	GreenAd survey, 2010
S5_electric heaters		2'507'496	12'537	GreenAd survey, 2010
S5_grillers		436'090	6'541	GreenAd survey, 2010
S5_electric/gas stoves		1'903'523	106'597	GreenAd survey, 2010
S5_washing machines		1'163'857	75'651	GreenAd survey, 2010
Small Household Appliances				
S5_iron		4'662'782	4'663	GreenAd survey, 2010
S5_kettle		2'910'737	2'911	GreenAd survey, 2010
S5_blender		3'531'545	7'063	GreenAd survey, 2010
S5_coffee machines		139'507	977	GreenAd survey, 2010
S5_electric lawnmower		111'605	1'451	GreenAd survey, 2010
S5_electric toothbrushes		91'789	18	GreenAd survey, 2010
S5_fans		8'942'881	89'429	GreenAd survey, 2010
S5_hair dryers		2'289'930	2'290	GreenAd survey, 2010
S5_microwaves		1'528'071	22'921	GreenAd survey, 2010
S5_mixer		749'690	750	GreenAd survey, 2010
S5_popcorn maker		55'803	112	GreenAd survey, 2010
S5_toaster		1'300'422	1'300	GreenAd survey, 2010
S5_vacuum cleaner		530'126	4'241	GreenAd survey, 2010
ICT				
S5_laptops		282'622	989	GreenAd survey, 2010
S5_computers		621'578	6'154	GreenAd survey, 2010
S5_LCD monitor		236'026	1'109	GreenAd survey, 2010
S5_CRT monitor		302'585	4'266	GreenAd survey, 2010
S5_mobile phones inkl. charger		17'350'579	8'675	GreenAd survey, 2010
S5_faxmachine		61'629	247	GreenAd survey, 2010
S5_phone (land line)		456'629	457	GreenAd survey, 2010
S5_modems		384'252	115	GreenAd survey, 2010
S5_printers		337'098	2'191	GreenAd survey, 2010
S5_scanners		187'038	1'309	GreenAd survey, 2010
S5_photocopiers		61'629	3'205	GreenAd survey, 2010
Consumer Electronics				
S5_television_crt		4'179'494	132'072	GreenAd survey, 2010
S5_television_lcd		441'603	6'624	GreenAd survey, 2010
S5_radio		3'635'775	7'272	GreenAd survey, 2010
S5_stereo		3'001'988	30'020	GreenAd survey, 2010
S5_alarm clock		969'591	291	GreenAd survey, 2010
S5_camera		2'021'987	1'415	GreenAd survey, 2010
S5_dvd player		4'064'180	20'321	GreenAd survey, 2010
S5_e instruments		725'378	5'078	GreenAd survey, 2010
S5_game consol		786'823	9'442	GreenAd survey, 2010
S5_mp3 player		2'002'376	400	GreenAd survey, 2010
S5_projector		265'573	1'328	GreenAd survey, 2010

S5_sum		83'164'377	838'899
% for missed EEE	10%		
S5_all			922'789

P5 - Private Consumer - Stored

Stored Base	Factor	Nr. of Units	Tons	Source
stored is % of installed base	30%			estimate
Stored5_all			276'837	

P5 - Private Consumer - Flows

Flows (/year)	Factor	Nr. of Units	Tons	Source
End-of-Life to Storage				
F5_Store5_all			38'418	
End-of-Life to Outside				
F5_outside_all			62'788	
Store to Outside				
to outside % of stored	10%			estimate
F5_store (% of Store)			27'684	
Total End-of-Life				
F5_endlife			101'206	
Total to Outside				
F5_all			90'471	

P6 - Corporate Consumer - Installed Base

Installed Base	Factor	Nr. of Units	Tons	Source
S6_refrigerator		216'327	7'571	1/3 ref&air HMPM,2008
S6_airconditioner		432'655	8'004	2/3 ref&air HMPM,2008
S6_laptops		71'127	249	GreenAd survey, 2010
S6_computers		480'360	10'568	GreenAd survey, 2010
S6_faxmachine		26'012	104	GreenAd survey, 2010
S6_phone		351'989	352	GreenAd survey, 2010
S6_printers		101'501	660	GreenAd survey, 2010
S6_scanners		29'570	207	GreenAd survey, 2010
S6_photocopiers		29'948	1'557	GreenAd survey, 2010
S6_television		22'741	659	GreenAd survey, 2010
S6_radio/hifi_calc		34'111	192	assumption
S6_sum		1'796'341	30'124	
% for missed EEE	20%			
S6_all			36'148	

P6 - Corporate Consumer - Stored Base

Stored Base	Factor	Nr. of Units	Tons	Source
% of installed base	30%			estimate
Store6_all			10'845	

P6 - Corporate Consumer - Flows

Flows (/year)	Factor	Nr. of Units	Tons	Source
End-of-Life to Storage				
F6_Store6_all			1'568	
End-of-Life to Outside				
F6_outside_all			3'660	
Store to Outside				
to outside % of stored	30%			estimate
F6_store (% of Store)			3'253	
Total End-of-Life				
F6_endlife			5'228	
Total to Outside				
F6_all			6'913	

P7 - Institutional Consumer - Installed Base

Installed Base	Factor	Nr. of Units	Tons	Source
S7_refrigerator		127'588	4'466	GreenAd survey, 2010
S7_aircondition		90'853	1'681	GreenAd survey, 2010
S7_laptops		94'216	330	GreenAd survey, 2010
S7_computers		370'622	8'154	GreenAd survey, 2010
S7_faxmachine		22'925	92	GreenAd survey, 2010
S7_phone		326'810	327	GreenAd survey, 2010
S7_printers		183'758	1'194	GreenAd survey, 2010
S7_scanners		13'761	96	GreenAd survey, 2010
S7_photocopiers		39'750	2'067	GreenAd survey, 2010
S7_television		59'326	1'720	GreenAd survey, 2010
S7_radio/hifi_calc		118'653	667	assumption
S7_sum		1'448'262	20'793	
% for missed EEE	20%			
S7_all			24'951	

P7 - Institutional Consumer - Stored Base

Stored Base	Factor	Nr. of Units	Tons	Source
% of installed base	30%			estimate
Store7_all			7'485	

P7 - Institutional Consumer - Flows

Flows (/year)	Factor	Nr. of Units	Tons	Source
End-of-Life to Storage				
F7_Store7_all			1'135	
End-of-Life to Outside				
F7_outside_all			2'649	
Store to Outside				
to outside % of stored	10%			estimate
F7_store (% of Store)			749	
Total End-of-Life				
F7_endlife			3'784	
Total to Outside				
F7_all			3'397	

P5-6-7 - All Consumers - Stocks

Stocks	Factor	Nr. of Units	Tons	Source
Total Installed Base				
S5-6-7			983'889	
Total Storage				
Store5-6-7			295'167	

P5-6-7 - All Consumers - Flows

Flows (/year)	Factor	Nr. of Units	Tons	Source
Total End-of-Life				
F5-6-7_endlife			110'218	
Total to Outside				
F5-6-7			100'782	
To Communal Collection				
communal collection	5%			estimate
F5-6-7,8			5'039	
To Fromal Recycling				
formal recycling	0.030%			interview
F5-6-7,13			30	
To Informal Sector				
F5-6-7,9-10			95'712	

P8 - Communal Collection

Flows (/year)	Factor	Nr. of Units	Tons	Source
from 5-6-7			5'039	
To Informal Sector				
beeing picked	95%			estimate
F8,9-10			4'787	
To Formal Dumpsite				
F8,17			252	

P9-10 - Informal Collectors /Scavangers & Dismantler / Scrap Dealer

Flows (/year)	Factor	Nr. of Units	Tons	Source
from 4 & 5-6-7 & 8 & 11			170'740	
To Industry				
% of weight recovered	42%			estimate, calculation
F9-10,14-15			71'457	
To Informal Dump				
F9-10,16			99'283	

P11 - Repairer

Flows (/year)	Factor	Nr. of Units	Tons	Source
from 5-6-7			159'491	
Back to Consumer				
F11,5-6-7			111'659	GreenAd survey, 2010
To Informal Sector				
F11,9-10			47'832	GreenAd survey, 2010

P13 - Formal Recycling

Flows (/year)	Factor	Nr. of Units	Tons	Source
from 5-6-7			30	
To Industry				
% in country sold	34%			interview, calculation
F13,14-15			10	
To Export				
F13,exp			20	