

Bob Coecke & Aleks Kissinger,
Picturing Quantum Processes,
Cambridge University Press, to appear.

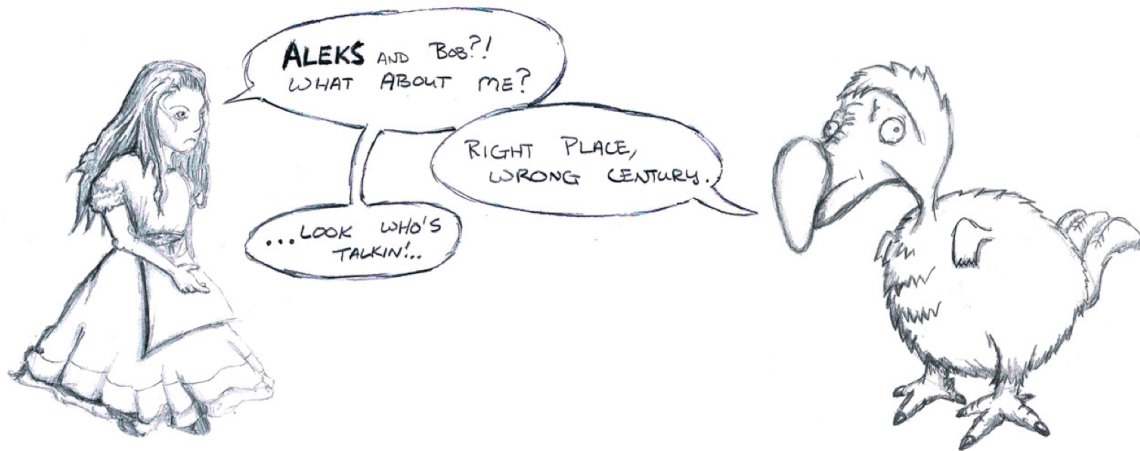

Bob:

- Ch. 01 Processes as diagrams
- Ch. 02 String diagrams
- Ch. 03 Hilbert space from diagrams
- Ch. 04 Quantum processes
- Ch. 05 Quantum measurement
- Ch. 06 Picturing classical processes

Aleks:

- Ch. 07 Picturing phases and complementarity
- Ch. 08 Quantum theory: the full picture
- Ch. 09 Quantum computing
- Ch. 10 Quantum foundations

— Ch. 1 – Processes as diagrams —

Philosophy [i.e. physics] is written in this grand book—I mean the universe—which stands continually open to our gaze, but it cannot be understood unless one first learns to comprehend the language and interpret the characters in which it is written. It is written in the language of mathematics, and its characters are triangles, circles, and other geometrical figures, without which it is humanly impossible to understand a single word of it; without these, one is wandering around in a dark labyrinth.

— Galileo Galilei, “Il Saggiatore”, 1623.

Here we introduce:

- process theories
- diagrammatic language

— Ch. 1 – Processes as diagrams —

– processes as boxes and systems as wires –

— Ch. 1 – Processes as diagrams —

– *processes as boxes and systems as wires* –

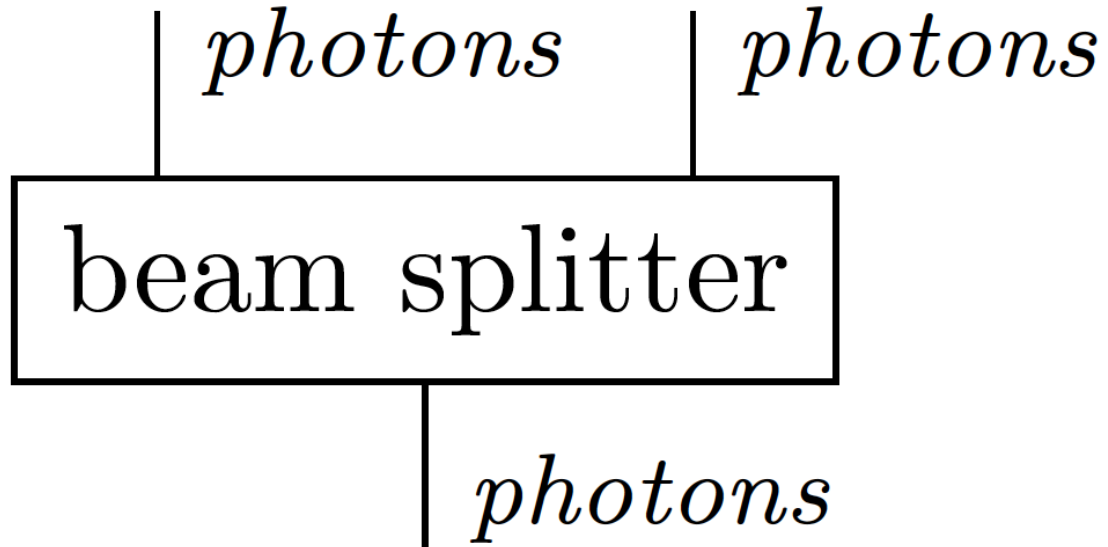

— Ch. 1 – Processes as diagrams —

– *processes as boxes and systems as wires* –

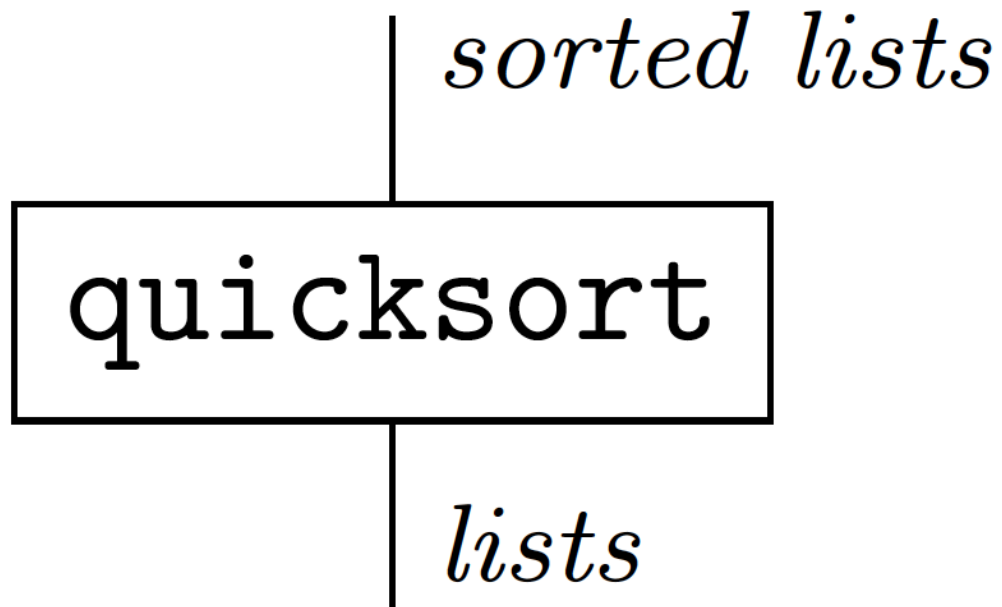

— Ch. 1 – Processes as diagrams —

– *processes as boxes and systems as wires* –

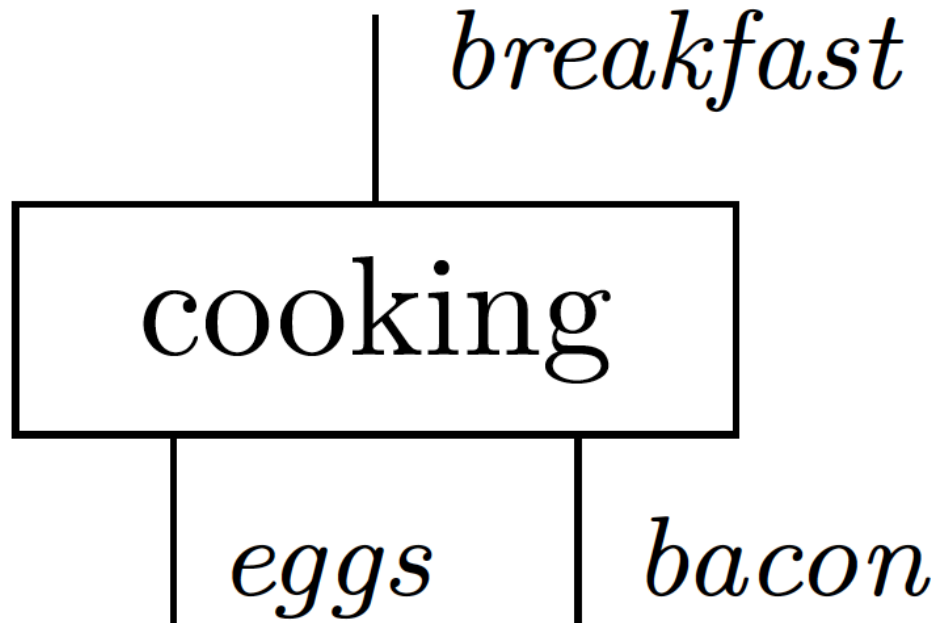

— Ch. 1 – Processes as diagrams —

– *processes as boxes and systems as wires* –

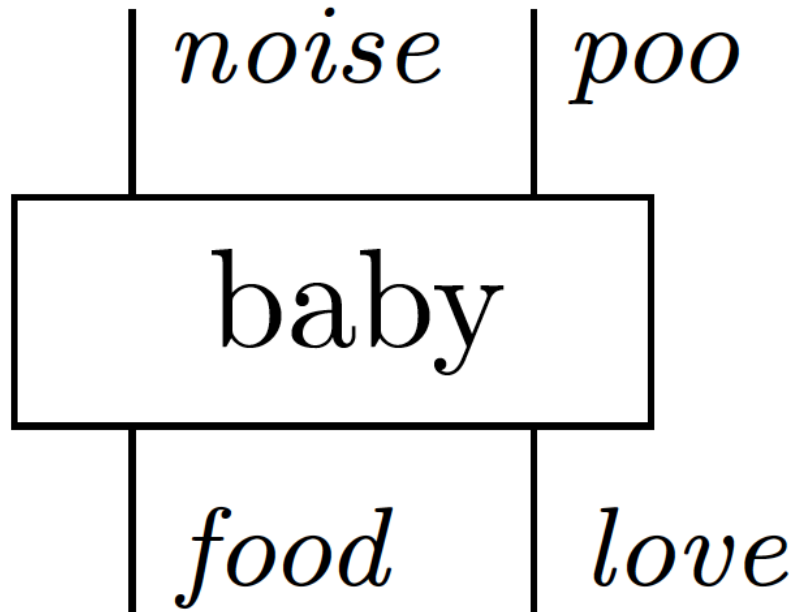

— Ch. 1 – Processes as diagrams —

– processes as boxes and systems as wires –

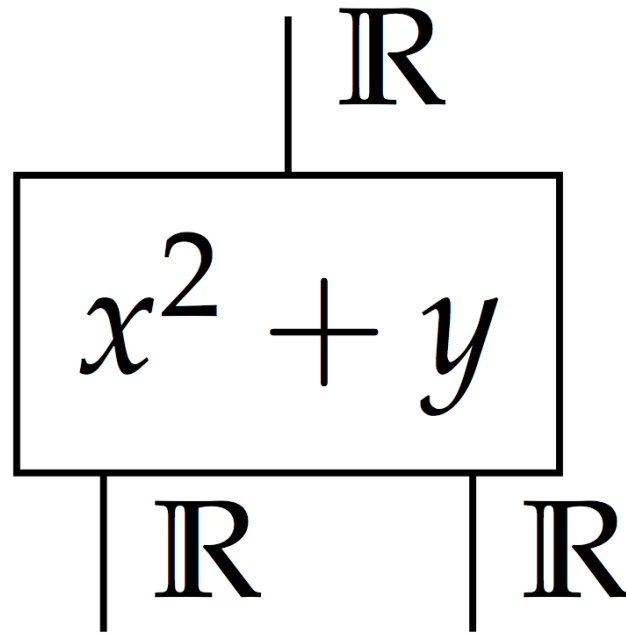

— Ch. 1 – Processes as diagrams —

– composing processes –

— Ch. 1 – Processes as diagrams —

– *composing processes* –

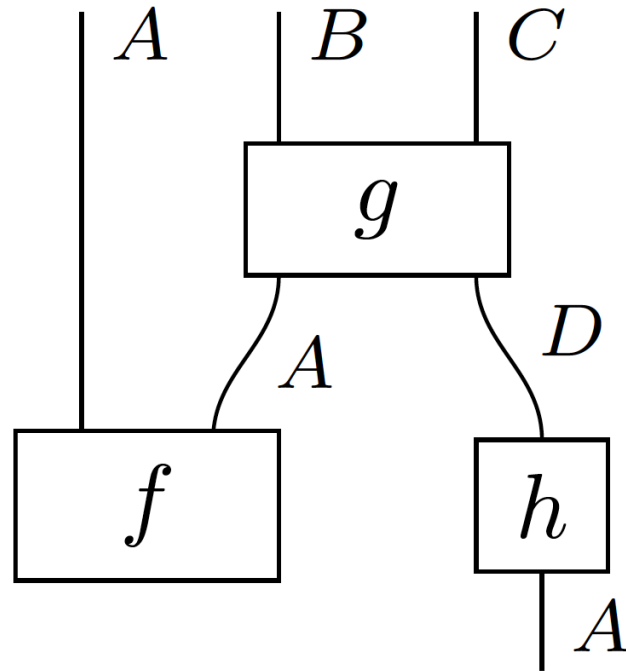

— Ch. 1 – Processes as diagrams —

– *composing processes* –

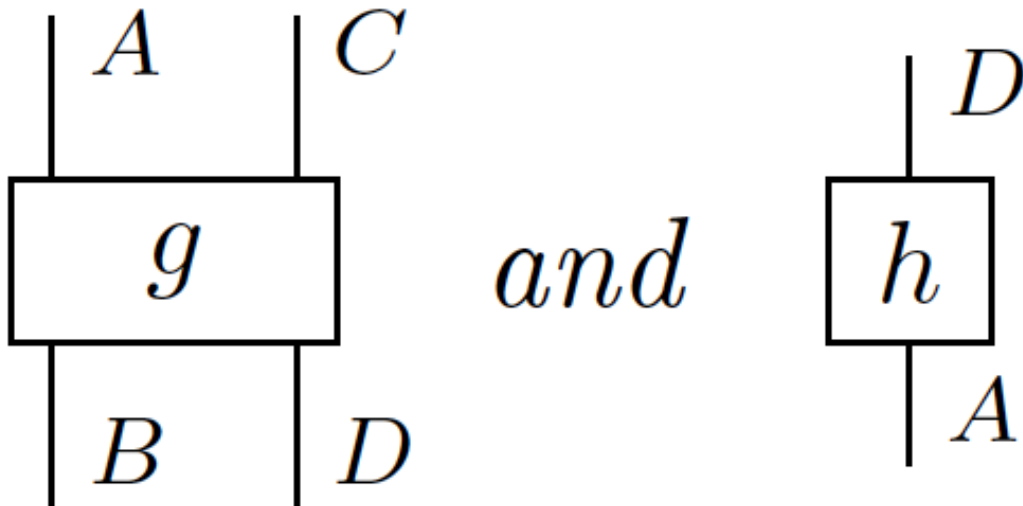

— Ch. 1 – Processes as diagrams —

– *composing processes* –

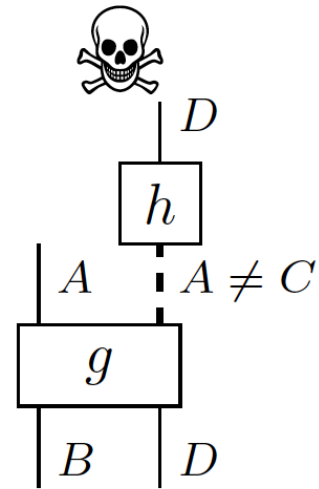
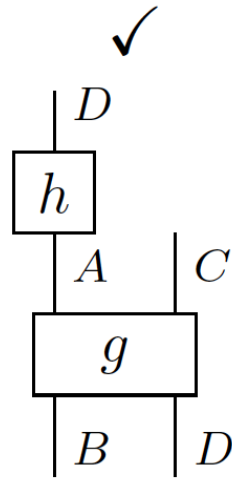
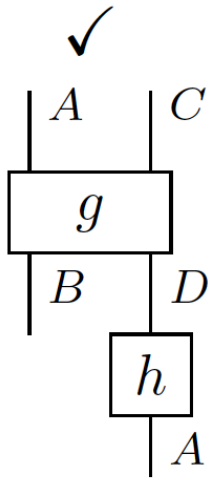

— Ch. 1 – Processes as diagrams —

– *composing processes* –

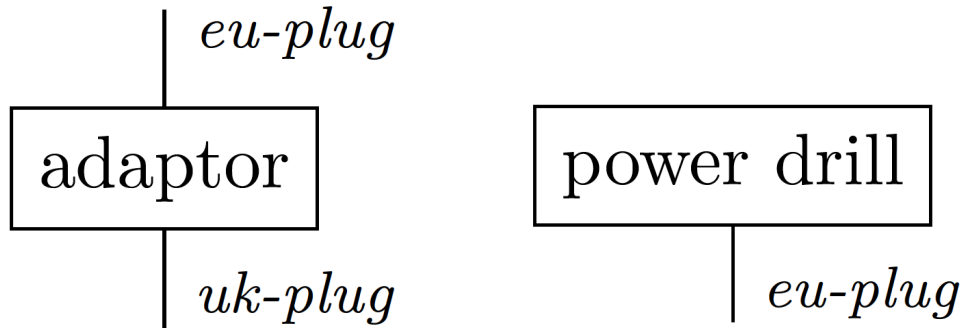
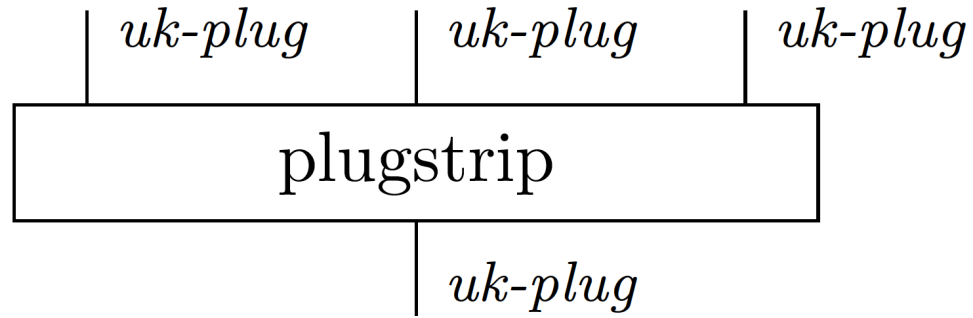

— Ch. 1 – Processes as diagrams —

– *composing processes* –

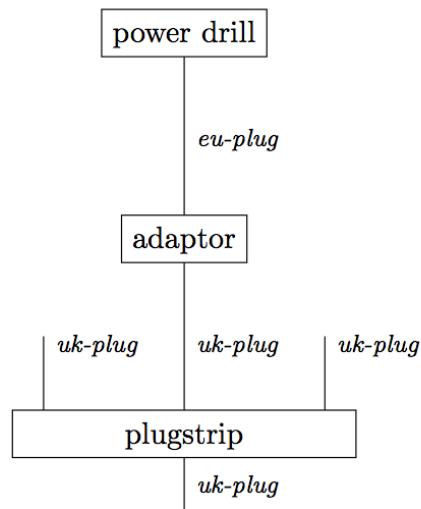

:=

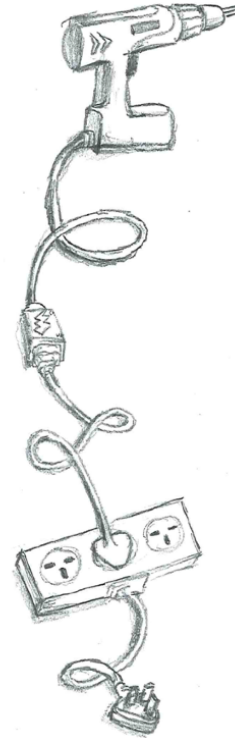

— Ch. 1 – Processes as diagrams —

– process theories –

— Ch. 1 – Processes as diagrams —

– *process theories* –

... consist of:

- set of systems S
- set of processes P , with ins and outs in S ,

— Ch. 1 – Processes as diagrams —

– *process theories* –

... consist of:

- set of systems S
- set of processes P , with ins and outs in S ,

which are:

- closed under “plugging”.

— Ch. 1 – Processes as diagrams —

– *process theories* –

... consist of:

- set of systems S
- set of processes P , with ins and outs in S ,

which are:

- closed under “plugging”.

They tell us:

- how to *interpret* boxes and wires,
- and hence, when two diagrams are equal.

— Ch. 1 – Processes as diagrams —

– *process theories* –

$$\begin{array}{c} | \\ \boxed{\text{quicksort}} \\ | \end{array} := \left\{ \begin{array}{l} \text{qs } [] = [] \\ \text{qs } (x :: xs) = \\ \quad \text{qs } [y \mid y \leftarrow xs; y < x] ++ [x] ++ \\ \quad \text{qs } [y \mid y \leftarrow xs; y \geq x] \end{array} \right.$$

— Ch. 1 – Processes as diagrams —

– *process theories* –

$$\begin{array}{c} | \\ \boxed{\text{quicksort}} \\ | \end{array} := \left\{ \begin{array}{l} \text{qs } [] = [] \\ \text{qs } (x :: xs) = \\ \text{qs } [y \mid y \leftarrow xs; y < x] ++ [x] ++ \\ \text{qs } [y \mid y \leftarrow xs; y \geq x] \end{array} \right.$$

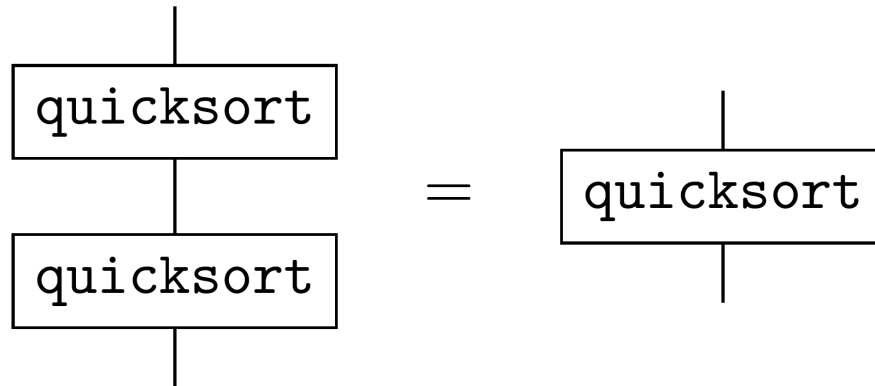

— Ch. 1 – Processes as diagrams —

– *process theories* –

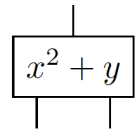

$:=$

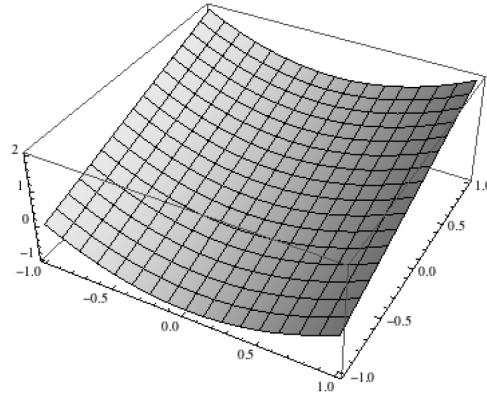

— Ch. 1 – Processes as diagrams —

– *process theories* –

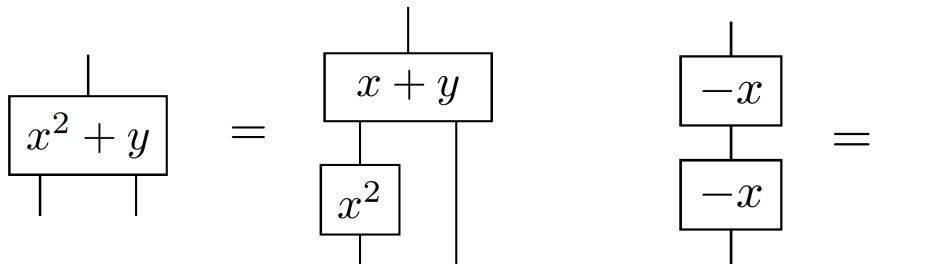
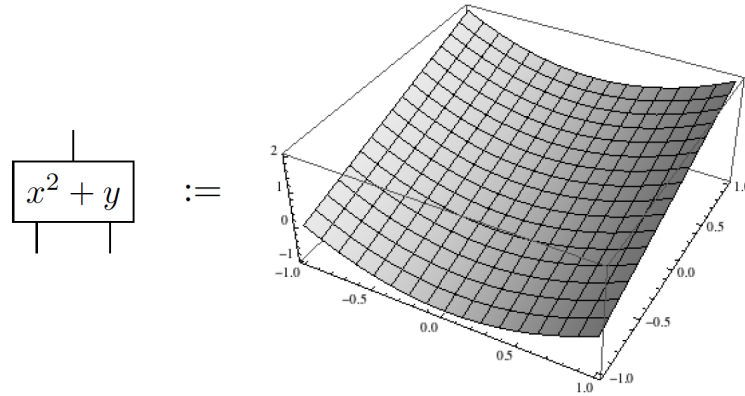

— Ch. 1 – Processes as diagrams —

– diagrams symbolically –

— Ch. 1 – Processes as diagrams —

– *diagrams symbolically* –

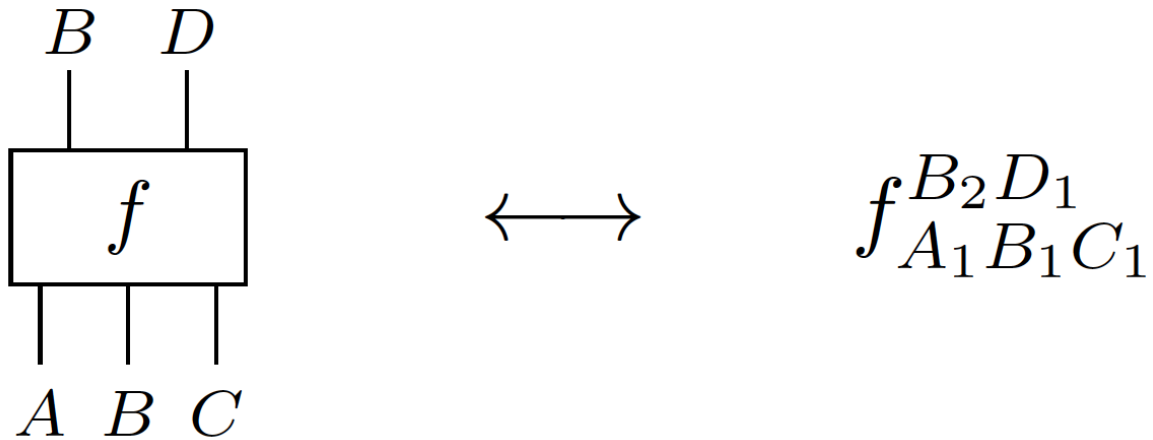

— Ch. 1 – Processes as diagrams —

– diagrams symbolically –

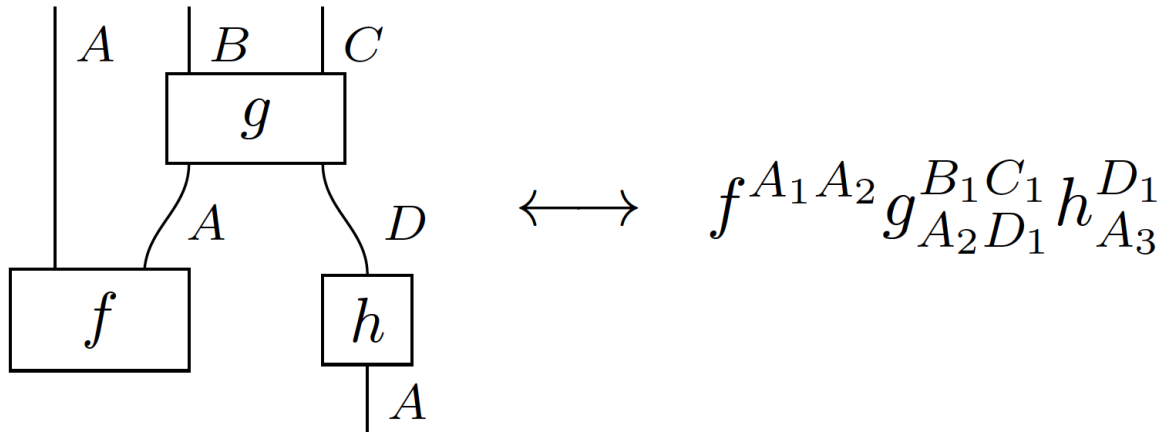

— Ch. 1 – Processes as diagrams —

– diagrams symbolically –

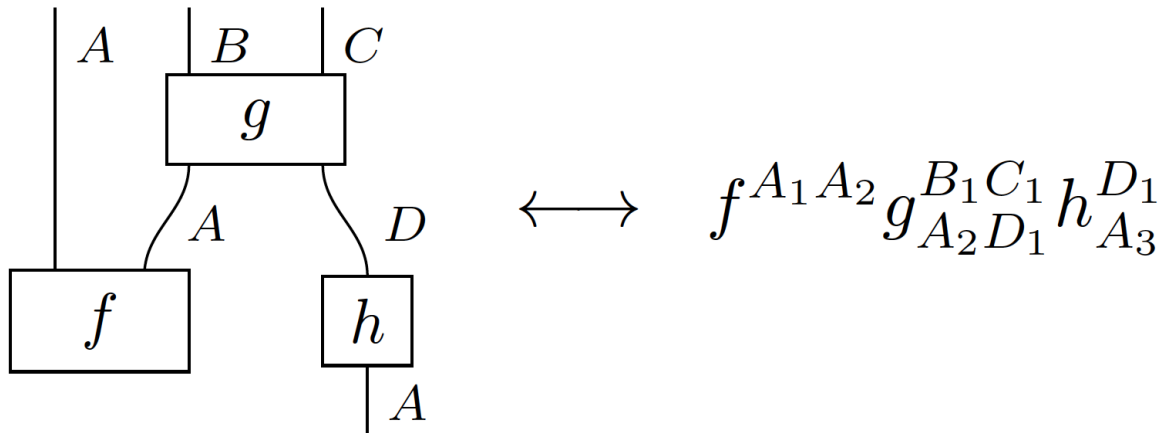

Thm. Diagrams \equiv these symbolic expressions.

— Ch. 1 – Processes as diagrams —

– composing diagrams –

— Ch. 1 – Processes as diagrams —

– *composing diagrams* –

Two operations:

$$“f \otimes g” := “f \text{ while } g”$$

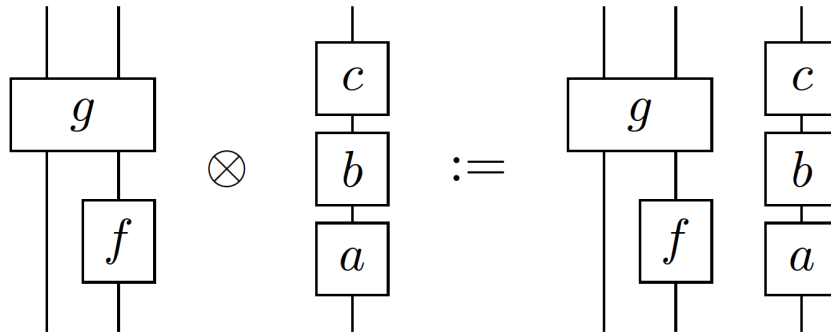

— Ch. 1 – Processes as diagrams —

– *composing diagrams* –

Two operations:

“ $f \circ g$ ” := “ f **after** g ”

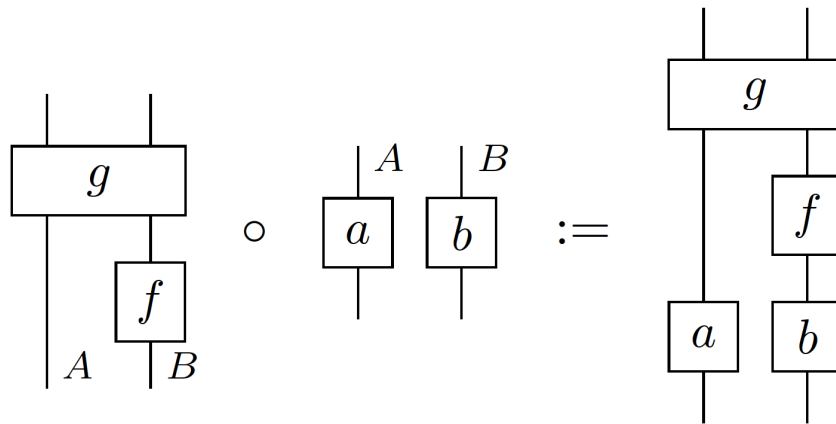

— Ch. 1 – Processes as diagrams —

– *composing diagrams* –

Two operations:

$$“f \otimes g” := “f \text{ while } g”$$
$$“f \circ g” := “f \text{ after } g”$$

These are:

- associative
- have as respective units:
 - ‘empty’-diagram
 - ‘wire’-diagram

— Ch. 1 – Processes as diagrams —

– circuits –

— Ch. 1 – Processes as diagrams —

– *circuits* –

Defn. ... := can be build with \otimes and \circ .

— Ch. 1 – Processes as diagrams —

– *circuits* –

Defn. ... := can be build with \otimes and \circ .

Thm. Circuit \Leftrightarrow no box ‘above’ itself.

— Ch. 1 – Processes as diagrams —

– *circuits* –

Defn. ... := can be build with \otimes and \circ .

Thm. Circuit \Leftrightarrow no box ‘above’ itself.

Corr. Circuit admits ‘causal’ interpretation.

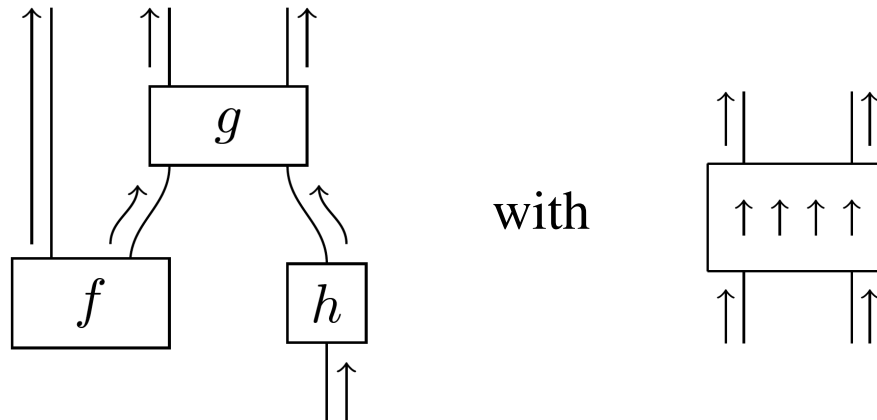

— Ch. 1 – Processes as diagrams —

– *circuits* –

Defn. ... := can be build with \otimes and \circ .

Thm. Circuit \Leftrightarrow no box ‘above’ itself.

Corr. Circuit admits ‘causal’ interpretation.

Not circuit:

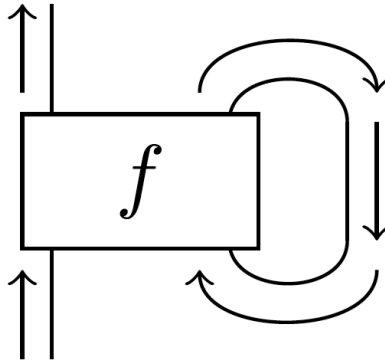

— **Ch. 1 – Processes as diagrams** —

– *why diagrams?* –

— Ch. 1 – Processes as diagrams —

– *why diagrams?* –

Since ‘by definition’ circuits can be build by means of symbolic connectives, why bother with diagrams?

— Ch. 1 – Processes as diagrams —

– *why diagrams?* –

Since ‘by definition’ circuits can be build by means of symbolic connectives, why bother with diagrams?

Since equations come for free!

— Ch. 1 – Processes as diagrams —

– *why diagrams?* –

Since ‘by definition’ circuits can be build by means of symbolic connectives, why bother with diagrams?

Since equations come for free!

$$(f \otimes g) \otimes h = \begin{array}{c} | \\ \boxed{f} \\ | \end{array} \begin{array}{c} | \\ \boxed{g} \\ | \end{array} \begin{array}{c} | \\ \boxed{h} \\ | \end{array} = f \otimes (g \otimes h)$$

— Ch. 1 – Processes as diagrams —

– *why diagrams?* –

Since ‘by definition’ circuits can be build by means of symbolic connectives, why bother with diagrams?

Since equations come for free!

$$(f \otimes g) \otimes h = \begin{array}{c} | \\ \boxed{f} \\ | \end{array} \begin{array}{c} | \\ \boxed{g} \\ | \end{array} \begin{array}{c} | \\ \boxed{h} \\ | \end{array} = f \otimes (g \otimes h)$$

$$f \otimes 1_I = \begin{array}{c} | \\ \boxed{f} \\ | \end{array} = f$$

— Ch. 1 – Processes as diagrams —

– *why diagrams?* –

Since ‘by definition’ circuits can be build by means of symbolic connectives, why bother with diagrams?

Since equations come for free!

$$\left(\begin{array}{c} | \\ \boxed{g_1} \\ | \end{array} \otimes \begin{array}{c} | \\ \boxed{g_2} \\ | \end{array} \right) \circ \left(\begin{array}{c} | \\ \boxed{f_1} \\ | \end{array} \otimes \begin{array}{c} | \\ \boxed{f_2} \\ | \end{array} \right)$$

?

$$\left(\begin{array}{c} | \\ \boxed{g_1} \\ | \end{array} \circ \begin{array}{c} | \\ \boxed{f_1} \\ | \end{array} \right) \otimes \left(\begin{array}{c} | \\ \boxed{g_2} \\ | \end{array} \circ \begin{array}{c} | \\ \boxed{f_2} \\ | \end{array} \right)$$

— Ch. 1 – Processes as diagrams —

– *why diagrams?* –

Since ‘by definition’ circuits can be build by means of symbolic connectives, why bother with diagrams?

Since all equations come for free!

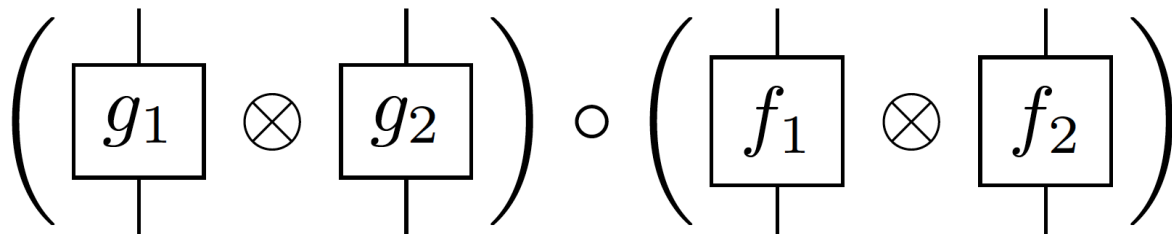

— Ch. 1 – Processes as diagrams —

– *why diagrams?* –

Since ‘by definition’ circuits can be build by means of symbolic connectives, why bother with diagrams?

Since all equations come for free!

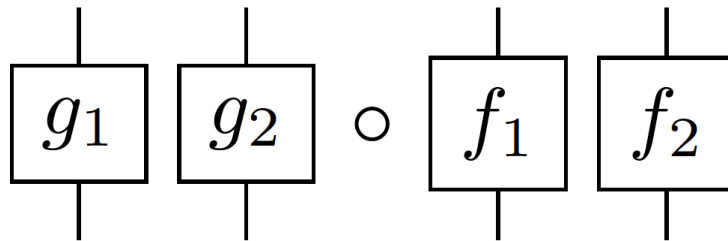

— Ch. 1 – Processes as diagrams —

– *why diagrams?* –

Since ‘by definition’ circuits can be build by means of symbolic connectives, why bother with diagrams?

Since all equations come for free!

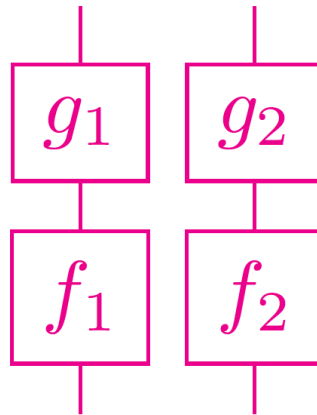

— Ch. 1 – Processes as diagrams —

– *why diagrams?* –

Since ‘by definition’ circuits can be build by means of symbolic connectives, why bother with diagrams?

Since all equations come for free!

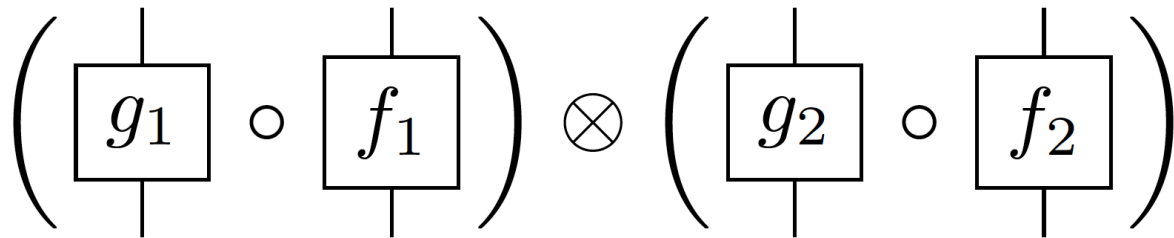

— Ch. 1 – Processes as diagrams —

– *why diagrams?* –

Since ‘by definition’ circuits can be build by means of symbolic connectives, why bother with diagrams?

Since all equations come for free!

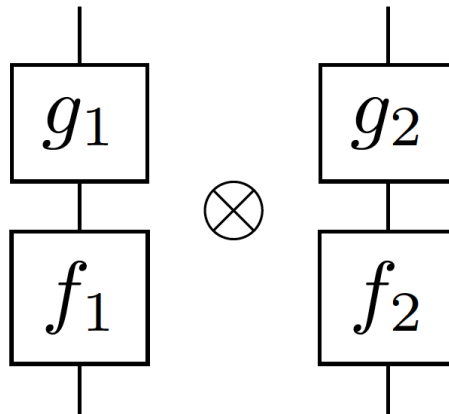

— Ch. 1 – Processes as diagrams —

– *why diagrams?* –

Since ‘by definition’ circuits can be build by means of symbolic connectives, why bother with diagrams?

Since all equations come for free!

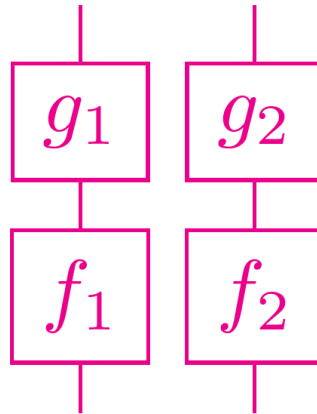

— Ch. 1 – Processes as diagrams —

– special processes/diagrams –

— Ch. 1 – Processes as diagrams —

– *special processes/diagrams* –

State :=

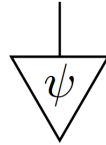

— Ch. 1 – Processes as diagrams —

– *special processes/diagrams* –

State :=

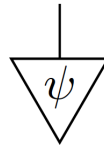

Effect / Test :=

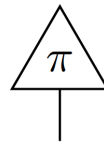

— Ch. 1 – Processes as diagrams —

– *special processes/diagrams* –

State :=

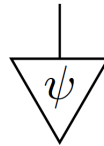

Effect / Test :=

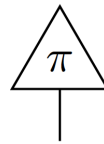

Number :=



— Ch. 1 – Processes as diagrams —

– *special processes/diagrams* –

Born rule :=

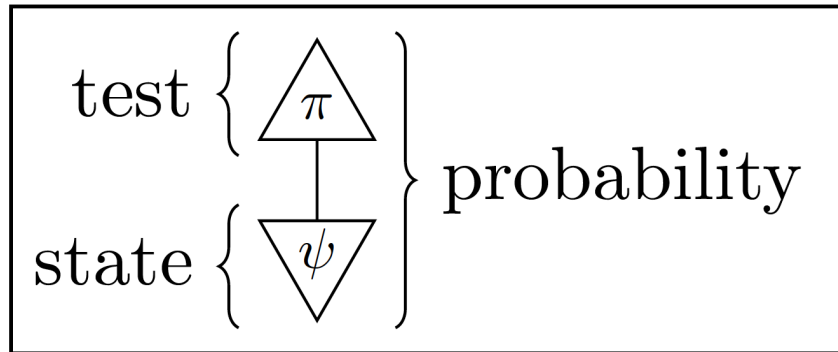

— Ch. 1 – Processes as diagrams —

– *special processes/diagrams* –

Dirac notation :=

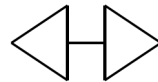
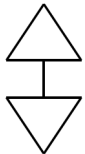
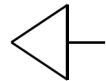
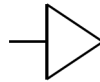
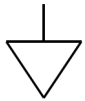

— Ch. 1 – Processes as diagrams —

– *special processes/diagrams* –

Separable \equiv disconnected $:=$

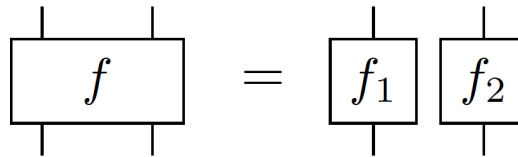

— Ch. 1 – Processes as diagrams —

– special processes/diagrams –

Separable \equiv disconnected :=

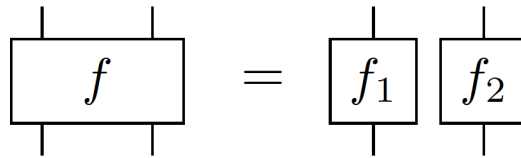

E.g.:

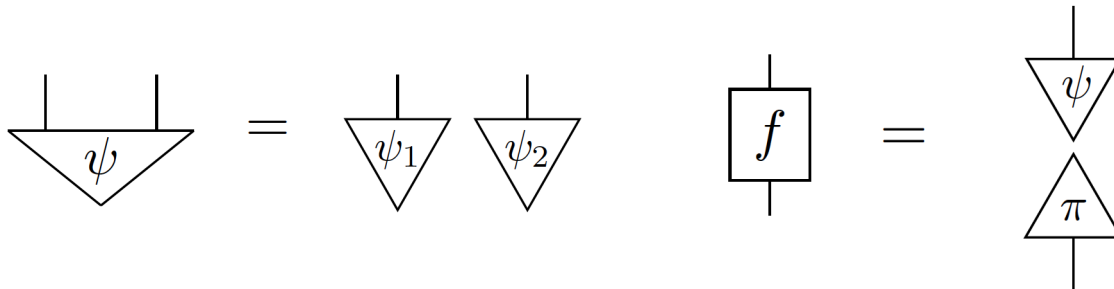

— Ch. 1 – Processes as diagrams —

– *special processes/diagrams* –

Non-separable := way more interesting!

— Ch. 2 – String diagrams —

When two systems, of which we know the states by their respective representatives, enter into temporary physical interaction due to known forces between them, and when after a time of mutual influence the systems separate again, then they can no longer be described in the same way as before, viz. by endowing each of them with a representative of its own. I would not call that one but rather the characteristic trait of quantum mechanics, the one that enforces its entire departure from classical lines of thought.

— Erwin Schrödinger, 1935.

Here we:

- introduce a wilder kind of diagram
- define quantum notions in great generality
- derive quantum phenomena in great generality

— **Ch. 2 – String diagrams** —

– *process-state duality* –

— Ch. 2 – String diagrams —

– *process-state duality* –

Exists **state** \cup and **effect** \cap :

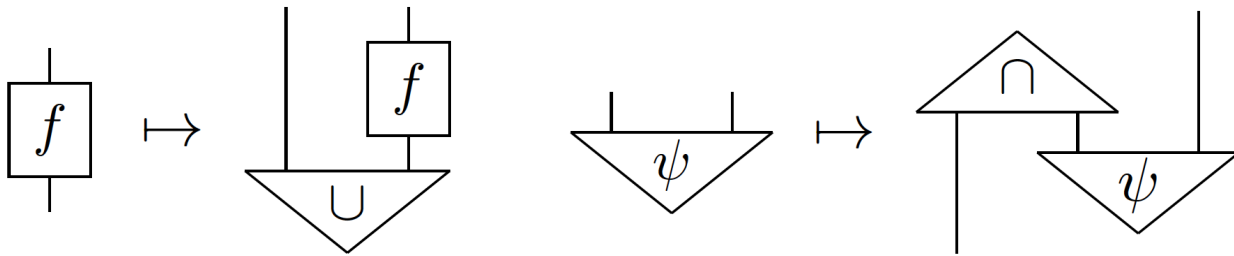

— Ch. 2 – String diagrams —

– *process-state duality* –

Exists **state** \cup and **effect** \cap :

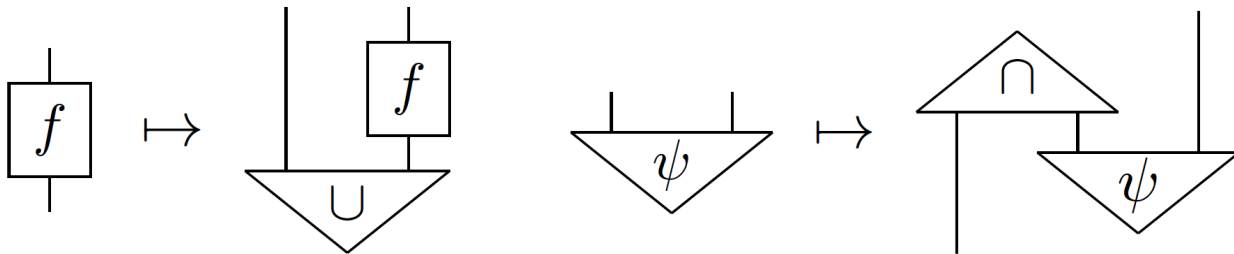

such that:

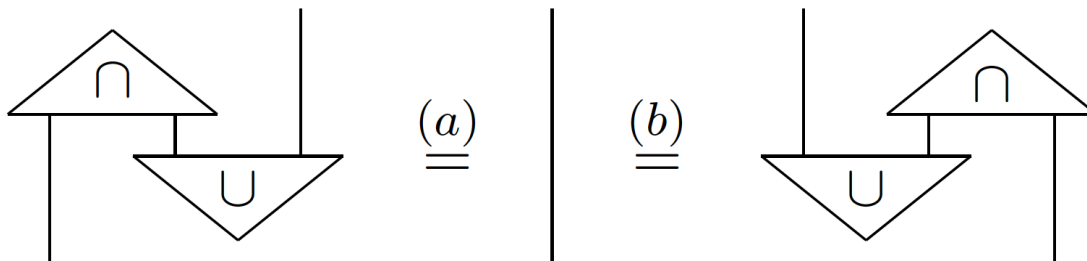

— Ch. 2 – String diagrams —

– *process-state duality* –

proof of duality:

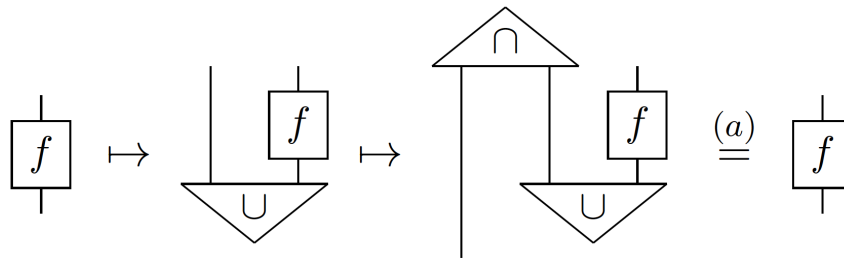

— Ch. 2 – String diagrams —

– *process-state duality* –

proof of duality:

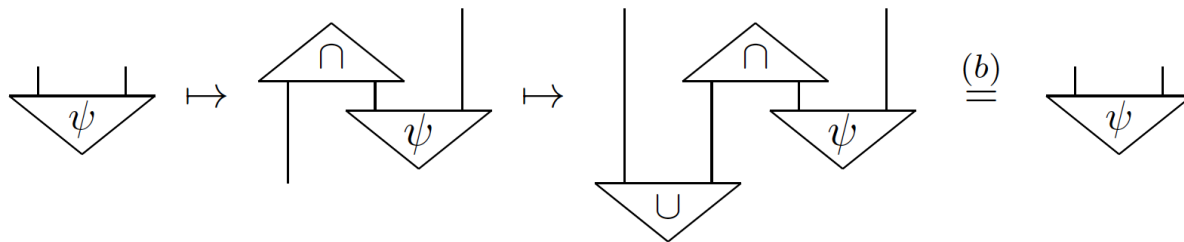
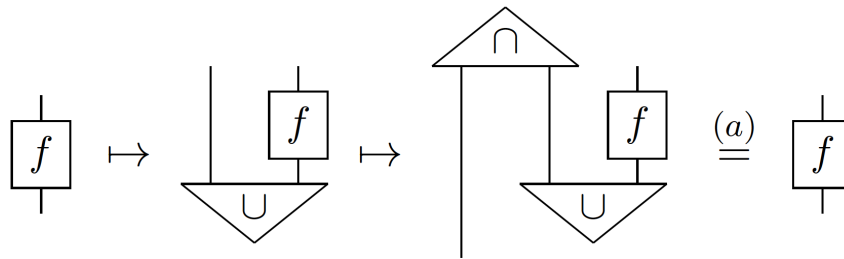

— Ch. 2 – String diagrams —

– *process-state duality* –

Change notation:

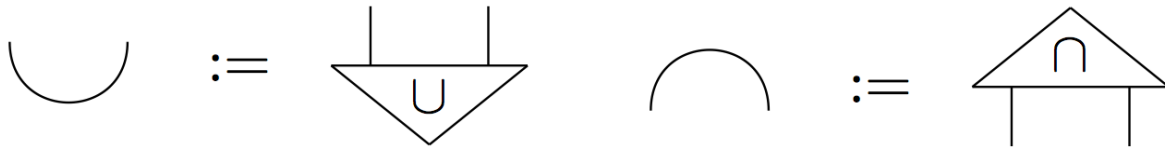

— Ch. 2 – String diagrams —

– *process-state duality* –

Change notation:

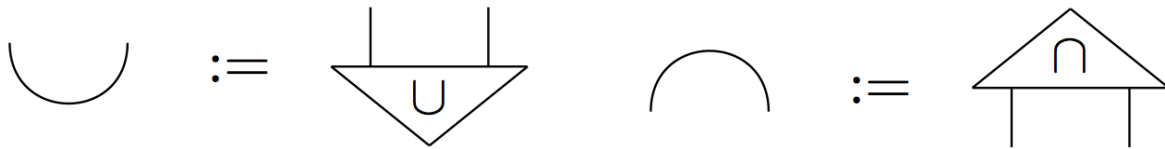

so that now:

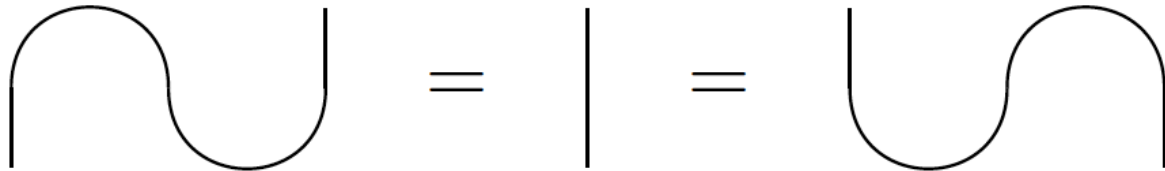

— Ch. 2 – String diagrams —

– *definition* –

— Ch. 2 – String diagrams —

– *definition* –

Thm. TFAE:

- circuits with process-state duality and:

$$\text{⊗} = \text{⌋}$$

— Ch. 2 – String diagrams —

– *definition* –

Thm. TFAE:

- circuits with process-state duality and:

$$\text{figure-eight} = \text{cup}$$

- diagrams with in-in and out-out connection:

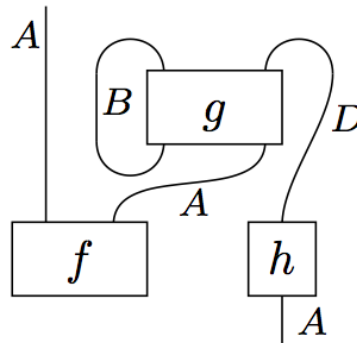

— Ch. 2 – String diagrams —

– definition –

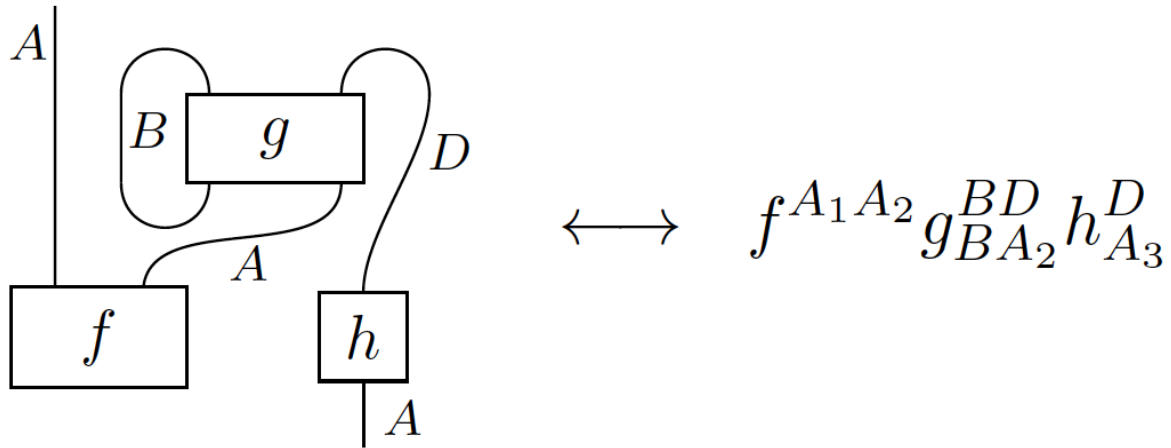

— Ch. 2 – String diagrams —

– *transpose* –

— Ch. 2 – String diagrams —

– *transpose* –

... :=

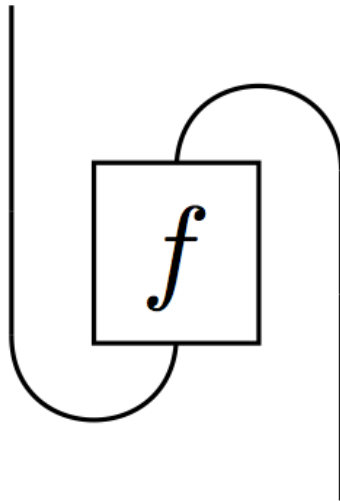

— Ch. 2 – String diagrams —

– *transpose* –

... :=

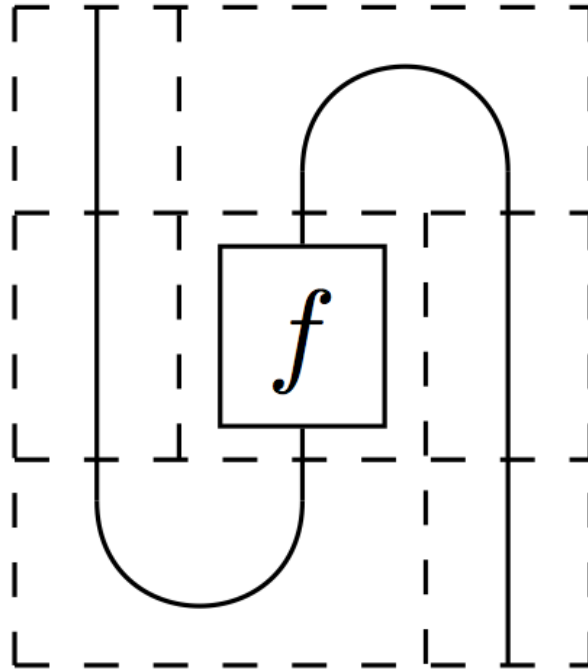

— Ch. 2 – String diagrams —

– *transpose* –

Prop. The transpose is an involution:

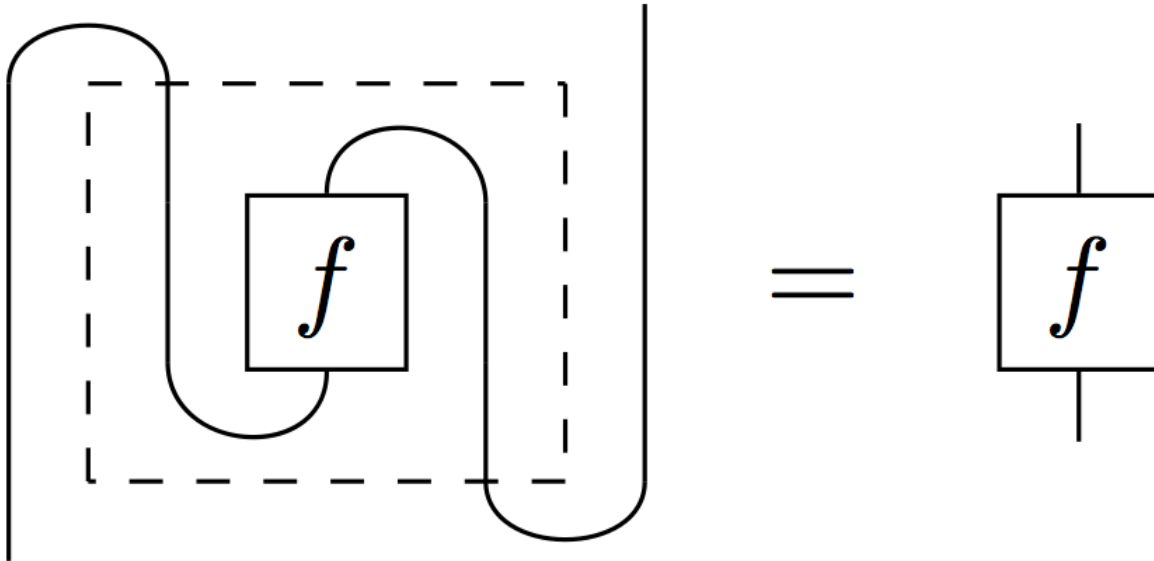

— Ch. 2 – String diagrams —

– *transpose* –

Prop. Transpose of ‘cup’ is ‘cap’:

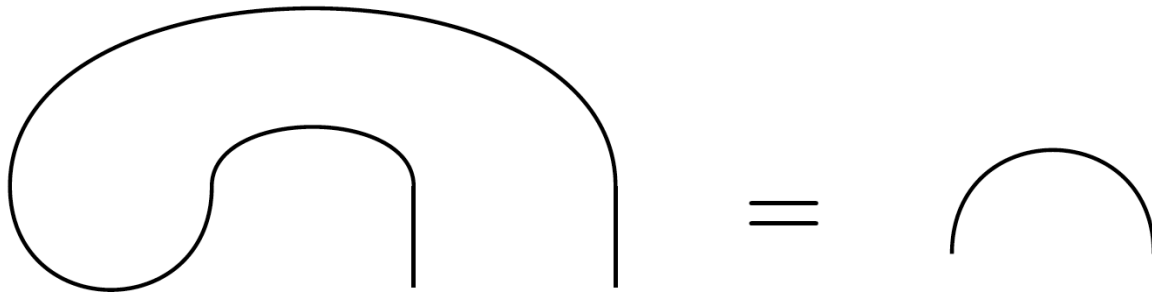

— Ch. 2 – String diagrams —

– *transpose* –

Clever new notation:

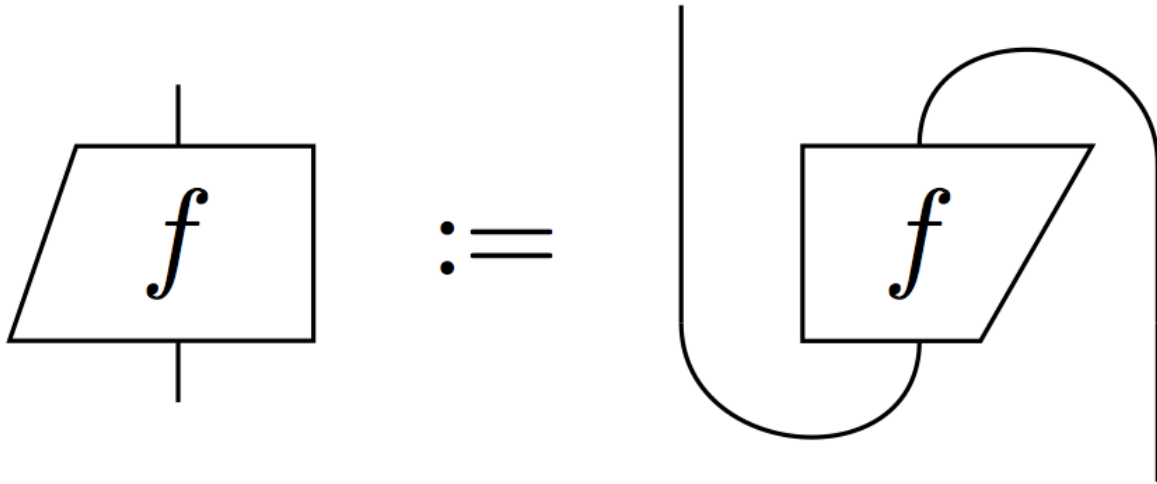

— Ch. 2 – String diagrams —

– *transpose* –

Clever new notation:

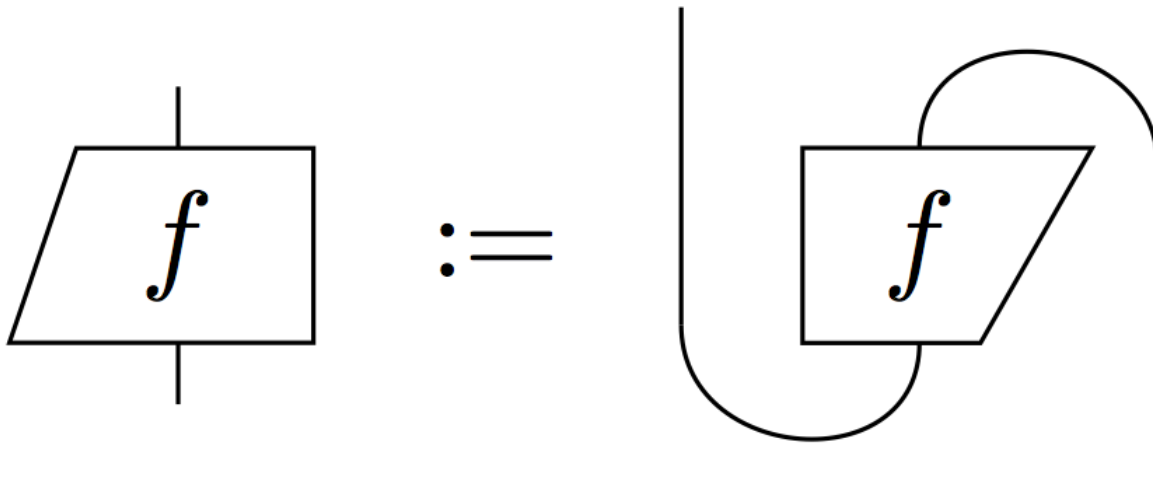

\Rightarrow just what happens when yanking hard!

— Ch. 2 – String diagrams —

– *transpose* –

Prop. Sliding:

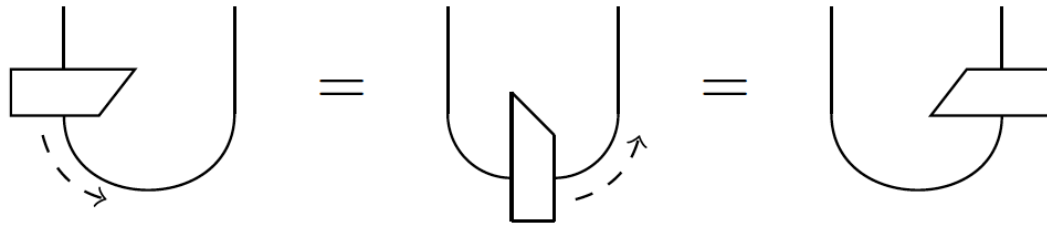

— Ch. 2 – String diagrams —

– transpose –

Prop. Sliding:

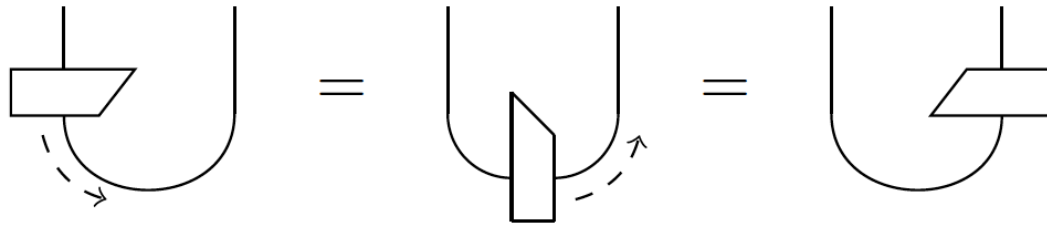

Pf.

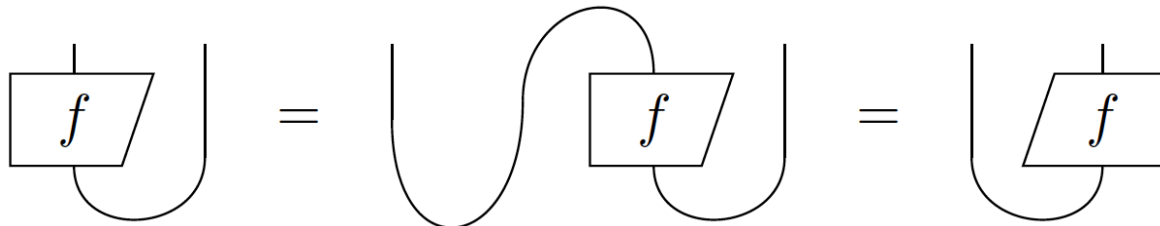

— Ch. 2 – String diagrams —

– transpose –

Prop. Sliding:

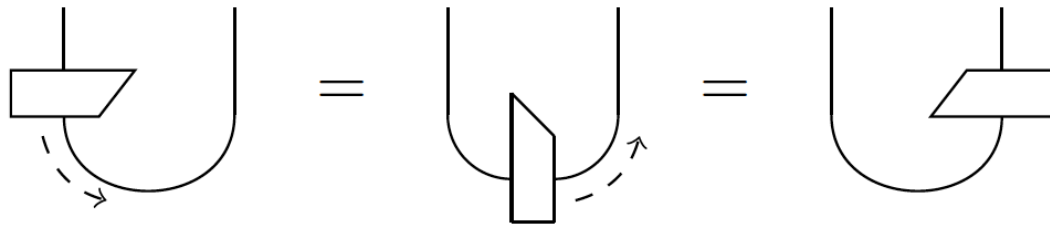

... so this is a mathematical equation:

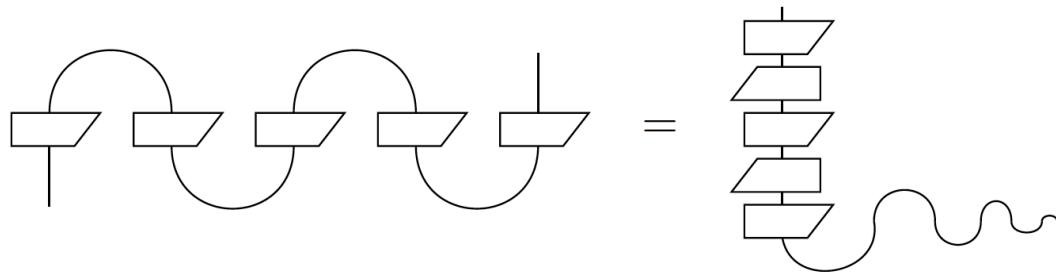

— Ch. 2 – String diagrams —

– *trace* –

— Ch. 2 – String diagrams —

– trace –

... :=

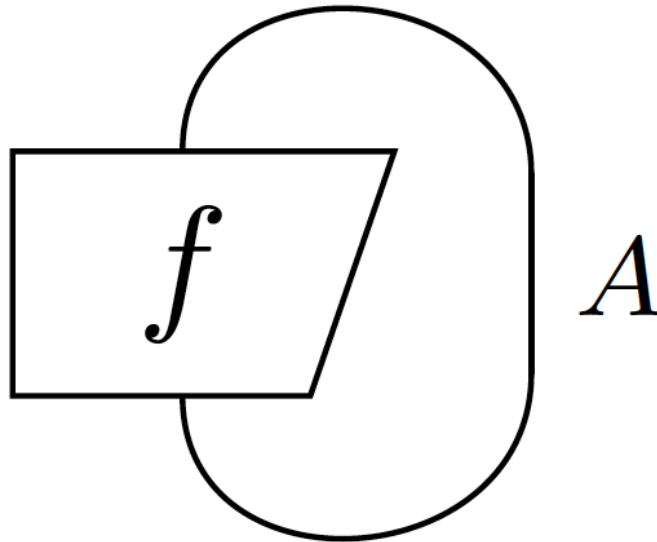

— Ch. 2 – String diagrams —

– trace –

Partial ... :=

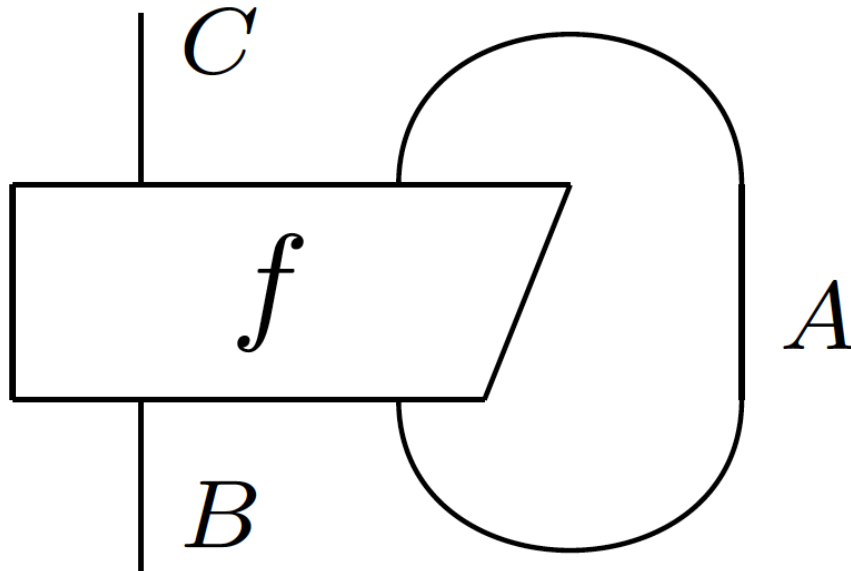

— Ch. 2 – String diagrams —

– trace –

Prop. Cyclicity:

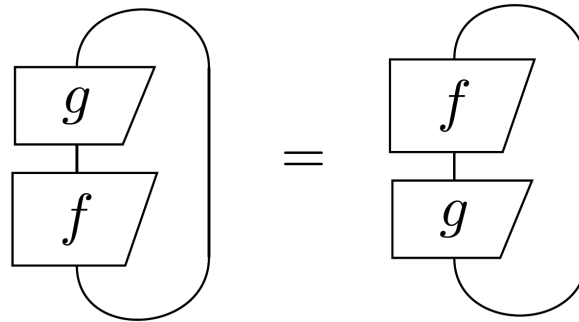

— Ch. 2 – String diagrams —

– trace –

Prop. Cyclicity:

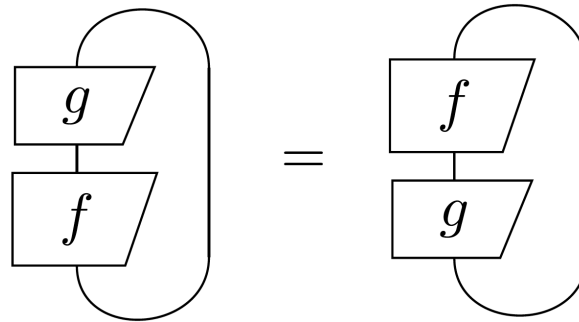

Redundant but fun ‘ferris wheel’ proof:

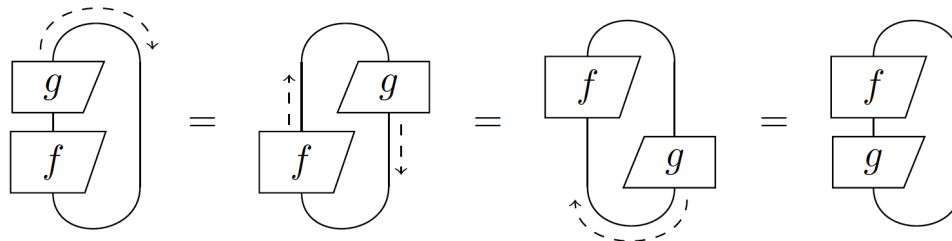

— Ch. 2 – String diagrams —

– ‘quantum’-like features –

$$\frac{\text{classical}}{\text{quantum}} = \frac{\begin{array}{c} \text{---} \\ | \quad | \\ \triangle \psi \\ \text{---} \end{array} = \begin{array}{c} | \quad | \\ \triangle \psi_1 \quad \triangle \psi_2 \\ \text{---} \end{array}}{\begin{array}{c} \text{---} \\ \cup \\ \text{---} \end{array} \neq \begin{array}{c} | \quad | \\ \triangle \psi_1 \quad \triangle \psi_2 \\ \text{---} \end{array}}$$

— Ch. 2 – String diagrams —

– ‘*quantum*’-like features –

Thm. All states separable \Rightarrow rubbish theory.

— Ch. 2 – String diagrams —

– ‘quantum’-like features –

Thm. All states separable \Rightarrow rubbish theory.

Lem. All states separable \Rightarrow wires separable.

Pf.

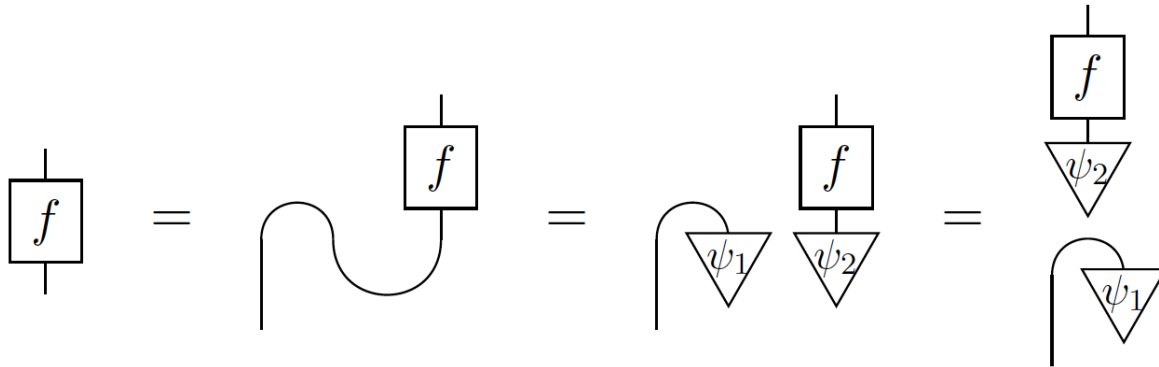

— Ch. 2 – String diagrams —

– ‘quantum’-like features –

Perfect correlations:

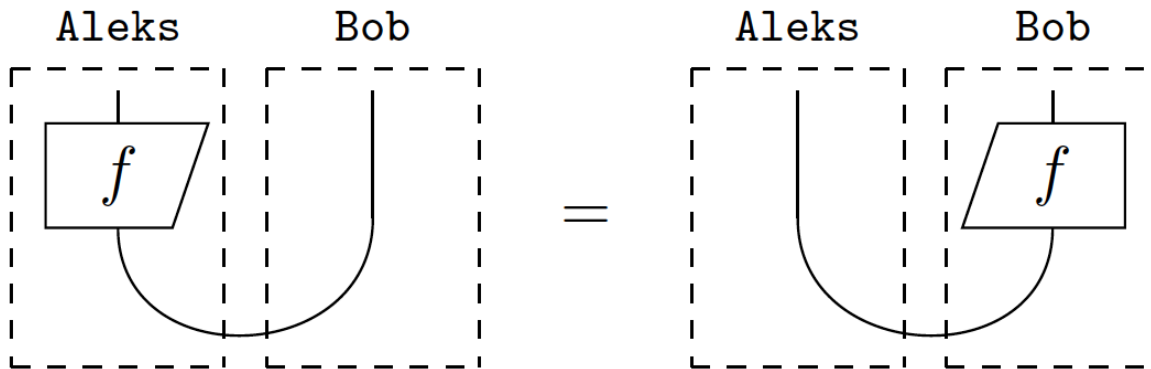

— Ch. 2 – String diagrams —

– ‘quantum’-like features –

Perfect correlations:

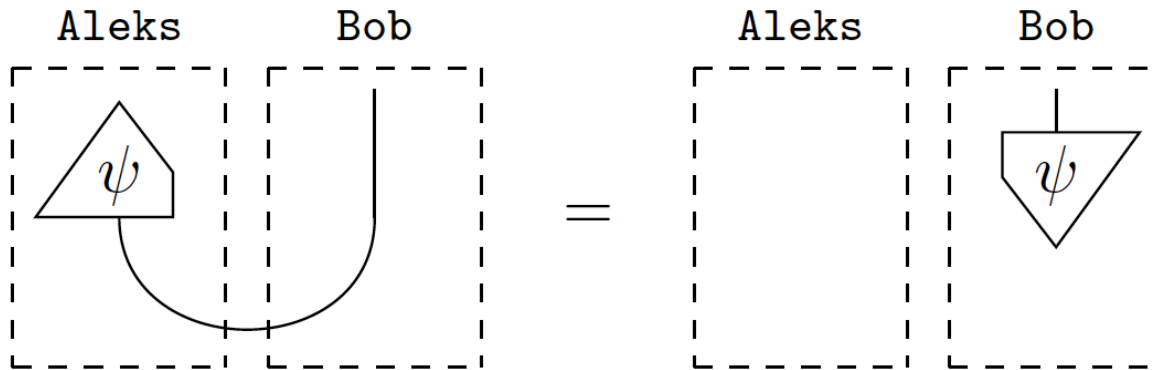

— Ch. 2 – String diagrams —

– ‘quantum’-like features –

Logical reading:

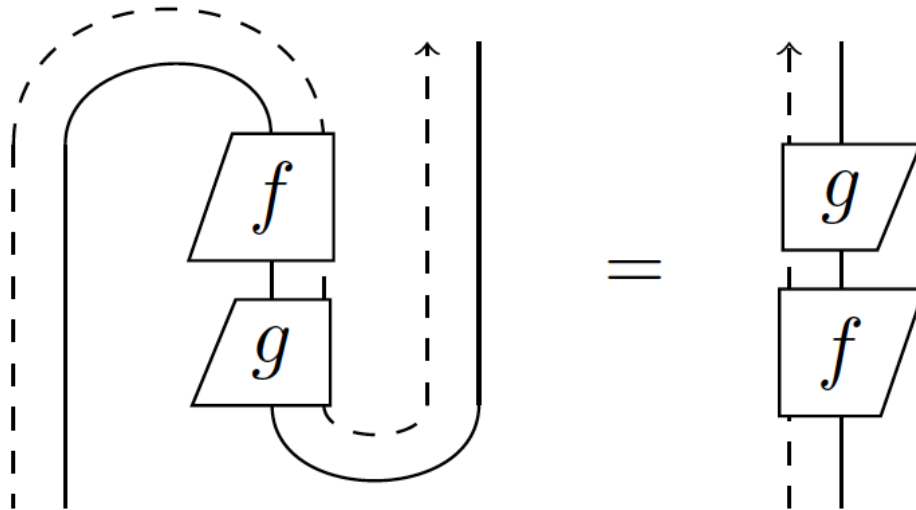

— Ch. 2 – String diagrams —

– ‘quantum’-like features –

Operational reading:

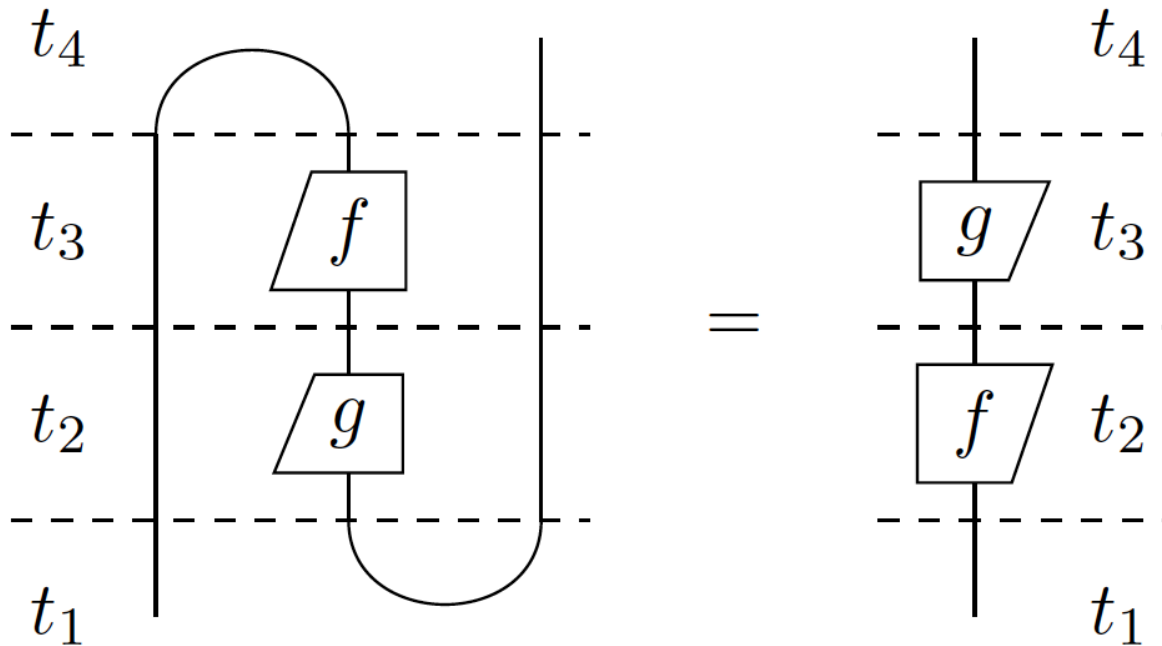

— Ch. 2 – String diagrams —

– ‘quantum’-like features –

Realising time-reversal (and make NY times):

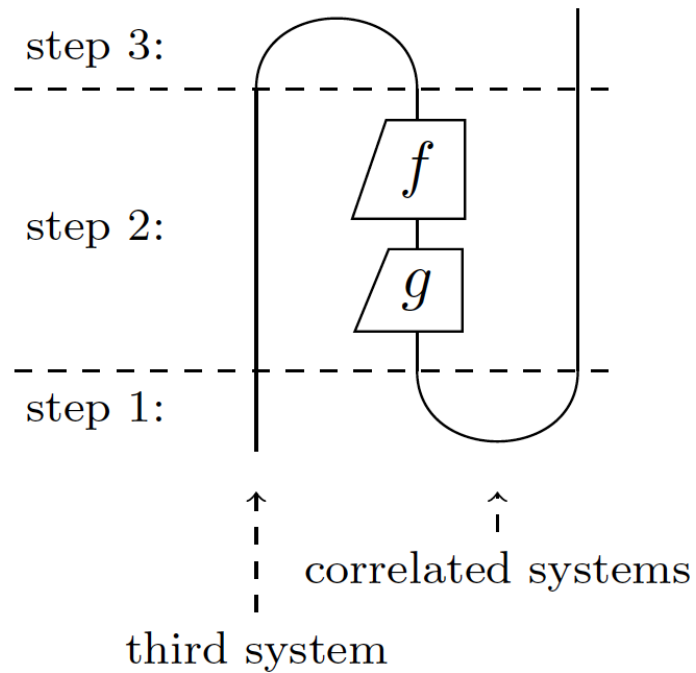

— Ch. 2 – String diagrams —

– ‘quantum’-like features –

Thm. No-cloning from assumptions:

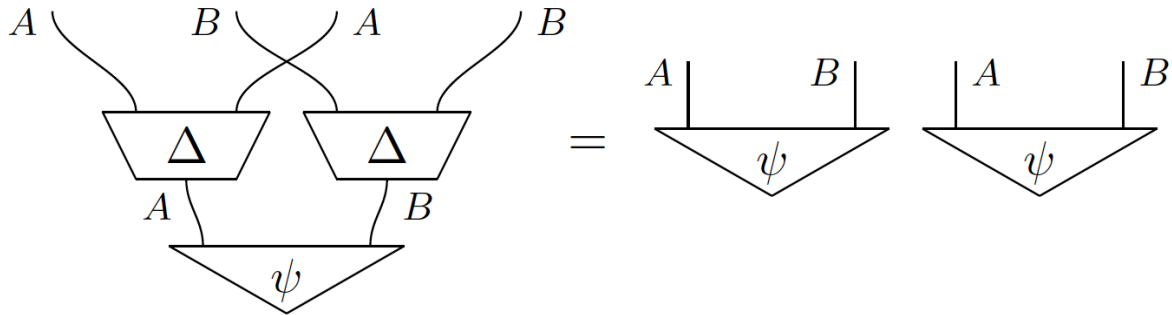

— Ch. 2 – String diagrams —

– ‘quantum’-like features –

Pf.

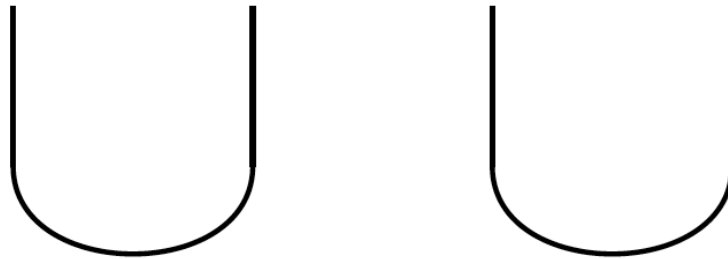

— Ch. 2 – String diagrams —

– ‘quantum’-like features –

Pf.

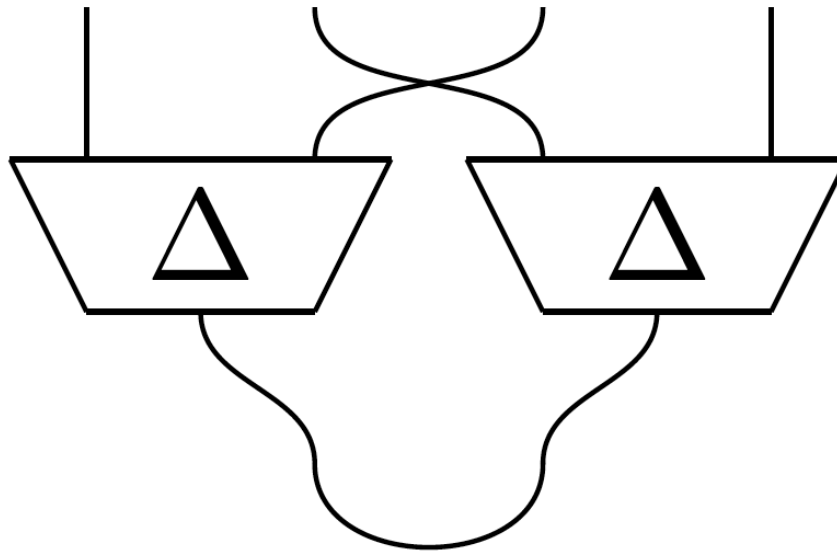

— Ch. 2 – String diagrams —

– ‘quantum’-like features –

Pf.

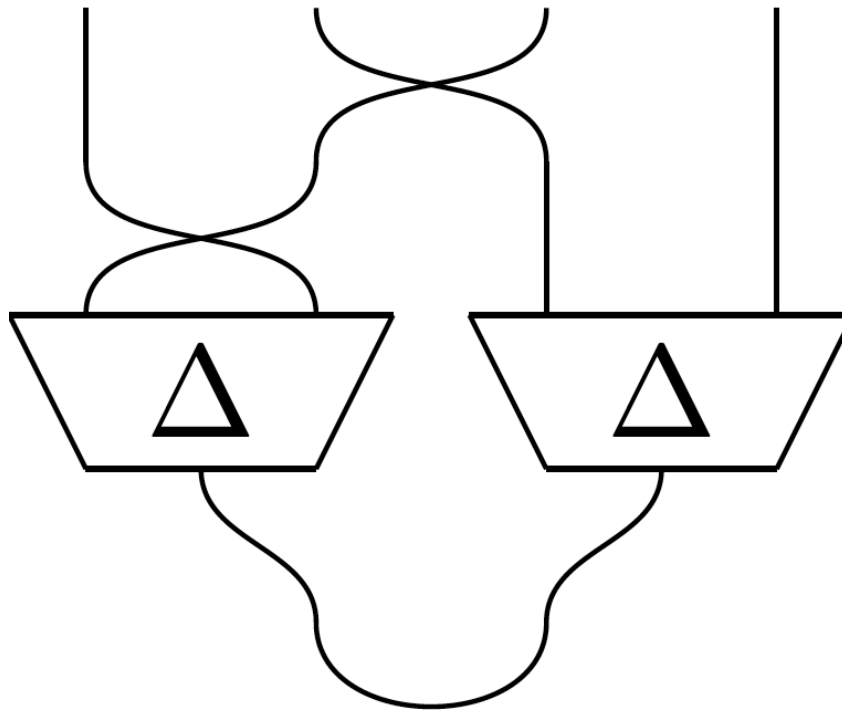

— Ch. 2 – String diagrams —

– ‘quantum’-like features –

Pf.

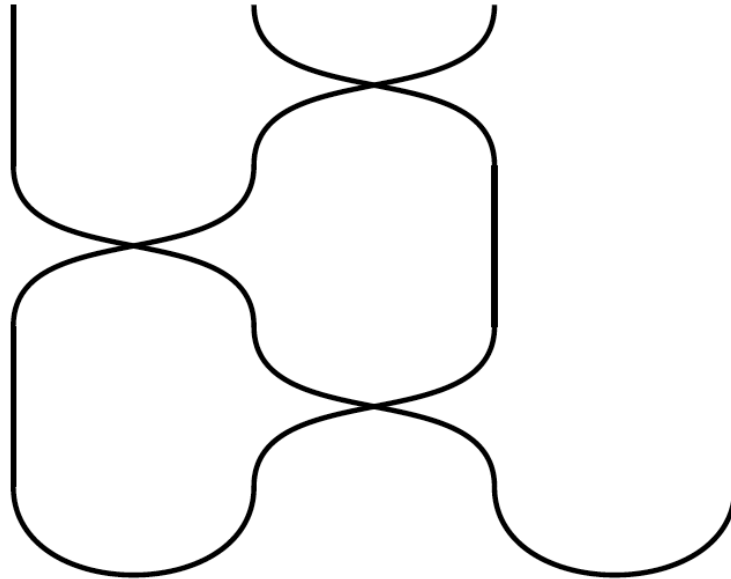

— Ch. 2 – String diagrams —

– ‘quantum’-like features –

Pf.

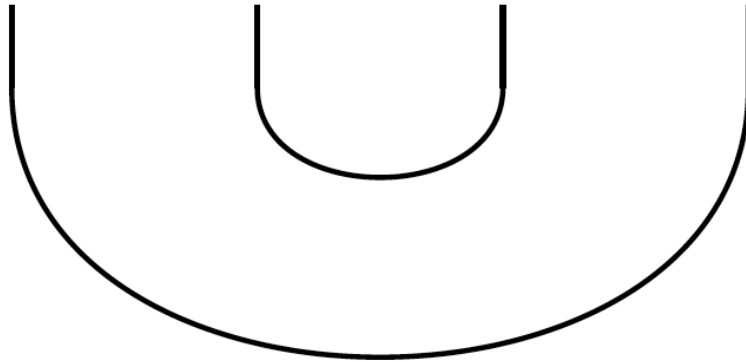

— Ch. 2 – String diagrams —

– ‘quantum’-like features –

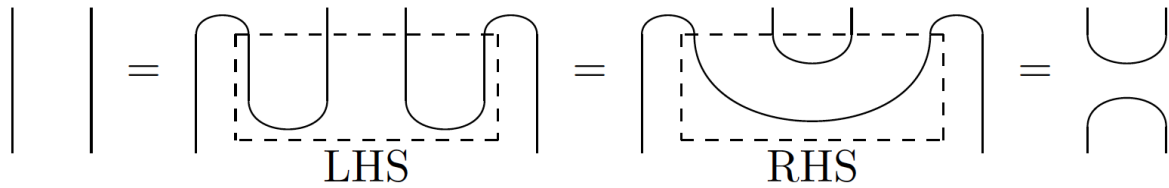

— Ch. 2 – String diagrams —

– ‘quantum’-like features –

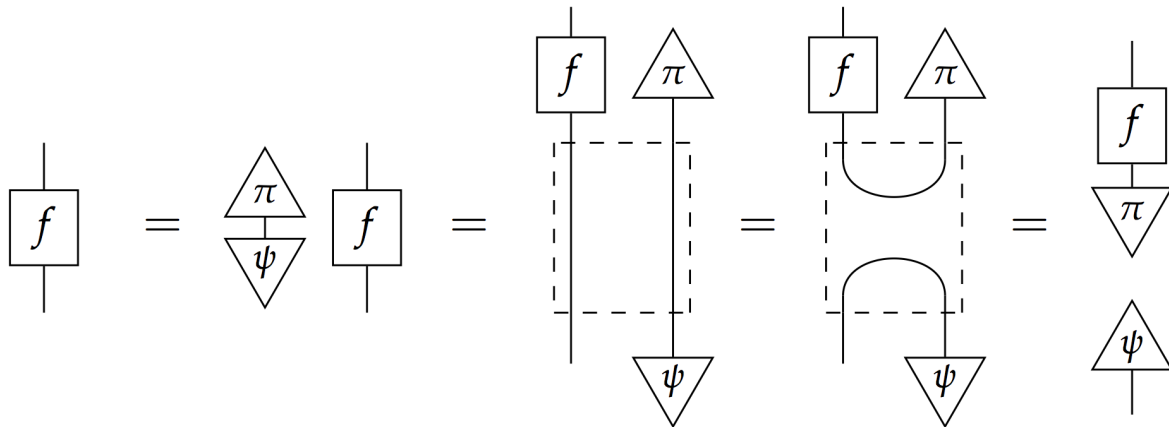
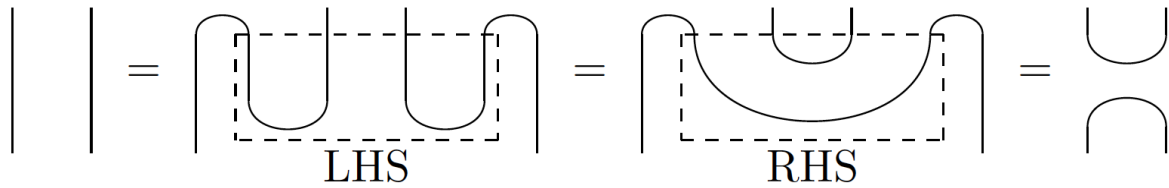

— **Ch. 2 – String diagrams** —

– *adjoint & conjugate* –

— Ch. 2 – String diagrams —

– *adjoint & conjugate* –

A ‘ket’ sometimes wants to be ‘bra’:

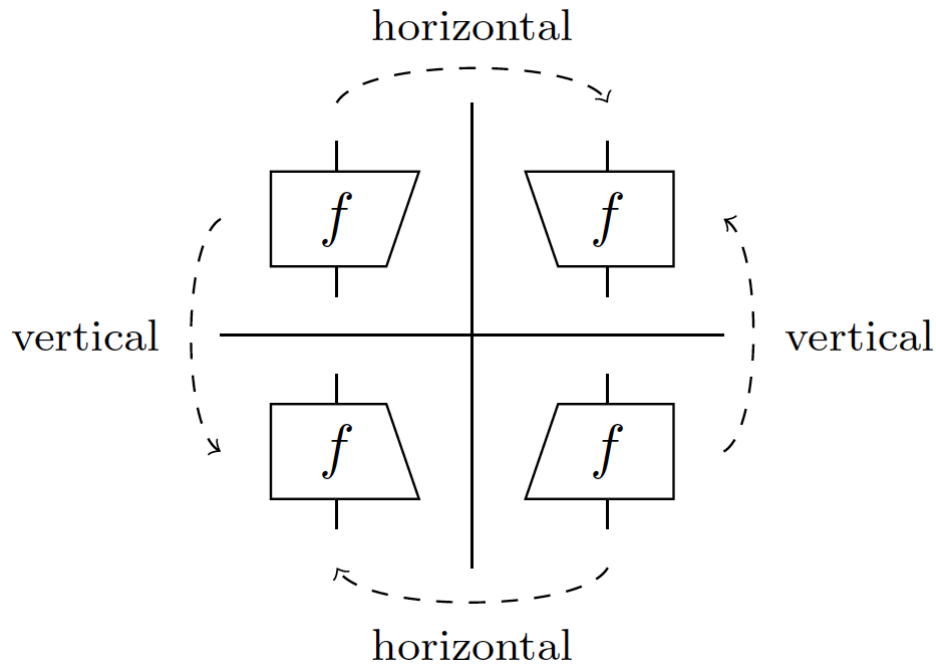

— Ch. 2 – String diagrams —

– adjoint & conjugate –

Conjugate :=

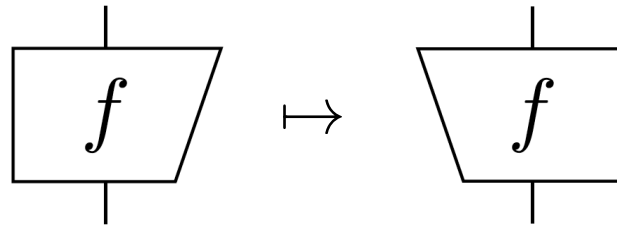

Adjoint :=

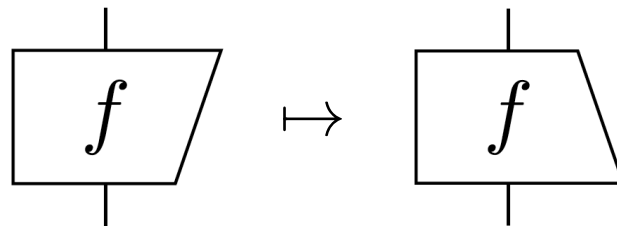

— Ch. 2 – String diagrams —

– *adjoint & conjugate* –

Unitarity/isometry :=

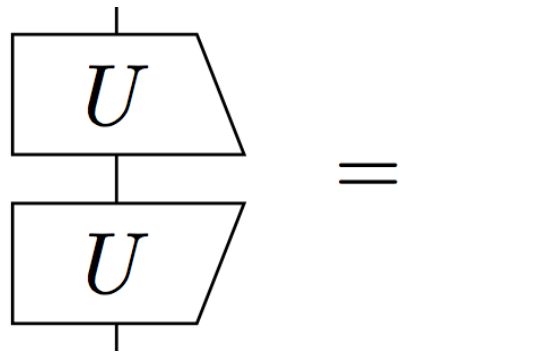

— Ch. 2 – String diagrams —

– adjoint & conjugate –

Teleportation:

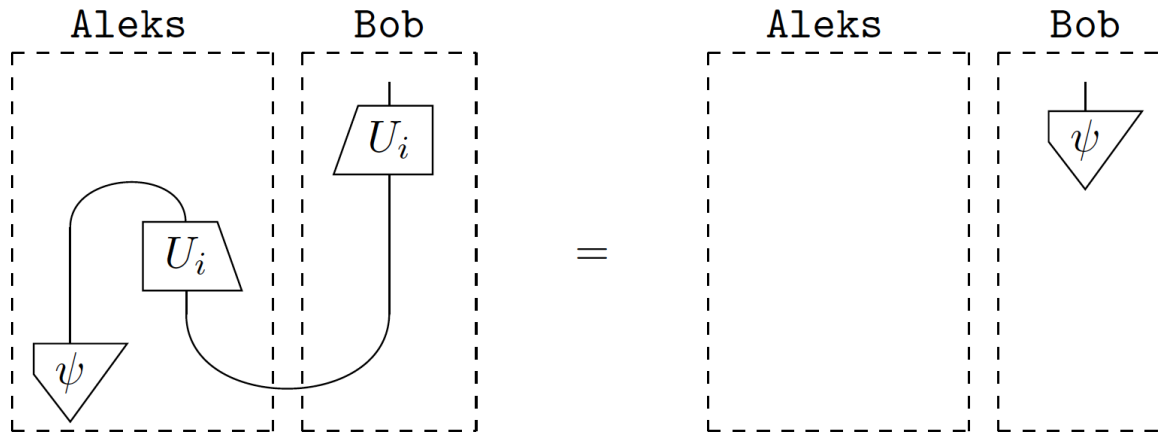

— Ch. 2 – String diagrams —

– adjoint & conjugate –

Entanglement swapping:

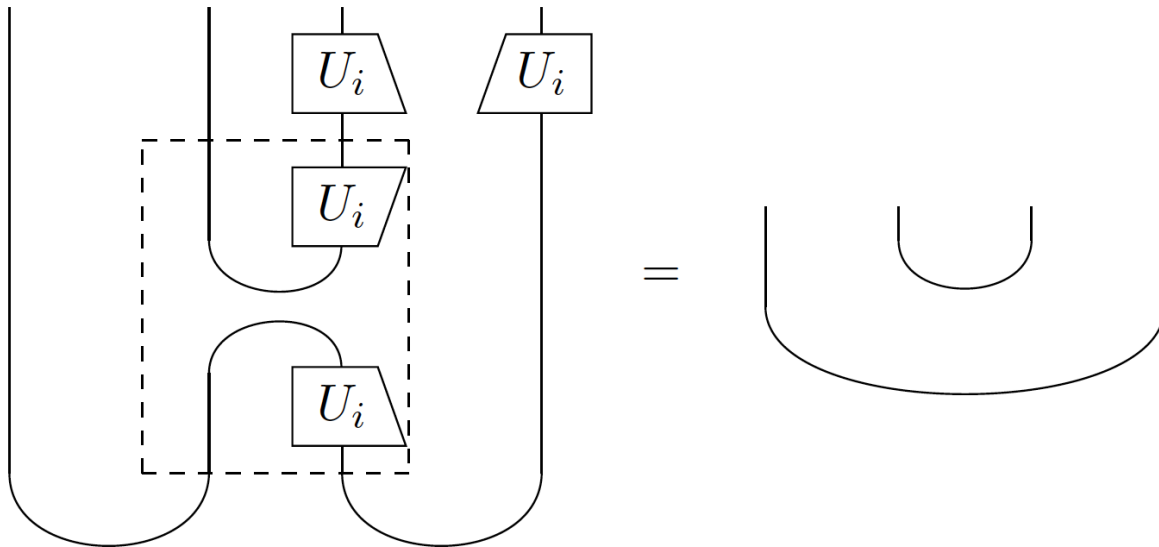

— Ch. 2 – String diagrams —

– *designing teleportation* –

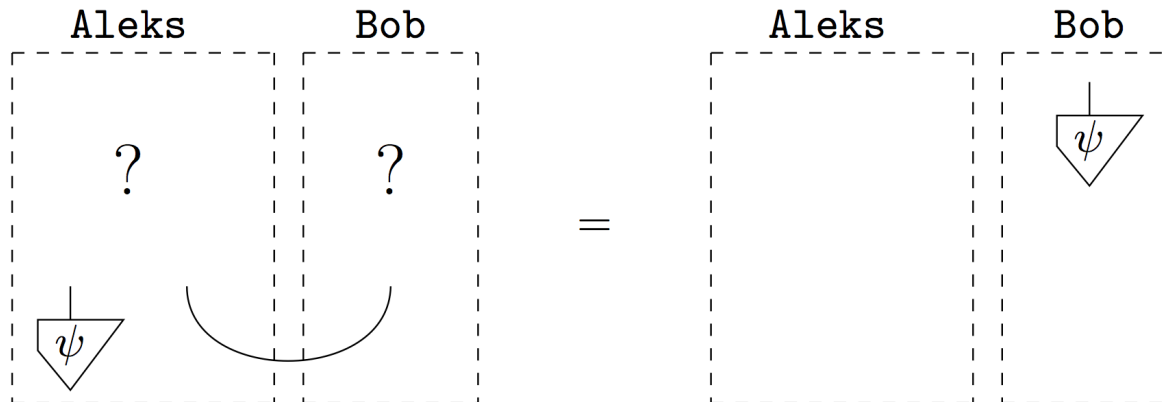

— Ch. 2 – String diagrams —

– *designing teleportation* –

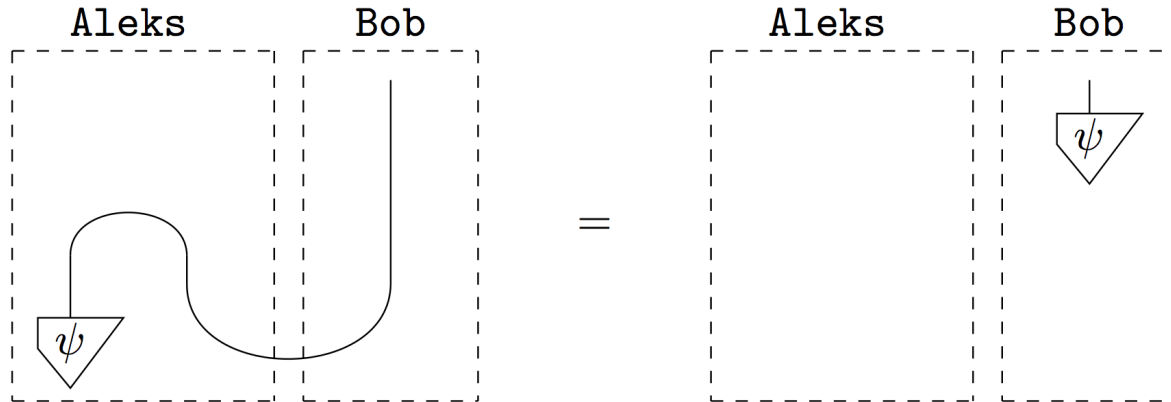

— Ch. 2 – String diagrams —

– *designing teleportation* –

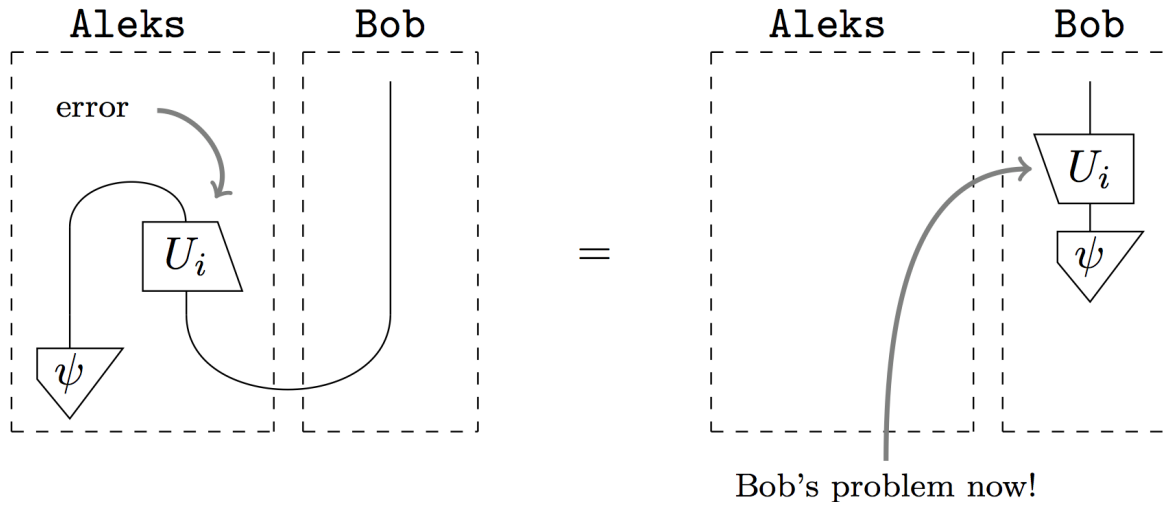

— Ch. 3 – Hilbert space from diagrams —

I would like to make a confession which may seem immoral: I do not believe absolutely in Hilbert space any more.

— John von Neumann, letter to Garrett Birkhoff, 1935.

Here we introduce:

- ONBs, matrices and sums
- (multi-)linear maps & Hilbert space

and relate:

- string diagrams
- (multi-)linear maps & Hilbert space

— Ch. 3 – Hilbert space from diagrams —

– *ONB* –

— Ch. 3 – Hilbert space from diagrams —

– ONB –

A set:

$$\mathcal{B} = \left\{ \begin{array}{c} | \\ \hline \nabla \\ \hline 1 \end{array}, \dots, \begin{array}{c} | \\ \hline \nabla \\ \hline n \end{array} \right\}$$

is **pre-basis** if:

$$\left(\forall i : \begin{array}{c} | \\ \hline \boxed{f} \\ \hline | \\ \hline \nabla \\ \hline i \end{array} = \begin{array}{c} | \\ \hline \boxed{g} \\ \hline | \\ \hline \nabla \\ \hline i \end{array} \right) \implies \begin{array}{c} | \\ \hline \boxed{f} \\ \hline | \end{array} = \begin{array}{c} | \\ \hline \boxed{g} \\ \hline | \end{array}$$

— Ch. 3 – Hilbert space from diagrams —

– ONB –

Orthonormal :=

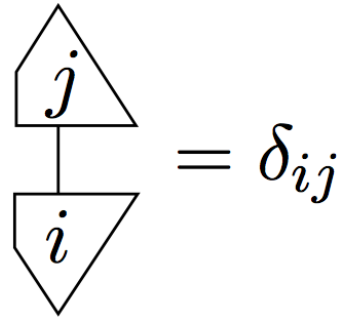

The diagram shows two triangles connected by a vertical line. The top triangle is upright and contains the letter j . The bottom triangle is inverted and contains the letter i . To the right of this diagram is an equals sign followed by the symbol δ_{ij} .

— Ch. 3 – Hilbert space from diagrams —

– ONB –

Orthonormal :=

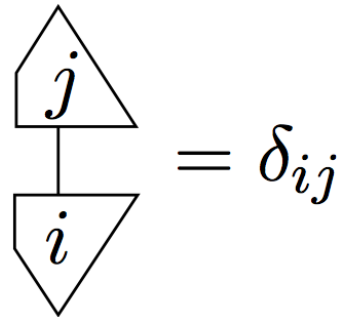
$$\begin{array}{c} \triangleup j \\ | \\ \triangleleft i \end{array} = \delta_{ij}$$

Canonical :=

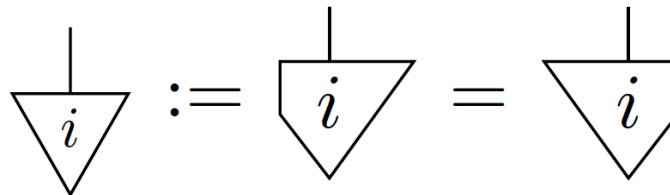
$$\begin{array}{c} | \\ \triangleleft i \end{array} := \begin{array}{c} | \\ \triangleleft i \end{array} = \begin{array}{c} | \\ \triangleleft i \end{array}$$

— Ch. 3 – Hilbert space from diagrams —

– *matrix calculus* –

— Ch. 3 – Hilbert space from diagrams —

– matrix calculus –

Thm. We have:

$$\left(\forall i, j : \begin{array}{c} \triangle i \\ | \\ \text{---} f \text{---} \\ | \\ \triangle j \end{array} = \begin{array}{c} \triangle i \\ | \\ \text{---} g \text{---} \\ | \\ \triangle j \end{array} \right) \implies \begin{array}{c} | \\ \text{---} f \text{---} \\ | \end{array} = \begin{array}{c} | \\ \text{---} g \text{---} \\ | \end{array}$$

so there is a **matrix**:

$$\left(\begin{array}{cccc} \diamond f_{11} & \diamond f_{12} & \cdots & \diamond f_{1n} \\ \diamond f_{21} & \diamond f_{22} & \cdots & \diamond f_{2n} \\ \vdots & \vdots & \ddots & \vdots \\ \diamond f_{m1} & \diamond f_{m2} & \cdots & \diamond f_{mn} \end{array} \right) \quad \text{with} \quad \diamond f_{ij} := \begin{array}{c} \triangle i \\ | \\ \text{---} f \text{---} \\ | \\ \triangle j \end{array}$$

— Ch. 3 – Hilbert space from diagrams —

– *matrix calculus* –

But one also may want to ‘glue’ things together:

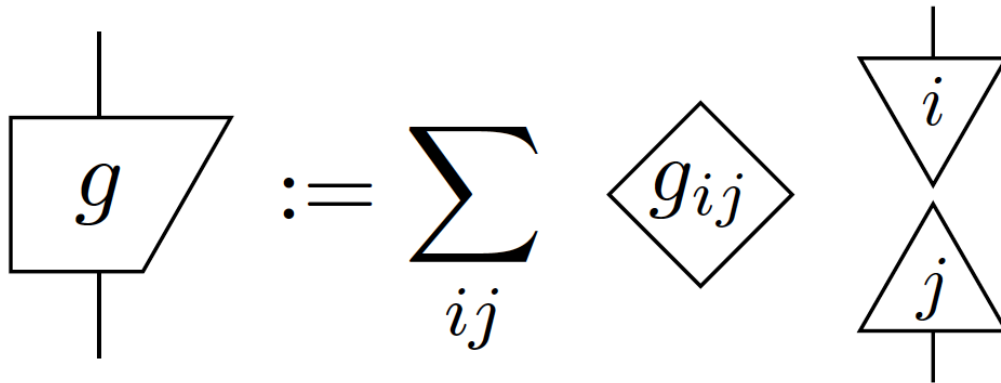

— Ch. 3 – Hilbert space from diagrams —

– matrix calculus –

Sums := for $\{f_i\}_i$ of the same type there exists:

$$\sum_{i=1}^N \begin{array}{c} | \\ \hline f_i \\ \hline | \end{array}$$

which ‘moves around’:

$$\sum_i \left(\begin{array}{c} \begin{array}{c} \hline g \\ \hline \end{array} \\ \begin{array}{c} \hline h_i \quad \hline f \\ \hline \end{array} \\ \begin{array}{c} \hline g \\ \hline \end{array} \\ | \quad | \end{array} \right) = \sum_i \left(\begin{array}{c} \begin{array}{c} \hline g \\ \hline \end{array} \\ \begin{array}{c} \hline h_i \quad \hline f \\ \hline \end{array} \\ \begin{array}{c} \hline g \\ \hline \end{array} \\ | \quad | \end{array} \right)$$

— Ch. 3 – Hilbert space from diagrams —

– matrix calculus –

In:

$$\sum_j \begin{array}{|c} \hline g_j \\ \hline \end{array} \begin{array}{|c} \hline f_i \\ \hline \end{array} = \sum_j \begin{array}{|c} \hline g_j \\ \hline \end{array} \begin{array}{|c} \hline f_i \\ \hline \end{array} = \begin{array}{|c} \hline g_j \\ \hline \end{array} \sum_i \begin{array}{|c} \hline f_i \\ \hline \end{array} = \begin{array}{|c} \hline g_j \\ \hline \end{array} \begin{array}{|c} \hline f_i \\ \hline \end{array} \sum_{ij}$$

the intuition is:

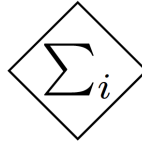

— Ch. 3 – Hilbert space from diagrams —

– matrix calculus –

In:

$$\sum_j \begin{array}{|c} \hline g_j \\ \hline \end{array} \begin{array}{|c} \hline f_i \\ \hline \end{array} = \sum_j \begin{array}{|c} \hline g_j \\ \hline \end{array} \begin{array}{|c} \hline f_i \\ \hline \end{array} = \begin{array}{|c} \hline g_j \\ \hline \end{array} \sum_i \begin{array}{|c} \hline f_i \\ \hline \end{array} = \begin{array}{|c} \hline g_j \\ \hline \end{array} \begin{array}{|c} \hline f_i \\ \hline \end{array} \sum_{ij}$$

the intuition is:

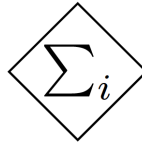

but better (see later):

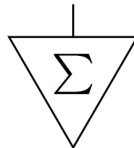

— Ch. 3 – Hilbert space from diagrams —

– *definition* –

— Ch. 3 – Hilbert space from diagrams —

– *definition* –

Defn.

Linear maps := String diagrams s.t.:

-
-
-

— Ch. 3 – Hilbert space from diagrams —

– *definition* –

Defn.

Linear maps := String diagrams s.t.:

- each system has ONB
-
-

— Ch. 3 – Hilbert space from diagrams —

– *definition* –

Defn.

Linear maps := String diagrams s.t.:

- each system has ONB
- \exists sums
-

— Ch. 3 – Hilbert space from diagrams —

– *definition* –

Defn.

Linear maps := String diagrams s.t.:

- each system has ONB
- \exists sums
- numbers are \mathbb{C}

— Ch. 3 – Hilbert space from diagrams —

– *definition* –

Defn.

Linear maps := String diagrams s.t.:

- each system has ONB
- \exists sums
- numbers are \mathbb{C}

Hilbert space := states for a system with Born-rule.

— Ch. 3 – Hilbert space from diagrams —

– model-theoretic completeness –

— **Ch. 3 – Hilbert space from diagrams** —

– *model-theoretic completeness* –

THM. (Selinger, 2008)

An equation between string diagrams holds, if and only if it holds for Hilbert spaces and linear maps.

— Ch. 3 – Hilbert space from diagrams —

– *model-theoretic completeness* –

THM. (Selinger, 2008)

An equation between string diagrams holds, if and only if it holds for Hilbert spaces and linear maps.

I.e. defining Hilbert spaces and linear maps in this manner is a ‘conservative extension’ of string diagrams.

— Ch. 4 – Quantum processes —

The art of progress is to preserve order amid change, and to preserve change amid order.

— Alfred North Whitehead, *Process and Reality*, 1929.

Here we introduce in terms of diagrams:

- pure quantum maps
- mixed/open quantum maps
- causality & Stinespring dilation
- general quantum processes done badly

— Ch. 4 – Quantum processes —

– doubling –

— Ch. 4 – Quantum processes —

– *doubling* –

Goal 1:

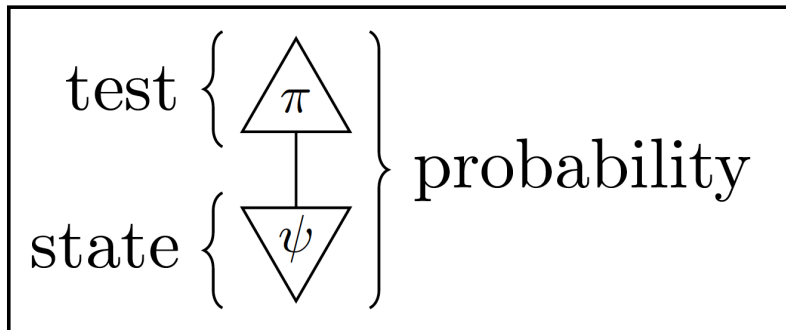

— Ch. 4 – Quantum processes —

– doubling –

Goal 1:

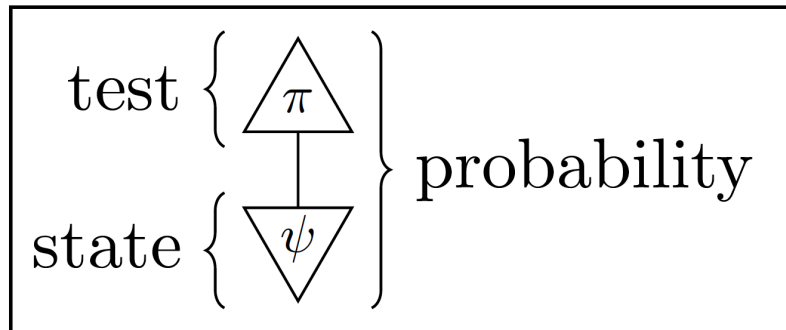

Goal 2:

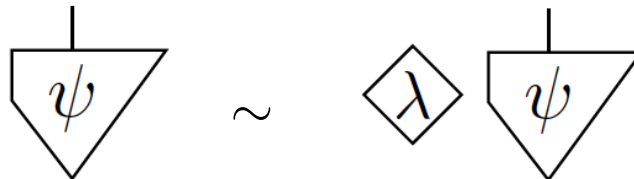

— Ch. 4 – Quantum processes —

– doubling –

Pure quantum state :=



:=

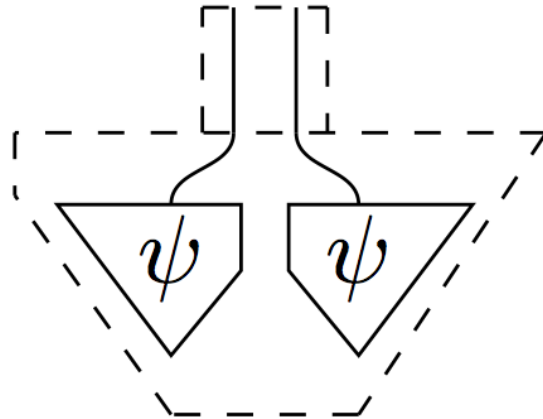

— Ch. 4 – Quantum processes —

– doubling –

Pure quantum effect :=

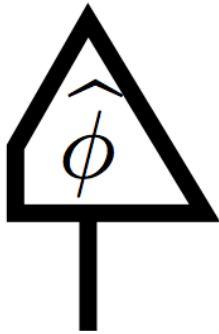

:=

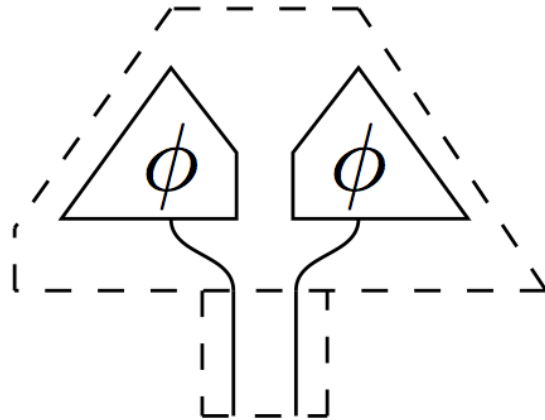

— Ch. 4 – Quantum processes —

– doubling –

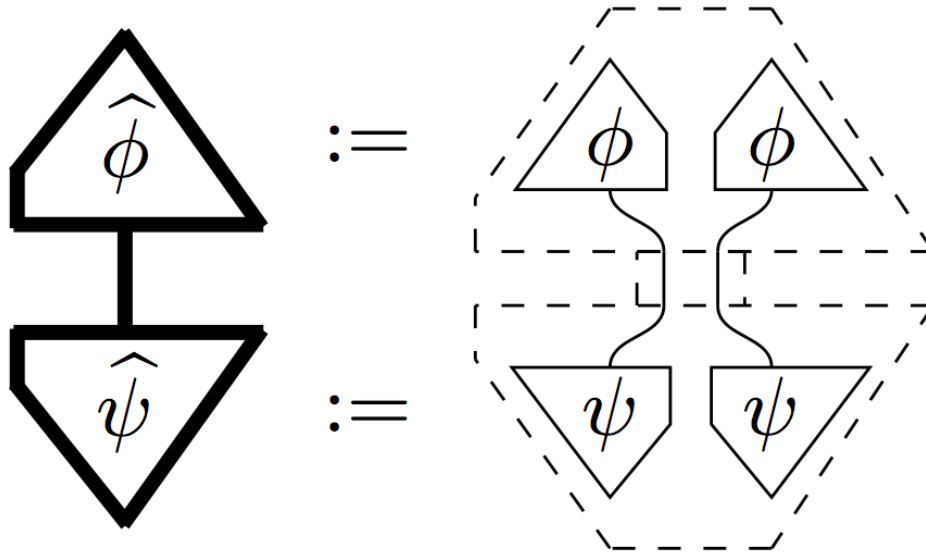

\Rightarrow genuine probabilities

— Ch. 4 – Quantum processes —

– doubling –

Pure quantum map $:=$

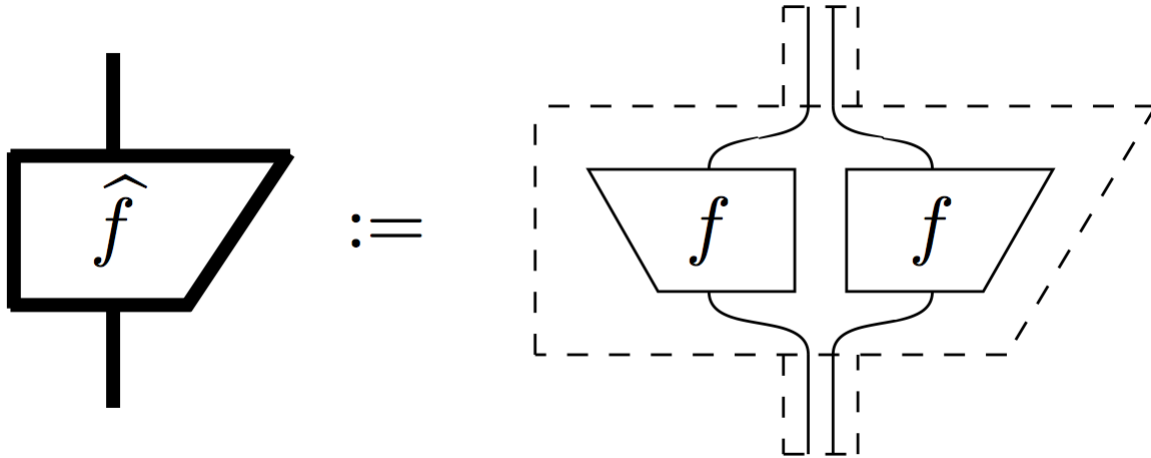

— Ch. 4 – Quantum processes —

– doubling –

Thm. We have:

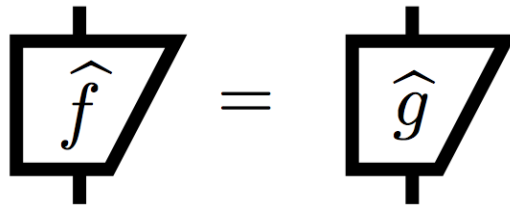
$$\boxed{\hat{f}} = \boxed{\hat{g}}$$

if and only if there exist $\lambda \bar{\lambda} = \mu \bar{\mu}$:

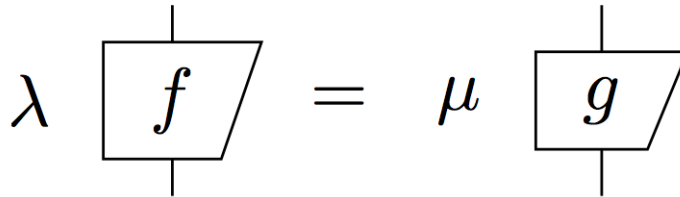
$$\lambda \boxed{f} = \mu \boxed{g}$$

— Ch. 4 – Quantum processes —

– doubling –

Pf. Setting:

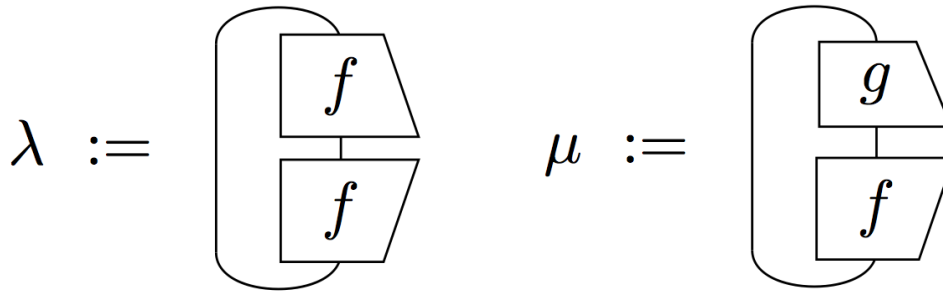

then:

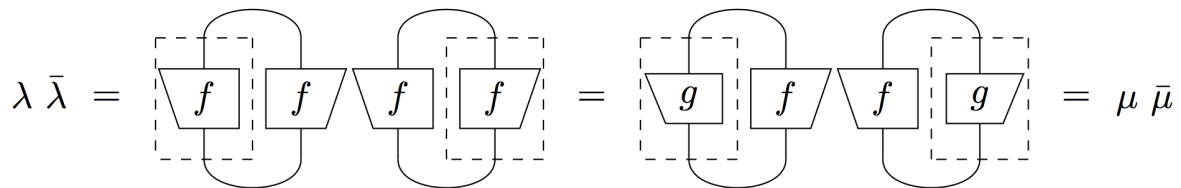

— Ch. 4 – Quantum processes —

– doubling –

Pf. Setting:

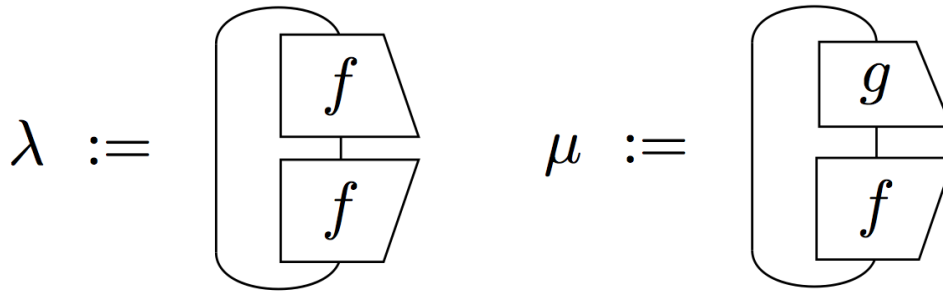

then:

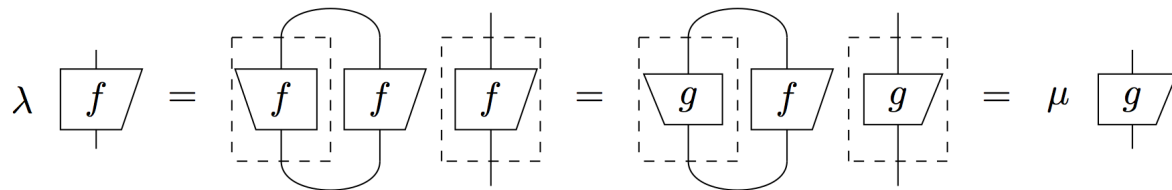

— Ch. 4 – Quantum processes —

– open systems –

— Ch. 4 – Quantum processes —

– open systems –

Discarding :=

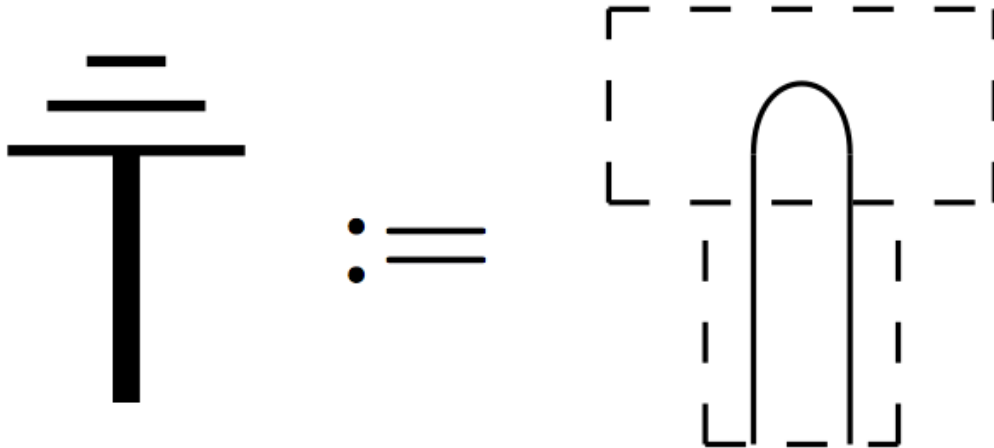

— Ch. 4 – Quantum processes —

– open systems –

Discarding :=

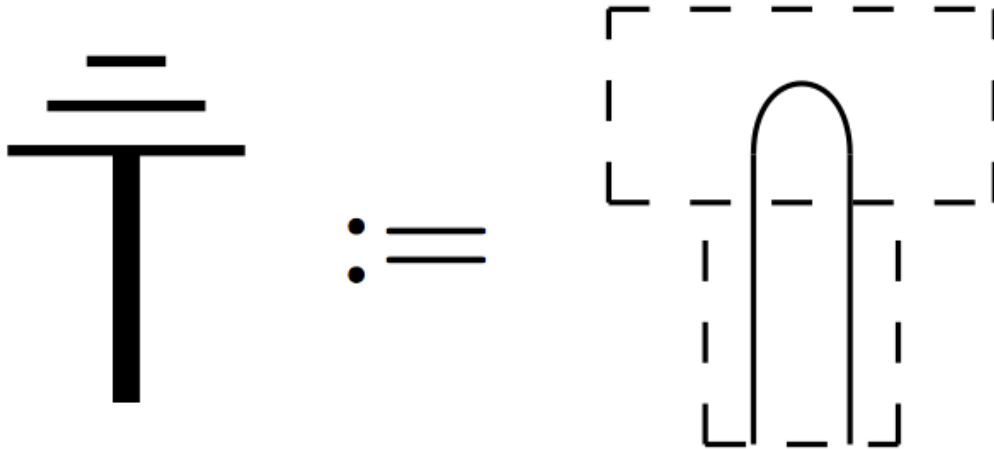

Thm. Discarding is not a pure quantum map.

— Ch. 4 – Quantum processes —

– open systems –

Discarding :=

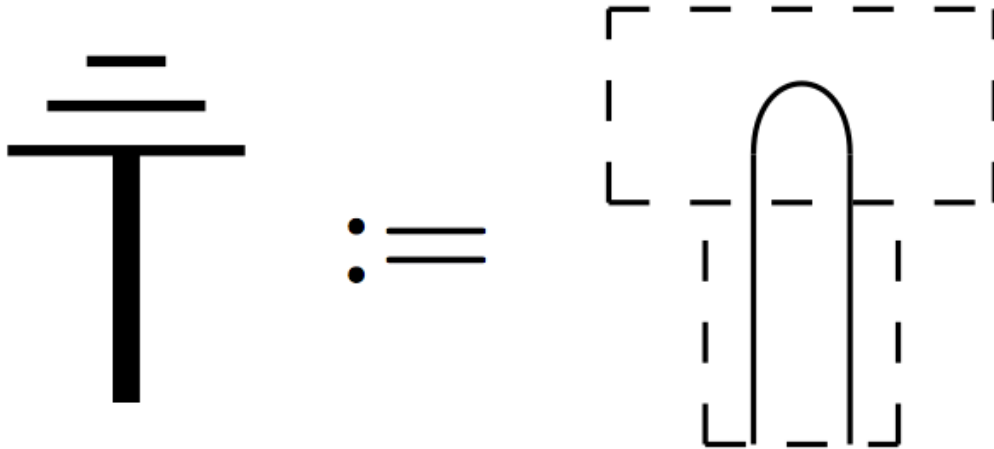

Thm. Discarding is not a pure quantum map.

Pf. Something connected \neq something disconnected.

— Ch. 4 – Quantum processes —

– *open systems* –

Quantum maps := pure quantum maps + discarding

— Ch. 4 – Quantum processes —

– *open systems* –

Quantum maps := pure quantum maps + discarding

E.g. ‘maximally mixed state :=

$$\frac{1}{D} \underline{\underline{\mathbb{1}}} = \boxed{\frac{1}{D} \mathbb{U}}$$

— Ch. 4 – Quantum processes —

– *open systems* –

Quantum maps := pure quantum maps + discarding

Prop. All quantum maps are of the form:

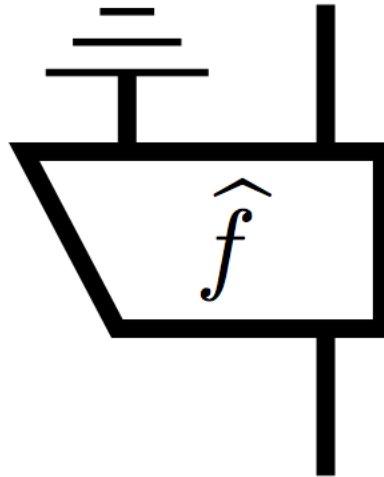

— Ch. 4 – Quantum processes —

– open systems –

Quantum maps := pure quantum maps + discarding

Prop. All quantum maps are of the form:

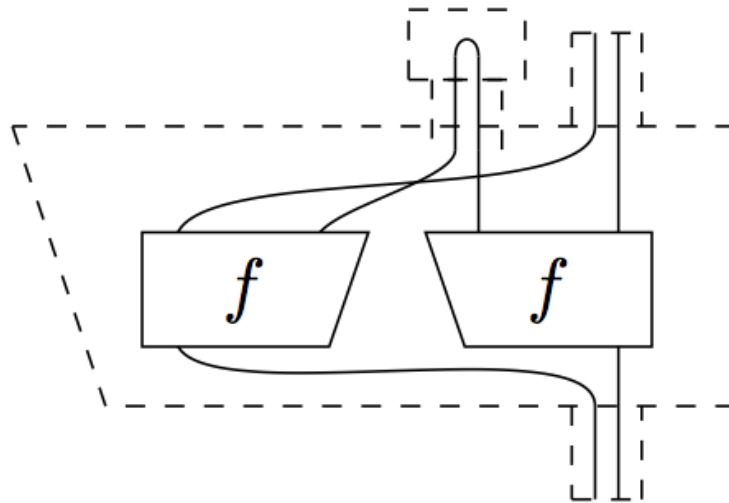

— Ch. 4 – Quantum processes —

– open systems –

Quantum maps := pure quantum maps + discarding

Prop. All quantum maps are of the form:

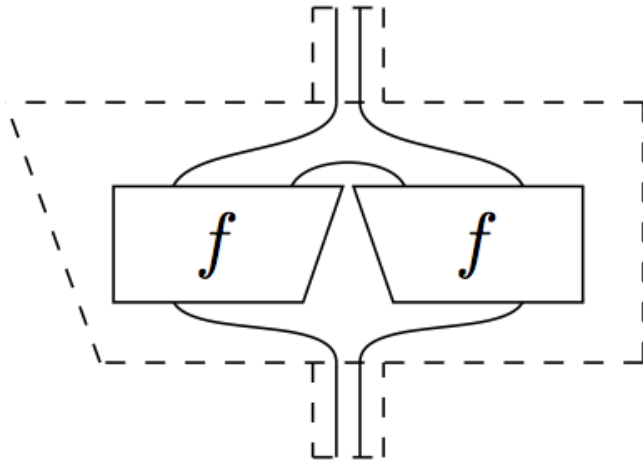

— Ch. 4 – Quantum processes —

– causality –

— Ch. 4 – Quantum processes —

– *causality* –

... of quantum maps:

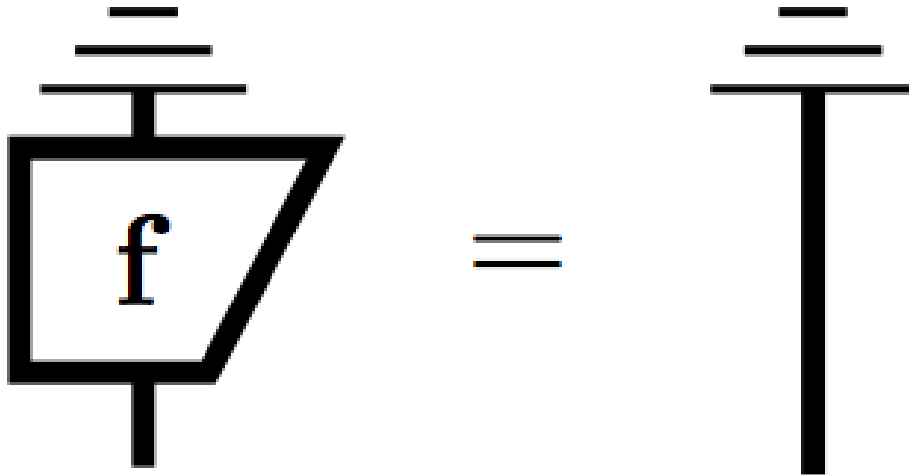

— Ch. 4 – Quantum processes —

– *causality* –

Prop. For pure quantum maps:

causality \iff isometry

— Ch. 4 – Quantum processes —

– *causality* –

Prop. For pure quantum maps:

causality \iff isometry

Pf.

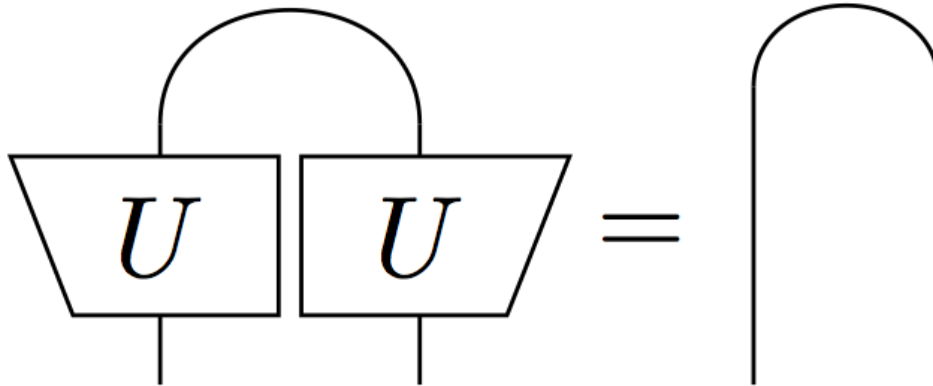

— Ch. 4 – Quantum processes —

– *causality* –

Prop. For general quantum maps:

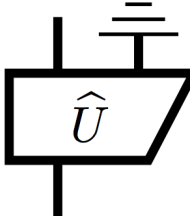
causality \iff of the form 

— Ch. 4 – Quantum processes —

– *causality* –

Prop. For general quantum maps:

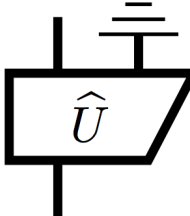
causality \iff of the form 

Pf.

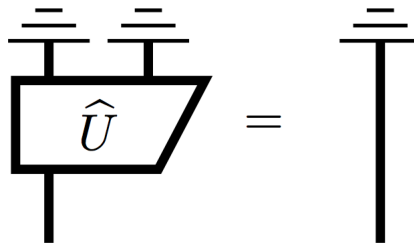

— Ch. 4 – Quantum processes —

– *causality* –

Prop. For general quantum maps:

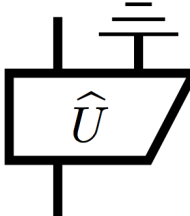
causality \iff of the form 

Pf.

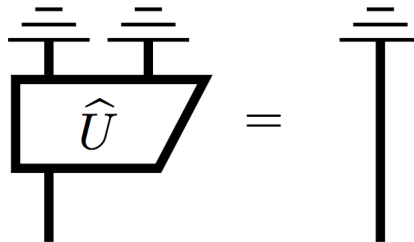

Cor. *Stinespring dilation.*

— Ch. 4 – Quantum processes —

– non-deterministic quantum processes –

— Ch. 4 – Quantum processes —

– *non-deterministic quantum processes* –

... :=

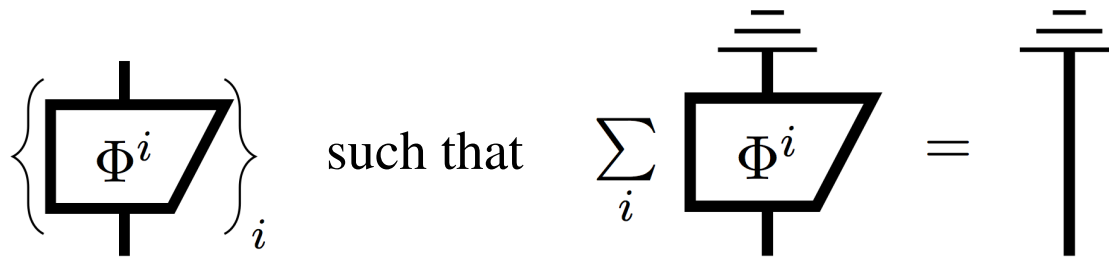

E.g. quantum measurements.

— Ch. 5 – Quantum measurement —

The bureaucratic mentality is the only constant in the universe.

— Dr. McCoy, Star Trek IV: The Voyage Home, 2286.

Here we briefly address:

- Next-best-thing to observing
- Measurement-induced dynamics
- Measurement-only quantum computing

— Ch. 5 – Quantum measurement —

– *is quantum measurement weird?* –

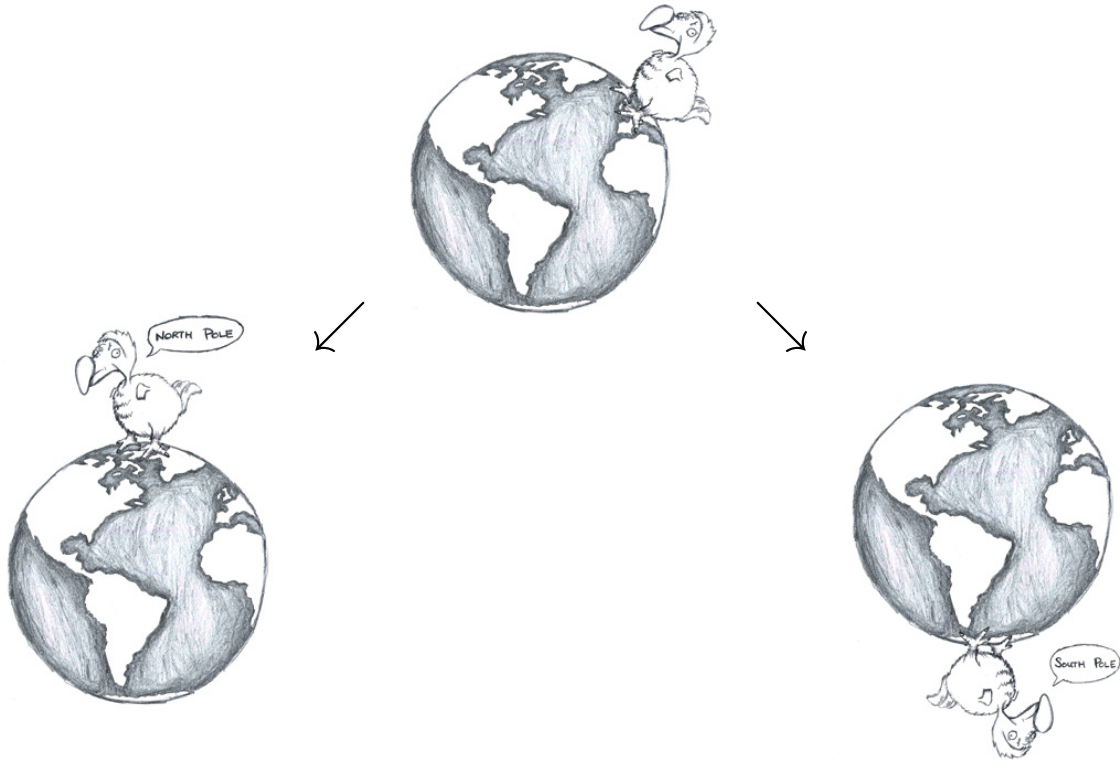

— **Ch. 5 – Quantum measurement** —

– *is quantum measurement weird?* –

Thm. Observing is not a quantum process

— Ch. 5 – Quantum measurement —

– *is quantum measurement weird?* –

Thm. Observing is not a quantum process i.e. \nexists :

$$\left\{ \begin{array}{c} \triangle \\ \Phi\phi \\ \uparrow \\ \phi \end{array} \right\} \quad \text{with} \quad \begin{array}{c} \triangle \\ \Phi\phi \\ \downarrow \\ \hat{\psi} \end{array} = \begin{cases} 1 & \text{iff } \psi = \phi \\ 0 & \text{iff } \psi \neq \phi \end{cases}$$

— Ch. 5 – Quantum measurement —

– *is quantum measurement weird?* –

Thm. Observing is not a quantum process i.e. \nexists :

$$\left\{ \begin{array}{c} \triangle \\ \Phi\phi \\ \uparrow \\ \phi \end{array} \right\} \quad \text{with} \quad \begin{array}{c} \triangle \\ \Phi\phi \\ \downarrow \\ \hat{\psi} \\ \triangle \end{array} = \begin{cases} 1 & \text{iff } \psi = \phi \\ 0 & \text{iff } \psi \neq \phi \end{cases}$$

Prop. Condition can only hold for orthogonal states.

— Ch. 5 – Quantum measurement —

– *is quantum measurement weird?* –

Thm. Observing is not a quantum process i.e. \nexists :

$$\left\{ \begin{array}{c} \triangle \\ \Phi\phi \\ \uparrow \\ \phi \end{array} \right\} \quad \text{with} \quad \begin{array}{c} \triangle \\ \Phi\phi \\ \downarrow \\ \hat{\psi} \\ \triangle \end{array} = \begin{cases} 1 & \text{iff } \psi = \phi \\ 0 & \text{iff } \psi \neq \phi \end{cases}$$

Prop. Condition can only hold for orthogonal states.

\Rightarrow “measurement” is next-best-thing to observing

— Ch. 5 – Quantum measurement —

– *is quantum measurement weird?* –

Bohr-Heisenberg:

any attempt to observe is bound to disturb

— Ch. 5 – Quantum measurement —

– *is quantum measurement weird?* –

Bohr-Heisenberg:

any attempt to observe is bound to disturb

Newtonian equivalent:

locating a balloon by mechanical means

— Ch. 5 – Quantum measurement —

– *is quantum measurement weird?* –

Heisenberg-Bohr:

any *attempt to observe* is bound to disturb

Newtonian equivalent:

locating a balloon by mechanical means

Resulting diagnosis:

we suffer from *quantum-blindness*

— Ch. 5 – Quantum measurement —

– *is quantum measurement weird?* –

BUT, the stuff that people call quantum measurement turns out to be extremely useful nonetheless!

— Ch. 5 – Quantum measurement —

– *what people call measurement* –

ONB-measurement :=

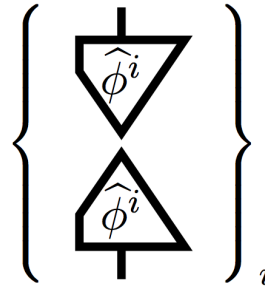
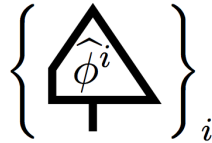

— Ch. 5 – Quantum measurement —

– *what people call measurement* –

ONB-measurement :=

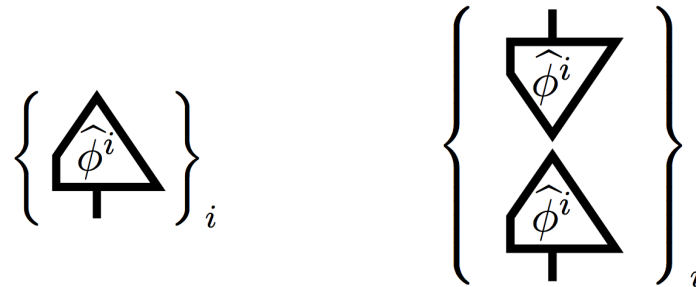

E.g. for $\{\beta_i\}_i$ Pauli-matrices:

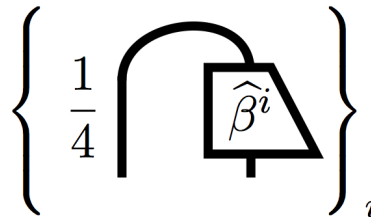

— **Ch. 5 – Quantum measurement** —

– *what people call measurement* –

Thm. All quantum maps arise from ONB-measurements.

— Ch. 5 – Quantum measurement —

– *what people call measurement* –

Thm. All quantum maps arise from ONB-measurements.

Pf. There are ‘enough ONB’s’ such that:

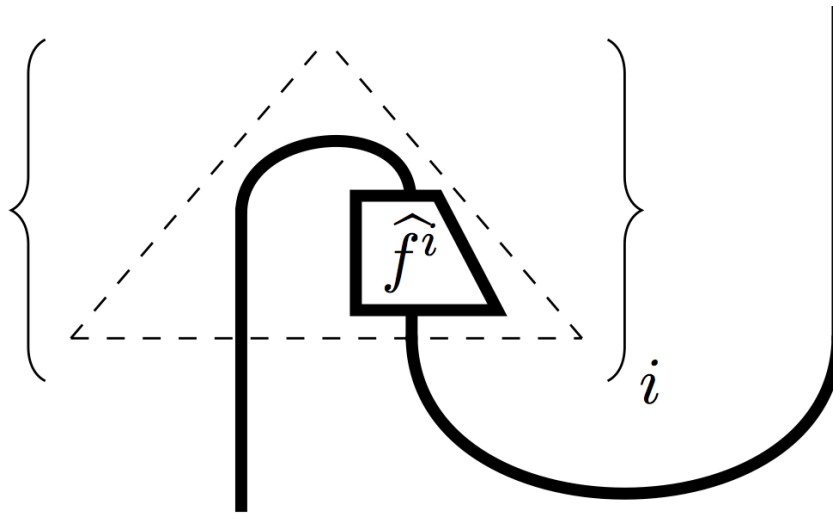

— Ch. 5 – Quantum measurement —

– measurement-induced dynamics –

— Ch. 5 – Quantum measurement —

– *measurement-induced dynamics* –

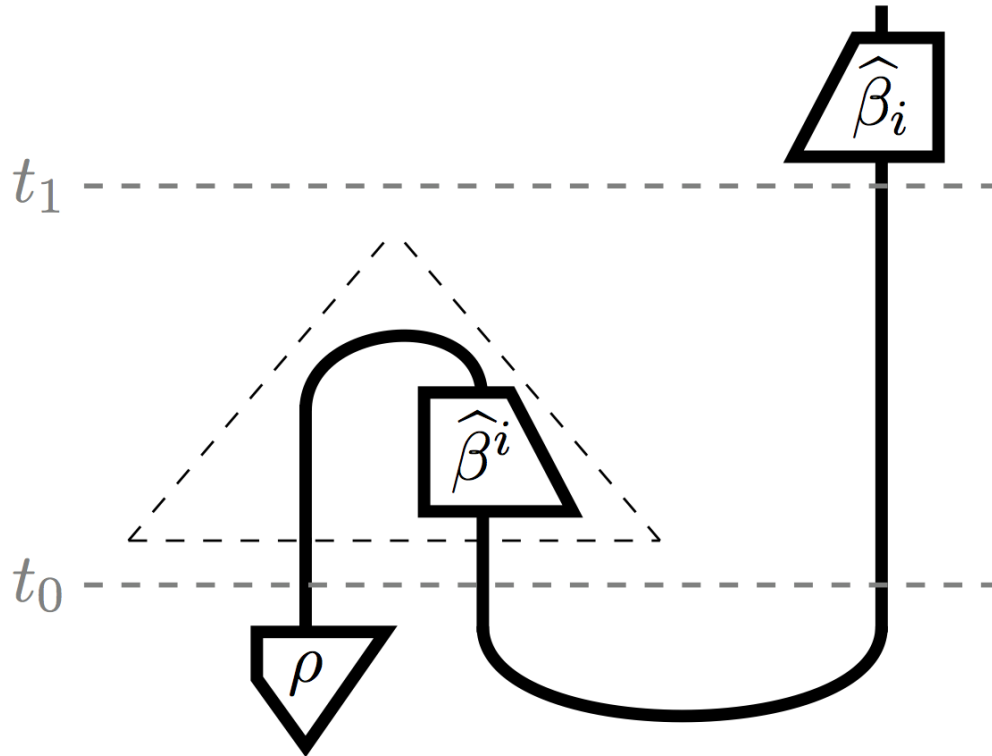

— Ch. 5 – Quantum measurement —

– *measurement-induced dynamics* –



— Ch. 5 – Quantum measurement —

– *measurement-induced dynamics* –

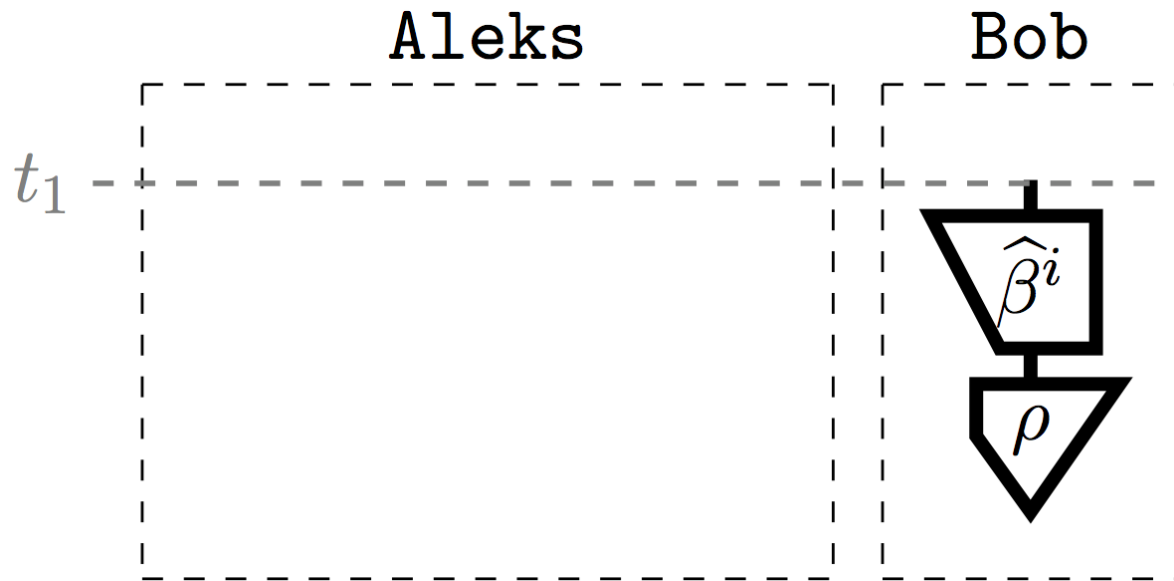

— Ch. 5 – Quantum measurement —

– measurement-only quantum computing –

— Ch. 5 – Quantum measurement —

– *measurement-only quantum computing* –

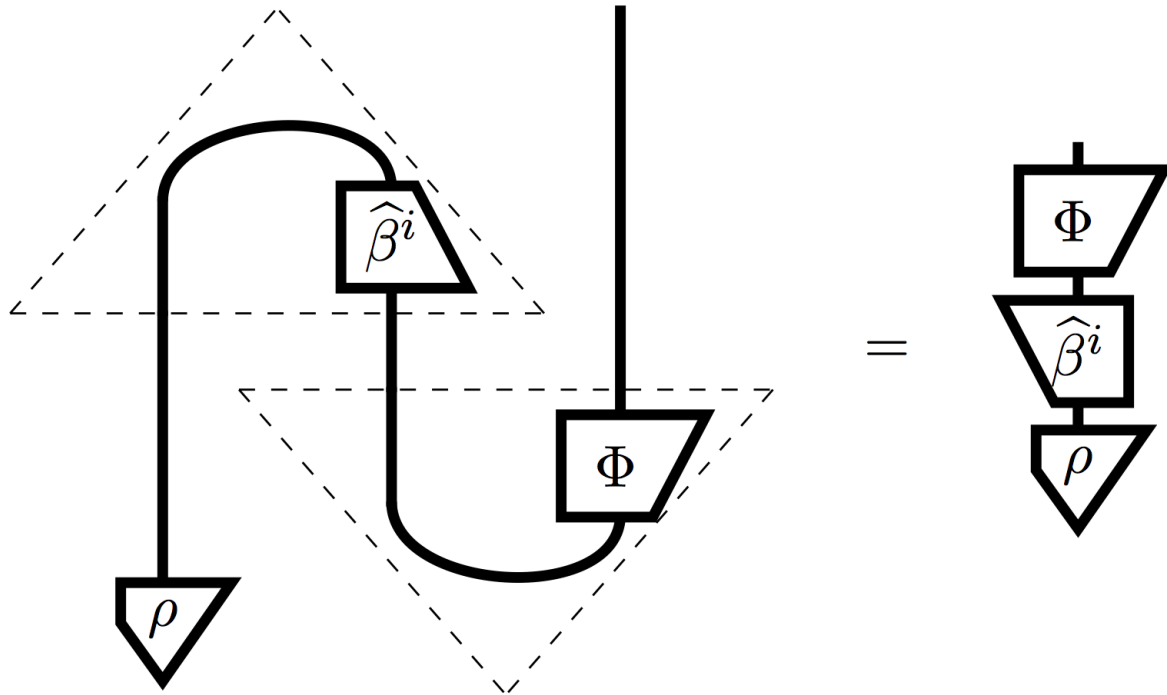

— Ch. 5 – Quantum measurement —

– *measurement-only quantum computing* –

1

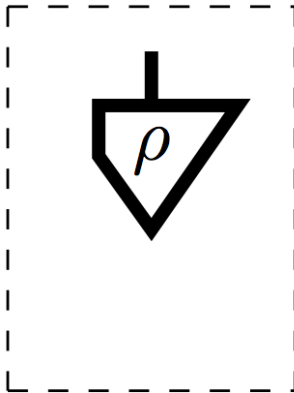

2a

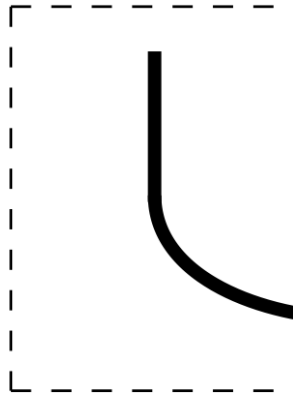

2b

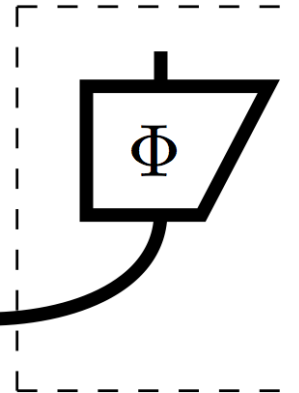

— Ch. 5 – Quantum measurement —

– *measurement-only quantum computing* –

1



2a

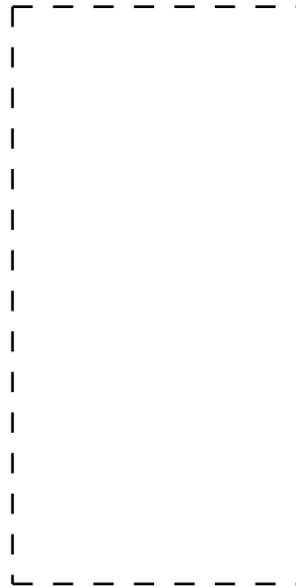

2b

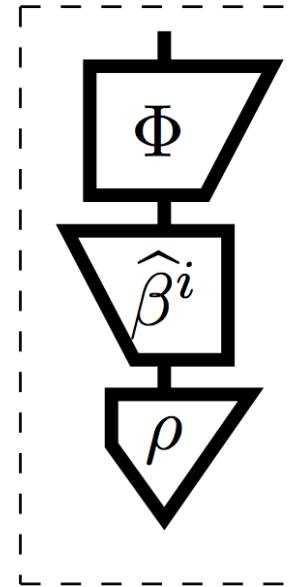

— Ch. 5 – Quantum measurement —

– *measurement-only quantum computing* –

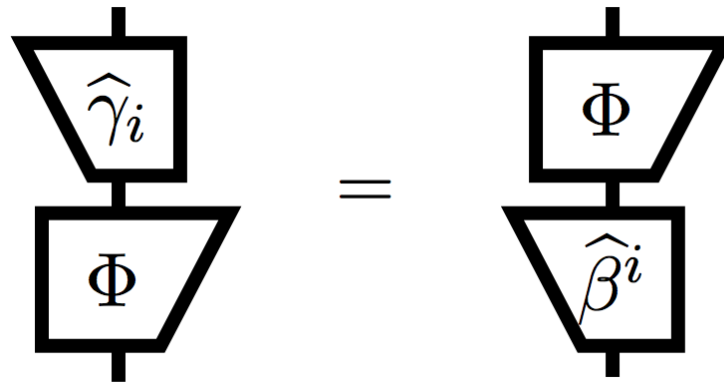

— Ch. 6 – Picturing classical processes —

Damn it! I knew she was a monster! John! Amy! Listen! Guard your buttholes.

— David Wong, *This Book Is Full of Spiders*, 2012.

Here we fully diagrammatically describe:

- all quantum processes
- special ones
- protocols

and introduce the humongously important notion of:

- spiders

— Ch. 6 – Picturing classical processes —

– classical vs. quantum wires –

— Ch. 6 – Picturing classical processes —

– *classical vs. quantum wires* –

They should meet:

quantum wires $\overset{\sim}{\longleftrightarrow}$ **classical wires**

— Ch. 6 – Picturing classical processes —

– *classical vs. quantum wires* –

They should meet:

quantum wires $\overset{\sim}{\longleftrightarrow}$ **classical wires**

but retain their distance:

quantum wires \neq **classical wires**

— Ch. 6 – Picturing classical processes —

– *classical vs. quantum wires* –

They should meet:

quantum wires $\overset{\sim}{\longleftrightarrow}$ **classical wires**

but retain their distance:

quantum wires \neq **classical wires**

which can be realised via ‘un-doubling’:

$$\frac{\text{classical wire}}{\text{quantum wire}} = \frac{\text{normal (i.e. 1)}}{\text{boldface (i.e. 2)}}$$

— Ch. 6 – Picturing classical processes —

– encoding classical data –

— Ch. 6 – Picturing classical processes —

– encoding classical data –

Classical data \equiv ONB:

— Ch. 6 – Picturing classical processes —

– *encoding classical data* –

Classical data \equiv ONB:

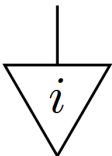
-  := “providing classical value i ”

— Ch. 6 – Picturing classical processes —

– *encoding classical data* –

Classical data \equiv ONB:

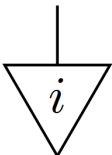
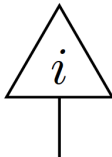
-  := “providing classical value i ”
-  := “testing for classical value i ”

— Ch. 6 – Picturing classical processes —

– *encoding classical data* –

Classical data \equiv ONB:

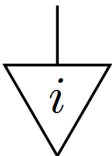
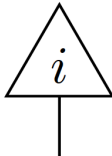
-  := “providing classical value i ”
-  := “testing for classical value i ”

Sanity check:

$$\begin{array}{c} \triangle \\ j \\ \hline i \\ \triangle \end{array} = \delta_{ij}$$

— Ch. 6 – Picturing classical processes —

– *encoding classical data* –

Non-deterministic quantum process:

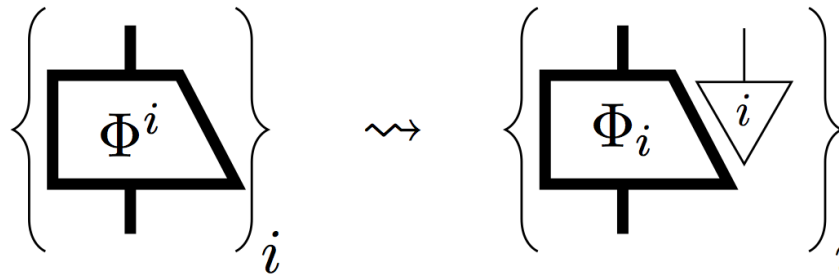

— Ch. 6 – Picturing classical processes —

– *encoding classical data* –

Non-deterministic quantum process:

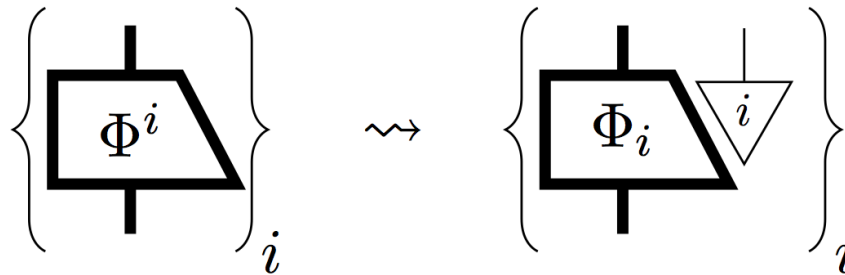

Process controlled by outcome:

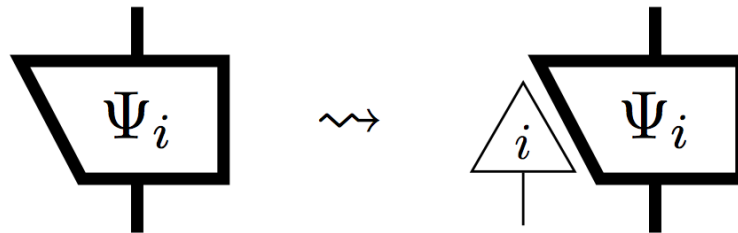

— Ch. 6 – Picturing classical processes —

– *encoding classical data* –

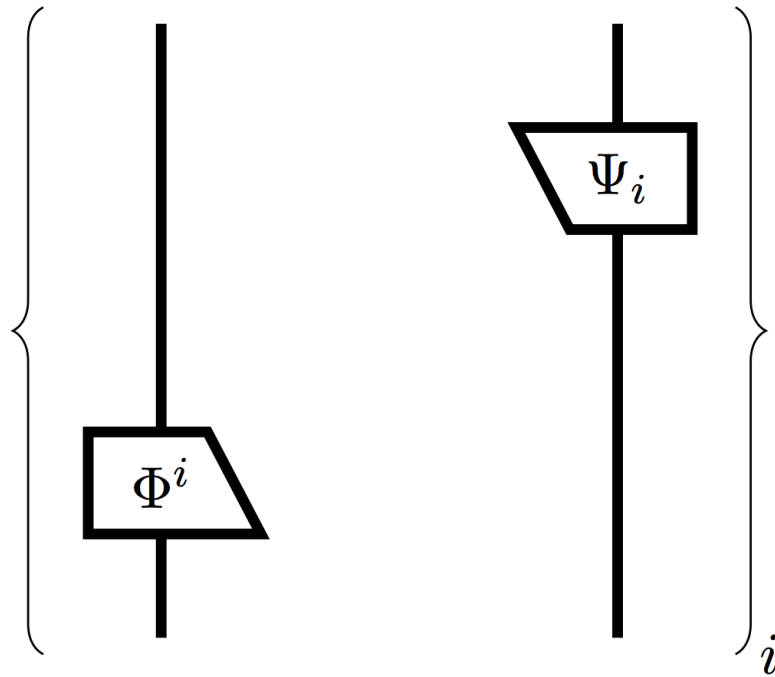

— Ch. 6 – Picturing classical processes —

– *encoding classical data* –

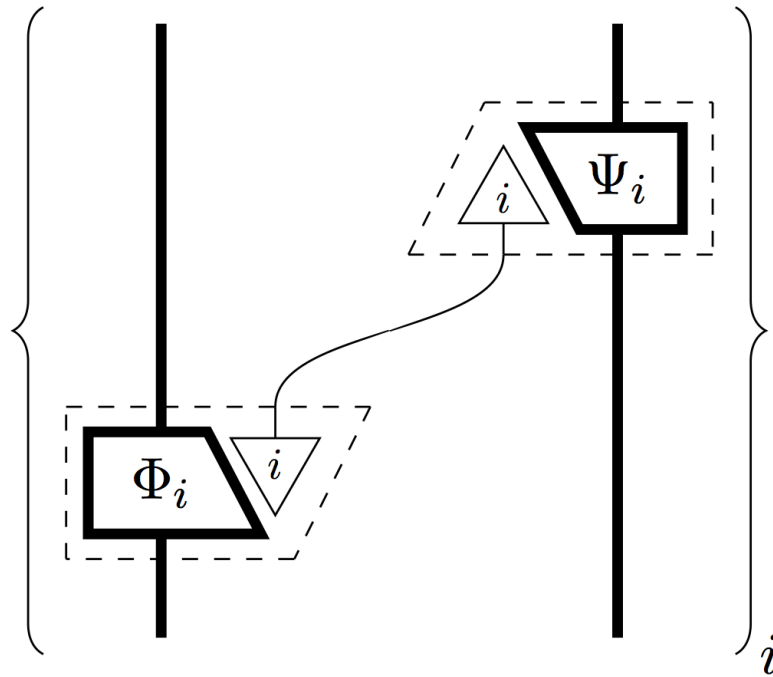

— Ch. 6 – Picturing classical processes —

– *encoding classical data* –

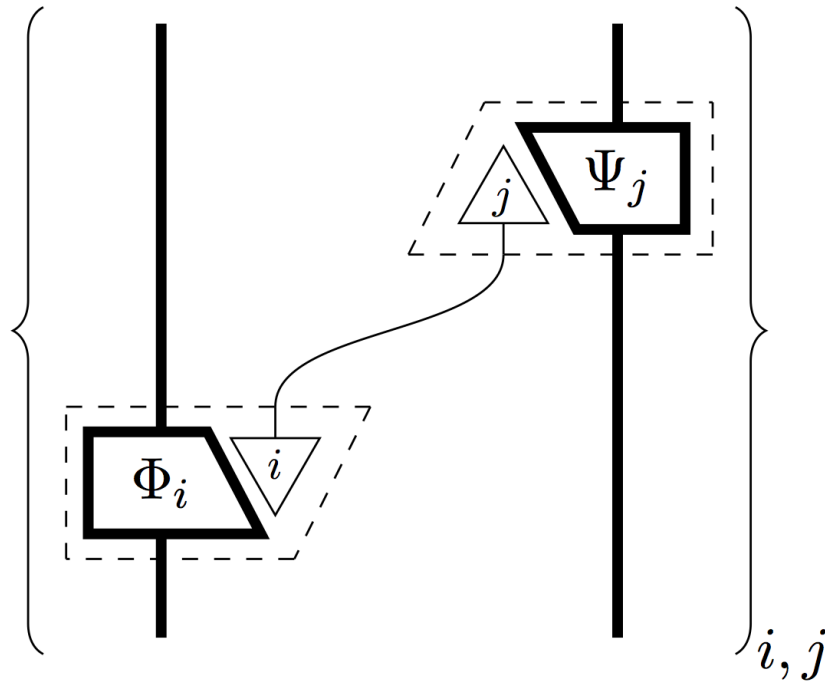

— Ch. 6 – Picturing classical processes —

– *encoding classical data* –

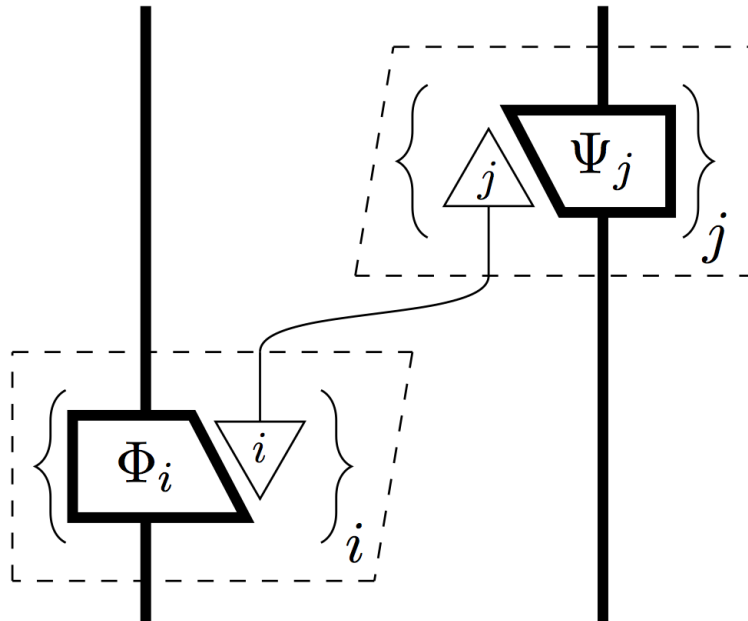

— Ch. 6 – Picturing classical processes —

– *classical data in diagrams* –

Prop. Braces \equiv sums

— Ch. 6 – Picturing classical processes —

– classical data in diagrams –

Prop. Braces \equiv sums

Pf.

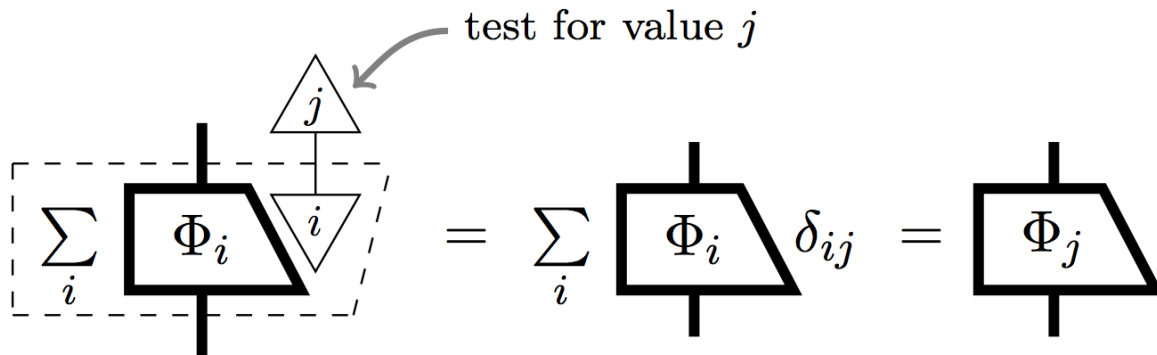

— Ch. 6 – Picturing classical processes —

– *encoding classical data* –

Non-deterministic quantum process:

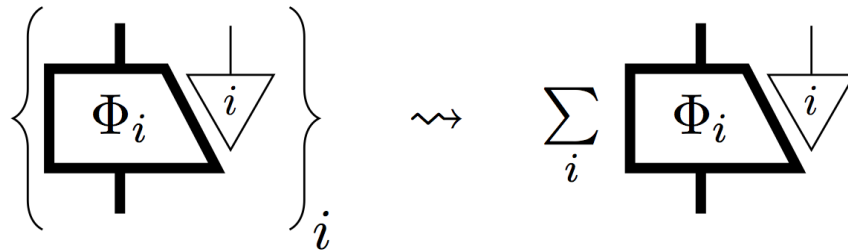

— Ch. 6 – Picturing classical processes —

– *encoding classical data* –

Non-deterministic quantum process:

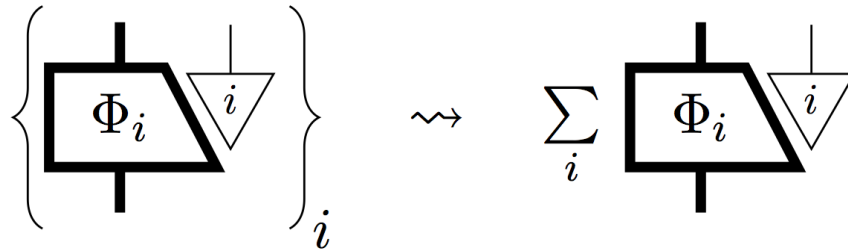

Process controlled by outcome:

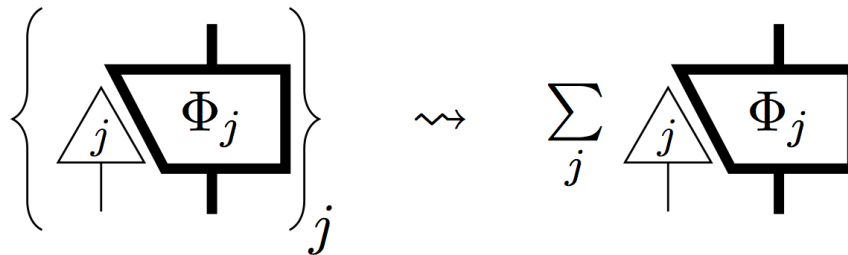

— Ch. 6 – Picturing classical processes —

– *encoding classical data* –

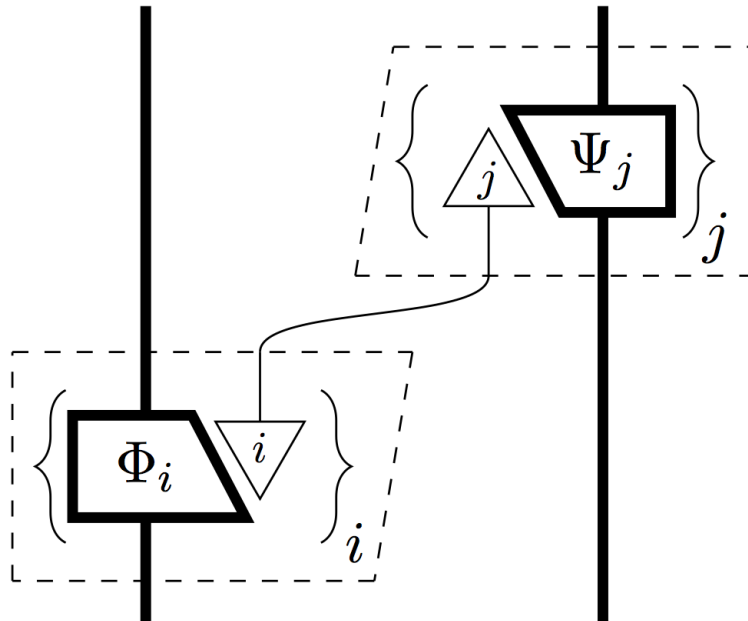

— Ch. 6 – Picturing classical processes —

– *encoding classical data* –

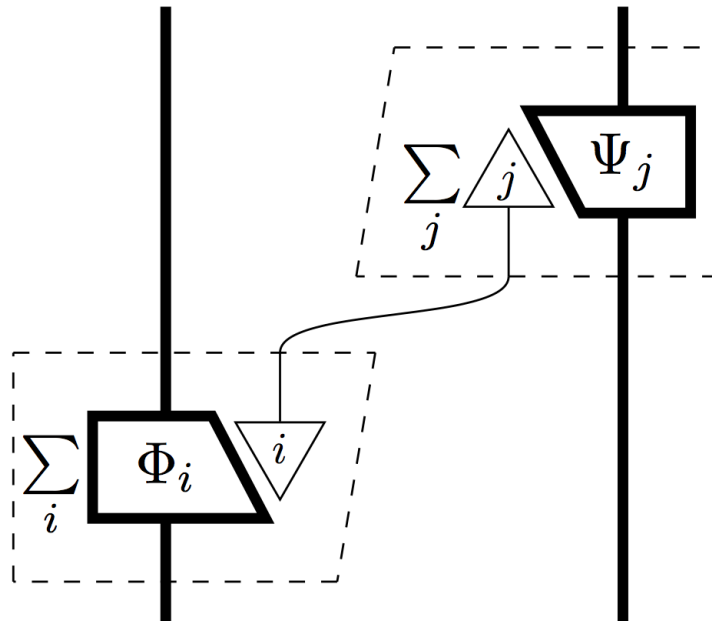

— Ch. 6 – Picturing classical processes —

– classical-quantum maps –

— Ch. 6 – Picturing classical processes —

– *classical-quantum maps* –

... :=

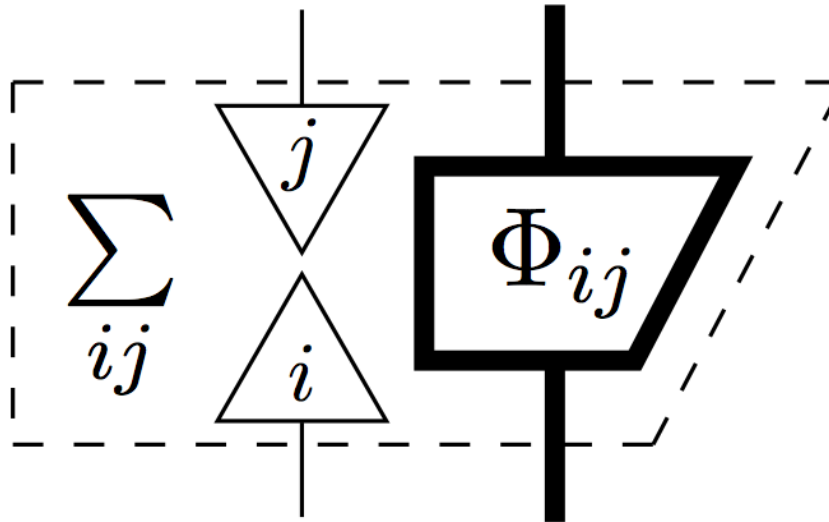

— Ch. 6 – Picturing classical processes —

– *classical-quantum maps* –

Classical map :=

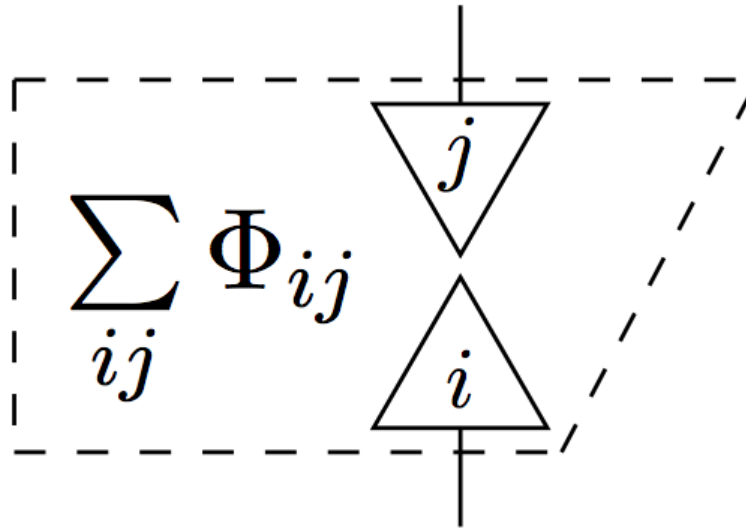

— Ch. 6 – Picturing classical processes —

– classical-quantum maps –

Classical map examples:

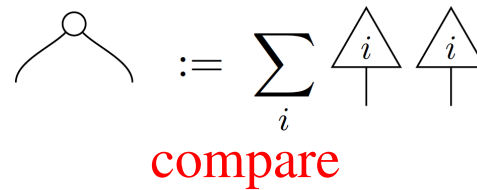
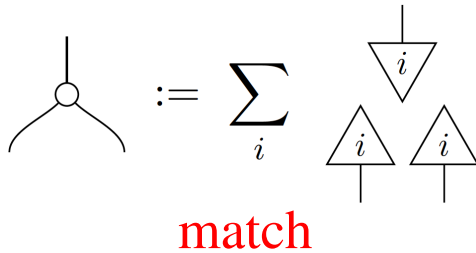
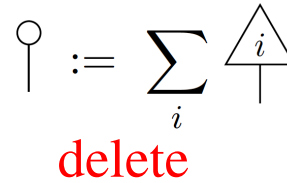
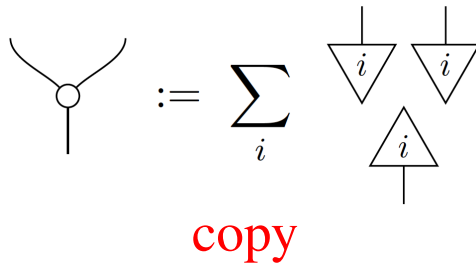

— Ch. 6 – Picturing classical processes —

– *classical-quantum maps* –

The name explains the action:

$$\begin{array}{c} \circ \\ | \\ \nabla_j \end{array} = \sum_i \begin{array}{c} \triangle_i \\ | \\ \nabla_j \end{array} =$$

— Ch. 6 – Picturing classical processes —

– *classical-quantum maps* –

The name explains the action:

$$\begin{array}{c} \circ \\ | \\ \nabla_j \end{array} = \sum_i \begin{array}{c} \triangle_i \\ | \\ \nabla_j \end{array} =$$

$$\begin{array}{c} \swarrow \quad \searrow \\ \circ \\ | \\ \nabla_j \end{array} = \sum_i \begin{array}{c} | \quad | \\ \nabla_i \quad \nabla_i \\ | \\ \triangle_i \\ | \\ \nabla_j \end{array} = \begin{array}{c} | \quad | \\ \nabla_j \quad \nabla_j \end{array}$$

— Ch. 6 – Picturing classical processes —

– classical-quantum maps –

Classical-quantum map examples:

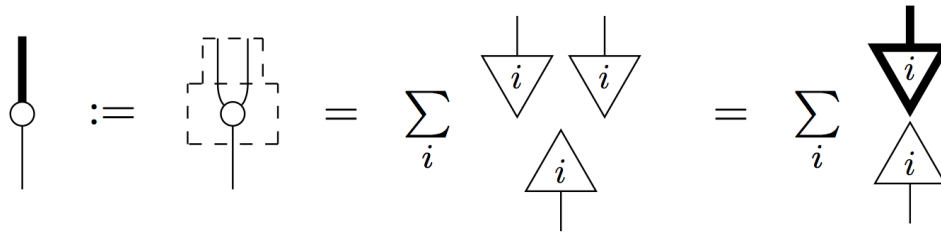

encode

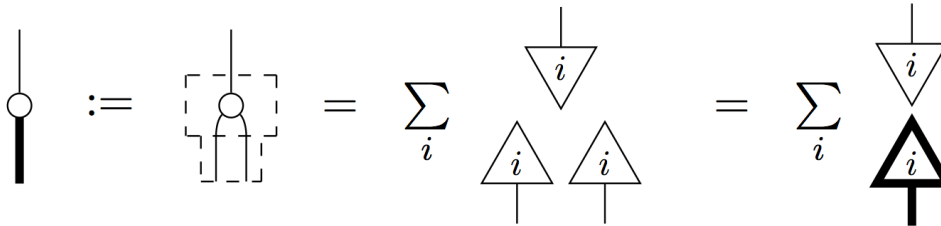

measure

— Ch. 6 – Picturing classical processes —

– *classical-quantum maps* –

Thm. ... are always of the form:

— Ch. 6 – Picturing classical processes —

– *classical-quantum maps* –

Thm. ... are always of the form:

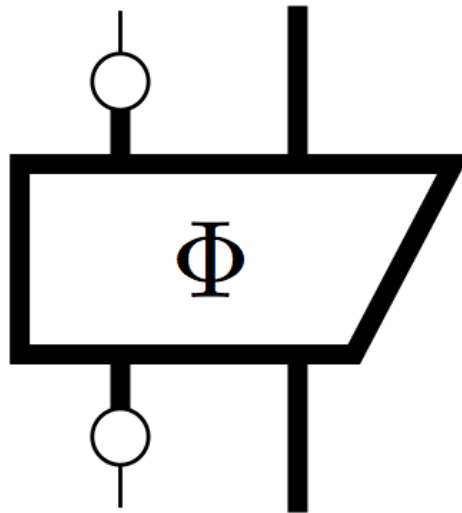

where f is a quantum map.

— Ch. 6 – Picturing classical processes —

– *classical-quantum maps* –

Thm. ... are always of the form:

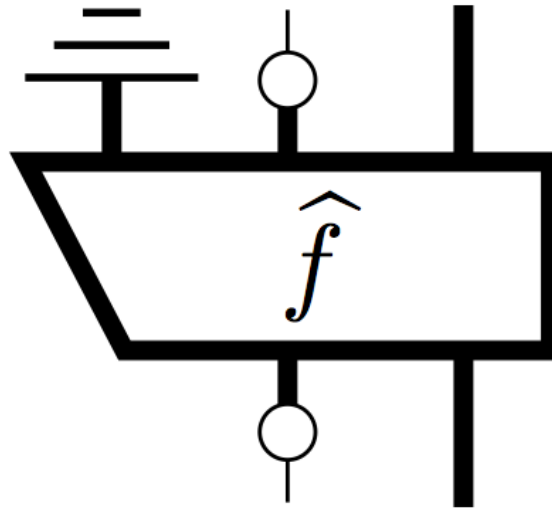

— Ch. 6 – Picturing classical processes —

– *classical-quantum maps* –

Thm. ... are always of the form:

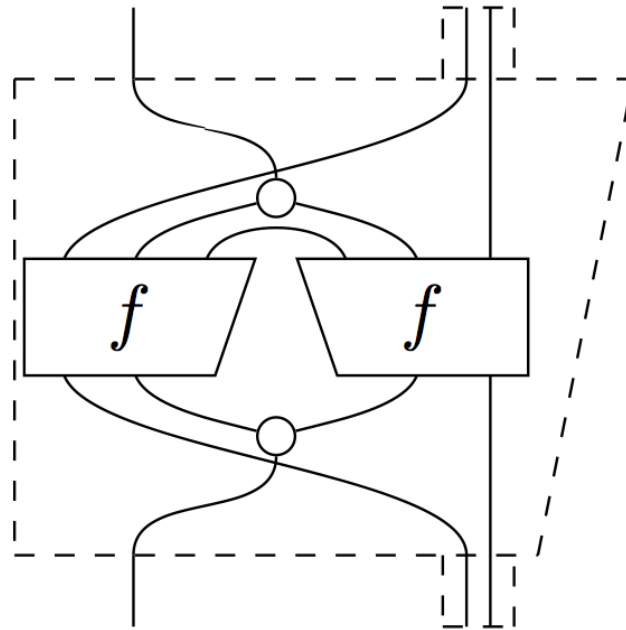

— Ch. 6 – Picturing classical processes —

– classical maps –

— Ch. 6 – Picturing classical processes —

– *classical maps* –

Thm. ... are always of the form:

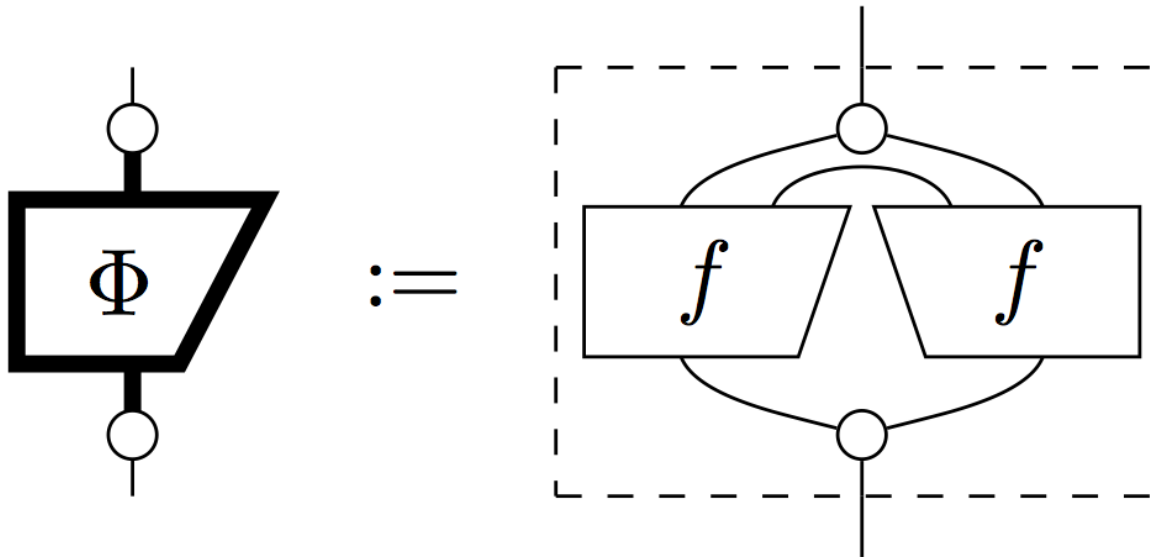

— Ch. 6 – Picturing classical processes —

– classical-quantum processes –

— Ch. 6 – Picturing classical processes —

– *classical-quantum processes* –

Thm. Causality:

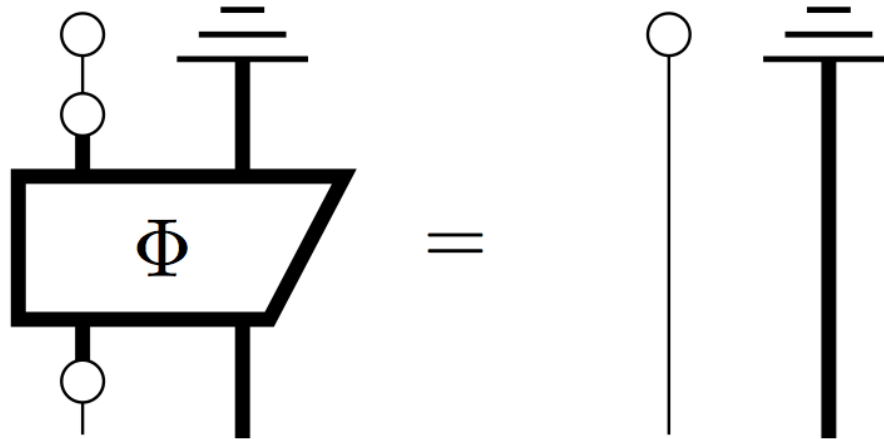

— Ch. 6 – Picturing classical processes —

– *classical-quantum processes* –

Lem.

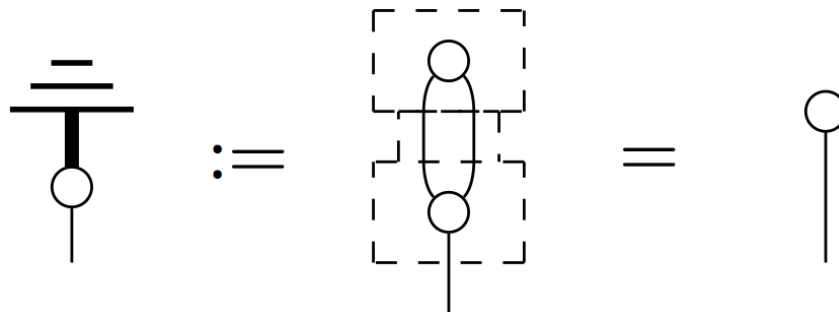
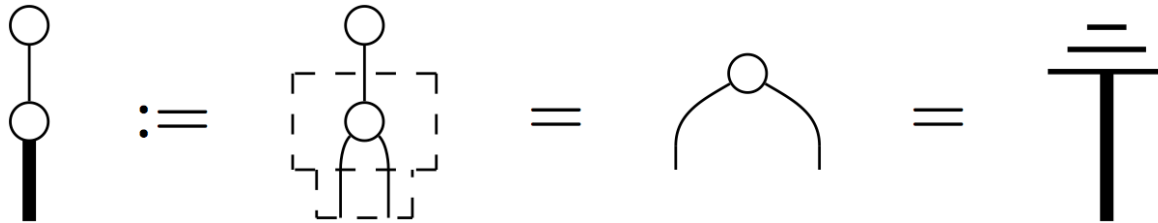

— Ch. 6 – Picturing classical processes —

– *classical-quantum processes* –

Thm. Causality:

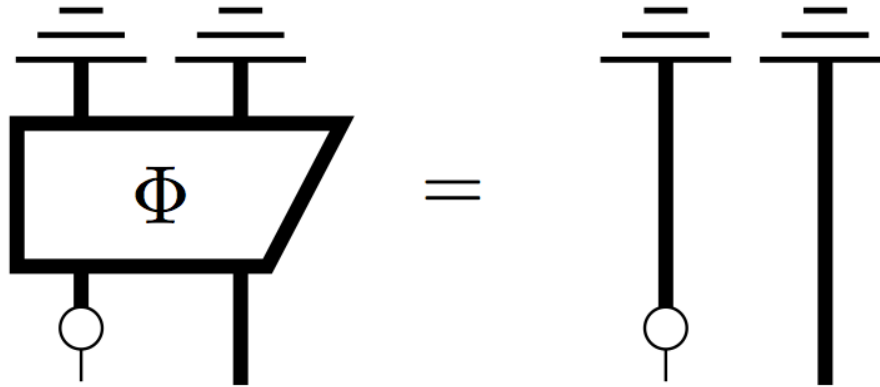

— Ch. 6 – Picturing classical processes —

– *classical-quantum processes* –

Thm. Causality:

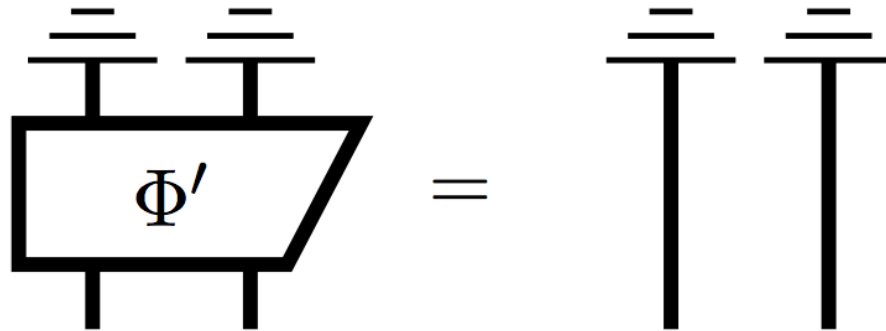

— Ch. 6 – Picturing classical processes —

– *classical-quantum processes* –

... :=

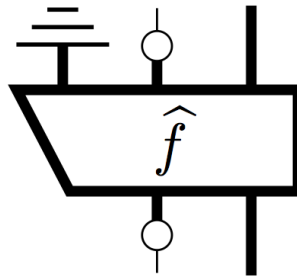

s.t.:

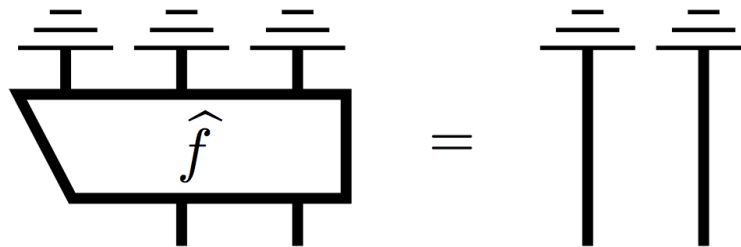

— Ch. 6 – Picturing classical processes —

– teleportation diagrammatically –

— Ch. 6 – Picturing classical processes —

– *teleportation diagrammatically* –

Thm. Controlled isometry:

— Ch. 6 – Picturing classical processes —

– teleportation diagrammatically –

Thm. Controlled isometry:

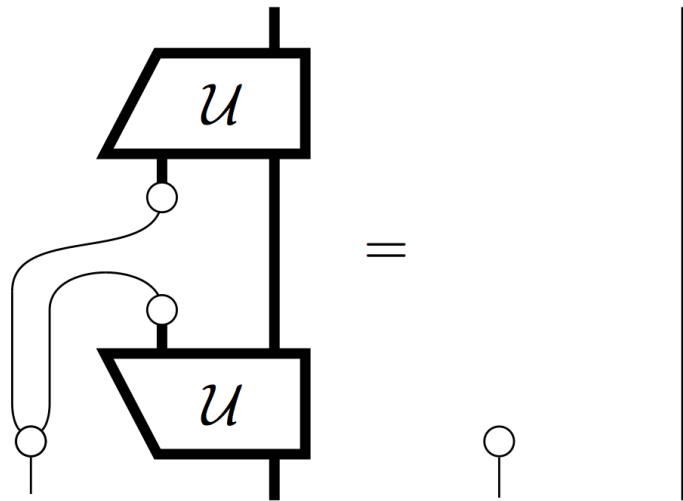

— Ch. 6 – Picturing classical processes —

– teleportation diagrammatically –

Pf.

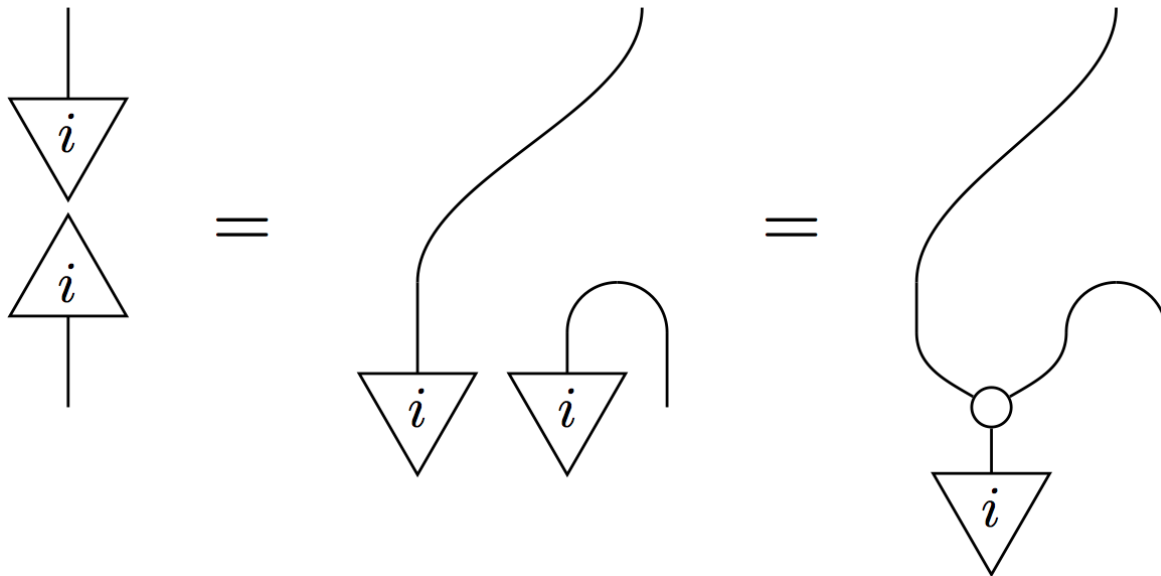

— Ch. 6 – Picturing classical processes —

– teleportation diagrammatically –

Pf.

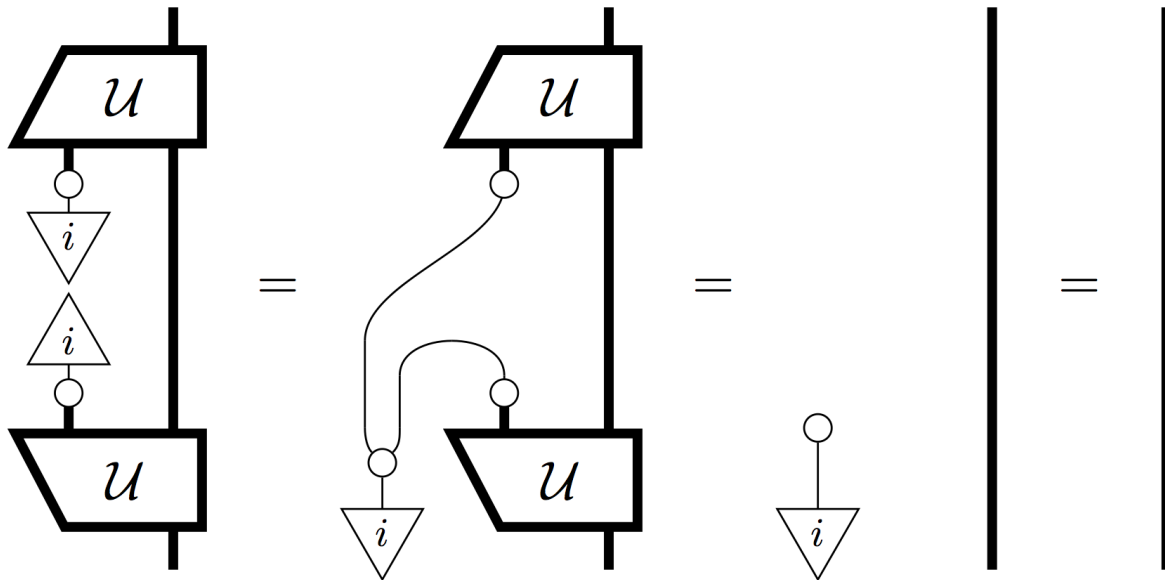

— Ch. 6 – Picturing classical processes —

– teleportation diagrammatically –

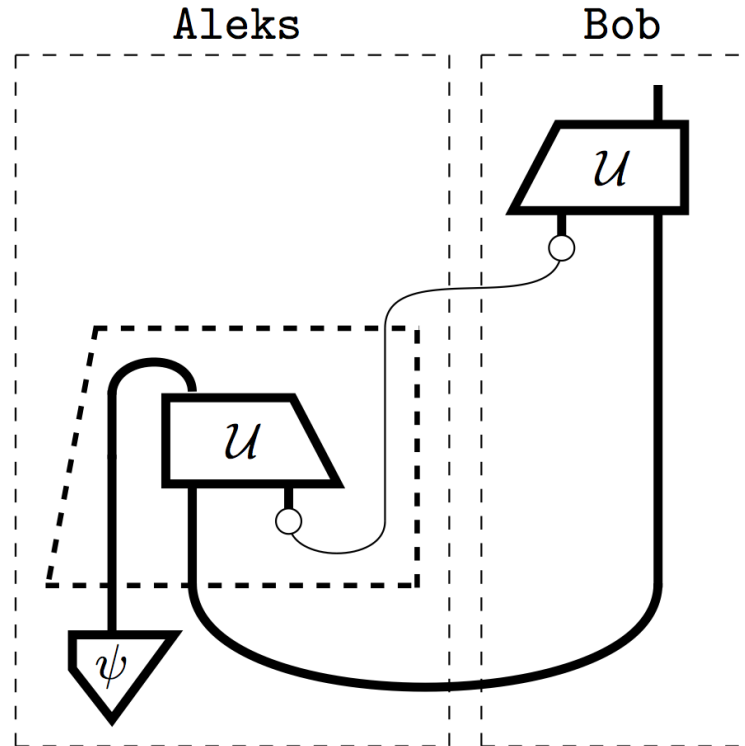

— Ch. 6 – Picturing classical processes —

– teleportation diagrammatically –

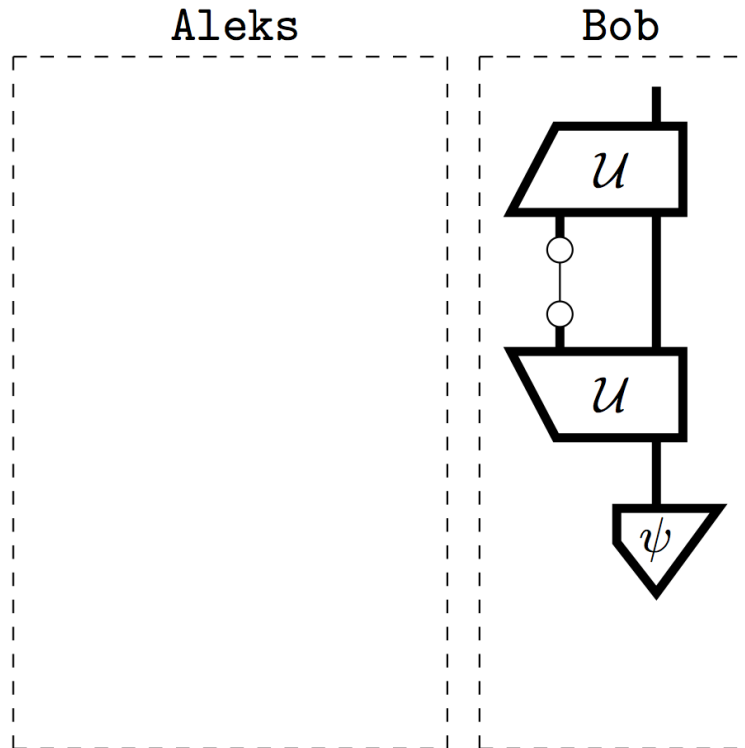

— Ch. 6 – Picturing classical processes —

– *teleportation diagrammatically* –

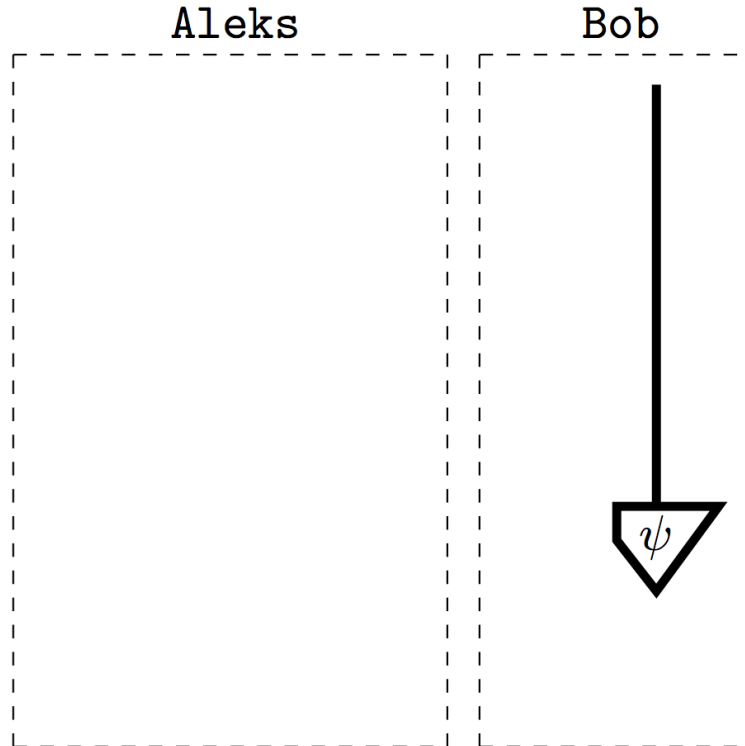

— Ch. 6 – Picturing classical processes —

– dense coding –

— Ch. 6 – Picturing classical processes —

– dense coding –

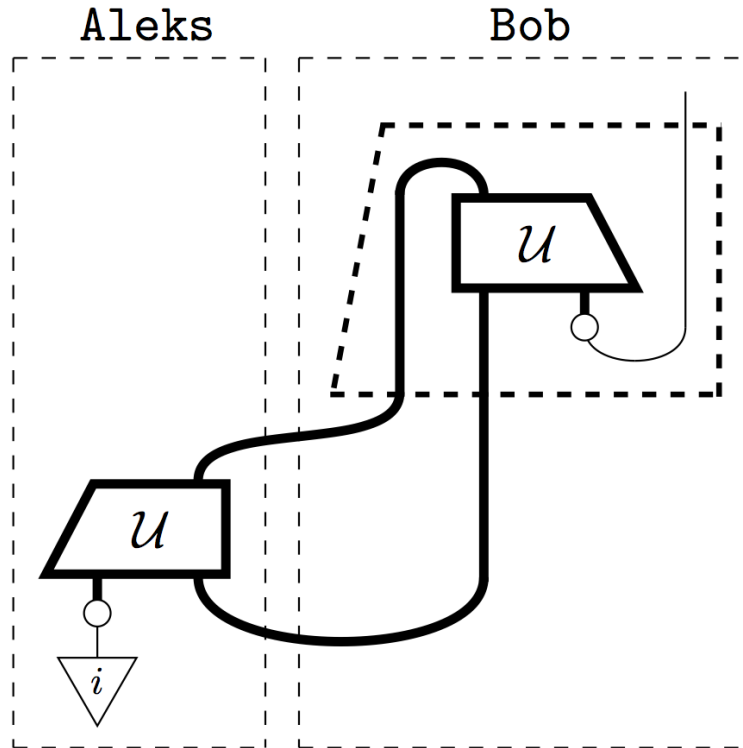

— Ch. 6 – Picturing classical processes —

– dense coding –

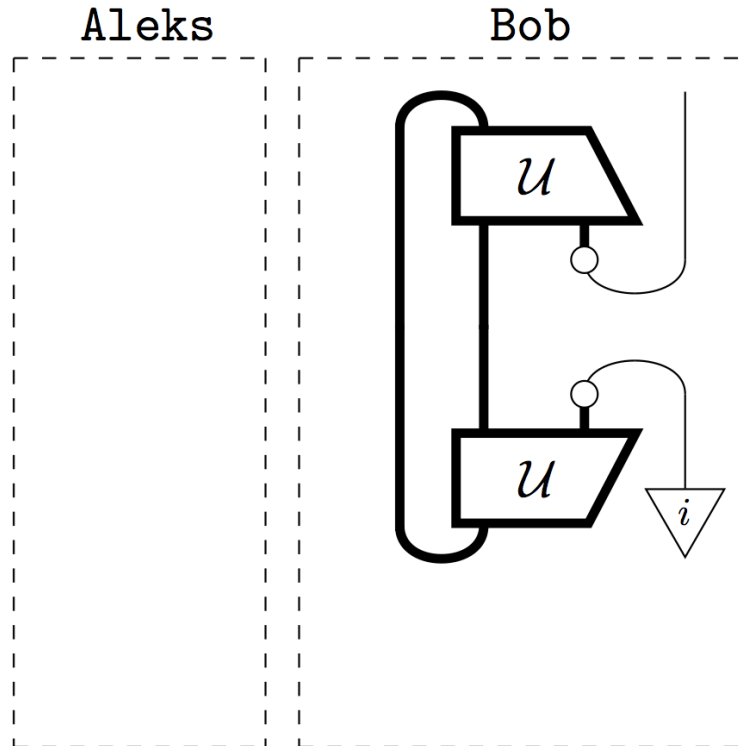

— Ch. 6 – Picturing classical processes —

– *dense coding* –

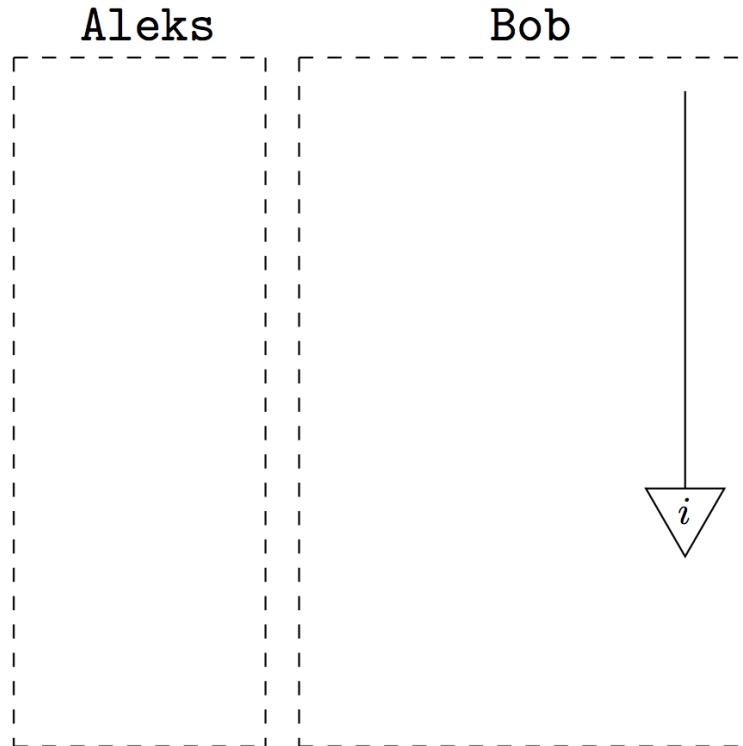

— Ch. 6 – Picturing classical processes —

– Naimark dilation –

— Ch. 6 – Picturing classical processes —

– *Naimark dilation* –

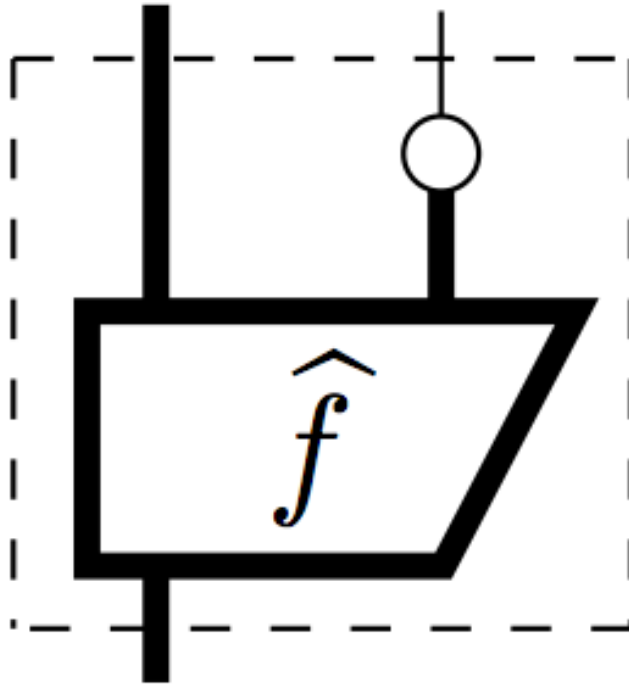

— Ch. 6 – Picturing classical processes —

– Naimark dilation –

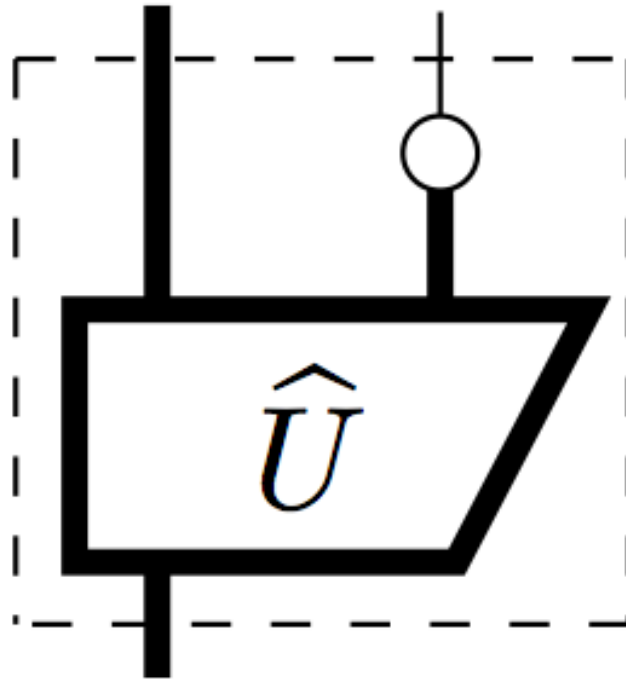

— Ch. 6 – Picturing classical processes —

– Naimark dilation –

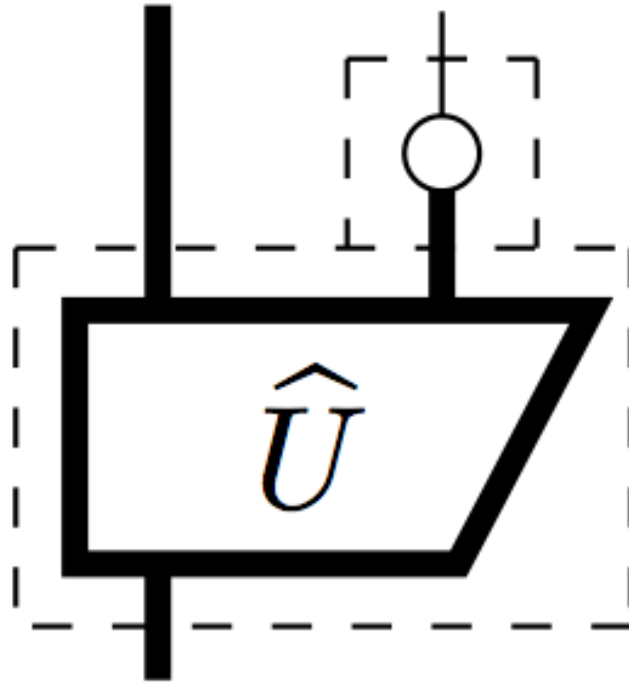

— Ch. 6 – Picturing classical processes —

– spiders –

— Ch. 6 – Picturing classical processes —

– spiders –

... :=

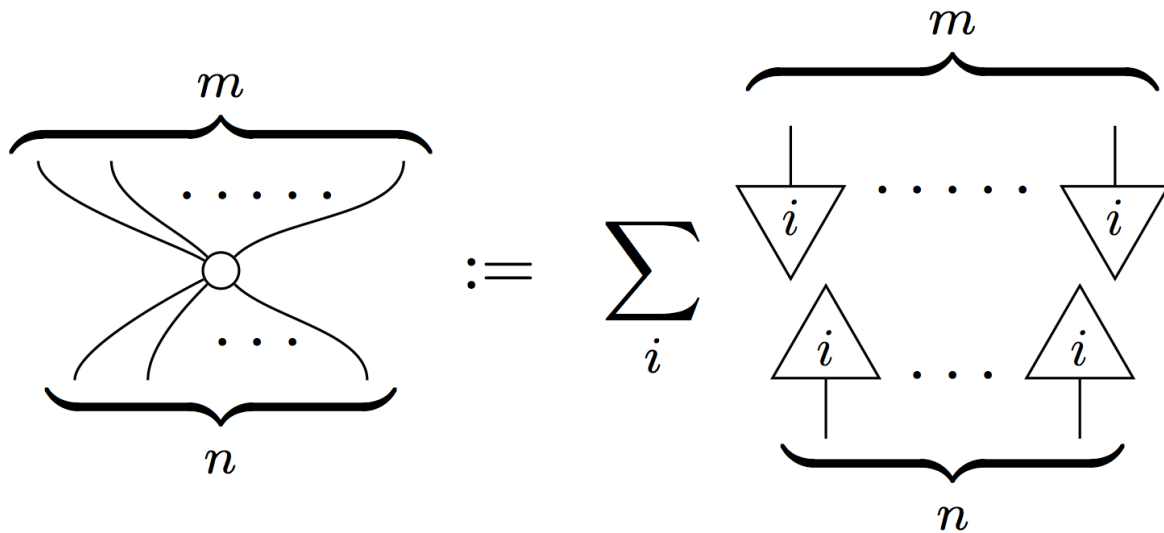

— Ch. 6 – Picturing classical processes —

– spiders –

Cf.

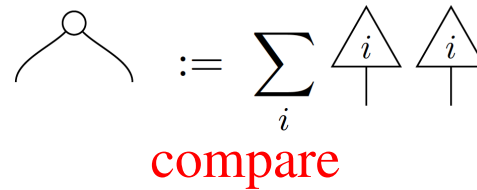
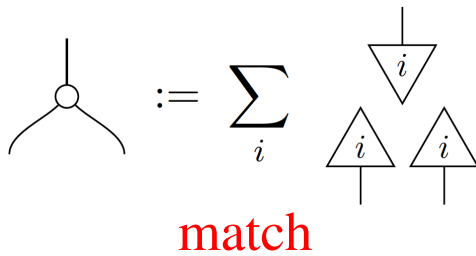
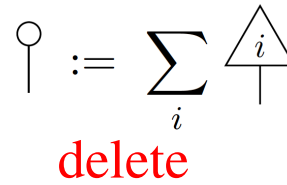
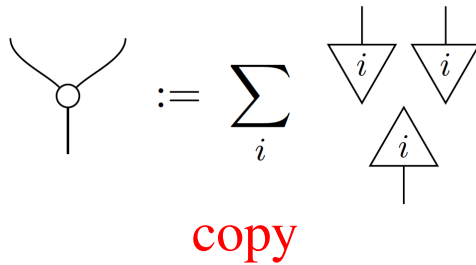

— Ch. 6 – Picturing classical processes —

– spiders –

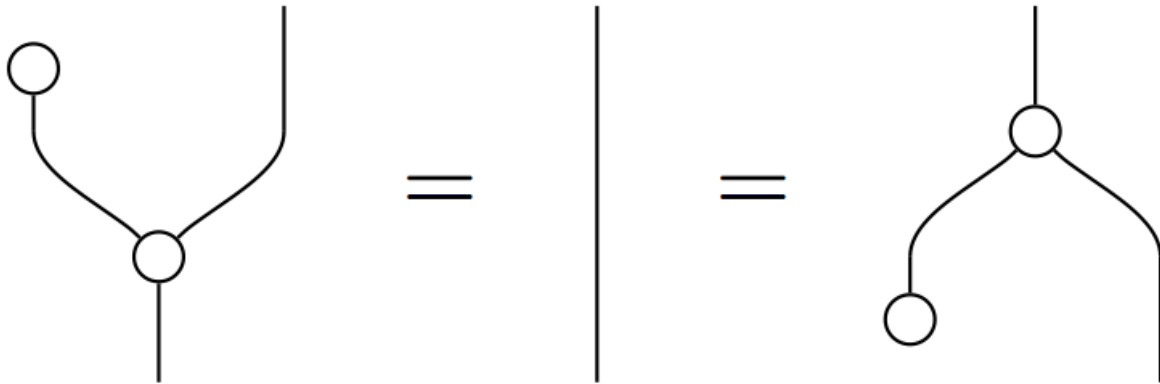

— Ch. 6 – Picturing classical processes —

– spiders –

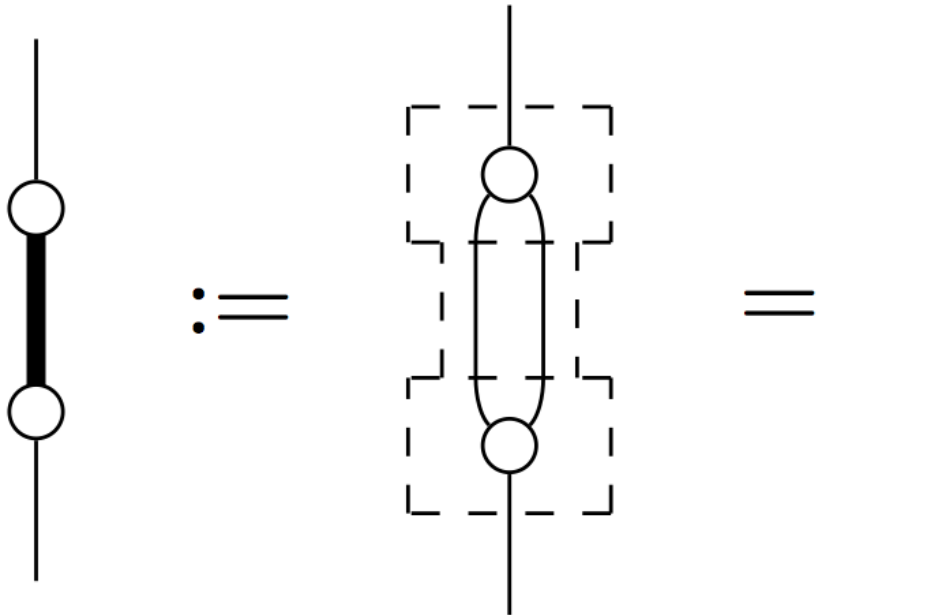

— Ch. 6 – Picturing classical processes —

– spiders –

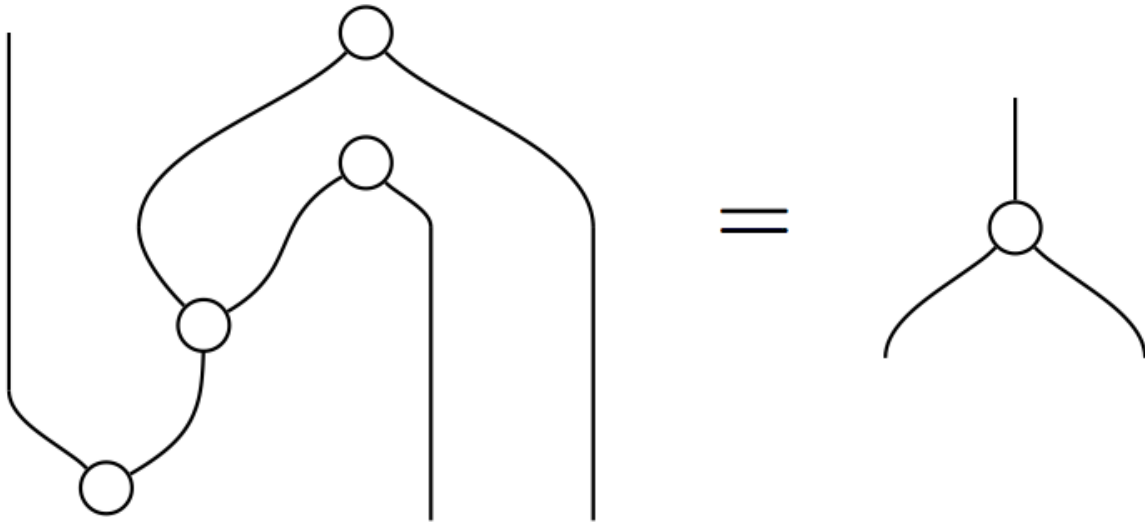

— Ch. 6 – Picturing classical processes —

– *spiders* –

Prop. Spiders obey:

— Ch. 6 – Picturing classical processes —

– spiders –

Prop. Spiders obey:

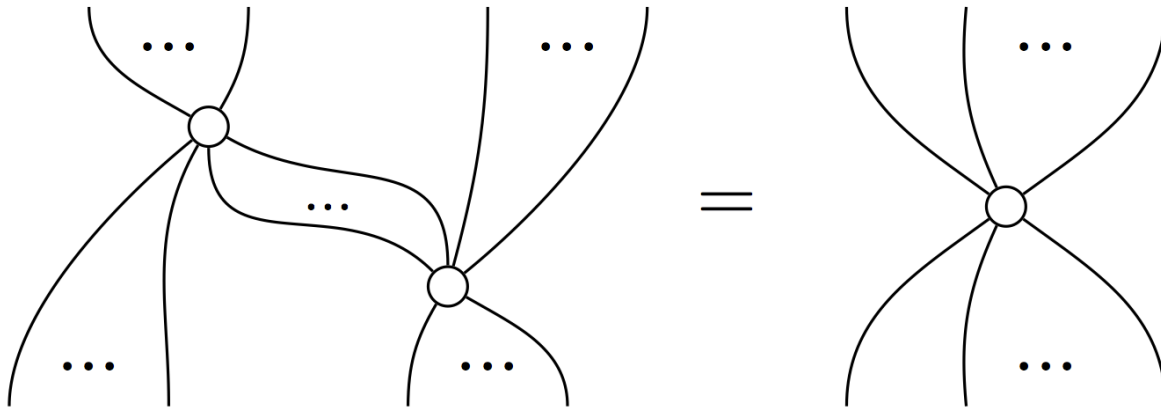

— Ch. 6 – Picturing classical processes —

– *spiders* –

Thm. Spiders \equiv ONBs

— Ch. 6 – Picturing classical processes —

– spiders –

Thm. Spiders \equiv ONBs

Pf. Consider copy spider:

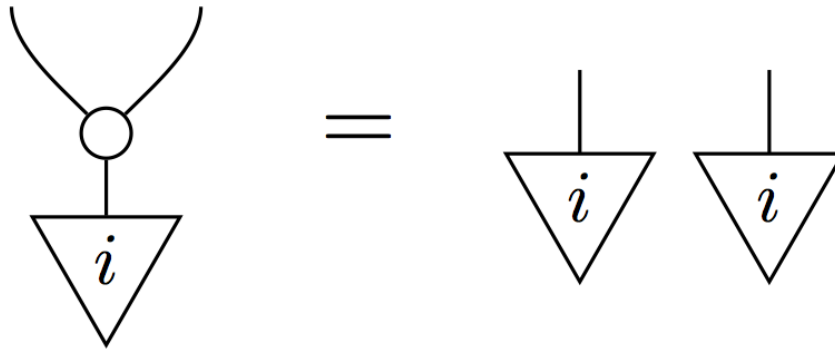

so claim follows by only-orthogonals-are-clonable.

— Ch. 6 – Picturing classical processes —

– spiders –

THM. (CPV) All families of linear maps:

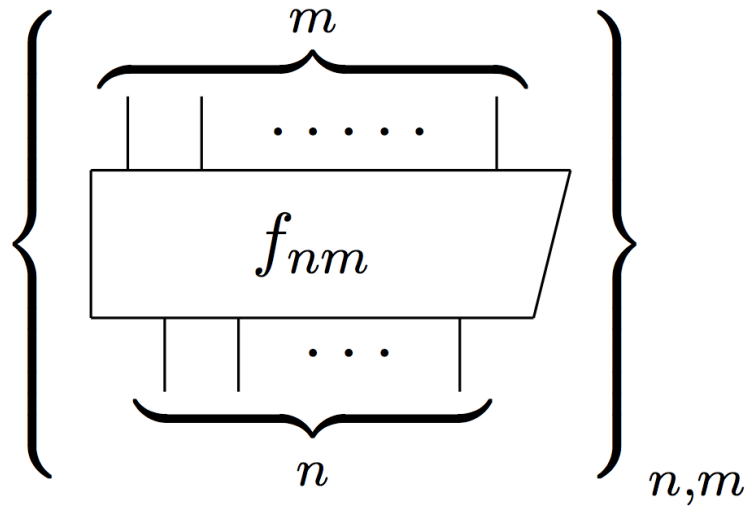

which ‘behave’ like spiders, are spiders.

— Ch. 6 – Picturing classical processes —

– spiders –

Classical spider :=

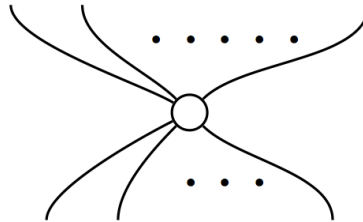

— Ch. 6 – Picturing classical processes —

– spiders –

Quantum spider :=

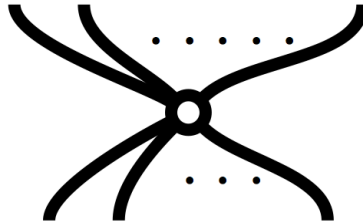

— Ch. 6 – Picturing classical processes —

– spiders –

Bastard spider :=

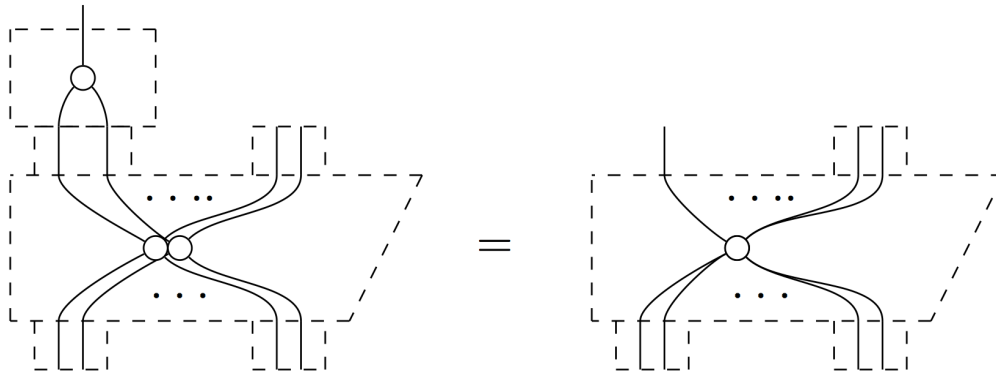

— Ch. 6 – Picturing classical processes —

– spiders –

Bastard spider :=

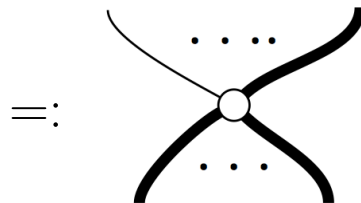
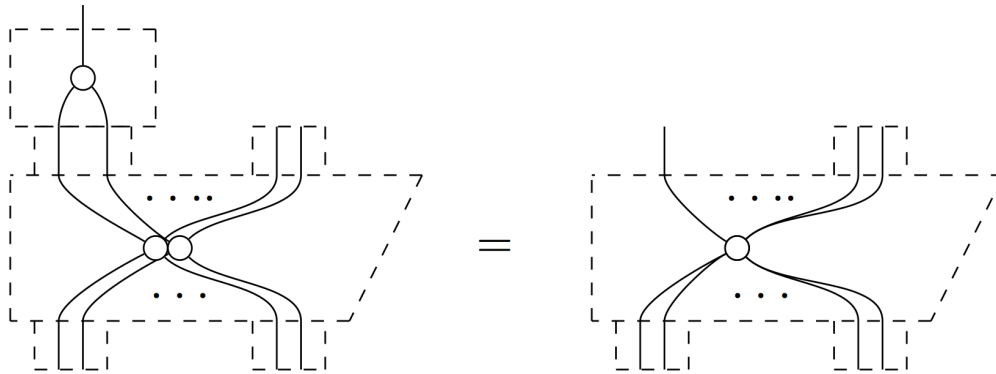

— References (for Ch. 1 till Ch. 6) —

Penrose, R. (1971) Applications of negative dimensional tensors. Pages 221-244 of: *Combinatorial Mathematics and its Applications*. Academic Press.

Coecke, B. (2003) *The Logic of Entanglement*. Tech. Rept. RR-03-12. Department of Computer Science, Oxford University. arXiv:quant-ph/0402014

Abramsky, S., and Coecke, B. (2004) A categorical semantics of quantum protocols. *LICS*. arXiv:quant-ph/0402130.

Coecke, B. (2005) Kindergarten quantum mechanics – lecture notes. In: *Quantum Theory: Reconsiderations of the Foundations III*. AIP Press. arXiv:quant-ph/0510032

Coecke, B. (2007) De-linearizing linearity: Projective Quantum Axiomatics From Strong Compact Closure. *ENTCS*. arXiv:quant-ph/0506134

Selinger, P. (2007) Dagger compact closed categories and completely positive maps. *ENTCS*.

Coecke, B., and Pavlovic, D. (2007) Quantum measurements without sums. In: *Mathematics of Quantum Computing and Technology*. Taylor and Francis. arXiv:quant-ph/0608035

Coecke, B., Pavlovic, D., and Vicary, J. (2011) A new description of orthogonal bases. MSCS. arXiv:quant-ph/0810.1037

Abramsky, S. (2010) No-cloning in categorical quantum mechanics. In: Semantic Techniques in Quantum Computation. CUP. arXiv:0910.2401

Coecke, B., Paquette, E. O., and Pavlovic, D. (2010) Classical and quantum structuralism. In: Semantic Techniques in Quantum Computation. CUP. arXiv:0904.1997

Selinger, P. (2011) Finite dimensional Hilbert spaces are complete for dagger compact closed categories. ENTCS.

Coecke, B., and Perdrix, S. (2010) Environment and classical channels in categorical quantum mechanics. CSL. arXiv:1004.1598.

Chiribella, G., D'Ariano, G.M., and Perinotti, P. (2010) Probabilistic theories with purification. Physical Review. arXiv:0908.1583

Hardy, L. (2013) On the theory of composition in physics. In: Computation, Logic, Games, and Quantum Foundations. Springer. arXiv:1303.1537