

S&E-ASTR-S-6-24
May 1, 1969



TECHNICAL INFORMATION SUMMARY

APOLLO-10 (AS-505)

APOLLO SATURN V SPACE VEHICLE

FACILITY FORM 602

N70-25085 (ACCESSION NUMBER) (SERIAL)
94 (PAGES)
TMX-62846 (NASA CR OR TMX OR AD NUMBER)
1 (CODE)
31 (CATEGORY)

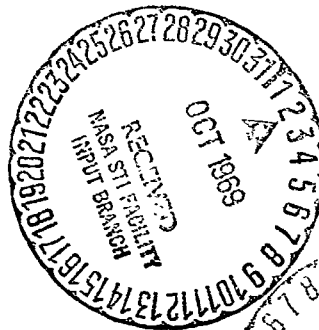

PREPARED BY:
S&E-ASTR-S
S&E-ASTN-VCN
S&E-AERO-P

NATIONAL AERONAUTICS AND SPACE ADMINISTRATION



507-59067K

AS-505

TECHNICAL INFORMATION

SUMMARY

This document is prepared jointly by the Marshall Space Flight Center Laboratories S&E-ASTR-S, S&E-AERO-P, and S&E-ASTN-VN. The document presents a brief and concise description of the AS-505 Apollo Saturn Space Vehicle. Where necessary, for clarification, additional related information has been included.

It is not the intent of this document to completely define the Space Vehicle or its systems and subsystems in detail. The information presented herein, by text and sketches, describes launch preparation activities, launch facilities, and the space vehicle. This information permits the reader to follow the space vehicle sequence of events beginning a few hours prior to liftoff to its journey into space.

1. Mission Purpose:

AS-505, Apollo 10, Mission F, is described as a Lunar Mission Development Flight which has been designed to demonstrate crew/space vehicle/mission support facilities during a manned lunar mission and to evaluate lunar module performance in lunar environment.

2. Launch Vehicle Mission Objectives

The Principal Detailed Test Objective (DTO) is to demonstrate the AS-505 Launch Vehicle capability to inject the Apollo Spacecraft onto a free return, translunar trajectory.

The Secondary Detailed Test Objectives are:

- Verify J-2 engine modifications.
- Confirm J-2 engine environment in S-II and S-IVB stages.
- Confirm launch vehicle longitudinal oscillation environmental during S-IC stage burn.
- Verify that S-IC modifications will suppress low frequency longitudinal oscillations.

3. Mission Description

Mission F, AS-505, (Apollo 10), has a flight duration of approximately 10 days.

The AS-505 mission has been divided into the following phases which are described below: Launch to parking orbit, coast in parking orbit, injection into translunar trajectory, lunar orbit insertion, restart and injection into transearth trajectory, reentry and splash down.

Figures 1 and 2 illustrate the boost to earth parking orbit and the balance of the mission profile to include lunar orbit and reentry.

Launch to Parking Orbit. AS-505 will be launched from Kennedy Space Center, complex 39B on a flight azimuth between 72 and 108 degrees. As the vehicle rises from the launch pad, a yaw maneuver is executed to insure that the vehicle does not collide with the tower in the event of high winds or possible engine failure. Once tower clearance has been accomplished, a pitch and roll maneuver is initiated to achieve the proper flight attitude and flight azimuth orientation.

A successful boost sequence, as illustrated in Figure 1, will insert the S-IVB/IU/SC into a 100 NMI circular earth parking orbit.

Coast in Earth Parking Orbit. Coast in earth parking orbit will consist of approximately two or three revolutions during which time the LV and SC will be checked out in preparation for translunar injection. Two injection opportunities have been programmed for AS-505.

Injection into Translunar Trajectory. This phase will begin with the S-IVB stage restart sequence which will occur midway during the second revolution (1st opportunity) or during the third revolution (2nd opportunity). This burn will inject the vehicle into a translunar, free return, trajectory. After injection, the CSM separates from the S-IVB/IU, turns around, docks with the LM/S-IVB and performs LM extraction. During translunar coast, spacecraft midcourse corrections are made as required. Following LM extraction, the S-IVB stage will undergo a residual propellant, retrograde dump and safeing sequence. Thrust from available propellants in the launch vehicle auxiliary propulsion system and from main propulsion system venting is used to "propel" the expended S-IVB/IU to pass behind the moon and into a solar orbit. (Figure 2)

Lunar Orbit Insertion. As the SC enters the lunar gravitational field, a decision will be made as to whether to remain on a "free return trajectory" which presents a path to transearth trajectory, or to brake into lunar orbit. If conditions are "go" for lunar orbit, one Astronaut will enter the lunar module and check the status of the critical systems. He will then return to the CM prior to lunar orbit insertion.

The SM propulsion system (SPS) is used to deboost the spacecraft into a circular lunar orbit. During lunar orbit, two crew members enter the LM, CSM/LM separation occurs and LM checkout proceeds.

During this activity phase, a LM excursion will simulate the descent and ascent phases of a lunar landing mission. After the simulation phase, CSM/LM final docking occurs and the astronauts will deactivate the LM and return to the CM. After the LM crew returns to the CSM, the LM will be jettisoned.

Restart and Injection to Transearth Trajectory. The SM propulsion system is used once again, to boost the CSM out of lunar orbit and onto a transearth trajectory.

Reentry and Recovery. The command and service module are separated prior to atmospheric reentry. The Service Module Reaction Control System is used to assist in separation.

A range of 2000 nautical miles approximates the distance between the point of atmospheric reentry and the point at which splash-down occurs. Recovery will take place in the Pacific Ocean.

IECO - Inboard Engine Cutoff
 OECO - Outboard Engine Cutoff
 LET - Launch Escape Tower
 IGM - Iterative Guidance Mode

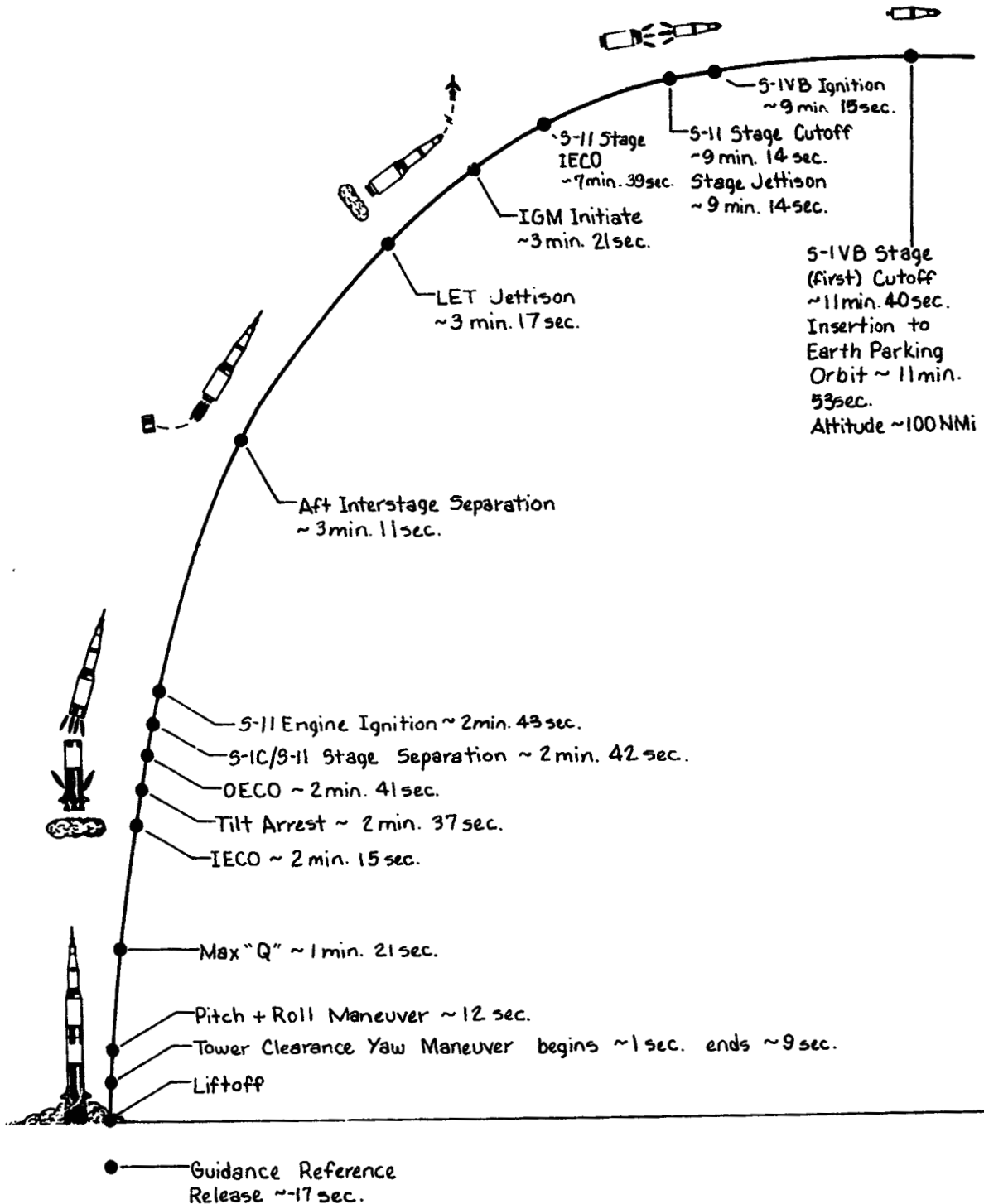

Figure 1

Mission Profile
Boost to Earth Orbit

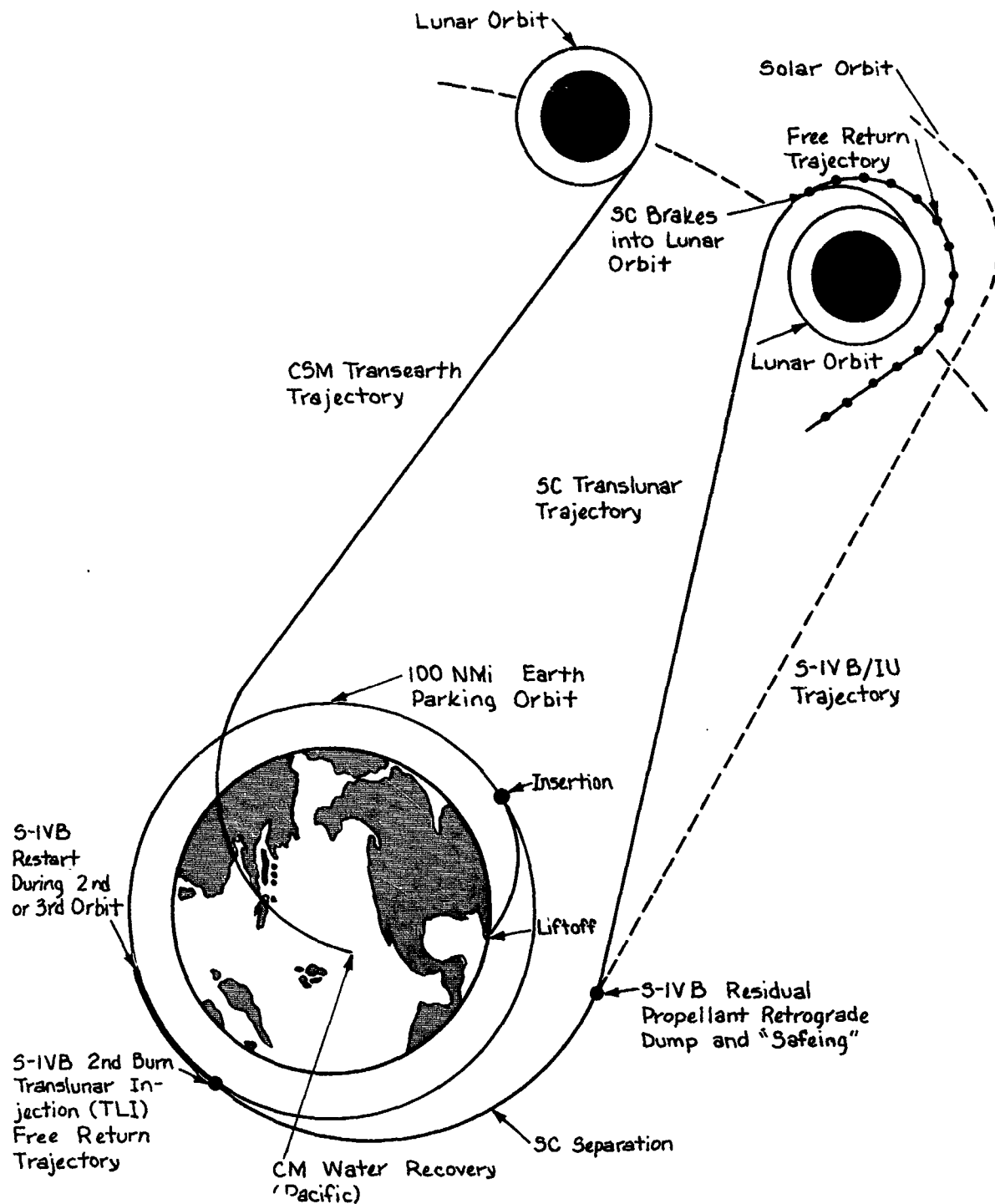

Figure 2

Trajectory Profile
Lunar Orbital Mission

LIST OF FIGURES

<u>Figure</u>	<u>Title</u>	<u>Page</u>
<u>GENERAL</u>		
1	Mission Profile -- Boost to Earth Orbit	4
2	Mission Profile -- Space Vehicle Trajectory	5
3	Space Vehicle	8
4	KSC - Launch Complex 39	9
5	Saturn V Mobile Launcher	11
6	Saturn Support Operations Electrical Support Equipment Systems	13
<u>SPACE VEHICLE</u>		
7	Secure Range Safety System	15
8	Emergency Detection System	17
9	Countdown Sequence	18
10	S-IC/S-II Stage Flight Sequencing	19
11	S-II/S-IVB Stage Flight Sequencing	20
12	S-IVB Stage Flight Sequencing	21
13	Time Base Sequencing	23
14	Guidance and Control System	25
15	Digital Command System	27
16	Measurement Summary	29
17	Vehicle Tracking Systems	31
18	Space Vehicle Weight vs Flight Time	33
<u>S-IC STAGE</u>		
19	S-IC Stage Configuration	35
20	F-1 Engine System	37
21	S-IC Stage Propellant System	39
22	S-IC Stage Thrust Vector Control System	41
23	S-IC Stage Measuring System	42
24	S-IC Stage Telemetry System	43
25	S-IC Stage Electrical Power and Distribution System	44
<u>S-II STAGE</u>		
26	S-II Stage Configuration	47
27	J-2 Engine System - S-II Stage	49
28	S-II Stage Propellant System	51
29	S-II Stage Propellant Management System	53
30	S-II Stage Thrust Vector Control System	55
31	S-II Stage Measuring System	56
32	S-II Stage Telemetry System	57
33	S-II Stage Electrical Power and Distribution System	58

LIST OF FIGURES (Continued)

<u>Figure</u>	<u>Title</u>	<u>Page</u>
<u>S-IVB STAGE</u>		
34	S-IVB Stage Configuration	61
35	J-2 Engine System S-IVB Stage	63
36	S-IVB Stage Propellant System	65
37	S-IVB Stage Propellant Management System	67
38	S-IVB Stage Thrust Vector Control System	69
39	Auxiliary Propulsion System	71
40	S-IVB Stage Measuring System	72
41	S-IVB Stage Telemetry System	73
42	S-IVB Stage Electrical Power and Distribution System	74
<u>INSTRUMENT UNIT</u>		
43	Instrument Unit Configuration	77
44	Instrument Unit Measuring System	78
45	Instrument Unit Telemetry System	79
46	Instrument Unit Electrical Power and Distribution System	80
47	IU/S-IVB Environmental Control System	83
<u>SPACECRAFT</u>		
48	Spacecraft Configuration	85
49	Spacecraft Telecommunication System	87
50	Spacecraft Electrical Power and Distribution System	88
51	Spacecraft Guidance and Navigation System	89
52	Lunar Module (LM)	90
53	Lunar Module Engine Locations	91
54	LM Guidance and Navigation Section	92
55	LM Communications Subsystem	93

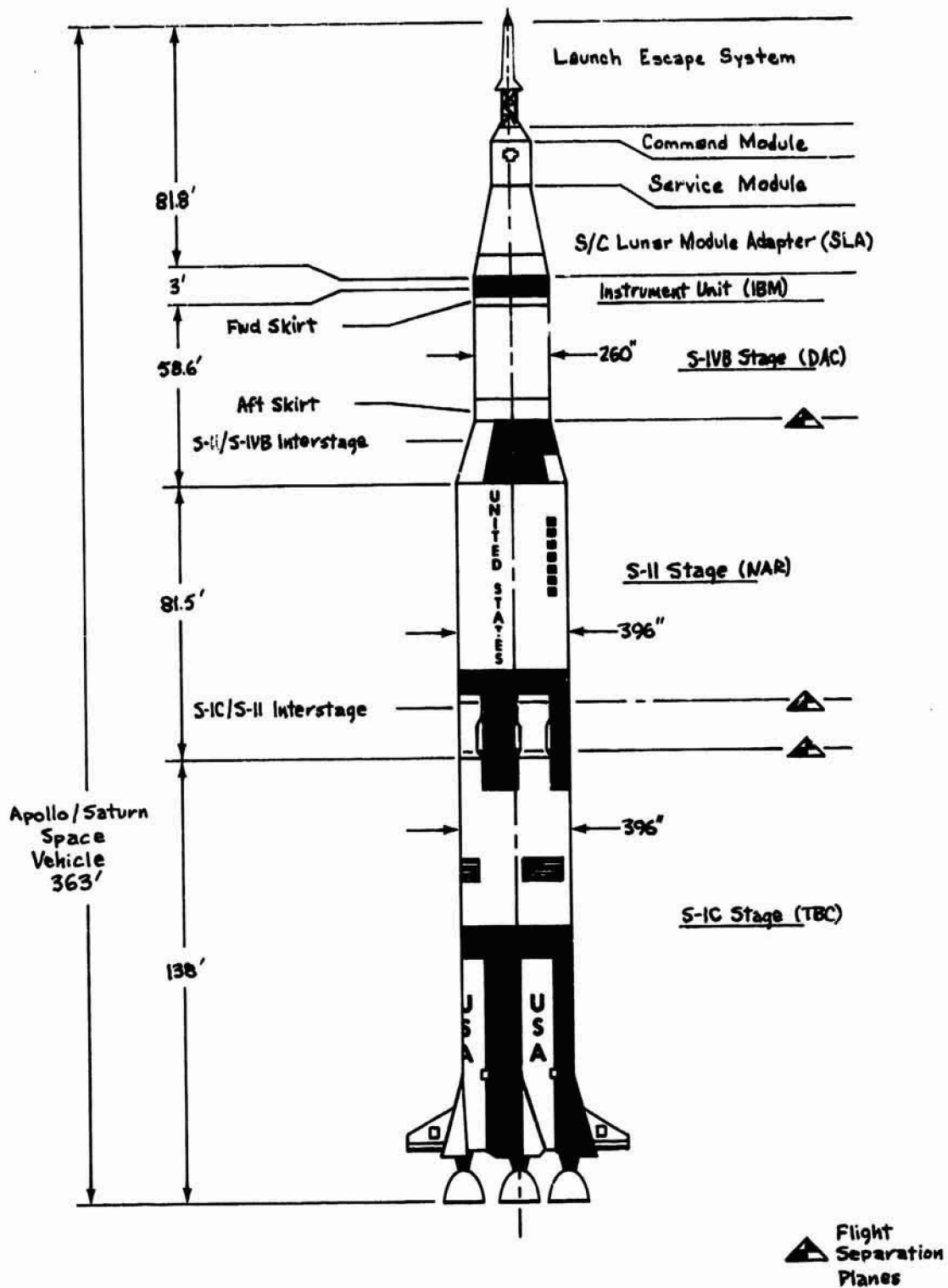

Figure 3

AS-505
Space Vehicle

- Pads "A" and "B" are located ~1500 ft. from the shoreline
- The Vehicle Assembly Building (VAB) and The Launch Control Center (LCC) are ~ 3 miles from the Launch Pads

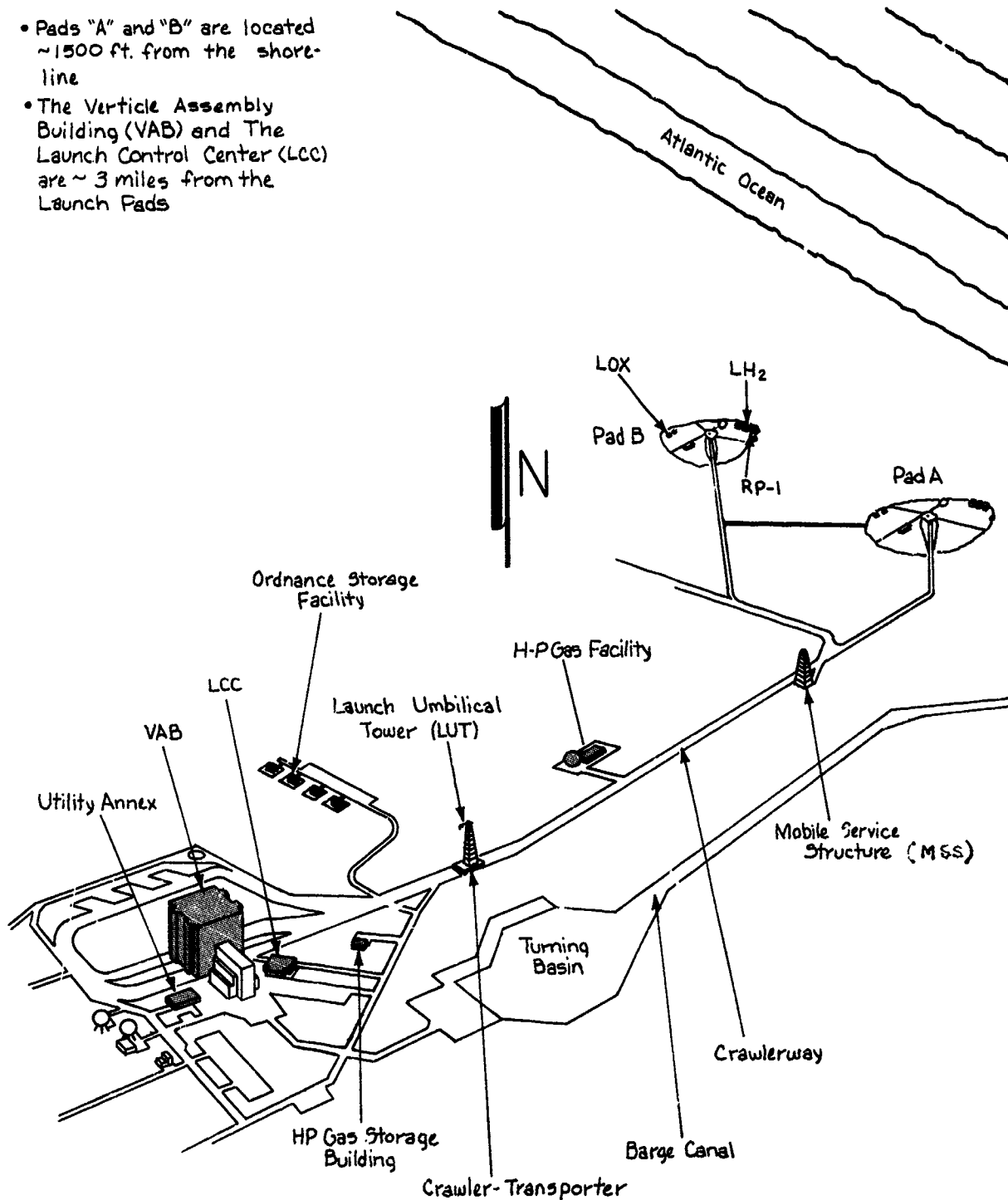

Figure 4

KSC
Launch Complex 39

MOBILE LAUNCHER

The Mobile Launcher, figure 5, is a transportable steel structure which provides the capability of moving the erected vehicle to the launch pad via the crawler-transporter. The umbilical tower, permanently erected on the mobile launcher base, is a means of ready access to all important levels of the vehicle during assembly, checkout and servicing prior to launch. The intricate vehicle-to-ground interfaces are established and checked out within the protected environment of the Vertical Assembly Building (VAB), and then moved undisturbed aboard the mobile launcher to the launch pad.

- ① S-1C Intertank (preflight). Provides LOX fill and drain. Arm may be reconnected to vehicle from LCC. Retract time 8 seconds. Reconnect time ~5 minutes.
- ② S-1C Forward (preflight). Provides pneumatic, electrical, and air conditioning interfaces. Retracted at T-16.2 seconds. Retract time 8 seconds.
- ③ S-11 Aft (preflight). Provides access to vehicle. Retracted prior to liftoff as required.
- ④ S-11 Intermediate (inflight). Provides LH₂ and LOX transfer, vent line, pneumatic, instrument cooling, electrical, and air-conditioning interface. Retract time 6.4 seconds.
- ⑤ S-11 Forward (inflight). Provides GH₂ vent, electrical, and pneumatic interfaces. Retract time 7.4 seconds.
- ⑥ S-1VB Forward (inflight). Provides LH₂ and LOX transfer, electrical, pneumatic, and air-conditioning interfaces. Retract time 7.7 seconds.
- ⑦ S-1VB Forward (inflight). Provides fuel tank vent, electrical, pneumatic, air-conditioning, and preflight conditioning interfaces. Retract time 8.4 seconds.
- ⑧ Service Module (inflight). Provides air-conditioning, vent line, coolant, electrical, and pneumatic interfaces. Retract time 9.0 seconds.
- ⑨ Command Module Access Arm (preflight). Provide Access to spacecraft through environmental chamber. Arm controlled from LCC. Retracted 12° park position until T-4 minutes.

Note:

Preflight arms are retracted and locked against umbilical tower prior to launch.

Inflight arms retract at vehicle liftoff on command from service arm control switches (located in hold-down arms).

Mobile Launcher:

Umbilical Tower ~ 380 ft. high

Launcher Base ~ 25 ft high
~ 160 ft. long
~ 135 ft. wide

~ 45 ft square opening in
base for S-1C exhaust

Tower serviced by 2 hi-speed
elevators (18 levels)

Vehicle holddown arms (4)
located 90° apart around
vehicle base.

Three Tail Service Mast (TSM)
Assemblies support service
lines to S-1C stage and
provide a means for rapid
retraction at liftoff

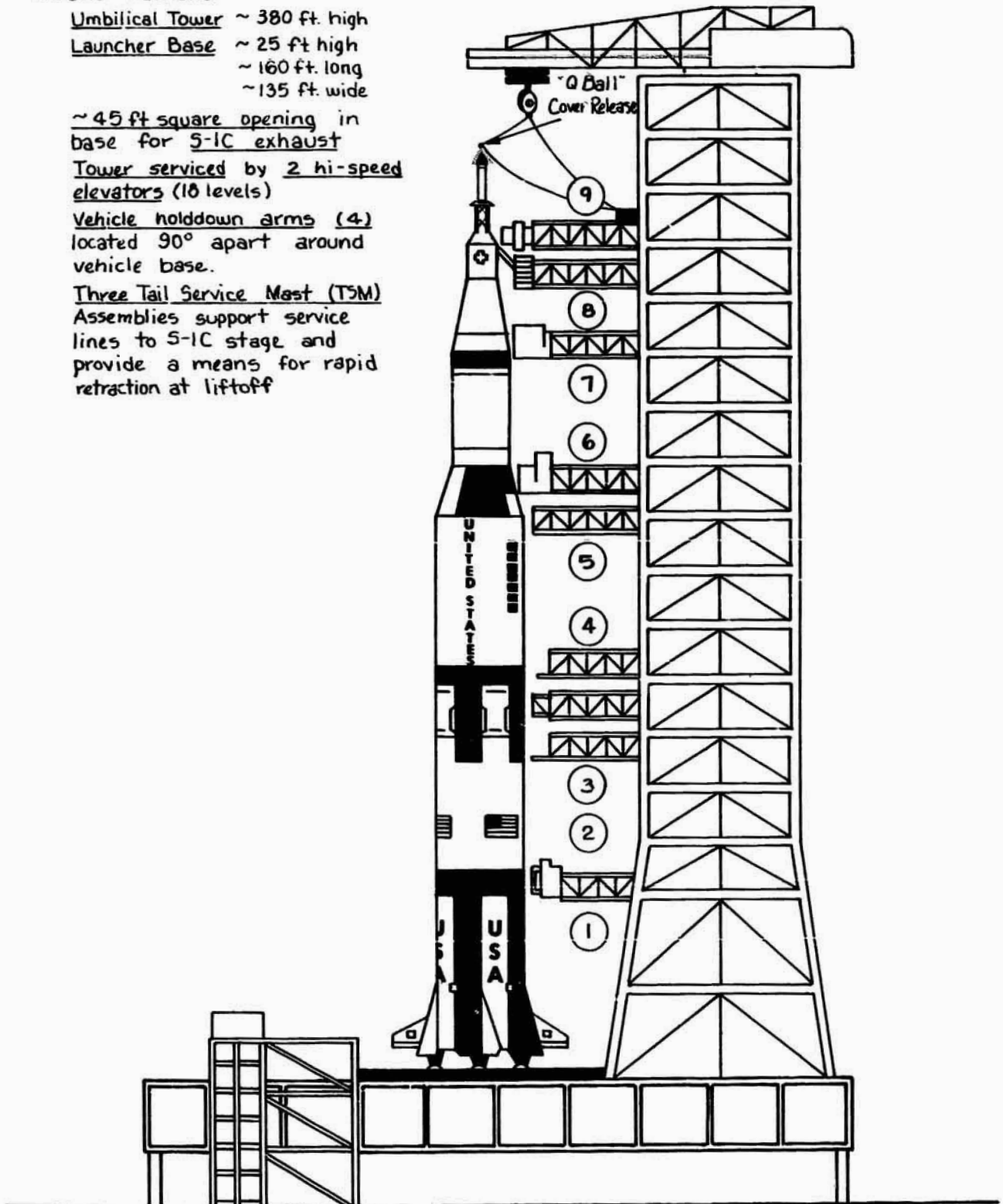

Figure 5

Saturn V
Mobile Launcher

GROUND SUPPORT INTERFACE

Test System

A computer controlled automatic checkout system is used to accomplish the Vertical Assembly Building (VAB) high bay and pad testing. An RCA 110A Computer and the other equipment necessary for service and check out are installed with the vehicle on the mobile launcher. Similar equipment, joined by an integration system (relay network), a facilities cabling tunnel and video cables for visual display is located in the Launch Control Center (LCC).

A Digital Data Acquisition System (DDAS) collects vehicle and support equipment responses to test commands and formulates test data for transmission to the LCC or ML.

Digital Events Evaluators (DEE) monitor the status of input lines and generate a time labeled printout for each change detected.

Final Countdown begins at T-102 hours. A countdown clock, located in the LCC, officially records this countdown.

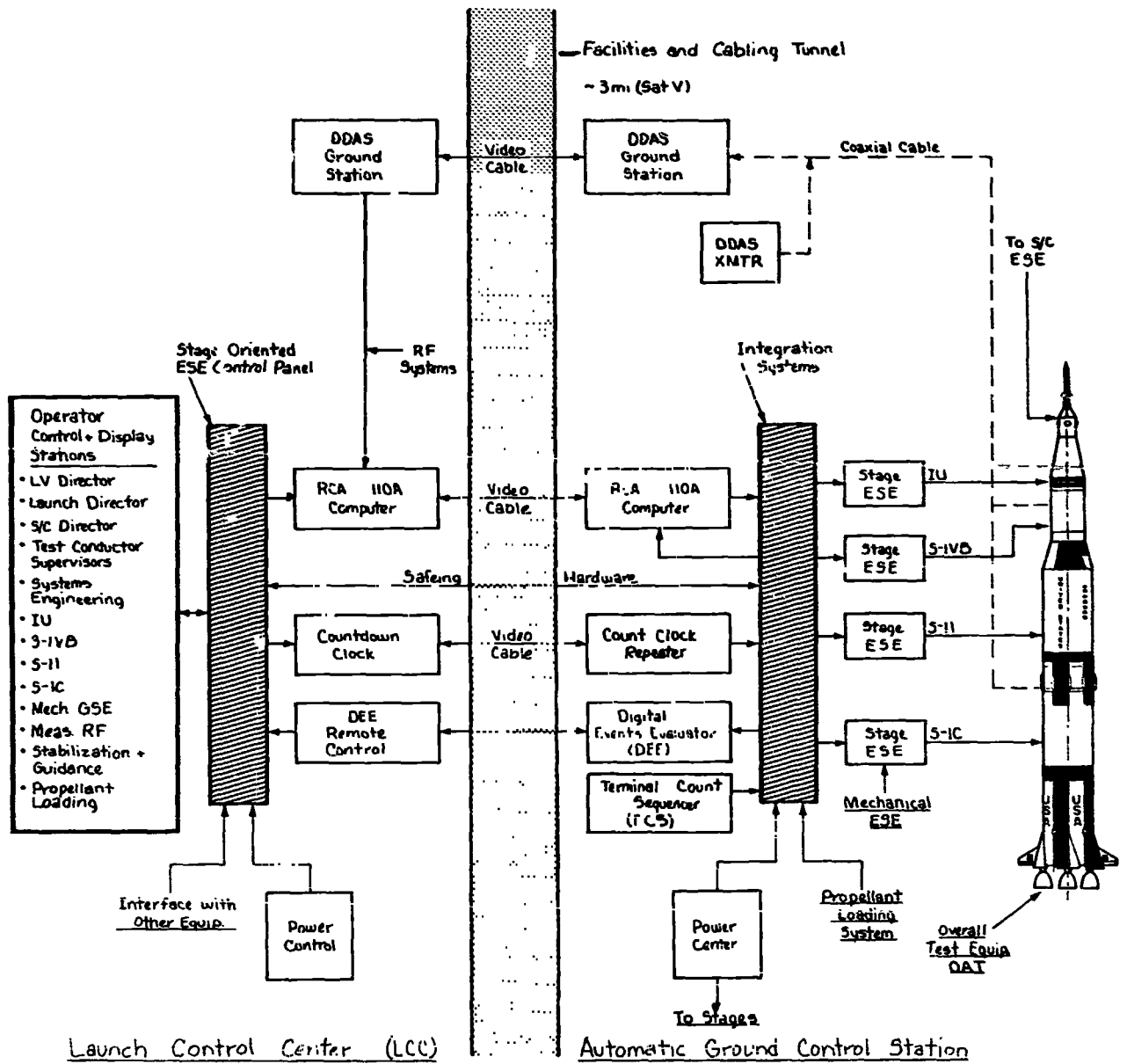

Figure 6

Saturn Launch Operations Electrical Support Equipment Systems

LAUNCH VEHICLE SECURE RANGE SAFETY SYSTEMS

The Secure Range Safety Systems, located on the S-IC, S-II and S-IVB stages, provide a means to terminate the flight of an erratic vehicle by the transmission of coded commands from ground stations to the vehicle during boost phase. The Range Safety Officer (RSO) terminates the flight of an erratic vehicle (trajectory deviations) by initiating the emergency engine cutoff command and, if necessary, the propellant dispersion command.

The command destruct system in each stage is completely separate and independent of those in the other stages.

The system in each powered stage consists of a range safety antenna subsystem, two secure command receivers, two Range Safety Controllers, two Secure Range Safety Decoders, two Exploding Bridge Wire (EBW) firing units, two EBW detonators and a common safe and arm device which connects the subsystem to the tank cutting charge. Electrical power for all elements appearing in duplicate is supplied from separate stage batteries.

Prior to launch, the safe and arm device is set to the "ARM" position by ground support equipment and the system remains active until orbital insertion. After orbital insertion, the S-IVB stage range safety receiver is deactivated (Safed) by ground command from the Range Safety Officer.

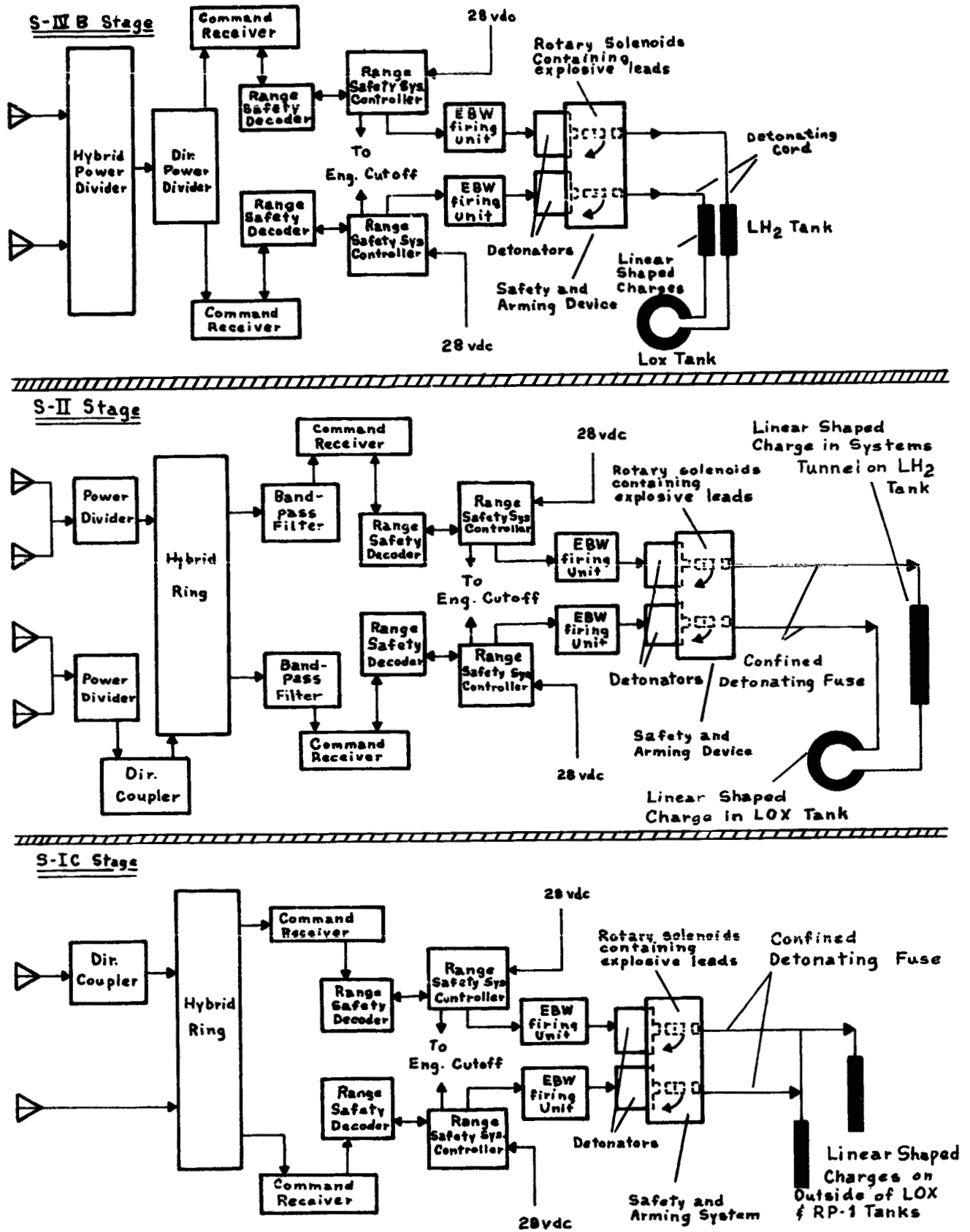

Figure 7

Secure Range Safety System

EMERGENCY DETECTION SYSTEM

The Emergency Detection System (EDS) is designed to sense and react to emergency situations resulting from launch vehicle malfunctions which may arise during the mission. Crew safety and protection is the primary function of the EDS. Triple redundant sensors and majority voting logic are used in the automatic abort system. Dual redundancy is used for most of the manual abort sensors. The redundancy in the sensing systems is designed to protect against inadvertent aborts.

Automatic Aborts - During most of the S-IC flight, the EDS provides the capability of automatically aborting the mission. The automatic abort system is enabled at liftoff and disabled by the crew at approximately 2 minutes or by the IU switch selector prior to S-IC inboard engine cutoff. The system responds to failure modes that lead to rapid vehicle breakup. The parameters and the associated limits monitored for an automatic abort are:

1. Loss of thrust on two or more S-IC engines
2. Vehicle rates in excess of $\pm 4^\circ/\text{sec}$ in pitch or yaw; or $\pm 20^\circ/\text{sec}$ in roll
3. Command Module to IU breakup.

Manual Aborts - After the automatic abort mode is disabled, aborts may be initiated manually by the astronauts. Manual aborts are initiated based on at least two separate and distinct indications. The indications may be a combination of EDS sensor displays, physiological indications, and ground information to the astronauts. EDS displays for the crew consist of lights and meters which indicate loss of thrust of each engine, staging sequences, launch vehicle attitude reference failure, angle of attack, tank ullage pressures, spacecraft attitude error and angular rates. The manual abort overrate limits are:

1. Pitch and Yaw - L/O to S-IC/S-II Staging - $\pm 4^\circ/\text{sec}$
- S-IC/S-II Staging to S-IV C/O - $\pm 9^\circ/\text{sec}$
2. Roll - L/O to S-IVB C/O - $\pm 20^\circ/\text{sec}$

Aborts performed during the launch phase will be performed by using either the Launch Escape System (LES) or the Service Propulsion System (SPS). The LES is used to propel the CM a safe distance from the launch vehicle and to ensure a water landing. The automatic abort sequence of events is dependent on the time (altitude) the abort is initiated. Aborts prior to 30 seconds do not terminate S-IC thrust in order to protect the launch area. The SPS aborts utilize the Service Module SPS engine to propel the CSM away from the launch vehicle, maneuver to a planned landing area or boost into a contingency orbit.

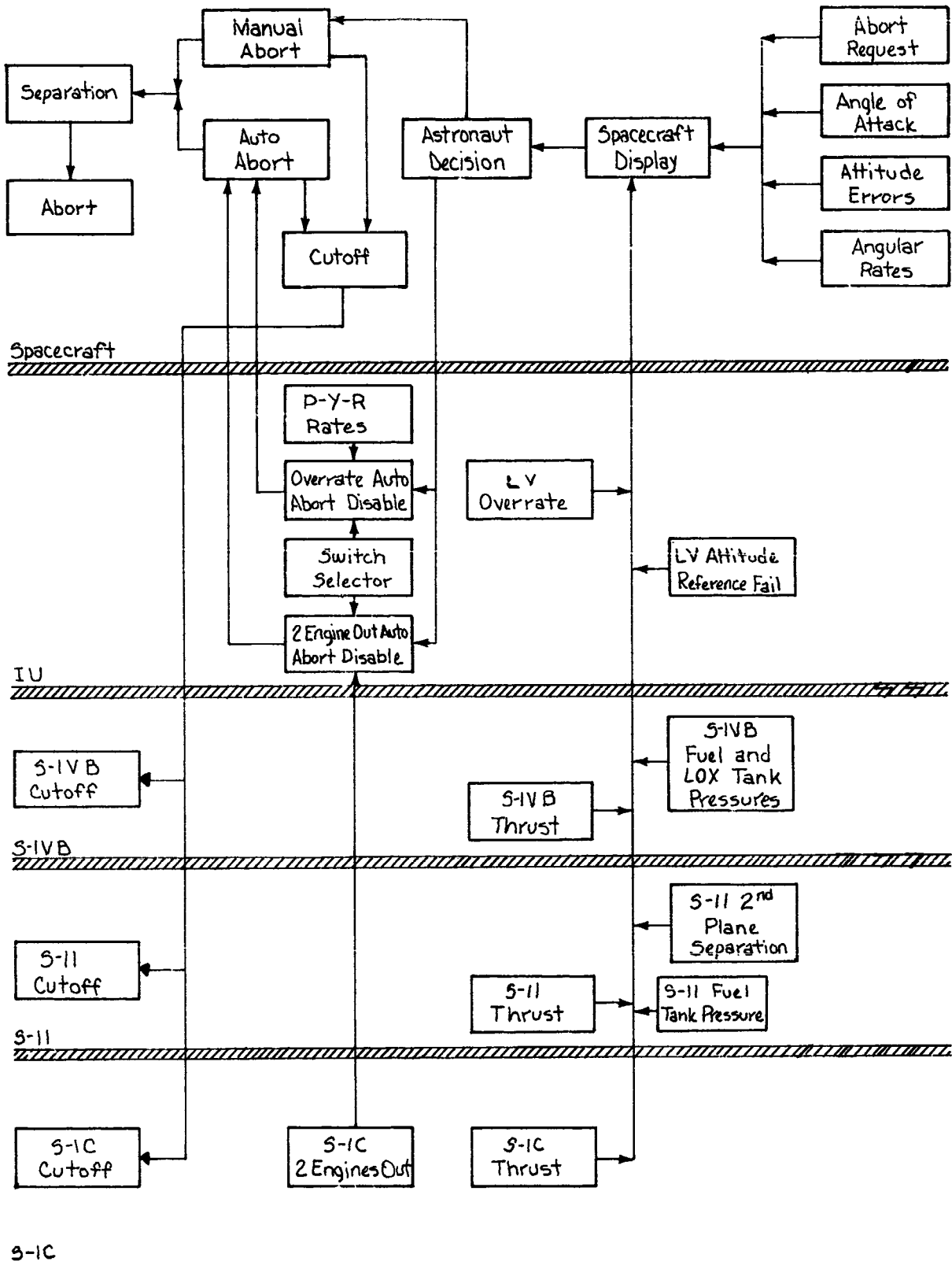

Figure 8

Emergency Detection System

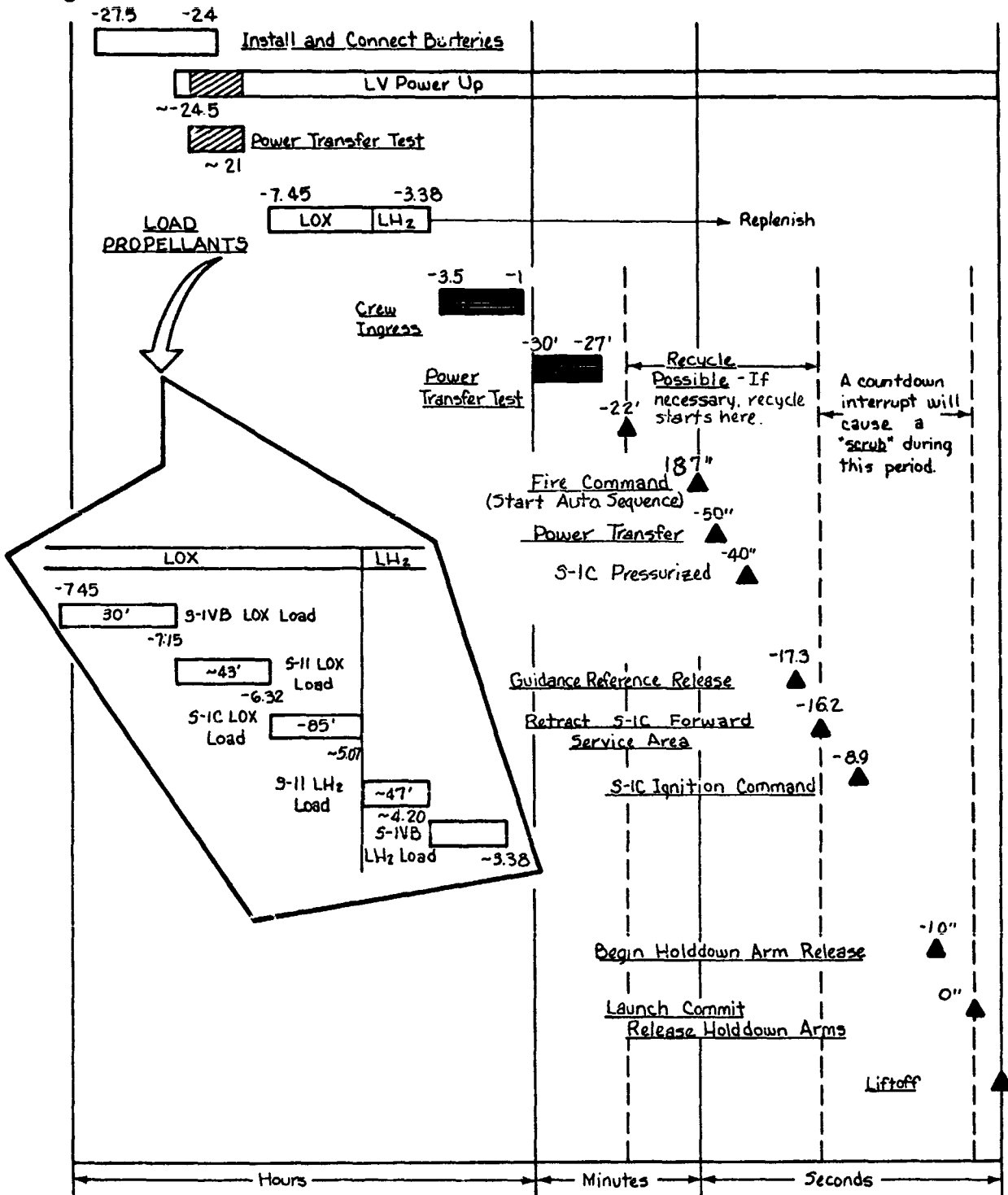

Figure 9

Countdown Sequence

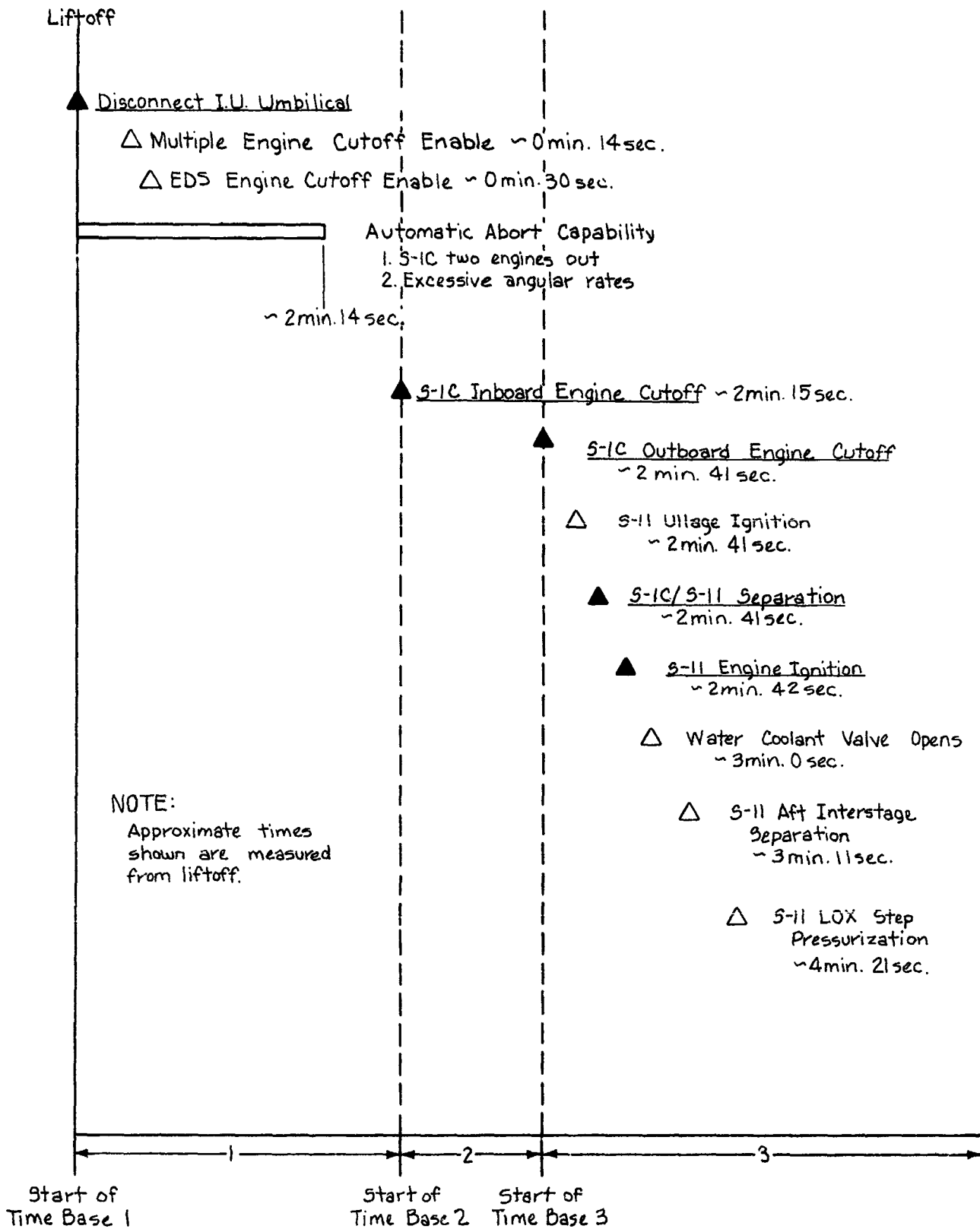

Figure 10

S-IC/S-II Stage
Flight Sequencing

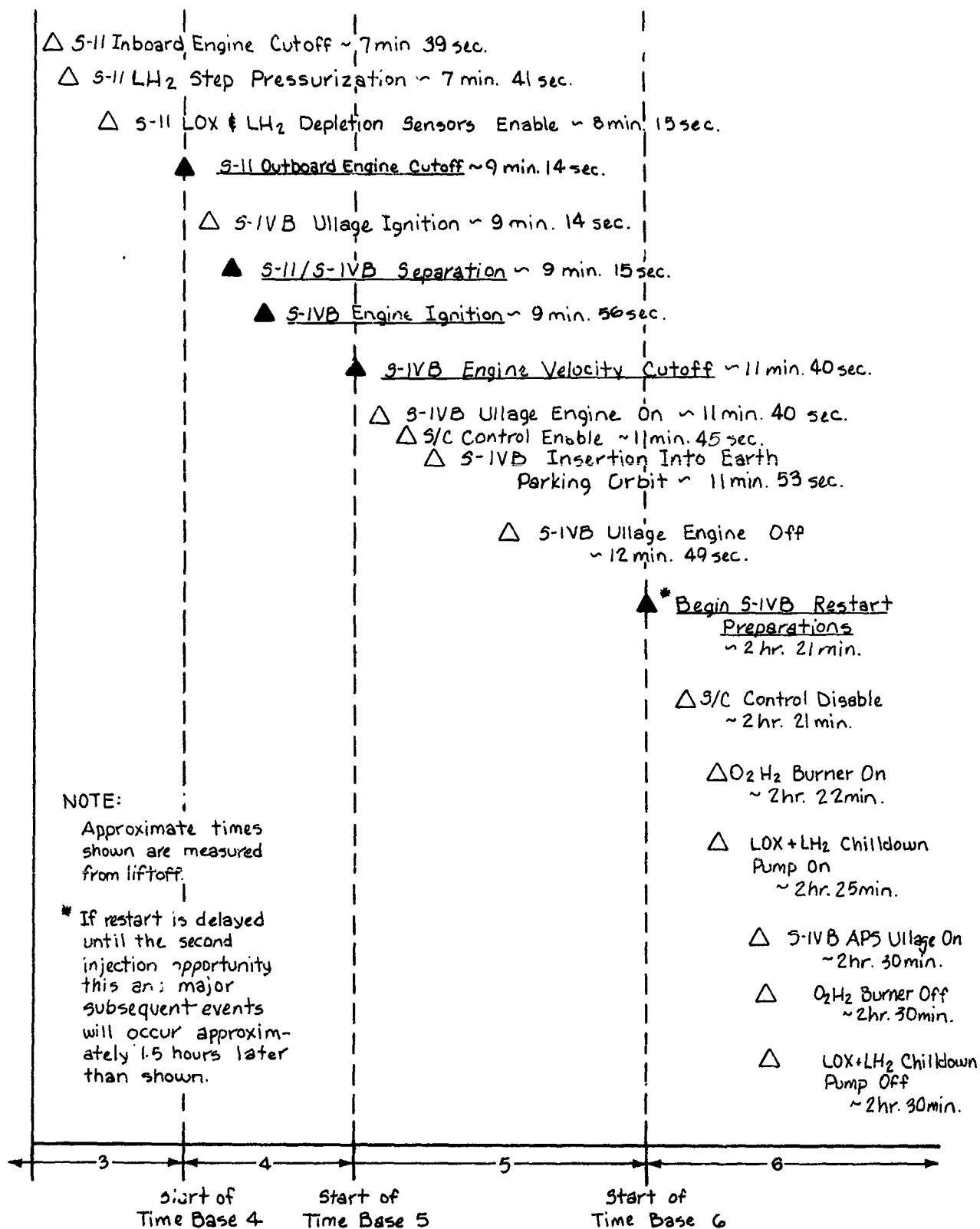

Figure 11

S-11/S-IVB Stage
Flight Sequencing

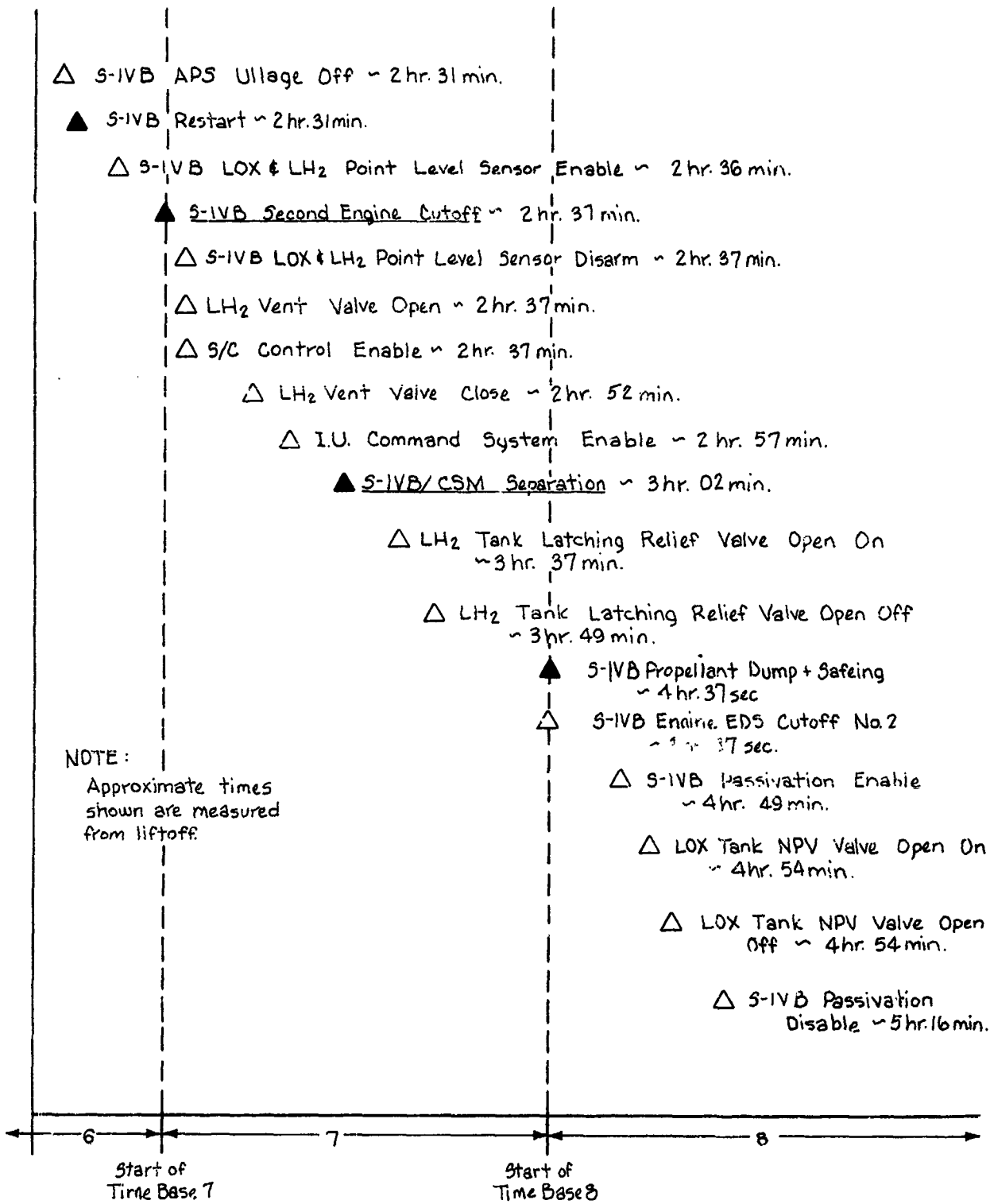
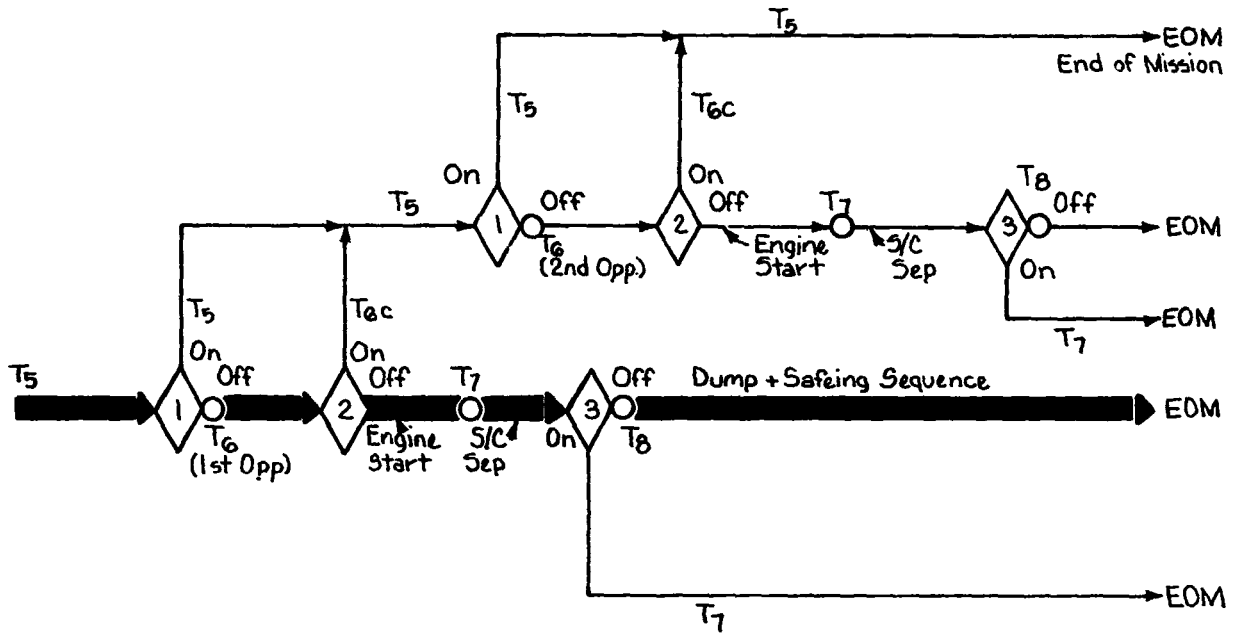

Figure 12

S-IVB Stage
Flight Sequencing

<u>Reference Event</u>	<u>Time Base References</u>		<u>Comments</u>
	<u>Time Base</u>	<u>G.E.T. Hr/Min/Sec</u>	
Guidance Reference Release	T ₀	- 0:00:17	Initiated by terminal count sequencer
Liftoff (I.U. Umbilical Release)	T ₁	0:00:00	Initiated by deactuation of I.U. liftoff relay at umbilical disconnect or vertical acceleration
S-IC Center Engine Cutoff	T ₂	0:02:15	Initiated by S-IC Inboard engine cutoff command from LVDC
S-IC Outboard Engine Cutoff	T ₃	0:02:41	Initiated by the propellant depletion sensors or the thrust-OK switches
S-II Engines Cutoff	T ₄	0:09:14	Initiated by the propellant depletion sensors or the thrust-OK switches
First S-IVB Engine Cutoff	T ₅	0:11:40	Initiated by any two of four functions; S-IVB velocity cutoff issued by the LVDC thrust-OK switches (2), or accelerometer reading
Restart Sequence	T ₆	2:21:00	Initiated when LVDC solves the restart equation
Second S-IVB Engine Cutoff	T ₇	2:37:00	Initiated by any two of four functions; S-IVB cutoff issued by the LVDC, thrust-OK switches (2), or accelerometer reading
S-IVB Propellant Dumping and Safing Sequence	T ₈	4:37:00	Initiated by ground command after T ₇ + 2 hrs
S-IVB Burner Malfunction	T _{6a}	Variable	Initiated by burner malfunction signal from S-IVB stage--T ₆ +48 seconds to T ₆ +341.3 seconds.
S-IVB Burner Malfunction	T _{6b}	Variable	Initiated by burner malfunction signal, S-IVB stage--T ₆ +341.3 seconds to T ₆ +496.7 seconds
Translunar Injection Inhibit	T _{6c}	Variable	Initiated by translunar injection switch in the spacecraft T ₆ + 0 seconds to T ₆ + 560 seconds



- 1 Translunar Injection Inhibit (S/C switch) Prior to Time Base 6
- 2 Translunar Injection Inhibit (S/C switch) During Time Base 6
- 3 Inhibit Removed by Ground Command After Time Base 7 + 2 Hours

█ Nominal Mission

NOTE:

During Time Base 5 the TD&E Ground Command will inhibit the initiation of Time Base 6 and Time Base 5 will continue to the EOM.

Figure 13

Time Base Sequencing

GUIDANCE AND CONTROL SYSTEM (G&C)

Function and Description

The G&C system provides the following basic functions during flight:

1. Stable positioning of the vehicle to the commanded position with a minimum amount of sloshing and bending.
2. A first stage tilt attitude program which gives a near zero lift trajectory through the atmosphere.
3. Steering commands during S-II and S-IVB burns which guide the vehicle to a predetermined set of end conditions while maintaining a minimum propellant trajectory for earth orbit insertion.
4. The proper vehicle position during earth orbit.
5. Guidance during the second S-IVB burn, placing the vehicle in the proper waiting orbit.

G&C Hardware

The Stabilized Platform (ST-124M) is a three gimbal configuration with gas bearing gyros and accelerometers mounted on the stable element. Gimbal angles are measured by redundant resolvers and inertial velocity is obtained from integrating accelerometers.

The Launch Vehicle Data Adapter (LVDA) is an input-output device for the Launch Vehicle Digital Computer (LVDC). The LVDA/LVDC components are digital devices which operate in conjunction to carry out the flight program. The flight program performs the following functions: (1) processes the inputs from the ST-124M, (2) performs navigation calculations, (3) provides the first stage tilt program, (4) calculates IGM steering commands, (5) calculates attitude errors, (6) issues launch vehicle sequencing signals.

The Control/EDS Rate Gyro Package contains nine rate gyros (triple redundant in three axes). Their outputs go to the Control Signal Processor (CSP) where they are voted and sent to the Flight Control Computer (FCC) for damping vehicle angular motion.

The FCC is an analog device which receives attitude error signals from the LVDA/LVDC and vehicle angular rate signals from the CSP. These signals are filtered and scaled, then sent as commands to the S-IC, S-II, and S-IVB engine actuators and to the Auxiliary Propulsion System (APS) Control Relay Packages. The Control Relay Packages accept FCC commands and relay these commands to operate propellant valves in the APS. During spacecraft control of the launch vehicle, the FCC receives attitude error signals from the Command Module Computer or the Astronaut hand controller.

The Switch Selectors in each stage are used to control the inflight sequencing as commanded from the LVDA/LVDC.

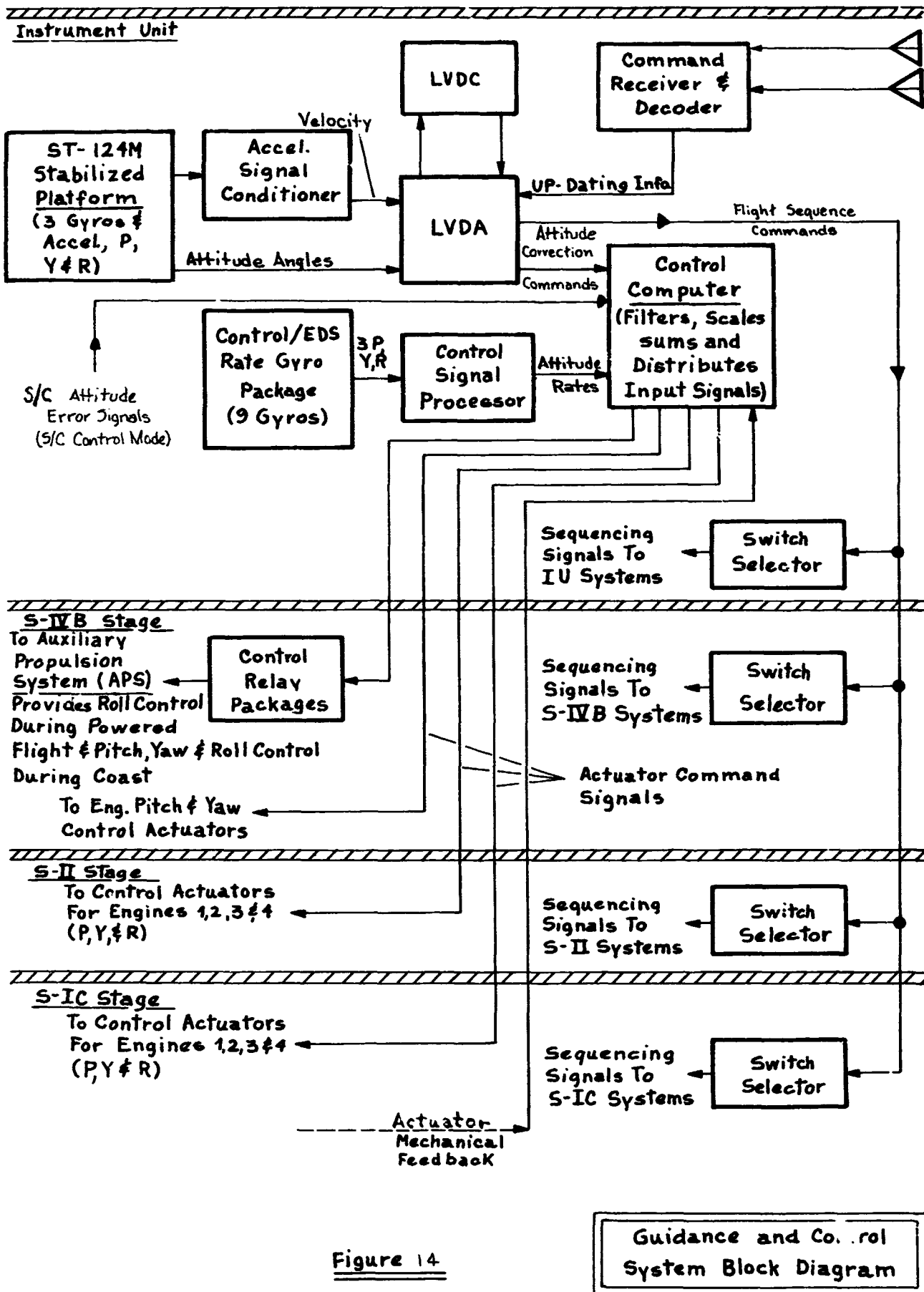

DIGITAL COMMAND SYSTEM CAPABILITY:

The following summary describes the Digital Command Systems' capability:

<u>Function</u>	<u>Description</u>	<u>Periods of Acceptance</u>
Maneuver inhibit	Inhibits Spacecraft separation maneuver.	From T5 + 0 seconds to T6 - 9 seconds and from T7 + 0 seconds to EOM
Maneuver update	Changes the time to start the separation maneuver	From T5 + 0 seconds to T6 - 9 seconds and from T7 + 0 seconds to EOM
Execute Maneuver A	Initiates maneuver to local horizontal in a retrograde position	From T7 + 0 seconds to EOM
Time base update	Changes the time base time	From T5 + 0 seconds to T6 - 9 seconds and from T7 + 0 seconds to EOM
Navigation update	Replaces onboard navigation state vector	From T5 + 100 seconds to T6 - 9 seconds and from T7 + 20 seconds to EOM
Target update	Replaces targeting quantities for second S-IVB burn	From T5 + 0 seconds to T6 - 9 seconds
TD & E enable	Inhibits T6 so that TD & E can be accomplished in earth orbit.	From T5 + 0 seconds to T6 - 9
Time Base 8 enable	Initiates propellant dump and safeing sequence	From T7 + 2 hrs. to EOM
Sector dump	Initiates telemetry of specified memory sector	From T5 + 100 seconds to T6 - 9 seconds and from T7 + 20 seconds to EOM
Single memory	Initiates telemetry of specified memory location	From T5 + 100 seconds to T6 - 9 seconds and from T7 + 20 seconds to EOM
Generalized switch selector	Executes specified switch selector function	From T5 + 0 seconds to T6 + 560 seconds and from T7 + 0 seconds to EOM
Inhibit water control valve logic	Inhibit logic which changes the position of the water control valve	From T5 + 0 seconds to T6 - 9 seconds from T7 + 0 seconds to EOM
Switch antenna to omni, low or high gain	Initiates switching of both PCM and CCS antennas.	From T5 + 100 seconds to T6 - 9 seconds and from T7 + 0 seconds to EOM
Terminate	Stops DCS processing and resets system for a new command	From T5 + 0 seconds to T6 + 560 seconds and from T7 + 0 seconds to EOM

EOM---End of Mission

Spacecraft (command module)

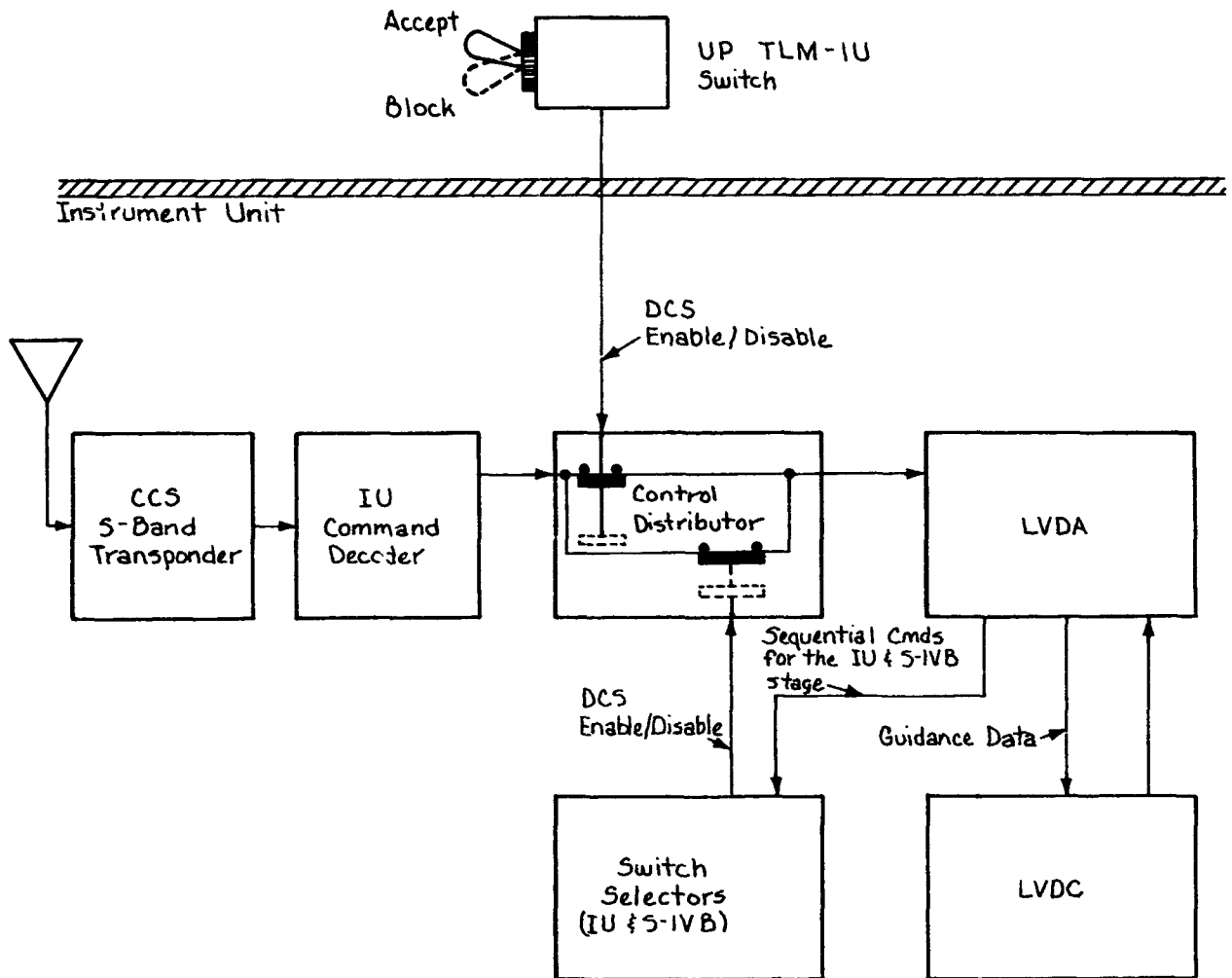

The Digital Command System (DCS) is not used during powered flight phases. During the orbital phases of the mission, the crew will place the UP-TLM-IU switch in the "Accept" position to enable the DCS hardware for the acceptance of ground commands. After S/C separation, the IU switch selector enables the DCS hardware for ground commands. However, commands will only be accepted by the flight program within the period of time programmed in the LVDC as described on page 26.

Figure 15

Digital Command System DCS

INSTRUMENTATION SYSTEMS

The Saturn V Instrumentation Systems are functionally divided into three parts on each stage. These separate divisions or subsystems are:

- Measuring Systems
- Telemetry Systems
- RF and Tracking Systems

Measuring

The purpose of the measuring systems is to detect the phenomena to be measured and to process and distribute this data to the input of each stage telemetry system. All measurements, regardless of their original characteristics, must be processed into electrical signals within a 0 to 5-volt range prior to delivery to the stage telemetry system. The telemetry system accepts these input signals for transmission to the ground receiving stations.

The following table contains a measurement breakdown for the launch vehicle and the spacecraft.

Telemetry

The Telemetry System for each stage of the vehicle must accept signals produced by the measuring portion of the instrumentation system, and accurately reproduce and transmit them to the ground stations. Measurement signals are accepted at a fixed input level, processed, and fed to the proper airborne antennas. In the case of checkout measurements, the signals are transmitted via breakaway cable arrangement to the ground checkout station prior to liftoff.

RF and Tracking

The Vehicle RF and Tracking Systems are described and illustrated on pages 30 and 31.

<u>Measurement Summary -L/V</u>					
Measurement Designation	S-1C Stage	S-11 Stage	S-1VB Stage	Inst. Unit	L/V Total
Acceleration	3	11	-	4	18
Acoustic	4	5	-	-	9
Temperature	166	308	71	14	559
Pressure	177	182	70	10	439
Vibration	67	60	-	-	127
Flow Rate	35	10	4	4	53
Position	1	36	8	21	66
Signals	142	225	71	63	501
Liquid Level	18	6	7	-	31
Voltage, Current, Frequency	11	65	38	17	126
Miscellaneous	12	4	8	-	24
Angular Velocity	3	3	-	24	30
Strain	-	27	-	-	16
RPM	5	10	2	-	17
Guidance and Control	-	-	-	45	45
RF and Telemetry	-	-	-	16	16
Totals	644	936	279	218	2077
ESE Display	97	82	100	177	456
Auxiliary Display	64	81	63	18	226
Flight Control	28	80	86	104	298

<u>Measurement Summary -S/C</u>				
	<u>CM</u>	<u>SM</u>	<u>LM</u>	<u>S/C Total</u>
Pressure	18	37	103	158
Temperature	19	43	153	215
Discrete Event	84	5	303	392
Voltage, Current, Frequency	44	3	206	253
Miscellaneous	30	55	115	200
Totals	195	143	880	1218

Figure 14

AS-505 Measurement Summary

VEHICLE TRACKING SYSTEMS

In the Saturn V Space Vehicle there is a continuous requirement to transmit information to ground stations in order to determine the vehicle's trajectory. This requirement is satisfied by the RF Tracking Systems. The tracking data is used by mission control, range safety, and for post-flight evaluation of the vehicle's performance.

The principal tracking systems used are:

- C-band radar - Used in the IU and spacecraft
- Unified S-band system - Used in the IU and spacecraft.

ODOP System

Note: The Offset Doppler System, previously used in the S-IC Stage, has been discontinued.

C-Band (IU and SC)

C-Band is a pulse radar system which is used for precise tracking during launch and orbit phases. Two C-Band radar transponders are carried in the IU to provide radar tracking capabilities independent of vehicle attitude.

Unified S-Band System (IU and SC)

The Unified Side Band (USB) System provides tracking capability to the USB ground stations.

Spacecraft

C-Band Radar System

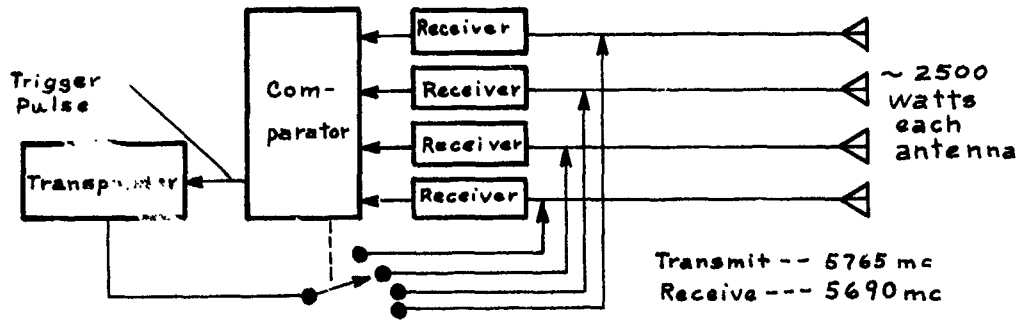

- Crystal switch driven by Comparator
- Automatically selects strongest receivers' antenna for output

Transmit -- 5765 mc
Receive --- 5690 mc

Note:
Different Pulse Code
than C-Band in IU.

Unified S-Band System

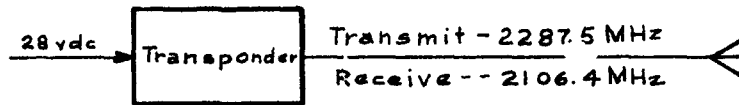

Instrument Unit

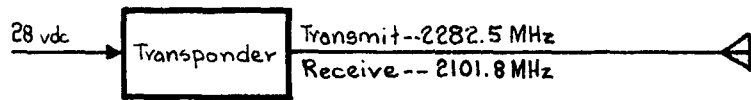

C-Band Radar System

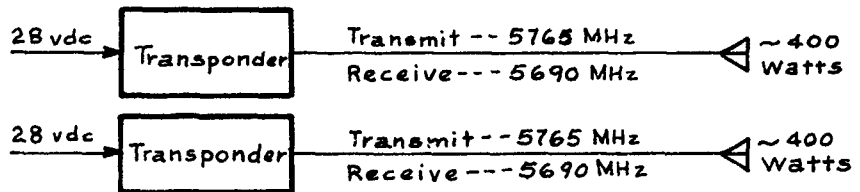

S-IC Stage

Note: The Offset Doppler, frequency measurement system, (ODOP), previously used in the S-IC Stage, has been discontinued.

Figure 17

Vehicle Tracking Systems

SPACE VEHICLE WEIGHT VS FLIGHT TIME

Mainstage propellant consumption during S-IC Stage powered flight (approximately 158 seconds) is approximately 4,609,300 pounds. Propellant consumption during S-II Stage powered flight (approximately 390 seconds) is approximately 974,900 pounds and during S-IVB Stage powered flight including first ignition, restart and burn (approximately 525 seconds) is approximately 229,500 pounds.

Vehicle Weight Data (Approximate)

	<u>Pounds</u>
Total at S-IC Stage ignition	6,492,800
Total at holddown arm release	6,407,000
Total at S-IC Stage O. E. C. O.	1,839,700
Total at S-II Stage ignition	1,459,300
Total at S-II Stage O. E. C. O.	471,500
Total at S-IVB Stage ignition	364,300
Total at S-IVB Stage E. C. O.	191,350
Total at S-IVB Stage engine restart	291,000
Total at S-IVB Stage 2nd E. C. O.	131,800
Total at S-IVB Stage/CSM separation	131,600
Total at SC Translunar injection	94,500

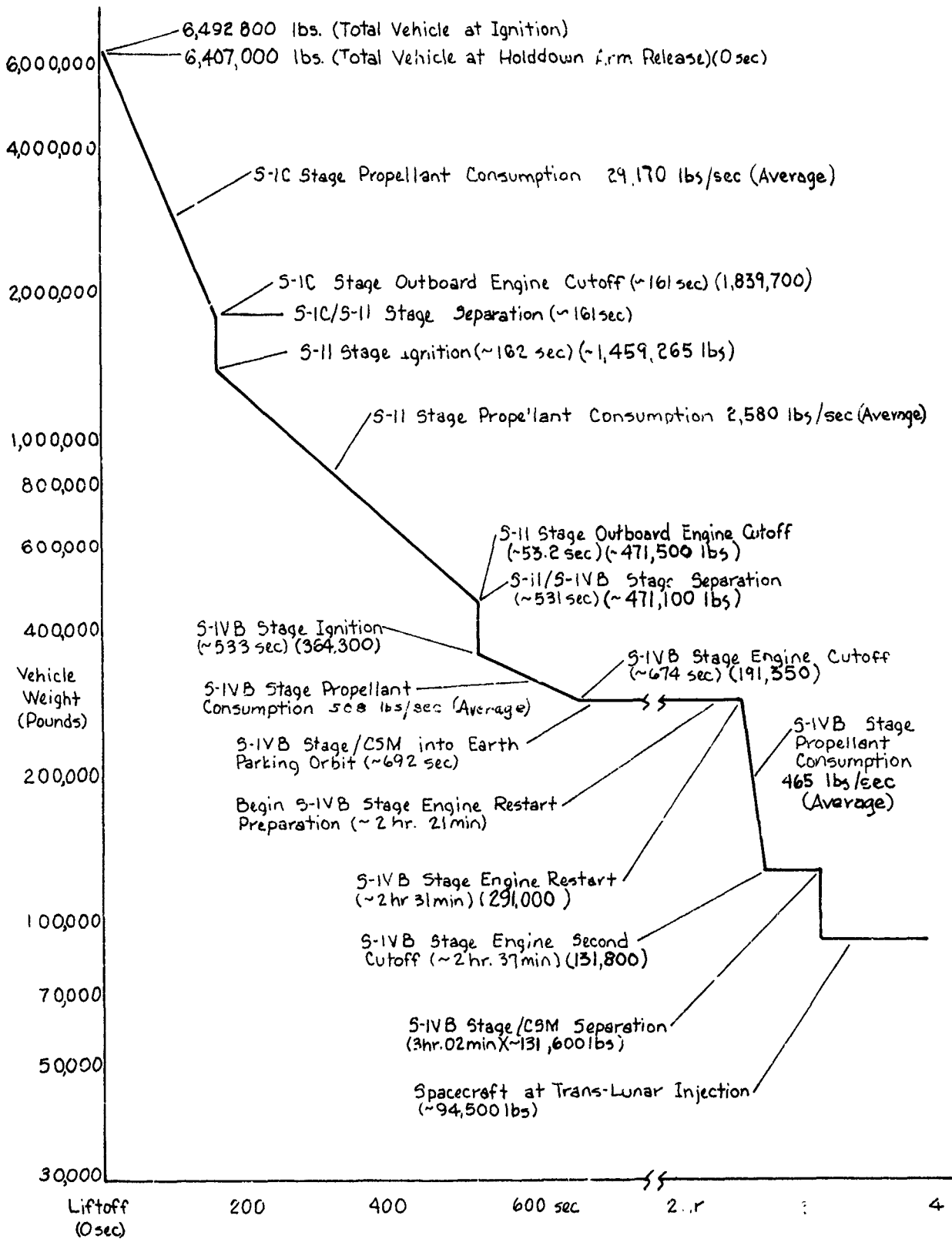

Figure 18

Space Vehicle Weight vs. Flight Time

S-IC STAGE STRUCTURE

The S-IC stage is approximately 138 feet long and 33 feet in diameter and is powered by five liquid-fueled Rocketdyne F-1 engines which generate a nominal thrust of 7,610,000 pounds. Stage engines are supplied by a bi-propellant system of liquid oxygen (LOX) as the oxidizer and RP-1 as the fuel. The S-IC stage interfaces structurally and electrically with the S-II stage (forward skirt structure).

- The Forward Skirt

The Forward Skirt accommodates the forward umbilical plate, the electrical and electronic canisters, and the venting of the Lox tank and interstage cavity. The aluminum skin panels are stiffened by ring frames and stringers.

- The Oxidizer Tank

The 345,000 gallon Lox tank is the structural link between the forward and inter-tank sections. Stiffened by machined "T" stiffeners the tank is internally equipped with ring baffles for additional stability as well as to reduce Lox sloshing. Ring baffles also provide support for four helium bottles.

- The Intertank Section

The intertank section provides structural continuity between the Lox and RP-1 tanks.

- The RP-1 (Fuel) Tank

The RP-1 fuel tank, located between the thrust structure and the intertank section, is a cylindrical aluminum structure with a load capacity of 216,000 gallons. Antislosh ring baffles are located on the inner walls while cruciform baffles are located on the lower bulkhead. A lightweight foam material, bonded to the lower bulkhead, serves as an exclusive riser to minimize unusable residual fuel.

- The Thrust Structure

The thrust structure provides support for the five engines, the base heat shield, engine fairings and fins, propellant lines, retro rockets and environmental control ducts. The lower thrust ring also has four hold-down points to restrain the vehicle, as necessary, from lifting off at full F-1 engine thrust.

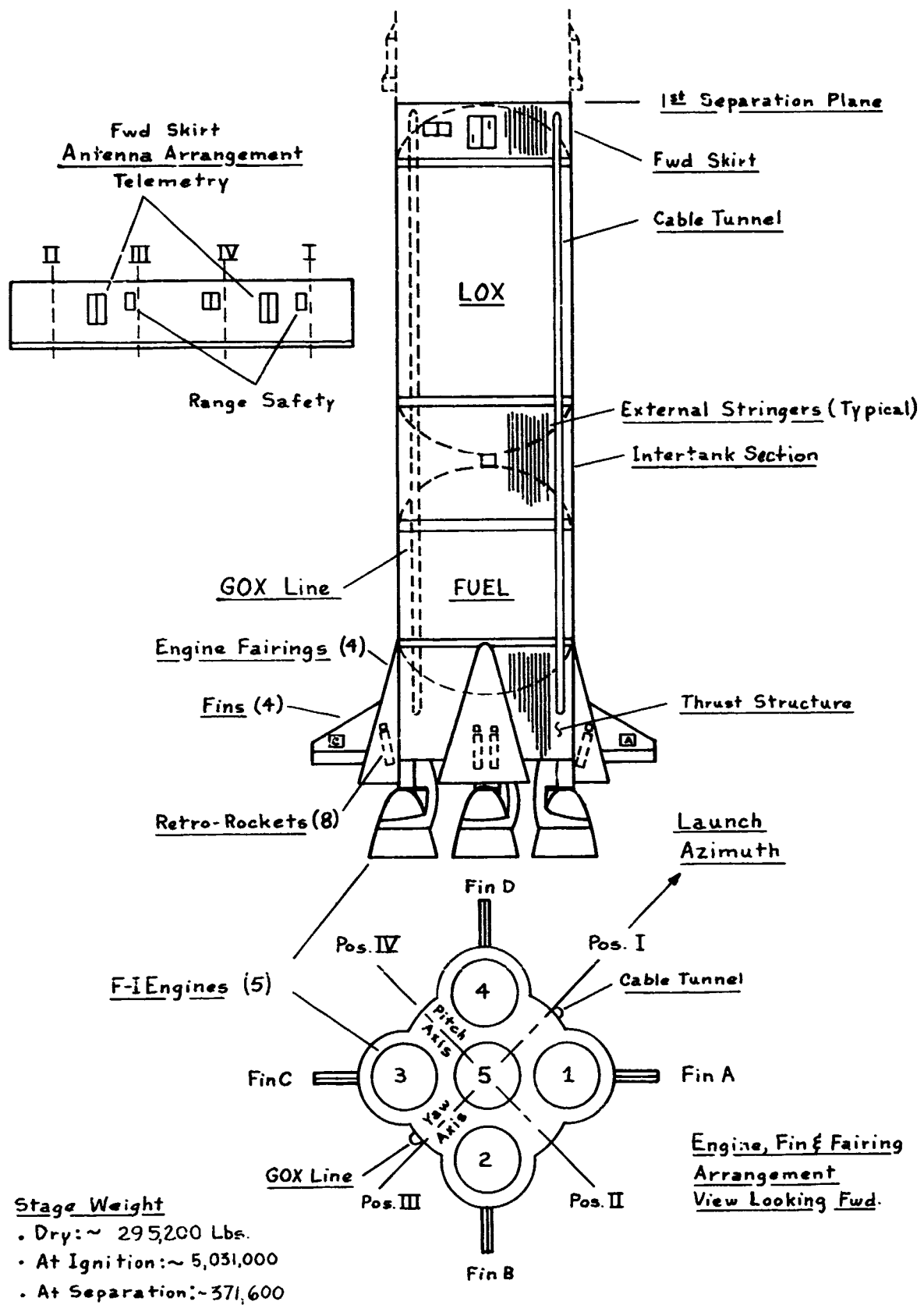

Figure 19

S-IC Stage Configuration

F-1 Engine Operation

The F-1 engine is started by ground support equipment. Ground fluid pressure opens ports in the main LOX valves. Opening of the main LOX valves admits LOX under tank pressure to the thrust chamber and allows control fluid to enter the gas generator. Opening of the gas generator valve permits LOX and RP-1 to enter the gas generator combustion chamber where it is ignited and the hot gasses are discharged into the thrust chamber where they are ignited by the turbine exhaust igniters. When the RP-1 reaches approximately 375 psig a valve in the hypergol cartridge opens allowing LOX and RP-1 to build up pressure against the hypergol burst diaphragm. At approximately 500 psig the diaphragm ruptures allowing hypergol and RP-1 to enter the thrust chamber causing spontaneous combustion upon contact with the LOX, thereby establishing primary ignition. As thrust pressure builds up the RP-1 valves open admitting RP-1 to the thrust chamber and the transition to mainstage operation is achieved.

The inboard engine is cutoff by a signal from the IU. Outboard engines are cutoff by optical type LOX depletion sensors with fuel depletion sensors as backup. A command from the IU supplies a command to the switch selector to enable the outboard engine cutoff circuitry. When two or more of the four LOX level sensors are energized, a timer is activated. Expiration of the timer energizes a stop solenoid for each engine which energizes the main LOX and main RP-1 valves. The sequence closing of the main LOX valve followed by sequence closing of the main RP-1 valve interrupts propellant flow and terminates engine operation.

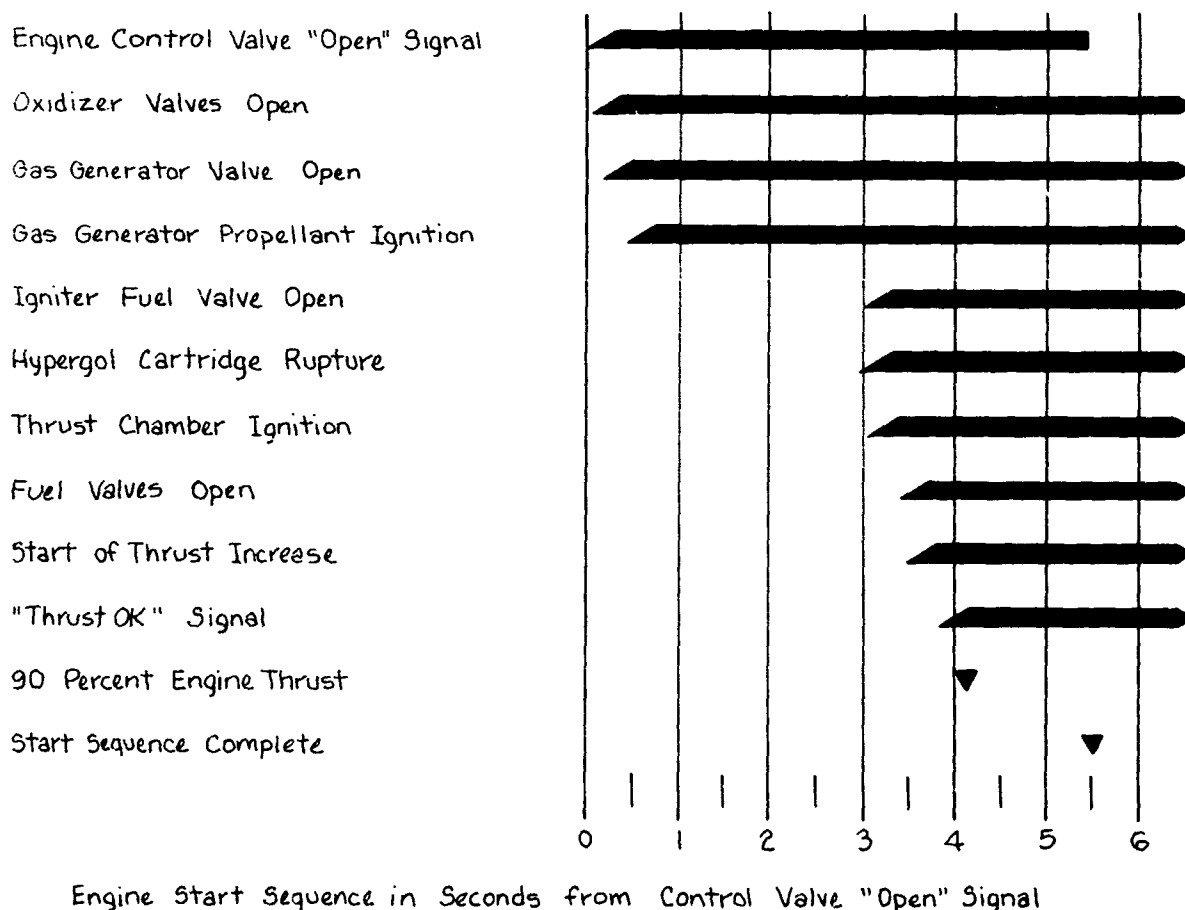

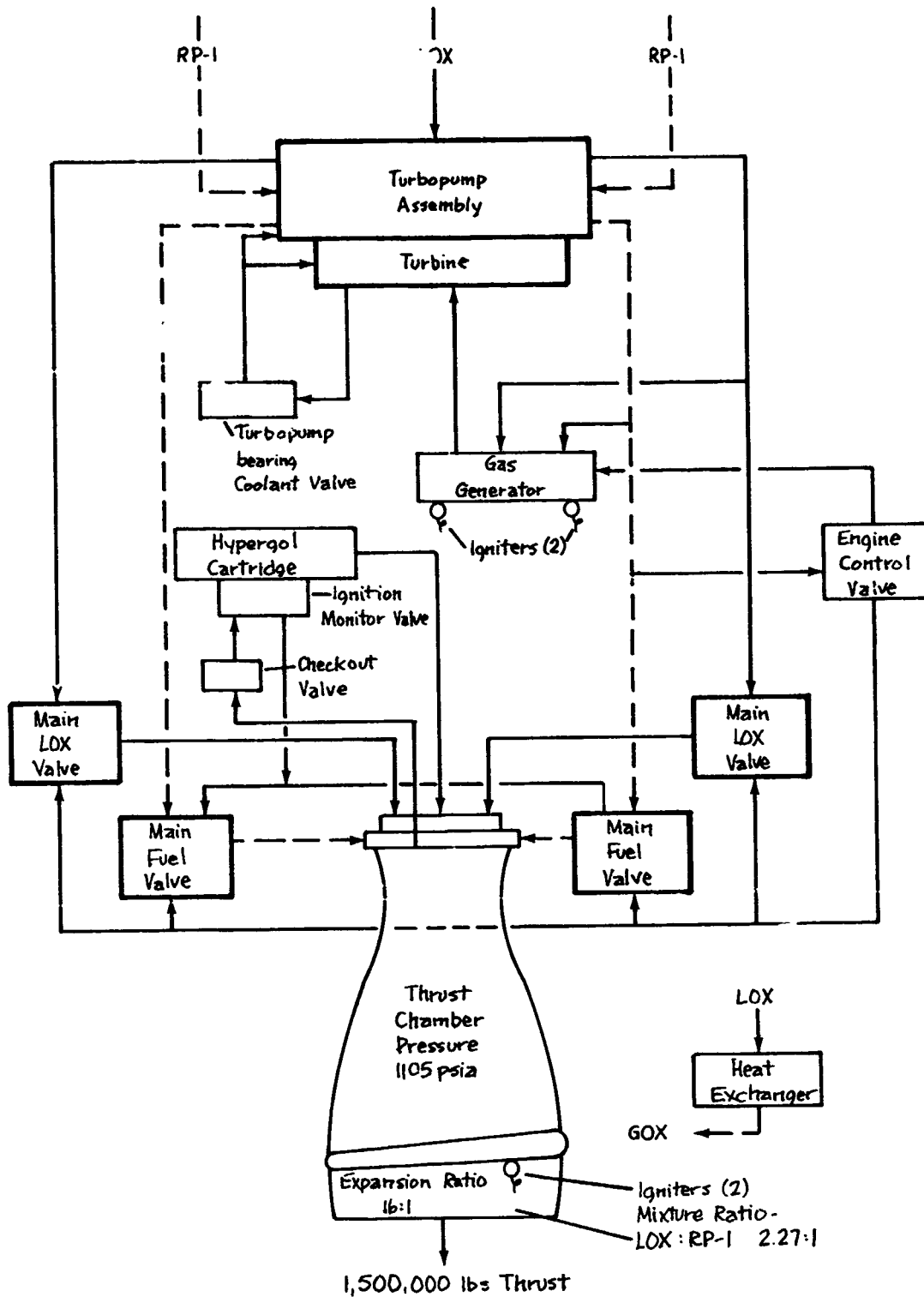

Figure 20

F-1 Engine System

S-IC STAGE PROPELLANT SYSTEM

The S-IC stage propellant system is composed of one LOX tank, one RP-1 tank, propellant lines, control valves, vents, and pressurization subsystems. Loading of LOX and RP-1 tanks is controlled by ground computers. RP-1 loading is completed approximately nine days prior to liftoff. LOX bubbling is started at the beginning of LOX chilldown operation and is continued throughout LOX loading and again before liftoff to prevent possible geysering. Prior to liftoff the RP-1 tank and the LOX tank is pressurized by helium from a ground source. At liftoff the RP-1 tank is pressurized with helium stored in bottles located in the LOX tank and heated by passing the helium through the heat exchanger. LOX tank pressurization is maintained by LOX bled from the engine and converted to GOX in the heat exchanger.

S-IC PROPELLANT LOAD AND OPERATIONAL SEQUENCE

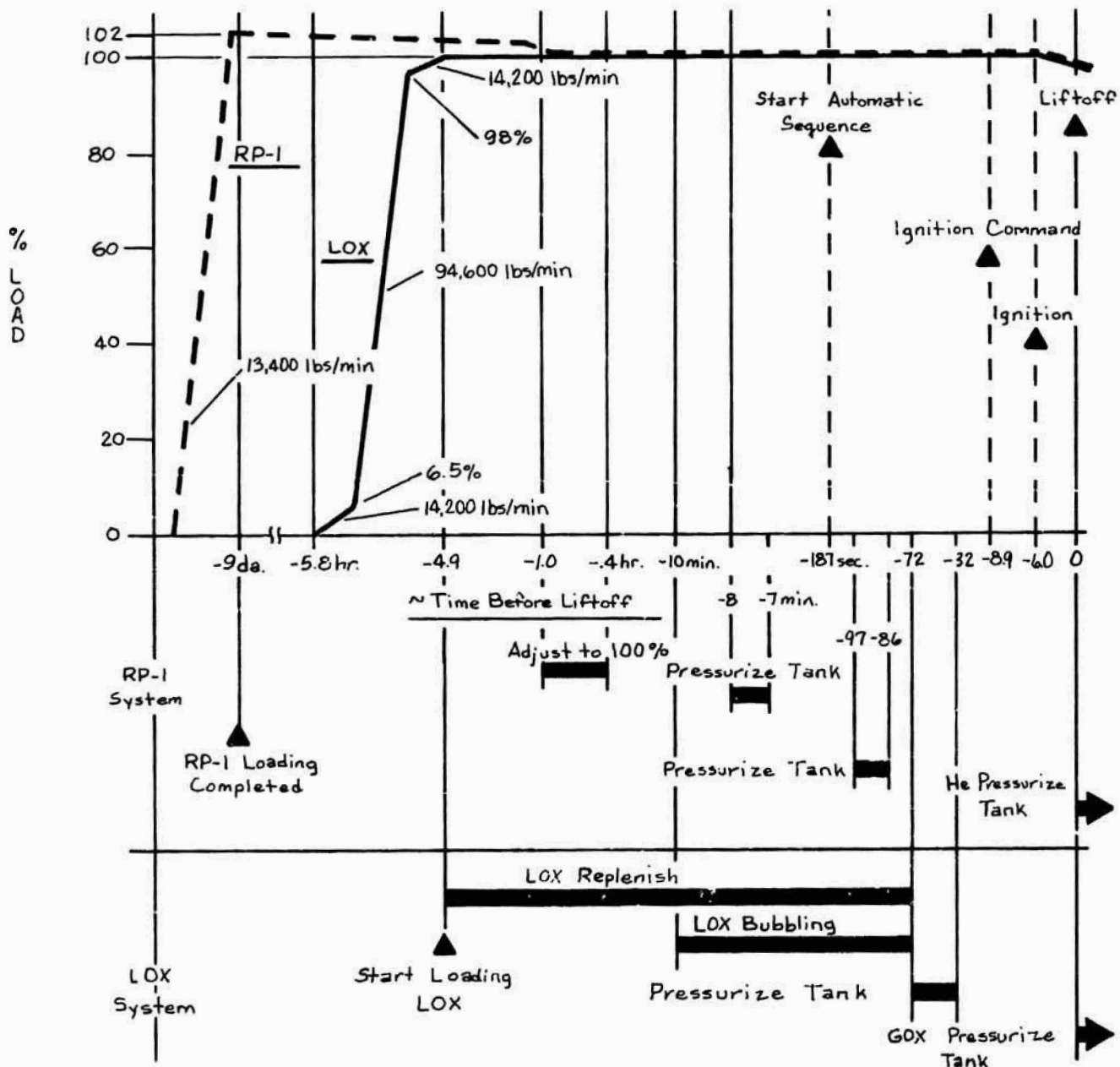

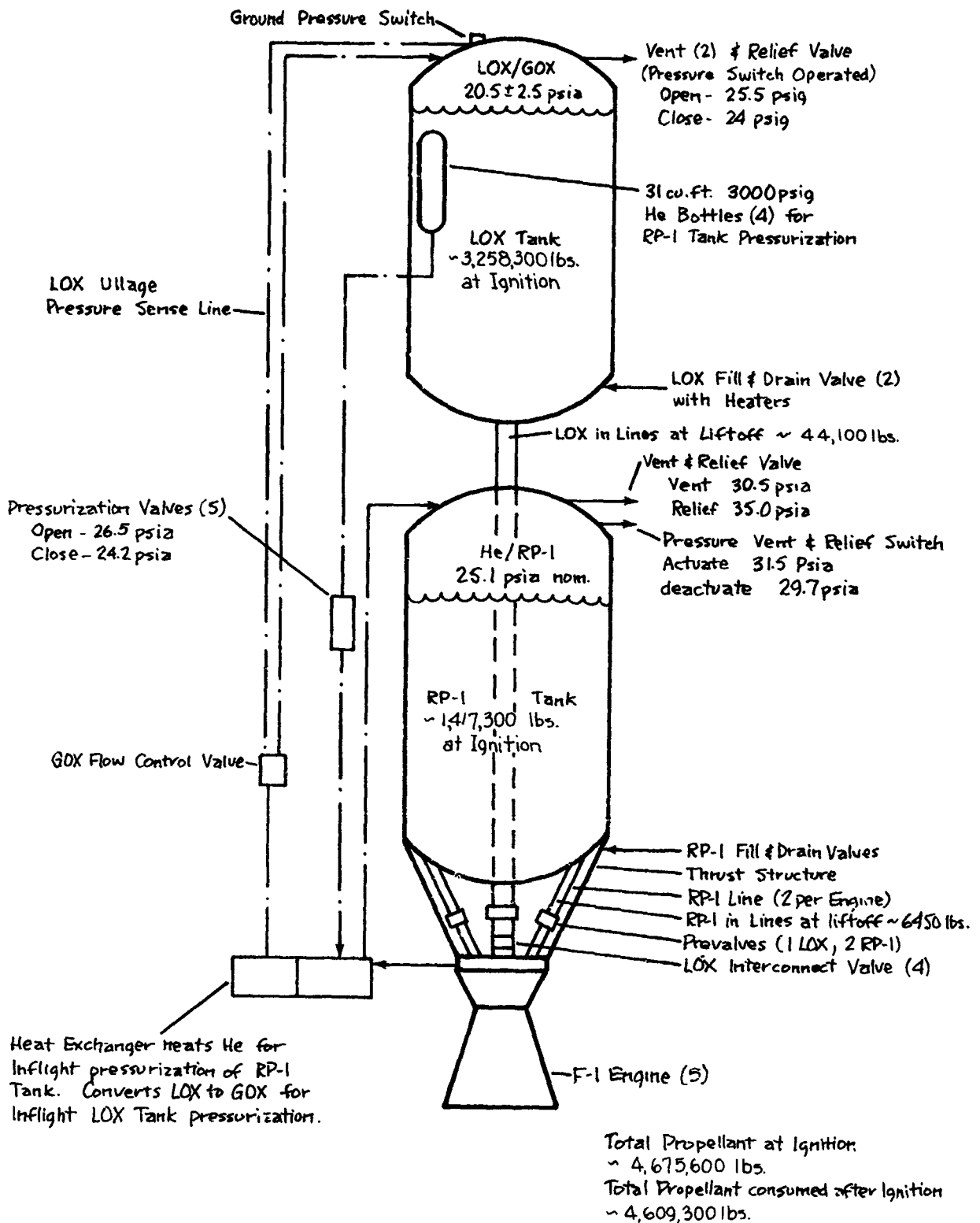

Figure 21

S-IC Stage Propellant System

S-IC STAGE THRUST VECTOR CONTROL SYSTEM

The four outboard F-1 engines are gimbal mounted on the stage thrust structure to provide attitude control during S-IC stage powered flight. Each independent gimbal system employs two hydraulic servo actuators. These servo actuators convert electrical command signals (Flight Control Computer) and hydraulic pressure into mechanical outputs which gimbal the outboard engines on the S-IC stage. An integral mechanical feedback, varied by piston position, modifies the effect of the control signal from the FCC. Built-in potentiometers sense servo actuator positions for telemetry as well as providing an interlock to preclude liftoff with an engine hardover.

Hydraulic pressure is supplied to the Thrust Vector Control System from a GSE pressure source during prelaunch checkout and engine start. The GSE pressure source utilizes RJ-1 ramjet fuel as the hydraulic fluid. During engine operation, hydraulic pressure is supplied from the fuel discharge of the engine turbo pump to the servo valve actuators. The fuel returns through a check valve to the fuel inlet of the turbo pump. RP-1, the fuel used by the S-IC stage, is used as the hydraulic fluid during engine operation.

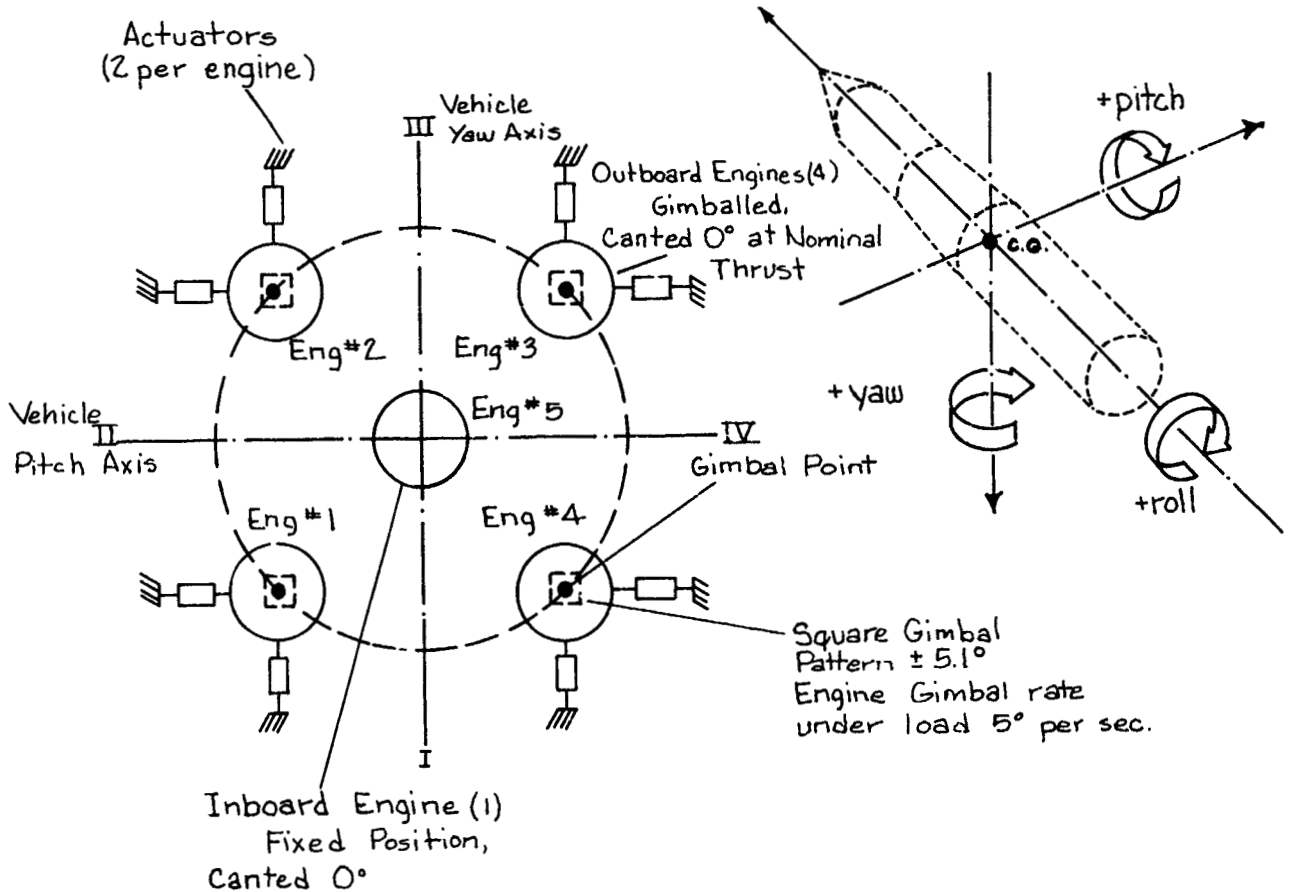
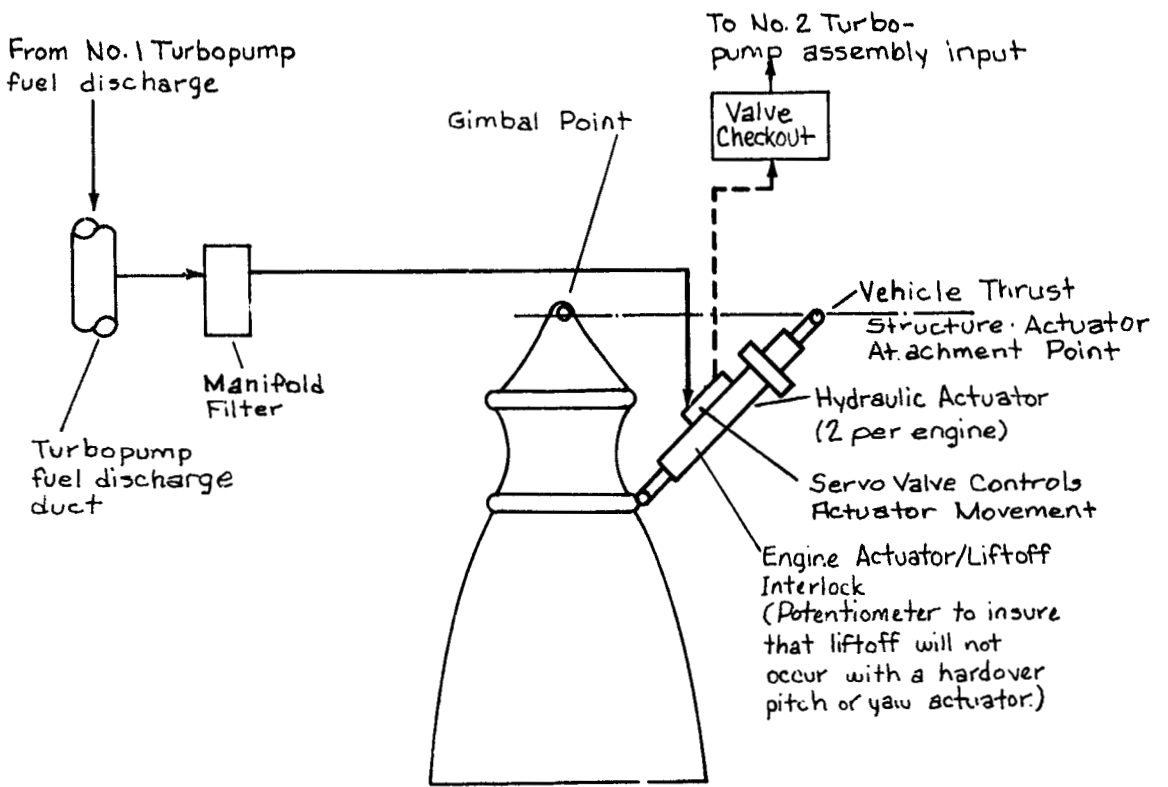

Figure 22

S-IC Stage Thrust Vector Control System

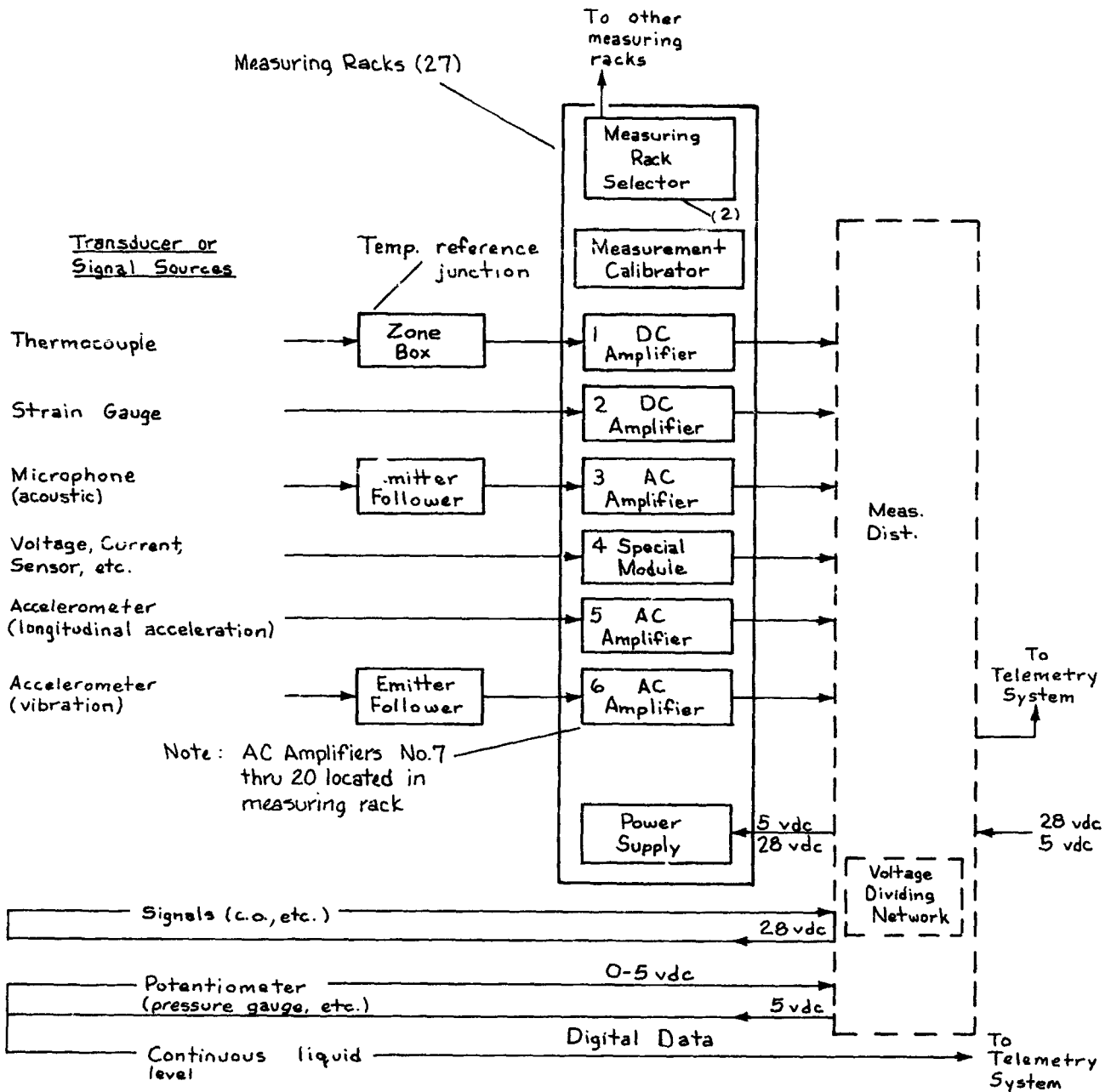
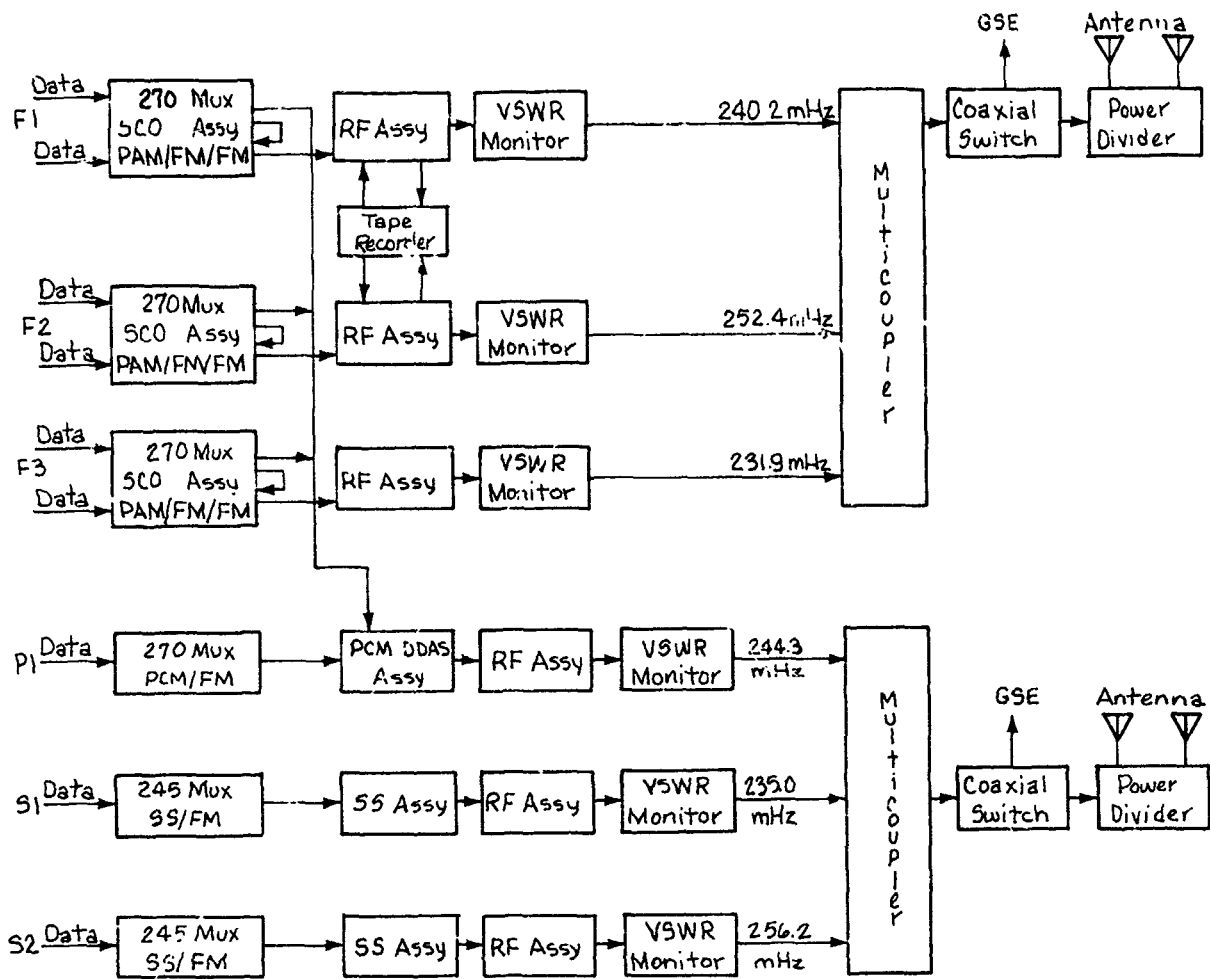

Figure 23

S-IC Stage
Measuring System



- PAM/FM/FM is used to transmit data in the frequency range below 100 Hertz.
- PCM/FM provide data acquisition link for analog and digital data plus a redundant means for monitoring the three PAM links.
- SS/FM links S1 and S2 transmit acoustical and vibration data in the frequency range of 50 to 3000 Hertz.
- The VSWR Monitor is used to monitor the performance of the telemetry antenna system and the output of the telemetry transmitter.

Figure 24

5-IC Stage Telemetry System

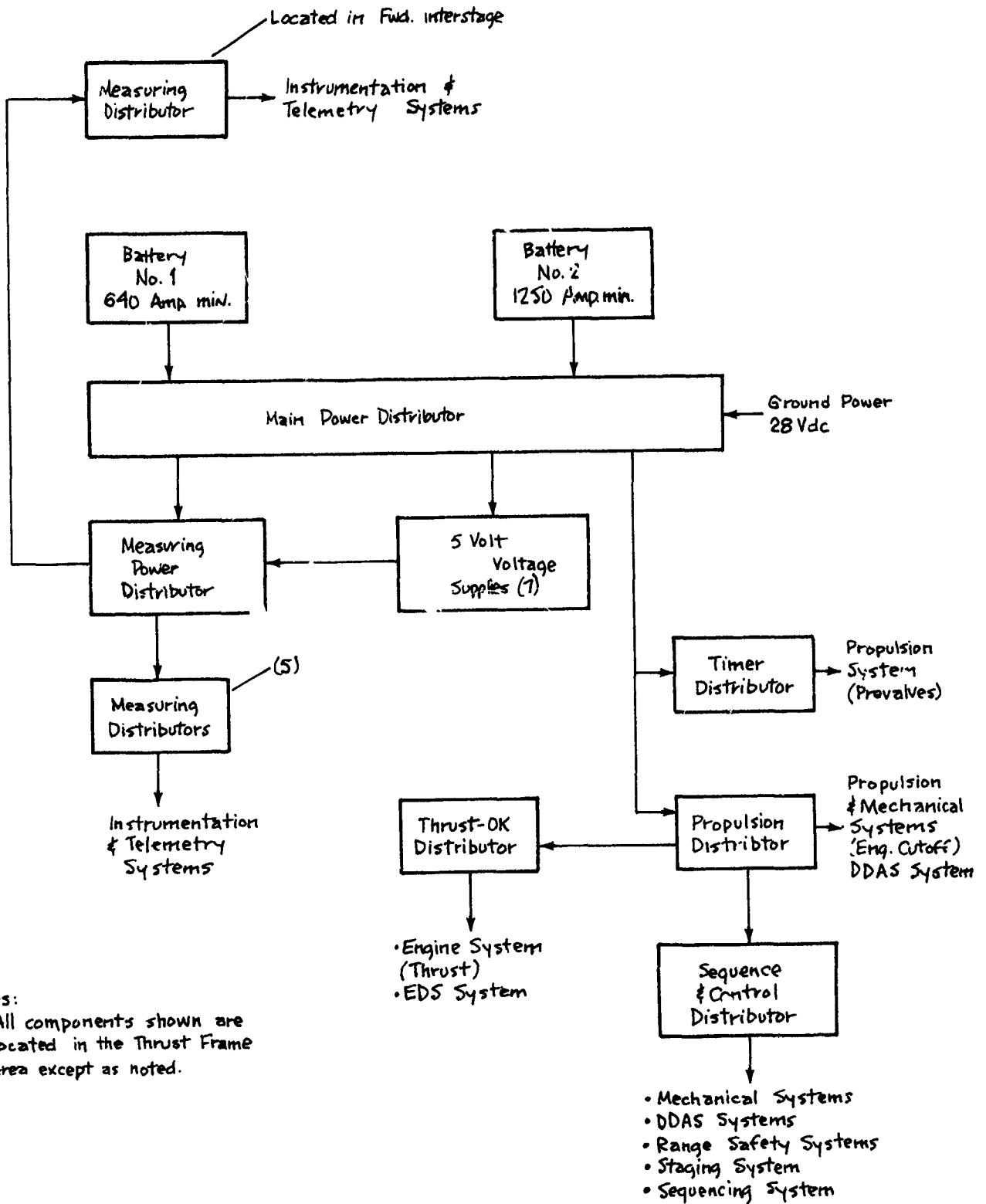

Figure 25

S-IC Stage Electrical Power and Distribution System

S-IC Battery Characteristics

Type:

- Dry charge
- Silver-Zinc Oxide
- Electrolyte consists of Potassium Hydroxide
in Pure Water.

Nominal Voltage: 28 ± 2 vdc (1.5 vdc per cell)

Current Ratings: Battery No. 1 - 640 amps/min
Battery No. 2 - 1250 amps/min

Gross Weight: Battery No. 1 - 22 lbs
Battery No. 2 - 55 lbs

S-II STAGE STAGE STRUCTURE

The S-II stage is a large cylindrical booster approximately 81 feet in length and 33 feet in diameter. The stage is powered by five liquid-propelled J-2 rocket engines which combine to develop a total thrust of 1,150,000 pounds.

- Body Shell Structure

The body shell structure consists of the forward skirt, aft skirt and interstage. Each unit is a cylindrical aluminum alloy shell of semimonocoque construction. The units are stiffened externally by stringers and are stabilized internally by circumferential ring frames.

- Thrust Structure

The thrust structure is of semimonocoque construction in the form of a truncated cone. The structure is stiffened circumferentially by ring frames and stringers. Thrust longerons and a cruciform assembly for the center engine, support and distribute the thrust loads of the J-2 engines. A fiberglass honeycomb heat shield protects the stage base area from excessive temperature during S-II boost.

- Propellant Tank Structure

The Liquid Hydrogen (LH₂) tank consists of a long cylinder with a forward convex bulkhead and an aft concave bulkhead. The aft bulkhead is common to the LOX tank. The LH₂ tank wall is composed of six cylindrical sections which incorporate longitudinal and circumferential stiffeners. The LOX tank consists of ellipsoidal fore and aft halves with waffle-stiffened gore segments. Slosh baffles are incorporated to control propellant sloshing and cruciform baffles to prevent vortices at the tank outlet ducts.

- System Tunnel

The systems tunnel houses electrical cables, pressurization lines and the propellant dispersion orifice. The tunnel is attached externally from the S-II stage aft skirt to the forward skirt.

Note: The retro-rockets for S-II Stage separation are located in the S-IVB aft interstage.

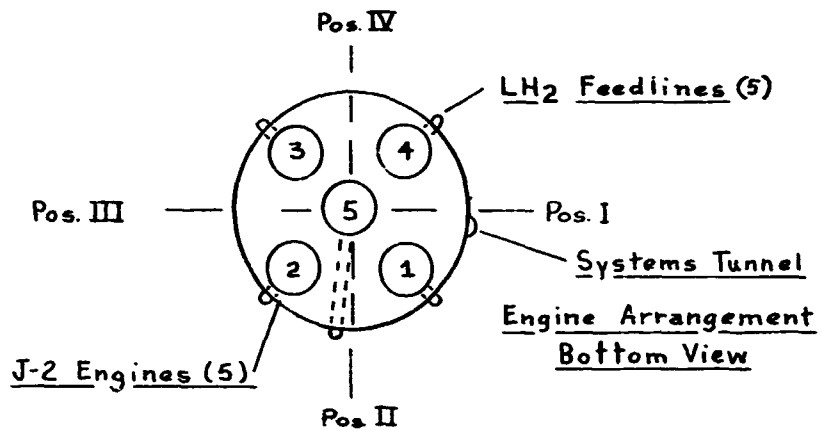
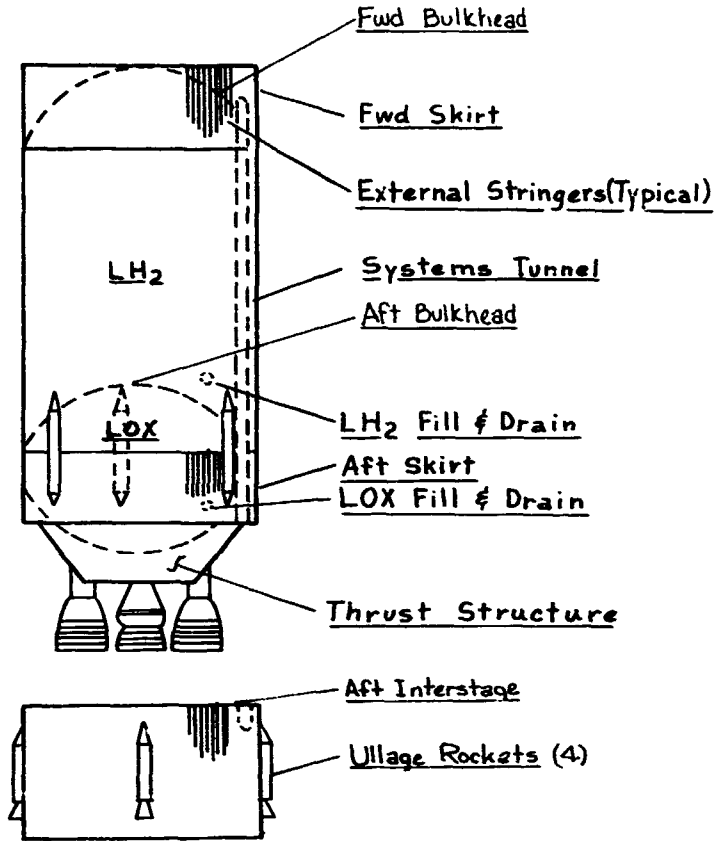
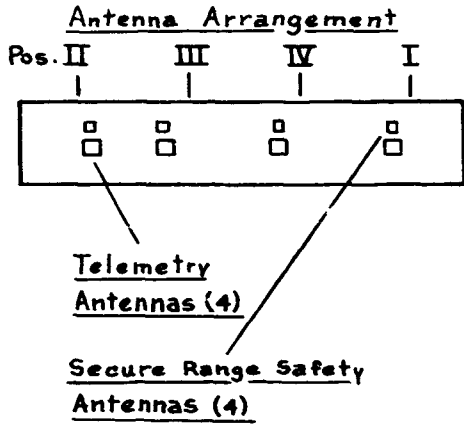

Stage Weight

- Dry: ~ 84,600 lbs.
- At S-II Ignition: ~ 1,067,800 lbs.
- At S-II Cutoff: ~ 98,900 lbs.
- At S-II Separation: ~ 98,600 lbs.

Figure 26

S-II Stage Configuration

J-2 ENGINE OPERATION S-II STAGE

The operating cycle of the J-2 Engine consists of prestart, start, steady-state operation and cutoff sequences. During prestart, LOX and LH₂ flow through the engine to temperature-condition the engine components, and to assure the presence of propellant in the turbopumps for starting. Following a timed cooldown period, the start signal is received by the sequence controller which energizes various control solenoid valves to open the propellant valves in the proper sequence. The sequence controller also energizes spark plugs in the gas generator and thrust chamber to ignite the propellant. In addition, the sequence controller releases GH₂ from the start tank. The GH₂ provides the initial drive for the turbopumps that deliver propellant to the gas generator and the engine. The propellant ignites, gas generator output accelerates the turbopumps, and engine thrust increases to main stage operation. At this time, the spark plugs are de-energized and the engine is in steady-state operation.

Steady-state operation is maintained until a cutoff signal is received by the sequence controller. The sequence controller de-energizes the solenoid valves which in turn close the engine propellant valves in the proper sequence. As a result, engine thrust decays and the cutoff sequence is complete.

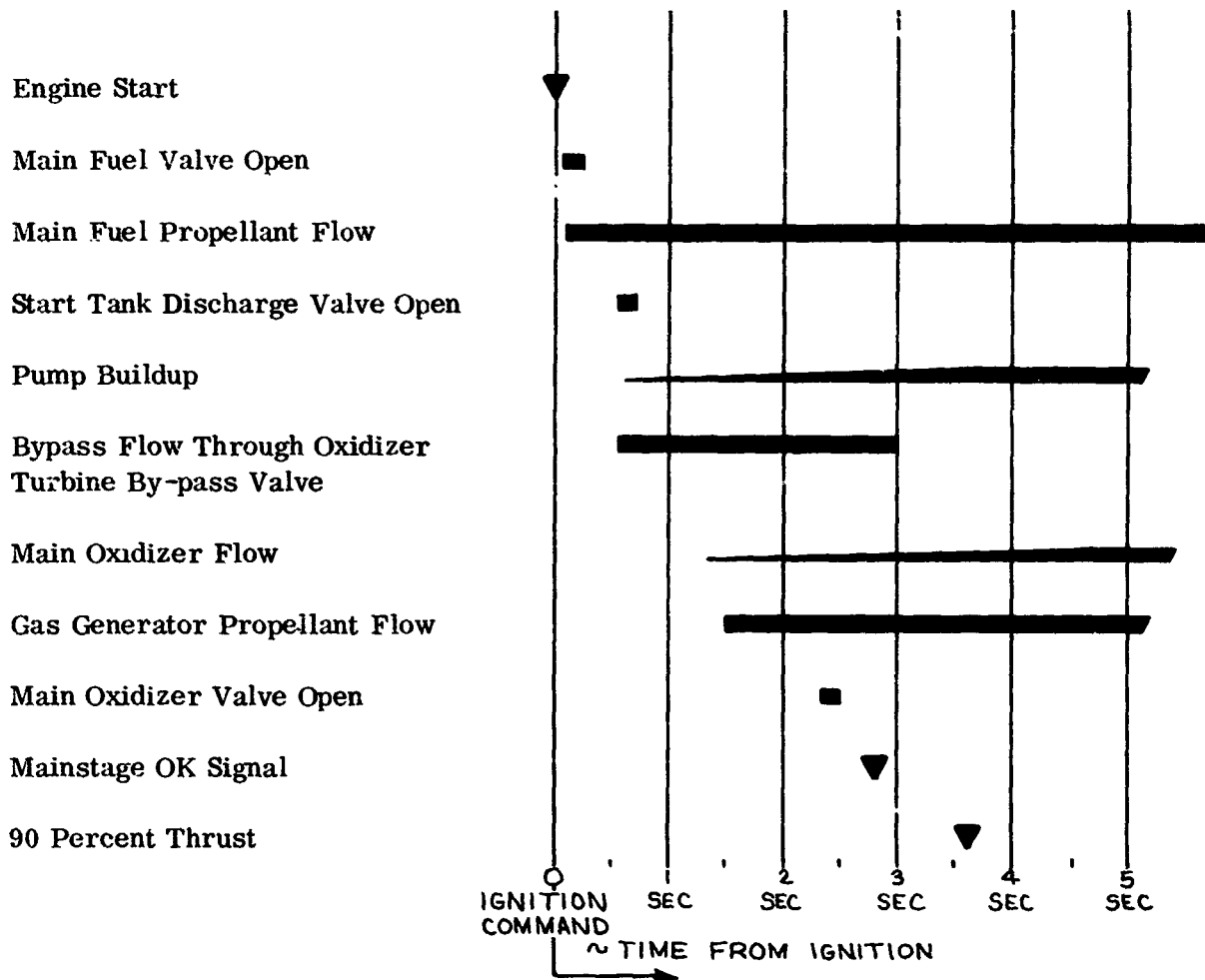

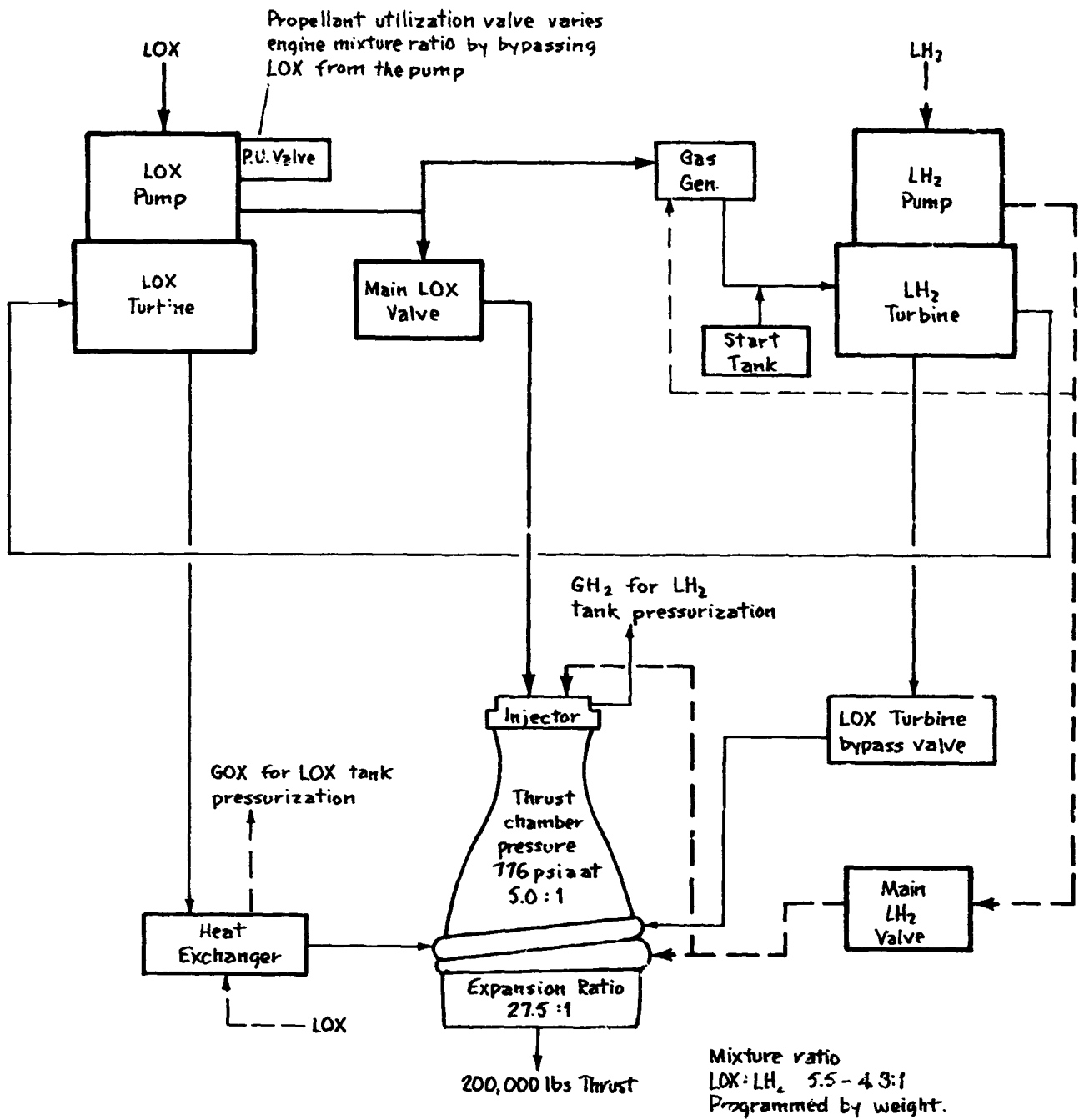

Figure 27

J-2 Engine System S-II Stage

S-II STAGE PROPELLANT SYSTEM

The S-II Stage propellant system is composed of integral LOX/LH₂ tanks, propellant lines, control valves, vents, and prepressurization subsystems. Loading of propellant tanks and flow of propellants is controlled by the propellant utilization systems. The LOX/LH₂ tanks are prepressurized by ground source gaseous helium. During powered flight of the S-II Stage, the LOX tank is pressurized by GOX bled from the LOX heat exchanger. The LH₂ tank is pressurized by GH₂ bled from the thrust chamber hydrogen injector manifold; pressurization is maintained by the LH₂ Pressure Regulator.

S-II PROPELLANT LOAD AND OPERATIONAL SEQUENCE

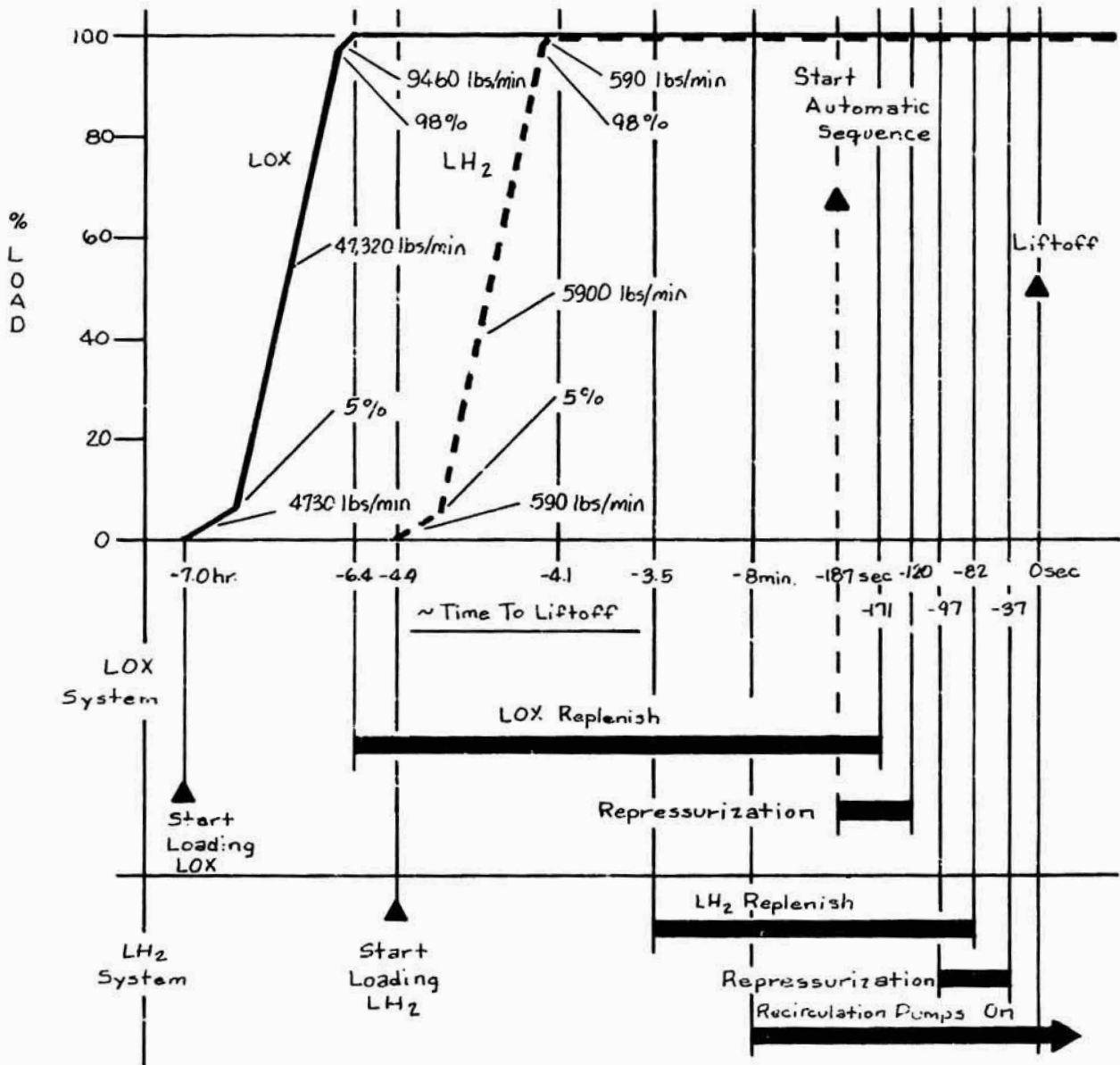

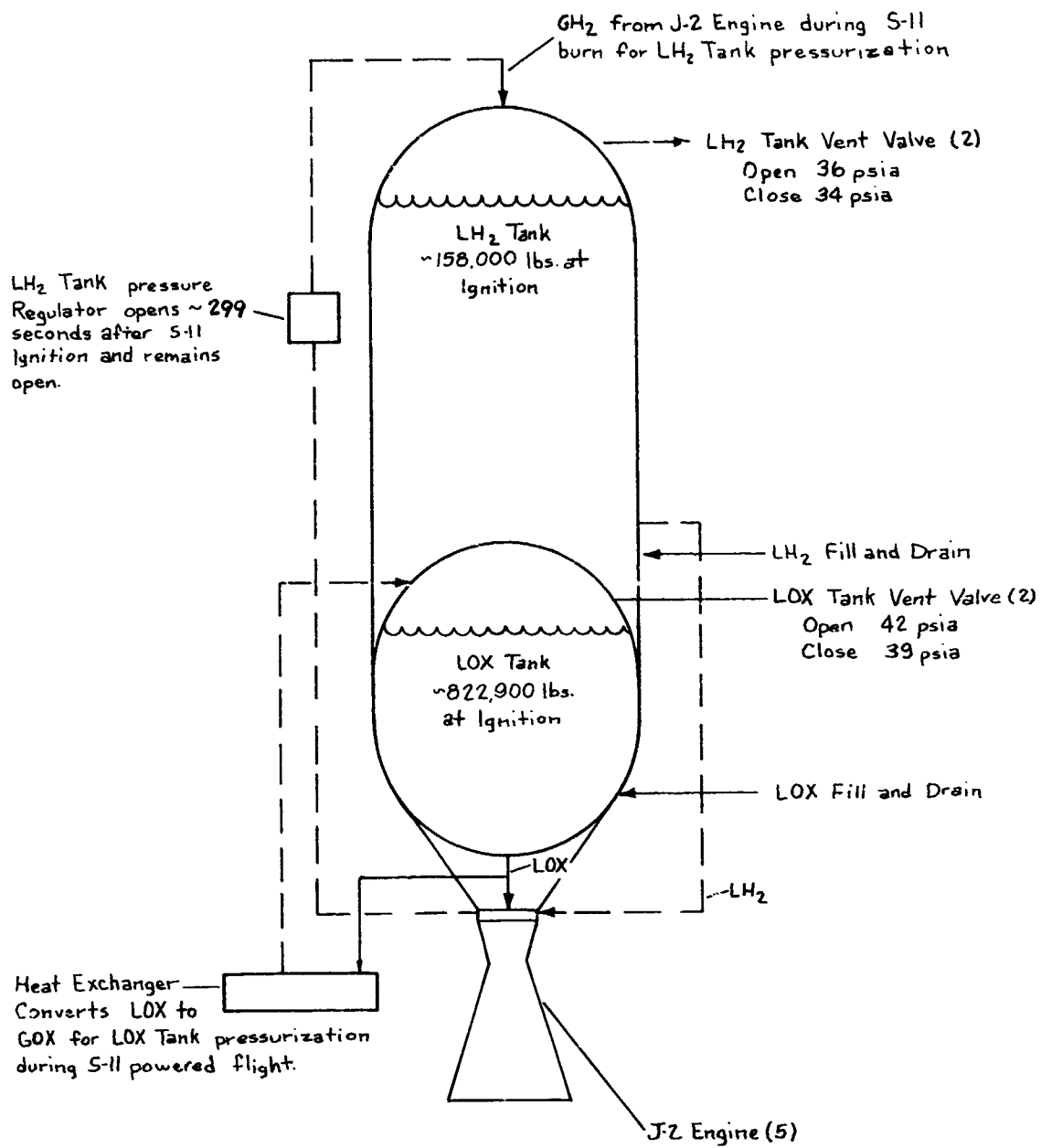

Total propellant at Ignition
 ~982,700 lbs
 Total propellant consumed after
 Ignition ~974,900 lbs.

Figure 28

S-II Stage Propellant System

S-II STAGE PROPELLANT MANAGEMENT SYSTEM

The propellant management system, in conjunction with the switch selector, controls mass propellant loading and engine mixture ratios (LOX to LH₂) to ensure balanced consumption of LOX and LH₂.

Capacitance probes, mounted in the LOX and LH₂ containers, monitor the mass of the propellants during powered flight. At engine start the mixture ratio is set to 5.0:1 and then at approximately 5 seconds after engine start, the PU system is armed in the open loop mode and the PU valve is commanded to 5.5:1 mixture ratio by the LVDC/LVDA. When the initial phase of IGM guidance is completed, (nominally engine start plus 318 seconds), the LVDC/LVDA through the S-II switch selector will command the PU valve to a mixture ratio of 4.5:1.

Outboard engine cutoff is initiated when any two of the five capacitance probes, in either tank, indicate dry. Prior to this cutoff, the LVDC/LVDA through the S-II switch selector commands S-II center engine cutoff.

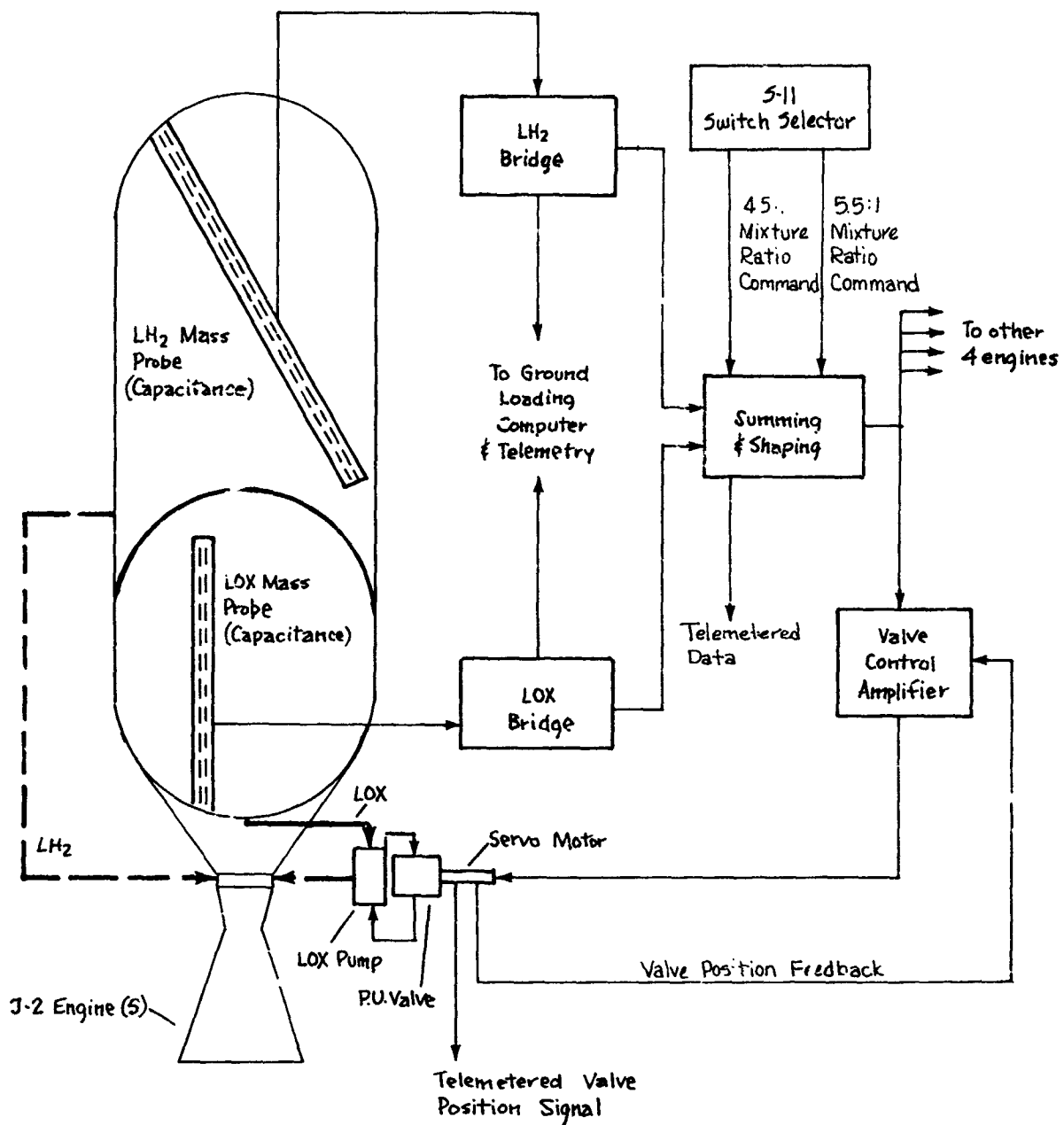

Figure 29

S-II Stage Propellant Management System

S-II STAGE THRUST VECTOR CONTROL SYSTEM

The four outboard J-2 engines are gimbal mounted to provide thrust vector control during powered flight. Attitude control is maintained by gimbaling the outboard engines in conjunction with electrical control signals from the IU flight control computer.

The gimbaling system consists of four independent closed-loop hydraulic control subsystems which provide power for engine gimbaling. The primary components of the subsystem are an auxiliary pump, a main pump, an accumulator/reservoir manifold assembly and two servo actuators (see page 55). The auxiliary pump is electrically driven from the GSE to provide hydraulic fluid circulation prior to launch. The main pump is mounted to and driven by the engine LOX turbopump. The accumulator/reservoir manifold assembly consists of a high pressure accumulator which receives high pressure fluid from the pump and a low pressure reservoir which receives return fluid from the servo actuators. The servo actuator is a power control unit that converts electrical signals and hydraulic power into mechanical outputs that gimbal the engine.

During the prelaunch period, the auxiliary hydraulic pump circulates the hydraulic fluid to preclude fluid freezing during propellant loading. Circulation is not required during the S-IC burn due to the short duration burn. After S-IC/S-II separation, an S-II switch selector command unlocks the accumulator lock up valves, releasing high pressure fluid to each of the servo actuators. The accumulators provide gimbaling power prior to the main hydraulic pump operation (S-IC/S-II separation transients). During S-II mainstage operation, the main hydraulic pump supplies high pressure fluid to the servo actuators. The return fluid from the actuators is routed to the reservoir which stores hydraulic fluid at sufficient pressure to supply a positive pressure at the main pump inlet.

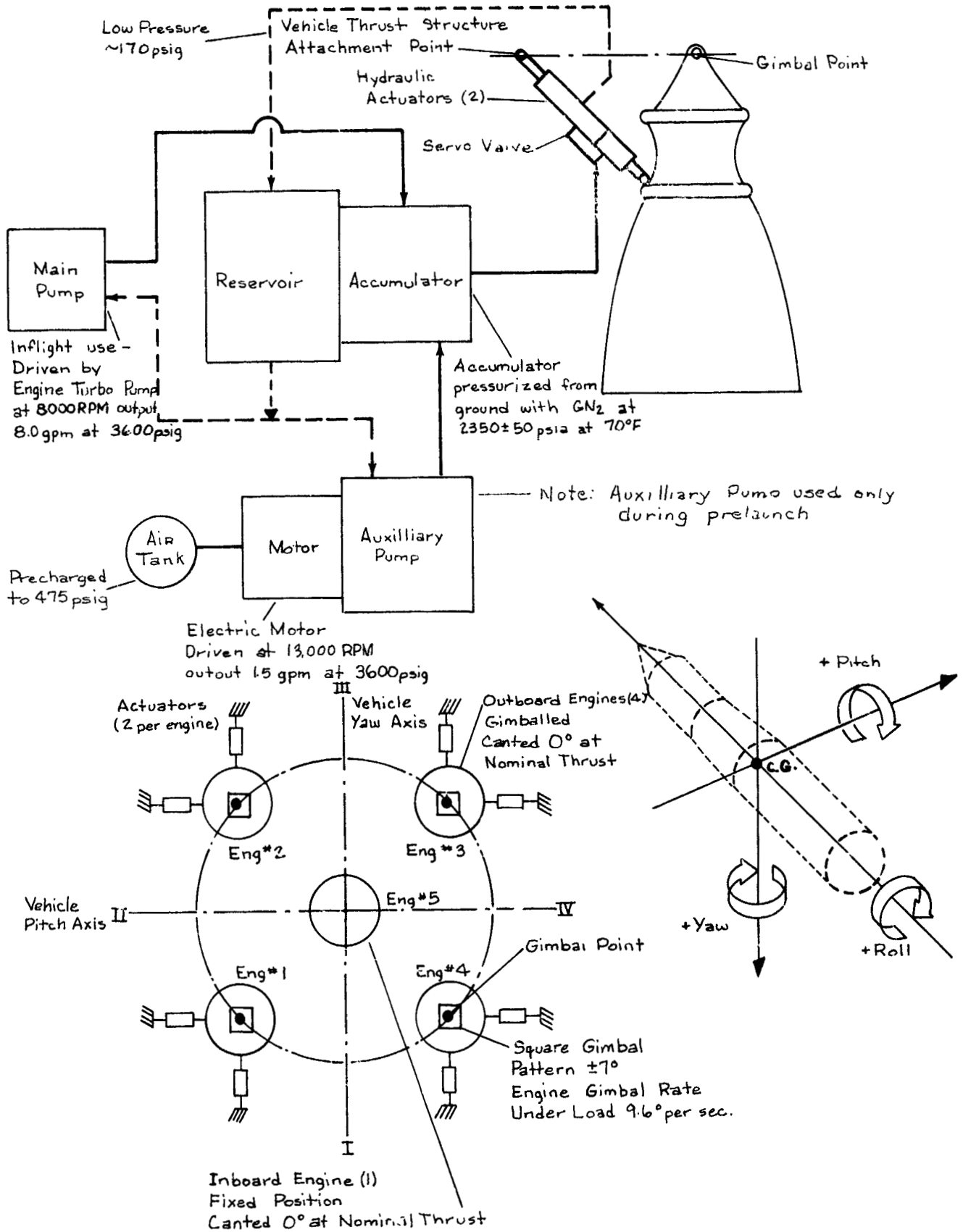

Figure 30

S-II Stage Thrust Vector Control System

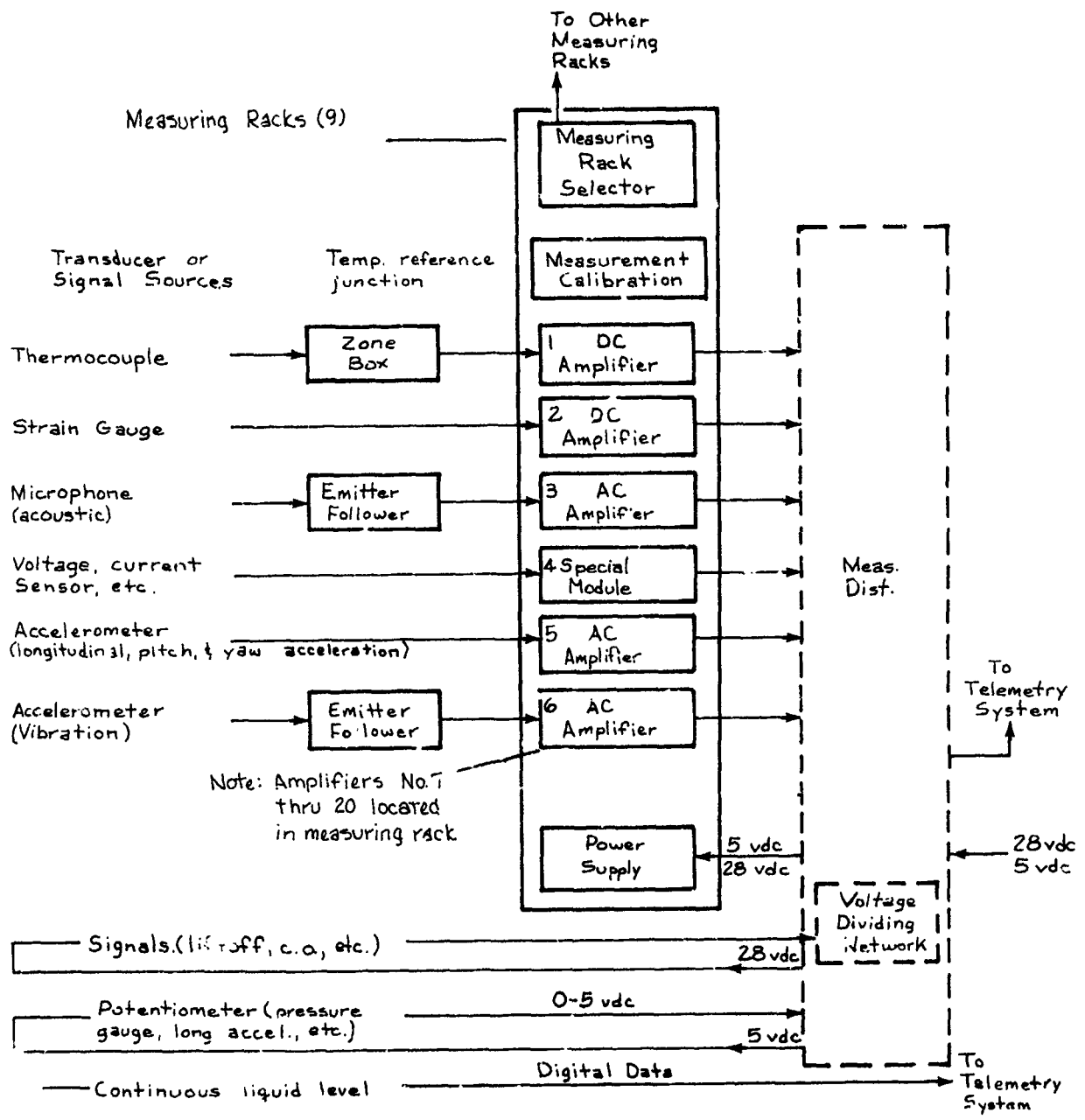

Figure 31

S-11 Stage Measuring System

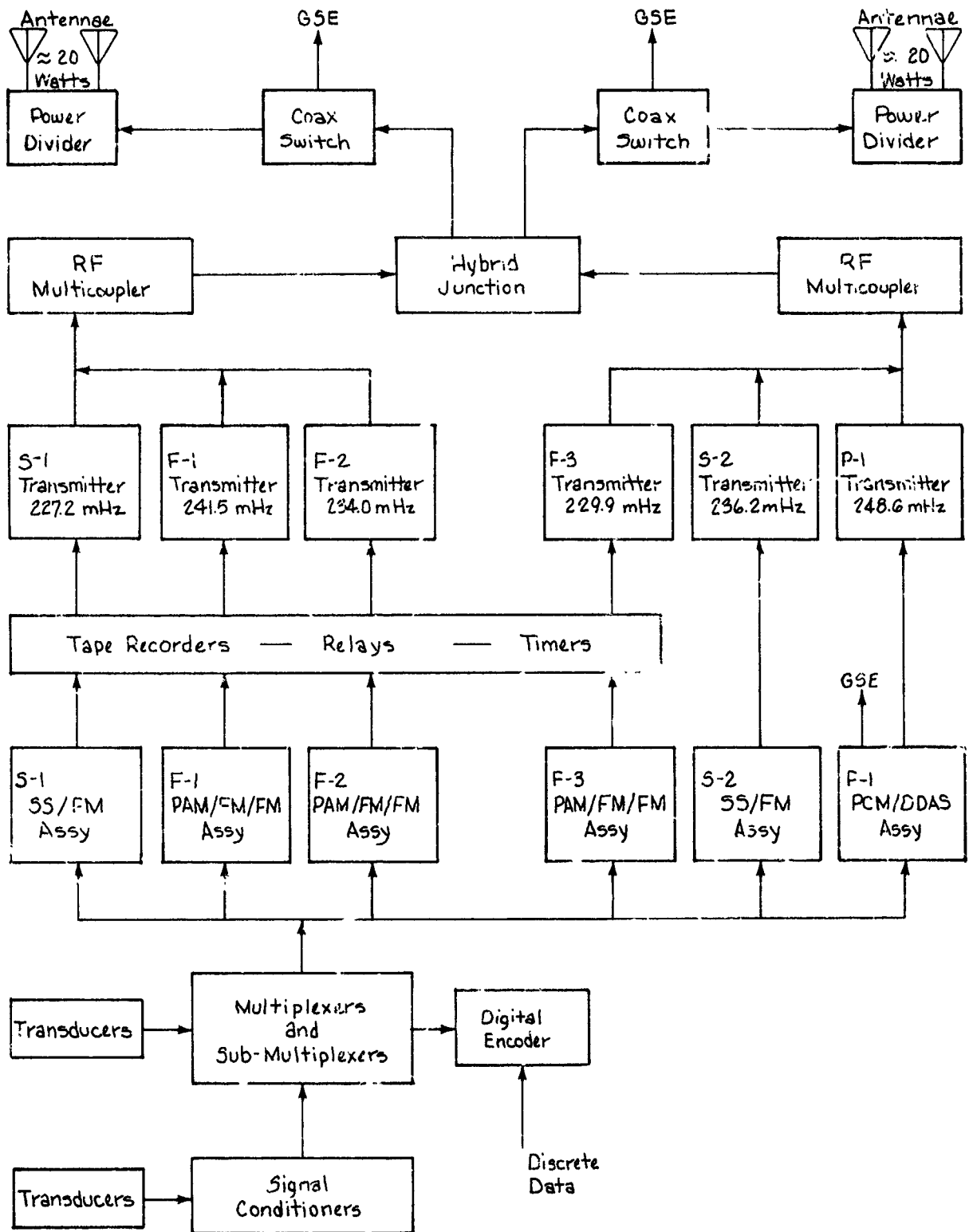

Figure 37

S-11 Stage Telemetry System

2

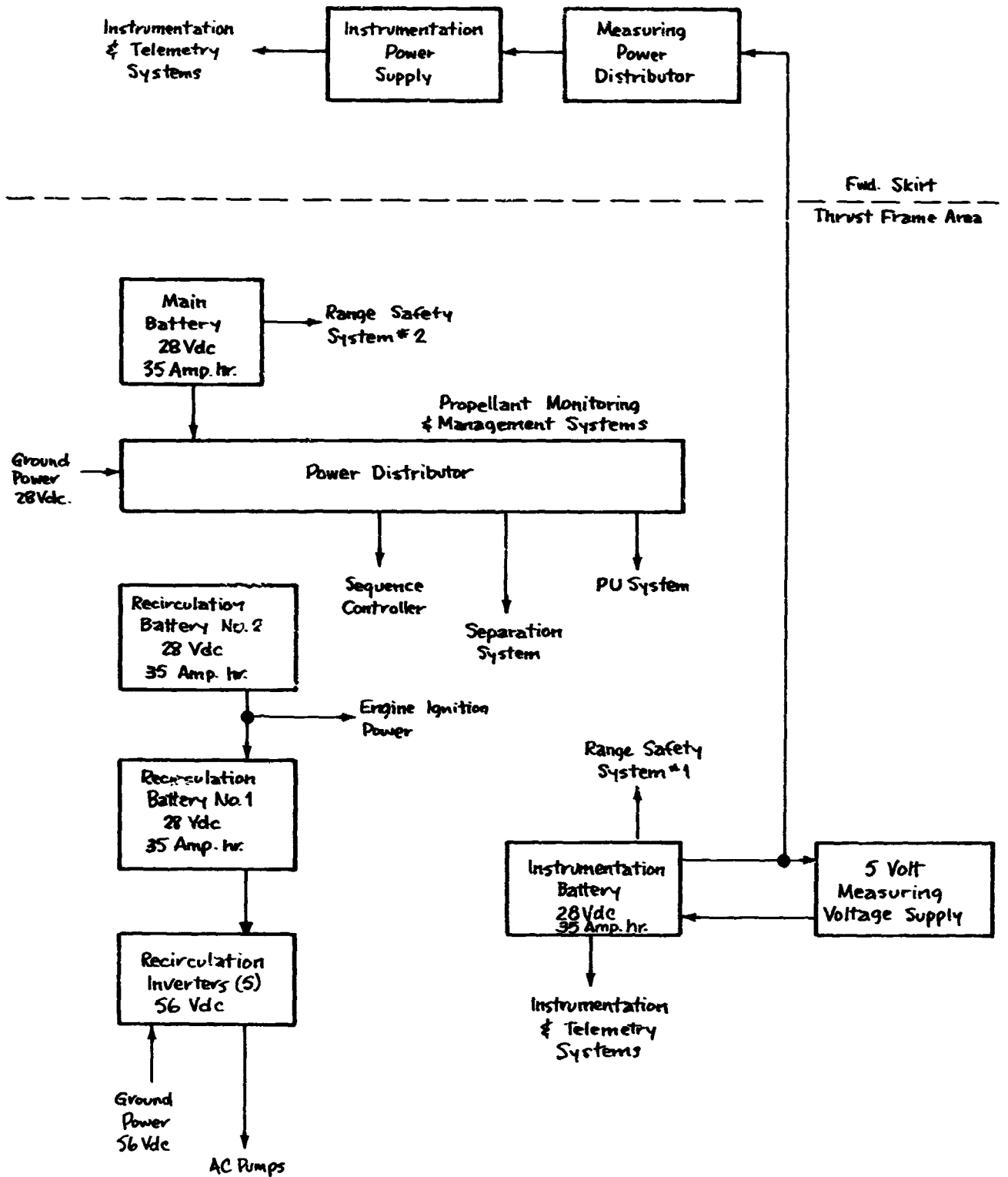

Figure 33

S-11 Stage Electrical Power & Distribution System

S-II Battery Characteristics

Type:

- Dry charge
- Silver Zinc Oxide
- Electrolyte consists of Potassium Hydroxide
in Pure Water.

Nominal Voltage: 28 ± 2 vdc

Current Rating: 35 amp/hours

Gross Weight: 165 lbs each

Note: There are four 28 volt batteries used in the S-II Stage however since the recirculation system requires a 56 volt source, two batteries, (28 volts each) are connected in series.

S-IVB STAGE STRUCTURE

The S-IVB, the third booster stage, is approximately 59 feet in length with a stage weight at liftoff of approximately 269,300 pounds. The S-IVB stage is powered by a single J-2 engine capable of providing 232,000 pounds of thrust at first burn and 211,000 pounds during second burn.

- The Forward Skirt Assembly

The forward skirt is the load supporting member between the LH₂ tank and the Instrument Unit. The forward umbilical plate, antennas, the LH₂ tank flight vents and tunnel fairings are attached externally to this skirt.

- Propellant Tank Assembly

The propellant tank assembly is a cylindrical aluminum structure with a hemispherical shaped dome at each end. Lox and LH₂ are separated by a common bulkhead of sandwich type construction which is bonded to and separated by a fiberglass-phenolic honeycomb core.

- LH₂ Tank

The LH₂ tank is equipped with polyurethane insulation blocks which are covered with fiberglass and a sealant coating to minimize LH₂ boiloff. These blocks are bonded to an intertank waffle-like structure which provides structural rigidity.

- Lox Tank

The Lox tank is located in the lower end of the propellant structure and is surrounded by the aft skirt assembly. The Lox tank is equipped internally with a slosh baffle, a chilldown pump, a 13.5 foot propellant utilization probe, temperature and level sensors, and fill, pressurization and ventpipes.

- Aft Skirt Assembly

The aft skirt assembly is the load bearing structure between the Lox tank and the aft interstage.

- Thrust Structure

The thrust structure is an inverted, truncated cone attached at its larger end to the aft dome of the Lox tank and at the smaller end to the J-2 engine mount.

- Aft Interstage

The aft interstage is a truncated cone that provides load support structure between the S-II and the S-IVB stages. S-II retro rocket mounts are attached to this stage. The aft interstage remains with the S-II at interstage separation.

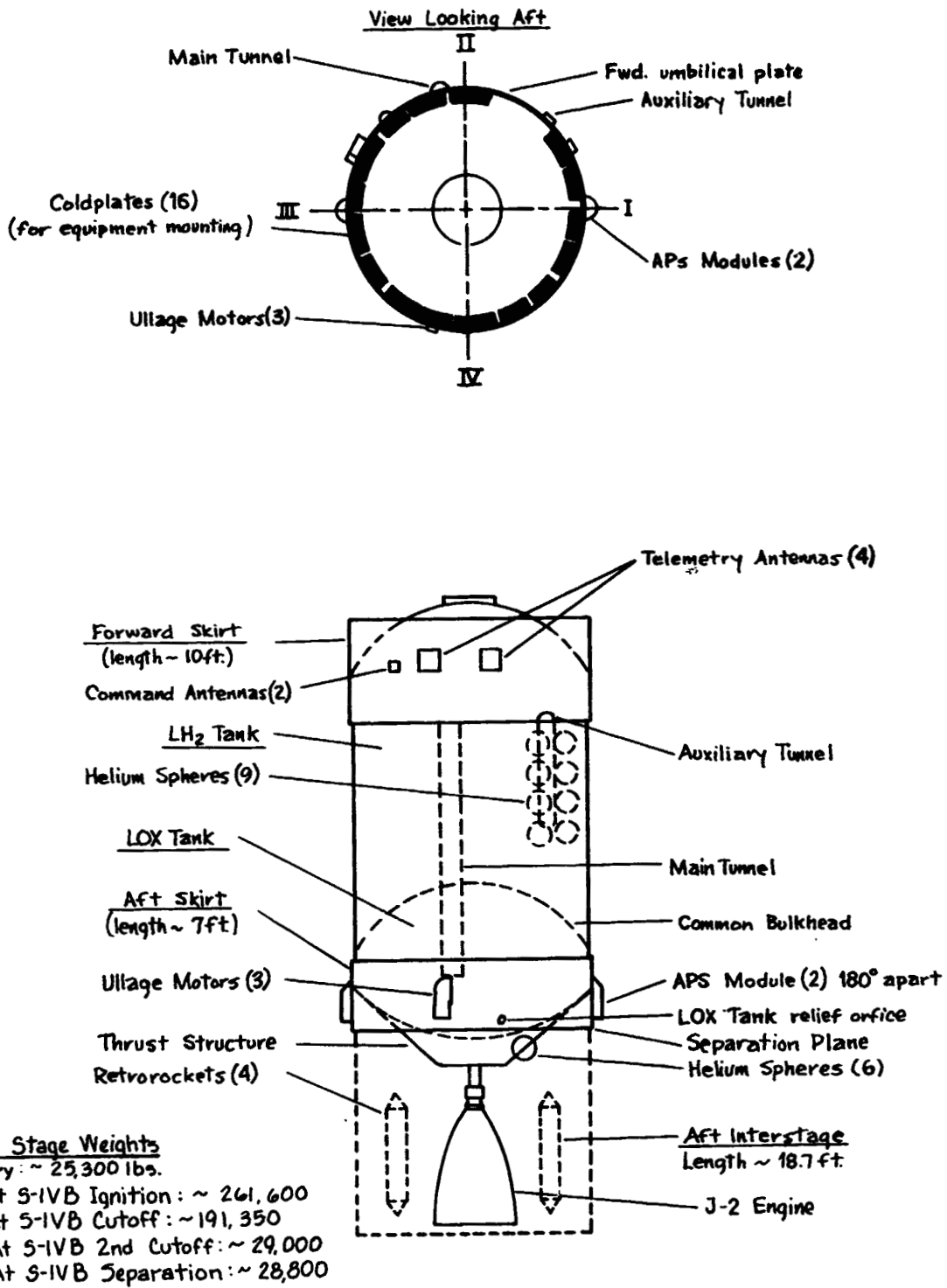

Figure 34

S-IVB Stage Configuration

J-2 ENGINE OPERATION S-IVB STAGE

The operating cycle of the J-2 Engine consists of prestart, start, steady-state operation and cutoff sequences. During prestart, LOX and LH₂ flow through the engine to temperature-condition the engine components, and to assure the presence of propellant in the turbopumps for starting. Following a timed cooldown period, the start signal is received by the sequence controller which energizes various control solenoid valves to open the propellant valves in the proper sequence. The sequence controller also energizes spark plugs in the gas generator and thrust chamber to ignite the propellant. In addition, the sequence controller releases GH₂ from the start tank. The GH₂ provides the initial drive for the turbopumps that deliver propellant to the gas generator and the engine. The propellant ignites, gas generator output accelerates the turbopumps, and engine thrust increases to main stage operation. At this time, the spark plugs are de-energized and the engine is in steady-state operation.

Steady-state operation is maintained until a cutoff signal is received by the sequence controller. The sequence controller de-energizes the solenoid valves which in turn close the engine propellant valves in the proper sequence. As a result, engine thrust decays and the cutoff sequence is complete.

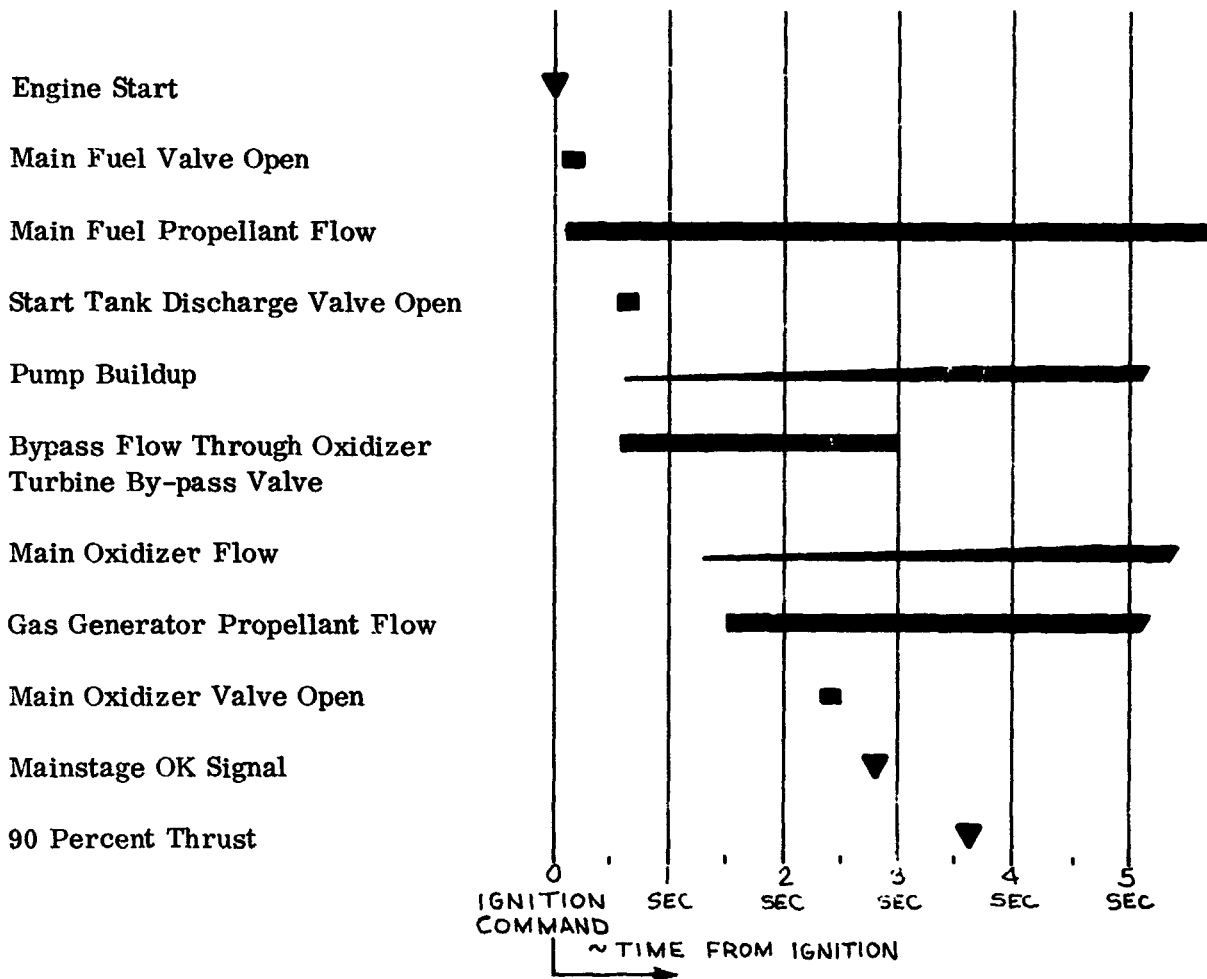

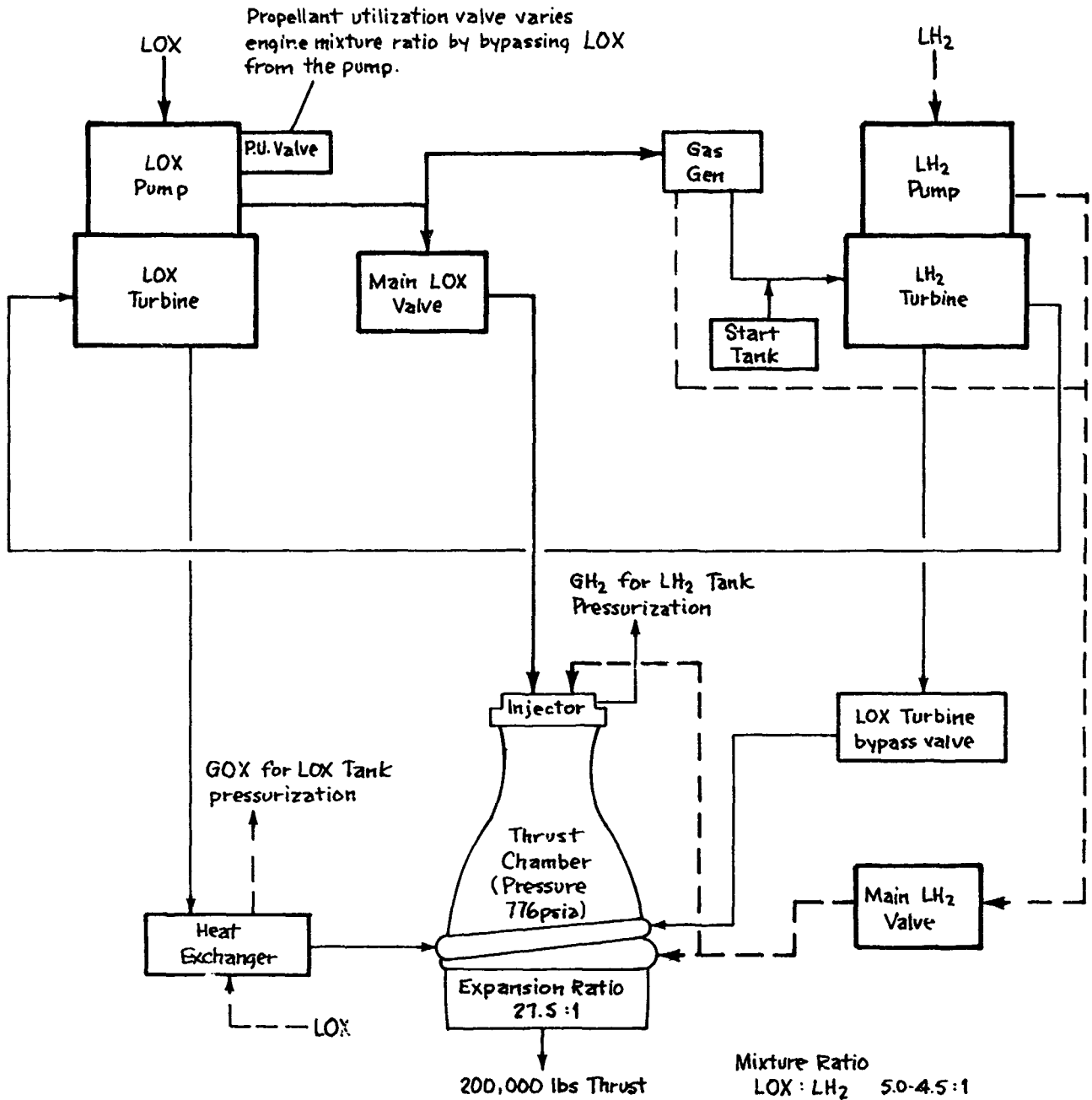

Figure 35

J-2 Engine System
S-IVB Stage

S-IVB STAGE PROPELLANT SYSTEM

The S-IVB stage propellant system is composed of integral LOX/LH₂ tanks, propellant lines, control valves, vents and pressurization subsystems. Loading of the propellant tanks and flow of propellants is controlled by the propellant utilization system. Both propellant tanks are initially pressurized by ground source cold helium.

LOX tank pressurization during S-IVB stage burn is maintained by helium supplied from spheres in the LH₂ tank, which is expanded by passing through the heat exchanger, to maintain positive pressure across the common tank bulkhead and to satisfy engine net positive suction head. LH₂ tank pressurization during S-IVB stage burn is maintained by GH₂ from the J-2 engine injector. Pressurization of the LH₂ tank strengthens the stage in addition to satisfying engine net positive suction head.

Repressurization of the propellant tanks, prior to J-2 engine restarts, is attained by passing cold helium, from the helium spheres in the LH₂ tank, through the O₂/H₂ burner. The heated helium is then routed to the propellant tanks. Should the O₂/H₂ burner fail, ambient repressurization will ensure propellant tank pressure for engine restarts.

S-IVB PROPELLANT LOAD AND OPERATIONAL SEQUENCE

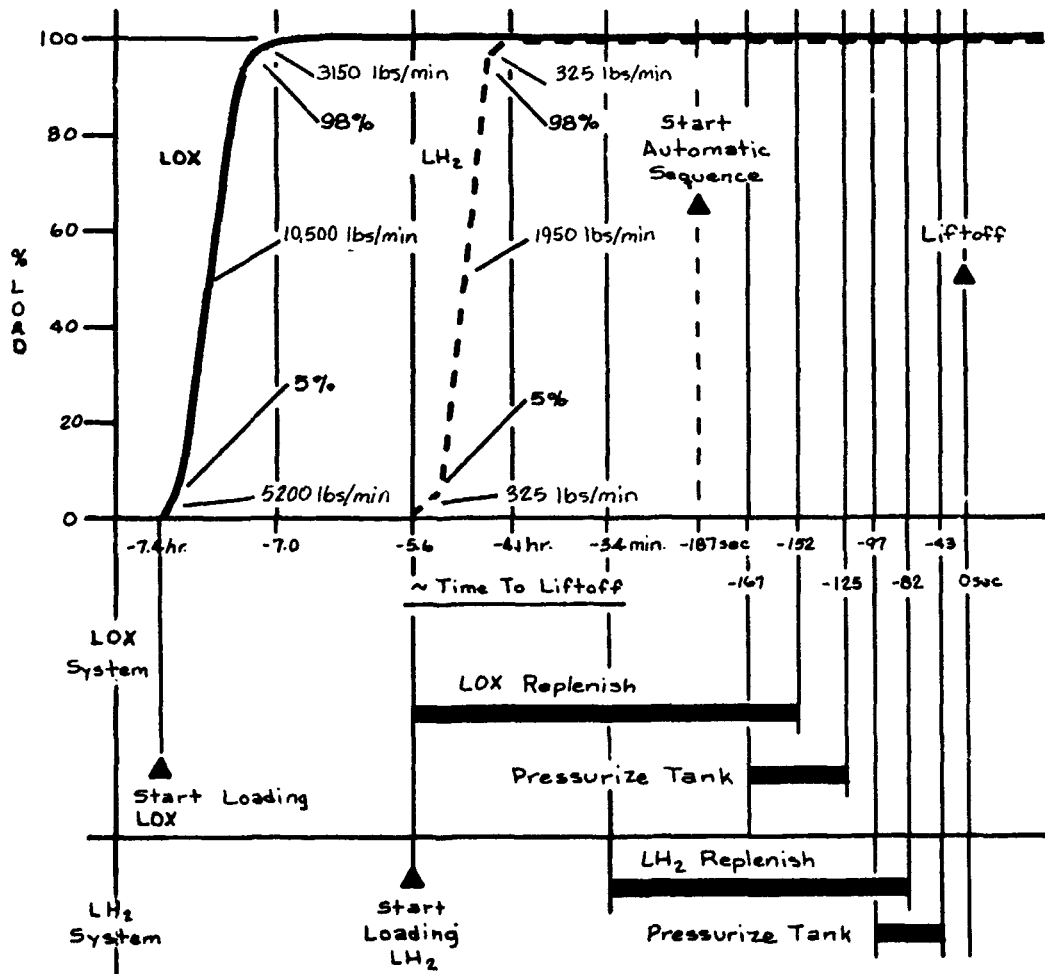

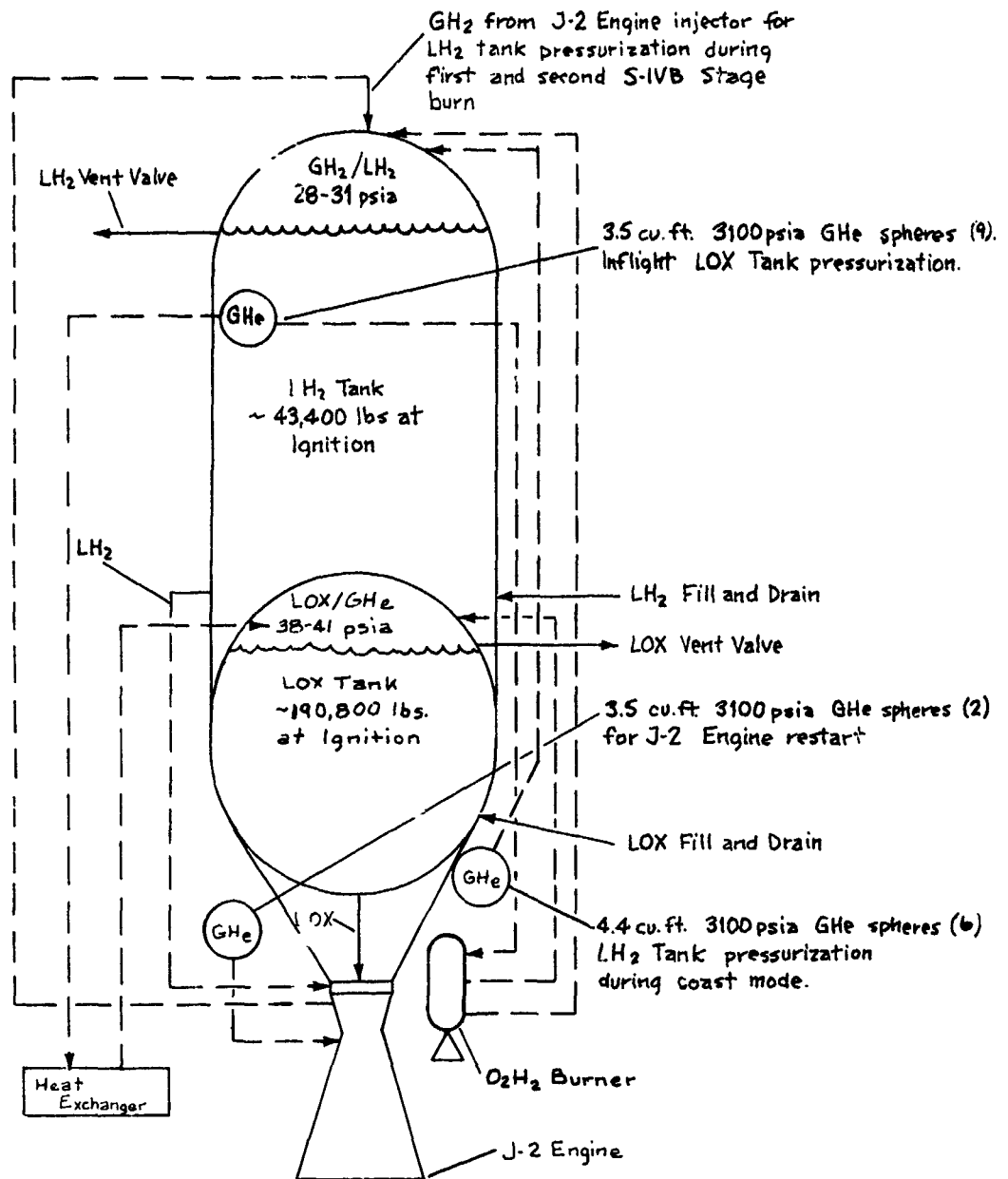

Total propellant at ignition
 ~ 254,700 lbs.
 Total propellant consumed after
 ignition ~ 229,500 lbs.

Figure 36

S-IVB Stage Propellant System

S-IVB STAGE PROPELLANT MANAGEMENT SYSTEM

The propellant management system, in conjunction with the switch selector, controls mass propellant loading and engine mixture ratios (LOX to LH₂) to ensure balanced consumption of LOX and LH₂.

The capacitance probes, located in the LOX and LH₂ tanks, monitor the mass of the propellants. During flight, the LOX and LH₂ capacitance probes are not utilized to control the propellant mixture ratio. The mixture ratio is controlled by switch selector outputs which are used to operate the propellant utilization (PU) valve. The PU valve is a rotary valve which controls the quantity of LOX flowing to the engine.

The PU valve is commanded to its null position to obtain an engine mixture ratio (EMR) of 5:1 (LOX/LH₂) prior to engine start. The PU valve remains at the 5:1 position during the first burn. Prior to engine restart (first opportunity) the PU valve is command by the switch selector to an EMR of 4.5:1 and remains at this position until approximately 2 minutes of S-IVB burn. Then the PU valve is commanded to its null position (5:1) by the switch selector. However, if the S-IVB restart is delayed to the second opportunity, the EMR is shifted from 4.5:1 to 5:1 by the switch selector at about the time the engine reaches 90 percent thrust.

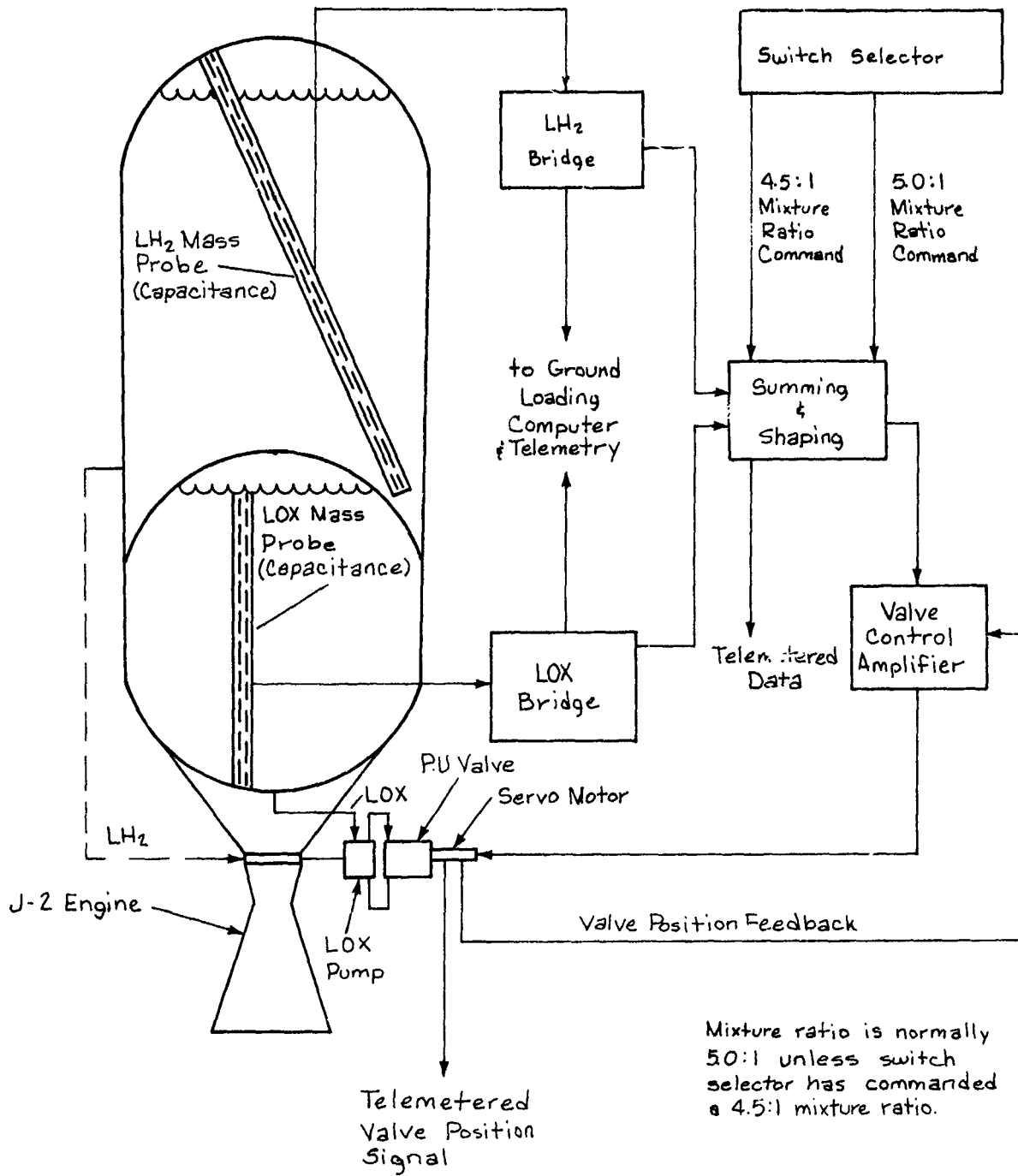

Figure 37

S-IVB Stage Propellant Management System

S-IVB THRUST VECTOR CONTROL SYSTEM

The single J-2 Engine is gimballed mounted on the longitudinal axis of the S-IVB Stage to provide pitch and yaw control during S-IVB powered flight. Engine gimbaling is accomplished by an independent closed loop hydraulic system which supplies power to the two servo-actuators. The two servo-actuators may extend or retract individually or simultaneously. Gimbal position is proportional to the magnitude of an electrical input to the electro-hydraulic servo valve located on each actuator. Mechanical feedback from the actuator to the servo valve completes the closed engine position loop.

During S-IC and S-II stage burns, the actuators hold the engine position to null. This is accomplished by utilizing the electrically driven auxiliary hydraulic pump. The auxiliary hydraulic pump is also used during orbit to periodically circulate the hydraulic fluid to prevent freezing. During the S-IVB burn, the main hydraulic pump, driven by the engine, provides the necessary pressure and circulation for actuator operation (pitch and yaw control). Roll control is provided by the Auxiliary Propulsion System (see page 71).

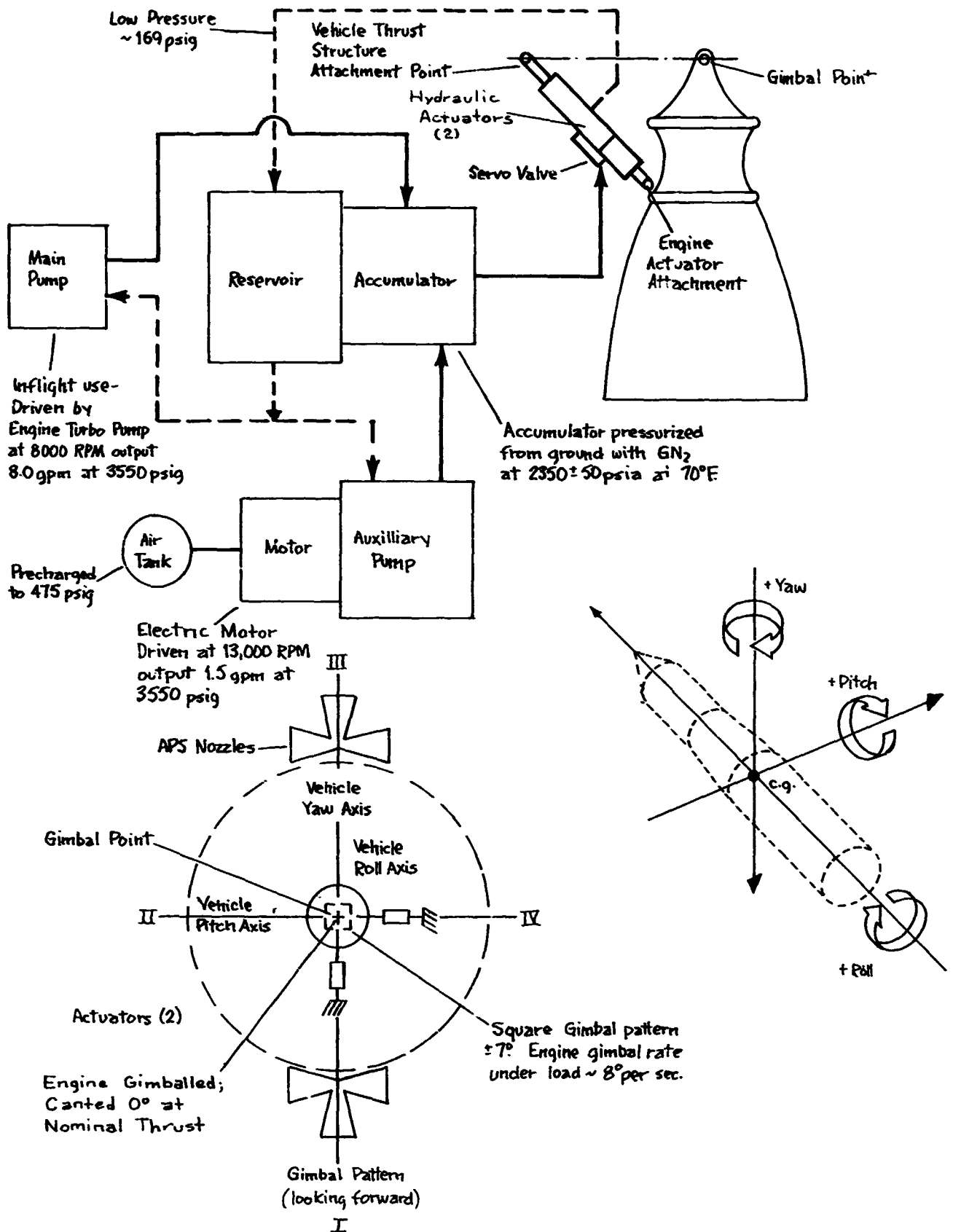

Figure 38

S-IVB Stage Thrust Vector Control System

AUXILIARY PROPULSION SYSTEM

The S-IVB Auxiliary Propulsion System (APS) provides vehicle attitude control during powered flight in the roll axis only and during S-IVB coast provides control in the pitch, yaw, and roll axes. Attitude corrections are made by firing the control engines, individually or in combination, in short bursts of approximately 65 ms minimum duration. Commands from the Flight Control Computer actuate fuel and oxidizer solenoid valve clusters that admit hypergolic propellants to the control engine combustion chambers.

The attitude control engines are located in two aerodynamically shaped modules, 180 degrees apart, on the aft end of the S-IVB stage (positions I and III). Each module contains four hypergolic engines, three 150 pound thrust attitude control engines and one 70 pound thrust ullage engine. The 70 pound thrust (ullage) engine in each module is used to settle the main stage propellants after S-IVB cutoff and again prior to restart. One control engine of each module is used to control the vehicles' attitude in pitch, while the other two are used for yaw and roll control.

Each APS module contains its own propellant supply and pressurization system. The hypergolic propellants used by the engines are monomethyl hydrazine (MMH) for the fuel and nitrogen tetroxide (N_2O_4) for the oxidizer. Helium is the pressurant used in the system.

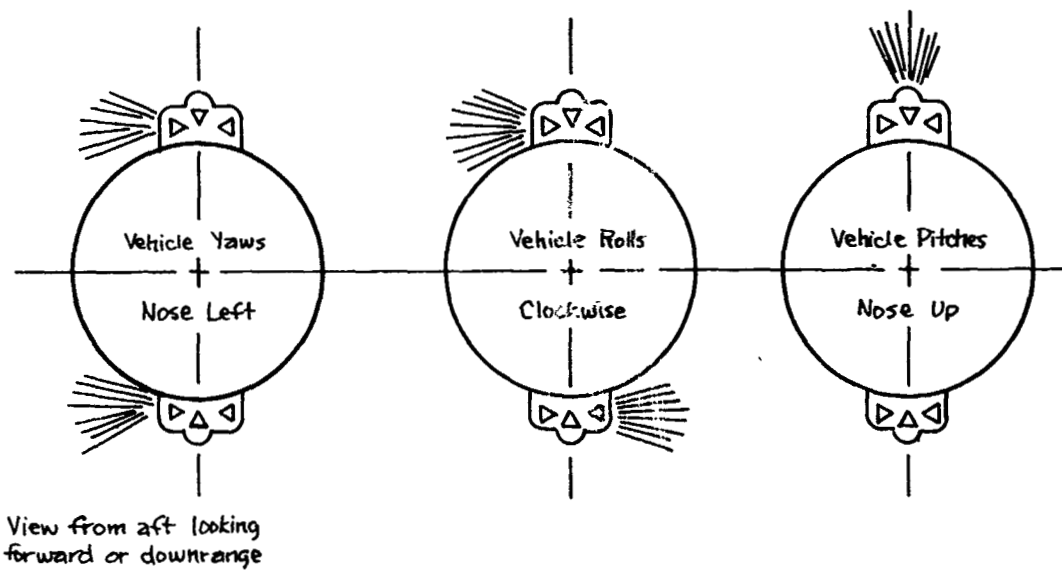
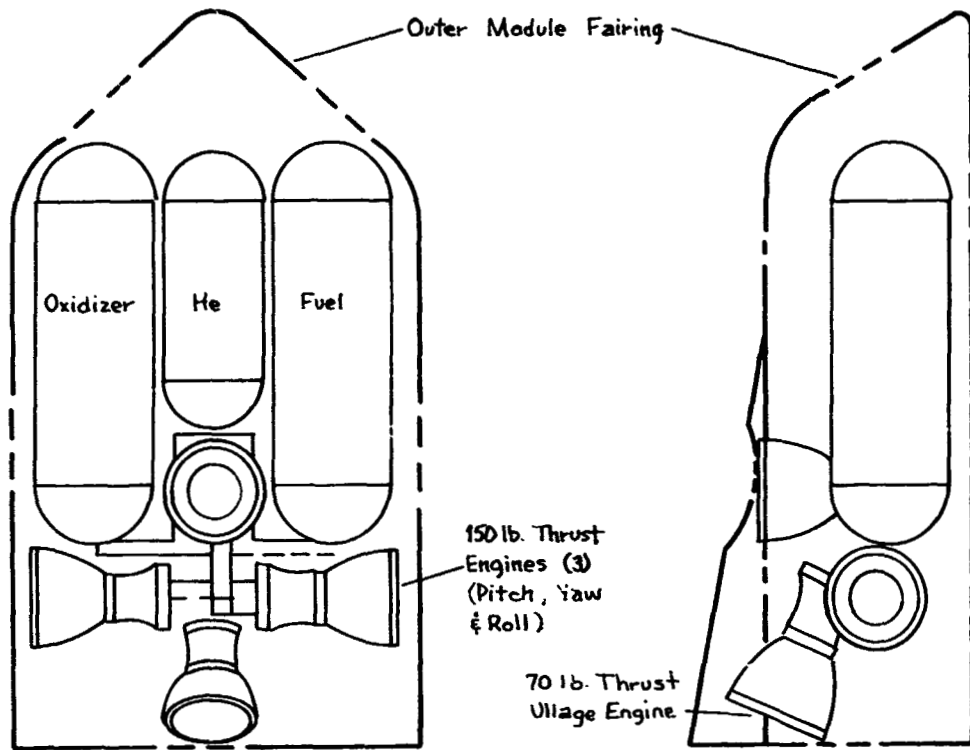

Figure 39

Auxiliary Propulsion System

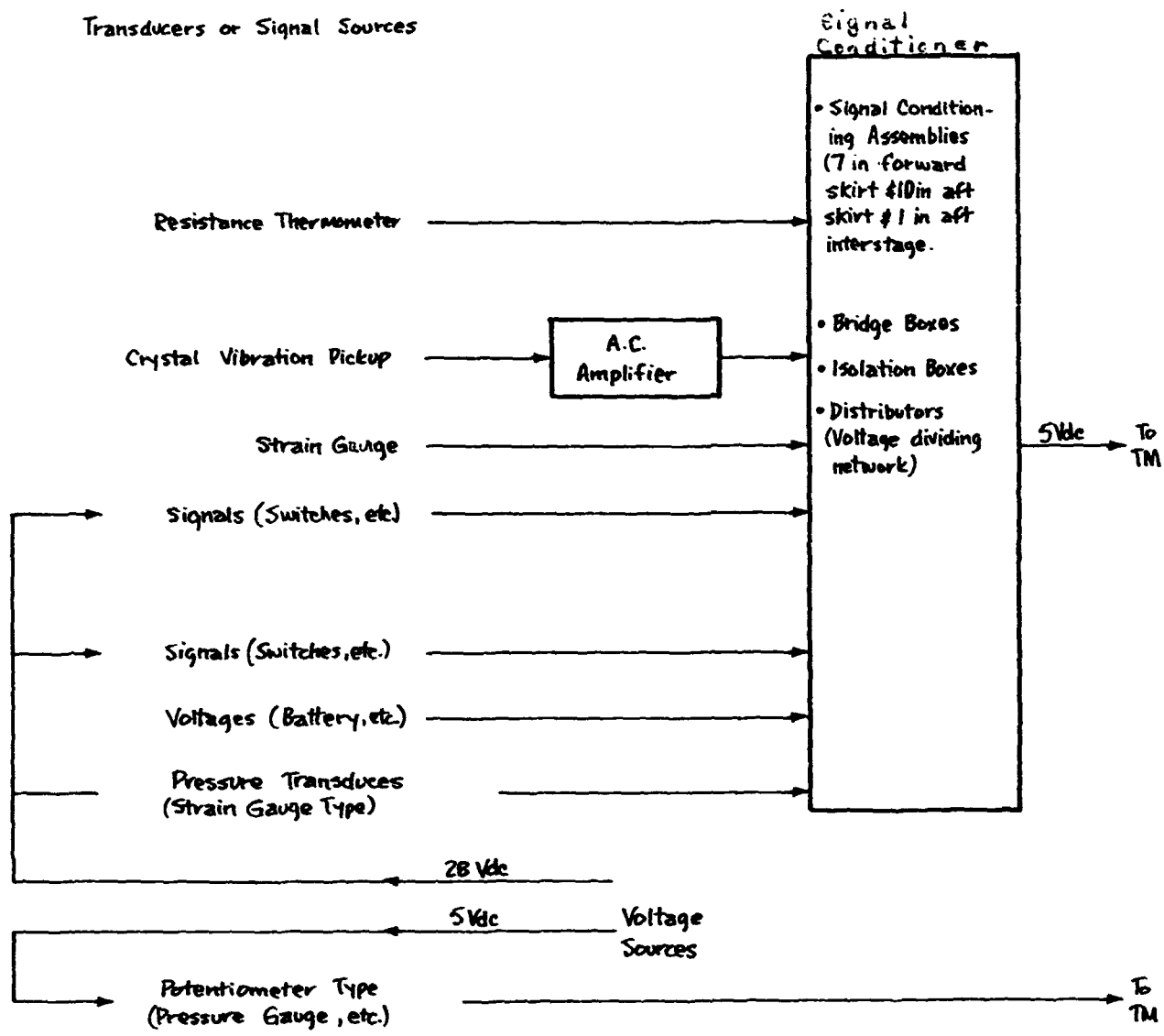

Figure 40

S-IVB Stage Measuring System

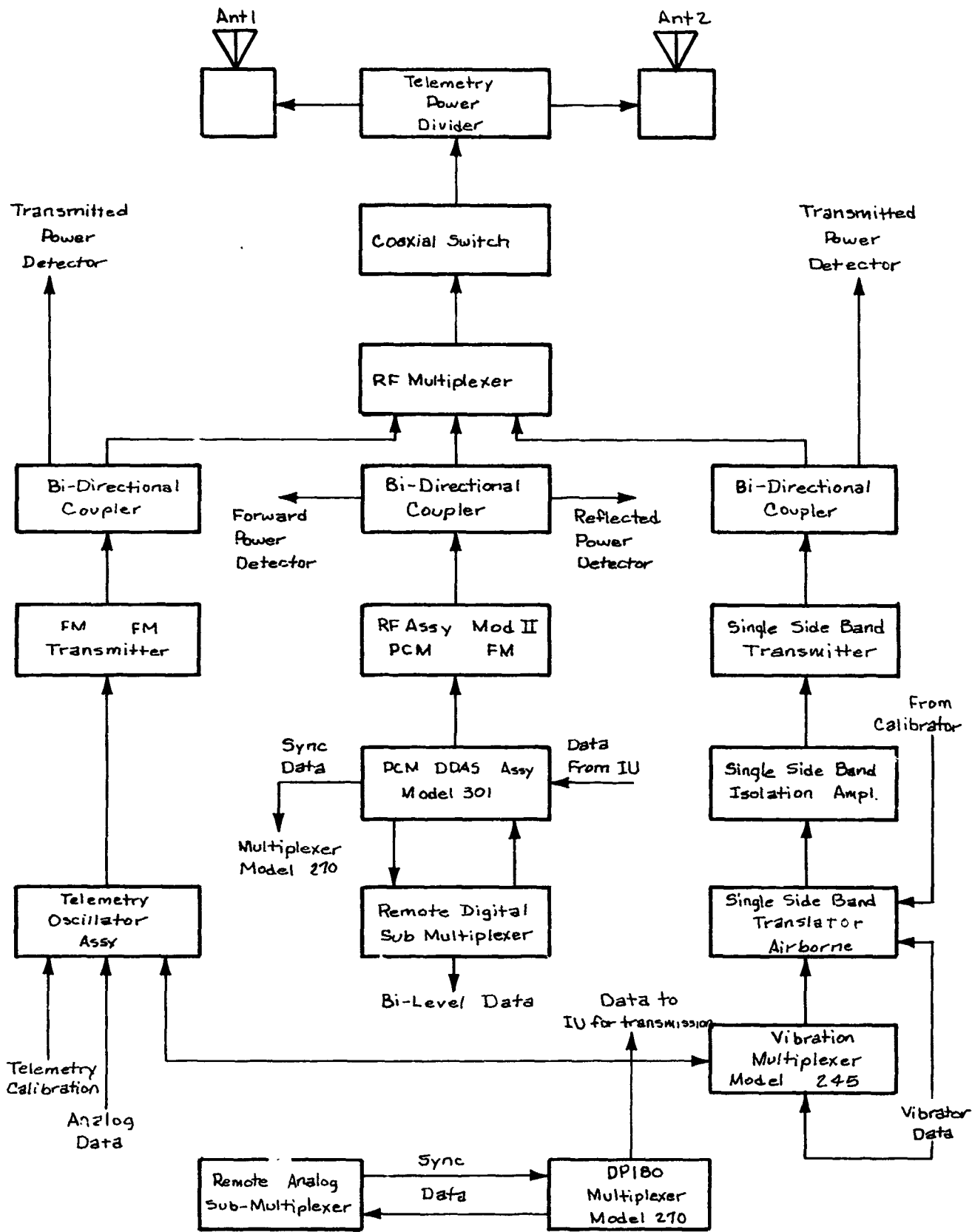

Figure 41

S-IVB Telemetry System

Note: Most forward Interstage Components Are Mounted On Coldplates

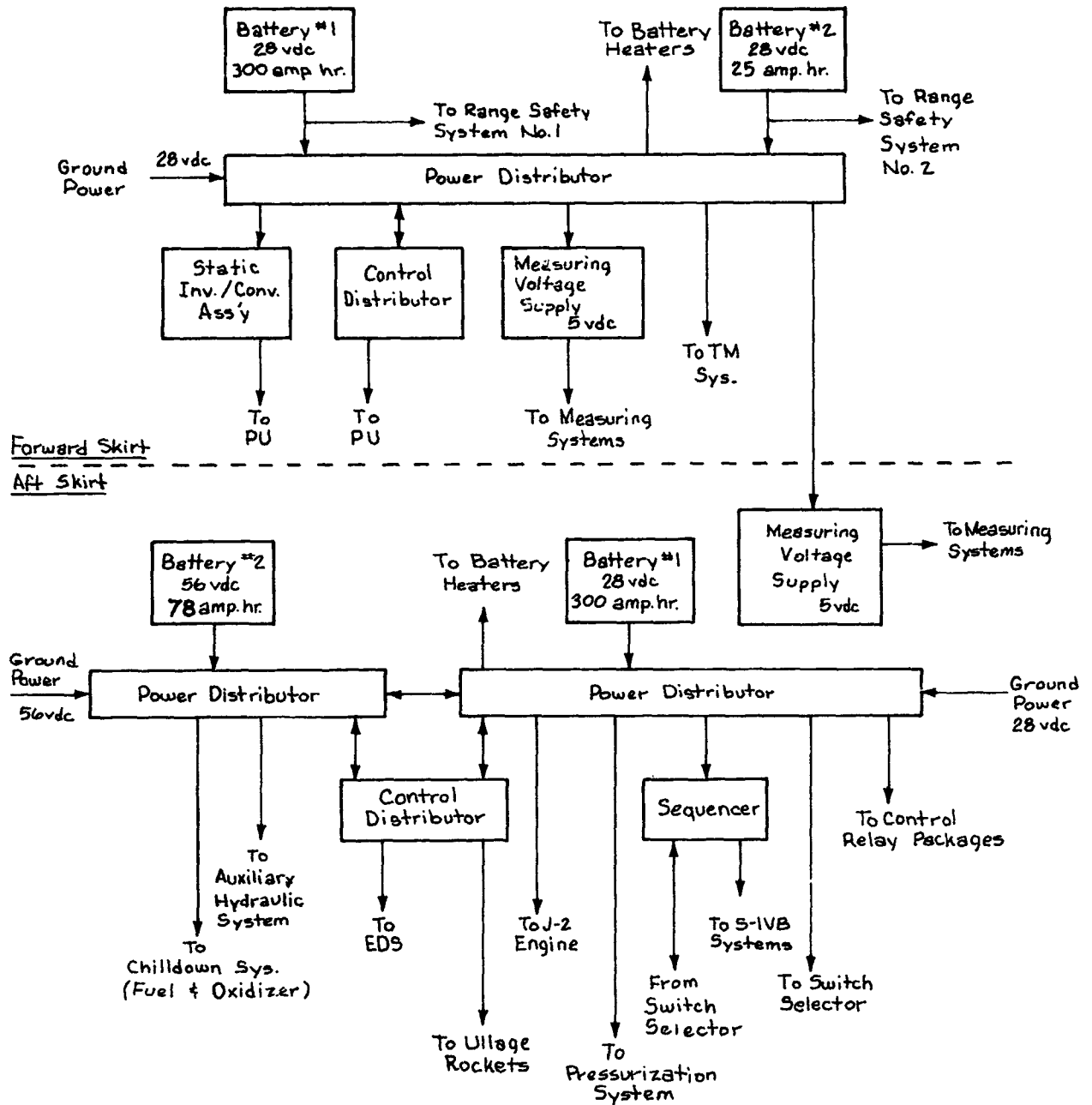

Figure 4-2

S-IVB Stage Electrical Power and Distribution System

S-IVB Battery Characteristics

- Type:
- Dry Charge
 - Silver-Zinc Oxide
 - Electrolyte - Potassium Hydroxide in Pure Water

Nominal Voltage: 28 (± 2) vdc (1.5 vdc per cell)

Note: Aft Battery No. 2 uses two 28 volt batteries, series connected to provide a 56 volt output.

Batteries

	<u>Fwd. #1</u>	<u>Fwd. #2</u>	<u>Aft #1</u>	<u>Aft #2</u>
Current Rating:	300 Ampere Hours	25 Ampere Hours	300 Ampere Hours	78 Ampere Hours
Gross Weight:	83 lbs	20 lbs	83 lbs	150 lbs

INSTRUMENT UNIT

The Instrument Unit is a cylindrical structure approximately 260 inches in diameter and 36 inches high which is attached to the forward end of the S-IVB stage. IU structure is composed of an aluminum alloy honeycomb sandwich material which was selected for its high strength-to-weight ratio, acoustical insulation, and thermal conductivity properties.

The cylinder is composed of three 120 degree segments--the access door segment, the flight control computer segment, and the ST-124-M segment.

The IU Stage contains:

- Guidance, Navigation and Control Equipment
- Telemetry Systems
- Tracking Systems
- Crew Safety Systems
- Environmental Control System

The guidance, navigation and control equipment contained in the IU includes that which is necessary for vehicle guidance and control during boost through orbital coast and subsequently for translunar injection.

Telemetry along with measuring systems is used to monitor certain conditions and events which take place in the IU and to transmit these monitored signals to ground receiving stations.

Tracking systems assist in the determination of the vehicle's trajectory. Tracking data is used for mission control, range safety and post flight evaluation of vehicle performance.

Crew Safety is provided by the Emergency Detection System, a portion of which is located in the IU stage. EDS senses conditions in the vehicle during boost phase which could cause vehicle failure.

Environmental Control maintains an acceptable operating environment during pre-flight and flight operations.

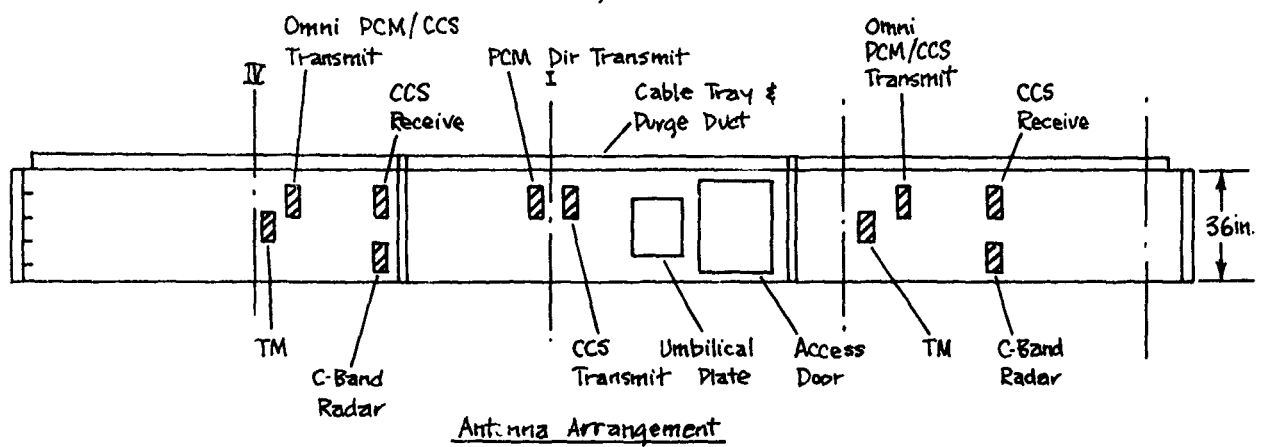
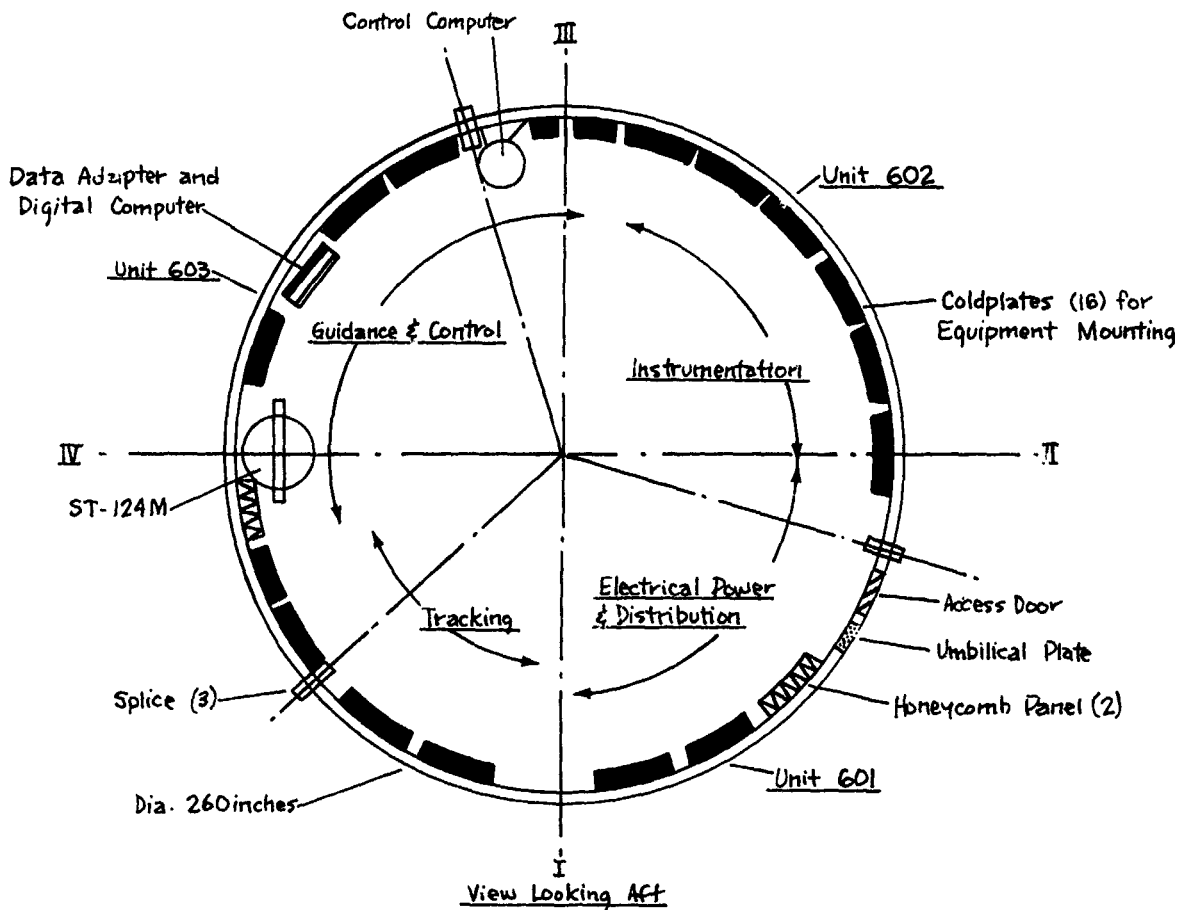

Weight:
 • Dry ~ 4,250 lbs.
 Serviced ~ 4,400 lbs.

Figure 43

Instrument Unit Configuration

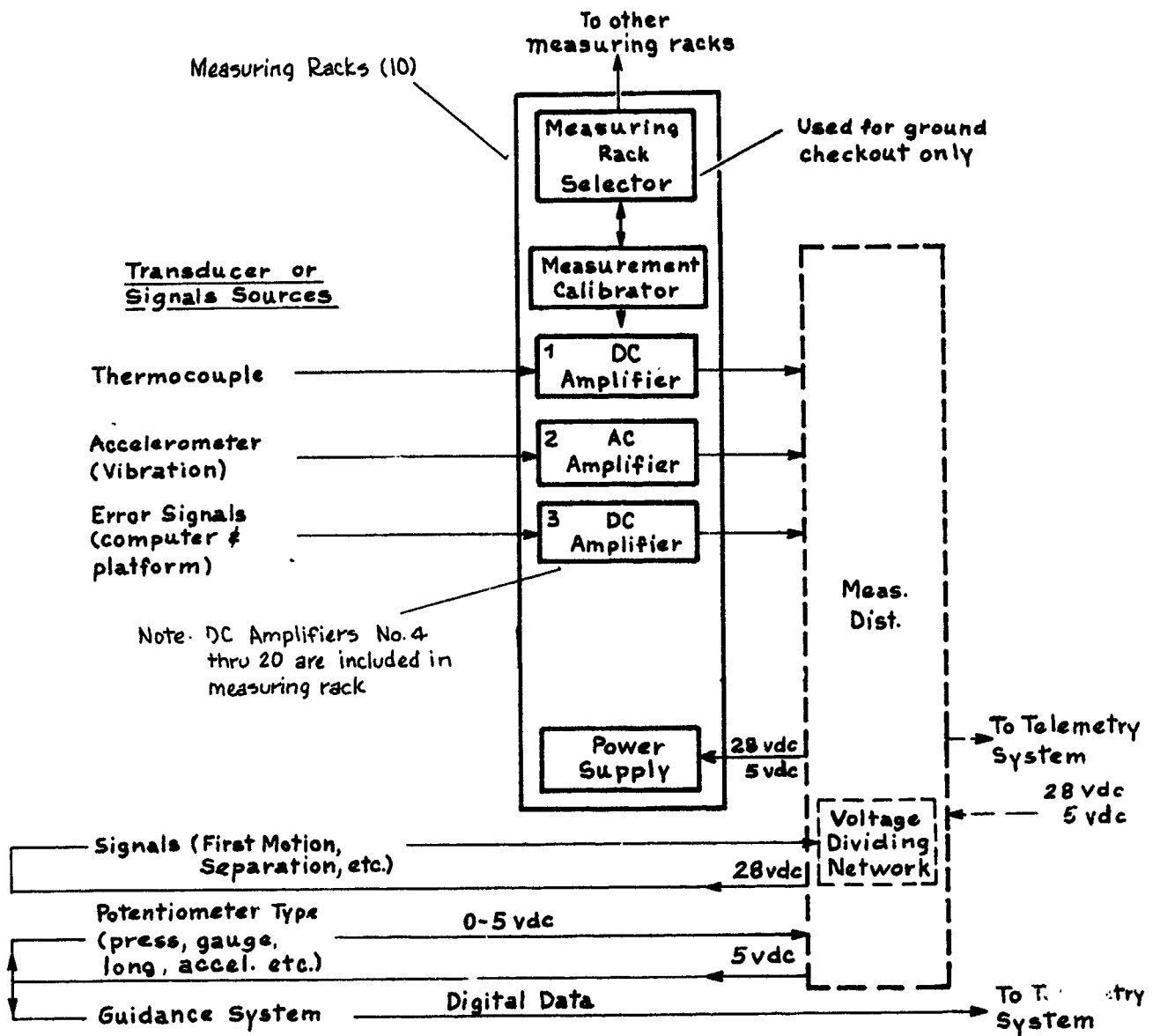

Figure 44

Instrument Unit
Measuring System

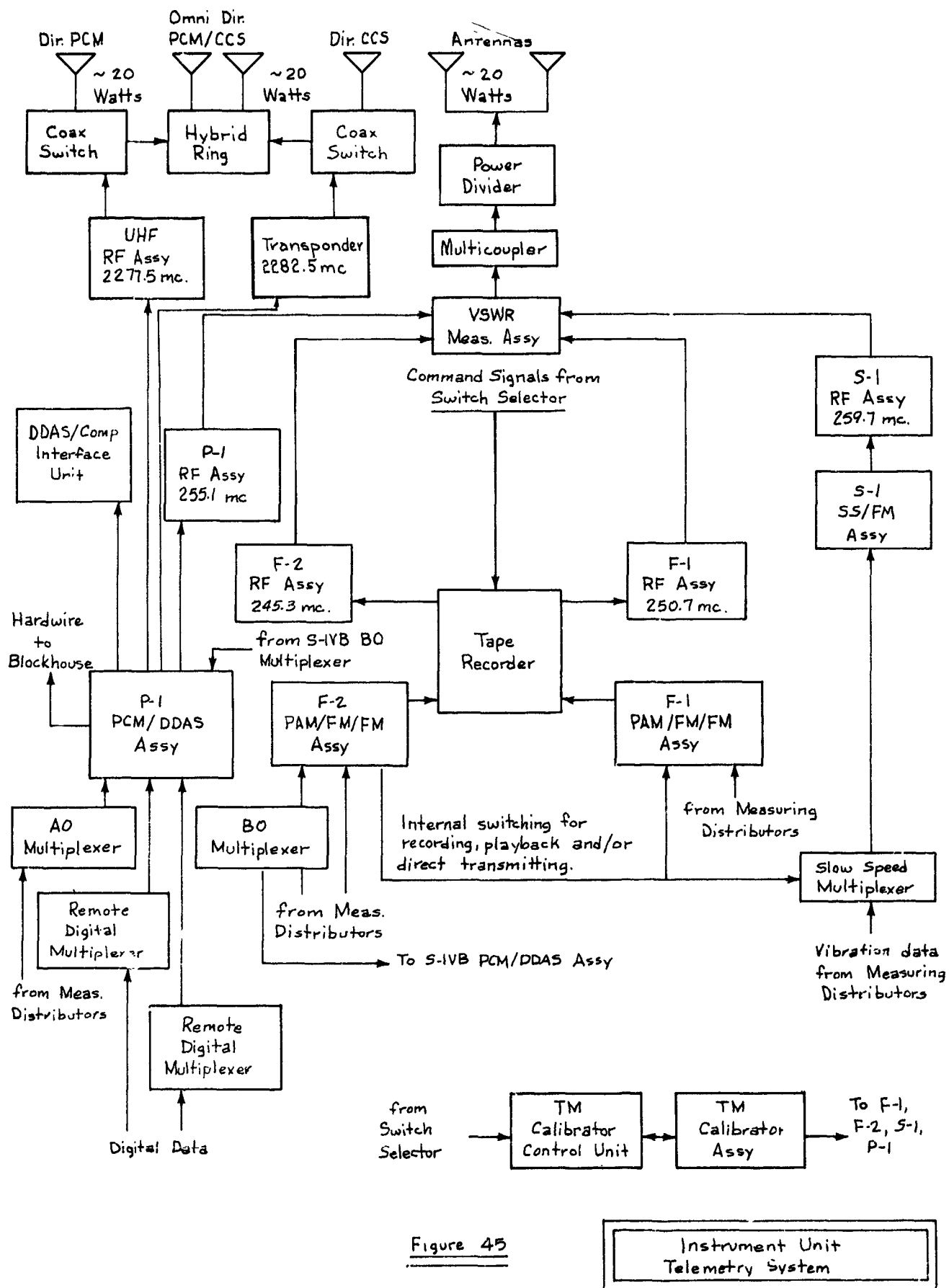

Figure 45

Instrument Unit Telemetry System

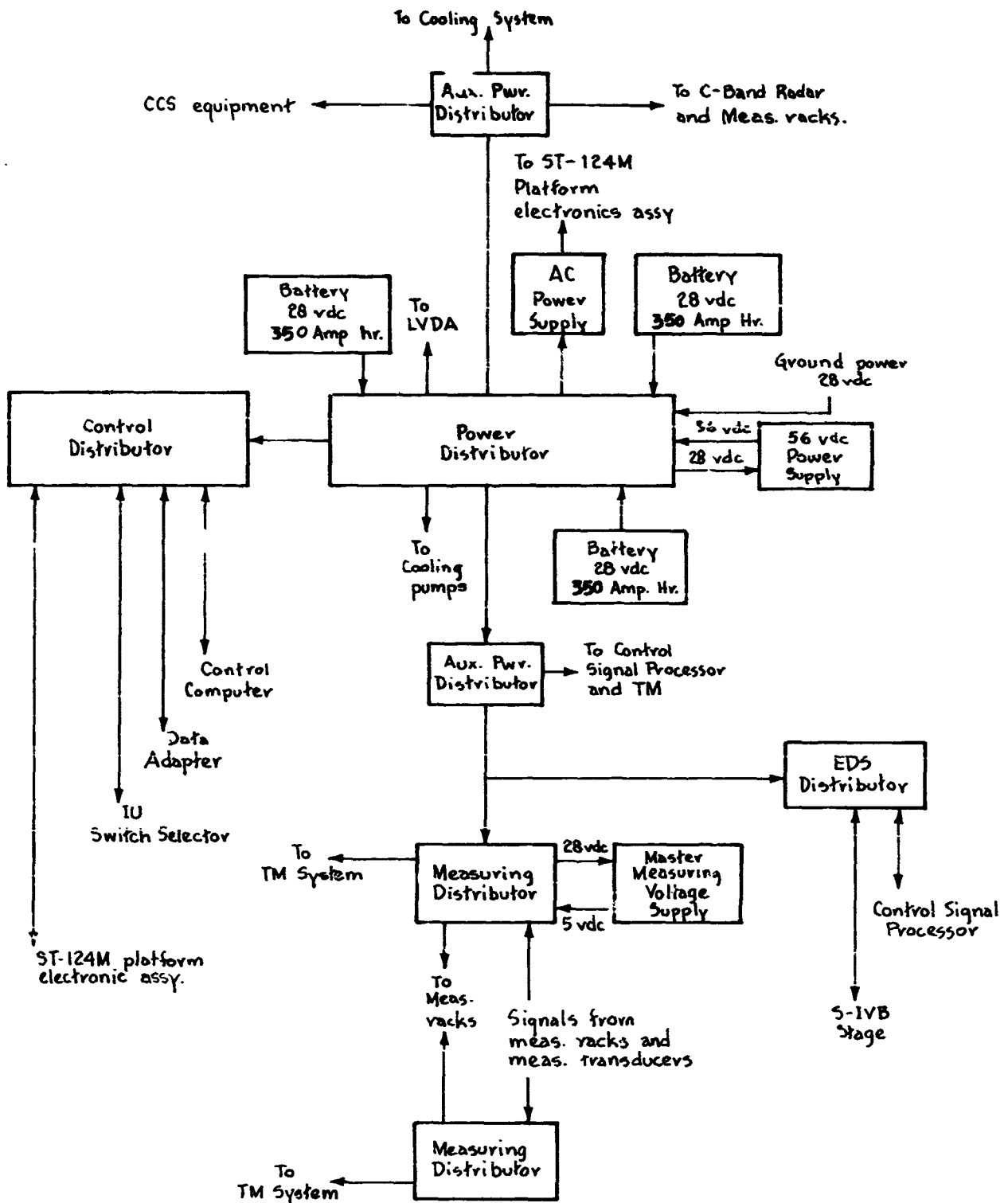

Figure 46

Instrument Unit Electrical Power and Distribution System

IU Stage Battery Characteristics

- Type:**
- Dry charge
 - Silver-Zinc Oxide
 - Electrolyte - Potassium Hydroxide in Pure Water.
- Nominal Voltage:** 28 ± 2 vdc (1.5 vdc per cell)
- Current Rating:** 350 amp/hours
- Gross Weight:** 165 lbs per battery (3 batteries are used in the IU Stage)

ENVIRONMENTAL CONTROL SYSTEM (ECS)

The Environmental Control System (ECS) has been developed to maintain an acceptable operating environment for the IU/S-IVB equipment during preflight and inflight operations.

The ECS is made up of the following:

- Thermal Conditioning System - maintains a circulating Methanol Water coolant temperature of approximately $59^{\circ} \pm 1^{\circ}\text{F}$.
- Preflight Purging System - maintains a supply of temperature and pressure regulated air/ GN_2 in the IU/S-IVB equipment.
- Gas Bearing Supply System - furnishes GN_2 to the ST-124-M3 inertial platform gas bearings.
- Hazardous Gas Detection System - monitors the IU/S-IVB forward interstage area for the presence of hazardous vapors.

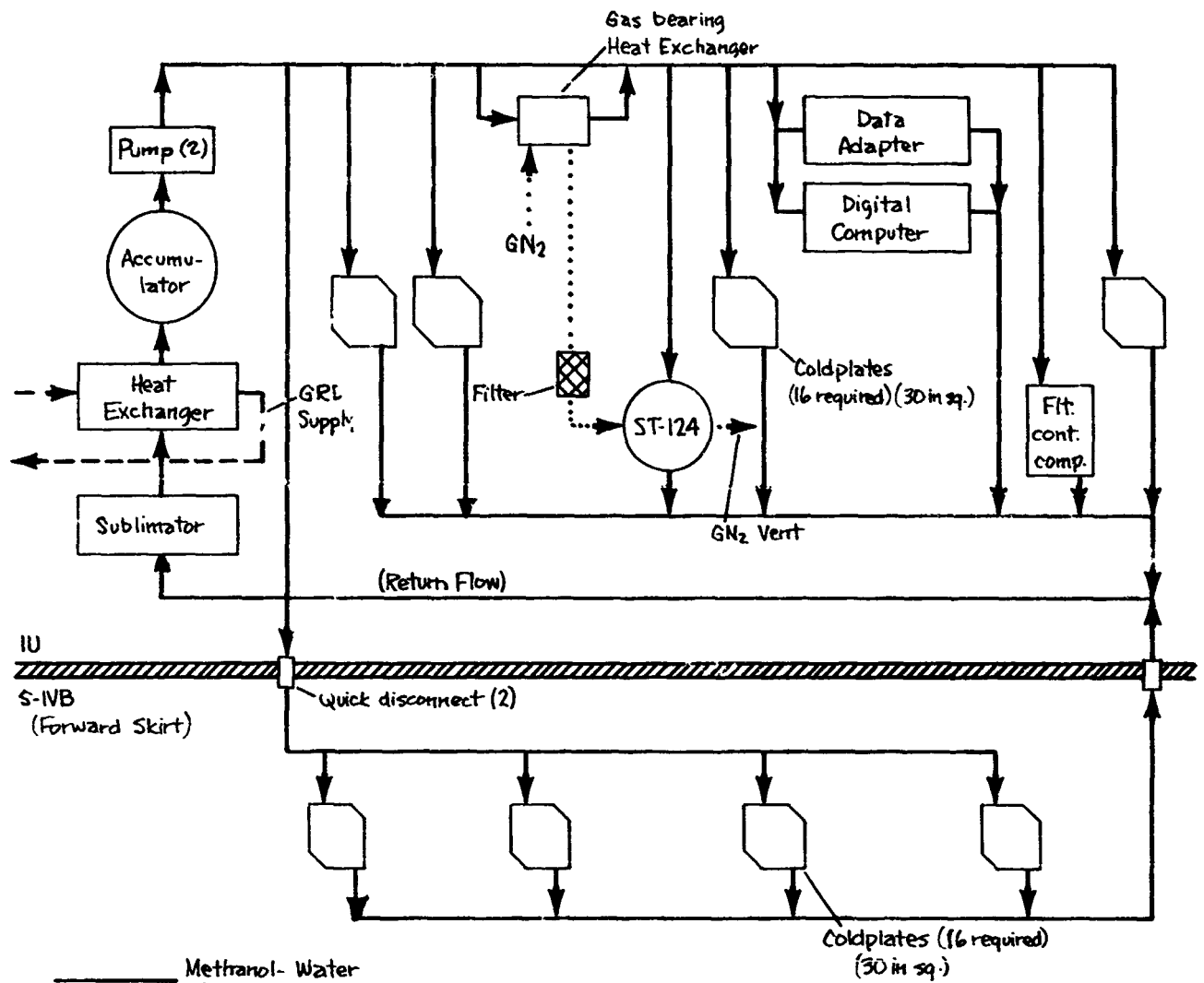

_____ Methanol-Water
 (closed system)
 - - - - - Methanol-Water
 (GSE supplied)
 GN₂

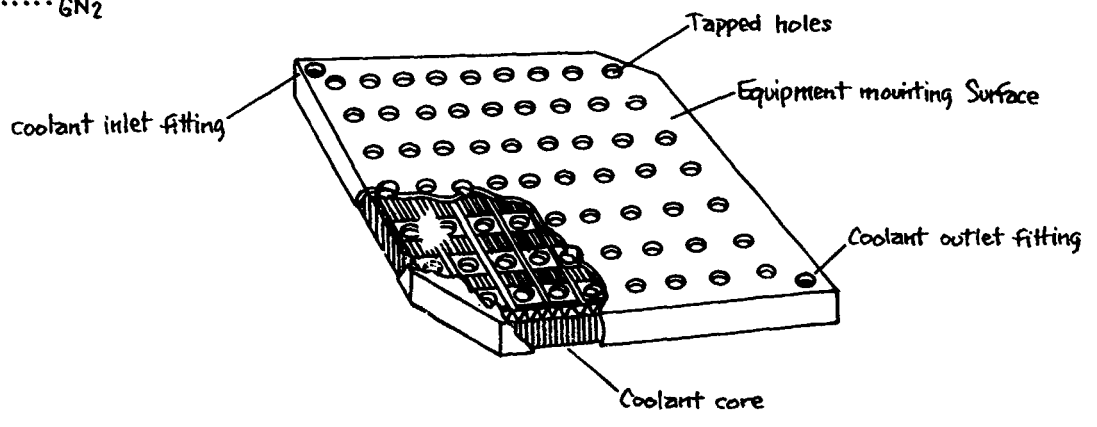

Typical Coldplate

Figure 47

IU/S-IVB Environmental Control System

SPACECRAFT DESCRIPTION

The Spacecraft for the AS-505 mission is composed of:

Launch Escape System (LES)
Command Module (CM)
Service Module (SM)
Lunar Module (LM)
Spacecraft Lunar Module Adapter (SLA)

Launch Escape System

The Launch Escape System, which is jettisoned approximately 35 seconds after S-II Ignition, is made up of a Launch Escape Tower (LET), and a three-motor propulsion system (Tower Jettison, Launch Escape and Pitch Control Motors).

Command Module

The Command Module is a Block II Configuration. The module's inner structure, or pressure vessel, is separated from the outer structure by a layer of insulation. A heat shield structure is made up in three segments consisting of a forward heat shield, a crew compartment heat shield, and an aft shield. The CM is slightly over 11 feet in length and is about 12 feet in diameter. A propulsion system consists of Reaction Control Engines which may operate pulsed or continuous.

Service Module

The Service Module may be described as a cylindrical, aluminum shell which is made up of honeycomb-sandwich panels and a forward and aft bulkhead. One gimballed propulsion engine (capable of up to 30 restarts) and a reaction control system (4 clusters, 4 chambers each) make up the SM Propulsion System. The Command and Service Module are joined by 3 tension ties each of which is equipped with explosive charges for SM/CM separation.

Lunar Module

The Lunar Module consists primarily of an Ascent and Descent Stage. The Ascent Stage, which contains the crew compartment, is equipped with a Reaction Control System which provides thrust capability, an ingress and egress hatch to the crew's compartment, VHF, S-Band and Rendezvous Radar capabilities plus numerous instrumentation and controls. The Descent Stage, consists primarily of a descent engine and four retractable landing gear assemblies. Over all weight of the Lunar Module is approximately 32,000 pounds.

Spacecraft Lunar Module Adapter

The Spacecraft Lunar Module Adapter (SLA) joins the Service Module (SM) to the S-IVB/IU. The SLA encloses the Lunar Module. Adapter panels which enclose the Lunar Module are jettisoned prior to docking and Lunar Module extraction.

Weights:

- Liftoff ~ 107,400 lbs.
- At Injection ~ 98,500 lbs.
- *(LES wgt. included)
- LES weight ~ 8900 lbs.
- Command Module ~ 12,300 lbs.
- Service Module ~ 10,600 lbs.
- Lunar Module ~ 30,850 lbs.

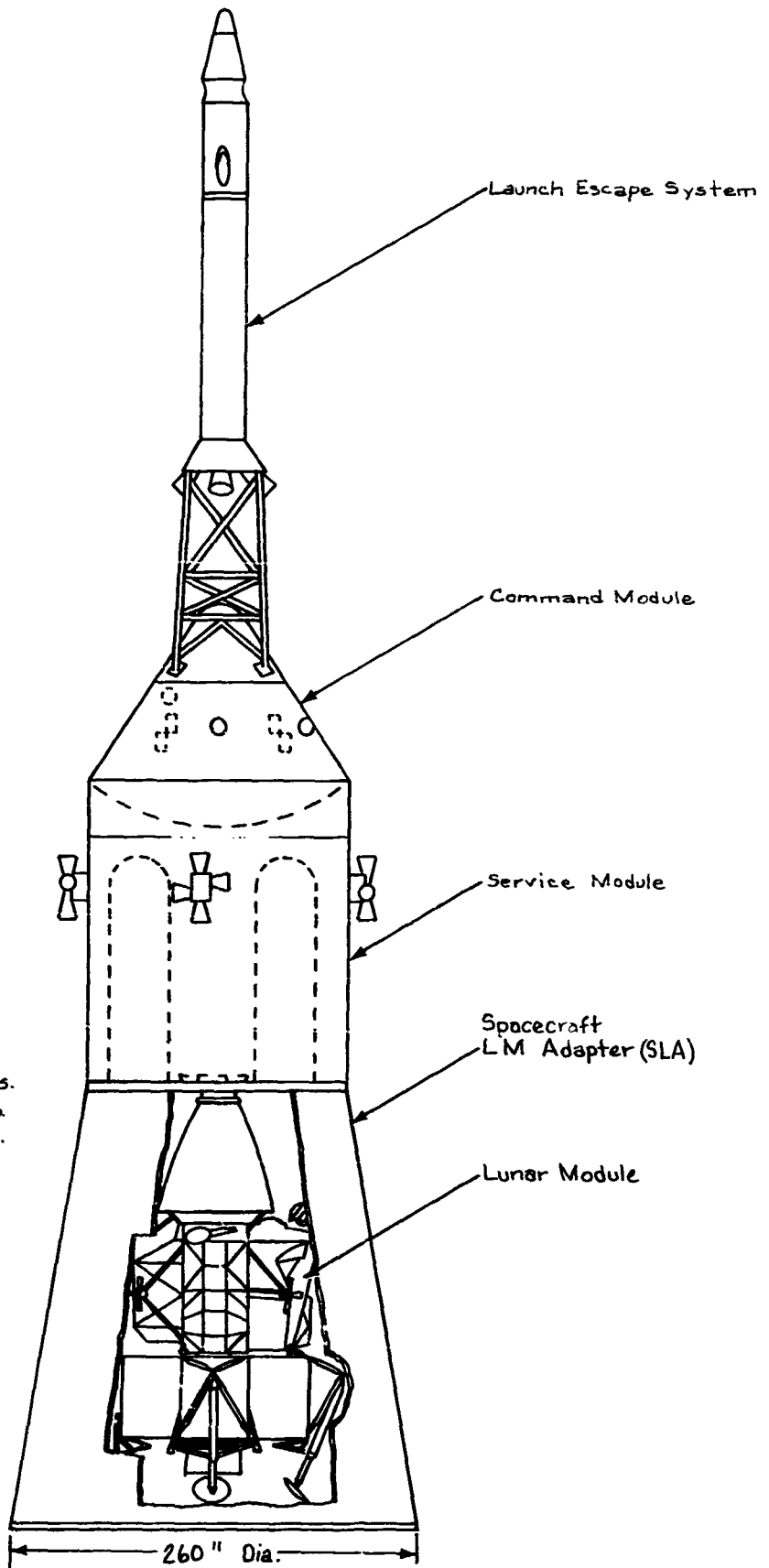
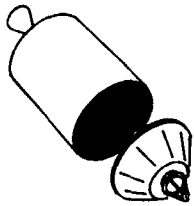
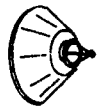

Figure 48

Spacecraft Configuration



SPS Deorbit Burn and CM/SM Separation



CM Re-entry



Drogue Chutes Deployed

~ 1min after parachute descent begins, drogue chutes are jettisoned and main chutes are deployed.

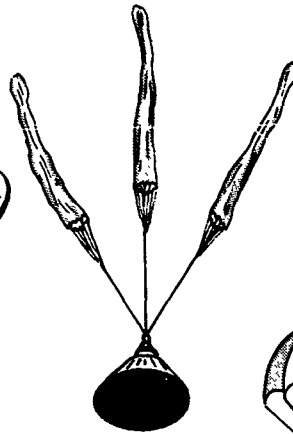
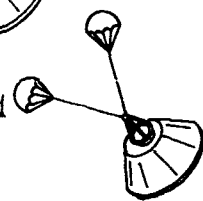

Main Chutes Released (Reefed)

Main Chutes Fully Deployed

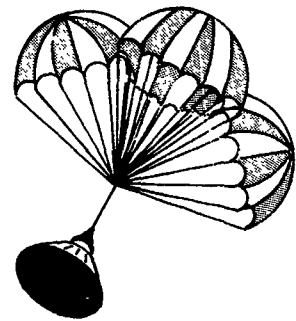

Note:

The desired flotation mode after splashdown is with CM Apex Up



To achieve this mode, the flotation bags are released from the forward hatch causing the module to float upright.

Apex Down



Apex Up

Flotation Bags



Main Chutes Released at Splashdown

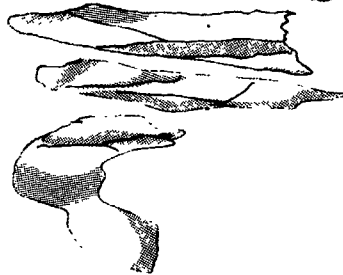

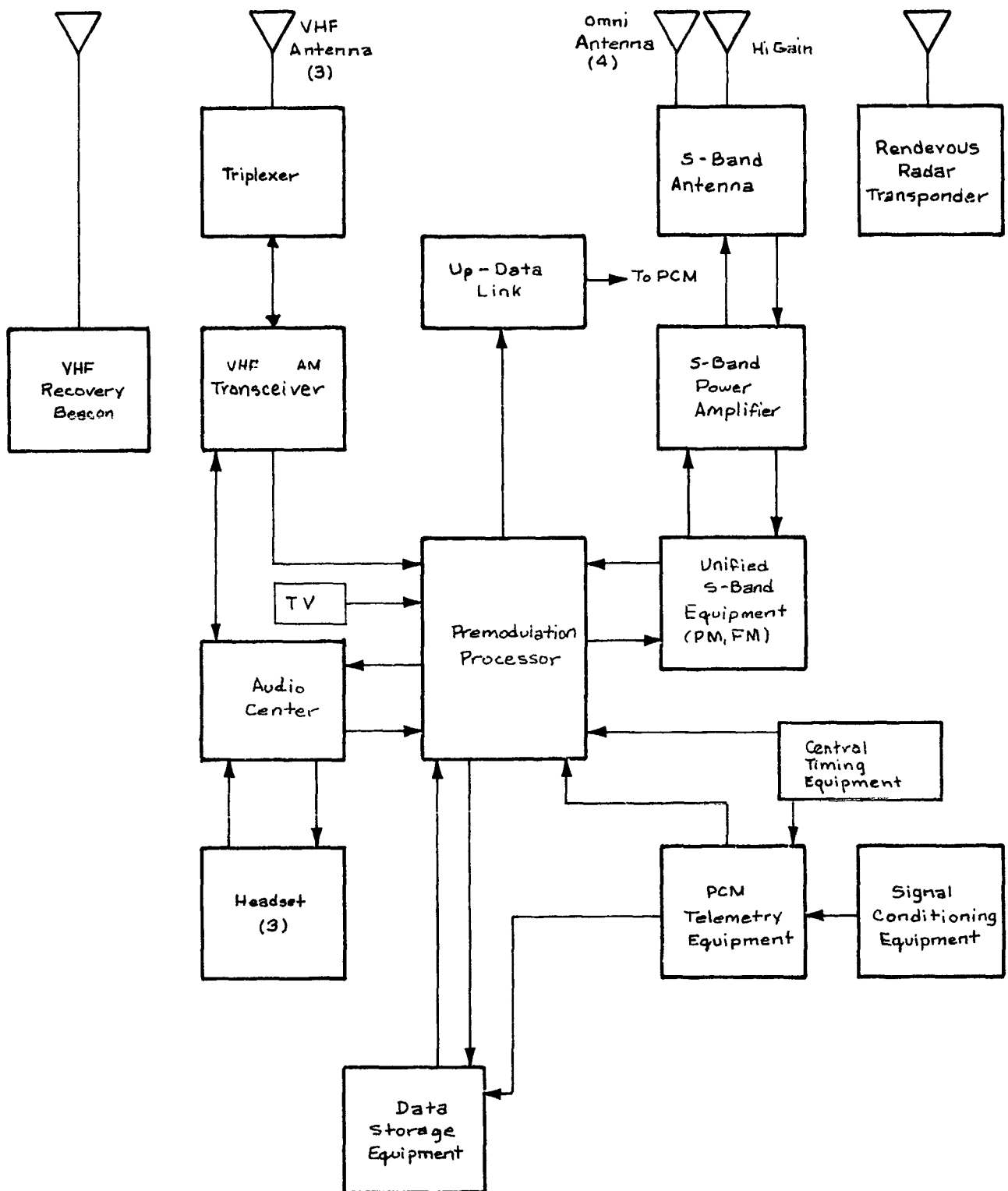

Figure 49

CM Telecommunication System

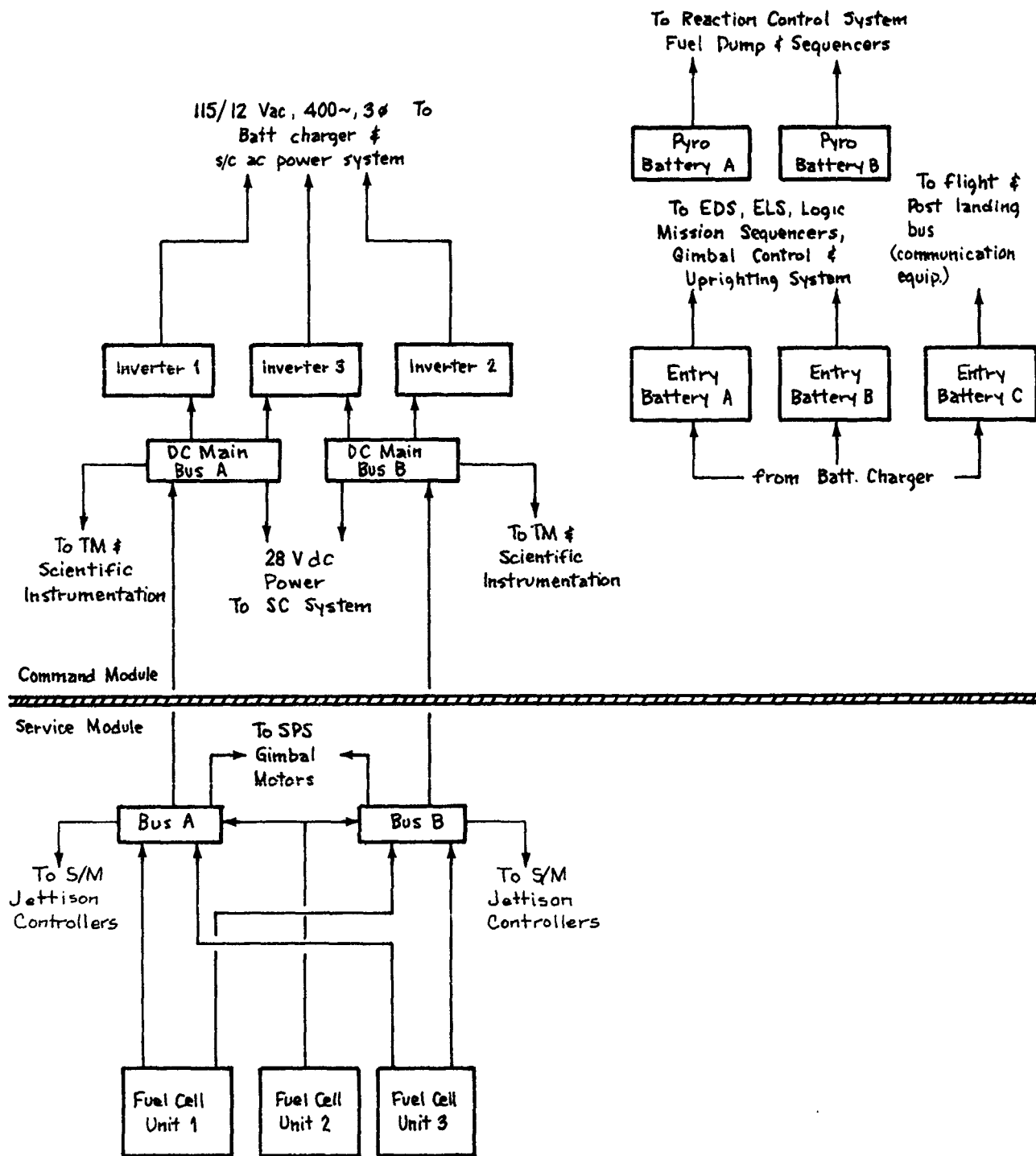

Figure 50

Spacecraft Electrical Power & Distribution System

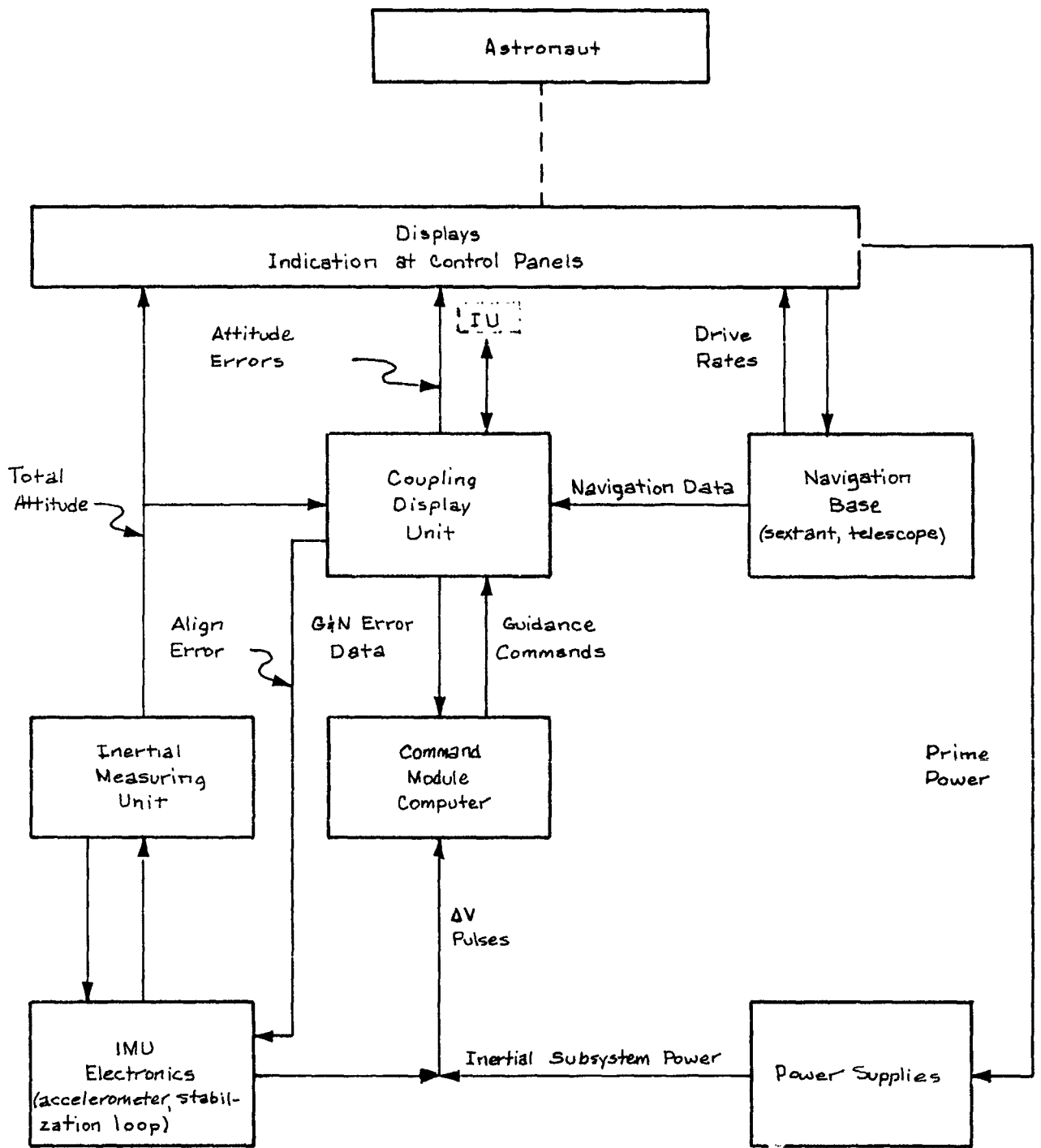

Figure 51

Spacecraft Guidance & Navigation System

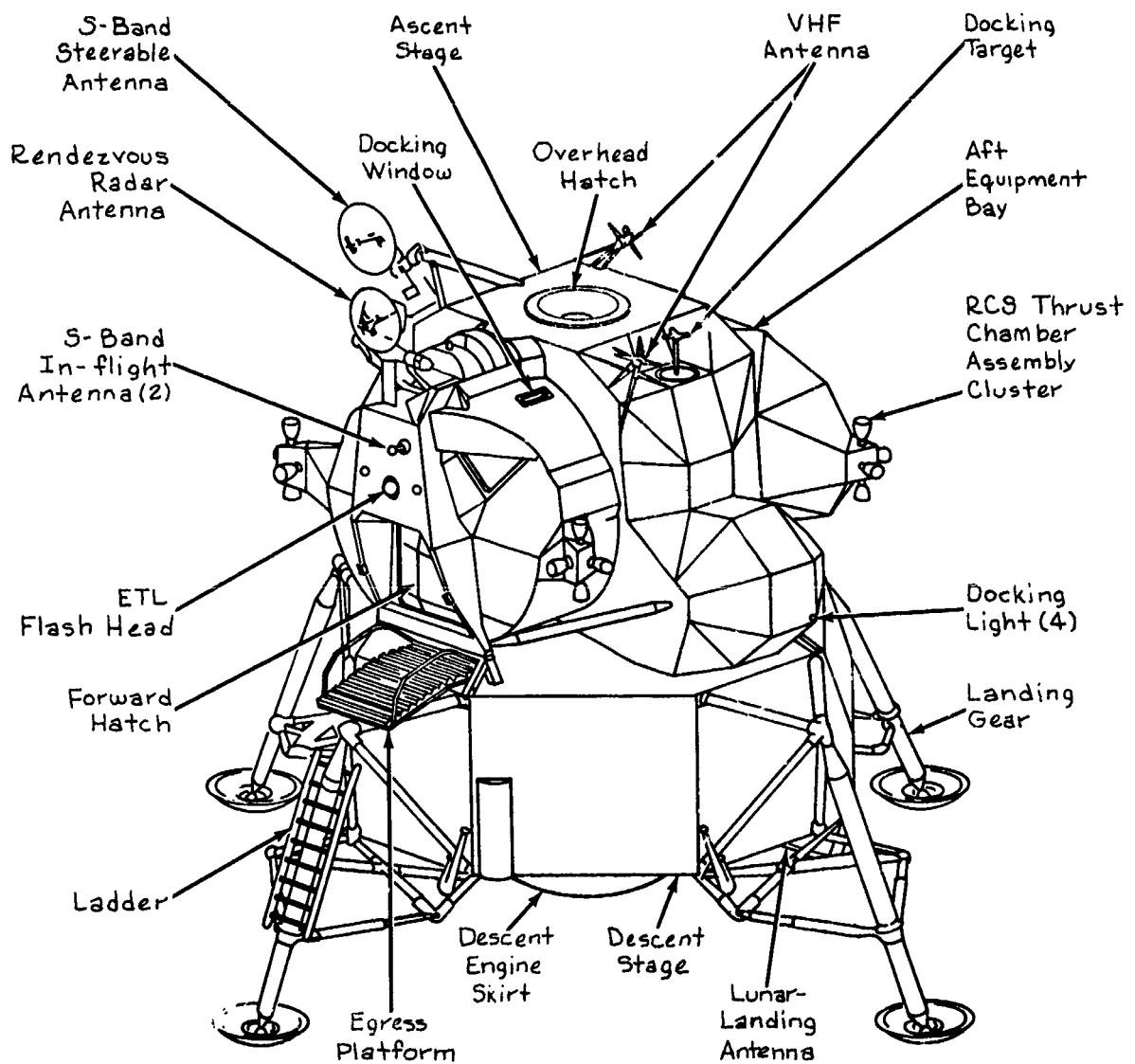

Figure 52

Lunar Module (LM)

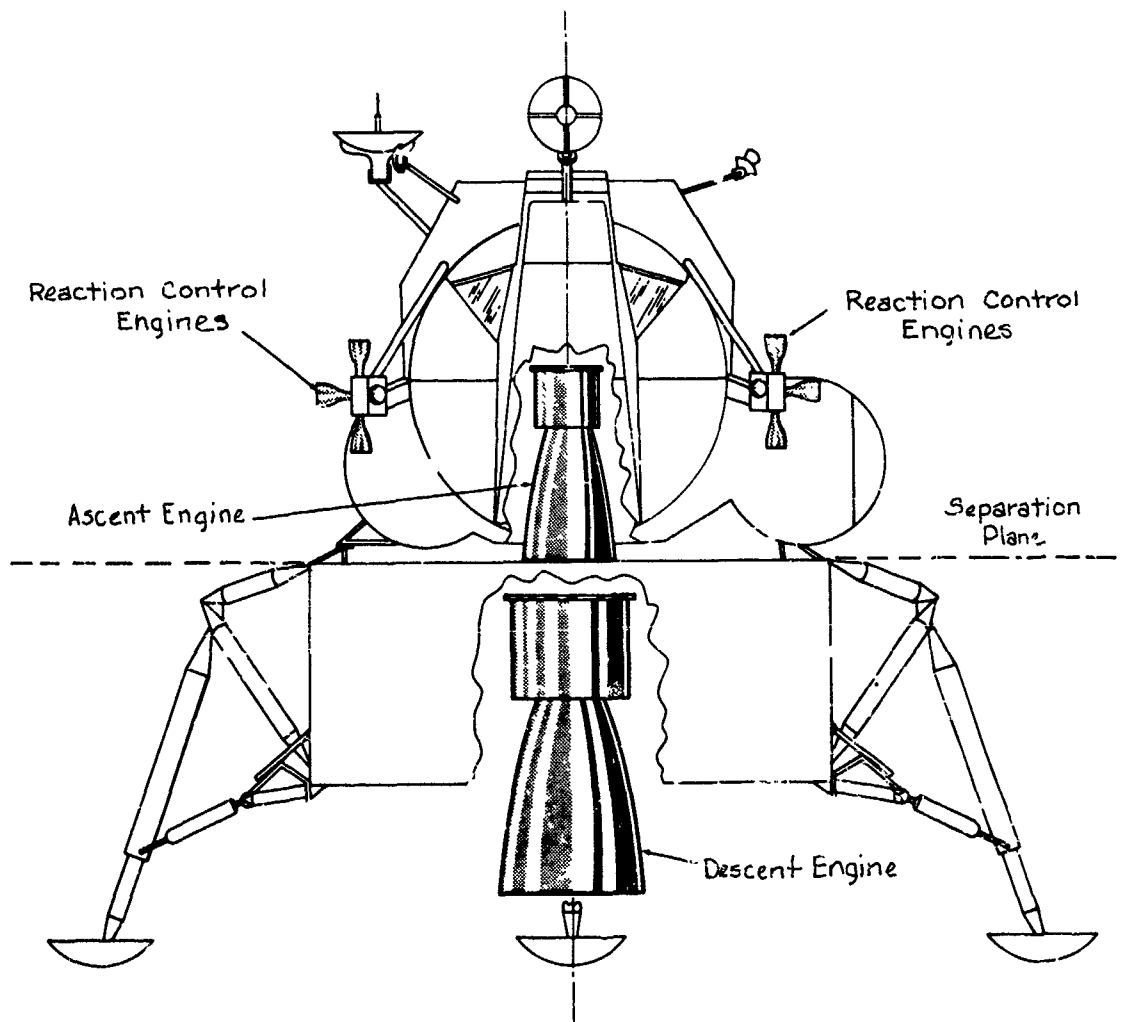

Figure 53

LM Engine Locations

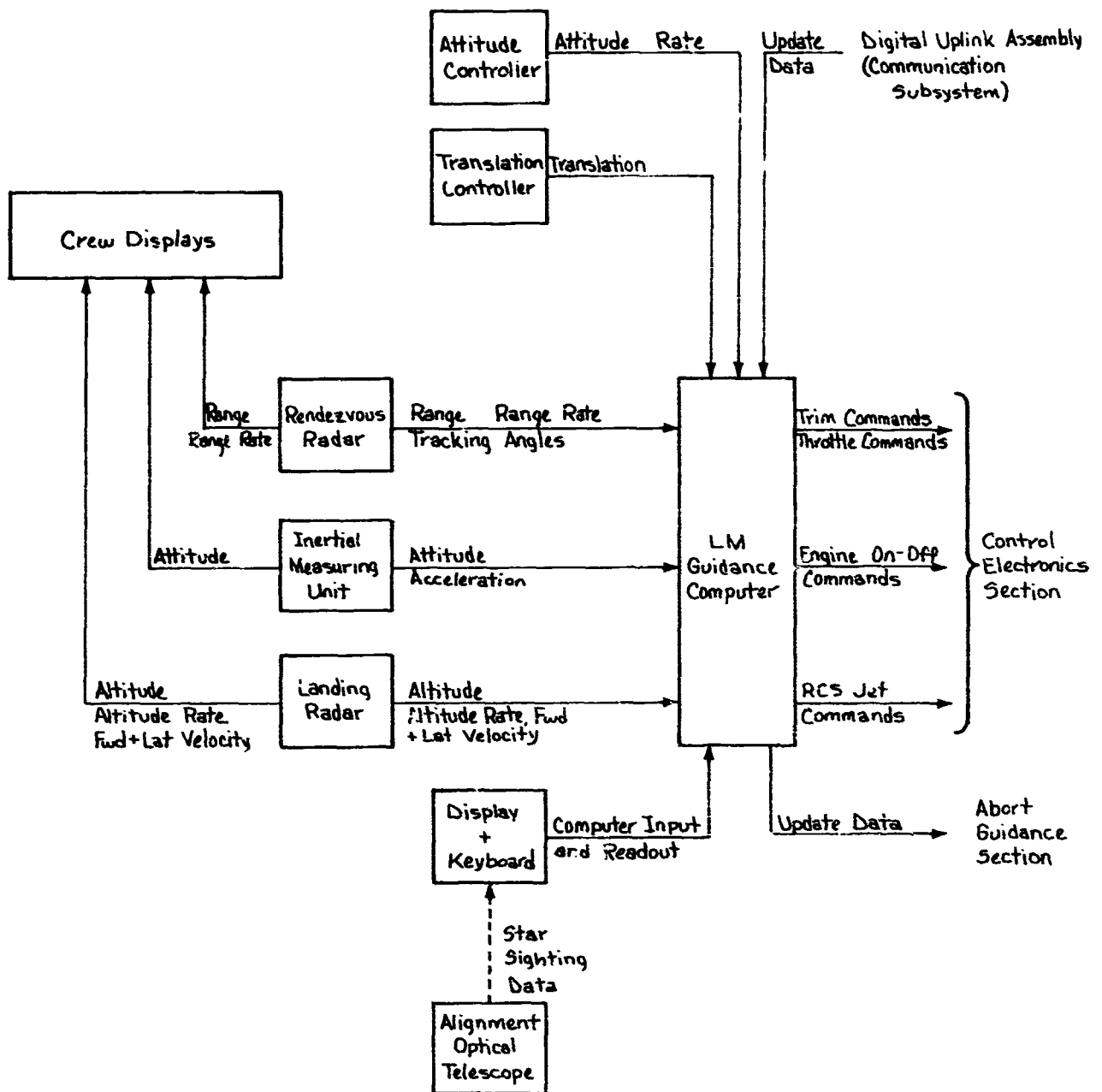

Figure 54

LM Guidance and Navigation Section

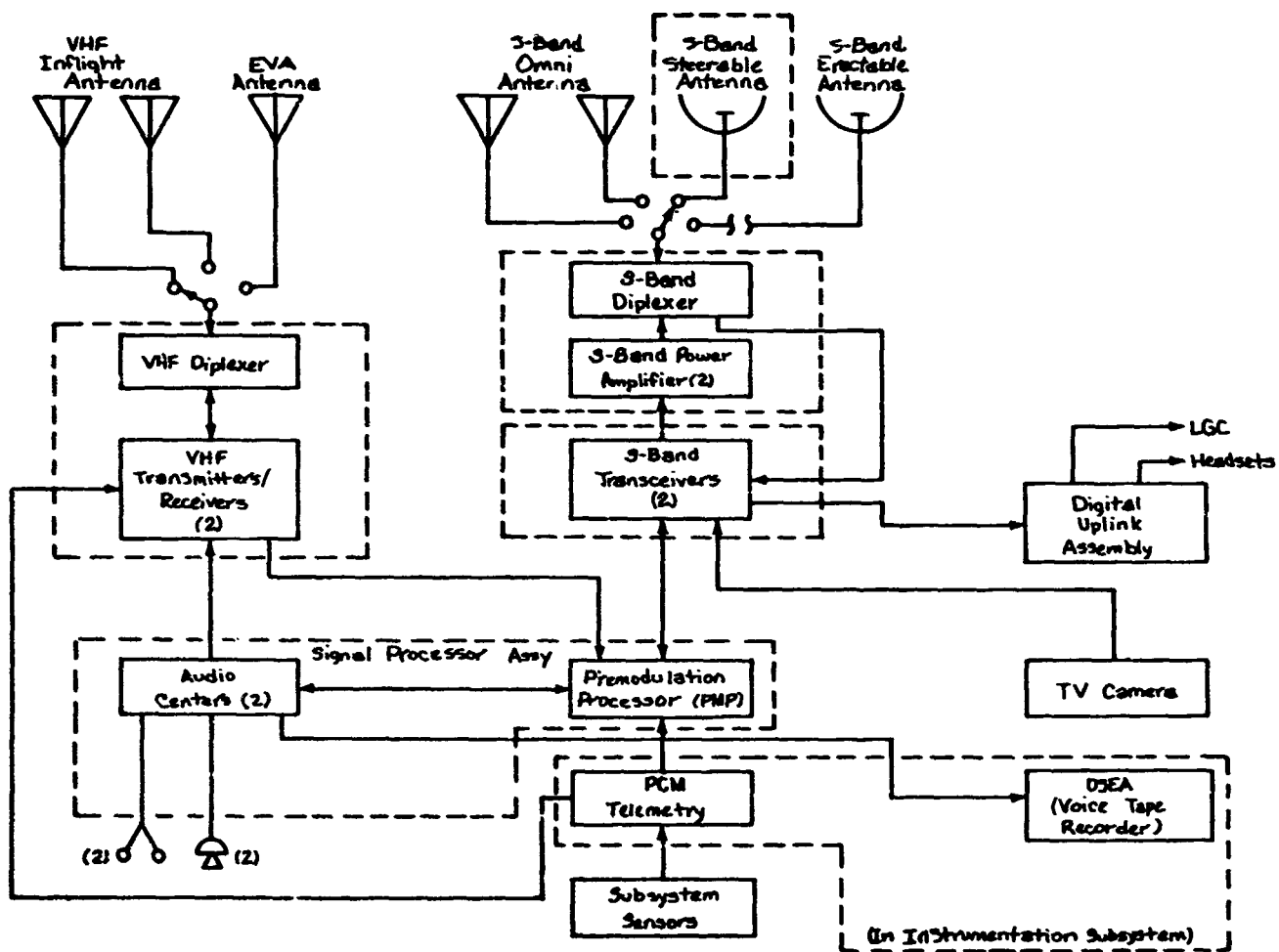

Figure 55

LM Communications Subsystem

DISTRIBUTION

DIR	Dr. von Braun (1)	A&T-MS-IL	Library (2)
AD-S	Dr. Rees (5)	S&E-SSL-DIR	Dr. Stuhlinger (2)
DEP-T	Mr. Neubert (40)	S&E-DIR	Mr. Weidner (2)
PA	Mr. Jones (2)	PM-SAT-MGR	Mr. Tier (1)
DIR-PM	Gen. O'Connor (1)	PM-SAT-E	Mr. Huff (1)
	Dr. Mrazek (1)	S&E-AERO-P	Mr. Teague (60)
	Dr. Farish (50)	S&E-CSE	Mr. Richards (2)
I-K	Mr. Montgomery (10)	S&E-COMP	Mr. Cochran (6)
PM-EP	Mrs. Watson (25)	S&E-ME-DIR	Mr. Kuers (10)
PM-MO-MGR	Dr. Speer (5)	S&E-QUAL-J	Mr. Klauss (10)
PM-MO-F	Mr. Park (10)		Mr. Crews (1)
PM-MO-OL	Mrs. Norman (15)	S&E-ASTR-S	Mr. Driscoll (5)
PM-MA-OB	Mr. Nuber (10)	S&E-ASTR	Dist "E" (258)
I-RL-(MSC Liaison)	Mr. Hamilton (200)	S&E-ASTR-BV/DAC	Mr. Arden (20)
KSC (LVO-5)	Mr. Williams (250)	DAC/H	Mr. Schar (12)
KSC (SO)	Mr. Gorman (9)	S&E-ASTN	Dist "E" (140)
PM-SAT-MGR	Mr. James (2)	S&E-ASTN-VNC	Mr. Moon (60)
PM-SAT-MGR	Mr. Bramlet (1)	IBM Tech. Library	P. O. Box 1250 (2)
PM-SAT-E	Mr. Bell (1)	HSV	Huntsville 35807
PM-SAT-E	Mr. Beaman (5)	IS-CAS-42C	H. C. Kelley (2)
PM-SAT-T	Mr. Burns (2)	KSC	Librarian
PM-SAT-Q	Mr. Moody (1)	NA/Rockwell	Mr. Anderson (1)
PM-SAT-F	Mr. Rowan (1)	Boeing SD	Mr. Runkel (1)
PM-SAT-G	Mr. Smith (1)	S&E-CSE-DIR	Mr. Mack (5)
PM-SAT-P	Mr. Sneed (1)		
PM-SAT-S-IC	Mr. Urlaub (1)		
PM-SAT-S-IVB	Mr. McCulloch (1)		
PM-SAT-S-II	Mr. Godfrey (1)		
PM-SAT-IU	Mr. Duerr (1)		
I-K-V	Mr. Shute (5)		