

405

NO

MSC-CF-P-69-10



NATIONAL AERONAUTICS AND SPACE ADMINISTRATION

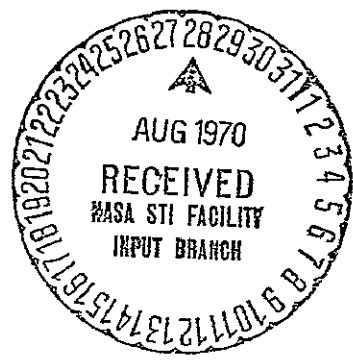

# CSM RENDEZVOUS PROCEDURES

## F MISSION

FINAL REVISION A

APRIL 25, 1969

**N70-36050**

FACILITY FORM 602	_____	_____
	(ACCESSION NUMBER)	(THRU)
	84	1
	(PAGES)	(CODE)
TMX-65033	31	
(NASA CR OR TMX OR AD NUMBER)	(CATEGORY)	

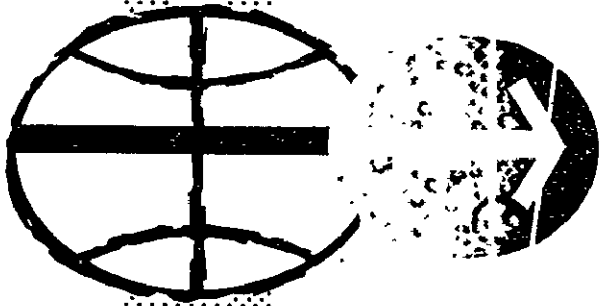

MANNED SPACECRAFT CENTER  
HOUSTON, TEXAS

PREPARED BY:

S. G. Paddock  
For Mission F Procedures Development Group  
Apollo Flight Crew Operations  
McDonnell Douglas Astronautics Company

D. K. Mosel<sup>+</sup>  
D. K. Mosel  
Technical Monitor (MDAC ED)  
Orbital Procedures Section  
Manned Spacecraft Center

APPROVED BY:

John C. Callihan  
J. C. Callihan  
Program Manager  
Apollo Flight Crew Operations  
McDonnell Douglas Astronautics Company

Donald W. Lewis  
D. W. Lewis  
Technical Manager (MDAC ED)  
Flight Procedures Branch  
Manned Spacecraft Center

Paul C. Kramer  
P. C. Kramer  
Chief Flight Procedures Branch  
Manned Spacecraft Center

J. W. Bilodeau  
J. W. Bilodeau  
Assistant Chief for Crew Integration  
Flight Crew Support Division  
Manned Spacecraft Center

W. J. North  
W. J. North  
Chief Flight Crew Support Division  
Manned Spacecraft Center

D. K. Slayton  
D. K. Slayton  
Chairman, Crew Procedures Control Board  
Manned Spacecraft Center

TABLE OF CONTENTS

	<u>PAGE</u>
1.0 PURPOSE -----	1
2.0 INTRODUCTION -----	2
3.0 DISCUSSION OF MAJOR EVENTS -----	9
3.1 Undocking and Separation -----	9
3.2 Descent Orbit Insertion -----	10
3.3 Phasing -----	10
3.4 Insertion -----	11
3.5 Concentric Sequence Initiation -----	12
3.6 Constant Delta Height and Plane Change -----	13
3.7 Terminal Phase Initiation -----	14
3.8 TPI To Station Keeping -----	15
4.0 NOMINAL ONBOARD RENDEZVOUS CHECKLIST -----	16
5.0 NOMINAL MAJOR PROCEDURES SUMMARY -----	27
5.1 Summary Timeline -----	28
5.2 Summary Rendezvous Checklist -----	36

	<u>PAGE</u>
6.0 NOMINAL DETAILED PROCEDURES -----	37
6.1 Procedures Ground Rules -----	38
6.2 Detailed Procedures -----	42
6.3 Rendezvous Navigation Summary With Sun Angles -----	78
6.4 CSM Attitude Summary -----	79
7.0 DISCUSSION OF LM RESCUE CASES -----	80
7.1 LM PDI Abort -----	80
7.2 LM Partial Phasing Greater Than or Equal to 40 FPS -----	80
7.3 LM Partial Phasing Less Than 40 FPS -----	81
7.4 LM Zero Insertion -----	82
7.5 LM Partial Insertion -----	83
8.0 LM RESCUE ONBOARD DATA -----	84
8.1 LM PDI Abort -----	85
8.1.1 Plot and Pads -----	86
8.1.2 Checklist -----	87
8.2 LM Partial Phasing Greater Than or Equal to 40 FPS -----	88
8.2.1 Plot and Pads -----	89
8.2.2 Checklist -----	90
8.3 LM Partial Phasing Less Than 40 FPS -----	91
8.3.1 Plot and Pads -----	92
8.3.2 Checklist -----	93
8.4 LM Zero Insertion -----	94
8.4.1 Plot and Pads -----	95
8.4.2 Checklist -----	96

	<u>PAGE</u>
8.5 LM Partial Insertion -----	97
8.5.1 Plot and Pads -----	98
8.5.2 Checklist -----	99
9.0 LM RESCUE PROCEDURES SUMMARY -----	100
9.1 Rescue Procedures Ground Rules -----	100
9.2 LM PDI Abort -----	101
9.2.1 Summary Timeline -----	102
9.2.2 Navigation Summary With Sun Angles -----	107
9.2.3 CSM Attitude Summary -----	108
9.3 LM Partial Phasing Greater Than or Equal to 40 FPS -----	109
9.3.1 Summary Timeline -----	110
9.3.2 Navigation Summary With Sun Angles -----	123
9.3.3 CSM Attitude Summary -----	124
9.4 LM Partial Phasing Less Than 40 FPS -----	125
9.4.1 Summary Timeline -----	126
9.4.2 Navigation Summary With Sun Angles -----	139
9.4.3 CSM Attitude Summary -----	140
9.5 LM Zero Insertion -----	141
9.5.1 Summary Timeline -----	142
9.5.2 Navigation Summary With Sun Angles -----	153
9.5.3 CSM Attitude Summary -----	154
9.6 LM Partial Insertion -----	155
9.6.1 Summary Timeline -----	156
9.6.2 Navigation Summary With Sun Angles -----	169
9.6.3 CSM Attitude Summary -----	170

10.0 REFERENCES ----- 171

FIGURES

MISSION F-RELATIVE MOTION FOR LM ACTIVE RENDEZVOUS  
FIGURE (2-1) ----- 4

MISSION F-LUNAR ORBIT RENDEZVOUS ATTITUDE TIME HISTORY  
FIGURE (2-2) ----- 5  
FIGURE (2-3) ----- 6  
FIGURE (2-4) ----- 7  
FIGURE (2-5) ----- 8

LIST OF ACRONYMS AND ABBREVIATIONS

ACQ	Acquisition
ADJ	Adjust
AOH	Apollo Operations Handbook
AOS	Acquisition of Signal
ATT	Attitude
AWY	Away
BEF	Blunt End Forward
B/U	Backup
CALIB	Calibration
CB	Circuit Breaker
CDH	Constant Delta Height
CDR	Commander
CM	Command Module
CMC	Command Module Computer
CMD	Command Module Commander's Position
CMP	Command Module Pilot
COAS	Crew Optical Alignment Sight .
CSI	Concentric Sequence Initiation
CSM	Command and Service Module
CT	Cease Tracking
DAP	Digital Autopilot
DH	Delta Height
DOI	Descent Orbit Insertion
DPS	Descent Propulsion System
DSKY	Display and Keyboard
DV	Delta Velocity
DWN	Down
EMS	Entry Monitor System
ET	Event Timer
FDAI	Flight Director Attitude Indicator
FPS	Feet Per Second

FWD	Forward
GDC	Gryo Display Coupler
GET	Ground Elapsed Time
GETI	Ground Elapsed Time of Ignition
GMBL	Gimbal
GND	Ground (Mission Control)
GPI	Gimbal Position Indicator
HA	Apogee Altitude
HGA	High-Gain Antenna
HOR	Horizon
HORIZ	Horizontal
HP	Perigee Altitude
IMU	Inertial Measurement Unit
INS	Insertion
IT	Initiate Tracking
LEB	Lower Equipment Bay
LGC	LM Guidance Computer
LLMK	Lunar Landmark
LM	Lunar Module
LMK	Landmark
LMP	Lunar Module Pilot
LOI	Lunar Orbit Injection
LOS	Loss of Signal
LV	Launch Vehicle
MNVR	Maneuver
MCC	Midcourse Correction
MCC-H	Mission Control Center - Houston
MDC	Main Display Console
MGA	Middle Gimbal Angle
MSFN	Manned Space Flight Network
MTCS	Move to Command Seat
MTLEB	Move to Lower Equipment Bay
MTVC	Manual Thrust Vector Control
NAV	Navigation



OPT	Optics
ORDEAL	Orbital Rate Drive Earth and Lunar
OSS	Optical Subsystem
PAD	Data Voiced to Crew From Ground
PB	Pushbutton
PC	Plane Change
PDI	Powered Descent Initiation
PGNCS	Primary Guidance, Navigation, and Control System
PHS	Phasing
PIPA	Pulse Integrating Pendulous Accelerometers
PLM	LM Pitch Angle
PRO	Proceed
PROG	Program
PROP	Propellant
R	Range
RCS	Reaction Control System
RDOT	Range Rate
REFSMMAT	Reference Stable Member Matrix
RHC	Rotation Hand Controller
RR	Rendezvous Radar
S	Shaft
SC	Spacecraft
SCS	Stabilization and Control System
SCT	Scanning Telescope
SECS	Sequence Events Control System
SEF	Small End Forward
SEP	Separation
S-IVB	Saturn S-IVB Stage
SM	Service Module
SPS	Service Propulsion System
S/U	Setup
SXT	Sextant
SYNC	Synchronize
TEI	Tranearth Injection
TEMCC	Tranearth Midcourse Correction

TFI	Time From Ignition
THC	Translation Hand Controller
THETA	Angle Between SC +X Axis and Local Horizontal
TIGN	Time of Ignition
TLI	Translunar Injection
TLM	Telemetry
TLMCC	Translunar Midcourse Correction
TPF	Terminal Phase Finalization
TPI	Terminal Phase Initiation
TRUN	Trunnion
TVC	Thrust Vector Control
VG	Velocity to be Gained
VHF	Very High Frequency
(XX:XX)	Indicates GET From Liftoff in Hours:Minutes
(XXX:XX:XX)	Indicates GET From Liftoff in Hours:Minutes:Seconds
(XXX,XXX/XXX,XXX)	(Ordeal/Inertial) Angles (Roll, Pitch, Yaw)
(XX,XX,XX)	Local Vertical DV's

Tracking Stations

ANG	Antigua Near Space Support Station
BDA	Bermuda Near Space Support Station
CRO	Carnarvon Near Space Support Station
CYI	Canary Near Space Support Station
GYM	Guaymas Near Space Support Station
HSK	Honeysuckle Deep Space Support Station
HTV	Huntsville Near Space Support Station
MAD	Madrid Deep Space Support Station
MER	Mercury Near Space Support Ship
MIL	MILA Near Space Support Station
RED	Redstone Near Space Support Ship
TEX	Corpus Christi Near Space Support Station
VAN	Vanguard Near Space Support Ship

## 1.0 PURPOSE

This document contains the nominal PGNCS crew procedures for the CSM-106 spacecraft which will be the target vehicle for the LM-4 active lunar orbit rendezvous. The procedures were developed in accordance with the Detailed Test Objectives P20.78 and P20.77 defined in Reference 10.1.

The purpose of the CSM Rendezvous Procedures document is to provide a single source of procedures information for use in flight planning, in crew training, and in preparing onboard data.

This is a control document, subject to review by all elements of the Apollo Program and to approval by the Procedures Configuration Control Board. Comments should be directed to Mr. Duane K. Mosel, Flight Procedures Branch, Flight Crew Support Division, Extension 5340 or to Mr. Stephen G. Paddock, Jr., Apollo Flight Crew Operations Group, Houston Operations, McDonnell Douglas Astronautics Company, Extension 6101.

## 2.0 INTRODUCTION

The CSM-106/LM-4 lunar orbit rendezvous exercise will begin during the twelfth revolution with undocking at 98:10:00 and end at approximately 105:52 with post rendezvous station keeping. The CSM procedures during this period are divided into eight segments of major activities which are discussed in detail in Section 3.0.

The nominal CSM-106/LM-4 mission profile is contained in Figure (2-1). This figure shows the locations in time and relative positions in space of the most significant nominal mission events. Trajectory data used to generate the mission profile and timeline for procedures development was obtained from References 10.2, 10.15, and 10.18. The rendezvous navigation update schedule assumed in the procedures was obtained from References 10.16 and 10.20. The schedule indicates tracking periods and assumes a one per minute SXT and VHF mark frequency. The minimum number of marks required during a tracking period has been defined as five at the beginning and five at the end of the period. However, the minimum number of marks is not recommended since simulation experience has shown that the planned number of marks is not always achieved due to systems monitoring requirements or target visibility problems. In addition, the general rules for SXT/VHF marking as defined in Reference 10.3 should be followed.

A history of the CSM body attitudes during the rendezvous is presented in Figure (2-2) through (2-5). Each figure illustrates the body attitudes with respect to the Moon, Sun, and Earth

and indicates FDAI roll, pitch, and yaw gimbal angles and the ORDEAL pitch angle for significant events during each lunar orbit. The orbital position of the CSM at each event is assumed and no attempt is made to show the LM orbital position other than an indication of it being above (below) and behind (ahead) the CSM.

Sections 4.0, 5.0, and 6.0 contain the onboard nominal rendezvous checklist; a summary timeline and summary checklist for the nominal mission, and the procedures ground rules, detailed nominal mission procedures, and CSM attitude summary, respectively. Section 7.0 contains a description of the five abort and rescue cases for which onboard rescue checklists have been developed. These cases are:

- 1) PDI Abort - LM Active/CSM Backup
- 2) Partial LM Phasing (DV greater than or Equal to 40 FPS) - CSM Active
- 3) Partial LM Phasing (DV less than 40 FPS) - CSM Active
- 4) Zero LM Insertion - CSM Active
- 5) Partial LM Insertion - CSM Active

Section 8.0 contains the one-page onboard rescue checklist and a relative motion plot and pad page for each of the five LM rescue cases. A LM rescue procedures summary is contained in Section 9.0 including rescue procedures ground rules, summary timelines, and CSM attitude and navigation summaries for each rescue case.

All nominal and rescue procedures and onboard data were generated assuming a Mission F liftoff on 18 May 1969, at 16:49:00 GMT.

MISSION F

FIGURE 2-2

LUNAR ORBIT RENDEZVOUS  
ATTITUDE TIME HISTORY  
FOR THE CSM

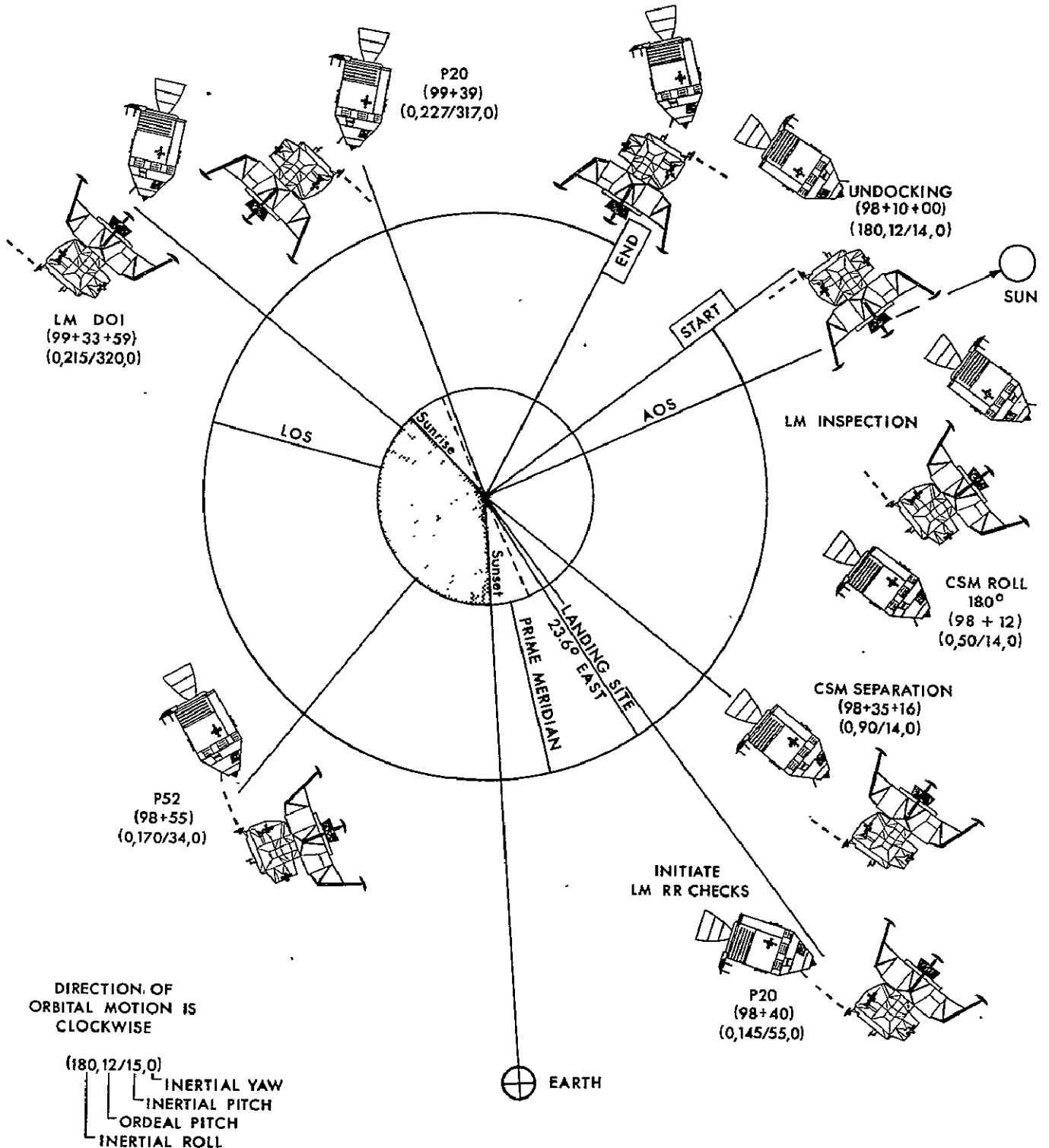

MISSION F

FIGURE 2-3

LUNAR ORBIT RENDEZVOUS  
ATTITUDE TIME HISTORY  
FOR THE CSM

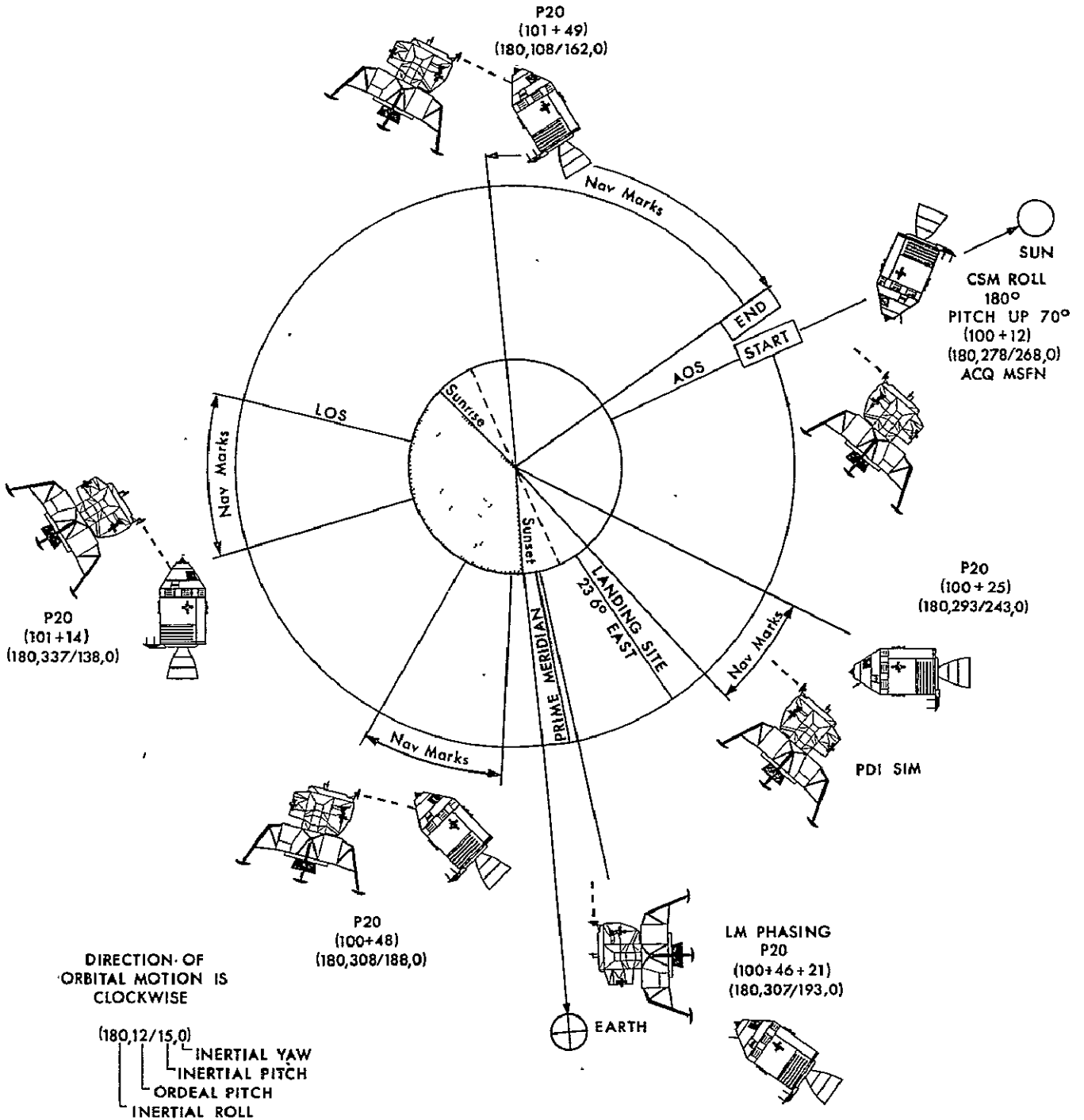

MISSION F

FIGURE 2-4

LUNAR ORBIT, RENDEZVOUS  
ATTITUDE TIME HISTORY  
FOR THE CSM

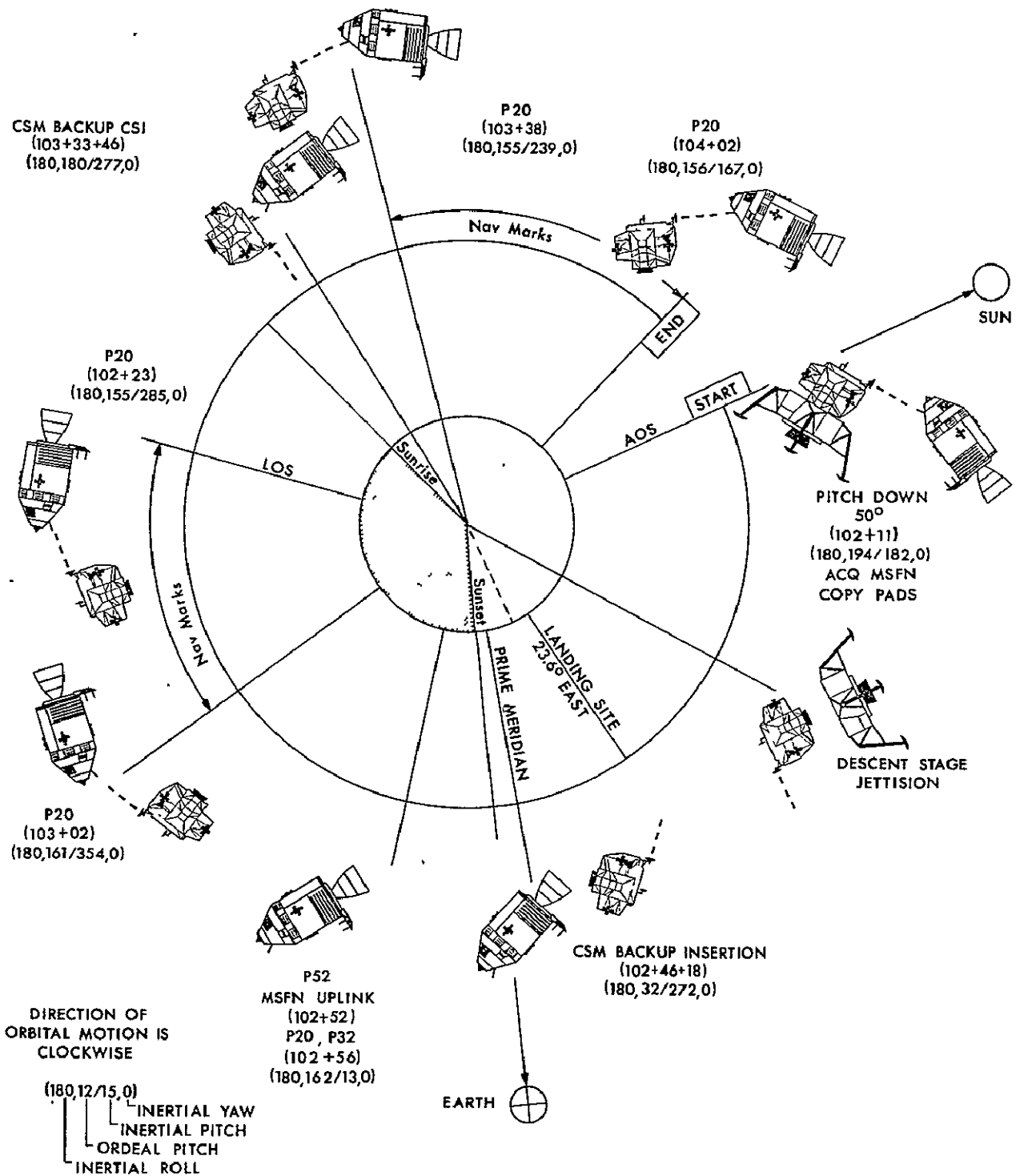



MISSION F

FIGURE 2-5

LUNAR ORBIT RENDEZVOUS  
ATTITUDE TIME HISTORY  
FOR THE CSM

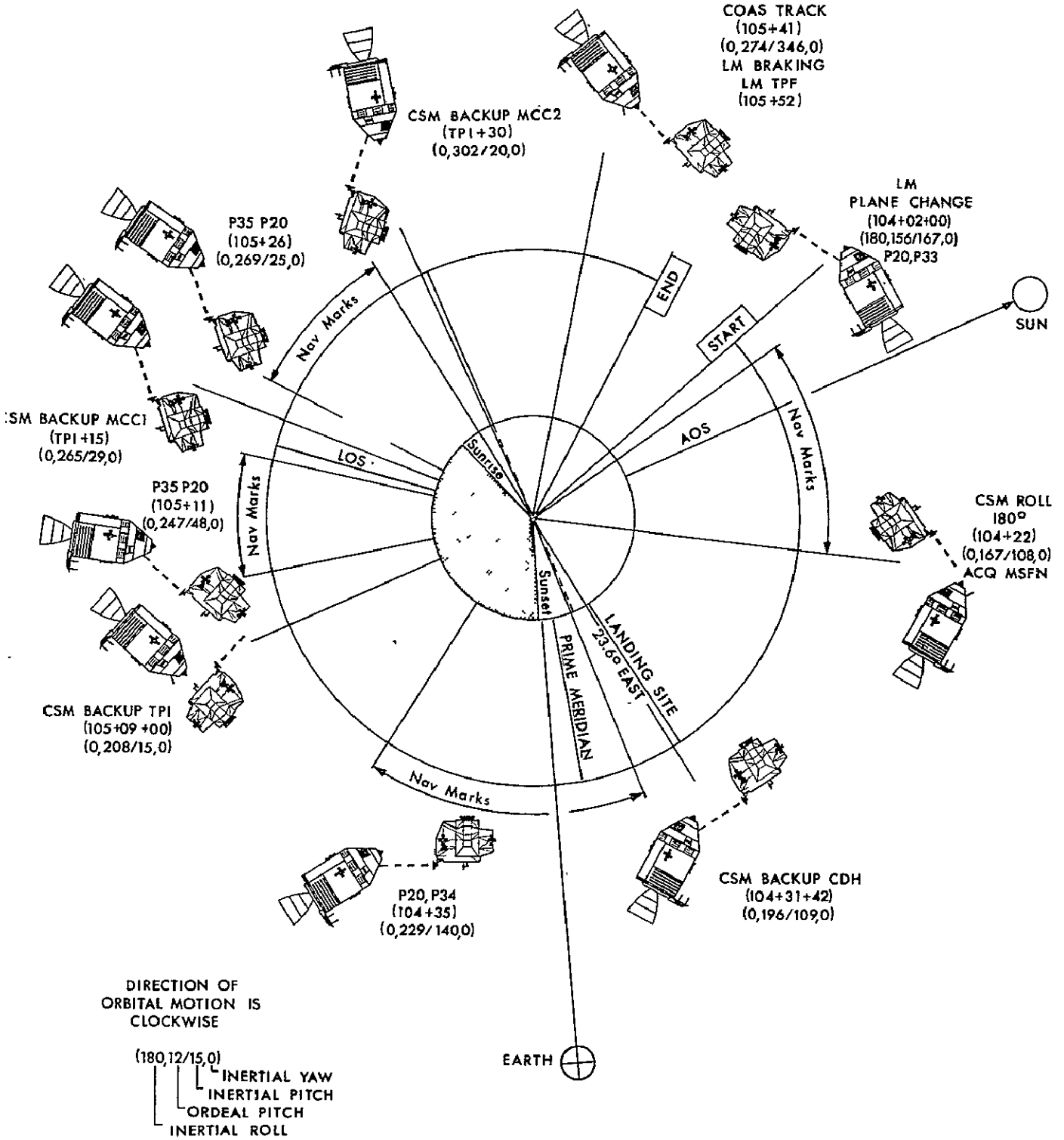

### 3.0 DISCUSSION OF NOMINAL MAJOR EVENTS

#### 3.1 Undocking and Separation

The preparation for undocking includes obtaining a MCC-H uplink of the CSM vector and copying the Separation maneuver pad at 97:05. Thirty minutes prior to undocking an automatic maneuver to the undocking attitude is performed using extended verb 49. This attitude is identical inertially to the Separation burn attitude except for the roll angle which is 180 degrees and a 14-degree yaw which is required during a pre-undocking LM AGS calibration. Prior to undocking, the CSM is yawed to zero degrees, a RR transponder check is made, the GDC is aligned to the IMU, the FDAI ORDEAL is verified, and the DAP is reloaded to reflect a CSM only configuration. At 98:10 undocking is performed after which the CSM will station keep in SCS control at about 40 feet. The CMP will then inspect and photograph the LM landing gear and descent engine bell as the LM does a 360-degree yaw maneuver. Prior to the inspection the CSM will manually roll 180 degrees to allow acquisition of the MSFN with the HGA for color TV. At 98:20 LM maneuver P76 pads will be copied for the DOI, Phasing, and PDI abort burns. Prior to the CSM-active separation burn at 98:35:16, the CMP will load the External DV Program, P30, with a minus 2.5 FPS  $V_{G_z}$  (local vertical). The RCS Thrust Program, P41, will be called and an automatic maneuver will be made to the burn attitude which is shown in Figure (2-2). (This should be a very small maneuver since the undocking attitude was the inertial separation burn attitude, except for roll.) The burn will be accomplished

by thrusting aft in the CSM minus X direction (i.e. radially down) and increasing the DSKY  $VG_X$  (body) from a plus 2.5 FPS to 5 FPS. The HGA can be utilized for communication during the separation burn.

### 3.2 Descent Orbit Insertion

Following the CSM Separation burn, the Rendezvous Navigation Program, P20, will be called and the CSM maneuvered automatically 40 degrees to the preferred track axis for LM radar, VHF range, and optics checks. An IMU realign to REFSMMAT will be performed after sunset at 98:55 using the IMU Realign Program, P52. At approximately 99:05 CSM and LM state vectors will be uplinked by MCC-H. Since the CSM does not backup the DOI burn, its only function will be to monitor the LM burn and hold an attitude which provides radar transponder coverage. This will be done in Program P20 with SXT tracking along the preferred track axis. The Target DV Program, P76, will be loaded with the LM DOI burn parameters and these data incorporated when the burn is confirmed by the LM. LM DOI occurs at 99:33:59.

The attitude of the CSM from the CSM Separation burn through LOS prior to the LM DOI burn is favorable for HGA communications.

### 3.3 Phasing

Following the DOI burn, Program P20 will be called and the CSM attitude will be trimmed to the preferred track axis if required. The CMP will confirm that the rendezvous navigation program is tracking the LM correctly. At 100:07 the CSM will be manually rolled 180 degrees and pitched up 70 degrees to allow acquisition

with the HGA. At 100:25 Program P20 will be called and the CSM will be maneuvered 25 degrees to the preferred track axis. A period of SXT/VHF marking will occur from 100:27 to 100:37. The CSM will not back up the LM Phasing burn so it will be tracking with the preferred track axis during the burn. LM Phasing occurs at 100:46:21. After confirmation of the nominal LM Phasing burn, the CMP will incorporate the LM Phasing burn parameters into Program P76. In the event the LM cannot perform the Phasing burn or performs a partial burn, the CSM will do nothing immediately but will setup to do the prescribed rescue burn at approximately 101:33. The CSM has HGA coverage continuously from AOS through the Phasing burn.

#### 3.4 Insertion

Following the LM Phasing burn, Program P20 will be called and tracking with the preferred track axis will again be established. A period of SXT/VHF marking occurs from 100:51 to 101:24. This period is interrupted for 13 minutes during which time the LM does a P52 (tracker light not visible). Only VHF marks are taken during this period. At approximately 101:10 maneuver pads for the LM Insertion burn and the CSM Backup Insertion burn are transmitted and copied. Another period of SXT/VHF navigation updates occurs from 101:49 to 102:09. These update periods include VHF marks only if the range is less than the 327 N.M. VHF range measurement limit. At 102:11 AOS occurs and the CSM will be pitched down 50 degrees and the MSFN acquired with the HGA. The MCC-H will uplink the CSM state vector and the CSM Backup Insertion burn pad will be updated at this time if required. The CSM Backup Insertion burn parameters, targeted three minutes after the LM ignition time, will be loaded into Program P30 at 102:30 and Program P40 will be called at 102:32. The maneuver to the burn

attitude will require a pitch down of 110 degrees. Following the attitude maneuver, the SPS will be configured for the backup burn and the GDC aligned to the IMU. The LM Insertion occurs at 102:43:18. After confirmation is received that the LM has completed the burn, Program P76 will be called and the LM burn data incorporated into the CMC LM state vector. The CSM attitudes as shown in Figure (2-3) and (2-4) are compatible with HGA usage during the phase.

### 3.5 Concentric Sequence Initiation

Immediately following the Insertion burn, a P52 IMU realign to REFSMMAT will be performed and the MCC-H will uplink the LM state vector to the CMC. The LM vector will be that computed by the LM after Insertion and relayed to the ground.

Program P20 will then be called and an automatic pitch maneuver of 101 degrees will be made to the preferred track attitude. At 102:59 the CSI Targeting Program, P32, is called and the CSM Backup CSI targeting parameters are loaded. The CSM CSI burn will be targeted for 103:33:46 which is identical to the LM TIGN. A period of SXT/VHF marking will then take place from 103:02 to 103:07 followed by a period of VHF only marks to 103:25. Concurrently with the VHF only tracking, the CMP will obtain the LM and CSM out-of-plane velocities from extended verb 90 for inclusion in the LM and CSM CSI targeting programs.

At approximately 103:28 the LM will voice over its CSI solution for P76. Program P40 will then be called and an automatic pitch maneuver of 11 degrees will be made to the Backup CSI burn attitude. The LM CSI burn occurs at 103:33:46. After verification of the nominal LM CSI burn, the CMP will incorporate the LM burn parameters in Program P76.

The CSM attitude, as specified in Figure (2-4) is compatible with HGA coverage from Insertion until the beginning of the track period at about 103:02 at which time the attitude may be unfavorable. The tracking attitude later in the period does afford HGA coverage until LOS at 103:23.

### 3.6 Constant Delta Height and Plane Change

At 103:38 approximately four minutes after the LM CSI burn, Program P20 will be called and an automatic maneuver of 38 degrees will be made to the preferred track axis. A period of SXT/VHF markings occurs from 103:41 to 104:02. At 103:44 after three SXT/VHF marks, the WR matrix (2000,2) will be loaded. Extended verb 90 will be called at 103:55 and the targeting parameters for the LM Plane Change maneuver will be computed and voiced to the LM. The CSM onboard state vectors are used instead of the LM state vectors, because the CSM knowledge of the out-of-plane positions with SXT tracking is more accurate than the LM knowledge of out-of-plane positions with radar tracking. Following the LM Plane Change burn at 104:02, the target DV parameters are incorporated into the LM state vector. At 104:05 the CDH targeting Program P33 will be called and the CSM Backup CDH burn will be targeted for 104:31:42 which is the LM TIGN. Since the CSM nominally does not backup the LM Plane Change burn, a trim maneuver to the preferred track axis should not be required when Program P33 is called. SXT and VHF marks will be taken from 104:08 to 104:20, at which time tracking is terminated and the CSM will voice to the LM an extended verb 90 out-of-plane solution. At 104:22 the CSM will be manually maneuvered 180 degrees in roll so that the MSFN can be acquired with the HGA. Approximately five minutes before the LM CDH burn the CMP copies the LM CDH pad for later loading of Program P76. The RCS Thrust Program, P41, is called at 104:29 and the burn

attitude maneuver is bypassed if the nominally zero burn is small. Following the LM CDH burn at 104:31:42, Program P76 is called and the LM CDH burn incorporated into the CMC LM state vector.

The CSM attitudes are favorable for HGA communications from approximately 104:22 through the CDH burn as shown in Figure (2-5).

### 3.7 Terminal Phase Initiation

After completion of the LM CDH burn, Program P20 will be called which will request an automatic maneuver of 49 degrees to the preferred tracking attitude. Program P34 will be called and the CSM Backup TPI burn Data will be loaded with the elevation angle option. SXT and VHF marks are scheduled for a period of 18 minutes starting at 104:38. It is probable that sun interference in the SXT will limit the total number of SXT marks to 11 taken in darkness.

After moving to the command seat, the CMP will verify the ORDEAL FDAI. He will then recall P34 and, using the "TIGN" option with the LM computed TPI TIGN, compute the CSM TPI Backup burn parameters. Program P40 will be called and an automatic maneuver of 53 degrees will be made to the TPI burn attitude. The TPI burn will nominally be performed at 105:09:00 with a CSM to LM elevation angle of 208.3 degrees. After the LM has completed the burn the CMP will incorporate the LM target DV in Program P76. As seen in Figure (2-5), the CSM has HGA coverage from acquisition right after AOS through the TPI burn.

### 3.8 TPI To Station Keeping

After the TPI burn, Program P20 will be called and the CSM will be automatically maneuvered 33 degrees to the preferred track attitude. The CMP will move to the LEB during the maneuver,

call the MCC Targeting Program, P35, and take SXT and VHF marks for eight minutes starting at 105:13. After obtaining the MCC1 solution in Program P35 he will compare it with the LM solution and call Program P41 in preparation for the backup burn. The CSM will not maneuver from the preferred tracking attitude. The MCC1 burn will nominally be performed by the LM at 105:24:00 (TPI plus 15 minutes). After MCC1 the CMP will incorporate the LM MCC1 Target DV in Program P76.

Following MCC1, Program P35 will be called and an automatic trim to the preferred tracking attitude will be made if required. SXT and VHF marks will be taken for a period of 9 minutes terminating at 105:35. The MCC2 solution will be compared with the LM TPI solution, after which Program P41 will be called. The CSM will remain at the preferred tracking attitude while the LM performs MCC2 at 105:39:00 (TPI plus 30 minutes). After MCC2 the CMP will incorporate the LM Target DV in Program P76.

The CSM will then be maneuvered automatically 34 degrees to the COAS tracking attitude using extended verb 89 while the CMP moves back to the command seat. The Thrust Monitor Program, P47, will be called at a range of 1.25 nautical miles and VHF ranging data and V83 will be used to monitor the LM line-of-sight control and braking. Should the LM experience difficulty, the CSM will perform the line-of-sight control and braking. The braking gates are specified in the checklist of Section 4.0. TPF nominally occurs at 105:52:00.



#### 4.0 NOMINAL ONBOARD RENDEZVOUS CHECKLIST

The nominal CSM onboard rendezvous checklist is presented in this Section. The rendezvous checklist was formulated to be compatible with crew operations in simulators and in flight. Therefore, the checklist reflects procedures in an extremely abbreviated form. The narrative presented in Section 3.0 provides a word description of the checklist events. The rendezvous checklist procedures have in part been verified on a man-in-the-loop simulator. Additional simulations will occur before launch and the rendezvous checklist updated accordingly to produce a verified checklist.

The nominal onboard rendezvous checklist includes procedures for performing all CSM PGNCS activities required during the LM active rendezvous. All activities required for the operation and/or monitoring of systems other than the PGNCS will be included in the rendezvous checklist by the appropriate systems personnel.

EXTERNAL DV PADS

CSM SEP PAD

33	00	:	000	:	0	.
81	+	0000.0	+	0000.0	-	0002.5
22	XXX		XXX		XXX	

CSM BACKUP  
INSERTION PAD  
INITIAL

47	+		+	00000.		
48						
33	00	:	000	:	0	.
81						
22	XXX		XXX		XXX	
$\Delta V_C$	X					
11	00	:	000	:	0	.
37	00	:	000	:	0	.
N						

CSM BACKUP  
INSERTION PAD  
UPDATE

47	+		+	00000.		
48						
33	00	:	000	:	0	.
81						
22	XXX		XXX		XXX	
$\Delta V_C$	X					
11	00	:	000	:	0	.
37	00	:	000	:	0	.
N						

NOMINAL LM IGNITION TIMES

CSI 11	00	:	000	:	0	.
PC 33	00	:	000	:	0	.
TPI 37	00	:	000	:	0	.

RESCUE TWO PAD

47	+		+	00000.		
48						
33	00	:	000	:	0	.
81						
22	XXX		XXX		XXX	
$\Delta V_C$	X					
11	00	:	000	:	0	.
37	00	:	000	:	0	.
N						

CANNED RESCUE TWO PADS FOR:

1. LM PDI ABORT
  2. PARTIAL PHASING (0 - 40)
  3. PARTIAL PHASING (40 - NOM)
  4. ZERO INSERTION
  5. PARTIAL INSERTION
- ARE INCLUDED ON RESCUE CHECKLISTS

CSM RENDEZVOUS  
RESCUE PADS

CSI ONE

11	00	:	000	:	0	.
81						
N						

CSI TWO

11	00	:	000	:	0	.
81						
N						

CDH

13	00	:	000	:	0	.
81						

TPI

37	00	:	000	:	0	.
81						
59						
LOS BT	XX	:	XX	:	XX	:

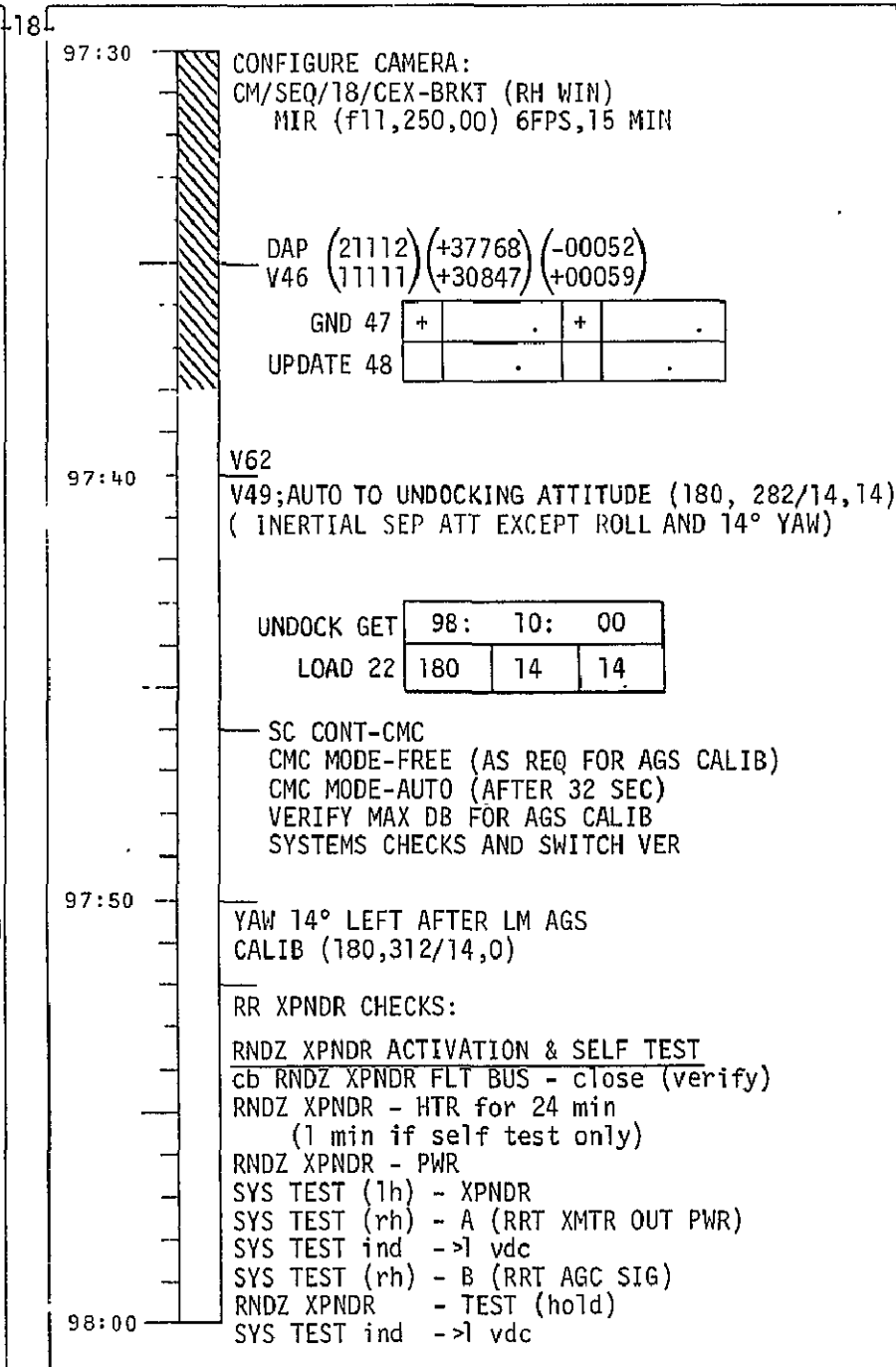
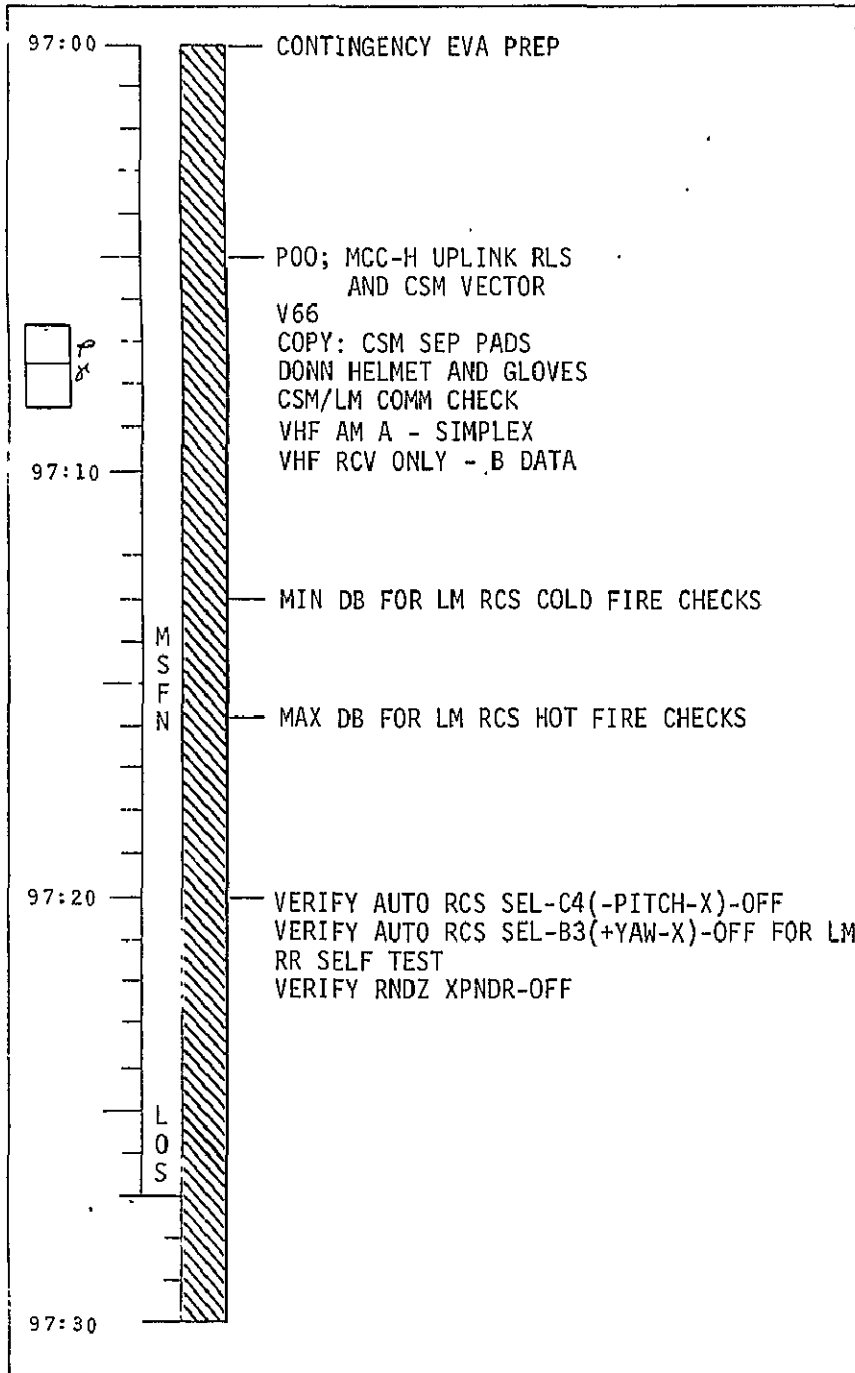

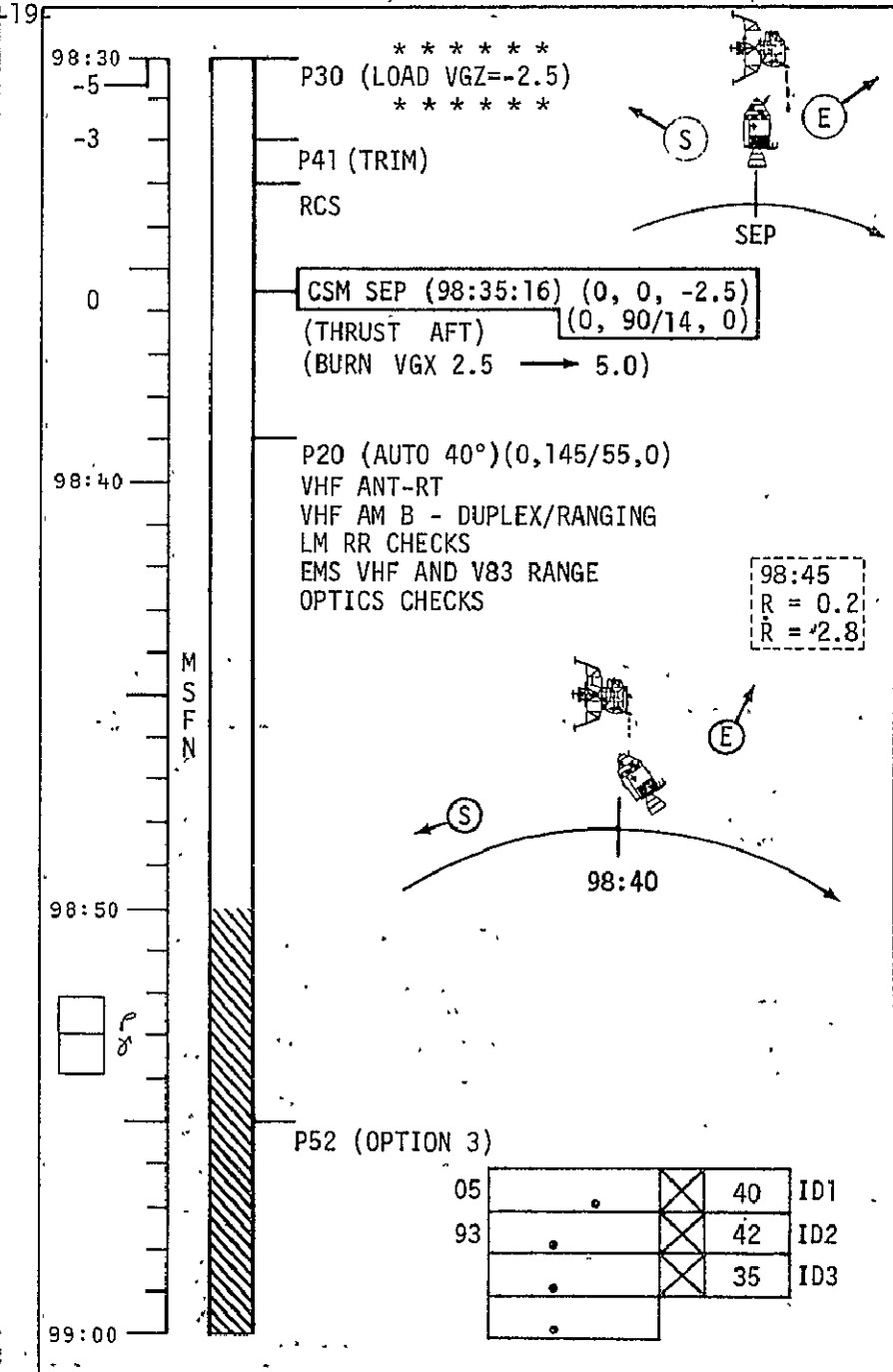
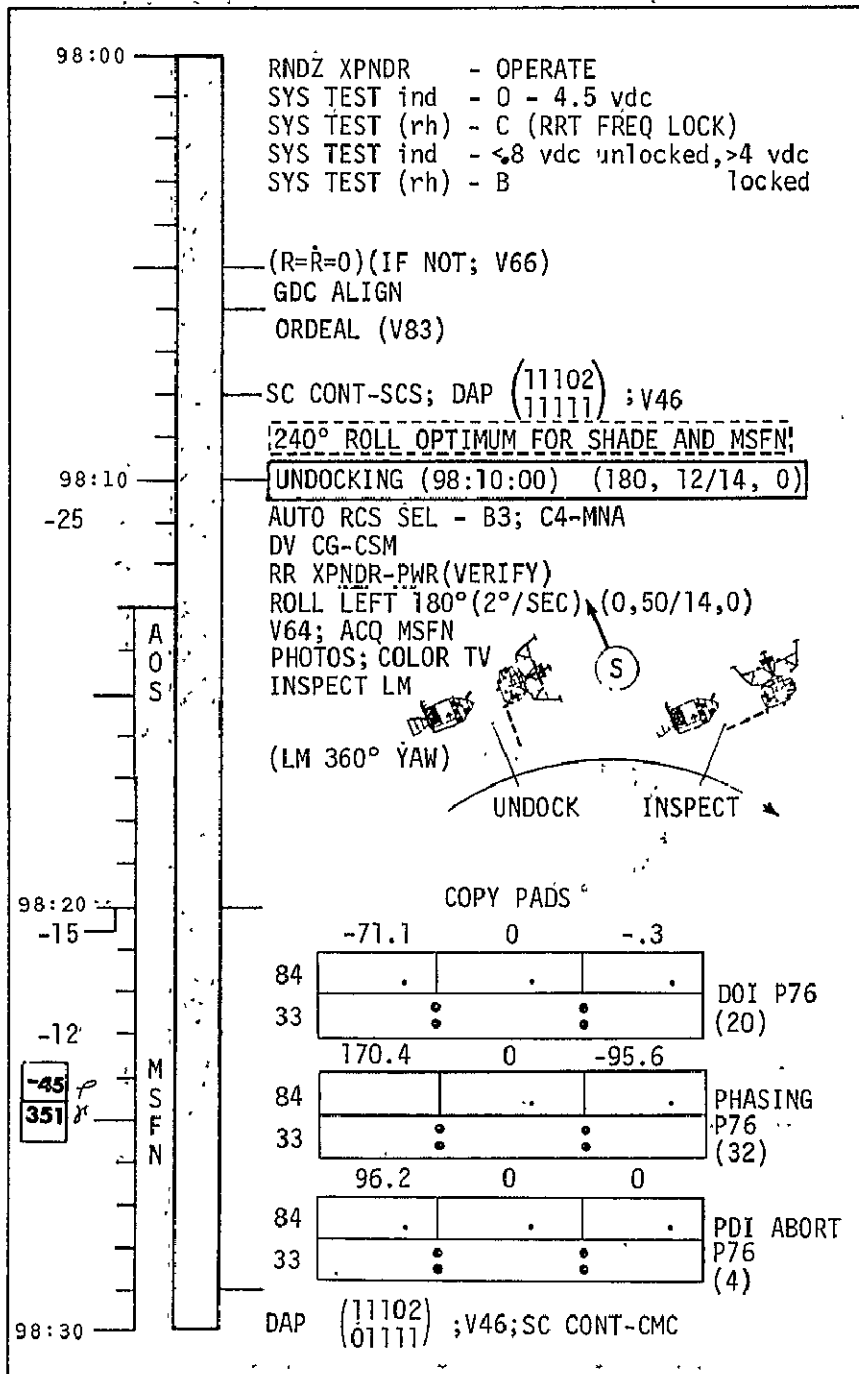

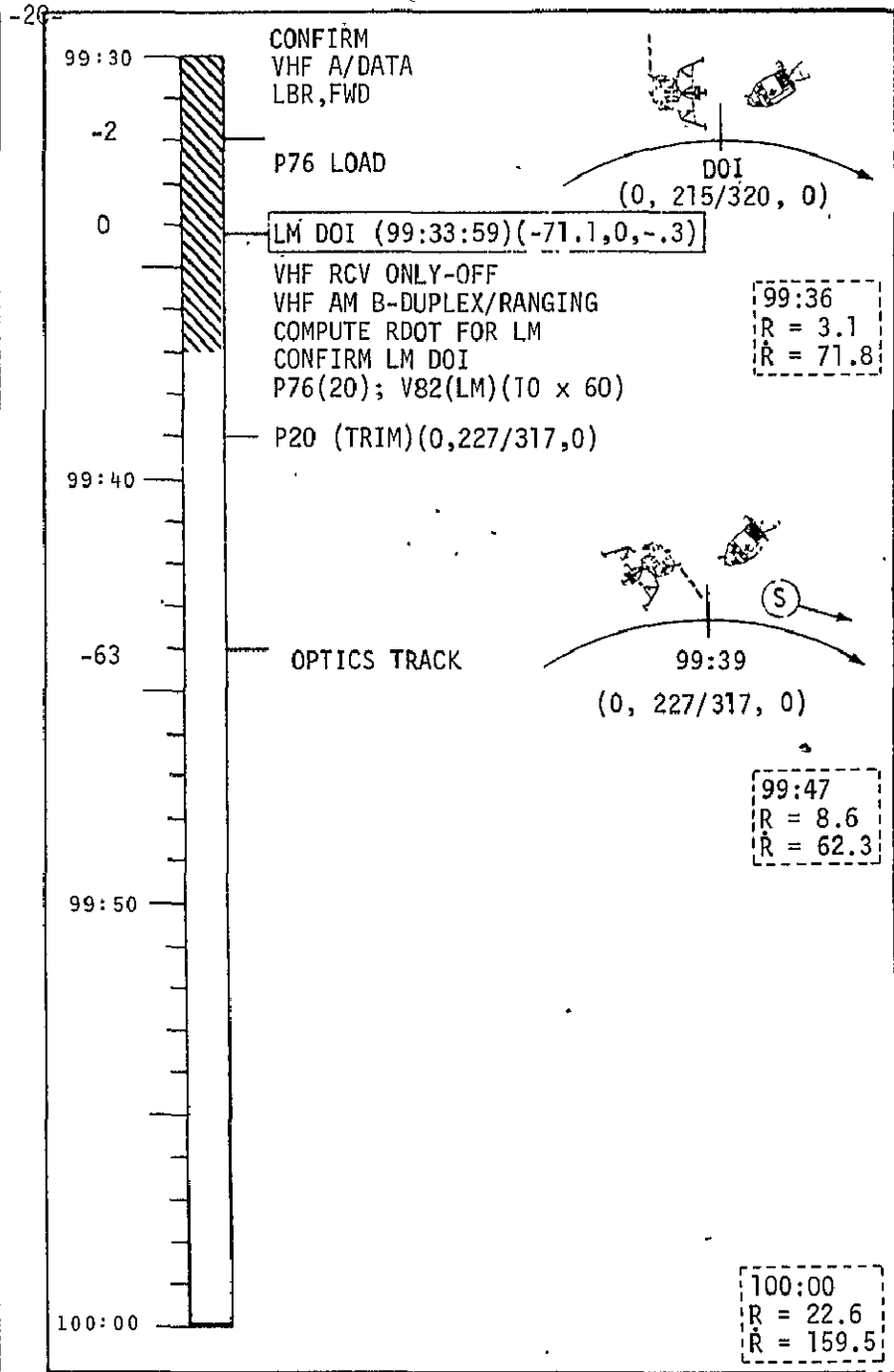
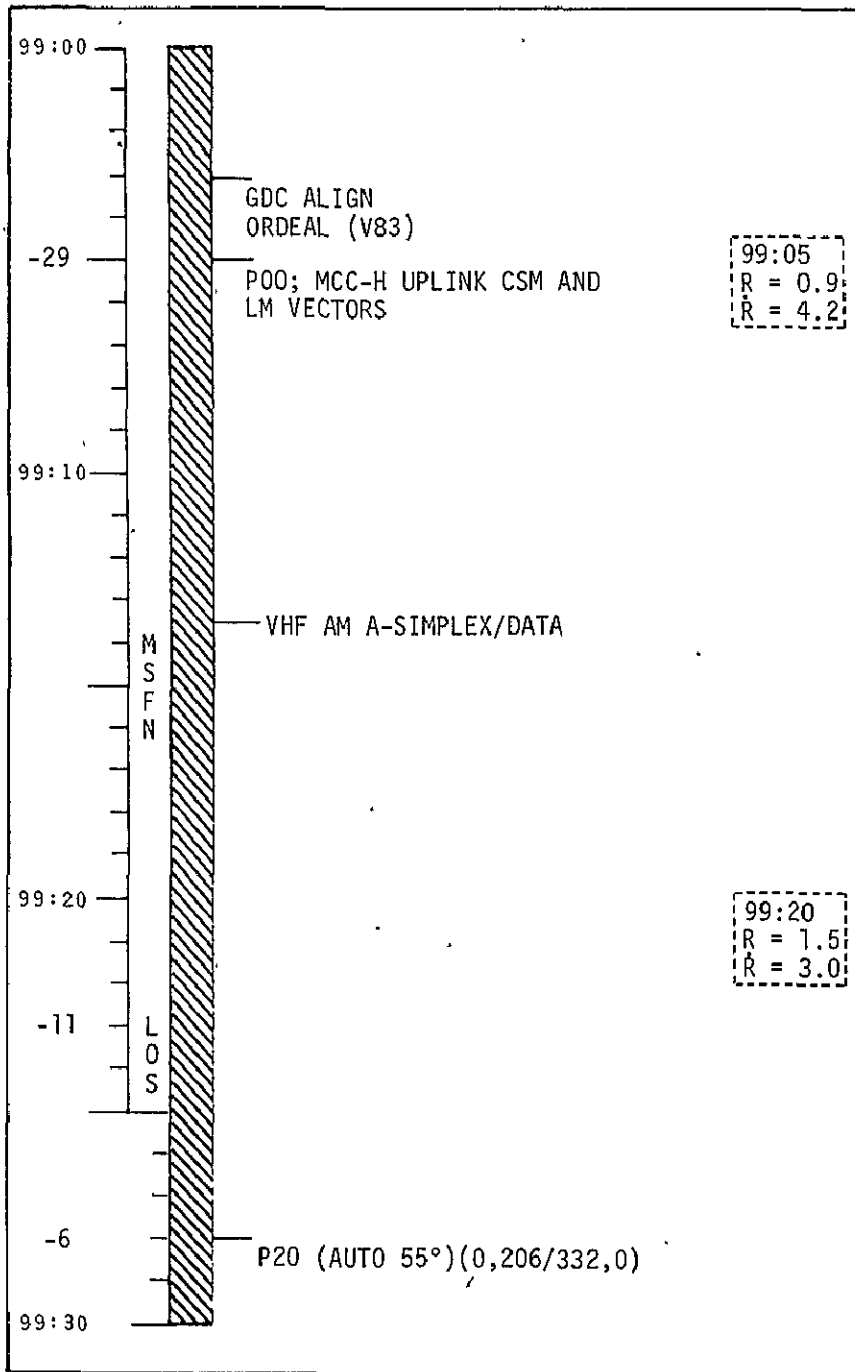

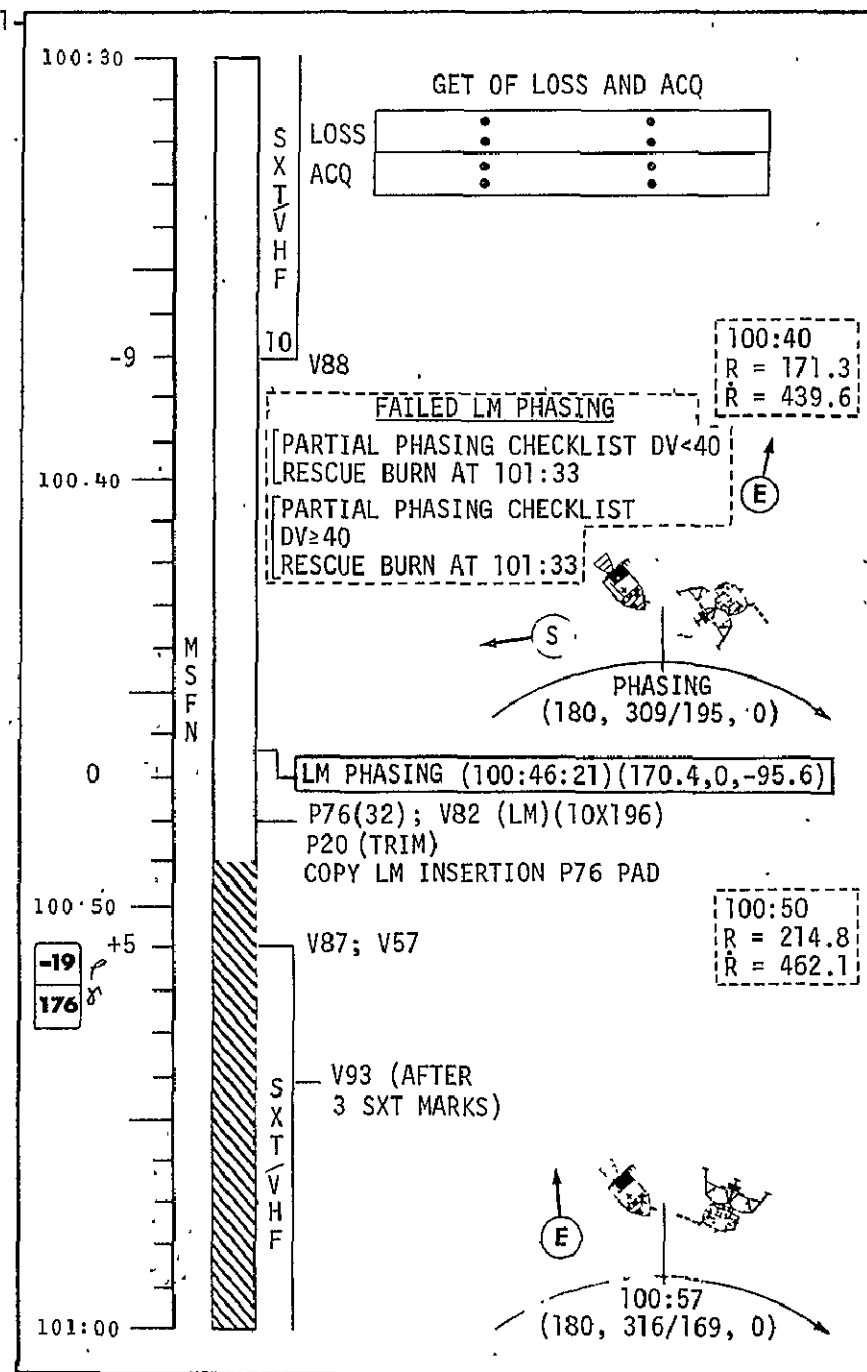
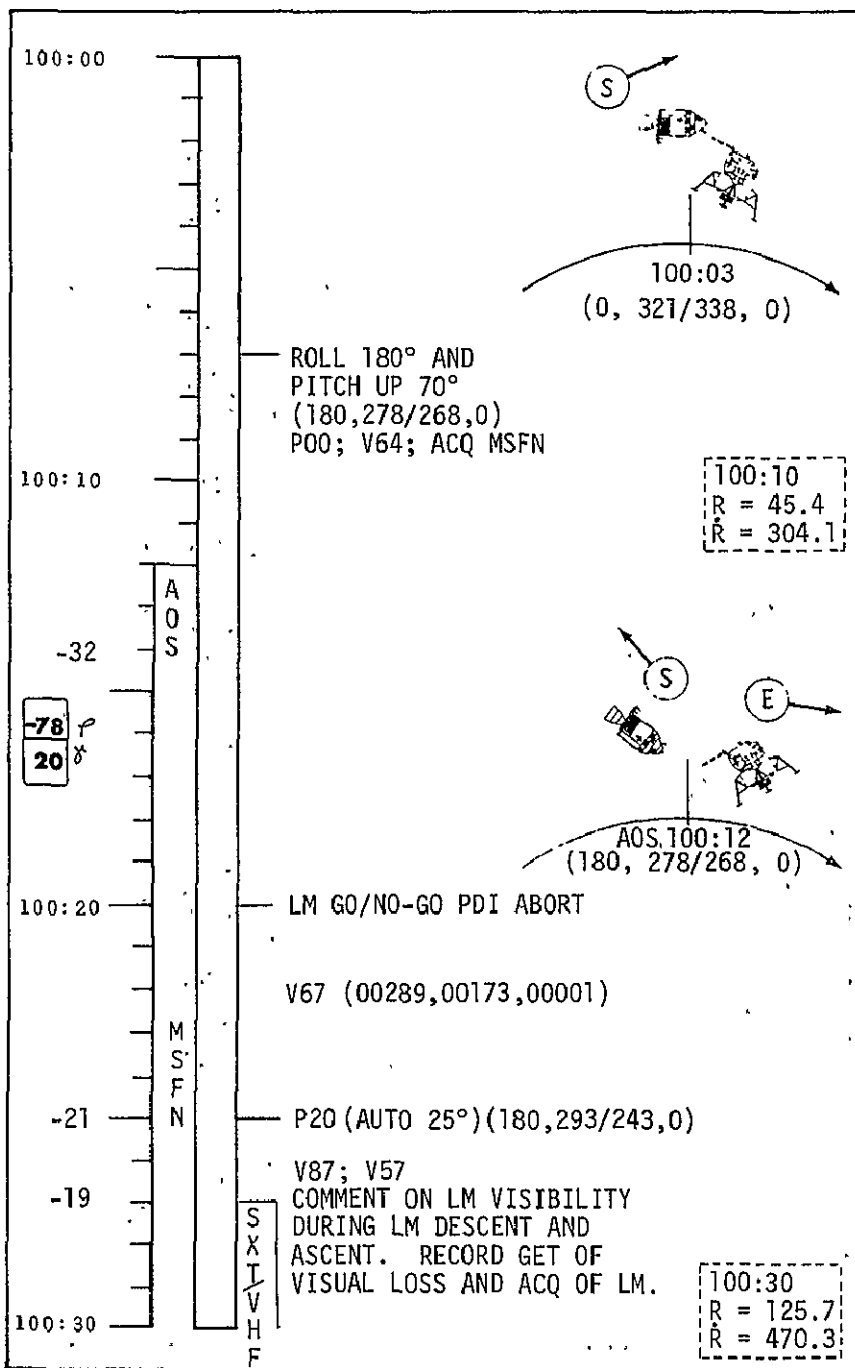

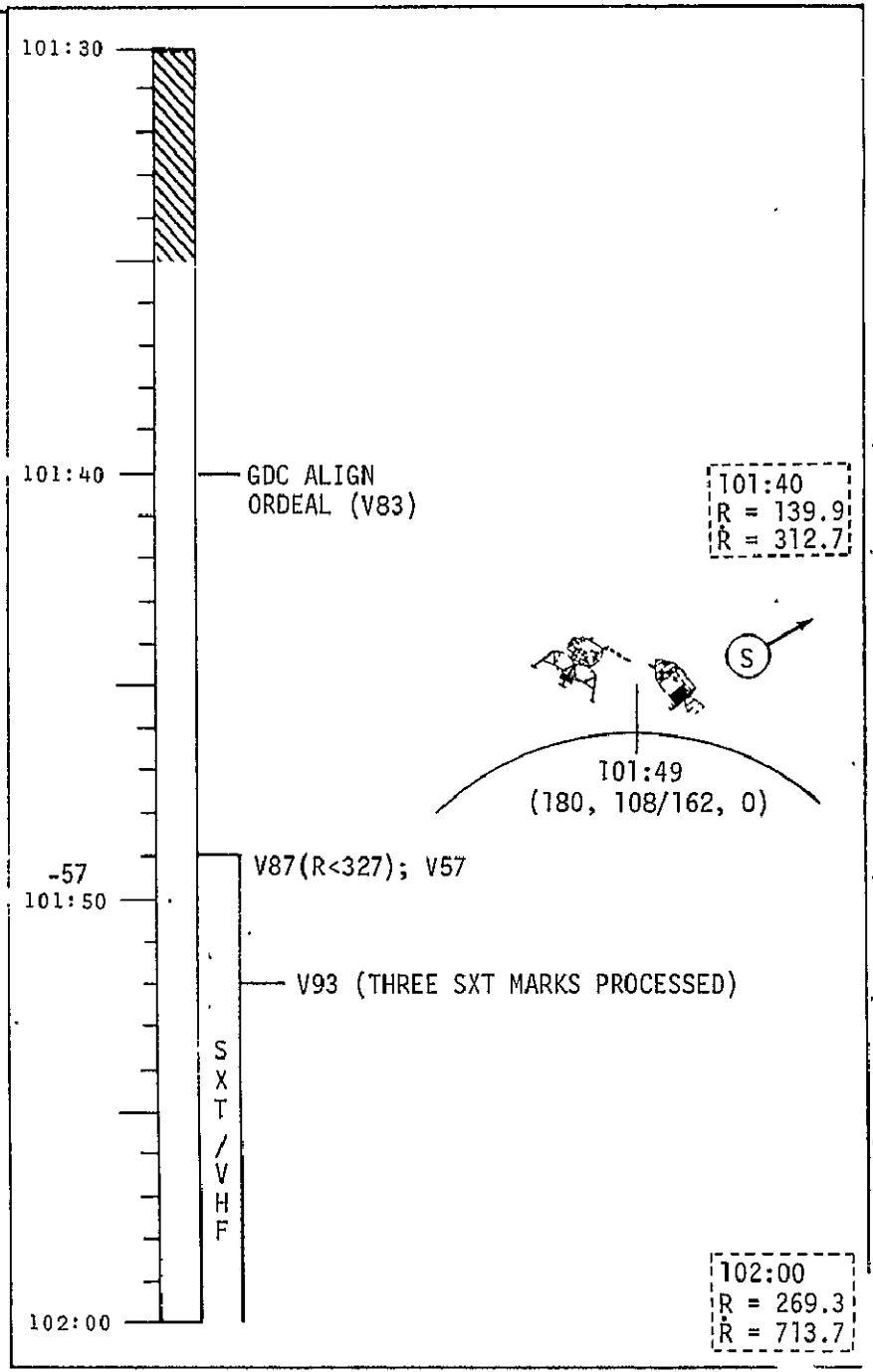
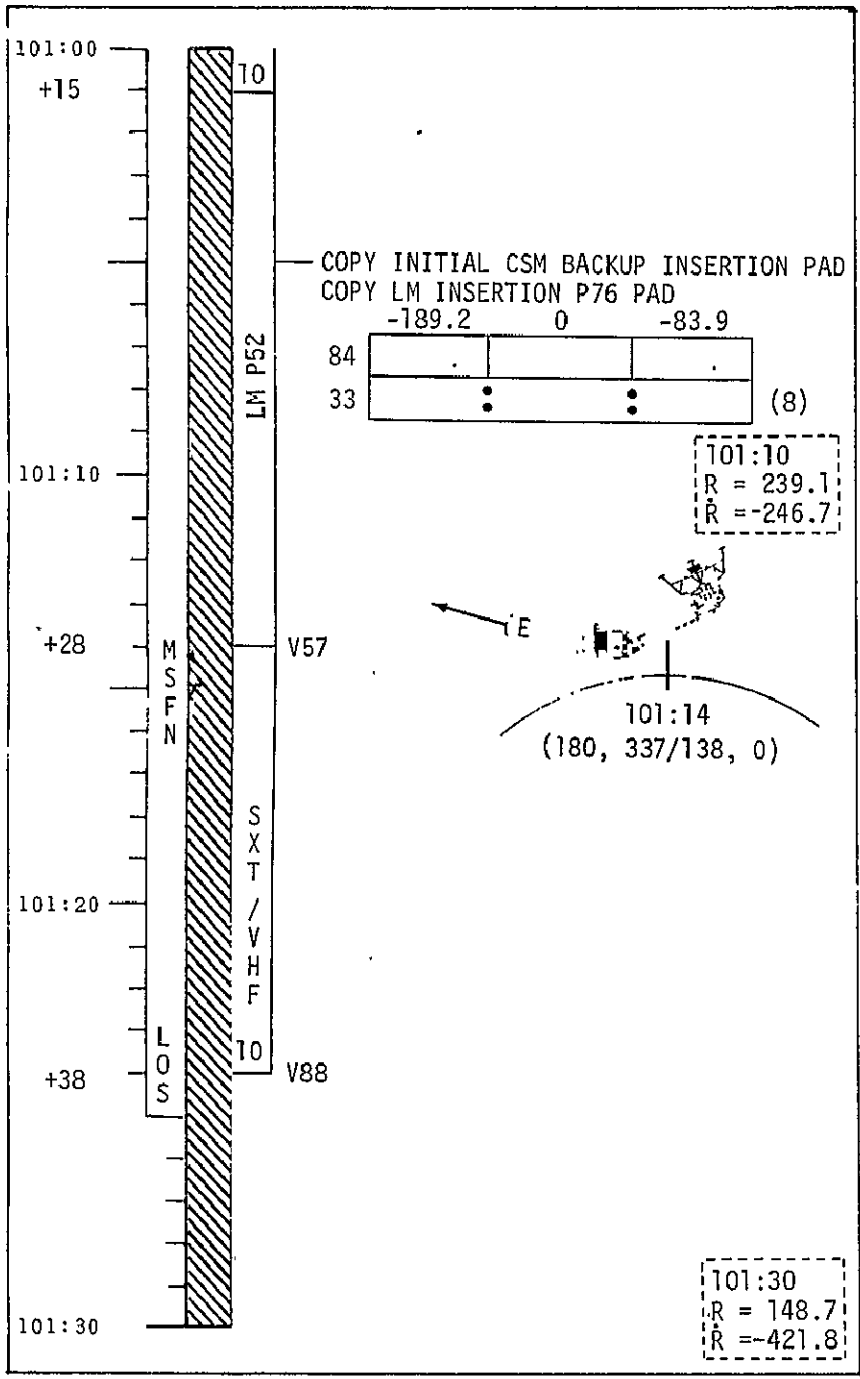

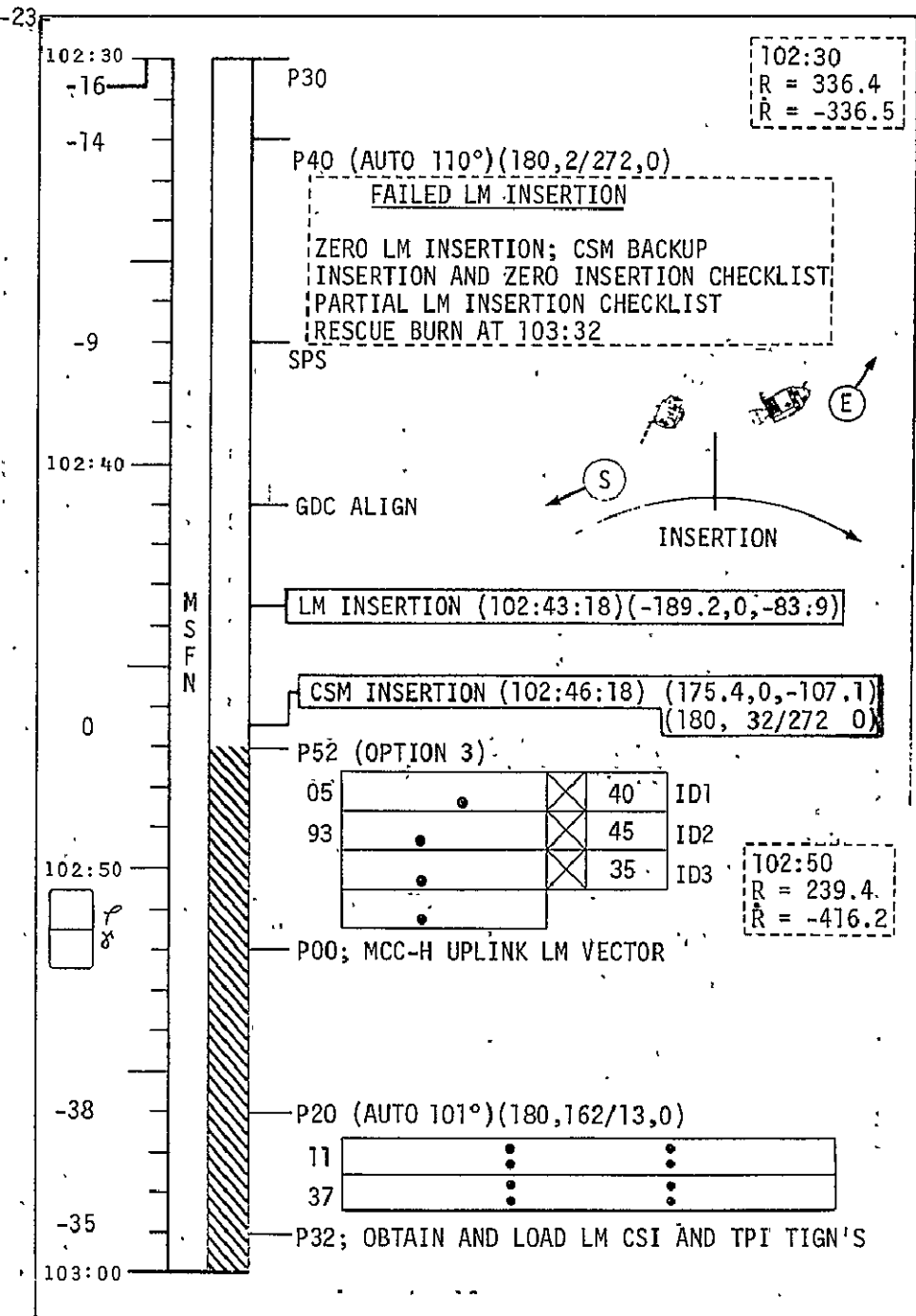
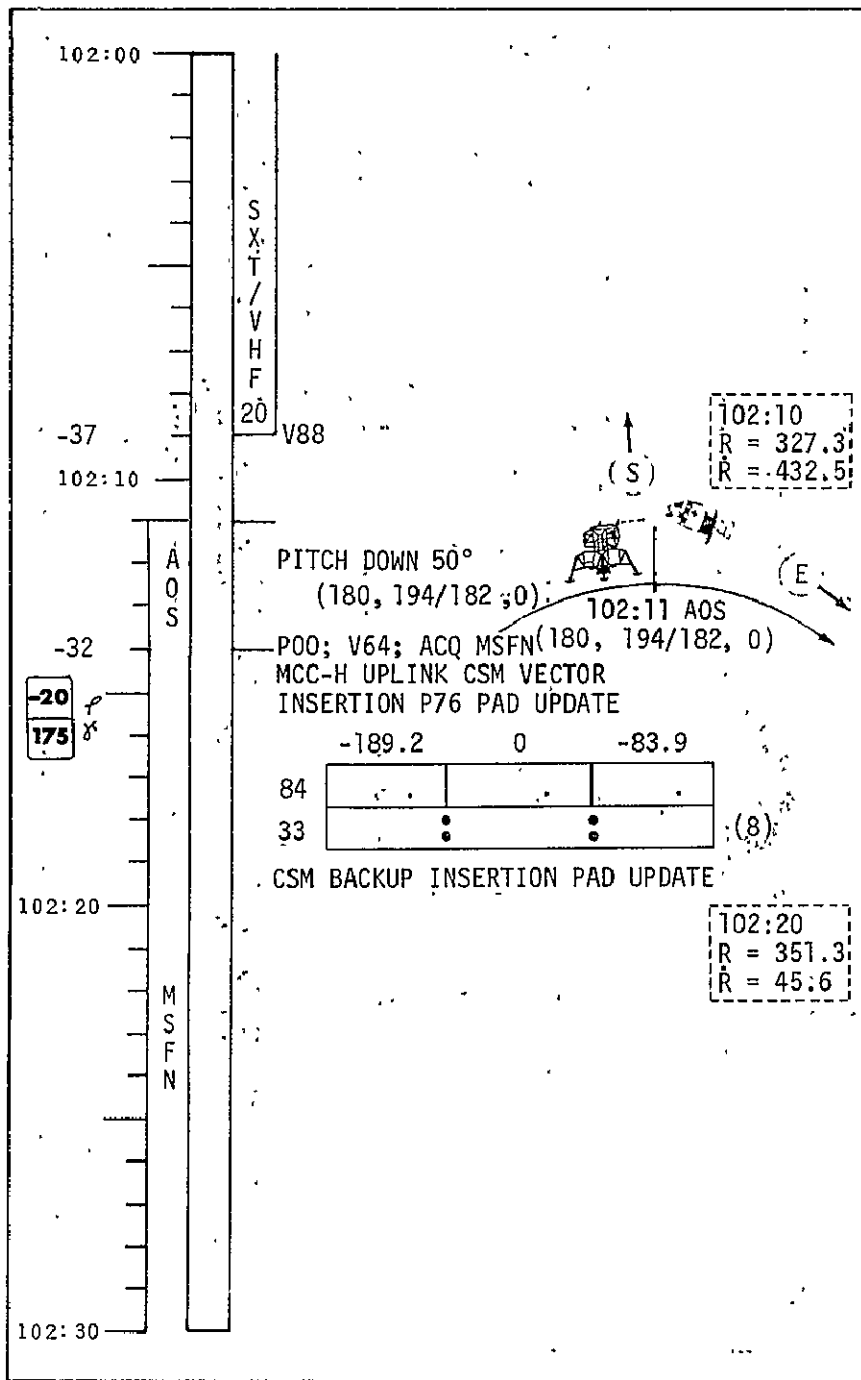



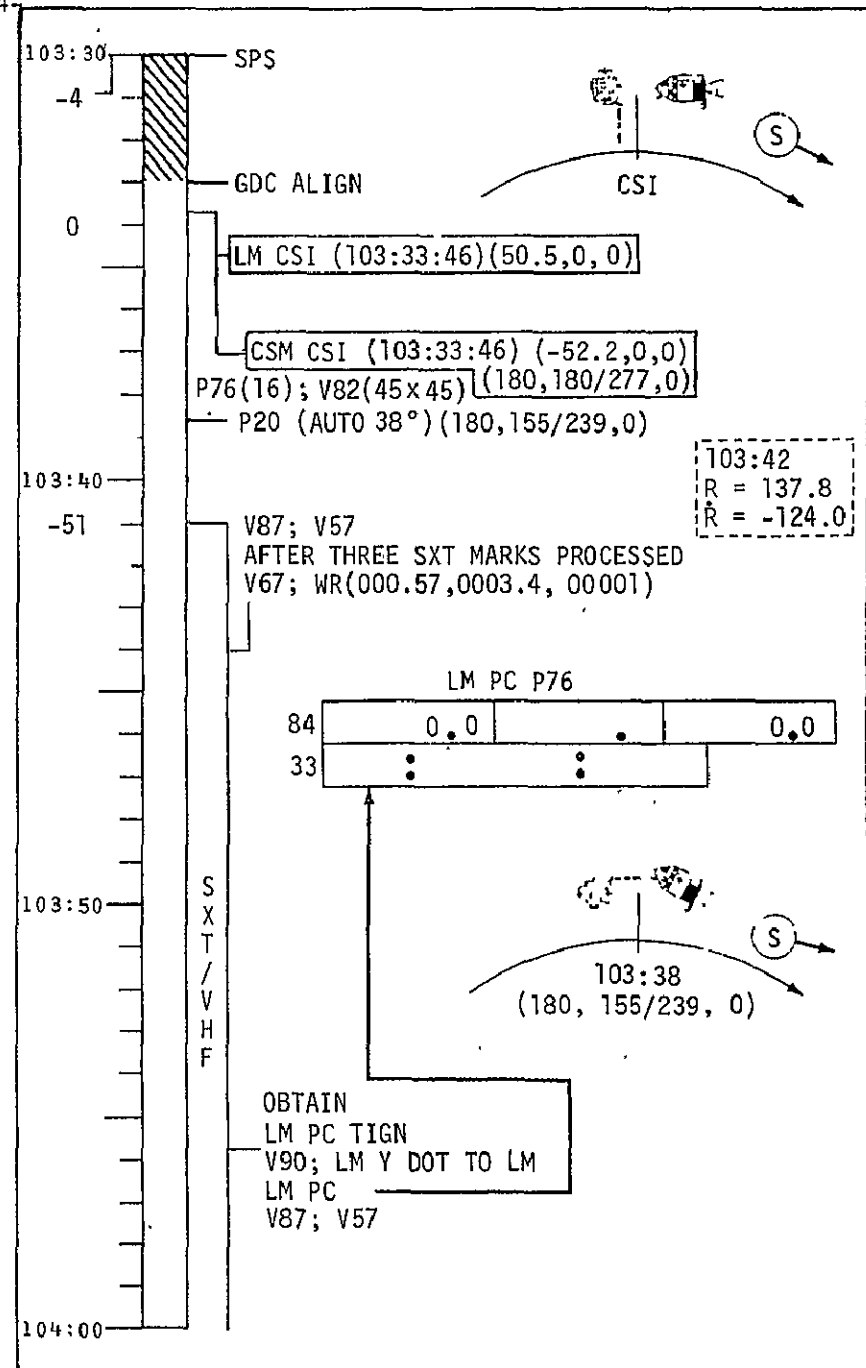
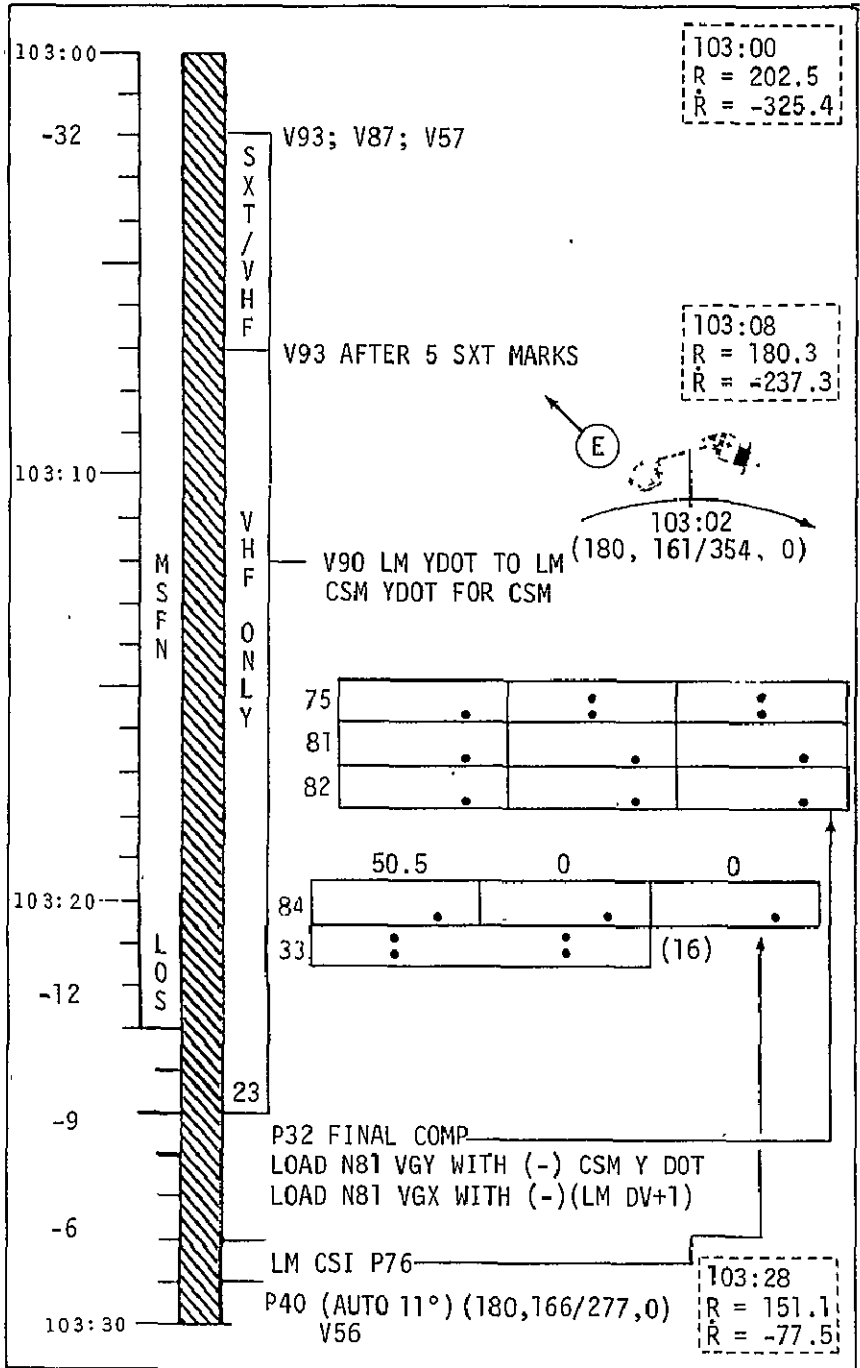

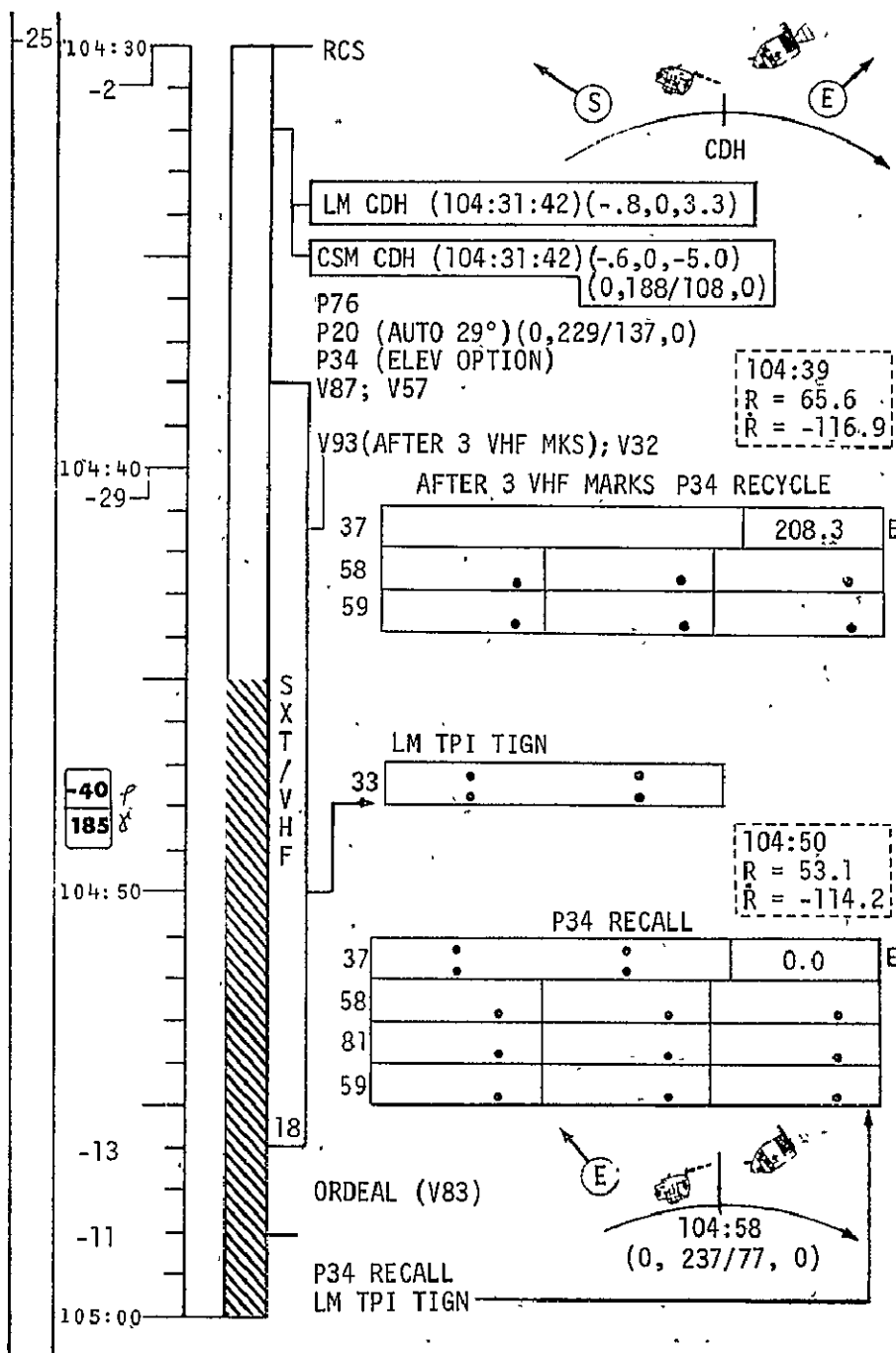
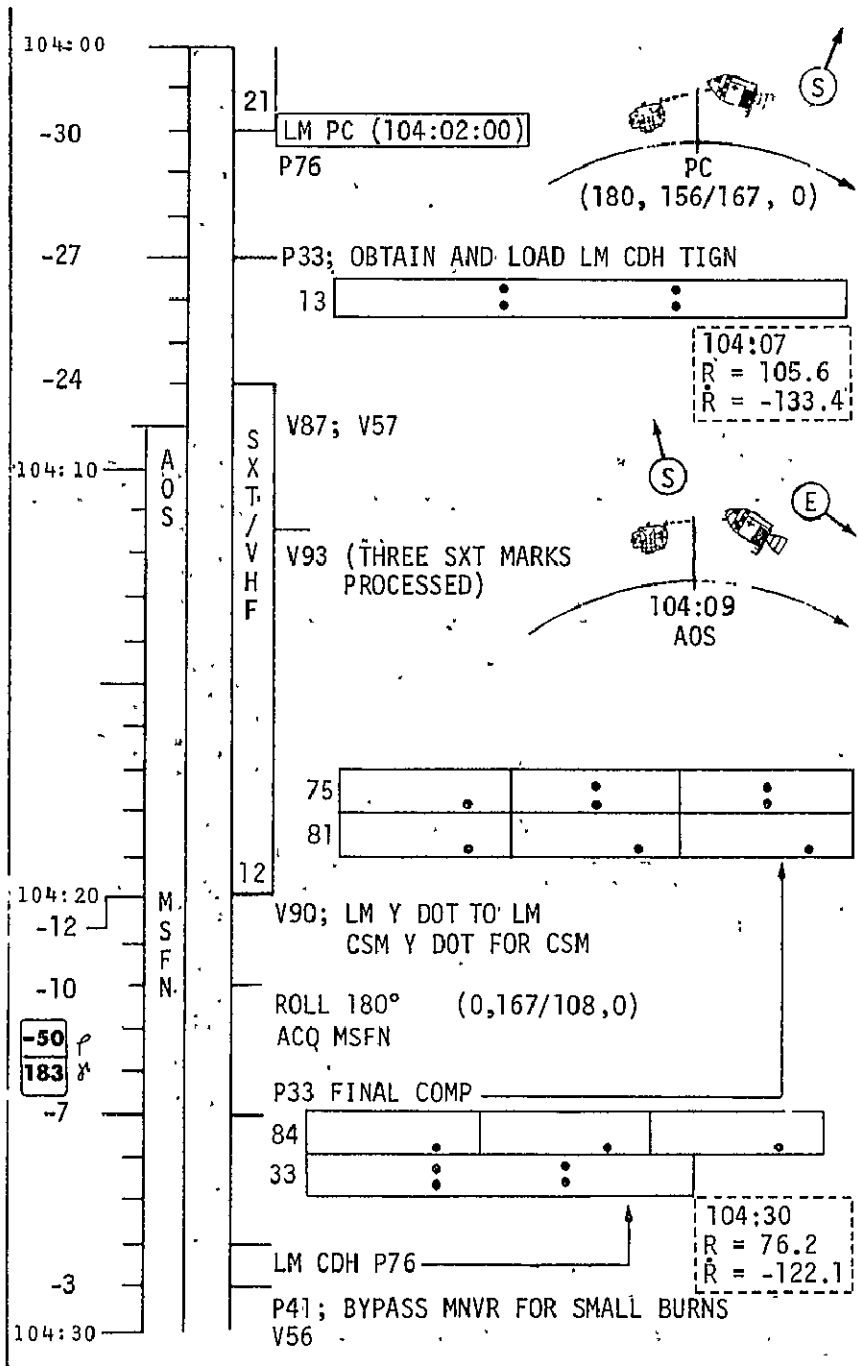

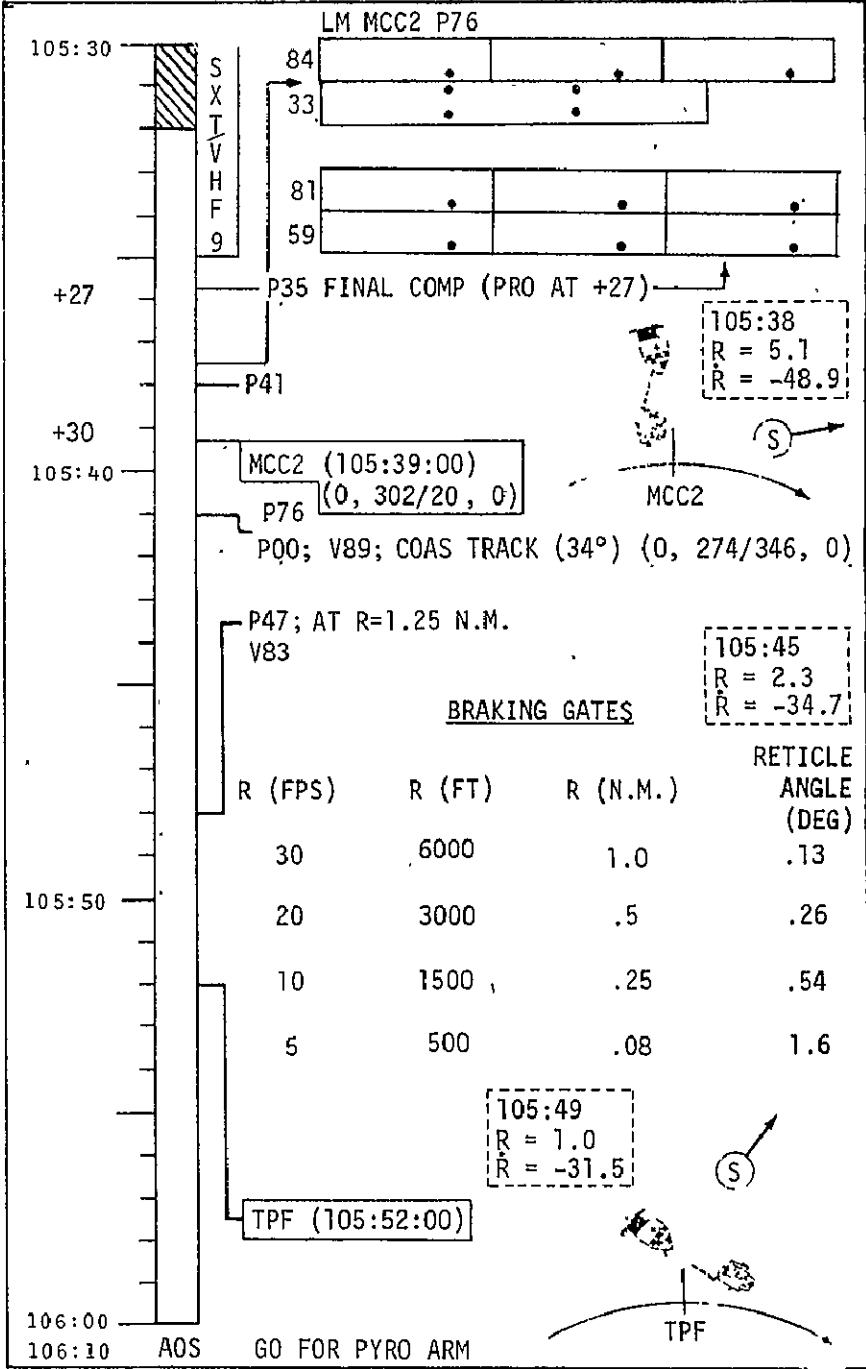
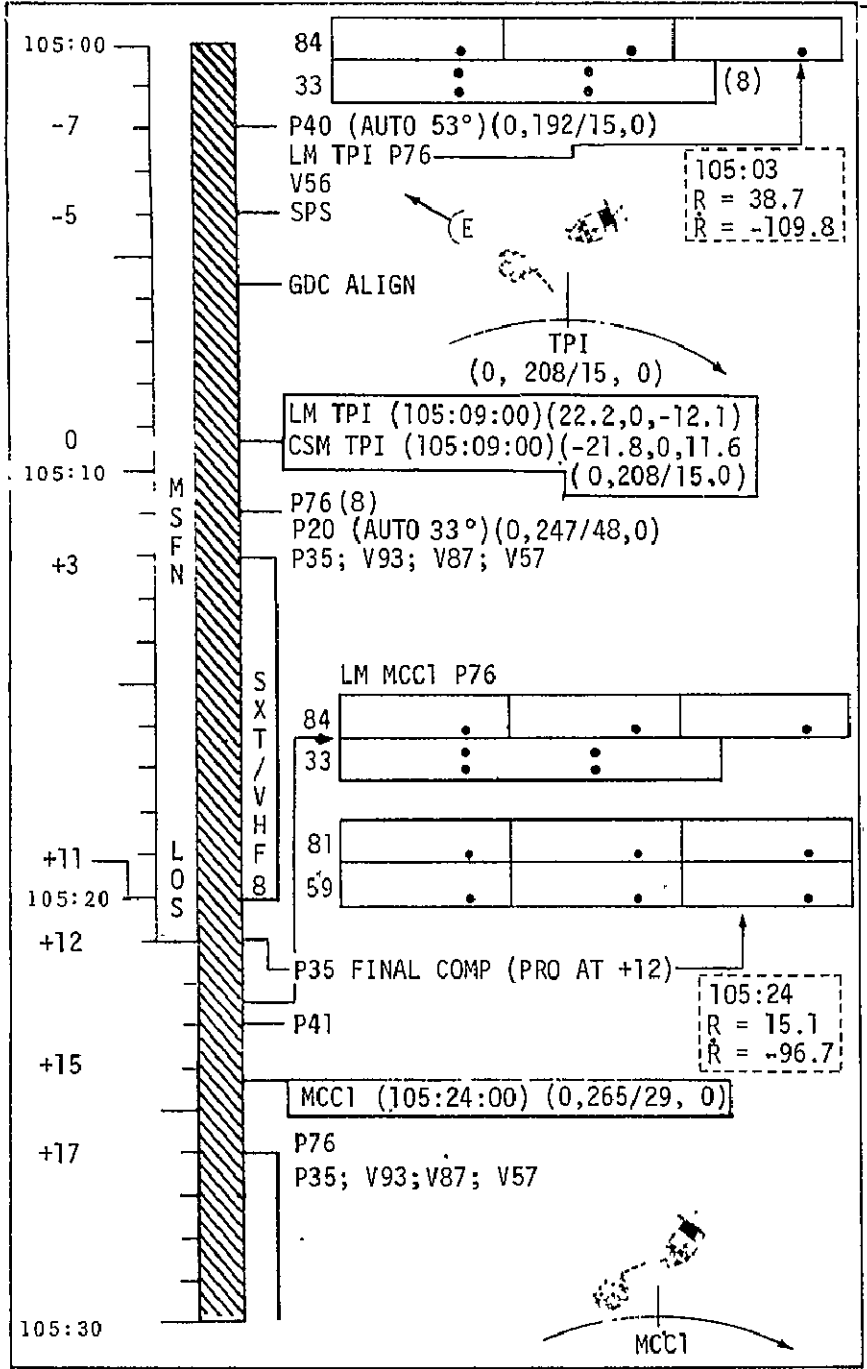

5.0 NOMINAL MAJOR PROCEDURES SUMMARY

The following sections present a summary timeline and checklist of major CSM activities during the nominal Mission F LM active rendezvous. The timeline in Section 5.1 will aid in interpreting the data included in the onboard rendezvous checklist and serves as a time correlated table of contents for the nominal detailed procedures which follow in Section 6.0. In addition, Section 5.2 includes a one-page summary checklist for the nominal mission in a format similar to that utilized for the LM rescue onboard data.

## 5.1 SUMMARY TIMELINE

-28-

GET	EVENT	PROG	GET	EVENT	PROG
(97+03)	MOVE TO COMMAND SEAT		(97+40)	V49,LOAD N22(180,14,14)	
(97+05)	MCC-H UPLINK(RLS AS REQUIRED(P00) AND CSM STATE VECTOR),V66			MNVR TO UNDOCKING ATTITUDE (INERTIAL SEP ATT EXCEPT ROLL AND 14 DEG YAW) (180,282/14,14)	
(97+14)	COPY CSM SEP PADS DON HELMET AND GLOVES CSM/LM COMM CHECK		(97+46)	CMC MODE-FREE(AS REQD FOR LM AGS CALIB)	
(97+20)	VERIFY DAP WIDE DB FOR LM RCS CHECKS		(97+50)	CMC MODE-AUTO(AFTER 32 SEC) PERFORM SYSTEMS CHECKS AND SWITCH VERIFICATION	
(97+27)	VERIFY AUTO RCS SEL -C4(-PITCH-X)-OFF -B3(+YAW-X)-OFF FOR LM RDR SELF TEST VERIFY RNDZ XPNDR=OFF		(97+52)	YAW 14 DEG LEFT AFTER LM AGS CALIB (180,312/14,0) MOVE TO LEB	
(97+30)	LOS		(98+05)	RNDZ XPNDR CHECKS MOVE TO COMMAND SEAT	
(97+35)	CONFIGURE CAMERA		(98+06)	GDC ALIGN TO IMU	
(97+38)	LOAD DAP (21112),(V46) (11111)		(98+07)	VERIFY ORDEAL (V83)	
	SUNUP	-25	(98+10+00)	RELOAD DAP (11102),(V46) (11111)	
	VHF AM A-SIMPLEX			SC CONT-SCS	
				***** UNDOCKING (180,12/14,0) ***** STATION KEEP AT 40 FT	

MISSION F NOMINAL TIMELINE APRIL 25, 1969

GET	EVENT	PROG	-29-	GET	EVENT	PROG
	DV CG-CSM			(98+39)		
	RNDZ XPNDR PWR-PWR(VERIFY)				RENDEZVOUS NAV PROGRAM	(P20)
	ROLL LEFT 180 DEG AT 2 DEG/SEC				AUTO MNVR TO SXT TRACK	
(98+13)	(0,50/14,0)				(40 DEG)	
	AOS				(0,142/54,0)	
	ACQUIRE MSFN (V64)	(P00)			VHF ANT-RT	
	ACTIVATE COLOR TV				VHF AM B-DUPLEX/RANGING	
	TAKE PHOTOS				MONITOR LM RR CHECKS	
-15	INSPECT LM DURING LM 360 DEG YAW				COMPARE EMS VHF AND V83 RANGE	
(98+20)					MOVE TO LEB	
	LM STATION KEEP			(98+50)	PERFORM OPTICS CHECKS	
(98+23)					SUNDOWN	
	COPY PADS			(98+55)		
(98+29)					IMU REALIGN TO REFSMMAT	(P52)
	RELOAD DAP(11102),(V46)				(OPTION 3)	
	(01111)				COPY GYRO TORQUE ANGLES	
	SC CONT=CMC			(99+03)		
-05	EXTERNAL DV TARGETING	(P30)			MOVE TO CMD SEAT	
(98+30)	(SEPARATION)				GDC ALIGN TO IMU	
-03				(99+05)	VERIFY ORDEAL(V83)	
(98+32)	RCS THRUST PROGRAM	(P41)	-29		MCC-H UPLINK(CSM AND	(P00)
	AUTO MNVR TO BURN ATTITUDE				AND LM VECTORS)	
	(TRIM)			(99+14)		
	RCS THRUST SETUP	(P41)			VHF AM A-SIMPLEX/DATA	
0	(98+35+16)			(99+25)		
	*****				LOS	
	SEPARATION BURN(0,0,-2.5)			(99+28)		
	(0,90/14,0)				RENDEZVOUS NAV PROGRAM	(P20)
	THRUST(=)X(2.5,0,0) TO (5.0,0,0)				AUTO MNVR TO SXT TRACK	
	*****				(55 DEG)	
					(0,206/332,0)	
					MOVE TO LEB	

MISSION F NOMINAL TIMELINE APRIL 25, 1969

GET	EVENT	PROG	-30-	GET	EVENT	PROG
-02	(99+32)			(100+12)	AOS	
	LOAD TARGET DV PROGRAM	(P76)			ACQUIRE MSFN (V64)	(P00)
	(DOI)			(100+20)	OBTAIN GO/NO GO FOR PDI ABORT	
	(99+33+59)				MOVE TO LEB	
	*****				V67 LOAD WI(002.89,0017.3,00001)	
	LM DOI BURN(-71.1,0,-.3)			(100+25)	RENDEZVOUS NAV PROGRAM	(P20)
	*****				AUTO MNVR TO SXT TRACK	
	MOVE TO CMD SEAT		-21		(25 DEG)	
	VHF AM B-DUPLEX/RANGING				(180+293/243,0)	
	VHF RCV ONLY-OFF			(100+27)	CALL MARKING ROUTINES(V87,V57)	
	COMPUTE RDOT FOR LM		-19		TERMINATE SXT/VHF MARKS(V88)	
	LM ORBIT PARAMETER DISPLAY(V82)			(100+37)		
	(9X60)				(100+46+21)	
	CONFIRM LM DOI				*****	
	INCORPORATE P76 DATA		-9		LM PHASING BURN(170.4,0,-95.6)	
	(DOI)				(180,307/193,0)	
	(99+37)		0		*****	
	SUNUP			(100+47)	TARGET DV PROGRAM	(P76)
	(99+38)				(PHASING)	
	RENDEZVOUS NAV PROGRAM	(P20)			LM ORBIT PARAMETER DISPLAY(V82)	
	POSSIBLE AUTO MNVR TO SXT TRACK				(10X196)	
	(TRIM)			(100+48)	RENDEZVOUS NAV PROGRAM	(P20)
	(0,227/317,0)				POSSIBLE AUTO MNVR TO SXT TRACK	
	MOVE TO LEB				(TRIM)	
	(99+44)			(100+49)	(180,308/188,0)	
	INITIATE LM OPTICS TRACK				SUNDOWN	
-39	(100+07)					
	MOVE TO CMD SEAT					
	ROLL 180 DEG AND PITCH UP 70 DEG					
	AT 1 DEG/SEC					
	(180,278/268,0)					

MISSION F NOMINAL TIMELINE APRIL 25, 1969

GET	EVENT	PROG	-31-	GET	EVENT	PROG
+05	(100+51)		-32	(102+14)	ACQUIRE MSFN (V64)	(P00)
	(101+01)	CALL MARKING ROUTINES (V87,V57) (PROCESS 3 MARKS,V93)			MCC-H UPLINK (CSM VECTOR)	
	(101+05)	TERMINATE SXT MARKS			COPY LM INSERTION P76 PAD UPDATE AS REQUIRED	
	(101+10)	COPY INITIAL CSM BACKUP INSERTION PAD		(102+29)	COPY CSM BACKUP INSERTION PAD UPDATE AS REQUIRED	
+28	(101+14)	COPY LM INSERTION P76 PAD	-16	(102+30)	VERIFY ORDEAL (V83)	
+38	(101+24)	CALL MARKING ROUTINE (V57)	-14	(102+32)	EXTERNAL DV TARGETING (INSERTION)	(P30)
	(101+35)	TERMINATE SXT/VHF MARKS,V88 LOS			SPS THRUST PROGRAM (INSERTION)	(P40)
	(101+40)	SUNUP MOVE TO COMMAND SEAT			AUTO MNVR TO BURN ATTITUDE (110 DEG) (180,3/272,0)	
	(101+49)	GDC ALIGN TO IMU VERIFY ORDEAL (V83) MOVE TO LEB	-09	(102+37)	↑ SPS THRUST SETUP (INSERTION)	(P40)
-57	(101+49)	CALL MARKING ROUTINES (V87,V57) (PROCESS 3 MARKS,V93)	-05	(102+41)	GDC ALIGN	
-37	(102+09)	TERMINATE SXT/VHF MARKS,V88 MOVE TO CMD SEAT	-03	(102+43+18)	***** LM INSERTION BURN (-189.2,0,-83.9) *****	
	(102+11)	AOS PITCH DOWN 50 DEG (180,174/162,0)	0	(102+46+18)	***** CSM BACKUP INSERTION BURN (175.4,0,-107.1) (180,32/272,0) *****	

MISSION F NOMINAL TIMELINE APRIL 25, 1969



GET	EVENT	PROG	-32-	GET	EVENT	PROG
	TARGET DV PROGRAM (INSERTION)	(P76)	-09	(103+25)	CSI TARGETING FINAL COMP	(P32)
	LM ORBIT PARAMETER DISPLAY(V82) (10X45)			(103+28)	COPY CSM CSI SOLUTION LOAD NR1 VGY WITH(=) CSM YDOT	
(102+47)	SUNDOWN MOVE TO LEB			(103+29)	COPY LM CSI PAD	
	IMU REALIGN TO REFSMMAT (OPTION 3)	(P52)			SPS THRUST PROGRAM,V56	(P40)
(102+52)	COPY GYRO TORQUE ANGLES				AUTO MNVR TO BURN ATTITUDE (11 DEG) (180.166/277.0)	
-41	MCC-H UPLINK(LM VECTOR)	(P00)	-04	(103+30)	SPS THRUST SETUP	(P40)
(102+56)	RENDEZVOUS NAV PROGRAM AUTO MNVR TO SXT TRACK(101 DEG) (180.162/13.0)	(P20)	-03	(103+31)	GDC ALIGN	
(102+59)	CSI TARGETING PROGRAM (P32)(P20) OBTAIN LM CSI AND TPI TIGNS, LOAD CSI TARGETING DATA		0	(103+33+46)	SUNUP ***** LM CSI BURN(50.5,0,0) ***** ***** CSM BACKUP CSI BURN (52.2,0,0) (180.180/277.0) ***** TARGET DV PROGRAM (P76) (CSI) LM ORBIT PARAMETER DISPLAY(V82) (45X45)	
-32	REINITIALIZE W MATRIX (V93) CALL MARKING ROUTINE(V87,V57)					
-27	TERMINATE SXT MARKS REINITIALIZE W MATRIX (V93) MOVE TO CMD SEAT					
-22	OUT OF PLANE DATA(V90) (CSM AND LM) VOICE LM Y DOT TO LM					
(103+23)	LOS					

MISSION F NOMINAL TIMELINE APRIL 25, 1969

GET	EVENT	PROG	-33-	GET	EVENT	PROG
(103+38)	RENDEZVOUS NAV PROGRAM AUTO MNVR TO SXT TRACK (39 DEG) (180,155/239,0)	(P20)		(104+08)	CALL MARKING ROUTINE(V87,V57)	
-54 (103+41)	CALL MARKING ROUTINES(V87,V57) (PROCESS 3 MARKS) V67 LOAD WR(000.57,0003,4,00001)		-12	(104+09)	AOS (PROCESS THREE MARKS,V93)	
(103+44)	CALL MARKING ROUTINE (V57)			(104+20)	TERMINATE SXT MARKS OUT OF PLANE DATA(V90) VOICE LM YDOT TO LM MOVE TO CMD SEAT	
(103+55)	TERMINATE SXT MARKS COPY LM PC TIGN OUT OF PLANE DATA(V90) VOICE LM YDOT TO LM COPY LM PC PAD		-07	(104+22)	ROLL 180 DEG AT 2 DEG/SEC ACQUIRE MSFN (0,167/108,0)	
(103+57)	CALL MARKING ROUTINE(V57)			(104+25)	CDH TARGETING FINAL COMP (P33) COPY CSM CDH SOLUTION	
30 (104+02+00)	TERMINATE MARKS ***** LM PLANE CHANGE(0,0,0) ***** LOAD TARGET DV PROGRAM (P76) INCORPORATE P76 DATA (PLANE CHANGE)		-03	(104+28)	COPY LM CDH PAD	
(104+05)	CDH TARGETING PROGRAM (P33) POSSIBLE AUTO MNVR TO SXT TRACK (TRIM) (180,157/158,0) OBTAIN LM CDH TIGN LOAD CDH TARGETING DATA		0	(104+29)	RCS THRUST PROGRAM (P41) BYPASS BURN ATTITUDE MNVR FOR SMALL BURNS	
			-02	(104+30)	RCS THRUST SETUP (P41) GDC ALIGN	
				(104+31+42)	***** LM CDH BURN(-.8,0,3,3) ***** ***** CSM CDH BURN (-.6,0,-5.0) (0,188/108,0) *****	

MISSION F NOMINAL TIMELINE APRIL 25, 1969

GET	EVENT	PROG	GET	EVENT	PROG
(104+34)	TARGET DV PROGRAM (CDH)	(P76)	-05 (105+04)	SPS THRUST SETUP (TPI)	(P40)
	RENDEZVOUS NAV PROGRAM	(P20)	-03 (105+06)	GDC ALIGN	
	AUTO MNVR TO SXT TRACK (29 DEG)		0 (105+09+00)	*****	
	(0,229/137,0)			LM TPI BURN (22.2,0,-12.1)	
	MOVE TO LEB			*****	
	TPI TARGETING PROGRAM (P34) (P20)			*****	
	LOAD TPI TARGETING DATA WITH ELEV OPTION			CSM TPI BACKUP BURN	
-31 (104+38)	CALL MARKING ROUTINE (V87,V57)			(-21,8,0,11.5)	
	AFTER 3 MARKS PROCESSED			(0,208/15,0)	
	RECYCLE TPI TARGETING PROGRAM	(P34)		*****	
	CALL MARKING ROUTINE (V57)		+02	TARGET DV PROGRAM (TPI)	(P76)
(104+45)	SUNDOWN			RENDEZVOUS NAV PROGRAM	(P20)
(104+50)	COPY LM TPI TIGN			AUTO MNVR TO SXT TRACK (33 DEG)	
-13 (104+56)	TERMINATE SXT MARKS			(0,247/48,0)	
	MOVE TO CMD SEAT		+03	MOVE TO LEB	
	VERIFY ORDEAL (V83)		+11	MCC TARGETING PROGRAM	(P35)
-11 (104+58)	TPI TARGETING PROGRAM (TIGN OPTION WITH LM TIGN)	(P34)		CALL MARKING ROUTINE (V93,V87,V57)	
-07 (105+02)	SPS THRUST PROGRAM V56	(P40)	+12 (105+21)	TERMINATE SXT MARKS	
	AUTO MNVR TO BURN ATTITUDE (53 DEG)			MOVE TO COMMAND SEAT	
	(0,192/15,0)			LOS	
	COPY LM TPI P76 PAD			MCC1 TARGETING FINAL COMP	(P35)
				COPY CSM MCC1 SOLUTION	
				COPY LM MCC1 PAD	

GET	EVENT	PROG	GET	EVENT	PROG
+13.5			+30	(105+39+00)	
	RCS THRUST PROGRAM (P41)			*****	
	BYPASS BURN ATTITUDE MNVR			LM MCC2 BURN	
+15	(105+24+00)			*****	
	*****			CSM MCC2 BACKUP BURN	
	LM MCC1 THRUST			(0,302/20,0)	
	*****			*****	
	CSM MCC1 BACKUP BURN			TARGET DV PROGRAM (P76)	
	(0,265/29,0)			(MCC2)	
	*****			AUTO MNVR TO COAS TRACK(V89)(P00)	
	TARGET DV PROGRAM (P76)			(34 DEG)	
	(MCC1)			(0,274/346,0)	
+16			+39	(105+48)	
	MCC2 TARGETING PROGRAM (P35)(P20)			THRUST MONITORING PROGRAM (P47)	
	POSSIBLE AUTO MNVR TO SXT TRACK			(KEY V83 AND MONITOR LM BRAKING)	
	(TRIM)			*****	
+17				* BRAKING GATES RETICLE ANGLE *	
	CALL MARKING ROUTINE(V93,V87,V57)			* 30 FPS AT 6000 FT .13 DEG. *	
	(105+32)			* 20 FPS AT 3000 FT .26 DEG. *	
	SUNUP			* 10 FPS AT 2500 FT .54 DEG. *	
+26				* 5 FPS AT 500 FT 1.60 DEG. *	
	TERMINATE SXT MARKS			*****	
	MOVE TO CMD SEAT		+43	(105+52)	
+27				*****	
	MCC2 TARGETING FINAL COMP (P35)			TPF(0,310/353,0)	
	COPY CSM MCC2 SOLUTION			*****	
	COPY LM MCC2 PAD				
+28.5					
	RCS THRUST PROGRAM (P41)				
	BYPASS BURN ATTITUDE MNVR				

5.2 NOMINAL SUMMARY CHECKLIST

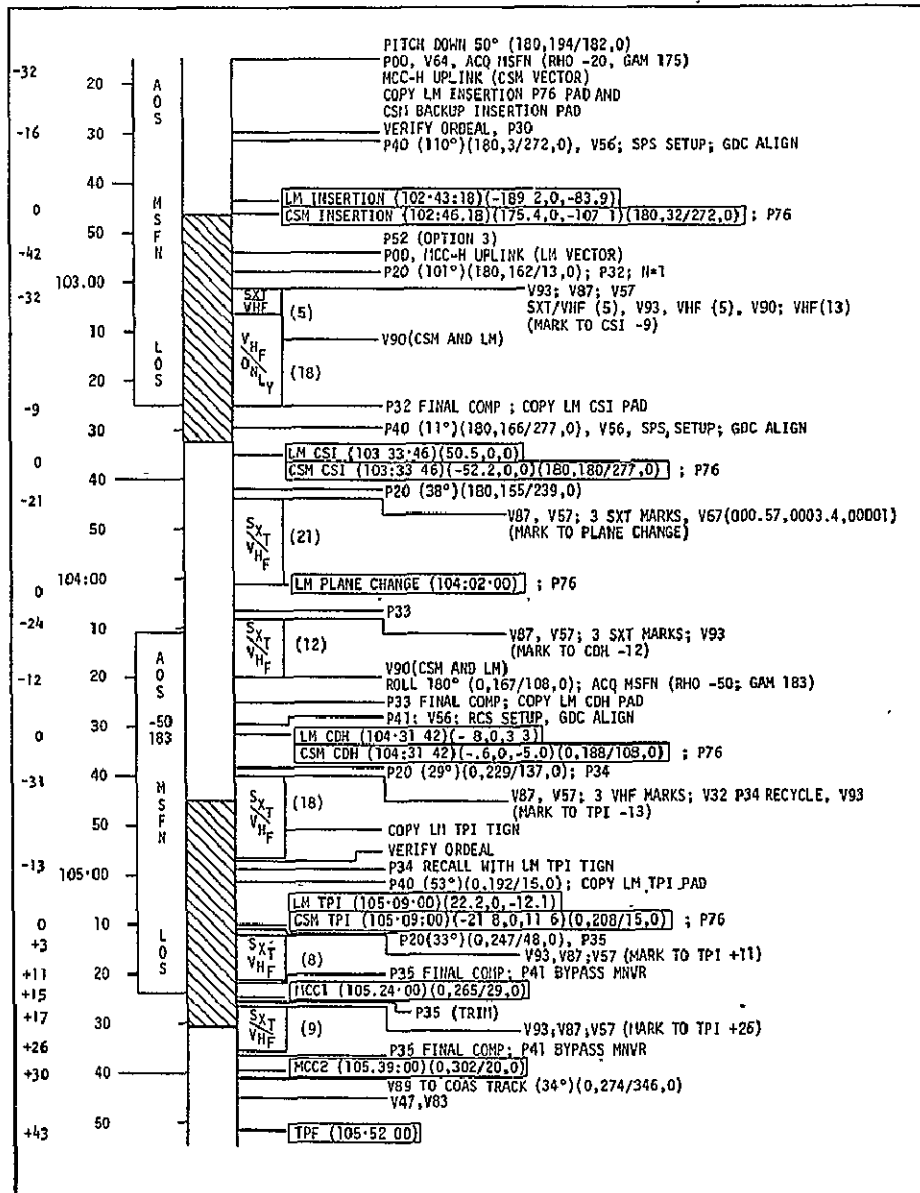
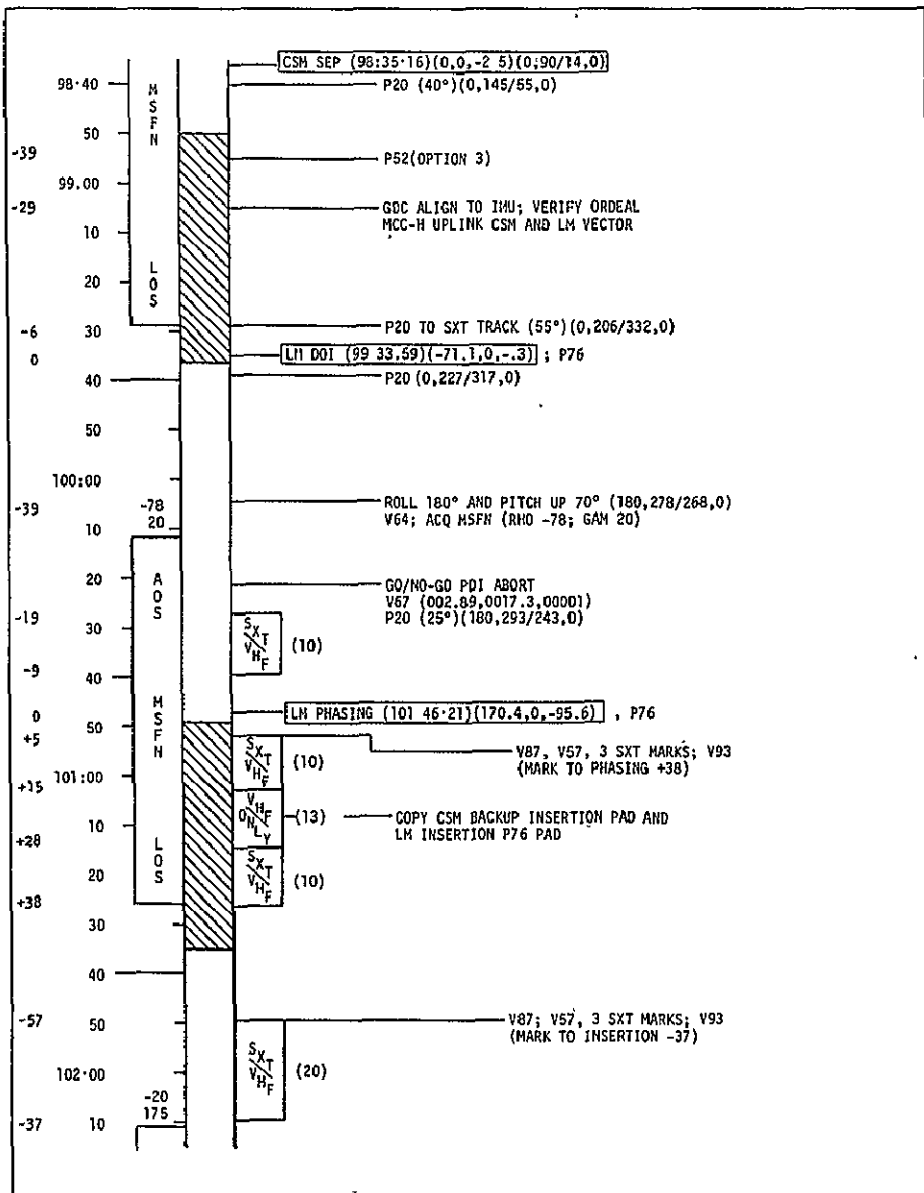

## 6.0 NOMINAL DETAILED PROCEDURES

The following four sections contain 1) The procedural ground rules assumed when generating procedures, 2) The detailed nominal procedures, 3) A summary of the rendezvous navigation schedule including the angle between the LOS to the Sun and LOS to the LM, and 4) A Summary of the inertial roll gimbal angle and the ORDEAL pitch and inertial pitch gimbal angles during the nominal F Mission.

## 6.1 Procedures Ground Rules

- 6.1.1 The CSM will be targeted for a TIGN three minutes after the LM TIGN for the insertion burn. No bias will be used for the CSI, CDH, or TPI burns.
- 6.1.2 The CSM will obtain from the LM the CSI, CDH, and TPI times utilized in the LGC targeting programs. These TIGN's loaded into the CMC targeting programs.
- 6.1.3 LM burn data will be incorporated into the CMC LM state vector using Program P76 following each LM burn. No attempt will be made to account for LM burn residuals. The LM burn TIGN loaded in Program P76 will be biased by a fixed number simulating an impulsive LM burn. The non-zero LM burns considered and the corresponding bias times are DOI (20 Sec), Phasing (32 Sec), Insertion (8 Sec), CSI (16 Sec), and TPI (8 Sec).
- 6.1.4 The CSM will compute using V90, the out-of-plane velocity of the LM prior to the CSI, Plane Change, and CDH burns for use in the LM targeting programs.
- 6.1.5 The ordeal setup on FDAI 2 will be verified approximately once per orbit.
- 6.1.6 The GDC will be aligned to the IMU prior to each backup CSM burn.
- 6.1.7 No burn attitude verification using stars or the horizon will be made in the CSM.
- 6.1.8 The PIPA bias determination, EMS DV test, and EMS accelerometer check, identified in the AOH as required

before each SPS burn, need be scheduled only prior to the entire rendezvous sequence.

- 6.1.9 The SM RCS propulsion check identified in the AOH as required before each SPS burn, should not include recording the values monitored.
- 6.1.10 It is assumed that the CMP is able to move to the LEB or command seat during automatic attitude maneuvers and the time required to move is less than one minute.
- 6.1.11 The procedures contained herein reflect the COMANCHE 44, 45 programs and routines.
- 6.1.12 The minimum times to be allowed for the CMC programs are:
  - A. P52 5 Min.
  - B. P76 1 Min.
  - C. P30 2 Min.
  - D. P32 Final Comp 3 Min.
  - E. P33 Final Comp 3 Min.
  - F. P34 Final Comp 3 Min.
  - G. P35 Final Comp 1.5 Min.
  - H. P41 (Excluding ATT Mnvr and Including RCS Setup) 1.5 Min.
  - I. P40 (Excluding ATT Mnvr and Including SPS Setup) 5 Min.
- 6.1.13 All automatic maneuvers (DAP) are made at a rate of .5 Deg/Sec.
- 6.1.14 The state vector of the active vehicle (LM) will be updated in the rendezvous navigation Program, P20.



- 6.1.15 The SXT navigation mark frequency during a tracking period is one per minute.
- 6.1.16 Recycles for CMC targeting Programs P32, P33, and P34 during mark periods have not been scheduled. They will be included, as desired for solution comparison purposes, when they do not preclude taking the minimum number of SXT and VHF marks prior to a burn.
- 6.1.17 The delta time between the PRO for Final Comp in Program P35 and the MCC is three minutes.
- 6.1.18 Program P20 will be terminated (V56) in the thrust program prior to each backup CSM burn. This will necessitate calling Program P20 after the burn in addition to a pre-thrust program.  
Exceptions: Insertion (POO does it) and the MCC burns.
- 6.1.19 The automatic star selection routine in Program P52 will be used during each IMU realignment.
- 6.1.20 The CSM attitude has been specified to be compatible with HGA communications when no other attitude constraint prohibits HGA coverage.
- 6.1.21 The procedures have been developed to be compatible with Mission G1 procedural requirements.
- 6.1.22 The SPS gimbal motors will not be activated for a CSM backup of a LM burn until the CSM knows it must become active.

- 6.1.23 Backup charts for the CSI, CDH, TPI, and MCC burns will not be used in the CSM.
- 6.1.24 VHF navigation marks cannot be taken at ranges greater than 327 nautical miles.

6.2 DETAILED PROCEDURES

```

*****
*
* MISSION F RENDEZVOUS PROCEDURES
*
*****

```

```

*****
* ASSUMED INITIAL SWITCH SETTINGS
*****

```

\*\*CDR SWITCH SETTINGS\*\*

```

CMC ATT-IMU
FDAI SCALE=5/1
FDAI SELECT=1/2
FDAI SOURCE=ATT SET
ATT SET-IMU
MAN ATT.(3)-RATE CMD
LIMIT CYCLE-OFF
ATT DB-MAX
RATE-LOW
THC-LOCKED
RHC-LOCKED
TRANS CONT PWR-ON(UP)
ROT CONTR PWR NORMAL(BOTH)-
AC/DC
ROT CONTR PWR DIRECT(BOTH)-
OFF
SC CONT-CMC
CMC MODE-AUTO
BMAG MODE(3)-RATE2
SPS THRUST DIRECT-NORMAL
DV THRUST(A,R)-OFF

```

```

SCS TVC (BOTH)-RATE CMD
SPS GMBL MTR(4)-OFF
DV CG-LM/CSM
IMU CAGE-OFF
EMS ROLL-OFF
.05 G-OFF
LV/SPS IND (BOTH)-PC,GPI
TVC GMBL DRIVE (BOTH)=1
FCSM(A,B)-RESET/OVERRIDE
EMS FUNCTION-OFF
EMS MODE-STBY
UP TLM(CM,IU)-BLOCK
RCS TRNFR-SM
PANEL 8 CB CLOSED EXCEPT
RCS LOGIC(2)
DOCK PROBE(2)
ELS BAT A,BAT B
PL VENT FLT/PL
FLOAT BAG(3)
SECS ARM BAT A,BAT B
AUTO RCS SEL(16)-MNA
EXCEPT
-C4(-PITCH-X)-OFF
-B3(+YAW-X)-OFF
TVC SERVO PWR (BOTH)-OFF
FDAI/GPI PWR-BOTH
LOGIC PWR 2/3-ON(UP)
SCS ELECT PWR-GDC/ECA
SIG COND/DRVR BIAS PWR(2)-AC1
BMAG PWR(BOTH)-ON
COAS PWR (L WIND)-ON

```

FDAI SW1-INERTIAL  
FDAI SW2-ORB RATE  
EARTH/LUNAR=LUNAR  
ALT SET KNOB TO AVE ALT  
MODE-OPR/SLOW

\*\*LMP SWITCH SETTINGS\*\*

G/N PWR-AC1  
MN BUS TIE(2)-OFF  
NONESS BUS-OFF  
PANEL 5 G/N CB(10)-CLOSED  
PANEL 229 CB CLOSED EXCEPT  
MN REL PYRO(2)

\*\*CMP SWITCH SETTINGS\*\*

G/N PWR OPTICS=ON  
G/N PWR, IMU=ON  
RNDZ XPONDER=OFF  
OPTICS MODE=CMC  
ZERO OPTICS=ZERO  
CONT SPEED=LO  
CONT COUPLING=RESOLVED  
SCT TRUN=SLAVE TO SXT  
CONDITION LAMPS=ON  
UP TLM(LEB)=ACCEPT  
C/W=NORMAL  
C/W=CSM  
C/W=POWER

```
*****
*
*   TIMELINED RENDEZVOUS PROCEDURES
*
*****
```

```
*****
*   PROCEDURES THRU UNDOCKING
*
*****
```

(97+03)

MOVE TO CMD SEAT

(97+05)

\*\*MCC-H UPLINK RLS (AS REQUIRED)\*\*  
AND CSM STATE VECTOR

P00

KEY V37E00E

UP TLM(CM)(MDC)=ACCEPT  
MONITOR UPLINK ACT LT=ON  
MONITOR GND UPLINK  
MONITOR UPLINK ACT LT=OFF  
UP TLM(CM)(MDC)=BLOCK  
CONFIRM COMP LT=OFF  
KEY V66E

COPY SEPARATION PAD  
DON HELMET AND GLOVES  
CSM/LM COMM CHECK

(97+14)

\*\*VERIFY DAP WIDE DB FOR\*\*  
LM RCS CHECKS

KEY V48E

F 04 46 (DAP CONFIGURATION)  
VERIFY R1 = XXX1X

PRO

F 06 47 (CSM AND LM WT)

PRO

F 06 48 (SPS GMBL TRIM)

PRO

SET MDC ET COUNTING DOWN TO  
SEPARATION TIGN  
(98+55+44)

(97+20)

VERIFY AUTO RCS SEL  
=C4(=PITCH=X)=OFF, AND  
=B3(=YAW=X)=OFF (FOR LM  
RDR SELF TEST)  
VERIFY RNDZ XPNDR=OFF

(97+27)

LOSS OF SIGNAL

(97+30)

CONFIGURE CAMERA!  
CM/SEQ/18/CEX=BRKT(RH WIN)  
MIR(F11,250,INFINITY)6FPS,  
15 MIN

(97+35)

\*\*LOAD DAP\*\*  
 KEY V48E  
 F 04 46 (DAP CONFIGURATION)  
 LOAD  
           21112  
           11111  
 PRO  
 F 06 47 (CSM AND LM WT)  
 LOAD  
           +37768  
           +30847  
 PRO  
 F 06 48 (SPS GMBL TRIM)  
 LOAD  
           -00052  
           +00059  
 PRO  
 KEY V46E  
 KEY V62E

(97+38)

SUNUP  
 VHF AM A-SIMPLEX  
 VHF RCY ONLY-B DATA

(97+40)

\*\*MANEUVER TO UNDOCKING ATTITUDE\*\*  
 (INERTIAL SEP ATT EXCEPT ROLL  
 AND 14 DEG YAW)  
 KEY V49E  
 F 06 22 (COMMANDED R,P,Y)  
 LOAD(180,14,14)  
 PRO  
 F 50 18 (COMMANDED R,P,Y)  
 PRO

06 18 (COMMANDED R,P,Y)  
 MONITOR AUTO MANEUVER  
 F 50 18 (COMMANDED R,P,Y)  
 (180,282/14,14)  
 KEY ENTER

(97+46)

CMC MODE=FREE (AS REQ FOR AGS  
 CALIB)  
 CMC MODE=AUTO (AFTER 32 SEC)  
 PERFORM SYSTEMS CHECK  
 AND SWITCH VERIFICATION

(97+50)

YAW 14 DEG LEFT AFTER  
 LM AGS CALIBRATION  
 (180,312/14,0)

(97+52)

MOVE TO LEB

\*\*RNDZ XPNDR ACTIVATION\*\*  
 AND SELF TEST

CB RNDZ XPNDR FLT BUS=CLOSE  
 RNDZ XPNDR PWR=HTR FOR 1 MIN  
 FOR SELF TEST  
 RNDZ XPNDR PWR=PWR  
 SYS TEST (LH)=XPONDER  
 SYS TEST (RH)=A (RRT XMTR OUT  
 PWR)  
 RNDZ XPNDR TEST=TEST (HOLD)  
 SYS TEST IND=GREATER THAN 1 VDC  
 SYS TEST (RH)=B (RRT AGC SIG)  
 RNDZ XPNDR TEST=TEST (HOLD)  
 SYS TEST IND=GREATER THAN 1  
 VDC

RNDZ XPNDR TEST-OPERATE  
 SYS TEST IND=0=4.5 VDC  
 SYS TEST(RH)=C(RRT FREQ LOCK)  
 SYS TEST IND  
 -LESS THAN .8 VDC UNLOCKED  
 -MORE THAN 4 VDC LOCKED  
 SYS TEST(RH)=B(RRT AGC SIG  
 OPERATE)

(98+05)

MOVE TO CMD SEAT

\*\*GDC ALIGN TO IMU\*\*

16 20 KEY V16N20E  
 (R,P,Y)  
 ATT SET THUMBWHEELS TO N20  
 FDAI SELECT=1  
 NULL ATT ERROR NEEDLES  
 ON FDAI 1 WITH ATT  
 SET THUMBWHEELS  
 FDAI SELECT=1/2  
 ATT SET=GDC  
 DEPRESS GDC ALIGN PB  
 ATT SET=IMU  
 KEY RELEASE

(98+06)

\*\*ORDEAL VERIFICATION\*\*

F 04 06 KEY V82E  
 (VEHICLE OPTION CODES)  
 PRO  
 F 16 44 (HA,HP,TFF)  
 CALC AVE ALT  
 PRO  
 ALT SET KNOB TO AVE ALT

-25 (98+10+00)

F 16 54 KEY V83E  
 (R,RDOT,THETA)  
 VERIFY R=RDOT=0  
 IF NOT,KEY V66E  
 SLEW/ADJUST FDAI TO THETA  
 PRO

(98+07)

S/C CONT=SCS  
 \*\*LOAD DAP\*\*

F 04 46 KEY V48E  
 (DAP CONFIGURATION)  
 LOAD

11102  
 11111  
 B

PRO  
 F 06 47 (CSM AND LM WT)  
 PRO

F 06 48 (SPS GMBL TRIM)  
 PRO  
 KEY V46E

\*\*PROCEDURES FOR UNDOCKING\*\*

INSTALL DOCKING TARGET  
 RATE=HI  
 ROT CONT PWR DIR(BOTH)=MNA/MNB  
 RMC=ARMED  
 THC=ARMED  
 CB DOCK PROBE(2)=CLOSED  
 EVNT TMR RESET=DOWN  
 EVNT TMR START (ON CDR SIGNAL)

PROBE EXTD/REL-EXTD/REL (HOLD  
UNTIL LM SEP PLUS 5 SEC)  
PROBE EXTD/REL TB(2)-GRAY TO  
BP TO GRAY  
MONITOR LM UNDOCKING/MAINTAIN  
UNDOCKING ATTITUDE  
(180,12/14,0)  
PROBE EXTD/REL-RETR  
DV CG-CSM  
AUTO RCS SELECT  
-B3(+Y&W=X)-MNA  
-C4(-PITCH=X)-MNA  
ROT CONT PWR DIR(BOTH)-OFF  
BMAG MODE(3)-ATT 1/RATE 2  
CB DOCK PROBE(2)-OPEN



```

***** -15 (98+20)
* PROCEDURES FOR * **LM STATION KEEPING**
* UNDOCKING THRU SEPARATION *
*****
THC-LOCKED
RHC-LOCKED

**CSM STATION KEEPING** -12 (98+23)
ATT DB-MIN
RNDZ XPNDR PWR=PWR(VERIFY)
PERFORM STATION KEEPING
MANEUVERS/MAINTAIN 40 FT
SEPARATION (98+29)
COPY DOI P76 PAD
COPY INITIAL PHASING P76 PAD
COPY INITIAL PDI ABORT P76 PAD
COPY NOMINAL BURN TIME PAD

F04 46 **RELOAD DAP**
KEY V48E
(DAP CONFIGURATION)
LOAD
11112
01111
B

F06 47 PRO
(CSM AND LM WT)
PRO
F06 48 (SPS GMBL TRIM)
PRO
SMAG MODE(3)-RATE 2
KEY V46E
S7C CONT=CMC

**ACQUIRE MSFN**
F06 51 (RHO,GAMMA,BLANK)
SLEW HI GAIN ANT
(98+13)
ACQUISITION OF SIGNAL
ACQUIRE MSFN
PRO

-5 (98+30)
ACTIVATE COLOR TV
TAKE PHOTOS
INSPECT LM DURING LM 360 DEG
YAW P30
F06 33 KEY V37E30E
(GET OF SEP)
LOAD GET OF SEPARATION
(98+55+44)
PRO

```

F 06 81 (VG-LV) -00+40  
 LOAD (0,0,-2.5)  
 PRO -00+35  
 F 06 42 (HA,HP,VG) -00+30  
 VERIFY VG=2.5  
 PRO  
 F 16 45 (MKS,TFI,MGA) -00+25  
 SET MDC ET TO TFI,COUNTING  
 DOWN  
 CONFIRM MGA LESS THAN 45 DEG  
 PRO  
 F 37 BB

MONITOR COMP ACTV LT-OUT  
 DSKY BLANKS  
 16 85 (VG-BODY) (AVG G ON)  
 COMP ACTV LT-2 SEC FLASH  
 EMS MODE=NORMAL  
 CK VG FOR HI PIPA BIAS  
 (LESS THAN 2.0 FPS PER 5  
 SEC)  
 THC=ARMED

3 (98+32)

\*\*RCS SEPARATION BURN SETUP\*\*

0+00 (98+35+16)

P41 KEY 41E  
 F 50 18 (COMMANDED R,P,Y)  
 PRO  
 06 18 (COMMANDED R,P,Y)  
 MONITOR ATT TRIM  
 F 50 18 (COMMANDED R,P,Y)  
 RHC=ARMED  
 ALIGN S/C IN ROLL  
 PRO  
 06 18 (COMMANDED R,P,Y)  
 MONITOR ATT TRIM  
 F 50 18 (COMMANDED R,P,Y)  
 KEY ENTER  
 06 85 (VG-BODY)  
 MONITOR COMP ACTV LT  
 BMAG MODE(3)-ATT 1/RATE 2  
 RATE=LOW  
 EMS FUNCTION=DV SET  
 SET DV IND TO +2.5  
 EMS FUNCTION=DV

F 16 85 (VG-BODY)  
 SET MDC ET COUNTING UP  
 FROM SEPARATION  
 INCREASE VG-BODY FROM  
 (+2.5,0,0) TO (+5.0,0,0)  
 BY THRUSTING AFT

\*\*\*\*\*  
 CSM PERFORMS SEPARATION BURN  
 (0,0,-2.5)  
 (0,90/14,0)  
 WHEN BURN COMPLETE, VOICE  
 CONFIRMATION TO LM  
 \*\*\*\*\*

EMS MODE=STBY  
RECORD DV IND  
EMS FUNCTION=OFF  
RHC=LOCKED  
THC=LOCKED  
BMAG MODE(3)=RATE 2  
AUTO RCS SEL A/C ROLL(4)=OFF  
PRO

F 37 BB

```

*****
*          PROCEDURES FOR          *
*          SEPARATION THRU PHASING *
*****

```

(98+39)

\*\*MANEUVER TO SXT TRACK ATTITUDE\*\*

P20

```

      KEY 20E
F 50 18 (COMMANDED R,P,Y)
      PRO
      06 18 (COMMANDED R,P,Y)
      MONITOR AUTO MNVR
F 50 18 (COMMANDED R,P,Y)
      (0,142/54,0)
      KEY ENTER

      VHF ANT=RT
      EMS FUNCTION=VHF RNG
      EMS MODE=VHF RNG
      VHF AM A=OFF
      VHF AM B=DUPLEX
      VHF RCV ONLY=OFF
      VHF RANGING=RNG
      VHF RNG=RESET
      MONITOR EMS FOR RANGE

      KEY V83E
F 16 54 (R,RDOT,THETA)
      COMPARE EMS AND V83 RANGE

```

```

COMPARE LM RR RANGE AND
RANGE RATE WITH EMS
AND V83 RANGE AND RANGE
RATE

```

PRO

MOVE TO LEB

PERFORM OPTICS CHECKS

```

ZERO OPTICS=OFF
ZERO OPTICS=ZERO(15 SEC)
ZERO OPTICS=OFF
MONITOR LM IN SCT AND SXT
OPTICS MODE=MAN

```

(98+50)

SUNDOWN

(98+55)

\*\*REALIGN IMU TO REFSMMAT\*\*

P52

```

      ADJUST RETICLE BRITNESS
      KEY V37E52E
F 04 06 (ALIGN OPTION CODE)
      LOAD 00003 IN R2 FOR
      REALIGN TO REFSMMAT

      PRO
F 50 25 (00015, PERFORM STAR ACQ)
      OHC=MANEUVER SCT TO ACQ
      TWO SUITABLE STARS
      (ALTAIR=40, PEACOCK=42)

      PRO
F 01 70 (STAR CODE)
      CHECK FIRST STAR CODE
      ZERO OPTICS=ZERO(15 SEC)
      ZERO OPTICS=OFF

```

OPTICS MODE=CMC PRO		F 06 93 (GYRO TORQ ANGLES) COPY DATA ON CHECKLIST PRO
06 92 (SHAFT,TRUN,BLANK) MONITOR OPT DRIVE TO STAR ONE IDENTIFY STAR ONE OPTICS MODE=MAN		F 50 25 (00014, PERFORM FINE ALIGN) PRO
F 51 88 (PLEASE MARK) CENTER FIRST STAR IN SXT MARK ON STAR ONE		F 50 25 (00015,PERFORM STAR ACQ) PRO
F 50 25 (00016, TERMINATE MARK SEQ) PRO		F 01 70 (STAR CODE) LOAD THIRD STAR CODE (RASALHAGUE=35)
F 01 71 (MARKED STAR CODE) PRO		
F 01 70 (STAR CODE) CHECK SECOND STAR CODE ZERO OPTICS-ZERO (15SEC) ZERO OPTICS-OFF OPTICS MODE=CMC PRO		ZERO OPTICS-ZERO (15SEC) ZERO OPTICS-OFF OPTICS MODE=CMC PRO
06 92 (SHAFT,TRUN,BLANK) MONITOR OPT DRIVE TO STAR TWO IDENTIFY STAR TWO OPTICS MODE=MAN		06 92 (SHAFT,TRUN,BLANK) MONITOR OPTICS DRIVE TO STAR THREE ZERO OPTICS-ZERO
F 51 88 (PLEASE MARK) CENTER SECOND STAR IN SXT MARK ON STAR TWO	P00	KEY V37E00E
F 50 25 (00016, TERMINATE MARK SEQ) PRO	(99+03)	SET LEB ET COUNTING DOWN TO LM DOI TIGN
F 01 71 (MARKED STAR CODE) PRO		MOVE TO CMD SEAT
F 06 05 (ANGLE DIFF) COPY DATA ON CHECKLIST PRO		**ALIGN GDC TO IMU**
		KEY V16N20E
		16 20 (R,P,Y) ATT SET THUMBWHEELS TO N20 FOAT SELECT-1

NULL ATT ERROR NEEDLES	=9	(99+25)	
ON FDAI 1 WITH ATT			LOSS OF SIGNAL
SET THUMBWHEELS	=6	(99+28)	**MANEUVER TO SXT TRACK ATTITUDE**
FDAI SELECT-1/2			
ATT SET=GDC			
DEPRESS GDC ALIGN PB.			
ATT SET=IMU			
KEY RELEASE			
**ORDEAL VERIFICATION**			
KEY V83E			
F 16 54 (R,RDOT,THETA)			
SLEW/ADJUST FDAI TO THETA			
PRO			
			P20 KEY V37E20E
			F 50 18 (COMMANDED R,P,Y)
			PR0
			06 18 (COMMANDED R,P,Y)
			MOVE TO LEB DURING AUTO MNVR
			F 50 18 (COMMANDED R,P,Y)
			(0,206/332,0)
			KEY ENTER
			ZERO OPTICS=OFF
			OPTICS MODE=CMC
-29 (99+05)	**MCC=H UPLINK(CSM AND LM VECTOR)**	=4	(99+30)
	UP TLM(CM)(MDC)=ACCEPT		
	MONITOR UPLINK ACT LT=ON		
	MONITOR GND UPLINK		
	MONITOR UPLINK ACT LT=OFF	=2	(99+32)
	UP TLM(CM)(MDC)=BLOCK		P76
	CONFIRM COMP ACT LT=OFF		
	SET MDC ET COUNTING DOWN		F 06 84 (DVS OF LM DOI BURN)
	TO LM DOI TIGN		LOAD (-71.1,0,-.3)
			PRO
			F 06 33 (GETI OF DOI)
			LOAD LM DOI TIGN +20 SEC
			(99+34+19)
(99+14)	VHF AM A=SIMPLEX	0+00	(99+33+59)
	VHF AM B=OFF		
	VHF RCV ONLY=B DATA		*****
	VHF RANGING=OFF		LM DOI BURN
			(-71.1,0,0,-.3)
			*****

(99+36)	MOVE TO CMD SEAT	=63 (99+44)	INITIATE LM TRACK
	VHF AM A=OFF		SET LEB ET COUNTING DOWN
	VHF AM B=DUPLEX		TO LM PHASING TIGN
	VHF RCV ONLY=OFF		
	VHF RANGING=RNG		ZERO OPTICS=ZERO
	VHF RANGING=RESET(NO VOICE 12		CEASE TRACKING
	SEC)		MOVE TO CMD SEAT
	COMPUTE RDOT FROM VHF RANGE		
	CONFIRM LM BURN COMPLETE	=39 (100+07)	FDAI SCALE=5/5
	PRO/INCORPORATE P76		RHC=ARMED
F 37 88			ROLL 180 DEG AND PITCH UP 70
	KEY V82E		DEG AT 1 DEG/SEC
F 04 06	(VEHICLE OPTION CODES)		(180,278/268,0)
	LOAD R2=00002		FDAI SCALE=5/1
	PRO	P00	RHC=LOCKED
F 16 44	(HA,HP,TFF)		KEY V37E00E
	PRO	F 06 51	KEY V64E
F 37 88			(RHO,GAMMA,BLANK)
			SLEW HI GAIN ANT
			PRO
(99+37)	SUNUP	(100+12)	ACQUISITION OF SIGNAL
(99+38)	**MANEUVER TO TRACK ATTITUDE**	(100+20)	ACQUIRE MSFN
P20	KEY 20E		OBTAIN GO/NO GO FOR PDI ABORT
	MOVE TO LEB		MOVE TO LEB
(99+41)	ZERO OPTICS=ZERO(15 SEC)	F 06 99	KEY V67E
	ZERO OPTICS=OFF		(POS,VEL ERR,OPTION CODE)

LOAD WI  
+002.89  
+0017.3  
+00001

0+00 (100+46+21)

\*\*\*\*\*  
LM PHASING BURN  
(170.4,0,-95.6)  
(180.307/193,0)  
\*\*\*\*\*

(100+25)

\*\*MANEUVER TO TRACK ATTITUDE\*\*

(100+47)

P20

KEY V37E20E  
F 50 18 (COMMANDED R,P,Y)  
PRO  
06 18 (COMMANDED R,P,Y)  
MONITOR AUTO MANUEVER  
F 50 18 (COMMANDED R,P,Y)  
(180,293/243,0)  
KEY ENTER  
ZERO OPTICS=OFF  
KEY V87E  
KEY V57E  
F 51 BB (PLEASE MARK)  
OPTICS MODE=MAN  
OHC=CENTER LM IN SXT  
MAKE 10 MARKS IN NEXT  
10 MINUTES  
COMMENT ON LM VISIBILITY  
DURING LM DESCENT AND  
ASCENT. RECORD GET OF  
VISUAL LOSS AND ACQ OF LM

CONFIRM LM BURN COMPLETE

P76

KEY V37E76E  
F 06 84 (DV,S OF LM PHASING BURN)  
LOAD(170.4,0,-95.6)  
PRO  
F 06 33 (GETI OF PHASING BURN)  
LOAD LM PHASING TIGN  
+32 SEC  
(100+46+53)  
PRO  
F 37 88  
KEY V82E  
F 04 06 (VEHICLE OPTION CODES)  
LOAD R2=00002  
PRO  
F 16 44 (HA,HP,TFF)  
PRO  
F 37 88

-9

(100+37)

PRO/PROCESS LAST MARK  
OPTICS MODE=CMC  
KEY V88E/TERMINATE VHF RNG



\*\*\*\*\*  
\* PROCEDURES FOR \*  
\* PHASING THRU INSERTION \*  
\*\*\*\*\*

(100\*48) \*\*MANEUVER TO TRACK ATTITUDE\*\*

P20 KEY 20E

(100\*49) SUNDOWN

(100\*51) KEY V87E  
KEY V57E  
F 51 BB (PLEASE MARK)  
OPTICS MODE=MAN  
OHC=CENTER LM IN SXT  
MAKE 4 MARKS IN NEXT  
3 MINUTES

(100\*54) KEY V93E (REINITIALIZE W MAT)  
MAKE 6 MARKS IN NEXT  
7 MINUTES

(101\*01) PRO/PROCESS LAST MARK  
OPTICS MODE=CMC

(101\*05) COPY INITIAL CSM BACKUP  
INSERTION PAD

(101\*10) COPY LM INSERTION P76 PAD

(101\*14)

KEY V57E  
F 51 BB (PLEASE MARK)  
OPTICS MODE=MAN  
OHC=CENTER LM IN SXT  
MAKE 10 MARKS IN NEXT  
10 MINUTES

(101\*24)

PRO/PROCESS LAST MARK  
KEY V88E/TERMINATE VHF RNG  
ZERO OPTICS=ZERO  
OPTICS MODE=CMC

MOVE TO CMD SEAT

LOSS OF SIGNAL

(101\*35)

SUNUP

(101\*40)

\*\*ALIGN GDC TO IMU\*\*

KEY V16N20E  
16 20 (R,P,O,Y)  
ATT SET THUMBWHEELS TO N20  
FDAI SELECT=1  
NULL ATT ERROR NEEDLES  
ON FDAI 1 WITH ATT  
SET THUMBWHEELS  
FDAI SELECT=1/2  
ATT SET=GDC  
DEPRESS GDC ALIGN PB  
ATT SET=IMU

\*\*ORDEAL VERIFICATION\*\*  
 KEY V83E  
 F 16 54 (R,RDOT,THETA)  
 SLEW/ADJUST FDAI TO THETA  
 PRO

MOVE TO LEB

-58 (101+48)  
 SET LEB ET COUNTING DOWN  
 TO INSERTION USING LM  
 INSERTION TIGN +3 MIN AND  
 MISSION TIMER

-57 (101+49)  
 ZERO OPTICS-OFF  
 KEY V87E  
 KEY V57E  
 F 51 BB (PLEASE MARK)  
 OPTICS MODE=MAN  
 OHC-CENTER LM IN SXT  
 MAKE 4 MARKS IN NEXT  
 3 MINUTES

-54 (101+52)  
 KEY V93E (REINITIALIZE W MAT)  
 TAKE 16 MARKS IN NEXT  
 17 MINUTES

-37 (102+09)  
 PRO/PROCESS LAST MARK  
 KEY V88E/TERMINATE VHF RNG  
 ZERO OPTICS=ZERO  
 OPTICS MODE=CMC

MOVE TO CMD SEAT

(102+11)  
 ACQUISITION OF SIGNAL  
 PITCH DOWN 50 DEG  
 (180,194/182,0)

-32 (102+14)  
 P00  
 KEY V37E00E  
 KEY V64E  
 F 06 51 (RHO GAMMA,BLANK)  
 SLEW HI GAIN ANT  
 ACQUIRE MSFN  
 PRO

\*\*MCC-H UPLINK CSM VECTOR\*\*  
 UP TLM(CM)(MDC)=ACCEPT  
 MONITOR UPLINK ACT LT-ON  
 MONITOR GND UPLINK  
 MONITOR UPLINK ACT LT-OFF  
 UP TLM(CM)(MDC)=BLOCK

COPY LM INSERTION P76 PAD  
 UPDATE AS REQUIRED  
 COPY CSM BACKUP INSERTION PAD  
 UPDATE AS REQUIRED

SET MDC ET COUNTING DOWN TO  
 INSERTION USING LM  
 INSERTION TIGN +3 MIN AND  
 MISSION TIMER

(102+29)  
 \*\*ORDEAL VERIFICATION\*\*  
 KEY V83E  
 F 16 54 (R,RDOT,THETA)  
 SLEW/ADJUST FDAI TO THETA  
 PRO

-16 (102+30) \*\*TARGET CSM INSERTION BACKUP\*\*

P30 KEY V37E30E  
 F 06 33 (GETI OF CSM INS BACKUP)  
 LOAD (102+46+18)  
 PRO  
 F 06 81 (VG - LV)  
 LOAD(175.4,0,-107.1)  
 PRO  
 F 06 42 (HA,HP,VG)  
 PRO  
 F 16 45 (MKS,TFI,MGA)  
 VERIFY ET=TFI  
 CONFIRM MGA LESS THAN 45 DEG  
 PRO  
 F 37 BB

LOAD INSERTION BURN VC  
 EMS FUNCTION=DV  
 FDAI SCALE=5/5  
 RATE=HIGH  
 RHC PWR DIRECT(BOTH)=MNA/MNB  
 BMAG MODE(3)=ATT1/RATE2  
 SCS TVC(BOTH)=RATE CMD  
 TVC GMBL DRIVE(BOTH)=AUTO  
 AUTO RCS SEL A/C ROLL(\*)=MNA  
 RHC=ARMED

ALIGN S/C TO 180 DEG ROLL  
 PRO

06 18 (COMMANDED R,P,Y)  
 MONITOR ATT TRIM  
 F 50 18 (COMMANDED R,P,Y)

-5

\*\*GDC ALIGN\*\*

-14 (102+32) \*\*MANEUVER TO INSERTION ATTITUDE\*\*

P40 KEY 40E  
 F 50 18 (COMMANDED R,P,Y)  
 PRO  
 06 18 (COMMANDED R,P,Y)  
 MONITOR ATT MNVR  
 F 50 18 (COMMANDED R,P,Y)  
 (180,3/272,0)

ATT SET THUMBWHEELS TO N18  
 FDAI SELECT=1  
 NULL ATT ERROR NEEDLES  
 ON FDAI 1 WITH ATT  
 SET THUMBWHEELS  
 FDAI SELECT=1/2  
 ATT SET=GDC  
 GDC ALIGN PB=PUSH  
 ATT SET=IMU

-9 (102+37)

\*\*SETUP SPS INSERTION BACKUP\*\*

EMS MODE=STBY  
 EMS FUNCTION=DV SET

KEY ENTER  
 F 50 25 (00204, GMBL DRIVE TEST)

```

*3 (102+43+18)
MONITOR LM ENGINE IGNITION *=-00+05
* F 99 40 (TFI,VG,DV)
* PRO
*****
LM INSERTION BURN *00+00(102+46+18)
(-189.2,0.1,-83.9) *****
***** CSM BACKUP INSERTION BURN
(175.4,0,-107.1)
(180,32/272,0)
*****
*****
*****
* IF LM CANNOT PERFORM THE BURN *+00+01
* (USE ZERO INSERTION CHECKLIST)
* (FOR PARTIAL LM INSERTION GO TO
* PARTIAL INSERTION CHECKLIST FOR
* RESCUE 2 BURN AT 103+32)
* *****
* MN BUS TIE(BOTH)-ON
* NONESS BUS-MNA
* SPS HE VLV TB (BOTH)-BP
* SPS HE VLV (BOTH)-AUTO
* VERIFY SPS TH LT-OFF
* GMBL MTRS(4)-ON(SEQUENTIALLY)
* TVC SERVO PWR 1-AC1/MNA
* TVC SERVO PWR 2-AC2/MNB
* KEY ENTER
* 06 40 (TFI,VG,DV)
* DV THRUST A-NORMAL
* THC-ARMED
*=-00+35
* DSKY BLANKS
*=-00+30
* 06 40 (TFI,VG,DV) (AVE G ON)
* EMS MODE-NORMAL
*=-00+15
* THC-APPLY ULLAGE
*
* 06 40 (TFC,VG,DV)
* THC-TERMINATE ULLAGE
* MONITOR SPS BURN
* F 16 40 (TFC,VG,DV)
* DV THRUST A-OFF
* GMBL MTRS(4)-OFF/SEQUENTIALLY
* PRO
* F 16 85 (VG-BODY)
* THC=NULL VGS
* THC-LOCKED
* EMS MODE-STBY
* TVC SERVO PWR(BOTH)-OFF
* SPS HE VLV (BOTH)-OFF
* MN BUS TIE(BOTH)-OFF
* NONESS BUS-OFF
* PRO
* F 37 BB
* (CONTINUE DETAILED PROCEDURES*
* BUT DELETE P76)
*****

```

CONFIRM LM BURN COMPLETE

P76

KEY V37E76E  
F 06 84 (DV,S OF LM INSERTION BURN)

RHC=LOCKED  
THC=LOCKED  
AUTO RCS SEL, A/C ROLL (4)=OFF  
EMS FUNCTION=VHF RNG  
EMS MODE=VHF RNG  
VHF RNG=RESET  
FDAI SCALE=5/1  
RATE=LOW  
ROT CONT PWR DIRECT (BOTH)=OFF  
BMAG MODE(3)=RATE2  
TVC GIMBAL DRIVE(BOTH)=1

LOAD (-189.2,0,-83.9)

PRO  
F 06 33 (GETI OF INSERTION BURN)  
LOAD LM INSERTION TIGN  
+8 SEC  
(102+43+18)

PRO  
F 37 BB

KEY V82E  
F 04 06 (VEHICLE OPTION CODES)  
LOAD R2=00002  
PRO

F 16 44 (HA,HP,TFF)  
PRO

F 37 BB

```

*****
*          PROCEDURES FOR          *
*          INSERTION THRU CSI      *
*****

```

(102\*47)

```

SUNDOWN
MOVE TO LEB
SET LEB ET COUNTING DOWN TO
  CSI USING LM CSI TIGN
  AND MISSION TIMER

**REALIGN IMU TO REFSMMAT**
P52  KEY 52E
      ADJUST RETICLE BRTNES
F 04 06 (ALIGN OPTION CODE)
      LOAD 00003 IN R2 FOR
      REALIGN TO REFSMMAT
      PRO
F 50 25 (00015, PERFORM STAR ACQ)
      OHC=MANEUVER SCT TO ACQ
      TWO SUITABLE STARS
      (ALTAIR=40, FOMALHAUT=45)
      PRO
F 01 70 (STAR CODE)
      CHECK FIRST STAR CODE
      ZERO OPTICS=OFF
      PRO
06 92 (SHAFT, TRUN, BLANK)
      MONITOR OPT DRIVE TO STAR ONE
      IDENTIFY STAR ONE
      OPTICS MODE=MAN

```

```

F 51 88 (PLEASE MARK)
      CENTER FIRST STAR IN SXT
      MARK ON STAR ONE
F 50 25 (00016, TERMINATE MARK SEQ)
      PRO
F 01 71 (MARKED STAR CODE)
      PRO

F 01 70 (STAR CODE)
      CHECK SECOND STAR CODE
      ZERO OPTICS=ZERO (15SEC)
      ZERO OPTICS=OFF
      OPTICS MODE=CMC
      PRO
06 92 (SHAFT, TRUN, BLANK)
      MONITOR OPT DRIVE TO STAR TWO
      IDENTIFY STAR TWO
      OPTICS MODE=MAN
F 51 88 (PLEASE MARK)
      CENTER SECOND STAR IN SXT
      MARK ON STAR TWO
F 50 25 (00016, TERMINATE MARK SEQ)
      PRO
F 01 71 (MARKED STAR CODE)
      PRO
F 06 05 (ANGLE DIFF)
      COPY DATA ON CHECKLIST
      PRO
F 06 93 (GYRO TORQ ANGLES)
      COPY DATA ON CHECKLIST
      PRO
F 50 25 (00014, PERFORM FINE ALIGN)
      PRO
F 50 25 (00015, PERFORM STAR ACQ)
      PRO

```

<p>F 01 70 (STAR CODE) LOAD THIRD STAR CODE (RASALHAGUE=35)</p> <p>ZERO OPTICS=ZERO (15SEC) ZERO OPTICS=OFF OPTICS MODE=CMC PRO</p> <p>06 92 (SHAFT,TRUN,BLANK) MONITOR OPTICS DRIVE TO STAR THREE ZERO OPTICS=ZERO</p> <p>(102+52) P00 KEY V37E00E</p> <p>**LM STATE VECTOR UPLINK**</p> <p>UP TLM(CM)(MDC)=ACCEPT MONITOR UPLINK ACT LT=ON MONITOR GND UPLINK MONITOR UPLINK ACT LT=OFF UP TLM(CM)(MDC)=BLOCK</p> <p>(102+56) **MANEUVER TO TRACK ATTITUDE**</p> <p>P20 KEY V37E20E</p> <p>F 50 18 (COMMANDED R,P,Y) PRO</p> <p>06 18 (COMMANDED R,P,Y) MONITOR AUTO MNVR</p> <p>F 50 18 (COMMANDED R,P,Y) (180,162/13,0)</p>	<p>(102+59)</p> <p>P32</p> <p>F 06 11 (GETI=CSI) LOAD LM CSI TIGN (103+33+46) PRO</p> <p>F 06 55 (N,E,CENTANG) LOAD R2=+208.30 LOAD R3=130.00 PRO</p> <p>F 06 37 (GETI=TPI) LOAD LM TPI TIGN (105+09+00) PRO</p> <p>F 16 45 (MKS,TFI=CSI,-00001) SET LEB ET=TFI KEY V32E</p> <p>F 06 75 (DH,DT=CSI/CDH,DT=CDH/TPI) PRO</p> <p>F 06 81 (CSI VG=LV) PRO</p> <p>F 06 82 (CDH VG=LV) PRO</p> <p>F 16 45 (MKS,TFI=CSI,-00001)</p> <p>-32 (103+02)</p> <p>F 51 88 (PLEASE MARK) OPTICS MODE=MAN OHC-CENTER LM IN SXT</p>	<p>KEY ENTER ZERO OPTICS=OFF</p> <p>COPY LM CSI AND TPI TIGNS</p> <p>KEY V37E32E</p> <p>LOAD LM CSI TIGN (103+33+46)</p> <p>(N,E,CENTANG) LOAD R2=+208.30 LOAD R3=130.00</p> <p>(GETI=TPI) LOAD LM TPI TIGN (105+09+00)</p> <p>(MKS,TFI=CSI,-00001) SET LEB ET=TFI KEY V32E</p> <p>(DH,DT=CSI/CDH,DT=CDH/TPI)</p> <p>(CSI VG=LV)</p> <p>(CDH VG=LV)</p> <p>(MKS,TFI=CSI,-00001)</p> <p>KEY V93/REINITIALIZE W MATRIX KEY V87E (VHF RANGING) KEY V57E</p>
---	--	--

MAKE 6 MARKS IN NEXT  
5 MINUTES

=27 (103+07) PRO/PROCESS LAST MARK  
F 16 45 (MKS,TFI-CSI,-00001)  
ZERO OPTICS=ZERO  
OPTICS MODE=CMC  
MOVE TO CMD SEAT

=22 (103+12) KEY V90E  
F 04 12 (VEHICLE OPTION)  
LOAD R2=00002  
PRO  
F 06 16 (TIME OF EVENT)  
LOAD LM CSI TIGN  
(103+33+46)  
PRO  
F 06 90 (Y,YDOT,PSI)  
VOICE LM YDOT TO LM  
PRO  
F 16 45 (MKS,TFI-CSI,-00001)

KEY V90E  
F 04 12 (VEHICLE OPTION)  
LOAD R2=00001  
PRO  
F 06 16 (TIME OF EVENT)  
LOAD CSM CSI TIGN  
(103+33+46)  
PRO  
F 06 90 (Y,YDOT,PSI)  
COPY (-)CSM YDOT  
ON CHECKLIST  
F 16 45 (MKS,TFI-CSI,-00001)

(103+23) LOSS OF SIGNAL

=9 (103+25) PRO/MAKE FINAL PASS  
F 06 75 (DH,DT=CSI/CDH,DT=CDH/TPI)  
COPY DATA ON CHECKLIST  
PRO  
F 06 81 (CSI VG=LV)  
OVERWRITE N81 VGY WITH  
(-) CSM YDOT  
COPY DATA ON CHECKLIST  
PRO  
F 06 82 (CDH VG=LV)  
COPY DATA ON CHECKLIST  
PRO  
F 16 45 (MKS,TFI=CSI,MGA)  
SET MDC ET=TFI  
PRO  
F 37 88  
(103+28) COPY LM CSI PAD (P76)

(103+29) P40 KEY 40E  
F 50 18 (COMMANDED R,P,Y)  
KEY V56E  
PRO  
06 18 (COMMANDED R,P,Y)  
MONITOR MANEUVER  
F 50 18 (COMMANDED R,P,Y)  
(180,166/277,0)

=4 (103+30) \*\*SETUP SPS CSI BACKUP\*\*  
EMS MODE=STBY  
EMS FUNCTION=DV SET  
LOAD CSI BURN VC



EMS FUNCTION=DV  
FDAI SCALE=5/5  
RATE=HIGH  
RHC PWR DIRECT (BOTH)=MNA/MNB  
RMAG MODE (3)=ATT 1/RATE 2  
TVC GMBL DRIVE (BOTH)=AUTO  
AUTO RCS SEL A/C ROLL (4)=MNA  
RHC=ARMED

-00+35

DSKY BLANKS

-00+30

06 40 (TFI, VG, DV) (AVE G ON)  
EMS MODE=NORMAL

-00+05

F 99 40 (TFI, VG, DV)

00+00 (103+33+46)

MONITOR LM ENGINE IGNITION

ALIGN S/C TO 180 DEG ROLL  
PRO

\*\*\*\*\*

06 18 (COMMANDED R,P,Y)

LM CSI BURN

MONITOR ATT TRIM

(50.5, 0, 0)

F 50 18 (COMMANDED R,P,Y)

\*\*\*\*\*

\*3

\*\*GDC ALIGN\*\*

\*\*\*\*\*

ATT SET THUMBWHEELS TO N18

\* \*\*\*\*\* \*

FDAI SELECT=1

\* IF LM CANNOT PERFORM THE BURN \*

NULL ATT ERROR NEEDLES

\* \*\*\*\*\* \*

ON FDAI 1 WITH ATT

\* MN BUS TIE (2)=ON(UP) \*

SET THUMBWHEELS

\* NONESS BUS=MNA \*

FDAI SELECT=1/2

\* SPS HE VLV TB (BOTH)=BP \*

ATT SET=GDC

\* SPS HE VLV (BOTH)=AUTO \*

GDC ALIGN PB=PUSH

\* VERIFY SPS TH LT=OFF \*

ATT SET=IMU

\* -00+15 \*

KEY ENTER

\* THC=APPLY ULLAGE \*

F 50 25 (00204, GMBL DRIVE TEST)  
(103+33)

\* GMBL MTRS (4)=ON (SEQUENTIAL Y) \*

SUNUP

\* TVC SERVO PWR 1=AC1/MNA \*

06 40 (TFI, VG, DV)

\* TVC SERVO PWR 2=AC2/MNB \*

DV THRUST A=NORMAL

\* PRO \*

THC=ARMED

\* \*\*\*\*\* \*

CSM BACKUP CSI BURN

(52.2, 0, 0)

(180, 180/277, 0)

\*\*\*\*\*

\*2

```

*
*+00+01
*
* 06 40 (TFC,VG,DV)
*   THC=TERMINATE ULLAGE
*   MONITOR SPS BURN
* F 16 40 (TFC,VG,DV)
*   DV THRUST A=OFF
*   GMBL MTRS(4)=OFF/SEQUENTIALLY
*   PRO
* F 16 85 (VG=BODY)
*   THC=NULL VGS
*   THC=LOCKED
*   TVC SERVO PWR(BOTH)=OFF
*   EMS MODE=STBY
*   SPS HE VLV (BOTH)=OFF
*   MN BUS TIE (BOTH)=OFF
*   NONESS BUS=OFF
*   PRO
* F 37 BB
*   (CONTINUE DETAILED PROCEDURES*
*   BUT DELETE P76)
*
*****

```

```

ROT CONT PWR DIRECT (BOTH)=OFF
BMAG MODE(3)=RATE 2
TVC GIMBAL DRIVE(BOTH)=1
(103+37)
LOAD(50.5,0,0)
PRO
F 06 33 (GETI OF CSI BURN)
LOAD LM CSI TIGN
+16 SEC
(103+33+46)
PRO
F 37 BB
KEY V82E
F 04 06 (VEHICLE OPTION CODES)
LOAD R2=00002
PRO
F 16 44 (HA,HP,TFE)
PRO
F 37 BB

```

CONFIRM LM BURN COMPLETE

```

P76
F 06 84 (DV,S OF CSI BURN)

```

```

RHC=LOCKED
THC=LOCKED
AUTO RCS SEL, A/C ROLL, (4)=OFF
EMS FUNCTION=VHF RNG
EMS MODE=VHF RNG
VHF RNG=RESET
FOAI SCALE=5/1
RATE=LOW

```

```

*****
*           PROCEDURES FOR           *
*           CSI THRU CDH             *
*****

```

(103+38)

\*\*MANEUVER TO TRACK ATTITUDE\*\*

P20

```

KEY 20E
F 50 18 (COMMANDED R,P,Y)
PRO
06 18 (COMMANDED R,P,Y)
MOVE TO LEB DURING
AUTO MANEUVER
F 50 18 (COMMANDED R,P,Y)
(180,155/239,0)
KEY ENTER

SET LEB ET COUNTING DOWN TO
CDH USING LM CDH TIGN
AND MISSION TIMER

ZERO OPTICS=OFF

```

(103+41)

```

KEY V87E (VHF TRACKING)
KEY V57E
F 51 88 (PLEASE MARK)
OPTICS MODE=MAN
OHC-CENTER LM IN SXT
MAKE 3 MARKS IN NEXT
2 MINUTES

```

(103+43)

PRO/PROCESS LAST MARK

```

KEY V67E
F 06 99 (POS ERR,VEL ERR,OPTION CODE)
LOAD WR
(000,57,0003,4,00001)

```

(103+44)

```

KEY V57E
F 51 88 (PLEASE MARK)
MAKE 11 MARKS IN NEXT
11 MINUTES

```

(103+55)

```

PRO/PROCESS LAST MARK
OPTICS MODE=CMC

OBTAIN LM PC TIGN

```

```

KEY V90E
F 04 12 (VEHICLE OPTION)
LOAD R2=00002
PRO

```

```

F 06 16 (TIME OF EVENT)
LOAD LM PC TIGN
(104+02+00)

```

```

PRO
F 06 90 (Y, YDOT, PSI)
VOICE LM YDOT TO LM
PRO

```

(103+57)

COPY LM PC PAD

```

KEY V57E
F 51 88 (PLEASE MARK)
OPTICS MODE=MAN

```

OHC-CENTER LM IN SXT  
 MAKE 5 MARKS IN NEXT  
 5 MINUTES

-30 (104+02+00)

PRO/PROCESS LAST MARK  
 OPTICS MODE=CMC

\*\*\*\*\*  
 LM PLANE CHANGE(0,0,0)  
 \*\*\*\*\*

P76 KEY V37E76E  
 F 06 84 (DV,S OF LM PC BURN)  
 LOAD LM PLANE CHANGE DV,S  
 PRO  
 F 06 33 (GETI OF PC BURN)  
 LOAD GETI=PC BURN  
 (104+02+00)

CONFIRM LM PC BURN

PRO/INCORPORATE P76

F 37 BB  
 (104+05)  
 P33 KEY 33E  
 F 06 13 (GETI=CDH)  
 OBTAIN LM CDH TIGN  
 LOAD LM CDH TIGN  
 (104+31+42)

COPY DATA ON CHECKLIST  
 PRO

F 16 45 (MKS,TFI=CDH,-00001)  
 KEY V32E

F 06 75 (DH,DT,CDH/TPI,DT-TPI/TPI)  
 PRO

F 06 81 (CDH VG-LV)  
 PRO

F 16 45 (MKS,TFI=CDH,-00001)  
 VERIFY ET=TFI

-24 (104+08)

KEY V87E (VHF RANGING)  
 KEY V57E  
 F 51 BB (PLEASE MARK)  
 OPTICS MODE=MAN  
 OHC-CENTER LM IN SXT  
 TAKE 4 MARKS IN NEXT  
 3 MINUTES  
 KEY V93E (REINITIALIZE W MAT)  
 TAKE 8 MARKS IN NEXT  
 9 MINUTES  
 PRO / PROCESS LAST MARK

F 16 45 (MKS,TFI,-00001)  
 ZERO OPTICS=ZERO  
 OPTICS MODE=CMC

(104+09)

-12 (104+20)

ACQUISITION OF SIGNAL

KEY V90E  
 F 04 12 (VEHICLE OPTION)  
 LOAD R2=00002  
 PRO

F 06 16 (TIME OF EVENT)  
 LOAD LM CDH TIGN  
 (104+31+42)

PRO

F 06 90 (Y,YDOT,PSI)  
 VOICE LM YDOT TO LM  
 PRO

F 16 45 (MKS,TFI=CDH,-00001)

(104+22) MOVE TO CMD SEAT  
 FDAI SCALE=5/5  
 RHC=ARMED  
 ROLL 180 DEG AT 2 DEG/SEC  
 (0.167/1.08,0)  
 RHC=LOCKED  
 FDAI SCALE=5/1.  
 ACQUIRE MSFN  
 (RHO=-50,GAMMA=183)

-7 (104+25) PRO/MAKE FINAL PASS  
 F 06 75 (DH\*DT=CDH/TPI,DT=TPI/TPI)  
 COPY DATA ON CHECKLIST  
 PRO  
 F 06 81 (CDH VG=LV)  
 KEY V90E  
 F 04 12 (VEHICLE OPTION)  
 LOAD R2=00001  
 PRO  
 F 06 16 (TIME OF EVENT)  
 LOAD LM CDH TIGN  
 (104+31+42)  
 PRO  
 F 06 90 (Y,YDOT,PSI)  
 COPY (-) CSM YDOT ON CHECKLIST  
 PRO  
 F 06 81 (CDH VG=LV).  
 OVER WRITE NAI WITH  
 (-) CSM YDOT  
 COPY DATA ON CHECKLIST  
 PRO  
 F 16 45 (MKS,TFI=CDH,MGA)  
 SET MDC ET=TFI  
 PRO  
 F 37 88

(104+28) COPY LM CDH P76 PAD

-3 (104+29) P41 KEY 41E  
 F 50 18 (COMMANDED R,P,Y)  
 KEY V56E  
 KEY ENTER(BYPASS MNVR)  
 06 85 (VG=BODY)

-2 (104+30) \*\*SETUP RCS CDH BACKUP\*\*  
 BMAG MODE(3)=ATT1/RATE2  
 AUTO RCS SEL A/C ROLL(4)=MNA

(104+31) \*\*ALIGN GDC TO IMU\*\*  
 KEY V16N20E  
 16 20 (R,P,Y)  
 ATT SET THUMBWHEELS TO N20  
 FDAI SELECT=1  
 NULL ATT ERROR NEEDLES  
 ON FDAI 1 WITH ATT  
 SET THUMBWHEELS  
 FDAI SELECT=1/2  
 ATT SET=GDC  
 DEPRESS GDC ALIGN PB  
 ATT SET=IMU  
 KEY RELEASE

=00+35 DSKY BLANKS

=00+30 16 85 (VG=BODY) (AVE G ON)  
 THC=ARMED  
 RHC=ARMED  
 EMS MODE=NORMAL

0+00 (104+31+42)  
F 16 85 (VG=BODY)  
MONITOR LM IGNITION

\*\*\*\*\*  
LM CDH BURN(-0.8,0,3.3)  
\*\*\*\*\*

\*\*\*\*\*  
\* IF LM CANNOT PERFORM THE BURN \*  
\* \*\*\*\*\* \*  
\* CSM BACKUP CDH BURN \*  
\* (-.6,0,-5.0) \*  
\* (0,188/108,0) \*  
\* \*\*\*\*\* \*  
\* THC=NULL VGS \*  
\* THC=LOCKED \*  
\* PRO \*  
\* F 37 BB \*  
\* (CONTINUE DETAILED PROCEDURES \*  
\* BUT DELETE P76 \*  
\*\*\*\*\*

CONFIRM LM BURN COMPLETE

PRO(TO BYPASS CSM=CDH BURN)  
F 37 BB  
RHC=LOCKED  
AUTO RCS SEL A/C ROLL(4)=OFF  
BMAG MODE (3)=RATE 2

P76  
F 06 84 KEY 76E  
(DV,S OF LM CDH BURN)  
LOAD LM CDH DV,S  
LOAD (-0.5,0,+5.8)  
PRO  
F 06 33 (GETI OF CDH BURN)  
LOAD LM CDH GETI  
(104+31+42)  
PRO  
F 37 BB

\*\*\*\*\*  
 \* PROCEDURES FOR \*  
 \* CDH THRU TPI \*  
 \*\*\*\*\*

-35 (104+34)

\*\*TARGET CSM TPI BACKUP\*\*  
 P20 KEY 20E  
 F 50 18 (COMMANDED R,P,Y)  
 PRO  
 06 18 (COMMANDED R,P,Y)  
 MOVE TO LEB DURING  
 AUTO MANEUVER  
 F 50 18 (COMMANDED R,P,Y)  
 (0,229/137,0)  
 KEY ENTER

P34 KEY V37E34E  
 F 06 37 (GETI=TPI)  
 LOAD TPI TIGN(105+09+00)  
 PRO  
 F 06 55 (BLANK,ELANG,CENTANG)  
 LOAD R2 = +208,30 (DEG)  
 LOAD R3 = +130,00 (DEG)  
 PRO  
 F 16 45 (MKS,TFI,=00001)  
 SET LEB ET TO TFI  
 COUNTING DOWN

-31 (104+38)

ZERO OPTICS=OFF  
 KEY V87E (VHF RANGING)  
 KEY V57E  
 F 51 88 (PLEASE MARK)  
 KEY V16N45E  
 F 16 45 (MKS,TFI,=00001)

-28 (104+41)

KEY RELEASE  
 F 51 88 (PLEASE MARK)  
 OPTICS MODE=MAN  
 OHC=CENTER LM IN SXT  
 MAKE 4 MARKS IN NEXT  
 3 MINUTES (INCORPORATE 4)  
 OPTICS MODE=CMC

KEY V32E  
 F 06 37 (GETI=TPI)  
 COPY DATA ON CHECKLIST  
 PRO  
 F 06 58 (HP,DVTPI,DVTPF)  
 COPY DATA ON CHECKLIST  
 PRO  
 F 06 59 (VG=LOS)  
 COPY DATA ON CHECKLIST  
 PRO  
 F 16 45 (MKS,TFI,=00001)

KEY V93E(REINITIALIZE W MAT)  
 KEY V57E  
 F 51 88 (PLEASE MARK)  
 OPTICS MODE=MANUAL  
 OHC=CENTER LM IN SXT  
 TAKE 14 MARKS IN NEXT  
 14 MINUTES

(104+45)

-19 (104+50)

-13 (104+56)

SUNDOWN  
 COPY LM TPI TIGN ON CHECKLIST  
 PRO/PROCESS LAST MARK  
 F 16 45 (MKS,TFI,=00001)  
 ZERO OPTICS=ZERO  
 OPTICS MODE=CMC

MOVE TO CMD SEAT

\*\*VERIFY ORDEAL\*\*

F 16 54 (R, RDOT, THETA)  
SLEW/ADJUST FDAI TO THETA  
PRO

F 16 45 (MKS, TFI, =00001)  
-11 (104+58)

KEY V37E34E  
F 06 37 (TPI TIGN)  
LOAD LM TPI TIGN  
(105+09+00)  
PRO

F 06 55 (BLNK, ELANG, CENTANG)  
LOAD R2 = +000.00  
PRO

F 16 45 (MKS, TFI, =00001)  
PRO/MAKE FINAL PASS

F 06 55 (BLNK, ELANG, CENTANG)  
COPY DATA ON CHECKLIST  
PRO

F 06 58 (HP, DV TPI, DV TPF)  
COPY DATA ON CHECKLIST  
PRO

F 06 81 (VG-LV)  
COPY DATA ON CHECKLIST  
PRO

F 06 59 (VG-LOS)  
COPY DATA ON CHECKLIST  
PRO

F 16 45 (MKS, TFI, MGA)  
RESET MDC ET WITH TFI  
PRO

-7 F 37 88  
(105+02) \*\*MANEUVER TO TPI BACKUP ATTITUDE\*\*

P40

F 50 18 KEY 40E  
(COMMANDED R,P,Y)  
KEY V56E  
PRO

06 18 (COMMANDED R,P,Y)  
MONITOR ATT MNVR

F 50 18 (COMMANDED R,P,Y)  
(0,192/15,0)

-5 (105+04) COPY LM TPI PAD(P76)  
\*\*SETUP SPS TPI BACKUP\*\*

EMS MODE=STBY  
EMS FUNCTION=DV SET  
LOAD INSERTION BURN VC  
EMS FUNCTION=DV  
FDAI SCALE=5/5  
RATE=HIGH  
RHC PWR DIRECT (BOTH)=MNA/MNB  
BMAC MODE (3)=ATTI/RATE2  
TVC GMBL DRIVE (BOTH)=AUTO  
AUTO RCS SEL A/C ROLL (4)=MNA  
RHC=ARMED  
ALIGN S/C TO ZERO ROLL  
PRO

06 18 (COMMANDED R,P,Y)  
MONITOR ATT TRIM

F 50 18 (COMMANDED R,P,Y)



-3

\*\*GDC ALIGN\*\*

ATT SET THUMBWHEELS TO N18  
 FDAI SELECT=1  
 NULL ATT ERROR NEEDLES  
 ON FDAI 1 WITH ATT  
 SET THUMBWHEELS  
 FDAI SELECT=1/2  
 ATT SET=GDC  
 DEPRESS GDC ALIGN PB  
 ATT SET=IMU

KEY ENTER  
 F 50 25 (00204; GMBL DRIVE TEST)  
 KEY ENTER  
 06 40 (TFI, VG, DV)  
 DV THRUST A=NORMAL  
 THC=ARMED

-00+35

DSKY BLANKS

-00+30

06 40 (TFI, VG, DV) (AVE 6 ON)  
 EMS MODE=NORMAL

-00+05

F 99 40 (TFI, VG, DV)

(105+09+00)

MONITOR LM ENGINE IGNITION

\*\*\*\*\*  
 LM TPI BURN(22.0,0-12.7)  
 \*\*\*\*\*

\*\*\*\*\*

\*\*\*\*\*  
 IF LM CANNOT PERFORM THE BURN  
 \*\*\*\*\*

MN BUS TIE (2)=011(UP)  
 NONE SS BUS=MNA  
 SPS HE VLV (BOTH)=AUTO  
 SPS HE VLV TB (BOTH)=BP  
 VERIFY SPS TH LT=OFF

\*=00+15

THC=APPLY ULLAGE  
 GMBL MTRS(4)=ON(SEQUENTIALY)  
 TVC SERVO PWR 1=AC1/MNA  
 TVC SERVO PWR 2=AC2/MNB  
 PRO

\* 0+00

\*\*\*\*\*  
 CSM TPI BACKUP BURN  
 (21.8,0,11.6)  
 (0,208/15,0)  
 \*\*\*\*\*

\*=00+01

06 40 (TFC, VG, DV)  
 THC=TERMINATE ULLAGE  
 MONITOR SPS BURN  
 F 16 40 (TFC, VG, DV)  
 DV THRUST A=OFF  
 GMBL MTRS(4)=OFF/SEQUENTIALY  
 PRO  
 F 16 85 (VG=BODY)  
 THC=NULL VGS  
 THC=LOCKED  
 EMS MODE=STBY  
 TVC SERVO PWR(BOTH)=OFF  
 SPS HE VLV (BOTH)=OFF  
 MN BUS TIE (BOTH)=OFF

\* NONESS BIJS=OFF \*  
\* PRO \*  
\* F 37 BB \*  
\* (CONTINUE DETAIL PROCEDURES \*  
\* BUT DELETE P76) \*  
\*\*\*\*\*

CONFIRM LM BURN COMPLETE

P76 KEY V37E76E  
F 06 84 (DV+S OF LM TPI BURN)  
RHC=LOCKED  
THC=LOCKED  
FDAI SCALE=5/1  
RATE=LOW  
ROT CONT. PWR DIRECT (BOTH)=OFF  
BMAG MODE (3)=RATE 2  
TVC GIMBAL DRIVE (BOTH)=OFF  
AUTO RCS SEL A/C ROLL (4)=OFF  
EMS FUNCTION=VHF RNG  
EMS MODE=VHF RNG  
VHF RNG=RESET

LOAD (22.2,0-12.1)

PRO  
F 06 33 (GETI OF TPI BURN)  
LOAD LM GET=TPI  
+8 SEC  
(105+09+08)

PRO  
F 37 BB

\*\*\*\*\*  
 \* PROCEDURES FOR \*  
 \* TPI THRU TPF \*  
 \*\*\*\*\*

OHC-CENTER LM IN SXT  
 MAKE 8 MARKS IN NEXT  
 8 MINUTES

\*\*\*\*\* +11 (105+20)

+2

\*\*MANEUVER TO SXT TRACK\*\*

P>0 KEY 20E  
 F 50 18 (COMMANDED R,P,Y)  
 PRO  
 06 18 (COMMANDED R,P,Y)  
 MOVE TO LEB DURING AUTO  
 MANEUVER  
 F 50 18 (COMMANDED R,P,Y)  
 (0,247/48,0)  
 KEY ENTER

+12+00(TIGN-3.0 MIN)

PRO/PROCESS LAST MARK  
 (MKS,TFI,-00001)  
 ZERO OPTICS-ZERO  
 OPTICS MODE-CMC

MOVE TO COMMAND SEAT

LOSS OF SIGNAL

PRO/MAKE FINAL PASS

F 06 81 (VG-LV)  
 COPY DATA ON CHECKLIST  
 PRO

F 06 59 (VG-LOS)  
 COPY DATA ON CHECKLIST  
 PRO

F 16 45 (MKS,TFI,MGA)  
 PRO

F 37 88

COPY LM MCC1 PAD (P76)

\*\*TARGET CSM MCC1 BACKUP\*\*

P35 KEY V37E35E  
 F 16 45 (MKS,TFI,-00001)  
 (TIME FROM TPI)  
 SET LEB ET TO TFI,  
 COUNTING UP  
 ZERO OPTICS-OFF

+13+30

P41

KEY 41E  
 F 50 18 (COMMANDED R,P,Y)  
 KEY ENTER(BYPASS MNVR)  
 06 85 (VG-BODY)

\*\*SET UP MCC1 BACKUP\*\*

DSKY BLANKS

+3

KEY V93E (REINITIALIZE W MAT)  
 KEY V87E (VHF RANGING)  
 KEY V57E  
 F 51 88 (PLEASE MARK)  
 KEY V16N45E  
 F 16 45 (MKS,TFI,-00001)  
 OPTICS MODE-MAN

+14+25

+14+30

16 85 (VG-BODY) (AVE G ON)  
THC-ARMED  
RHC-ARMED

+15 (105+24+00)

F 16 85 (VG-BODY)

\*\*\*\*\*

LM PERFORMS MCC1 BURN

\*\*\*\*\*

\*\*\*\*\*

CSM MCC1 BACKUP BURN

(0,265/29,0)

\*\*\*\*\*

CONFIRM LM BURN COMPLETE

F 37 BB PRO (TO BYPASS CSM-MCC1 BURN)

THC-LOCKED  
RHC-LOCKED  
KEY 76E

P76

F 06 84 (DV,S OF LM MCC1 BURN)  
LOAD LM MCC1 DV,S  
PRO

F 06 33 (GETI OF MCC1 BURN)  
LOAD LM GET-MCC1  
(105+24+00)

PRO

F 37 BB

MOVE TO LEB

+17

+26

+27

\*\*TARGET CSM MCC2 BACKUP\*\*

P35

F 16 45 KEY 35E  
(MKS,TFI,-00001)  
ZERO OPTICS-OFF

KEY V93E (REINITIALIZE W MAT)  
KEY V87E (VHF RANGING)  
KEY V57E

F 51 BB (PLEASE MARK)

KEY V16N45E  
F 16 45 (MKS,TFI,-00001)  
OMC-CENTER LM IN SXT  
OPTICS MODE-MAN  
MAKE 9 MARKS IN NEXT  
9 MINUTES

(105+32)

SUNUP

F 16 45 PRO/PROCESS LAST MARK  
(MARKS,TFI,-00001)  
ZERO OPTICS-ZERO

MOVE TO COMMAND SEAT

(TIGN=3.0 MIN)

F 06 81 PRO/MAKE FINAL PASS  
(VG-LV)  
COPY DATA ON CHECKLIST  
PRO

F 06 59 (VG-LOS)  
COPY DATA ON CHECKLIST  
PRO

F 16 45 (MARKS,TFI,MGA)  
PRO

F 37 BB

COPY LM MCC2 PAD  
COMPARE CSM SOLN WITH LM  
SOLUTION

\*28+30  
P41

KEY 41E  
F 50 18 (COMMANDED R,P,Y)  
KEY V56E  
KEY ENTER (BYPASS MNV...  
06 85 (VG-BODY)

\*\*SET UP MCC2 BURN\*\*

\*29+25

DSKY BLANKS

\*29+30

16 85 (VG-BODY) (AVE G ON)  
THC-ARMED  
RHC-ARMED

\*30+00 (105+39+00)

F 16 85 (VG-BODY)

\*\*\*\*\*

LM PERFORMS MCC2 BURN

\*\*\*\*\*

\*\*\*\*\*

CSM MCC2 BACKUP BURN  
(0,302/20,0)

\*\*\*\*\*

CONFIRM LM BURN COMPLETE

PRO (TO BYPASS CSM=MCC2 BURN)  
THC-LOCKED  
RHC-LOCKED

F 37 BB

P76

KEY 76E  
F 06 84 (DV,S OF LM MCC2 BURN)  
LOAD LM MCC2 DV,S

PRO

F 06 33 (GETI OF MCC2 BURN)  
LOAD LM GET=MCC2  
(105+39+00)

PRO

F 37 BB

\*31

\*\*MANEUVER TO COAS TRACK ATTITUDE\*\*

P00

KEY 00E

KEY V89E

F 04 06 (00003,00001,BLNK)  
LOAD R2 = 00002  
PRO

F 06 18 (COMMANDED R,P,Y)  
PRO

F 50 18 (COMMANDED R,P,Y)  
PRO

06 18 (COMMANDED R,P,Y)  
MONITOR ATT NMVR

F 50 18 (COMMANDED R,P,Y)  
ALIGN S/C TO ZERO DEG ROLL  
PRO

06 18 (COMMANDED R,P,Y)

F 50 18 (COMMANDED R,P,Y)  
(0,274/346,0)

KEY ENTER

```

*****
*   PROCEDURES FOR BRAKING   *
*****

```

+34

```

RHC-ARMED
CENTER LM IN RETICLE
BMAG MODE(3)-ATT1/RATE 2
MONITOR EMS FOR RANGE

```

+39

P47

```

KEY V37E47E
F 16 83 (DV-BODY)
KEY V83E
F 16 54 (R,RDOT,THETA)
THC-ARMED
MONITOR LOS CONTROL
MONITOR R AND R DOT
*****
* BRAKING GATES AND RET ANG,S *
*
* 30 FPS AT 6000 FT-.13 DEG *
* 20 FPS AT 3000 FT-.26 DEG *
* 10 FPS AT 1500 FT-.54 DEG *
* 5 FPS AT 500 FT-1.6 DEG *
*****

```

```

USE RANGE ON DSKY TO CHECK EMS
RANGE INDICATOR. USE
RETICLE ANGLE AS THIRD
VOTE.

```

+43 (105+52)

```

*****
TPF(0,310/353,0)
*****

```

6.3 P20 NAVIGATION SUMMARY WITH SUN ANGLES

IT - INITIATE TRACK  
 CT - CEASE TRACK  
 (OUT-OF-PLANE SUN ANGLE IS 4 DEG)

GET	EVENT	SUN ANGLE (L.O.S. TO SUN) DEG
98:35	CSM SEP	
98:50	SUNSET	
99:34	LM DOI	
99:37	SUNRISE	
100:27	IT (SXT/VHF) (10/10)	207
100:32		186
100:37	CT (SXT/VHF)	174
100:46	LM PHASING	
100:49	SUNSET	
100:51	IT (SXT/VHF) (4/3,V93,6/7)	
101:01	CT (SXT)	
101:14	IT (SXT/VHF) (10/10)	
101:24	CT (SXT/VHF)	
101:35	SUNSET	
101:49	(T (SXT/VHF) (4/3,V93,16/17)	131
101:54		117
101:59		111
102:04		102
102:09	CT (SXT/VHF)	93
102:43	LM INSERTION	
102:47	SUNSET	
103:02	IT (SXT/VHF) (V93,6/5,V93,17/18)	
103:07	CT (SXT)	
103:25	CT (VHF)	
103:33	SUNRISE	
103:34	LM CSI	
103:41	IT (SXT/VHF) (3/3;V67,00057,00034,00001; 16/16)	186
103:46		171
103:51		156
103:55		144
103:57		138
104:02	CT	123
104:02	LM PLANE CHANGE	
104:08	IT (SXT/VHF) (4/3,V93,8/9)	105
104:14		87
104:20	CT (SXT/VHF)	70
104:32	LM CDH	
104:38	IT (SXT/VHF) (4/3,V93,14/15)	17
104:43		4
104:45	SUNSET	5
104:56	CT (SXT/VHF)	
105:09	LM TPI	
105:12	IT (SXT/VHF) (V93,8/8)	
105:20	CT (SXT/VHF)	
105:24	LM MCC1	
105:26	IT (SXT/VHF) (V93,9/9)	
105:32	SUNRISE	91
105:35	CT (SXT/VHF)	92
105:39	MCC2	
105:52	TPF	

6.4

CSM ATTITUDE SUMMARY  
INERTIAL AND ORDEAL FDIAT GIMBAL ANGLE  
PROFILE FOR THE NOMINAL F MISSION  
(YAW = 0.0)

TIME GET	ROLL	PITCH ORDEAL	PITCH INERTIAL	PITCH MNVR
97:40	180	282	14 (Yaw = 14.0)	
97:50	180	312	14	
98:10	180	12	14	
98:12	0	21	14	
98:35	0	90	14	
98:39	0	142	54	40
98:55	0	170	34	
99:28	0	206	332	55
99:39	0	227	317	
100:07	180	278	268	70
100:25	180	293	243	25
100:48	180	308	188	
101:14	180	337	138	
101:49	180	108	162	
102:11	180	174	162	50
102:36	180	3	272	110
102:46	180	32	272	
102:56	180	162	13	101
103:05	180	161	346	
103:29	180	166	277	11
103:34	180	180	277	
103:38	180	155	239	39
104:02	180	156	167	
104:05	180	157	158	
104:25	0	167	108	
104:32	0	188	108	
104:36	0	229	137	29
104:58	0	235	75	
105:02	0	192	15	53
105:09	0	208	15	
105:11	0	247	48	33
105:24	0	265	29	
105:39	0	302	20	
105:42	0	274	346	34
105:52	0	310	353	



## 7.0 DISCUSSION OF LM ABORT AND RESCUE CASES

### 7.1 LM Active PDI Abort

A LM active PDI abort rendezvous is planned if a failure occurs after DOI which precludes continuation of the nominal rendezvous mission. The LM PDI abort burn is targeted to occur at LM perilune one-half revolution after LM DOI. This burn provides phasing such that the LM TPI burn occurs one revolution earlier than the nominal TPI time. The LM CSI burn occurs one-half revolution after the PDI abort burn, and the LM CDH burn occurs one-half revolution after the CSI burn. The CDH burn is targeted to produce a 15 nautical mile delta height. The LM TPI burn will be cued at an elevation angle of 26.6 degrees and will occur near the midpoint of darkness.

Since the LM is active for this rendezvous, the function of the CSM will be to target the CSI, CDH, and TPI burns and backup the LM burns.

The onboard data for this case is valid if the CSM becomes active following the LM PDI abort burn.

### 7.2 Partial LM Phasing Greater Than or Equal to 40 FPS

This abort and rescue case was developed to provide a rendezvous capability assuming the LM could not complete the Phasing burn but could apply at least 40 FPS. This is the most likely partial Phasing situation since the LM RCS could be used to apply 40 FPS even if a failure of both the LM DPS and APS engines precluded application of the burn. The rendezvous sequence assuming a partial Phasing burn greater than or equal to 40 FPS requires the CSM to perform a rescue burn approximately one revolution after the LM DOI burn. This rescue burn is sized, based upon the magnitude of the partial Phasing burn, so that the terminal rendezvous approach is similar to that in the nominal case. A canned rescue burn (48.7 FPS retrograde)

will be provided onboard which is valid for the partial phasing equal to 40 FPS, the most likely failure situation. This burn will nominally be updated by the ground 20 minutes after the failed LM burn based upon the LM DV applied at phasing. Updating the Rescue burn preserves the nominal terminal rendezvous approach.

The CSM Rescue burn at 101:33 lowers the CSM perilune to about 20 nautical miles and provides phasing which results in TPI occurring near the nominal TPI time (105:09). The CSM CSI One burn is targeted so that the CDH burn occurs one revolution after the CSI One burn. A CSI Two burn (nominally zero) is scheduled half way between the CSI One and CDH burns. The CSM TPI burn at a delta height of 15 nautical miles will be cued on an elevation angle of 208.3 degrees which results in TPI at the midpoint of darkness. There exists the possibility that the LM could become active following the CSM Rescue burn. This would require slightly different targeting for the terminal rendezvous phase; however, the CSM onboard data would not be affected significantly.

### 7.3 Partial LM Phasing Less Than 40 FPS

In the event the LM cannot apply 40 FPS of the Phasing burn (the DPS, APS, and RCS have failed), a rendezvous plan similar to that in Section 7.2 will be utilized. A CSM rescue burn is applied at 101:33, one revolution after the DOI burn, and the magnitude of the rescue burn is a function of the LM DV applied (zero to 40 FPS). A canned rescue burn (57.1 FPS retrograde) is also provided onboard for this case. This canned burn is valid for a LM DV of 20 FPS and will be updated after the failed LM burn. A partial LM burn of 20 FPS was chosen simply because it is midway in the zero to 40 FPS partial burn range.

This rendezvous plan differs from the LM partial Phasing greater than 40 FPS plan in that there are two revolutions between the CSM

CSI One and CSM CDH burns. A CSI Two burn is scheduled half way between the CSI One and CDH burns and a CSI Three burn is scheduled half way between the CSI Two and CDH burns. Both the CSI Two and CSI Three burns are nominally zero. The CDH burn for this rescue is targeted so that the delta height between CDH and TPI is 10 nautical miles instead of the nominal 15 nautical miles. The TPI burn is cued as in the nominal case at an elevation angle of 208.3 degrees. The LM could be active after the CSM rescue burn.

#### 7.4 Partial LM Insertion

Should the LM APS fail during the Insertion burn DV be outside the LM-RCS capability either to complete the Insertion burn or to null out the applied DV (i.e.,  $DV > 40$  or  $V_G > .80$ ) a CSM active rescue will be initiated. For LM applied DV of less than 45 FPS the LM will use the RCS to burn the DV back to zero. If the velocity-to-go is less than 80, the LM will use the RCS to complete the burn. For other LM-applied DV's, the LM will use the RCS to apply an additional 80 FPS along the burn vector to prevent the subsequent maximum ranges from becoming greater than 400 nautical miles. Based upon the LM DV applied, the MCC-H will target the CSM Rescue burn magnitude to preserve the nominal Terminal Phase characteristics, but will result in a TPI one revolution later than nominal. A pad containing this Rescue burn, as well as CSI, CDH, and TPI burn data will be voiced to the CSM approximately 20 minutes after the failed LM Insertion burn. Should the CSM fail to receive these pads, the CSM will apply a canned Rescue burn of 44.9 FPS (regrograde) at DOI + 238 min. (2 revs after DOI). This Rescue burn is valid for a LM applied DV of 120 FPS at the

partial Insertion burn, which is approximately in the middle of the range of LM-applied DV's for which this rescue would be initiated.

After the CSM Rescue burn, the usual concentric rendezvous sequencing of CSI, CDH, and TPI is initiated, with CSI scheduled to occur at one-half revolution after the Rescue burn, and CDH one revolution after the CSI burn. Half-way between CSI and CDH a second, nominally zero, CSI is scheduled, followed by a Plane Change burn half-way between the second CSI and CDH. TPI occurs 35 minutes after CDH at an elevation angle of 208.3, approximately 23 minutes before sunrise. TPF occurs approximately two and one-half revolutions after the failed Insertion burn. The LM could become active after the CSM Rescue burn.

#### 7.5 Zero LM Insertion

Should the LM APS fail at the Insertion burn with less than 45 FPS being applied, the LM will use the RCS to reduce the total DV to zero. The CSM will initiate a ground supplied backup Insertion burn at 102:46:18, three minutes after the LM Insertion TIGN.

This burn preserves the relative trajectory, producing a CSI, CDH, TPI sequence similar to the nominal case; however, due to the increased orbital period of the CSM, the delta times between burns will be somewhat larger than nominal. The resulting TPI time is seven minutes later than nominal and 23 minutes before sunrise. TPI occurs at an elevation angle of 208.3, and at a delta height of 15 nautical miles. The LM could become active after the CSM Backup Insertion burn.

## 8.0 LM RESCUE ONBOARD DATA

The onboard procedures data required to perform CSM active LM rescues will take the form of a one-page summary checklist which covers the complete timeline for each rescue case. Each summary checklist will show all activities from the failed LM burn to TPF required to complete the LM rescue including program requirements, navigation schedules, and burn schedules. In addition, sunrise/sunset, LOS/AOS, and tracking and burn attitudes will be indicated. In order to condense activities into one page, considerable abbreviation from the nominal checklist format is required. This may necessitate the crew referring to the nominal checklist if additional detail on a particular activity is desired.

Accompanying each one page checklist will be a relative motion plot (LM centered) showing the orbital position of the CSM with respect to the LM. In addition to the plot, maneuver pads for copying onboard data will be provided for each burn during the five contingency rendezvous situations.

The rescue checklist timelines, relative motion plots, and burn data for the two partial LM Phasing cases and one partial LM Insertion case were formulated assuming the CSM applied the canned rescue burn. The onboard data for the zero LM Insertion rescue case assumes a nominal trajectory to Insertion and a ground targeted CSM Backup Insertion burn. The PDI abort case assumes the LM DOI burn was nominal and the LM is active for the rendezvous. The CSM in this case provides a backup to the LM maneuvers after the PDI abort burn.

8.1 · LM PDI Abort

8.1.1 Plot and Pads  
LM ACTIVE PDI ABORT (LM CENTERED)

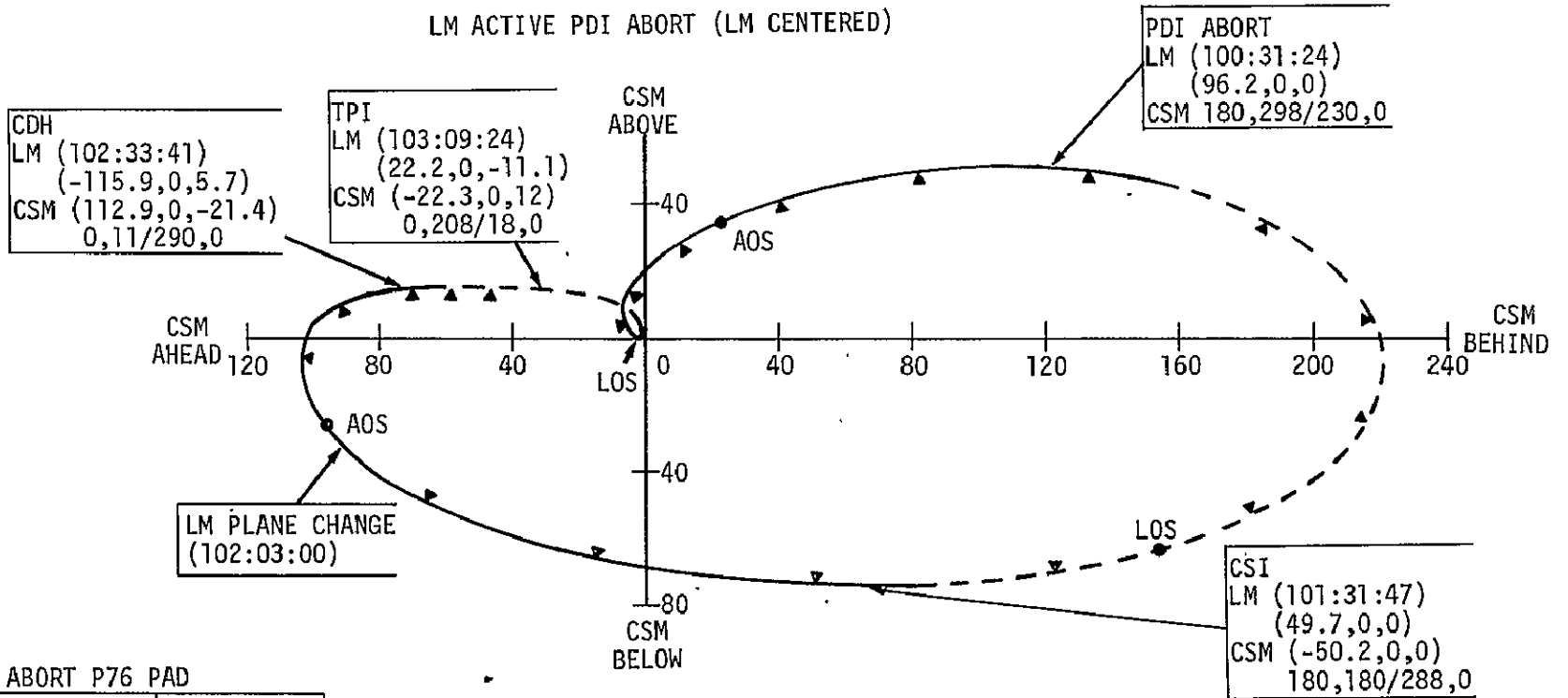

PDI ABORT P76 PAD

84	.	.	.
33	:	:	:

CSM CSI COPY

11	:	:	:
37	:	:	:
75	.	.	.
81	.	.	.
82	.	.	.

LM CSI P76

84	.	.	.
33	:	:	:

CSM PC COPY

33	:	:	:
81	.	.	.

LM PC P76

84	.	.	.
33	:	:	:

CSM CDH COPY

13	:	:	:
75	.	.	.
81	.	.	.

LM CDH P76

84	.	.	.
33	:	:	:

CSM TPI COPY

37	:	:	:
58	.	.	.
81	.	.	.
59	.	.	.

LM TPI P76

84	.	.	.
33	:	:	:

8.1.2 Checklist  
LM ACTIVE PDI ABORT

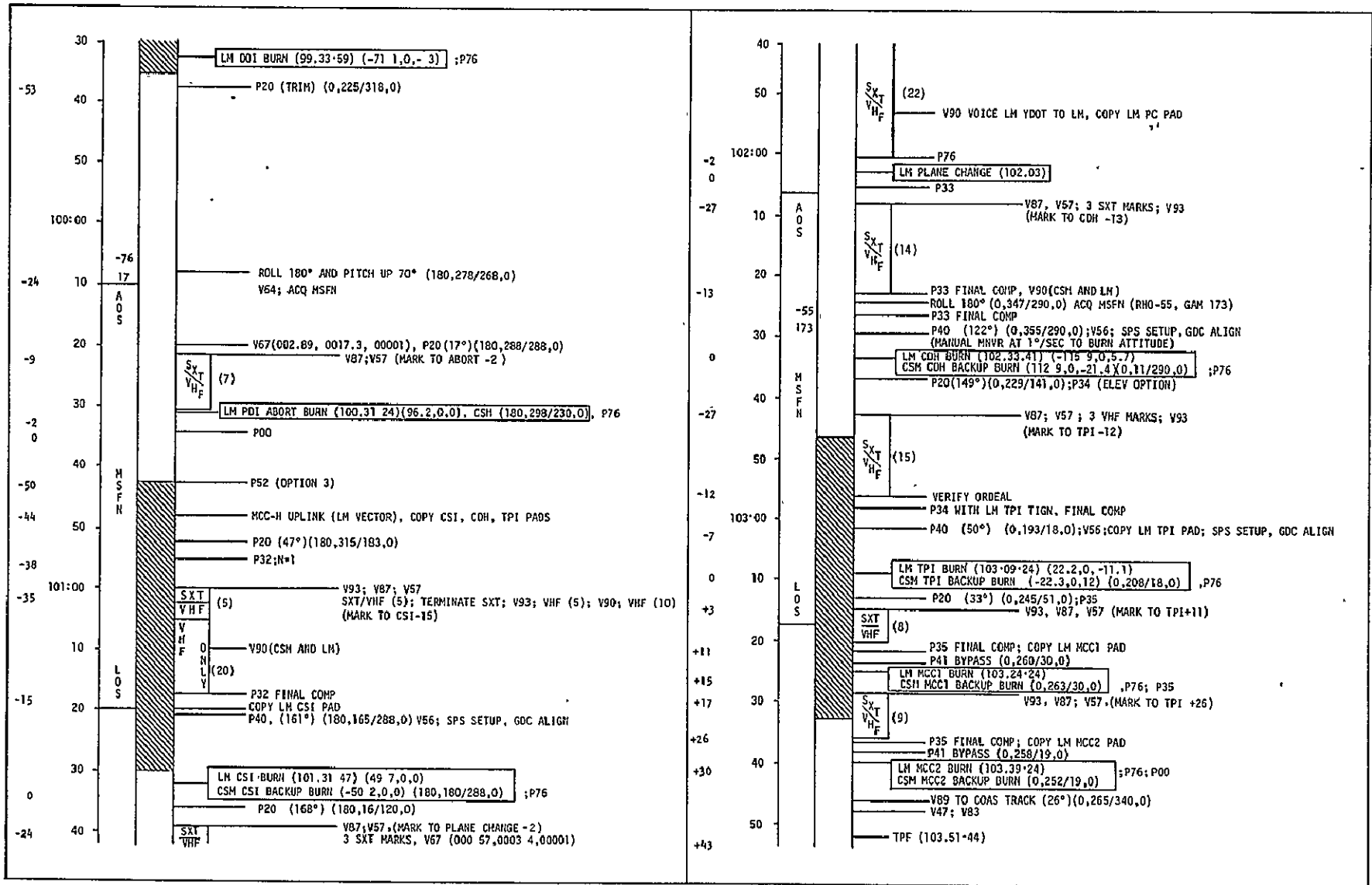



8.2 LM Partial Phasing Greater or Equal To 40 FPS

### 8.2.1 Plot and Pads

CSM ACTIVE LM RESCUE PARTIAL PHASING  $\geq 40$ fps (LM CENTERED)

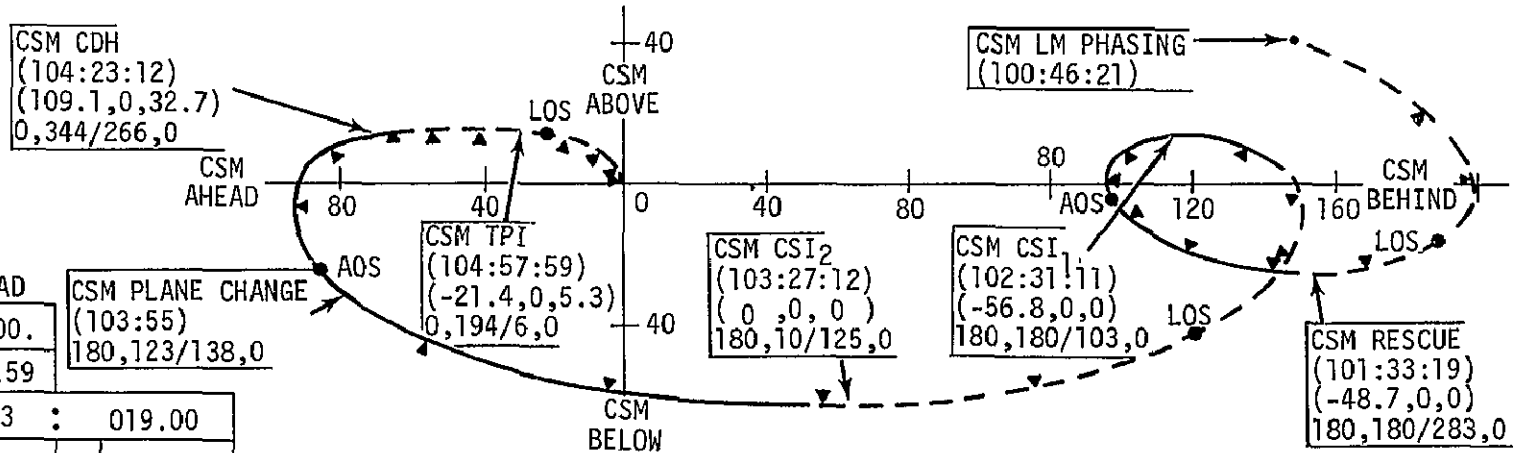

CANNED RESCUE TWO PAD

47	+	37768.	+	00000.
48	-	000.52	+	000.59

CSM PLANE CHANGE  
(103:55)  
180,123/138,0

33	00101	:	00033	:	019.00	
81	-	0048.7	+	0000.0	+	0000.0
22	XXX180		XXX283		XXX000	
ΔV <sub>C</sub>	X0038.8					
11	00102	:	00031	:	011.00	
37	00104	:	00057	:	059.00	
N	2					

CSM CSI TWO COPY

11	:	:
37	:	:
75	.	:
81	.	.
82	.	.

CSM CDH COPY

13	:	:
75	.	:
81	.	.

CSM CSI ONE COPY

11	:	:
37	:	:
75	.	:
81	.	.
82	.	.

LM CSI TWO P76

84	.	.
33	:	:

CSM TPI COPY

37	:	:
58	.	.
81	.	.
59	.	.

LM CSI ONE P76

84	.	.
33	:	:

LM PC P76

84	.	.
33	:	:

CSM PC COPY

33	:	:
81	.	.

LM TPI P76

84	.	.
33	:	:

8.2.2 Checklist

CSM ACTIVE LM RESCUE - LM PHASING  $\geq$  40 FPS ( $\Delta V$  APPLIED = 40 FPS)

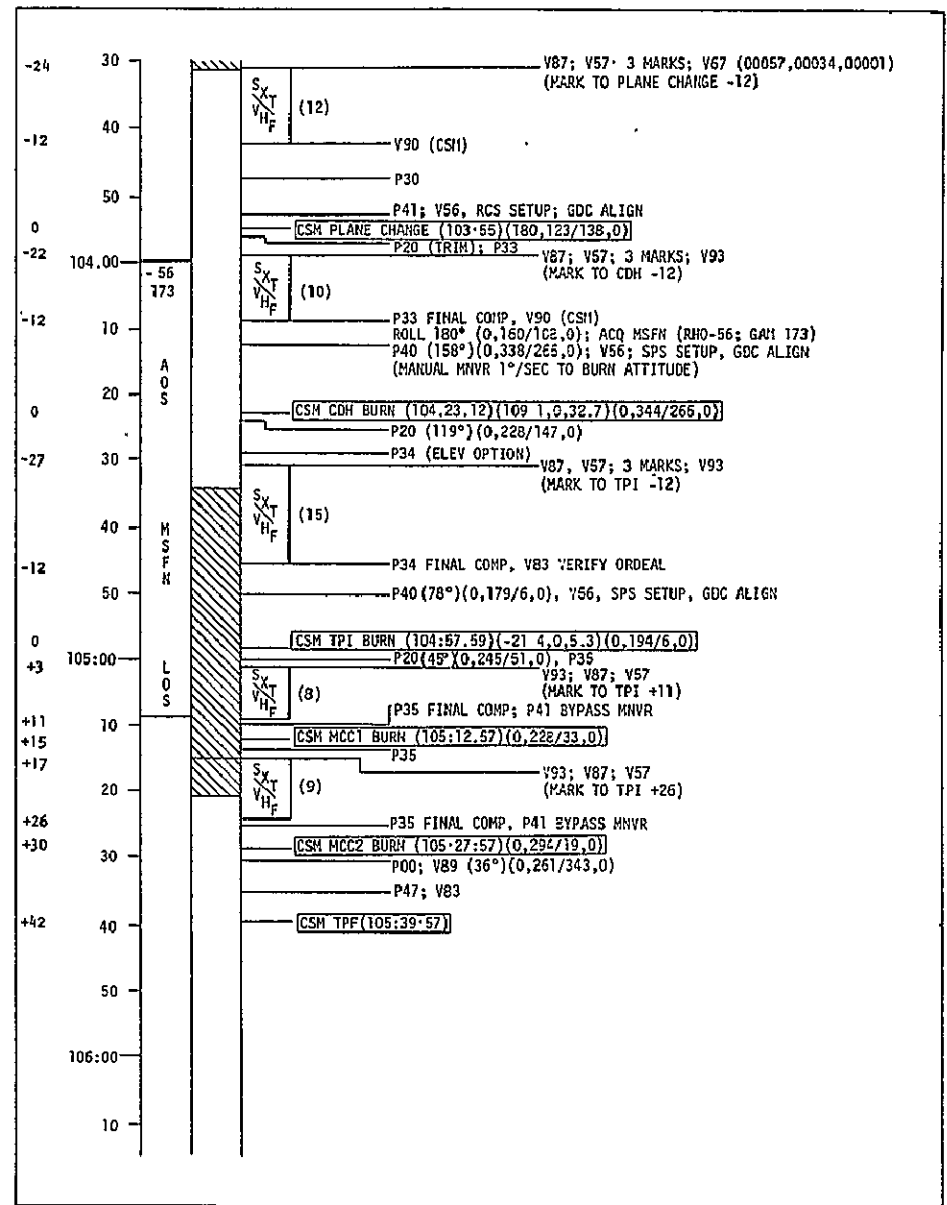
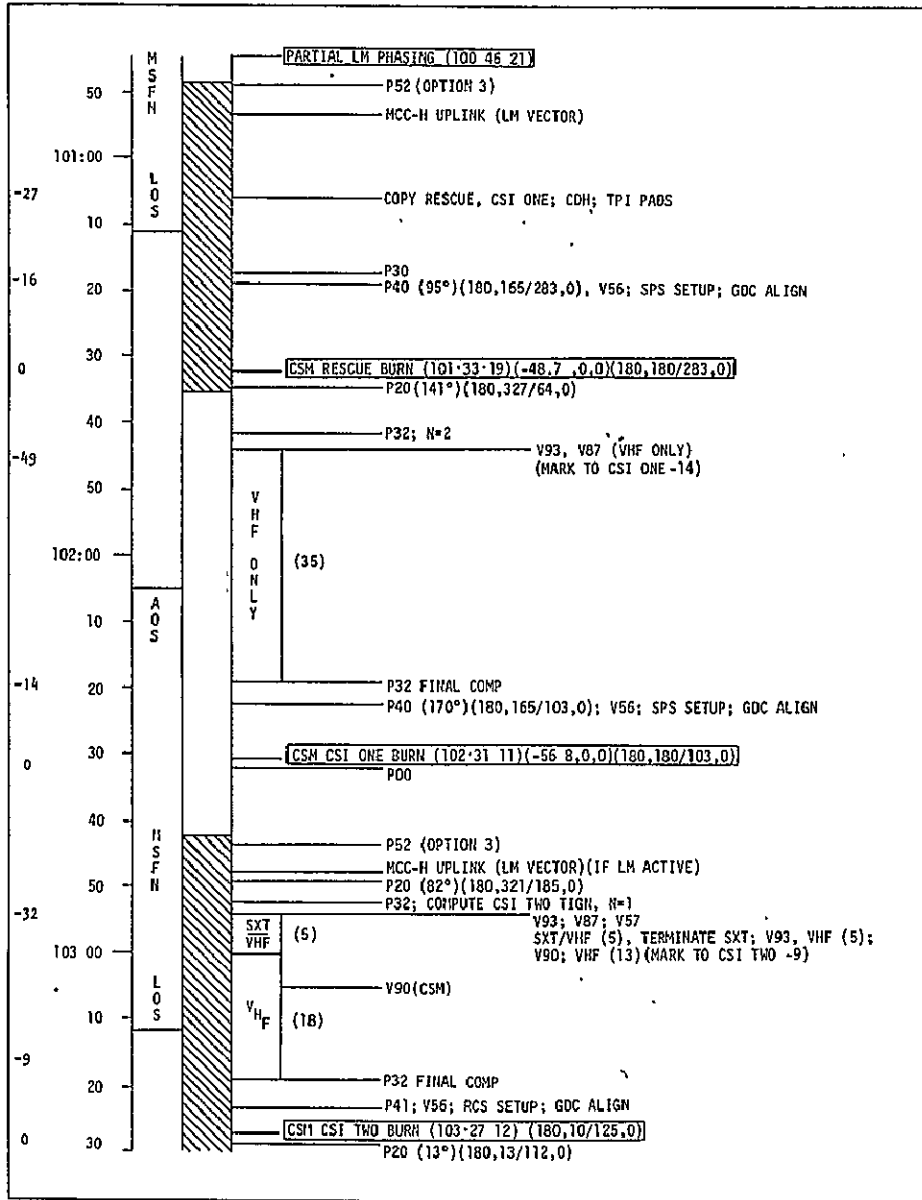

8.3 LM Partial Phasing Less Than 40 FPS

8.2.1 Plot and Pads  
PARTIAL LM PHASING <40 FPS

CANNED RESCUE TWO PAD

47	+	37768.	+	00000.		
48	-	000.52	+	000.59		
33		00101	•	00032	•	059.00
81	-	0057.1	+	0000.0	+	0000.0
22		XXX180		XXX283		XXX000
$\Delta V_C$		X0047.1				
11		00102	•	00030	•	035.00
37		00106	•	00050	•	057.00
N		4				

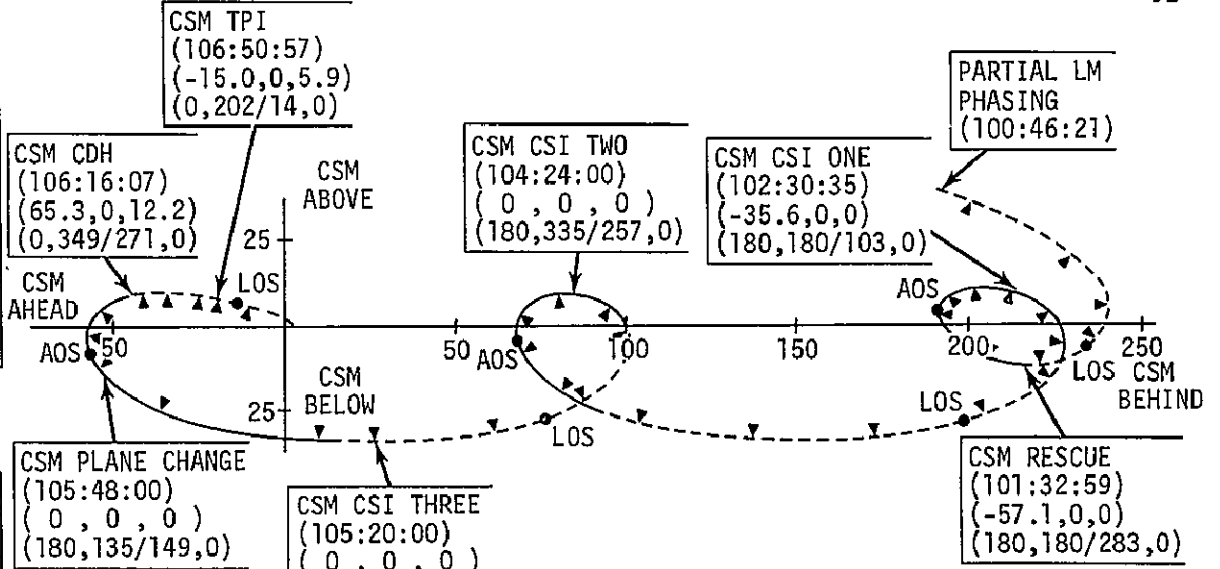

CSM CSI ONE COPY

11	•	•
37	•	•
75	•	•
81	•	•
82	•	•

LM CSI ONE P76

84	•	•	•
33	•	•	

CSM CSI TWO COPY

11	•	•
37	•	•
75	•	•
81	•	•
82	•	•

LM CSI TWO P76

84	•	•	•
33	•	•	

CSM CSI THREE COPY

11	•	•
37	•	•
75	•	•
81	•	•
82	•	•

LM CSI THREE P76

84	•	•	•
33	•	•	

CSM PC COPY

33	•	•
81	•	•

LM PC P76

84	•	•	•
33	•	•	

CSM CDH COPY

13	•	•
75	•	•
81	•	•

LM CDH P76

84	•	•	•
33	•	•	

CSM TPI COPY

37	•	•
58	•	•
81	•	•
59	•	•

LM TPI P76

84	•	•	•
33	•	•	

8.3.2 Checklist  
CSM ACTIVE LM RESCUE PHASING LESS THAN 40 FPS

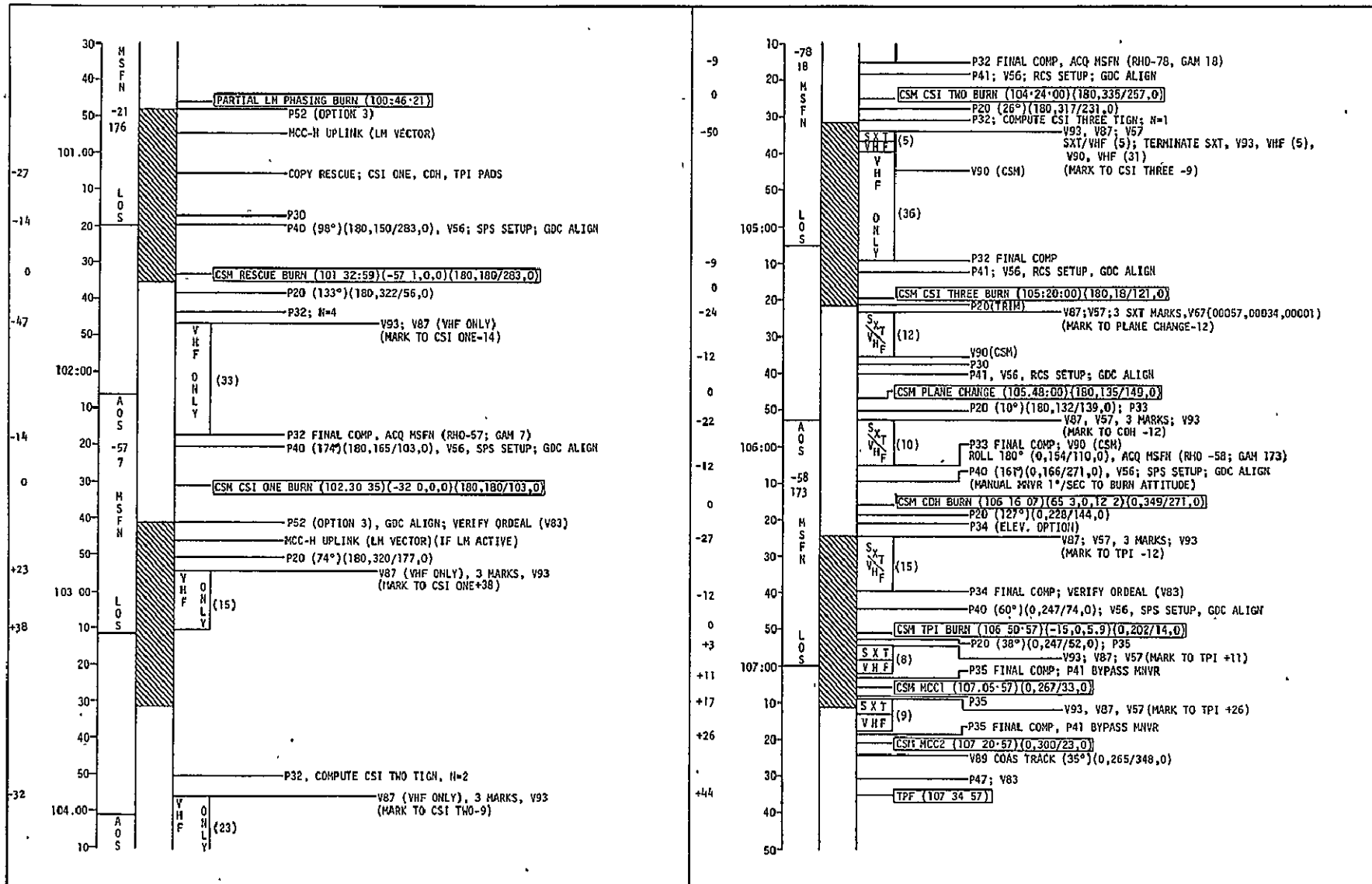

8.4 LM Zero Insertion

8.4.1 Plot and Pads

CSM ACTIVE LM RESCUE-ZERO INSERTION (LM CENTERED)

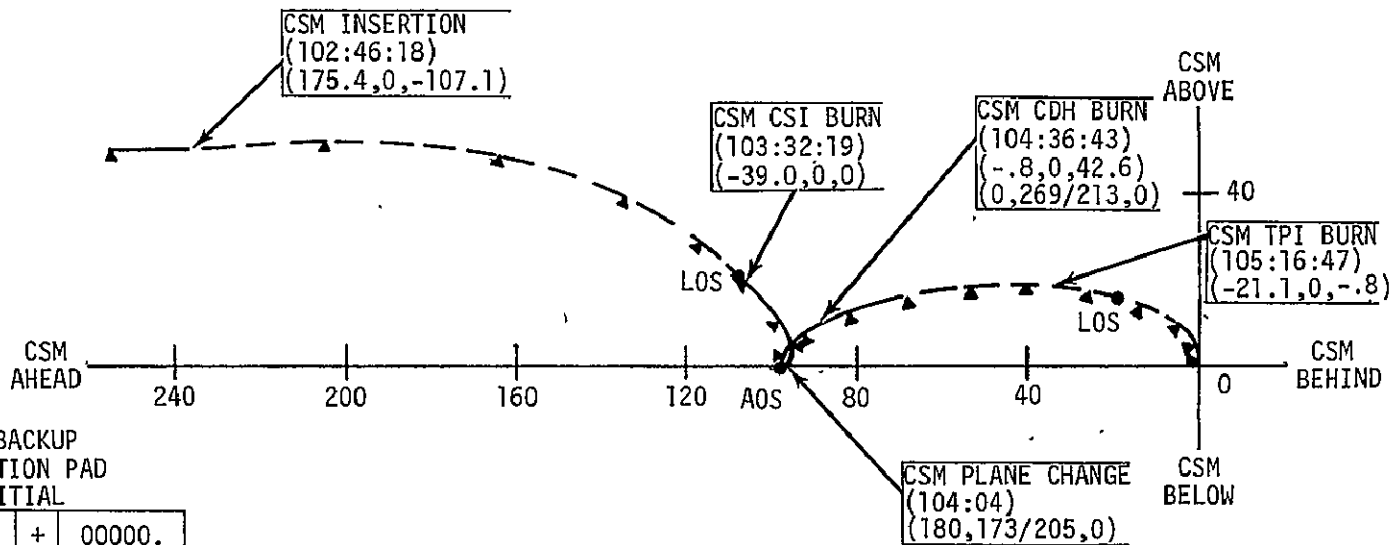

CSM BACKUP  
INSERTION PAD  
INITIAL

47	+	37768.	+	00000.
48	-	000.52	+	000.59
33	00102 : 00046 : 018.00			
81	+	175.4	+	0000.0 - 107.1
22	XXX180	XXX272	XXX00	
$\Delta V_C$	X192.7			
11	00103	00032	019.	
37	00105	00016	047.	
N	1			

CSM CSI COPY			
11	:	:	:
37	:	:	:
75	.	:	:
81	.	.	.
82	.	.	.

LM CSI P76			
84	.	.	.
33	:	:	:
CSM PC COPY			
33	:	:	:
81	.	.	.
LM PC P76			
84	.	.	.
33	:	:	:
CSM CDH COPY			
13	:	:	:
75	.	:	:
81	.	.	.

LM CDH P76			
84	.	.	.
33	:	:	:
CSM TPI COPY			
37	:	:	:
58	.	.	.
81	.	.	.
59	.	.	.
LM TPI P76			
84	.	.	.
33	:	:	:



8.4.2 Checklist

CSM ACTIVE LM RESCUE - LM INSERTION = 0

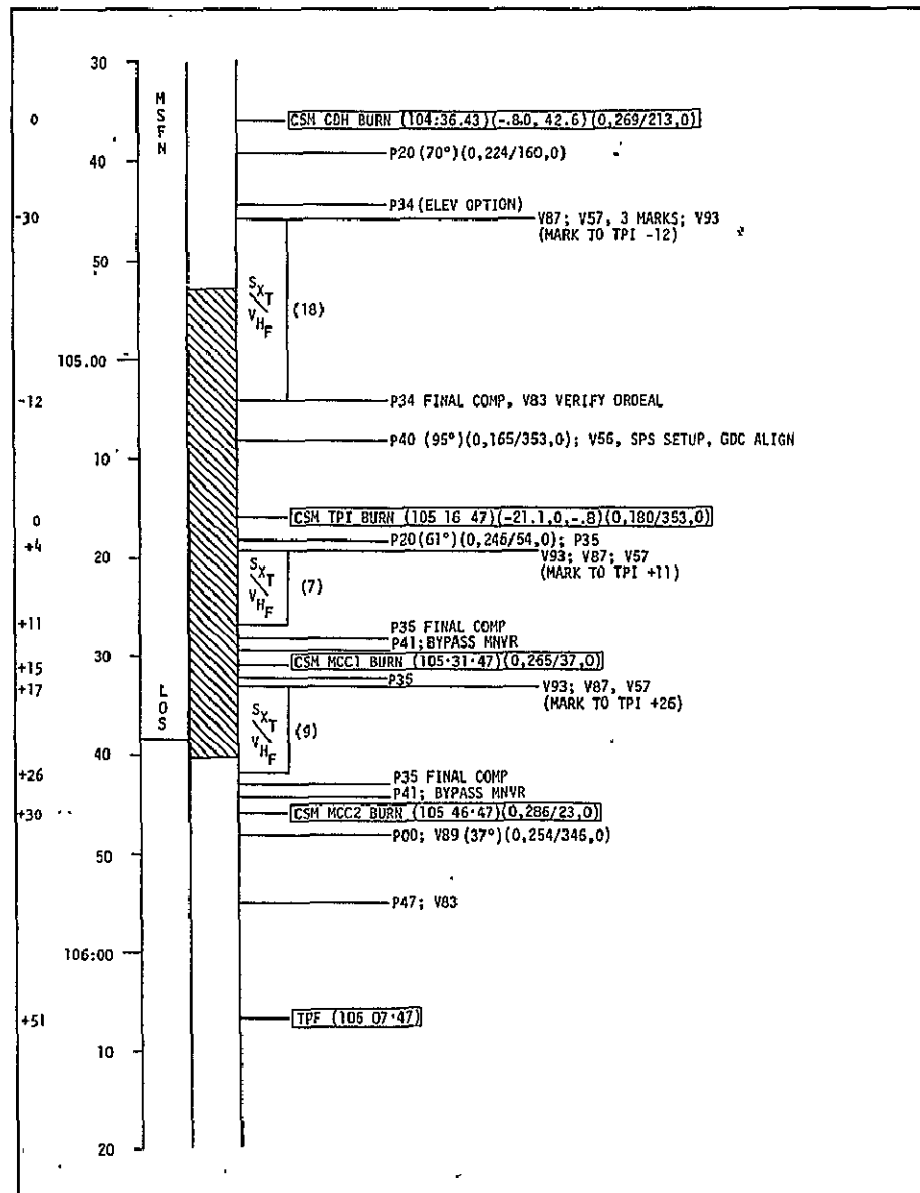
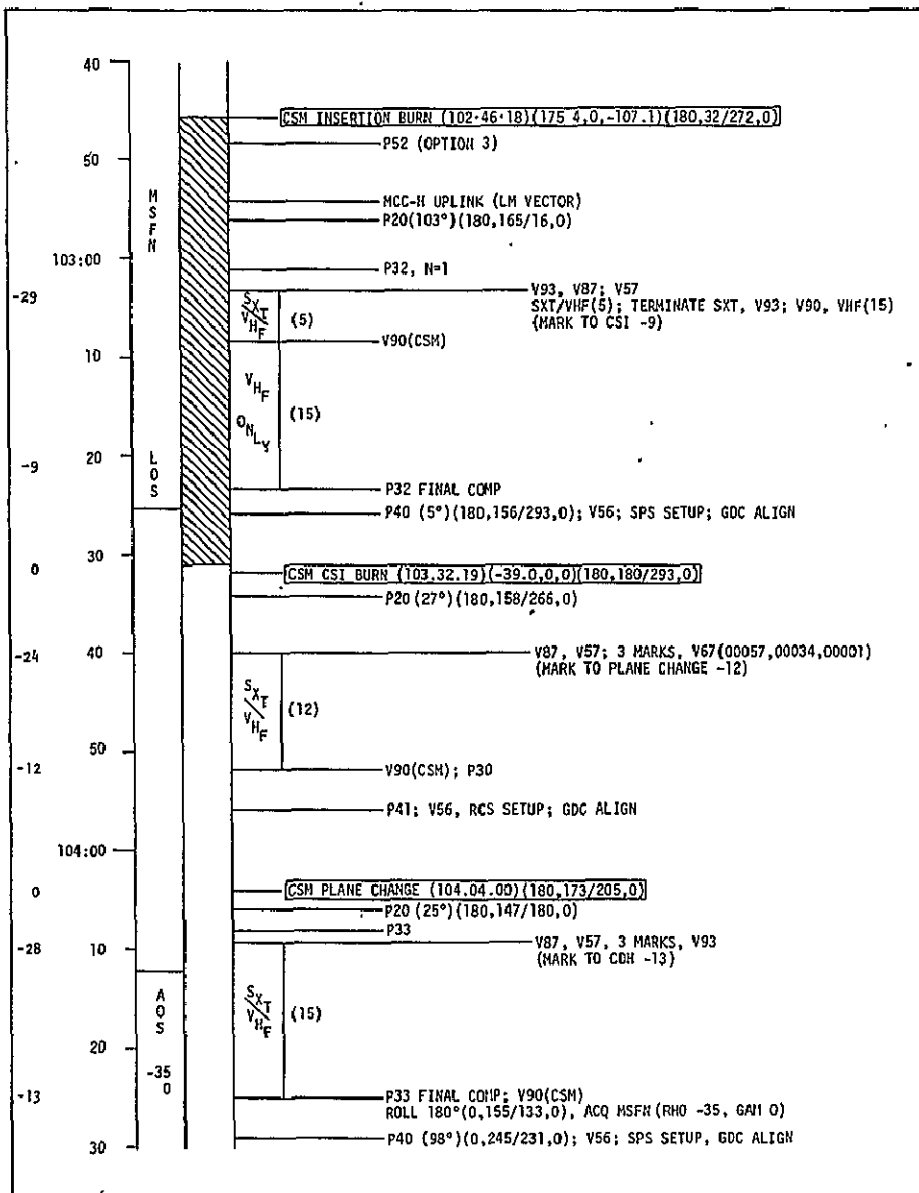

8.5 LM Partial Insertion

8.5.1 Plot and Pads  
 CSM ACTIVE LM - PARTIAL LM INSERTION (LM CENTERED)

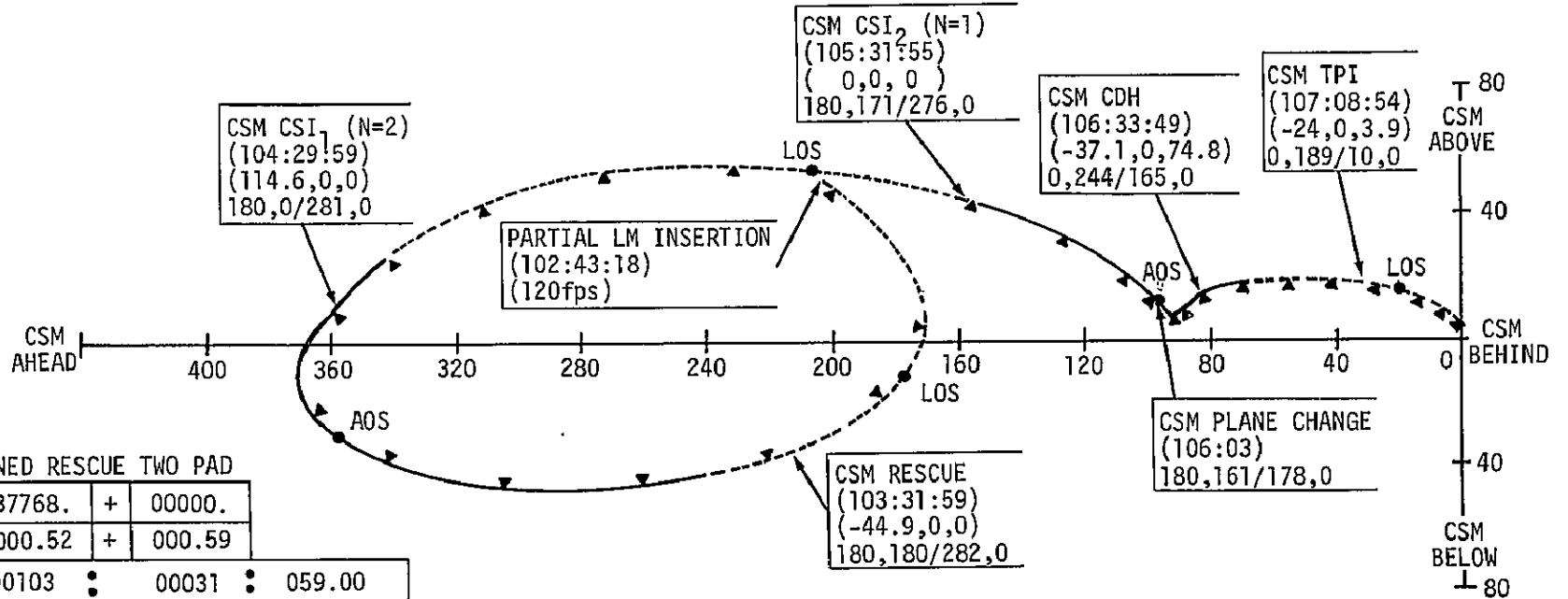

CANNED RESCUE TWO PAD

47	+	37768.	+	00000.
48	-	000.52	+	000.59
33		00103	:	00031
			:	059.00
81	-	0044.9	+	0000.0
			+	0000.0
22		XXX180		XXX282
				XXX000
V <sub>C</sub>		X0035.0		
11		00104	:	00029
			:	059.00
37		00107	:	00008
			:	054.00
N		2		

CSM RESCUE  
 (103:31:59)  
 (-44.9,0,0)  
 180,180/282,0

CSM CSI TWO COPY

11			
37			
75	.	.	.
81	.	.	.
82	.	.	.

CSM CDH COPY

13			
75	.	.	.
81	.	.	.

CSM CSI ONE COPY

11			
37			
75	.	.	.
81	.	.	.
82	.	.	.

LM CSI TWO P76

84	.	.	.
33			

LM CDH P76

84	.	.	.
33			

CSM PC COPY

33			
81	.	.	.

CSM TPI COPY

37			
58	.	.	.
81	.	.	.
59	.	.	.

LM CSI ONE P76

84	.	.	.
33			

LM PC P76

84	.	.	.
33			

LM TPI P76

84	.	.	.
33			

8.5.2 Checklist  
 CSM ACTIVE LM RESCUE - PARTIAL LM INSERTION ( $\Delta V$  APPLIED = 120 FPS)

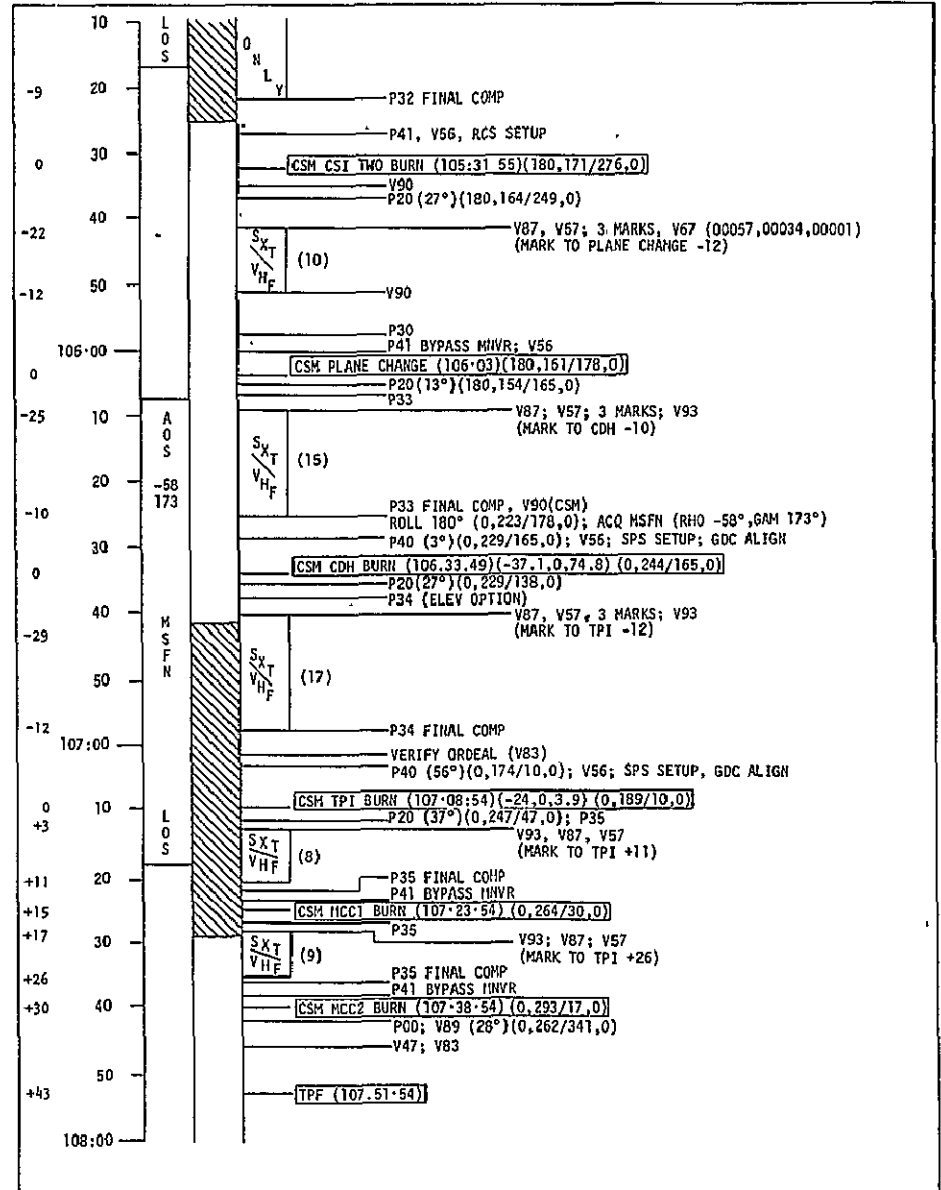
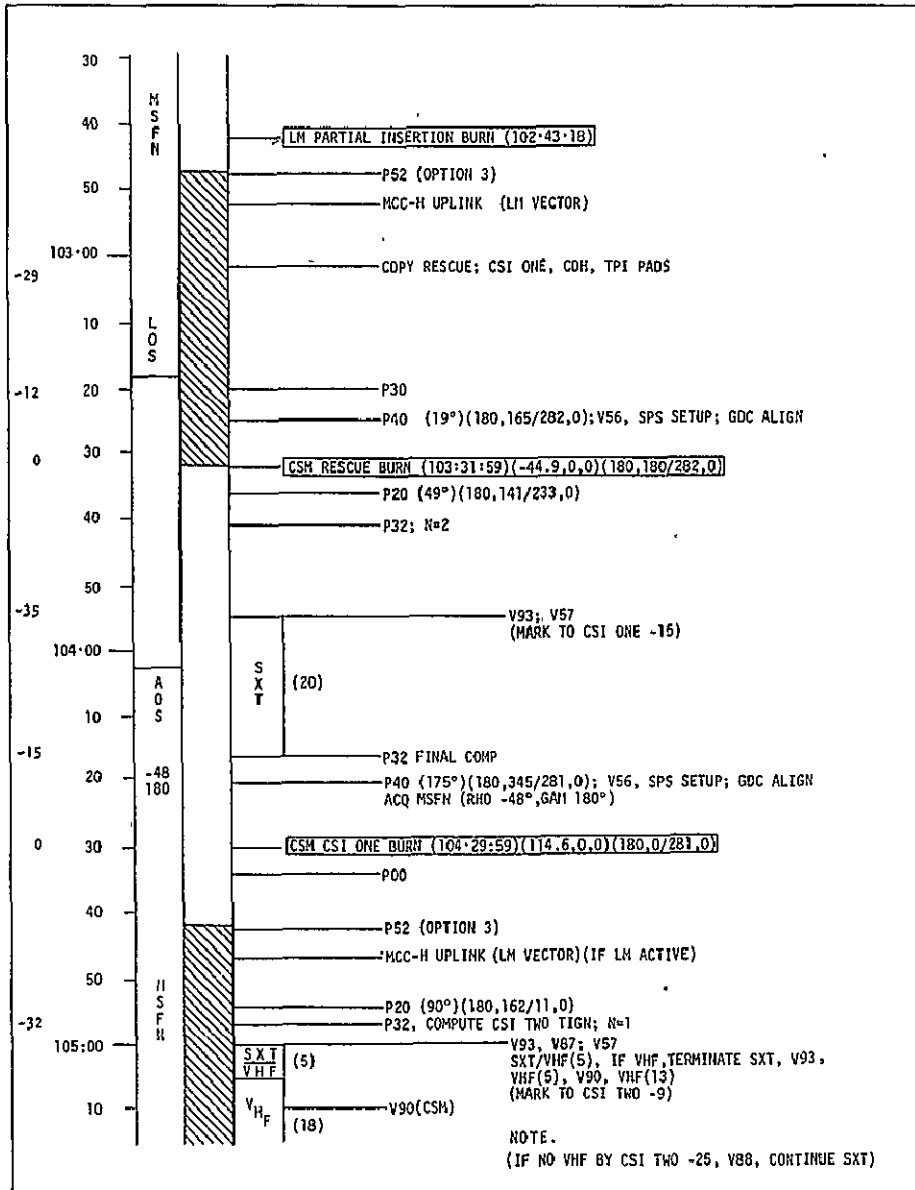

9.0 LM RESCUE PROCEDURES SUMMARY

9.1 Rescue Procedures Ground Rules

- 9.1.1 The GDC will be aligned to the IMU before all SPS burns.
- 9.1.2 P20 will be terminated with a verb 56 before all SPS burns and the Plane Change burn.
- 9.1.3 A rescue pad will be received by the CSM 20 minutes after LM failure in all cases where a Rescue rather than Backup burn is used. The pad will include CSI, CDH, and TPI burn data.
- 9.1.4 The detailed procedures for SPS burns are listed on the timelines because gimbal motor checks are included which are not employed in the nominal backups.
- 9.1.5 Moves to the LEB or CMD seat are not made during auto maneuvers unless time is limited.
- 9.1.6 The 180-degree option should be taken in P32 by loading in a non-zero central angle of 130 degrees.
- 9.1.7 TIGN for CSI Two (and Three) burns will be computed onboard to be half way between the previous CSI TIGN and P32 CDH TIGN.
- 9.1.8 The LM state vector will always be updated unless notified otherwise by the ground.

9.2 LM PDI ABORT

9.2.1 SUMMARY TIMELINE

-102-

GFT	EVENT	PROG	GFT	EVENT	PROG
		-11	(100+20)	V67 LOAD WI(002.89,0017.3,00001) MOVE TO LEB	
(99+33+59)	POI ABORT ***** LM DOI BURN(-71.1,0,-.3) ***** CONFIRM LM DOI INCORPORATE P76 DATA (DOI)	-10	(100+21)	RENDEZVOUS NAV PROGRAM (P20) AUTO MNVR TO SXT TRACK (17 DEG) (180,288/251,0)	
(99+37)	SUNUP	-9	(100+22)	CALL MARKING ROUTINES(VA7,V57)	
-52 (99+38)	RENDEZVOUS NAV PROGRAM (P20) POSSIBLE AUTO MNVR TO SXT TRACK (TRIM) (0,225/318,0) MOVE TO LEB	-2	(100+29)	TERMINATE MARKS (7)	
		0	(100+31+24)	***** LM POI ABORT BURN (06.2,0,0) (180,298/230,0) ***** TARGET DV PROGRAM (P76)	
-47 (99+44)	INITIATE LM OPTICS TRACK		(100+34)	CMC IDLING PROGRAM (P00)	
-24 (100+07)	MOVE TO CMD SEAT ROLL 180 DEG AND PITCH UP 70 DEG AT 1 DEG/SEC ACQUIRE MSFN (V64) (P00) (180,278/268,0)	-50	100+42)	SUNDOWN IMU REALIGN TO REFSMMAT (P52) (OPTION 3) COPY GYRO TORQUE ANGLES	
(100+09)	AOS RH0=-76 , GAMMA=17	-44	(100+48)	MCC-H UPLINK(LM VECTOR) (P00) COPY CSI,CDH,TPI PAHS	

GET	EVENT	PROG	-103-	GET	EVENT	PROG
-40	(100+52)	RENDEZVOUS NAV PROGRAM AUTO MNVR TO SXT TRACK (47 DEG) (180,315/183,0)	(P20)	-11	(101+21)	SPS THRUST PROGRAM,V56 (P40) AUTO MNVR TO BURN ATTITUDE (161 DEG) (180,165/288,0)
-38	(100+54)	CSI TARGETING PROGRAM (P32)(P20) OBTAIN LM CSI AND TPI TIGNS, LOAD N55 WITH R1=00001 R2=20830 R3=13000 MOVE TO LEB		-5	(101+27)	SPS THRUST SETUP (P40) GDC ALIGN
-35	(100+57)	CALL MARKING ROUTINE(V93,V87,V57) (AFTER 5 MARKS V93)		-2	(101+30)	SUNUP
-30	(101+02)	TERMINATE SXT MARKS,V93 CONTINUE VHF		0	(101+31+47)	***** LM CSI BURN (49.7,0,0) *****
-25	(101+07)	OUT OF PLANE DATA(V90) VOICE LM Y DOT TO LM CONTINUE VHF				***** CSM CSI BACKUP BURN (-50,2,0,0) (180,180/288,0) *****
-15	(101+17)	TERMINATE MARKS(20) MOVE TO CMD SEAT CSI TARGETING FINAL COMP (P32) COPY CSM CSI SOLUTION OVERWRITE N81 WITH(-)CSM YDOT(V90)		-30	(101+33)	TARGET DV PROGRAM (P76) (CSI)
-12	(101+20)	COPY LM CSI PAD LOS		-24	(101+39)	RENDEZVOUS NAV PROGRAM (P20) AUTO MNVR TO SXT TRACK (168 DEG) (180,16/120,0) CALL MARKING ROUTINES(V87,V57) AFTER 3 SXT MARKS PROCESSED V67 LOAD WR(000.57,1003.4,00001)

MISSION F RESCUE TIMELINE APRIL 25,1969



GFT	EVENT	PROG	GFT	EVENT	PROG
-10	(101+53) COPY LM PC TIGN OUT OF PLANE DATA(V90) VOICE LM YDOT TO LM COPY LM PC PAD	13	(102+21)	TERMINATE MARKS (14) OUT OF PLANE DATA(V00) VOICE LM YDOT TO LM MOVE TO CM SFAT	
-2	(102+01) TERMINATE MARKS (22) LOAD TARGET DV PROGRAM	(P76)		ROLL 180 DEG AT 2 DEG/SEC ACQ MSFN	(P00)
0	(102+03+00) ***** LM PLANE CHANGE(0,0,0) ***** INCORPORATE P76 DATA (PLANE CHANGE)			RHO=-55 , GAMMA=173 (0,347/290,0) CDH TARGETING FINAL COMP COPY CSM CDH SOLUTION COPY LM CDH PAD	(P33)
-29	(102+05) CDH TARGETING PROGRAM POSSIBLE AUTO MNVR TO SXT TRACK (TRM) OBTAIN LM CDH TIGN LOAD CDH TARGETING DATA	(P33) -9 -5	(102+25)	SPS THRUST PROGRAM, V56 MANUAL MNVR AT 1 DEG/SEC TO BURN ATTITUDE (122 DEG) (0,356/290,0)	(P40)
-27	(102+07) CALL MARKING ROUTINE(V87,V57) PROCESS THREE MARKS,V93) AOS	0	(102+29) (102+33+41)	(SPS THRUST SETUP GDC ALIGN ***** LM CDH BURN (-115.9,0,5.7), ***** ***** CSM CDH BACKUP BURN (112.9,0,-21.4 (0,11/290,0) *****	(P40)

GET	EVENT	PROG	-105-	GET	EVENT	PROG
-33	(102+36)		-5	(103+04)		
	TARGET DV PROGRAM. (FDH)	(P76)			SPS THRUST SETUP (TPI)	(P40)
	RENDEZVOUS NAV PROGRAM AUTO MNVR TO SXT TRACK (149 DEG) (0,229/141,0) MOVE TO LEB	(P20)	0	(103+09+24)	GDC ALIGN	
	TPI TARGETING PROGRAM (P34) (P20) LOAD N55 WITH R2=20830 R3=13000				***** LM TPI BURN (22.2,0,-11.1) *****	
-27	(102+42)				***** CSM TPI BACKUP BURN (-22.3,0,12) (0,208/18,0) *****	
	CALL MARKING ROUTINE (V87,V57) (PROCESS THREE MARKS,V93)				TARGET DV PROGRAM (TPI)	(P76)
-22	(102+47)		+02			
	SUNDOWN				RENDEZVOUS NAV PROGRAM AUTO MNVR TO SXT TRACK (33 DEG) (0,245/51,0)	(P20)
-17	(102+52)				MCC TARGETING PROGRAM MOVE TO LEB	(P35)
-12	(102+57)					
	TERMINATE MARKS (15) MOVE TO CMD SEAT VERIFY ORDEAL (V83)		+03		CALL MARKING ROUTINE (V93,V87,V57)	
-10	(102+59)			(103+18)	LOS	
	TPI TARGETING PROGRAM (P34) FINAL COMP (TIGN OPTION WITH LM TIGN)		+11		TERMINATE MARKS (8)	
-7	(103+02)		+12		MCC1 TARGETING FINAL COMP COPY CSM MCC1 SOLUTION COPY LM MCC1 PAD	(P35)
	SPS THRUST PROGRAM,V56 AUTO MNVR TO BURN ATTITUDE (50 DEG) (0,193/18,0) COPY LM TPI P76 PAD	(P40)				

MISSION F RESCUE TIMELINE APRIL 25, 1969

GET	EVENT	PROG	GET	EVENT	PROG
13.5	RCS THRUST PROGRAM BYPASS BURN ATTITUDE MNVR (0.260/30.0)	(P4)	+30	(103+39+24)	***** LM MCC2 BURN ***** ***** CSM MCC2 BACKUP BURN (0.252/19.0) *****
15	(103+24+24) ***** LM MCC1 THRUST ***** ***** CSM MCC1 BACKUP BURN (0.263/30.0) ***** TARGET DV PROGRAM (P76) (MCC1)		+39	(103+48)	TARGET DV PROGRAM (P76) (MCC2) AUTO MNVR TO COAS TRACK (V89) (P00) (26 DEG) (0.265/340.0)
16	MCC2 TARGETING PROGRAM (P35) (P20) POSSIBLE AUTO MNVR TO SXT TRACK (TRIM) (0.264/27.0)		+39	(103+48)	THRUST MONITORING PROGRAM (P47) ***** * BRAKING GATES RETICLE ANGLE * * 30 FPS AT 6000 FT .13 DEG. * * 20 FPS AT 3000 FT .26 DEG. * * 10 FPS AT 2500 FT .54 DEG. * * 5 FPS AT 500 FT 1.60 DEG. * *****
17	CALL MARKING ROUTINE (V93, V87, V57)				
18+33)	SUNUP		+43	(103+52)	***** TPF *****
26	TERMINATE MARKS(9) MOVE TO CMD SEAT				
27	MCC2 TARGETING FINAL COMP (P35) COPY CSM MCC2 SOLUTION COPY LM MCC2 PAD				
28.5	RCS THRUST PROGRAM BYPASS BURN ATTITUDE MNVR (0.258/19.0)	(P4)			

-107-  
 9.2.2 RENDEZVOUS NAVIGATION SUMMARY WITH SUN ANGLES  
 LM ACTIVE - PDI ABORT  
 (MISSION F)  
 IT - INITIATE TRACK  
 CT - CEASE TRACK  
 (OUT-OF-PLANE SUN ANGLE IS 4 DEG)

GET	EVENT	SUN ANGLE (LOS TO SUN) DEG
-99:34	LM DOI	
99:37	SUNRISE	
100:22	IT (SXT/VHF) (7/7)	156
100:29	CT (SXT/VHF)	171
100:31	LM PDI ABORT	
100:42	SUNSET	
100:57	IT (SXT/VHF) (V93,6/5,V93,14/15)	
101:02	CT (SXT)	
101:17	CT (VHF)	
101:30	SUNRISE	
101:32	LM CSI	
101:39	IT (SXT/VHF) (4/3,V67,00057,00034,00001;18/19)	80
101:44		91
101:49		101
101:54		103
101:59		101
102:01	CT (SXT/VHF)	99
102:03	LM PLANE CHANGE	
102:07	IT (SXT/VHF) (4/3,V93,10/11)	90
102:12		83
102:17		71
102:21	CT (SXT/VHF)	63
102:34	LM CDH	
102:42	IT (SXT/VHF) (4/3,V93/11/12)	8
102:47	SUNSET	6
102:57	CT (SXT/VHF)	
103:09	LM TPI	
103:12	IT (SXT/VHF) (V93,8/8)	
103:20	CT (SXT/VHF)	
103:24	LM MCC1	
103:26	IT (SXT/VHF) (V93,9/9)	
103:33	SUNRISE	96
103:35	CT (SXT/VHF)	97
103:39	LM MCC2	
103:52	TPF	

9.2.3 CSM ATTITUDE SUMMARY

\*\* \_\_\_\_\_ \*\*

INERTIAL AND ORDEAL FDAI BALL GIMBAL ANGLE PROFILE FOR THE LM  
ACTIVE PDI ABORT RESCUE CASE (MISSION F) (YAW = 0.0)

\*\* \_\_\_\_\_ \*\*

TIME GET	ROLL	PITCH ORDEAL	PITCH INERTIAL	PITCH MNR
99:34	0	215	320	
99:38	0	225	318	
100:07	180	278	268	70
100:21	180	288	251	17
100:31	180	298	230	
100:52	180	315	183	47
101:21	180	165	288	161
101:32	180	180	288	
101:33	180	16	120	168
102:03	180	130	143	
102:21	0	347	290	
102:25	0	356	290	122
102:34	0	11	290	
102:36	0	229	141	149
103:02	0	193	18	50
103:09	0	208	18	
103:11	0	245	51	33
103:23	0	260	30	
103:24	0	263	30	
103:25	0	264	27	
103:37	0	258	19	
103:39	0	252	19	
103:40	0	265	340	26
103:52	0	277	340	

9.3 LM PARTIAL PHASING GREATER THAN  
OR EQUAL TO 40 FPS

9.3.1 Summary Timeline

-110-

LM PHASING GREATER THAN 10 FPS RESCUE TIMELINE

GET	EVENT	PROG	GET	EVENT	PROG
(100+46+21)	***** LM PHASING HIGH(34.9,0.-10.55) *****	*		RHC-LOCKED PRO	*
(100+48)	SUNSET MOVE TO LER	*	06 18	(COMMANDED R,P,V) MONITOR MNVR	*
(100+49)	IMM REALIGN TO REFMMAT (OPTION 3)	(P52)	F 50 18	(COMMANDED R,P,V) MN BUS TIF(2)-ON(UP) SPS HE VIV TR(BOTH)-BP SPS HE VIV(BOTH)-AUTO MONESS BUS-MNA PRO	*
(100+54)	MCC-H UPLINK(LM VECTOR) MOVE TO CMD SEAT	(P00)	06 18	(COMMANDED R,P,V) MONITOR ATT TRIM	*
(101+06)	COPY RESCUE,CSI ONF,CDH,TPT PADS	-8	F 50 18	(COMMANDED R,P,V) *****	*
-16 (101+17)	EXTERNAL DV PROGRAM (P30)(P20)	*****		SPS THRUST SETUP (P40) *****	*
14 (101+19)	SPS THRUST PROGRAM,V56 (P40) AUTO MNVR TO HUPN ATTITUDE (95 DEG) (180,165/283,U)	* * * * *	-8 (101+25)	***** **GDC ALIGN** * * *	* * * * *
(101+20)	LOS	*		ALT SET KNOB TO 60 NM FDAI SELECT-1	* *
-14 (101+19)	KEY 40E F 50 18 (COMMANDED R,P,V) KEY V56E RHC-ARMED ALIGN ROLL TO 180 DEG.	* * * * *		ATT SET THUMBWHEELS TO N18 NULL ATT ERROR NEEDLES ON FDAI 1 WITH ATT SET THUMBWHEELS ATT SET-GDC DEPRESS GDC ALIGN OR FDAI SELECT-1/2	* * * * * * *

GET	EVENT	PRG	TIME	GET	EVENT	PRG
	ATT SET-TMU	*	*		MONITOR GMBL DRIVE	*
	**MTVC CHECKS**	*	*		SEQ AND TRIM	*
		*	*	06 40	(TFI, VG, DVM)	*
		*	*-02+00			*
	BMAG MODE(3)-ATT1/RATE?	*	*		FDAI SCALE-5/5	*
	TVC SERVO PWR 1-AC1/MNA	*	*		VERIFY SPS TH LT-OFF	*
	TVC SERVO PWR 2-AC2/MNB	*	*		EMS MODE STBY	*
	TRANS CONTR PWR=ON	*	*		EMS FUNCTION-DV SET	*
	RHC PWR NORM 2-AC	*	*		LOAD RESCUE VC	*
	GMBL MTRS PITCH 1 STRT-ON	*	*		EMS FUNCTION-DV	*
	GMBL MTRS YAW 1 STRT-ON	*	*		THC-ARMED	*
	THC-CLOCKWISE	*	*		RHC-ARMED	*
	RHC-ARMED	*	*		DV THRUST(A)-NORMAL	*
	RHC-VERIFY NO MTVC	*	*-00+35			*
	GMBL MTRS PITCH 2-STRT-ON	*	*		DSKY BLANKS	*
	GMBL MTRS YAW 2-STRT-ON	*	*-00+30			*
	SET SPS GIMBALS TW(2)-	*	*	06 40	(TFI, VG, DVM)	*
	PITCH = -.52	*	*		EMS MODE=NORMAL	*
	YAW = +.59	*	*-00+15			*
	RHC-VERIFY MTVC	*	*		PERFORM ULLAGE	*
	THC-NEUTRAL	*	*-00+05			*
	RHC PWR NORM 2-AC/DC	*	*	F 99 40	(REQUEST FOR ENGINE ENABLE)	*
	RHC-LOCKED	*	*		PRO	*
	PRO	*	*	06 40	(TFI, VG, DVM)	*
06 18	(COMMANDED R,P,Y)	*	*	*	*****	*
	MONITOR ATT TRIM	*	0 (101+33+19)			*
F 50 18	(COMMANDED R,P,Y)	*	*	*	*****	*
	KEY ENTER	*	*		CSM RESCUE BURN(-48, 75, 0, 0)	*
F 50 25	(00204, GMBL DRIVE TEST)	*	*		(180, 180/283, 0)	*
	RHC PWR DIRECT(BOTH)-MNA/MNB	*	*	*	*****	*
	RATE-HIGH	*	*			*
	AUTO RCS SEL A/C ROLL(4)-MNA	*	*			*
	PRO	*	*			*

MISSION F RESCUE TIMELINE APRIL 25, 1969



GET	EVENT	PRG	AFT	EVENT	PRG
	*****			FMS MODE-VHF RNG	*
	SET MUC EI-KFSET, START	* *		VHF RNG-RESET	*
	MONITOR	* *		VN BUS TIE (?) - OFF	*
	SPS THRUST IT-ON	* *		PRG	*
	DV INDICATOR-DECREASING	* *	F 37 BR		*
+00+01				*****	
	ILLAGE-OFF	*		MOVE TO LER	
06 40	(TFC, VG, DVM)	*	(101+34)	SUNRISE	
	MONITOR SPS OPERATION	*			
	PC INDICATOR=95-105 PSI	*	(101+35)	RENDEZVOUS NAV PROGRAM (P20)	
	MONITOR SPS ENGINE CUTOFF	*		AUTO MNVR TO SXT TRACK	
	SPS THRUST IT-OFF	*		(141 DEG)	
F 16 40	(TFC, VG, DVM)	*		(180, 327/64, 0)	
	DV THRUST (BOTH) - OFF	*			
	MONITOR	*	(101+40)	CSI TARGETING PROGRAM (P35) (P20)	
	PC INDICATOR = 0	*		LOAD N55 R1=+00002	
	SPS INJ VLV JND(4) - CLOSE	*		R2=+20830	
	SPS HE VLV TR (BOTH) - RP	*		R3=+13000	
	SPS GMRLS RETURN TO SERVO	*			
	NULL	* -49	(101+42)	CALL MARKING ROUTINE (V93, V87)	
	GMRL MTRS-OFF (SEQUENTIALLY)	*			
	TVC SERVO PWR (BOTH) - OFF	*	(102+07)	AOS	
	FDAI SCALE-5/1	*			
	RATE-LOW	* -14	(102+17)	TERMINATE MARKS (35)	
	ROT CONT PWR DIRECT (BOTH) - OFF	*		CSI TARGETING FINAL (P32) (P20)	
	PRG	*		COMP	
F 16 85	(VG-BODY)	*		MOVE TO CMD SEAT	
	THC-NULL VG COMPONENTS	*			
	THC-LOCKED	* -11	(102+20)	SPS THRUST PROGRAM, 56 (P40)	
	PHC-LOCKED	*		AUTO MNVR TO BURN ATTITUDE	
	FMS FUNCTION-VHF RNG	*		(170 DEG)	
				(180, 165/103, 0)	

MISSION F RESCUE TIMELINE APRIL 25, 1969

GET	EVENT	PROG	GET	EVENT	PROG
*****		*****		NULL ATT ERROR NEEDLES	*
-11 (102+20)		**		ON FDAI 1 WITH ATT	*
	KEY 40E	**		SET THUMBWHEELS	*
	F 50 1A (COMMANDED R,P,Y)	**		ATT SET-GDC	*
	KEY V56E	**		DEPRESS GDC ALIGN PB	*
	RHC=ARMED	**		FDAI SELECT-1/2	*
	ALIGN ROLL TO 180 DEG.	**		ATT SET-TMU	*
	RHC=LOCKED	**			*
	PRO	**		**MTVC CHECKS**	*
	06 1A (COMMANDED R,P,Y)	**			*
	MONITOR MNVR	**		BMAG MODE(3)-ATT1/RATE2	*
	F 50 1B (COMMANDED R,P,Y)	**		TVC SERVO PWR 1-AC1/MNA	*
	MN BUS TIE(2)-ON(UP)	**		TVC SERVO PWR 2-AC2/MNB	*
	SPS HE VLV TB(ROTH)-BP	**		TRANS CONTR PWR-ON	*
	SPS HE VLV(BOTH)-AUTO	**		RHC PWR NORM 2-AC	*
	NONESS BUS-MNA	**		GMBL MTRS PITCH 1 STRT-ON	*
	PRO	**		GMBL MTRS YAW 1 STRT-ON	*
	06 1A (COMMANDED R,P,Y)	**		THC-CLOCKWISE	*
	MONITOR ATT TRIM	**		RHC=ARMED	*
	F 50 1A (COMMANDED R,P,Y)	**		RHC-VERIFY NO MTVC	*
*****		*****		GMBL MTRS PITCH 2-STRT-ON	*
5 (102+26)	SPS THRUST SETUP (P40)	*		GMBL MTRS YAW 2-STRT-ON	*
*****		*****		SET SPS GIMBALS TW(2)-	*
-5 (102+26)		**		PITCH = -.52	*
		**		YAW = +.59	*
	**GDC ALIGN**	**		RHC-VERIFY MTVC	*
		**		THC-NEUTRAL	*
		**		RHC PWR NORM 2-AC/DC	*
		**		RHC=LOCKED	*
	ALT SET KNOB TO 60 NM	**		PRO	*
	FDAI SELECT-1	**	06 1B (COMMANDED R,P,Y)		*
	ATT SET THUMBWHEELS TO N18	**	MONITOR ATT TRIM		*
		*	F 50 1A (COMMANDED R,P,Y)		*
		**	KEY ENTER		*

GET	EVENT	PRGR	GET	EVENT	PRGR
	F 50 25 (00204.GMRL DRIVE TEST)	*	0	(102+31+11)	
	RHC PWR DIRECT (BOTH) -MNA/MNB	*		*****	
	RATE-HIGH	*		CSM CSI ONE QUIN (-54.8,0,0)	
	AUTO RCS SEL AZC ROLL (4) -MNA	*		(180,180/103,0)	
	PRO	*		*****	
	MONITOR GMRL DRIVE	*		*****	
	SEN AND TRIM	**		SET MDC ET-RESET, START	*
	06 40 (TFI, VG, DVM)	**		MONITOR	*
		**		SPS THRUST LT-ON	*
		**		DV INDICATOR DECREASING	*
	FDAI SCALE-5/5	**			*
	VERIFY SPS TH LT-OFF	**+00+01			*
	FMS MODE STBY	**		ULLAGE-OFF	*
	EMS FUNCTION (ON-DV) SET	**	06 40	(TFC, VG, DVM)	*
	LOAD CSI VC	**		MONITOR SPS OPERATION	*
	FMS FUNCTION-DV	**		PC INDICATOR 95-105 PSI	*
	THC-ARMED	**		MONITOR SPS ENGINE CUTOFF	*
	RHC-ARMED	**		SPS THRUST LT-OFF	*
	DV THRUST (A) -NORMAL	**	F 16 40	(TFC, VG, DVM)	*
		**		DV THRUST (BOTH) OFF	*
		**		MONITOR	*
	DSKY BLANKS	**		PC INDICATOR = 0	*
		**		SPS INJ VLV IND (4) -CLOSE	*
	06 40 (TFI, VG, DVM)	**		SPS HE VLV TB (BOTH) -BP	*
	EMS MODE-NORMAL	**		SPS GMRLS RETURN TO SERVO	*
		**		NULL	*
	PERFORM ULLAGE	**		GMRL MTRS-OFF (SEQUENTIALLY)	*
		**		TVC SERVO PWR (BOTH) -OFF	*
	F 99 40 (REQUEST FOR ENGINE ENABLE)	**		FDAI SCALE-5/1	*
	PRO	**		RATE-LOW	*
	06 40 (TFI, VG, DVM)	**		ROT CONT PWR DIRECT (BOTH) -OFF	*
	*****	**		PRO	*
		**	F 16 85	(VG-RODY)	*
		**		THC-NULL VG COMPONENTS	*
		**		THC-LOCKED	*

GET	EVENT	PROG	GET	EVENT	PROG
*	RHC-LOCKED	*	(103+00)		
*	EMS FUNCTION-VHF RNG	*		TERMINATE SXT,CONT. VHF	
*	EMS MODE-VHF RNG	*	(103+05)		
*	VHF RNG-RESET	*		OUT OF PLANE DATA(V80)	
*	MN BUS TIE(2)-OFF	*		COPY CSM YDOT	
*	PRO	*	(103+12)		
*	F 37 RR	*		LOS	
*****	*****	-9	(103+18)		
(102+32)	CMC IDLING PROGRAM	(P00)		TERMINATE MARKS(23)	
	MOVE TO LEB			CSI TARGETING FINAL	(P32)(P20)
(102+42)	SUNSET	-6	(103+21)	COMP	
	IMU REALIGN TO REFSMMAT	(P52)		OVERWRITE N81 WITH(-)CSM YDOT	
	(OPTION 3)			RCS THRUST PROGRAM,V56	(P41)
(102+47)	MOVE TO CMD SEAT		(103+25)	AUTO MNVR TO BURN ATTITUDE	
	MCC-H UPLINK(LM VECTOR)			RCS THRUST SETUP	(P41)
	(IF LM ACTIVE)	0	(103+27)	GDC ALIGN	
(102+49)	RENDEZVOUS NAV PROGRAM	(P20)		*****	
	AUTO MNVR TO SXT TRACK			CSM CSI TWO BURN(	
	(82 DEG)			(180,10/125,0)	
	(180,321/185,0)		(103+28)	*****	
(102+52)	CSI TARGETING PROGRAM	(P32)(P20)		RENDEZVOUS NAV PROGRAM	(P20)
	LOAD N55 R1=+00001			AUTO MNVR TO SXT TRACK	
	R2=+20830			(13 DEG)	
	R3=+13000	-24	(103+31)	(180,13/112,0)	
	MOVE TO LEB			SUNRISE	
-32	(102+55)			CALL MARKING ROUTINE(V87,V57)	
	CALL MARKING ROUTINE(V93,V87,V57)			AFTER 3 MARKS PROCESSED	
	(V93 AFTER 5 MKS PROCESSED)			V67,LOAD WR(00057,00034,00001)	

GET	EVENT	PROG	GET	EVENT	PROG
-12	(103+43)	TERMINATE MARKS(12) OUT OF PLANE DATA(V90)		OUT OF PLANE DATA(V90) OVERWRITE NRI WITH(-) CSM YDOT)	
	(103+47)	EXTERNAL DV TARGETING (P30)(P20)	(104+13)	SPS THRUST PROGRAM,V56 MANUAL MNVR (1 DEG/SEC) TO BURN ATT (158 DEG) (0.338/266.0)	(P40)
-8	(103+53)	RCS THRUST PROGRAM,V56 (P41) BY PASS BURN ATTITUDE MNVR RCS THRUST SETUP (P41) GDC ALIGN		***** *-8 (104+13)	
n	(103+55)	***** CSM PLANE CHANGE(180,123/138,0) *****		KEY 40E F 50 18 (COMMANDED R,P,V)	
	(103+56)	RENDEZVOUS NAV PROGRAM (P20) POSSIBLE AUTO MNVR TO SXT TRACK (TRIM)		KEY V56F RHC-ARMED ALIGN ROLL TO 0 DEG. RHC-LOCKED PRO	
	(103+57)	CMD TARGETING PROGRAM (P33)(P20)		06 18 (COMMANDED R,P,V) MONITOR MNVR	
	(104+00)	AOS		F 50 18 (COMMANDED R,P,V) MN BUS TIE(2)-ON(UP)	
-22	(104+01)	CALL MARKING ROUTINE(V87,V57) (V93 AFTER 3MKS PROCESSED)		SPS HE VLV TB(BOTH)-BP SPS HE VLV(BOTH)-AUTO NONESS BUS-MNA PRO	
-12	(104+11)	TERMINATE MARKS(10) MOVE TO CMD SEAT ROLL 180 DEG,ACQ MSFN (0.160/108,0) (RHO -56, GAM 173) CMD TARGETING FINAL (P33)(P20) COMP		06 18 (COMMANDED R,P,V) MONITOR ATT TRIM F 50 18 (COMMANDED R,P,V) ***** -5 (104+18)	
				SPS THRUST SFTUP	(P40)

GET	EVENT	PROG	GET	EVENT	PROG
	*****	*		THC-NEUTRAL	*
*-5	(104+18)	**		RHC PWR NORM 2-AC/DC	*
	**GDC ALIGN**	**		RHC-LOCKED	*
		**		PRO	*
	ALT SET KNOB TO 60 NM	**	06 18	(COMMANDED R,P,Y)	*
	FDAI SELECT-1	**		MONITOR ATT TRIM	*
	ATT SET THUMBWHEELS TO N18	**	F 50 18	(COMMANDED R,P,Y)	*
	NULL ATT ERROR NEEDLES	**		KEY ENTER	*
	ON FDAI 1 WITH ATT	**	F 50 25	(00204 GMBL DRIVE TEST)	*
	SET THUMBWHEELS	**		RHC PWR DIRECT (BOTH)-MNA/MNB	*
	ATT SET-GDC	**		RATE-HIGH	*
	DEPRESS GDC ALIGN PB	**		AUTO RCS SEL A/C ROLL(4)-MNA	*
	FDAI SELECT-1/2	**		PRO	*
	ATT SET-TMU	**		MONITOR GMBL DRIVE	*
		**		SEQ AND TRIM	*
	**MTVC CHECKS**	**	06 40	(TFI,VG,DVM)	*
		**			*
	BMAG MODE(3)-ATT1/RATE2	**		FDAI SCALE-5/5	*
	TVC SERVO PWR 1-AC1/MNA	**		VERIFY SPS TH LT-OFF	*
	TVC SERVO PWR 2-AC2/MNB	**		EMS MODE STBY	*
	TRANS CONTR PWR-ON	**		EMS FUNCTION-DV SET	*
	RHC PWR NORM 2-AC	**		LOAD CDH VC	*
	GMBL MTRS PITCH 1 STRT-ON	**		EMS FUNCTION-DV	*
	GMBL MTRS YAW 1 STRT-ON	**		THC-ARMED	*
	THC-CLOCKWISE	**		RHC-ARMED	*
	RHC-ARMED	**		DV THRUST(A)-NORMAL	*
	RHC-VERIFY NO MTVC	**			*
		**		DSKY BLANKS	*
	GMBL MTRS PITCH 2-STRT-ON	**			*
	GMBL MTRS YAW 2-STRT-ON	**	06 40	(TFI,VG,DVM)	*
	SET SPS GIMBALS TW(2)-	**		EMS MODE-NORMAL	*
	PITCH = -.52	**			*
	YAW = +.59	**		PERFORM ULLAGE	*
	RHC-VERIFY MTVC	**			*

GET	EVENT	PRG	GET	EVENT	PRG
*-00+05		* *		ROT CONT PWR DIRECT (BOTH)-OFF*	*
*	F 99 40 (REQUEST FOR ENGINE ENABLE)	* *		PRO	*
*	PRO	* *	F 16 85 (VG-BODY)		*
*	06 40 (TFI, VG, DVM)	* *		THC-MIJL VG COMPONENTS	*
*****	*****	*****		THC-LOCKED	*
0	(104+23+12)	*		RHC-LOCKED	*
	*****	*****		EMS FUNCTION-VHF RNG	*
	CSM CDH HUPN(109.1,0,32.7)	*		EMS MODE-VHF RNG	*
	(11,344/266,0)	*		VHF RNG-RESET	*
	*****	*****		MN BUS TIF(2)-OFF	*
*****	*****	*****		PRO	*
*	SET MUC ET-RESET, START	* *	F 37 88		*
*	MONITOR	*	*****	*****	*****
*	SPS THRUST LT-ON	*	(104+24)		
*	DV INDICATOR-DECREASING	*		RENDEZVOUS NAV PROGRAM (P20)	
*+00+01		*		AUTO MNVR TO SXT TRACK	
*	HLLAGE-OFF	*		(119 DEG)	
*	06 40 (TFC, VG, DVM)	*		(0,228/147,0)	
*	MONITOR SPS OPERATION	*	(104+28)		
*	PC INDICATOR-95-105 PSI	*		TPI TARGETING PROGRAM (P34) (P20)	
*	MONITOR SPS ENGINE CUTOFF	*		LOAD R2=+20830	
*	SPS THRUST LT-OFF	*		R3=+13000	
*	F 16 40 (TFC, VG, DVM)	*		MOVE TO LER	
*	DV THRUST (BOTH)-OFF	* -27	(104+31)		
*	MONITOR	*		CALL MARKING ROUTINE (V87, V57)	
*	PC INDICATOR = 0	*		(V93 AFTER 3 MKS PROCESSED)	
*	SPS INJ VLV IND(4)-CLOSE	*	(104+34)		
*	SPS HE VLV TR (BOTH)-RP	*		SUNSET	
*	SPS GMRLS RETURN TO SERVO	* -12	(104+46)		
*	NULL	*		TERMINATE MARKS (15)	
*	GMRL MTRS-OFF (SEQUENTIALY)	*		MOVE TO CMD SEAT	
*	TVC SERVO PWR (BOTH)-OFF	*		VERIFY ORDLAL (V83)	
*	FDAI SCALE-5/1	*		TPI TARGETING FINAL (P34) (P20)	
*	RATE-LOW	*		COMP	

GET	EVENT	PROG	GET	EVENT	PROG
-7	(104+51)	*		FDAI SELECT-1	*
	SPS THRUST PROGRAM,V56 (P40)	*		ATT SET THUMBWHEELS TO N18	*
	LAUTO MNVR TO BURN ATTITUDE	*		NULL ATT ERROR NEEDLES	*
	(78 DEG)	*		ON FDAI 1 WITH ATT	*
	(0,179/6,0)	*		SET THUMBWHEELS	*
	*****	*		ATT SET-GDC	*
-7	(104+51)	**		DEPRESS GDC ALIGN PB	*
	KEY 40E	**		FDAI SELECT-1/2	*
	F 50 18 (COMMANDED R,P,Y)	**		ATT SET-TMU	*
	KEY V56E	**			*
	RHC-ARMED	**	**MTVC CHECKS**		*
	ALIGN ROLL TO 0 DEG.	**		BMAG MODE(3)-ATT1/RATE2	*
	RHC-LOCKED	**		TVC SERVO PWR 1-AC1/MNA	*
	PRO	**		TVC SERVO PWR 2-AC2/MNB	*
	06 18 (COMMANDED R,P,Y)	**		TRANS CONTR PWR-ON	*
	MONITOR MNVR	**		RHC PWR NORM 2-AC	*
	F 50 18 (COMMANDED R,P,Y)	**		GMBL MTRS PITCH 1 STRT-ON	*
	MN BUS TIE(2)-ON(UP)	**		GMBL MTRS YAW 1 STRT-ON	*
	SPS HE VLV TB(BOTH)-BP	**		THC-CLOCKWISE	*
	SPS HE VLV(BOTH)-AUTO	**		RHC-ARMED	*
	NONESS BUS-MNA	**		RHC-VERIFY NO MTVC	*
	PRO	**		GMBL MTRS PITCH 2-STRT-ON	*
	06 18 (COMMANDED R,P,Y)	**		GMBL MTRS YAW 2-STRT-ON	*
	MONITOR ATT TRIM	**		SET SPS GIMBALS TW(2)-	*
	F 50 18 (COMMANDED R,P,Y)	**		PITCH = -.52	*
	*****	*		YAW = +.59	*
-5	(104+53)	*		RHC-VERIFY MTVC	*
	SPS THRUST SETUP	*		THC-NEUTRAL	*
	*****	*		RHC PWR NORM 2-AC/DC	*
-5	(104+53)	**		RHC-LOCKED	*
	**GDC ALIGN**	**		PRO	*
		**	06 18 (COMMANDED R,P,Y)		*
		**	MONITOR ATT TRIM		*
		**			*
	ALT SET KNOB TO 60 NM	**			*



GET	EVENT	PRGR	GET	EVENT	PRGR
*	F 50 18 (COMMANDER) R.P.V)	* 0	(104+57+59)		
*	KEY ENTER	*	*****		
*	F 50 25 (00204,GMPL DRIVE TEST)	*	CSM TPI HURN(-21.4,0,5.3)		
*	RHC PWR DIRECT(BOTH)-MNA/MNR	*	(0,194/6.0)		
*	RATE-HIGH	*	*****		
*	AUTO RCS SEL XYZ ROLL(4)-MNA	*	*****		
*	PRO	*	SET MDC ET-RESET, START		*
*	MONITOR GMPL DRIVE	*	MONITOR		*
*	SEN AND TRIM	*	SPS THRUST LT-ON		*
*	06 40 (TFI, VG, DVM)	*	DV INDICATOR DECREASING		*
*-02+00		* +00+01			*
*	FDAI SCALE-5/5	*	ULLAGE-OFF		*
*	VERIFY SPS TH LT-OFF	*	06 40 (TFC, VG, DVM)		*
*	EMS MODE STBY	*	MONITOR SPS OPERATION		*
*	EMS FUNCTION-DV SET	*	PC INDICATOR 95-105 PSI		*
*	LOAD TPI VC	*	MONITOR SPS ENGINE CUTOFF		*
*	EMS FUNCTION-DV	*	SPS THRUST LT-OFF		*
*	THC-ARMED	*	F 16 40 (TFC, VG, DVM)		*
*	RHC-ARMED	*	DV THRUST(BOTH)-OFF		*
*	DV THRUST(A)-NORMAL	*	MONITOR		*
*-00+35		*	PC INDICATOR = 0		*
*	DSKY BLANKS	*	SPS INJ VLV IND(4)-CLOSE		*
*-00+30		*	SPS HF VLV TR(BOTH)-RP		*
*	06 40 (TFI, VG, DVM)	*	SPS GMPLS RETURN TO SERVO		*
*	EMS MODE-NORMAL	*	NULL		*
*-00+15		*	GMPL MTRS-OFF(SEQUENTIALLY)		*
*	PERFORM ULLAGE	*	TVC SERVO PWR(BOTH)-OFF		*
*-00+05		*	FDAI SCALE-5/1		*
*	F 99 43 (REQUEST FOR ENGINE ENABLE)	*	RATE-LOW		*
*	PRO	*	POT CONT PWR DIRECT(BOTH)-OFF		*
*	06 40 (TFI, VG, DVM)	*	PRO		*
*****		*	F 16 85 (VG-HODY)		*
		*	THC-MULT VG COMPONENTS		*
		*	THC-LOCKED		*

GET	EVENT	PRG	GET	EVENT	PRG
* * * * * * *	RHC-LOCKED EMS FUNCTION-VHF RNG EMS MODE-VHF RNG VHF RNG-RESET MN BUS TIE(2)-OFF PRO	* +16 * * * +17 * * +23 *		MCC TARGETING PROGRAM (P35) (P20) POSSIBLE MNVR TO SXT TRACK CALL MARKING ROUTINE (V93, V87, V57). SUNRISE	
+2	F 37 RH ***** RENDEZVOUS NAV PROGRAM (P20) AUTO MNVR TO SXT TRACK! (45 DEG) (0.245/51,0) MOVE TO LER DURING AUTO MNVR . MCC TARGETING PROGRAM (P35) (P20)	+26 +27 +28.5		TERMINATE MARKS(9) MOVE TO CMD SEAT MCC TARGETING FINAL (P35) (P20) COMP	
+3	(105+08) CALL MARKING ROUTINE (V93, V87, V57) LOS	+30	(105+27+57)	RCS THRUST PROGRAM (P41) BYPASS BURN ATTITUDE MNVR RCS THRUST SETUP (P41) ***** MCC2 BURN(0,294/19,0) *****	
+11 +12	TERMINATE MARKS(8) MCC TARGETING FINAL (P35) (P20) COMP	+31		AUTO MNVR TO COAS TRACK (V89) (P00) (36 DEG) (0,261/343,0)	
+13.5 +15	RCS THRUST PROGRAM (P41) BYPASS BURN ATTITUDE MNVR RCS THRUST SETUP (P41) (105+12+57) ***** MCC1 BURN(0,228/33,0) *****			CALL P47 WHEN R=1.25 N.M. THRUST MONITOR PROGRAM (P47) V83, PERFORM BRAKING AND LOS CONTROL	

GET EVENT

PROG

```
*****  
*BRAKING GATES      RETICLE ANGLE*  
* 30 FPS AT 6000 FT   .13 DEG. *  
* 20 FPS AT 3000 FT   .26 DEG. *  
* 10 FPS AT 2500 FT   .54 DEG. *  
*  5 FPS AT  500 FT   1.60 DEG. *  
*****
```

+42 (105+39+57)

```
*****  
TPF  
*****
```

9.3.2 NAVIGATION SUMMARY  
 LM PARTIAL PHASING  $\geq$  40 FPS  
 P20 NAVIGATION SUMMARY WITH SUN ANGLES  
 IT-INITIATE TRACK  
 CT-CEASE TRACK  
 (OUT-OF-PLANE SUN ANGLE IS 4 DEG)

GET	EVENT	SUN ANGLE (LOS TO SUN) DEG
100:46	LM PHASING	
100:48	SUNSET	
101:33	CSM RESCUE BURN	
101:34	SUNRISE	
101:42	IT (VHF) (V93,35/35)	108
102:17	CT (VHF)	144
102:31	CSM CSI ONE BURN	
102:42	SUNSET	
102:55	IT (SXT/VHF) (V93,675,V93,14/15)	
103:00	CT (SXT)	
103:15	CT (VHF)	
103:27	CSM CSI TWO BURN	
103:31	SUNRISE	
	IT (SXT/VHF) (4/3;V67,00057,00034,00001;8/9)	66
103:43	CT (SXT/VHF)	83
103:55	CSM PLANE CHANGE	
104:01	IT (SXT/VHF) (4/3,V93,6/7)	82
104:06		72
104:11	CT (SXT/VHF)	61
104:23	CSM CDH BURN	
104:31	IT (SXT/VHF) (4/3,V93,11/12)	1
104:34	SUNSET	14
104:46	CT (SXT/VHF)	
104:58	CSM TPI BURN	
105:01	IT (SXT/VHF) (V93,8/8)	
105:09	CT (SXT/VHF)	
105:13	CSM MCC1 BURN	
105:15	IT (SXT/VHF) (V93,9/9)	
105:21	SUNRISE	97
105:24	CT (SXT/VHF)	100
105:28	CSM MCC2 BURN	
105:40	TPF	

9.3.3 CSM ATTITUDE SUMMARY.  
INERTIAL AND ORDEAL FDAI BALL GIMBAL ANGLE  
PROFILE FOR LM PHASING  $\geq 40$  FPS (MISSION F)  
(YAW = 0.0)

TIME GET	ROLL	PITCH ORDEAL	PITCH INERTIAL	PITCH MNVR
100:46	180	307	193	
101:19	180	165	283	95
101:33	180	180	283	
101:35	180	327	64	141
102:20	180	165	103	170
102:31	180	180	103	
102:49	180	321	185	82
103:27	180	10	125	
103:28	180	13	112	13
103:55	180	123	138	
104:11	0	160	108	
104:13	0	338	266	158
104:23	0	344	266	
104:24	0	228	147	119
104:51	0	179	6	78
104:58	0	194	6	
105:00	0	245	51	45
105:13	0	228	33	
105:28	0	294	19	
105:29	0	261	343	36

9.4 LM PARTIAL PHASING LESS THAN 40 FPS

9.4.1 SUMMARY TIMELINE

-126-

GET	EVENT	PROG	GET	EVENT	PROG
	PHASING LESS THAN 4. FRS	*		BHC-LOCKED	*
		*		PRO	*
	(100+46+21)	*	06 18	(COMMANDED R,P,Y)	*
	*****	*		MONITOR MNVR	*
	PARTIAL LM PHASING PURN	*	F 50 18	(COMMANDED R,P,Y)	*
	*****	*		MN BUS TIE(2)-ON(UP)	*
-45	(100+48)	*		SPS HE VLV TR(BOTH)-BP	*
	SUN SET	*		SPS HE VI V(BOTH)-AUTO	*
	IMI REALIGN TO RFFSMAT (P52)	*		MONESS BUS-MNA	*
	(OPTION 3)	*	06 18	(COMMANDED R,P,Y)	*
-39	(100+54)	*		MONITOR ATT TRIM	*
	MCC-H UPLINK(LM VECTOR) (P00)	*	F 50 18	(COMMANDED R,P,Y)	*
	RHO=-21,GAMMA=176	*		*****	*
-27	(101+06)	-10	(101+23)		*
	COPY RESCUE,CSI ONE,CDH,TPT PADS	*		SPS THRUST SETUP (P40)	*
-16	(101+17)	*****		*****	*
	EXTERNAL DV TARGETING (P30)	*	-10	(101+23)	*
-14	(101+19)	*		**GDC ALIGN**	*
	SPS THRUST PROGRAM,V56 (P40)	*			*
	AUTO MNVR TO HURN ATTITUDE	*			*
	(90 DEG)	*			*
	(180,150/283,0)	*		ALT SET KNOB TO 60 NM	*
	LOS	*		FDAI SELECT-1	*
	*****	*		ATT SET THUMBWHEELS TO N18	*
-14	(101+19)	*		NULL ATT ERROR NEEDLES	*
	KEY 40F	*		ON FDAI 1 WITH ATT	*
	F 50 18 (COMMANDED R,P,Y)	*		SET THUMBWHEELS	*
	KEY V56E	*		ATT SET-GDC	*
	BHC-ARMED	*		DEPRESS GDC ALIGN PR	*
	ALIGN ROLL TO	*		FDAI SELECT-1/2	*

GET	EVENT	PROG	-127-	GET	EVENT	PROG
*	ATT SET-TMU	*	*		MONITOR GMBL DRIVE	*
*		*	*		SEQ AND TRIM	*
*	**MTVC CHECKS**	*	*	06 40	(TFI,VG,DVM)	*
*		*	** -02+00		FDAI SCALE-5/5	*
*	RMAG MODE(3)-ATT1/RATE2	*	*		VERIFY SPS TH LT-OFF	*
*	TVC SERVO PWR 1-AC1/MNA	*	*		EMS MODE STBY	*
*	TVC SERVO PWR 2-AC2/MNR	*	*		EMS FUNCTION-DV SET	*
*	TRANS CONTR PWR-ON	*	*		LOAD RESCUE VC	*
*	RHC PWR NORM 2-AC	*	*		EMS FUNCTION-DV	*
*	GMBL MTRS PITCH 1 STRT-ON	*	*		THC-ARMED	*
*	GMBL MTRS YAW 1 STRT-ON	*	*		RHC-ARMED	*
*	THC-CLOCKWISE	*	*		DV THRUST(A)-NORMAL	*
*	RHC-ARMED	*	*			*
*	RHC-VERIFY NO MTVC	*	** -00+35		DSKY BLANKS	*
*	GMBL MTRS PITCH 2-STRT-ON	*	*			*
*	GMBL MTRS YAW 2-STRT-ON	*	** -00+30			*
*	SET SPS GIMBALS TW(2)-	*	*	06 40	(TFI,VG,DVM)	*
*	PITCH = -.52	*	*		EMS MODE-NORMAL	*
*	YAW = +.59	*	** -00+15			*
*	RHC-VERIFY MTVC	*	*		PERFORM ULLAGE	*
*	THC-NEUTRAL	*	** -00+05			*
*	RHC PWR NORM 2-AC/DC	*	*	F 99 40	(REQUEST FOR ENGINE ENABLE)	*
*	RHC-LOCKED	*	*	PRO		*
*	PRO	*	*	06 40	(TFI,VG,DVM)	*
*	06 1R (COMMANDED R.P.Y)	*	*	*****		
*	MONITOR ATT TRIM	*		(101+32+59)		*
*	F 50 1R (COMMANDED R.P.Y)	*	*	*****		
*	KEY ENTER	*	*		CSM RESCUE BURN(-57,1,0,0)	*
*	F 50 25 (00204,GMBL DRIVE TEST)	*	*		(180,180/283,0)	*
*	RHC PWR DIRECT(ROTH)-MNA/MNB	*	*	*****		
*	RATE-HIGH	*	*	*****		
*	AUTO RCS SEL A/C ROLL(4)-MNA	*	*		SET MDC ET-RESET,START	*
*	PRO	*	*			*

MISSION F RESCUE TIMELINE APRIL 25,1969



GFT	EVENT	PRG	GFT	EVENT	PRG
*	MONITOR:	*	*****		
*	SPS THRUST IT-ON	*	(101+35)		
*	DV INDICATOR-DECREASING	*		SUMRISF	
*+00+01		*		MOVE TO LFB	
*	NULLAGE-OFF	* -55	(101+36)		
*	06 40 (TFC,VG,DVM)	*		RENDEZVOUS NAV PROGRAM	(P20)
*	MONITOR SPS OPERATION:	*		AUTO MNVR TO SXT TRACK	
*	PC INDICATOR-45-105 PSI	*		(133 DEG)	
*	MONITOR SPS ENGINE CUTOFF:	*		(180,322/56,0)	
*	SPS THRUST IT-OFF	* -50	(101+41)		
*	F 16 40 (TFC,VG,DVM)	*		CSI TARGETING PROGRAM	(P32)
*	DV THRUST(BOTH)-OFF	*		LOAD N55 WITH	
*	MONITOR:	*		R1=+00004	
*	PC INDICATOR = 0	*		R2=+20830	
*	SPS INJ. VLV IND(4)-CLOSE	*		R3=+13000	
*	SPS HE VLV TR(BOTH)-RP	* -47	(101+44)		
*	SPS GMBLS RETURN TO SERVO	*		CALL MARKING ROUTINE(V93,V87)	
*	NULL	*	(102+06)		
*	GMBL MTRS-OFF(SFQUENTIALLY)	*		AOS	
*	TVC SERVO PWR(BOTH)-OFF	* -14	(102+17)		
*	FDAI SCALE-5/1	*		TERMINATE MARKS(33)	
*	RATE-LOW	*		MOVE TO CMD SEAT	
*	ROT CONT PWR DIRECT(BOTH)-OFF	*		CSI TARGETING FINAL COMP	(P32)
*	PRG	*		ACQ. MSFN,RHO=-57,GAMMA=7	
*	F 16 85 (VG-RDNY)	*		OUT OF PLANF DATA(V=0)	
*	THC=NULL VG COMPONENTS	*		OVERWRITE NR1 WITH (-) CSM YDOT	
*	THC-LOCKED	* -11	(102+19)		
*	RHC-LOCKED	*		SPS THRUST PROGRAM,V56	(P40)
*	EMS FUNCTION-VHF RNG	*		AUTO MNVR TO BURN ATTITUDE	
*	EMS MODE-VHF RNG	*		(174 DEG)	
*	VHF RNG-RESET	*		(180,165/103,0)	
*	MN BUS TIE(2)-OFF	*	*****		
*	PRG	* -11	(102+19)		
*	F 37 RR	*		KEY 40E	

GET	EVENT	PROG	GET	EVENT	PROG
F 50 1R	(COMMANDED R,P,Y)	* *		FDAI SELECT-1/2	*
	KEY V56E	* *		ATT SET-TMU.	*
	RHC-ARMED	* *			*
	ALIGN ROLL TO	* *		**MTVC CHECKS**	*
	RHC-LOCKED	* *			*
	PRO	* *		RMAG MODE (3)-ATT1/RATE2	*
06 1R	(COMMANDED R,P,Y)	* *		TVC SERVO PWR 1-AC1/MNA	*
	MONITOR MNVR	* *		TVC SERVO PWR 2-AC2/MNB	*
F 50 1R	(COMMANDED R,P,Y)	* *		TRANS CONTR PWR-ON	*
	MN BUS TIE (2)-ON(UP)	* *		RHC PWR NORM 2-AC	*
	SPS HE VLV TB (BOTH)-BP	* *		GMBL MTRS PITCH 1 STRT-ON	*
	SPS HE VLV (BOTH)-AUTO	* *		GMBL MTRS YAW 1 STRT-ON	*
	NONESS BUS-MNA	* *		THC-CLOCKWISE	*
	PRO	* *		RHC-ARMED	*
06 1R	(COMMANDED R,P,Y)	* *		RHC-VERIFY NO MTVC	*
	MONITOR ATT TRIM	* *		GMBL MTRS PITCH 2-STRT-ON	*
F 50 1R	(COMMANDED R,P,Y)	* *		GMBL MTRS YAW 2-STRT-ON	*
*****				SET SPS GIMBALS TW(2)-	*
-5	(102+26)	*		PITCH = -.52	*
	SPS THRUST SETUP	(p40) *		YAW = +.59	*
*****				RHC-VERIFY MTVC	*
-5	(102+26)	* *		THC-NEUTRAL	*
	**GDC ALIGN**	* *		RHC PWR NORM 2-AC/DC	*
		* *		RHC-LOCKED	*
		* *		PRO	*
	ALT SET KNOB TO 60 NM	* *	06 18	(COMMANDED R,P,Y)	*
	FDAI SELECT-1	* *		MONITOR ATT TRIM	*
	ATT SET THUMBWHEELS TO N18	* *	F 50 18	(COMMANDED R,P,Y)	*
	MULL ATT ERROR NEEDLES	* *		KEY ENTER	*
	ON FDAI 1 WITH ATT	* *	F 50 25	(00204 GMBL DRIVE TEST)	*
	SET THUMBWHEELS	* *		RHC PWR DIRECT (BOTH)-MNA/MNB	*
	ATT SET-GUC	* *		RATE-HIGH	*
	DEPRESS GUC ALIGN PB	* *		AUTO RCS SEL A/C ROLL(4)-MNA	*
				PRO	*

GET	EVENT	PROC	GET	EVENT	PROC
	MONITOR GMRL DPLVF SEN AND TRIM	*		SET MDC FT-RESET START	*
	06 40 (TFI, VG, DVM)	*		MONITOR	*
*-02+00	FDAI SCALE=5/5	*		SPS THRUST LT-ON	*
	VERIFY SPS TH LT-OFF	**+00+01		DV INDICATOR DECREASING	*
	EMS MODE STBY	*		ULLAGE-OFF	*
	EMS FUNCTION-DV SET	*	06 40 (TFC, VG, DVM)	MONITOR SPS OPERATION	*
	LOAD CSI (VC	*		PC INDICATOR 95-105 PSI	*
	EMS FUNCTION-DV	*		MONITOR SPS ENGINE CUTOFF	*
	THC-ARMED	*		SPS THRUST LT-OFF	*
	RHC-ARMED	*	F 16 40 (TFC, VG, DVM)	DV THRUST (BOTH)-OFF	*
	DV THRUST(A)-NORMAL	*		MONITOR	*
*-00+35	DSKY BLANKS	*		PC INDICATOR = 0	*
*-00+30	06 40 (TFI, VG, DVM)	*		SPS INJ VLV IND(4)-CLOSE	*
	EMS MODE-NORMAL	*		SPS HF VLV TR(BOTH)-BP	*
*-00+15	PERFORM ULLAGE	*		SPS GMRLS RETURN TO SERVO	*
*-00+05	F 99 40 (REQUEST FOR ENGINE ENABLE)	*		NULL	*
	PRD	*		GMRL MTRS-OFF (SEQUENTIALLY)	*
	06 40 (TFI, VG, DVM)	*		TVC SERVO PWR (BOTH)-OFF	*
*****	*****	*		FDAI SCALE=5/1	*
(102+30+35)	*****	*		RATE-LOW	*
	*****	*		ROT CONT PWR DIRECT (BOTH)-OFF	*
	CSM CST ONE BURN (-35.6, 0, 0)	*	F 16 85 (VG-RDGY)	PRD	*
	(180, 180/103, 0)	*		THC=NULL VG COMPONENTS	*
*****	*****	*		THC-LOCKED	*
	*****	*		RHC-LOCKED	*
		*		EMS FUNCTION-VHF RNG	*
		*		EMS MODE-VHF RNG	*
		*		VHF RNG-RESET	*
		*		MN BUS TIF(2)-OFF	*

GET	EVENT	PROG	GET	EVENT	PROG
* * * F 37 RR *****	PRO	* -32 *	(103+52)	MOVE TO LEB CALL MARKING ROUTINE (V87) (V93 AFTER 3 MARKS PROCESSED)	
(102+32)	CMC IDLING PROGRAM	(P00)	(104+00)	AOS	
(102+40)	SUNSET IMU REALIGN TO REFMMAT (OPTION 3) GDC ALIGN VERIFY ORDEAL (V83)	(P52)	-9 (104+15)	TERMINATE MARKS(23) MOVE TO CMD SEAT CSI TARGETING FINAL COMP (P32) ACQ. MSFN,RHO=-77.5,GAMMA=18.1	
(102+46)	MCC-H UPLINK(LM VECTOR,IF LM ACTIVE)	(P00)	-6 (104+18)	RCS THRUST PROGRAM,V56 (P41) AUTO MNVR TO BURN ATTITUDE	
(102+51)	RENDEZVOUS NAV PROGRAM AUTO MNVR TO SXT TRACK (74 DEG) (180,320/177,0)	(P20)	-2 (104+22)	RCS THRUST SETUP,GDC ALIGN (P41)	
*23 (102+54)	CALL MARKING ROUTINE(V87) THREE MARKS,V93	-54	(104+24+00)	***** CSM CSI TWO BURN(180,335/257,0) *****	
*38 (103+09)	TERMINATE MARKS(15)		(104+26)	RENDEZVOUS NAV PROGRAM (P20) AUTO MNVR TO SXT TRACK (26 DEG) (180,317/231,0)	
(103+11)	LOS				
(103+29)	SUNRISE	-53	(104+27)	CSI TARGETING PROGRAM (P32) LOAD N55 WITH R1 = +00001 R2 = +20830 R3 = +13000 MOVE TO LEB	
-38 (103+46)	CSI TARGETING PROGRAM (P32) LOAD N55 WITH R1=+00002 R2=+20830 R3=+13000				

GET	EVENT	PROG	GET	EVENT	PROG
-50	(104+30) CALL MARKING ROUTINE (V93,V87,V57) (V93 AFTER 5 MARKS PROCESSED)	-25	(105+22)	RENDEZVOUS NAV PROGRAM (P20) AUTO MNVR TO SXT TRACK (TRIM) (180,18/120,0)	
-45	(104+35) TERMINATE SXT MARKS,V93 CONTINUE VHF	-24	(105+24)	MOVE TO LEB CALL MARKING ROUTINE (V87,V57) AFTER 3 SXT MARKS PROCESSED V67,LOAD W0(00057,00034,00001)	
-40	(104+40) OUT OF PLANE DATA (V90) VOICE LM YDOT TO LM CONTINUE VHF	-12	(105+30)	TERMINATE MARKS(12) MOVE TO CMD SEAT OUT OF PLANE DATA (V90)	
-9	(105+11) LOS TERMINATE MARKS(41) MOVE TO CMD SEAT CSI TARGETING FINAL COMP (P32)	-9	(105+39)	EXTERNAL DV TARGETING (P30)	
-5	(105+15) RCS THRUST PROGRAM,V56 (P41) AUTO MNVR TO BURN ATTITUDE	-6	(105+42)	RCS THRUST PROGRAM,V56 (P41) AUTO MNVR TO BURN ATTITUDE	
-2	(105+18) RCS THRUST SETUP,GDC ALIGN (P41)	-2	(105+46)	RCS THRUST SETUP,GDC ALIGN (P41)	
0	(105+20+00) ***** CSM CSI THREE BURN (180,18/121,0) *****	0	(105+48+00)	***** CSM PLANE CHANGE (180,135/149,0) *****	
	(105+21) SURPRISE	-26	(105+50)	RENDEZVOUS NAV PROGRAM (P20) AUTO MNVR TO SXT TRACK (10 DEG) (180,132/139,0)	
		-25	(105+51)	CDH TARGETING PROGRAM (P33) MOVE TO LEB	

GET	EVENT	-133- PROG	GET	EVENT	PROG
	(105+52)	*		SPS HE VLV (BOTH) -AUTO	*
-22	AOS	*		NONESS BUS-MNA	*
	(105+54)	*		PRO	*
	CALL MARKING ROUTINE (V87,V57)	*	06 18	(COMMANDED R,P,Y)	*
	(V93 AFTER 3 MARKS PROCESSED)	*		MONITOR ATT TRIM	*
-12	(106+04)	*	F 50 18	(COMMANDED R,P,Y)	*
	TERMINATE MARKS(10)	*****		*****	
	MOVE TO CMD SEAT	-5	(106+11)		
	CDH TARGETING FINAL COMP (P33)			SPS THRUST SETUP (P40)	
	OUT OF PLANE DATA (V90)	*****		*****	
	OVERWRITE NB1 WITH (-) CSM YDOT	*-5	(106+11)		*
	ROLL 180 DEG, ACQ MSFN	*			*
	RHO=-58 GAMMA=173	*		**GDC ALIGN**	*
	(0.154/110,0)	*			*
-8	(106+08)	*			*
	SPS THRUST PROGRAM, V56 (P40)	*		ALT SET KNOB TO 60 NM	*
	MANUAL MNVR TO 1 DEG/SET TO BURN	*		FDAI SELECT=1	*
	ATTITUDE	*		ATT SET THUMBWHEELS TO N18	*
	(161 DEG)	*		NULL ATT ERROR NEEDLES	*
	(0,166/271,0)	*		ON FDAI 1 WITH ATT	*
	*****	*		SET THUMBWHEELS	*
-8	(106+08)	*		ATT SET-GDC	*
	KEY 40E	*		DEPRESS GDC ALIGN PB	*
	F 50 18 (COMMANDED R,P,Y)	*		FDAI SELECT=1/2	*
	KEY V56E	*		ATT SET-TMU	*
	RHC-ARMED	*			*
	ALIGN ROLL TO	*		**MTVC CHECKS**	*
	RHC-LOCKED	*			*
	PRO	*			*
	06 18 (COMMANDED R,P,Y)	*		BAG MODE(3)-ATT1/RATE2	*
	MONITOR MNVR	*		TVC SERVO PWR 1 AC1/MNA	*
	F 50 18 (COMMANDED R,P,Y)	*		TVC SERVO PWR 2 AC2/MNB	*
	MN BUS TIE(2)-ON(UP)	*		TRANS CONTR PWR-ON	*
	SPS HE VLV TB (BOTH)-BP	*		RHC PWR NORM 2-AC	*
		*		GMBL MTRS PITCH 1 STRF-ON	*

MISSION F RESCUE TIMELINE APRIL 25, 1969

GFT	EVENT	PRG	GFT	EVENT	PRG
*	GMHL MTRS YAW 1-START-ON	*	*	RHC-ARMED	*
*	THC-CLOCKWISE	*	*	LV THRUST(A)-NORMAL	*
*	RHC-ARMED	**--00+35	*		*
*	RHC-VERIFY NO RTVC	**	*	OSKY BLANKS	*
*	GMHL MTRS PITCH 2-START-ON	**--00+30	*		*
*	GMHL MTRS YAW 2-START-ON	**	06 40	(TFI,VG,DVM)	*
*	SET SPS GIMBALS TW(2)-	**	*	EMS MODE-NORMAL	*
*	PITCH = -.52	**--00+15	*		*
*	YAW = +.59	**	*	PERFORM ULLAGE	*
*	RHC-VERIFY RTVC	**--00+05	*		*
*	THC-NEUTRAL	**	F 99 40	(REQUEST FOR ENGINE ENABLE)	*
*	RHC PWR NORM 2-AC/DC	**	PRO		*
*	RHC-LOCKED	**	06 40	(TFI,VG,DVM)	*
*	PRO	*****			*
*	06 18 (COMMANDED R,P,Y)	* 0	(106+16+07)		*
*	MONITOR AIT TRIM	*	*****		*
*	F 50 18 (COMMANDED R,P,Y)	*	CSM CDH BURN(65.3+0.12.2)		*
*	KEY ENTER	*	(0,349/271,0)		*
*	F 50 25 (00204,GMHL DRIVE TEST)	*	*****		*
*	RHC PWR DIRECT(BOTH)-MNA/MNB	*****	*****		*
*	RATE-HIGH	**	SET MDC ET-RESEY-START		*
*	AUTO RCS SEL A/C ROLL(4)-MNA	**	MONITOR		*
*	PRO	**	SPS THRUST LT-ON		*
*	MONITOR GMHL DRIVE	**	DV INDICATOR-DECREASING		*
*	SEQ AND TRIM	**+00+01			*
*	06 40 (TFI,VG,DVM)	**	ULLAGE-OFF		*
*	-02+00	**	06 40	(TFC,VG,DVM)	*
*	FDAL SCALE-5/5	**	MONITOR SPS OPERATION		*
*	VERIFY SPS TH LT-OFF	**	PC INDICATOR 95-105 PSI		*
*	EMS MODE STBY	**	MONITOR SPS ENGINE CUTOFF		*
*	FMS FUNCTION-DV SET	**	SPS THRUST LT-OFF		*
*	LOAD CDH VC	**	F 16 40	(TFC,VG,DVM)	*
*	EMS FUNCTION-DV	**	DV THRUST(BOTH)-OFF		*
*	THC-ARMED	**	MONITOR		*

GET	EVENT	-135- PROG	GET	EVENT	PROG
	PC INDICATOR = 0	* -27	(106+24)		
	SPS INJ VLV IND(4)-CLOSE	*		CALL MARKING ROUTINE(V87,V57)	
	SPS HE VLV TB(BOTH)-BP	*		(V93 AFTER 3 MARKS PROCESSED)	
	SPS GMBLS RETURN TO SERVO	*	(106+26)	SUNSET	
	NULL	*			
	GMBL MTRS-OFF(SEQUENTIALLY)	* -12	(106+39)	TERMINATE MARKS(15)	
	TVC SERVO PWR(BOTH)-OFF	*		MOVE TO CMN SEAT	
	FOAI SCALE=5/1	*		TPI TARGETING FINAL COMP	(P34)
	RATE=LOW	*		VERIFY ORDFAL(V83)	
	ROT CONT PWR DIRECT(BOTH)-OFF	*			
	PRO	* -7	(106+44)	SPS THRUST PROGRAM,V56	(P40)
F.16 85	(VG=BODY)	*		AUTO MNVR TO BURN ATTITUDE	
	THC=NULL VG COMPONENTS	*		(60 DEG)	
	THC-LOCKED	*		(0,247/74,0)	
	RHC=LOCKED	*		*****	
	EMS FUNCTION=VHF RNG	*		*****	
	EMS MODE=VHF RNG	* -7	(106+44)	*****	
	VHF RNG=RESET	*		KEY 40E	
	MN BUS TIE(2)-OFF	*		F 50 18 (COMMANDED R,P,V)	
	PRO	*		KEY V56E	
	F 37 88	*		RHC-ARMED	
	*****	*		ALIGN BOLL TO	
-33	(106+18)	*		RHC-LOCKED	
	RENDEZVOUS NAV PROGRAM	(P20)		PRO	
	AUTO MNVR TO SXT TRACK	*		06 18 (COMMANDED R,P,V)	
	(127 DEG)	*		MONITOR MNVR	
	(0,228/144,0)	*		F 50 18 (COMMANDED R,P,V)	
	MOVE TO LEB	*		MN BUS TIE(2)-ON(UP)	
-29	(106+22)	*		SPS HE VLV TB(BOTH)-BP	
	TPI TARGETING PROGRAM	(P34)		SPS HE VLV(BOTH)-AUTO	
	LOAD N55	*		NONESS BUS-MNA	
	R2=+20830	*		PRO	
	R3=+13000	*		06 18 (COMMANDED R,P,V)	
		*		MONITOR ATT TRIM	



```

* F 50 14 (COMMANDED R,P,V) *
*****
-5 (106+46) SPS THRUST SETUP (P40) *
*****
*-5 (106+46) *
**GDC ALIGN** *
* *
* ALT SET KNOB TO 60 NM *
* FDAI SELECT-1 *
* ATT SET THUMBWHEELS TO 018 *
* NULL ATT ERROR NEEDLES *
* ON FDAI 1 WITH ATT *
* SET THUMBWHEELS *
* ATT SET-GDC *
* DEPRESS GDC ALIGN PR *
* FDAI SELECT-1/2 *
* ATT SET-TMU *
* *
**TVC CHECKS** *
* *-02+00 *
* *
* RMAG MODE (3) =ATT1/RATE2 *
* TVC SERVO PWR 1-AC1/MNA *
* TVC SERVO PWR 2-AC2/MNB *
* TRANS CONTR PWR-ON *
* RHC PWR NORM 2-AC *
* GMPL MTRS PITCH 1 STRT-ON *
* GMRL MTRS YAW 1 STRT-ON *
* THC-CLOCKWISE *
* RHC-ARMED *
* RHC-VERIFY NO TVC *
* GMRL MTRS PITCH 2-STRT-ON *

```

```

* GMPL MTRS YAW 2-STRT-ON *
* SET SPS GIMBALS TW(2)- *
* PITCH = -.52 *
* YAW = +.59 *
* RHC-VERIFY MTRC *
* THC-NEUTRAL *
* RHC PWR NORM 2-AC/DC *
* RHC-LOCKED *
* PRO *
* 06 18 (COMMANDED R,P,V) *
* MONITOR ATT TRIM *
* F 50 18 (COMMANDED R,P,V) *
* KEY ENTER *
* F 50 25 (00204 GMRL DRIVE TEST) *
* RHC PWR DIRECT (BOTH)-MNA/MNB *
* RATE-HIGH *
* AUTO RPS SEL A/C ROLL(4)-MNA *
* PRO *
* MONITOR GMRL DRIVE *
* SFO AND TRIM *
* 06 40 (TFI, VG, DVM) *
* *
* FDAI SCAIF-5/5 *
* VERIFY SPS TH LT-OFF *
* EMS MODE STBY *
* EMS FUNCTION-DV SET *
* LOAD TST VC *
* EMS FUNCTION-DV *
* THC-ARMED *
* RHC-ARMED *
* DV THRUST(A)-NORMAL *
* *
* DSKY BLANKS *

```

GET	EVENT	PROG	GET	EVENT	PROG
*-00+30		* *		SPS GMBLS RETURN TO SERVO *	
*	06 40 (TFI,VG,DVM)	* *		NULL *	
*	EMS MODE=NORMAL	* *		GMBL MTRS=OFF (SEQUENTIALLY) *	
*-00+15		* *		TVC SERVO PWR (BOTH)=OFF *	
*	PERFORM ULLAGE	* *		FDAI SCALE=5/1 *	
*-00+05		* *		RATE=LOW *	
*	F 99 40 (REQUEST FOR ENGINE ENABLE)	* *		ROT CONT PWR DIRECT (BOTH)=OFF *	
*	PRO	* *		PRO *	
*	06 40 (TFI,VG,DVM)	* *	F 16 85	(VG-BODY) *	
*****	*****	*****		THC=NULL VG COMPONENTS *	
0 (106+50+57)		*		THC=LOCKED *	
*****	*****	*****		RHC=LOCKED *	
	CSM TPI BURN(-15,0,5.9)	*		EMS FUNCTION=VHF RNG *	
	(0,202/14,0)	*		EMS MODE=VHF RNG *	
*****	*****	*****		VHF RNG=RESET *	
*****	*****	*****		MN BUS TIE (2)=OFF *	
*	SET MDC ET=RESET, START	* *		PRO *	
*	MONITOR:	* *	F 37 BB		
*	SPS THRUST LT=ON	* *	*****		
*	DV INDICATOR=DECREASING	* +2			
*-00+01		*		RENDEZVOUS NAV PROGRAM (P20)	
*	ULLAGE=OFF	*		AUTO MNVR TO SXT TRACK	
*	06 40 (TFC,VG,DVM)	*		(38 DEG)	
*	MONITOR SPS OPERATION:	*		(0,247/52,0)	
*	PC INDICATOR=95-105 PSI	*		MCCI TARGETING PROGRAM (P35) (P20)	
*	MONITOR SPS ENGINE CUTOFF:	*		MOVE TO LE <sup>B</sup>	
*	SPS THRUST LT=OFF	* +3			
*	F 16 40 (TFC,VG,DVM)	*	(107+00)	CALL MARKING ROUTINE (V93,V87,V57)	
*	DV THRUST (BOTH)=OFF	*		LOS	
*	MONITOR:	*		TERMINATE MARKS (8)	
*	PC INDICATOR = 0	* +11			
*	SPS INJ VLV IND(4)=CLOSE	*		MCCI TARGETING FINAL COMP (P35)	
*	SRS HE VLV TR (BOTH)=BP	* +12			

GET	EVENT	PROG	GET	EVENT	PROG
+13.5	RCS THRUST PROGRAM BYPASS BURN ATTITUDE MNVR RCS THRUST SETUP	(P41)	+33 (107+24)	THRUST MONITORING PROGRAM V83, PERFORM BRAKING AND LOS CONTROL	(P47)
+15	(107+05+57) ***** CSM MCC1 (0,267/33,0) *****			***** * BRAKING GATES      PITCH ANGLE * * 30 FPS AT 6000 FT      .13 DEG. * * 20 FPS AT 3000 FT      .26 DEG. * * 10 FPS AT 2500 FT      .54 DEG. * * 5 FPS AT 500 FT      1.60 DEG. * *****	
+16	MCC2 TARGETING PROGRAM (P35) (P20)				
+17	CALL MARKING ROUTINE (V93, V87, V57)				
	(107+14) SUNRISE		+44 (107+34+57)	***** TPF *****	
+26	TERMINATE MARKS(0) MOVE TO CMD SEAT				
+27	MCC2 TARGETING FINAL COMP (P35)				
+28.5	RCS THRUST PROGRAM BYPASS BURN ATTITUDE MNVR RCS THRUST SETUP	(P41)			
+30	(107+20+57) ***** CSM MCC2 (0,300/23,0) *****				
+32	MNVR TO COAS TRACK (V89) (35 DEG) (0,265/348,0)	(P001)			

9.4.2 RENDEZVOUS NAVIGATION SUMMARY WITH SUN ANGLES  
CSM ACTIVE LM RESCUE - PARTIAL PHASING < 40 FPS

(MISSION F)

IT - INITIATE TRACK

CT - CEASE TRACK

(OUT-OF-PLANE SUN ANGLE IS 4 DEG)

GET	EVENT	SUN ANGLE (LOS TO SUN) DEG
100:46	PARTIAL LM PHASING	
100:48	SUNSET	
101:33	CSM RESCUE	
101:35	SUNRISE	
101:44	IT (VHF) (V93,33/33)	15
101:49		30
101:54		46
101:59		63
102:04		80
102:09		97
102:14		113
102:17	CT (VHF)	123
102:31	CSM CSI ONE	
102:40	SUNSET	
102:54	IT (VHF) (4/3,V93,11/12)	
103:09	CT (VHF)	
103:29	SUNRISE	
103:52	IT (VHF) (4/3,V93,19/20)	48
103:57		68
104:02		98
104:07		105
104:12		129
104:15	CT (VHF)	141
104:24	CSM CSI TWO	
104:30	IT (SXT/VHF) (V93,6/5,V93,35/36)	171
104:33	SUNSET	163
104:35	CT (SXT)	
105:11	CT (VHF)	
105:20	CSM CSI THREE	
105:21	SUNRISE	
105:24	IT (SXT/VHF) (4/3,V67,00057,00034,00001;8/9)	77
105:29		87
105:33		98
105:36	CT (SXT/VHF)	101
105:48	CSM PLANE CHANGE	
105:54	IT (SXT/VHF) (4/3,V93,6/7)	84
105:59		73
106:04	CT (SXT/VHF)	62
106:16	CSM CDH	
106:24	IT (SXT/VHF) (4/3,V93,11/12)	4
106:26	SUNSET	9
106:39	CT (SXT/VHF)	
106:51	CSM TPI	
106:54	IT (SXT/VHF) (V93,8/8)	
107:02	CT (SXT/VHF)	
107:06	CSM MCC1	
107:08	IT (SXT/VHF) (V93,9/9)	
107:14	SUNRISE	96
107:17	CT (SXT/VHF)	96
107:21	CSM MCC2	
107:35	TPF	

9.4.3 CSM ATTITUDE SUMMARY

\*\*\_\_\_\_\_\*\*

INERTIAL AND ORDEAL FDAI BALL GIMBAL ANGLE PROFILE  
FOR THE LM PARTIAL PHASING < 40 FPS RESCUE CASE  
(MISSION F) (YAW = 0.0)

\*\*\_\_\_\_\_\*\*

TIME GET	ROLL	PITCH ORDEAL	PITCH INERTIAL	PITCH MNVR
100:46	180	307	193	
101:19	180	150	283	98
101:33	180	180	283	
101:36	180	322	56	133
102:19	180	165	103	174
102:31	180	180	103	
102:51	180	320	177	74
104:24	180	335	257	
104:26	180	317	231	26
105:20	180	18	121	
105:22	180	18	120	
105:48	180	135	149	
105:50	180	132	139	10
106:04	0	154	110	
106:08	0	166	271	161
106:16	0	349	271	
106:18	0	228	144	127
106:44	0	247	74	60
106:51	0	202	14	
106:53	0	247	52	38
107:06	0	267	33	
107:21	0	300	23	
107:23	0	265	348	35
107:35	0	298	348	

9.5 LM ZERO INSERTION

9.5.1 Summary Timeline

-742-

LM INSERTION EQUALS 0 FPS RESCUE TIMELINE

GET	EVENT	PROG	GET	EVENT	PROG
(102+46+18)	***** CSM INSERTION BURN(175.4,0,-107.1) (180.32/272,0) *****			MOVE TO CMD SEAT CSI TARGETING FINAL (P32) (P20) COMP OVERWRITE N81 WITH(=)CSM YDOT	
	SUNSET	-6	(103+26)	SPS THRUST PROGRAM,V56 (P40) AUTO MNVR TO BURN ATTITUDE (5 DEG) (180,156/293,0)	
(102+48)	IMU REALIGN TO REFSMMAT (P52) (OPTION 3)				
(102+53)	MCC-H UPLINK(LM VECTOR) MOVE TO LEB	(P00)	*-6 (103+26)	*****	
(102+56)	RENDEZVOUS NAV PROGRAM (P20) AUTO MNVR TO SXT TRACK (103 DEG) (180,165/16,0)			KEY 40E F 50 18 (COMMANDED R,P,Y) KEY V56E RHC-ARMED ALIGN ROLL TO 180 DEG RHC-LOCKED PRO	
(103+01)	CSI TARGETING PROGRAM (P32) (P20) LOAD N55 R1=+00001 R2=+20830 R3=+13000			06 18 (COMMANDED R,P,Y) MONITOR MNVR F 50 18 (COMMANDED R,P,Y) MN BUS TIE(2)=ON(UP)	
-29 (103+03)	CALL MARKING ROUTINE(V93,V87,V57) (V93 AFTER 5 MKS PROCESSED)			SPS HE VLV TB(BOTH)=BP SPS HE VLV(BOTH)=AUTO NONESS BUS=MNA PRO	
(103+08)	TERMINATE SXT,CONT,VHF V90(CSM) COPY CSM YDOT			06 18 (COMMANDED R,P,Y) MONITOR ATT TRIM F 50 18 (COMMANDED R,P,Y)	
-9 (103+23)	TERMINATE MARKS(20)			*****	

GET	EVENT	PROG	-144-	GET	EVENT	PROG
	(103+25)		*		SET SPS GIMBALS TW(2)=	*
	LOS		*		PITCH = -.52	*
-5	(103+27)		*		YAW = +.59	*
	SPS THRUST SETUP		*		RHC-VERIFY MTVC	*
	*****		*		THC-NEUTRAL	*
-5	(103+27)		**		RHC PWR NORM 2-AC/DC	*
	**GDC ALIGN**		**		RHC-LOCKED	*
			**		PR0	*
			**	06 18	(COMMANDED R,P,Y)	*
	ALT SET KNOB TO 60 NM		**		MONITOR ATT TRIM	*
	FDAI SELECT-1		**	F 50 18	(COMMANDED R,P,Y)	*
	ATT SET THUMBWHEELS TO N18		**		KEY ENTER	*
	NULL ATT ERROR NEEDLES		**	F 50 25	(00204,GMBL DRIVE TEST)	*
	ON FDAI 1 WITH AIT		**		RHC PWR DIRECT(BOTH)=MNA/MNB	*
	SET THUMBWHEELS		**		RATE=HIGH	*
	ATT SET=GDC		**		AUTO RCS SEL A/C ROLL(4)=MNA	*
	DEPRESS GDC ALIGN PB		**		PR0	*
	FDAI SELECT=1/2		**		MONITOR GMBL DRIVE	*
	ATT SET=TMU		**		SEQ AND TRIM	*
			**	06 40	(TFI,VG,DVM)	*
	**MTVC CHECKS**		**			*
			**		FDAI SCALE=5/5	*
			**		VERIFY SPS TH LT-OFF	*
	BMAG MODE(3)=ATT1/RATE2		**		EMS MODE STBY	*
	TVC SERVO PWR 1=AC1/MNA		**		EMS FUNCTION=DV SET	*
	TVC SERVO PWR 2=AC2/MNB		**		LOAD CSI VC	*
	TRANS CONTR PWR=ON		**		EMS FUNCTION=DV	*
	RHC PWR NORM 2=AC		**		THC=ARMED	*
	GMBL MTRS PITCH 1 STRT=ON		**		RHC=ARMED	*
	GMBL MTRS YAW 1 STRT=ON		**		DV THRUST(A)=NORMAL	*
	THC=CLOCKWISE		**			*
	RHC=ARMED		**		DSKY BLANKS	*
	RHC-VERIFY NO MTVC		**			*
	GMBL MTRS PITCH 2-STRT=ON		**	06 40	(TFI,VG,DVM)	*
	GMBL MTRS YAW 2-STRT=ON		**			*

MISSION F RESCUE TIMELINE APRIL 25, 1969

Original Document  
 Page 143  
 Missing in



GET	EVENT	PROG	GET	EVENT	PROG
*	EMS MODE=NORMAL	* *		GMBL MTRS=OFF (SEQUENTIALLY)	*
*-00+15		* *		TVC SERVO PWR (BOTH)=OFF	*
*	PERFORM ULLAGE	* *		FDAI SCALE=5/1	*
*-00+05		* *		RATE=LOW	*
*	F 99 40 (REQUEST FOR ENGINE ENABLE)	* *		ROT CONT PWR DIRECT (BOTH)=OFF	*
*	PRO	* *		PRO	*
*	06 40 (TFI, VG, DVM)	* *	F 16 85	(VG-BODY)	*
*****	*****	*****		THC=NULL, VG COMPONENTS	*
0	(103+32+19)	*		THC=LOCKED	*
	*****	*****		RHC=LOCKED	*
	CSM CSI BURN(-39,0,0,0)	*		EMS FUNCTION=VHF RNG	*
	(180,180/293,0)	*		EMS MODE=VHF RNG	*
	*****	*****		VHF RNG=RESET	*
	SUNRISE	*		MN BUS TIE (2)=OFF	*
*****	*****	*****		PRO	*
*	SET MDC ET=RESET, START	* *	F 37 88		*
*	MONITOR	* *	*****	*****	*****
*	SPS THRUST LT=ON	*	(103+34)	RENDEZVOUS NAV PROGRAM (P20)	
*	DV INDICATOR=DECREASING	*		AUTO MNVR TO SXT TRACK	
*-00+01		*		(27 DEG)	
*	ULLAGE=OFF	*		(180,158/266,0)	
*	06 40 (TFC, VG, DVM)	*		MOVE TO LEB	
*	MONITOR SPS OPERATION	*			
*	PC INDICATOR=95-105 PSI	* -24	(103+40)	CALL MARKING ROUTINE (V87, V57)	
*	MONITOR SPS ENGINE CUTOFF	*		AFTER 3 MARKS PROCESSED	
*	SPS THRUST LT=OFF	*		V67, LOAD WR (+00057, +00034, +00001)	
*	F 16 40 (TFC, VG, DVM)	*		TERMINATE MARKS (12)	
*	DV THRUST (BOTH)=OFF	* -12	(103+52)	OUT OF PLANE DATA (V90)	
*	MONITOR	*		EXTERNAL DV PROGRAM (P30) (P20)	
*	PC INDICATOR = 0	*		LOAD OUT OF PLANE DATA	
*	SPS INJ VLV IND (4)=CLOSE	*			
*	SPS HE VLV TB (BOTH)=BP	*			
*	SPS GMBLS RETURN TO SERVO	*			
*	NULL	*			

GET	EVENT	PROG	GET	EVENT	PROG
-8	(103+56)	RCS THRUST PROGRAM,V56 (P41) BYPASS BURN ATTITUDE MNVR RCS THRUST SETUP	-9	(104+28)	SPS THRUST PROGRAM,V56 (P40) AUTO MNVR TO BURN ATTITUDE (98 DEG) (0,245/231,0)
	(104+04+00)	***** CSM PLANE CHANGE(180,173/205,0) *****	*-9	(104+28)	*****
	(104+05)	RENDEZVOUS NAV PROGRAM (P20) AUTO MNVR TO SXT TRACK (25 DEG) (180,147/180,0)	*	F 50 18	KEY 40E (COMMANDED R,P,Y) KEY V56E RHC=ARMED ALIGN ROLL TO 0 DEG. RHC=LOCKED PRO
-30	(104+07)	CDH TARGETING PROGRAM (P33)(P20)	*	06 18	(COMMANDED R,P,Y)
-28	(104+09)	CALL MARKING ROUTINE(V87,V57) (V93 AFTER 3 SXT MARKS PROCESSED)	*	F 50 18	MONITOR MNVR (COMMANDED R,P,Y)
	(104+12)	AOS	*		MN BUS TIE(2)=ON(UP) SPS HE VLV TB(BOTH)=BP SPS HE VLV(BOTH)=AUTO NONESS BUS=MNA PRO
-13	(104+24)	TERMINATE MARKS(15) MOVE TO CMD SEAT ROLL 180 DEG,ACQ MSFN (0,155/133,0) (RHO -35, GAM 0) CDH TARGETING FINAL (P33)(P20) COMP	*	06 18	(COMMANDED R,P,Y) MONITOR ATT TRIM
		OUT OF PLANE DATA(V90) OVERWRITE N81 WITH(-)CSM YDOT	*-5	F 50 18 (104+32)	(COMMANDED R,P,Y) ***** SPS THRUST SETUP (P40) *****
			*-5	(104+32)	**GDC ALIGN**
			*		ALT SET KNOB TO 60 NM

GET	EVENT	PROG	GET	EVENT	PROG
*	FDAI SELECT-1	* *	F 50 18	(COMMANDED R,P,Y)	*
*	ATT SET THUMBWHEELS TO N18	* *		KEY ENTER	*
*	NULL ATT ERROR NEEDLES	* *	F 50 25	(00204, GMBL DRIVE TEST)	*
*	ON FDAI 1 WITH ATT	* *		RHC PWR DIRECT (BOTH) -MNA/MNB	*
*	SET THUMBWHEELS	* *		RATE-HIGH	*
*	ATT SET-GDC	* *		AUTO RCS SEL A/C ROLL (4) -MNA	*
*	DEPRESS GDC ALIGN PB	* *		PRO	*
*	FDAI SELECT-1/2	* *		MONITOR GMBL DRIVE	*
*	ATT SET-TMU	* *		SEQ AND TRIM	*
*	**MTCV CHECKS**	* *	06 40	(TFI,VG,DVM)	*
*		* *-02+00			*
*	BMAG MODE(3)-ATT1/RATE2	* *		FDAI SCALE=5/5	*
*	TVC SERVO PWR 1=AC1/MNA	* *		VERIFY SPS TH LT-OFF	*
*	TVC SERVO PWR 2=AC2/MNB	* *		EMS MODE STBY	*
*	TRANS CONTR PWR=ON	* *		EMS FUNCTION=DV SET	*
*	RHC PWR NORM 2=AC	* *		LOAD CDH Vc	*
*	GMBL MTRS PITCH 1 STRT=ON	* *		EMS FUNCTION=DV	*
*	GMBL MTRS YAW 1 STRT=ON	* *		THC=ARMED	*
*	THC=CLOCKWISE	* *		RHC=ARMED	*
*	RHC=ARMED	* *-00+35		DV THRUST (A)=NORMAL	*
*	RHC-VERIFY NO MTCV	* *		DSKY BLANKS	*
*	GMBL MTRS PITCH 2-STRT=ON	* *-00+30			*
*	GMBL MTRS YAW 2-STRT=ON	* *	06 40	(TFI,VG,DVM)	*
*	SET SPS GIMBALS TW(2)=	* *		EMS MODE=NORMAL	*
*	PITCH = -.52	* *-00+15			*
*	YAW = +.59	* *		PERFORM ULLAGE	*
*	RHC-VERIFY MTCV	* *-00+05			*
*	THC=NEUTRAL	* *	F 99 40	(REQUEST FOR ENGINE ENABLE)	*
*	RHC PWR NORM 2=AC/DC	* *		PRO	*
*	RHC=LOCKED	* *		06 40 (TFI,VG,DVM)	*
*	PRO	* *		*****	*
*	06 18 (COMMANDED R,P,Y)	* *			*
*	MONITOR ATT TRIM	* *			*

GET	EVENT	PROG	GET	EVENT	PROG
0	(104+36+43)	*		RHC=LOCKED	*
	*****	*		EMS FUNCTION=VHF RNG	*
	CSM CDH BURN(-.8,0,42.6)	*		EMS MODE=VHF RNG	*
	(0,269/213,0)	*		VHF RNG=RESET	*
	*****	*		MN BUS TIE(2)=OFF	*
	*****	*		PRO	*
*	SET MDC ET=RESET, START	*	F 37 BB		*
*	MONITOR	*	*****		*
*	SPS THRUST LT=ON	* -37		RENDEZVOUS NAV PROGRAM (P20)	
*	DV INDICATOR=DECREASING	*		AUTO MNVR TO SXT TRACK	
**00+01		*		(70 DEG)	
*	ULLAGE=OFF	*		(0,224/160,0)	
*	06 40 (TFC, VG, DVM)	*			
*	MONITOR SPS OPERATION	* -32		TPI TARGETING PROGRAM (P34) (P20)	
*	PC INDICATOR=95-105 PSI	*		LOAD N55 R2=+20830	
*	MONITOR SPS ENGINE CUTOFF	*		R3=+13000	
*	SPS THRUST LT=OFF	*			
*	F 16 40 (TFC, VG, DVM)	* -30		CALL MARKING ROUTINE (V87, V57)	
*	DV THRUST (BOTH)=OFF	*		(V93 AFTER 3 SXT MARKS PROCESSED)	
*	MONITOR	*	(104+53)	SUNSET	
*	PC INDICATOR = 0	*		TERMINATE MARKS (18)	
*	SPS INJ VLV IND(4)=CLOSE	*		MOVE TO CMD SEAT	
*	SPS HE VLV TB (BOTH)=BP	* -12		TPI TARGETING FINAL (P34) (P20)	
*	SPS GMBLS RETURN TO SERVO	*		COMP	
*	NULL	*		VERIFY ORDEAL (V83)	
*	GMBL MTRS=OFF (SEQUENTIALLY)	*			
*	TVC SERVO PWR (BOTH)=OFF	*		SPS THRUST PROGRAM, V56 (P40)	
*	FDAI SCALE=5/1	*		AUTO MNVR TO BURN ATTITUDE	
*	RATE=LOW	* -8		(95 DEG)	
*	ROT CONT PWR DIRECT (BOTH)=OFF	*		(0,165/353,0)	
*	PRO	*			
*	F 16 85 (VG=BODY)	*			
*	THC=NULL VG COMPONENTS	*			
*	THC=LOCKED	*			

GET	EVENT	PROG	GET	EVENT	PROG
	*****	*		ATT SET=GDC	*
*-8		**		DEPRESS GDC ALIGN PB	*
*	KEY 40E	**		FDAI SELECT=1/2	*
*	F 50 18 (COMMANDED R,P,Y)	**		ATT SET=TMU	*
*	KEY V56E	**			*
*	RHC=ARMED	**		**MTVC CHECKS**	*
*	ALIGN ROLL TO 0 DEG	**			*
*	RHC=LOCKED	**		BMAG MODE(3)=ATT1/RATE2	*
*	PRO	**		TVC SERVO PWR 1=AC1/MNA	*
*	06 18 (COMMANDED R,P,Y)	**		TVC SERVO PWR 2=AC2/MNB	*
*	MONITOR MNVR	**		TRANS CONTR PWR=ON	*
*	F 50 18 (COMMANDED R,P,Y)	**		RHC PWR NORM 2=AC	*
*	MN BUS TIE(2)=ON(UP)	**		GMBL MTRS PITCH 1 STRT=ON	*
*	SPS HE VLV TB(BOTH)=BP	**		GMBL MTRS YAW 1 STRT=ON	*
*	SPS HE VLV(BOTH)=AUTO	**		THC=CLOCKWISE	*
*	NONESS BUS=MNA	**		RHC=ARMED	*
*	PRO	**		RHC=VERIFY NO MTVC	*
*	06 18 (COMMANDED R,P,Y)	**		GMBL MTRS PITCH 2=STRT=ON	*
*	MONITOR ATT TRIM	**		GMBL MTRS YAW 2=STRT=ON	*
*	F 50 18 (COMMANDED R,P,Y)	**		SET SPS GIMBALS TW(2)=	*
	*****	*		PITCH = -.52	*
*-5		**		YAW = +.59	*
	SPS THRUST SETUP	**		RHC=VERIFY MTVC	*
	*****	*		THC=NEUTRAL	*
*-5		**		RHC PWR NORM 2=AC/DC	*
	**GDC ALIGN**	**		RHC=LOCKED	*
*		**		PRO	*
*		**	06 18	(COMMANDED R,P,Y)	*
*	ALT SET KNOB TO 60 NM	**		MONITOR ATT TRIM	*
*	FDAI SELECT=1	**	F 50 18	(COMMANDED R,P,Y)	*
*	ATT SET THUMBWHEELS TO N18	**		KEY ENTER	*
*	NULL ATT ERROR NEEDLES	**	F 50 25	(00204,GMBL DRIVE TEST)	*
*	ON FDAI 1 WITH ATT	**		RHC PWR DIRECT(BOTH)=MNA/MNB	*
*	SET THUMBWHEELS	**		RATE=HIGH	*

GET	EVENT	PROG	GET	EVENT	PROG
*	AUTO RCS SEL A/C ROLL(4)-MNA	*	*	*****	*
*	PRO	*	*	SET MDC ET-RESET, START	*
*	MONITOR GMRL DRIVE	*	*	MONITOR	*
*	SEQ AND TRIM	*	*	SPS THRUST LT-ON	*
*	06 40 (TFI, VG, DVM)	*	*	DV INDICATOR-DECREASING	*
*-02+00		* *+00+01			*
*	FDAI SCALE=5/5	*	*	ULLAGE=OFF	*
*	VERIFY SPS TH LT-OFF	*	06 40	(TFC, VG, DVM)	*
*	EMS MODE STBY	*	*	MONITOR SPS OPERATION	*
*	EMS FUNCTION=DV SET	*	*	PC INDICATOR=95=105 PSI	*
*	LOAD TPI VC	*	*	MONITOR SPS ENGINE CUTOFF	*
*	EMS FUNCTION=DV	*	*	SPS THRUST LT-OFF	*
*	THC=ARMED	*	F 16 40	(TFC, VG, DVM)	*
*	RHC=ARMED	*	*	DV THRUST(BOTH)=OFF	*
*	DV THRUST(A)=NORMAL	*	*	MONITOR	*
*-00+35		*	*	PC INDICATOR = 0	*
*	DSKY BLANKS	*	*	SPS INJ VLV IND(4)=CLOSE	*
*-00+30		*	*	SPS HE VLV TB(BOTH)=BP	*
*	06 40 (TFI, VG, DVM)	*	*	SPS GMBLS RETURN TO SERVO	*
*	EMS MODE=NORMAL	*	*	NULL	*
*-00+15		*	*	GMBL MTRS=OFF(SEQUENTIALLY)	*
*	PERFORM ULLAGE	*	*	TVC SERVO PWR(BOTH)=OFF	*
*-00+05		*	*	FDAI SCALE=5/1	*
*	F 99 40 (REQUEST FOR ENGINE ENABLE)	*	*	RATE=LOW	*
*	PRO	*	*	ROT CONT PWR DIRECT(BOTH)=OFF	*
*	06 40 (TFI, VG, DVM)	*	*	PRO	*
*****		*	F 16 85	(VG-BODY)	*
(105+16+47)		*	*	THC=NULL VG COMPONENTS	*
*****		*	*	THC=LOCKED	*
CSM TPI BURN(-21.1, 0, -.8)		*	*	RHC=LOCKED	*
(0, 180/353, 0)		*	*	EMS FUNCTION=VHF RNG	*
*****		*	*		*

MISSION F RESCUE TIMELINE APRIL 25, 1969

GET	EVENT	PROG	GET	EVENT	PROG
*	EMS MODE-VHF RNG	*	(105+40)		
*	VHF RNG=RESET	*		SUNRISE	
*	MN BUS TIE(2)=OFF	* +26		TERMINATE MARKS(9)	
*	PRO	*			
*	F 37 BB	* +27			
*****					
+2	RENDEZVOUS NAV PROGRAM (P20)	+28.5		MCC TARGETING FINAL (P35)(P20)	
	AUTO MNVR TO SXT TRACK (61 DEG)			COMP	
	(0,246/54,0)				
	MCC TARGETING PROGRAM (P35)(P20)	+30	(105+46+47)	RCS THRUST PROGRAM (P41)	
	MOVE TO LEB DURING AUTO MNVR			BYPASS BURN ATTITUDE MNVR	
+4	CALL MARKING ROUTINE(V93,V87,V57)			RCS THRUST SETUP (P41)	
+11	TERMINATE MARKS(7)	+32		*****	
+12	MCC TARGETING FINAL (P35)(P20)			MCC2 BURN(0,286/23,0)	
	COMP			*****	
+13.5	RCS THRUST PROGRAM (P41)			AUTO MNVR TO COAS TRACK(V89)(P00)	
	BYPASS BURN ATTITUDE MNVR			MOVE TO CMD SEAT (37 DEG)	
	RCS THRUST SETUP (P41)			(0,254/346,0)	
+15	(105+31+47)			CALL P47 AT R=1.25N.M.	
	*****			THRUST MONITOR PROGRAM (P47)	
	MCC1 BURN(0,265/37,0)			V83, PERFORM BRAKING AND	
	*****			LOS CONTROL	
	LOS			*****	
+16	MCC TARGETING PROGRAM (P35)(P20)			* BRAKING GATES RETICLE ANGLE *	
	POSSIBLE MNVR TO SXT TRACK			* 30 FPS AT 6000 FT .13 DEG *	
				* 20 FPS AT 3000 FT .26 DEG *	
				* 10 FPS AT 2500 FT .54 DEG *	
				* 5 FPS AT 500 FT 1.60 DEG *	
+17	CALL MARKING ROUTINE(V93,V87,V57)			*****	

GET      EVENT

\*51      (106\*07\*47)

\*\*\*\*\*  
TPF  
\*\*\*\*\*

MISSION F RESCUE TIMELINE APRIL 25, 1969



9.5.2 NAVIGATION SUMMARY

LM INSERTION = 0 FPS

P20 NAVIGATION SUMMARY WITH SUN ANGLES

IT - INITIATE TRACK

CT - CEASE TRACK

(OUT-OF-PLANE SUN ANGLE IS 4 DEG)

GET	EVENT	SUN ANGLE (LOS TO SUN) DEG
102:46	CSM INSERTION BURN SUNSET	
103:03	IT (SXT/VHF) (V93;6/5;V93;14/15)	
103:08	CT (SXT)	
103:23	CT (VHF)	
103:32	CSM CSI BURN SUNRISE	
103:40	IT (SXT/VHF) (4/3;V67,00057,00034,00001;8/9)	158
103:45		172
103:50		174
103:52	CT (SXT/VHF)	168
104:04	CSM PLANE CHANGE	
104:09	IT (SXT/VHF) (4/3,V93,11/12)	123
104:14		109
104:19		97
104:24	CT (SXT/VHF)	83
104:37	CSM CDH BURN	
104:47	IT (SXT/VHF) (4/3,V93,14/15)	19
104:52		1
104:53	SUNSET	1
105:05	CT (SXT/VHF)	
105:17	CSM TPI BURN	
105:21	IT (SXT/VHF) (V93,7/7)	
105:28	CT (SXT/VHF)	
105:32	CSM MCC1 BURN	
105:33	IT (SXT/VHF) (V93,9/9)	
105:40	SUNRISE	93
105:42	CT (SXT/VHF)	94
106:02	CSM MCC2 BURN	
106:08	TPF	

9.5.3 CSM ATTITUDE SUMMARY  
INERTIAL AND ORDEAL FDAI BALL GIMBAL ANGLE  
PROFILE FOR LM INSERTION = 0 RESCUE CASE  
(MISSION F) (YAW = 0.0)

TIME GET	ROLL	PITCH ORDEAL	PITCH INERTIAL	PITCH MNVR
102:46	180	32	272	
102:56	180	165	16	103
103:26	180	156	293	5
103:32	180	180	293	
103:34	180	158	266	27
104:04	180	173	205	
104:05	180	147	180	25
104:26	0	155	133	
104:28	0	245	231	98
104:37	0	269	231	
104:40	0	244	160	70
105:09	0	165	353	95
105:16	0	180	353	
105:19	0	246	54	61
105:32	0	265	37	
106:02	0	286	23	
106:04	0	254	346	37

9.6 LM PARTIAL INSERTION

9.6.) SUMMARY TIMELINE

-156-

GET	EVENT	PR0G	GET	EVENT	PR0G
	(LM INSERTION=120 FPS)			*****	
			*-7 (103+25)		*
(102+43+18)	*****			KEY 40E	*
	LM INSERTION BURN (-106.8,0,-54.5)		F 50 18 (COMMANDED R,P,Y)		*
	*****			KEY V56E	*
(102+47)	SUNSET			RHC=ARMED	*
	MOVE TO LER			ALIGN ROLL TO	*
	IMJ REALIGN TO REF'SMMAT		06 18 (COMMANDED R,P,Y)	RHC=LOCKED	*
	(OPTION 3)	(P52)		PRO	*
(102+52)	MCC-H UPLINK (LM STATE		F 50 18 (COMMANDED R,P,Y)		*
	VECTOR)	(P00)		MN BUS TIE(2)-ON(UP)	*
-29 (103+03)	COPY RESCUE,CSI ONE,CDH,TPI PADS			SPS HE VLV TB(BOTH)-BP	*
				SPS HE VLV(BOTH)-AUTO	*
(103+17)	LOS			NONES BUS-MNA	*
	MOVE TO CMD SEAT		06 18 (COMMANDED R,P,Y)	PRO	*
-12 (103+20)	EXTERNAL DV PROGRAM	(P30)		MONITOR ATT TRIM	*
			F 50 18 (COMMANDED R,P,Y)		*
-7 (103+25)	SPS THRUST PROGRAM,V56	(P40)		*****	
	AUTO MNVR TO BURN ATTITUDE		-5 (103+27)		
	(19 DEG)			SPS THRUST SETUP	(P40)
	(180,165/282.0)			*****	
			*-5 (103+27)		*
				**GDC ALIGN**	*
					*
					*
				ALT SET KNOB TO 60 NM	*
				FDAI SELECT-1	*

GET	EVENT	-157- PROG	GET	EVENT	PROG
	ATT SET THUMBWHEELS TO N18	* *		KEY FNTR	*
	NULL ATT ERROR NEEDLES	* *	F 50 25	(00204, GMBL DRIVE TEST)	*
	ON FDAI 1 WITH ATT	* *		RHC PWR DIRECT (BOTH) -MNA/MNB	*
	SET THUMBWHEELS	* *		RATE-HIGH	*
	ATT SET-GDC	* *		AUTO RPS SEL A/C ROLL (4) -MNA	*
	DEPRESS GDC ALIGN PB.	* *		PRO	*
	FDAI SELECT-1/2	* *		MONITOR GMBL DRIVE	*
	ATT SET-TMU	* *		SEQ AND TRIM	*
		* *	06 40	(TFI, VG, DVM)	*
	**MTVC CHECKS**	* *-02+00		FDAI SCALE=5/5	*
		* *		VERIFY SPS TH LT-OFF	*
	BMAG MODE (3) -ATT1/RATE?	* *		EMS MODE STBY	*
	TVC SERVO PWR 1-AC1/MNA	* *		EMS FUNCTION-DV SET	*
	TVC SERVO PWR 2-AC2/MNR	* *		LOAD RESCUE VC	*
	TRANS CONTR PWR-ON	* *		EMS FUNCTION-DV	*
	RHC PWR NORM 2-AC	* *		THC=ARMED	*
	GMBL MTRS PITCH 1 STRT-ON	* *		RHC=ARMED	*
	GMBL MTRS YAW 1 STRT-ON	* *		DV THRUST (A) =NORMAL	*
	THC=CLOCKWISE	* *			*
	RHC=ARMED	* *-00+35		DSKY BLANKS	*
	RHC-VERIFY NO MTVC	* *			*
	GMBL MTRS PITCH 2-STRT-ON	* *-00+30			*
	GMBL MTRS YAW 2-STRT-ON	* *	06 40	(TFI, VG, DVM)	*
	SET SPS GIMBALS TW(2) -	* *		EMS MODE=NORMAL	*
	PITCH = -.52	* *-00+15			*
	YAW = +.59	* *		PERFORM ULLAGE	*
	RHC-VERIFY MTVC	* *-00+05			*
	THC-NEUTRAL	* *	F 99 40	(REQUEST FOR ENGINE ENABLE)	*
	RHC PWR NORM 2-AC/DC	* *		PRO	*
	RHC-LOCKED	* *	06 40	(TFI, VG, DVM)	*
	PRO	* *		*****	*
06 1R	(COMMANDED R,P,Y)	*			*
	MONITOR ATT TRIM	*			*
F 50 1R	(COMMANDED R,P,Y)	*			*

MISSION F RESCUE TIMELINE APRIL 25, 1969

GET	EVENT	-158- PROG	GET	EVENT	PROG
0	(103+31+59)	*	F 16 85	(VG=BODY)	*
	*****	*		THC=NULL, VG COMPONENTS	*
	CSM RESCUE BURN (-44.9,0.0),	*		THC-LOCKED	*
	(180,180/282.0)	*		RHC-LOCKED	*
	*****	*		EMS FUNCTION-VHF RNG	*
	*****	*		EMS MOSE-VHF RNG	*
	SET MUC ET-RESFT,START	**		VHF RNG-RESET	*
	MONITOR:	**		MN BUS TIF(2)-OFF	*
	SPS THRUST LT-ON	**		PRO	*
	DV INDICATOR-DECREASING	**	F 37 88		*
*+00+01		*	*****		*
	ULLAGE-OFF	*	(103+33)		*
06 40	(TFC,VG,DVM)	*		SUNRISE	
	MONITOR SPS OPERATION:	* -55	(103+35)		
	PC INDICATOR-95-105 PSI	*		RENDEZVOUS NAV PROGRAM	(P20)
	MONITOR SPS ENGINE CUTOFF:	*		AUTO MNVR TO SXT TRACK	
	SPS THRUST LT-OFF	*		(49 DEG)	
F 16 40	(TFC,VG,DVM)	*		(180,141/233.0)	
	DV THRUST(BOTH)-OFF	*		MOVE TO LEB	
	MONITOR:	* -52	(103+38)		
	PC INDICATOR = 0	*		CSI TARGETING PROGRAM	(P32)
	SPS INJ VLV IND(4)-CLOSE	*		LOAD N55 WITH	
	SPS HE VLV TR(BOTH)-RP	*		R1=+00002	
	SPS GMBLS RETURN TO SERVO	*		R2=+20830	
	NULL	*		R3=+13000	
	GMBL MTRS-OFF(SEQUENTIALLY)	* -35	(103+55)		
	TVC SERVO PWR(BOTH)-OFF	*		CALL MARKING ROUTINE(V93,V57 SXT	
	FDAI SCALE-5/1	*		ONLY)	
	RATE-LOW	*	(104+05)		
	ROT CONT PWR DIRECT(BOTH)-OFF*	*		AOS	
	PRO	*			

GET	EVENT	-159- PROG	GET	EVENT	PROG
-15	(104+15)		-5	(104+25)	
	TERMINATE MARKS(20)			SPS THRUST SETUP	(P40)
	MOVE TO CMD SEAT			*****	
	CST TARGETING PROGRAM	(P32)	*-5	(104+25)	*
	FINAL COMP		*	**GDC ALIGN**	*
	OUT OF PLANE DATA(V90)		*		*
	OVERWRITE N81 WITH (-) CSM YDOT		*		*
-11	(104+19)			ALT SET KNOB TO 60 NM	*
	SPS THRUST PROGRAM,V56	(P40)		FDAI SELECT-1	*
	AUTO MNVR TO BURN ATTITUDE			ATT SET THUMBWHEELS TO N18	*
	(175 DEG)			NULL ATT ERROR NEEDLES	*
	(180,345/281,0)			ON FDAI 1 WITH ATT	*
	ACQ MSFN,R40=-48,GAMMA=180			SET THUMBWHEELS	*
	*****			ATT SET-GDC	*
	*****			DEPRESS GDC ALIGN PB	*
*-11	(104+19)			FDAI SELECT-1/2	*
	KEY 40E			ATT SET-TMU	*
	F 50 1R (COMMANDED R,P,Y)				*
	KEY V56E				*
	RHC-ARMED			**MTVC CHECKS**	*
	ALIGN ROLL TO				*
	RHC-LOCKED			BMAG MODE(3)-ATT1/RATE2	*
	PRO			TVC SERVO PWR 1-AC1/MNA	*
	06 1R (COMMANDED R,P,Y)			TVC SERVO PWR 2-AC2/MNB	*
	MONITOR MNVR			TRANS CONTR PWR-ON	*
	F 50 1R (COMMANDED R,P,Y)			RHC PWR NORM 2-AC	*
	MN.BUS TIE(2)-ON(UP)			GMBL MTRS PITCH 1 STRT-ON	*
	SPS HE VLV TB(BOTH)-RP			GMBL MTRS YAW 1 STRT-ON	*
	SPS HE VLV(BOTH)-AUTO			THC-CLOCKWISE	*
	NONESS BUS=MNA			RHC-ARMED	*
	PRO			RHC-VERIFY NO MTVC	*
	06 1R (COMMANDED R,P,Y)			GMBL MTRS PITCH 2-STRT-ON	*
	MONITOR ATT TRIM			GMBL MTRS YAW 2-STRT-ON	*
	F 50 1R (COMMANDED R,P,Y)				*
	*****				

MISSION F RESCUE TIMELINE APRIL 25, 1969

-160-  
PROG

GET	EVENT	PROG	GET	EVENT	PROG
	SET SPS GIMBALS TW(2)-	* *-00+30			*
	PITCH = -.52	* *	06 40	(TFI,VG,DVM)	*
	YAW = +.59	* *		EMS MODE=NORMAL	*
	RHC-VERIFY MTVC	* *-00+15		PERFORM ULLAGE	*
	THC-NEUTRAL	* *			*
	RHC PWR NORM 2-AC/DC	* *-00+05	F 99 40	(REQUEST FOR ENGINE ENABLE)	*
	RHC-LOCKED	* *		PRO	*
	PRO	* *	06 40	(TFI,VG,DVM)	*
06 1A	(COMMANDED R,P,Y)	* *			*
	MONITOR ATT TRIM	* *****			*
F 50 1A	(COMMANDED R,P,Y)	* (104+29+59)			*
	KEY ENTER	* *****			*
F 50 25	(00204,GMBL DRIVE TEST)	* CSM CSI ONE BURN(114.6,0+0)			*
	RHC PWR DIRECT(BOTH)-MNA/MNR	* (180,0,281,0)			*
	RATE-HIGH	* *****			*
	AUTO RCS SEL A/C ROLL(4)-MNA	* *****			*
	PRO	* *		SET MDC ET-RESET,START	*
	MONITOR GMBL DRIVE	* *		MONITOR	*
	SEQ AND TRIM	* *		SPS THRUST LT=ON	*
06 40	(TFI,VG,DVM)	* *		DV INDICATOR DECREASING	*
		* **00+01			*
	FDAI SCALE-5/5	* *		ULLAGE-OFF	*
	VERIFY SPS TH LT-OFF	* *	06 40	(TFC,VG,DVM)	*
	EMS MODE STBY	* *		MONITOR SPS OPERATION	*
	EMS FUNCTION-DV SET	* *		PC INDICATOR 95-105 PSI	*
	LOAD CSI VC	* *		MONITOR SPS ENGINE CUTOFF	*
	EMS FUNCTION-DV	* *		SPS THRUST LT=OFF	*
	THC-ARMED	* *	F 16 40	(TFC,VG,DVM)	*
	RHC-ARMED	* *		DV THRUST(BOTH)-OFF	*
	DV THRUST(A)-NORMAL	* *		MONITOR	*
		* *		PC INDICATOR = 0	*
	DSKY BLANKS	* *		SPS INJ VLV IND(4)=CLOSE	*
		* *		SPS HE VLV TR(BOTH)=RP	*

MISSION F RESCUE TIMELINE APRIL 25,1969



GET	EVENT	-161- PROG	GET	EVENT	PROG
	SPS GMBLS RETURN TO SERVO	* -35	(104+57)		
	NULL	*		CSI TARGETING PROGRAM	(P32)
	GMRL MTRS-OFF (SEQUENTIALLY)	*		LOAD N55 WITH	
	TVC SERVO PWR (BOTH)-OFF	*		R1=+00001	
	FDAI SCALE-5/1	*		R2=+20830	
	RATE-LOW	*		R3=+13000	
	ROT CONT PWR DIRECT (BOTH)-OFF	* -32	(105+00)		
	PRO	*		CALL MARKING ROUTINE (V93,V87,V57)	
	F 16 RS (VG-BODY)	*		(V93 AFTER 5 MARKS PROCESSED)	
	THC=NULL VG COMPONENTS	*	(105+05)		
	THC-LOCKED	*		TERMINATE SXT MARKS V93	
	RHC-LOCKED	*		CONTINUE VHF	
	EMS FUNCTION-VHF RNG	*	(105+10)		
	EMS MODE-VHF RNG	*		OUT OF PLANE DATA (V90)	
	VHF RNG=RESET	*		OVERWRITE N81 WITH (-) CSM YDOT	
	MN BUS TIE (2)-OFF	*		CONTINUE VHF	
	PRO	*	(105+18)		
	F 37 BR	*		LOS	
	*****	* -9	(105+23)		
	(104+34)			TERMINATE MARKS (23)	
	CMC IDLING PROGRAM	(P00)		MOVE TO CMD SEAT	
-50	(104+42)			CSI TARGETING FINAL COMP	(P32)
	SUNSET	-5	(105+27)		
	MOVE TO LER			RCS THRUST PROGRAM, V56	(P41)
	IMU REALIGN TO REFSMMAT	(P52)		AUTO MNVR TO BURN ATTITUDE	
	(OPTION 3)		(105+29)	(180,165/276.0)	
-45	(104+47)			SUNRISE	
	MCC-H UPLINK (LM VECTOR) (IF LM				
	ACTIVE)	(P00) -2	(105+30)		
-40	(104+52)			RCS THRUST SETUP	(P41)
	RENDEZVOUS NAV PROGRAM	(P20)			
	AUTO MNVR TO SXT TRACK				
	(90 DEG)				
	(180,162/11,0)				

MISSION F RESCUE TIMELINE APRIL 25, 1969

GET	EVENT	PROG	GET	EVENT	PROG
(105+31+55)	***** CSM CST TWO BURN( ,0, ) (180,171/276,0) *****	0	(106+03+00)	***** CSM PLANE CHANGE(0, ,0) (180,161/178,0) *****	
-2A (105+35)	OUT OF PLANE DATA(V90) MOVE TO LER	-30	(106+04)	RENDEZVOUS NAV PROGRAM (P20) AUTO MNVR TO SXT TRACK (13 DEG) (180,154/165,0)	
-26 (105+37)	RENDEZVOUS NAV PROGRAM (P20) AUTO MNVR TO SXT TRACK (27 DEG) (180,164/249,0)		(106+06)	AOS	
-22 (105+41)	CALL MARKING ROUTINE(V87,V57) AFTER 3 SXT MARKS PROCESSED V67,LOAD WR(00057,00034,00001)	-27	(106+07)	CDH TARGETING PROGRAM (P33) MOVE TO LER	
-12 (105+51)	TERMINATE MARKS(10) MOVE TO CMD SEAT OUT OF PLANE DATA V90	-25	(106+09)	CALL MARKING ROUTINE(V87,V57) (V93 AFTER 3 MARKS PROCESSED)	
-5 (105+58)	EXTERNAL DV TARGETING (P30) OVERWRITE NB1 WITH (-) CSM YDOT	-10	(106+24)	TERMINATE MARKS(15) MOVE TO CMD SEAT CDH TARGETING FINAL COMP (P33) ROLL 180 DEG,ACQ MSFN (0,223/178,0) (RH0=-58,GMMA=173)	
-3 (106+00)	RCS THRUST PROGRAM,V56 (P41) BYPASS BURN ATTITUDE MNVR (180,155/178,0)			OUT OF PLANE DATA (V90) OVERWRITE NB1 WITH (-) CSM YDOT	
-2 (106+01)	RCS THRUST SETUP (P41)	-6	(106+27)	SPS THRUST PROGRAM,V56 (P40) AUTO MNVR TO BURN ATTITUDE (3 DEG) (0,229/165,0)	

```

-163-
GET      EVENT      PROG
*****
*-6 (106+27)
      KEY 40E
      F 50 1R (COMMANDED R,P,Y)
      KEY V56E
      RHC-ARMED
      ALIGN ROLL 10
      RHC-LOCKED
      PRO
      06 1R (COMMANDED R,P,Y)
      MONITOR MNVR
      F 50 1R (COMMANDED R,P,Y)
      MN BUS TIE(2)-ON(UP)
      SPS HE VLV TB(BOTH)-RP
      SPS HE VLV(BOTH)-AUTO
      NONESS BUS-MNA
      PRO
      06 1R (COMMANDED R,P,Y)
      MONITOR ATT TRIM
      F 50 1R (COMMANDED R,P,Y)
*****
*-5 (106+29)
      SPS THRUST SETUP (P40)
*****
*-5 (106+29)
      **GDC ALIGN**
      ALT SET KNOB TO 60 NM
      FDAI SELECT-1
      ATT SET THUMBWHEELS TO N18
*****

```

```

GET      EVENT      PROG
NULL ATT ERROR NEEDLES
      ON FDAI 1 WITH ATT
      SET THUMBWHEELS
      ATT SET-GDC
      DEPRESS GDC ALIGN PR
      FDAI SELECT-1/2
      ATT SET-TMU
*****
**MTVC CHECKS**
      BMAG MODE(3)-ATT1/RATE2
      TVC SERVO PWR 1-AC1/MNA
      TVC SERVO PWR 2-AC2/MNB
      TRANS CONTR PWR ON
      RHC PWR NORM 2-DC
      GMBL MTRS PITCH 1 STRT-ON
      GMBL MTRS YAW 1 STRT-ON
      THC-CLOCKWISE
      RHC-ARMED
      RHC-VERIFY NO MTVC
      GMBL MTRS PITCH 2-STRT-ON
      GMBL MTRS YAW 2-STRT-ON
      SET SPS GYMBALS TW(2)-
      PITCH = -.52
      YAW = +.59
      RHC-VERIFY MTVC
      THC-NEUTRAL
      RHC PWR NORM 2-AC/DC
      RHC-LOCKED
      PRO
      06 1R (COMMANDED R,P,Y)
      MONITOR ATT TRIM
*****

```

GET	EVENT	-164- PRG	GET	EVENT	PRG
*	F 50 1R (COMMANDED R.P.Y)	* 0	(106+33+49)		
*	KFY ENTER	*	*****		
*	F 50 25 (00204,GMHL DRIVE TEST)	*	CSM CDH RURN (-37.1,0,74.H),		
*	RHC PWR DIRECT (BOTH)-MNA/MNR	*	(0,244/165,0)		
*	RATE-HIGH	*	*****		
*	AUTO RCS SEL A/C ROLL(4)-MNA	*	*****		
*	PRG	*	*****		
*	MONITOR GMHL DRIVE	**	SET MDC ET-RESEY, START	*	
*	SEQ AND TRIM	**	MONITOR	*	
*	06 40 (TFI, VG, DVM)	**	SPS THRUST LT-ON	*	
*-02+00		**	DV INDICATOR DECREASING	*	
*	FDAI SCALE-5/5	**+00+01		*	
*	VERIFY SPS TH LT-OFF	**	ULLAGE-OFF	*	
*	EMS MODE STBY	**	06 40 (TFC, VG, DVM)	*	
*	EMS FUNCTION-DV SET	**	MONITOR SPS OPERATION	*	
*	LOAD CDH VC	**	PC INDICATOR 95-105 PSI	*	
*	EMS FUNCTION-DV	**	MONITOR SPS ENGINE CUTOFF	*	
*	THC-ARMED	**	SPS THRUST LT-OFF	*	
*	RHC-ARMED	**	F 16 40 (TFC, VG, DVM)	*	
*	DV THRUST(A)-NORMAL	**	DV THRUST(BOTH)-OFF	*	
*-00+35		**	MONITOR	*	
*	DSKY BLANKS	**	PC INDICATOR = 0	*	
*-00+30		**	SPS INU VLV IND(4)-CLOSE	*	
*	06 40 (TFI, VG, DVM)	**	SPS HE VLV TB (BOTH)-RP	*	
*	EMS MODE-NORMAL	**	SPS GMRLS RETURN TO SERVO	*	
*-00+15		**	NULL	*	
*	PERFORM ULLAGE	**	GMRL MTRS-OFF (SEQUENTIALLY)	*	
*-00+05		**	TVC SERVO PWR (BOTH)-OFF	*	
*	F 99 40 (REQUEST FOR ENGINE ENABLE)	**	FDAI SCALE-5/1	*	
*	PRG	**	RATE-LOW	*	
*	06 40 (TFI, VG, DVM)	**	ROT CONT PWR DIRECT (BOTH)-OFF	*	
*****		**	PRO	*	

MISSION F RESCUE TIMELINE APRIL 25, 1969.

GET	EVENT	-165- PROG	GET	EVENT	PROG
	F 16 R5 (VG-BODY)	* -7	(107+02)		
	THC=NULL VG COMPONENTS	*		SPS THRUST PROGRAM,V56	(P40)
	THC-LOCKED	*		AUTO MNVR TO BURN ATTITUDE	
	RHC-LOCKED	*		(56 DEG)	
	EMS FUNCTION-VHF RNG	*		(0,174/10,0)	
	EMS MODE-VHF RNG	*	*****	*****	*****
	VHF RNG-RESET	* -7	(107+02)		
	MN BUS TIE(2)-OFF	*		KEY 40E	
	PRO	*		F 50 18 (COMMANDED R,P,V)	
	F 37 RR	*		KEY V56E	
	*****	*		RHC=ARMED	
33	(106+36)	*		ALIGN ROLL TO	
	RENDEZVOUS NAV PROGRAM (P20)	*		RHC-LOCKED	
	AUTO MNVR TO SXT TRACK	*		PRO	
	(27 DEG)	*	06 18	(COMMANDED R,P,V)	
	(0,229/138,0)	*		MONITOR MNVR	
	MOVE TO LEB	*	F 50 18	(COMMANDED R,P,V)	
31	(106+38)	*		MN BUS TIE(2)-ON(UP)	
	TPI TARGETING PROGRAM (P34)	*		SPS HE VLV TB(BOTH)-BP	
	LOAD N55 WITH	*		SPS HE VLV(BOTH)-AUTO	
	R2=+20830	*		NONESS BUS-MNA	
	R3=+13000	*		PRO	
29	(106+40)	*	06 18	(COMMANDED R,P,V)	
	CALL MARKING ROUTINE(V87,V57)	*		MONITOR ATT TRIM	
	(V93 AFTER 3 MARKS PROCESSED)	*	F 50 18	(COMMANDED R,P,V)	
	(106+44)	*	*****	*****	*****
	SUNSET	-4	(107+05)		
12	(106+57)	*		SPS THRUST SETUP	(P40)
	TERMINATE MARKS(17)	*	*****	*****	*****
	MOVE TO CMD SEAT	*			
	TPI TARGETING FINAL COMP (P34)	*			
8	(107+01)	*-4	(107+05)		
	VERIFY ORDEAL(V83)	*		**GDC ALIGN**	
		*			

MISSION F RESCUE TIMELINE APRIL 25, 1969

GET	EVENT	-166- PRG	GET	EVENT	PRG
	ALT SET KNOB TO 60 NM	* *	06 18	(COMMANDED R,P,γ)	*
	FDAI SELECT-1	* *		MONITOR ATT TRIM	*
	ATT SET THUMBWHEELS TO #18	* *	F 50 18	(COMMANDED R,P,γ)	*
	NULL ATT ERROR NEEDLES	* *		KEY ENTER	*
	ON FDAI 1 WITH ATT	* *	F 50 25	(00204, GMBL DRIVE TEST)	*
	SET THUMBWHEELS	* *		RHC PWR DIRECT (BOTH) -MNA/MNB	*
	ATT SET-GUC	* *		RATE-HIGH	*
	DEPRESS GUC ALIGN PB	* *		AUTO RCS SEL A/γ ROLL (4) -MNA	*
	FDAI SELECT-1/2	* *		PRO	*
	ATT SET-TMU	* *		MONITOR GMBL DRIVE	*
		* *		SEQ AND TRIM	*
	**MTVC CHECKS**	* *	06 40	(TFI, VG, DVM)	*
		* *#02+00			*
	BMAG MODE (3) -ATT1/RATE?	* *		FDAI SCALE -5/5	*
	TVC SERVO PWR 1-AC1/MNA	* *		VERIFY SPS TH LT-OFF	*
	TVC SERVO PWR 2-AC2/MNB	* *		EMS MODE STBY	*
	TRANS CONTR PWR-ON	* *		EMS FUNCTION-DV SET	*
	RHC PWR NORM 2-AC	* *		LOAD TH VC	*
	GMBL MTRS PITCH 1 STRT-ON	* *		EMS FUNCTION-DV	*
	GMBL MTRS YAW 1 STRT-ON	* *		THC-ARMED	*
	THC-CLOCKWISE	* *		RHC-ARMED	*
	RHC-ARMED	* *#00+35		DV THRUST (A) -NORMAL	*
	RHC-VERIFY NO MTVC	* *		DSKY BLANKS	*
	GMBL MTRS PITCH 2-STRT-ON	* *#00+30			*
	GMBL MTRS YAW 2-STRT-ON	* *	06 40	(TFI, VG, DVM)	*
	SET SPS GIMBALS TW (2) -	* *		EMS MODE-NORMAL	*
	PITCH = -.52	* *#00+15			*
	YAW = +.59	* *		PERFORM ULLAGE	*
	RHC-VERIFY MTVC	* *#00+05			*
	THC-NEUTRAL	* *	F 99 40	(REQUEST FOR ENGINE ENABLE)	*
	RHC PWR NORM 2-AC/DC	* *		PRO	*
	RHC-LOCKED	* *	06 40	(TFI, VG, DVM)	*
	PRO	* *****			*

MISSION F RESCUE TIMELINE APRIL 25, 1969

GET	EVENT	-167- PROG	GET	EVENT	PROG
(107+08+54)	*****	*	F 16 85	(VG=BODY)	*
	CSM TPT BURN(-24.0,3.9)	*		THC=NULL VG COMPONENTS	*
	(0,189/10.0)	*		THC-LOCKED	*
	*****	*		RHC-LOCKED	*
	*****	*		EMS FUNCTION=VHF RNG	*
	SET MDC ET-RESET*START	**		EMS MODE=VHF RNG	*
	MONITOR	**		VHF RNG-RESET	*
	SPS THRUST LT-ON	**		MN BUS TIE(2)-OFF	*
	DV-INDICATOR-DECREASING	**		PRO	*
+00+01	ULLAGE-OFF	*	F 37 88	*****	*
	06 40 (TFC,VG,DVM)	* +2		RENDEZVOUS NAV PROGRAM (P20)	
	MONITOR SPS OPERATION	*		AUTO MNVR TO SXT TRACK	
	PC INDICATOR-95-105 PSI	*		(37 DEG)	
	MONITOR SPS ENGINE CUTOFF	*		(0,247/47,0)	
	SPS THRUST LT-OFF	*		MOVE TO LEG	
F 16 40 (TFC,VG,DVM)	DV THRUST(BOTH)-OFF	* +3		MCC TARGETING PROGRAM (P35)	
	MONITOR	*		CALL MARKING ROUTINE(V93,V87,V57)	
	PC INDICATOR = 0	*	(107+18)	LOS	
	SPS INJ VLV IND(4)-CLOSE	*		TERMINATE MARKS(8)	
	SPS HE VLV TR(BOTH)-HP	* +11		MCC TARGETING FINAL COMP (P35)	
	SPS GMBLS RETURN TO SERVO	*		RCS THRUST PROGRAM (P41)	
	NULL	* +12		BYPASS BURN ATTITUDE MNVR	
	GMBL MTRS-OFF(SEQUENTIALLY)	*		(0,258/30,0)	
	TVC SERVO PWR(BOTH)-OFF	* +13.5		RCS THRUST SETUP (P41)	
	FDAI SCALE-5/1	*			
	RATE-LOW	*			
	ROT CNT PWR DIRECT(BOTH)-OFF*	*			
	PRO	*			

MISSION F RESCUE TIMELINE APRIL 25, 1969

GET	EVENT	PR0G	GET	EVENT	PR0G
+15	(107+23+54)				
	*****			*****	
	CSM MCC1 BURN			* BRAKING GATES RETICLE ANGLE *	
	(0,264/30,0)			M 30 FPS AT 6000 FT .13 DEG. *	
	*****			* 20 FPS AT 3000 FT .26 DEG. *	
+16	MCC TARGETING PROGRAM (P35)			* 10 FPS AT 2500 FT .54 DEG. *	
+17	CALL MARKING ROUTINE (V93,V87,V57)			* 5 FPS AT 500 FT 1.60 DEG. *	
	(107+31)		+43	(107+51+54)	
	SUNRISE			*****	
+26	TERMINATE MARKS (9)			TPF	
				*****	
27	MCC TARGETING FINAL COMP (P35)				
28.5	RCS THRUST PROGRAM (P41)				
	BYPASS BURN AUTO MNVR				
	(0,287/17,0)				
	RCS THRUST SET UP (P41)				
+30	(107+38+54)				
	*****				
	CSM MCC2 BURN				
	((0,293/17,0)				
	*****				
31	AUTO MNVR TO COAS TRACK (V89) (P00)				
	(28 DEG)				
	(0,262/341,0)				
	MOVE TO CMD SEAT				
37	(107+46)				
	THRUST MONITORING PROGRAM (P47)				
	V87, PERFORM BRAKING AND LOS				
	CONTROL				



9.6.2 RENDEZVOUS NAVIGATION SUMMARY WITH SUN ANGLES

CSM ACTIVE LM RESCUE-PARTIAL INSERTION=120 FPS  
(MISSION F)  
IT - INITIATE TRACK  
CT - CEASE TRACK  
(OUT-OF-PLANE SUN ANGLE IS 4 DEG)

GET	EVENT	SUN ANGLE (LOS TO SUN) DEG
102:43	LM PARTIAL INSERTION	
102:47	SUNSET	
103:32	CSM RESCUE	
103:33	SUNRISE	
103:55	IT (SXT) (V93,20/20)	129
104:00		116
104:05		102
104:10		87
104:15	CT (SXT)	74
104:30	CSM CSI ONE	
104:42	SUNSET	
105:00	IT (SXT/VHF) (V93,6/5,V93,17/18)	
105:05	CT (SXT)	
105:23	CT (VHF)	
105:29	SUNRISE	
105:32	CSM CSI TWO	
105:41	IT (SXT/VHF) (4/3,V67,00057,00034,00001;6/7)	171
105:46		174
105:51	CT (SXT/VHF)	159
106:03	CSM PLANE CHANGE	
106:09	IT (SXT/VHF)(4/3,V93,11/12)	99
106:14		84
106:19		68
106:24	CT (SXT/VHF)	59
106:34	CSM CDH	
106:40	IT (SXT/VHF) (4/3,V93,13/14)	9
106:44	SUNSET	4
106:57	CT (SXT/VHF)	
107:09	CSM TPI	
107:12	IT (SXT/VHF) (V93,8/8)	
107:20	CT (SXT/VHF)	
107:24	CSM MCC1	
107:26	IT (SXT/VHF) (V93,9/9)	
107:31	SUNRISE	63
107:35	(CT (SXT/VHF)	77
107:39	CSM MCC2	
107:52	TPF	

9.6.3 CSM ATTITUDE HISTORY

\*\*-----\*\*  
INERTIAL AND ORDEAL FDAI BALL GIMBAL ANGLE PROFILE FOR THE LM  
PARTIAL INSERTION = 120 FPS RESCUE CASE (MISSION F) (YAW = 0.0)  
\*\*-----\*\*

TIME GET	ROLL	PITCH ORDEAL	PITCH INERTIAL	PITCH MNVR
102:46	180	32	272	
103:25	180	165	282	19
103:32	180	180	282	
103:35	180	141	233	49
104:19	180	345	281	175
104:30	180	0	281	
104:52	180	162	11	90
105:27	180	165	276	
105:32	180	171	276	
105:37	180	164	249	27
106:00	180	155	178	
106:03	180	161	178	
106:04	180	154	165	13
106:22	0	223	178	
106:27	0	229	165	
106:34	0	244	165	
106:36	0	229	138	27
107:02	0	174	10	56
107:09	0	189	10	
107:11	0	247	47	37
107:22	0	258	30	
107:24	0	264	30	
107:37	0	287	17	
107:39	0	293	17	
107:40	0	262	341	28
107:52	0	298	341	

10.0 REFERENCES

- 10.1 Mission Requirements, SA-505/CSM-106/LM-4, "F" Type Mission, Lunar Orbit; dated 11 February 1969.
- 10.2 Alexander, J.D.; Moore, R.H.; Currently Proposed LM-Active Phase of Mission F; Memo No. 68-FM64-333; dated 15 November 1968. (Updated as per conversations with R. H. Moore and review of an unofficial trajectory print-out on 17 January 1969.)
- 10.3 Shreffler, J.H.; On the Efficacious Utilization of VHF Range Data When Sextant Marking is Interrupted; Memo No. 68-FM46-482, dated 19 December 1968.
- 10.4 Puschinsky, R.W. and Lewis, D.W.; CSM Rendezvous "D" Mission, Final, dated 16 December 1968.
- 10.5 Guidance System Operations Plan for Manned CM Earth Orbital and Lunar Missions Using Program COLOSSUS II Section Four, GNCS Operational Modes, Revision 7, dated March 1969.
- 10.6 Pippert, E.B., Apollo AS-505/106/LM-4 Reference Flight Plan, dated 22 November 1968.
- 10.7 Apollo Operations Handbook Command and Service Modules - Volume II, Operational Procedures, dated 2 December 1968.
- 10.8 Paddock, S.G. and Mosel, D.K.; CSM Rendezvous Procedures F Mission, Preliminary Copy; dated 23 January 1969.
- 10.9 McRae, M.J., Otto, R., Puschinsky R.W.; CSM Rendezvous Procedures D Mission, Final Revision A; dated 1 February 1969.
- 10.10 Paddock, S.G.; MDAC Apollo Design Note No. 85, "Procedures for CSM Backup of a LM Active Catch-up Maneuver During Mission D Rendezvous"; dated 17 May 1968.

- 10.11 Paddock, S.G.; MDAC Apollo Design Note No. 86, "TPI - Iteration Logic for Design and Off Design Approach Orbits"; dated 20 May 1968.
- 10.12 Dugge, P.M.; MDAC Apollo Design Note No. 101, "W-Matrix Initialization Schedules for Mission D, Assuming 1000;1 W-Matrix"; dated 16 August 1968.
- 10.13 Alexander, J.D. and DuPont, A.L.; Preliminary LM Abort and Rescue Procedures for Apollo Mission F - Volume I, Nontime-Critical Procedures; MSC Internal Note No. 69-FM-34, dated 11 February 1969.
- 10.14 Tindall, H. W.; Apollo Mission Techniques Mission F and G Lunar Orbit Activities - Volume I, Techniques Descriptions, MSC Internal Note No. S-PA-9T-044, dated 28 February 1969.
- 10.15 Collins, M.A.; Preliminary Apollo 10 (F) Mission Operational Trajectory Simulator Data Package; Memo No. 69-FM13-45; dated 30 January 1969.
- 10.16 Shreffler, J.; Onboard Tracking Schedules for Missions F and G; Memo No. 69-FM46-29, dated 7 February 1969.
- 10.17 Hutchins, J.E. and Axford, J.C.; AS-504/CSM-105/LM-4, LM Rendezvous Procedures F Mission; dated 28 January 1969.
- 10.18 Collins, M.A.; Update to Preliminary Apollo 10 (F) Mission Operational Trajectory Simulator Data Package; Memo No. 69-FM13-73; dated 11 February 1969.
- 10.19 Guidance Navigation and Control Command Module Functional Description and Operations Using Flight Program COLOSSUS IA-Volume II, Normal Procedures; dated January 1969.

- 10.20 Pixley, P. T.; F Rendezvous Navigation Mission  
Techniques Panel Meeting; MSC Memorandum 69-FM46-107;  
dated 10 April 1969.
- 10.21 Final Flight Mission Rules, Apollo 10 (AS-505/CSM-106/LM-4);  
dated 15 April 1969.
- 10.22 Fudurich, R.; MDAC Apollo Design Note No. 108, "Mission  
F Nominal Reference Trajectory;" dated 23 April 1969.