

NATIONAL AERONAUTICS AND SPACE ADMINISTRATION

GEMINI PROGRAM MISSION REPORT

GEMINI X

(U)

CILITY FORM 61

(ACCESSION NUMBER) _____
6177
(PAGES)

(THRU) _____
(CODE) _____

CLASSIFICATION CHANGE

To UNCLASSIFIED

By authority of _____ Date _____
Changed by _____
Classified Document Master Control Station, NASA
Scientific and Technical Information Facility

GROUP 1
DOWNGRADED
AT 5 YEAR INTERVALS
DECLASSIFIED
AFTER 10 YEARS

REPRODUCED BY
NATIONAL TECHNICAL
INFORMATION SERVICE
U.S. DEPARTMENT OF COMMERCE
SPRINGFIELD, VA. 22161

(NASA-TM-X-60402) GEMINI PROGRAM MISSION
REPORT, GEMINI 10 (NASA) 617 p

N75-73892

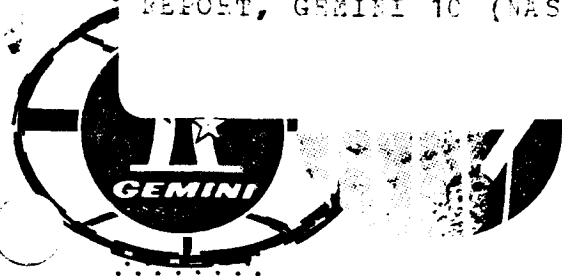

MANAGED SPACECRAFT CENTER
HOUSTON, TEXAS

AUGUST 1966

Inclas
00/98 20358

GEMINI FLIGHT HISTORY			
Mission	Description	Launch date	Major accomplishments
Gemini I	Unmanned 64 orbits	Apr. 8, 1964	Demonstrated structural integrity. Demonstrated launch vehicle systems performance.
Gemini II	Unmanned suborbital	Jan. 19, 1965	Demonstrated spacecraft systems performance.
Gemini III	Manned 3 orbits	Mar. 23, 1965	Demonstrated manned qualification of the Gemini spacecraft.
Gemini IV	Manned 4 days	June 3, 1965	Demonstrated spacecraft systems performance and crew capability for 4 days in space. Demonstrated EVA.
Gemini V	Manned 8 days	Aug. 21, 1965	Demonstrated long-duration flight. Demonstrated rendezvous radar capability and rendezvous maneuvers.
Gemini VI	Manned 2 days rendezvous (canceled after failure of GATV)	Oct. 25, 1965	Demonstrated dual countdown procedures (GAATV and GLV-spacecraft), flight performance of TLV and flight readiness of the GATV secondary propulsion system. Mission canceled after GATV failed to achieve orbit.
Gemini VII	Manned 14 days	Dec. 4, 1965	Demonstrated 2-week duration flight and station keeping with GLV Stage II, evaluated "shirt sleeve" environment, acted as the rendezvous target for Spacecraft 6, and demonstrated controlled reentry to within 7 miles of planned landing point.
Gemini VI-A	Manned 1 day rendezvous	Dec. 15, 1965	Demonstrated on-time launch procedures, closed-loop rendezvous capability, and station keeping technique with Spacecraft 7.

(Continued inside back cover)

UNCLASSIFIED

i-a

GEMINI PROGRAM MISSION REPORT

GEMINI X

Prepared by: Gemini Mission Evaluation Team

Approved by:



Charles W. Mathews
Manager, Gemini Program



George M. Low
Deputy Director

NATIONAL AERONAUTICS AND SPACE ADMINISTRATION

MANNED SPACECRAFT CENTER

HOUSTON, TEXAS

UNCLASSIFIED

UNCLASSIFIED

NASA-S-66-8072 AUG

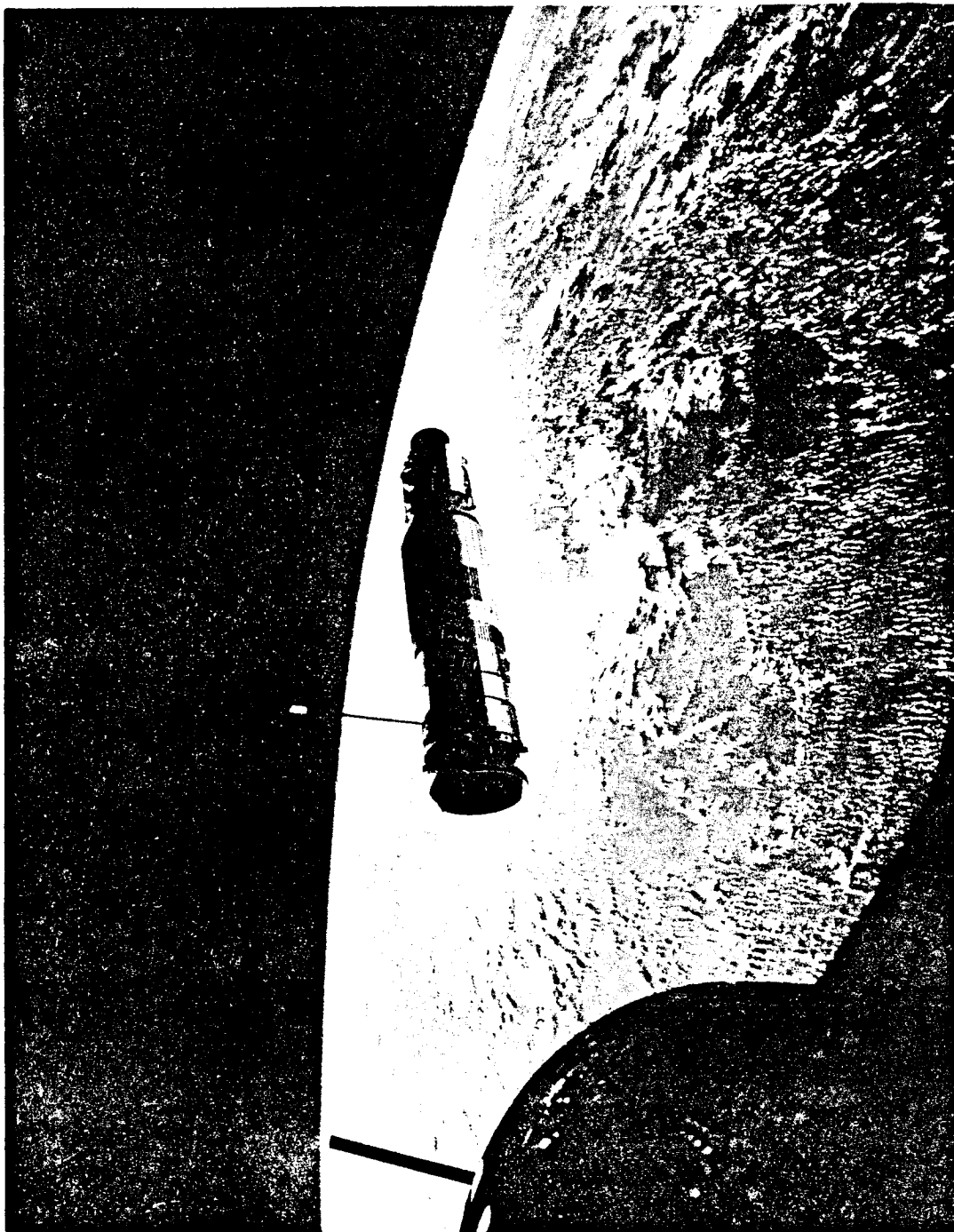

Gemini X GATV as viewed through the window of Spacecraft 10.

UNCLASSIFIED

UNCLASSIFIED

iii

CONTENTS

Section		Page
	TABLES	xix
	FIGURES	xxiii
1.0	<u>MISSION SUMMARY</u>	1-1
2.0	<u>INTRODUCTION</u>	2-1
3.0	<u>VEHICLE DESCRIPTION</u>	3-1
3.1	GEMINI SPACECRAFT	3-7
3.1.1	Spacecraft Structure	3-7
3.1.2	Major Systems	3-8
3.1.2.1	Communication System	3-8
3.1.2.2	Instrumentation and Recording System	3-8
3.1.2.3	Environmental Control System	3-9
3.1.2.4	Guidance and Control System	3-9
3.1.2.5	Time Reference System	3-9
3.1.2.6	Electrical System	3-9
3.1.2.7	Propulsion System	3-10
3.1.2.8	Pyrotechnic System	3-10
3.1.2.9	Crew-station furnishings and equipment	3-10
3.1.2.10	Landing System	3-12
3.1.2.11	Postlanding and Recovery System	3-12
3.1.2.12	Extravehicular equipment.	3-12
3.2	GEMINI LAUNCH VEHICLE	3-30
3.3	GEMINI SPACE VEHICLE WEIGHT AND BALANCE DATA	3-30
3.4	GEMINI AGENA TARGET VEHICLE	3-32
3.4.1	Structure	3-33

UNCLASSIFIED

UNCLASSIFIED

Section		Page
	3.4.1.1 Gemini Agena Target Vehicle	3-33
	3.4.1.2 Target Docking Adapter	3-33
	3.4.2 Major Systems	3-34
	3.4.2.1 Propulsion System	3-34
	3.4.2.2 Electrical System	3-34
	3.4.2.3 Guidance and Control System	3-34
	3.4.2.4 Communications and Command System	3-34
	3.4.2.5 Range Safety System	3-35
3.5	TARGET LAUNCH VEHICLE	3-35
	3.5.1 Structure	3-36
	3.5.2 Major Systems	3-36
	3.5.2.1 Propulsion System	3-36
	3.5.2.2 Guidance System	3-36
	3.5.2.3 Flight Control System	3-36
	3.5.2.4 Electrical System	3-37
	3.5.2.5 Pneumatic System	3-37
	3.5.2.6 Instrumentation System	3-37
	3.5.2.7 Range Safety	3-37
3.6	GEMINI ATLAS-AGENA TARGET VEHICLE WEIGHT AND BALANCE DATA	3-37
4.0	<u>MISSION DESCRIPTION</u>	4-1
	4.1 ACTUAL MISSION	4-1
	4.2 SEQUENCE OF EVENTS	4-3
	4.3 FLIGHT TRAJECTORIES	4-3
	4.3.1 Gemini Spacecraft	4-4
	4.3.1.1 Launch	4-4
	4.3.1.2 Orbit	4-5
	4.3.1.3 Reentry	4-9

UNCLASSIFIED

UNCLASSIFIED

v

Section		Page
	4.3.2 Gemini Atlas-Agena Target Vehicle	4-9
	4.3.2.1 Launch	4-9
	4.3.2.2 Orbit	4-10
	4.3.3 Gemini Launch Vehicle Second Stage. . .	4-11
5.0	<u>VEHICLE PERFORMANCE</u>	5-1
5.1	SPACECRAFT PERFORMANCE	5-1
5.1.1	Structure	5-1
	5.1.1.1 Handrail and recovery antenna anomalies	5-1
	5.1.1.2 Spacecraft 10/GATV dynamic response	5-2
	5.1.1.3 Reentry aerodynamics and heating	5-3
5.1.2	Communications System	5-3
	5.1.2.1 UHF voice communications. . .	5-3
	5.1.2.2 HF voice communications . . .	5-3
	5.1.2.3 Radar transponders	5-3
	5.1.2.4 Digital Command System . . .	5-4
	5.1.2.5 Telemetry transmitters . . .	5-4
	5.1.2.6 Antenna systems	5-4
	5.1.2.7 Recovery aids	5-4
5.1.3	Instrumentation and Recording System	5-4
	5.1.3.1 Umbilical EVA resets	5-5
	5.1.3.2 System performance	5-5
	5.1.3.3 Delayed-time data quality	5-5
	5.1.3.4 Real-time data quality	5-5
5.1.4	Environmental Control System	5-8
	5.1.4.1 Coolant temperature control valve	5-8
	5.1.4.2 Eye irritation	5-9

UNCLASSIFIED

UNCLASSIFIED

Section		Page
5.1.5	Guidance and Control System	5-10
	5.1.5.1 Summary	5-10
	5.1.5.2 Inertial Guidance System performance evaluation. . .	5-10
	5.1.5.3 Control system performance evaluation	5-29
5.1.6	Time Reference System	5-86
5.1.7	Electrical System	5-86
	5.1.7.1 Silver-zinc batteries	5-86
	5.1.7.2 Fuel-cell power system . . .	5-86
	5.1.7.3 Reactant supply system . . .	5-87
	5.1.7.4 Power distribution system	5-87
	5.1.7.5 Sequential system	5-88
5.1.8	Spacecraft Propulsion System	5-93
5.1.9	Pyrotechnics	5-96
5.1.10	Crew Station Furnishings and Equipment	5-96
	5.1.10.1 Crew station design and layout	5-96
	5.1.10.2 Pilots' operational equipment	5-97
	5.1.10.3 Pilots' personal equipment	5-99
	5.1.10.4 Space suits and accessories	5-99
	5.1.10.5 Extravehicular equipment. . .	5-101
	5.1.10.6 Bioinstrumentation	5-104
5.1.11	Landing System	5-107
5.1.12	Postlanding	5-113
5.2	GEMINI LAUNCH VEHICLE PERFORMANCE	5-115
5.2.1	Airframe	5-115

UNCLASSIFIED

Section	Page
5.2.1.1	Structural loads 5-115
5.2.1.2	Longitudinal oscillation (POGO) 5-116
5.2.1.3	Post-SECO disturbance 5-116
5.2.1.4	Post-staging event 5-116
5.2.2	Propulsion 5-117
5.2.2.1	Engines 5-117
5.2.2.2	Propellants 5-118
5.2.2.3	Pressurization 5-118
5.2.3	Flight Control System 5-119
5.2.3.1	Stage I flight 5-119
5.2.3.2	Staging sequence 5-121
5.2.3.3	Stage II flight 5-121
5.2.3.4	Post-SECO and separation phase 5-121
5.2.4	Hydraulic System 5-122
5.2.5	Guidance System 5-122
5.2.5.1	Programmed guidance 5-122
5.2.5.2	Radio guidance 5-123
5.2.6	Electrical 5-124
5.2.7	Instrumentation 5-125
5.2.7.1	Ground 5-125
5.2.7.2	Airborne 5-125
5.2.8	Malfunction Detection System 5-125
5.2.8.1	Engine MDS 5-125
5.2.8.2	Airframe MDS 5-126
5.2.8.3	Tank pressure indicators 5-126
5.2.9	Range Safety and Ordnance Systems 5-126
5.2.9.1	Flight Termination System 5-126

UNCLASSIFIED

Section	Page
5.2.9.2	Range safety tracking system 5-126
5.2.9.3	Ordnance 5-126
5.2.10	Prelaunch Operations 5-127
5.3	SPACECRAFT/GEMINI LAUNCH VEHICLE INTERFACE PERFORMANCE 5-137
5.4	GEMINI AGENA TARGET VEHICLE PERFORMANCE 5-139
5.4.1	Airframe 5-140
5.4.1.1	Launch phase 5-140
5.4.1.2	Separation 5-140
5.4.1.3	Ascent maneuver 5-140
5.4.1.4	Docking phase 5-141
5.4.1.5	Orbital phase 5-141
5.4.2	Propulsion 5-141
5.4.2.1	Primary propulsion system 5-142
5.4.2.2	Secondary propulsion system 5-143
5.4.3	Communications and Command System 5-143
5.4.3.1	Command system 5-143
5.4.3.2	Tracking system 5-143
5.4.3.3	Telemetry system 5-143
5.4.4	Hydraulic and Pneumatic Systems 5-144
5.4.4.1	Hydraulic System 5-144
5.4.4.2	Pneumatics 5-144
5.4.4.3	Attitude control system 5-144
5.4.5	Guidance and Control System 5-144
5.4.5.1	Ascent guidance sequence 5-145
5.4.5.2	Orbit guidance sequence 5-146

UNCLASSIFIED

Section		Page
5.4.6	Electrical System	5-148
5.4.6.1	Main bus voltage	5-148
5.4.6.2	Main bus current	5-148
5.4.6.3	Pyro bus voltage	5-149
5.4.7	Instrumentation System	5-149
5.4.8	Range Safety	5-150
5.4.8.1	Flight termination system	5-150
5.4.8.2	Tracking system	5-150
5.5	TARGET LAUNCH VEHICLE PERFORMANCE	5-167
5.5.1	Airframe	5-167
5.5.2	Propulsion System	5-168
5.5.2.1	Propulsion System	5-168
5.5.2.2	Propellant utilization	5-170
5.5.2.3	Propellant loading	5-170
5.5.3	Flight Control System	5-170
5.5.4	Pneumatic and Hydraulic Systems	5-172
5.5.4.1	Pneumatic System	5-172
5.5.4.2	Hydraulic System	5-172
5.5.5	Guidance System	5-173
5.5.5.1	Programmed guidance	5-173
5.5.5.2	Radio guidance system	5-173
5.5.6	Electrical System	5-174
5.5.7	Instrumentation System	5-174
5.5.7.1	Telemetry	5-174
5.5.7.2	Landline	5-175
5.5.8	Range Safety System	5-175

UNCLASSIFIED

Section	Page
5.6 GATV/TLV INTERFACE PERFORMANCE	5-177
5.7 GEMINI SPACECRAFT/GATV INTERFACE PERFORMANCE	5-179
6.0 <u>MISSION SUPPORT PERFORMANCE</u>	6-1
6.1 FLIGHT CONTROL	6-1
6.1.1 Prepermission Operations	6-1
6.1.1.1 Prepermission activities	6-1
6.1.1.2 Documentation	6-2
6.1.1.3 MCC/network flight control operations	6-2
6.1.1.4 Gemini Atlas-Agena Target Vehicle countdown	6-2
6.1.2 Powered Flight	6-2
6.1.2.1 GAATV powered flight	6-2
6.1.2.2 Period between GAATV lift-off and Gemini Space Vehicle lift-off	6-3
6.1.2.3 Final Gemini Space Vehicle countdown	6-4
6.1.2.4 Gemini Space Vehicle powered flight	6-4
6.1.3 Spacecraft Orbital Flight	6-6
6.1.4 Reentry	6-14
6.1.5 Gemini Agena Target Vehicle Orbital Flight	6-15
6.2 NETWORK PERFORMANCE	6-23
6.2.1 MCC and Remote Facilities	6-23
6.2.2 Network Facilities	6-23
6.2.2.1 Telemetry	6-23
6.2.2.2 Computers	6-24

UNCLASSIFIED

UNCLASSIFIED

Section	Page
6.2.2.3 Communications	6-26
6.3 RECOVERY OPERATIONS	6-29
6.3.1 Recovery Force Deployment	6-29
6.3.2 Location and Retrieval	6-30
6.3.3 Recovery Aids	6-32
6.3.3.1 UHF recovery beacon (243.0 mc)	6-32
6.3.3.2 HF transmitter (15.016 mc)	6-32
6.3.3.3 UHF voice transmitter (296.8 mc)	6-32
6.3.3.4 UHF survival radio (243.0 mc)	6-32
6.3.3.5 Flashing light	6-32
6.3.3.6 Fluorescein sea marker	6-33
6.3.3.7 Swimmer interphone	6-33
6.3.4 Postretrieval Procedures	6-33
6.3.5 Reentry Control System Deactivation	6-34
7.0 <u>FLIGHT CREW</u>	7-1
7.1 FLIGHT CREW PERFORMANCE	7-1
7.1.1 Crew Activities	7-1
7.1.1.1 Prelaunch through insertion	7-1
7.1.1.2 Orbit determination and navigation predict operations	7-1
7.1.1.3 First rendezvous	7-3
7.1.1.4 Second rendezvous	7-4
7.1.1.5 Extravehicular activity	7-5
7.1.1.6 Operational checks	7-7
7.1.1.7 Experiments	7-7
7.1.1.8 Retrofire and reentry	7-9

UNCLASSIFIED

Section		Page
	7.1.1.9 Landing and recovery	7-10
	7.1.1.10 Mission training and training evaluation	7-11
7.1.2	Gemini X Pilots' Report	7-23
	7.1.2.1 Prelaunch	7-23
	7.1.2.2 Powered flight	7-23
	7.1.2.3 Insertion	7-23
	7.1.2.4 Orbit navigation sequence	7-23
	7.1.2.5 Rendezvous	7-25
	7.1.2.6 Gemini Agena Target Vehicle operations	7-28
	7.1.2.7 Extravehicular activity . . .	7-31
	7.1.2.8 Experiments	7-35
	7.1.2.9 Reentry	7-37
	7.1.2.10 Landing	7-39
	7.1.2.11 Systems operation	7-39
7.2	AEROMEDICAL	7-45
	7.2.1 Preflight	7-45
	7.2.1.1 General preparations	7-45
	7.2.1.2 Specific preflight preparations	7-45
	7.2.1.3 Medical examinations	7-46
	7.2.1.4 Special data collection . . .	7-46
	7.2.1.5 Precount medical activities	7-46
	7.2.2 Inflight	7-47
	7.2.2.1 Physiological monitoring	7-47
	7.2.2.2 Medical observations	7-47
	7.2.3 Postflight	7-50
	7.2.3.1 Recovery medical activities	7-50
	7.2.3.2 Examinations	7-51
	7.2.3.3 Tilt table studies	7-52
	7.2.3.4 Bicycle ergometer studies	7-52

UNCLASSIFIED

UNCLASSIFIED

xiii

Section		Page
8.0	<u>EXPERIMENTS</u>	8-1
8.1	EXPERIMENT D005 (D-5), STAR OCCULTATION NAVIGATION	8-8
	8.1.1 Objectives	8-8
	8.1.2 Equipment	8-8
	8.1.3 Procedures	8-9
	8.1.4 Results	8-10
	8.1.5 Conclusions	8-11
8.2	EXPERIMENT D010 (D-10), ION-SENSING ATTITUDE CONTROL	8-13
	8.2.1 Objectives	8-13
	8.2.2 Equipment	8-13
	8.2.3 Procedures	8-15
	8.2.4 Results	8-15
8.3	EXPERIMENT M405 (MSC-3), TRI-AXIS MAGNETOMETER	8-20
	8.3.1 Objective	8-20
	8.3.2 Equipment	8-20
	8.3.3 Procedures	8-21
	8.3.4 Results	8-21
8.4	EXPERIMENT M408 (MSC-6), BETA SPECTROMETER	8-23
	8.4.1 Objective	8-23
	8.4.2 Equipment	8-23
	8.4.3 Procedures	8-23

UNCLASSIFIED

UNCLASSIFIED

Section		Page
	8.4.4 Results	8-24
	8.4.5 Conclusions	8-25
8.5	EXPERIMENT M409 (MSC-7), BREMSSTRAHLUNG SPECTROMETER	8-27
	8.5.1 Objective	8-27
	8.5.2 Equipment	8-27
	8.5.3 Procedures	8-29
	8.5.4 Results	8-29
8.6	EXPERIMENT M410 (MSC-8), COLOR PATCH PHOTOGRAPHY	8-31
	8.6.1 Objective	8-31
	8.6.2 Equipment	8-31
	8.6.3 Flight Procedure	8-32
	8.6.4 Results	8-32
	8.6.5 Conclusion	8-33
8.7	EXPERIMENT M412 (MSC-12), LANDMARK CONTRAST MEASUREMENTS	8-35
	8.7.1 Objective	8-35
	8.7.2 Description	8-35
	8.7.3 Equipment	8-36
	8.7.4 Procedures	8-37
	8.7.5 Results	8-37
8.8	EXPERIMENT SO01 (S-1), ZODIACAL LIGHT PHOTOGRAPHY	8-38
	8.8.1 Objective	8-38

UNCLASSIFIED

UNCLASSIFIED

Section		Page
	8.8.2 Equipment	8-38
	8.8.3 Procedures	8-38
	8.8.4 Results	8-39
	8.8.5 Conclusions	8-40
8.9	EXPERIMENT S005 (S-5), SYNOPTIC TERRAIN PHOTOGRAPHY	8-41
	8.9.1 Objective	8-41
	8.9.2 Equipment	8-41
	8.9.3 Procedures	8-41
	8.9.4 Results	8-41
	8.9.5 Conclusions	8-42
8.10	EXPERIMENT S006 (S-6), SYNOPTIC WEATHER PHOTOGRAPHY	8-48
	8.10.1 Objective	8-48
	8.10.2 Equipment	8-48
	8.10.3 Procedures	8-48
	8.10.4 Results	8-48
	8.10.5 Conclusions	8-49
8.11	EXPERIMENT S010 (S-10), AGENA MICROMETEORITE COLLECTION	8-54
	8.11.1 Objective	8-54
	8.11.2 Description	8-54
	8.11.3 Equipment	8-54
	8.11.4 Procedures	8-55
	8.11.5 Results and Conclusions	8-55

UNCLASSIFIED

UNCLASSIFIED

Section		Page
8.12	EXPERIMENT S012 (S-12), MICROMETEORITE COLLECTION	8-59
8.12.1	Objectives	8-59
8.12.2	Equipment	8-59
8.12.3	Procedures	8-59
8.12.4	Results	8-60
8.13	EXPERIMENT S013 (S-13), ULTRAVIOLET ASTRONOMICAL CAMERA	8-62
8.13.1	Objective	8-62
8.13.2	Description	8-62
8.13.3	Equipment	8-62
8.13.4	Procedures	8-62
8.13.5	Results	8-63
8.13.6	Conclusions	8-64
8.14	EXPERIMENT S026 (S-26), ION-WAKE MEASUREMENT	8-70
8.14.1	Objectives	8-70
8.14.2	Description	8-70
8.14.3	Equipment	8-71
8.14.4	Procedures	8-72
8.14.5	Results	8-72
8.14.6	Conclusions	8-73
9.0	<u>CONCLUSIONS</u>	9-1
10.0	<u>RECOMMENDATIONS</u>	10-1

UNCLASSIFIED

xvii

Section		Page
11.0	<u>REFERENCES</u>	11-1
12.0	<u>APPENDIX</u>	12-1
12.1	VEHICLE HISTORIES	12-1
	12.1.1 Spacecraft Histories	12-1
	12.1.2 Gemini Launch Vehicle Histories	12-1
	12.1.3 Gemini Agena Target Vehicle and Target Docking Adapter Histories	12-1
	12.1.4 Target Launch Vehicle History	12-1
	12.1.5 Extravehicular Life Support System History	12-2
12.2	WEATHER CONDITIONS	12-4
12.3	FLIGHT SAFETY REVIEWS	12-24
	12.3.1 Spacecraft Flight Readiness Review	12-24
	12.3.2 Gemini Design Certification Review	12-25
	12.3.3 Gemini Launch Vehicle Technical and Preflight Reviews	12-25
	12.3.4 Gemini Atlas-Agena Target Vehicle Technical and Preflight Reviews	12-26
	12.3.5 Mission Briefing	12-26
	12.3.6 Launch Vehicles Flight Safety Review Board	12-26
12.4	SUPPLEMENTAL REPORTS	12-27
12.5	DATA AVAILABILITY	12-29

UNCLASSIFIED

UNCLASSIFIED

Section	Page
12.6 POSTFLIGHT INSPECTION	12-40
12.6.1 Spacecraft Systems	12-40
12.6.1.1 Structure	12-40
12.6.1.2 Environmental Control System	12-41
12.6.1.3 Communications System	12-41
12.6.1.4 Guidance and Control System	12-42
12.6.1.5 Pyrotechnic System	12-42
12.6.1.6 Instrumentation and Recording System	12-42
12.6.1.7 Electrical System	12-43
12.6.1.8 Crew-station furnishings and equipment	12-44
12.6.1.9 Propulsion System	12-45
12.6.1.10 Postlanding recovery aids	12-45
12.6.1.11 Experiments	12-46
12.6.2 Continuing Evaluation	12-46

UNCLASSIFIED

UNCLASSIFIED

xix

TABLES

Table		Page
3.1-I	SPACECRAFT 10 MODIFICATIONS	3-15
3.1-II	CREW-STATION STOWAGE LIST	3-18
4-I	SEQUENCE OF EVENTS FOR GEMINI SPACE VEHICLE LAUNCH PHASE	4-12
4-II	SEQUENCE OF EVENTS FOR GEMINI SPACECRAFT ORBITAL AND REENTRY PHASES	4-13
4-III	SEQUENCE OF EVENTS FOR GAATV LAUNCH PHASE	4-14
4-IV	SEQUENCE OF EVENTS FOR GATV ORBITAL PHASE	4-15
4-V	PLANNED AND ACTUAL GEMINI LAUNCH VEHICLE AND SPACECRAFT TRAJECTORY PARAMETERS	4-16
4-VI	SPACECRAFT ORBITAL ELEMENTS	4-18
4-VII	SPACECRAFT ORBITAL ELEMENTS BEFORE AND AFTER MANEUVERS	4-20
4-VIII	RENDEZVOUS MANEUVERS	4-23
4-IX	PLANNED AND ACTUAL TLV AND GATV TRAJECTORY PARAMETERS	4-30
4-X	PLANNED AND ACTUAL GAATV CUTOFF AND GATV INSERTION CONDITIONS	4-32
4-XI	GATV MANEUVERS AFTER SPACECRAFT LANDING	4-33
4-XII	COMPARISON OF GEMINI X GATV ORBITAL ELEMENTS	4-34
5.1.3-I	DELAYED-TIME DATA FROM SELECTED STATIONS	5-6
5.1.5-I	SPACECRAFT GUIDANCE AND CONTROL SUMMARY CHART.	5-31
5.1.5-II	ORBIT INJECTION PARAMETERS AT AT SECO + 20 SECONDS	5-36
5.1.5-III	ASCENT IGS AND TRACKING SYSTEMS ERRORS	5-37

UNCLASSIFIED

UNCLASSIFIED

Table	Page
5.1.5-IV	GUIDANCE ERRORS AT SECO + 20 SECONDS 5-39
5.1.5-V	MANEUVER SUMMARY 5-40
5.1.5-VI	ORBIT DETERMINATION STAR SIGHTINGS 5-41
5.1.5-VII	ORBIT DETERMINATION SEXTANT MEASUREMENT EFFECTIVENESS 5-42
5.1.5-VIII	FIRST RENDEZVOUS MANEUVERS 5-43
5.1.5-IX	SIMULATED MANEUVER COMMANDS - IVI COORDINATES. . . 5-44
5.1.5-X	SIMULATED MANEUVER COMMANDS - NAVIGATIONAL COORDINATES 5-45
5.1.5-XI	COMPUTER PROGRAM CONFIGURATION 5-46
5.1.5-XII	TRANSLATIONAL MANEUVERS 5-47
5.1.5-XIII	IVI SERVICING CYCLE COMPARISON 5-49
5.1.5-XIV	PLATFORM ALIGNMENT ACCURACY 5-50
5.1.5-XV	DUAL RENDEZVOUS MANEUVERS 5-51
5.1.5-XVI	COMPARISON OF COMPUTER TELEMETRY REENTRY PARAMETERS WITH POSTFLIGHT RECONSTRUCTION . . . 5-52
5.1.5-XVII	COMPARISON OF RADAR AND IGS REENTRY DATA
	(a) Trajectories 5-53
	(b) Contributors to IGS-BET difference at guidance termination 5-53
5.1.5-XVIII	SHIFT IN PROJECTED FOOTPRINT DUE TO RETROFIRE. . . 5-54
5.2-I	STAGE I ENGINE PERFORMANCE 5-128
5.2-II	STAGE II ENGINE PERFORMANCE 5-129
5.2-III	GEMINI LAUNCH VEHICLE STAGE I PROPELLANT OUTAGES 5-130

UNCLASSIFIED

UNCLASSIFIED

xxi

Table		Page
5.2-IV	STAGE I ULLAGE PRESSURE	5-131
5.2-V	STAGE II ULLAGE PRESSURE	5-131
5.2-VI	VEHICLE RATES BETWEEN SECO AND SPACECRAFT SEPARATION	5-132
5.2-VII	MALFUNCTION DETECTION SYSTEM SWITCHOVER PARAMETERS	5-133
5.4-I	PRIMARY PROPULSION SYSTEM START TRANSIENTS DATA	5-151
5.4-II	PPS NORMAL TRANSIENT EVENTS	5-152
5.4-III	SPS UNIT I PERFORMANCE	5-153
5.4-IV	SPS UNIT II PERFORMANCE	5-154
5.4-V	ASCENT SEQUENCE OF EVENTS	5-155
5.4-VI	HORIZON SENSOR TO INERTIAL REFERENCE PACKAGE GAINS	5-156
5.4-VII	GUIDANCE AND CONTROL SYSTEM PERFORMANCE	5-157
6.1-I	GATV PROPULSION SYSTEM DATA (a) PPS (b) SPS Unit II	 6-21 6-22
6.2-I	GEMINI X NETWORK CONFIGURATION	6-28
6.3-I	RECOVERY SUPPORT	6-36
7.1.1-I	COMPARISON OF SOLUTIONS FOR FIRST RENDEZVOUS MANEUVERS	7-12
7.1.1-II	SUMMARY OF SOLUTIONS FOR SECOND RENDEZVOUS MANEUVERS	7-13
7.1.1-III	CREW TRAINING SUMMARY	7-14

UNCLASSIFIED

UNCLASSIFIED

Table		Page
7.2-I	HEMATOLOGY	
	(a) Command pilot	7-53
	(b) Pilot	7-55
7.2-II	URINALYSIS	
	(a) Command pilot	7-57
	(b) Pilot	7-58
7.2-III	LAUNCH DAY ACTIVITIES, JULY 18, 1966	7-60
8.0-I	EXPERIMENTS ON GEMINI X	8-2
8.0-II	FINAL EXPERIMENT FLIGHT PLAN FOR GEMINI X	8-4
8.13-I	EXPERIMENT SOL3 INFLIGHT EXPOSURES	8-66
12.2-I	LAUNCH AREA ATMOSPHERIC CONDITIONS FOR THE GEMINI ATLAS-AGENA TARGET VEHICLE AT 20:39 G.m.t., JULY 18, 1966	12-16
12.2-II	LAUNCH AREA ATMOSPHERIC CONDITIONS FOR THE GEMINI SPACE VEHICLE AT 22:20 G.m.t., JULY 18, 1966	12-17
12.2-III	REENTRY AREA ATMOSPHERIC CONDITIONS AT 21:07 G.m.t., JULY 21, 1966	12-19
12.4-I	GEMINI X SUPPLEMENTAL REPORTS	12-28
12.5-I	INSTRUMENTATION	12-30
12.5-II	SUMMARY OF PHOTOGRAPHIC DATA AVAILABILITY	12-32
12.5-III	LAUNCH PHASE ENGINEERING SEQUENTIAL CAMERA DATA AVAILABILITY	
	(a) Spacecraft and GLV	12-33
	(b) TLV and GATV	12-35
12.5-IV	SUMMARY OF DATA AVAILABILITY ON GEMINI X GATV	12-37

UNCLASSIFIED

FIGURES

Figure		Page
3.0-1	GLV/spacecraft relationships	
	(a) Launch configuration	3-2
	(b) Dimensional axes and guidance coordinates	3-3
3.0-2	TLV/GATV relationship	
	(a) Launch configuration	3-4
	(b) Dimensional axes and guidance coordinates, GATV-TDA	3-5
	(c) Dimensional axes and guidance coordinates, TLV	3-6
3.1-1	Spacecraft arrangement and nomenclature	3-22
3.1-2	Electrical system	3-23
3.1-3	Orbital Attitude and Maneuver System	3-24
3.1-4	Orbital Attitude and Maneuver System schematic	3-25
3.1-5	Spacecraft controls and displays	3-27
3.1-6	Spacecraft interior stowage areas	
	(a) View looking into command pilot's side	3-28
	(b) View looking into pilot's side	3-29
4-1	Planned and actual Gemini X mission with planned alternates included	4-35
4-2	Ground track for the Gemini X orbital mission	
	(a) Revolutions 1 through 4	4-36
	(b) Revolutions 28 through 30	4-37
	(c) Reentry	4-38

UNCLASSIFIED

Figure		Page
4-3	Trajectory parameters for GLV/spacecraft launch phase	
	(a) Altitude and range	4-39
	(b) Space-fixed velocity and flight-path angle	4-40
	(c) Earth-fixed velocity and flight-path angle	4-41
	(d) Dynamic pressure and Mach number	4-42
	(e) Longitudinal acceleration	4-43
4-4	Apogee and perigee altitudes of Spacecraft 10 . . .	4-44
4-5	First (M=4) rendezvous during the Gemini X mission	
	(a) Relative range, azimuth, and elevation from Spacecraft 10 to Gemini X GATV during midcourse maneuvers	4-45
	(b) Relative range, azimuth, and elevation from Spacecraft 10 to Gemini X GATV during terminal phase maneuvers	4-46
	(c) Relative trajectory profile measured from Gemini X GATV to Spacecraft 10 in curvilinear coordinate system	4-47
	(d) Relative trajectory profile of first rendezvous from TPI to TPF as measured from Gemini X GATV to Spacecraft 10 in curvilinear coordinate system	4-48
4-6	Second (Gemini VIII GATV) rendezvous during the Gemini X mission	
	(a) Relative range, azimuth, and elevation from Spacecraft 10 to Gemini VIII GATV during midcourse maneuvers	4-49
	(b) Relative range, azimuth, and elevation from Spacecraft 10 to Gemini VIII GATV during terminal phase maneuvers	4-50
	(c) Relative trajectory profile of second rendezvous from Gemini VIII GATV to Spacecraft 10 in curvilinear coordinate system	4-51
	(d) Relative trajectory profile of second rendezvous from TPI to TPF as measured from Gemini VIII GATV to Spacecraft 10 in curvilinear coordinate system	4-52

UNCLASSIFIED

UNCLASSIFIED

xxv

Figure		Page
4-7	Trajectory parameters for the Gemini X mission reentry phase	
	(a) Latitude, longitude, and altitude	4-53
	(b) Space-fixed velocity and flight-path angle	4-54
	(c) Earth-fixed velocity and flight-path angle	4-55
	(d) Dynamic pressure and Mach number	4-56
	(e) Longitudinal deceleration	4-57
4-8	Trajectory parameters for the GAATV launch phase	
	(a) Altitude and range	4-58
	(b) Space-fixed velocity and flight-path angle	4-59
	(c) Earth-fixed velocity and flight-path angle	4-60
	(d) Dynamic pressure and Mach number	4-61
	(e) Longitudinal acceleration	4-62
4-9	Apogee and perigee altitudes of Gemini X GATV . . .	4-63
5.1.3-1	Periods of continuous PCM multiplexer resets during the umbilical EVA	5-7
5.1.5-1	Comparisons of launch vehicle and spacecraft steering errors	5-55
5.1.5-2	Spacecraft acceleration measured after SECO	5-56
5.1.5-3	Comparisons of spacecraft IGS and radar tracking velocities	5-57
5.1.5-4	IMU error coefficient history	
	(a) Shift of accelerometer biases and scale factors	5-58
	(b) Shift of gyro mass unbalances and constant drifts	5-59
5.1.5-5	Orbit determination time line	5-60
5.1.5-6	Onboard navigational charts	5-61

UNCLASSIFIED

UNCLASSIFIED

Figure		Page
5.1.5-7	Rendezvous catch-up relative motion comparison	5-62
5.1.5-8	Computer data for the closed-loop rendezvous	5-63
5.1.5-9	Comparison of spacecraft radar-measured azimuth angles with postflight-simulated angles	5-64
5.1.5-10	Comparison of spacecraft radar-measured elevation angles with postflight-simulated angles	5-65
5.1.5-11	First rendezvous out-of-plane position history	5-66
5.1.5-12	Braking maneuver - first rendezvous (a) 5:01:00 to 5:08:30 g.e.t. (b) 5:08:30 to 5:16:00 g.e.t.	5-68 5-69
5.1.5-13	First rendezvous simulations, no platform misalignment	5-70
5.1.5-14	First rendezvous simulations, with fixed platform misalignment	5-71
5.1.5-15	First rendezvous final approach	5-72
5.1.5-16	First rendezvous final approach (expanded scale)	5-73
5.1.5-17	Module III functional block diagram	5-74
5.1.5-18	Module VI functional block diagram	5-75
5.1.5-19	Vernier correction comparison	5-76
5.1.5-20	Velocity changes during N_{CH2} PPS maneuver	5-77
5.1.5-21	Platform alignment prior to TPI of the first rendezvous (a) 3:57:00 to 4:05:00 g.e.t. (b) 4:05:00 to 4:13:00 g.e.t.	5-78 5-79

UNCLASSIFIED

UNCLASSIFIED

xxvii

Figure		Page
5.1.5-22	Braking maneuvers during second rendezvous	
	(a) 47:43:30 to 47:51:30 g.e.t.	5-80
	(b) 47:51:30 to 47:59:30 g.e.t.	5-81
5.1.5-23	Touchdown comparisons	5-82
5.1.5-24	Reentry guidance parameters	5-83
5.1.5-25	Reentry Control System performance	
	(a) 70:32:40 to 70:37:10 g.e.t.	5-84
	(b) 70:37:10 to 70:41:40 g.e.t.	5-85
5.1.7-1	Spacecraft 10 fuel-cell performance	5-89
5.1.7-2	Fuel-cell section 1 and 2 performance (uncorrected for temperature and pressure)	5-90
5.1.7-3	Load sharing between fuel-cell sections	5-91
5.1.7-4	Load sharing between fuel-cell stacks	5-92
5.1.8-1	OAMS propellant consumption	
	(a) 0 to 35 hours g.e.t.	5-94
	(b) 35 to 70 hours g.e.t.	5-95
5.1.10-1	EVA events	
	(a) Standup	5-105
	(b) Umbilical	5-106
5.1.11-1	Landing system performance	5-110
5.1.11-2	Spacecraft pitch and yaw gimbal angles during landing maneuver	5-111
5.1.11-3	Spacecraft roll gimbal angles during landing maneuver	5-112
5.2.2-1	Stage I engine performance	5-134
5.2.2-2	Stage II engine performance	5-135

UNCLASSIFIED

UNCLASSIFIED

Figure		Page
5.4-1	PPS performance transients during ascent maneuver	5-158
5.4-2	SPS unit II performance (3rd docked SPS firing)	5-159
5.4-3	Ascent guidance performance	
	(a) Pitch axis	5-160
	(b) Yaw axis	5-161
	(c) Roll axis	5-162
5.4-4	Guidance performance during PPS docked height-adjust maneuver	
	(a) Pitch axis	5-163
	(b) Yaw axis	5-164
	(c) Roll axis	5-165
5.4-5	GATV attitude control gas usage	5-166
5.7-1	Electrostatic charge monitor functional diagram	5-181
5.7-2	Charge on capacitor C_1	
	(a) Lift-off to 13 minutes GATV target elapsed time	5-182
	(b) 3:06:32 to 3:12:33 spacecraft ground elapsed time	5-183
	(c) 5:40:32 to 5:54:00 spacecraft ground elapsed time	5-184
6.3-1	Launch site landing area recovery force deployment	6-38
6.3-2	Gemini X launch abort areas and recovery ship and aircraft deployment	6-39
6.3-3	Gemini X landing zone location and force deployment	6-40
6.3-4	Contingency recovery force deployment	6-41

UNCLASSIFIED

UNCLASSIFIED

xxix

Figure		Page
6.3-5	Recovery force and network aircraft deployment in primary landing area	6-42
6.3-6	Spacecraft landing information, as determined on the prime recovery ship	6-43
6.3-7	Spacecraft 10 immediately after landing	6-44
7.1.1-1	Summary flight plan	
	(a) 0 to 10 hours g.e.t.	7-15
	(b) 10 to 20 hours g.e.t.	7-16
	(c) 20 to 30 hours g.e.t.	7-17
	(d) 30 to 40 hours g.e.t.	7-18
	(e) 40 to 50 hours g.e.t.	7-19
	(f) 50 to 60 hours g.e.t.	7-20
	(g) 60 to 70 hours g.e.t.	7-21
	(h) 70 to 71 hours g.e.t.	7-22
7.1.2-1	Onboard target-centered coordinate plot of first rendezvous	7-44
7.2-1	Tilt table studies	
	(a) Command pilot	7-62
	(b) Pilot	7-63
7.2-2	Exercise capacity test data	7-64
7.2-3	Exercise studies on the Gemini X pilot	7-65
7.2-4	Physiological measurements	
	(a) Command pilot	7-66
	(b) Pilot	7-67
7.2-5	Physiological data during standup EVA, pilot	7-68
7.2-6	Physiological data during umbilical EVA, pilot	7-69
8.1-1	Experiment D005, star occultation photometer	8-12
8.2-1	Experiment D010, location of equipment	8-17

UNCLASSIFIED

UNCLASSIFIED

Figure		Page
8.2-2	Experiment D010, ion-sensing configuration	8-18
8.2-3	Experiment D010, ion-sensing attitude control electronics system	8-19
8.3-1	Experiment M405, measurement of earth magnetic field in South Atlantic Anomaly	8-22
8.4-1	Experiment M408, beta spectrometer count-rate as a function of spacecraft attitude (South Atlantic Anomaly, revolution 32)	8-26
8.5-1	Experiment M409, bremsstrahlung spectrometer	8-30
8.6-1	Experiment M410, hardware configuration	8-34
8.9-1	Experiment S005, typical synoptic terrain photography	
(a)	Morocco, Spanish Sahara, looking northwest along Uda Um Chemel (center), Gued Dra is on left, Sidi Ifni is beneath clouds on coast	8-43
(b)	Corpus Christi-Brownsville, Texas, areas. Corpus Christi is at extreme top, Padre Island and sand-choked Laguna Madre extend southward along coast. Brownsville and ship channel are just south of large bay (bottom half, center). Laguna Madre in Mexico is at bottom edge	8-44
(c)	Southern end of Taiwan (Formosa) and Bashi Channel, looking south. Taitung on east coast (left, at mouth of long river). Tung Chiang (Kaohsiung) at right center. T'ainan at top center on west coast	8-45
(d)	Western half of Taiwan (Formosa) and Pescadores Islands, looking east. China coast and Haitan Tao Island are at lower left	8-46
(e)	Guyana, Georgetown and Essequibo River looking northwest to the Orinoco River delta with Trinidad in background	8-47

UNCLASSIFIED

UNCLASSIFIED

xxxi

Figure		Page
8.10-1	Experiment S006, a series of four typical synoptic weather photographs	
	(a) Cumulus cloud patterns over northeastern Brazil reflect the location of the underlying Amazon River system. The view is northeast	8-50
	(b) Cumulus cloud lines over the ocean form open polygon-shaped cells	8-51
	(c) A cloud eddy southwest of Gibraltar fits the contour of the Moroccan coastline of Africa	8-52
	(d) Cirrus clouds form a thick overcast north of Sumatra, which appears at the upper right	8-53
8.11-1	Experiment S010, sample collection device	8-56
8.11-2	External surfaces on recovered Experiment S010. . .	8-57
8.11-3	Experiment S010 micrometeorite crater, 400-micron diameter	8-58
8.12-1	Experiment S012, hardware location	8-61
8.13-1	Experiment S013, ultraviolet camera mounting configuration	8-68
8.13-2	Ultraviolet spectra of stars in the Carina-Vela region of the Southern Milky Way	8-69
8.14-1	Experiment S026, configuration on Target Docking Adapter	8-74
8.14-2	Experiment S026, typical ion-wake profile	8-75
8.14-3	Experiment S026, Gemini undocking maneuvers for ion-wake measurements	8-76
12.1-1	Spacecraft 10 test history at contractor facility	12-3
12.1-2	Spacecraft 10 significant problems at contractor facility	12-4

UNCLASSIFIED

UNCLASSIFIED

Figure		Page
12.1-3	Spacecraft 10 history at Cape Kennedy	12-5
12.1-4	Spacecraft 10 significant problems at Cape Kennedy	12-6
12.1-5	GLV-10 history at Denver and Baltimore	12-7
12.1-6	GLV-10 history at Cape Kennedy	12-8
12.1-7	GATV history at contractor facility	12-9
12.1-8	GATV test history and significant problems at Cape Kennedy	12-10
12.1-9	TLV-5305 history at contractor facility	12-11
12.1-10	TLV-5305 history and significant events at Cape Kennedy	12-12
12.1-11	ELSS III test history and significant problems at Cape Kennedy	12-13
12.2-1	Variation of wind direction and velocity with altitude for the GAATV at 20:39 G.m.t., July 18, 1966	12-21
12.2-2	Variation of wind direction and velocity with altitude for the Gemini Space Vehicle at 22:20 G.m.t., July 18, 1966	12-22
12.2-3	Variation of wind direction and velocity with altitude for the Gemini X reentry area at 21:07 G.m.t., July 21, 1966	12-23

UNCLASSIFIED

UNCLASSIFIED

1-1

1.0 MISSION SUMMARY

Gemini X was the eighth manned mission and the fourth rendezvous mission of the Gemini Program. The Gemini Atlas-Agena Target Vehicle was launched from Complex 14, Cape Kennedy, Florida, at 3:39:46 p.m. e.s.t. on July 18, 1966. The Gemini Space Vehicle was launched from Complex 19, Cape Kennedy, Florida, at 5:20:27 p.m. e.s.t. on July 18, 1966, with Astronaut John W. Young as the Command Pilot and Astronaut Michael Collins as the Pilot. The flight was successfully concluded on July 21, 1966, when the spacecraft was landed within sight of the prime recovery ship at 70:46:39 ground elapsed time. The flight crew elected to be retrieved by helicopter and were on the deck of the prime recovery ship approximately 28 minutes after landing.

The primary objective, to rendezvous and dock, was completed. The secondary objectives completed were (1) to rendezvous and dock during the fourth revolution, (2) to use large propulsion systems in space (attempt dual rendezvous using Gemini Agena Target Vehicle primary and secondary propulsion systems), (3) to conduct extravehicular operations, and (4) to conduct systems evaluations. One secondary objective, to conduct experiments, was only partially achieved, in that some experiments could not be completed because of time limitations and a constraint on the use of spacecraft propellants. Also, for the same reasons, a secondary objective to conduct docking practice was not attempted.

The launch of the Gemini Atlas-Agena Target Vehicle was satisfactory. The countdown was completed with no holds, and the Gemini Agena Target Vehicle was placed in a near-circular orbit having an apogee of 162.0 nautical miles and a perigee of 156.6 nautical miles.

The lift-off of the Gemini Space Vehicle occurred approximately 1 hour and 40 minutes after the lift-off of the Gemini Atlas-Agena Target Vehicle. The performance of the Gemini Space Vehicle during the countdown and launch was satisfactory in all respects. The spacecraft was separated from the launch vehicle approximately 30 seconds after second stage engine cutoff, and the Insertion Velocity Adjust Routine of the onboard computer was used to calculate the necessary velocity to add at insertion and/or first apogee in order to achieve the planned orbit. The single required velocity increment, 26 ft/sec at insertion, was applied by the crew and the spacecraft was placed in a very satisfactory orbit. The apogee of the orbit was 145.1 nautical miles, and the perigee was 86.3 nautical miles. These altitudes were only 0.1 of a mile low at apogee and 0.4 of a mile low at perigee, when compared with the planned altitudes. The slant range to the Gemini Agena Target Vehicle was very close to the nominal 1000 nautical miles.

UNCLASSIFIED

UNCLASSIFIED

Beginning at 20 minutes ground elapsed time (start of the first darkness period), the crew started a series of measurements and computations to obtain onboard rendezvous solutions for the phase adjust, plane change, and coelliptic maneuvers. The onboard computer had been programmed to calculate these solutions from the measured ascent vector and target ephemeris data. The computer was also programmed to accept star-sighting data and predict the spacecraft orbit. These data were combined with the target ephemeris to compute solutions for the pretransfer maneuvers for the first rendezvous. In real time, the values obtained directly from the ascent vector solution, as well as from the star-sighting data, were judged to be outside the acceptable limits and the ground-computed solutions were applied by the crew. Postflight analysis has shown that the causes for the dispersions in the ascent solution were a small inaccuracy in the vertical component of the Inertial Guidance System insertion vector and a slight ellipticity in the target vehicle orbit. Postflight analysis has also shown that the pretransfer maneuvers were actually within acceptable limits and that the rendezvous could probably have been achieved using the ascent solution for these maneuvers and the closed-loop onboard-computer solutions for the terminal phase maneuvers.

The crew completed the rendezvous during the fourth revolution, as planned, at 5 hours 23 minutes ground elapsed time and, about 30 minutes later, docked with the Gemini X Agena Target Vehicle.

As a result of a higher-than-predicted propellant usage during the first rendezvous, an alternate flight plan was developed which enabled the mission to be completed with the major portion of the objectives being accomplished. The spacecraft remained docked with the target vehicle for approximately 39 hours. During the docked period, a bending mode test was conducted to determine the dynamics of the docked vehicles. The spacecraft Orbital Attitude and Maneuver System thrusters were used for the test. Standup extravehicular activities were also conducted during the docked phase of the mission. The hatch was opened at 23 hours 24 minutes ground elapsed time and closed at 24 hours 13 minutes ground elapsed time. During this 49-minute period, several photographic experiments were conducted.

The Gemini Agena Target Vehicle propulsion system was used to successfully accomplish six maneuvers of the docked vehicles in preparation for the rendezvous with the passive Gemini VIII Agena Target Vehicle. The primary propulsion system was used for three of the maneuvers and the secondary propulsion system for the other three.

UNCLASSIFIED

UNCLASSIFIED

1-3

At approximately 44 hours 40 minutes ground elapsed time, the spacecraft was separated from the Gemini X Agena Target Vehicle, and the remaining maneuvers for the second rendezvous were made with the spacecraft thrusters. The second rendezvous was completed at 48 hours ground elapsed time. The Gemini VIII Agena Target Vehicle was in a stable attitude and the command pilot was able to maneuver to within a short distance of the target vehicle. The second extravehicular activity, during which a 50-foot umbilical and the Extravehicular Life Support System chestpack were used, was begun at 48 hours 42 minutes ground elapsed time. After making the necessary preparations, the pilot translated to the Gemini Agena Target Vehicle and retrieved the micrometeorite collection package (Experiment S010).

During the extravehicular activity, the command pilot was required to control the spacecraft attitude so that he could see both the pilot and the Gemini Agena Target Vehicle. This procedure required a considerable expenditure of propellant; therefore, the extravehicular activity was terminated after about 38 minutes to conserve propellant for the remaining required maneuvers. The hatch was opened again about an hour later to jettison extraneous equipment in preparation for reentry.

The crew performed a true anomaly adjust maneuver at 51:38:51 ground elapsed time to position retrofire to a true anomaly of 240 degrees. This was done to minimize reentry dispersions as a result of the retrofire maneuver.

After the third sleep period, the crew performed several more experiments and made final preparations for retrofire which occurred at 70:10:25 ground elapsed time. The landing occurred at 70 hours 46 minutes ground elapsed time in the revolution-44 primary landing area within sight of the prime recovery ship. The crew elected to be flown by helicopter to the U.S.S. Guadalcanal and were aboard 28 minutes after landing.

Three maneuvers were performed with the Gemini Agena Target Vehicle after the spacecraft landed. These maneuvers placed the target vehicle in a 190-nautical-mile circular orbit for possible use as a passive target on future missions.

UNCLASSIFIED

1-4

UNCLASSIFIED

THIS PAGE INTENTIONALLY LEFT BLANK

UNCLASSIFIED

2.0 INTRODUCTION

A description of the Gemini X mission and a discussion of the mission results are contained in this report. The report covers the time from the start of the simultaneous countdown of the Gemini Atlas-Agena Target Vehicle and the Gemini Space Vehicle to the date of publication of this report. Detailed discussions are found in the major sections related to each principal area of effort. Some redundancy may be found between the various sections where it is required for a logical presentation of the subject matter.

Data were reduced from telemetry, onboard records, and ground-based radar tracking but were reduced only in areas of importance. The evaluation of all vehicles consisted of analyzing the flight results and comparing those results with results of ground tests and previous missions.

Section 6.1, FLIGHT CONTROL, is based on observations and evaluations made in real time and may not coincide with the results of the postflight analyses.

Brief descriptions of the experiments flown on this mission are presented in section 8.0, and preliminary results and conclusions are included.

The primary objective of the Gemini X mission was to rendezvous and dock.

The secondary objectives were as follows:

- (a) Rendezvous and dock during the fourth revolution (check of onboard navigation)
- (b) Use large propulsion systems in space (attempt dual rendezvous using Gemini Agena Target Vehicle primary and secondary propulsion systems)
- (c) Conduct extravehicular operations
- (d) Conduct docking practice
- (e) Conduct experiments

UNCLASSIFIED

- (f) Conduct systems evaluations
 - (1) Perform bending-mode tests
 - (2) Maneuver docked Spacecraft 10/Gemini Agena Target Vehicle
 - (3) Monitor static discharges
 - (4) Perform post-docked Gemini Agena Target Vehicle maneuvers
 - (5) Demonstrate reentry guidance
 - (6) Maneuver Gemini Agena Target Vehicle into a suitable orbit for possible future use as a passive rendezvous target.

At the time of publication of this report, more detailed analyses on the performance of the launch vehicles and the guidance systems were continuing. Supplemental reports, listed in section 12.4, will be issued to provide documented results of these analyses.

The results of previous Gemini missions are reported in references 1 through 10.

UNCLASSIFIED

UNCLASSIFIED

3-1

3.0 VEHICLE DESCRIPTION

The manned Gemini Space Vehicle for the Gemini X mission consisted of Spacecraft 10 and Gemini Launch Vehicle (GLV) 10. The Gemini Atlas-Agena Target Vehicle (GAATV) consisted of Gemini Agena Target Vehicle (GATV) 5005 and Target Launch Vehicle (TLV) 5305.

The general arrangement and major reference coordinates of the manned Gemini Space Vehicle are shown in figure 3.0-1. Section 3.1 of this report describes the spacecraft configuration, including the Extravehicular Life Support System (ELSS); section 3.2 describes the GLV configuration; and section 3.3 provides the space vehicle weight and balance data. The general arrangement and major reference coordinates of the GAATV are shown in figure 3.0-2. Section 3.4 describes the GATV configuration, including the Target Docking Adapter (TDA); section 3.5 describes the TLV configuration; and section 3.6 provides the weight and balance data of the GAATV.

UNCLASSIFIED

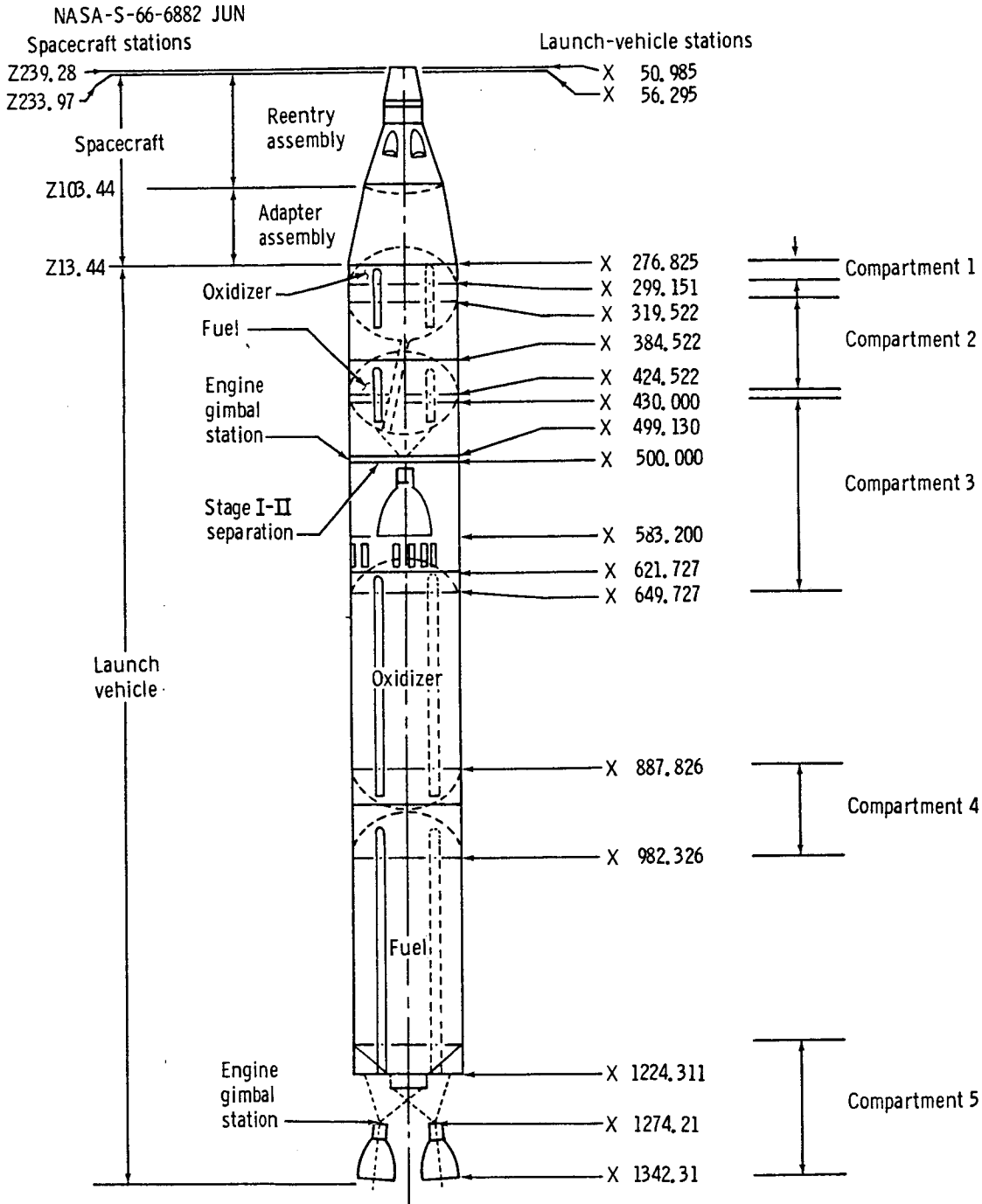

(a) Launch configuration.

Figure 3.0-1. - GLV/spaceship relationships.

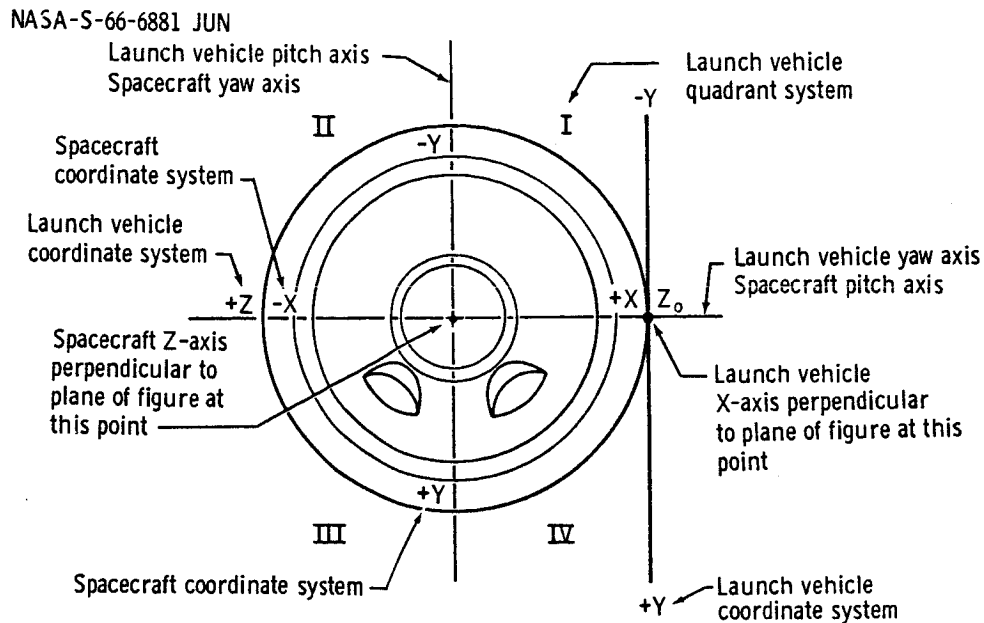

Dimensional axes

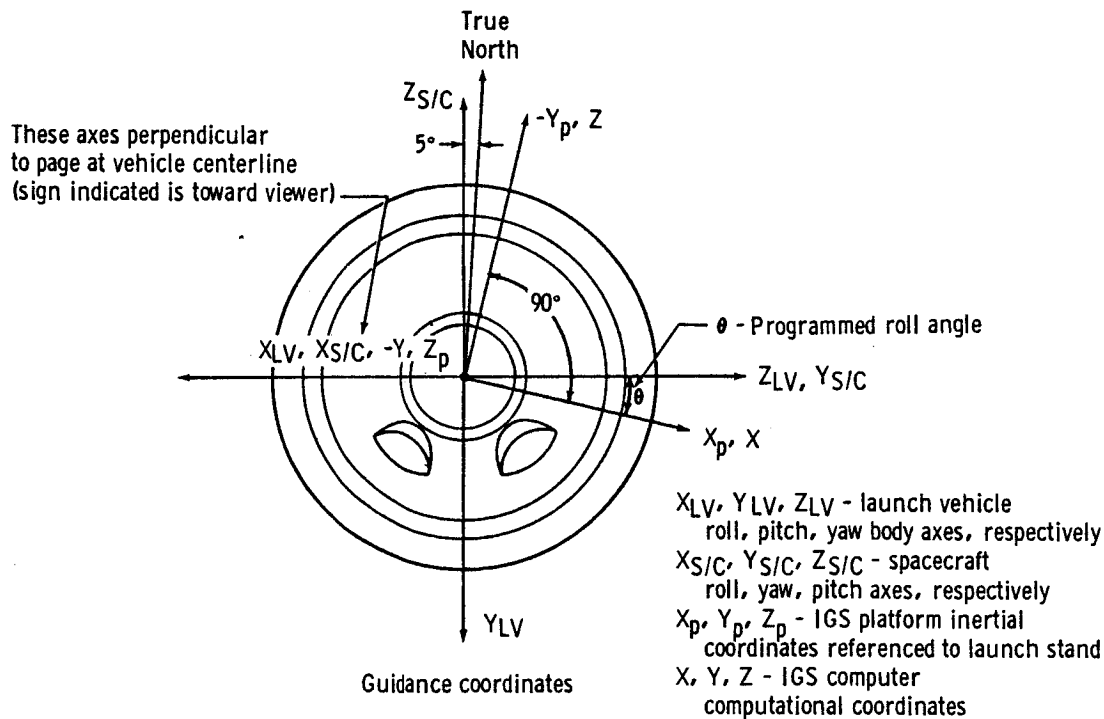

(b) Dimensional axes and guidance coordinates.
Figure 3.0-1. -Concluded.

NASA-S-65-11,267A

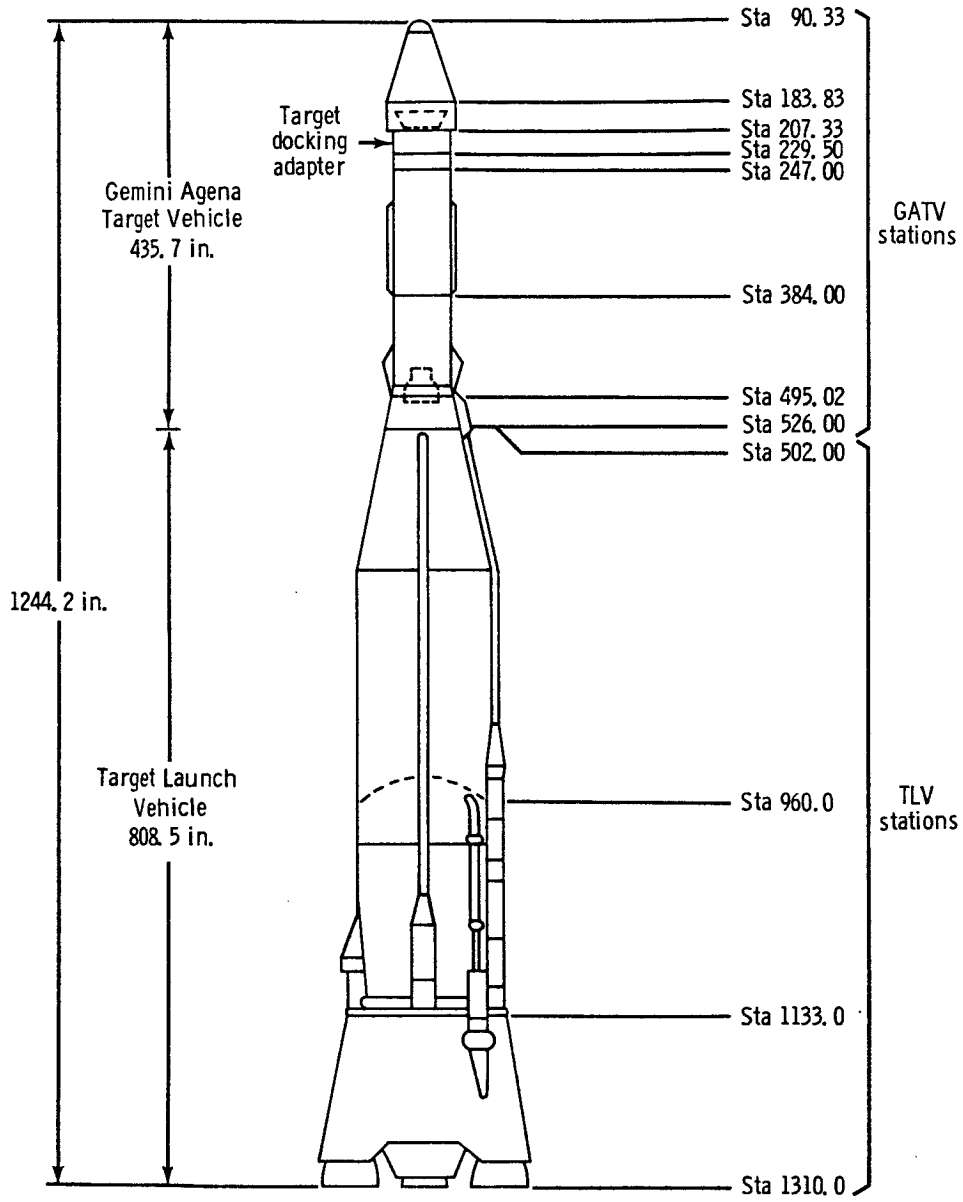

(a) Launch configuration.

Figure 3.0-2 - TLV/GATV relationship.

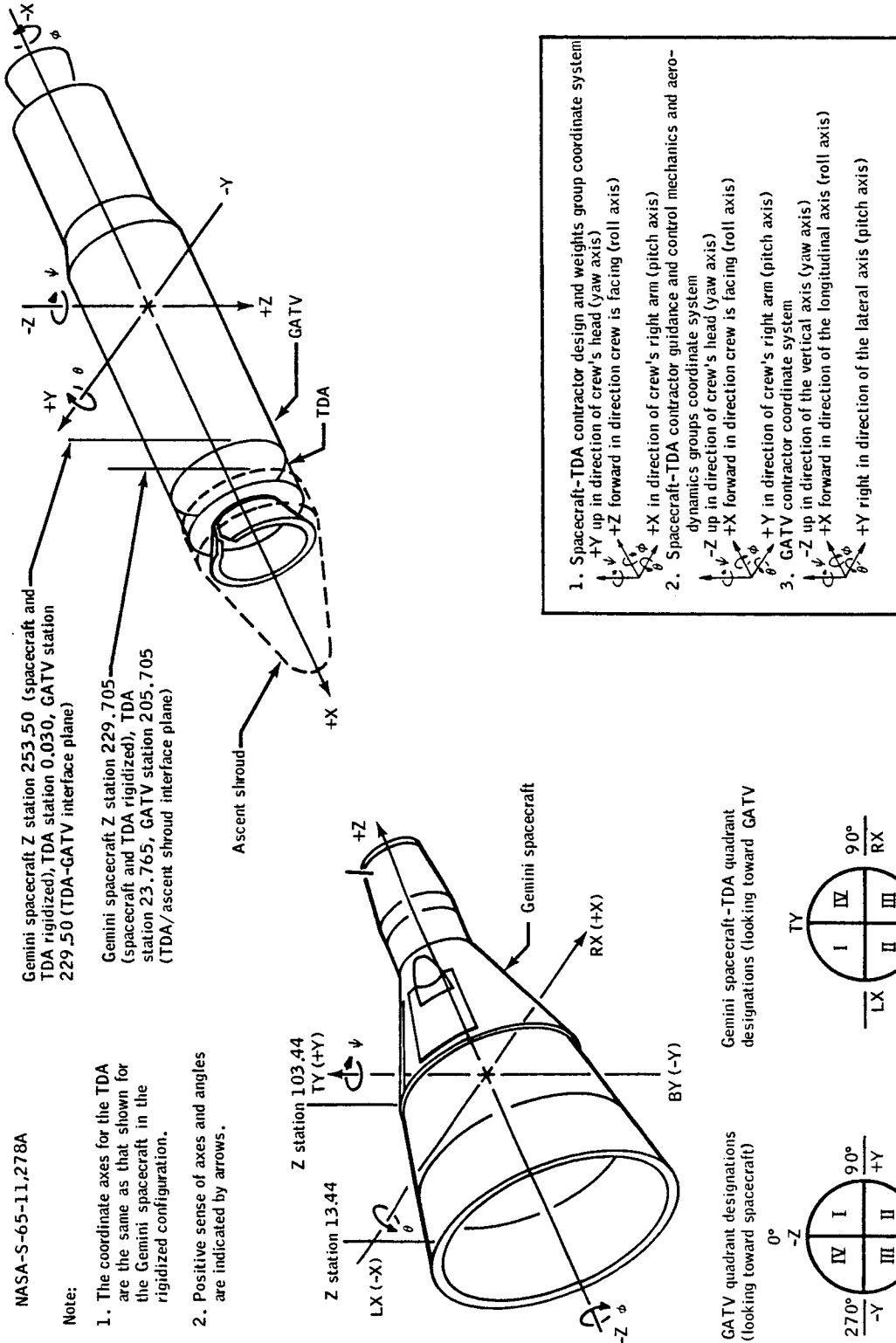

(b) Dimensional axes and guidance coordinates, GATV-TDA.
 Figure 3.0-2. - Continued.

NASA-S-66-6899 JUN

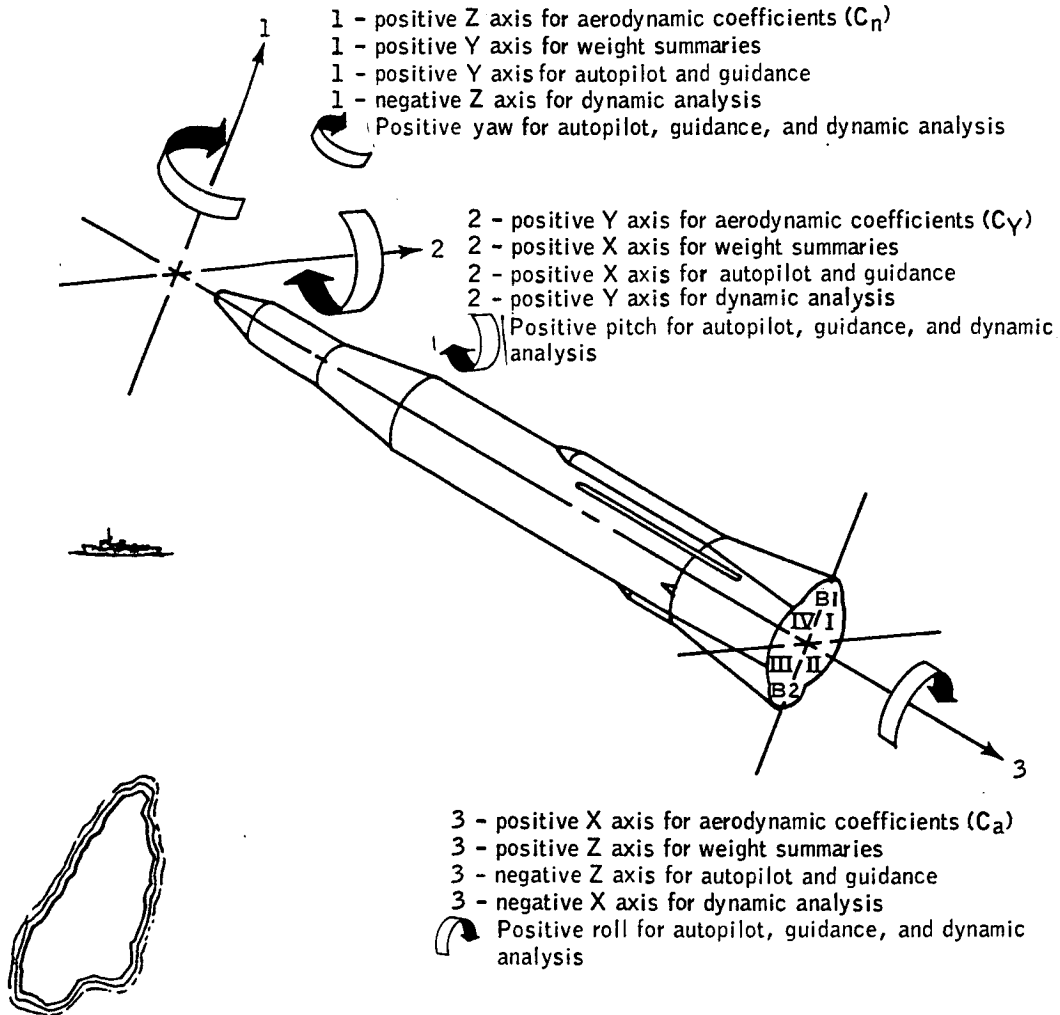

Vehicle shown in flight attitude

(c) Dimensional axes and guidance coordinates, TLV.

Figure 3.0-2. - Concluded.

3.1 GEMINI SPACECRAFT

The structure and major systems of Spacecraft 10 (fig. 3.1-1) were of the same general configuration as the previous Gemini spacecraft. Reference 2 provides a detailed description of the basic spacecraft (Spacecraft 2), and references 3 through 10 describe the modifications incorporated into the subsequent spacecraft. Except for the extravehicular equipment, Spacecraft 10 closely resembled Spacecraft 9 (ref. 10), and only the significant differences (table 3.1-I) between these two spacecraft are included in this report. A detailed description of Spacecraft 10 is contained in reference 11.

3.1.1 Spacecraft Structure

The primary load-bearing structure of Spacecraft 10 was essentially the same as that of Spacecraft 9. The few significant changes are described in the following paragraphs.

The Environmental Control System (ECS) primary oxygen supply tank was relocated to the structure for the fuel-cell module (see figure 3.1-2), and a 22-inch-diameter spherical Orbital Attitude and Maneuver System (OAMS) propellant tank was added to the blast-shield panel previously used to support the ECS oxygen tank. The fuel-cell sections were positioned in the same manner as in the Spacecraft 7 configuration. The tank for fuel-cell product-water storage was also relocated to the fuel-cell module, as shown in figure 3.1-2.

An extendable telescopic boom was used to deploy the tri-axis flux-gate magnetometer for Experiment M405. This boom was mounted in the adapter retrograde section, and an opening for extension of the boom was provided in the adapter skin. Additional structural modifications for this experiment consisted of mounts for a relay panel and an electronics package in the adapter retrograde section. An Aerospace Ground Equipment (AGE) connector was also installed in the adapter assembly to permit pre-flight functional checks and calibration of the magnetometer without disconnecting the electronics-package connector.

For Experiment M408 (Beta Spectrometer), a spring-loaded door was installed in the adapter retrograde section to allow exposure of the sensing unit to the orbital environment. This experiment employed the relay panel provided for Experiment M405; however, an additional electronics package was mounted in the adapter retrograde section.

UNCLASSIFIED

The structural modifications for incorporation of Experiment D010 (Ion-Sensing Attitude Control) consisted of providing two mold-line doors in the adapter retrograde section to permit deployment of two sensing systems.

A micrometeorite collector unit and a fairing for Experiment S012 (Micrometeorite Collection) were mounted on the outer skin of the adapter retrograde section in the area immediately behind the pilot's hatch. The fairing was constructed so that it could be manually released by the pilot for retrieval of the micrometeorite collector.

The extravehicular sequence-camera mount on the adapter retrograde section was provided with a positive lock by replacing the spring-loaded plunger with a screw having a knurled head.

A bracket was provided on the pilot's inboard hatch sill for attachment of the 70-mm camera used in Experiment S013 (Ultraviolet Astronomical Camera).

Because the Astronaut Maneuvering Unit (AMU) was not used on the Gemini X mission, the nitrogen and hydrogen peroxide lines needed on Spacecraft 9 to service the AMU were not provided on Spacecraft 10, and neither were the adapter handholds, foot supports, and floodlights, nor the modifications to the thermal curtain. Other changes required for the Gemini X extravehicular operations are described in section 3.1.2.12.

3.1.2 Major Systems

3.1.2.1 Communication System.- The Communication System was basically the same as the one used on Spacecraft 9. Minor changes were:

(a) The special Astronaut Maneuvering Unit (AMU) telemetry receiver used on Spacecraft 9 was not installed in Spacecraft 10.

(b) The helmet microphone provided for the pilot was of a different design.

3.1.2.2 Instrumentation and Recording System.- The turns on the negator spring in the PCM tape recorder were increased from 88 to 94 to ensure tape tension from the beginning to the end of the usable tape supply.

The wiring change on Spacecraft 9 to permit recording of AMU telemetry data while the AMU was in the stowed configuration was not incorporated on Spacecraft 10.

UNCLASSIFIED

A mating plug was added to extend the AGE disconnect on the programmer. This modification was required to incorporate Experiments M408 (Beta Spectrometer) and M409 (Bremsstrahlung Spectrometer).

3.1.2.3 Environmental Control System.- The ECS primary oxygen supply system was modified to permit the primary-oxygen tank to furnish all fuel-cell reactant oxygen as well as breathing oxygen (see paragraph 3.1.2.6).

To provide an easier hook-up, bulkhead-type tube fittings were installed on the ECS package in the reentry assembly, replacing the quick disconnects previously used for oxygen purge and connection of the demand regulators.

3.1.2.4 Guidance and Control System.- The Guidance and Control System was basically the same as the Spacecraft 9 system except for the following changes:

(a) The rendezvous radar contained a modification to improve damping of the range/range-rate indicator.

(b) A hand-held space sextant, like that used on Gemini IV and Gemini VII for Experiment D009 (Simple Navigation), and a star occultation navigation photometer (also used for Experiment D005 on this mission) were included with the operational guidance and control equipment.

(c) The computer operational program (Math Flow 7) contained Modules II, III, IV, V, and VI whereas the program for Spacecraft 9 contained only Modules IV and V.

3.1.2.5 Time Reference System.- The Time Reference System configuration was the same as the one used on Spacecraft 9.

3.1.2.6 Electrical System.- The Spacecraft 10 Electrical System (fig. 3.1-2) differed from the Spacecraft 9 system in the following respects:

(a) The fuel-cell sections were rearranged as noted in section 3.1.1.

(b) The reactant supply system (RSS) cryogenic oxygen tank and the RSS/ECS oxygen crossfeed valve were removed. The ECS primary oxygen supply system was modified to provide both breathing oxygen and fuel-cell oxygen, as described in section 3.1.2.3.

UNCLASSIFIED

(c) No telemetry readouts of fuel-cell differential pressures were provided on Spacecraft 10.

3.1.2.7 Propulsion System.- The Propulsion System was the same as the Spacecraft 9 system except as discussed in the following paragraphs.

3.1.2.7.1 Orbital Attitude and Maneuver System: The usable propellant storage capacity for the OAMS was increased from approximately 700 pounds on Spacecraft 9 to approximately 940 pounds on Spacecraft 10. This was accomplished by (1) adding a 22-inch spherical oxidizer tank to a panel of the blast shield previously used to support the ECS oxygen tank, (2) replacing a 20-inch spherical oxidizer tank with a 20-inch spherical fuel tank, and (3) replacing the 30-inch-long cylindrical reserve fuel tank with a similar reserve oxidizer tank. The OAMS configuration is shown in figure 3.1-3, and a schematic diagram of the system is shown in figure 3.1-4.

Because of the changed propellant capacities, resistors were added in series with the propellant quantity indicator to make the indicator reading agree with the propellant-depletion calibration used for previous spacecraft.

A 10-watt heater and a 25° to 35° F thermostat were added to each end of the cylindrical tank, and a 1/4-watt oxidizer line heater was added in series with one of the tank heaters. The OAMS RESV switch and wiring and the provisions for telemetry and cabin readout of pressure remained the same as the Spacecraft 9 configuration.

To provide additional protection to the engine propellant-valve heater and thermostat wires, the aluminized tape previously used was replaced with fiber glass tubing covered with silicone rubber.

3.1.2.7.2 Reentry Control System: The thrust chamber assemblies installed in the Spacecraft 10 Reentry Control System (RCS) were all of the 6-degree-chamber-wrap configuration with the exception of two 90-degree-wrap engines installed in positions 3 and 8 of the A-ring.

3.1.2.8 Pyrotechnic System.- Except for the addition of pyrotechnic devices required to deploy the sensors for Experiments D010, M405, and M408, and the deletion of the pyrotechnic devices associated with the Gemini IX-A experiments, the Pyrotechnic System was similar to the one used on Spacecraft 9.

3.1.2.9 Crew-station furnishings and equipment.-

UNCLASSIFIED

3.1.2.9.1 Controls and displays: In addition to the following changes, the crew-station controls and displays also included minor changes in the operation and nomenclature of controls and indicators (see figure 3.1-5).

(a) Auxiliary power and telemetry receptacles for Experiment D005 (Star Occultation Navigation) were incorporated in the right-hand utility bracket as they were in Spacecraft 5 and Spacecraft 7.

(b) A switch combining the ON-OFF functions of Experiments M405 and M408 was added to the pilot's panel adjacent to the Auxiliary Tape Memory Unit (ATMU) controls.

(c) An ON-OFF switch to control the bremsstrahlung spectrometer used for Experiment M409 was added to the pilot's panel adjacent to the switch described in the preceding paragraph.

(d) Controls for Experiment D010 (Ion-Sensing Attitude Control) were added to the pilot's panel in place of the Experiment D014 (UHF/VHF Polarization) controls used on Spacecraft 9.

(e) The labeling of the computer mode selector switch was changed to conform to the computer operational program used on this mission, and a plastic plate was added to the selector switch knob to permit notation of the number of the computer module loaded.

(f) The switch for AMU deployment and telemetry control on the command pilot's panel of Spacecraft 9 was also installed on Spacecraft 10; however, it was not operational because the AMU experiment was not flown on this mission.

(g) The ATDA STAB OFF/NORM switch on the right switch/circuit-breaker panel was changed back to the GATV ENGINE ARM/STOP switch, its normal function.

(h) The oxygen crossfeed switch on the main console was replaced by the H₂ TANK VAC switch. The function of the H₂ TANK VAC switch was to initiate a pyrotechnic device to sever the pinch-off tube of the RSS cryogenic hydrogen tank. The oxygen crossfeed switch previously had the same capability.

(i) A positive external stop for the encoder control switch was incorporated to preclude the possibility of failure due to the application of excessive force.

UNCLASSIFIED

3.1.2.9.2 Miscellaneous equipment changes: The following changes were made in the spacecraft cabin:

(a) The special support bracket which was mounted on the right-hand hatch window of Spacecraft 9 for Experiment S011 (Airglow Horizon Photography) was not installed in Spacecraft 10.

(b) A welded tubular frame was installed at the forward end of the left footwell, and the plotboard brackets were removed from the center pedestal to provide for stowage of the 50-foot umbilical. Items formerly stowed in the plotboard container were relocated to other stowage pouches.

(c) A bracket was installed on the left-hand-hatch torque box to attach the stowage container for the photometer provided for Experiments D005 (Star Occultation Navigation) and M412 (Landmark Contrast Measurements).

(d) A bracket was installed on the right-hand-hatch torque box to attach the stowage container for a miniature hand-held space sextant.

(e) The center-stowage-frame door mount was used to attach the Experiment D009 hand-held space sextant which was included with the operational guidance and control equipment.

(f) An attachment point for a portable block-and-tackle hatch closing device was incorporated in the lower left-hand corner of the pilot's instrument panel. The upper attachment point for the device was the same as that used for the regular hatch closing lanyard.

3.1.2.9.3 Stowage facilities: The stowage containers are shown in figure 3.1-6. Table 3.1-II lists the major items of equipment stowed in the containers at launch.

3.1.2.10 Landing System.-- No significant changes were made to the Landing System.

3.1.2.11 Postlanding and Recovery System.-- No significant changes were made to the Postlanding and Recovery System.

3.1.2.12 Extravehicular equipment.-- The following modifications were incorporated in the spacecraft, space suits, and ELSS to support the Gemini X extravehicular activities (EVA).

3.1.2.12.1 Structural modifications: Handrails and Velcro patches like those installed on Spacecraft 8 and 9 were also installed on

UNCLASSIFIED

Spacecraft 10. To provide propellant for the Hand Held Maneuvering Unit (HHMU) (see paragraph 3.1.2.12.3) during the umbilical extravehicular operation, two nitrogen tanks were installed in the adapter equipment section, and a quick disconnect fitting and a manual ON-OFF valve were installed on the external surface of the adapter equipment section to permit attachment of the HHMU nitrogen line.

3.1.2.12.2 Space suits: The space suit configuration for the command pilot was the same as that used on the Gemini IX-A mission—a G-4C suit with a lightweight coverlayer. The pilot's space suit was also a G-4C suit; however, it was fitted with an extravehicular coverlayer of the same configuration as the Gemini VIII pilot's suit.

The pressure visor on both helmets was of the same configuration as that used on the Gemini IX-A mission. The pilot's visor assembly also included an additional single-lens removable sunvisor similar to the one used by the Gemini IX-A pilot. As a result of the fogging of the pilot's visor during Gemini IX-A extravehicular operations, a temporary wetting agent was provided the Gemini X crew for onboard application prior to each EVA period.

3.1.2.12.3 Extravehicular Life Support System: The major components of the ELSS were the same as those used on the Gemini IX-A mission except for the differences noted in the following paragraphs.

The ELSS umbilical assembly was 50 feet in length rather than the 25-foot length used on Gemini IX-A. In addition to the electrical, oxygen, and tether connections provided by the 25-foot umbilical, the 50-foot umbilical incorporated a nitrogen line to furnish propellant to the HHMU. The attachment points in the spacecraft cabin for the electrical line, oxygen line, and tether were the same as those used for the 25-foot umbilical. After egress, the nitrogen line was attached to the quick disconnect fitting located on the adapter equipment section. The attachment points for the EVA crewman's end of the umbilical were:

- Electrical (spacecraft power and audio warning) ELSS chestpack
- Electrical (communications and biomedical instrumentation) Space suit
- Oxygen ELSS chestpack
- Tether Restraint harness (left hip)
- Nitrogen HHMU

UNCLASSIFIED

The ELSS chestpack modifications for Gemini X were as follows:

- (a) Velcro was added to the left display panel.
- (b) The emergency oxygen quantity scale was reduced in size (with consequent reduction in range from 7000 psi to 5000 psi).
- (c) A modified oxygen fill-line check valve was incorporated.

3.1.2.12.4 Hand Held Maneuvering Unit: The HHMU was basically the same as the one provided for the Gemini VIII mission (ref. 9), except that nitrogen was used as the propellant rather than Freon-14, and the propellant was delivered to the HHMU through the 50-foot umbilical assembly rather than from a self-contained propellant supply. The HHMU trigger and handle assembly was modified to provide easier one-handed operation; however, the basic configuration of the unit remained unchanged.

UNCLASSIFIED

TABLE 3.1-I.- SPACECRAFT 10 MODIFICATIONS

System	Significant differences between Spacecraft 10 and Spacecraft 9 configurations
Structure	<p>(a) The following changes were made to the adapter equipment section primarily to increase the OAMS propellant storage capacity:</p> <ul style="list-style-type: none"> (1) The ECS primary oxygen tank was moved to the fuel-cell module. (2) An OAMS oxidizer tank was installed on the blast shield panel in the position previously occupied by the ECS oxygen tank. (3) The fuel-cell sections were rearranged. (4) The fuel-cell product-water storage tank was moved to the fuel-cell module. <p>(b) Experiment provisions were modified.</p> <p>(c) EVA provisions were modified.</p>
Instrumentation and Recording	<p>(a) The turns on the negator-spring in the PCM tape recorder were increased.</p> <p>(b) Wiring for recording of AMU data was not installed.</p>
Environmental Control	<p>(a) The primary oxygen tank supplied all fuel-cell reactant oxygen in addition to breathing oxygen.</p> <p>(b) Bulkhead-type tube fittings were installed on the reentry assembly ECS package for oxygen-purge and demand-regulator connections.</p>
Guidance and Control	<p>(a) The rendezvous radar system was modified to improve damping of the range/range-rate indicator.</p>

UNCLASSIFIED

TABLE 3.1-I.- SPACECRAFT 10 MODIFICATIONS - Continued

System	Significant differences between Spacecraft 10 and Spacecraft 9 configurations
Guidance and Control - concluded	<p>(b) A hand-held space sextant (like the one previously used for Experiment D009) and a photometer (also used for Experiments D005 and M412) were included with the operational guidance and control equipment.</p> <p>(c) The onboard computer program (Math Flow 7) included Modules II, III, and VI.</p>
Electrical	<p>(a) The fuel-cell module components were rearranged.</p> <p>(b) The RSS oxygen tank was deleted.</p> <p>(c) Fuel-cell differential pressure telemetry readouts were not provided.</p>
Propulsion	<p>(a) The OAMS usable propellant storage capacity was increased from approximately 700 pounds to approximately 940 pounds by:</p> <ol style="list-style-type: none"> (1) Adding a 22-inch-diameter oxidizer tank. (2) Replacing a 20-inch-diameter oxidizer tank with a 20-inch-diameter fuel tank. (3) Replacing the reserve fuel tank with a similar reserve oxidizer tank. <p>(b) Heaters and thermostats were added to each end of the OAMS reserve oxidizer tank.</p> <p>(c) OAMS engine propellant-valve heaters and thermostat wires were protected by fiber glass tubing and silicone rubber rather than by aluminized tape.</p> <p>(d) Two 90-degree-wrap thrust chamber assemblies were used in RCS A-ring.</p>
Pyrotechnics	No significant difference other than provisions for deployment of experiment sensors.

UNCLASSIFIED

TABLE 3.1-I.- SPACECRAFT 10 MODIFICATIONS - Concluded

System	Significant differences between Spacecraft 10 and Spacecraft 9 configurations
Crew-station furnishings and equipment	<ul style="list-style-type: none"> (a) Minor changes were made in switch operation and nomenclature resulting primarily from different experiments and extravehicular operations. (b) The plotboard brackets were removed from the center pedestal to allow the installation of a frame for stowage of the 50-foot umbilical in the command pilot's footwell. (c) An attachment point for a portable block-and-tackle hatch closing device was incorporated on the pilot's instrument panel.
EVA equipment	<ul style="list-style-type: none"> (a) Structural modifications to incorporate the AMU on Spacecraft 9 were not needed on Spacecraft 10. (b) The pilot's space suit was similar to the Gemini Gemini IX-A pilot's suit, except that the EVA coverlayer did not have additional thermal protection for the legs. (c) An HHMU was included. (d) The ELSS umbilical was 50 feet in length and included a nitrogen line for the HHMU. (e) Two nitrogen tanks and a fitting for attachment of the HHMU nitrogen line were installed in the adapter equipment section. (f) A modified oxygen-fill-line check valve was incorporated in the ELSS chestpack.

UNCLASSIFIED

TABLE 3.1-II.- CREW-STATION STOWAGE LIST

Stowage area (see fig. 3.1-6)	Item	Quantity
Centerline stowage container	Mirror mounting bracket	1
	18-mm lens, 16-mm camera	2
	75-mm lens, 16-mm camera	1
	16-mm sequence camera with film magazine	2
	70-mm camera, superwide angle	1
	16-mm film magazine	8
	70-mm film magazine	5
	5-mm lens, 16-mm camera	1
	Ring viewfinder	1
	70-mm camera with film magazine	1
	f/2.8 lens, general purpose	1
Left sidewall containers	Personal hygiene towel	2
	Roll-on cuff receiver assembly (urine system)	1
	Lightweight headset	1
	EVA remote control cable, 16-mm camera	1
	Penlight	1
	Voice tape cartridges	8
	Velcro pile, 2 by 6 in.	1
	Velcro hook, 2 by 6 in.	1
	Velcro back-to-back tape, 1 by 8 in.	8 pcs.
	Pilot's preference kit	1
	Circuit breaker, 16-mm camera	1
Urine hose and filter	1	

UNCLASSIFIED

UNCLASSIFIED

3-19

TABLE 3.1-II.- CREW-STATION STOWAGE LIST - Continued

Stowage area (see fig. 3.1-6)	Item	Quantity
Left aft stowage container	16-mm film magazine	3
	Postlanding kit	1
	70-mm film magazine	2
	Manual blood-pressure inflator	1
	Dual "Y" connector	2
	ELSS restraint assembly	2
	Food, one-man meal	6
	Glareshield	1
	Hand Held Maneuvering Unit	1
	EVA movie camera adapter	1
	Zodiacal-light camera	1
	Radiation measuring system	1
	Left footwell	50-foot umbilical
Right sidewall containers	Mirror mounting bracket	1
	Spotmeter	1
	Exposure dial	1
	Personal hygiene towel	2
	Waste container	2
	Lightweight headset	1
	Penlight	1
	Defecation device	1
	Pilot's preference kit	1
	Circuit breaker, 16-mm camera	1
	Single utility cord	1
	Medical kit	1
	Ultraviolet lens	1

UNCLASSIFIED

UNCLASSIFIED

TABLE 3.1-II.- CREW-STATION STOWAGE LIST - Continued

Stowage area (see fig. 3.1-6)	Item	Quantity
Right aft stowage container	70-mm camera with film magazine	1
	Waste container	2
	Pressure gloves, thermal	1 pr.
	Defecation device	4
	Hose nozzle interconnector	2
	ELSS hose, short	1
	ELSS hose, long	1
	Standup electrical cable	1
Right pedestal pouch	Tether, short	1
	16-mm film magazine	5
	70-mm film magazine	1
	Experiment log book	1
Right footwell	Systems book	1
	Orbital path display assembly	1
	Celestial display, Mercator	1
	Celestial display, polar	1
	Flight data book	1
Orbital utility pouch	Rendezvous log book	1
	Bracket, 16-mm camera	1
	Hatch closing lanyard	1
Right and left circuit-breaker fairings	Hatch closing device	1
	Glareshield, optical sight	1
	Clamp for urine collection device	2
	Latex roll-on cuffs	6
	Velcro pile, 1 by 4 in.	1
	Tape, 3/4 in. by 10 ft	1
Tape, 2 by 9 in.	2	

UNCLASSIFIED

UNCLASSIFIED

3-21

TABLE 3.1-II.- CREW-STATION STOWAGE LIST - Concluded

Stowage area (see fig. 3.1-6)	Item	Quantity
Right and left circuit-breaker fairings - con- cluded	Urine receiver - removable cuff	1
	Visor anti-fog pads	1 pkg.
Center stowage rack	ELSS chestpack	1
Left and right hatch pouches	Food, one-man meal	12
Hatch torque box	Sextant, miniature hand-held	1
Water management console	Roll-on cuff receiver assembly (urine system)	1
	Urine receiver - removable cuff	1
Left and right dry- stowage bags	Tissue dispenser	2
	Visor cover	2
	Auxiliary window shade	2
	Auxiliary reflecting shade	2

UNCLASSIFIED

UNCLASSIFIED

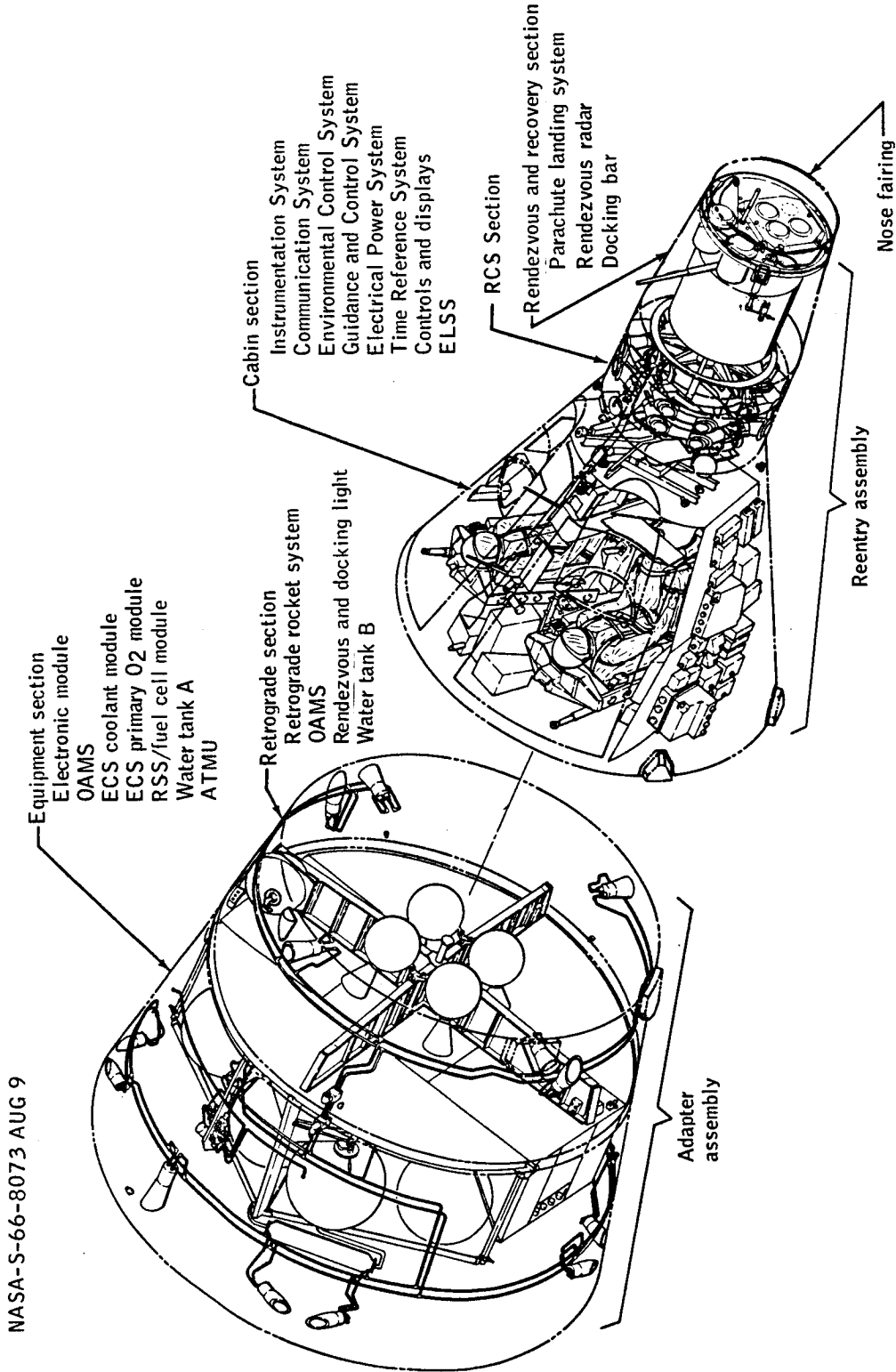

Figure 3.1-1. - Spacecraft arrangement and nomenclature.

UNCLASSIFIED

NASA-S-66-8153 AUG 17

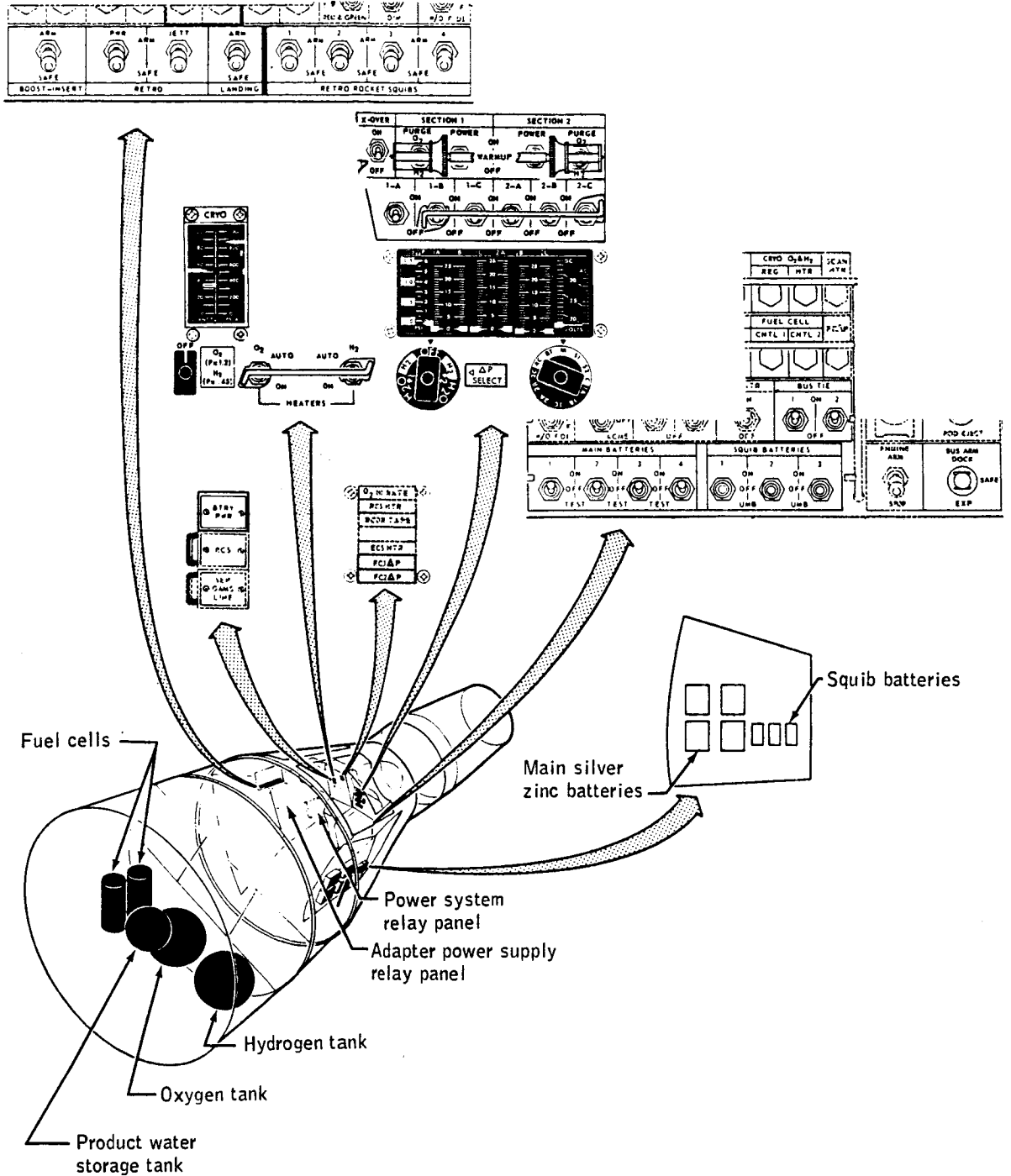

Figure 3.1-2. - Electrical system.

NASA-S-66-8065 AUG 9

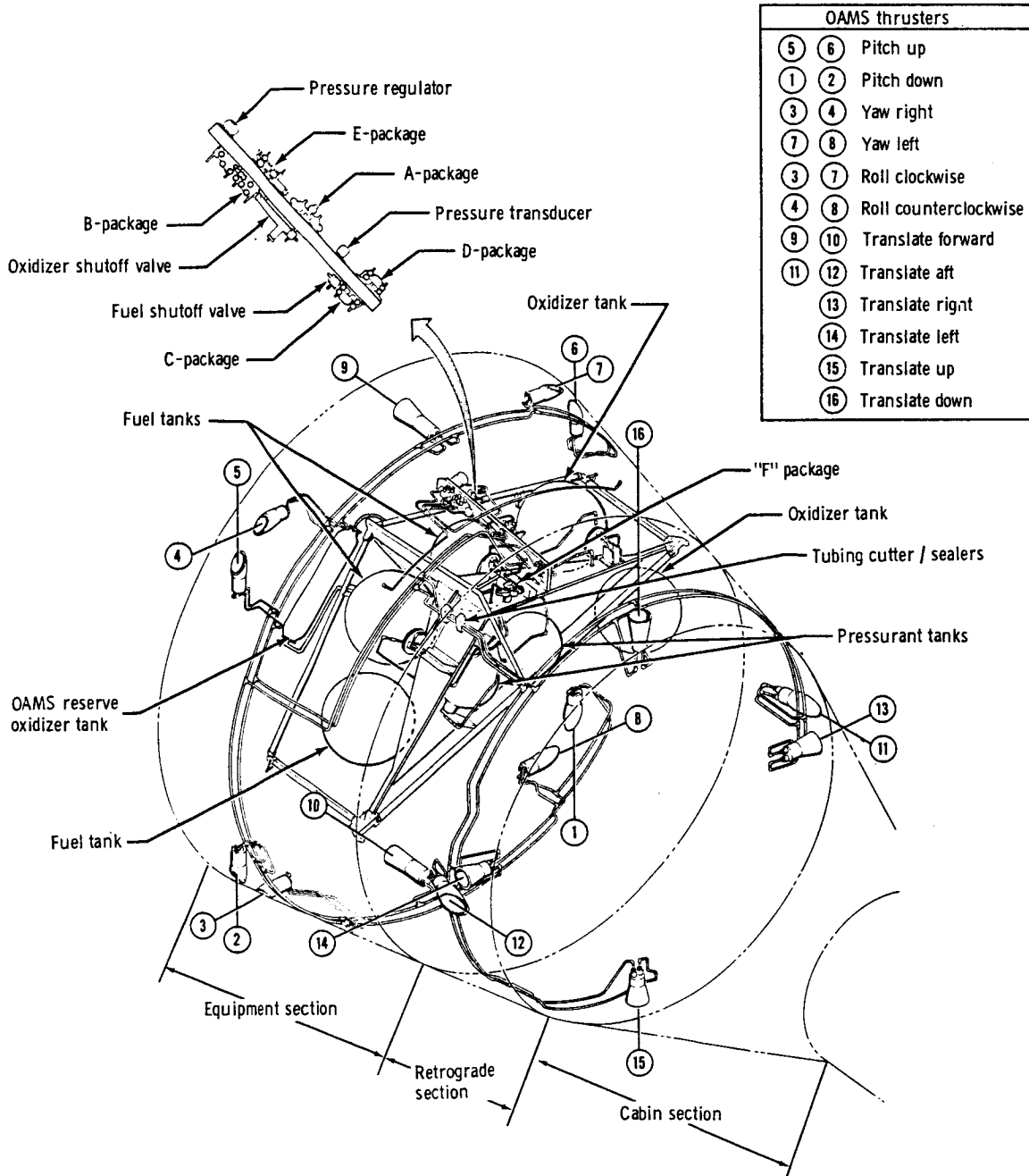

Figure 3.1-3. - Orbital Attitude and Maneuver System.

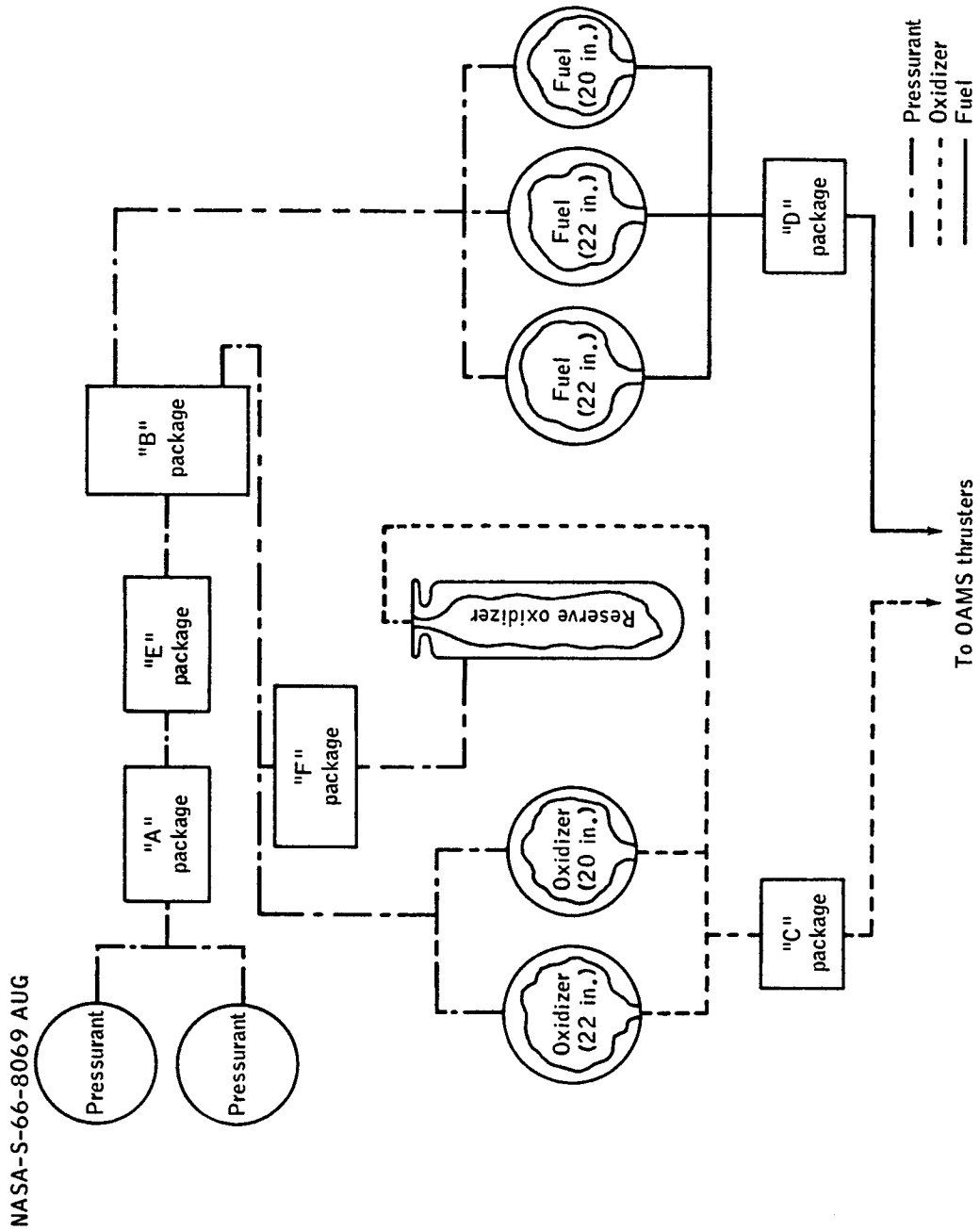

Figure 3.1-4. - Orbital Attitude and Maneuver System schematic.

3-26

UNCLASSIFIED

THIS PAGE INTENTIONALLY LEFT BLANK

UNCLASSIFIED

UNCLASSIFIED

3-27

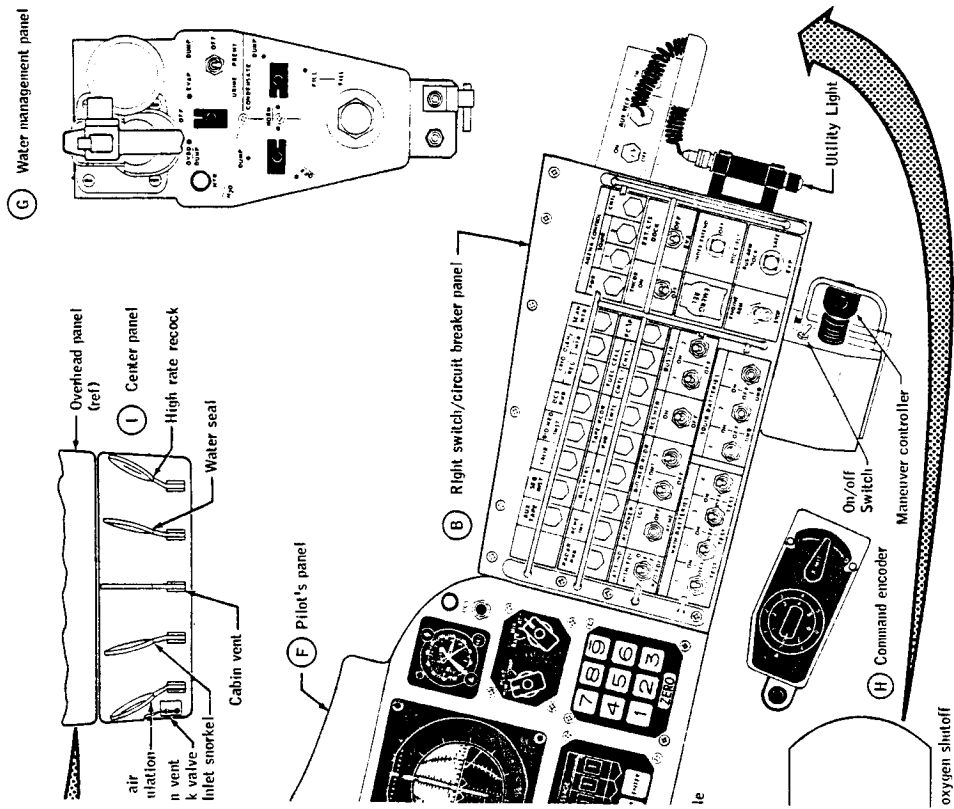
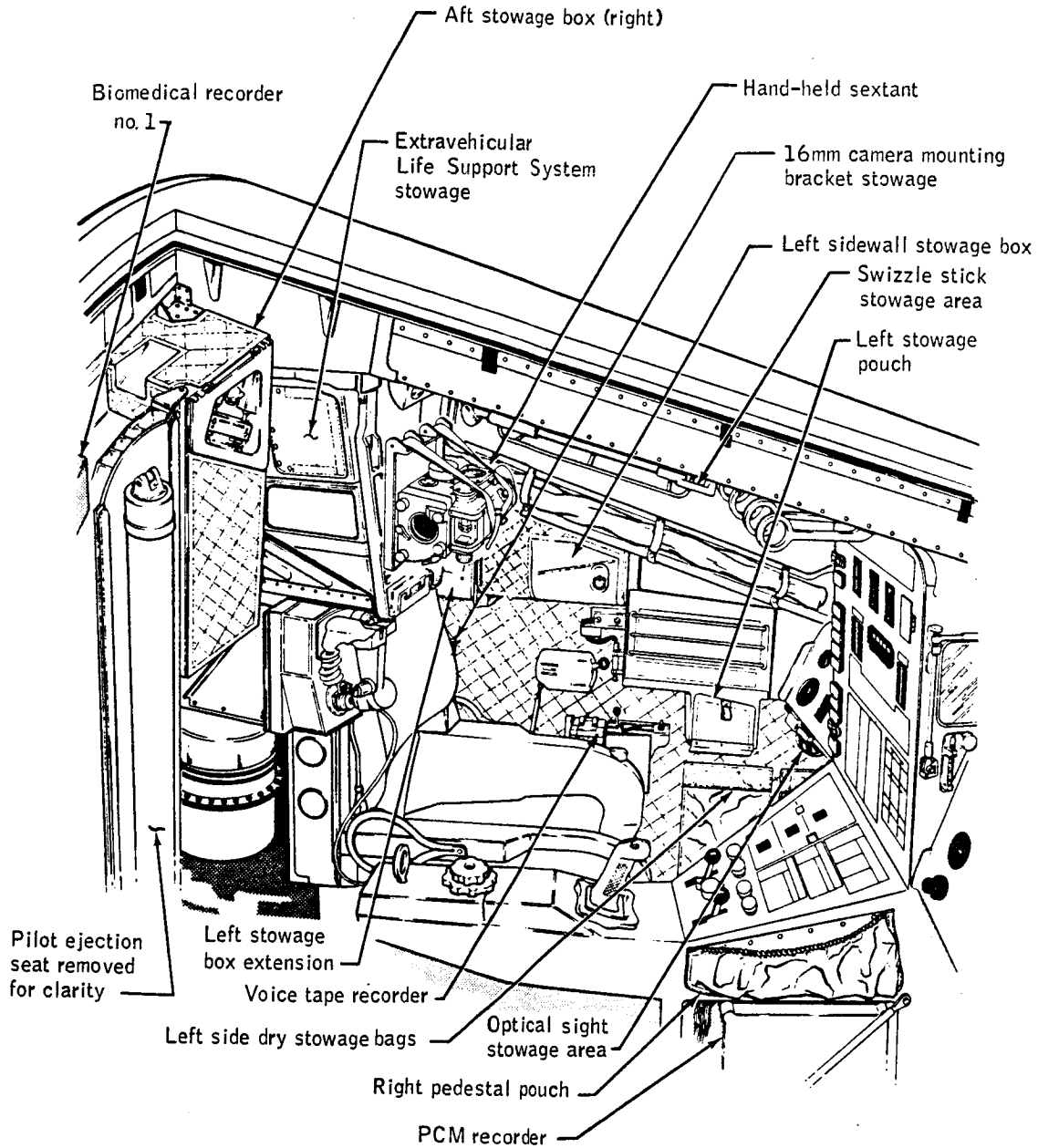

Figure 3.1-5. - Spacecraft controls and displays.

3-27-C

UNCLASSIFIED

NASA-S-66-8169 AUG 17



(a) View looking into command pilot's side.

Figure 3.1-6. - Spacecraft interior stowage areas.

NASA-S-66-8170 AUG 17

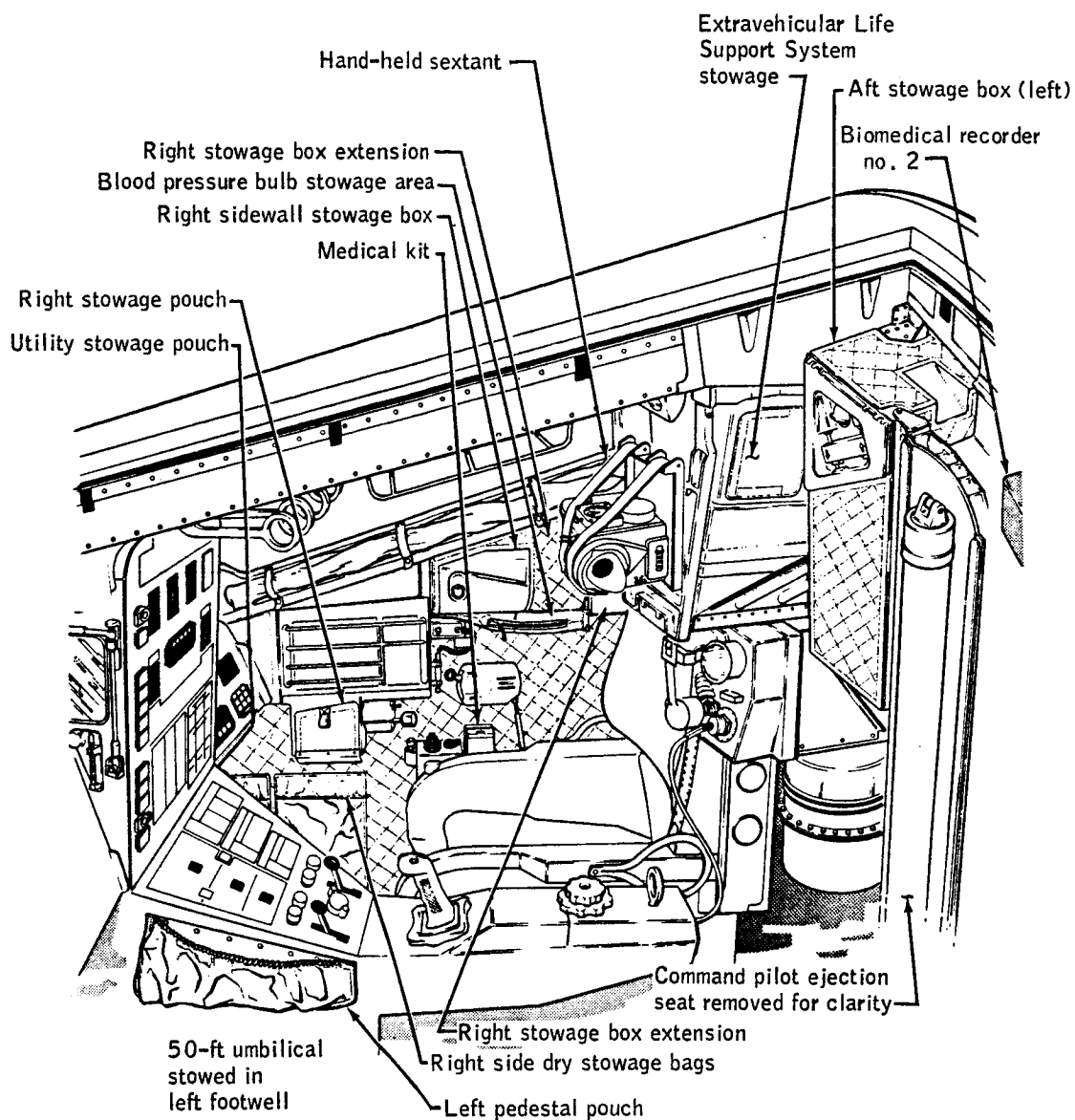

(b) View looking into pilot's side.

Figure 3.1-6. - Concluded.

~~CONFIDENTIAL~~

3.2 GEMINI LAUNCH VEHICLE

There were no significant differences between Gemini Launch Vehicle 10 (GLV-10) and GLV-9.

3.3 GEMINI SPACE VEHICLE WEIGHT AND BALANCE DATA

Weight and balance data for the Gemini X Space Vehicle are as follows:

Condition	Weight (including spacecraft), lb (a)	Center-of-gravity location, in. (a), (b)		
		X	Y	Z
Ignition	344 856	751.7	-0.049	59.96
Lift-off	341 164	752.0	-0.050	59.95
First stage engine cutoff (BECO)	86 921	349.0	-0.202	59.84
Second stage start of steady-state combustion	73 995	343.0	-0.041	59.97
Second stage engine cutoff (SECO)	14 243	283.0	-0.145	59.97

^aWeights and center-of-gravity data were obtained from the GLV contractor.

^bRefer to figure 3.0-1 for the Gemini Space Vehicle coordinate system. Along the X-axis, the center of gravity is referenced to GLV station 0.00. Along the Y-axis, the center-of-gravity location is referenced to buttock line 0.00 (vertical centerline of horizontal vehicle). Along the Z-axis, the center of gravity is referenced to waterline 0.00 (60 inches below the horizontal centerline of the horizontal vehicle).

~~CONFIDENTIAL~~

Spacecraft 10 weight and balance data are as follows:

Condition	Weight, lb	Center-of-gravity location, in. (a)		
		X	Y	Z
Launch, gross weight	8295	-1.35	+2.11	+104.68
Retrograde	5578	+0.01	-1.07	+129.85
Reentry (0.05g)	4764	+0.06	-1.49	+136.72
Main parachute deployment	4365	+0.02	-1.60	+129.91
Touchdown (no parachute)	4254	+0.02	-1.66	+127.84

^aRefer to figure 3.0-1 for spacecraft coordinate system. The X-axis and the Y-axis are referenced to the centerline of the spacecraft. The Z-axis is referenced to a plane located 13.44 inches aft of the launch vehicle/spacecraft separation plane.

UNCLASSIFIED

3.4 GEMINI AGENA TARGET VEHICLE

The Gemini Agena Target Vehicle (GATV-5005) for the Gemini X mission was similar to GATV-5003, which was used for the Gemini VIII mission (ref. 9) and as the passive target for the Gemini X dual rendezvous. The following table lists the significant differences between GATV-5005 and GATV-5003.

System	Significant differences between GATV-5005 (Gemini X mission) and GATV-5003 (Gemini VIII mission)
Structure	<ul style="list-style-type: none"> (a) One primary battery was removed, one running-light battery was removed, and lead ballast was added to the forward auxiliary rack to alter the vehicle center of gravity. (b) Heat reflective aluminum tape was applied over 15 percent of the forward auxiliary rack and forward equipment rack skin panels. (c) The GATV/TLV separation monitor was modified by adding a retainer to limit the travel of the actuating lever of the switch and by rotating the three switch trips 180 degrees. (d) Sensing devices and a programmer for Experiment S026 and an electric charge monitor were installed in the TDA.
Propulsion	Five temperature sensors were relocated to provide more usable data on main-engine post-fire venting.
Electrical	The battery removals resulted in a decrease in the overall life of the electrical power system and also resulted in the capability to automatically reactivate only the forward running lights.
Guidance and Control	<ul style="list-style-type: none"> (a) Five additional functions were incorporated into the ascent sequence timer. (b) A modified velocity-meter counter was installed.
Communications and Command	The ranges of the pitch, roll, and yaw gyro telemetry readouts were increased from ± 5 degrees to ± 10 degrees.

UNCLASSIFIED

These differences are further described in the following paragraphs.

3.4.1 Structure

3.4.1.1 Gemini Agena Target Vehicle.- GATV-5005 was modified to alter the vehicle center of gravity to avoid the yaw-offset rate encountered during the Gemini VIII mission (ref. 9). The major structural modifications were as follows:

- (a) One primary battery was removed.
- (b) One running-light battery was removed.
- (c) Approximately 150 pounds of lead ballast was added to the forward auxiliary rack. The ballast weight was supported partly by the forward auxiliary rack longerons and partly by a stainless steel door installed in place of the magnesium door used previously. The changes resulted in a net vehicle weight decrease of 85 pounds.

To obtain better thermal interaction between the forward auxiliary rack and the forward equipment rack, heat-reflective aluminum tape was applied over approximately 15 percent of the external surfaces of the forward-auxiliary-rack/forward-equipment-rack skin panels. No paint removal, additional painting, or other surface preparation was performed.

The GATV/TLV separation monitor was modified because of erratic telemetry indications on previous flights. A retainer for the actuating lever of the switch was added, and the three switch trips were rotated 180 degrees to eliminate oscillations which had caused erratic readings.

3.4.1.2 Target Docking Adapter.- The Target Docking Adapter (TDA) used on the Gemini X mission was essentially the same as the one used on the Gemini VIII mission. The significant differences were as follows:

Ion-sensing devices and a programmer were added for Experiment S026 (Ion-Wake Measurement).

An electric charge monitor was installed to collect and measure the charge exchanged between the spacecraft and the GATV at the time of docking.

The L-band transponder coaxial cable connectors were packed with silicon lubricant to eliminate the possibility of corona.

UNCLASSIFIED

3.4.2 Major Systems

3.4.2.1 Propulsion System.- Five temperature sensors were relocated to provide more usable data on main-engine post-fire venting effects. This information was needed to better determine engine condition prior to refiring.

3.4.2.2 Electrical System.- The deletion of the two batteries described in paragraph 3.4.1.1 caused minor changes in Electrical System operation. The deletion of the primary battery decreased the overall life of the power system but did not affect the Gemini X mission.

The deletion of the running-light battery did not change the operation of the running lights when the lights were commanded on from the ground or the spacecraft. However, when they are commanded on by the timer, only the forward three running lights will illuminate.

3.4.2.3 Guidance and Control System.-

3.4.2.3.1 Guidance system: Additional functions were incorporated into the ascent sequence timer to provide a backup capability for initiation of the following five events between primary propulsion system thrust cutoff and sequence timer shutdown in case of a command link failure.

- (a) Event 14 - Extend L-band boom antenna
- (b) Event 18 - Remove power from L-band boom extend relay
- (c) Event 21 - Unrigidize TDA
- (d) Event 22 - Remove power from unrigidize TDA relay
Redundant shutdown sequence timer signal
- (e) Event 23 - Remove redundant shutdown sequence timer signal.

A modified velocity-meter counter, incorporating transistors not affected by moisture, was installed.

3.4.2.3.2 Flight Control System: No changes were made to the Flight Control System.

3.4.2.4 Communications and Command System.- The communications system was changed to increase the range of the pitch, roll, and yaw gyro telemetry readouts from ± 5 degrees to ± 10 degrees. On the Gemini VIII mission, the gyro displacement exceeded ± 5 degrees.

UNCLASSIFIED

The telemetry orbit antenna receptacle assembly was rotated 90 degrees to prevent its cracking when the antenna was folded in an aft direction to permit the TLV adapter installation.

3.4.2.5 Range Safety System.- No significant changes were made to the Range Safety System.

3.5 TARGET LAUNCH VEHICLE

The Target Launch Vehicle (TLV-5305) was an Atlas Standard Launch Vehicle (SLV-3) and was of the same basic configuration as the TLV-5304 used for the Gemini IX-A mission (ref. 10). The following table lists the significant differences between TLV-5305 and TLV-5304.

System	Significant differences between TLV-5305 and TLV-5304 configurations
Propulsion	<ul style="list-style-type: none"> (a) Two booster liquid-oxygen gas-generator hoses were replaced with a single hose, and the gas-generator-valve cover plate was redesigned. (b) The liquid-oxygen start-tank fill and check valve was redesigned. (c) The liquid-oxygen high-pressure relief valve and the ullage fitting on the liquid-oxygen start tank were redesigned. (d) The booster liquid-oxygen gas-generator manifold was redesigned. (e) Propellant utilization system circuits were modified by incorporating a noise filter in the 28-volt dc input line and by incorporating a pulse suppression circuit in the computer trigger input.
Flight Control	<ul style="list-style-type: none"> (a) Loose bolts formerly used to install the rate gyro package were replaced with captive mounting hardware. (b) Special quality parts and reworked circuit boards were incorporated in the autopilot.

UNCLASSIFIED

These differences are described further in the following paragraphs (ATDA-peculiar changes on TLV-5304 (ref. 10) are not considered).

3.5.1 Structure

No significant structural changes were made.

3.5.2 Major Systems

3.5.2.1 Propulsion System.- Because of cryogenic oxygen leakage on several SLV flights prior to the Gemini X mission, the following modifications were incorporated in the Propulsion System:

(a) Two booster liquid-oxygen gas-generator hoses were replaced with a single hose, and the liquid-oxygen gas-generator-valve cover plate was redesigned to eliminate the bulkhead fitting used previously.

(b) The liquid-oxygen start-tank fill and check valve body was redesigned to provide a flange joint with a Naflex seal, and interconnecting tubing was modified.

(c) The liquid-oxygen high-pressure relief valve and the ullage fitting on the liquid-oxygen start tank were redesigned to eliminate bulkhead fittings, and interconnecting tubing was modified.

(d) The booster liquid-oxygen gas-generator manifold was redesigned to eliminate bulkhead fittings and the check valve for the bypass fill system.

As a result of problems on two recent SLV flights in which the propellant utilization computer jumped stations and experienced a noise "scramble," a noise filter was incorporated in the 28-volt dc input line, and a pulse suppression circuit was incorporated in the trigger input.

3.5.2.2 Guidance System.- No significant changes were made to the Guidance System.

3.5.2.3 Flight Control System.- The loose bolts formerly used to install the rate gyro package were replaced with captive mounting hardware in order to shorten replacement time and eliminate the possibility of hardware being dropped in the SLV section after CAMV/TLV mat

UNCLASSIFIED

3-37

Because of a previous SLV flight failure, the autopilot was improved by replacing electronic parts with special-quality parts and by reworking circuit-board assemblies.

3.5.2.4 Electrical System.- No significant changes were made to the Electrical System.

3.5.2.5 Pneumatic System.- No significant changes were made to the Pneumatic System.

3.5.2.6 Instrumentation System.- No significant changes were made to the Instrumentation System.

3.5.2.7 Range Safety.- No significant changes were made to the Range Safety System.

3.6 GEMINI ATLAS-AGENA TARGET VEHICLE

WEIGHT AND BALANCE DATA

Weight and balance data for the Gemini Atlas-Agena Target Vehicle are as follows:

Condition	Weight (including GATV), lb (a)	Center-of-gravity location, in. (a)		
		X	Y	Z
Ignition	281 288	-	-	-
Lift-off	278 881	821.1	-0.5	-0.4
Booster engine cutoff (BECO)	72 547	847.9	-1.7	-1.5
Sustainer engine cutoff (SECO)	26 560	549.4	-2.0	-3.3
Vernier engine cutoff (VECO)	26 451	544.1	-2.1	-3.4

^aRefer to figure 3.0-2(c) for TLV/GATV coordinate system.

UNCLASSIFIED

UNCLASSIFIED

Gemini Agena Target Vehicle weight and balance data are as follows:

Condition	Weight, lb	Center-of-gravity location, in. (a)		
		X	Y	Z
Launch, gross weight	18 074	339.6	0	0
Separation	17 664	337.0	0	0
Insertion weight (in-orbit)	7 184	343.7	-0.1	-0.1

^aRefer to figure 3.0-2(b) for GATV coordinate system.

UNCLASSIFIED

UNCLASSIFIED

4-1

4.0 MISSION DESCRIPTION

4.1 ACTUAL MISSION

The Gemini X mission was initiated at lift-off of the Gemini Atlas-Agena Target Vehicle (GAATV) on July 18, 1966, at 20:39:46.131 G.m.t. The flight-controller and range-safety plotboards all indicated a normal flight of the Target Launch Vehicle (TLV). The Gemini Agena Target Vehicle (GATV) achieved a nearly circular orbit with a perigee of 156.6 nautical miles and an apogee of 162.0 nautical miles.

One hour, 40 minutes, and 40.517 seconds after the GAATV lift-off, the Gemini Space Vehicle was launched at the beginning of the 35-second launch window available for a rendezvous in the fourth revolution of the spacecraft with the Gemini X GATV and for a subsequent rendezvous with the Gemini VIII GATV.

The Gemini X mission is outlined in figure 4-1, which shows both the planned and the actual mission activities. The first (M=4) rendezvous was achieved within five minutes of the planned time. After docking, a bending-mode test was accomplished over the Hawaii tracking station to obtain dynamic data in the docked configuration, prior to maneuvering the spacecraft with the GATV primary propulsion system (PPS). To conserve spacecraft propellant, all docking practice was deleted from the flight plan.

The second rendezvous was carried out using both the Gemini X GATV primary and secondary propulsion systems (PPS and SPS) and the spacecraft Orbital Attitude and Maneuver System (OAMS). The initial maneuver was a PPS phase adjustment to allow catch-up of the Gemini VIII GATV. This maneuver placed the docked configuration in an elliptical orbit having an apogee of 412.2 nautical miles and a perigee of 158.5 nautical miles.

During the first sleep period from 9 hours to 16 hours 30 minutes ground elapsed time (g.e.t.), Experiment S012 (Micrometeorite Collection) was open. After this sleep period, a height adjust maneuver and a coelliptic maneuver were performed with the GATV PPS to place the vehicles in the proper relative positions for rendezvous.

Extravehicular activity (EVA) was conducted with the vehicles docked, and nearly all of the tasks planned for the standup EVA were performed. Experiments M410 (Color Patch Photography) and S013 (Ultraviolet

UNCLASSIFIED

UNCLASSIFIED

Astronomical Camera) were conducted. However, the duration of the EVA was reduced approximately six minutes due to eye irritation and subsequent watering which severely blurred the vision of both crewmembers.

At 26 hours 31 minutes g.e.t., Mode A of Experiment D005 (Star Occultation Navigation) was performed for 19 minutes. A docked phase adjust maneuver using the GATV SPS was performed at 27:45:36 g.e.t., followed by a 9-hour sleep period beginning at approximately 30 hours g.e.t. During the undocking operations, Experiment S026 (Ion-Wake Measurement) was conducted for about 40 minutes. The final two docked maneuvers for rendezvous with the Gemini VIII GATV were accomplished following the second sleep period. These consisted of a phase adjust maneuver and a plane change maneuver using the Gemini X GATV SPS. The spacecraft was then separated from the Gemini X GATV. The second rendezvous was achieved after accomplishing corrective combination, coelliptic, and terminal phase maneuvers, all using the spacecraft propulsion system. The crew was station keeping with the Gemini VIII GATV at 48 hours 3 minutes g.e.t.

An earlier test of the spacecraft Environmental Control System (ECS) showed that the effects of the eye irritation in the suit circuit were apparently reduced when only one suit fan was in operation; therefore, it was decided to initiate the umbilical EVA while restricting ECS operation to one suit fan. Approximately 40 minutes after the start of station keeping, the pilot egressed the spacecraft. The operations scheduled for the umbilical EVA, which included retrieving Experiments S010 and S012 packages and evaluating the Hand Held Maneuvering Unit, were nearly all accomplished; however, a greater-than-expected quantity of propellant was expended in station keeping and attitude control, and the EVA period was terminated a few minutes early in order to conserve propellant for subsequent required maneuvers. After the conclusion of the umbilical EVA and a subsequent reopening of the hatch to jettison extraneous equipment, a height adjustment was performed to separate the spacecraft from the Gemini VIII GATV, and a true anomaly adjust maneuver was performed to minimize the spacecraft trajectory dispersions during reentry.

During the period between the true anomaly adjust maneuver and the third sleep period, Mode A of Experiment D010 (Ion-Sensing Attitude Control) was conducted. During the early portion of the sleep period, many photographs were taken for Experiments S005 (Synoptic Terrain Photography) and S006 (Synoptic Weather Photography). Also Mode G of Experiment D010 was activated for a major portion of the sleep period. Following the end of the sleep period, Experiments D010 and D005 were performed in various modes for 2 1/2 hours. Experiment D010 was again activated

UNCLASSIFIED

at 66 hours 50 minutes g.e.t. and left activated until about two minutes prior to retrofire. Retrofire and reentry were normal, and the spacecraft was landed within three nautical miles of the planned landing point. The crew elected to be brought aboard the prime recovery ship by helicopter, and 28 minutes after landing they were on the deck of the U.S.S. Guadalcanal.

After spacecraft recovery, two PPS and one SPS Gemini X GATV solo maneuvers were conducted to determine the PPS operational characteristics at higher than previously attained altitudes. The first maneuver placed the Gemini X GATV in an elliptical orbit having an apogee of 750.0 nautical miles and a perigee of 208.2 nautical miles to set up the desired phasing with the Gemini VIII GATV. The final two maneuvers placed the vehicle in a circular orbit at the required altitude of 190.2 nautical miles to permit the vehicle to serve as a passive rendezvous target vehicle for future missions.

4.2 SEQUENCE OF EVENTS

The times at which major events were planned and executed are presented in tables 4-I and 4-II for the Gemini Space Vehicle and in tables 4-III and 4-IV for the Gemini Atlas-Agena Target Vehicle.

4.3 FLIGHT TRAJECTORIES

The launch and orbital trajectories referred to as planned are either preflight-calculated nominal trajectories (refs. 12 through 14) or trajectories based on nominal outputs from the Real Time Computer Complex (RTCC) at the Mission Control Center-Houston (MCC-H) and planned attitudes and sequences as determined in real time in the Auxiliary Computer Room (ACR). The actual trajectories are based on the Manned Space Flight Network tracking data and actual attitudes and sequences, as determined from airborne instrumentation. For all trajectories except the actual launch phase, the Patrick Air Force Base atmosphere was used for altitudes below 25 nautical miles and the 1959 ARDC model atmosphere was used for altitudes above 25 nautical miles. For the launch phase, the current atmosphere, as measured up to an altitude of 25 nautical miles at the time of launch, was used. The earth model for all trajectories contained geodetic and gravitational constants representing the Fischer ellipsoid. Ground tracks of the spacecraft revolutions for the periods of the first rendezvous and the second rendezvous and the period from retrofire to landing are shown in figure 4-2. The Gemini Space

~~CONFIDENTIAL~~

Vehicle launch, orbit, rendezvous, and reentry trajectory curves are presented in figures 4-3 through 4-7. The Gemini Atlas-Agena Target Vehicle (GAATV) launch trajectory curves are presented in figure 4-8.

4.3.1 Gemini Spacecraft

4.3.1.1 Launch.- The Gemini Space Vehicle was launched on a rendezvous launch azimuth of 98.8 degrees. The nominal azimuth calculated prior to the GAATV launch was 98.6 degrees, but minor deviations in the GAATV launch trajectory required a shift of 0.2 of a degree in launch azimuth to effect a nominal rendezvous. The flight-controller plotboards indicated a launch trajectory that was satisfactory in every respect. The velocity at first stage engine cutoff (BECO) was 128 ft/sec low (approximately two sigma). Vehicle closed-loop steering corrected an out-of-plane velocity of approximately 225 ft/sec.

The launch trajectory data shown in figure 4-3 are based on the real-time output of the Range Safety Impact Prediction Computer (IP 3600) and the Guided Missile Computer Facility (GMCF). The IP 3600 used data from the Missile Trajectory Measurement System (MISTRAM) and from FPS-16 and TPQ-18 radars. The GMCF used data from the GE MOD III radar. Data from these tracking facilities were used during the time periods shown in the following table:

Facility	Time from lift-off, sec
IP 3600 (FPS-16, TPQ-18)	0 to 41
GMCF (GE MOD III)	41 to 463
IP 3600 (FPS-16, MISTRAM)	463 to 494

The actual launch trajectory, compared with the planned launch trajectory (fig. 4-3), was low in altitude, velocity, and flight-path angle during first stage powered flight. At BECO the altitude, velocity, and flight-path angle were low by 4280 feet, 128 ft/sec, and 0.39 of a degree, respectively. After BECO, the Radio Guidance System (RGS) corrected the errors accumulated during first stage flight and guided Stage II to an insertion that was close to nominal. At second stage engine cutoff (SECO), altitude and velocity were low by 152 feet and 4 ft/sec, respectively, and the flight-path angle, measured to the nearest one-hundredth of a degree, was zero, as planned. At spacecraft separation, the actual

~~CONFIDENTIAL~~

~~CONFIDENTIAL~~

altitude and flight-path angle were high by 62 feet and 0.01 of a degree, respectively, and the velocity was low by 7 ft/sec.

Table 4-V contains a comparison of planned and actual conditions at BECO, SECO, and spacecraft separation. The actual conditions at BECO were obtained from MISTRAM. The actual conditions at SECO and spacecraft separation were obtained by integrating the best estimated trajectory orbital fit back through the Insertion Velocity Adjust Routine (IVAR) maneuver, the separation maneuver, and the tail-off impulse, as determined from telemetry records of Inertial Guidance System (IGS) data. (NOTE: This best estimated trajectory was based on tracking data obtained during the complete first revolution.)

The GE MOD III tracking and MISTRAM radar tracking data after SECO were used to compute a go/no-go for spacecraft insertion by averaging 10 seconds of data starting at SECO + five seconds. The go/no-go conditions obtained from GE MOD III contained a velocity and a flight-path angle that were low by 19 ft/sec and high by 0.13 of a degree, respectively, when compared with the more accurate ephemeris data. The conditions obtained from MISTRAM showed the velocity and the flight-path angle to be high by 4 ft/sec and low by 0.08 of a degree, respectively, when compared with the later ephemeris data.

4.3.1.2 Orbit.- Tables 4-VI and 4-VII show the planned and actual spacecraft orbital elements from insertion to retrofire, and figure 4-4 shows the actual apogees and perigees for the same periods. The planned elements shown in tables 4-VI and 4-VII were those calculated in real time by the RTCC, and the actual elements in table 4-VII were obtained by integrating the Gemini tracking network vectors after each maneuver. The maneuvers accomplished to rendezvous and dock with the Gemini X GATV and to rendezvous with the Gemini VIII GATV are described in more detail in the following paragraphs.

4.3.1.2.1 First rendezvous: The planned trajectory and the actual trajectory for the first (M=4) rendezvous are presented in figure 4-5. This figure does not show the final braking trajectory. (The relative trajectory during final braking was determined from onboard radar data. The trajectory is shown in figures 5.1.5-15 and 5.1.5-16.) The planned maneuvers, the ground-commanded maneuvers, and the actual maneuvers are presented in table 4-VIII.

The planned trajectory for the initial rendezvous in spacecraft revolution 4 was obtained from the real-time solution using the Bermuda revolution 3 vector for the Gemini X GATV and the Ascension revolution 2 vector for the spacecraft. The ground-commanded maneuvers were determined from spacecraft and GATV vectors as the planned maneuvers were

~~CONFIDENTIAL~~

UNCLASSIFIED

updated after each maneuver. The actual trajectory during the initial rendezvous was reconstructed utilizing anchor vectors obtained from the best estimated trajectory and the actual maneuvers, as derived from the Inertial Guidance System (IGS) postflight analysis, applied as instantaneous changes in velocity.

After spacecraft orbital insertion, ground computations indicated a nominal situation for obtaining a fourth-orbit rendezvous. At spacecraft insertion, the range between Spacecraft 10 and the Gemini X GATV was approximately 1000 nautical miles, and the out-of-plane velocity error resulting after the GLV ascent yaw steering was 5.4 ft/sec.

At 2:18:11 g.e.t., a phase adjust maneuver (N_{C1}) was initiated near second apogee. The horizontal, posigrade ΔV of 55.8 ft/sec was applied with the aft-firing thrusters. The resultant altitude at perigee was about 117 nautical miles, and the resultant apogee was about 145 nautical miles. At 2:30:49 g.e.t., the plane change (N_{PC}) maneuver was initiated and required a ΔV of 10.5 ft/sec.

The coelliptic maneuver (N_{SR}) was initiated at 3:47:36 g.e.t. and performed orthogonally with the aft-firing and down-firing thrusters. The actual ΔV 's applied were 47 ft/sec forward and 5 ft/sec up. The resultant spacecraft orbit was about 143 by 147 nautical miles, and the differential altitude (Δh) between the spacecraft and the Gemini X GATV orbits was about 15.6 to 16.5 nautical miles. Prior to the terminal phase initiate (TPI) maneuver, the Δh varied from 16.3 to 16.5 nautical miles with a value of 16.4 nautical miles at TPI.

The TPI maneuver was initiated at 4:33:44 g.e.t. when the elevation angle to the Gemini X GATV was approximately 26.0 degrees and the range was about 37 nautical miles. A total ΔV of 42.3 ft/sec was applied. In computer coordinates, the actual ΔV applied resulted in a ΔV_x of 37.0 ft/sec, ΔV_y of minus 20.5 ft/sec, and a ΔV_z of 0.17 ft/sec. Ground-commanded maneuvers indicated that TPI should occur at 4:34:05 g.e.t. with a ΔV of 34.0 ft/sec to be applied. In computer coordinates, the ground-commanded ΔV resulted in a ΔV_x of 30.6 ft/sec, ΔV_y of minus 14.8 ft/sec, and a ΔV_z of minus 1.2 ft/sec.

For the first midcourse correction, the spacecraft onboard computer called for 15.0 ft/sec aft, 22 ft/sec down, and 1 ft/sec right in spacecraft body coordinates. In computer coordinates, considering the target boresighted, this resolves into a ΔV_x of 4 ft/sec, ΔV_y of 26 ft/sec,

UNCLASSIFIED

and a ΔV_Z of minus 1 ft/sec. The actual first midcourse correction applied resulted in a ΔV_X of minus 2.5 ft/sec, ΔV_Y of 20.3 ft/sec, ΔV_Z of 0.8 ft/sec in computer coordinates. This correction was initiated at 4:46:23 g.e.t.

The actual second midcourse correction, at an angle of orbit travel to rendezvous (ωt) of 33.6 degrees, resulted in a ΔV_X of 29.0 ft/sec, a ΔV_Y of minus 12.2 ft/sec, and a ΔV_Z of minus 5.7 ft/sec in computer coordinates, and the correction was initiated at 4:58:24 g.e.t. The spacecraft onboard computer displayed 1 ft/sec forward, 25 ft/sec down, and 5 ft/sec right in spacecraft body coordinates. In computer coordinates, the onboard computer ΔV approximately resolves into a ΔV_X of 23 ft/sec, ΔV_Y of 12 ft/sec, and ΔV_Z of minus 5 ft/sec.

The actual midcourse corrections applied resulted in a non-nominal closing trajectory, requiring difficult line-of-sight control and braking thrusts during the last several miles to rendezvous.

The terminal phase finalize (TPF) maneuver was initiated at approximately 5 hours g.e.t., and braking thrusts were applied almost continuously over the next 15 minutes. At 5 hours 15 minutes g.e.t. the spacecraft was less than 200 feet from the Gemini X GATV, and the crew was station keeping. The total translation cost of the terminal phase maneuvers, including TPI and braking, was approximately 400 pounds of propellant, which is more than three times the average amount used during this phase of rendezvous on previous missions.

A detailed evaluation of the spacecraft trajectory between 5 hours 5 minutes and 5 hours 15 minutes g.e.t. is contained in section 5.1.5. A simulation of the actual trajectory between TPI and TPF is presented in figure 4-5. The onboard radar outputs and planned profile are also shown for the same period in figure 4-5. The actual trajectory from TPF to rendezvous is shown in figures 5.1.5-15 and 5.1.5-16.

4.3.1.2.2 Second rendezvous: The planned trajectory and the actual trajectory for the rendezvous with the Gemini VIII GATV, a passive target, are presented in figure 4-6. The planned maneuvers, ground-commanded maneuvers, and actual maneuvers are presented in table 4.3-VIII.

The planned trajectory for the second rendezvous was obtained from a real-time solution of an RTCC vector for the Gemini VIII GATV, measured on the day before the launch of Gemini X, and the Bermuda revolution 2 Gemini X GATV vector for the docked vehicles. The ground-commanded

UNCLASSIFIED

maneuvers were determined from various spacecraft and GATV vectors as the planned maneuvers were updated after each actual maneuver. The actual trajectory during the second rendezvous was reconstructed utilizing anchor vectors obtained from the best estimated trajectory and the actual maneuvers, as derived from IGS postflight analysis.

At 7:38:34 g.e.t., the first of the docked configuration maneuvers was performed. The Gemini X GATV primary propulsion system (PPS) was used to apply the ground-commanded ΔV of 420 ft/sec. IGS postflight analysis indicated that approximately 424 ft/sec was actually applied. This maneuver, a phase adjust maneuver (N_{CH1}), raised the spacecraft apogee to 412 nautical miles, setting up a Spacecraft 10 rendezvous with the Gemini VIII GATV during revolution 30 of the spacecraft. The PPS was then used to perform a height adjust maneuver (N_{CH2}) at 20:20:12 g.e.t. The near-nominal ΔV of 346 ft/sec lowered the spacecraft apogee to approximately 206 nautical miles. The final docked PPS maneuver occurred at 22:37:06 g.e.t. and resulted in a ΔV of 82 ft/sec. The ground-commanded maneuver ΔV was 75.7 ft/sec. This maneuver circularized the orbit of the docked vehicles about nine miles below the orbit of the Gemini VIII GATV.

Small dispersions in docked maneuvers and inaccuracies in predicting exact forces due to spacecraft drag made it necessary to perform several small orbit-shaping maneuvers. At 27:45:36 g.e.t., the Gemini X GATV secondary propulsion system (SPS) was used to perform a phase adjust maneuver of 9.7 ft/sec, the first of the shaping maneuvers. The ΔV of the ground-commanded maneuver was 7.7 ft/sec. At 41:04:26 g.e.t., the SPS was used to apply a plane change maneuver of 16 ft/sec, and at 41:35:50 g.e.t., a phase adjust maneuver of 4.4 ft/sec. The ΔV 's of these ground-commanded maneuvers were 14.8 ft/sec for the plane change maneuver and 3.5 ft/sec for the phase adjust maneuver.

Spacecraft 10 was separated from the Gemini X GATV at approximately 44:40:16 g.e.t. with a ΔV of 2.0 ft/sec. This maneuver also served as a vernier phase adjustment.

A spacecraft corrective combination (N_{CC}) maneuver of 4.2 ft/sec was applied at 45:54:01 g.e.t., and a coelliptic (N_{SR}) maneuver of 10.6 ft/sec at 46:09:29 g.e.t. allowed Spacecraft 10 to achieve a Δh of approximately 7.2 nautical miles with the passive Gemini VIII GATV. This maneuver also served to control phasing so that TPI would occur at the desired time (32 minutes before spacecraft sunset).

UNCLASSIFIED

The ground-commanded solution for TPI was very close to the onboard computed solution based on optical techniques. TPI was applied at 47:26:44 g.e.t. and resulted in a ΔV of approximately 22 ft/sec. At TPI, the relative range between the spacecraft and the passive GATV was about 14.2 nautical miles and the elevation angle to the target was about 31 degrees. Spacecraft corrective maneuvers at 47:34:10 g.e.t. and 47:38:58 were approximately 4 ft/sec and 1 ft/sec and were computed entirely by means of onboard optical techniques.

At 47:39:10 g.e.t. the command pilot began braking maneuvers (TPF), and almost continuous thrusts were applied until station keeping started at 47:59:22 g.e.t. The total propellant expenditure for the final braking maneuver was approximately 150 pounds, or only about the same as the average expenditure for simulations of this type of rendezvous. The crew reported that the target was stabilized.

4.3.1.3 Reentry.- The planned and actual reentry trajectories are shown in figure 4-7. The planned trajectory was determined by integrating the Carnarvon vector in revolution 42 through planned retrofire sequences determined by the RTCC and then using the Math Flow 7 reentry-guidance scheme described in reference 15. The Carnarvon vector, taken one revolution before retrofire, was used because the retrofire time that had been transmitted to the spacecraft was based on that solution. The actual trajectory was obtained by integrating the White Sands vector from after retrofire to landing using the Math Flow 7 reentry-guidance technique.

The times of the events associated with the reconstructed reentry trajectory agree very well with the actual times of the reentry events. The reconstructed guidance commands agree with the onboard guidance commands, the maximum acceleration loads compare with telemetry within 0.6g at analogous times, and the parachute deployment altitudes at recorded sequence times are in accord with those reported in section 5.1.11. Table 4-V contains a comparison of reentry dynamic parameters and landing points. The actual landing was within three nautical miles of the planned landing point. (See section 5.1.5 for a more detailed description of the spacecraft landing coordinates.)

4.3.2 Gemini Atlas-Agena Target Vehicle

4.3.2.1 Launch.- The Gemini Atlas-Agena Target Vehicle was launched from an initial azimuth of 105 degrees to a final flight azimuth of 83.85 degrees. Sustainer steering was used to obtain the desired longitude of the ascending node and inclination angle. Minor booster steering was required. The flight-controller and range-safety plotboards all indicated a nominal Target Launch Vehicle (TLV) flight.

UNCLASSIFIED

The Gemini Agena Target Vehicle (GATV) performed as planned, executing the 90 deg/min pitch-down rate after separation and continuing this rate until the D-timer started the minus 3.99 deg/min orbital geocentric pitch rate. The GATV achieved a nearly circular orbit with a perigee of 156.6 nautical miles and an apogee of 162.0 nautical miles.

The launch trajectory data presented in figure 4-8 are based on the real-time outputs of the GMCF, the IP 3600, and the Bermuda FPS-16 tracking radar. Data from these tracking facilities were used during the time periods listed in the following table:

Facility	Time from lift-off, sec
GMCF (GE MOD III)	0 to 355
IP 3600 (TPQ-18, FPS-16)	355 to 404
Bermuda (FPS-16)	404 to 614

The actual launch trajectory, as compared with the planned trajectory in figure 4-8 was essentially nominal. The differences indicated in table 4-IX are not representative of errors or dispersions (see section 5.5.5) because the TLV is targeted for coast-ellipse orbital elements rather than for a specific position and velocity. Table 4-X presents the targeting parameters and osculating elements at GAATV vernier engine cutoff (VECO) and GATV insertion.

4.3.2.2 Orbit.- The GATV was placed into the desired orbit for the planned Gemini Space Vehicle launch and spacecraft rendezvous (see paragraph 4.3.1.2.1). Table 4-IX contains a comparison of the planned and actual insertion conditions of the GATV. The actual conditions were obtained by integrating the best estimated trajectory orbital fit back to the time of GATV primary propulsion system (PPS) cutoff.

After the conclusion of the spacecraft flight, the Gemini X GATV was placed in a circular orbit at an altitude of 190 nautical miles for possible use as a passive target during later missions. Table 4-XI contains data concerning these maneuvers, and table 4-XII presents the orbital parameters before and after these maneuvers. Figure 4-9 shows the altitudes of the apogees and perigees of the Gemini X GATV for the entire mission.

UNCLASSIFIED

UNCLASSIFIED

4-11

4.3.3 Gemini Launch Vehicle Second Stage

The second stage of the Gemini Launch Vehicle was inserted into an orbit having apogee and perigee altitudes of 131 and 86.8 nautical miles, respectively. North American Air Defense Command (NORAD) network tracking equipment was able to skin-track the GLV second stage during the ensuing 25-hour orbital lifetime. NORAD predicted reentry in revolution 16, with a predicted impact point in the Atlantic Ocean east of the southern tip of Africa.

UNCLASSIFIED

UNCLASSIFIED

TABLE 4-I.- SEQUENCE OF EVENTS FOR GEMINI SPACE VEHICLE LAUNCH PHASE

Event	Time from lift-off, sec		Difference, sec
	Planned	Actual	
Stage I engine ignition signal (87FS1)	-3.40	-3.26	+0.14
Stage I MDTCPs make, subassembly 1	-2.30	-2.33	-0.03
Stage I MDTCPs make, subassembly 2	-2.30	-2.32	-0.02
Shutdown lockout (backup)	-0.10	-0.10	0.00
Lift-off (pad disconnect separation)	22:20:26.648 G.m.t.		
Roll program start (launch azimuth = 98.8 deg)	9.36	9.35	-0.01
Roll program end	20.48	20.45	-0.03
Pitch program rate no. 1 start	23.04	23.00	-0.04
Pitch program rate no. 1 end, no. 2 start	88.32	88.08	-0.24
Control system gain change no. 1	104.96	104.69	-0.27
First IGS update sent	105.00	105.41	+0.41
Pitch program rate no. 2 end, no. 3 start	119.04	118.73	-0.31
Stage I engine shutdown circuitry arm	144.64	144.26	-0.38
Second IGS update sent	145.00	145.41	+0.41
Stage I MDTCPs unmake	151.66	152.34	+0.68
BECO (stage I engine cutoff) (87FS2)	152.38	152.38	0.00
Staging switches actuate	152.38	152.38	0.00
Signals from stage I rate gyro package to Flight Control System discontinued	152.38	152.38	0.00
Hydraulic switchover lockout	152.38	152.38	0.00
Telemetry ceases, stage I	152.38	152.38	0.00
Staging nuts detonate	152.38	152.38	0.00
Stage II engine ignition signal (91FS1)	152.38	152.38	0.00
Control system gain change	152.38	152.38	0.00
Stage separation begin	152.44	153.10	+0.66
Stage II engine MDFJPS make	152.64	153.02	+0.38
Pitch program rate no. 3 end	162.56	162.13	-0.43
RGS guidance enable	162.56	162.13	-0.43
First guidance command signal received by TARS	169.00	168.27	-0.73
Stage II engine shutdown circuitry arm	317.44	316.58	-0.86
SECO (stage II engine cutoff) (91FS2)	339.74	340.57	+0.83
Redundant stage II shutdown	339.74	340.61	+0.87
Stage II MDFJPS break	340.04	340.71	+0.67
Spacecraft separation (shaped charge fired)	369.74	371.44	+1.70
OAMS on	369.74	370.95	+1.21
OAMS off (final) ^a	399.74	441.65	+41.91

^aOver a 71.7-second time interval two maneuvers were made, a separation maneuver of 0.7 seconds and an Insertion Velocity Adjust Routine (IVAR) maneuver of 34.6 seconds.

UNCLASSIFIED

UNCLASSIFIED

4-13

TABLE 4-II.- SEQUENCE OF EVENTS FOR GEMINI SPACECRAFT ORBITAL AND REENTRY PHASES

Event	Ground elapsed time, hr:min:sec		Difference, sec
	Planned	Actual	
M=4 rendezvous			
Phase adjust maneuver	02:18:09	02:18:11	+2
Plane change maneuver	02:30:49	02:30:49	0
Coelliptic maneuver	03:47:34	03:47:36	+2
Terminal phase initiate maneuver	04:34:13	04:33:44	-29
First midcourse correction		04:46:23	--
Second midcourse correction		04:58:24	--
Terminal phase finalize	05:06:15	05:01:52	-263
Second rendezvous			
Phase adjust maneuver	07:38:34	07:38:34	0
Height adjust maneuver	20:20:12	20:20:12	0
Coelliptic maneuver	22:37:07	22:37:06	-1
Phase adjust maneuver	27:45:36	27:45:36	0
Plane change maneuver	41:04:26	41:04:26	0
Phase adjust maneuver	41:35:50	41:35:50	0
Spacecraft separation and phase adjust maneuver	44:40:15	44:40:16	+1
Corrective combination maneuver	45:54:01	45:54:01	0
Coelliptic maneuver	46:09:28	46:09:29	+1
Terminal phase initiate maneuver	47:27:20	47:26:44	-36
First midcourse correction		47:34:10	--
Second midcourse correction		47:38:58	--
Terminal phase finalize	47:47:31	47:39:10	-501
Spacecraft separation maneuver	51:16:00	51:16:00	0
True anomaly adjust maneuver	51:38:51	51:38:52	+1
Equipment adapter separation	70:09:25	70:08:37	-48
Retrofire initiation	70:10:25	70:10:24	-1
Begin blackout	70:34:46	^a 70:34:39	-7
End blackout	70:39:34	^a 70:39:26	-8
Drogue parachute deployment	70:41:08	70:41:34	+26
Pilot parachute deployment, main parachute initiation	70:42:42	70:42:51	+9
Landing	70:46:42	70:46:39	-3

^aThese times were obtained from the actual reentry trajectory simulation because telemetry signal-strength records were not available.

UNCLASSIFIED

UNCLASSIFIED

TABLE 4-III.- SEQUENCE OF EVENTS FOR GAATV LAUNCH PHASE

Event	Time from lift-off, sec		Difference, sec
	Planned	Actual	
Lift-off	20:39:46.131 G.m.t.		
Booster engine cutoff (BECO)	131.00	130.37	-0.63
Booster engine separation	134.00	133.41	-0.59
Primary sequencer start	276.23	275.50	-0.73
Sustainer engine cutoff (SECO)	279.20	279.34	+0.14
Vernier engine cutoff (VECO)	297.47	298.06	+0.59
TLV/GATV separation	300.00	300.70	+0.70
Initiate horizon sensor roll control	302.50	302.70	+0.20
Start 90 deg/min pitch down	337.23	336.40	-0.83
Stop 90 deg/min pitch down	350.23	349.50	-0.73
Start orbital pitch rate	350.23	349.50	-0.73
SPS ignition	352.23	351.44	-0.79
Open PPS gas generator - valve	370.23	369.40	-0.83
PPS ignition	370.73	370.37	-0.36
SPS thrust cutoff	372.23	371.45	-0.78
Jettison nose shroud	380.23	380.17	-0.06
Velocity meter cutoff	556.19	558.05	+1.86
PPS thrust cutoff backup	564.50	566.68	+2.18

UNCLASSIFIED

TABLE 4-IV.- SEQUENCE OF EVENTS FOR GATV ORBITAL PHASE

Event	Ground elapsed time, hr:min:sec		Difference, sec
	Planned	Actual	
Phase adjust maneuver	07:38:34	07:38:34	0
Height adjust maneuver	20:20:12	20:20:12	0
Coelliptic maneuver	22:37:07	22:37:06	-1
Phase adjust maneuver	27:45:36	27:45:36	0
Plane change maneuver	41:04:26	41:04:26	0
Phase adjust maneuver	41:35:50	41:35:50	0
Height adjust maneuver	72:21:07	72:21:05	-2
Height adjust maneuver	79:11:41	79:11:38	-3
Height adjust maneuver	82:58:08	82:58:06	-2

~~CONFIDENTIAL~~

TABLE 4-V.- PLANNED AND ACTUAL GEMINI LAUNCH
VEHICLE AND SPACECRAFT TRAJECTORY PARAMETERS

Condition	Planned	Actual	
		Preliminary	Final
BECO			
Time from lift-off, sec	152.38	152.38	152.38
Geodetic latitude, deg north	28.38	28.38	28.38
Longitude, deg west	79.64	79.65	79.65
Altitude, ft	210 860	206 500	206 580
Altitude, n. mi.	34.7	33.9	34.0
Range, n. mi.	48.8	47.8	47.8
Space-fixed velocity, ft/sec	9 869	9 739	9 741
Space-fixed flight-path angle, deg	19.58	19.18	19.19
Space-fixed heading angle, deg east of north	98.18	97.94	97.93
SECO			
Time from lift-off, sec	339.74	340.57	340.57
Geodetic latitude, deg north	27.12	27.13	27.13
Longitude, deg west	71.94	71.93	71.94
Altitude, ft	527 300	527 155	527 252
Altitude, n. mi.	86.8	86.8	86.8
Range, n. mi.	465.3	465.8	467.3
Space-fixed velocity, ft/sec	25 637	25 633	25 633
Space-fixed flight-path angle, deg	0	0	0
Space-fixed heading angle, deg east of north	100.66	100.69	100.68
Spacecraft separation			
Time from lift-off, sec	369.74	371.44	371.44
Geodetic latitude, deg north	26.72	26.72	26.72
Longitude, deg west	69.80	69.73	69.73
Altitude, ft	526 871	526 933	526 933
Altitude, n. mi.	86.7	86.7	86.7
Range, n. mi.	584.3	588.0	588.0
Space-fixed velocity, ft/sec	25 719	25 712	25 712
Space-fixed flight-path angle, deg	0.00	0.01	0.01
Space-fixed heading angle, deg east of north	101.69	101.73	101.73

~~CONFIDENTIAL~~

TABLE 4-V.- PLANNED AND ACTUAL GEMINI LAUNCH
VEHICLE AND SPACECRAFT TRAJECTORY PARAMETERS - Concluded

Condition	Planned	Actual	
		Preliminary	Final
Maximum conditions			
Altitude, statute miles	472.6	474.0	474.0
Altitude, n. mi.	411.0	412.2	412.2
Space-fixed velocity, ft/sec	25 740	25 738	25 738
Earth-fixed velocity, ft/sec	24 374	24 372	24 372
Exit acceleration, g	7.2	7.1	7.1
Exit dynamic pressure lb/ft ²	742	748	748
Reentry deceleration, g (tracking data)	6.4	6.1	6.1
Reentry deceleration, g (telemetry data)	N/A	5.5	5.5
Reentry dynamic pressure, lb/ft ²	416	400	400
Landing point			
Latitude, North	26 deg 43 min	^a 26 deg 42 min	^b 26 deg 45 min
Longitude, West	72 deg 00 min	^a 72 deg 02 min	^b 71 deg 57 min

^aLanding point based on IGS at drogue deploy.

^bLanding point based on determinations made on U.S.S. Guadalcanal.

UNCLASSIFIED

TABLE 4-VI.- SPACECRAFT ORBITAL ELEMENTS

Revolution	Condition	Planned (a)	Actual (b)
1 (Insertion)	Apogee, n. mi.	145.2	145.1
	Perigee, n. mi.	86.7	86.3
	Inclination, deg	28.89	28.87
	Period, min	88.72	88.79
4 (Before first rendezvous)	Apogee, n. mi.	147.0	145.8
	Perigee, n. mi.	144.0	143.3
	Inclination, deg	28.86	28.85
	Period, min	89.81	89.88
4 (After first rendezvous)	Apogee, n. mi.	162.8	161.9
	Perigee, n. mi.	158.8	156.5
	Inclination, deg	28.85	28.85
	Period, min	90.38	90.56
12 (After N _{CH1} , PPS phase adjustment)	Apogee, n. mi.	411.0	412.2
	Perigee, n. mi.	160.0	158.5
	Inclination, deg	28.89	28.88
	Period, min	94.92	95.31
24 (After N _{CH2} , PPS height adjustment)	Apogee, n. mi.	210.1	209.9
	Perigee, n. mi.	208.0	205.0
	Inclination, deg	28.87	28.88
	Period, min	92.15	92.34
29 (Before second rendezvous)	Apogee, n. mi.	208.9	209.2
	Perigee, n. mi.	208.6	205.9
	Inclination, deg	28.88	28.90
	Period, min	92.13	92.38

^aPlanned elements are those computed in real time by the RTCC. The apogee and perigee are measured over a spherical earth with Launch Complex 19 radius. The periods were calculated by the anomalistic apogee and perigee curve in reference 12.

^bActual elements are measured over an oblate earth. Period and inclination are osculating elements.

UNCLASSIFIED

UNCLASSIFIED

TABLE 4-VI.- SPACECRAFT ORBITAL ELEMENTS - Concluded

Revolution	Condition	Planned (a)	Actual (b)
29 (After second rendezvous)	Apogee, n. mi.	216.2	216.0
	Perigee, n. mi.	216.0	213.5
	Inclination, deg	28.90	28.91
	Period, min	92.41	92.63
43 (Retrofire)	Apogee, n. mi.	216.0	215.5
	Perigee, n. mi.	158.3	157.9
	Inclination, deg	28.88	28.87
	Period, deg	91.35	91.48

^aPlanned elements are those computed in real time by the RTCC. The apogee and perigee are measured over a spherical earth with Launch Complex 19 radius. The periods were calculated by the anomalistic apogee and perigee curve in reference 12.

^bActual elements are measured over an oblate earth. Period and inclination are osculating elements.

UNCLASSIFIED

TABLE 4-VII.- SPACECRAFT ORBITAL ELEMENTS BEFORE AND AFTER MANEUVERS

Maneuver	Condition	Before maneuver		After maneuver	
		Planned (a)	Actual (b)	Planned (a)	Actual (b)
<u>First rendezvous</u> Phase adjust (^N Cl)	Apogee, n. mi.	145.2	145.1	147.0	144.5
	Perigee, n. mi.	86.7	86.3	118.3	117.2
	Inclination, deg	28.89	28.87	28.88	28.87
	Period, min	88.72	88.79	89.45	89.39
Plane change (^N PC)	Apogee, n. mi.	147.0	144.5	147.0	144.5
	Perigee, n. mi.	118.3	117.2	118.3	117.2
	Inclination, deg	28.88	28.87	28.86	28.85
	Period, min	89.45	89.39	89.45	89.39
Coelliptic (^N SR)	Apogee, n. mi.	147.0	144.5	147.0	145.8
	Perigee, n. mi.	118.3	117.2	144.4	143.3
	Inclination, deg	28.86	28.85	28.86	28.85
	Period, min	89.45	89.39	89.81	89.88
Terminal phase initiate (TPI)	Apogee, n. mi.	147.0	145.8	162.8	160.6
	Perigee, n. mi.	144.0	143.3	144.4	143.3
	Inclination, deg	28.86	28.85	28.84	28.85
	Period, min	89.81	89.88	90.13	90.18
Terminal phase finalize (TPF)	Apogee, n. mi.	162.8	160.6	162.8	161.9
	Perigee, n. mi.	144.4	143.3	158.8	156.5
	Inclination, deg	28.84	28.85	28.85	28.85
	Period, min	90.13	90.18	90.38	90.56
<u>Second rendezvous</u> Phase adjust (^N CH1) (docked)	Apogee, n. mi.	162.8	161.9	411.0	412.2
	Perigee, n. mi.	158.8	156.5	160.0	158.5
	Inclination, deg	28.85	28.85	28.98	28.88
	Period, min	90.38	90.56	94.92	95.31
Height adjust (^N CH2) (docked)	Apogee, n. mi.	411.0	412.2	205.7	205.8
	Perigee, n. mi.	160.0	158.5	160.0	158.4
	Inclination, deg	28.89	28.88	28.86	28.89
	Period, min	94.92	95.31	91.20	91.45

^aPlanned elements are those computed in real time by the RTCC. The apogee and perigee are measured above a spherical earth with Launch Complex 19 radius. The periods were calculated by the anomalistic apogee and perigee curve in reference 12.

^bActual elements are measured above an oblate earth. Period and inclination are osculating elements.

UNCLASSIFIED

TABLE 4-VII.- SPACECRAFT ORBITAL ELEMENTS BEFORE AND AFTER MANEUVERS - Continued

Maneuver	Condition	Before maneuver		After maneuver	
		Planned (a)	Actual (b)	Planned (a)	Actual (b)
Coelliptic (^N SR) (docked)	Apogee, n. mi.	205.7	205.8	207.2	208.7
	Perigee, n. mi.	160.0	158.4	203.9	203.9
	Inclination, deg	28.86	28.89	28.85	28.88
	Period, min	91.20	91.45	92.00	92.18
Phase adjust (^N Cl) (docked)	Apogee, n. mi.	207.2	208.7	210.1	209.9
	Perigee, n. mi.	203.9	203.9	208.0	205.0
	Inclination, deg	28.85	28.88	28.87	28.88
	Period, min	92.00	92.18	92.15	92.34
Plane change (^N PC) (docked)	Apogee, n. mi.	210.1	209.9	210.1	209.9
	Perigee, n. mi.	208.0	205.0	208.0	205.0
	Inclination, deg	28.87	28.88	28.87	28.87
	Period, min	92.15	92.34	92.15	92.34
Phase adjust (^N Cl) (docked)	Apogee, n. mi.	210.1	209.9	208.8	208.5
	Perigee, n. mi.	208.0	205.0	207.1	205.5
	Inclination, deg	28.87	28.87	28.87	28.90
	Period, min	92.15	92.34	92.11	92.32
Separation (^N Cl)	Apogee, n. mi.	208.8	208.5	209.2	208.2
	Perigee, n. mi.	207.1	205.5	207.9	205.4
	Inclination, deg	28.89	28.90	28.91	28.91
	Period, min	92.11	92.35	92.13	92.35
Corrective combination (^N CC)	Apogee, n. mi.	209.2	208.2	208.9	209.2
	Perigee, n. mi.	207.9	205.4	208.6	205.9
	Inclination, deg	28.91	28.91	28.88	28.90
	Period, min	92.13	92.35	92.13	92.38
Coelliptic (^N SR)	Apogee, n. mi.	208.9	209.2	208.8	208.9
	Perigee, n. mi.	208.6	205.9	208.3	206.1
	Inclination, deg	28.88	28.90	28.90	28.91
	Period, min	92.13	92.38	92.13	92.36

^aPlanned elements are those computed in real time by the RTCC. The apogee and perigee are measured above a spherical earth with Launch Complex 19 radius. The periods were calculated by the anomalistic apogee and perigee curve in reference 12.

^bActual elements are measured above an oblate earth. Period and inclination are osculating elements.

UNCLASSIFIED

TABLE 4-VII.- SPACECRAFT ORBITAL ELEMENTS BEFORE AND AFTER MANEUVERS - Concluded

Maneuver	Condition	Before maneuver		After maneuver	
		Planned (a)	Actual (b)	Planned (a)	Actual (b)
Terminal phase initiate (TPI)	Apogee, n. mi.	208.8	208.9	217.0	216.8
	Perigee, n. mi.	208.3	206.1	209.4	207.4
	Inclination deg	28.90	28.91	28.90	28.90
	Period, min	92.13	92.36	92.30	92.61
Terminal phase finalize (TPF)	Apogee, n. mi.	217.0	216.8	216.2	216.0
	Perigee, n. mi.	209.4	207.4	216.0	213.5
	Inclination, deg	28.90	28.90	28.90	28.91
	Period, min	92.30	92.61	92.41	92.63
<u>After separation</u> True anomaly adjust	Apogee, n. mi.	216.2	216.0	216.0	215.5
	Perigee, n. mi.	216.0	213.5	158.3	157.9
	Inclination, deg	28.90	28.91	28.88	28.87
	Period, min	92.41	92.63	91.35	91.48

^aPlanned elements are those computed in real time by the RTCC. The apogee and perigee are measured above a spherical earth with Launch Complex 19 radius. The periods were calculated by the anomalistic apogee and perigee curve in reference 12.

^bActual elements are measured above an oblate earth. Period and inclination are osculating elements.

UNCLASSIFIED

TABLE 4-VIII.- RENDEZVOUS MANEUVERS

Maneuver	Preflight planned	Ground-commanded	Actual
First rendezvous			
Phase adjust (N_{CL})			
Initiate time, g.e.t.	2:18:11	2:18:09	2:18:11
ΔV , ft/sec	55.8	55.9	55.8
Pitch, deg	0.0	0.0	0.0
Yaw, deg	0.0	0.0	0.0
Δt , sec	74.0	75.0	75.0
Plane change (N_{PC})			
Initiate time, g.e.t.	2:33:09	2:30:49	2:30:49
ΔV , ft/sec	9.2	9.6	10.5
Pitch, deg	0.0	0.0	2.0
Yaw, deg	90.0	90.0	90.0
Δt , sec	12.0	13.0	^a 95.0
Coelliptic (N_{SR})			
Initiate time, g.e.t.	3:47:32	3:47:34	3:47:36
ΔV , ft/sec	48.6	48.7	^b 47.5
Pitch, deg	9.2	9.0	^b 0.0
Yaw, deg	0.0	0.0	0.0
Δt , sec	64.0	65.0	65.0

^aThe time interval (Δt) indicated here is the amount of time that was taken to perform the maneuver which includes the zeroing of the IVI.

^bThis maneuver was performed orthogonally, with ΔV 's of 47 ft/sec forward and 5 ft/sec up.

UNCLASSIFIED

TABLE 4-VIII.- RENDEZVOUS MANEUVERS - Continued

Maneuver	Preflight planned	Ground-commanded	Actual
First rendezvous - Continued			
Terminal phase initiate (TPI)			
Initiate time, g.e.t.	4:35:58	4:34:05	4:33:44
ΔV , ft/sec	35.0	34.0	42.3
Pitch, deg	26.5	26.7	^d 26.2
Yaw, deg	0.0	0.2	^d 0.0
V_X, V_Y, V_Z^c , ft/sec	Not computed	30.6, -14.8, -1.2	37.0, -20.5, 0.2
Δt , sec	45.0	45.0	^a 55.0
First midcourse correction			
Initiate time, g.e.t.	Not computed	Not sent	4:46:23.4
ΔV , ft/sec	Not computed	Not sent	20.4
Pitch, deg			^d 42.0
Yaw, deg			^d 1.2
V_X, V_Y, V_Z^c , ft/sec			-2.5, 20.3, 0.8
Δt , sec			54.0
Second midcourse correction			
Initiate time, g.e.t.	Not computed	Not sent	4:58:24
ΔV , ft/sec	Not computed	Not sent	32.0
Pitch, deg			^d 63.0
Yaw, deg			^d 6.0
V_X, V_Y, V_Z^c , ft/sec			29.0, -12.2, -5.7
Δt , sec			^a 73.0

^aThe time interval (Δt) indicated here is the amount of time that was taken to perform the maneuver which includes the zeroing of the IVI.

^c V_X, V_Y, V_Z are the velocity vector components in computer coordinates. V_X is positive in the direction of motion, V_Y is positive towards the center of the earth, and V_Z is positive to the right of the orbit path (South).

^dApproximate line-of-sight angles to target during corrections.

UNCLASSIFIED

TABLE 4-VIII.- RENDEZVOUS MANEUVERS - Continued

Maneuver	Preflight planned	Ground-commanded	Actual
First rendezvous - Concluded			
Terminal phase finalize (TPF) (braking)			
Initiate time, g.e.t.	Not computed	Not sent	5:01:52
ΔV , ft/sec	Not computed	Not sent	^e 66
Pitch, deg			
Yaw, deg			
Δt , sec			^f 900
Second rendezvous			
Phase adjust (^N _{CH1})			
Initiate time, g.e.t.	^g 7:39:42	7:38:34	7:38:34
ΔV , ft/sec	420.0	420.0	423.6
Pitch, deg	0.0	0.0	0.0
Yaw, deg	0.0	0.0	0.0
Δt , sec	79.0	79.0	80.0
Height adjust (^N _{CH2})			
Initiate time, g.e.t.	^g 20:20:57	20:20:12	20:20:12
ΔV , ft/sec	336.2	340.0	346.2
Pitch, deg	0.0	0.0	0.0
Yaw, deg	180.0	180.0	180.0
Δt , sec	76.0	78.0	78.0

^eThis is the resultant ΔV applied during the braking; however, the total ΔV expended during the semi-optical approach was about 350 ft/sec.

^fBraking lasted intermittently for about 15 minutes.

^gPPS 75 percent full thrust.

UNCLASSIFIED

TABLE 4-VIII.- RENDEZVOUS MANEUVERS - Continued

Maneuver	Preflight planned	Ground-commanded	Actual
Second rendezvous - Continued			
Coelliptic (N_{SR})			
Initiate time, g.e.t. . . .	22:37:53	22:37:07	22:37:06
ΔV , ft/sec	84.4	75.7	82.2
Pitch, deg	-7.0	0.0	0.0
Yaw, deg	0.0	0.0	0.0
Δt , sec	69.0	69.0	70.0
Phase adjust (N_{Cl})			
Initiate time, g.e.t. . . .	Not computed	27:45:36	27:45:36
ΔV , ft/sec	Not computed	7.7	9.7
Pitch, deg		0.0	0.0
Yaw, deg		0.0	0.0
Δt , sec		9.0	10.0
Plane change (N_{PC})			
Initiate time, g.e.t. . . .	Not computed	41:04:26	41:04:26
ΔV , ft/sec	Not computed	14.8	16.0
Pitch, deg		0.0	0.0
Yaw, deg		-90.0	-90.0
Δt , sec		17.0	20.0
Phase adjust (N_{Cl})			
Initiate time, g.e.t. . . .	Not computed	41:35:50	41:35:50
ΔV , ft/sec	Not computed	3.5	4.4
Pitch, deg		0.0	0.0
Yaw, deg		180.0	180.0
Δt , sec		5.0	4.0

UNCLASSIFIED

TABLE 4-VIII.- RENDEZVOUS MANEUVERS - Continued

Maneuver	Preflight planned	Ground-commanded	Actual
Second rendezvous - Continued			
Separation			
Initiate time, g.e.t. . . .	Not computed	44:40:15	44:40:16
ΔV , ft/sec	Not computed	1.5	2.0
Pitch, deg		0.0	0.0
Yaw, deg		0.0	0.0
Δt , sec		3.0	3.0
Corrective combination (N_{CC})			
Initiate time, g.e.t. . . .	Not computed	45:54:01	45:54:01
ΔV , ft/sec	Not computed	4.2	4.2
Pitch, deg		65.0	65.0
Yaw, deg		-53.0	-53.0
Δt , sec		6.0	6.0
Coelliptic (N_{SR})			
Initiate time, g.e.t. . . .	Not computed	46:09:28	46:09:29
ΔV , ft/sec	Not computed	9.8	10.64
Pitch, deg		-85.0	-85.0
Yaw, deg		0.0	0.0
Δt , sec		12.0	15.0

UNCLASSIFIED

TABLE 4-VIII.- RENDEZVOUS MANEUVERS - Continued

Maneuver	Preflight planned	Ground-commanded	Actual
Second rendezvous - Continued			
Terminal phase initiate (TPI)			
Initiate time, g.e.t. . . .	Not computed	47:27:20	47:26:44
ΔV , ft/sec	Not computed	25.1	22.3
Pitch, deg		32.9	^d 31.0
Yaw, deg		-0.1	^d 0.0
V_X, V_Y, V_Z^c , ft/sec		21.5, -12.5, -3.2	18.0, -12.0, -0.6
Δt , sec		31.0	26.0
First midcourse correction			
Initiate time, g.e.t. . . .	Not computed	Not sent	47:34:10
ΔV , ft/sec	Not computed	Not sent	4.4
Pitch, deg			^d 44.0
Yaw, deg			^d 3.0
V_X, V_Y, V_Z^c , ft/sec			4.2, 1.2, 0.2
Δt , sec			9.0
Second midcourse correction			
Initiate time, g.e.t. . . .	Not computed	Not sent	47:38:58
ΔV , ft/sec	Not computed	Not sent	0.9
Pitch, deg			^d 56.0
Yaw, deg			^d 9.0
V_X, V_Y, V_Z^c , ft/sec			0.5, -1.3, -0.4
Δt , sec			1.2

^c V_X, V_Y, V_Z are the velocity vector components in computer coordinates. V_X is positive in the direction of motion, V_Y is positive towards the center of the earth, and V_Z is positive to the right of the orbit path (south).

^dApproximate line-of-sight angles to target during corrections.

UNCLASSIFIED

4-29

TABLE 4-VIII.- RENDEZVOUS MANEUVERS - Concluded

Maneuver	Preflight planned	Ground-commanded	Actual
Second rendezvous - Concluded			
Terminal phase finalize (TPF) (braking)			
Initiate time, g.e.t.	Not computed	Not sent	47:39:10
ΔV , ft/sec	Not computed	Not sent	^h 28.5
Pitch, deg			
Yaw, deg			
Δt , sec			ⁱ 1200

^hThis is the resultant ΔV applied during the braking; however, the total ΔV expended during the approach was about 160 ft/sec.

ⁱBraking was performed intermittently for about 20 minutes.

UNCLASSIFIED

TABLE 4-IX.- PLANNED AND ACTUAL TLV AND GATV TRAJECTORY PARAMETERS

Condition	Planned	Actual	
		Preliminary	Final
BECO			
Time from lift-off, sec	131.00	130.43	130.37
Geodetic latitude, deg north	28.57	28.56	28.56
Longitude, deg west	79.74	79.75	79.75
Altitude, ft	197 379	198 000	197 776
Altitude, n. mi.	32.5	32.6	32.6
Range, n. mi.	42.9	43.1	42.9
Space-fixed velocity, ft/sec	9 835	9 825	9 818
Space-fixed flight-path angle, deg	21.37	21.45	21.46
Space-fixed heading angle, deg east of north	84.96	85.20	85.20
SECO			
Time from lift-off, sec	279.20	279.34	279.34
Geodetic latitude, deg north	28.92	28.89	28.89
Longitude, deg west	74.66	74.63	74.64
Altitude, ft	655 762	658 500	658 482
Altitude, n. mi.	107.9	108.4	108.4
Range, n. mi.	311.4	313.5	313.1
Space-fixed velocity, ft/sec	17 637	17 620	17 610
Space-fixed flight-path angle, deg	10.22	10.21	10.19
Space-fixed heading angle, deg east of north	87.20	87.70	87.21
VECO			
Time from lift-off, sec	297.47	298.07	298.09
Geodetic latitude, deg north	28.95	28.93	28.93
Longitude, deg west	73.78	73.74	73.74
Altitude, ft	710 315	713 800	713 993
Altitude, n. mi.	116.9	117.5	117.5
Range, n. mi.	357.9	360.6	360
Space-fixed velocity, ft/sec	17 569	17 561	17 560
Space-fixed flight-path angle, deg	9.30	9.22	9.23
Space-fixed heading angle, deg east of north	87.67	87.68	87.68
PPS start			
Time from lift-off, sec	370.23	370.37	370.37
Geodetic latitude, deg north	29.04	29.01	29.01
Longitude, deg west	70.28	70.34	70.34

UNCLASSIFIED

TABLE 4-IX.- PLANNED AND ACTUAL TLV AND GATV TRAJECTORY PARAMETERS - Concluded

Condition	Planned	Actual	
		Preliminary	Final
PPS start - concluded			
Altitude, ft	874 941	875 500	875 500
Altitude, n. mi.	144.0	144.1	144.1
Range, n. mi.	542	537	537
Space-fixed velocity, ft/sec	17 288	17 295	17 295
Space-fixed flight-path angle, deg	5.50	5.75	5.75
Space-fixed heading angle, deg east of north	89.51	98.56	89.56
GATV insertion			
Time from lift-off, sec	556.39	558.27	558.27
Geodetic latitude, deg north	28.65	28.61	28.61
Longitude, deg west	59.60	59.49	59.49
Altitude, ft	981 051	979 215	979 215
Altitude, n. mi.	161.5	161.2	161.2
Range, n. mi.	1105	1111	1111
Space-fixed velocity, ft/sec	25 368	25 366	25 366
Space-fixed flight-path angle, deg01	-.03	-.03
Space-fixed heading angle, deg east of north	94.91	94.91	94.91
Maximum conditions			
Altitude, statute miles	862	862	862
Altitude, n. mi.	750	750	750
Space-fixed velocity, ft/sec	25 368	25 367	25 367
Earth-fixed velocity, ft/sec	23 970	23 969	23 969
Exit acceleration, g	6.3	6.3	6.3
Exit dynamic pressure, lb/ft ²	945	967	967

UNCLASSIFIED

TABLE 4-X.- PLANNED AND ACTUAL GAATV
CUTOFF AND GATV INSERTION CONDITIONS

Condition	Planned	Actual	Difference
VECO targeting parameters			
Semi-major axis, n. mi.	2331	2330	-1
Eccentricity	0.5436	0.5437	+0.0001
Inclination, deg	28.88	28.86	-0.02
Inertial ascent node, deg	153.09	153.10	+0.01
VECO osculating elements			
Apogee altitude, n. mi.	158.1	158.0	-0.1
Perigee altitude, n. mi.	-2376.9	-2377.3	-0.4
Period, min	47.07	47.07	0.0
Inclination, deg	28.88	28.86	-0.02
True anomaly, deg	172.00	172.07	+0.07
Argument of perigee, deg	-86.24	-86.28	-0.04
Insertion osculating elements			
Semi-major axis, n. mi.	3604	3603	-1.0
Eccentricity	0.0008	0.0008	0.0
Inclination, deg	28.88	28.85	-0.03
Inertial ascent node, deg	153.30	153.42	+0.12
Apogee altitude, n. mi.	167.1	164.3	-2.8
Perigee altitude, n. mi.	161.4	158.5	-2.9
Period, min	90.50	90.46	-0.04
True anomaly, deg	13.85	-45.92	^a -59.77
Argument of perigee, deg	85.12	144.89	^a +59.77

^aThese elements are not well defined for circular orbits.

UNCLASSIFIED

TABLE 4-XI.- GATV MANEUVERS AFTER SPACECRAFT LANDING

Condition	Ground Commanded	Actual
First PPS maneuver		
Maneuver initiate, g.e.t., hr:min:sec . . .	72:21:07	72:21:05
Δ_{tB} , sec	30	30
ΔV , ft/sec	856.8	845.3
Pitch, deg	0	-1.3
Yaw, deg	0	+2.2
Second PPS maneuver		
Maneuver initiate, g.e.t., hr:min:sec . . .	79:11:41	79:11:38
Δ_{tB} , sec	31	29.3
ΔV , ft/sec	886.3	865.7
Pitch, deg	0	-1.9
Yaw, deg	180	181.8
SPS maneuver		
Maneuver initiate, g.e.t., hr:min:sec . . .	82:58:08	82:58:06
Δ_{tB} , sec	12	11.7
ΔV , ft/sec	32.2	32.7
Pitch, deg	0	-0.2
Yaw, deg	180	180

UNCLASSIFIED

TABLE 4-XII.- COMPARISON OF GEMINI X GATV ORBITAL ELEMENTS

Revolution	Condition	Planned (a)	Actual (b)
1 (Insertion)	Apogee, n. mi.	163.3	162.0
	Perigee, n. mi.	158.6	156.6
	Inclination, deg	28.86	28.87
	Period, min	90.50	90.56
12 (After N _{CH1} , PPS phase adjustment)	Apogee, n. mi.	411.0	412.2
	Perigee, n. mi.	160.0	158.5
	Inclination, deg	28.89	28.88
	Period, min	94.92	95.31
24 (After N _{CH2} , PPS height adjustment)	Apogee, n. mi.	210.1	209.9
	Perigee, n. mi.	208.0	205.0
	Inclination, deg	28.87	28.88
	Period, min	92.15	92.3
29 (Before second rendevvous)	Apogee, n. mi.	209.0	209.2
	Perigee, n. mi.	207.0	205.9
	Inclination, deg	28.88	28.90
	Period, min	92.13	92.38
46 (Before parking)	Apogee, n. mi.	750.5	750.0
	Perigee, n. mi.	208.6	208.2
	Inclination, deg	28.91	28.89
	Period, min	102.60	102.75
52 (After parking)	Apogee, n. mi.	190.2	190.3
	Perigee, n. mi.	190.2	187.6
	Inclination, deg	28.90	28.91
	Period, min	91.45	91.67

^aPlanned elements are those computed in real time by the RTCC. The apogee and perigee are measured over a spherical earth with Launch Complex 19 radius. The periods were calculated by the anomalistic apogee and perigee curve in reference 12.

^bActual elements are measured over an oblate earth. Period and inclination are osculating elements.

UNCLASSIFIED

UNCLASSIFIED

4-35

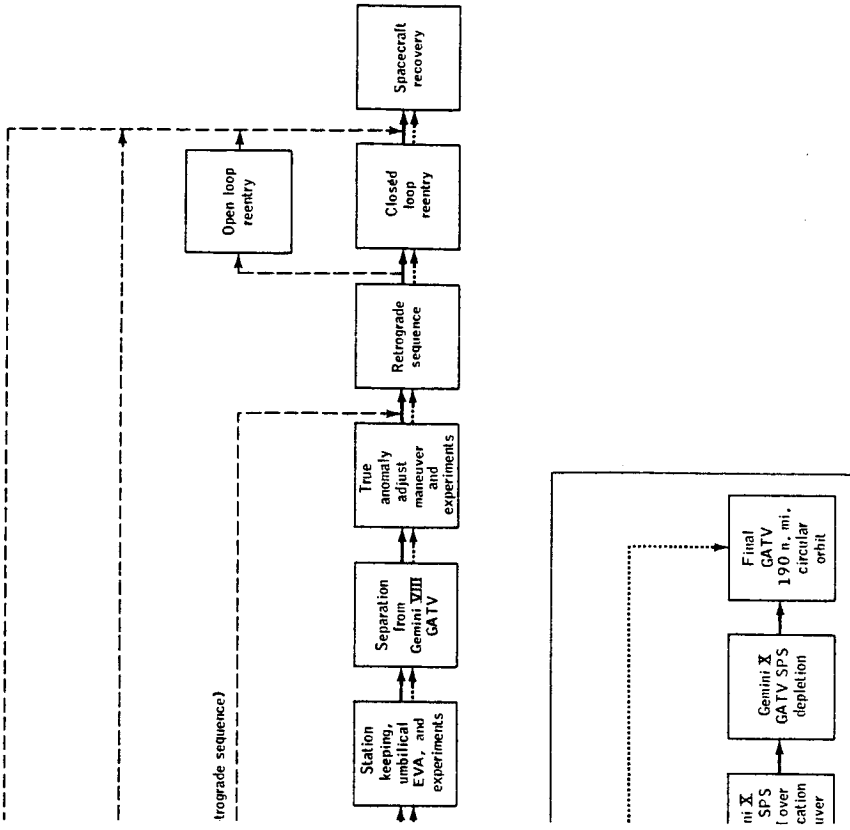
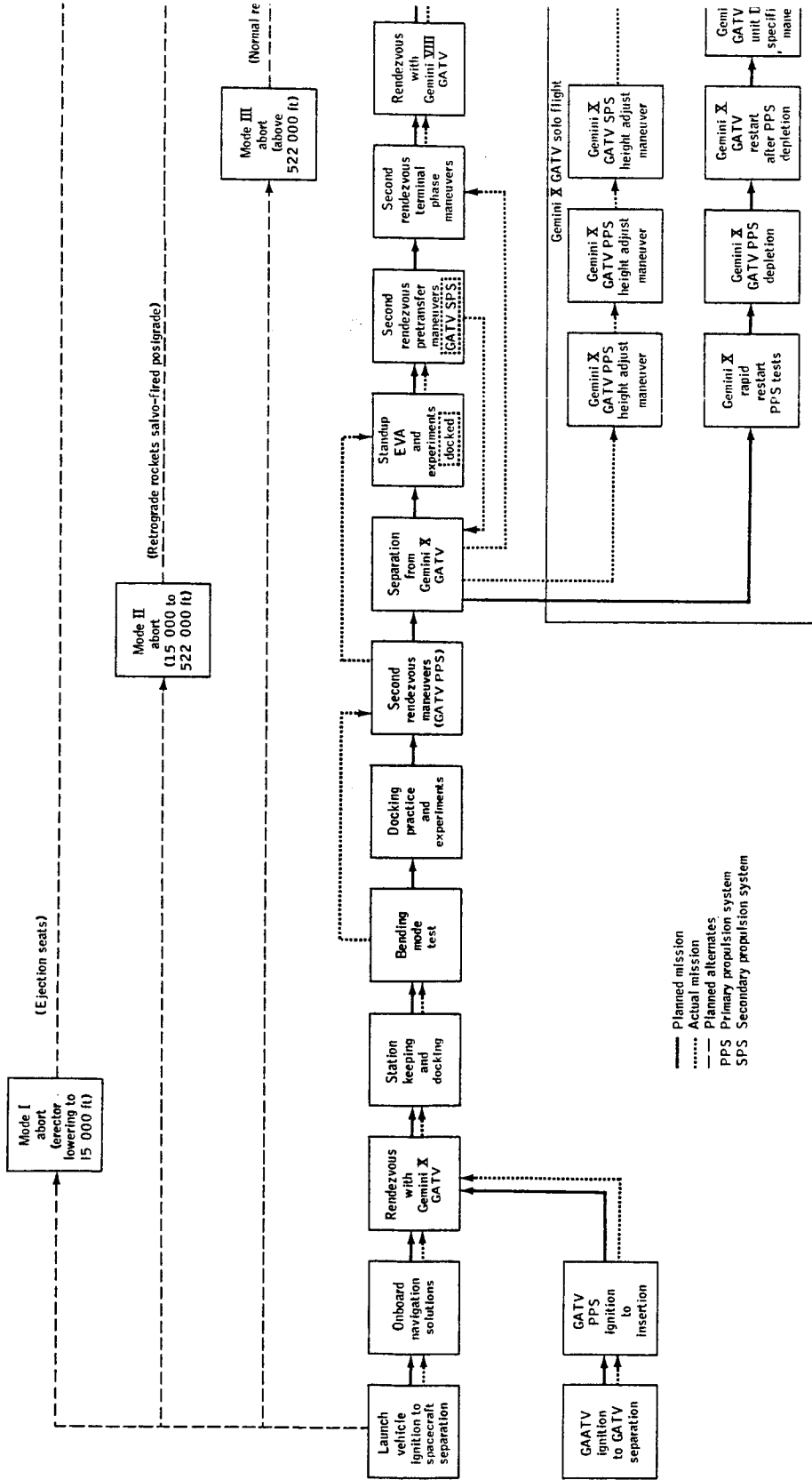

Figure 4-1. - Planned and actual Gemini X mission with planned alternates included.
4-35-C.

UNCLASSIFIED

NASA-S-66-8101 AUG 12



4-35-0

4-35-6

UNCLASSIFIED

4-36

NASA-S-66-8040 AUG 3

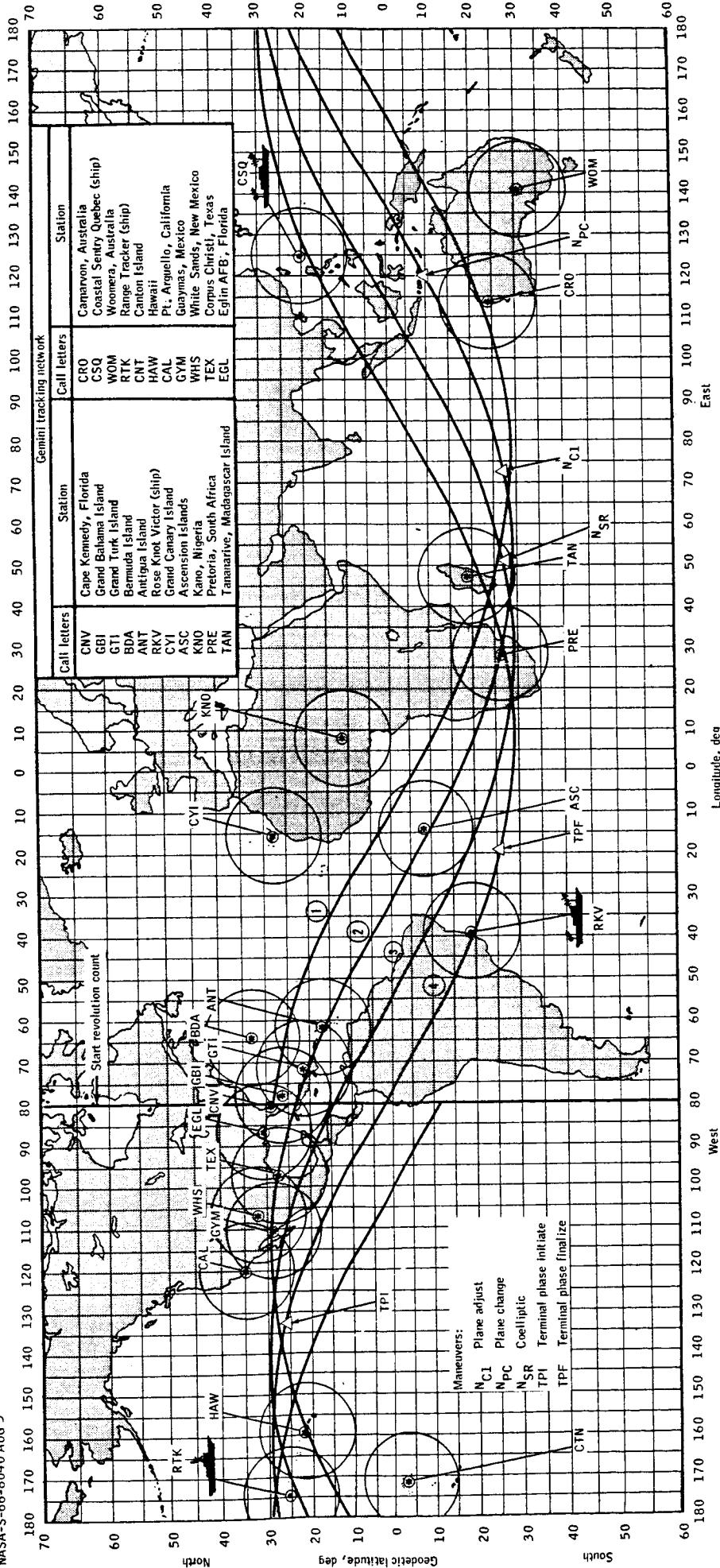

(a) Revolutions 1 through 4.

4-36-C

4-36-1a

4-36-c

Figure 4-2. - Ground track for the Gemini X orbital mission.

UNCLASSIFIED

UNCLASSIFIED

4-37

NASA-S-66-8041 AUG 3

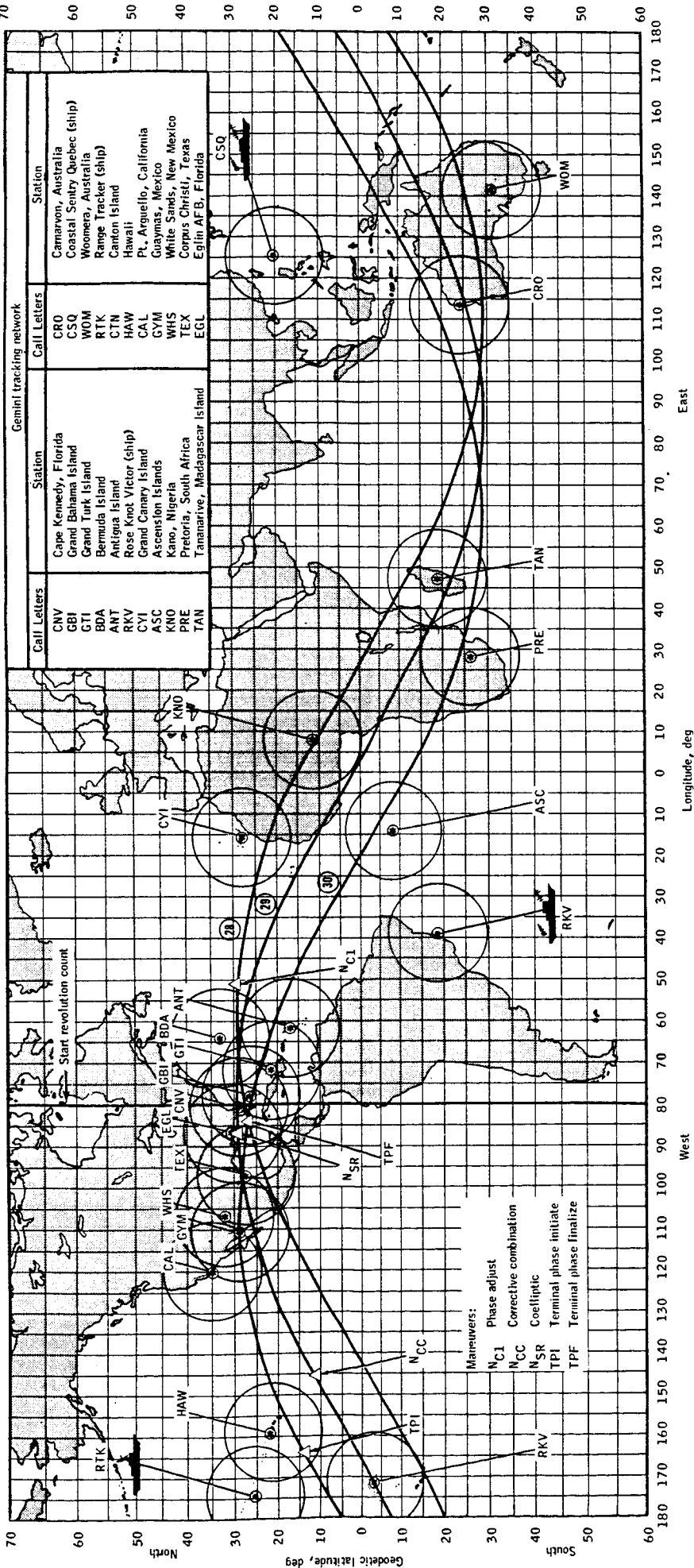

4-37-β

(b) Revolutions 28 through 30.

Figure 4-2. - Continued.

UNCLASSIFIED

4-37-γ

4-37-α

UNCLASSIFIED

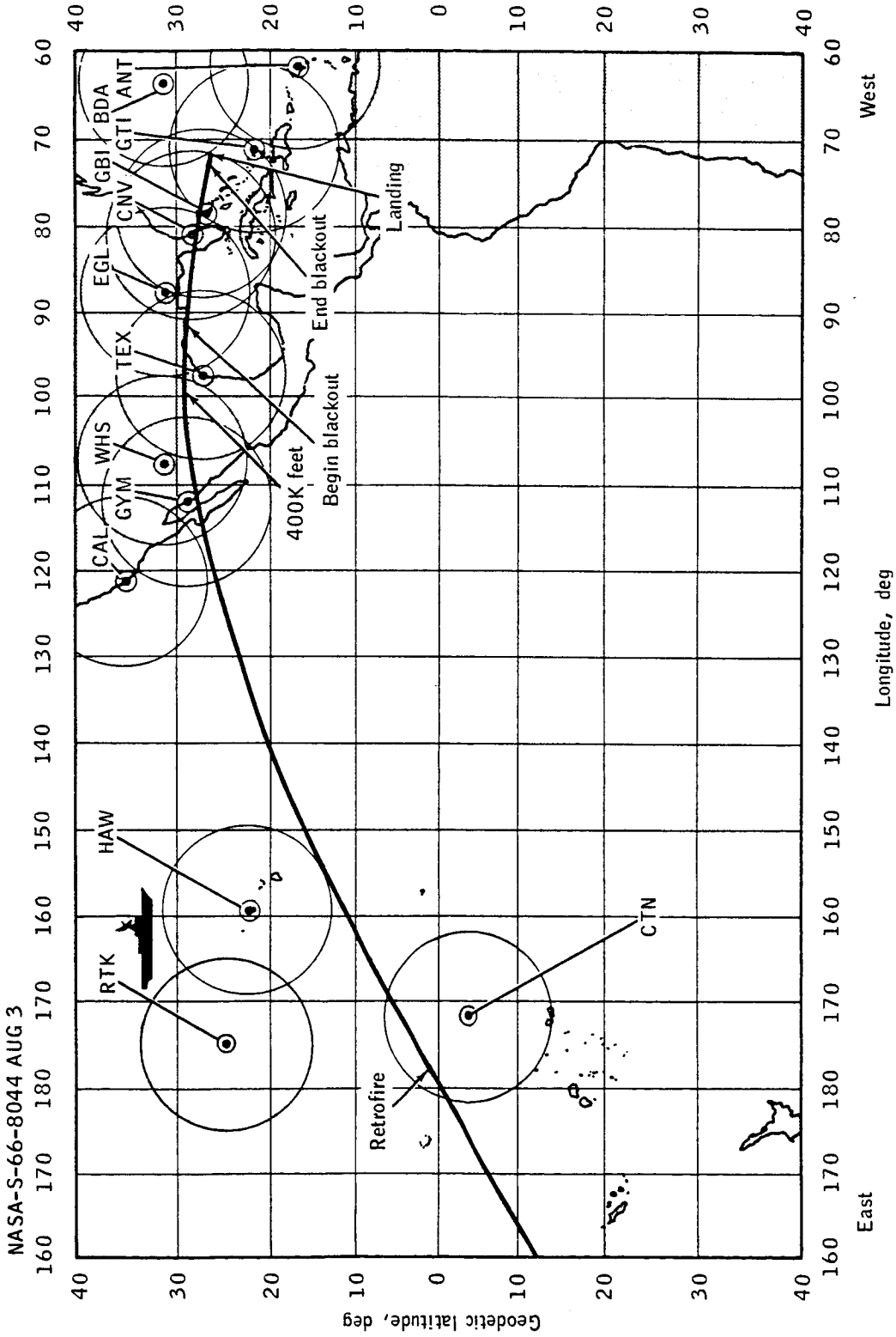

NASA-S-66-8044 AUG 3

UNCLASSIFIED

(c) Reentry.

Figure 4-2. - Concluded.

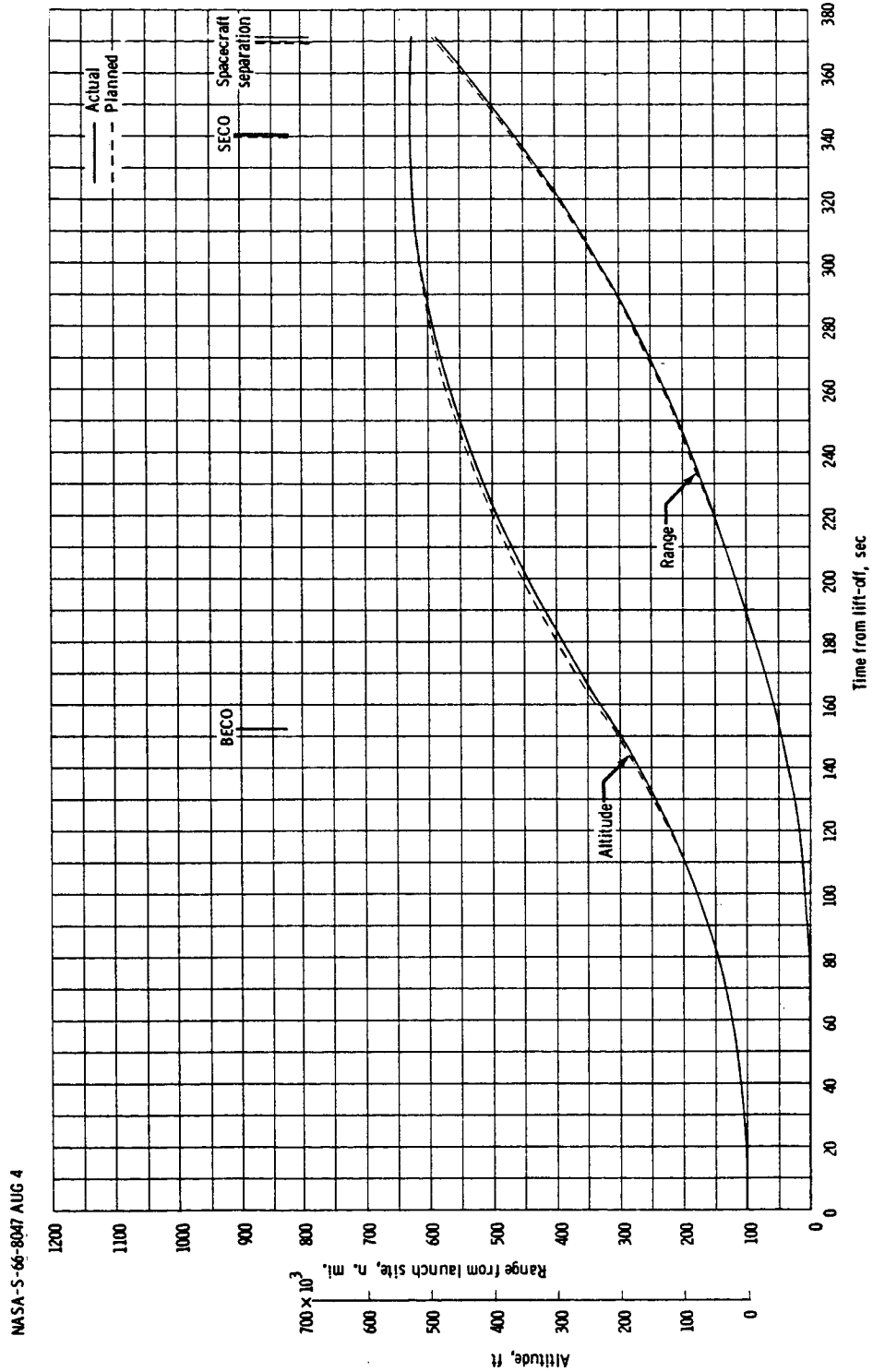

(a) Altitude and range.

Figure 4-3. - Trajectory parameters for GLV/Spacecraft launch phase.

UNCLASSIFIED

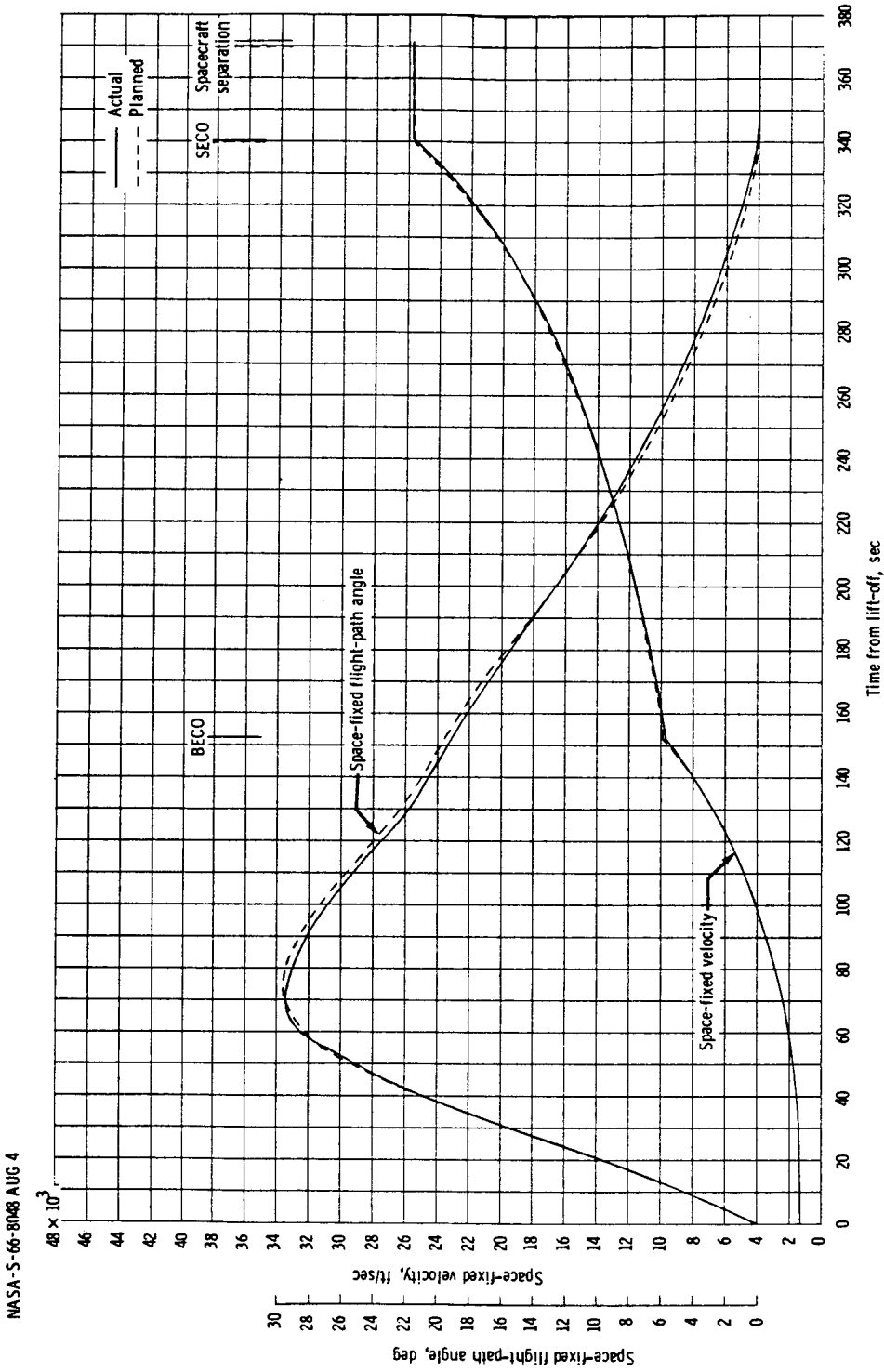

(b) Space-fixed velocity and flight-path angle.

Figure 4-3. - Continued.

UNCLASSIFIED

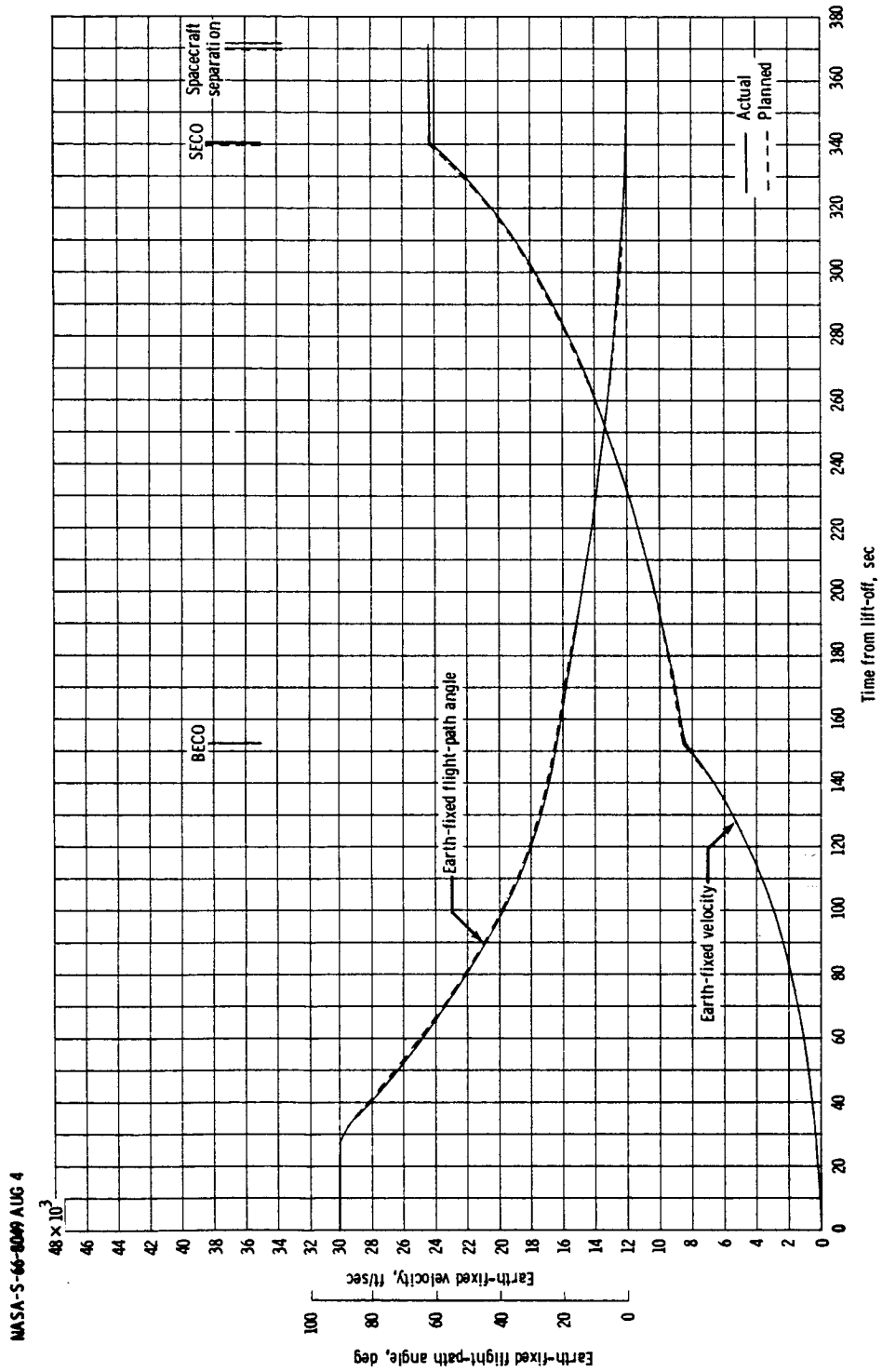

(c) Earth-fixed velocity and flight-path angle.

Figure 4-3. - Continued.

UNCLASSIFIED

NASA-S-66-8050 AUG 4

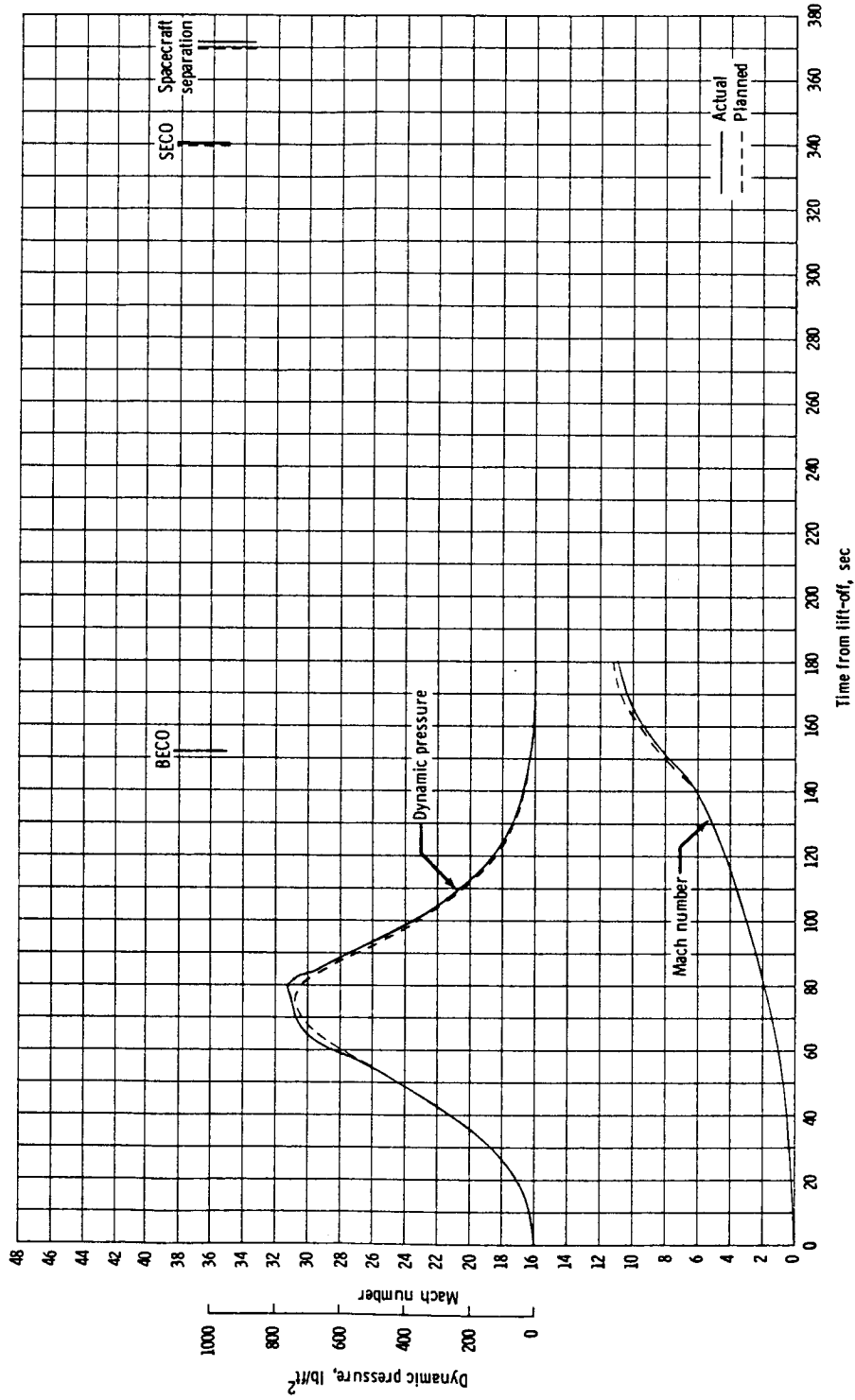

(d) Dynamic pressure and Mach number.

Figure 4-3. - Continued.

UNCLASSIFIED

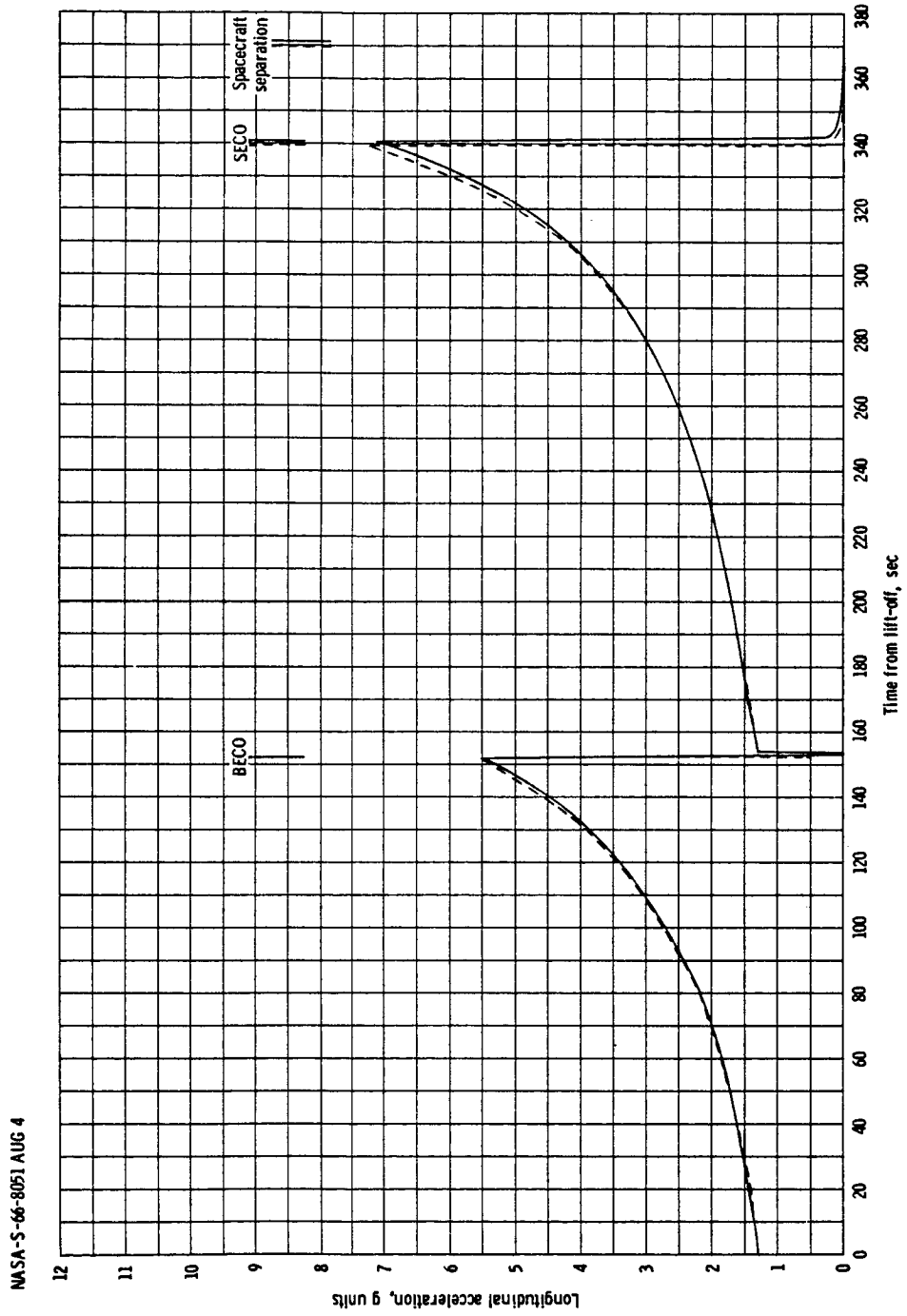

(e) Longitudinal acceleration.

Figure 4-3. - Concluded.

UNCLASSIFIED

NASA-S-66-805Z AUG 4

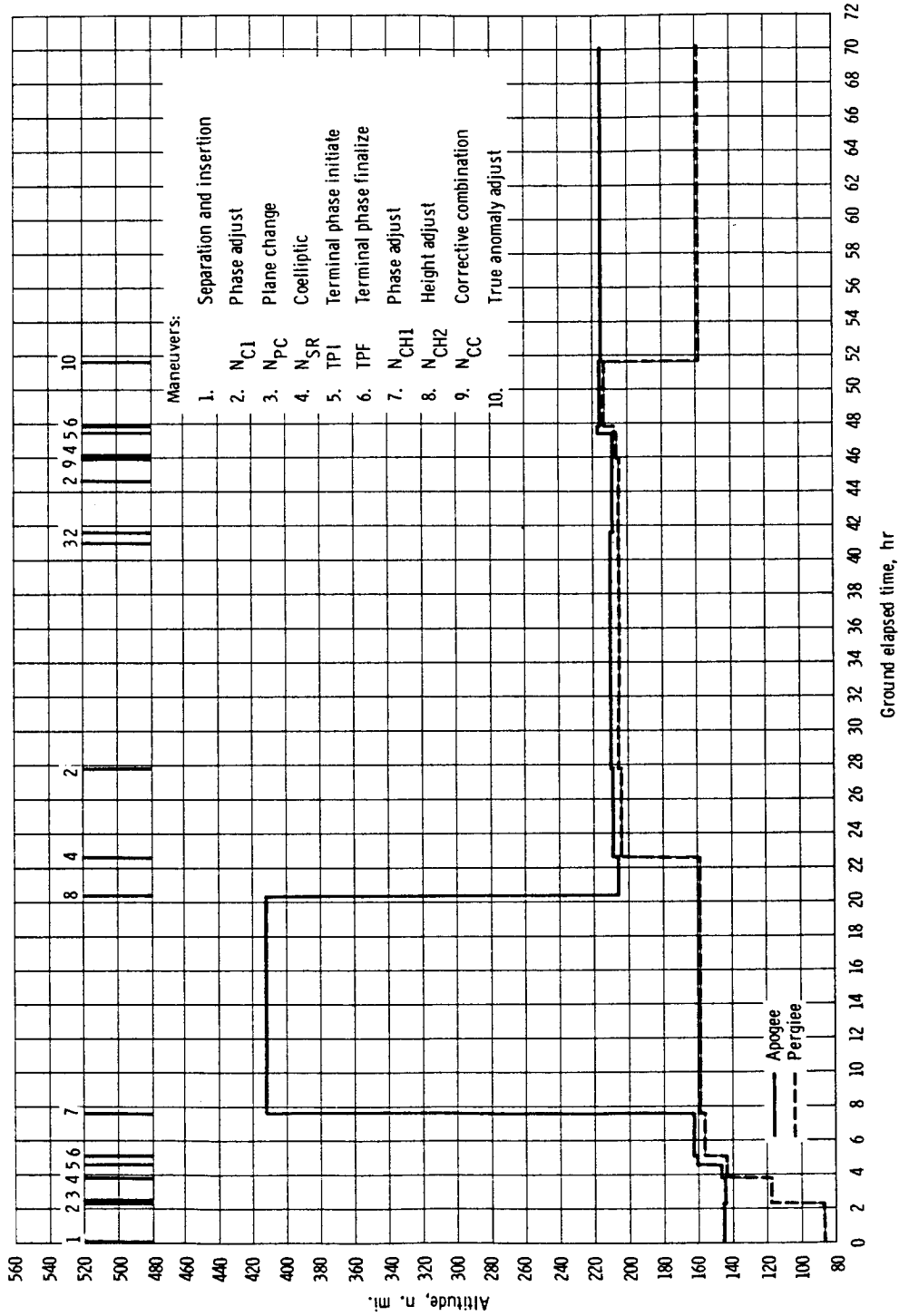
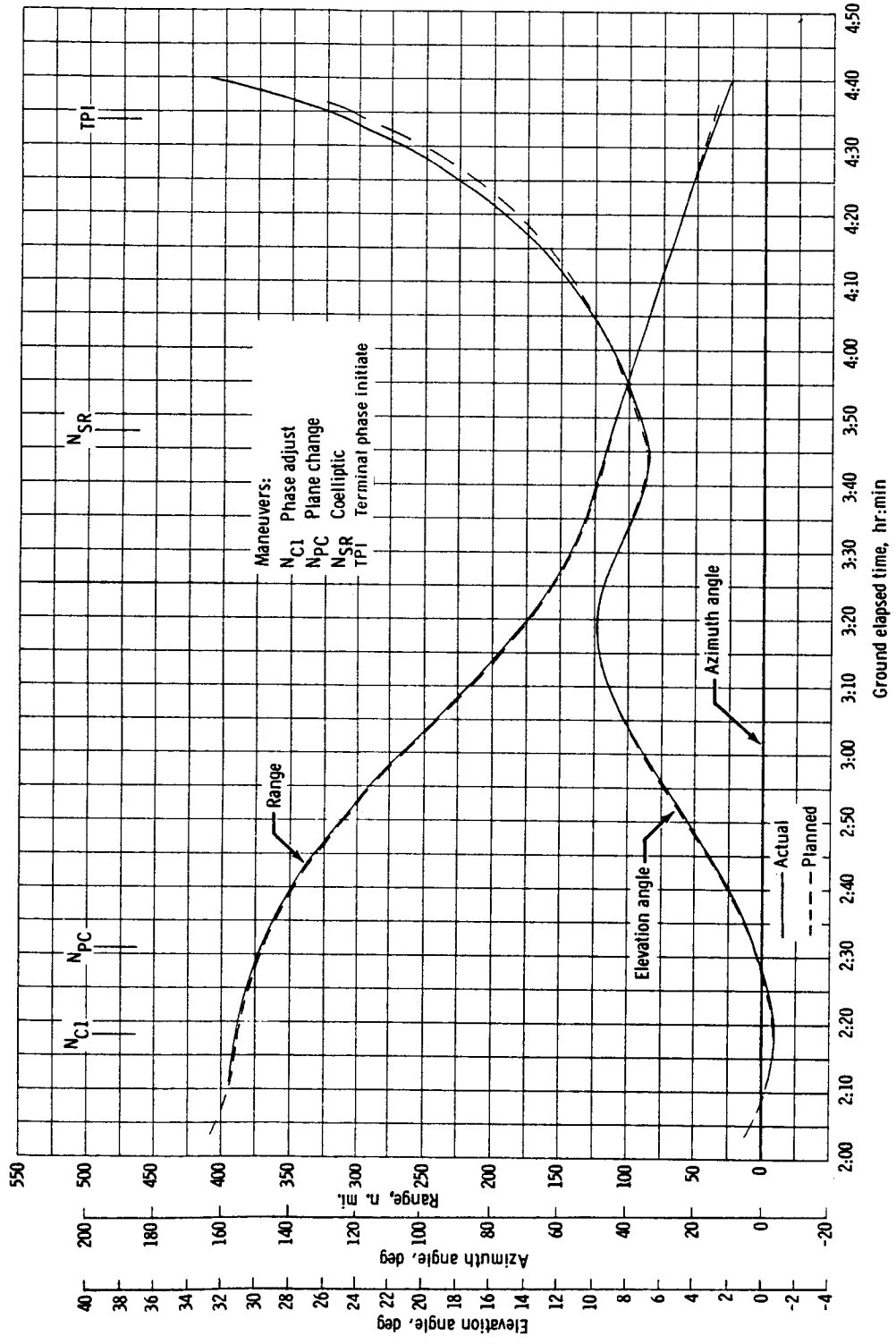

Figure 4-4. - Apogee and perigee altitudes of Spacecraft 10.

UNCLASSIFIED

NASA-S-66-8160 AUG 17



(a) Relative range, azimuth, and elevation from Spacecraft 10 to Gemini X GATV during midcourse maneuvers.

Figure 4-5. - First (M=4) rendezvous during the Gemini X mission.

UNCLASSIFIED

NASA-S-66-8158 AUG 17

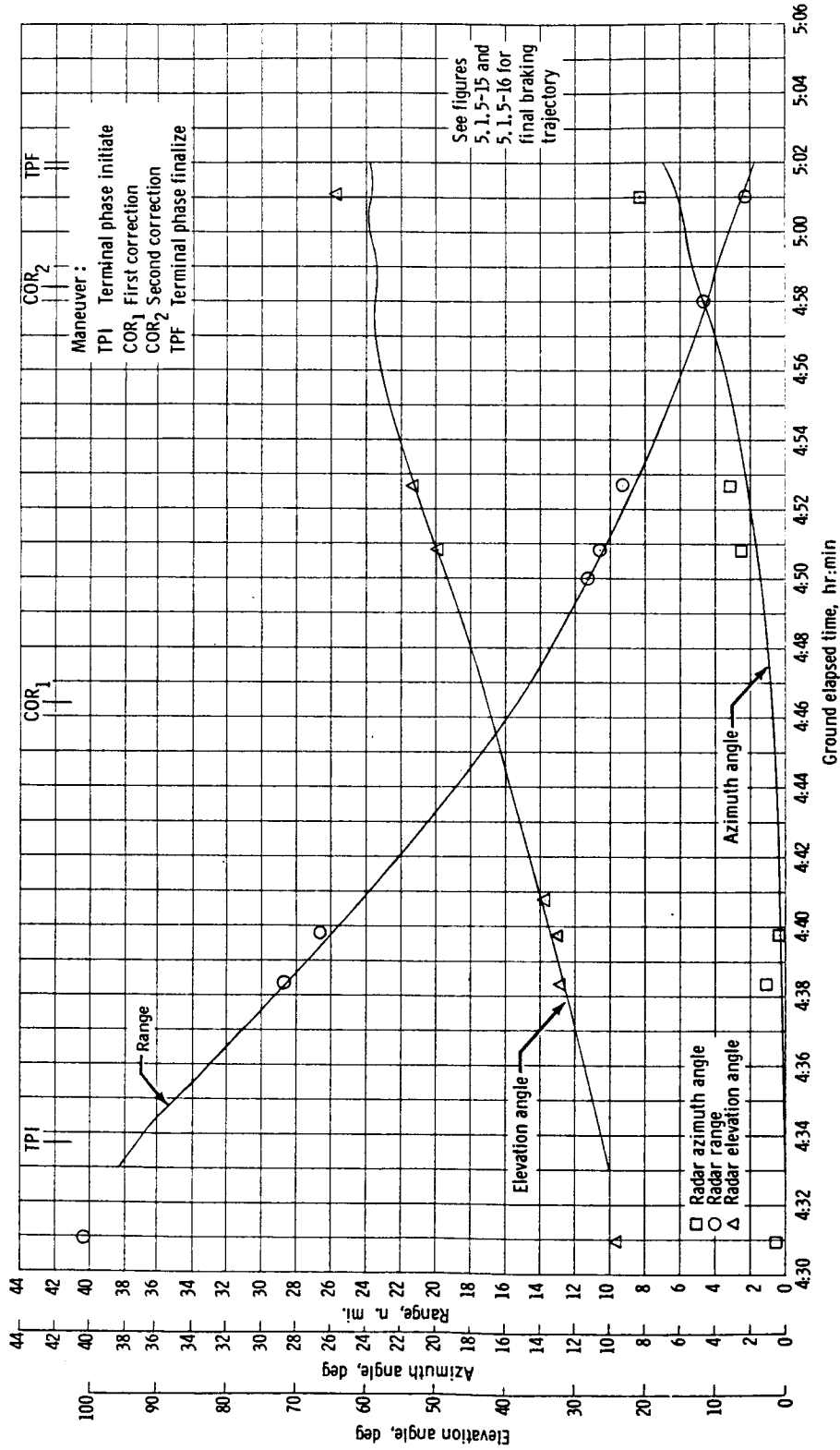

(b) Relative range, azimuth, and elevation from Spacecraft 10 to Gemini X GATV during terminal phase maneuvers.

Figure 4-5. - Continued.

UNCLASSIFIED

NASA-S-66-8161 AUG 17

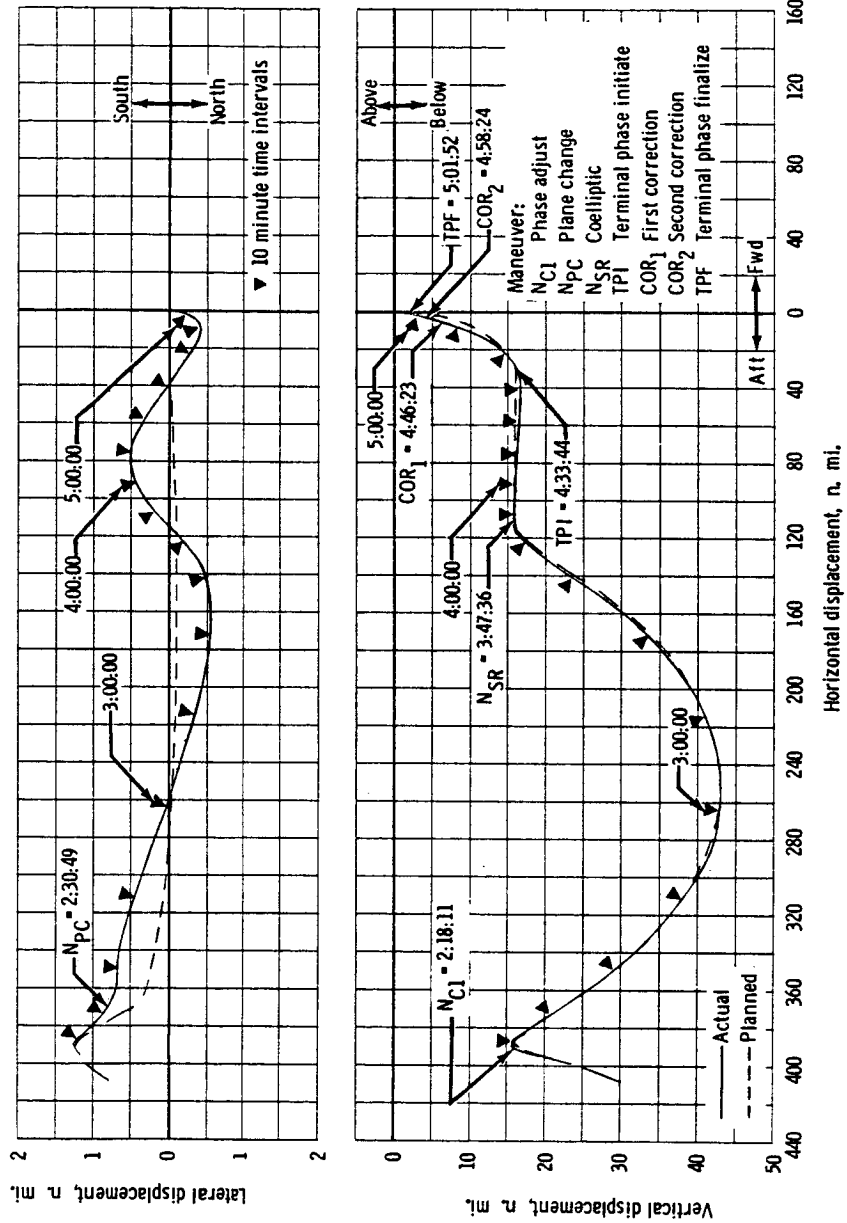

(c) Relative trajectory profile measured from Gemini X GATV to Spacecraft 10 in curvilinear coordinate system.

Figure 4-5. - Continued.

UNCLASSIFIED

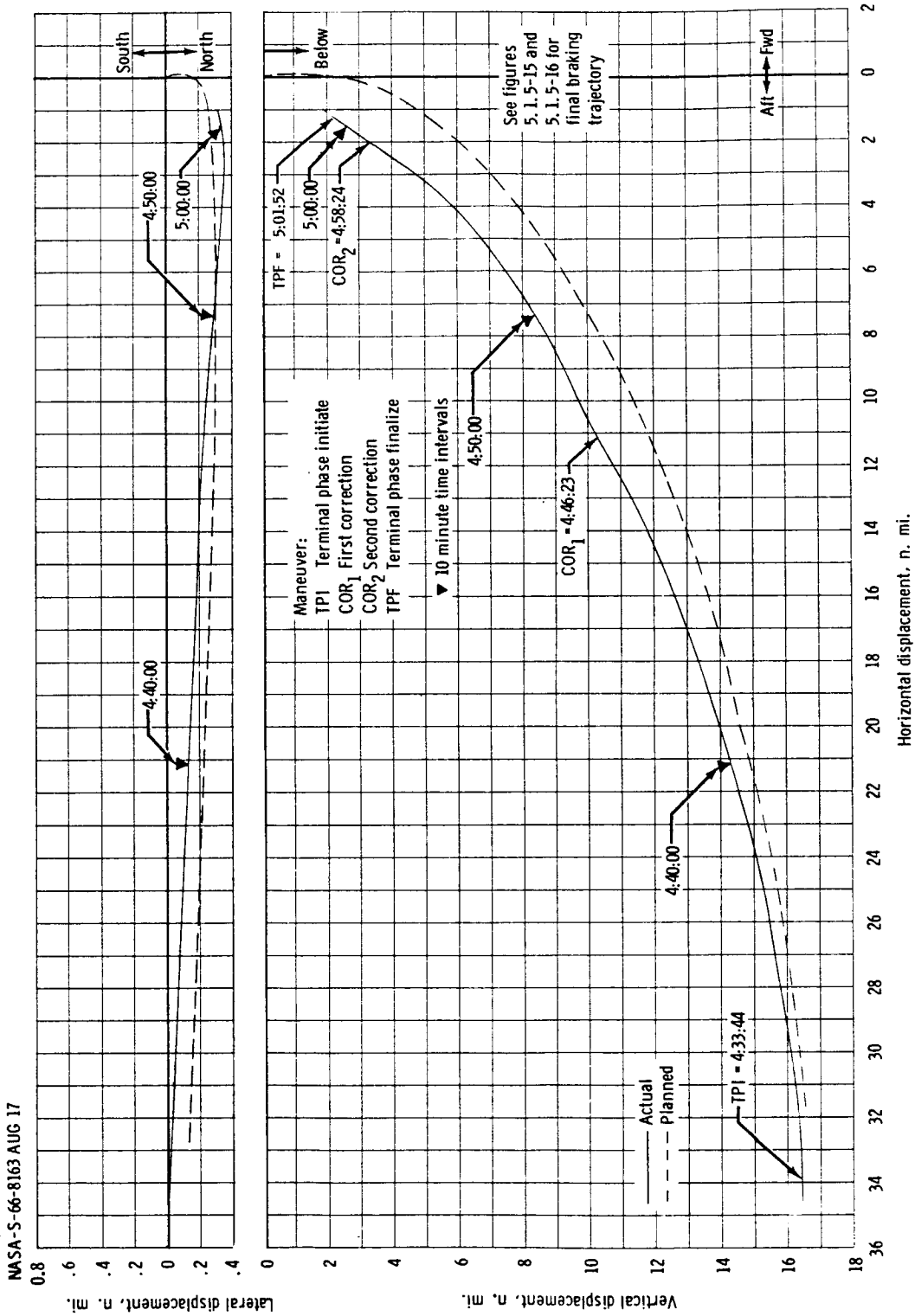

(d) Relative trajectory profile of first rendezvous from TPI to TPF as measured from Gemini X GATV to Spacecraft 10 in curvilinear coordinate system.

Figure 4-5. - Concluded.

UNCLASSIFIED

UNCLASSIFIED

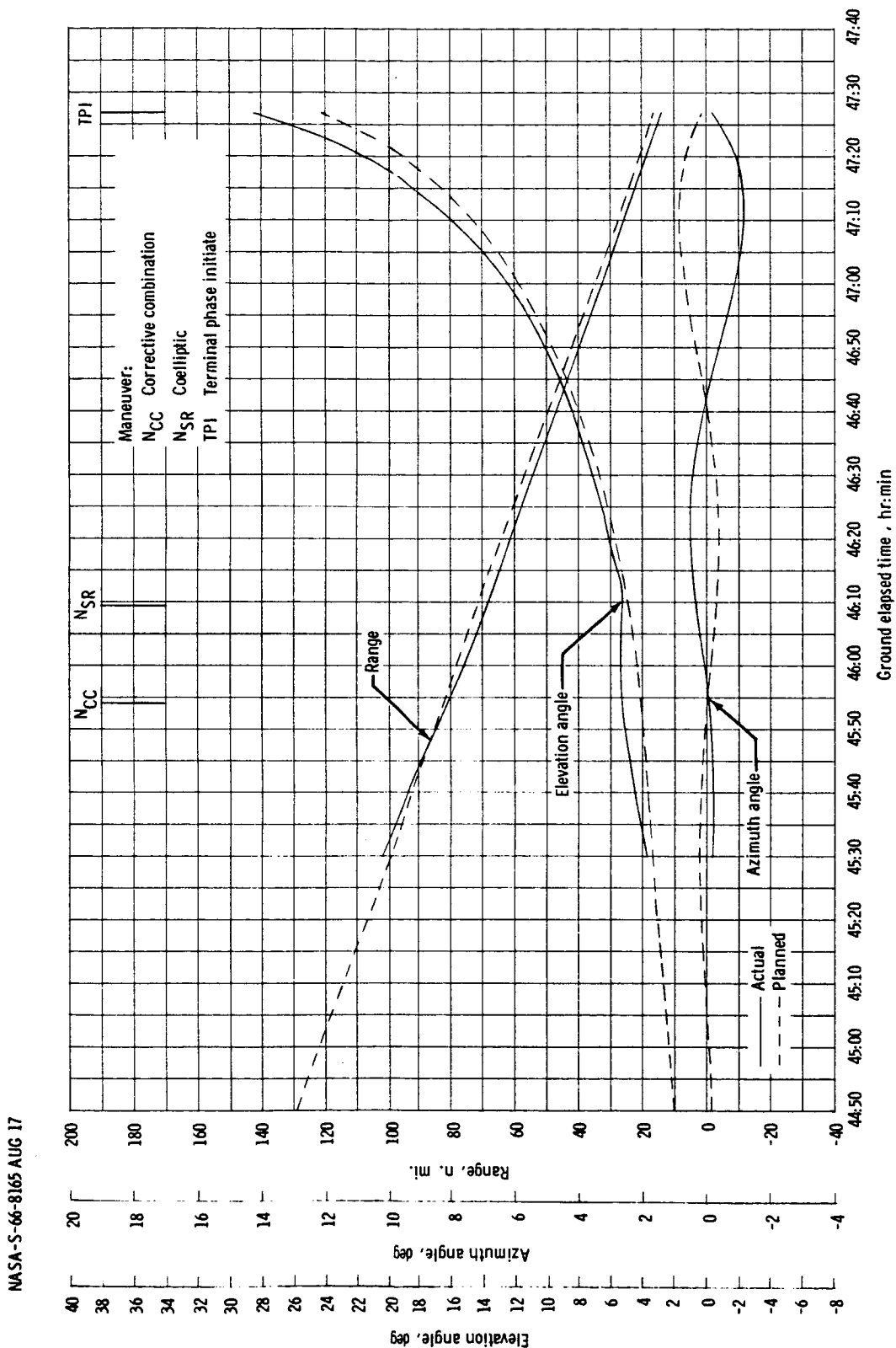

NASA-S-66-8165 AUG 17

UNCLASSIFIED

(a) Relative range, azimuth, and elevation from Spacecraft 10 to Gemini VIII GATV during midcourse maneuvers.

Figure 4-6. - Second (Gemini VIII GATV) rendezvous during the Gemini X mission.

UNCLASSIFIED

UNCLASSIFIED

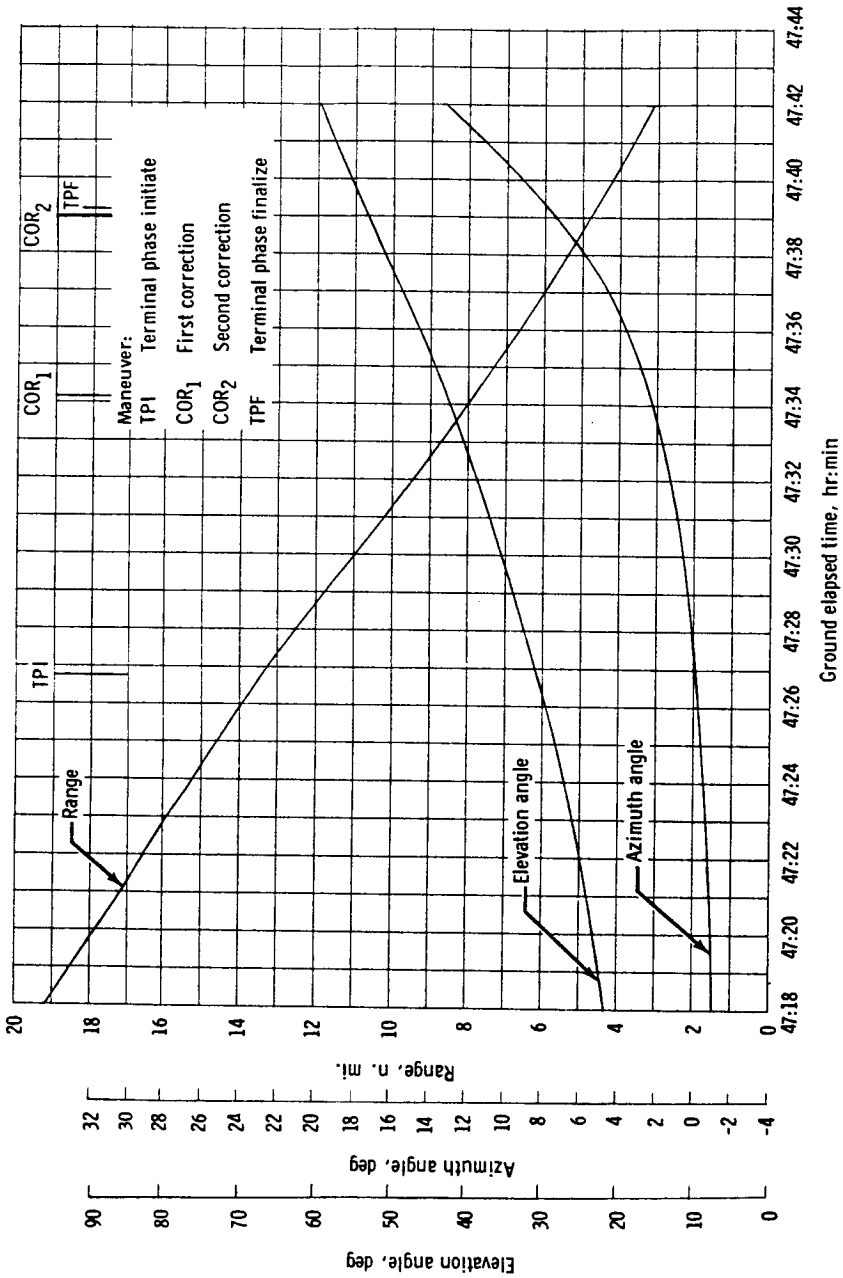

(b) Relative range, azimuth, and elevation from Spacecraft 10 to Gemini VIII GATV during terminal phase maneuvers.

Figure 4-6. - Continued.

NASA-S-66-8159 AUG 17

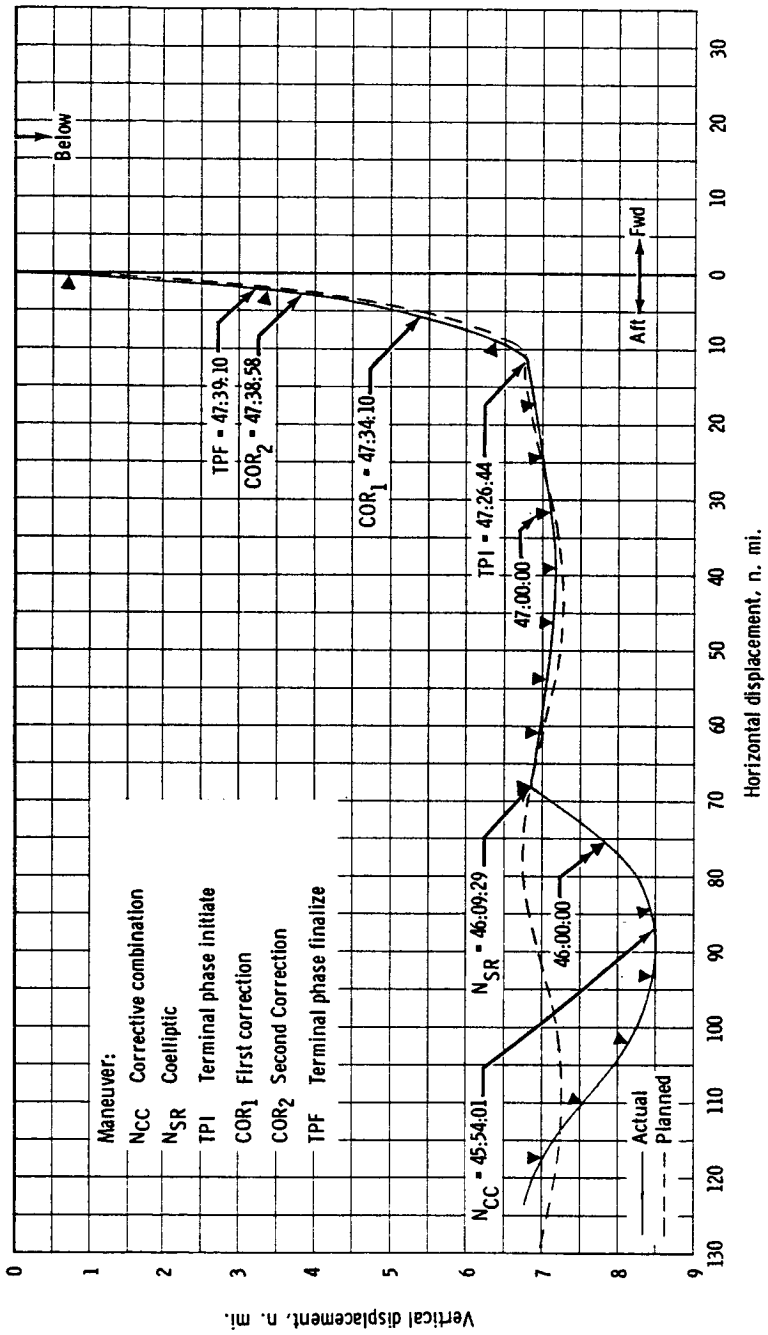
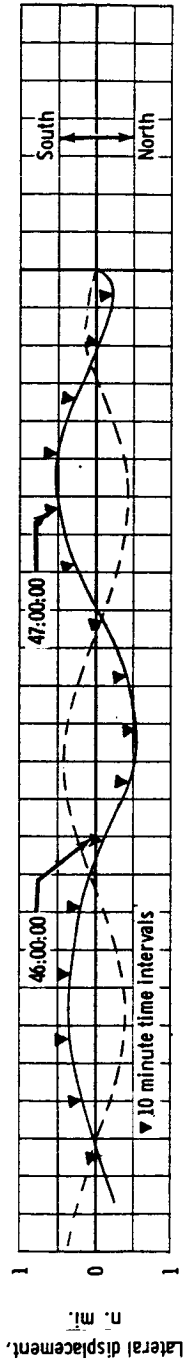

(c) Relative trajectory profile of second rendezvous from Gemini VIII GATV to Spacecraft 10 in curvilinear coordinate system.

Figure 4-6. - Continued.

UNCLASSIFIED

NASA-5-66-8164 AUG 17

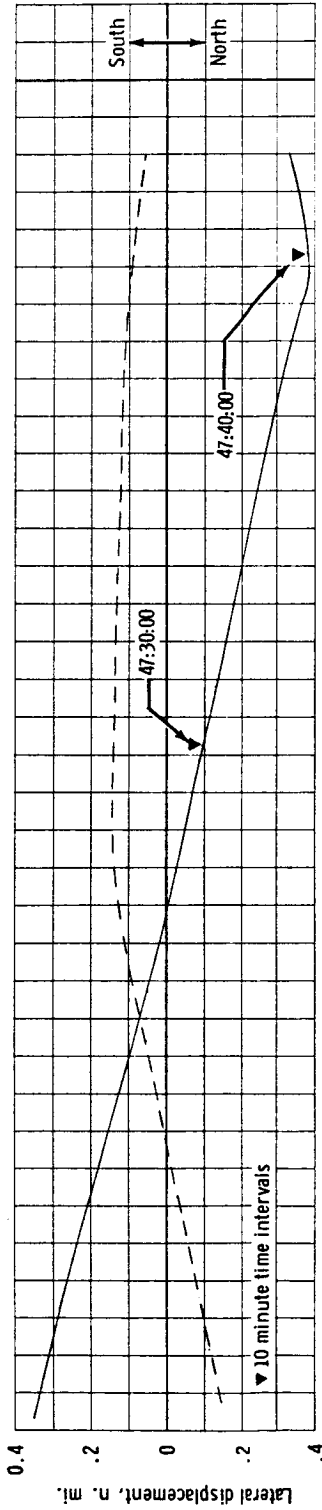

UNCLASSIFIED

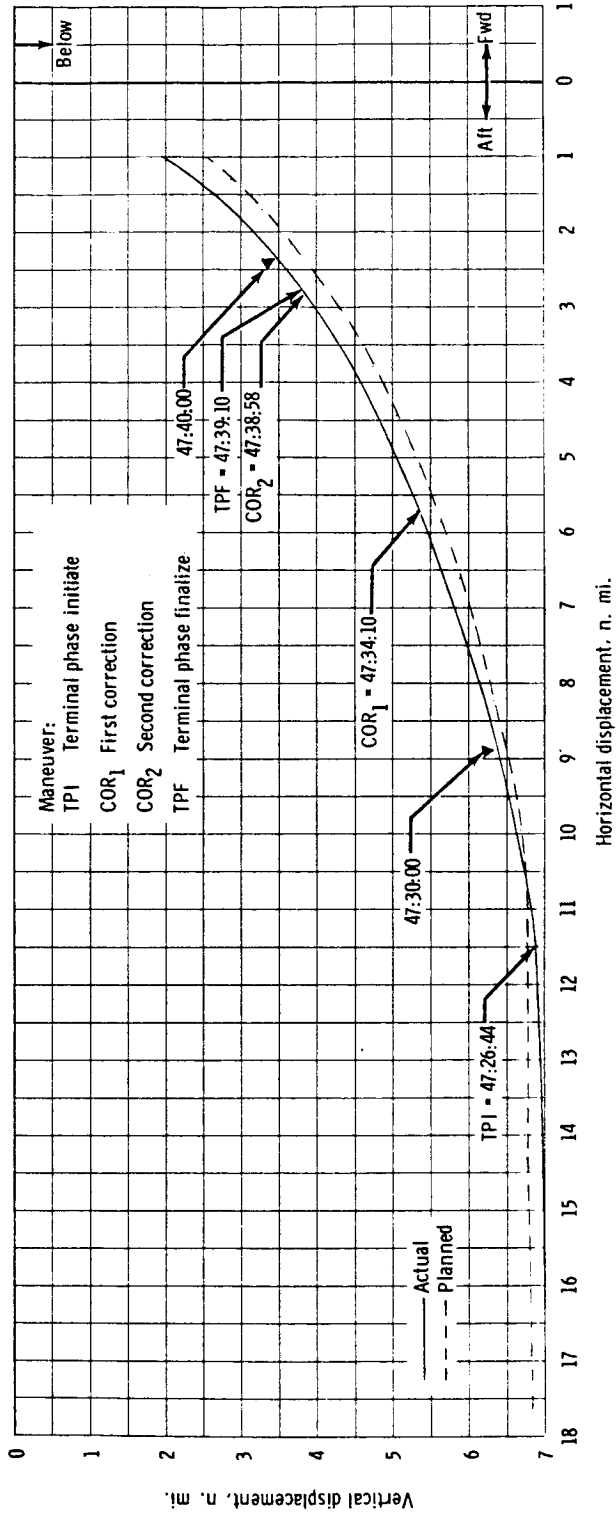

1-1) Relative trajectory profile of second rendezvous from TPI to TPF as measured from Gemini VIII GATV to Spacecraft 10 in curvilinear coordinate system.

Figure 4-6. - Concluded.

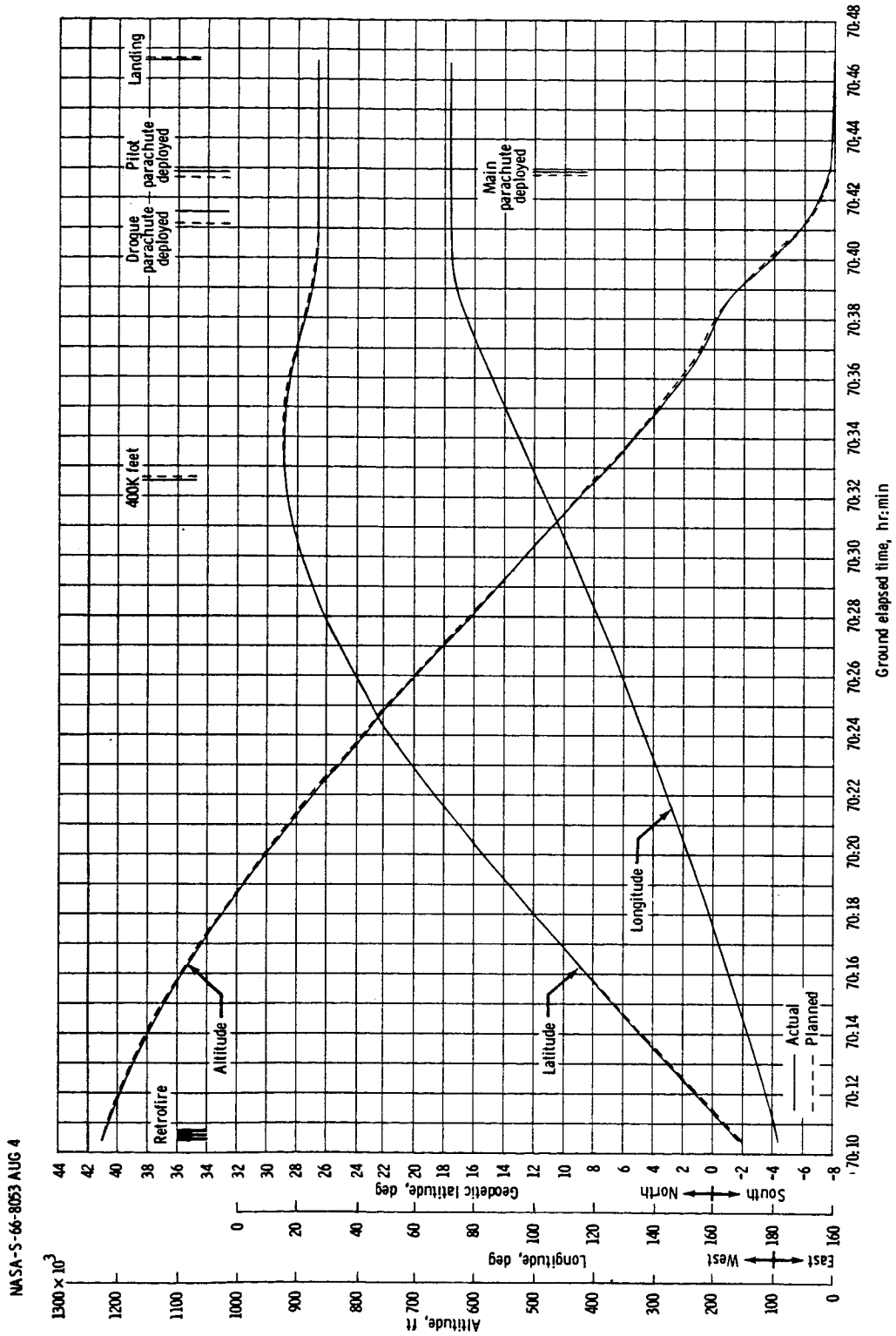

(a) Latitude, longitude, and altitude.
Figure 4-7. - Trajectory parameters for the Gemini X mission reentry phase.

UNCLASSIFIED

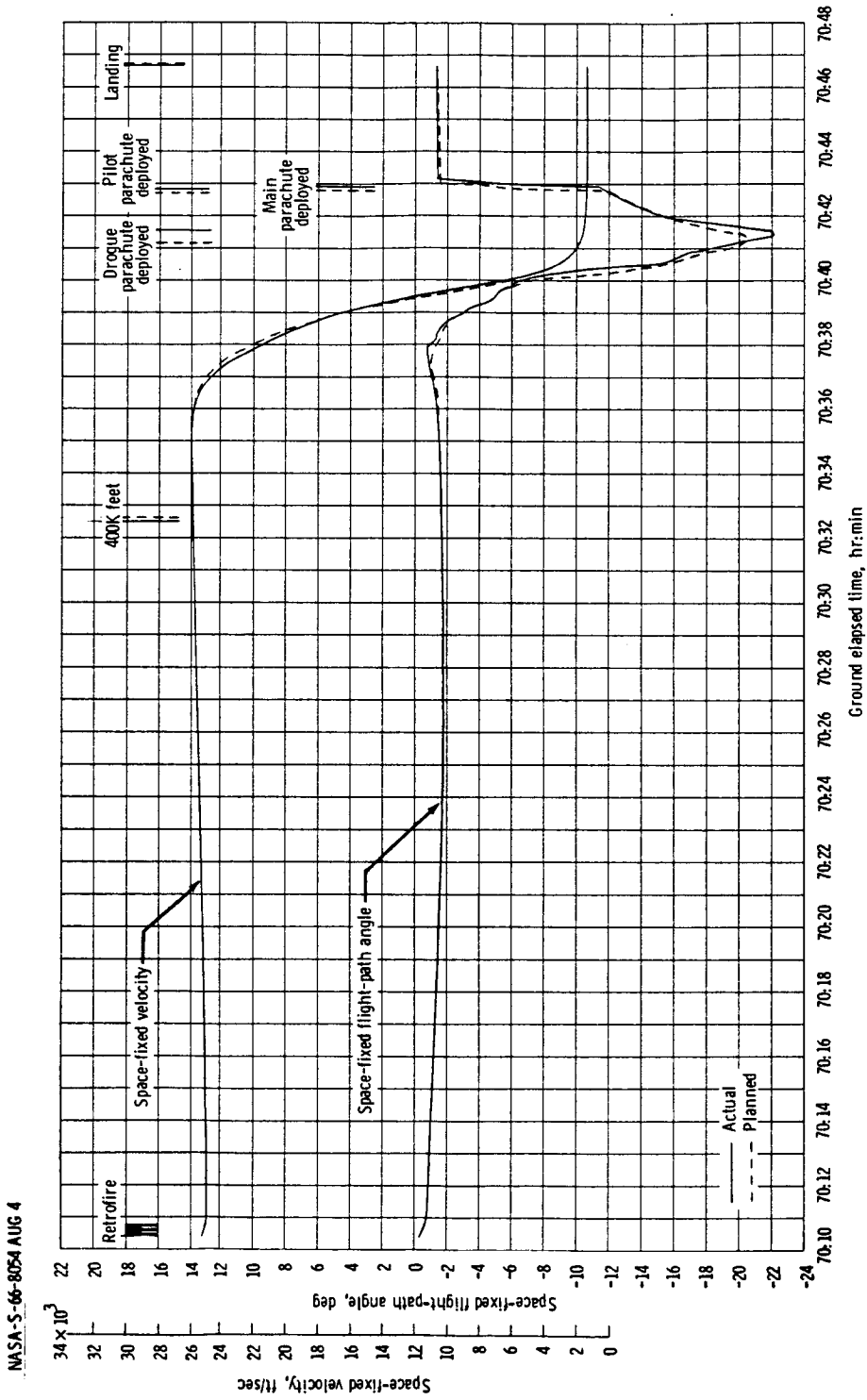

(b) Space-fixed velocity and flight-path angle.

Figure 4-7. -Continued.

UNCLASSIFIED

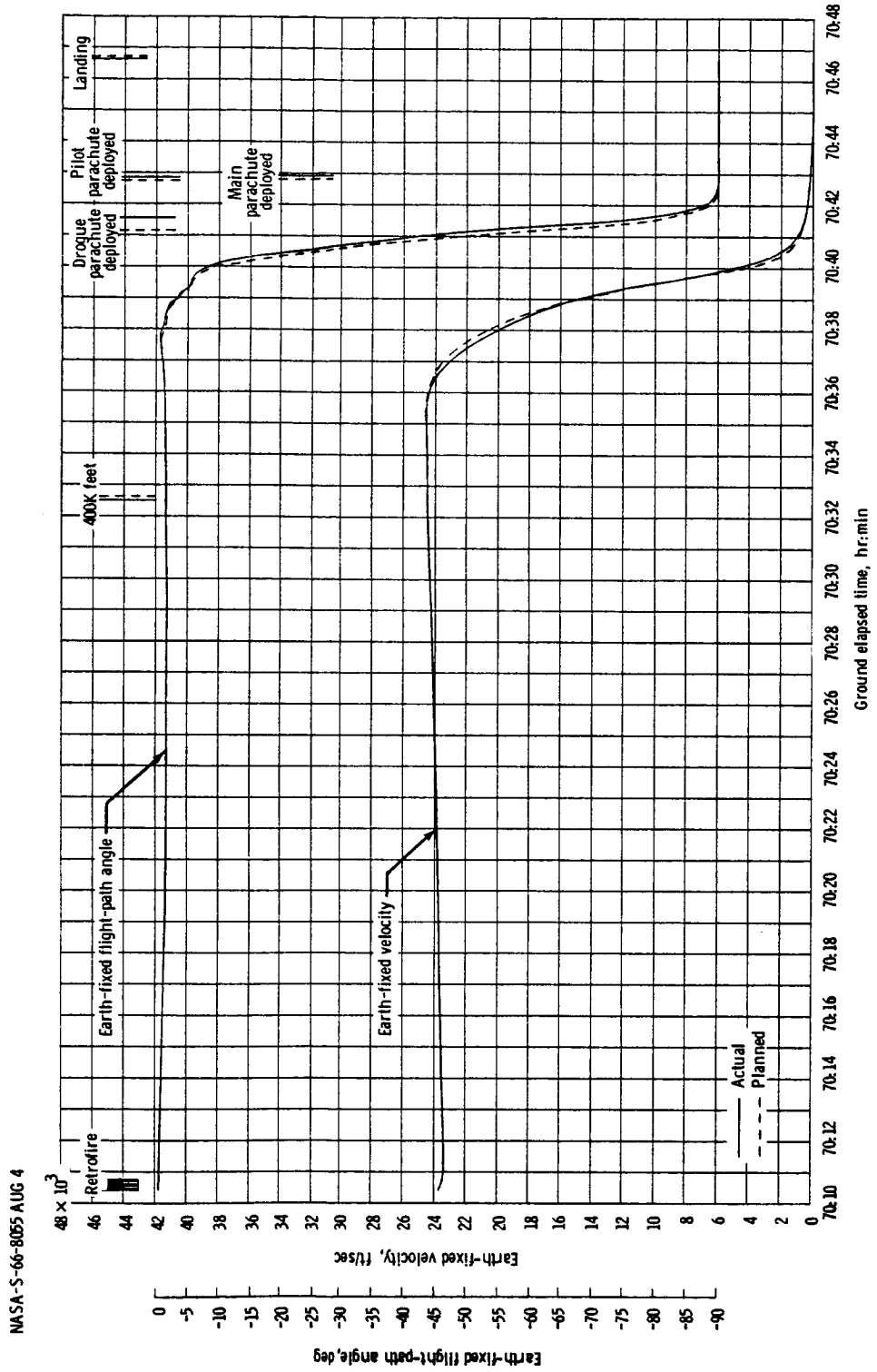

(c) Earth-fixed velocity and flight-path angle.

Figure 4-7. - Continued.

UNCLASSIFIED

NASA-S-66-8056 AUG 4

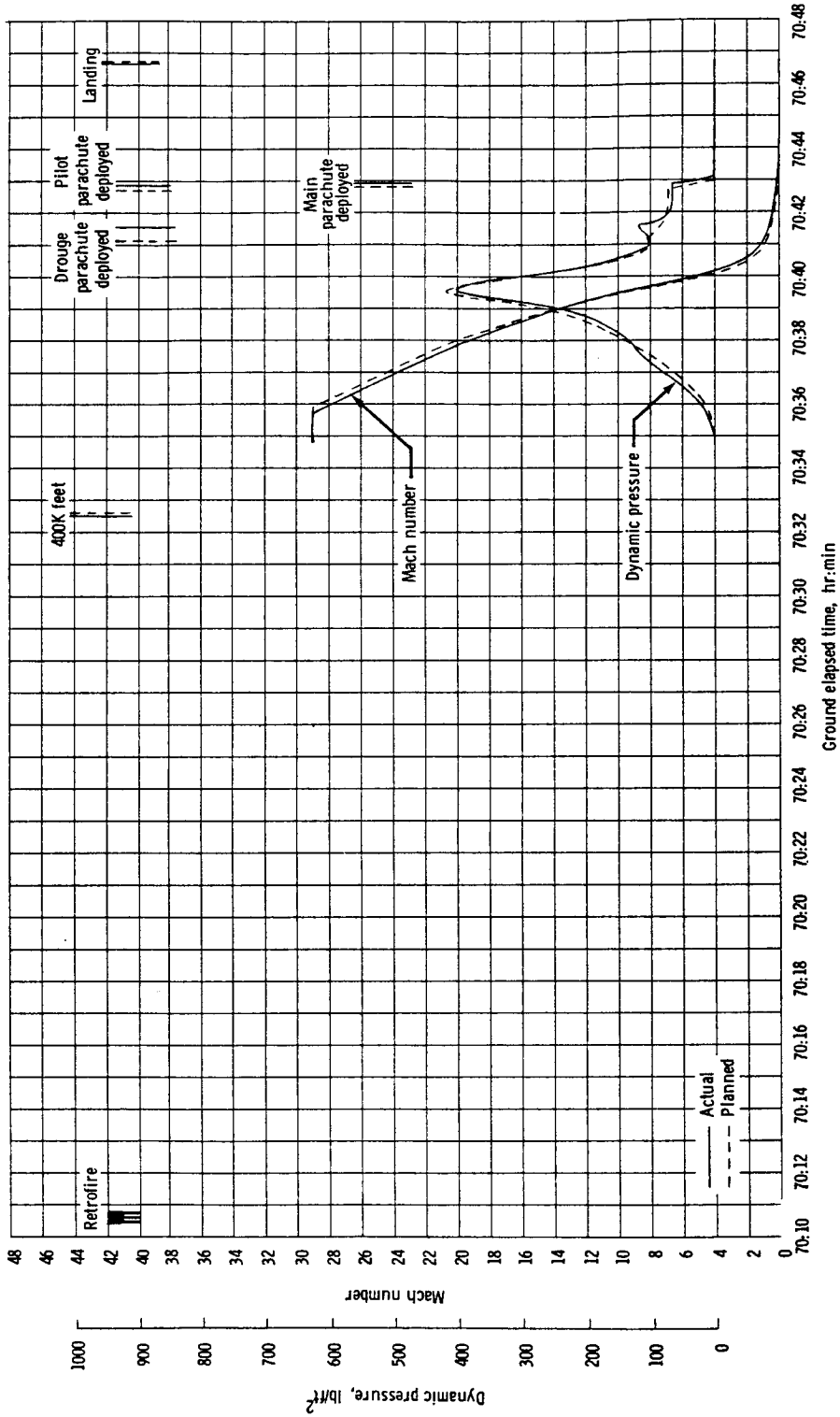

(d) Dynamic pressure and Mach number.

Figure 4-7. - Continued.

UNCLASSIFIED

NASA-S-66-8057 AUG 4

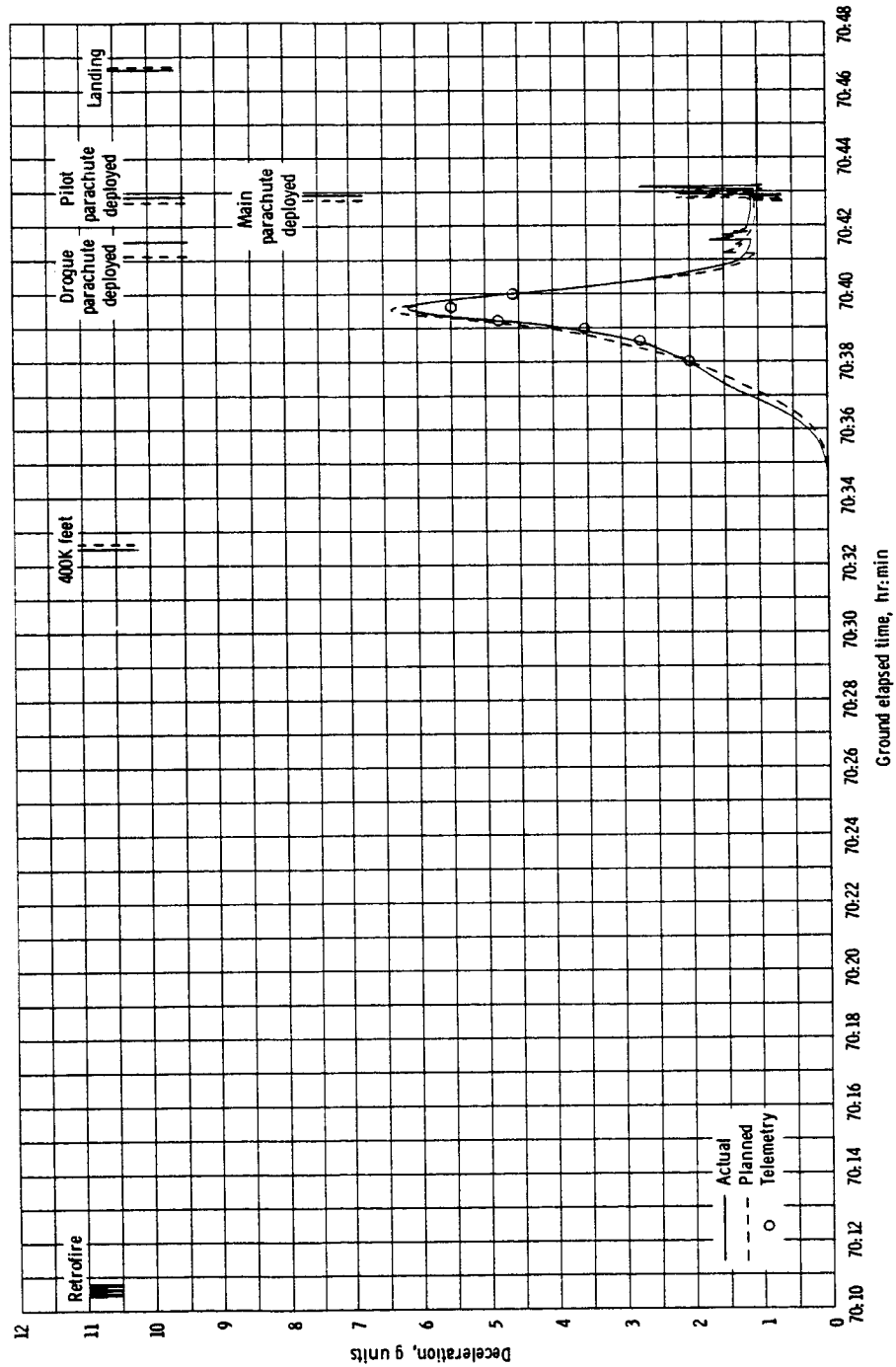

(e) Longitudinal deceleration.

Figure 4-7. - Concluded.

UNCLASSIFIED

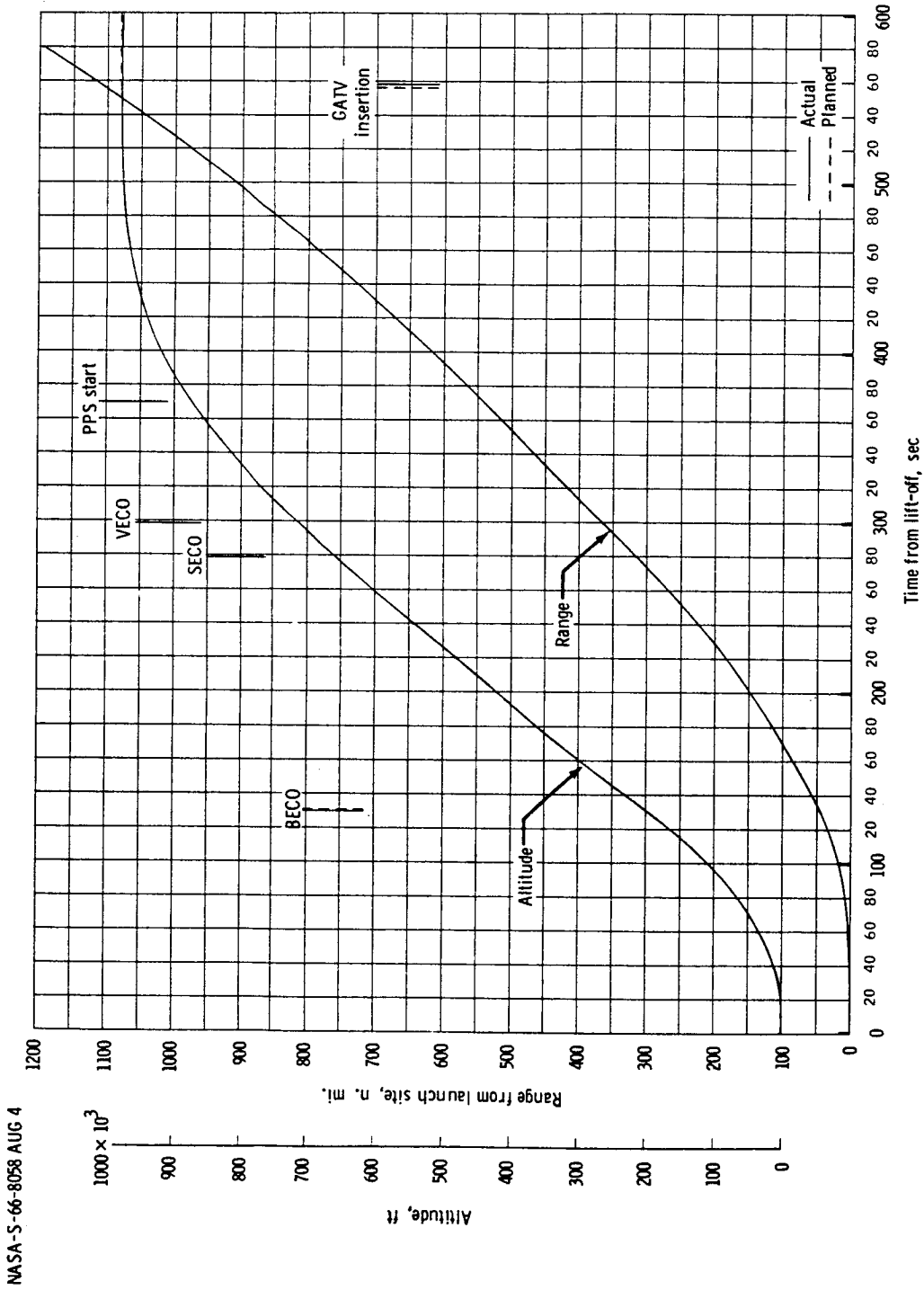

(a) Altitude and range.

Figure 4-8. - Trajectory parameters for the GAATV launch phase.

UNCLASSIFIED

NASA-S-66-8059 AUG 4

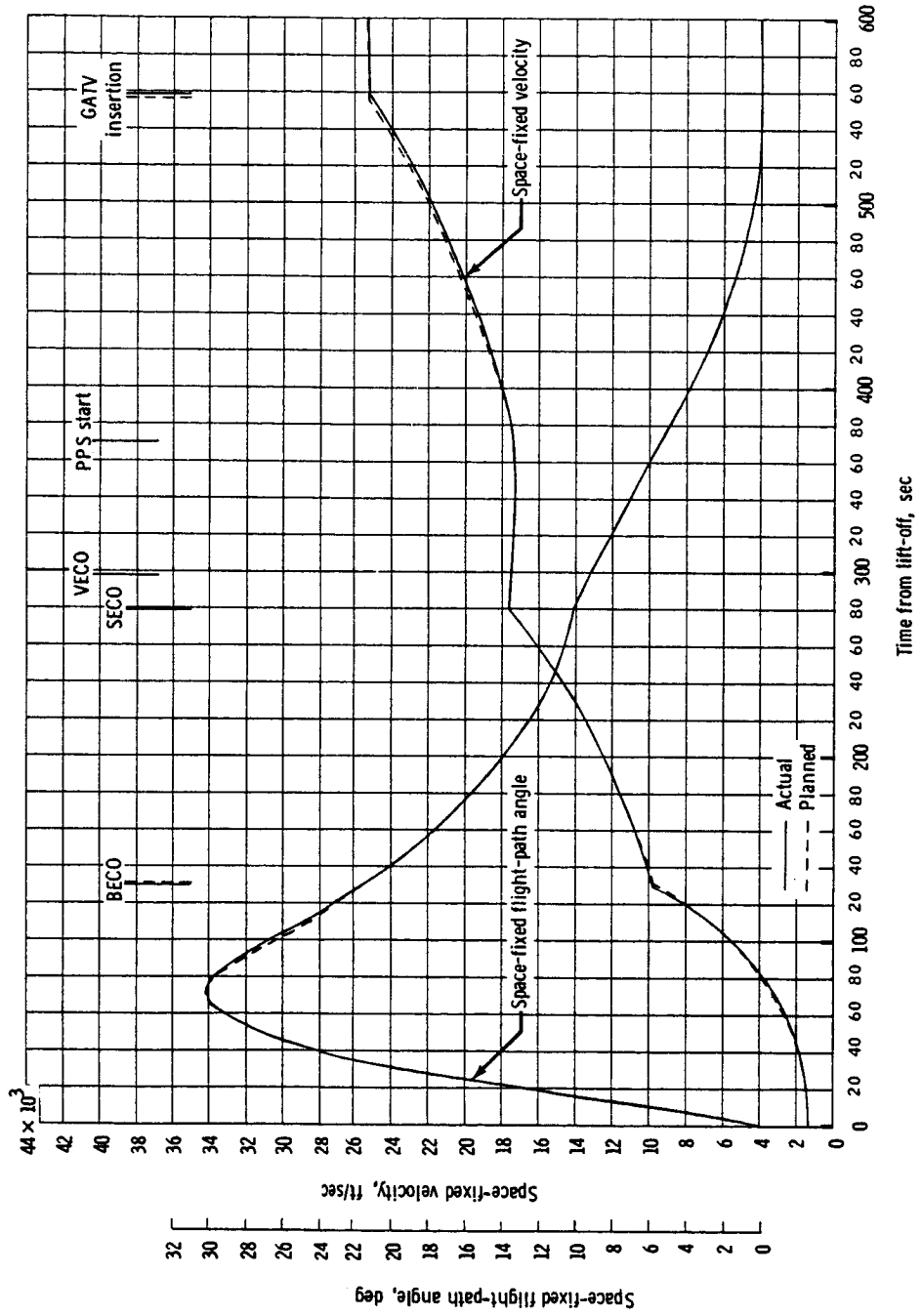

(b) Space-fixed velocity and flight-path angle.

Figure 4-8. - Continued

UNCLASSIFIED

NASA-S-66-8060 AUG 4

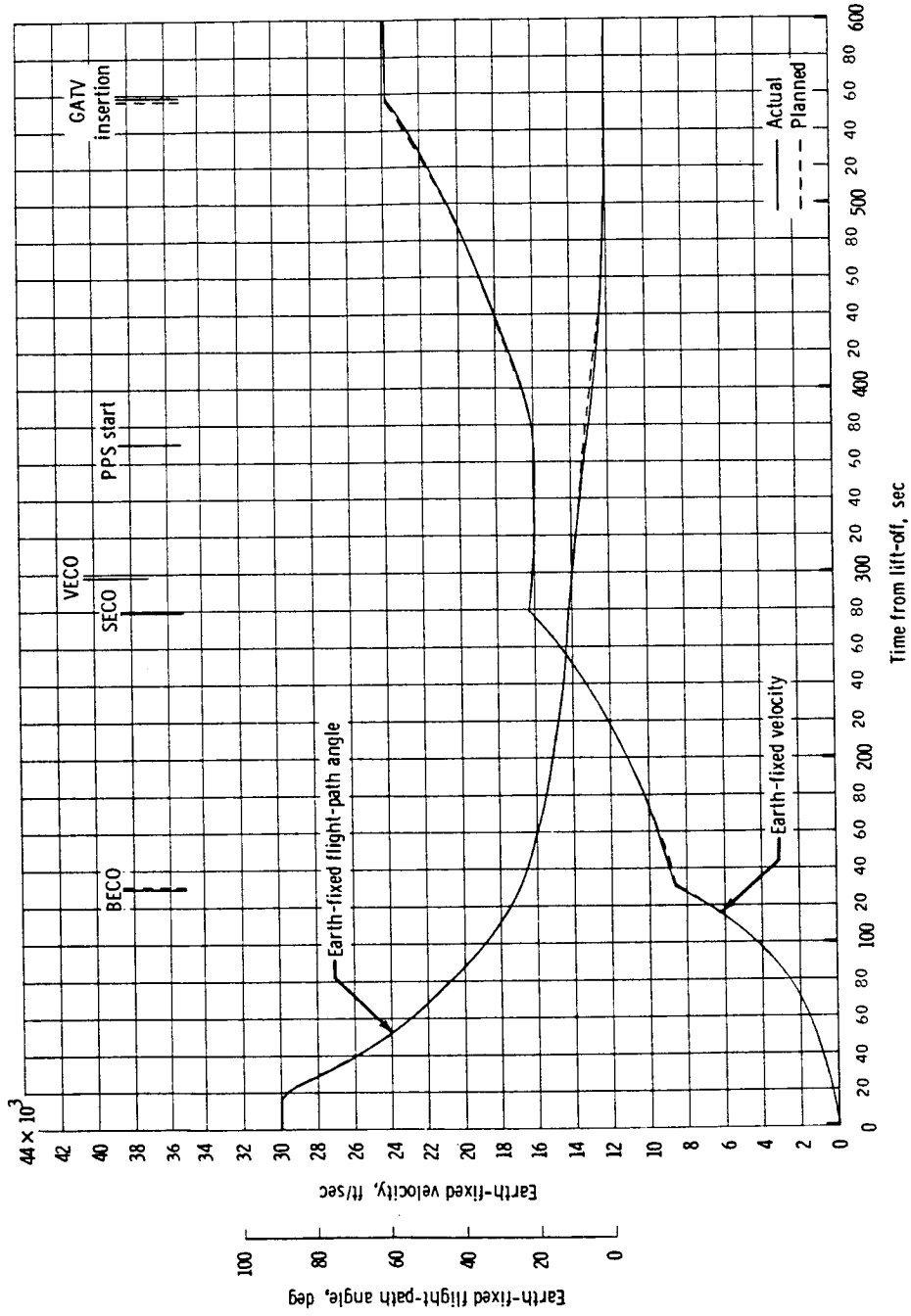

(c) Earth-fixed velocity and flight-path angle.

Figure 4-8. - Continued.

UNCLASSIFIED

NASA-S-66-8061 AUG 4

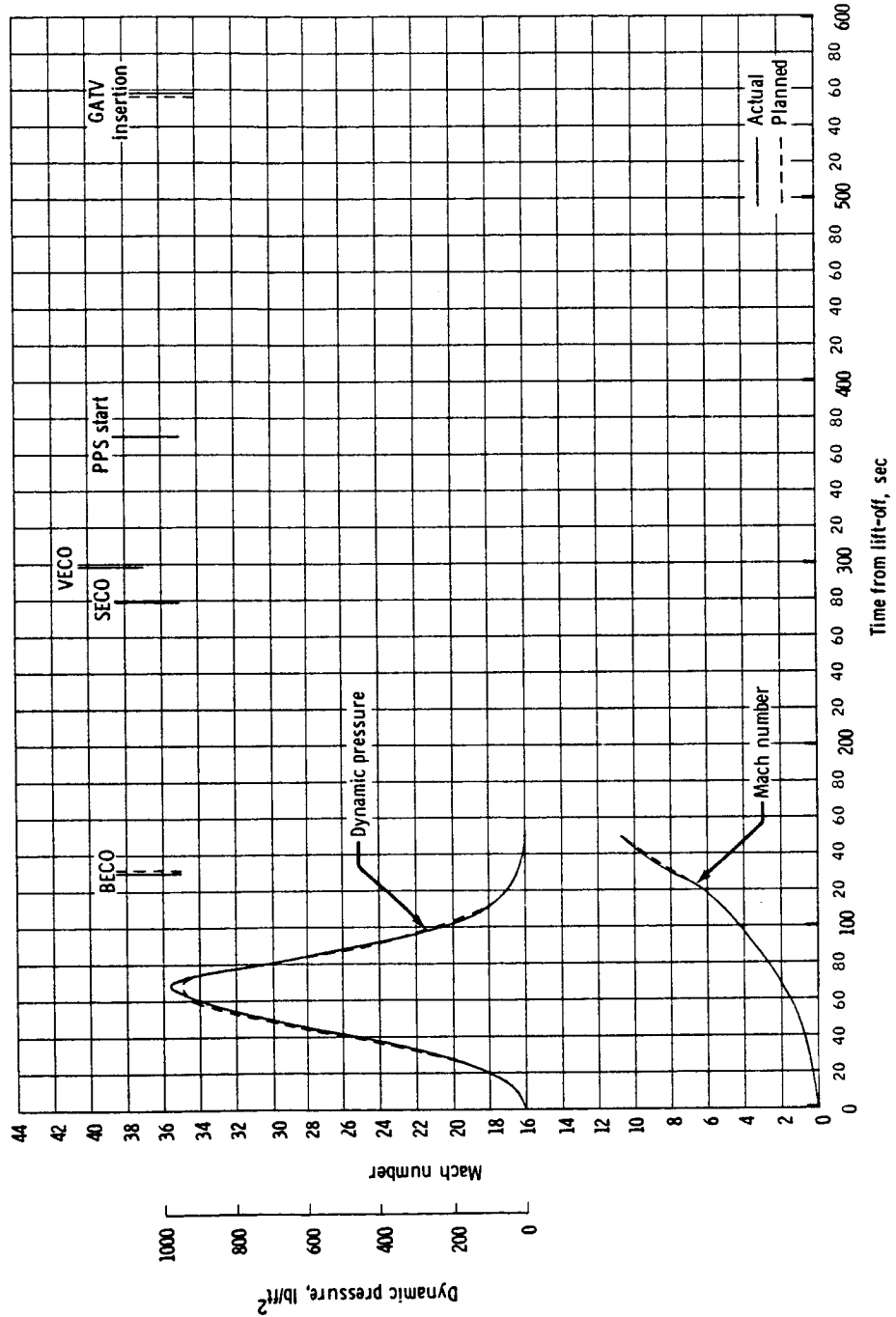

(d) Dynamic pressure and Mach number.

Figure 4-8. - Continued.

UNCLASSIFIED

NASA-S-66-8062 AUG 4

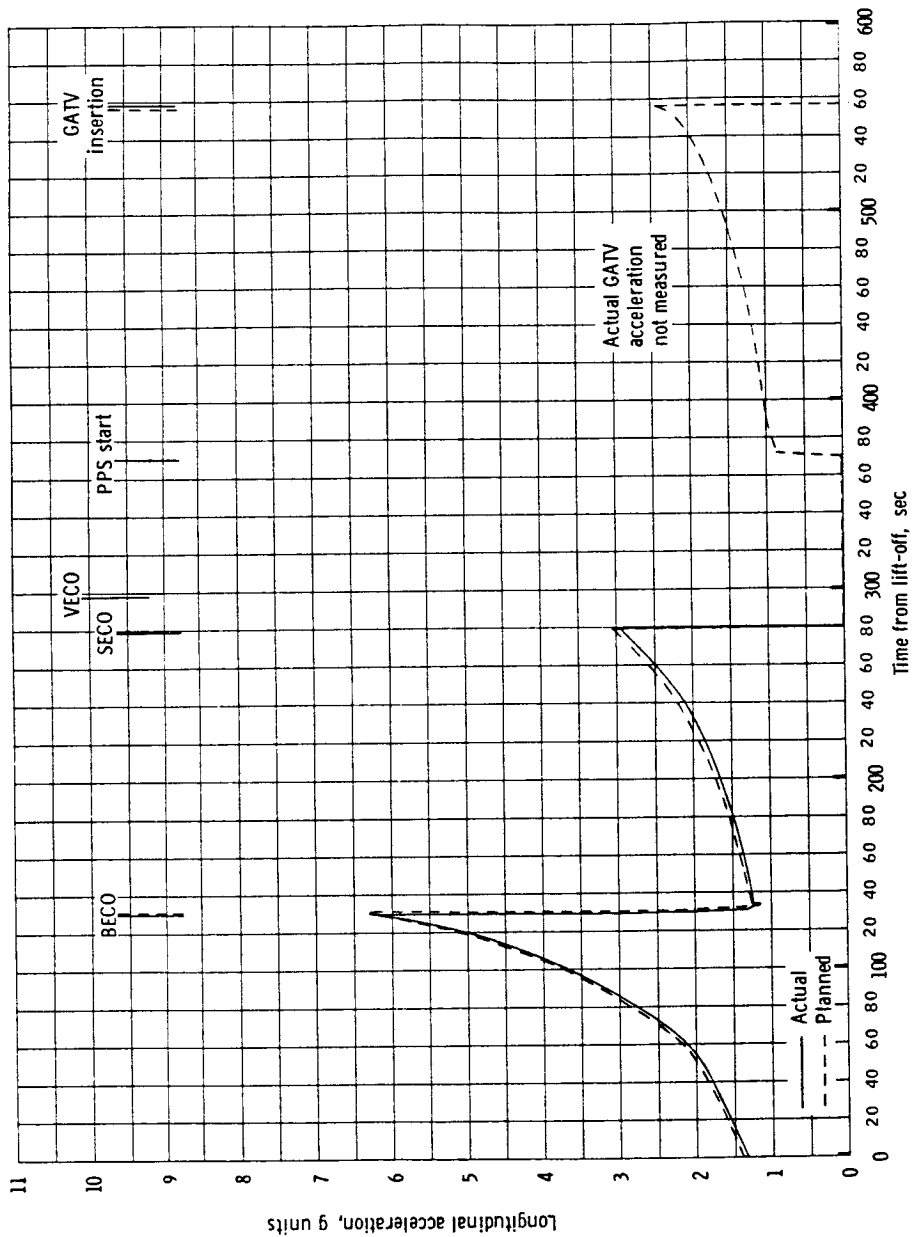

(e) Longitudinal acceleration.

Figure 4-8. - Concluded.

UNCLASSIFIED

UNCLASSIFIED

THIS PAGE INTENTIONALLY LEFT BLANK

UNCLASSIFIED

5.0 VEHICLE PERFORMANCE

5.1 SPACECRAFT PERFORMANCE

5.1.1 Structure

The spacecraft structure sustained all loads satisfactorily, and all mechanisms functioned properly except that the aft handrail on the adapter deployed improperly and the recovery beacon antenna did not deploy. The dynamic response of the Spacecraft 10/Gemini Agena Target Vehicle docked configuration to the excitation of the Gemini Agena Target Vehicle (GATV) primary propulsion system firings was as expected. The hatch opened and closed easily during all three operations in orbit. Reentry trim attitude, lift-to-drag ratio, and heating were nominal.

5.1.1.1 Handrail and recovery antenna anomalies.- The extravehicular pilot reported that the aft handrail on the adapter did not deploy properly. He reported that the forward end was up and the aft end down. A parallelogram mechanism should have deployed both ends of the handrail so that it would be parallel to the adapter surface. The handrail is normally released when the spacecraft separates from the launch vehicle second stage. This action releases a stop which allows the handrail to be spring-driven aft about a quarter of an inch and to disengage from a hold-down flange at each end. After handrail release, the mechanism is spring-driven from the forward crank link to an upright position. It is believed that the forward end of the handrail released first and started deploying upward before the aft end was unlocked. This action would jam the mechanism in the position described by the pilot. The design is being corrected by providing less engagement of the aft end of the handrail with the hold-down flange to ensure that the aft end releases before the forward end.

The recovery beacon antenna did not deploy because the D-5 ablative material covering the parachute line trough did not shear out properly. The parachute bridle line should shear the D-5 material on both sides of the trough, and the material should come off to permit the antenna to deploy. Instead, the parachute bridle line sheared only one side; consequently, the D-5 material acted as a flap and held the antenna down. The D-5 material has an inverted fiber glass channel bonded to it at each of the two antenna locations. Each channel section fits down over the bridle line to acquire the proper tear-out loading on the D-5 material. It is possible that the bridle line was inadvertently shifted under one flange of the channel while a minor change was being made in the UHF antenna. It is also possible that a rotation of the spacecraft on the main-parachute bridle could have caused the two-point bridle to shear

UNCLASSIFIED

out on only one side (see section 5.1.11). Investigation is continuing to determine if corrective action should be taken either in the design or in the installation procedure.

5.1.1.2 Spacecraft 10/GATV dynamic response.- One orbit prior to the first docked GATV primary propulsion system (PPS) firing, the docked Spacecraft 10/GATV configuration was tested for verification of the first bending-mode design parameters. Frequency and damping of this mode indicate the structural integrity of the joined vehicles and the degree to which the structural dynamics of the joined vehicles will couple with the GATV control system dynamics and affect the overall "flexible body" system stability. The spacecraft Orbital Attitude and Maneuver System (OAMS) thrusters were used to excite the mode, and accelerometers in the spacecraft adapter measured the response.

A frequency of four cps was measured for the fundamental mode. This was about ten percent higher than the 3.3 to 3.7 cps expected; however, the higher frequency provides a greater stable-gain margin. Cross coupling, which is the cross-axis response compared with the forced-axis response, was measured to be 20 percent maximum. Studies had shown that structural cross coupling would not significantly affect the stability of the coupled vehicle system, although a value as high as 50 percent had been investigated. However, it was necessary to measure the cross coupling because of its effect upon damping measurements. With a large amount of cross coupling, the mode can appear to be highly damped in one axis, when actually the damping may be quite low and the energy is simply transferring to some other axis.

The damping ratio of the first bending mode was found to be between 4.5 and 5.5 percent for the pitch axis and between 5.5 and 6.5 percent for the yaw axis, after accounting for the cross coupling influence. This range is higher than the 1.5 percent to 4.0 percent expected and is considerably above the 0.8-percent damping which would give zero-stability margin. Ground tests had indicated that damping might be as low as two percent. The GATV control system network was compensated to give at least +6 dB stable-gain margin for structural damping of 1.5 percent.

Hence, the inflight dynamic response test indicated that all structural parameters, frequency, cross coupling, and damping were such as to provide conservative stability margins. This finding was confirmed by the first PPS maneuver when the structural mode was excited to an amplitude of less than 0.04g peak-to-peak by the ignition transient, and the oscillations were quickly damped in a few cycles with only a low-amplitude 0.83 cps GATV fuel-slosh oscillation which persisted until PPS cutoff.

UNCLASSIFIED

5.1.1.3 Reentry aerodynamics and heating.- The environment experienced by the spacecraft during reentry was as expected and was well within the spacecraft limits. The apparent heat shield stagnation point measured 17.2 inches below the centerline, which tends to confirm the predicted trim angle of eight to ten degrees.

The peak reentry stagnation heating rate was $48 \text{ Btu/ft}^2/\text{sec}$ as determined by a trajectory fitting technique and comparison with lift-to-drag parameters. The total stagnation heat sustained was about 7950 Btu/ft^2 .

5.1.2 Communications System

All spacecraft communications equipment performed in a satisfactory manner and without evidence of malfunction. During the postflight debriefings and data analyses, a few areas of minor concern were noted and investigated.

Nine tapes of acceptable quality were recorded on the spacecraft voice tape recorder during the mission. Portions of both transmitted and received voice communications were recorded.

The reentry communications blackout was predicted to occur from 70:34:46 to 70:39:34 ground elapsed time (g.e.t.). Real-time telemetry signal-strength charts were not available to verify the blackout times.

5.1.2.1 UHF voice communications.- UHF voice communications were satisfactory for mission support during launch and during the orbital phase of the mission. Voice communications were excellent between the spacecraft and the recovery forces from shortly after the predicted time of communications blackout until after landing.

5.1.2.2 HF voice communications.- HF voice communication equipment is included in the Gemini spacecraft for emergency purposes during orbital flight and to aid in locating the spacecraft after landing. The HF equipment was not needed while in orbit and was not used. Because of the accurate landing and immediate recovery, the HF equipment was not used for direction-finding or voice communications after landing.

5.1.2.3 Radar transponders.- The operation of the C-band radar transponders was satisfactory, as evidenced in the excellent tracking information supplied by the network stations.

UNCLASSIFIED

5.1.2.4 Digital Command System.- The performance of the Digital Command System (DCS) was satisfactory throughout the mission. Flight control personnel reported that all commands sent to the spacecraft were validated.

5.1.2.5 Telemetry transmitters.- Satisfactory operation of all telemetry transmitters was indicated by the quantity and quality of data received. Several network signal-strength charts were reviewed, and the signal levels were found to be more than adequate for good telemetry reception and tracking.

5.1.2.6 Antenna systems.- All antennas which were deployed operated properly during the mission, as evidenced by the adequate performance of the communications system. The HF whip antenna installed on the adapter assembly was not extended in orbit, and the HF whip antenna installed on the reentry assembly was not deployed for the postlanding phase of the mission.

The UHF recovery beacon antenna failed to deploy at spacecraft two-point suspension on the main parachute. Postflight inspection revealed that the part of the tear strip which covered this antenna was torn on only one side and remained in place, preventing deployment of the antenna (see section 5.1.1).

5.1.2.7 Recovery aids.- All communication recovery aids operated normally. The UHF recovery beacon was turned on after spacecraft two-point suspension on the main parachute; however, because the UHF recovery beacon antenna failed to deploy, reception of beacon signals was reported only by aircraft in the immediate vicinity of the spacecraft.

UHF voice communications between the spacecraft and the recovery forces were satisfactory. The flashing light extended normally, but its use was not required and it was not turned on by the crew. During the recovery prior to opening the hatches, communication between the swimmers and the crew was excellent. The operation of spacecraft recovery aids is further discussed in section 6.3.3.

5.1.3 Instrumentation and Recording System

The Instrumentation and Recording System performed satisfactorily throughout the mission. The PCM tape recorder was used continuously from before lift-off until seven minutes after landing, and excellent data were obtained. The remote PCM multiplexers, however, experienced a brief period of continuous resets from 48:58:11.3 to 49:05:38.1 g.e.t during the umbilical extravehicular activity (EVA).

UNCLASSIFIED

5.1.3.1 Umbilical EVA resets.- During the umbilical EVA, the reentry and the adapter low-level remote PCM multiplexers and the adapter high-level remote PCM multiplexer were spuriously reset continuously over two time periods—from 48:58:11.3 until 48:58:46.6 g.e.t., a period of 35.3 seconds; and from 48:59:25.5 until 49:05:38.1 g.e.t., a period of six minutes and 12.6 seconds. The manual oxygen heater was turned on at 48:43:07 g.e.t., operated continuously during this period, and was turned off at 49:05:24 g.e.t., within 14 seconds of the time the continuous resets completely stopped, but this time was almost coincidental with the end of the resets on both low-level multiplexers. The continuous reset periods and the period of manual heater operation are shown in figure 5.1.3-1 with reference to the pilot's extravehicular activity. The cause of these resets has not been established, but an investigation into the possible causes is underway.

5.1.3.2 System performance.- Satisfactory operation was obtained from all 241 parameters monitored during this mission.

5.1.3.3 Delayed-time data quality.- The quality of the delayed-time data received at the Cape Kennedy, Hawaii, and Antigua ground stations is summarized in table 5.1.3-I. This table represents 21 of the 43 delayed-time data dumps as well as data from the last orbit and reentry recovered from the onboard PCM tape recorder. For all ground stations and the onboard PCM tape recorder, the usable data exceeded 99.5 percent of that recorded. All percentages were derived from computer-processed data edits. The excessive data losses at Hawaii are attributed to the low signal-to-noise ratios associated with a low elevation-angle pass during revolution 31.

5.1.3.4 Real-time data quality.- Proper operation of the delayed-time PCM tape recorder during this mission resulted in a minimum requirement for computer processing of the real-time telemetry data. From the computer-processed time edits which were accomplished, the following percentages of usable data were obtained:

Station	Revolution	Usable data, percent
MCC-K	1/2	99.8
MCC-K	2/3	99.27
HAW	3	^a 86.5
GYM	1	99.35

^aMaximum elevation angle = 16 degrees.

UNCLASSIFIED

TABLE 5.1.3-I.- DELAYED-TIME DATA FROM SELECTED STATIONS

Station	Revolution	Total data received		Total losses		Usable data, percent
		Duration, hr:min:sec	Prime subframes	Subframes	Percent	
Cape Kennedy	Launch, 1, 2, 11, 12, 13, 14, 15, 28, 29, 30, 40, 42	17:37:58	634 776	692	0.109	^a 99.891
Hawaii	2, 3, 4, 5, 6, 17, 31, 32	8:28:54	305 343	4346	1.423	98.577
Antigua	9, 10, 40	2:32:21	91 414	363	0.397	99.603
Onboard recorder	43, reentry	1:46:43	64 029	12	0.018	99.982
Summation		30:25:56	1 095 562	5413	0.494	99.506

^aThe partial data losses caused by resets during the umbilical EVA are not included.

UNCLASSIFIED

NASA-S-66-8092 AUG 11

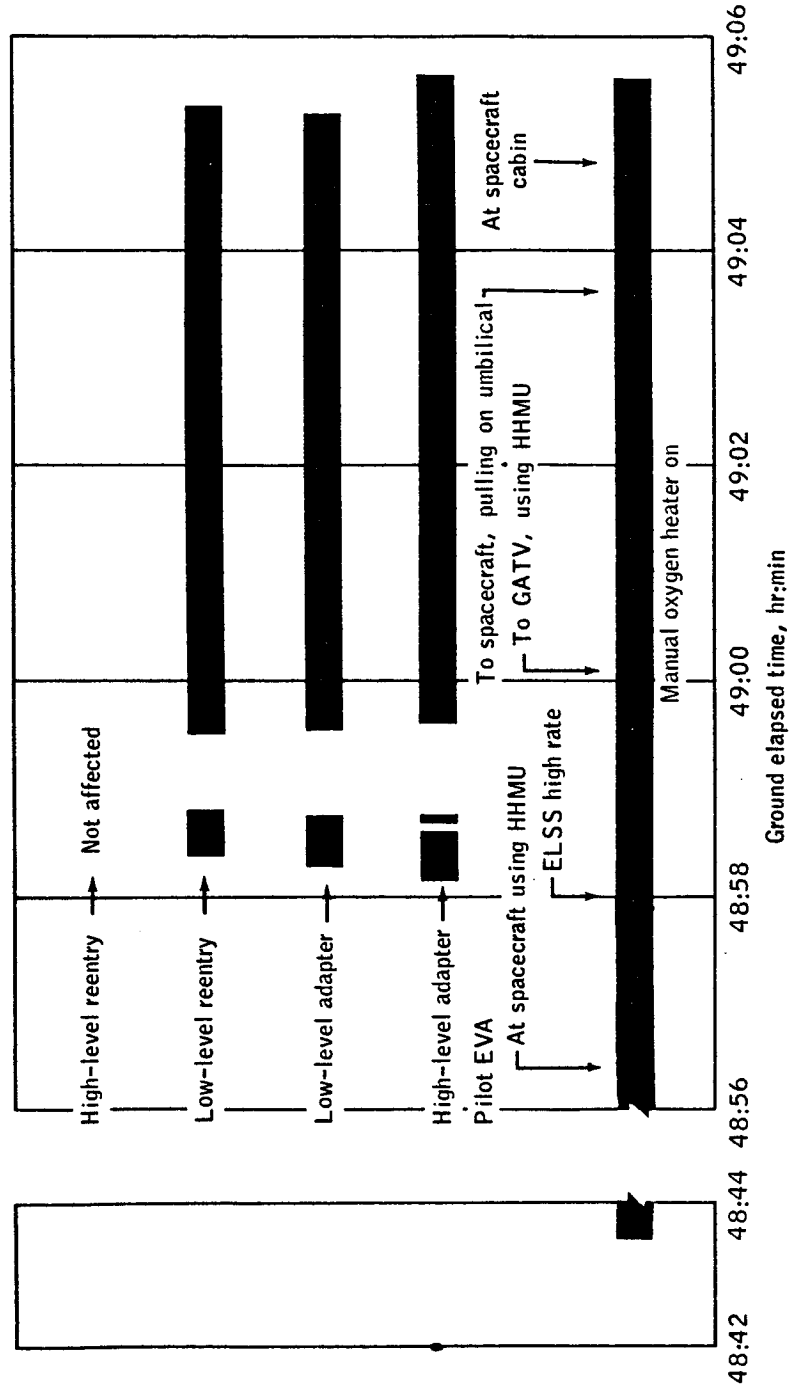

Figure 5.1.3-1. - Periods of continuous PCM multiplexer resets during the umbilical EVA.

UNCLASSIFIED

5.1.4 Environmental Control System

The performance of the Environmental Control System (ECS) was generally good throughout the mission. All parameters were as expected except those reported herein.

5.1.4.1 Coolant temperature control valve.- During the early portion of the mission, the temperature of the coolant out of both ECS coolant temperature control valves was above the normal control range of 36° to 42° F for short periods of time. This occurred at ground elapsed times of approximately 1 1/2 hours, 3 hours, and 6 1/2 hours, and the peak temperatures during these periods were 50° F, 47° F, and 46° F, respectively. Each of these temperature rises occurred near the end of a dayside period when the radiator outlet temperature is normally at a maximum. The spacecraft electrical load was approximately 60 amperes at the time of these temperature peaks. Computations based upon previous flight and test data indicate that such power levels can result in peak radiator outlet temperatures of this magnitude. This, then, would cause the outlet temperature of the ECS coolant temperature control valve to be above the normal control band.

At approximately 8 hours 30 minutes g.e.t., the temperature of the coolant out of the primary ECS coolant temperature control valve began to decrease from the nominal 40° F control point and was down to 32° F by approximately 13 hours 30 minutes g.e.t. The start of this transition appears to be coincident with the switching of the primary coolant loop from operation with the A coolant pumps (high flow) to operation with the B coolant pumps (low flow). At 18 hours 19 minutes g.e.t., the primary A coolant pump was again activated, and the control valve outlet temperature rapidly returned to its normal control range.

At 29 hours 20 minutes g.e.t., the primary B coolant pump was again selected, and by 29 hours 56 minutes g.e.t. the control valve outlet temperature had decreased to 32° F. The crew was then requested to return to use of the primary A coolant pump for the remainder of the mission. After switching pumps, the control valve outlet temperature rapidly returned to the normal control band. This anomaly did not occur in the secondary coolant loop which was operated with the low-flow B coolant pump during nearly all of the mission.

Previous testing and flight use of this valve have shown that the valve may exhibit unstable regulating characteristics when used with the low-flow coolant pumps. During the Gemini VII mission, the coolant temperature out of this valve began to cycle over a wide range when the B pump was used and radiator outlet temperature was below 0° F. This cycling was duplicated in ground testing and was attributed to poor mixing of hot and cold fluids in the sensing section of the valve.

UNCLASSIFIED

The characteristics experienced on Gemini X have not occurred in any previous flight or ground testing. Calculations have shown that the control valve was not stuck in a fixed position. The anomaly is attributed to poor mixing within the valve, causing an instability which is characteristic of this particular valve.

5.1.4.2 Eye irritation.- At approximately 24 hours g.e.t. during the standup EVA, both crewmen reported the sudden onset of eye watering and irritation and terminated the EVA. It was believed at that time that suit compressor no. 2 may have caused the problem. A special ECS test was conducted in flight on compressor no. 1 to assure its satisfactory operation for the umbilical EVA.

Postflight debriefing revealed that the command pilot had experienced mild eye, nose, and throat irritation at approximately 9 hours g.e.t. and also during the third sleep period. Both crewmen noticed mild watering of the eyes during the special ECS test.

The cause of this anomaly is not readily apparent; therefore, an extensive investigation of spacecraft components and crew equipment was made in an attempt to determine the cause. Spacecraft investigations included operation of the ECS in an altitude chamber simulating the standup EVA conditions, and operating suit compressor no. 2 deadheaded. A particle trap was used during the first test, and gas samples were taken during both tests for chemical analysis. Also, chemical analyses were made of samples taken from the solids traps, suit heat exchangers, lithium hydroxide, charcoal, and wet wipes of ducts. The pressure suits and underwear were subjected to chemical analysis. All analyses have failed to show any contaminant in sufficient quantity to have caused the anomaly. The majority of samples showed small amounts of ammonia, sodium, silicone, argon, lithium, carbon dioxide, carbon monoxide, and numerous metals. These results are similar to those on previous flights and, therefore, are as expected.

Several of the samples contained pectin esterase which has been traced to the orange juice powder that was spilled by the crew. This was not the source of the eye irritation, as the crew reported that the spillage occurred after the standup EVA. Another possible source of the irritation concerns the flow of oxygen across the faces of the crew. This possibility is also being investigated. During EVA the suit circuit pressure is approximately 3.7 psia, and, because the weight of oxygen from the fan remains nearly constant, the velocity of the air stream across the face is at its highest level at this low density. This condition is also worse when operating with both suit fans, rather than one. All possibilities will continue to be explored in an attempt to isolate the cause of the eye irritation. On future flights, EVA will be conducted

UNCLASSIFIED

using a single suit fan which will lessen the effect, if the cause is present, and the present high standards of cleanliness will be maintained in an attempt to preclude any contaminants that may have caused the problem.

Corrective action is planned to prevent reoccurrence of the anomaly on the remaining Gemini flights. The cleaning procedures for installation of the flight lithium hydroxide canisters will be improved. Also, the lithium-hydroxide canister verification test will be conducted with both suit compressors operating, which was the configuration during the anomaly and should increase the probability of detecting the presence of possible irritants.

5.1.5 Guidance and Control System

5.1.5.1 Summary.- The performance of the Guidance and Control System was excellent throughout the mission, with no equipment malfunctions reported and none detected in the analysis. Ascent backup guidance was nominal, and rendezvous guidance was adequate to place the spacecraft in an acceptable closing configuration. The onboard orbit-navigation computer program, mechanized for the first time on this mission, operated properly; however, go/no-go criteria for the ascent vector derived from the Inertial Guidance System (IGS) and difficulties with the procedures for orbit determination prevented the use of the computer outputs for the rendezvous catch-up phase. A partial assessment of the potential performance of the system is discussed in section 5.1.5.2. The onboard radar/computer solution for the coelliptic (N_{SR}) maneuver was acceptable; however, the solution computed on the ground was used. The two solutions resulted in nearly the same thrust vectors but called for slightly different times of initiation. The Auxiliary Tape Memory Unit (ATMU) was used to reprogram the onboard computer, and the operation was completely satisfactory. Reentry guidance was adequate, and the spacecraft was sighted from the recovery carrier prior to landing. The control system performance was nominal throughout the mission. Table 5.1.5-I contains a summary of significant guidance and control events for this mission.

5.1.5.2 Inertial guidance system performance evaluation.-

5.1.5.2.1 Ascent phase: Steering-command deviations of the IGS in roll, pitch, and yaw are presented in figure 5.1.5-1. Superimposed on the IGS steering quantities are the primary guidance system steering signals along with the upper and lower IGS attitude error limit lines for nominal, zero-wind steering signals for the Gemini X trajectory. Analog time histories of predicted pitch and yaw attitude errors for winds at T minus five hours are shown for the first 90 seconds of flight. A

UNCLASSIFIED

comparison of steering signals for the two guidance systems indicates that the IGS roll, pitch, and yaw steering commands were correct and agreed very closely with those of the primary system. The only deviations noted between primary and secondary signals were in pitch and yaw attitude errors at guidance initiation and in pitch attitude errors during the second-stage closed-loop radio guidance phase. Aside from these minor steering deviations, the IGS attitude time histories were within the preflight zero-wind limits. Other differences between the two systems are attributed to known programmer and timing differences, initial engine misalignments, and drifts in the primary guidance Three Axis Reference System (TARS).

The IGS pitch and yaw attitude errors indicated a normal response to closed-loop steering commands at guidance initiation. IGS error signal saturation on this mission occurred at lift-off (LO) + 167.9 seconds. At that time, the IGS pitch steering command saturated to a full pitch-down command and stayed there for a period of 7.25 seconds. The primary guidance system did not initiate a 100-percent pitch-down command until four seconds later. The primary-system pitch guidance-validation test lasted four seconds longer than expected because the GLV velocity was lower than the reference value set in the primary guidance equations. The primary decoder output indicated a 6-percent pitch-down command during the 4-second time interval. Because the primary system yaw commands at guidance initiation are dependent on the time when the pitch decoder indicates full pitch commands, the yaw output was zero during this time period.

The behavior of the second-stage pitch steering signals indicated positive error signals (pitch-down commands) for the primary system and negative error commands for the secondary system. The behavior of the primary system in maintaining positive error signals throughout second stage flight is attributed to a pitch actuator bias of 1.0 degree, which has been used in the primary guidance system since Gemini II. This adjustment to the null linkage on the pitch actuator included a 3-sigma approximation adjustment, which apparently over-compensated on this mission. During the last 20 seconds prior to SECO, oscillations in pitch commands were indicated which were slightly greater than those which had occurred on previous missions. These oscillations are attributed to the effects of atmospheric refraction of the tracking signals at low elevation angles.

The sequence between SECO and spacecraft/GLV separation was as expected, with no evidence of spurious accelerations noted. Figure 5.1.5-2 contains a time history of inertial measurement unit (IMU) accelerometer outputs during this period.

UNCLASSIFIED

If guidance switchover had occurred during early second stage flight, the insertion conditions prior to the separation maneuver would have deviated from nominal by minus 2.5 ft/sec in velocity, plus 0.03 of a degree in flight-path angle, and plus 2050 feet in altitude. The IGS SECO discrete was delivered within 30 milliseconds of the primary SECO discrete signal, verifying the comparison between primary and secondary guidance systems. Following an Insertion Velocity Adjust Routine (IVAR) correction, the resultant orbit for an IGS-guided launch phase would have had a 145.6-nautical-mile apogee and 87.3-nautical-mile perigee, very close to the desired 145.2 and 86.7 nautical miles.

The in-plane IVAR correction was applied during this mission with a resultant 86.3 by 145.1 nautical-mile orbit, indicating that both the IVAR solution and application were accurate. The Incremental Velocity Indicator (IVI) display, as actually computed by the onboard IVAR, was reconstructed using IGS navigational and gimbal-angle data. For separation, the reconstructed IVAR, in component form, indicated 25 ft/sec forward, 4 ft/sec left, and 5 ft/sec down, for a 26 ft/sec in-plane and 4.5 ft/sec out-of-plane correction vector. Following reconstruction of the roll and yaw maneuvers to zero-zero and nulling of the pitch attitude errors, the reconstructed IVAR indication was 25 ft/sec forward and 1 ft/sec right, confirming the reported crew IVI readings. Following the 35-second IVAR maneuver, the reconstructed IVAR indication was 1 ft/sec aft and 1 ft/sec right, again confirming the reported crew IVI readings. The out-of-plane velocity component was less than 2.5 ft/sec during the IVAR maneuver. The perigee correction to be applied at apogee, as computed by IVAR, was about 0.7 ft/sec, reflecting the 2050-foot altitude error in the IGS navigation.

Table 5.1.5-II contains an estimate of orbital injection parameters at second-stage engine cutoff (SECO) + 20 seconds, as determined from the IGS, the real-time tracking data, and the postflight corrected data. A preliminary estimate of IMU component errors was obtained by comparing ground tracking measurements with guidance position and velocity data (fig. 5.1.5-3). The external tracking data used for these comparisons were GE MOD III final (postflight corrected) data and Missile Trajectory Measurement (MISTRAM) data (postflight corrected) using the 100K-foot legs. The differences between the real-time MISTRAM and MOD III and the postflight MISTRAM and MOD III data indicate the extent of postflight corrections to the data. The tracking data agree within the accuracy expected. The residuals obtained using MISTRAM were used to estimate component errors which could account for the velocity error propagations along the computer X, Y, and Z axes. The accelerometer telemetry data acquired during ascent had no significant dropouts and were excellent for analysis. On this flight, compensations for the gyro drift terms were made in addition to the normal accelerometer compensations on previous flights. The values used for compensation were predicted using a least-square fit of the preflight data to a first order curve, with a

UNCLASSIFIED

~~CONFIDENTIAL~~

50-ppm bias to the accelerometer scale-factor term only. The preflight test data and the predicted drift values are shown in figure 5.1.5-4.

The velocity error along the X axis can be explained by the coupling of the drift-induced vertical velocity error into X, a scale factor error, and timing errors. A large time bias of 55.6 milliseconds between the computer clock and range time and a computer clock drift of minus 99 ppm were noted. Most of the gyro terms which can induce velocity error along the Z axis appear to have been adequately compensated. The major velocity error contributor appears to be a shift of 0.1 deg/hr/g of the Z gyro input axis unbalance from its compensated value. The error sources which could have induced the velocity errors along the computer axes are shown in table 5.1.5-III. Two fits were made primarily to match the Y-velocity errors. The first fit, although more complete, attributes the errors to gyro parameter errors. The second fit attributes the errors to change in orientation of the Z accelerometer sensitive axis. A review of preflight data (fig. 5.1.5-4) shows that the misalignment fit is more consistent with test data. Further analysis is planned to verify this condition. In addition, sensor and tracker errors obtained from a preliminary Error Coefficient Recovery Program (ECRP) run are presented. The major velocity-error contributors obtained from the ECRP are consistent with those obtained by a hand fit although, because the propagation characteristics of accelerometer misalignment and mass unbalance gyro terms are similar, it is difficult to choose between the two fits.

The present best estimates of the guidance position and velocity errors at injection are given in table 5.1.5-IV. These quantities were obtained from position and velocity comparisons using the best estimates of the tracker reference trajectory. In this table, the IMU error consists of sensor errors, whereas navigation errors result from various approximations within the airborne computer.

5.1.5.2.2 Primary Rendezvous Phase: In order to further explore onboard capabilities, three onboard techniques were developed for the rendezvous portion of this flight. The first used a simple hand-held sextant to take star-to-horizon measurements which were used with a deterministic onboard-computer program to derive the state vector of the spacecraft. This state vector was then used with computer readouts and charts to compute the N_{C1} and N_{SR} rendezvous maneuvers. The second technique used the state vector measured by the IGS during ascent and the same charts as the first technique to compute a second set of N_{C1} and N_{SR} maneuvers and an N_{PC} maneuver. The third technique used radar data provided by the computer and a chart to determine the N_{SR} maneuver. A ground solution for each of the maneuvers was also to have been

~~CONFIDENTIAL~~

UNCLASSIFIED

calculated and transmitted to the spacecraft, giving the crew three solutions for N_{Cl} , two for N_{PC} , and four for N_{SR} . Paragraph 5.1.5.2.3 contains a brief summary of the onboard computer program capabilities added for this and subsequent flights.

Prior to using the sextant measurements to obtain a state vector, it was necessary to define the radius of the sensible horizon. This was accomplished on this flight by providing a horizon calibration chart based on comparing the measured horizon altitude with that obtained from the onboard computer using the ascent vector. After a calibrated horizon height was obtained and entered into the computer, subsequent star-to-horizon measurements were taken to determine the spacecraft state vector. Figure 5.1.5-5 shows the nominal and actual onboard timeline activities for this portion of the flight. The figure is a summary of the maneuver determination period and indicates the command pilot and pilot activities. Figure 5.1.5-6 shows the onboard charts which were used to determine the required catch-up rendezvous maneuvers. A star chart is also included for reference of star locations. The chart formats were specifically designed to reduce plotting and numerical complexity.

The procedures began on schedule with the application of IVAR (see paragraph 5.1.5.2.1). The spacecraft entered the first darkness period at about 9 minutes 15 seconds g.e.t. The alignment of the platform, the automatic loading of Module VI, and the completion of the insertion checklist were accomplished ahead of schedule. A D009 sextant, which has a 12-degree field of view to improve acquisition and an 80/20 light split to improve the visibility of the horizon, was used to obtain star-to-horizon measurements. This sextant exhibited fine quality optics and excellent operating characteristics; however, the crew reported difficulties with the horizon definition as the result of the new-moon conditions which existed.

At 24 minutes 46 seconds g.e.t., the crew decided to take the first star-to-horizon measurement from the star Schedar to the top of the airglow, after which the pilot decided to use the real horizon for subsequent measurements. The calibration measurements were obtained quickly and the command pilot plotted the residuals from the five calibration measurements on a flight chart (see figure 5.1.5-6, chart no. 1) to obtain a new reference horizon altitude. (See section 7.1.2 for the crew report on star sightings.) During this process, a plotting error was made, the details of which are reported in section 7.1.1. The reference horizon altitude obtained was 27 500 yards instead of the correct value of about 32 000 yards. This caused a bias of about 0.14 of a degree in all subsequent star-to-horizon angle residuals. The resulting reference horizon altitude of 27 500 yards was entered into the computer, completing the horizon altitude calibration.

UNCLASSIFIED

The spacecraft was yawed SEF to acquire the star Hamal at about 32 minutes g.e.t. At this point the pilot was unable to get the star image to separate properly as the sextant angle was changed. This was determined during postflight discussions to be caused by holding the sextant such that the upper line of sight of the sextant was obstructed by the window frame. When unable to "split" the star image with the D009 sextant, the pilot tried the small modified marine sextant. With the small sextant the star image would "split", but the crew reported that the horizon was not well enough defined for accurate measurements because of the 50/50 light split in the instrument. The pilot then tried the D009 sextant again and was able to "split" the star image. Another measurement on Hamal was made at 40 minutes 24 seconds g.e.t. and properly entered into the computer. The inputting of a dummy star local-vertical measurement (used to obtain the out-of-plane components) was completed at 41 minutes 53 seconds g.e.t.

The crew elected to take the next measurement on the alternate star Vega rather than on the nominal star Altair and inserted the correct star coordinates. The required setting of logic choice was not selected to indicate to the computer that a sextant measurement was to be made. The logic choice remained set for a star-to-local-vertical measurement, the setting used for the previous dummy measurement (see figure 5.1.5-5). As a result, when the sighting on Vega was made at 44 minutes 15 seconds g.e.t and the measured sextant angle of 5.36 degrees entered into the computer, a residual of minus 76.30 degrees was computed and displayed to the crew. The crew rejected this residual and chose to return to the nominal star Altair and take the measurement rather than use a dummy measurement (set the residual to zero as planned for questionable measurements). They assumed that the large residual was due to incorrect star coordinates. The star coordinates were changed to those of Altair, but the logic choice was again not entered for a star-to-horizon measurement. The crew had difficulty identifying the star constellation (possibly due to the similarity of the guard star orientations; see section 7.1.2) and may have acquired the star Antares instead of Altair. Telemetered gibal angles show that the spacecraft was pointed southwest, in the general direction of Antares, instead of northwest, toward Altair. (See figure 5.1.5-6, chart no. 8.) The measured angle has been calculated to agree with the actual Antares-to-horizon angle at the time of the sighting to within 1.7 degrees but is more than 25.8 degrees from the Altair-to-horizon actual angle.

An odd combination of circumstances led the crew to believe that the measurement on Antares (which they believed to be on Altair) was valid and accurate. The measurement was taken at 46 minutes 21 seconds g.e.t, and the sextant-measured angle to Antares (4.97 degrees) was entered in the computer. (The best estimate of the correct angle to

UNCLASSIFIED

Antares at this time is 6.7 degrees; to Altair, 30.8 degrees.) An angle residual of $\boxed{-0013}$ degrees was displayed on the MDIU which would appear to the crew to be a reasonable measurement. However, computer telemetry shows that the actual residual was -100.13 degrees. This residual was computed for the measured star-to-horizon angle to Antares, using the Altair coordinate and the star-to-local-vertical logic. The hundreds digit was dropped from the MDIU display because only five digits, including sign, can be displayed, and the crew accepted the measurement. This measurement ended the orbit-determination activity in the first darkness period. Figure 5.1.5-5 shows that, even with the difficulties encountered, the last measurement was taken only about 30 seconds later than the nominal time.

On entering the daylight phase the rendezvous maneuver computations began, using the orbit prediction method based upon the ascent state vector and flight charts, and values were determined for the N_{C1} , N_{PC} , and N_{SR} maneuvers (the second method previously discussed). The pilot completed the first chart (fig. 5.1.5-6, chart no. 2) and obtained a ΔV for N_{C1} of 58 ft/sec, with a time of the midpoint of the maneuver at 2:20:20 g.e.t.

The chart (fig. 5.1.5-6, chart no. 3) used to calculate the N_{SR} maneuver yielded a ΔV for N_{SR} of 46 ft/sec. The time of the midpoint of the N_{SR} maneuver was calculated by the command pilot to be at 3:49:43 g.e.t.

In using the chart (fig. 5.1.5-6, chart no. 4) to locate the nodal crossing of the spacecraft and target vehicle planes, difficulty was encountered due to the effect of nodal crossings on the sign of the out-of-plane velocity (see figure 5.1.5-5 and figure 5.1.5-6). However, a solution for the ΔV of N_{PC} of 8.0 ft/sec, spacecraft nose to the south, at 2:53:25 g.e.t. (thrust midpoint) was obtained. Postflight chart calculations resulted in about 10 ft/sec, spacecraft nose to the south, with a thrust midpoint of 2:45:00 g.e.t.

The solutions obtained for N_{C1} and N_{SR} were read to the ground at 1 hour 16 minutes g.e.t., and the solution for N_{PC} was read to the ground at 1 hour 31 minutes g.e.t. The ground checked these solutions, using the ground tracking RTCC state vector, to determine if these solutions would place the spacecraft on a trajectory that would reach TPI within 15 minutes of the correct time and with a coellipticity error of less than five nautical miles. This conservative go/no-go criteria was

UNCLASSIFIED

selected prior to flight because postflight analysis would permit investigation of the results of applying the onboard determined maneuvers. The no-go decision from the ground on the ascent-vector maneuver solutions determined onboard was based on a coellipticity error. The time at TPI was nine minutes in error which was acceptable. Two factors contributed to the coellipticity error: (1) The onboard solution for N_{SR} (horizontal maneuver) was designed to accommodate only circular or near-circular target orbits in order to reduce chart complexity, whereas the actual target orbit had an ellipticity of about five nautical miles. (2) The ascent vector (with a velocity error (see paragraph 5.1.5.2.1)) caused an additional coellipticity error of about four nautical miles. A total of nine nautical miles resulted when the maneuvers were checked with the ground state vector available in real time. By using the radar determined N_{SR} maneuver or by adding a procedure and using the existing program to calculate and read out the relative radial velocity, a correction could have been made to compensate for target ellipticity; however, procedures for the latter case were not made available for this flight.

The final orbit-determination sextant-measurement sequence was begun at approximately 1 hour 35 minutes g.e.t. at the start of the second darkness period when the pilot switched to the orbit-determination computer mode and set the required initializing inputs. The proper inputs were made in preparation for the dummy measurement, the first activity in this darkness period. At 1 hour 44 minutes g.e.t., the nominal planned time, the dummy measurement was made. The correct logic setting was made prior to the actual sextant measurements and the final orbit determination measurement, a sighting on Arcturus, was made at the nominal time of 1 hour 56 minutes g.e.t.

The acceptance of this final (sixth) measurement was followed immediately by the normal illumination of the COMP light, indicating that the computer had begun to process the information provided by the four sightings and the two dummy measurements in order to obtain an updated state vector. However, the large residual resulting from the incorrectly set logic choice (effective during the first darkness period) produced an erroneous state vector which prevented determination of the N_{C1} and N_{SR} maneuvers.

An onboard solution for the N_{SR} maneuver was obtained using chart no. 7 in figure 5.1.5-6. This solution, which is obtained using radar data in conjunction with chart no. 7, yielded ΔV 's of 48 ft/sec forward and 6.0 ft/sec up compared with the ground-computed values of 47.8 ft/sec forward and 6.0 ft/sec up. The correct value for the forward component, based on the postflight BET, is 45.2 ft/sec.

UNCLASSIFIED

Table 5.1.5-V shows a summary of the maneuver calculations. The ascent vector solution magnitudes were close to the ground values. The BET time of second and third apogees was different from those used to compute the ground determined maneuver times. The rendezvous catch-up maneuvers actually applied were based on ground-computed values.

Figure 5.1.5-7 presents a number of spacecraft/target relative trajectories covering the period from insertion through rendezvous. Each of the trajectories is a result of a digital simulation and shows the effect of differently computed N_{C1} and N_{SR} maneuvers on the spacecraft orbit. In each case, the terminal phase of rendezvous was obtained from a closed-loop simulation assuming no measurement errors. Curve (a) was obtained by applying the real-time ground computed N_{C1} and N_{SR} maneuvers to the postflight Best Estimate Trajectory (BET) and represents the actual spacecraft orbit from insertion to TPI. From TPI to rendezvous, the trajectory was obtained from a closed-loop simulation and indicates the trajectory which would have been followed for the case where the input data to the onboard computer contain no errors.

Curve (b) was obtained by applying the N_{C1} and N_{SR} maneuvers to the BET, which were obtained by the crew during the mission using the ascent-mode-navigation insertion vector and the onboard flight charts. It represents the orbit which would have been followed had the onboard ascent maneuvers been applied. The conditions prior to TPI resulting from these maneuvers would have resulted in a normal rendezvous with essentially no propellant penalty and nominal final approach conditions.

Curve (c) was obtained by applying the ascent N_{C1} and N_{SR} maneuvers to the ascent insertion vector. This curve indicates the relative motion information of the spacecraft orbit available to the crew from the onboard computer.

Curve (d) was obtained by applying the N_{C1} and N_{SR} maneuvers, obtained from the BET and flight charts, to the BET. It represents the spacecraft trajectory which would have been followed had the IGS accuracy been perfect and the onboard maneuvers calculated from this perfect vector been applied, and shows the accuracy of the onboard charts.

Curve (e) was obtained by applying maneuvers to the BET obtained from an orbit-determination updated vector. In order to obtain the orbit-determination vector, the procedural errors and the horizon altitude calibration errors made during the mission were corrected. The actual star measurements made to Hamal, Fomalhaut, and Arcturus were used in calculating a vector update; however, the sighting to Altair was

UNCLASSIFIED

rejected by zeroing the residuals. The resulting vector update was used in conjunction with the onboard flight charts to obtain solutions for N_{C1} and N_{SR} . The curve, then, represents the spacecraft orbit which would have been obtained had the orbit-determination maneuvers (based on the previously mentioned star measurements) been applied. The star measurements were not totally correct and, as a result, the vector update was inaccurate; however, the resulting N_{C1} , as shown, would have placed the apogee for the N_{SR} maneuver several miles prior to a 30-degree line-of-sight transfer TPI. If the N_{SR} maneuver had been calculated using the radar, an adequate rendezvous could probably have been conducted with little difference in propellant requirements.

Table 5.1.5-VI shows all the sextant measurements taken during the flight and the spacecraft rates at the time of the measurement. The residuals calculated by the computer for each of the measurements are shown. The large residual shown on the intended Altair measurement caused the orbit-determination solution to be incorrect.

Table 5.1.5-VII presents data showing the effect of sextant measurements on the corrections to the spacecraft state vector assuming four different combinations of measurements. Each of these cases assumed an h_{ref} in the onboard computer of 32 000 yards (height above a spherical earth radius of 2.09099×10^7 feet). For those cases which involved perfect measurements, postflight BET values were computed using a horizon altitude above the oblate earth of 90 000 feet. Component corrections, resulting from measured residuals, of the spacecraft state vector are included. The sum of these component corrections gives the total corrections which would have resulted from that combination of measurements. It can be seen that missing the Altair measurement and the inaccurate radial component of the Arcturus measurement prevented an effective correction of the ascent vector using the actual measurements. For this case it is assumed that the crew would follow the planned procedure of zeroing or inserting a dummy measurement for any questionable residuals for sextant measurements. These data show that the Hamal and Fomalhaut star measurements were ineffective in correcting the actual spacecraft state vector errors; however, the use of local vertical measurements might have improved the sensitivity. Taking more measurements at these times on these two stars, Hamal and Fomalhaut, and using a recursive and statistical technique probably would not have improved the accuracy significantly because of the low sensitivity. The accuracy of the orbit-determination state vector for the flight was very dependent on the accuracy of the Arcturus measurement, which was the least accurate measurement on this flight.

UNCLASSIFIED

A set of numbers has been presented in the flight charts (fig. 5.1.5-6) based on actual flight computer data to clarify the intended use of the charts. Any errors which may have been made during the mission have been corrected. Thus, the charts, as shown, indicate the proper handling of actual computer flight data, the solutions obtained from them, and the proper solutions available from the IGS.

During the primary rendezvous, a more than normal amount of propellant was expended after TPI. A detailed analysis was conducted to identify the major periods when this expenditure occurred and to evaluate the alternate onboard solutions available to the crew between the TPI and braking maneuvers. The abnormal readout of the N_{SR} maneuvers is discussed in paragraph 5.1.5.2.3. The N_{SR} maneuver was completed 100 minutes after completion of the onboard maneuver calculations and TPI occurred 46 minutes after the N_{SR} maneuver.

Figure 5.1.5-i is a time history of gimbal angles, radar angles, and range data, and the telemetered values of total velocity to rendezvous ΔV_T calculated onboard and displayed to the crew prior to TPI. Also included are ΔV_T 's calculated postflight in simulations using the RTCC and TRW Best Estimate Trajectory (BET) state vectors. The unusually large values of ΔV_T calculated onboard prior to 4 hours 10 minutes g.e.t. were caused by an orbit-rate-torquing compensation problem similar to that during the N_{SR} maneuver and discussed in paragraph 5.1.5.2.3. When the orbit-rate compensation was removed, the ΔV_T displayed to the crew rapidly decreased and, after the platform alignment, began to more closely approach the simulated values, indicating adequate system operation. As on previous flights, the effect of the radar off-boresight error on ΔV_T was seen during the platform alignment.

Table 5.1.5-VIII lists the values displayed to the crew for the TPI maneuver and the subsequent midcourse maneuvers, as well as the ΔV 's actually applied. The onboard backup and computer closed-loop values agreed in the vertical plane; however, the polar plot and the ground-transmitted values were lower for the TPI maneuver. The closed-loop computer rendezvous indicated a 16 ft/sec out-of-plane maneuver which did not agree with the ground value. A brief summary of the analysis to determine the cause of these differences is contained in the following paragraphs.

UNCLASSIFIED

Figures 5.1.5-9 and 5.1.5-10 are time histories of azimuth and elevation look angles from the spacecraft to the target as collected by the onboard computer. The same angles calculated from Best Estimate Trajectory data are also included. The relatively constant bias of 0.5 to 0.8 of a degree including trajectory errors shown in the elevation data was sufficient to cause the somewhat high forward component in the TPI command. The cause of this bias is not definitely known; however, because the crew reported no pitch boresight error in the radar data, it possibly may be attributed to platform misalignment. The azimuth bias shown in figure 5.1.5-9 is not constant, reflecting the sinusoidal transfer (in 90 degrees of orbital travel) of platform alignment error from yaw to roll and vice-versa. The variable bias noted in the figure is representative of 1.4 to 1.9 degrees yaw misalignment and resulted in the history of out-of-plane maneuver commands noted in table 5.1.5-VIII.

Figure 5.1.5-11 contains a history of the apparent target out-of-plane position relative to the spacecraft based on radar and platform data collected by the computer prior to each maneuver. Also shown are the positions calculated from the BET, the projected apparent target trajectory based on the pre-TPI data, and the spacecraft trajectory which would have resulted had the 16 ft/sec out-of-plane TPI command been followed. The data collected during the pre-TPI period show the resulting out-of-plane displacement caused by the yaw misalignment, and the decreasing effect of misalignment as range decreases. The data from 4 hours 15 minutes to 4 hours 30 minutes g.e.t. are the basis for the computer determination of TPI out-of-plane maneuver commands. The radar data to the computer indicate that the target vehicle was following a trajectory with a maximum displacement of approximately two nautical miles and with a nodal crossing shortly after TPI. The computer calculates a maneuver to place the spacecraft in a trajectory commencing at TPI which will cause an interception 40 degrees following the point of maximum travel away from the original orbit plane or at $\omega t = 130$ degrees. The ΔV required for this amount of plane change is about 16 ft/sec to the left commanded by the onboard computer at TPI. The out-of-plane ΔV was not applied, leaving the spacecraft in its initial plane. The crew correctly (for this flight) decided not to apply the out-of-plane computer-displayed value because the history of the out-of-plane radar angles prior to TPI and the ground transmitted TPI maneuvers did not indicate a large out-of-plane condition. Following TPI the radar tracking indicated the data points shown for the first midcourse correction between 4 hours 38 minutes and 4 hours 46 minutes g.e.t. (see figure 5.1.5-11) and show that the radar/platform combination indicated that the vehicles were traveling on a parallel path at that time (that is, the orbits would intersect in approximately 90 degrees of travel). The computer calculation to rendezvous in 82 degrees indicated

UNCLASSIFIED

that essentially no out-of-plane component was required (1 ft/sec) for the first midcourse correction. The data points for the second midcourse correction also gave an apparently near parallel trajectory but, because only 34 degrees of travel remained, a larger correction to the right was needed and 5 ft/sec was displayed.

The velocity change applied at TPI would have raised the spacecraft altitude 19.4 nautical miles in 130 degrees of orbital travel (approximately three nautical miles high) and would have caused a lagging phase angle. The first midcourse solution from the onboard closed-loop system would have reduced this altitude overshoot by 2.8 nautical miles and would have compensated for 5.3 nautical miles of the phasing error introduced at TPI. Because the down component for the first midcourse actually applied was between the backup and closed-loop solutions, it placed the spacecraft on a trajectory which would have been 0.6 of a nautical mile high and 1.2 nautical miles behind at the intended rendezvous time. The backup solution was 10 ft/sec down and the closed loop was 22 ft/sec down and the crew applied 14 ft/sec down.

Because the first midcourse corrections were not as large as required, the second midcourse solution was larger than normally necessary. The second closed-loop midcourse correction would have adjusted the altitude by 0.13 of a nautical mile and the phase by two nautical miles in the 33.6 degrees of orbital travel remaining. The midcourse maneuvers applied resulted in a trajectory which deviated more from a nominal final approach than the computer midcourse solutions would have. The crew intended to apply the closed-loop solution; however, the problem discussed in paragraph 7.1.2.5.1 resulted in a deviation in the fore/aft component.

Figure 5.1.5-12 is a time history of spacecraft attitudes, ΔV applications, and range and range rate during the braking phase. At approximately 5 hours 10 minutes g.e.t., the closing rate dropped to zero at a range of 1000 feet. From this point to the time the pilot reported station keeping, the line-of-sight rates were high and, during this period, approximately 65 ft/sec of maneuvering thrusts were applied.

The analysis has shown that the large fuel usage during rendezvous was caused by a combination of the midcourse maneuvers applied and a thrusting schedule to facilitate line-of-sight control which caused the closing velocity to decrease prematurely (prior to station keeping). Postflight analysis of the onboard solutions for the terminal phase maneuvers has not revealed any malfunction of the equipment.

To investigate possible platform or radar errors and to determine their effects on the onboard-computed solutions, several simulation runs were conducted. The first run, using no platform misalignments, was

UNCLASSIFIED

obtained by integrating the TRW-BET forward and applying combinations of applied flight actual, onboard-computer, and simulator-calculated maneuvers. The simulator was mechanized to solve the same equations as the onboard system. A second series of runs was conducted by choosing a value of fixed (non-time dependent) platform misalignment which would result in duplicating the onboard-computed TPI solutions, assuming all the differences between the simulated solution with no misalignments (using the BET) and the flight computed values was due to misalignment. Figures 5.1.5-13 and 5.1.5-14 and tables 5.1.5-IX and 5.1.5-X summarize the results.

The larger-than-zero value of the CSS second midcourse correction in table 5.1.5-X (see legend on figure 5.1.5-13) without misalignments results from the first midcourse correction because it is calculated impulsively but applied as a continuous thrust starting at the impulse time. This becomes more significant when thrusts are applied over an extended period, and the last midcourse correction was applied over a period of 180 seconds. The first midcourse value for this case shows the correction resulting from initiating TPI with too large a velocity along the line of sight. The second midcourse (CSS with misalignment) shows that the assumed misalignment made the vertical velocity too negative by (4.2 and 1.0) approximately 5 ft/sec. This is larger than the actual misalignment, because a smaller error existed in the onboard solution (on the order of 1.3 ft/sec FFC-FFS).

The SSS trajectories show that the second midcourse correction in yaw calculated with a fixed misalignment is 8 ft/sec. The actual yaw alignment error (4.9 ft/sec) had a smaller effect on the onboard computer computations, indicating that the misalignment during this period was less than the simulated values. The results of this type of analysis brackets the effect of the misaligned platform.

The comparison of the FFF cases with and without misalignment in the tables shows that the required TPF maneuvers are very similar, indicating that the accelerometer measurement errors caused by the misalignment, as expected, did not significantly contribute to the size of the onboard-computer flight-midcourse corrections.

Comparison between the FFS and FCS simulations with and without misalignment for the second midcourse correction in table 5.1.5-X shows that the onboard-computed first midcourse was more correct than that flown (without misalignment—20.2 versus 0.8 ft/sec ΔX and 10.1 versus minus 2.5 ft/sec ΔY) and shows that the pitch misalignment used in the simulation produced a much larger measurement error (with misalignment—1.7 and minus 0.3 ft/sec ΔY versus FFC of 11.4 ft/sec ΔY) than actually existed in flight during the measurement period for the first midcourse.

UNCLASSIFIED

The trajectories for the cases without platform misalignments are shown in figure 5.1.5-13. The SSS trajectories follow the nominal quite closely and approach the terminal braking phase from ahead and below. The misalignment trajectories (fig. 5.1.5-14) show a greater deviation from nominal at TPI, as expected; however, the simulator and computer midcourse cases direct the trajectory to return to an approach path closer to the nominal than does the FFF case. These data indicate that the ground and closed-loop solutions were adequate to achieve a normal rendezvous and would have approached the nominal terminal phase more closely than the maneuvers chosen in the flight case. It also shows that a platform misalignment of less than 0.5 of a degree in pitch and less than 1.5 degrees in yaw actually existed in flight. However, the closed-loop solutions would have been adequate to achieve rendezvous. It is clear that the yaw misalignment was not constant but cyclic, as expected from an earth-rate-torqued platform, and, therefore, the error was probably due to the platform and not to the radar.

In order to investigate the terminal approach and braking phase, a detailed analysis was conducted. First the RTCC and BET state vectors for the spacecraft and target were used with the flight maneuvers to determine how the relative trajectory would approach the target. Several simulations were conducted to determine the most adequate method of obtaining a more correct terminal relative trajectory to use to conduct an analysis. Simulations integrating forward from TPI using improved state vectors and integrating backward from a point close to the target were tried using the most accurate integration of the applied maneuvers available from the telemetry data. Because of the extended period of time of the approach and errors in the state vectors, this approach is difficult. A trajectory was obtained using the measured radar and platform data as recorded by the computer and is shown in figures 5.1.5-15 and 5.1.5-16. The data points were obtained at one-minute intervals and are plotted with the assumed actual flight path which was confirmed by the crew as representing essentially the actual trajectory flown. These figures show that braking was commenced soon after the second midcourse and that the in-plane trajectory was depressed by the applied maneuvers and the spacecraft passed below the target, with the result that the subsequent approach was from ahead and below. During the period starting after the second midcourse correction until the spacecraft went ahead of the target, the applied maneuvers caused the spacecraft to approach the target with a constant out-of-plane displacement. At about 5 hours 8 minutes g.e.t., with the spacecraft north and ahead and below the target, line-of-sight control was used and the trajectory converged on the target.

5.1.5.2.3 Orbital phase: Table 5.1.5-XI contains a listing of the program modules contained in the Auxiliary Tape Memory Unit (ATMU) for this mission along with the periods during which each was loaded

UNCLASSIFIED

into the onboard computer. The table also includes a summary of each module size and the size of the program contained in the computer when a given module is loaded. Module I remains in the computer and serves as a "hard core". Each module is redundantly loaded on the tape in that it is contained in two separate locations to provide a completely independent check on any module loaded. The ATMU significantly increased the capacity of the onboard computer memory over the 12 288 13-bit equivalent instruction words normally available. Modules I, IV, and V had been previously utilized on Gemini VIII and IX-A and Modules II, III and VI were added on this mission. Module II provided the capability for inertial component compensation of gyro mass unbalance along the input and output axes and for constant gyro drifts. Additional MDIU readouts were provided for the IVAR exercises. Module III, shown in block diagram in figure 5.1.5-17, contained additional capabilities over the catch-up and rendezvous modes previously used. Orbit rate torquing compensation, which reduces fuel penalties during rendezvous maneuvers for those orbits having different orbital periods than that set into the platform, is provided along with the capability for calculating maneuvers based on relative state vectors and offset targets, thereby allowing rendezvous with an offset target and subsequent rendezvous with the real target. Module VI, which has three modes of operation, is shown in block diagram form in figure 5.1.5-18. The orbit predict mode of Module VI contains the capability of integrating either of two state vectors (typically spacecraft or target) or both (relative) to a selected point in time, either ahead or backward, and to simulate impulsive maneuvers at selected points in the spacecraft trajectory. The orbit navigation mode allows integration of the equations of motion using accelerometer outputs during periods of thrusting. The orbit determination mode provides the capability of updating existing knowledge of the spacecraft orbit by processing the data provided by six star sightings in a deterministic solution (star-to-horizon or star-to-local vertical).

The automatic reprogram mode of the Auxiliary Tape Memory (read, load, and verify operation) was utilized throughout the mission. No automatic reverify procedures using the redundant modules stored on the tape were conducted on this flight because the crew was satisfied with the operation of the verification features included in the automatic reprogram operation.

A summary of major translation activity, as calculated from telemetered accelerometer data, is shown in table 5.1.5-XII. Acceleration bias checks were made periodically throughout the flight, with small bias updates in the X and Z axes required only prior to retrofire.

The crew reported that, during the insertion of the N_{SR} maneuver into the computer on the first rendezvous, 12 ft/sec instead of 6 ft/sec appeared in the "up" IVI window each time the crew attempted to enter

UNCLASSIFIED

the maneuver. This was caused by not setting the "logic choice" which controls whether or not the computer utilizes orbit rate compensation in its transformation of the commanded ΔV from platform to spacecraft coordinates for display in the IVI. At the time of the ΔV insertion, this compensation value was approximately five degrees, computed by the computer platform-pitch-gimbal-angle reading, and was added to the solution resulting in an IVI display of 47 forward, 0 left/right, and 12 up rather than the correct (uncompensated) reading of 48 forward, 0 left/right, and 8 up. The discrepancy was diagnosed (on the ground) immediately after the N_{SR} maneuver and the crew were notified at the next opportunity (prior to TPI calculations) to insert into the computer a logic choice which removed the compensation. No further difficulty in this area was reported after the logic choice insertion.

An analysis was performed to determine the effect of varying IVI display cycle times on the ability of the crew to perform a precise translation maneuver. Table 5.1.5-XIII contains the computer computation cycle and IVI servicing cycle times associated with each mode of interest. Figure 5.1.5-19 is a time history of thruster firings and resulting ΔV applications during the "tweaking" phase following the N_{C1} and N_{SR} maneuvers for the first rendezvous. More firings were commanded after the N_{C1} maneuver using Module VI than after N_{SR} which used Module III with orbit-rate-torquing compensation; however, the maneuver was more precise, showing less than 0.1 ft/sec residual compared to approximately 0.9 ft/sec for N_{SR} . The differences between planned and actual ΔV 's noted in table 5.1.5-XII using Module III with compensation and Module VI are representative of those seen on previous mission using Module III without compensation, as are the number of thruster firings needed to adjust residuals. A review of the translation maneuvers conducted during this flight indicates that no adverse effect can be detected relating to the difference in display cycle time.

Figure 5.1.5-20 is a time history of spacecraft attitudes and platform accelerometer outputs for the second docked PPS maneuver. The period of ullage prior to PPS ignition can be seen as well as the tail-off at the end of the maneuver. The attitudes indicate that small residual errors remained in all three axes at the end of the thrust. The computer mode which allowed changing the scale on the forward/aft IVI indicator by a factor of ten was used. The fore/aft IVI was serviced once every 1.35 seconds during the 10-second PPS thrusting period and would have been counting in increments of 10 ft/sec. At 20:21:20 g.e.t. the IVI read minus 33 and at 20:21:32 read plus 1 which meant that the IVI read plus 10 ft/sec at the end of the thrust. Therefore the IVI was not delayed and provided the crew with an indication to actuate cutoff. A backup cutoff could be obtained by using nominal firing time.

UNCLASSIFIED

Sufficient information was available to the crew (rates, attitude, cross-axis and longitudinal IVI readings) to allow adequate reaction to attitude control type malfunctions or gross overspeeds. The velocities accrued in this and the other docked translations (SPS and PPS) were consistently larger than planned. The IGS measured ullage-positioning ΔV , using the GATV SPS Unit II propulsion, was approximately 5 ft/sec.

Table 5.1.5-XIV contains a summary of platform alignment checks performed by computing the difference between horizon sensor and platform pitch and roll outputs. These spot checks indicate alignment accuracies comparable to previous flights; however, due to a possible misalignment during the first rendezvous, the alignment prior to TPI was examined in detail. A time history of sensor and platform roll and pitch differences during this period is contained in figure 5.1.5-21. The lack of gyro torquing currents and IMU mode switching information from telemetry precludes exact determination of alignment time; therefore, the assumption was made that the alignment began immediately after pitching down to horizontal and continued until just before pitching up to boresight. The data appear normal, indicating that an acceptable alignment was in progress, until 4:09:18 g.e.t. when a rather large roll difference appeared, as may be seen in the figure. The initial peak in the roll difference was caused by an increase in the horizon sensor roll output; however, the duration was short and did not significantly contribute to the yaw misalignment. This horizon sensor output may have been caused by a cloud (although no significant pitch error resulted) or by a combination of yaw and roll error. Telemetry data indicate that pulse mode was selected and that thruster firings and attitude controller operation were in the direction to initiate the roll maneuver which created a roll error. The roll error extended over approximately a 1-minute period and was sufficiently large to have torqued the platform between 5.4 and 7.2 degrees in yaw. At 4:09:55 g.e.t., the control mode was switched from PULSE to PLAT and, as indicated in the figure, the difference rapidly disappeared and remained close to zero for the rest of the alignment period. Without torque current data, the effect of the roll disturbance is difficult to determine; however, if the alignment had continued until the pitch-up maneuver started, the yaw gyro would have been torqued back approximately 4.0 to 5.3 degrees, leaving a residual yaw alignment error of between 1.4 and 1.9 degrees. This value is of the same order of magnitude as that detected in the rendezvous analysis. An evaluation of the preretrofire alignment is being conducted to identify the cause of the possible misalignment indicated in paragraph 5.1.5.2.2.

5.1.5.2.4 Dual rendezvous phase: Table 5.1.5-XV shows the maneuvers during the passive rendezvous and figure 5.1.5-22 contains a time history of the measured acceleration and platform gimbal angles. The differential altitude for passive rendezvous was seven nautical miles

UNCLASSIFIED

which required a smaller TPI maneuver than required for the primary rendezvous at a nominal 15 nautical miles separation attitude. The table shows that the largest ΔV requirement occurred after the last terminal midcourse correction. The relative motion trajectory is shown in figure 4-6. The onboard charts indicated a nominal approach to rendezvous. The crew reported that measuring range with the sextant was accurate for ranges less than one mile. Figure 5.1.5-22 indicates that braking was initiated soon after the last midcourse correction at approximately 47:39:10 g.e.t. and completed at 47:59:22 g.e.t. A significant amount of maneuvering was conducted between 47:53:15 g.e.t. and 47:57:00 g.e.t.

5.1.5.2.5 Reentry phase: The IGS operated properly throughout the retrofire and reentry phases of the mission. The total velocity change as a result of the firing of the retrorockets was 0.98 ft/sec higher than predicted. A comparison of the actual and planned velocity components can be found in table 5.1.5-XII. The pitch and yaw attitudes were held within 1.5 degrees, and the roll attitude was held within 2.0 degrees. The total footprint shift due to the retrofire maneuver was approximately 14 nautical miles, as shown in figure 5.1.5-23.

From retrofire to an altitude of 400K feet, a 10-degree bank angle toward the south was flown as planned. At 70:32:46.7 g.e.t., the computer commanded a zero-degree bank angle. This indicated proper spacecraft navigation to the 400K-foot level when compared with the time of 400K feet as computed on the ground by using IVI data acquired after retrofire. From the 400K-foot level to guidance initiation, the backup angle of 45 degrees toward the south was flown as planned. At 70:34:55.6 g.e.t., the spacecraft acceleration passed through a level of 1.0 ft/sec² (density-altitude factor of 8.73971) and the computer began to calculate the bank-angle commands necessary to guide the spacecraft to the desired target.

At 70:35:36 g.e.t., the command pilot started to fly the bank angles commanded by the onboard computer. From this time until guidance termination at 70:40:39 g.e.t., the commands from the computer were accurately followed. The time histories of bank-angle commands and actual bank angles, downrange errors, and crossrange errors are presented in figure 5.1.5-24. Only small downrange and no crossrange oscillations occurred. Figure 5.1.5-25 is a time history of the spacecraft attitudes, rates, aerodynamic data, and hand-controller positions during a typical period of the reentry. The computer properly terminated guidance at a density-altitude factor of 4.625.

Table 5.1.5-XVI contains a comparison of the reentry parameters obtained from telemetry data with the same parameters reconstructed after the flight using the DCS update, gimbal angles, spacecraft body rates,

UNCLASSIFIED

and platform accelerometer outputs. This table shows close agreement between the sets of data and demonstrates the proper functioning of the computer in the reentry mode.

At guidance termination the IGS-computed position of the spacecraft was 2.3 nautical miles South Southeast of the target point, while radar data showed the spacecraft to be approximately 2.5 nautical miles North of the target point.

Table 5.1.5-XVII contains a comparison of radar with IGS data. This table shows a difference between the two sets of data at retrofire of zero nautical miles and at guidance termination of 4.2 nautical miles.

The second portion of the table shows the results of fitting the platform errors to the reentry-tracking velocity and position differences in a manner similar to the ascent IGS analysis.

The touchdown point reported by the recovery forces was 3.4 nautical miles East Northeast of the target. Figure 5.1.5-23 shows the position of the spacecraft relative to the planned landing point during reentry and the position of the reentry footprint before and after retrofire.

5.1.5.3 Control system performance evaluation.-

5.1.5.3.1 Attitude Control and Maneuver Electronics: The control system performed properly throughout the flight. Platform, pulse, rate-command, and reentry rate-command modes were utilized and each exhibited proper performance. The separation sequence was nominal, response to disturbance torques during translations was proper, and line-of-sight control capability during rendezvous was satisfactory. Disturbance torques introduced by the extravehicular pilot were noted on this flight and, as during previous flights, control authority was more than adequate.

Reentry Control System (RCS) thruster firing indications were not telemetered on this mission; therefore, a thorough analysis of the RCS performance could not be made. However, performance appeared nominal. Following retrofire, the control mode was switched from rate command to pulse. At 400K feet altitude, about 22 minutes after retrofire, the rate-command mode was utilized, and five seconds later, the reentry rate-command mode was energized. The control mode remained in this configuration until the spacecraft was powered down. The crew reported single-ring RCS operation; however, approximately four minutes after the spacecraft passed through 400K-feet altitude, the telemetered fuel depletion indicated that both the A-ring and the B-ring were on and remained on until the spacecraft was powered down. The maximum rates

UNCLASSIFIED

experienced by the spacecraft prior to drogue parachute deployment were approximately 5 deg/sec in pitch and yaw, comparable to the rates observed on previous missions, indicating normal operation of the RCS using the reentry rate-command mode. Table 5.1.5-XVIII shows the effect of the retrofire maneuver on the position of the zero-lift point, as determined by various sources.

5.1.5.3.2 Horizon sensors: The horizon sensors performed satisfactorily throughout the flight (see paragraph 5.1.5.2.4). The secondary sensor was turned on and performed satisfactorily for 13 minutes during the first revolution. The primary sensor was used for the remainder of the mission with no difficulties reported by the crew. The horizon-scanner mode was not utilized.

UNCLASSIFIED

TABLE 5.1.5-I.- SPACECRAFT GUIDANCE AND CONTROL SUMMARY CHART

Ground elapsed time, hr:min:sec	Event	Component status					Remarks
		ACME	Computer	IMU	Horizon sensor	Radar	
00:06:10.0	Separation (spacecraft/GLV)	Direct, then rate command	Ascent	Free	Off	Off	Separation $\Delta V = 1.49$ ft/sec
00:06:46.0	IVAR maneuver	Rate command	Ascent	Free	Off	Off	$\Delta V = 26.0$ ft/sec
00:12:17	Load module VI	Platform	Prelaunch	SEF	Primary	Off	
00:25:12	Horizon calibration star sightings	Pulse	Orbit determination	Orbit rate	Primary	Off	First calibration measurement
00:37:50	Orbit determination star sighting	Pulse	Orbit determination	Orbit rate	Primary	Off	First star measurement
00:49:19	Accelerometer bias check	Pulse	Prelaunch	Orbit rate	Primary	Off	No changes made in bias values
02:18:06.6	N _{CI} maneuver	Rate command	Orbit navigation	Orbit rate	Primary	Off	$\Delta V = 55.8$ ft/sec; Module VI loaded
02:30:49.2	N _{PC} maneuver	Rate command	Orbit navigation	Orbit rate	Primary	Off	$\Delta V = 10.5$ ft/sec
02:33:56	Load Module III	Pulse	Prelaunch	Orbit rate	Primary	Off	
03:08:30	Radar lock-on	Pulse		Orbit rate		On	Range = 240 nautical miles

UNCLASSIFIED

TABLE 5.1.5-I.- SPACECRAFT GUIDANCE AND CONTROL SUMMARY CHART - Continued

Ground elapsed time, hr:min:sec	Event	Component status					Remarks
		ACME	Computer	IMU	Horizon sensor	Radar	
03:47:35.9	N _{SR} maneuver	Rate command	Catch-up	Orbit rate	Primary	On	$\Delta V = 47.5$ ft/sec Module III loaded
03:56:00	Platform alignment	Pulse and platform	Rendezvous	SEF	Primary	On	Aligns approximately 17 minutes
04:33:43.8	Terminal phase initiate maneuver	Rate command	Rendezvous	Orbit rate	Primary	On	$\Delta V = 42.3$ ft/sec
04:46:23.4	82-degree correction	Rate command	Rendezvous	Orbit rate	Primary	On	$\Delta V = 20.4$ ft/sec
04:58:24.1	34-degree correction	Pulse and rate command	Rendezvous	Orbit rate	Primary	On	$\Delta V = 34.6$ ft/sec
05:01:51.5	Terminal phase finalize	Rate command	Catch-up and rendezvous	Orbit rate	Primary	On	
05:14:38	Station keeping	Pulse, rate command, and platform	Catch-up	Orbit rate	Primary	On	Crew reported radar off at 5:57:22 g.e.t.
05:52:35.3	Docking	Rate command	Catch-up	Orbit rate	Primary	On then off	Crew reported radar off at 5:57:22
07:38:34	Dual rendezvous N _{CH1} maneuver	Off	Catch-up	Orbit rate	Off	Off	GATV SPS and PPS maneuver $\Delta V = 423.6$ ft/sec
08:30(approx)	Power down	Off	Off	Off	Off	Off	
17:24:29	Power up	Off	Off	Off	Off	Off	
20:20:12	Dual rendezvous height adjust maneuver	Off	Catch-up	Orbit rate	Off	Off	GATV SPS and PPS maneuver $\Delta V = 346.3$ ft/sec

UNCLASSIFIED

TABLE 5.1.5-1.- SPACECRAFT GUIDANCE AND CONTROL SUMMARY CHART - Continued

Ground elapsed time, hr:min:sec	Event	Component status					Remarks
		ACME	Computer	IMU	Horizon sensor	Radar	
20:30:00	Standup EVA preparation	Off	Catch-up	Orbit rate	Off	Off	
22:37:06.4	Dual rendezvous N _{SR} maneuver	Off	Catch-up	Orbit rate	Off	Off	$\Delta V = 82.2 \text{ ft/sec}$
25:00:00	Power down	Off	Off	Off	Off	Off	
25:55:00	Power up	Off	Off	Off	Off	Off	
27:45:36.4	Dual rendezvous height adjust maneuver	Off	Orbit navigation	Orbit rate	Off	Off	$\Delta V = 9.7 \text{ ft/sec}$
29:01:29	Power down	Off	Off	Off	Off	Off	
39:53:32	Power up	Off	Off	Off	Off	Off	
41:04:26.4	Dual rendezvous plane change	Off	Catch-up	Orbit rate	Off	Off	$\Delta V = 16.0 \text{ ft/sec}$
41:35:50.4	Dual rendezvous phase adjust maneuver	Off	Catch-up	Orbit rate	Off	Off	$\Delta V = 4.4 \text{ ft/sec}$
43:07:51	Power down	Off	Off	Off	Off	Off	
44:29:12	Power up	Off	Off	Off	Off	Off	
44:40:15.8	Spacecraft/GATV separation	Direct	Catch-up	Orbit rate	Off	Off	$\Delta V = 2.0 \text{ ft/sec}$ Radar on right after separation
44:55	Radar lock on	Pulse	Catch-up	Orbit rate	Primary	On	Crew reported lock-on
45:54:01.7	Corrective combination maneuver	Rate command	Catch-up	Orbit rate	Primary	Primary	$\Delta V = 4.2 \text{ ft/sec}$

UNCLASSIFIED

TABLE 5.1.5-I.- SPACECRAFT GUIDANCE AND CONTROL SUMMARY CHART - Continued

Ground elapsed time, hr:min:sec	Event	Component status					Remarks
		ACME	Computer	IMU	Horizon sensor	Radar	
46:09:29.0	Dual rendezvous N_{SR}	Rate command	Catch-up	Orbit rate	Primary		$\Delta V = 10.6$ ft/sec
47:26:43.6	Dual rendezvous terminal phase initiate	Rate command	Catch-up	Orbit rate	Primary		$\Delta V = 22.3$ ft/sec
47:34:09.9	First correction maneuver	Rate command	Catch-up	Orbit rate	Primary		$\Delta V = 4.5$ ft/sec
47:38:58.2	Second correction maneuver	Pulse and rate command	Catch-up	Orbit rate	Primary		$\Delta V = 3.9$ ft/sec
47:43:31.8	Terminal phase finalize	Pulse and rate command	Catch-up	Orbit rate	Primary		
47:59:22	Station keeping	Pulse	Catch-up	Orbit rate	Primary		
48:43	EVA	Rate command and platform	Catch-up	Orbit rate	Primary		
49:12	EVA terminated	Pulse	Catch-up	Orbit rate	Primary		
51:15:59.9	Out-of-plane separation maneuver	Rate command	Catch-up	Orbit rate	Primary		$\Delta V = 1.5$ ft/sec
51:38:51.7	True anomaly adjust maneuver	Rate command	Catch-up	Orbit rate	Primary		$\Delta V = 99.8$ ft/sec
53:02:50	Power down	Off	Off	Off	Off		
63:00:00	Power up						
63:25:23	Load Module VI						

UNCLASSIFIED

TABLE 5.1.5-1.- SPACECRAFT GUIDANCE AND CONTROL SUMMARY CHART - Concluded

Ground elapsed time, hr:min:sec	Event	Component status					Remarks
		ACME	Computer	IMU	Horizon sensor	Radar	
66:13:26	Load Module IV	Pulse	Prelaunch		Primary		$\Delta V_x = 303.0 \text{ ft/sec}$ $\Delta V_y = 118.9 \text{ ft/sec}$ $\Delta V_z = -5.3 \text{ ft/sec}$ $\Delta V = 325.5 \text{ ft/sec}$
67:27	Accelerometer bias update	Platform			Primary		
68:13	Reentry update	Platform			Primary		
68:49	RCS squibs blown	Platform			Primary		
70:10:24.4	Retrofire	Rate command	Reentry	Free	Primary	Off	
400K			Reentry	Free	Off	Off	
70:32:46.7	Guidance initiate	Reentry rate command	Reentry	Free	Off	Off	
70:40:39.1	Guidance termination	Reentry rate command	Reentry	Free	Off	Off	
70:41:33.8	Drogue deploy	Reentry rate command	Reentry	Free	Off	Off	
70:46:45	Landing	Off	Off	Off	Off	Off	

TABLE 5.1.5-II.- ORBIT INJECTION PARAMETERS AT SECO + 20 SECONDS

Data source	Inertial velocity, ft/sec	Inertial flight-path angle, deg	Inertial velocity components (computer coordinates), ft/sec		
			X	Y	Z
Flight plan	25 719	0	--	--	--
IGS	25 711	-0.055	25 287	4652	-75
Preliminary best estimate trajectory	25 709	-0.026	25 287	4637	-80
MISTRAM 100K	25 712	-0.035	25 920	4641	-79
GE MOD III final	25 707	-0.021	25 286	4635	-80
GE MOD III real time	26 693	+0.14	--	--	--
MISTRAM IP	25 716	-0.07	--	--	--

~~CONFIDENTIAL~~

~~CONFIDENTIAL~~

TABLE 5.1.5-III.- ASCENT ICS AND TRACKING SYSTEMS ERRORS

Error source	Specification value	Engineering estimates ^a			Error coefficient Recovery Program estimates				
		Error	Velocity error, ft/sec		Error	Velocity error, ft/sec			
			X	Y	Z		X	Y	Z
Constant drift	0.3 deg/hr	deg/hr				deg/hr			
X _p -gyro		N (N)							
Y _p -gyro		N (N)							
Z _p -gyro		N (N)							
g-sensitive drift	0.5 deg/hr/g	deg/hr/g				deg/hr/g			
X _p -gyro spin-axis unbalance		N (N)							
Y _p -gyro spin-axis unbalance		N (N)							
Z _p -gyro spin-axis unbalance		N (N)							
X _p -gyro input-axis unbalance		N (N)							
Y _p -gyro input-axis unbalance		0.56 (N)	1.9 (0)	15.3 (0)		0.6 ± 0.1	1.6	16.3	
Z _p -gyro input-axis unbalance		0.10 (0.10)				0.07 ± 0.02			2.4
Accelerometer bias	300 ppm	ppm				ppm			
X _p		50 (N)	0.2 (0)	-1.3 (0)		46.6 ± 5	0.2	-1.2	
Y _p		N (N)							
Z _p		80 (80)		0.9(0.9)		77.7 ± 5		0.8	

N = negligible

^aNumbers in parentheses refer to fit assuring errors in the misalignment of the Z accelerometer sensitive axis.

~~CONFIDENTIAL~~

~~CONFIDENTIAL~~

TABLE 5.1.5-III.- ASCENT IGS AND TRACKING SYSTEMS ERRORS - Concluded

Error source	Specification value	Engineering estimates ^a			Error coefficient Recovery Program estimates						
		Error	Velocity error, ft/sec			Error	Velocity error, ft/sec				
			X	Y	Z		X	Y	Z		
Accelerometer scale factor	360 ppm										
X _p		-50 (N)	-1.2(0)								
Y _p		N (N)									
Z _p		-400 (-300)	2.7(2.0)								
Misalignments											
Azimuth misalignment	60 arc sec	20 (20)		2.4							3.7
Pitch misalignment	100 arc sec	-17.5 (90)									-3.6
Time bias		55.6 (55.6)	12.3 (12.3)								13.3
IGS time scale factor	50 ppm	-92	-7.0 (-7.0)								-8.5
Total velocity error			6.2	16.9 (15.1)							5.6
				5.8 (5.8)							16.6
											6.1
External tracker errors											
System	Range bias, ft	P-bias, ft	Q-bias, ft	Azimuth, radians	Elevations, radians	Refraction, n units					
GE MOD III (final)	80 ± 50	N/A	N/A	5 × 10 ⁻⁶	-1.8	13 ± 8					
MISTRAM 100K											

N = negligible
 N/A = not applicable
^aNumbers in parentheses refer to fit assuring errors in misalignment of the Z accelerometer sensitive axis.

~~CONFIDENTIAL~~

~~CONFIDENTIAL~~

TABLE 5.1.5-IV.- GUIDANCE ERRORS AT SECO + 20 SECONDS

Error	Position, ft			Velocity, ft/sec		
	X	Y	Z	X	Y	Z
IMU	450 ±100	2500 ±100	450 ±50	0.6 ±1.0	15.3 ±3.0	^a 5.8 ±2.0
Navigation	95	-50	-10	-0.6	0.2	-0.4
Total guidance	545 ±100	2450 ±100	440 ±50	0 ±1.0	15.5 ±3.0	5.4 ±2.0

^aIncludes 2.4 ft/sec RGS update error.

~~CONFIDENTIAL~~

UNCLASSIFIED

TABLE 5.1.5-V.- MANEUVER SUMMARY

Source	Time of N _{Cl} , g.e.t.	ΔV , ft/sec	Time of N _{PC} , g.e.t.	ΔV , ft/sec	Time of N _{SR} , g.e.t.	ΔV , ft/sec
Ascent ^a	2:19:52	58	2:53:25	8.0	3:49:13	46
Orbit determination ^a			No solutions obtained			
Radar ^a					3:47:34	48.0 X -6.0 Y
Ground ^b	2:18:09	55.9	2:30:49	9.6	3:47:34	47.8 X -6.5 Y
BET ^c	2:18:49	57.3	2:36:40	9.6	3:48:19	45.2
Ascent ^c	2:19:42	58	2:45:45	10.0	3:49:13	46
Orbit determination ^c	2:20:31	45	2:45:45	10.0	3:49:35	61

^a Obtained onboard in real time from flight charts.^b Obtained from ground in real time.^c Obtained postflight from flight charts.

UNCLASSIFIED

TABLE 5.1.5-VI.- ORBIT DETERMINATION STAR SIGHTINGS

Star	Ground elapsed time, hr:min:sec	Measured angle, deg	Angle residual, deg	Spacecraft body rates, deg		
				Pitch	Roll	Pitch
Schedar	0:25:09.3	4.45	^a -3.62	+0.13	-0.38	-0.54
	0:27:06.9	8.75	-0.37	-0.12	+0.23	+0.04
	0:28:05.9	9.09	^b -0.59	+0.09	+0.13	-0.08
	0:29:20.0	9.85	^b -0.56	-0.12	+0.02	+0.36
	0:30:22.6	10.61	^b -0.44	-0.04	-0.21	-0.32
	0:31:32.4	11.57	-0.20	-0.29	+0.40	+0.50
Hamal	0:40:24.0	32.67	^b -0.02	-0.54	-0.21	-0.14
Vega	0:44:14.5	5.36	^a -76.73	+0.09	+0.35	-0.28
Altair						
Possibly Antares	0:46:20.6	4.97	100.13 (-00.13)	+0.01	-0.44	-0.30
Fomalhaut	1:47:31.9	9.09	^b -0.15	-0.04	+0.02	-0.06
Arcturus	1:58:32.1	18.02	^a +0.35	+0.03	+0.10	+0.12

^aProblems other than those associated with spacecraft rates.

^bPossible good measurements.

UNCLASSIFIED

TABLE 5.1.5-VII.- ORBIT DETERMINATION SEXTANT MEASUREMENT EFFECTIVENESS

g.e.t. = 7112.1 seconds h _{ref} = 32 000 yards	Radial		Downrange		Out of plane		Radial		Downrange		Out of plane	
	δR (ft)	δD (ft)	δD (ft)	δD (ft)	δC (ft)	δC (ft)	$\delta \dot{R}$ (ft/sec)	$\delta \dot{D}$ (ft/sec)	$\delta \dot{D}$ (ft/sec)	$\delta \dot{C}$ (ft/sec)	$\delta \dot{C}$ (ft/sec)	$\delta \dot{C}$ (ft/sec)
Corrections required for a perfect update	10 000	-44 000	-44 000	-44 000	-4 400	-4 400	48 000	-13 000	-13 000	0	0	0
Component corrections												
Hamal (actual)	141	5 800	5 800	5 800	17	17	-2.1	-0.1	-0.1	0	0	0
Altair zeroed residual	0	0	0	0	0	0	0	0	0	0	0	0
Fomalhaut (actual)	-560	-2 300	-2 300	-2 300	3	3	-3.0	0.8	0.8	0	0	0
Arcturus (actual)	12 000	-140 000	-140 000	-140 000	74	74	150.0	-6.0	-6.0	0	0	0
Total	12 000	-140 000	-140 000	-140 000	94	94	150.0	-5.3	-5.3	0	0	0
Component corrections												
Hamal (actual)	141	5 800	5 800	5 800	17	17	-2.1	-0.1	-0.1	0	0	0
Altair zeroed residual	0	0	0	0	0	0	0	0	0	0	0	0
Fomalhaut (actual)	-560	-2 300	-2 300	-2 300	3	3	3.0	0.8	0.8	0	0	0
Arcturus (perfect)	4 800	-55 000	-55 000	-55 000	27	27	57.0	-2.3	-2.3	0	0	0
Total	4 300	-52 000	-52 000	-52 000	48	48	58.0	-1.5	-1.5	0	0	0
Component corrections												
Hamal (actual)	141	5 800	5 800	5 800	17	17	-2.1	-0.1	-0.1	0	0	0
Altair (perfect)	6 200	25 000	25 000	25 000	-67	-67	-16.0	-11.7	-11.7	0	0	0
Fomalhaut (actual)	-560	-2 300	-2 300	-2 300	3	3	3.0	0.8	0.8	0	0	0
Arcturus (perfect)	4 800	-55 000	-55 000	-55 000	27	27	57.0	-2.3	-2.3	0	0	0
Total	10 000	-26 000	-26 000	-26 000	-18	-18	42.0	-13.0	-13.0	0	0	0
Component corrections												
Hamal (perfect)	1 200	5 100	5 100	5 100	15	15	1.9	-0.1	-0.1	0	0	0
Altair (perfect)	6 200	25 000	25 000	25 000	-67	-67	-16.0	-11.0	-11.0	0	0	0
Fomalhaut (perfect)	-940	-3 800	-3 800	-3 800	5	5	5.1	1.4	1.4	0	0	0
Arcturus (perfect)	4 800	-55 000	-55 000	-55 000	27	27	+57.0	-2.3	-2.3	0	0	0
Total	11 000	-28 000	-28 000	-28 000	-18	-18	44.0	-12.0	-12.0	0	0	0

^aPreliminary estimates.

UNCLASSIFIED

TABLE 5.1.5-VIII.- FIRST RENDEZVOUS MANEUVERS

Maneuver	Ground backup	Computer closed loop	Onboard backup	Polar plot	Intended to apply	Actually applied
Terminal phase initiate (130 deg) 4:33:43.8	34 Fwd 0.6 Down	41 Fwd 1 Up ^b 16 Left	41 Fwd 4 Down 0	37 Fwd ^a -- --	41 Fwd 0 0	41 Fwd 1 Down 1 Right
First midcourse correction (82 deg) 4:46:23.4	N/A	15 Aft 22 Down 1 Right	17 Aft 10 Down 0	-- Down --	15 Aft 14 Down 0	15 Aft 14 Down 0
Second midcourse correction (34 deg) 4:58:24.1	N/A	1 Fwd ^c 25 Down 5 Right	3 Aft 14 Down 0	-- Large down --	0 25 Down 5 Right	10 Fwd 21 Down 2 Right

^a Crew estimated ΔV based upon being 2 miles low in altitude and a correction of 2 ft/sec/mile to the nominal of 33 for Δh of 15 nautical miles.

^b Computer data showed 2 up; pilot's log showed 1 up.

^c Computer data showed 0 fwd; pilot's log showed 1 fwd.

UNCLASSIFIED

TABLE 5.1.5-IX.- SIMULATED MANEUVER COMMANDS - IVI COORDINATES

	FFF		FFC		FFS		FCS		FSS		GSS		CSS		SSS	
		(a)		(a)		(a)		(a)		(a)		(a)		(a)		(a)
TPI	42F OR 2U	42F 1L 5U	42F OR 2U	42F 1L 5U	42F OR 2U	42F 1L 5U	42F OR 2U	42F 1L 5U	42F OR 2U	42F OR 2U	42F OR 2U	34F 1R OD	42F 15L 3U	41F 16L 3U	33F 2R 3D	42F 16L 2U
COR ₁ (82 deg)	14A 1R 3D	14A OL 15D	14A 1R 3D	14A OL 15D	14A 1R 3D	14A OL 15D	14A 1R 3D	14A OL 15D	14A 1R 3D	14A OL 15D	14A OL 15D	0F OR 3D	16A 15R 22D	16A 9R 25D	0F OR OD	17A 9R 26D
COR ₂ (34 deg)	9F 3R 21D	11F 3R 20D	1F 5R 24D	1F 5R 24D	1F 2R 22D	8F 4R 18U	1F 2R 22D	3F OR OD	8F 4R 18U	1F 2R 22D	2F OR 4U	1F OR OD	1F OR 1D	1A 9R 1D	1F OR OD	1A 9R 1D
Total IVI readings	95	111	92	107	87	107	82	92	87	114	39	115	121	39	123	
Time of mini- mum range, g.e.t.	5: 04: 52	5: 05: 05	5: 06: 25	5: 06: 27	5: 06: 32	5: 05: 59	5: 06: 26	5: 06: 25	5: 06: 26	5: 05: 59	5: 06: 24	5: 06: 27	5: 06: 28	5: 06: 26	5: 06: 30	

^a Constant misalignment: -0.75° pitch, -1.7° yaw.

UNCLASSIFIED

TABLE 5.1.5-X.- SIMULATED MANEUVER COMMANDS - NAVIGATIONAL COORDINATES

Maneuvers	FFF		FFC		FFS		FCS		FSS		GSS		CSS		SSS	
	(a)		(a)		(a)		(a)		(a)		(a)		(a)		(a)	
TPI	$\Delta\dot{X}$	36.9	36.9	36.9	36.9	36.9	36.9	36.9	36.9	36.9	36.9	30.6	36.6	36.6	31.6	37.4
	$\Delta\dot{Y}$	-20.3	-20.3	-20.3	-20.3	-20.3	-20.3	-20.3	-20.3	-20.3	-20.3	-14.8	-20.0	-20.0	-11.1	-20.0
	$\Delta\dot{Z}$	0.0	0.0	0.0	0.0	0.0	0.0	0.0	0.0	0.0	0.0	-1.2	15.2	15.2	-2.0	15.0
COR ₁ (82 deg)	$\Delta\dot{X}$	-2.3	-2.3	-2.3	-2.3	-2.3	3.7	3.7	3.7	2.6	7.4	2.0	2.5	4.9	-0.2	4.0
	$\Delta\dot{Y}$	20.5	20.5	20.5	20.5	20.5	26.3	26.3	29.1	33.0	2.1	28.2	30.2	0.4	31.6	
	$\Delta\dot{Z}$	0.8	0.8	0.8	0.8	0.8	-0.3	-0.3	-1.4	5.0	-0.4	-13.0	-6.8	0.1	-6.6	
COR ₂ (34 deg)	$\Delta\dot{X}$	22.9	21.6	21.6	20.2	20.1	0.8	4.5	2.1	1.4	0.0	0.0	1.5	0.3	0.3	0.8
	$\Delta\dot{Y}$	0.6	11.4	11.4	10.1	1.7	-2.5	-0.3	0.2	7.5	-0.7	-1.0	4.2	-0.8	4.1	
	$\Delta\dot{Z}$	-3.9	-4.9	-4.9	-2.9	-4.7	0.4	-2.4	0.0	-8.0	0.0	0.0	-0.3	-7.8	0.3	-8.0
TPF	$\Delta\dot{Y}_f$	0.6	-0.8	-0.6	-2.6	-3.8	-17.0	-13.5	-15.6	-11.4	-24.5	-16.6	-15.8	-25.4	-15.3	
	$\Delta\dot{Y}_f$	-61.4	-48.3	-48.3	-48.2	-52.6	-46.9	-48.5	-46.9	-48.1	-43.7	-46.5	-44.5	-42.1	-44.6	
	$\Delta\dot{Z}_f$	4.5	5.4	5.1	3.4	4.5	1.3	2.4	1.5	6.6	0.6	13.5	18.3	-0.3	18.2	

^aConstant misalignment: -0.75° pitch, -1.7° yaw.

UNCLASSIFIED

TABLE 5.1.5-XI.- COMPUTER PROGRAM CONFIGURATION

Module	Module size	Program size	Time loaded, hr:min g.e.t.	
	13-bit equivalent		From	To
I Common subprograms, including bootstrap	5 486			
II Ascent/abort/reentry	5 988	11 474	Lift-off	00:10
III Catch-up/rendezvous	4 549	10 035	02:40 27:30	26:00 63:25
IV Touchdown predict/reentry	3 996	9 482	66:10	Touchdown
V Ascent/catch-up/rendezvous	5 623	11 109	Not used	
VI Orbit navigation/prediction determination	6 109	11 695	00:10 63:25	02:40 66:10
	<u>31 751</u>	<u>53 795</u>		

^aEach module is redundantly loaded on the tape; therefore, it contains 63 502 words.

UNCLASSIFIED

TABLE 5.1.5-XII.- TRANSLATION MANEUVERS

Maneuver	Ground elapsed time, hr:min:sec	ΔV_X , ft/sec	ΔV_Y , ft/sec	ΔV_Z , ft/sec	ΔV_{total} , ft/sec	$\Delta V_{planned}$, ft/sec	Computer mode
Tail-off	0:05:40.6	93.6	23.8	2.0	96.6	--	Ascent
Separation	0:06:10.9	1.3	0.5	-0.5	1.5	--	Ascent
IVAR	0:06:47.0	25.3	6.0	0.7	26.0	--	Ascent
First rendezvous							
Phase adjust	2:18:10.8	55.8	-0.2	0.4	55.8	55.9	Orbit navigation
Plane change	2:30:49.2	-0.1	-0.5	-10.5	10.5	9.6	Orbit navigation
Coelliptic	3:47:36.0	47.5	-6.1	-0.4	47.5	48.4	Catch-up
Terminal phase initiate	4:33:43.8	37.0	-20.5	0.2	42.3	34.6	Rendezvous
82-degree correction	4:46:23.4	-2.5	20.3	0.9	20.4	--	Rendezvous
34-degree correction	4:58:24.1	23.0	1.1	-4.0	23.4	--	Rendezvous
Terminal phase finalize	5:01:51.5	5.9	64.7	11.8	66.0	48.5	Catch-up
Second rendezvous							
Phase adjust 1 ^a	7:38:34.4	423.3	0.1	-13.6	423.6	420.0	Catch-up
Height adjust 1 ^a	20:20:12.0	-346.2	6.2	-1.3	346.3	340.0	Catch-up
Coelliptic 1 ^a	22:37:06.4	82.1	-1.4	-0.8	82.2	75.7	Catch-up
Phase adjust 2 ^a	27:45:36.4	9.7	-0.2	-0.1	9.7	7.7	Orbit navigation
Plane change	41:04:26.4	0.5	0.4	16.0	16.0	14.8	Catch-up
Phase adjust 3 ^a	41:35:50.4	-4.4	0.1	-0.1	4.4	3.5	Catch-up
Separation from Gemini X	44:40:15.6	2.0	-0.1	-0.1	2.0	1.5	Catch-up
GATV							
Corrective combination	45:54:01.0	1.2	-3.8	1.3	4.2	4.2	Catch-up

^aManeuver made with the GATV propulsion system.

UNCLASSIFIED

TABLE 5.1.5-XII.- TRANSLATION MANEUVERS - Concluded

Maneuver	Ground elapsed time, hr:min:sec	ΔV_x , ft/sec	ΔV_y , ft/sec	ΔV_z , ft/sec	ΔV_{total} , ft/sec	$\Delta V_{planned}$, ft/sec	Computer mode
Coelliptic 2	46:09:29.0	1.0	10.6	0.2	10.6	9.8	Catch-up
Terminal phase initiate	47:26:43.6	18.7	-12.1	-0.9	22.3	25.1	Catch-up
First vernier	47:34:09.9	4.4	1.1	0.2	4.5	--	Catch-up
Second vernier	47:38:58.2	0.3	-1.5	-3.6	3.9	--	Catch-up
Terminal phase finalize	47:42:42.4	-3.5	28.0	01.3	28.2	--	Catch-up
Out-of-plane separation	51:15:59.9	0.8	0.0	-1.3	1.5	1.0	Catch-up
True anomaly adjust	51:38:51.8	-99.8	-0.7	-2.8	99.8	100.0	Catch-up
Retrofire	70:10:24.5	-303.0	118.9	-5.3	325.5	324.7	Reentry

UNCLASSIFIED

TABLE 5.1.5-XIII.- IVI SERVICING CYCLE COMPARISON

	Module III, catch-up without orbit-rate- torquing compensation	Module III, catch-up with orbit-rate- torquing compensation	Module VI, orbit navigation
Computation cycle, sec	0.458	0.900	0.729
IVI service cycle, sec	1.374	Never	2.187
IVI service cycle time, sec (with telemetry interrupt	1.447	2.774	2.247

UNCLASSIFIED

TABLE 5.1.5-XIV.- PLATFORM ALIGNMENT ACCURACY

Event	Pitch	Roll
Post-IVAR	0.3	0.5
Phase adjust maneuver	0.3	0.3
Plane change maneuver	0.3	0.4
Coelliptic maneuver	0.2	0.2
Terminal phase initiation	0.4	0.5
Predocking	0.4	0.6
Postseparation from GATV	0.2	0.3
Preretrofire	0.2	0.1

UNCLASSIFIED

TABLE 5.1.5-XV.- DUAL RENDEZVOUS MANEUVERS

Maneuvers	AV planned, ft/sec		IGS AV measured, ft/sec		Difference, ft/sec	
	Required	Corrections	Required	Corrections		
GATV	Transfer					
	Phase adjust	420.0		423.6		
	Height adjust	340.0		346.3		
	Coelliptic	<u>75.7</u>		<u>82.2</u>		
	Total	835.7		852.1	+16.4	
	Corrections					
	Phase adjust		7.7		9.7	
	Height adjust		14.8		16.0	
	Coelliptic		3.5		4.4	
	Separation		<u>1.5</u>		<u>2.0</u>	
Total		27.5		32.1	+4.6	
Spacecraft	Corrections					
	Altitude and phase		4.2		4.2	
	Δh (relative altitude)		<u>9.8</u>		<u>10.6</u>	
	Total		14.0		14.8	+0.8
	Rendezvous					
TPI	25.0		22.3		-2.8	
First midcourse	9.0			4.5		
Second midcourse	<u>0.0</u>			<u>3.9</u>		
Total	25.1		22.3	8.4	+8.4	
Braking						
Period (BR to BR + 10)				46.5		
(BR + 10) to (BR + 15)				29.0		
(BR + 15) to station keeping				47.0		
Total	<u>(43)</u>	<u>(0)</u>	<u>(43)</u>	<u>122.5</u>	+122.5	

CONFIDENTIAL

TABLE 5.1.5-XVI.- COMPARISON OF COMPUTER TELEMETRY REENTRY PARAMETERS WITH POSTFLIGHT RECONSTRUCTION

Parameters	Time in mode = 2 634.869 sec Altitude = 400K ft		Time in mode = 3 107.378 sec Guidance termination	
	Telemetry	MAC	Telemetry	MAC
Radius vector, ft	21 299 264	21 299 916	20 966 856	20 967 561
Velocity, ft/sec	24 498.9	24 498.3	1 795.4	1 785.0
Flight-path angle, deg	-1.719	-1.718	-38.961	-38.868
Spacecraft heading, deg	87.34	87.34	110.63	110.62
Longitude, deg	259.66	259.65	288.01	288.01
Latitude, deg	28.75	28.75	26.52	26.53
Range to target, n. mi.	1 507.5	1 508.4	2.33	-1.83
Crossrange error, n. mi.	1.13	0.81	1.82	1.44
Downrange error, n. mi.	NA	NA	-4.16	-1.11
Predicted zero-lift range, n. mi.	NA	NA	2.71	2.77
Density altitude factor	NA	NA	4.629	4.622
Bank-angle command, deg	0.0	0.0	-90.0	-90.0
Integration time, sec	1 342.6	1 342.6	1 815.14	1 815.20
				IBM
				20 968 760
				1 789.5
				-38.868
				110.62
				288.01
				26.53
				2.18
				1.88
				-3.89
				2.78
				4.625
				-90.0
				1 815.15

NA = not available

CONFIDENTIAL

TABLE 5.1.5-XVII.- COMPARISON OF RADAR AND IGS REENTRY DATA

(a) Trajectories

Event	Time from retrofire, sec	Radar/BET ^a		IGS		Difference, n. mi.
		Longitude	Latitude	Longitude	Latitude	
Retrofire	0	177.17	-1.91	177.15	-1.90	1.3
400K	1325.7	-101.60	28.69	101.61	28.70	0.8
Guidance initiate	1474.7	-90.36	28.74	-90.37	28.75	0.8
Guidance termination	1815.1	-71.98	26.60	-71.99	26.53	4.2

^aRadar coverage from 1550 to 1815 seconds from retrofire, BET for other time periods. BET uses radar and IGS.

(b) Contributors to IGS-BET difference at guidance termination

	X, n. mi.	Y, n. mi.	Z, n. mi.	Total, n. mi.
Initial alignment error				
$\phi_X = -0.65$ deg	0	0.01	-3.61	
$\phi_Y = -0.56$ deg	-3.10	-0.98	0.00	
$\phi_Z = -0.44$ deg	-0.01	0	-0.77	
Total	-3.11	-0.99	-4.38	
Update initialization	+1.26	+0.16	+0.22	
Total, alignment and initialization	-1.84	-0.83	-4.16	
Other (gyro, accelerometer, and timing)				+1.8
TOTAL				4.2

UNCLASSIFIED

TABLE 5.1.5-XVIII.- SHIFT IN PROJECTED FOOTPRINT
DUE TO RETROFIRE

Source	Shift, n. mi.
Actual IVI data (real time)	14.0
Hawaii tracking, (real time after retrofire)	43.0
White Sands tracking, real time (after retrofire)	43.0
Best estimate trajectory (preretro and postretro tracking and IVI data post-flight)	14.3

UNCLASSIFIED

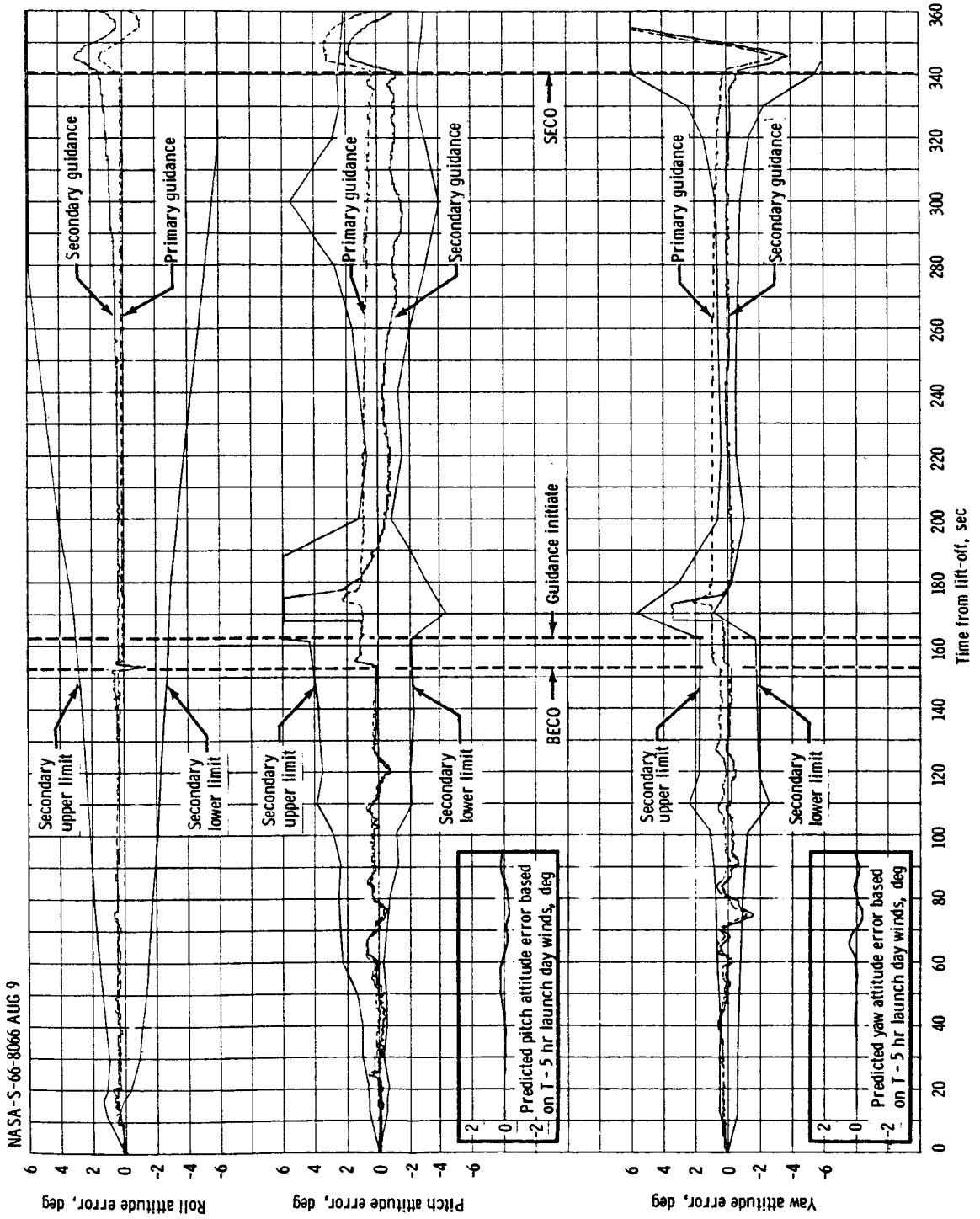

Figure 5.1.5-1. - Comparisons of launch vehicle and spacecraft steering errors.

UNCLASSIFIED

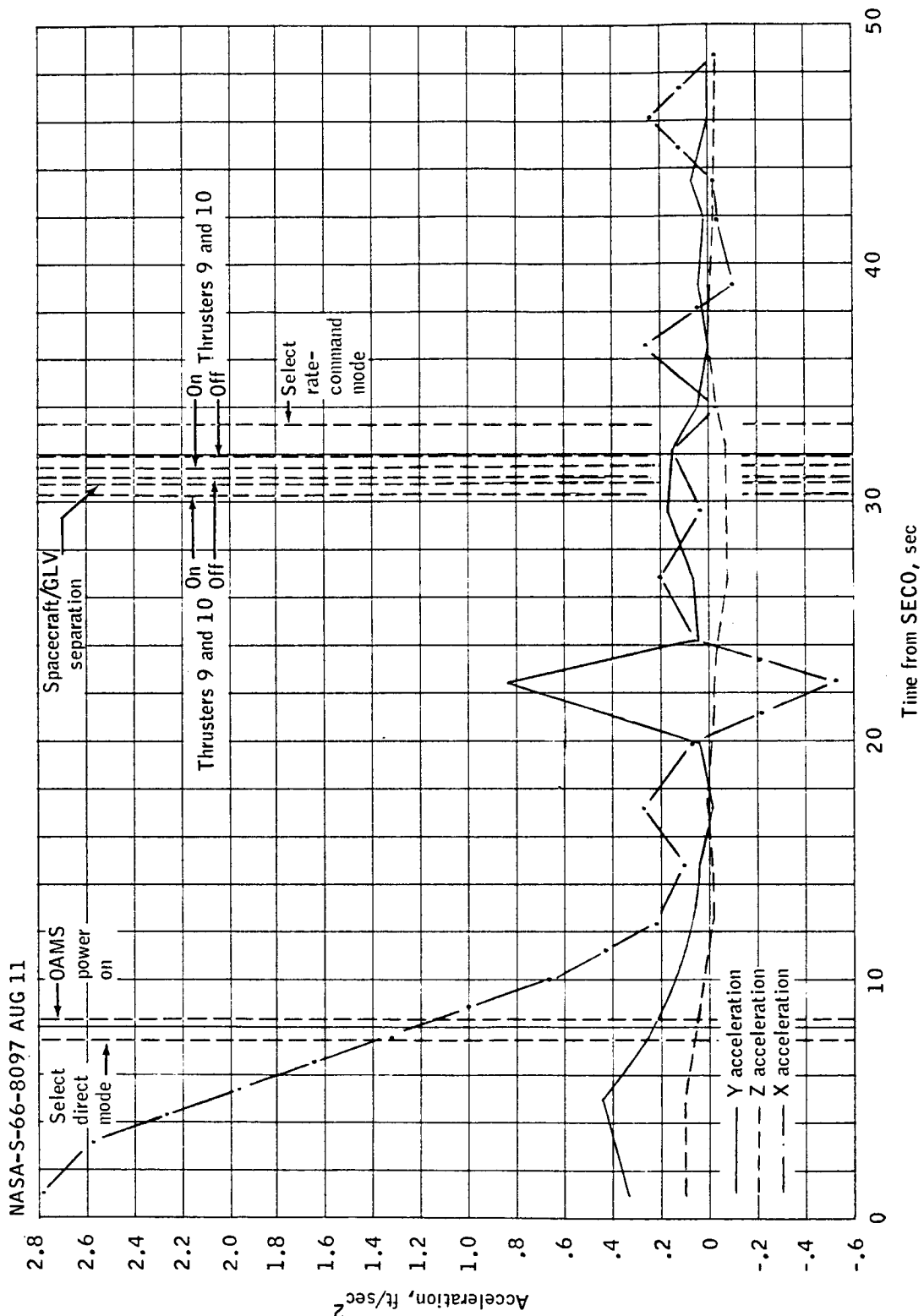

Figure 5.1.5-2. - Spacecraft acceleration measured after SECO.

UNCLASSIFIED

NASA-S-66-8181 AUG 23

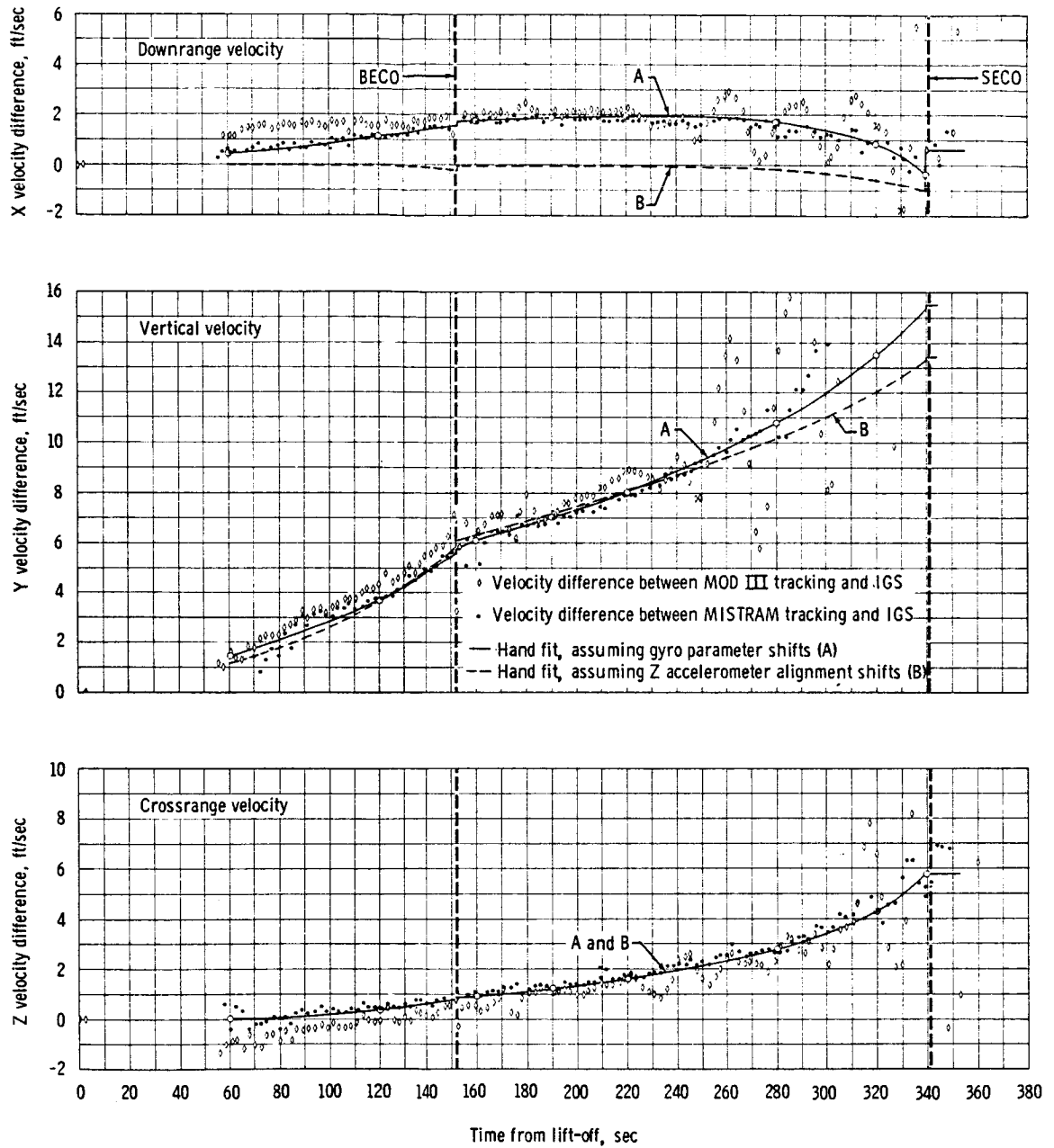
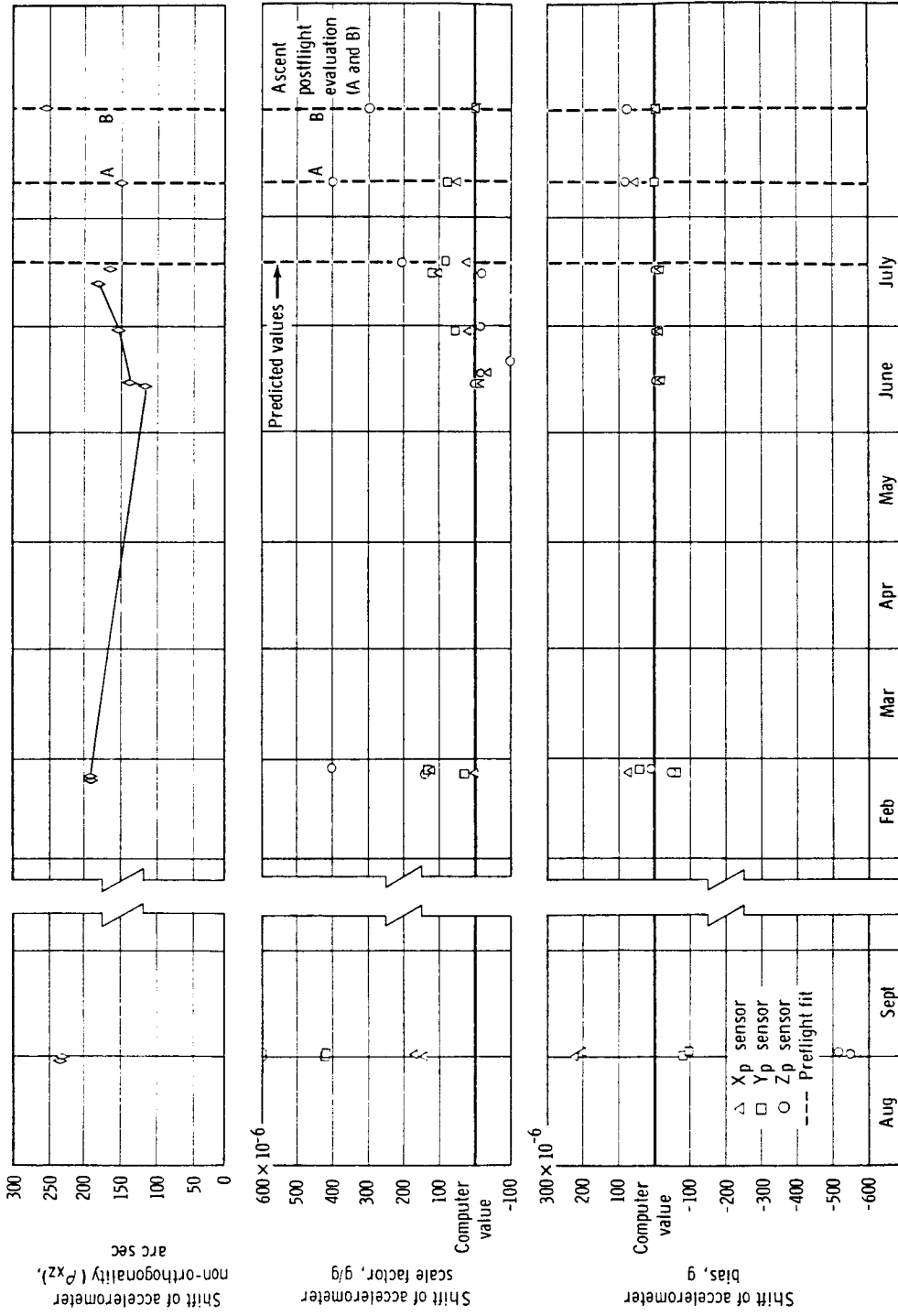

Figure 5.1.5-3. - Comparisons of spacecraft IGS and radar tracking velocities.

~~CONFIDENTIAL~~

NASA-S-66-8176 AUG 19



~~CONFIDENTIAL~~

(a) Shift of accelerometer biases and scale factors.
Figure 5.1.5-4. - IMU error coefficient history.

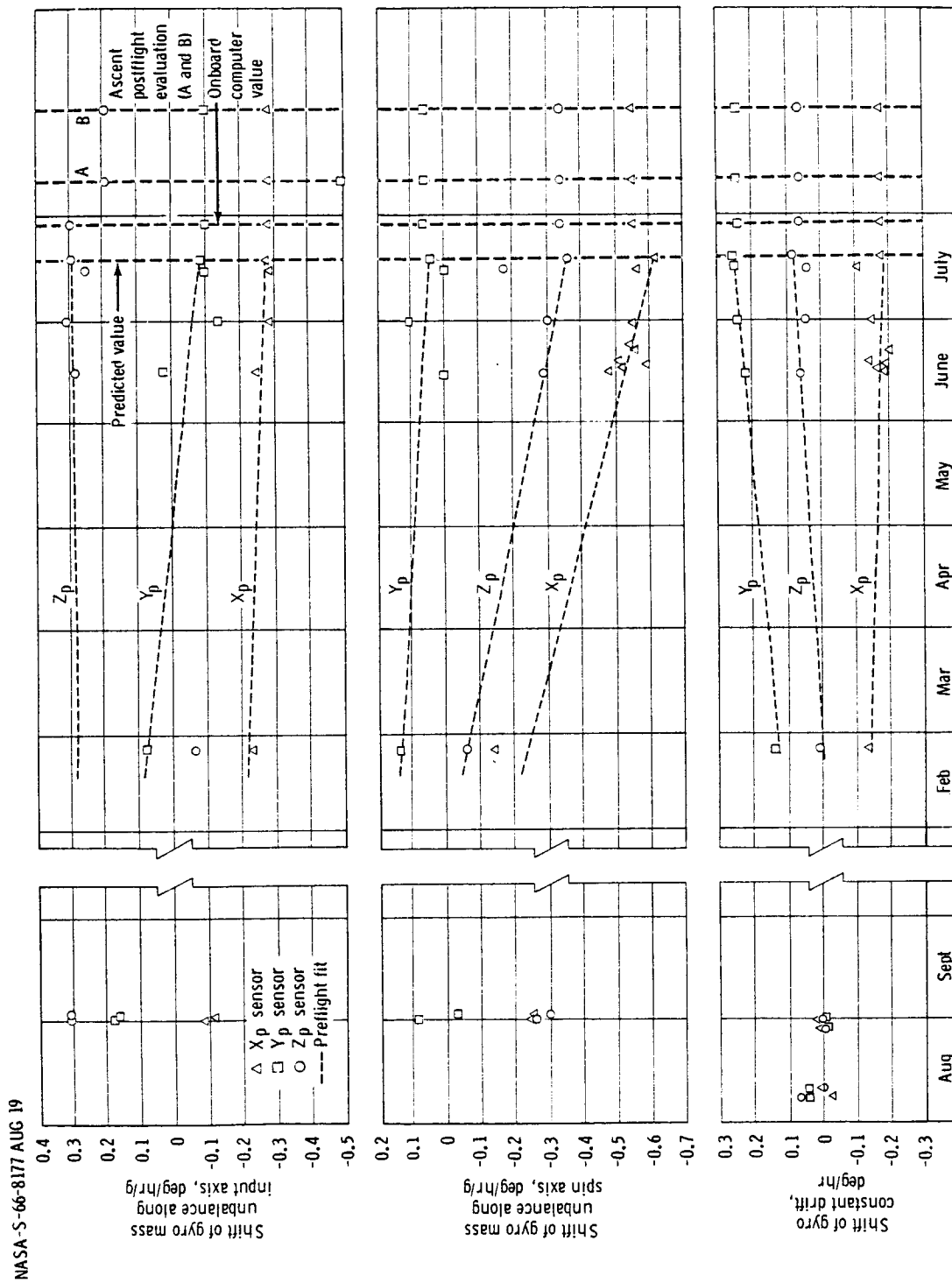

(b) Shift of gyro mass unbalances and constant drifts. Figure 5.1.5-4. - Concluded.

UNCLASSIFIED

Figure 5.1.5.5 - Orbit determination time line.

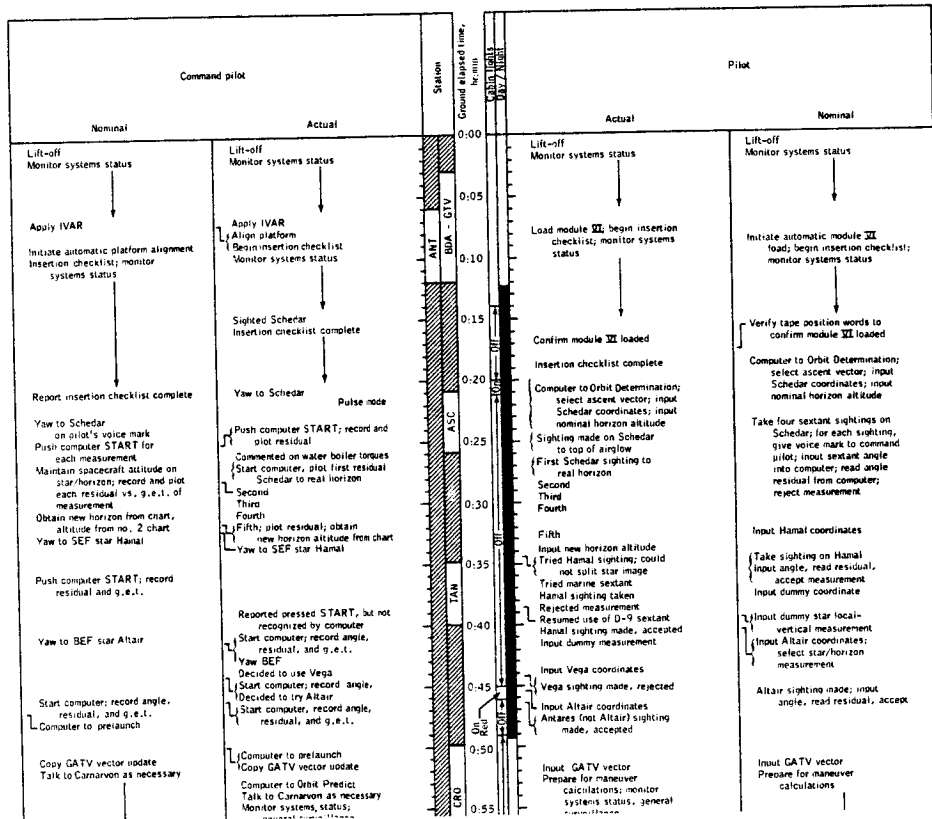

UNCLASSIFIED

5-60-B

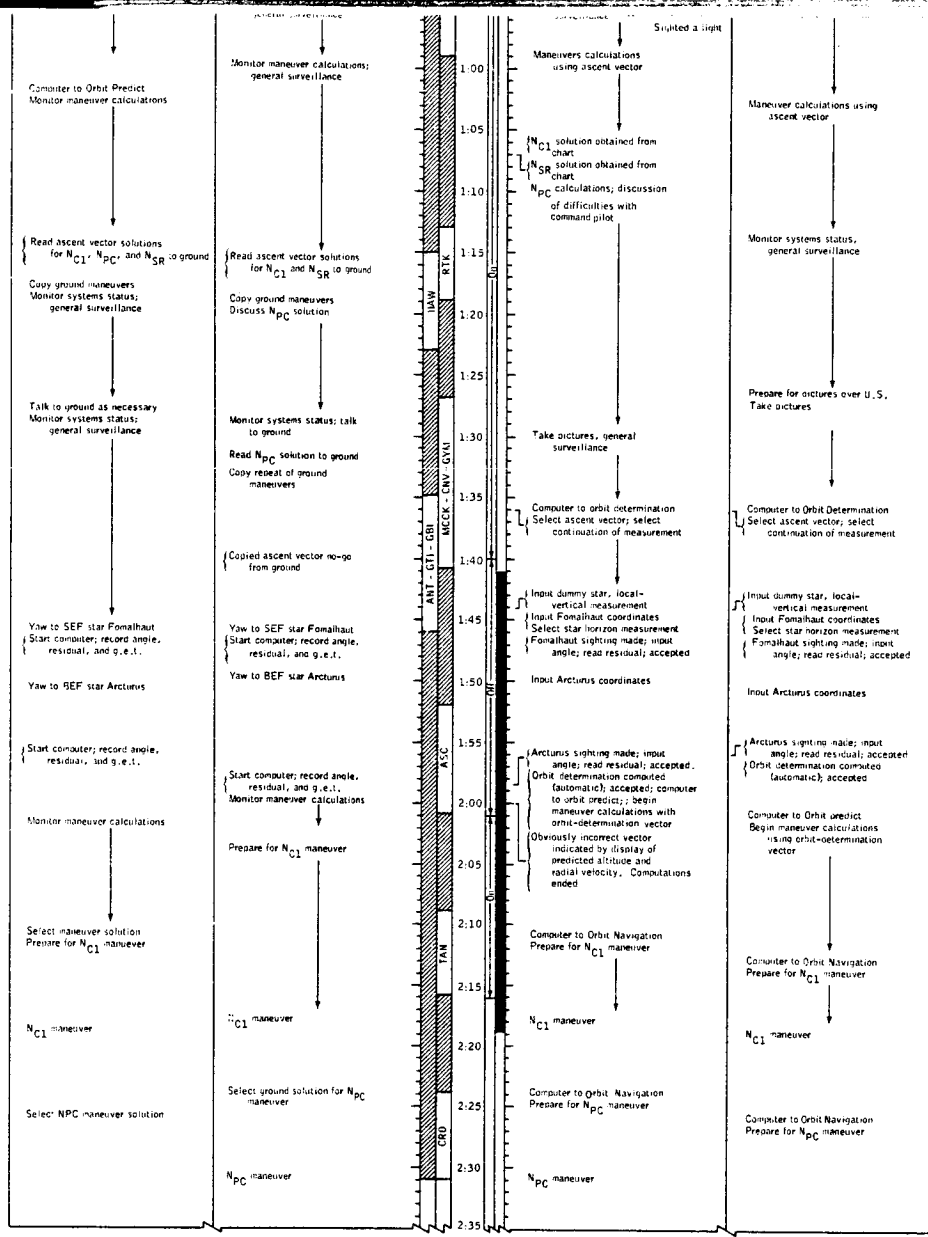

5-60-C

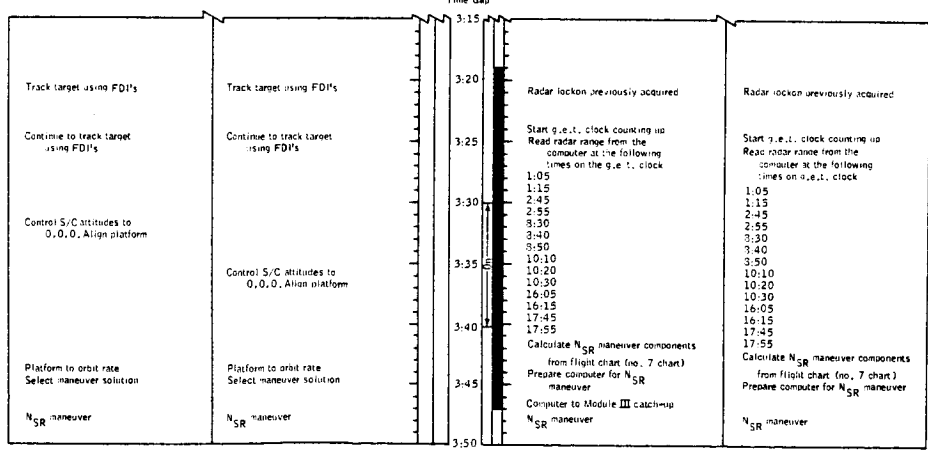

1

PHASE	START	END	ORBITAL PERIOD (MIN SEC)	PERIOD (MIN SEC)	PERIOD (MIN SEC)	PERIOD (MIN SEC)	PERIOD (MIN SEC)	PERIOD (MIN SEC)	PERIOD (MIN SEC)
1	00:00:00	00:00:00	00:00:00	00:00:00	00:00:00	00:00:00	00:00:00	00:00:00	00:00:00
2	00:00:00	00:00:00	00:00:00	00:00:00	00:00:00	00:00:00	00:00:00	00:00:00	00:00:00
3	00:00:00	00:00:00	00:00:00	00:00:00	00:00:00	00:00:00	00:00:00	00:00:00	00:00:00
4	00:00:00	00:00:00	00:00:00	00:00:00	00:00:00	00:00:00	00:00:00	00:00:00	00:00:00
5	00:00:00	00:00:00	00:00:00	00:00:00	00:00:00	00:00:00	00:00:00	00:00:00	00:00:00

ANGLE (DEG)	ANGLE (DEG)	ANGLE (DEG)	ANGLE (DEG)	ANGLE (DEG)	ANGLE (DEG)	ANGLE (DEG)	ANGLE (DEG)	ANGLE (DEG)	ANGLE (DEG)
0	0	0	0	0	0	0	0	0	0
10	10	10	10	10	10	10	10	10	10
20	20	20	20	20	20	20	20	20	20
30	30	30	30	30	30	30	30	30	30
40	40	40	40	40	40	40	40	40	40
50	50	50	50	50	50	50	50	50	50
60	60	60	60	60	60	60	60	60	60
70	70	70	70	70	70	70	70	70	70
80	80	80	80	80	80	80	80	80	80
90	90	90	90	90	90	90	90	90	90

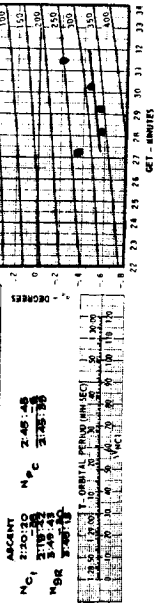

Δ VNSR DETERMINATION (ASCENT VECTOR)

3

ENTER CHART TO FIND ΔVTC
FROM PREV PAGE

RECORD ΔVNSR IN MANEUVER TABLE (ADD 25)

ΔVNSR: 3.00
ΔVTC: 3.00
ΔVTC - FPS: 3.00

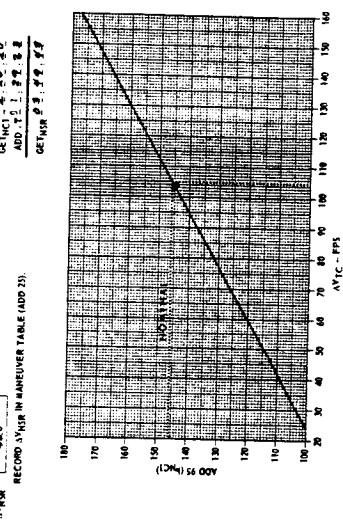

Δ VNSR DETERMINATION (ORB. DET. VECTOR)

5

ENTER CHART TO FIND ΔVTC
FROM PREV PAGE

RECORD ΔVNSR IN MANEUVER TABLE (ADD 25)

ΔVNSR: 3.00
ΔVTC: 3.00
ΔVTC - FPS: 3.00

5-61-3

2

READOUT
GET ΔVNSR
SUBTRACT
CONVERT MINS TO MIN
ENTER
MONITOR UNTIL START COMP OUT

REPEAT UNTIL N. 5
REPEAT UNTIL N. 5
REPEAT UNTIL N. 5

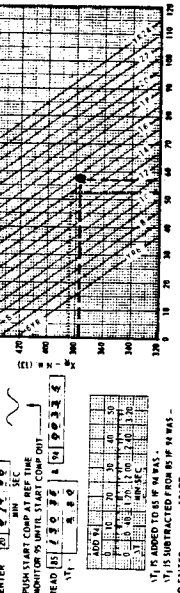

Δ VNSR DETERMINATION (ASCENT VECTOR)

3

ENTER CHART TO FIND ΔVTC
FROM PREV PAGE

RECORD ΔVNSR IN MANEUVER TABLE (ADD 25)

ΔVNSR: 3.00
ΔVTC: 3.00
ΔVTC - FPS: 3.00

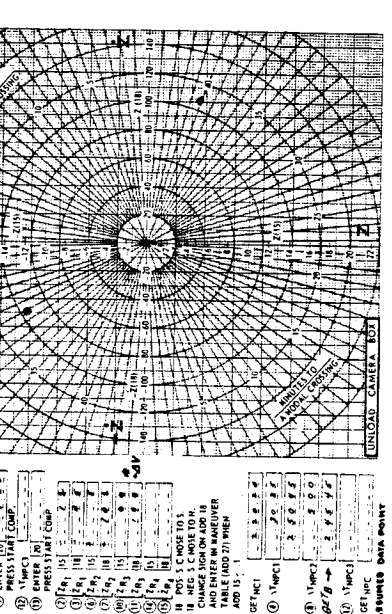

Δ VNSR DETERMINATION (ORB. DET. VECTOR)

5

ENTER CHART TO FIND ΔVTC
FROM PREV PAGE

RECORD ΔVNSR IN MANEUVER TABLE (ADD 25)

ΔVNSR: 3.00
ΔVTC: 3.00
ΔVTC - FPS: 3.00

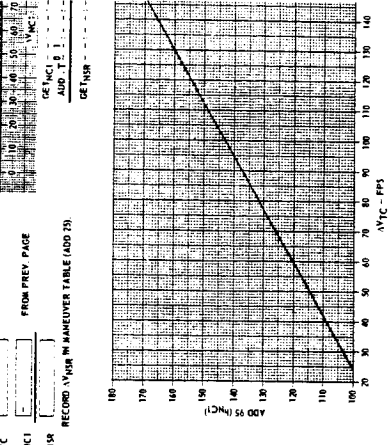

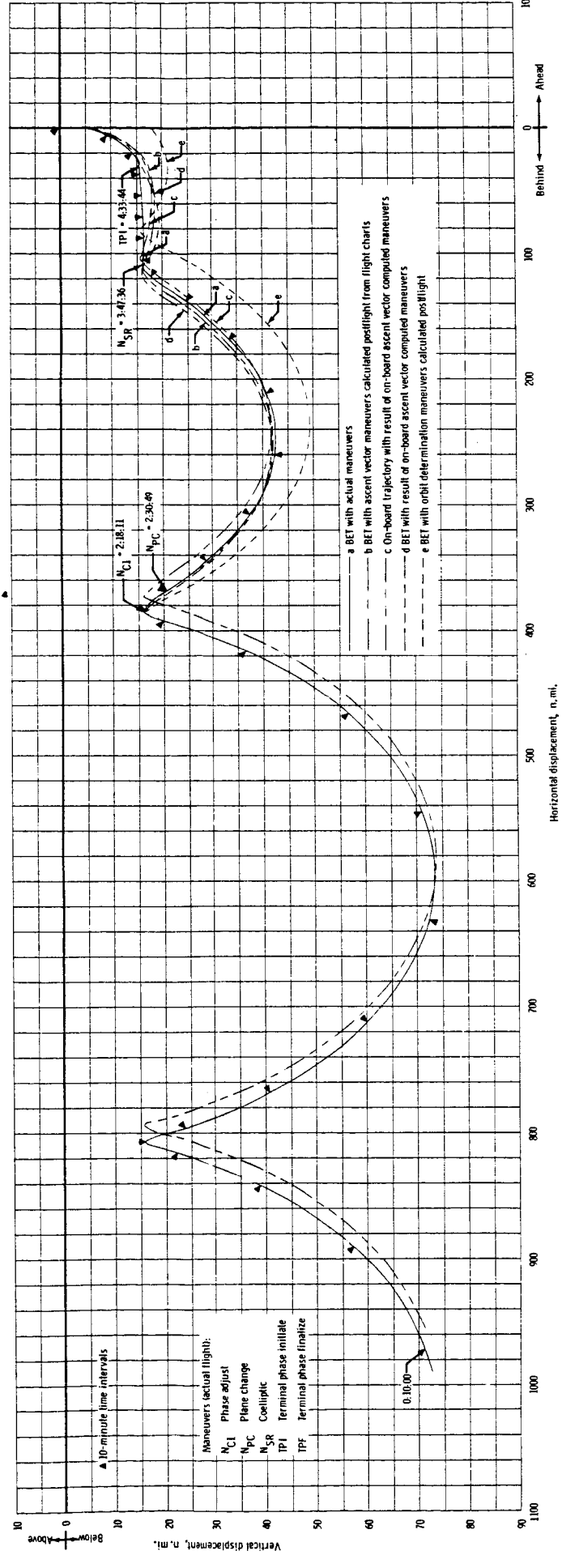
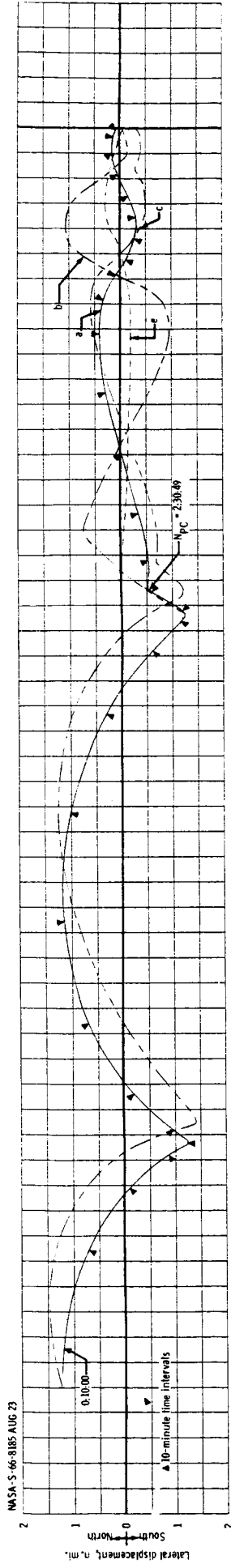

Figure 5.1.5-7. - Rendezvous catch-up relative motion comparison.

NASA-S-66-8129 AUG 13

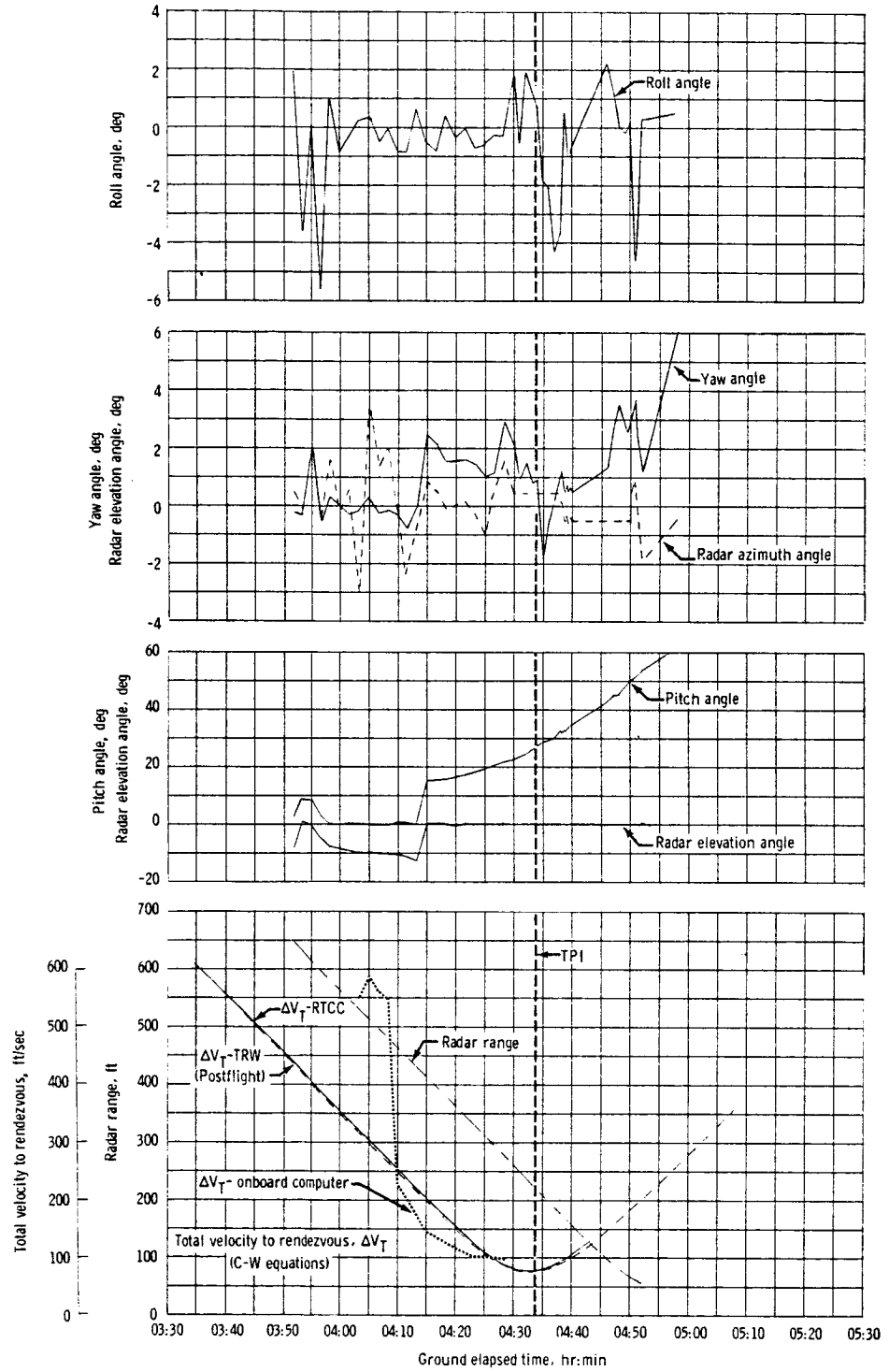
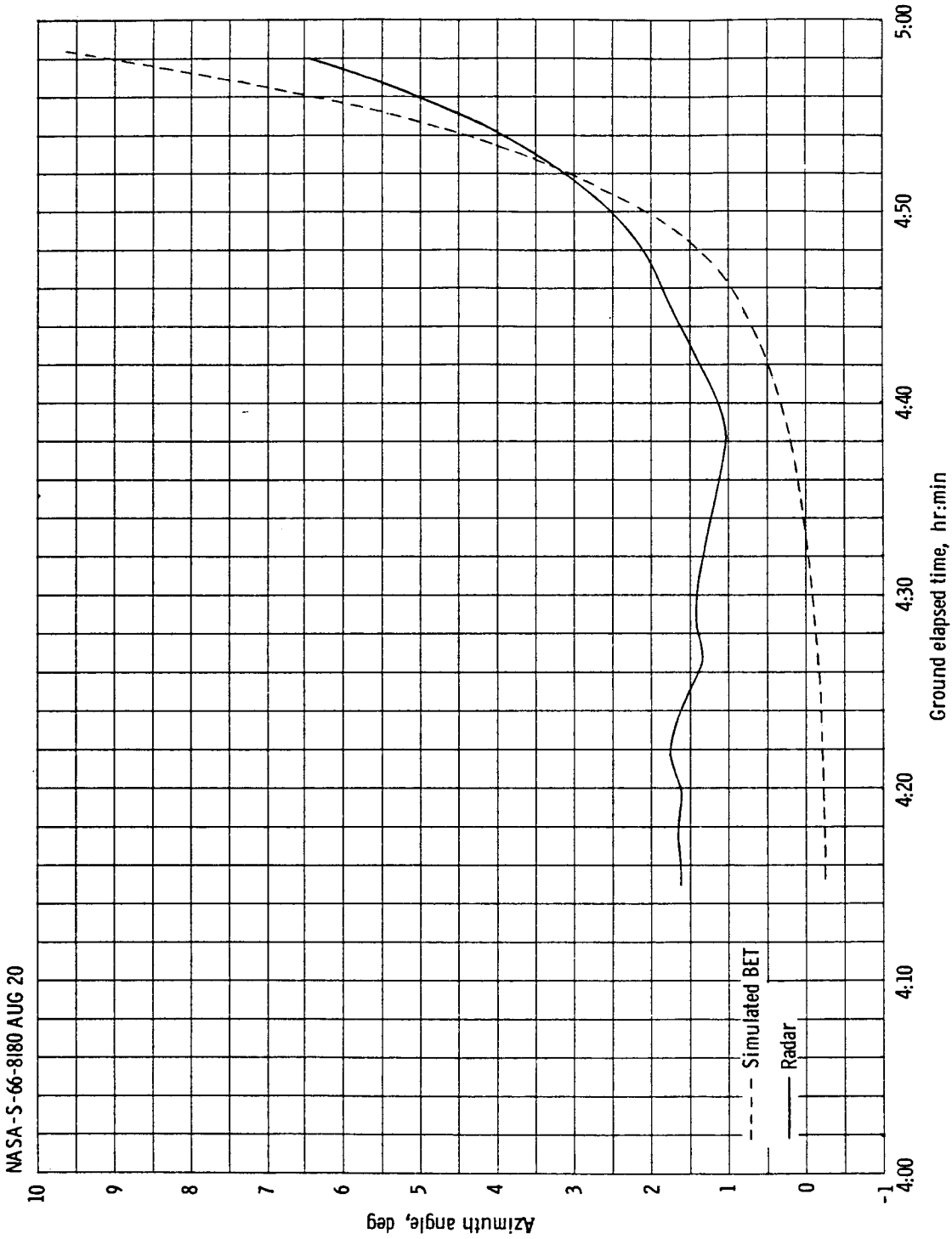

Figure 5.1.5-8. - Computer data for the closed-loop rendezvous.

UNCLASSIFIED



NASA-S-66-8180 AUG 20

UNCLASSIFIED

Figure 5.1.5-9. - Comparison of spacecraft radar-measured azimuth angles with postflight-simulated angles.

NASA-S-66-8189 AUG 20

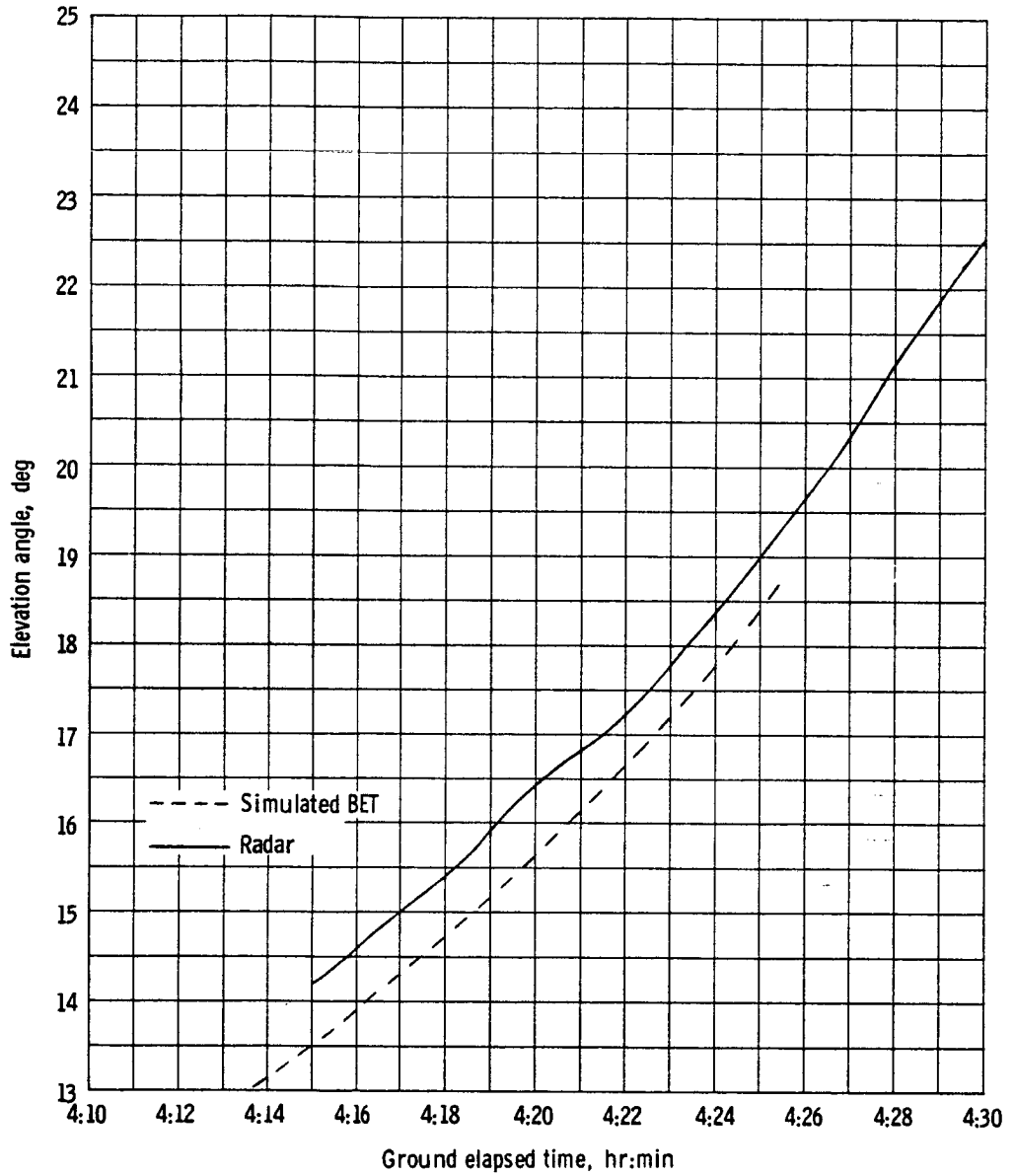

Figure 5.1.5-10. - Comparison of spacecraft radar-measured elevation angles with postflight-simulated angles.

UNCLASSIFIED

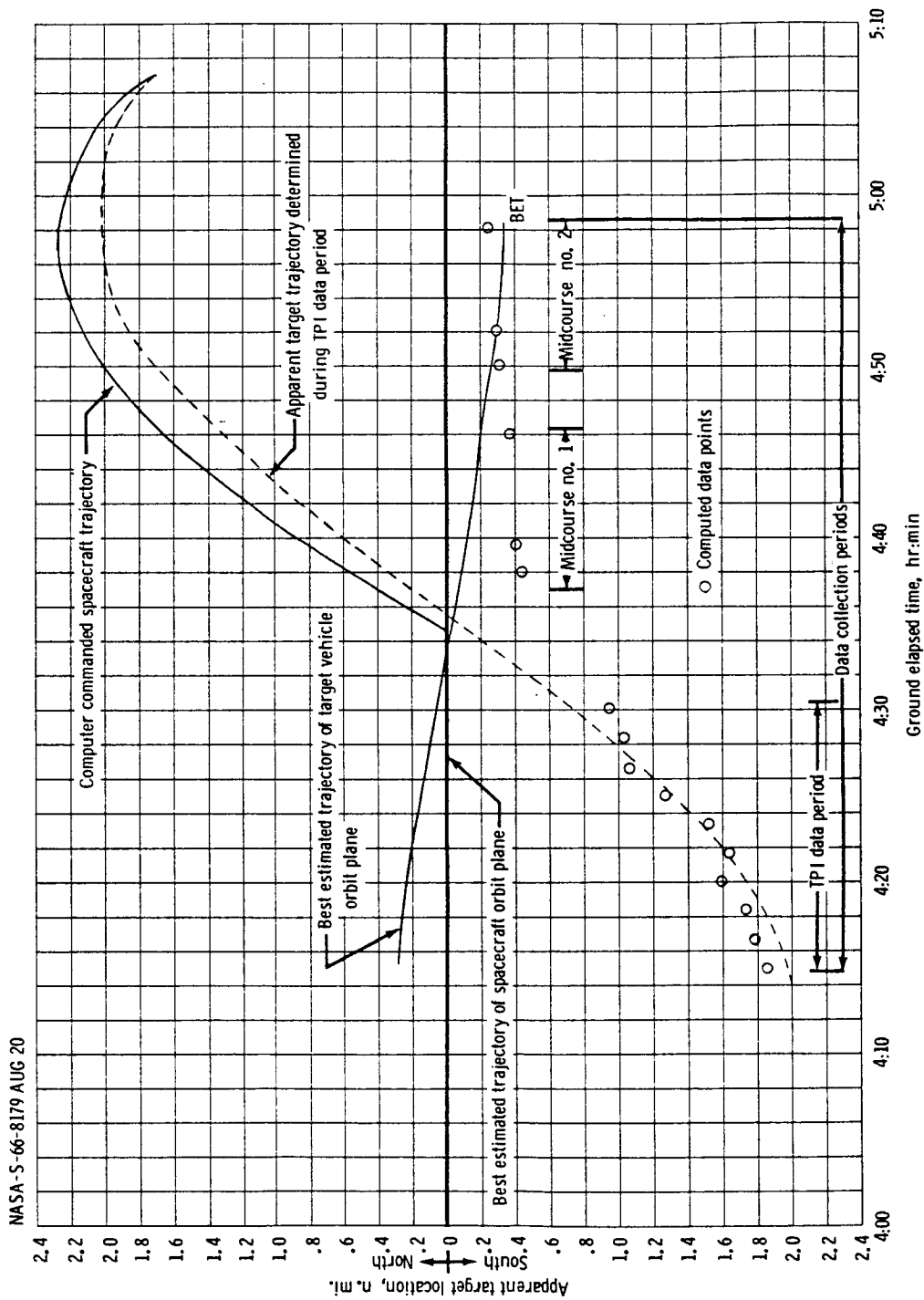

Figure 5.1.5-11. - First rendezvous out-of-plane position history.

UNCLASSIFIED

UNCLASSIFIED

5-67

THIS PAGE INTENTIONALLY LEFT BLANK

UNCLASSIFIED

UNCLASSIFIED

5-68

NASA-5-66-8167 AUG 17

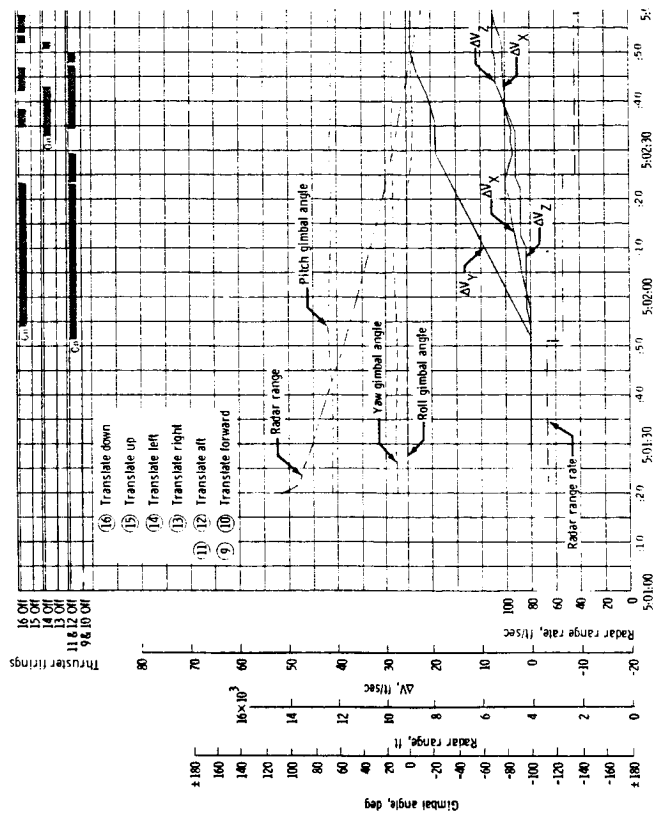

5-68-a

Preceding page blank

Figure 5.1.5-12. - Braking maneuver - first rendezvous.

UNCLASSIFIED

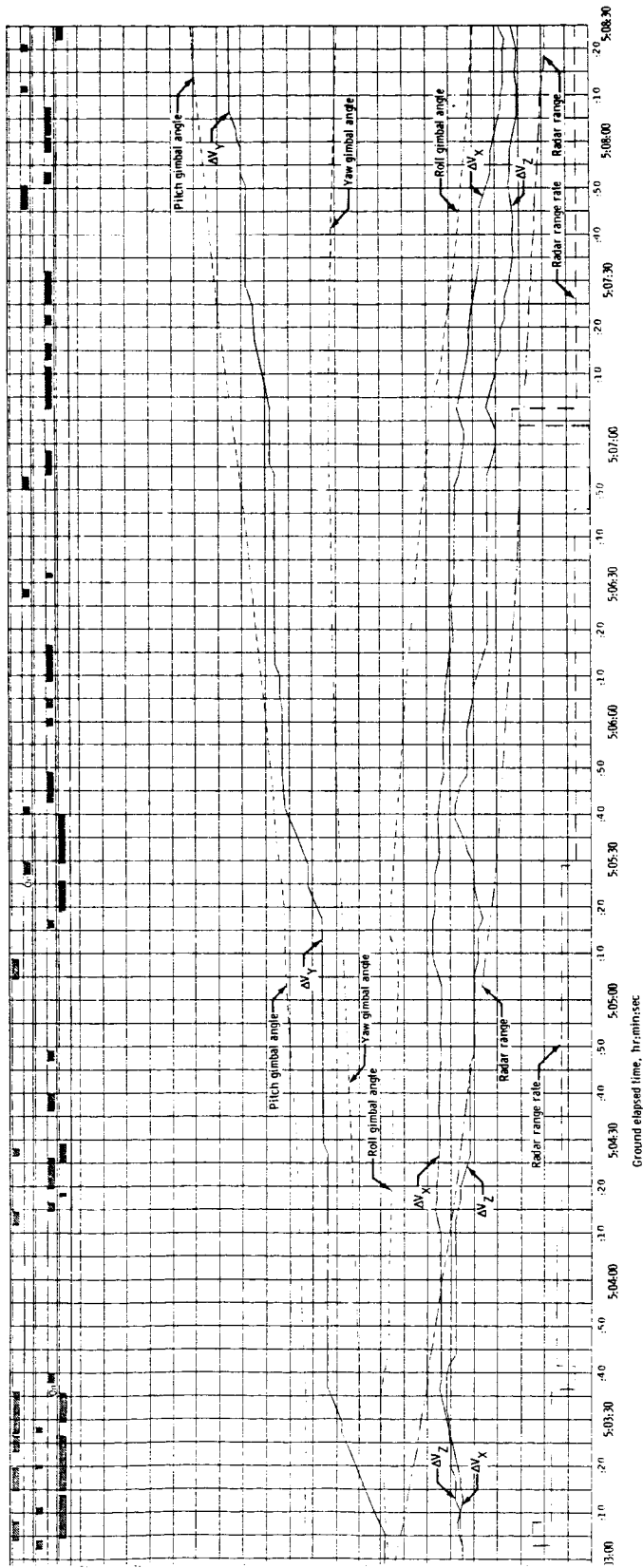

5-68-C

5-68-d

UNCLASSIFIED

5-69

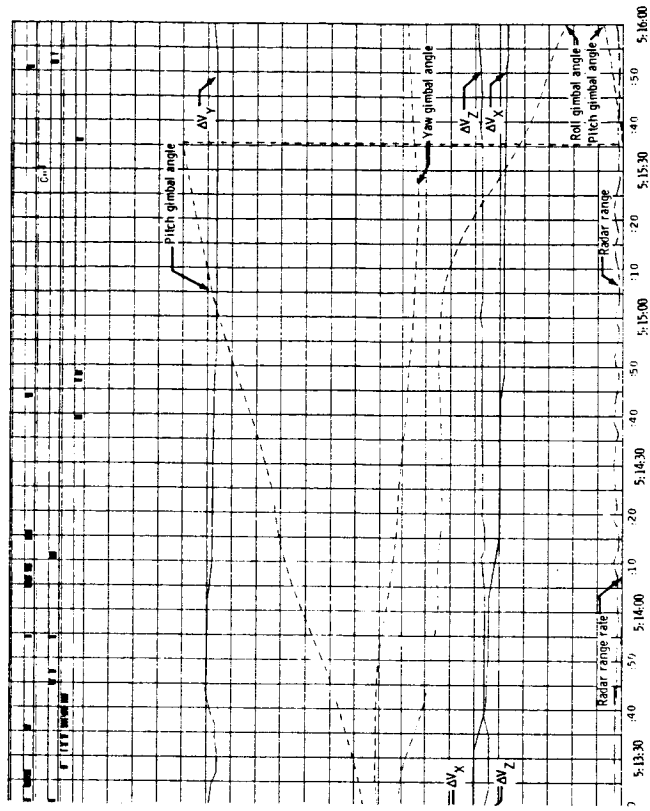

5-69-C

(b) 5:08:30 to 5:16:00 g. e. l.
Figure 5.1.5-12. - Concluded.

UNCLASSIFIED

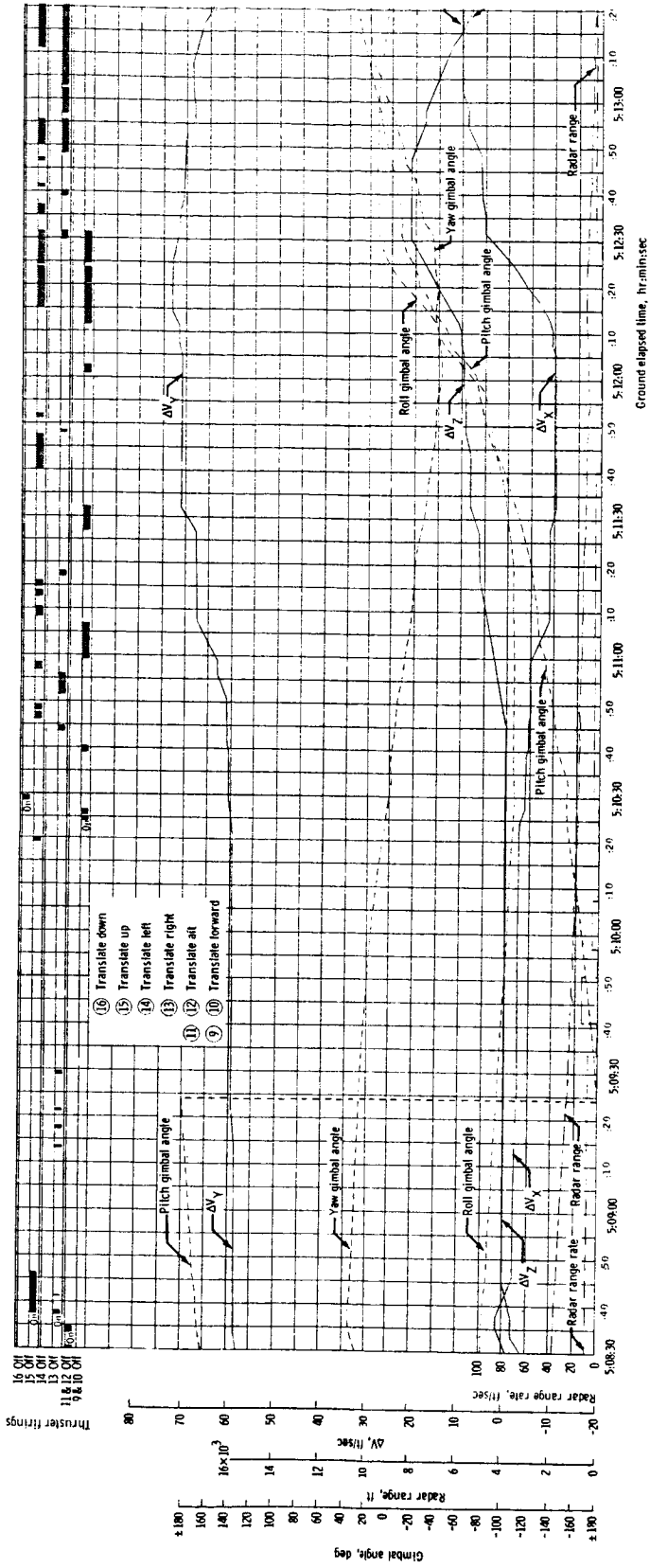

5-69-6

5-69-a

UNCLASSIFIED

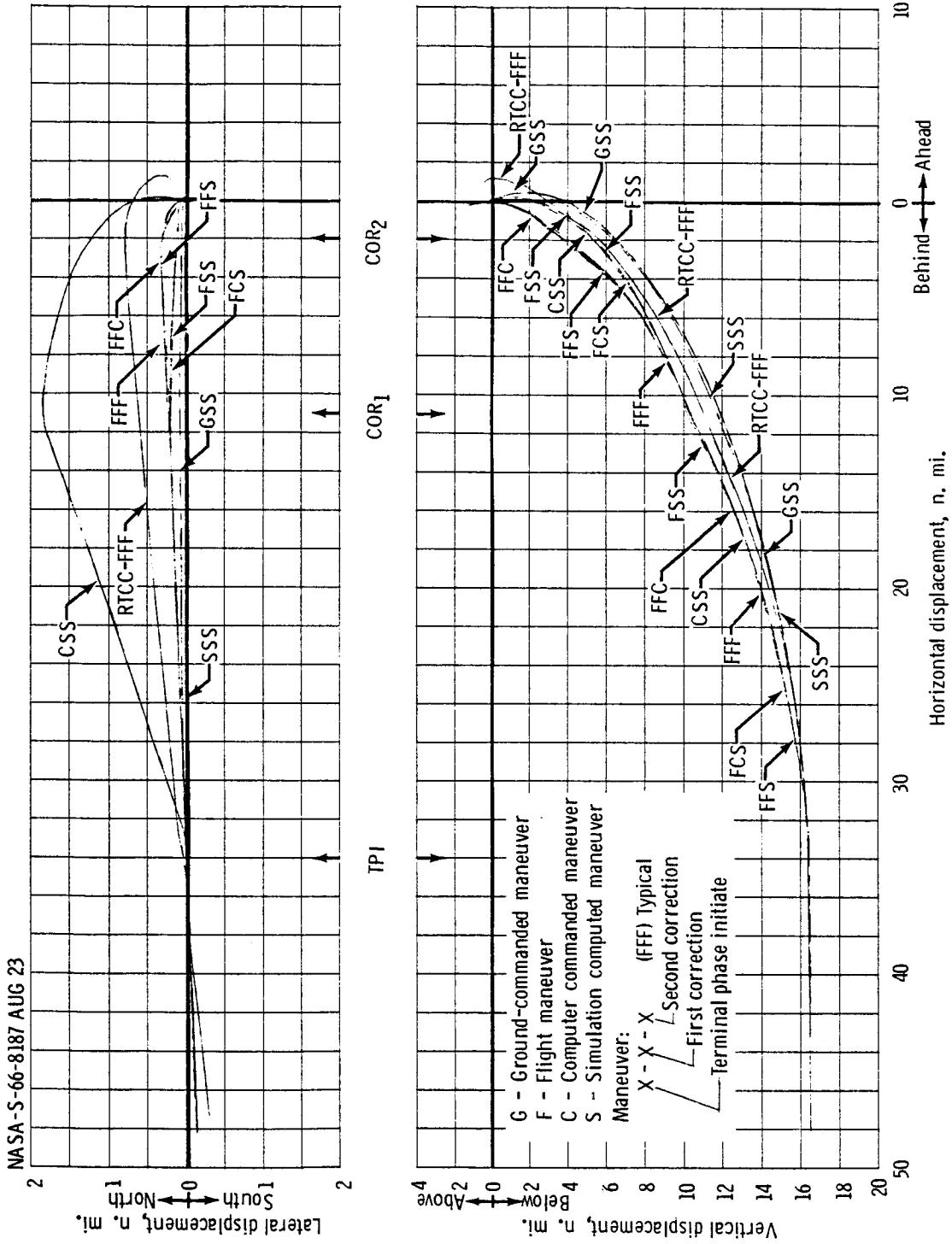

Figure 5.1.5-13. - First rendezvous simulations, no platform misalignment.

UNCLASSIFIED

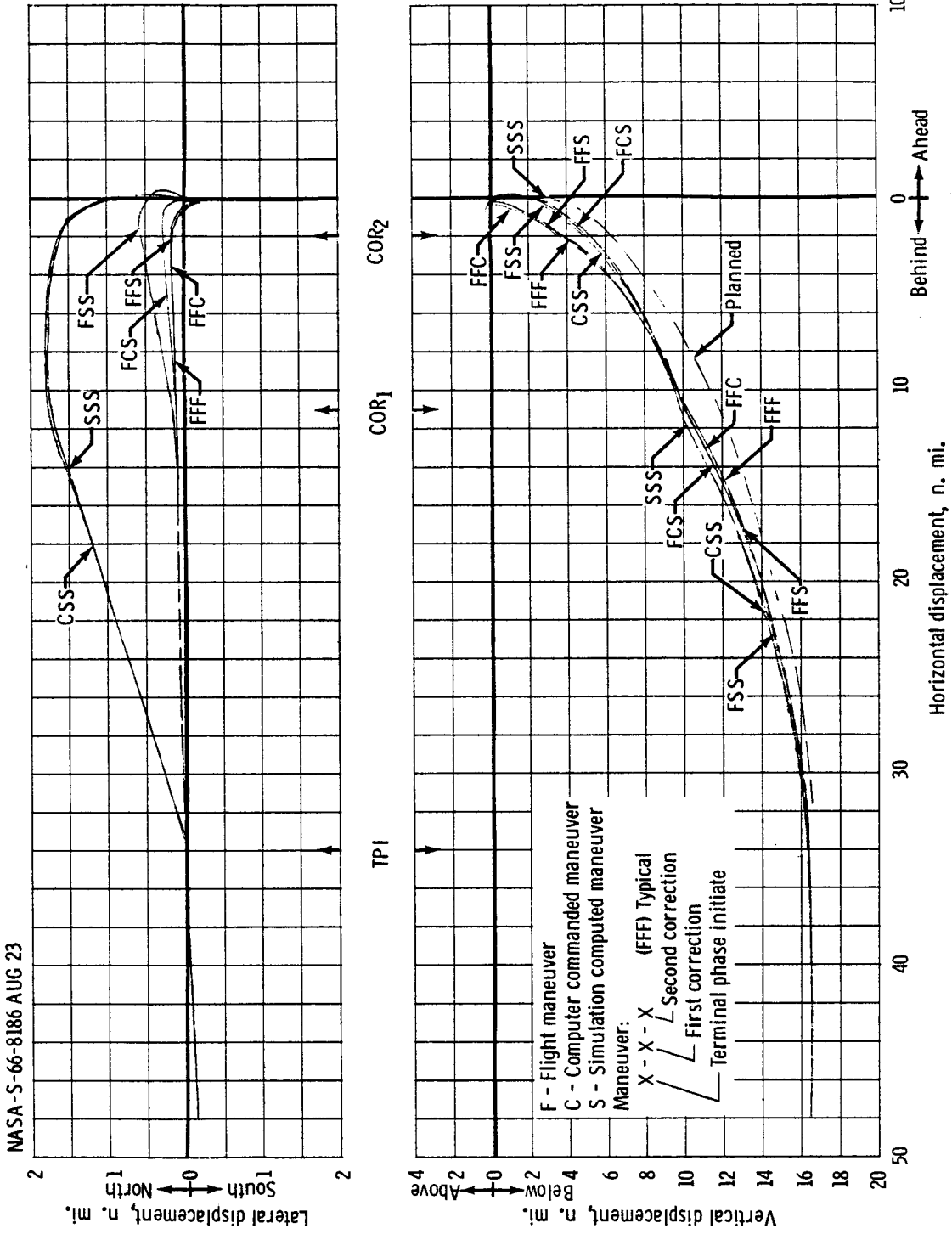

Figure 5.1.5-14. - First rendezvous simulations, with fixed platform misalignment.

NASA-S-66-8184 AUG 23

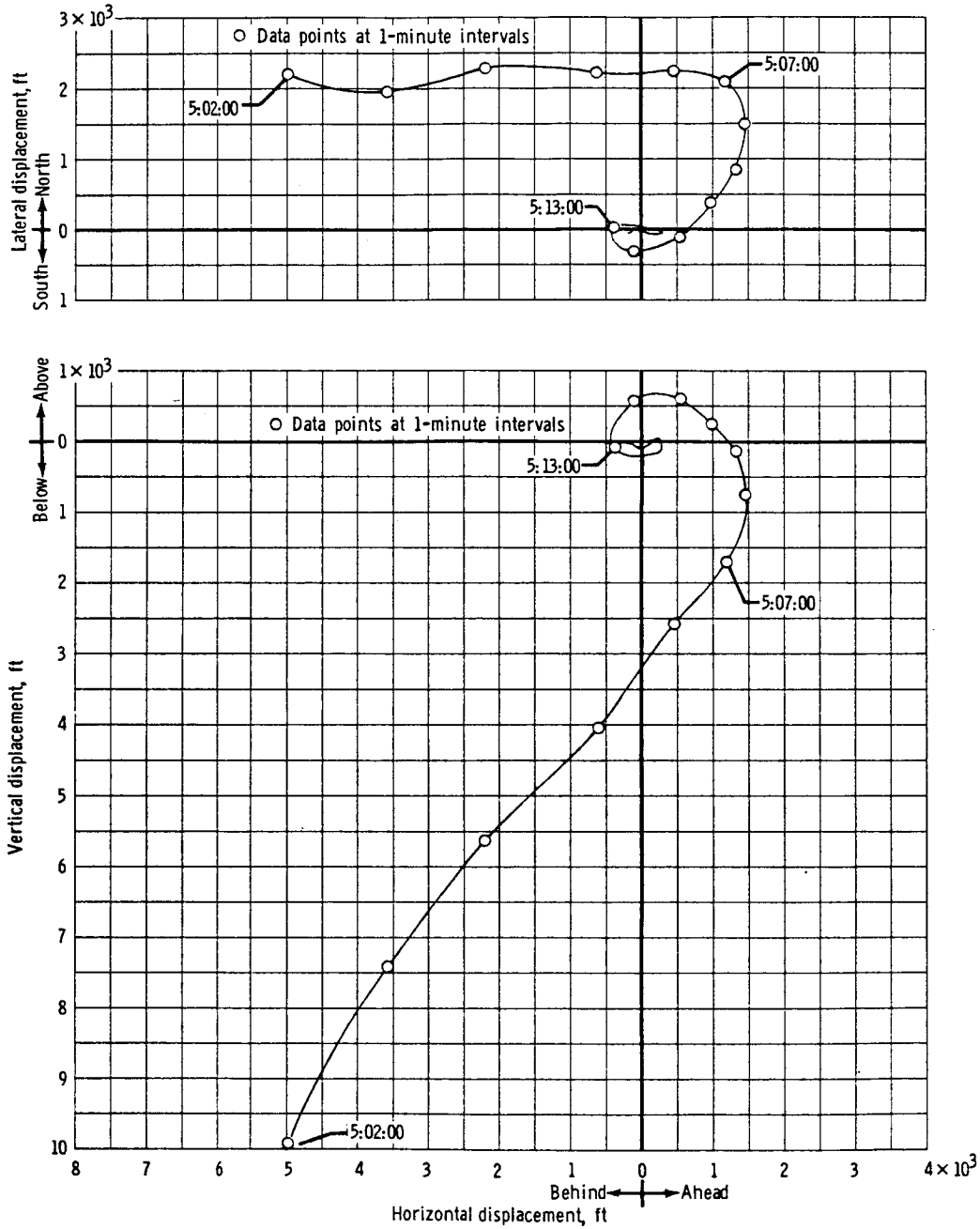

Figure 5.1.5-15. - First rendezvous final approach.

NASA-S-66-8183 AUG 23

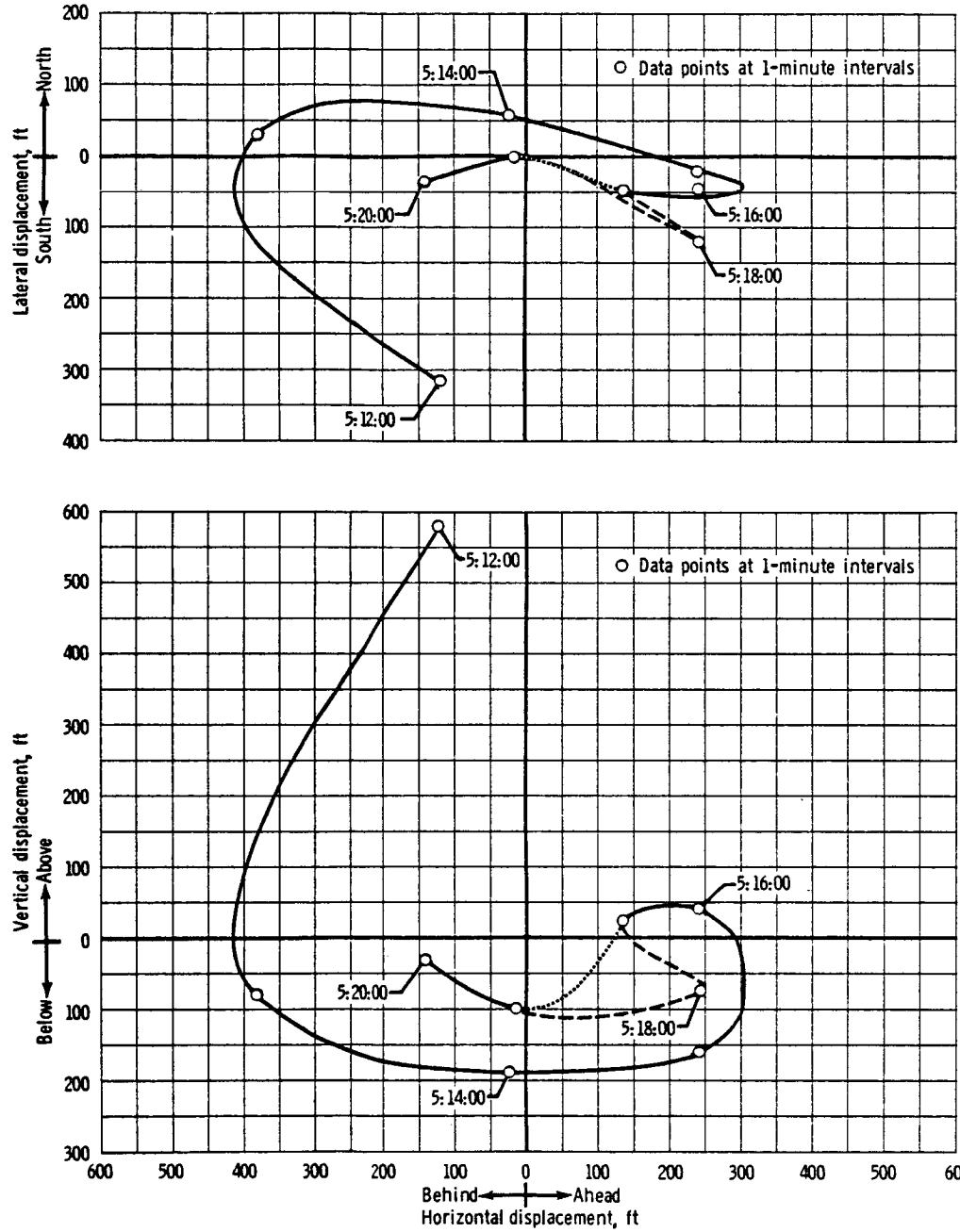

Figure 5.1.5-16. - First rendezvous final approach (expanded scale).

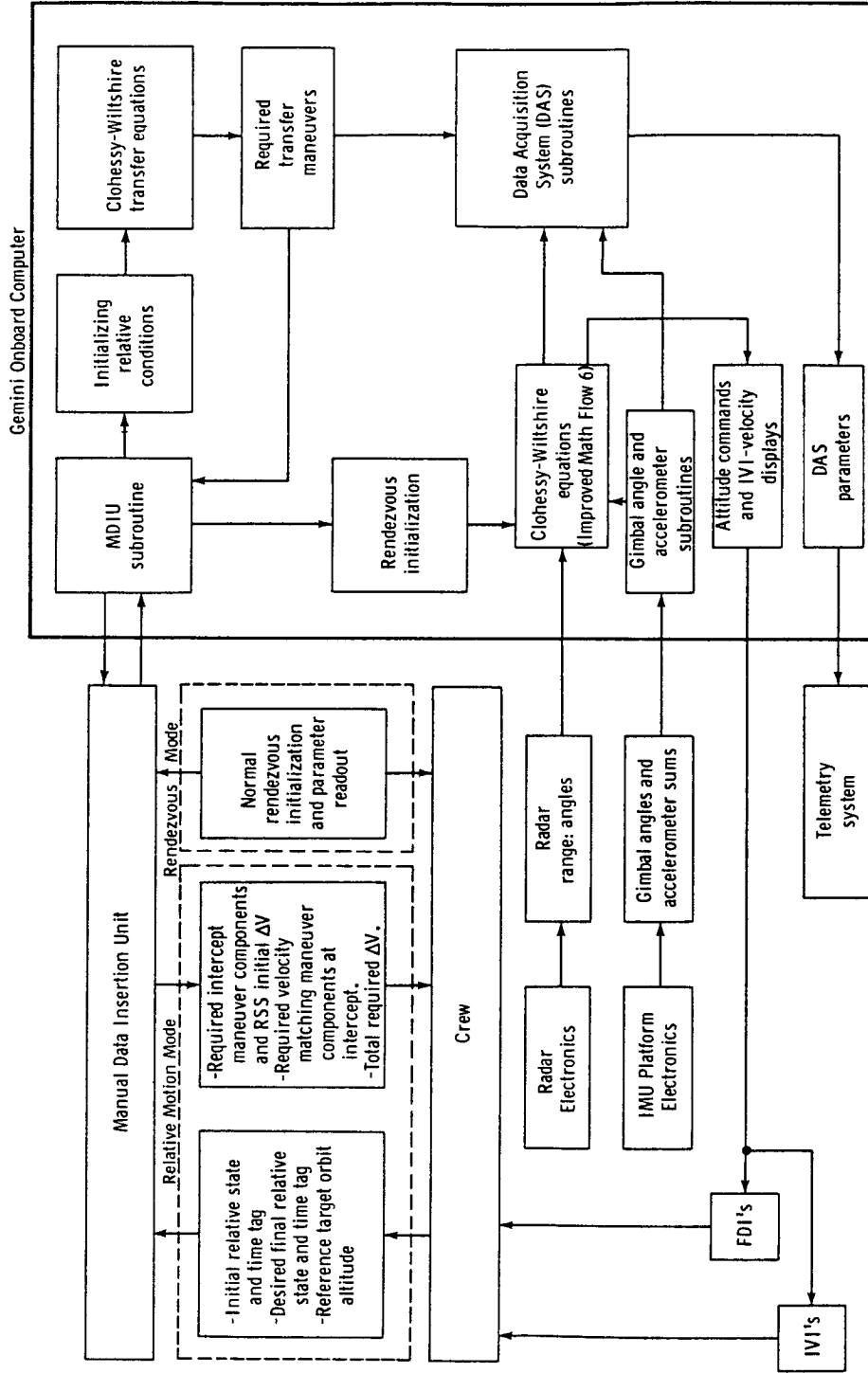

Figure 5.1.5-17. - Module III functional block diagram.

NASA-S-66-8175 AUG 19

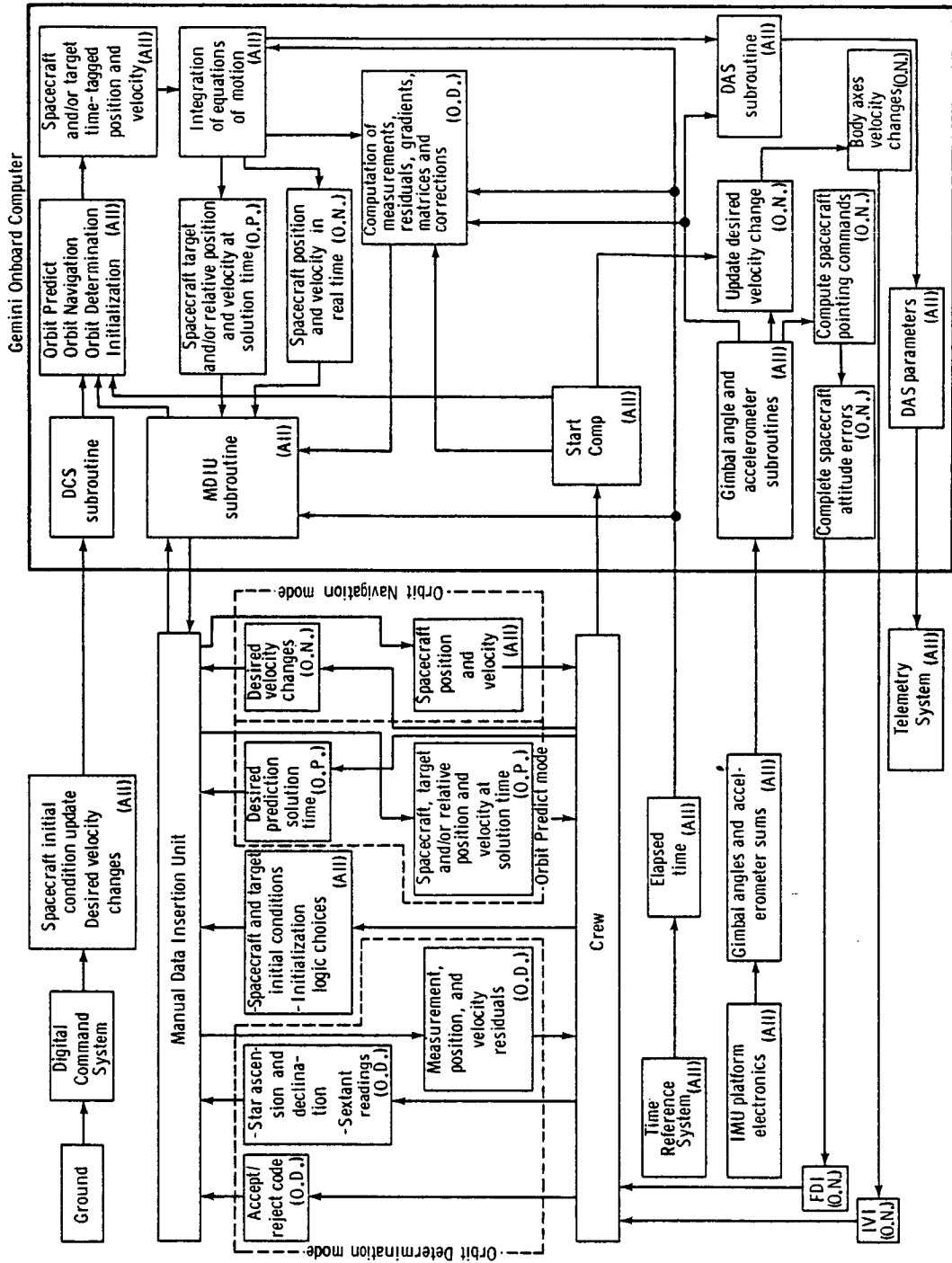

Figure 5.1.5-18. - Module VI functional block diagram.

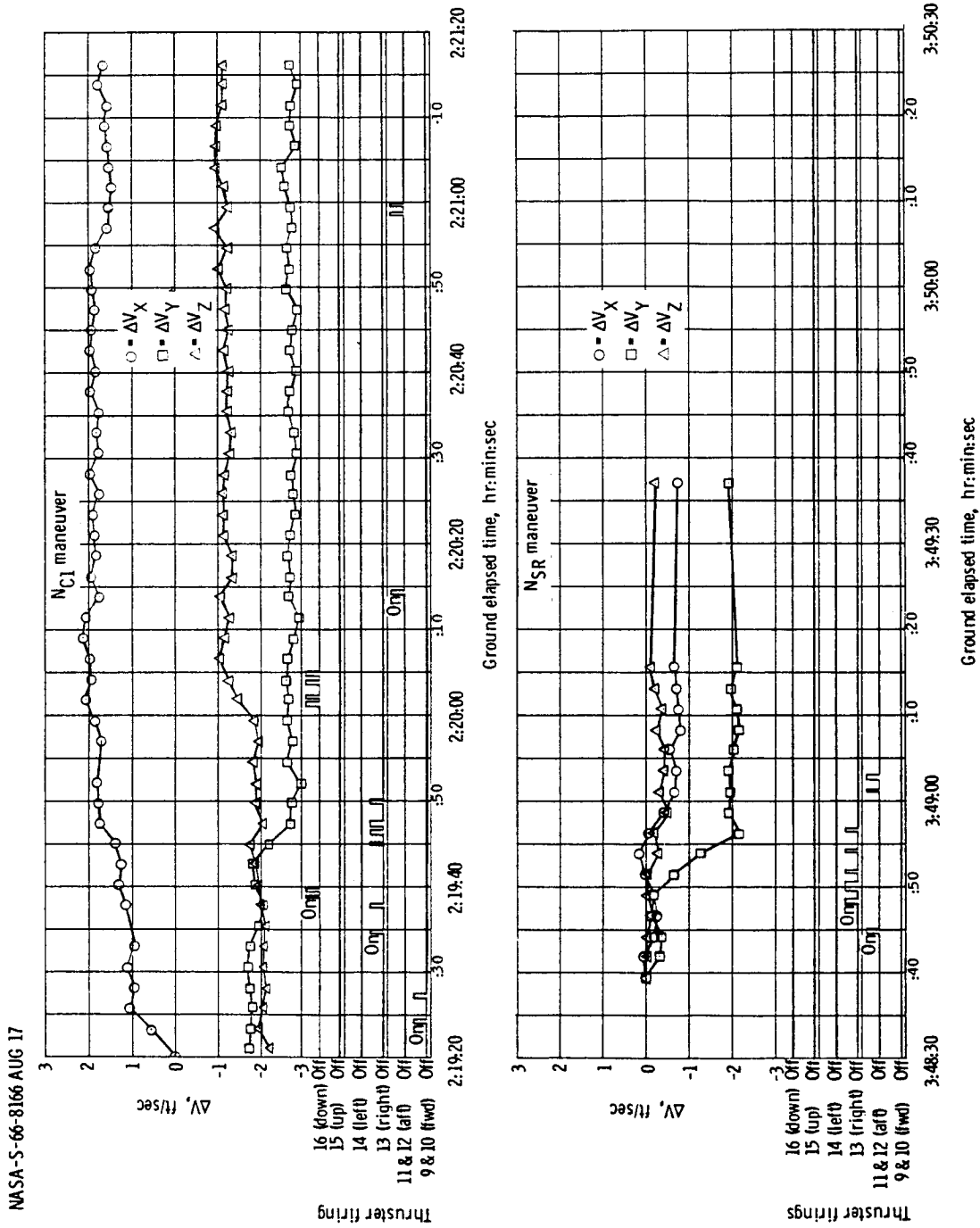

Figure 5.1.5-19. - Vernier correction comparison.

NASA-S-66-8089 AUG 10

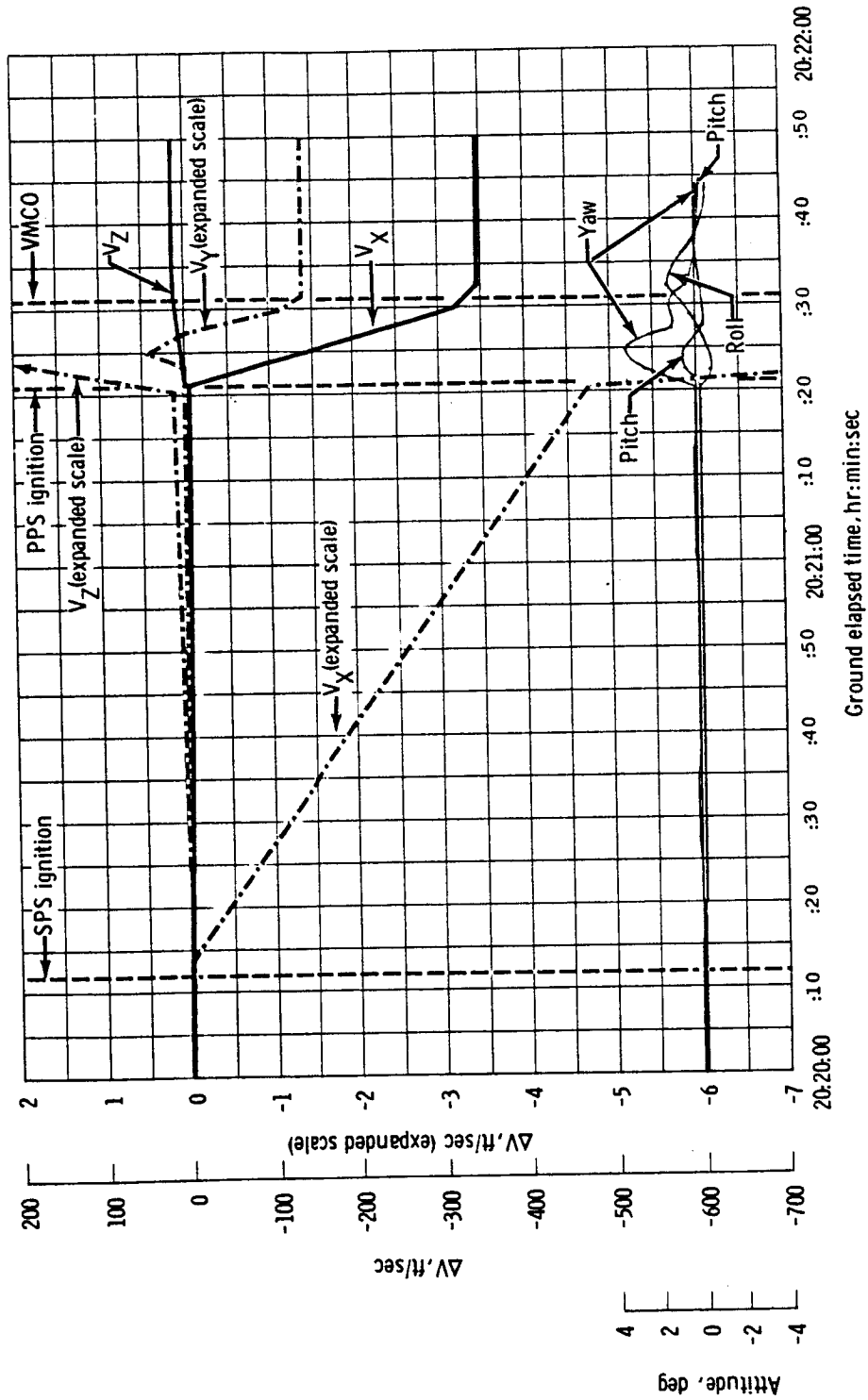
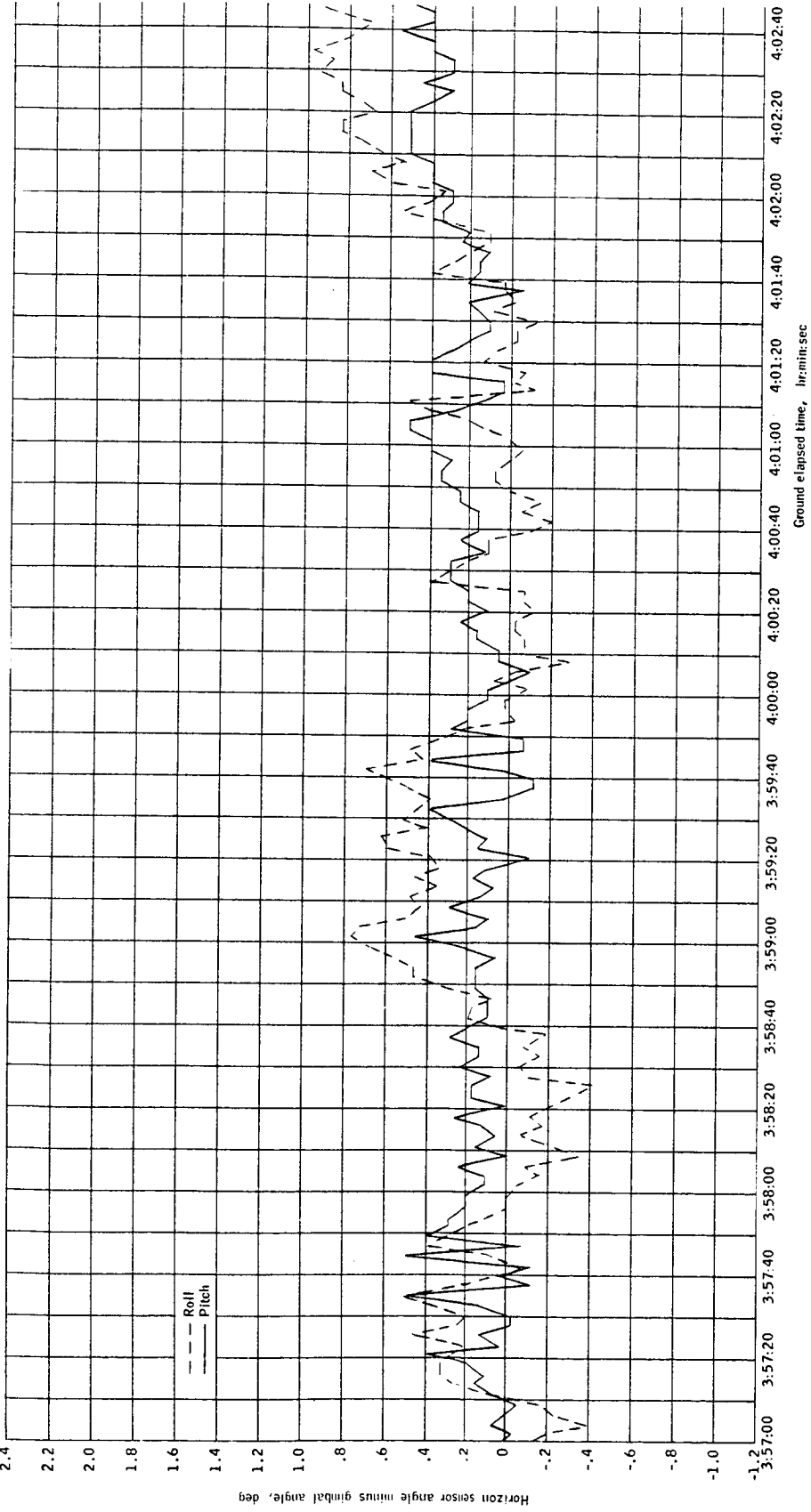

Figure 5.1.5-20. - Velocity changes during N_{CH2} PPS maneuver.

UNCLASSIFIED

5-78

NASA-S-66-8135 AUG 15



(a) 3:57:00 to 4:05:00 g.e.t.

Figure 5.1.5-21. -Platform alignment prior to TPI of the first rendezvous.

UNCLASSIFIED

5-78-11

5-78-0-

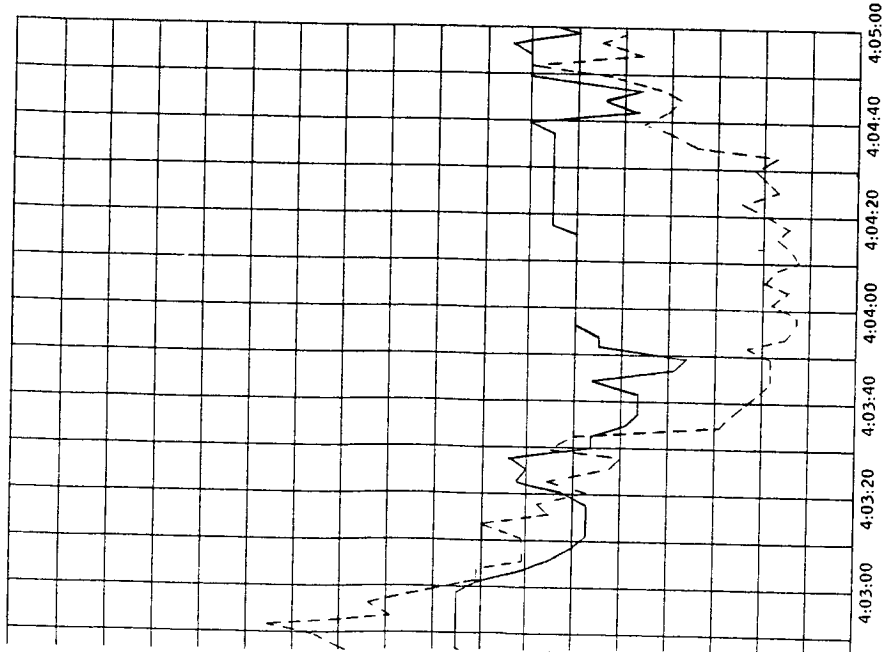

5-78-C

NASA-S-66-8136 AUG 15

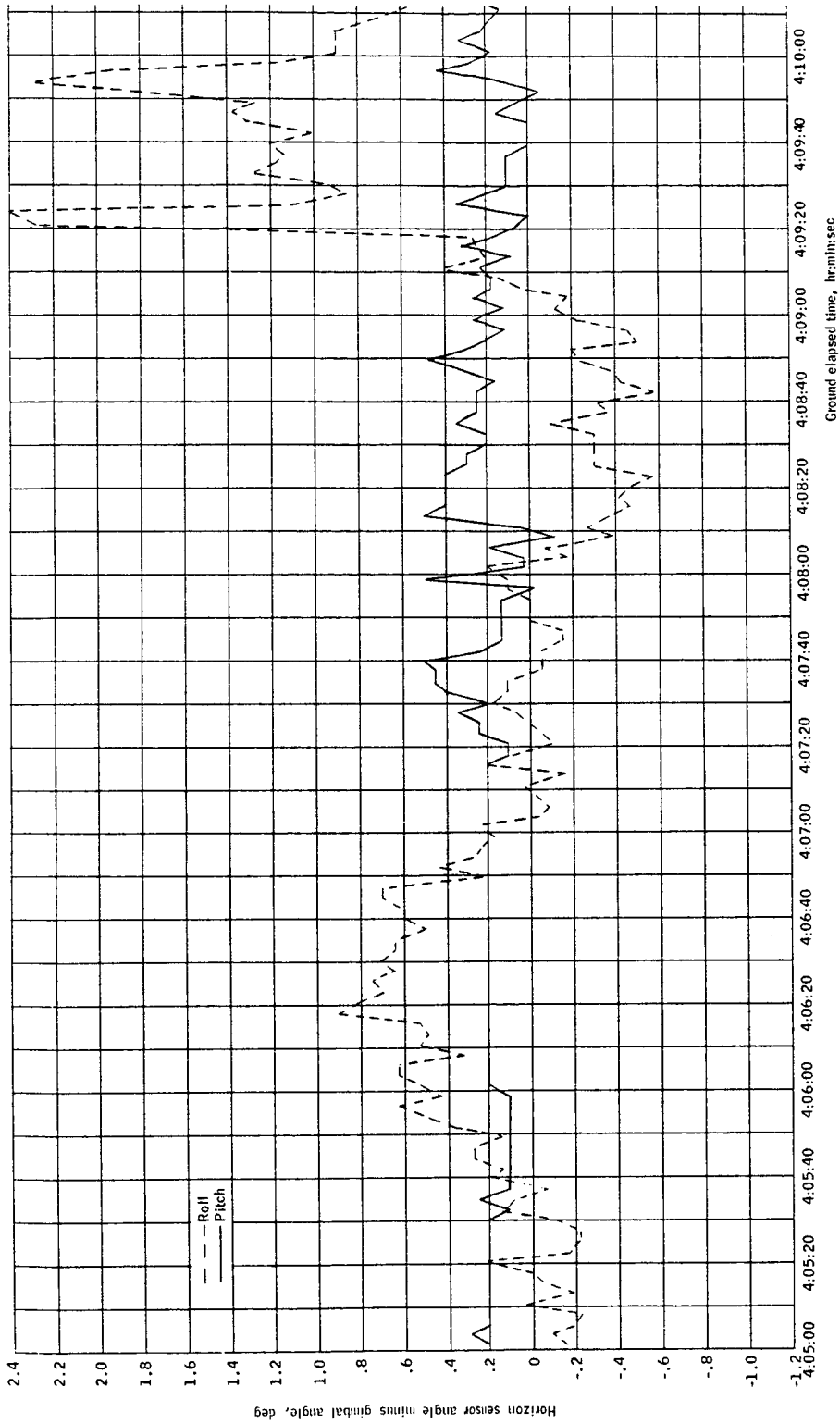

5-79-c

5-79-d

UNCLASSIFIED

5-79

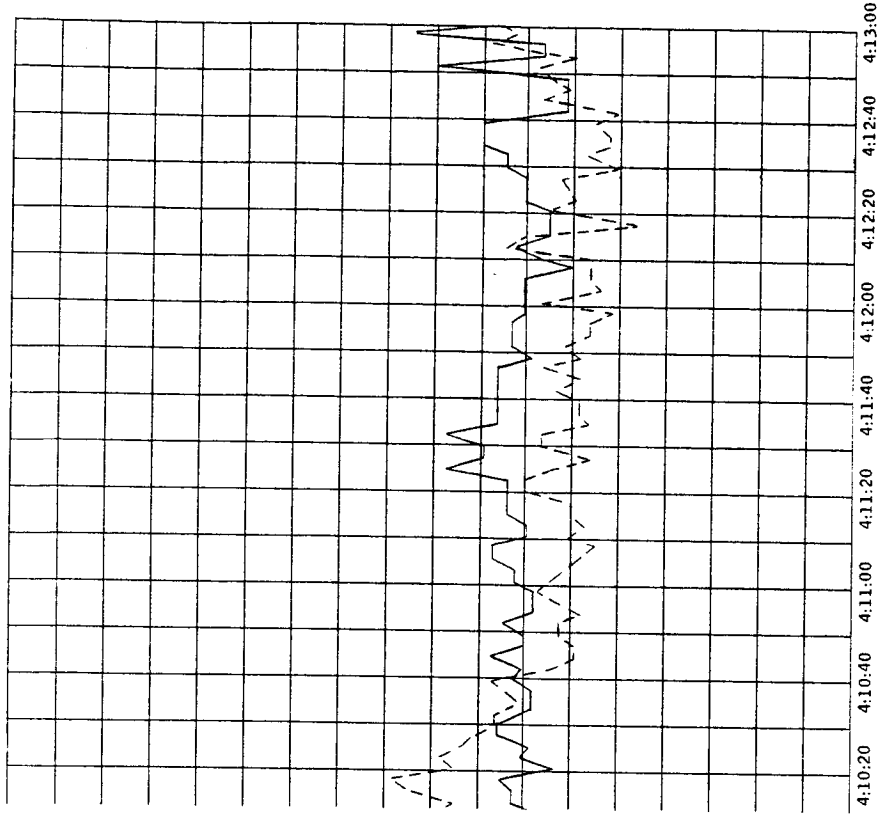

(b) 4:05:00 to 4:13:00 g.e.t.

5-79-C

Figure 5.1.5-21, - Concluded.

UNCLASSIFIED

NASA-S-66-8171 AUG 79

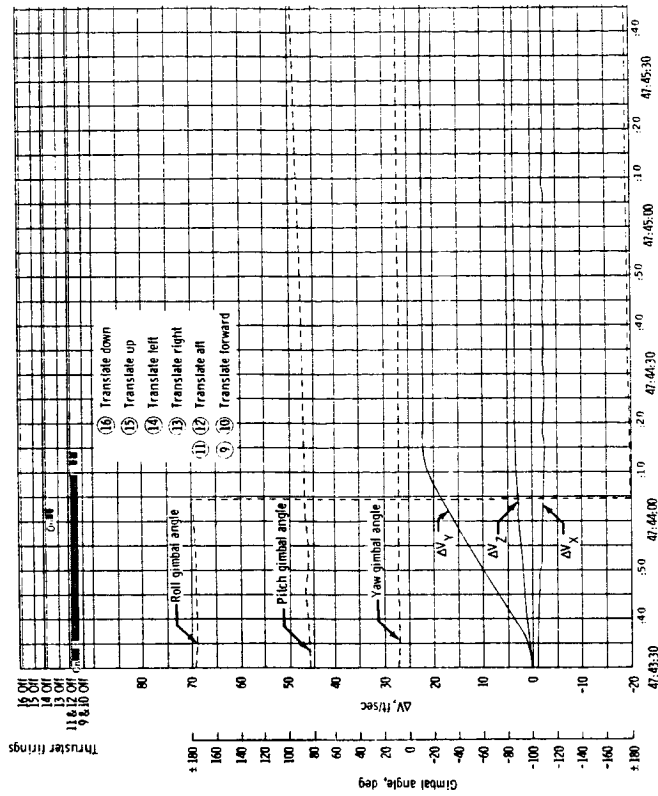

5-80-a

UNCLASSIFIED

5-80

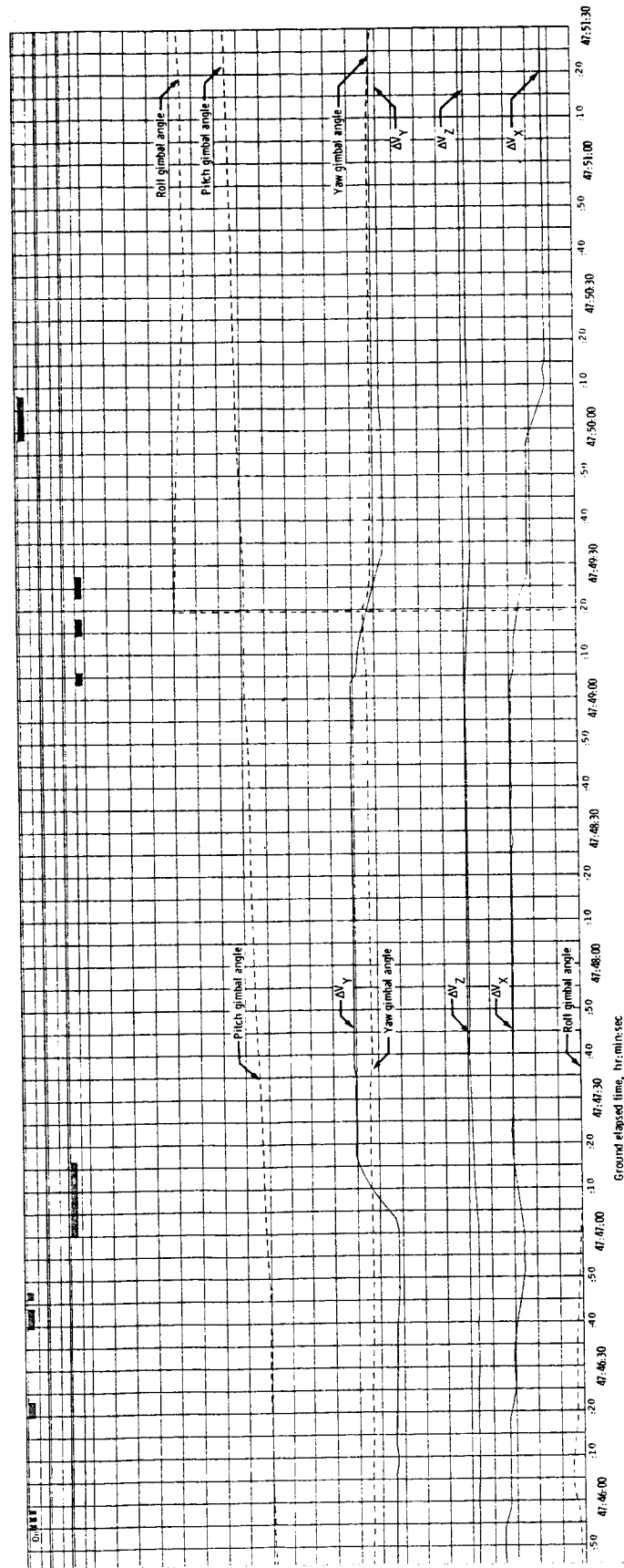

5-80 - C.

5-80 - 6

(a) 47:43:30 to 47:51:30, p.p.1.

Figure 5.1.5-22. - Braking maneuvers during second rendezvous.

UNCLASSIFIED

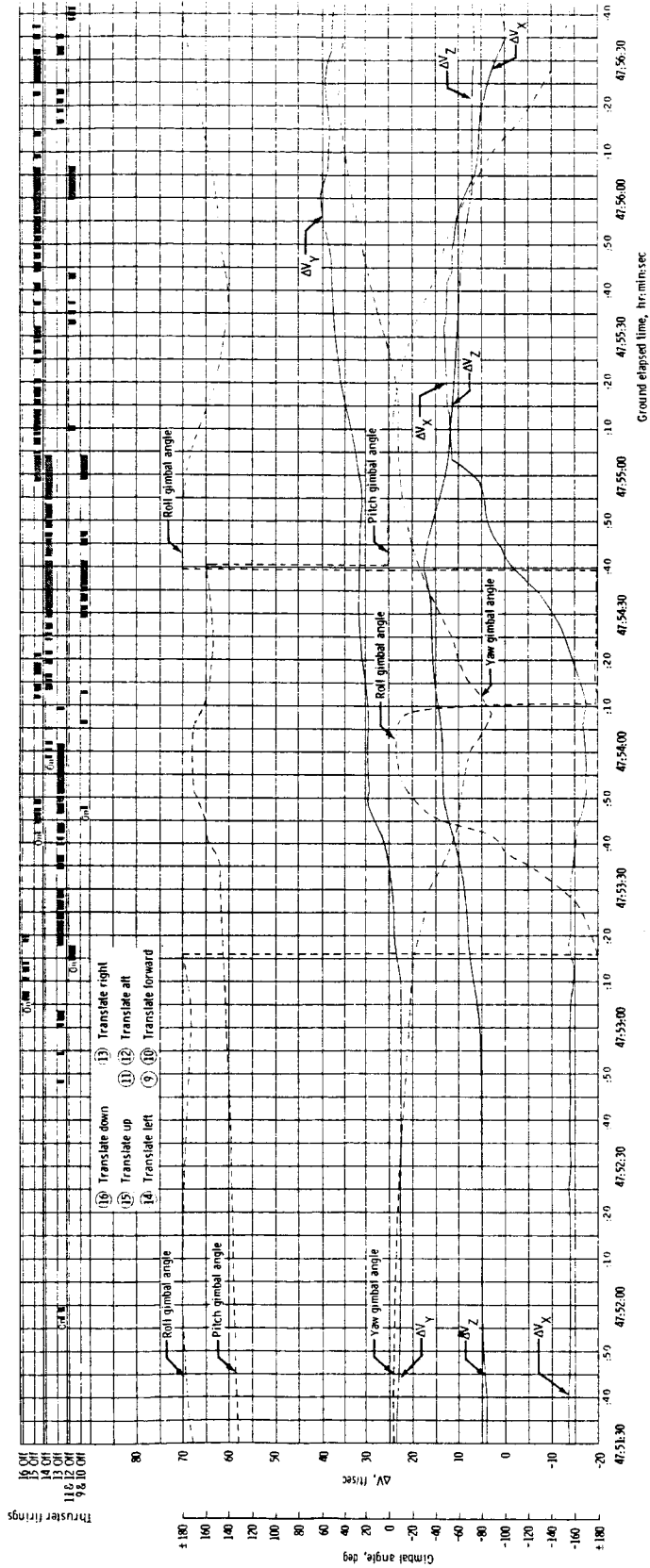

5-81-6

5-81-Q

UNCLASSIFIED

5-81

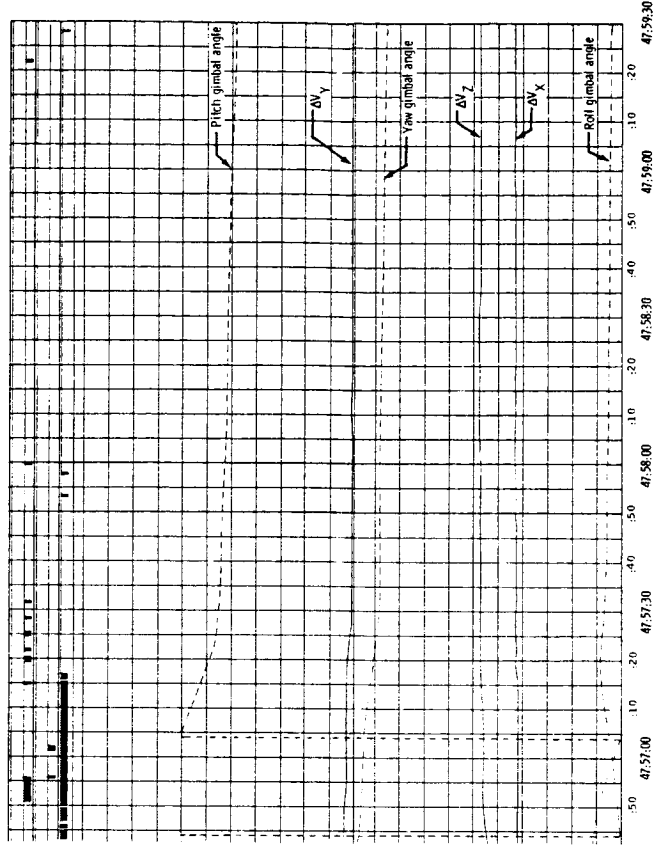

5-81-C

01 47:51:30 to 47:59:30 g-a.t.
Figure 5.1.5-22 - Concluded.

UNCLASSIFIED

UNCLASSIFIED

NASA-S-66-8085 AUG 9

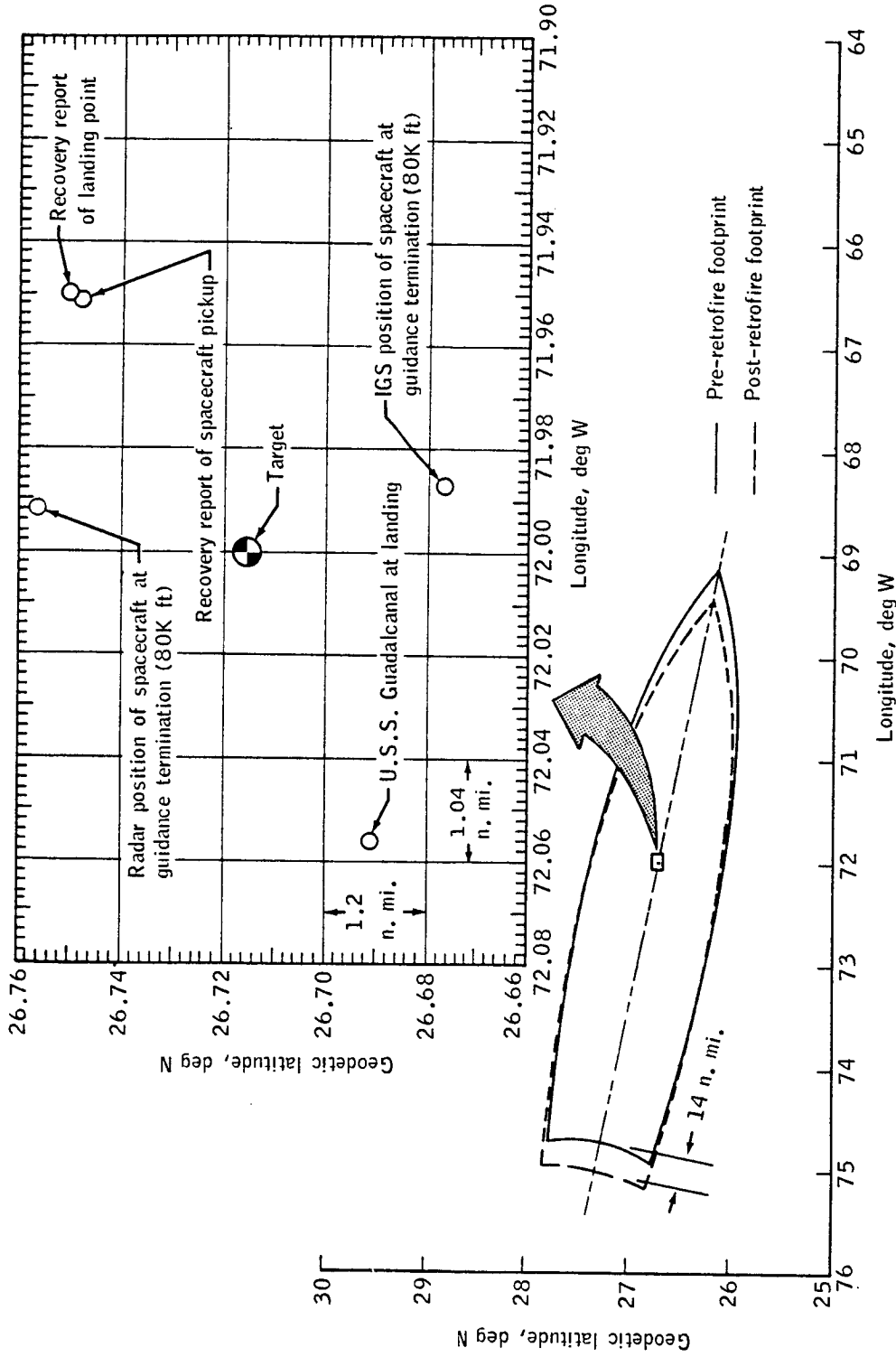

Figure 5.1.5-23. - Touchdown comparisons.

UNCLASSIFIED

NASA-S-66-8137 AUG 15

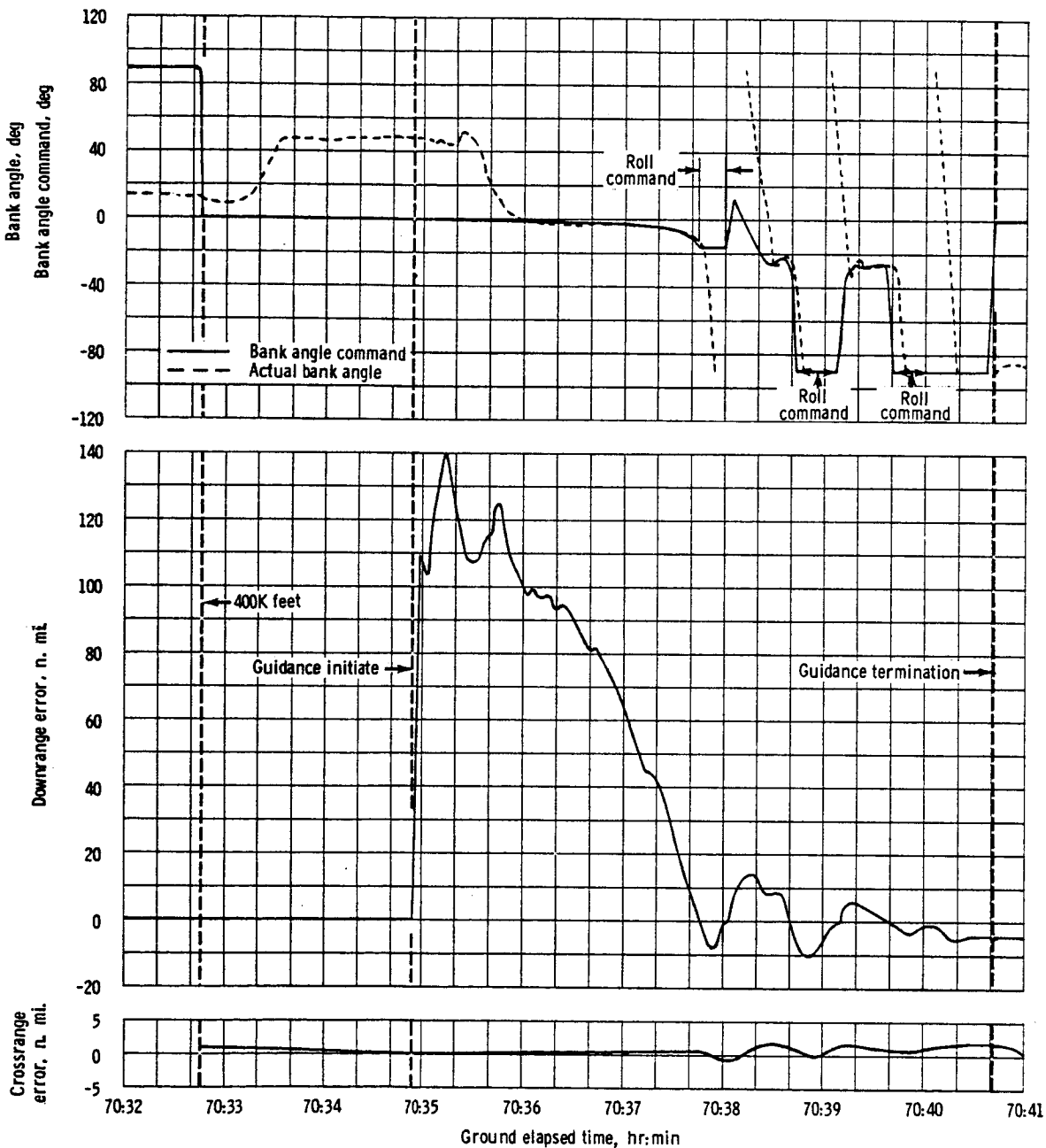
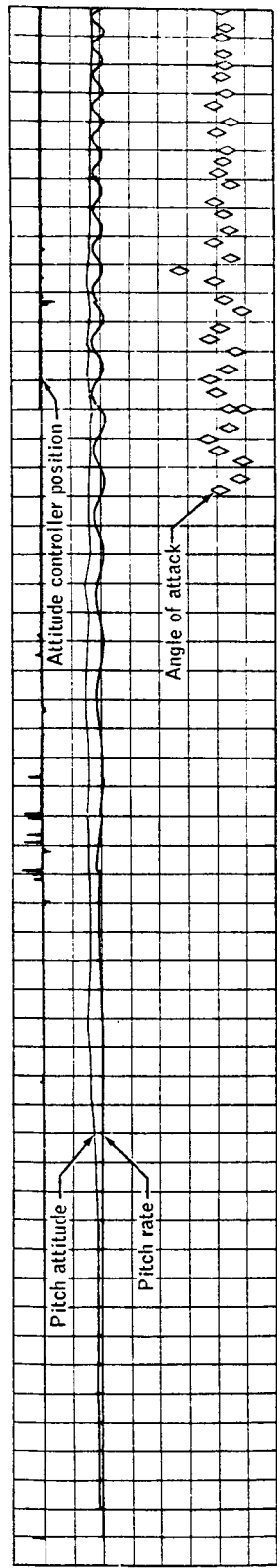

Figure 5.1.5-24. - Reentry guidance parameters.

CONFIDENTIAL

NASA-S-66-8149 AUG 15

Attitude controller position, deg



Attitude controller position, deg

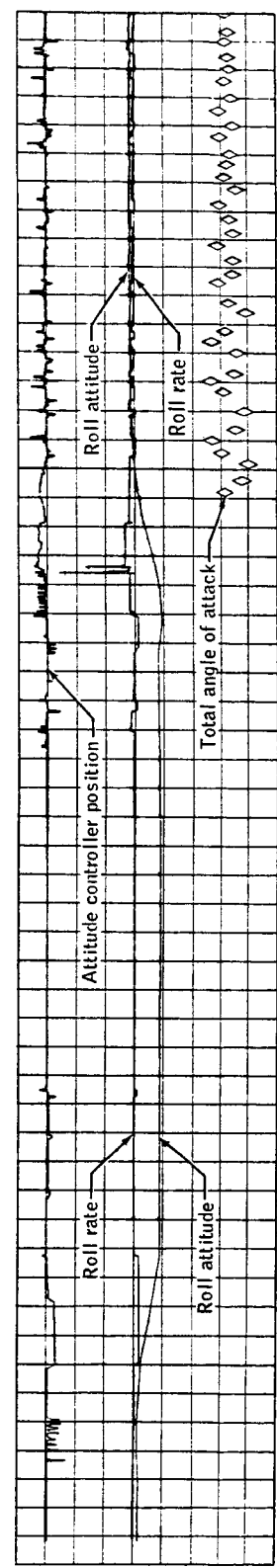

Attitude controller position, deg

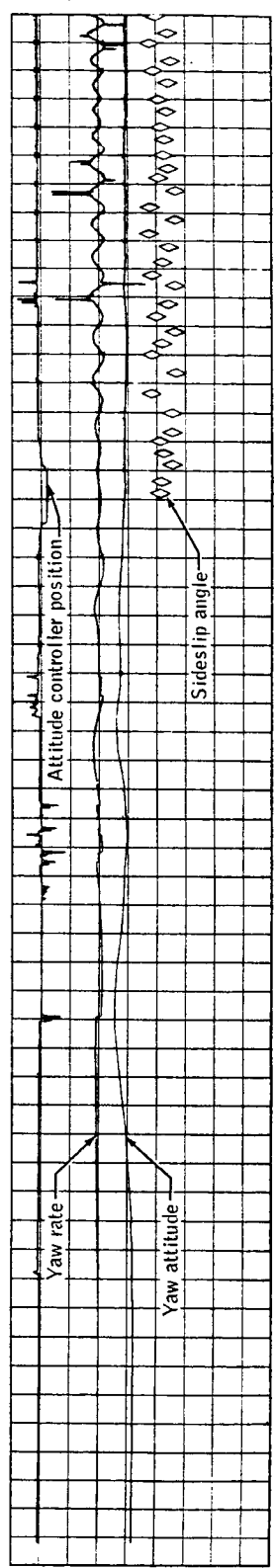

Ground elapsed time, hr:min:sec
70:32:40 70:33:00 70:34:00 70:35:00 70:36:00 70:37:00

(a) 70:32:40 to 70:37:10 g.e.t.
Figure 5.1.5-25. - Reentry Control System performance.

CONFIDENTIAL

~~CONFIDENTIAL~~

NASA-S-66-8150 AUG 15

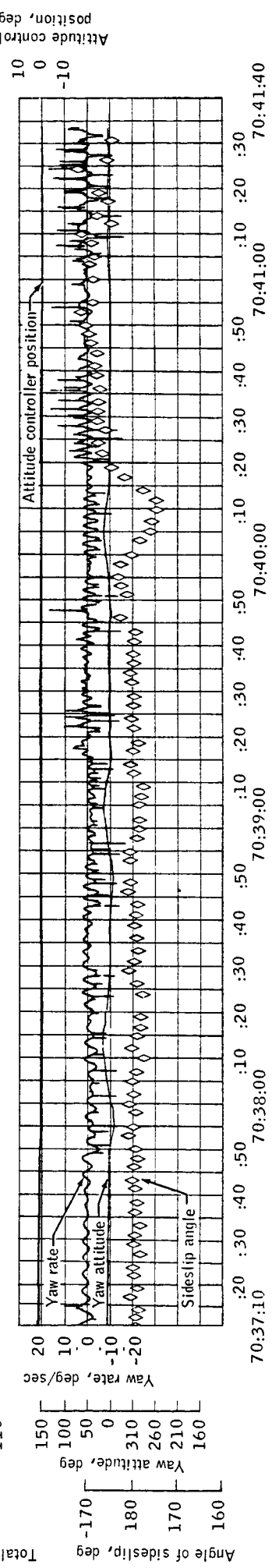
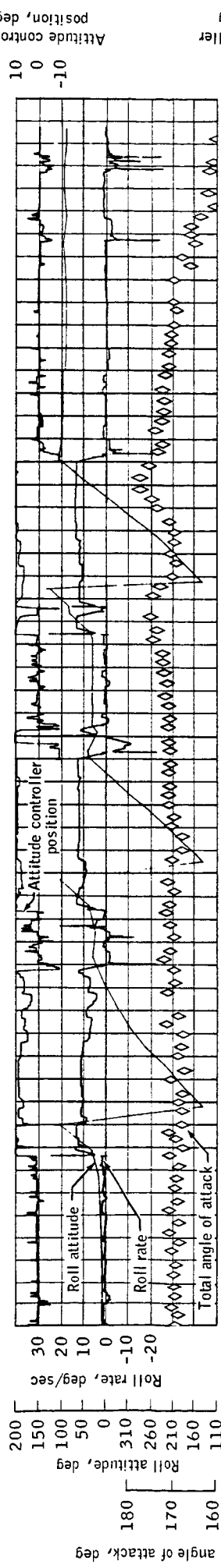
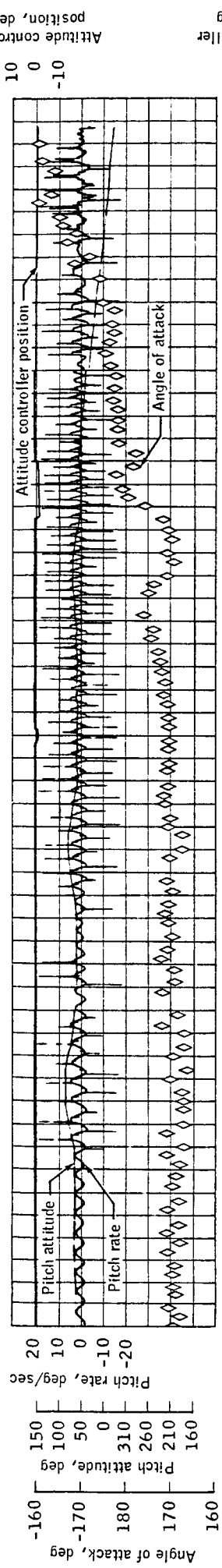

Ground elapsed time, hr:min:sec

(b) 70:37:10 to 70:41:40 g.e.t.
Figure 5.1.5-25. - Concluded.

~~CONFIDENTIAL~~

UNCLASSIFIED

5.1.6 Time Reference System

Analysis of data indicates that all components of the Time Reference System (TRS) performed according to specification. The electronic timer began counting elapsed time approximately 33 milliseconds after lift-off. Maximum error during the first 242 767 seconds (67:26:07 g.e.t.) of flight was 206 milliseconds, or 0.84 parts per million, which is well within the specification requirement of 10 parts per million at $25^{\circ} \pm 10^{\circ}$ C. In addition, the electronic timer successfully initiated the automatic retrofire sequence at 70:10:24 g.e.t.

The event timer was reported to be 1.5 seconds late at the Carnarvon station during the first revolution. The flight crew reported that the elapsed-time digital clock was inadvertently turned off twice during the mission and that it was difficult to get a time check in order to restart the clock. During the recovery sequence, the two G.m.t. clocks in the spacecraft were compared with the G.m.t. clock on the prime recovery ship; the battery-operated clock showed no error, but the mechanical clock was running approximately one minute fast. Satisfactory timing on the tapes from the biomedical and voice tape recorders indicated normal operation of the time correlation buffer.

5.1.7 Electrical System

The Electrical System performed in a satisfactory manner throughout the mission. The performance of the fuel-cell power system was excellent, and the fuel cells supplied peak spacecraft electrical loads that were higher than those supplied on any previous mission.

5.1.7.1 Silver-zinc batteries.- The main-bus and squib-bus batteries performed satisfactorily during the mission. Performance data obtained during the inflight battery tests correlated very well with the performance of the batteries during the mission. A modified test procedure allowed sufficient test time under load to permit battery stabilization, and a more accurate measure of the condition of the batteries was achieved.

5.1.7.2 Fuel-cell power system.- The fuel-cell power system performed as required in delivering electrical power to the spacecraft systems. The fuel cells supplied approximately 2260 ampere-hours during the mission. The electrical load ranged between 13 amperes (spacecraft powered down) and 62 amperes (all equipment on), as shown in figure 5.1.7-1. The ampere-hours delivered and the total operating time under sustained high loads were approximately equal to the ampere-hours and operating time experienced during the Gemini IX-A mission; however,

UNCLASSIFIED

the use of a manually operated cryogenic oxygen heater resulted in higher peak loads than had been experienced during any previous mission.

The first and second fuel-cell activations were performed on June 14 and July 17, 1966, respectively. Figure 5.1.7-2 shows the performance achieved by both sections at second activation. These performances were within the range achieved previously by sections that had experienced similar storage periods after initial activation. Similarly, the decrease in performance of both sections while in standby operation (between second activation and operation during the final countdown) was consistent with previous flight sections. Unlike previous missions, however, no decrease of inflight performance of either section was readily discernible. Out-of-tolerance differential pressure indications were not observed except during the launch period (as expected) and during the docked GATV primary propulsion system maneuvers. Load sharing, between sections (fig. 5.1.7-3) and between stacks within each section (fig. 5.1.7-4), was within the narrow ranges previously experienced.

5.1.7.3 Reactant supply system.- The reactant supply system operated normally throughout the mission. The oxygen container was serviced with 115.7 pounds of oxygen and contained 106.6 pounds at lift-off. The oxygen quantity remaining at retrofire was 21.4 pounds. The hydrogen container was serviced with 8.3 pounds of hydrogen and contained 7.5 pounds at lift-off. The hydrogen quantity remaining at retrofire was 1.2 pounds. The hydrogen-container pinch-off-tube cutter was actuated at 67 hours 28 minutes g.e.t. with no adverse effect (see ref. 10, section 5.1.7).

5.1.7.4 Power distribution system.- At approximately 1 hour 30 minutes g.e.t., hydrogen pressure dropped to an abnormal level. A check by the crew revealed that the cryogenics heater circuit breaker was open. When it was closed, the hydrogen pressure returned to normal. There were no other instances in which this circuit breaker was found open. Examination of the main bus currents has revealed no excessive currents which could have caused the breaker to open. It is concluded that the breaker was inadvertently opened by one of the crew during a period of high activity.

Prior to landing, the main bus was powered down to approximately 8.2 amperes. Approximately 40 seconds after landing, a rapid rise in the current occurred. The current drain continued to oscillate between the values of 12.3 amperes and 26.0 amperes until the end of the data when the recorder was turned off. A similar sequence occurred during the Gemini V mission when the main bus current at landing was also 8.2 amperes and a rapid current rise occurred approximately 25 seconds later. In that case, the current drain after landing oscillated between

UNCLASSIFIED

12.8 and 37.9 amperes. These two missions are the only missions for which data were recorded longer than 25 seconds after landing, the earliest this phenomenon has been noted.

5.1.7.5 Sequential system.- The performance of the sequential system was nominal, as indicated in tables 4-I and 4-II.

UNCLASSIFIED

UNCLASSIFIED

5-89

NASA-S-66-8111 AUG 12

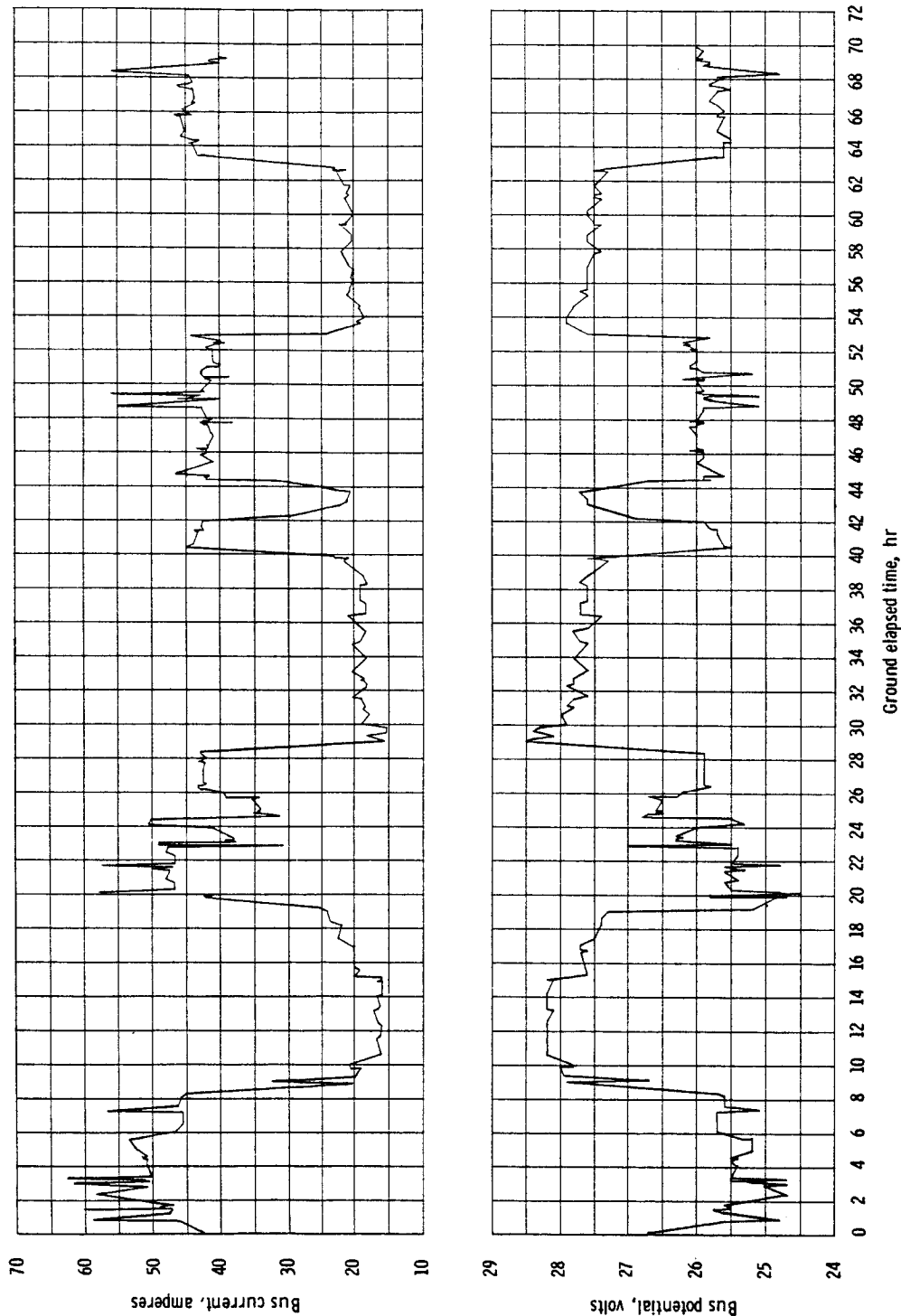

Figure 5.1.7-1. - Spacecraft 10 fuel-cell performance.

UNCLASSIFIED

UNCLASSIFIED

NASA-S-66-8093 AUG 10

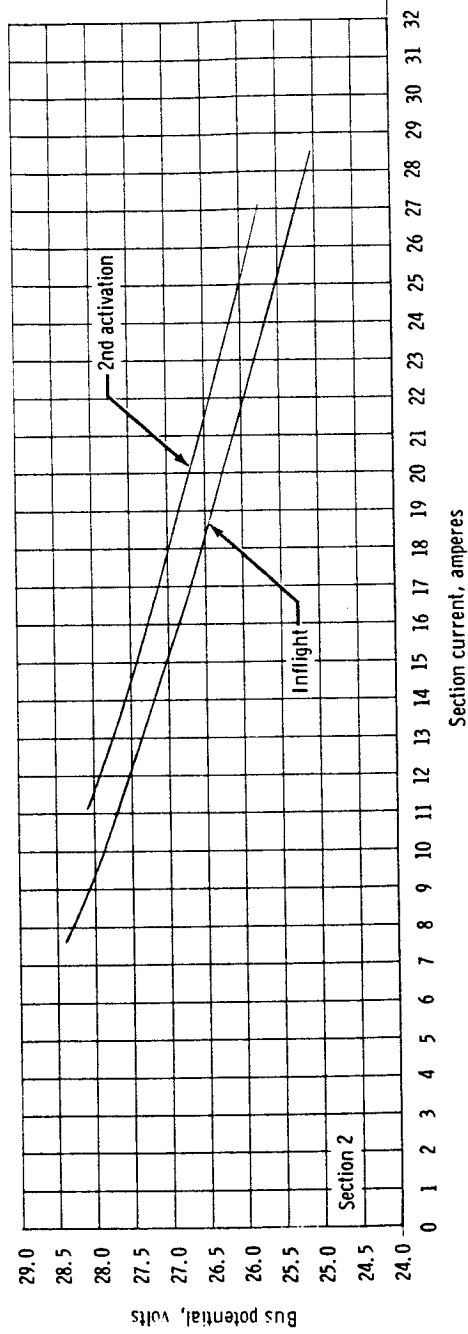
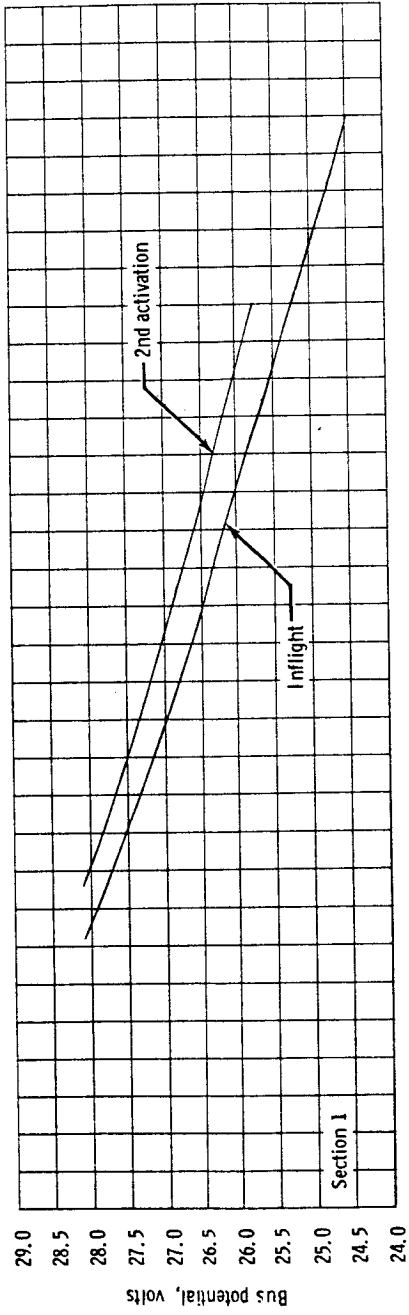

Figure 5.1.7-2. - Fuel-cell section 1 and 2 performance (uncorrected for temperature and pressure).

UNCLASSIFIED

NASA-S-66-8063 AUG 8

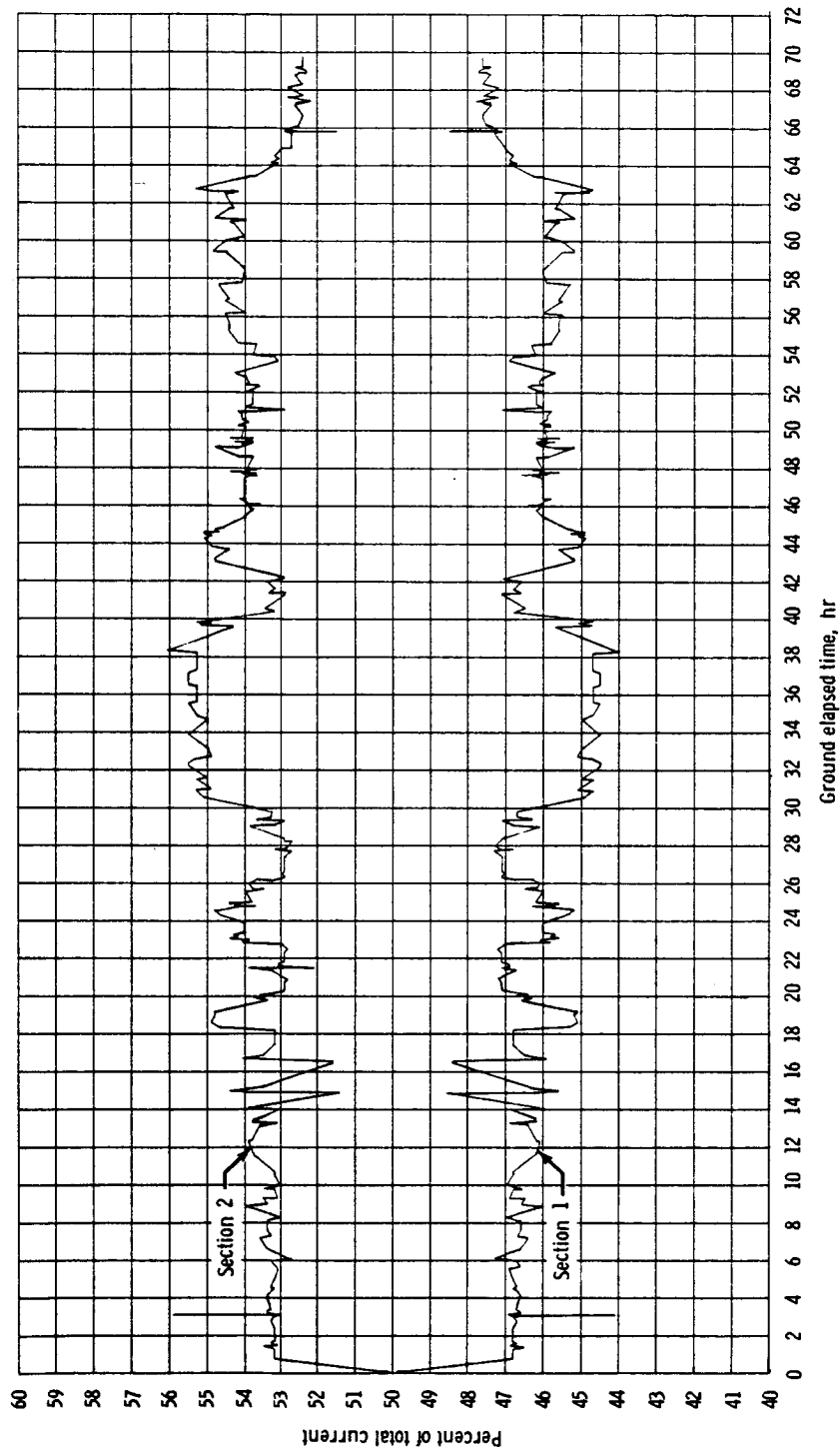

Figure 5.1.7-3. - Load sharing between fuel-cell sections.

UNCLASSIFIED

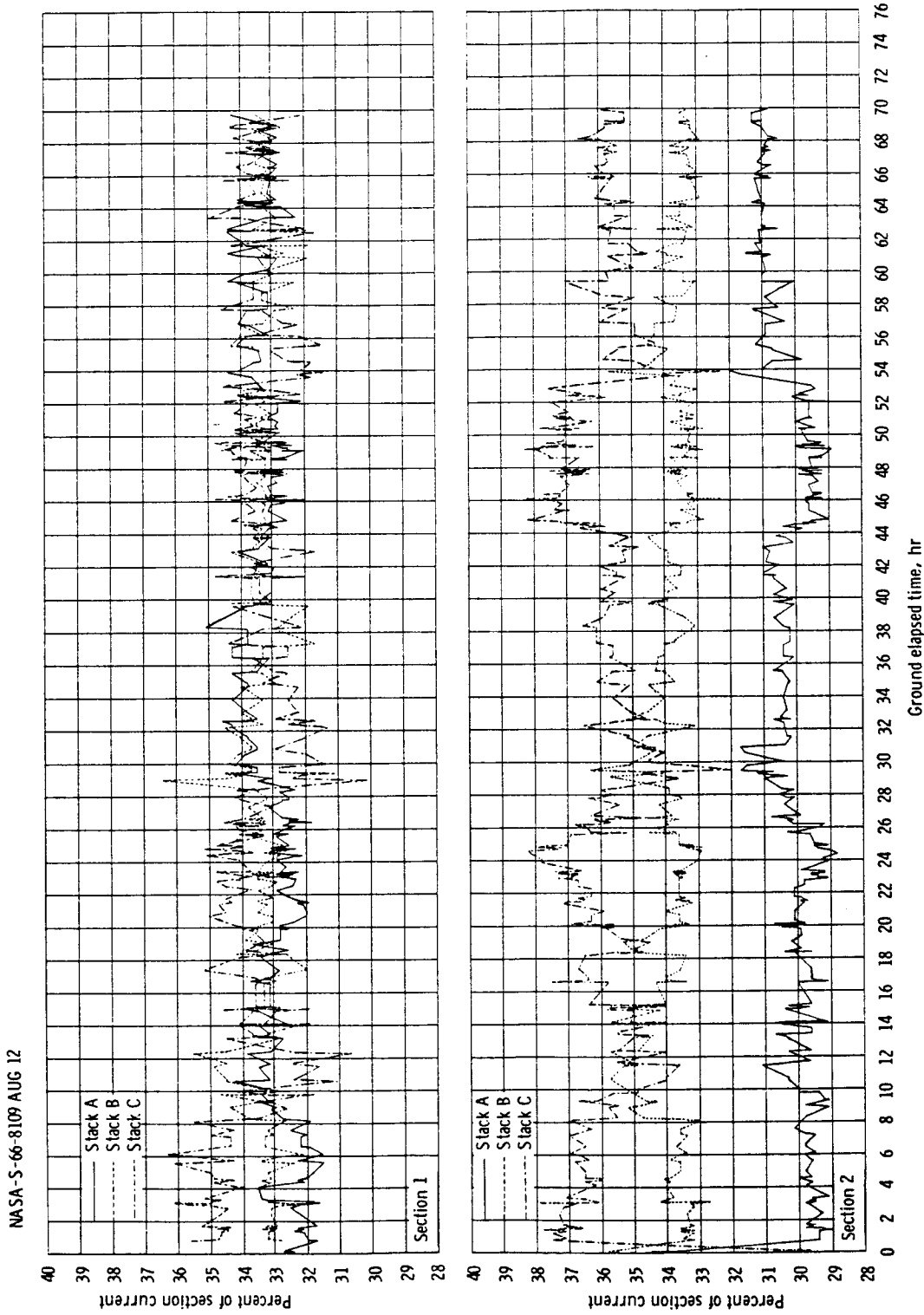

Figure 5.1.7-4. - Load sharing between fuel-cell stacks.

UNCLASSIFIED

UNCLASSIFIED

5-93

5.1.8 Spacecraft Propulsion System

Flight performances of the Orbital Attitude and Maneuver System (OAMS), the Reentry Control System, and the Retrograde Rocket System were, in general, satisfactory. There were several periods of time during which the performance of individual components did not fall within specification boundaries, but these slight deviations were not noticed by the crew and did not detract from overall system performance.

The excessive consumption of OAMS propellant relative to planned estimates was a normal response to the demands placed upon the system. The actual propellant consumption rate during the mission is compared with the preflight estimate in figure 5.1.8-1. The importance of the increased propellant quantity onboard Spacecraft 10 toward the attainment of mission objectives is readily apparent in the figure. The second rendezvous and the umbilical EVA could not have been accomplished without the additional propellant that was made available as a result of the change in tank configuration (see section 3.1).

UNCLASSIFIED

UNCLASSIFIED

NASA-S-66-8093 AUG 11

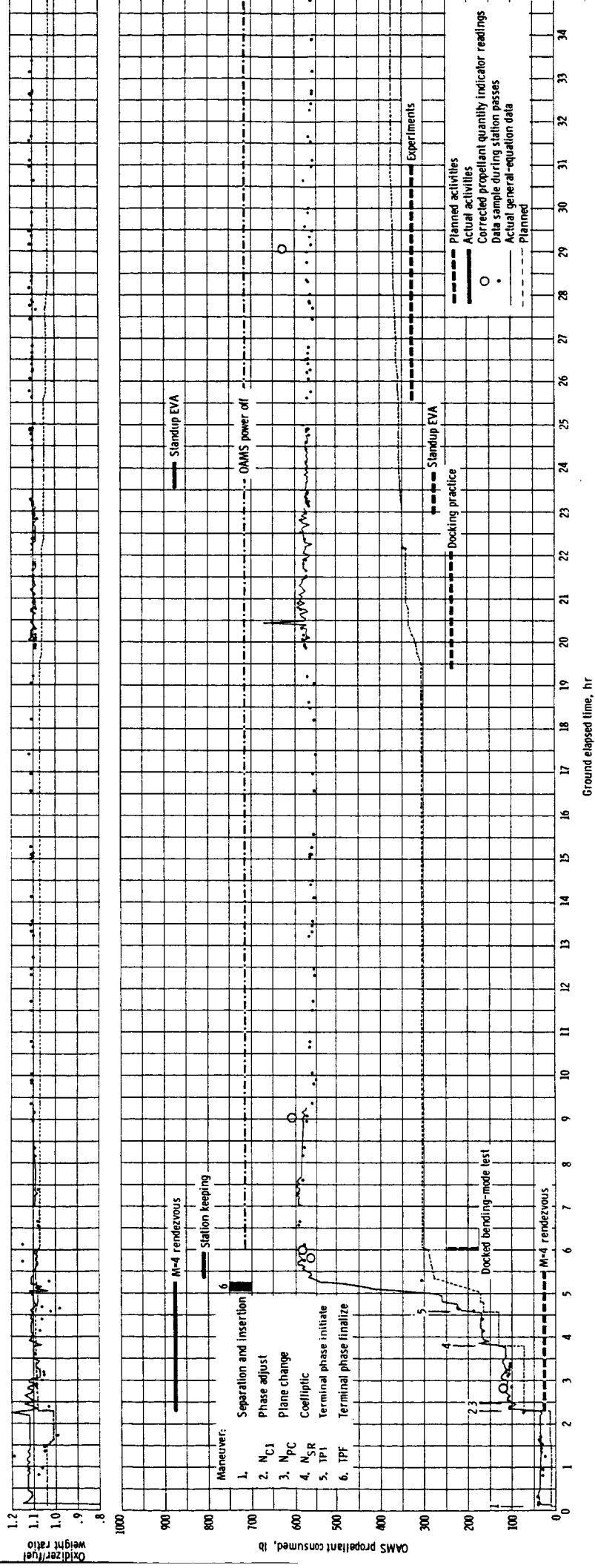

(a) 0 to 35 hours g.e.t.
Figure 5.1.8-1. - OAMS propellant consumption, 5-74-a

UNCLASSIFIED

5-75-b

5-75-c

UNCLASSIFIED

5-9

NASA-S-66-8094 AUG 11

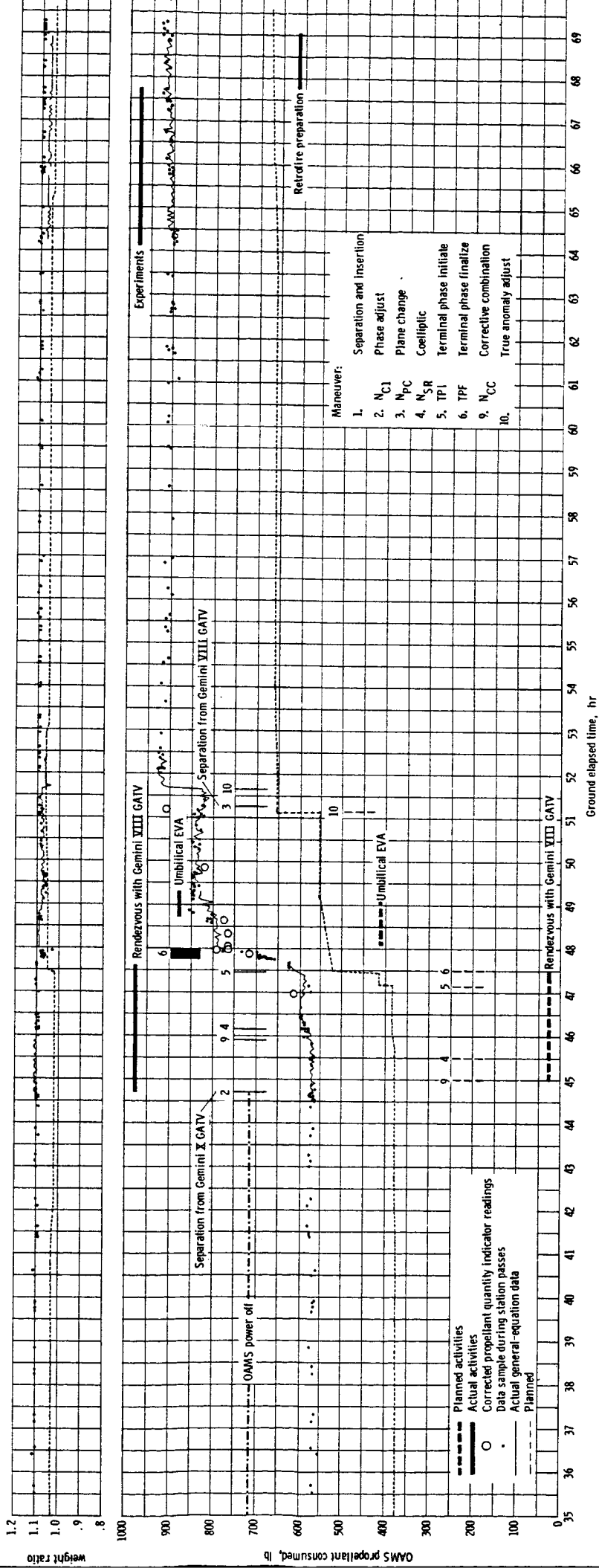

5-95-2

5-95-2

5-95-2

(b) 35 to 70 hours g.e.t.
Figure 5.1.8-1. - Concluded.

UNCLASSIFIED

5-95-C

UNCLASSIFIED

5.1.9 Pyrotechnics

All pyrotechnic functions were satisfactorily performed.

5.1.10 Crew Station Furnishings and Equipment

5.1.10.1 Crew station design and layout.-- The overall design of the crew station was satisfactory for the Gemini X mission. Minor discrepancies are discussed in the following paragraphs.

5.1.10.1.1 Displays and controls: The displays and controls functioned normally for this mission. The command pilot reported objectionable parallax in the propellant quantity indicator. He stated that reading the gage was particularly difficult in a pressurized suit because he was unable to move his head down in front of the gage to eliminate the parallax. Because of the convex face on the instrument, the parallax was much larger at the low end of the scale, where the readings were more critical.

The crew reported that several switches were turned off unintentionally during EVA preparation and also during ingress after EVA. This condition was primarily the result of difficulties encountered in handling the 50-foot umbilical. No significant problems resulted from the inadvertent switch operation.

5.1.10.1.2 Equipment stowage: Equipment stowage provisions were satisfactory for the mission except that the stowage of the 50-foot EVA umbilical in the left-hand footwell restricted the mobility of the command pilot during the first day. This condition became less objectionable as the flight progressed. The crew experienced difficulty during ingress at the conclusion of the umbilical EVA because of the length and bulk of the umbilical, but they were able to restow the umbilical in the stowage bag and jettison the equipment as planned. Paragraph 5.1.10.5.2 presents a detailed discussion of this problem.

5.1.10.1.3 Lighting: The interior cabin lighting was satisfactory with two minor exceptions. The crew reported that the water management panel lighting was poor. This condition has been reported previously; however, because of the infrequent use of this panel, no change to the lighting is planned. Either the utility light or a penlight had to be used to illuminate the encoder, and no difficulty was encountered with this arrangement. The fingertip lights were used for reading cabin gages, particularly when one crewman was sleeping.

UNCLASSIFIED

When the pilot was unstowing the Extravehicular Life Support System (ELSS) during EVA preparation, the ELSS slid forward and struck the center bright light. The crew reported that a flash occurred and some broken parts came loose after the ELSS struck the light. Subsequent investigation showed that no parts were missing from the light but that its filament was broken. It is believed that the loose pieces were broken off the edge-lit display panel of the ELSS chestpack.

The external docking light was satisfactory for illuminating the target vehicle while station keeping on the dark side. The crew reported that this light illuminated the nose section of the spacecraft and the docking cone while docked.

5.1.10.1.4 Crew furnishings: The ejection seats were not used except for restraint and support of the crew. The ejection-control-mechanism safety pins were difficult to install after insertion of the spacecraft into orbit. The D-rings would not remain in the stowed position while the crew attempted to insert the safety pins. This condition increased the time required for this task.

5.1.10.2 Pilots' operational equipment.-

5.1.10.2.1 Optical sight: The optical sight reticle was compared with the radar boresight during the first rendezvous. The crew reported that when the radar pitch and yaw indicators were centered, the GATV appeared one-half degree off to the right of the reticle center. There was no readable error in pitch.

5.1.10.2.2 Sextants: The miniature hand-held sextant proved to be unsatisfactory for star-to-horizon measurements because of the limited field of view (8.33 degrees), and because of difficulty in seeing the horizon. The optics of the sextant split the light path so that 50 percent of the light from the star and 50 percent of the light from the horizon reached the pilot's eye. Under darkside lighting conditions with virtually no moon, the horizon could not be located in the brief period that the sextant was used during the orbit-determination phase. There were no further attempts to use this sextant for star-sighting or range-finding on the GATV.

The Air Force hand-held space sextant was used successfully for star-sighting during the orbit-determination phase and for range-finding on the Gemini VIII GATV during the passive rendezvous. This sextant split the light path so that 80 percent of the light from the horizon and 20 percent from the star reached the pilot's eye. With this light distribution and a 12-degree field of view, the Air Force sextant enabled the pilot to see the horizon adequately and take star-to-horizon

UNCLASSIFIED

measurements quickly in most cases. On one or two stars the pilot was unable to get the star image to split. The cause of this problem is believed to have been the obstruction of the upper optical path of the sextant by the spacecraft window frame. For those star sightings accomplished, the accuracy of the measurements appeared to be better than 0.2 of a degree, based on the residual velocity components computed by the IGS. A more detailed description of the results of the star sightings is given in section 5.1.5. For range finding during the passive rendezvous, the crew reported that they believed the Air Force sextant was accurate at a range of less than one mile when sighting on the 5-foot diameter of the Gemini VIII GATV.

5.1.10.2.3 Still cameras: The lanyard attachment was not adequate for the 70-mm still camera with the superwide angle lens used during EVA. The lanyard attachment screw backed out of the camera during EVA, and, as a result, the camera was lost. The problem was aggravated because the camera mounting bracket would not remain engaged in the ELSS keyhole slot during EVA. This condition allowed the camera to float free, which ultimately led to backing out of the lanyard attachment screw.

5.1.10.2.4 Sequence cameras: Two 16-mm sequence cameras were used for onboard photography. Ten magazines of color film and two magazines of black-and-white film were exposed. Photographic coverage was obtained of the Gemini X GATV during the final approach and docking. General coverage during orbital flight and reentry was also obtained.

During the second day, the crew reported intermittent operation of the right-hand 16-mm sequence camera, which was scheduled for external use during EVA. This camera would not function properly during the umbilical EVA preparations, and the crew elected not to use it. Post-flight investigation revealed the cause of the malfunction to be inadequate clearance between the start button operating lever and the two start-stop microswitches. When the start button was released, the lower microswitch did not open the ground circuit. As a result, the camera timing circuit remained grounded, and no timing pulse could be generated to operate the clutch for the film advance and shutter mechanisms. A similar problem was encountered on Gemini IX-A when for a brief period the camera would not operate. Intentional jolting of the camera by the pilot resulted in the malfunction disappearing. Subsequent postflight testing at MSC and a failure analysis by the vendor did not reveal the source of the problem. The failure did occur again during final acceptance testing of the same camera on July 20, 1966, prior to Cape delivery after the Gemini X launch. The problem was identified as related to the switch. Therefore, the existence of the same deficiency in the Gemini X cameras was not detected in time. Corrective measures being implemented on all 16-mm sequence cameras prior to further flight use include (1) a stronger return spring for the start button, (2) increased clearance between the start button operating lever and the microswitches,

UNCLASSIFIED

(3) improved mounting of the return spring and microswitches, and (4) performance of additional acceptance tests which check microswitch and lever operation.

5.1.10.2.5 Water-metering device: The water metering device, which was used for drinking and rehydrating food, performed satisfactorily.

5.1.10.3 Pilots' personal equipment.-

5.1.10.3.1 Food: Overall food consumption by the crew amounted to approximately 16 1/2 man-meals of the 18 complete man-meals provided. Because the used food bags were jettisoned in orbit, no precise food intake could be determined. The meals consisted of rehydratable and bite-size foods similar to those provided for previous Gemini missions. The crew reported that the time required to rehydrate and eat the rehydratable foods was excessive. Minor leakage occurred in several food bags around the food-bag valves; however, this leakage was not extensive enough to cause any problems.

Dehydrated orange-juice particles were released in the cabin when a crewman inadvertently cut through the overwrap into one of the inner food packages. A significant quantity of the orange-juice particles accumulated in suit compressor no. 2 and prevented this compressor from operating when it was first tested after the mission (see section 5.1.4.2).

5.1.10.3.2 Waste equipment: Removal of the launch day urine collection devices occurred after approximately 8 hours g.e.t. No problem was encountered in their use, and they were eventually discarded overboard.

One defecation device per crewman was used during the mission. No problem was encountered with these devices.

Each crewman used a separate urine receiver system for this mission. Minor problems were reported concerning the urine receiver systems, and some urine spillage occurred.

5.1.10.4 Space suits and accessories.- The space suits used during the Gemini X mission operated satisfactorily in all modes.

5.1.10.4.1 Command pilot's space suit: The command pilot's suit (G4C-19) operated satisfactorily throughout the mission, and a detailed postflight analysis has shown no anomalies.

UNCLASSIFIED

5.1.10.4.2 Pilot's space suit: The pilot's space suit (G4C-36), with an extravehicular coverlayer, performed satisfactorily during the mission. The pilot reported that approximately 30 to 40 percent of the gold coating on the removable sunvisor had flaked off prior to the extravehicular activity. This was caused by contact with the inside of the spacecraft at various times during the mission and during EVA preparation.

Postflight analysis of the pilot's suit revealed that the suit relief valve exhibited excessive leakage. An inspection showed that this relief valve was being held in a partially open position by a small piece of elastomer. Removal of this piece of elastomer returned the relief valve to a satisfactory condition. Analysis of the elastomer showed that it was the same material as was used in fabricating the valve. It appears that a piece of flashing broke loose and became lodged in the valve. The last time this valve was known to have been actuated was during the suit relief-valve check just after the pilot donned his suit for flight. There is no evidence of subsequent actuation until the discrepancy was discovered. These facts indicate that the foreign material was in the relief valve prior to launch and remained there throughout the flight. The resulting leakage through the valve would have been approximately 3000 cc/min, and this low value was apparently not detectable in the suit integrity checks conducted in flight. During EVA this leakage would have been small in comparison to the flow supplied to the suit, and no noticeable change in suit pressure would have resulted.

To preclude this discrepancy in future missions, a final suit integrity check is being added to the pre-launch suiting procedures, to be performed after the completion of the relief valve check. In addition, the preinstallation inspection for the space suits is being modified to include an additional visual inspection of the relief valve just prior to final installation of the suit cover layer.

The neck ring of the pilot's helmet also exhibited excessive leakage during postflight tests. Inspection showed numerous deep scratches on the back side of the neck ring. The scratches were on the suit half of the neck ring but not on the helmet half, indicating that the damage occurred while the helmet was removed. Examination revealed that the seal located on the upper surface of the lower half of the neck ring was torn loose approximately two inches circumferentially on the ring. This unbonding of the seal produced the excessive leakage. An investigation is being conducted to determine the source of the damage to the helmet neck ring.

UNCLASSIFIED

5.1.10.4.3 Visor anti-fog wiping pads: Wet wiping pads soaked in a visor anti-fog solution were used during this mission. Both crewmen applied the solution to the insides of their helmet visors prior to the standup EVA, and they reported that no visor fogging occurred. Only the pilot used the solution on his visor prior to the umbilical EVA. The pilot reported that he left a small section of visor uncoated for comparison purposes. No fogging occurred on either the treated or the untreated portion of the visor at any time during the mission. This indicates that the extravehicular workload during the mission was probably within the system capabilities.

5.1.10.5 Extravehicular equipment.- All extravehicular equipment operated satisfactorily during the Gemini X mission. Three extravehicular or open-hatch periods were planned and conducted: standup EVA from 23 hours 24 minutes to 24 hours 13 minutes g.e.t., umbilical EVA from 48 hours 42 minutes to 49 hours 20 minutes g.e.t. and a hatch-open period to jettison used equipment from 50 hours 30 minutes to 50 hours 34 minutes g.e.t. The detailed activities are outlined in figure 5.1.10-1.

5.1.10.5.1 Extravehicular Life Support System: The Gemini X ELSS chestpack performed satisfactorily without incident during the 38-minute umbilical EVA (48 hours 42 minutes to 49 hours 20 minutes g.e.t.).

The pilot had difficulty removing the ELSS from the center stowage frame. Initially, some resistance was experienced in attempting to slide the ELSS forward. The forces exerted by the pilot caused the ELSS to slide forward rapidly in the stowage frame and strike the center cabin light, causing damage as described in 5.1.10.1.3. The remainder of ELSS donning was accomplished without incident.

No free water was observed at any time, indicating that the initial ELSS heat exchanger charge of 0.626 of a pound of water was held in the storage wicks. The two ELSS restraint straps were like those worn by the Gemini IX-A pilot except for the direction of attachment. They were attached tightly enough to fix the ELSS in position so that it would not ride either up or down.

The ELSS emergency oxygen supply indicator showed 6300 psi at egress. This value resulted from some oxygen depletion during and after checkout of the ELSS. The largest depletion occurred when the pilot opened his space-suit visor briefly while waiting for the designated time to commence depressurization.

UNCLASSIFIED

At the time of hatch opening and egress (48 hours 42 minutes g.e.t.) the ELSS was set on medium flow and the panel lighting intensity was set on bright. After moderate sustained exertion in conjunction with the extravehicular transfer to the Gemini VIII GATV, the pilot noticed that he was warm and selected ELSS high flow, which restored his comfort. The ELSS cooling was adequate during ingress, and although the pilot's workload was moderate to high, he reported that he was cooler than in ground simulations in the vacuum chamber prior to the mission. After ingress and hatch closure at 49 hours 20 minutes g.e.t. the crew terminated flow from the spacecraft repressurization valve and went to the high-plus-bypass mode of the chestpack to expedite repressurization of the cabin. The spacecraft circuit breaker for the ELSS power remained closed because there was only a brief period of operation of the ELSS emergency-oxygen heater while on the high-plus-bypass mode. The pilot reported that, after advancing to high flow, he felt neither hot nor cold until ingress, at which time he was warm, though not overheated. No difficulties with the restraint straps or the ELSS restraint position were experienced.

A qualitative assessment of the heat load to the ELSS indicates that the pilot's heat output prior to ingress was significantly less than that experienced during Gemini IX-A, although in excess of ELSS design values. The pilot's heat load during the ingress operation (including hatch closure and latching) was about equal to that encountered during the Gemini IX-A mission. Total time on the ELSS in the vacuum environment was about 40 minutes. The ELSS chestpack, hoses, and restraint straps were jettisoned during the revolution after ingress, at 50 hours 32 minutes g.e.t.

5.1.10.5.2 Fifty-foot umbilical: The 50-foot umbilical was satisfactory for the mission. The following anomalies were noted.

The full 50-foot length was not required to make extravehicular contact because the Gemini VIII GATV was stable. The extra length caused some problems with crew ingress because of the bulk and because of the tendency of the pilot to become entangled in the slack. The pilot reported that several turns of the umbilical were wrapped around his body and legs. This condition impeded the pilot in that he could not get low enough in the seat to close the hatch. The crew, acting jointly, were able to unsnarl the umbilical except for one loop around the pilot's lower body. At that point, the pilot was able to move far enough into the spacecraft to allow the hatch to be closed and latched.

The crew station was very cluttered after hatch closing and required the effort of both crewmen to organize the EVA equipment. The crew first placed the umbilical into the right-hand footwell and then stuffed it into the jettison bag along with the other miscellaneous EVA equipment. The bag was then successfully jettisoned along with the ELSS.

UNCLASSIFIED

The pin which locks the structural attachment fitting of the umbilical to the pilot's restraint harness came loose during EVA. The crew reported that they had checked it in position prior to egress. The structural fitting attachment plate remained in place even though the pin had come loose. This condition will be corrected prior to the Gemini XI mission.

The pilot reported that the umbilical was completely flexible during the EVA, even when subjected to the normal nitrogen pressure.

There were no torques imposed on the pilot due to the umbilical, but it had a random motion which he was unable to control. At ingress, both crewmembers cooperated in pulling and stuffing the umbilical into the cockpit, and this was ultimately successful.

5.1.10.5.3 Hand Held Maneuvering Unit: The Hand Held Maneuvering Unit (HHMU) performed satisfactorily during two relatively brief periods of use. Although the early termination of the umbilical EVA prevented the stability and control evaluation planned for the HHMU, the pilot used the HHMU successfully to transfer a distance of approximately 15 feet from the Gemini VIII GATV back to the spacecraft after the first attempt at retrieving the Experiment S010 (Agena Micrometeorite Collection) package. This first use was initiated when the pilot was in a slight tumble after letting go of the GATV. The HHMU was effective in regaining attitude control and translating back to the spacecraft. The pilot found that use of the HHMU in space was similar to its use on the air bearing table on which he had trained. It was quite feasible to perform pitch and yaw corrections simultaneously. Roll corrections were not required. The thrust level and control response of the HHMU were reported to be satisfactory when using the tractor thrusters. The pusher thruster was not used; therefore, control tasks during braking maneuvers were not evaluated. The HHMU trigger force and travel were reported to be satisfactory, and no difficulty was encountered with the new trigger design.

The HHMU was used a second time to transfer approximately 12 feet from the spacecraft back to the Gemini VIII GATV. In this transfer maneuver a pitch transient was introduced while departing the spacecraft. In using the HHMU to correct the pitch transient, the pilot introduced an upward translation. A downward translation correction was necessary to avoid missing the Gemini VIII GATV. The relative velocity of contact with the GATV was about one ft/sec. Because the HHMU was used for less than a total of only 30 seconds, the results, although favorable, cannot be considered as a complete or adequate stability and control evaluation of the HHMU. A further HHMU evaluation is scheduled as part of the Gemini XI mission.

UNCLASSIFIED

5.1.10.5.4 Spacecraft provisions: The HHMU nitrogen gas supply, stored in tanks in the spacecraft adapter, proved satisfactory. The pilot reported little difficulty in connecting the umbilical nitrogen line to the nitrogen quick-disconnect fitting located on the adapter surface. Approximately two minutes were required to route the line and make the connection.

The aft handrail on the equipment adapter section did not fully deploy in that only the front end of the rail deployed properly. A design change is being incorporated to correct this problem prior to the Gemini XI mission (see section 5.1.1).

5.1.10.5.5 GATV provisions: The pilot reported that the lack of handholds on the Gemini VIII GATV caused some problems during the first attempt to recover the SO10 experiment. He attempted to grasp the smooth leading edge of the docking cone. During his second attempt to retrieve the experiment, he grasped wire bundles and struts between the docking cone and the cylindrical section of the Target Docking Adapter which provided better restraint. The SO10 experiment package retrieval was satisfactorily accomplished with all disconnects functioning normally.

5.1.10.5.6 Miscellaneous extravehicular equipment: The spacecraft was fitted with a special hatch closing device which was a small block-and-tackle. This cable device was provided as an aid for closing the hatch in the event of difficulty; however, it was not required. The normal hatch closing device had sufficient advantage to overcome the hatch closing forces.

5.1.10.6 Bioinstrumentation.- The bioinstrumentation equipment performed satisfactorily during this mission, and satisfactory bio-medical data were obtained on both pilots.

UNCLASSIFIED

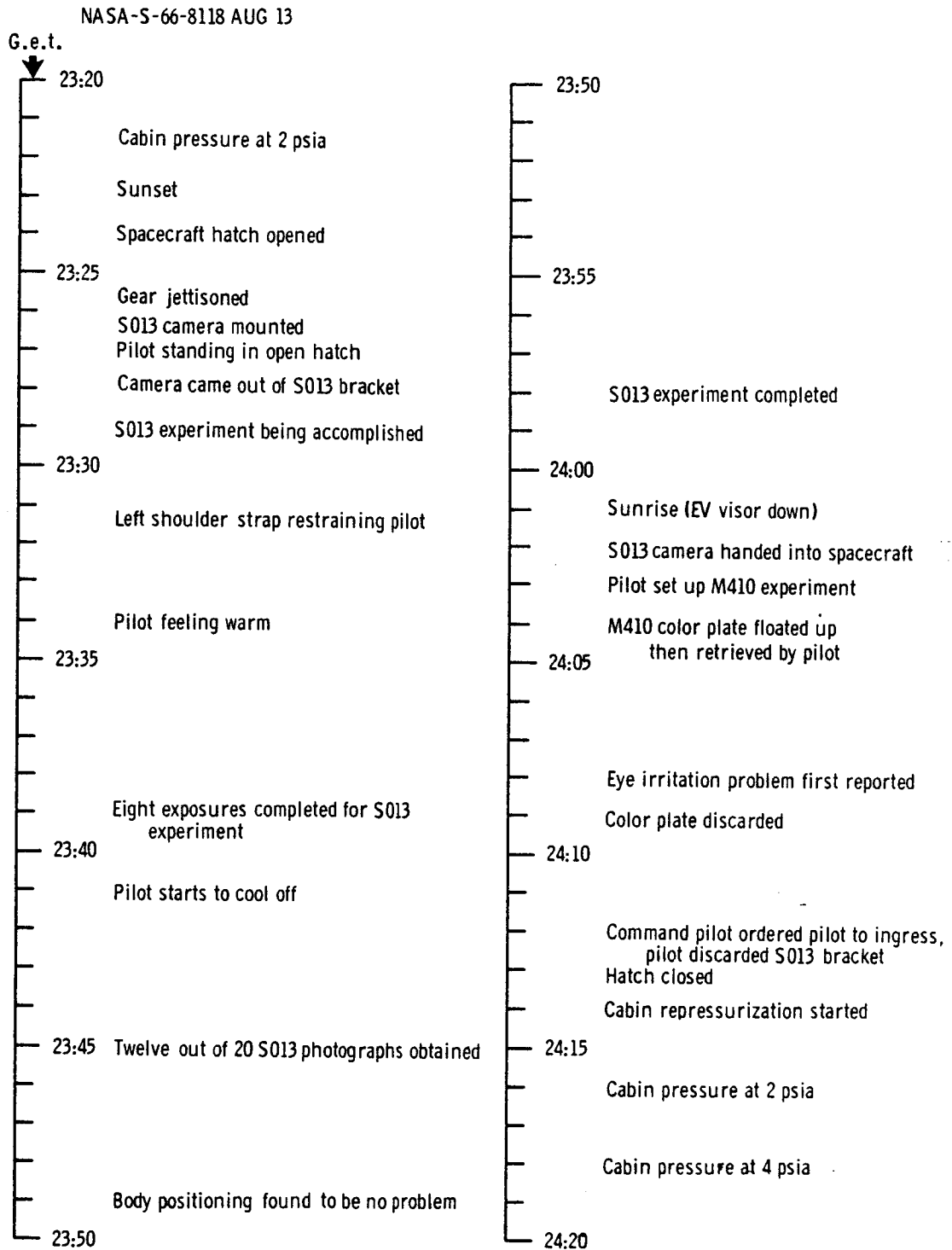

(a) Standup.

Figure 5.1.10-1. - EVA events.

NASA-S-66-8130 AUG 13

G.e.t.

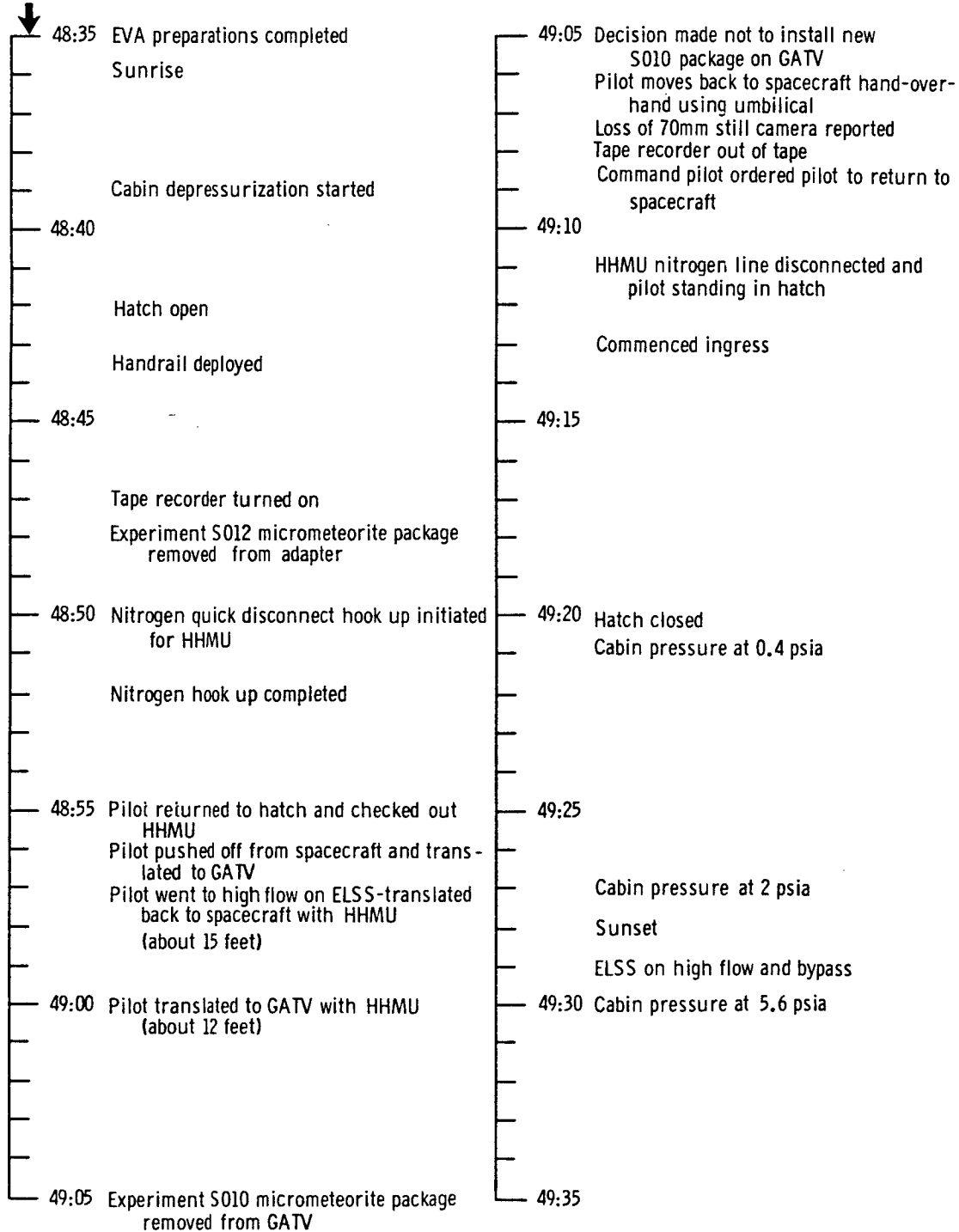

(b) Umbilical.

Figure 5.1.10-1. - Concluded.

5.1.11 Landing System

The parachute landing system operated satisfactorily, and all system events occurred within established tolerances when commanded by the flight crew. Figure 5.1.11-1 illustrates the sequence of major events with respect to ground elapsed time and pressure altitude.

The drogue parachute was deployed at approximately 40 000 feet instead of the design altitude of 50 000 feet. The delayed deployment contributed to the subsequent large oscillations of the spacecraft on the drogue parachute. Wind tunnel data indicate that a body the shape of the Gemini reentry assembly becomes aerodynamically unstable in pitch and yaw at subsonic velocities. Without the stabilizing control of the RCS or a drogue parachute, the spacecraft will go unstable in pitch and yaw at about 40 000 feet. Figure 5.1.11-2 shows the buildup of oscillations in pitch and yaw.

Even though the drogue parachute was deployed below the design altitude, the disreefed drogue parachute controlled spacecraft oscillations to within the design limit of ± 24 degrees except for two data points in pitch. Because of the bridle geometry, this is the least constrained plane of oscillation. The Spacecraft 4 drogue parachute was also deployed at 40 000 feet, and the oscillations that followed were very similar to those experienced during this mission.

Following a normal 50 000-foot deployment, the oscillations are of a lesser magnitude and are damped out in less time. On the Gemini VI-A mission, the drogue parachute was deployed at an altitude of 50 000 feet and the data indicated maximum spacecraft oscillations of ± 15 degrees. Furthermore, these oscillations were damped in about 75 percent of the time required to damp the oscillations on Spacecraft 10.

The crew reported rotation of the spacecraft in the yaw plane after the single-point disconnect had been released and the spacecraft had assumed the landing attitude. During landing system development and qualification testing, a slow rotation of this type was observed but not of this magnitude; however, this action has never been reported by the crew of any previous spacecraft.

It can be seen in figure 5.1.11-3 that the spacecraft began to build up a roll rate at approximately 28 000 feet. This is probably due to the transfer of energy from one axis to another. The spacecraft was in the region of maximum oscillations in pitch and yaw (see figure 5.1.11-2) during the time period that the drogue disreefed and the RCS was turned off. The opening shock force of the drogue disreefing was probably applied to the spacecraft through only one leg of the attachment cables

UNCLASSIFIED

and thus induced a rolling moment to the spacecraft. The spacecraft continued to roll after separation of the Rendezvous and Recovery section and while the main parachute was being stripped from the stowage bag. Figure 5.1.11-3 also shows that the spacecraft reversed its direction of rotation about 5.5 seconds after full inflation of the main parachute and continued this direction of rotation until single-point disconnect. When the spacecraft assumes the landing attitude, it rotates about the IGS platform such that the platform roll axis becomes the spacecraft yaw axis. This is approximate, as the spacecraft is pitched up 35 degrees from the horizontal. Figure 5.1.11-3 indicates the approximate motions of the spacecraft in its yaw axis after single-point release. The spacecraft continued to revolve after single-point release, then changed its direction of rotation before settling down to a back-and-forth oscillation. The data correlate with the time period on the voice tape when the crew commented that the rotation had stopped.

An analysis of spacecraft data and a physical inspection of the main parachute indicate that the following events probably occurred. During the canopy and suspension line deployment and while the reefed canopy was filling with air, the rolling spacecraft twisted the suspension lines. When the canopy inflated to its full diameter, it spread the 72 suspension lines out and wound them up at their point of confluence with the six risers. Postflight inspection revealed that the six risers were twisted underneath the fabric keeper located at the point where all six risers are sewn together to form one large riser. This stored rotational energy was then imparted to the spacecraft, as noted in the preceding paragraph, at 5.5 seconds after full inflation of the main canopy. There is also evidence that the two bridle legs had wound together. This probably occurred during the initial stage of repositioning to the landing attitude. Traces of the silver-coated thermal tape from the aft bridle leg were found imbedded in several places on the forward bridle leg, and there were also signs of abrasions on the forward leg by the aft leg. If the two bridle legs were actually wound together, this condition would also impart rotation to the spacecraft as the two bridle legs were being stretched apart.

There is also another factor that may be relevant to this problem. Data indicate that the spacecraft was rolling left at the time of single-point release. This would cause the bridle to tear out the right-hand side of the stowage trough. Postflight inspection has revealed that this was the case and that it was a possible contributing cause for the failure of the D-5 ablative material to be properly removed (see section 5.1.1).

Weather and sea-state conditions were very calm in the landing area, resulting in a gentle landing. This is in contrast to the preceding

UNCLASSIFIED

UNCLASSIFIED

5-109

flight which experienced a hard landing because of a more severe landing environment. The main canopy settled down over the nose of the spacecraft. As a result, the bridle did not pull free from the two disconnects as it normally does when there is sufficient wind to push the parachute to one side.

UNCLASSIFIED

NASA-S-66-8075 AUG 9

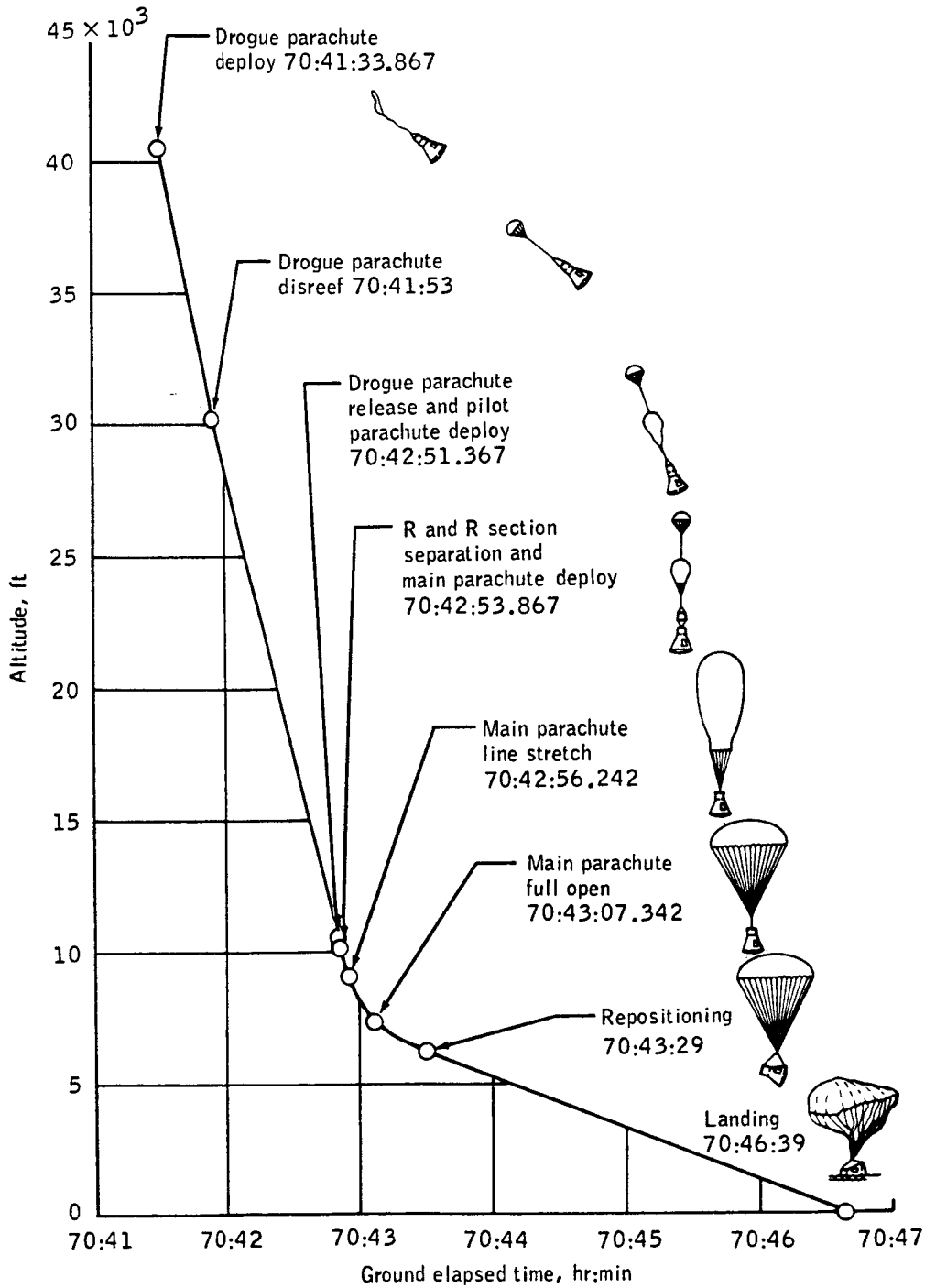

Figure 5.1.11-1. - Landing system performance.

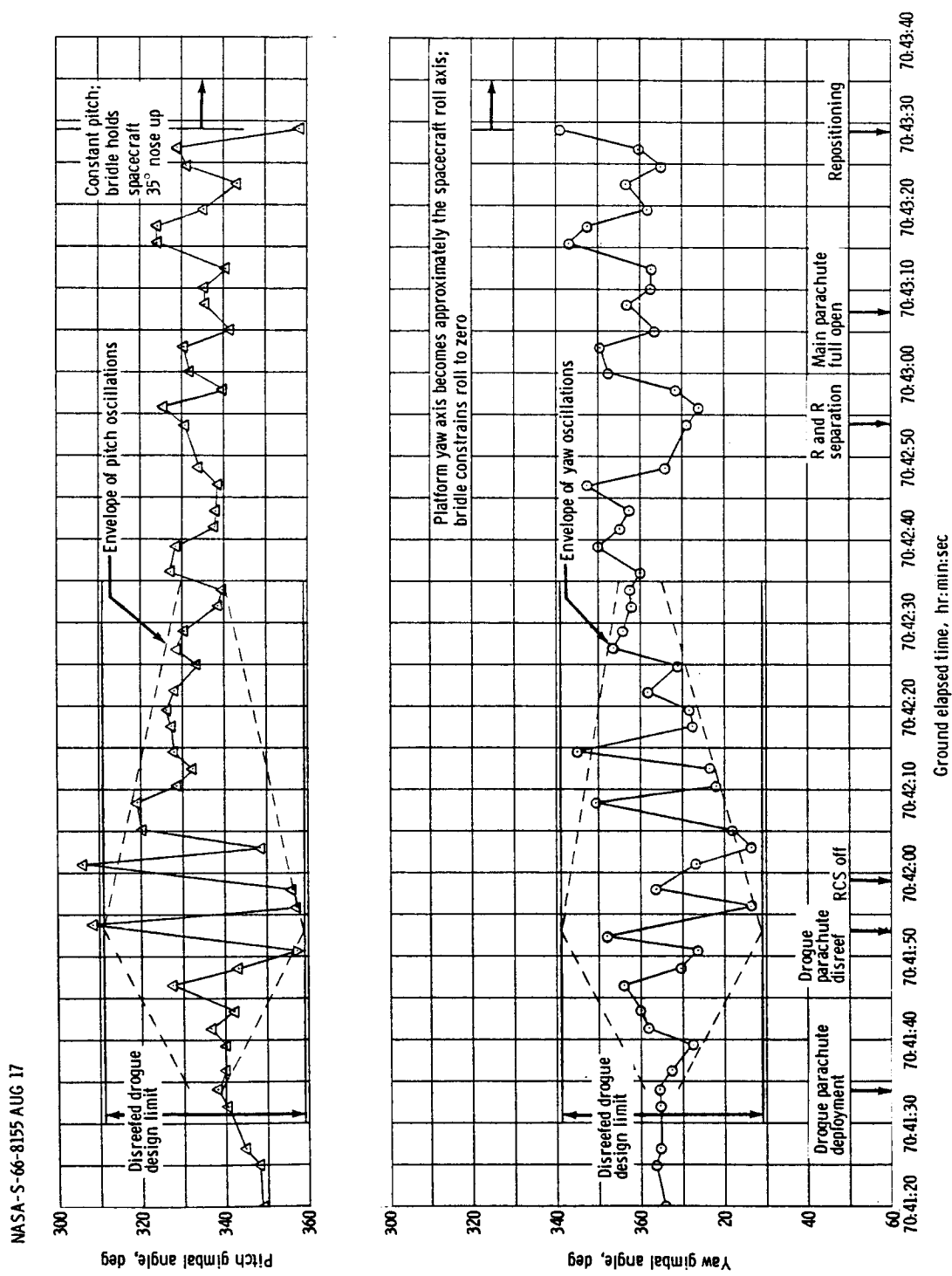
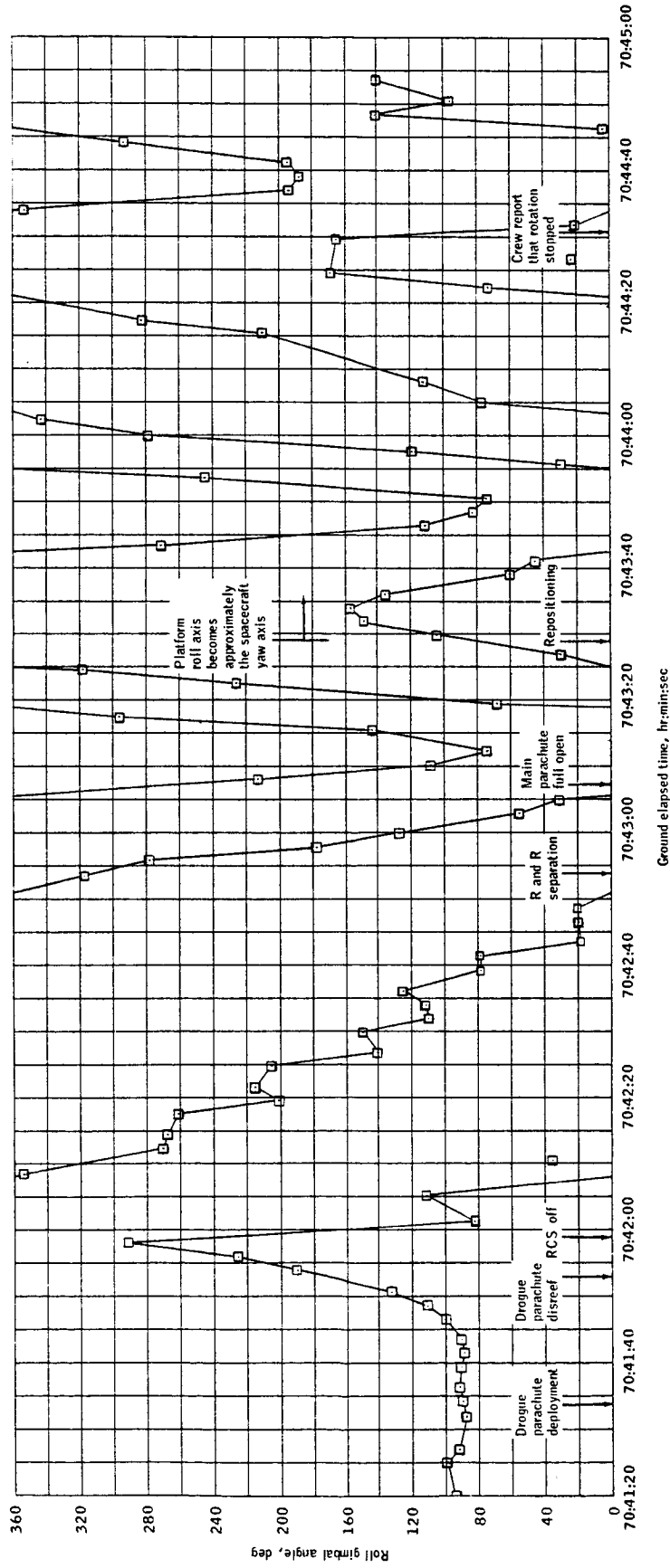

Figure 5.1.11-2. - Spacecraft pitch and yaw gimbal angles during landing maneuver.

UNCLASSIFIED

MASA-S-66-8154 AUG 17



5-112-A

5-112-C

Figure 5.1.1.1.1-3 - Spaccraft roll gimbal angles during landing maneuver.

UNCLASSIFIED

UNCLASSIFIED

5-113

5.1.12 Postlanding

The UHF descent antenna extended properly and functioned satisfactorily. However, the UHF recovery beacon antenna did not extend because the D-5 ablative material covering the aft parachute bridle trough did not tear out properly. The analysis of this problem is discussed in section 5.1.1. The recovery hoist loop and flashing light were deployed when the main parachute was jettisoned by the crew, and the sea dye marker was automatically dispensed upon touchdown. There was no requirement for HF communications, and the crew did not extend the antenna. The operational effectiveness of the recovery aids is discussed in section 6.3.

UNCLASSIFIED

5-114

UNCLASSIFIED

THIS PAGE INTENTIONALLY LEFT BLANK

UNCLASSIFIED

~~CONFIDENTIAL~~

5-115

5.2 GEMINI LAUNCH VEHICLE PERFORMANCE

The Gemini Launch Vehicle (GLV) was launched on time after a countdown that involved no unplanned holds. All systems performed satisfactorily and the spacecraft was inserted into a near-nominal orbit. The following discrepancies have been identified during a review of the data:

- (a) The Stage II fuel tank vent and topping umbilical failed to release at lift-off. Approximately 14.5 feet of hose and five feet of lanyard were carried aloft.
- (b) The Stage I oxidizer outage was 1621 pounds, the highest value for all GLV flights to date. The probable cause was a shift in the Stage I engine mixture ratio of minus 1.9 percent which resulted in a fuel depletion shutdown for the third successive mission. (An oxidizer depletion shutdown is the desired mode.)
- (c) Tracking films indicate that the Stage I oxidizer tank ruptured after the staging sequence was completed. The event had no detectable effect on the satisfactory operation of Stage II; however, further study is being conducted by the contractor and additional information will be provided in a supplemental report.

Calculations of payload capability, performed during the countdown, indicated that the nominal payload capability would be 8717 pounds. The predicted minimum payload capability was calculated to be 8087 pounds, and the spacecraft weight was 8294 pounds, providing a payload margin of minus 207 pounds (relative to minus three sigma). The postflight-reconstructed burning-time margin was +1.61 seconds, indicating that the achieved vehicle performance was 8862 pounds. The achieved payload capability was 568 pounds greater than the spacecraft weight.

5.2.1 Airframe

Flight loads on the launch vehicle were well within its structural capability. The flight loads and vibration environment were comparable to those of previous flights.

5.2.1.1 Structural loads.- Ground winds of approximately 13 miles per hour during the prelaunch phase caused a peak GLV bending moment equal to 20 percent of the design-limit wind-induced bending moment.

Estimated loads on the launch vehicle during the launch phase of the Gemini X mission are shown in the following table. These loads are related to design loads of spacecraft in the weight range from 8000 pounds

Preceding page blank

~~CONFIDENTIAL~~

UNCLASSIFIED

to 8500 pounds. These data indicate that the highest percentage of design loading occurred at station 320 during the region of flight just prior to first stage engine cutoff (BECO).

Maximum qa				Pre-BECO		
Station	Compression load, lb	Percent of design		Compression load, lb	Percent of design	
		Limit	Ultimate		Limit	Ultimate
276	24 300	29.0	23.2	50 800	60.4	48.3
320	135 800	44.3	35.5	272 200	88.9	71.1
935	423 900	70.7	56.6	442 500	73.8	59.0

5.2.1.2 Longitudinal oscillation (POGO).- Accelerometer data indicate the same intermittent characteristic of the suppressed longitudinal oscillation that has been experienced on previous flights. Maximum response at the spacecraft/launch vehicle interface occurred at lift-off (LO) plus 123.0 seconds and had an amplitude of $\pm 0.10g$ at a frequency of 10.9 cycles per second (filtered data).

5.2.1.3 Post-SECO disturbance.- Four indications of disturbances on the low-range accelerometer data after second stage engine cutoff (SECO) are listed in the following table:

Time from SECO, sec	Axial-acceleration amplitude (peak-to-peak), g
3.35	2.55
4.21	2.39
9.74	0.05
17.79	0.06

5.2.1.4 Post-staging event.- Motion picture tracking films indicate that an amber cloud appeared at approximately 1.2 seconds after BECO, followed by an unusual amount of debris. This evidence indicates that the Stage I oxidizer tank ruptured after a normal staging sequence.

UNCLASSIFIED

Telemetered data did not provide any evidence of the cause, and the event had no detectable effect on the satisfactory operation of Stage II.

5.2.2 Propulsion

5.2.2.1 Engines.-

5.2.2.1.1 Stage I: Performance of the Stage I engine throughout flight was, with one exception, close to nominal, as shown in table 5.2-I. The Stage I engine mixture ratio at the Stage I engine ignition signal (87FS1) + 55 seconds, corrected to standard inlet conditions, was minus 1.9 percent from the acceptance test value. This value exceeds the 3-sigma run-to-run repeatability of ± 1.38 percent. The lower-than-expected mixture ratio resulted in a fuel depletion shutdown.

The start transient appeared normal in that the measured chamber pressure had characteristics similar to those on previous flights, although the true magnitude of the chamber pressure spike was obscured by the heavily damped type of transducers used on GLV-10. Steady-state thrust and specific impulse were very close to the predicted values, as noted in figure 5.2-1. The shutdown transient was normal for a fuel exhaustion shutdown. The thrust level had decayed to approximately 80 000 pounds at BECO.

5.2.2.1.2 Stage II: The Stage II engine performance data showed good agreement with the predicted values, as noted in table 5.2-II. The engine mixture ratio, corrected to standard inlet conditions, was minus 1.33 percent from the acceptance-test value but within the 3-sigma limits of ± 2.28 percent. The start transient showed an earlier thrust chamber pressure rise than has been the case on Gemini launch vehicles; however, the pressure was within the range experienced on Titan II and Gemini flights and was considered normal. The steady-state thrust and specific impulse were close to the predicted values, as shown in figure 5.2-2. Second stage engine shutdown was initiated by guidance command. The shutdown impulse was slightly less than the GLV-9 shutdown impulse, as shown in the following table:

Launch vehicle	Predicted, lb-sec	Actual, lb-sec
GLV-9	36 100 \pm 7000	35 422
GLV-10	36 100 \pm 7000	35 081

~~CONFIDENTIAL~~

Minor post-SECO disturbances were seen at 3.35, 4.21, 9.74 and 17.79 seconds following SECO. The first two disturbances were similar to those observed on the GLV-8 flight, when chamber pressure indicated activity during both perturbations. The disturbance at SECO + 17.79 seconds was a cyclic oscillation (approximately four cps) and has been attributed to the Stage II engine oscillating at its natural frequency during a time period of minimum engine control (that is, low hydraulic pressure and turbine speed). The disturbance at SECO + 9.74 seconds was unexplained at the time of preparation of this report.

5.2.2.2 Propellants.-

5.2.2.2.1 Loading: A summary of GLV-10 propellant loading on July 17, 1966, is presented in the following table. All loadings were within the required ± 0.35 percent of the requested amounts. The actual flight loads were calculated from the GLV-10 engine performance and propellant level sensor data.

Tank	Requested, lb	Actual, lb	Difference, percent
Stage I oxidizer	171 583	171 383	-0.12
Stage I fuel	89 418	89 339	-0.09
Stage II oxidizer	38 952	38 850	-0.26
Stage II fuel	21 920	21 945	+0.11

5.2.2.2.2 Utilization: Stage I oxidizer outage is the amount of usable oxidizer remaining after a fuel depletion shutdown. Stage II oxidizer outage is the amount of usable oxidizer which would have remained if all of the usable fuel had been expended at the time of the commanded engine shutdown. As shown in table 5.2-III, the apparent Stage I mixture-ratio shift resulted in the highest Stage I outage experienced on any Gemini launch vehicle to date. The amount of propellant remaining at Stage II engine shutdown could have sustained Stage II flight an additional 1.61 seconds. This is 0.49 of a second greater than the predicted nominal burning-time margin of 1.12 seconds at Stage I engine ignition.

5.2.2.3 Pressurization.- The predicted and actual GLV-10 tank pressures for various flight times are given in tables 5.2-IV and 5.2-V.

~~CONFIDENTIAL~~

The close agreement between predicted and actual pressures indicates nominal performance of the launch vehicle pressurization system.

5.2.3 Flight Control System

Performance of the Flight Control System was satisfactory during Stage I and Stage II flight. The flight was accomplished using the primary system; however, switchover to the secondary system could have been successfully accomplished at any time during the powered phase.

5.2.3.1 Stage I flight.- Normal actuator transients occurred during ignition. The maximums of travel recorded during the ignition and hold-down periods are presented in the following table:

Actuator	Maximum travel during ignition		Maximum travel during holddown null check, in.
	Travel in.	Time from lift-off, sec	
Pitch 1 ₁	-0.06	-2.43	+0.01
Yaw-roll, 2 ₁	+0.05	-2.43	+0.01
Yaw-roll, 3 ₁	+0.06	-2.43	+0.05
Pitch, 4 ₁	-0.08	-2.43	+0.01

The combination of thrust and engine misalignments at full thrust initiated a roll transient at lift-off. The corrective response of the Flight Control System resulted in a maximum roll rate of +0.60 deg/sec clockwise at lift-off + 0.08 of a second. A roll attitude error bias of 0.10 of a degree clockwise was introduced at lift-off by an equivalent engine misalignment of 0.02 of a degree. A roll transient of 0.5 deg/sec clockwise, starting at lift-off + 2.16 seconds, occurred at the same time as with the breaking of the fuel tank vent and topping line.

The Three Axis Reference System (TARS) roll and pitch programs were performed as planned. The planned and actual rates and times are listed

~~CONFIDENTIAL~~

in the following table. The discrettes initiated by the TARS were executed within the normal times.

Program	Planned time, LO + sec	Actual time, LO + sec	Rate gyro, deg/sec	Torquer monitor, deg/sec	Nominal rate, deg/sec
Roll					
Start	9.36	9.35	-1.23	-1.24	-1.250
Stop	20.48	20.45			
Pitch, step 1					
Start	23.04	23.00	-0.71	-0.68	-0.709
Pitch, step 2					
Start	88.32	88.08	-0.48	-0.49	-0.516
Pitch, step 3					
Start	119.04	118.73	-0.22	-0.25	-0.235
Stop	162.56	162.13			

Primary (TARS) and secondary (Inertial Guidance System (IGS)) attitude error signals correlated well throughout Stage I flight. These attitude errors indicate the response of the control system to the first-stage guidance programs and to the vehicle disturbances caused by the prevailing winds aloft. The maximum vehicle rates and attitude errors which occurred during Stage I flight are presented in the following table.

Axis	Maximum rate, deg/sec	Time from lift-off, sec	Maximum attitude error, deg	Time from lift-off, sec
Pitch	+0.10	0.2	+0.89	61.3
	-1.00	25.0, 67.4, 73.0	-0.58	119.1
Yaw	+0.58	75.7	+0.84	83.5
	-0.72	71.5	-1.05	74.2
Roll	+0.59	0.8	+0.47	9.7, 17.7, 74.6
	-1.56	10.0	-0.10	0.1

~~CONFIDENTIAL~~

The dispersions between the primary and secondary attitude-error signals were the result of a combination of drift in the TARS and in the IGS inertial measurement unit, errors in TARS roll and pitch guidance programs, and cross-coupling of the reference axes within each of the systems.

5.2.3.2 Staging sequence.- Telemetry data received during the staging sequence indicated normal staging rates and attitudes. The maximum attitude errors and rates recorded during staging are given in the following table.

Axis	Maximum rate, deg/sec	Time from BECO ^a , sec	Maximum attitude error, deg	Time from BECO ^a , sec
Pitch	+1.80	1.82	+1.36	2.7
	-1.74	0.69		
Yaw	+1.57	0.69	+0.42	2.1
	-1.08	0.68		
Roll	+3.76	1.33	-1.68	1.0
	-5.65	0.01		

^aBECO occurred 152.38 seconds after lift-off.

5.2.3.3 Stage II flight.- Primary system pitch and yaw responses to radio guidance commands were satisfactory. The pitch and yaw steering commands transmitted to the launch vehicle during Stage II flight are discussed in section 5.2.5. The Stage II attitude biases resulted from the Stage II thrust-vector misalignment, the center-of-gravity offset from the longitudinal axis, and the offset of the roll thrust from the longitudinal axis.

TARS and IGS attitude-error signals were as shown in figure 5.1.5-1. After the initial 100-percent-pitch guidance command, the TARS pitch attitude error remained positive while the IGS pitch attitude error remained negative. This total difference was 1.35 degrees, of which thrust misalignment contributed 0.92 of a degree.

5.2.3.4 Post-SECO and separation phase.- Vehicle attitude rates between SECO and spacecraft separation were normal. The maximum rates

~~CONFIDENTIAL~~

experienced during this time are listed in table 5.2-VI. At approximately SECO + 17.9 seconds, there were minor disturbances of the Stage II yaw actuator and the Stage II yaw rate gyro at the natural frequency of the Stage II engine. These disturbances had no detrimental effect on spacecraft separation.

5.2.4 Hydraulic System

The vehicle hydraulic systems performed satisfactorily during Stage I and Stage II flight. No anomalous pressures were noted during ignition transients or steady-state flight, indicating low flow demands and a smooth flight. Prior to the simulated flight test, the engine-driven pumps were replaced with newly cleaned units, and the action of the pressure compensators in these units was verified by a gaussmeter check. Selected hydraulic system pressures are shown in the following table:

Event	Hydraulic pressure, psia		
	Stage I		Stage II system
	Primary system	Secondary system	
Start transient (minimum)	2680	--	--
Start transient (maximum)	3180	3280	3610
Steady state	3000	2990	2840
BECO	2710	2720	--
SECO	--	--	2650

5.2.5 Guidance System

Performance of the Stage I and Stage II guidance systems was satisfactory throughout powered flight and resulted in placing the spacecraft in an acceptable orbit.

5.2.5.1 Programmed guidance.- As shown by actual and nominal data presented in paragraph 5.2.3.1, programmed guidance is considered to have been within acceptable limits. The errors at BECO, compared with the

~~CONFIDENTIAL~~

~~CONFIDENTIAL~~

5-123

no-wind prelaunch nominal trajectory, were 130 ft/sec low in velocity, 4360 feet low in altitude, and 0.4 of a degree low in flight-path angle.

5.2.5.2 Radio guidance.— The Radio Guidance System (RGS) acquired the pulse beacon of the vehicle, tracked in the monopulse automatic mode, and was locked on continuously from lift-off to 46 seconds after SECO. There was a 36-second period of intermittent lock before final loss-of-signal at 82 seconds after SECO. Track was maintained to an elevation angle of 1.06 degrees above the horizon. The received signal strength at the Central Station during Stage II operation was satisfactory. Rate lock was continuous from LO + 27.9 seconds to LO + 386.6 seconds (46.0 seconds after SECO). Pitch steering commands were initiated, as planned, by the airborne decoder, commencing at LO + 168.27 seconds. At this time, an initial 7-percent pitch-down steering command (0.14 deg/sec) was given for 4.0 seconds, followed by the characteristic 100-percent pitch-down steering command (2.0 deg/sec) for 3.0 seconds. During the following 14.0 seconds, the steering commands gradually decreased to 0.2 deg/sec. For approximately the next 100 seconds, there were continuous pitch-down steering commands of less than 0.2 deg/sec until LO + 292 seconds. At this time, because of noisy tracking data, the rates became oscillatory. This phenomenon is characteristic of tracking data when the ground guidance system is being influenced by unfavorable seasonal atmospheric effects. Past experience has shown that the high-frequency noise also increases as the tracking elevation angle decreases. As a result, the peak amplitude of steering commands ranged from plus 0.2 deg/sec to minus 0.3 deg/sec until termination of guidance (SECO minus 2.5 seconds).

Yaw steering was initiated at LO + 168.27 seconds, with the first command being sent, as expected, at LO + 172.27 seconds. As a result, yaw-left commands of 75 percent (1.5 deg/sec) were sent for a duration of 1.0 second. Nine seconds later, the steering gradually returned to yaw-left commands of less than 0.04 deg/sec until termination of guidance. At SECO + 20 seconds, the yaw velocity was minus 5.0 ft/sec and the yaw position was minus 6109 feet, as compared with the planned values of 1.0 ft/sec and minus 2590 feet (prelaunch guidance residuals due to insertion targeting accuracies).

SECO occurred at an elevation angle of 6.5 degrees above the horizon. The conditions at SECO + 20 seconds were within 3-sigma limits. Table 4-V is a comparison of the actual values with the planned values. The errors at SECO + 20 seconds may be attributed primarily to high-frequency noise in the guidance data. An evaluation of the near-nominal shutdown thrust transient has indicated that the transient contributed 3.1 ft/sec to the estimated 7.3 ft/sec total underspeed at SECO + 20 seconds.

~~CONFIDENTIAL~~

~~CONFIDENTIAL~~

The yaw position and velocity errors at SECO + 20 seconds required the spacecraft to make a 9.6 ft/sec out-of-plane maneuver in the second orbit. Vehicle rates were minus 0.57 deg/sec down, 1.06 deg/sec right, and 0.38 deg/sec roll clockwise.

The ground-based A-1 guidance computer, in conjunction with the GE MOD III tracking and missileborne guidance system, performed satisfactorily during prelaunch and flight. No anomalies were encountered with the airborne pulse, rate, and decoder hardware. All guidance discretizes were properly generated and executed as required.

The target ephemeris data were satisfactorily transmitted and verified between the Real Time Computer Complex at the Mission Control Center in Houston and the Guided Missile Computer Facility at Cape Kennedy.

The inertial guidance system updates, as sent by the ground-based computer, were correct and were as follows:

Time from lift-off, sec		Value, ft/sec
Update reference	Update transmission	
100	105	+40.19
140	145	-120.05

5.2.6 Electrical

The Instrumentation Power Supply (IPS) provided power at a nominal 29.5 volts throughout the countdown and launch. IPS amperage indicated that a short existed during the staging sequence and that it cleared after separation was accomplished. This phenomenon is anticipated because of the possibility that the wires to the squibs of the staging nuts and/or the Stage II engine start-cartridge short to structure when the squibs are initiated. The Auxiliary Power Supply (APS) performed nominally at 29.8 volts throughout the countdown and launch. Spacecraft separation was easily detectable from transients on the respective current traces of both the APS and the IPS.

The 5-volt instrumentation power supply; the 115-volt, 400-cycle supply; the 40-volt supply; and the 25-volt supply also reflected normal operation throughout the flight.

~~CONFIDENTIAL~~

5.2.7 Instrumentation

5.2.7.1 Ground.- There were 155 recorder channels programmed for use on the Launch Complex 19 landline system for the Gemini X mission. These recorder channels were utilized for propellant loading as well as for the launch sequence, and data acquisition was 100 percent. The separation sequence of the electrical umbilicals was as planned and was completed in 0.784 of a second.

5.2.7.2 Airborne.- The airborne instrumentation system for GLV-10 was of the same configuration as that used for GLV-9. GLV-10 had 188 measurements scheduled for use, and valid data were obtained from all measurements. The expected telemetry data loss (RF blackout) at staging was similar to previous flights and lasted 320 milliseconds. Final loss of the telemetry signal, as monitored at Telemetry Station II, occurred at approximately L0 + 420 seconds (49 seconds after spacecraft separation).

5.2.8 Malfunction Detection System

Performance of the Malfunction Detection System (MDS) during pre-flight checkout and flight was satisfactory. Flight data indicated all MDS hardware functioned properly. MDS parameters are shown in table 5.2-VII.

5.2.8.1 Engine MDS.- Actuations of the malfunction-detection thrust-chamber pressure switches (MDTCPS) and the malfunction-detection fuel-injector pressure switch (MDFJPS) were as follows:

Switch	Condition	Actuation time from lift-off, sec	Thrust chamber pressure, psia
Subassembly 1 MDTCPS	Make	-2.331	595
	Break	+152.334	535
Subassembly 2 MDTCPS	Make	-2.316	585
	Break	+152.345	535
Subassembly 3 MDFJPS	Make	+153.024	(a)
	Break	+340.713	(a)

^aMDFJPS is not actuated by thrust chamber pressure but is actuated by fuel injector pressure which is a function of thrust chamber pressure.

UNCLASSIFIED

5.2.8.2 Airframe MDS.- The MDS rate-switch package performed properly throughout the flight. No vehicle overrates occurred from lift-off through spacecraft separation.

5.2.8.3 Tank pressure indicators.- All tank pressure indicators performed acceptably throughout flight.

5.2.9 Range Safety and Ordnance Systems

The performance of all range safety and ordnance items was satisfactory.

5.2.9.1 Flight Termination System.- Both GLV command receivers received adequate signal for proper operation throughout powered flight and beyond spacecraft separation. The following command facilities were used:

Time from lift-off, sec	Facility
0 to 67	Cape Kennedy - 600-watt transmitter and single helix antenna
67 to 120	Cape Kennedy - 10-kilowatt transmitter and quad-helix antenna
120 to 259	Bermuda - 10-kilowatt transmitter and steerable antenna
259 to 434	Grand Turk - 10-kilowatt transmitter and steerable antenna
434 to 722	Antigua - 10-kilowatt transmitter and steerable antenna

The auxiliary second stage engine cutoff (ASCO) signal was transmitted from Grand Turk Island at LO + 341 seconds for 5 seconds.

5.2.9.2 Range safety tracking system.- The Missile Trajectory Measurement (MISTRAM) System I was used as the primary source for impact prediction and provided accurate information through insertion.

5.2.9.3 Ordnance.- The performance of all ordnance items was satisfactory.

UNCLASSIFIED

5.2.10 Prelaunch Operations

The propellant loading operation was started with the loading of oxidizer at 10:26 G.m.t. on July 18, 1966. Loading of the fuel was delayed 30 minutes when the temperature of the propellant at the conditioning unit (approximately 18.5° F) was found to be within the range at which the propellant freezes. To eliminate the uncertainty which would have resulted from using the cold propellant, the secondary ready storage vessel (RSV) system was utilized and the vehicle was successfully loaded by 14:13 G.m.t. Actual loading time was 3 hours 17 minutes.

The range countdown for the launch vehicle was started, as planned, at 18:14 G.m.t. The planned hold at T minus three minutes was reached without incident. The countdown was resumed after five minutes and 26 seconds in order to launch at the required time of 22:20:26 G.m.t.

Postlaunch inspection of the launch area and a review of engineering films revealed that the vehicle had lifted off and carried along the Stage II fuel tank vent and topping umbilical, a section of the vent line, and several feet of the umbilical-release lanyard. The failure of the umbilical to release caused the Teflon vent line to separate at its tie point to the umbilical tower. Approximately 14.5 feet of vent line and five feet of release lanyard remained attached to the vehicle. The rigging of all umbilicals is being intensively reviewed by the contractor, and tests are being conducted on the rigging scheme in use on this particular umbilical in an effort to ascertain the cause of the failure.

During the launch stand damage inspection, it was discovered that a fire in the erector actuator room had scorched several cables. There is at present no explanation for a fire in this area. The launch complex overall damage was considered minimal. Erection of the launch vehicle for the Gemini XI mission was accomplished on July 23, 1966, just five days after the successful launch of Gemini X.

~~CONFIDENTIAL~~

TABLE 5.2-I.- STAGE I ENGINE PERFORMANCE

Parameter	Preflight prediction	Postflight reconstruction	Difference, percent
Standard inlet condition performance			
Thrust, lb	439 214	437 769	-0.33
Specific impulse, lb-sec/lb	260.48	261.03	+0.21
Engine mixture ratio, oxidizer to fuel	1.9467	1.9098	-1.90
Oxidizer overboard flow rate, lb/sec	1113.60	1100.34	-1.19
Fuel overboard flow rate, lb/sec	572.56	576.72	+0.73
Flight average performance			
Thrust, lb	464 199	462 750	-0.31
Specific impulse, lb-sec/lb	277.22	277.83	+0.22
Engine mixture ratio, oxidizer to fuel	1.9326	1.8981	-1.79
Oxidizer overboard flow rate, lb/sec	1103.15	1090.51	-1.15
Fuel overboard flow rate, lb/sec	571.33	575.07	+0.65

~~CONFIDENTIAL~~

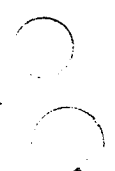

~~CONFIDENTIAL~~

TABLE 5.2-II.- STAGE II ENGINE PERFORMANCE

Parameter	Preflight prediction	Postflight reconstruction	Difference, percent
Standard inlet condition performance			
Thrust, lb	99 694	99 474	-0.22
Specific impulse, lb-sec/lb	309.33	309.82	+0.16
Engine mixture ratio, oxidizer to fuel	1.8262	1.8020	-1.33
Oxidizer overboard flow rate, lb/sec	208.41	206.64	-0.84
Fuel overboard flow rate, lb/sec	113.88	114.43	+0.49
Flight average performance			
Thrust, lb	99 242	99 168	-0.07
Specific impulse, lb-sec/lb	310.07	310.53	+0.15
Engine mixture ratio, oxidizer to fuel	1.7878	1.7662	-1.21
Oxidizer overboard flow rate, lb/sec	205.41	204.06	-0.66
Fuel overboard flow rate, lb/sec	114.65	115.30	+0.57

~~CONFIDENTIAL~~

~~CONFIDENTIAL~~TABLE 5.2-III.- GEMINI LAUNCH VEHICLE
STAGE I PROPELLANT OUTAGES

Mission	Outage, lb
Gemini I	912 fuel
Gemini II	12 fuel
Gemini III	None
Gemini IV	614 oxidizer
Gemini V	866 fuel
Gemini VI-A	834 fuel
Gemini VII	45 fuel
Gemini VIII	252 oxidizer
Gemini IX-A	785 oxidizer
Gemini X	1621 oxidizer

~~CONFIDENTIAL~~

~~CONFIDENTIAL~~

TABLE 5.2-IV.- STAGE I ULLAGE GAS PRESSURE

Tank	Lift-off - 3.26 sec		Lift-off + 47 sec		Lift-off + 97 sec		Lift-off + 147 sec	
	Predicted, psia	Actual, psia	Predicted, psia	Actual, psia	Predicted, psia	Actual, psia	Predicted, psia	Actual, psia
Oxidizer	27.2	27.3	20.1	19.2	19.0	18.5	20.0	19.4
Fuel	26.0	26.6	22.5	22.5	22.0	22.3	22.5	23.1

TABLE 5.2-V.- STAGE II ULLAGE GAS PRESSURE

Tank	Lift-off + 152 sec (staging)		Lift-off + 202 sec		Lift-off + 252 sec		Lift-off + 332 sec	
	Predicted, psia	Actual, psia	Predicted, psia	Actual, psia	Predicted, psia	Actual, psia	Predicted, psia	Actual, psia
Oxidizer	55.2	55.16	22.1	20.8	13.9	12.9	9.8	9.0
Fuel	50.5	50.21	47.5	47.4	47.1	47.3	47.0	47.9

~~CONFIDENTIAL~~

UNCLASSIFIED

TABLE 5.2-VI.- VEHICLE RATES BETWEEN SECO AND SPACECRAFT SEPARATION

Axis	Rate, deg/sec
Pitch: Maximum positive rate at SECO + 1.16 sec Maximum negative rate at SECO + 17.81 sec Rate at SECO + 20 sec Rate at spacecraft separation (SECO + 30.88 sec)	+0.98 -0.75 -0.57 -0.38
Yaw: Maximum positive rate at SECO + 17.96 sec Maximum negative rate at SECO + 2.06 sec Rate at SECO + 20 sec Rate at spacecraft separation (SECO + 30.88 sec)	+1.25 -1.06 +1.06 +0.58
Roll: Maximum positive rate at SECO + 0.41 sec Maximum negative rate at SECO + 7.51 sec Rate at SECO + 20 sec Rate at spacecraft separation (SECO + 30.88 sec)	+0.58 -0.28 +0.38 +0.00

UNCLASSIFIED

TABLE 5.2-VII.- MALFUNCTION DETECTION SYSTEM SWITCHOVER PARAMETERS

Parameter	Switchover setting	Maximum or positive (a)	Time from lift-off, sec	Minimum or negative (b)	Time from lift-off, sec
Stage I primary hydraulics	Shuttle spring (1500 psia equiv.)	3200 psi	-2.08	2680 psi	-2.37
Stage I tandem actuators:					
No. 1 subassembly 2 pitch	±4.0 deg	0.50 deg	77.0	0.30 deg	63.0
No. 2 subassembly 2 yaw-roll	±4.0 deg	0.46 deg	84.0	0.85 deg	75.0
No. 3 subassembly 1 yaw-roll	±4.0 deg	0.73 deg	75.0	0.52 deg	84.0
No. 4 subassembly 1 pitch	±4.0 deg	0.30 deg	63.0	0.47 deg	77.0
Stage I pitch rate	+2.5 deg/sec -3.0 deg/sec	0.00 deg/sec	123.5	0.90 deg/sec	25.5
Stage I yaw rate	±2.5 deg/sec	0.44 deg/sec	80.0	0.58 deg/sec	73.0
Stage I roll rate	±20 deg/sec	0.70 deg/sec	0.8	2.95 deg/sec	152.7
Stage II pitch rate	±10 deg/sec	0.85 deg/sec	154.5	1.80 deg/sec	175.0
Stage II yaw rate	±10 deg/sec	0.55 deg/sec	153.5	1.55 deg/sec	174.5
Stage II roll rate	±20 deg/sec	2.55 deg/sec	153.7	0.35 deg/sec	155.0

^aPositive indicates pitch up, yaw right, and roll clockwise.

^bNegative indicates pitch down, yaw left, and roll counterclockwise.

~~CONFIDENTIAL~~

NASA-S-66-8088 AUG 10

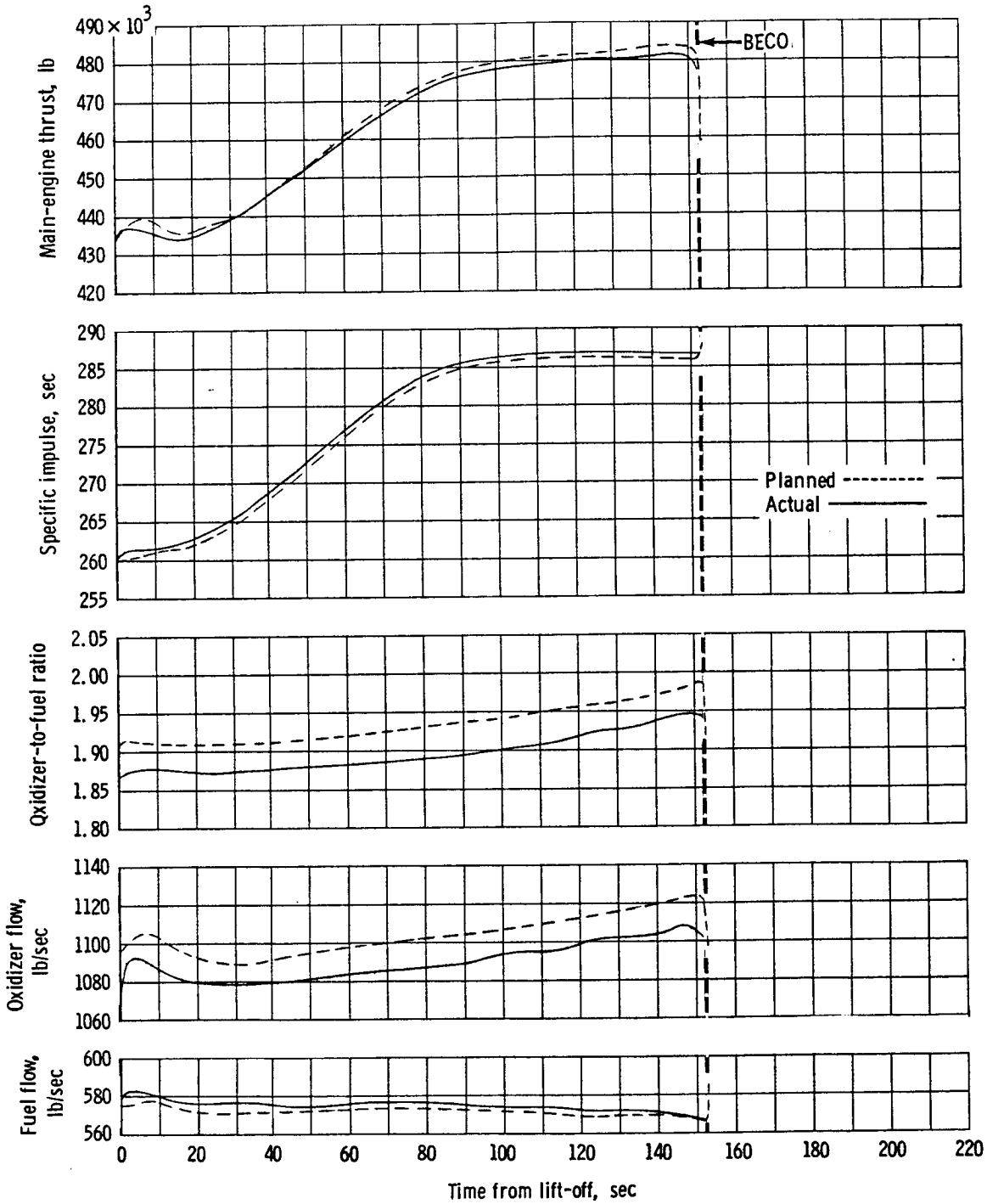

Figure 5.2-1. - Stage I engine performance.

~~CONFIDENTIAL~~

NASA-S-66-8090 AUG 10

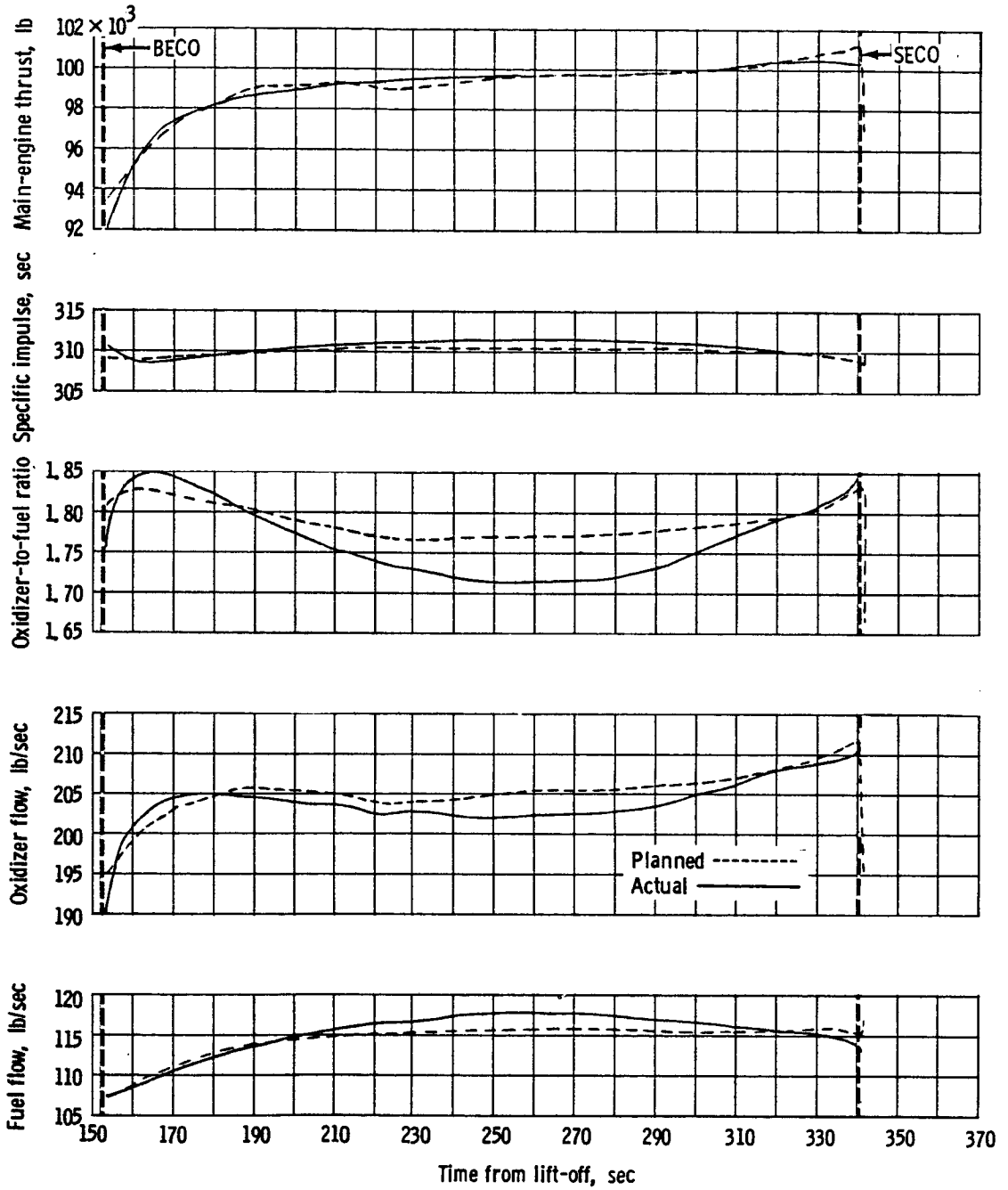

Figure 5.2-2 - Stage II engine performance.

5-136

UNCLASSIFIED

THIS PAGE INTENTIONALLY LEFT BLANK

UNCLASSIFIED

5.3 SPACECRAFT/GEMINI LAUNCH VEHICLE INTERFACE PERFORMANCE

The requirements of the spacecraft/Gemini launch vehicle interface, as defined in reference 16, were met within the established limits.

The electrical circuitry performed as anticipated. As usual, shorting was present during the spacecraft/launch vehicle separation event; however, no problems were experienced on either the spacecraft or launch vehicle. The separation event, as described by the flight crew, was normal in all respects.

UNCLASSIFIED

THIS PAGE INTENTIONALLY LEFT BLANK

UNCLASSIFIED

5.4 GEMINI AGENA TARGET VEHICLE PERFORMANCE

All Gemini Agena Target Vehicle (GATV) systems performed properly during launch and orbital operations.

Structural damping characteristics of the docked GATV and spacecraft were verified during the bending mode tests. Data indicated that the natural frequency and damping characteristics of the docked combination were within safe limits for the GATV control system during primary propulsion system (PPS) maneuvers. Docked operations were significant because the spacecraft remained docked with the GATV for 38 hours and 47 minutes. During this period, six firings were performed—three with the primary propulsion system and three with the secondary propulsion system (SPS). In addition, SPS Unit I firings for propellant orientation preceded each PPS firing. An analysis has shown that a negative bias can cause an accumulation of negative counts between velocity-meter activation and initiation of positive accelerations. This accumulation may have caused the velocity meter to appear to be late in sensing initial changes in velocity.

The GATV flight control system functioned as predicted during the PPS maneuvers. The docked vehicles yawed to approximately 2.5 degrees within approximately three seconds after PPS ignition, but this yaw error was rapidly corrected by the flight control system.

The GATV attitude control system was used for stabilization of the docked vehicles including the period during the standup extravehicular activity (EVA). After the EVA, the Experiment D005 (Star Occultation Navigation) was conducted using the attitude control system to orient the spacecraft for the star sightings. However, the experiment was terminated early because of excessive use of GATV attitude control gas (see section 6.1.5).

After undocking the spacecraft from the Gemini X GATV, the crew completed the rendezvous with the Gemini VIII GATV. The crew reported that the Gemini VIII GATV appeared to be very stable in an engine-down attitude. The crew did not notice whether or not the running lights were illuminated.

During EVA with the Gemini VIII GATV, the Experiment S010 (Agena Micrometeorite Collection) package was retrieved from the vehicle. During this activity, the electrostatic discharge fingers and attaching ring came loose from the docking cone, indicating a failure of the bonding material after four months in orbit.

UNCLASSIFIED

After reentry of the spacecraft, the Gemini X GATV PPS was used to place the vehicle in a 750.5 by 208.6 nautical-mile orbit in order to determine the temperature effects of this orbit on the vehicle. The temperature data showed no appreciable difference from that obtained at the lower orbits.

The PPS was fired again to circularize the orbit. This maneuver was followed by an SPS Unit II maneuver to place the Gemini X GATV in a proper orbit for possible use as a Gemini XI rendezvous target. The final orbit was 190.2 nautical miles circular. The vehicle was left in a main-engine down attitude and the attitude control system was turned off. The vehicle was monitored from Hawaii until electrical power depletion which occurred approximately 160 hours after lift-off.

Approximately 1700 commands were sent to the GATV—1350 by the ground controllers and 350 by the pilot of Spacecraft 10.

5.4.1 Airframe

Structural integrity of the GATV was satisfactorily maintained throughout the launch and orbital phases of flight.

5.4.1.1 Launch phase.— Temperature measurements on the shroud indicated the maximum temperature of 263° F was reached at lift-off (LO) + 176 seconds. The maximum temperature measured on the Target Docking Adapter (TDA) was 156° F at LO + 110 seconds. The horizon-sensor fairing temperature reached a maximum of 518° F at LO + 136 seconds.

The acceleration observed at booster engine cutoff (BECO) was 6.28g, and the acceleration at sustainer engine cutoff (SECO) was 2.87g, as obtained from the Target Launch Vehicle (TLV) telemetry system.

5.4.1.2 Separation.— The GATV separated from the TLV with an average relative velocity of 3.3 ft/sec, calculated using data from the separation monitor. This value compares very closely with data obtained from earlier flights.

5.4.1.3 Ascent maneuver.— During the ascent maneuver, there were no abnormal vibrations or accelerations indicated. This period included main engine ignition, horizon-sensor cover jettison, and shroud separation. All measured temperatures were close to predicted values. The aft section temperatures started increasing at separation (LO + 300 seconds) with peaks ranging to 255° F for the aft bulkhead temperatures. These peaks occurred at about main engine cutoff (LO + 558.07 seconds) and then decreased to orbital temperatures.

UNCLASSIFIED

5.4.1.4 Docking phase.- Docking of the spacecraft with the GATV took place at 5 hours 53 minutes ground elapsed time (g.e.t.). The docking was very smooth as indicated by the accelerometer data. The lateral accelerometers indicated a disturbance of less than one-g peak-to-peak. Motion pictures taken from the right-hand window of the spacecraft indicated only a slight misalignment off the centerline at first contact.

5.4.1.5 Orbital phase.- During the mission, the spacecraft remained docked to the GATV for 38 hours and 47 minutes. A bending mode test was conducted using the spacecraft propulsion system to pulse the docked vehicles. This test was made to determine the natural frequency and structural damping characteristics of the docked configuration. The test verified predictions that the combined vehicles had adequate damping characteristics to allow PPS maneuvers while docked. These data are discussed in detail in paragraph 5.1.1.2.

During docked maneuvers, vibration and noise transmitted to the crew compartment were not considered a problem by the crew.

Temperatures varied within predicted limits and are comparable to those obtained on the GATV during the Gemini VIII mission. Temperature sensors on the TDA indicated a temperature range of 20° to 120° F. The highest variation (about 60° F) was shown by the temperature sensor on the top of the TDA. Shear-panel temperatures showed similar variations. Temperatures sustained on the vehicle while in a 750.5 by 208.6 nautical-mile orbit showed no appreciable difference from the temperatures measured in the lower orbits.

Photographs of the GATV taken from the spacecraft show bubbles in the paint and aluminum tape used for temperature control. These were also noted on the Gemini VIII GATV. It is surmised that these bubbles were caused by entrapped air and out-gassing from the materials rather than blistering due to heat. The Gemini X crew also noted that the Gemini VIII GATV showed evidence of slight aging in the space environment.

5.4.2 Propulsion

The primary and secondary propulsion systems, including the associated pressurization and feed systems, performed in a normal manner during the ascent phase and all subsequent firings. Five PPS and four SPS Unit II firings were made in addition to the ascent maneuver. Three of each were made in the docked configuration. Cumulative thrust times and velocity changes in orbit were 40.73 seconds and 2595 ft/sec for the PPS and 43.2 seconds and 62.32 ft/sec for the SPS. The PPS operations

UNCLASSIFIED

also included three 70-second firings and two 22-second firings of the SPS Unit I thrusters for ullage orientation.

5.4.2.1 Primary propulsion system. - The start and shutdown transients for all PPS firings were nominal, repeatable, and consistent with performance data from the Gemini VIII flight. The ascent maneuver, which is typical of PPS firings, is shown in figure 5.4-1; table 5.4-I contains start-transient data for each PPS operation.

At main engine ignition, the oxidizer-pump lip-seal pressure dropped to 1.53 psi, which is below the specification of 5 ± 3 psi. The oxidizer-pump inlet pressure decreased six psi approximately 32 seconds after main engine ignition. A similar phenomenon was observed 20 seconds after ignition on the Gemini VIII GATV. In neither case was the occurrence detrimental to performance; however, this anomaly is under investigation.

PPS thermal limits were not exceeded during the flight, and the start sequences were characteristically smooth. The description by the crew of visual and dynamic start-transient effects was in accordance with expected events as shown in table 5.4-II. However, some accumulation of film and particles was reported on the spacecraft windows after main engine operations. This could result in reduced visibility, and the problem is being investigated.

The final PPS firing was initiated at 79:11:58.492 g.e.t. Approximately 900 pounds of PPS propellant remained after that firing. This propellant could not be used due to excessive usage of attitude control gas during the D005 experiment. Attitude control system operation is required during PPS firings to correct for roll torques imparted by the turbine and turbine exhaust.

A review of data taken on postfiring propellant isolation valve (PIV) venting effects indicated satisfactory system operation without undesirable side effects. Significant decreases in injector backface temperature were noted after each firing due to cooling by the normal oxidizer postflow. The minimum value reached was $+12^{\circ}$ F after the final PPS maneuver, but heat soakback from the thrust chamber quickly warmed the injector.

The fuel-pump inlet-pressure instrumentation indicated a zero shift of at least 6.1 psi after the first orbital firing. Transducer damage may have occurred due to the normal pressure transient spiking which occurs in the pump inlet after PIV opening or at the time of the main fuel-valve closure during engine shutdown.

UNCLASSIFIED

5.4.2.2 Secondary propulsion system.- The SPS Unit I thrust chambers were fired six times during this mission, once with each PPS usage. The engines accumulated 274 seconds of successful operation. The Unit II chambers were fired four times for a total of 43.2 seconds. The performance of SPS Unit I and Unit II are summarized in tables 5.4-III and 5.4-IV. In both systems, performance was highly satisfactory and within specification. SPS thermal measurements remained within the expected limits.

The Unit II plus Y chamber pressure measurement indicated 14.7 to 11.0 psi less than expected throughout flight operations (see fig. 5.4-2). However, this appears to be due to a transducer bias problem, as no other SPS deficiency or vehicle indication of improper SPS performance could be detected. A comparison of vehicle velocity gains versus Unit II thrust times also verified that the engine thrust levels were normal. The data indicate that a partially or totally blocked ambient-pressure sensing port on the transducer may have been the cause of this bias. This problem is being investigated.

The minus Y Unit I and Unit II skin temperature transducers both appear to have failed during the first firing of the thrust chambers. The instrumentation anomalies are covered in detail in section 5.4.7.

5.4.3 Communications and Command System

The performance of the Communications and Command System was excellent throughout the docked and undocked portions of the flight. The command system accepted commands through the UHF, L-band radar, and hardline links. The telemetry and tracking systems functioned very well.

5.4.3.1 Command system.- The command system functioned as expected, and all commands from the spacecraft and ground stations were verified by message acceptance pulses (MAP's). During this flight approximately 1350 commands were sent from the ground stations and 350 from the spacecraft.

5.4.3.2 Tracking system.- The C-band and S-band transponders oper-

5.4.3.3 Telemetry system.- The telemetry system operated satisfactorily during the entire flight. The tape recorder operated properly throughout the period of spacecraft flight and for approximately 52 hours after spacecraft reentry. At the end of that time, the tape recorder had been operating for approximately 28 hours in the playback mode when it failed to reverse the tape direction. Operation was restored by

UNCLASSIFIED

commanding the recorder to OFF and then back to ON. There were several subsequent failures, and it was necessary to use the off-on sequence each time to restore recorder operation. The failure to reverse tape direction was probably caused by an excessive buildup of tape oxide on the capstans and idlers or a worn tape. Although the malfunction did occur, this 28 hours of continuous operation at four times the record speed is abnormal and would increase the probability of failing prior to the design mean-time-to-failure. This was not considered a failure to meet design requirements.

5.4.4 Hydraulic and Pneumatic Systems

5.4.4.1 Hydraulic System.- The Hydraulic System operated properly throughout each of the PPS maneuvers. During Hydraulic System operation, the pump discharge pressure increased normally from zero to 2860 psia and occasionally to as high as 2960 psia during a maneuver. After each period of operation, the pump discharge pressure decreased to zero within two seconds after engine cutoff. Hydraulic reservoir pressure was normal and varied between 50 and 95 psig.

5.4.4.2 Pneumatics.- The propellant tank pressurization system functioned normally throughout the mission. Prior to lift-off, the propellant tanks were pressurized to 30.9 and 39.1 psig for the oxidizer and fuel tanks, respectively, and the helium pressurization tank was charged to 2480 psia. The pyrotechnically operated helium control valve operated properly for the pressurization of the propellant tanks. The propellant tank pressures varied from 25.0 to 22.9 psia for the oxidizer tank and 42.1 to 38.4 psia for the fuel tank. These pressures were within the expected values.

5.4.4.3 Attitude control system.- The attitude control system (ACS) was activated a few seconds after separation of the GATV from the TLV. The system functioned normally throughout the mission. After the GATV was placed in the final orbit, the ACS was deactivated by ground command. Approximately 10 pounds of ACS gas remained in the tanks at the end of the mission.

5.4.5 Guidance and Control System

The Guidance and Control System performed satisfactorily throughout the mission. Evaluation of the flight data indicated that the system performed its required functions as follows:

- (a) Performed all inflight switching requirements and programming
- (b) Responded properly to all commands

UNCLASSIFIED

- (c) Sensed and maintained vehicle attitude properly
- (d) Reacted to attitude errors with control forces of the proper polarity
- (e) Provided proper PPS engine cutoff through the velocity meter
- (f) Provided proper shutdown of SPS by command
- (g) Consumed a nominal amount of attitude control gas.

Guidance and control flight parameters are tabulated in tables 5.4-V through 5.4-VII.

5.4.5.1 Ascent guidance sequence. - All guidance and control parameters appeared nominal through the ascent portion of the flight. The ascent sequence timer was started by a booster discrete command at 275.5 seconds after lift-off. Events which occurred throughout the ascent phase are listed in table 5.4-V. Sequence timer performance was nominal throughout its period of operation.

TLV/GATV separation was initiated at 300.70 seconds after lift-off and was completed two seconds later. Rates imparted to the GATV at separation were zero deg/sec in pitch, +0.05 deg/sec in yaw, and +0.16 deg/sec in roll.

The programmed pitch-down maneuver following separation occurred at LO + 336.4 seconds at a rate of minus 1.48 deg/sec compared with a nominal of minus 1.5 deg/sec ± 15 percent. The torque rate saturated but the initial slope of the pitch position gyro was minus 1.48 deg/sec. The ascent PPS engine firing commenced at 369.4 seconds after lift-off and lasted for 188.6 seconds. The initial transients in pitch and yaw were greatly reduced from the flight of the Gemini VIII GATV. The maximum gyro deflection in pitch was minus 3.5 degrees and in yaw plus 2.57 degrees. These transients were essentially damped out in ten seconds. Roll characteristics were similar to those of the Gemini VIII GATV. Roll attitude error was 2.9 degrees and was corrected to less than one degree in 35 seconds. The PPS firing was terminated by a velocity meter cutoff. This maneuver and subsequent SPS and PPS maneuvers are summarized in table 5.4-VII.

The Gemini X GATV was essentially the same as the Gemini VIII GATV except for the addition of functions to the sequence timer, expansion of the telemetry limits of the attitude gyro preamplifiers outputs, and a correction of the center-of-gravity offset in pitch and yaw. The expansion of the gyro instrumentation limits and the center-of-gravity

UNCLASSIFIED

offset are discussed in section 5.4.5.2.2. The additional functions in the sequence timer were to provide a redundant sequence timer shutdown and to assure a docking capability in the event of a communication link failure between the GATV and the ground. The added sequences were extension of the L-band antenna at 558.07 seconds and unrigidizing the TDA at 700.5 seconds. The primary timer did shut down as programmed, and the redundant timer shutdown circuit was not required.

The flight data indicate that the hydraulic return pressures slowly increased from 80 psig to slightly greater than 100 psig during the PPS engine ascent firing. This is considered a normal increase with a full hydraulic reservoir at the fluid temperature reached during the maneuver (161.7° F).

5.4.5.2 Orbit guidance sequence.--

5.4.5.2.1 Docking: Docking occurred at 5:52:37.1 g.e.t. The docking maneuver appears to have been quite normal and similar to that performed during the Gemini VIII mission. Maximum attitude excursions were 0.6 of a degree in pitch, 1.27 degrees in yaw, and minus 3.3 degrees in roll.

5.4.5.2.2 PPS engine firings: There were six PPS engine firings during the flight including the insertion maneuver, and three of the remaining five were for docked maneuvers. Performance of the Guidance and Control System during these firings is contained in table 5.4-VII. Pitch, yaw, and roll control parameters are plotted in figures 5.4-3 and 5.4-4 for PPS maneuvers 1 and 3, which are typical of the undocked and docked firings.

Pitch and yaw heading errors were reduced during PPS maneuvers for this mission by locating the center of gravity closer to the vehicle X axis than it was for the Gemini VIII mission. Known heading errors were different from predicted values but were within the uncertainty error limits established prior to the flight. The telemetered gyro limits were increased for this flight from ± 5 to ± 10 degrees to permit detection of possible larger heading errors; however, pitch and yaw gyro deflections did not exceed four degrees.

It is impossible to derive actual hydraulic vehicle-to-engine gains due to actuator null uncertainty biases in pitch and yaw. However, vehicle dynamic response and control were as predicted, verifying proper autopilot gains. Control gas usage through all the PPS firings appeared nominal (see figure 5.4.5). All PPS firings were terminated by a velocity meter cutoff.

UNCLASSIFIED

5.4.5.2.3 SPS Unit II firings: Four SPS Unit II firings were performed during the flight—three docked and one undocked. The attitude control system provided adequate control during all SPS firings. The control gas usage was as follows:

SPS firing	Duration, sec	Control gas usage, lb		Actual usage rate, lb/sec
		Predicted	Actual	
1 (docked)	10.25	0.40	1.7	0.166
2 (docked)	16.88	0.65	2.5	0.148
3 (docked)	4.13	0.16	^a 1.0	0.242
4 (undocked)	11.68	0.25	1.5	0.129

^aThe one-pound usage is based on a best estimate. The resolution on control gas pressure and temperature changes is too large to accurately determine gas consumption.

The actual control gas usage was larger than predicted. Probable causes for this are:

- (a) Center-of-gravity and thrust misalignment uncertainties
- (b) Removal of vehicle rates at thrust shutdown
- (c) Narrow-deadband limit-cycle rates
- (d) Propellant slosh movement causing minor center-of-gravity shifts in low-g acceleration field.

5.4.5.2.4 Heading changes: Heading changes, docked and undocked, were made by two methods—programmed rates and gyrocompassing. The heading changes made with the programmed rates were nominal. Control gas consumption (± 1.5 deg/sec maneuver) averaged 0.9 of a pound per 90-degree maneuver against a predicted 1.0 pound. Control gas consumption using the gyrocompassing method was approximately 0.5 of a pound per 90-degree maneuver against a predicted 0.3 of a pound.

5.4.5.2.5 Velocity meter operation: SPS Unit II thrusting times were longer than expected. Nominal and actual firing times, along with

UNCLASSIFIED

desired and actual velocity gains, are listed below:

SPS firing no.	Vehicle configuration	Duration, sec		Velocity gained, ft/sec	
		Nominal	Actual	Desired	Actual
1	Docked	7.90	10.25	7.69	9.85
2	Docked	15.12	16.88	14.73	16.16
3	Docked	3.47	4.13	3.39	3.98
4	Undocked	11.58	11.68	32.20	32.12

The preceding data indicate degraded velocity meter performance during the SPS firings. During docked operations, spacecraft data did not agree with data from the GATV velocity meter. It is believed that a negative bias in the velocity meter electronics resulted in the observed difference. The bias caused a velocity meter negative count during the period between velocity meter activation and engine operation. The negative count must be neutralized prior to normal operations; therefore, the velocity meter appeared to be late in sensing positive velocity changes.

5.4.6 Electrical System

The GATV Electrical System performed satisfactorily, and no malfunctions or anomalies of the Electrical System were evident within the readability of the monitored data. The system functioned properly to power depletion at approximately 160 hours after GATV lift-off.

5.4.6.1 Main bus voltage.- The main bus unregulated dc voltage closely followed the predicted discharge characteristic of the type 1-C primary batteries. The initial potential was 28.48 volts and the sustained potential was 24.63 volts.

5.4.6.2 Main bus current.- The main bus load was normal and the average current for the life of the batteries was 14.6 amperes. The lowest value was 9.34 amperes and the highest value was 51.47 amperes. The reflected load responses were as expected and well within the capability of the system.

UNCLASSIFIED

5.4.6.3 Pyro bus voltage.— The pyro bus voltage, with diode isolation from the main bus, displayed normal operating characteristics. The initial potential was 28.76 volts and the prolonged level was 25.27 volts; the 0.64-volt differential above the main bus was as anticipated. Near main battery depletion, the pyro bus battery contributed an unequal share of the main bus load, as expected.

5.4.7 Instrumentation System

The Instrumentation System provided for the monitoring of 156 analog and 27 step-function (tell-tale) parameters. All instrumentation parameters were operative at lift-off, and only two parameters—temperature sensors B-247 (SPS Unit I minus Y skin temperature) and B-249 (SPS Unit II minus Y skin temperature)—failed to provide good data during the mission. Two additional parameters—B-1 (fuel-pump inlet pressure) and B-214 (SPS Unit II plus Y chamber pressure)—provided degraded but adequate data.

The SPS Unit I minus Y skin temperature did not indicate the peak temperature of the SPS firing during ascent. The lower temperature of this measurement and the slow response compared with a similar temperature monitor on the plus Y monitor indicated an improper attachment of the sensor to the Unit I minus Y thruster.

A similar problem was detected on the SPS Unit II minus Y skin temperature. This failure was attributed to an improper bond of the sensor to the thruster skin.

The PPS fuel-pump inlet pressure indicated a linear shift at the conclusion of the first orbital PPS maneuver. Upon closure of the main fuel valve, a transient pressure developed which caused a shift in indicated pressure of approximately 4.7 pounds. Data prior to the second PPS orbital maneuver indicated an increase in residual pressure from 0.4 psi to 5.3 psi, which remained as a bias throughout the remainder of the mission. Apparently the large pressure transient resulted in damage to this transducer. An orifice in the pressure transducer line of future vehicles is being considered as a remedy to the problem. The use of an orifice will not adversely affect the response of fuel-pump inlet pressure data.

The SPS Unit II plus Y chamber pressure initially indicated a pressure of 14.7 psi less than nominal compared with Unit II minus Y chamber pressure. Throughout the mission this pressure increased, and during the last SPS Unit II firing it was 11.3 psi below nominal. The performance of the SPS Unit II thrusters was observed to be nominal. The

UNCLASSIFIED

initial pressure of 14.7 psi led to the conclusion that Unit II plus Y chamber pressure was indicating a pressure referenced to one atmosphere rather than a gage pressure as required. The decreasing pressure (as referenced to the Unit II minus Y chamber pressure) indicated that the transducer's reference port was restricted and was bleeding off. Recommendations are being made to assure that pressure transducer reference ports are checked and free of constricting materials.

5.4.8 Range Safety

Performance of the Range Safety System was satisfactory.

5.4.8.1 Flight termination system.- The range safety command receivers received adequate signal to execute commands throughout the ascent phase. No commands were sent and no spurious commands were received.

5.4.8.2 Tracking system.- The C-band transponder was used by various radars to provide input position data for the Instantaneous Impact Predictor (IIP) computer. System performance was satisfactory.

UNCLASSIFIED

TABLE 5.4-I.- PRIMARY PROPULSION SYSTEM START TRANSIENTS DATA

	1	2	3	4	5
PPS maneuver number					
Time of PPS FS, g.e.t.	7:39:40.963	20:21:20.248	22:38:15.302	72:21:24.944	79:11:58.492
Time of PPS SS, g.e.t.	7:39:53.999	20:21:30.710	22:38:18.266	72:21:34.890	79:12:07.786
Time, FS to FGGV open, sec	0.062	0.075	0.053	0.084	0.084
Time, FS to OGGV open, sec	0.051	0.032	0.073	0.042	0.073
Time, FS to TMP rapid rise, sec	0.241	0.229	0.231	0.263	0.263
Time, FS to oxidizer valve open, sec	0.387	0.472	0.409	0.440	0.375
Time, FS to OMP or OFF switch make, sec	0.831	0.887	0.875	0.928	0.875
Time, FS to both switches made, sec	0.866	0.958	0.875	1.009	0.875
Time, FS to fuel valve open, sec	0.941	0.963	0.973	1.028	0.978
Time, FS to ignition, sec	0.964	1.020	0.991	1.053	1.009
Time, FS to 75 percent thrust, sec	0.979	1.046	1.007	1.060	1.024
Firing duration 75 percent P _c to B-108 off, sec	12.057	9.442	1.957	8.896	8.270
Average PPS P _c , psia	478	473	475	476	478.3
Gas generator P _c peak, psig	539	557	563	484	503.2
Gas generator P _c average, psig	433	424	408	416	432.3
Calculated preflow (±0.5 lb), lb	6.72	6.72	6.06	6.38	6.69
Prefire OVIP, psia	1158	1042	1085	996	1085
Prefire FVIP, psia	1142	1075	1088	1014	1075
Prefire OSP, psig	29.2	27.2	26.3	24.7	23.1
Prefire FSP, psig	49.4	50.6	48.2	47.8	45.8

^aTime from GAATV lift-off, sec.

Abbreviations

- FGGV Fuel gas generator valve
- FS Fire signal
- FSP Fuel suction pressure
- FVAP Fuel valve actuation pressure
- FVIP Fuel venturi inlet pressure
- g.e.t. Ground elapsed time
- o/f Oxidizer/fuel
- OFF Oxidizer feed pressure
- OGGV Oxidizer gas generator valve
- OMP Oxidizer manifold pressure
- OSP Oxidizer suction pressure
- OVIP Oxidizer venturi inlet pressure
- PPS Primary Propulsion System
- P_c Chamber pressure
- SS Shutdown signal
- TMP Turbine manifold pressure

UNCLASSIFIED

TABLE 5.4-II.- PPS NORMAL TRANSIENT EVENTS

Item	Approximate time, sec	Astronaut indication
Fire signal	0.0	None.
SPS Unit I start	16.0	May be visible. Not audible.
PPS gas generator ignition	68.3	Visible glow. Possibly some sparks and noise at start.
Oxidizer preflow starts	69.0	Flashes at rear as oxidizer mixes with fuel-rich turbine exhaust.
Main engine ignition	69.1	1 to 1.5g within 0.030 seconds. Visible.
Engine shutdown	As commanded	Loss of thrust and lighting.
Engine postflow	Shutdown to + 10	Tailoff, spectacular, characterized by sparks in a continuous tenuous bright yellow glowing gas stream.

UNCLASSIFIED

TABLE 5.4-III.- SPS UNIT I PERFORMANCE

	1	2	3	4	5
SPS maneuver number	7:38:33.75	20:20:12.03	22:37:07.8	72:21:04.91	79:11:38.43
Start time, g.e.t.	0.210	0.215	0.240	0.218	0.230
90-percent P _c time	0.247	0.288	0.270	0.228	0.245
+Y	78.7	80.0	80.7	83.2	82.7
-Y	81.0	80.5	80.9	83.4	82.9
P _c average					
+Y	206.3	208.8	210.0	217.3	213.7
-Y	209.2	204.3	201.9	211.6	209.2
Average fuel feed pressure, psia					
+Y	207.4	211.1	214.7	220.8	217.2
-Y	209.4	203.3	202.1	210.6	208.2
Thrust duration, sec	70.22	70.25	70.25	22.06	22.06
Propellant temperature, °F					
Oxidizer +Y	76.9	73.4	73.4	62.7	62.7
Oxidizer -Y	69.9	69.9	68.1	62.7	59.2
Fuel +Y	69.9	64.5	66.3	59.2	55.6
Fuel -Y	76.9	76.9	76.9	69.9	69.9

^aTime in seconds from GAATV lift-off.

UNCLASSIFIED

TABLE 5.4-IV.- SPS UNIT II PERFORMANCE

	1	2	3	4
SPS maneuver number	27:45:36.47	41:04:26.60	41:35:50.52	82:58:06.09
Start time, g.e.t.	(a)	(a)	(a)	(a)
90-percent P _c time, sec	0.115	0.112	0.115	0.130
+Y	79.6	82.0	85.2	82.9
-Y	93.8	93.8	96.0	94.2
P _c average, psia				
+Y	195.4	197.8	207.6	195.4
-Y	197.1	198.7	201.9	197.1
Average fuel feed pressure, psia				
+Y	197.7	200.1	209.8	200.1
-Y	197.2	197.2	202.1	197.2
Thrust duration, sec	10.38	17.00	4.25	11.66
Propellant temperature, °F				
Oxidizer +Y	69.9	65.7	66.3	62.7
Oxidizer -Y	66.3	65.5	62.7	59.2
Fuel +Y	59.2	55.6	59.2	59.2
Fuel -Y	73.4	73.4	73.4	69.9

^aNot valid because of P_c reference problem.

UNCLASSIFIED

TABLE 5.4-V.- ASCENT SEQUENCE OF EVENTS

Event	Time from lift-off, sec	
	Nominal	Actual
Lift-off	0.0	0.0
Start sequence timer	276.2	275.5
Gyros uncaged	297.5	298.1
Horizon sensor doors jettisoned		
TLV/GATV separation	300.0	300.7
Primacord and retrorockets fired		
Enable ACS	302.5	302.7
Programmed pitch-down maneuver (-1.5 deg/sec)	337.2	336.4
Programmed pitch-down maneuver off	350.2	349.5
Geocentric rate on (-3.99 deg/sec)		
Enable velocity meter		
Disable pitch and yaw pneumatics	370.2	369.4
PPS thrust initiate		
PPS thrust cutoff (velocity meter)	556.2	558.1
Enable pitch and yaw pneumatics		
Extend L-band down antenna	556.2	558.1
ACS deadband wide	572.2	571.5
Disable velocity meter	588.2	587.6
Gyrocompassing on, low gain		
ACS gain low	695.2	694.5
ACS pressure low		
Unrigidize TDA	701.2	700.5
Fire horizon-sensor zero-degree position squib	702.2	701.2
Shutdown sequence timer	702.2	701.8

UNCLASSIFIED

TABLE 5.4-VI.- HORIZON SENSOR TO INERTIAL
REFERENCE PACKAGE GAINS

Axis	Very high gain		High gain	
	Nominal	Actual	Nominal	Actual
Pitch	3.0 ±0.6	2.6	1.0 ±0.2	0.9
Roll	9.0 ±1.8	9.6	1.0 ±0.2	1.1
Yaw (gyrocompassing)	0.0	0.0	8.0 ±1.6	7.0

NOTE: All gains measured in deg/min/deg HS.

UNCLASSIFIED

TABLE 5.4-VII.- GUIDANCE AND CONTROL SYSTEM PERFORMANCE

Maneuver no.	Heading error, deg				Velocity-meter load, ft/sec	Velocity-meter cutoff time, g.e.t.	Velocity-meter tailoff ^a , ft/sec	Total velocity gains, ft/sec		
	Pitch		Yaw					Desired	Velocity-meter indication	Actual ^b
	Predicted	Actual	Predicted	Actual						
SPS 1	+0.07	+0.11	-0.02	-0.24	8237.000	558.074 (seconds after lift-off)	12.5	8249.5		
2	+1.18	-0.54	+1.06	+2.00	413.832	7:39:53.971	6.5	419.4	420.0	
3	+0.93	-0.58	+1.39	+2.36	332.995	20:21:30.685	6.9	339.9	340.0	
4	+0.39	-0.29	+0.50	+0.98	68.842	22:38:18.238	6.5	75.4	79.0	
5	+1.04	-1.32	-0.49	+2.18	838.880	Bad data	6.4	845.3	856.8	
6	+1.00	-1.90	-0.50	+1.77	865.736	79:12:07.772		865.7	886.3	
SPS 1	-0.16	0.00	-0.17	-0.13	7.692	27:45:46.798	0.0	7.7	7.7	
2	-0.16	-0.10	-0.17	-0.10	14.733	41:04:43.521	0.0	14.7	14.8	
3	-0.16	-0.10	-0.17	-0.13	3.390	Spacecraft shutdown	No data	None	3.5	
4	-0.37	-0.25	-0.30	0.00	32.204	Bad data	0.5	32.7	32.2	

^aTailoff velocity-meter word is converted to ft/sec as follows: (32 767 - (no. of pulses) - 1) x velocity-meter scale factor.

^bActual velocity gains are calculated as follows for SPS firings: $\Delta V = \frac{(SPS \text{ average thrust}) \times \Delta t \times 32.17}{W_{avg}}$ where SPS thrust average is 394 pounds for

$$W_{avg} = W_{act} + \frac{W_{avg_initial} + W_{avg_final}}{2}$$

firings 1, 3, and 4 and 392 for firing 2, and $\Delta V = 0.1$ ft/sec. Calculations exclude thrust buildup and tailoff impulse.

^cExclusive of tailoff.

UNCLASSIFIED

NASA-S-66-8087 AUG 10

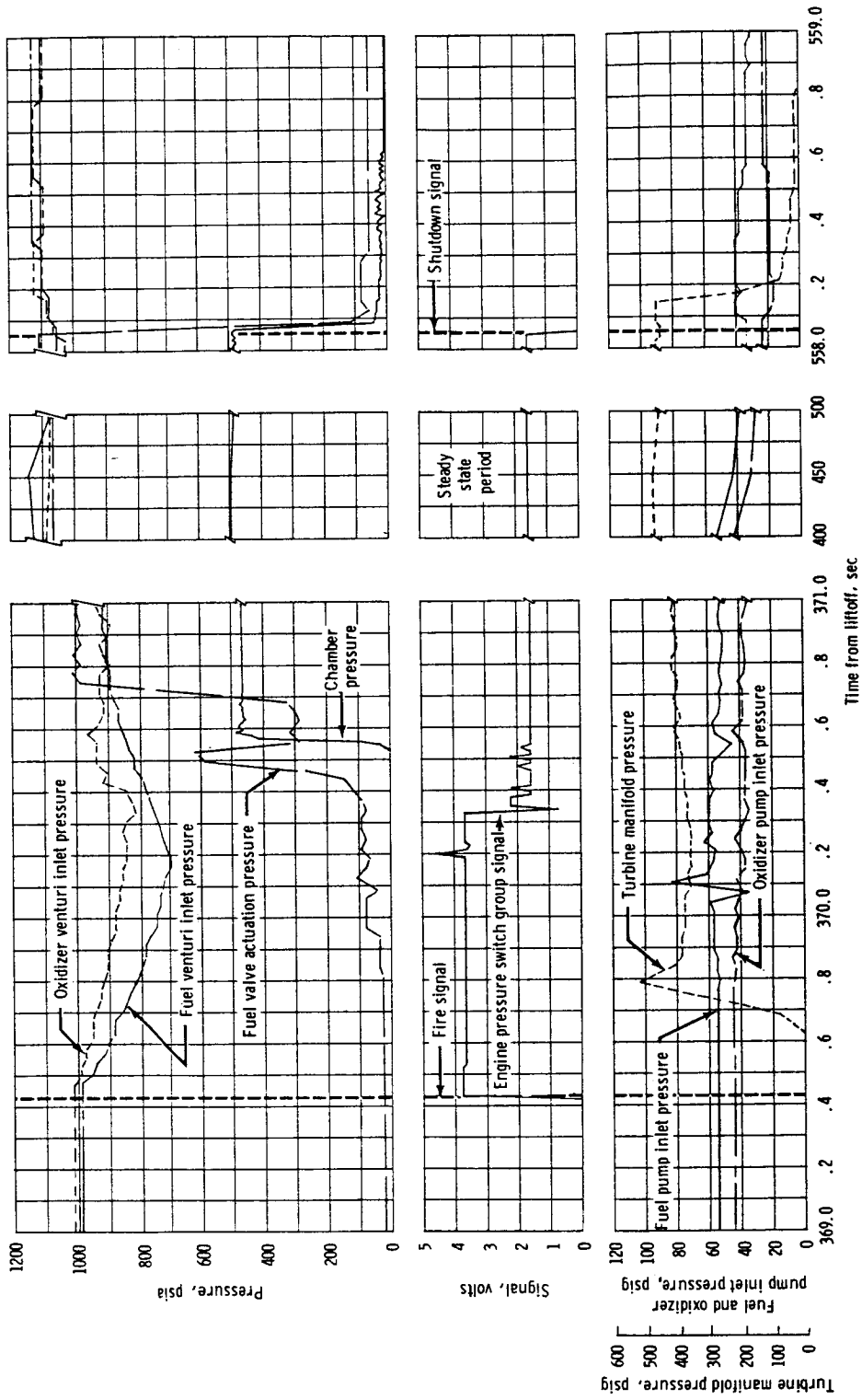
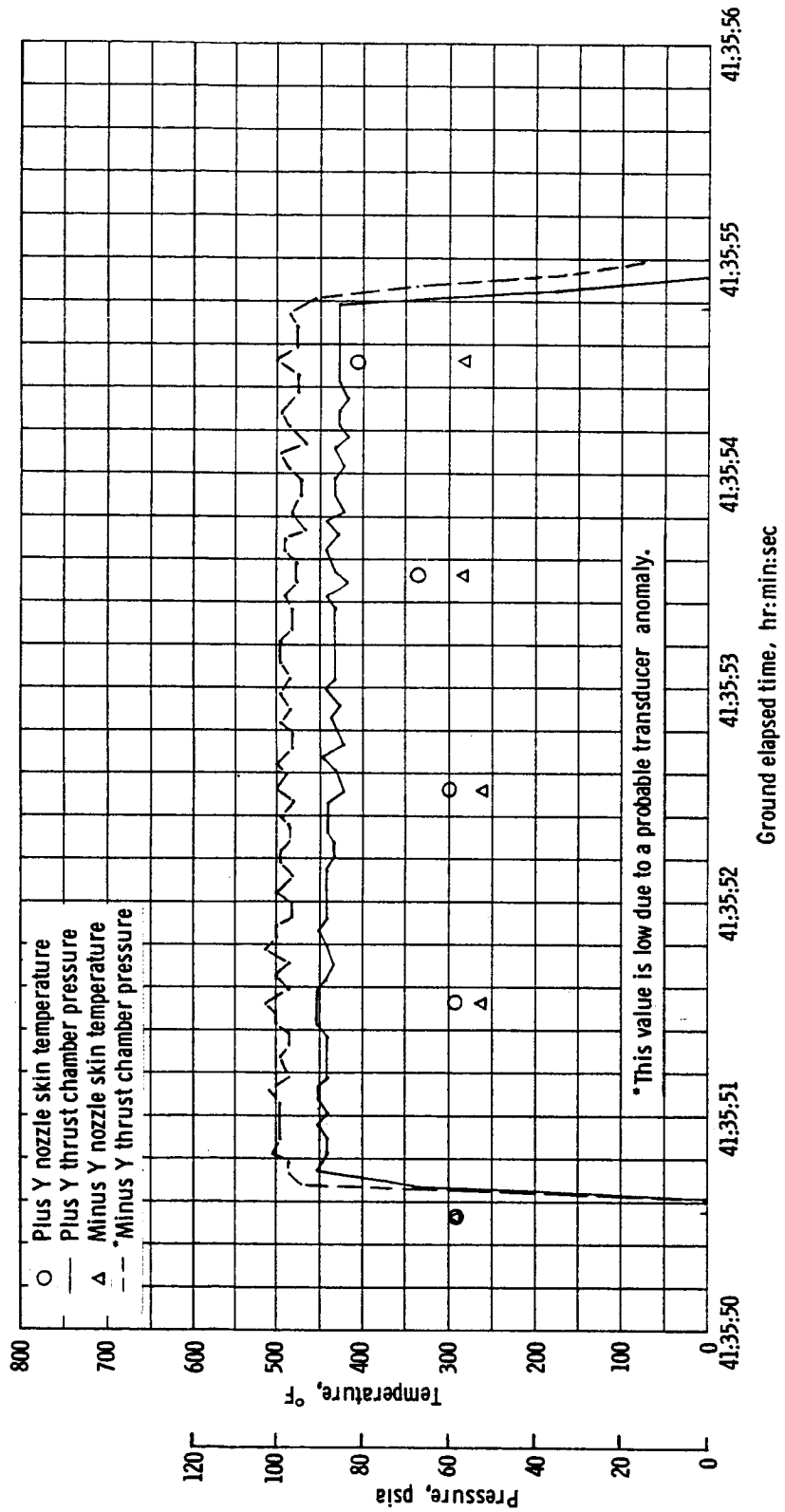

Figure 5.4-1.- PPS performance transients during ascent maneuver.

UNCLASSIFIED

UNCLASSIFIED

NASA-S-66-8110 AUG 12



UNCLASSIFIED

Figure 5.4-2. - SPS unit II performance (3rd docked SPS firing).

UNCLASSIFIED

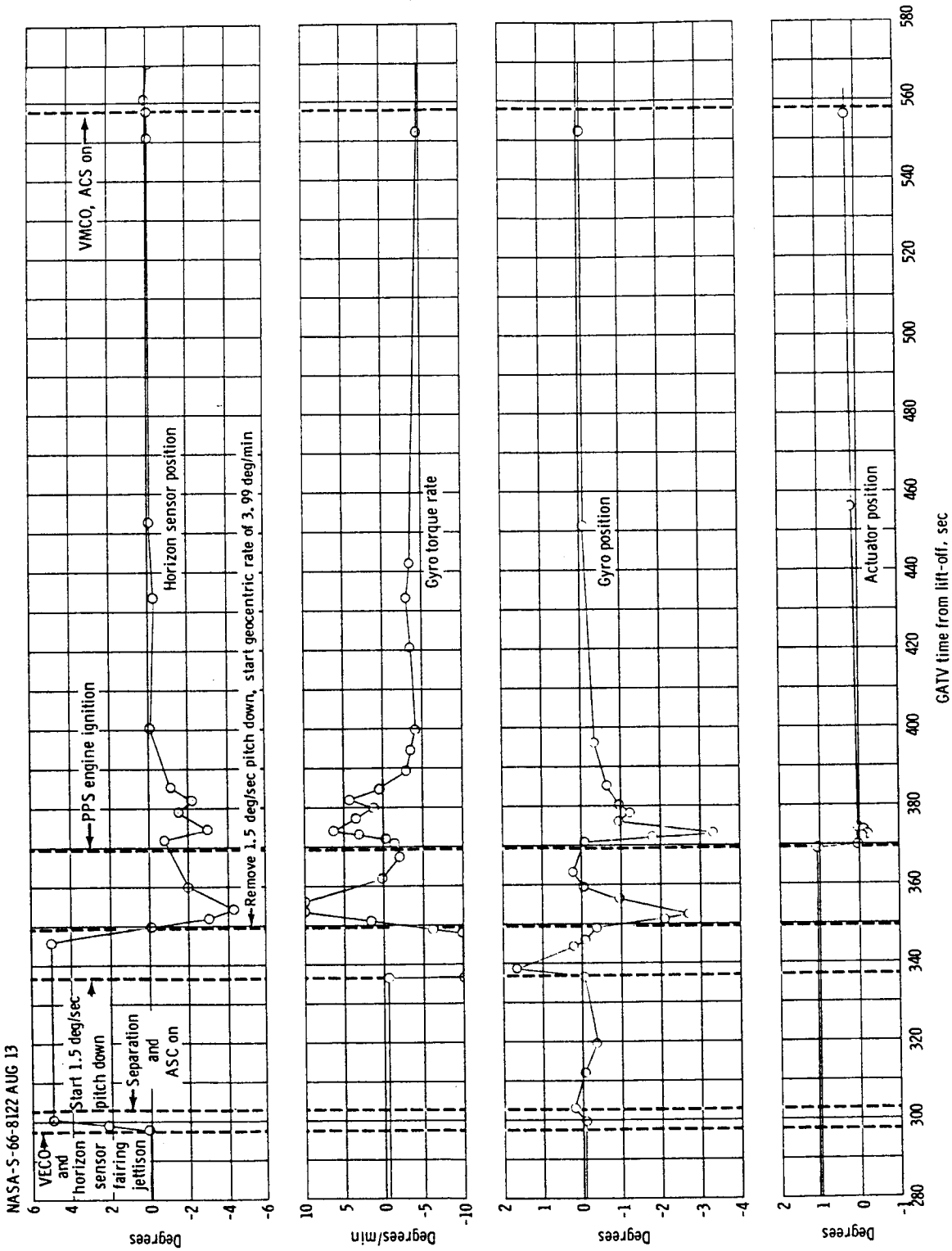

(a) Pitch axis.
Figure 5.4-3. - Ascent guidance performance.

UNCLASSIFIED

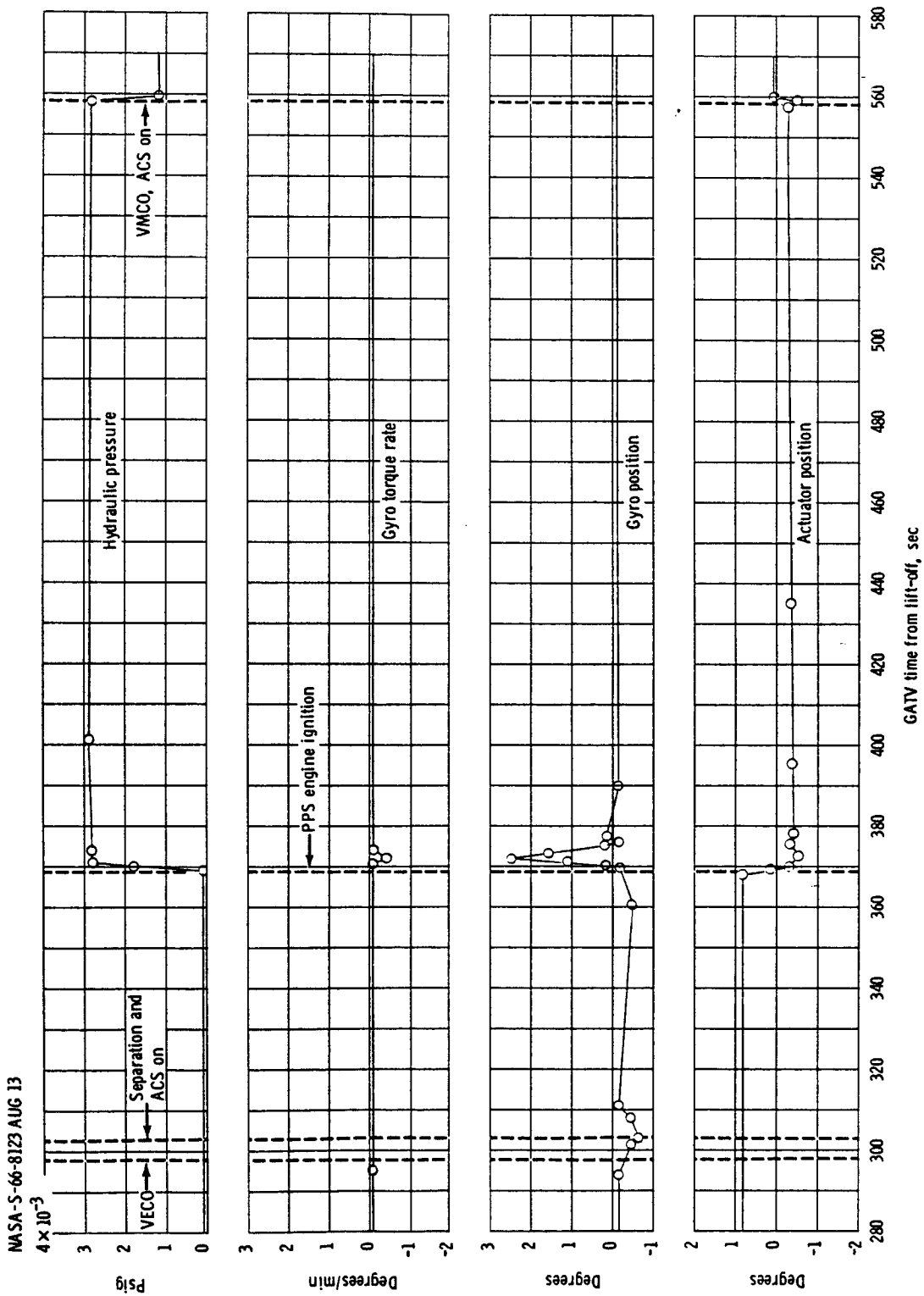

(b) Yaw axis.
Figure 5.4-3. - Continued.

UNCLASSIFIED

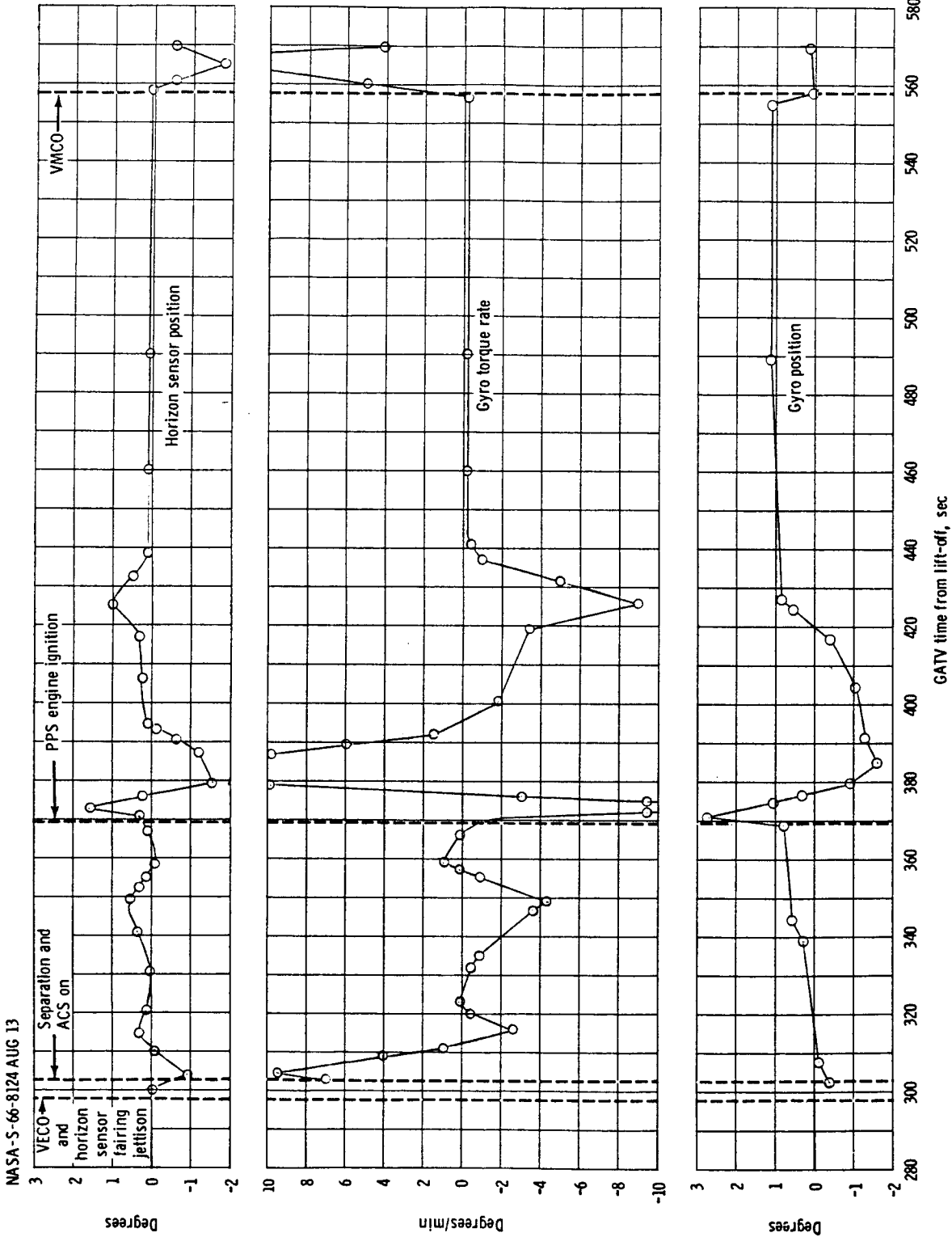

(c) Roll axis.
Figure 5.4-3. - Concluded.

UNCLASSIFIED

NASA-S-66-8126 AUG 13

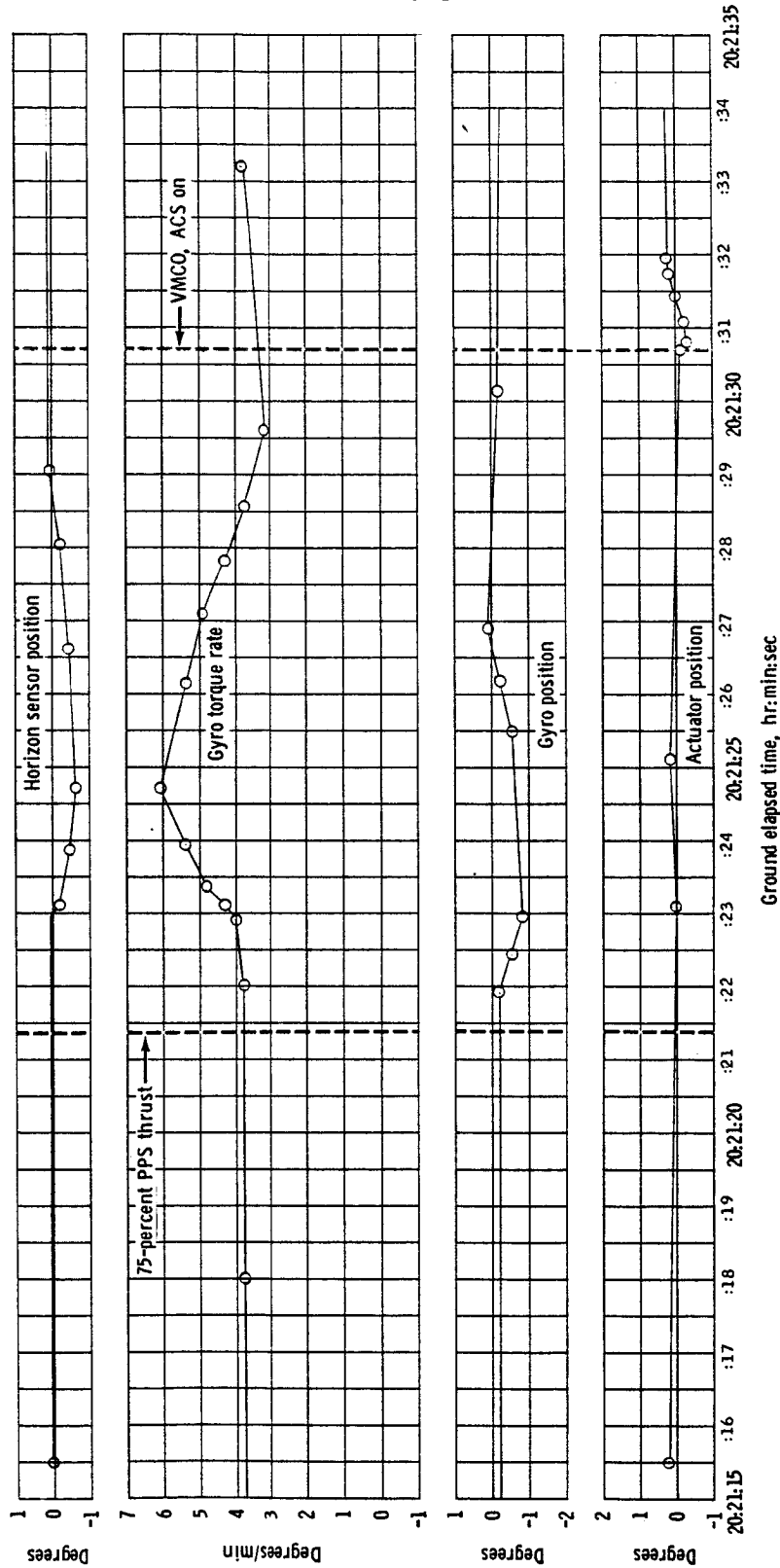

(a) Pitch axis.

Figure 5.4-4. - Guidance performance during PPS docked height-adjust maneuver.

UNCLASSIFIED

NASA-5-66-8121 AUG 13

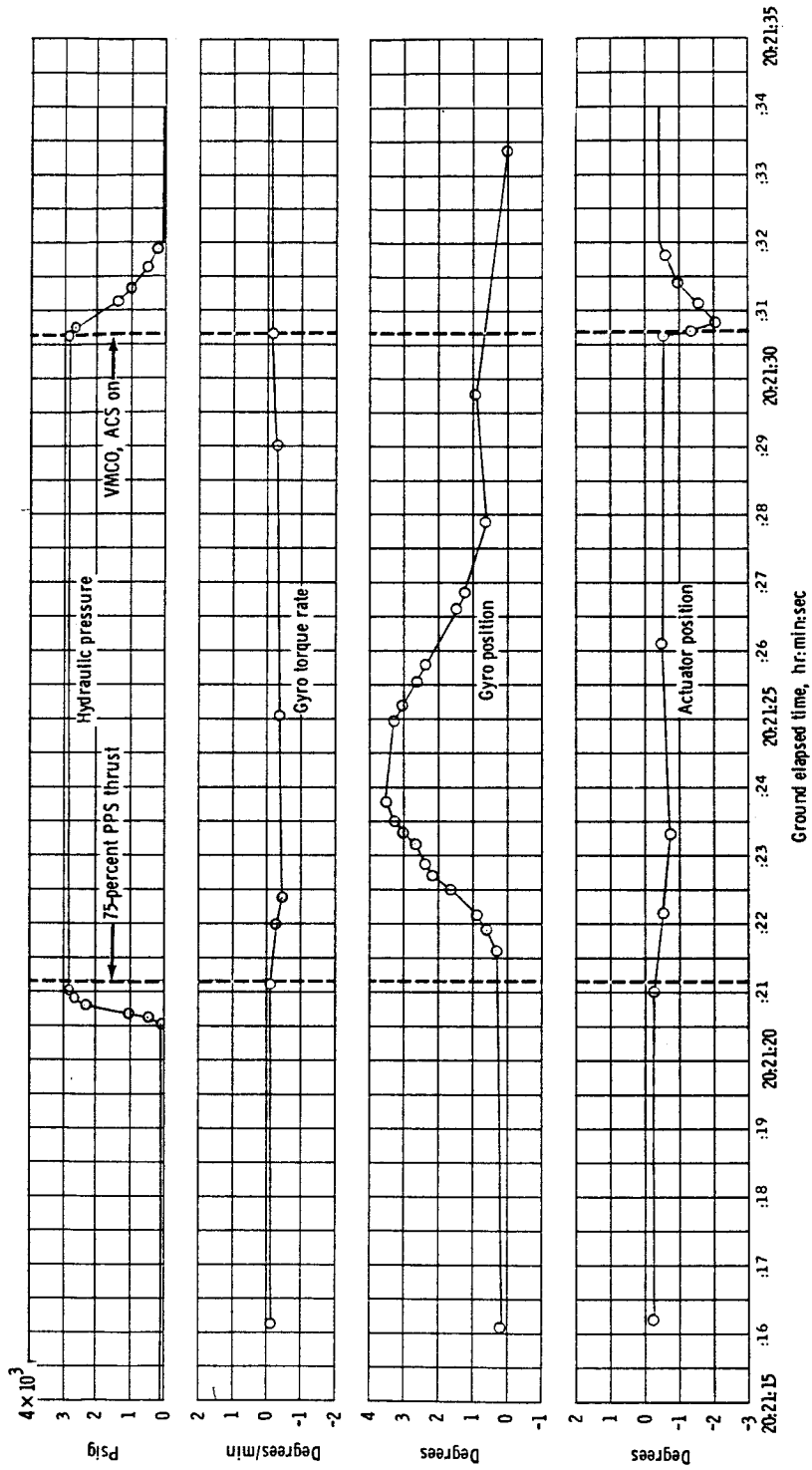

(b) Yaw axis.

Figure 5.4-4. - Continued.

UNCLASSIFIED

UNCLASSIFIED

NASA-S-66-8127 AUG 13

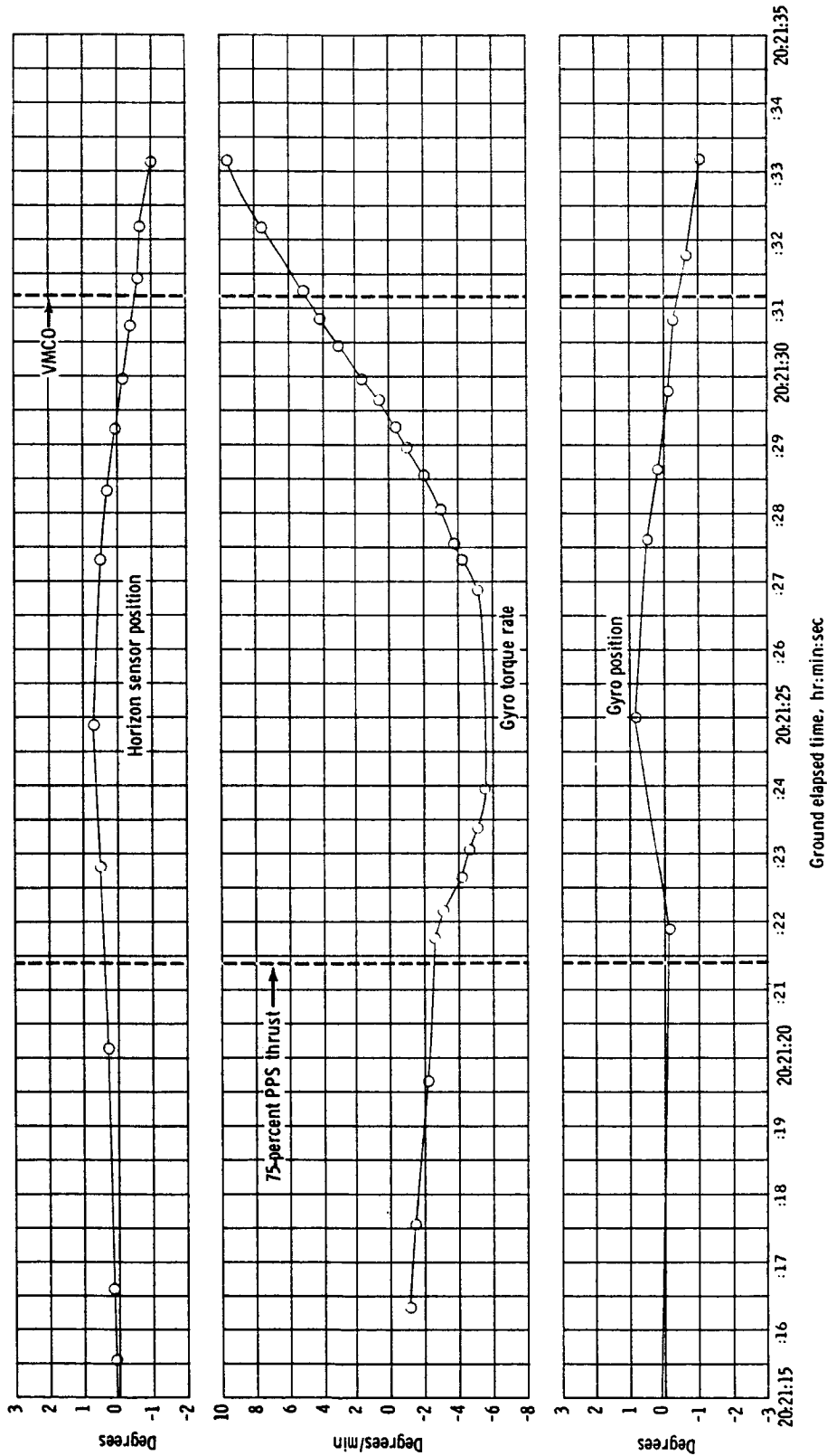

UNCLASSIFIED

(c) Roll axis.

Figure 5.4-4. - Concluded.

UNCLASSIFIED

NASA-S-66-8103 AUG

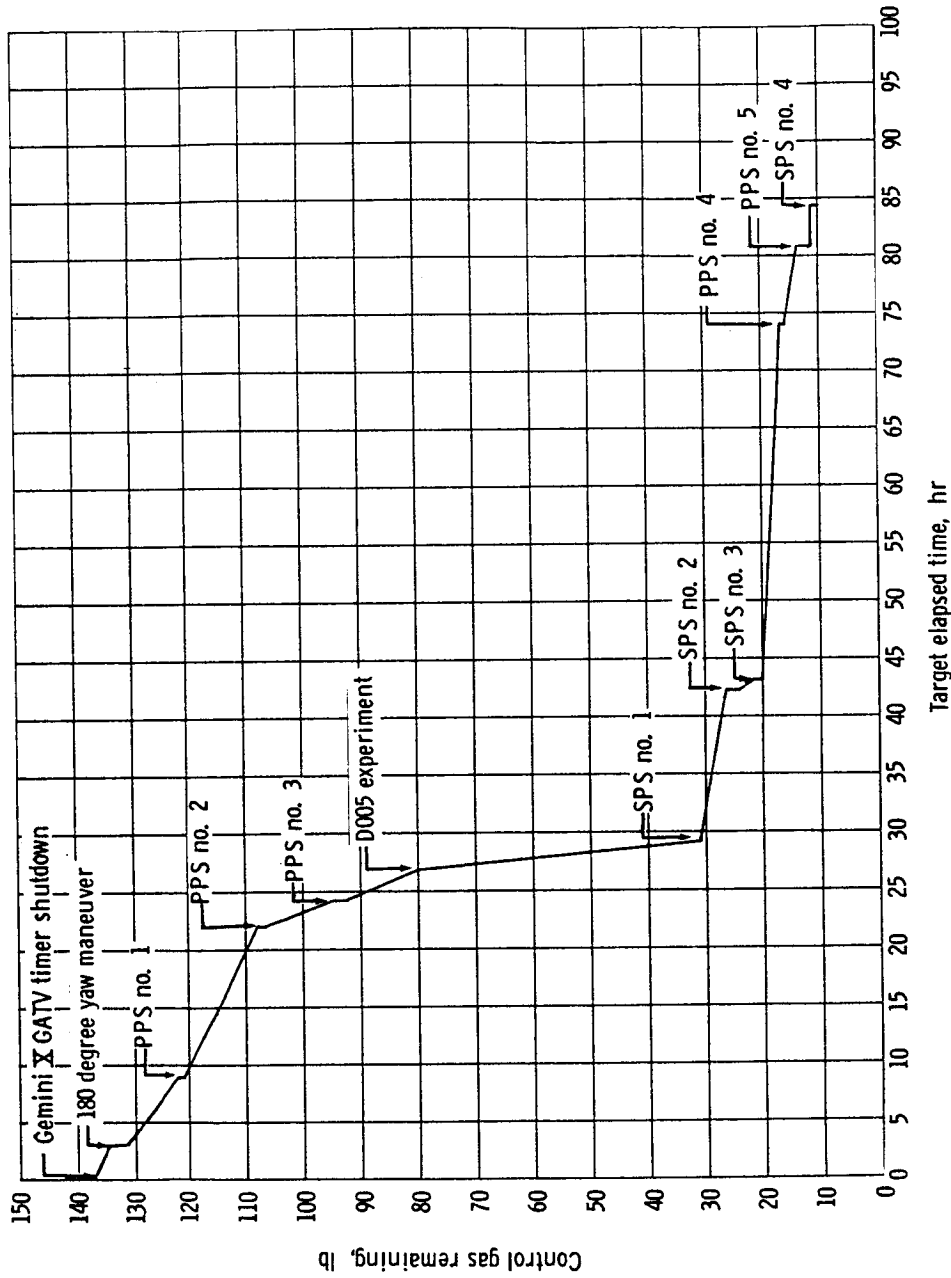

Figure 5.4-5. - GATV attitude control gas usage.

UNCLASSIFIED

5.5 TARGET LAUNCH VEHICLE PERFORMANCE

The performance of the Target Launch Vehicle (TLV) was satisfactory. The TLV boosted the Gemini Agena Target Vehicle (GATV) to the required velocity and position for subsequent insertion into the specified orbit. The TLV also provided the discrete signals to the GATV for staging-system operation and for separation from the TLV. The actual insertion parameter values indicated satisfactory adherence to the inflight desired values.

The TLV/GATV was launched from Complex 14, Air Force Eastern Test Range (ETR) at 3:39:46.131 p.m. e.s.t. on July 18, 1966. No holds or difficulties were encountered during the TLV/GATV launch countdown. All times in this section, unless otherwise noted, are referenced to 2-inch motion of the TLV as zero time.

5.5.1 Airframe

Structural integrity of the TLV Airframe was satisfactorily maintained throughout the flight. The 5-cps longitudinal oscillation normally encountered after lift-off reached a maximum amplitude of 0.45g peak-to-peak at approximately lift-off (LO) + 4 seconds and was damped by LO + 25 seconds. This oscillation is excited during release of the launcher hold-down arms.

Telemetered axial acceleration data indicated the following peak accelerations:

Reference	Axial accelerations, g	
	Planned	Actual
Booster engine cutoff (BECO)	6.30	6.28
Sustainer engine cutoff (SECO)	3.08	2.87

Booster-section jettison at LO + 133.407 seconds and GATV separation at LO + 300.447 seconds were normal. TLV telemetered gyro and acceleration data indicated normal transients and vehicle disturbances at these times.

Starting at approximately LO + 65 seconds, the measurement of ambient temperature on the jettison rail support in Quadrant IV of the engine

UNCLASSIFIED

compartment reflected a condition indicative of a cryogenic leak. The measured temperature decreased at a rate of 4.5 deg/sec and reached the lower instrumentation bandwidth (IBW) of -50° F at LO + 117 seconds. The temperature remained offscale (below -50° F) until LO + 163 seconds and then increased to $+40^{\circ}$ F by SECO. This is the fifth SLV-3 flight during which this temperature has dropped below -50° F. The other four thrust-section temperature parameters did not reflect the indicated cryogenic leak. This cryogenic condition was also evidenced by an apparent freezing of one propulsion system instrumentation sensing line.

The maximum boost-phase temperature, recorded at BECO, was 112° F in the area of the sustainer fuel pump. Ambient pressure and temperature conditions within the interstage adapter were satisfactory. The ambient pressure exhibited a normal exponential decay during the flight. The ambient temperature increased from 16° F at lift-off to 76° F at TLV/GATV separation.

5.5.2 Propulsion System

5.5.2.1 Propulsion System.- Operation of the engine systems, utilizing the MA-5 booster, sustainer, and vernier components, was satisfactory in performance and operational characteristics. Indications of cryogenic leakage on several previous flights resulted in several design changes and implementation of precautionary measures to reduce the probability of cryogenic leakage and to protect critical areas in the event of a cryogenic leak. Refer to section 3.5 for details of design changes incorporated on this vehicle.

A comparison of actual computed thrust obtained during flight with the expected thrust levels is shown in the following table.

Engine		Thrust, lb			
		Lift-off	BECO	SECO	VECO
Booster	Predicted	330 230	379 990	NA	NA
	Actual	326 714	379 761	NA	NA
Sustainer	Predicted	56 940	80 492	79 632	NA
	Actual	55 950	78 478	77 902	NA
Vernier	Predicted	1 151	1 407	1 149	1 155
	Actual	1 134	1 405	1 060	912

NA - Not applicable

UNCLASSIFIED

The engines ignited at LO minus 3.39 seconds; ignition, thrust rise, and thrust levels were normal prior to lift-off. The booster, sustainer, and vernier engines were cut off by guidance system commands. The booster and sustainer engine shutdown characteristics were as expected. The vernier system transitioned to tank-fed operation satisfactorily. A summary of the engine cutoff relay activations and start-of-thrust-decay times is shown in the following table.

Event	Engine relay activation, time from lift-off, seconds	Start of thrust decay, time from lift-off, seconds
BECO	130.434	130.502
SECO	279.344	279.399
VECO	298.088	298.171

The vernier-engine liquid-oxygen tank pressure measurement indicated an anomaly similar to one noted on numerous other flights. The pressure should complete a pressure rise from the start-system regulator-discharge-pressure level to the sustainer liquid-oxygen pump-discharge-pressure level within approximately 15 seconds after BECO. On this flight, the normal pressure rise was interrupted 7.4 seconds after BECO, when the pressure stabilized briefly at 675 psia and then dropped to 665 psia. The normal rate of pressure rise resumed at BECO + 27.4 seconds and reached the operating steady-state level of 725 psia at BECO + 39 seconds. This slow repressurization is attributed to helium leakage in the vernier-engine liquid-oxygen system while the system was being refilled with liquid oxygen. When the liquid-oxygen level was sufficient to cover the point of leakage, the pressure within the tank rose to the normal level. Although the leak was still present, the leakage rate changed drastically because the leaking substance changed from gaseous helium to liquid oxygen. Previously, leakage was believed to exist at the bulkhead fitting and seal of the tanks. As a result of the slow repressurization indicated on this flight, the previous analysis and corrective action will be reevaluated.

The sustainer fuel-pump discharge pressure indicated a condition which is considered to be indicative of an instrumentation sensing line being frozen as a result of a cryogenic leak. This cryogenic leak is not associated with the suspected leak in the vernier-engine liquid-oxygen tank.

As noted in section 5.5.1, engine-compartment ambient temperature data also gave evidence of a low-temperature environment in Quadrant IV of the thrust section. The data recorded for the sustainer fuel-pump

UNCLASSIFIED

discharge pressure indicated a decay beginning at approximately LO + 238.5 seconds. The pressure decayed from a steady-state level of 910 psia and reached 660 psia by SECO. The normal abrupt pressure drop resulting from SECO was not noted. The indicated pressure continued to decay slowly after SECO, stabilizing at 630 psia at LO + 287 seconds. A slow pressure increase began at LO + 315 seconds, and, at the time of TLV telemetry signal loss (LO + 570 seconds), the indicated pressure was 1275 psia. This problem has been under investigation because of a prior history of cryogenic leakage. The investigation resulted in several design changes and precautionary measures being accomplished on this vehicle. Refer to section 3.5 for details of design changes incorporated on this vehicle. Items still being studied are seals of a new design for the sustainer engine liquid-oxygen elbow-to-dome connection and the use of higher pressures during engine leak checks.

5.5.2.2 Propellant utilization.- The propellant utilization system operated properly throughout the flight. Propellant residuals at SECO were calculated by using the uncover times of the instrumented head-pressure ports in the liquid-oxygen and fuel tanks in conjunction with the flow rates determined between sensor stations 5 and 6 (corrected for propellant-utilization valve-angle change after sensor station 6 uncover). Usable propellant residuals based on this method of calculation are presented in the following table.

	Liquid oxygen, lb	Fuel, lb	Time from SECO to theoretical liquid-oxygen depletion, sec	Excess fuel at theoretical liquid-oxygen depletion, lb
Predicted	930	537	--	--
Actual	980	643	5.29	212

5.5.2.3 Propellant loading.- The normal propellant loading procedure was used for this vehicle. Fuel was tanked to 12 gallons above the 100-percent probe level on July 15, 1966. Liquid oxygen was tanked during the countdown to near the 100-percent probe and maintained at this level until the fill system was closed. Total fuel and liquid-oxygen weights at ignition were 76 673 pounds and 173 546 pounds, respectively.

5.5.3 Flight Control System

The performance of the Flight Control System was satisfactory. Attitude control and vehicle stability were maintained throughout flight,

UNCLASSIFIED

UNCLASSIFIED

5-171

and the proper sequence of events was performed by the autopilot programmer. Moderate transients at lift-off were rapidly damped following autopilot activation at 42-inch motion, as indicated by initial engine movements at LO + 0.65 of a second. The lift-off roll transients reached 0.16 of a degree in the clockwise direction at a peak rate of 1.3 deg/sec. Vehicle first-mode bending, excited at lift-off, was predominant in both pitch and yaw from LO + 0.7 of a second to LO + 1.5 seconds. Maximum oscillations at a frequency of 2.3 cps reached 0.5 deg/sec peak-to-peak in pitch and 0.3 deg/sec peak-to-peak in yaw. Second-mode bending was excited by the 5-cps lift-off longitudinal oscillations. Maximum oscillations in pitch, at a frequency of 5.1 cps, reached 0.23 deg/sec peak-to-peak but were completely damped by LO + 12 seconds.

The roll and pitch maneuvers were properly executed; however, the usual rigid-body oscillations were observed as the vehicle passed through the region of maximum dynamic pressure. Maximum booster-engine positive-pitch deflections to counteract the effects of aerodynamic loading occurred at approximately LO + 82.5 seconds with an average deflection of 0.7 of a degree.

The programmer enabled guidance steering at LO + 80 seconds. Guidance pitch-down commands were acted upon by the autopilot system. Low amplitude sloshing of TLV propellants was observed between LO + 65 seconds and LO + 95 seconds, inducing maximum peak-to-peak vehicle rates of less than 0.2 deg/sec.

Very low first-mode bending in pitch and yaw was observed between LO + 90 seconds and BECO. Maximum oscillations at 4.3 cps did not exceed 0.2 deg/sec peak-to-peak in both pitch and yaw.

The guidance-initiated staging discrete signal was indicated at the programmer input at LO + 130.290 seconds, and the resultant switching sequence was successfully executed. Vehicle transients associated with BECO and booster-section jettison were not excessive and were quickly damped by the autopilot system. The vehicle first-mode bending which normally occurs between BECO and booster jettison was evident in the pitch and yaw planes. Maximum oscillations at a frequency of 4.3 cps reached 1.8 deg/sec peak-to-peak in pitch and 0.4 deg/sec peak-to-peak in yaw. The oscillations were damped by the time of booster jettison. Rigid-body oscillations at a frequency of 0.27 cps in pitch and yaw were excited by booster jettison but did not exceed 0.8 deg/sec peak-to-peak. The oscillations were damped to negligible values by LO + 245 seconds. There was no evidence of TLV propellant slosh or bending during the sustainer phase.

UNCLASSIFIED

UNCLASSIFIED

Proper system response was exhibited to all guidance steering commands including small spurious steering commands between LO + 100 seconds and LO + 104 seconds; however, the TLV response to these spurious commands was negligible (refer to section 5.5.5).

The sustainer engine cutoff signal was received by the programmer at LO + 279.341 seconds. Vernier-phase steering commands consisted of a pitch down and a yaw right. TLV rate and displacement gyro signals indicated a high degree of vehicle stability throughout the vernier phase. The VECO signal was received at LO + 298.085 seconds. GATV separation occurred at LO + 302.57 seconds, and a normal TLV retrorocket operation sequence followed.

5.5.4 Pneumatic and Hydraulic Systems

5.5.4.1 Pneumatic System.- Operation of the Pneumatic System was satisfactory. The tank pressurization system properly regulated the liquid-oxygen and fuel ullage pressures in the main tanks during the boost phase of flight, and the control system provided adequate pressurization for sustainer and vernier propulsion system control. The liquid-oxygen and fuel ullage pressures were 29.0 psig and 66.3 psig at lift-off, respectively, and 29.5 psig and 66.0 psig at BECO. The differential pressure across the propellant tank intermediate bulkhead (fuel tank pressure minus the sum of liquid-oxygen ullage and head pressures) was positive throughout flight. The minimum differential pressure of 10.4 psid was recorded at LO + 0.5 of a second.

During the boost phase, 86.4 pounds of the 152.2 pounds of helium aboard were used for pressurization of the propellant tanks.

5.5.4.2 Hydraulic System.- The booster and sustainer/vernier hydraulic subsystems supplied adequate pressure to support the demands of user systems throughout the countdown and flight.

Normal hydraulic pressure transients were indicated at engine start, followed by stabilization of system pressures at 3150 psia in the booster subsystem and 3080 psia in the sustainer subsystem. The pressure in the booster and sustainer subsystems was satisfactorily maintained until BECO and SECO, respectively. After SECO and the cessation of sustainer hydraulic-pump operation, hydraulic pressure was supplied to the vernier subsystem by the dual vernier-solo accumulators. The accumulators supplied pressure for 44.9 seconds after VECO before bottoming out at 875 psia.

UNCLASSIFIED

5.5.5 Guidance System

The TLV was guided by the autopilot and the MOD III-G Radio Guidance System (RGS), both of which operated satisfactorily throughout the countdown and flight. The five planned discrete commands and required steering commands were properly generated and transmitted by the ground equipment, and all commands were received and correctly decoded by the TLV airborne equipment.

5.5.5.1 Programmed guidance.- The initial open-loop steering of the TLV, as indicated by rate and displacement gyro outputs from the autopilot, was properly accomplished. The pre-set roll and pitch programs of the Flight Control System successfully guided the vehicle into the planned trajectory (refer to section 5.5.3).

5.5.5.2 Radio guidance system.-

5.5.5.2.1 Booster steering: The radio-guidance ground station acquired the TLV in the cube-acquisition mode, as planned, with vehicle-borne rate and track lock-on established at LO + 56 and LO + 58 seconds, respectively. Track lock-on was intermittent between LO + 101 and LO + 104 seconds, when antenna look angles were unfavorable. As a result, spurious pitch and yaw steering commands were evident during this period. Because booster steering was enabled at this time, the spurious commands were acted upon by the Flight Control System. These commands, however, were minor, reaching maximum values of less than 4 percent, and had a negligible effect on the vehicle attitude. Spurious steering commands can be expected during periods of intermittent track lock-on and have been noted on earlier flights. Following the period of intermittent track lock-on, both track and rate lock-on were satisfactorily maintained until approximately LO + 401 seconds, when tracking was intentionally terminated.

Booster steering, implemented to correct open-loop dispersions, was enabled by the Flight Control System at LO + 80 seconds, as planned, and was active at LO + 104.3 seconds. A 50-percent pitch-down command of 0.5-second duration was initiated at this time. The booster engine cutoff signal was received at the autopilot programmer input at LO + 130.290 seconds at an elevation angle of 35.6 degrees. The errors at BECO were 10 ft/sec low in velocity, 621 feet high in altitude, and 0.08 of a degree high in flight-path angle (see table 4-IX).

5.5.5.2.2 Sustainer steering: Sustainer steering was initiated at LO + 147 seconds with a series of pitch and yaw commands varying between plus and minus 20 percent. Commands were reduced to below 10 percent.

UNCLASSIFIED

by LO + 170 seconds and remained below this level until approximately 1.5 seconds prior to SECO, when a 25-percent pitch-down command was generated. The sustainer engine cutoff signal was received at the programmer input at LO + 279.341 seconds.

5.5.5.2.3 Vernier steering: Vernier steering was initiated at 279.7 seconds and consisted of approximately 0.8 of a degree pitch-up and 0.2 of a degree yaw-right commands. The vernier engine cutoff signal was received at the programmer input at LO + 298.085 seconds.

5.5.5.2.4 VECO conditions: The VECO conditions were very close to the planned values. The horizontal velocity was 0.7 ft/sec high, the vertical velocity was 7.8 ft/sec low, and the lateral velocity was 1.1 ft/sec to the right.

The following table lists the actual insertion conditions for comparison with the filtered inflight desired values.

VECO conditions	Filtered inflight desired	Actual
Time from lift-off, sec	297.47	298.088
Horizontal velocity, ft/sec	17 559.3	17 560.0
Vertical velocity, ft/sec	2 811.0	2 803.2
Yaw velocity, ft/sec	0.0	1.1

5.5.6 Electrical System

Operation of the electrical system was satisfactory during the count-down and throughout flight. All electrical parameters were at normal levels, remained within tolerance, and revealed no unusual transients. On several previous vehicles, a period of inverter instability caused slight fluctuations of the main dc bus voltage. The inverter for this flight was screened for instability characteristics, and no fluctuations were indicated between LO minus 470 seconds and LO plus 560 seconds.

5.5.7 Instrumentation System

5.5.7.1 Telemetry.- The TLV telemetry system operated satisfactorily throughout the flight. One lightweight telemetry package was used

UNCLASSIFIED

to monitor a total of 110 parameters on 9 continuous and 5 commutated channels. All channels provided usable data for a system recovery of 100 percent.

Measurement A743T (ambient temperature at sustainer instrument panel) indicated that an open circuit occurred at booster jettison, but the measurement provided satisfactory data during the period of predominant interest. This open circuit, which has occurred on other flights at the same time, is attributed to sustainer exhaust blowback.

5.5.7.2 Landline.- The landline instrumentation system provided a total of 48 analog and 56 discrete vehicle measurements. Of the 104 measurements, there was one failure. This measurement failed because of an improper connection. The recorder displaying four hydraulic-pressure measurements was switched to fast speed 2 seconds late. As a result, the oil evacuation sequence was recorded on slow speed, which is undesirable for analysis purposes.

5.5.8 Range Safety System

Operation of the Range Safety System was satisfactory. No range safety functions were required or transmitted, and no spurious command signals were received or generated. Range-safety plots and telemetry readouts in Central Control were normal throughout the flight. The ground-based transmitter was turned off at LO + 312.8 seconds.

The RF signal strength received at command receiver 1 indicated that sufficient signal margins were available for proper operation of the RF command link at all times during the flight.

5-176

UNCLASSIFIED

THIS PAGE INTENTIONALLY LEFT BLANK

UNCLASSIFIED

UNCLASSIFIED

5-177

5.6 GATV/TLV INTERFACE PERFORMANCE

The Gemini Agena Target Vehicle (GATV)/Target Launch Vehicle (TLV) interface performed as planned. Accelerometer data and separation monitor data indicated a nominal separation sequence between the GATV and the TLV.

Preceding page blank

UNCLASSIFIED

5-178

UNCLASSIFIED

THIS PAGE INTENTIONALLY LEFT BLANK

UNCLASSIFIED

5.7 GEMINI SPACECRAFT/GATV INTERFACE PERFORMANCE

Performance of the spacecraft/GATV interface was satisfactory throughout the flight, and all systems functioned within the specification requirements of reference 17. The performance of the electrical, mechanical, and command system interfaces was derived from instrumentation of the various systems and from crew observations.

All interfacing functions, including the GATV status display panel, the mooring drive system, the L-band command link, and the acquisition and approach lights, functioned normally throughout the flight. Aerodynamic shroud jettison at LO + 380 seconds was normal. Target Docking Adapter (TDA) skin temperatures are discussed in section 5.4.1.

The Gemini X GATV was acquired in sunlight at a range of 48 miles. Although all lights operated normally, none were required for the mission as both rendezvous and docking were accomplished in sunlight. The running lights on the Gemini VIII GATV were not noted to be operating during the second rendezvous, although the running-light timer had been set to turn the lights on one day prior to the rendezvous.

All lights and gages on the Gemini X GATV status display panel operated normally. The crew reported difficulty in monitoring the panel during primary propulsion system operation and, as reported on the Gemini VIII mission, under various angles of direct sunlight.

The TDA mooring drive system operated normally during docking and undocking. Automatic rigidizing occurred 6.9 seconds after spacecraft engagement of the docking cone latches. Undocking was initiated by means of the "Undock" switch, and the "Spacecraft Free" indication was received two seconds later.

An electrostatic charge monitor was added to the TDA to collect and measure the static charge that was transferred between the spacecraft and the GATV. A simplified block diagram of the monitor is shown in figure 5.7-1. As the spacecraft approached and contacted the electrostatic probes on the TDA, the spacecraft charge was transferred to capacitor C_1 . The voltage on C_1 resulting from the charge was monitored at the output of an amplifier with a field-effect transistor-input circuit which provided a very high input impedance, and this voltage was recorded by the GATV instrumentation system. The threshold detector monitored this output and showed less than 4.5 volts during the docking period, indicating a low-scale reading (see figure 5.7-1). Had the measured potential been greater than 4.5 volts, a switch would have activated, enabling capacitor C_2 , changing the telemetry indication to high scale.

Three significant effects are noted from the data. The first occurred during the launch sequence (fig. 5.7-2) when an apparent charge

UNCLASSIFIED

accumulated on capacitor C_1 at approximately 1 minute 3 seconds after GATV lift-off. The origin of this charge is uncertain but may be associated with maximum dynamic pressure. The charge step at 9 minutes 29 seconds after GATV lift-off is due to application of a calibration voltage to the monitor. The calibration voltage was removed at 11 minutes 41 seconds after GATV lift-off, "zeroing" the monitor, which temporarily shorts capacitors C_1 and C_2 .

Another effect occurred in the period from 3:06:32 to 3:12:33 ground elapsed time (g.e.t.) (fig. 5.7-3). The change in polarity of the measured charge coincided with the execution of a 180-degree yaw maneuver which was initiated at 03:09 g.e.t. Prior to this maneuver, the GATV was oriented with the TDA south.

The third effect was during the period of docking from 5:40:00 to 5:54:00 g.e.t. From figure 5.7-4, it is seen that the electrostatic interaction of the two vehicles begins several minutes prior to docking and culminates at docking with an apparently small transfer of charge. The total transfer of charge between the vehicles was -12.5×10^{-9} coulombs. From the polarity of the charge accumulated on C_1 it was deduced that the spacecraft was negatively charged with respect to the GATV.

Differential voltage is a function of capacitance as well as charge between the two vehicles. Since the capacitance is inversely proportional to the separation distance between the two vehicles, the capacitance increases and the voltage therefore decreases as the two vehicles approach one another. Considerable variation exists in the calculated capacitance between the two vehicles even for a fixed separation distance. To provide an order of magnitude, consider the capacitance between the two vehicles, $C_{S/A}$, to be equal to 75 pico farads. Where Q equals the total charge between the two vehicles, the voltage differential between the two vehicles separated 18 inches would be:

$$V_{S/A} = \frac{Q}{C_{S/A}} = \frac{12.5 \times 10^{-9}}{75 \times 10^{-12}}$$

or 167 volts. The total energy would be:

$$\text{Energy} = \frac{1}{2} C_{S/A} V_{S/A}^2 = 1.05 \times 10^{-6} \text{ joules}$$

An energy transfer of this magnitude is not considered a hazard to personnel or equipment.

UNCLASSIFIED

NASA-S-66-8188 AUG 23

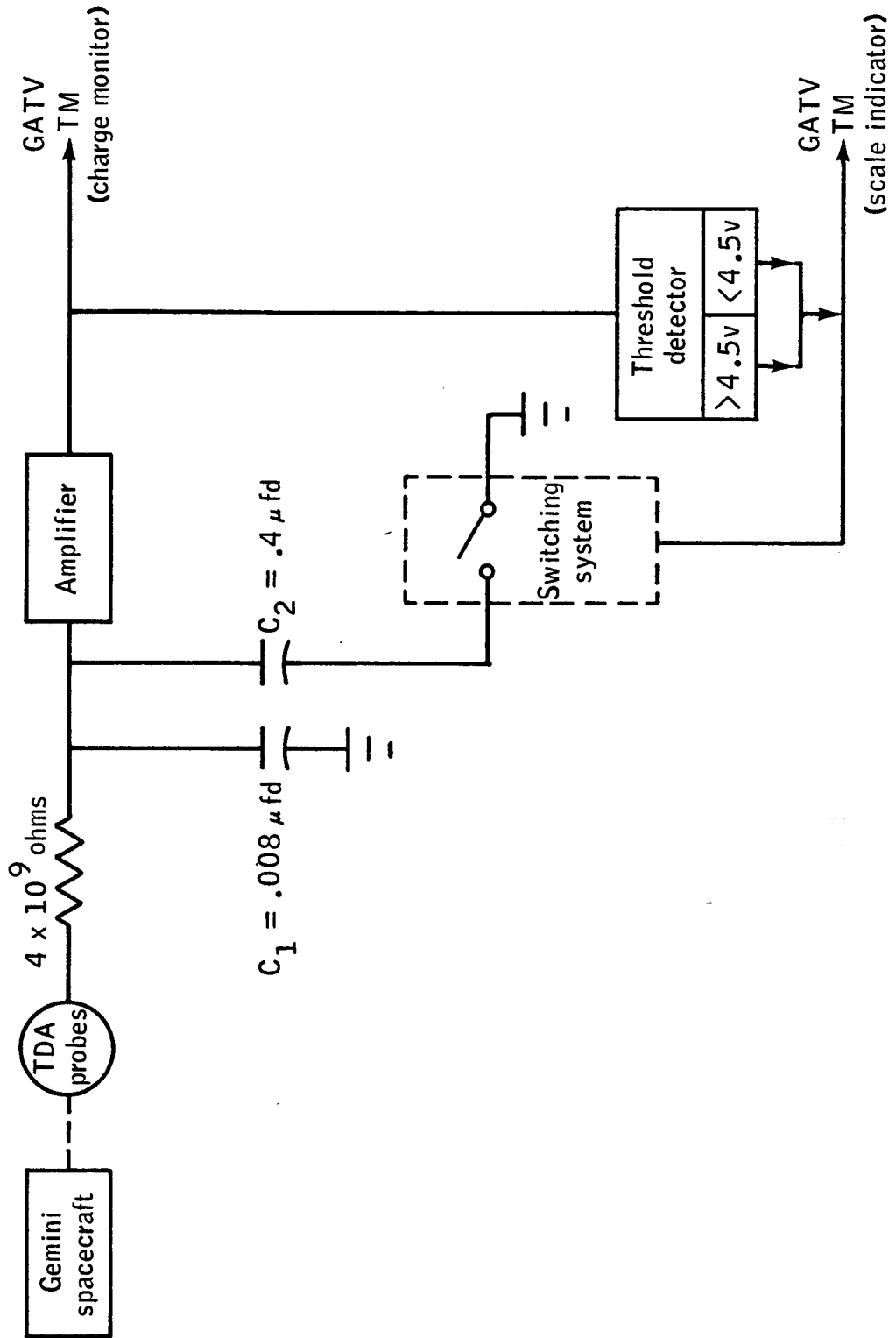
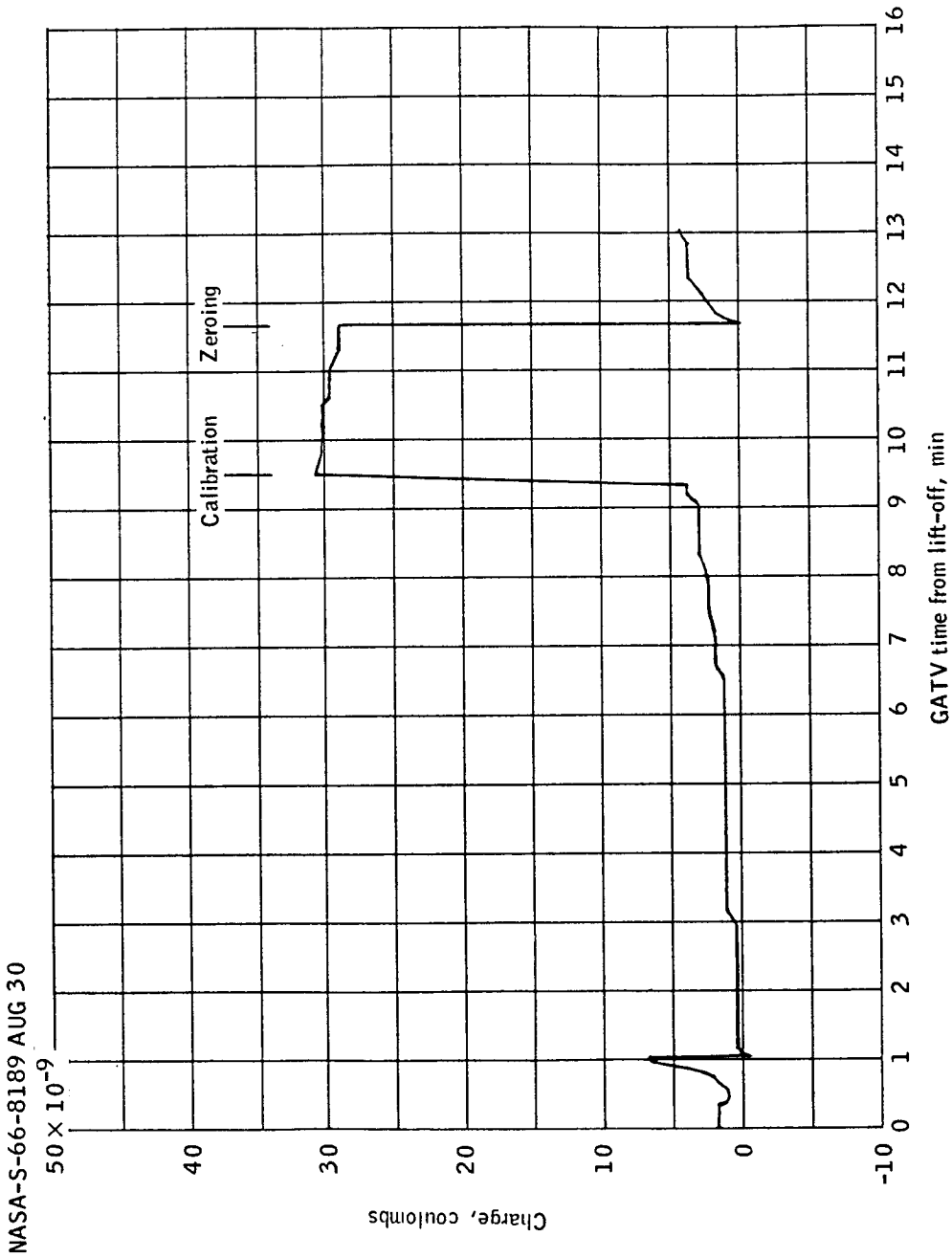

Figure 5.7-1. - Electrostatic charge monitor functional diagram.

UNCLASSIFIED



(a) Lift-off to 13 minutes, GATV target elapsed time

Figure 5.7-2. - Charge on capacitor C1.

UNCLASSIFIED

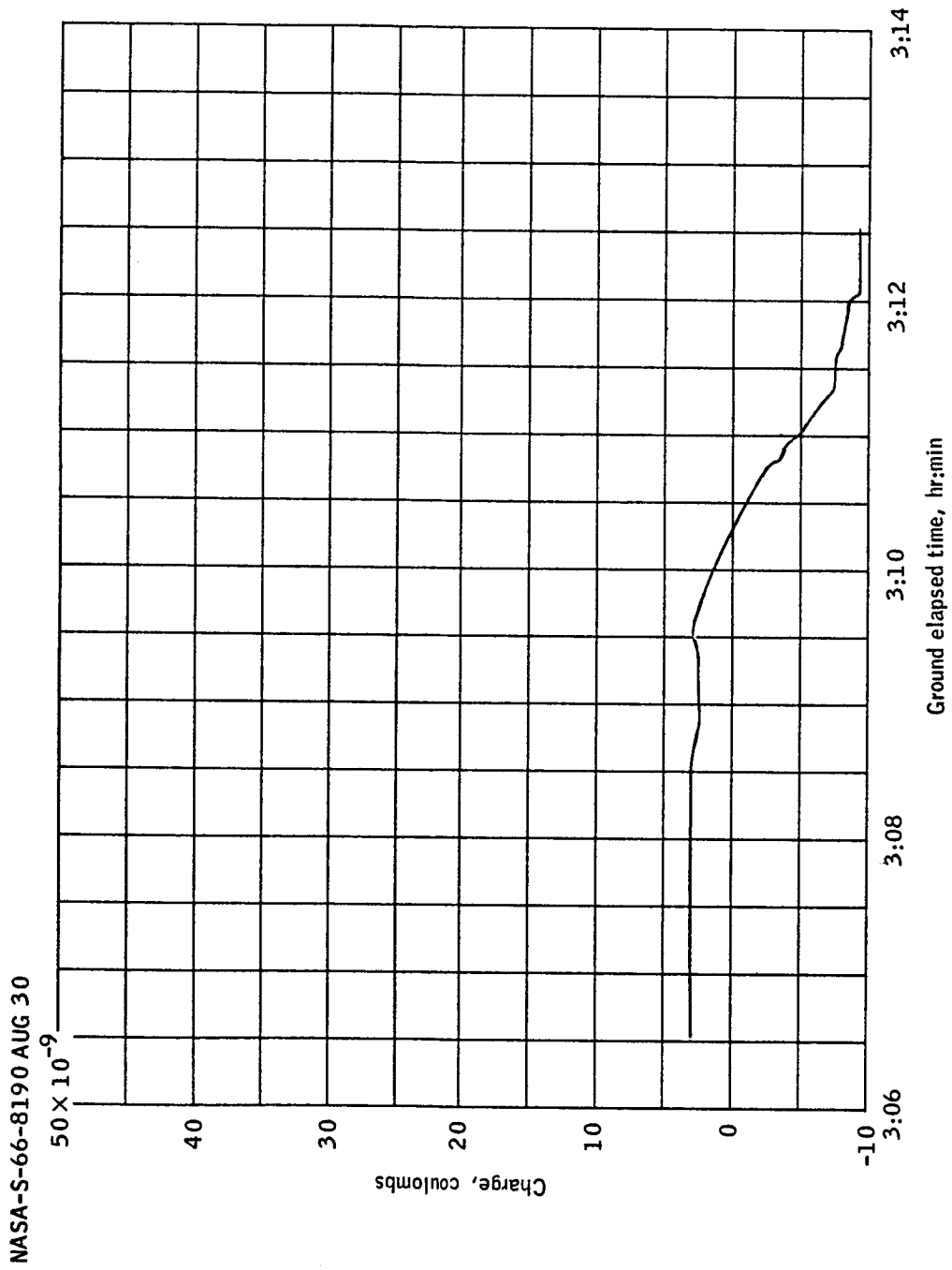

(b) 3:06:32 to 3:12:33 spacecraft ground elapsed time

Figure 5.7-2. - Continued.

UNCLASSIFIED

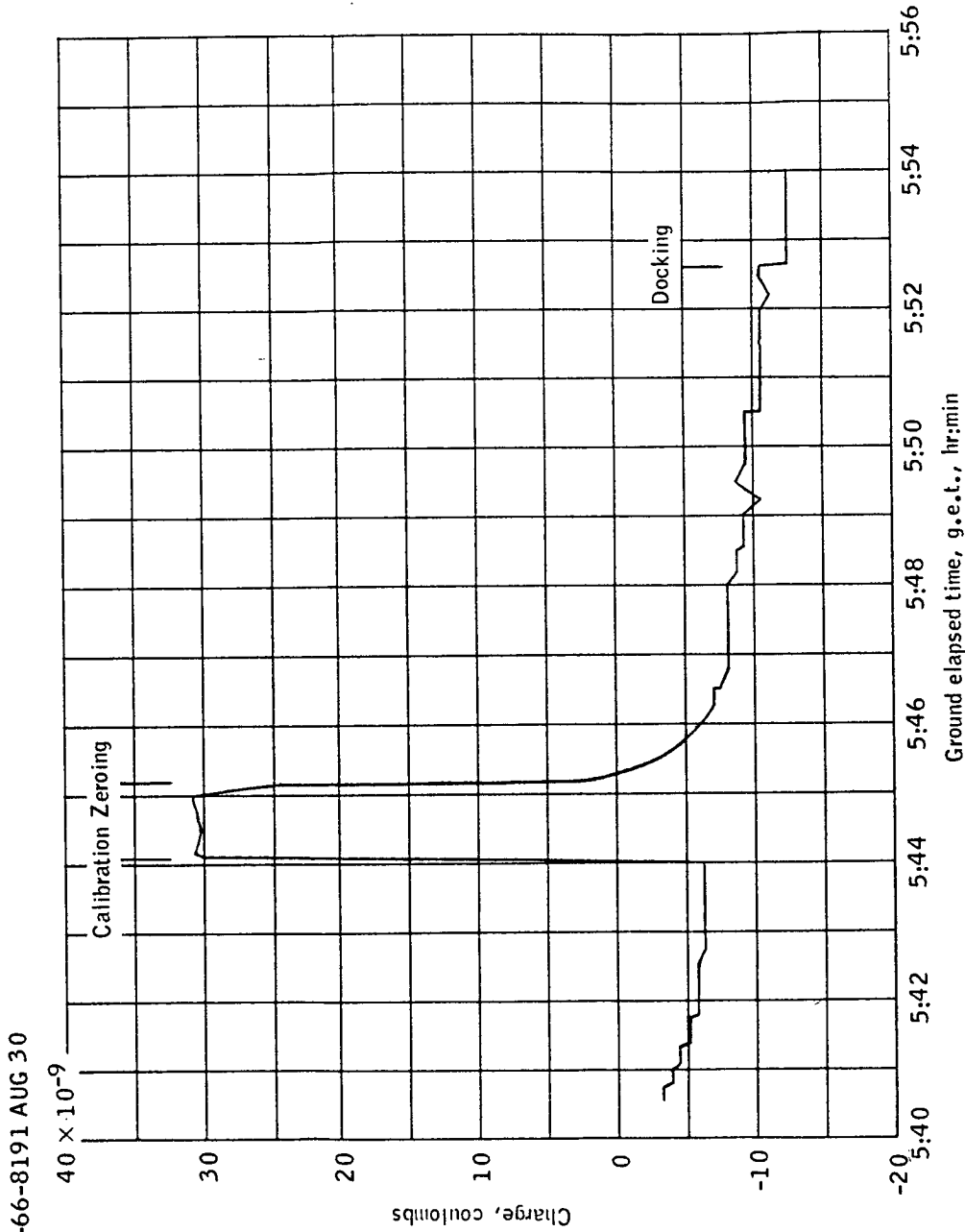

(c) 5:40:32 to 5:54:00 spacecraft ground elapsed time

Figure 5.7-2. - Concluded.

UNCLASSIFIED

6.0 MISSION SUPPORT PERFORMANCE

6.1 FLIGHT CONTROL

The Gemini X mission was controlled from the Mission Control Center (MCC-H) at the Manned Spacecraft Center, Houston, Texas. This section of the report is based on real-time observations and may not agree with the detailed postflight analysis and evaluation in other sections of this report.

6.1.1 Prepermission Operations

6.1.1.1 Prepermission activities.- The flight control team at MCC-H conducted simulations and provided support to Launch Complexes 14 and 19 during the prepermission phase. Support was provided for the Simultaneous Launch Demonstration on July 12, 1966; the Final Simulated Flight on July 14, 1966; the Precount on July 15, 1966; the Midcount on July 16, 1966; the Final Countdown on July 18, 1966; and the Gemini Atlas-Agena Target Vehicle (GAATV) and the Gemini Space Vehicle launches on July 18, 1966.

Initially, data were obtained from Air Force Eastern Test Range (ETR) sites scheduled by North American Air Defense Command (NORAD) to track the Gemini VIII GATV. Problems were encountered in obtaining sufficient data of adequate quality to pinpoint the Gemini VIII GATV orbit. These problems were solved by receiving and processing the data in real time. Three separate days of Manned Space Flight Network (MSFN) real-time tracking of the Gemini Agena Target Vehicle (GATV) launched for the Gemini VIII mission were scheduled in order to finalize the Gemini X GATV lift-off time and the docked phasing maneuvers required to complete the planned dual rendezvous. On the first of these days, the tracking data were transmitted to MCC-H in real time and recorded at the Communications Processor (CP) for later Real Time Computer Complex (RTCC) processing. On the subsequent two days, the data were transmitted to MCC-H and processed in real time. The final prepermission Gemini VIII GATV skin-tracking was on July 17, 1966. From these data, the Gemini X GATV lift-off was finalized to 20:39:44 G.m.t.

During the spacecraft Precount, a low open-circuit voltage was noted on squib battery no. 2. The problem was suspected to be a connector short-to-case. The battery was replaced, and subsequent internal-power checks verified that the batteries were ready for flight.

UNCLASSIFIED

When the crew ingressed during the Midcount, the pilot noted that the secondary A-pump warning light was on. The pump was cycled off and on, and thereafter the light remained extinguished. In order to verify that proper flow was being obtained with the A pump, the secondary loop was powered down for five minutes. Temperature measurements in the secondary loop diverged from the primary loop, which indicated that the A pump was producing adequate flow. During the final count, the pump was again cycled several times, with no indication of performance deviation. It was concluded that the malfunction indication was the result of binding in the pressure switch, as had been encountered on a previous occasion, and presented no problem for flight.

6.1.1.2 Documentation.- Documentation was adequate in all areas. All mission documentation was updated in a timely manner.

6.1.1.3 MCC/network flight control operations.- The flight control personnel began deployment to the remote sites on July 5, 1966, and the Manned Space Flight Network went on mission status on July 10, 1966. The tests of the command and telemetry data flow between MCC-H and the remote sites were conducted successfully, and all sites were ready to support the launches.

6.1.1.4 Gemini Atlas-Agena Target Vehicle countdown.- The GAATV countdown proceeded smoothly and slightly ahead of schedule. At T minus 235 minutes, the GAATV trajectory run using the Impact Predictor (IP) 3600 computer was successfully completed. At T minus 145 minutes, this run was again completed successfully.

6.1.2 Powered Flight

6.1.2.1 GAATV powered flight.- The predicted GAATV lift-off time was 20:39:44 G.m.t., and the actual lift-off occurred at 20:39:46.131 G.m.t. The trajectory was very close to nominal throughout, although the data were noisy beginning approximately midway through the GATV primary propulsion system (PPS) thrust period at insertion. The GATV insertion parameters are shown in the following table:

Condition	IP (raw)	Bermuda
Velocity ratio, V/V_R	1.000	1.000
Insertion velocity, ft/sec	25 372	25 369
Flight-path angle, deg	-0.06	-0.04
Altitude, n. mi.	161.0	161.0
Inclination angle, deg	28.8	28.8

UNCLASSIFIED

The resultant orbit, based on the transferred Bermuda insertion vector, was 158.9 by 164.8 nautical miles. Subsequent low-speed tracking data through the Grand Canary Island tracking station showed the orbit to be 158.9 by 163.3 nautical miles. At the start of the PPS insertion thrust, there was a small positive yaw transient of 2.5 degrees and a negative pitch transient of four degrees; however, after approximately five seconds, both gyro positions were back to zero. The steady-state offset due to a center-of-gravity offset that was observed during the Gemini VIII GATV insertion maneuver was not observed in this launch.

6.1.2.2 Period between GAATV lift-off and Gemini Space Vehicle lift-off.- Initial rendezvous mission planning was begun based on Canary Island C-band tracking. The computation resulted in a recommended Gemini Space Vehicle lift-off time of 22:20:27 G.m.t., with a biased launch azimuth of 98.8 degrees. Final targeting and prelaunch mission planning were based on Gemini X GATV tracking from Carnarvon and Woomera, Australia. The recommended lift-off time computed using these data was 22:20:26 G.m.t., with a biased launch azimuth of 98.8 degrees. The latest spacecraft lift-off time for an M=4 (fourth apogee) rendezvous was 22:21:03 G.m.t., indicating a total launch window of 37 seconds. The prelaunch rendezvous mission plan for an optimum M=4 rendezvous represented a total minimum spacecraft ΔV of 188.2 ft/sec, including the terminal phase of rendezvous. The maneuver times and ΔV costs for the recommended lift-off time were as follows:

Maneuver	Ground elapsed time, hr:min:sec	ΔV , ft/sec
N_{C1} (phase adjust)	2:19:01	53.9
N_{SR} (coelliptic)	3:48:21	54.4
TPI (terminal phase initiate)	4:35:00	33.9
TPF (terminal phase finalize)	5:07:04	46.0

The Agena Ephemeris Data (AED) transfer to the GE/Burroughs computer was completed and verified at T minus 24 minutes. At T minus 15 minutes, the Inertial Guidance System (IGS) targeting parameters were transmitted to the spacecraft. The T minus three minute IGS update computed by GE/Burroughs was accepted by the spacecraft and the launch azimuth was transferred to MCC-H.

UNCLASSIFIED

Based on a predicted T minus zero of 22:20:23 G.m.t., the following roll information was transmitted to the crew:

Start roll program: 10 seconds (roll is critical)

Ball reading on pad: 79 degrees (after roll - 93 degrees)

Roll gimbal angle: 101 minutes 3 seconds

Launch azimuth: 98.8 degrees

Steering azimuth: 96.0 degrees

6.1.2.3 Final Gemini Space Vehicle countdown.- The terminal phase of the launch countdown was picked up by MCC-H at T minus 615 minutes and proceeded slightly ahead of schedule. The onboard rendezvous radar tests were completed and declared to be satisfactory at T minus 339 minutes. At T minus 48 minutes, the primary horizon scanner search indicator showed that the scanner was locking on without seeing a horizon. This was not a prohibitive malfunction and the countdown continued. At T minus 45 minutes, the spacecraft test conductor called for a Digital Command System (DCS) command (real-time telemetry on) to be sent. This could not be accomplished because a Cape Kennedy telemetry station was performing telemetry calibrations. After the calibrations were completed, the command was sent and verified. At T minus 20 minutes, the spacecraft static-fire test was accomplished. During the 5 minute 46 second built-in hold at T minus three minutes, the spacecraft cryogenic oxygen heater was turned on for approximately three minutes to raise the cryogenic oxygen pressure to the desired value of 900 psia for lift-off. The increase in electrical current due to the heater operation was a nominal 10.6 amperes.

6.1.2.4 Gemini Space Vehicle powered flight.- Lift-off occurred on time at 22:20:26.648 G.m.t. The IP smooth data were satisfactory at lift-off and remained solid throughout powered flight. GE/Burroughs achieved solid radar lock-on early and was selected as the primary data source at 41 seconds into first stage flight. Data quality was good throughout first stage flight, and all data sources agreed with the preflight nominal. The GE/Burroughs steering, nominally beginning at lift-off (LO) + 167.5 seconds, was 3.5 seconds late. The GE/Burroughs data were quite noisy from a V/V_R of 0.8 to second stage engine cutoff (SECO), but the data seemed to average out near the nominal. SECO appeared nominal on the projection plotters, and approval was given for an Insertion Velocity Adjust Routine (IVAR) maneuver, if required. The

UNCLASSIFIED

UNCLASSIFIED

6-5

computed cutoff parameters from the various sources are shown in the following table:

Source	Insertion velocity, ft/sec	Flight-path angle, deg	Altitude, n. mi.	Wedge angle, deg
GE/Burroughs	25 693	0.14	87.0	0.03
IP smooth	25 716	-0.07	86.9	0.03
IP raw				
Initial	25 709	0.04	86.9	0.02
Final	25 738	0.08	87.4	0.02
Bermuda				
Initial	25 719	-0.05	86.9	0.02
Final	26 911	0.38	87.4	1.03

The final Bermuda radar high-speed solution was obviously unreliable; the problem is thought to have been caused by masking from another radar antenna under construction near the Bermuda C-band radar. At an elapsed time of 15 seconds into the powered flight, the oxygen-to-water differential pressure warning light came on and remained on until first stage engine cutoff (BECO). After staging, the light came back on and remained on until SECO. This unbalance in pressure is thought to have been the result of the acceleration during the launch phase and has been experienced in some previous flights. All subsequent differential pressure indications were normal.

At orbital insertion, the crew reported that they would execute an IVAR maneuver of 25 ft/sec forward. The separation and subsequent IVAR thrust required 36 seconds, which corresponds to 27 ft/sec. Prior to Cape Kennedy loss-of-signal (LOS), the accelerometer bias changes, as measured from telemetry, were small. It was determined that an accelerometer bias update would not be necessary if the Carnarvon data were in the same range. Theta DCS was not updated at SECO plus ten seconds because the actual T minus zero was 22:20:23.3 G.m.t.

UNCLASSIFIED

UNCLASSIFIED

6.1.3 Spacecraft Orbital Flight

The IP (raw) insertion vector was transferred to the orbit phase and predicted an initial orbit of 87.0 by 145.6 nautical miles. Low-speed tracking through Carnarvon gave an orbit of 86.8 by 144.8 nautical miles. Over Carnarvon on revolution 1, the accelerometer bias check was satisfactory and no update was required. Based on Carnarvon data, a rendezvous plan for M=4 was calculated with the maneuver points shifted to coincide with the actual spacecraft line of apsides. This maneuver plan, which was passed to the crew over Hawaii, was as follows:

Maneuver	Ground elapsed time, hr:min:sec	ΔV , ft/sec
N_{Cl} (phase adjust)	2:18:09	56.2
N_{PC} (plane change)	2:30:22	9.5
N_{SR} (coelliptic)	3:47:34	48.7
TPI (terminal phase initiate)	4:36:12	34.0
TPF (terminal phase finalize)	5:08:16	46.2

Over Hawaii during revolution 1, the cryogenic hydrogen pressure decayed to a point below the heater control band. Subsequent questioning of the crew isolated the problem to an open circuit breaker (CRYO O_2 & H_2 heater). The circuit breaker was reset and hydrogen pressure returned to normal. It was concluded that the circuit breaker was inadvertently opened by one of the crew. Also over Hawaii, the crew transmitted their onboard solution of the rendezvous midcourse maneuvers based on the IGS insertion vector. The N_{Cl} and N_{SR} maneuvers calculated by the crew were as follows:

Maneuver	Ground elapsed time, hr:min:sec	ΔV , ft/sec
N_{Cl} (phase adjust)	2:19:52	58.0
N_{SR} (coelliptic)	3:49:13	46.0

UNCLASSIFIED

The crew-computed solution for the N_{PC} maneuver was transmitted to Guaymas during revolution 1 as 8 ft/sec south at 2:53:20 ground elapsed time (g.e.t.). During the subsequent pass over the United States, using Carnarvon vectors on both vehicles, a calculation was made of the terminal phase conditions which would result if the crew-calculated maneuvers were applied. This calculation showed that the TPI time would be approximately 11 minutes earlier than nominal and that the coellipticity between N_{SR} and TPI would vary between 20.7 and 11.3 nautical miles. This coellipticity error of 9.4 nautical miles violated the mission-rules number of five nautical miles maximum; therefore, a decision was made not to use the IGS insertion solution. For comparison with the onboard orbit determination solution, the N_{C1} and N_{PC} maneuvers were updated through Ascension Island in revolution 2 as follows:

Maneuver	Ground elapsed time, hr:min:sec	ΔV , ft/sec
N_{C1} (phase adjust)	2:18:09	55.9
N_{PC} (plane change)	2:30:49	9.6

The crew reported over Tananarive during revolution 2 that the orbit determination solution was not acceptable and that the ground-updated N_{C1} and N_{PC} maneuvers would be performed. Over Hawaii on revolution 2, the crew read 84 percent Orbital Attitude and Maneuver System (OAMS) propellant quantity remaining. This correlated with the ground-computed quantity of 85.5 percent remaining.

Based on Carnarvon, Hawaii, California, and White Sands revolution 2 tracking data, the N_{SR} maneuver was transmitted to the crew as a ΔV of 48.4 ft/sec to be applied at 3:47:34 g.e.t. The total ΔV represented a V_X of 47.9 ft/sec posigrade and V_Y of 6.5 ft/sec up. Based on tracking data through Antigua on revolution 3, the N_{SR} maneuver was again updated over the Rose Knot Victor (RKV) tracking ship as a total ΔV of 48.7 ft/sec—a V_X of 48.1 ft/sec posigrade and V_Y of 7.6 ft/sec up.

Based on this maneuver, the TPI time was predicted to be 30 seconds earlier than nominal. Over Tananarive, the crew reported that a combination of ground and onboard radar solutions was actually applied: V_X of 48.0 ft/sec posigrade, and V_Y of 6.0 ft/sec up. Confirmation of

UNCLASSIFIED

this maneuver in the Real Time Computer Complex (RTCC) gave a predicted TPI time of 57 seconds early.

The two-impulse processor was used to compute the terminal phase initiate maneuver in both the Auxiliary Computer Room (ACR) and the RTCC. Both the ACR and the RTCC ran a two-impulse solution using the Pretoria, revolution 3, spacecraft C-band vector and the Guaymas, revolution 3, GATV S-band vector (pre- N_{SR} maneuver data), and both solutions were in close agreement.

A TPI update was passed to the crew over the tracking ship Coastal Sentry Quebec (CSQ) during revolution 3. This TPI information was: 4:35:42 g.e.t., ΔV of 34.0 ft/sec forward and ΔV of 0.6 ft/sec down. This update was based on the assumption of the crew performing N_{SR} perfectly with no tracking after N_{SR} . The crew reported that they had performed N_{SR} at the ground computed time, using onboard radar information. They also reported that they had a problem with address 26 in the onboard computer. The Hawaii data were interrupted and a second two-impulse solution was run in the RTCC on the Hawaii revolution 3, C-band spacecraft vector and the Guaymas revolution 3, S-band GATV vector. (These were the only post- N_{SR} data that were available.) The resulting conditions at TPI were as follows:

Maneuver initiation	
time, g.e.t.	4:34:05 (a change of one minute and 37 seconds from the previous TPI)
Out-of-plane velocity,	
ft/sec	4.2 left (a change of 3.0 ft/sec)
Δh , n. mi.	16 (no change)
ΔV , ft/sec	35 forward (a change of one ft/sec)

Only the time was updated over Hawaii because of a lack of time before loss of signal (LOS). The line-of-sight components were essentially the same except for the out-of-plane component. Based on the ACR relative-motion printout and the polar plot used by the crew, the TPI should have been 35 ft/sec for a Δh of 16 nautical miles, which was

UNCLASSIFIED

UNCLASSIFIED

6-9

in close agreement with both the premaneuver and postmaneuver solutions. The crew was directed to enter logic choice 1 over the CSQ on revolution 3. This was to ensure that orbit-rate torquing compensation would not be used for the terminal phase.

Prior to docking in revolution 4, the OAMS propellant quantity was read onboard as 36 percent, and an estimated 355 pounds of usable OAMS remained at that time. There was some concern about the possibility of an OAMS leak, but the crew verified that they had used a large amount of propellant during the terminal phase. Further verification was made through the OAMS thruster firing program from the Hawaii tape dump. After systems stabilization, it was determined that there was 375 pounds of propellant remaining at a mixture ratio of 1.15. During the rendezvous exercise, the cryogenic oxygen pressure decay was approximately 420 psi/hour. This decay required a manual heater duty cycle of approximately ten percent, or nine minutes of heater operation per revolution. Crew reports over the CSQ and Hawaii during revolution 4 indicated that they had had no problems in docking with the GATV and that the electric charge monitor test and the bending-moment test had been accomplished satisfactorily. Based on this information, work was begun on the second rendezvous.

The spacecraft and the Gemini X GATV weights were combined in the spacecraft ephemeris, and the Gemini VIII GATV F minus one day vector was inserted into the spacecraft ephemeris. Because the Gemini VIII GATV was behind the docked spacecraft/GATV, creating a negative phase angle, the RTCC was unable to calculate the initial second-rendezvous maneuvers. Instead, this computation was made in the Auxiliary Computer Room, and the details for the first docked maneuver, a phase adjust maneuver, were given to the GATV flight controllers as soon as the actual Gemini X GATV orbit was defined. The maneuver was calculated to be 420.0 ft/sec posi-grade at 7:38:33 g.e.t. The resulting orbit was predicted to be 160.0 by 410.9 nautical miles. Postmaneuver tracking showed an actual orbit of 160.2 by 413.6 nautical miles.

The first real-time Gemini VIII GATV skin-track since F minus one day occurred at the Ascension Island station during revolution 8. The tracking data agreed well with the predicted orbit. Actual parameters showed 215.0 by 216.9 nautical miles.

Over the CSQ at 9 hours 17 minutes g.e.t., the crew began their first sleep period with the spacecraft and Gemini X GATV docked. During the sleep period, while over the Canary Islands during revolution 10 (15 hours 5 minutes g.e.t.), cabin pressure rose from 5.27 psid at acquisition of signal (AOS) to 5.43 psid at LOS, with a corresponding decrease in cryogenic oxygen tank pressure from 898 psia to 859 psia. It was later theorized that these pressure changes were the result of

UNCLASSIFIED

UNCLASSIFIED

one of the crew bumping the repressurization valve partly open; then, sensing the increase in pressure, a crewman waked up and reclosed the valve. The crew ended their sleep period at 17 hours g.e.t, and the spacecraft was powered up over Guaymas at approximately 19 hours 52 minutes g.e.t, in preparation for the second day's activities.

Approximately three hours prior to the docked height adjust maneuver, the phase angle between the Gemini VIII GATV and the docked vehicles became positive, making it possible for the RTCC to calculate a second- rendezvous plan. The RTCC computed the maneuver, which agreed with the one computed in the Auxiliary Computer Room, as 340.0 ft/sec retrograde at 20:20:12 g.e.t. The predicted orbit after this maneuver was 160.2 by 210.0 nautical miles. Subsequent tracking showed the actual orbit to be 160.2 by 206.8 nautical miles.

After the height adjust maneuver, the docked vehicles were approximately 12 ft/sec out-of-plane with respect to the Gemini VIII GATV. It was decided, however, to delay the plane change maneuver until after the large PPS in-plane maneuvers were completed. The coelliptic maneuver was planned to be a 75.7 ft/sec posigrade maneuver at 22:37:07 g.e.t. The predicted orbit after the maneuver was 203.0 by 206.7 nautical miles. Actual tracking after the maneuver showed the orbit to be 204.2 by 208.4 nautical miles.

Over Hawaii during revolution 14, the crew performed their suit integrity check for the upcoming egress over the Canary Islands for the standup extravehicular activity (EVA). Cabin depressurization was accomplished by 23 hours 23 minutes g.e.t; however, the data indicated that the crew did not stop depressurization at 3.0 psia to verify suit integrity before depressurizing completely.

Over Canton Island the crew reported that they had closed the hatch and repressurized the cabin because something was irritating their eyes and causing them to water. Over Cape Kennedy, each suit fan was operated singly in an attempt to isolate the problem to an overheated suit compressor; however, this was not successful. Oxygen high-rate was initiated several times to purge the suit circuit. Based on the crew's report of the presence of eye irritation and a definite odor but no presence of nose or throat irritation, the possibility of lithium hydroxide as the irritant was partially ruled out. Because the exact cause of the problem was not known, a special test was scheduled to be performed prior to the umbilical EVA. This test consisted of closing the suit circuit, depressurizing the cabin to 3.0 psia, and selecting one suit fan only. It was believed that this test would determine whether the odor and eye irritation would reoccur and, if so, whether oxygen high-rate would alleviate the problem.

UNCLASSIFIED

UNCLASSIFIED

6-11

The spacecraft was powered down over the RKV during revolution 18 in preparation for the second sleep period. Over Hawaii and Guaymas during the same revolution, telemetry indicated that the primary coolant-loop control-valve outlet temperature was dropping below the regulation point. Over the RKV about 1 1/2 hours after power down, the temperature had dropped to 31.9 degrees. Under these conditions the water boiler could freeze in a period of approximately two hours; therefore, the crew were awakened to select the A-pump in the primary loop. This resulted in stabilization of the temperature at 40 degrees, which indicated that the control valve was not able to maintain regulation under the low flow rate of the B-pump. Based on this, the power-down checklist was modified so that the primary A-pump and the secondary B-pump would be selected prior to the next sleep period.

Because the quantity of OAMS propellant remaining was less than planned, a decision was made to remain docked and use the GATV secondary propulsion system (SPS) to make three of the remaining pretransfer maneuvers prior to the terminal phase of the second rendezvous. The maneuvers performed prior to undocking were as follows:

Maneuver	Ground elapsed time, hr:min:sec	Planned ΔV , ft/sec	Actual ΔV , ft/sec
N _{Cl} (phase adjust)	27:45:36	7.7	10.0
N _{PC} (plane change)	41:04:26	14.8	15.8
N _{Cl} (phase adjust)	41:35:50	3.5	4.2

The spacecraft was powered up over Carnarvon during revolution 25 (40 hours 30 minutes g.e.t.) in preparation for the third day's activities, and the procedures for the special Environmental Control System (ECS) test described previously were transmitted to the crew. At that time, the crew reported that their eyes had very little redness or swelling, but they remarked that the odor was still present on occasions. The ECS test was initiated over Carnarvon at 42 hours g.e.t. Over Kano, Nigeria, at 43 hours 20 minutes g.e.t., the test was reported to be complete and no abnormalities had been found. It was then decided that the umbilical EVA would be attempted.

UNCLASSIFIED

UNCLASSIFIED

In order to establish guidelines for conducting the umbilical EVA and station keeping with the Gemini VIII GATV, onboard readings of OAMS propellant quantity were taken over the CSQ during revolution 28 and over Carnarvon during revolution 29. The reading over the CSQ was approximately six percent low, and the reading over Carnarvon was about two percent low, as compared with ground-computed values. Two gage cutoffs were computed: the first was seven percent for attitude control during EVA, and the second was ten percent for rendezvous and station keeping. The onboard propellant quantity indication was assumed to be four percent low at that time.

At 44 hours 40 minutes g.e.t., the crew undocked and immediately executed a 1.5 ft/sec separation and phase adjust maneuver. At 45:54:01 g.e.t., a 4.2 ft/sec corrective combination maneuver was performed, and at 46:09:28 g.e.t. a coelliptic maneuver of 9.8 ft/sec was accomplished. While the spacecraft was over Carnarvon during revolution 29, the ground solution for TPI was transmitted to the crew. The solution for TPF was not transmitted but is included here for reference. The maneuver parameters were as follows:

	<u>TPI</u> ^a	<u>TPF</u>
Maneuver initiate time, g.e.t.	47:27:20	47:47:31
ΔV , ft/sec	25.1	42.9
Pitch, deg	29.9	86.0
Yaw, deg	8.5	-179.7
Thruster	Aft	Forward
ΔV_X , ft/sec	21.5	3.0
ΔV_Y , ft/sec	-12.5	42.8
ΔV_Z , ft/sec	-3.2	0.0

^aThe desired TPI time for optimum lighting considerations was 47:29:06 g.e.t.

Over the ETR during revolution 30, the crew reported the OAMS propellant quantity remaining as 20 percent; at that time, the spacecraft had closed to within 700 to 800 feet of the Gemini VIII GATV. The onboard OAMS propellant quantity indicator showed 15 percent remaining

UNCLASSIFIED

UNCLASSIFIED

6-13

at the start of station keeping. The propellant remaining, as computed by the RTCC, was 138 pounds at that time. By the time the spacecraft had reached Carnarvon during revolution 30, propellant quantity remaining was updated to 148 pounds.

The pilot egressed at approximately 48 hours 42 minutes g.e.t. over Carnarvon during revolution 30. The oxygen heater was turned on just prior to Carnarvon LOS, and pressure appeared to be building normally. Over Hawaii at 49 hours 3 minutes g.e.t., oxygen pressure was near the vent point, so it was requested that the heater be returned to automatic operation.

During the umbilical EVA over Hawaii in revolution 30, the OAMS propellant quantity had been reduced to the extent that the crew was advised to terminate the EVA and discontinue station keeping with the Gemini VIII GATV. Cabin repressurization was initiated at 49 hours 21 minutes g.e.t.

A true anomaly adjust maneuver of 100 ft/sec was computed by the ACR. This maneuver, which occurred at 51:38:51 g.e.t., shaped the spacecraft orbit so that retrofire for the revolution 44 primary landing area would occur at a true anomaly of 240 degrees. While over Hawaii on revolution 31, the crew reported that the Gemini VIII GATV was approximately 3000 feet behind and slightly above the spacecraft. To ensure that the spacecraft would not recontact the Gemini VIII GATV after the 100 ft/sec retrograde maneuver, a one ft/sec plane-change thrust was scheduled to be performed over the RKV at 51:16:00 g.e.t. The crew confirmed that this maneuver was executed at 1.3 ft/sec south.

The true anomaly adjust maneuver was performed on time and increased the footprint remaining after retrofire dispersions from approximately minus 308 percent to plus 26 percent. Subsequent tracking showed the new orbit to be 158.3 by 216.0 nautical miles.

In planning for the true anomaly adjust maneuver, the decision was made to thrust until main-oxidizer-tank depletion or to a ΔV of 100 ft/sec, whichever should occur first. Based on the oxidizer remaining, it was estimated that between 77 and 100 ft/sec could be obtained prior to main-oxidizer-tank depletion. However, the true anomaly adjust maneuver of 100 ft/sec was made without depleting the main oxidizer tank. At the completion of the maneuver, the onboard propellant quantity indicator showed no propellant remaining, and the RTCC computation showed 23 pounds of oxidizer and 16 pounds of fuel remaining. An estimated six pounds of propellant was used subsequently for Experiment D010 (Ion-Sensing Attitude Control), and platform alignment was accomplished without depleting the main oxidizer tank.

UNCLASSIFIED

UNCLASSIFIED

While over the RKV during revolution 33 at 53 hours g.e.t., the spacecraft was powered down and the crew entered their final sleep period, which lasted until 62 hours 45 minutes g.e.t. when the spacecraft was over the Canary Islands in revolution 39. At 66 hours 40 minutes g.e.t., Module IV was loaded in the Auxiliary Tape Memory Unit, and at 67:27:30 g.e.t. over Cape Kennedy, the squib was ignited to sever the hydrogen tank pinch-off tube. Monitoring of the hydrogen quantity indicated that no change due to actuation of the squib occurred as was experienced in the Gemini IX-A flight.

Accelerometer biases were again checked after spacecraft power-up on the day of reentry. The X-axis and Z-axis biases were constant but slightly in error, so both were updated when the spacecraft was over the United States during revolution 42 at 67 hours 28 minutes g.e.t. The retrofire update and time to retrofire (T_r) were sent when the spacecraft was over the United States in revolution 43. It was noted during this pass that the yaw-right thrusters were very active, but no appreciable rates were being induced. The platform control mode was in use at the time. It is not known whether this anomaly was caused by fuel depletion or by some problem with the thrusters.

The primary landing area aiming point was located at 26 degrees 43 minutes north by 72 degrees 0 minutes west. The ground elapsed time of retrofire-computed (GETRC) was calculated by both the ACR and RTCC as 70:10:25 g.e.t. Spacecraft T_r and reentry parameters for landing area 44-1 were updated via the DCS at 69 hours g.e.t.

6.1.4 Reentry

Retrofire occurred on time at 20:30:51 G.m.t. (70:10:25 g.e.t.). Incremental velocity indications read by the crew were 303 aft, 5 right, and 119 down, as opposed to nominals of 304 aft and 114 down. The true anomaly at retrofire was 240.4 degrees. Hawaii telemetry indicated the retrofire velocities to be 305 aft, 6.7 right, and 119.4 down. After retrofire, the Incremental Velocity Indicator (IVI) readings were input to the RTCC, and the RTCC indicated that a spacecraft bank angle of 51 degrees should be used in order to hit the target. The Hawaii post-retrofire tracking data indicated a bank angle of 39 degrees. White Sands data were interrupted in order to furnish a backup solution to the crew before communications blackout. This solution was to enter the lifting portion of the trajectory at a roll left of 45 degrees and to reverse the roll to 45 degrees right 27 minutes 38 seconds after retrofire.

UNCLASSIFIED

Good tracking (skin-track) was accomplished from Merritt Island, Patrick Air Force Base, and Grand Bahama Island during spacecraft communications blackout. As the spacecraft reenters, the size of the landing footprint decreases as a function of distance remaining to the landing point. The last track from Grand Bahama Island showed that the landing footprint was reduced from 288 nautical miles (at retrofire) to 38 nautical miles. After blackout, data were obtained for approximately three seconds. The Reentry Control System (RCS) propellant remaining was 22 pounds in A-ring and 23 pounds in B-ring. Final telemetry readings showed that the downrange error was minus 4.34 nautical miles and the crossrange error was 1.82 nautical miles. The landing point reported by the recovery forces was given as 26 degrees 44.7 minutes North by 71 degrees 57 minutes West.

6.1.5 Gemini Agena Target Vehicle Orbital Flight

The complete GATV mission profile is shown in table 6.1-I. This table includes the vehicle heading and the PPS and SPS operations. The GATV was gyrocompassed to +90 degrees during the first GATV pass over ETR in order to gather ambient data for Experiment S026 (Ion-Wake Measurement). Over Hawaii during GATV revolution 3, the first part of the rendezvous DCS load was executed, which turned on the acquisition lights and the approach lights, turned the status display panel lights on bright, and activated the L-band beacon. The L-band boom antenna was extended and the docking cone was unrigidized during the ascent sequence of events. During GATV pass 3/4 over the ETR, the remainder of the rendezvous DCS load was executed, which was a commanded yaw to minus 90 degrees. At this point the vehicle was ready for docking except for going to flight control mode 6 (attitude control system mode having high pressure, narrow deadband, and high gain). The crew sent a command for this mode just prior to docking.

Docking occurred while the spacecraft and the GATV were between the CSQ and Hawaii during GATV revolution 5; approximately two pounds of attitude control system gas was used. Immediately after docking, the GATV attitude control system was turned off and the spacecraft propulsion system was satisfactorily used to conduct the bending moment test. The spacecraft OAMS was then used to yaw the docked vehicles in-plane, with the Target Docking Adapter (TDA) heading east, in preparation for the first docked maneuver using GATV propulsion. Then, the attitude control system was turned on. A total of six GATV firings were performed with the vehicles docked: three PPS firings for maneuvers of 420, 340, and 79 ft/sec, and three SPS Unit II firings for maneuvers of 7.7, 14.8, and 3.5 ft/sec.

UNCLASSIFIED

Very little vehicle-yaw transient due to center-of-gravity offset was noted during PPS operations. Peak control transients of approximately three degrees in yaw and one degree in pitch, which after four seconds were back to zero, were noted at the start of both the docked and the undocked PPS firings. The out-of-plane velocity component resulting from the yaw transient was 13.3 ft/sec for the first docked PPS firing (a 420 ft/sec posigrade maneuver). No attempt was made to yaw the vehicle to compensate for the center-of-gravity offset yaw transient. It was noted, however, that the vehicle center of gravity and resulting transients observed were very close to preflight predictions.

The first docked PPS firing was for a phasing maneuver performed at 7:38:18 g.e.t. over Hawaii during GATV revolution 6. This was a 420 ft/sec posigrade maneuver, and the resultant orbit was 160.2 by 413.6 nautical miles.

Over the ETR during GATV pass 13/14, a 180-degree docked gyrocompassing yaw was performed. This was the first time such a yaw had ever been tried, and the crew reported everything was as expected.

The second docked PPS firing was for a height adjust maneuver. A 340 ft/sec retrograde thrust was used and resulted in an orbit of 206.8 by 160.2 nautical miles. The maneuver was initiated at 20:19:56 g.e.t. over Kano, Nigeria, during GATV revolution 14. During this maneuver, the apogee was lowered three nautical miles more than desired, indicating a possible velocity-meter problem.

At the Hawaii station during GATV revolution 15, it was discovered that, when docked and in flight control mode 6, there was considerable thruster activity because of the high/docked gains and high horizon-sensor gains. The high horizon-sensor gains caused excessive torquing of the roll and yaw gyros, resulting in higher control gas usage than anticipated. There was not sufficient information available on which to base gas usage for planning purposes, as this was the first time data were obtained on system performance in the docked configuration. In order to reduce the gas usage rate, the crew was advised to use flight control mode 1 (mode having low pressure, wide deadband, and low gain) for in-orbit coast.

The third PPS firing, a coelliptic maneuver, was performed with a ΔV of 79 ft/sec posigrade. This maneuver was to lower the apogee to 206.7 nautical miles and raise the perigee to 203 nautical miles in order to position the docked vehicles for a subsequent spacecraft rendezvous with the Gemini VIII GATV. This maneuver was performed at 22:36:50 g.e.t. between Antigua and the Canary Islands during GATV revolution 16. The resultant orbit was 208.4 by 204.2 nautical miles.

UNCLASSIFIED

Over the ETR during GATV revolution 18, the crew started Experiment D005 (Star Occultation Navigation). Normally, this experiment would have been performed using the spacecraft to yaw the docked vehicles. Because there was a constraint on the use of OAMS propellant, however, the GATV attitude control system was used to perform the necessary yaw maneuvers. The quantity of GATV attitude control gas consumed during one complete revolution, starting at Hawaii in GATV revolution 17, was approximately 50 pounds, which was considerably more than expected. The crew reported that the vehicle kept returning to its initial cardinal heading after each yaw maneuver, although no system malfunctions were evident. The crew was advised to turn off the horizon sensors, thus removing all inputs to the gyros except the geocentric rate signal. The crew reported that the system was functioning normally shortly thereafter; however, it is believed that the horizon sensors were not actually turned off. One possible explanation of the vehicle response during the D005 experiment is that the crew did not recognize what was actually normal vehicle response. Being accustomed to the rapid and precise spacecraft response, the normal deadband overshoot and return of the GATV when yaw rates were removed was probably mistaken as the vehicle returning to zero. This normal movement back toward the deadbands probably was interpreted as the vehicle returning to its initial cardinal heading. Crew attempts to quickly stabilize the vehicles probably resulted in the use of excessive attitude control gas during this period.

The first docked SPS maneuver occurred at 27:45:20 g.e.t. over Hawaii during GATV revolution 18. This was a phase adjust maneuver, in which a 7.7 ft/sec posigrade thrust was used to raise perigee and apogee. The resultant orbit was 207.6 by 209 nautical miles.

The second SPS firing was for a plane change maneuver. This was a 14.8 ft/sec thrust with the TDA north, performed to change the orbit inclination to that of the Gemini VIII GATV. This maneuver occurred at 41:04:10 g.e.t. between Carnarvon and the ETR during GATV resolution 26. The resultant orbit was 208.2 by 209 nautical miles with an inclination angle of 28.90 degrees.

During these first two docked SPS Unit II firings, it was noted that the thrust chamber pressure of the +Y module was approximately 10 psi low and that the thrust chamber temperature of the module was running higher than nominal. It was recommended that the duration of any subsequent firing of the SPS Unit II be limited to 12 seconds maximum. There was a possibility that a partially blocked injector was causing the low thrust chamber pressure and that thruster damage could result if the firing time was longer than 12 seconds. With the low thrust chamber pressure, thrust was degraded approximately 7 percent. The firing time of the last SPS Unit II maneuver (GATV revolution 52) was increased

UNCLASSIFIED

the required amount to compensate for this lower thrust. The velocity meter was disabled one memory row after SPS cutoff in order to measure the accuracy of the firing-time calculations. The stored program command (SPC) shut down the SPS 0.65 ft/sec short of the desired 32.2 ft/sec.

The third SPS firing was for another phase adjust maneuver. This was a 3.5 ft/sec retrograde thrust to lower perigee and was accomplished at 41:35:34 g.e.t. during GATV revolution 27 over the Canary Islands. The resultant orbit was 206.9 by 208.9 nautical miles with an inclination angle of 28.91 degrees. Immediately after the third SPS maneuver, the spacecraft was undocked from the GATV, and spacecraft maneuvers were used to complete the rendezvous with the Gemini VIII GATV.

Over the ETR in revolution 31, the GATV was gyrocompassed around to +90 degrees in order to obtain Experiment S026 (Ion-Wake Measurement) ambient measurements for a few revolutions. This maneuver was accomplished in flight control mode 1 (which includes low horizon-sensor gains), and the amount of time to reach the new heading was approximately 30 minutes. (The time for a normal 90-degree gyrocompassing yaw is approximately seven minutes, a time which was also observed on the Gemini VIII GATV.) When the GATV was positioned with the TDA south and in daylight, the hydraulic-oil-return temperature and attitude control gas-supply temperature increased, but the temperatures decreased when the vehicles passed into darkness.

Over the ETR during revolution 33, a stored program command load was transmitted, which switched the radar transponders and telemetry transmitter off between sites and back on just prior to site acquisition. Also, the vehicle was gyrocompassed to a heading of TDA east, a "01" word (1/000/000/001/111/111) was transmitted, and the velocity meter was enabled to start the velocity meter bias check. The flight controllers were asked to send "VM interrogate" as the GATV passed over each ground station in order to verify any change in the stored velocity-meter word. The velocity meter bias check was terminated over the RKV during GATV revolution 36, and the stored velocity meter word was unchanged, which indicates that the velocity meter was insensitive to small accelerations. The Gemini VIII GATV velocity meter showed a change of 7 ft/sec for the same test. The command and communications load was erased from the memory by an all-zeros load over Hawaii during GATV revolution 34 in order to aid in the depletion of GATV battery power. There were no further GATV activities until after spacecraft landing.

The GATV activities conducted after spacecraft landing consisted of three maneuvers, two using the PPS and one using the SPS Unit II. The first PPS firing was a height adjust maneuver. A posigrade thrust of 856 ft/sec was applied to raise apogee to 750 nautical miles. This

UNCLASSIFIED

UNCLASSIFIED

6-19

firing occurred at 72:21:06 g.e.t. over Grand Bahama Island during GATV revolution 46. The resultant orbit was 208.6 by 750.5 nautical miles. The GATV was placed in this orbit for a few revolutions in order to gather data on system performance at this altitude. This high apogee had no noticeable effect on the vehicle systems, except that the geocentric rate was calculated for a 161 by 161 nautical mile orbit, and, at this apogee, the rate was too large. Consequently, the horizon sensors were torquing the pitch gyro to make the resultant pitch torque rate the proper amount for the high apogee. During this maneuver, a velocity meter check was made. Velocity-meter disable was to be commanded 1/64 of a second after the PPS cutoff command. However, the velocity meter actually turned the PPS off at the proper delta velocity, and the command was not required. The velocity meter counted properly on the undocked PPS firings because the undocked ullage acceleration was twice as much as it was while docked; therefore, it is conceivable that acceleration would have been enough to cause the velocity meter to count properly.

Immediately after the first undocked PPS firing, the velocity meter was enabled to measure the change in velocity caused by venting of the propellant isolation valves. The normal ΔV for this venting is approximately 1.7 ft/sec, but the amount measured was 0.26 ft/sec during a period of approximately 15 minutes. After that time, there was no change in the velocity meter word.

The second PPS firing was another height adjust maneuver. It consisted of an 886 ft/sec retrograde thrust to lower the apogee. This firing occurred at 79:11:41 g.e.t. between the CSQ and the RKV during GATV revolution 50. The resultant orbit was 190.2 by 208.7 nautical miles.

The last GATV firing occurred at 82:58:07 g.e.t. between the CSQ and the RKV during GATV revolution 52. The SPS Unit II was fired for a coelliptic maneuver. It consisted of a 32.2 ft/sec retrograde maneuver to circularize the orbit at 190 nautical miles. The resultant orbit was 190.2 by 190.2 nautical miles, at an inclination angle of 28.90 degrees.

Over the Canary Islands during GATV revolution 54, a stored program command load was transmitted to place the GATV in a nose-up attitude in order that the vehicle would be captured by gravity-gradient stabilization. This load was executed during GATV revolution 54 when the vehicle passed over the CSQ. The GATV was gyrocompassed to a heading of TDA east. After that time, the vehicle flew inertial for one-fourth of an orbit (22 minutes and 50 seconds); then geocentric rate was turned on for a period of three minutes. After that, the geocentric

UNCLASSIFIED

UNCLASSIFIED

rate, the horizon sensors, and the attitude control system were turned off. MCC-H mission support was terminated at this point, and the Hawaii station assumed the responsibility for support until GATV power depletion. At the time Hawaii assumed responsibility, the vehicle weight was 4586.13 pounds and consumables remaining were as follows:

PPS ΔV , ft/sec	1590
SPS ΔV , ft/sec	431
PPS firing time, sec	13.6
SPS Unit II firing time, sec	148.9
Control gas, lb	10
Power, A-h	1080

The Hawaii support continued from GATV revolutions 58 through 92. During this support period, it was confirmed that the vehicle had been captured by gravity-gradient stabilization and was very stable in the TDA-up attitude. A salvo real-time command (RTC) test was conducted by transmitting ten RTC's and verifying them all in one second. This procedure is not standard, but its use would be very convenient when a number of RTC's are required, such as changing flight-control modes. After many recording and dumping sessions, the tape recorder started to "hang up" on tape reversal during a dump. In order to reverse the tape direction, it was necessary to turn the telemetry transmitter off, then on, and then send "recorder-to-playback". At this time, there is no explanation for the recorder sticking on tape reversal during a dump. The last Gemini X GATV pass over Hawaii with electrical power remaining was during revolution 92. At that time, the main bus voltage was 23 volts, and 60 ampere-hours remained. The next scheduled pass was revolution 101, but the Hawaii station had no contact except for a few seconds of C-band skin tracking.

UNCLASSIFIED

TABLE 6.1-1.- GATV PROPULSION SYSTEM DATA

(a) PPS

	Maneuver number								
	1 (a)	2 (a)	3 (a)	4 (a)	5 (a)	6 (a)	7	8	9
Type of start	C	C	C				A	A	
Station	HAW	KNO	ANT/CYI				GBI	CSQ/RKV	
GATV revolution	6	14	16				46	50	
Time of start signal, g.e.t.	^b 336 7:38:18	20:19:56	22:36:50				72:21:06	79:11:41	
ΔV required, ft/sec	420.0	340.0	79.0				856.8	886.3	
Fuel consumed, lb	185.56	145.37	34.95	0.0	0.0	0.0	136.79	126.75	0.0
Oxidizer consumed, lb	519.24	414.43	132.68	0.0	0.0	0.0	329.20	366.49	0.0
Vehicle weight at end of firing, lb	6505.45	5931.59	5753.30				5117.16	4619.57	
Fuel remaining, lb	801.30	655.93	620.72	620.72	620.72	620.72	483.93	357.18	357.18
Oxidizer remaining, lb	1843.01	1428.58	1296.56	1296.56	1296.56	1296.56	904.40	553.90	553.90
Firing time remaining, sec	60.0	47.49	33.30	33.30	33.30	33.30	23.13	13.60	13.60
Resulting orbit									
Apogee, n. mi.	163.3	413.6	208.4				750.5	208.7	
Perigee, n. mi.	158.6	160.2	204.2				208.6	190.2	
Orbit inclination angle, deg	28.86	28.89	28.87				28.91	28.89	
Vehicle attitude, deg	0, 0, 0	0, 0, 0	0, 0, 0				0, 0, 0	0, 180, 0	

^aDocked maneuver.

^bTime from lift-off, seconds.

UNCLASSIFIED

TABLE 6.1-1.- GATV PROPULSION SYSTEM DATA
(b) SPS Unit II

	Maneuver number								
	1 (a)	2 (a)	3 (a)	4 (a)	5 (a)	6 (a)	7	8	9
Type of start									
Station				HAW	CRO/EPR	CYI			CSQ/RKV
GATV revolution				18	26	27			52
Time of start signal, g.e.t.				27:45:20	41:04:10	41:35:34			82:58:07
ΔV required, ft/sec				7.7	14.8	3.5			32.2
Fuel consumed, lb	4.32	4.32	4.32	7.48	11.16	2.99	1.36	1.36	8.42
Oxidizer consumed, lb	4.74	4.74	4.74	8.67	12.92	3.44	1.49	1.49	9.75
Vehicle weight at end of firing, lb				5683.74	5659.60	5651.30			4584.00
Fuel remaining, lb	150.68	146.36	142.04	134.56	123.40	120.43	119.07	117.72	109.29
Oxidizer remaining, lb	171.47	166.73	161.99	153.32	140.40	136.96	135.47	133.98	124.23
Firing time remaining, sec	205.70	202.09	196.40	183.84	168.50	164.30	162.44	160.65	148.96
Resulting orbit									
Apogee, n. mi.				209.0	209.0	208.9			190.2
Perigee, n. mi.				207.6	208.2	206.9			190.2
Orbit inclination angle, deg				28.87	28.90	28.91			28.90
Vehicle attitude, deg				0, 0, 0, 0	-90, 0	0, 180, 0			0, 180, 0

^aDocked maneuver.

UNCLASSIFIED

6.2 NETWORK PERFORMANCE

The network was placed on mission status for Gemini X on July 10, 1966, and supported the mission satisfactorily. The GAATV was launched at 20:39:46 G.m.t. on July 18, 1966. The Gemini Space Vehicle lift-off occurred at 22:20:26 G.m.t. on July 18, 1966, and the Gemini spacecraft landed at 21:07:00 G.m.t. on July 21, 1966.

6.2.1 MCC and Remote Facilities

The network configuration and general support provided by each station are indicated in table 6.2-I. The Texas station was released from the mission to complete installation of modifications for Apollo mission support. Figure 4-2 shows the worldwide network stations. In addition, approximately 15 aircraft provided supplementary photographic, weather, telemetry, and voice relay support in the launch and recovery areas. Certain North American Air Defense Command (NORAD) radars provided track of the Gemini Launch Vehicle, the Target Launch Vehicle, the Gemini VIII GATV, the Gemini X GATV, and the spacecraft.

6.2.2 Network Facilities

Performance of the network is reported on a negative basis by system and site. All performance not discussed in this report was satisfactory.

6.2.2.1 Telemetry.- There were no major telemetry problems during the mission. Transmission of telemetry data from the Grand Turk Island (GTI) and Antigua (ANT) stations to MCC-H was noisy during launch because of an electrical storm in the area of San Salvador Island where the sub-cable makes a landing. The 40.8-kilobit data from GTI and ANT were estimated to be 90 percent and 80 percent usable, respectively. This had no detrimental effect on the mission.

6.2.2.1.1 Radar: Radar tracking during the mission was satisfactory. The California (CAL) S-band radar was inoperative for the first three passes because of servo problems; the problem was corrected prior to the fourth pass. The Hawaii (HAW) S-band radar data were rejected on spacecraft revolution 14; a magnetron was replaced and the data were good thereafter. The Canary Island (CYI) S-band radar was not in operation for spacecraft revolutions 39, 40, and 41 because of a range system problem. The Carnarvon (CRO) S-band radar was not operative for spacecraft revolutions 41, 42, and 43 because of a range system problem. The

UNCLASSIFIED

Pretoria (PRE) tracking data were delayed on six occasions during the mission because of poor radio propagation conditions, but no data were lost.

6.2.2.1.2 Acquisition aids and timing: All acquisition aid systems operated satisfactorily during the mission with no significant problems. The only timing failure occurred on spacecraft revolution 23 at CRO, when an IMC oscillator failed. The station switched to the standby oscillator, and no data were lost. The problem is believed to have been caused by a badly seated valve or a dry joint.

6.2.2.1.3 Command: No significant problems involving the Digital Command System were encountered during the mission.

6.2.2.2 Computers.-

6.2.2.2.1 Real Time Computer Complex: Several support problems of a minor nature occurred in the Real Time Computer Complex (RTCC) during the mission. These are identified as three program stops, three machine failures, and one printout-routine suppression problem of an undetermined nature. Six of the above problems caused no loss of mission support, but one did result in a computer restart instead of a normal switchover.

Of the three program stops experienced, two occurred on the mission operations computer (MOC) and required a computer switchover; the third stop occurred on the dynamic standby computer (DSC). All three program stops were apparently caused by the same suspected software problem. The effect of the problem is that an instruction in the main memory core is altered to a halt-and-transfer instruction which, when executed, results in a program stop. Efforts to isolate the problem have not been successful at the time of publication of this report.

The printout-routine suppression problem also resulted in a computer restart. The initial failure apparently occurred about ten hours prior to the time the program stop occurred, and dumps of restart tapes taken during this 10-hour period do not isolate the cause. All that is known is that an executive printout routine was suppressed, which caused an accumulation of print statements and eventually overflowed the buffer pool. Because of the buffer pool condition, type B restart tapes, taken near the end of this 10-hour period, could not be used to restart the computers. These restart tapes would reinitialize the computers with the buffer pool nearly full, and within a short period of time a buffer pool overflow would again cause a program stop. Hence, a type C restart was required to continue mission support.

UNCLASSIFIED

UNCLASSIFIED

6-25

The three machine failures all occurred on the dynamic standby computers. These required only that a restart tape be written out of the MOC to bring a DSC back on line.

After a trajectory update based on HAW radar data at 27:54:16 g.e.t., the spacecraft and GATV ephemerides showed that the GATV was leading the spacecraft after the N_{SR} maneuver at $M=30$. This caused the terminal-phase processor to attempt a solution with a positive phase angle of approximately 359 degrees. This solution required approximately 12 minutes of computer time. Because two updates were performed before this condition was known, approximately 24 minutes of computer time was used, during which time ephemeris data projection was not effective. However, all telemetry was processed during this period. The problem has been corrected for Gemini XI.

At about 15:39:33 g.e.t., three computer restarts were performed to bring up the DSC for any upcoming pass over the United States. One restart tape was not used because a redundancy occurred in writing the tape. The second restart tape was not used because the two computers were out of time synchronization. It was not accurately determined at that point which computer was out of time synchronization, and a third restart tape was written. This was a procedural problem, and the procedure has been corrected.

A telemetry group display, which shows sites in acquisition, in the Mission Operations Control Room indicated several times during the mission that a site such as Bermuda (BDA) was tracking the GATV while, in fact, the GATV was over another part of the world. Printout of outputs from the RTCC show that these displays were not being driven by the RTCC at these times.

At about 73 hours 3 minutes g.e.t., contractor electricians working in the Apollo computer controller area tripped a circuit breaker which caused television monitors, switch inputs, and other modules on the Gemini computer telemetry console and the television monitors on the Gemini computer command console to go out. Power was restarted immediately, but the right television monitor on the Gemini computer telemetry console had to be replaced because it would not stabilize. Procedures are being established to preclude a recurrence.

At about the time the power was turned off on the Gemini computer telemetry console, the control area junction unit failed. This unit formats and routes switch module inputs and manual entry device inputs from the computer controller consoles. Hence, during the time from 73 hours 29 minutes g.e.t. to 74 hours 45 minutes g.e.t., all switch

UNCLASSIFIED

UNCLASSIFIED

module and manual entry device inputs to the computer were made by punched cards via the on-line card reader and a satellite switch box. This greatly increased the response time of the RTCC to requests for computation by flight controllers, but no loss of mission support resulted. During this period, a GATV command load for an upcoming maneuver was formatted and transmitted to the appropriate site.

6.2.2.2.2 Real Time Computer Facility: The only problem with the Real Time Computer Facility (RTCF) at Cape Kennedy occurred during the launch of the GAATV when it was observed that raw data from the RTCF were of poor quality. During the Gemini Space Vehicle launch, however, the data were of good quality. The problem is being investigated at this time.

6.2.2.2.3 Goddard Real Time System: No significant problems concerning the Goddard Real Time System were encountered during the mission.

6.2.2.2.4 Remote Site Data Processors: The hardware and software performance of the Remote Site Data Processors was satisfactory. The following problems occurred but were not determined to be either software or hardware problems:

- (a) Faulting of the HAW computer in GATV revolution 1 at LOS and during spacecraft revolution 28
- (b) Faulting of the CRO computer in spacecraft revolution 28
- (c) Faulting of the Guaymas (GYM) computer in spacecraft revolutions 27 and 28
- (d) Faulting of the ANT computer in spacecraft revolutions 27 and 28.

Tape playback of data for these passes resulted in no faults.

The ship Coastal Sentry Quebec (CSQ) had a problem with five parameters printing out in error. Reloading of the program prior to each pass and switching PCM formats and input cables corrected the problem. Further investigation of this problem is being conducted by CSQ personnel.

6.2.2.3 Communications.-

6.2.2.3.1 Ground communications: The usual communications problems caused by ionospheric day/night transitions occurred on this mission.

UNCLASSIFIED

UNCLASSIFIED

6-27

Also, a blown fuse caused a microwave fade in HAW during the launch phase. During the second day of the mission, a landline problem occurred between Adelaide and Carnarvon, Australia. This hindered communications with CRO for approximately three hours. On the final day of the mission, both voice and teletype communications with the ship Rose Knot Victor (RKV) were extremely difficult, and no usable communications were available over long periods. Storm conditions in the Arizona-Mexico border area also caused some outages in communications with GYM.

UNCLASSIFIED

UNCLASSIFIED

TABLE 6.2-1.- GEMINI X NETWORK CONFIGURATION

Systems Stations ^a	Acquisition aid	Air-to-ground remoting	C-band radar	Digital Command System	Data routing and error detection	Downrange uplink	Flight controller, air-to-ground	Flight controller, manned	Gemini launch data system	GLV telemetry	High-speed radar data	High-speed telemetry data	Biomedical remoting	Radio frequency command	Remote-site data-processor summary	S-band radar	Delayed time telemetry	Recovery antenna telemetry	R and R telemetry	Real-time telemetry display	Teletype	Voice (SCAMA)
MCC-H		X		⊗			X				X				X		X		X	X	X	X
MCC-K	X	X		X	X				X	X	X	X	X				X		X	0	X	X
A/C		X																	X			
ANT	X	X	X			X						X	X	X			X		X	X	0	
ASC		X	X															X		X		
BDA	X	X	X			X					X	X	X	X		X	X		X	0	X	X
CAL	X	X	X												X				X		X	X
CNV			X ^b			X				X				X					X	X		
CRO	X		X	X			X	X					X	X	X	X	X		X	X	X	X
CSQ	X			X			X	X					⊗	X	X		X		X	X	X	X
CTN	X	X																	X		X	X
CYI	X		X	X			X	X					X	X	X	X	X		X	X	X	X
EGL	X		X																		X	X
GBI	X	X	X			X				X		X	X	X		X	X	X	X	0		
GTI	X	X	X			X				X		X	X	X		X	X	X	X	0		
GYM	X						X	X					X		X	X	X		X	X	X	X
HAW	X		X	X			X	X					X	X	X	X	X		X	X	X	X
KNO	X	X																	X		X	X
MLA			X																			
PAT			X																			
PRE			X																			
RKV	X			X			X	X					⊗	X	X		X		X	X	X	X
RTK	X	X	X																X		X	X
TAN	X	X																	X		X	X
TEX ^c																						
WHS	X		X																		X	X
WLP ^d			X													X					X	X
WOM	X		X																		X	X

^aLocation of stations is shown in figure 4.3-1.

^bWind profile measurements in support of recovery operations.

^cReleased to complete modifications for Project Apollo.

^dIf available.

Legend:

⊗ Master Digital Command System

0 Remoting

⊗ Post-pass biomed remoting

6.3 RECOVERY OPERATIONS

6.3.1 Recovery Force Deployment

Recovery plans and procedures were established for the Gemini X mission to ensure the rapid location and safe retrieval of the flight crew and spacecraft following any conceivable landing situation. Planned and contingency landing areas were defined in accordance with the probability of a landing in the area. Planned landing areas included the launch-site landing area, the launch-abort landing area, the primary landing area, and secondary landing areas. A landing outside of these planned areas was considered a contingency landing.

Department of Defense (DOD) forces provided recovery support in each of the various landing areas. The level of support provided was commensurate with the probability of landing within a particular area and with any anticipated problems associated with such a landing. Table 6.3-I contains a summary of the forces committed for Gemini X recovery support. The planned landing areas, in which support forces were positioned for search, on-scene assistance, and retrieval, were located and defined as follows:

(a) The launch-site landing area was that area in which a spacecraft landing would have occurred following an abort prior to launch or during the early part of powered flight. It included the area in the vicinity of Launch Complex 19 and extended seaward along the ground track for a distance of 41 nautical miles. Recovery forces deployed in this area are outlined in figure 6.3-1.

(b) Launch-abort landing areas were those in which a spacecraft landing would have occurred following an abort after approximately 100 seconds of flight and before insertion into orbit. These areas originated at the seaward extremity of the launch-site landing area and were bounded by the most northern and southern planned launch azimuths. An illustration of the area and an indication of the recovery support that was provided are presented in figure 6.3-2.

(c) Secondary landing areas were located within, or near, three recovery zones, spaced such that a rapid-access recovery capability existed at frequent intervals throughout the flight. These zones were located in the East Atlantic, West Pacific, and Mid-Pacific.

(d) The primary landing area is the planned end-of-mission landing area in the West Atlantic zone. Support in this area included the

UNCLASSIFIED

prime recovery ship. Because areas within the West Atlantic zone were designated go/no-go areas and probabilities were that the mission would be terminated with a landing in this zone, a Landing Platform Helicopter (LPH) ship and helicopter detachment were assigned for recovery support. Additionally, tracking and fixed-wing search/rescue aircraft were located in the vicinity to assist in the recovery operation. Figure 6.3-3 illustrates the recovery zone concept and the support provided for both secondary and primary landing areas.

Provisions for recovery support in the event of a contingency landing consisted of fixed-wing search/rescue aircraft on alert at staging bases located such that any point on the Gemini X ground track could be reached within 18 hours after notification of spacecraft landing (fig. 6.3-4). Staging bases used during the mission included the following:

Ascension Island	Pago Pago, Samoa
Bermuda	Perth, Australia
Dakar, Senegal	San Diego, USA
Hawaii, USA	San Francisco, USA
Lajes, Azores	Singapore
Lima, Peru	Tachikawa, Japan
Mauritius Island	

Wherever possible, preselected contingency aiming points were designated near recovery zones or at positions close to recovery forces.

6.3.2 Location and Retrieval

Retrofire was initiated to effect a landing at the beginning of the 44th revolution in the West Atlantic recovery zone. The U.S.S. Guadalcanal (LPH 7) was positioned at 26 degrees 41.5 minutes north latitude and 72 degrees 3.4 minutes west longitude. Aircraft from the U.S.S. Guadalcanal and fixed-wing search/rescue aircraft were positioned in an array as shown in figure 6.3-5.

The spacecraft was landed at 21:07 G.m.t. on July 21, 1966, at 26 degrees 44.7 minutes north latitude and 71 degrees 57.0 minutes west

UNCLASSIFIED

UNCLASSIFIED

6-31

longitude, 3.4 nautical miles from the aiming point. Position information was determined by multiple LORAN fixes taken at the time of recovery and also based on celestial fixes taken in the morning and evening on recovery day. The position of the spacecraft at the time of retrieval was 26 degrees 44.9 minutes north latitude and 71 degrees 57.1 minutes west longitude. Figure 6.3-6 shows relative landing and pickup positions.

The following is a sequence of events as they occurred during the recovery operation:

July 21, 1966 G.m.t., hr:min	Ground elapsed time, hr:min	Event
21:01	70:41	Voice transmission from Gemini X read out 26°38.4'N, 71°55'W
21:02	70:42	Two sonic booms reported by U.S.S. Guadalcanal
21:03	70:43	Visual sighting of spacecraft on main parachute from U.S.S. Guadalcanal; observed to be rotating on suspension lines
21:04	70:44	Visual sighting by rescue helicopter
21:07	70:47	Spacecraft landing; rescue helicopter arrived at spacecraft
21:09	70:49	Datum Report No. 1, estimates spacecraft position 26°43'N, 72°06'W; based on ship's radar fix of rescue helicopter
21:09	70:49	Swimmers and flotation collar deployed from rescue helicopter
21:12	70:52	Flotation collar installed and inflated
21:17	70:57	Swimmers opened command pilot's hatch
21:28	71:08	Flight crew retrieval by rescue helicopter begun
21:30	71:10	Flight crew retrieval completed

UNCLASSIFIED

UNCLASSIFIED

July 21, 1966 G.m.t., hr:min	Ground elapsed time, hr:min	Event
21:34	71:14	Rescue helicopter with flight crew aboard U.S.S. Guadalcanal
21:58	71:38	Spacecraft prepared for retrieval; hook-on complete
22:01	71:41	Spacecraft resting in cradle aboard U.S.S. Guadalcanal

6.3.3 Recovery Aids

6.3.3.1 UHF recovery beacon (243.0 mc).-- The recovery antenna did not erect because of failure of the parachute bridle trough cover to release properly. As a result, only weak reception at short range was possible. Only the search helicopters and Air Boss 2 were able to receive a signal. Search 1 and Search 2, both 17 miles from the spacecraft at 8000 feet altitude, received a weak pulse signal shortly after visual contact. Search 3, located above the recovery ship at 8000 feet altitude, received a continuous wave (CW) signal shortly after visual contact. Air Boss 1 received a signal after the spacecraft landed in the water; the type of signal (pulse or CW) was not reported. Kindley Rescue 1, Kindley Rescue 2, and Air Boss 2 were unable to receive a signal.

6.3.3.2 HF transmitter (15.016 mc).-- The HF whip antenna was not erected by the crew, and no HF voice or HF/DF signals were transmitted.

6.3.3.3 UHF voice transmitter (296.8 mc).-- The descent antenna erected properly, and the UHF voice transmitter functioned normally. Both Air Boss 1 and Air Boss 2 received voice transmission from the crew at 21:02 G.m.t. at a range of approximately 75 nautical miles. The U.S.S. Guadalcanal received UHF voice transmissions from the crew beginning at 21:01 G.m.t. with transmission of the computer-predicted landing coordinates.

6.3.3.4 UHF survival radio (243.0 mc).-- The UHF survival radio was not used.

6.3.3.5 Flashing light.-- The flashing light erected properly but was not activated by the flight crew.

UNCLASSIFIED

6.3.3.6 Fluorescein sea marker.— The sea dye marker diffusion was normal, and the dye was sighted at a range of 7400 yards by the recovery ship. Recovery aircraft sighted it at ranges of three to eight nautical miles.

6.3.3.7 Swimmer interphone.— The swimmers connected the interphone upon arrival at the spacecraft. Communications with the crew were very good.

6.3.4 Postretrieval Procedures

The crew were transported to the U.S.S. Guadalcanal by helicopter. Spacecraft retrieval was normal, with no difficulties encountered. Post-retrieval observations were as follows:

- (a) The HF antenna was not extended.
- (b) The recovery antenna did not erect. It was held down by the parachute bridle trough cover.
- (c) The UHF descent antenna was erected.
- (d) The flashing light and recovery loop were erected. The light had not been activated.
- (e) Both windows were about 75 percent fogged, and a sooty deposit was on the outside of each.
- (f) Heating effects appeared normal.
- (g) The main parachute attach points released normally, but, because of the lack of wind, the parachute settled next to the spacecraft with several risers draped across the spacecraft. Figure 6.3-7 shows the fogged windows and also the parachute lying in the water after landing.
- (h) All spacecraft power was on—four main batteries and three squib batteries.
- (i) Several items were loose on the floor of the spacecraft.

Approximately 16 hours after spacecraft landing, the first data and film flight departed for Patrick Air Force Base, Florida. All urgent-return items were delivered to Patrick, Cape Kennedy, and Houston.

UNCLASSIFIED

The flight crew departed the U.S.S. Guadalcanal for Cape Kennedy at approximately 9:00 a.m. e.s.t., July 22, 1966. The spacecraft was off-loaded at Mayport, Florida, at approximately 9:00 p.m. e.s.t. the same day, and deactivation procedures were started immediately.

6.3.5 Reentry Control System Deactivation

The Landing Safing Team (LST), consisting of NASA and spacecraft contractor engineers and technicians, was responsible for deactivating the RCS according to the procedures of reference 18.

The RCS deactivation was performed at the Mayport Naval Station, Mayport, Florida, on July 22, 1966. The primary reason for deactivation of the RCS at Mayport was to safe the system prior to transporting the spacecraft aboard a USAF C-130 aircraft to the spacecraft contractor's facility in St. Louis, Missouri.

Immediately following the arrival of the U.S.S. Guadalcanal at Mayport, the spacecraft was off-loaded from the ship's hangar deck. The RCS shingles had been removed aboard ship. No visual damage was apparent to the system, and the deactivation procedures were immediately initiated by the LST. Throughout the operation, normal safety procedures were observed, and there was no visual indication of toxic vapors from any of the 16 RCS thrust chamber assemblies.

Before the pressurant in each ring was relieved to atmospheric pressure, the LST obtained pressure readings of source pressure from test point 1 on the A-package of both rings and of regulated lock-up pressure from test point 6 on the B-package of both rings. For this operation, a 1/4-inch-ID flexible hose, four feet in length, was connected from test point 1 to a calibrated 300 psi precision pressure gage. Source pressure readings of 1405 and 1440 psig (ambient dry bulb temperature of 70° F) were obtained from the A-ring and the B-ring, respectively. Regulator lock-up pressure readings of 300 and 297 psig were obtained from A-ring and B-ring, respectively. The pressure in each ring was then relieved to atmospheric pressure. Immediately following the source pressurant draining operation, the pressurant upstream of the propellant bladders and downstream of the system B-package check valves was relieved through test points 4 and 6 by venting through separate propellant scrubber units.

Prior to system flushing, raw propellant samples were taken for analysis. The analysis indicated that the propellants in both rings met the required cleanliness specifications. All remaining propellant in the systems was drained for a rough approximation of the oxidizer-to-fuel

UNCLASSIFIED

UNCLASSIFIED

6-35

ratio. The following propellant weights were obtained: A-ring oxidizer, 3.43 pounds; A-ring fuel, 3.50 pounds; and B-ring fuel, 2.63 pounds. Only heavy vapors were drawn from the B-ring oxidizer system. No definite conclusion is available as to why only vapors were obtained.

At no time prior to the flushing operation did a propellant solenoid valve leak vapors as if the valve were partially stuck open. Upon activation of the valves, all valves appeared to function normally.

In order to remove as much hypergolic propellants as possible from the RCS, both the A-ring and the B-ring of the RCS were completely flushed, with Freon-MF used in the oxidizer system and methyl alcohol in the fuel system; in addition, a nitrogen gas purge was used in both systems. This brought the propellant in the system to less than five parts per million. No problems were encountered during the RCS deactivation.

Following delivery of the spacecraft to St. Louis, the Reentry Control System (RCS) was vacuum dried in an altitude chamber, and a post-flight analysis was conducted.

UNCLASSIFIED

UNCLASSIFIED

TABLE 6.3-I.- RECOVERY SUPPORT

Landing area	Access time, hr:min		Support
	Aircraft	Ship	
Launch site area:			
Pad	0:05		3 M-113 (tracked land vehicles)
Land	0:10		4 LARC (amphibious vehicles)
Water (if flight crew ejects)	0:02		2 LVTR (amphibious vehicles with spacecraft retrieval capability)
Water (if flight crew are in spacecraft)	0:15		4 CH-3C (helicopters with para-rescue teams) 1 LCU (large landing craft with spacecraft retrieval capability) 1 boat (50-foot) with water salvage team
Launch abort area:			
A-1	4:00	11:00	1 LPH (aircraft carrier) with onboard helicopter capabilities, 3 DD (destroyers), 1 AO (oiler), and 6 aircraft on station (3 HC-97 and 3 HC-130H)
A-2	4:00	38:00	
B	4:00	5:00	
C	4:00	12:00	
D	4:00	36:00	
Primary:			
West Atlantic	1:00	4:00	1 LPH (aircraft carrier) from area A-1 1 DD ^a 2 HC-130H (search and rescue) 6 SH-3A helicopters (3 location, 2 swimmer, 1 photo) 2 P3-A (on-scene commander)

^aOne launch abort DD remained in area and was available if required.

UNCLASSIFIED

UNCLASSIFIED

6-37

TABLE 6.3-I.- RECOVERY SUPPORT - Concluded

Landing area	Access time, hr:min		Support
	Aircraft	Ship	
Secondary landing areas:			
West Atlantic (Zone 1)		4:00	1 LPH (carrier), 1 DD ^a
East Atlantic (Zone 2)		6:00	1 DD, 1 AO (Oiler ^b)
West Pacific (Zone 3)		6:00	2 DD
Mid-Pacific (Zone 4)		6:00	1 DD, 1 AO (Oiler ^b)
Secondary and contingency aircraft			27 aircraft on strip alert at staging bases.
Total			8 ships, 10 helicopters, 29 aircraft

^aOne launch abort DD remained in area and was available if required.

^bAssigned to area for logistic purposes.

UNCLASSIFIED

NASA-S-66-8067 AUG 9

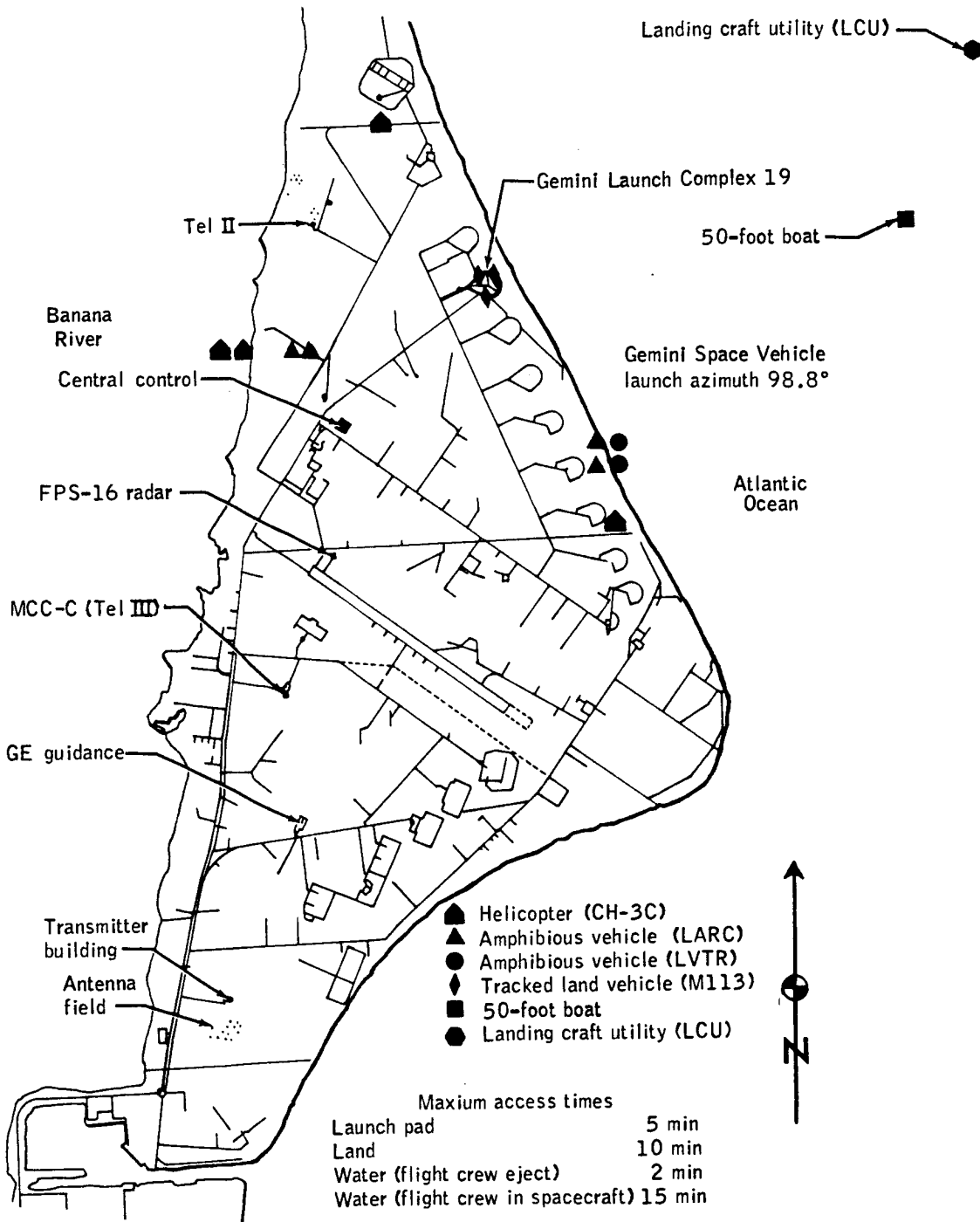
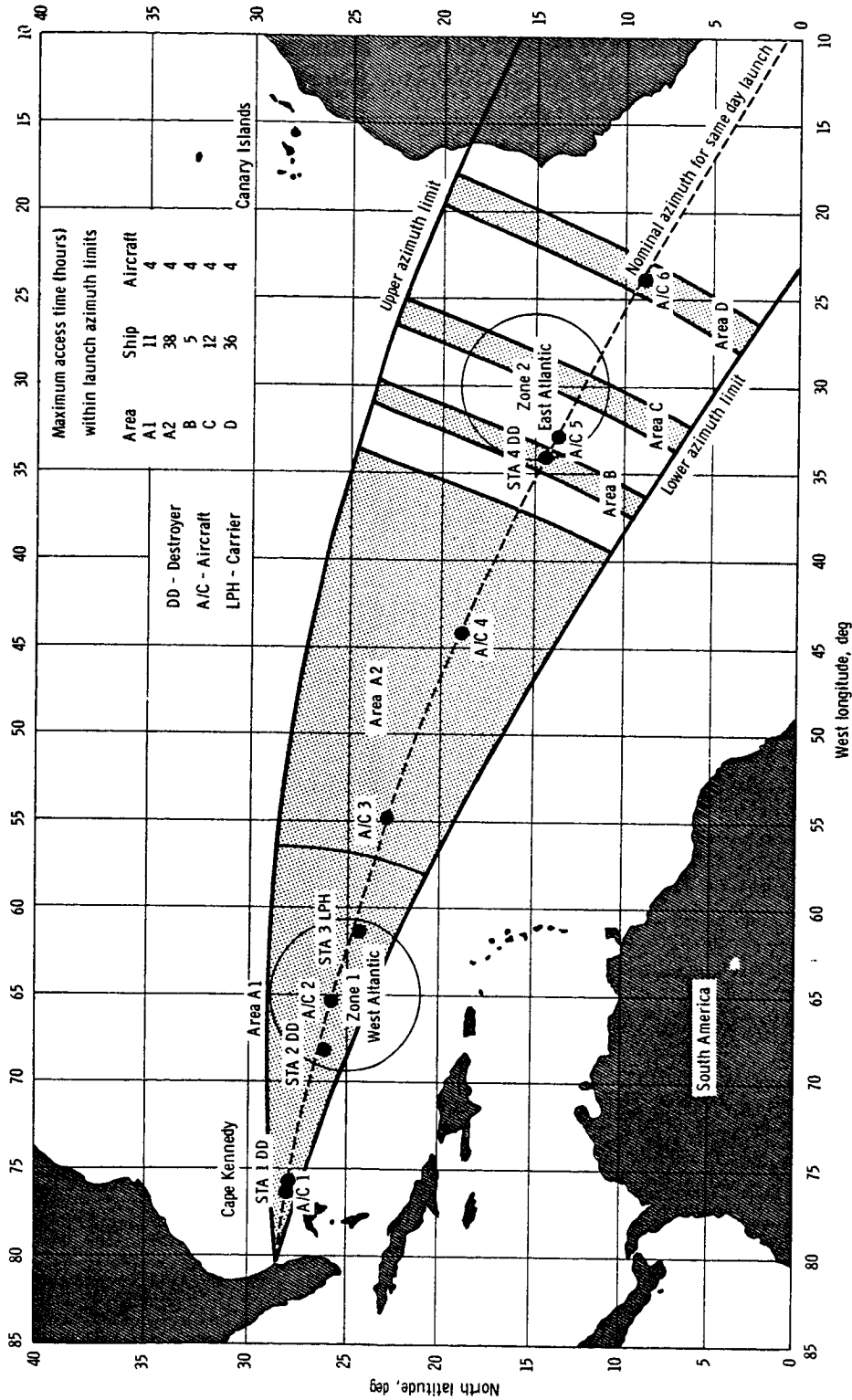

Figure 6.3-1. - Launch site landing area recovery force deployment.

UNCLASSIFIED

NASA-S-66-8070 AUG



UNCLASSIFIED

Figure 6.3-2. - Gemini X launch areas and recovery ship and aircraft deployment.

UNCLASSIFIED

NASA-S-66-8068 AUG

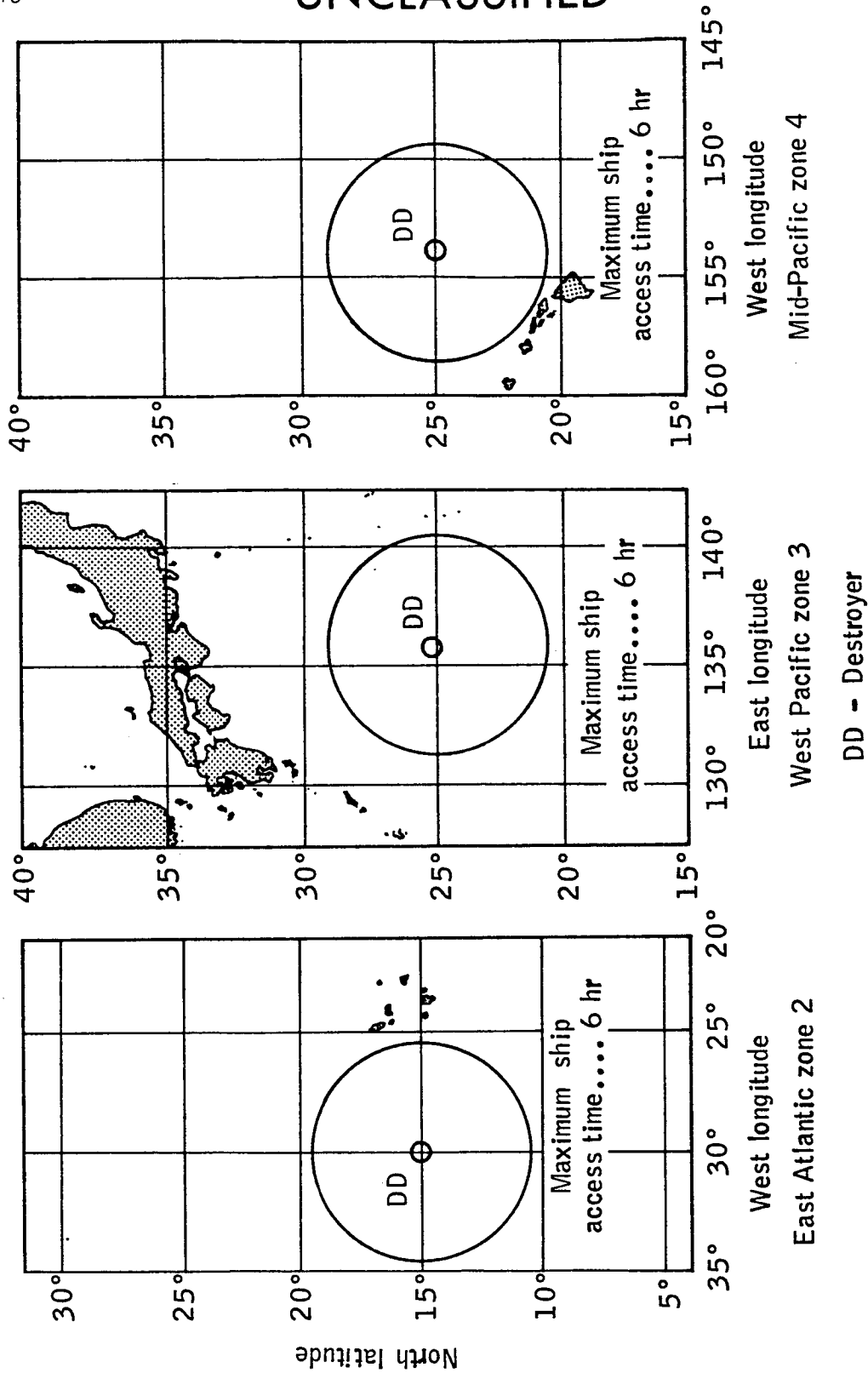
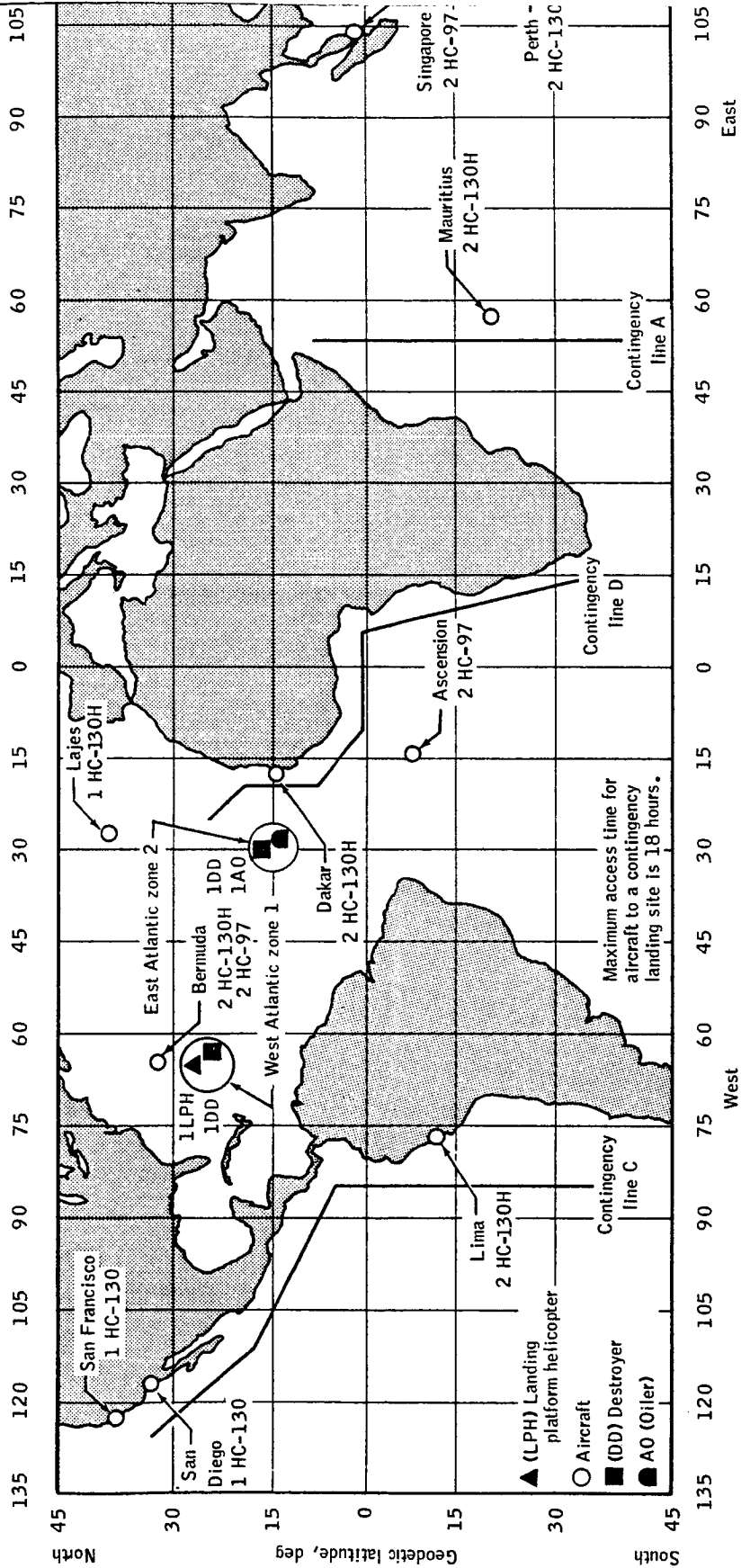

Figure 6.3-3. - Gemini X landing zone location and force deployment.

UNCLASSIFIED

NASA-S-66-8074 AUG 9



6-41-8

6-41-a

UNCLASSIFIED

6-41

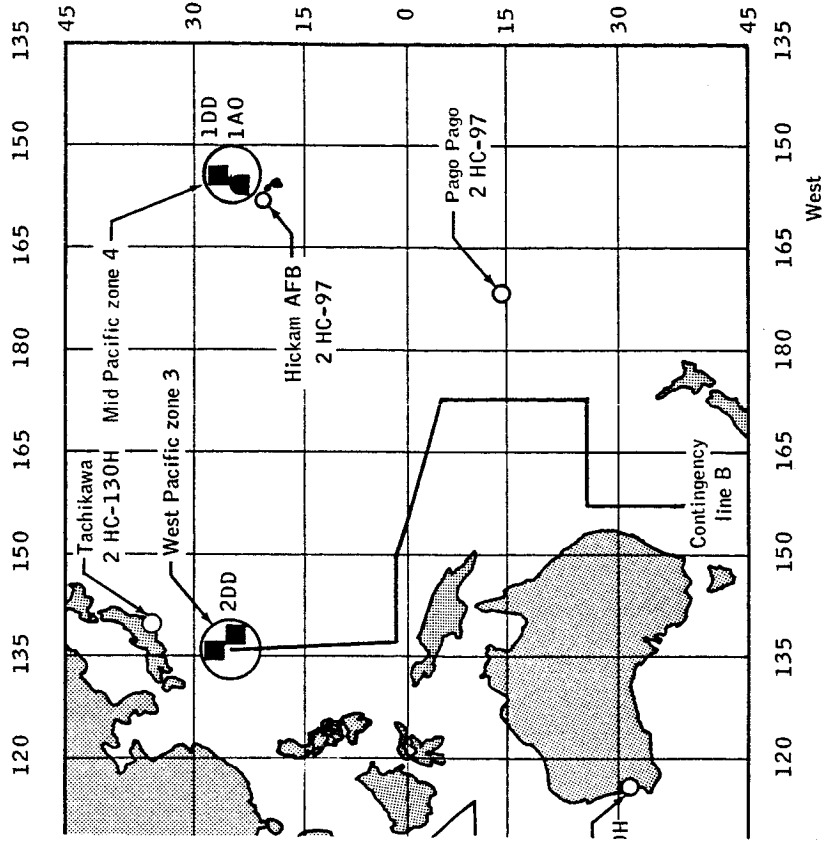

6-41-C

Figure 6.3-4. - Contingency recovery force deployment.

UNCLASSIFIED

UNCLASSIFIED

NASA-S-66-8114 AUG 12

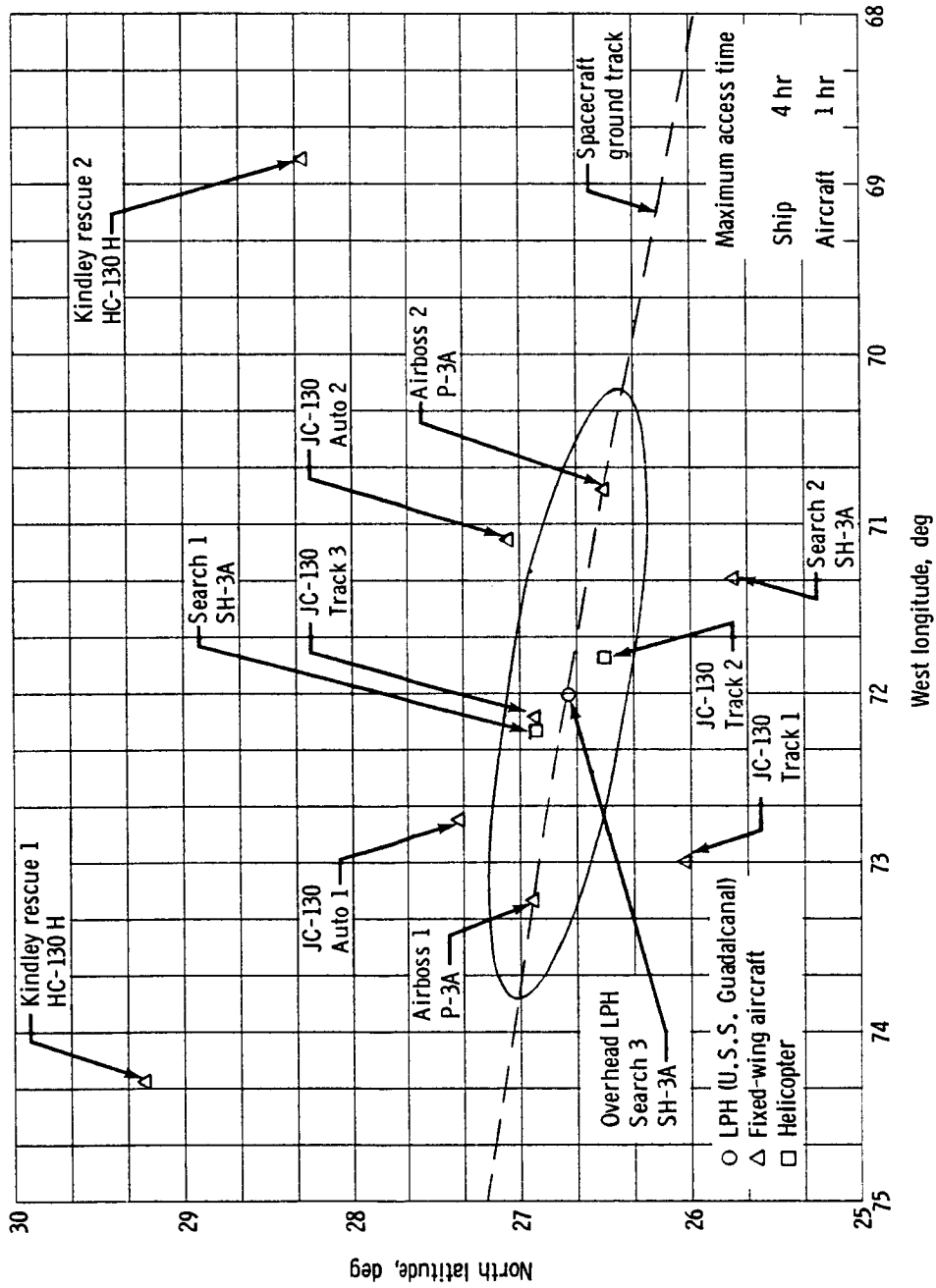

Figure 6.3-5. - Recovery force and network aircraft deployment in primary landing area.

UNCLASSIFIED

NASA-S-66-8119 AUG 13

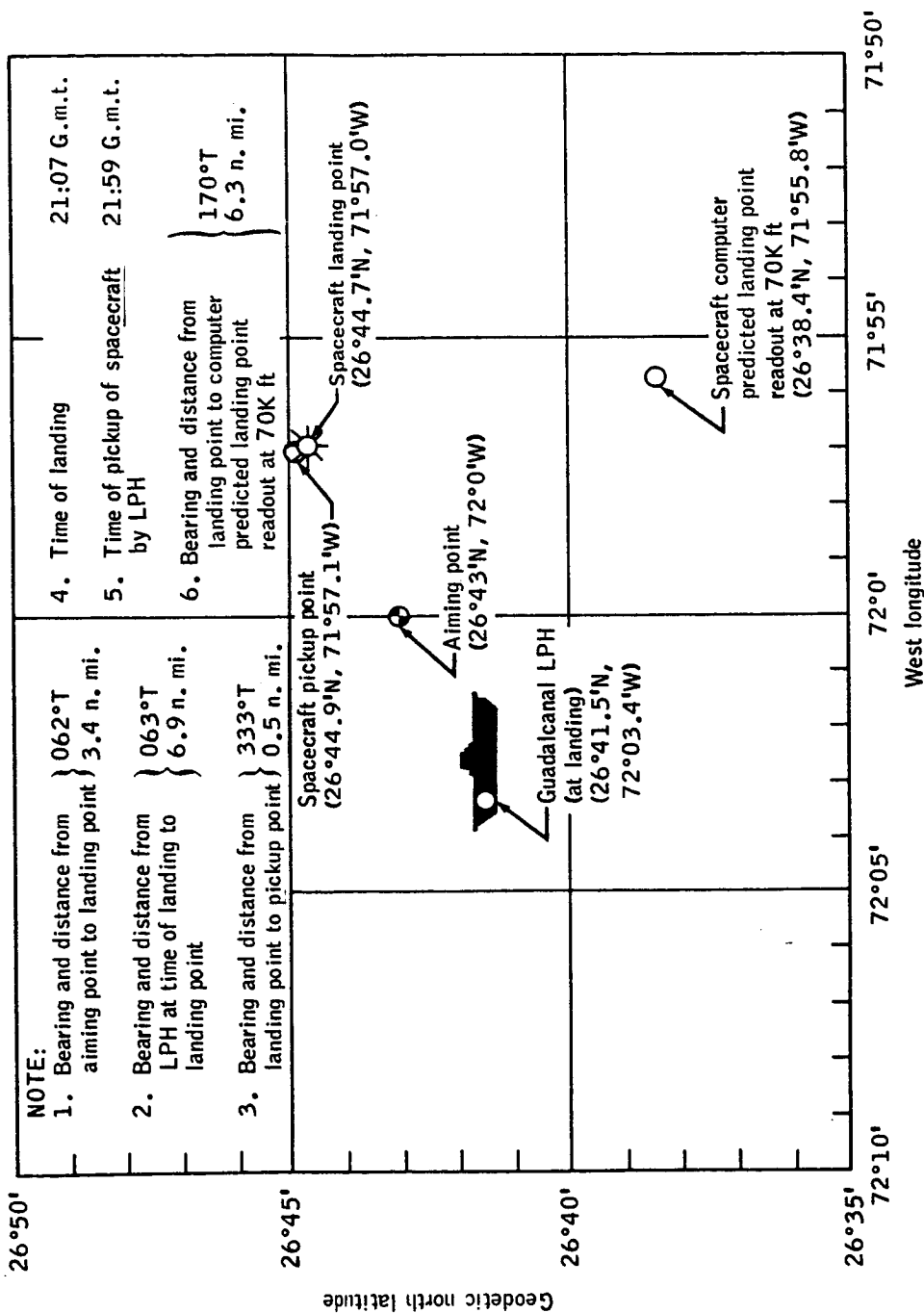

Figure 6.3-6. - Spacecraft landing information, as determined on the prime recovery ship.

NASA-S-66-8117 AUG 13

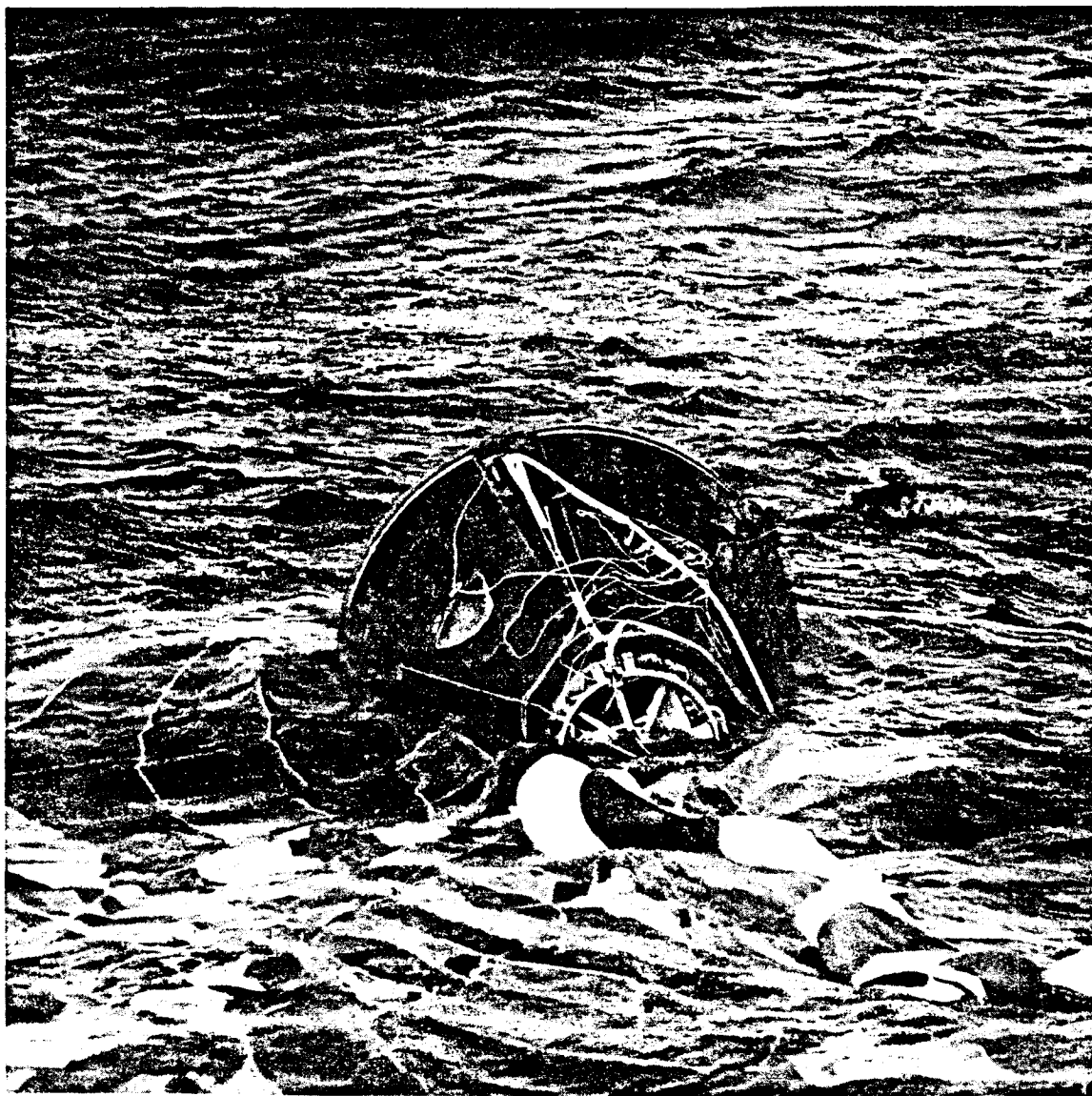

Figure 6.3-7. - Spacecraft 10 immediately after landing.

7.0 FLIGHT CREW

7.1 FLIGHT CREW PERFORMANCE

7.1.1 Crew Activities

In executing rendezvous with the Gemini X Gemini Agena Target Vehicle (GATV), an off-nominal transfer trajectory contributed to an excessive use of propellants by the crew, although station keeping and docking with the target vehicle were satisfactory. By staying attached to the Gemini X GATV, the crew was able to conserve spacecraft fuel and complete all major objectives of the mission. While docked with the GATV, the crew fired the GATV primary and secondary propulsion systems, performed standup extravehicular activity (EVA), accomplished a large percentage of the planned experiments, and performed several pretransfer maneuvers for rendezvous with the Gemini VIII GATV. The crew separated the spacecraft from the Gemini X GATV prior to the terminal phase of the rendezvous with the Gemini VIII GATV. The visual rendezvous with the passive GATV was accomplished, and, while station keeping, the pilot performed an umbilical EVA, retrieved the SOLO experiment package from the Gemini VIII GATV and evaluated the Hand Held Maneuvering Unit (HHMU). The flight plan activities which were accomplished are shown in figure 7.1.1-1.

7.1.1.1 Prelaunch through insertion.- The crew ingressed the spacecraft and performed all prelaunch functions with time to spare. Lift-off was very apparent to the crew, and powered flight was normal. The command pilot recognized launch-vehicle pitch-gain changes on the Flight Director Attitude Indicator (FDAI), and the pilot acknowledged the Digital Command System (DCS) launch-azimuth updates as they were received. First stage engine cutoff (BECO), staging, and second stage operations were normal. Immediately after second stage engine cutoff (SECO), the pilot read the insertion parameters from the computer. The crew separated the spacecraft from the launch vehicle at SECO plus 30 seconds and rolled to the 0, 0, 0 attitude. The pilot again checked the insertion parameters in the computer, and the command pilot executed the Insertion Velocity Adjust Routine (IVAR) maneuver to adjust the orbit. Immediately thereafter, the insertion checklist was completed and all systems indicated satisfactory operation.

7.1.1.2 Orbit determination and navigation predict operations.- An attempt was made to use an onboard capability to determine the velocity changes required for the first rendezvous and to update the spacecraft state vector. The onboard rendezvous solution may be divided into four

UNCLASSIFIED

areas: horizon calibration, orbit determination, ascent-vector translation solutions, and orbit-determination-vector translation solutions.

7.1.1.2.1 Horizon calibration: The horizon calibration procedure consisted of four star-to-horizon measurements taken during the first darkness period. The measurement residual, derived by the computer, was plotted against the ground elapsed time (g.e.t.) of the star measurement. The residual obtained by the crew was 27 500 yards. However, a post-flight analysis shows that the graphic solution should have yielded an answer of 37 500 yards. This error was caused by an error in plotting the residuals on a prepared chart.

Horizon definition was extremely difficult. The airglow was thought to be the horizon until stars were seen below the airglow. The pilot used as the horizon the line below which no stars were visible.

7.1.1.2.2 Orbit determination: Sextant difficulties jeopardized the orbit determination phase of the flight. The pilot had difficulty in splitting the star image using the Experiment D009 sextant. At times the sextant field was blocked by the upper window frame. The pilot then attempted to use the miniature sextant, and, although the star image would split, he could not distinguish the horizon. After this difficulty, he returned to the D009 sextant.

During the first orbit determination period, operations were normal until the second star-to-horizon measurement. Logic Choice M6 was not set to the plus state to indicate a star horizon measurement. The first residual was a large number and was rejected by the crew. However, because the five digit readout of the computer displayed a six-digit residual of -100.13 as -00.13, the crew accepted this incorrect measurement.

From an analysis of flight data, it appears that the wrong star—possibly Antares—was used for Altair. Throughout this phase of the mission, the spacecraft was being yawed by the water-boiler exhaust, which contributed to the problem.

7.1.1.2.3 Ascent-vector translation solution: Some difficulties appeared in the calculation of the ascent-vector translation solution but no significant errors resulted. The crew obtained the correct time to the midpoint of the phase adjust maneuver but made an error when calculating the time to initiate the maneuver.

During the calculation of the nodal crossing time, the crew failed to note a change of sign from Z, relative to the present prediction, to

UNCLASSIFIED

Z, relative to the next prediction. They continued to add time and, as a result, actually predicted to the second nodal crossing.

7.1.1.2.4 Orbit-determination-vector translation solutions: After entering the erroneous data obtained during the orbit determination phase on the charts, it was apparent that the solutions were out of tolerance, and the orbit determination effort was suspended. Further elaboration on piloting techniques are discussed in section 7.1.2.

7.1.1.3 First rendezvous.- The first rendezvous was made using the M=4 mission plan which includes two phasing maneuvers, a coelliptic maneuver (N_{SR}), and terminal phase maneuvers. This section includes only the maneuvers after N_{SR} . The N_{SR} maneuver and all maneuvers prior to that were performed in accordance with ground-computed parameters.

7.1.1.3.1 Terminal phase preparations: Radar lock-on was achieved 41 minutes prior to N_{SR} at a range of 234 nautical miles, and the computer was switched to the rendezvous mode at $N_{SR} + 4$ minutes. After switching to the rendezvous mode, the computer constants were verified, and ωt (total angle of orbital travel to rendezvous) and other constants were entered.

Platform alignment was initiated at $N_{SR} + 10$ minutes 40 seconds at an elevation angle of eight degrees, about one degree earlier than planned. The eight data points of angle and ΔR taken during the alignment showed Δh at that time to be near 15 nautical miles. Alignment was terminated about one minute later than planned.

The range and angle data points subsequent to the platform alignment showed that Δh had changed abruptly to 17 nautical miles, indicating a possible guidance system error. The remainder of the data taken prior to the terminal phase initiate maneuver (TPI) confirmed that Δh was staying near 17 nautical miles. Most of the data available to the crew indicated that the rendezvous at this point was very near nominal. Therefore, after applying a correction to the nominal TPI solution of 33 ft/sec forward of +2 ft/sec forward for each mile below the nominal Δh of 15 nautical miles, the crew interpreted this information as requiring 37 ft/sec forward at TPI.

About 14 minutes before sunset, visual contact was made at a range of 48 nautical miles and a pitch angle of 20 degrees. The angle between the sun and the line of sight was approximately 120 degrees. The crew reported that agreement between the radar and the reticle boresight was within half a degree in yaw and virtually on center in pitch.

UNCLASSIFIED

7.1.1.3.2 Terminal-phase rendezvous maneuvers: Table 7.1.1-I shows the terminal phase maneuvers that were calculated by the ground computer, by the onboard computer, and by the crew with backup charts, and the table also shows the terminal phase maneuvers that were actually applied.

TPI occurred at 4:33:44 ground elapsed time (g.e.t.), about seven minutes before darkness. Because of the general agreement of the onboard computer solution with the backup solution, the fore/aft and up/down components of the onboard computer solution were applied at TPI. The crew believed that the out-of-plane component of the closed-loop solution was in error, as it disagreed with FDAI trends during the coelliptic phase and with the ground solution. Therefore, this component was rejected.

The forward component of the onboard computer TPI solution was confirmed to have been too large by both the first and second backup midcourse solutions and by the first midcourse correction calculated by the onboard computer ($\omega t = 82$ degrees); therefore, the aft component of the onboard computer solution was applied in full for the first midcourse correction. The downward component of the onboard computer solution was weighted by the backup solution because the performance of the guidance system up to that point appeared to the crew to be somewhat erratic. The first correction out-of-plane component from the computer was more representative of the crew's estimate of the approach trajectory than the out-of-plane component at TPI and was small enough to be neglected.

The third backup midcourse correction indicated insufficient down ΔV from the first correction. This was confirmed by both the fourth backup solution and the second onboard computer solution ($\omega t = 34$ degrees). The computer solution was chosen, and, by observing the in-plane target drift after the maneuver, it was determined that the correction was adequate in this axis. The computer out-of-plane solution was applied, but the crew reported it did not significantly reduce the relative motion in that axis. Therefore, it was necessary to apply considerable ΔV to null the out-of-plane drift shortly after the second correction. This resulted in an approach from the side, and a high propellant expenditure was experienced at that time. Rendezvous was reported as being completed at dawn. After the second midcourse correction, the crew reported an unintentional forward velocity input that may have been associated with an interference problem between the translation controller and a pocket on the leg of the command pilot's suit (see section 7.1.2).

7.1.1.4 Second rendezvous.- The coelliptic phase of the second rendezvous began with N_{SR} at 46:09:28 g.e.t. This maneuver fixed Δh at 7.2 nautical miles. Platform alignment was initiated at sunrise which

UNCLASSIFIED

occurred at 47 hours 4 minutes g.e.t. The Gemini VIII GATV was reported visible during the platform alignment at 47 hours 7 minutes, when the sun was below the nose of the spacecraft. As the sun came above the nose of the spacecraft, visibility was lost until after the platform alignment was completed and a 180-degree roll maneuver had been executed. Visibility was reacquired at a sun angle of approximately 28 degrees above the line-of-sight at which time the elevation angle to the target was about 26 degrees.

The TPI maneuver occurred at 47:27:20 g.e.t. at an elevation angle of 32.8 degrees, allowing 33 minutes before sunset to complete the rendezvous. The forward component computed onboard agreed with the ground solution and was applied by thrusting 30 seconds forward because the computer was not started prior to the maneuver. Table 7.1.1-II is a summary of the solutions for the TPI maneuver and the midcourse corrections.

After TPI, the crew reported that visibility improved enough for very accurate tracking. The first and second midcourse corrections were 4 ft/sec up and 1 ft/sec down, respectively, and both were applied. After the second midcourse correction was performed, the in-plane inertial line-of-sight rate was very low and required little correction. A ΔV of 5 ft/sec was applied in nulling the out-of-plane drift. A range estimate with the sextant confirmed that the time at two nautical miles was near nominal, and braking was initiated at a range of 1.5 nautical miles. Difficulty was experienced in optically establishing the proper closing rates required at ranges less than 1000 feet. A considerable amount of time was spent in closing from 1000 to 20 feet. However, station-keeping was initiated with three minutes remaining before darkness.

7.1.1.5 Extravehicular activity.- Two extravehicular operations were performed. The first was a standup EVA, and the second was an umbilical EVA after rendezvous with the passive Gemini VIII GATV.

7.1.1.5.1 Standup EVA: Preparations for the standup EVA were accomplished as practiced. The EVA started at 23:24:00 g.e.t. (sunset) after the spacecraft was depressurized and the hatch was opened without difficulty. The extravehicular pilot performed Experiment S013 (Ultraviolet Astronomical Camera) during the night pass and began Experiment M410 (Color Patch Photography) after sunrise. The crew reported that eye irritation hampered vision to the extent that they could not see to make the required camera f-stop adjustment to complete Experiment M410; consequently, they terminated the EVA six minutes early at 24:13:00 g.e.t. When the EVA was terminated early, the color plate for Experiment M410

UNCLASSIFIED

was discarded because the pilot could not see to disconnect it from the rod before throwing the rod away. Further discussion of the eye irritation problem is contained in section 5.1.4.

7.1.1.5.2 Umbilical EVA: Prior to the umbilical EVA preparation, a test was performed on the Environmental Control System (ECS) to determine whether the eye irritation problem would be likely to occur in the ECS configuration that would be used during the EVA. The crew experienced a slight watering of the eyes, but they considered this acceptable.

Preparation for the EVA was performed according to plan. As the pilot was unstowing the Extravehicular Life Support System (ELSS), the ELSS hit the center bright light, causing the filament to break. There were no other problems during the preparation.

The spacecraft was depressurized and the hatch was opened at sunrise at about 48 hours 42 minutes g.e.t. The pilot deployed the adapter handrails manually while standing in the seat. One of the two 16-mm cameras had malfunctioned earlier in the flight, and the crew elected to use the second camera in the left-hand window mount. During the umbilical EVA, the spacecraft could not be oriented so that the pilot would be within the field of view of the boresighted camera, and the command pilot's control task was too demanding to stop to remove and stow the optical sight so that the general purpose 70-mm still camera could be positioned to take photographs; therefore, no EVA photographs were obtained. The pyrotechnically actuated handrail did not extend properly, requiring the pilot to loop the nitrogen line around the manually actuated handrail. The lack of the rear handrail caused the pilot some trouble connecting the nitrogen quick disconnect to the spacecraft fitting, because of the difficulty in maintaining body position without the full benefit of the rear handrail. The pilot removed the Micrometeorite Collection package (Experiment S012) from the spacecraft adapter and placed the package inside the cabin, but it was lost later when it floated out of the cabin. The pilot retrieved the S010 package from the Gemini VIII GATV on his second attempt after his first attempt failed because of problems with holding on to the GATV. The pilot had difficulty in moving around the GATV because of the lack of adequate handholds. The new S010 experiment package was not installed on the GATV because the pilot was concerned that the umbilical might become entangled in the various projections on the vehicle. After the pilot returned to the spacecraft, the EVA was terminated because of a shortage of spacecraft propellant. The pilot ingressed at 49 hours 20 minutes g.e.t. but had some difficulties getting himself low enough into the cabin so that the hatch could be closed, because he was entangled in the umbilical. The command pilot assisted the pilot in removing enough of the entangled umbilical to allow complete

21. The hatch was closed and latched with no trouble

There were no problems during the preparation for jettison of equipment. The equipment was jettisoned at 50 hours 30 minutes g.e.t. in two bundles—first, the ELSS, and then a bag containing the remaining equipment. The EVA cleanup was performed with no problems before a true anomaly maneuver was performed at 51:38:52 g.e.t.

7.1.1.6 Operational checks.— The crew activated the digital-readout dosimeter prior to entering the high-apogee portion of the flight. Readings were communicated to Mission Control Center-Houston (MCC-H) as required.

7.1.1.7 Experiments.— Fifteen experiments were assigned to this mission. Performance of one of these was impossible because of the new moon. Of the remaining 14, one was not attempted, and two others did not yield useful data. In spite of the restraints imposed (extended period of docked flight, limitations on available time, constraints on propellant usage, et cetera), the crew accomplished over half of the requested activities.

7.1.1.7.1 Experiment D005, Star Occultation Navigation: The photometer for Experiment D005 was unstowed and an attempt was made to perform the experiment while the spacecraft and the GATV were docked. This attempt, performed at about 26 hours 30 minutes g.e.t., proved to be extremely difficult and resulted in an excessive use of attitude control gas; therefore, this attempt was terminated before completion of the planned sequence. At about 64 hours 45 minutes g.e.t., a successful attempt was made which included onboard computer operation in conjunction with the experiment. Propellant restraints and a lack of time made more extensive operations impossible.

7.1.1.7.2 Experiment D010, Ion-Sensing Attitude Control: The Experiment D010 sensors were deployed at about 51 hours 45 minutes g.e.t. From deployment until about 64 hours g.e.t., data were gathered in a random-orientation mode. At 64 hours g.e.t. a series of maneuvers was initiated which ended at about 66 hours 20 minutes g.e.t. There was one break in this series, from 64 hours 45 minutes to 65 hours 20 minutes g.e.t., while another experiment (D005) was being conducted. At about 66 hours 55 minutes g.e.t., the spacecraft control system was placed in platform-controlled attitude hold to obtain more data. The sensors were turned off at about 70 hours g.e.t. Because of time and propellant shortages, all the desired maneuvers were not made; however, all but one of the possible activities that had been requested were accomplished. The sensor readings appeared to be in such good agreement with the IGS platform reference that the crew used sensor readouts to align the platform on at least one occasion.

UNCLASSIFIED

7.1.1.7.3 Experiment S001, Zodiacal Light Photography: At about 66 hours 30 minutes g.e.t., a series of photographs was begun for this experiment and the crew followed the nominal plan to obtain the required exposures.

7.1.1.7.4 Experiment S005, Synoptic Terrain Photography: No updates were sent to the crew because of time constraints and the low propellant quantity. On their own initiative, the crew obtained a number of usable photographs. Most of these photographs were taken in drifting flight during the early portion of the third rest period, from about 53 hours to 54 hours g.e.t.

7.1.1.7.5 Experiment S006, Synoptic Weather Photography: No updates were sent to the crew because of time constraints and the low propellant quantity. The crew took a large number of usable photographs as opportunities arose. Most of these photographs were taken during the early portion of the third rest period, from about 53 hours to 54 hours g.e.t.

7.1.1.7.6 Experiment S010, Agena Micrometeorite Collection: The collection device from the Gemini VIII GATV was retrieved during the umbilical EVA at about 49 hours 05 minutes g.e.t. An unexposed collector which was to be opened and deployed on the GATV was abandoned when the umbilical EVA had to be terminated early.

7.1.1.7.7 Experiment S012, Micrometeorite Collection: The collector was opened at about 9 hours g.e.t., then closed and locked at about 17 hours g.e.t. as planned. Planned recovery of the package during the standup EVA was not accomplished because of the early termination of EVA. The collector was removed and passed into the cabin during the umbilical EVA at about 48 hours 48 minutes g.e.t. Subsequently, the collector apparently drifted out of the cabin and was lost, although the command pilot thought he had sufficiently secured it under his leg.

7.1.1.7.8 Experiment S013, Ultraviolet Astronomical Camera: Because of the requirement to remain docked, the procedures for Experiment S013 were modified to achieve partial completion of the nominal goals. Using the GATV control system to control attitude, over 20 exposures were taken of the southern sky during the darkness portion of the standup EVA (from about 23 hours 35 minutes to 24 hours 3 minutes g.e.t.). Due to failure of the cable shutter release, the camera operations were made more difficult. In spite of several detrimental factors, a substantial data return was effected.

UNCLASSIFIED

7.1.1.7.9 Experiment S026, Ion-Wake Measurement: Experiment S026 was only partially accomplished because of constraints placed on the flight (remain docked, minimize propellant usage). The only wake data obtained were gathered during the final separation from the GATV at 44 hours 40 minutes g.e.t. The crew did obtain the required camera coverage of the separation, although the sun glare on the windows had a degrading effect on the results. The operations involved in undocking, doing a very precise correcting maneuver, and obtaining the required experiment data involved a large number of almost simultaneous actions by both crewmembers. Most of the actions were time-critical as well as sequence-critical.

7.1.1.7.10 Experiment M405, Tri-Axis Magnetometer: Experiment M405 was activated after insertion at about 20 minutes ground elapsed time and turned off prior to retrofire at about 70 hours g.e.t., as required in the nominal flight plan.

7.1.1.7.11 Experiment M407, Lunar Ultraviolet Spectral Reflectance: Experiment M407 required a lunar phase within seven days either side of full moon. The mission was launched one day after a new moon; hence the experiment could not be accomplished. It was included in the flight plan on the remote chance that a delay of the launch might occur. All the required equipment was being flown to support Experiment S013, Ultraviolet Astronomical Camera.

7.1.1.7.12 Experiment M408, Beta Spectrometer: Experiment M408 was activated after insertion at about 20 minutes ground elapsed time and shut off prior to retrofire at about 70 hours g.e.t., as required in the nominal flight plan.

7.1.1.7.13 Experiment M409, Bremsstrahlung Spectrometer: Experiment M409 was activated after insertion at about 20 minutes ground elapsed time and shut off prior to retrofire at about 70 hours g.e.t., as required in the nominal flight plan.

7.1.1.7.14 Experiment M410, Color Patch Photography: Due to the early termination of the standup EVA as a result of eye irritation, only three of the desired nine photographs were obtained for this experiment.

7.1.1.7.15 Experiment M412, Landmark Contrast Measurement: Experiment M412 was not attempted due to time constraints, propellant priorities, and attitude constraints while docked.

7.1.1.8 Retrofire and reentry. - Stowage of experiment and operational equipment was completed without any difficulty prior to retrofire. The platform was aligned blunt end forward (BEF) using the Orbital

UNCLASSIFIED

Attitude and Maneuver System (OAMS) in the platform mode during the last revolution. Numerous attitude cross checks were made by the crew using star patterns, yaw track, and the platform to verify correct spacecraft attitude prior to retrofire. The preretrofire checklist items were completed without incident.

The retrorockets were fired automatically, and the pilot activated the manual sequence as a backup. The spacecraft was flown in the rate-command control mode during retrofire in order to hold the correct attitude very accurately and no difficulty was encountered. Because retrofire was accomplished on the nightside, spacecraft attitude was maintained by reference to the Flight Director Indicator (FDI). The Incremental Velocity Indicator (IVI) showed changes in velocity of 303 ft/sec aft, 119 ft/sec down, and 5 ft/sec right, all of which were within the expected limits.

After jettison of the adapter retrograde section, the crew selected single-ring operation of the Reentry Control System (RCS) in the pulse mode, and this configuration was maintained until approximately 400K feet. At this point the reentry-rate-command mode was selected, and the spacecraft was initially positioned to the reentry bank angle of 48 degrees left. Approximately a minute later, the crew started to follow the commanded bank angle as displayed by the roll indication on the FDI. At approximately 120K feet, the crew went to a 90-degree bank angle to correct an indicated 2-mile miss in crossrange. Photographs of the reentry ionization and shock wave patterns were obtained with the 16-mm sequence camera.

The deployment of the drogue parachute was accomplished at 38K feet instead of 50K feet, and subsequent to drogue deployment the crew experienced severe spacecraft oscillations. In an attempt to reduce the oscillation, the crew selected the rate-command control mode, which had no apparent damping effect. During reentry, the command pilot had difficulty in attempting to unstow his D-ring and arm the seat separation system. This is discussed in detail in section 7.1.2.

Main-parachute deployment was normal with the exception of the apparent spinning of the spacecraft during descent. The crew noted that the spacecraft appeared to wind up in one direction and then unwind in the opposite direction.

7.1.1.9 Landing and recovery.- A helicopter from the prime recovery ship, U.S.S. Guadalcanal, was over the spacecraft within seconds after spacecraft landing. Installation of the flotation collar and telephone contact with the swimmers both were normal. The crew completed their postflight checks, then egressed to the swimmer's liferaft. The crew

UNCLASSIFIED

complained of being hot while in the spacecraft prior to egress. After helicopter pickup, the crew was flown to the U.S.S. Guadalcanal.

7.1.1.10 Mission training and training evaluation.- Flight crew training was accomplished as shown in the Gemini X Mission Training Plan. In addition to this, the command pilot had flown as pilot on Gemini III and trained as backup pilot for Gemini VI-A. The pilot had trained as backup pilot for Gemini VII. Table 7.1.1-III contains a summary of crew training for the Gemini X mission.

This flight had the most ambitious flight plan of all the Gemini missions to date. Even though the probability of accomplishing 100 percent of the flight plan was quite low, the crew trained with 100-percent accomplishment of the flight plan as their goal. The 16-day delay of the Gemini IX-A mission resulted in the planned seven weeks of training at Cape Kennedy being accomplished in only five weeks. The ambitious flight plan, the Gemini IX-A launch delay, and a fixed launch date imposed an extra heavy work schedule on the crew.

The Rendezvous Simulator and the Gemini Mission Simulator were used for rendezvous training and for practicing and developing procedures for orbit determination and orbit-predict navigation. The Translation and Docking Trainer and the Gemini Mission Simulator were used to practice docking and station-keeping maneuvers. The crew used the zero-g aircraft, the Gemini mockup, and the air-bearing table to develop and practice EVA procedures.

Crew performance during the mission showed they were trained to accomplish all objectives of the flight plan. After using an excessive amount of fuel on the initial rendezvous, the crew completed all major objectives of the mission and, in addition, completed a large portion of the planned experiments. After three days of continuous work in space, they performed a satisfactory and very accurate landing.

UNCLASSIFIED

TABLE 7.1.1-I.- COMPARISON OF SOLUTIONS FOR
FIRST RENDEZVOUS MANEUVERS

Solution	Fwd/Aft	Up/Dn	Lt/Rt
<u>TPI</u>			
Closed loop	41 Fwd	1 Up	16 Lt
Onboard backup	41 Fwd	4 Dn	0
Polar plot	36.5 Fwd	0	0
ΔR	35 Fwd	0	0
Ground backup	34 Fwd	0.6 Dn	1 Rt
Applied (desired)	41 Fwd	1 Up	0
Applied (actual)	41 Fwd	1 Dn	1 Rt
<u>First midcourse correction</u>			
Closed loop	15 Aft	22 Dn	1 Rt
Onboard backup	16 Aft	10 Dn	0
Applied (desired)	15 Aft	14 Dn	0
Applied (actual)	15 Aft	14 Dn	0
<u>Second midcourse correction</u>			
Closed loop	1 Fwd	25 Dn	5 Rt
Onboard backup	3 Aft	24 Dn	0
Applied (desired)	0 Fwd	25 Dn	5 Rt
Applied (actual)	10 Fwd	21 Dn	2 Rt

UNCLASSIFIED

TABLE 7.1.1-II.- SUMMARY OF SOLUTIONS FOR
SECOND RENDEZVOUS MANEUVERS

Solution	Fwd/Aft	Up/Dn	Lt/Rt
<u>TPI</u>			
Charts	25 Fwd	0	0
Ground	24.9 Fwd	1.1 Up	3.3 Lt
Applied	25 Fwd	1 Up	0
<u>First midcourse correction</u>			
Charts	0	4 Dn	0
<u>Second midcourse correction</u>			
Charts	0	1 Up	0

UNCLASSIFIED

TABLE 7.1.1-III.- CREW TRAINING SUMMARY

Activity	Training time, hr:min	
	Command pilot	Pilot
System briefings	76:00	83:25
Spacecraft tests	90:30	91:30
Gemini Mission Simulator	148:50	112:05
Rendezvous Simulator	103:30	102:30
Dynamic Crew Procedures Simulator	15:10	2:50
Translation and Docking Trainer	13:15	4:30
Mockup	13:00	13:00
Egress training	8:30	8:30
Planetarium	8:30	8:30
Experiments	61:30	69:30

UNCLASSIFIED

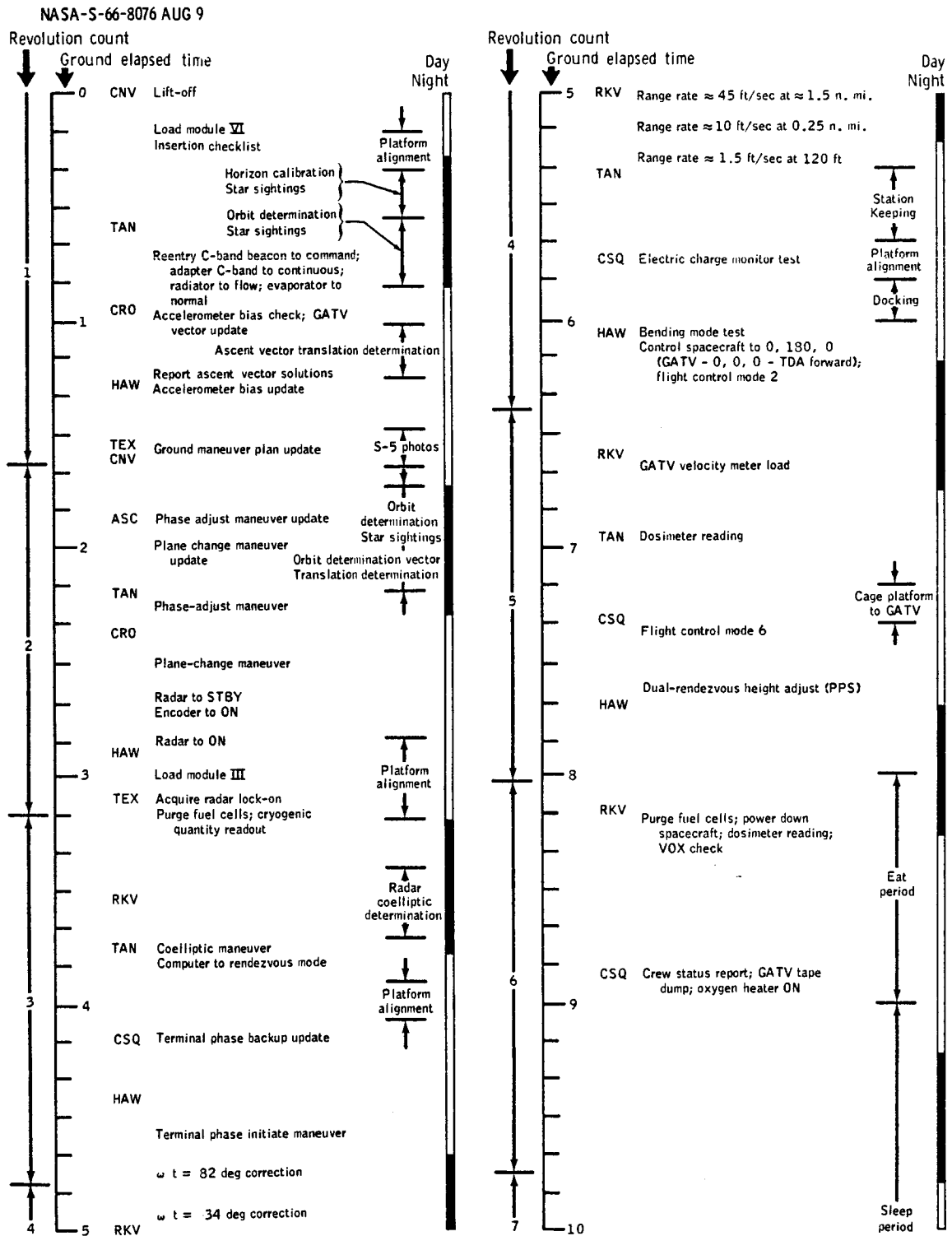

(a) 0 to 10 hours g.e.t.
Figure 7.1.1-1. - Summary flight plan.

NASA-S-66-8077 AUG 9

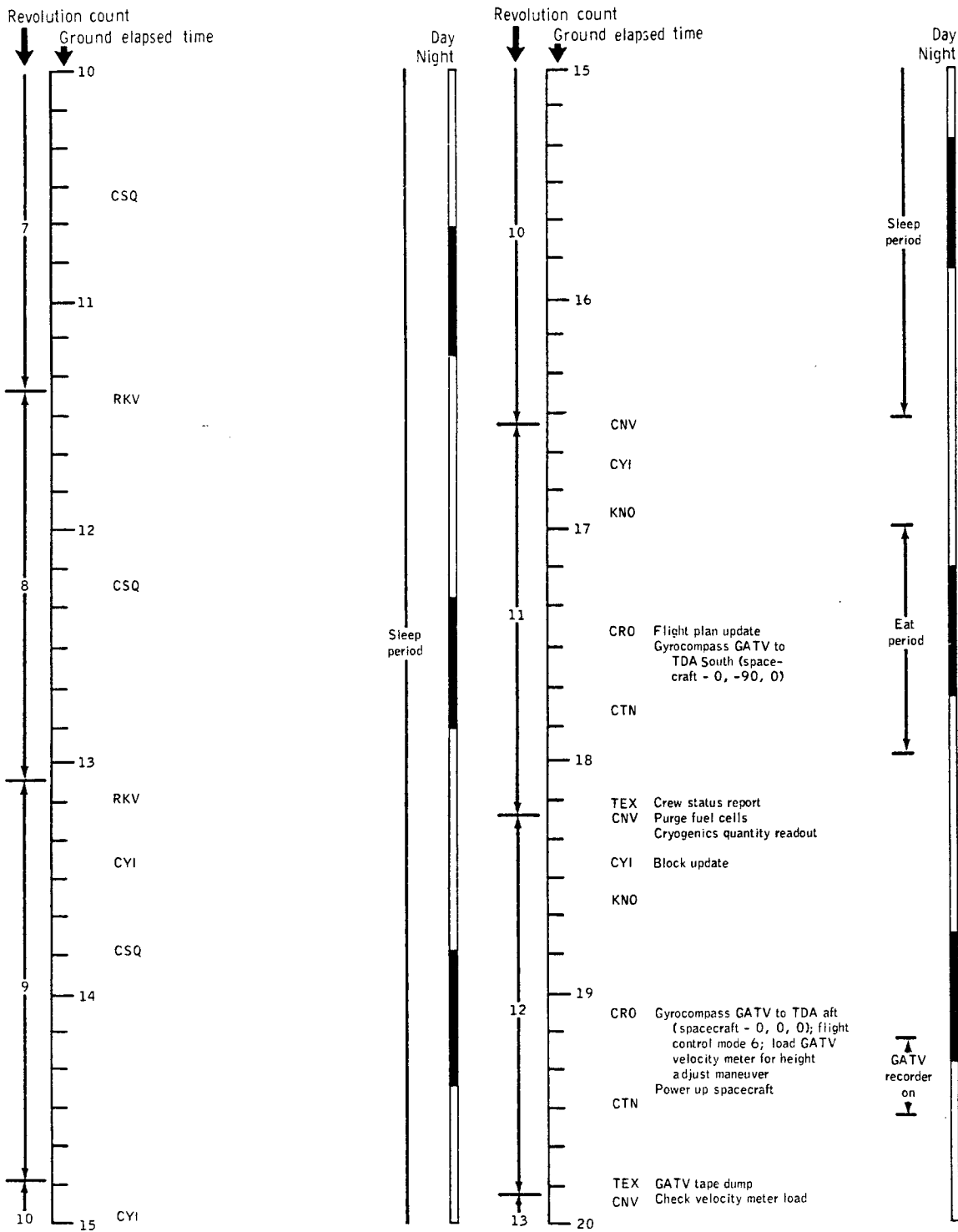

(b) 10 to 20 hours g.e.t.
 Figure 7.1.1-1. - Continued.

NASA-S-66-8078 AUG 9

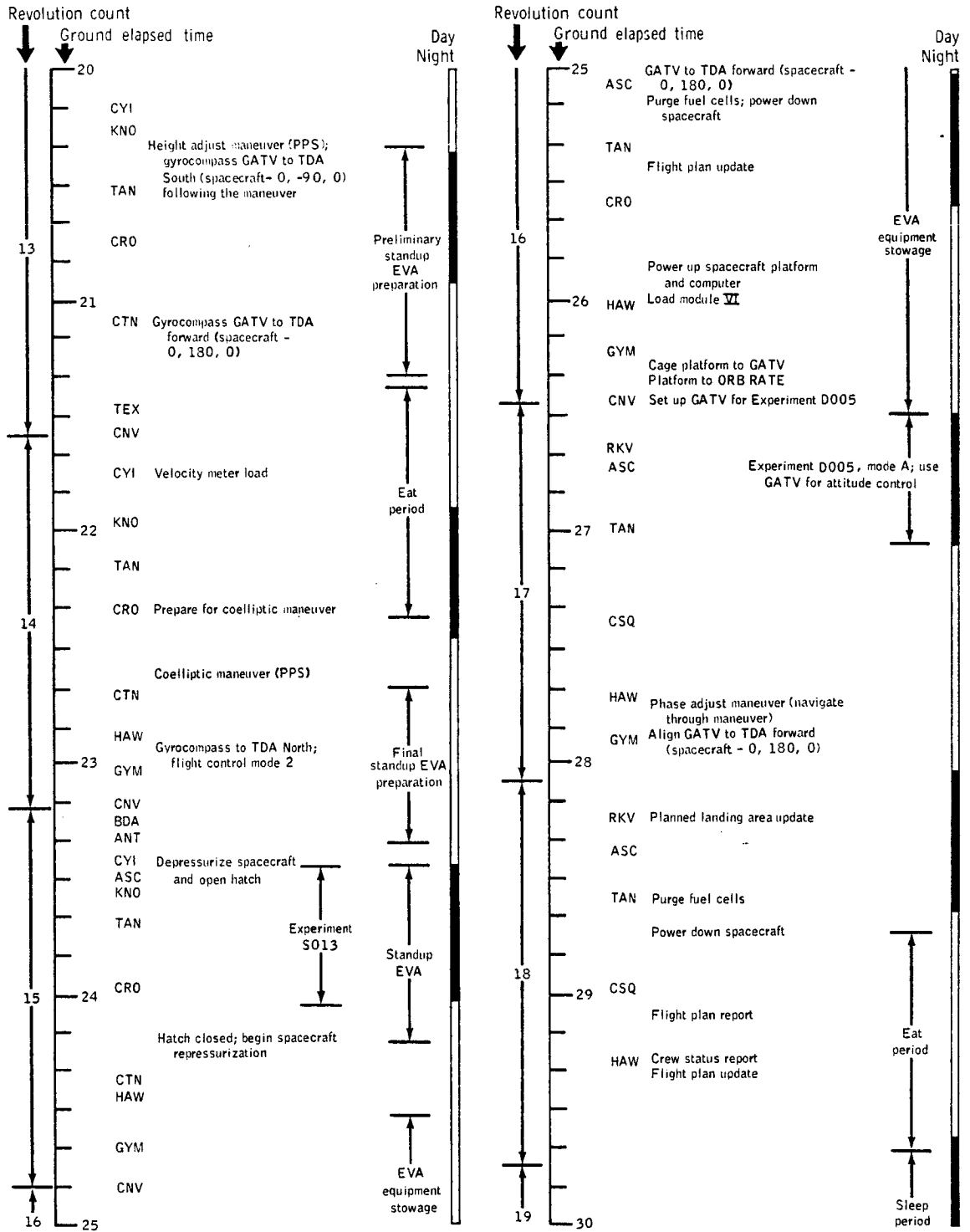

(c) 20 to 30 hours g.e.t.
Figure 7.1.1-1. - Continued.

NASA-S-66-8079 AUG 9

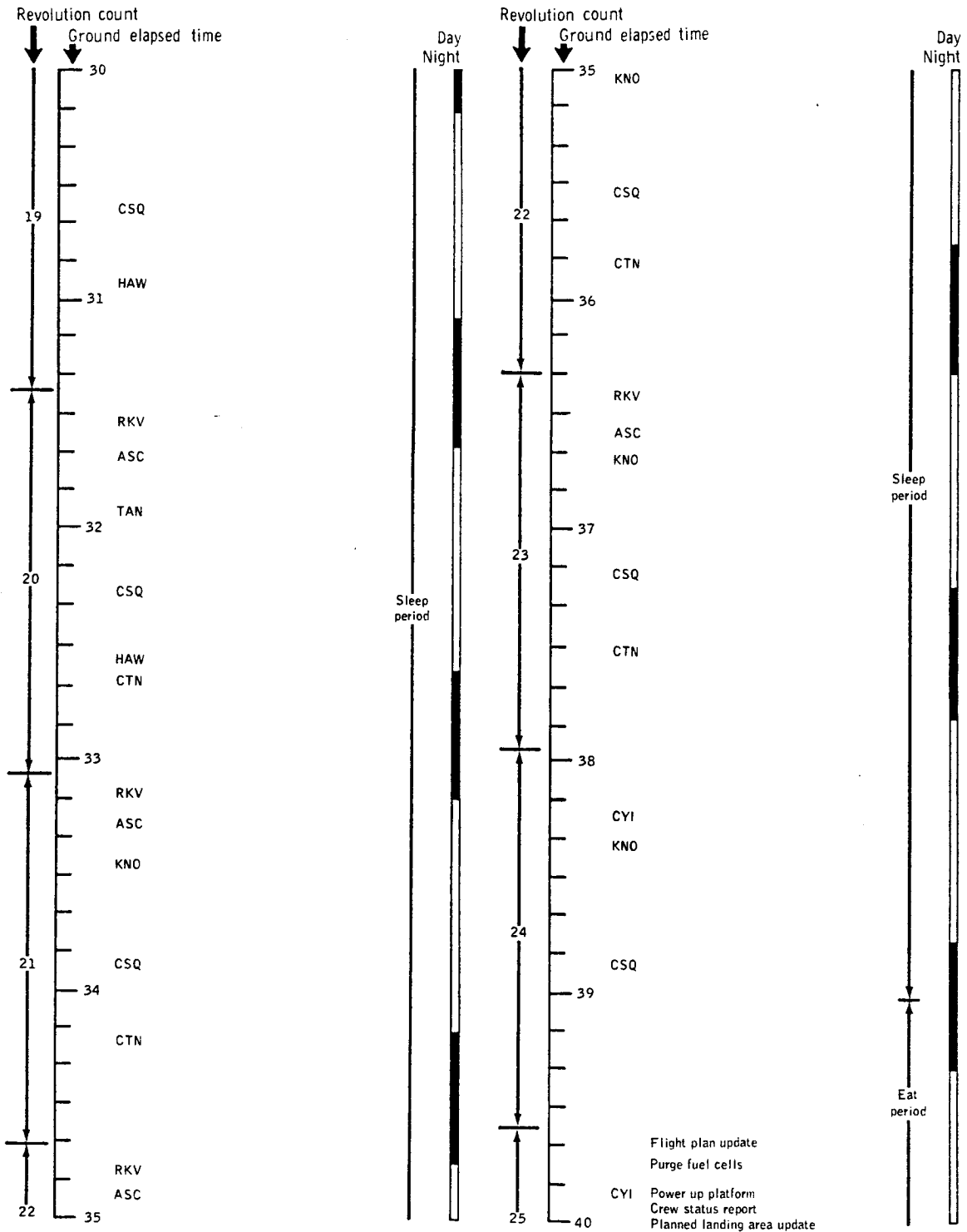

(d) 30 to 40 hours g. e. t.
Figure 7.1.1-1. - Continued.

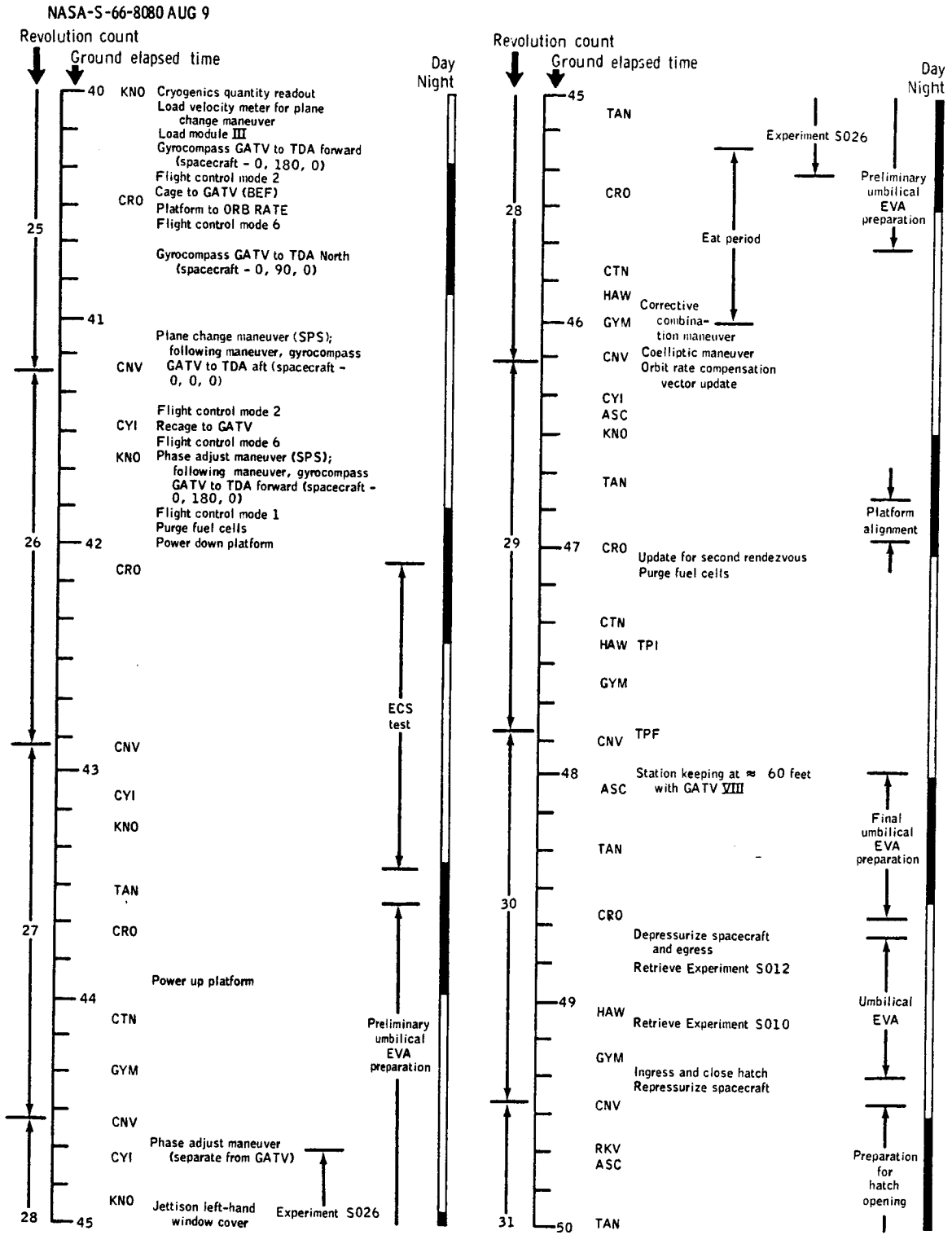

(e) 40 to 50 hours g.e.t.
Figure 7.1.1-1. - Continued.

NASA-S-66-8081 AUG 9

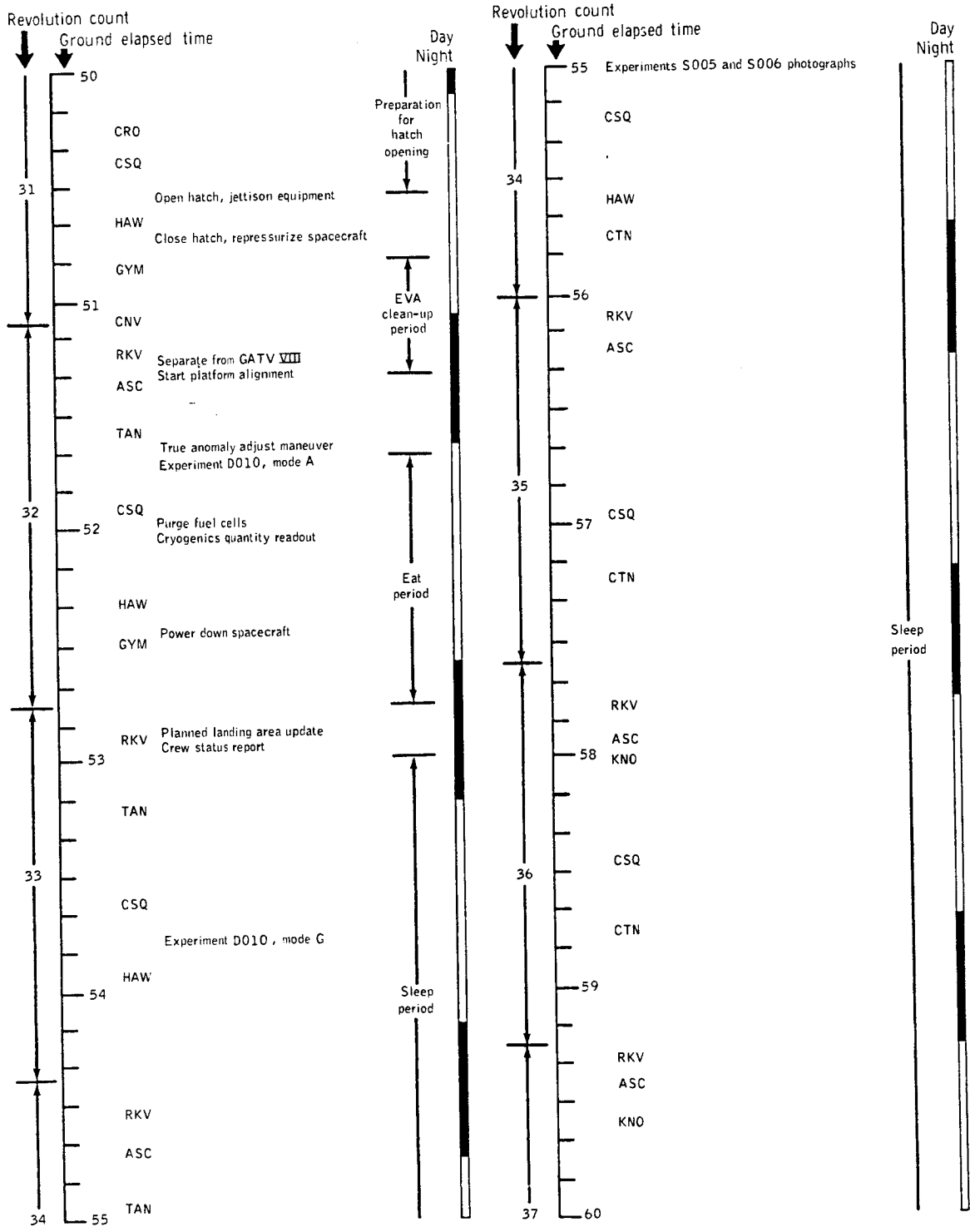

(f) 50 to 60 hours g.e.t.
Figure 7.1.1-1. - Continued.

NASA-S-66-8082 AUG 9

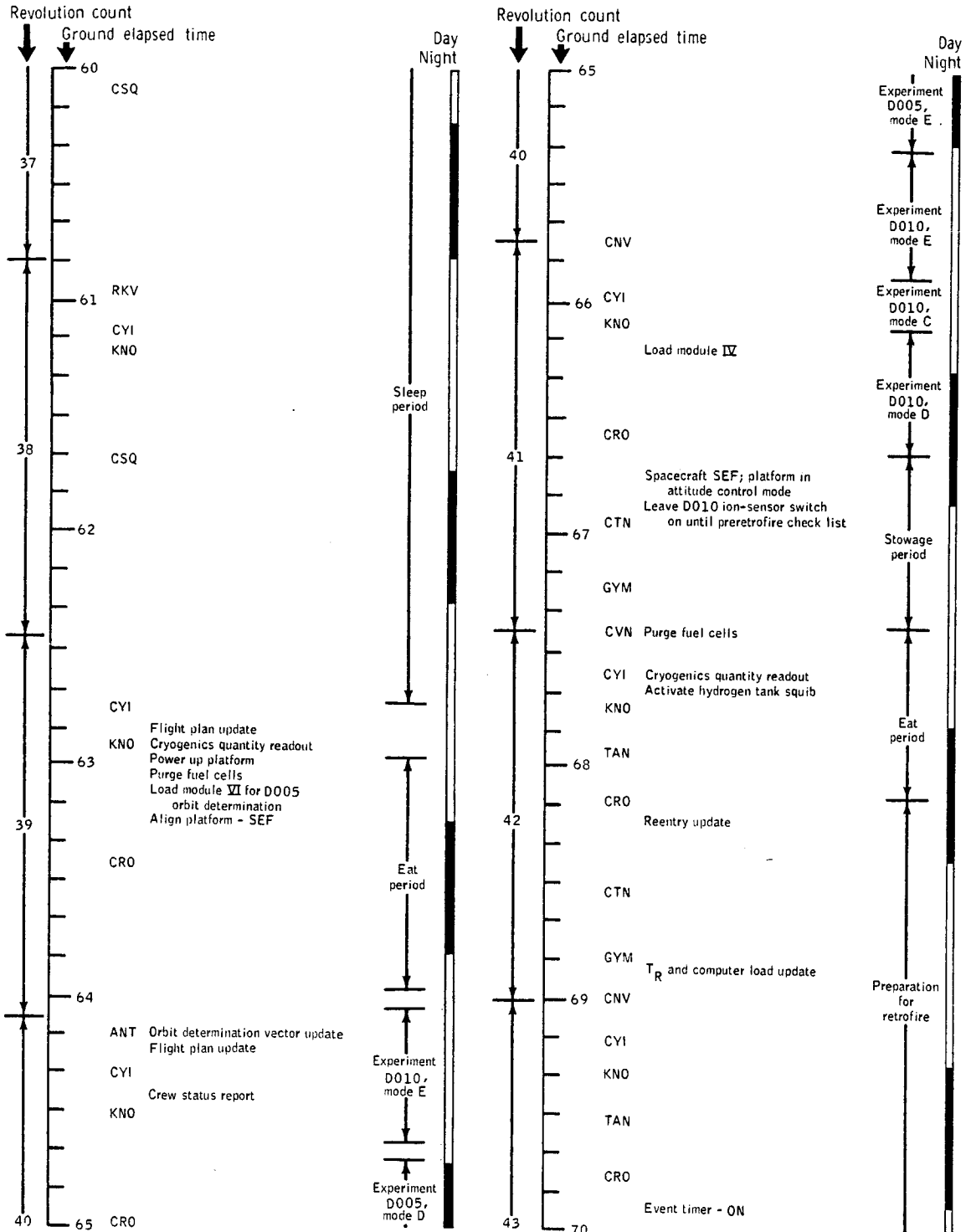

(g) 60 to 70 hours g.e.t.

Figure 7.1.1-1. - Continued..

UNCLASSIFIED

NASA-S-66-8083 AUG 9
Revolution count
Ground elapsed time

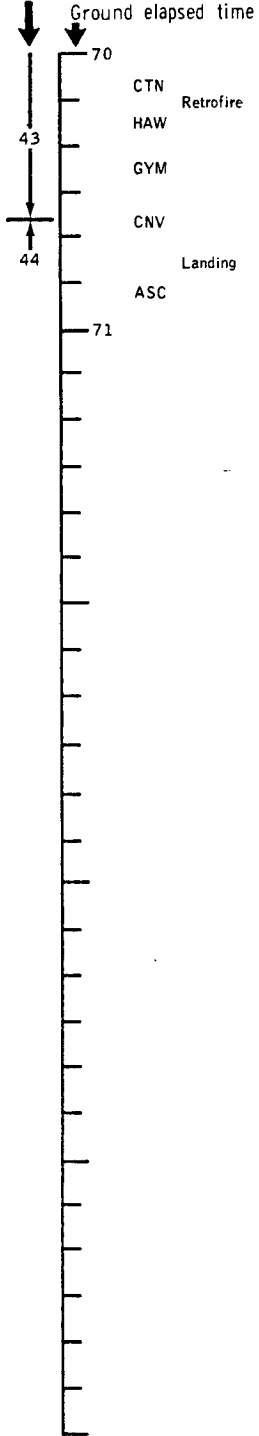

Revolution count
Ground elapsed time

Day
Night

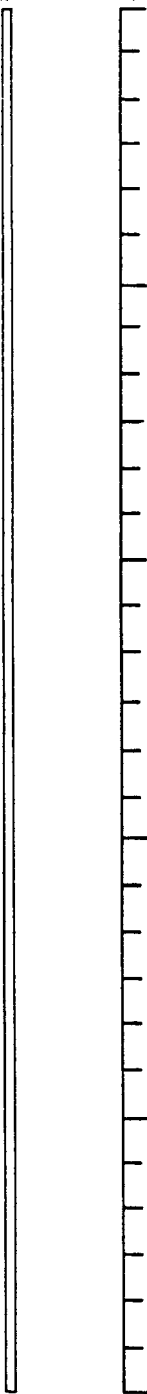

Day
Night



(h) 70 to 71 hours g. e. t.
Figure 7.1.1-1. - Concluded.

UNCLASSIFIED



Astronauts John W. Young, command pilot, and Michael Collins, pilot.

7-29-a

7.1.2 Gemini X Pilots' Report

7.1.2.1 Prelaunch.- Ingress was nominal; however, UHF communications were noisy. The T minus three minute Inertial Guidance System (IGS) launch-azimuth update was received on time.

7.1.2.2 Powered flight.- Lift-off was nominal. Fuel-cell differential pressure warning lights were noted two seconds after lift-off. Fuel and oxidizer tank pressures of both Gemini Launch Vehicle (GLV) stages were in the normal high range. The nominal Digital Command System (DCS) updates were received on time. It was reported after the flight that the first stage oxidizer tank ruptured just after separation of the first and second stages; however, staging appeared completely normal to the crew. Radio Guidance System (RGS) initiation was as predicted prior to the flight and second-stage IGS steering indicated slight GLV lofting. No abnormal vibrations or longitudinal oscillations (POGO) were noted. At second stage engine cutoff (SECO), vehicle rates were extremely low. At approximately SECO + 17 seconds, two distinct engine burps were felt. Spacecraft/GLV separation was nominal; however, later in the mission a length of the silicone-rubber holder for the flexible linear shaped charge from the spacecraft/GLV separation plane slapped across the window area. Due to the afternoon launch, sunlight did not affect monitoring of the GLV or IGS performance.

7.1.2.3 Insertion.- When the IGS attitude indicators were nulled, the Incremental Velocity Indicators (IVI's) indicated 25 ft/sec forward and 1 to 2 ft/sec right. The Insertion Velocity Adjust Routine (IVAR) correction was immediately applied, and 1 ft/sec aft and 1 ft/sec right remained at the completion of the maneuver. The computer prelaunch mode was then selected, and the platform alignment, the insertion checklist, and loading of Module VI of the computer program were completed simultaneously. Completion of the insertion checklist was slowed by stowage of the D-ring. In the weightless environment, the D-ring repeatedly floated free from its stowage fitting before the D-ring safety pin could be installed.

7.1.2.4 Orbit navigation sequence.- Module VI of the Math Flow 7 computer program contained the orbit prediction and orbit determination modes. Orbit-determination star sightings were commenced after the insertion checklist was complete, at a ground elapsed time (g.e.t.) of approximately 20 minutes. The first star, Schedar, was used to determine the horizon altitude. This was found by comparing the measured actual angle with the IGS-predicted angle. The star-to-horizon measurements on Schedar determined a horizon altitude of 27 500 yards. This information was entered in the onboard computer and used during all subsequent star-to-horizon measurements. The natural horizon was very indefinite under the new-moon condition during these sightings. There was not much contrast between the two sides of the horizon line

UNCLASSIFIED

separating the sky and the earth. There was a black void below the horizon line, and above the line the sky was an extremely dark shade of gray. On at least four occasions, the star image was inadvertently passed through the horizon by the pilot while looking through the sextant. The sextant used had an 80/20 light split. (Eighty percent of the available light was directed from the horizon and 20 percent from the star.)

The first star used in the orbit determination measurements was Hamal. The pilot could not cause the star image to split while looking through the sextant. The most likely explanation is that the sextant was held at the upper part of the window and the upper image was occluded by spacecraft structure adjacent to the window. The lower image was unobstructed, which resulted in the pilot's being able to see the star field clearly through the sextant, but he could not see the movable image. The period of time between sightings was increased by the spacecraft water-boiler thrust which continually yawed the spacecraft away from line-of-sight to the star. Therefore, while the command pilot was plotting the star residuals during horizon calibration, water-boiler yaw repeatedly required the additional control task of returning the spacecraft to the star to be sighted.

A good measurement was finally obtained using Hamal; however, this measurement was made 50 seconds after the scheduled time of the sighting. This delay introduced a timing error of unknown magnitude into the orbit determination calculations using the second star (a dummy star designed for zero out-of-plane error). In addition, postflight analysis shows that a procedural error was committed which caused the subsequent measurement taken on the blunt-end-forward (BEF) star, Altair, to be invalid. The procedural errors in using Module VI were not apparent to the crew. The remainder of the orbit determination procedure was completed without incident, except for additional time-consuming problems associated with horizon definition and water-boiler yaw.

After the first night pass, the orbit-predict mode was exercised using the Gemini X GATV state vector received from Carnarvon and the onboard spacecraft insertion state vector. The orbit-predict mode was used to predict the orbit ahead in time and the relative trajectories of the two vehicles were calculated by the Module VI program. Values for the phase-adjust, the plane-change, and the coelliptic maneuvers were determined from this prediction.

The onboard solutions were outside the envelope of acceptable deviations from ground solutions. The Gemini X GATV was not in a perfectly circular orbit, and, in addition, postflight analysis revealed radial velocity errors in the spacecraft state vector. The orbit determination calculations using star sightings in place of the insertion

UNCLASSIFIED

state vector were not within acceptable limits and could not be calculated.

Operationally, it was considered that the onboard navigation procedures mechanized in Module VI were extremely tedious. The requirement for crew success in onboard navigation was the perfect performance of a chain of time-critical events. When these operations were combined with the necessary checkout of the new spacecraft and with the associated voice reporting procedures, the first two revolutions of the flight were crowded to an unacceptable degree. Further, there can be no doubt that the crew-training effort (over a hundred hours in various simulators) required for using these particular orbit prediction and determination modes of operation detracted from training for other facets of the mission.

7.1.2.5 Rendezvous.

7.1.2.5.1 First rendezvous ($M=4$): Maneuvers conducted prior to the first rendezvous were composed of the IVAR apogee-adjust maneuver and ground-commanded maneuvers for the phase adjust, the plane change, and the coelliptic maneuvers. Performance of these maneuvers was nominal. No problems were encountered in reducing maneuver residuals to an acceptable level. The final phase of the primary rendezvous started with the platform alignment that was accomplished after the coelliptic maneuver. This alignment was continued as the pitch angle changed from 8 to 12 degrees. At a range of 58 nautical miles from the GATV, the radar attitude indicators indicated a 2-1/2 mile out-of-plane error. The assumption was made, based on the ground backup solution, that the platform alignment was faulty. Data taken after the platform alignment showed the total ΔV , with the computer in the rendezvous mode, to be reducing in an orderly and expected manner until about three data points (300 seconds) prior to terminal phase initiate (TPI). Then the total ΔV stopped decreasing at the expected rate. At the point when the computer solution was accepted, the total ΔV was 93 ft/sec. The polar plot (fig. 7.1.2-1) showed the spacecraft to be two miles low. Computation of $\Delta \Delta R$, the semi-independent calculation based on radar range, showed that the spacecraft was more than one mile low, and the ground also reported that the spacecraft was one mile low.

The terminal phase solutions and the maneuvers applied are shown in table 7.1.1-I. At terminal phase initiate, the closed-loop solution, with the exception of the out-of-plane component, was applied. Correction of the out-of-plane error was to be made with the closed-loop solution during the first midcourse maneuver. The first midcourse correction applied was 15 ft/sec aft and 14 ft/sec down. All the closed-loop down thrust was not applied because of a probable error in the up/down ΔV . The possibility of an error was first noticed during

UNCLASSIFIED

preparations for the coelliptic maneuver, when repeated attempts to enter 6 ft/sec in address 26 resulted in 12 ft/sec in address 26. The range rate, after the application of the second midcourse correction, was excessive. The solutions for the second midcourse correction were as shown in the table, and the down-and-right closed-loop (25 ft/sec down and 5 ft/sec right) was applied. Upon completion of the application of the down-and-right correction, it was noted that a ΔV reading of 22 ft/sec appeared in the aft IVI window. Of this ΔV , 15 ft/sec was due to the down-and-right correction, but it is possible that the other 7 ft/sec resulted from an inadvertent forward-thruster firing caused by a new pressure suit configuration with a full left-thigh pocket and by a cramped leg position. Immediately after application of the second midcourse correction, an additional 13 ft/sec was braked because the range rate was still excessive. Braking was commenced and right-thrust corrections were immediately made to null target drift. When the target was sighted against the star background, there was a large out-of-plane-to-the-right motion of the target across the stars. Continual right thrusting and additional braking corrections were made. The out-of-plane drift proceeded so swiftly that even lagging braking did not null the out-of-plane line-of-sight rate. (Note: Lagging braking consists of moving the spacecraft attitude off the line-of-sight to the target in a direction to take advantage of vertical and/or lateral components of the resultant vector to null line-of-sight errors.) A decision was then made to continue with the same procedure and complete the rendezvous, knowing that a high propellant expenditure would be required. Completion of this rendezvous on time was mandatory in order to continue the flight plan and attempt the dual rendezvous with the Gemini VIII GATV.

The spacecraft passed out-of-plane 700 to 900 feet to the south and above the GATV. The final approach was made from the south, above, and behind the target. From this quadrant, 4 or 5 ft/sec had to be added twice to complete the rendezvous. In the command pilot's mind, there was one significant mistake made in the primary rendezvous, in that excessive energy was applied during the terminal phase initiate maneuver. It is his opinion that if the $\Delta\Delta R$ semi-independent onboard solution or the ground solution had been applied, the problems resulting from the large midcourse corrections would never have occurred. The probable bad platform alignment caused the closed-loop solution and the onboard backup solution at TPI to be almost unacceptable. However, there was no information available to the crew to determine that these maneuvers were less correct than either the $\Delta\Delta R$ solution or the ground backup TPI solution. Clearly, a method of rendezvous which reduces the effect of variations between the several TPI vector solutions is highly desirable. The total rendezvous energy requirement and the significance of variations between TPI solutions would be minimized by a considerable reduction in the normal coelliptic altitude differential. The optical rendezvous discussed in section 7.1.2.5.2 has shown that the lighting constraints on initiation of the terminal phase intercept can be

UNCLASSIFIED

significantly decreased by using smaller differential coelliptic altitudes. Low-energy braking can be readily accomplished in darkness as was demonstrated on the Gemini IX-A mission. It cannot be overemphasized that the maximum probability of a rendezvous with low fuel consumption is best established by the correct terminal phase initiate maneuver.

7.1.2.5.2 Second rendezvous: On the third day of the mission, a platform alignment was started as sunrise occurred on the Gemini VIII GATV, the second target vehicle for the dual rendezvous. During this alignment, it was possible to see the target for the first time as a dim star-like dot until the sun rose above the spacecraft nose. Platform alignment was completed approximately 11 minutes after target sunrise. The spacecraft was then inverted and was pitched up to the expected pitch sighting angle of about 20 degrees; however, because of earthshine streaming into the window (and sunshine when the nose was rolled slightly in either direction), the target could not be seen. From 15 minutes to 18 minutes after sunrise, the target was seen intermittently as a point light source at an estimated range of 20 to 16 miles. Thereafter the target was seen continuously.

The terminal phase initiate maneuver was applied 22 minutes and 40 seconds after spacecraft sunrise, with ΔV 's of 25 ft/sec forward and 1 ft/sec up. The ground backup initiation time for the TPI maneuver was 23 minutes and 17 seconds after sunrise on the spacecraft, and the associated ΔV 's were 24.9 ft/sec forward, 1.1 ft/sec up, and 3.3 ft/sec left. Target tracking was accomplished by continuously scanning between the Gemini VIII GATV and the spacecraft Flight Director Attitude Indicator (FDAI) to establish zero roll and to null spacecraft rates. The change in light intensity from the bright outside illumination to the relatively dim attitude indicator in the cockpit was fatiguing to the eyes, making the tracking task extremely difficult. Accurate tracking was required for the pilot to compute the midcourse corrections—4 ft/sec down (first midcourse) and 1 ft/sec up (second midcourse). After the second midcourse correction, a 3 ft/sec left thrust was applied and the inertial needles were selected. The inertial needles were perfectly nulled (indicating zero inertial line-of-sight rates) from completion of the second midcourse correction until the spacecraft was well inside the ground-supplied arrival time for a 2-mile range (16 minutes and 16 seconds after the initiation of the transfer maneuver). At an estimated range of 1 1/2 miles, the closing velocity was arbitrarily reduced by 20 ft/sec. Left thrust of 3 to 5 ft/sec was also added. Inside an estimated range of one mile, the closing velocity was arbitrarily reduced by an additional 10 ft/sec. It then appeared to both crewmen that closure was slowed considerably. Therefore, the closing velocity was increased by 5 ft/sec. The spacecraft passed close to the GATV while braking velocity was being applied. Braking with the forward-firing thrusters was continued. The target was kept in sight

UNCLASSIFIED

and braking was converted to the vertical and lateral thrusters. Braking was completed using the aft thrusters. Closure was made to within 100 feet of the target approximately 30 minutes and 30 seconds after the transfer maneuver was initiated.

Both the inability of the crew to establish satisfactory range and range rates by using the onboard sextant and the difficulty encountered in tracking by continuously looking outside and inside the cockpit should not be minimized. It was estimated that the sextant readings provided useful ranges to the crew when the spacecraft was within a range of one mile. At that time, however, it was too late to perform the braking schedule with a reasonable propellant consumption. The second rendezvous required that station keeping with the Gemini VIII GATV be achieved before sunset. Therefore, in order to assure the completion of rendezvous, the range rate was purposely maintained relatively high. With this high range rate, the transfer from inertial line-of-sight nulling to station keeping at the last possible moment required the use of additional propellant to avoid over-controlling in the close vicinity of the GATV.

7.1.2.6 Gemini Agena Target Vehicle operations.-

7.1.2.6.1 Gemini X GATV station keeping and docking: Station keeping with the Gemini X GATV presented no problem except that, in one instance, sunlight impinged on the spacecraft window and made it impossible to see the GATV for an estimated 30 seconds. The predocking inspection of the GATV revealed no evidence of any vehicle discrepancies. Because of the bright sunlight, it was difficult to determine the configuration of the GATV status display panel until the spacecraft was within ten feet of the target vehicle. A visual check of the GATV and the spacecraft, after platform alignment and just prior to docking, showed the attitude control systems of both vehicles to be in close agreement. The electric charge test was performed and docking was readily accomplished. The Target Docking Adapter rigidized in approximately five seconds. An immediate postdocking alignment check showed that the attitudes measured with the spacecraft inertial system and the GATV commanded attitudes agreed within one degree in all axes. During the bending-mode check, the crew detected no motion between the two mated vehicles. The GATV was yawed to a TDA-forward heading using the spacecraft propulsion system and the attitude control in the direct mode. This maneuver demonstrated an alternate, easily controlled heading-change maneuver which could be used in the event of GATV attitude gas shortage.

7.1.2.6.2 Cruise configuration and yaw maneuvers: The most economical docked cruise configuration was Flight Control Mode 1. In this mode, the GATV yaw, roll, and pitch deadbands are ± 5.0 , ± 5.0 , and ± 2.0 degrees, respectively. No significant motion within these deadbands was felt. The crew had to refer to the spacecraft attitude

UNCLASSIFIED

indicators to observe the small yaw deviations in Flight Control Mode 1. Therefore, the crew believe that Flight Control Mode 1 should become the standard docked cruise configuration.

Gyrocompassing was used for all cardinal-heading-change yaw maneuvers. At least eleven 90-degree gyrocompass cardinal heading change maneuvers were made. In addition one 180-degree gyrocompass heading change was made. It is believed that this method of attitude yaw maneuvering should be adopted as standard for docked GATV operations. GATV attitude control gas was conserved by making the gyrocompass maneuver in Flight Control Mode 1 and changing the attitude control system to low gain upon completion of the maneuver. Standardized cruise and yaw maneuver procedures would minimize the use of the GATV digital command encoder and simplify crew training.

7.1.2.6.3 Primary propulsion system operations: Firing of the GATV primary propulsion system (PPS) engine was performed and monitored as follows: GATV fine alignment using Flight Control Mode 2 was made for five minutes with the spacecraft inertial system caged to the GATV. The docked-maneuver mode (Flight Control Mode 6) was selected following the alignment. The times-ten forward-firing logic choice and the required ΔV were input into the computer. The docked-maneuver firing mode (Flight Control Mode 7) was set up three to six minutes prior to engine ignition and was confirmed over a ground station. The engine was armed two to three minutes prior to ignition. The computer was also started two to three minutes prior to engine ignition to assure that the inertial velocity indications in the aft IVI window displayed the proper velocity. At the engine start time, the pilot initiated PPS-start based on digital-clock time. At this point, the inertial system was again caged to the GATV for the 68-second period prior to PPS firing to return all ΔV to the aft window of the IVI.

Three docked PPS firings were performed, all preceded by secondary propulsion system (SPS) Unit I firings for ullage orientation. Sixteen seconds after pushing the start button, the firing of the SPS Unit I engines was visible on two of the firings which occurred at sunset. On the third firing, which occurred at sunrise, the computer was interrogated to ascertain that the ullage maneuver was taking place. If the velocity meter shutdown had failed, shutdown would have been commanded by the crew when the aft IVI indicated 50 ft/sec or less. Conservatively, the command pilot called shutdown at zero on the incremental velocity indicator, backed up by time. The pilot placed the engine ARM/STOP switch to STOP on the shutdown mark and sent command 500 to recycle the PPS. During the maneuver, the pilot monitored the status display panel and attempted to monitor spacecraft rate errors. This dual monitoring procedure is not recommended. The command pilot monitored attitude error, with a 10-degree error established preflight as cause for shutdown. In every case, the vehicle immediately yawed two

UNCLASSIFIED

to three degrees TDA-right (spacecraft left) and immediately returned to zero. The start was characterized by sparks, tenuous yellow glows and flame escaping in every direction, a small bump followed by an explosive bump, and a sudden one-g eyeballs-out acceleration. The shoulder harness was fastened, but it was not required. The tailoff was very spectacular and was characterized by a bright, continuous yellow glow, with sparks streaming in all directions. The tailoff lasted an estimated 10 to 15 seconds. The ground-transmitted ΔV of the PPS firing did not include the ΔV for tailoff because PPS shutdown was based on the IVI countdown.

For a large out-of-plane PPS firing, it is believed that the inertial system should be caged small end forward (SEF) or blunt end forward (BEF) to the GATV, as necessary, so that the ΔV will be indicated in the aft window (after a gyrocompass out-of-plane maneuver following the fine alignment in Flight Control Mode 2). If the crew is to take action based on the GATV status display panel lights, these lights should be in the cockpit because it is improbable that the crew will be able to see any of the four critical green lights extinguish or the MAIN red light come on during PPS operation. Also, it will be impossible to see the status display under certain sunlight conditions.

7.1.2.6.4 Secondary propulsion system operations: The GATV SPS Unit II engine firings were performed and monitored as follows: GATV fine alignment (Flight Control Mode 2) was conducted for five minutes with the spacecraft inertial system caged to the GATV. The ΔV to be used, together with the forward-firing logic choice, was input into the computer. The docked-maneuver mode was established three to six minutes prior to the maneuver. The required flight-control mode was set up two minutes prior to ignition, and the computer was started in order to check the incremental velocity indications in the aft window. The engine-arm and SPS-ready were established one minute prior to pushing the start button. The maneuver was initiated by the pilot on digital-clock time. The thrust was timed and shut down when the IVI's read zero. The SPS ΔV could have been terminated within 0.3 ft/sec; however, in order to test the velocity meter shutdown, slightly delayed callouts for shutdown were executed. The three SPS firings were characterized by an overshoot of 0.7 to 1.3 ft/sec.

Secondary propulsion system thruster firing was seen during all three maneuvers. The spacecraft platform was not caged to the GATV for the out-of-plane maneuver. GATV SPS operations were very similar to firing the forward-firing spacecraft thrusters. It is believed that the SPS could be operated with the GATV attitude control system off, using spacecraft attitude stabilization with no control problem.

UNCLASSIFIED

7.1.2.6.5 Station keeping with the Gemini VIII GATV: Station keeping with the Gemini VIII GATV commenced at sunset. The running lights on the GATV did not appear to be operative. The docking light on the spacecraft was used to illuminate the vehicle. Station keeping was maintained on the PPS engine section, and the spacecraft was yawed to its BEF axis (platform in ORB RATE). To remain perpendicular to the GATV longitudinal axis, it was necessary to pitch up from 190 degrees to over 85 degrees, as indicated by the spacecraft Inertial Guidance System. This indicated that the GATV was nearly inertially stabilized. No roll motion of the GATV was apparent. Throughout the umbilical extravehicular activity (EVA), the TDA of the GATV appeared to be moving down toward the earth.

During EVA, while the nitrogen hose was being attached, station keeping required continual coordination to prevent firing the top thruster on the extravehicular pilot. The first transfer of the pilot to the Gemini VIII GATV was accomplished by closing to within four to six feet of the vehicle. The angle between the longitudinal axis of the GATV and the longitudinal axis of the spacecraft was approximately 120 degrees. Separation along this line varied from one to fifteen feet. Maintaining this angle prevented the forward-firing and up-firing thrusters from impinging on the GATV or the extravehicular pilot. It was also possible to keep both the GATV and the pilot in sight at all times. However, considerable movement around and to the side of the GATV was required to keep both the pilot and the target vehicle in sight. These unexpected maneuvers resulted in increased fuel consumption. Station keeping while monitoring the position of the extravehicular pilot did not permit adequate attention to be given to temporary stowage of the Experiment S012 micrometeorite collection package.

Movies taken during EVA did not show the extravehicular crewman or the Gemini VIII GATV because of the offset angle between the GATV and the spacecraft.

7.1.2.7 Extravehicular activity.-

7.1.2.7.1 Standup EVA preparation: The preparation for standup EVA required longer in flight than during training because it was combined with recording of flight plan updates, purging the fuel-cells, and sending configuration commands to the GATV. In general, though, preparations for the standup EVA were simple and were still performed in the allotted time.

7.1.2.7.2 Standup EVA: The hatch was opened after dark. Without adequate light, mounting the camera used for ultraviolet star photography (Experiment S013) was difficult. Furthermore, darkness made it impossible to visually check hose and line routing. After the

UNCLASSIFIED

S013 camera was mounted, the experiment was conducted without incident, except that some difficulty was encountered in locating the shutter button on the camera. Hand dexterity is quite limited with the pressure suit glove inflated; therefore, it is believed that the size of the shutter button should be increased. The S013 experiment was completed at sunrise, and the color-plate photography experiment (M410) was commenced. The M410 experiment was interrupted prior to completion, however, by severe eye watering. This eye irritation, which persisted for several minutes and affected both crewmembers, caused early termination of the standup EVA.

The hatch and its associated mechanisms performed flawlessly. Forces required to move the hatch against the actuator were estimated to be 10 to 15 pounds, while the forces required to compress the seal during closure were estimated to be 35 to 40 pounds. All equipment associated with standup EVA performed well except the extravehicular gold-coated outer visor. The visor coating was susceptible to scratching, peeling, and flaking, and a large portion of the coating had come off before the visor was required. A more durable sunshield is required. The Velcro attachment of the sunshield was satisfactory; however, it was found undesirable to have to use both hands for adjusting the visor.

7.1.2.7.3 Umbilical EVA preparation: Preparation for the umbilical EVA was divided into two phases: the preliminary period, accomplished at approximately 45 hours g.e.t.; and the final period, completed after the second rendezvous, prior to 49 hours g.e.t. The first phase included all equipment preparations and attachments which could be made before unstowing the ELSS. This considerably simplified the final preparations which, of necessity, took place during the Gemini VIII GATV station keeping. The preliminary phase was performed without incident. The final phase (which required 30 minutes in training) was allocated only 35 minutes in the flight because the arrival of the spacecraft at the GATV was planned to occur at sunset and it was desired to open the hatch promptly at the following dawn. During the 35-minute night period, the command pilot was fully engaged in maintaining the station-keeping position, and the pilot was busily engaged in EVA preparations. There was little opportunity for checklist confirmation or connector double checking. The preparations were barely completed in time to open the hatch at sunrise; however, this phase of the mission had long been recognized as critical. Therefore, considerable training time had been devoted to it and it went smoothly.

7.1.2.7.4 Umbilical EVA: The sequence of events performed by the extravehicular crewman during the umbilical EVA were as follows:

- (a) Retrieved Experiment S012 micrometeorite collection package from the spacecraft adapter

UNCLASSIFIED

UNCLASSIFIED

7-33

- (b) Connected the nitrogen line for the Hand Held Maneuvering Unit (HHMU) to the adapter quick disconnect fitting
- (c) Pushed-off from the spacecraft and transferred to the GATV docking cone
- (d) Returned to the spacecraft hatch using the HHMU
- (e) Translated to the GATV docking cone using the HHMU
- (f) Removed the Experiment S010 micrometeorite collection package from the GATV
- (g) Returned to the spacecraft hatch by pulling in on the umbilical
- (h) Removed the HHMU nitrogen line from the adapter quick disconnect fitting
- (i) Closed the hatch.

Both the S012 nose fairing and the experiment package were easily removed. The nose fairing was discarded, and the experiment package was passed to the command pilot. Prior to hooking up the HHMU nitrogen line, the forward handrail was manually released without incident. The aft handrail failed to deploy properly and was not available as a body positioning aid.

The nitrogen line was attached to the quick disconnect fitting on the second attempt. On the first attempt, the collar on the end fitting of the nitrogen line quick disconnect snapped forward into the engaged position prematurely and had to be recycled (a two-handed operation). The design of such fittings should be improved to preclude this possibility.

After ascertaining that the HHMU was being supplied with nitrogen, the pilot, standing in the open hatch, gently pushed up and forward and translated about five feet to the GATV docking cone. When contact was made, the spacecraft was backed off to a distance of 10 to 15 feet so as to keep the GATV, the extravehicular pilot, and the umbilical in sight. The pilot moved hand-over-hand around the docking cone until he reached the S010 experiment package. When he attempted to stop, however, the inertia of his body caused the motion to continue, and his hands slipped from the smooth, tapered leading edge of the docking cone. As soon as the pilot was free of the GATV, he located the HHMU (which had come loose from its position on the front of the ELSS) by pulling in on its nitrogen feed line. He then unfolded the arms of the HHMU and used it to translate back to the spacecraft hatch. The combination of

UNCLASSIFIED

UNCLASSIFIED

initial tangential velocity plus the translational velocity supplied by the HHMU resulted in the pilot's moving along a curved path similar to the 180-degree turn from downwind to final approach used in a left-hand circling approach to an airport.

When he had stopped his body motion by grabbing the open right hatch, the pilot repositioned himself for a second translation to the GATV. This time, the HHMU was used over a distance of approximately 12 feet, with the relative position of the GATV again being upward and forward at a 45-degree angle. During this translation, an inadvertent downward pitching motion developed, and the HHMU was used to counteract it. In the process, some upward translation was induced by the upward rotation, and a last-second downward pitch and translational correction was required to avoid passing over the top of the GATV. This time the pilot avoided using the docking cone as a handhold. Instead, he found wires and other handholds in the recess between the cone and the TDA body. In response to instructions from the command pilot, he moved around the end of the GATV, using these handholds, until he reached the S010 experiment package.

The S010 nose fairing was removed by pushing two buttons (each of which worked on the second try) and then pulling the nose fairing from its bracket. This was done gently, to avoid putting tension on the two wires which connected the nose fairing to the main body of the experiment. In this manner the nose fairing and experiment remained connected when the experiment package was pulled from its housing. Holding this in one hand, the pilot returned to the open hatch by pulling on the umbilical, and he handed the package to the command pilot. The nitrogen valve on the adapter was then closed and the quick disconnect fitting removed. The nitrogen line was pulled back into the cockpit along with the rest of the 50-foot umbilical and the HHMU.

The hatch closing was complicated by the fact that, in pulling the umbilical back inside, two loops had formed around the pilot's body. One of these was removed by changing body position, but one remained and hindered the knee bending required for proper hatch closing position. The umbilical, the least predictable and controllable of the EVA components, should be limited to the length required to perform the objectives of each mission. On Gemini X, a 30-foot umbilical would have sufficed. Again, the hatch closing was nominal, with very low forces.

After the spacecraft had been repressurized, it was noted that the retaining pin, which holds the tether metal bracket in place on the left hip, had pulled loose so that only the friction of the tight fit between the bracket and the parachute harness was holding the tether in place.

UNCLASSIFIED

In general, two factors complicated the EVA sequence: the lack of handholds, and the dynamics of two bodies in a zero gravity field. All perturbations caused body motions which were damped only by counteracting forces. The counteracting forces inevitably contained components in undesired directions; these, in turn, induced new body motions which had to be damped. This chain continued uninterrupted through any task performed with the body unrestrained. The "handholds" in the vicinity of the Gemini VIII GATV were not adequate, and these unwanted motions resulted in the extravehicular pilot slipping off the handhold and away from the desired location. Even with adequate handholds, hands which should be doing useful work must be used to merely hang on or torque the body. In the case of a cooperative vehicle, one solution could be the incorporation of body restraints into the EVA work site plans. If the vehicle could not be prepared beforehand, some device could be carried by the extravehicular crewman for attaching himself to the vehicle. A single attachment point might suffice, but a double or triple attachment point would obviously give much better stability.

7.1.2.7.5 Equipment jettison: A third hatch opening was performed, as scheduled, to jettison all gear not required during the remainder of the flight. The major items jettisoned were the ELSS, the 50-foot umbilical, the HHMU, and all the EVA hoses, connectors, and straps. The pilot positioned his body in the proper ingress configuration (a deep knee bend into the right-hand footwell) prior to opening the hatch and maintained the position throughout the sequence. After the two packages had been jettisoned (the ELSS and a bag containing the other items), the pilot took several pictures with the general-purpose 70-mm camera and then closed the hatch.

7.1.2.8 Experiments.-

7.1.2.8.1 Star Occultation Navigation (D005): Two series of star occultations were made. The first was a sequence of simply tracking the star before it entered the airglow until after it disappeared. The second series tied the star occultation to the orbit determination of Module VI.

The use of a photometer to define a repeatable horizon by recording the instant that starlight intensity was cut in half by the airglow was considered an excellent idea for navigation and should be further pursued. Two unexplained anomalies were noted while using the photometer. First, the instant of star occultation, as measured by the pilot through the photometer, did not always coincide with the instant of occultation noted by the command pilot with his naked eye. A dim star had already disappeared by the time the pilot reported the occultation, but a bright star could still be seen several seconds after the pilot's report of occultation. Second, during the first series of star occultations, the

UNCLASSIFIED

middle of the airglow completely occulted the stars. During the second series of star occultations on the following day, the same stars could be seen all the way through the airglow layer.

7.1.2.8.2 Ion-Sensing Attitude Control (D010): The ion-sensing attitude control experiment was performed as follows: The equipment was extended before the third sleep period and an operating background study was made while in drifting flight with a spacecraft horizon scanner operating and the spacecraft inertial platform off. Two yaw wake and plasma sheath evaluations were made on the third day with the spacecraft completely powered up. One pitch-attitude study and a wake and plasma sheath sequence were made with the spacecraft completely powered up. One roll-attitude study was also made with the spacecraft fully powered up. Qualitatively, on the FDAI, the equipment appeared to be performing perfectly. During platform alignment in the pulse attitude control mode and SEF, a slight roll misalignment, which coupled into yaw drift, was readily apparent on the D010 attitude-error needles. After ten minutes of platform alignment, the D010 attitude-error needles indicated zero attitude errors in pitch and yaw. When attitude thrusters were fired, the D010 attitude error indicators oscillated at high frequencies. The oscillations damped instantaneously, however, when thruster firing ceased. Attitude errors of the D010 needles were as expected in all studies. Sequence photographs were made of the attitude error needles during several evaluations. Most of the evaluations were made with the inertial platform in the orbit rate mode. Platform torquing in orbit rate was 240.5 deg/hr while the spacecraft was in a 215 by 158 nautical-mile orbit which would require a rate of 236.2 deg/hr. After a short time, the incorrect torquing was indicated as an error on the D010 pitch attitude needle. This platform torquing should be accounted for during data correlation.

7.1.2.8.3 Ion-Wake Measurement (S026): The ambient ion-wake flux with the TDA facing south was measured on the morning of the second day. Ambient measurements were made for one revolution while in the docked configuration in the high orbit. Linear wake mapping was performed by undocking with a separation velocity of 1.5 ft/sec on the third day. Because of a procedural error, the GATV recorder was inadvertently switched off at an estimated range of 600 feet. Sequence photographs were made of the undocking, however, and show precisely the distances of the spacecraft from the GATV and the relative locations. The spacecraft attitude during the undocking was maintained at 0, 180, 0 (BEF).

7.1.2.8.4 Micrometeorite Collection (S010 and S012): Experiment S010 (Agena Micrometeorite Collection), discussed in paragraph 7.1.2.7.4, was retrieved during the umbilical EVA. Experiment S012 (Micrometeorite Collection), discussed in paragraphs 7.1.2.6.5 and

UNCLASSIFIED

7.1.2.7.4, was retrieved from the spacecraft adapter and lost during the umbilical EVA.

7.1.2.8.5 Zodiacal Light Photography (S001): This experiment was commenced too late in the night period to obtain pictures of the zodiacal light. However, 17 or 18 pictures were made of our galaxy, and of the southern, northern, northeastern, and eastern airglow. Subjectively, it appeared that star-field tracking during the 30-second exposure was well below the minimum impulse (0.1 deg/sec) produced by the pulse attitude control mode.

7.1.2.8.6 Synoptic Terrain Photography (S005): Still and 16-mm strip photographs of land areas were made during drifting flight. Included were photographs of North America, Central America, South America, Southeast Asia, Indonesia, Africa, Southern Europe, and the Arabian Peninsula; atolls in the Pacific Ocean and Indian Ocean; and islands in the Pacific Ocean, Atlantic Ocean, and Caribbean Sea.

7.1.2.8.7 Synoptic Weather Photography (S006): Synoptic weather (70-mm and 16-mm) strip pictures were made during drifting flight and while docked with the GATV. Several groups of these pictures will make stereo pairs. Hurricane Celia and several other unique, but small, circulation systems were also recorded.

7.1.2.8.8 Tri-Axis Magnetometer (M405), Beta Spectrometer (M408), and Bremsstrahlung Spectrometer (M409): Experiments M405, M408, and M409 were performed as scheduled. The crew noted no effects from activation of any equipment.

7.1.2.8.9 Color Patch Photography (M410): The color patch photography experiment was partially performed during the standup extravehicular operation, as discussed under section 7.1.2.7.

7.1.2.8.10 Landmark Contrast Measurements (M412): Experiment M412 was not performed because of the propellant shortage problem.

7.1.2.9 Reentry. - Prior to reentry, Module IV was loaded and the reentry math-flow test was conducted. The Reentry Control System (RCS) was checked in all modes. Stowage, preretrofire procedures with the ground controllers, and the preretrofire checklist were performed normally, except that the main batteries were put on the line earlier than the checklist required. The time to retrofire (T_r) minus one minute checklist was completed at T_r minus two minutes.

At retrofire, the pilot started the computer (to initiate reentry computations) and the stopwatch simultaneously. One second later, the pilot initiated manual retrofire. The IVI indication of retrofire was

UNCLASSIFIED

303 ft/sec aft, 119 ft/sec down, and 5 ft/sec right. Attitude error dispersions at retrofire were minimal. There appeared to be a slight firing delay between the third and the last retrorocket. The onboard backup bank-angle computations were 48 degrees left, with a reverse bank-angle time of $T_r + 27$ minutes 36 seconds, which compared favorably with the ground-supplied update numbers of 45 degrees left bank angle, and the reverse bank-angle time of $T_r + 27$ minutes 38 seconds. The spacecraft was flown in single-ring pulse attitude control mode, in a 10-degree left-bank until reaching 400 000 feet. As shown by the flight director roll indicator, arrival at the 400 000-foot altitude was an estimated 12 seconds late, well within tolerance. At 400 000 feet, the backup bank angle was selected. After guidance initiate the crossrange error needle passed back-and-forth an estimated seven miles north to seven miles south of track at least twice before stopping near the center of the flight director attitude indicator. The downrange error needle initially indicated about 70 miles short. The downrange error indicator moved slowly up and down in several 20-mile-long oscillations. The backup bank angle was flown for 20 to 30 seconds after guidance initiate, until the crossrange and downrange needles stopped their slow oscillations. The roll indicator was then commanding full lift. The majority of the reentry was flown at, or near, full lift. Because of the afternoon reentry, it was necessary for the command pilot to raise his arm to shade his eyes from the sun and prevent the sunlight from destroying his view of the crossrange and downrange error indicators. The downrange indicator moved to zero downrange miss. Because of parallax, the downrange needle null was a full needle width below the airplane indicator on the flight director indicator. When the downrange indicator indicated zero-miss, a full roll was commanded. The downrange error remained nulled. For the remainder of the reentry, the roll indicator was followed. At an estimated 120 000 feet, the crossrange indicator showed a two and one-quarter mile error, so a 90-degree roll in that direction was maintained until an altitude of 38 000 feet was reached.

At 80 000 feet, when guidance terminated, the crossrange error appeared to be less than two miles and the downrange error close to zero. The maximum g during reentry could not have been more than 6 or 7. During reentry, the out-the-window appearance of the colored plasma streams and the small pieces of the ablative material leaving the spacecraft was as expected. The pilot took out-the-window pictures with the 16-mm hand-held sequence camera throughout most of the reentry. The downrange-needle performance in the spacecraft was not similar to that of the Gemini Mission Simulator. In the simulator, it was necessary to continually correct downrange error to the neglect of crossrange error. This was negative training for this flight.

UNCLASSIFIED

The drogue parachute was not activated until 38 000 feet. Post-flight information indicates that this late activation caused the wild spacecraft oscillations, estimated at ± 40 degrees, experienced between 35 000 and 25 000 feet. These oscillations made it impossible for the command pilot to unstow the D-ring at 35 000 feet. The RCS propellant motor valves were closed at 27 000 feet with the RCS in the rate-command mode. The drogue stabilized the spacecraft from 25 000 feet to main parachute deployment. The RCS thrusters had small curling flames at the thruster throats prior to parachute deployment. Parachute deployment was accomplished at 10 600 feet. There were no visible tears in the parachute. The crewmen were braced for single-point release but the release was actually very soft. However, it was characterized by two separate release-like jolts. After the spacecraft was stabilized in pitch in the landing attitude, it began spinning to the right. Spin rotation finally slowed and stopped, and a spin started to the left. Prior to landing, the vertical velocity was noted to be 29 ft/sec on the rate-of-descent indicator.

7.1.2.10 Landing.- Just prior to completion of the second cycle of rotation to the left, when the spacecraft had slowed its spin, it hit the water. Impact was extremely mild. Parachute jettison was normal except that there was so little wind that the parachute did not pull free and the straps and the riser lines were lying on top of the spacecraft. Helicopters were overhead shortly after landing and swimmers were immediately in the water. The flotation collar was attached to the spacecraft in a matter of minutes. There was no apparent leakage in the Environmental Control System (ECS) package well. The usual smell of highly heated metal was noted in the spacecraft. The spacecraft hatch was secured and a normal egress was made to an attached raft. The helicopter hoist was normal except that, due to a signal mixup, the pilot was hoisted up to the helicopter before he could properly position himself in the rescue collar.

7.1.2.11 Systems operation.-

7.1.2.11.1 Guidance and Navigation System: The inertial platform operated properly; however, it was believed that the initial platform alignment, after the coelliptic maneuver (N_{SR}) and prior to the primary rendezvous, was incorrect for some reason unknown to the crew. The computer operated properly in all modes, except that during the orbit determination phase, one start-computer indication (computer-running light on) did not take place, although the command pilot hit the start-computer button. It was noted that this was similar to several occurrences in the Gemini Mission Simulator in which the start-computer cycle would not initiate if the start-computer button was not pressed to the end of its travel.

UNCLASSIFIED

The computer did not accept the proper velocity numbers in address 26 at N_{SR} . Three different attempts were made to properly insert a velocity of about 6 ft/sec up in core 26 and in each case the result was always 12 ft/sec up in the up-down windows of the IVI. Information made available to the crew after the flight revealed that this was caused by not removing the orbit-rate compensation logic which was programmed to be automatically entered into the computer. The crew were advised to make a particular computer entry during the calculations for TPI. This entry corrected the logic, but the crew were not made aware of details. This particular problem tended to degrade the crew's confidence in the performance of the computer during the closed-loop-rendezvous mode of operation. The Auxiliary Tape Memory Unit operated properly in the automatic configuration, transferring six separate module loads.

The performance of the L-band radar was exceptional. Initial lock-on range was in excess of 234 miles. A steady radar lock was maintained from that range. After N_{SR} , evaluation of the attitude indicator motion showed that the indicators were steady, with no apparent radar attitude-error-indicator oscillations. However, on three occasions, after the second midcourse correction during the primary rendezvous, the analog range and range-rate meter indicator pointers momentarily showed large opening range rates while the range was still fairly high (1 1/2 to 3 miles). In no case was there an indication of broken radar lock. Checks of range rates during this period showed the expected values from the computer.

7.1.2.11.2 Communication System: Air-to-ground communications were adequate throughout the mission. A suspected air-to-ground communication difficulty over Hawaii early in the flight was due to lightweight-headset microphone positioning. Shifting of the lightweight-headset microphone was a problem during the entire flight. On several occasions, ground-to-air communications fadeouts were corrected by changing from the adapter to the reentry antenna. Inasmuch as the spacecraft was over the station, these fadeouts were probably caused by the adapter antenna pattern nulls.

7.1.2.11.3 Environmental Control System: The ECS performed normally throughout the mission except for the eye-irritation problem. Both suit fans were used until eye watering terminated the standup EVA. Following the standup EVA, only suit fan no. 1 was used. There was no appreciable increase in eye irritation. In order to validate this configuration for use during the umbilical EVA, an ECS test was conducted. This test was conducted with the suits pressurized, the recirculation valve closed, and the system operating on one suit fan. The spacecraft was depressurized to three psi for a period of one hour. No eye irritation was noted during this test.

UNCLASSIFIED

7.1.2.11.4 Electrical System: The fuel cells operated normally throughout the mission. Fuel-cell differential-pressure warning lights were noted several seconds after lift-off and the lights remained on for an unknown portion of powered flight. They also came on during the first GATV PPS firing but were not noticed during the second or third firings. During the unstowage of the ELSS, the front corner of the chestpack struck the rear of the left-center bright-light housing, resulting in a flash and the burning out of the light; it appeared that the rear of the light housing came off.

7.1.2.11.5 Cryogenic oxygen supply: It was necessary to frequently operate the manual cryogenic oxygen heater when the spacecraft was powered up, especially during the first and second days of the mission. Ground stations had to remind the crew several times of decreasing cryogenic pressure. The automatic heater should have been sized to maintain the cryogenic oxygen supply above the dome when the spacecraft is fully powered under all oxygen tank loading conditions.

7.1.2.11.6 Propellant quantity system: It was difficult to accurately report the propellant percentage reading on the quantity indicator at low propellant readings (below 20 percent) because of gage parallax. During depressurized operation, it was impossible to read the gage accurately. It should be noted that the complete umbilical EVA could have been performed if an accurate estimate of the propellant onboard had been available.

7.1.2.11.7 Radiation monitoring system: After docking, the radiation measuring system was unstowed, activated, and mounted on the hatch. The total dose at the last reading prior to stowage for reentry was 0.94 of a rad. All crew observations of the dose-rate indicator showed the dose-rate indication off-scale low. The command pilot's left-leg-mounted pocket dosimeter indicated less than two rads total dose.

7.1.2.11.8 Spacecraft equipment:

(a) Camera box A-frame cover - At least 30 minutes of orbital time was spent closing the A-frame on the center camera box. Much effort was spent aligning, holding, and forcing the box frame to the closed position. It is recommended that a simple, easily operated box lid be developed.

(b) Window visibility degradation - Out-the-window visibility degraded throughout the mission. Still pictures taken outside the spacecraft showed an amazing increase in clarity. Inspection showed some of this degradation occurring between the inner and outer panes. Several photographs were made focused on the right window. It is recommended that these photographs be examined as stereoscopic pairs to

UNCLASSIFIED

determine the location of the particles and that the internal visibility degradation be eliminated.

(c) Pilot's lap belt - The pilot's lap belt could not be adjusted after the first day. The fabric of the right-hand strap doubled over itself where it passed under its roller and became wedged so that it could be neither lengthened nor shortened. This meant that the pilot was not properly strapped into the seat for ejection, should it have been required during reentry.

(d) Clocks and timers - Throughout the mission, the digital clock was used as the primary means of establishing the time for the various operations. Twice, the digital clock was inadvertently stopped during depressurized operations. Restarting the digital clock consumed an entire station pass. The need to rely on the digital clock with its poorly protected stop-start switch could have resulted in missing a significant event. The following standard events aboard Spacecraft 10 were repeatedly overshot or forgotten due to interruptions from other operations or ground communications: the fuel-cell oxygen 2-minute purge, the 3-minute urine-preheat cycle, and the oxygen manual heater. The crew need an easily set timing device with an audible signal for timing thrusts.

(e) Footwell equipment stowage - The 50-foot umbilical was packed in the left footwell. It was impossible for the command pilot to straighten his legs. The first day, the command pilot's knees were particularly cramped and ached considerably. The erect left knee also set up the inadvertent thruster firing during the primary rendezvous.

7.1.2.11.9 Crew equipment: The left and right overhead hatch pouches were difficult to unpack. Most of this problem was due to the bulk of the aluminum covers on the man-meal containers. Due to the inability to see the contents of the pouch, one of the food packages was inadvertently cut open.

Six food packages leaked water at the reconstitution valve. Too much time was required to reconstitute all food packages due to difficulty encountered in inserting the water gun and difficulty involved in opening food packages. Ninety percent of the period allotted for a meal was spent in unstowing, preparing, and reconstituting the food, the remainder in eating it.

7.1.2.11.10 Camera equipment:

(a) Sequence cameras - During the mission, one of the sequence cameras malfunctioned. It was impossible to determine whether the camera was operating. The circuit breaker light indicated only that there was

UNCLASSIFIED

UNCLASSIFIED

7-43

power to the camera. It was not possible to determine the amount of film remaining in the camera.

The color film did not record true colors that the eye readily discerns. Firings of all GATV engines, the PPS tailoff, the RCS thruster firings, and the reentry plasma effects were either missed entirely or were incorrectly recorded on the film.

(b) Still cameras - The 70-mm EVA still camera was lost because the camera-restraining-lanyard screw backed out while in the weightless environment. The 70-mm EVA still camera was an easily operated camera. The general-purpose 70-mm camera operated satisfactorily in most modes; however, its bulk prevented positioning the camera out of the spacecraft window, resulting in recording only half of what the eye could see during docked GATV operations.

UNCLASSIFIED

UNCLASSIFIED

NASA-S-66-8131 AUG 13

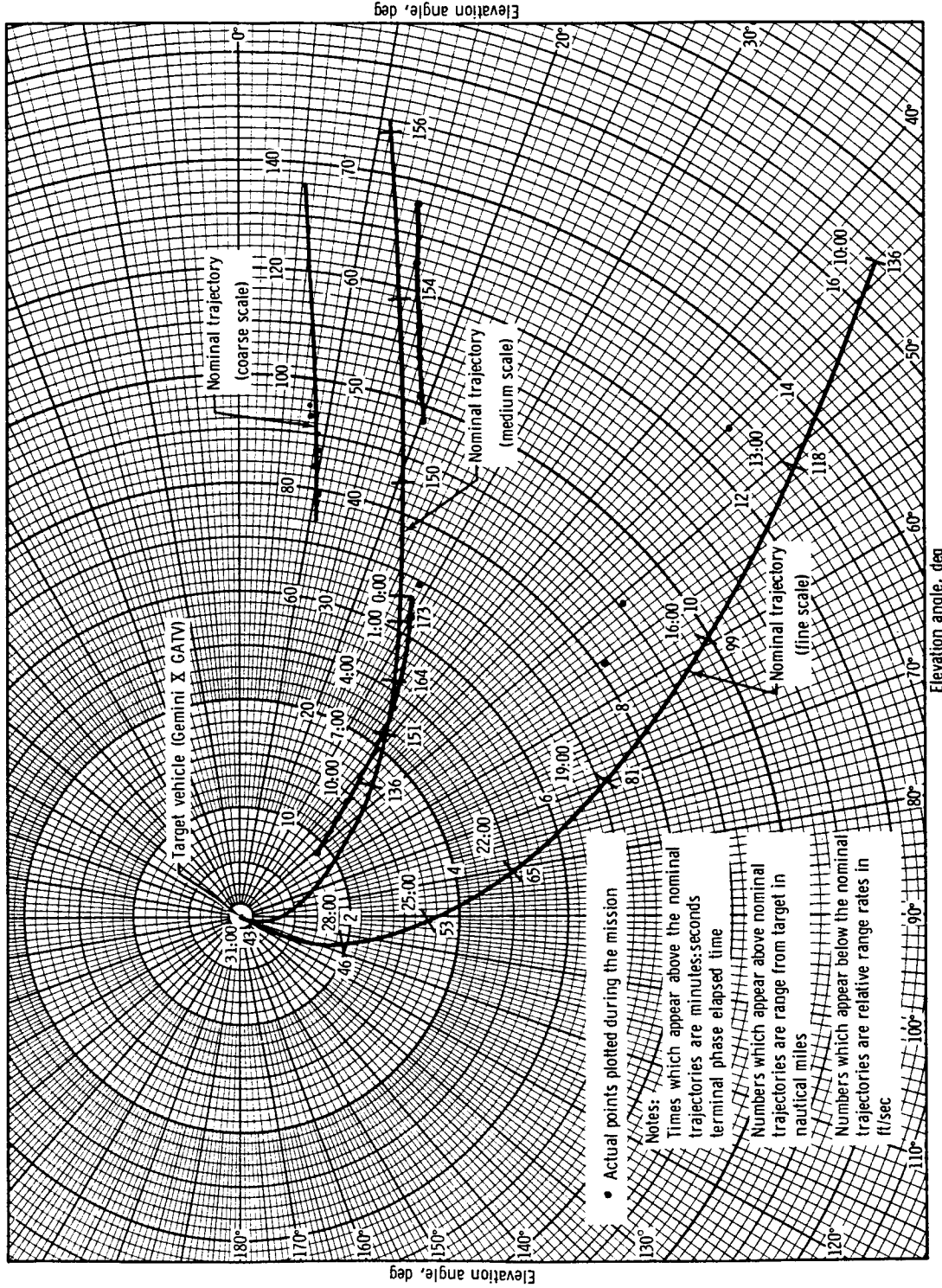

UNCLASSIFIED

Figure 7.1.2-1. - Onboard target-centered coordinate plot of first rendezvous.

UNCLASSIFIED

7-45

7.2 AEROMEDICAL

Gemini X was a 3-day mission which included rendezvous, docking, and docked maneuvers with the Gemini X GATV, rendezvous with the Gemini VIII GATV, two periods of extravehicular activities (EVA), and one additional hatch opening. The only medical problem which occurred during this flight was an onset of eye irritation during standup EVA. The problem caused considerable eye irritation and watering, making it impossible to complete the activities scheduled for the first EVA period. After ingress, repressurization, and selection of high oxygen rate, the symptoms cleared. Although the symptoms continued to be present at times during the remainder of the flight, it presented no problem during umbilical EVA and did not interfere with other programmed activities.

7.2.1 Preflight

7.2.1.1 General preparations.- The customary review of both the prime and the backup crews' medical records was carried out following their selection for this flight. Testing for sensitivity to the onboard medications was well underway prior to the departure of the crew for Cape Kennedy in early June 1966, and the testing was completed after their arrival. Tests for skin sensitivity to the electrolyte jelly and the biosensor adhesives had been completed prior to that time in the course of special tests conducted at the Manned Spacecraft Center in Houston or in connection with the altitude chamber runs at the spacecraft contractor's facility in St. Louis. No medical-historical contraindications for flight were found for any of the crewmen in the medical record search, nor were any sensitivities to onboard medications or biosensor attachment materials found in the course of testing.

7.2.1.2 Specific preflight preparations.- Both prime crewmen engaged in a self-designed preflight exercise program. The pilot reported that he was doing some specific exercises to strengthen his forearms and hands in preparation for EVA. The crew began their modified low-residue diet on July 15, 1966, and remained on this diet until launch day. Because the Gemini X launch was scheduled for approximately 5:20 p.m. e.s.t., and because it was desirable to schedule the inflight sleep periods at times that were equivalent to 2:00 a.m. through 10:00 a.m. e.s.t., it was considered necessary to have the crew change their preflight work-rest cycle to increase the probability of their obtaining satisfactory inflight sleep. It was therefore recommended and accepted that, for the last 10 days of the preflight period, the crew retire near midnight and not rise until approximately 10:00 a.m. e.s.t. The crew readily adapted to this minor change and their sleep was extremely satisfactory. On both July 17 and July 18, 1966, the crewmen retired at 2:00 a.m. On

UNCLASSIFIED

UNCLASSIFIED

July 17, just prior to retiring, the command pilot took two ducolax and the pilot took one ducolax. They both awoke that day at approximately 10:30 a.m., and during their subsequent waking hours both crewmembers reported having had several bowel movements, which had the effect of clearing out their lower intestinal tracts. On July 18, the command pilot slept until noon and the pilot slept until 10:00 a.m. No bowel activity occurred on July 18.

7.2.1.3 Medical examinations.- On July 8, the crewmen were examined by an internist and the crew flight surgeons. The remainder of the medical specialty team, consisting of a neuropsychiatrist, an ophthalmologist, and an otorhinolaryngologist, conducted their examination of the crew on July 15. The crew flight surgeons conducted the preflight examination on the day of the launch. Neither of the crewmen was found to have had any history or to have any symptoms or signs of significant illness during the 30 days immediately prior to the flight. In the preflight examination of the pilot's white blood cells, a differential shift was found which will be seen in table 7.2-I. No explanation could be found from either history or examination. Analysis of the blood sample taken on July 8 revealed that the command pilot had a blood urea nitrogen (BUN) in the high range of normal, and the pilot's BUN was at or just above the upper limit of normal for the laboratory. The examination of the blood sample taken on July 15, however, revealed that both crewmen had a normal BUN. A small healing blister was found on the dorsum of the fourth right toe of the command pilot on the morning of the flight. The pilot's hemoglobin remained in the low range of normal, which is a known and characteristic finding.

7.2.1.4 Special data collection.- Two tilt-table studies were carried out on each crewman prior to the flight. These were conducted on July 8 and July 15, 1966. The data from these studies are shown in figure 7.2-1. A bicycle ergometer test of the pilot's exercise capacity was carried out on July 15, and a similar test was performed postflight. Exercise-capacity tests of the pilot are shown in figure 7.2-2, and the workloads experienced by the pilot during these tests are shown in figure 7.2-3. No special clinical laboratory studies were carried out because of the cancellation of the M-5 experiment, and the routine laboratory studies are reported in the previous paragraph and in the accompanying tables. Laboratory results are presented in tables 7.2-I and 7.2-II.

7.2.1.5 Precount medical activities.- Precount medical activities were accomplished according to the plan shown in table 7.2-III. During the application of biomedical sensors just prior to suiting, it was discovered that the command pilot had just had the hair removed from part of his forearm to obviate snagging of the forearm hair in the wrist ring when donning the gloves. There was no time to check this area thoroughly before it was required to suit the crewman for the flight; however, it

UNCLASSIFIED

appeared that the skin had not been abraided and that corrective action was not necessary. Both crewmen were considered prepared for flight.

7.2.2 Inflight

7.2.2.1 Physiological monitoring.- The Gemini bioinstrumentation system was unchanged from previous flights with one exception. During umbilical extravehicular activities, only the sternal electrocardiogram and the pneumogram tracing were available to the Gemini bioinstrumentation system through the 50-foot electrical umbilical.

7.2.2.1.1 Electrocardiograms: The rate and pattern of electrocardiograms on each crewman remained within normal and expected limits. Heart rate data may be seen in figure 7.2-4. Data obtained from real-time records and the biomedical tape recorders during the extravehicular activities are shown in figures 7.2-5 and 7.2-6. Heart rates were considerably lower than those obtained during previous extravehicular activities. Figure 7.2-3 is a plot of the pilot's heart rate against Btu output during preflight and postflight ergometry studies. These data may indicate that the workload experienced by the extravehicular pilot during this flight was significantly reduced from previous flights.

7.2.2.1.2 Respiration: Respiratory rates are included in figures 7.2-4, 7.2-5, and 7.2-6. The rates were within normal expected limits during the entire flight.

7.2.2.1.3 Oral temperature: The oral temperature probes were deleted from the lightweight headsets; however, one probe was attached to the ear piece in each helmet and was available if required. No oral temperature measurements were programmed during this flight.

7.2.2.2 Medical observations.-

7.2.2.2.1 Lift-off and powered flight: No unusual sensations were described during powered flight or upon transition into the weightless state.

7.2.2.2.2 Environment: An evaluation of the Environmental Control System is found in section 5.1.4. It is noted that, because of the extra thermal layer in the pilot's suit, the pilot was subjectively warmer than the command pilot during the entire flight. The pilot expressed no significant thermal discomfort during extravehicular activities. At an elapsed time of approximately 24 hours 8 minutes, both crewmen experienced considerable eye irritation and tearing possibly as a result of contamination in the suit circuit. This problem caused their eyes to water to the extent that it was impossible for either crewman to

UNCLASSIFIED

see well enough to change a camera setting. Because of this, the crew elected to terminate the standup extravehicular activities and repressurize the spacecraft. This problem occurred after loss of signal at Carnarvon and before acquisition at the Canton station. When the crew were contacted by voice over the Canton station, they reported this problem and that they had terminated EVA, ingressed, and were fully repressurized. They also reported the problem had diminished somewhat; however, considerable eye irritation and watering were still present during the pass over the United States. At that time, the crew were directed to close their suit circuit and select the high oxygen rate. This action caused the symptoms to decrease. A detailed account of the methods used in the attempts to trace the origin of the problem is included in section 5.1.4. Extensive postflight tests and analyses, however, have not established the source of the irritant. The irritation was still present at times during the remainder of the flight; however, it was not serious enough to curtail any of the planned activities.

7.2.2.2.3 Food, water, sleep, and waste: Three meals of Gemini flight food per crewman per day were stored aboard the spacecraft. Additional food was carried in each flight suit. The crew was to report any variation from the planned food intake. The pilot reported that he did not eat the second meal on the second day. It was assumed that all the other food was consumed. This would be an average of approximately 2500 calories per day. A postflight analysis of the food remaining inside the spacecraft indicates that approximately 4500 calories were consumed by each crewman, for an average of 1500 per day. It must be emphasized that these are approximations and extrapolations based on uneaten food and empty food wrappers which were not discarded in orbit.

Each crewman planned to drink approximately five pounds of water per day. Although it is not possible with the present configuration to measure the amount of water consumed by each crewmember, the water gun indicated that approximately 33 pounds of water were consumed during the flight. Assuming that the water intake was divided equally between the crewmembers and that they drank the same amount each day, it can be estimated that each crewman consumed approximately 5.5 pounds of water during each 24-hour period of the flight.

As on all previous missions, the crew found it difficult to sleep the first night. Although both crewmen rested during the first sleep period, they did not experience any sound sleep. During this entire period they were constantly aware of their surroundings. However, during the second sleep period, both crewmen reported that they slept well. Sleep during the third sleep period was somewhat less sound and of a slightly shorter duration than during the second sleep period; however, prior to retrofire both crewmen felt well rested and alert.

UNCLASSIFIED

UNCLASSIFIED

7-49

Each crewman defecated once during the flight. Although the defecation bags were not considered completely satisfactory, there was no undue difficulty associated with this procedure.

The housekeeping procedures associated with food, water, and waste continue to be a major problem during space flight. During these short duration missions, with very full flight plans, the time utilized in preparing and eating food, drinking water, and eliminating waste is considered inappropriately large. It is believed by most crewmen that the time spent accomplishing these routine procedures could better be spent performing active work or experiments.

7.2.2.2.4 Medications: On the first night the command pilot took an APC tablet in an attempt to induce sleep. During the second day he took two lomotil tablets in an attempt to decrease the urge to defecate. Prior to retrofire he took one Actifed. The pilot experienced a slight headache during the first and second nights. Although the headache was not severe enough to require medication, he elected to take two APC tablets from the inflight medical kit on each occasion.

7.2.2.2.5 Vision: During this flight, the crew had the opportunity to observe ground targets from an altitude never before attained. From these altitudes, the crew reported that the curvature of the earth was somewhat more pronounced and that ground targets, as expected, were more difficult to find. There was no other significant visual finding on this flight which has not been previously reported.

The gold reflective coating on the outer side of the pilot's extravehicular visor was damaged prior to the first extravehicular activity. It was estimated that 40 percent of the gold had flaked off prior to EVA. The pilot reported no visual discomfort during the extravehicular activities as a result.

7.2.2.2.6 Orientation: The pilot reported that during extravehicular activities, although he had some difficulty positioning himself to do simple tasks, there was no question as to his orientation at any time.

7.2.2.2.7 Radiation: During this flight, the spacecraft attained an altitude of over 400 nautical miles. On three occasions, the flight plan took the crew through the South Atlantic Anomaly area at an altitude higher than on any previous flight. As a result of this, the accumulated radiation dosage was larger than that seen on previous missions. The radiation dosage was measured by the passive dosimeter packages which are placed in pockets on each crewman's undergarment and helmet. The highest level previously recorded was 0.25 of a rad, experienced during Gemini VII. The dosage during this flight, as reported by this method, was approximately 0.75 of a rad in all locations. These readings were confirmed by the Gemini radiation measuring system, an active dosimeter

UNCLASSIFIED

UNCLASSIFIED

giving accumulative dosages and dose rate. The readings after the first high-altitude pass through the South Atlantic Anomaly area was 0.18 of a rad, with a dose rate at less than 0.1 rad/hour. The final accumulative reading was 0.91 of a rad. The sensor position was on the overhead panel about six inches from the command pilot's head. Although internal shielding undoubtedly has some influence on these readings, the apparent radiation levels at this altitude are significantly lower than expected. This indicates that decay of the Van Allen belt, at this altitude, is greater than has been estimated from previously available data.

7.2.2.2.8 Retrofire and reentry: Retrofire and reentry were essentially normal. The sensations during deceleration were the same as those reported by previous crews. The crew noticed more spin on the drogue and main parachutes than had been previously reported. There was no difficulty in going to a two-point suspension, and the water landing was normal.

7.2.3 Postflight

This portion of the report includes aeromedical observations from spacecraft landing until medical evaluations were completed at Kennedy Space Center after recovery. These data were obtained from clinical examination, medical debriefings, and laboratory determinations. Variations from normal included the following:

- (a) Weight loss
- (b) Slight to moderate crew fatigue
- (c) Marked diaphoresis
- (d) Subjective dehydration
- (e) Hemoconcentration
- (f) Labile pulse pressure and elevated heart rate during initial postflight tilt study as compared with preflight and subsequent post-flight tilt-table studies
- (g) Slight residual conjunctivitis.

7.2.3.1 Recovery medical activities.- Recovery medical activities for Gemini X were essentially unchanged from other Gemini short-duration missions.

UNCLASSIFIED

7.2.3.1.1 Planned procedures: The postflight medical evaluation was planned to be less detailed than those which followed the long-duration Gemini flights. Some modification of the usual recovery medical procedures were dictated by the late time of day for recovery. Only one tilt-table study was scheduled for recovery day; the second postflight tilt was to be performed shortly after return of the crewmen to Kennedy Space Center approximately 18 hours after recovery. Subsequent tilt studies were to be made daily thereafter until crewmember responses returned to preflight values. Laboratory procedures were to be limited to routine chest roentgenograms, complete blood counts, and urinalyses. The blood and urine specimens collected specifically for the M-5 experiment were to be omitted. Postflight medical examinations were to be less comprehensive than those performed following previous flights, with special emphasis on the cardiovascular system. Therefore, only the internist-cardiologist member of the medical evaluation team was deployed on the primary recovery ship. Additional medical examinations were performed as indicated by the NASA physician and/or the Department of Defense (DOD) members of the Recovery Medical Team.

7.2.3.1.2 Actual procedures: After spacecraft landing, the crew elected to egress the spacecraft and board the raft as soon as the swimmers had secured the flotation collar. Egress was performed without difficulty. Both crewmembers remained in their pressure suits. The command pilot experienced no discomfort before and during egress. The pilot was extremely warm and sweaty and experienced some stomach awareness, as well as slight heaviness of the legs. Both crewmembers had been hoisted aboard the helicopter by 23 minutes after spacecraft landing. The crew stepped onto the deck of the prime recovery ship 28 minutes after spacecraft landing and walked from the helicopter to the ship's medical area without difficulty. They gave no indication of ill effects from their space flight and reported no orthostatic hypotension either on the water or on the deck of the recovery ship.

7.2.3.2 Examinations. - Postflight medical examinations were completed approximately two hours after the crew arrived on the deck of the recovery ship. During the desuited process, it was noted that the undergarments of both crewmembers were saturated with perspiration. The pilot's underwear was stained with urine in the lower abdominal and perineal areas. The skin of both crewmembers was normal except for minimal reaction at the sensor sites. The command pilot exhibited slight erythema at the sensor sites on the upper thorax and a few pustules at the sensor site over the right anterior lateral chest. There was minimal desquamation of the skin which was in contact with the electrode paste. The pilot exhibited mild hyperemia at all sensor sites. There were no pustules. There was a 1/2-inch abrasion surrounded by an erythematous area in the pilot's right mid forearm and slight hyperemia in the pressure areas over the right forehead. Small flecks of gold from the

UNCLASSIFIED

pilot's extravehicular visor covered the entire body of both crewmembers. Both crewmembers showed slight to moderate fatigue and dehydration. Both showed moderate diaphoresis with no undue body odor. The skin of both astronauts, other than that described above, was in excellent condition and showed no signs of maceration, desquamation, or erythema. The internist report revealed no changes other than mild dehydration as manifested by weight loss and subjective thirst. During the flight, the command pilot lost no weight, and the pilot lost three pounds. These weights were determined by subtracting the weights determined aboard the recovery ship from the weights obtained during the physical examinations four days prior to flight. Both crewmembers showed minimal residual palpebral conjunctivitis.

7.2.3.3 Tilt table studies.- Two postflight tilt-table studies were performed on each crewmember. The results are presented in figures 7.2-1 and 7.2-2. During the initial postflight tilt-table study, the pilot became presyncopal at approximately 12 and 13 minutes of tilt. Post hoc analysis revealed that vibration created by the movement of the ship and the heat of the examining room produced minimal subjective motion sickness symptoms which were reflected in the tilt table study. The excellent results obtained in the tilt-table study 18 hours after recovery tend to confirm these impressions. The command pilot tolerated his initial tilt procedure well. The response to the tilt-table studies of both crewmembers returned to within the normal envelope on the second postflight tilt.

7.2.3.4 Bicycle ergometer studies.- A bicycle ergometer study was performed on the pilot the morning after spacecraft landing. The result of these studies is shown in figure 7.2-3. There was no degradation in the pilot's ventilation, oxygen uptake, or endurance.

UNCLASSIFIED

TABLE 7.2-I.- HEMATOLOGY
(a) Command pilot

Determination Date	Preflight		Postflight	
	July 8, 1966	July 15, 1966	Recovery + 30 min	Recovery + 20 hr
Red blood cells/mm ³	5 310 000	5 550 000	5 330 000	5 330 000
Hematocrit, percent	46	48	49.5	47
Hemoglobin, grams percent	16.0	16.9	16.5	16.5
Indices:				
Mean corpuscular volume, μ^3	87	87	93	88
Mean corpuscular hemoglobin, $\gamma\gamma$	31	30	32	31
Mean corpuscular hematocrit, percent	35	35	31	35
White blood cells/mm ³	9 750	9 990	7 400	
Neutrophiles				
Segmented, percent	57 (5558)	57 (5643)	60 (4440)	
Stab, percent	0	0	0	
Lymphocytes, percent	29 (2828)	36 (3564)	32 (2368)	
Monocytes, percent	10 (975)	5 (495)	6 (444)	
Eosinophiles, percent	3 (293)	2 (198)	1 (74)	
Basophiles, percent	1 (97)	0	1 (74)	
Sodium, mEq/l	143	152	143	

UNCLASSIFIED

TABLE 7.2-1.- HEMATOLOGY - Concluded
(a) Command pilot

Determination Date	Preflight		Postflight	
	July 8, 1966	July 15, 1966	Recovery + 30 min	Recovery + 20 hr
	Potassium, mEq/l	4.9	5.2	5.6
Calcium, mEq/l	4.6	4.7	-	
Calcium, mgm percent	9.2	9.4	-	
Alkaline phosphatase (B-L units)	1.4	-	-	
Creatinine, mgm percent	-	-	-	
Chloride, mEq/l	105	106	106	
Phosphate, mgm percent	3.8	4.3	-	
Glucose, mgm percent	106	87	-	
Blood urea nitrogen, mgm percent	20	19	19	
Total protein, gm percent	7.5	7.8	7.6	
Albumin, gm percent	4.9	-	4.7	
Uric acid, mgm percent	7.2	7.9	-	
Cholesterol, mgm percent	199	215	-	
Bilirubin, total, mgm percent	0.41	0.87	-	
Bilirubin, direct, mgm percent	0.13	0.18	-	
Osmolality, mOs/kg	290	-	296	

UNCLASSIFIED

TABLE 7.2-I.- HEMATOLOGY
(b) Pilot

Determination Date	Preflight		Postflight	
	July 8, 1966	July 15, 1966	Recovery + 30 min	Recovery + 20 hr
	Red blood cells/mm ³	4 490 000	4 680 000	4 900 000
Hematocrit, percent	42.25	45	44	42
Hemoglobin, grams percent	13.8	14.4	15.0	12.6
Indices:				
Mean corpuscular volume, μ^3	94	96	90	99
Mean corpuscular hemoglobin, $\gamma\gamma$	31	31	31	30
Mean corpuscular hematocrit, percent	33	32	34	30
White blood cells/mm ³	7 600	8 100	6 300	30
Neutrophiles				
Segmented, percent	38 (2888)	34 (2750)	68 (4410)	
Stab, percent	0	0	2	
Lymphocytes, percent	53 (4028)	55 (4455)	21 (1323)	
Monocytes, percent	8 (608)	7 (567)	2 (378)	
Eosinophiles, percent	1 (76)	3 (243)	6 (126)	
Basophiles, percent	0	1 (81)	1 (63)	
Sodium, mEq/l	147	150	150	

UNCLASSIFIED

TABLE 7.2-I.- HEMATOLOGY - Concluded
(b) Pilot

Determination Date	Preflight		Postflight	
	July 8, 1966	July 15, 1966	Recovery + 30 min	Recovery + 20 hr
	Potassium, mEq/l	4.1	5.0	4.5
Calcium, mEq/l	4.6	4.7	-	
Calcium, mgm percent	9.2	9.4	-	
Magnesium, mEq/l	1.9	-	-	
Alkaline phosphatase (B-L units)	1.8	-	-	
Creatinine, mgm percent	-	-	1.2	
Chloride, mEq/l	105	106	108	
Phosphate, mgm percent	3.8	4.3	-	
Glucose, mgm percent	93	90	-	
Blood urea nitrogen, mgm percent	28	20	21	
Protein, total, gm percent	7.3	7.4	7.4	
Albumin, gm percent	4.8	-	4.3	
Uric acid, mgm percent	6.3	6.5	-	
Cholesterol, mgm percent	157	164	-	
Bilirubin, total, mgm percent percent	0.31	0.52	-	
Bilirubin, direct, mgm percent	0.08	0.15	-	
Osmolality, mOs/kg	293	-	299	

UNCLASSIFIED

TABLE 7.2-II.- URINALYSIS

(a) Command pilot

Determination Date	Preflight		Postflight
	July 9, 1966, 9:46 a.m.		
Volume, cc	75		Not available
pH	6		
Specific gravity	1.029		
Protein, mgm/vol	Negative		
Glucose	Negative		
Creatinine g/vol	0.20		
Creatine g/vol	0.30		
Urea nitrogen, gm/vol	1.29		
Total nitrogen, gm/vol	1.43		
Uric acid, gm/vol	0.090		
α amino acid nitrogen, mgm/vol	24		
Sodium, mEq/vol	16		
Potassium, mEq/vol	78		
Chloride, mEq/vol	8.0		
Magnesium, mEq/vol	0.72		
Calcium, mEq/vol	1.2		
Calcium, mgm/vol	24		
Phosphate, gm/vol	0.07		
17-OHCS, mgm/vol	0.95		
Osmolality, mOs/kg.	993		

UNCLASSIFIED

TABLE 7.2-II.- URINALYSIS

(b) Pilot

Determination Date	Preflight		Inflight ^a	Postflight
	July 9, 1966, 8:15 a.m.			
Volume, cc	520		270	Not collected
pH	5		6.5	
Specific gravity	1.019		1.021	
Protein, mgm/vol	Negative		8.1	
Glucose	Negative		Negative	
Creatinine, gm/vol	0.64		0.39	
Creatine, gm/vol	0.10		0.054	
Urea nitrogen, gm/vol	5.50		2.86	
Total nitrogen, gm/vol	5.97		-	
Hydroxy proline, g/vol	-		10.3	
Uric acid, gm/vol	0.27		-	
α amino acid nitrogen, mgm/vol	68		36	
Sodium, mEq/vol	29		48	
Potassium, mEq/vol	17		-	
Lithium, mEq/vol	0.028		0.014	
Chlorine, mEq/vol	14		39	
Magnesium, mEq/vol	2.7		1.9	
Calcium, mEq/vol	1.98		3.0	

^aSample from urine collection device.

UNCLASSIFIED

TABLE 7.2-II.- URINALYSIS - Concluded

(b) Pilot

Determination	Preflight		Inflight ^a	Postflight
	Date			
Date	July 9, 1966, 8:15 a.m.			
Calcium, mg/vol		40	60	
Phosphate, g/vol73	-	
17-OHCS, mgm/vol16	-	
Osmolality, mOs/kg		616	785	

^a Sample from urine collection device.

UNCLASSIFIED

TABLE 7.2-III.- LAUNCH DAY ACTIVITIES, JULY 18, 1966

Time, e.s.t.	Activity
10:00 a.m. (Pilot) 12:00 a.m. (Command pilot)	Crew awake
1:16 p.m.	Medical examination
1:30 p.m.	Brunch
2:45 p.m.	Begin suiting
2:56 p.m.	Begin suit purge
3:17 p.m.	Ingress
5:20:26 p.m.	Lift-off

UNCLASSIFIED

UNCLASSIFIED

7-61

THIS PAGE INTENTIONALLY LEFT BLANK

UNCLASSIFIED

UNCLASSIFIED

NASA-S-66-8045 AUG 4

--- Heart rate
— Blood pressure
▨ Pulse pressure

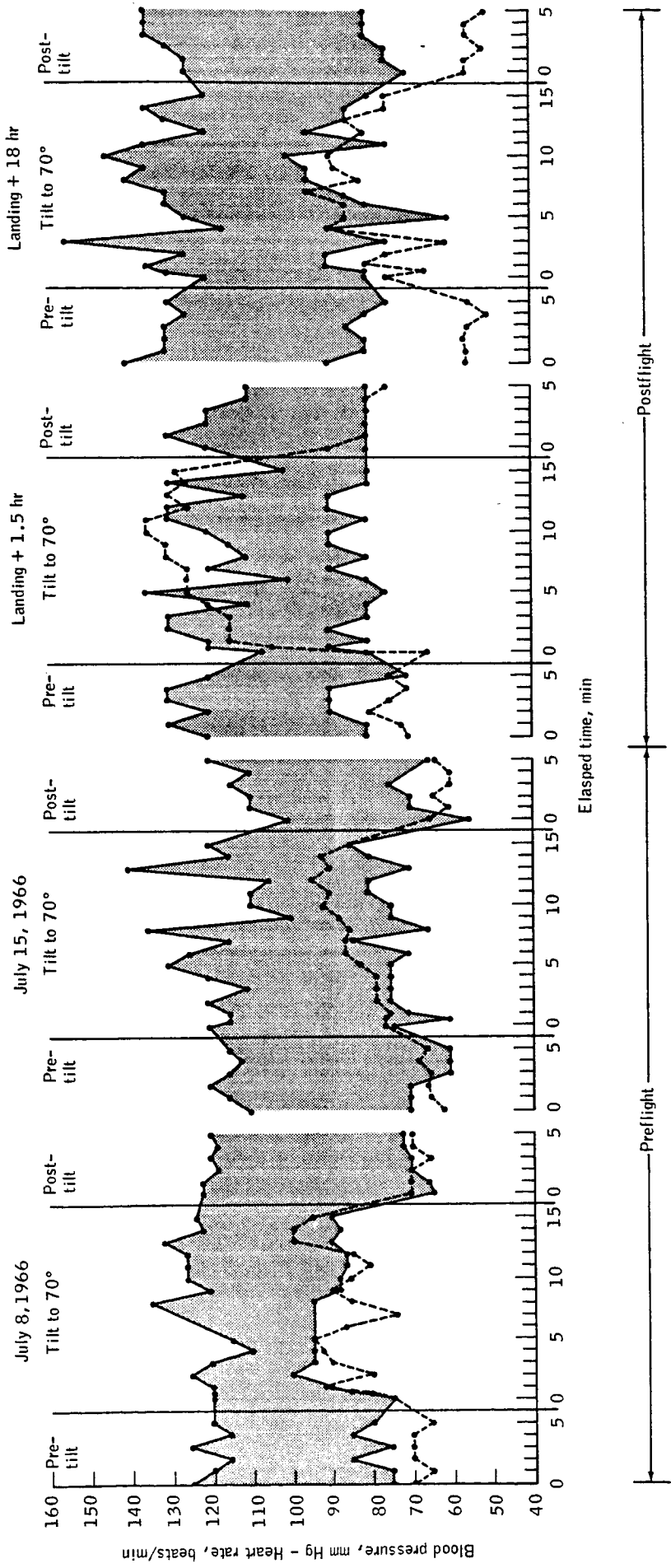

(a) Command pilot.
Figure 7.2-1. - Tilt table studies.

UNCLASSIFIED
Preceding page blank

NASA-S-66-8046 AUG 4

- - - Heart rate
 — Blood pressure
 ■ Pulse pressure

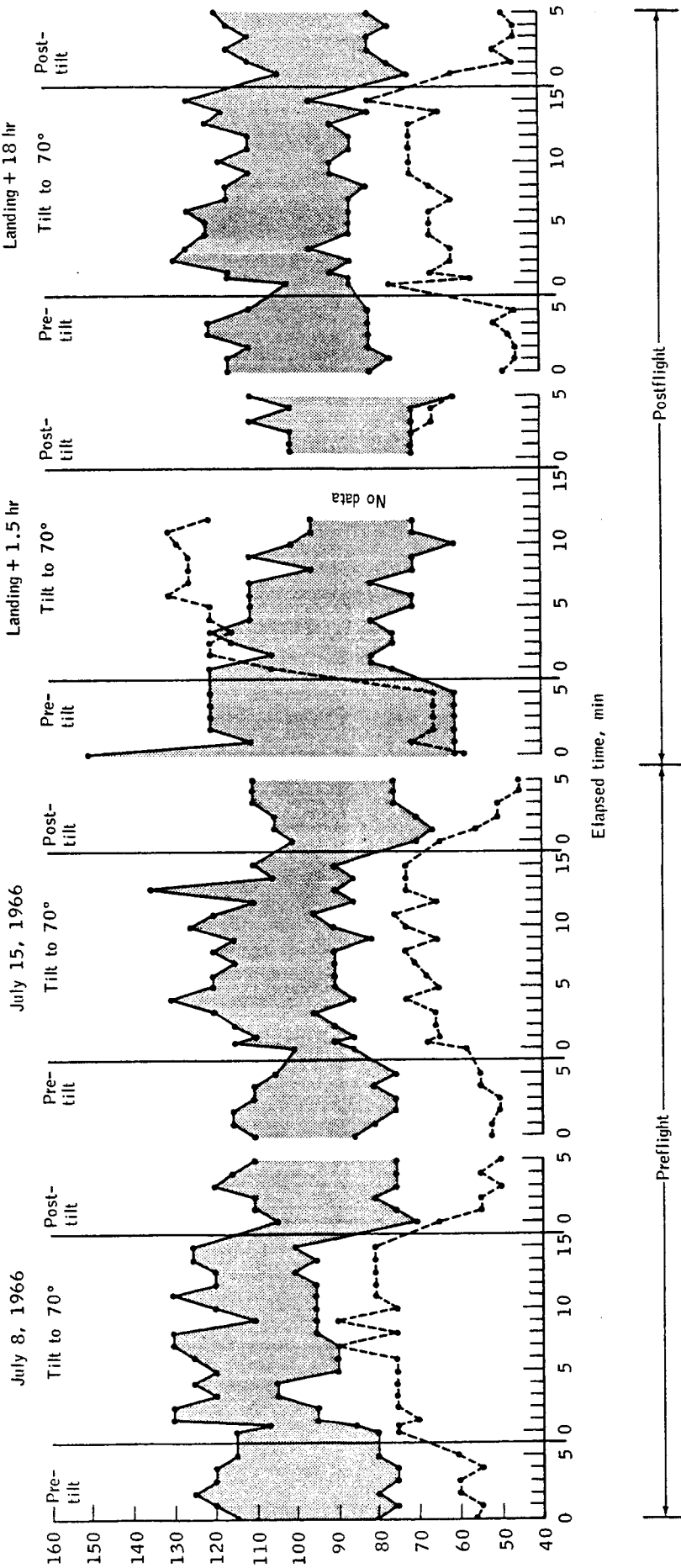

(b) Pilot, 7-63 c

Figure 7.2-1. - Concluded.

7-63-4r

7-63-a

NASA-S-66-8157 AUG 17

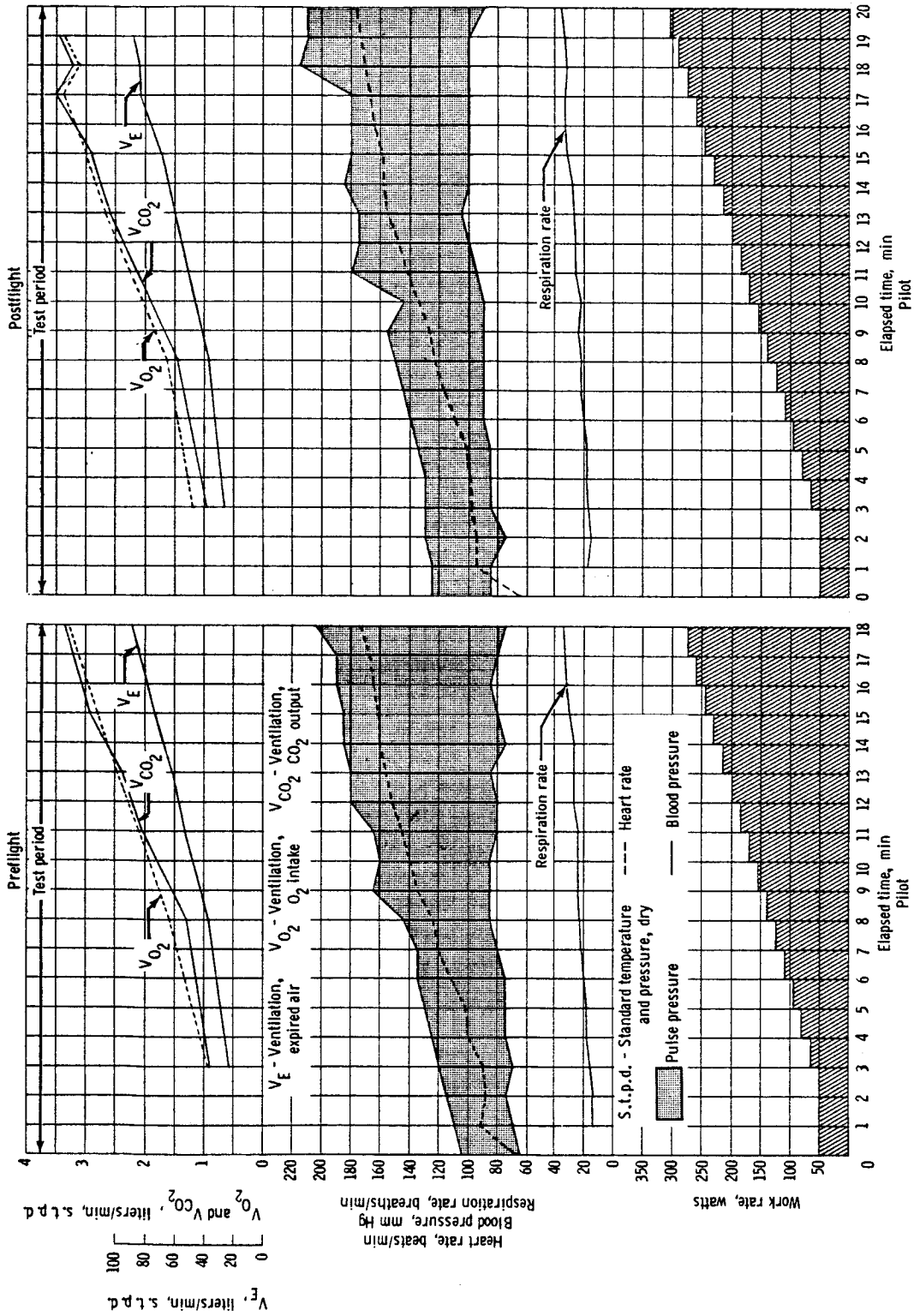

Figure 7.2-2. - Exercise-capacity test data.

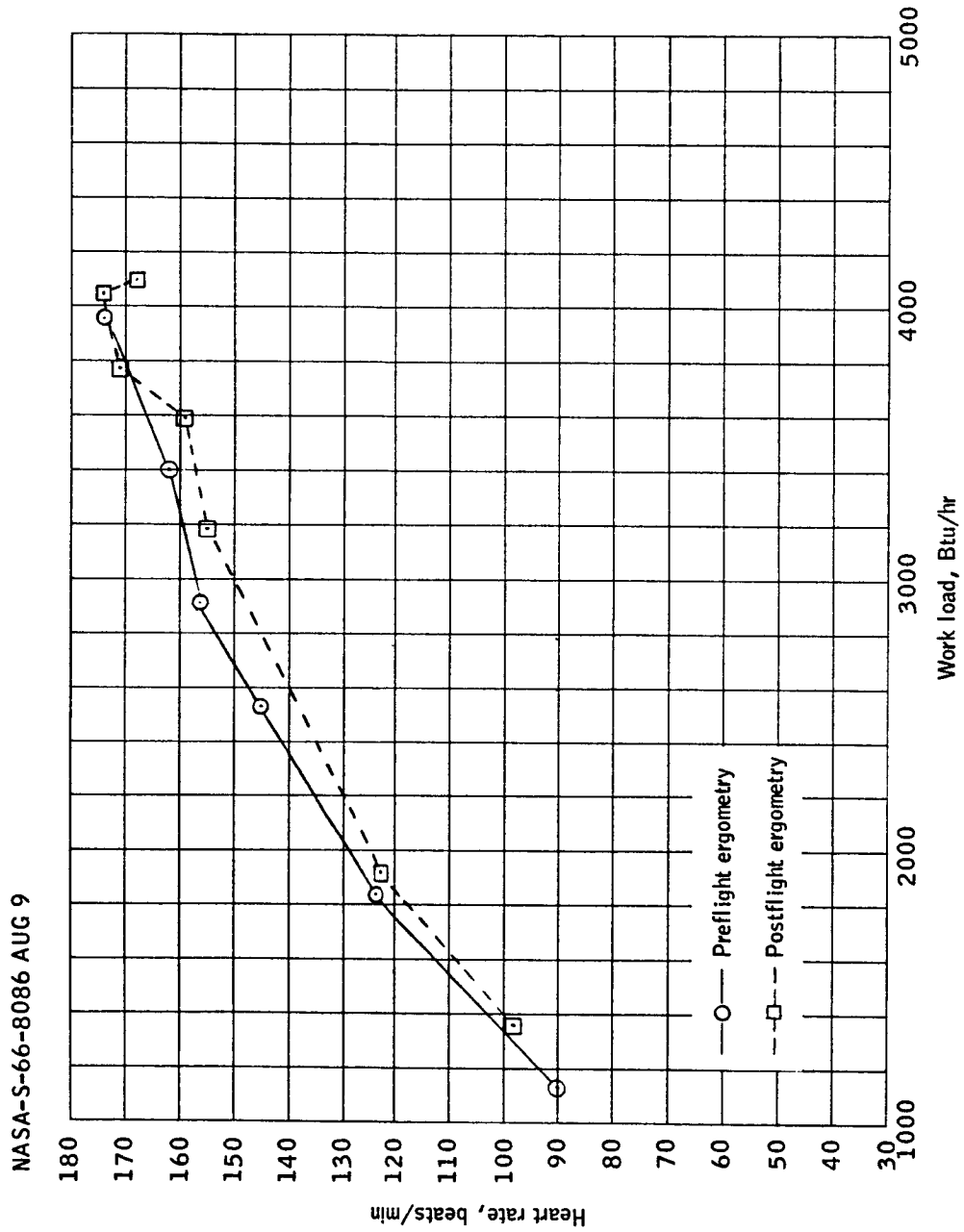
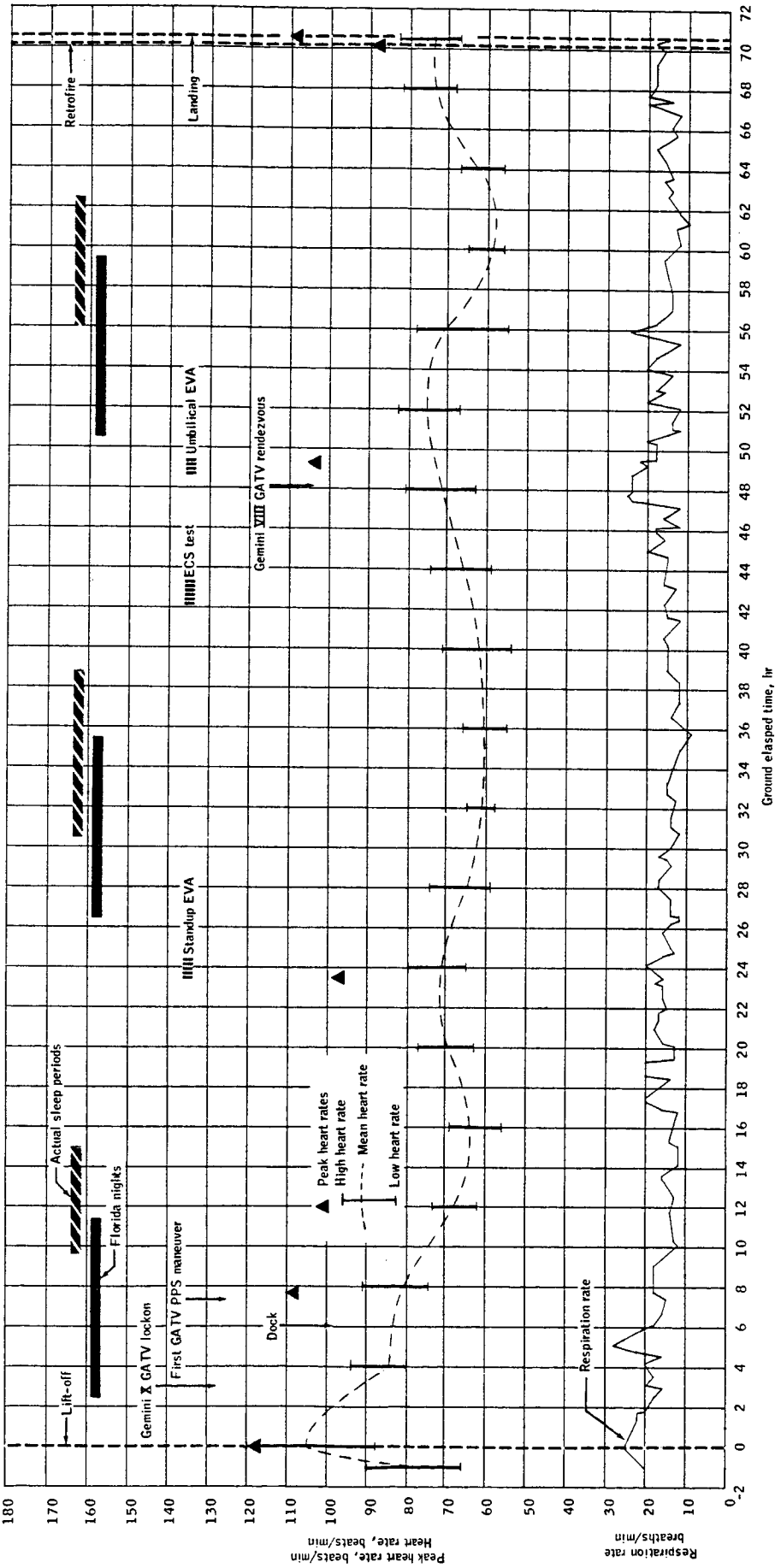

Figure 7.2-3. - Exercise studies on the Gemini X pilot.

UNCLASSIFIED

NASA-S-66-8113 AUG 13



(a) Command pilot
Figure 7.2-4.- Physiological measurements.

7-66-1A

7-66-6

UNCLASSIFIED

UNCLASSIFIED

7-67

NASA-5-66-8115 AUG 13

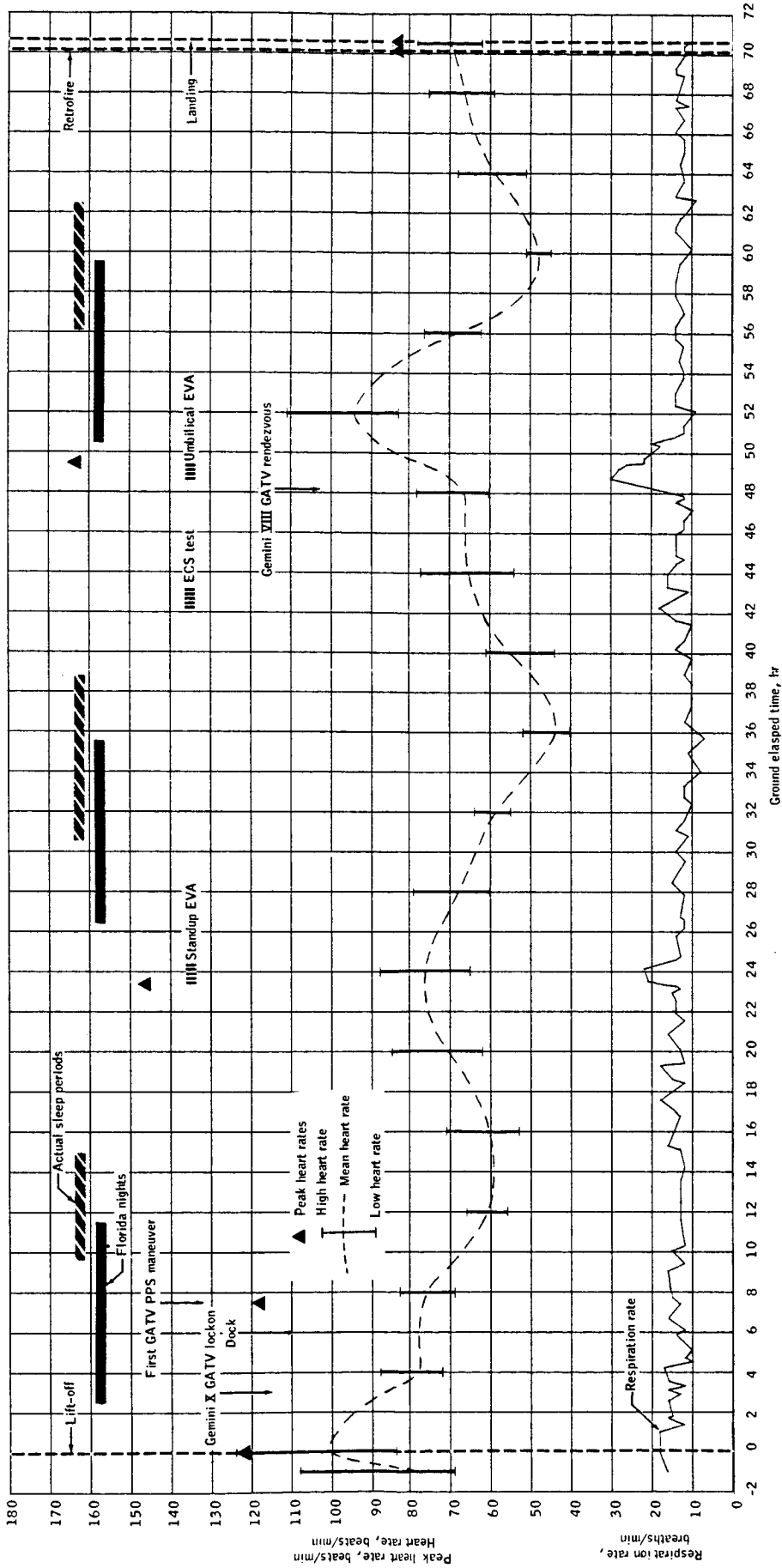

(b) Pilot
Figure 7.2-4. - Concluded. 7-67-6

7-67-6

UNCLASSIFIED

UNCLASSIFIED

7-68

NASA-5-66-8095 AUG 11

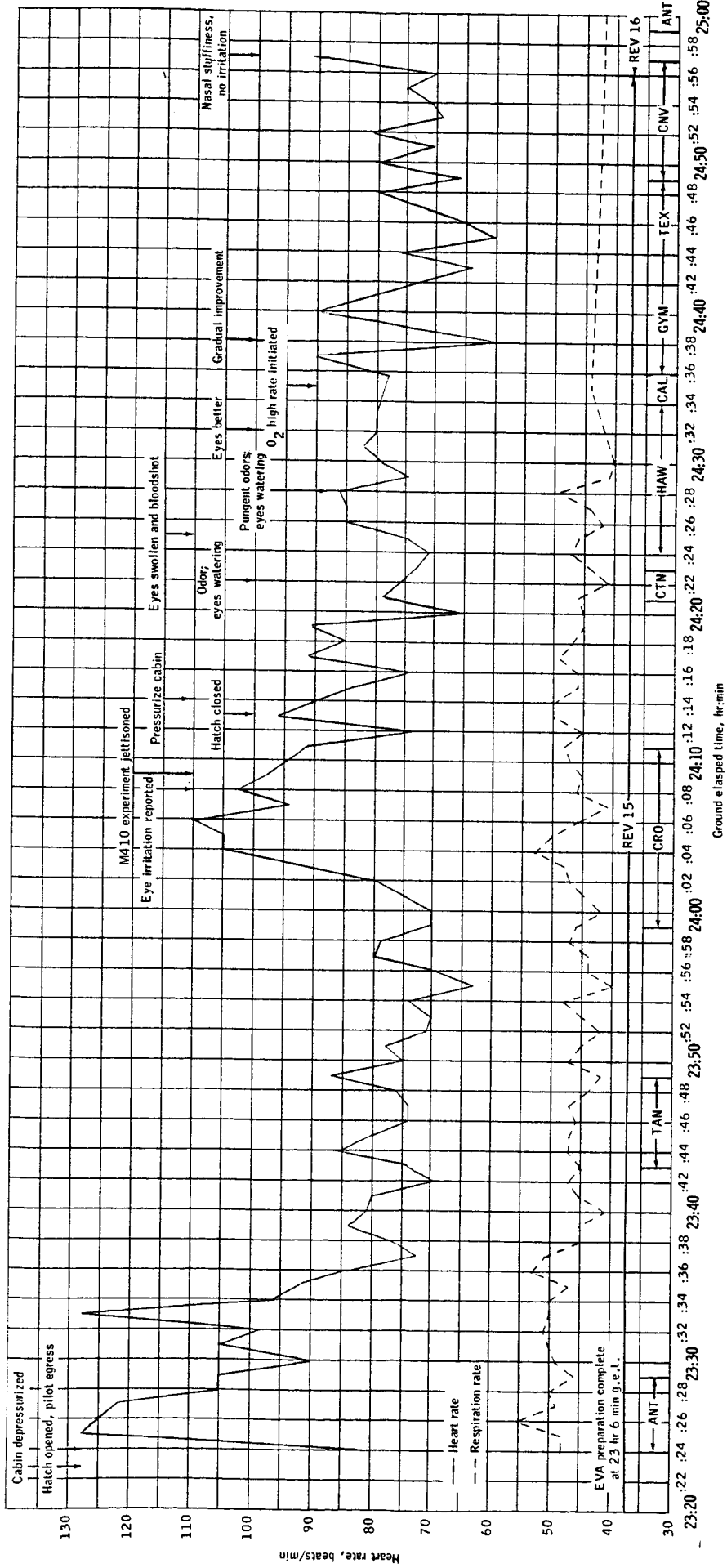

7-68-6-

Figure 7.2-5. - Physiological data during standup EVA, pilot.

UNCLASSIFIED

7-68-C

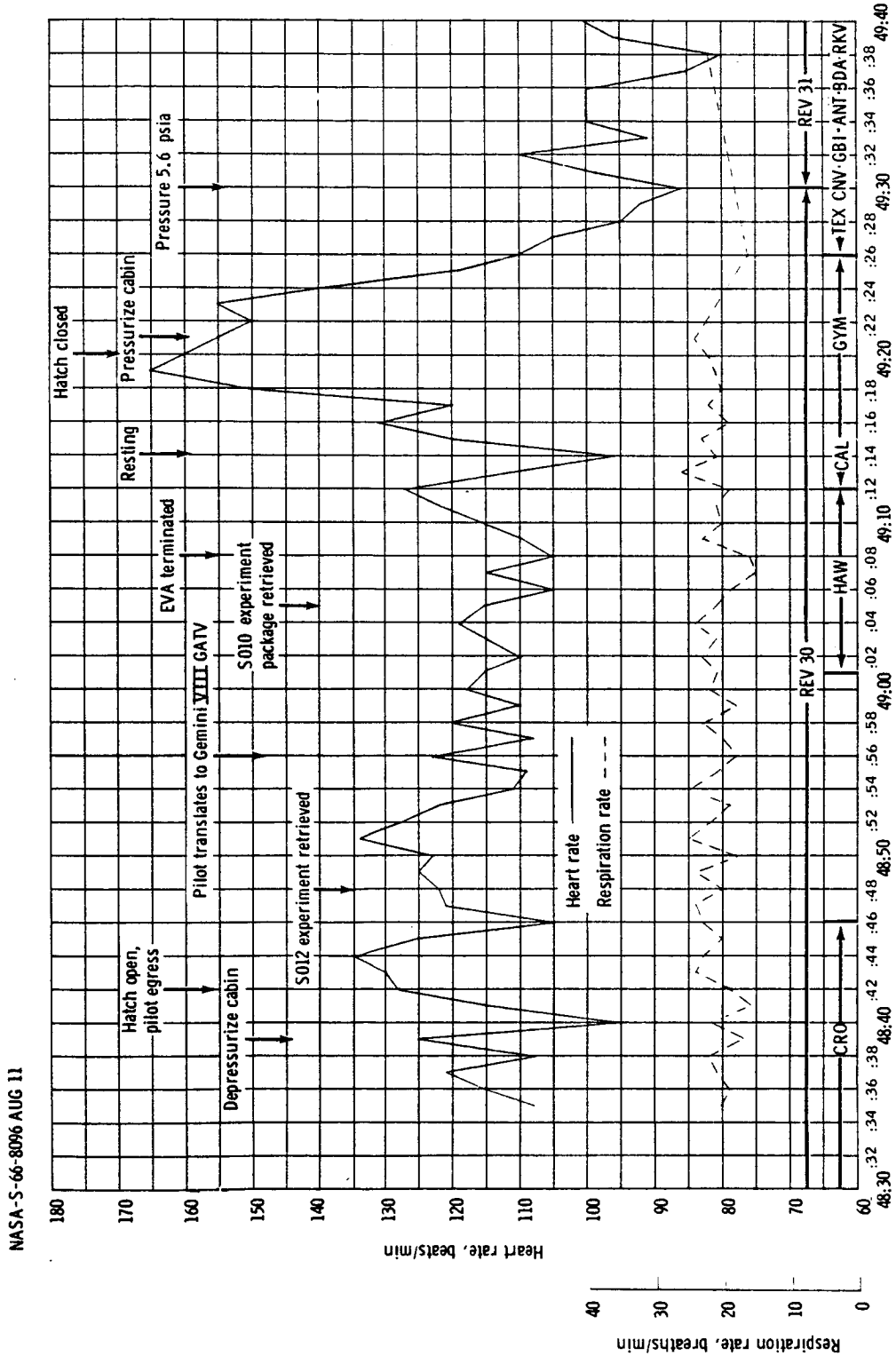

Figure 7.2-6. - Physiological data during umbilical EVA, pilot.

UNCLASSIFIED

THIS PAGE INTENTIONALLY LEFT BLANK

UNCLASSIFIED

8.0 EXPERIMENTS

Fifteen scientific or technological experiments were planned for the Gemini X mission, of which one was cancelled at the time of launch. Table 8.0-I is a list of the experiments in alphanumeric order showing the title, sponsoring agency, principal investigator, and qualitative success on this mission. The experiment inflight operations schedule was considerably changed from the preflight flight plan. The actual schedule of experiment activities shown in table 8.0-II was reconstructed from the onboard voice tapes, mission notes, crew flight logs, and scientific debriefing. The Lunar Ultraviolet Spectral Reflectance (M407) experiment was scheduled contingent upon the phase of the moon at the time of launch, and would have been performed only if the launch date had been postponed.

Preliminary analyses of data indicated that the basic objectives of 12 out of the 14 experiments were met. Each experiment scheduled for the Gemini X mission is described in the sections that follow. Success or failure of each experiment is so indicated. The experiment principal investigators have indicated only the quality of information obtained. Detailed analyses and evaluation of the data, particularly the photographic information, may require several months to reach definitive conclusions. Specific scientific or technological reports will be published as appropriate when these analyses are complete.

UNCLASSIFIED

TABLE 8.0-I.- EXPERIMENTS ON GEMINI X

Experiment number	Experiment title	Principal investigator	Sponsor	Data obtained	Completion of planned objectives
D005 (D-5)	Star Occultation Navigation	Air Force Avionics Laboratory, Wright Patterson AFB, Ohio	Department of the Air Force, Detachment 2, Space Systems Division (AFSC)	Two periods of useful data	Partial
D010 (D-10)	Ion-Sensing Attitude Control	Air Force Cambridge Research Laboratory, Hanscom AFB, Massachusetts	Department of the Air Force, Detachment 2, Space Systems Division (AFSC)	Five periods of useful data	Substantial
M405 (MSC-3)	Tri-Axis Magnetometer	NASA Manned Spacecraft Center, Space Sciences Division	NASA/MSC	Data available during all revolutions	Completed
M408 (MSC-6)	Beta Spectrometer	NASA Manned Spacecraft Center, Space Sciences Division	NASA/MSC	One period of useful data	Partial
M409 (MSC-7)	Bremsstrahlung Spectrometer	NASA Manned Spacecraft Center, Space Sciences Division	NASA/MSC	Data available during all revolutions	Completed
M410 (MSC-8)	Color Patch Photography	NASA Manned Spacecraft Center, Photographic Technology Laboratory	NASA/MSC	All photographic data available	Substantial

UNCLASSIFIED

TABLE 8.0-I.- EXPERIMENTS ON GEMINI X - Concluded

Experiment number	Experiment title	Principal investigator	Sponsor	Data obtained	Completion of planned activities
M412 (MSC-12)	Landmark Contrast Measurements	NASA Manned Spacecraft Center, Guidance and Control Division	NASA/MSC	No data obtained	Not attempted
S001 (S-1)	Zodiacal Light Photography	University of Minnesota, Institute of Technology, Minneapolis, Minnesota	NASA/OSSA	Fifteen frames of photographic data	Partial
S005 (S-5)	Synoptic Terrain Photography	NASA Goddard Spaceflight Center	NASA/OSSA	75 frames of photographic data	Partial
S006 (S-6)	Synoptic Weather Photography	U.S. Weather Bureau, National Weather Satellite Center	NASA/OSSA	260 frames of photographic data	Completed
S010 (S-10)	Agona Micrometeorite Collection	Dudley University, Albany, New York	NASA/OSSA	Four plates of data	Partial
S012 (S-12)	Micrometeorite Collection	Dudley University, Albany, New York	NASA/OSSA	Data package not recovered	Not completed
S013 (S-13)	Ultraviolet Astronomical Camera	Dearborn Observatory, Northwestern University	NASA/OSSA	Several frames of photo data	Substantial
S026 (S-26)	Ion-Wake Measurement	Electro-Optical Systems, Inc., Pasadena, California	NASA/OSSA	Several periods of useful data including one undocking maneuver	Partial

UNCLASSIFIED

TABLE 8.0-II.- FINAL EXPERIMENT FLIGHT PLAN FOR GEMINI X

Experiment title	Priority	Activation time, g.e.t., hr:min	Revolution	Condition	Remarks
D005 (D-5) Star Occultation Navigation	1	26:31 to 26:50	17	Mode-A from flight plan	1. Stars Alioth and Alkaid were acquired and tracked 2. Spacecraft was docked with GATV. Attitude was maintained using GATV attitude control system 3. Fifty pounds of GATV propellant gas used
		28:00	18	Mode-A	Cancelled by Flight Director at 27:40 g.e.t. due to excessive fuel requirements
		64:46 to 65:23	40	Modified mode-D	The computer function was to be deleted from mode-D if time prevented its use
D010 (D-10) Ion-Sensing Attitude Control	2	51:45	32	Mode-A	Mode-A is equipment extension and activation
		54:00 to 62:00	34 to 39	Mode-G (Random Data Accumulation)	All four temperature parameters stabilized to approximately 35° F during the mission
		64:05 to 64:40	40	Mode-E (Yaw Attitude Study)	Sensors were used for platform alignment. Good results were obtained
		65:25 to 65:55	40	Mode-E	
		65:55 to 66:10	41	Mode-C (Roll Attitude Study)	

UNCLASSIFIED

TABLE 8.0-II.- FINAL EXPERIMENT FLIGHT PLAN FOR GEMINI X - Continued

Experiment title	Priority	Activation time, g.e.t., hr:min	Revolution	Condition	Remarks
D010 (D-10) Ion-Sensing Attitude Control - continued	2	66:05 to 66:40	41	Mode-D (Pitch Attitude Study)	Mode-B (Ambient Data Accumulation) Mode-F (Photo Emission Effects) and Mode-H (Translation Thruster Effects) were not accomplished due to fuel constraints
M405 (MSC-3) Tri-Axis Magnetometer	10	00:20 to 70:10	All	Boom extended	1. Experiment was on at all times. Orbits of particular interest were those passing through the South Atlantic Anomaly region 2. Sensors performed satisfactorily throughout the mission
M407 (MSC-5) Lunar Ultraviolet Spectral Reflectance	13	--	-	Deleted	Experiment cancelled at launch in accordance with contingency plan
M408 (MSC-6) Beta Spectrometer	10	--	All	Free flight	1. Attitude control was desired but not provided due to a fuel constraint. Data for revolutions 32 and 33 showed good correlation with M405 data. Spacecraft was tumbling at this time. 2. Approximately 2 minutes of useful data were obtained
M409 (MSC-7) Bremsstrahlung Spectrometer	11	--	All	Sensors on during entire orbital flight	1. Data from revolutions 4, 16, 17, 18, 19, 20, 32, and 33 showed sensors functioned normally 2. Quick-look data showed useful results throughout mission

UNCLASSIFIED

TABLE 8.0-II.- FINAL EXPERIMENT FLIGHT PLAN FOR GEMINI X - Continued

Experiment title	Priority	Activation time, g.e.t., hr:min	Revolution	Condition	Remarks
M410 (MSC-8) Color Patch Photography	14	23:42	15	Photos taken during standup EVA	Three sunlight and one shadow exposures were taken
M412 (MSC-12) Landmark Contrast Measurements	12	--	-	--	Because of fuel limitation and time allocation, the experiment could not be accomplished
S001 (S-1) Zodiacal Light Photography	7	66:30	41	Attitude Control required during night passes	1. Several photos taken were underexposed 2. Quality of picture sharp- ness showed excellent attitude control hold
S005 (S-5) Synoptic Terrain Photography	8	Varied	28 29	Targets of opportunity	Approximately 10 straight-down 70-mm pictures taken. A total of 75 are useful
S006 (S-6) Synoptic Weather Photography	9	Varied	27 28 29	Targets of opportunity	1. The crew confirmed that weather photos were taken during stateside passes on revolutions 27, 28, and 29. An attempt was made to photo- graph Hurricane Celia located northeast of Bermuda 2. Approximately 260 pictures were taken
S010 (S-10) Agena Micro- meteorite Collection	6	Gemini VIII GATV launch to 49:06	30	Closed position only; 4-month operating period	1. The crew retrieved S010 from Gemini VIII GATV during umbilical EVA 2. The EVA pilot did not place additional hardware on the GATV due to lack of handrails and possible umbilical entanglement

UNCLASSIFIED

TABLE 8.0-II.- FINAL EXPERIMENT FLIGHT PLAN FOR GEMINI X - Concluded

Experiment title	Priority	Activation time, g.e.t., hr:min	Revolution	Condition	Remarks
S012 (S-12) Micrometeorite Collection	5	9:00 to 17:00 Retrieved at 48:50	6 to 11 30	Opened during first crew sleep period Umbilical EVA	1. The crew reported locking of the S012 collector door at 29:06 g.e.t. 2. The crew stated retrieval was accomplished just prior to umbilical EVA and prior to M410 operation 3. The crew indicated at 64:15 g.e.t. the S012 hardware could not be located in the spacecraft. They surmised the experiment hardware floated through the open hatch during umbilical EVA
S013 (S-13) Ultraviolet Astronomical Camera	4	23:28 to 24:00	15	Standup EVA	1. 18 exposures were reported taken of the β Crucis star field 2. 24 stars have usable spectra 3. 22 additional stars show usable energy density
S026 (S-26) Ion-Wake Measurement	3	44:40	29	Mode-A (Linear Mapping)	Undocking was accomplished over Cape Kennedy. S026 was per- formed over Canary Islands. Real-time data showed wake activity at approximately 100 feet

UNCLASSIFIED

8.1 EXPERIMENT D005 (D-5), STAR OCCULTATION NAVIGATION

8.1.1 Objectives

The objectives of this experiment were to determine the usefulness of star occultation measurements for space navigation and to establish a density profile for updating atmospheric models for horizon-based measurement systems.

8.1.2 Equipment

The star occultation photometer is a single-unit, dual-mode, hand-held externally powered instrument for electronically determining the extent to which the sight line to a selected star penetrates a planetary atmosphere. It also measures the contrast of a sun-illuminated ground target. Data from the instrument, when calibrated and plotted against time, provide the attenuation curve of a star passing through the earth's atmosphere relative to an unattenuated intensity. General characteristics of the instrument are as follows:

Size, in.	5 by 5 by 3
Weight, lb.	2.5
Volume, cu. in.	30
Magnification	× 6.0

The star occultation photometer optical system is a dual-path type, separated on a wavelength basis by a dichroic reflector. One path carries the short-wavelength star spectrum (0.4 to 0.5 micron) to the photomultiplier cathode; the remainder of the star light continues into the operator's eye. The electronic system consists of a photomultiplier detector, preamplifier, active bandpass-filter amplifier, and postfilter amplifier-demodulator in the carrier signal section. A unijunction oscillator and flip-flop are used to generate two-phase, 100 cps power for the size-5 hysteresis-synchronous modulator motor. Input power to the motor is regulated. Additional voltage supplies provide an isolated low voltage to the signal circuitry and high voltage to the photomultiplier. The output of the low-pass filter is conducted to the input of the Schmitt trigger level detector biased at approximately one volt. Depressing the calibrate pushbutton inserts a nominal 5-to-1 attenuator in both day and night signal paths, lowering the full signal amplitude from 5 volts to 1 volt for calibration. The photometer is readied for

use by plugging in one cable for power and one for high-level telemetry and by placing the mode switch to NIGHT. The photometer is shown in figure 8.1-1.

The Gemini X photometer was an instrument which had been refurbished and recalibrated after its inflight failure during the Gemini VII mission. The failure was caused by loose particles in the photomultiplier tube. A stringent quality control program designed to identify and count all loose particles was instituted in preparation for the Gemini X flight. Each photomultiplier tube considered for use was examined under a microscope, and all particles were sized to assure that the aggregate was not larger than the smallest element spacing in the photomultiplier tube. Since the equipment worked as designed on the Gemini X mission, these quality control measures apparently had the desired effect.

8.1.3 Procedures

Knowledge of the time of occultation of a known star by a celestial body, as seen by an orbiting observer, determines a cylinder of position whose axis is the line through the star and the body center and whose radius is equal to the occulting body radius. The times of six occultations provide information to uniquely determine all orbital parameters of the body. Determination of these times of occultation from the earth is difficult due to atmospheric attenuation of the star light. The star does not arbitrarily disappear but dims gradually into the horizon. Measurement of the percentage of dimming with respect to the altitude of this grazing ray from the star to the observer provides a percentage altitude for occultation. In other words, a star can be assumed to be occulted when it reaches a predetermined percentage of its unattenuated value.

The experiment procedures provide the means of measuring this attenuation with respect to time to determine the usefulness of the measurements for autonomous space navigation. In addition, the measurements provide a density profile of the atmosphere to update the atmospheric model for use in star occultation navigation as well as other forms of horizon-based navigation and orbit prediction.

Star occultation measurements are made by identifying, acquiring, and tracking a selected star in the 1/2-degree reticle of the 10-degree field of view of the photometer. The light intensity of the star is normalized to the 5-volt telemetry output by depressing a calibrate button and adjusting the gain to drive the reticle light to an alternating red-green condition. Thus normalized, the button is released and the star is tracked as it disappears into the horizon. The star

UNCLASSIFIED

intensity is measured, recorded, and time-correlated on the onboard telemetry tape for postflight analysis. On any night pass, four to six stars are acquired, calibrated, and tracked to occultation, and the star and approximate time of occultation are recorded in the flight log for postflight correlation with tape-recorded data and ground-track information. Timing marks are recorded on the telemetry (using the calibrate button) on some runs to identify special selected observations such as time of star passage through the top of the airglow. Postflight data reduction and analysis include the following:

- (a) Occultation measurements are inserted into the navigation equations to determine orbital parameters. Results are then compared with ephemeris data to determine the accuracy of the calculations.
- (b) Ground track position data are used to determine the altitude of the grazing rays with respect to atmospheric attenuation to provide an atmospheric density profile.
- (c) The newly determined atmospheric model is used to recompute navigation parameters from the star occultation measurements. These are compared with ephemeris data and the previous navigation measurements to evaluate the degree of improvement.

A mode-D procedure was established shortly before printing of the Gemini X final flight plan. This mode required the use of the spacecraft computer and photometer data for real-time orbit navigation determination. Ground analysis will compare this solution with ground-track data to determine how well the orbit was established by the onboard technique.

8.1.4 Results

The photometer was used twice during the mission. It was used the first time at 26 hours 30 minutes ground elapsed time (g.e.t.), while the spacecraft was docked with the Gemini Agena Target Vehicle (GATV), and the second time at 64 hours 46 minutes g.e.t. after the spacecraft and GATV had separated.

During the first attempt to perform the experiment in mode-A (calibration), difficulty was encountered in vehicle-attitude control because of the docked configuration. Five stars were tracked to total occultation. As the stars passed through the green glow layer, they disappeared momentarily. When acquisition was lost, the pilot discontinued sighting through the photometer until the stars reappeared below the green glow, and then he resumed tracking the stars through the photometer until they disappeared into the lower, dark horizon.

UNCLASSIFIED

Excessive attitude control gas expenditure during this procedure led to cancellation of further runs until after undocking.

The second experiment run was a mode-D sequence using the undocked configuration. No difficulties were encountered on this run with regard to the acquisition and tracking of seven stars to occultation; however, procedural difficulties were encountered in entering the visual occultation data into the computer. Computation of an orbit solution was precluded because of improper entry of the right ascension and declination of the last star, and computer workload problems encountered after the measurement taken on the fourth star.

A calibration check on three stars in Cygnus was not properly accomplished on either run. An attempt was made to calibrate on each star independently rather than to retain one gain setting. This does not affect the use of the occultation technique for navigation but was included to aid in data analysis and reduction.

Visual occultations through the photometer reported by the pilot were somewhat different from those reported by the command pilot. The command pilot could still observe some stars visually after the pilot had reported their disappearance. The phenomenon was probably caused by the selective reflection within the instrument which is designed to allow maximum blue light to fall on the photomultiplier tube.

8.1.5 Conclusions

The experiment equipment appeared to function nominally, indicating that the stringent quality control procedures effected after the failure of the photomultiplier tube on a previous mission were justified. The compact design of the equipment allowed the equipment to exhibit its versatility when used during the docked configuration. The possibility of using the photometer, suitably modified to provide direct inputs into the spacecraft computer, for onboard orbit determination was verified.

UNCLASSIFIED

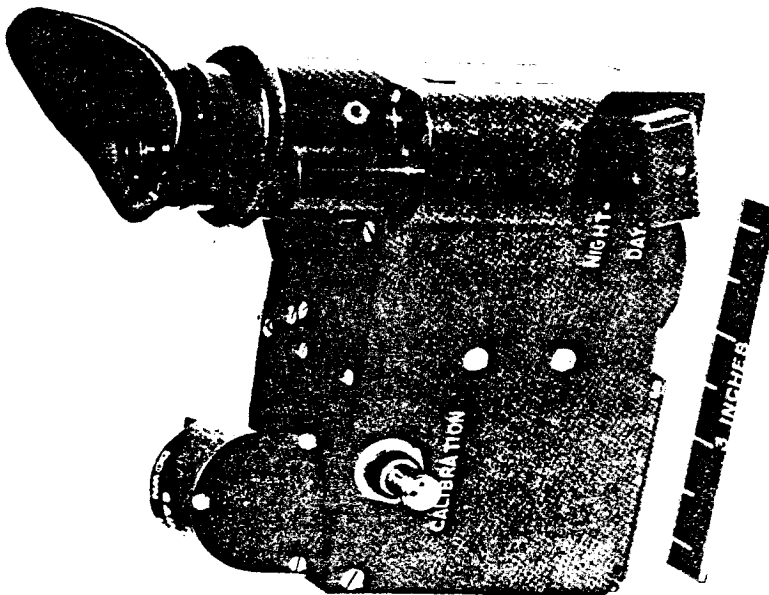
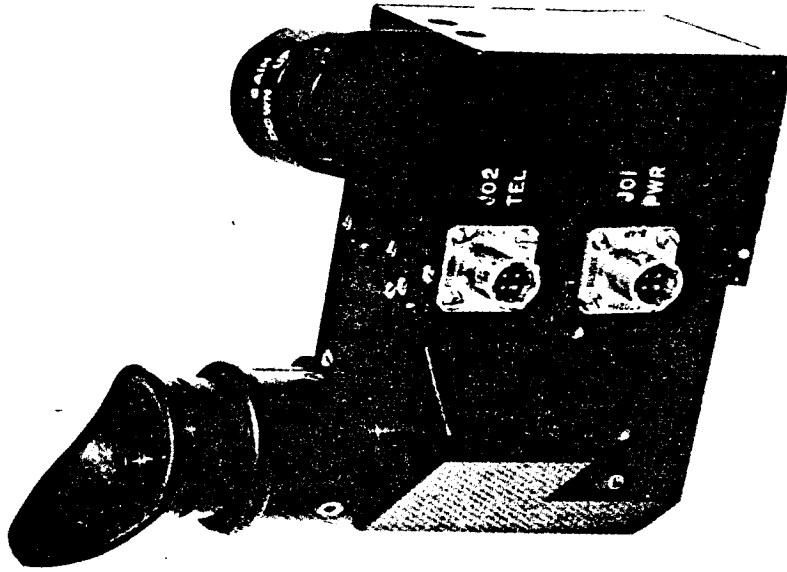

UNCLASSIFIED

Figure 8.1-1. - Experiment D005, star occultation photometer.

NASA-S-66-8112 AUG 12

8.2 EXPERIMENT D010 (D-10), ION-SENSING ATTITUDE CONTROL

8.2.1 Objectives

The principal objective of the Ion-Sensing Attitude Control experiment was to investigate the feasibility of an attitude control system using environmental positive ions and an electrostatic detection system to measure spacecraft pitch and yaw. A secondary objective was to measure the spatial and temporal variations of ambient positively-charged particles along the orbital path of the Gemini spacecraft.

8.2.2 Equipment

The onboard spacecraft equipment consisted to two independent systems for the measurement of pitch and yaw attitudes. Dimensionally and electrically, each system was identical, except for placement of the sensor about the pitch and yaw axis. Each sensor configuration was mounted on a boom approximately three feet in length. The boom was extended by crew command after spacecraft orbital insertion. The locations of the booms and sensors are shown in figure 8.2-1. The sensor locations and boom lengths used were selected to minimize vehicle shadowing and space charge effects.

To illustrate the principle of operation of the sensor systems, the measurement of pitch is analyzed. Except for the alignment change, the analysis of the yaw measurement is identical. By aligning two sensors along the pitch axis as shown in figure 8.2-2, the current to the collector of each sensor is given by

$$i_1 = N e v a A \cos (45 - \theta) \quad (1)$$

where i_1 is the current to sensor 1, and by

$$i_2 = N e v a A \cos (45 + \theta) \quad (2)$$

where i_2 is the current to sensor 2, and when

N = ambient positive ion density

e = electron charge

v = spacecraft velocity

UNCLASSIFIED

a = experimentally determined grid transmission factor

A = aperture area of sensors 1 and 2 (identical)

θ = pitch-angle deviation from 0 degree.

Solving equations 1 and 2 for θ ,

$$\tan \theta = \frac{i_1 - i_2}{i_1 + i_2}$$

For θ less than or equal to 20 degrees, $\tan \theta$ is approximately equal to θ , in radians. The output of the sensors may, therefore, be displayed on a meter calibrated in degrees.

A block diagram for the pitch or yaw system is shown in figure 8.2-3. The output of each sensor is amplified by two electrometer amplifiers. To obtain desired accuracy over the current range of 10^{-6} to 10^{-10} amperes, linear amplifiers with range switching are employed. The outputs of the electrometers, designated V_1 and V_2 , are then electronically added, subtracted, integrated, and compared. The final output, $\tan \theta$, referred to as the compared output, is indicated on a meter in the crew station and transmitted by telemetry to the ground stations. To fully evaluate the experiment, the direct outputs of the electrometers, the range analog indication, and the calibrate monitor signal are also transmitted by the spacecraft telemetry. These outputs would not be required in an operational attitude control system. The experiment was designed for precise pitch and yaw angular measurements over the range of ± 20 degrees; however, there is no basic limitation to the magnitude of the angle which can be measured.

Sensor system characteristics are as follows for each of the two systems:

Weight (including electronics and sensors), lb	7
Power (at 28 V), watts	3.5
Electronics response time, milliseconds	<1

UNCLASSIFIED

Dimensions, in. 11 by 6.5 by 6
Angular measurement range, deg ±20

8.2.3 Procedures

Seven principal modes of operation were requested for the Gemini X mission and four were accomplished. These were as follows:

(a) Mode-C, Roll Attitude Study: This procedure consisted of rolling the spacecraft through 720 degrees at a rate of approximately three deg/sec while holding the spacecraft pitch and yaw constant at zero.

(b) Mode-D, Pitch Attitude Study: This procedure consisted of maintaining a fixed yaw and roll attitude, then varying the pitch angle through a specified angular range at a rate of approximately 0.1 deg/sec. This rate was specified to ensure good comparison of the experiment results with the Inertial Guidance System. The rate of 0.1 deg/sec was determined by the telemetry bandwidth available for the experiment.

(c) Mode-E, Yaw Attitude Study: This procedure consisted of maintaining a fixed pitch and roll position, then varying the yaw angle through a specified angular range at the rate of approximately 0.1 deg/sec.

(d) Mode-G, Random Data Accumulation: The ion-sensor switch was left on in this mode while the spacecraft was in drifting flight.

The other three modes of operation consisted of mode-B, ambient ion accumulation under controlled spacecraft conditions, mode-F, the study of photo-emission effects on the sensor, and mode-H, the study of translation-thruster effects. These were not accomplished because of the real-time constraint placed on use of spacecraft propellants.

8.2.4 Results

A quick look at the experiment signals on real-time telemetry records shortly after power was turned on indicated that all parameters were within the ranges expected. Because of the volume of data required from postflight reduction, final data were not scheduled for delivery prior to the publication of this report.

UNCLASSIFIED

Discussions with the flight crew at the experiment debriefing provided information on the flight operation of the experiment. These discussions resulted in the following conclusions:

(a) In both mode-D and mode-E, the crew were able to compare the two flight-direction meters. One meter showed the output of the Inertial Guidance System and one showed the experiment sensor output of pitch plus yaw. The results showed that the experiment sensors agreed very well with the spacecraft Flight Director Indicator.

(b) The response of the experiment sensors to variations in pitch and yaw was extremely rapid.

(c) When the spacecraft thrusters were firing, the experiment sensor indications went off-scale due to the varying charge on the vehicle and/or the contamination in the immediate vicinity of the spacecraft. Readings returned to normal rapidly after the thrusters ceased firing.

(d) The experiment operated for approximately 12 hours—2 hours 15 minutes in mode-A, 8 hours in mode-G, approximately 1 hour in mode-E, 35 minutes in mode-D, and 15 minutes in mode-C.

Because only preliminary data were available for analysis prior to submission of this report, the only conclusion at this time is that the experiment appeared to be working satisfactorily. Detailed results will not be available until all final data is received and the analysis completed.

UNCLASSIFIED

NASA-S-66-8105 AUG 12

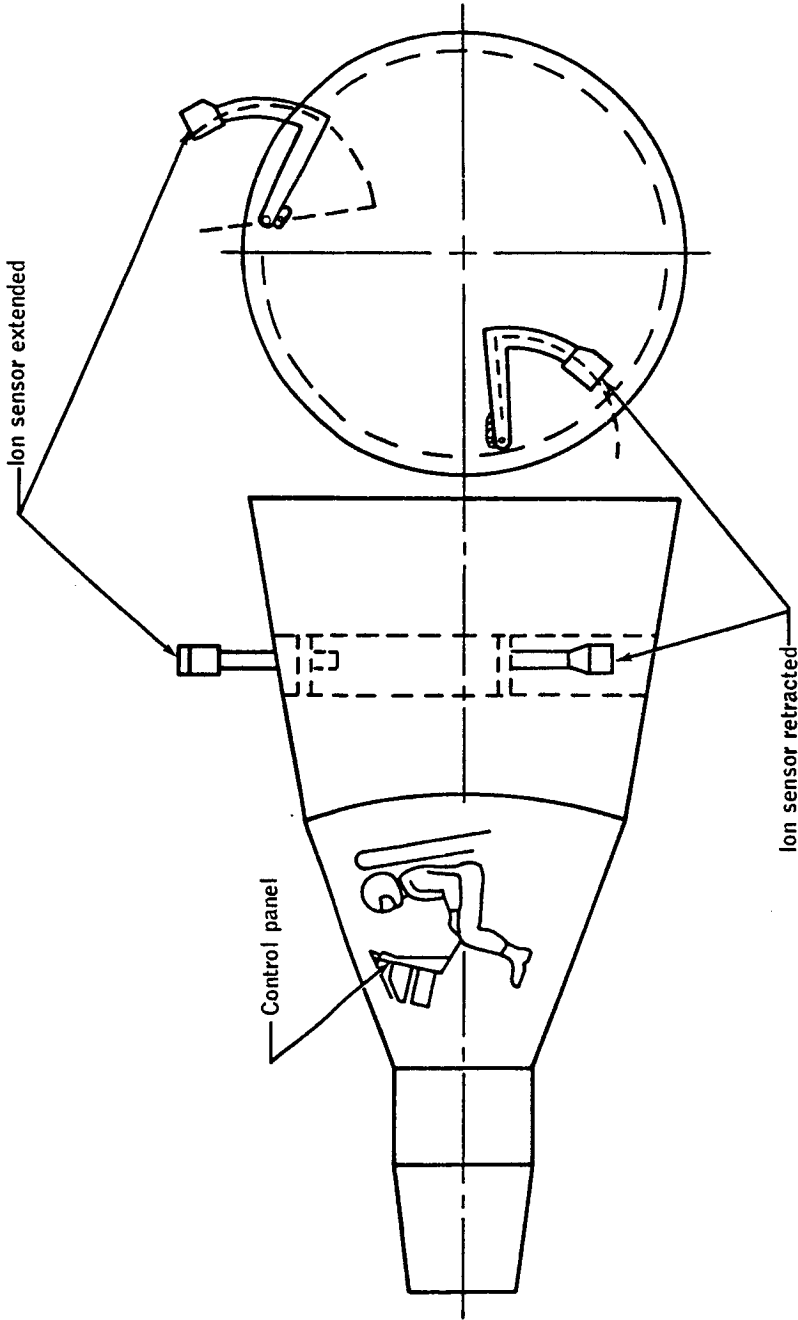
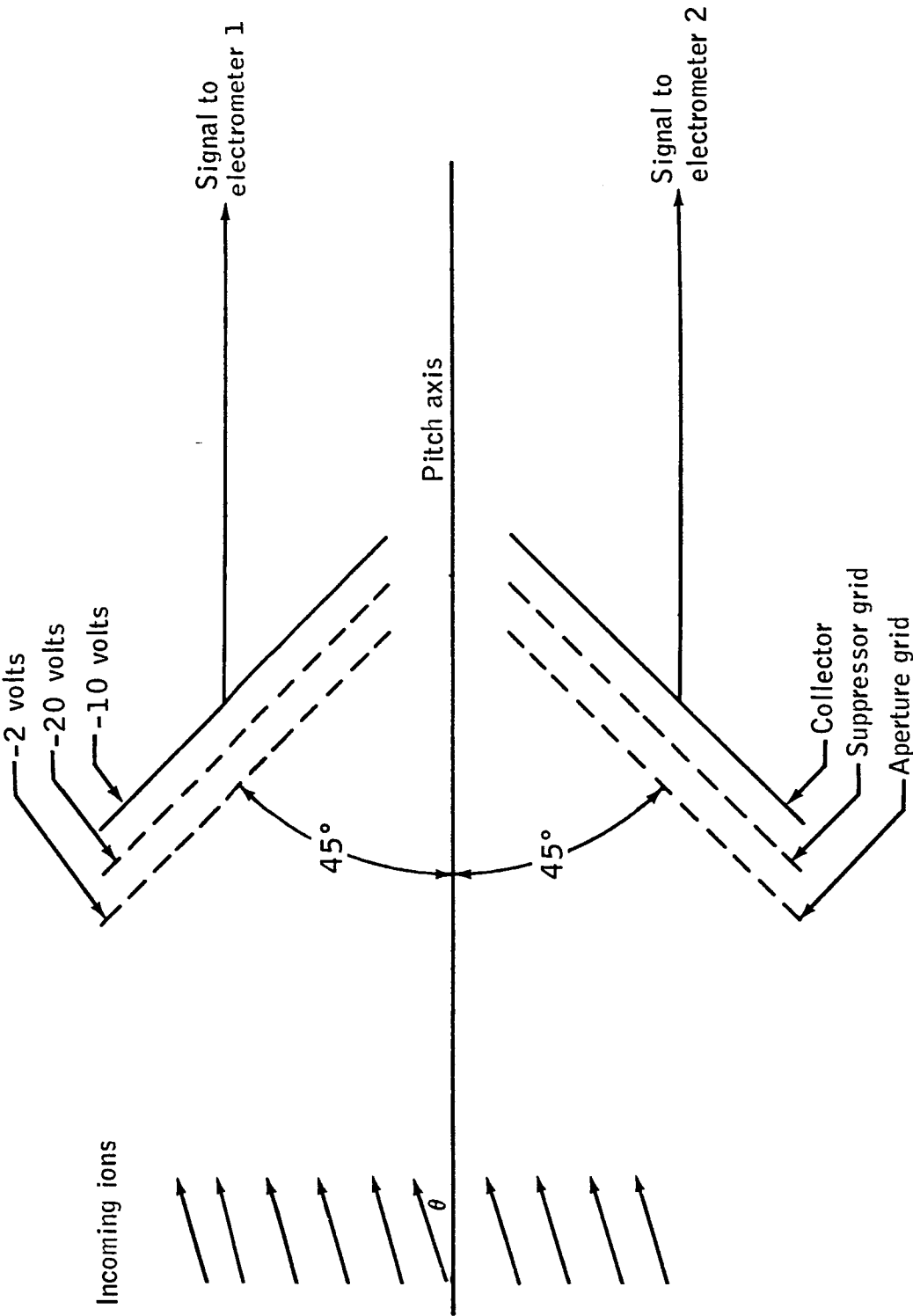

Figure 8.2-1. - Experiment D010, location of equipment.

UNCLASSIFIED

NASA-S-66-8102 AUG 12



UNCLASSIFIED

Figure 8.2-2. - Experiment D010, ion-sensing configuration.

NASA-S-66-8138 AUG 15

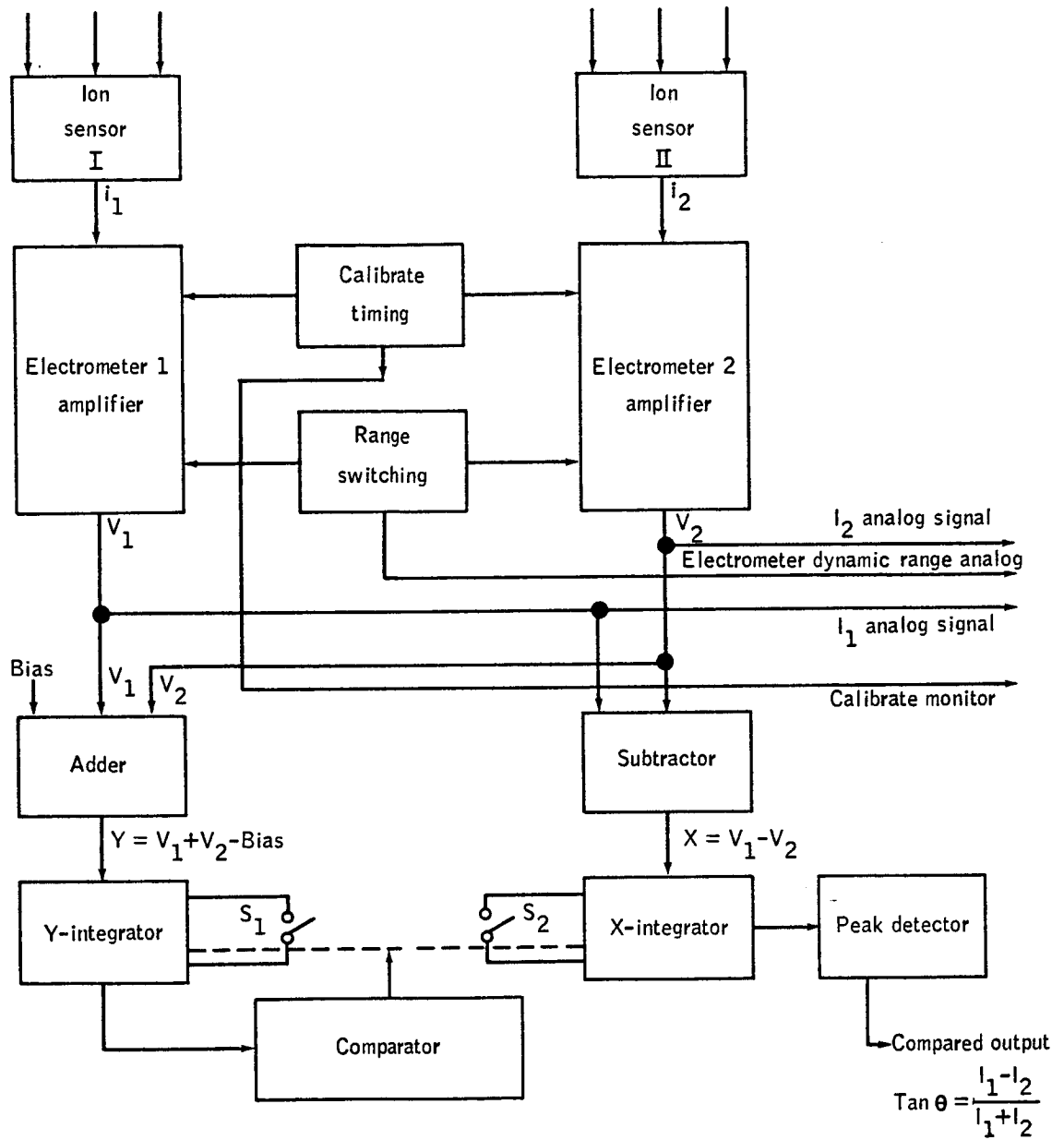

Note: $i_{1,2}$ = Ion sensor current signals

$V_{1,2}$ = Ion sensor voltage signals

Figure 8.2-3. - Experiment D010, ion-sensing attitude control electronics system.

UNCLASSIFIED

8.3 EXPERIMENT M405 (MSC-3), TRI-AXIS MAGNETOMETER

8.3.1 Objective

The objective of this experiment was to determine the magnitude and direction of the earth's geomagnetic field in the South Atlantic Anomaly regions to support Experiment M408, Beta Spectrometer.

8.3.2 Equipment

The tri-axis magnetometer was of the fluxgate type. It consisted of a sensor unit, an electronics unit, and an interconnecting cable which served as an electrical connection between the electronics and sensor units. The electronics unit contained a converter which supplied the necessary sensor drive currents, detected and transformed the magnetic field sensor signals, and converted them to a 0-5 analog dc voltage. The electronics unit was hard-mounted to the adapter retrograde section and electrically connected to the spacecraft instrument panel. The sensor and interconnecting cable were mounted to the end of a telescopic boom which was extended approximately 40 inches from the side of the adapter retrograde section.

The magnetometer had three sensor probes mounted orthogonally to measure vector components H_x , H_y , and H_z of the magnetic field. By measuring the vector components, the direction and total field could be calculated from the following equations:

$$H_t = \sqrt{H_x^2 + H_y^2 + H_z^2}$$

$$\theta_x = \cos^{-1}\left(\frac{H_x}{H_t}\right), \quad \theta_y = \cos^{-1}\left(\frac{H_y}{H_t}\right), \quad \theta_z = \cos^{-1}\left(\frac{H_z}{H_t}\right)$$

H_t is the total field; H_x , H_y , and H_z are vector components of the field; and θ_x , θ_y , and θ_z are the component angles measured from their respective axes. If the location of the sensor unit with respect to the spacecraft is known, the direction of the field with respect to the spacecraft can be calculated.

UNCLASSIFIED

The tri-axis magnetometer supported a beta spectrometer designed to measure charged particles trapped in a magnetic field. The beta spectrometer detectors had a directional response; and therefore, needed information showing their orientation with respect to magnetic lines of force.

8.3.3 Procedures

The equipment was turned on with a console toggle switch by the flight crew at spacecraft orbital insertion. It was turned off just prior to retrofire. These were the only operational requirements necessary for the experiment.

The magnetometer and the beta spectrometer were scheduled to operate for at least ten revolutions while the spacecraft passed over the region bounded approximately by 30 degrees east longitude and 60 degrees west longitude, and by 15 degrees and 55 degrees south latitude. In addition, the equipment was to be operated for a period of at least 15 minutes while the spacecraft was not within this region.

8.3.4 Results

Data obtained from the experiment hardware while passing through the South Atlantic Anomaly was dumped by telemetry at the Hawaii tracking station for on-site evaluation in support of the Beta Spectrometer (M408) experiment requirements. The data indicated the equipment functioned as designed and provided information throughout the mission.

An example of data obtained through an anomaly pass is presented in figure 8.3-1. For a typical pass, these data illustrate values of the total magnetic field vector and the angle made with respect to the center line of the spectrometer detector. The figure shows the total field vector, expressed in thousands of gammas, and the angle alpha, in degrees, for a ground elapsed time from 51 hours 20 minutes to 51 hours 30 minutes. The total field vector between 20 100 gammas and 23 800 gammas for this pass agrees with the theoretical calculated total field calculated by Jensen and Cain. The wide variation in angle can be explained by a tumbling motion of the spacecraft or its random attitude during this time period. The data shown in the figure were measured during a sleep period of the Gemini X flight crew. Additional analysis is continuing as computer-determined computations become available.

UNCLASSIFIED

NASA-S-66-8106 AUG 12

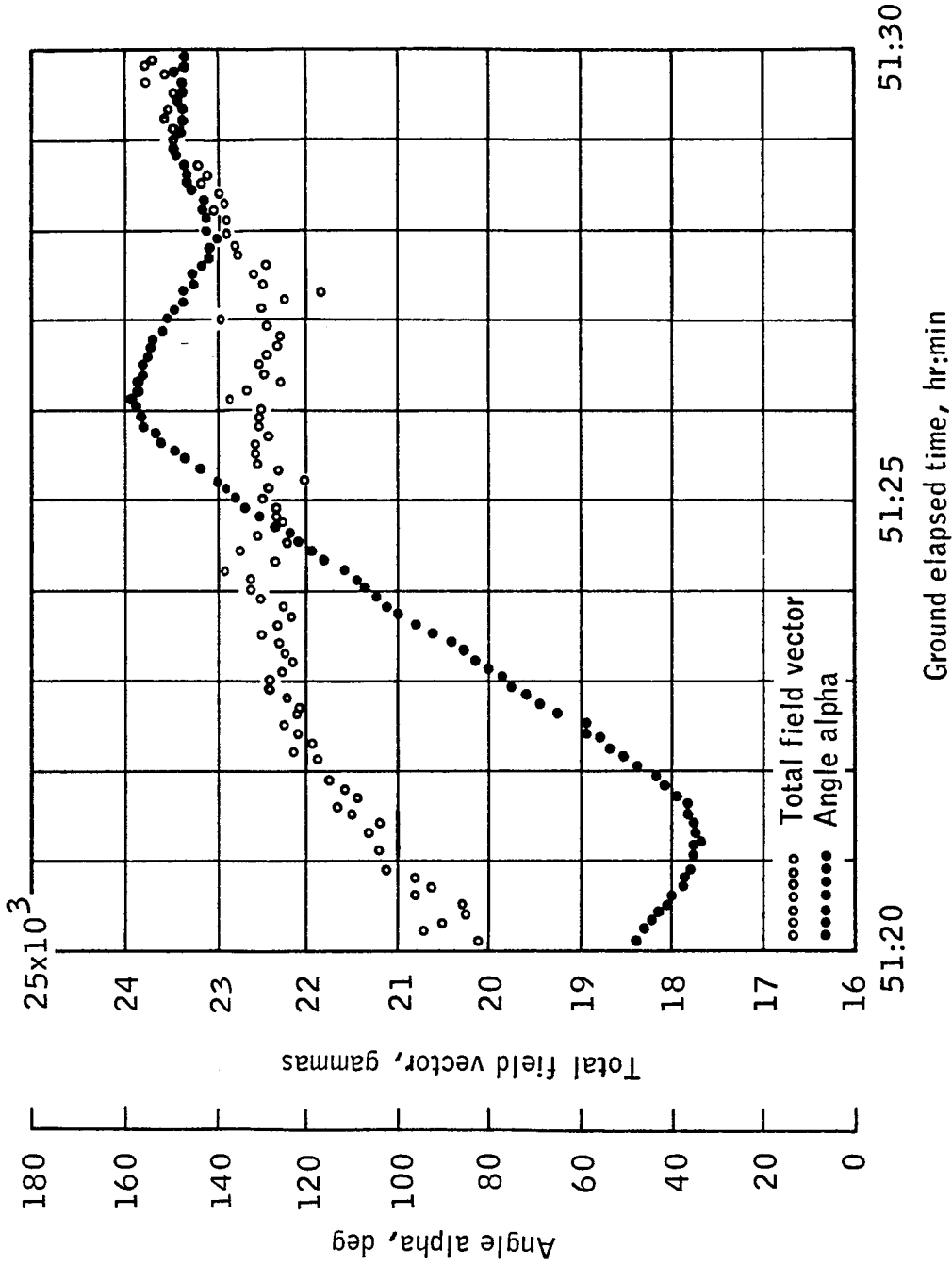

Figure 8.3-1. - Experiment M405, measurement of earth magnetic field in South Atlantic Anomaly.

UNCLASSIFIED

8.4 EXPERIMENT M408 (MSC-6), BETA SPECTROMETER

8.4.1 Objective

The Beta Spectrometer (M408) experiment was on the spacecraft to determine the radiation environment external to the spacecraft. The data will provide input to calculational techniques under development whereby the radiation hazard to a flight crew can be estimated prior to a mission.

The radiation dose is estimated for a particular Gemini mission and compared with the measured values which are obtained on all manned space flights. A check on the mathematical approach is thereby realized. The data obtained are also used to update and fill voids in knowledge of the radiation environment in manned earth orbital missions.

8.4.2 Equipment

The beta spectrometer is similar in function to the proton-electron spectrometer for Experiment M404, flown on previous Gemini missions; however, it is quite different in design. The instrument utilizes a stack of four lithium-drifted silicon semiconductors as the detector, and it provides seven channels of electron-energy information in a digital format. The beta spectrometer is constructed to be highly directional, with the advantage that the sensors can provide information on the highly directional nature of the trapped radiation encountered in the Van Allen radiation belts. The equipment is located in the adapter retrograde section of the Gemini spacecraft and uses the spacecraft PCM telemetry system for data recording.

8.4.3 Procedures

The only operation required by the crew is to turn on a console toggle switch early in the mission, then turn it off prior to retrofire. Because the spectrometer is very directional, as is the sensed radiation, the success of the experiment depends greatly on the attitude of the spacecraft passing through the radiation belt. The trapped radiation lies very nearly in a plane normal to the direction of the earth's magnetic field. Ideally, the instrument should detect radiation normal to this field whenever data are desired in the radiation belt regions. A slow traversal of the instrument through the normal is desirable in order to obtain a map of the directional distribution of the radiation and useful data statistics.

UNCLASSIFIED

During the mission, when normal operations permitted, the crew was to exercise a controlled roll maneuver through the South Atlantic Anomaly, where radiation is encountered. This maneuver sweeps the experiment sensors through the normal to the field twice for every 360-degree roll of the spacecraft.

The principal investigator was stationed at the Kokee tracking site in Hawaii, where the dumped telemetry data were evaluated following each of the anomaly passes. The requirements for controlled spacecraft attitude could then be augmented or reduced during the mission, depending on quick-look data obtained during other mission operations. The Tri-Axis Magnetometer experiment (M405) provided instantaneous "magnetic attitude" of the beta spectrometer so that the data received could be continuously related to spacecraft attitude.

8.4.4 Results

Data received at Hawaii during the first 48 hours of the mission indicated that spacecraft attitudes through the anomaly areas were unfavorable for this experiment. Except for a few instances during this period, the spectrometer was pointed in directions at large angles from the normal to the magnetic field. The desire for improved spacecraft attitude was relayed to the Mission Control Center at Houston; however, because of a propellant usage constraint, a controlled roll maneuver was not performed. On the third day, the spacecraft was in drifting flight just prior to the anomaly passes. This resulted in random spacecraft attitudes such that, on revolution 32, a traversal of the normal to the magnetic field was achieved. Data obtained during revolution 32 will be usable. Data from two other revolutions have not been evaluated to date; therefore, the amount and quality of all data cannot be estimated at the time of publication of this report.

The data from revolution 32 indicate excellent correlation between this experiment and the Tri-Axis Magnetometer experiment (M405). Figure 8.4-1 is a plot of relative electron count rate by the spectrometer versus the indicated magnetic attitude, as given by the Experiment M405 magnetometer. The plot indicates a very peaked electron distribution about the normal to the magnetic field, as was expected. The computed omnidirectional flux normal to the field based on this data is approximately 9.1×10^3 electrons/cm²/sec.

Summaries of the real-time data obtained during the mission indicate that the equipment functioned exactly as planned. The detector was provided with a specially designed evaporative cooler, and the

UNCLASSIFIED

UNCLASSIFIED

8-25

detector temperature followed a satisfactory profile. Shortly after being turned on, the detector temperature sensor indicated temperatures of less than 10° C and cooled to about 3° C on the second revolution. Throughout the rest of the mission temperatures remained between 2° and 3.5° C.

8.4.5 Conclusions

The beta spectrometer functioned as planned throughout the Gemini X mission. The cool temperatures recorded from the instrument during the mission indicate that the evaporative cooler, coupled with apparently lower-than-expected spacecraft adapter temperatures, provided ideal operating conditions. The data provide a good picture of the electron directional distribution. The omnidirectional flux calculated from revolution 32 appears to be in good agreement with previous measurements. Detailed reports will be published when additional data are received and evaluated.

UNCLASSIFIED

UNCLASSIFIED

NASA-S-66-8108 AUG 12

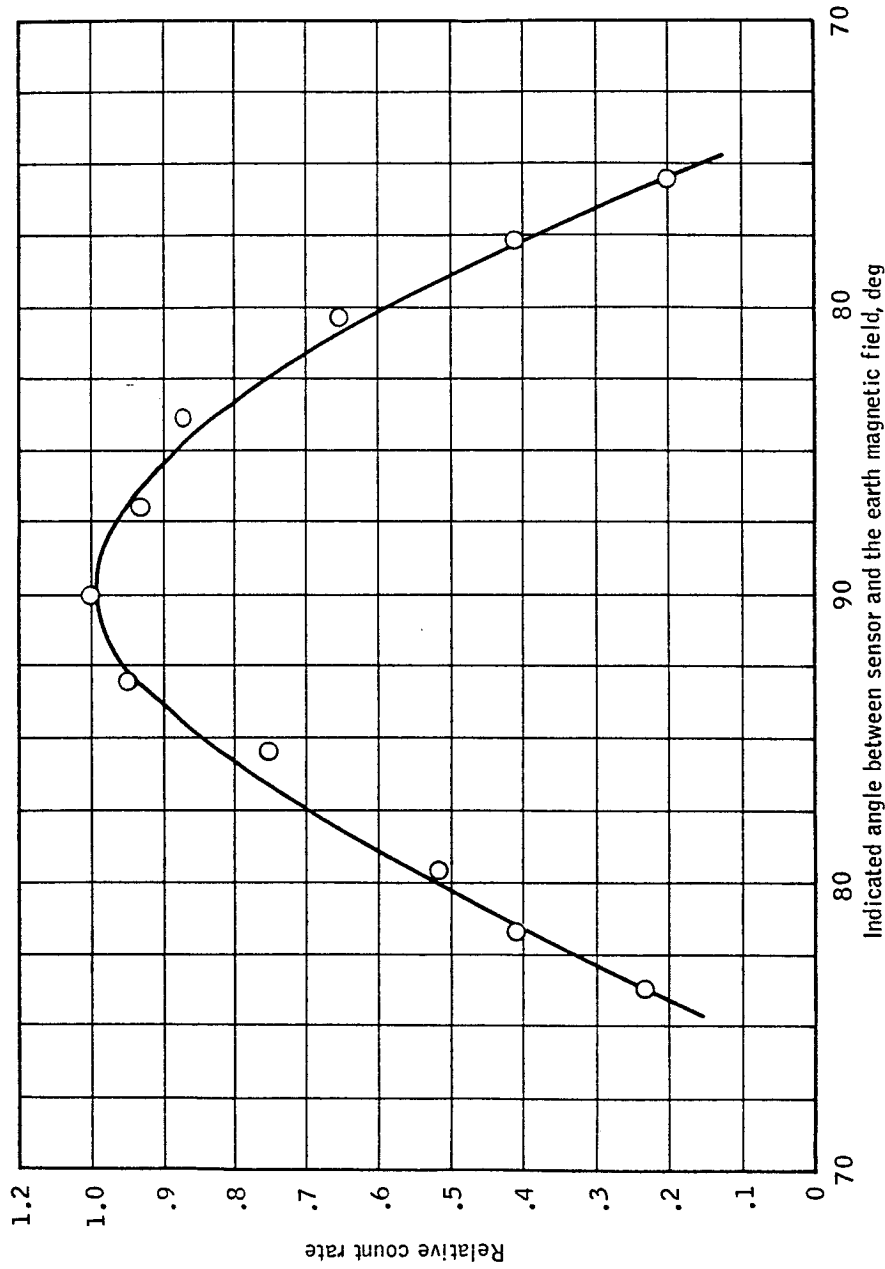

Figure 8.4-1. - Experiment M408, beta spectrometer count-rate as a function of spacecraft attitude (South Atlantic Anomaly, revolution 32).

UNCLASSIFIED

8.5 EXPERIMENT M409 (MSC-7), BREMSSTRAHLUNG SPECTROMETER

8.5.1 Objective

The objective of the Bremsstrahlung Spectrometer (M409) experiment is to determine the bremsstrahlung flux-energy spectra inside the Gemini spacecraft while passing through the South Atlantic Magnetic Anomaly regions. The spectra will be compared with computer-predicted bremsstrahlung spectra using data from the Beta Spectrometer (M408) experiment.

Secondary gamma rays produced in the Gemini spacecraft material by trapped electrons are not expected to reach biologically significant levels. On long-duration missions which may be flown in high trapped-electron flux environments, the problem attains considerably more importance. The calculations of bremsstrahlung radiation involve uncertainties due to the small amount of information available on cross-section interaction and the complex, heterogeneous makeup of the spacecraft. The bremsstrahlung detector was designed to give a time-differentiated measurement of the electron-induced gamma rays over a large section of the vehicle.

8.5.2 Equipment

The bremsstrahlung spectrometer is of the standard phosphor-plastic design employing a cesium iodide, thalium activated, main scintillator surrounded by a plastic scintillator for charged-particle rejection. A photomultiplier tube views this combined scintillator. Signals arising from events in the cesium iodide crystal are transferred by the photomultiplier tube to a ten-channel analog-to-digital converter for energy determination. The analog-to-digital converter drives ten scalars, and the system is sequenced by the spacecraft telemetry system prime-subframe clock. Power is controlled by an on-off switch located on the spacecraft instrument panel.

The ten-channel spectrometer occupies less than 148 cubic inches, weighs less than 7 1/2 pounds, and requires 2 watts of power at 28 volts dc. The instrument is inside the reentry assembly behind the command pilot's seat, about shoulder height. The telemetry electronics consist of (1) eight bilevel, 10-sample-per-second telemetry channels sampled in parallel, (2) two 1.25-sample-per-second analog channels, and (3) one telemetry pulse at 10 samples per second, synchronized with the bilevel word. A photograph of the equipment hardware is shown in figure 8.5-1.

UNCLASSIFIED

The bremsstrahlung spectrometer is designed to determine gamma flux and energy spectra with ± 5 percent accuracy between 100 and 4000 keV. The data will be time-correlated with exterior electron measurements. Determination of bremsstrahlung fluxes with this accuracy is a considerable improvement over existing bremsstrahlung calculations. The flux of electrons with energies above 250 keV should be between 10^5 and 10^6 electrons/cm²/sec in the South Atlantic Magnetic Anomaly at an altitude of 300 kilometers.

The calculation of the anticipated bremsstrahlung count rate is, of course, crude due to lack of information concerning spacecraft shielding and orientation in the directional electron field. For purposes of obtaining a maximum count rate, the following assumptions are made:

- (a) The spacecraft is a uniform sphere of radius d
- (b) The spacecraft is oriented such that approximately 100 percent of its area is producing bremsstrahlung photons
- (c) The efficiency of the number of bremsstrahlung photons produced per electron per unit time is one percent.

The bremsstrahlung production rate (R) radiating into 4π steradians of solid angle will be the electron flux (F) times the spacecraft surface area (A) times the efficiency (E), as follows:

$$R = F A E = 10^6 \times 4\pi d^2 \times 10^{-2} = 4\pi d^2 \times 10^4 \text{ photons/sec}$$

The solid angle subtended by a point on the spacecraft surface to the detector is

$$\frac{a}{A} = \frac{\pi D^2/4}{4\pi d^2} = \frac{D^2}{16d^2}$$

where a is the area of a detector having diameter D . The bremsstrahlung production rate into this solid angle is

$$\frac{D^2}{16d^2} 4\pi d^2 \times 10^4 \text{ photons/sec} = 2.5\pi D^2 \times 10^3 \text{ photons/sec}$$

If the detector has a counting efficiency of 0.4, the count rate (C) is

$$C = \pi D^2 \times 10^3 \text{ photons/sec}$$

UNCLASSIFIED

A 1-inch detector diameter would, therefore, produce a maximum count rate of

$$C = 2 \times 10^4 \text{ photons/sec}$$

8.5.3 Procedures

The requirements for the flight crew were to turn the equipment on at insertion and off prior to retrofire. No other operational procedures were required during the mission.

8.5.4 Results

A few spectra were observed during post-pass telemetry dumps at the Hawaii ground station. These spectra indicated that the spectrometer functioned as expected. The computer data processing will consist of reconstruction of spectra as a function of spacecraft time and path. The reconstruction will involve decompressing transmitted numbers, adding sensor efficiency, dead time, and calibration factors, and correlating spacecraft attitude and position. The final results of the experiment will be determined after data from several complete revolutions are processed and analyzed.

NASA-S-66-8151 AUG 15

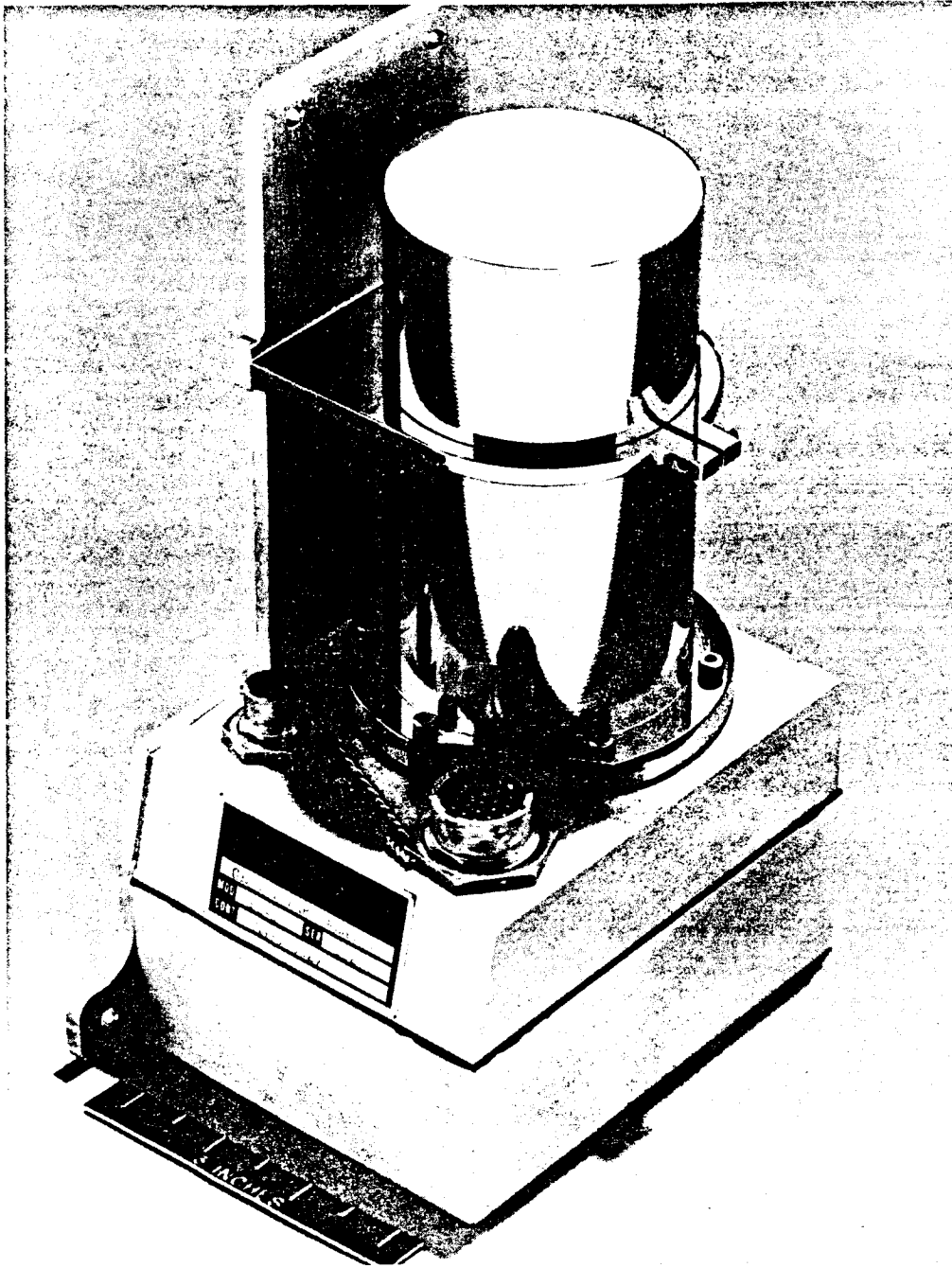

Figure 8.5-1. - Experiment M409, bremsstrahlung spectrometer.

8.6 EXPERIMENT M410 (MSC-8), COLOR PATCH PHOTOGRAPHY

8.6.1 Objective

The objective of the Color Patch Photography (M410) experiment was to determine if existing photographic materials can accurately reproduce the color of objects photographed under the environmental conditions which exist in space.

On previous Gemini missions, the crew's observations of colors in space often did not agree with the color rendition obtained in their flight pictures. An analysis of the various factors which could cause the apparent false color rendition indicated that color change might be caused by the unattenuated solar spectrum. Standard film is not balanced for excessive ultraviolet energy from the sun.

8.6.2 Equipment

To evaluate the capabilities of existing photographic materials under space conditions, a target of known colors was photographed outside the spacecraft. A subjective comparison of the target color and that rendered by the film indicated the degree of suitability of existing photographic materials for space photography.

The experiment equipment is shown in figure 8.6-1. It consisted of a color patch slate, a 3-foot extension rod, and a 70-mm general-purpose camera. The color patch slate was a titanium plate having dimensions of 8 by 8 by 1/16 inches. This plate supported four color targets composed of ceramic material in a matte finish. The four colors were the National Bureau of Standards primary colors—red, blue, and yellow—and a neutral gray.

The 3-foot rod was composed of four sections of one-half-inch-diameter aluminum and held the color patch at a predesignated distance of 36 inches from the camera. The rod sections were held together by a nylon cord. The rod was attached to the camera with a ring-sight adapter and to the color patch with a clip.

The 70-mm general-purpose camera was fitted with an f/2.8 80-mm lens for the experiment. The camera was selected for superior optical qualities suitable for a photographic experiment of this type. To reduce the effect of ultraviolet energy on the film, a filter, cutting off at 3500 Å, was attached in front of the lens.

UNCLASSIFIED

The camera used 70-mm film with a 2.5 mil base. This film had excellent color-reproducing qualities and had been used on previous Mercury and Gemini flights.

8.6.3 Flight Procedure

Prior to the Gemini X mission, the flight color patch was photographed under controlled lighting conditions at the Kennedy Space Center, using the flight camera and film. Six exposures were made: two each at 1/250 of a second at f/8, at 1/250 of a second at f/11, and at 1/250 of a second at f/16. The purpose was to obtain photographs that could be compared with similar postflight photographs taken under the same controlled conditions. This would determine whether or not the film had undergone changes during the mission.

During the mission, the extravehicular crewman was to assemble the experiment hardware, photograph the color patch nine times during the standup extravehicular activity (EVA), and then return the color-patch slate to the spacecraft for postflight calibration and analysis. The exposures were to be made in groups of three, beginning with 1/250 of a second at f/8, followed by 1/250 of a second at f/16, and ending with 1/250 of a second at f/11. The solar illumination angle was to be within 30 degrees of the patch normal line.

The standup EVA was terminated early, preventing completion of the experiment. To expedite ingress, the pilot discarded the color patch and rod. The crew did obtain four color-patch photographs with an exposure of 1/250 of a second at f/8. The remaining film in the magazine was used for weather and terrain photographs of the earth.

8.6.4 Results

The pictures taken provided enough data that certain conclusions can be drawn. The results of a subjective comparison of the flight film and the backup color patch, identical to the flight color patch, confirm the suitability of existing film to record true colors in space.

Density measurements made from the gray section of the flight film exposures showed a difference of 10 percent between the first and third exposures and a difference of 17 percent between the lightest and the most dense exposures. The density difference can be attributed either to variances in the shutter mechanism or to slight changes in the incident illumination angle, or to both.

UNCLASSIFIED

UNCLASSIFIED

8-33

Almost identical saturation of the four colors was noted on the first and third exposures. The colors on the second exposure are richer because they approached the nominal exposures of 1/250 of a second at f/11.

8.6.5 Conclusion

The experiment provided sufficient information to confirm that objects can be photographed in space with a high degree of color fidelity using existing materials. It can be generally stated that available color film is balanced to the solar spectrum in space, and the effect of ultraviolet energy appears to be negligible to film degradation.

UNCLASSIFIED

UNCLASSIFIED

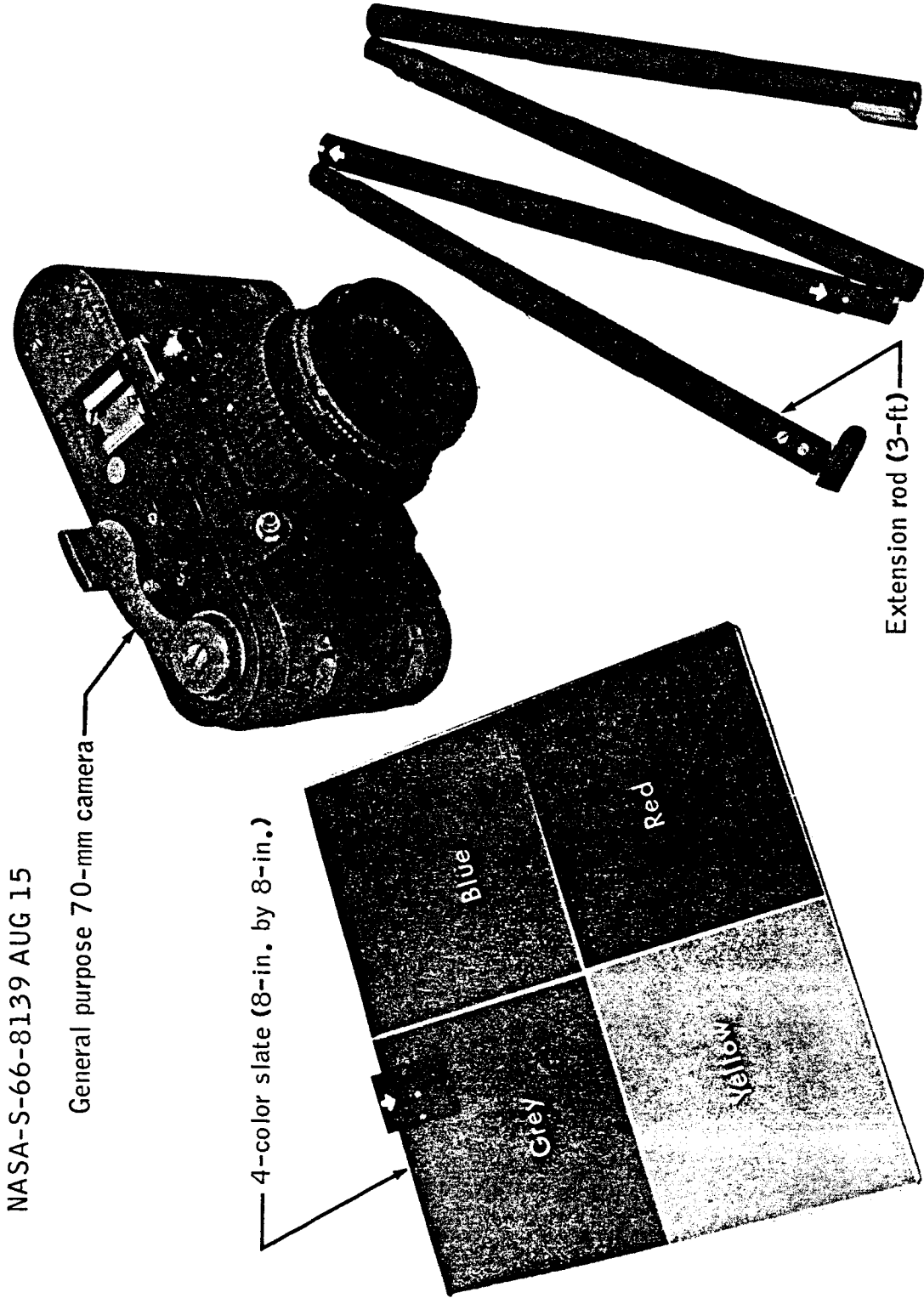

Figure 8.6-1. - Experiment M410, hardware configuration.

UNCLASSIFIED

8.7 EXPERIMENT M412 (MSC-12), LANDMARK CONTRAST MEASUREMENTS

8.7.1 Objective

The objective of the Landmark Contrast Measurements (M412) experiment was to measure the visual contrast of landmarks against their surroundings in order to determine the relative visibility of terrestrial landmarks from outside the atmosphere. These landmarks would provide a source of navigational data for Apollo onboard guidance and navigation systems.

8.7.2 Description

The ability to perceive, identify, and align on landmarks is closely related to their luminance and contrast with the surrounding areas. The visual contrast of a terrestrial feature against its surroundings is reduced according to the amount of atmosphere between the feature and the eye of the observer. Therefore, the visual contrast of ground targets, as seen from outside the atmosphere, will be considerably reduced from that of the targets observed at close range.

The measured parameter required during the mission was the visual contrast of landmarks, where contrast is defined as follows:

$$\text{Contrast} = \frac{\text{Luminance of landmark} - \text{Luminance of surroundings}}{\text{Luminance of surroundings}}$$

This value can be positive or negative. The measured contrast of a light-colored land mass viewed against a darker ocean might be more than ten. The contrast of a dark object viewed against lighter colored surroundings, however, can never exceed unity.

Visual contrast, as defined, is a useful criterion for target visibility because of the constancy of threshold values through several orders of magnitude of luminance levels. Because contrast is a ratio, the measurement is independent of long-term photometric equipment gain stability, a predominant source of error in those devices that use photo-multiplier sensors. The effect of scattered light entering a photometer is also lessened because of the measured ratio.

UNCLASSIFIED

8.7.3 Equipment

This experiment required the use of the photometer provided for Experiment D005, with the addition of two optical filters which fit over the photometer lens. The instrument consisted of an objective lens which received landmark-reflected sunlight radiation and optically transferred it to a field stop and then to a photomultiplier sensor. The amplified output from the photomultiplier was to be sampled twice per second, and the resulting signal telemetered to the ground and also recorded onboard the spacecraft by means of the standard Gemini telemetry system.

The linearity of the photomultiplier and its associated circuitry was typically better than one percent of full scale. The dynamic range of the instrument was designed to cover the expected luminance range of sunlit terrain as follows:

Maximum landmark	
luminance	2.4 candles/cm ² (7000 foot-lamberts)
Minimum landmark	
luminance	0.02 candles/cm ² (58 foot-lamberts)

The signal-to-noise ratio of the photometer was estimated to be in excess of 800:1 for the minimum landmark luminance using the sample rate of two per second.

The probable error of measurement was expected to be near three percent after adjustment for near-maximum signal level. Error due to scattered light in the photometer during an observation could not be assessed accurately, except that it would tend to reduce measured contrast.

Landmark contrast data for use in guidance and navigation design in Project Apollo have been calculated by extrapolation of airborne spectrophotometric measurements. Other data have been obtained by densitometer measurement of photographs taken during Gemini and other orbital missions. A comparison of these data with direct measurements obtained in this experiment was expected to verify correctness of calculated contrasts as well as reduce the present uncertainty of landmark contrast variance with change of sun aspect angle.

8.7.4 Procedures

The photometer was to be mounted on the right-hand window as it was for the Star Occultation Navigation (D005) experiment. Several minutes before the appearance of the target landmark, the observer was to turn on the photometer power source. The spacecraft was to be turned so that the photometer pointed normal to the landmark direction; then, the spacecraft was to be positioned so that the sun was behind the observer, thus shading the spacecraft window from direct sunlight.

It was anticipated that the landmark would be recognizable at about 60 degrees from the nadir. This would have allowed the observer time to aim the photometer and adjust the instrument gain so that target area luminance would provide a strong signal level to the telemetry system. When the landmark was at 20 degrees of nadir, the pilot was to have aligned the spacecraft attitude and angular rates to slowly scan the target. The maximum angular rate was to have been one-half deg/sec to prevent gaps in the scan field measurements due to the telemetry sampling rate. The angular scan was to have been eight degrees, which would have required from 30 to 50 seconds of operating time.

The pilot was to have verbally described the landmark, cloud cover, weather, sun aspect, and filter used. If available, operational camera film was to be used to photograph a few landmarks to assist data validation.

8.7.5 Results

This experiment was not performed by the flight crew because of fuel-usage constraints and time limitations. The experiment was attempted on a previous Gemini mission, but because of equipment failure no results were obtained. This experiment is not scheduled for either remaining Gemini mission. Consequently, there are no results or conclusions obtainable from the two attempts to perform this experiment.

UNCLASSIFIED

8.8 EXPERIMENT S001 (S-1), ZODIACAL LIGHT PHOTOGRAPHY

8.8.1 Objective

The purpose of the Zodiacal Light Photography (S001) experiment was to obtain 30-second exposures of several subjects of astronomical interest using a lens setting of f/1. These subjects included the airglow (viewed in profile from above), the zodiacal light, and the Milky Way.

8.8.2 Equipment

The camera was designed to view a wide-angle field of approximately 50 by 130 degrees. Mechanically, it was the same kind of camera as that flown on the Gemini V, VIII, and IX-A missions. The exposure sequence was automatic and alternated 30-second exposures with 10-second off periods. During these off periods, thrusters could be fired for attitude-hold without exposing the film. The film used was 35-mm, high-speed, black and white.

8.8.3 Procedures

The flight plan required that the camera be hand-held on night passes, with the pilot taking photographs through his window. The pilot held the camera against the window during the exposure periods, sighting past the camera and directing the command pilot to maneuver to appropriate positions. Astronomical objects were not in the command pilot's field of view, and his role was to null the spacecraft rates. The planned procedure required that photographs be taken with the following camera orientations:

- (a) Horizontal toward the west
- (b) Aligned along the Milky Way to include the southwest horizon
- (c) Aligned along the Milky Way in the zenith
- (d) Aligned along the Milky Way to include the northeast horizon
- (e) Horizontal toward the northeast
- (f) Horizontal toward the east
- (g) Horizontal toward the south.

UNCLASSIFIED

UNCLASSIFIED

8-39

8.8.4 Results

Twenty photographs were obtained. They are tabulated as follows:

Exposure number	Camera orientation	Object
1, 2, 3	Horizontal toward the west	
4		Spacecraft thruster plumes
5, 6	Along the Milky Way	α and β Centaurus centered in the field of view
7, 8, 9	Along the Milky Way	Galactic center in the upper right
10, 11, 12	Along the Milky Way	Northeastern sectors
13, 14	Along the Milky Way	From stars Vega to Cassiopeia
15, 16, 17, 18, 19, 20	Horizontal toward the east	Orion's star field centered

The spacecraft attitude held by the crew during the exposures was very adequate; however, a combination of the following three factors make the pictures obtained difficult to use quantitatively:

(a) The film was only half as sensitive as the film used during the Gemini IX-A mission.

(b) Observations of the same star field in various exposures show that light transmission through the dirty spacecraft window varied by a factor of at least six.

(c) The earth horizon was seldom observed in the pictures.

UNCLASSIFIED

UNCLASSIFIED

8.8.5 Conclusions

Results obtained from these pictures will be qualitative or geometrical only. For example, the airglow heights are measurable in two pictures showing the earth horizon. One picture confirms the existence of a higher airglow layer at 200 to 300 kilometers. This layer was also seen in the Gemini IX-A photography. One picture shows the presence of wisps extending upward from the lower airglow layer. These wisps had been seen for the first time in the Gemini IX-A SOO1 experiment photographs. Complete analysis and interpretation will continue for several more months.

UNCLASSIFIED

8.9 EXPERIMENT S005 (S-5), SYNOPTIC TERRAIN PHOTOGRAPHY

8.9.1 Objective

The objective of the Synoptic Terrain Photography (S005) experiment was to obtain high-quality color photographs of selected areas of the earth for geologic, geographic, and oceanographic study. In particular, coverage was desired of the Red Sea and adjacent land areas, Mexico, West Pakistan, North Africa, and northwestern South America. Individual sites were also selected, including the mouths of the Mississippi and Ganges Rivers, the Bahama Islands, the Philippine Islands, and the Mekong delta.

8.9.2 Equipment

The equipment used for the experiment was the 70-mm general-purpose camera equipped with a haze filter and medium-speed color-reversal film on a 2.5 mil polyester base.

8.9.3 Procedures

The crew was instructed to take vertically oriented, systematic, overlapping pictures of the areas listed in the first paragraph. For individual photographic sites, pairs or single pictures were desired. It was stressed that good photographs of any cloud-free land area would be of value.

8.9.4 Results

Despite the difficulty of obtaining vertical photography while the spacecraft was docked with the Gemini X GATV, the experiment was successful. A large number of pictures were taken, and 75 of these appear to be of use for the purposes of the experiment. Because of the camera orientation, the number of geologically useful pictures is relatively small; however, many of these pictures have potential oceanographic or geographic value.

Figure 8.9-1(a) is one of several photographs which will be useful in the study of earlier pictures of North Africa. The Tindouf Basin of Algeria and Morocco is especially well shown. Figure 8.9-1(b), showing part of the Rio Grande delta and the Texas Gulf coast, should be of considerable value in the study of near-shore sedimentation. The process

UNCLASSIFIED

of formation of barrier islands, such as Padre Island, is not completely understood, nor are sedimentation processes in lagoons such as Laguna Madre. Figure 8.9-1(c), showing the southern end of Formosa, is of both geographic and oceanographic use. Considerable detail in the glitter patterns may give information on current distribution and internal waves. Figure 8.9-1(d) also shows Formosa with detailed bottom topography. Figure 8.9-1(e) illustrates the value of orbital photographs in the study of sedimentation off the mouths of large rivers by showing the distribution of turbid effluent.

8.9.5 Conclusions

The experiment was successful from several viewpoints. First, the pictures are potentially useful for oceanographic, geographic, and geologic study. Second, experience with photographs from altitudes up to 412 nautical miles has been gained. The high-altitude pictures were taken over areas having poor atmospheric conditions; however, the pictures are of sufficient quality to indicate that orbital photography is feasible at these altitudes. Also, the importance of taking vertically oriented photographs has been reemphasized from the photographic results of this mission.

UNCLASSIFIED

UNCLASSIFIED

8-43

NASA-S-66-8144 AUG 15



(a) Morocco, Spanish Sahara, looking northwest along Uda Um Chemel (center), Gued Dra is on left, Sidi Ifni is beneath clouds on coast.

Figure 8.9-1. - Experiment S005, typical synoptic terrain photography.

UNCLASSIFIED

UNCLASSIFIED

NASA-S-66-8145 AUG 15



(b) Corpus Christi-Brownsville, Texas, areas. Corpus Christi is at extreme top, Padre Island and sand-choked Laguna Madre extend southward along coast. Brownsville and ship channel are just south of large bay (bottom half, center). Laguna Madre in Mexico is at bottom edge.

Figure 8.9-1. - Continued.

UNCLASSIFIED

UNCLASSIFIED

8-45

NASA-S-66-8147 AUG 15



(c) Southern end of Taiwan (Formosa) and the Bashi Channel, looking south. Taitung on east coast (left, at mouth of long river). Tung Chiang (Kaohsiung) at right center. T'ainan at top center, on west coast.

Figure 8.9-1. - Continued.

UNCLASSIFIED

UNCLASSIFIED

NASA-S-66-8146 AUG 15



(d) Western half of Taiwan (Formosa) and Pescadores Islands, looking east.
China coast and Haitan Tao Island are at lower left.

Figure 8.9-1. - Continued.

UNCLASSIFIED

UNCLASSIFIED

8-47

NASA-S-66-8148 AUG 15

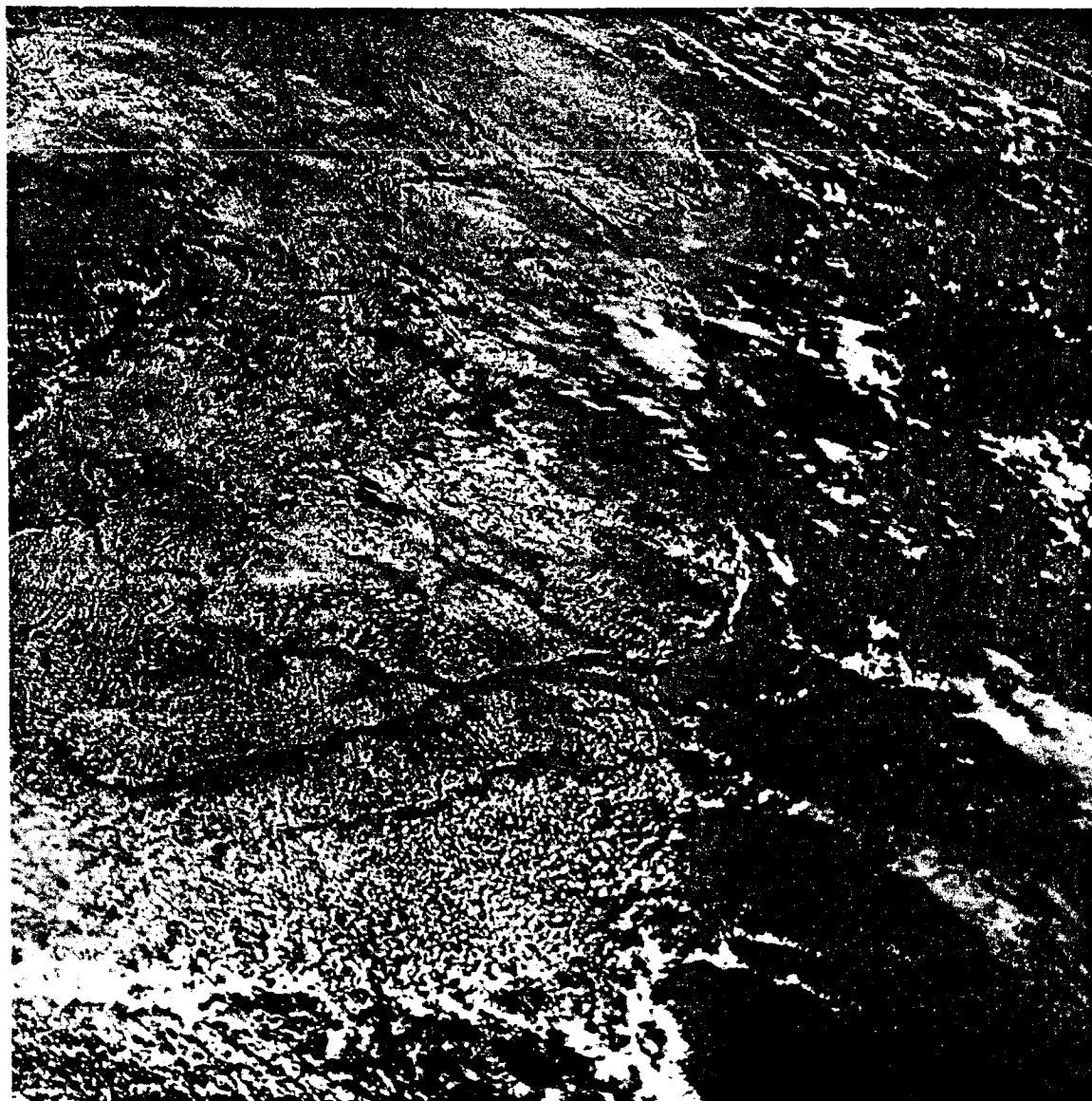

(e) Guyana, Georgetown and Essequibo River looking northwest to the Orinoco River delta with Trinidad in background.

Figure 8.9-1. - Concluded.

UNCLASSIFIED

UNCLASSIFIED

8.10 EXPERIMENT S006 (S-6), SYNOPTIC WEATHER PHOTOGRAPHY

8.10.1 Objective

The objective of the Synoptic Weather Photography (S006) experiment was to obtain detailed selective color photographs of the earth's cloud cover in order to amplify and verify the information obtained from weather satellite pictures and to provide new evidence for studies of atmospheric behavior.

8.10.2 Equipment

The experiment equipment consisted of a 70-mm film magazine for use with the 70-mm general-purpose camera. It contained sufficient film for approximately 50 exposures. The camera used an 80-mm f/2.8 lens fitted with an ultraviolet filter.

8.10.3 Procedures

The crew was briefed prior to the flight on the various types of weather systems of interest for the experiment. During the mission, meteorologists used pictures from the ESSA weather satellite and world-wide weather maps to select specific areas likely to contain cloud patterns of interest. This information was communicated to the crew, whenever it was operationally feasible, so that they could photograph these patterns. In addition, views were to be taken of clouds which the crew observed and had time to photograph.

8.10.4 Results

Over 200 pictures showing cloud patterns were obtained, and all but a few were of very good quality. Figure 8.10-1(a) shows cumulus cloud lines in the convective cloud pattern over the northeast coast of Brazil. The absence of clouds over the Amazon River system shows the location of the rivers.

Cumulus cloud lines form open, polygon-shaped cells at times over the oceans, as illustrated in figure 8.10-1(b). The open cells, three to six miles in diameter, would be undetected by weather satellite television pictures because the cloud walls are too thin and the cell diameters are very small.

UNCLASSIFIED

Figure 8.10-1(c) shows an eddy southwest of Gibraltar off the Moroccan coast. Other eddies were photographed near the Canary Islands and off the coast of Guadalupe Island near Baja California.

Figure 8.10-1(d) is one of a series of photographs taken over Sumatra and Malaya, depicting equatorial cloud conditions at various altitudes in the atmosphere.

Excellent photographs were made on two successive revolutions over the southeast China coast and Formosa to show the changes that may occur in the cloud pattern during a 90-minute period.

Part of tropical storm Celia was photographed southeast of Florida. Cirrus cloud bands appear in a number of pictures taken over northern Africa, and cloud eddies were observed off the northwest coast of Africa. Several pictures show the sunglint patterns from the ocean surface. These will be useful for studies relating the brightness of the pattern to the surface roughness.

Pacific Ocean islands and atolls, where meteorological radiosonde stations are located, were also photographed. The weather observations from these stations will be useful in interpreting the cloud formations near these islands.

8.10.5 Conclusions

Experiment S006 was extremely successful. The photographs obtained will be analyzed and evaluated for information useful in understanding the behavior of the atmosphere. This information, not available at this time, will be presented in later scientific publications.

8-50

UNCLASSIFIED

NASA-S-66-8140 AUG 15



UNCLASSIFIED

8-51

NASA-S-66-8141 AUG 15



(b) Cumulus cloud lines over the ocean form open polygon-shaped cells.

Figure 8.10-1. - Continued.

UNCLASSIFIED

NASA-S-66-8143 AUG 15



(c) A cloud eddy southwest of Gibraltar fits the contour of the Moroccan coastline of Africa.

Figure 8.10-1. - Continued.

UNCLASSIFIED

UNCLASSIFIED

8-53

NASA-S-66-8142 AUG 15

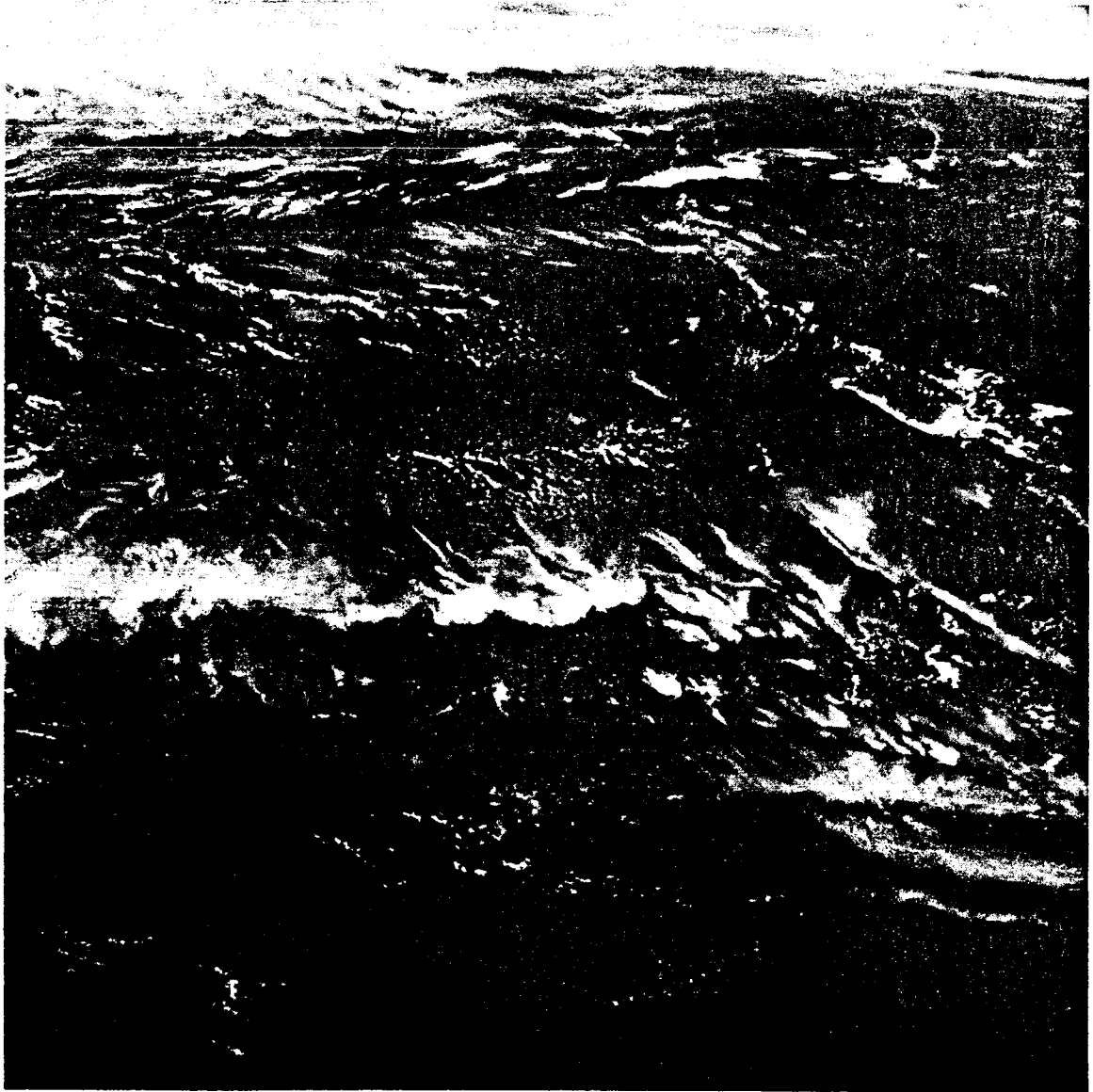

(d) Cirrus clouds form a thick overcast north of Sumatra, which appears at the upper right.

Figure 8.10-1. - Concluded.

UNCLASSIFIED

UNCLASSIFIED

8.11 EXPERIMENT S010 (S-10),

AGENA MICROMETEORITE COLLECTION

8.11.1 Objectives

The basic scientific objectives of the Agena Micrometeorite Collection (S010) experiment were to study the micrometeorite content of the upper atmosphere and the near-earth space environment and to study the effect of this environment on biological microorganisms.

8.11.2 Description

Accomplishment of objectives was attempted by (1) exposing polished metal and plastic surfaces to the particle flux for later study of the resulting impact craters, (2) exposing highly polished sections of meteorite material to the particle flux to obtain direct measurement of meteor erosion rates, (3) exposing optically polished glass surfaces to the particle flux for determining the deterioration of optical surface properties, (4) exposing thin films to the particle flux to observe thin-film penetration, (5) exposing extremely clean surfaces to the particle environment in an attempt to collect ultrasmall particles, and (6) exposing biological specimens to the space environment. Experiment data include the particulate material collected, holes and craters in the specially prepared surfaces, and numbers of viable microorganisms remaining on the biological exposure plates. The microorganisms used were ubiquitous agents which are absolutely harmless to man. Two of the organisms used were:

- (1) T-bacteriophage (an E. coliphage).
- (2) Penicillium roqueforti mold spores.

8.11.3 Equipment

The hardware configuration consisted of an aluminum structure designed to provide a mounting platform for the polished plates and collection surfaces. The device was interfaced with the Target Docking Adapter (TDA) of the Gemini VIII target vehicle by a mounting plate which allowed detachment of the experiment hardware from the vehicle. Cratering samples were installed on the outside surface of the aluminum structure. During launch and the insertion of the target vehicle into orbit, these external surfaces were protected from direct impact of airborne particles by a fairing which directed airflow over the mounting.

UNCLASSIFIED

The pilot was to remove this fairing cover during extravehicular activity (EVA). Figure 8.11-1 is a diagram of the S010 hardware in the closed position.

8.11.4 Procedures

The extravehicular pilot was to retrieve the S010 micrometeorite experiment hardware, replace it with another collection package, and then open the cover plate, thereby exposing the inner collection surfaces to the outside environment.

8.11.5 Results and Conclusions

The pilot recovered the S010 experiment package from the Gemini VIII target vehicle and handed it to the command pilot at approximately 49 hours 5 minutes g.e.t. The hardware was in a closed position; only the outer four test panels had been exposed to the space environment. Additional S010 hardware was not placed on the target vehicle because the pilot was concerned that the umbilical might become entangled in the various projections on the vehicle.

A photograph of the flight package retrieved from the Gemini VIII GATV by the extravehicular pilot is shown in figure 8.11-2. The photograph clearly shows the various erosions incurred by the collection surfaces during a 4-month period in a space environment. Figure 8.11-3 is an enlarged picture of one of the larger craters formed by micrometeorite impact. The crater is approximately 400 microns in diameter and 30 microns in depth. Several months are required to complete the scanning and photographic recording of the four exposed plate surfaces that were recovered. It is expected that a density profile of the micrometeorite environment will be determined from an evaluation of the data obtained.

The biological microorganisms on the outside surfaces did not survive the 4-month period of exposure. However, the same kinds of specimens inside the hardware package showed good survival rates. The shielding offered by the closed covers contributed directly to the protection and survival of these microorganisms. Continuing analysis of the S010 hardware is expected to provide additional and more conclusive results.

UNCLASSIFIED

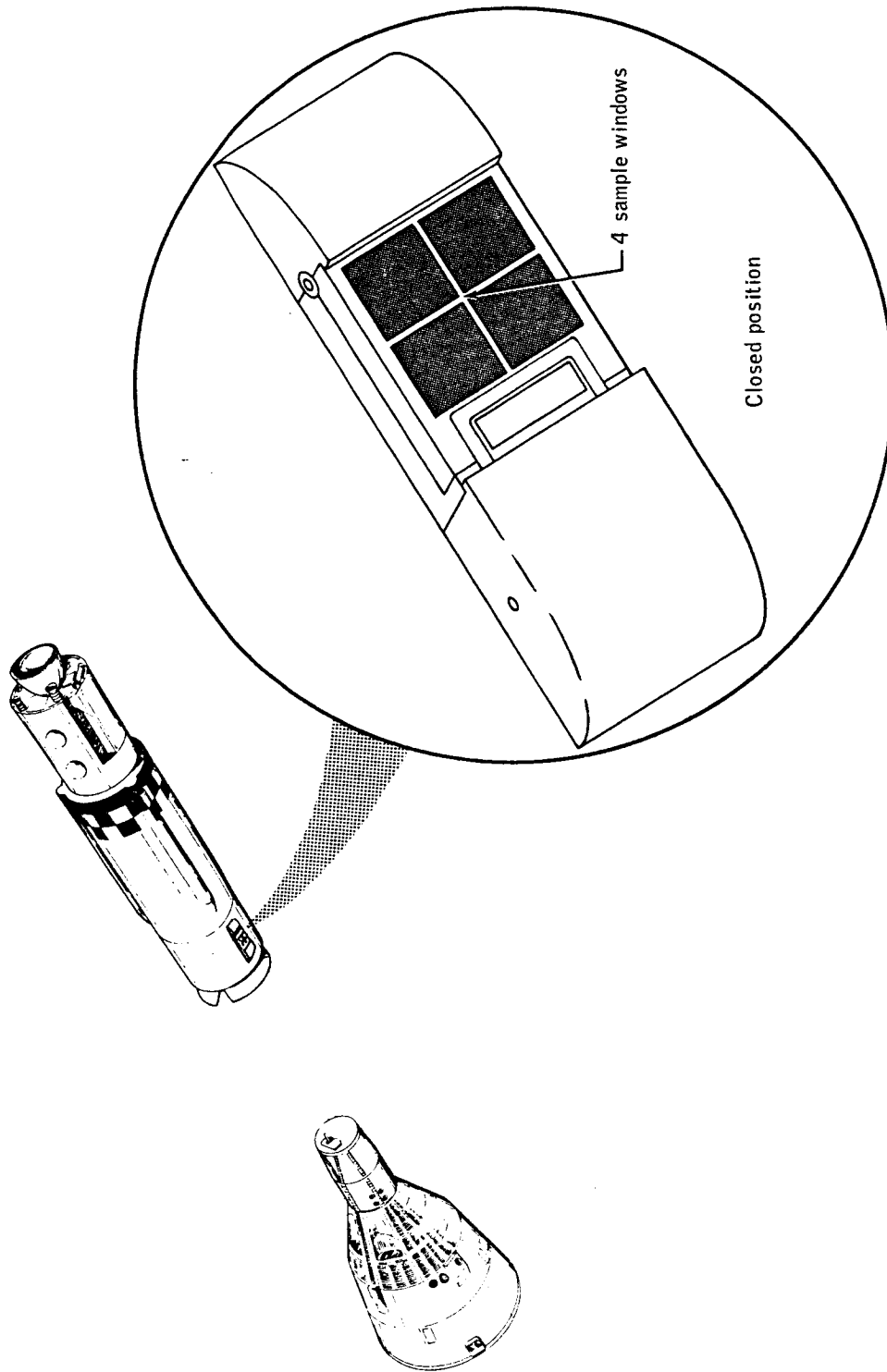

Figure 8.11-1. - Experiment S010, sample collection device.

NASA-S-66-8100 AUG 12

UNCLASSIFIED

UNCLASSIFIED

8-57

NASA-S-66-8099 AUG 12

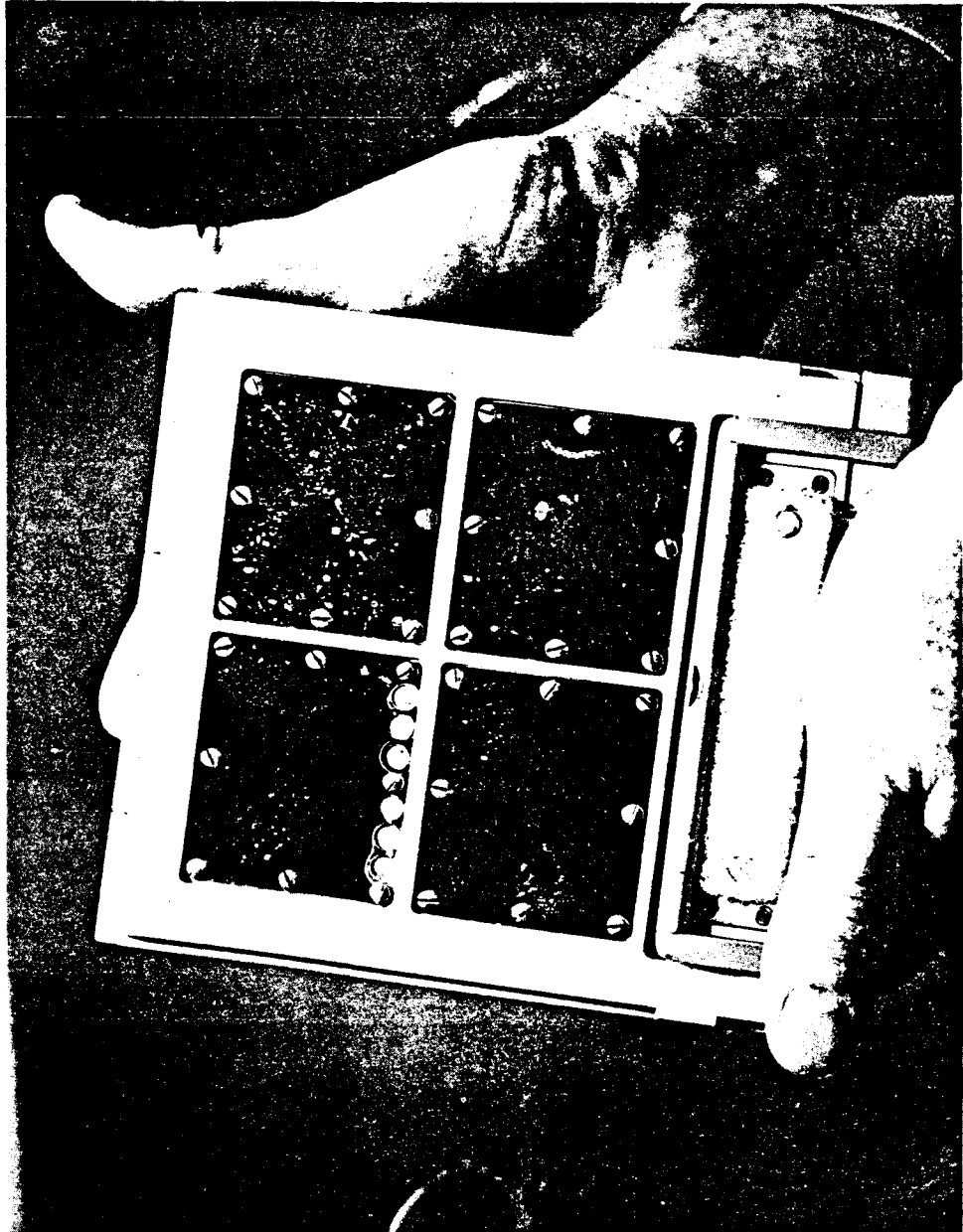

Figure 8.11-2. - External surfaces on recovered experiment S010.

UNCLASSIFIED

UNCLASSIFIED

NASA-S-66-8098 AUG 12

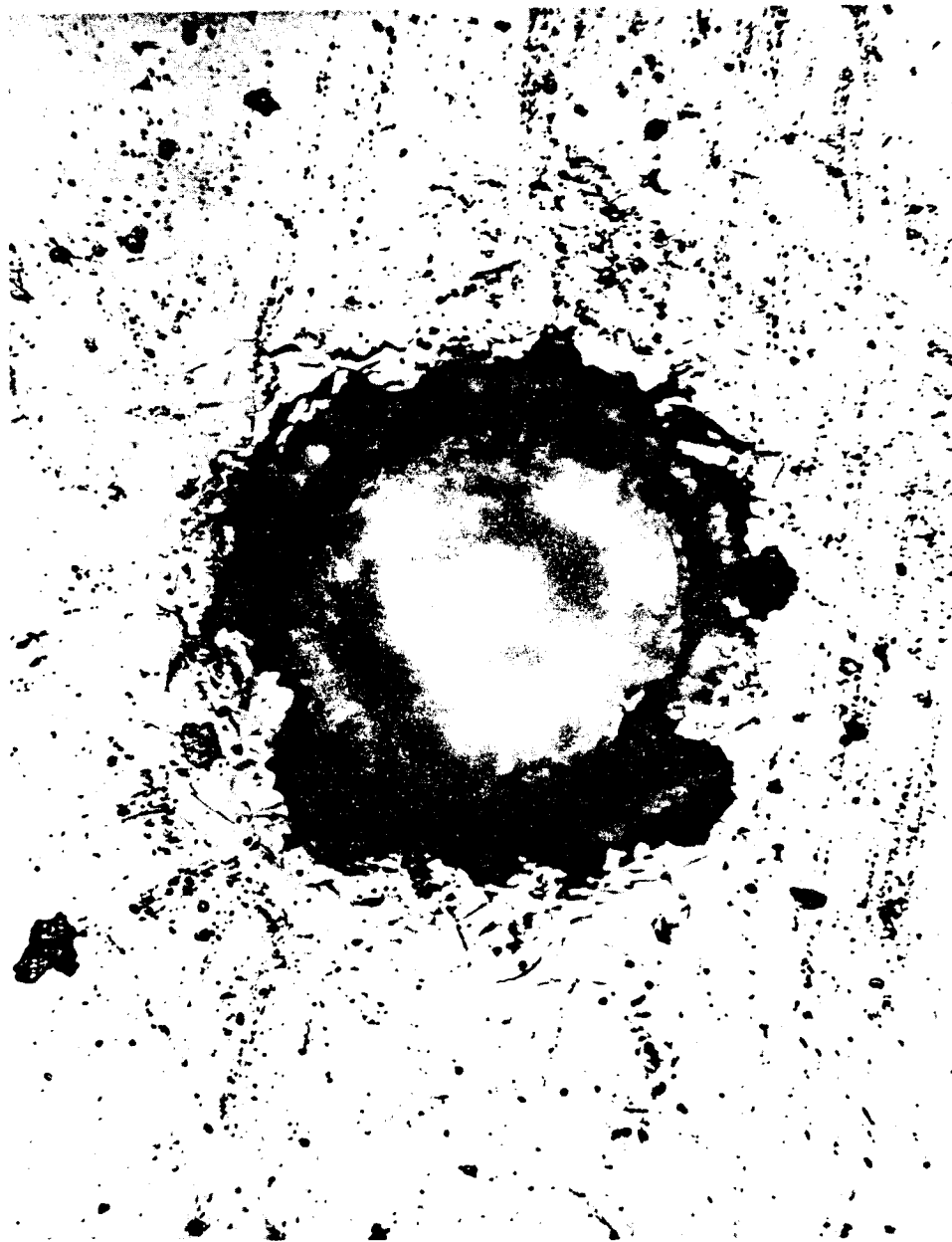

Figure 8.11-3. - Experiment S010 micrometeorite crater,
400 - micron diameter.

UNCLASSIFIED

8.12 EXPERIMENT S012 (S-12), MICROMETEORITE COLLECTION

8.12.1 Objectives

The objectives of the Micrometeorite Collection (S012) experiment were to determine the micrometeorite activity in a near-earth environment and to study the effect of the environment on biological microorganisms.

8.12.2 Equipment

The basic objectives were to be accomplished by exposing polished metal and plastic surfaces to the environment outside the Gemini spacecraft. Environmental data to be acquired included the particulate material collected, holes and craters in the specially prepared surfaces, and numbers of viable microorganisms remaining on the biological exposure plates. The microorganisms used were ubiquitous agents which are absolutely harmless to man. Laboratory tests have shown these organisms to be resistant to adverse conditions, hence their selection for space studies. All material specimens were to be returned to earth by stowage in the Gemini reentry assembly for postflight examination and analysis at special laboratories.

The micrometeorite collection hardware consisted of an aluminum structure mounted on the spacecraft adapter retrograde section. Mounting spaces were designed for 24 surfaces, materials, or specimens. Figure 8.12-1 shows the hardware configuration on the spacecraft. The collector cover door was remotely controlled by the flight crew, thereby allowing the cover to be opened or closed, as required, to expose the experiment samples.

8.12.3 Procedures

The cover door of the micrometeorite collection device remained in the closed position until just prior to the first crew sleep period. This activation time was required to prevent exposing the sample surfaces to particles caused by thruster firing, fuel-cell purging, or dumping of liquids overboard. The collector door was left open for one period of eight hours. The S012 hardware was retrieved during the egress part of EVA at 49 hours 50 minutes ground elapsed time (g.e.t.) and then stowed in the spacecraft.

UNCLASSIFIED

8.12.4 Results

The flight crew reported at 64 hours 15 minutes g.e.t. that the S012 hardware could not be located in the spacecraft. They believed that the experiment hardware floated through the open hatch during extravehicular operations. Consequently, data samples were not recovered for postflight analysis. Results or conclusions are therefore, unobtainable.

UNCLASSIFIED

NASA-S-66-8156 AUG 17

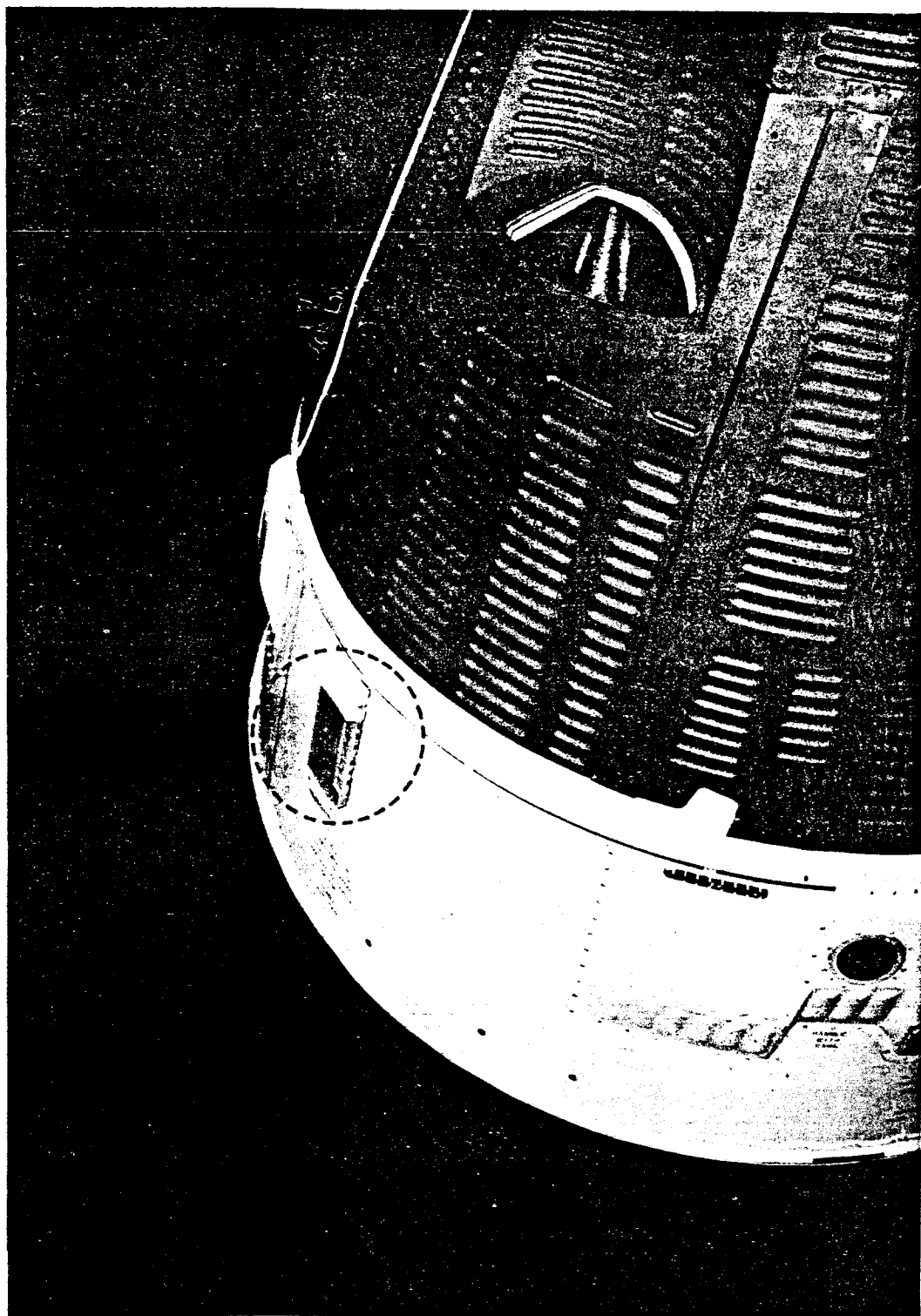

Figure 8.12-1. - Experiment S012, hardware location.

UNCLASSIFIED

8.13 EXPERIMENT S013 (S-13), ULTRAVIOLET ASTRONOMICAL CAMERA

8.13.1 Objective

The fundamental objective of the Ultraviolet Astronomical Camera (S013) experiment was to record the ultraviolet radiation of stars in the wavelength regions from 2000 to 4000 Å.

8.13.2 Description

The objective was to be accomplished by recording radiation spectra, using a 70-mm general purpose camera, and an objective prism or an objective grating.

An analysis of the surface temperatures of these stars, of the absorption effects taking place in their atmospheres, and of the absorption effects of the interstellar dust will be made of the photographic data obtained. The high resolution photographs are expected to show both the absorption and the emission lines, making possible the study of atomic excitation and ionization processes in these wavelength regions.

In addition to the acquisition of basic astronomical data, the best techniques by which objective-prism spectra may be obtained from spacecraft will be determined. Practical experience will be useful in planning similar astronomical observations with larger telescopes on future missions.

8.13.3 Equipment

The experiment equipment consists of a 70-mm general-purpose camera equipped with a 73-mm ultraviolet lens, a 10-degree objective prism in a cell which provides attachment to the ultraviolet lens, and a reflection grating in a cell which provides attachment to the ultraviolet lens. Figure 8.13-1 shows the camera and prism assembly mounted to the spacecraft in the position used during flight.

8.13.4 Procedures

Prior to EVA, the pilot unstows the camera and the prism or grating, then locks them to the bayonet joint of the lens. The camera is then attached to the bracket located near the pilot's seat.

UNCLASSIFIED

After hatch opening, the spacecraft is pointed toward the first star target, using a reticle located on the command pilot's window. Because the camera axis is parallel to the roll axis of the spacecraft, the roll rate is the least critical of the three motions. Roll rates to 0.5 deg/sec can be tolerated with little loss of image definition. Both pitch and yaw rates are decreased to 0.1 deg/sec or less. Pitch motion is the most critical because it is parallel to the direction of dispersion and will degrade the wavelength resolution of the spectra.

A series of three 5-second time exposures are made on each star field and the film is advanced between each exposure. Two exposures of one minute each are made during periods when the stabilizing thrusters are operated to hold the spacecraft attitude constant. Finally, a sixth exposure is made with a yaw rate appreciably greater than the pitch rate.

8.13.5 Results

Because of a constraint on the usage of spacecraft propellants, the experiment was performed while the spacecraft was docked with the Gemini Agena Target Vehicle (GATV). During experiment activation, the GATV/spacecraft roll axis was held at zero degrees pitch and 90 degrees left yaw. Stabilization was provided by the GATV attitude control system.

Twenty-two exposures were obtained and each was, nominally, 20 seconds in duration. All exposures were pointed to the β Crucis field, because it was near the pole of the spacecraft orbit and on the southern horizon throughout the night pass. Apparently, when the equipment was assembled and mounted during the flight, the reflection grating was inadvertently twisted counterclockwise 17 degrees. The orbital motion of the spacecraft, therefore, produced a migration of the field centers from the region of β Crucis to the region of γ Velorum. Consequently, the region which is probably the most interesting in the entire Milky Way was scanned. Spectra were obtained for many more stars than were expected to appear on the film. The twist of the grating did prevent proper widening of the spectra and resulted in a greater-than-expected trailing of the star images. The trailing of the star images was generally in the direction of dispersion. While this provided more spectra than expected at the longer exposures, it also degraded the wavelength resolution so that emission or absorption lines were not seen in the spectra.

A frame-by-frame log of the flight film is given in table 8.13-I. The spectra of 54 stars have been tentatively identified on the film. Quantitative spectra analysis of stars having a magnitude of two or greater should be possible.

UNCLASSIFIED

Figure 8.13-2 is a composite of one frame with the specific star names. Ultraviolet energy curves for a least twenty stars will eventually be determined. The degraded wavelength resolution makes it impossible to resolve lines in these spectra. A preliminary inspection indicates that the photometric measures of the zero-order images may yield useful ultraviolet data of stars as faint as seventh magnitude at 2200 Å. It is anticipated that stars with previously unsuspected ultraviolet energy will be found.

8.13.6 Conclusions

Four separate equipment problems occurred during the mission.

(a) Twelve of the frames were marred by a vertical streak which does not appear to be caused by ordinary light leaks. Static electricity rising from camera operation under vacuum conditions could cause this effect.

(b) Preflight and postflight calibration exposures with the flight camera showed images of good quality at the center of the field. The inflight exposures showed poor image quality at the center of the field and good image quality away from the center. The shape of the images indicates the film was too close to the lens, apparently caused by film bowing towards the lens in vacuum conditions.

(c) The cable release was broken during assembly of the camera. A more suitable cable release has been provided for the Gemini XI mission.

(d) One of the screws in the bracket assembly backed out preventing proper insertion in the ways. According to the pilot, difficulty was encountered during bracket insertion.

About ten percent of the field of first-order star spectra was obscured by the GATV when in the docked configuration. About 40 percent of the field of zero-order star images was obscured. The masking of zero-order images prevented interference with most of the first-order spectra.

Extraneous light was not observed either originating in or reflected from the GATV. GATV stabilization which was achieved during the second half of the night exposure period appears to have been adequate for the purpose of this experiment. The experiment operation while in a docked configuration is now recommended in order to use the greater inertia of the combined masses of the two vehicles. This provides increased sensitivity of the pulse control mode in attitude-hold.

UNCLASSIFIED

UNCLASSIFIED

8-65

It is planned that, during the next mission, the spacecraft/GATV will be inertially oriented on each of the series of observed fields. This should greatly reduce the trailing of the stars which degraded wavelength resolution of the spectra obtained on Gemini X.

In summary, this experiment can be considered successful in that it achieved useful scientific data and established needs for better equipment and procedures on additional flights.

UNCLASSIFIED

UNCLASSIFIED

TABLE 8.13-I.- EXPERIMENT S013 INFLIGHT EXPOSURES

Frame number	Number of spectra	Remarks
S66-45306	--	Blank frame
07	--	Spacecraft interior—out of focus
08	--	Spacecraft interior—out of focus
09	--	Spacecraft interior—out of focus
10	6	L-band antenna (?) seen
11	8	--
12	6	--
13	8	--
14	10	--
15	9	Faint vertical fog line
16	7	Two spectra doubtful
17	4	--
18	4	One spectrum doubtful
19	6	One spectrum doubtful—moderate vertical fog line
20	8	--
21	7	Three spectra doubtful
22	9	One spectrum doubtful—weak vertical fog line
23	11	Strong vertical fog line
24	8	Strong vertical fog line
25	14	Three spectra doubtful—moderate vertical fog line
26	15	Two spectra doubtful—strong vertical fog line

UNCLASSIFIED

UNCLASSIFIED

8-67

TABLE 8.13-I.- EXPERIMENT S013 INFLIGHT EXPOSURES - Concluded

Frame number	Number of spectra	Remarks
S66-45327	14	Very strong vertical fog line
28	23	One spectrum doubtful
29	13	Weak fog at lower left
30	25	Four spectra doubtful—very strong vertical fog line—structure smoother than before
31	34	One spectrum doubtful—light leak fog upper left—strong crescents in center and lower right

UNCLASSIFIED

UNCLASSIFIED

NASA-S-66-8134 AUG 15

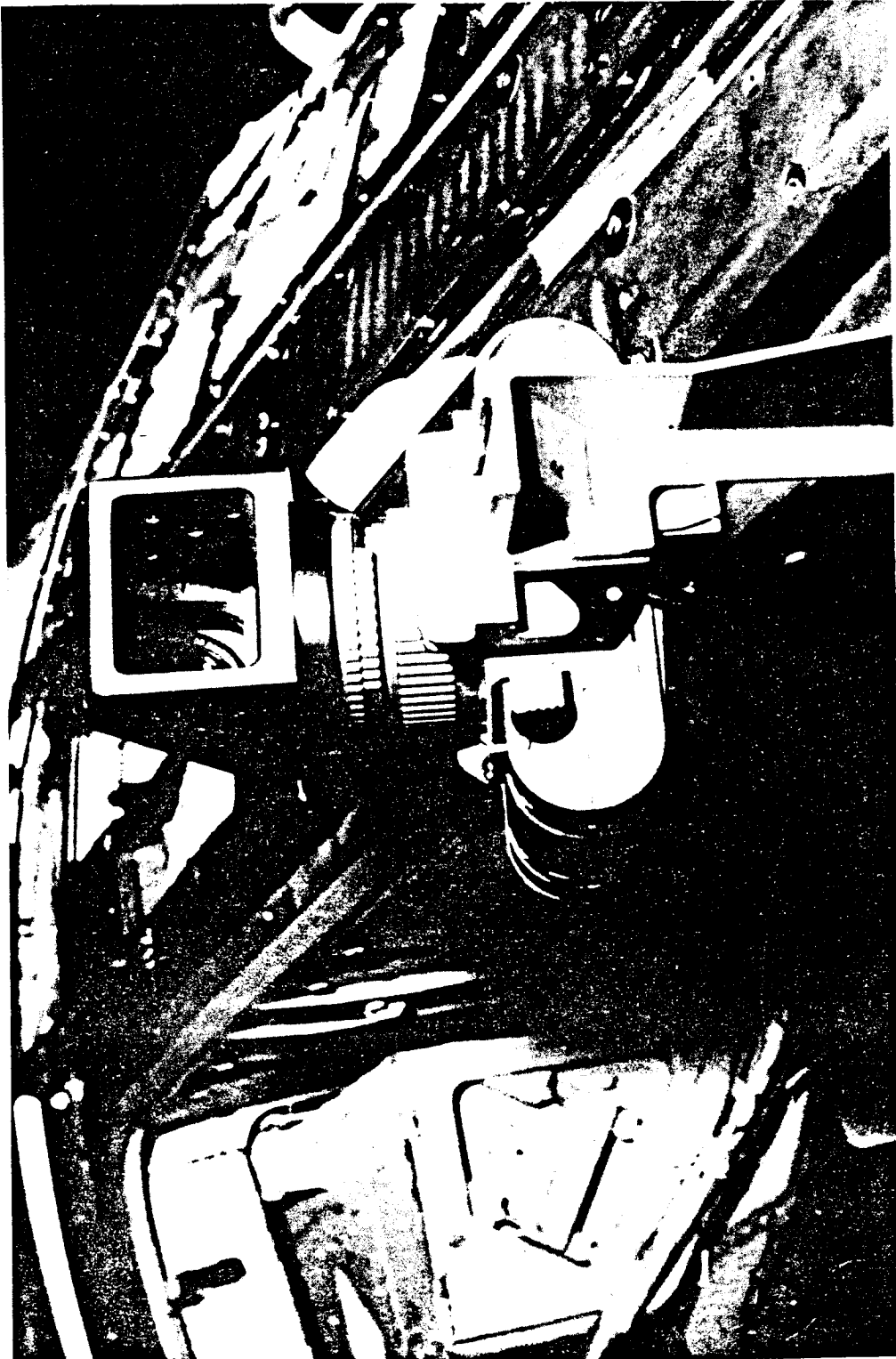
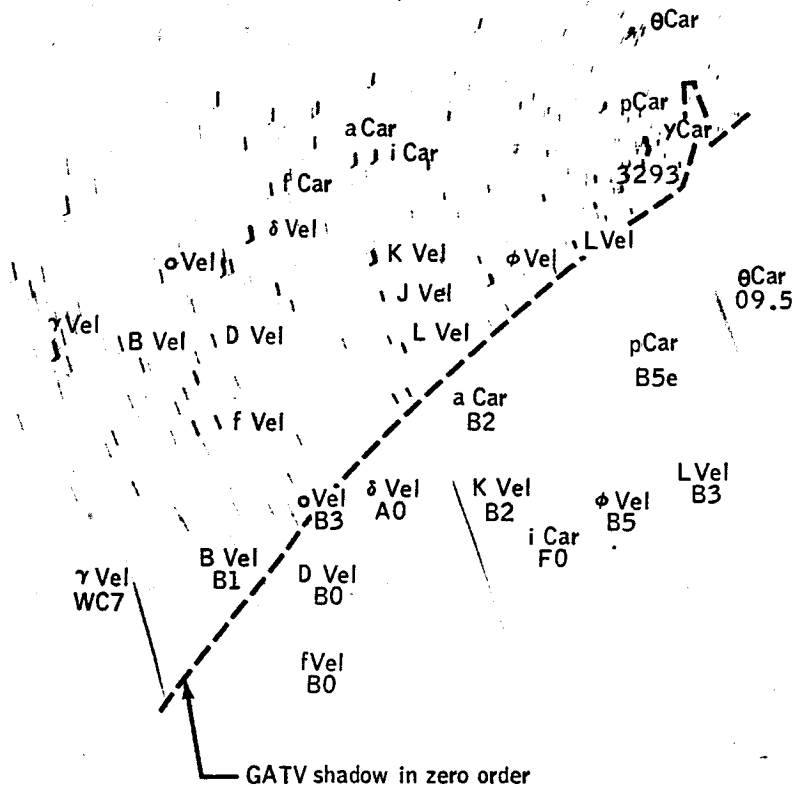

Figure 8.13-1. - Experiment S013, ultraviolet camera mounting configuration.

UNCLASSIFIED

NASA-S-66-8133 AUG 13



These spectra were obtained during standup EVA with the general purpose 70-mm camera, taken at an f setting of 3.3 using a 73-mm lens and an objective grating. The spectra extend from 2200 Å to about 3500 Å.

The spacecraft was docked with the Gemini X GATV resulting in an apparent field rotation due to orbital motion of 80 arc seconds during the 20-second exposure period.

Figure 8.13-2. - Ultraviolet spectra of stars in the Carina-Vela region of the Southern Milky Way

UNCLASSIFIED

8.14 EXPERIMENT S026 (S-26), ION-WAKE MEASUREMENT

8.14.1 Objectives

The objective of the Ion-Wake Measurement (S026) experiment is to measure and confirm the ion and electron wake structure and perturbation of the ambient medium produced by the orbiting Gemini spacecraft. The experiment is designed to obtain the following:

(a) A mapping of the spacecraft ion density wake as a function of position coordinates relative to the reference frame of the spacecraft

(b) A contour mapping of the spacecraft electron density wake as

(c) Determination of electron temperature as a function of the position coordinates

(d) Detailed information on ambient ion and electron densities and electron temperature as a function of altitude and diurnal variations from the Gemini Agena Target Vehicle (GATV)

(e) Ionization transients caused by spacecraft thruster firings.

8.14.2 Description

The Gemini spacecraft moves through the ionospheric medium with a velocity that is high compared with the random thermal velocities of the ions but small compared with the random thermal motions of the electrons. The vehicle motion is supersonic with respect to the ions and subsonic with respect to the electrons. Electrons, therefore, approach the vehicle from all directions as if it were standing still, whereas the ions are swept up by the vehicle motion.

shadow region. The electrostatic forces between these charged particles prevent substantial imbalances in the local space charge from occurring. The electrons are thus constrained by electric fields from moving too far away from their positive-ion counterparts.

The electron detector is located on the GATV Target Docking Adapter (TDA) and operates continuously during the experiment. Operation of the inboard and outboard ion detectors depends upon the angular relationship of the GATV with respect to the orbital velocity vector. The inboard ion detector provides useful data whenever the GATV moves TDA-forward with its axis parallel to the orbital path; the outboard detector is operative whenever the GATV yaws at right angles to the orbital path. The placement of the equipment on the GATV is shown in figure 8.14-1, and figure 8.14-2 shows a general ion-wake profile.

8.14.3 Equipment

The sensors are five-element retarding potential analyzers with ac-modulation for low-threshold operation. They are designed to measure ion and electron densities over a range from 5×10^6 per cm^3 to 50 per cm^3 , with electron temperature measurements in a range from three electron volts down to zero. For contour mapping, position resolution to approximately one foot in accuracy is obtained from a 16-mm general-purpose sequence camera.

The sensor-electrometer systems each collect and modulate plasma current in a faraday cup containing four grids followed by a collector plate. The voltage bias placed on the front grid limits the minimum energy plasma particle which can enter the sensor. The second grid accelerates the properly charged particles which passed the first grid.

A third grid is driven by a 3840-hertz square wave which modulates the plasma current by alternately blocking and accelerating the particles passing through the second grid. A fourth grid actually consists of three screens connected together to act as a capacitive shield between the modulation grid (grid three) and the final collector. The third screen in the final grid also serves as a collector for secondary photo electrons produced in the sensor.

The sensor output current is designed to swing from zero to the dc value of the input plasma current and back within one microsecond, with a 50-percent duty cycle at a frequency of 3840 hertz. This square-wave current is amplified by an ac electrometer located behind the sensor. Electrometer signals are synchronously demodulated and averaged by an analog signal processor carried aboard the GATV. A

UNCLASSIFIED

resulting voltage proportional to the logarithmic average is generated and buffered, then input to the analog-to-digital converter in the GATV telemetry system for transmission to the network tracking stations.

8.14.4 Procedures

Two distinct modes are used during flight. These modes have been designed to obtain a maximum amount of information on the wake structure with minimal consumption of spacecraft fuel. Mode-A constitutes a direct axial mapping of the wake, which is accomplished by linear separation of the spacecraft from the GATV. This type of maneuver is accomplished during final departure of the spacecraft from the GATV. In this mode, ion data are obtained by the inboard ion sensor.

The primary data mode of the S026 experiment is mode-B, illustrated in figure 8.14-3. The maneuvers are intended to map the spacecraft wake using in-plane maneuvers. Mapping commences with docked spacecraft/GATV configuration in a TDA-south orientation. The spacecraft separates from the target vehicle and performs a maneuver to a specific position. This position is on an axis along the orbital velocity vector of both the spacecraft and target vehicle and passing through the outboard sensors, with the spacecraft nose approximately one to three feet away from the target vehicle. The spacecraft then translates downward, maintaining the axial separation as constant as possible for a distance of approximately 15 feet. The spacecraft stops and then proceeds to carry out the portions of the trajectory described in figure 8.14-3. The distances off-axis corresponding to the transverse motion of the spacecraft were purposely chosen in excess of the anticipated wake dimensions in order that all thruster firings required to change direction in the manner shown will occur in regions where plasma-wake data are not of critical interest.

8.14.5 Results

The objectives of the experiment were met to only a limited degree due to fuel constraints encountered during the mission. The sensors were operative immediately after GATV shroud removal (six minutes from Gemini Atlas-Agena Target Vehicle lift-off) until GATV power depletion several days after spacecraft landing. During the Gemini X mission, there were two distinct measurements of wake and/or bow shock effects. These occurred during the docking and undocking maneuvers of the spacecraft.

A large amount of ambient data over the altitude band covered by the GATV from 160 nautical miles to 750 nautical miles were obtained.

UNCLASSIFIED

These data will be of considerable interest to those engaged in studies of the ionosphere and also to those concerned with the effects of charges and the relaxation of charges on space vehicles during and following powered propulsion in the ionosphere.

Real-time telemetry data were obtained from all three sensors during passes over the Air Force Eastern Test Range. Real-time telemetry data from the Canary Islands were transmitted over the aeromedical lines during the crucial undocking maneuvers. This real-time information was essential, because the GATV delayed-time tape recorder was inadvertently turned off during part of the undocking.

Photographs obtained with the 16-mm general-purpose sequential camera during the undocking maneuver show that a considerable effort will be required to determine the effects of an apparent nonlinear separation which may have caused wake structure oscillations. In attempting a frame-to-frame reduction of the relative position coordinates of the two vehicles, a problem exists because of poor GATV definition and total loss of the GATV image during most of the departure after the separation distance had become approximately 100 feet. Other data were obtained during docking and station keeping and during the GATV primary propulsion system posigrade and retrograde firings.

8.14.6 Conclusions

Quick-look analysis of the data from the GATV orbits indicates that electron and ion temperatures were higher than estimated. The high electron temperature accounts for the sensor saturation observed during the mission. This temperature measurement was 0.3 of an electron-volt at a 200-nautical-mile altitude during daytime conditions.

Spacecraft wake structure has been observed out to a distance of 100 feet from the vehicle. Some oscillatory behavior in the wake structure was observed. The theory of Gurevich and other Soviet scientists predicted an oscillatory wake structure. It is not clear at this point whether these S026 observations are the result of spacecraft motion in and out of the wake or represent a confirmation of the Gurevich theory.

UNCLASSIFIED

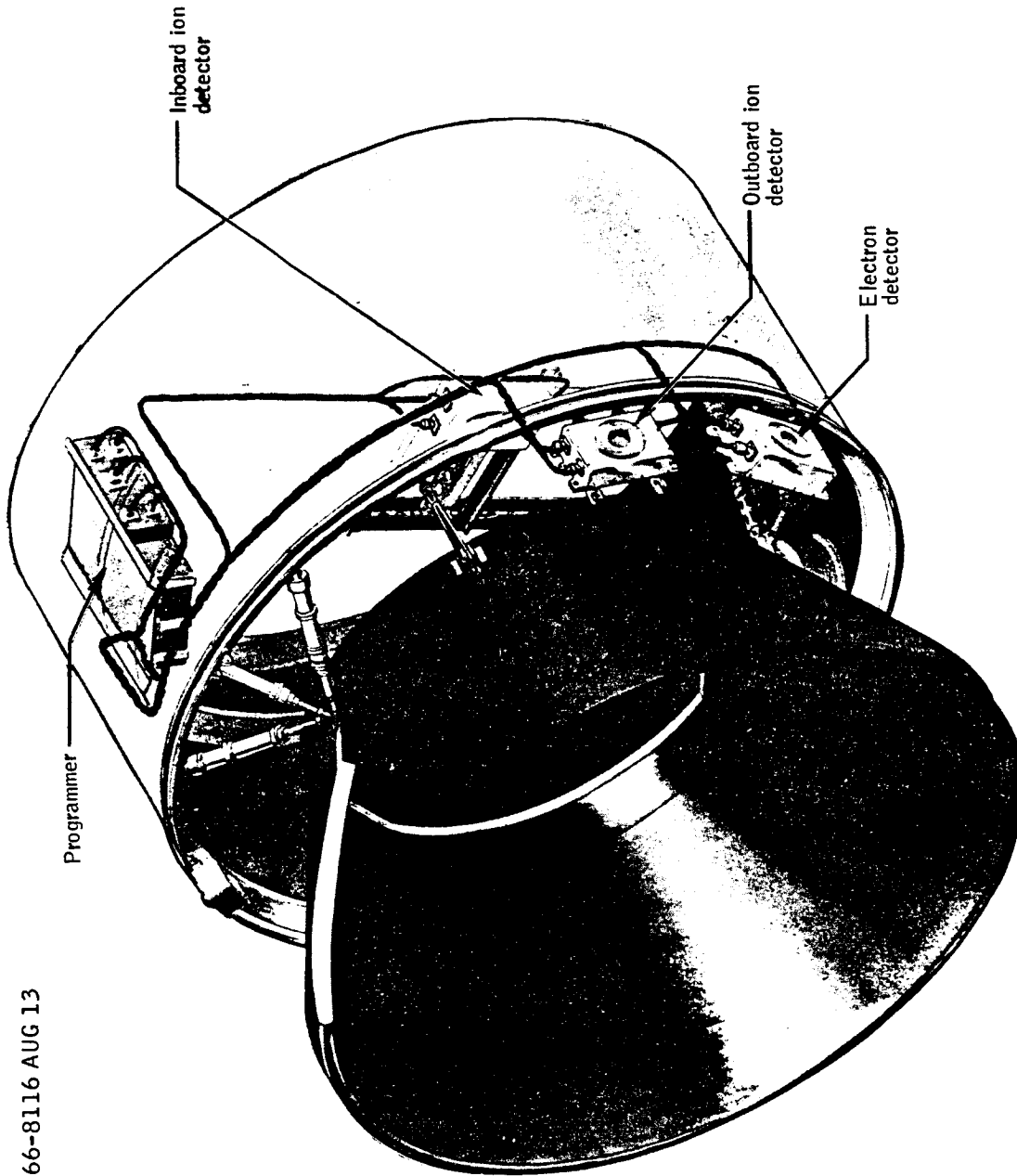

Figure 8.14-1. - Experiment S026, configuration on Target Docking Adapter.

NASA-S-66-8116 AUG 13

UNCLASSIFIED

NASA-S-66-8107 AUG 12

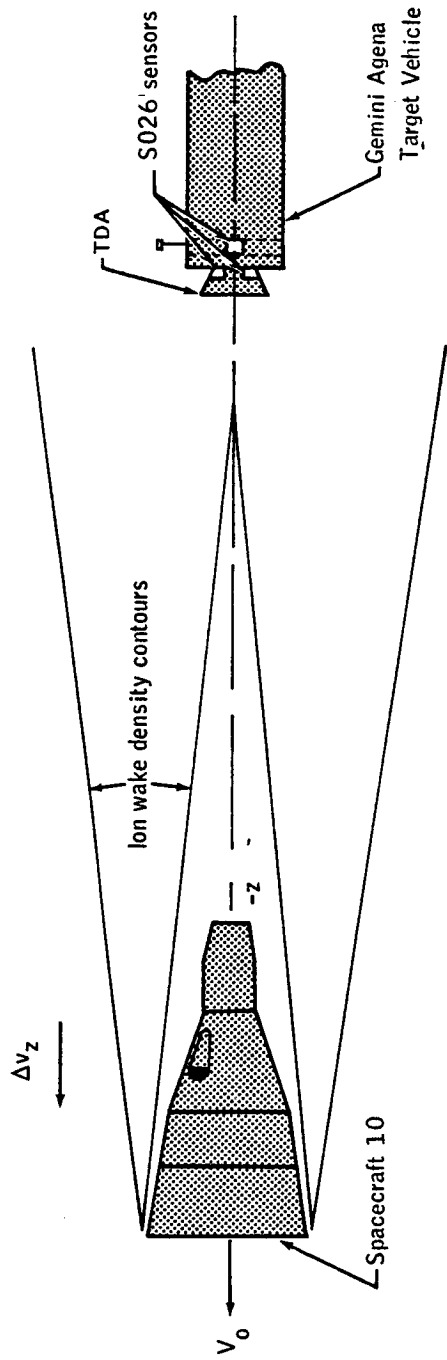
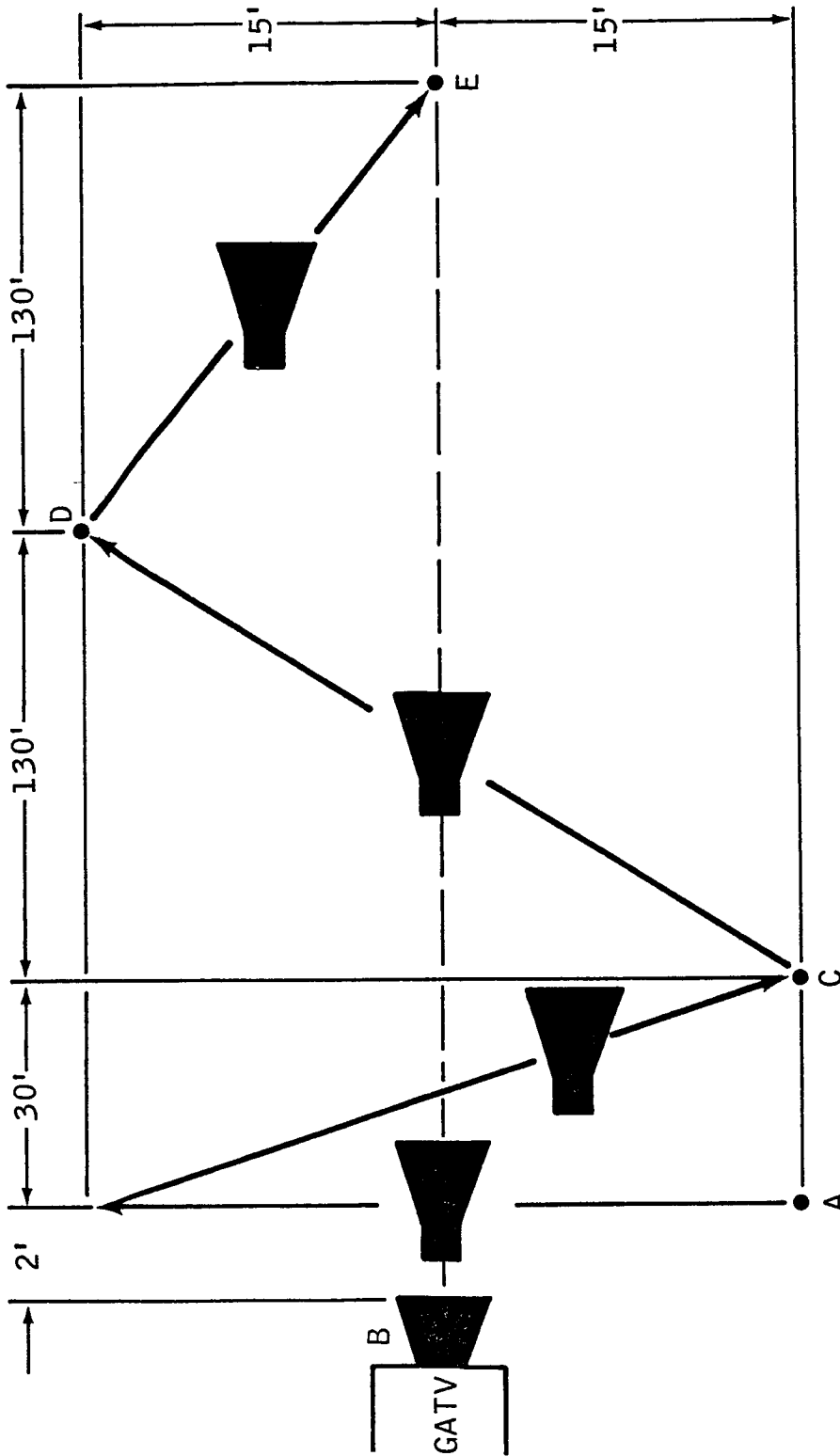

Figure 8.14-2. - Experiment S026, typical ion-wake profile.

UNCLASSIFIED



Total time of maneuvers = 10 min

NASA-S-66-8104 AUG 12

UNCLASSIFIED

Figure 8.14-3. - Experiment S026, Gemini undocking maneuvers for ion-wake measurements.

9.0 CONCLUSIONS

The overall performance of the two launch vehicles, the Gemini Agena Target Vehicle, the spacecraft, the flight crew, and mission support was most satisfactory for all phases of the Gemini X mission. The flight contributed significantly to the knowledge of manned space flight, especially in the areas of rendezvous, docked maneuvering with large propulsion systems, extravehicular activity, and controlled reentry.

The following conclusions were obtained from data evaluation and crew observations:

1. The Gemini X mission was the most complex flight of the Gemini Program. This mission demonstrated the ability to perform a wide variety of complex operations during a relatively short-duration flight.
2. The Gemini Agena Target Vehicle propulsion systems accurately provided the desired velocities to initiate the rendezvous with the passive Gemini VIII Gemini Agena Target Vehicle. Three primary propulsion system and three secondary propulsion system docked maneuvers were performed to achieve the desired orbital phase and plane after which the crew undocked and completed the passive rendezvous.
3. The Guidance and Control System operated in an excellent manner during the Gemini X mission. The guidance solutions for the first rendezvous were adequate to place the spacecraft in an acceptable closing trajectory for rendezvous. In executing the first rendezvous, an off-nominal transfer trajectory contributed to an excessive use of spacecraft propellants by the crew; however, station keeping and docking were satisfactory.
4. The optical techniques for rendezvous were shown to be adequate; however, the terminal phase maneuvers for an optical rendezvous were more difficult because the onboard computer and radar could not be used.
5. The onboard orbit-navigation computer program (Module VI) was mechanized for this mission and operated properly; however, pre-established criteria for the use of the ascent vector and difficulties with the procedures for orbit determination prevented the use of the onboard solutions for the rendezvous catch-up phase of the first rendezvous. The results of the mission show that the deterministic orbit navigation mode of operation is feasible and indicate that further study should be accomplished in exploring this method of operation for use in future programs.

UNCLASSIFIED

6. The Auxiliary Tape Memory Unit was loaded with all modules planned for use on the Gemini Program and operated in an excellent manner in reprogramming the onboard computer many times during the Gemini X mission. This unit increased the memory capability of the computer from 12 288 13-bit words to 31 751 13-bit words. These 31 751 words were redundantly stored on the tape giving a total storage of 63 502 words, which is about 65 percent of the Auxiliary Tape Memory Unit capacity. The excellent operation of the Auxiliary Tape Memory Unit on the last three Gemini missions has demonstrated that this unit provides an operational capability of reprogramming the compact onboard computer to perform a variety of additional functions beyond its original intended capability.

7. The extravehicular activities were performed very satisfactorily. The crew operated the hatch very easily on three occasions, twice for operations outside the spacecraft and once to discard equipment not required for the remainder of the mission. During the first extravehicular period (standup), Experiment M410 (Color Patch Photography) and Experiment S013 (Ultraviolet Astronomical Camera) were accomplished satisfactorily. During the second extravehicular period (umbilical) the pilot satisfactorily retrieved the Experiment S012 (Micrometeorite Collection) package from the spacecraft adapter and Experiment S010 (Agena Micrometeorite Collection) package from the Gemini VIII target vehicle. During this extravehicular period, the pilot evaluated the Hand Held Maneuvering Unit and found it to be satisfactory for translating to other satellites and returning to the spacecraft.

8. During the third hatch opening, the pilot satisfactorily jettisoned equipment not required for the remainder of the mission and found this to be a very satisfactory solution to inflight housekeeping problems.

9. During the standup extravehicular activity, the pilot experienced eye irritation coupled with eye watering which caused a temporary loss of clear vision. The command pilot experienced the same irritation but to a lesser degree. This condition resulted in termination of the standup extravehicular activity about six minutes earlier than planned.

10. The concurrent operations of station keeping with the passive target vehicle and extravehicular activity preparation and operation resulted in a high workload on the crew and hindered them from aiding each other in performing their tasks.

11. The Gemini Orbital Attitude and Maneuver System control characteristics permitted station keeping within a few feet of another vehicle, thereby enabling effective crew transfer to another orbiting vehicle.

UNCLASSIFIED

UNCLASSIFIED

9-3

12. Handholds which permit positive engagement are required for extravehicular operations on the surface of an orbiting satellite. Without such handholds, an extravehicular astronaut will have difficulty controlling his body position and may not be able to maintain contact with the orbiting body.

13. The extravehicular tasks of crew transfer, maneuvering in space, and equipment removal can be accomplished with low workloads (under 2000 Btu/hr) under favorable conditions. Tasks involving gross body movements, such as ingress to the Gemini spacecraft, require high workloads, which appear to exceed 2000 Btu/hr. The reduction of the extravehicular workload and the application of the visor anti-fog solution were effective in preventing visor fogging during this mission.

14. The success of the mission was not jeopardized, nor was a hazard created, as a result of the Stage I oxidizer tank rupturing 1.2 seconds after staging.

15. The instrumentation and telemetry system operated very satisfactorily during the Gemini X mission. However, during the umbilical extravehicular activity, the instrumentation system experienced a period of continuous spurious resets; however, the lack of telemetry data did not jeopardize the success of the mission.

16. Although experiment operations were limited by propellant availability considerations, data were obtained from 12 of the 14 experiments attempted on the Gemini X mission. Results of the experiments, contained in section 8.0, further enhanced the knowledge of the space environment and operations in space.

17. The Gemini X spacecraft accomplished a precision controlled reentry to within 3.4 nautical miles of the planned landing point. This is the fifth consecutive mission in which a precision controlled reentry has been achieved thus demonstrating a sound operational capability

9-4

UNCLASSIFIED

THIS PAGE INTENTIONALLY LEFT BLANK

UNCLASSIFIED

10.0 RECOMMENDATIONS

The following recommendations were made as a result of engineering analyses and crew observation of the Gemini X mission:

1. The 100-percent timeline margin for extravehicular operations preparations should be continued on all missions.
2. The extravehicular equipment cramped the cockpit and would have been exceedingly difficult to adequately stow for reentry; therefore, the procedure of jettisoning this equipment is highly recommended.
3. The length of the umbilical for extravehicular activity should be no longer than required for the intended use.
4. Adequate restraints or handholds should be provided on other vehicles and on the spacecraft for use during extravehicular activity.
5. Opening of the hatch and egressing the spacecraft for extravehicular activity should be accomplished in daylight, if possible.
6. Adequate covers should be provided for the suit visor and extravehicular visor to prevent the scratching and flaking which occurred during the Gemini X mission.
7. The tether lock pin should be modified to prevent accidental removal.
8. All equipment which is to be retrieved during extravehicular activities should have integral restraint hooks or snaps to permit temporary stowage until the spacecraft hatch is closed. All equipment to be used during the extravehicular operation should be temporarily attached by straps or hooks to the extravehicular crewman or to the inside of the cockpit.
9. Station keeping operations in the pressurized suit with the pilot extravehicular presented camera interface problems which must be corrected in order to properly document these events. These problems were the absence of clearance between the command pilot's shoulder and the camera lens, the impossibility of determining whether the camera was operating, the inability to determine the amount of film remaining in the camera, and the impossibility of changing the f-stops to cover the swiftly changing lighting conditions. In order to document the extravehicular activities and station-keeping operations, the above problems

UNCLASSIFIED

should be corrected by development of an integrally mounted sequence camera with sufficient controls and displays conveniently located and compatible with pressurized-suit operations. For routine camera operations a small hand-held camera should be used in order to cover the field of interest.

10. When practical, the more propellant-conservative control modes of the Gemini Agena Target Vehicle should be used, such as the use of flight control mode 1, whenever wide deadband control of attitudes is acceptable. Also, gyrocompassing in flight control mode 1 should be used to establish new headings, if time permits.

11. Should further onboard navigation be conducted, the procedures should be streamlined to allow time for each step to be systematically checked after completion.

12. All spacecraft equipment should be stowed before a Gemini Agena Target Vehicle primary propulsion system maneuver.

13. Gemini Agena Target Vehicle tailoff should be included in the spacecraft computer load for immediate knowledge of the total overshoot, if any.

14. For a large out-of-plane PPS firing, the inertial system should be caged small end forward (SEF) or blunt end forward (BEF), as necessary, following a gyrocompass out-of-plane maneuver and the fine alignment in flight control mode 2. The system should be placed in the orbit rate mode just prior to the PPS fire signal so that the ΔV will be displayed in the incremental-velocity-indicator aft window.

15. The times-ten multiplication factor of the incremental velocity indicator provides the crew a satisfactory monitor for accurately commanding primary propulsion system shutdown and should be considered for use as the standard technique for shutdown.

16. For future programs, if the crew is to maneuver with a docked vehicle, all instruments for monitoring and/or controlling the docked vehicle should be in the spacecraft cabin.

17. The flight crew should maintain a detailed log of occurrences or events which are other than expected; this information will enable more detailed postflight evaluation.

18. The digital clock stop-start switch should be of the lever-lock type to avoid inadvertent shutoff.

UNCLASSIFIED

UNCLASSIFIED

10-3

19. Every effort should be made to develop food which can be prepared in a short time.

20. The drogue parachute should be deployed at an altitude of 50 000 feet to ensure maximum stabilization of the spacecraft and maximum protection for the crew.

21. All training equipment should be identical to flight equipment, and an engineering evaluation of the accuracy of the training equipment should be completed prior to crew training.

22. Noise from all external sources should be eliminated during prelaunch communication checks. Also, a standard format should be adopted for transmission of updates and maneuver information to the crew, and updates should be transmitted slower to allow the flight crew to copy them with ease.

UNCLASSIFIED

10-4

UNCLASSIFIED

THIS PAGE INTENTIONALLY LEFT BLANK

UNCLASSIFIED

UNCLASSIFIED

11-1

11.0 REFERENCES

1. Gemini Mission Evaluation Team: Gemini Program Mission Report for Gemini-Titan I (GT-1). MSC-R-G-64-1, NASA Manned Spacecraft Center, May 1964.
2. Gemini Mission Evaluation Team: Gemini Program Mission Report GT-2, Gemini 2. MSC-G-R-65-1, NASA Manned Spacecraft Center, Feb. 1965.
3. Gemini Mission Evaluation Team: Gemini Program Mission Report GT-3, Gemini 3. MSC-G-R-65-2, NASA Manned Spacecraft Center, Apr. 1965.
4. Gemini Mission Evaluation Team: Gemini Program Mission Report, Gemini IV. MSC-G-R-65-3, NASA Manned Spacecraft Center, June 1965.
5. Gemini Mission Evaluation Team: Gemini Program Mission Report, Gemini V. MSC-G-R-65-4, NASA Manned Spacecraft Center, Aug. 1965.
6. Gemini Mission Evaluation Team: Gemini Program Mission Report, Gemini VI. MSC-G-R-65-5, NASA Manned Spacecraft Center, Oct. 1965.
7. Gemini Mission Evaluation Team: Gemini Program Mission Report, Gemini VII. MSC-G-R-66-1, NASA Manned Spacecraft Center, Jan. 1966.
8. Gemini Mission Evaluation Team: Gemini Program Mission Report, Gemini VI-A. MSC-G-R-66-2, NASA Manned Spacecraft Center, Feb. 1966.
9. Gemini Mission Evaluation Team: Gemini Program Mission Report, Gemini VIII. MSC-G-R-66-4, NASA Manned Spacecraft Center, Apr. 1966.
10. Gemini Mission Evaluation Team: Gemini Program Mission Report, Gemini IX-A. MSC-G-R-66-6, NASA Manned Spacecraft Center, July 1966.
11. McDonnell Aircraft Corp.: Gemini Spacecraft Number 10 Performance/Configuration Specification. Report A900-10. (Revision D to be published in the as-launched configuration on or about August 15, 1966.)

UNCLASSIFIED

UNCLASSIFIED

12. TRW Systems: Orbital and Rendezvous Report for Gemini 10.
TRW Note 66 FMT-419, June 13, 1966.
13. Aerospace Corp.: Systems Tests Objectives for Gemini Launch Vehicle NASA Mission Gemini X. TOR-669 (6126-80)-11,
July 18, 1966.
14. Lockheed Missiles and Space Co.: Pre-injection Trajectory and Data for Gemini X. LMSC-A819879, June 1, 1966.
15. International Business Machines Corp.: Gemini Reentry Math Flow 7 Description. IBM No. 64-528-0001.
16. NASA Manned Spacecraft Center: Gemini Spacecraft/Launch Vehicle Specification and Control Document. Report ISCD-1, Nov. 22, 1963.
(As revised)
17. NASA Manned Spacecraft Center: Gemini Agena Interface Specification and Control Document. Report ISCD-2, April 20, 1965.
(As revised)
18. McDonnell Aircraft Corp.: Gemini Spacecraft Postflight RCS Deactivation. SEDR F-399, March 1965.
19. McDonnell Aircraft Corp.: Postflight Evaluation Procedures for Spacecraft 10. SEDR 499-10, July 6, 1966.
20. McDonnell Aircraft Corp.: Corrosion Control Procedures for Recovered Spacecraft. Procedural Specification 186, Aug. 1965.

UNCLASSIFIED

12.0 APPENDIX

12.1 VEHICLE HISTORIES

12.1.1 Spacecraft Histories

The spacecraft history at the contractor's facility in St. Louis, Missouri, is shown in figures 12.1-1 and 12.1-2. The spacecraft history at Cape Kennedy, Florida, is shown in figures 12.1-3 and 12.1-4. Figures 12.1-1 and 12.1-3 are summaries of activities, with emphasis on spacecraft systems testing and prelaunch preparation. Figures 12.1-2 and 12.1-4 are summaries of significant problem areas.

12.1.2 Gemini Launch Vehicle Histories

The Gemini Launch Vehicle (GLV) history and significant manufacturing activities at the contractor's facilities in Denver, Colorado, and in Baltimore, Maryland, are presented in figure 12.1-5. Of special note in this figure is the history of the Stage II fuel tank. The original GLV-10 Stage II fuel tank was damaged while in shipment from Denver to Baltimore, and, as a result, the GLV-11 Stage II fuel tank was assigned to GLV-10. The GLV history at Cape Kennedy, Florida, is presented in figure 12.1-6. This figure also includes problem areas which were concurrent with normal GLV launch preparation activities.

12.1.3 Gemini Agena Target Vehicle and Target Docking Adapter Histories

The Gemini Agena Target Vehicle (GATV) history at the contractor's facility in Sunnyvale, California, is shown in figure 12.1-7. The history of the GATV and the Target Docking Adapter (TDA) and significant problems encountered after delivery to Cape Kennedy, Florida, are shown in figure 12.1-8.

12.1.4 Target Launch Vehicle History

The Target Launch Vehicle (TLV) history at the contractor's facility in San Diego, California, is shown in figure 12.1-9. Figure 12.1-10 includes significant events and concurrent problems encountered during testing at Cape Kennedy, Florida.

UNCLASSIFIED

12.1.5 Extravehicular Life Support System History

Figure 12.1-11 is a summary of the history of the Extravehicular Life Support System (ELSS). This figure also identifies significant problems encountered while testing the ELSS at Cape Kennedy.

UNCLASSIFIED

NASA-S-66-8042 AUG 3

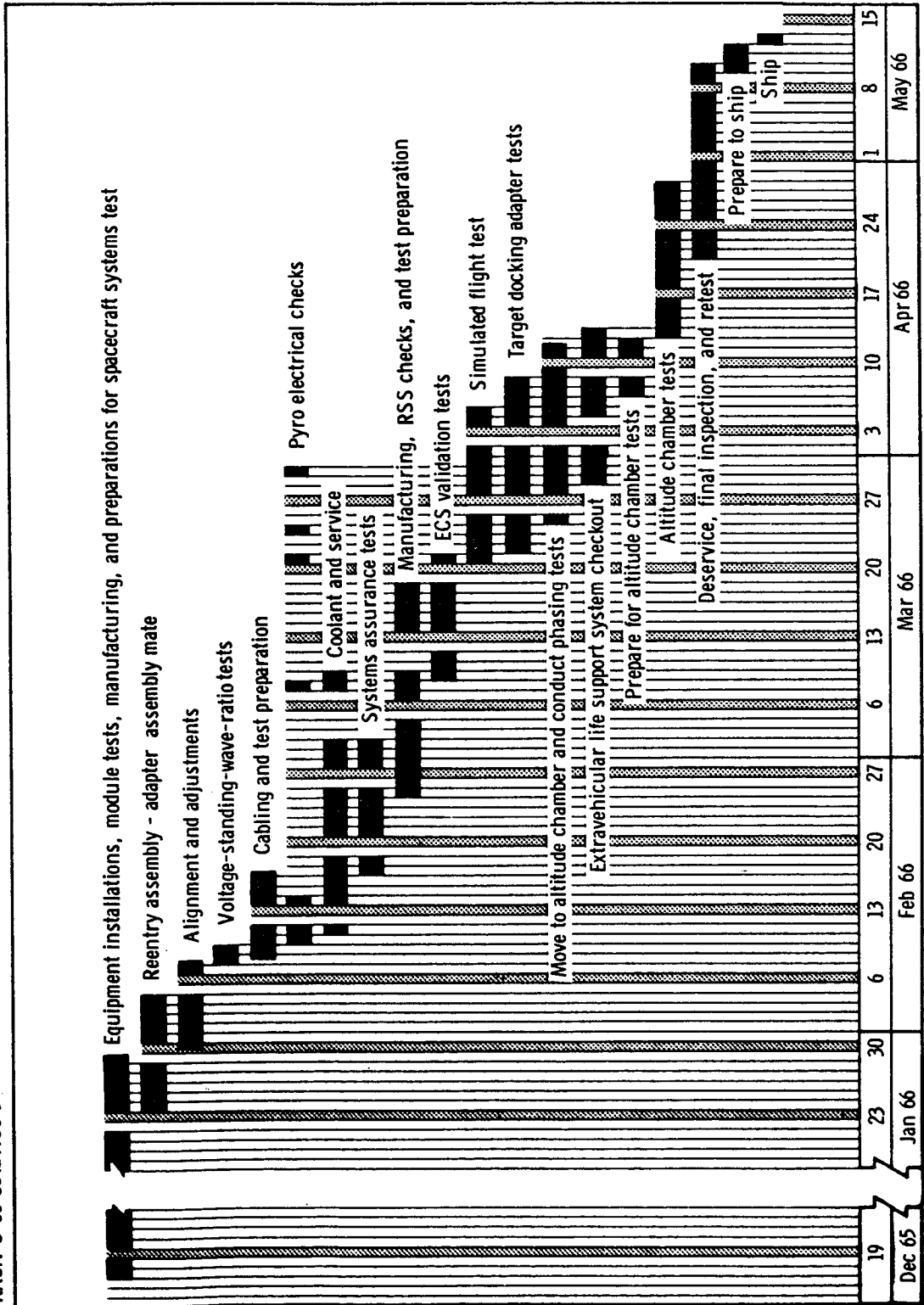

Figure 12.1.1. - Spacecraft 10 test history at contractor facility.

NASA-S-66-8043 AUG 3

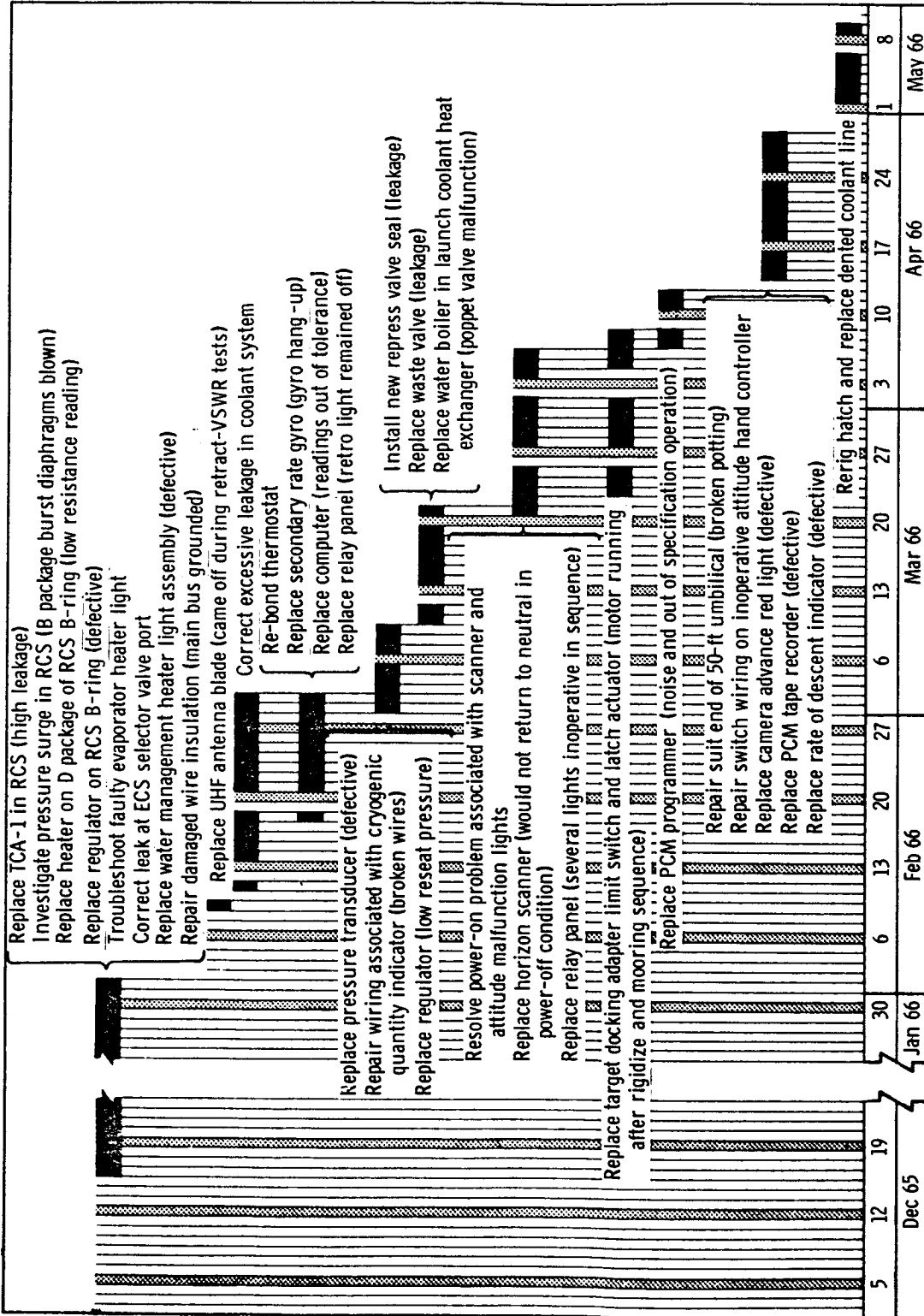

Figure 12.1-2. - Spacecraft 10 significant problems at contractor facility.

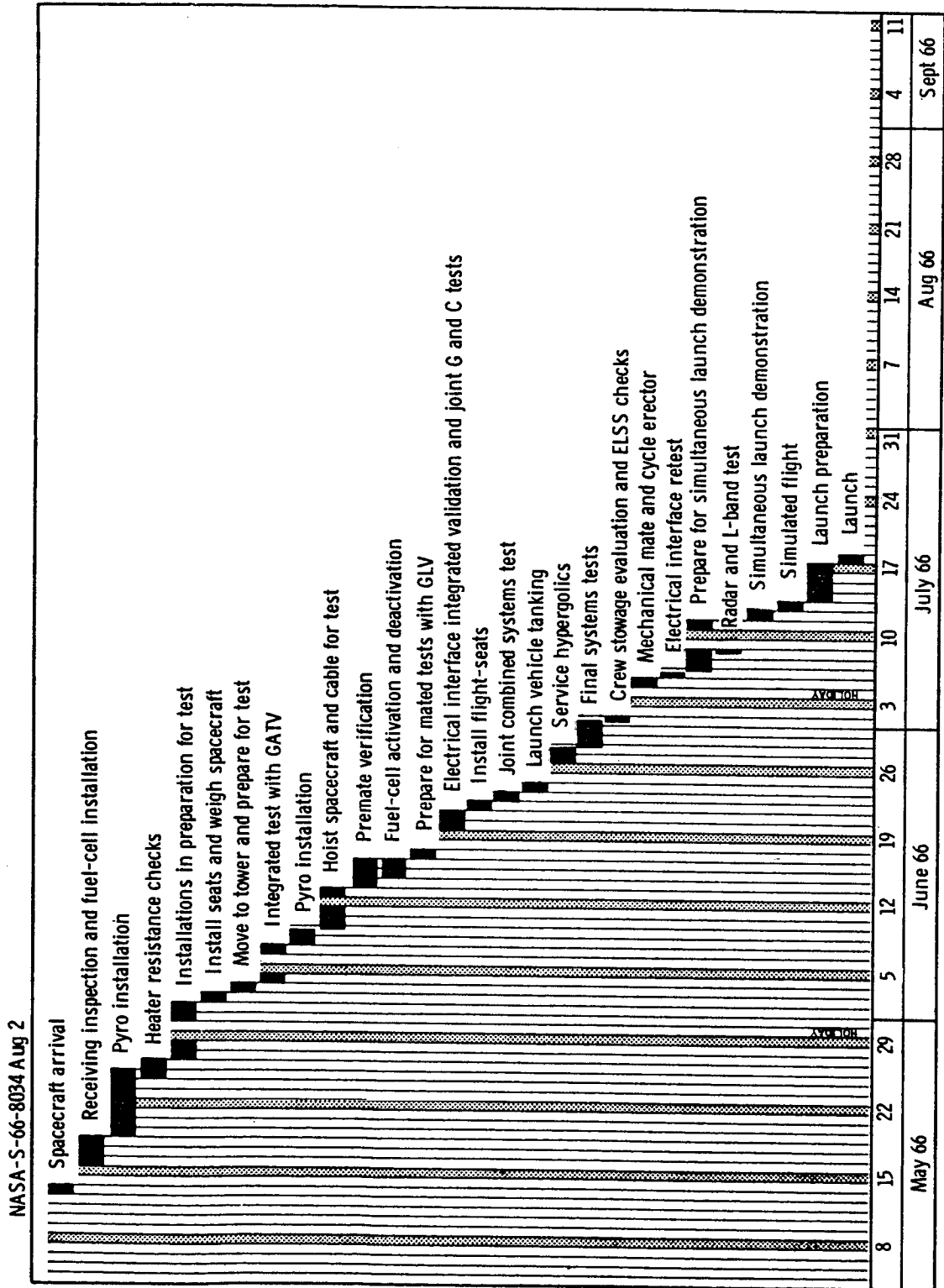

Figure 12.1-3. - Spacecraft 10 history at Cape Kennedy.

UNCLASSIFIED

NASA-S-66-8039 Aug 2

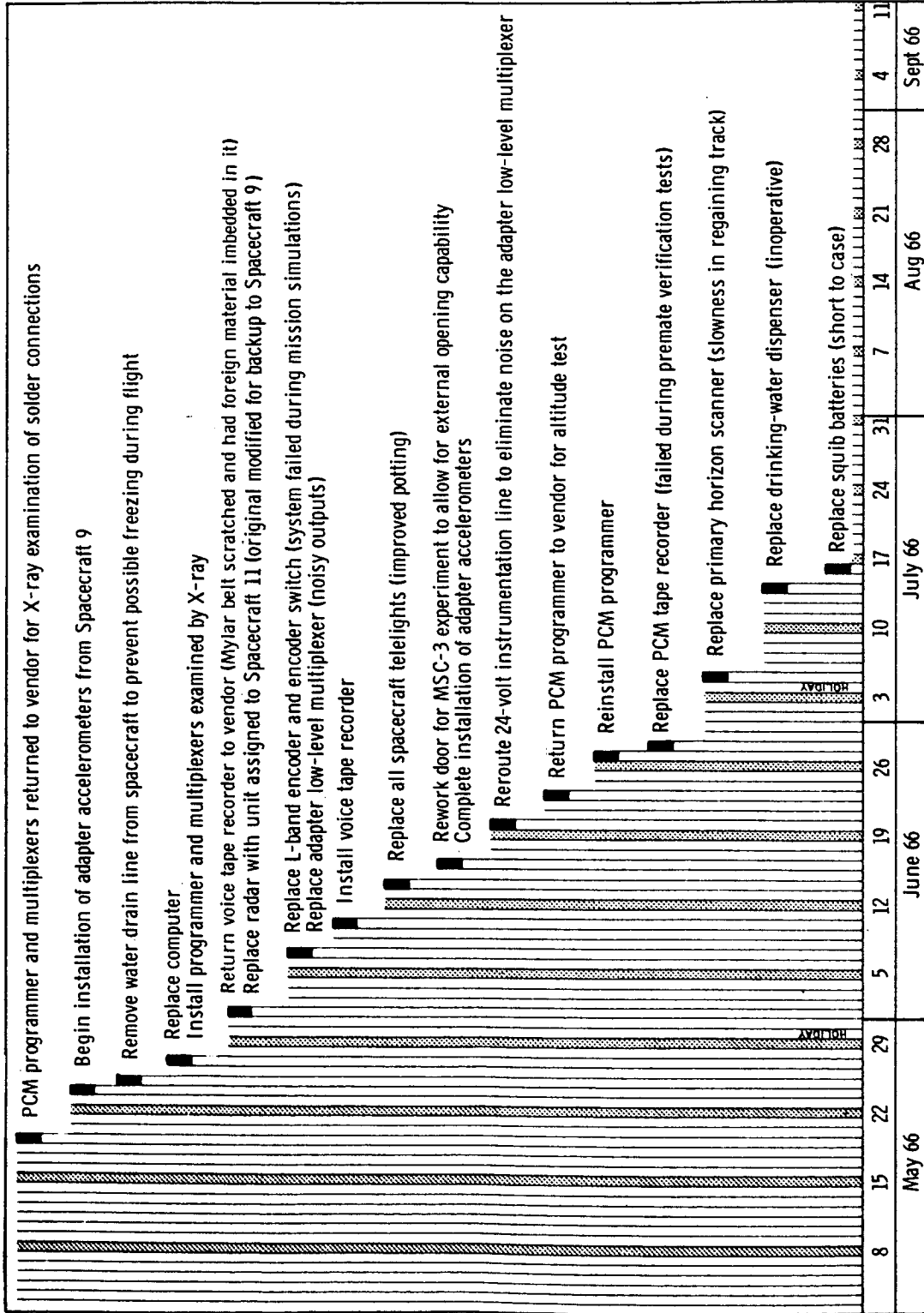

Figure 12.1-4. - Spacecraft 10 significant problems at Cape Kennedy.

UNCLASSIFIED

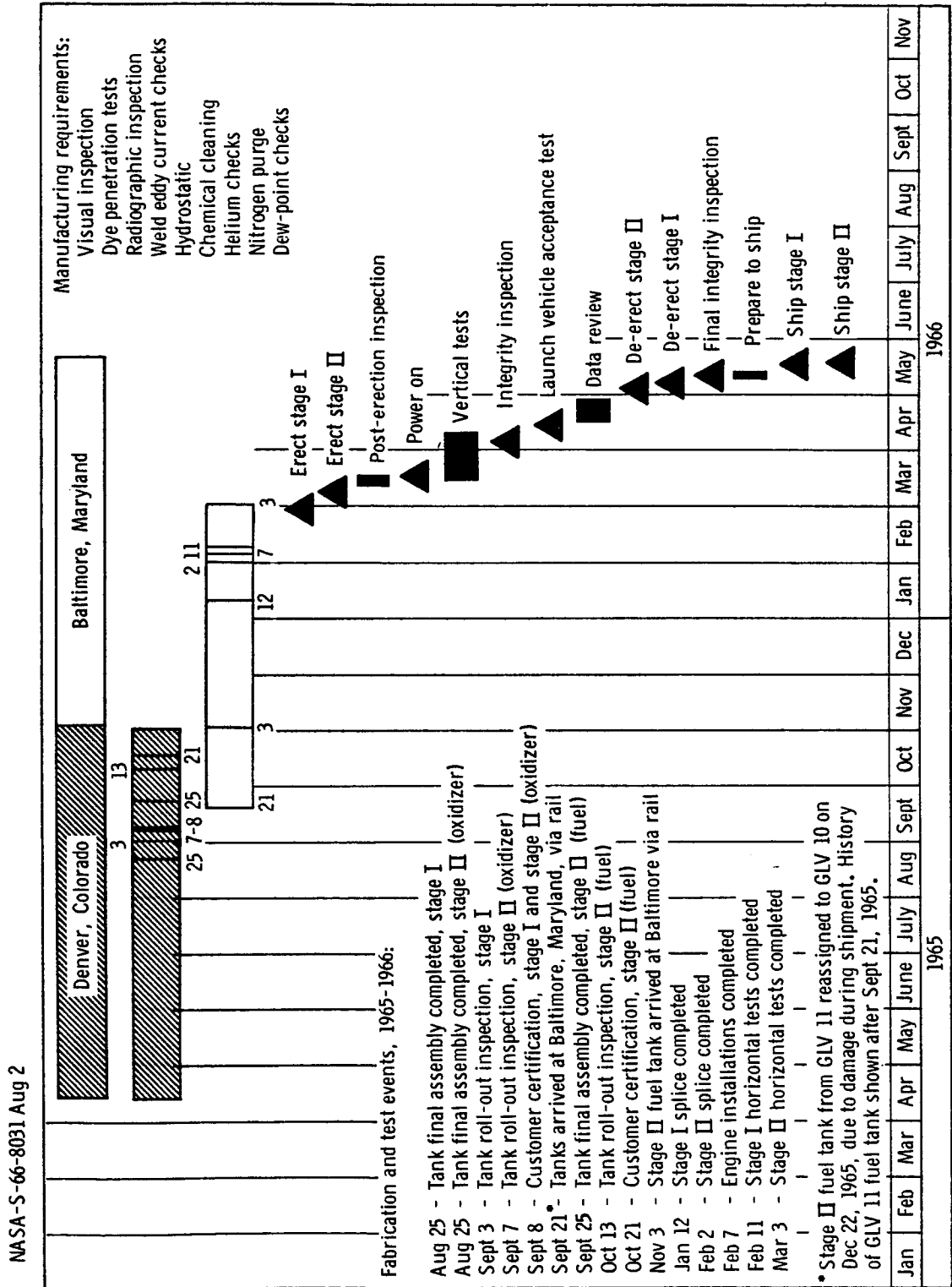

Figure 12.1-5. - GLV-10 history at Denver and Baltimore.

UNCLASSIFIED

NASA-S-66-8033 Aug 2

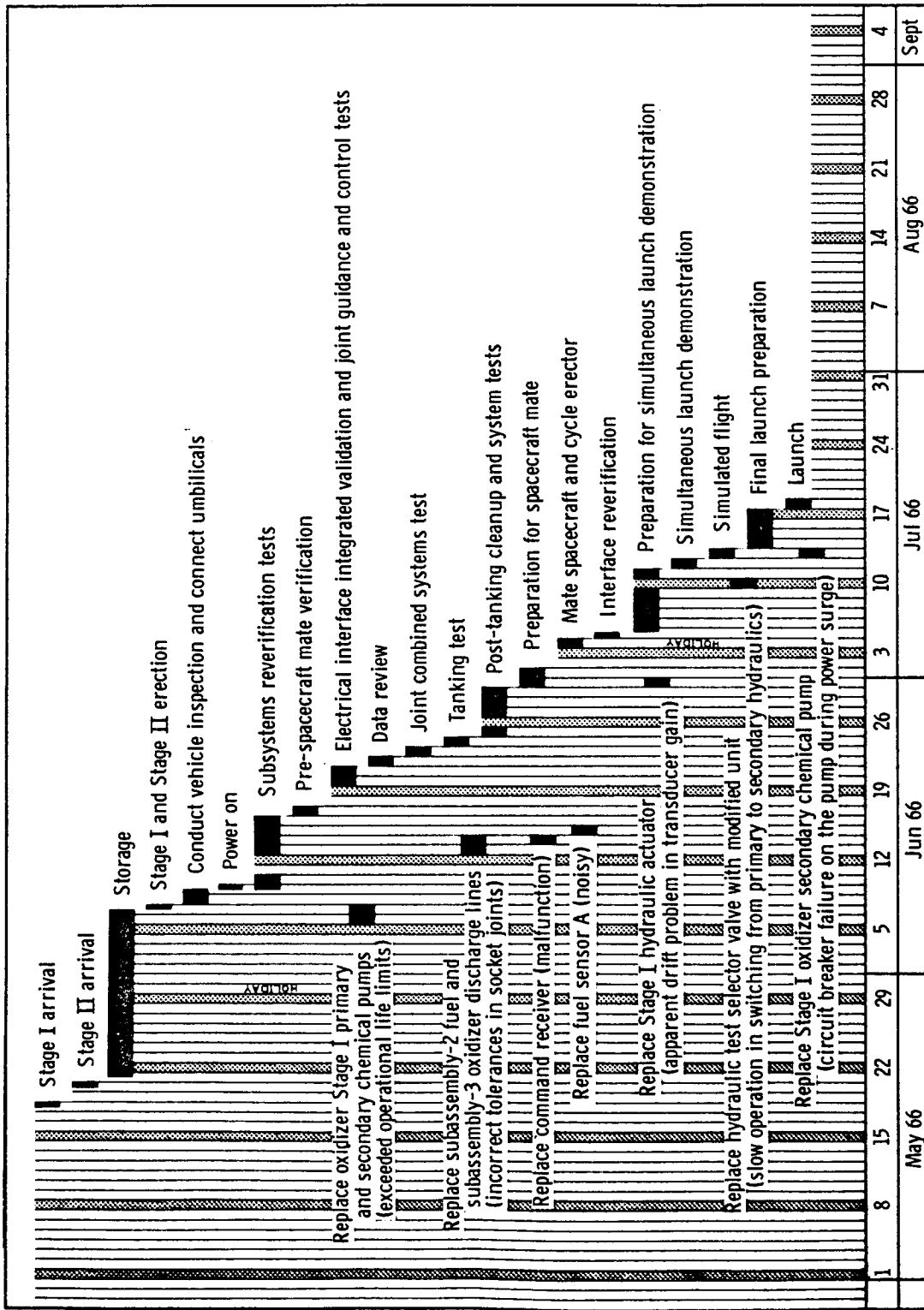

Figure 12.1-6. - GLV-10 history at Cape Kennedy.

UNCLASSIFIED

NASA-S-66-8035 Aug 2

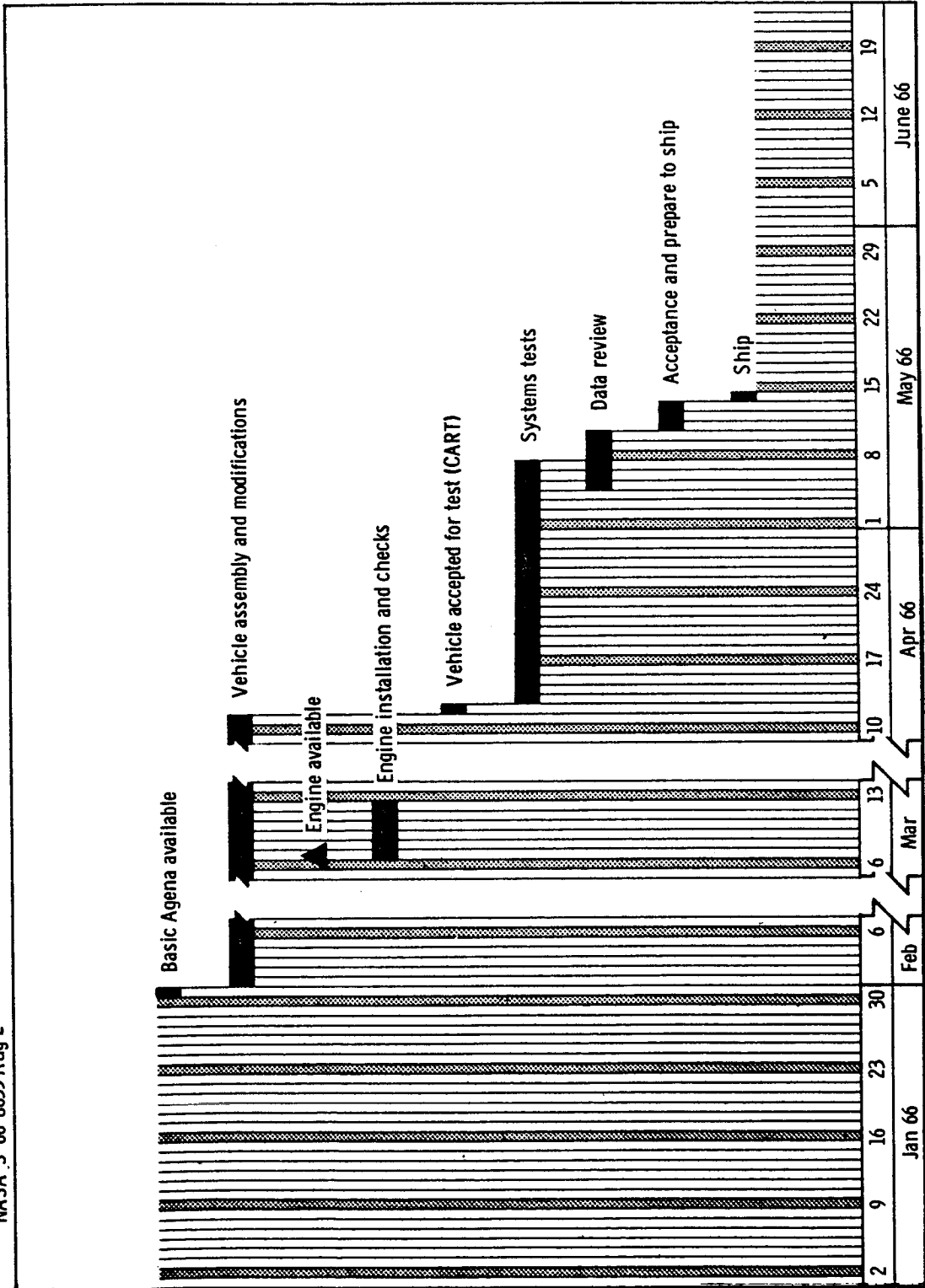

Figure 12.1-7. - GATV history at contractor facility.

UNCLASSIFIED

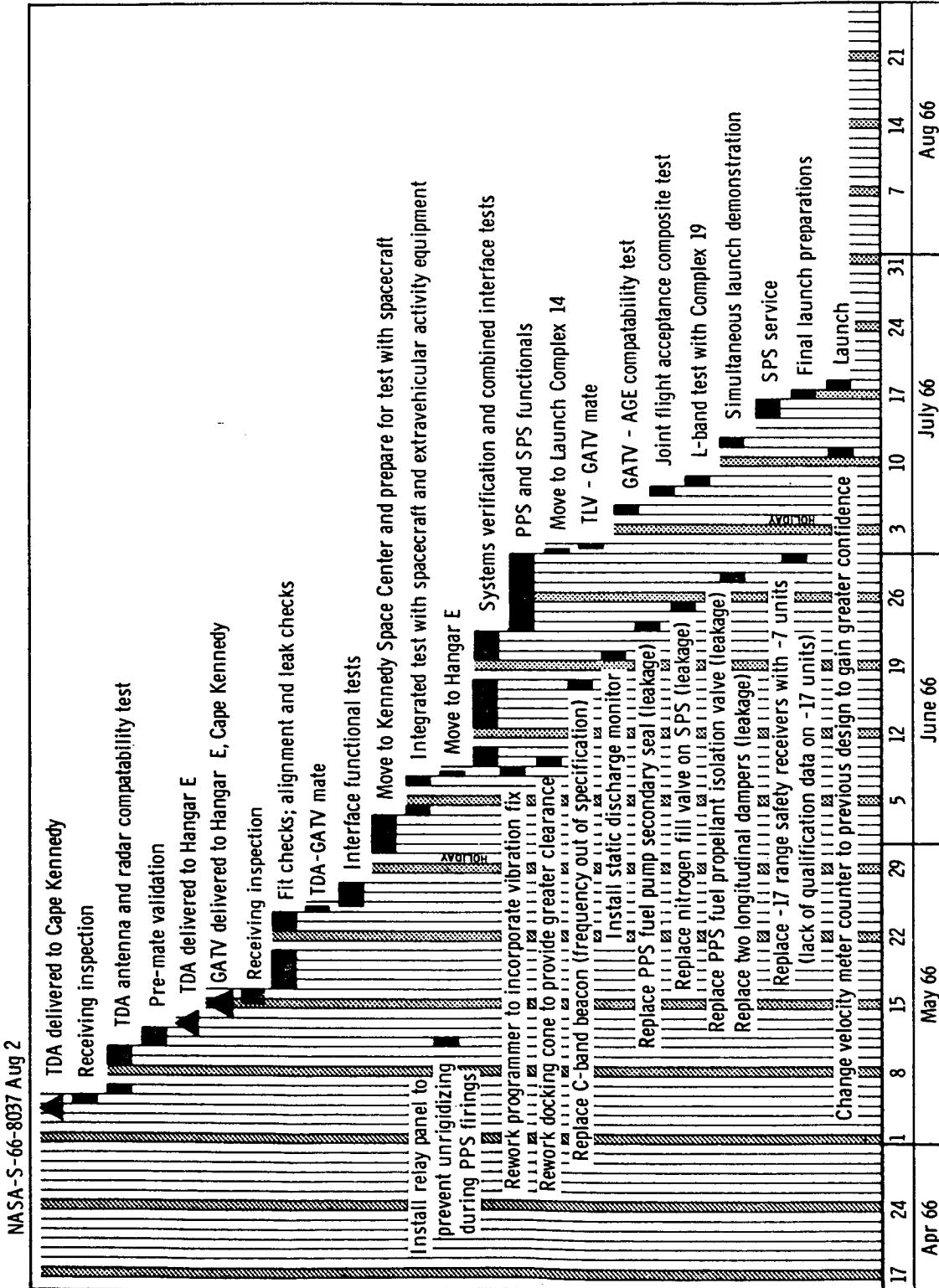

Figure 12.1-8. - GATV test history and significant problems at Cape Kennedy.

UNCLASSIFIED

NASA-S-66-8036 Aug 2

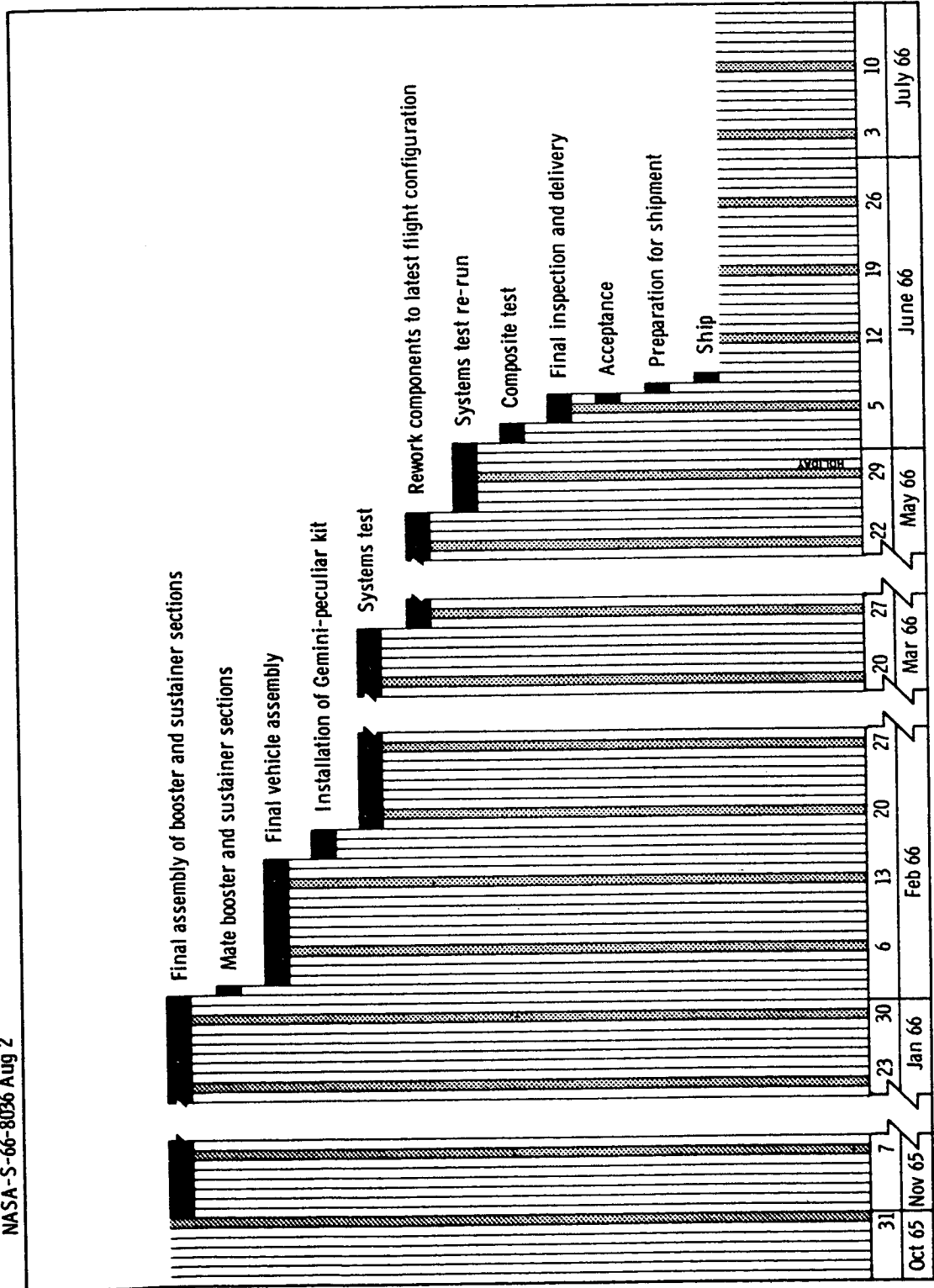

Figure 12.1-9. - TLV-5305 history at contractor facility.

UNCLASSIFIED

NASA-S-66-8038 Aug 2

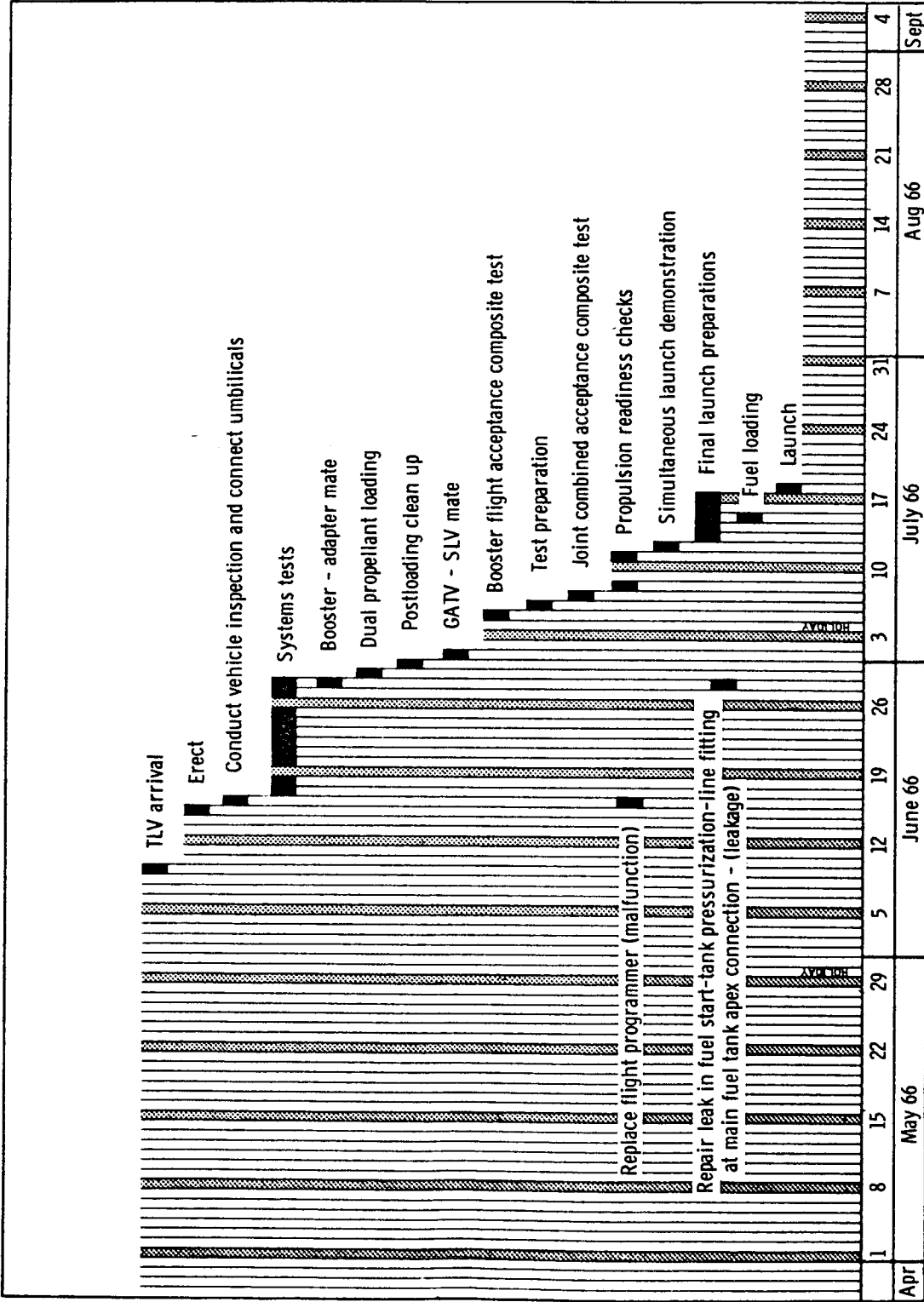

Figure 12.1-10. - TLV-5305 history and significant events at Cape Kennedy.

UNCLASSIFIED

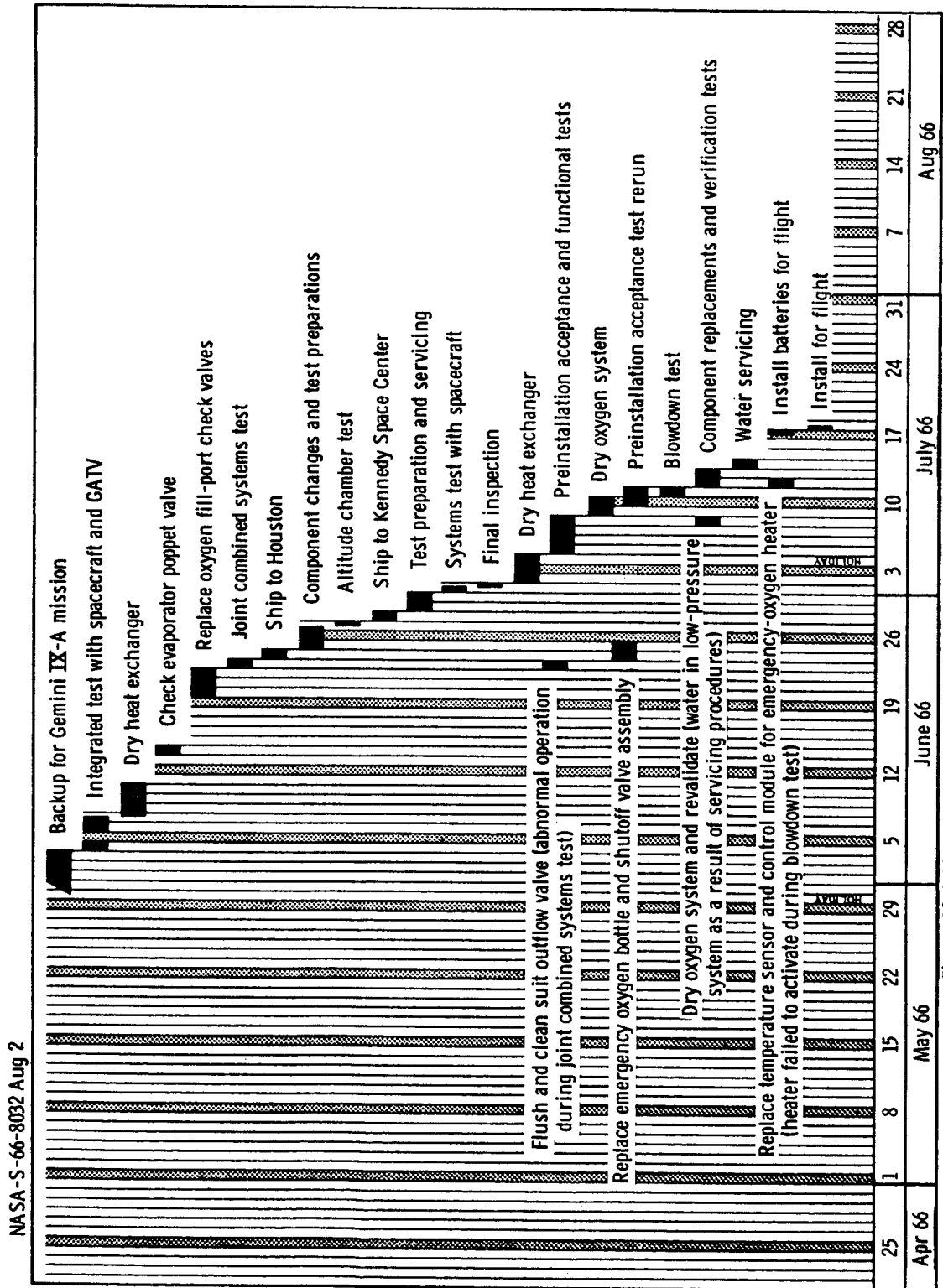

Figure 12.1-11. - ELSS III test history and significant problems at Cape Kennedy.

UNCLASSIFIED

12.2 WEATHER CONDITIONS

The weather conditions in the launch area at Cape Kennedy were satisfactory for all operations on the day of the launch, July 18, 1966. Surface weather conditions in the launch area at approximately 5:00 p.m. e.s.t. were as follows:

Cloud coverage	Scattered clouds, 2200 feet; high overcast
Wind direction, deg from north	10
Wind velocity, knots	12
Visibility, miles	10
Pressure, in. Hg	29.95
Temperature, °F	81
Dew point, °F	74
Relative humidity, percent	71

The prime recovery ship for the Gemini X mission was the U.S.S. Guadalcanal, which was stationed at 26 degrees 41.5 minutes north, 72 degrees 3.4 minutes west on July 21, 1966. Weather conditions observed in the area at approximately 20:00 G.m.t. were as follows:

Cloud coverage	3/10 altocumulus, 3000 feet; high cirrus overcast
Wind direction, deg from north	200
Wind velocity, knots	8
Visibility, miles	15
Pressure, in. Hg	30.02
Temperature, °F	86
Dew point, °F	80

UNCLASSIFIED

UNCLASSIFIED

Relative humidity, percent	74
Sea temperature, °F	80
Sea state	2-foot waves from 150 deg true

Atmospheric conditions for the launch of the Gemini Atlas-Agena Target Vehicle are shown in table 12.2-I. Atmospheric conditions for the launch of the Gemini Space Vehicle are shown in table 12.2-II and for the spacecraft recovery area in table 12.2-III. Figures 12.2-1 and 12.2-2 show the launch area and reentry area wind velocities and directions plotted against altitude.

UNCLASSIFIED

TABLE 12.2-I.- LAUNCH AREA ATMOSPHERIC CONDITIONS FOR THE

GEMINI ATLAS-AGENA TARGET VEHICLE

AT 20:39 G.m.t., JULY 18, 1966

Altitude, ft (a)	Temperature, °F (a)	Pressure, lb/ft ² (a)	Density, slugs/ft ³ (a)
0 × 10 ³	70.3	2120.3	2267.8 × 10 ⁻⁶
5	59.8	1762.5	1938.0
10	48.5	1482.3	1684.7
15	34.3	1230.5	1444.0
20	19.0	1015.0	1232.5
25	2.4	833.3	1045.1
30	-18.4	672.3	895.0
35	-40.2	532.5	757.5
40	-52.3	430.0	632.1
45	-83.5	342.1	522.5
50	-89.2	262.2	417.5
55	-88.2	202.3	320.0
60	-79.0	157.2	243.0
65	-73.8	122.0	187.6
70	-70.2	95.6	145.0
75	-65.8	74.5	113.7
80	-58.0	60.1	90.0
85	-57.1	48.9	70.0
90	-49.8	37.5	55.0
95	-40.5	28.9	43.5
100	-33.3	23.2	34.5
105	-29.0	19.0	25.0

^aThe accuracy of the readings is shown in the following table:

Altitude, ft	Temperature error, °F	Pressure rms error, percent	Density rms error, percent
0 to 60 × 10 ³	1	1	0.5
60 to 105	1	1	0.8

UNCLASSIFIED

UNCLASSIFIED

12-17

TABLE 12.2-II.- LAUNCH AREA ATMOSPHERIC CONDITIONS

FOR GEMINI LAUNCH VEHICLE

AT 22:20 G.m.t., JULY 18, 1966

Altitude, ft (a)	Temperature, °F (a)	Pressure, lb/ft ² (a)	Density, slugs/ft ³ (a)
0 × 10 ³	79.7	2117.6	2263.6 × 10 ⁻⁶
5	63.7	1777.9	1969.5
10	47.7	1484.0	1696.9
15	33.4	1232.3	1453.3
20	19.2	1017.5	1238.0
25	2.3	834.1	1051.9
30	-15.9	678.4	898.2
35	-42.3	545.8	762.1
40	-62.5	434.2	637.2
45	-84.6	340.9	529.7
50	-92.0	265.0	420.2
55	-92.9	205.6	326.6
60	-81.0	160.3	246.7
65	-78.3	125.5	191.8
70	-72.8	98.5	148.4
75	-67.2	77.6	115.2
80	-64.1	61.3	90.3
85	-57.6	48.5	70.4
90	-47.2	38.7	54.6
95	-48.8	30.9	43.8
100	-42.7	24.7	34.5
105	-39.3	19.8	27.4
110	-26.2	16.5	21.9
115	-24.3	13.3	17.8
120	-24.6	10.8	14.4
125	-13.5	8.7	11.4

^aThe accuracy of the readings is indicated at the end of the table.

UNCLASSIFIED

UNCLASSIFIED

TABLE 12.2-II.- LAUNCH AREA ATMOSPHERIC CONDITIONS

FOR GEMINI LAUNCH VEHICLE

AT 22:20 G.m.t., JULY 18, 1966 - Concluded

Altitude, ft (a)	Temperature, °F (a)	Pressure, lb/ft ² (a)	Density, slugs/ft ³ (a)
130 × 10 ³	0.8	7.1	9.0
135	18.5	5.9	7.1
140	25.6	4.8	5.8
145	32.2	4.0	4.7
150	35.0	3.3	3.9
155	32.5	2.8	3.3
160	24.1	2.3	2.7
165	18.0	1.9	2.3
170	14.3	1.6	1.9
175	15.7	1.3	1.6
180	12.9	1.1	1.3

^aThe accuracy of the readings is shown in the following table:

Altitude, ft	Temperature error, °F	Pressure rms error, percent	Density rms error, percent
0 to 60 × 10 ³	1	1	0.5
60 to 120	1	1	.8
120 to 165	4	1.5	1.0
165 to 180	6	1.5	1.5

UNCLASSIFIED

UNCLASSIFIED

12-19

TABLE 12.2-III.- REENTRY AREA ATMOSPHERIC CONDITIONS

AT 21:07 G.m.t., JULY 21, 1966

Altitude, ft (a)	Temperature, °F (a)	Pressure, lb/ft ² (a)	Density, slugs/ft ³ (a)
0 × 10 ³	75.2	2118.2	2283.0 × 10 ⁻⁶
5	63.1	1779.0	1966.1
10	47.5	1485.4	1697.0
15	34.0	1232.4	1461.4
20	19.6	1017.3	1234.0
25	3.7	834.8	1048.7
30	-14.1	680.0	889.0
35	-35.0	548.9	753.0
40	-59.4	438.0	637.6
45	-81.0	344.6	530.7
50	-95.4	268.0	428.8
55	-92.0	207.4	328.5
60	-86.4	161.2	251.7
65	-74.2	126.4	190.7
70	-66.6	99.4	147.3
75	-63.0	78.5	115.3
80	-64.3	62.0	91.4
85	-55.1	49.3	70.8
90	-51.7	39.3	55.9
95	-51.2	31.3	44.4
100	-19.7	25.3	33.5
105	-20.1	20.5	27.2
110	-22.2	16.6	22.1
115	-21.2	13.4	17.9
120	-13.9	10.9	14.3
125	-9.5	8.9	11.5
130	1.6	7.3	9.2

^aThe accuracy of the readings is indicated at the end of the table.

UNCLASSIFIED

UNCLASSIFIED

TABLE 12.2-III.- REENTRY AREA ATMOSPHERIC CONDITIONS

AT 21:07 G.m.t., JULY 21, 1966 - Concluded

Altitude, ft (a)	Temperature, °F (a)	Pressure, lb/ft ² (a)	Density, slugs/ft ³ (a)
135 × 10 ³	10.6	5.9	7.4 × 10 ⁻⁶
140	13.7	4.9	6.0
145	16.2	4.0	4.9
150	22.4	3.3	4.0
155	26.8	2.8	3.3
160	32.1	2.3	2.7
165	32.6	1.9	2.2
170	24.4	1.6	1.9
175	15.6	1.3	1.6
180	11.5	1.1	1.3

^aThe accuracy of the readings is shown in the following table:

Altitude, ft	Temperature error, °F	Pressure rms error, percent	Density rms error, percent
0 to 60 × 10 ³	1	1	0.5
60 to 120	1	1	.8
120 to 165	4	1.5	1.0
165 to 180	6	1.5	1.5

UNCLASSIFIED

NASA-S-66-8128 AUG 13

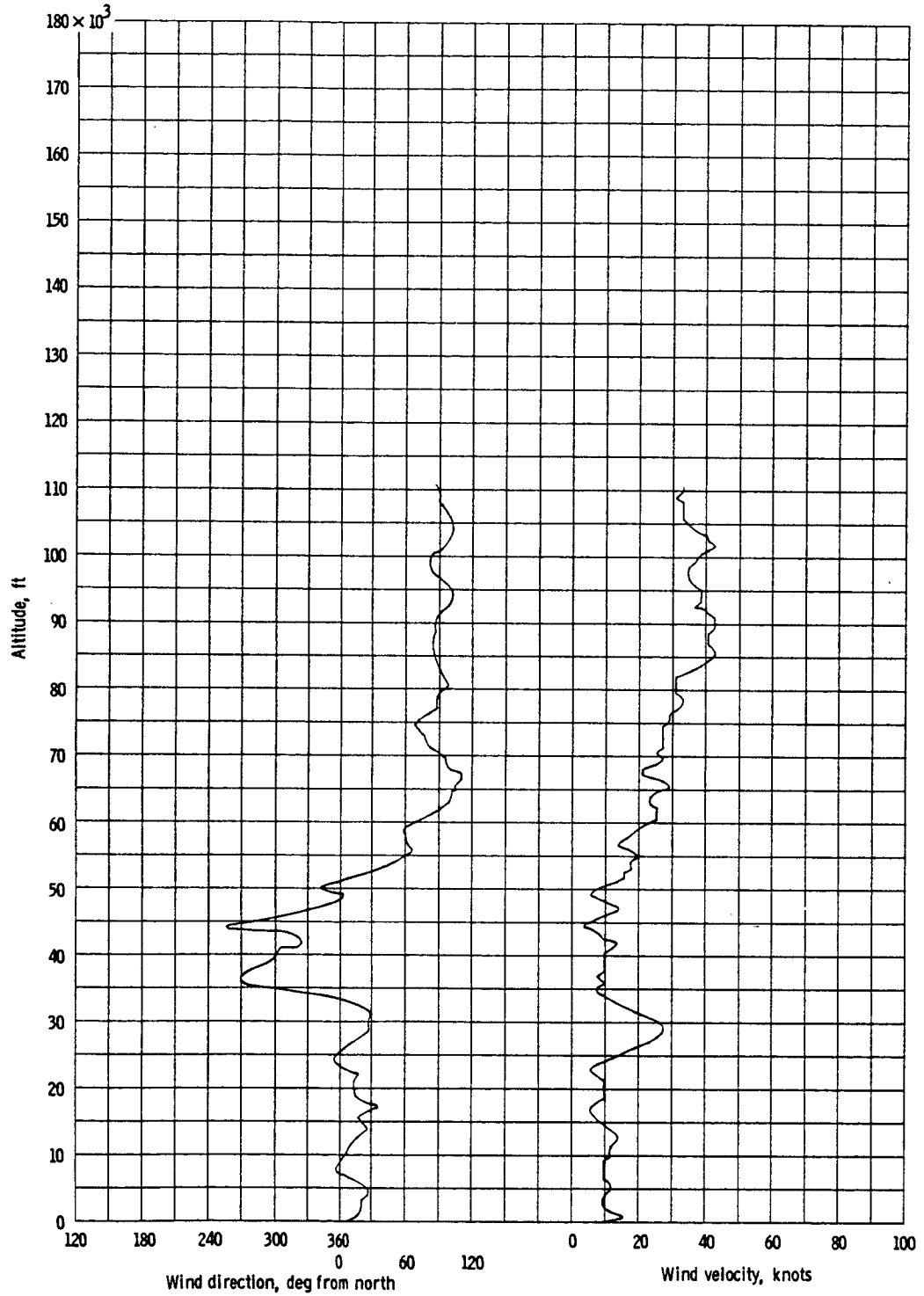

Figure 12.2-1. - Variation of wind direction and velocity with altitude for the GAATV at 20:39 G.m.t., July 18, 1966.

UNCLASSIFIED

NASA-S-66-8120 AUG 13.

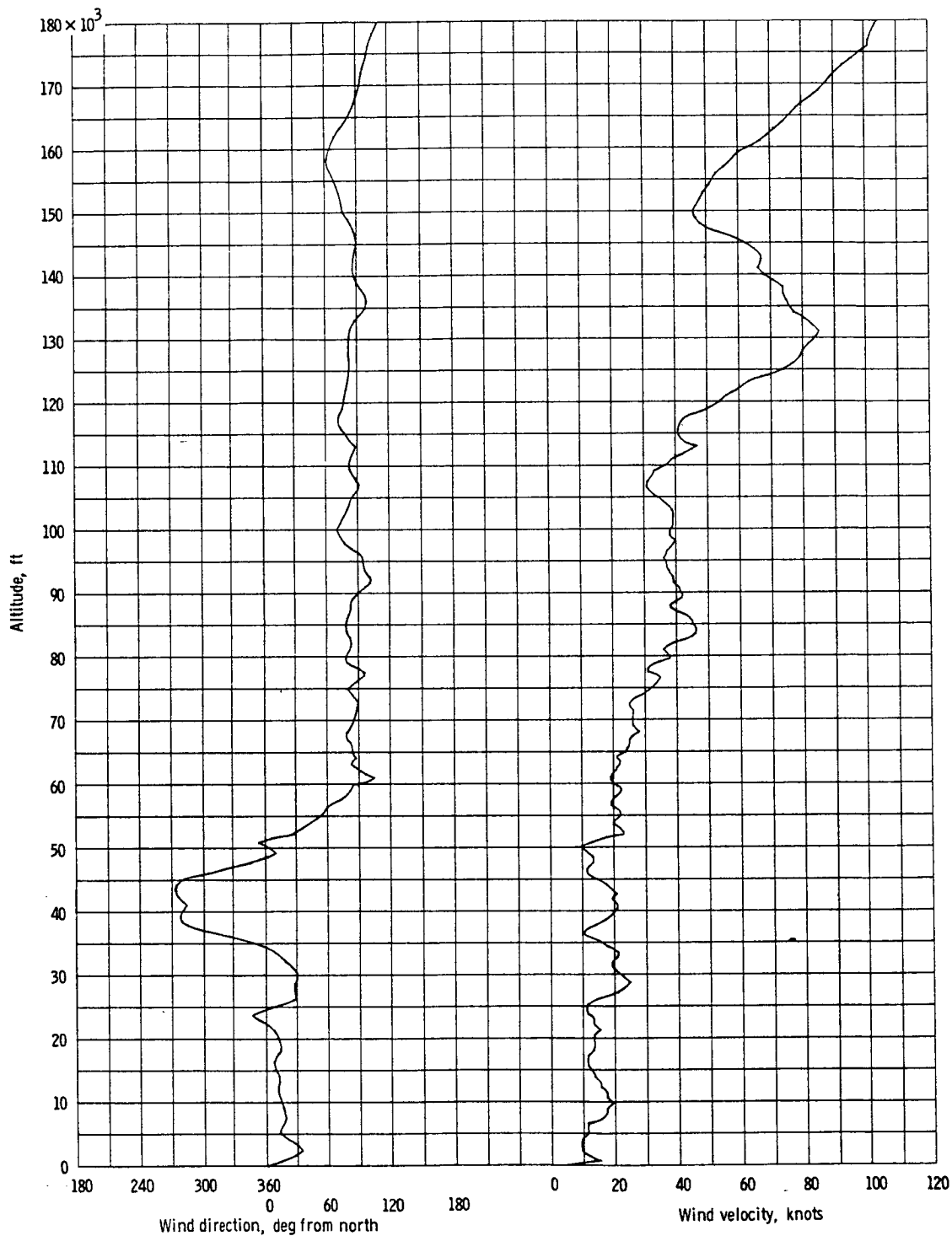

Figure 12.2-2. - Variation of wind direction and velocity with altitude for the Gemini Space Vehicle at 22:20 G.m.t., July 18, 1966.

UNCLASSIFIED

NASA-S-66-8125 AUG 13

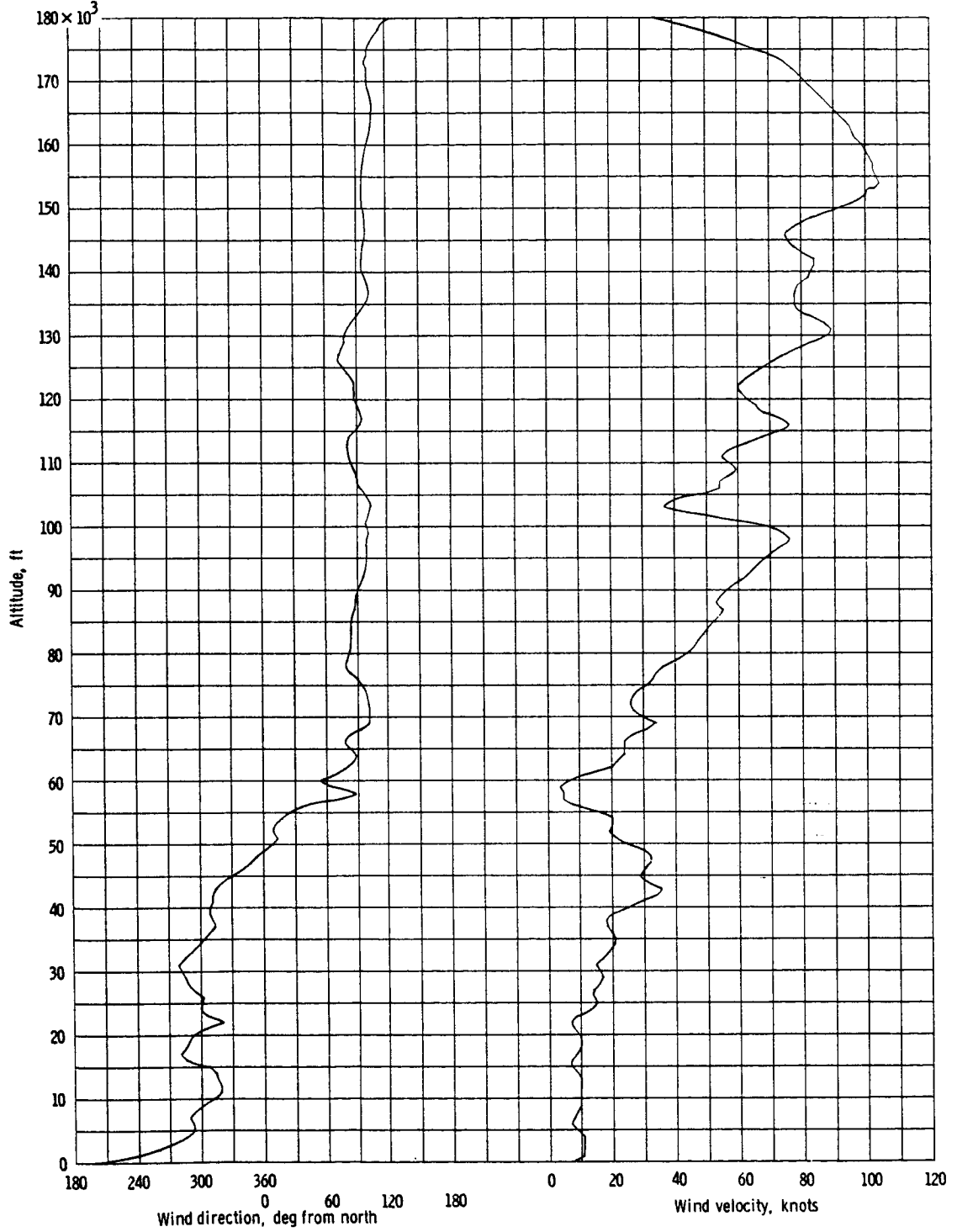

Figure 12.2-3. - Variation of wind direction and velocity with altitude for the Gemini X reentry area at 21:07 G.m.t., July 21, 1966.

UNCLASSIFIED

12.3 FLIGHT SAFETY REVIEWS

The flight readiness of both launch vehicles, the spacecraft, the Gemini Agena Target Vehicle, and all support elements for the accomplishment of the Gemini X mission was determined at the review meetings noted below.

12.3.1 Spacecraft Flight Readiness Review

The Flight Readiness Review of Spacecraft 10 was held on July 7 and 8, 1966, at the Kennedy Space Center. The following action items were to be completed prior to launch:

- (a) The pulse code modulation (PCM) tape recorder was to be exercised as much as possible prior to flight.
- (b) The contractor was to conduct pull tests on all space suit hoses.
- (c) The contractor was to initiate action to preclude recurrence of circumstances such as those which led to the Gemini IX-A shroud failure.
- (d) The MSC Crew Systems Division was to perform sea-level tests on the wetting agent for the helmet pressure visor to determine its useful lifetime after application.
- (e) The contractor was to perform tests during a simulated mission profile to determine the degradation, if any, in hatch actuator operations.
- (f) The contractor was to place Versalube on the bearing surfaces of the block-and-tackle hatch closing device and determine the maximum force that the command pilot could exert with this device under simulated flight conditions.
- (g) The contractor was to provide the results of the failure analysis of the Spacecraft 9 relay panel P/N52-77610.
- (h) The contractor was to expedite the investigation of the computer start-compute discrete problem encountered during the flight of Spacecraft 9.

UNCLASSIFIED

(i) The contractor was to ensure that the voice-operated transmitter (VOX) circuits were properly adjusted.

(j) Teflon tape was to be added to the end of the descent and recovery antennas to prevent damage to them or to the two-point-suspension bridle.

(k) The contractor was to determine the cause of the contamination found in the Spacecraft 9 water system and report the corrective action taken for Spacecraft 10.

(l) The Kennedy Space Center and the 6555th Aerospace Test Wing were to assure that the T minus three-minute IGS update would be accomplished with the same equipment, cabling, procedures, et cetera, used in the Simultaneous Launch Demonstration.

12.3.2 Gemini Design Certification Review

The Design Certification Review Board convened on July 11, 1966, at NASA Headquarters, Washington, D.C. The purpose of this review was to discuss the following:

- (a) The Gemini IX TLV failure
- (b) The Gemini IX-A Augmented Target Docking Adapter shroud separation failure
- (c) The spacecraft hatch opening forces
- (d) The qualification status and operating plan for EVA equipment
- (e) The status of the Astronaut Maneuvering Unit
- (f) The resolution of Gemini IX-A communications and PCM tape recorder problems
- (g) The T minus three-minute IGS update.

12.3.3 Gemini Launch Vehicle Technical and Preflight Reviews

On July 1, 1966, a Technical Review of the GLV was held at Air Force Space System Division (AFSSD) Headquarters, Los Angeles, California.

UNCLASSIFIED

On July 13, 1966, a Preflight Readiness Review was held at Cape Kennedy. All items affecting GLV-10 were discussed and resolved.

12.3.4 Gemini Atlas-Agena Target Vehicle Technical and Preflight Reviews

On June 30, 1966, a Technical Review of SLV-5305 and GATV-5005 was held at AFSSD Headquarters, Los Angeles, California. On July 14, 1966, a Preflight Status Review was held at Cape Kennedy. Items discussed included the wet tantalum capacitor problem and the anomalies on recent Atlas and Agena flights. Atlas tank-pressure oscillation and propellant utilization computer modifications were also discussed. All problems were resolved.

12.3.5 Mission Briefing

The Mission Director conducted the Gemini X Mission Briefing on July 15, 1966, at the Kennedy Space Center. The status of each element of the mission was reviewed and all elements were declared ready to support the mission.

12.3.6 Launch Vehicles Flight Safety Review Board

The AFSSD Flight Safety Review Board met on July 17, 1966, at Cape Kennedy. All flight systems and ground-support systems for the GLV and the GAATV were reviewed and found to be satisfactory. A recommendation was made to the Mission Director that the vehicles be committed to flight for the Gemini X mission.

UNCLASSIFIED

UNCLASSIFIED

12-27

12.4 SUPPLEMENTAL REPORTS

Supplemental reports for the Gemini X mission are listed in table 12.4-I. The format of these reports will conform to the external distribution format of NASA or that of the external organization preparing the report. Each report will be identified on the cover page as a Gemini X supplemental report. Before publication, the supplemental reports will be reviewed by the cognizant Senior Editor, the Chief Editor, and the Mission Evaluation Team Manager, and will be approved by the Gemini Program Manager. Distribution of the supplemental reports will be the same as that of this Gemini Program Mission Report.

UNCLASSIFIED

UNCLASSIFIED

TABLE 12.4-I.- GEMINI X SUPPLEMENTAL REPORTS

Number	Report title	Responsible organization	Completion due date
1	Launch Vehicle Flight Evaluation Report - NASA Mission Gemini/Titan GT-10	Aerospace Corp.	September 19, 1966
2	Launch Vehicle No. 10 Flight Evaluation	Martin Co.	September 2, 1966
3	Manned Space Flight Network Performance Analysis for GT-10 Mission	Goddard Space Flight Center	September 19, 1966
4	Gemini GT-10 IGS Evaluation Trajectory Reconstruction	TRW Systems	September 21, 1966
5	GT-10 Postflight Analysis Report	International Business Machines Corp.	September 21, 1966
^a 6	Gemini Launch Vehicle (GLV)-10 Stage I Oxidizer Tank Rupture Report	Martin Co.	September 2, 1966

^aTo be submitted as an appendix to Supplemental Report 2.

UNCLASSIFIED

UNCLASSIFIED

12-29

12.5 DATA AVAILABILITY

Tables 12.5-I through 12.5-IV list the mission data available at the NASA Manned Spacecraft Center. The trajectory and telemetry data will be on file in the Central Metric Data File of the Computation and Analysis Division. The photographic data will be on file at the Photographic Technology Laboratory.

UNCLASSIFIED

UNCLASSIFIED

TABLE 12.5-I.- INSTRUMENTATION

Data description	
<p><u>Paper recordings</u></p> <p>Spacecraft telemetry measurements and selected parameters (revolutions 1, 2, 3, 4, 5, 6, 11, 12, 13, 14, 15, 16, 27, 28, 29, 30, 31, 32, 33, 40, 41, 42, 43, and reentry)</p> <p>GLV telemetry measurements (launch)</p> <p>Telemetry signal-strength recordings</p> <p>MCC-H plotboards (Confidential)</p> <p>Range safety plotboards (Confidential)</p> <p><u>Radar data</u></p> <p>IP-3600 trajectory data (Confidential)</p> <p>MISTRAM (Confidential)</p> <p style="padding-left: 20px;">Natural coordinate system</p> <p style="padding-left: 20px;">Final reduced</p> <p>C-band (launch phase) (Confidential)</p> <p style="padding-left: 20px;">Natural coordinate system</p> <p style="padding-left: 20px;">Final reduced</p> <p>Trajectory data processed at MSC and GSFC</p>	<p><u>Voice transcripts</u></p> <p>Air-to-ground</p> <p>Onboard recorder (Confidential)</p> <p>Technical debriefing (Confidential)</p> <p><u>GLV reduced telemetry data (Confidential)</u></p> <p>Engineering units versus time plots</p> <p><u>Spacecraft reduced telemetry data</u></p> <p><u>Engineering units versus time</u></p> <p>Ascent phase</p> <p style="padding-left: 20px;">Time history tabulations for all parameters</p> <p>Orbital phase</p> <p style="padding-left: 20px;">Time history tabulations of selected parameters for selected times for revolutions 1, 2, 3, 4, 29, 40, and 41</p> <p style="padding-left: 20px;">Time history plots for selected parameters and selected times for revolutions 9 and 10</p> <p style="padding-left: 20px;">Band pass tabulations for selected parameters for revolutions 1, 3, 4, 5, 6,</p>

UNCLASSIFIED

TABLE 12.5-I.- INSTRUMENTATION - Concluded

Data description	
7, 8, 9, 10, 11, 12, 13, 14, 15, 28, 29, 30, 31, 32, 39, 40, 41, and 42 and real-time passes for revolutions 1, 3, 27, 38, and 40	MOD III RGS versus IGS velocity comparison (Confidential)
Reentry phase	Orbital phase
Plots and tabulations of all systems parameters	OAMS propellant remaining computations for revolutions 1, 2, 3, 4, 5, 6, 7, 8, 13, 14, 15, 28, 29, 30, 31, 32, 39, 40, 41, 42, and 43
<u>Event tabulations</u>	OAMS thruster activity computations for revolutions 1, 2, 3, 4, 5, 6, 10, 11, 12, 13, 14, 15, 17, 25, 26, 28, 29, 30, 31, 32, 39, 40, 41, and 42 and for selected real-time passes for revolutions 1, 2, 3, 16, 28, and 40
Sequence of event tabulations versus time (including thruster firings) for ascent, reentry, and revolutions 1, 2, 3, 4, 5, 6, 7, 8, 9, 10, 11, 12, 13, 14, 15, 17, 25, 26, 28, 29, 30, 31, 32, 39, 40, 41, and 42 and for selected real-time passes for revolutions 1, 2, 3, 16, 28, and 40	OAMS thrust duration computations for revolutions 1, 2, 3, 4, 5, 6, 13, 14, 15, 28, 29, 30, 31, 32, 39, 40, 41, 42, and 43
<u>Special computations</u>	Reentry phase
Ascent phase	RCS propellant remaining and thruster activity computations (MAC)
IGS computer-word flow tag corrections (Confidential)	
Special aerodynamic and guidance parameter calculations (Confidential)	
Steering deviation calculation (Confidential)	
MISTRAM versus IGS velocity comparison (Confidential)	

UNCLASSIFIED

TABLE 12.5-II.- SUMMARY OF PHOTOGRAPHIC DATA AVAILABILITY

Category	Number of still photographs	Motion picture film, feet
Launch		
TLV/GATV	(a)	^b 2180
GLV-spacecraft	(a)	^b 4846
Recovery		
Spacecraft in water	37	400
Loading of spacecraft on carrier	25	300
Inspection of spacecraft	12	50
Mayport, Florida		
General activities	10	100
Inspection of spacecraft	25	--
Postflight inspection	55	--
Inflight photography		
Rendezvous and docking	81	300
Weather and terrain	228	--
Reentry	--	80
Miscellaneous	43	220

^aStill launch photography is not normally used for evaluation purposes.

^bEngineering sequential film only.

UNCLASSIFIED

TABLE 12.5-III.- LAUNCH PHASE ENGINEERING SEQUENTIAL CAMERA DATA AVAILABILITY

(a) Spacecraft and GLV

Sequential film coverage, item	Size, mm	Location	Presentation	Total length of film, ft
1.2-9	16	50-foot tower, 19-1	GLV launch	155
1.2-10	16	50-foot tower, 19-5	GLV launch	165
1.2-12	16	50-foot tower, 19-2	Spacecraft launch	69
1.2-14	16	Umbilical tower, second level	GLV Stage II umbilical	120
1.2-15	16	50-foot tower, 19-7A	GLV, engine observation	120
1.2-16	16	East launcher	GLV, possible fuel leakage	130
1.2-17	16	West launcher	GLV, possible fuel leakage	125
1.2-18	16	North launcher	GLV, engine observation	130
1.2-19	16	South launcher	GLV, engine observation	215
1.2-20	16	Umbilical tower, first level	GLV, umbilical disconnect	116
1.2-21	16	Umbilical tower, second level	GLV, umbilical disconnect	120
1.2-22	16	Umbilical tower, fourth level	GLV, umbilical disconnect	130
1.2-24	16	Umbilical tower, sixth level	GLV, umbilical disconnect	140
1.2-25	16	Umbilical tower, sixth level	GLV, umbilical disconnect	220
1.2-26	16	Umbilical tower, top level, no. 1	GLV, upper umbilical disconnect	140

UNCLASSIFIED

TABLE 12.5-III.- LAUNCH PHASE ENGINEERING SEQUENTIAL CAMERA DATA AVAILABILITY - Continued

(a) Spacecraft and GLV

Sequential film coverage, item	Size, mm	Location	Presentation	Total length of film, ft
1.2-27	16	Umbilical tower, top level, no. 2	J-bars and lanyard observation	130
1.2-28	16	50-foot tower, east side	Spacecraft umbilical	171
1.2-34	16	South of Pad 19	Tracking	302
1.2-36	35	South of Pad 19	Tracking	205
1.2-37	35	South of Pad 19	Tracking	260
1.2-40	70	Cocoa Beach	Tracking, ROTI	129
1.2-42	35	Patrick AFB, Florida	Tracking, IGOR	148
1.2-44	16	Umbilical tower, sixth level	Cable-cutter action	222
1.2-45	16	Umbilical tower, 93-foot level	Boom deflection during launch	213
None	70	Airborne Lightweight Optical Tracking System (ALOTS) aircraft	Tracking	500

UNCLASSIFIED

TABLE 12.5-III.-- LAUNCH PHASE ENGINEERING SEQUENTIAL CAMERA DATA AVAILABILITY - Continued

(b) TLV and GATV

Sequential film coverage, item	Size, mm	Location	Presentation	Total length of film, ft
1.2-4	16	East of Pad 14	Atlas engine observation	120
1.2-5	16	West of Pad 14	Atlas engine observation	120
1.2-6	16	Northwest of Pad 14	Atlas engine observation	120
1.2-7	16	Ramp, south of Pad 14	Atlas engine observation	115
1.2-8	16	West of Pad 14	Atlas launch	52
1.2-9	16	Northwest of Pad 14	Atlas launch	60
1.2-10	16	Northwest of Pad 14	Atlas vernier-engine heat shield	95
1.2-11	16	Southeast of Pad 14	Atlas vernier-engine heat shield	110
1.2-12	16	Umbilical tower, 72-foot level	Upper umbilical disconnect	85
1.2-13	16	Umbilical tower, 72-foot level	Lower umbilical disconnect	85
1.2-14	16	West of Pad 14	Umbilical disconnect	95
1.2-15	70	Southwest of Pad 14	Explosive bolt action	30
1.2-16	16	Northwest of Pad 14	Tracking	185
1.2-17	16	South-southwest of Pad 14	Tracking	130
1.2-18	35	West of Pad 14	Tracking	144

UNCLASSIFIED

TABLE 12.5-III.- LAUNCH PHASE ENGINEERING SEQUENTIAL CAMERA DATA AVAILABILITY - Concluded

(b) TLV and GATV

Sequential film coverage, item	Size, mm	Location	Presentation	Total length of film, ft
1.2-19	35	Patrick Air Force Base	Tracking, IGOR	184
None	70	ALOTS aircraft	Tracking	450

UNCLASSIFIED

TABLE 12.5-IV.- SUMMARY OF DATA AVAILABILITY ON GEMINI X GATV

GATV event	Revo- lution	Nearest station	Reduced data (engineering units) and paper recordings ^a									
			Bandpass	Billevels	Time history plot groups (b)	Time history tab groups (b)	Turbine speed and velocity meter	Programmer memory	Control gas impulse	Paper recordings		
Launch		CNV	X	X	1, 2, 4, 7, 8, 9		X	X				X
90-deg yaw	3/4	MCC-K	X	X	8		X					X
Static discharge and docking	5	CSQ/HAW	X	X	8, 11		X					X
Bending-mode test			X								X	
Primary propul- sion system firing no. 1	6	HAW	X	X	8			X		X		
Gyrocompass	12	CRO	X		8							
Primary propul- sion system firing no. 2	14	CYI	X	X	1, 2, 4, 6, 7, 8, 9			X		X		X
Gyrocompass	14	CRO	X		8							
Primary propul- sion system firing no. 3	15	CRO/HAW	X	X	8			X		X		X
D005 experiment	18	ANT/RKV	X	X	8					X		
Secondary pro- pulsion system firing no. 1	18	HAW	X	X	1, 2, 6, 7, 8, 9	11, 12, 13, 14, 15		X		X		X

^aIn addition to the data listed in this table, the following data are available: TLV telemetry measurements (launch), MCC-H and Range Safety plotboards (launch), C-band overlapping trajectory - final reduced coordinate system 2 and 3 (launch) (Confidential), Ravindsonde weather data (launch), Sunrise-sunset computations (orbital).

^bSee note at end of this table.

UNCLASSIFIED

TABLE 12.5-IV.- SUMMARY OF DATA AVAILABILITY ON GEMINI X GATV - Concluded

GATV event	Revo- lution station	Nearest station	Reduced data (engineering units) and paper recordings ^a							
			Bandpass	Bilevels	Time history plot groups (b)	Time history tab groups (b)	Turbine speed and velocity meter	Programmer memory	Control gas impulse	Paper recordings
Secondary propulsion system firing no. 2	26	ETR	X	X	1, 2, 6, 7, 8, 9	11, 12, 13, 14, 15	X	X	X	X
Secondary propulsion system firing no. 3	27	CYI	X	X	1, 2, 6, 7, 8, 9	11, 12, 13, 14, 15	X	X	X	X
Undocking and S026 experiment	28/29	ANT	X	X	8			X		X
Gyrocompass	30/31	MCC-K	X		8					
Primary propulsion system firing no. 4	45	GYM	X	X	8	5, 6, 7, 7A, 8, 9, 10	X	X	X	X
Gyrocompass	46/47	MCC-K	X		8					
Primary propulsion system firing no. 5	49	CSQ/HAW	X	X	8		X	X	X	X
Secondary propulsion system firing no. 4	51	CSQ/RKV	X	X	8		X	X	X	X

^aIn addition to the data listed in this table, the following data are available: TLV telemetry measurements (launch), MCC-H and Range Safety plotboards (launch), C-band overlapping trajectory - final reduced coordinate system 2 and 3 (launch) (Confidential), Rawindsonde weather data (launch), Sunrise-sunset computations (orbital).

^bTime history plot and tabulation group numbers listed in table 12.5-IV are related to GATV systems as shown in the following table.

UNCLASSIFIED

^bTime history plot and tabulation group numbers listed in table 12.5-IV are related to GATV systems as shown in the following table:

Systems	Time history plot groups	Time history tab groups
Structural	1, 2	1, 1A, 2, 3, 4A
Primary propulsion	3, 4, 5	5, 6, 7, 7A, 8, 9, 10
Secondary propulsion	6	11, 12, 13, 14, 15
Electrical	7	16, 17, 18, 19
Guidance and control	8	20, 21, 22, 23, 24
Command and communications	9	25, 26, 27, 28, 29, 30
Experimental parameters	10, 11	31, 32

UNCLASSIFIED

12.6 POSTFLIGHT INSPECTION

The postflight inspection of the Spacecraft 10 reentry assembly was conducted in accordance with reference 19 and with approved Spacecraft Test Requests (STR's) at the contractor's facility in St. Louis, Missouri, from July 23, 1966, to August 5, 1966. The spacecraft rendezvous

Torques of 400 and 300 inch-pounds applied at the external hatch sockets were required to unlock the left-hand and right-hand hatches, respectively. The heat shield and the heat-affected areas of the exterior surface appeared similar to those of previous spacecraft after reentry.

12.6.1.2 Environmental Control System.- The drinking water was removed and dispositioned for analysis per reference 19. The total water remaining in the system was 17.2 pounds. The lithium hydroxide cartridge was removed from the Environmental Control System (ECS) package and weighed. The cartridge weighed 111.55 pounds with a center-of-gravity 8.15 inches from the bottom. The cartridge was dispositioned to MSC for analysis per reference 19. The secondary oxygen system was deserviced, and no pressure was found in the left-hand or right-hand tank before or after deservicing.

The ECS control levers were actuated in accordance with reference 19, and the maximum force recorded was 21 pounds on the control lever for the left-hand secondary oxygen shutoff valve.

The spacecraft was placed in the 30-foot altitude chamber, and the ECS was operated at altitude. Particle counts and gas samples were taken for analysis per STR 10501A. Prior to the chamber test, suit compressor no. 2 would not operate and was removed for failure analysis per STR 10503. Analysis of the compressor revealed that a gummy residue between the cover plate and the impeller was preventing rotation. The residue was removed for chemical analysis, and the compressor was reassembled, tested, and installed in the spacecraft after which the ECS test was completed per STR 10501A.

After the chamber test, the ECS package was placed in the failure analysis laboratory for controlled disassembly per STR 10016. Suit compressor no. 2 was removed for a dead-head test per STR 10015. The carbon dioxide sensor was removed and inspected for contamination per STR 10017. Samples of the residue from the inside of the ECS access door were removed for analysis per STR 10504. Two samples of the water-absorbent material were removed from the walls of the spacecraft cabin and dispositioned to MSC for analysis per STR 10018.

12.6.1.3 Communications System.- The external appearance of all communications equipment was good. The D-5 insulation material covering the UHF recovery antenna was not completely broken out and the antenna had not deployed. Visual inspection of the D-5 material revealed that the main parachute bridle had torn out only one side of the material. STR 10011 was written to further investigate the anomaly.

UNCLASSIFIED

12.6.1.4 Guidance and Control System.- The Inertial Measurement Unit (IMU) was removed aboard the prime recovery ship and dispositioned to the vendor representative in Mayport, Florida, per STR 10003. The computer, the Auxiliary Control Power Unit, the Attitude Control and Maneuver Electronics, and the Horizon Sensor Electronics were removed on the prime recovery ship, returned to St. Louis, and dispositioned to the vendors (STR's 10002, 10004, 10005, 10006).

12.6.1.5 Pyrotechnic System.- Pyrotechnic resistance measurements were made of all electrically initiated pyrotechnic devices in the reentry assembly in accordance with reference 19. Tests of the retro-rocket wire pyrotechnic switch-H cartridge bridgewires indicated resistances near the unfired range, and the cartridge was removed for visual inspection per STR 10502. The inspection revealed that the cartridge had detonated normally. The measured resistances were due to the conductive residue remaining in the cartridge after firing.

The wire-bundle guillotines, parachute bridle-release mechanisms, and other pyrotechnically operated devices all appeared to have functioned normally.

The electrical connectors to the mild-detonating-fuse (MDF) detonators on the left and right sides of the Z192 bulkhead had the bayonet pins sheared off and were hanging loose from the cartridges. This condition has been noted on nearly all previous spacecraft and is considered acceptable. Both of the MDF detonators appeared to have had high-order detonation.

The right-hand ejection seat was functionally tested without the rocket catapult and hatch actuator in the system per STR 10013.

12.6.1.6 Instrumentation and Recording System.- The PCM programmer and multiplexers were removed from the spacecraft on the prime recovery ship and dispositioned to the vendor representative at Mayport, Florida, per STR 10001. Instrumentation package 2 was removed on the prime recovery ship and returned with the spacecraft to St. Louis (STR 10007). The PCM tape recorder was also removed on the ship and returned by courier aircraft to St. Louis per STR 10000.

The dc-to-dc converters were removed on the prime recovery ship and returned to St. Louis (STR 10500). The biomedical tape recorders were removed on the prime recovery ship and immediately flown to MSC for data processing (STR 10000). The voice tape recorder was removed in St. Louis and dispositioned to the vendor in accordance with reference 19.

UNCLASSIFIED

12.6.1.7 Electrical System.- The main batteries and the squib batteries were removed and discharged in accordance with reference 19. The following table lists the ampere-hours remaining in each battery when discharged to the level of 20 volts with the batteries still delivering the current specified in reference 19.

Main battery	Discharge, A-h	Squib battery	Discharge, A-h
1	43.75	1	9.25
2	41.25	2	10.24
3	43.90	3	9.20
4	43.75		

The main and squib batteries were recharged and placed in bonded storage for use in ground tests.

An AGE test-point inspection was conducted per reference 19. Water was found in AGE test points 5 and 205 behind access doors 21 and 32, respectively.

A resistance of approximately 1000 ohms was measured when the main battery switches were actuated during the electrical check to determine current leakage caused by salt-water immersion, per reference 19. STR 10505 was written to investigate the anomaly. The electrical check was conducted again after vacuum-chamber drying of the spacecraft, and the original resistance readings could not be duplicated. This indicated that the resistance path resulted from water in the wire-bundle connectors or other components. Several wire-bundle connectors in the main bus circuit were disconnected and inspected. No traces of water contamination could be found. The relay panel similar to the one that split open on Spacecraft 9 (ref. 10) was removed from Spacecraft 10 and inspected, but no defects were found.

UNCLASSIFIED

The fuse blocks were checked for blown fuses per reference 19. The following fuses were blown:

Fuse block	Pin no.	Fuse no.
XF-AF	5	5-121
XF-AG	5	5-124
XF-C	2	4-5
XF-E	4	5-16
XF-F	6	4-57
XF-J	3	4-39
XF-M	4	4-27
XF-M	6	4-56
XF-W	2	4-47
XF-AC	6	13-12
XF-AE	4	13-13
XF-AE	5	13-14
XF-AE	6	13-15
XF-AQ	2	14-37

Abort relay no. 1 on the relay panel assembly mounted on the Z160 bulk-head had a dent in the outer cover.

12.6.1.8 Crew-station furnishings and equipment.- The appearance of the cabin interior was good. The switch positions and instrument panels were photographed in accordance with reference 19. The ejection seats were removed and deactivated in accordance with reference 19. The backboard contours, pelvic blocks, and lap belts were placed in bonded storage at the contractor's plant in St. Louis. The seat ballast was shipped to the Kennedy Space Center (KSC) for reuse. The survival kits,

UNCLASSIFIED

the astronaut retractable pencils, the water metering dispenser, and the 8-day and Accutron clocks were removed for disposition to MSC per STR 10000.

Resistance checks performed on the center cabin floodlight assembly per STR 10020 revealed a lack of continuity through the bright (left) light. The dim (right) light appeared to be normal. Visual inspection revealed no major physical damage. The bright-light filament appeared to be open. The center cabin light assembly was removed from the spacecraft for failure analysis.

The right-hand ejection seat D-ring stowage mechanism was inspected for defects per STR 10022. The pip-pin showed no signs of being bent or burred. Inspection of the sleeve revealed no burrs. The pip-pin and D-ring were installed and removed several times and they operated smoothly.

The right-hand-seat lap belt was inspected per STR 10019.

The Velcro bonded to the exterior of the spacecraft was heat damaged but did not appear to be as burned as that on Spacecraft 9.

12.6.1.9 Propulsion System.-- The Reentry Control System (RCS) thrust chamber assemblies appeared normal. The upper right-hand yaw thrusters in the A-ring and B-ring showed some delamination. This has been noted on previous spacecraft.

The RCS was deactivated at Mayport, Florida, in accordance with reference 18, prior to shipping the spacecraft to St. Louis. The propellants remaining in the RCS tanks and samples of the purge gas were dispositioned from Mayport to Kennedy Space Center (KSC) for analysis, and the results of the analysis were recorded in reference 19. The following amounts of propellants were recovered from the RCS tanks at Mayport:

	A-ring	B-ring
Oxidizer, lb	3.43	0
Fuel, lb	3.50	2.63

The RCS section was dried in the 30-foot altitude chamber per reference 19.

12.6.1.10 Postlanding recovery aids.-- The flashing recovery light and the hoist-loop door appeared to have functioned normally. The sea dye marker was removed on the prime recovery ship and returned to

UNCLASSIFIED

St. Louis as a loose piece. The UHF recovery antenna had not deployed (see section 12.6.1.3).

12.6.1.11 Experiments.- The hatch mounting bracket for the photometer was returned with the spacecraft and removed in St. Louis for disposition to MSC. The bremsstrahlung spectrometer was removed from between the ejection seats and dispositioned to MSC per STR 10000.

12.6.2 Continuing Evaluation

The following is a list of STR's that were approved for the post-flight evaluation of reported spacecraft anomalies.

STR no.	System	Purpose
10008	Crew Station	To determine extent and cause of failure of 16-mm EVA sequence camera
10009	Crew Station; Environmental Control	To investigate the cause of the odor and eye irritation.
10011	Communications	To determine whether the deployment sequence of the UHF recovery beacon antenna is adequate
10012	Environmental Control (lithium hydroxide canister)	To further investigate the cause of the odor and eye irritation
10014	Crew Station (radiation dosimeters)	To further investigate the cause of the eye irritation
10015	Environmental Control (suit compressor no. 2)	To investigate the cause of the eye irritation
10016	Environmental Control (chemical analysis of component contamination)	To further investigate the cause of the odor and eye irritation

UNCLASSIFIED

UNCLASSIFIED

12-47

STR no.	System	Purpose
10017	Environmental Control (carbon dioxide sensor)	To investigate the cause of the odor and eye irritation
10018	Environmental Control (water-absorbent material)	To investigate the cause of the odor and eye irritation
10019	Crew Station	To evaluate the right-hand-seat lap belt
10020	Crew Station	To determine how the center light was broken
10021	Crew Station	To determine why food bags leaked
10022	Crew Station	To evaluate the D-ring and safety pin for the right-hand ejection seat
10023	Structure	To evaluate the performance of the window covers
10501A	Environmental Control (test system at altitude)	To investigate the cause of odor and eye irritation
10503	Environmental Control	To investigate the anomaly concerning suit compressor no. 2
10504	Environmental Control	To determine the constituents of the residue found on the access door
10505	Electrical	To investigate the resistive leakage path from the main bus to spacecraft ground

UNCLASSIFIED

12-48

UNCLASSIFIED

THIS PAGE INTENTIONALLY LEFT BLANK

UNCLASSIFIED

(Continued from inside front cover)

GEMINI FLIGHT HISTORY			
Mission	Description	Launch date	Major accomplishments
Gemini VIII	Manned 3 days rendezvous and dock, and EVA	Mar. 16, 1966	Demonstrated rendezvous and docking with GATV, controlled landing, emergency recovery, and multiple restart of GATV in orbit. Spacecraft mission terminated early because of an electrical short in the control system.
Gemini IX	Manned 3 days rendezvous and dock, and EVA (canceled after fail- ure of TLV)	May 17, 1966	Demonstrated dual countdown procedures.
Gemini IX-A	Manned 3 days rendezvous and dock, and EVA	June 3, 1966	Demonstrated three rendezvous techniques, EVA with detailed work tasks, and precision landing capability.
Gemini X	Manned 3 days rendezvous and dock, and EVA	July 18, 1966	Demonstrated dual rendezvous using GATV propulsion for docked maneuvers, removal of experiment package from passive target vehicle during EVA, and feasibility of using onboard navigational techniques for rendezvous.