

EX

MSC-00126



NATIONAL AERONAUTICS AND SPACE ADMINISTRATION

APOLLO 10 MISSION REPORT

DISTRIBUTION AND REFERENCING

This paper is not suitable for general distribution or referencing. It may be referenced only in other working correspondence and documents by participating organizations.

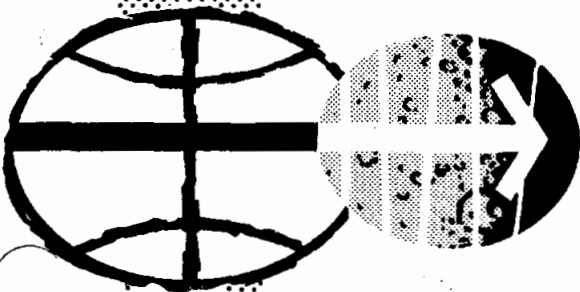

MANNED SPACECRAFT CENTER
HOUSTON, TEXAS
AUGUST 1969

APOLLO SPACECRAFT FLIGHT HISTORY

<u>Mission</u>	<u>Spacecraft</u>	<u>Description</u>	<u>Launch date</u>	<u>Launch site</u>
PA-1	BP-6	First pad abort	Nov. 7, 1963	White Sands Missile Range, N. Mex.
A-001	BP-12	Transonic abort	May 13, 1964	White Sands Missile Range, N. Mex.
AS-101	BP-13	Nominal launch and exit environment	May 28, 1964	Cape Kennedy, Fla.
AS-102	BP-15	Nominal launch and exit environment	Sept. 18, 1964	Cape Kennedy, Fla.
A-002	BP-23	Maximum dynamic pressure abort	Dec. 8, 1964	White Sands Missile Range, N. Mex.
AS-103	BP-16	Micrometeoroid experiment	Feb. 16, 1965	Cape Kennedy, Fla.
A-003	BP-22	Low-altitude abort (planned high- altitude abort)	May 19, 1965	White Sands Missile Range, N. Mex.
AS-104	BP-26	Micrometeoroid experiment and service module RCS launch environment	May 25, 1965	Cape Kennedy, Fla.
PA-2	BP-23A	Second pad abort	June 29, 1965	White Sands Missile Range, N. Mex.
AS-105	BP-9A	Micrometeoroid experiment and service module RCS launch environment	July 30, 1965	Cape Kennedy, Fla.
A-004	SC-002	Power-on tumbling boundary abort	Jan. 20, 1966	White Sands Missile Range, N. Mex.
AS-201	SC-009	Supercircular entry with high heat rate	Feb. 26, 1966	Cape Kennedy, Fla.
AS-202	SC-011	Supercircular entry with high heat load	Aug. 25, 1966	Cape Kennedy, Fla.

(Continued inside back cover)

APOLLO 10 MISSION REPORT

PREPARED BY

Mission Evaluation Team

APPROVED BY



George M. Low
Manager, Apollo Spacecraft Program

NATIONAL AERONAUTICS AND SPACE ADMINISTRATION

MANNED SPACECRAFT CENTER

HOUSTON, TEXAS

August 1969

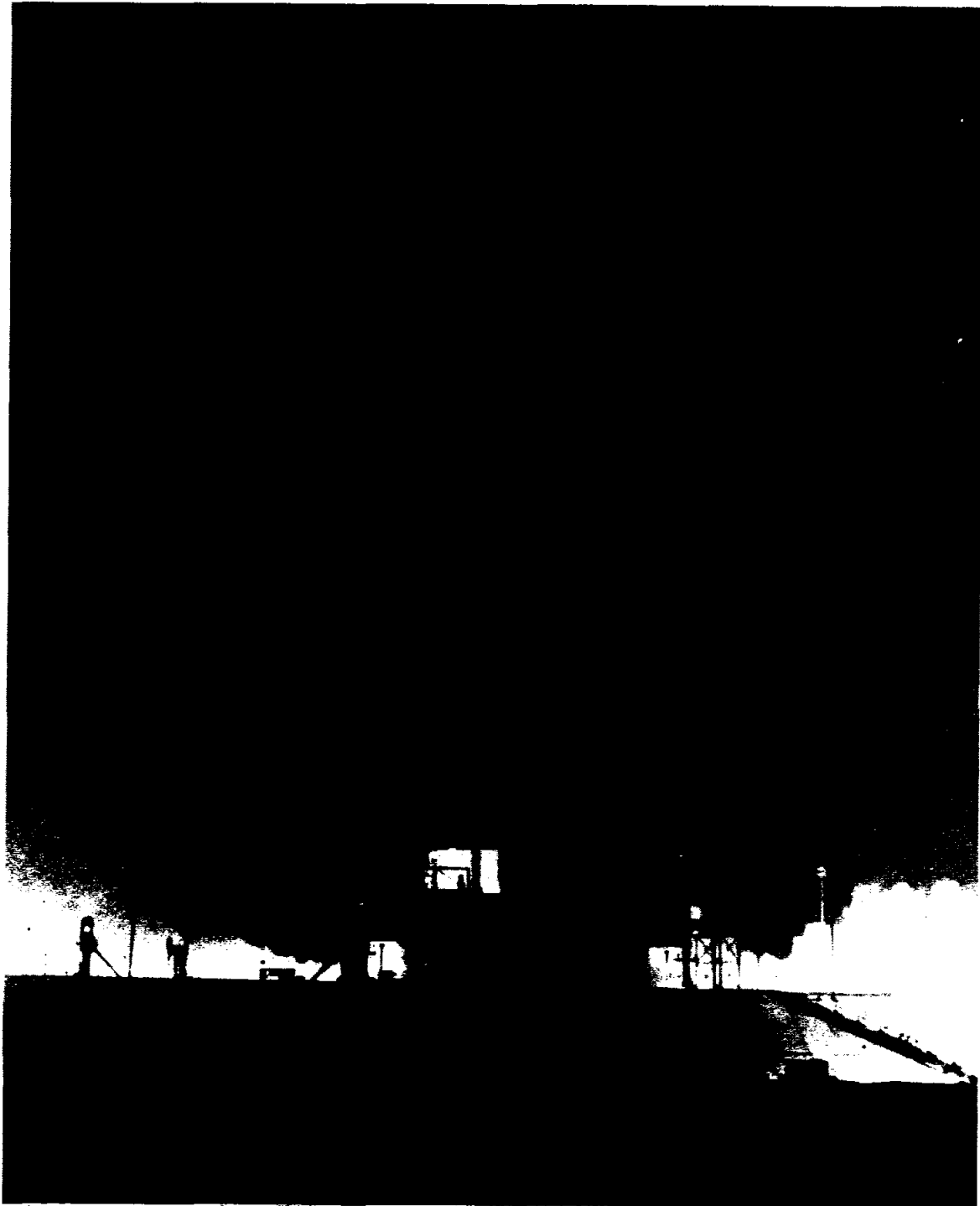

Apollo 10 lift-off

CONTENTS

Section		Page
1.0	<u>SUMMARY</u>	1-1
2.0	<u>INTRODUCTION</u>	2-1
3.0	<u>MISSION DESCRIPTION</u>	3-1
4.0	<u>RENDEZVOUS</u>	4-1
4.1	TRAJECTORY	4-1
4.2	CREW PROCEDURES	4-3
4.3	GUIDANCE, NAVIGATION, AND CONTROL	4-5
4.4	VISIBILITY	4-6
4.5	VHF RANGING	4-6
5.0	<u>COMMUNICATIONS</u>	5-1
6.0	<u>TRAJECTORY</u>	6-1
6.1	LAUNCH PHASE	6-1
6.2	EARTH PARKING ORBIT	6-2
6.3	TRANSLUNAR INJECTION AND SEPARATION	6-2
6.4	TRANSLUNAR MIDCOURSE CORRECTION	6-3
6.5	LUNAR ORBIT INSERTION AND CIRCULARIZATION	6-4
6.6	RENDEZVOUS	6-4
6.7	TRANSEARTH INJECTION	6-4
6.8	TRANSEARTH MIDCOURSE CORRECTIONS	6-5
6.9	COMMAND MODULE ENTRY	6-5
6.10	SERVICE MODULE ENTRY	6-5
6.11	LUNAR ORBIT DETERMINATION	6-6
7.0	<u>COMMAND AND SERVICE MODULE PERFORMANCE</u>	7-1
7.1	STRUCTURAL AND MECHANICAL SYSTEMS	7-1
7.2	ELECTRICAL POWER	7-6
7.3	CRYOGENIC STORAGE	7-10
7.4	COMMUNICATIONS EQUIPMENT	7-10
7.5	INSTRUMENTATION	7-14

Section		Page
7.6	GUIDANCE, NAVIGATION, AND CONTROL	7-15
7.7	REACTION CONTROL SYSTEMS	7-38
7.8	SERVICE PROPULSION SYSTEM	7-42
7.9	ENVIRONMENTAL CONTROL SYSTEM	7-45
7.10	CREW STATION	7-48
7.11	CONSUMABLES	7-50
8.0	<u>LUNAR MODULE PERFORMANCE</u>	8-1
8.1	STRUCTURAL AND MECHANICAL SYSTEMS	8-1
8.2	THERMAL CONTROL	8-1
8.3	ELECTRICAL POWER	8-2
8.4	COMMUNICATIONS EQUIPMENT	8-4
8.5	INSTRUMENTATION	8-5
8.6	LUNAR MODULE GUIDANCE AND CONTROL	8-6
8.7	REACTION CONTROL	8-27
8.8	DESCENT PROPULSION SYSTEM	8-30
8.9	ASCENT PROPULSION	8-34
8.10	ENVIRONMENTAL CONTROL SYSTEM	8-37
8.11	CREW STATION	8-37
8.12	RADAR	8-38
8.13	CONSUMABLES	8-41
9.0	<u>PILOTS' REPORT</u>	9-1
9.1	PREFLIGHT ACTIVITIES	9-1
9.2	EARTH ASCENT	9-2
9.3	EARTH ORBIT COAST	9-3
9.4	TRANSLUNAR INJECTION	9-3
9.5	TRANSPOSITION, DOCKING, AND EJECTION	9-3
9.6	TRANSLUNAR COAST	9-5
9.7	LUNAR ORBIT INSERTION	9-7
9.8	LUNAR MODULE ACTIVATION	9-8
9.9	DESCENT AND RENDEZVOUS	9-9

Section	Page
9.10 LUNAR LANDMARK TRACKING	9-19
9.11 TRANSEARTH INJECTION	9-21
9.12 TRANSEARTH COAST	9-21
9.13 ENTRY AND LANDING	9-22
10.0 <u>BIOMEDICAL EVALUATION</u>	10-1
10.1 PHYSIOLOGICAL DATA	10-1
10.2 MEDICAL OBSERVATIONS	10-1
10.3 FOOD	10-4
10.4 WATER	10-5
10.5 MEDICAL EXAMINATIONS	10-6
11.0 <u>PHOTOGRAPHY</u>	11-1
11.1 PHOTOGRAPHIC OBJECTIVES	11-1
11.2 FILM DESCRIPTION AND PROCESSING	11-2
11.3 PHOTOGRAPHIC RESULTS	11-3
11.4 LUNAR LIGHTING OBSERVATIONS	11-5
11.5 THE LUNAR INTERNATIONAL OBSERVERS NETWORK	11-6
12.0 <u>MISSION SUPPORT PERFORMANCE</u>	12-1
12.1 FLIGHT CONTROL	12-1
12.2 NETWORK PERFORMANCE	12-3
12.3 RECOVERY OPERATIONS	12-3
13.0 <u>ASSESSMENT OF MISSION OBJECTIVES</u>	13-1
13.1 LUNAR MODULE STEERABLE ANTENNA PERFORMANCE	13-1
13.2 RELAY MODES VOICE/TELEMETRY	13-1
14.0 <u>LAUNCH VEHICLE SUMMARY</u>	14-1
15.0 <u>ANOMALY SUMMARY</u>	15-1
15.1 COMMAND MODULE	15-1
15.2 LUNAR MODULE	15-15
15.3 CAMERA EQUIPMENT	15-31
16.0 <u>CONCLUSIONS</u>	16-1

Section	Page
APPENDIX A - <u>VEHICLE DESCRIPTIONS</u>	A-1
A.1 COMMAND AND SERVICE MODULES	A-1
A.2 LUNAR MODULE	A-4
A.3 LAUNCH VEHICLE	A-9
A.4 MASS PROPERTIES	A-9
APPENDIX B - <u>SPACECRAFT HISTORIES</u>	B-1
APPENDIX C - <u>POSTFLIGHT TESTING</u>	C-1
APPENDIX D - <u>DATA AVAILABILITY</u>	D-1

1.0 SUMMARY

The Apollo 10 space vehicle, with a crew of Thomas P. Stafford, Commander, John W. Young, Command Module Pilot, and Eugene A. Cernan, Lunar Module Pilot, was launched from Kennedy Space Center, Florida, at 11:49:00 a.m. e.s.t., May 18, 1969. Following a satisfactory launch phase, the spacecraft and S-IVB combination was inserted into an earth parking orbit of 102.6 by 99.6 nautical miles. After onboard systems were checked, the S-IVB engine was ignited at 2-1/2 hours elapsed time to place the spacecraft on a translunar trajectory.

At 3 hours, the command and service modules were separated from the S-IVB and were then transposed and docked with the lunar module. Forty minutes later, the docked spacecraft were ejected, and a separation maneuver of 18.8 feet per second was then performed. The S-IVB was placed into a solar orbit by propulsive venting of residual propellants.

The option for the first spacecraft midcourse correction was not exercised. A preplanned midcourse correction that adjusted the trajectory to coincide with a July lunar landing trajectory was executed at 26-1/2 hours. The passive thermal control technique was employed throughout the translunar coast except when a specific attitude was required.

At 76 hours, the spacecraft was inserted into a lunar orbit of 60 by 171 nautical miles. Following two revolutions of tracking and ground updates, a maneuver was performed to circularize the orbit at 60 nautical miles. The Lunar Module Pilot entered the lunar module, checked all systems, and then returned to the command module for the scheduled sleep period.

Activation of the lunar module systems was begun at 95 hours, and the spacecraft were undocked at 98-1/4 hours. After station-keeping, a small separation maneuver was performed by the command and service modules, and the lunar module was inserted into the descent orbit at 99-3/4 hours. An hour later, the lunar module made a low-level pass over Apollo Landing Site 2, the planned site for the first lunar landing. The pass was highlighted by a test of the landing radar, visual observation of lunar lighting, stereo photography, and execution of the phasing maneuver using the descent engine. The lowest measured point in the trajectory was 47 400 feet from the lunar surface. Following one revolution in the phasing orbit, about 8 by 194 miles, the lunar module was staged, and the ascent engine was used to perform an insertion maneuver at about 103 hours. Conditions following this maneuver were identical to those expected after a normal ascent from the lunar surface, and the fidelity for the rendezvous which followed was therefore valid.

The rendezvous operation commenced with the coelliptic sequence initiation maneuver about one-half revolution from insertion, followed by a small constant differential height maneuver. With the altitude difference between the two orbits established at the proper 15 nautical miles, the terminal phase was initiated normally at 105-1/2 hours. Braking was performed on schedule. Docking was complete at 106-1/2 hours, and the crew transferred into the command module. The ascent stage was jettisoned, and the ascent engine was fired to propellant depletion at 109 hours.

After a rest period, the crew conducted landmark tracking and photography exercises. Transearth injection was performed at 137-1/2 hours.

The passive thermal control technique and the navigation procedures used on the translunar portion of flight were also performed during the earth return. Only one midcourse correction, 2.2 feet per second, was required, and it was made 3 hours prior to command module/service module separation. The command module entered the atmosphere (400 000 feet altitude), and it landed near the primary recovery vessel, USS Princeton, at about 192 hours. At daybreak, the crew were retrieved by helicopter.

All systems in the command and service modules and the lunar module were managed very well. While some problems were encountered, most were minor and none caused a constraint to completion of mission objectives. Communications quality at the lunar distance was generally adequate. Color television pictures were transmitted sixteen times during the mission for a total transmission time of almost 6 hours, and picture quality was extremely good.

Crew performance was excellent throughout the mission, and timelines were followed very closely. Valuable data concerning lunar gravitation were obtained during the 60 hours of lunar orbit.

2.0 INTRODUCTION

The Apollo 10 mission was the tenth in a series of flights using specification Apollo hardware and was the first lunar flight of the complete spacecraft. It was also the fourth manned flight of the command and service modules and the second manned flight of the lunar module. The purpose of the mission was to confirm all aspects of the lunar landing mission exactly as it would be performed, except for the actual descent, landing, lunar stay, and ascent from the lunar surface. Additional objectives included verification of lunar module systems in the lunar environment, evaluation of mission support performance for the combined spacecraft at lunar distance, and further refinement of the lunar gravitational potential.

Because of the excellent performance of the entire spacecraft, only the systems performance that significantly differed from that of previous missions is reported. This report is concentrated on lunar module flight results and on those activities involving combined vehicle operations peculiar to the lunar environment. The rendezvous and mission communications are reported in sections 4 and 5, respectively. A treatise on the lunar gravitation field and its relationship to lunar orbit navigation for future missions is contained in section 6. The launch escape system and the spacecraft/launch-vehicle adapter performed as expected, and their performance is not documented.

A complete analysis of certain flight data is not possible within the time frame for preparation of this report. Therefore, report supplements will be published for the guidance, navigation, and control system; the biomedical evaluation; the lunar photography; and the trajectory analysis. Other supplements will be published as need is identified.

In this report, all times are elapsed time from range zero, established as the integral second before lift-off. Range zero for this mission was 16:49:00 G.m.t., May 18, 1969. Also, all references to mileage distance are in nautical miles.

3.0 MISSION DESCRIPTION

Apollo 10 was an 8-day mission to qualify the combined spacecraft in the lunar environment. Particular primary objectives were demonstration of lunar module rendezvous and command module docking in the lunar gravitational field and evaluation of docked and undocked lunar navigation. The crew timelines used for this mission duplicated those for the lunar landing mission, with the exception of the actual descent to the surface. In addition, visual observation and stereo photography of Apollo Landing Site 2, the planned location of the first lunar landing, were to be completed. Table 3-I and figure 3-1 are timelines of mission events. Figure 3-2 is a summary flight plan of the Apollo 10 mission.

The space vehicle was launched at 11:49:00 a.m. e.s.t., May 18, 1969, and inserted into an earth parking orbit of 102.6 by 99.6 miles. After 2-1/2 hours of system checkout activities, the translunar injection sequence was completed precisely using the S-IVB. The command and service modules were separated from the S-IVB and then were transposed and docked with the lunar module. The docking latches were secured, the tunnel was pressurized, and the spacecraft were ejected from the S-IVB at about 4 hours. A separation maneuver using the service propulsion system was then performed, and residual propellants were propulsively vented to place the S-IVB into a solar orbit.

The option for the first midcourse correction, scheduled for about 12 hours, was not exercised because of the precision of the translunar injection. Instead, a passive thermal control technique, similar to that used on Apollo 8, was initialized to stabilize onboard temperatures. The only translunar midcourse correction, approximately 50 ft/sec, was performed at 26-1/2 hours using the service propulsion system. This correction was preplanned to adjust the Apollo 10 translunar trajectory to coincide with the lunar landing trajectory planned for the month of July.

At about 76 hours, the service propulsion engine was fired for 356 seconds to insert the spacecraft into lunar orbit. The resulting orbit was 60 by 171 miles; after two revolutions, the orbit was circularized at approximately 60 miles.

The lunar module was entered for the first time at about 82 hours for a check of systems. Equipment was transferred to the lunar module, and the tunnel hatch was replaced. After a normal sleep period, the Commander and the Lunar Module Pilot entered the lunar module for a complete systems check in preparation for the lunar orbit rendezvous.

The spacecraft were undocked at 98-1/4 hours. Following various radar and communications checks and a command and service module separation maneuver, the lunar module was inserted into the descent orbit using

the descent propulsion system. The landing radar was operated successfully at approximately 8 miles altitude over Landing Site 2; visual wash-out effects were assessed and photographs of the approach terrain were taken. Soon after pericyynthion passage, a phasing maneuver was performed to insert the lunar module into an 11- by 190-mile orbit to establish the conditions for rendezvous. After one revolution in this orbit, the lunar module was staged, and an insertion maneuver was executed at about 103 hours, using the ascent propulsion system. Conditions after this maneuver closely simulated those for a normal ascent from the lunar surface.

Lunar module rendezvous was initiated with the coelliptic sequence maneuver at 103-3/4 hours using the reaction control system, interconnected with the ascent propellant tanks. The intermediate plane change maneuver was not required, and at 104-3/4 hours a small (3.0 ft/sec) constant differential height maneuver was performed using the reaction control system. The Command Module Pilot used VHF ranging and sextant information to calculate the backup maneuvers he could have used in the event of certain lunar module failures. The terminal phase was initiated accurately at 105-1/4 hours, and docking was performed from the command module an hour later.

After crew transfer, the lunar module ascent stage was jettisoned, and the ascent propulsion system was fired to propellant depletion at 109 hours. The firing was nominal and placed the vehicle into a solar orbit.

The final day in lunar orbit was spent in performing a series of landmark tracking and platform alignment exercises and stereo and sequence photography. The transearth injection maneuver was performed accurately at about 137-1/2 hours using the service propulsion system.

The fast-return flight of about 54 hours duration was completed normally using the passive thermal control techniques and cislunar navigation. The only transearth midcourse correction was performed at about 189 hours, or 3 hours prior to entry, and a velocity change of only 2.2 ft/sec was required. The command module was separated from the service module at 191.5 hours, followed by entry 15 minutes later.

Entry was controlled by the primary guidance and navigation system to effect spacecraft landing very close to the target at about 15 degrees south latitude and 165 degrees west longitude. The crew were retrieved by helicopter soon after daylight and taken aboard the primary recovery vessel, USS Princeton, 39 minutes after landing. The spacecraft was recovered by the recovery ship 1-1/2 hours after landing.

TABLE 3-I.- SEQUENCE OF EVENTS

Event	Time, hr:min:sec
Range zero - 16:49:00 G.m.t., May 18, 1969	
Lift-off	00:00:00.6
Maximum dynamic pressure	00:01:22.6
S-IC outboard engine cutoff	00:02:41.6
S-II engine ignition (command)	00:02:43.1
Launch escape tower jettison	00:03:17.8
S-II engine cutoff	00:09:12.6
S-IVB engine ignition (command)	00:09:13.6
S-IVB engine cutoff	00:11:43.8
Parking orbit insertion	00:11:53.8
S-IVB ignition (translunar injection)	02:33:28
Translunar injection (S-IVB cutoff + 10 sec)	02:39:21
Command and service module separation	03:02:42
First docking	03:17:37
Spacecraft ejection	03:56:26
Spacecraft separation maneuver	04:39:10
First midcourse correction	26:32:57
Lunar orbit insertion	75:55:54
Lunar orbit circularization	80:25:08
Undocking	98:11:57
Command and service module separation maneuver	98:47:17
Descent orbit insertion	99:46:02
Phasing orbit insertion	100:58:26
Lunar module staging	102:45:17
Ascent insertion maneuver	102:55:02
Coelliptic sequence initiation	103:45:55
Constant differential height maneuver	104:43:53
Terminal phase initiation	105:22:56

TABLE 3-I.- SEQUENCE OF EVENTS - Concluded

Event	Time, hr:min:sec
Second docking	106:22:02
Ascent stage jettison	108:24:36
Final separation maneuver	108:43:23
Ascent engine firing to propellant depletion	108:52:06
Transearth injection	137:36:29
Second midcourse correction	188:49:58
Command module/service module separation	191:33:26
Entry interface (400 000 feet altitude)	191:48:55
Enter communications blackout	191:49:12
Exit communications blackout	191:53:40
Drogue deployment	191:57:18
Main parachute deployment	191:58:05
Landing	192:03:23

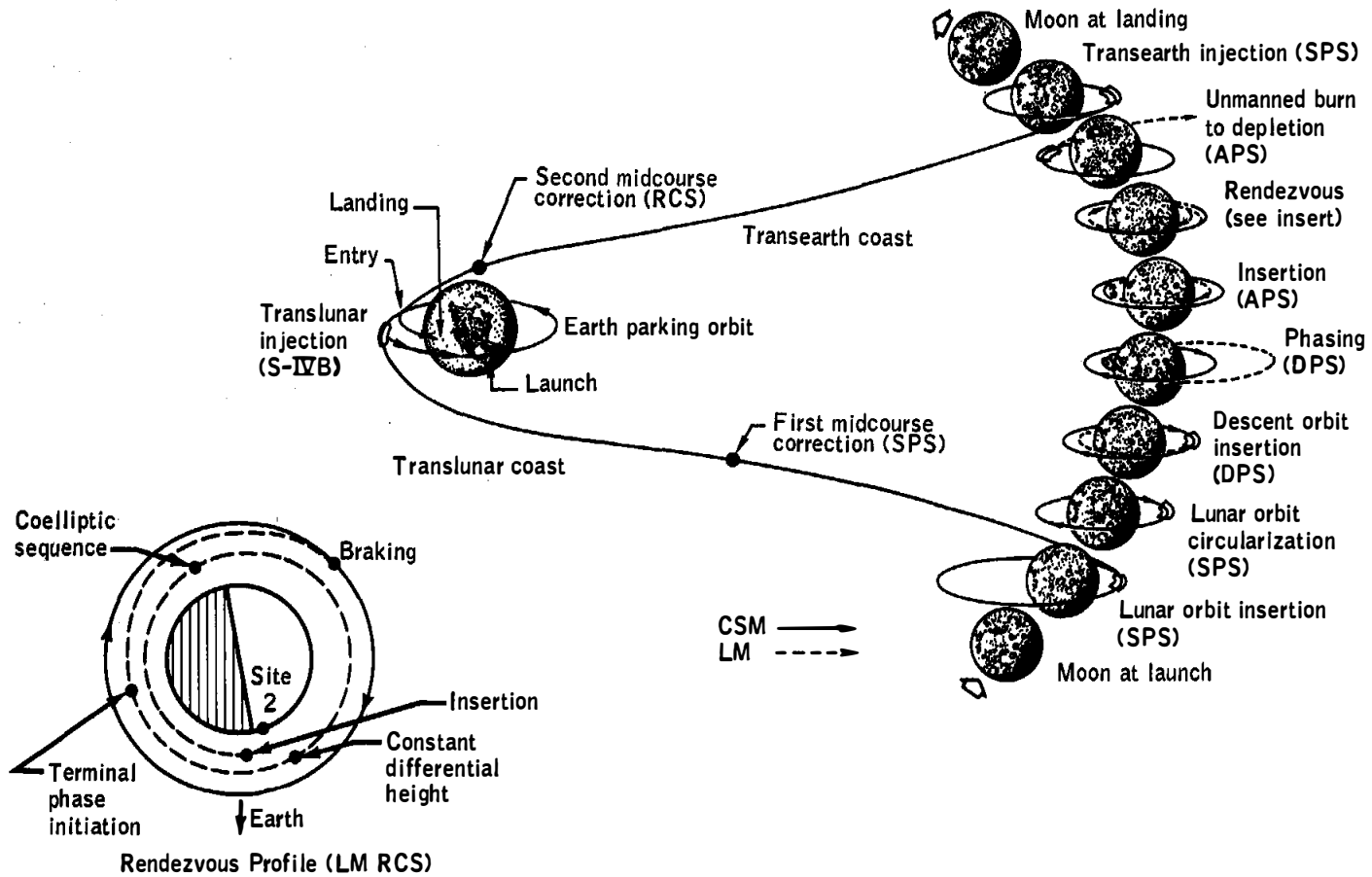
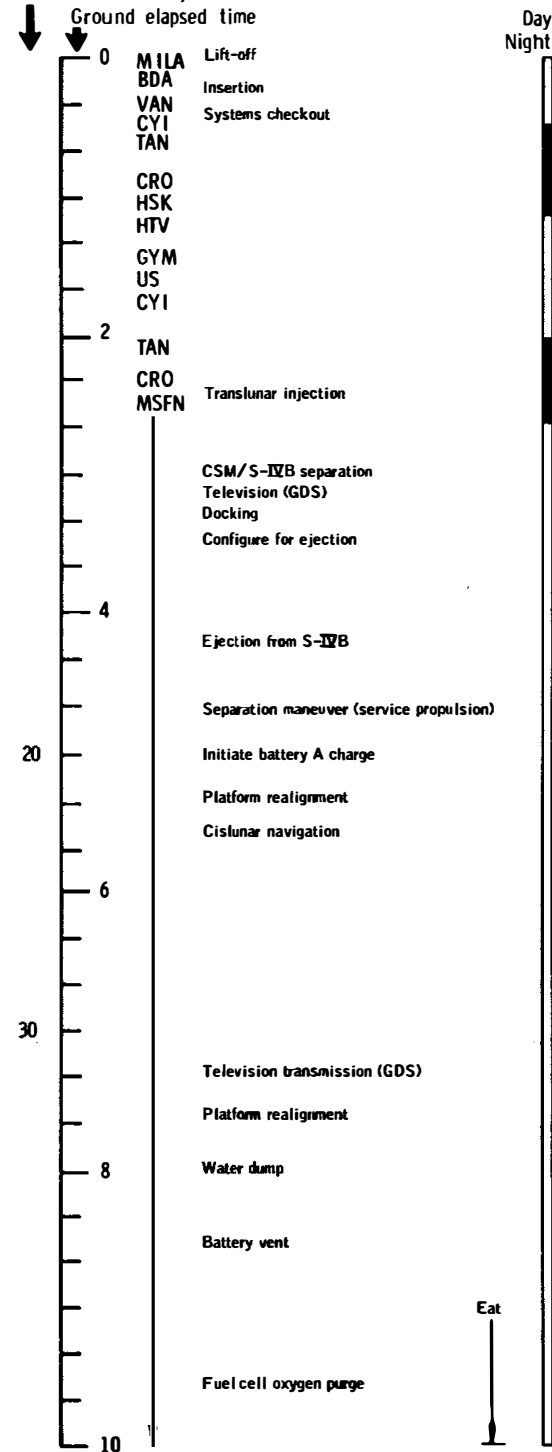
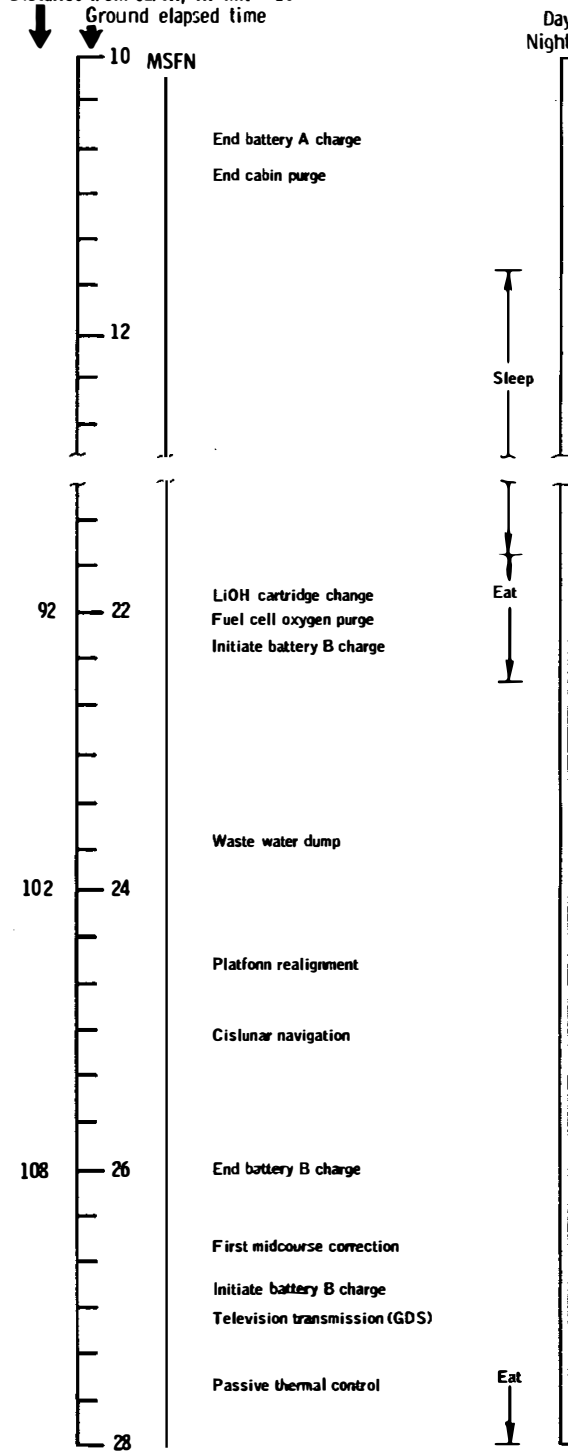

Figure 3-1.- Apollo 10 mission profile.

Distance from earth, n. mi. $\times 10^{-3}$



Distance from earth, n. mi. $\times 10^{-3}$



(a) 0 to 28 hours.

Figure 3-2.- Summary flight plan.

NASA-S-69-2652

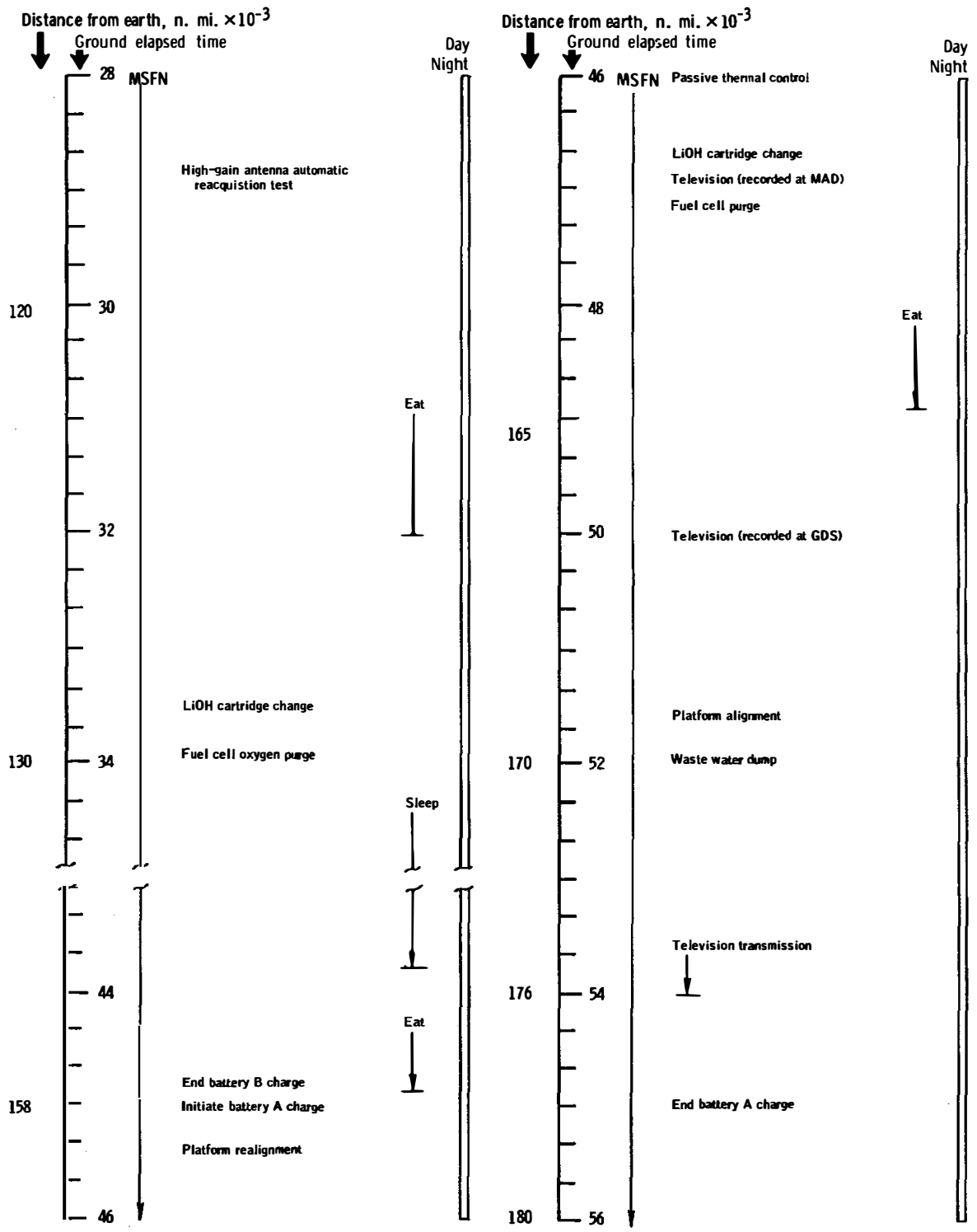

(b) 28 to 56 hours.

Figure 3-2. - Continued.

Distance from earth, n. mi. $\times 10^{-3}$
 Ground elapsed time

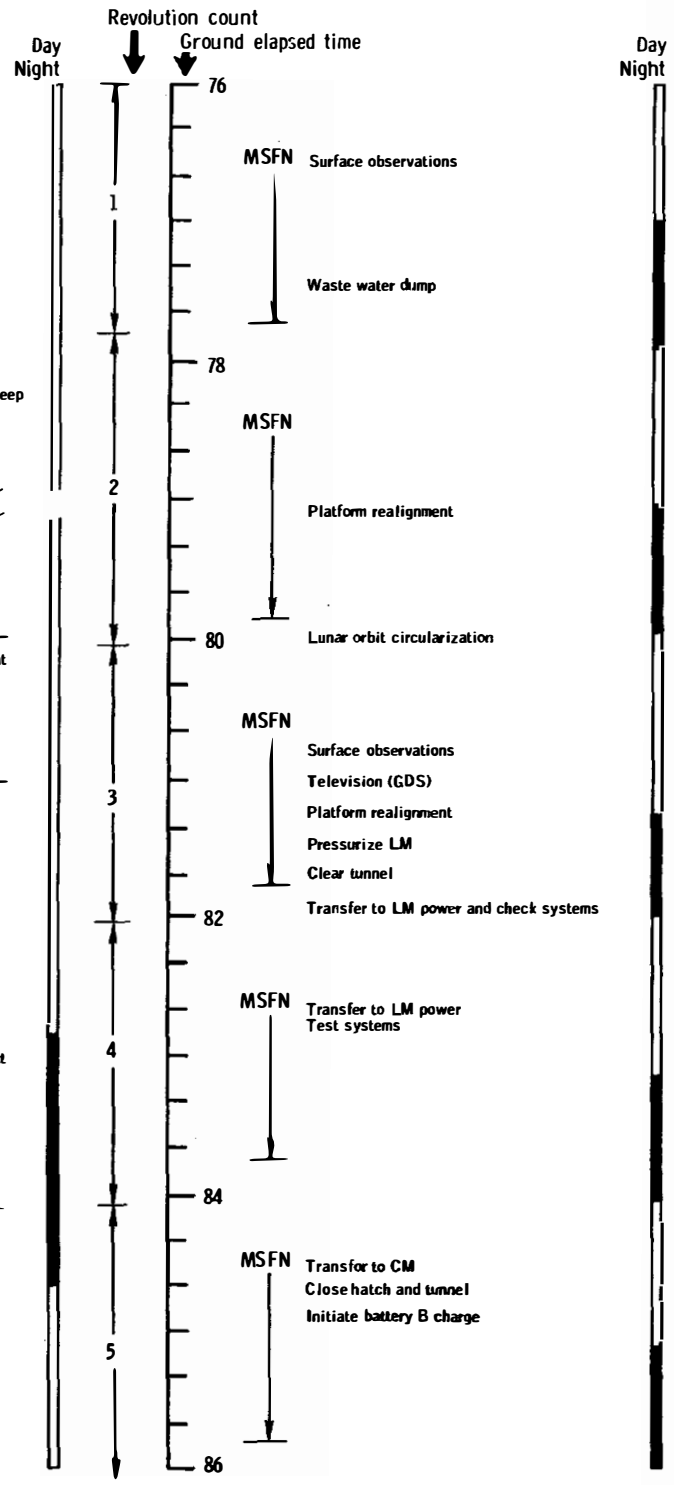
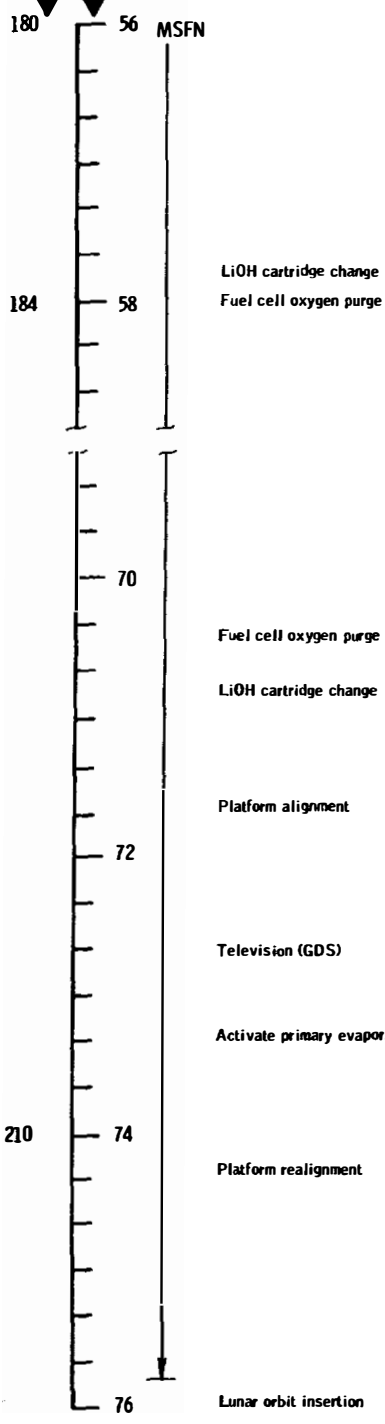

(c) 56 to 86 hours.
 Figure 3-2. - Continued.

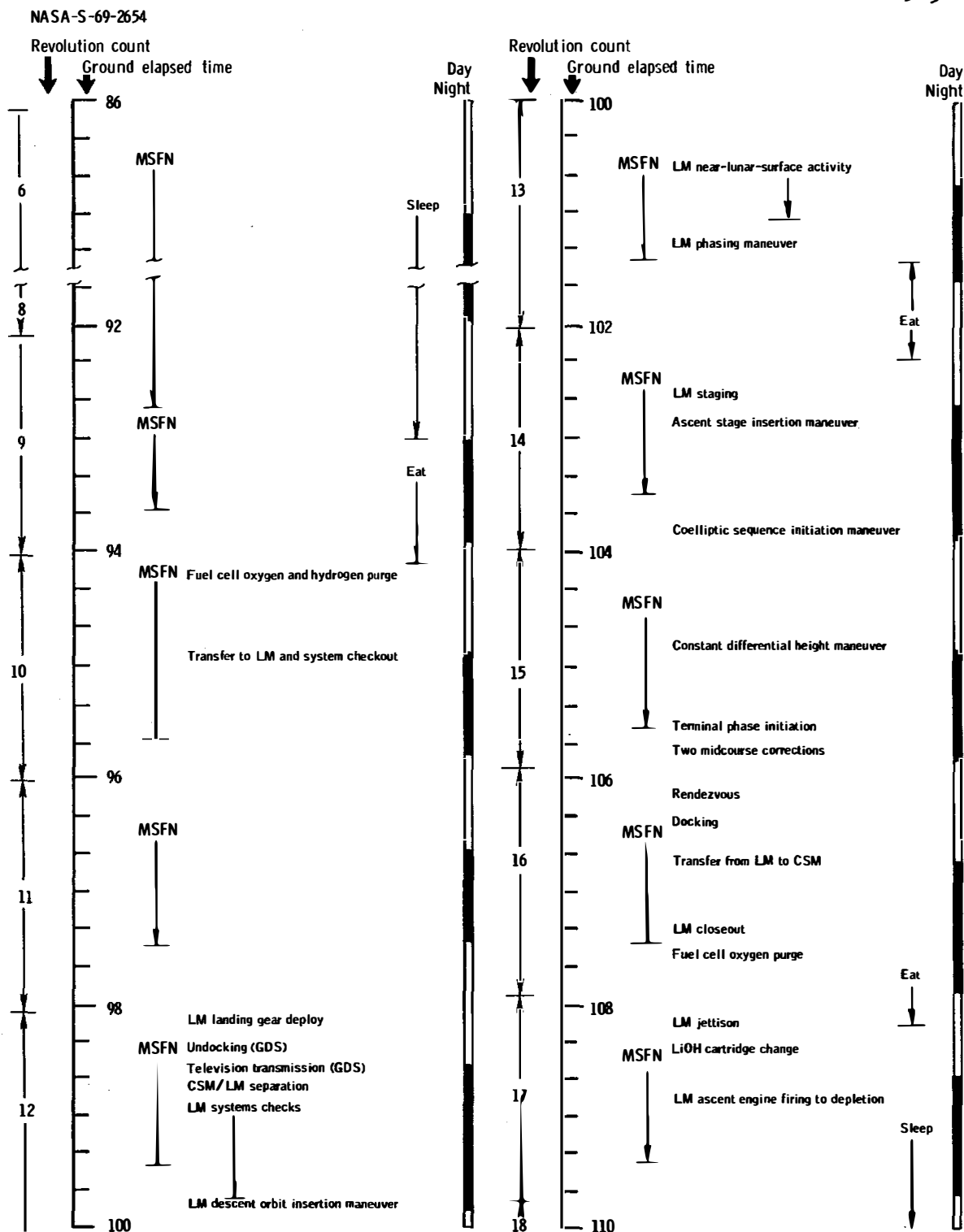
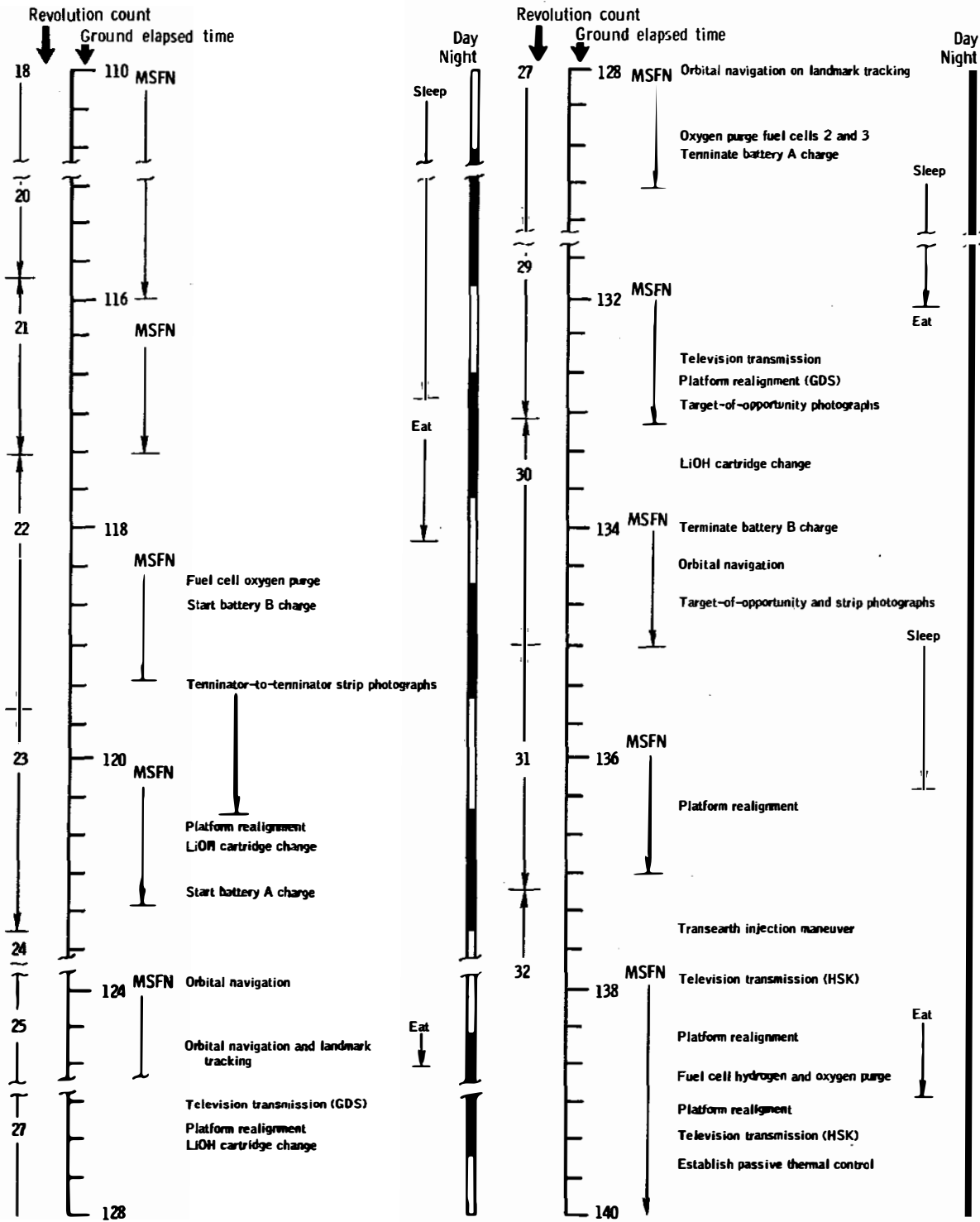
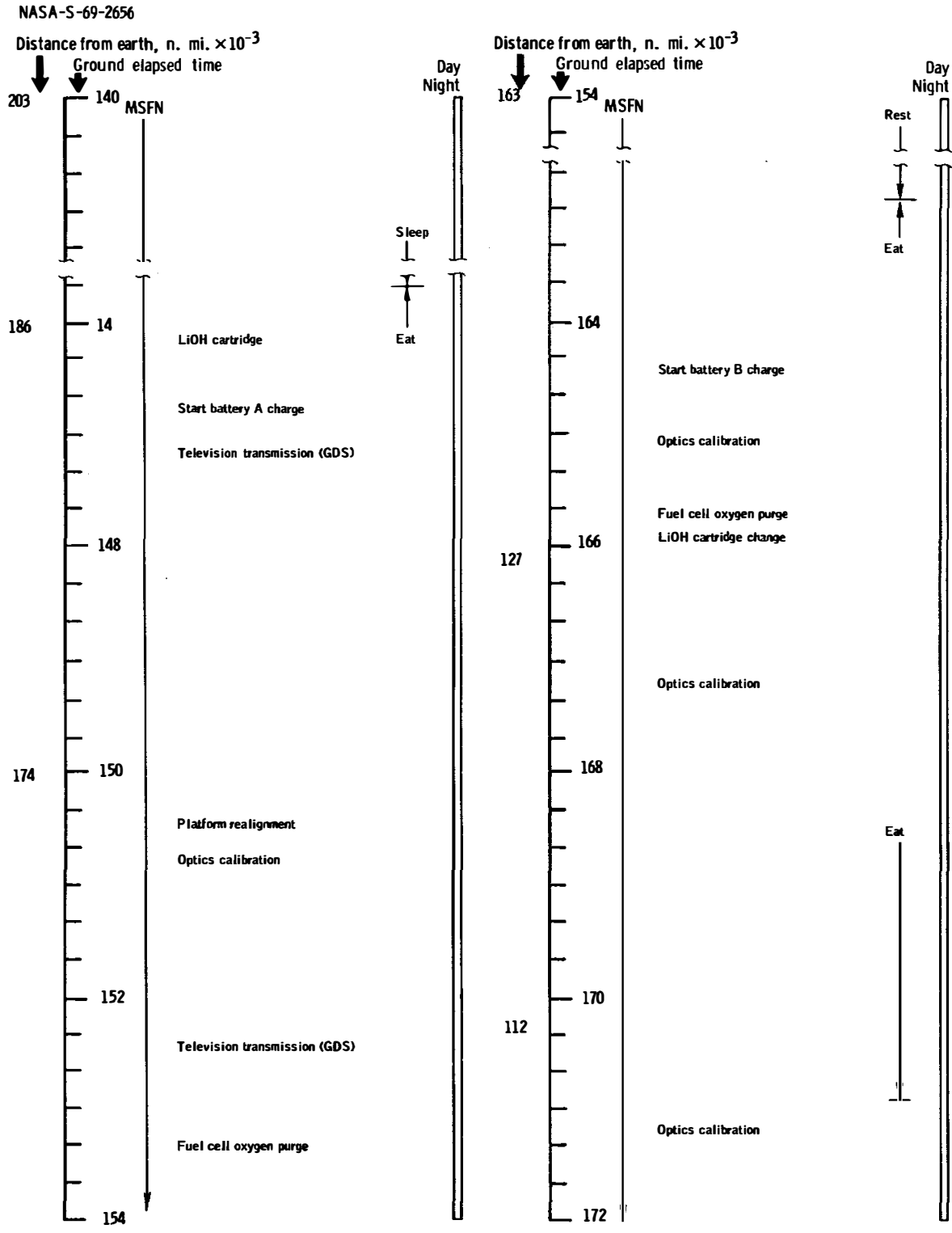

Figure 3-2.- Continued.



(e) 110 to 140 hours.

Figure 3-2. - Continued.



(f) 140 to 172 hours.
 Figure 3-2. - Continued.

NASA-S-69-2657

Distance from earth, n. mi. $\times 10^{-3}$

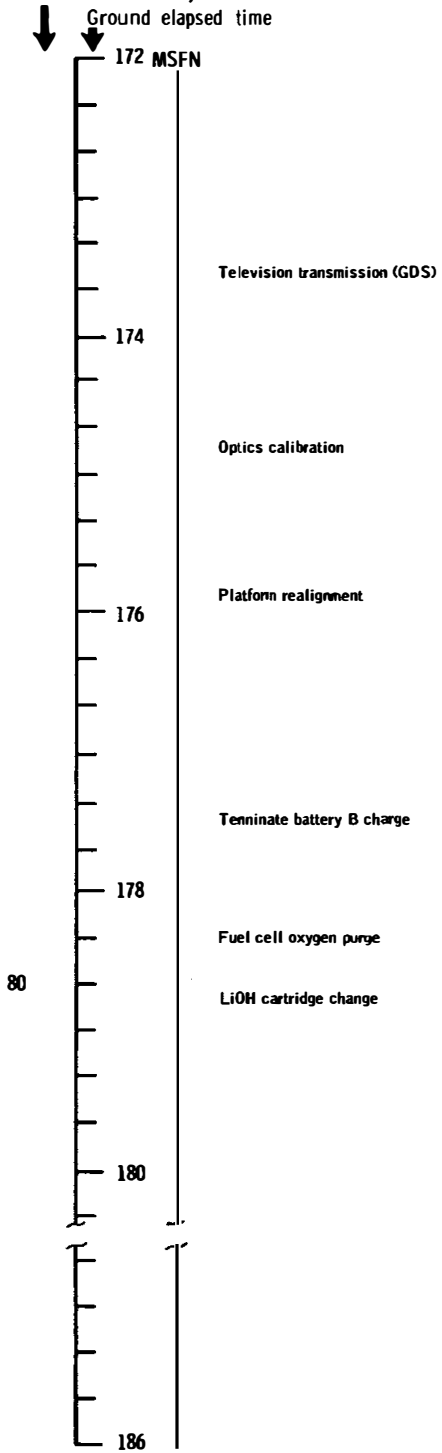

Distance from earth, n. mi. $\times 10^{-3}$

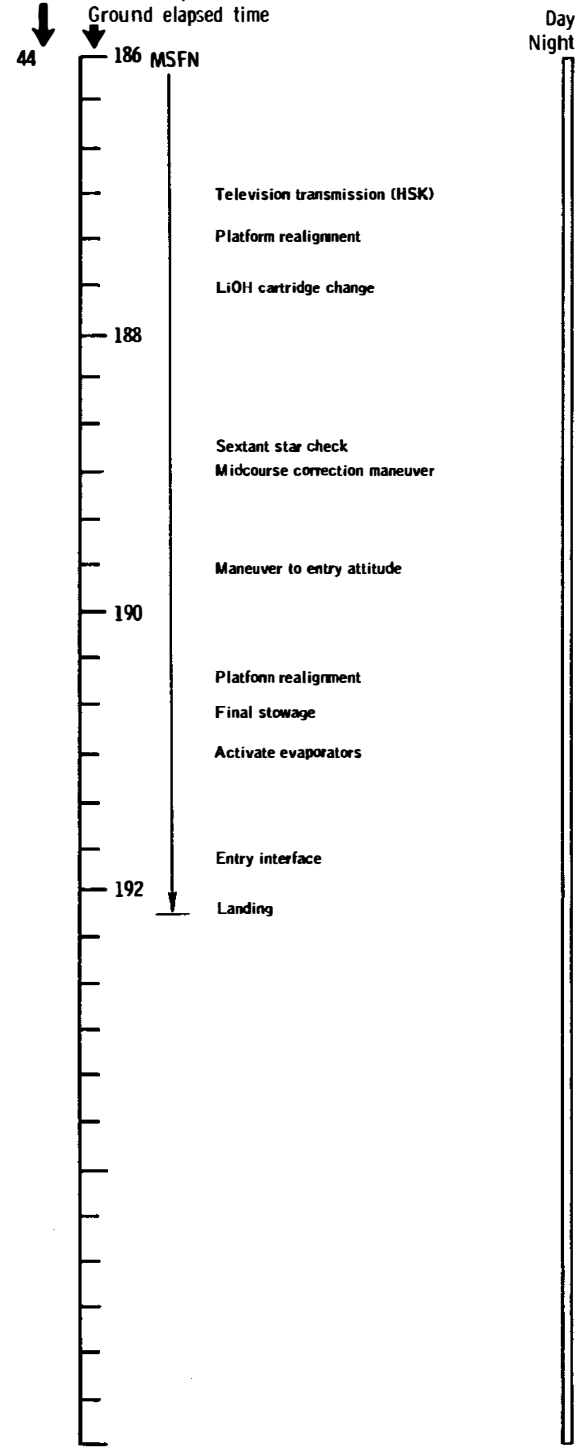

Sleep

Eat

(g) 172 to 192 hours.

Figure 3-2.- Concluded.

4.0 RENDEZVOUS

The lunar module was separated from the command module for 8 hours in lunar orbit, and the maximum separation distance was 340 miles. The lunar module then returned to the command module after a series of rendezvous maneuvers. All phases of lunar module operations were successful, and all associated mission objectives were accomplished. Computer solution maneuver times in this section refer to computer time, which is 0.73 second less than elapsed times referenced to range zero.

One of the eleven translation maneuvers performed during the rendezvous, the phasing maneuver, will not be a part of the nominal lunar landing profile. Although the duration of the insertion maneuver was not equal to ascent from the surface, this maneuver had to establish the initial position and velocity conditions that would nearly duplicate the rendezvous following a lift-off from the lunar surface.

Ground support during the rendezvous was similar to previous missions. However, Network tracking data were not processed to obtain an independent solution for the coelliptic sequence rendezvous maneuvers because this sequence was initiated behind the moon. Instead, telemetry data of the state vectors from the lunar module computer prior to onboard navigation updates were used on the ground to compute maneuvers as a backup to onboard computations.

4.1 TRAJECTORY

This section contains a brief description of trajectory events and an analysis of the slight out-of-plane condition that existed at the beginning of rendezvous. Figure 4-1 depicts the relative motion between the lunar module and command module, and figure 4-2 shows their relative positions during rendezvous. Tables 6-II and 6-IV contain the rendezvous trajectory and maneuver parameters, respectively.

During the eleventh lunar revolution, a nominal pre-separation rendezvous plan was computed. A comparison of this plan with the actual and onboard solutions (table 4-I) confirms that the sequence was nominal.

The vehicles undocked during the twelfth lunar revolution. At 98:47:17.4, a maneuver was executed with the service module reaction control system to establish an equiperiod orbit for a relative separation of about 2 miles at descent orbit insertion. The planned 2.5-ft/sec separation maneuver, conducted radially downward also had a residual in retrograde horizontal velocity of about minus 0.2 ft/sec. This caused the separation distance at descent orbit insertion to be about 0.4 mile greater than planned, but the added distance was not critical.

Descent orbit insertion was the first lunar module maneuver and was executed accurately and on time with the descent propulsion system to lower the pericyynthion to 8.5 miles. The phasing maneuver was also performed with the descent propulsion system, and the lunar module was inserted into a 190- by 12-mile phasing orbit.

The lunar module was staged at 102:45:17, 10 minutes prior to the insertion maneuver. The insertion maneuver placed the lunar module into almost precisely the predicted orbit of 46.5 by 11.0 miles. Following insertion, both vehicles began onboard tracking to compute coelliptic sequence solutions. Table 4-I illustrates the excellent agreement between the final onboard solution for coelliptic sequence initiation and that computed on the ground from the original pre-separation state vectors and incorporating the confirmed maneuvers.

At coelliptic sequence initiation, the onboard sensors first detected a slight but unexpected out-of-plane position error of about 1 mile at maximum plane separation. The lunar module out-of-plane solution was plus 4.1 ft/sec relative to the command module orbit plane. The command module sextant detected a similar rate of plus 6.4 ft/sec; however, a misunderstanding in the procedure for comparing the two solutions and their sign conventions caused the crew to delay any out-of-plane correction until terminal phase initiation; this delay was acceptable for dispersions of this magnitude. The out-of-plane dispersion between the two vehicles most probably resulted from vehicle ephemeris errors during the phasing and insertion maneuvers. Maneuver execution based on an onboard state vector in error with respect to the orbital plane would create out-of-plane dispersions.

The constant differential height maneuver was executed under abort guidance control at 104:43:53.4 and established the height differential at a very constant and nearly nominal value of 14.9 miles.

The lunar module initiated the terminal phase at 105:22:55.6, or about 2 minutes later than the targeted value calculated before the rendezvous. The expected one-sigma dispersion in this time was about 4 minutes. The terminal phase initiation solution and execution were very accurate, as evidenced by the two midcourse maneuvers of less than 2 ft/sec for each.

The braking maneuvers were performed behind the moon, and since the lunar module had no onboard recorder, no accurate description of this phase can be given. Nevertheless, the nominal propellant usage and the lack of any negative crew remarks indicate that braking was performed effectively. The vehicles were only a few feet apart at Network acquisition, about 13 minutes after theoretical intercept.

4.2 CREW PROCEDURES

The method of operating the guidance, navigation, and control systems to effect rendezvous was very similar to that for Apollo 9, despite numerous changes made to onboard computer programs. The major differences between the procedures used for Apollo 10 and those for Apollo 9 resulted from (1) a VHF ranging system installed in the command module to provide navigation data to supplement sextant sightings; (2) the command module was the active vehicle for all docking operations; and (3) the rendezvous was conducted in lunar orbit rather than earth orbit, therefore necessitating numerous timeline adjustments.

4.2.1 Lunar Module

The lunar module crew successfully performed all required rendezvous maneuvers utilizing procedures developed and verified during the Apollo 9 mission and Apollo 10 crew training. The high degree of success was evident from the reaction control system propellant utilization, which was about ten percent less than budgeted. Because the nominal rendezvous procedures, documented in detailed preflight reports, were followed very closely, they are not repeated. The significant deviations from planned procedures are discussed in the following paragraphs.

A period of radar updating had been scheduled prior to the staging maneuver, but the crew reported they were unable to establish radar navigation updating as planned. This resulted from the command module attitude being outside the limits required for proper radar transponder coverage.

While under control of the abort guidance system, lunar module attitudes deviated from expected during the staging maneuver. Telemetry data indicated the automatic mode was engaged twice for short periods prior to and at staging. Since the automatic mode had been used previously to point the lunar module Z-axis at the command module, the guidance system returned the vehicle to that attitude. While considerable deviation in attitude was experienced temporarily (see section 15.2.14), no adverse effects on the rendezvous resulted.

At the coelliptic sequence initiation maneuver, solutions for the lunar module out-of-plane velocity were obtained from both vehicle computers, with the Command Module Pilot reporting a plus 6.4-ft/sec and the Lunar Module Pilot obtaining plus 4.1 ft/sec. The command module solution was erroneously changed in sign and then compared with the lunar module value, thereby presenting an apparent disagreement to the crew. Since these solutions were both small in magnitude and appeared opposite

in sign, the crew believed an out-of-plane correction to be unnecessary and elected to delay this correction until terminal phase initiation, where in-plane and out-of-plane solutions are combined. Actually, the agreement in sign of the out-of-plane velocity solutions was valid, since each vehicle computed precisely the same parameter, the out-of-plane velocity of the lunar module. A crew misunderstanding of the sign notation for this parameter existed and apparently resulted from the fact that all command-module mirror-image solutions for rendezvous require a sign reversal when used by the lunar module crew. Since the determination of lunar module out-of-plane velocity is a separate routine in the command module computer and not a mirror-image solution, this parameter should not be reversed in sign when used for comparison. This fact had not been made clear enough before flight, and the crew was acting on what they believed to be the correct comparison procedure. No difficulties were encountered by this misunderstanding and subsequent delay in the out-of-plane correction, since errors of this type do not increase (propagate). This sign convention will be fully defined in training programs for future missions.

4.2.2 Command Module

The Command Module Pilot successfully performed all procedures required during both command-module-active translation maneuvers, separation and docking, and all lunar module maneuvers. As a result, the Command Module Pilot was able to assist in determining the maneuvers and was prepared at all times to perform a rendezvous. The excellent performance of crew procedures during this period was reflected in the propellant usage of the service module reaction control system being considerably less than the budgeted value (see section 7.7). This saving resulted from maintaining minimum attitude rates throughout the rendezvous and efficient execution of the docking maneuver. Because the nominal rendezvous procedures were followed very closely, only the significant deviations from the planned procedures are discussed in the following paragraphs.

Prior to undocking, an attitude dispersion in yaw developed because the spacecraft was in the wrong stabilization and control system mode, but the condition was quickly corrected.

After undocking, initial checks of the rendezvous radar were unsuccessful; however, the transponder power switch in the command module was recycled and the transponder and radar then operated normally (see section 15.1.3). After separation, the rendezvous navigation program was selected later than planned; consequently, the command module did not assume the preferred track attitude. When transponder coverage was requested from the lunar module, the command module was maneuvered manually to the required attitudes.

After insertion, the command module computer initially obtained an abnormal lunar module apocynthion altitude because a routine data entry procedure had been overlooked when the insertion maneuver was incorporated into the command module computer. This altitude discrepancy was promptly recognized by the Command Module Pilot, who then reloaded the maneuver and obtained the correct solution.

The taking of navigation marks was discontinued 5 minutes earlier than specified by the checklist to allow more time for the final computations of terminal phase initiation.

The Command Module Pilot did not terminate the rendezvous navigation program until after the terminal phase initiation maneuver. This delay enabled him to orient the command module to the proper track attitude immediately after this maneuver, after which the terminal phase solution was incorporated into the command module computer. This reversal of the planned procedure to first incorporate lunar module maneuver data into the computer and then rotate to the track attitude did not impact the mission.

4.3 GUIDANCE, NAVIGATION, AND CONTROL

Rendezvous navigation was satisfactorily performed, based on the nearly nominal maneuver solutions and pilot reports of the minor corrective thrusting required during the intercept trajectory. A final comparison of the onboard state vectors with those from the best estimated trajectory is not yet available; however, preliminary indications are that the state vector update process in both vehicles was satisfactory. Visual tracking of the lunar module against a sunlit lunar background was difficult when the sextant was used, and little sighting data are available.

The computer interfaces, data incorporation routines, and recursive navigation processes of both the VHF ranging and rendezvous radar systems were thoroughly demonstrated. All solutions executed in the lunar module were computed by the onboard computer solely from rendezvous radar data. The close agreement between these completely independent measurement systems lends evidence to the validity of both sets of data. These data were satisfactorily incorporated into the respective computers.

All maneuver solutions executed during the rendezvous were compared with the velocity changes that had been predicted before flight (table 4-I), and the total velocity change required to perform all lunar module maneuvers was within 1 percent of the predicted value.

During the rendezvous, a variety of maneuver solutions were available in the lunar module (table 4-I). The out-of-plane velocity component was calculated during the coelliptic sequence initiation and constant differential height maneuvers but was not used, thus accounting for the small out-of-plane error of minus 5.7 ft/sec at terminal phase initiation.

Inertial component stabilities in the platforms of both spacecraft and in the lunar module abort sensor assembly were within specified limits. Platform alignments were sufficiently accurate to have no appreciable effect on rendezvous targeting. The digital autopilots in both vehicles were used satisfactorily during the rendezvous sequence for attitude and translation control and for automatic positioning of the radar antenna and optical devices. The lunar module abort guidance system was occasionally used for automatic positioning to facilitate tracking the command module.

4.4 VISIBILITY

The lighting situation during the Apollo 10 mission was essentially the same as will be experienced on the lunar landing mission. All required sightings of landmarks, stars, and the target vehicle were successfully made, and no major problems were uncovered. Figure 4-3 summarizes the significant visual events for each vehicle during the rendezvous. Therefore, presently defined procedures for platform alignments, rendezvous tracking, terminal phase lighting, and landmark recognition are compatible with the lighting environment planned for the lunar landing mission.

4.5 VHF RANGING

The VHF ranging system performed satisfactorily. The maximum range measured by the system was 340 miles, whereas the maximum specified operating range is 200 miles. Acquisition was also accomplished at ranges greater than 200 miles. All acquisitions were performed with a "hot-mike" configuration in the lunar module, which resulted in two false acquisitions. Both false indications were readily noted by the Command Module Pilot and reacquisition was accomplished normally. Range correlation between the VHF ranging and the rendezvous radar was well within the error limits of the two systems. At ranges between 3000 and 300 feet, the crew reported that the two systems agreed within approximately 100 feet, which is well within specification limits.

TABLE 4-I.- SUMMARY OF RENDEZVOUS MANEUVERS

Parameters*	Lunar module guidance	Command module guidance	Ground	Pre-rendezvous nominal	Actual target solution
Separation maneuver (service module reaction control system)					
Velocity change, ft/sec - X			0.0	0.0	-0.1
- Y			0.0	0.0	-0.2
- Z			2.5	2.5	+3.2
Ignition time, hr:min:sec			98:47:16	98:47:16	98:47:16
Residual velocity, ft/sec - X					-0.1
- Y					-0.2
- Z					+0.7
Resultant orbital altitudes, miles					62.9/57.7
Maximum horizontal trailing distance, miles				1.8	2.4
Descent orbit insertion (descent engine)					
Velocity change, ft/sec - X			-69.9	-69.9	-69.8
- Y			0.0	0.0	-0.3
- Z			-13.8	-13.8	-13.3
Ignition time, hr:min:sec			99:46:01	99:46:01	99:46:01
Residual velocity, ft/sec - X					-0.1
- Y					-0.3
- Z					-0.5
Resultant orbital altitudes, miles					60.9/8.5
Phasing (descent engine)					
Velocity change, ft/sec - X			166.6	166.6	166.6
- Y			0.0	0.0	-0.5
- Z			-59.4	-58.8	-58.5
Ignition time, hr:min:sec			100:58:25	100:58:26	100:58:25
Residual velocity, ft/sec - X					+0.2
- Y					-0.5
- Z					-0.9
Resultant orbital altitudes, miles			189.8/11.7	189.9/11.7	190.1/12.1
Insertion (ascent engine)					
Velocity change, ft/sec - X			-183.2	-183.9	-183.2
- Y			+0.2	+0.2	+0.2
- Z			-123.5	-124.0	-124.8
Ignition time, hr:min:sec			102:55:01	102:55:02	102:55:01
Residual velocity, ft/sec - X					0.0
- Y					0.0
- Z					1.3
Resultant orbital altitudes, miles			46.6/11.1	46.0/10.7	46.5/11.0
Coelliptic sequence initiation (lunar module reaction control)					
Velocity change, ft/sec - X	45.3	45.9	45.3	45.9	45.3
- Y	0.0	0.0	0.0	0.0	-0.4
- Z	0.0	0.0	0.0	0.0	0.0
Ignition time, hr:min:sec	103:45:55	103:45:55	103:45:55	103:45:34	103:45:55
Residual velocity, ft/sec - X					0.0
- Y					-0.4
- Z					0.0
Resultant orbital altitudes, miles			47.2/41.8	47.8/41.9	48.7/40.7
Time of constant differential height maneuver, hr:min:sec	104:43:52	104:43:52	104:43:51	104:43:31	
Out-of-plane velocity, ft/sec	+4.1	+6.4		0.0	

*Velocity changes are shown in a local vertical coordinate system with X measured along the velocity vector, Z measured radially downward, and Y measured orthogonally to X and Z.

TABLE 4-I.- SUMMARY OF RENDEZVOUS MANEUVERS - Concluded

Parameters*	Lunar module guidance	Command module guidance	Ground	Pre-rendezvous nominal	Actual target solution
Constant differential height (lunar module reaction control)					
Velocity change, ft/sec - X	+0.1	+0.3	1.5	0.0	0.0
- Y	0.0	0.0	0.0	0.0	0.0
- Z	3.0	2.9	2.4	1.7	3.7
Ignition time, hr:min:sec	104:43:53	104:43:52	104:43:52	104:43:31	104:43:43
Residual velocity, ft/sec - X					+0.1
- Y					0.0
- Z					-0.1
Resultant orbital altitudes, miles			47.9/41.0	47.0/42.1	48.8/42.1
Differential heights, miles	14.9	14.8	15.4	15.0	
Out-of-plane velocity, ft/sec	-5.2	-4.2		0.0	
Terminal phase initiation (lunar module reaction control)					
Velocity change, ft/sec - X	+21.7	+21.7	No solution	22.1	21.7
- Y	-5.7	-4.8		0.0	-4.9
- Z	-9.6	-9.3		-10.8	-9.7
Ignition time, hr:min:sec	105:22:56	105:23:11		105:21:01	
Residual velocity, ft/sec - X					0.0
- Y					-0.1
- Z					+0.1
Resultant orbital altitudes, miles	57.9/47.9	58.0/47.9			58.3/46.8
Elevation angle, deg	26.6	28.3		26.6	
Time slip, min:sec	1:55	2:10		0:00	
First midcourse correction (reaction control)					
Velocity change, ft/sec - X	0.0				0.0
- Y	-0.4				-0.4
- Z	+1.2				+1.2
Ignition time, hr:min:sec	105:37:56				105:37:56
Second midcourse correction (reaction control)					
Velocity change, ft/sec - X	-0.8	-0.8			-0.8
- Y	1.5	1.7			1.5
- Z	-0.7	-3.0			1.7
Ignition time, hr:min:sec	105:52:56	105:52:56			105:52:56
Braking (reaction control)					
Velocity change, ft/sec - X	18.5	18.5		18.6	Behind moon
- Y	-2.6	-3.0		0.1	
- Z	25.5	25.3		25.6	
Ignition time, hr:min:sec	106:05:49	106:06:04		106:03:59	64.0/56.3
Resultant orbital altitudes, miles	63.3/56.4			63.5/56.9	

*Velocity changes are shown in a local vertical coordinate system with X measured along the velocity vector, Z measured radially downward, and Y measured orthogonally to X and Z.

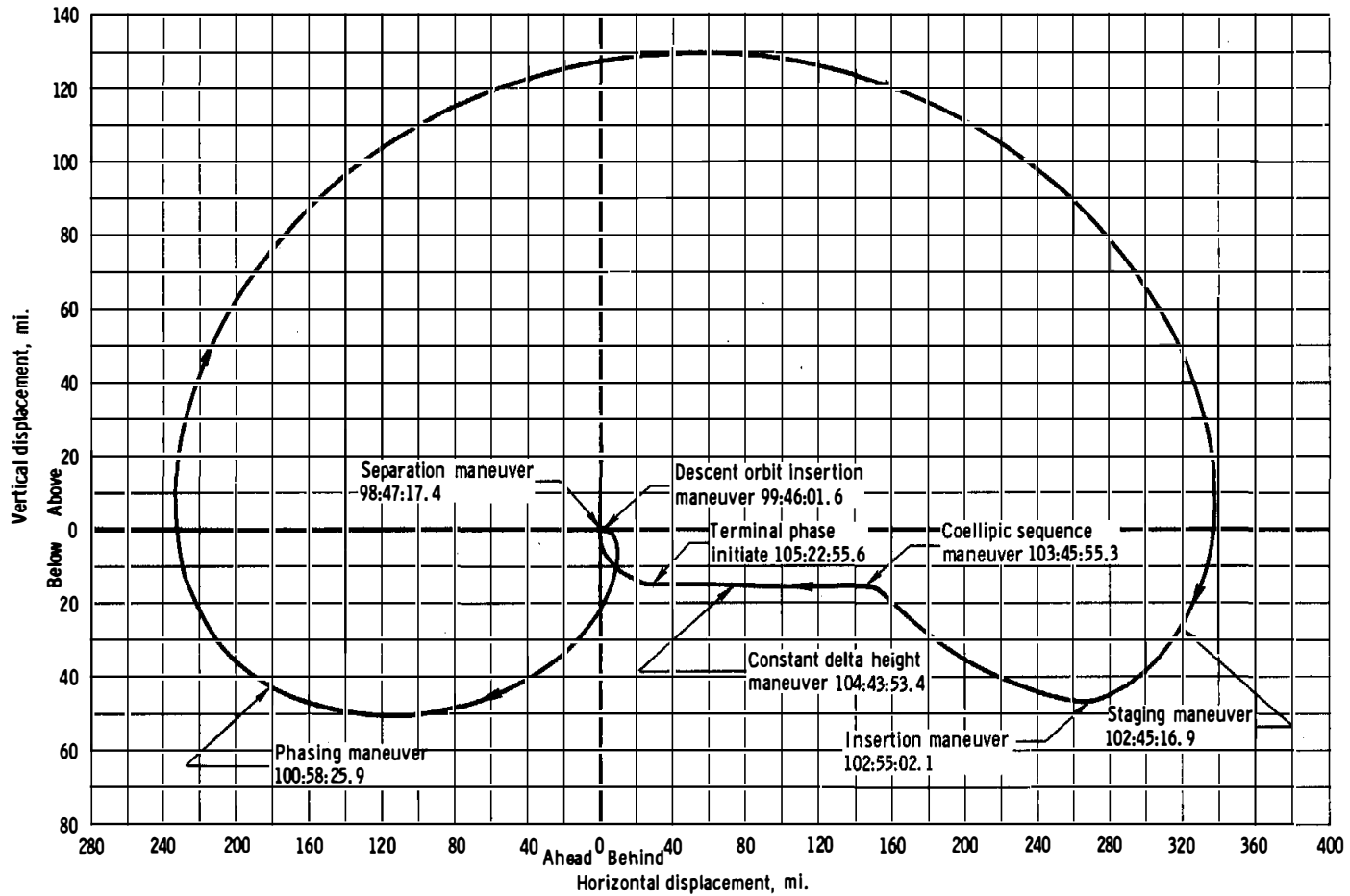

Figure 4-1. - Lunar module motion relative to the command module.

NASA-S-69-2659

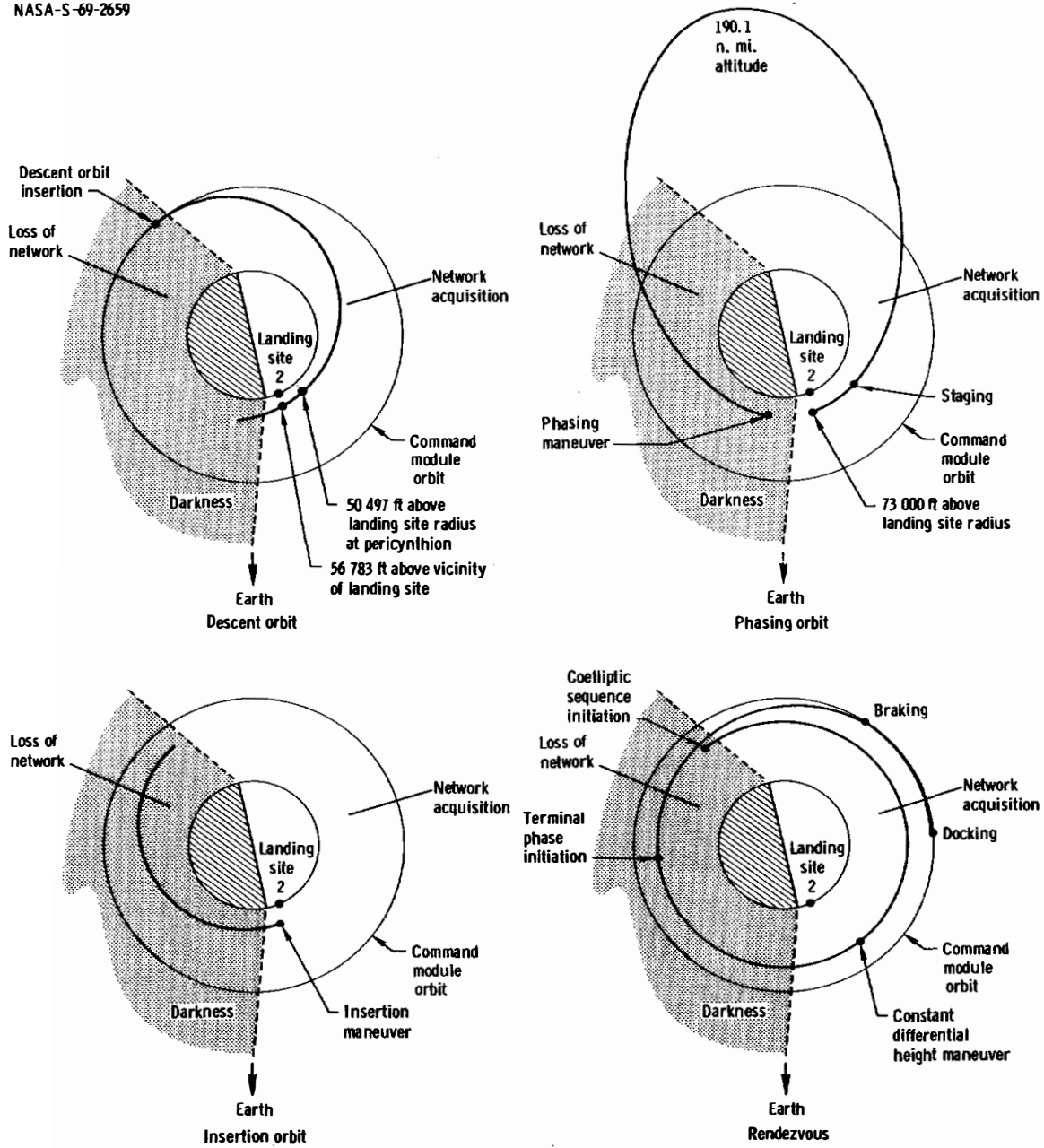
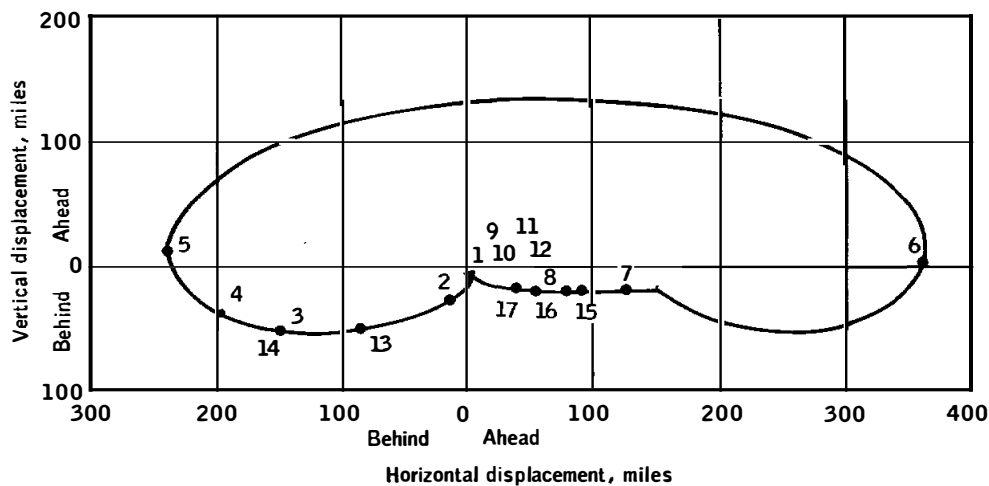

Figure 4-2. - Lunar module rendezvous profile.

NASA-S-69-2660



No.	Device	Command Module Sightings	No.	Device	Lunar Module Sightings
1	Crewman sight	Tracked descent orbit insertion maneuver	9	Telescope	Stars Antares and Acrux were used in darkness to perform a platform alignment
2	Telescope and sextant	Acquired lunar module at dawn with telescope and tracked with sextant to 14 miles range	10	Crewman sight	Saw command module at range of 2500 feet after separation maneuver
3	Sextant	Tracked lunar module prior to phasing maneuver	11	Crewman sight	Saw command module flashing light at range of 0.5 mile
4	Sextant	Could not see phasing maneuver	12	Unaided	Saw thrusters firing during command module separation maneuver
5	Sextant	Saw lunar module in sextant just after phasing; continued to mark on lunar module	13	Visual and landing point grid	Monitored approach to landing site from phasing minus 25 minutes to phasing minus 10 minutes. Extremely easy to recognize landmarks and monitor grid track for position
6	Sextant	With sextant saw lunar module in sunlight at 300 miles range	14	Unaided	Landing site recognized obliquely. No washout over site prior to phasing
7	Sextant	Tracked lunar module, although barely visible against sunlit surface, at a range of 140 miles	15	Unaided	Saw command module in reflected sunlight as a yellow dot at a range of 90 miles
8	Sextant	Not possible to take navigation marks after the constant differential height maneuver until after sun had set	16	Unaided	Command module light was not visible at sunset at range of 60 miles
			17	Unaided	Began to see command module light faintly at range of 42 miles just prior to the terminal phase maneuver

Figure 4-3.- Significant visual sightings during rendezvous.

5.0 COMMUNICATIONS

Performance of all communications systems, including those of the command module and lunar module (see sections 7.4 and 8.4) and the Manned Space Flight Network, was generally as expected. The S-band communications system provided good quality voice, as did the VHF link within its normal range capabilities. The performance of the command module and lunar module S-band updata links was nominal. Real-time and playback telemetry channel performance was excellent. Color television pictures of high quality were received during each of the sixteen transmissions from the command module. The received uplink and downlink S-band signal levels corresponded to predictions. Communication system management, including antenna switching, was generally good.

Two-way phase lock with the command module S-band equipment was established by the Manned Space Flight Network prior to launch. The Merritt Island, Grand Bahama Island, Bermuda Island, and USNS Vanguard stations successfully maintained phase lock through orbital insertion, except during station-to-station handovers. These handovers were accomplished with a minimum loss of data. During the Bermuda coverage, the uplink and downlink carrier power levels varied rapidly and data were lost at least once because the antenna switching from omni B to omni D, scheduled for 0:06:15, was not performed until 0:10:12.

The USNS Mercury and Redstone ships provided coverage of the trans-lunar injection maneuver. Early handovers of the command module and instrument unit uplinks from Carnarvon to Mercury and of the instrument unit uplink from Mercury to Redstone were performed because of command computer problems at Carnarvon and Mercury. The combination of an early handover of the instrument unit uplink and handover of the command module uplink at a scheduled time apparently caused operator errors within the Mercury Station. The Redstone transmitter was activated at the scheduled handover time; however, the Mercury transmitter was not de-energized until 2 minutes 7 seconds later. The presence of the two uplink carriers caused difficulty in acquiring two-way phase lock at Redstone. Even after the Mercury transmitter was turned off, the Redstone still lost downlink phase lock suddenly at 2:37:36.5 and could not reacquire solid two-way lock.

Prior to each rest period except the first, the S-band voice sub-carrier was switched off. With the resulting signal combination, high-bit-rate telemetry could be received during approximately 25 percent of each passive-thermal-control revolution at a slant range exceeding 200 000 miles.

Communications during the translunar and transearth coast phases were maintained by the crew switching between omni antennas or between omni and high gain antennas, by ground command switching between omni antenna D and the high gain antenna, or by ground command switching between omni antennas B and D. The latter technique was used during the crew rest periods.

The service module high gain antenna was used extensively in lunar orbit, and the automatic reacquisition mode was utilized with excellent results during crew rest periods. Telemetry and voice data recorded while the spacecraft line of sight was occluded were played-back through the high gain antenna during each revolution. Solid frame synchronization by the telemetry decommutation system was reported on each playback of command module data. Solid frame synchronization was established on the lunar module data played through the command module recorder during the thirteenth revolution, and this was the only one of the attempted lunar module data dumps that contained data. All voice dumped at the recorded speed was of good quality. Voice dumped at 32 times the record speed was good at all 85-foot stations except Madrid. The 64-kilohertz post-detection voice filter at Madrid was relocated during the transearth coast phase and the problem was corrected.

Downlink voice from the Command Module Pilot was not received at the Mission Control Center until approximately 14 minutes after acquisition of signal in the twelfth lunar revolution. Prior to acquisition of signal, the Goldstone station had been selected to relay voice; however, no voice was received at the Mission Control Center until the Madrid station was requested to relay voice. Operator errors within the Goldstone station and at the Goddard Space Flight Center voice control center inhibited voice transmission to the Control Center. To eliminate similar delays in establishing two-way voice communications during future missions, the backup stations will notify the Network Controller in the Mission Control Center when vehicle transmissions are received but are not being answered by the Communicator within the Control Center.

The crew reported receipt of an echo during some dual-vehicle operations. This echo was heard approximately 2 seconds after a downlink transmission and at a level considerably lower than the normal uplink transmissions; therefore, the echo was probably caused by cross-talk within the ground communications network (see section 12.2).

During the fourth revolution, lunar module communications equipment was activated for the first time, and a special series of communications checks were performed. During these checks, good quality voice and high-bit-rate telemetry were received while the spacecraft was operating in the PM and FM modes and transmitting through the steerable antenna. Good quality high-bit-rate telemetry data were received and recorded through

the Goldstone 210-foot antenna, and good quality low-bit-rate telemetry, backup voice, and normal voice were received through the 85-foot antenna at Goldstone while the lunar module was operating on an omni antenna. Reception of normal S-band voice at the site was possible only because the line-of-sight angle was within a positive gain region of the antenna. Since the gain distribution of the lunar module omni antennas is such that positive gain is available only within a small region of the antenna pattern, reception of normal voice through an 85-foot antenna can be expected only over a narrow range of line-of-sight angles.

During the check of the S-band backup up-voice, in conjunction with backup down-voice, the Capsule Communicator received his own transmissions delayed by the two-way transmission time between the ground and the spacecraft. This retransmission is normal when backup up-voice is used and the lunar module transmitter is keyed.

The nominal received uplink and downlink carrier power levels, antenna selection, and normal and backup downvoice utilization for selected lunar module revolutions are presented in figure 5-1. As shown in this figure, received uplink and downlink carrier power varied 6 dB peak-to-peak during steerable antenna operation between 98:41:14 and 98:53:38. Variations of 2 dB peak-to-peak were noted between 99:02:00 and 99:07:58, at which time the signal was lost because the antenna reached its gimbals limits as the spacecraft was being maneuvered to a platform alignment attitude. The 6-dB variations in the received carrier power levels are not commensurate with correct antenna automatic tracking. Between 98:41:14 and 98:48:00, the line-of-sight to Goldstone was within a region where signal reflection from the lunar module may have caused the variations. Between 98:49:00 and 98:53:38, the line-of-sight to Goldstone was outside this region, and the cause of the variation is unknown.

At 99:34:57, switching from the steerable to an omni antenna momentarily interrupted uplink phase lock. The transients resulting from the sudden loss-of-lock caused the lunar module transceiver to reacquire lock on an uplink subcarrier instead of the carrier. The Madrid station recognized the false lock and reacquired valid two-way lock at 99:37:58.

Between acquisition of signal from the lunar module during the thirteenth lunar revolution at 100:26:20 and initiation of the phasing maneuver, steerable antenna auto-track was not maintained, and the omni antenna with best orientation was selected. This antenna selection negated receipt of high-bit-rate telemetry and degraded the downlink voice quality. The problem was probably caused by an improper switch configuration (see section 15.2.4). The steerable antenna was reacquired prior to the phasing maneuver, and performance was nominal throughout the remainder of lunar module activities.

Selection of the omni antenna during the thirteenth revolution resulted in receipt of degraded voice at the Mission Control Center. A review of the events surrounding selection of the omni antenna has shown that the backup down-voice mode was selected in accordance with the checklist. Playback of the voice recorded within the Goldstone station showed that excellent quality backup voice was received and recorded throughout the period of omni antenna usage. A playback showed that the speech level at the interface with the audio lines to the Mission Control Center decreased when backup down-voice was selected. The decrease in speech level degraded the voice quality; therefore, either a backup voice processing configuration or equipment malfunctions within the Goldstone station caused the voice communication problems on the thirteenth revolution.

The steerable antenna was pointed to earth, and the antenna manual mode was selected for the ascent propulsion firing to propellant depletion. Except for a momentary loss of two-way lock following ascent-stage jettison, this technique enabled continuous tracking of the ascent stage to approximately 122 hours.

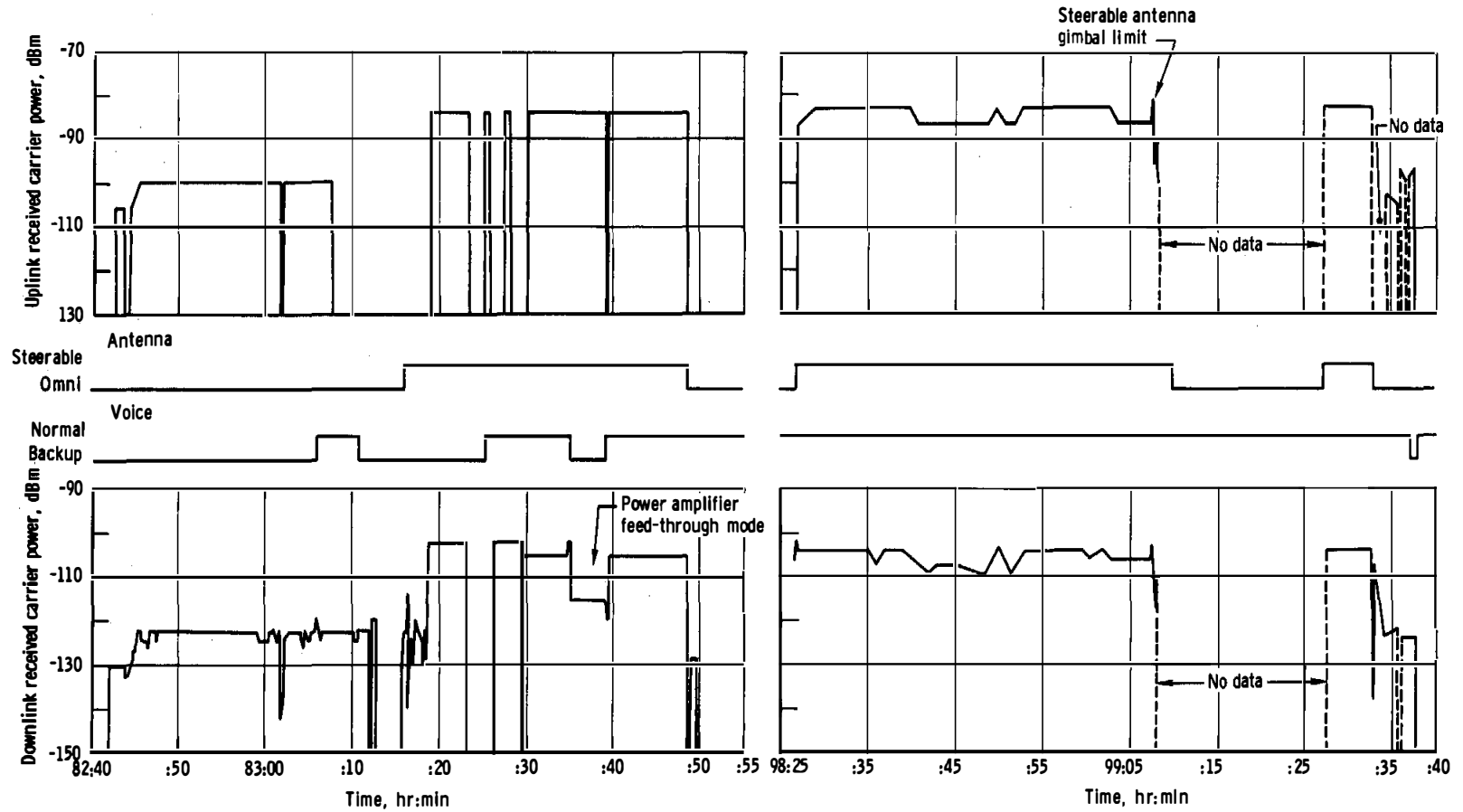

(a) Goldstone, revolution 4.

(b) Madrid, revolution 12.

Figure 5-1. - Uplink and downlink carrier power levels during lunar operations.

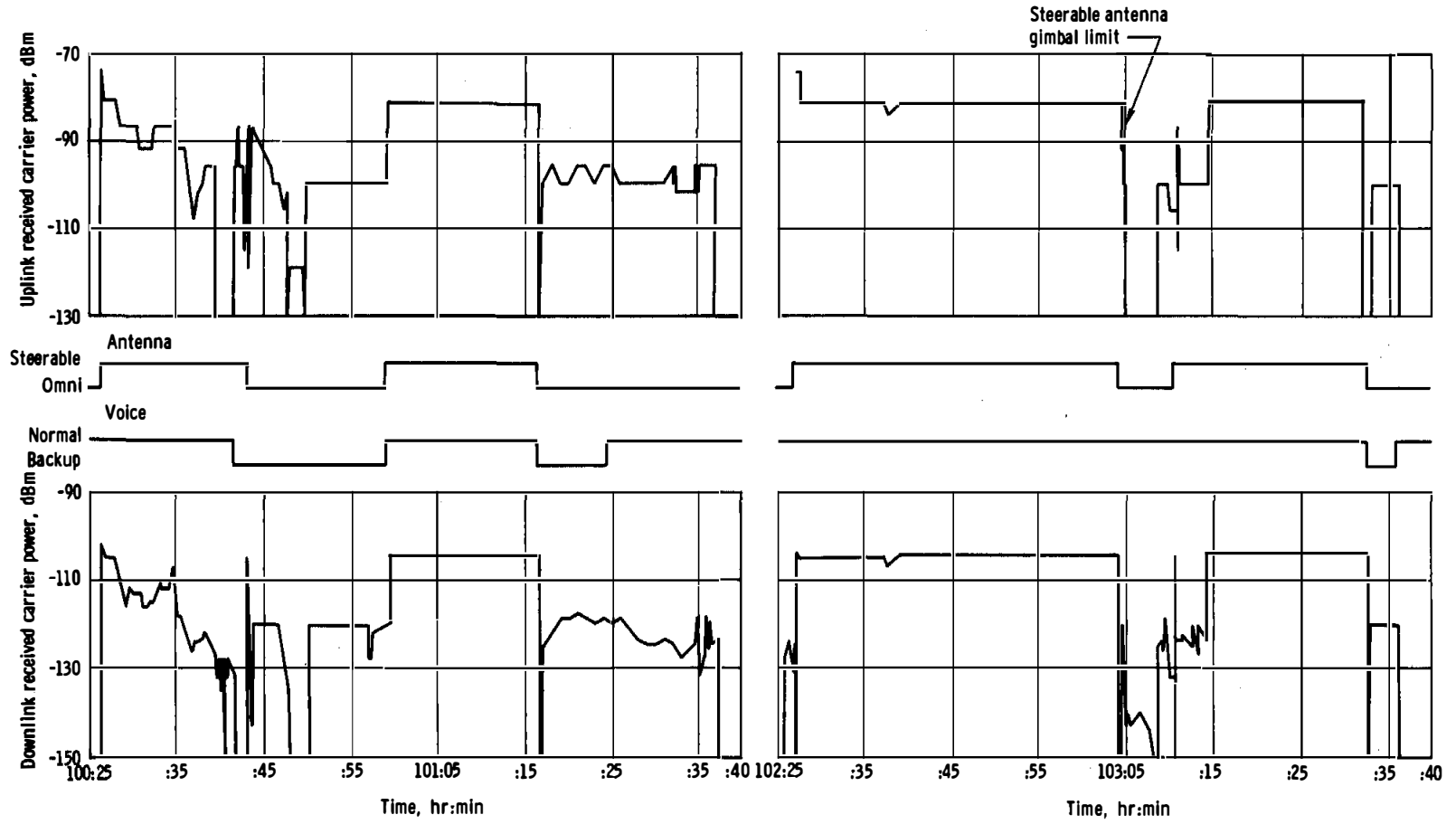

(c) Goldstone, revolution 13.

(d) Goldstone, revolution 14.

Figure 5-1. - Continued.

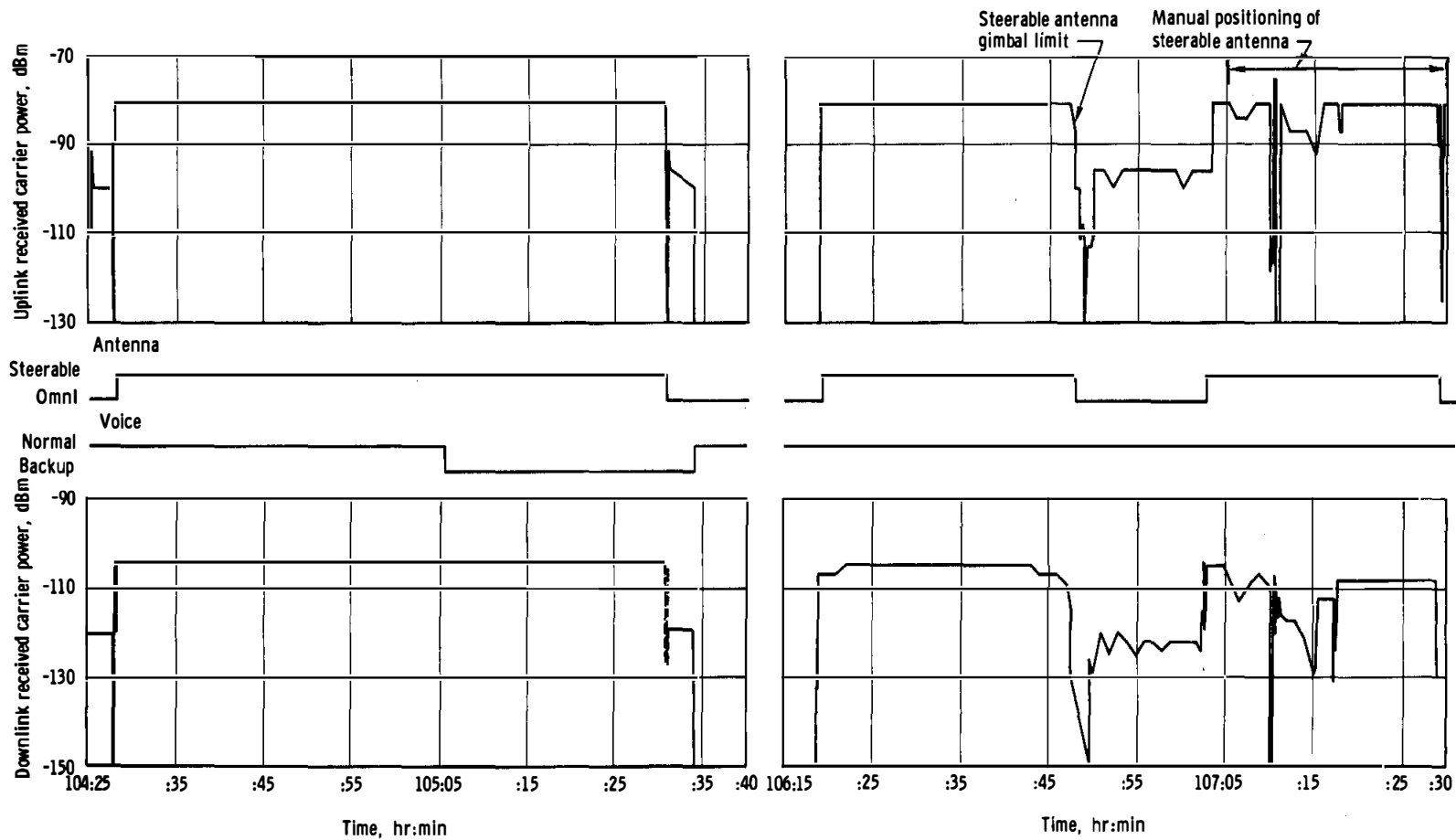

(e) Goldstone, revolution 15.

(f) Goldstone, revolution 16.

Figure 5-1.- Concluded.

6.0 TRAJECTORY

The targeting data used to calculate the planned trajectory from lift-off to spacecraft/S-IVB separation were provided by the Marshall Space Flight Center (ref. 1); after separation, the planned parameters are real-time predictions generated by the Real Time Computer Complex in the Mission Control Center. The actual trajectories are based on tracking data from the Manned Space Flight Network. The orbital trajectory analysis is based on the best estimated trajectory generated after the flight.

The following models were used for the trajectory analysis: (1) the earth model was geometrically the Fischer ellipsoid but containing gravitational constants for the spherical harmonics, and (2) the moon model was geometrically a sphere containing gravitational constants for the R2 potential. Table 6-I defines the trajectory parameters and orbital elements.

6.1 LAUNCH PHASE

The trajectory during S-IC boost was essentially nominal and is shown in figure 6-1. The center and outboard engines cut off within 1.7 seconds of the planned times; at outboard engine cutoff, velocity was high by 35 ft/sec and flight-path angle and altitude were low by 0.6 degree and 1678 feet, respectively.

The trajectory during S-II boost was also nominal, as shown in figure 6-1. The launch escape system was jettisoned within 1.4 seconds of the predicted time. The S-II engines cut off within 1.4 seconds of the planned times. The velocity and altitude were low by 43 ft/sec and 2930 feet, respectively, and the flight-path angle was high by 0.007 degree.

The small trajectory deviations during S-IC and S-II boost converged during the S-IVB firing, and the trajectory followed the predicted profile through parking orbit insertion. The S-IVB engine cut off within 1 second of the planned time. At cutoff, altitude was low by 102 feet, and flight-path angle and velocity were nominal.

6.2 EARTH PARKING ORBIT

The spacecraft/S-IVB combination was inserted into earth parking orbit at 0:11:54 with the conditions shown in table 6-II. The parking orbit was perturbed by the propulsive venting of liquid oxygen through the S-IVB engine until 2:23:49, the time of preparation for S-IVB restart. Figure 6-2 shows the ground track for the parking orbit.

6.3 TRANSLUNAR INJECTION AND SEPARATION

The S-IVB was reignited for the translunar injection maneuver at 2:33:27.6, which was within 3 seconds of the predicted time. As shown in figure 6-3, the maneuver conditions were nominal, and the engine was cut off at 2:39:10.5, with translunar injection defined as 10 seconds later. Table 6-II presents the conditions for this phase.

The translunar injection maneuver was performed with excellent results. The resulting pericynthion altitude solution was 907.7 miles, as compared with the preflight prediction of 956.8 miles. This altitude difference is consistent with a 0.5-ft/sec accuracy in the injection maneuver. Upon completion of circumlunar flight, earth capture of the spacecraft would have been assured, since the uncorrected flight-path angle at entry was minus 64.24 degrees. The service module reaction control system could easily have adjusted these entry conditions to acceptable values if the service propulsion system had failed.

Separation of the command and service modules from the S-IVB was initiated at 3:02:42 and docking was completed at 3:17:37, but the estimated distance at turnaround was reported to have been 150 feet, instead of the intended 50 feet. Crew procedures for this maneuver were based on those for Apollo 9 and were executed properly; however, a reduced S-IVB weight from Apollo 9 and the fact that some plus-X translation velocity remained when an attempt was made to null the separation rate probably resulted in the increased separation distance. The lower S-IVB weight affected separation in that the impulse derived during firing of the pyrotechnic separation charge and the velocity gained from any reaction-control plume impingement would both be greater than expected. Each of these effects have been analyzed, and results show the increased separation distance can be accounted for within the estimation accuracy of the crew.

The spacecraft were ejected normally and then separated from the S-IVB by a small service propulsion maneuver at 4:39:10. The S-IVB was then placed into a solar orbit, as in Apollo 8, by propulsively venting the residual propellants through the engine for an impulsive velocity gain so

that the stage passed the trailing edge of the moon. The resultant orbit had a period of 344.9 days and apohelion and perihelion altitudes of approximately 82 100 000 and 73 283 000 miles, respectively.

The best estimated trajectory parameters for each maneuver are presented in table 6-II. Tables 6-III through 6-V present the respective maneuver parameters for each propulsive event and the resulting orbital parameters. The free-return conditions shown in table 6-VI indicate the entry interface conditions resulting from each translunar maneuver, assuming no additional orbit perturbations. The included results are based on guidance system telemetry data and on network tracking information.

6.4 TRANSLUNAR MIDCOURSE CORRECTION

The first and only translunar midcourse correction, which was preplanned, was executed at 26:32:56.8, using the service propulsion system. The targeting for this midcourse correction was based on a preflight consideration to have the orbit inclination such that the lunar module approach azimuth to the landing site would be very close to that for the first lunar landing. The translunar injection targeting, however, was still optimum for the earth-moon geometry and launch-window constraints imposed by the May 18 launch date. A resulting pericyynthion altitude of 60.9 miles was indicated for the executed 49.2 ft/sec firing. The maneuver results indicate that an adjustment of 0.39 ft/sec would have been required to attain the desired nodal position at the moon and 0.14 ft/sec to correct the perilune altitude error.

At the time for the third midcourse correction option (22 hours prior to lunar orbit insertion), a velocity change of only 0.7 ft/sec would have satisfied nodal targeting constraints. However, this maneuver was not executed since the real-time solution at the fourth correction option, 5 hours before orbit insertion, was only 2.8 ft/sec.

Approximately 7 hours prior to lunar orbit insertion, a velocity change of only 3.6 ft/sec was calculated to satisfy the nodal targeting constraints. However, the perilune altitude was in error such that only a 0.75 ft/sec correction would actually be required. The extra velocity change required was for nodal targeting to correct for time dispersions. Neither constraint was considered mandatory, and the decision was made not to execute a further midcourse correction, since the perilune altitude at 3.5 hours prior to orbit insertion was determined to be 60.7 miles, very close to nominal.

The translunar trajectory is shown in figure 6-4.

6.5 LUNAR ORBIT INSERTION AND CIRCULARIZATION

The lunar orbit insertion maneuver was executed using the service propulsion system. The firing was very near nominal, with a resultant orbit of 170.0 by 60.2 miles, as compared with the planned orbit of 169.2 by 59.5 miles.

The circularization maneuver was preceded by a 18.1 second propellant settling firing by the reaction control system. The orbit after cutoff of the service propulsion system was only slightly elliptical (61.0 by 59.2 miles) and did not impose a significant change to the initial conditions at rendezvous.

The altitude of the lunar module above the vicinity of Apollo Landing Site 2 was 56 783 feet. However, the lowest approach to the lunar surface (from landing radar determination) was 47 400 feet.

6.6 RENDEZVOUS

The trajectory analysis for the rendezvous is presented in section 4, but the trajectory parameters and maneuver results are presented in tables 6-II and 6-IV. A ground track is shown in figure 6-5 and an altitude profile is indicated in figure 6-6.

6.7 TRANSEARTH INJECTION

The transearth injection maneuver was so precise that no transearth midcourse correction would have been required for a proper entry corridor at earth. The resulting flight-path angle predicted at the entry interface was minus 7.04 degrees, which would have required only a 0.6 ft/sec correction at the first transearth option point. Table 6-V presents the trajectory results for transearth injection. The best estimated trajectory at 15 hours before entry predicted an entry flight-path angle of minus 6.69 degrees, only 0.17 degree from the planned value. A hydrogen purge and water evaporator usage during transearth coast perturbed the trajectory, and the effects of these at the entry interface are presented in table 6-VI.

6.8 TRANSEARTH MIDCOURSE CORRECTIONS

The only transearth midcourse correction, a 2.2 ft/sec impulse, was initiated about 3 hours before entry and the results are shown in table 6-V.

6.9 COMMAND MODULE ENTRY

The actual entry trajectory is shown in figure 6-7. The actual parameters were generated by correcting the guidance system accelerometer data for known inertial measurement unit errors. Table 6-VII presents the actual conditions at the entry interface. The entry flight-path angle was 0.02 degree steeper than planned and resulted in a peak load factor of 6.78g. The guidance system indicated only a 1.4-mile overshoot at drogue parachute deployment, and the postflight trajectory reconstruction indicates a corresponding 1.3-mile overshoot.

6.10 SERVICE MODULE ENTRY

Following command module/service module separation, the service module reaction control system should have fired to fuel depletion; this firing was to insure that the service module would not enter and endanger the command module and the recovery forces. Real-time evaluation indicated that the reaction control propellant remaining at separation corresponded to approximately 370 seconds of firing time. In terms of velocity, this should have resulted in a positive velocity change of 370 ft/sec, sufficient to have caused the service module to enter the earth's atmosphere and then skip out (because of the shallow flight-path angle and near parabolic velocity). The resulting trajectory would either have been a heliocentric orbit or an earth orbit with an apogee in excess of a million miles.

Tracking data predictions indicate that the service module did not skip out but landed in the Pacific Ocean about 500 miles uprange from the command module. C-band radar skin tracking from the Redstone ship indicated the impact point of the service module to be 19.14 degrees south latitude and 173.37 degrees west longitude. Based on the separation attitude and service module weight of 13 072 pounds, an effective velocity change of only 55 ft/sec would have resulted in an impact at this location.

Therefore, either the service module became unstable in attitude some time during the firing or the firing terminated prematurely. Six-degree-of-freedom simulations have shown that tumbling during the firing

is very unlikely, and past experience and ground testing of the reaction control thrusters indicate that a premature thrust termination is not probable. Although recontact between the two modules was virtually impossible because of the out-of-plane velocity at separation, no conclusive explanation for the uprange impact location can be given at this time. A supplemental report will be published after a thorough dynamic analysis of service module separation.

6.11 LUNAR ORBIT DETERMINATION

As on Apollo 8, the most significant navigation errors were encountered in lunar orbit. However, the general quality of the orbit determination and prediction capabilities was considerably better than that of Apollo 8 because of a more effective data processing procedure and the use of a greatly improved lunar potential model.

The procedure for orbit determination during Apollo 8 included trajectory fits for only one front-side pass, whereas for Apollo 10, two pass fits were employed with considerably greater accuracy. With a more precisely determined orbit, the prediction capability was correspondingly improved. However, this improvement was largely restricted to in-plane elements, since determination of the orbit plane was found to be more precise with a one-pass solution than with two passes. This fact stems from a known deficiency in the new lunar potential model, called the R2 Model. The following table compares the orbit prediction capabilities for Apollo 8 and 10, with data added to indicate the accuracy expected before the Apollo 10 flight using the R2 Model.

Position parameter	Position errors, ft/rev		
	Apollo 8 inflight ^a	Apollo 10 preflight ^b	Apollo 10 inflight
In-plane			
Downtrack	15 000	3000	2000
Radial	1 500	500	500
Crosstrack	500	500	2000

^aBased on triaxial moon model.

^bBased on Apollo 8 postflight results and use of R2 Model.

TABLE 6-I.- DEFINITION OF TRAJECTORY AND ORBITAL PARAMETERS

<u>Parameter</u>	<u>Definition</u>
Geodetic latitude	Spacecraft position measured north or south from the earth's equator to the local vertical vector, deg
Selenographic latitude	Spacecraft position measured north or south from the true lunar equatorial plane to the local vertical vector, deg
Longitude	Spacecraft position measured east or west from the reference body's prime meridian to the local vertical vector, deg
Altitude	Perpendicular distance from the reference body surface to the point of orbit intersect, ft or miles
Space-fixed velocity	Magnitude of the inertial velocity vector referenced to the body-centered, inertial reference coordinate system, ft/sec
Space-fixed flight-path angle	Flight-path angle measured positive upward from the body-centered, local horizontal plane to the inertial velocity vector, deg
Space-fixed heading angle	Angle of the projection of the inertial velocity vector onto the local body-centered, horizontal plane, measured positive eastward from north, deg
Apogee	Maximum altitude above the oblate earth model, miles
Perigee	Minimum altitude above the oblate earth model, miles
Apocynthion	Maximum altitude above the moon model, miles
Pericynthion	Minimum altitude above the moon model, miles
Period	Time required for spacecraft to complete 360 degrees of orbit rotation, min

TABLE 6-II.- TRAJECTORY PARAMETERS

Event	Ref. body	Time, hr:min:sec	Latitude, deg	Longitude, deg	Altitude, miles	Space-fixed velocity, ft/sec	Space-fixed flight-path angle, deg	Space-fixed heading angle, deg E of N
Launch Phase								
S-IC center engine cutoff	Earth	0:01:15.2	28.75N	80.16W	23.4	6 473	22.81	76.46
S-IC outboard engine cutoff	Earth	0:02:41.6	22.88N	79.71W	35.2	9 029	18.95	75.54
S-II inboard engine cutoff	Earth	0:07:40.6	31.12N	69.49W	96.7	18 630	1.03	79.57
S-II outboard engine cutoff	Earth	0:09:12.6	31.92N	64.02W	101.2	22 632	0.74	82.46
S-IVB engine cutoff	Earth	0:11:43.8	32.68N	53.29W	103.4	25 563	0.01	88.50
Parking Orbit								
Parking orbit insertion	Earth	0:11:54	32.70N	52.53W	103.3	25 568	0.00	88.93
S-IVB restart preparation	Earth	2:07:09	32.67S	92.37E	106.3	25 568	0.03	91.79
Translunar Injection								
S-IVB ignition	Earth	2:33:27.6	25.76E	135.54E	106.9	25 561	0.05	69.17
S-IVB cutoff	Earth	2:39:10.5	14.07S	159.13E	172.7	35 586	6.92	61.26
Translunar injection	Earth	2:39:20.5	13.63S	159.92E	179.9	35 563	7.38	61.06
Command module/S-IVB separation	Earth	3:02:42.4	23.00N	139.35W	3 503.3	25 556	43.93	67.47
Separation maneuver								
Ignition	Earth	4:39:09.8	31.70N	114.86W	17 938.5	14 220.2	65.15	91.21
Cutoff	Earth	4:39:12.7	31.70N	114.87W	17 944.7	14 203.7	65.10	91.22
First midcourse correction								
Ignition	Earth	26:32:56.8	26.34N	49.82W	110 150.2	5 094.4	77.30	108.36
Cutoff	Earth	26:33:03.9	26.34N	49.85W	110 155.9	5 111.0	77.80	108.92
Lunar Orbit Phase								
Lunar orbit insertion								
Ignition	Moon	75:55:54.0	1.76S	162.68W	95.1	8 232.3	-11.70	-65.71
Cutoff	Moon	76:01:50.1	0.19W	174.60E	61.2	5 471.9	-0.90	-77.75
Lunar orbit circularization								
Ignition	Moon	80:25:08.1	0.55N	153.46E	60.4	5 484.7	-0.01	-84.79
Cutoff	Moon	80:25:22.0	0.57N	152.70E	59.3	5 348.9	0.01	-85.09
Undocking	Moon	98:11:57	0.52N	146.42E	58.1	5 357.9	-0.09	-83.7
Separation								
Ignition	Moon	98:47:17.4	0.62N	38.37E	59.2	5 352.2	0.15	-90.84
Cutoff	Moon	98:47:25.7	0.61N	38.00E	59.2	5 352.1	0.15	-90.84
Descent orbit insertion								
Ignition	Moon	99:46:01.6	0.66S	139.67W	61.6	5 339.6	-0.15	-89.19
Cutoff	Moon	99:46:28.0	0.69S	141.12W	61.2	5 271.2	-0.03	-89.13
Phasing maneuver								
Ignition	Moon	100:58:25.9	0.22S	11.19W	17.7	5 512.4	1.19	-91.09
Cutoff	Moon	100:59:05.9	0.34S	13.67W	19.0	5 672.9	1.88	-91.05
Staging	Moon	102:45:16.9	0.82N	51.23E	31.4	5 605.6	-3.06	-90.75
Ascent orbit insertion								
Ignition	Moon	102:55:02.1	0.30W	19.58E	11.6	5 705.2	-0.78	-91.06
Cutoff	Moon	102:55:17.6	0.29W	18.72E	11.7	5 520.6	0.49	-91.06
Coelliptic sequence initiation								
Ignition	Moon	103:45:55.3	0.64S	141.57W	44.7	5 335.5	-0.16	-89.10
Cutoff	Moon	103:46:22.6	0.58S	143.13W	44.6	5 381.7	-0.19	-89.08
Constant differential height								
Ignition	Moon	104:43:53.3	0.59W	36.98E	44.3	5 394.7	0.20	-90.91
Cutoff	Moon	104:43:55.0	0.59W	36.89E	43.8	5 394.9	0.17	-90.92
Terminal phase initiation								
Ignition	Moon	105:22:55.6	1.08S	84.16W	48.4	5 369.2	-0.02	-90.04
Cutoff	Moon	105:23:12.1	1.09S	85.63W	47.0	5 396.7	-0.10	-90.34
Docking	Moon	106:22:02	1.12N	94.03E	54.7	5 365.9	0.03	-89.70
Final separation								
Ignition	Moon	108:43:23.3	0.68N	23.27E	57.3	5 352.3	0.21	-90.95
Cutoff	Moon	108:43:29.9	0.67N	22.94E	57.6	5 352.1	0.21	-90.95
Ascent engine firing to depletion								
Ignition	Moon	108:52:05.5	0.18N	3.23W	59.1	5 343.0	0.21	-91.15
Cutoff	Moon	108:56:14.5	0.44N	20.22W	89.7	9 056.4	11.63	-90.81
Transearth injection								
Ignition	Moon	137:36:28.9	0.34N	155.72E	56.0	5 362.7	-0.44	-73.60
Cutoff	Moon	137:39:13.7	0.42N	144.62E	56.5	8 987.2	2.53	-76.68
Transearth Phase								
Second midcourse correction								
Ignition	Earth	188:49:58	0.59N	88.84E	25 570.4	12 540.0	-69.65	119.34
Cutoff	Earth	188:50:04.7	0.59N	88.82E	25 557.4	12 543.5	-69.64	119.34

TABLE 6-III.- TRANSLUNAR MANEUVER SUMMARY

Maneuver	System	Ignition time, hr:min:sec	Firing time, sec	Velocity change, ft/sec	Resultant pericyynthion conditions				
					Altitude, miles	Velocity, ft/sec	Latitude, deg	Longitude, deg	Arrival time, hr:min:sec
Translunar injection	S-IVB	2:33:27.6	342.9		907.7	6596	4.39N	170.97W	76:10:18.4
Command and service module/S-IVB separation	Reaction control	3:02:42.4	3.3	0.7	898.9	6608	4.33N	171.06W	76:10:19.1
Spacecraft/S-IVB separation	Service propulsion	4:39:09.8	2.9	18.8	286.1	7674	3.61N	179.32W	76:40:01.4
First midcourse correction	Service propulsion	26:32:56.8	7.1	49.2	60.9	8352	0.67N	177.65E	76:00:15.2

TABLE 6-IV.- LUNAR ORBIT MANEUVER SUMMARY

Maneuver	System	Ignition time, hr:min:sec	Firing time, sec	Velocity change, ft/sec	Resultant orbit	
					Apocynthion, miles	Pericyynthion, miles
Lunar orbit insertion	Service propulsion	75:55:54.0	356.1	2982.4	170.0	60.2
Lunar orbit circularization	Service propulsion	80:25:08.1	13.9	139.0	61.0	59.2
Command module/lunar module separation	Command module reaction control	98:47:17.4	8.3	2.5	62.9	57.7
Descent orbit insertion	Descent propulsion	99:46:01.6	27.4	71.3	60.9	8.5
Phasing	Descent propulsion	100:58:25.9	40.0	176.0	190.1	12.1
Ascent orbit insertion	Ascent propulsion	102:55:02.1	15.5	220.9	46.5	11.0
Coelliptic sequence initia- tion	Lunar module reaction control	103:45:55.3	27.3	45.3	48.7	40.7
Constant differential height	Lunar module reaction control	104:43:53.3	1.7	3.0	48.8	42.1
Terminal phase initiation	Lunar module reaction control	105:22:55.6	16.5	24.1	58.3	46.8
Final separation	Lunar module reaction control	108:43:23.3	6.5	2.1	64.0	56.3
Ascent engine firing to depletion	Ascent propulsion	108:52:05.5	249.0	4600.0	-2211.6	56.2

TABLE 6-V.- TRANSEARTH MANEUVER SUMMARY

Event	System	Ignition time, hr:min:sec	Firing time, sec	Velocity change, ft/sec	Resultant entry interface conditions				
					Flight-path angle, deg	Velocity, ft/sec	Latitude, deg	Longitude, deg	Arrival time, hr:min:sec
Transearth injection	Service propulsion	137:36:28.9	164.8	3680.3	-7.04	36 314.8	23.90S	173.44E	191:48:38.9
After hydrogen purge and water boiler dump	Not applicable	177:01:00	N/A	0.3	-6.69	36 314.7	23.69S	174.11E	191:48:50.9
Second midcourse correc- tion	Reaction control	188:49:58.0	6.7	2.2	-6.54	36 314.0	23.60S	174.39E	191:48:54.4

TABLE 6-VI.- FREE RETURN CONDITIONS FOR TRANSLUNAR MANEUVERS

Vector description	Vector time, hr:min:sec	Entry interface conditions				
		Velocity, ft/sec	Flight-path angle, deg	Latitude, deg	Longitude, deg	Arrival time, hr:min:sec
After translunar injection	2:41:00	36 083	-64.24	20.47N	62.95W	167:50:04.8
After command and service module/S-IVB separation	4:31:00	36 084	-64.72	21.32N	58.83W	167:36:47.5
After separation maneuver	7:21:00	36 121	-64.48	18.38N	98.89W	153:13:05.6
After first midcourse correction	29:21:00	36 140	-13.18	7.38S	54.50E	149:31:03.3
Before lunar orbit insertion	72:21:00	36 140	-13.19	7.36S	54.54E	149:30:47.6

TABLE 6-VII.- ENTRY TRAJECTORY PARAMETERS

Entry interface (400 000 feet altitude)	
Time, hr:min:sec	191:48:54.5
Geodetic latitude, deg south	23.60
Longitude, deg east	174.39
Altitude, miles	65.8
Space-fixed velocity, ft/sec	36 314
Space-fixed flight-path angle, deg	-6.54
Space-fixed heading angle, deg east of north	71.89
Maximum conditions	
Velocity, ft/sec	36 397
Acceleration, g	6.78
Drogue deployment	
Time, hr:min:sec	191:57:18.0
Geodetic latitude, deg south	
Recovery ship report	15.03
Best-estimate trajectory	15.06
Onboard guidance	15.07
Target	15.07
Longitude, deg west	
Recovery ship report	164.65
Best-estimate trajectory	164.65
Onboard guidance	164.65
Target	164.67

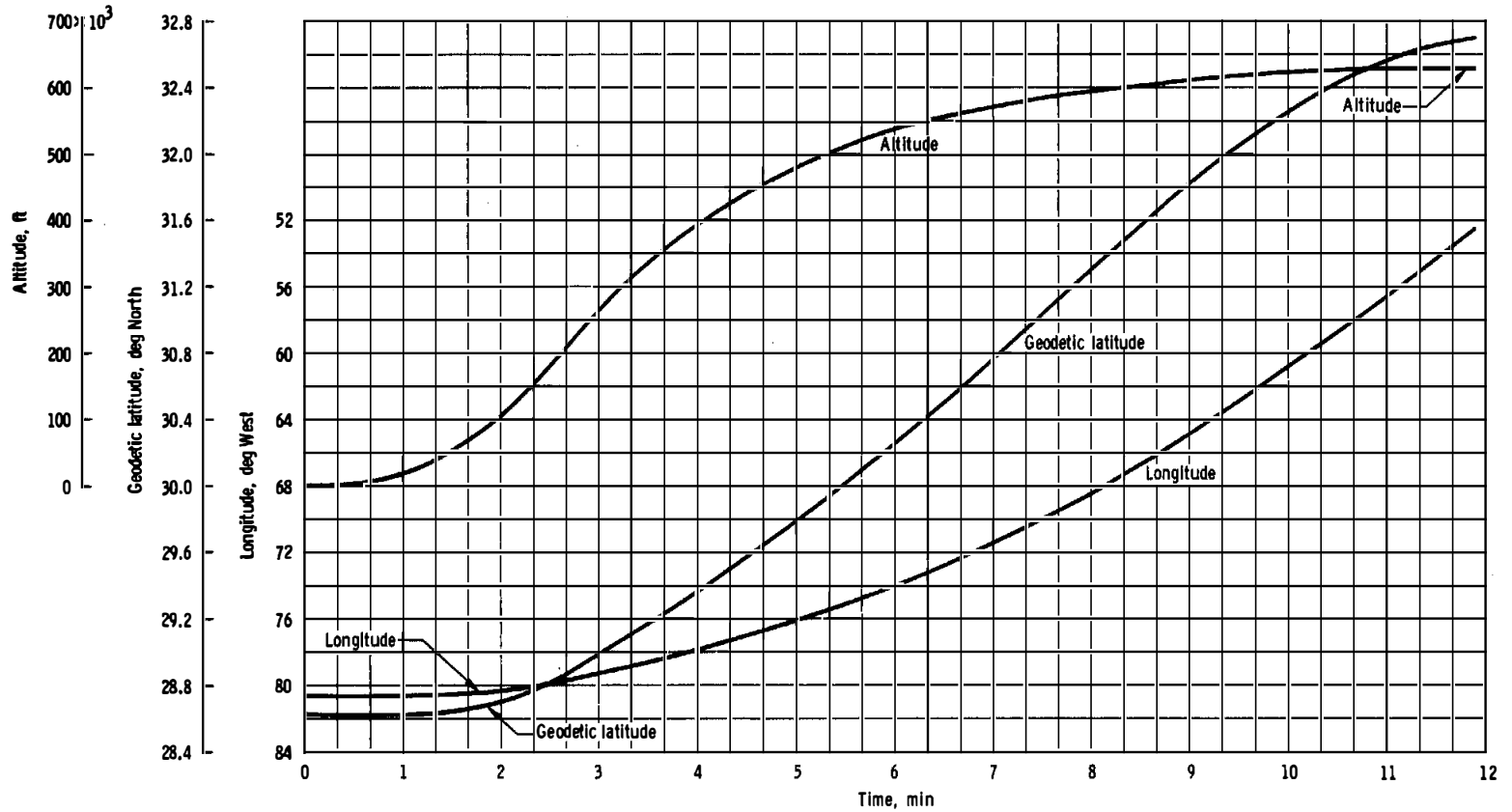

(a) Altitude, latitude, and longitude.

Figure 6-1.- Trajectory parameters during launch phase.

NASA-S-69-2665

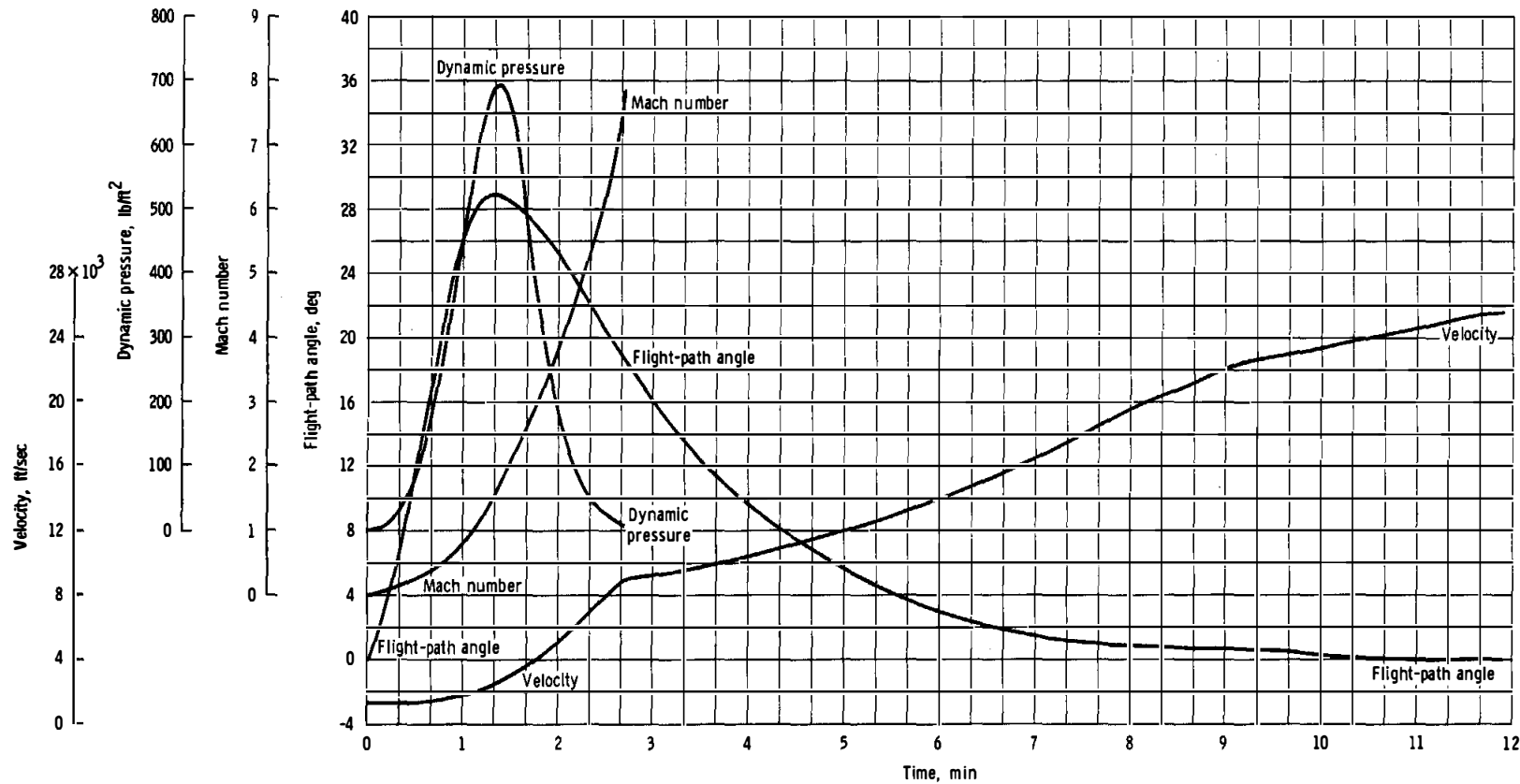

(b) Space-fixed flight-path angle, Mach number, dynamic pressure and velocity.

Figure 6-1.- Concluded.

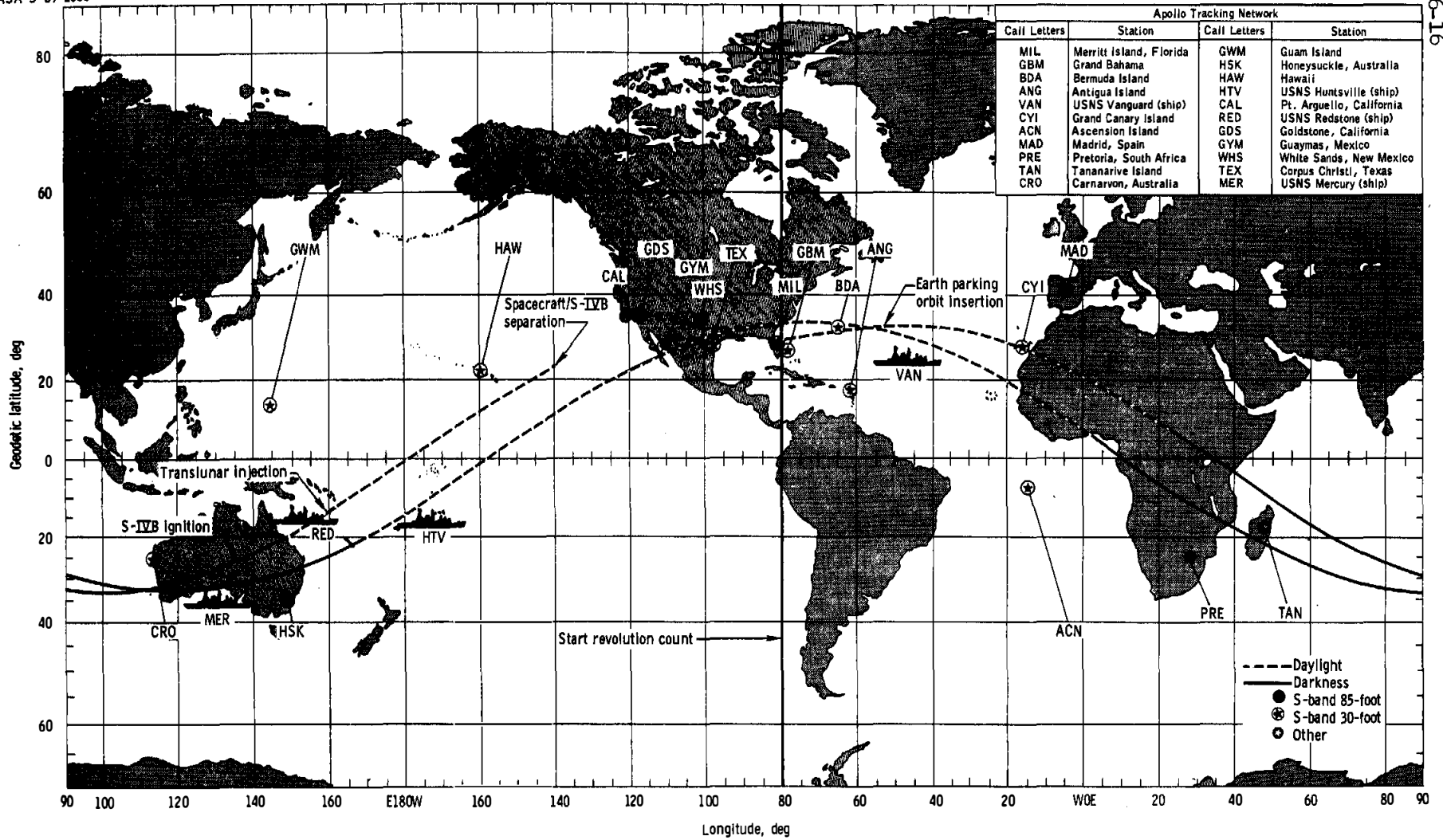

Figure 6-2. - Ground track for earth parking orbits.

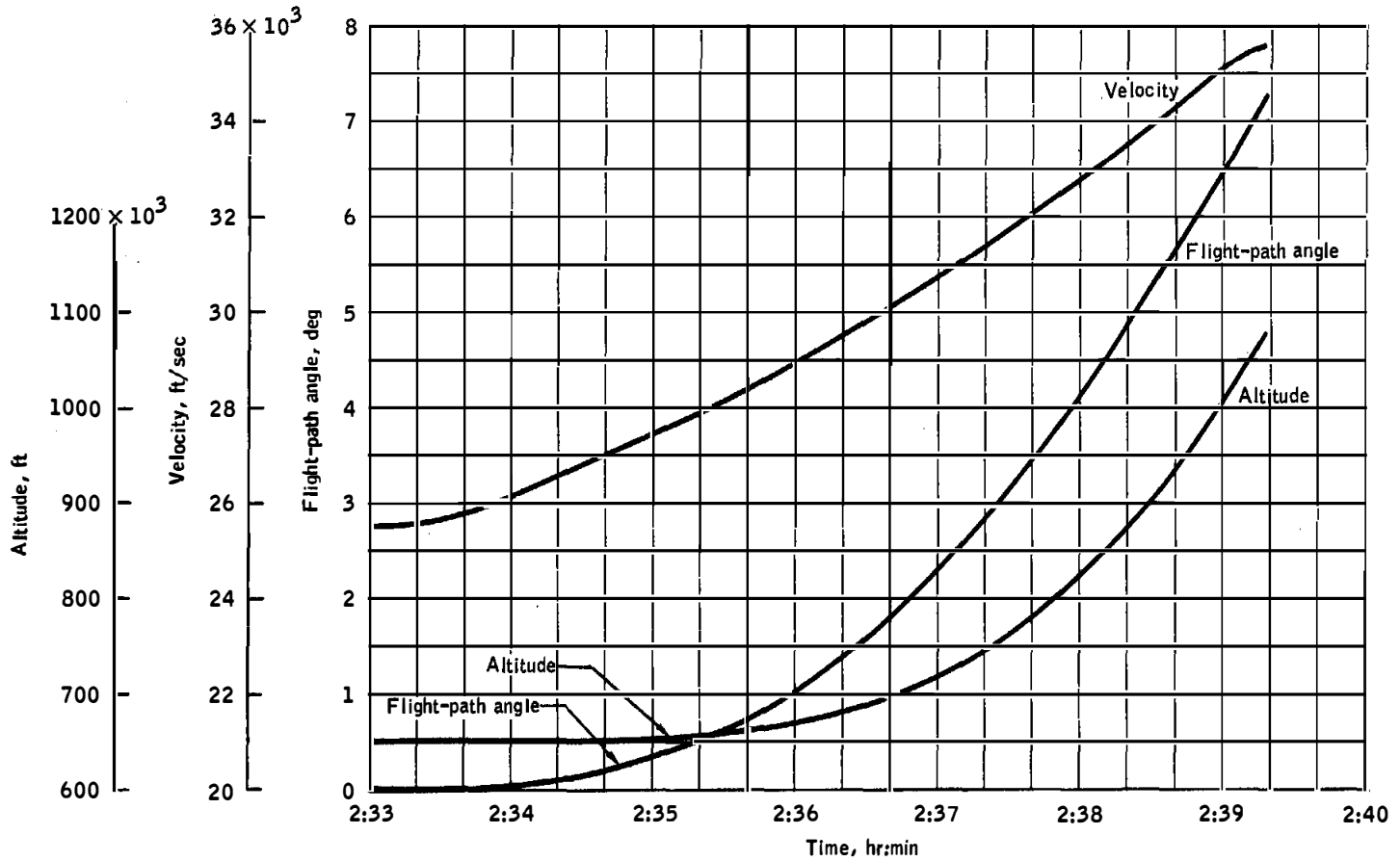

Figure 6-3.- Trajectory parameters during translunar injection.

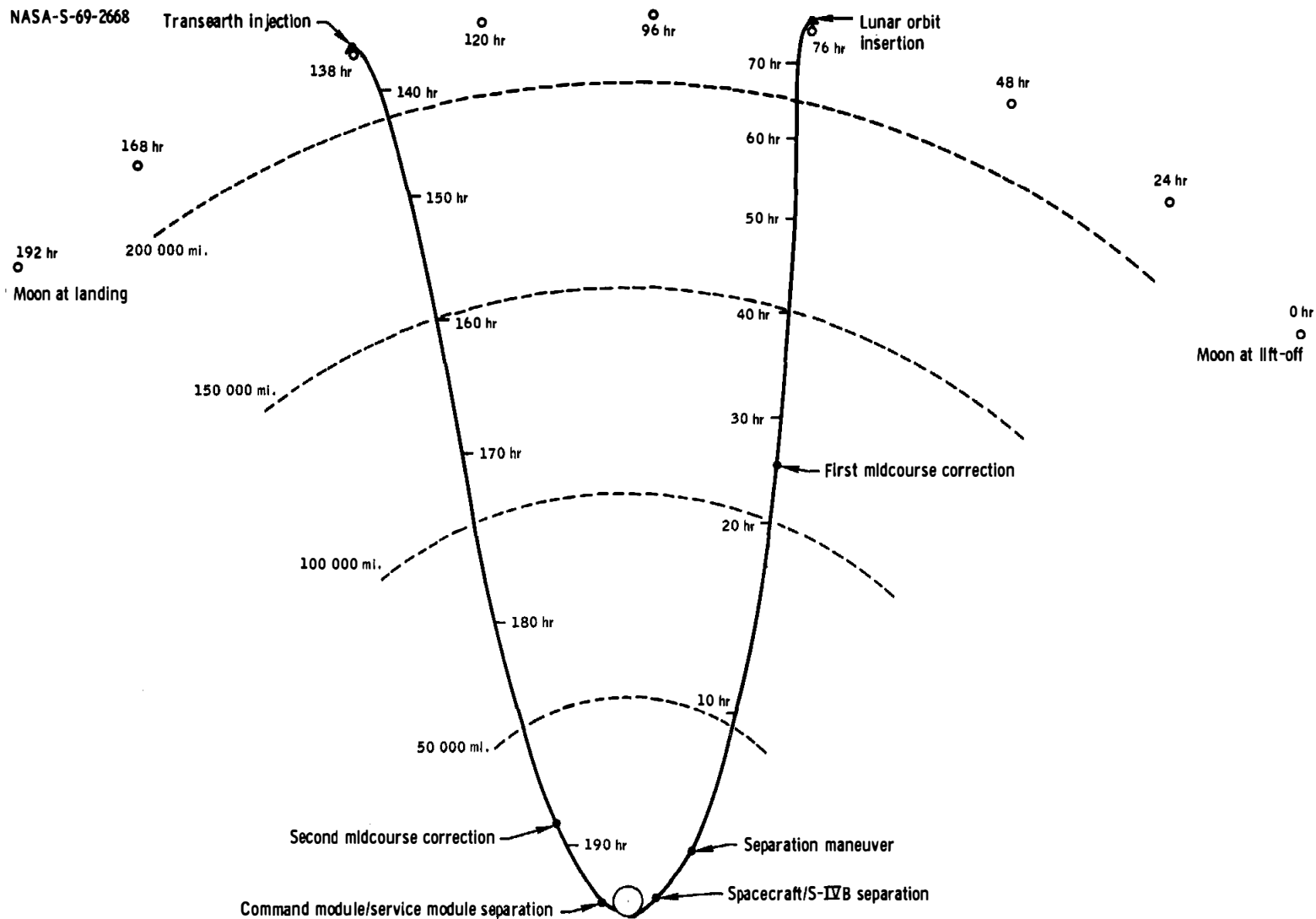

Figure 6-4. - Translunar and transearth trajectories.

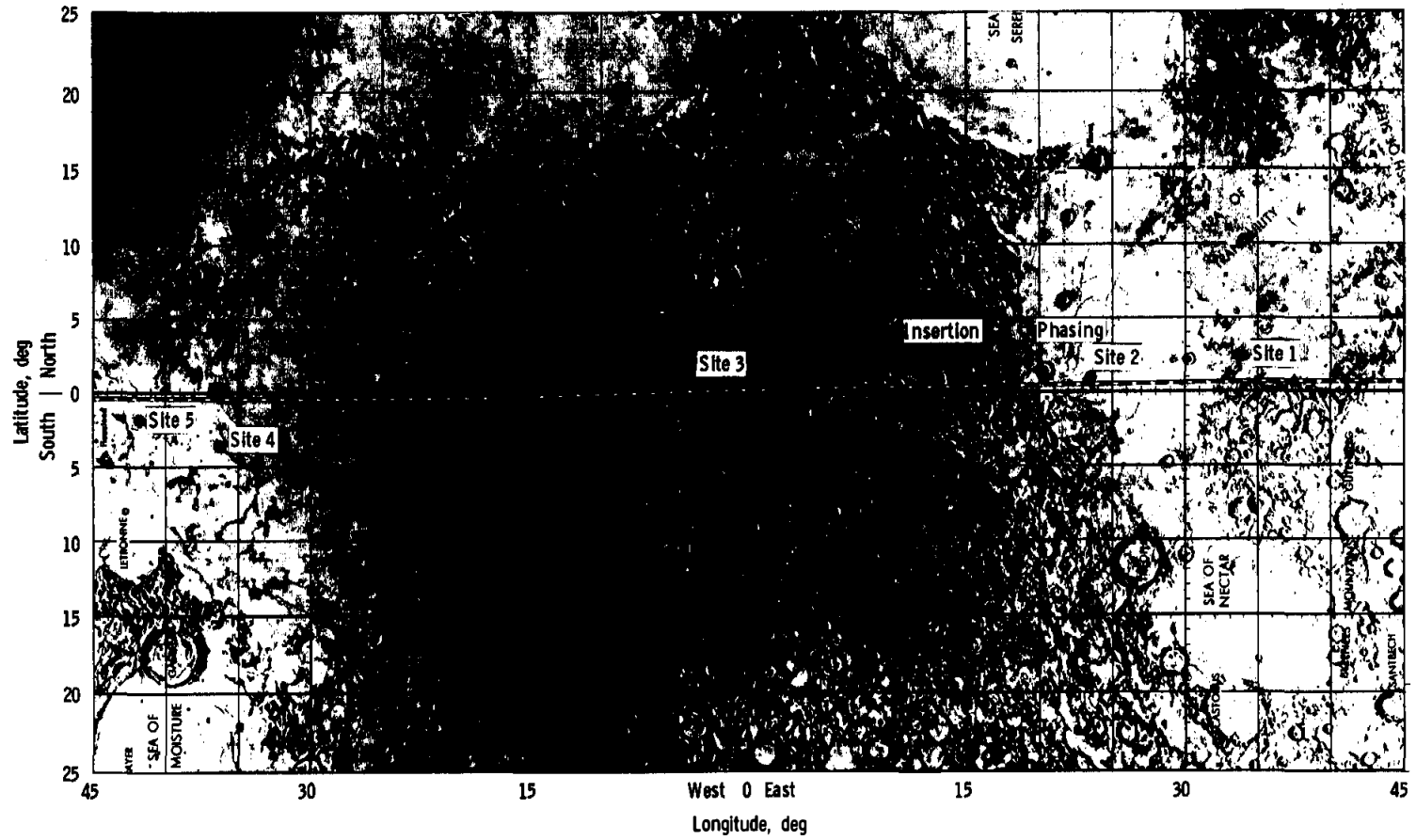
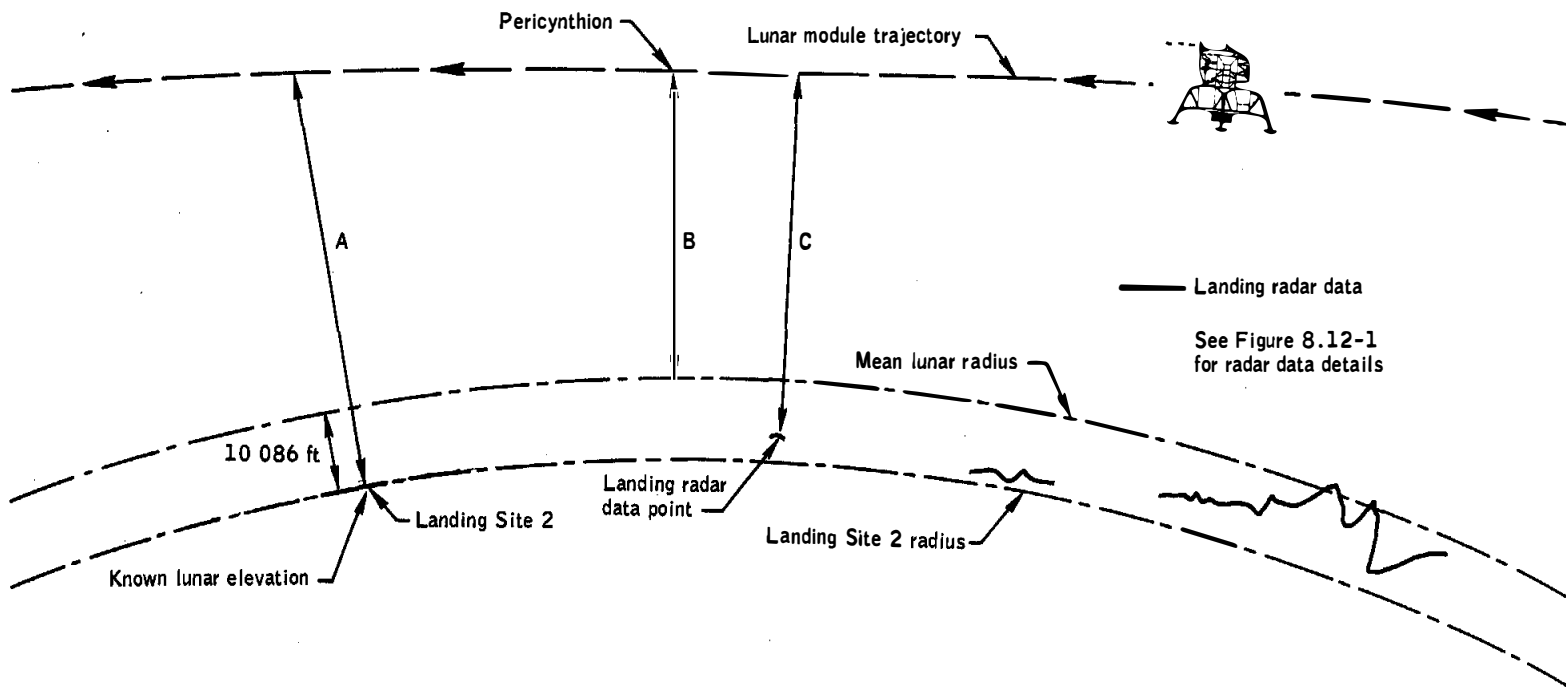
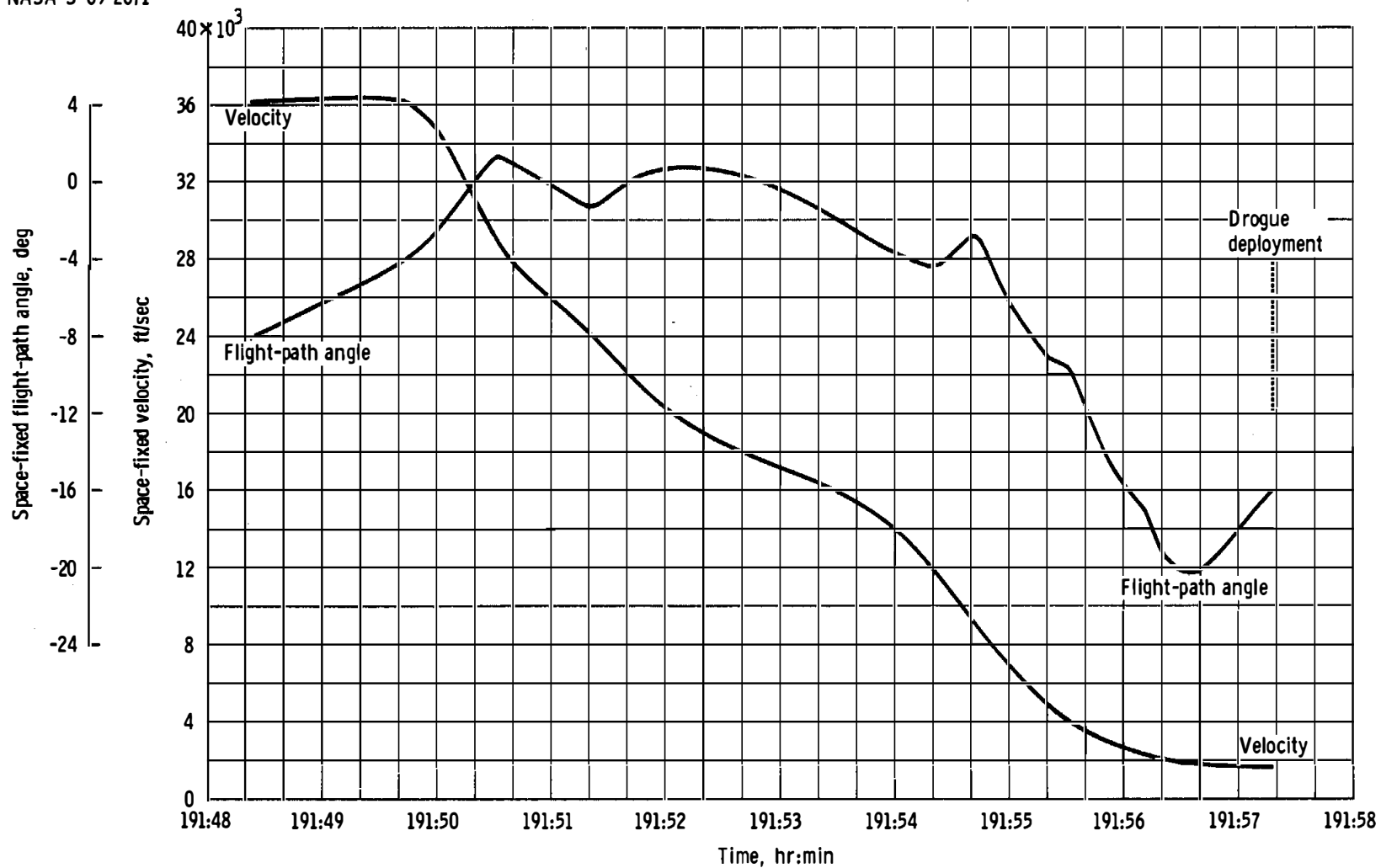

Figure 6-5. - Ground track for low-pass revolution.



	<u>Distance, ft</u>	<u>Time</u>
A. Altitude above surface at longitude of Landing Site 2 (actually 5 miles south of Site)	56 783	100:48:00
B. Pericynthion, above mean radius	40 411	100:43:00
C. Lowest measured (radar) altitude above surface	47 400	100:41:40

Figure 6-6.- Lunar module altitude profile.



(a) Space-fixed flight-path angle and velocity.

Figure 6-7. - Trajectory parameters during entry.

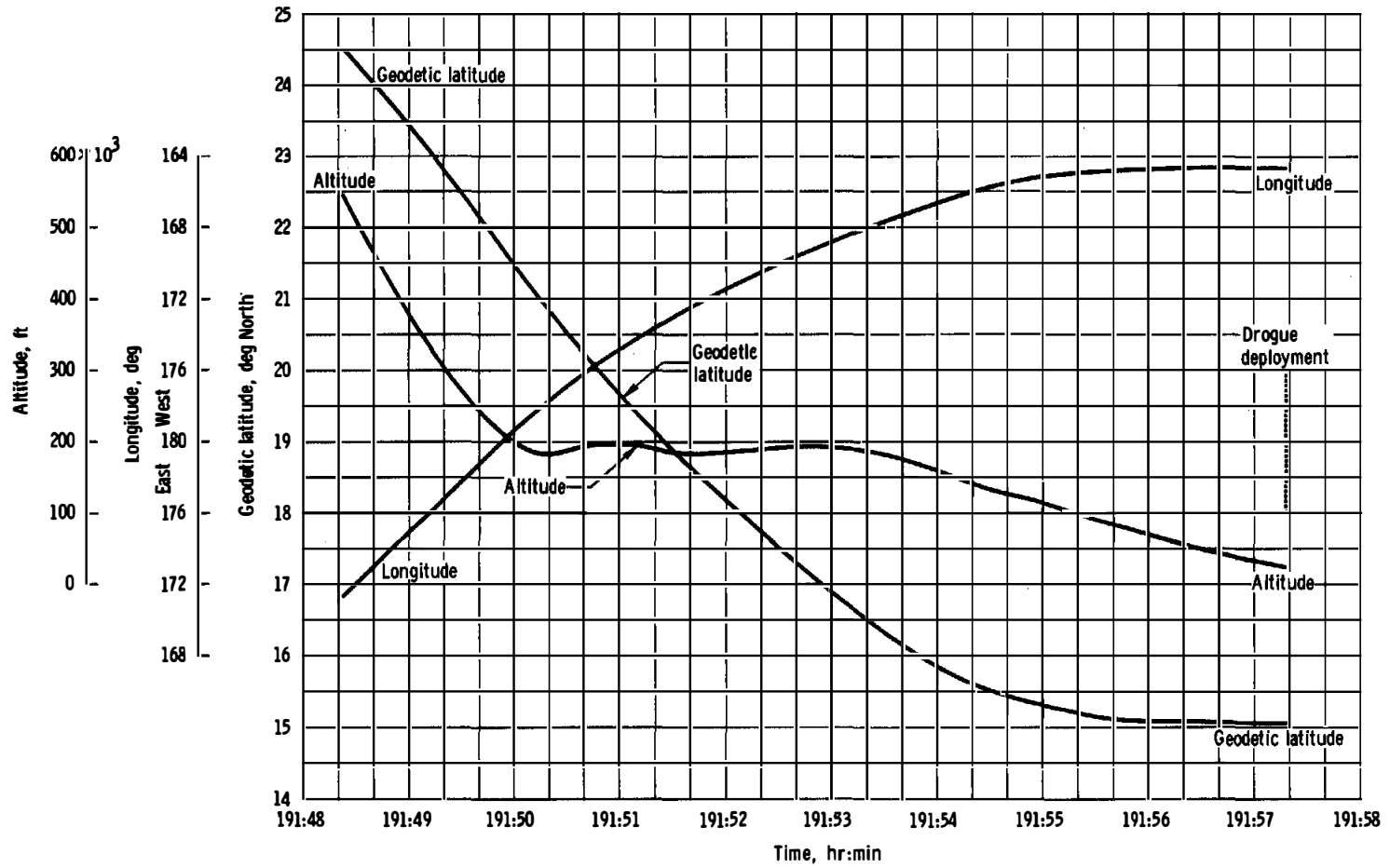

(b) Altitude, longitude, and latitude.

Figure 6-7. - Continued.

NASA-S-69-2673

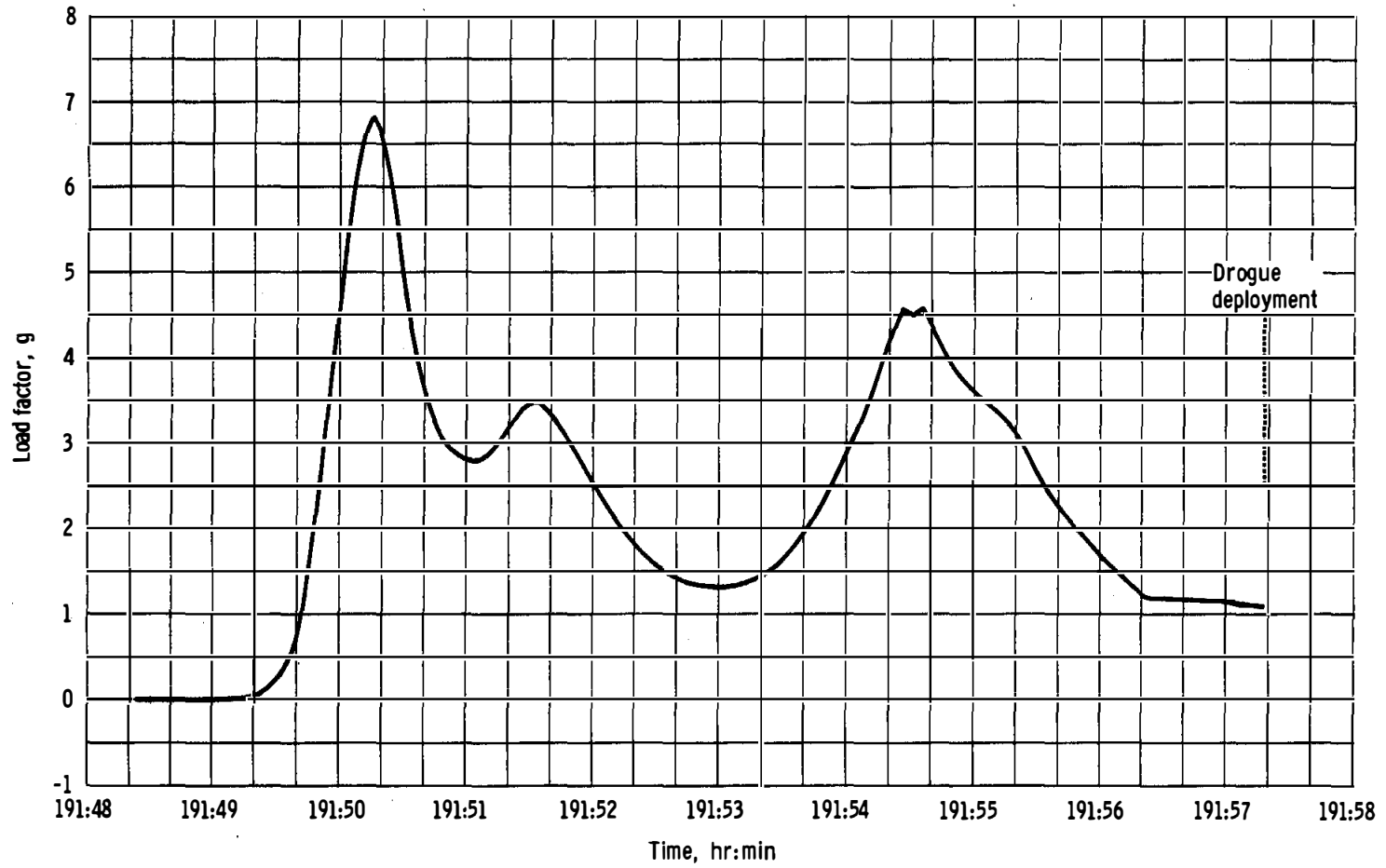

(c) Load factor.

Figure 6-7. - Concluded.

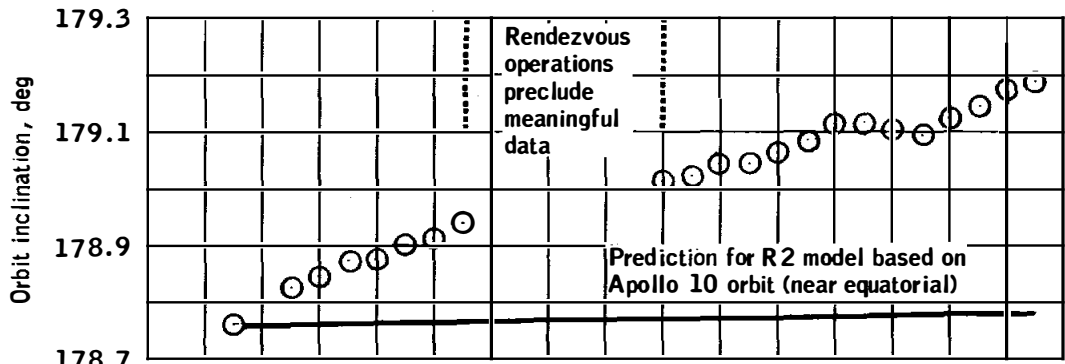

(a) Orbit inclination.

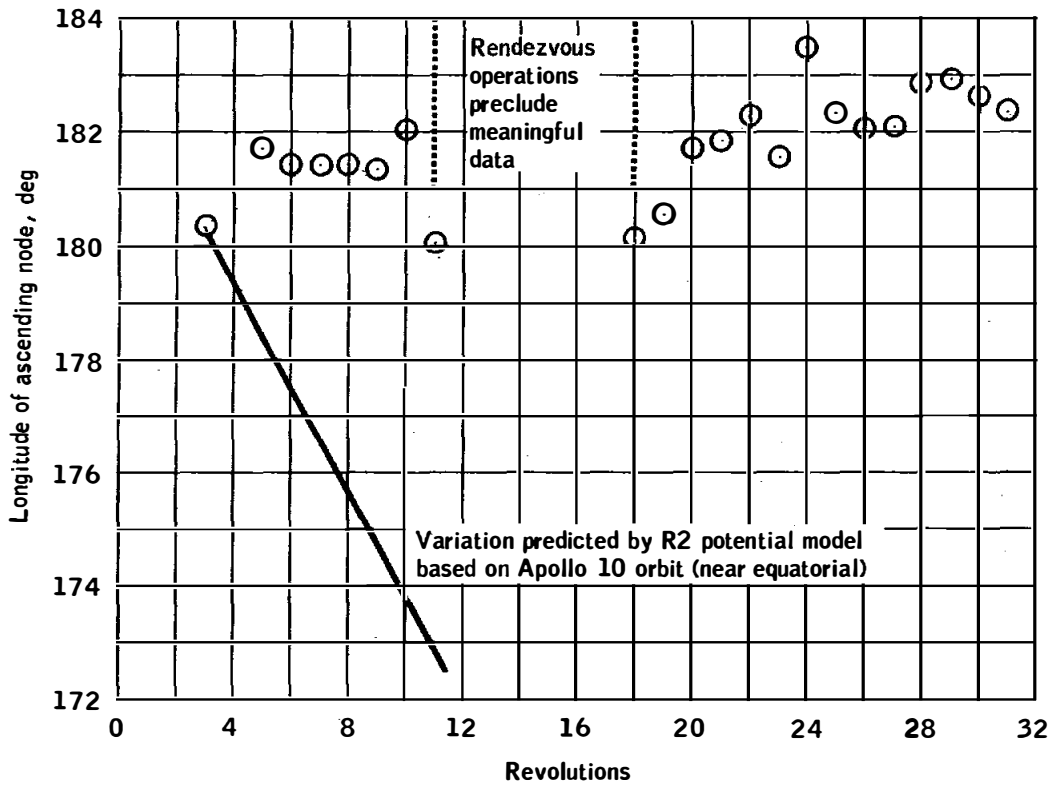

(b) Ascending node.

Figure 6-8.- Comparison of predicted with actual orbit prediction data.

7.0 COMMAND AND SERVICE MODULE PERFORMANCE

Performance of command and service module systems is discussed in this section. The sequential, pyrotechnic, thermal protection, earth landing, power distribution, and emergency detection systems operated as intended and are not documented. Discrepancies and anomalies are mentioned in this section but are discussed in detail in section 15.

7.1 STRUCTURAL AND MECHANICAL SYSTEMS

7.1.1 Structural Loads

Spacecraft structural loads, based on measured-acceleration, angular rate, aerodynamic, and engine-performance data, were less than design values for all phases of flight.

At lift-off, peak wind gusts were 20 knots at the 60-foot level and 82 knots at 47 000 feet. The predicted and calculated spacecraft loads at lift-off, in the region of maximum dynamic pressure, at the end of the first stage boost, and during staging are shown in table 7.1-I.

The crew reported having experienced an oscillatory longitudinal acceleration during S-IC shutdown and staging. During this staging, the maximum negative acceleration was 0.55g in the command module. The longitudinal accelerations measured in the command module agreed well with the predicted values (fig. 7.1-1). Accelerometer data indicate no structurally significant oscillations during the S-II and first S-IVB firings. The crew reported low-level, high-frequency lateral and longitudinal oscillations during the S-IVB translunar injection firing. The maximum amplitude, as measured at the command module forward bulkhead, was 0.05g at combined frequencies of 15 and 50 hertz; this amplitude is well within acceptable structural levels.

Marshall Space Flight Center has determined that the 15 hertz frequency is consistent with the uncoupled thrust oscillations produced by the J-2 engine and the 50 hertz frequency is consistent with the oscillations produced by cycling of the hydrogen tank non-propulsive vent valves.

Although the docking hardware was not instrumented, the initial contact conditions for both docking events produced only minimal loading of the probe and drogue. Based on analysis of onboard film and crew comments, the following conditions demonstrate nearly perfect docking operation.

	First docking	Second docking
Axial velocity at contact, ft/sec	<0.3	<0.3
Lateral velocity at contact, ft/sec . . .	0	0
Angular velocity at contact, ft/sec . . .	0	0
Angular misalignment at contact, deg	0	0
Lateral displacement at contact, in	1.0	-
Initial contact-to-capture time, sec	<1	<1
Probe retraction time, sec	7.0	-
Docking ring contact velocity, ft/sec	0.1	-
Roll attitude misalignment after docking, deg	-0.1	+0.1

The command module angular rates during the first docking were less than 1.0 deg/sec prior to probe retraction and 1.75 deg/sec during ring-latch actuation. The maximum calculated bending moment at the docked interface was 330 000 in-lb, well within structural limits. No rate data were recorded during the second docking; however, because of the similarity in initial conditions and the lower lunar module inertia, loads are believed to have been less than during the first docking.

Structural loads during all service propulsion maneuvers were well within design limit values. During entry, the maximum longitudinal acceleration was 6.78g.

7.1.2 Mechanical Systems

All mechanical systems performed nominally.

The undocking procedure requires the crew to verify that command module roll commands are inhibited until the command module cabin-to-tunnel differential pressure is 3.5 psid or greater. This pressure minimum was not attained on Apollo 10 because the tunnel could not be vented. Prior to the first undocking, the roll engines were fired while the differential pressure was less than 3.5 psid while the docking latches were disengaged. As a result, the command module moved 3.5 degrees in roll with respect to the lunar module, but this slippage caused no difficulty. Tests have shown that relative movements of at least 180 degrees are permissible.

Four retaining springs were added on Apollo 10 to contain the docking-ring pyrotechnic charge holder following lunar module jettison. The two springs on the minus Y side failed to capture the charge holder. This is discussed further in section 15.1.20.

7.1.3 Thermal Control

The temperature responses of all passively controlled elements remained within normal operating limits. Passive thermal control during the translunar and transearth coast phases involved a roll maneuver of three revolutions per hour, with the spacecraft longitudinal axis maintained perpendicular to both the sun-earth and earth-moon lines. This technique was used for 54 hours of the 73-hour translunar coast period and 36 hours of the 54-hour transearth coast. Temperatures for the service propulsion and reaction control system tanks remained within a range of 57° to 87° F. During periods when passive thermal control was not used in coasting flight, these temperatures ranged from 54° to 95° F.

In lunar orbit, the only passive thermal control employed was during the crew sleep periods; for those, the spacecraft longitudinal axis was maintained at 45 degrees to the sun line. During the first sleep period, the temperature of the helium tank in service module reaction control quad A reached 98° F. The helium tank temperature is monitored as a measure of reaction control propellant tank temperature, which is not instrumented. An allowable maximum limit of 108° F on the helium tank was established. This limit was set to preclude the propellant tank temperatures from exceeding the allowable of 118° F. Because the quad A helium tank temperature was approaching 108° F, the orientation of the solar impingement point was changed from between quads A and B to directly on quad B for the remaining sleep periods. Service propulsion tank temperatures in lunar orbit varied from 57° F (27° above minimum) to 90° F (18° below maximum). At the same time, reaction control helium tank temperatures varied between 60° F (13° above minimum) and 101° F (7° below maximum).

Some insulation on the forward hatch was blown loose during tunnel pressurization, and particles were dispersed throughout the cabin. No insulation remained after entry. This problem is discussed in section 15.1.17.

TABLE 7.1-I.- MAXIMUM SPACECRAFT LOADS DURING LAUNCH PHASE

Interface	Load	Lift-off		Maximum q _a		End of first-stage boost		Staging	
		Calculated ^a	Predicted ^b	Calculated ^a	Predicted ^b	Calculated ^a	Predicted ^b	Calculated ^a	Predicted ^b
Launch escape system/command module	Bending moment, in-lb . . .	670 000	1 010 000	637 000	510 000	193 000	172 000	105 000	94 000
	Axial force, lb	-12 500	-11 000	-23 200	-24 000	-35 400	-35 800	5 200	6 000
Command module/service module	Bending moment, in-lb . . .	890 000	1 340 000	717 000	520 000	710 000	594 000	155 000	140 000
	Axial force, lb	-29 700	-36 000	-91 400	-84 000	-84 200	-89 600	12 300	14 000
Service module/adaptor	Bending moment, in-lb . . .			2 490 000	1 590 000	2 510 000	2 810 000	450 000	404 000
	Axial force, lb			-201 200	-194 500	-288 000	-296 000	35 000	40 000
Adaptor/instrument unit	Bending moment, in-lb . . .			9 052 000	7 100 000	4 050 000	5 060 000	850 000	760 000
	Axial force, lb			-296 000	-293 200	-426 000	-441 000	57 000	65 000

NOTE: Negative axial force indicates compression.

The flight conditions at maximum q_a were:

Condition	Measured	Predicted ^b
Flight time, sec	82.6	81.1
Mach no.	1.7	1.7
Dynamic pressure, psf . . .	695	670
Angle of attack, deg	4.07	3.95
Maximum q _a , psf-deg	2760	2660

The accelerations at the end of first-stage boost were:

Acceleration	Measured	Predicted ^b
Longitudinal, g	3.97	4.04
Lateral, g	0.06	0.05

^aCalculated from flight data.

^bPredicted Apollo 10 loads for Saturn V, block II design conditions.

NASA-S-69-2675

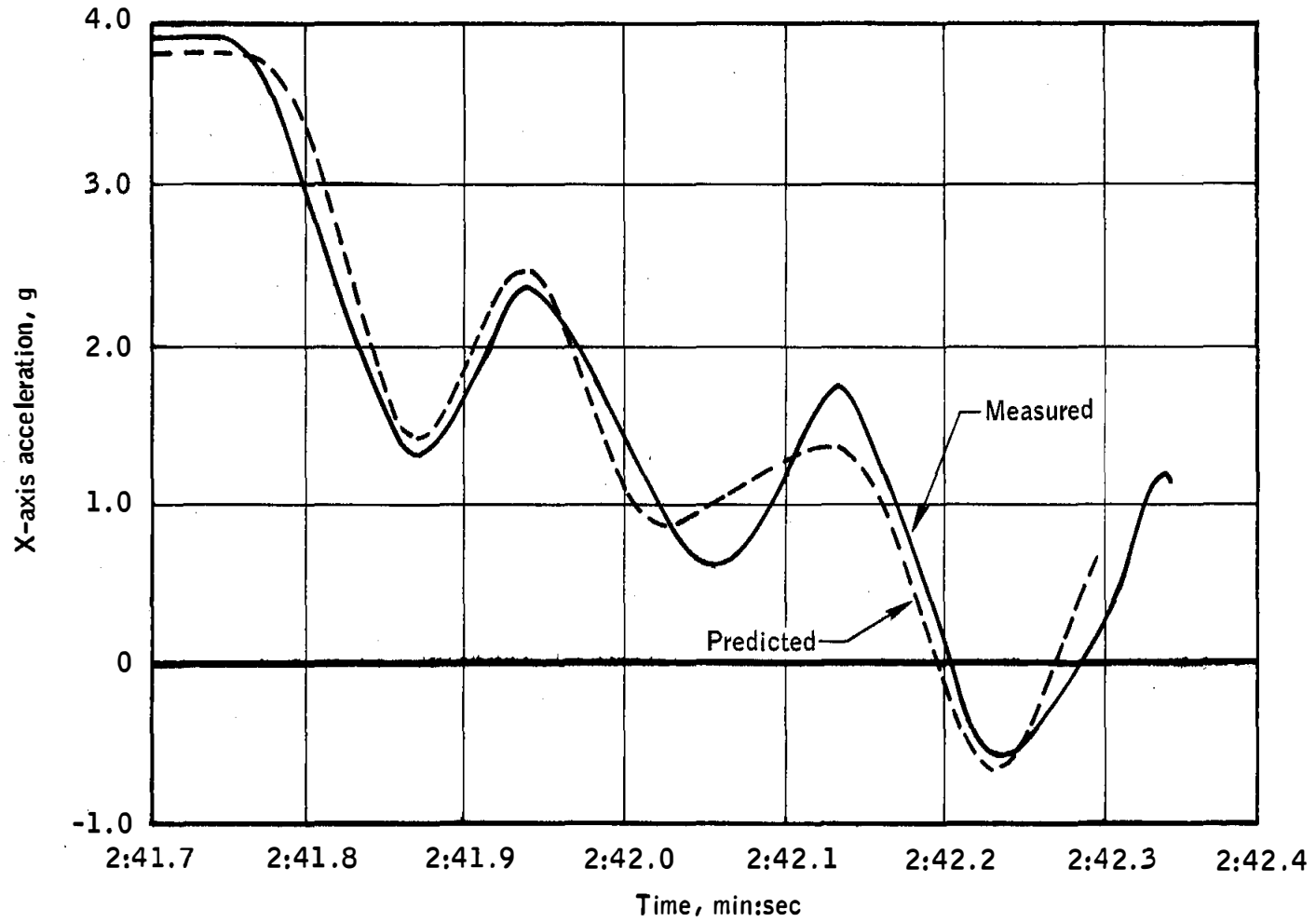

Figure 7.1-1.- Command module longitudinal acceleration at S-IC outboard engine cutoff.

7.2 ELECTRICAL POWER

7.2.1 Fuel Cells

The three fuel cells were activated 57 hours prior to launch and shared the spacecraft loads with ground support equipment until they assumed the full load 12 hours prior to launch.

The fuel cells provided approximately 387 kW of energy at an average total current of 70 amperes and an average bus voltage of 29 V dc for three-cell operation and 28 V dc for two-cell operation. Based on total generated power, reactant consumption was 35 pounds of hydrogen and 276 pounds of oxygen, excluding purges; these quantities agree with measured cryogenic quantities.

At 120:46:49, a short in the ac pump package (or its associated wiring) for fuel cell 1 caused the associated circuit breaker to trip. Attempts to reset the breaker resulted in a master alarm and illumination of bus undervoltage and failure lights; therefore, fuel cell 1 was removed from the bus. The failure in the pump circuit is discussed in section 15.1.7. Subsequently, fuel cell 1 was kept operative by connecting it to the bus only when the skin temperature cooled to 370° F and then removing it when the temperature reached 420° to 425° F. Three such cycles were completed. Although the cell continued to be operational, the useful life was limited because the water produced could not be removed and the performance was diminished by the associated increase in electrolyte water concentration. To remove some of the water, a continuous hydrogen purge was initiated at about 167 hours. Three hours later, the purge was terminated, and the hydrogen flow took 30 minutes to decay to zero. As the flow approached zero, the regulated pressure increased to a maximum of 71.4 psia before slowly decaying to the normal level of 62 psia. These anomalies are discussed in greater detail in section 15.1.8.

The condenser exit temperature on fuel cell 2 exhibited periodic disturbances of a few degrees throughout the flight. On several occasions during lunar orbit, the temperature disturbances excited oscillations of about two cycles per minutes within a 20° F temperature range. These oscillations occurred while under two-fuel-cell operation, with radiator temperatures less than 80° F, and frequently triggered the caution and warning lower temperature limit. The oscillations ceased when the radiator temperatures went above 115° F. The average exit temperature was within the normal range during the oscillation behavior, and fuel cell performance was not affected. This anomaly is discussed in section 15.1.21.

Fuel cell 3 performance was normal in every respect throughout the flight. All parameters remained within nominal limits during two-cell and three-cell operation.

7.2.2 Batteries

The entry and pyrotechnic batteries performed satisfactorily. Battery bus voltages were maintained at normal levels, and battery charging was nominal. Until separation of the command module and service module, the battery capacity was always above 96.6 A-h; this level was reached at about 5 hours. A time history of the entry battery capacity remaining is presented in figure 7.2-1. Battery A contained Permion separators and battery B contained the new cellophane separators. The difference in charging performance between these two batteries was insignificant under load; however, battery B delivered as much as 50 percent more current. Figure 7.2-2 is a comparison of the current-voltage characteristics exhibited by the batteries during the Apollo 8, 9, and 10 missions. All batteries were at a high state of charge prior to command module/service module separation.

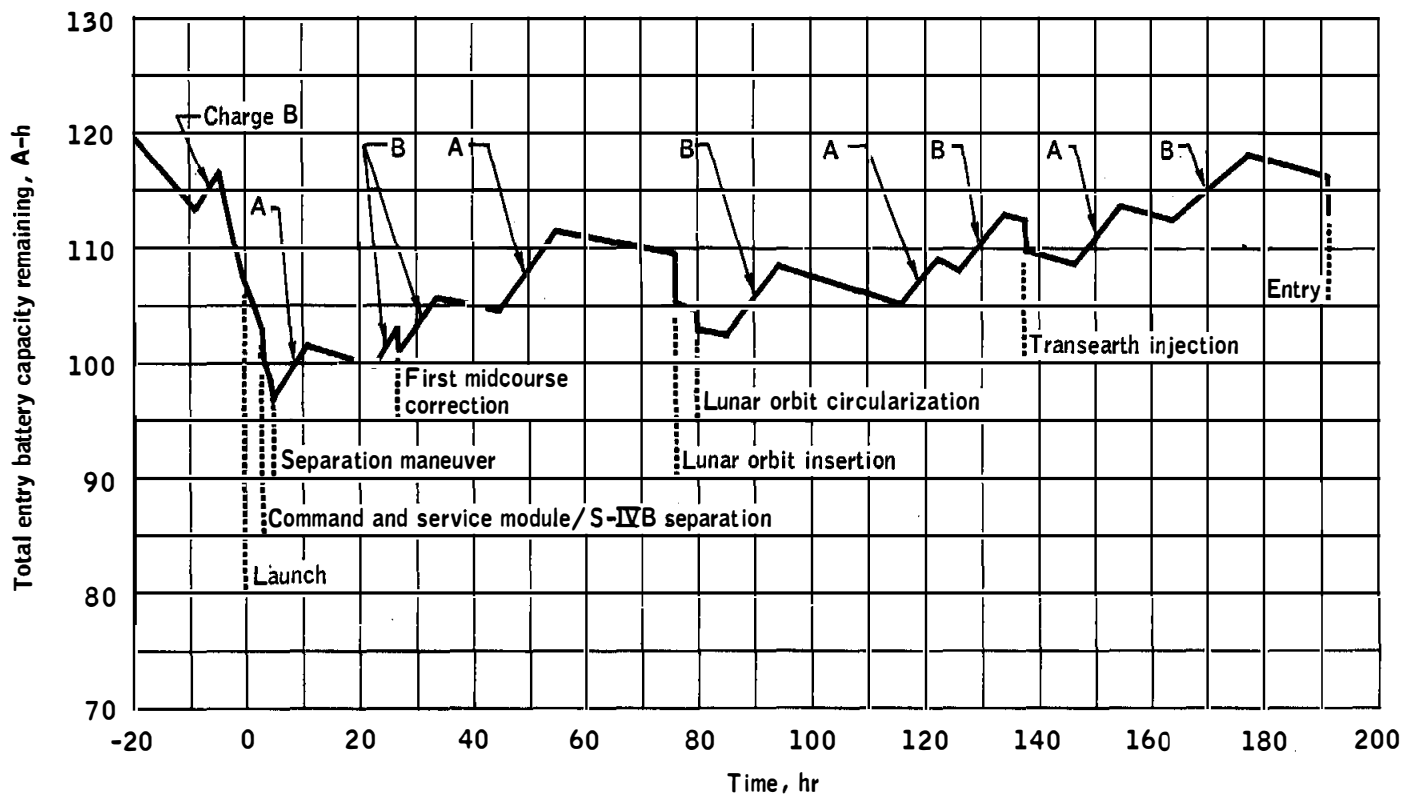

Figure 7.2-1.- Battery capacity remaining.

NASA-S-69-2677

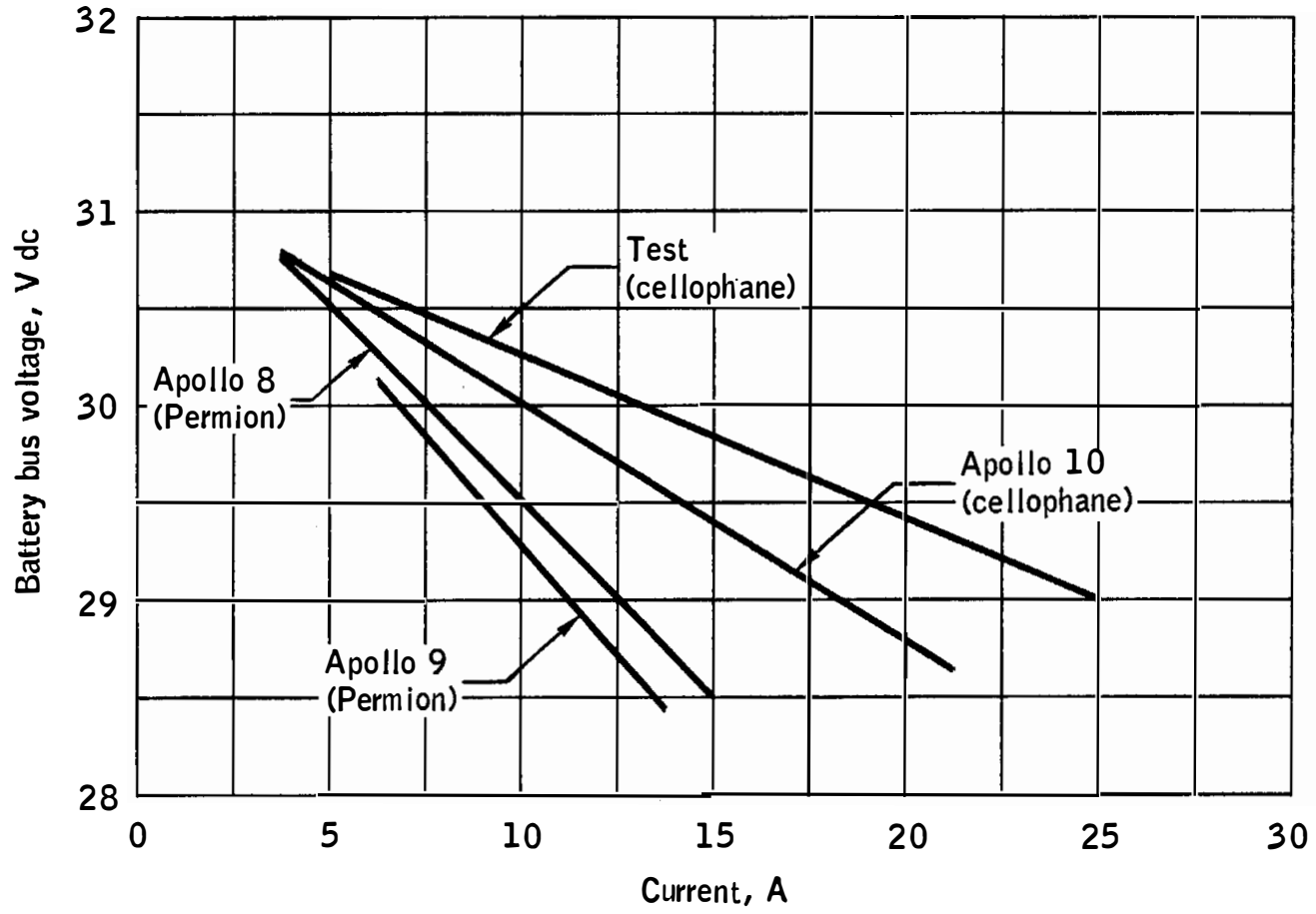

Figure 7.2-2.- Comparison of battery B performance.

7.3 CRYOGENIC STORAGE

The cryogenic storage system satisfactorily supplied reactants to the fuel cells and metabolic oxygen to the environmental control system. At launch, the total oxygen quantity was 629.0 pounds, or 125.8 pounds above the minimum requirements; the total hydrogen quantity was 55.1 pounds, or 5.0 pounds above the minimum.

The usage during the mission corresponds to an average fuel-cell current of 70.5 amperes and an average oxygen flow rate to the environmental control system of 0.43 lb/hr. The hydrogen usage agrees with the average power level to within the accuracy of the quantity measurement system.

Two low-pressure caution and warning alarms resulted from thermal stratification and the associated pressure decay. This behavior was expected since the fans are only used periodically. Hydrogen tank heater selection and manual operation were similar to Apollo 9 because of the settings of the caution and warning alarms and the tank pressure switches. After approximately 169 hours, the hydrogen system was controlled manually as a result of an apparent failure in the automatic pressure control system. This incident is discussed further in section 15.1.9.

7.4 COMMUNICATIONS EQUIPMENT

The S-band communication system provided excellent voice quality and the VHF/AM link provided good voice within its normal range capability. The quality of recorded voice played back from the data storage equipment was generally good. The performance of the real-time and playback telemetry functions was excellent and consistent with received power levels. The quality of color television pictures was nearly always excellent. The black-and-white television camera was never used. The received downlink S-band signal levels for both the PM and the FM links corresponded to preflight predictions.

Switching between record and playback modes of the data storage equipment, high- and low-bit-rate telemetry, and most antenna configurations was accomplished by real-time ground commands to relieve crew workload.

7.4.1 Onboard Equipment

VHF duplex-B, which employs A transmitter and B receiver, was used satisfactorily for the launch phase. Over the Canary Island station, the VHF simplex-A mode was selected and performed nominally until the expected slant range-limit was exceeded during translunar coast. While the spacecraft were in lunar orbit, VHF was again used in simplex-A (the primary communication mode), and performance was satisfactory in all but one instance. At about 95 hours, a check of the VHF simplex-A was unsuccessful; however, a subsequent check was satisfactory. A switch configuration problem is suspected; see section 15.1.5 for more detail.

During recovery, the VHF voice link (simplex-A) and recovery beacon operated satisfactorily. VHF recovery beacon antenna 1, however, did not deploy properly (see section 15.1.13).

The S-band equipment provided the primary air-to-ground link throughout most of the mission. S-band squelch was available for the first time and operated satisfactorily. The squelch inhibits noise when the uplink voice subcarrier is lost. The primary PM S-band transponder was used continuously through the primary power amplifier. The updata link was used frequently to perform ground-commanded switching functions in the communications system, as well as for computer updates.

Communications during passive thermal control were maintained by switching between two diametrically opposed omnidirectional antennas (B and D) or by switching between the high-gain antenna and omni D. The high-gain antenna was used to transmit to earth telemetry and voice recorded on the data storage equipment while the spacecraft were behind the moon.

The performance of the VHF ranging system is discussed in section 4.0.

7.4.2 Television

Sixteen color television transmissions were made from the spacecraft. The total time of these telecasts was 5 hours 47 minutes 35 seconds, and the system performed nominally. Color and resolution were consistent with design specifications and test performance. Signal-to-noise ratios for the television signal were consistent with those of the received carrier.

Two minor problems were experienced with the television camera. A horizontal distortion appeared as a bulge on the side of the earth. This problem was noted in preflight testing and is attributed to electromagnetic interference within the camera. The second problem was the inability of the automatic light-level control to accommodate small bright objects, as evidenced by the cloud cover image saturation when viewing the

earth at lunar distance. This problem is not serious enough to require a change in the light-level control loop for the next mission. New cameras will have improved light-level control characteristics.

7.4.3 High Gain Antenna

The high gain antenna automatically deployed at command module/S-IVB separation and was activated soon thereafter. At approximately 3 hours, the crew confirmed proper operation. The antenna was powered continually until just before command module/service module separation, except for a few brief periods to conserve electrical power.

All three modes (manual, automatic, and reacquisition) and all three beamwidths were used at various times. The manual mode was used 67 percent of the operating time, and the automatic mode 24 percent. A review of signal strengths shows excellent correlation with predictions.

Reacquisition performance.- A check of the automatic reacquisition mode was performed during the second lunar revolution. Narrow beam was selected, and the manual pitch and yaw controls were set to approximately the predicted earthrise direction prior to loss of signal. Acquisition was accomplished on time, and the narrow-beam antenna gain was available almost immediately. Thus, so long as the spacecraft does not block the line of sight to earth, the high-gain antenna can be used without crew attention during lunar operations.

High gain/omnidirectional switching.- During transearth flight, essentially continuous communications, with narrow beam gain available more than half the time, were provided during passive thermal control without crew attention. Switching between the high gain and omni D antennas through ground command was generally accomplished before the high gain antenna reached the scan limit. This switching precluded the antenna's driving against the mechanical gimbal limits for approximately 30 percent of each spacecraft revolution.

Data indicate that the antenna generally acquired from a relatively large offset angle from the boresight axis, based on the duration of data loss when switching was performed. When switching from high gain to omni D and between omni D and B, data were lost for only a few seconds; when switching from omni D to high gain, the loss generally lasted from 10 to 30 seconds but was still within minimum design requirements.

Inflight tests.- A reacquisition test similar to that performed during Apollo 8 was conducted, except that the ground-station transmitter power was reduced to 500 watts (minus 13 dB) from the 10 kilowatts normal for a distance of 120 000 miles. Transmitter power was reduced to determine whether phase lock would be lost when the antenna was slewed to the

predicted earthrise position. The reacquisition test involved two revolutions of the spacecraft at a roll rate of approximately 3 revolutions per hour. The antenna was in the reacquisition/narrow-beam configuration. Two reacquisitions were performed, and data indicate the antenna switched to wide beam and slewed as required upon reaching the scan limit. The antenna also returned to the earthset side of the spacecraft, hit the mechanical gimbal stop, and remained there for approximately one-third of a revolution (7 minutes). The antenna tracked normally in wide beam when the earth was within the scan-limit warning zone and then switched to narrow beam as the earth exited the warning zone. This test also verified the ability of the antenna to provide high gain communications approximately 60 percent of the time and showed that antenna contact with the mechanical gimbal stops cannot be prevented by a practical reduction in transmitter power.

A reflectivity test, originally scheduled for approximately 27 hours, was performed at 168 hours at a distance of 120 000 miles. This test verified the probabilities of acquisition interference resulting from service module reflection for antenna look angles near the plus-X axis.

The results of the test showed that the antenna could acquire in wide beam and then lock up on a side lobe of the narrow beam, or once having acquired, the antenna could track continuously in wide beam mode with no evidence of beam switching, or the antenna could acquire and track satisfactorily.

Acquisition problems experienced during this test were expected on the basis of ground test data.

Performance during service propulsion maneuvers and station hand-overs.- During the translunar midcourse correction (service propulsion system), the high gain antenna was in the auto-track mode with medium beam. No change in either uplink or downlink signal strengths was observed during or after the firing, which lasted approximately 7 seconds. Antenna performance before and after the lunar orbit insertion maneuver verified that the antenna is not adversely affected by a prolonged service propulsion firing. At approximately 28 hours, a ground station hand-over from Goldstone to Madrid, with the high gain antenna in auto-track and narrow beam, was accomplished with no significant loss of data. Several subsequent station handovers were accomplished with the same excellent results.

Performance discrepancies.- No significant problems were encountered with the high gain antenna throughout the mission. The antenna being driven into a scan limit and various switching problems resulted in interrupted communications. Normal operating procedures quickly restored communications in all cases. During a television program at approximately 132.5 hours, the antenna stopped tracking and switched to wide beam upon

entering a scan limit zone and data were lost. The spacecraft had undergone a 0.5-deg/sec pitch rate prior to the dropout, and normal narrow-beam tracking was resumed approximately 7 minutes later, after the attitude rate was changed so that the earth line-of-sight was outside the scan limit.

7.5 INSTRUMENTATION

The instrumentation system, consisting of 283 operational measurements, adequately supported the mission. Only two measurements failed, and a malfunction in the data storage equipment (onboard recorder) caused a momentary loss of data.

The carbon dioxide partial-pressure measurement became questionable about 3 hours after lift-off and was considered to have failed. The measurement has a history of failures attributed to moisture from the suit coolant loop.

The package temperature of the nuclear particle detection analyzer, located in the service module, became intermittent at about 73 hours, probably because of a wiring failure between the thermocouple and signal conditioner.

About 33 seconds of recorded data were lost during entry because the tape transport in the data storage equipment momentarily slowed during cabin repressurization. The pressure differential across the recorder cover caused it to contact the tape reel sufficiently to slow the transport mechanism (see section 15.1.11).

During the loading of propellants for the service propulsion system, several auxiliary point sensors in the propellant gaging system failed. Subsequently, the fuse in the power supply was found open. The auxiliary system was waived for flight.

The oxygen flow meter for fuel cell 1 failed to respond during the countdown, and the measurement was waived. The nuclear particle detector and analyzer package temperatures were also waived because of VHF radio-frequency interference, but this interference did not significantly affect measurement data from the flight.

7.6 GUIDANCE, NAVIGATION, AND CONTROL

Performance of the guidance and control systems was excellent throughout the mission, as discussed in the following paragraphs. Performance during the rendezvous is discussed in section 4.

7.6.1 Mission Related Performance

The inertial measurement unit was released from gyrocompassing and was inertially fixed at 0.73 second, after recognition of the launch vehicle lift-off signal. Monitoring of the first-stage roll and pitch programs was nominal, and accurate position and velocity comparisons were generated for go/no-go evaluations. The velocities measured by the primary guidance and the entry monitor systems were very close to those telemetered by the launch vehicle and those calculated from ground tracking.

Transposition, docking, and ejection were performed without difficulty. The separation distance reported after transposition was larger than expected because of a longer plus-X than minus-X translation and because of the pyrotechnic impulse applied to a relatively lightweight S-IVB. Spacecraft dynamics during docking and ejection were very similar to those experienced during the Apollo 9 mission.

The alignment data for the inertial measurement unit are recorded in table 7.6-I, and results are comparable to those of previous missions. The system remained powered and aligned throughout the flight; therefore, the capability for a platform orientation determination while docked was not demonstrated. Inability of the crew to recognize constellations was not conclusive because no attempt was made in the optimum sun-impingement attitude for the optics. Constellation recognition is required for orientation determination.

Midcourse navigation techniques using star/horizon measurements with either the earth or moon horizon and using star/lunar-landmark sightings were exercised with excellent results. Twenty-two sets of star/horizon and nine sets of star/lunar-landmark sightings were made (table 7.6-II). The initial sets of earth sightings were made to establish and verify the altitude of the horizon. Based on these measurements, the onboard computer compensation for horizon altitude was updated from 24 to 34 kilometers. The optics were calibrated before each group of sightings, and the bias error was within the anticipated tolerance. The crew reported that the star/lunar-landmark sightings were easier to perform than the star/horizon measurements and that the star/earth-landmark sightings could have been made since identifiable features of Saudi Arabia and Mexico were visible and free from cloud cover throughout the mission.

The return-to-earth targeting program was exercised several times to calculate midcourse corrections. A comparison of the velocity changes determined onboard with those calculated on the ground indicates that a safe return could have been made if communications had been lost. A comparison of the respective solutions for the transearth midcourse correction at 176:40:00 showed the following results:

	Velocity change, ft/sec	
	Onboard	Ground
X	2.5	2.2
Y	0.0	0.0
Z	-0.1	-0.1

A series of landmark tracking sequences (table 7.6-III) was conducted while docked and undocked in lunar orbit. The primary objective was to provide additional data on the lunar potential model, and the preliminary indications are that the desired results were obtained (see section 6). The pitch technique was used for all sequences.

All attitude control functions were satisfactory, both docked and undocked. Passive thermal control was used extensively enroute to and returning from the moon (table 7.6-IV). The roll axis technique was used exclusively, generally under digital autopilot control. During the first attempt (first sleep period), attitudes quickly reached and oscillated at one edge of the 20-degree pitch and yaw deadbands. On subsequent maneuvers, the roll rate was increased from 0.1 to 0.3 deg/sec, the deadbands were increased to 30 degrees, and all body rates were carefully nulled before the roll rate was established. These changes resulted in long periods (on the order of 20 hours) without thruster activity. Representative attitude control performance during translunar and transearth coast is shown in figure 7.6-2.

A summary of data for major translation maneuvers is contained in table 7.6-V. All maneuvers were performed under digital autopilot control.

The primary guidance system was employed throughout the entry phase, and the events reconstructed from telemetry data are shown in figure 7.6-3. Dynamic parameters during the entry phase are presented in figure 7.6-4. The pitch and yaw oscillations were comparable to those experienced during the Apollo 4, 6, and 8 missions, with long periods of operation within the rate deadbands. The velocity and flight-path angle at entry interface,

as calculated onboard, were 36 315 ft/sec and minus 6.54 degrees, respectively, and compare almost exactly with the interface conditions obtained from the tracking data. The spacecraft computer reached entry interface with the entry-initialization program in command but at that time properly switched to the post-0.05g entry program. The system indicated a desired inertial entry range of 1376.7 miles and a predicted cross-range error of plus 11.8 miles.

The guidance system indicated that the peak deceleration during first entry was 6.8g at a velocity of 31 995.5 ft/sec and the peak deceleration during second entry was 4.6g at a velocity of 9972.2 ft/sec. The onboard computer terminated its guidance routine when the relative velocity dropped below 1000 ft/sec.

Figure 7.6-5 is a summary of landing-point data. The onboard computer indicated a landing at 164 degrees 39 minutes west longitude and 15 degrees 4.2 minutes south latitude, or 1.4 miles downrange from the target, based on telemetered computer data at drogue deployment. The recovery forces estimated the landing point to be 164 degrees 39 minutes west longitude and 15 degrees 2 minutes south latitude, or 2.5 miles from the target. The best estimated trajectory shows a landing point of 164 degrees 39 minutes west longitude and 15 degrees 3.6 minutes south latitude, or 1.3 miles from the target. Table 7.6-VI presents a comparison of computer navigation data with the best estimated trajectory and shows a navigation error at the entry interface of 0.21 mile in position and 212 ft/sec in velocity. This error, when propagated through entry to drogue deployment, results in a miss distance of approximately 0.2 mile, well within the predicted 1-sigma touchdown accuracy.

7.6.2 Guidance and Navigation System Performance

A statistical summary of inertial component test history is contained in table 7.6-VII. The accelerometer bias and gyro-null bias drift, the only quantities measurable in flight, indicate excellent stability. The gyro drift computed from back-to-back alignments is shown in table 7.6-I. The accelerometers show evidence of the dual moding also experienced on Apollo 7; this moding appears as a zero bias in zero-g throughout trans-lunar and transearth coast. The accelerometer biases also indicate a dependence on temperature; figure 7.6-6 covers the lunar orbit period when the primary evaporator was not operating. Figure 7.6-7 contains a time history of velocity differences between the S-IVB and spacecraft guidance systems during ascent. The error buildup, assuming perfect S-IVB guidance, indicates performance well within the real-time go/no-go criteria.

The sextant and scanning telescope operated properly throughout the entire mission. The crew reported that the shaft and trunnion drive systems worked smoothly in all modes and that control capability was adequate.

Computer performance was excellent throughout the mission. All required guidance, navigation, and control functions within the computer were accomplished without incident, and no computer restarts were recorded. State vector updates, erasable memory dumps, and clock updates were routinely accomplished by network commands. Program alarms and operator error indications were observed, but none were associated with hardware malfunctions. The interface with the VHF ranging system was operational for the first time, and performance was excellent (see section 5.0).

7.6.3 Entry Monitor System Performance

The entry monitor system satisfied all required backup and monitoring functions. The velocity counter was used to monitor all service propulsion and reaction control translation maneuvers, and the measured velocities agreed closely with those computed by the primary system. The accelerometer bias measured in flight was reported to have been 0.003 ft/sec. Although a scroll scribing problem (see section 15.1.12) was encountered during entry preparation, the system operated properly and would have provided the necessary backup capability if required. Figure 7.6-8 shows the scroll markings recorded during entry.

7.6.4 Stabilization and Control System Performance

All attitude control functions of the stabilization and control system were nominal throughout the mission. However, late in the mission, the attitude reference provided by the gyro display coupler was reported to have drifted excessively (see section 15.1.10 for further discussion).

TABLE 7.6-I.- PLATFORM ALIGNMENT SUMMARY

Time, hr:min	Program option*	Star used	Gyro torquing angle, deg			Star angle difference, deg	Gyro drift, mERU			Comments
			X	Y	Z		X	Y	Z	
0:41			-0.102	+0.034	-0.076	--	--	--	--	
5:15	3	21 Alpheratz; 30 Menkent	+0.117	-0.093	+0.001	00001	-1.7	+1.4	0.0	
7:48	1	1 Alpheratz; 41 Dabih	-0.066	+0.007	-0.069	00001				Reference matrix change
24:30	3	23 Denebola; 30 Menkent	+0.360	-0.290	-0.040	00002	-1.4	+1.2	-0.2	
45:06	3	36 Vega; 44 Enif	+0.431	-0.366	-0.063	00001	-1.4	+1.2	-0.2	
51:52	3	23 Denebola; 32 Alphecca	+0.163	-0.111	-0.018	00002	-1.6	+1.1	-0.2	Check star 31 (Arcturus)
71:45			0.198	0.001	0.392					Reference matrix change
74:17	3	22 Regulus; 24 Gienah	+0.057	-0.035	-0.004	00000	-1.5	+0.9	+0.1	
77:15	3	25 Acrux; 33 Antares	+0.078	-0.044	-0.036	00001	-1.8	+1.0	-0.8	Check star 30 (Menkent)
79:24	3	23 Denebola; 30 Menkent	+0.048	-0.053	+0.007	00001	-1.5	+1.6	+0.2	
81:20	3	30 Menkent; 35 Rasalhague	+0.052	-0.017	-0.007	00001	-2.0	+0.6	-0.2	
95:14	1	30 Menkent; 34 Atria	+0.339	-0.251	-0.039	00001				Reference matrix change
99:15	3	40 Altair; 42 Peacock	+0.078	-0.069	-0.031		-1.3	+1.1	-0.5	
103:09	3	37 Nunki; 44 Enif	+0.091	-0.073	-0.005	00001	-1.6	+1.3	-0.1	Check star 41 (Dabih)
119:11	3	44 Enif; 45 Fomalhaut	+0.335	-0.272	-0.035	00001	-1.4	+1.1	-0.2	
121:13	3	17 Regor;	+0.056	-0.020	-0.011	--	-1.8	+0.7	+0.4	
122:58	3	1 Alpheratz; 2 Diphda	+0.046	-0.042	-0.012	00001	-1.8	+1.6	-0.5	
124:50	3	1 Alpheratz; 2 Diphda	+0.024	-0.028	-0.007	00000	-0.9	+1.0	-0.3	
126:50	3	1 Alpheratz; 2 Diphda	+0.044	-0.028	-0.007	00000	-1.5	+0.9	-0.2	
132:49	3	26 Spica; 33 Antares	+0.146	-0.102	-0.037	00002	-1.6	+1.1	-0.4	
132:52	3	24 Gienah; 33 Antares	+0.010	+0.004	-0.010	00000	--	--	--	Repeat
136:40	3	2 Diphda; 41 Dabih	+0.072	-0.075	-0.017	00000	-1.3	+1.3	-0.3	
139:17	1	40 Altair; 45 Fomalhaut	+0.015	-0.021	-0.013					Reference matrix change
150:34	3	26 Spica; 27 Alkaid	+0.202	-0.202	-0.035	00000	-1.2	+1.2	-0.2	
165:05	3	21 Alpheratz; 25 Acrux	+0.286	-0.239	+0.058	00001	-1.3	+1.1	-0.3	
176:33	3	32 Alphecca; 40 Altair	+0.207	-0.184	-0.012	00001				Reference matrix change
										Reference matrix change
187:41	3	30 Menkent; 34 Atria	-0.222	-0.098	-0.159	00001	+1.3	+0.6	-1.0	Check star 25 (Acrux)
190:11	3		+0.045	-0.034	+0.016	00002	-1.3	+1.0	+0.5	
190:14	3		+0.002	-0.005	+0.001					Repeat

*1 - Preferred; 2 - Nominal; 3 - Reference matrix.

TABLE 7.6-II.- MIDCOURSE NAVIGATION

Group	Set/marks	Star	Horizon	Landmark	Time, hr:min	Distance from earth, miles	Remarks
1	1/3 2/3 3/3 4/3 5/3	40 Altair 40 Altair 33 Antares 33 Antares Peacock	Earth near Earth near Earth far Earth far Earth near		5:33	25 000	This group of sightings determined the differential height of the horizon. Software updated with data obtained. Optics calibration was 0.005 degree.
2	1/3 2/3 3/3 4/3 5/3	44 Enif 37 Nunki 37 Nunki 37 Nunki 45 Fomalhaut	Earth near Earth far Earth far Earth far Earth near		25:00	106 000	Unable to calibrate because of earthshine. Used same bias as previously.
3	1/3 2/3 3/3 4/3 5/3 6/3 7/3 8/3 9/3	26 Spica 23 Denebola 31 Arcturus 24 Gienah 26 Spica 31 Arcturus 26 Spica 23 Denebola 31 Arcturus		Taruntius P Taruntius P Taruntius P Secchi K Secchi K Secchi K Messier B Messier B Messier B	151:00		Sightings performed on lunar landmarks; distance was 50 000 miles from the moon. Crew reported this set was performed with ease and was not as difficult as star/horizon measurements. Optics calibration was 0.003 degree.
4	1/3 2/3 3/3	2 Diphda 44 Enif 45 Fomalhaut	Earth near Earth far Earth far		165:20	129 000	
5	1/3 2/3 3/3	2 Diphda 44 Enif 45 Fomalhaut	Earth near Earth far Earth far		167:16	121 000	Optics calibration was 0.005 degree.
6	1/3 2/3 3/3	2 Diphda 44 Enif 45 Fomalhaut	Earth near Earth far Earth far		171:35	107 000	Optics calibration was 0.003 degree.
7	1/3 2/3 3/3	2 Diphda 44 Enif 45 Fomalhaut	Earth near Earth far Earth far		174:00	98 000	Optics calibration was 0.003 degree.

TABLE 7.6-III.- LUNAR LANDMARK TRACKING

Mark time, hr:min:sec		Landmark	No. of marks	Optics and mode*	Remarks
First	Second				
82:43:28	82:45:40	F1	5	Sextant, resolved	Good marking. Pitch rate was 0.2 deg/sec. Started marking about 1-1/2 minutes early.
82:59:55	83:03:05	B1	5	Sextant, resolved	Pitch rate was 0.15 deg/sec, a little low.
96:30:		130	0		Terminated in order to maneuver to high-gain antenna attitude.
121:43:17	121:45:07	CP1	5	Sextant, resolved	
121:56:57	121:57:21	CP2	2	Sextant, resolved	Lost target in sextant; too much glare.
122:11:06	122:12:47	F1	5	Sextant, resolved	Almost lost during transfer from scanning telescope to sextant because of brightness and presence of two images in sextant.
122:31:36	122:32:47	130	5	Sextant, resolved	
123:41:36	123:43:38	CP1	5	Sextant, resolved	Tracked different landmark from first pass.
123:55:37	123:57:11	CP2	5	Sextant, resolved	
124:08:37	124:09:28	F1	4	Scanning telescope, resolved	In attitude hold. Ran out of trunnion before all marks were completed.
124:28:54	124:30:36	130	5	Sextant, resolved	Started about 50 seconds early.
125:40:02	125:41:45	CP1	5	Scanning telescope, resolved	
125:53:58	125:55:33	CP2	4	Scanning telescope, resolved	Started late. Pitch rate too slow. Ran out of trunnion.
126:06:38	126:08:16	F1	5	Scanning telescope, resolved	
126:27:34	126:29:34	130	5	Sextant, resolved	
127:37:	127:40:15	CP1	5	Scanning telescope, resolved	
127:52:31	127:53:51	CP2	4	Scanning telescope, resolved	Low pitch rate; ran out of trunnion.
128:05:12	128:06:46	F1	4	Scanning telescope, resolved	Low pitch rate; ran out of trunnion.
128:25:37	128:27:46	130	5	Sextant, resolved	
134:17:47	134:19:18	B1	4	Scanning telescope, resolved	Pitch rate not fast enough.
134:30:00	134:31:47	150	5	Scanning telescope, resolved	Had right target on first mark but switched to wrong target on last four.

*When sextant was used, the scanning telescope was used to acquire and identify the landmark prior to tracking.

TABLE 7.6-IV.- PASSIVE THERMAL CONTROL SUMMARY

Time, hr:min		Roll rate, deg/sec	Deadband, deg	Initial rate, deg/sec		Cone angle (C), deg			Cone angle divergence rate (a), rad/hr*	Comments
Start	Stop			Pitch	Yaw	Initial	Later	Maximum		
10:06	13:00	0.10	20	0.022	-0.005					
13:05	24:25	0.07	20							
28:01	29:22	0.35	30			30	30 after 1 hr	30		Quads A and C dis- abled for starting roll rate
29:51	51:20	0.3	30	0.0012	0.0006	6	21 after 15 hr	30	0.11	All quads on; hit deadband at 51:20
54:15	71:06	0.3	30	0.0015	0.0003	3	26 after 14 hr	30	0.15	
139:40	150:30	0.3	30	-0.0004	0.0008	6	13.5 after 9 hr	14	0.09	
154:24	164:50	0.3	30							Stopped for mid- course correction
172:14	174:02	0.3	30							
175:18	176:02	0.3	30	0.0005	-0.0006	2.1	5.7 after 2 hr		0.45	
176:40	186:48	0.3	30							

*The cone angle C is determined by: $C = C_0 e^{at}$ and the divergence rate a was determined from flight data.

TABLE 7.6-V.- MANEUVER SUMMARY

Parameter	Maneuver			
	First midcourse correction	Lunar orbit insertion	Lunar orbit circularization	Transearth injection
Time				
Ignition, hr:min:sec	26:32:56.8	75:55:54.0	80:25:08.1	137:36:28.9
Cutoff, hr:min:sec	26:33:03.9	76:01:50.1	80:25:22.0	137:39:13.7
Duration, min:sec	0:07.1	5:56.1	0:13.9	2:44.8
Velocity after trimming, ft/sec (actual/desired)				
X	-26.2/-26.1	2440.2/2440.3	135.0/135.4	-2931.1/-2931.2
Y	-39.8/-38.9	1004.6/1004.8	21.9/22.0	-1953.7/-1954.4
Z	-13.9/-13.4	1389.1/1389.2	11.0/11.4	-877.5/-876.0
Velocity residual, ft/sec				
X	-0.2	0.0	+0.5	+0.3
Y	0.0	-0.2	-0.4	+1.6
Z	+0.3	0.0	-0.4	-0.1
Entry monitor			-0.9	
Engine gimbal position, deg				
Initial				
Pitch	+0.87	+0.91	+1.83	-0.59
Yaw	-0.17	-0.10	-0.70	+0.91
Maximum excursion				
Pitch	0.65	+0.44	+0.22	-0.34
Yaw	+0.49	-0.38	+0.29	+0.59
Steady-state				
Pitch	+0.87	+1.20	+1.52	-0.55
Yaw	-0.23	+0.57	-0.53	+0.91
Cutoff				
Pitch	+0.89	+1.61	+1.52	-0.72
Yaw	-0.23	+0.57	-0.53	-0.74
Maximum rate excursion, deg/sec				
Pitch	-0.34	+0.31	-0.20	+0.48
Yaw	+0.22	+0.12	-0.08	-0.32
Roll	-0.20	-0.46	-0.32	-1.00*
Maximum attitude error, deg				
Pitch	+0.27	+0.23	<0.1	<0.1
Yaw	+0.14	<0.1	<0.1	<0.1
Roll	-0.33	-5.0*	-1.45	-5.0*

*Saturated.

NOTE: Velocities are in earth-centered inertial coordinates. All maneuvers made with service propulsion system.

TABLE 7.6-VI.- ENTRY NAVIGATION

Parameter	Onboard computer	Best-estimated trajectory
Altitude of 400 000 feet (191:48:55)		
X position, ft	11 976 174	11 976 744
Y position, ft	-15 451 660	-15 452 783
Z position, ft	-8 506 213.9	-8 506 040.2
X velocity, ft/sec	27 484.5	27 485.5
Y velocity, ft/sec	20 511.8	20 510.1
Z velocity, ft/sec	11 927.6	11 926.6
Peak g (191:50:14)		
X position, ft	14 134 875	14 135 504
Y position, ft	-13 745 026	-13 746 279
Z position, ft	-7 514 842.5	-7 514 740.7
X velocity, ft/sec	23 546.8	23 547.0
Y velocity, ft/sec	18 698.4	18 697.1
Z velocity, ft/sec	10 934.5	10 933.6
Program 67 (191:51:10)		
X position, ft	15 260 899	15 261 505
Y position, ft	-12 817 684	-12 818 976
Z position, ft	-6 961 509.1	-6 961 444.8
X velocity, ft/sec	17 017.5	17 016.7
Y velocity, ft/sec	15 798.5	15 798.2
Z velocity, ft/sec	9 351.5	9 311.2
40 seconds prior to drogue deployment (191:56:38)		
X position, ft	17 683 418	17 683 006
Y position, ft	-9 869 311.0	-9 870 342.2
Z position, ft	-5 419 055.1	-5 418 997.5
X velocity, ft/sec	333.5	328.0
Y velocity, ft/sec	1697.6	1699.1
Z velocity, ft/sec	310.5	310.7

TABLE 7.6-VII.- INERTIAL COMPONENT PREFLIGHT HISTORY - COMMAND MODULE

Error	Sample mean	Standard deviation	No. of samples	Countdown value	Flight load
Accelerometers					
X - Scale factor error, ppm	-178	50.737	4	-120	-100
Bias, cm/sec ²	-0.065	0.136	4	-0.14	-0.27
Y - Scale factor error, ppm	-237	8.485	2	-277	-230
Bias, cm/sec ²	-0.055	0.162	2	-0.05	-0.07
Z - Scale factor error, ppm	-129	65.053	2	-124	-80
Bias, cm/sec ²	-0.045	0.035	2	0.01	0.05
Gyroscopes					
X - Null bias drift, mERU	0.4	0.152	3	-1.0	0.4
Acceleration drift, spin reference axis, mERU/g	9.8	0.282	2	8.4	10.0
Acceleration drift, input axis, mERU/g	2.3	7.212	2	9.1	1.0
Y - Null bias drift, mERU	-1.3	0.655	3	-2.2	-1.3
Acceleration drift, spin reference axis, mERU/g	3.4	2.969	2	4.7	3.0
Acceleration drift, input axis, mERU/g	8.7	3.818	2	10.9	13.0
Z - Null bias drift, mERU	0.9	1.436	3	1.7	1.2
Acceleration drift, spin reference axis, mERU/g	0.9	8.061	2	-3.7	7.0
Acceleration drift, input axis, mERU/g	8.6	+0.424	2	16.4	11.0

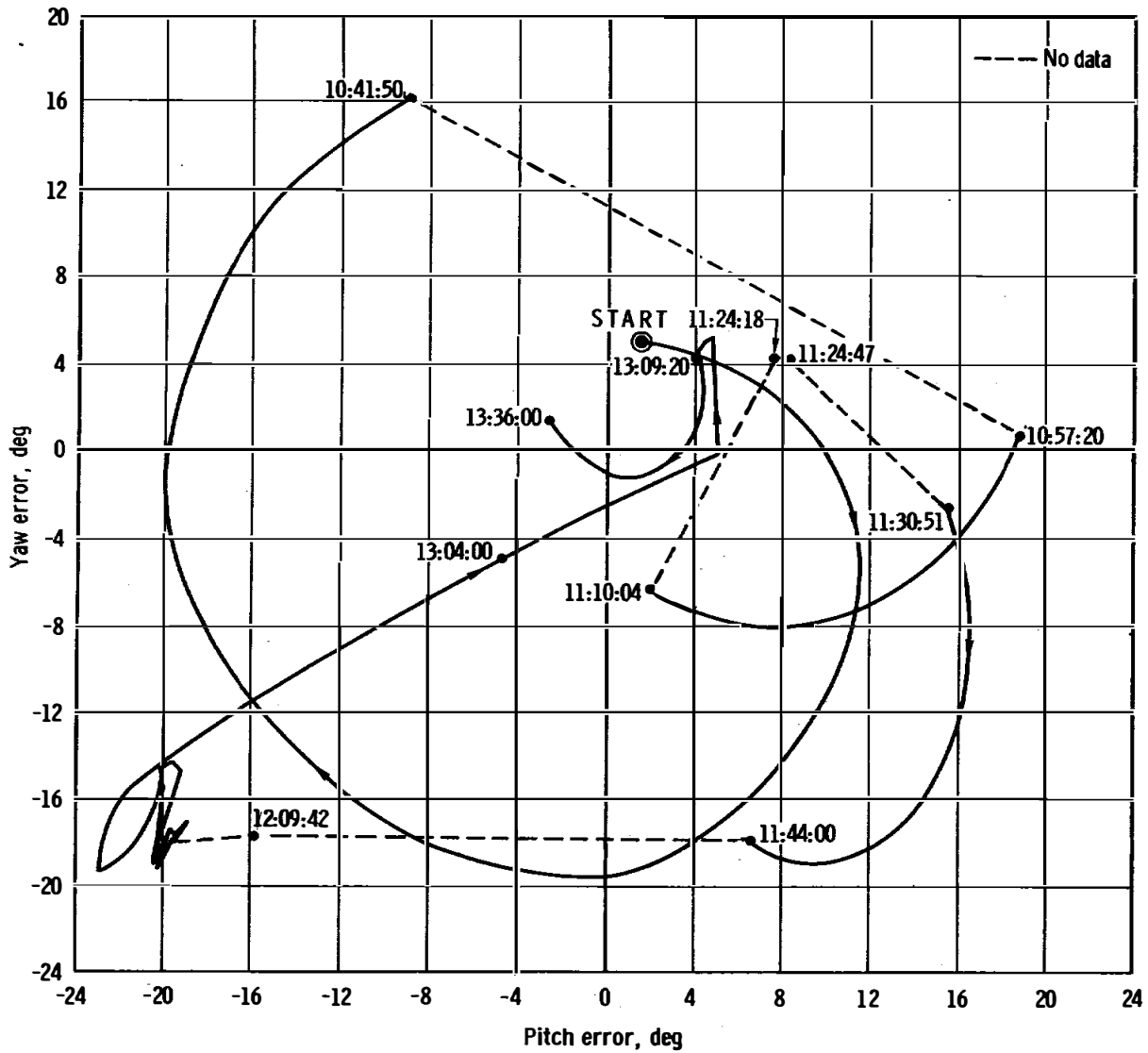
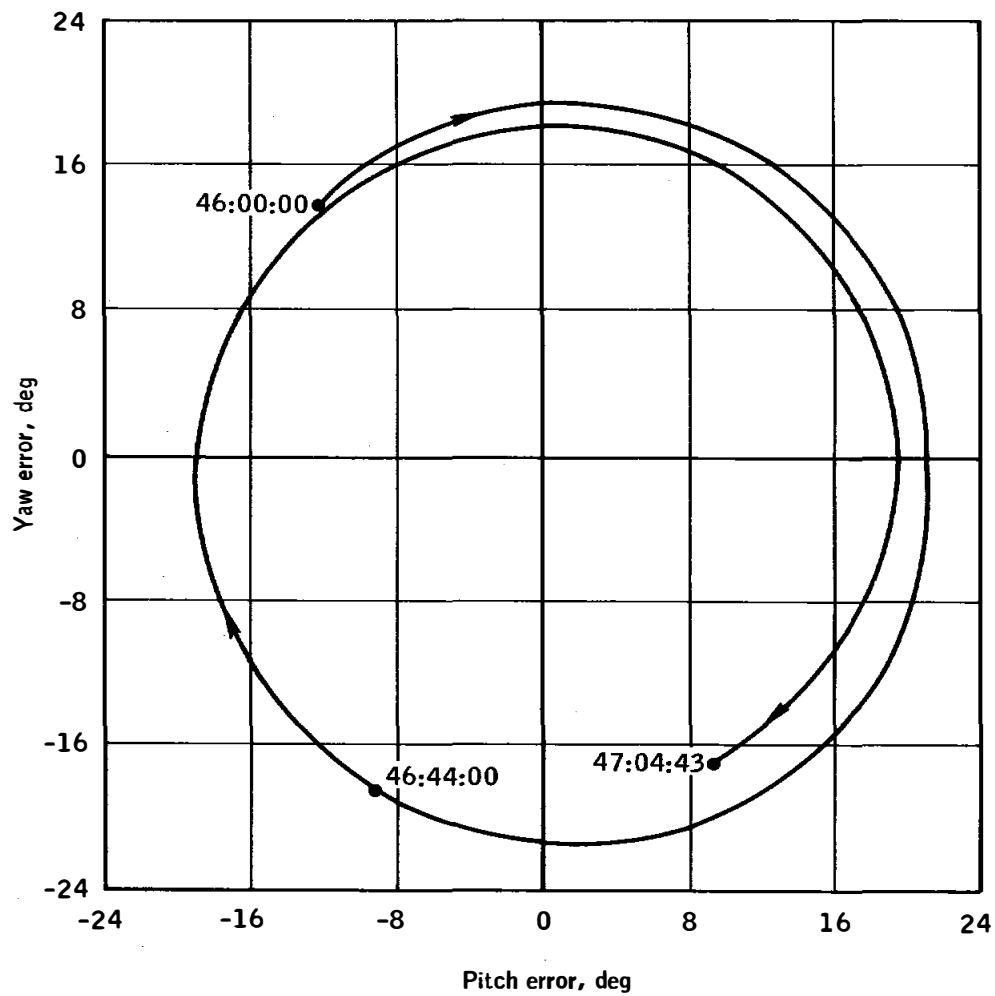

Figure 7.6-1. - Pitch and yaw errors during first passive thermal control period.

NASA-S-69-2679



(a) Translunar.

Figure 7.6-2.- Pitch and yaw errors during passive thermal control period with roll rate of 0.3 deg/sec.

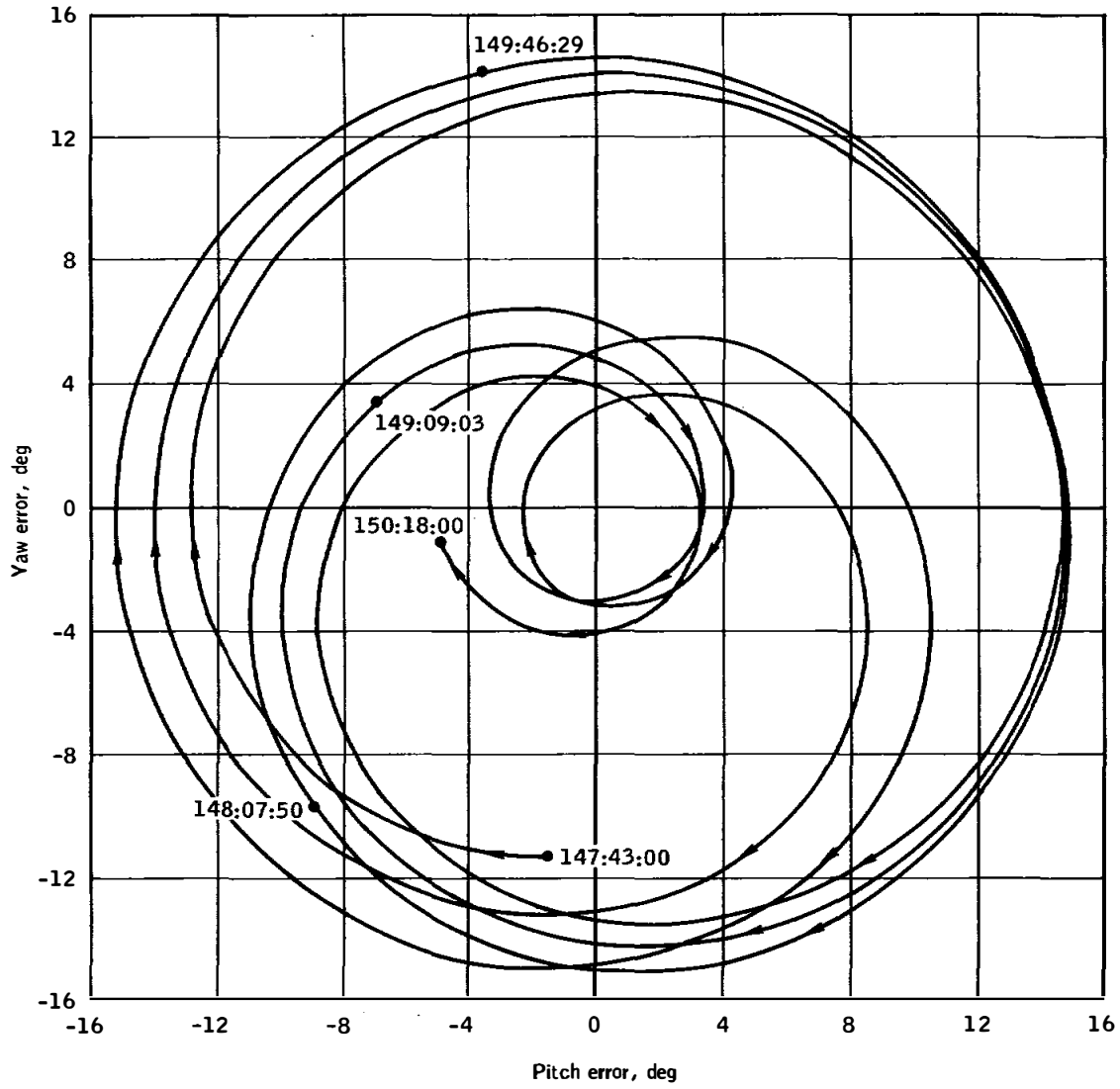

(b) Transearth.

Figure 7.6-2.- Concluded.

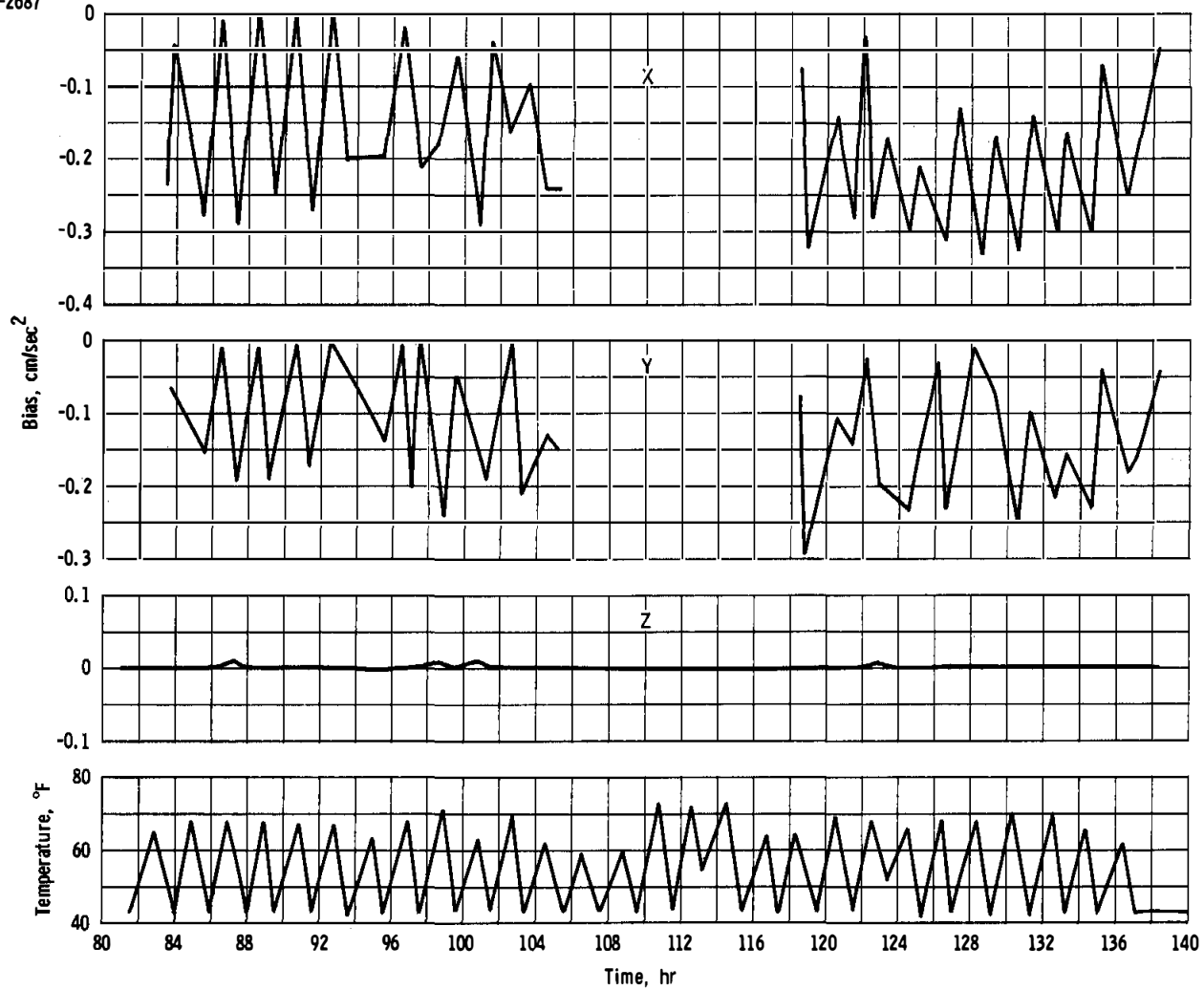

Figure 7.6-6. - Accelerometer bias compared with evaporator outlet temperature.

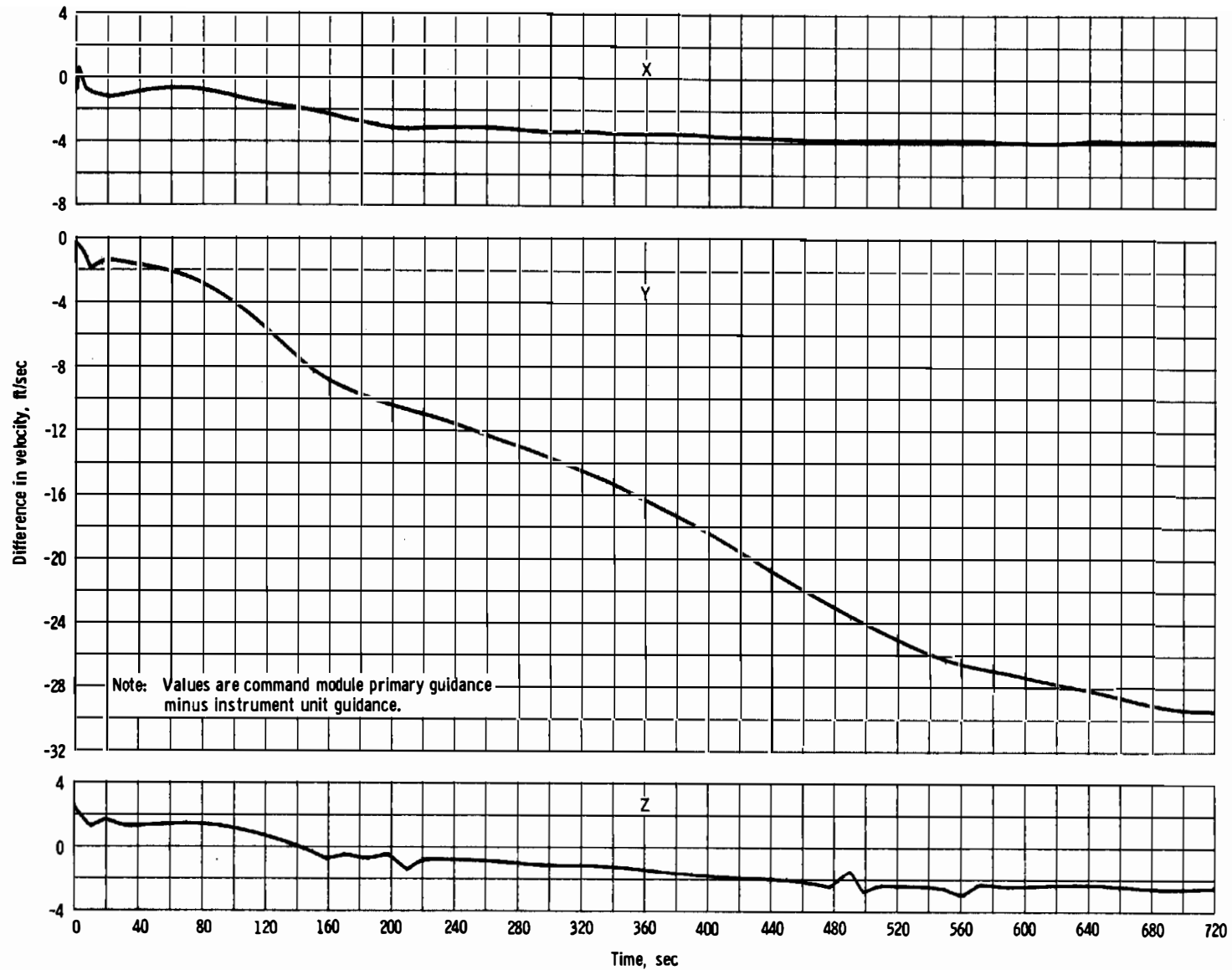

Figure 7.6-7. - Comparison of ascent velocity.

NASA-S-69-2689

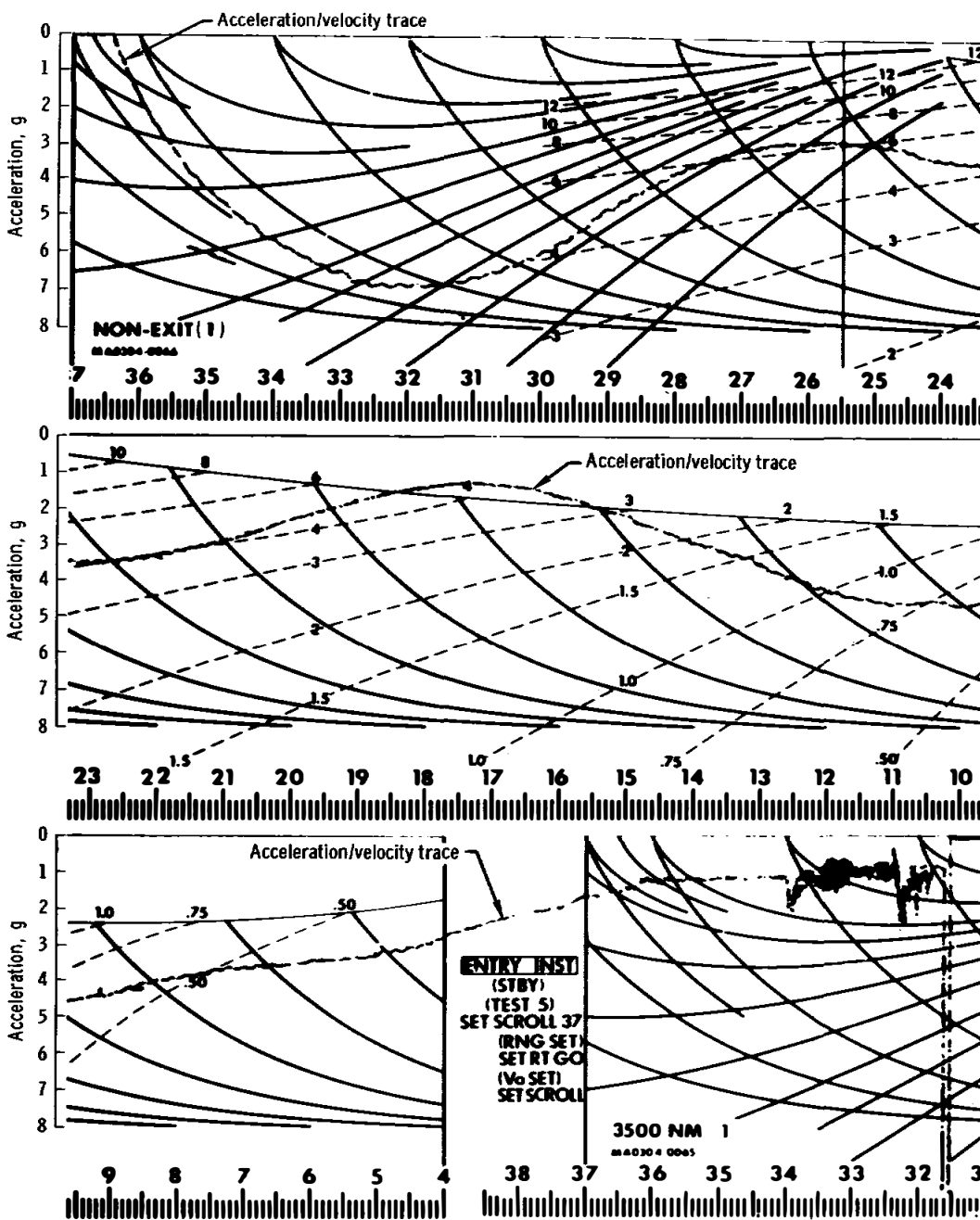

Figure 7.6-8. - Entry monitor system scroll.

7.7 REACTION CONTROL SYSTEMS

Performance of the service module reaction control system was nominal. The total propellant consumption, as shown in figure 7.7-1, was 580 pounds (282 pounds below the predicted usage); usage from each quad is shown in figure 7.7-2. During all phases, quad-package temperatures remained well below the maximum allowable. Two problems, discussed in greater detail in section 15, are summarized below.

The command module reaction control system operated as expected during entry. Prior to launch, the helium pressurization system for system 1 developed a small leak; the leak could not be located but caused the pressure in system 1 to decrease from 44 psia at launch to 30 psia at system activation just prior to entry. However, operation of the helium pressurization system after activation was not affected.

The isolation burst disc in the oxidizer supply of system 2 was inadvertently ruptured during prelaunch checkout. As a result, oxidizer filled the manifold between the burst disc and the engines after the propellant isolation valves were opened during the countdown. Because both the isolation and engine valves were redundant, as were the two systems, the decision was made to launch with the burst disc ruptured. After orbital insertion, the propellant isolation valves were closed, as planned; however, to preclude damage from thermal expansion of the oxidizer, the engine valves were opened to vent the oxidizer in the lines.

Approximately 1 minute after command module/service module separation, system 2 was disabled and system 1 was used for entry control as planned. Both manual and automatic control modes were used. As shown in figure 7.7-3, 38 pounds of propellant were consumed for attitude control during entry.

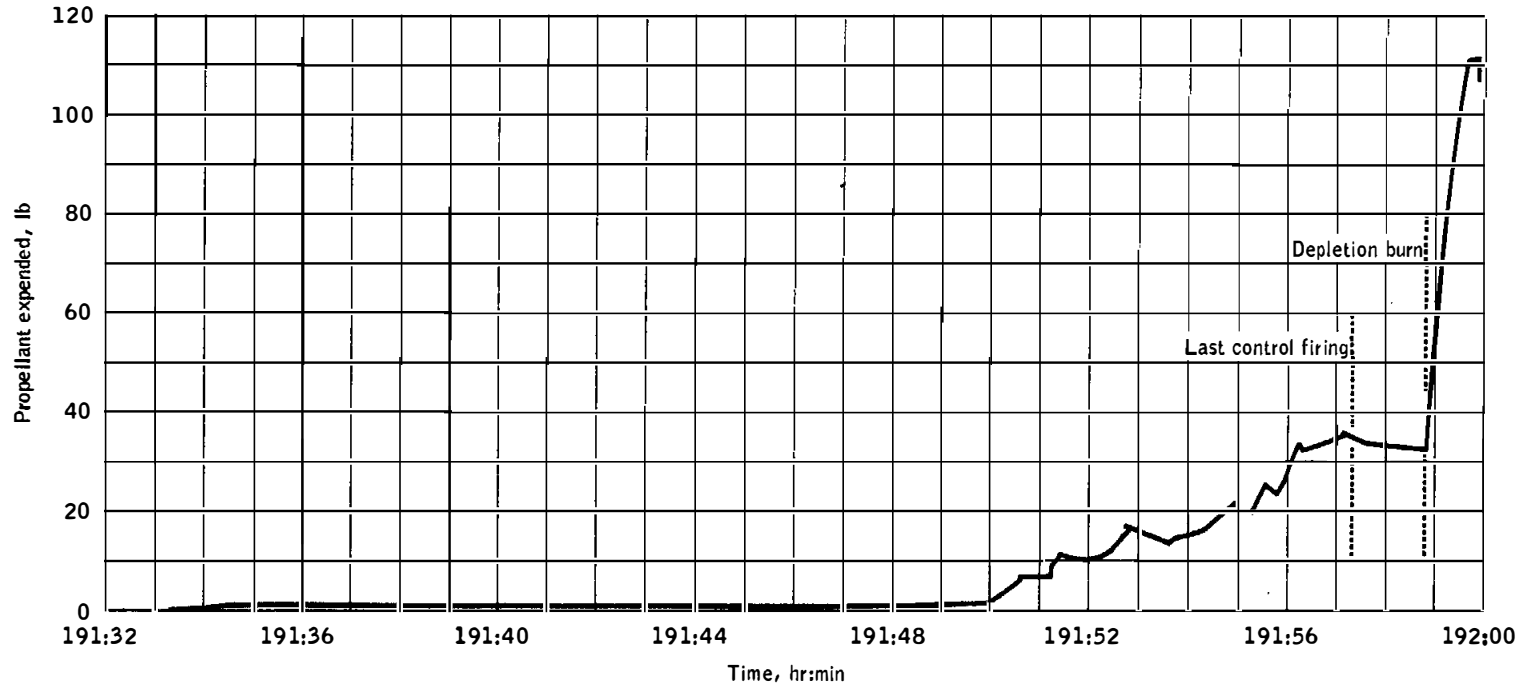

Figure 7.7-3.- Propellant consumption during entry.

7.8 SERVICE PROPULSION SYSTEM

Service propulsion system performance was satisfactory during each of the five maneuvers, with a total firing time of 545 seconds. The actual ignition times and firing durations are contained in table 6-III. The longest engine firing was the 356-second lunar orbit insertion maneuver. The fourth and fifth service propulsion maneuvers were preceded by a plus-X reaction control translation to effect propellant settling, and all firings were conducted under automatic control.

Engine transient performance during all starts and shutdowns was satisfactory, with no excessive chamber pressure overshoots on any maneuver. Steady-state pressures during each of the five firings were consistent with those of previous flights and confirm that performance was essentially nominal. However, gaging system data indicate a lower-than-expected mixture ratio.

The primary gaging system operated normally during propellant loading, but the auxiliary system did not. Eleven oxidizer and two fuel point-sensors either failed or displayed intermittent operation prior to launch. The propellant tanks were loaded to correspond with a mixture ratio of 1.6.

The mode selection switch for the propellant utilization and gaging system was set in the primary position for all service propulsion maneuvers. The propellant utilization valve was in the normal position for the first, second, and fourth engine firings. The third firing was initiated with the propellant utilization valve in the normal position, but during the firing, the crew made several valve position changes in an attempt to maintain the propellant unbalance within the desired 100-pound limit. The fifth firing was also initiated with the valve in the normal position, but after the 5-second ignition transient, the valve was placed in the increase position for the remainder of the firing to reduce the indicated unbalance.

Figure 7.8-1 shows the telemetered gaging quantities and telemetered unbalance that was indicated to the crew at selected times, and the approximate times at which the position of the propellant utilization valve was changed. The computed indicated unbalance shown in the figure essentially agrees with that reported by the crew. The telemetry data show that the unbalance indications prior to crossover were lower than the actual unbalance. First, the minus-0.4 percent adjustment bias in the oxidizer tank primary gage caused an increasing negative error in the tank reading as the oxidizer level approached zero. This zero adjustment bias was incorporated to prevent erroneous storage-tank readings after crossover, as was experienced during Apollo 9. At the bottom of the tank, the error would therefore be approximately 97 pounds. Secondly, the oxidizer level

exceeded the maximum gageable quantity in the sump tank because oxidizer was transferred from the storage tank to the sump tank as a result of helium absorption from sump tank ullage. These two effects together explain the indicated step in the unbalance at crossover because all oxidizer in the sump tank becomes gageable soon after crossover and the error from the storage tank is no longer present. The step at crossover was between 150 and 200 pounds (increase) and is expected to occur on future flights.

During the third firing, the indicated unbalance was slightly increasing after crossover, even with the propellant utilization valve in the increase position. When the valve was moved to the normal position for the last 24 seconds of the firing, the rate of increase in the unbalance became progressively greater. At the end of the firing, data show an unbalance of approximately 460 pounds on the increase side. After crossover, the telemetered indications for both storage tanks were zero, verifying that the zero-adjustment bias in the primary gage for the oxidizer storage tank achieved the desired results.

At the end of the fifth firing, the crew reported displayed quantity readings of 9.2 percent for oxidizer and 6.7 percent for fuel, with the unbalance meter off-scale (greater than 600 pounds) on the increase side. These values indicate that the unbalance continually increased from the end of the third firing, even though the valve was in the increase position for almost the full duration of the fifth firing.

Based on the telemetered gaging data and predicted effects of the propellant utilization valve positions, mixture ratios of about 1.52 for the normal valve position were derived, compared with an expected ratio of 1.58. The expected ratio was lower than for most engines to account for results from the actual engine acceptance test. Nonetheless, the flight mixture ratio was approximately 4-percent lower than the expected value at the normal position of the propellant utilization valve. The reason for the downward shift in mixture ratio is unexplained, but an analysis for the engine to be used on the next flight shows more than adequate margin with a shift of this magnitude. However, the propellant utilization valve operated normally and provided the expected mixture ratio changes as indicated by the changes in oxygen interface pressure and verified by computer simulations.

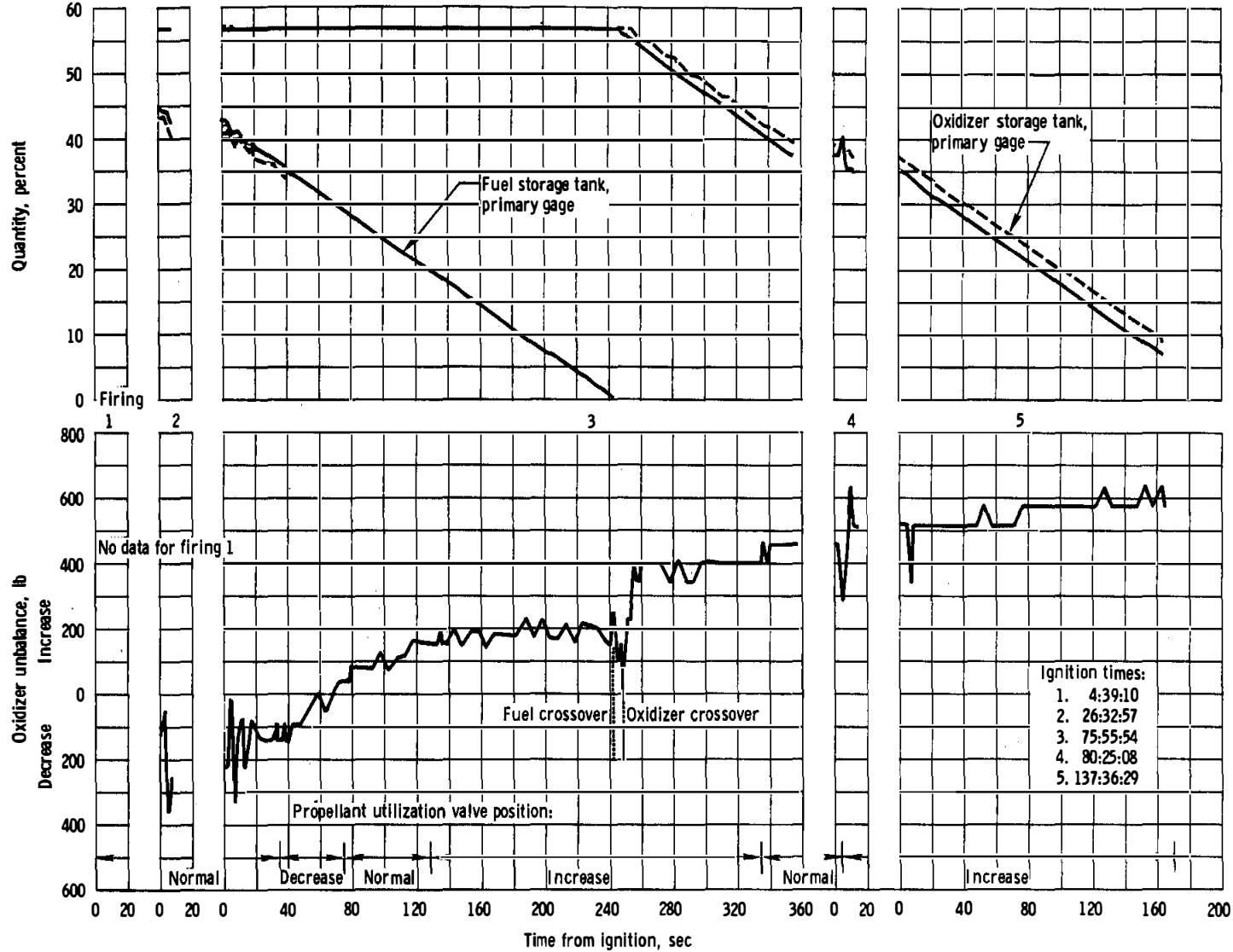

Figure 7.8-1. - Gaging system quantities and propellant unbalance.

7.9 ENVIRONMENTAL CONTROL SYSTEM

The environmental control system provided a habitable environment for the crew and adequate thermal control of the spacecraft equipment.

The performance of the oxygen distribution system was normal and was comparable to previous flights. As usual, the cabin fans were not used during the mission, and adequate oxygen circulation was achieved by selective placement of the suit hoses. After docking, the command module was pressurized to approximately 5.48 psia, and the pressure equalization valve between the command module and the lunar module was opened; afterward, the equalized cabin pressures stabilized at approximately 3.7 psia. The repressurization oxygen supply increased the combined cabin pressure to the operating level of 5.0 psia.

Prior to undocking, the tunnel vent valve failed to depressurize the tunnel. As a result, alternate procedures were established to perform the command module hatch integrity check: for the initial undocking, lunar module cabin pressure was decreased to 3.5 psia; for the final undocking, the command module cabin pressure was increased to 5.3 psia. Postflight inspection of the tunnel vent valve revealed that the valve port did not have the required vent holes. Section 15.1.16 has a detailed discussion of this anomaly.

Operation of the carbon dioxide sensor was erratic throughout the mission. Historically, the sensors have frequently operated improperly. The operation of the lithium hydroxide canisters in parallel and the overlapping changeout periods precludes any reliance on instrumentation.

During the launch countdown, servicing difficulty was experienced with the water-separator wicks in the suit heat exchanger. Gas penetrated the water/gas separation plate at a pressure below the specification value of 2.6 psi. Incomplete wetting of the wick during servicing will cause a premature breakthrough when pressure-tested. The water injection pressure was then increased from the normal 4 psi to 10 psi to achieve a gas breakthrough level within specification limits. The separator was tested and inspected postflight and found to be normal in all respects. The suit heat exchanger performed normally throughout the entire flight.

The primary evaporator began operation soon after lift-off but dried out after operating only a few minutes. The secondary coolant system was then activated and operated without difficulty until the primary radiators became operational. The primary evaporator was deactivated and was not reserviced or reactivated until just prior to lunar orbit insertion. It dried out again during the second lunar revolution and was not reactivated until just prior to entry. The failure to operate was caused by a micro-switch adjustment (see section 15.1.4).

During most of the translunar and transearth coasts, the spacecraft was maintained in a passive thermal control mode, and the primary radiators provided excellent spacecraft cooling. During lunar orbit coast, the primary radiators provided all spacecraft cooling, except for the brief period when the primary evaporator was operating. The maximum radiator outlet temperature during each revolution ranged between 61° and 75° F. This caused the peak suit inlet and water/glycol inlet temperatures for the electronic-equipment cold-plate network to increase approximately 18° F above normal for brief periods but caused no crew discomfort. Typical coolant system operation during lunar orbit is shown in figure 7.9-1.

The potable water tank was serviced with water prior to lift-off to provide a maximum amount of hydrogen-free water. However, the crew found that there was too much gas in the preflight-loaded water (see section 15.1.14).

During one chlorine injection, chlorine solution leaked from the fitting and the buffer ampule would not back-fill with water when the plunger was unscrewed. The flight ampules, used and unused, were examined for defects, and no anomalous conditions were found. The problem was probably caused by a procedural error; the needle may not have been fully inserted into the rubber gland and therefore would not penetrate into the water. This could account for both the leakage of the chlorine and the failure to obtain water in the buffer ampule.

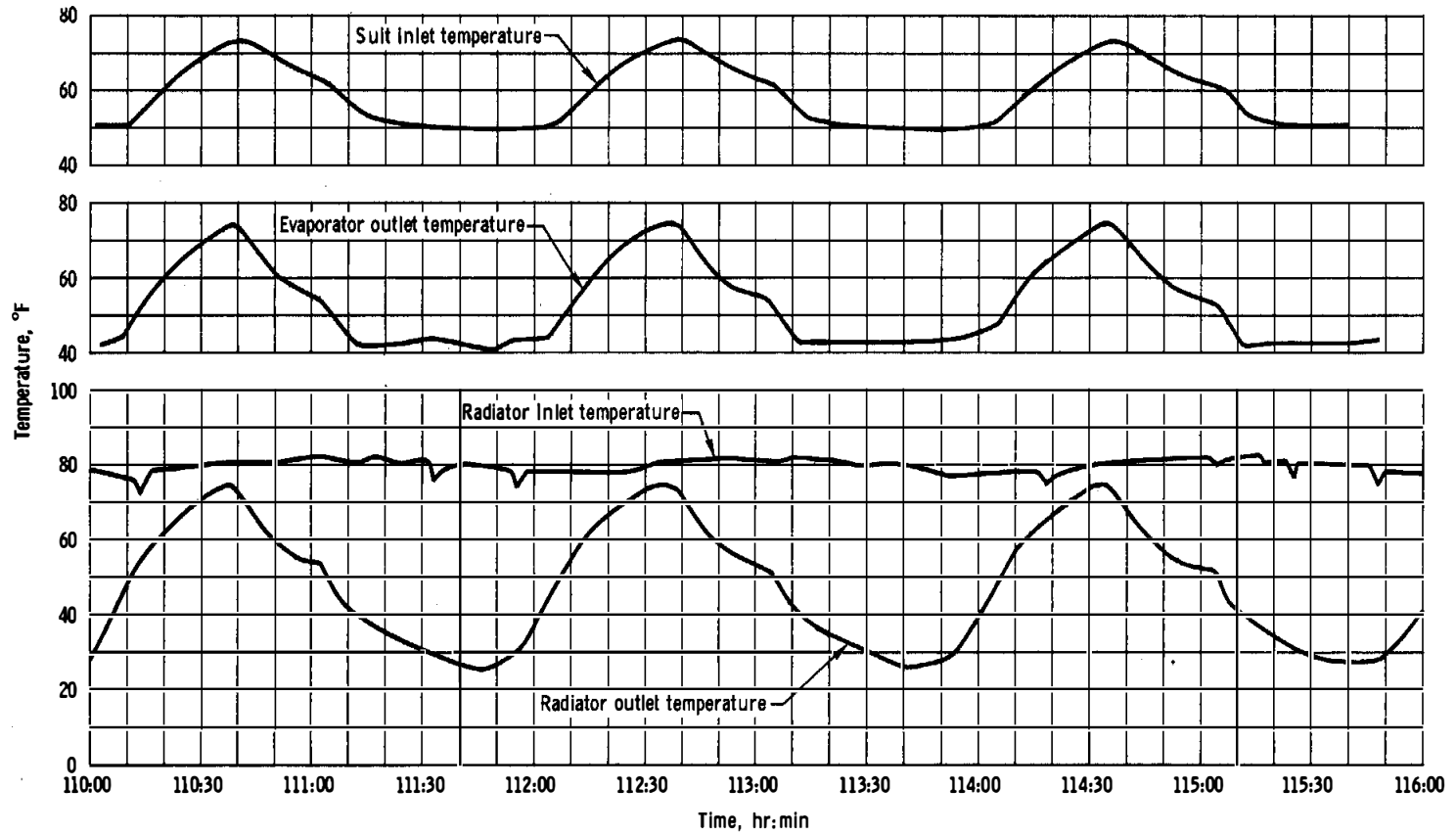

Figure 7.9-1. - Typical primary coolant loop parameters during lunar orbit.

7.10 CREW STATION

The crew provisions, displays, and controls at the crew station operated satisfactorily for the mission.

A major point made by the crew was that the Velcro had insufficient holding power. Testing indicates that the holding capability of the new low flammability Velcro compares favorably with the all-nylon type used in the Gemini spacecraft. The reported problem apparently resulted from the small contact areas, in some cases 1/2-inch square, making proper alignment and maximum contact difficult.

The crew also commented on the lack of accessible stowage space for near-simultaneous operations using many different crew items. As a corrective measure, springs with snaps on each end will provide more ready-access stowage. These springs will act as a bungee-type hold-down and will attach to snaps already in the spacecraft.

The crew stated that the cushion inserts used to protect cameras and other fragile equipment were very bulky and wasted space which could be put to a better use. An evaluation of these cushions has been made. Some minor areas (e.g., penlights) were found where the cushions could be reduced or eliminated. Action is in progress to resolve the effectivity of these changes to subsequent spacecraft.

The following anomalies were noted:

- a. A two-compartment bag with inlet and outlet valves was provided to separate objectionable gas from the drinking water. The separation was accomplished by spinning the bag; however, the bag did not function as intended (section 15.1.14).
- b. The couch strut brace, which is normally stowed for launch, was inadvertently left in the unstowed position and connected to the couch. With the strut in place, the couch cannot stroke properly at landing (section 15.1.6).
- c. Water pressure from the drinking water dispenser appeared to be less than normal for a short period during the seventh day of the mission (section 15.1.15).
- d. The 16-mm sequence camera operated intermittently near the end of the mission (section 15.3.3).

The forward hatch stowage bag was not used during the mission. As a result of comments by the Apollo 9 crew, the bag had been redesigned

to allow easier stowage. However, the need for the bag on future spacecraft is being evaluated.

The displays and controls were satisfactory, except for the following discrepancies. The launch vehicle engine warning annunciator operated intermittently during prelaunch testing of the engine indicators (section 15.1.18). The digital event timer jumped 2 minutes during preparations for the first midcourse correction. The same timer also jumped in increments of 10 seconds at other times in the flight (section 15.1.19).

All caution-and-warning master alarms noted during the flight have been correlated with out-of-limit system performance, except for one without an annunciator indication and one during entry. Although these two alarms are unexplained, they are of no significance because other data indicate satisfactory system performance.

During prelaunch operations in the altitude chamber, three caution and warning master alarms occurred without the accompanying annunciator indications. One alarm was associated with docking simulator contact and the others with accelerations in the tunnel area; none could be repeated outside the altitude chamber. No anomalous conditions were found at the time of the alarms. Additionally, no master alarms occurred during the docking operations during the mission.

An additional repeatable master alarm occurred during prelaunch operations when the fuel cell switch was rotated to the fuel cell 1 position. The oxygen flow measurement, which provides an input to the fuel cell 1 caution and warning channel, was indicating zero flow on both the telemetry and the cabin meter. The oxygen flow input to the caution and warning comparator could cause a master alarm if the input to the comparator could cause a master alarm if the input to the comparator was between minus 5 millivolts and plus 10 millivolts. In switching to the fuel cell 1 position, the meter impedance was introduced to the oxygen flow transducer; the impedance load on the transducer in turn tripped the master alarm.

7.11 CONSUMABLES

The usage of all liquid consumables, including cryogenics, is summarized in this section. Electrical power consumption is discussed in section 7.2.

7.11.1 Service Propulsion System Propellants

The quantities of service propulsion propellant loaded and consumed are shown below. The loadings were calculated from gaging system readings and measured densities prior to lift-off.

	<u>Fuel, lb</u>	<u>Oxidizer, lb</u>
Loaded		
In tanks	15 630	24 973
In lines	<u>79</u>	<u>124</u>
	15 709	25 097
Consumed	14 309	22 234
Remaining at separation	1 400	2 863

7.11.2 Reaction Control System Propellants

Service module.- The propellant utilization and loading data for the service module reaction control system are presented below. Consumption was calculated from telemetered helium tank pressures using the relationships between pressure, volume, and temperature.

	<u>Fuel, lb</u>	<u>Oxidizer, lb</u>
Loaded		
Quad A	109.9	226.9
Quad B	109.4	224.9
Quad C	109.4	225.7
Quad D	<u>109.4</u>	<u>225.3</u>
Total	438.1	902.8
Consumed	207.1	372.8
Remaining at separation	231.0	530.0

Command module.- The propellant loading and utilization data for the command module reaction control system are tabulated below. Consumption was calculated from pressure, volume, and temperature relationships.

	<u>Fuel, lb</u>	<u>Oxidizer, lb</u>
Loaded		
System A	43.9	78.3
System B	<u>44.1</u>	<u>78.2</u>
	88.0	156.5
Consumed		
System A	11.6	20.5
System B	<u>0</u>	<u>0</u>
Remaining at parachute deploy		
System A	32.3	57.8
System B	<u>44.1</u>	<u>78.2</u>
	76.4	136.0

7.11.3 Cryogenics

The cryogenic hydrogen and oxygen quantities loaded at lift-off and consumed during the mission are given in the following table. Consumption values are based on the electrical power produced by the fuel cells.

	<u>Hydrogen, lb</u>	<u>Oxygen, lb</u>
Loaded		
Tank 1	27.8	312.5
Tank 2	<u>27.3</u>	<u>316.5</u>
	55.1	629.0
Consumed		
Tank 1	20.0	174.0
Tank 2	<u>18.8</u>	<u>172.9</u>
	38.8	346.9

Remaining at separation

Tank 1	7.8	138.5
Tank 2	<u>8.5</u>	<u>143.6</u>
	16.3	282.1

7.11.4 Water

The water quantities loaded, consumed, produced, and expelled during the mission are summarized in the following table.

	<u>Quantity, lb</u>
Loaded	
Potable water tank	37
Waste water tank	18
Produced inflight	
Fuel cells	316
Lithium hydroxide, metabolic	42
Dumped overboard (including urine)	318
Evaporated	5
Remaining postflight	
Potable water tank	37
Waste water tank	53

8.0 LUNAR MODULE PERFORMANCE

This section is a discussion of lunar module systems performance. The more significant problems encountered are described in this section and are discussed in detail in section 15.2.

8.1 STRUCTURAL AND MECHANICAL SYSTEMS

8.1.1 Structural Loads

No structural instrumentation was installed on the lunar module; consequently, the structural performance evaluation is based on lunar module guidance and control and cabin pressure data, on command module acceleration data, and on analytical results.

Lunar module loads during boost were inferred from command module accelerations to have been within structural limits. During S-IC shut-down on Apollo 9, interference was detected between the descent stage aft oxidizer tank and the descent stage upper deck without any effect on system operation. The validity of an analysis which predicted less tank response for Apollo 10 was substantiated by good agreement between the predicted and measured command module accelerations (see fig. 7.1-1) and normal operation of systems.

Loads at docking, as discussed in section 7.1.1, were well within structural limits.

The command module linear accelerometers and lunar module guidance and control rate data and lunar module cabin pressure data indicate that structural performance was nominal prior to ascent stage jettison. During the ascent stage jettison the lunar module cabin pressure decayed abruptly (see section 15.2.12).

8.2 THERMAL CONTROL

The passive and active thermal control systems performed nominally, and no thermal problems were evident during the mission. The lunar module insulation performed satisfactorily, as evidenced by a total change in bulk propellant temperature of 3° F for the entire mission. Rendezvous and landing radar temperatures remained within predicted limits.

The paint on the lunar module skin outboard of the right front window blistered. This surface had been painted with black Pyromark paint for glare reduction, not thermal control. For the Apollo 10 lunar module, the Pyromark was painted over silicon oxide, which does not provide a proper bond. For subsequent lunar modules, the black Pyromark is applied directly to the anodized aluminum, which will provide a good bond.

8.3 ELECTRICAL POWER

The power distribution system performed nominally during the mission.

The voltages on both dc buses were maintained above 29 volts with maximum total loads of 84 amperes. The ac bus voltages were maintained between 116 and 118 volts at 400 hertz.

The descent, ascent, and pyrotechnic batteries performed satisfactorily. At staging, the descent batteries had supplied 440 A-h of a nominal total capacity of 1600 A-h. The difference in load-sharing at staging was 12 A-h on batteries 1 and 2 and 16 A-h on batteries 3 and 4. On Apollo 9, these differences, at the same discharge level, were 18 and 28 A-h, respectively. A capacity history is shown in figure 8.3-1.

At the completion of the ascent propulsion firing to depletion, the two ascent batteries had delivered a total of approximately 318 A-h; the rated capacity was 296 A-h per battery at 28 volts. After the firing, the ascent batteries were allowed to deplete with the two dc buses tied together. The battery voltages remained above 28 volts until battery 5 had delivered 346 A-h and battery 6 had delivered 330 A-h.

NASA-S-69-2695

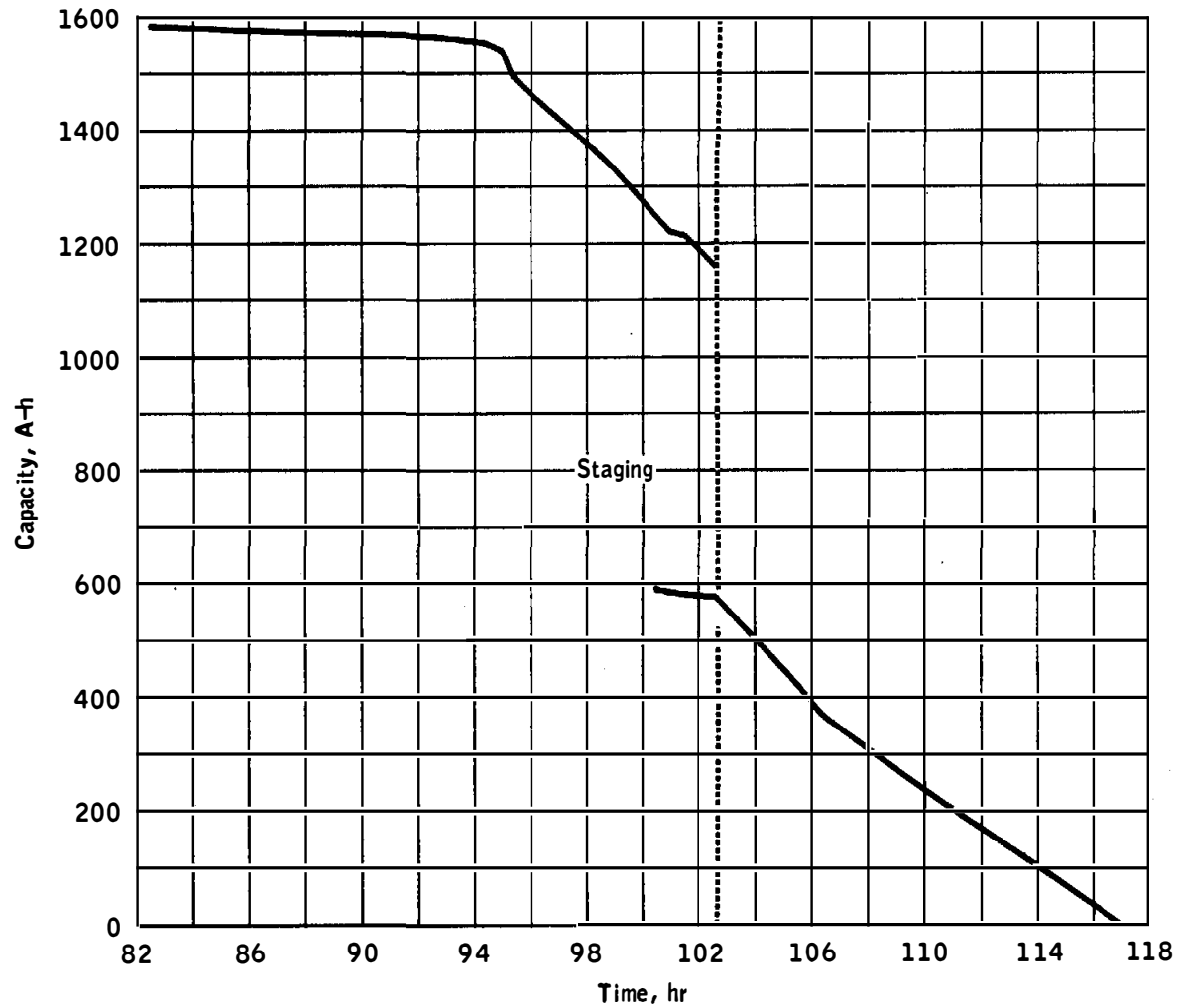

Figure 8.3-1.- Battery capacity remaining.

8.4 COMMUNICATIONS EQUIPMENT

Operation of the communication equipment was nominal, except as briefly discussed in the following paragraphs. All tests were successfully completed except the relay tests, which were deleted because of time limitations, and the steerable antenna tracking test during the roll-over maneuver, which was not performed because of antenna operational problems at the time.

During the beginning of lunar orbit revolution 13, the S-band steerable antenna did not track properly. Ground station data indicate the antenna was at a fixed position, and changes in vehicle attitude were causing a gradual drop in signal level. The cause, verified by the crew, was that the antenna mode switch was changed from SLEW (manual) to OFF instead of to AUTO (see section 15.2.4).

During revolution 13, the S-band backup voice on the omnidirectional antenna was marginal at the Mission Control Center. This problem has been isolated to the Network (see section 15.2.3).

Transmission from the lunar module to the command module on simplex-A was not obtained during two periods of revolution 10. The first was at 94 hours 46 minutes, when the Lunar Module Pilot had returned to the command module. At the time, the circuit breaker which supplies voltage for transmitter A was open, and the link could not be used. Use of simplex-A was unsuccessfully attempted a second time at about 95 hours. Numerous configuration changes were being made in both vehicles, and the two vehicles were probably not configured simultaneously for VHF A communications (see section 15.1.5).

A short interval of lunar module dump data was received from 99:35:10 to 99:38:52, then modulation of the carrier, as recorded at various ground stations, ceased abruptly (see section 15.29).

8.5 INSTRUMENTATION

The operational instrumentation system monitored 139 analog and digital measurements and 130 bilevel events. The performance was satisfactory except as discussed in the following paragraphs.

The indicated fuel manifold pressure in reaction control system A was low after launch and decreased to zero during the ascent engine firing to depletion. The system operated properly; therefore, the transducer first shifted negative, then failed completely. The transducer measuring oxidizer manifold pressure in system B also shifted negatively after launch.

The temperature on the radioisotope thermal generator cask read "upper level" during the flight. Before launch, the reading was correct. At 10 000 feet, this measurement is switched from a transducer on the cask to one behind an adjacent heat shield. Either the barometric switch or an open circuit in the transducer wiring are considered the probable sources of failure.

The ullage pressure for the descent oxidizer tank read zero on the cabin display prior to the descent engine firing. A redundant measurement was normal, and another measurement using the same display meter also was normal. The probable cause of failure was the transducer or the 26-gage wire between the transducer and the display.

The indicated temperature in the primary coolant loop was zero during the first manning, when pump 2 was used. During the second manning, pump 1 in the primary loop was used and the measurement was normal. The temperature measurement is connected through the pump selection switch, with a jumper wire between the pump 1 and pump 2 contacts; thus, the measurement is routed to the display meter regardless of which pump is selected. Since the measurement read correctly in one position and not the other, a broken jumper wire is the probable cause of failure.

Five thrust chamber pressure switches in the reaction control system either failed or were intermittent. System operation was not affected.

All of the above instrumentation anomalies are discussed in additional detail in Section 15.2.11.

8.6 LUNAR MODULE GUIDANCE AND CONTROL

The performance of the guidance and control systems was excellent. Power-up, initialization, and alignment of the primary and abort guidance systems were accomplished as planned except that the scheduled inflight calibration of the abort guidance system was omitted. Following undocking, the inertial measurement unit was aligned three times and the abort guidance system was frequently aligned to the primary system.

Guidance and control of all ascent and descent engine firings was nominal. A gimbal drive actuator alarm occurred during the phasing maneuver; however, the data indicate normal operation. The suspected cause is motion with no drive command present (see section 15.2.1). The ascent propulsion firing to depletion was controlled by the abort guidance system.

All attitude control operations were nominal, including those during the staging maneuver when the vehicle rotated to an attitude which pointed the Z-axis toward the command module. The yaw rate gyro output during this period was incorrect (see section 15.2.10).

8.6.1 Mission Related Performance

The guidance and control systems were powered up prior to undocking. During loading of the primary system erasable memory, the abort system time initialization constant had to be reloaded to correct a load. Transfers of the state vector from the primary to the abort guidance were accurately accomplished (table 8.6-I).

The initial alignment of the primary system was nominal, as indicated by the command module platform gimbal angles. However, a subsequent gimbal angle comparison indicated a shift of approximately 3.5 degrees about the X-axis. This shift was at the docking interface, apparently in response to command module roll thruster firings. Three optical alignments were performed after undocking (table 8.6-II), and the small gyro torquing angles from the first alignment indicate that the docked alignment was accurate to well within the reported 3.5-degree shift. The gyro torquing angles obtained from the second and third alignments indicate either an alignment error or a larger than expected shift in the X-axis gyro drift.

The abort system alignment accuracies were within the specified computational transfer error of 0.067 degree (table 8.6-III). Before and after undocking, the rendezvous parameter display calculations from both the primary system and the abort system were used to check for state vector and alignment agreement between the two systems. This display is

used during rendezvous to determine the elevation angle of the command module with respect to the lunar module local horizontal, assuming the Z-axis is pointing at the command module. When the comparison was made, differences of up to 36 degrees were noted, but they disappeared after undocking. The angle calculated by the primary system is the angle between the spacecraft Z-axis and the local horizontal plane. The angle calculated by the abort system is the angle between the Z-axis and the intersection of the local horizontal and orbital planes. The two angles are equivalent and comparable only when the Z-axis is in the orbital plane (zero yaw angle). The apparent dependence on docking occurred because the Z-axis normally is rotated into the orbital plane after undocking.

All attitude control operations were nominal even during the attitude gyrations at staging. The crew remarked on the great amount of control authority available in the lightweight ascent stage configuration; however, operation was as expected.

Pertinent information from each of the translation maneuvers is summarized in table 8.6-IV. Spacecraft dynamics during the phasing maneuver are shown in figure 8.6-1; although a gimbal drive actuator alarm occurred 14 seconds after ignition, the behavior of the actuators was nominal. If the gimbal trim had been incorrect, the thruster duty cycle would have been much higher. Figure 8.6-2 shows velocity-to-be-gained during this maneuver and also indicates nominal performance.

Figures 8.6-3 and 8.6-4 present the time histories for the insertion maneuver, which was inadvertently performed in a 0.3-degree rather than the intended 1.0-degree deadband. Despite this, the maneuver results were nominal. Figure 8.6-5 presents gimbal angles for this maneuver. Although the crew remarked on the apparent "wallowing" tendency, the performance was as expected.

Figures 8.6-6 and 8.6-7 present the ascent firing-to-depletion histories. The variation in the thruster duty cycle was caused by movement of the center of gravity toward the thrust vector.

8.6.2 Primary System Performance

The preflight test history of the inertial components is summarized in table 8.6-V. The inflight accelerometer bias measurements are summarized in figure 8.6-8. The accelerometers exhibited excellent stability.

The alignment optical telescope operated properly throughout the mission. Although the crew reported several operational problems with this unit (see section 15.2.5), their ability to perform alignments was not affected.

Performance of the lunar module guidance computer was nominal. The interfaces between the computer and the rendezvous and landing radar systems were demonstrated to be operational, although some procedural problems were experienced.

The initial computer readout of range rate from the rendezvous radar consisted of random and very large values. The result was that the state vector update loaded into the computer erasable memory exceeded the allowable limits. The excessive update parameters were displayed to the crew by a flashing "Verb 06 Noun 49" on the display and keyboard unit. The crew discarded the data by entering "Verb 32 Enter" on the keyboard unit; this entry causes the rendezvous radar data READ routine to recycle.

The large initial range-rate value is the correct response from the hardware/software/procedural interface used on this vehicle. The rendezvous radar output shift register is not reset to zero when the radar is powered up, and the initial bit configuration is unpredictable; however, the design of the register is such that it is predominantly loaded with ones at activation. This initial bit configuration is then shifted to the computer as range rate when the first readout command is sent to the rendezvous radar. Subsequently, the rendezvous radar output register is cleared, and valid range data are inserted for transfer to the computer. The second readout command will shift valid range data to the computer; consequently, the radar data associated with the first "mark" will consist of valid range and invalid range rate information. This condition did not occur during the Apollo 9 mission because different software and procedures were used. The problem has been corrected procedurally for Apollo 11.

The landing radar spurious return test, which was to be conducted during the descent phasing maneuver, produced no telemetry data because of an improper keyboard entry. The test routine (R77) had been properly selected (Verb 78 Enter) prior to the near-lunar surface activities; as a result, the landing radar beam velocities had been placed in the computer downlist. A request for out-of-plane rendezvous display (Verb 90 Enter) was entered on the keyboard after the low-level pass. This entry improperly terminated the R77 routine and removed valid landing radar data from the downlist. In order to reenter the R77 routine after an improper exit, the operator must make a keyboard entry of "Verb 79 Enter," followed by the normal Verb 78 sequence. However, this entry was not made and valid data were not obtained for the test routine.

A procedural problem resulted in an attitude deadband of 0.3 degree for the insertion maneuver rather than the 1-degree deadband normally used by the digital autopilot. The smaller deadband resulted because of a unique feature in the Luminary program. Although the thrusting programs establish a 1-degree deadband, if the autopilot configuration is

requested for observation after a thrusting program is entered, one of the two selectable deadbands will be chosen. The crew options are 5 degrees and 0.3 degree, and the smaller deadband had been selected before the insertion maneuver. The telemetry data indicate that the digital autopilot configuration was called for observation after the P42 thrusting program was entered; hence, the 0.3-degree deadband was used for the maneuver. The program will be corrected for subsequent missions.

The computer demonstrated the ability to accept ground updates, perform abort system initializations and alignments, control the rendezvous and landing radar, align the inertial subsystem, control firings, and provide rendezvous targeting as will be required for a lunar mission. The programs utilized by the computer during the mission are listed in table 8.6-VI.

8.6.3 Abort Guidance System

Performance of the abort sensor assembly was nominal. A summary of the pre-installation calibration data is shown in table 8.6-VII. An in-flight calibration was planned prior to undocking during the twelfth lunar revolution but was not completed because of a timeline constraint. The accelerometer bias was estimated from the accumulation of accelerometer counts during coasting flight (table 8.6-VIII). The relative gyro drift was estimated from a comparison of attitudes of the abort and primary guidance systems during coasting flight (table 8.6-VIII). Sensor performance was as expected, and successive inflight measurement results indicated good sensor stability. Close agreement existed between the velocity-to-be-gained residuals from the abort and primary guidance systems. A comparison of the change-in-velocity residuals for five firings are shown in table 8.6-IX.

The abort electronics assembly, using Flight Program 5, successfully performed all functions required for the mission. The performance of the data entry and display assembly was nominal.

8.6.4 Control Electronics

The control electronics section was used by the primary and abort guidance systems to provide attitude and translation control of the spacecraft. The performance level of the control electronics section permitted satisfactory completion of all required mission functions, including the staging activities. Two anomalies were associated with the system: (1) a gimbal drive actuator fail indication occurred during the phasing maneuver, and (2) the yaw rate gyro output was offset prior to staging. A more detailed discussion of these anomalies is contained in section 15.

TABLE 8.6-I.- INITIALIZATION COMPARISON

Initialization completion time, hr:min:sec	Primary to abort guidance update accuracy*	
	Position, ft	Velocity, ft/sec
96:57:11	1547	1.4
97:06:08	1397	0.8
97:09:29	1072	1.0
97:17:13	513	0.2
104:36:02	395	0.5
104:58:58	341	0.8
107:14:03	859	0.0

*Obtained from vector magnitude differences,
downlink station tapes.

TABLE 8.6-II.- PLATFORM ALIGNMENT SUMMARY

Time, hr:min	Star used	Gyro torquing angle, deg			Star angle difference, deg	Gyro drift, mERU		
		X	Y	Z		X	Y	Z
99:20	33 Antares; 25 Acrux	-0.668	-0.195	-0.055	00009			
101:30	25 Acrux; 33 Antares	-0.169	+0.050	+0.066	00002	+5.1	-1.5	+1.9
103:	40 Altair; 33 Antares	+0.311	+0.121	+0.081	00004	-13.8	-5.4	+3.6

TABLE 8.6-III.- GUIDANCE SYSTEM ALIGNMENT COMPARISONS

Alignment completion time, hr:min:sec	Primary guidance minus abort guidance, deg*
1. 97:00:28	<0.03
2. 97:03:20	<0.06
3. 97:29:18	<0.05
4. 98:57:58	<0.03
5. 100:52:25	<0.06
6. 102:48:18	<0.03
7. 103:27:	<0.06
8. 104:36:12	<0.05
9. 105:09:45	<0.04
10. 107:14:55	<0.04**

*Not corrected for timing differences.

**Six minutes after alignment.

TABLE 8.6-IV.- MANEUVER SUMMARY

Parameter	Maneuver					
	Descent orbit insertion	Phasing	Ascent orbit insertion	Constant differential height	Terminal phase initiation	Ascent engine firing to depletion
	PGNCS-DPS	PGNCS-DPS	PGNCS-APS	PGNCS-RCS	PGNCS-RCS	AGS-APS
Time						
Ignition, hr:min:sec	99:46:01.6	100:58:25.93	102:55:02.13	104:43:53.28	105:22:55.58	108:52:06
Cutoff, hr:min:sec	99:46:29.0	100:59:05.88	102:55:17.68	104:43:54.93	105:23:12.08	108:56:14
Duration, sec	27.4	39.95	15.55	1.65	16.5	248.9
Velocity change, ft/sec (actual/desired)						
X		97.4/97.5	-181.5/-181.2	+2.6/+2.6	26.1/24.1	-2292.7/-2686
Y		134.0/135.6	-117.2/-115.7	0.0/0.0	0.0/-0.2	-2839.8/-3432
Z		56.9/58.1	-51.8/-51.1	+0.1/+0.1	+1.0/0.0	-1187.4/-1474
Residual after trimming, ft/sec						
X		+0.2	0.0	+0.1	+0.1	
Y		-0.5	+0.1	0.0	-0.2	
Z		-0.9	-1.3	-0.1	+0.1	
Gimbal drive actuator position, deg						
Initial						
Pitch		-0.71				
Roll		+0.12				
Maximum excursion						
Pitch		+0.92				
Roll		+0.86				
Steady-state						
Pitch		-0.69				
Roll		+0.23				
Cutoff						
Pitch		-0.74				
Roll		+0.21				
Maximum rate excursion, deg/sec						
Pitch		-0.79				
Roll		-0.89				
Yaw		0.10				
Maximum attitude excursion, deg						
Pitch		-3.29				
Roll		-3.31				
Yaw		+0.84				

NOTE: No other data are available for these maneuvers and none are available for the coelliptic sequence initiation maneuver.
DEFINITIONS: PGNCS - Primary guidance, navigation, and control system; DPS - Descent propulsion system; APS - Ascent propulsion system;
AGS - Abort guidance system.

TABLE 8.6-V.- INERTIAL COMPONENT PREFLIGHT HISTORY - LUNAR MODULE

Error	Sample mean	Standard deviation	No. of samples	Countdown value	Flight load
Accelerometers					
X - Scale factor error, ppm	-378.6	26.801	5	-368	-430
Bias, cm/sec ²	-0.395	0.047	5	-0.42	-0.41
Y - Scale factor error, ppm	-714.4	77.354	5	-780	-840
Bias, cm/sec ²	0.173	0.091	2	0.12	0.18
Z - Scale factor error, ppm	-405.2	62.523	5	-486	-530
Bias, cm/sec ²	-0.013	0.028	5	0.04	-0.03
Gyroscopes					
X - Null bias drift, mERU	-3.4	1.681	15	-3.5	-3.2
Acceleration drift, spin reference axis, mERU/g	5.6	2.095	7	2.9	5.0
Acceleration drift, input axis, mERU/g	7.2	12.381	11	-0.2	1.0
Y - Null bias drift, mERU	1.1	0.794	7	0.86	1.5
Acceleration drift, spin reference axis, mERU/g	0.5	3.710	5	1.16	2.0
Acceleration drift, input axis, mERU/g	18.6	3.587	5	21.0	20.0
Z - Null bias drift, mERU	0.2	1.064	7	-0.82	-1.2
Acceleration drift, spin reference axis, mERU/g	-0.1	1.882	5	-1.04	-1.0
Acceleration drift, input axis, mERU/g	-22.8	+0.874	5	26.1	-24.0

TABLE 8.6-VI.- PROGRAMS USED

No.	Description
P00	Lunar module idling
P06	Computer power down
P20	Rendezvous navigation
P22	Lunar surface navigation
P27	Computer update
P30	External velocity change
P32	Coelliptic sequence initiation
P33	Constant differential height
P34	Terminal phase initiation
P35	Terminal phase midcourse
P40	Descent propulsion system thrusting
P41	Reaction control system thrusting
P42	Ascent propulsion system thrusting
P47	Thrust monitor
P52	Platform realignment

TABLE 8.6-VII.- SUMMARY OF ABORT GUIDANCE SECTION PREINSTALLATION CALIBRATION DATA

Accelerometer bias	Sample mean, μg	Standard deviation, μg	Sample size	Final calibration value, μg	Flight compensation value*, μg
X	41	17	21	59	98
Y	-90	17	21	-107	-119
Z	66	49	21	17	24

Accelerometer scale factor	Time constant, days	Standard deviation, ppm	Sample size	Final calibration value, ppm	Flight compensation value, ppm
X	76.7	16.3	12	-520	-521
Y	58.2	19.5	12	-606	-606
Z	78.6	14.6	12	-530	-530

Gyro scale factor	Sample mean, ppm	Standard deviation, ppm	Sample size	Final calibration value, ppm	Flight load value, ppm
X	2191	18	21	2186	2185
Y	1082	12	21		1095
Z	-1925	5	21		-1925

Gyro fixed drift	Sample mean, deg/hr	Standard deviation, deg/hr	Sample size	Final calibration value, deg/hr	Flight load value, deg/hr
X	-0.17	0.06	21	-0.11	-0.106
Y	-0.40	0.09	21	-0.41	-0.413
Z	-0.50	0.09	21	-0.44	-0.442

Gyro spin axis mass unbalance	Sample mean, deg/hr/g	Standard deviation, deg/hr/g	Sample size	Final calibration value, deg/hr/g	Flight load value, deg/hr/g
X	0.05	0.10	21	0.05	0.043

*Equivalent calibration values.

TABLE 8.6-VIII.- ABORT GUIDANCE BIAS AND DRIFT

Axis	Accelerometer bias, μg	Expected, μg	Relative gyro drift, deg/hr	Expected, deg/hr
X	-56	± 220	+0.02	± 0.8
Y	+6	± 220	-0.16	± 0.8
Z	-111	± 220	-0.14	± 0.8

TABLE 8.6-IX.- VELOCITY RESIDUALS

Maneuver	Velocity residuals, ft/sec	
	Abort guidance	Primary guidance
Phasing	2.0	1.0
Insertion	1.1	1.7
Constant differential height	0.2	0.1
Terminal phase initiation	0.4	0.1
Ascent propulsion	762*	765*

*Large residual caused by targeting well beyond propellant capability to insure depletion before cutoff.

NASA-S-69-2702

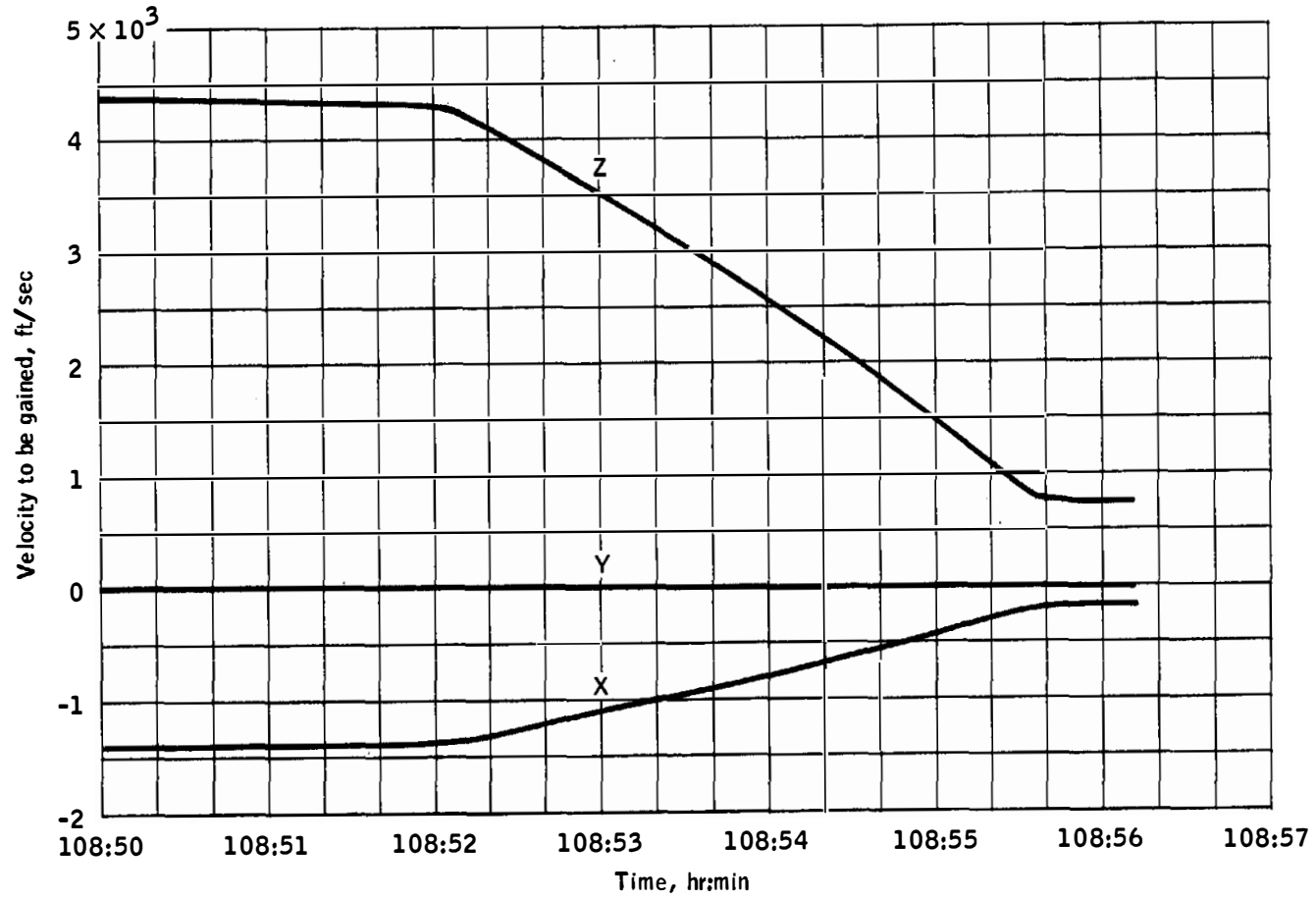

Figure 8.6-7.- Velocity-to-be-gained, ascent propulsion firing to depletion.

NASA-S-69-2703

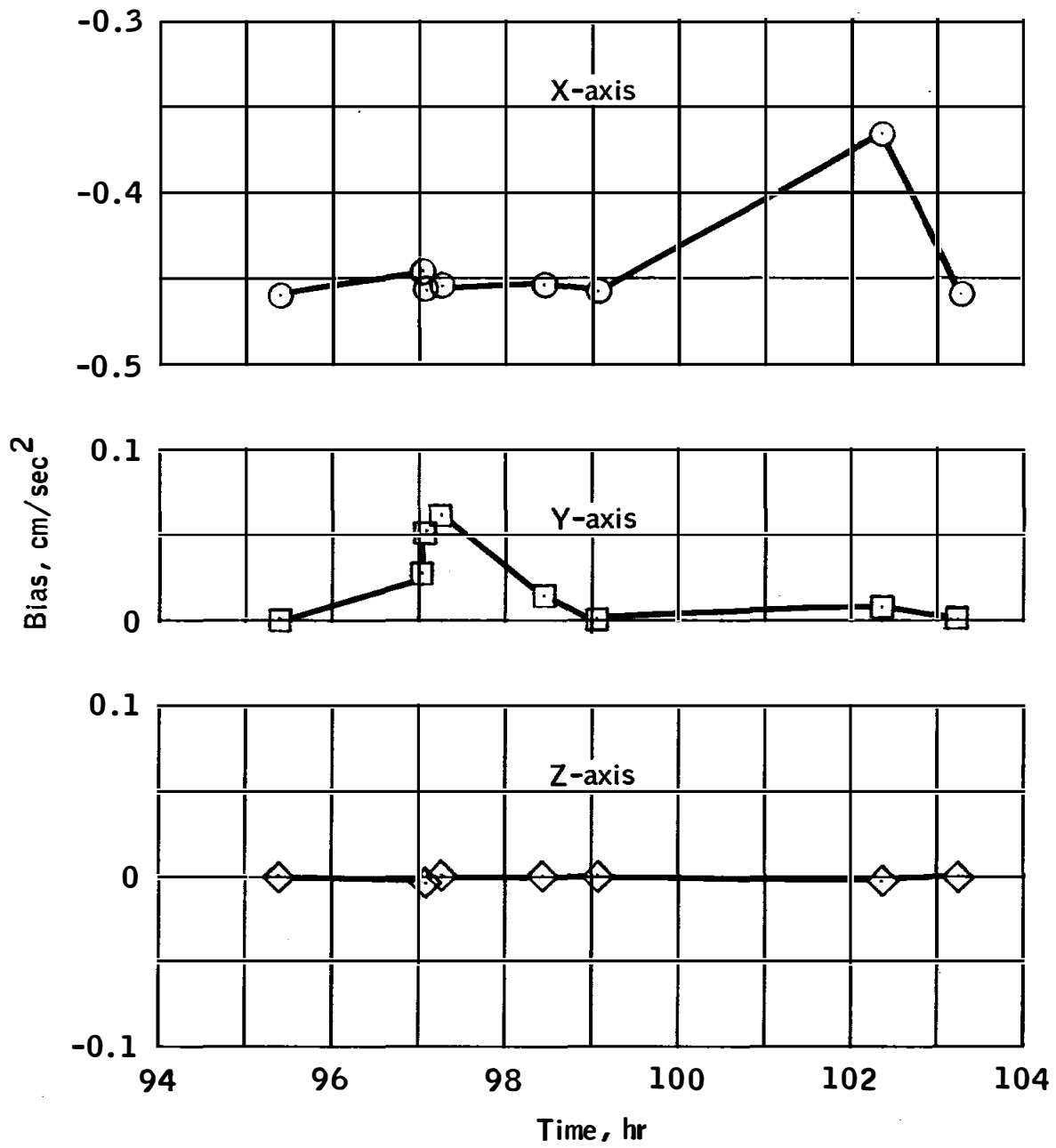

Figure 8.6-8.- Measured accelerometer biases.

8.7 REACTION CONTROL

Performance of the reaction control system was nominal. The system pressurization sequence was nominal, and the regulators maintained acceptable outlet pressures (between 178 and 184 psia) throughout the mission.

The switches used to monitor thrust chamber pressure on the up-firing engines of quads 1, 2, and 4 and the down-firing engines on quads 2 and 3 failed in the closed position. Engine operation was nominal, and the switch failures had no effect on the mission. Further discussion is contained in section 15.2.11.

Thermal characteristics were satisfactory throughout the mission, and all values were well within the caution and warning limits. Fuel tank temperatures ranged from 70° to 71° F during manned operation and decreased to a minimum of 64° F during unmanned operation after the ascent propulsion firing to depletion.

Propellant consumption measured by the onboard propellant quantity measuring devices, during manned operations was 278 pounds, about 12 percent less than predicted. Figures 8.7-1 and 8.7-2 include total and individual system propellant consumption profiles, respectively.

The reaction control system was used in the ascent interconnect mode during portions of the coelliptic sequence initiation and terminal phase initiation maneuvers. As a result, approximately 42 pounds of propellant was used from the ascent propulsion tanks.

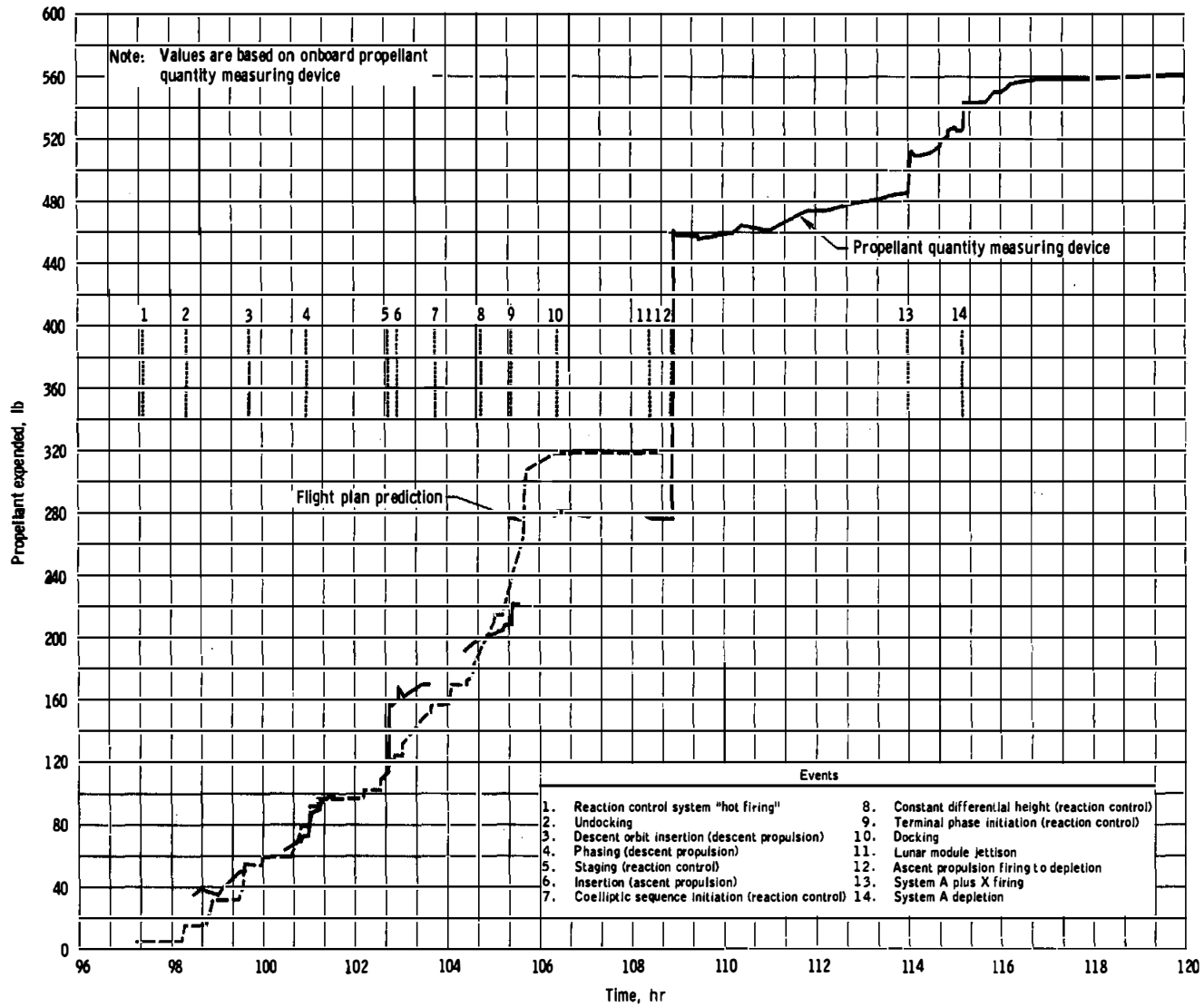

Figure 8.7-1. - Total propellant consumption.

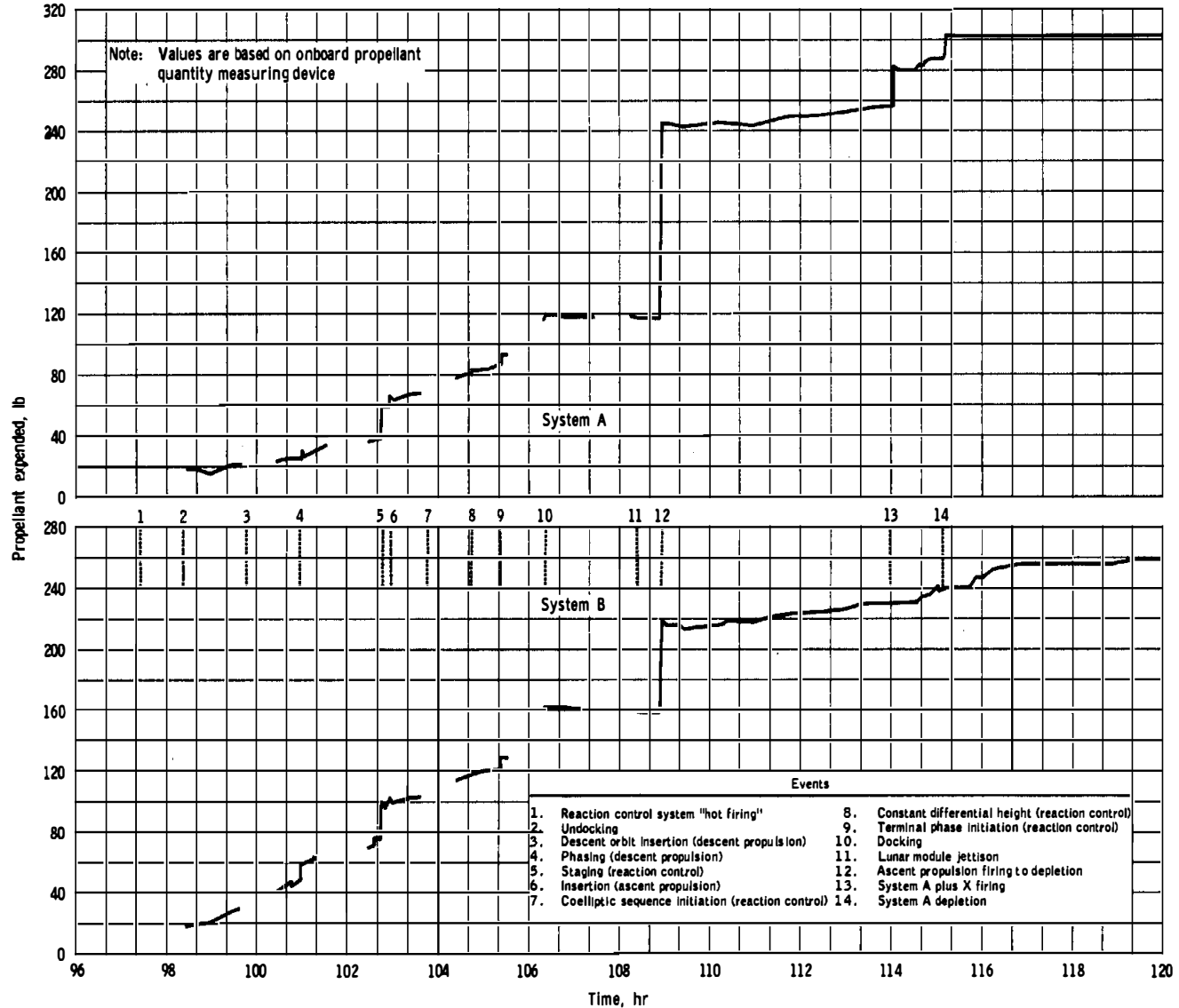

Figure 8.7-2. - Individual system propellant consumption.

8.8 DESCENT PROPULSION SYSTEM

The descent propulsion system operated satisfactorily for the descent orbit insertion and phasing maneuvers.

8.8.1 Inflight Performance

The first descent propulsion firing was initiated at 99:46:02 and lasted 27 seconds. The engine was started at the minimum throttle setting of approximately 11.3 percent of full thrust, and after approximately 15 seconds, it was throttled to 40 percent thrust for the remainder of the firing. Satisfactory performance is indicated by the actual firing time of 27.4 seconds, as compared with the predicted duration of 28 seconds and the low residual velocity components. The second firing was initiated at 100:58:25.9 and lasted 40.0 seconds, corresponding to a change in velocity of 177 ft/sec. Analysis of the engine transient and throttle response indicates nominal behavior. Table 8.8-I is a comparison of the predicted and measured propulsion system parameters.

8.8.2 System Pressurization

The oxidizer tank ullage pressure decayed from 168 to 97 psia during the period from lift-off to the first system activation at about 83 hours. During the same period, the fuel tank pressure decreased from 188 to 152 psia. Both decays resulted from helium absorption into the propellants and were within the expected range.

The measured supercritical helium tank pressure profile was essentially nominal. The preflight and inflight pressure rise rates were 7.3 and 5.9 psi/hr, respectively. These rates compare favorably with previous missions.

8.8.3 Gaging System Performance

At engine ignition for the second descent firing, the two oxidizer propellant gages were indicating off-scale, as expected (greater than the maximum 95 percent indication). Fuel tank probes 1 and 2 were indicating 94.2 and 94.5 percent, respectively, but should also have been reading off-scale. This deviation existed before launch. Table 8.8-II presents a comparison of the measured and calculated quantities for the end of the second firing. All readings were within 1.3 percent of the predicted values.

The crew reported three master alarms during the phasing maneuver, and two of these alarms were associated with propellant low-quantity indications. The first alarm was concurrent with the engine firing command. A descent propellant low-quantity indicator light came on but went out when the master alarm was reset, and immediately after 100 percent throttle was reached, the master alarm came on at the same time the low-quantity indicator came on for the second time.

Further discussion of this anomaly is contained in section 15.2.2.

TABLE 8.8-I.- DESCENT PROPULSION MEASUREMENTS DURING SECOND FIRING

Parameter	10 seconds after ignition		35 seconds after ignition	
	Predicted	Measured	Predicted	Measured
Throttle position, percent	11.3	13.1	Full	Full
Regulator outlet pressure, psia	247	247	247	247
Oxidizer bulk temperature, °F	70	69	70	69
Fuel bulk temperature, °F	70	70	70	70
Oxidizer interface pressure, psia . . .	244	235	225	218
Fuel interface pressure, psia	244	243	225	225
Engine chamber pressure, psia	13	^a 13	106	^a 106

^aBased on observed bias.

TABLE 8.8-II.- DESCENT PROPULSION GAGING SYSTEM PERFORMANCE

[Measured values at 100:59:06, the end of the phasing
orbit insertion maneuver]

Oxidizer tank 1

Measured quantity, percent	94.3
Calculated quantity, percent	98.1

Oxidizer tank 2

Measured quantity, percent	94.5
Calculated quantity, percent	93.2

Fuel tank 1

Measured quantity, percent	92.4
Calculated quantity, percent	92.9

Fuel tank 2

Measured quantity, percent	92.0
Calculated quantity, percent	93.0

8.9 ASCENT PROPULSION

The ascent propulsion system duty cycle consisted of a 15.6-second manned lunar insertion maneuver and a 248.9-second unmanned firing to depletion. System performance was nominal during both firings.

The regulator lockup pressure at initial ascent propulsion pressurization was 184 psia. Regulation during the insertion maneuver and lock-up after the firing were nominal.

At the start of the firing to depletion, the regulator outlet pressure dropped to the expected value of 181 psia. At 118 seconds into the firing, oscillations in helium regulator outlet pressure were measured by both transducers. These oscillations were caused by the interaction between downstream regulators and check valves and were present for the remainder of the firing. While these oscillations have been seen in acceptance tests but not during Apollo 9, their presence did not adversely affect flight performance.

Table 8.9-I is a summary of actual and predicted performance during the lunar insertion maneuver and the firing to depletion. A second prediction was made from flight regulator, propellant temperatures, and load data, and the measured flight data match this second set of predicted values. A shift in the oxidizer interface pressure instrumentation has been accounted for in the data presented in table 8.9-I. The first indication of chamber pressure decay in the firing to depletion was at 108:55:32.3. Chamber pressure during the fuel depletion is shown in figure 8.9-1. The pressure decay compared well with ground test data. The fuel low-level sensor was uncovered at 108:55:24, or 199 seconds into the firing to depletion (predicted time was 200 seconds). The oxidizer low-level sensor was uncovered at 108:55:37, or 212 seconds into the firing. Based on this information and the propellant available at ignition, the average propellant mixture ratio was 1.59.

TABLE 8.9-I.- STEADY-STATE PERFORMANCE

Parameter	First firing 10 seconds after ignition			Second firing					
				15 seconds after ignition			150 seconds after ignition		
	Predicted ^a	Predicted ^b	Measured ^c	Predicted ^a	Predicted ^b	Measured ^c	Predicted ^a	Predicted ^b	Measured ^c
Regulator outlet pressure, psia	185	181	181	185	181	181	185	181	181
Oxidizer bulk temperature, °F	70	70	70	70	70	70	70	70	70
Fuel bulk temperature, °F	70	71	71	70	71	71	70	71	71
Oxidizer interface pressure, psia	171	167	167	171	167	167	171	167	166
Fuel interface pressure, psia	171	167	167	171	167	167	171	167	166
Engine chamber pressure, psia	123	121	121	123	121	121	123	121	121
Mixture ratio	1.592	1.592	--	1.591	1.591	--	1.587	1.588	--
Thrust, lb	3499	3434	--	3499	3435	--	3478	3411	--
Specific impulse, sec	308	308	--	308	308	--	309	309	--

^aPreflight prediction based on acceptance test data and assuming nominal system performance.

^bPrediction based on regulator outlet pressure, propellant bulk temperatures, and propellant load data from flight.

^cActual flight data with known biases removed.

NASA-S-69-2706

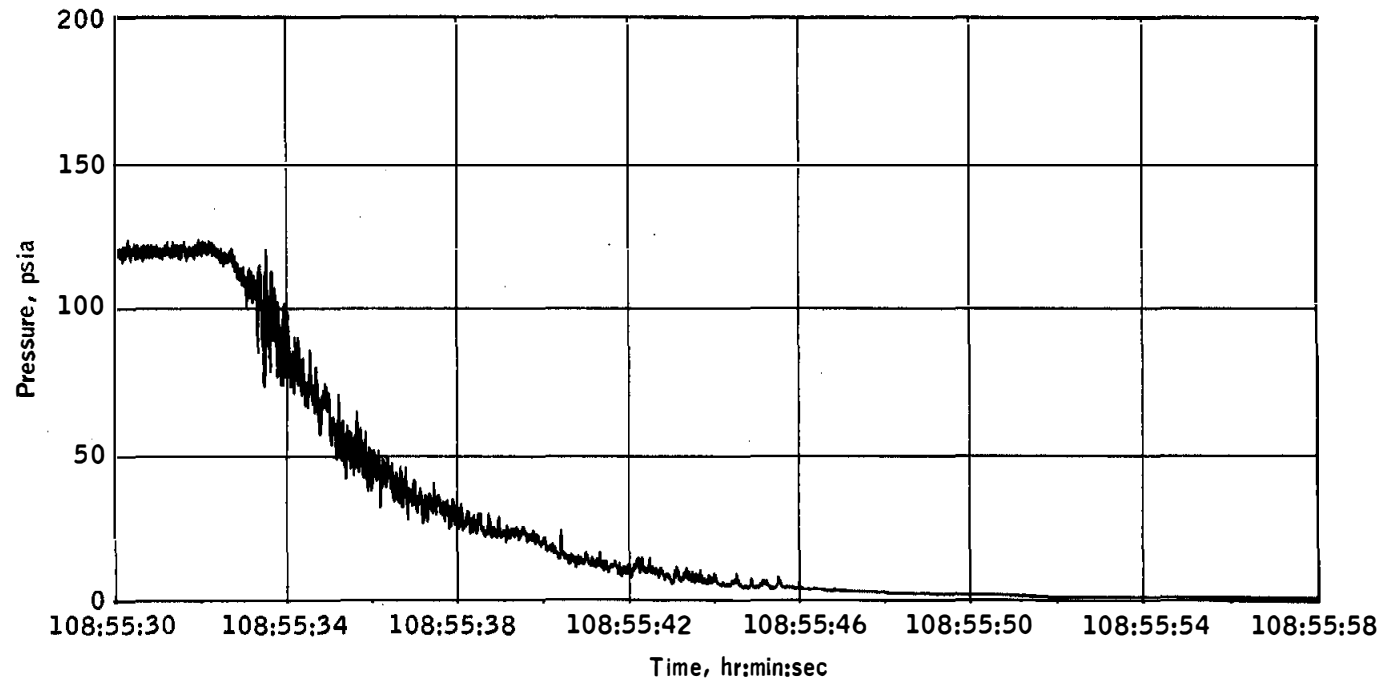

Figure 8.9-1.- Chamber pressure during propellant depletion.

8.10 ENVIRONMENTAL CONTROL SYSTEM

The environmental control system was activated for approximately 12 hours and performed satisfactorily.

The apparent rate of carbon dioxide buildup in the suit loop was considerably higher than predicted (0.65 mm Hg/hr compared to 0.08 mm Hg/hr). The carbon dioxide partial pressure stabilized at 2.4 mm Hg, but it jumped to 4.3 mm Hg briefly during closed loop operation. Prior to lunar module closeout, the secondary cartridge was selected, and the indicated carbon dioxide level dropped immediately to 0.2 mm Hg. See section 15.2.13 for further details.

Cabin pressure was lost during lunar module jettison, providing an opportunity to evaluate the environmental control system under a rapid decompression failure. The automatic functions of the suit loop were verified when the suit loop locked up at 4.4 psia. Additionally, the cabin control logic was verified to perform satisfactorily.

The prelaunch cabin leakage was 0.06 lb/hr, and the inflight leakage, using a metabolic rate of 320 Btu/hr per crewman, was approximately 0.02 lb/hr. During 4 hours of ascent stage operations, 0.5 pound of oxygen was used. This is less than predicted and can only be explained by low metabolic usage and low leak rates.

During water servicing prior to launch, the nitrogen used to pressurize the water tanks permeated the water tank bladder and totally saturated the water at the fill pressure of 43.6 psia. When the water pressure was dropped to 5.0 psia for drinking, some nitrogen was released from solution, and 12.2 percent by volume was expelled through the drink gun. This percentage decreased as the absolute pressure of the water tank decreased. The gas dissolved in the water had no effect on operation of the water system or the sublimator.

The primary glycol loop was activated without the sublimator during the initial manning. The glycol temperature increased 3.5° F, compared with the predicted increase of 3.1° F.

8.11 CREW STATION

The Lunar Module Pilot reported that when he donned his gloves, the sleeves of the liquid cooling garment interfered with the wrist disconnects on the pressure garment. Prior to launch, the elastic cuffs had

been removed from the liquid cooling garment. In doing so, the resultant seam between the outer Spandex cover and the inner liner allowed the liner to drop. Custom fitting and improved quality control will be implemented on future flights.

Following the communication checks on the initial lunar module manning, the Commander initiated the oxygen purge system checkout. On one of the units, when the Commander moved the actuator mechanism into the active position, the oxygen pressure gage indicated the normal 5800 psi. However, when the Commander pushed the heater test button, the test lights did not come on. Postflight simulation tests have not been able to repeat this malfunction. Further discussion of this anomaly is contained in section 15.2.8.

8.12 RADAR

Landing radar.- The spacecraft was oriented for the radar overpass test at approximately 100:32:00. Beam acquisition occurred at 100:32:22, and the beams acquired tracker lock within 2 seconds of each other. Slant range at acquisition was about 75 500 feet, which corresponds to a true altitude above the surface of nearly 71 000 feet. Radar lock was maintained until an S-band communications problem caused loss of continuous downlink data at 100:36:32. Sporadic data points were obtained until 100:41:43; at that time, the radar indicated a slant range of 50 460 feet, equivalent to a true altitude of 47 400 feet, or less than 8 miles, above the local surface.

The ground track of Apollo 10 has been determined from a comparison of mission photographs with Lunar Orbiter photography and the 16-mm fixed camera film. These data and the corresponding radar altitude data are shown in figure 8.12-1.

As shown in the figure, acquisition occurred at 75 degrees east, where the terrain was sloping downward. Then at 100:33:10, the terrain rose rather rapidly to 9000 feet in 20 seconds. This correlates with the mosaic as the ground track passes into a crater, then out. Correlation is not evident between 100:33:30 and 100:34:30. This could be attributed to uncertainty in Orbiter photography. A detailed evaluation of landing radar performance will be published in a supplemental report.

Radar data correlate with the ground track through the Foaming Sea from 100:35:20 to 100:36:30, at which time data became sporadic.

The measurements between 100:37:50 and 100:39:15 were in the Sea of Fertility between Webb U and Taruntius K and P. The isolated measurement at 100:41:42 was near Secchi.

Rendezvous radar.- Rendezvous radar performance during the entire mission was nominal. Velocity changes calculated using radar data compared to within 1 ft/sec with Network calculations. The radar tracked the command and service modules at ranges in excess of 320 miles.

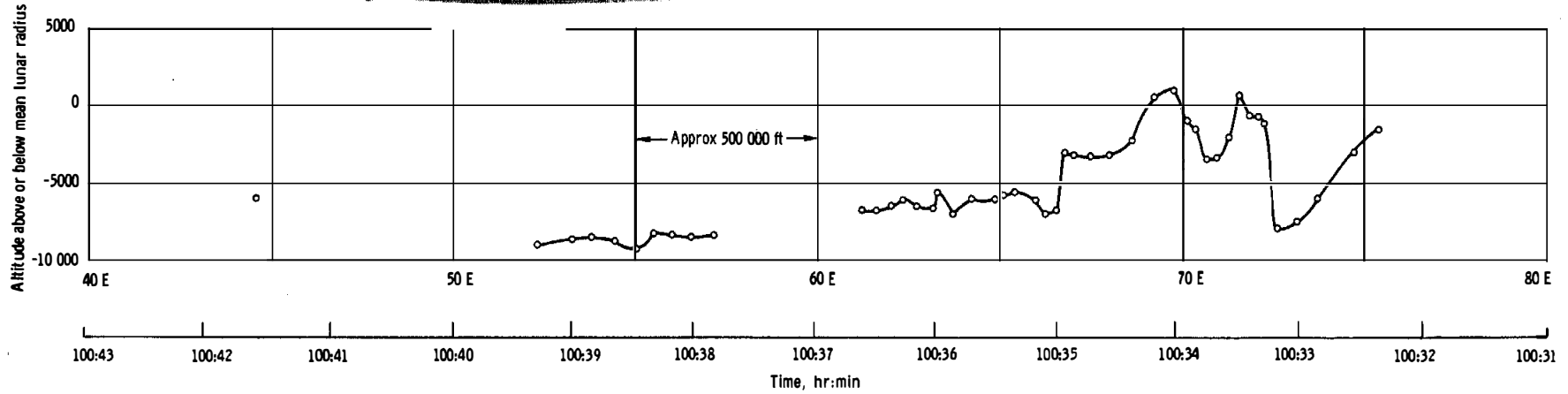
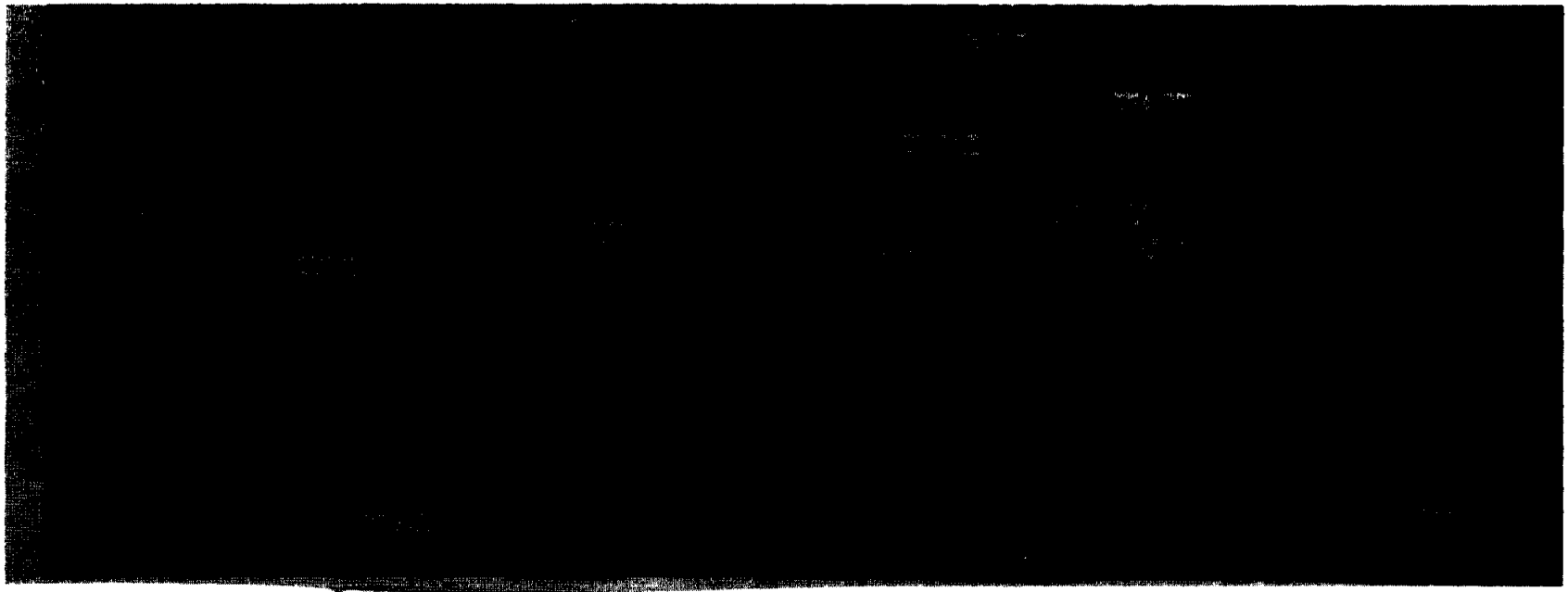

Figure 8.12-1. - Landing radar data.

8.13 CONSUMABLES

The usage of all lunar module consumables is summarized in this section. Electrical power consumption is discussed in section 8.3.

8.13.1 Descent Propulsion System Propellants

The quantities of descent propulsion system propellant loaded and consumed are shown in the following table. (The loadings were calculated from readings and measured densities prior to lift-off.)

	<u>Fuel, lb</u>	<u>Oxidizer, lb</u>
Loaded	7 009.5	11 209.2
Consumed (estimated)	295.0	470
Remaining at separation	6 714.5	10 739.2

8.13.2 Ascent Propulsion System Propellants

The total ascent propulsion system propellant loading and consumption values were as follows (the loadings were determined by weighing the off loaded propellants and measured densities prior to lift-off):

	<u>Fuel, lb</u>	<u>Oxidizer, lb</u>
Loaded	981	1650
Consumed by ascent propulsion system prior to ascent stage jettison	67	108
Consumed by reaction control system	14	28
Total consumed at fuel depletion	887	1408
Total remaining at fuel depletion (residual)		106

A portion of the ascent propulsion system propellants were used by the reaction control system during the coelliptic sequence and terminal

phase initiation maneuvers. A summary of reaction control system propellant usage from the ascent propulsion tanks is as follows:

	<u>Oxidizer,</u> <u>lb</u>	<u>Fuel,</u> <u>lb</u>	<u>Total,</u> <u>lb*</u>
Coelliptic sequence initiation	19.4	9.6	29.0
Terminal phase initiation	<u>8.6</u>	<u>4.3</u>	<u>12.9</u>
Totals	28.0	13.9	41.9

*Based on engine firing time and flow rate data. Duration of interconnect operation during coelliptic sequence initiation is estimated.

8.13.3 Reaction Control System Propellants

The propellant utilization and loading for the lunar module reaction control system, including manifolds, are shown in the following table. (Consumption was calculated from telemetered helium tank pressure histories using the relationship between pressure, volume, and temperature; the mixture ratio was assumed to be 2.0.)

	<u>Fuel, lb</u>	<u>Oxidizer, lb</u>
Loaded		
System A	108	209
System B	108	209
Consumed		
System A	101	197
System B	86	173
Remaining at last data transmission (120 hours)		
System A*	7	12
System B*	22	36

*System B values based on onboard propellant quantity measuring device. All usable propellant in system A was depleted.

8.13.4 Oxygen

The oxygen quantities loaded at lift-off and those consumed, based on telemetered data, were as follows:

	<u>Oxygen, lb</u>
Loaded	
Ascent stage	
Tank 1	2.4
Tank 2	2.4
Descent stage tank	47.4
Consumed	
Ascent stage at last data transmission	
Tank 1	0.5
Tank 2	0.0
Descent stage tank at separation	4.6
Remaining	
Ascent stage at last data transmission	
Tank 1	1.8
Tank 2	2.3
Descent stage at separation	42.8

8.13.5 Water

The water quantities loaded and consumed, based on telemetered data, were as follows:

	<u>Water, lb</u>
Loaded	
Ascent stage	
Tank 1	42.5
Tank 2	42.5
Descent stage tank	318.7

Consumed

Ascent stage through last data transmission

Tank 1 37.2

Tank 2 36.2

Descent stage tank at separation 56.7

Remaining

Ascent stage at last data transmission

Tank 1 5.3

Tank 2 6.0

Descent stage at separation 262.0

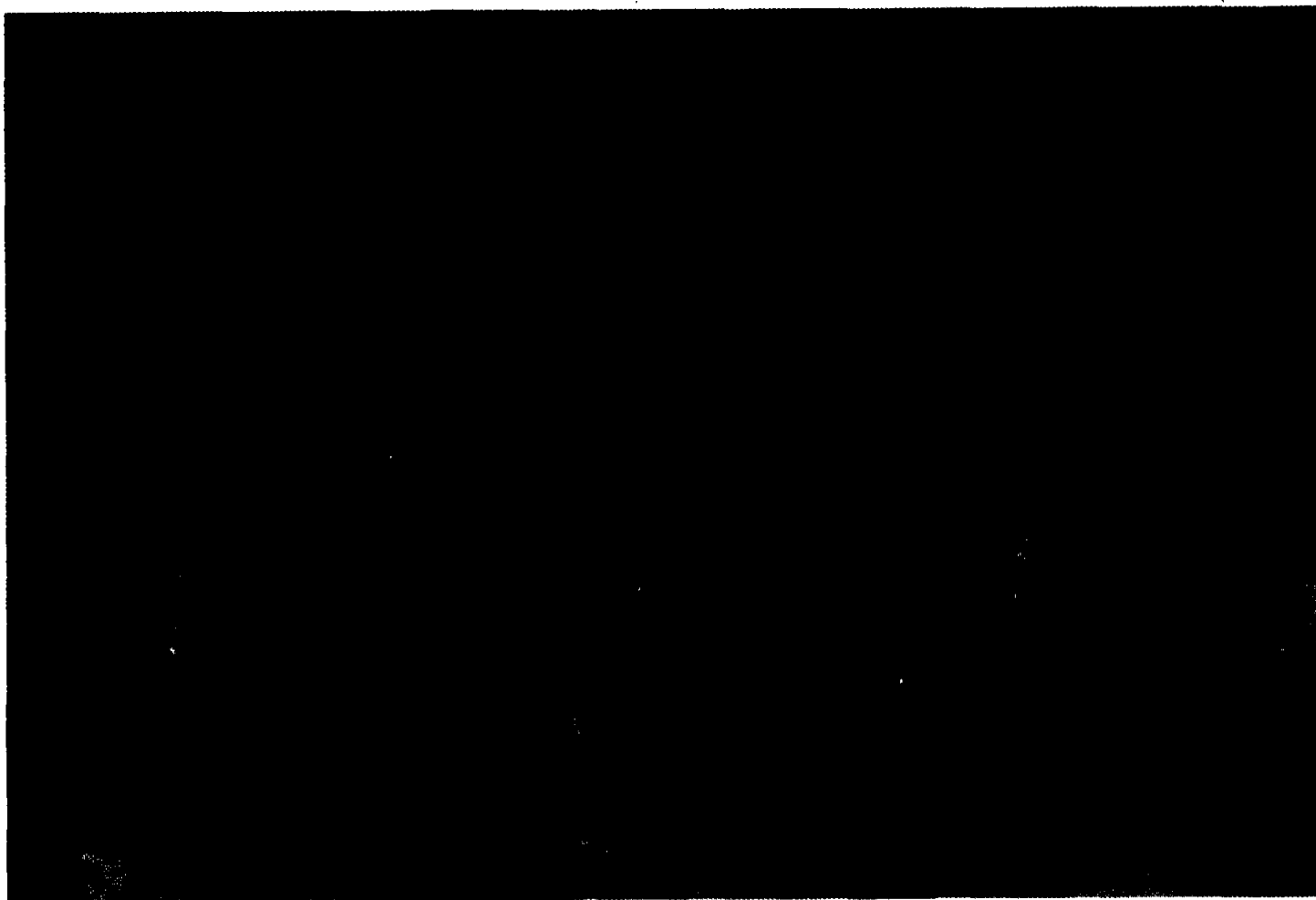

Apollo 10 flight crew

**Lunar Module Pilot Eugene A. Cernan, Command Module Pilot John W. Young,
and Commander Thomas P. Stafford.**

9.0 PILOTS' REPORT

9.1 PREFLIGHT ACTIVITIES

The Apollo 10 mission was conceived 2 years before launch to test the crew, the entire spacecraft, and all support facilities in a lunar orbit mission prior to a lunar landing.

Combined training with both mission simulations and the Mission Control Center began in mid-March 1969. Flight crew simulations had demonstrated that the crew could stay 20 to 30 minutes ahead of non-time dependent spacecraft checks in earth parking orbit. This margin in the schedule allowed the crew to be prepared for time-critical events. Throughout the mission, the preflight simulations proved to be representative of the actual flight. All major simulation activity ended 8 days before launch, and only refresher runs were conducted after this time.

Other simulators used during the earlier training included the dynamic crew procedures simulator for launch and launch aborts, the terminal docking simulator, the rendezvous and docking simulator at Langley Research Center, and the centrifuge for closed-loop entry. These hybrid simulators provided realistic training in specific areas not available with the mission trainers. Two weeks prior to launch, the crew were confident they could perform all facets of the mission and were familiar with all available control modes and spacecraft capabilities.

In a concerted effort to assure a reasonably fresh crew in the lunar landing mission, the lunar module checkout requirements prior to descent were successfully reduced from 10 to 6 hours.

Considerable effort was also spent in simplifying and eliminating any unnecessary procedures for the time the command module was operated by a single crewman in lunar orbit. Abbreviated checklist procedures on cue cards mounted at the main display console provided readily available data for the Command Module Pilot during these solo operations.

A rigid training schedule commenced in November 1968, terminated in the first week of May 1969, and averaged a workload of 6 days a week 12 hours per day. The opportunity for the crew to both relax and concentrate on physical conditioning during the 2 weeks before launch contributed to their excellent state of well-being and health throughout the flight.

9.2 EARTH ASCENT

Throughout the uneventful countdown, the test conductor and the crew maintained a timeline approximately 20 minutes ahead of the scheduled countdown activities. The final verbal count was initiated by the block-house communicator at 15 seconds prior to lift-off. Engine vibration and noise were first noted at 3.5 seconds before lift-off, then increased in magnitude until launch-vehicle release, at which time the level decreased. The planned yaw maneuver started at 2 seconds with approximately two-thirds the magnitude experienced in simulators. Tower clearance was confirmed at approximately 12 seconds, followed by initiation of the programmed roll and pitch maneuvers. The roll program ended exactly at the predicted time. Noise and vibration levels again increased; however, these were less than had been experienced during a Gemini launch, and adequate intercommunications were maintained. Cabin pressure relieved at approximately 1 minute after lift-off. After the maximum dynamic pressure region, the noise decreased to a low steady roar. Inboard engine shutdown occurred on time and was accompanied by a slight longitudinal oscillation that damped rapidly. Outboard engine shutdown occurred at exactly 02:40:00 and was accompanied by longitudinal oscillations that damped after four cycles. The staging sequence and second-stage ignition occurred during these oscillations, and the appropriate engine lights were extinguished when the oscillations ended. The crew had anticipated one large negative pulse and were therefore surprised by the series of rapid and relatively large fore-and-aft longitudinal oscillations.

Second-stage engine noise was very low, and the entire stage operation was characterized by a smooth hum. Guidance initiation occurred on time with a very smooth response, and the remainder of the S-II flight was nominal. Inboard engine shutdown was observed at 7 minutes 40 seconds, and the outboard engine shut down at the predicted time. Outboard engine shutdown was accompanied by longitudinal oscillations that were approximately one-half the magnitude noted at the end of first-stage boost. These longitudinal oscillations stopped abruptly when the second stage was jettisoned. During the entire boost phase, trajectory progress was recorded and the data points indicated that the launch vehicle was steering according to the nominal inertial-velocity and altitude-rate profiles.

S-IVB ignition was accompanied by a noise and vibration level that was considerably louder than expected. The vibrations were estimated to be about 20 hertz and could be sensed in all three spacecraft axes. Engine cutoff occurred exactly at the predicted time.

9.3 EARTH ORBIT COAST

Insertion conditions from the onboard computer were 25 565 ft/sec inertial velocity, minus 1 ft/sec altitude rate, and 102.6 miles perigee. The post-insertion checklist was completed prior to Canary Island station acquisition, and the Command Module Pilot immediately commenced spacecraft checkout in the lower equipment bay. During the first dark period, the platform was realigned and only small gyro torquing angles were noted.

9.4 TRANSLUNAR INJECTION

All checks in preparation for translunar insertion were completed prior to first-pass acquisition over Hawaii. Backup monitoring procedures for the insertion maneuver resulted in the crew having complete confidence that backup guidance, using the manual S-IVB steering mode, was feasible. After the second S-IVB ignition, the crew again sensed vibrations at the estimated 20 hertz as had been experienced during the first firing to orbit. At approximately 4 minutes into the insertion firing, the crew sensed a high-frequency, low-amplitude vibration (estimated 50 to 70 hertz) superimposed on the low-frequency vibration. This vibration could be felt on the main display panel and other parts of the spacecraft and continued until S-IVB shutdown. Final shutdown was nominal and was followed by S-IVB maneuvering to the undocking attitude.

9.5 TRANSPOSITION, DOCKING, AND EJECTION

Preparations for transposition and docking included the Commander and Command Module Pilot exchanging seat positions and fastening lap belts. Helmets and gloves were worn throughout this mission phase and through the lunar module pressurization sequence. Hot-firing checks of thrusters could not be heard with helmets and gloves on, but the network confirmed their operation. Continuous monitoring of the isolation-valve position indicators for the service module reaction control system showed that, unlike Apollo 9, these valves remained open from lift-off. Separation of the command and service modules from the S-IVB was completed under digital autopilot control in the minimum deadband mode and at a 0.5-deg/sec rate. The operation was characterized by a mild "shotgun" report, with considerable lingering debris.

After separation, an automatic maneuver to the docking attitude was initiated. The S-IVB could be seen through the hatch window at a distance

in excess of 150 feet with a small departure velocity. The adapter panels were also seen drifting away from and to the rear of the S-IVB. Following the digital autopilot maneuver to the docking attitude, an estimated velocity change of 1.2 ft/sec was required to close on the S-IVB. Minimal lateral and vertical translations were required to align the optical alignment sight with the docking-target crossbar, and closure and docking were completed effectively using the digital autopilot. The probe contacted the drogue at approximately 0.2 ft/sec, with immediate capture-latch engagement. Thruster firings were inhibited and the spacecraft drifted down approximately 2 degrees. No adverse post-contact dynamics were observed and the pulse mode of control was used to correct the 2-degree attitude error. The retraction sequence appeared to be slower than those observed in simulations. The noise level during docking-latch engagement was lower than expected, because suits and helmets were worn. Post-docking inspection of the drogue showed no probe contact marks of any kind. The roll alignment angle at the docking interface was minus 0.1 degree.

Lunar module pressurization was nominal in all respects and was completed within 8 minutes. The tunnel hatch was removed when the cabin pressure indicated approximately 4.5 psia. It was observed that the Mylar covering near the hatch pressure-equalization valve on the lunar module side had pulled loose, and large patches of fiber glass insulation were seen floating in the tunnel area and adhering to the probe and drogue. A considerable number of insulation particles floated immediately into the command module when the hatch was removed. The preflight repositioning of the suit hose connections from the Commander and the Lunar Module Pilot facilitated removal of the tunnel hardware. All automatic docking latches were engaged, but latches 3, 4, and 10 had recessed bungees which showed them to require only one stroke to cock. After the tunnel hatch was reinstalled, the tunnel vent valve was placed in the command module/lunar module DELTA-P position to measure the lunar module cabin leak rate during translunar coast.

Spacecraft ejection was performed as expected, with the lunar module moving smoothly away from the S-IVB. After completion of an automatic maneuver to the final separation firing attitude, using the service propulsion system, the S-IVB was observed in the left side window. Immediately prior to the maneuver, the spacecraft was approximately 800 to 1000 feet in front of and 100 feet laterally from the S-IVB. The crew remained well ahead of the timeline for this separation maneuver, which was a 19-ft/sec firing on bank A only. Service propulsion chamber pressure was 95 psi, and all systems performed normally.

9.6 TRANSLUNAR COAST

Suit doffing following the separation maneuver from the S-IVB proved to be a difficult task because of the extreme difficulty in removing the suit from the shoulders and slipping the neck ring over the head. About 4 minutes were spent struggling to remove the suit from over the torso and head area, and in every case, at least one crewman was required to help another.

Star/earth-horizon measurements were made to determine the bias calibration for horizon altitude required to execute the return-to-earth navigation program in the event of a communication loss. The sightings were easy to perform with automatic positioning of the optics; however, earthlight "banding" in the telescope optics hindered visual acquisition of a star in the vicinity of the earth, such as when conducting a trunnion bias check. Fortunately, a sextant search in the vicinity of Mars located Antares, and the trunnion checks could be completed. Because of the difficulty in locating a star for bias-calibration check in the vicinity of bright bodies, automatic maneuvers to the star/landmark line-of-sight axis should be incorporated into future star/navigation computer programs.

The only noteworthy system problem experienced during the period from lift-off through the first star/horizon navigation sighting was a primary water boiler dryout during the launch phase.

Platform realignment to the passive-thermal-control reference attitude was accomplished early because at the first option point it was decided not to perform a midcourse correction. The gyro torquing option was used extensively, and approximately 5 minutes were required for the platform to reorient itself. Following this torquing, automatic positioning of the optics placed the platform-realignment stars well within the sextant field of view.

At approximately 10.5 hours, passive thermal control was initiated using a 0.1 deg/sec roll rate and a 20-degree deadband about the other two axes. This control configuration resulted in frequent reaction control thruster firings when the spacecraft drifted into the yaw and pitch deadbands.

Thruster firing produced a small vibration when the lunar module was attached that was readily noticeable by all three crewmen. Damping of the vibration occurred in about three to four cycles. Even with the above perturbations, the crew slept soundly the first night.

The waste stowage vent valve was closed at 10.5 hours, and in two hours the oxygen flow decreased from 0.7 to 0.2 lb/hr. Prior to the

first sleep period, the crew was instructed by the ground to service the potable water system with chlorine while the potable tank inlet valve was closed. The crew twice requested clarification of this procedure, since it was contrary to the normal procedure. With this valve closed, it appeared the chlorine would not circulate into the potable tank. Upon awakening, the crew soon discovered by taste that the potable water lines were full of chlorine and the valve should have been opened, as originally suspected.

Crew activities on the second day were relaxed and normal. Most of the second group of star/horizon sightings were performed completely in auto-optics mode. Therefore, it was seldom necessary to operate the off-control-axis minimum impulse controller in the lower equipment bay, which was never consistent to motion about normal spacecraft axes.

At the second option point, the first midcourse correction maneuver was performed with the service propulsion system. Ignition occurred with only the bank B valves open. When the bank A valves were opened 3 seconds after ignition, the chamber pressure reading increased to approximately 100 psia. The engine performed well, and velocity residuals were negligible.

After the midcourse correction, passive thermal control was reestablished using a modified procedure in which all attitude rates were completely nulled before a roll was commenced. The roll rate was also increased to 0.3 deg/hr and the deadband opened to ± 30 degrees. This modified procedure was excellent in that no reaction control thrusters were fired after the roll rate was established. It is believed the precision in nulling rates before setting in a roll was the primary reason for the stability, with the roll rate increase having only minor effect. Because of the low propellant consumption of this revised mode, it is recommended for all future lunar flights.

The one system anomaly that resulted in considerable crew discomfort throughout the mission was the quantity of bubbles in the potable water system. These bubbles resulted in a bloated feeling in the stomach which gave all three crew members the continual feeling of just having eaten a full meal.

Following the star/horizon sightings, activities were characterized primarily by spacecraft operation in the passive thermal control mode. The crew was able to sleep even more soundly the second night because the spacecraft never approached the increased deadband limits.

During the second and third days, approximately 6 hours was spent reviewing all lunar orbit activities. These reviews required detailed study of charts, maps, procedures, flight plans, lunar orbit rendezvous activities, and landmark tracking maps.

No further translunar midcourse corrections were required. While in the passive thermal control mode at approximately the end of the second day, it was possible for the first time to see the new moon next to the sun in the shadow of the right-hand side window. Periodic photographic coverage of the earth was conducted throughout the entire translunar coast period.

9.7 LUNAR ORBIT INSERTION

Prior to lunar orbit insertion, the spacecraft went into a night period when it entered lunar shadow. An accurate platform alignment was made using easily recognizable stars. This activity and all subsequent lunar-orbit maneuvers were performed approximately 10 minutes later than planned because of an extended translunar trajectory resulting from the delay of the first midcourse correction. The time change did not appear to cause any adverse effect on crew operations in lunar orbit.

The lunar orbit insertion maneuver was performed on time. The maneuver was characterized by very small pitch and yaw oscillations (less than 0.1 deg/sec), which damped out prior to completion of the firing. One noticeable difference from simulations was the ± 5 -degree deadband in roll from the command module guidance system as the firing progressed. The maneuver was performed 2 minutes after sunrise. Even with the low sun angle, the lunar surface was clearly visible and was first noticed as a reflection in the lunar module overhead window prior to initiation of the maneuver. Onboard computer velocity residuals at shutdown were essentially zero and resulted in an onboard computed orbit of 59.6 by 169.1 miles which was later confirmed by network tracking. The predetermined attitude maneuver profiles were performed at the specified times, and the S-band high-gain antenna acquisition was obtained immediately during the first attempt. S-band voice communications throughout the lunar orbit phase were excellent on both the high-gain and omnidirectional antennas.

The circularization maneuver was nominal and the spacecraft computer indicated an orbit of 61.2 by 60.0 miles, which was also confirmed by ground tracking. The only problems during the post-insertion period were encountered in camera operations. As a result, several significant geological areas were not photographed because these features were not sunlit during subsequent opportunities for photography.

9.8 LUNAR MODULE ACTIVATION

The lunar module required a repressurization of 1.5 psi to equalize the pressure between the two vehicles. The hatch and probe were withdrawn and stowed temporarily in the command module. When the Lunar Module Pilot opened the hatch, he was confronted by numerous particles of insulation that had blown into the lunar module cabin during the repressurization cycles. The insulation, however, created no great hazard. To maintain good circulation during initial checkout and to alleviate some of the stuffiness, the Lunar Module Pilot's suit hoses were placed through the tunnel into the lunar module. This technique provided ample circulation and adequate cooling. Initial checkout was planned and executed efficiently in a shirtsleeve environment. Reorientation to the new up-down environment of the lunar module proved to be no problem, as has been reported during water/tank simulations. The Velcro on the soles of the slippers provided adequate tension to keep the Lunar Module Pilot's feet on the floor during movements between the left and right consoles.

The lunar module appeared to be in the same condition as observed during closeout activity before launch. The checkout progressed smoothly and was completed in approximately 2 hours. During the first day, one of the major events was the transfer of stowage items and performance of the required housekeeping chores, and this schedule is recommended for future missions. Transfer from command module to lunar module power was made without incident, and a subsequent checkout of the lunar module batteries showed the voltage levels to be normal. The electrical power system was operated for approximately 1.5 hours on the descent battery low-voltage taps, and the battery bus voltage was stabilized well above 27 volts through this entire period. Throughout the activation period, the lunar module window shades, which transmitted only a small amount of light, were never removed. The use of floodlights and penlights facilitated the activation and checkout routine. Communications between the two vehicles were conducted by normal voice through the tunnel, with the Command Module Pilot often acting as a go-between for communications on the transferring of articles. Although insulation problems are not anticipated, it is recommended on future flights that the hatch seal and dump valve be inspected thoroughly on the initial checkout.

During the checkout period, a docked landmark tracking training exercise was conducted. Postflight analysis showed the first landmark tracking site (B-1) was missed because the marks were made on an adjacent crater. The field of view of the telescope optics is restricted by the lunar module structure and the small lunar craters often look alike, therefore a wrong target may be selected for marking. Because docked landmark acquisition and tracking against the bright lunar surface background is a most difficult single pilot task; it is highly recommended that only easily acquired landmarks be selected.

After lunar module closeout prior to the first lunar orbit rest period, preparations were made in the command module to stay ahead of the lunar module activities on the day of rendezvous. It was also decided to change the constant wear garments, including biomedical transducers. The Lunar Module Pilot, who had to be ready for operations using the portable life support system, donned the liquid cooling garment, and this proved to be a time consuming job.

Although it had been planned to sleep with the probe and drogue stowed, a real-time procedural change during lunar module closeout was to reinstall them in the tunnel because of their ease of installation. The breakfast meal was semi-prepared and all housekeeping functions completed prior to the rest period. It is recommended that all possible miscellaneous tasks be accomplished during the initial activation to free the timeline for subsequent lunar module activities.

9.9 DESCENT AND RENDEZVOUS

9.9.1 Descent Preparation

On rendezvous day, the crew awakened a half hour prior to the scheduled time and commenced immediate removal of the hatch, probe, and drogue. The probe was temporarily strapped under the right seat pan, and the drogue was placed underneath the probe without restraint. The hatch was stowed underneath the left couch and also required no restraint. There was no tendency for the drogue or hatch to move from their temporary stowage locations.

The scheduled lithium hydroxide canister change was performed early so it would not interfere with pressure suit donning by the Commander and lunar module checkout. When the tunnel was cleared, the Lunar Module Pilot proceeded into the lunar module in shirtsleeves. The Commander and then the Command Module Pilot donned suits in the command module while the Lunar Module Pilot completed that part of the initial checkout that did not require assistance.

After about 30 minutes, the Commander entered the lunar module, as planned, in a suited configuration, attached to the suit hoses and communication umbilical, and started the powerup of the environmental system. The Lunar Module Pilot completed the unsuited operation in the lunar module and then returned to the command module to don his suit. The Commander, in parallel, continued with the checkout of the lunar module. The Lunar Module Pilot, wearing the liquid cooling garment from the previous sleep period, donned his suit and reentered the lunar module within 10 minutes. The only assistance required for the suit donning was

the Command Module Pilot's verification that the zippers were clear and some help in closing out the suit. At this time all three crewmen were suited, and the coordinated activities of the lunar module checkout proceeded normally.

The drogue installation was performed by the Commander and checked by the Command Module Pilot. The probe installation was easily performed in accordance with the tunnel checklist. The Command Module Pilot was completely suited when all 12 docking latches were successfully cocked after the probe was preloaded. Latch no. 1 had to be released with the auxiliary release switch, and latches 3, 4, and 10, as anticipated, required only one stroke to cock. After the latches were cocked, they were visually inspected to insure that each was well clear of the docking ring. The lunar module dump valve was confirmed to be in AUTO and the hatch was closed and sealed. The tunnel valve was placed to the tunnel vent position and recycled to lunar module/command module differential pressure; however, there was no indication of tunnel venting. Subsequently, during postflight inspection, it was discovered that an improper fitting had prevented tunnel venting. Because the differential pressure across the installed hatch was only 1 psi, the command module slipped slightly with respect to the lunar module when the service module roll thrusters were fired on one occasion. The roll jets were then disabled to prevent the possibility of further slippage between the two docking rings.

The crew decided to talk with the ground at the next Network acquisition concerning the tunnel venting problem. However, to stay ahead of the specified timeline, the crew proceeded with certain checkout items that did not require Network contact. The lunar module was pressurized 0.3 psi higher than the tunnel, and this check verified the integrity of the lunar module hatch and dump valve seal, proving that the tunnel vent problem was not caused by a continual oxygen bleed from the lunar module to the tunnel.

The displayed values from the display keyboard during the rate command portion of the reaction control system checkout were not consistent with those seen in preflight simulations. However, flight control personnel determined that the displayed values were within allowable tolerances and a satisfactory reaction control system was evident when the hot-fire tests were completed.

All pyrotechnic functions were performed satisfactorily, and each could be heard and felt. Landing gear extension was similar to that experienced in an aircraft. The general noise level in the lunar module was largely produced by the reaction control system (thrusters firing with a loud "bang"), the glycol pump (by far the loudest and the most annoying), and the S-band antenna (a grinding noise in both pitch and yaw everytime it was moved). This latter noise could be heard and felt

in the command module while docked. The S-band antenna noise was not a surprise, since it had been observed in the altitude chamber. The cabin fan also produced an additional noise that was found somewhat annoying. A single cabin fan was operated for about 30 minutes during the rendezvous and did not appear to produce any effective cooling or circulation. As in Apollo 9, when the cabin repressurization valve was turned on or off, a loud "bang" could be heard in both spacecraft.

Since the roll thrusters in the service module had been disabled, the required attitudes and deadbands for the abort guidance system calibration could not be maintained. Consequently, this check was eliminated without subsequent problems.

9.9.2 Undocking and Separation

After undocking and with the lunar module pitched up approximately 30 degrees, the Command Module Pilot observed the four landing gear legs to be fully extended; therefore, the 360-degree yaw inspection maneuver was eliminated. Command module station keeping was performed using the digital autopilot, and service module reaction control thruster firings were minimal. The 2.5 ft/sec separation maneuver was completed at the specified time. In the separation orbit, recycling of the VHF A-transceiver switches showed a full capability in both VHF voice and ranging. Postflight analysis has shown that the initial inability to transmit from the lunar module resulted from an incorrect checklist procedure that required the audio circuit breaker to be open during that phase. It was also discovered that the rendezvous radar transponder power switch in the command module required recycling to enable lunar module lock-on (see section 15.1.3). Once the radar transponder was reset, acquisition was immediate, with indications on the tape meter and from raw radar data available on the display keyboard. Correlation between the VHF ranging in the command module and rendezvous radar showed the range difference to be within 60 to 120 feet throughout the entire operation of the two systems.

Based upon the state vector update received after the separation firing, the abort guidance system was updated and aligned to the primary guidance system. The target load was also verified. The platform fine-alignment mode was entered and automatic optics showed that the docked alignment received from the command module was satisfactory. The star was well within the field of view and within about 10 star widths from the crosshairs. Through the telescope, constellations could be seen with no difficulty, verifying the auto-optics designation. The only discrepancy noted was that the telescope had a small amount of contamination around the crosshairs (see section 15.2.5). The light intensity decreased within about five star widths of the crosshairs so that stars were lost

on the top side of the field of view (see section 15.2.5). The alignment technique practiced in the simulator consisted of marking a star on the minus Y axis and either on the plus or minus X axis, but inflight this technique could not be accomplished near the center of the reticle because of the increased control authority of the reaction control system with a lighter-weight ascent stage. The alignment progressed satisfactorily, however, and the primary guidance pulse mode was adequate to maneuver the unstaged vehicle. After the landing radar check, the guidance system update and alignment were performed 7 minutes prior to descent orbit insertion to configure the system properly.

An automatic maneuver was performed by the command and service module to permit auto-optics tracking of the lunar module. However, while the lunar module was in the equiperiod separation orbit, this could not be seen in the sextant. Nevertheless, the Command Module Pilot used the telescope to observe the entire descent orbit insertion maneuver which appeared as a bright orange glow.

9.9.3 Descent Orbit Insertion

The only system anomaly noted prior to descent orbit insertion was that the descent oxidizer gage indicated zero (see section 15.2.11). The network, however, verified nominal oxidizer pressure from telemetry sources and gave a "go" for the descent orbit insertion. The firing was initiated on time through the computer. At ignition, it appeared that the chamber pressure was slightly greater than 10 percent. At the preflight programmed time of ignition plus 15 seconds, the Commander throttled up rapidly to 40 percent. The engine accelerated smoothly with no vibration and the attitude errors were minimal throughout the entire maneuver. After a nominal firing with no nulling of residuals required, immediate plus-Z radar lock-on was manually obtained and verified the raw radar data from the data tape. Approximately 3.5 minutes were required to maneuver the lunar module and radar antenna for lock-on and range-rate verification. Prior to that time, the command module VHF ranging provided adequate data to verify the descent orbit insertion.

The lunar module was tracked manually in the command module optics out to 14 miles. At this distance, the auto-optics mode was activated, but the lunar module was not optically visible and could not be reacquired until radar ranging was initiated at 70 miles. After several VHF mark updates, the lunar module appeared in the command module sextant as a bright star against the lunar surface. Optics marks were then made until the lunar module image disappeared against the bright lunar surface at a range of about 125 miles.

Radar tracking of the command module was facilitated by the abort guidance system acquisition steering mode. The abort guidance attitude-error needles, plus the preflight planned inertial and orbital rate angles, were used to manually place the lunar module plus-Z axis along the line of sight to the command module. In every instance, the abort guidance system boresighted the lunar module on the command module so that radar acquisition, either manual or automatic using the computer, was immediate.

Prior to phasing, the landing radar was activated and immediately locked onto the lunar surface. The spacecraft plus-Z axis was pitched down to zero degrees at the time specified by the flight plan. One minute prior to passage over the landing site, the direct control mode was used to pitch the lunar module with the plus-Z axis at 30 degrees below the local horizontal. The lunar surface was photographed with both the 16-mm and 70-mm cameras. The 70-mm camera began to malfunction after passing pericyynthion and finally failed over the landing site. However, at least two sequences were made in proximity to Apollo Landing Site 2.

9.9.4 Phasing

After passing Landing Site 2, the lunar module was pitched down to the predetermined inertial attitude for the phasing maneuver. The appropriate computer programs were selected, and an automatic maneuver was made to the proper phasing attitude. This maneuver required less than 5 degrees travel from the preflight estimated attitude.

Prior to phasing, the ascent batteries were connected without incident. Unlike the descent orbit insertion maneuver, the phasing maneuver was a descent engine firing and could require a staging sequence to an abort. Preflight planning for ascent and descent engine firings required that inverter no. 1 circuit breaker should be closed, a configuration that provided for a single switch actuation to return ac power to both buses.

The landing radar test and the pass across Landing Site 2 proceeded without incident, except that subsequent trajectory analysis revealed the ground track to be about 5 miles south of the landing site. The 7-minute update and alignment of the primary and abort guidance systems, targeting abort guidance for an external delta V, and entering the thrust program were performed nominally, with ample time for checklist verification and mission rules review. The external delta V steering used prior to firings did not freeze the reference vector by cycling from zero to one, as had been noted in Apollo 9.

The phasing maneuver was initiated by the computer, and the propellant settling firing was initiated on time for a proper ignition sequence. The engine started smoothly, and no attitude error deviations were noted. However, during the initial 26 seconds at 10-percent thrust, a caution-and-warning master alarm was initiated by the descent propulsion low-level quantity warning light (see section 15.2.2). The master caution light was reset but was illuminated a few seconds later with a corresponding descent engine gimbal light. This anomaly was anticipated on this spacecraft and indicated a possible gimbal brake slippage (see section 15.2.2). The attitude errors remained zero; therefore, the engine gimbal was not disabled. After automatic engine throttle-up to 100 percent at 26 seconds, the master alarm for the descent propulsion low-level quantity again came on. The throttle from the 10 percent to 100 percent was smooth and rapid. There were no noticeable vibrations or chugging in the engine. Guidance was excellent, and engine shutdown occurred on time with nominal residuals.

VHF communications between the command module and lunar module were lost approximately 5 minutes prior to the phasing maneuver and were not restored until after the maneuver was completed. However, the command module was able to monitor phasing operations by a communications relay from S-band ground stations. Both spacecraft attitudes and antenna selections should be precisely planned for all lunar module maneuvers, including lift-off from the lunar surface. Loss of VHF communications was probably caused by VHF antenna selection in the lunar module. This potential problem should be investigated and simulated in the integrated training for the next flight.

Following the phasing maneuver, the command module tracked the lunar module according to a preflight marking schedule. The initial VHF ranging indicated a velocity of 21 ft/sec above that expected by the Command Module Pilot. This was not an anomalous condition and since subsequent optics marks produced a similar velocity change, the VHF marks were accepted. Thereafter, the range and velocity increment changes steadily decreased until they were less than the display threshold values of 2000 feet and 2 ft/sec, respectively. The lunar module was tracked optically from the command module at night at distances exceeding 230 miles, and in daylight at about 275 miles. VHF ranging marks were taken out to about 275 miles, but ranges to 320 miles were observed. The VHF ranging system lost lock when VHF communications were interrupted prior to the phasing and insertion maneuvers, and also during periods of lunar and command module attitude changes. Resetting the VHF ranging system, even though the lunar module was using a live microphone, produced valid acquisitions in every case. However, in two cases VHF ranging reset produced a half-range value on the entry monitor system display. In both instances, correct ranges were noted when the VHF-reset switch was recycled. One surprising characteristic during optical tracking of the lunar module is that the image

through the lunar-landmark line-of-sight optics was at times superimposed in the sextant with a red hue when the lunar module was above the lunar horizon.

Following the phasing firing, radar track was initiated manually, and errors of 4 and 5 digit magnitude were noted during the first mark sequence. This mark was rejected, and the second mark showed near-nominal range and velocity values. This unexpected indication occurred repeatedly upon initiating navigation or weighting matrix initializations (see section 8.6). In most every instance, maneuver to the proper track attitude was completed manually; however, rendezvous navigation in the automatic mode performed was also satisfactorily several times.

Prior to the insertion maneuver, command module control was performed primarily either with the digital autopilot in wide deadband at rates of 0.2 or 0.5 deg/sec or with the pulse mode of the stabilization and control system. With the wide deadband mode, additional pilot attention to spacecraft roll was required to maintain the preflight angles for nominal high-gain antenna acquisition and lockon and still provide the proper line-of-sight coverage for the rendezvous radar transponder.

9.9.5 Staging and Insertion

The far side of the moon could not be photographed as planned from an altitude near 200 miles because of the 70-mm camera failure. At 40 minutes prior to insertion, the ascent batteries were placed on the line. Descent batteries 1 and 3 were removed from the buses at that time, and batteries 2 and 4 were disconnected at insertion minus 25 minutes. Ascent stage power was used for the remainder of the mission.

Helmets and gloves were donned for staging, which was scheduled 10 minutes prior to insertion. While in the abort guidance system pulse mode, the digital autopilot was reset for the lightweight ascent stage. Preflight planning required that the abort guidance control mode be used for staging and that, at 2 minutes before staging, the mode control switch be placed in ATTITUDE HOLD and the attitude switches in MODE CONTROL. At staging minus 28 seconds, the spacecraft started to "wallow" off slowly in yaw and then stopped after a few seconds. A rate gyro discrepancy was suspected, and following a correction with the attitude controller, the spacecraft returned to near the original staging attitude (see section 15.2.14).

At approximately 5 seconds before staging, the spacecraft started a motion that was characterized by a rapid roll rate accompanied by small yaw and pitch rates. The vehicle was staged with the planned velocity change of approximately 2 ft/sec. An attempt was made using the direct

coils of the reaction control thrusters to pitch the vehicle to avoid gimbal lock and to damp the resulting rates (see section 15.2.14). Spacecraft motion stopped in approximately 8 seconds. The gimbal-lock light came on, but a quick inspection revealed that the platform had not performed a coarse alignment and was therefore stable, indicating satisfactory operation of the primary guidance system.

The guidance control switch was placed in primary guidance mode, and the pulse configuration was used to maneuver the spacecraft to the insertion attitude. The abort guidance system was confirmed to be operating satisfactorily if required for the insertion maneuver.

Approximately 20 minutes before the insertion maneuver, the command module maneuvered to the backup insertion firing attitude to be prepared for a mirror-image maneuver, if required. The attitude maneuver was performed with the autopilot in tight deadband and a 0.5 deg/sec rate; this would be the primary control mode until after docking. In this mode, spacecraft roll was maintained at 0 to 180 degrees to provide a gross indication of any out-of-plane rendezvous errors, satisfactory positioning of the radar transponder pattern, and satisfactory high-gain antenna angles.

Ascent engine ignition was accompanied by an immediate acceleration to the full thrust level. The engine could not be heard, but small vibrations could easily be felt. The reaction control thrusters however, produced a low amplitude noise that the crewmen could hear even with helmets on. Immediately after ignition, the lunar module began to wallow around the thrust vector axis. The motion was noticeable visually out the window, as well as on the attitude indicators, and the attitude excursions were as high as 2 degrees. The insertion firing following ascent from the surface for a lightweight vehicle may produce oscillations more rapid than those seen on this short insertion firing with a heavier-than-normal stage. The post-insertion platform alignment, was planned to incorporate only three pairs of star marks because of the time constraint induced by the requirement for backup radar data at the coelliptic sequence initiation maneuver. This alignment was performed with excellent results. However, with a light ascent stage, approximately four times the authority in the primary guidance pulse mode exists than is required for those alignment maneuvers. An ascent stage with fully depleted propellant tanks will produce even higher rates and could result in a very difficult control task. It is recommended that the simulators be made as realistic as possible for the lightweight ascent configuration so that this problem can be fully appreciated during training.

It became evident that the recording of backup marks for all lunar module rendezvous maneuvers interfered with the nominal timeline. It is suggested that these marks be taken for failure modes of operation only and not for a comparison evaluation of normal closed-loop guidance

operation; otherwise, backup mark information could interfere with normal operations and result in a net degradation of effectiveness.

Following the insertion maneuver, the command module maneuvered to the track attitude. Preflight rendezvous procedures were followed except that at 12 minutes prior to the coelliptic sequence initiation maneuver, the command module was maneuvered to its backup attitude.

9.9.6 Rendezvous

Although no out-of-plane solutions were actually executed during the rendezvous sequence until terminal phase initiation, the solutions from both vehicles agreed very favorably. The maximum out-of-plane velocity correction calculated was 6.5 ft/sec, but all solutions were ignored because there was no apparent yaw in tracking by either spacecraft. The coelliptic sequence initiation maneuver was performed using plus-X reaction control thrust with the ascent interconnect lines open. The only surprise was that the valve position indicators did not properly indicate valve position until the switch was released to the neutral position.

Following coelliptic sequence initiation, the command module was automatically maneuvered to the track attitude, and after three sextant marks, the weighting matrix was initialized to 2000 ft and 2 ft/sec. It was reinitialized after the plane change was cancelled. Optical and VHF track marking during this period was nominal. Prior to the constant differential height maneuver, the command module was rolled 180 degrees to reacquire the network. The backup constant differential height attitude was maintained at the attitude used to track the maneuver, because the firing was brief and a time-consuming attitude change would have been necessary. Following the constant differential height maneuver, approximately six VHF range marks were made in the command module before optical mark taking could be resumed after the sunset.

All lunar module pre-thrust calculated maneuvers through the final midcourse correction agreed very closely (within 1 ft/sec) with those of the command module. A comparison of radar signal strength and actual range agreed closely with the preflight predicted values, and there was no evidence of any tendency for side-lobe lock-on or abnormal radar-angle bias.

During all reaction control maneuvers, the thrusters could be heard upon initial activation and throughout their firing cycle. Minus-Z axis automatic tracking proved to be too sensitive for the vehicle weight and deadband used. However, it performed well throughout the rendezvous. A wide deadband or pulse mode could be used during the Z axis rendezvous radar track with a resultant fuel saving.

After 5 minutes before terminal phase initiation, the command module was oriented to the backup maneuver attitude. The normal maneuver time was delayed in real time to allow the lunar module to take a final radar backup mark with satisfactory range rate transponder signal strength. Two minutes prior to terminal phase initiation, the command module was in the proper attitude to make the backup maneuver. However, obtaining backup radar data this close to the time a maneuver might be required, unnecessarily delays maneuver preparation. Therefore, the backup radar marks should be deleted when the two vehicles consistently have satisfactory guidance solutions. Terminal phase initiation was performed nominally and with very small residuals. After the second midcourse correction, the lunar module guidance computer was activated to provide raw range and range rate data on the display keyboard to support the braking phase.

9.9.7 Braking and Docking

The first braking gate at 1 mile was crossed with a range rate of 32 ft/sec, and no retarding impulse was applied. The first actual braking was accomplished at the 0.5-mile range, with the range rate being reduced to 20 ft/sec. The handling characteristics of the lightweight vehicle during the braking were slightly more sensitive than those experienced in the simulator. Oscillations were evident, and thruster firings were noticeably more frequent than during the simulations. Station keeping was commenced at approximately 20 feet, followed by a combined 90-degree pitch and 60-degree yaw maneuver to align the two vehicles for docking. At this time, the Command Module Pilot gave directions for small lunar module maneuvers to place the two vehicles in the final attitude for docking. The lunar module was then placed in abort guidance attitude hold and minimum deadband, and the command module became the active vehicle for docking.

9.9.8 Docking and Lunar Module Jettison

Docking was performed with the command module in autopilot control, and minimal thruster firing was required. The alignment sight reticle washed out because of reflected sunlight from the lunar module at distances between 25 and 10 feet. Docking could be done using only the plus-X thrusters of the lunar module to insure capture. There were no significant post-contact dynamics and no apparent interface attitude changes. Completion of the retraction sequence was characterized by the reassuring sound of the automatic latches retracting.

The command module autopilot was then reconfigured in the ascent-stage-only mode. The tunnel was pressurized rapidly from the command

module, and the command module forward hatch was removed and stowed underneath the couch. The probe and drogue were also removed without any problems. The probe head and the upper damping arm structures were quite warm to the touch (estimated 110° to 120° F). Equipment was then transferred both ways in preparation for lunar module jettison. It is recommended that preparation for lunar module jettison be accomplished by only one crewman located in the lunar module. The crewmen with suits and hoses continually interfere with each other during this activity, a problem that was readily apparent during restowage of lunar module equipment for final jettison.

The probe and drogue were easily stowed with restraining cables in the left-hand side of the crew station. The debris, such as used food containers and other disposable items, that had collected in the command module over the 4-day period was stowed in the hatch stowage bag and secured in the lunar module at the right-hand crew station.

The reconfiguration and the ascent firing to propellant depletion was completed as planned. While the lunar module was being prepared for jettison, the command module was maneuvered to the separation attitude. Again, the tunnel could not be vented; therefore, the command module was pressurized with the repressurization tank to approximately 5.4 psia to insure tunnel-hatch integrity. The lunar module was separated after verification that the S-band steerable antenna was locked onto earth. The velocity imparted to the command module at separation was approximately 0.3 ft/sec, and it appeared that the lunar module received a velocity in excess of 5 ft/sec. Sequence films were made of separation, but after approximately 13 frames the lunar module disappeared into the sunlight and was only seen momentarily during the depletion firing.

The lunar module final separation sequence imparted the largest velocity change and was accompanied by the loudest audible pyrotechnic cue during the flight. It is recommended that crewmen be suited with helmets and gloves for this separation function. The crew then maneuvered the spacecraft to a new sleep attitude for passive thermal control.

9.10 LUNAR LANDMARK TRACKING

The planned activity for the final day in lunar orbit included lunar surface photography from terminator to terminator and lunar landmark tracking. The spacecraft was pitching at the orbital rate, but roll was 180 degrees from the planned attitude, which was established to minimize solar reflection on the window. However, it appears there was no degradation to lunar surface photography from reflected sunlight.

Landmark tracking was performed on four landmarks each revolution for four consecutive revolutions. This activity required close coordination between the Commander, Command Module Pilot, and the Network. Upon completion of each tracking revolution, a pitch maneuver to a predetermined attitude was made for platform realignment. At a time determined by the ground, orbital rate in pitch was established with the spacecraft plus-X axis at the landmark tracking attitude.

Landmark tracking and marking were relatively easy tasks. As usual, landmark acquisition was the most difficult task. For example, landmarks near the subsolar point were washed out in the sextant, and only the telescope could be used to track these sites. When the sextant was used, all marks were most easily made on small craters about 120 to 140 feet in diameter.

Earlier in the day, the fuel cell 1 pump package had failed, and the pump circuit breaker could not be reset. Fuel cell 1 was then open circuited and not placed back on the line until 1.5 hours prior to the transearth insertion (and also was used two subsequent times prior to entry). The performance of this fuel cell when on line was very nominal except that it required a half-hour for the fuel cell to share a balanced load with the other two. When fuel cell 1 was placed on line, the fuel cell bus disconnect and master alarm lights came on. A master alarm is expected when passing through the center position of the fuel cell switch as a ground is available to the caution and warning circuit which triggers the master alarm.

Just after loss of signal during the thirtieth revolution, the fuel cell 2 caution and warning light illuminated during systems checks. The condenser exhaust temperature was found to be cycling between high and low limits at approximately 2 cycles per minute. The lower limit of the cycle frequently activated the condenser-exhaust master-alarm warning light. The temperature cycling of fuel cell 2 condenser exhaust continued throughout the lunar-orbit phase when on the dark side, but would damp out somewhat on the sunlit side. Following transearth injection, the fuel cell 2 condenser-exhaust temperature ceased to cycle, and performance was nominal (see section 15.1.21).

After completion of initial landmark tracking, a short crew rest period ensued, followed by another revolution of landmark tracking on two different landmarks. During the next revolution, a series of photographs were taken, including oblique shots of Landing Site 3. The spacecraft was then maneuvered to the platform realignment and transearth injection attitudes.

9.11 TRANSEARTH INJECTION

Service propulsion system checks were normal, and the transearth injection maneuver was commenced on time. The maneuver was nominal in all respects, except that the spacecraft exhibited the same roll-deadband oscillations exhibited during lunar orbit insertion. The pitch and yaw rates were nearly zero for the entire maneuver, and velocity residuals were only 0.3, 1.6 and 0.2 ft/sec in the X, Y, and Z axes, respectively. The 0.3 ft/sec residual was nulled to 0.2 ft/sec. Fuel remaining was 6.7 percent, and oxidizer remaining was 9.2 percent; the oxidizer unbalance indicator was "pegged" at high increase, indicating an unbalance of more than 600 pounds (see section 7.8). The spacecraft was then maneuvered to an attitude in preparation for high-gain antenna acquisition, as well as lunar television coverage and documentary. Upon completion of the television transmissions, the passive thermal control mode was initiated, and the crew rest period began.

9.12 TRANSEARTH COAST

Following the crew rest period, star/lunar-landmark sightings were initiated using four small lunar craters, each readily acquired because of their proximity to the large crater Messier A. This tracking mode is recommended for earth-return navigation in the event that communications are lost, since it is a much easier task than star/lunar-horizon measurements. Star/earth-landmark sightings would also be very easy for cloud-free earth landmarks.

After a television transmission, the spacecraft was reestablished in the passive thermal control mode for the second crew rest period. It was noticed that the spacecraft appeared to be more stable in this control mode with the lighter weight (approximately 27 000 pounds) than it had been in the docked configuration with a weight of nearly 96 000 pounds.

During the transearth coast phase, one safety razor and a tube of brushless shave cream, stowed in the crew's personal preference kit, were used for the first time during a space flight. The process of shaving was relatively easy and no problems were evident. The shave cream retained all whiskers, and no free particles were noted.

Following the sleep period and breakfast, guidance platform was re-aligned, and four different groups of midcourse-navigation star/earth-horizon measurements were made. These measurements were to determine if the constraints on the proximity of stars to the intersection of the earth terminator and the horizon could be relieved thus providing more optimum star measurement sets for future missions in the event of a communications

loss. The navigation technique of making star/horizon measurements was found to be unaffected by the proximity of the designated stars to the terminator. Although the star measurements were not made on optimally located star groups, the navigation program was selected and compared to ground-computed midcourse data. The onboard midcourse correction solutions agreed closely with those completed by the ground.

Because of the incredible accuracy in executing the transearth injection maneuver, no midcourse corrections were actually required to reach the entry corridor. A very small correction was made 3 hours before entry to position the spacecraft in the center of the corridor, but entry and landing at the designated location could have been accomplished without this correction.

Since command module reaction control thruster temperatures on the systems test meter were well above the minimum required for pre-entry heating, use of the thruster valve heating technique was not required. During the rather uneventful 2 days of transearth coast, considerable time was spent in study of the procedures for entry; postlanding stabilization, ventilation, and communications; stable I and stable II egress; stable II uprighting; and all associated emergency conditions. It is recommended that during all phases of a lunar flight specific time be provided for the crew to review procedures prior to critical events.

9.13 ENTRY AND LANDING

9.13.1 Entry Preparation

The crew awoke approximately one half hour prior to the planned entry preparation period. Reentry stowage was completed according to the checklist, except the Command Module Pilot's suit was stowed under the right sleeping bag, which was lashed to the floor. The lithium hydroxide canister from the lunar module was stowed in the lower end of the right sleeping bag. The spacecraft preliminary stowage was completed with no problems 6 hours prior to reentry.

The VHF-transmitter was activated on time, but due to the extreme range, the communications were not readable until just prior to entry. The platform was realigned to the entry reference data, and all entry systems checks were nominal. However, the computer self-check and the display keyboard light test were not performed. A midcourse maneuver of 1.6 ft/sec was performed on time, and residuals were nulled to zero. The ground reported the spacecraft was in the entry corridor at a 6.52-degree entry angle. Because it had dried out after previously being switched for 2 minutes, the primary water evaporator was reserviced for 3 minutes. When activated for entry, the primary evaporator operated properly to below 90 000 feet.

The spacecraft was then maneuvered to the entry attitude and the entry sextant star check was performed. Final platform realignment was completed with the gyro torquing angles all less than 0.005 of a degree. Final entry checks and procedures were completed well ahead of the flight plan for all functions not dependent on time. The entry monitoring system test pattern checked out satisfactorily, but when the system was slewed to the first non-exit pattern, it scribed for 5 inches and then ceased scribing (see section 15.1.12). After the scroll was rotated backwards, it again started to scribe. The changes required in the systems test panel configuration were completed 50 minutes prior to entry. The secondary water boiler was activated and also operated nominally to below 90 000 feet. The crew strapped into the couches very tightly at approximately 40 minutes prior to entry, and all crewmembers noticed the physiological sensation of being back at one-g because of the distinct pressure points. All final pyrotechnic and circuit-breaker checks were normal.

The command module reaction control pressure system was activated, and the pressure could be heard "gurgling" through the lines. An audible noise indicated both rings of the command module reaction control system were hot fired satisfactorily. At this time, the command module was maneuvered to the separation attitude.

At earth sunset, the final gross check of platform attitudes was made by positioning the horizon on the 31.7-degree line in the right rendezvous window. It is recommended that the continual platform drift check, accomplished by tracking the horizon after command and service module separation, be deleted because of the impracticality of sighting the night horizon. A satisfactory check can be made by comparing the gyro display coupler attitudes with those of the platform. It is important to maintain entry attitude so that computer performance can also be monitored.

The separation checklist procedures were performed on time, and the only change was that fuel cell 1, which had already been open-circuited, was left off line. The pyrotechnic firing was very loud at command and service module separation. The command module separation impulse was in excess of 0.5g, because the entry monitoring system, which had been inadvertently left in the delta V and normal configuration, started operating. The entry monitoring system was immediately reset to the next non-exit pattern and was reinitialized.

9.13.2 Entry

The initial computer entry program was selected and onboard computer displays of maximum acceleration, entry time inertial velocity, and entry angle agreed closely with data computed on the ground. A running commentary provided the network with the current status of onboard checks. After

separation, reaction control ring B was isolated, and the pulse-control mode was used to maneuver the spacecraft in yaw back to the proper entry attitude.

Approximately 15 seconds prior to reaching 0.05g, a brilliant white plasma flow outside the spacecraft made entry a completely "IFR" event, and the cabin lights were turned full bright. The pitch attitude error check at 0.05g was satisfactory, and the entry monitoring system commenced functioning on time. At 0.1g, spacecraft control was switched from manual to the digital autopilot. The g-meter operated normally, and the primary guidance system commanded full lift-up through the period of peak acceleration (6.8g). At approximately 5.8g under automatic control, the spacecraft commenced a roll to 90 degrees. At 5.3g, the spacecraft was commanded to a roll attitude of 180 degrees, or lift-down. There was no evidence that spacecraft roll performance was sluggish, and the spacecraft roll to 180 degrees was accomplished without violating any entry monitoring system tangency lines.

There appeared to be a slight acceleration overshoot of approximately 2.8g on the entry monitoring system, even though the spacecraft was maintaining full lift-down after reading an acceleration of 5g. At approximately 2 minutes 8 seconds after entry, the system-indicated velocity was subcircular. All display performance during entry was nominal. When the downrange error decreased to minus 9 miles on the display keyboard, a roll error was indicated on the attitude displays and the autopilot began correcting for crossrange error. Crossrange corrections continued to be made throughout the remainder of the entry. When the final entry display appeared, the total error was 0.9 mile and the target latitude and longitude in the computer were coincident with the pad target data. Throughout entry, scribe indications of the entry monitor system agreed closely with the acceleration meter indications. The range potential and range-to-go from this system were also typical of the nominal values simulated before flight. At a displayed velocity of 4000 ft/sec, the range-to-go was approximately 21 miles and the scroll range potential on the scroll appeared to be about 20 miles.

After exiting blackout, S-band communications were attempted but were generally unsuccessful. However, crew observations of spacecraft performance were transmitted to the Mission Control Center until the spacecraft was below 100 000 feet.

9.13.3 Parachute Deployment

As the spacecraft descended through the 90 000-foot level, the water-evaporator steam pressure increased very slowly to the maximum indicator

value of 0.25 psi. The estimate of 60 000 feet, based upon the water boiler being at the full increase position at 90 000 feet was approximately 15 seconds after the actual 60 000-foot mark on the altimeter. Nevertheless, this backup altimeter-time method of predicting drogue and main parachute deploy times appeared satisfactory. The pyrotechnic devices were rearmed at 50 000 feet and the drogues were deployed automatically. During drogue reefing, there were some momentary and moderately violent spacecraft oscillations which damped very rapidly when the drogues disreefed. The time between drogue and main parachute deployment appeared to pass very rapidly. When the main parachutes deployed and disreefed, the physiological effect was a pleasant series of soft cushioned jolts.

The pressure relief valves were not placed in the entry position until 24 000 feet. Air inflow through the cabin pressure relief valve was satisfactory, since the cabin-pressure indicator showed a normal rise. At approximately 8000 feet on the cabin altimeter, both cabin pressure relief valves were closed. Reaction control propellant was dumped with an audible firing noise. All thrusters were fired out completely in an estimated incremental altitude of 2500 feet. The reaction control purge was initiated and was characterized by a very loud "swishing" sound. An exhaust plume observed out the right side window was approximately 6 feet long and 3 feet across at its widest point. When the purge was completed, a flame was seen out of the right-hand window, and it progressed to the upper edge of the window. The flame persisted for approximately 1 minute and burned out prior to landing. The reaction control systems were then isolated, and the cabin pressure relief valves were opened. There was no noticeable smell of any cabin air contamination as the outside air flowed into the spacecraft. Postlanding bus power transfer was normal. Following main parachute deployment, a recovery helicopter was contacted on VHF, and the spacecraft position was reported. Radio contact was maintained continuously following main parachute deployment. Between 3000 and 4000 feet, recovery helicopters commenced flying formation with the spacecraft until it landed.

9.13.4 Landing

The spacecraft landed softly and remained in the stable I attitude. The main parachute release circuit breakers and switch were activated immediately, and the main parachutes fell into the water near the spacecraft. The cabin environment was very comfortable after landing; consequently, the postlanding ventilation system was not activated. Appropriate circuit breakers were opened and switches turned off, and the spacecraft was powered down. The hatch was opened against a slightly negative pressure. Crew ingress into the life raft, recovery by the helicopter, and transfer to the recovery ship were completed without incident within a short time after landing.

10.0 BIOMEDICAL EVALUATION

This section is a summary of Apollo 10 medical findings and anomalies, based on a preliminary analysis of biomedical data. A more comprehensive evaluation will be published in a supplemental report.

During this mission, the three crewmen accumulated 576 man-hours of space flight experience. The general condition of the crewmen was excellent, and no inflight illnesses were experienced. The crew participated in a series of special medical studies designed to assess changes incident to space flight. In general, the physiological changes observed after the mission were consistent with those observed after previous flights.

10.1 PHYSIOLOGICAL DATA

The total times of telemetered electrocardiogram and impedance-pneumogram data were 90 hours for the Commander, 103 hours for the Command Module Pilot, and 89 hours for the Lunar Module Pilot. Descriptive statistics for heart rates are shown in table 10-I. The Command Module Pilot's heart rate ranged from 55 to 85 beats/min during normal activities and showed less variation than the rates of the other two crewmen. The heart rates of the Commander and the Lunar Module Pilot ranged from 57 to 93 and from 49 to 91 beats/min, respectively, during normal activities. The variations observed in the heart rate data are normal. Although the heart rates were elevated, as expected, during critical mission phases, these rates rapidly returned to their respective baselines after phase termination.

10.2 MEDICAL OBSERVATIONS

10.2.1 Weightlessness and Intravehicular Activity

Following orbital insertion, the characteristic feelings of fullness of the head were reported by the Commander, the Lunar Module Pilot, and the Command Module Pilot to have lasted for approximately 8, 24, and 12 hours, respectively.

There were no symptoms of dizziness, spacial disorientation, or acute nausea; however, the Lunar Module Pilot experienced some mild vestibular disturbance, or sensitivity to motion, during the first 2 days of the mission. Consequently, he limited his movements to avoid possible nausea and vomiting. Prior to flight, it had been recommended that each

crewman perform a total of 2 hours of cardinal head movements as a possible aid in adapting to weightlessness. On the first and second days, the Lunar Module Pilot practiced these movements but reached the point of nausea within 2 minutes. After becoming acclimated to weightlessness, he again performed the head movements on the seventh day, but after about 5 minutes, he again approached the point of nausea.

10.2.2 Fiber Glass Contamination

The H-film insulation near the command module hatch vent detached when the tunnel was pressurized, and fiber glass insulation underneath this film was blown into the docking tunnel (see section 15.1.18). When the hatch was opened, the fluffy insulation material permeated the atmosphere of the command module. Also, when the lunar module was pressurized through the command module hatch vent, a large amount of fiber glass insulation from the hatch was blown into the lunar module. Pieces of the insulation material ranged from 2 inches in diameter to dust-particle size. Wet paper tissues and utility towels were used to collect part of the loose insulation material. Most of the remaining material was collected in the filters of the environmental control systems. Small particles of fiber glass were still present in the command module cabin atmosphere at recovery. Fiber glass insulation is a skin and mucous membrane irritant and caused the crew to be uncomfortable inflight. The effects on the crew consisted of some scratchy throats, coughing, nasal stuffiness, mild eye irritation, and some skin rash. The nasal stuffiness cleared in about 5 days, and the eye irritation was relieved by using water rinses and eye drops.

10.2.3 Crew Status Reports

The integrated radiation dose received, the estimated quantity and quality of sleep, and the inflight medications used by the crew were reported on a daily basis.

The crew reported taking the following medications:

Commander	2 aspirin
	4 Lomotil
	1 Actifed
Command Module Pilot	2 aspirin
	3 Lomotil
Lunar Module Pilot	6 aspirin
	3 Lomotil

The crewmen took Lomotil to diminish the abdominal rumblings caused by the ingestion of hydrogen gas present in the potable water, since they were concerned that diarrhea might develop. The use of Lomotil, however, was not medically indicated; the drug decreases the propulsive activity of the lower intestinal tract and reduces the amount of gas that can be expelled.

Water consumption during the first 36 hours was reported to have been 3 pounds per man per day. The crew then began to consume more fruit juices and wet-pack foods, as well as attempt to increase their water intake.

The personal radiation dosimeters provided an onboard reading of the total integrated radiation dose received by each crewman. This dose was 470 millirads for the flight. Three passive dosimeters containing thermoluminescent powders were also carried by each crewman to measure the total radiation at chest, thigh, and ankle locations. The following readings, all well below the threshold of biological damage, were obtained after the flight.

	Total dose, millirads		
	Chest	Thigh	Ankle
Commander	410	386	460
Command Module Pilot	560	465	550
Lunar Module Pilot	470	455	450

The Van Allen belt dosimeter provided a telemetered measurement of the rates of ionizing radiation inside the command module. During ascent through the belts, the maximum radiation rates measured were 3.63 rad/hr for a skin dose and 2.09 rad/hr for a depth dose. The maximum rates during the return to earth were 0.21 rad/hr for skin dose and 0.16 rad/hr for depth dose.

The total absorbed radiation dose for each crewman was approximately 0.5 rad, well below the medically significant threshold. Results of radio-chemical assays of feces and urine and an analysis of onboard nuclear emulsion dosimeters will be presented in the supplemental medical report.

10.2.4 Work/Rest Cycles

The three crewmen were scheduled to sleep simultaneously, and in general, they slept very well during the nine periods. Estimates of the

quality and quantity of sleep were based entirely on subjective reporting by the crew. In postflight debriefings, the Commander commented that the sleep stations and sleeping bags were satisfactory.

10.2.5 Inflight Exercise

As in previous Apollo missions, inflight exercise was solely for assistance in crew relaxation, and a calibrated exercise program was not planned. Isometric exercises were performed during the translunar coast. The inflight exerciser functioned well.

10.3 FOOD

As for previous missions, each crewman was provided with a 4-day supply of flight food prior to launch for evaluation and menu selection. The flight menus provided approximately 2100 kilocalories per man per day. Some rehydratable food items were contained in a new spoon/bowl package (fig. 10-1) which has a pair of zippers acting as a stiffener when the package is open to keep it in a bowl shape. The quantity of thermostabilized wet-pack foods was increased for this mission. For snacks and variety, the following foods were also placed onboard the spacecraft: (1) ham and chicken salad spreads packed in tubes for use on bread; (2) bread, both white and rye; (3) dried fruits, including peaches, pears, and apricots; and (4) extra beverage packages.

The crew reported they were satisfied with the quantity and quality of flight foods. While they stated that flavors were very good, they were generally not hungry during the mission. There were no complaints about food palatability; however, the crew reported that in some instances the food (for example, rye bread) tasted differently in the spacecraft atmosphere. The dried fruits, wet-packs, and rehydratable foods in the spoon-bowl packages were highly acceptable items. The latter foods were easily eaten with a spoon, and no problems with spillage were encountered. The sandwich spreads on bread were not as popular inflight as had been anticipated by the crew.

A combination of the following factors during the flight adversely influenced eating: (1) the potable water supply contained excessive gas which formed bubbles that could not be separated or eliminated in the food packages; (2) the spacecraft lacked temporary stowage and work areas to assist in preparation of the rehydrated food packages; and (3) inflight activities at times precluded adequate food preparation and consumption.

Examination of the returned food, empty food packages, and inflight food logs indicates an estimated daily food consumption of approximately 1407, 1484, and 1311 kilocalories for the Commander, Command Module Pilot, and Lunar Module Pilot, respectively.

10.4 WATER

The inflight water consumption, based on calculated water depletion rates, were as follows: 12.9 pounds of water during the first 35 hours (3 pounds/man/day), 13.6 pounds of water from 35 to 50 hours (7.5 pounds/man/day); a total of 75 pounds was consumed in the first 128 hours (5 pounds/man/day).

10.4.1 Command Module Water

Prior to flight, the command module water system was loaded with water containing 9 mg/liter of residual chlorine. The system was soaked for about 8 hours, flushed, and filled with non-chlorinated, de-ionized, microbially filtered water. Three hours before lift-off, the system was chlorinated using inflight equipment and procedures.

The ampules of sodium hypochlorite and sodium dihydrogen phosphate were injected at the scheduled inflight chlorination time of 12 hours. Because of a procedural error after this first chlorination, the potable water tank valve was not opened to allow dispersion of the injected solutions into the tank. The result was that the concentrated chlorine-buffer solution passed directly through the drinking water dispenser when the system was used the next morning, with associated unpalatability. All subsequent inflight chlorinations, with one exception, were accomplished normally and as scheduled.

An additional problem was created inflight by degassing of water from the use ports. The amount of gas dissolved in the water was large enough to cause problems with drinking and food preparations similar to those experienced on Apollo 9. After many attempts, the crew was unable to separate gas from the water using a new water/gas separation bag (see section 15.1.14).

Analyses of potable water samples obtained about 27 hours after the last inflight chlorination showed a free-chlorine residual of 0.5 mg/liter at the hot water food preparation port and 6.0 mg/liter at the drinking dispenser port. Chemical analysis of the water from the hot water port showed a nickel concentration of 0.34 mg/liter and from the drinking dispenser port a total solid concentration of 15.88 mg/liter, just above the recommended maximum. All other chemical values were within specified

limits. No adverse effects on crew health were caused by the elevated nickel and total solids concentrations.

Tests for coliform and anaerobic bacteria, as well as for yeasts and molds, were negative in all preflight and postflight samples.

10.4.2 Lunar Module Water

Prior to flight and after the initial sterilization, the lunar module water system was loaded with microbially filtered, de-ionized water which had been iodinated to a residual of 25 mg/liter in both the ascent and descent stage tanks. The preflight iodine residual was 2.5 mg/liter at approximately 40 hours before launch, when the final test samples were obtained. The iodine depletion rate indicated that the water microbial filter should be used in flight; however, through an oversight, it was not used. All preflight chemical and microbiological analyses were acceptable.

10.5 MEDICAL EXAMINATIONS

The preflight medical examinations were conducted at 30, 14, and 5 days prior to launch. A brief physical examination was performed on the morning of flight, and a comprehensive physical examination was completed immediately after recovery.

The crew reported their physical condition was good during the entry phase. The impact at landing was less than the crew expected and caused no discomfort. No sea sickness was experienced while awaiting helicopter pickup. The crew appeared well while in the helicopter and aboard the recovery ship.

The postflight medical protocol was accomplished in about 3 hours, and all planned postflight medical procedures were conducted. The total time in the medical bay was 4 hours. The crew appeared to be well rested, although they had been awake from 8 to 10 hours prior to landing.

The only abnormal findings during the postflight physical examinations and interviews involved skin changes and weight losses. The Commander and the Lunar Module Pilot had mild rashes on their forearms, apparently resulting from exposure to the fiber glass insulation or from irritation caused by Beta cloth in the flight suits. They also had some generalized itching caused by their exposure to the fiber glass insulation. The skin under the Commander's left axillary and upper sternal biomedical sensors had small superficial pustules, and his skin was abraded under a portion of the micropore tape covering the left axillary sensor. The Command Module Pilot had some pustules under his sternal sensors. The Lunar Module Pilot had no skin irritations.

All crewmen had weight losses, but none showed changes in skin turgor, skin hydration, or oral secretions. All postflight examinations showed normal changes from preflight conditions. Changes in body weights are shown in the following table.

Time	Weight, lb		
	Commander	Command Module Pilot	Lunar Module Pilot
Preflight	170-1/2	165-1/4	172-1/2
Recovery day	168-1/2	159-1/2	163
Day after recovery	170-3/4	161-1/4	164

The postflight physical examinations of the crewmen showed no significant changes which were attributable to their exposure to fiber glass. The chest X-rays and electrocardiograph data were within normal limits. There was no evidence of respiratory tract irritation. The crewmen's chests were normal to percussion and auscultation. The mucous membranes of the nasal passages, the mouth, and the oral-pharynx were normal and demonstrated no abnormal secretions. The conjunctivae, sclerae, and corneas were normal, and no excessive material was seen in the inner canthi of the eyes.

The audiometric and visual acuity examinations were unsatisfactory because of the vibration and noise of the recovery ship. The orthostatic tolerance and exercise response tests showed the characteristic changes due to flight and the characteristic return times to the preflight levels.

Four days after recovery, the Lunar Module Pilot developed a mild infection in his left nostril; this may have been caused by a small piece of fiber glass acting as a foreign body. He responded rapidly to treatment, and the subsequent course of the illness was uneventful.

TABLE 10-I.- REPRESENTATIVE AVERAGE HEART RATES

Time/event	Heart rate, beats/min		
	Commander	Command Module Pilot	Lunar Module Pilot
Minus 10 minutes	70	63	78
Minus 5 minutes	80	65	73
Lift-off	115	120	119
S-IC cutoff	120	92	98
Tower jettison	120	110	110
S-II cutoff	110	97	96
Insertion	98	98	96
Earth orbit	95	86	89
Translunar coast	72	^a 64	70
Lunar orbit	69	67	71
Transearth coast	72	68	65

^aMedian value.

NASA-S-69-2708



Figure 10-1.- Spoon/bowl package.

11.0 PHOTOGRAPHY

A preliminary analysis of the photography planned and accomplished during the mission is discussed in this section. No formal scientific experiments were planned, but engineering tests were performed, considerable photography was obtained, and landmark and tracking data were used to reduce the size of the landing ellipse.

During the mission, all nine magazines of 70-~~mm~~ film and fifteen of the eighteen magazines of 16-~~mm~~ film were exposed.

Approximately 70 percent of the total photographic objectives were accomplished, including about 75 percent of the requested lunar photography and about 60 percent of the specified targets of opportunity. Considerable farside photography was obtained, including some areas at the eastern limb where only poor imagery had existed. The photography also contains a number of views of the approaches to Landing Sites 2 and 3, and a good portion will be useful for crew training.

11.1 PHOTOGRAPHIC OBJECTIVES

The following photographic objectives were included in the mission:

- a. The relative motion of the S-IVB during transposition and the docking and ejection operations
- b. The lunar module, with emphasis on the landing gear struts
- c. The relative motion of the two spacecraft during rendezvous operations
- d. Crew intravehicular tasks and mobility
- e. Lunar surface photography for vertical stereo-strip coverage from terminator to terminator, oblique strips to the lighted landing sites, vertical stereo-strips to a proposed highlands landing site, and specified targets of opportunity
- f. Long-distance earth and lunar terrain photography to obtain an earth weather and terrain analysis under global and long-distance lunar-perspective photography.

11.2 FILM DESCRIPTION AND PROCESSING

Special care was taken in the selection, preparation, calibration, and processing of flight film to maximize the information retrieval from returned exposures. Processing standards similar to those for Apollo 8 film were used. No exposure problems existed on this mission, and results are excellent. The types of film included and exposed are listed in the following table.

Film type	Film size	Magazines		ASA speed	Resolution, lines/mm	
		Stowed	Exposed		High contrast	Low contrast
SO-368, color	16-mm	13	11	64	80	35
	70-mm	2	2	80	80	36
SO-168, color	16-mm	5	4	^a 160	80	36
3400, black/white	70-mm	6	6	^b 40	170	70
Kodacolor	70-mm	1	1	80	50	32

^aSpecial processing can boost speed to 1000.

^bManufacturer quotes speed of 80.

Exposure settings. - The exposure settings specified for lunar surface 70-mm photography are given in the following table.

Film	Lens	Aperture	Shutter speed, sec	Targets
Black/white	80-mm	f4	1/250	Vertical strips and targets of opportunity
	250-mm	f5.6	1/250	
	80-mm	f4	1/125	Oblique strips of Sites 2 and 3; vertical strips of Site 3
Color	250-mm	f8	1/250	Targets of opportunity

11.3 PHOTOGRAPHIC RESULTS

The discussion of preliminary photographic results is divided into performance, scientific results, and crew observations. The preliminary analysis of lunar surface photography will comprise most of the discussion of photographic results. Figure 11-1 indicates by magazine and vehicle, the lunar surface photography accomplished, and table 11-I lists the specific frame exposures for each magazine used. Figure 11-2 is a group of typical earth and lunar surface photographs taken throughout the mission. While these photographs are not specifically discussed, a subtitle describes the individual targets, many of which are mentioned in the following general analyses.

A 70-mm Kodacolor film magazine was to be used in order to make a technical evaluation of this type film for determining the color of the lunar surface. The film has been processed, but the technical analysis has not been completed. A supplemental report will be published.

11.3.1 Strip Photography

The objective of the stereo strip photography was to obtain vertical coverage of the lunar surface from terminator to terminator. This strip would be used to update the position of features on the lunar surface. The plan included the use of one magazine of black and white film, the electric Hasselblad camera, an 80-mm lens, the rendezvous window bracket, and the 20-second intervalometer. Each photograph was to overlap the previous photograph by approximately 60 percent to allow viewing of the surface from photographic positions separated by about 16 miles. This overlap would permit stereoscopic viewing of surface features and mathematical determination of their position.

The vertical strip photography was accomplished on lunar revolution 23, when the spacecraft was flown with a roll attitude 180 degrees from that planned. This attitude change, coupled with a 12-degree change in the alignment of the camera optical axis with the spacecraft X-axis, produced photography with 24 degrees of tilt. The tilt is forward along the trajectory for the first half of the daylight pass and backward for the last half. The forward overlap is greater than 60 percent, and the photography should prove suitable for its intended use. The crew indicated some variation in the exposure interval due to failure of the camera to cycle and the effect of this has not been evaluated to date. The strip was not taken on one magazine, and the magazine change at about 75 degrees east longitude resulted in loss of coverage over about 10 degrees of lunar surface.

In addition to the terminator-to-terminator strip, systematic photography was planned for revolution 31 from about 90 degrees east into the highland site and then into Site 3. The photography was to have been vertical with the exception of a 20-degree yaw to the south to pick up the approach path to the highland site. This strip of photography was intended to be used to help produce descent monitoring charts and improve the topographic detail of the approach terrain. This photography was not taken as planned and cannot be used for the specified purpose.

On revolution 22, strip photography was to be obtained showing an oblique view to Landing Site 2. The actual photographic coverage is nearly vertical, and is of the highland site; only the final part of the strip is of a view looking back into Landing Site 2. The strip runs from about 44 to 29 degrees east and may be useful for a monitoring descent chart into the proposed highland site.

On revolution 29, forward-looking oblique views into Landing Site 3 were planned, but the spacecraft was rotated to the east of the site. Therefore, this strip shows only the proposed highland site but has systematic photography that might be used to define the surrounding terrain in greater detail.

The terminator-to-terminator strip photography has been rectified and is being used to update descent monitoring graphics and simulator film strips. Photogrammetric evaluation is in progress and will be published in a separate scientific report.

11.3.2 Targets of Opportunity

The crew photographed approximately 60 percent of the 50 designated targets of opportunity, which were different from those of Apollo 8. Some areas were photographed with both color and black and white film. The crew, at their own selection, made numerous other photographs, including oblique terminator photographs, to document their visual observations. Included with the target of opportunity photography are many excellent moon photographs taken through the 250-mm lens.

11.3.3 Sequence Photography

The 16-mm photography included some very interesting sequences that included a great many farside features. While approaching and traversing Landing Sites 1, 2, and 3, the crew made sequences that will be useful for crew training. As stated in section 6.0, orbit inclination errors resulted in the lunar ground track being some 5 miles south of Landing Site 2; therefore, some of the photography would not be consistent with a normal landing site approach.

11.3.4 Crew Observations

During lunar orbit, no limb brightening was observed, but a bright streak above the horizon was observed just prior to the solar emergence during sunrise. The solar corona or zodiacal light was visible for about 12 minutes after sunset and prior to sunrise, and there were arch-shaped rays of light for about 5 minutes after sunset and before sunrise. There was also a bright, narrow band of light on the horizon immediately after sunset and before sunrise. It was light as soon as the edge of the solar disc could be seen. The crew attempted to photograph the solar corona, but as yet there is no evidence whether they were successful.

The crew saw the lunar horizon clearly in all directions during total darkness and believed this was because the horizon marked an abrupt end to an abundant star field. The rings of Saturn could be seen through the sextant when Saturn was within about 25 degrees of the sun. The San Joaquin Valley on earth could also be seen from lunar orbit.

During the first revolution, a volcanic cone was mentioned and later identified on a photograph. However, the darkness of the black and the brightness of the white were described as much more intense during lunar orbit than appears in the photograph. The crew believed that, during lunar orbit, the very bright white areas seemed a much more distinguishing characteristic for indicating new craters than did the sharpness of the rims. The rays from Messier were observed as seeming to travel across the entire nearside. The crew believed that a sight should be provided for use with the 250-mm lens and that hand-held photography should be taken without the intervalometer. The crew also thought it worthwhile to include target of opportunity photography on future missions.

11.4 LUNAR LIGHTING OBSERVATIONS

As in Apollo 8, the magnitude of the washout effect, when the sun line is at zero phase, is much less pronounced than had been expected. Photography was obtained at a very low sun angle (including color photography), and some of this is included in this section. The very low sun angle does cover the sites in shadow but brings out the topographic detail very dramatically.

11.5 THE LUNAR INTERNATIONAL OBSERVERS NETWORK

The objective of the International Observer Program is to determine the cause of certain lunar phenomena and whether ground-based identification of transient lunar events can be confirmed in real-time by Apollo crew members. This program began with the Apollo 8 mission. During Apollo 10, there were 46 American observers in 15 states and 130 observers in 31 foreign countries.

During lunar orbit, 19 reports of transient lunar events were recorded. Thirteen of these, indicating activity around the crater Aristarchus, were forwarded to the Flight Director in the Mission Control Center; however, the crew reported they were unable to observe anything unusual in that area.

TABLE 11-I.- PHOTOGRAPHY

(a) Still photography, 70-mm Hasselblad camera

Magazine	Frame no.	Major subjects
M	AS10-34-5009 thru -5173	Earth and moon from high altitude; spacecraft ejection; lunar module; lunar surface
N*	-27-3855 thru -3987	Command and service modules; lunar surface from high altitude; earthrise; approach to Landing Site 3
O*	-28-3988 thru -4163	Lunar surface from low altitude; near vertical of Site 2; lunar far side
P*	-29-4164 thru -4326	Command and service modules; oblique of Site 2
Q	-30-4327 thru -4499	Oblique views of approach to Sites 1 and 2
R	-31-4500 thru -4674	Near vertical views of area between Sites 1 and 2
S	-32-4675 thru -4856	Sites 1, 2, and 3 from high altitude
T	-33-4857 thru -5008	Obliques of Sea of Tranquility

(b) Sequence photography, 16-mm camera

Magazine	Major subjects
A	Docking of command module to lunar module within S-IVB
B	Intravehicular activity
C	Lunar surface
D	Lunar surface; entire moon; earth
F*	Lunar surface
G*	Lunar surface
H*	Lunar surface; earthrise
I*	Lunar surface
J	Entry; parachute deployment
K*	Command and service modules; lunar surface; earthrise
L*	Lunar surface; command and service modules
V	Earth; lunar surface
W	Lunar surface; earth
Y	Docking after rendezvous; ascent stage jettison; lunar surface
AA	Intravehicular activity

*Taken from lunar module; all others taken from command module.

NOTE: A detailed listing of all photographs will be provided in the Apollo 10 scientific report, to be published at a later date.

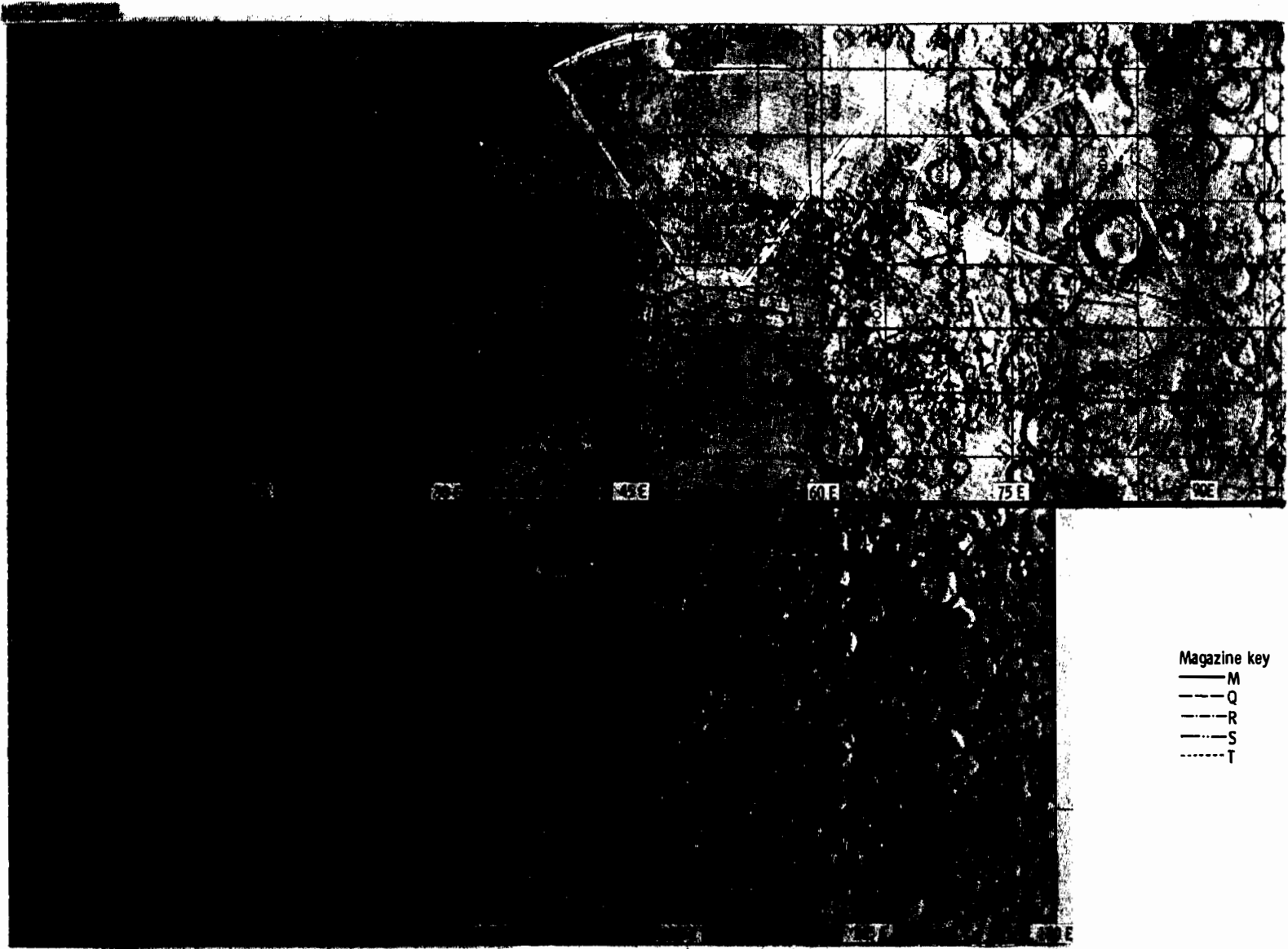

Magazine key
—— M
- - - Q
- - - R
- - - S
- - - T

(a) Command module 70-mm photography.
Figure 11-1.- Lunar surface photographic coverage.

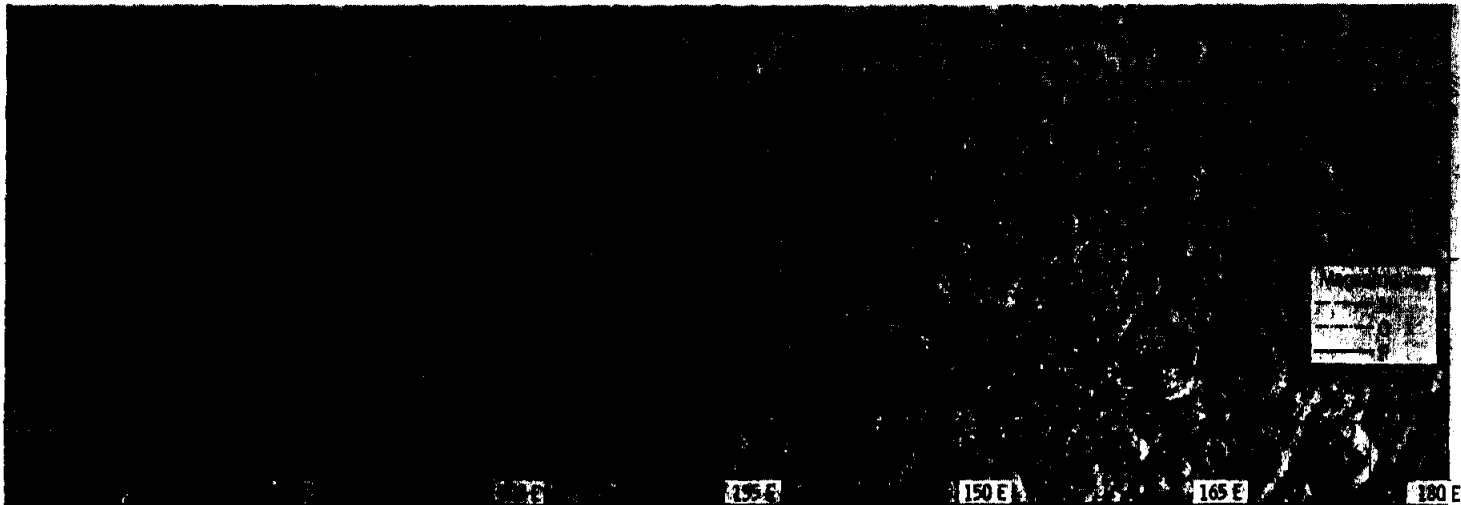

(b) Lunar module 70-mm photography.

Figure 11-1. - Continued.

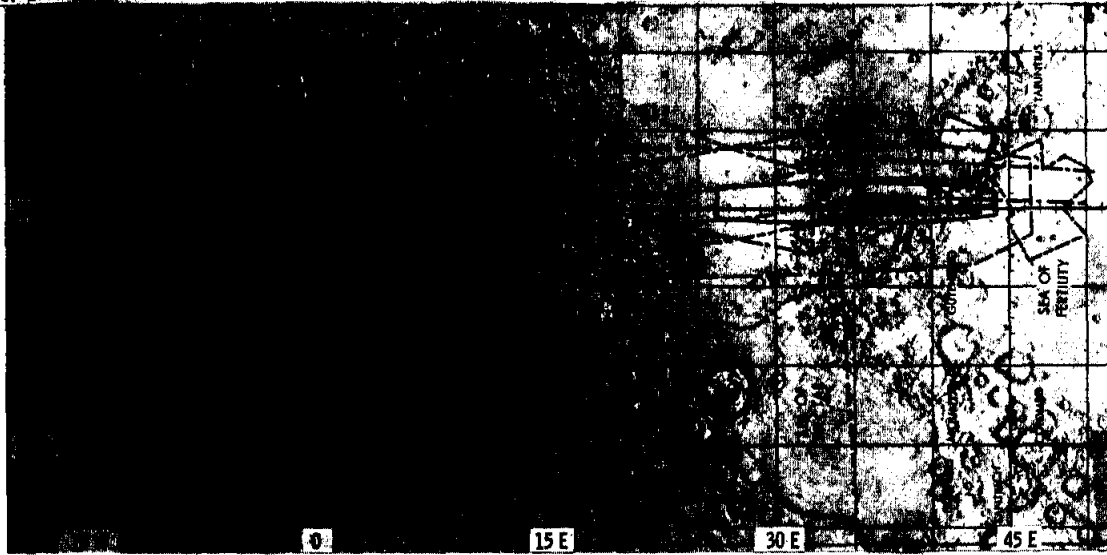

Magazine key
--- C
--- D
--- V
--- W
--- Y

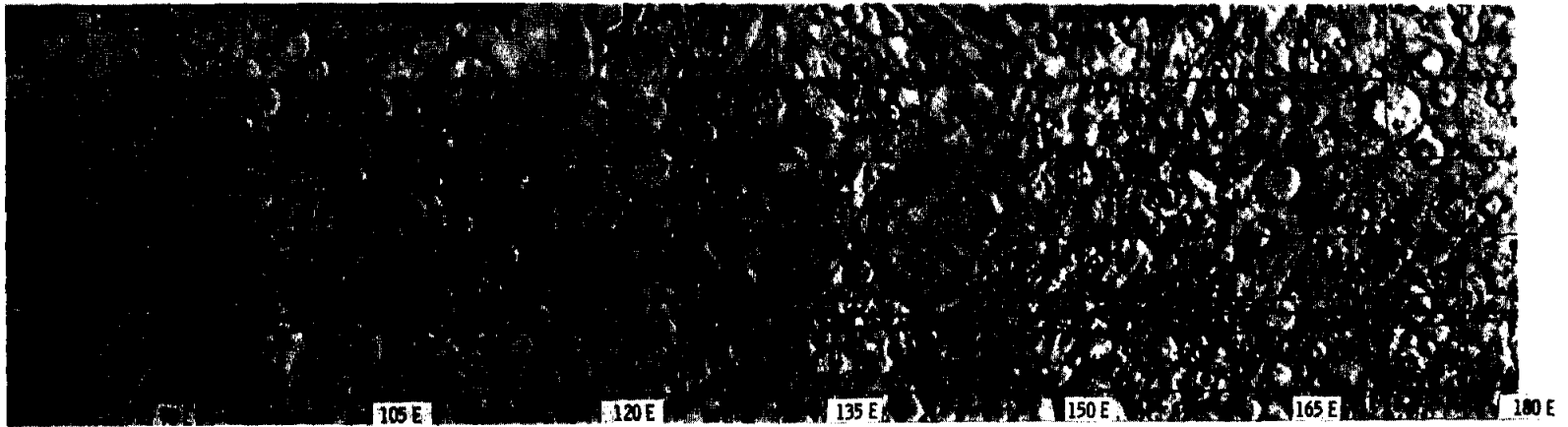

(c) Command module sequence photography.

Figure 11-1. - Continued.



Magazine key
- - - - F
- - - - G
- - - - H
- - - - I
- - - - K
- - - - L

(d) Lunar module sequence photography.

Figure 11-1.- Concluded.

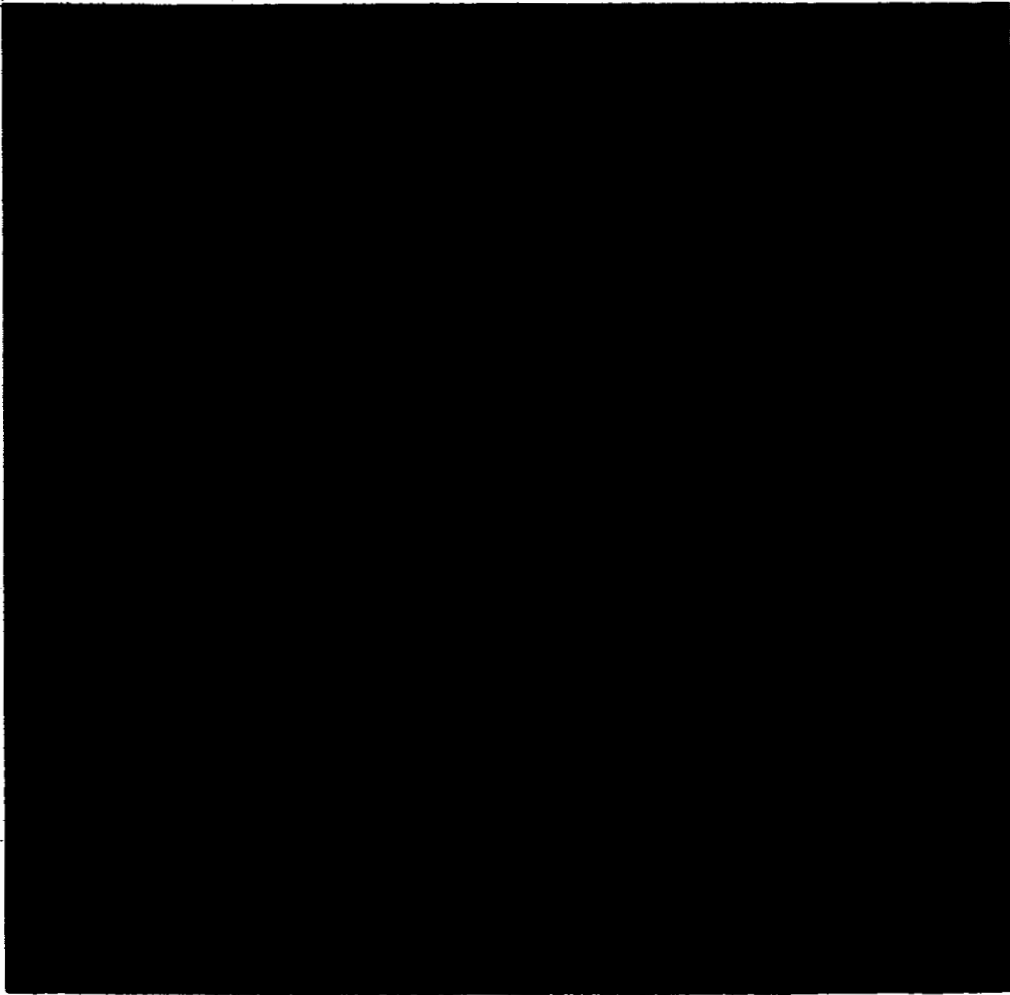

This photograph, taken during trans lunar coast, is a view of earth illustrating various types of cloud patterns. A large synoptic view such as this provides a hemispheric study of meteorological data.

Figure 11-2 (a):- Photography.

NASA-S-69-2714

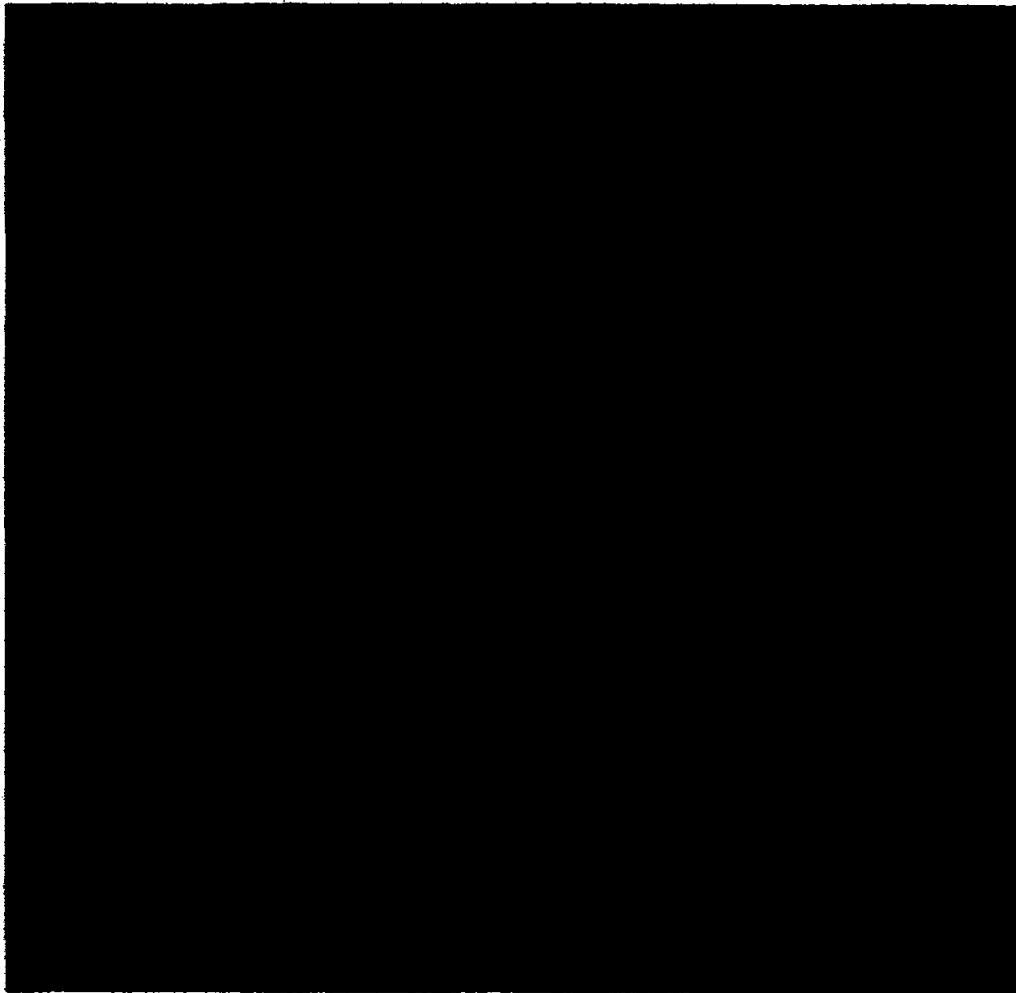

This view of earth, also taken during translunar coast, shows the northern third of Africa, with Europe covered by clouds. The terminator, at approximately 30 degrees east latitude, is over east Africa and Europe.

Figure 11-2 (b).- Photography.

11-14

NASA-S-69-2715

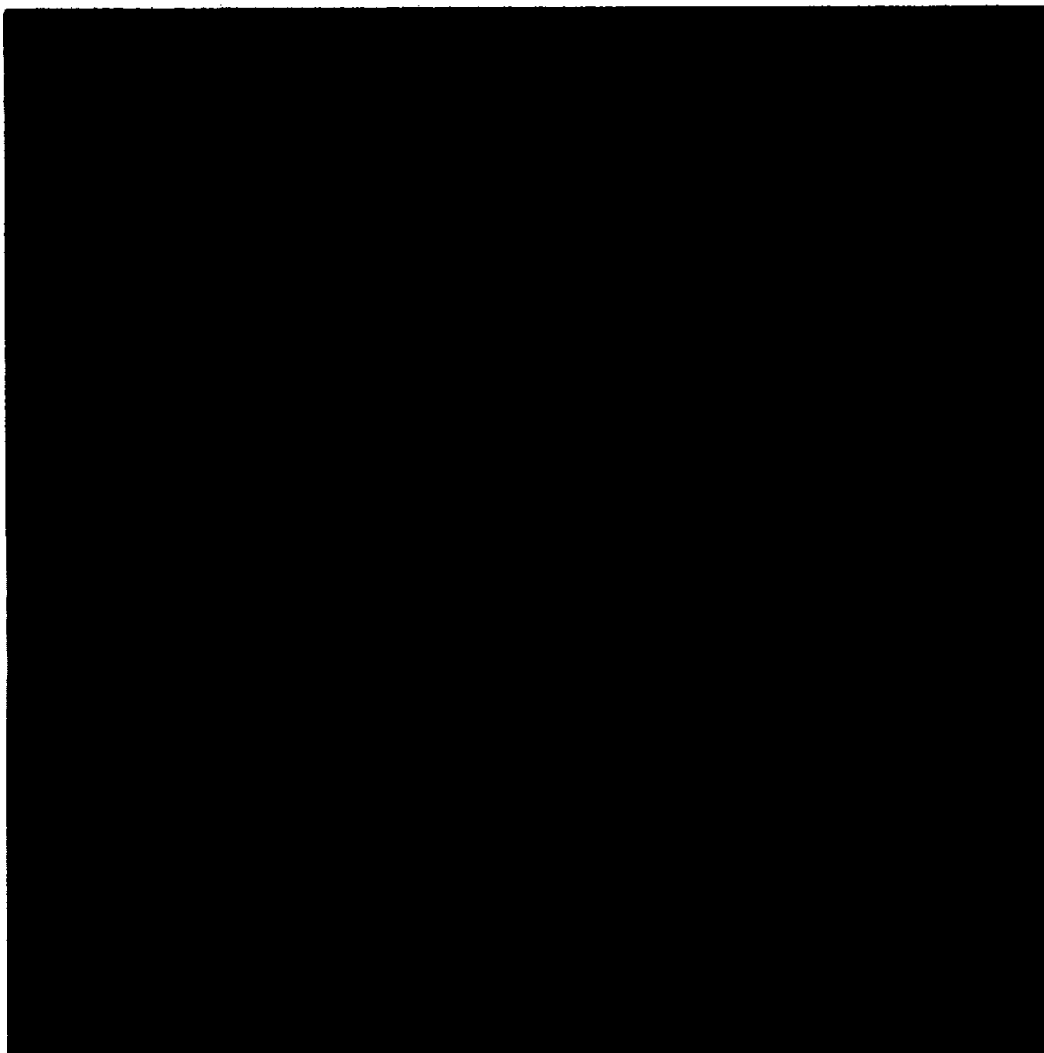

This photograph was taken while the spacecraft was crossing Smyth's Sea located on the eastern limb of the moon. The view is toward the west over the highlands separating Smyth's Sea from Mare Fecunditatis still further to the west. The photograph was taken at earthrise using the 80-mm lens.

Figure 11-2 (c).- Photography.

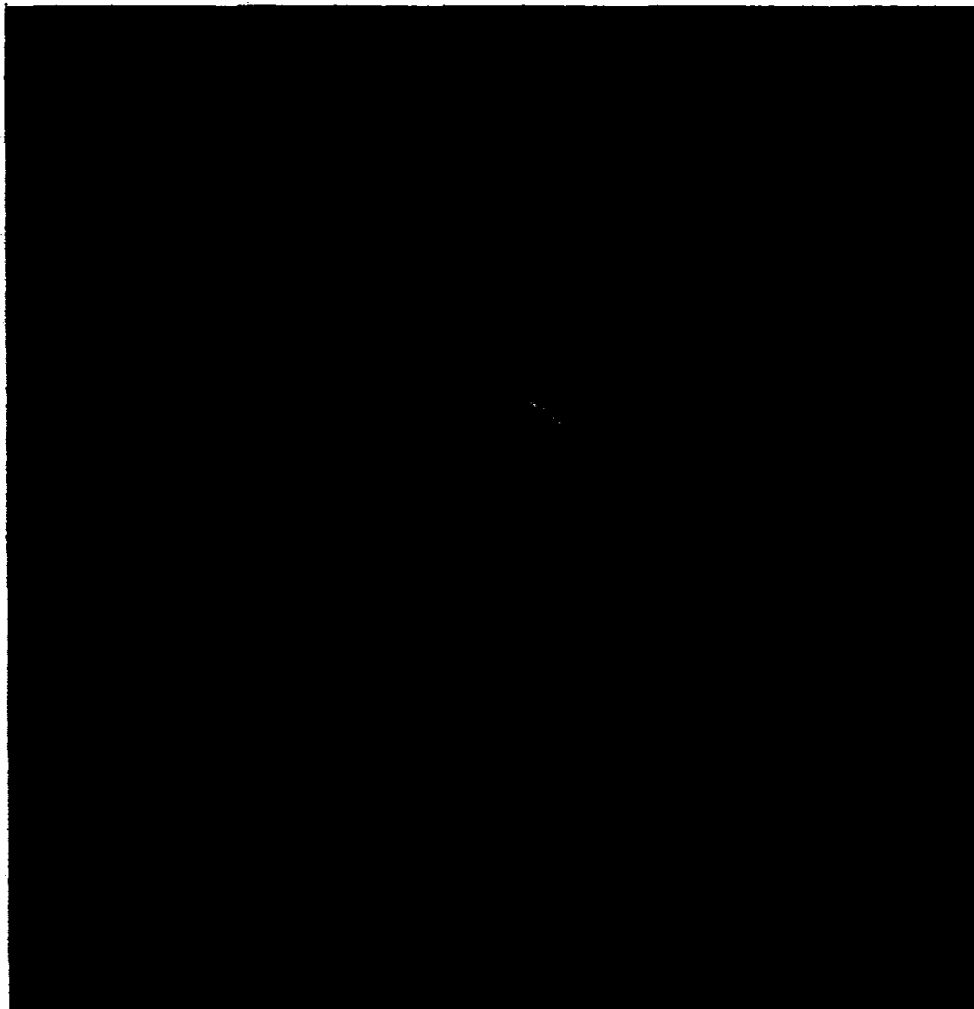
NASA-S-69-2716

This photograph of earthrise was taken from the lunar module looking in the direction of travel. At the time of exposure, the spacecraft was located above the far-side highlands at approximately 105 degrees east longitude. The mare surface seen in this sequence is known as Smyth's Sea and is just barely visible on the moon's eastern limb from earth.

Figure 11-2 (d).- Photography.

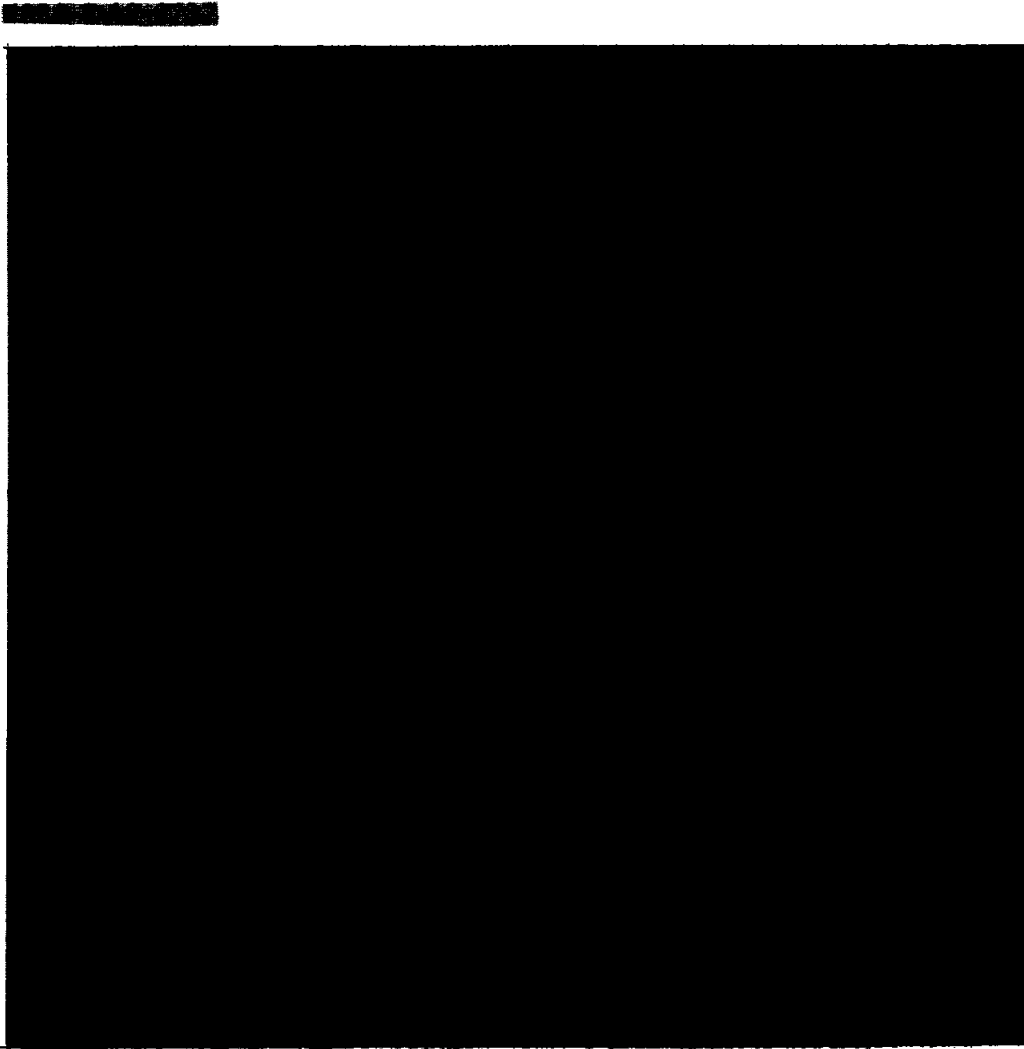

This photograph, taken from the command module, shows Apollo Landing Site 2 and the southwestern portion of Mare Tranquilitatis. The center of the photograph is at approximately 23 degrees east longitude and 0.5 degree north latitude. The details of the lunar surface becomes more obscure toward the horizon. The double craters Ritter and Sabine can barely be detected in the upper right portion of the photograph. Rima Hypatia is also partially obscured in the central portion of the frame because of the high sun angle.

Figure 11-2 (e).- Photography.

NASA-S-69-2718

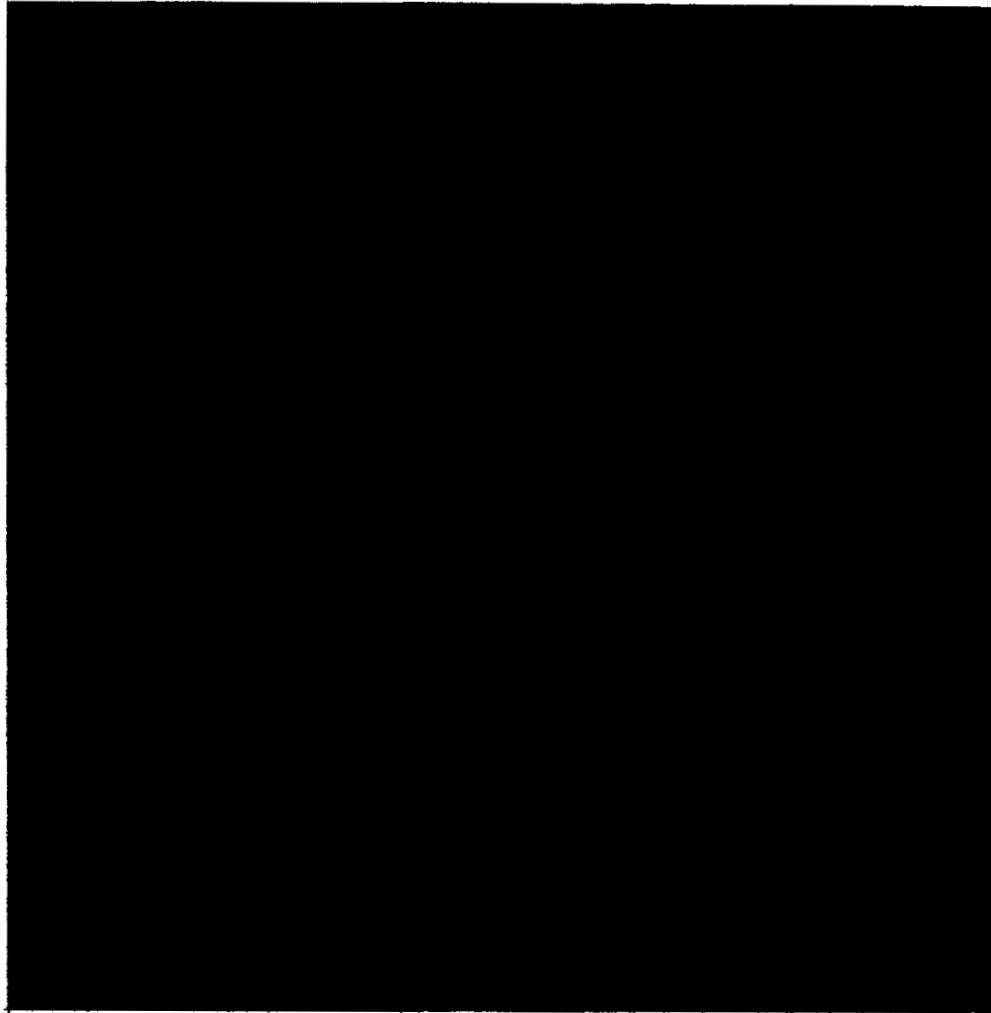

This photograph is a view of the approach to Apollo Landing Site 2 (just out of view, upper right center) in the Sea of Tranquility. The crew used code names such as "Thud Ridge, The Gashes, Fay Ridge, Diamondback and Sidewinder Rilles, Last Ridge and U.S. Road 1," for most of the prominent features in this photograph.

Figure 11-2 (f).- Photography.

NASA-S-69-2719

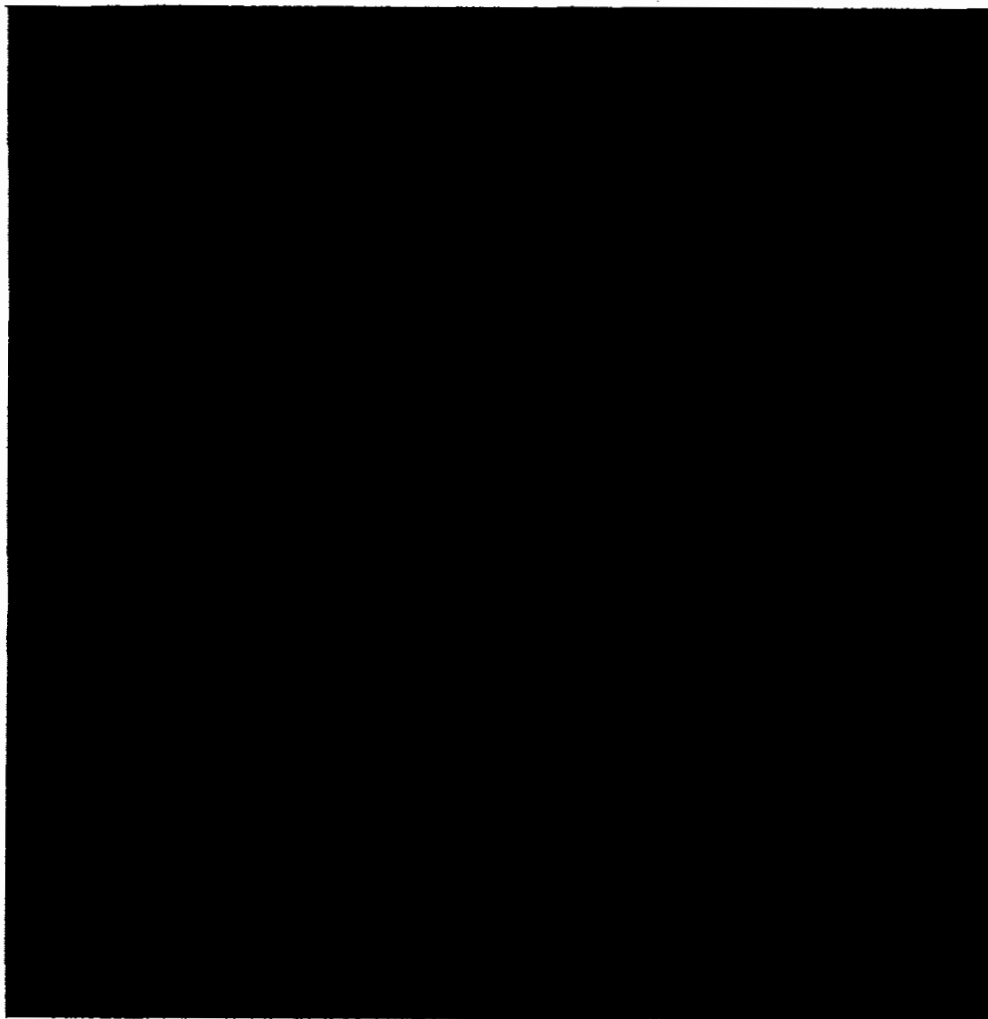

This photograph is an oblique view of the central portion of the Rima Ariadaeus near the contact zone between Mare Tranquilitatis and the highlands to the west.

Figure 11-2 (g).- Photography.

NASA-S-69-2720

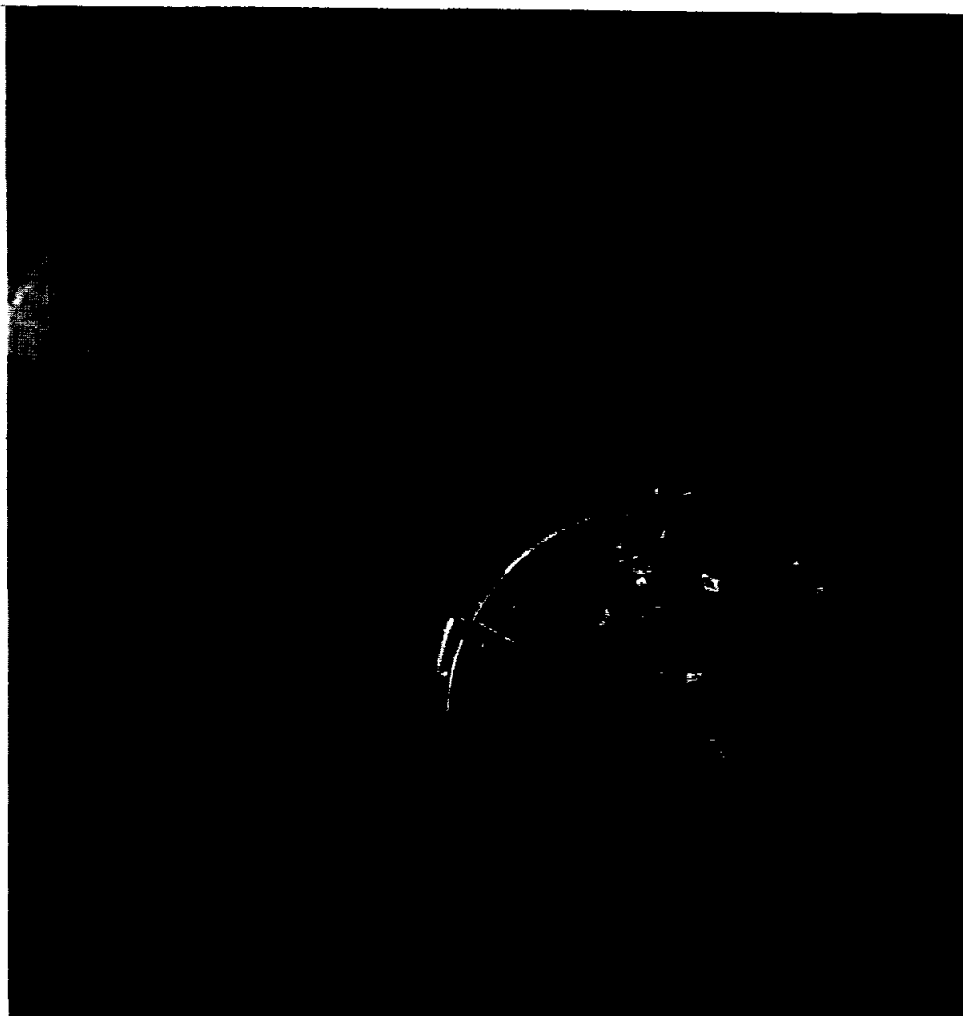

This photograph of the command and service modules was taken just after passing over Smyth's Sea. The area shown in the background is approximately at 75 degrees longitude. The reflective nature of the outer skin of the spacecraft can be readily seen.

Figure 11-2 (h).- Photography.

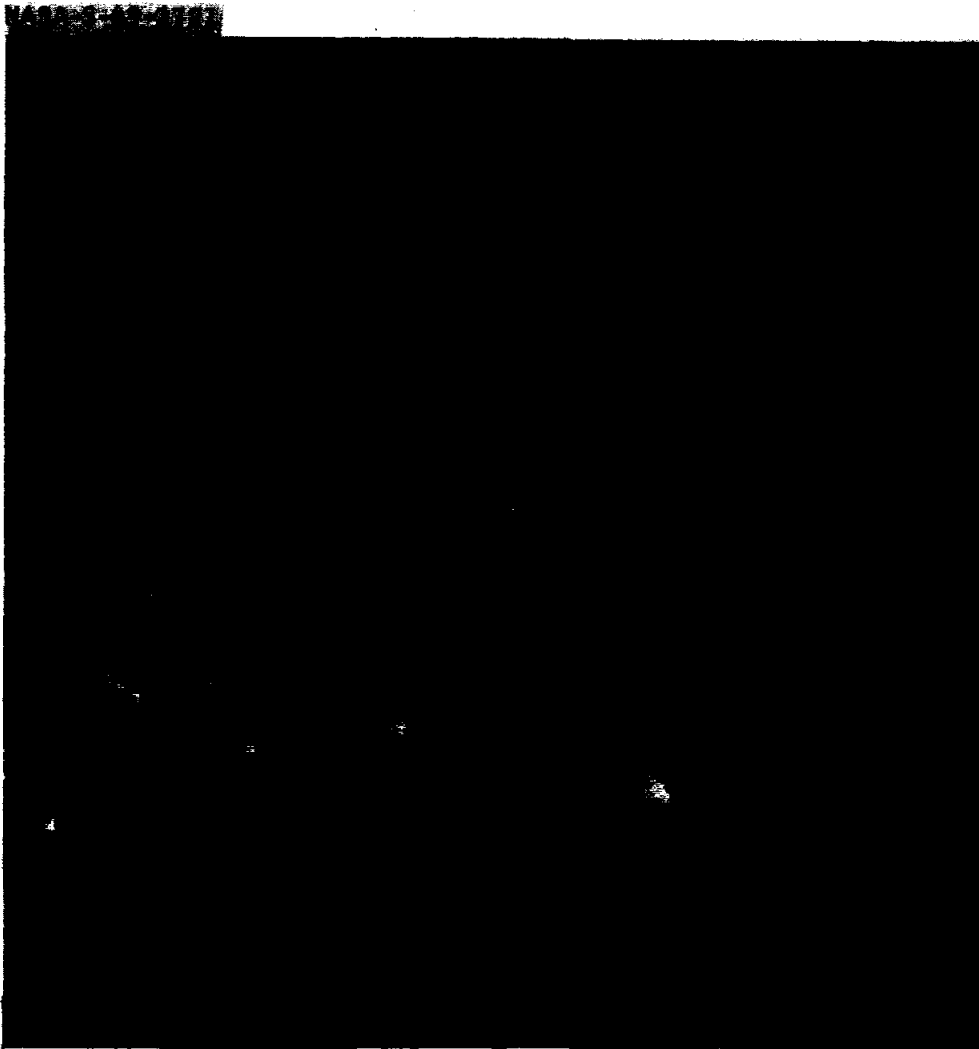

This high oblique photograph was taken from the command module looking south at Crater 302 at a low sun angle. The photographed area is located in the highlands on the back side of the moon, with center of the photograph approximately 161 degrees east longitude and 9 degrees south latitude.

Figure 11-2 (i).- Photography.

NASA-S-69-2722

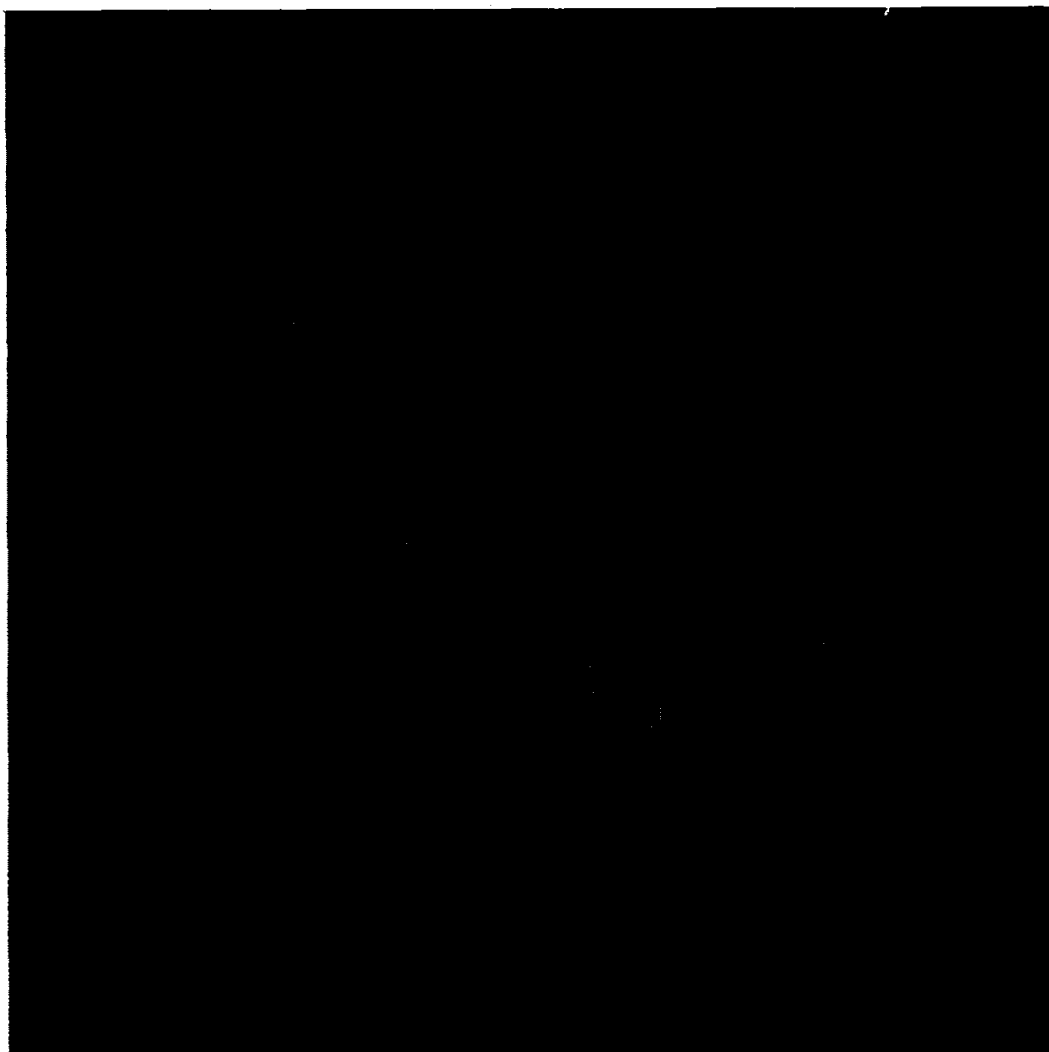

Crater IX, at 143 degrees east longitude and 4 degrees 30 minutes north latitude on the lunar farside, is approximately 200 statute miles in diameter. In this view taken from the command module, the floor of the crater resembles typical highland surface, and only a small portion of the crater rim is visible in the upper right-hand corner of the photograph.

Figure 11-2 (j).- Photography.

NASA-S-69-2723

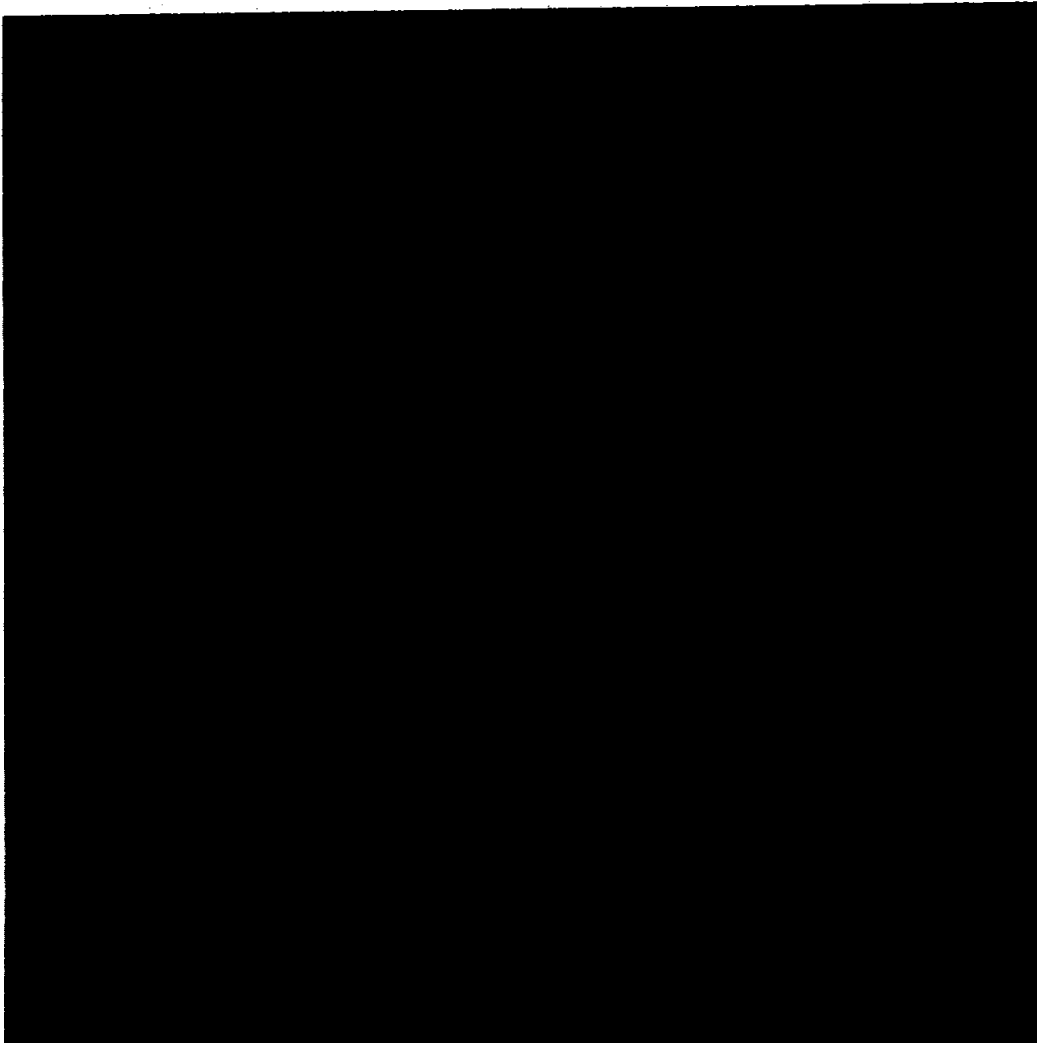

This view was taken from the command module at 120 degrees east longitude looking north from a point near the lunar equator. The large crater is known as Crater 211 and is approximately 50 statute miles in diameter. This crater is unique in that it has two central ridges, with slumping evident along the crater wall.

Figure 11-2 (k).- Photography.

NASA-S-69-2724

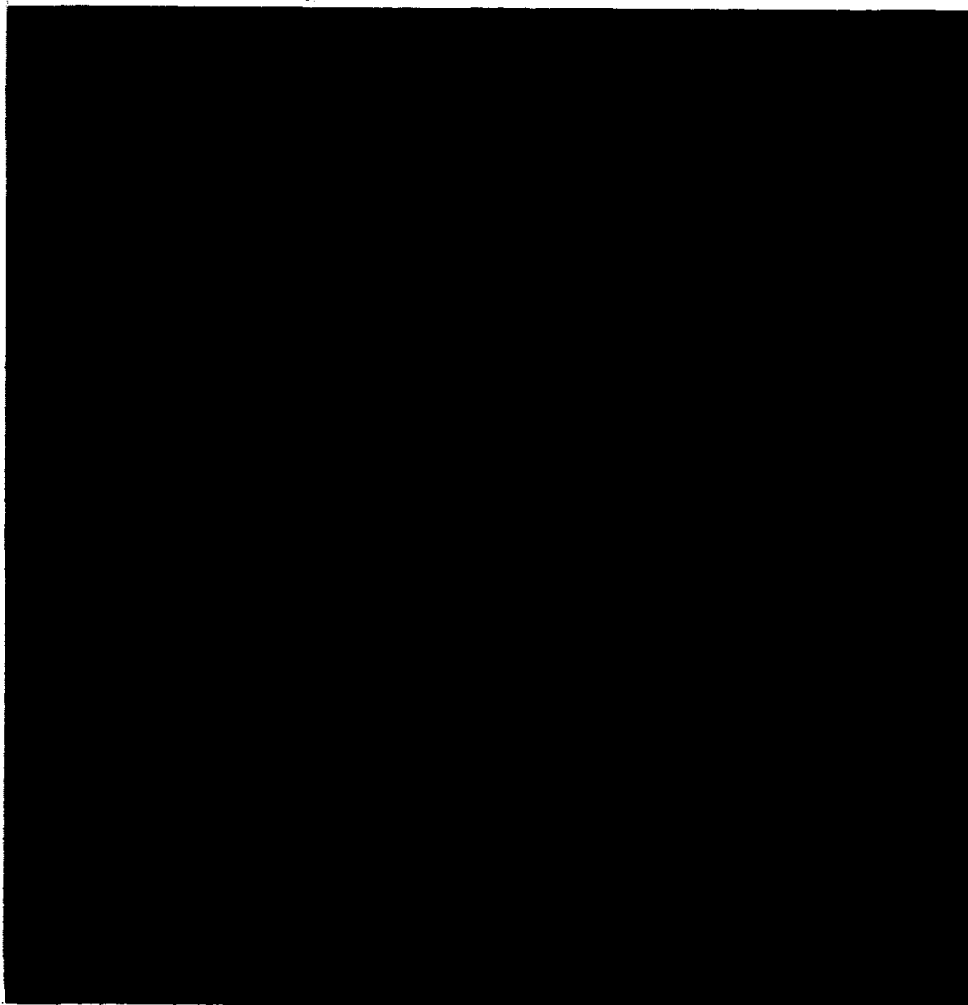

This photograph is located in the eastern part of the Sea of Fertility and shows an intersecting ridge pattern on the mare surface. The approximate coordinates are 56 degrees east longitude and 2 degrees 30 minutes south latitude.

Figure 11-2 (I).- Photography.

NASA-S-69-2725

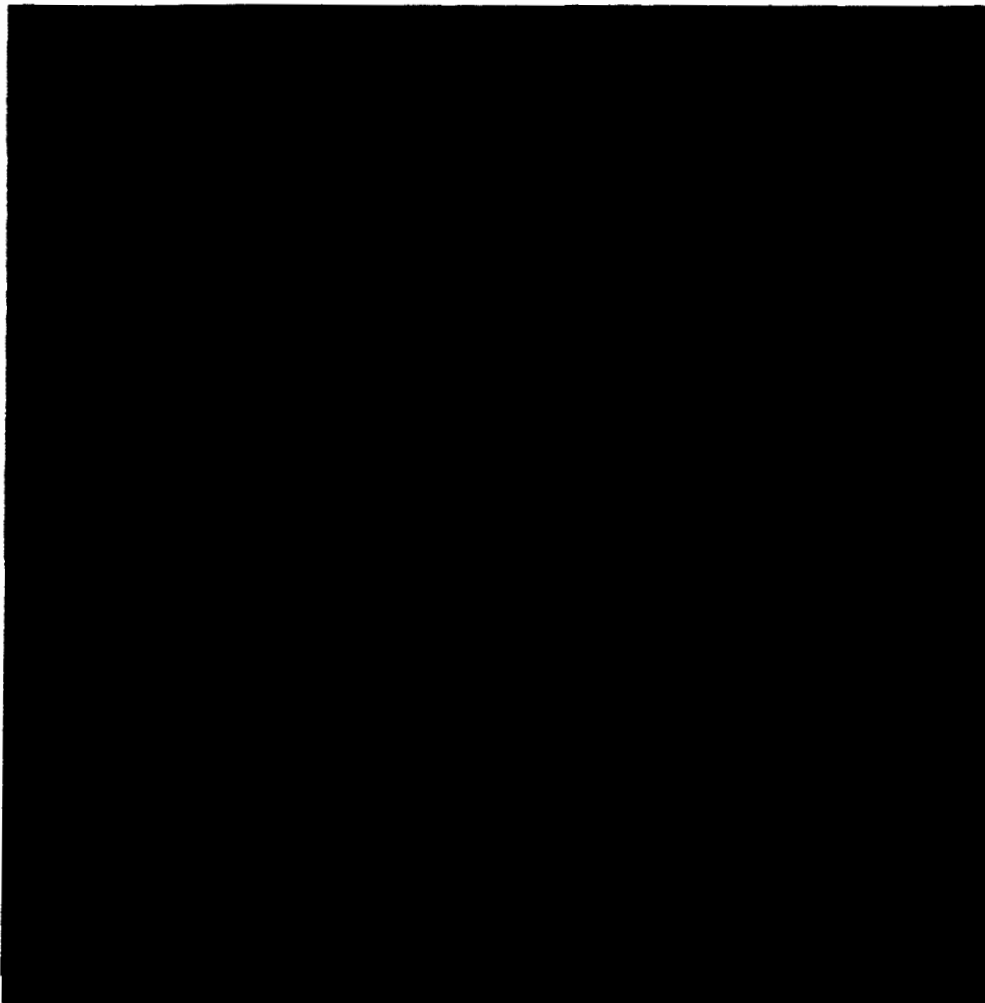

This photograph is a low oblique view of the Landing Site 2 area taken from the command module. This area is located adjacent to the highlands in the southern part of Mare Tranquilitatis. Rima Hypatia is clearly visible in the lower portion of the photograph, with the crater Moltke to the north. The central point of the photograph is located just north of Moltke at approximately 23 degrees east longitude and 0.2 degree north latitude.

Figure 11-2 (m).- Photography.

NASA-S-69-2726



This photograph is a high oblique view taken from the command module of an area near the crater Triesnecker and Sinus Medii at a very low sun angle. The view is looking westward into the terminator. The center of the photograph is at approximately 1 degree west and 5 degrees north, and Triesnecker is the crater to the north which is cut by the right edge of the frame.

Figure 11-2 (n).- Photography.

NASA-S-69-2727

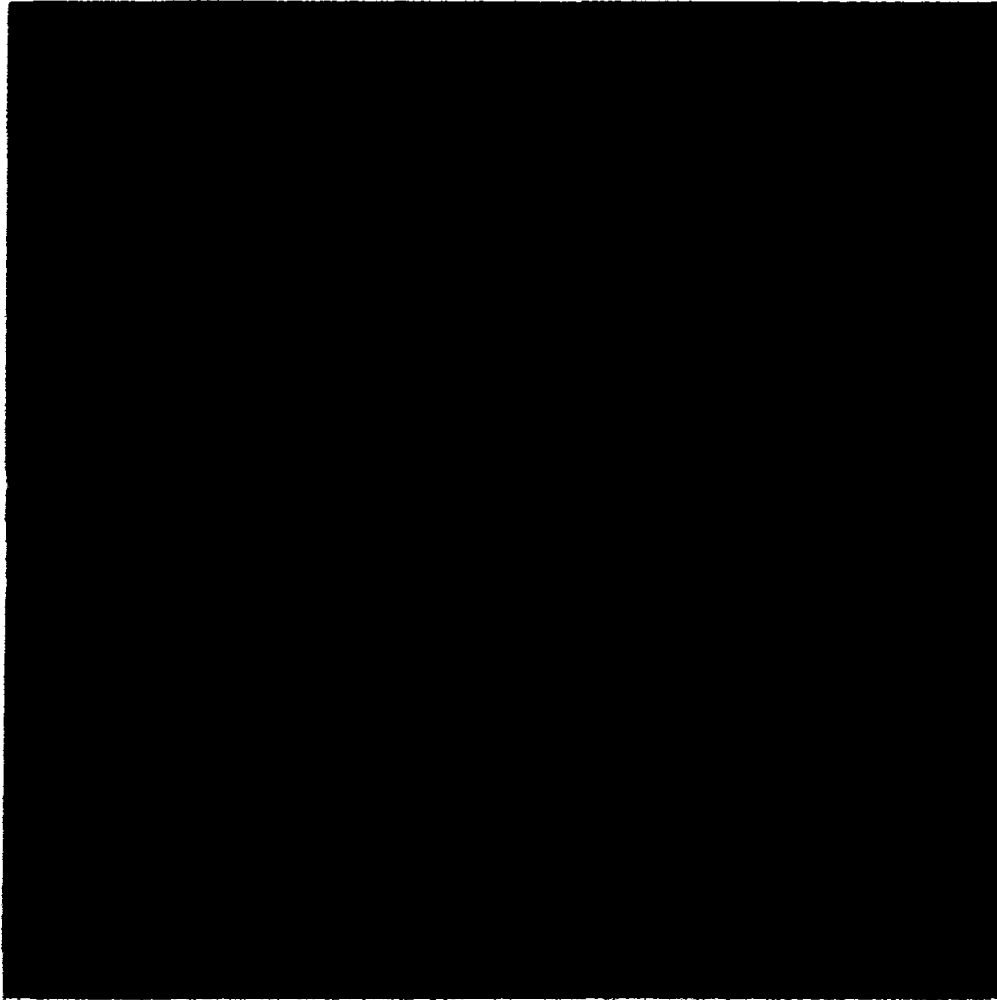

This photograph is a high oblique view of the Landing Site 3 area, taken at a relatively low sun elevation, and shows many small craters and other surface details. The photograph, taken from the command module looking westward, has its center located at approximately 3 degrees west longitude and 1 degree north latitude.

Figure 11-2 (o).- Photography.

NASA-S-69-2728

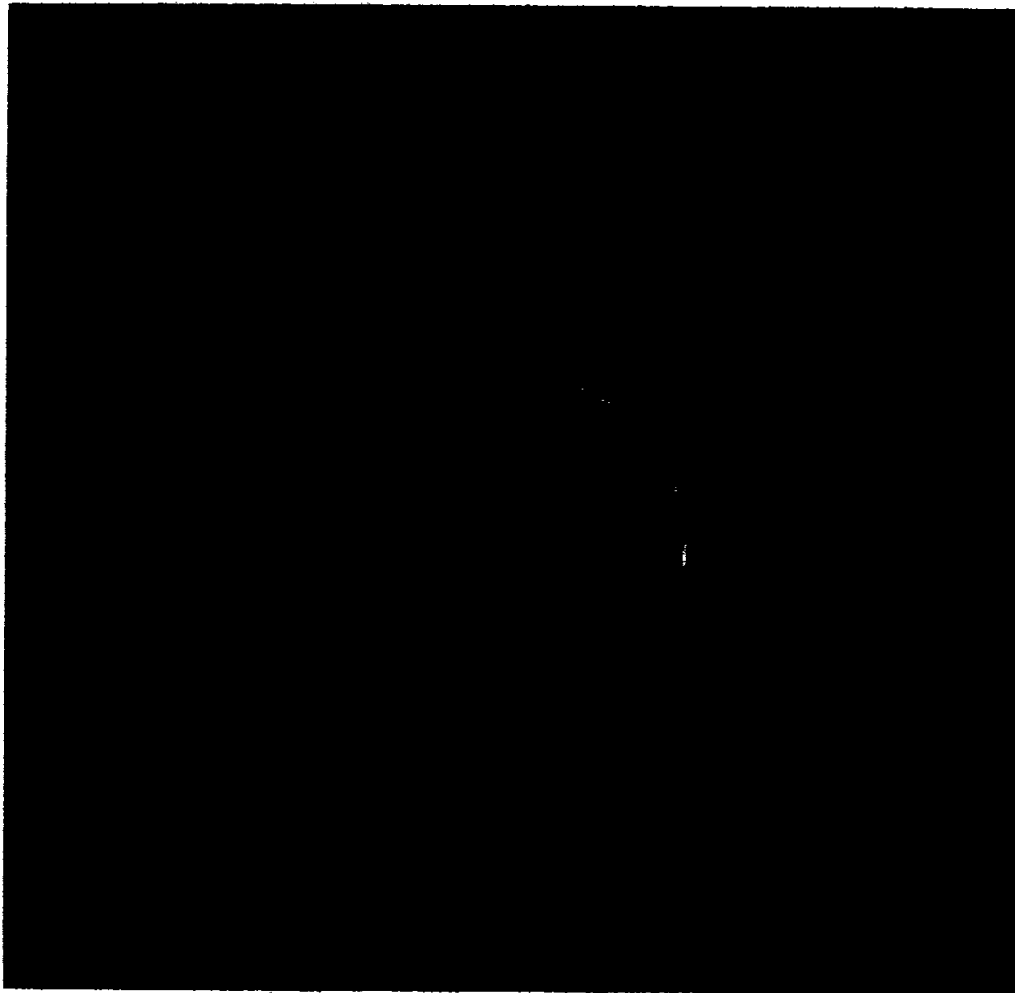

This view was taken approximately halfway between the moon and earth on the return trip. The terminator passes through the large crater Archimedes located on the eastern side of Mare Imbrium and also the craters Ptolemaeus and Alphonsus in the Central Highlands.

Figure 11-2 (p).- Photography.

12.0 MISSION SUPPORT PERFORMANCE

12.1 FLIGHT CONTROL

This section of the report presents an evaluation of real-time mission support and identifies those problems which occurred during the mission and were of significance to real-time flight control operations. The flight-control response to those problems identified was based on real-time data, and no attempt is made to evaluate the validity of any corrective action taken.

Prelaunch operations involving the interface between the various computers throughout the Manned Space Flight Network and the space vehicle were significantly reduced by deletion of the Software Integration Test. Validation of the specific software interfaces was derived with sufficient confidence during the lunar-module simulated flight, the Flight Readiness Test, Countdown Demonstration, and the actual countdown.

Flight control teams were exercised extensively, using both math-model and simulator training, for all major mission phases. Emphasis was placed on lunar module and launch operations. This preflight training was effective and resulted in a smooth procedural interface between the flight crew and the Mission Control Center.

Because of the accuracy of the translunar injection, the first scheduled midcourse correction was not performed. The preflight plan was to delete this firing if the velocity change required for the second midcourse correction would be less than 50 ft/sec. The accurate trajectory conditions after translunar injection permitted deletion of the first midcourse correction but resulted in the spacecraft being on a slightly slower translunar velocity profile. The slower profile delayed all lunar orbit flight plan events by approximately 12 minutes.

Because of flight control errors in calling out closing the potable water tank inlet valve for water chlorination, the crew got a high concentration of chlorine from the potable water tank during the breakfast period at approximately 22 hours (see section 10). The crew was advised to draw off a bag of water and dispose of it.

A detailed communications test was scheduled after lunar orbit insertion to verify several of the lunar-module/Network modes of operation. Previous flight experience had shown that inflight communications testing of this type is operationally difficult, even with the extended coverage available at lunar distances. Prior to lift-off, the ground team was well

prepared to support the communications tests, and the procedures were verified. All tests, which consisted of various combination modes and antennas and checkout of specific primary and backup hardware for vehicle-to-vehicle direct and vehicle-to-ground direct communications, were accomplished except for the command and service module relay and the Network relay. A Network relay was accomplished during the rendezvous when the Mission Control Center voice key was depressed to allow air-to-ground conferencing between the network and both vehicles, but this technique was different from that intended in the primary Network relay mode.

At approximately 96.5 hours, the Lunar Module Pilot reported he was unable to vent the tunnel (see section 15.1.17). Before undocking could be performed, a leak verification of both tunnel hatches was essential. A procedure was devised to allow depressurization of the tunnel through the lunar module down to 3.5 psi, and the resulting differential pressure (1.5 psi) was held until command module hatch integrity was verified. The lunar module was then pressurized to the normal level to again verify lunar module hatch integrity.

A fuel cell 1 warning light and main bus A and B undervoltage were observed at about 121 hours. The crew reported the associated ac circuit breaker for the fuel cell 1 pump package was open and could not be reset. Without the hydrogen pump, the temperature rise on fuel cell 1 was predicted to be approximately 30 deg/hr under a 20-amp load. Off the line, the fuel-cell skin temperature was expected to cool at a rate of 3 or 4 deg/hr. These characteristics permitted use of the fuel cell before sleep periods to raise the temperature, while deactivation during sleep periods allowed the cell to gradually cool so that caution and warning limits were never exceeded. At 166 hours, a hydrogen purge of 3 hours duration was recommended, increasing the fuel-cell lifetime to about 50 A-h. At about 174 hours, the crew was advised that fuel cell 1 would not have to be placed on line again to remain within temperature limits.

The sixth option for midcourse corrections was not exercised because of a disturbance in Doppler tracking data caused by the vent thrusting of both the 3-hour hydrogen purge and a water dump. It was first requested that the maneuver be delayed 30 minutes to allow more tracking time. Finally, a recommendation was made that the maneuver be delayed 3 hours to the time for the seventh midcourse correction so more accurate data and targeting could be obtained after continuous tracking of an unperturbed trajectory. Thus, only one correction was made to the trans-earth trajectory.

The Mission Control Center, Network, and spacecraft interfaces were effective throughout the mission. The Control Center/flight crew interface, especially for procedures during the rendezvous, was effective, and no major operations problems were encountered.

12.2 NETWORK PERFORMANCE

The Mission Control Center and the Manned Space Flight Network were placed on mission status May 6, 1969, and satisfactorily supported the simultaneous flight of two vehicles at lunar distance.

Support by the Manned Space Flight Network was excellent, with only minor discrepant conditions in the remote-site data processors and the air-to-ground communications links. No discrepancy had a significant impact because backup support stations were available for all mission phases after translunar injection.

Network support through orbital insertion was excellent. The Carnarvon computer operated intermittently from prior to launch through translunar injection, but this caused no mission impact. The Mercury ship, which was positioned geographically adjacent to Carnarvon, also experienced a command computer failure during translunar injection.

Air-to-ground communications were very good, including those in the pseudo-network relay mode. During lunar orbit, command module voice communications between Goldstone and the Mission Control Center were lost for several minutes. The loss was a station problem, and an operator error is suspected.

The command computers at both the 30- and 85-foot antenna stations experienced several faults; the majority of these were corrected by recycling the computer. Software verification procedures will be reviewed to ascertain whether additional testing is required.

12.3 RECOVERY OPERATIONS

The Department of Defense provided recovery support commensurate with the probability of landing within a specified area and with any special problems associated with such a landing. Recovery force deployment was similar to that for Apollo 8 and is detailed in table 12-I.

Support provided for the primary landing area in the Pacific Ocean consisted of the USS Princeton, accompanied by a communications support ship, USS Arlington, and a weather avoidance ship, USS Carpenter. Air support consisted of three HC-130 rescue aircraft staged from Samoa and seven SH-3D helicopters flown from USS Princeton. Three of the helicopters were for recovery, three were designated as "airboss" aircraft for communications support and recovery control, and the other was used as a photographic platform (fig. 7.6-6).

12.3.1 Command Module Location and Retrieval

At about 191:51:00 (1640 G.m.t., May 26, 1969) recovery forces had first visual contact with the spacecraft as it concluded the high-heat-load portion of entry and appeared as a streak on the night sky. Subsequent radar contact was made at 1641 G.m.t. by the Princeton. S-band signals were then received, and the spacecraft was observed descending on the main parachutes in predawn twilight. Voice contact was established on 296.8 MHz with recovery helicopters about 5 minutes before landing. The flashing light was observed by a recovery helicopter during command module descent but not after landing. The spacecraft landed at 192:03:23 (1652 G.m.t.) at a point calculated by recovery forces to be 15 degrees 2 minutes south latitude and 164 degrees 39 minutes west longitude.

The command module remained in the stable I (apex up) flotation attitude after landing, and the swimmers were deployed to install the flotation collar. The crew was retrieved and onboard the Princeton 39 minutes after landing. The command module was hoisted aboard the Princeton 1 hour 36 minutes after landing.

The weather conditions, as reported by USS Princeton at 1652 G.m.t. were as follows:

Wind direction, deg true	100
Wind speed, knot	5
Water temperature, °F	85
Cloud cover	10 percent at 2000 feet 20 percent at 7000 feet
Visibility, mi	10
Wave height, ft	3

12.3.2 Postrecovery Inspection

The following is a summary of discrepancies noted during the post-recovery inspection. All other aspects of the spacecraft were normal.

a. VHF antenna 1 had not deployed. The release mechanism had performed normally; however, the antenna had fouled in its stowage housing. Only two radials had deployed and these only partially. Approximately 3 hours after recovery, the antenna fully deployed to the upright position, apparently as a result of vibration.

b. One radial of VHF antenna 2 had not deployed. It also appeared to be binding in the stowage receptacle.

c. The minus Y portion of the shaped charge holder ring was outboard of the holder springs on the tunnel top; however, the ring was still contained within the envelope of the tunnel top and did not appear to have been bent out of shape. All four holder springs appeared to be in good shape.

d. The electrical terminal board (for apex cover parachute pyrotechnique circuit) located on the plus-Y side of the roll bar on the upper deck was damaged, and two pieces of this board were found in the postlanding vent valve opening.

e. The sea dye marker produced very little dye. Initial inspection of the marker revealed that one of the marker openings may have been clogged.

f. The ablator buildup around the sea anchor attach point had been damaged by the swimmers while installing the sea anchor and collar hardware.

12.3.3 Command Module Deactivation

Following offloading from the recovery ship, deactivation of the command module began at Ford Island, Hawaii, at 1800 G.m.t., May 31, 1969. No abnormal system condition was found except that one radioluminescent disc on the forward heat shield was cracked and found to be contaminated at a level of 9 milliroentgens per hour. This disc was covered with lead foil and taped with a contamination sticker.

Deactivation was completed at 0556 G.m.t., June 3, 1969. The command module arrived in Long Beach, California, at 1015 G.m.t., June 4, 1969.

TABLE 12-I.- RECOVERY SUPPORT

Landing area	Maximum retrieval time, hr	Maximum access time, hr	Support		Remarks
			Number	Unit	
Launch site	--	1/2	1	LCU	Landing craft utility (landing craft with command module retrieval capability)
			2	LVTR	Landing vehicle tracked retrieval (tracked amphibious vehicle with command module retrieval capability)
			1	HH-3E	Helicopter with para-rescue team
			2	HH-53C	Helicopters capable of lifting the command module; each with para-rescue team
			1	ATF	USS Salinan
Launch abort	24 to 48	4	1	DD	USS Rich
			1	AIS	USNS Vanguard
			1	LPA	USS Chilton
			3	HC-130	Fixed wing aircraft; one each staged from Pease AFB, New Hampshire; Kindley AFB, Bermuda; and Hickam AFB, Hawaii
Earth orbit secondary	40	6	2	DD	USS Rich and USS Carpenter
			3	HC-130	One each at Pease AFB, Kindley AFB, and Hickam AFB
Deep space secondary	26	10	1	MCS	USS Ozark
			1	LPH	USS Princeton
			4	SH-3D	Helicopters, 3 with swimmers and 1 photographic platform
			4	HC-130	Two each staged from Hawaii and Ascension
Primary	16 to 24	2	1	LPH	USS Princeton
			1	DD	USS Carpenter
			4	SH-3D	Three with swimmers, one photographic platform
			3	HC-130	Staged from Pago Pago, Samoa
Contingency		18	6	HC-130	One each staged from Hickam AFB; Kindley AFB; Ascension; Mauritius Island; Anderson AFB, Guam; and Howard AFB, Canal Zone

13.0 ASSESSMENT OF MISSION OBJECTIVES

The primary objectives for the Apollo 10 mission are defined in reference 1 and were as follows:

a. Demonstrate crew/space-vehicle/mission-support-facilities performance during a manned lunar orbit mission with a command and service module and lunar module.

b. Evaluate lunar module performance in the cislunar and lunar environments.

Detailed test objectives defining the tests required to fulfill the primary mission objectives are described in reference 2. These detailed test objectives are listed in table 13-I, where they are referenced to the two primary objectives.

The data presented in other sections of this report are sufficient to verify that the primary mission objectives were met. However, in two cases, specific functional tests related to detailed test objectives were not met. These objectives and their significance are discussed in the following paragraphs.

13.1 LUNAR MODULE STEERABLE ANTENNA PERFORMANCE

One detailed objective was to evaluate steerable antenna procedures during a pilot-yaw maneuver from face down to face up and pitch up to local vertical; this maneuver corresponds to the attitude profile for descent to lunar surface. S-band communications were lost during this test objective because the steerable-antenna track-mode was not switched properly. However, the operation of the steerable antenna during the abnormal staging excursions demonstrated the ability of the antenna to track under extremely high rates. On future missions, if the steerable antenna does not track properly, S-band communications will require the use of the omnidirectional antennas and a 210-foot ground-based receiving antenna.

13.2 RELAY MODES VOICE/TELEMETRY

Two portions of the relay modes voice/telemetry detailed test objective were not met: (1) demonstrate a voice conference capability via S-band between the lunar module, the command module, and the Network with

voice relay provided by the Network, (2) demonstrate a voice conference capability via VHF between the lunar module, the command module, and the Network with the relay provided by the command module, and (3) demonstrate a voice conference capability via VHF between the two spacecraft and between the lunar module and the Network, with relay provided by the lunar module.

The three relay modes were not demonstrated because of lack of time. The first is primary for voice between the lunar module and command module during the lunar stay. If this mode could not be used, voice communications between the two vehicles would be limited to times when the command module was above the lunar module horizon.

The second and third relay modes are primarily intended for the contingency loss of S-band voice communications between the lunar module and the Network.

TABLE 13-I.- DETAILED TEST OBJECTIVES

Number	Description	Primary objectives supported	Completed
S1.39	Midcourse navigation/star-lunar landmark	1	Yes
S6.9	Command and service module high gain antenna reflectivity	1	Yes
S7.26	Space environment thermal control	1, 2	Yes
P11.15	Primary guidance, undocked, descent propulsion performance	1	Yes
S11.17	Lunar module inertial measurement unit performance	1, 2	Yes
S12.6	Abort guidance performance	1	Yes
S12.8	Abort guidance/control electronics attitude/translation control	1	Yes
S12.9	Unmanned abort guidance-controlled ascent propulsion firing	1	Yes
S12.10	Abort guidance rendezvous evaluation	1	Yes
S13.13	Long duration, unmanned ascent propulsion firing	1	Yes
S13.14	Lunar module supercritical helium	2	Yes
P16.10	Lunar module steerable antenna	1, 2	Partially
S16.12	Lunar module omni antennas, lunar distance	1, 2	Yes
P16.14	Landing radar test	1, 2	Yes
S16.15	Rendezvous radar performance	1	Yes
S16.17	Relay modes, voice/telemetry	1, 2	Partially
S20.46	Transposition/docking/lunar module ejection	1	Yes
P20.66	Crew activities, lunar distance	1	Yes
S20.77	VHF ranging	1	Yes
P20.78	Command and service module/lunar module rendezvous capability	1	Yes
S20.79	Passive thermal control modes	1	Yes
S20.80	Ground support, lunar distance	1	Yes
S20.82	Primary guidance/abort guidance monitoring	1	Yes
S20.83	Lunar module consumables, lunar orbit	1, 2	Yes
S20.86	Lunar orbit visibility	1, 2	Yes
P20.91	Lunar landing site determination	1	Yes
S20.95	Midcourse correction capability	1	Yes
S20.117	Lunar orbit insertion	1	Yes
P20.121	Lunar orbit determination	1	Yes
Functional tests added and accomplished during the mission:			
1	Color television - translunar, lunar orbit, and transearth		
2	Command and service module high gain antenna automatic reacquisition test - translunar		
3	Command and service module high gain antenna automatic reacquisition/ omni D test - transearth		
4	Midcourse navigation/star-earth horizon - transearth		
5	Four sets of minimum sun elevation constraint tests		
6	Photography - descent strips, stereo strips, obliques, and terminator-to-terminator sequences		
7	Tests of lunar module guidance and reaction control systems after ascent engine firing to depletion		

14.0 LAUNCH VEHICLE SUMMARY

Apollo 10 was the third manned flight using a Saturn V launch vehicle (AS-505) and was the fifth in a series of Saturn V launches. All major flight objectives were accomplished. Ground system performance was satisfactory, and all problems encountered during countdown were resolved. The space vehicle was launched on an azimuth of 90 degrees east of north; then after 13 seconds of vertical flight, the vehicle began to roll into a flight azimuth of about 72 degrees east of north. All trajectory parameters were near nominal. At translunar injection, the total space-fixed velocity was 7.84 ft/sec less than nominal.

All S-IC propulsion systems performed satisfactorily. In the period from 35 to 38 seconds after lift-off, the average engine thrust, reduced to standard conditions, was 0.2 percent lower than predicted. The S-II propulsion system performed satisfactorily, and because of center-engine low frequency oscillations during the Apollo 8 and 9 missions, the center engine was shut down early to avoid these oscillations. The J-2 engine in the S-IVB stage operated satisfactorily throughout the operational phase of the first and second firings, and both shutdowns were normal. The continuous vent system adequately regulated pressure in the liquid hydrogen tank during the earth parking orbit, and the oxygen/hydrogen burner satisfactorily repressurized the liquid hydrogen tank for restart. Repressurization of the liquid oxygen tank was not required.

A helium leak was noted in module 1 of the auxiliary propulsion system at 6.5 hours. The leak persisted until loss of data at 10.9 hours; however, system performance was nominal. The hydraulic systems performed satisfactorily on the S-IC and S-II stages, and during the first S-IVB firing and coast phase, all parameters remained within specification limits. During the second S-IVB firing and translunar coast, the output pressure of the S-IVB engine-driven hydraulic pump exceeded the normal 3635 psi by 3 percent. In response, the auxiliary pump feathered to no-flow, and the auxiliary pump current dropped to 21 amperes. Subsequently, the current dropped unexpectedly to 19 amperes and remained at that level during the 4-second interval after shutdown when it should have been 40 to 70 amperes. However, neither problem affected overall performance.

The structural loads and dynamic environments were well within the launch-vehicle structural capability. During powered flight, there was no evidence of the coupled structure/propulsion system instability noted in previous missions. The early shutdown of the S-II stage center engine successfully eliminated the low frequency oscillation experienced during Apollo 9. During the S-IVB first and second firings, very mild low frequency (12 to 19 Hz) oscillations were experienced, with a recorded maximum amplitude of $\pm 0.25g$ peak to peak. Engineering analyses have shown that the 12- to 19-Hz frequency is consistent with the uncoupled thrust

oscillations from the J-2 engine. During the last 70 seconds of the second S-IVB firing, the crew also observed higher frequency (46 Hz) oscillations superimposed on the low frequency oscillations, but these were well within structural design capability. This frequency is consistent with the oscillations produced by cycling of the hydrogen tank non-propulsive vent valves.

The guidance and control system functioned satisfactorily throughout the flight. After translunar injection, attitude control was maintained for the propellant dumps and a planned chilldown experiment. The ascent system propellants were not depleted by the last ullage maneuver, therefore attitude control was maintained until the batteries were exhausted.

The command and communications system in the instrument unit performed satisfactorily except that between 06:40:51 to 06:58:16, the downlink signal strength dropped sharply. The cause of the drop is suspected to be a malfunction in the directional antenna system.

The vehicle internal, external, and base region pressure environments were generally in good agreement with the predictions and compared well with data from previous flights. The pressure environment was well within design levels. The measured acoustic levels were generally in good agreement with the lift-off and inflight predictions and with data from previous flights.

15.0 ANOMALY SUMMARY

This section contains a discussion of the significant anomalies. The discussion of these items is divided into three major areas: command and service modules, lunar module, and government-furnished equipment.

15.1 COMMAND AND SERVICE MODULES

15.1.1 Ruptured Burst Disc in Reaction Control System

When the propellant isolation valves in command module reaction control system B were opened about 10 hours prior to launch, the helium manifold pressure dropped from 44 to 37 psia. A pressure drop of this magnitude would be expected if the oxidizer burst disc was ruptured, allowing oxidizer to flow from the tank into the oxidizer manifold.

The isolation valve and the burst disc are redundant devices; therefore, a decision was made to proceed with the launch even though the disc was ruptured. The isolation valves were closed after orbital insertion. The engine valves were then opened by means of the reaction control heater circuits, and the oxidizer was vented from the manifold for 25 minutes. Afterward, the helium manifold pressure remained at 37 psia except for changes caused by thermal effects. When the isolation valves were opened just prior to system activation for entry, the helium manifold pressure dropped from 37 to 25 psia, confirming that the venting procedure had been effective and that the manifold was empty.

After the mission, the oxidizer and fuel burst discs were similar in physical appearance, indicating that the oxidizer burst disc had failed because of pressure.

Caution notes have been added to the prelaunch checkout procedures in the places where the allowable limits on the burst disc (241 \pm 16 psid in the flow direction and 10 psid in the reverse direction) could be exceeded. To allow early detection of any similar problem in the future, a leak check of the burst disc has been added after reaction control system propellant servicing.

This anomaly is closed.

15.1.2 Reaction Control System Helium Leak

The helium manifold pressure in command module reaction control system A began to decay at a rate of 0.13 psi/hr following helium servicing 3-1/2 days prior to launch. After 2-1/2 days, the pressure had dropped from 45 to 37 psia. The pressure in the helium manifolds between the propellant tanks and the check valves was checked; the oxidizer side was at the initial pressure, but the fuel side was low. Neither a helium leak nor a fuel leak could be detected; however, a fuel leak of sufficient magnitude to cause the pressure drop would have been discovered. The conclusion was, therefore, that the low pressure helium manifold in the fuel leg was leaking slightly but at a rate acceptable for the mission. The system was then repressurized to 49 psia.

Figure 15-1 shows the system pressures for both the prelaunch and mission periods. The leak rate decreased as the mission progressed, reaching 0.04 psi/hr by the end of the mission. Only part of this decrease resulted from the reduced system pressure; thus, the leak corrected itself to some extent and/or the characteristics of the helium changed as it became diluted by propellant permeating the bladder.

Postflight testing of the command module included a very thorough mass spectrometer leak check on system A, at both 50 and 285 psig. No leaks were detected; however, during the postflight decontamination procedures, certain types of leaks could be eliminated.

For future missions, the system will be pressurized to 100 psia about 30 days prior to flight to insure that any leaks can be detected and appropriate corrective action taken prior to start of the launch countdown.

This anomaly is closed.

15.1.3 Rendezvous Radar Transponder Failed to Operate

At 98:51:54, following undocking, the rendezvous radar transponder in the command module would not operate. An earlier self-test had been conducted successfully. The Command Module Pilot checked the circuit breaker and initiated the self-test; all readings were zero. The three-position PWR-OFF-HEATER switch was cycled to OFF and back to PWR. The transponder then worked properly for the remainder of its use.

During postflight tests of the switch and wiring, no anomalous conditions were uncovered. The switch was removed from the panel and disassembled. No contamination was found nor were any improper tolerances discovered.

The only remaining possibilities are an intermittent failure in the service module wiring, the rendezvous radar power control box, or the transponder itself, or an improper switch configuration in the command module.

This anomaly is closed.

15.1.4 Primary Evaporator Dryout

The primary evaporator in the environmental control system began operation soon after lift-off but dried out after only a few minutes. The secondary cooling system was activated and functioned nominally. The primary evaporator was deactivated and was not reserviced with water until just prior to lunar orbit insertion. It dried out again during the second lunar orbit. Just prior to entry, the evaporator was serviced again. During entry, it functioned normally, but information is not available to indicate whether or not additional water was automatically provided to the evaporator.

This evaporator had dried out once during altitude chamber tests at the launch site, and the cause was not determined. During later tests, the evaporator functioned satisfactorily.

After the mission, the spacecraft wiring and control circuits were checked. Continuity and resistance measurements were normal. Further tests of the system duplicated the inflight condition and revealed that the water control circuit operated intermittently. When a microswitch in this circuit opens, the water section of the environmental temperature control unit is activated and begins to supply water to the evaporator on demand (fig. 15-2).

A check of the switch assembly revealed that the actuator moved as little as 0.0008 inch beyond the point at which the switch should have opened. With changes in environment, the actuator travel was at times not sufficient to open the switch. Actuator rigging procedures will be modified to assure proper overtravel.

This anomaly is closed.

15.1.5 VHF Simplex-A Did Not Operate

Twice during revolution 10, transmissions from the lunar module on VHF simplex-A were not received in the command module.

At 94 hours 46 minutes, the Commander attempted a transmission on simplex-A; however, the circuit breaker supplying power for the keying relay was open, rendering VHF simplex-A inoperative.

Transmission on simplex-A was attempted again at 95 hours 16 minutes. A check of switch positions for both spacecraft was performed. Both lunar module crewmen attempted unsuccessfully to transmit on simplex-A. The Commander then tried simplex-B with no success; however, his simplex-B switch had been left in the "receive" position from the previous check, and he could not transmit at that time. The Commander then switched to "transmit/receive" and simplex-B performed satisfactorily. With the press of time, the crew decided to use simplex-B. However, during the backside pass of revolution 11, VHF simplex-A was tried again, and it performed satisfactorily. The "A" transmitter was used for both voice and ranging for the remainder of the flight.

The most probable cause for the apparent failures of VHF simplex-A was that because of the numerous switch configuration changes in both vehicles, the two were not configured simultaneously for communications on simplex-A.

This anomaly is closed.

15.1.6 Stabilizer Not Stowed Prior to Launch

The stabilizer, which maintains couch positioning when the foot strut of the center couch is removed, was connected during the launch (fig. 15-3). The stabilizer should have been in the stowed position to allow stroking of the couch struts for an abort landing. The crew properly stowed the stabilizer prior to entry.

A specific mandatory inspection point has been added to the pre-ingress checklist for subsequent missions.

This anomaly is closed.

15.1.7 Failure of Fuel Cell Pump Package

At 120 hours 47 minutes, a short circuit in the ac pump package of fuel cell 1 caused the associated circuit breaker to trip. Fuel cell 1 performance was normal up to that time. Figure 15-4 shows the observed current and voltage variations. The breaker could not be reset; therefore, fuel cell 1 was removed from the bus because both the hydrogen and the coolant pumps were inoperative. The fuel cell was thereafter placed on the bus only when the skin temperature decreased to 370° F; this procedure kept the fuel cell operative.

Circuit analysis and inverter testing indicated that the failure was a phase-to-phase short either in the hydrogen pump or in the glycol pump. Glycol pumps, which have canned stators, have never failed electrically.

Failures of this nature have been observed on hydrogen pumps during endurance testing under normal operating temperatures. Of fifteen development power plants that exhibited an insulation resistance equal to or less than the Apollo 10 unit, six had shorts in the hydrogen pump stator windings. Four of these six were phase-to-phase, and the other two were phase-to-ground. This kind of failure is caused by the hot, moist hydrogen flowing across the windings; the insulation is degraded and phase-to-phase shorts result. In these tests, no stator failed in less than 1000 hours, and the maximum time to failure was 3960 hours. The unit flown on Apollo 10 had operated approximately 300 hours.

Except for a major redesign of the hydrogen pump, no procedural or design changes have been identified which would further improve the reliability of the hydrogen pump.

The most probable cause of the phase-to-phase short was a breakdown in the insulation within the hydrogen pump. The basic design leads to a limited life of the motors.

This anomaly is closed.

15.1.8 Hydrogen Purge Flow and Pressure Excursion

At 166 hours 49 minutes, the skin temperature of fuel cell 1 was 420° F, and a continuous hydrogen purge was initiated to reduce the concentration of water in the electrolyte. Three hours later, the fuel cell was sufficiently dry and hot, the purge was terminated, and the heater for the hydrogen vent line was turned off. However, hydrogen flow to the fuel cell decayed very slowly (fig. 15-5). Normally, flow decays to zero in less than 1 minute. The purge valve was reopened, and the flow rate increased to the upper limit, indicating that the purge valve was functioning. The valve was closed again but the flow decrease was still very slow. As the flow rate was approaching zero after about 30 minutes, the regulated hydrogen pressure for the fuel cell began to increase, reaching a maximum of 72 psia before slowly decaying to the normal 62 psia.

As shown in figure 15-6, the regulator operation depends on a regulated nitrogen reference pressure. The nitrogen pressure did not change during the hydrogen pressure excursion, nor did the regulated oxygen pressure, eliminating the possibility of a reference pressure change.

In tests simulating the flight conditions, the regulator temperature reached minus 23° F in 5 minutes and minus 100° F in 15 minutes during cryogenic hydrogen purges. Below minus 10° F, the regulator vent and supply valves leak because the seal stiffens and does not conform to the seat. Further, testing has shown that if the vent is blocked under low-temperature conditions, regulated pressure rises approximately 10 psia. Proper sealing is restored when the regulator temperature increases to minus 10° F.

These test results demonstrate that the extended hydrogen purge in flight created low temperatures on the regulator; the consequent regulator leakage explains the continued flow. With the heater off, the vent line became blocked, leading to the increase in regulated hydrogen pressure.

For future missions, extended hydrogen purging from cryogenic tanks will not be performed. For a greater margin of operational assurance, the vent line heater will be left on for 10 minutes after termination of a hydrogen purge. This change has been incorporated into the Apollo Operations Handbook.

This anomaly is closed.

15.1.9 Failure of Hydrogen Automatic Pressure Control

During the 3-hour purge of fuel cell 1, the automatic pressure control system was believed to have failed twice to turn the hydrogen tank heaters off (fig. 15-7). After 170-1/2 hours, the heaters were switched on and off manually.

For automatic operation, the pressure switches in both tanks must close in order to actuate the heaters, but only one pressure switch must open to deactivate them (fig. 15-8). As shown in figure 15-7, the heaters in tank 1 were in AUTO and those in tank 2 were in OFF before the purge was started. Also, the pressure switch for tank 1 was open and for tank 2 was closed. Shortly after the purge was started, the heaters in tank 1 were switched to OFF and in tank 2 to AUTO; this change was made to balance the quantity in the two tanks. After 5 minutes of purging, the pressure switch in tank 1 closed at 236 psia, activating the heaters in tank 2 and affecting pressures in the manner expected. Since the pressure in tank 1 continued to drop and a master alarm was received, the heaters in tank 1 were turned to AUTO. As shown in figure 15-7, the pressures were at a maximum of 8 psia above the switching level when the heaters were manually turned off.

During testing under conditions simulating the extended purge, the output of the pressure transducer drifted upward 5 to 7 psi when the

temperature dropped as low as minus 140° F. This kind of performance can be expected, since the transducer is temperature-compensated only to minus 20° F. During calibration tests, a hydrogen pressure transducer cold-soaked at minus 94° F drifted upward 3.9 psi at 260 psia and downward 80 psi at 350 psia.

The transducers on Apollo 10 were subjected to temperatures between minus 100° and minus 140° F during the extended purge; the transducer output drifted upward and created an apparent loss of automatic pressure control. Long-duration purges will not be performed on future flights. The Apollo Operations Handbook has been changed appropriately.

This anomaly is closed.

15.1.10 Gyro Display Coupler Drift

The gyro display coupler was reported to drift excessively in roll and yaw (approximately 5 degrees in 20 minutes). Attitudes displayed by the gyro display coupler and the inertial measurement unit were compared after earth orbital insertion, indicating differences of less than 0.1 degree in all axes. These values and crew comments indicate proper performance early in the mission.

A simplified block diagram of the stabilization and control system showing the functions of the gyro display coupler and the spacecraft control loops is shown in figure 15-9. One of the two gyro assemblies provides only rate information and is normally used to drive the gyro display coupler. The other gyro assembly can provide either rate or attitude error, at crew option, and can be selected to drive the gyro display coupler.

The Apollo 10 gyro display coupler was driven by both gyro assemblies, and the crew reported similar indications from each, therefore isolating the cause of the drift to the gyro display coupler.

The specification for the gyro display coupler contains allowable attitude display deviations for attitude and translation maneuvers, for ascent, and for entry. It does not contain an allowable value for long-term constant attitude drift. A value of 10 deg/hour is considered reasonable for the system.

The gyro display coupler does not directly control any spacecraft maneuvers. If the inertial measurement unit in the primary guidance system fails, the crew can manually maneuver to the desired inertial attitude and then allow the stabilization and control system to automatically maintain attitude. To minimize drift effect when the gyro display coupler is to be used for a maneuver, it should be aligned as near in time to the maneuver as is practicable.

The two gyro assemblies and the gyro display coupler were removed from the spacecraft and returned to the vendor for individual acceptance tests and a system test.

All three units passed individual tests with no discrepancies which could have caused the reported inflight performance. The gyro display coupler was then operated alone with the inputs set at zero. Drift rates were 2, 4, and 1 deg/hr for pitch, yaw, and roll, respectively. A gyro package was then connected, and the system was operated on a test stand. Under quiescent operation, with gyro inputs, the performance was the same as that recorded above. Finally, a run was made simulating passive thermal control in which a 20 deg/hr roll rate was introduced. The drifts recorded were 5.1 and 5.0 deg/hr for pitch and yaw, respectively. The drift rates experienced during these tests are not indicative of the performance reported inflight. It is possible, because no attempt was made to accurately measure drift, that the actual divergence of the attitude indicator was not as rapid as it appeared.

This anomaly is closed.

15.1.11 Data Storage Equipment

The data storage equipment experienced loss of data three times during entry, which resulted in a loss of approximately 33 seconds of recorded PCM data and 2 seconds of recorded voice data.

Testing of the recorder has revealed that an outside-to-inside pressure differential of 2.25 psi is sufficient to deform the cover, causing it to contact the tape reels (fig. 15-10).

The recorder vent valve is specified to operate at 2.0 ± 0.5 psi differential pressure. Acceptance test data on the Apollo 10 vent valve shows a cracking pressure of 2.40 psid. However, this pressure deformed the cover sufficiently to contact the reel and slow it.

An in-line change will be implemented to select valves that crack on the low side of the specification to insure no recurrence of this problem.

This anomaly is closed.

15.1.12 Intermittent Scribing of Entry Monitor

The stylus of the entry monitor stopped scribing while the scroll was being driven to the entry pattern following a successful completion of the pre-entry tests. The scroll was slewed back and forth, and the

stylus began to cut through the emulsion on the scroll. The trace of acceleration versus velocity was normal throughout entry.

The emulsion used on the scroll film is a latex rubber/soap base. The formulation of the soap, which was commercially procured, was recently changed, with uric acid being added. This addition tends to cause the emulsion to harden by a chemical reaction with the gelatinous film on the Mylar scroll.

No change will be made for Apollo 11 or 12; however, for subsequent vehicles, either the scroll emulsion base will be made using the originally formulated soap or pressure-sensitive scroll coating which was recently qualified will be used for the scroll.

This anomaly is closed.

15.1.13 Failure of Recovery Beacon Antenna to Deploy

The VHF recovery beacon antenna did not properly deploy. Recovery photographs show that the radiating element and three ground-plane radials were not properly deployed. However, RF signals from the beacon were received by the recovery forces.

The antenna did not deploy because one radial was caught under the outboard edge of the ramp shown in figure 15-11.

No change is required for Apollo 11; however, an engineering study has been initiated to consider modification of the ramp.

This anomaly is closed.

15.1.14 Water Problems

During the initial phases of the flight, the crew stated that the ground-serviced potable water contained gas. The tank is serviced with non-deaerated water, which is forced into the system by nitrogen at approximately 20 psia. When the water, which was saturated with gas at 20 psia, is drawn from the tank into the cabin at 5 psia, some gas is released from solution but remains mixed with the water.

The use of deaerated water would not significantly decrease the gas concentration because the water would become saturated with oxygen through the permeable bladder within 3 to 4 days. Consequently, there would be no advantage to using deaerated water.

As was experienced on earlier flights, the fuel cell water contained hydrogen.

To alleviate the problems, a two-compartment bag with a handle for whirling the bag in a circular motion was provided (fig. 15-12). This bag had been developed rapidly with insufficient time for a complete test program. It did not function as intended in flight.

A membrane device (fig. 15-13), which attaches to the exit port of the water gun and allows the gas to pass into the cabin, will be used on future missions.

This anomaly is closed.

15.1.15 Low Pressure From Water Gun

For about 2 hours on the seventh day of the flight, the flow from the command module water dispenser appeared to be less than normal. An 0.03-inch orifice within the dispenser normally limits flow to approximately 6 cc/sec (see fig. 15-14). A reduction in flow at the food preparation panel could not be verified. The driving force for the water is oxygen at 20 psia, and this pressure was normal. Also, the crew reported that the hose was not kinked.

The gun and hose were back-flushed and a particulate count taken. No particles over 500 microns were found. In the range of 100 to 500 microns, 316 particles were found. The interior of the gun contained about 1 milligram of a lubricant with silicon dioxide. The only lubricant containing silicon dioxide used in the water system is used on O-ring seals in the quick disconnect. The lubricant is the most likely suspect for the clogging.

Processing specifications are being reviewed to assure that excess lubricant is not used. Should the gun become clogged in flight, several alternatives are available for drinking water. Two guns are carried aboard the lunar module and could be used. Also, water is available at the food preparation panel of the command module, as well as at the fire-fighting nozzle on the gun (the nozzle is upstream of the metering orifice).

This anomaly is closed.

15.1.16 Tunnel Would Not Vent

The pressure in the tunnel between the command module and the lunar module could not be lowered to ambient pressure through the tunnel vent

system. Postflight inspection of the vent system revealed that an incorrect fitting had been installed on the vent (fig. 15-15). The proper part was specified in the installation procedures.

For Apollo 11 and subsequent flights, an end-to-end test will be performed to verify the system. On Apollo 10, this test had been waived.

This anomaly is closed.

15.1.17 Thermal Coating on Forward Hatch Flaked Off

When the lunar module cabin was first pressurized the thermal coating on the command module hatch came off in pieces. The insulation blanket vent holes were plugged, producing the damage (fig. 15-16). One possibility is that the preflight baking of the hatch at 900° F for 15 hours weakened the insulation to the extent that internal pieces of insulation broke loose and plugged the holes during tunnel depressurization. Another possibility is that the vent holes were inadvertently sealed when the insulation blanket was potted with RTV or when the H-film tape was installed on the hatch surface.

Postflight examination of the forward hatch has shown that no insulation remained after entry. This condition probably existed in lunar orbit and explains the water condensation observed on the hatch mechanisms and adjacent structure in lunar orbit and the ice formed during transearth flight.

On the Apollo 11 command module, the insulation has been deleted because of the effects noted and because a reevaluation of thermal conditions has shown that the insulation is not necessary. However, to minimize condensation, a single layer of H-film tape has been applied over the exterior surface of the hatch ablator. Some water and ice can be expected on Apollo 11 but to a lesser degree than observed on Apollo 10.

This anomaly is closed.

15.1.18 Launch Vehicle Engine Warning Annunciator

During spacecraft testing prior to launch, the launch vehicle engine warning indicators operated intermittently. The indicator for each of the five engines has two redundant miniature lamps, and one lamp in four of the indicators was intermittent.

Postflight, only three of the four lamps were intermittent. The annunciator was removed from the spacecraft and disassembled. On six of the ten lamps, including the four intermittent ones, cold-solder joints

were found where the lamp lead was attached to the printed circuit board (fig. 15-17). The cold-solder joint would have caused intermittent lamp operation.

There are also three other status lights in each annunciator: launch vehicle overrate, S-II separation, and launch vehicle guidance fail. The six bulbs in these lights were not intermittent prior to launch nor were any faults found in them during postflight examination.

The units for Apollo 11 and subsequent vehicles have been screened, whereas the Apollo 10 unit had not been.

This anomaly is closed.

15.1.19 Digital Event Timer Miscounts

The digital event timer on panel 1 advanced a total of 2 minutes during the countdown for first midcourse correction. At other times, the tens of seconds failed to advance.

The increments of time are electrically advanced through a circuit activated when a conductor segment contacts a brush in each revolution of the units wheel.

The tens of seconds problem was duplicated postflight in the count-up and the countdown modes. Inspection disclosed that the units wheel had been rubbed by the motor gear; paint had flaked and contaminated the units tab and brush assembly (see fig. 15-18). Contamination between the tab and brush would have prevented electrical contact.

The 2-minute jump was not duplicated, and no condition was found in the timer that could have produced the jump. Since this timer is sensitive to electrical noise, the most probable cause was a spurious noise input.

A screening test has been developed for the timers installed in future spacecraft; however, the capability of the test to isolate unreliable timers has not yet been proven.

This anomaly is closed.

15.1.20 Docking Ring Charge Holder

The minus Y charge holder ring was not captured by the retention springs, while the plus Y holder was captured (fig. 15-19). Although the holder was not captured, it remained in a position above the groove, resting on top of the springs within a nonhazardous envelope area.

Even though the two charge holder segments are restrained at one end, there is a remote possibility of a free charge holder damaging the fabric components of the earth landing system. As a result of one of the holders on Apollo 9 coming from the groove and being in the hazardous envelope, four spring retention devices were installed on Apollo 10 to increase the probability of capturing the charge holders.

A marginal situation existed on Apollo 10 since two of the springs captured and the other two did not. A mathematical analysis indicates that pressure in the tunnel area will make the ring follow the tunnel. Although the pressure was worse on Apollo 10 than it will be for a normal separation, the math model itself does not indicate that the situation will be markedly improved. Testing without any pressure in the tunnel has shown that the springs will work.

Based on the Apollo 10 flight experience, ground tests, and analytical results, there is still a probability that the springs will not capture. The probability of capture may be higher on Apollo 11 than it was on Apollo 10. In any event, the risk of a catastrophic failure is extremely small. The charge holders are unlikely to detach completely and, therefore, cannot cause major damage to the parachutes. The possibility of abrasion of a riser line exists; but, based on analysis and the experience of Apollo 9 and Apollo 10, this also is small.

On in-line vehicles, a better means of retaining the charge holder is being studied.

This anomaly is closed.

15.1.21 Fuel Cell 2 Exit Temperature Oscillations

At 134 hours, the crew reported that the condenser exit temperature on fuel cell 2 had been cycling between 149° and 168° F at the rate of 2 cycles/minute for 30 to 40 minutes while the spacecraft was behind the moon and that the caution and warning alarm for low temperature had been triggered about every tenth cycle. Figure 15-20 shows typical oscillations which were noted during five occasions in lunar orbit. The maximum amplitude of the oscillations in temperature was about 20° F.

Prior to and after the series of temperature oscillations, disturbances in the condenser exit temperature occurred throughout the flight, as typically shown in figures 15-21 and 15-22. Flight results for Apollo 7, 8, and 9 show disturbances in condenser exit temperature similar to those on Apollo 10 for one fuel cell in each flight. The time between recurrent disturbances was about 8 minutes during low current operation (less than 30 amperes) and 4 minutes during two-fuel-cell operation (greater than 30 amperes). The two-fuel-cell operation was employed because of a pump circuit failure in one of the fuel cells (see section 15.1.9). The disturbances excited oscillations when low radiator temperatures (less than 80° F) and high current loads prevailed. Furthermore, the oscillations damped out for radiator temperatures greater than 115° F.

Tests and system response analyses have confirmed that these oscillations can occur under conditions similar to those observed inflight. Thermal response analyses and test results are being studied to determine the mechanism for exciting these oscillations.

The observed behavior, although abnormal, is not detrimental to fuel cell component life or performance but does represent a nuisance to the crew because the caution and warning must be reset manually.

This anomaly is open.

15.1.22 Left Hand Head Strut Lockout Handle

Postflight, the left hand head strut lockout handle was in the ready (locked) position. During lever force checks, it was determined that the lever spring did not have sufficient force to prevent the hood from returning to the locked position. Disassembly showed that the spring had been improperly installed. A review of manufacturing records indicated that the locking mechanism had been modified and that no inspection or test had been performed subsequent to this modification.

A mandatory inspection point has been added to the manufacturing process to assure proper assembly. The Apollo 11 and 12 spacecraft at the launch site have been inspected.

This anomaly is closed.

15.1.23 Flashing Light Failure

The recovery forces observed that the flashing light was operating while the spacecraft was descending on the main parachutes but not after the spacecraft landed. Postflight, the glass tube which contains the flashing element was found to be cracked. The bulb assembly, part of the

flashing recovery beacon, was replaced, and the beacon operated properly. Further analysis is being performed.

This anomaly is open, and an Anomaly Report will be published.

15.2 LUNAR MODULE

15.2.1 Gimbal Drive Actuator Fail Indication

A master alarm and associated engine pitch gimbal fail warning were received during the phasing maneuver. "Coasting," an uncommanded gimbal movement which results when the spring-loaded brake fails to engage after removal of drive signals, had occurred during checkout of this gimbal. A recurrence of the coasting, which is not detrimental, was not unexpected.

The telemetry data indicate that the pitch and roll actuators both drove as expected. The small number of thruster firings also demonstrate that thrust vector control was maintained using the actuators. During the maneuver, the gimbal fail was indicated at the time of a reversal in pitch gimbal motion.

Because of the sample rate of the telemetry data, the time of the gimbal fail indication cannot be precisely established, but the data encompass a period during which the gimbal command reversed (fig. 15-23). Thus, the coasting could have allowed gimbal movement for 0.25 second without a command, which causes the fail indication. Figure 15-24 shows the descent engine trim control failure detection logic. For Apollo 11 and subsequent, the brake mechanism has been redesigned, and the allowable time for movement without command has been increased to 0.50 second.

This anomaly is closed.

15.2.2 Master Alarms During Phasing Maneuver

The crew reported having received three master alarms during the descent engine phasing maneuver; and the second alarm was associated with the gimbal drive actuator previously mentioned. The first alarm was concurrent with the engine-on command and a descent propellant low quantity indication which went out when the master alarm was reset.

The data (see fig. 15-25) confirmed the first low-propellant and the pitch-trim alarms and associated fail signals. In addition, the propellant measurement on telemetry began indicating low-level 23 minutes before engine-on and it remained on throughout the firing.

The low-level indication was believed to be caused by a gas bubble which, under zero gravity, could uncover the low-level sensor. Once the low-level sensor is uncovered the indicator would have then electrically

latched as shown by the telemetry data. This condition had also been noted on Apollo 9. The low-level indication is not displayed to the crew until the engine firing circuit is enabled. Since the low-level sensor was already latched, a master alarm and a caution and warning indication were received coincident with engine-on. As shown in figure 15-26, once the low-level indicator latches and engine-on occurs, the low-level light should remain on, even though the master alarm is reset. The low-level indicator can be reset by cycling the power switch for the gaging system; then, unless the indicator is latched again, the master alarm should not recur.

The crew reported that when the master alarm was reset, the caution and warning low-level indication also went out. As explained, this should not have happened.

This condition was probably caused by an open-circuit downstream of the telemetry indication since the telemetry showed low-level sensor "on" during the entire phasing maneuver. Recontact at the open would have activated the master alarm and the caution and warning lights, as discussed previously. Thus, the crew could have seen another master alarm caused by the low-level indication. The alarm could have been reset in less than 1 second; and since the master alarm is sampled once per second, this could account for not getting the master alarm indication.

A tape playback from the lunar module recorder during this period revealed two master alarm warning tones: one at engine on and the other coincident with the pitch trim fail. No warning tone was found for the second propellant low-level alarm. The tone circuit is in parallel with the master alarm system; therefore, there is nothing common to both systems which could have caused both to malfunction. Further, no malfunction of the master alarm system was apparent after the phasing maneuver.

The signal path between the signal conditioner buffer and the master alarm is shown in figure 15-26. One of the following failures in the signal path must have occurred intermittently:

- a. Output circuit of the buffer which conditions the propellant low-level signal or the one which conditions the engine-on signal
- b. Connectors at these buffer outputs
- c. Signal wiring
- d. Caution and warning input connector
- e. Caution and warning electronic circuits.

In summary, to satisfy the crew observations, the failure was probably an intermittent wire, electronics circuit, or connector with an intermittent failure of the tone system during the second low-level indication.

On Apollo 11 and subsequent, the descent propellant low quantity alarm has been removed from the master alarm (see fig. 15-25).

This anomaly is closed.

15.2.3 S-Band Backup Voice

During lunar revolution 13, the backup downvoice received from the lunar module at the Mission Control Center was unusable because of low speech levels. Playback of the voice tape recorded at the Goldstone station showed that excellent quality backup voice was recorded at the output of the demodulation system. However, the speech levels on the Goldstone lunar module air-to-ground and Network 1 loops which interface with the lines to the Mission Control Center were extremely low. Investigation showed that the only way the problem could be duplicated was by simultaneously remoting both normal and backup downvoice from Goldstone to the Mission Control Center. This is not a standard configuration. Thus, the investigation results indicate that the receipt of unusable backup voice was caused by an operator error within the Goldstone station.

This anomaly is closed.

15.2.4 S-Band Steerable Antenna

During the beginning of revolution 13, the S-band steerable antenna did not properly track. At acquisition of signal, the received signal strength at the ground station indicated near-boresight condition for the antenna. Over the next 13 minutes, the signal strength gradually decreased 20 dB. A plot of expected signal strength (fig. 15-27), considering spacecraft attitude changes and antenna gain patterns, showed that the antenna was not moving at this time. The antenna performed well both before and after this period.

The possible causes for failure of the antenna to move were either that the servo system circuit was open or the antenna track-mode switch was in the SLEW or OFF position.

The track-mode switch for the steerable antenna is a three-position switch (down - SLEW; center - OFF; up - AUTO). The crew reported that the switch may have inadvertently been switched to OFF instead of to AUTO at the time acquisition had been established.

This anomaly is closed.

15.2.5 Optical System Problems

Three operational anomalies in use of the lunar module optical system were reported by the crew. These problems are discussed in the following paragraphs.

Reticle contamination. - The crew reported hair-like objects on the reticle of the alignment optical telescope. Several mechanical clearances

in the telescope can provide paths for contamination. The fixed redirection mirror at the elbow of the telescope (fig. 15-28) has an air gap of 0.005 to 0.007 inch to allow thermal expansion of the mirror. Other possible paths are located outside the cabin and would require that particles filter through lubricated bearings to reach the focal plane of the telescope. Preflight records show that the telescope was assembled, tested, and stored in a Class 10 000 clean room (particle size allowable is 0.00001-inch diameter per 10 000 cubic feet of volume) until installed in the vehicle. Once installed, covers were provided and the telescope was inspected and cleaned periodically. The last cleaning was on the day before launch, and at that time, the field of view was not contaminated.

The reticle may have been contaminated through the air gap at the redirection mirror/telescope housing interface. Foreign particles could have been lodged and then released during lunar module dynamics or during the pressurization/depressurization of the lunar module, and the reticle could have been contaminated by the breathing created through the telescope.

This anomaly is closed.

Computer control and reticle dimmer. - The crew reported mechanical difficulty with the dimmer control of the computer control and reticle dimmer. The rheostat control knob (thumbwheel) would physically fall forward from the bright position to maximum brightness, thus requiring manual hold to maintain the dimmer control in position. The operation described by the crew is normal.

The thumbwheel operates a variable resistor through a shaft/cam mechanical interface (fig. 15-29). Frictional force generated by the arm of the microswitch is present from the fully counterclockwise position (full dim) through 270 degrees of clockwise rotation (80 percent brightness). The typical torque required to overcome the frictional force in the 270-degree sector is 1.5 inch-ounces. When the microswitch depresses into the 60-degree detent area of the cam, the frictional force decreases. Although the thumbwheel can rotate through an additional 60 degrees, reticle brightness is not changed, since the microswitch has bypassed potentiometer control of the circuit and has applied full voltage to the reticle lamps (fig. 15-29). In the depressed area of the cam, any motion imparted to the thumbwheel will continue until the mechanical stops of the variable resistor are reached. This feature increases the reliability of the reticle lamp control by including a mechanical override that will assure reticle brightness if an electrical component fails.

This anomaly is closed.

Star disappearance. - The crew reported that at approximately six star diameters from the center of the reticle, stars disappeared from view. No imperfections existed in the reticle or other elements of the optical train that would cause the problem. However, the surface of the prism may have been contaminated (such as a fingerprint smudge) during final installation of the telescope sunshade. Contamination on the prism will not be in focus but could cause stars to disappear and light transmittance to vary. The LM-5 prism and reticle were cleaned and inspected when the sunshade was installed. A Test Change Notice is being written to require a similar cleaning for subsequent vehicles.

This anomaly is closed.

15.2.6 Gas in Lunar Module Drinking Water

The crew reported that the lunar module drinking water contained gas. The nitrogen used to pressurize the water system permeates the tank bladder, and the water becomes saturated within 100 hours after servicing. As the absolute pressure is reduced the dissolved nitrogen is released. The first water withdrawn should have contained about 12 percent of gas. At staging, the mixture should have contained 6.3 percent nitrogen because of the reduced water tank pressure at that time. The water hose, water gun, and connecting plumbing were not serviced and this entrapped air would initially add to the problem. Prelaunch procedures have been changed to include servicing the water hose and connecting plumbing.

On Apollo 9, no significant gas was reported to be present. A bacteria filter was installed in the drinking line. This filter allows only water to pass until it becomes loaded with gas, which increases the pressure drop across the filter and eventually causes a breakthrough of gas. The gas then "belches" out through the water nozzle. On Apollo 10, the filter was not used.

This anomaly is closed.

15.2.7 Cabin Noise

The crew reported that the cabin was noisy, primarily because of the glycol pump. One of the cabin fans was used for approximately 30 minutes and was then turned off because it was not needed. Molded ear pieces provided significant attenuation of the pump sound but did not eliminate it.

Tests were performed on Lunar Module 8 to verify the use of flexible hoses to isolate the pump from the tubing and act as an attenuator; however, noise was only slightly reduced. Further modification to the

lunar module hardware does not appear practical. Therefore, ear plugs will be obtained for the crew to use during sleep periods.

This anomaly is closed.

15.2.8 Oxygen Purge System Heater Light

During checkout of the Commander's oxygen purge system, the heater light did not come on. Component and circuit analyses do not indicate a design defect. Also, components were vibration-tested to failure and the system was vibration tested using flight type brackets, but these tests did not duplicate the failure.

Analytical studies had indicated that without the heaters, the minimum temperature of the gas at the helmet will be about minus 10° F. Manned tests indicate that this temperature is acceptable for comfort and that the heater is not needed. In addition, without the heaters, no mechanical problems within the system were encountered. No hardware change is required for Apollo 11.

This anomaly is closed.

15.2.9 Loss of Recorded Data

The dump of the lunar module low-bit-rate PCM data recorded in the command module ceased abruptly at 99:38:52. The data should have continued through the descent orbit insertion maneuver at approximately 99:46:00. A review of the data from 99:35:10 to 99:38:52 verified that the command module was configured for VHF simplex-A voice and VHF simplex-B data. The flight plan required that the command module be reconfigured from this mode to VHF/AM duplex-B/ranging at approximately 99:37:00. Since the flight plan times were incorrect by approximately 12 minutes, the reconfiguration should have been at 99:49:00.

The annotated copy of the flight plan and associated timeline functions indicates that the command module was reconfigured from voice and data mode to ranging at approximately 99:38:00. The lunar module data were therefore, not recorded after that time.

This anomaly is closed.

15.2.10 Yaw Rate Gyro Output Error

The yaw rate gyro output differed from actual yaw rate during the 50-second period before staging and several seconds after staging. Figure 15-30 contains a time history of the difference between the rate gyro output and actual vehicle rate as computed from attitude data. No evidence of abnormal operation has been found before or after this period. The rate gyro torquing test performed prior to undocking was normal.

The rate gyro is a spring-restrained, single-degree-of-freedom unit with the spring force being supplied by a torsion bar (fig. 15-31). The wheel assembly is partially floated in a silicon damping fluid. Damping is supplied by a paddle wheel which pumps fluid through a temperature-controlled orifice. Three gyros are mounted orthogonally in a rigid block and placed in the spacecraft such that each gyro input axis is parallel to a spacecraft axis.

Prior to installation, each gyro is subjected to acceptance tests (stiction and cross coupling) which exercise it well beyond the rates normally experienced in flight. Once installed, polarity and electrical torquing tests, using built-in test circuits, are the only gyro checks performed.

The electrical circuits associated with the gyro have been analyzed and discounted as a likely source of the problem. The gyro error could be reproduced by introducing a varying voltage into the torquing circuit; however, a reasonable source for such a voltage is not available. The output circuit was also examined and discounted because of the improbable nature of the failures required to give a temporary phase shift in the 800 hertz output.

A mechanical cause of the trouble appears more likely, since clearances of 0.002 to 0.003 inch exist between the float and case. If a particle of contamination became lodged in this space, it could cause a temporary offset and could have been removed during the high rates following staging.

No gyro failures caused by contamination have occurred after acceptance; however, eight rejections associated with contamination have been experienced by the vendor. One of those occurred on this gyro during buildup when it failed a stiction test. The unit was rebuilt but again failed because of a bellows leak. Finally, after a second rebuilding, it passed acceptance. Because of this history, the suspected malfunction is stiction caused by contamination probably introduced during rebuilding.

The history of the gyros on Apollo 11 was analyzed and found to have no discrepancies.

This anomaly is closed.

15.2.11 Instrumentation Discrepancies

Chamber pressure switches. - Chamber pressure switches in the reaction control system failed closed. Switch B3D failed closed during the initial hot-fire checkout. Shortly after undocking, switch B4U failed for approximately 2 hours, then later failed closed permanently. During the ascent propulsion firing to depletion, switch B2U failed closed for approximately 2 minutes, then recovered and operated properly. After the ascent propulsion firing to depletion, switch A2D failed closed for 13 seconds, and later, switch A1U became erratic.

The B2U and A2D failures are unique, in that the switches closed without the presence of chamber pressure, whereas all the other failures were initiated by engine firings. The former failures occurred when the engine clusters reached high heat-soakback temperatures after the extremely high firing activity associated with the ascent propulsion firing.

The failure mode for these five switches is believed to be the same as that of one LM-3 unit and several others during ground testing. Particulate contamination and/or propellant residue is forced under the switch diaphragm by chamber pressure and holds the diaphragm deflected and the electrical contacts closed (fig. 15-32). The small stroke of the diaphragm (0.007 inch) and the low diaphragm restoring force generated by the return spring make the switch extremely susceptible to failure by contamination.

Reaction control system performance was unaffected by these switch failures. The only consequence was the loss of capability to detect an engine failed off.

No corrective action for resolution of the chamber pressure switch failures is planned.

This anomaly is closed.

Glycol temperature. - During the first manning, the water/glycol pump switch was in the pump 2 position, and the indicated glycol temperature was zero. At 94 hours, the selector switch was set to pump 1, and the temperature reading was normal.

The coolant pump switch is used to route either the primary or the secondary coolant temperature to the display. A jumper across the pump 1 and pump 2 contacts allows display of the primary temperature when the switch is in either position. Therefore, the most likely cause of the problem was a broken jumper or an incomplete contact in the pump 2 switch position.

This anomaly is closed.

Reaction control manifold pressures.- At 103 hours, the indicated fuel manifold pressure in reaction control system-A dropped from 181 to 168 psia and then returned to 181 psia at 106-1/2 hours. At 108-1/2 hours, this measurement dropped to zero. Satisfactory operation of the reaction control system indicates a measurement anomaly. The most probable cause of this anomaly is either a defective splice in the 26-gage wiring associated with the transducer or an intermittent connection internal to the transducer.

This anomaly is closed.

The indicated oxidizer manifold pressure in system-B read 15 to 20 psi low (10 percent) after pressurization of the system. Since system-B operated satisfactorily and the fuel manifold and helium regulator pressures read as expected, the most likely cause of the problem was that the pressure transducer shifted in calibration. Calibration shifts have previously been experienced during preinstallation testing of this transducer. On LM-9 and subsequent spacecraft, critical measurements will be instrumented with an improved transducer.

This anomaly is closed.

Cask thermal shield temperature.- The temperature measurement of the thermal shield for the radioisotope thermal generator cask read upper limit throughout the lunar module portion of the flight. The telemetry is switched to this measurement from cask temperature by a baroswitch at 10 000 foot altitude (fig. 15-33).

The probable causes of the failure were a broken wire in the shield temperature measurement, a failed transducer, or a failure of the baroswitch to transfer. The transducer and baroswitch were tested prior to installation at the launch site.

After installation, work was performed in the area, and no further checkout was performed.

For future missions, the instrumentation wiring will be checked after final installation. The measurement is not mandatory for flight operations, and no further changes will be made.

Cooling air is furnished to the cask from the launch vehicle instrument unit through a 5-inch duct. Prelaunch, indications were that air was not being supplied. Since the cask on this mission was not activated, the requirement was waived and no corrective action taken. Tests at Marshall Space Flight Center indicate the most probable cause was a rupture of the duct at the umbilical interface inside the instrument unit wall. Design changes to correct the problem have been made by Marshall.

This anomaly is closed.

Descent oxidizer tank pressure.- Prior to the descent engine firing, the ullage pressure for the descent oxidizer tank read zero on the cabin display. The telemetry measure of engine inlet oxidizer pressure was indicating normal. Later, the display meter was used to read the ascent propulsion oxidizer pressure, which also indicated normal. It is therefore concluded that the most probable cause of failure was either the transducer or the wiring between the transducer and the cabin display.

This anomaly is closed.

15.2.12 Drop in Cabin Pressure at Jettison

During the ascent stage separation from the command module, the lunar module cabin pressure dropped rapidly, as measured by three separate transducers. Telemetry data were lost for 12 seconds beginning at the initiation of separation. As shown in figure 15-34, the cabin pressure was 4.86 psia at the initiation of separation and 0.70 psia at the end of the telemetry dropout and continued to decay slowly.

Motion pictures of the final separation were taken from the command module. A brown material, shown projecting from the tunnel and flapping, was the insulation around the command module docking ring. The lunar module hatch was closed in the first frame in which it was visible. This frame was taken 2 seconds after initiation of separation.

The film was used for determining a history of relative separation distance between the command module and the lunar module (fig. 15-35). A time history of relative acceleration, or the required pressure force, was then estimated from the data, as shown in fig. 15-36. The maximum acceleration of 50 ft/sec/sec shown is considerably in excess of the acceleration caused by separation pyrotechnic effects. However, the acceleration history shown in figure 15-36 can be obtained by dumping the cabin pressure in the first 0.3 second of separation. A 4-psi drop in cabin pressure in 0.3 second requires a constant venting area of 290 square inches. The impulse from dumping cabin pressure through the hatch is consistent with the direction and magnitude of the lunar module velocity change (5 ft/sec in minus X direction) noted from the flight data. Further, the upper hatch is the only item on top of the lunar module that could open and close, allowing the cabin to vent while satisfying the pressure history. The hatch has a maximum area of 838 square inches, which is more than enough to vent the cabin from 4.8 to less than 1.0 psia in 0.3 second.

The events postulated to vent the cabin are as follows. The hatch differential pressure resulting from the pyrotechnic firing broke the hatch latch and allowed the cabin to vent through the docking tunnel. The outflow closed the hatch 0.3 second after separation but did not seal

it completely. The remaining gap of about 1.4 square inches allowed a slight pressure decrease, as indicated by cabin pressure data. Figure 15-37 presents a history of hatch area that allows the cabin pressure to decrease rapidly and also yields an acceleration time history which agrees with figure 15-36.

The hatch and latch assembly was statically pressure-tested to failure. At a differential pressure of 4.1 psi, the latch failed as indicated in figure 15-38.

On Apollo 9, the cabin pressure was maintained after separation. The only difference between Apollo 9 and 10 was that the Apollo 10 tunnel could not be vented because the vent line was capped (see previous discussion). At the time the separation pyrotechnics were fired on Apollo 9, the tunnel pressure was less than the lunar module cabin pressure; thus, the dynamic pressure in the tunnel was not sufficient to fail the hatch latch. On Apollo 10, with the tunnel pressurized to 4.86 psia, the differential pressure when the pyrotechnics were fired was enough to fail the latch.

In summary, the analyses indicate that the loading on the lunar module hatch at separation exceeded the capability of the latch. The hatch then opened and closed resulting in a cabin pressure decay as shown in figure 15-34 and separation distance and relative accelerations as shown in figures 15-35 and 15-36.

No corrective action is required since the conditions at separation were not normal.

This anomaly is closed.

15.2.13 Primary Lithium Hydroxide Cartridge Performance

Two aspects of the indicated carbon dioxide level were considered anomalous. First, the rate of carbon dioxide increase from 97 to 101 hours exceeded the predicted by a factor of approximately 8. Secondly, the level remained constant for the next 5 hours (see fig. 15-39).

The peaks at 97, 101, and 102-1/2 hours were caused by operation with the suit-loop closed and were not considered anomalous. The rapid decrease at 106 hours was expected because the secondary lithium hydroxide cartridge was selected.

Tests and analysis have shown the following:

1. No evidence of channeling was found following chemical and X-ray diffraction analysis of the flight cartridge.

2. The spring loading on the lithium hydroxide bed was satisfactory, indicating no detrimental vibration effects.

3. Inadvertently bypassing the cartridge could not be made to analytically match the flight data.

4. The special charcoal outgassing (implemented on Apollo 10 shortly before flight) was verified by test to cause no unusual cartridge performance.

5. A qualification test cartridge exhibited a high rate similar to the flight data, except that the rate began to decrease at a lower level of partial pressure (fig. 15-39).

6. Cartridge performance varies considerably. The flight predictions were very optimistic.

7. The possibility of a carbon dioxide sensor fault was examined, and several failure modes were identified which could explain the high rate. However, failure histories and analytical failure rates would make this possibility unlikely.

8. A constant carbon dioxide level over a long duration existed in qualification testing, although it was at a lower partial pressure, thus, a steady carbon dioxide level is not necessarily anomalous.

9. Some indications exist that the flight cartridge was not reacting chemically as uniformly as a sample test cartridge. This was probably because of variations in moisture content; such variations are not fully understood. Additional testing will be performed to provide a controlled data base required for longer missions. Existing data are believed adequate for the Apollo 11 mission.

10. The carbon dioxide sensor tolerance is plus and minus 10 percent of full-scale voltage output. Superimposing a 5-percent tolerance on the qualification performance curve will approximate the flight data, as shown in figure 15-39.

Lithium hydroxide cartridge variations, combined with carbon dioxide sensor tolerances, could account for the flight performance. The prediction for future flights will be modeled around more realistic operational characteristics.

This anomaly is closed.

15.2.14 Attitude Excursions at Staging

Large attitude excursions occurred prior to and during staging (fig. 15-40). Body rates of 19 deg/sec in pitch and greater than 25 deg/sec in roll and yaw were recorded. Smaller attitude excursions occurred approximately 40 seconds prior to staging. The mode switching, telemetry, and associated attitude commands indicate that the abort guidance mode changed from ATT HOLD to AUTO coincident with the vehicle gyrations.

The attitude control switches on panels 3 and 4 are shown in figure 15-41, and a simplified functional switching diagram is shown in figure 15-42. Approximately 4 minutes before staging, with the guidance select switch in AGS and the attitude control switches in PULSE, the crew verified that the abort guidance mode control switch was in ATT HOLD since the intent was to perform staging in AGS ATT HOLD. After some discussion, they selected MAX deadband to save propellant.

The abort guidance system steering logic was set to Z-axis steering throughout the staging sequence. If AUTO mode is selected, Z-axis logic will produce the steering commands required to point the Z-axis at the command module. If the guidance select switch is in AGS and attitude control switches in MODE CONT, the Z-axis steering commands are accepted and acted upon by the control system.

The attitude control switches were sequentially thrown to MODE CONT, as shown in figure 15-40, 51 seconds before staging. Five seconds after the selection of MODE CONT, the mode control switch indication changed from ATT HOLD to AUTO, remained in AUTO for 3 seconds, then returned to ATT HOLD. During this period, the vehicle moved in all three axes in response to Z-axis steering commands. After the mode indication returned to ATT HOLD, the dynamics again returned to normal for wide deadband. (Note: The yaw rate gyro output was incorrect during this period, as shown in figure 15-40 and discussed elsewhere in this report. The gyro problem was properly diagnosed by the crew after a number of hand controller operations.) After approximately 40 seconds, the mode indication again returned to AUTO, and the vehicle responded to Z-axis steering commands. The vehicle was staged 4 seconds later, and the dynamic response increased abruptly. The data indicate that staging was coincident with a minus X translation and that the primary guidance system mode control switch was thrown to AUTO 7 seconds later. Because of the relative scaling of the hand controller, rate gyros, and attitude errors, attempts to manually control the motion were ineffective, and the vehicle stabilized with the Z-axis pointing toward the command module. Approximately 24 seconds after staging, the attitude control switches returned to DIR, and the two mode control switch indications returned to ATT HOLD.

Three conditions during the staging sequence were apparently abnormal:

1. The abort guidance mode control transferred from attitude-hold to automatic.
2. The yaw rate gyro was erroneously indicating minus 1.7 deg/sec.
3. No indication of direct firing of reaction control engines was received. (The crew recalled enabling the direct function and actuating the hand controller to the hard stops.)

Three hardware areas have been analyzed in an attempt to resolve the abnormalities.

Switches.-- Functions in each of the anomalous areas are controlled by switches (see fig. 15-41).

The rate gyro test switch on panel 3 applies a test voltage, both positive and negative, that torques the gyro to an indicated output of 5 deg/sec. The circuit was used earlier in the flight and performed properly. Malfunction of the switch, shorting of the contacts on two poles, would apply the test voltage and yield the 5 deg/sec gyro output. Malfunction of this switch as the cause of the yaw rate gyro problem is considered highly unlikely.

The ACA/4 JET ENABLE-DISABLE switch, on panel 4, enables the hand controller switches for the direct coils of the reaction control engines. This switch was placed to the ENABLE position before undocking, and the reaction control engines were fired. For all major maneuvers, the switch was placed to ENABLE. With the exception of the staging sequence, the crew did not attempt to use the direct coils for firing the reaction control engines. Malfunction of this switch is not considered likely but cannot be completely eliminated. Either the ACA/4 JET ENABLE-DISABLE switch was not in the ENABLE position or an open circuit existed in the wiring.

The abort guidance system mode control switch, on panel 3, was used several times before and after staging with no evidence of abnormality. To produce the flight results requires the contacts to transfer on at least two of the three poles of this switch. No known failure modes in the switch would produce this type of failure. Two failure modes postulated would allow the contact rocker arms to become free-floating. However, testing under a simulated flight environment has shown that because of frictional forces at the contact arm pivot point, the free-floating contacts will not transfer (see fig. 15-43). The observed anomaly would have required the simultaneous motions of two rocker arms.

In summary, it is considered highly remote that switch malfunctions could have caused the anomalies at staging.

Connectors.- Each of the affected components have wiring routed through two electrical connectors behind panel 3.

The functions through connectors P1400 and P805 showed no anomalous indications in factory or launch-site testing or in flight except during the staging sequence. The connectors could not have been mated. Indications resulting from improperly mated connectors (i.e., bent or loosely connected pins) would have been recurring. It is considered highly unlikely that the cause of the problem was in the electrical connectors. Simultaneous failures in two connectors would be required to duplicate the events that occurred in flight.

Wiring.- Four inches of electrical wiring contained in a single wire bundle behind panel 3 is the only point common to all the anomalous circuits (see fig. 15-44).

To produce the flight anomaly, the wiring would have to incur particular but major damage, including the following:

1. Abort guidance system AUTO wire — insulation broken and a ground applied.
2. Abort guidance system ATT HOLD wire — wire open.
3. Telemetry for the abort guidance system AUTO wire — insulation broken and a ground applied.
4. Telemetry for the abort guidance system ATT HOLD wire — wire open.

In an attempt to assess the potential for damage to this common bundle, an inspection was conducted on lunar module 10. The following was concluded from that inspection:

1. The area behind panel 3 is highly congested.
2. The panel 3 installation is very difficult because of the congestion and the mating of blind connectors.
3. Several wire bundles require sharp bends but not the suspect bundle.
4. The suspect bundle does bear on the back of a meter on panel 3.
5. Structural fasteners are a potential source of damage only during installation.

6. Anti-chaffing material on bundles is sufficient to preclude damage to wiring during and after installation.

Considering the particular nature of the damage which must be sustained by the suspect wire bundle and the configuration of that wire bundle and the area behind panel 3, it is considered highly unlikely that the type of damage would be caused by the installation procedures or the installation itself.

It is, therefore, concluded that the anomaly was caused by the inadvertent cycling of the abort guidance mode control switch, followed immediately by an incorrect output of the yaw rate gyro. In diagnosing the yaw rate gyro problem, and in reacting to it, the abort guidance mode control switch was transferred to the AUTO position, resulting in high vehicle rates during the staging sequence.

This anomaly is closed.

15.2.15 Ascent Propulsion Low-Level Indications

The ascent propulsion warning light indicating low propellant level came on approximately 1 second after the start of the first ascent engine firing and triggered a master alarm. The low-level light went out 1 second later, and the master alarm was subsequently reset. Data indicate that the low-level light and master alarm were triggered by the oxidizer sensor.

Each of the tanks, oxidizer and fuel, contains one sensor. One low-level warning light monitors both sensors, and this light is enabled only while the ascent engine is firing. Neither the sensors nor the low-level warning light are latching, so the warning light will come on when the sensor is uncovered and will extinguish when the sensor is re-covered with propellant.

Data indicate that the sensors functioned properly for the remainder of the mission. Both low-level indications came on at the correct time during the second ascent engine firing, the firing to depletion. This indicates that the first warning was valid and caused by the sensor being uncovered by a gas bubble.

On Apollo 10, the ascent propellant tanks were filled approximately 50 percent, and the +X translation required to settle the propellants was calculated to be 3 seconds. This firing time was to prevent helium ingestion into the engine. Based on the Apollo 10 data, the prediction technique will be revised, and the +X translation firing time will be increased to prevent a recurrence of the low-level master alarm at ignition.

No corrective action is required for Apollo 11 and subsequent. For nominal missions, only one ascent engine firing is planned. This will occur from the lunar surface (1/6-g field), and the propellants will be well settled.

This anomaly is closed.

15.3 CAMERA EQUIPMENT

15.3.1 Lunar Module 70-mm Camera

During the low-altitude lunar pass, the Hasselblad 70-mm camera, which had the last magazine installed, stopped because of film binding in the magazine. The binding resulted from internal damage to the film-advance mechanism, including burrs on the film guide (see fig. 15-45). The emulsion scraped from the film by the burrs built up on the rollers, decreasing the clearance. This condition continuously overloaded the drive motor until the motor failed approximately five frames from the end of film. The 1.6-ampere fuse in the camera would have protected the motor against a direct short, but not against a continuous overload.

The cameras are handled a number of times before launch, and the following actions will be taken to preclude a similar occurrence on Apollo 11:

- a. Cameras and magazines will be inspected for damage, clearances, and contamination.
- b. High-reliability, 1.2 ampere fuses will be installed (each camera will have one fuse and one slug).

This anomaly is closed.

15.3.2 Lunar Module 16-mm Camera

During the low-altitude pass, the lunar module 16-mm camera failed to operate with magazine F installed. Magazine F was replaced immediately with magazine G, and the camera operated satisfactorily. Magazine F was reinstalled later for staging and the terminal phase of the rendezvous, and the camera operated satisfactorily.

Proper alignment of the camera and the magazine required greater care with magazine F because of marginal clearances at the interface surfaces

and edges. All magazines for subsequent missions will be selected for adequate clearance on the interface edges for a satisfactory fit to either camera (see fig. 15-46).

This anomaly is closed.

15.3.3 Command Module 16-mm Camera

At approximately 173 hours, during transearth coast, the command module 16-mm camera ceased to operate in the pulse mode because the magazine interlock microswitch failed. The switch was not a high reliability item and failed because of internal contamination and a faulty plunger (fig. 15-47).

High reliability microswitches have been installed in the cameras for Apollo 11 and subsequent.

This anomaly is closed.

NASA-S-69-2729

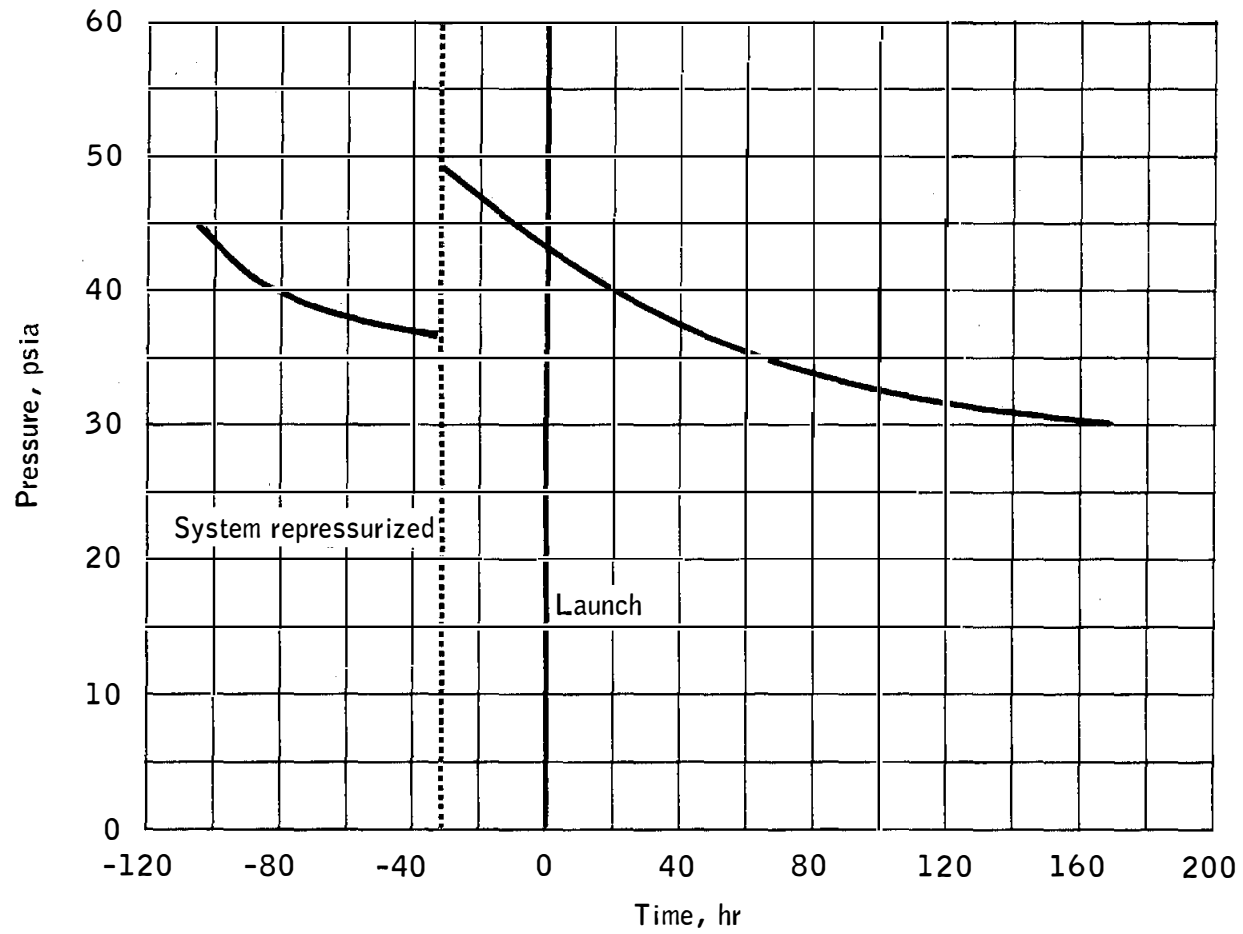

Figure 15-1.- Helium manifold pressure in reaction control system A.

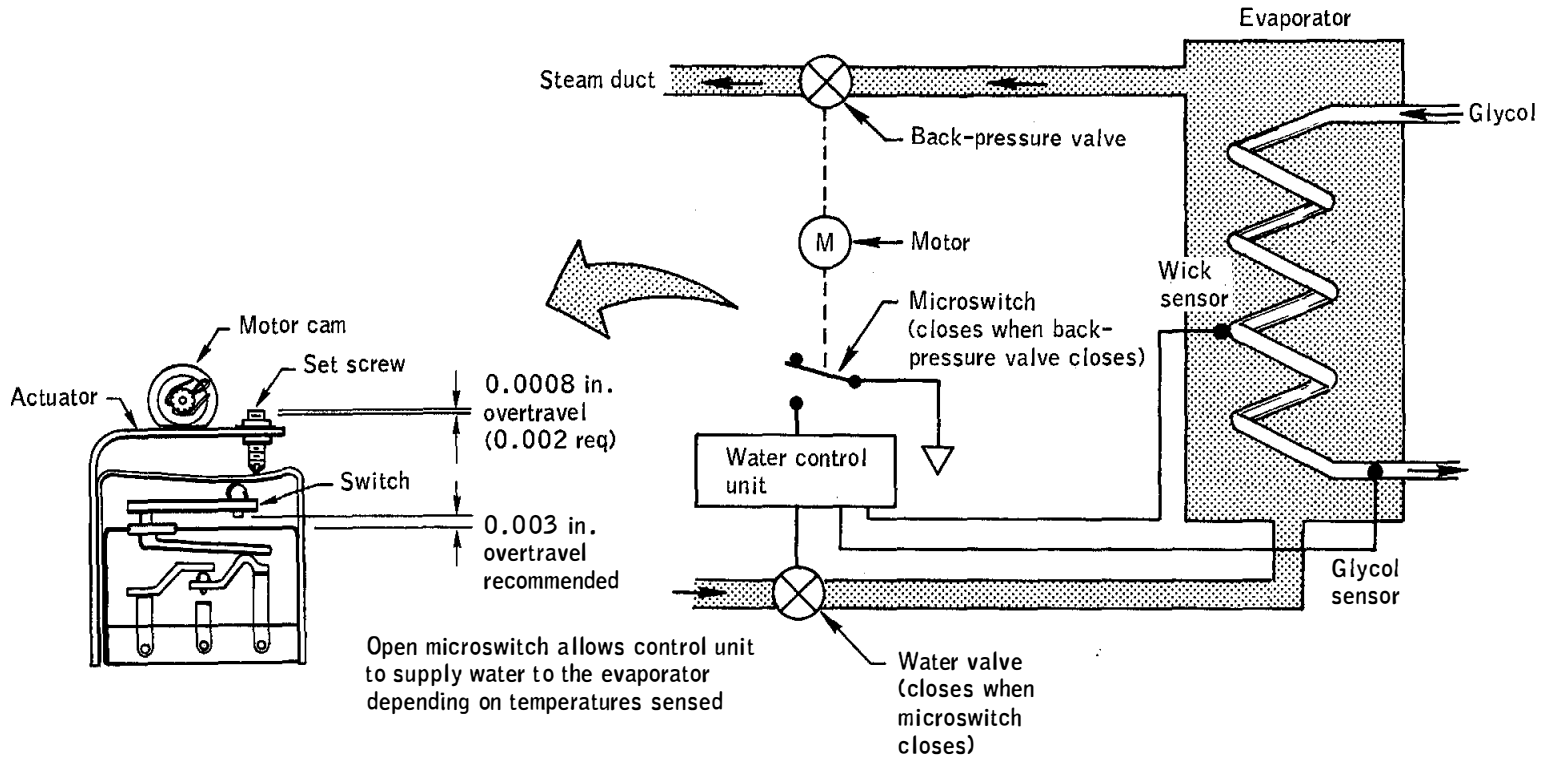

Figure 15-2.- Water control circuit.

NASA-S-69-2731

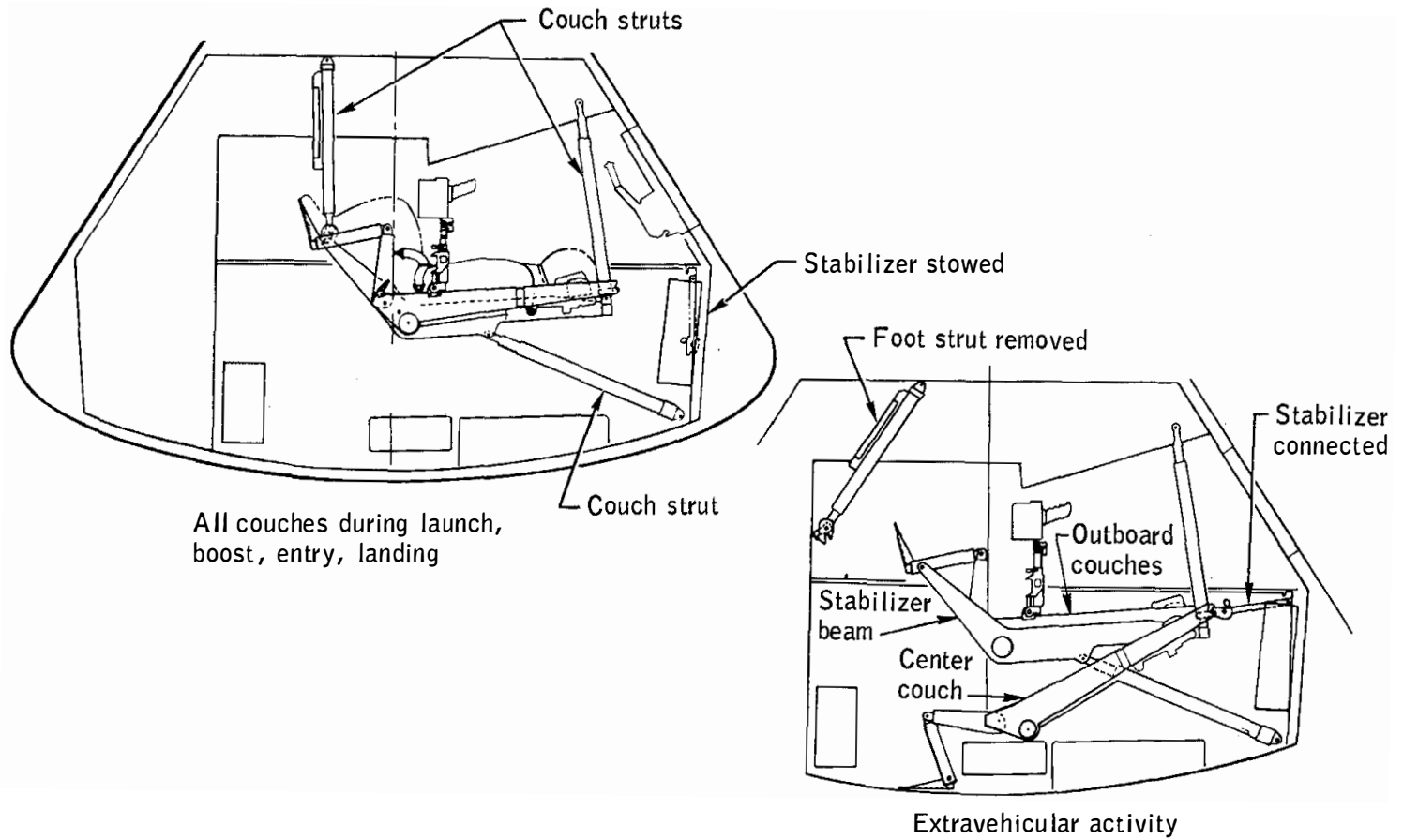

Figure 15-3.- Stabilizer usage.

NASA-S-69-2732

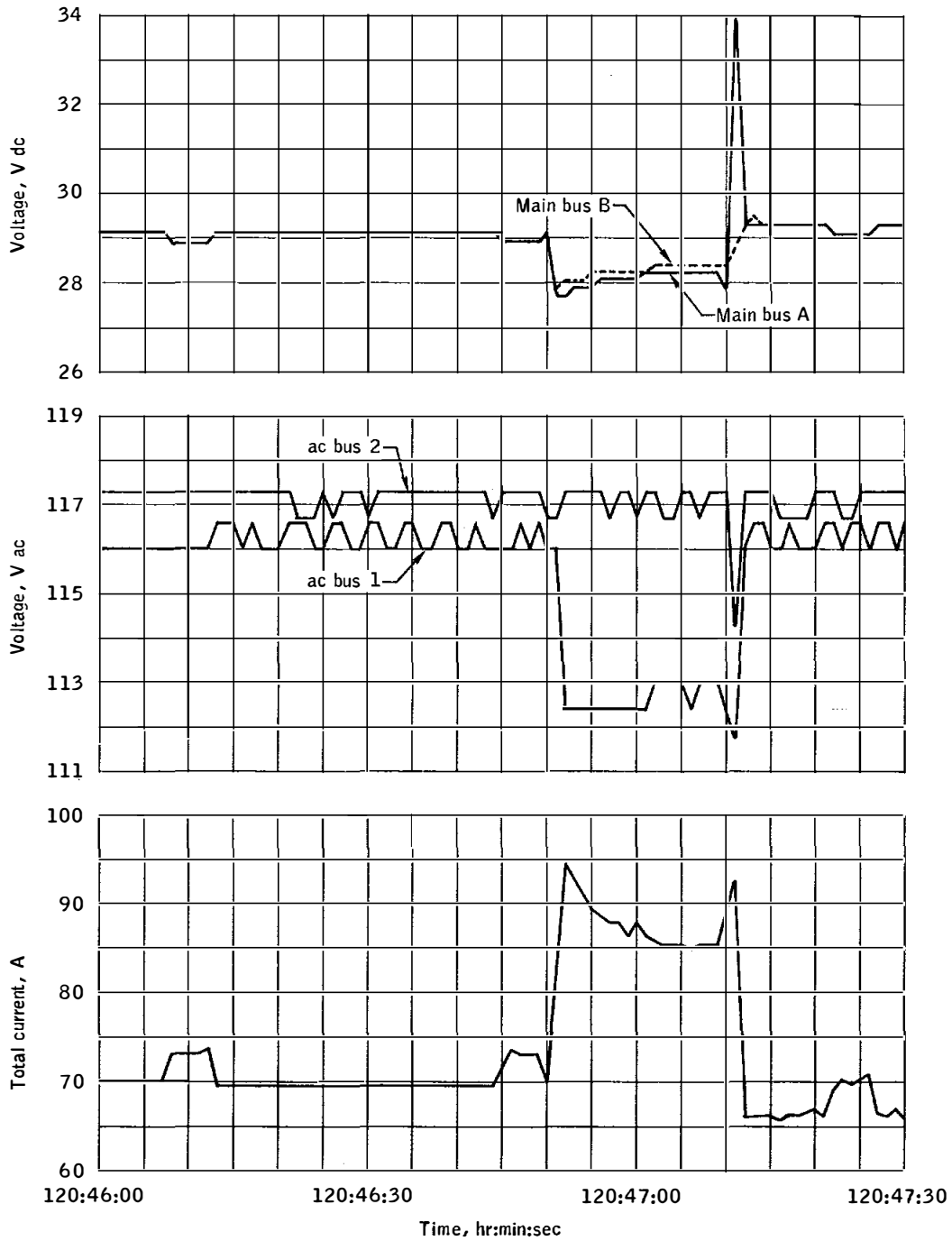

Figure 15-4.- Power variations at pump failure.

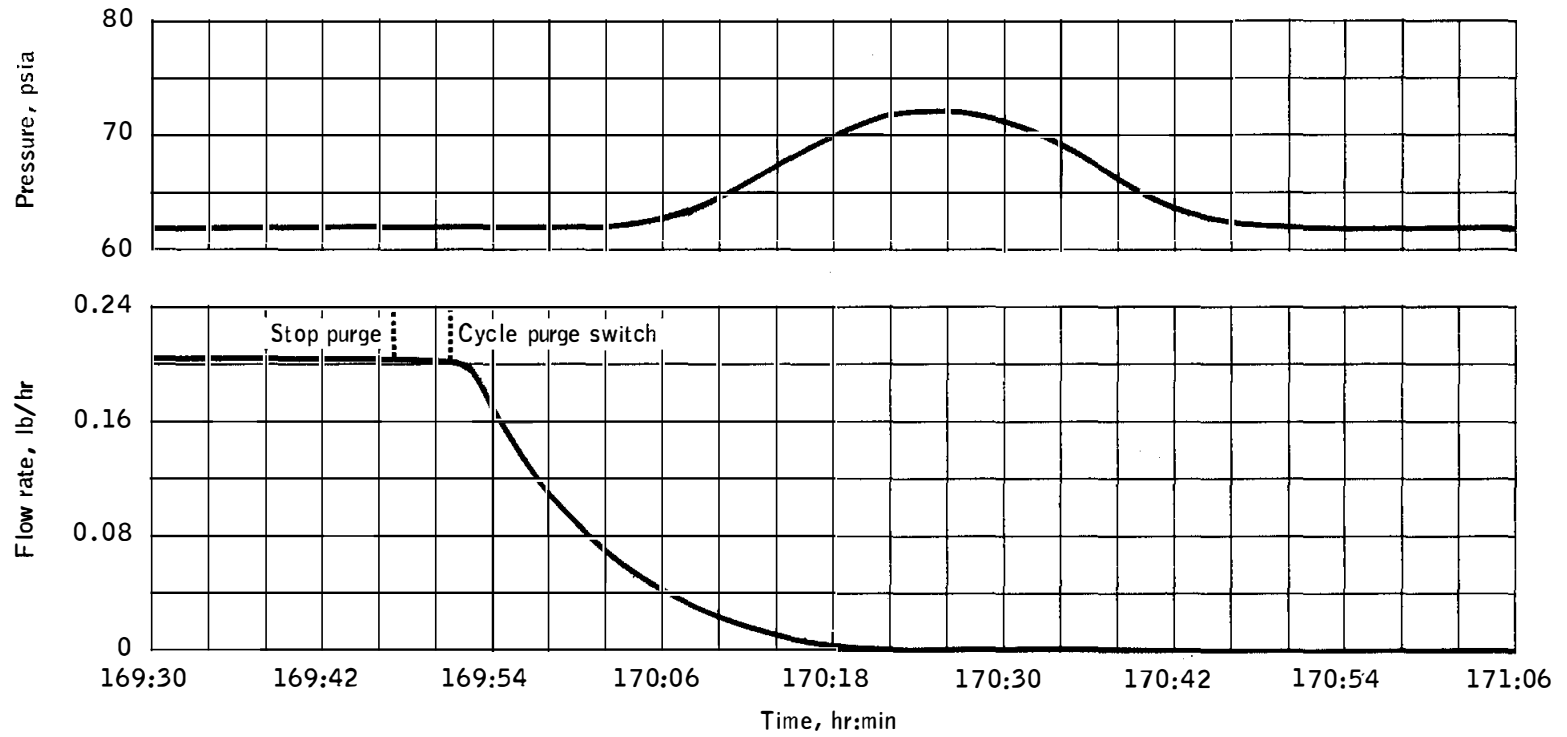

Figure 15-5.- Flow rate and pressure after purge.

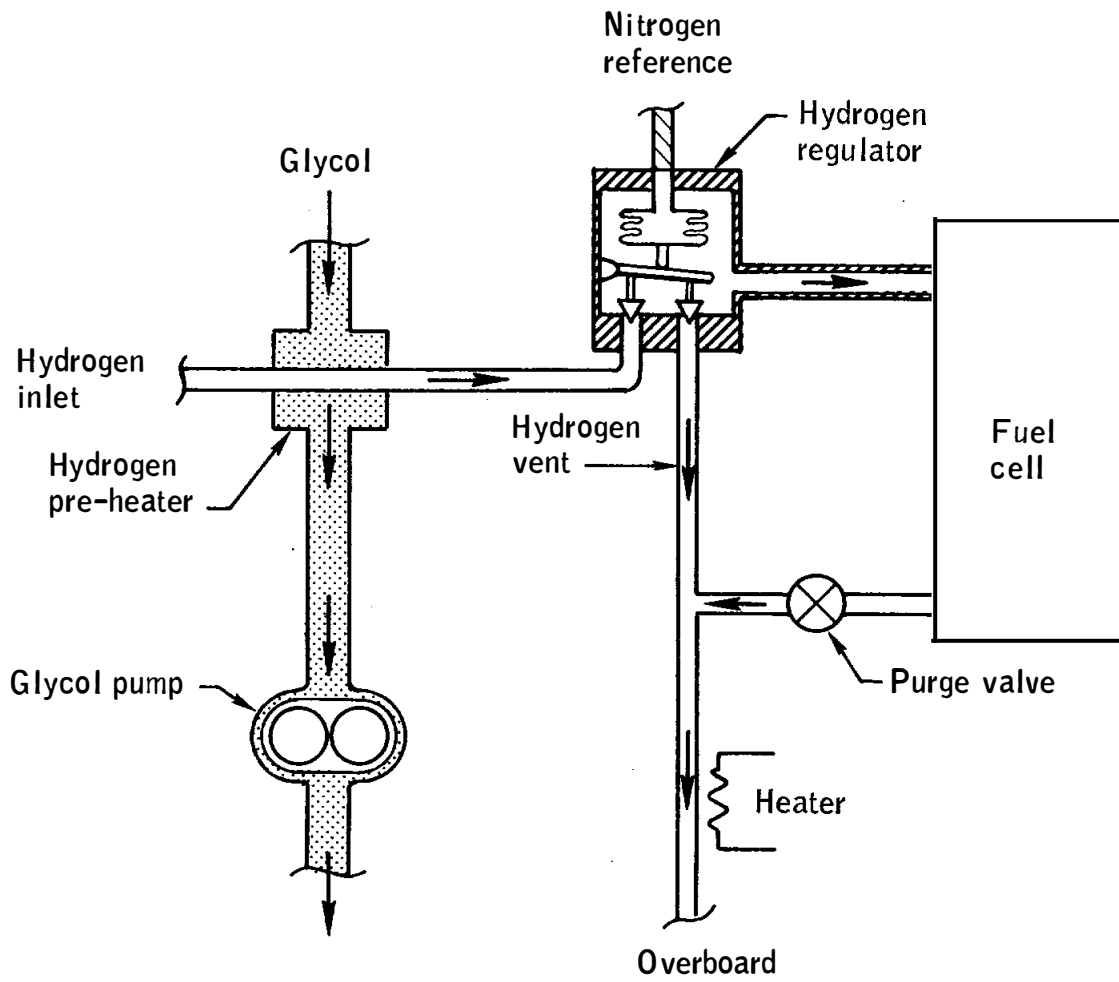

Figure 15-6.- Fuel cell hydrogen system.

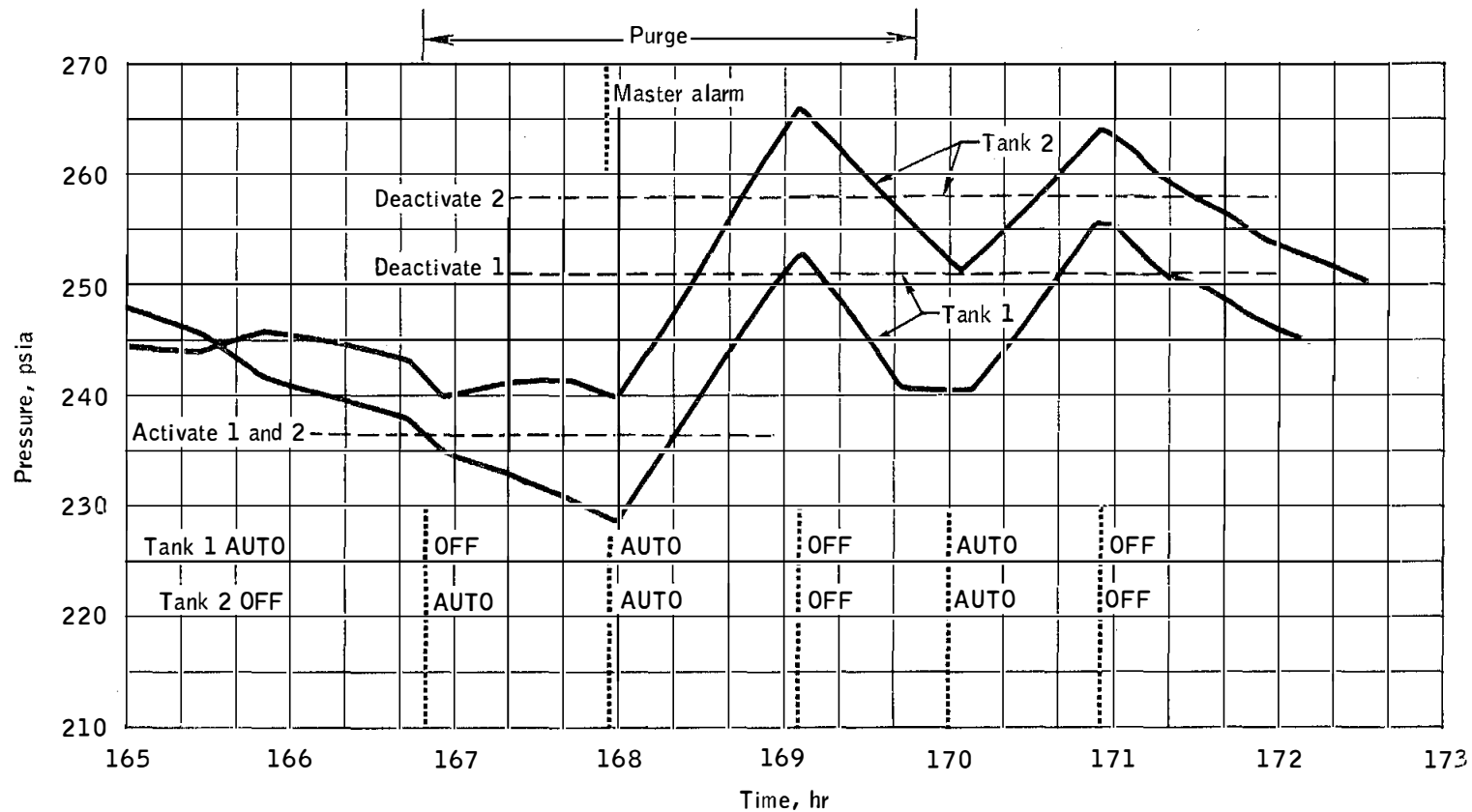

Figure 15-7.- Hydrogen pressures during apparent failure of automatic pressure control.

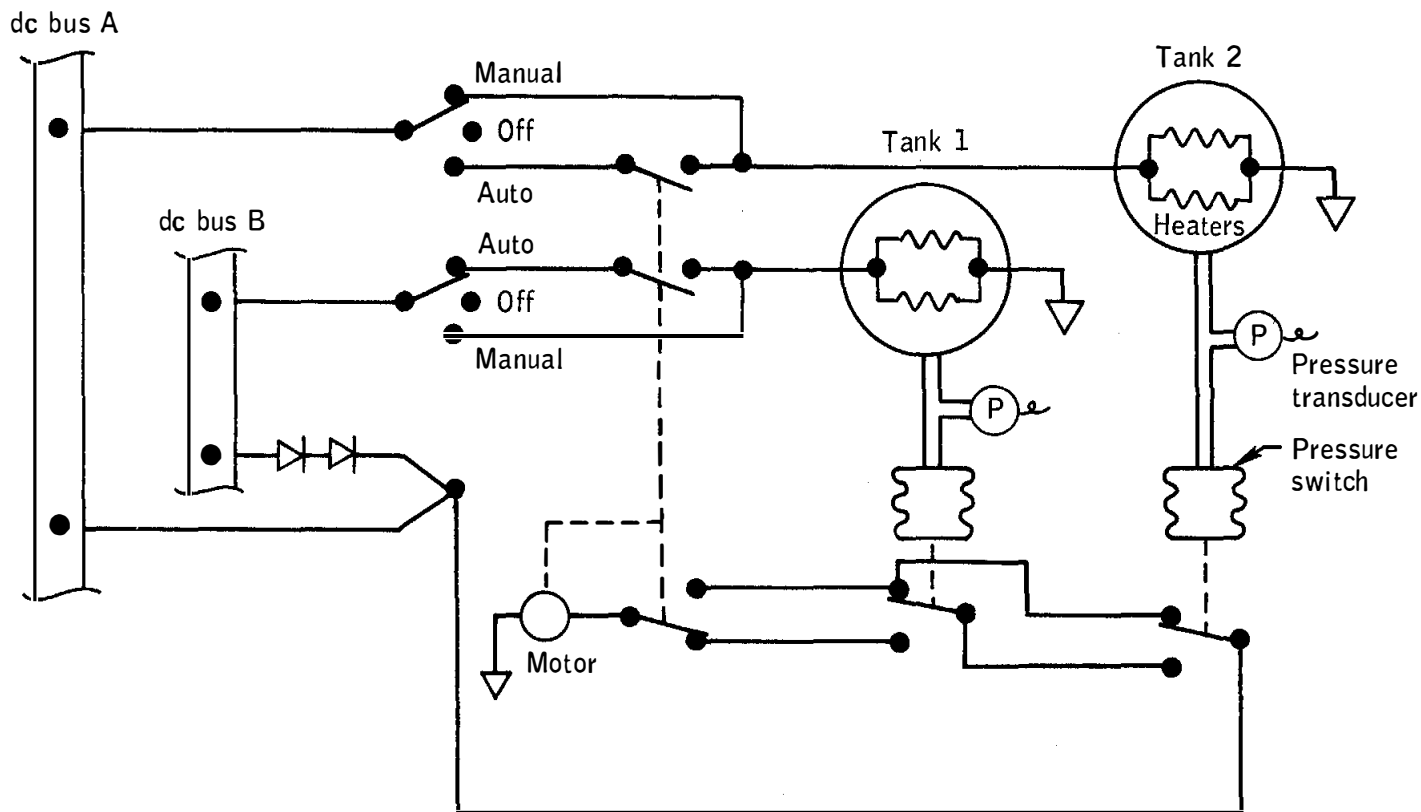

Figure 15-8.- Hydrogen tank pressure control.

NASA-S-69-2737

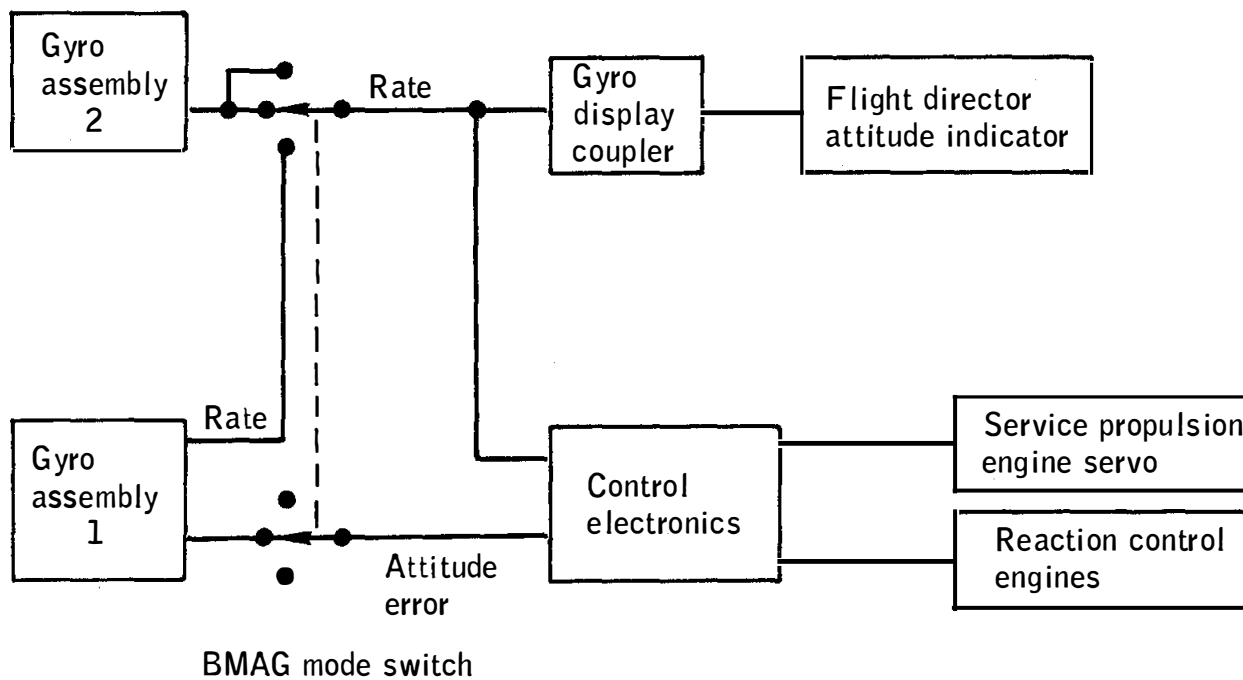
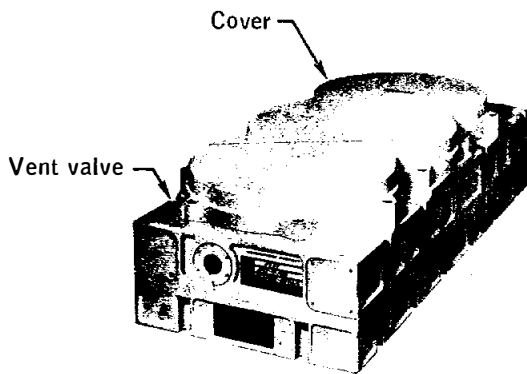
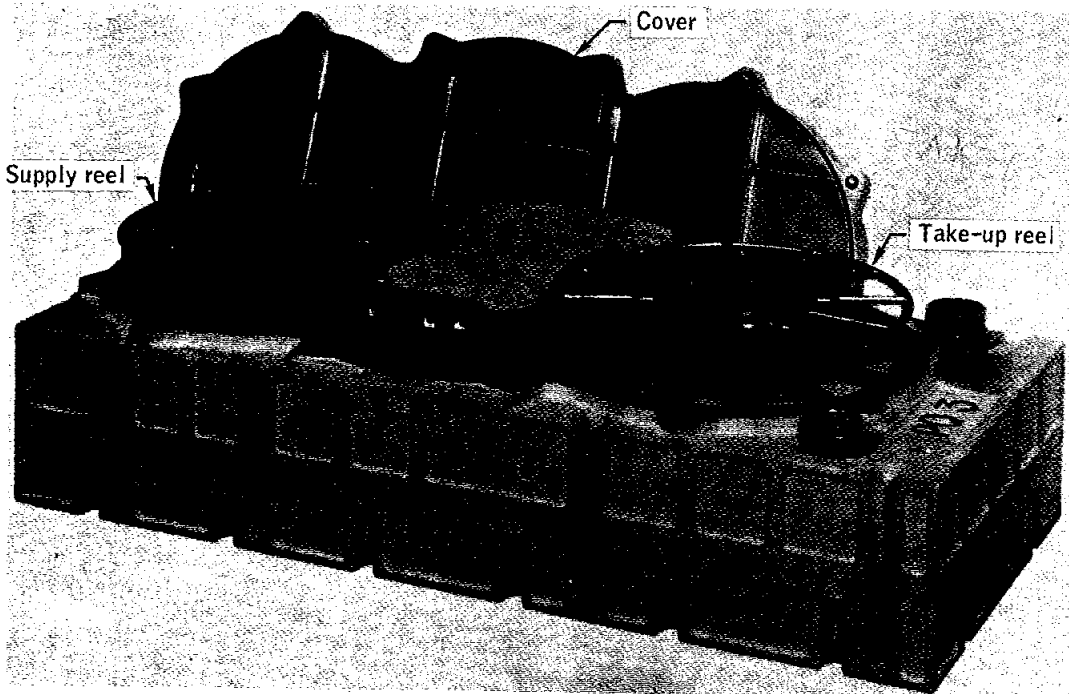

Figure 15-9.- Stabilization and control system.

NASA-S-69-2738



Clearance between cover and reel hubs is 0.058 to 0.053 in.

Figure 15-10.- Data storage equipment.

NASA-S-69-2739

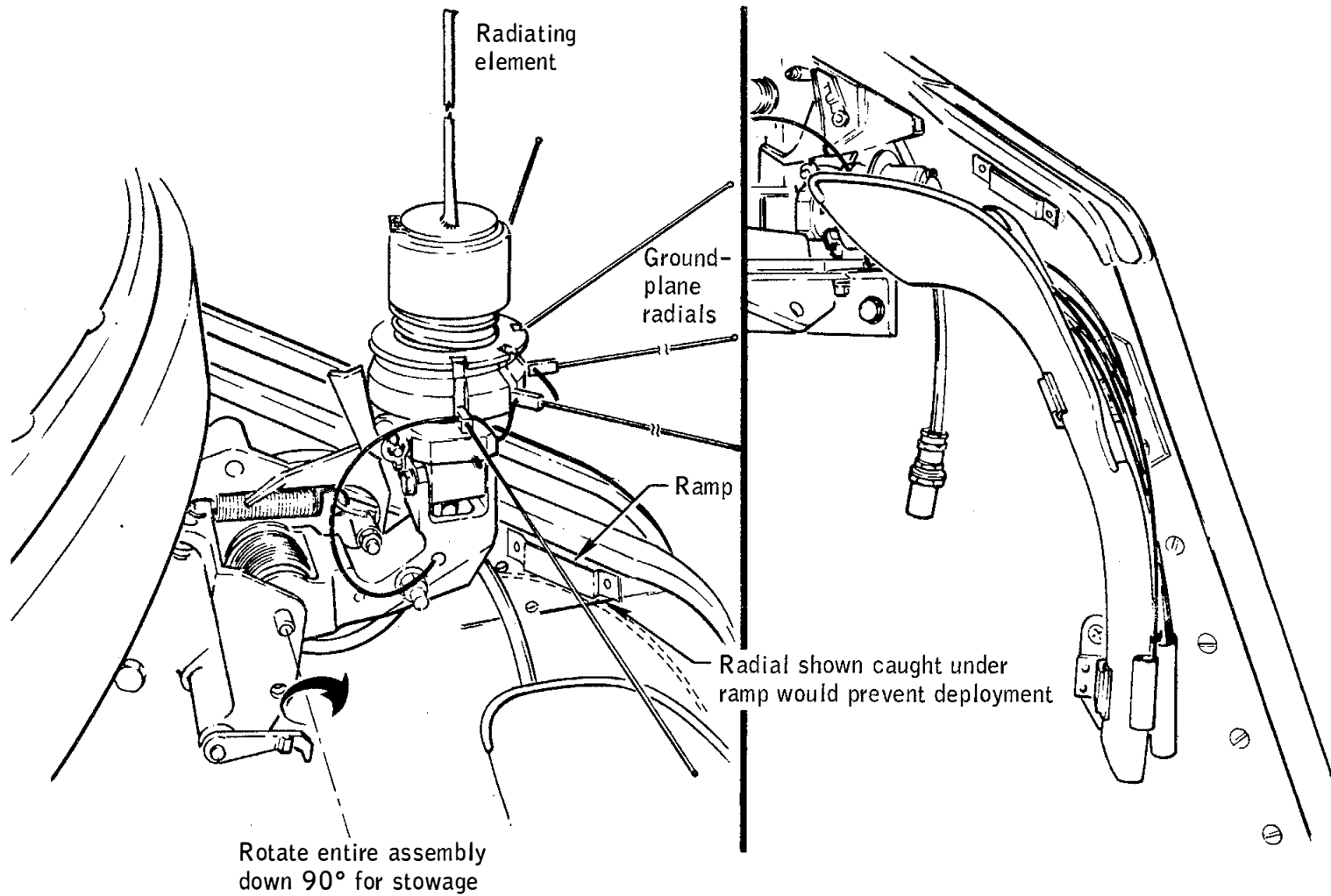

Figure 15-11.- VHF recovery beacon antenna deployed.

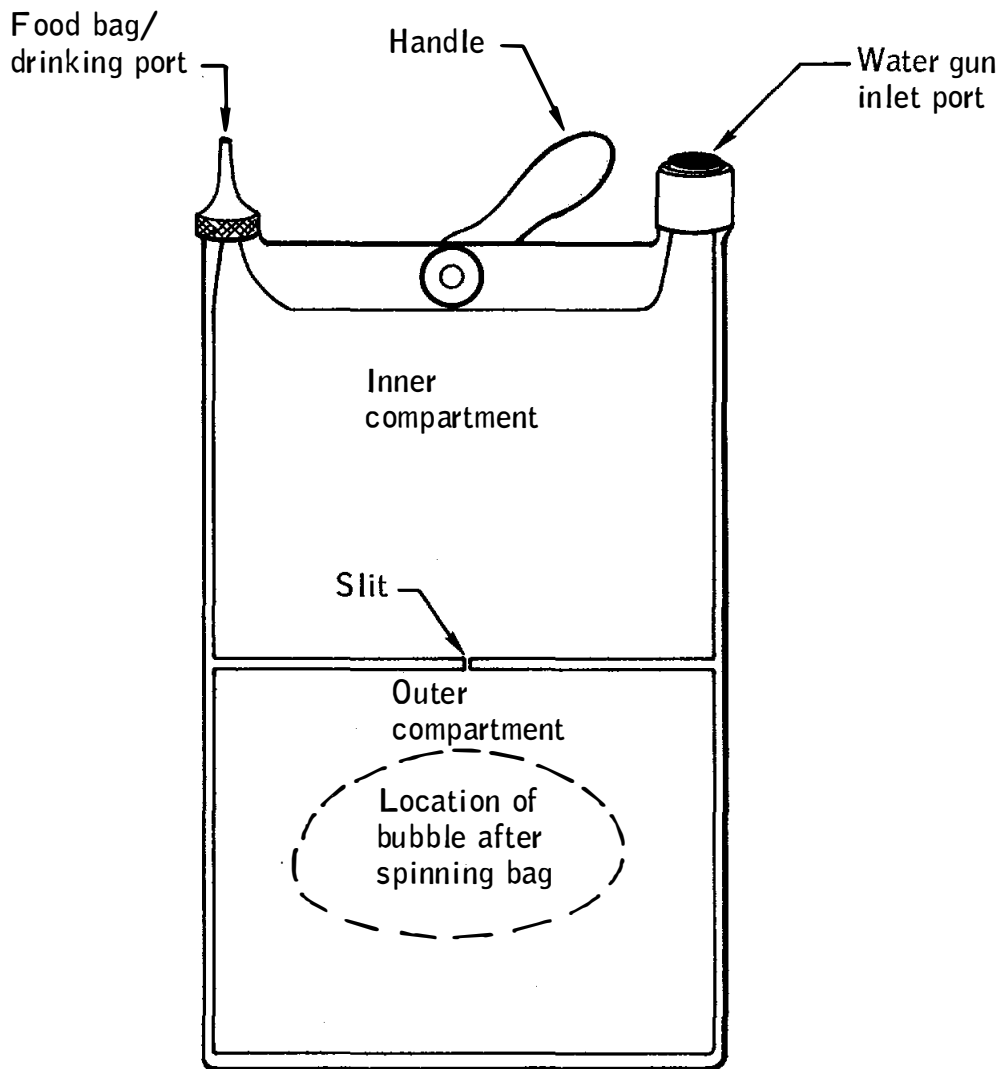

Figure 15-12.- Water/gas separation bag.

NASA-S-69-2741

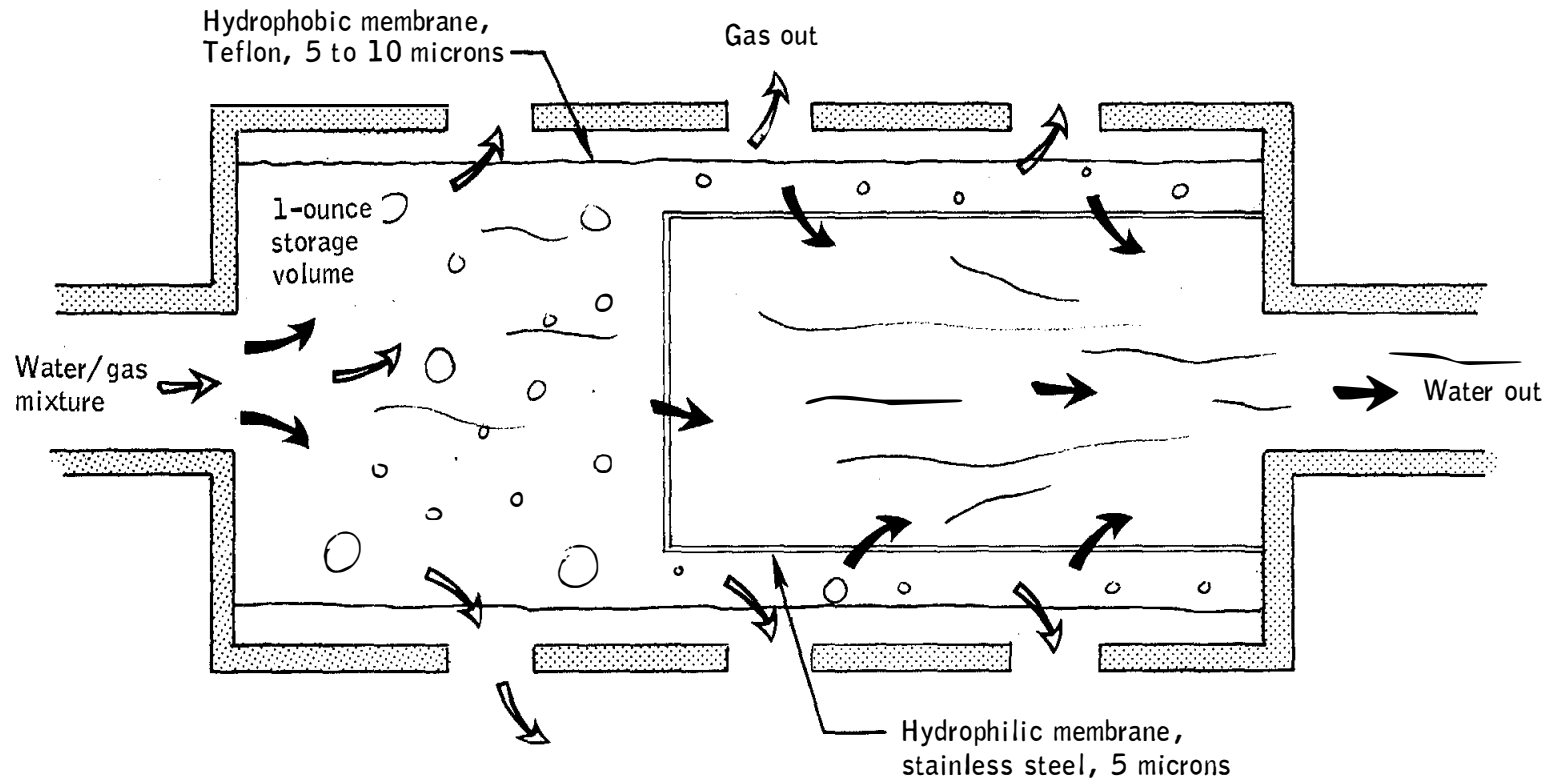

Figure 15-13.- Water/gas separation membrane.

15-46

NASA-S-69-2742

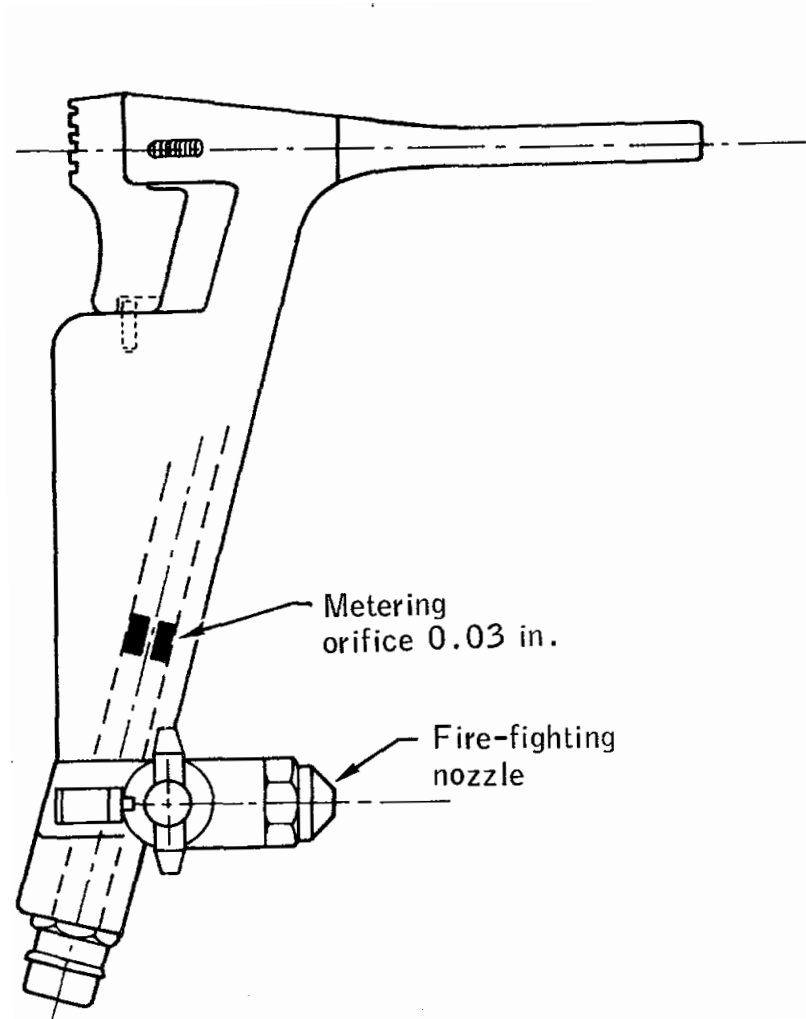

Figure 15-14.- Water gun.

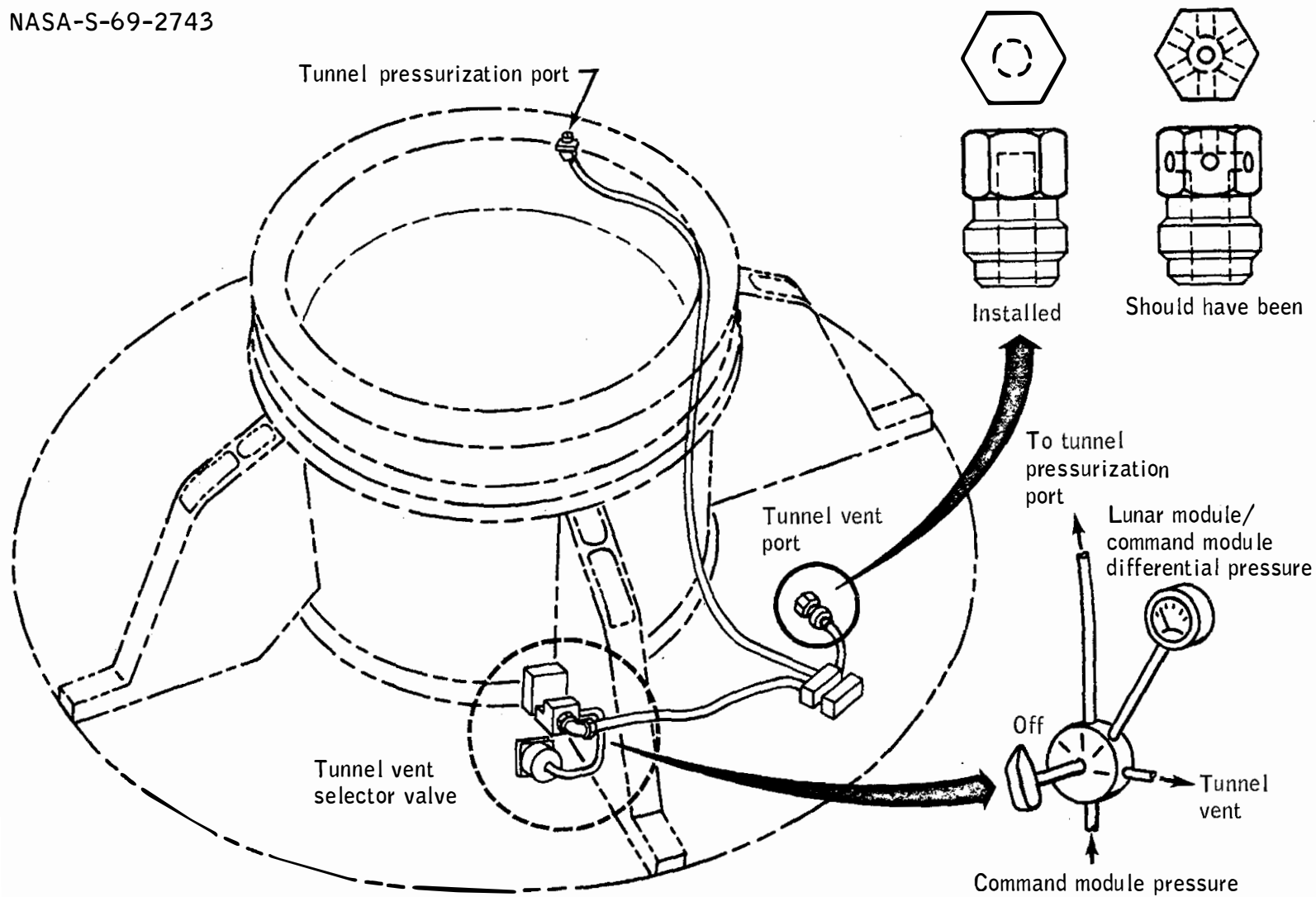

Figure 15-15.- Tunnel vent system.

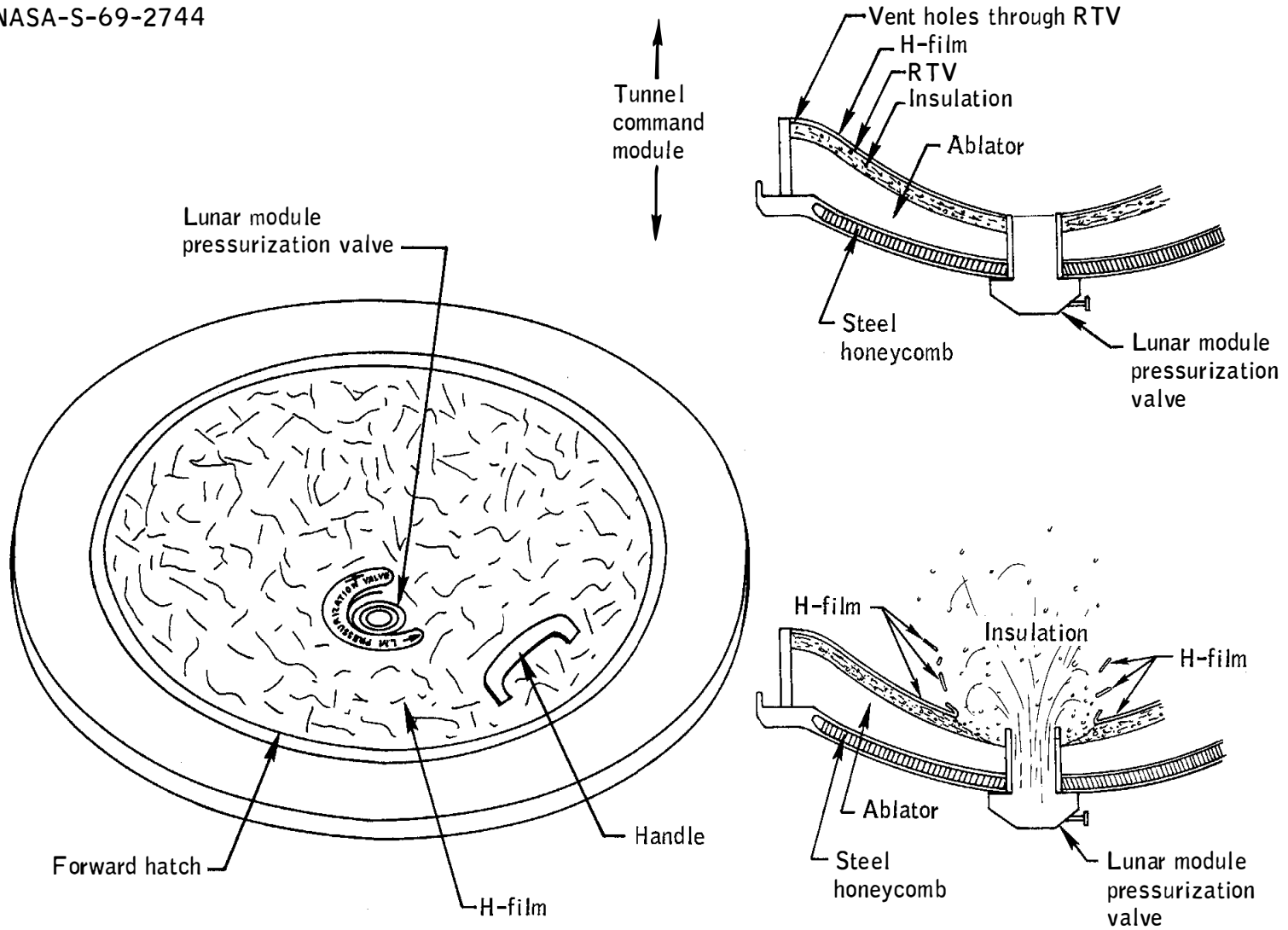

Figure 15-16.- Forward hatch thermal coating.

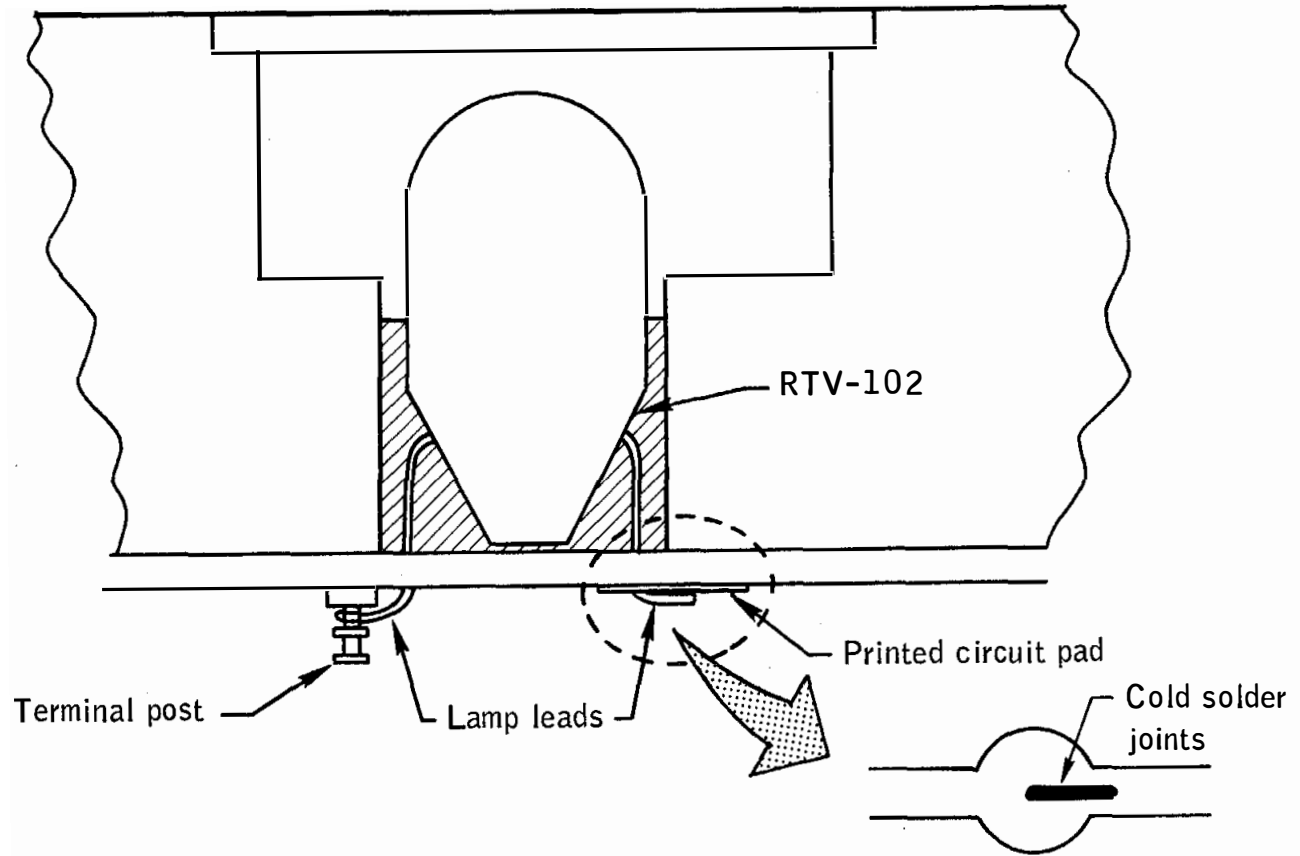

Figure 15-17.- Lamp assembly.

NASA-S-69-2746

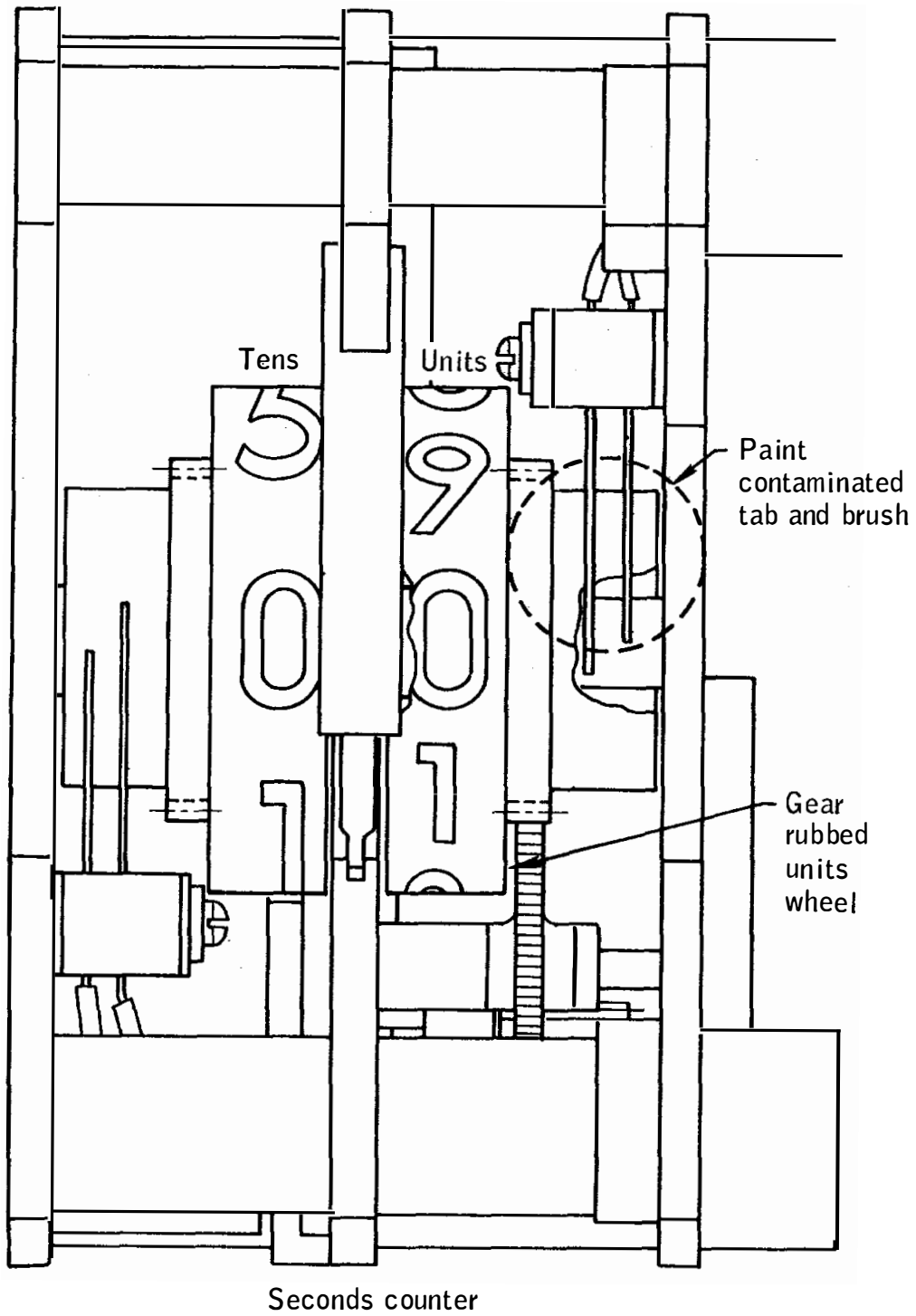

Figure 15-18.- Digital event timer.

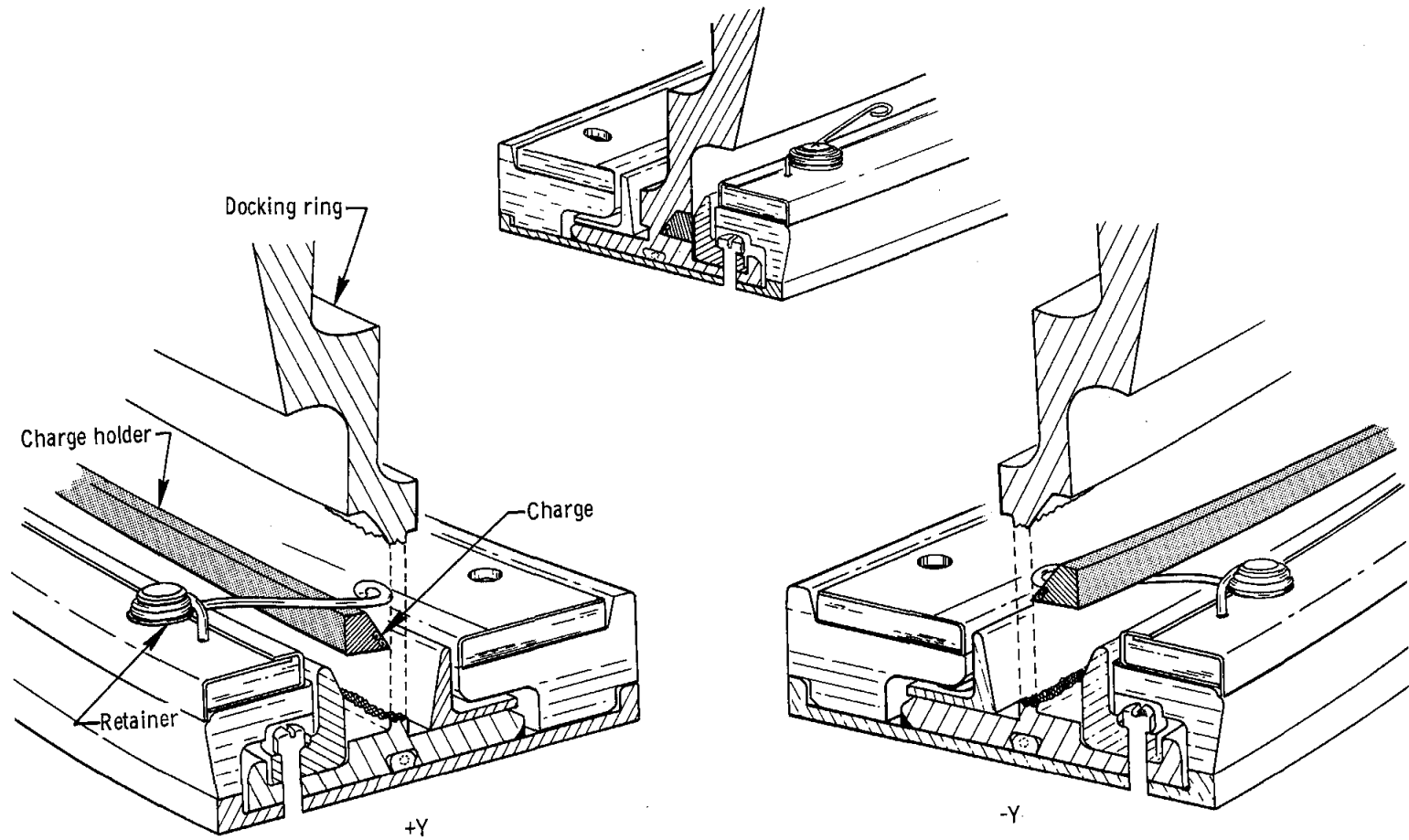

Figure 15-19. - Charge holder retention.

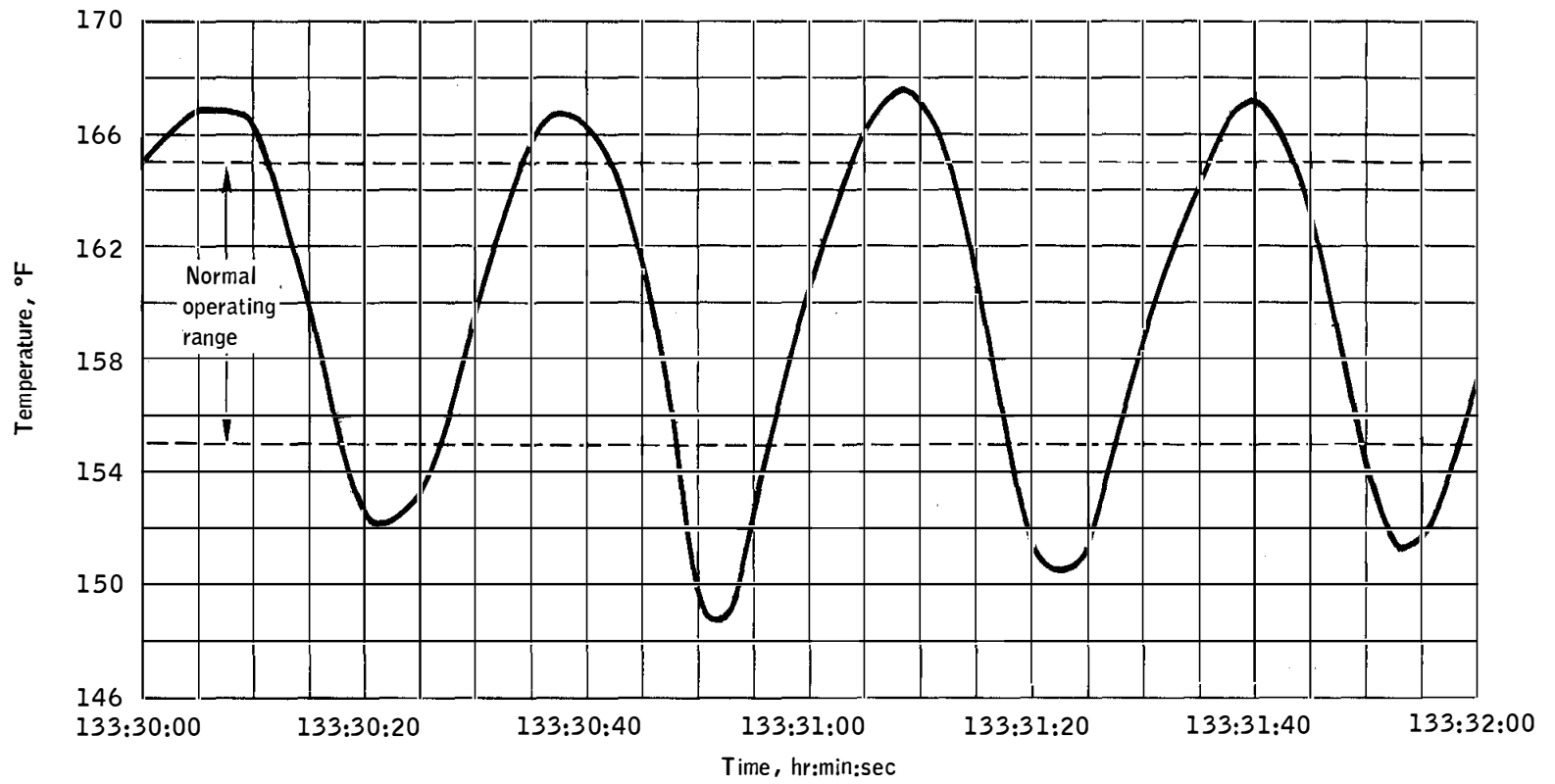

Figure 15-20.- Typical fuel cell 2 condenser exit temperature oscillations during lunar orbit.

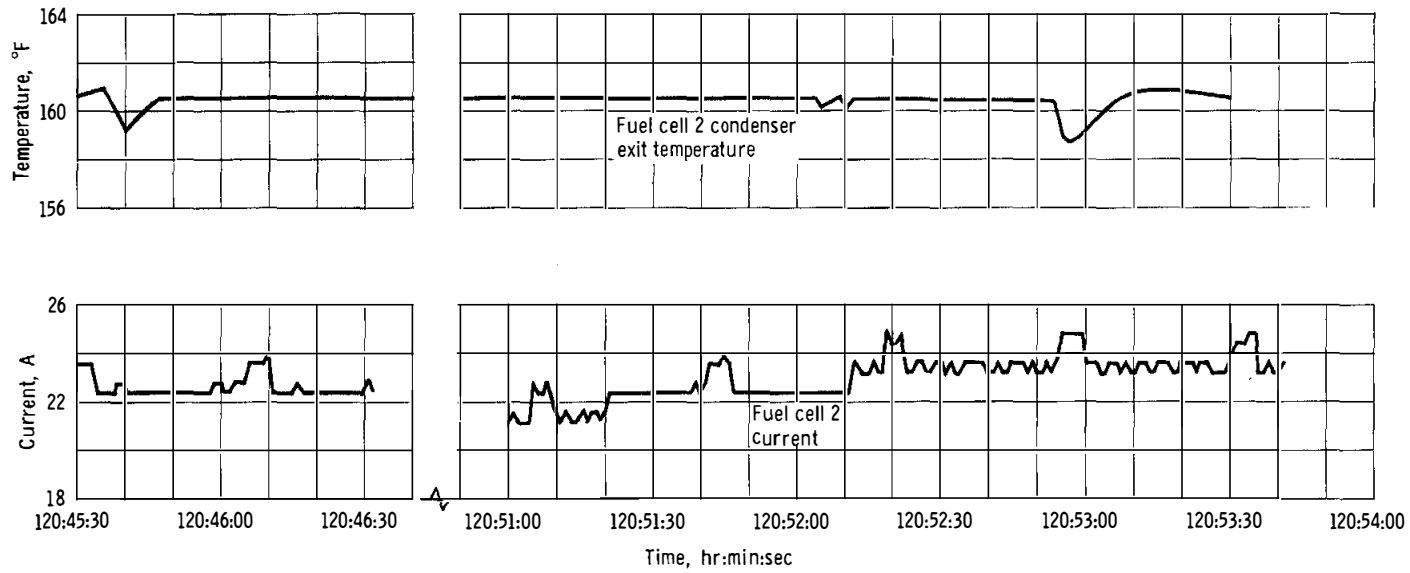

Figure 15-21. - Typical fuel cell 2 behavior with 3 fuel cells operating.

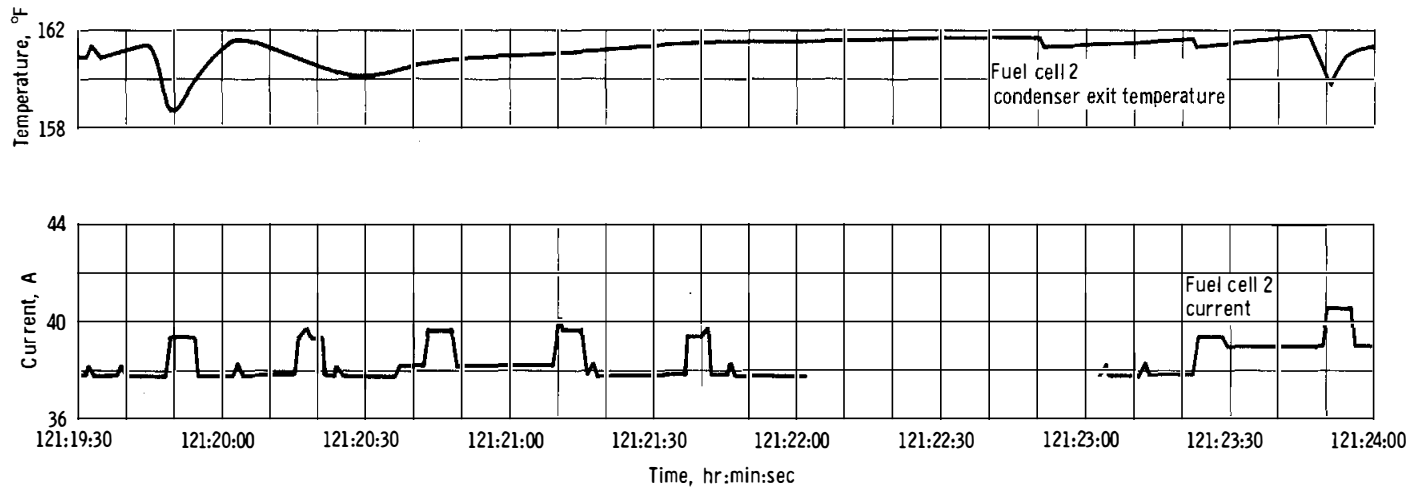

Figure 15-22. - Typical fuel cell 2 behavior with 2 fuel cells operating.

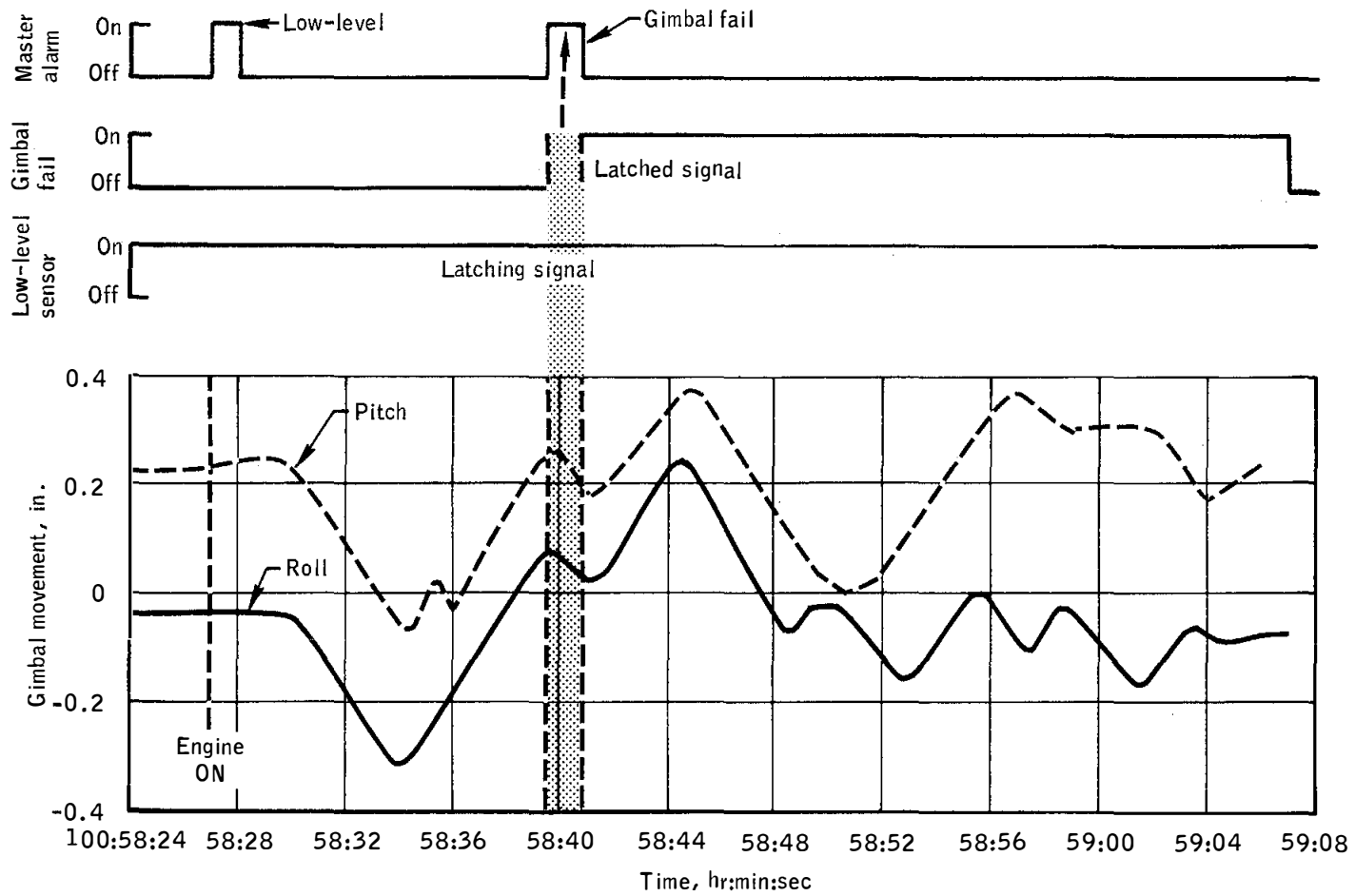

Figure 15-23.- Gimbal drive actuator operation.

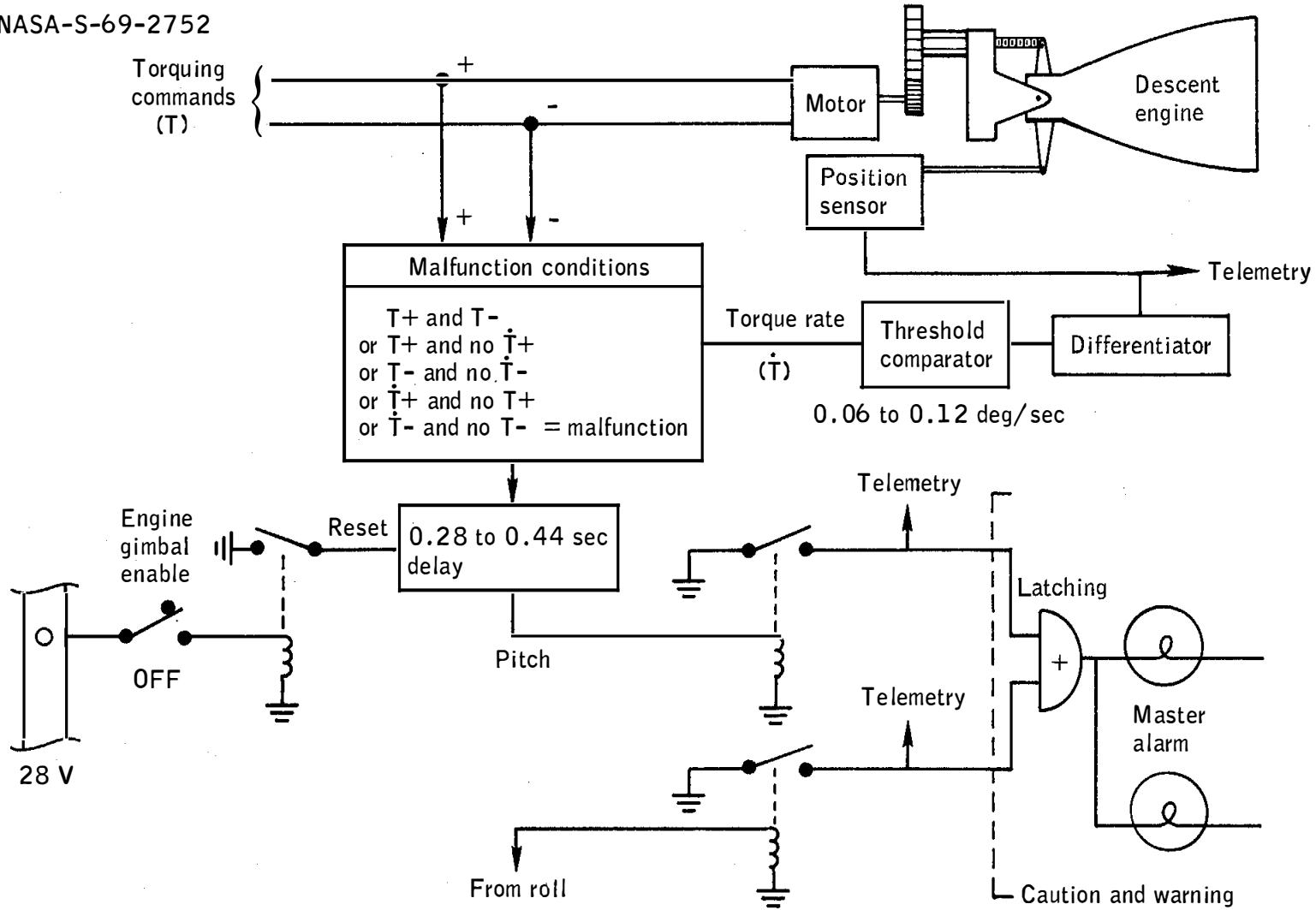

Figure 15-24.- Descent engine trim control.

NASA-S-69-2753

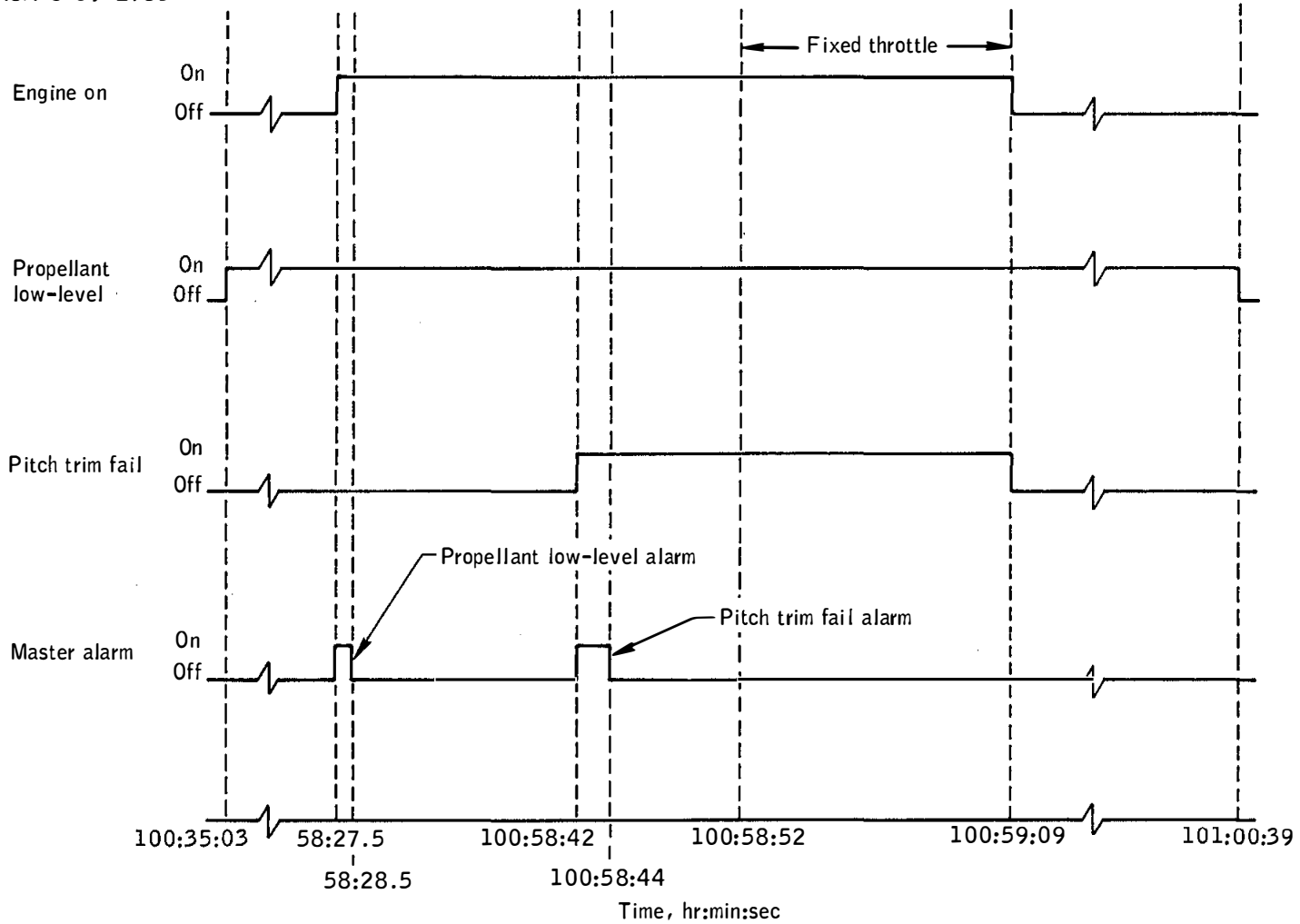

Figure 15-25.- Master alarms during phasing maneuver.

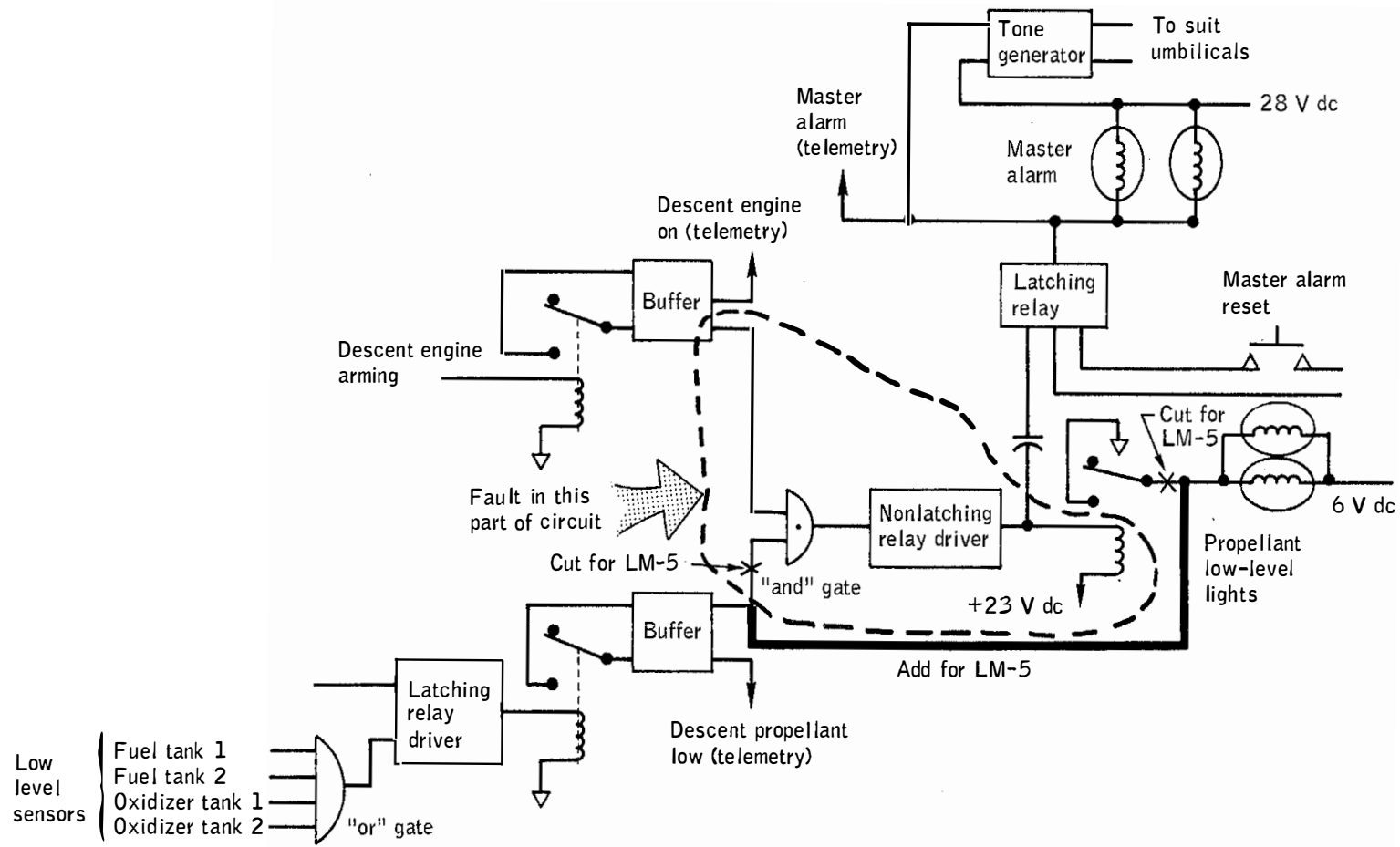

Figure 15-26.- Master alarm and propellant level circuits.

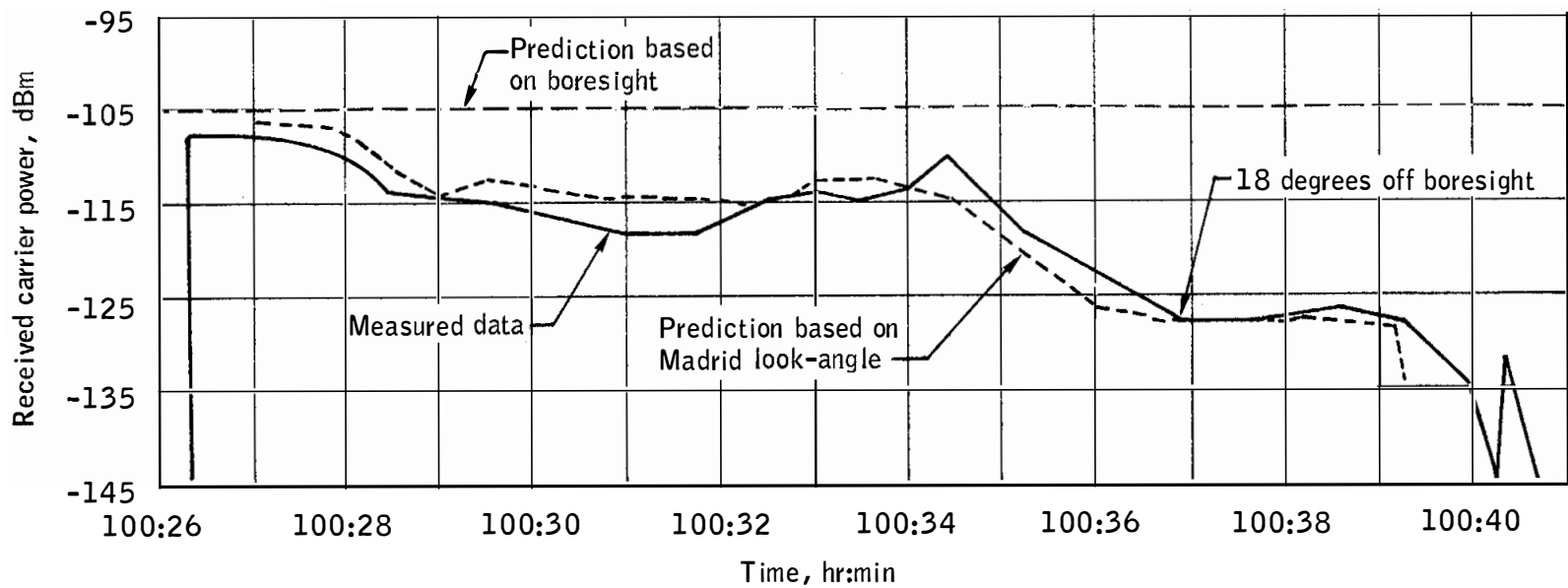

Figure 15-27.- Signal strength from steerable antenna.

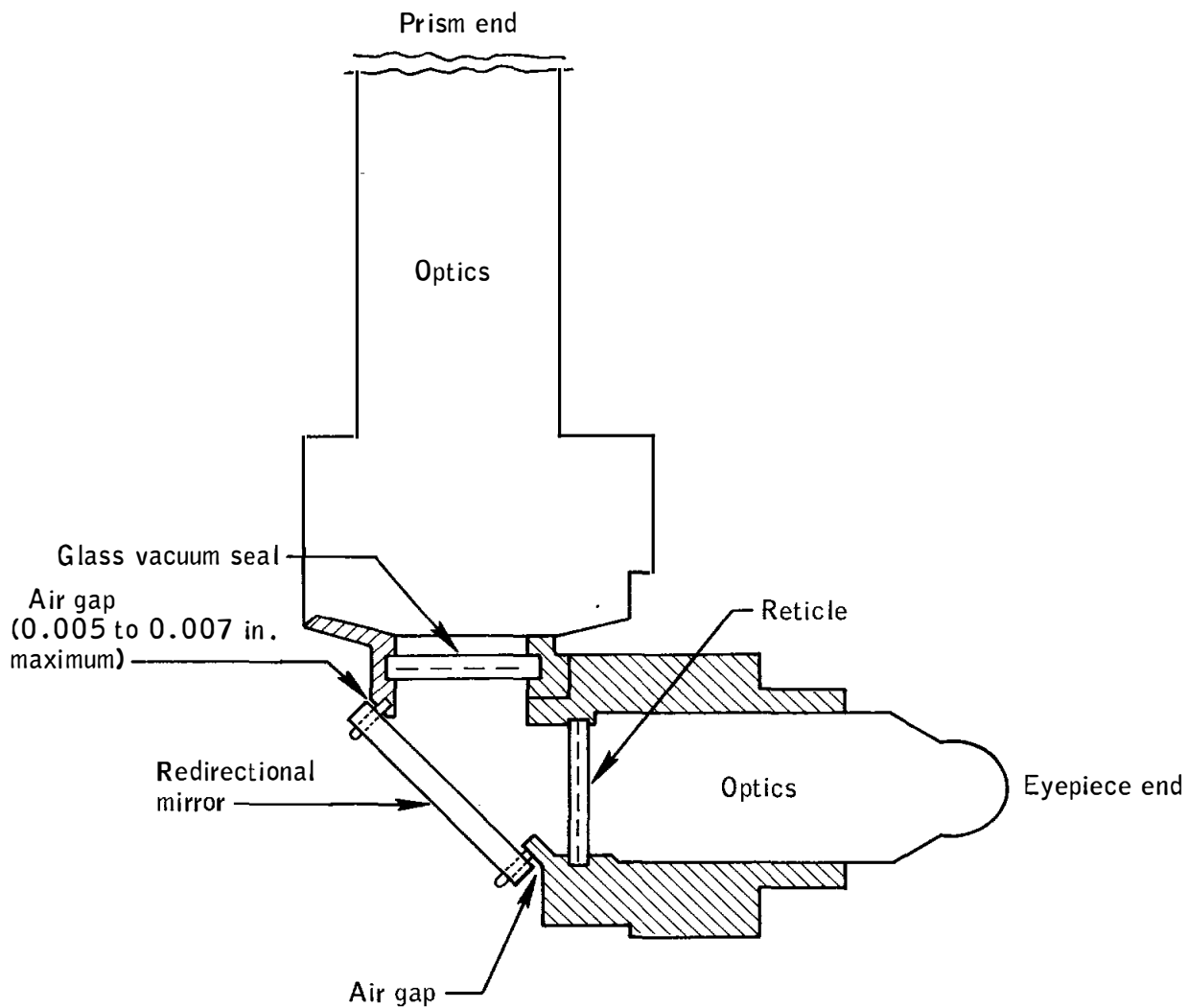

Figure 15-28.- Alignment optical telescope.

NASA-S-69-2759

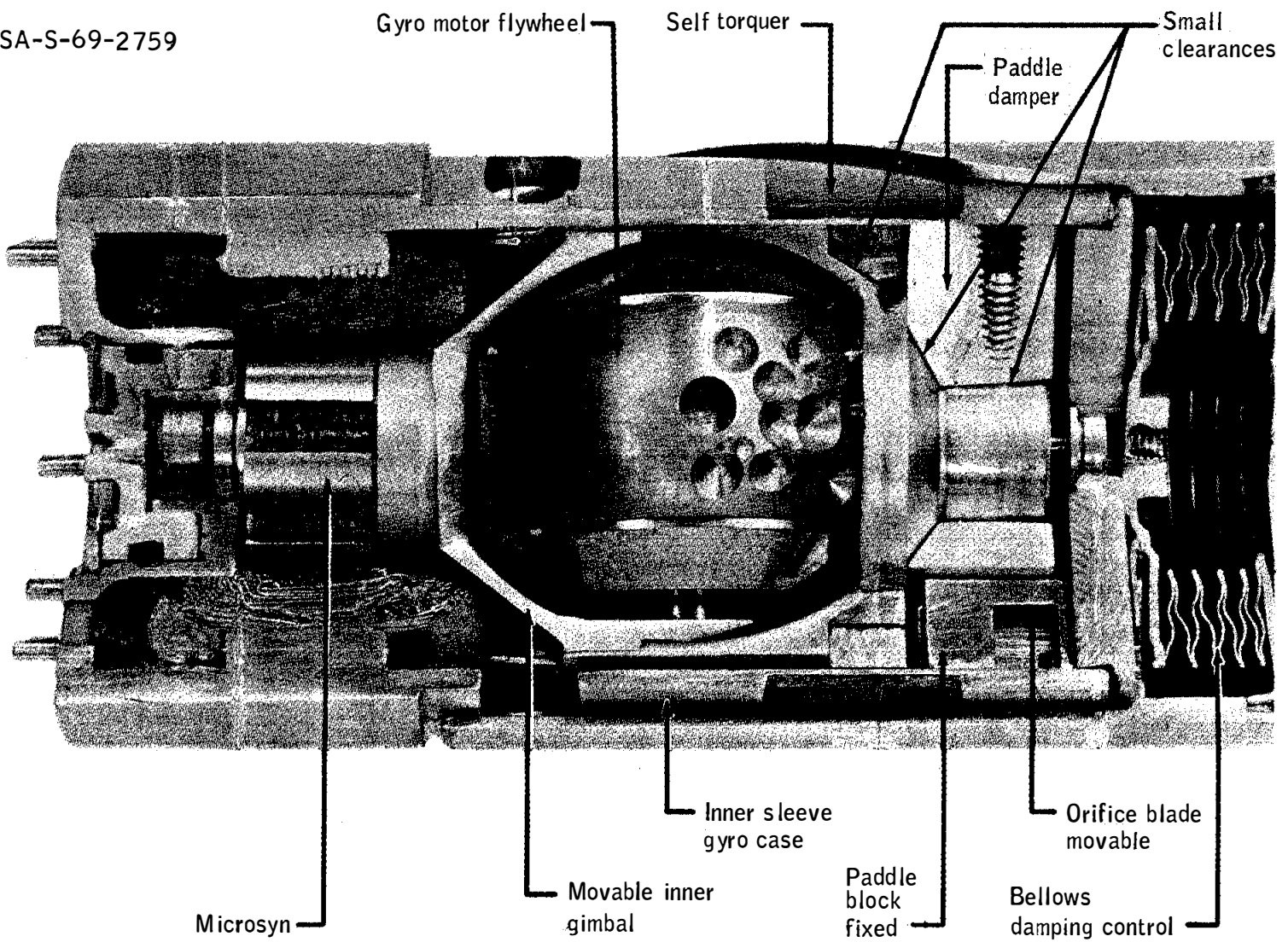

Figure 15-31.- Cross sectional view of rate gyro.

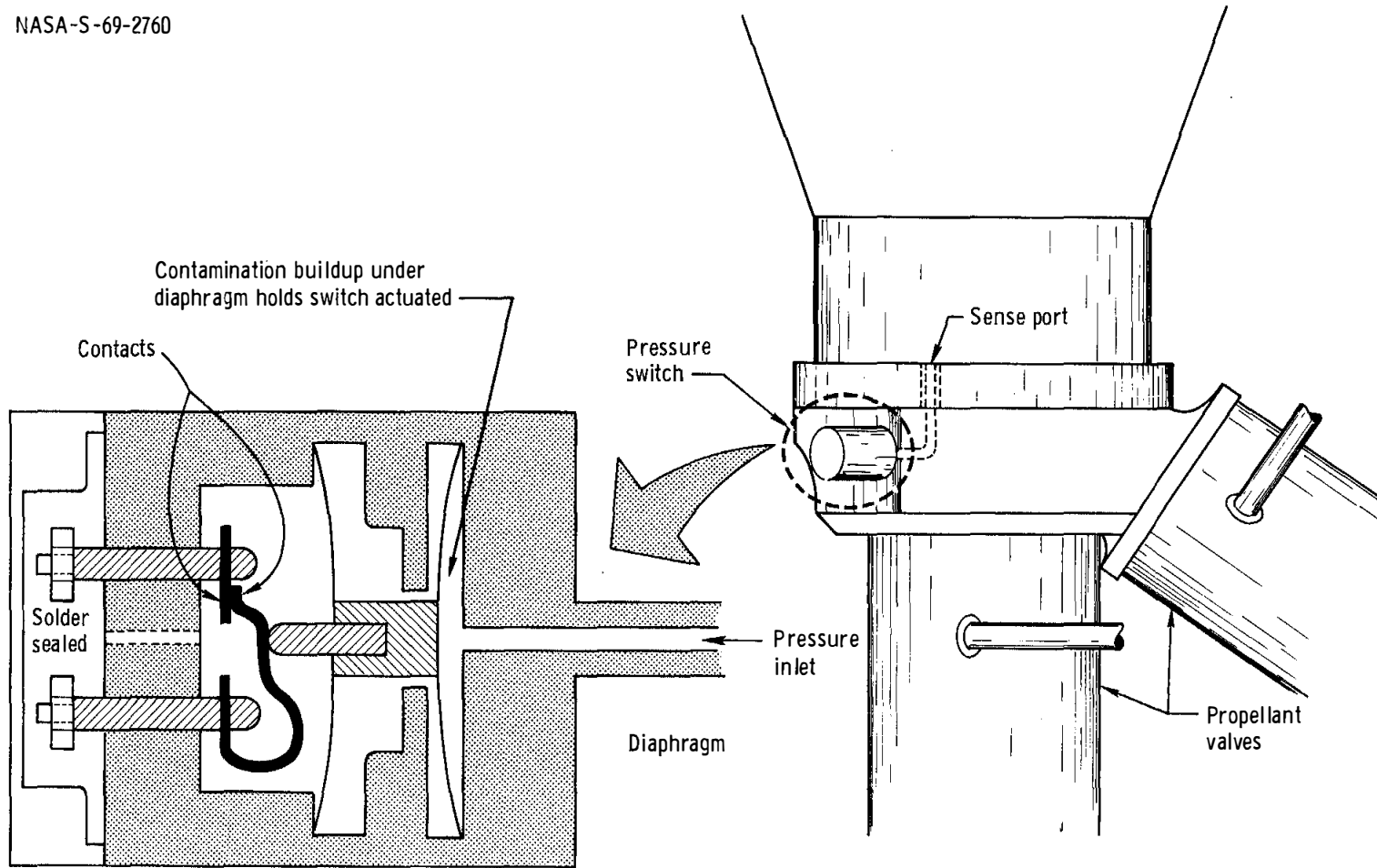

Figure 15-32. - Lunar module reaction control system thrust chamber switch.

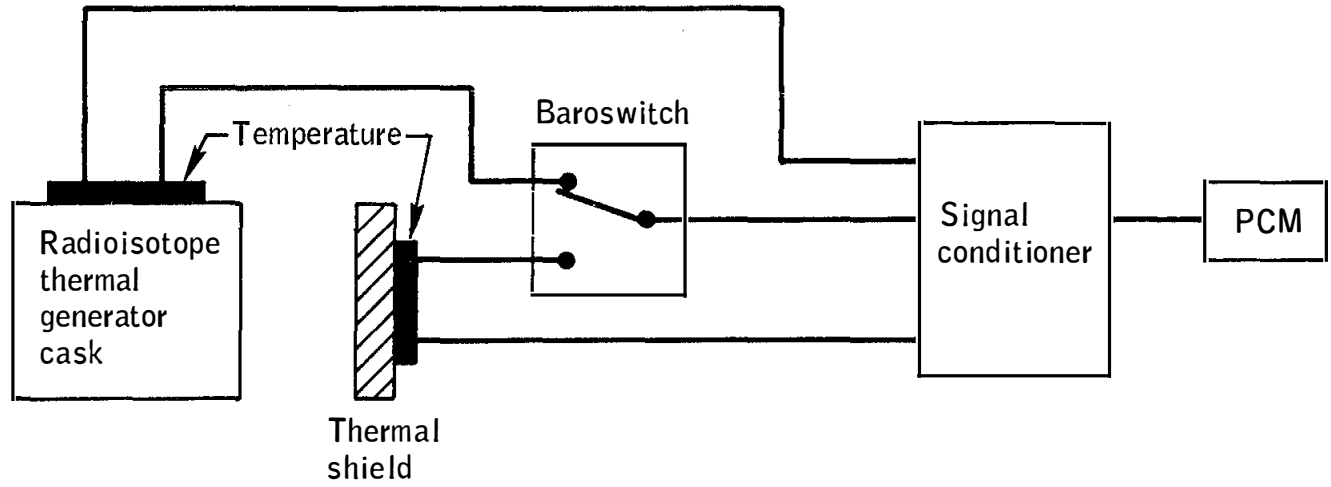

Figure 15-33.- Cask temperature.

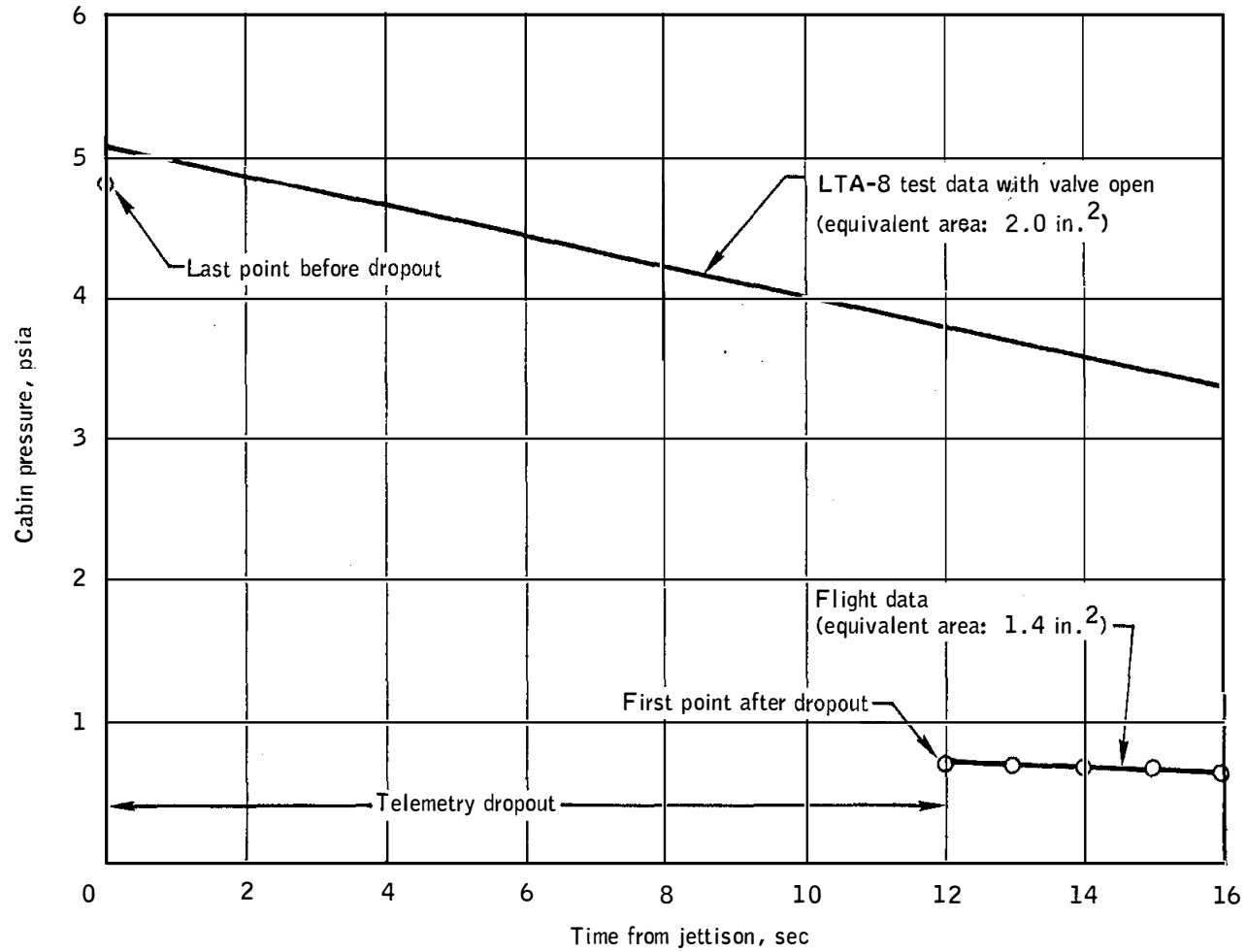

Figure 15-34.- Measured cabin pressure during jettison.

NASA-S-69-2763

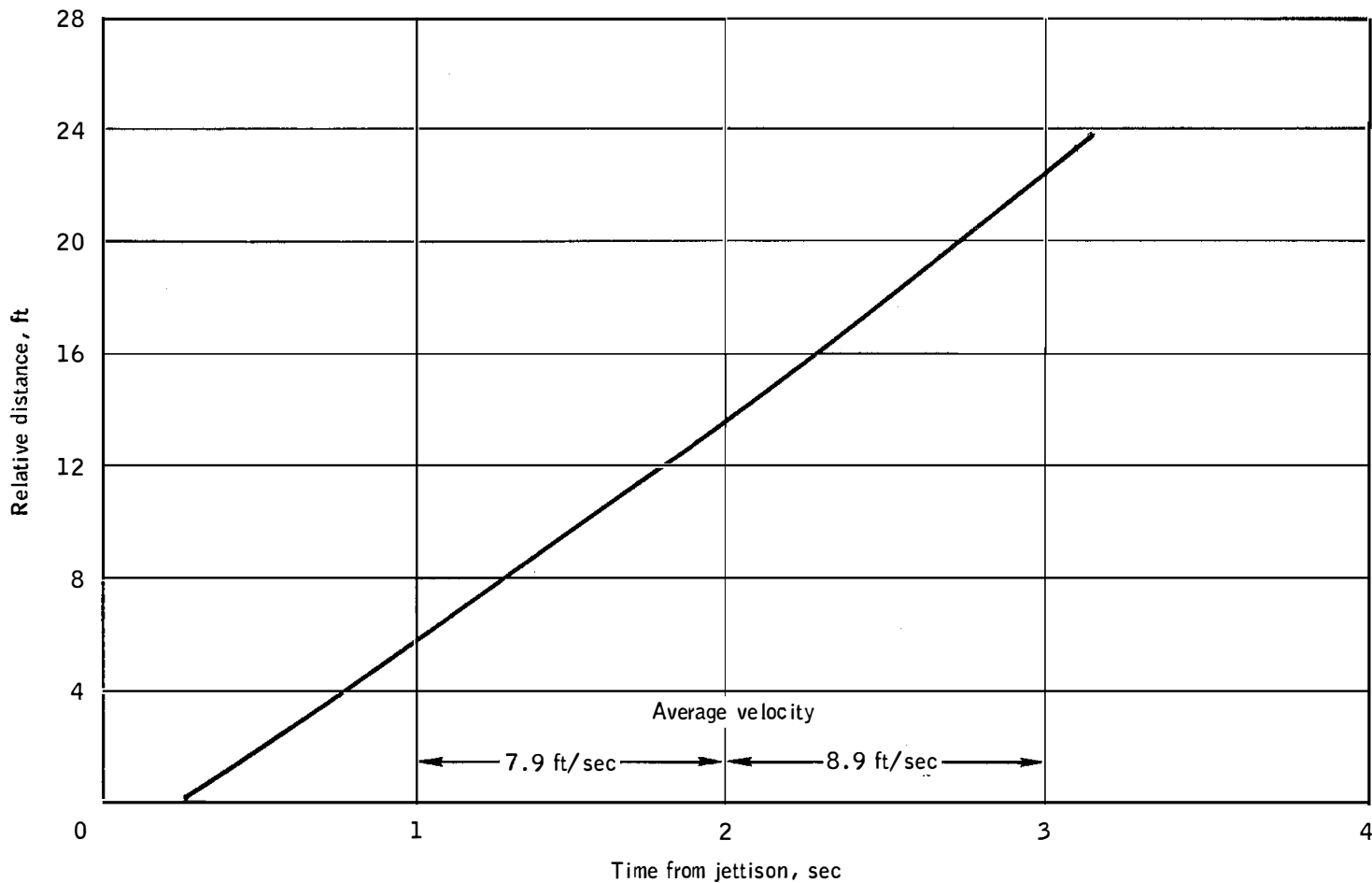

Figure 15-35.- Relative separation distance .

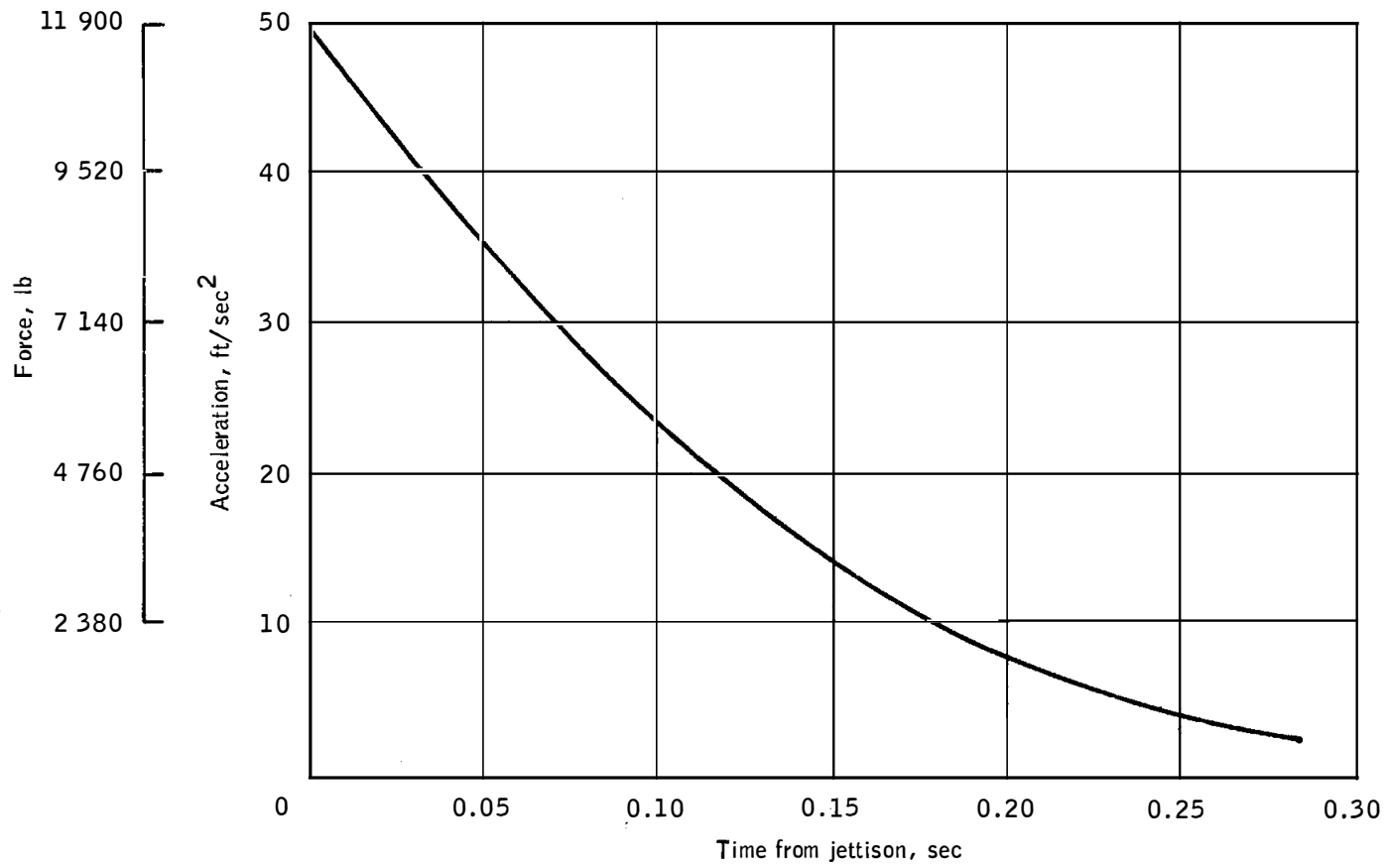

Figure 15-36.- Lunar module/command module relative acceleration after staging.

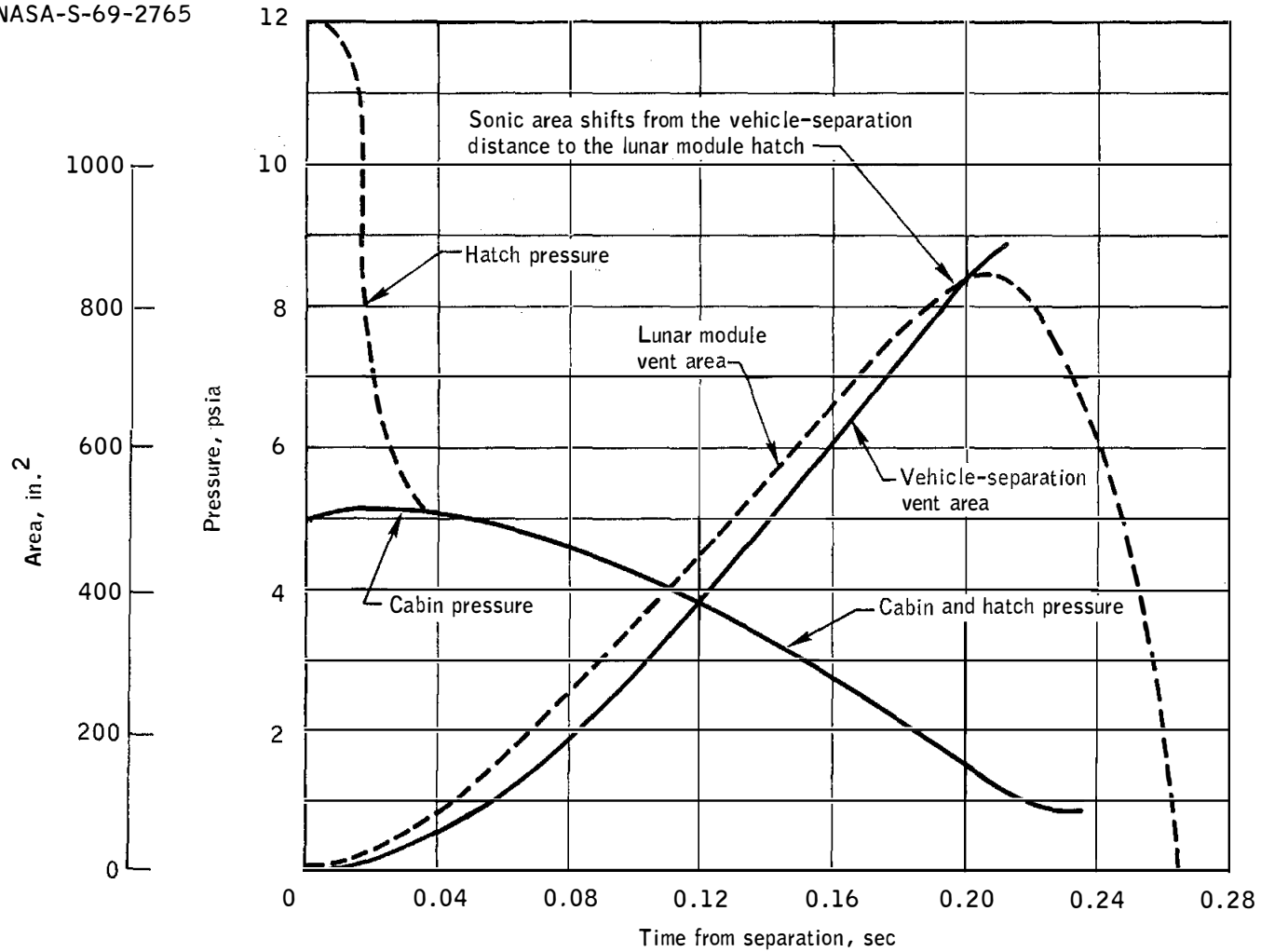

Figure 15-37.- Pressures and vent areas during separation sequence.

NASA-S-69-2766

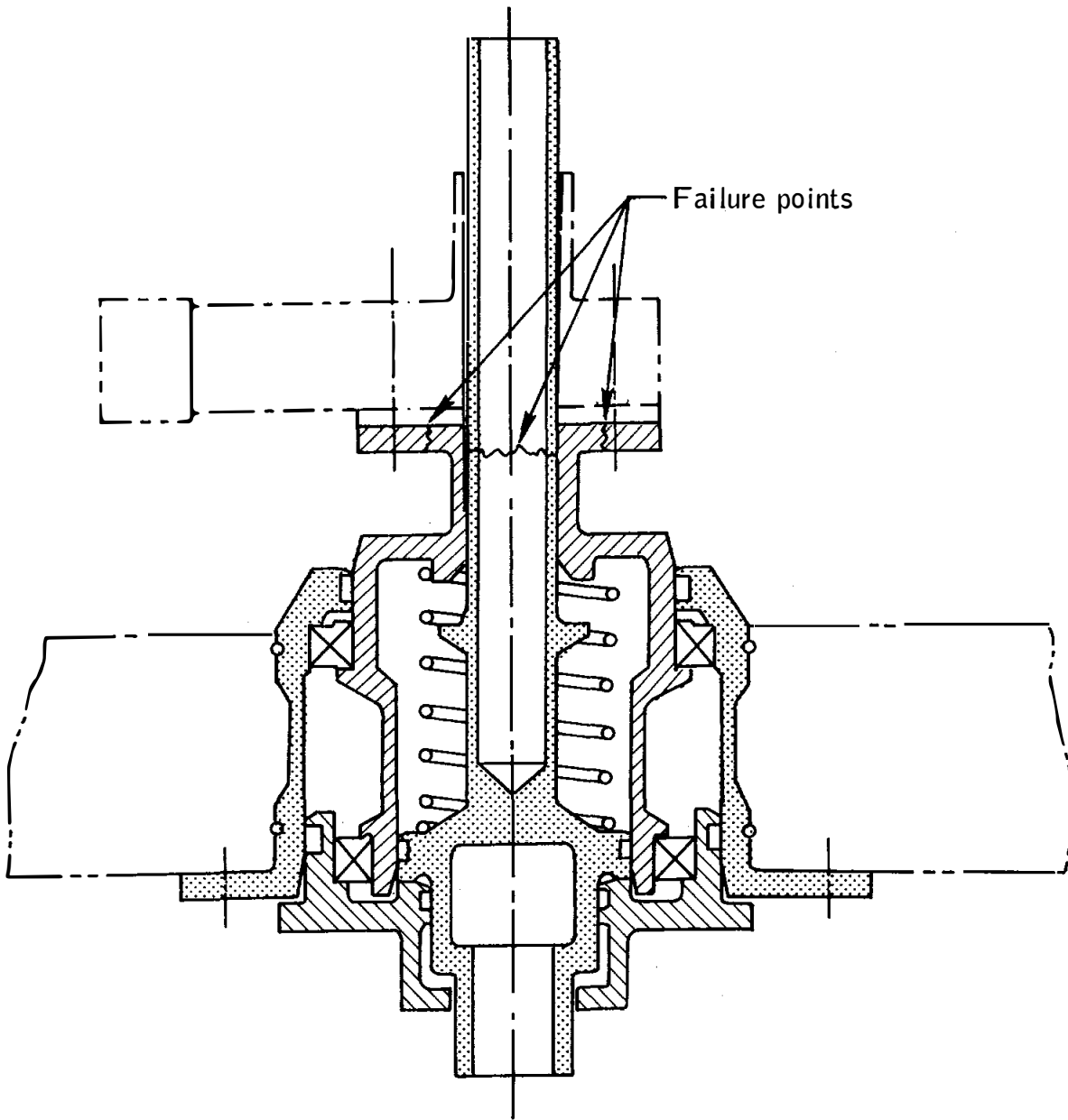

Figure 15-38.- Lunar module hatch latch.

NASA-S-69-2769

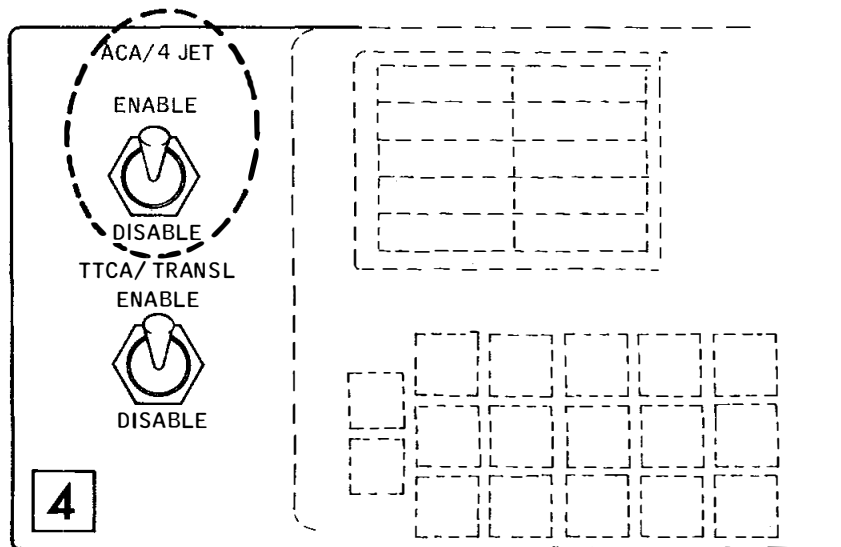
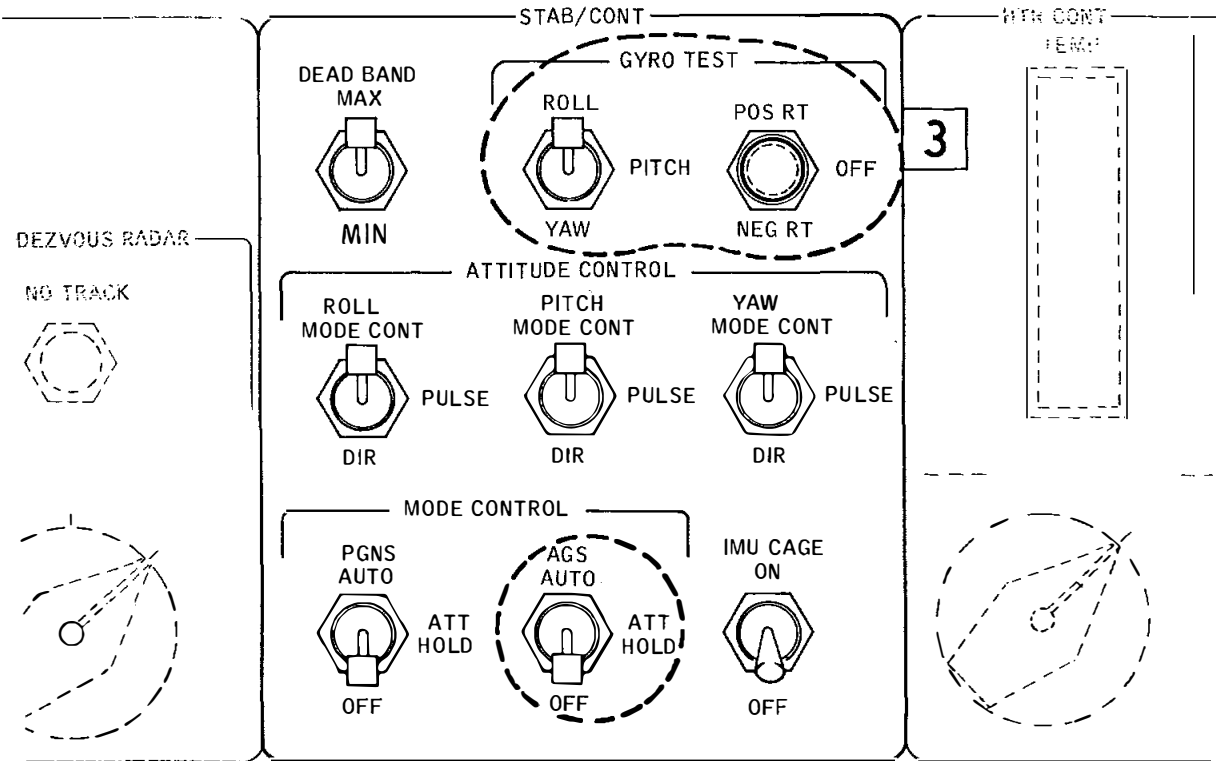

Figure 15-41. - Lunar module guidance switch locations.

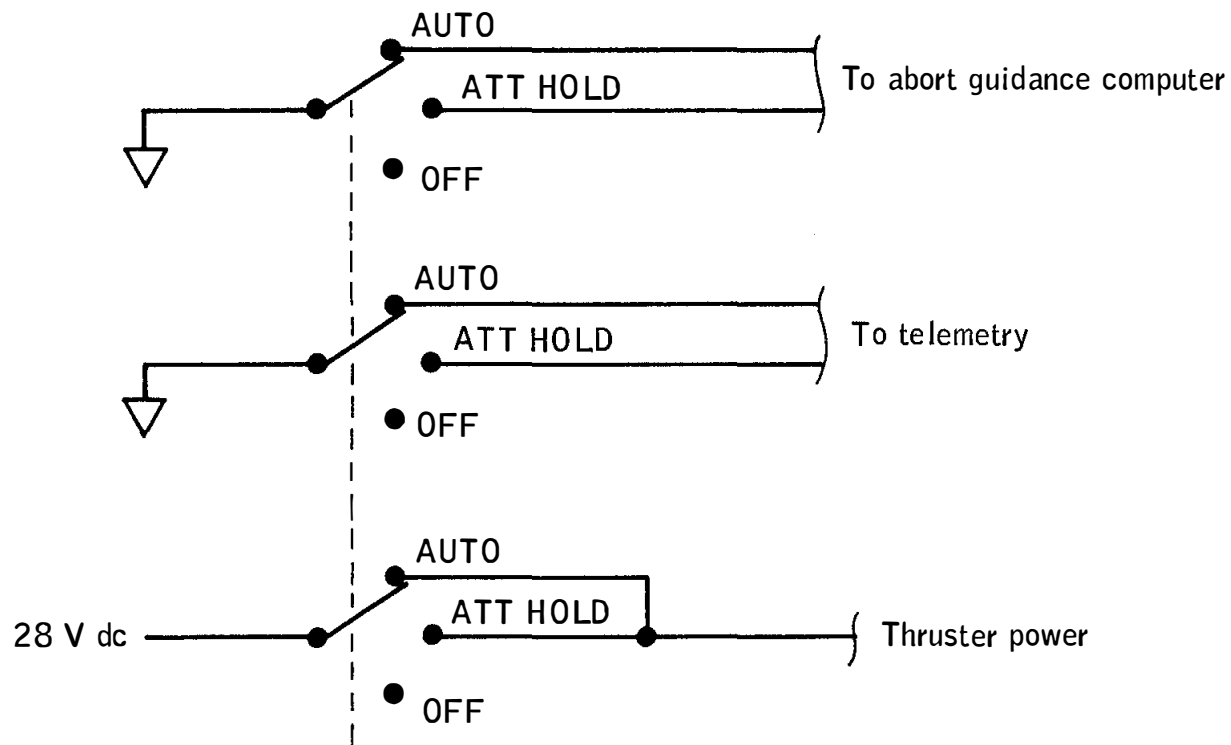
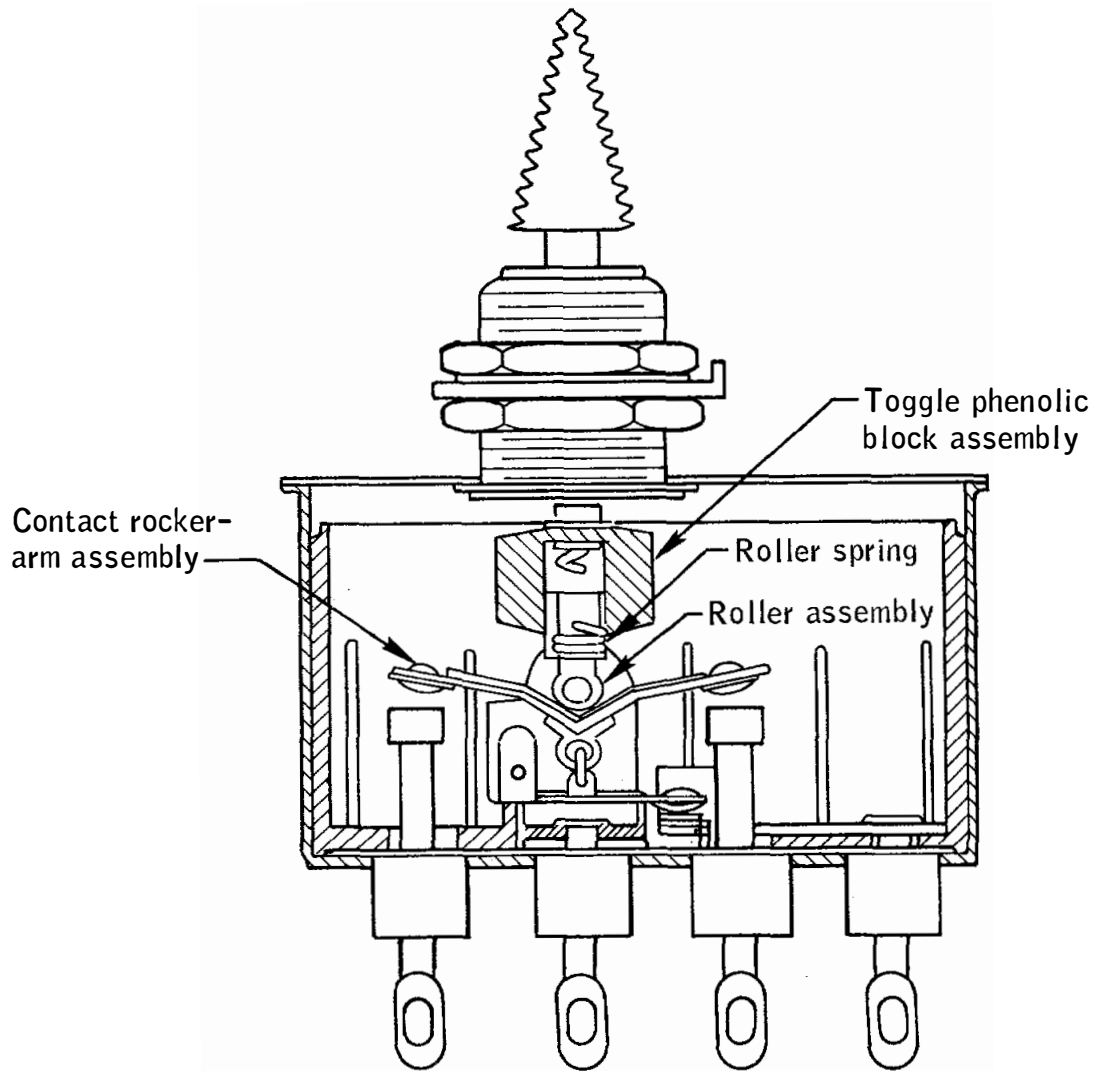

Figure 15-42.- Mode control switch operation.



One of three similar sections

Figure 15-43.- Abort guidance mode control switch.

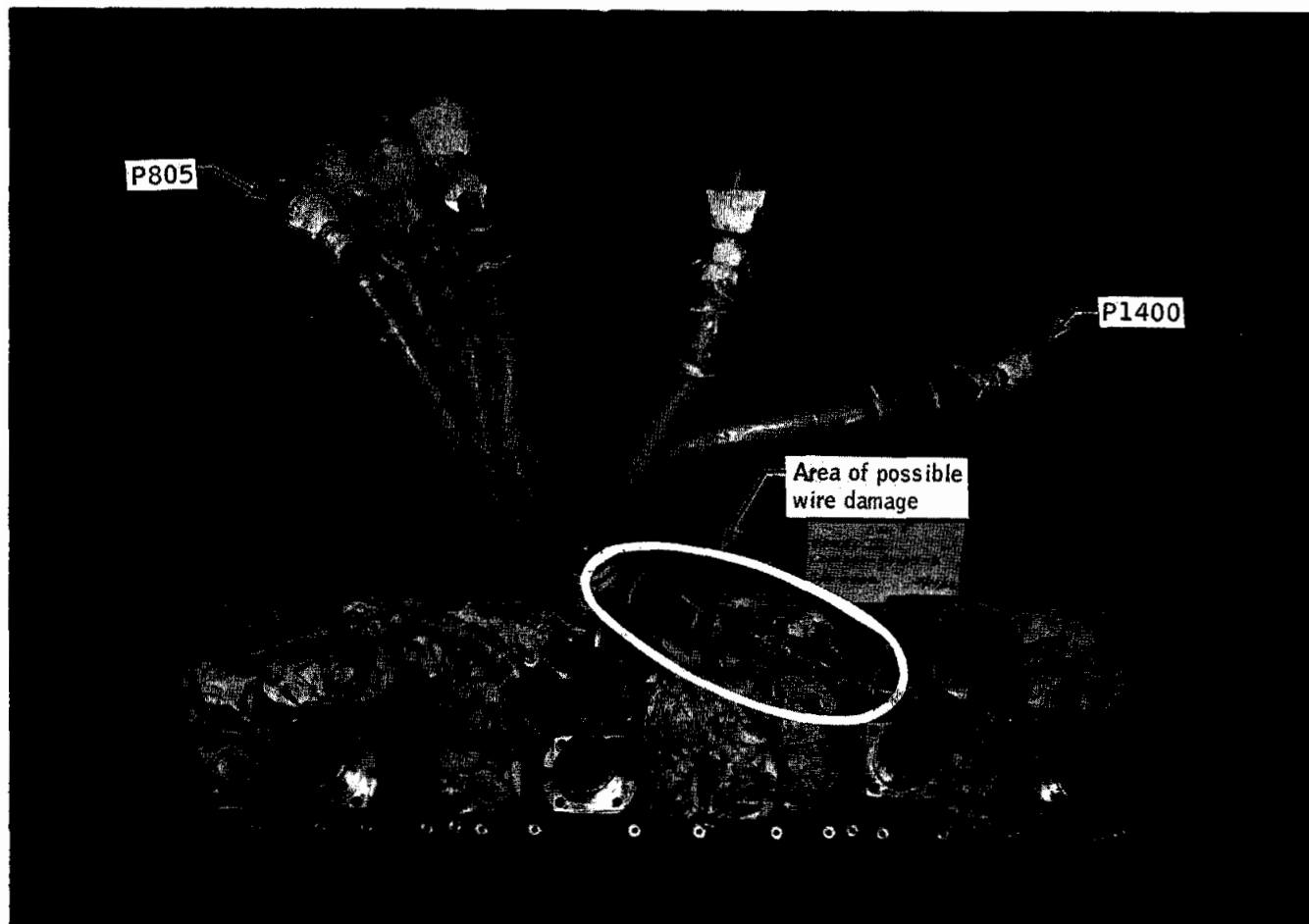

Figure 15-44.- Panel 3 wiring.

NASA-S-69-2773

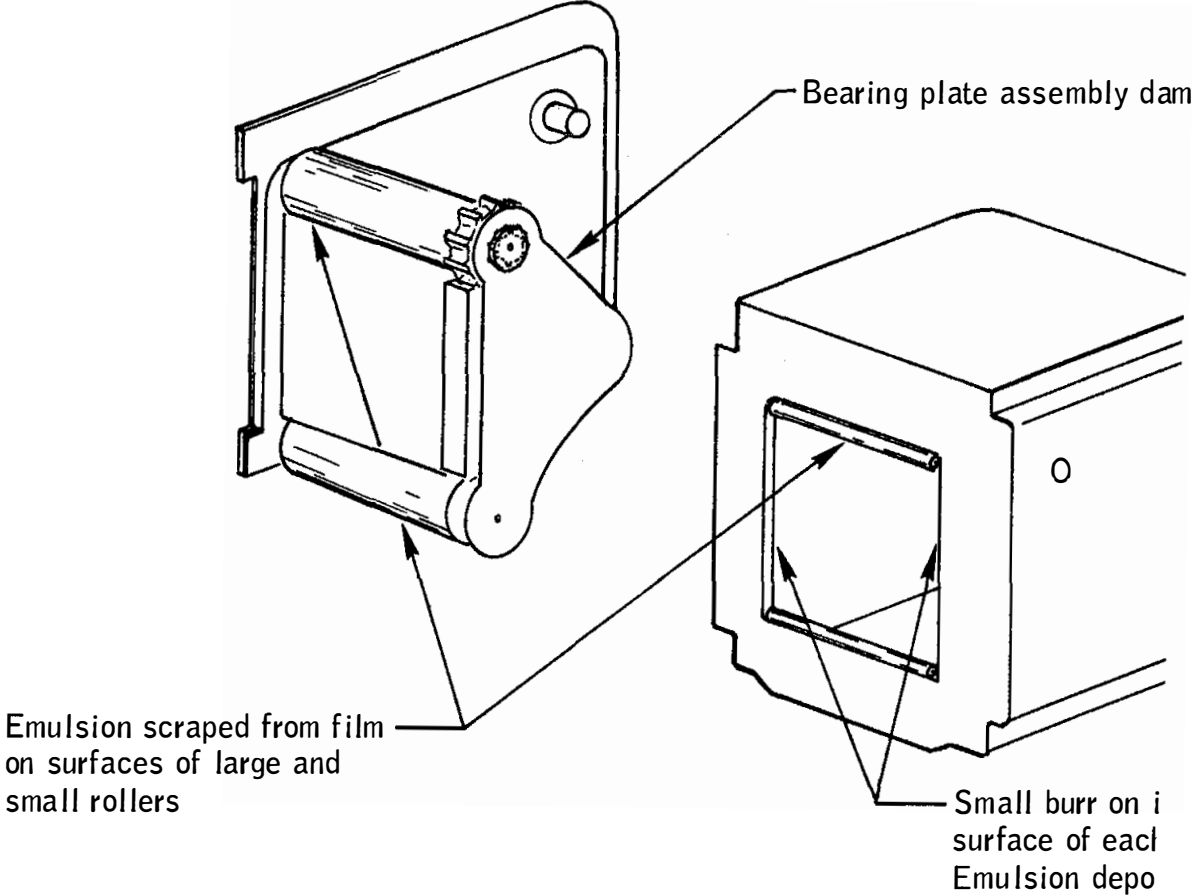

Figure 15-45.- Failure of 70-mm camera.

NASA-S-69-2774

Radii on edges to be large enough to relieve corner for easy insertion into either camera

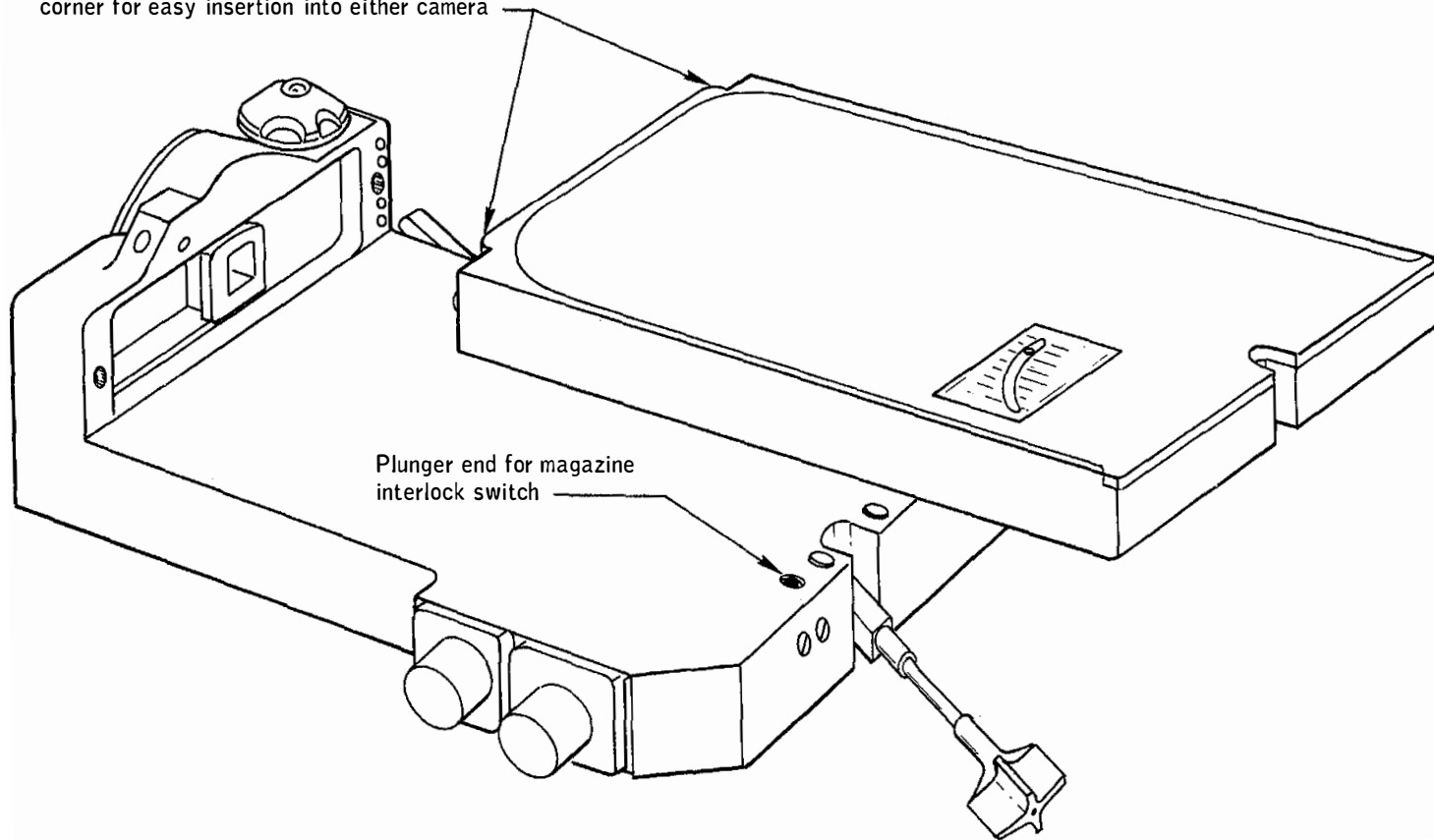

Figure 15-46.- Magazine installation in 16-mm cameras.

NASA-S-69-2775

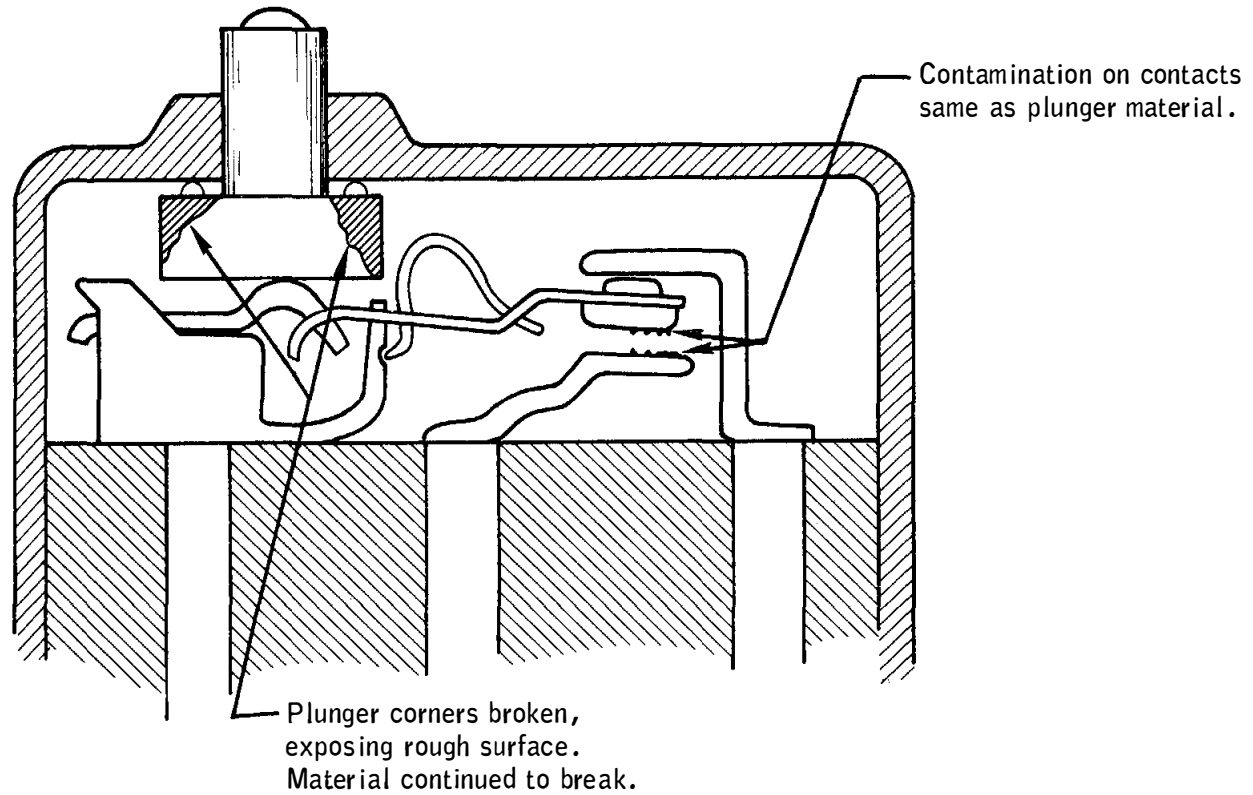

Figure 15-47.- Magazine interlock switch.

16.0 CONCLUSIONS

The Apollo 10 mission provided the concluding data and final environmental evaluation to proceed with a lunar landing. The following conclusions are drawn from the information contained in this report.

1. The systems in both the lunar module and the command and service modules are operational for manned lunar landing.

2. The crew activity timeline, in those areas consistent with the lunar landing profile, demonstrated that critical crew tasks associated with lunar module checkout, initial descent, and rendezvous are both feasible and practical without unreasonable crew workload.

3. The lunar module S-band communications capability using either the steerable or the omnidirectional antennas was satisfactory at lunar distances.

4. The operating capability of the landing radar in the lunar environment during a descent propulsion firing was satisfactorily demonstrated for the altitudes experienced.

5. The range capability of the lunar module rendezvous radar was demonstrated in the lunar environment with excellent results. Used for the first time, VHF ranging information from the command module provided consistent correlation with radar range and range-rate data.

6. The lunar module abort guidance system capability to control an ascent propulsion system maneuver and to guide the spacecraft during rendezvous was demonstrated.

7. The capability of the Mission Control Center and the Manned Space Flight Network to control and monitor two vehicles at lunar distance during both descent and rendezvous operations was proved adequate for a lunar landing.

8. The lunar potential model was significantly improved over that of Apollo 8, and the orbit determination and prediction procedures proved remarkably more precise for both spacecraft in lunar orbit. After a combined analysis of Apollo 8 and 10 trajectory reconstructions, the lunar potential model is expected to be entirely adequate for support of lunar descent and ascent.

APPENDIX A - VEHICLE DESCRIPTIONS

The Apollo 10 space vehicle consisted of a block II configuration spacecraft and a Saturn V launch vehicle (AS-505). The spacecraft comprised a launch escape system, command and service modules (CSM 106), spacecraft/launch-vehicle adapter, and lunar module (LM-4). All components were very similar to those for Apollo 9, and only the major differences are discussed.

The extravehicular mobility unit was nearly identical to that for Apollo 9; however, the differences in the pressure garment assembly are described in section A.1.8, and differences in the remaining components are discussed in section A.2.12.

A.1 COMMAND AND SERVICE MODULES

A.1.1 Structural and Mechanical Systems

The major changes to the structural and mechanical systems were that the sealant for windows 2 and 4 was cured in a manner similar to that used on windows 1, 3, and 5 for Apollo 9; spring-action retainer clips were added in the separation charge holder for the docking ring to preclude recontact with parachute risers; a lightweight side hatch was substituted for the slab design previously used; and the knob on the hatch counterbalance assembly was replaced with a ratchet-type handle to facilitate manual actuation. In addition, the Z-axis attenuation struts in the crew couch assembly were modified to stroke at a deceleration threshold of 6.3g, instead of 8.5g. This change was made because the deceleration levels experienced in previous flights were insufficient to cause stroking, and the initial level was conservative.

The only major change to the service module structure was that the load-carrying capability of the oxidizer sump-tank skirt in the service propulsion system was increased.

The ballast weight in the launch-escape-system forward structure was changed from 870 to 942 pounds to lessen sensitivity of the launch escape system dynamics to command module weight changes.

A.1.2 Communications

The S-band power amplifier was of the same configuration as that used for Apollo 7 and 8; filter chokes were removed and certain diodes in the power supply were replaced. The premodulation processor incorporated an S-band squelch capability controlled by a switch to prevent a noise burst if the 30-kHz S-band uplink subcarrier was lost.

The VHF transceiver was modified to accommodate a ranging capability for backup rendezvous calculations. The three tones used in this ranging system (3.95 kHz, $247 + 3.95$ kHz, and 31.6 kHz) were transmitted and subsequently received by the VHF transceiver in the command module after coherent demodulation and retransmission through the transceiver in the lunar module. These transmitters were modulated by the three tones sequentially during acquisition and by the 31.6-kHz tone continuously after acquisition. The received signal in the command module was then compared with the transmitted signal to determine phase delay, which corresponded to the slant range between the two vehicles. The system provided slant range with a data-good signal to the computer for a state vector update, if required. The entry monitor system can display slant range data continuously to the crew. A block diagram of the VHF ranging system is shown in figure A-1.

A.1.3 Environmental Control System

The sponges in the primary and secondary glycol evaporators were trimmed away from the temperature sensors at the wick. The relief mechanism in the water pressure relief valve was removed from one side of the parallel valve configuration to allow direct dumping of the waste water tank, rather than using the urine transfer hose. The primary and secondary water/glycol lines from the command-module pressure vessel to the environmental control unit were fully insulated to eliminate condensation on the aft bulkhead.

A.1.4 Guidance, Navigation, and Control Systems

The diastimeter (manual ranging device) was deleted, and a VHF ranging interface was added to the command module computer to accommodate the backup rendezvous function. The computer program was changed from the Colossus to a Manche configuration to accommodate the lunar rendezvous operation. The entry monitor system was modified to include an interface with the VHF ranging system (see section A.1.2), and the scroll assembly was changed to incorporate a higher preload in the stylus for more positive scribing.

A.1.5 Electrical Power

Battery B incorporated cellophane separators for comparative evaluation with the Permion separators used in batteries A and C. The fuel cells were modified by substitution of an improved hydrogen-pump pinion gear capable of extended operation with condenser exit temperatures above 200° F.

A.1.6 Service Propulsion System

The significant changes to the service propulsion system, both of which improved operation at low temperature, were incorporation of the same bipropellant valve configuration as that used in Apollo 8, and addition of strip heaters in the propellant distribution lines from the tank outlets to the bipropellant valves.

A.1.7 Reaction Control Systems

For consistent operation, the range of the thermostats on the secondary quad heaters in the service module reaction control system was made identical to that of thermostats on the primary quad heaters.

A.1.8 Crew Provisions

Added to the crew provisions were a sleeping restraint, a water bag for separation of any gas from the potable water, and tools for disassembly of the docking probe. The forward-hatch stowage bag under the left-hand couch was increased in size. In the crew optical alignment sight, the inner filter was replaced by a diffuser lens, and an external clip-on filter was added. The hose material for the water dispenser assembly was changed from Neoprene to Viton to reduce the leaching of organic compounds and to improve the taste of the water.

For increased mobility, a looser fit, and reduced heat leak, Teflon patches were incorporated in the outer layer of the pressure garment assembly and Dacron and aluminized Mylar in the insulation layer. For higher temperature resistance, Nomex was used instead of nylon for the link net. The oxygen umbilical connectors at the environmental control panel were reversed for increased mobility through the tunnel, and the construction of these umbilicals was changed from partially to completely silicone, with two Beta-fabric sleeves for added flexibility.

A.1.9 Television

The television systems were completely different from the system employed on Apollo 9. The Apollo 9 system used the lunar-configuration camera and accessories and operated from the ascent stage of the lunar module. The Apollo 10 systems involved two television cameras, one black-and-white and the other color, operated from the command module. The black-and-white television system consisted of a camera, 80-degree wide-angle lens, 9-degree (100-mm) lens, and 12-foot power cable. This system was identical to those on Apollo 7 and 8, with the exception of the lenses and the addition of a new ring sight to the camera.

The color television system consisted of a special camera employing a camera tube and a synchronized color filter system. The camera operated at a scan rate of 30 frames per second; this rate is compatible with scanning rates of commercial television. The required frequency bandwidth of 2 MHz was available in the S-band transmitter. The color camera was equipped with a zoom-type lens having a 9- to 53-degree variable field-of-view. The system used 28 watts of power and had a minimum signal-to-noise ratio of 30 dB and a resolution of 160 by 370 lines (horizontal by vertical).

A black-and-white television monitor with a 3- by 2.25-inch picture tube was also used with the color system to permit better camera pointing. The color camera used the same power cable and mounting bracket as the black-and-white camera. A cable carrying power and video signals connected the monitor and the camera.

A.2 LUNAR MODULE

A.2.1 Structures

The descent stage structural webs were increased to a minimum thickness of 0.015 inch, and the upper deck webs incorporated bonded doublers. Support structures and mass simulators were added for the modular equipment storage assembly. The Apollo Lunar Surface Experiments Package support structure, including the deployment mechanism, was redesigned. The location of the electrical power system batteries was changed from four batteries in quad IV to two in each of quads I and IV.

A.2.2 Thermal

To decrease weight, the thermal blankets on the ascent stage were changed to a composite of 16 layers of 0.5-mil aluminized Kapton and

11 layers of 0.125-mil aluminized Mylar. Thermal shielding was modified to the revised criteria for firing time of the service module reaction control system and for deployment of the adapter panels. The thermal shields were generally lighter in weight as a result of the reduced thickness and the smaller number of shields, except that the lower portion of the ascent stage used shields like those on LM-1 (Apollo 5). Additional thermal installation was installed around the interstage umbilical.

The window shades used were capable of withstanding temperatures of up to 300° F. The material used on previous spacecraft could withstand temperatures of only up to 200° F.

A.2.3 Electrical Power

The only difference in the electrical power system from Apollo 9 was that a reverse-operating contact in the circuit interrupter was connected in parallel with contacts in the descent electrical control assemblies so that power could be provided from the command module to the ascent stage alone.

A.2.4 Displays and Controls

The displays and controls were modified by the addition of two switches which allowed isolation of a failed hand controller. In addition, the mode control switch for the attitude control assembly was changed from a rotary switch to two toggle switches in order to improve reliability. As a result of the addition of the VHF uplink squelch capability and VHF ranging, two 2-position toggle switches on the communications panel were replaced with 3-position switches. Also, the television camera connector and various circuit breakers and toggle switches associated with earth orbital missions were deleted, and the rotary switch for exterior lights was changed to a 3-position maintain toggle switch.

A.2.5 Instrumentation

The only significant instrumentation change from the Apollo 9 flight was the deletion of the development flight instrumentation.

A.2.6 Communications System

A significant change to the communications system configuration was the addition of the digital uplink assembly which decoded ground commands transmitted on the 70-kHz S-band subcarrier. The decoder section was

identical to that of the digital command assembly, which also contained a UHF command receiver for use in the earth orbital missions. The decoded data were routed to the guidance computer and the ascent engine arming assembly. The computer processed the data and routed a verification signal to the pulse code modulation and timing electronics for transmission to the ground station, to indicate that the uplink commands had been processed by the computer. Another verification signal was transmitted to indicate that the uplink commands were properly decoded and had been routed to selected lunar module equipment. The digital uplink commands addressed to the computer were parallel to those inputs available through the display and keyboard. The digital uplink assembly also provided a voice backup capability if the received S-band audio circuits in the premodulation processor had failed.

Other changes to the system included voice improvement changes in the signal processor assembly, a pressurized case for the S-band power amplifier, an "increased coverage" modification to the S-band steerable antenna, the ranging modification for the VHF transceiver, and the addition of the ranging tone transfer assembly. This latter assembly operated with VHF receiver B and transmitter A to provide a transponder function for command and service module/lunar module VHF ranging. It received VHF ranging tones from VHF receiver B and routed these signals, properly processed, to transmitter A. A block diagram is shown in figure A-1.

A.2.7 Radar

The three velocity beam channels and the altimeter beam channel of the landing radar were reconfigured as four separate channels for the four receiver planar arrays of the antenna. Any one of the four receiver arrays could detect lunar surface returns or spurious signals emanating from the lunar module body and could transmit range and velocity data for the individual beams via the guidance computer downlink.

A.2.8 Guidance and Control

The ascent engine arming assembly was modified to add the capability for switching from primary guidance to abort guidance. This additional function allowed an ascent propulsion system firing to be controlled by the abort guidance system with the vehicle unmanned.

The pulse ratio modulator circuit of the attitude and translation control assembly was modified to effectively increase the ratio of thruster on-time to off-time for a given input signal. This change was made to obtain more control authority over the desired operating range when the lunar module was under abort guidance control.

Primary guidance and navigation system changes included redesign of the alignment optical telescope to save weight, eliminating the gyro temperature circuit from the signal conditioner assembly, and adding a shield over the display and keyboard to prevent glass breakage.

The computer programs Luminary 69 in the primary guidance and Flight Program 5 in the abort guidance were changed to lunar programs.

A.2.9 Descent Propulsion System

For the descent propulsion system, the surge tanks associated with pressure transducers in the development flight instrumentation were deleted, and the helium explosive valve was modified to include an external braze where the inlet and lines were attached to the valve body.

A.2.10 Ascent Propulsion System

The configuration differences on the ascent propulsion system included modifying the relief valves to a gold-brazed unit with a notched poppet step, changing the propellant tank support cones to bolts rather than rivets, and deleting the rough combustion cutoff assembly. In addition, the solenoid latching valves were revised with an improved diode and changed to the gold-brazed configuration.

A.2.11 Environmental Control System

The major difference in the environmental control system was the deletion of the cold plates previously used for the development flight instrumentation and the lunar mission programmer.

The solenoid valve in the primary sublimator feedline was removed, since it was redundant and originally designed for an unmanned vehicle. This change also allowed the sublimator feedline to be routed external to the water module.

A fourth cold rail was added to the descent stage heat transport system. Two cold rails were in quad IV and two were added in quad I. This change required relocating the water/glycol lines.

The water/glycol pump package, cabin fan assembly, and suit circuit assembly had high-reliability components. For better operation of fan motors, the suit circuit assembly had an aluminum frame instead of a titanium frame.

A.2.12 Crew Provisions

The waste management assembly was modified by the addition of germicide to a lighter weight bag. Changes in stowage included moving the oxygen purge system from the aft wall of the vehicle to the left-hand console and moving two man-days supply of food from the right-hand side stowage compartment to the midsection. The netting arrangement was modified to permit access to condensate in the portable life support system. The internal filter was replaced with a diffuser lens and an external clip-on filter was added to the crew optical alignment sight.

A.3 LAUNCH VEHICLE

The basic description of the Saturn V launch vehicle is presented in reference 1. The Apollo 10 launch vehicle was configured nearly the same as the Apollo 9 vehicle, with only a few significant exceptions. The propellant utilization system in the second stage was used in the open-loop mode to improve reliability.

Cork insulation material was added to the outer surface of the instrument unit, and a sheet of vibration damping material was substituted for the steel channels used for damping of platform vibration. This change increased the instrument unit safety factor at S-IC inboard engine cutoff from 1.14 to 1.55.

A.4 MASS PROPERTIES

Spacecraft mass properties for the Apollo 10 mission are summarized in table A.4-I. These data represent the conditions as determined from postflight analyses of expendable loadings and usage during the flight. Variations in spacecraft mass properties are determined for each significant mission phase from lift-off through landing. Expendables usage is based on reported real-time and postflight data as presented in other sections of this report. The weights and centers of gravity of the individual command and service modules were measured prior to flight and the inertia values were calculated. All changes incorporated after the actual weighing were monitored, and the spacecraft mass properties were updated. Spacecraft mass properties at lift-off did not vary significantly from the preflight predicted values.

TABLE A.4-I.- MASS PROPERTIES

Event	Weight, lb	Center of gravity, in.			Moment of inertia, slug-ft ²			Product of inertia, slug-ft ²		
		X _A	Y _A	Z _A	I _{XX}	I _{YY}	I _{ZZ}	I _{XY}	I _{XZ}	I _{YZ}
Combined Spacecraft										
Lift-off	107 206	852.1	2.3	3.7	66 191	1 142 344	1 143 199	2901	9 243	3673
Earth orbit insertion	98 273	811.6	2.5	4.0	65 332	697 963	698 859	4994	11 710	3657
Command and service modules prior to transposition and docking	63 560	934.0	4.0	6.4	34 414	76 599	79 278	-1820	-143	3152
Docking	94 243	1033.6	2.5	4.4	55 093	516 215	520 276	-8384	-8 809	2688
After separation maneuver	94 063	1033.7	2.5	4.3	54 999	515 969	520 107	-8381	-8 792	2762
First midcourse correction - ignition	93 889	1033.9	2.6	4.3	54 846	515 509	519 672	-8423	-8 756	2804
- cutoff	93 414	1034.2	2.6	4.3	54 598	514 816	519 184	-8417	-8 709	2734
Lunar orbit insertion - ignition	93 318	1034.4	2.6	4.3	54 530	514 388	518 754	-8490	-8 626	2755
- cutoff	69 429	1074.9	1.5	2.9	42 152	402 902	411 181	-6350	-4 932	-146
Lunar orbit circularization - ignition	69 385	1075.0	1.5	2.9	42 115	402 768	411 068	-6365	-4 903	-134
- cutoff	68 455	1076.9	1.4	2.9	41 644	398 519	406 365	-6080	-4 943	-192
At separation	68 268	1078.1	1.6	2.9	42 795	398 877	406 785	-5773	-5 184	-231
Command and service modules, first lunar revolution	37 101	1043.4	2.9	5.5	20 802	57 096	63 528	-2029	790	280
Ascent stage manned	7 935	1177.4	3.3	-1.3	4 733	3 820	3 507	-190	57	247
Docking	44 930	984.8	3.0	4.3	25 494	138 079	144 140	-2105	-1 383	549
Transearth injection - ignition	37 254	943.8	2.9	5.3	20 771	56 820	63 283	-2105	705	312
- cutoff	26 172	964.2	-0.5	6.9	15 105	48 177	49 303	-646	67	-296
Command module/service module separation	25 905	964.8	-0.4	6.7	14 886	47 966	49 098	-720	134	-240
Command module after separation	12 138	1040.5	-0.3	5.9	6 208	5 328	4 821	19	-395	-53
Entry interface	12 137	1040.5	-0.3	5.9	6 208	5 328	4 821	19	-394	-53
Mach 10	11 966	1040.8	-0.3	5.8	6 092	5 208	4 716	19	-389	-52
Drogu deployment	11 639	1039.4	-0.3	5.9	6 016	4 973	4 496	20	-367	-53
Main parachute deployment	11 558	1039.1	-0.3	6.1	5 999	4 913	4 451	20	-341	-52
Landing	10 901	1037.4	-0.2	5.0	5 812	4 509	4 143	7	-312	-32
Lunar Module										
Lift-off	30 735	181.0	-0.2	-0.5	20 466	23 185	21 583	201	395	382
Separation	31 166	182.0	-0.2	0.2	21 846	24 321	22 551	208	689	391
Descent orbit insertion - ignition	31 137	182.0	-0.2	0.2	21 827	24 278	22 502	206	687	390
- cutoff	30 903	181.9	-0.2	0.2	21 680	24 218	22 476	206	688	390
Phasing - ignition	30 824	181.8	-0.1	0.3	21 626	24 124	22 372	201	683	371
- cutoff	30 283	181.7	-0.1	0.3	21 284	23 983	22 309	201	684	371
Ascent stage after staging	8 273	245.8	0.5	3.4	4 923	3 443	4 200	46	191	-18
Insertion	8 077	246.0	0.5	3.5	4 794	3 422	4 054	45	189	-16
Coelliptic sequence initiation	8 052	245.9	0.5	3.5	4 784	3 412	4 036	45	190	-16
Docking	7 935	245.4	0.5	3.5	4 733	3 371	3 955	45	193	-12
Unmanned	7 663	245.5	0.2	1.7	4 578	3 359	4 031	54	145	-31
Depleted	5 243	258.2	-0.3	2.5	2 930	2 779	1 814	69	110	-29

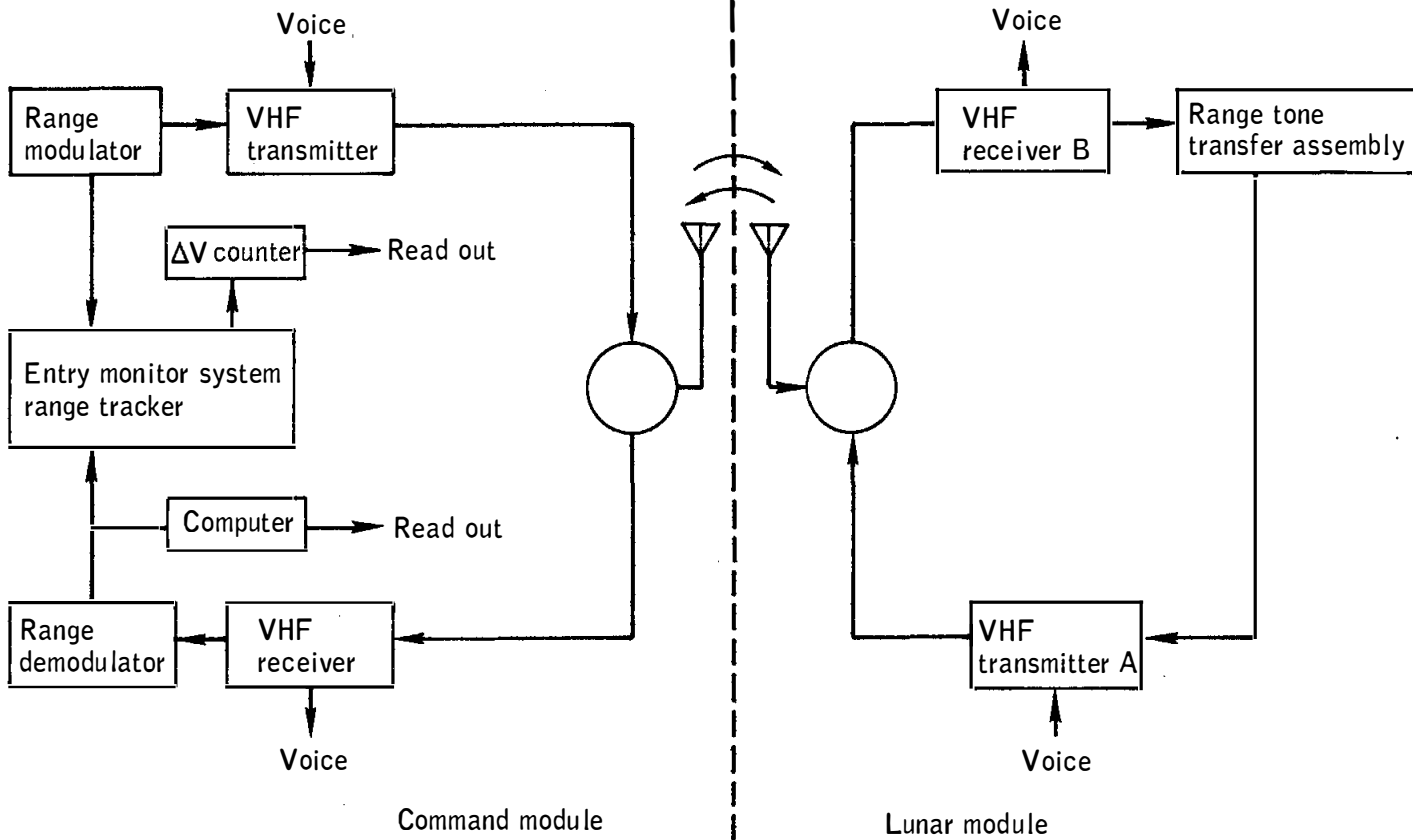

Figure A-1.- VHF ranging system.

APPENDIX B - SPACECRAFT HISTORIES

The history of command and service module (CSM 106) operations at the manufacturer's facility, Downey, California, is shown in figure B-1, and the operations at Kennedy Space Center, Florida, in figure B-2.

The history of the lunar module (LM-4) at the manufacturer's facility, Bethpage, New York, is shown in figure B-3, and LM-4 operations at Kennedy Space Center, Florida, in figure B-4.

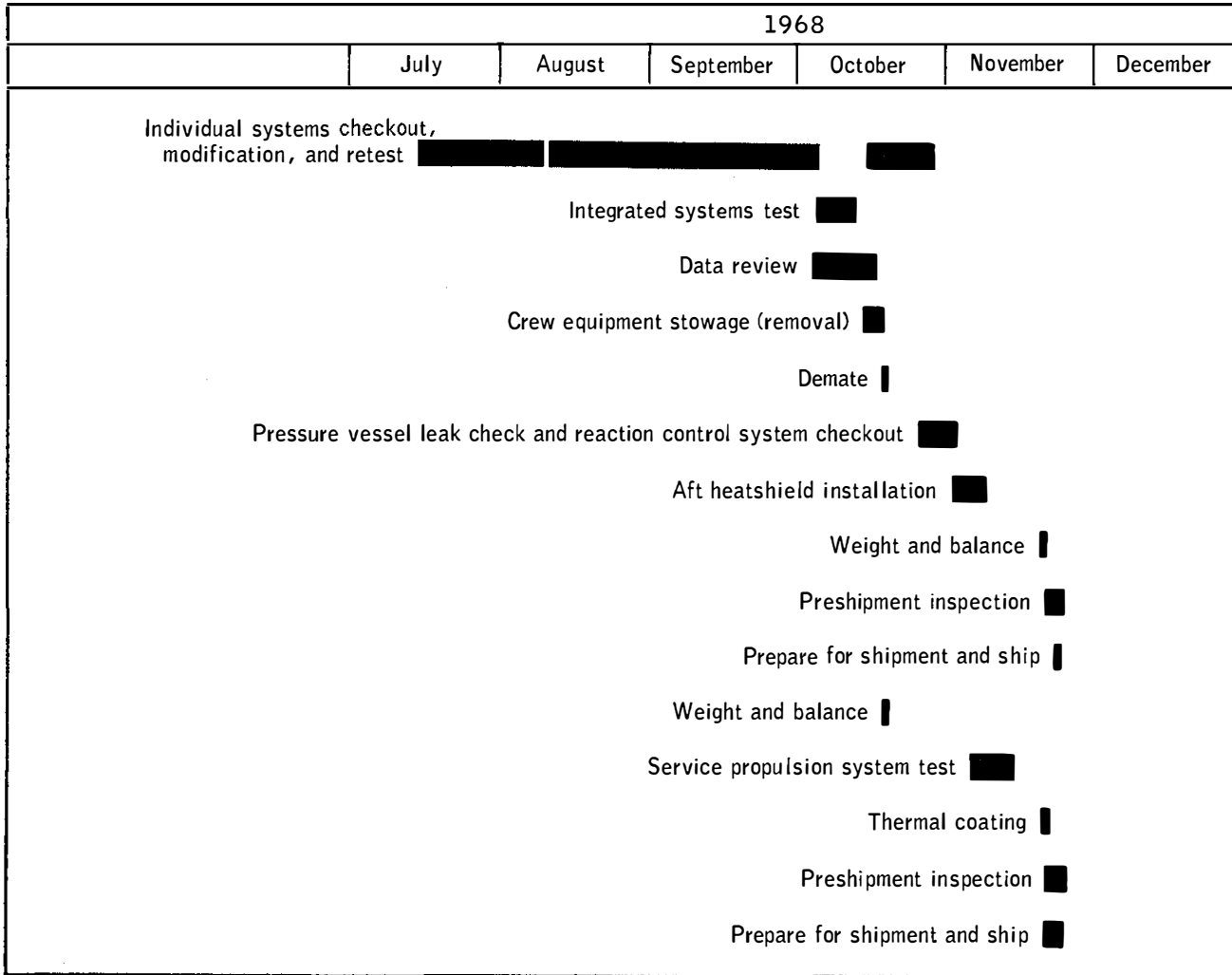

Figure B-1.- Factory checkout flow for command and service modules at contractor facility.

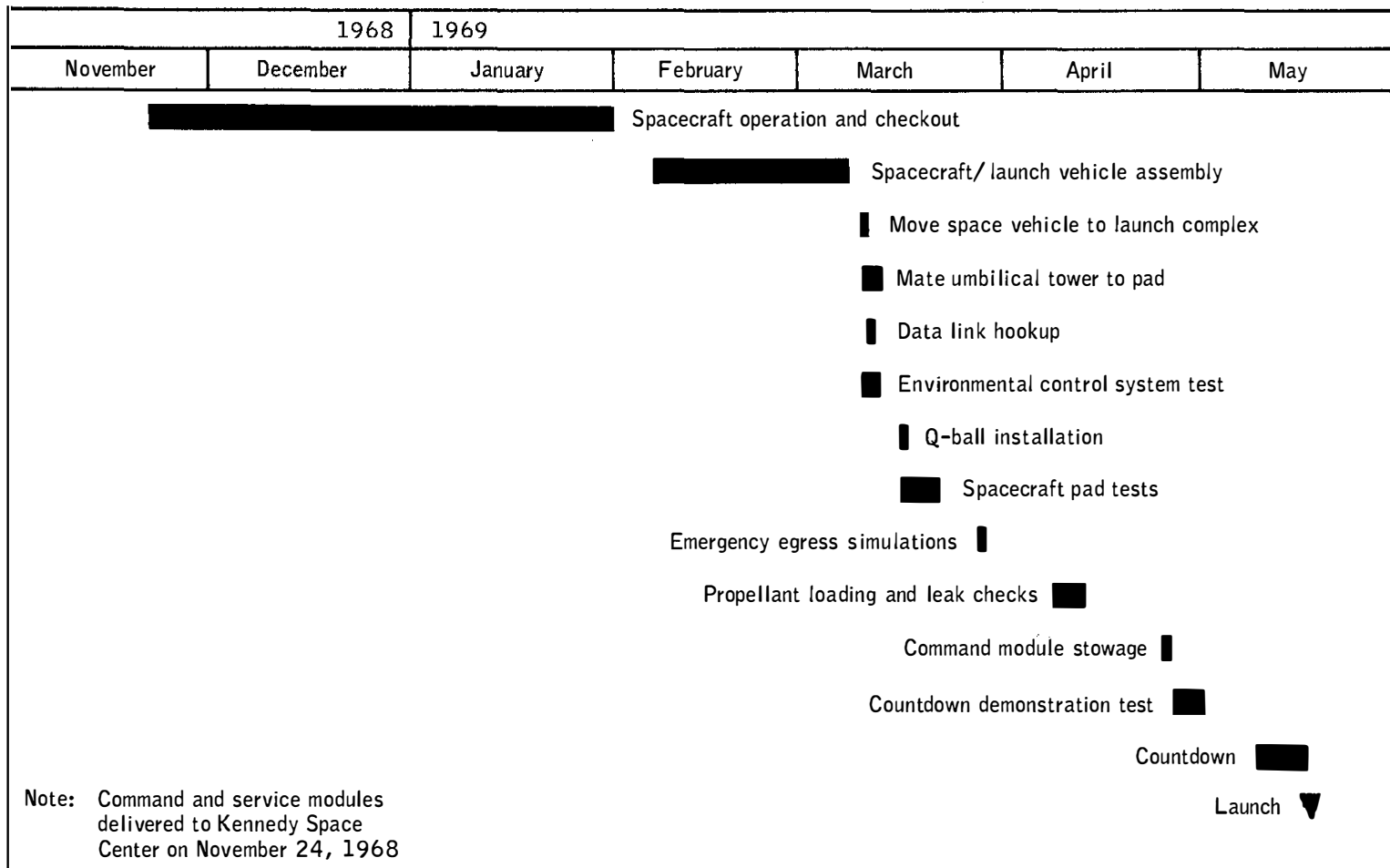

Figure B-2.- Spacecraft checkout history at Kennedy Space Center.

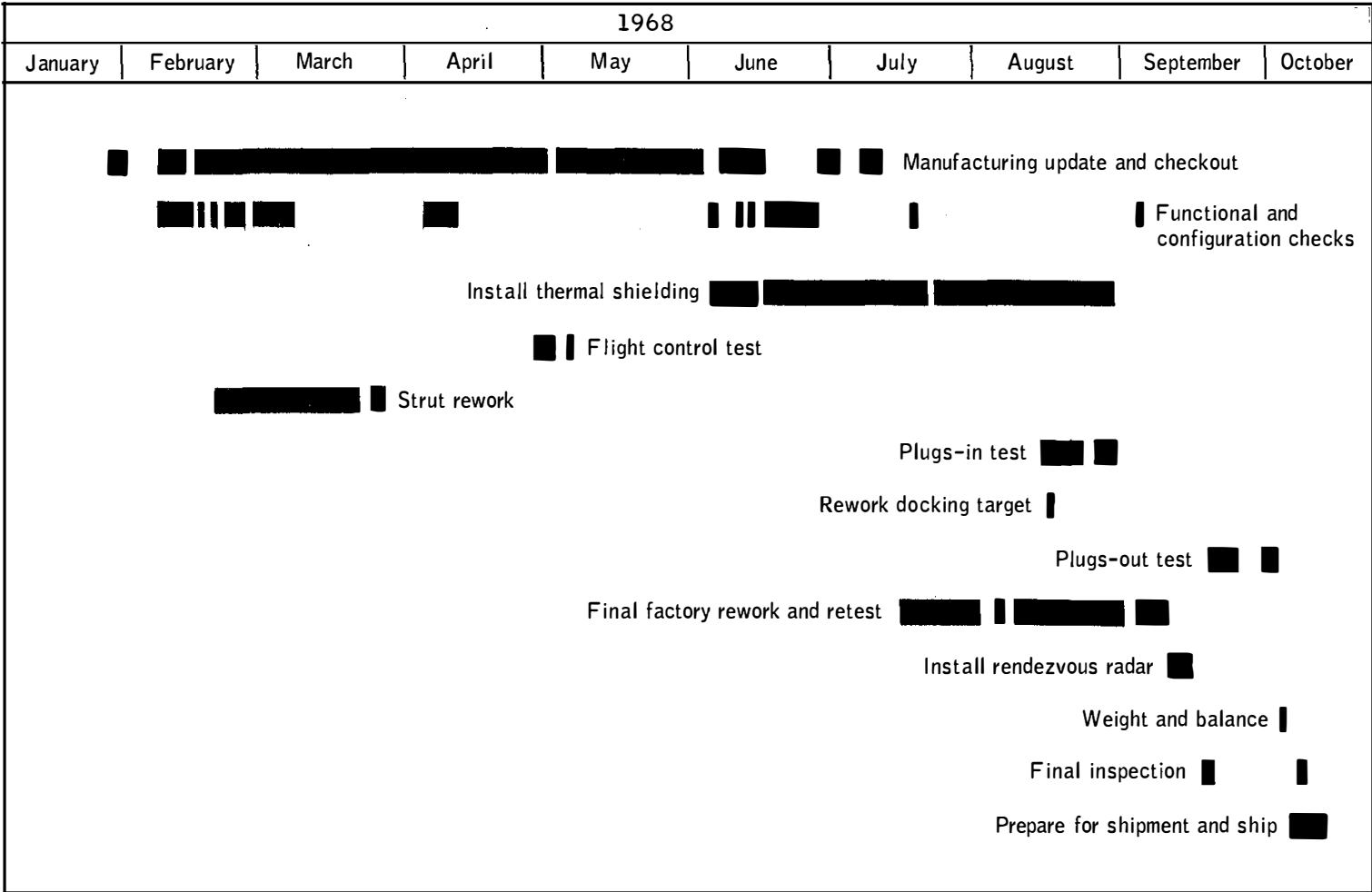

Figure B-3.- Factory checkout flow for lunar module at contractor facility.

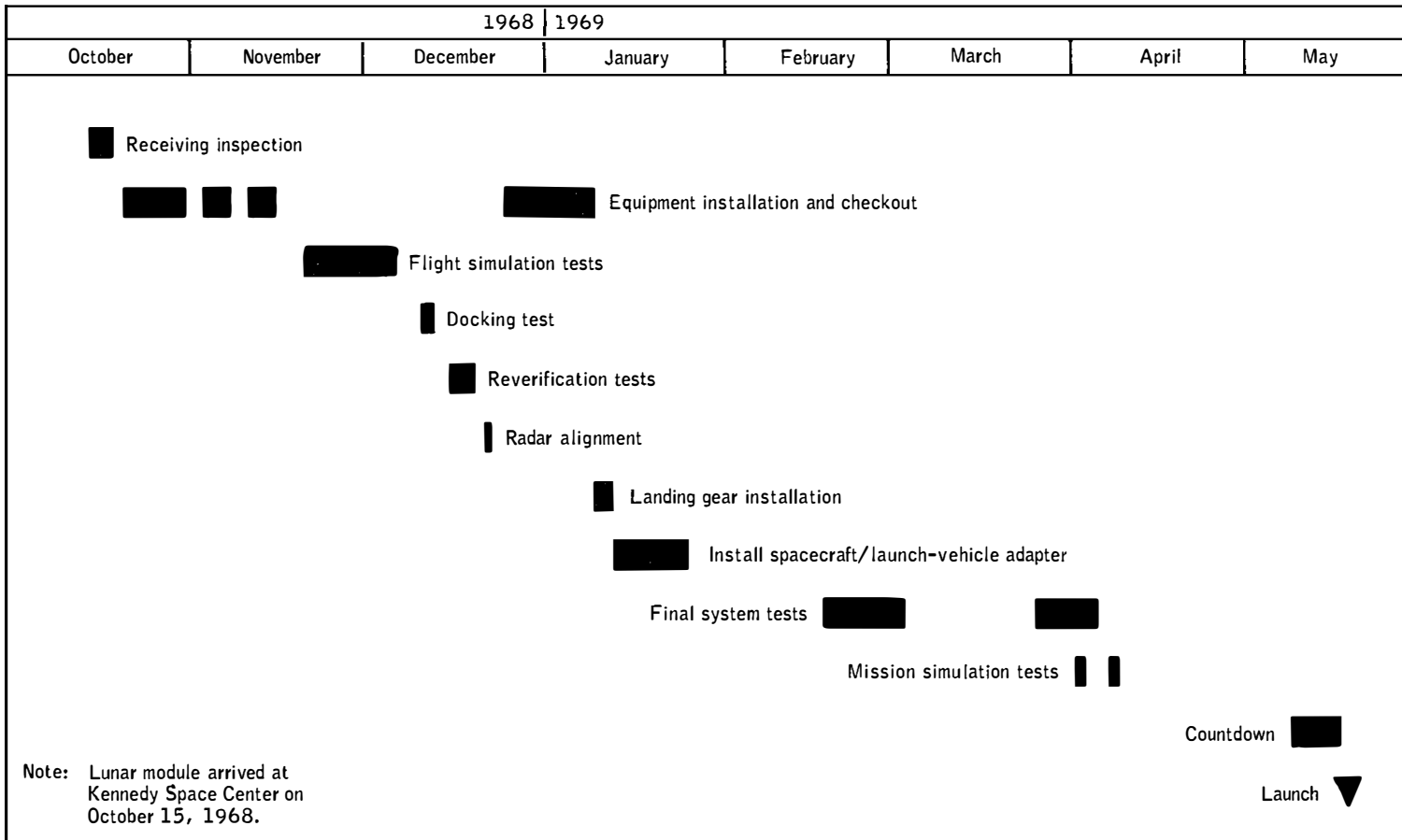

Figure B-4.- Lunar module checkout history at Kennedy Space Center.

APPENDIX C - POSTFLIGHT TESTING

The command module arrived at the contractor's facility in Downey, California, on June 4, 1969, after reaction control system deactivation and pyrotechnic safing in Hawaii. Postflight testing and inspection of the command module for evaluation of the inflight performance and investigation of the flight irregularities were conducted at the contractor's and vendor's facilities and at the MSC in accordance with approved Apollo Spacecraft Hardware Utilization Requests (ASHUR's). The tests performed as a result of inflight problems are described in table C-I and discussed in the appropriate systems performance sections of this report. Tests being conducted for other purposes in accordance with other ASHUR's and the basic contract are not included.

TABLE C-I.- POSTFLIGHT TESTING SUMMARY

ASHUR no.	Purpose	Tests performed	Results
Reaction Control			
106500	To determine the cause for command module system 2 helium manifold pressure drop when the propellant isolation valves were opened pre-launch	Inspect burst disc for corrosion pitting or other defects	Burst disc appeared to have operated normally. No evidence of corrosion was found.
106501	To determine cause for leakage of command module system 1 helium manifold pressure	Conduct external leakage check	No leak was detected
Guidance and Navigation			
106026	To investigate the entry monitor system scribing problems	Perform complete acceptance test	Emulsion on scroll was brittle because uric acid was added to plasticized formula
106044	To determine the cause of excessive drift in the stabilization and control system attitude reference	Perform complete acceptance test of gyro assemblies and gyro display coupler	System test complete without evidence of excessive drift. Special test simulating passive thermal control indicates no excessive drift
Structures and Thermal			
106005 106021 106022	To determine the source of fiberglass contamination in crew compartment	Take contamination samples in eight locations. Vacuum-clean accessible areas in crew compartment. Inspect suits and constant wear garments	Predominant material found was TG-15000 from tunnel hatch
106503	To investigate cause for retention springs not retaining charge holder	Measure the free play and spring rate of the springs	Charge holder retainer springs were in specification
Environmental Control			
106004	To investigate high and erratic carbon dioxide partial pressure observed in lunar module	Perform chemical analysis on lunar module primary lithium hydroxide cartridge	No evidence of cartridge malfunction
106010	To determine cause of difficulty with servicing the suit heat exchanger preflight	Perform breakthrough test and failure analysis	Breakthrough pressure was 2.6 psig, which is in specification
106011	To determine cause for the primary evaporator dryout during launch and lunar orbit		Command module wiring and control circuits were normal. A microswitch which senses the position of the backpressure valve and, if closed, inhibits the flow of water to the evaporator was intermittent
106012	To determine cause for the inability to vent the tunnel	Measure flow rate through tunnel vent valve	A "solid" type plug was found in the place of a "vent" type plug in the end of the vent line
106052	To investigate report of low water pressure from water gun	Check for contamination by back-flushing through water dispenser and hose	Silicon lubricant particles discovered when gun was back-flushed
106058	To investigate chlorine leakage and failure of buffer ampule to fill	Inspect and perform failure analysis of chlorine and buffer ampules	No discrepancies were found
106505A	To investigate carbon dioxide sensor failure to change reading	Perform calibration check and failure analysis	Sensor output is erratic regardless of input

TABLE C-I.- POSTFLIGHT TESTING SUMMARY - Continued

ASHUR no.	Purpose	Tests performed	Results
Communications and Instrumentation			
106025	To determine whether failure of fuel cell 1 oxygen flow rate measurement was caused by defective wiring	Check wiring continuity	Wiring was proper
106032	To determine cause for command module onboard recorder changing speed during entry	Perform failure analysis	At a differential pressure of 2.25 psi, the cover would deform to bind the reel hub
106033	To determine cause for failure of VHF recovery beacon antenna to deploy	Inspect and perform deployment test	During antenna deployment, an RF ground-plane radial, adjacent to gusset 4, hung on the out-board edge of the ramp
106040	To determine cause for VHF recovery antenna 2 whisker hangup	Inspect and perform deployment test	The whisker hung when tightly stowed in the retention slot
106045	To investigate loss of data during descent orbit insertion	Verify command module wiring	All applicable data paths were normal
106053	To determine whether intermittent nuclear particle detection system temperature measurement was caused by defective wiring	Check wiring continuity	Wiring was proper
106058	To investigate loss of uplink voice prelaunch	Perform time domain reflectometer test on coaxial uplink subcarrier cable	Test indicated coaxial cable was identical to cable used during mission
Electrical Power			
106008	To investigate short between command module circuit breaker 1 and fuel cell 1	Perform isolation, resistance, and insulation resistance checks on command module wiring	Wiring was proper and circuit breaker trip characteristics were normal
Displays and Controls			
106009	To investigate intermittent operation of launch vehicle annunciator lamps	Verify wiring to the annunciator. Perform failure analysis	System A lights 2 and 5 open and 3 and 4 intermittent
106013	To determine the cause for inverter 1 high temperature caution and warning being out of limits	Verify command module wiring and inspect connectors. Perform caution and warning system failure analysis	Wiring was proper
106014	To investigate the 2-minute jump of the digital event timer	Perform failure analysis	Tens of seconds failure duplicated in the normal countdown mode. Minutes jump could not be duplicated.
106043	To investigate abnormal operation of the rendezvous radar transponder switch	Verify command module wiring. Perform switch functional test and X-ray	Wiring was proper. Switch functioned properly and X-ray showed no problem. Switch is to be dissected

TABLE C-I.- POSTFLIGHT TESTING SUMMARY - Concluded

ASHUR no.	Purpose	Tests performed	Results
Crew Equipment			
106007	To investigate the marginal operation of the water/gas separator bag	Perform zero-g tests	Bag inspected and all measurements in tolerance. Comparison with other design indicates new bag will work better.
106015 106028	To investigate malfunction of the Hasselblad electric camera	Perform failure analysis	Damaged magazine caused binding of film, causing continuous overload on motor and subsequent failure
106016 106017	To investigate difficulty in applying the magazine to the 16-mm camera and failure of camera to operate	Check mechanical interface of camera and magazine. Perform electrical test and failure analysis	Magazine interlock microswitch was intermittent because of a faulty plunger and contamination. Interface fit relief on magazine on low side of tolerances

APPENDIX D - DATA AVAILABILITY

Tables D-I and D-II are a summary of the data made available for system performance analyses and anomaly investigations. Table D-I lists the data from the Command and Service Modules and Table D-II lists the data from the Lunar Module. Although the tables reflect only data processed from Network magnetic tapes, Network data tabulations and computer words were available during the mission with approximately a 4-hour delay. For additional information regarding data availability, the status listing of all mission data in the Central Metric Data File, building 12, MSC, should be consulted.

TABLE D-I.- COMMAND MODULE DATA AVAILABILITY

Time, hr:min		Range station	Bilevels	Standard bandpass	Special bandpass	Computer words	Special programs	O'graphs or brush recordings	Special plots or tabs
From	To								
-04:00	00:00	MSFN		X					
-00:01	+00:10	MIL	X	X		X			X
+00:01	00:23	MSFN		X	X	X			
00:02	00:14	BDA	X	X		X	X	X	
00:13	00:52	MSFN		X	X				X
00:52	00:59	CRO		X					
01:01	01:06	HSK		X					
01:33	01:44	GBM		X					
01:43	01:49	BAN		X					
01:50	01:56	CYI		X					
02:25	02:29	CRO		X					
02:28	02:36	MER		X					
02:32	02:40	GDS	X	X		X	X	X	X
02:45	02:50	HAW		X					
02:50	03:20	GDS	X	X	X	X	X	X	X
03:20	03:30	GDS		X					
03:30	04:41	GDS	X	X	X	X	X	X	X
03:37	07:11	MSFN		X	X	X			
03:50	03:54	GDS	X	X		X		X	
06:15	06:35	GDS	X						
07:21	11:10	MSFN		X	X	X		X	
08:40	09:10	GDS	X	X		X			
11:10	16:09	MSFN		X	X	X	X		
16:13	19:31	MSFN		X	X	X	X		
19:50	23:10	MSFN		X	X	X	X		
20:24	20:27	GDS					X		
23:19	24:13	MSFN		X	X	X	X		
24:15	27:19	MSFN		X	X	X	X		
26:30	26:40	MAD	X	X		X	X	X	
27:01	30:28	MSFN		X	X	X	X		
27:45	28:15	MAD		X		X		X	
30:29	33:40	MSFN		X	X	X	X		
30:32	30:50	GDS				X			
33:40	33:44	GDS		X		X	X		
33:43	34:17	MSFN		X	X	X	X		
33:44	34:15	GDS		X		X	X		
34:17	34:49	MSFN		X	X	X	X		
34:49	36:16	MSFN		X	X	X	X		
36:18	39:11	MSFN		X	X	X	X		
39:21	41:54	MSFN		X	X	X	X		
43:16	47:12	MSFN		X	X	X	X		
45:53	47:26	MSFN		X	X	X			
47:23	48:13	MSFN		X	X	X	X		
47:26	50:25	MSFN		X	X	X	X		
49:36	51:15	MSFN		X	X	X	X		
50:25	64:00	MSFN		X	X	X	X		
63:14	65:07	MSFN		X	X	X			
65:14	67:12	MSFN		X	X	X			
71:52	74:11	MSFN		X	X	X	X		
75:43	77:48	MSFN		X	X	X	X		
75:55	76:23	GDS	X	X	X	X	X	X	
77:48	78:36	GDS		X		X			
78:20	81:52	MSFN		X	X	X	X		
79:55	80:41	GDS		X		X			
80:24	80:27	GDS	X	X		X		X	
80:48	81:08	GDS				X			
81:53	82:40	GDS		X		X			

TABLE D-I.- COMMAND MODULE DATA AVAILABILITY - Continued

Time, hr:min		Range station	Bilevels	Standard bandpass	Special bandpass	Computer words	Special programs	O'graphs or brush recordings	Special plots or tabs
From	To								
82:46	87:47	MSFN		X	X	X	X		
83:50	84:38	HSK		X		X			
85:49	86:37	HSK		X		X		X	
87:47	88:35	HSK		X		X			
88:35	91:20	MSFN		X	X	X	X		
89:45	90:33	MAD		X		X			
91:41	95:40	MSFN		X	X	X	X		
91:42	92:32	MAD		X		X			
93:41	94:29	MAD		X		X			
94:56	95:43	MADX	X			X		X	
95:41	96:27	MAD		X		X			
96:27	96:48	MSFN		X	X	X	X		
96:42	96:55	MADX	X			X			
97:06	97:38	MADX	X			X			
97:06	99:37	MSFN		X	X	X	X		
97:39	98:27	GDS	X	X		X			
98:23	98:54	MADX	X		X	X	X	X	
99:35	100:25	GDS		X		X			
100:26	103:20	MSFN		X	X	X	X		
101:31	102:22	GDS		X		X			
104:23	107:30	MSFN		X	X	X	X		
105:32	106:20	GDS		X		X			
107:31	108:17	GDS		X		X			
108:15	108:57	HSK	X					X	
108:17	111:12	MSFN		X	X	X	X		
108:18	108:40	HSKX	X				X	X	
109:29	110:15	GDS		X		X			
111:22	115:02	MSFN		X	X	X	X		
111:27	112:14	HSKX		X		X			
113:26	114:12	HSKX		X		X			
115:24	116:11	MAD		X		X			
116:42	120:16	MSFN		X	X	X	X		
117:21	118:10	MAD		X		X			
119:20	120:17	MAD		X	X	X	X		
120:16	123:05	MSFN		X	X	X	X		
120:17	121:08	MAD	X	X	X	X	X		
121:04	122:37	GDS		X		X			
123:11	126:49	MSFN		X	X	X	X		
123:17	124:05	GDS		X		X			
125:16	126:06	GDS		X		X			
125:44	132:38	MSFN		X	X	X	X		
127:14	128:02	GDS		X		X			
129:13	130:00	GDS		X		X			
131:11	131:58	GDS		X		X			
132:38	136:39	MSFN		X	X	X	X		
133:10	133:57	HSK		X		X			
134:18	139:05	MSFN		X	X	X	X		
135:50	136:05	HSK	X	X		X			
137:07	137:35	HSK		X		X	X		
137:35	137:47	HSK	X	X		X	X	X	X
139:19	143:21	MSFN		X	X	X	X		
143:06	148:40	MSFN		X	X	X	X		
145:41	146:08	MAD				X			
148:40	151:03	MSFN		X	X	X	X		
150:07	150:15	GDS	X	X		X			
151:08	155:07	MSFN		X	X	X	X		
155:17	163:10	MSFN		X	X	X	X		

TABLE D-I.- COMMAND MODULE DATA AVAILABILITY - Concluded

Time, hr:min		Range station	Bilevels	Standard bandpass	Special bandpass	Computer words	Special programs	O'graphs or brush recordings	Special plots or tabs
From	To								
163:18	167:08	MSFN		X	X	X	X		
164:20	164:35	MAD	X						
167:12	177:32	MSFN		X	X	X	X		
177:22	177:32	GDS	X	X	X		X	X	
177:32	191:45	MSFN		X	X	X	X		
187:57	190:05	HSK	X	X		X	X	X	
190:05	190:26	CRO				X			
190:52	191:51	HSK	X	X		X	X	X	
191:30	192:04	DSE	X	X	X	X	X	X	

TABLE D-II.- LUNAR MODULE DATA AVAILABILITY

Time, hr:min		Rev.	Range station	Bandpass tabs or plots	Bilevels	Computer word tabs	Special programs	O'graphs or Brush recorder	Bit rate
From	To								
82:42	83:08	4	GDS	X	X			X	Low
83:17	83:23	4	GDS	X	X	X		X	High
83:25	83:30	4	GDS	X	X	X		X	High
83:31	83:35	4	GDS	X	X	X		X	High
83:35	83:40	4	GDS	X	X			X	Low
83:40	83:48	4	GDS	X	X	X		X	High
94:32	94:37	11	MAD	X	X			X	Low
94:44	94:55	11	MAD	X	X	X	X	X	High
94:56	95:40	11	MAD	X	X	X		X	High
96:29	96:41	12	MAD	X					Low
96:41	96:55	12	MAD	X	X	X		X	High
96:55	97:36	12	MAD	X	X	X	X	X	High
98:05	98:26	13	MAD	X	X			X	Low
98:27	98:55	13	MAD	X	X	X	X	X	High
98:55	99:03	13	MAD	X	X	X	X	X	High
99:03	99:34	13	MAD	X	X	X	X	X	High
99:35	99:38	13	MAD	X	X			X	Low
100:26	100:41	14	MAD	X	X	X	X	X	High
100:41	100:50	14	MAD	X					Low
100:50	101:15	14	GDS	X	X	X	X	X	High
101:16	101:36	14	GDS	X					Low
102:27	103:32	15	GDS	X	X	X	X	X	High
104:23	105:17	16	GDS	X	X	X	X	X	High
106:19	106:47	17	GDS	X	X	X		X	High
106:47	107:02	17	GDS	X	X				Low
107:02	107:29	17	GDS	X	X	X		X	High
108:17	108:57	18	GDS	X	X	X	X	X	High
109:02	110:00	-	GDS		X	X	X	X	High
110:00	116:10	-	HSK		X	X	X	X	High
116:10	120:00	-	MAD		X	X	X	X	High

REFERENCES

1. Marshall Space Flight Center, Huntsville, Alabama: Saturn V Launch Vehicle Flight Evaluation Report AS 504 Apollo 9 Mission. MPR-SAT-FE-69-4, May 4, 1969.
2. Office of Manned Space Flight, National Aeronautics and Space Administration, Washington, D.C.: Apollo Flight Mission Assignments. M-D-MA-500-11. April 1969.
3. _____: Mission Requirements, F-type Mission. SPD 9-R-037, May 7, 1969.

APOLLO SPACECRAFT FLIGHT HISTORY

(Continued from inside front cover)

<u>Mission</u>	<u>Spacecraft</u>	<u>Description</u>	<u>Launch date</u>	<u>Launch site</u>
Apollo 4	SC-017 LTA-10R	Supercircular entry at lunar return velocity	Nov. 9, 1967	Kennedy Space Center, Fla.
Apollo 5	IM-1	First lunar module flight	Jan. 22, 1968	Cape Kennedy, Fla.
Apollo 6	SC-020 LTA-2R	Verification of closed-loop emergency detection system	April 4, 1968	Kennedy Space Center, Fla.
Apollo 7	CSM 101	First manned flight; earth-orbital	Oct. 11, 1968	Cape Kennedy, Fla.
Apollo 8	CSM 103	First manned lunar orbital flight; first manned Saturn V launch	Dec. 21, 1968	Kennedy Space Center, Fla.
Apollo 9	CSM 104 LM-3	First manned lunar module flight; earth orbit rendezvous; EVA	Mar. 3, 1969	Kennedy Space Center, Fla.
Apollo 10	CSM 106 LM-4	First lunar orbit rendezvous; low pass over lunar surface	May 18, 1969	Kennedy Space Center, Fla.