



# LIST OF EFFECTIVE PAGES

INSERT LATEST CHANGED PAGES. DESTROY SUPERSEDED PAGES.

NOTE: The portion of the text affected by the changes is indicated by a vertical line in the outer margins of the page

TOTAL NUMBER OF PAGES IN THIS PUBLICATION IS 957 CONSISTING OF THE FOLLOWING:

Page No.	Issue	Page No.	Issue
Title . . . . .	26 September 1971	4.8-1 thru 4.8-6A . . . . .	26 September 1971
A thru B . . . . .	26 September 1971	4.8-6B Blank . . . . .	26 September 1971
C Blank . . . . .	26 September 1971	4.8-7 thru 4.8-12A . . . . .	26 September 1971
i thru vii . . . . .	26 September 1971	4.8-12B Blank . . . . .	26 September 1971
viii Blank . . . . .	26 September 1971	4.8-13 thru 4.8-18A . . . . .	26 September 1971
ix thru xviii . . . . .	26 September 1971	4.8-18B Blank . . . . .	26 September 1971
xix thru xxxiii . . . . .	26 September 1971	4.8-19 thru 4.8-22C . . . . .	26 September 1971
xxxiv Blank . . . . .	26 September 1971	4.8-22D Blank . . . . .	26 September 1971
4.0-1 . . . . .	26 September 1971	4.8-23 thru 4.8-26A . . . . .	26 September 1971
4.0-2 Blank . . . . .	26 September 1971	4.8-26B Blank . . . . .	26 September 1971
4.1-1 thru 4.1-11 . . . . .	26 September 1971	4.8-27 thru 4.8-28 . . . . .	26 September 1971
4.1-12 Blank . . . . .	26 September 1971	4.9-1 thru 4.9-6A . . . . .	26 September 1971
4.2-1 thru 4.2-12A . . . . .	26 September 1971	4.9-6B Blank . . . . .	26 September 1971
4.2-12B Blank . . . . .	26 September 1971	4.9-7 thru 4.9-10A . . . . .	26 September 1971
4.2-13 thru 4.2-28A . . . . .	26 September 1971	4.9-10B Blank . . . . .	26 September 1971
4.2-28B Blank . . . . .	26 September 1971	4.9-11 thru 4.9-12D . . . . .	26 September 1971
4.2-29 thru 4.2-61 . . . . .	26 September 1971	4.9-13 thru 4.9-14A . . . . .	26 September 1971
4.2-62 Blank . . . . .	26 September 1971	4.9-14B Blank . . . . .	26 September 1971
4.3-1 thru 4.3-28 . . . . .	26 September 1971	4.9-15 thru 4.9-16D . . . . .	26 September 1971
4.4-1 thru 4.4-4A . . . . .	26 September 1971	4.9-17 thru 4.9-22B . . . . .	26 September 1971
4.4-4B Blank . . . . .	26 September 1971	4.9-23 thru 4.9-28B . . . . .	26 September 1971
4.4-5 thru 4.4-46A . . . . .	26 September 1971	4.9-29 thru 4.9-30 . . . . .	26 September 1971
4.4-46B Blank . . . . .	26 September 1971	4.10-1 thru 4.10-12A . . . . .	26 September 1971
4.4-47 thru 4.4-62B . . . . .	26 September 1971	4.10-12B Blank . . . . .	26 September 1971
4.4-63 thru 4.4-67 . . . . .	26 September 1971	4.10-13 thru 4.10-18A . . . . .	26 September 1971
4.4-68 Blank . . . . .	26 September 1971	4.10-18B Blank . . . . .	26 September 1971
4.5-1 thru 4.5-2A . . . . .	26 September 1971	4.10-19 thru 4.10-44A . . . . .	26 September 1971
4.5-2B Blank . . . . .	26 September 1971	4.10-44B Blank . . . . .	26 September 1971
4.5-3 thru 4.5-4A . . . . .	26 September 1971	4.10-45 thru 4.10-54B . . . . .	26 September 1971
4.5-4B Blank . . . . .	26 September 1971	4.10-55 thru 4.10-66A . . . . .	26 September 1971
4.5-5 thru 4.5-40 . . . . .	26 September 1971	4.10-66B Blank . . . . .	26 September 1971
4.6-1 thru 4.6-8A . . . . .	26 September 1971	4.10-67 thru 4.10-118A . . . . .	26 September 1971
4.6-8B Blank . . . . .	26 September 1971	4.10-118B Blank . . . . .	26 September 1971
4.6-9 thru 4.6-14A . . . . .	26 September 1971	4.10-119 thru 4.10-127 . . . . .	26 September 1971
4.6-14B Blank . . . . .	26 September 1971	4.10-128 Blank . . . . .	26 September 1971
4.6-15 thru 4.6-28A . . . . .	26 September 1971	4.11-1 thru 4.11-11 . . . . .	26 September 1971
4.6-28B Blank . . . . .	26 September 1971	4.11-12 Blank . . . . .	26 September 1971
4.6-29 thru 4.6-42A . . . . .	26 September 1971	4.12-1 thru 4.12-2A . . . . .	26 September 1971
4.6-42B Blank . . . . .	26 September 1971	4.12-2B Blank . . . . .	26 September 1971
4.6-43 thru 4.6-46A . . . . .	26 September 1971	4.12-3 thru 4.12-23 . . . . .	26 September 1971
4.6-46B Blank . . . . .	26 September 1971	4.12-24 Blank . . . . .	26 September 1971
4.6-47 thru 4.6-64A . . . . .	26 September 1971	4.13-1 thru 4.13-16A . . . . .	26 September 1971
4.6-64B Blank . . . . .	26 September 1971	4.13-16B Blank . . . . .	26 September 1971
4.6-65 thru 4.6-66A . . . . .	26 September 1971	4.13-17 thru 4.13-46A . . . . .	26 September 1971
4.6-66B Blank . . . . .	26 September 1971	4.13-46B Blank . . . . .	26 September 1971
4.6-67 thru 4.6-83 . . . . .	26 September 1971	4.13-47 thru 4.13-49 . . . . .	26 September 1971
4.6-84 Blank . . . . .	26 September 1971	4.13-50 Blank . . . . .	26 September 1971
4.7-1 thru 4.7-34B . . . . .	26 September 1971	4.13-51 . . . . .	26 September 1971
4.7-35 thru 4.7-44A . . . . .	26 September 1971	4.13-52 Blank . . . . .	26 September 1971
4.7-44B Blank . . . . .	26 September 1971	4.14-1 thru 4.14-14 . . . . .	26 September 1971
4.7-45 thru 4.7-48 . . . . .	26 September 1971		

NASA

INSERT LATEST CHANGED PAGES. DESTROY SUPERSEDED PAGES.

# LIST OF EFFECTIVE PAGES

NOTE: The portion of the text affected by the changes is indicated by a vertical line in the outer margins of the page.

Page No.	Issue	Page No.	Issue
4.15-1 thru 4.15-26A . . .	26 September 1971	5.3-10B Blank . . . . .	26 September 1971
4.15-26B Blank . . . . .	26 September 1971	5.3-11 thru 5.3-16 . . . . .	26 September 1971
4.15-27 thru 4.15-43 . . . . .	26 September 1971	5.4-1 thru 5.4-14A . . . . .	26 September 1971
4.15-44 Blank . . . . .	26 September 1971	5.4-14B Blank . . . . .	26 September 1971
5.0-1 . . . . .	26 September 1971	5.4-15 thru 5.4-24C . . . . .	26 September 1971
5.0-2 Blank . . . . .	26 September 1971	5.4-24D Blank . . . . .	26 September 1971
5.1-1 . . . . .	26 September 1971	5.4-25 thru 5.4-38 . . . . .	26 September 1971
5.1-2 Blank . . . . .	26 September 1971	D-1 thru D-19 . . . . .	26 September 1971
5.2-1 thru 5.2-29 . . . . .	26 September 1971	D-20 Blank . . . . .	26 September 1971
5.2-30 Blank . . . . .	26 September 1971	E-1 . . . . .	26 September 1971
5.2-31 thru 5.2-50A . . . . .	26 September 1971	E-2 Blank . . . . .	26 September 1971
5.2-50B Blank . . . . .	26 September 1971	E-3 . . . . .	26 September 1971
5.2-51 thru 5.2-54A . . . . .	26 September 1971	E-4 Blank . . . . .	26 September 1971
5.2-54B Blank . . . . .	26 September 1971	E-5 . . . . .	26 September 1971
5.2-55 thru 5.2-63 . . . . .	26 September 1971	E-6 Blank . . . . .	26 September 1971
5.2-64 Blank . . . . .	26 September 1971	F-1 thru F-16 . . . . .	26 September 1971
5.3-1 thru 5.3-10A . . . . .	26 September 1971		

NASA



**LMA790-3-LM**  
**APOLLO OPERATIONS HANDBOOK**

**INTRODUCTION**

**PURPOSE**

The Apollo Operations Handbook (AOH) is the primary means of documenting LM descriptions and procedures. The AOH is published in two separately bound volumes. This information is useful in support of program management, engineering, test, flight simulation, and real-time flight support efforts.

**DESCRIPTION**

Volume I describes the LM subsystems and equipment.

Volume II contains crew operational procedures: normal, backup, abort, malfunction, and emergency. These procedures define the sequence of actions necessary for safe and efficient subsystem operation. The procedures are verified during vehicle and component testing and simulations.

Normal procedures are used when all subsystems are operating properly. Backup procedures are used to accomplish the objectives of the normal procedures, when equipment failure or other anomaly prevents use of the normal procedures. Abort procedures cover crew activity for abort modes. Malfunction procedures provide symptoms, diagnoses, and corrective actions for subsystem malfunctions. Emergency procedures deal with situations that require immediate action to avoid or alleviate a hazardous condition.

Changes to volume II will be submitted through MSC CG2. GAC changes will show justification and authorization, and will be submitted to LM Crew Systems for approval.

**RESPONSIBLE CONTRACTOR ORGANIZATION**

At GAC, the single point of contact for the procedures in volume II of the AOH is the Head, LM Crew Systems Group, Systems Engineering Section, LM Project, Grumman Aerospace Corporation, Bethpage, N.Y. 11714. The LM Crew Systems Group is the central coordination and control agency in providing LM subsystems procedures for use by NASA in training flight crewmen and mission support personnel. The LM Crew Systems Group ensures that all data are current and technically correct.

**LMA790-3-LM**  
**APOLLO OPERATIONS HANDBOOK**

FORMAT

**NORMAL/BACKUP PROCEDURES**

Normal/backup procedures are presented in the following sequence: basic modular operational blocks, subgroups of functional tasks or subsystems, and numerical sequence within subgroups. The following paragraphs explain the tabular format.

The "CREWMAN" column indicates which crewmember is assigned to perform the specific procedure. The following abbreviations are used in this column.

CDR . . . . Commander  
CMP . . . . Command Module Pilot  
LMP . . . . Lunar Module Pilot

The "PNL" column indicates the location of a particular control or display, by panel number or equipment designation. (See figure E-1 and E-2.) In addition to the panel numbers, the following equipment designations are used in this column.

ACA . . . . attitude controller assembly  
ALSEP . . . . Apollo lunar surface experiment package  
AOT . . . . alignment optical telescope  
ECS . . . . ECS module  
MESA . . . . modularized equipment stowage assembly  
PGA . . . . pressure garment assembly  
PLSS . . . . portable life support system  
RCU . . . . remote control unit  
TTCA . . . . thrust/translation controller assembly  
UTL . . . . utility light panel  
+Z27 . . . . +Z27 bulkhead

The "PROCEDURES" column contains groups of steps, or overall tasks, involved in performing a complete operation.

The "REMARKS" column provides the constraints and rationale that support the operational procedure. The scope of this information will increase as the procedures are refined through continued application by GAC and NASA during mission simulations and real-time mission operations.

Controls and displays are identified by their respective placards. Lengthy placards have been shortened herein. The following abbreviations are used for controls and displays.

caut lt . . . . . caution annunciator  
CB . . . . . d-c circuit breaker  
CB/AC . . . . . a-c circuit breaker  
comp caut lt . . . . component caution light  
cont . . . . . continuous rotary control  
ind . . . . . meter, gage, or digital display  
ind pwr fail lt . . . . indicator power failure light  
lt . . . . . light  
pb . . . . . pushbutton switch (except pushbutton/light)  
pb/lt . . . . . pushbutton/light  
sel . . . . . detent rotary switch  
sw . . . . . toggle switch  
tb . . . . . talkback  
tw . . . . . thumbwheel control  
vlv . . . . . manually operated valve  
warn lt . . . . . warning annunciator

NOTE

MASTER ALARM - on (or off) indicates that both MASTER ALARM pb/lts and the audible tone are on (or off).

**LMA790-3-LM**  
**APOLLO OPERATIONS HANDBOOK**

**CONTINGENCY PROCEDURES**

Contingency procedures comprise abort, malfunction, and emergency procedures.

Abort Procedures

Abort procedures are not included at this time. They may be supplied by NASA at a later date.

Malfunction Procedures

Malfunction procedures enable recognition of subsystem malfunctions, determination of their cause, isolation and/or correction of the failure, and determination of the effect on the subsystem and the mission. The procedures cover all significant single failures. To prevent the procedures from becoming complex and unmanageable, double unrelated failures are not covered. The malfunction procedures are arranged by subsystem, or subsystem section (PGNS, AGS, CES, DPS, APS, etc), in a three-column format explained in the following paragraphs.

The "SYMPTOM" column contains logic blocks that allow entry into the malfunction procedure. When applicable, data under these blocks explain and qualify the symptom or condition. The symptoms are arranged numerically within each subsystem or subsystem section.

The "PROCEDURE" column contains a step-by-step logic flow diagram, consisting primarily of action blocks, decision blocks, and failure blocks that enable failure correction and isolation. Caution and warning blocks are included for conditions, which, if not corrected, may degrade the operational integrity of a subsystem or may adversely affect crew safety. Remote event symbols refer to related remarks, to another step of the procedure, or to a step in another malfunction procedure.

The "REMARKS" column contains supplemental data related to, and referenced from, the logic blocks in the "SYMPTOM" and "PROCEDURE" columns.

Emergency Procedures

Emergency procedures follow the same format as normal/backup procedures.

**LMA790-3-LM**  
**APOLLO OPERATIONS HANDBOOK**

**CHANGE REQUEST SUBMISSION GUIDELINES**

1. Be specific in your recommendations or comments; for example:
  - When recommending changes in text, provide new text to replace the old.
  - When pointing out technical errors, provide new technical data.
  - When suggesting deletions, specify exactly what should be deleted.
2. Consider the following when preparing recommendations:
  - Are data in usable engineering units?
  - Does arrangement of data facilitate use? If not, suggest appropriate changes.
  - What areas need revision? Be specific.
3. If you have knowledge or sources that could be used to update any part of the handbook, provide this information and cite references.
4. Indicate specific technical or administrative problems that may be created by the handbook contents or format. Suggest specific changes to eliminate these problems.
5. Note the impact on, and relationship with, specifications criteria, constraints, etc. that this handbook should or should not have.
6. GAC personnel use GAC form No. 3163 (7-70). The following information is keyed to, and explains how to fill in, the GAC change request form:
  - ① This space is left blank by the originator. GAC change numbers are assigned by LM Publications.
  - ② The originator shall indicate which vehicles are affected by the change request.
  - ③ Enter the date that the change request is initiated.
  - ④ The originator shall enter his name, department, and telephone extension.
  - ⑤ Enter the vehicle number that appears on the title page of the AOH, Vol II, to which the change request is written.
  - ⑥ Enter the basic or change date that appears on the title page of the AOH, Vol II, to which the change request is written.
  - ⑦ Enter the number of the page affected by the change request.
  - ⑧ Enter the number of the paragraph affected by the change request.
  - ⑨ Enter the number of the step and, if necessary, the number of the line affected by the change request.
  - ⑩ Explain, in detail, the change being requested.
  - ⑪ Explain, in detail, the reason for the change.
  - ⑫ The cognizant GAC subsystem engineer shall initial and date all change requests.
  - ⑬ ⑭ ⑮ GAC disposition shall be made by the head of LM Crew Systems. He shall indicate whether the change request is approved or disapproved, sign his full name, and fill in the date of disposition.
  - ⑯ ⑰ ⑱ NASA disposition shall be made by the MSC Change Control Board. A representative of the board shall indicate whether the change request is approved or disapproved, sign his full name, and fill in the date of disposition.
  - ⑲ The MSC Change Control Board shall assign all suspense dates.



**LMA790-3-LM**  
**APOLLO OPERATIONS HANDBOOK**

7. NASA personnel use MSC form No. 482 (Rev Jun 68). The following information is keyed to, and explains how to fill in, the MSC change request form:
- ① ② ③ The originator shall enter his name, organization, and the date that the change request is initiated.
  - ④ This space is left blank by the originator. MSC change numbers are assigned by the MSC Change Control Board.
  - ⑤ The originator shall indicate which vehicles are affected by the change request.
  - ⑥ Enter the title of the manual, including the vehicle number that appears on the title page, to which the change request is written.
  - ⑦ Enter the document number to which the change request is written.
  - ⑧ Enter the number of the page affected by the change request.
  - ⑨ Enter the basic or change date that appears on the title page of the AOH, Vol II, to which the change request is written.
  - ⑩ Enter the number of the step and, if necessary, the number of the line affected by the change request.
  - ⑪ Explain, in detail, the change being requested.
  - ⑫ Explain, in detail, the reason for the change.
  - ⑬ If applicable, enter pertinent remarks.
  - ⑭ ⑮ ⑯ GAC disposition shall be made by the head of LM Crew Systems. He shall indicate whether the change request is approved or disapproved, sign his full name, and fill in the date of disposition.
  - ⑰ ⑱ Final disposition shall be made by the NASA MSC Change Control Board. A representative of the board shall indicate whether the change request is approved or disapproved, sign his full name, and fill in the date of disposition.
  - ⑳ The MSC Change Control Board shall assign all suspense dates.

**LMA790-3-LM  
APOLLO OPERATIONS HANDBOOK**

**APOLLO OPERATIONS HANDBOOK, VOLUME II CHANGE REQUEST**

CHANGE NO. (1)	S/C EFFECTIVITY (2)	DATE (3)
INITIATED BY (4)	DEPT.	TELEPHONE EXT.
DOCUMENT AFFECTED		
VEHICLE (5)	BASIC/CHANGE DATE (6)	PAGE NO. (7)
	PARA. NO. (8)	STEP/LINE NO. (9)
DETAIL CHANGE IN EXACT WORDING		
(10)		
REASON		
(11)		
		SUBSYSTEM REVIEW DATE (12)
GAC DISPOSITION		
<input type="checkbox"/> APPROVED (13) <input type="checkbox"/> DISAPPROVED	HEAD. CREW SYSTEMS SIGNATURE (14)	DATE SIGNED (15)
NASA DISPOSITION		
<input type="checkbox"/> APPROVED (16) <input type="checkbox"/> DISAPPROVED	FCOD SIGNATURE (17)	DATE SIGNED (18)
		SUSPENSE DATE (19)

\*GAC 3163  
7-70

GAC Change Request Form

Basic Date 26 September 1971

Change Date \_\_\_\_\_

Page vi

**LMA790-3-LM  
APOLLO OPERATIONS HANDBOOK**

CREW PROCEDURES CHANGE REQUEST			
INITIATED BY (1)	ORGANIZATION (2)	DATE (3)	
CHANGE NUMBER (4)	S/C EFFECTIVITY (5)		
DOCUMENT AFFECTED			
TITLE (6)	DOCUMENT NO. (7)	PAGE NO. (8)	BASIC OR CHANGE DATE TIME OR STEP NO. (9) (10)
DETAIL CHANGE IN EXACT WORDING			
(11)			
REASON:			
(12)			
REMARKS:			
(13)			
<input type="checkbox"/> APPROVED (14) <input type="checkbox"/> DISAPPROVED	COORDINATOR'S SIGNATURE (15)		DATE (16)
FINAL DISPOSITION			
<input type="checkbox"/> APPROVED (17) <input type="checkbox"/> DISAPPROVED	COORD SIGNATURE (18)	DATE SIGNED (19)	SUSPENSE DATE (20)

MSC Form 482 (Rev Jun 68) (Previous editions are obsolete)

MSC Change Request Form

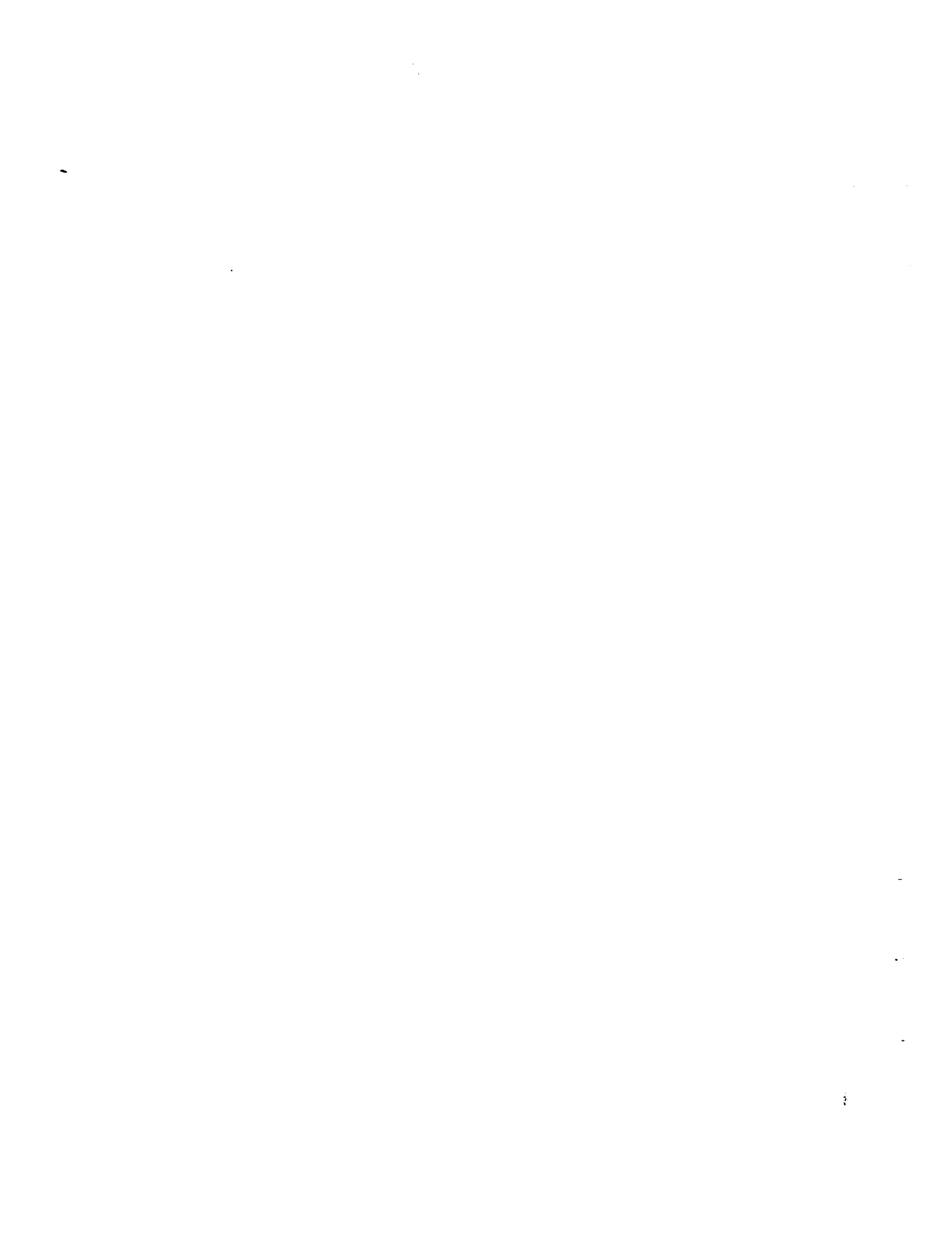

**LMA790-3-LM**  
**APOLLO OPERATIONS HANDBOOK**  
 TABLE OF CONTENTS

SECTION	TITLE	PAGE
	INTRODUCTION . . . . .	i
	FORMAT . . . . .	11
	CHANGE REQUEST SUBMISSION GUIDELINES . . . . .	iv
*1.0	SPACECRAFT . . . . .	1-1
*2.0	SUBSYSTEMS DATA . . . . .	2-1
*3.0	CONTROLS AND DISPLAYS . . . . .	3-1
4.0	NORMAL/BACKUP PROCEDURES . . . . .	4.0-1
4.1	Prelaunch Closeout Check . . . . .	4.1-2
4.2	Subsystem Activation . . . . .	4.2-2
4.2.1	Initial Entry Status Check . . . . .	4.2-2
4.2.2	EPS Activation & Checkout . . . . .	4.2-5
4.2.3	Primary Glycol Loop Activation . . . . .	4.2-9
4.2.4	Circuit Breaker Activation . . . . .	4.2-10
4.2.5	Primary Sublimator Activation . . . . .	4.2-16
4.2.6	Lighting Activation & Checkout . . . . .	4.2-16
4.2.7	Utility Lights Activation & Checkout . . . . .	4.2-17
4.2.8	AOT Lighting Check . . . . .	4.2-17
4.2.8	COAS Lighting Check . . . . .	4.2-18
4.2.9	COAS Lighting Check . . . . .	4.2-19
4.2.10	Caution & Warning Array Checkout . . . . .	4.2-20
4.2.11	Timer Electroluminescent (EL) Numeric Check . . . . .	4.2-20
4.2.12	Set Mission Timer . . . . .	4.2-20
4.2.13	ECS Activation & Checkout . . . . .	4.2-21
4.2.13.1	Consumables Check . . . . .	4.2-21
4.2.13.2	Glycol Pump Check . . . . .	4.2-21
4.2.13.3	SUIT ISOL Valve Check . . . . .	4.2-22
4.2.13.4	O2 Supply Activation . . . . .	4.2-23
4.2.13.5	Suit Fan Activation, Checkout, and Water Separator Check . . . . .	4.2-23
4.2.13.6	O2 Demand Regulator Checkout . . . . .	4.2-24
4.2.13.7	In-Flight O2 Demand Regulator Check (Alternative) . . . . .	4.2-27
4.2.14	Crewman Connect to LM ECS . . . . .	4.2-28
4.2.15	Crewman Disconnect Transfer Umbilical . . . . .	4.2-28A
4.2.16	ARS/PGA Pressure Integrity Check . . . . .	4.2-29
4.2.17	VHF Activation & Checkout . . . . .	4.2-31
4.2.18	VHF B Simplex Check . . . . .	4.2-33
4.2.19	S-Band Activation & Checkout, Using Omni Antenna . . . . .	4.2-34
4.2.20	S-Band Steerable Antenna Activation and Checkout . . . . .	4.2-34
4.2.21	Low-Power S-Band Backup Voice, LBR Check With Steerable Antenna . . . . .	4.2-40
4.2.22	S-Band Ranging, Voice, and Telemetry Check . . . . .	4.2-43
4.2.23	S-Band FM Check . . . . .	4.2-43
4.2.24	Secondary S-Band Transceiver & Power Amplifier Check . . . . .	4.2-44
4.2.25	S-Band Backup Voice & Keying Check . . . . .	4.2-45
4.2.26	Ascent Battery Activation & Checkout . . . . .	4.2-45
4.2.27	APS Temp/Press Prepressurization Check . . . . .	4.2-48
4.2.28	DPS Temp/Press Prepressurization Check . . . . .	4.2-49
4.2.29	DPS Pressurization & Checkout . . . . .	4.2-50
4.2.30	RCS Pressurization . . . . .	4.2-54
4.2.31	RCS Hot/Cold Firing Check . . . . .	4.2-57
4.2.32	Landing Gear Deploy . . . . .	4.2-61

Preceding page blank

\*Apollo Operations Handbook, Volume I.

**LMA790-3-LM**  
**APOLLO OPERATIONS HANDBOOK**

TABLE OF CONTENTS (cont)

SECTION	TITLE	PAGE
4.0	NORMAL/BACKUP PROCEDURES (cont)	
4.3	Subsystem Deactivation . . . . .	4.3-2
4.3.1	Preparation For Sublimator Dryout . . . . .	4.3-2
4.3.2	Sublimator Dryout . . . . .	4.3-10
4.3.3	Final Subsystem Deactivation . . . . .	4.3-12
4.3.4	LM Transfer to CSM Power . . . . .	4.3-21
4.3.4.1	LM Transfer to CSM Power (Unstaged) . . . . .	4.3-21
4.3.4.2	LM Transfer to CSM Power (Staged) . . . . .	4.3-22
4.3.5	LM Transfer to LM LV Power (Backup) . . . . .	4.3-24
4.3.6	CSM Transfer to LM Power . . . . .	4.3-25
4.3.6.1	LM Initial Power-Up (CSM Powered Down) . . . . .	4.3-25
4.3.6.2	CSM Transfer to LM Power (Staged) . . . . .	4.3-26
4.3.6.3	CSM Transfer to LM Power (Unstaged) . . . . .	4.3-27
4.3.6.4	CSM Transfer to LM Power (Staged) - Lifeboat . . . . .	4.3-28
4.3.7	LM-to-CSM Power Transfer (Unstaged) (Power Removal from CSM/LM Umbilical) . . . . .	4.3-28
4.4	G&C Reference Data . . . . .	4.4-2
4.4.1	LGC/DSKY Restrictions . . . . .	4.4-2
4.4.2	AEA/DEDA Restrictions . . . . .	4.4-5
4.4.3	Jet Select Logic . . . . .	4.4-8
4.4.4	LGC Programs . . . . .	4.4-10
4.4.5	LGC Routines . . . . .	4.4-11
4.4.6	Verb List . . . . .	4.4-12
4.4.7	Noun List . . . . .	4.4-14
4.4.8	Star/Planet List . . . . .	4.4-26
4.4.9	Checklist Reference Codes (V50 N25) . . . . .	4.4-28
4.4.10	Option Codes (V04 N06, V04 N12 or V05 N06) . . . . .	4.4-28
4.4.11	Alarm Codes (V05 N09) . . . . .	4.4-29
4.4.12	AOT Detent/LPD/COAS Codes (N70, N71) . . . . .	4.4-32
4.4.13	Flagwords . . . . .	4.4-33
4.4.14	AGS Selector Logic . . . . .	4.4-49
4.4.15	DEDA Input List . . . . .	4.4-51
4.4.16	DEDA Output List . . . . .	4.4-54
4.4.17	DEDA Accessible Parameters List . . . . .	4.4-57
4.5	G&C Reference Modes . . . . .	4.5-2
4.5.1	Attitude Control Modes . . . . .	4.5-2
4.5.1.1	RCS Primary Coil Enable . . . . .	4.5-2
4.5.1.2	PGNCS Automatic . . . . .	4.5-2A
4.5.1.3	PGNCS Attitude Hold/Rate Command . . . . .	4.5-4
4.5.1.4	PGNCS Minimum Impulse . . . . .	4.5-4A
4.5.1.5	AGS Automatic . . . . .	4.5-6
4.5.1.6	AGS Attitude Hold/Rate Command . . . . .	4.5-8
4.5.1.7	AGS Pulse . . . . .	4.5-10
4.5.1.8	AGS Direct . . . . .	4.5-12
4.5.1.9	ACA Hardover . . . . .	4.5-14
4.5.2	Translation Control Modes . . . . .	4.5-14
4.5.2.1	Descent Engine On/Off Control . . . . .	4.5-14
4.5.2.2	Ascent Engine On/Off Control . . . . .	4.5-19
4.5.2.3	Descent Engine Throttle Control . . . . .	4.5-22
4.5.2.4	GDA Enable . . . . .	4.5-27
4.5.2.5	RCS Translation . . . . .	4.5-28
4.5.3	Dynamic Display Modes . . . . .	4.5-30
4.5.3.1	PGNCS Total Attitude Display . . . . .	4.5-30
4.5.3.2	PGNCS Attitude Rate/Error Display . . . . .	4.5-32
4.5.3.3	AGS Total Attitude Display . . . . .	4.5-33
4.5.3.4	AGS Attitude Error Display . . . . .	4.5-34
4.5.3.5	Attitude Rate Display . . . . .	4.5-34
4.5.3.6	RR Shaft Angle/Trunnion Angle Display . . . . .	4.5-35
4.5.3.7	RR Azimuth Rate/Elevation Rate Display . . . . .	4.5-36
4.5.3.8	Forward Velocity/Lateral Velocity Display . . . . .	4.5-36
4.5.3.9	Altitude/Altitude Rate Display . . . . .	4.5-37
4.5.3.10	Range/Range Rate Display . . . . .	4.5-37

**LMA790-3-LM**  
**APOLLO OPERATIONS HANDBOOK**  
 TABLE OF CONTENTS (cont)

SECTION	TITLE	PAGE
4.0	NORMAL/BACKUP PROCEDURES (cont)	
4.5.3.11	Thrust Display . . . . .	4.5-38
4.5.3.12	Radar Signal Strength Display . . . . .	4.5-39
4.5.3.13	Heater Control Temperature Monitor Display . . . . .	4.5-39
4.5.3.14	RR LOS Azimuth and Elevation Display (V85) . . . . .	4.5-40
4.6	G&C General . . . . .	4.6-3
4.6.1	PGNS . . . . .	4.6-3
4.6.1.1	LGC Power-Up . . . . .	4.6-3
4.6.1.2	LGC Power-Down Program (P06) . . . . .	4.6-4
4.6.1.3	IMU Power-Up (LGC Operating) . . . . .	4.6-4
4.6.1.4	IMU Power-Up (LGC Off) . . . . .	4.6-4
4.6.1.5	IMU Power-Down . . . . .	4.6-5
4.6.1.6	LGC Idling Program (P00) . . . . .	4.6-5
4.6.1.7	LGC Update Program (P27) . . . . .	4.6-6
4.6.1.8	DAP Data Load Routine (R03) . . . . .	4.6-8
4.6.1.9	Crew-Defined Maneuver Routine (R62) . . . . .	4.6-11
4.6.1.10	Rendezvous Final Attitude Routine (R63) . . . . .	4.6-13
4.6.1.11	Rendezvous Parameter Display Routine (R31) . . . . .	4.6-16
4.6.1.12	Show Banksum . . . . .	4.6-17
4.6.1.13	LGC Self-Test . . . . .	4.6-17
4.6.1.14	DSKY Light Test . . . . .	4.6-19
4.6.1.15	LGC/CMC Clock Synchronization Routine (R33) . . . . .	4.6-20
4.6.1.16	PIPA Bias Measurement & Loading . . . . .	4.6-21
4.6.1.17	Rate of Descent Controller/LGC Interface Check . . . . .	4.6-23
4.6.1.18	AGS Initialization Routine (R47) . . . . .	4.6-23
4.6.1.19	Preferred Tracking Attitude Program (P25) . . . . .	4.6-26
4.6.1.20	Fresh Start . . . . .	4.6-29
4.6.1.21	ICDU Zero . . . . .	4.6-30
4.6.1.22	RR CDU Zero . . . . .	4.6-31
4.6.1.23	Load IMU Attitude Error Meters . . . . .	4.6-31
4.6.1.24	Increment LGC Time . . . . .	4.6-32
4.6.1.25	Initialize Erasable Dump Via Downlink . . . . .	4.6-32
4.6.1.26	Enable W-Matrix Initialization . . . . .	4.6-33
4.6.1.27	ORDEAL Initialization . . . . .	4.6-33
4.6.1.28	LGC Erasable Memory Display/Update . . . . .	4.6-35
4.6.1.29	Restart . . . . .	4.6-36
4.6.1.30	S-Band Antenna Routine (R05) . . . . .	4.6-37
4.6.1.31	Interrupt Integration . . . . .	4.6-38
4.6.1.32	Mode I Attitude Error Display . . . . .	4.6-38
4.6.1.33	Mode II Attitude Error Display . . . . .	4.6-38
4.6.1.34	W-Matrix Error Display . . . . .	4.6-39
4.6.1.35	Move This Vehicle State Vector to Other State Vector . . . . .	4.6-39
4.6.1.36	Final Automatic Request Terminate Routine (R00) . . . . .	4.6-40
4.6.1.37	Erasable Modification Routine (R01) . . . . .	4.6-41
4.6.1.38	Input ΔRLS for Pinpoint Landing . . . . .	4.6-41
4.6.1.39	DSKY 88888 Clear . . . . .	4.6-42
4.6.2	AGS/CES . . . . .	4.6-42A
4.6.2.1	AGS Power-Up . . . . .	4.6-42A
4.6.2.2	AGS Power-Down . . . . .	4.6-44
4.6.2.3	AEA Self-Test . . . . .	4.6-45
4.6.2.4	AGS Checkout . . . . .	4.6-46
4.6.2.5	AGS Gyro & Accelerometer Calibration . . . . .	4.6-46
4.6.2.6	AGS Manual Absolute Time Initialization . . . . .	4.6-49
4.6.2.7	AGS Manual LM State Vector Update/Initialization . . . . .	4.6-50
4.6.2.8	Load AGS Contingency LM Lunar Touchdown State Vector . . . . .	4.6-51
4.6.2.9	AGS Manual CSM State Vector Update/Initialization . . . . .	4.6-52
4.6.2.10	Deleted . . . . .	4.6-53
4.6.2.11	Rate Gyro Check . . . . .	4.6-54
4.6.2.12	AEA Readiness Check . . . . .	4.6-55
4.6.2.13	AGS Orientation to Initial Computed Steering Attitude . . . . .	4.6-56
4.6.2.14	AGS Accelerometer Calibration . . . . .	4.6-58
4.6.2.15	AGS Wb Vector Update . . . . .	4.6-59
4.6.2.16	AGS Lunar Surface Gyro Calibration . . . . .	4.6-60
4.6.2.17	AGS Lunar Azimuth Store . . . . .	4.6-61

**LMA790-3-LM**  
**APOLLO OPERATIONS HANDBOOK**

TABLE OF CONTENTS (cont)

SECTION	TITLE	PAGE
4.0	NORMAL/BACKUP PROCEDURES (cont)	
4.6.2.18	AGS Rescaling From Lunar to Earth Mission . . . . .	4.6-61
4.6.2.19	AGS Power-Up From AGS Partial Power-Down . . . . .	4.6-63
4.6.2.20	AGS Partial Power-Down . . . . .	4.6-63
4.6.3	Radar . . . . .	4.6-64
4.6.3.1	Rendezvous Radar Power-Up . . . . .	4.6-64
4.6.3.2	Rendezvous Radar Initial Activation & Checkout . . . . .	4.6-64A
4.6.3.3	Rendezvous Radar Coarse Align . . . . .	4.6-69
4.6.3.4	Rendezvous Radar Manual Designation to Mode II . . . . .	4.6-70
4.6.3.5	Rendezvous Radar Manual Side-Lobe Acquisition Check & Main-Lobe Acquisition Verification . . . . .	4.6-71
4.6.3.6	Terminate Rendezvous Radar Continuous Designate . . . . .	4.6-79
4.6.3.7	Landing Radar Power-Up . . . . .	4.6-79
4.6.3.8	Landing Radar Checkout . . . . .	4.6-80
4.6.3.9	Command Landing Radar to Position 2 . . . . .	4.6-82
4.6.3.10	Landing Radar Spurious Test Routine (R77) . . . . .	4.6-82
4.6.3.11	Landing Radar Power-Down . . . . .	4.6-83
4.7	Prethrust . . . . .	4.7-2
4.7.1	PGNCS/AGS . . . . .	4.7-2
4.7.1.1	External $\Delta V$ (LGC P30, AEA 410+50000) . . . . .	4.7-2
4.7.1.2	Coelliptic Sequence Initiation (LGC P32, AEA (410+10000) . . . . .	4.7-7
4.7.1.3	Constant $\Delta$ Altitude (LGC P33, AEA 410+20000) . . . . .	4.7-14
4.7.1.4	Transfer Phase Initiation (LGC P34, AEA 410+30000, Search; & 410+40000, Execute) . . . . .	4.7-20
4.7.1.5	Transfer Phase Midcourse (LGC P35, AEA 410+40000) . . . . .	4.7-28
4.7.2	PGNCS . . . . .	4.7-32
4.7.2.1	Rendezvous Out-Of-Plane Display Routine (R36) . . . . .	4.7-32
4.7.2.2	Target $\Delta V$ Program (CSM) (P76) . . . . .	4.7-33
4.7.2.3	Target $\Delta V$ Program (LM) (P77) . . . . .	4.7-34
4.7.3	AGS . . . . .	4.7-34A
4.7.3.1	AGS Out-Of-Plane Maneuver . . . . .	4.7-34A
4.7.3.2	AGS Orbit Insertion . . . . .	4.7-36
4.7.4	CSM Backup . . . . .	4.7-38
4.7.4.1	CSM Coelliptic Sequence Initiation Targeting Program (P72) . . . . .	4.7-38
4.7.4.2	CSM Constant $\Delta$ Altitude Targeting Program (P73) . . . . .	4.7-41
4.7.4.3	CSM Transfer Phase Initiation Targeting Program (P74) . . . . .	4.7-43
4.7.4.4	CSM Transfer Phase Midcourse Targeting Program (P75) . . . . .	4.7-46
4.8	Navigation . . . . .	4.8-2
4.8.1	Orbital Navigation . . . . .	4.8-2
4.8.1.1	Ground Track Determination Program (P21) . . . . .	4.8-2
4.8.1.2	Orbit Parameter Display (PGNCS R30 & AGS) . . . . .	4.8-3
4.8.2	LM Rendezvous Navigation . . . . .	4.8-6
4.8.2.1	LM Rendezvous Navigation Program (P20) . . . . .	4.8-6
4.8.2.2	AGS Manual Rendezvous Radar LM State Vector Update . . . . .	4.8-19
4.8.2.3	AGS Automatic Rendezvous Radar LM State Vector Update (Raw Data Transfer Via LGC) . . . . .	4.8-22
4.8.3	Lunar Surface Navigation . . . . .	4.8-22B
4.8.3.1	Lunar Surface Navigation Program (P22) . . . . .	4.8-22B



**LMA790-3-LM**  
**APOLLO OPERATIONS HANDBOOK**

TABLE OF CONTENTS (cont)

SECTION	TITLE	PAGE
4.0	NORMAL/BACKUP PROCEDURES (cont)	
4.9	Alignment . . . . .	4.9-2
4.9.1	PGNCS . . . . .	4.9-2
4.9.1.1	IMU Orientation Determination Program (P51) . . . . .	4.9-2
4.9.1.2	IMU Realign Program (P52) . . . . .	4.9-5
4.9.1.3	ISS Coarse Align . . . . .	4.9-14
4.9.1.4	Torque Gyros . . . . .	4.9-14A
4.9.1.5	Docked Manual IMU Coarse Alignment . . . . .	4.9-16
4.9.1.6	Crescent Alignment of PGNCS (IMU) . . . . .	4.9-16A
4.9.1.7	LM IMU Alignment to CSM Gyro Display Coupler (GDC) . . . . .	4.9-16C
4.9.2	AGS . . . . .	4.9-17
4.9.2.1	PGNCS/AGS Align . . . . .	4.9-17
4.9.2.2	Backup AGS Alignment (Using AGS Body-Axis Alignment and PGNCS IMU) . . . . .	4.9-19
4.9.2.3	Backup AGS Alignment (Using AGS Body-Axis Alignment and AOT) . . . . .	4.9-20
4.9.2.4	Crescent Alignment to AGS (ASA) . . . . .	4.9-22
4.9.2.5	AGS Alignment of CSM Gyro Display Coupler or CSM Primary System . . . . .	4.9-22A
4.9.3	Lunar Surface Alignment . . . . .	4.9-22B
4.9.3.1	PGNCS Lunar Surface Align Program (P57) . . . . .	4.9-22B
4.9.3.2	AGS Lunar Align (400+40000) . . . . .	4.9-29
4.10	Thrust . . . . .	4.10-2
4.10.1	Orbital Thrust . . . . .	4.10-2
4.10.1.1	DPS Thrust Program (P40) With AGS Followup/In Control . . . . .	4.10-2
4.10.1.2	APS Thrust Program (P42) With AGS Followup/In Control . . . . .	4.10-22
4.10.1.3	RCS Thrust Program (P41) With AGS Followup/In Control . . . . .	4.10-38
4.10.1.4	Thrust Monitor Program (P47) . . . . .	4.10-49
4.10.1.5	AGS RCS Axis-by-Axis Thrust . . . . .	4.10-51
4.10.1.6	RCS Burn for Lunar Impact (Unmanned Ascent Stage) . . . . .	4.10-53
4.10.1.7	Docked DPS Thrust Program (P40) With AGS Followup . . . . .	4.10-61
4.10.2	Powered Descent . . . . .	4.10-73
4.10.2.1	Braking Phase Program (P63) With AGS Preparation for Orbit Insertion (410+00000) . . . . .	4.10-73
4.10.2.2	Approach Phase Program (P64) . . . . .	4.10-86
4.10.2.3	Landing Phase (ROD) Program (P66) . . . . .	4.10-88
4.10.2.4	Landing Confirmation Program (P68) . . . . .	4.10-91
4.10.3	Powered Ascent . . . . .	4.10-92
4.10.3.1	Powered Ascent Program (P12) With AGS Followup/In Control . . . . .	4.10-92
4.10.3.2	DPS Abort (LGC, P70, AEA 410+00000) . . . . .	4.10-106
4.10.3.3	APS Abort (P71, AEA 410+00000) . . . . .	4.10-116
4.11	Undocking & Docking . . . . .	4.11-2
4.11.1	LM Undocking From CSM . . . . .	4.11-2
4.11.2	LM Docking . . . . .	4.11-6
4.12	Staging . . . . .	4.12-2
4.12.1	DPS Propellant Tank Venting . . . . .	4.12-2
4.12.2	DPS Supercritical He Venting (Lunar Surface Only) . . . . .	4.12-2A
4.12.3	APS Pressurization & Checkout . . . . .	4.12-3
4.12.4	APS Pressurization & Checkout (Alternate) . . . . .	4.12-4
4.12.5	EPS Prestaging Check . . . . .	4.12-6
4.12.6	ED Prestaging Check . . . . .	4.12-8
4.12.7	ECS Prestaging Check . . . . .	4.12-8
4.12.8	EPS Postaging Check . . . . .	4.12-8
4.12.9	RCS Staging . . . . .	4.12-9
4.12.10	AGS FITH . . . . .	4.12-14

**LMA790-3-LM**  
**APOLLO OPERATIONS HANDBOOK**  
 TABLE OF CONTENTS (cont)

SECTION	TITLE	PAGE
4.0	NORMAL/BACKUP PROCEDURES (cont)	
4.13	Subsystem Management . . . . .	4.13-3
4.13.1	ECS . . . . .	4.13-3
4.13.1.1	ECS Basic (Unstaged & Staged) . . . . .	4.13-3
4.13.1.2	ECS Periodic Monitoring (Unstaged) . . . . .	4.13-5
4.13.1.3	ECS Periodic Monitoring (Staged) . . . . .	4.13-7
4.13.1.4	Secondary Coolant Loop (HTS) Activation . . . . .	4.13-8
4.13.1.5	Primary LiOH Cartridge Replacement . . . . .	4.13-9
4.13.1.6	Secondary LiOH Cartridge Replacement . . . . .	4.13-10
4.13.1.7	Cabin Depressurization . . . . .	4.13-11
4.13.1.8	Cabin Repressurization . . . . .	4.13-13
4.13.1.9	Cabin Leak Check . . . . .	4.13-14
4.13.1.10	LCG Recharge . . . . .	4.13-14
4.13.1.11	Reverse O2 Umbilicals for PGA Cooling . . . . .	4.13-15
4.13.1.12	H2O Dispenser Activation . . . . .	4.13-16
4.13.1.13	Cabin Atmosphere Filtering . . . . .	4.13-17
4.13.2	Communications . . . . .	4.13-17
4.13.2.1	Communications Basic . . . . .	4.13-17
4.13.2.2	S-Band Configuration for LOS . . . . .	4.13-19
4.13.2.3	Relay Mode: EVA (Two-Man EVA) . . . . .	4.13-20
4.13.2.4	Relay Mode: EVA (One-Man EVA) . . . . .	4.13-21
4.13.2.5	Relay Mode: CSM Voice to MSFN . . . . .	4.13-22
4.13.2.6	VHF B Data Enable . . . . .	4.13-23
4.13.2.7	S-Band LBR Data Enable . . . . .	4.13-23
4.13.2.8	S-Band CWEA Enable . . . . .	4.13-23
4.13.2.9	DSEA Check . . . . .	4.13-23
4.13.2.10	VHF Ranging Check . . . . .	4.13-24
4.13.2.11	DUA Enable . . . . .	4.13-25
4.13.2.12	DUA Disable . . . . .	4.13-25
4.13.2.13	DUA Backup Voice Enable . . . . .	4.13-26
4.13.2.14	DUA Backup Voice Disable . . . . .	4.13-26
4.13.2.15	S-Band Antenna Cooldown . . . . .	4.13-26
4.13.2.16	S-Band Operation in PTC Mode . . . . .	4.13-26
4.13.3	Propulsion . . . . .	4.13-28
4.13.3.1	MPS Basic (Unstaged) . . . . .	4.13-28
4.13.3.2	MPS Basic (Staged) . . . . .	4.13-28
4.13.3.3	APS/RCS Propellant Interconnect . . . . .	4.13-29
4.13.3.4	DPS Periodic Monitoring . . . . .	4.13-30
4.13.3.5	APS Periodic Monitoring . . . . .	4.13-31
4.13.3.6	RCS Periodic Monitoring . . . . .	4.13-34
4.13.4	EPS . . . . .	4.13-35
4.13.4.1	EPS Basic (Unstaged) . . . . .	4.13-35
4.13.4.2	EPS Basic (Staged) . . . . .	4.13-36
4.13.4.3	EPS Preparation for DPS Burn . . . . .	4.13-36
4.13.4.4	EPS Check, Post-DPS Burn . . . . .	4.13-38
4.13.4.5	EPS Periodic Monitoring (Unstaged) . . . . .	4.13-38
4.13.4.6	EPS Periodic Monitoring (Staged) . . . . .	4.13-40
4.13.4.7	LCA Duty Cycle During Secondary Coolant Loop Operation . . . . .	4.13-40
4.13.4.8	Lunar Stay Battery Management . . . . .	4.13-41
4.13.5	Heaters Status Check . . . . .	4.13-44
4.13.6	Set Event Timer . . . . .	4.13-44
4.13.7	Waste Management . . . . .	4.13-44
4.13.7.1	Transfer Urine to D/S Waste Container (Prime Mode) . . . . .	4.13-45
4.13.7.2	Transfer Urine to D/S Waste Container (Alternative Mode) . . . . .	4.13-46
4.13.7.3	Transfer Urine to Small Urine Collection Assembly . . . . .	4.13-47
4.13.7.4	Emesis Disposal . . . . .	4.13-48
4.13.7.5	Deleted . . . . .	4.13-49/4.13-50
4.13.7.6	Defecation Disposal . . . . .	4.13-49/4.13-50
4.13.8	Installation of 16-MM Sequence Camera Wedge . . . . .	4.13-49/4.13-50
4.13.9	Window Shades (CDR, LMP, & Docking) . . . . .	4.13-51/4.13-52

**LMA790-3-LM**  
**APOLLO OPERATIONS HANDBOOK**  
 TABLE OF CONTENTS (cont)

SECTION	TITLE	PAGE
4.0	NORMAL/BACKUP PROCEDURES (cont)	
4.13.9.1	Deploy Shades . . . . .	4.13-51/4.13-52
4.13.9.2	Stow Shades . . . . .	4.13-51/4.13-52
4.13.10	Crash Bar Deployment . . . . .	4.13-51/4.13-52
4.13.10.1	Unstow Crash Bar . . . . .	4.13-51/4.13-52
4.13.10.2	Stow Crash Bar . . . . .	4.13-51/4.13-52
4.14	Intravehicular Operations . . . . .	4.14-2
4.14.1	Initial Intravehicular Transfer to LM . . . . .	4.14-2
4.14.2	Intravehicular Transfer to LM (Second Crewman) . . . . .	4.14-3
4.14.3	Prepare for LM-to-CSM Transfer . . . . .	4.14-3
4.14.4	Intravehicular Transfer to CSM . . . . .	4.14-5
4.14.5	Enable LM Cabin Repressurization System . . . . .	4.14-5
4.14.6	Disable LM Cabin Repressurization System . . . . .	4.14-6
4.14.7	Connect to LM ECS & Communications . . . . .	4.14-6
4.14.8	Disconnect From LM ECS & Communications . . . . .	4.14-8
4.14.9	Open Overhead Hatch (LM Side) . . . . .	4.14-9
4.14.10	Open Overhead Hatch (CSM Side) . . . . .	4.14-9
4.14.11	Close Overhead Hatch (LM Side) . . . . .	4.14-10
4.14.12	Close Overhead Hatch (CSM Side) . . . . .	4.14-10
4.14.13	Install Drogue (LM Side) . . . . .	4.14-10
4.14.14	Install Drogue (CSM Side) . . . . .	4.14-11
4.14.15	Remove Drogue (LM Side) . . . . .	4.14-11
4.14.16	Remove Drogue (CSM Side) . . . . .	4.14-12
4.14.17	Tunnel Pressure Equalization From LM . . . . .	4.14-12
4.14.18	Tunnel Pressurization From LM, Without Using LM Consumables . . . . .	4.14-12 4.14-13
4.14.19	Tunnel Pressurization From LM, Using LM Consumables . . . . .	4.14-13
4.14.20	Vacuum Brush Operation . . . . .	4.14-14
4.15	Lunar Stay Operations . . . . .	4.15-2
4.15.1	Cabin Operations . . . . .	4.15-2
4.15.1.1	EPS Check, Post-Lunar-Landing . . . . .	4.15-2
4.15.1.2	Lunar Stay Subsystems Check . . . . .	4.15-3
4.15.1.3	Open Forward Hatch (Cabin Side) . . . . .	4.15-13
4.15.1.4	Open Forward Hatch (Outside) . . . . .	4.15-13
4.15.1.5	Close Forward Hatch (Cabin Side) . . . . .	4.15-13
4.15.1.6	Close Forward Hatch (Outside) . . . . .	4.15-14
4.15.1.7	ARS Purge (EVA Preparation) . . . . .	4.15-14
4.15.1.8	Subsystem Configuration for EVA Preparation . . . . .	4.15-15
4.15.1.9	PLSS/EVCS Electrical Checkout, Two-Man EVA . . . . .	4.15-17
4.15.1.10	PLSS/EVCS Electrical Checkout, One-Man EVA . . . . .	4.15-20
4.15.1.11	Final Subsystems Configuration for Egress . . . . .	4.15-23
4.15.1.12	ECS Status (Two Men on Lunar Surface) . . . . .	4.15-24
4.15.1.13	Post-EVA Final Subsystems Configuration . . . . .	4.15-26A
4.15.1.14	Cooling H2O Changeover, PLSS H2O to LM H2O (LCG) . . . . .	4.15-28
4.15.1.15	Cooling H2O Changeover, LM H2O (LCG) to PLSS H2O . . . . .	4.15-28
4.15.1.16	PLSS Recharge . . . . .	4.15-28
4.15.1.16.1	Oxygen Recharge . . . . .	4.15-28
4.15.1.16.2	Feedwater Reservoir and Auxiliary Tank Recharge, Gravity Environment . . . . .	4.15-29 4.15-32
4.15.1.17	Raise EVA Antenna . . . . .	4.15-32
4.15.1.18	Stow EVA Antenna . . . . .	4.15-32
4.15.1.19	Sleep Station . . . . .	4.15-32
4.15.1.19.1	Deploy Sleep Station . . . . .	4.15-32
4.15.1.19.2	Stow Sleep Station . . . . .	4.15-33
4.15.1.20	Buddy Umbilical Stowage Bag Removal . . . . .	4.15-34
4.15.1.21	PGA Protective Stowage . . . . .	4.15-34

**LMA790-3-LM**  
**APOLLO OPERATIONS HANDBOOK**

TABLE OF CONTENTS (cont)

SECTION	TITLE	PAGE
4.0	NORMAL/BACKUP PROCEDURES (cont)	
4.15.2	Extravehicular Activity . . . . .	4.15-34
4.15.2.1	MESA Operations . . . . .	4.15-34
4.15.2.1.1	MESA Remote Deployment . . . . .	4.15-34
4.15.2.1.2	MESA Manual Deployment . . . . .	4.15-35
4.15.2.1.3	MESA Height Adjustment . . . . .	4.15-35
4.15.2.1.4	MESA Exterior Blanket Removal . . . . .	4.15-35
4.15.2.1.5	TV Camera Deployment . . . . .	4.15-36
4.15.2.1.6	MESA Equipment Handling and Transfer . . . . .	4.15-36
4.15.2.1.7	SRV Removal . . . . .	4.15-37
4.15.2.2	LRV Deployment . . . . .	4.15-37
4.15.2.3	ALSEP Operations . . . . .	4.15-37
4.15.2.3.1	Open Scientific Equipment (SEQ) Bay . . . . .	4.15-37
4.15.2.3.2	Pallet Assembly Remote Deployment . . . . .	4.15-38
4.15.2.3.3	Pallet Assembly Manual Deployment . . . . .	4.15-39
4.15.2.3.4	Pallet Assembly Manual Deployment in Low Attitude . . . . .	4.15-40
4.15.2.3.5	Removal of RTG Fuel Element . . . . .	4.15-41
4.15.2.4	Deleted . . . . .	4.15-42
4.15.2.5	TV Camera Operation . . . . .	4.15-42
4.15.2.6	Lunar Launch Contingency Stowage . . . . .	4.15-42
5.0	CONTINGENCY PROCEDURES	
5.1	Abort Procedures . . . . .	5.1-1
5.2	Malfunction Procedures . . . . .	5.2-2
5.2.1	Guidance & Control Flight Displays . . . . .	5.2-3
5.2.2	Primary Guidance & Navigation Section . . . . .	5.2-7
5.2.3	Abort Guidance Section . . . . .	5.2-13
5.2.4	Control Electronics Section . . . . .	5.2-15
5.2.5	Descent Propulsion Section . . . . .	5.2-23
5.2.6	Ascent Propulsion Section . . . . .	5.2-27
5.2.7	Reaction Control Subsystem . . . . .	5.2-31
5.2.8	Electrical Power Subsystem . . . . .	5.2-35
5.2.9	Communications Subsystem . . . . .	5.2-43
5.2.10	Environmental Control Subsystem . . . . .	5.2-49
5.2.11	Explosive Devices . . . . .	5.2-57
5.2.12	Heaters . . . . .	5.2-61
5.3	Emergency Procedures . . . . .	5.3-2
5.3.1	Excessive Cabin Leak . . . . .	5.3-2
5.3.2	Fire/Smoke in Cabin (Not in suit loop) . . . . .	5.3-3
5.3.3	Fire/Smoke in suit loop . . . . .	5.3-3
5.3.4	Suit Leak in Depressurized Cabin . . . . .	5.3-4
5.3.5	Vacuum Changeover - PLSS to LM . . . . .	5.3-5
5.3.6	Crewman Vacuum Transfer to CSM . . . . .	5.3-6
5.3.7	Emergency Transfer, Using OPS . . . . .	5.3-7
5.3.8	Emergency Forward Hatch Opening (Cabin Side) . . . . .	5.3-8
5.3.9	Contaminants In ARS/Cabin Atmosphere . . . . .	5.3-8
5.3.10	Smoke In Cabin (Crew Unsuitd) . . . . .	5.3-9
5.3.11	Loss of Descent Power . . . . .	5.3-11
5.3.12	Loss of CDR Bus During Powered Descent . . . . .	5.3-11
5.3.12.1	To Abort (DPS Engine) . . . . .	5.3-11
5.3.12.2	To Abort (APS Engine) . . . . .	5.3-12
5.3.12.3	Reconfigure . . . . .	5.3-13
5.3.13	Loss of LMP Bus During Powered Descent . . . . .	5.3-13
5.3.13.1	To Abort (DPS Engine) . . . . .	5.3-13
5.3.13.2	To Abort (APS Engine) . . . . .	5.3-14
5.3.13.3	Reconfigure . . . . .	5.3-14
5.3.14	Extravehicular Transfer (Staged Vehicle) . . . . .	5.3-15
5.3.14.1	Subsystem Preparation for Egress . . . . .	5.3-15
5.3.14.2	Final Subsystem Preparation for EVT . . . . .	5.3-16

**LMA790-3-LM**  
**APOLLO OPERATIONS HANDBOOK**

TABLE OF CONTENTS (cont)

SECTION	TITLE	PAGE
5.0	CONTINGENCY PROCEDURES (cont)	
5.4	Contingency Management Procedures . . . . .	5.4-2
5.4.1	EPS Prestaging Check - Lunar Contingency (One Ascent Battery only) . . . . .	5.4-2
5.4.2	PLSS Makeup to LM Suit Loop via PGA Interface . . . . .	5.4-3
5.4.3	PLSS O2 Transfer to LM Suit Loop via Manifold . . . . .	5.4-4
5.4.4	PLSS H2O Transfer to LM Sublimator . . . . .	5.4-4
5.4.5	ARS Configuration for use of CM L1OH Cartridges . . . . .	5.4-5
5.4.6	AGS Passive Thermal Control (PTC) for LM/CM Configuration . . . . .	5.4-6
5.4.7	AGS Passive Thermal Control (PTC) for LM/CSM Configuration . . . . .	5.4-8
5.4.8	PGNCS Passive Thermal Control (PTC) for LM/CSM Configuration . . . . .	5.4-9
5.4.9	LM Staging While Docked with CM only . . . . .	5.4-11
5.4.10	LM/LGC-Controlled Spin Stabilization of CM . . . . .	5.4-13
5.4.11	LM/AGS-Controlled Spin Stabilization of CM . . . . .	5.4-14
5.4.12	Minimizing DPS Supercritical Helium Pressure Rise at Start of Burn . . . . .	5.4-15
5.4.12A	DPS Supercritical Helium Venting (Zero G, Docked Only). Deleted	5.4-16
5.4.13	DPS Supercritical Helium Vent During a Burn . . . . .	5.4-17
5.4.14	Loss of Both Ascent H2O Tanks . . . . .	5.4-19
5.4.15	Loss of Both Ascent O2 Tanks . . . . .	5.4-20
5.4.16	Loss of Both Press Regs (Failed Closed) . . . . .	5.4-21
5.4.17	Loss of Both Suit Fans . . . . .	5.4-22
5.4.18	Optimization of APS Helium Manifold Leak . . . . .	5.4-23
5.4.19	Ascent Stage Oxygen Tank Bleed-Down Procedure . . . . .	5.4-24A
5.4.20	Ascent Stage Oxygen Tank Top-Off Procedure . . . . .	5.4-24B
5.4.21	Descent O2 Venting . . . . .	5.4-24B
5.4.22	Loss of Manual and Auto APS Start Capability . . . . .	5.4-25
5.4-23	Loss of Manual and Auto APS Start Capability	
5.4-24	(with loss of one bus) . . . . .	5.4-31
5.4-25	Loss of ED Sub-system . . . . .	5.4-35

**LMA790-3-LM**  
**APOLLO OPERATIONS HANDBOOK**

TABLE OF CONTENTS (cont)

SECTION	TITLE	PAGE
	NOTE	
	Appendixes A, B, and C are in Apollo Operations Handbook, Volume I.	

APPENDIX

D	Definitions of Symbols and Abbreviations . . . . .	D-1
E	Controls and Displays . . . . .	E-1
F	Alphabetical Index . . . . .	F-1

LIST OF TABLES

TABLE	TITLE	PAGE
4-1	RCS Jet Select Logic . . . . .	4.4-8
4-2	Communications Modes . . . . .	4.13-27
5-1	G&C FLT DISP Procedure Entry Sheet . . . . .	5.2-3
5-2	PGNS Procedure Entry Sheet . . . . .	5.2-7
5-3	AGS Procedure Entry Sheet . . . . .	5.2-13
5-4	CES Procedure Entry Sheet . . . . .	5.2-15
5-5	DPS Procedure Entry Sheet . . . . .	5.2-23
5-6	APS Procedure Entry Sheet . . . . .	5.2-27
5-7	RCS Procedure Entry Sheet . . . . .	5.2-31
5-8	EPS Procedure Entry Sheet . . . . .	5.2-35
5-9	CS Procedure Entry Sheet . . . . .	5.2-43
5-10	ECS Procedure Entry Sheet . . . . .	5.2-49
5-11	ED Procedure Entry Sheet . . . . .	5.2-57
5-12	HTR Procedure Entry Sheet . . . . .	5.2-61
D-1	Definition of Symbols and Abbreviations . . . . .	D-1

LIST OF ILLUSTRATIONS

FIGURE	TITLE	PAGE
4-1	Prelaunch Closeout Check (Panel 11) . . . . .	4.1-3
4-2	Prelaunch Closeout Check (Panel 16) . . . . .	4.1-8
4-3	Initial Entry Status Check (Panel 11) . . . . .	4.2-3
4-4	Initial Entry Status Check (Panel 16) . . . . .	4.2-4
4-5	Circuit Breaker Activation (Panel 11) . . . . .	4.2-13
4-6	Circuit Breaker Activation (Panel 16) . . . . .	4.2-15
4-7	S-Band Steerable Antenna Vehicle Blockage Diagram (Relative to RF Bore-sight) . . . . .	4.2-39
4-8	Ascent Helium Loading . . . . .	4.2-51
4-9	Descent Ambient Helium Bottle Loading . . . . .	4.2-52
4-10	Theoretical Supercritical Helium Prepressurization . . . . .	4.2-53
4-11	RCS Theoretical Helium Bottle Loading Envelope, Pressure vs Temperature . . . . .	4.2-55
4-12	Preparation For Sublimator Dryout (Panel 11) . . . . .	4.3-9
4-13	Preparation For Sublimator Dryout (Panel 16) . . . . .	4.3-11
4-14	Sublimator Dryout Time Required vs Initial Inlet Temperature . . . . .	4.3-13
4-15	Final Subsystem Deactivation, Panel 11 (Sheet 1 of 4) . . . . .	4.3-14
4-15	Final Subsystem Deactivation, Panel 16 (Sheet 2 of 4) . . . . .	4.3-16
4-15	Final Subsystem Deactivation, Panel 11 (Sheet 3 of 4) . . . . .	4.3-19
4-15	Final Subsystem Deactivation, Panel 16 (Sheet 4 of 4) . . . . .	4.3-20
4-16	RCS Thruster Geometry . . . . .	4.4-7
4-17	Nomogram for Interpretation of Rendezvous Radar AGC (Normalized to -109 dbm 400 nm) . . . . .	4.6-74
4-18	Test Data, Designation Loci to Stable Tracking Angles . . . . .	4.6-75
4-19	Test Data, AGC Signal Surface at Close Range (< 4 nm) . . . . .	4.6-76
4-20	Test Data, Rendezvous Radar Shaft Traverses at Fixed Trunnion Values . . . . .	4.6-77

**LMA790-3-LM**  
**APOLLO OPERATIONS HANDBOOK**

LIST OF ILLUSTRATIONS (cont)

FIGURE	TITLE	PAGE
4-21	Test Data, Rendezvous Radar Trunnion Traverses at Fixed Shaft Values . . . . .	4.6-78
4-22	RCS Burn For Lunar Impact (Panel 11) . . . . .	4.10-58
4-23	RCS Burn For Lunar Impact (Panel 16) . . . . .	4.10-60
4-24	Predicted APS Helium Tank Temperature During Burn . . . . .	4.13-32
4-25	Predicted APS Helium Tank Pressure During Burn . . . . .	4.13-33
4-26	Lunar Stay Subsystems Check (Panel 11) . . . . .	4.15-5
4-27	Lunar Stay Subsystems Check (Panel 16) . . . . .	4.15-11
5-1	Supplemental Carbon Dioxide Removal System . . . . .	5.4-7
E-1	Cabin Controls and Displays . . . . .	E-3
E-2	ECS Aft Bulkhead Controls . . . . .	E-5

**LMA790-3-LM**  
**APOLLO OPERATIONS HANDBOOK**

Change No.	Date Change Incorporated	Page No. Affected	Para No. Affected	Step No. Affected
96	7-1-71	5.2-23	5.2.5.2.3	
97	9-26-71	5.2-40	Symptom 5	
98	9-26-71	5.2-39	Symptom 3	
99	9-26-71	5.2-60	Symptom 4	
961	7-1-71	4.3-11	Fig 4-13	
962	7-1-71	4.3-16	Fig 4-15	Sht 2 of 4
969	7-1-71	4.3-19	Fig 4-15	Sht 3 of 4
971	7-1-71	4.3-22	4.3.4.1	7
979A	7-1-71	4.9-7 4.9-8 4.9-12 4.9-13	4.9.1.2 4.9.1.2 4.9.1.2 4.9.1.2	9 11 20 thru 36 20 thru 36
980	7-1-71	4.3-26	4.3.6.2	4
981A	7-1-71	5.2-4	Symptom 1	
983	7-1-71	4.8-22b	4.8.2.3	5
986A	7-1-71	5.2-39 5.2-41	Symptom 5 Symptom 7	
987A	7-1-71	5.2-60	Symptom 4a Symptom 4b	
988A	7-1-71	5.2-58	Symptom 1	
989	7-1-71	5.2-59	Symptom 3	
990	7-1-71	5.2-58	Symptom 2	
992	7-1-71	4.12-6 4.13-36 4.13-36 5.2-36 5.2-37 5.2-38	4.12.5 4.13.4.2 4.13.4.2 Symptom 1 Symptom 1 Symptom 2	1 1 2
993	7-1-71	5.2-42	SSR-1	
994	7-1-71	4.15-29 4.15-30	4.15.1.16.2 4.15.1.16.2	8
996	7-1-71	5.2-37 5.2-38	Symptom 1 Unstaged Symptom 2	
997A	7-1-71	5.2-39	Symptom 3	
998A	7-1-71	5.2-42	SSR-1	



**LMA790-3-LM**  
**APOLLO OPERATIONS HANDBOOK**

Change No.	Date Change Incorporated	Page No. Affected	Para No. Affected	Step No. Affected
999	7-1-71	4.6-24	4.6.1.18	1
		4.3-36	4.6.1.29	1
		4.8-19	4.8.2.1	21
		4.10-27	4.10.1.2	5
		4.10-81	4.10.2.1	1b
1580	7-1-71	4.10-34	4.10.1.2	12
1581	7-1-71	4.4-49	4.4.14	Add. 411
		4.4-50	4.4.14	Add. 415
		4.4-50	4.4.14	Add. 417
1582	7-1-71	4.4-51	4.4.15	Add. 223
		4.4-52	4.4.15	Add. 306
		4.4-52	4.4.15	Add. 310
		4.4-53	4.4.15	Add. 377
1583	7-1-71	4.4-54	4.4.16	Add. 263
		4.4-54	4.4.16	Add. 270
		4.4-54	4.4.16	Add. 303
		4.4-54	4.4.16	Add. 310
		4.4-55	4.4.16	Add. 312
		4.4-55	4.4.16	Add. 347
		4.4-55	4.4.16	Add. 371
		4.4-55	4.4.16	Add. 372
		4.4-55	4.4.16	Add. 377
		4.4-55	4.4.16	Add. 402
		4.4-56	4.4.16	Add. 470
		4.4-56	4.4.16	Add. 471
		4.4-56	4.4.16	Add. 472
		4.4-56	4.4.16	Add. 544
		4.4-56	4.4.16	Add. 545
4.4-56	4.4.16	Add. 546		
4.4-56	4.4.16	Add. 621		
1584	7-1-71	4.4-57	4.4.17	Add. 034
				Add. 054
				Add. 055
				Add. 056
				Add. 147
		4.4-58	4.4.17	Add. 157
		4.4-54	4.4.17	Add. 174
				Add. 175
				Add. 176
		4.4-60	4.4.17	Add. 227
		Add. 254		
		Add. 271		
		Add. 272		
		Add. 274		
4.4-61	4.4.17	Add. 303		
		Add. 305		
		Add. 310		
		Add. 316		
4.4-61	4.4.17	Add. 317		
		Add. 347		
		Add. 360		
		Add. 361		
		Add. 362		
		Add. 364		
		Add. 365		

**LMA790-3-LM  
APOLLO OPERATIONS HANDBOOK**

Change No.	Date Change Incorporated	Page No. Affected	Para No. Affected	Step No. Affected
1584	7-1-71	4.4-62	4.4.17	Add. 366
		4.4-62	4.4.17	Add. 371
				Add. 407
				Add. 411
				Add. 415
				Add. 415
				Add. 446
				Add. 463
				Add. 465
				Add. 470
				Add. 471
				Add. 472
				Add. 477
				Add. 500
				Add. 501
				Add. 502
				Add. 503
				Add. 514
				Add. 515
				Add. 516
				Add. 517
				Add. 522
				Add. 523
				Add. 527
				Add. 526
				Add. 544
				Add. 545
				Add. 546
				Add. 554
				Add. 555
				Add. 556
				Add. 560
		Add. 561		
		Add. 563		
		Add. 564		
		Add. 565		
		Add. 566		
		Add. 571		
		Add. 576		
		Add. 577		
		Add. 600		
		Add. 601		
		Add. 602		
		Add. 606		
		Add. 607		
		Add. 610		
		Add. 611		
		Add. 612		
		Add. 613		
		Add. 614		
		Add. 616		
		Add. 621		
		Add. 622		
		Add. 644		
		Add. 645		
		Add. 646		
		Add. 647		
		Add. 650		

**LMA790-3-LM**  
**APOLLO OPERATIONS HANDBOOK**

Change No.	Date Change Incorporated	Page No. Affected	Para No. Affected	Step No. Affected
1584	7-1-71	4.4-67/4.4-68	4.4.17	Add. 651 Add. 652 Add. 653 Add. 656 Add. 657 Add. 665
		4.4-67/4.4-68	4.4.17	Add. 662 Add. 700 Add. 701 Add. 702 Add. 703 Add. 704
1586	7-1-71	4.4-15	4.4.7	No. 06 No. 07 No. 41
1587	7-1-71	4.4-29	4.4.11	00107 00114
		4.4-30	4.4.11	00514M, P
1588	7-1-71	4.4-35	4.4.13	Bit 4
		4.4-44	4.4.13	Bit 4
		4.4-45	4.4.13	Bit 2
		4.4-45	4.4.13	Bit 1
		4.4-47	4.4.13	Bit 10
			4.4.13	Bit 9
			4.4.13	Bit 15
	4.4-48	4.4.13	Bit 14 Bit 13 Bit 12 Bit 11 Bit 10 Bit 9 Bit 8 Bit 7 Bit 6 Bit 5 Bit 4	
	4.4-49	4.4.13	Bit 3 Bit 2 Bit 1	
1589	7-1-71	4.4-28	4.4.9	00016
1590	7-1-71	4.10-54A	4.10.1.6	2A
1591	7-1-71	4.4-6	4.4.2	q
1592	7-1-71	4.10-109	4.10.3.2	-
1593	7-1-71	4.8-15	4.8.2.1	15
1594	7-1-71	4.10-88	4.10.2.3	-
1595	7-1-71	4.8-7	4.8.2.1	1
		4.8-23	4.8.3.1	1
1596	7-1-71	4.10-14	4.10.1.1	12a
		4.10-32	4.10.1.2	9a
		4.10-81	4.10.2.1	16

**LMA790-3-LM**  
**APOLLO OPERATIONS HANDBOOK**

Change No.	Date Change Incorporated	Page No. Affected	Para No. Affected	Step No. Affected
1597	7-1-71	4.4-19	4.4.7	-
1599	7-1-71	4.4-4	4.4.1	ac
1600	7-1-71	4.4-3	4.4.1	v
1601	7-1-71	4.4-5	4.4.1	ap
1602	7-1-71	4.6-41	4.6.1.37	1
1604	9-26-71	5.2-58	Symptom 1	
1605	9-26-71	4.13-45 4.13-46	4.13.7.1 4.13.7.1	3 8, 10
1606	9-26-71	5.2-31 5.3-10A/10B 5.4-5 5.4-6 4.6-19 4.6-20 4.8-19 4.8-25 4.10-72 4.10-118 4.10-120 4.10-123 5.2-15	5.2.7.2.2 5.3.10 5.4.5 5.4.6 4.6.1.14 4.6.1.14 4.8.2.2 4.8.3.1 4.10.1.7 4.10.3.3 4.10.3.3 4.10.3.3 5.2.4.1	- - - - 2 3 - 8 30 1 4 12 -
1607	9-26-71	4.4-55 4.8-22B	4.4.16 4.8.2.3	Add. 317 5b
1608	9-26-71	5.2-17/5.2-18	Symptom 4	
2001	7-1-71	5.2-50A/5.2-50B 5.2-51 5.2-52 5.2-53	Symptom 2 & 2A Symptom 3 Symptom 4 Symptom 6	
2002	7-1-71	5.2-54	Symptom 7	
2003	7-1-71	5.2-53	Symptom 6	
2004	7-1-71	5.3-9 5.3-10	5.3.10 5.3.10	
2005	7-1-71	5.2-24	Symptom 1	
2006A	7-1-71	5.2-53	Symptom 3	
2007	7-1-71	4.15-27	4.15.1.13	1
2008A	7-1-71	5.2-50 5.2-50A/5.2-50B	Symptom 1 Symptom 2 & 2A	
2009	7-1-71	5.2-58	Symptom 1	
2010	7-1-71	4.2-12 4.2-15	4.2.4 Fig 4-6	7 -

**LMA790-3-LM  
APOLLO OPERATIONS HANDBOOK**

Change No.	Date Change Incorporated	Page No. Affected	Para No. Affected	Step No. Affected
2011	7-1-71	4.1-5	4.1	7
		4.1-7	4.1	12
2012	7-1-71	4.2-58	4.2.31	3
2013	7-1-71	4.6-54	4.6.2.11	2,3
		4.6-55	4.6.2.11	3
2014	7-1-71	4.10-76	4.10.2.1	4
2015	7-1-71	5.2-36	Symptom 1	-
2016	7-1-71	5.2-36A	Symptom 1	-
2017	9-26-71	5.2-40	Symptom 5	-
2018	9026-71	4.13-14	4.13.1.10	2 thru 6
		4.13-15	4.13-1.10	7 thru 21
2019	7-1-71	4.6-18A/4.6-18B	4.6.1.13	7
2020A	9-26-71	5.4-15	5.4.12	1 thru 6
		5.4-16	5.4.12A	5 thru 10
		5.4-16A/16B	5.4.13	1 thru 6
		5.4-17	5.4.14	1 thru 18
2021	9-26-71	5.2-39	Symptom 3	-
2022A	9-26-71	5.2-36B	Symptom 1	
2023	9-26-71	5.2-38	Symptom 2	
2024	9-26-71	5.2-39	Symptom 3	
2025	9-26-71	5.2-36B	Symptom 1	
		5.2-36A	Symptom 1	
		5.2-37	Symptom 1	
2030	9-26-71	5.2-51	Symptom 3	
2031	9-26-71	5.3-11	5.3.12.1	6
		5.3-12	5.3.12.1	7A
		5.3-12	5.3.12.1	8
3158	7-1-71	4.6-13	4.6.1.9	6
		4.6-15	4.6.1.10	7
		4.6-28	4.6.1.19	5
		4.6-9	4.8.2.1	5
		4.8-12	4.8.2.1	10
		4.8-15	4.8.2.1	14
		4.8-18	4.8.2.1	19
		4.9-10	4.9.1.2	16
		4.9-11	4.9.1.2	16
		4.10-11	4.10.1.1	8
		4.10-29	4.10.1.2	7
		4.10-45	4.10.1.3	6
		4.10-66	4.10.1.7	8
		4.10-80	4.10.2.1	13
3166A	7-1-71	4.9-8	4.9.1.2	11
		4.9-12	4.9.1.2	19
		4.9-12	4.9.1.2	20

**LMA790-3-LM**  
**APOLLO OPERATIONS HANDBOOK**

Change No.	Date Change Incorporated	Page No. Affected	Para No. Affected	Step No. Affected
3181A	7-1-71	4.8-22	4.8.2.3	1, 2, 3, 4, 5
3191	7-1-71	4.3-26	4.3.6.3	1, 2, 3, 4, 5, 6
3193	7-1-71	4.13-22 4.15-20 4.15-22 4.15.42	4.13.2.4 4.15.1.9 4.15.1.10 4.15.2.4	4 35 25 42
3196	7-1-71	4.10-54A 4.10-54B 4.10-54B	4.10.1.6 4.10.1.6 4.10.1.6	2A 2C 2D
3197	7-1-71 7-1-71	4.10-79 4.10-84	4.10.2.1 4.10.2.1	12 24
3198	7-1-71 7-1-71	4.10-102 4.10-102	4.10.3.1 4.10.3.1	16 18
3199	7-1-71	4.6-19 4.6-20 4.8-8 4.8-9 4.8-11 4.8-13 4.8-14 4.8-14 4.8-15 4.8-16 4.8-17 4.8-18 4.8-24 4.8-25 4.8-25 4.8-25 4.8-27	4.6.1.14 4.6.1.14 4.8.2.1 4.8.2.1 4.8.2.1 4.8.2.1 4.8.2.1 4.8.2.1 4.8.2.1 4.8.2.1 4.8.2.1 4.8.2.1 4.8.3.1 4.8.3.1 4.8.3.1 4.8.3.1 4.8.3.1 4.8.3.1	2 3 4 6 9 11 13 14 16 17 18 20 8 9 10 11 12
3201	7-1-71	4.3-26	4.3.6.4	1-6
3202	7-1-71	4.3-27	4.3.7	1, 2, 3, 4
3203	7-1-71	4.2-46 4.2-47	4.2.26 4.2.26	3 6
3204	7-1-71	4.3-10	4.3.1	21
3207	7-1-71	4.5-5 4.5-6 4.6-3 4.6-4 4.6-5 4.6-19 4.6-25 4.6-29 4.6-30	4.5.1.3 4.5.1.4 4.6.1.1 4.6.1.3 4.6.1.5 4.6.1.14 4.6.1.18 4.6.1.20 4.6.1.20	4 2 1 & 2 2 2 2 & 3 8 1 3

**LMA790-3-LM**  
**APOLLO OPERATIONS HANDBOOK**

Change No.	Date Change Incorporated	Page No. Affected	Para No. Affected	Step No. Affected	
3207	7-1-71	4.6-30	4.6.1.21	1	
		4.6-30	4.6.1.21	2	
		4.6-31	4.6.1.23	2	
		4.6-36	4.6.1.29	1	
		4.6-47	4.6.2.5	1b	
		4.6-48	4.6.2.5	3c	
		4.6-58	4.6.2.14	2c	
		4.9-4	4.9.1.1	8	
		4.9-12	4.9.1.2	19	
		7-1-71	4.9-14	4.9.1.3	3
			4.9-18	4.9.2.1	1a
			4.10-21	4.10.1.1	26b
			4.10-38	4.10.1.2	20b
			4.10-63	4.10.1.7	2
	4.10-71		4.10.1.7	27	
	4.10-71		4.10.1.7	28	
	4.10-115		4.10.3.2	15b	
	7-1-71	4.10-126	4.10.3.3	17b	
		4.11-5	4.11.1	19	
		4.11-6	4.11.2	22	
		4.11-6	4.11.2	2	
		4.11-10	4.11-2	19	
		5.4-10	5.4.8	6	
		5.4-10	5.4.8	9a	
		5.4-11	5.4.8	9b	
		5.4-14	5.4.10	2	
		3208	7-1-71	4.6-48	4.6.2.5
3209	7-1-71	4.10-114	4.10.3.2	10	
		4.10-118	4.10.3.3	1h	
		4.10-125	4.10.3.3	9	
3210	7-1-71	4.15-37	4.15.2.2	2, 3	
3211	7-1-71	4.13-48	4.13.7.5		
		4.13-49	4.13.7.6		
3212	7-1-71	5.2-16 5.2-17	Symptom 1 Symptom 2	Remark 3 New	
3213	7-1-71	4.10-90	4.10.2.3	10	
		4.10-91	4.10.2.3	10	
3214	7-1-71	4.6-67	4.6.3.2	24	
		4.6-67	4.6.3.2	27	
		4.6-67	4.6.3.2	29	
		4.6-68	4.6.3.2	35	
3215	7-1-71	4.2-28	4.2.13.7	9	
		4.13-16	4.13.1.11	5a	
		4.13-16	4.13.1.11	9a	
		4.15-27	4.15.1.13		
3216	7-1-71	4.2-10	4.2.3	8	
		4.2-22	4.2.13.2	15	
		4.3-9	Figure 12		
		4.13-5	4.13.1.1	3	
3217A	7-1-71	5.4-24	5.4.20	1-10	

**LMA790-3-LM**  
**APOLLO OPERATIONS HANDBOOK**

Change No.	Date Change Incorporated	Page No. Affected	Para No. Affected	Step No. Affected
3218	7-1-71	5.4-24	5.4.21	-
3220	7-1-71	4.13-45	4.13.7.1	7A
3221	7-1-71	4.6-66 4.6-67	4.6.3.2 4.6.3.2	18 25
3222	7-1-71	4.2-28	4.2.14	8 & 9
3223	7-1-71	4.2-34 4.2-43 4.2-44 4.13-17 4.13-17 4.13-27	4.2.19 4.2.22 4.2.23 4.2.24 4.2.24 4.13.2.1 4.13.2.1 Table 4-2	4 1 1 3 7 6
3224	7-1-71	4.1-11/4.1-12	4.1	21
3225	7-1-71	4.1-9	4.1	17
3226	7-1-71	4.14-3	4.14.1	12
3227A	7-1-71	5.4-24	5.4.22	1-9
3228	7-1-71	4.10-108 4.10-118	4.10.3.2 4.10.3.3	1 1
3229	7-1-71	4.10-98 4.10-102 4.10-102	4.10.3.1 4.10.3.1 4.10.3.1	8 PGNS 19 AGS 17
3230	7-1-71	5.2-45	Symptom 4	
3231	7-1-71	1, ix, x, xii, xiii, xvi, xvii 4.2-1 4.2-17 4.2-60 4.3-8 4.3-9 4.3-23 4.4-1 4.4-2 4.4-6 4.4-10 4.4-11 4.4-12 4.4-13 4.4-15 4.4-16 4.4-19 4.4-21 4.4-22 4.4-25 4.4-26 4.4-27 4.4-29	- - - 4.2.7 4.2.31 4.3.1 Fig 4-12 4.3.4.2 - 4.4.1 4.4.2 4.4.4 4.4.5 4.4.6 4.4.6 4.4.7 4.4.7 4.4.7 4.4.7 4.4.7 4.4.7 4.4.8 4.4.8 4.4.11	- - - 1 7 20 - - - k,u i 41, 42 05 17, 27, 30, 31 44 67 06, 07 14 46 63, 69 71, 72, 77 99 - - -



**LMA790-3-LM**  
**APOLLO OPERATIONS HANDBOOK**

Change No.	Date Change Incorporated	Page No. Affected	Para No. Affected	Step No. Affected
3231	7-1-71	4.4-30	4.4.11	-
		4.4-31	4.4.11	-
		4.4-33	4.4.13	-
		4.4-34	4.4.13	-
		4.4-39	4.4.13	-
		4.4-45	4.4.13	-
		4.4-47	4.4.13	-
		4.4-49	4.4.14	-
		4.4-50	4.4.14	-
		4.5-3	4.5.1.2	-
		4.5-5	4.5.1.3	3
		4.5-9	4.5.1.6	2
		4.5-15	4.5.2	1
		4.5-24	4.5.2.3	1c
		4.5-25	4.5.2.3	1d
		4.5-28	4.5.2.5	1
		4.5-32	4.5.3.2	1B
		4.5-33	4.5.3.2	2
		4.5-37	4.5.3.9	2
		4.5-40	4.5.3.14	3
		4.6-6	4.6.1.7	4
		4.6-7	4.6.1.7	7
		4.6-8	4.6.1.7	7b
		4.6-8	4.6.1.8	2
		4.6-8A/4.6-8B	4.6.1.8	2
		4.6-9	4.6.1.8	2, 3
		4.6-10	4.6.1.8	6
		4.6-11	4.6.1.8	6
		4.6-11	4.6.1.9	-
		4.6-16	4.6.1.11	-
		4.6-18	4.6.1.13	3
		4.6-20	4.6.1.14	3
		4.6-21	4.6.1.15	6
		4.6-22	4.6.1.16	5, 6, 7
		4.6-23	4.6.1.17	3
		4.6-24	4.6.1.18	1, 2
		4.6-26	4.6.1.18	9, 10
		4.6-28	4.6.1.19	4
		4.6-29	4.6.1.19	6
		4.6-29	4.6.1.20	2
		4.6-30	4.6.1.20	3
		4.6-31	4.6.1.22	1
		4.6-32	4.6.1.24	1
		4.6-32	4.6.1.24	2
		4.6-33	4.6.1.26	-
		4.6-33	4.6.1.27	1
		4.6-36	4.6.1.28	7, 9
		4.6-37	4.6.1.30	-
		4.6-38	4.6.1.32	-
		4.6-39	4.6.1.33	-
		4.6-39	4.6.1.34	2
		4.6-41	4.6.1.37	1
		4.6-42	4.6.1.39	-
		4.6-43	4.6.2.1	-
		4.6-44	4.6.2.1	6
		4.6-47	4.6.2.5	1c
		4.6-49	4.6.2.6	-
		4.6-50	4.6.2.6	-
		4.6-56	4.6.2.13	-
		4.6-57	4.6.2.13	2
4.6-59	4.6.2.15	-		

**LMA790-3-LM  
APOLLO OPERATIONS HANDBOOK**

Change No.	Date Change Incorporated	Page No. Affected	Para No. Affected	Step No. Affected
3231	7-1-71	4.6-64A/B	4.6.3.1	3
		4.6-67	4.6.3.2	22, 23, 24, 25
		4.6-69	4.6.3.3	1, 3
		4.6-71	4.6.3.5	-
		4.6-73	4.6.3.5	5
		4.6-76	Fig. 4-19	-
		4.6-79	4.6.3.6	-
		4.6-80	4.6.3.8	4
		4.6-82	4.6.3.9	1
		4.6-83/84	4.6.3.10	1
		4.7-1	-	-
		4.7-4	4.7.1.1	-
		4.7-14	4.7.1.2	11
		4.7-18	4.7.1.3	5
		4.7-23	4.7.1.4	2, 3
		4.7-26	4.7.1.4	8
		4.7-27	4.7.1.4	9
		4.7-28	4.7.1.4	9
		4.7-29	4.7.1.5	1
		4.7-30	4.7.1.5	2
		4.7-31	4.7.1.5	3, 4
		4.7-33	4.7.2.1	3
		4.7-34	4.7.2.2	3
		4.7-34A	4.7.2.3	3
		4.7-40	4.7.4.1	7, 9
		4.7-43	4.7.4.3	-
		4.7-44	4.7.4.3	3
		4.7-44A/B	4.7.4.3	7, 8
		4.7-47	4.7.4.4	1, 2
		4.7-48	4.7.4.4	3
		4.8-3	4.8.1.2	-
		4.8-6	4.8.2.1	-
		4.8-8	4.8.2.1	2A, 3
		4.8-10	4.8.2.1	7
		4.8-11	4.8.2.1	8a
		4.8-13	4.8.2.1	11
		4.8-15	4.8.2.1	15, 16
		4.8-19	4.8.2.1	21
		4.8-19	4.8.2.2	-
		4.8-20	4.8.2.2	5
		4.8-22	4.8.3.1	-
		4.8-24	4.8.3.1	5, 6
		4.8-25	4.8.3.1	8, 9
		4.8-26	4.8.3.1	11
		4.9-1	-	-
		4.9-3	4.9.1.1	6
		4.9-4	4.9.1.1	8
		4.9-5	4.9.1.1	10
		4.9-6	4.9.1.2	-
		4.9-6A/6B	4.9.1.2	7
		4.9-7	4.9.1.2	7
		4.9-11	4.9.1.2	17
		4.9-12	4.9.1.2	19
		4.9-13	4.9.1.2	34
		4.9-14A/B	4.9.1.4	2, 3
		4.9-16	4.9.1.5	5
		4.9-16A	4.9.1.5	10, 11
		4.9-16B	4.9.1.6	4
		4.9-22	4.9.2.4	4
		4.9-23	4.9.3.1	5
4.9-25	4.9.3.1	12		
4.9-26	4.9.3.1	16, 17		

**LMA790-3-LM**  
**APOLLO OPERATIONS HANDBOOK**

Change No.	Date Change Incorporated	Page No. Affected	Para No. Affected	Step No. Affected
3231	7-1-71	4.9-27	4.9.3.1	20
		4.9-28A	4.9.3.1	28
		4.10-1	-	-
		4.10-3	4.10.1.1	-
		4.10-14	4.10.1.1	14
		4.10-15	4.10.1.1	14, 15
		4.10-16	4.10.1.1	18
		4.10-17	4.10.1.1	19
		4.10-22	4.10.1.2	-
		4.10-23	4.10.1.2	-
		4.10-24	4.10.1.2	1
		4.10-27	4.10.1.2	5
		4.10-28	4.10.1.2	6a
		4.10-29	4.10.1.2	7a
		4.10-32	4.10.1.2	10
		4.10-34	4.10.1.2	14
		4.10-39	4.10.1.3	-
		4.10-40	4.10.1.3	-
		4.10-45	4.10.1.3	6
		4.10-46	4.10.1.3	7
		4.10-48	4.10.1.3	-
		4.10-50	4.10.1.4	-
		4.10-52	4.10.1.5	-
		4.10-54	4.10.1.6	-
		4.10-54A	4.10.1.6	2A
		4.10-54B	4.10.1.6	2c
		4.10-65	4.10.1.7	7
		4.10-73	4.10.2.1	-
		4.10-77	4.10.2.1	9
		4.10-78	4.10.2.1	9
		4.10-79	4.10.2.1	12
		4.10-81	4.10.2.1	16
		4.10-82	4.10.2.1	18
		4.10-84	4.10.2.1	22
		4.10-85	4.10.2.1	25
		4.10-86	4.10.2.2	-
		4.10-90	4.10.2.3	4
		4.10-93	4.10.3.1	-
		4.10-97	4.10.3.1	5
		4.10-98	4.10.3.1	6
		4.10-100	4.10.3.1	13
		4.10-101	4.10.3.1	18
		4.10-102	4.10.3.1	19
		4.10-107	4.10.3.2	-
		4.10-109	4.10.3.2	3
		4.10-111	4.10.3.2	9
		4.10-115	4.10.3.2	15
		4.10-119	4.10.3.3	3
		4.10-120	4.10.3.3	4
		4.10-126	4.10.3.3	17
		4.11-2	4.11	-
		4.11-3	4.11.1	2
		4.11-7	4.11.2	-
		4.12-1	-	-
		4.12-10	4.12.9	1
		4.12-11	4.12.9	8
		4.12-20	4.12.10	8
4.12-21	4.12.10	15		
4.14-2	4.14.1	5		
4.14-5	4.14.4	2		

**LMA790-3-LM**  
**APOLLO OPERATIONS HANDBOOK**

Change No.	Date Change Incorporated	Page No. Affected	Para No. Affected	Step No. Affected		
3231	7-1-71	4.15-34	4.15.1.20	-		
		4.15-36	4.15.2.1.6	5, 7		
		5.2-12	SSR-1	-		
		5.3-1	-	-		
		5.3-2	5.3	-		
		5.4-1	-	-		
		5.4-2	5.4.1	4		
		5.4-3	5.4.2	-		
		5.4-10	5.4.8	7		
		5.4-11	5.4.8	9		
		5.4-14	5.4.10	-		
		5.4-15	5.4.12	1		
		D4, D5 D12, D13, D14, D16	Table D1			
		3232	7-1-71	5.2-4	Sympton 1	
				5.2-5	Sympton 2	
5.2-6	Sympton 5					
5.2-9	Sympton 4					
3233	7-1-71	4.6-50	4.6.2.7	1		
		4.6-52	4.6.2.9	1		
3234	7-1-71	4.15-34	4.15.2.1.1	1		
		4.15-34	4.15.2.1.1	2		
3235	7-1-71	4.1-5	4.1	7		
		4.1-5	4.1	8		
		4.5-3	4.5.1.2	3		
		4.5-5	4.5.1.3	3		
		4.5-6	4.5.1.4	2		
		4.6-31	4.6.1.23	2		
		4.10-96	4.10.3.1	PGNS 5		
		4.11-3	4.11.1	1		
		4.11-11	4.11.2	PGNS 22		
		5.2-8	Sympton 2			
3236	7-1-71	4.7-27	4.7.1.4	9b(2)		
3237	7-1-71	4.2-45	4.2.26	A11		
		4.2-46	4.2.26	A11		
		4.2-47	4.2.26	A11		
3240A	9-26-71	5.4-25	5.4.23	1 thru 24		
		5.4-31	5.4.24	1 thru 19		
		5.4-35	5.4.25	1 thru 32		
3242		4.15-30	4.15.1.16.2	8		
3243	9-26-71	5.3-12	5.3.12.1	8, 9		
3244	9-26-71	4.13-45	4.13.7.1	3		
		4.13-46	4.13.7.1	7F, 7G		
		4.13-46	4.13.7.1	8		
3245	9-26-71	4.10-106	4.10.3.1	PGNS 28		
		4.10-106	4.10.3.2	AGS 27		
3246	9-26-71	5.2-63	Sympton 3	-		

**LMA790-3-LM**  
**APOLLO OPERATIONS HANDBOOK**

Change No.	Date Change Incorporated	Page No. Affected	Para No. Affected	Step No. Affected
3247	9-26-71	5.4-6	5.4.6	-
		5.4-8	5.4.7	-
		5.4-9	5.4.8	-
		5.4-11	5.4.9	-
		5.4-13	5.4.10	-
		5.4-14	5.4.11	-
3248	9-26-71	4.6-61	4.6.2.18	-
		4.6-62	4.6.2.18	-
3249	9-26-71	4.6-66	4.6.3.2	18
		4.6-67	4.6.3.2	25
3250	9-26-71	4.1-8	Figure 4-2	
		4.2-4	Figure 4-4	
		4.2-9	4.2.2	14
		4.6-63	4.6.2.1	3
3251	9-26-71	5.2-18	Symptom 4	-
3252	9-26-71	5.2-8	Symptom 1	-
3253	9-26-71	5.2-16	Symptom 1	-
3254	9-26-71	5.2-17	Symptom 3	-
3255	9-26-71	5.2-17	Symptom 3	-
		5.2-18	Symptom 4	-
3256	9-26-71	5.2-20	Symptom 9	-
3257	9-26-71	5.2-14	Symptom 1	-
3258	9-26-71	5.2-14	Symptom 1	-
3259	9-26-71	5.2-8	Symptom 1	-
3260	9-26-71	5.2-16	Symptom 1	-
		5.2-19	Symptom 7	-
		5.2-33	Symptom 4	-
3261	9-26-71	5.2-58	Symptom 1	-
3262	9-26-71	5.2-59	Symptom 3	-
		5.2-60	Symptom 4	-



**LMA790-3-LM**  
**APOLLO OPERATIONS HANDBOOK**

PRELAUNCH CLOSEOUT CHECK

SUBSYSTEM ACTIVATION

SUBSYSTEM DEACTIVATION

G & C REFERENCE DATA

G & C REFERENCE MODES

G & C GENERAL

PRETHRUST

NAVIGATION

ALIGNMENT

THRUST

SEPARATION & DOCKING

STAGING

SUBSYSTEM MANAGEMENT

INTRAVEHICULAR OPERATION

LUNAR STAY OPERATIONS





LMA790-3-LM  
APOLLO OPERATIONS HANDBOOK

PRELAIM  
CLOSED

PARA	TITLE	PAGE
4.1	Prelaunch Closeout Check . . . . .	4.1-2

**LMA790-3-LM  
APOLLO OPERATIONS HANDBOOK**

CREW: MAN	PNI	PROCEDURES	REMARKS
		<p><b>4.1 PRELAUNCH CLOSEOUT CHECK</b></p>	
	11	<p>The prelaunch closeout check is performed by a backup flight crew. It is assumed that a complete prelaunch checkout, including stowage of loose gear, has been performed by ground support personnel before the backup flight crew enters the LM.</p> <p>1. All cb's - open, except:            CB HTR:              ENDZ RDR STBY - close              LDG RDR - close            CB LTG: ANUM/DOCK/COMPNT - close            CB PGNS: IMU STBY - close            CB EPS:              BAT FRED TIE (2) - close              CROSS TIE BAL LOADS - close              DES ECA - close              DC BUS VOLT - close            Verify cb status per Prelaunch Closeout Check.</p>	<p>All tb's indicate no-power condition. Because some switches are spring loaded to center positions, desired status of solenoid valves (or relays) is presented.</p>
	8	<p>2. DES PROPUL:            FUEL VENT sw - center; tb - bp            OXID VENT sw - center; tb - bp            HTR CONT:              MESA sw - LO              URINE LINE sw - OFF            ED:              DES PPPLNT ISOL VLV sw - SAFE              MASTER APH sw - OFF              DES VENT sw - SAFE              ASC He SEL sw - BOTH              LDG CLEAR DEPLOY sw - SAFE; tb - bp              RCS He PRESS sw - SAFE              DES STAKT He PRESS sw - SAFE              ASC He PRESS sw - SAFE              STAGE sw - SAFE              STAGE RELAY sw - OFF            AUDIO:              S BAND T/R sw - OFF              ICS T/R sw - OFF              RELAY ON sw - RELAY OFF              S BAND VOL tv - as desired              ICS VOL tv - as desired              MODE sw - ICS/PTI              AUDIO CONT sw - NORH              VHF A sw - OFF              VHF B sw - OFF</p>	<p>See figure 4-1.</p> <p>FUEL VENT latching valve - open.            OXID VENT latching valve - open.</p>

# LMA790-3-LM APOLLO OPERATIONS HANDBOOK

PARA	TITLE	PAGE
4.2	Subsystem Activation . . . . .	4.2-2
4.2.1	Initial Entry Status Check . . . . .	4.2-2
4.2.2	EPS Activation & Checkout . . . . .	4.2-5
4.2.3	Primary Glycol Loop Activation . . . . .	4.2-9
4.2.4	Circuit Breaker Activation . . . . .	4.2-10
4.2.5	Primary Sublimator Activation . . . . .	4.2-16
4.2.6	Lighting Activation & Checkout . . . . .	4.2-16
4.2.7	Utility Lights Activation & Checkout . . . . .	4.2-17
4.2.8	AOT Lighting Check . . . . .	4.2-17
4.2.9	COAS Lighting Check . . . . .	4.2-18
4.2.10	Caution & Warning Array Checkout . . . . .	4.2-19
4.2.11	Timer Electroluminescent (EL) Numeric Check . . . . .	4.2-20
4.2.12	Set Mission Timer . . . . .	4.2-20
4.2.13	ECS Activation & Checkout . . . . .	4.2-21
4.2.13.1	Consumables Check . . . . .	4.2-21
4.2.13.2	Glycol Pump Check . . . . .	4.2-21
4.2.13.3	SUIT ISOL Valve Check . . . . .	4.2-22
4.2.13.4	O2 Supply Activation . . . . .	4.2-23
4.2.13.5	Suit Fan Activation, Checkout, and Water Separator Check . . . . .	4.2-23 4.2-24
4.2.13.6	O2 Demand Regulator Checkout . . . . .	4.2-27
4.2.13.7	In-Flight O2 Demand Regulator Check (Alternative) . . . . .	4.2-28
4.2.14	Crewman Connect to LM ECS . . . . .	4.2-28A
4.2.15	Crewman Disconnect Transfer Umbilical . . . . .	4.2-29
4.2.16	ARS/PGA Pressure Integrity Check . . . . .	4.2-31
4.2.17	VHF Activation & Checkout . . . . .	4.2-33
4.2.18	VHF B Simplex Check . . . . .	4.2-34
4.2.19	S-Band Activation & Checkout, Using Omni Antenna . . . . .	4.2-34
4.2.20	S-Band Steerable Antenna Activation and Checkout . . . . .	
4.2.21	Low-Power S-Band Backup Voice, LBR Check With Steerable Antenna . . . . .	4.2-40 4.2-43
4.2.22	S-Band Ranging, Voice, and Telemetry Check . . . . .	4.2-43
4.2.23	S-Band FM Check . . . . .	4.2-44
4.2.24	Secondary S-Band Transceiver & Power Amplifier Check . . . . .	4.2-45
4.2.25	S-Band Backup Voice & Keying Check . . . . .	4.2-45
4.2.26	Ascent Battery Activation & Checkout . . . . .	4.2-48
4.2.27	APS Temp/Press Prepressurization Check . . . . .	4.2-49
4.2.28	DPS Temp/Press Prepressurization Check . . . . .	4.2-50
4.2.29	DPS Pressurization & Checkout . . . . .	4.2-54
4.2.30	RCS Pressurization . . . . .	4.2-57
4.2.31	RCS Hot/Cold Firing Check . . . . .	4.2-61
4.2.32	Landing Gear Deploy . . . . .	





**LMA790-3-LM**  
**APOLLO OPERATIONS HANDBOOK**

CREW-MAN	PNL	PROCEDURES	REMARKS
		<p>4.1 <u>PRELAUNCH CLOSEOUT CHECK (cont)</u></p> <p>VOX SENS tv - as desired  VHP A VOL tv - as desired  VHP B VOL tv - as desired  MASTER VOL tv - as desired  COAS sw - OFF</p> <p>3. ORDEAL:  FDAL 1 sw - INRTL  FDAL 2 sw - INRTL  EARTH/LUNAR sw - PWR OFF  LTG sw - OFF  MODE sw - HOLD/FAST  SLEW sw - center  ALI SET cont - TRD nm</p> <p>TTCA 4.: THROTTLE/JETS cont (CDR) - JETS  Throttle friction cont (CDR) - as desired</p> <p>5. DES RATE sw - center  Eng STOP pb/lt - reset  Eng START pb/lt - not depressed  +X TRANSL pb - not depressed  MSN THR:  TMR CONT sw - STOP  SLEW CONT HOURS sw - center  SLEW CONT MIN sw - center  SLEW CONT SEC sw - center  LIC:  OVERRIDE ANUN sw - OFF  OVERRIDE NUM sw - OFF  OVERRIDE INTEGRAL sw - OFF  SIDE PANELS sw - OFF  FLOOD cont - BRIGHT  ANUN/NUM cont - DIM  INTEGRAL cont - DIM</p> <p>ACA 6. PTT pb (CDR) - not depressed</p> <p>1 7. X POINTER SCALE sw - HI MULT  MASTER ALARM pb/lt - not depressed  RATE/ERR MON sw - LDG RDR/CMPT  ATTITUDE MON sw - PGNS</p>	

# LMA790-3-LM APOLLO OPERATIONS HANDBOOK

PRELAUNCH  
CLOSEOUT

CREW-MAN	PNL	PROCEDURES	REMARKS
LM3225	14	<p>4.1 PRELAUNCH CLOSEOUT CHECK (cont)</p> <p>17. EPS:  ED VOLTS sw - OFF  POWER/TEMP MON sel - ED/OFF  INVERTER sw - OFF  LMP BAT 1 HI V &amp; LO V sws (2) - center; tb - bp  LMP BAT 2 sw - center; tb - bp  LMP BAT 3 sw - center; tb - bp  CDR BAT 4 HI V &amp; LO V sws (2) - center; tb - bp  CDR &amp; LMP LUNAR BAT sws (2) - center; tb - bp  DES BATS sw - center; tb - bp  BAT 5 NORMAL LMP FEED sw - center; tb - bp  BAT 5 BACK UP CDR FEED sw - center; tb - bp  BAT 6 NORMAL CDR FEED sw - center; tb - bp  BAT 6 BACK UP LMP FEED sw - center; tb - bp  COMM: UPLINK SQUELCH sw - ENABLE</p>	<p>LMP bat 1 HI V &amp; LO V - off  LMP bat 2 - off  CDR bat 3 - OFF  CDR bat 4 HI V &amp; LO V - off  CDR &amp; LMP lunar bat - off  Des bats - connect  Bat 5 normal LMP feed - off  Bat 5 backup CDR feed - off  Bat 6 normal CDR feed - off  Bat 6 backup LMP feed - off</p>
	12	<p>18. UP DATA LINK sw - OFF</p> <p>AUDIO:  AUDIO CONT sw - NORM  S BAND T/R sw - OFF  ICS T/R sw - OFF  RELAY ON sw - RELAY OFF  S BAND VOL tw - as desired  ICS VOL tw - as desired  MODE sw - ICS/PTI  VHF A sw - OFF  VHF B sw - OFF  VOX SENS tw - as desired  VHF A VOL tw - as desired  VHF B VOL tw - as desired  MASTER VOL tw - as desired</p> <p>COMM:  S BAND MODULATE sw - PM  S BAND XMTR/RCVR sw - OFF  S BAND PWR AMPL sw - OFF  S BAND VOICE sw - OFF  S BAND PCM sw - OFF  S BAND RANGE sw - OFF/RESET  VHF A XMTR sw - OFF  VHF A RCVR sw - OFF  VHF B XMTR sw - OFF  VHF B RCVR sw - OFF  TLM BIOMED sw - OFF</p>	

**LMA790-3-LM  
APOLLO OPERATIONS HANDBOOK**

CREW- MAN	PNI	PROCEDURES	REMARKS
		<p>4.1 <u>PRELAUNCH CLOSEOUT CHECK (cont)</u></p> <p>TLH PCM sw - HI  VHP A SQUELCH tv - as desired  VHP B SQUELCH tv - as desired  RECORDER sw - OFF  RECORDER TAPE tb - bp  COMM ANT:  VHP sel - AFT  TRACK MODE sw - OFF  PITCH cont - -75°  YAW cont - -12°  S BAND sel - AFT</p>	
	UTL	<p>19. Ovhd floodlights (CDR &amp; LMP) - rotate aft  CDR &amp; LMP UTILITY LIGHTS sw - OFF</p>	
	ECS	<p>20. SUIT GAS DIVERTER vlv - PULL EGRESS  CABIN REPRESS vlv - CLOSE  LO PLSS FILL vlv - CLOSE  PRESS REG A vlv - CLOSE  PRESS REG B vlv - CLOSE  DES O2 vlv - CLOSE  #1 ASC O2 vlv - CLOSE  #2 ASC O2 vlv - CLOSE  SUIT ISOL vlv (CDR) - SUIT DISC  SUIT ISOL vlv (LMP) - SUIT DISC  ASC H2O vlv - CLOSE  SEC EVAP FLOW vlv - CLOSE  PRI EVAP FLOW #2 vlv - CLOSE  DES H2O vlv - CLOSE  PRI EVAP FLOW #1 vlv - CLOSE  WATER TANK SELECT vlv - DES  SUIT TEMP vlv - COLD  CABIN GAS RETURN vlv - AUTO  SUIT CIRCUIT RELIEF vlv - AUTO  CO2 CANISTER SEL vlv - PRIM  PRIM CO2 CANISTER cover - CLOSE  SEC CO2 CANISTER cover - CLOSE  WATER SEP SEL vlv - FULL SEP 2  Cabin relief &amp; dump vlv (ovhd) - OPEN  Cabin relief &amp; dump vlv (fwd) - AUTO  LIQUID GARMENT COOLING vlv - COLD  HI PLSS O2 FILL vlv - CLOSE</p>	
	+Z27		



**LMA790-3-LM  
APOLLO OPERATIONS HANDBOOK**

PRELUN  
CLOSED

CREW-MAN	PNL	PROCEDURES	REMARKS
	MESA	<p>4.1 PRELAUNCH CLOSEOUT CHECK (cont)</p> <p>21. CDR, LMP, &amp; docking window shades - deployed (window covered) &amp; secure, crash bars - stowed</p> <p>22. Color TV control settings:            Aperture - F/11            Zoom - 25 mm            Focus - 6 (feet)            ALC sw (Peak/Average sw) - AVERAGE            TRANSMIT/STANDBY sw - TRANSMIT</p>	<p>Lens cap must be folded back over lens barrel and secured with thermal blanket so that cap will not swing back in front of lens and obstruct optical field of view.</p>

LM3224

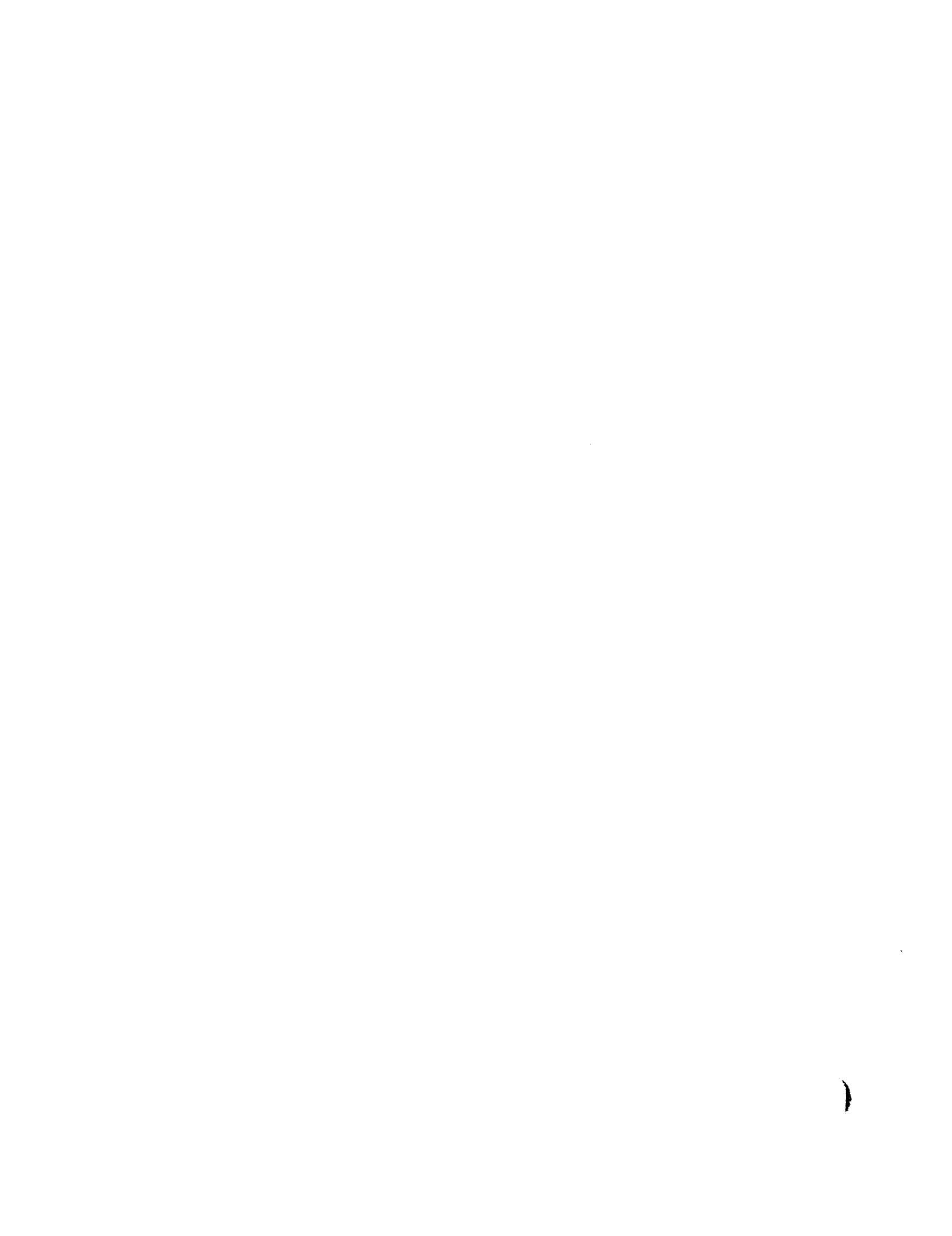

# LMA790-3-LM APOLLO OPERATIONS HANDBOOK

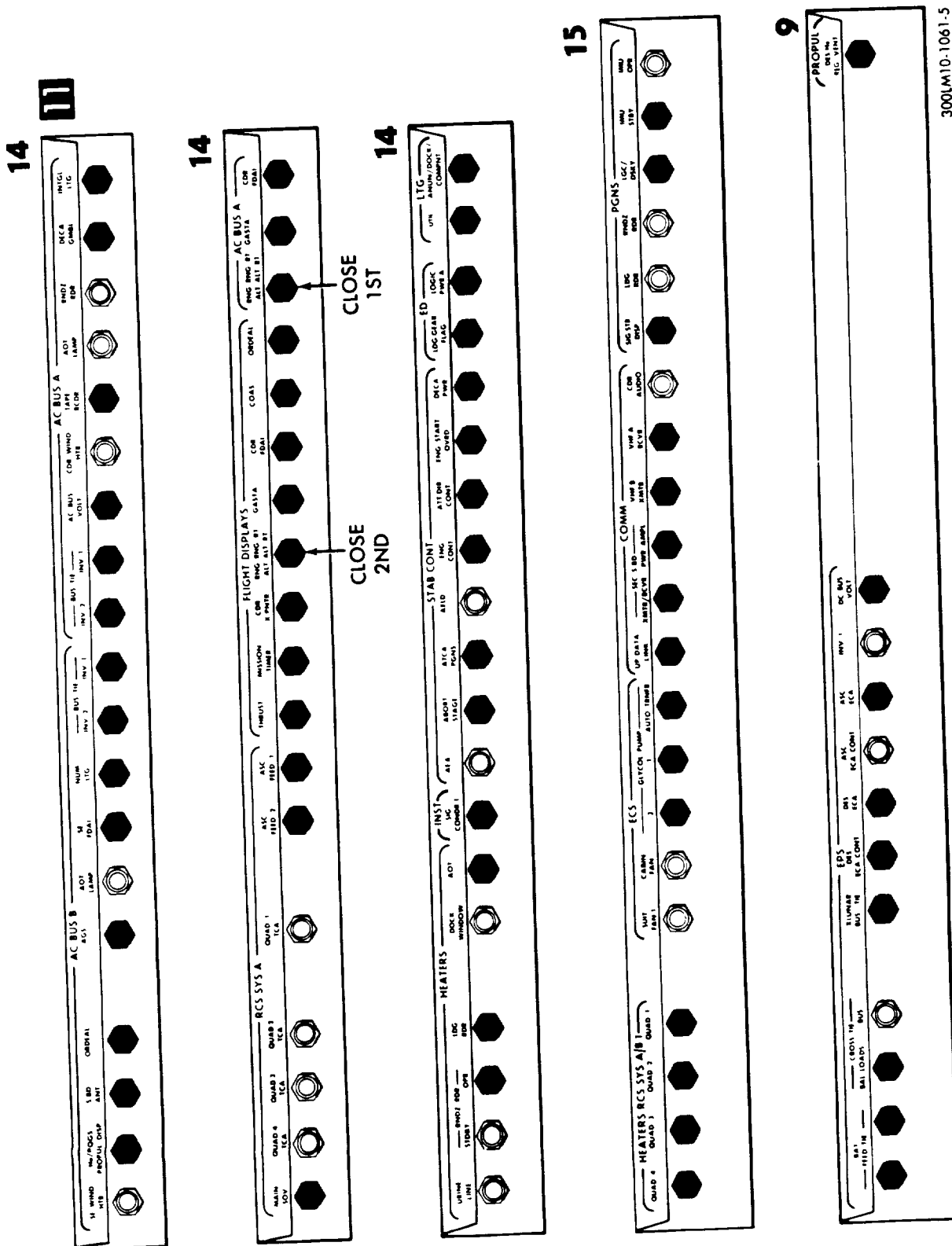

300LM10-1061-5

Figure 4-5. Circuit Breaker Activation (Panel 11)

LMA790-3-LM  
 APOLLO OPERATIONS HANDBOOK

CREW- MAN	PNL	PROCEDURES	REMARKS
		<p>4.2.4 <u>CIRCUIT BREAKER ACTIVATION (cont)</u></p> <p>CB ECS:            GLYCOL PUMP SEC - open            LCG PUMP - as required            CB CAMR: SEQ - open            CB EPS:            ASC ECA CONT - open            CROSS TIE BUS - open            CROSS TIE BAL LOADS - open            Verify cb status per Circuit Breaker Activation</p>	<p>LCG pump activation is crew comfort item.</p>
16 1,2 2 16 1/2 1 2 16		<p>8. CB INST: CWEA - open            MASTER ALARM - on            C/N PWR caut lt - on            CB INST: CWEA - close            MASTER ALARM pb/lt - reset            CES AC warn lt - off            CES DC warn lt - off            PRE AMPS caut lt - off            C/N PWR caut lt - off            CB S/C: ARLD - open</p>	<p>See figure 4-6.</p> <p>Cycling CB INST: CWEA resets CES AC and CES DC warn lt logic, allowing lights to go off.</p>
1		<p>9. MPS: PRESS ind pwr fail lt - off            ASC He REG 1 tb - gray            ASC He REG 2 tb - gray            DES He REG 1 tb - gray            DES He REG 2 tb - bp</p>	<p>ASC He REG latching valve is open when tb - gray.            ASC He REG latching valve is open when tb - gray.            DES He REG latching valve is open when tb - gray.            DES He REG latching valve is closed when tb - bp.</p>
2		<p>10. RCS:            PRESS ind pwr fail lt - off            QUANTITY ind pwr fail lt - off            SYS A ASC FUEL tb - bp            SYS A ASC OXID tb - bp            SYS B ASC FUEL tb - bp            SYS B ASC OXID tb - bp            SYS A QUAD 1, 4, 2, &amp; 3 tb - gray            SYS B QUAD 1, 4, 2, &amp; 3 tb - gray            SYS A &amp; B MAIN SOV tb - gray            CRSPD tb - bp            X pointer ind pwr fail lt - off            FDAI pwr tb - on (out of view)</p>	<p>RCS: ASC FUEL (ASC OXID) tb - bp indicates that ASC FEED 1 fuel (oxidizer) valve or ASC FEED 2 fuel (oxidizer) valve, or both valves, are closed. Normal configuration is ASC FEED 2 valves closed and ASC FEED 1 valves open.</p>



**LMA790-3-LM**  
**APOLLO OPERATIONS HANDBOOK**

CREW MAN	PNL	PROCEDURES	REMARKS
		<p><u>4.2.5 PRIMARY SUBLIMATOR ACTIVATION</u></p> <p>1. PRI EVAP FLOW #1 vlv - OPEN</p> <p>2. ECS: GLYCOL temp ind - monitor</p> <p><u>4.2.6 LIGHTING ACTIVATION &amp; CHECKOUT</u></p> <p>3 1. LTG: SIDE PANELS sw - ON FLOOD sw - OVRD/FWD, then OFF, then ALL FLOOD cont - BRIGHT, then DIM, then adjust as desired EXTERIOR LTG sw - TRACK, then DOCK, then OFF</p> <p>5 2. LTG: FLOOD cont - BRIGHT, then DIM, then adjust as desired ANUN/NUM cont - BRIGHT, then DIM OVERRIDE ANUN sw - ON, then OFF OVERRIDE NUM sw - ON, then OFF ANUN/NUM cont - adjust as desired INTEGRAL cont - BRIGHT, then DIM SIDE PANELS sw - ON OVERRIDE INTEGRAL sw - ON, then OFF INTEGRAL cont - adjust as desired</p>	<p>Activated primary sublimator requires minimum of 1200 Btu/hr heat input to prevent freezing and bursting. Previous circuit breaker activation supplies sufficient heat input.</p> <p>GLYCOL caut lt - off when ECS: GLYCOL temp ind decreases below 50° F. Time required is function of initial vehicle temperature, vehicle orientation, and glycol loop heat load. Periodically monitor ECS: GLYCOL temp ind to verify temperature is decreasing.</p> <p>Panel 5 or 3 (or both) LTG: SIDE PANELS sw - OFF (if desired) after check.</p>

**LMA790-3-LM**  
**APOLLO OPERATIONS HANDBOOK**

CREW-MAN	PNI	PROCEDURES	REMARKS
		<p>4.2.7 <u>UTILITY LIGHTS ACTIVATION &amp; CHECKOUT</u></p> <p>1. Remove both utility lights from stowage.</p> <p align="center">WARNING</p> <p>Before utility lights are connected or disconnected, to avoid mating or demating a hot connector, perform step 2.</p> <p>2. CDR &amp; LMP UTILITY LIGHTS sw - OFF CB LTG: UTIL - open</p> <p>3. Remove dust caps from utility light connectors.</p> <p>4. Connect utility lights to power receptacle.</p> <p>5. CB LTG: UTIL - close CDR UTILITY LIGHTS sw - BRIGHT, then DIM, then OFF LMP UTILITY LIGHTS sw - BRIGHT, then DIM, then OFF</p> <p>6. Place utility lights in operational locations.</p> <p>4.2.8 <u>AOT LIGHTING CHECK</u></p> <p>1. CB/AC BUS A: AOT LAMP - close</p> <p>2. RETICLE BRIGHTNESS cont - decr, then incr, adjust as desired</p> <p>3. CB/AC BUS A: AOT LAMP - open</p>	<p>If utility lights are connected, omit steps 1 thru 4.</p> <p>For trans-lunar coast and lunar landing, both utility lights may be stowed on AOT guard.</p> <p>RETICLE BRIGHTNESS cont is on computer control and reticle dimmer assembly (CCRD). Lights are in AOT. Reticle seen through AOT optics, legends on CCRD, and angle counter should be illuminated.</p>

SUBSYS  
ACT

LM 3231

LMA790-3-LM  
 APOLLO OPERATIONS HANDBOOK

CREW-MAN	PNI	PROCEDURES	REMARKS
		<p>4.2.9 <u>COAS LIGHTING CHECK</u></p> <ol style="list-style-type: none"> <li>1. COAS sw - OVHD</li> <li>2. COAS brightness cont - dim, then bright</li> <li>3. COAS sw - OFF</li> </ol> <p style="text-align: center;">CAUTION</p> <p>To avoid damage to connectors, be careful when mating or demating COAS.</p> <ol style="list-style-type: none"> <li>4. Remove COAS from overhead position.</li> <li>5. COAS detent - LW</li> <li>6. Install COAS in forward position.</li> <li>7. COAS sw - FWD</li> <li>8. COAS brightness cont - dim, then bright</li> <li>9. COAS sw - OFF</li> <li>10. Remove COAS from forward position.</li> <li>11. COAS detent - overhead position</li> <li>12. Install COAS in overhead mounting position.</li> </ol>	
	8		
	COAS		
	8		
	COAS		
	8		



**LMA790-3-LM  
APOLLO OPERATIONS HANDBOOK**

SUBS  
ACT

CREW-MAN	PNL	PROCEDURES	REMARKS
		<p><u>4.2.10 CAUTION &amp; WARNING ARRAY CHECKOUT</u></p> <p>1. CB INST: CWEA - open C/W PWR caut lt - on</p> <p>2. LTG: LAMP/TONE TEST sel - C/W 1 Left bank warn lts - on</p> <p>3. LTG: LAMP/TONE TEST sel - ENG PB C/W 2 Left bank warn lts - off Right bank warn lts - on Eng START pb/lt - on Eng STOP pb/lt (2) - on</p> <p>4. LTG: LAMP/TONE TEST sel - C/W 3 Right bank warn lts - off Left bank caut lts - on Eng START pb/lt - off Eng STOP pb/lt (2) - off</p> <p>5. LTG: LAMP/TONE TEST sel - C/W 4 Left bank caut lts - off Right bank caut lts - on</p> <p>6. LTG: LAMP/TONE TEST sel - COMPNT Right bank caut lts - off; except C/W PWR caut lt - on ED: STAGE SEQ RLY SYS A comp caut lt - on STAGE SEQ RLY SYS B comp caut lt - on EPS: BAT FAULT comp caut lt - on DC FEEDER FAULT comp caut lt - on SUIT FAN comp caut lt - on GLYCOL comp caut lt - on CO2 comp caut lt - on H2O SEP comp caut lt - on RNDZ RADAR: NO TRACK lt - on LUNAR CONTACT lt (2) - on</p> <p>7. LTG: LAMP/TONE TEST sel - OFF All lts in step 6 - off</p>	<p>C/W PWR caut lt remains on while CB INST: CWEA - open.</p>
	16 2 3 1 3 1 5 5, 6 3 1 2 5 5, 6 3 2 8 14 2 3 1, 3 3		

**LMA790-3-LM  
APOLLO OPERATIONS HANDBOOK**

CREW-MAN	PNI	PROCEDURES	REMARKS
		<p>4.2.10 CAUTION &amp; WARNING ARRAY CHECKOUT (cont)</p> <p>8. CB INST: CMEA - close C/W PWR caut lt - off RCS A REG warn lt - on RCS B REG warn lt - on ECS caut lt - on GLYCOL caut lt - on (if glycol temp &gt;50° F) HZO SEP comp caut lt - on SHUT FAN comp caut lt - on</p> <p>9. CB LTC: MASTER ALARM - close MASTER ALARM - on MASTER ALARM pb/lt - reset</p> <p>4.2.11 <u>TIMER ELECTROLUMINESCENT (EL) NUMERIC CHECK</u></p> <p>1. MSN TMR: SLEW CONT (HOURS, MIN, &amp; SEC) sw - TENS &amp; UNITS to step thru range of numbers for digit (at least 0 thru 5) &amp; observe configuration to check all EL numeric segments.</p> <p>2. EVNT TMR: SLEW CONT (MIN &amp; SEC) sw - TENS &amp; UNITS to step thru range of numbers for digit (at least 0 thru 5) &amp; observe configuration to check all EL numeric segments.</p> <p>4.2.12 <u>SET MISSION TIMER</u></p> <p>1. MSN TMR: TMR CONT sw - RESET SLEW CONT HOURS sw - TENS, then UNITS</p> <p>2. Repeat step 1 for MSN TMR: SLEW CONT MIN &amp; SLEW CONT SEC sw.</p> <p>3. MSN TMR: TMR CONT sw - START</p>	<p>CB INST: CMEA - close resets flip-flops, causing annunciator lights to go on.</p>

# LMA790-3-LM APOLLO OPERATIONS HANDBOOK

CREW MAN	PNI	PROCEDURES	REMARKS
		<p>4.2.13 ECS ACTIVATION &amp; CHECKOUT</p> <p>4.2.13.1 Consumables Check</p> <p>2 1. 02/H2O QTY MON sel - ASC 2 ECS: 02 QUANTITY ind - approx 100% H2O QUANTITY ind - approx 76%</p> <p>2. 02/H2O QTY MON sel - ASC 1 ECS: 02 QUANTITY ind - approx 100% H2O QUANTITY ind - approx 76%</p> <p>3. 02/H2O QTY MON sel - DES 2 ECS: 02 QUANTITY ind - approx 100% H2O QUANTITY ind - approx 66%</p> <p>4. 02/H2O QTY MON sel - DES 1 ECS: 02 QUANTITY ind - approx 100% H2O QUANTITY ind - approx 66%</p> <p>4.2.13.2 Glycol Pump Check</p> <p>2 1. GLYCOL sel - PUMP 1</p> <p>11 2. CB ECS: GLYCOL PUMP 2 - close GLYCOL PUMP 1 - close GLYCOL PUMP AUTO TRNFR - close GLYCOL PUMP 1 - open</p> <p>1, 2 3. MASTER ALARM - on 1/2 MASTER ALARM pb/lt - reset 11 CB ECS: GLYCOL PUMP 1 - close 2 GLYCOL comp caut lt - on</p> <p>4. ECS: GLYCOL press ind - 21 to 37 psia</p> <p>5. GLYCOL sel - INST (SEC)</p>	<p>Assumption: Water tank fill ratio is 0.75.</p> <p>Assumption: 15 pounds sampling per descent tank.</p> <p>Simulates pump No. 1 failure.</p> <p>If Glycol Pump Check is performed after ECS is completely activated, ECS caut lt and GLYCOL comp caut lt will flicker once as pump No. 2 is activated via glycol pump automatic transfer circuit. If Glycol Pump Check is performed before ECS is completely activated, omit step 3. When other signals are routed (via OR gates) to ECS caut lt, GLYCOL comp caut lt will flicker once and MASTER ALARM will not go on. If failure of pump</p>

SUBSYS  
ACT

**LMA790-3-LM**  
**APOLLO OPERATIONS HANDBOOK**

LM 3216

CREW-MAN	PNL	PROCEDURES	REMARKS
		<p>4.2.13.2 <u>Glycol Pump Check (cont)</u></p> <p>6. ECS: GLYCOL press ind - monitor GLYCOL temp ind - monitor</p> <p>16 CB ECS: GLYCOL PUMP SEC - close</p> <p>2 ECS: GLYCOL press ind - increase</p> <p>16 CB ECS: GLYCOL PUMP SEC - open</p> <p>2 GLYCOL sel - PUMP 2 GLYCOL comp caut lt - off</p> <p>11 ECS: GLYCOL press ind - 21 to 37 psia</p> <p>12 CB ECS: GLYCOL PUMP AUTO TRNFR - open</p> <p>2 GLYCOL sel - PUMP 1</p> <p>14 ECS: GLYCOL press ind - 21 to 37 psia</p>	<p>No. 1 occurs, other than an overcurrent, causing CB ECS: GLYCOL PUMP 1 to open, ECS caut lt will flicker once, MASTER ALARM will go on and GLYCOL comp caut lt will remain on until appropriate corrective actions are performed.</p> <p>ECS: GLYCOL press ind will increase 10 to 20 psia above reading in step 6.</p>
		<p>4.2.13.3 <u>SUIT ISOL Valve Check</u></p> <p>ECS</p> <p>1. SUIT ISOL vlv (LMP) - SUIT FLOW SUIT ISOL vlv (CDR) - SUIT FLOW</p> <p>2. SUIT ISOL vlv (LMP): ACTUATOR OVRD - PULL ACT</p> <p>3. SUIT ISOL vlv (LMP) - SUIT DISC</p> <p>4. SUIT ISOL vlv (CDR): ACTUATOR OVRD - PULL ACT</p> <p>5. SUIT ISOL vlv (CDR) - SUIT DISC</p>	<p>If Glycol Pump Check is performed after ECS is completely activated, ECS caut lt and GLYCOL comp caut lt may flicker once and activate MASTER ALARM. If this occurs, MASTER ALARM pb/lt - reset.</p> <p>If Glycol Pump Check is performed before ECS is completely activated, and other signals are routed (via OR Gates) to ECS caut lt, GLYCOL comp caut lt may flicker once.</p>

**LMA790-3-LM**  
**APOLLO OPERATIONS HANDBOOK**

CREW-MAN	PNL	PROCEDURES	REMARKS
		<p>4.2.13.4 <u>O2 Supply Activation</u></p> <p>1. DES O2 vlv - OPEN CB ECS: CABIN FAN CONT - open</p> <p>2. PRESS REG A vlv - EGRESS PRESS REG B vlv - EGRESS</p> <p>3. ECS: SUIT PRESS ind - 5±0.2 psia</p> <p>4.2.13.5 <u>Suit Fan Activation, Checkout, and Water Separator Check</u></p> <p>1. SUIT FAN sel - 2</p> <p>2. CB ECS: SUIT FAN 2 - close</p> <p>3. MASTER ALARM - on SUIT/FAN warn lt - on, then off MASTER ALARM pb/lt - reset SUIT FAN comp caut lt - off H2O SEP comp caut lt - off ECS caut lt - off</p> <p>4. ECS: PART PRESS CO2 ind - zero mm Hg</p> <p>5. CB ECS: SUIT FAN 2 - open</p> <p>6. MASTER ALARM - on SUIT/FAN warn lt - on SUIT FAN comp caut lt - on ECS caut lt - on H2O SEP comp caut lt - on MASTER ALARM pb/lt - reset</p>	<p>When CB ECS: CABIN FAN CONT - open, there is override of automatic deactivation of cabin fan, with PRESS REG A or B vlv - EGRESS.</p> <p>PRESS REG A and B vlv - EGRESS to preclude LM from supplying oxygen to LM and CSM while hatches are open.</p> <p>CSM O2 supply is 5±0.2 psia.</p> <p>MASTER ALARM may go on approximately 7 seconds after selection of suit fan No. 2 subsequent to use or failure of suit fan No. 1.</p> <p>ECS caut lt and H2O SEP comp caut lt - off when water separator comes up to speed. Time is approximately 1 minute when dry; up to 15 minutes when wet.</p> <p>CO2 level is function of time that crew is on ARS. At initial ARS activation or following LiOH cartridge replacement, reading should be zero mm Hg.</p> <p>When suit fans are deactivated, water separator slows down, causing delayed activation of ECS caut lt and H2O SEP comp caut lt. Time for water separator to slow down is approximately 15 seconds when wet; 2.5 to 3 minutes when dry. ECS caut lt and H2O SEP comp caut lt - off when selected water separator comes up to speed, approximately 1 minute when dry; up to 15 minutes when wet.</p>

SUBSYS  
ACT

**LMA790-3-LM**  
**APOLLO OPERATIONS HANDBOOK**

CREW-MAN	PNL	PROCEDURES	REMARKS
		<p>4.2.13.5 <u>Suit Fan Activation, Checkout, and Water Separator Check (cont)</u></p> <p>7. WATER SEP SEL vlv - PUSH SEP 1</p> <p>8. CB ECS: SUIT FAN 1 - close</p> <p>9. SUIT FAN sel - 1</p> <p>10. SUIT/FAN warn lt - off SUIT FAN comp caut lt - off ECS caut lt - off H2O SEP comp caut lt - off</p> <p>11. CB ECS: SUIT FAN 2 - close</p> <p>4.2.13.6 <u>O2 Demand Regulator Checkout</u></p> <p style="text-align: center;">WARNING</p> <p>This procedure requires approx 2.2 to 2.5 pounds of oxygen to be dumped overboard. This checkout must not be performed when staged. It may be performed (using descent oxygen) when unstaged only if dumping 2.2 to 2.5 pounds of oxygen overboard does not compromise mission.</p> <p style="text-align: center;">NOTE</p> <p>When dumping cabin pressure in following steps, observe ECS: SUIT PRESS ind on panel 2, to verify suit loop lockup (seating of SUIT CIRCUIT RELIEF vlv at 4.3 psia).</p> <p>1. PRESS REC A vlv - CABIN SUIT CIRCUIT RELIEF vlv - AUTO CABIN GAS RETURN vlv - EGRESS</p>	<p>Assumption: ARS/PGA Pressure Integrity Check (para 4.2.16) has been performed.</p> <p>If CB ECS: CABIN FAN - open, references to cabin fan do not apply.</p>

**LMA790-3-LM**  
**APOLLO OPERATIONS HANDBOOK**

CREW-MAN	PNL	PROCEDURES	REMARKS
		<p>4.2.13.6 02 Demand Regulator Checkout (cont)</p> <p style="text-align: center;">CAUTION</p> <p>Rapid switching of CABIN REPRESS vlv from AUTO to CLOSE, or CLOSE to AUTO, causes loud bang. This does not damage valve. To change CABIN REPRESS vlv position, smooth, slow movement is recommended.</p> <p>CABIN REPRESS vlv - AUTO SUIT GAS DIVERTER vlv - PUSH CABIN</p> <p>2. Verify overhead hatch - closed (docked only)</p> <p>3. Cabin relief &amp; dump vlv (ovhd) - OPEN (docked only)</p> <p>4. PRESS REG B vlv - EGRESS</p> <p>5. Cabin relief &amp; dump vlv (fwd) - OPEN until cabin pressure drops below 4.0 psia (nominal), then AUTO MASTER ALARM - on CABIN warn lt - on CABIN REPRESS vlv opens.</p> <p>6. CB ECS: CABIN REPRESS - onen</p> <p>7. PRESS REG A vlv - CLOSE MASTER ALARM pb/lt - reset CABIN warn lt - off</p> <p style="text-align: center;">CAUTION</p> <p>Rapid switching of CABIN REPRESS vlv from AUTO to CLOSE, or CLOSE to AUTO, causes loud bang. This does not damage valve. To change CABIN REPRESS vlv position, smooth, slow movement is recommended.</p>	<p>Depressurizes docking tunnel during cabin depressurization.</p> <p>Cabin fan goes off and SUIT GAS DIVERTER vlv moves to EGRESS position.</p> <p>Activation pressure band for valve opening is between 4.45 and 3.7 psia.</p> <p>Automatic repressurization starts.</p> <p>CABIN REPRESS vlv closes and CABIN warn lt - off when CB ECS: CABIN REPRESS - open or if cabin pressure reaches 4.4 to 5.0 psia.</p> <p>When PRESS REG A and/or B vlv - CLOSE, ensure handle is rotated to full hard stop position.</p>

SUBSYS  
ACT

**LMA790-3-LM**  
**APOLLO OPERATIONS HANDBOOK**

CREW-MAN	PNI	PROCEDURES	REMARKS
		4.2.13.6 02 Demand Regulator Checkout (cont)	
	ECS	<p>8. CABIN REPRESS vlv - CLOSE Cabin relief &amp; dump vlv (fwd) - OPEN until cabin pressure decays to 3.5 psia, then AUTO (4.3 psia in ARS, decaying to 3.8±0.2 psia.)</p> <p>9. PRESS REG B vlv - CLOSE</p> <p>10. SUIT CIRCUIT RELIEF vlv - OPEN until suit loop pressure decays to 3.5 psia, then AUTO PRESS REG B vlv - EGRESS (Suit loop pressure rises to 3.8±0.2 psia.)</p> <p>11. PRESS REG B vlv - CLOSE</p> <p>12. SUIT CIRCUIT RELIEF vlv - OPEN until suit loop pressure decays to 3.5 psia, then AUTO PRESS REG A vlv - EGRESS (Suit loop pressure rises to 3.8±0.2 psia.)</p> <p>13. MASTER ALARM pb/lt - reset</p> <p style="text-align: center;">CAUTION</p> <p>Rapid switching of CABIN REPRESS vlv from AUTO to CLOSE, or CLOSE to AUTO, causes loud bang. This does not damage valve. To change CABIN REPRESS vlv position, smooth, slow movement is recommended.</p> <p>14. CABIN REPRESS vlv - AUTO Cabin relief &amp; dump vlv (ovhd) - AUTO (docked only)</p> <p>MASTER ALARM - on CB ECS: CABIN REPRESS - close CABIN warn lt - on (Suit and cabin pressure begins to rise; CABIN REPRESS vlv opens.)</p>	<p>Cabin fan goes on. When PRESS REG A and/or B vlv - CLOSE, ensure handle is rotated to full hard stop position.</p> <p>Cabin fan goes off.</p> <p>Cabin fan goes on. When PRESS REG A and/or B vlv - CLOSE, ensure handle is rotated to full hard stop position.</p> <p>Cabin fan goes off.</p> <p>CABIN REPRESS vlv closes and CABIN warn lt - off when cabin pressure reaches 4.4 to 5.0 psia.</p>
	1/2		
	ECS		
	1,2 16 1		



**LMA790-3-LM**  
**APOLLO OPERATIONS HANDBOOK**

CREW-MAN	PNL	PROCEDURES	REMARKS
		<p>4.2.13.6 <u>O2 Demand Regulator Checkout (cont)</u></p>	
1,2 ECS		<p>15. MASTER ALARM ph/lt - reset PRESS REG A vlv - CABIN CABIN GAS RETURN vlv - AUTO SUIT GAS DIVERTER vlv - PUSH CABIN</p>	<p>Cabin fan goes on.</p>
		<p>4.2.13.7 <u>In-Flight O2 Demand Regulator Check (Alternative)</u></p> <p style="text-align: center;">WARNING</p> <p>This procedure must not be performed when staged. It may be performed (using descent oxygen) when unstaged.</p>	<p>Assumptions: (1) ARS/PGA Pressure Integrity Check (para 4.2.16) has been performed, (2) CSM tunnel hatch closed, (3) CSM pressure equalization valve closed, (4) CSM tunnel vent valve closed, and (5) tunnel is vented.</p>
ECS		<p>1. CABIN REPRESS vlv - MANUAL (verify flow), then AUTO</p>	
16 ECS		<p>2. Cabin relief &amp; dump vlv (ovhd) - AUTO</p> <p>3. CB ECS: CABIN REPRESS - open PRESS REG A &amp; B vlv - EGRESS SUIT GAS DIVERTER vlv - PULL EGRESS CABIN GAS RETURN vlv - EGRESS</p>	
		<p>4. Cabin relief &amp; dump vlv (fwd) - OPEN, then AUTO at 4.5 psia</p>	<p>Suit circuit pressure should follow cabin pressure to 4.5 psia during dump.</p>
		<p>5. SUIT CIRCUIT RELIEF vlv - OPEN &amp; verify suit pressure at 4.5 psia, then CLOSE PRESS REG A vlv - CABIN &amp; verify suit pressure rises to 4.6 to 5.0 psia.</p>	
		<p>6. PRESS REG A vlv - EGRESS SUIT CIRCUIT RELIEF vlv - OPEN until suit pressure decays to 4.5 psia, then CLOSE PRESS REG B vlv - CABIN &amp; verify suit pressure rises to 4.6 to 5.0 psia</p>	

SUBSYS  
ACT

**LMA790-3-LM  
APOLLO OPERATIONS HANDBOOK**

LM 3215, LM 3222

CREW- MAN	PNL	PROCEDURES	REMARKS
		<p>4.2.13.7 <u>In-Flight O2 Demand Regulator Check (Alternative) (cont)</u></p> <p>7. SUIT CIRCUIT RELIEF vlv - AUTO CABIN GAS RETURN vlv - AUTO PRESS REG A vlv - CABIN SUIT GAS DIVERTER vlv - PUSH CABIN ECS: CABIN PRESS ind - 4.6 to 5.0 psia (in approx 5 min)</p> <p>8. CB ECS: CABIN REPRESS - close Doff helmets &amp; gloves (crew option).</p> <p>9. Doff helmets &amp; gloves Reverse O2 hoses R/B &amp; B/R SUIT GAS DIVERTER vlv - FULL EGRESS CABIN GAS RETURN vlv - EGRESS PGA DIVERTER vlvs - HORIZONTAL</p> <p>4.2.14 <u>CREWMAN CONNECT TO LM ECS</u></p> <ol style="list-style-type: none"> <li>Unstow LM umbilical.</li> <li>Remove plugs from PGA &amp; stow.</li> <li>Connect O2 umbilical to PGA, inlet to inlet (blue to blue), outlet to outlet (red to red).</li> <li>SUIT ISOL vlv (LMP) - SUIT FLOW or SUIT ISOL vlv (CDR) - SUIT FLOW</li> <li>Request CSM shut off O2 flow in transfer umbilical.</li> <li>Verify O2 flow to PGA from LM ARS.</li> <li>Unstow LCG H2O umbilical.</li> </ol>	<p>For water separator speed control</p> <p>Assumption: Suit Fan Activation, Checkout, and Water Separator Check (para 4.2.13.5) has been completed.</p>

**LMA790-3-LM**  
**APOLLO OPERATIONS HANDBOOK**

CREW- MAN	PNL	PROCEDURES	REMARKS
		<p>LM 3215, LM 3222</p> <p>4.2.14 <u>CREWMAN CONNECT TO LM ECS (cont)</u></p> <p>8. Remove &amp; stow PGA/LCG plug</p> <p style="text-align: center;">CAUTION</p> <p>Do not connect LM LCG H20 umbilical to PGA if LCG accumulator bob was found to be bottomed during Initial Entry Status Check.</p> <p>9. Connect LCG H20 umbilical to PGA.</p> <p>4.2.15 <u>CREWMAN DISCONNECT TRANSFER UMBILICAL</u></p> <p>1. Disconnect transfer umbilical 02 connectors from PGA.</p> <p>2. Remove PGA plugs from 02 umbilical stowage &amp; insert in open PGA 02 receptacles.</p> <p>3. Release restraints from PGA.</p>	



**LMA790-3-LM**  
**APOLLO OPERATIONS HANDBOOK**

CREW- MAN	PNL	PROCEDURES	REMARKS
		<p>4.2.15 <u>CREWMAN DISCONNECT TRANSFER UMBILICAL (cont)</u></p>	
		<p>4. Return transfer umbilical to CSI.</p>	
		<p>5. Return to flight station &amp; attach restraints to PGA.</p>	
		<p>4.2.16 <u>ARS/PGA PRESSURE INTEGRITY CHECK</u></p>	
		<p style="text-align: center;">CAUTION</p>	
		<p>ARS/PGA Pressure Integrity Check should not be performed until at least 40 minutes after water sublimator activation. To prevent overheating suit circuit fan and/or breakthrough in HIS primary sublimator, ARS/PGA shall not be maintained at elevated pressure for more than 5 minutes.</p>	<p>ARS/PGA Pressure Integrity Check verifies that there are no gross leaks in ARS, PGA, or EMU or in any two or all three of these. Onboard instrumentation (ECS: SUIT PRESS ind and PGA pressure gage) is too coarse to determine exact leakage rates. If one crewman only is connected to ARS, verify other crewman's SUIT ISOL vlv - SUIT DISC.</p>
LMP	ECS	<p>1. SUIT GAS DIVERTER vlv - PULL EGRESS</p>	<p>Steps 1 and 2 should be performed in sequence. If they are reversed, suit fan may stall and water separator may slow down, causing: MASTER ALARM - on ECS caut lt - on SUIT FAN comp caut lt - on H2O SEP comp caut lt - on</p>
		<p>2. CABIN GAS RETURN vlv - EGRESS</p>	
		<p>3. SUIT CIRCUIT RELIEF vlv - CLOSE</p>	
	2	<p>4. O2/H2O QTY MON sel - DES 2</p>	<p>If ECS: O2 QUANTITY ind - &lt;30%, PRESS REG A vlv - DIRECT O2 to limit time to pressurize to 2 minutes. Both regulators should then be set to EGRESS in step 8.</p>
		<p>5. ECS: O2 QUANTITY ind - monitor</p>	<p>If ECS: O2 QUANTITY ind - &lt;17%, do not depressurize cabin.</p>
ECS		<p>6. PRESS REG A vlv - EGRESS</p>	<p>PRESS REG B vlv may be cycled between CABIN and DIRECT O2 to permit comfortable buildup of pressure.</p>
		<p>7. PRESS REG B vlv - DIRECT O2</p>	
PGA ECS		<p>8. When PGA cuff gage indicates 3.7 to 4.0 psig: PRESS REG B vlv - EGRESS</p>	

SUBSV  
ACT

**LMA790-3-LM**  
**APOLLO OPERATIONS HANDBOOK**

CREW-MAN	PNL	PROCEDURES	REMARKS
		4.2.16 <u>ARS/PGA PRESSURE INTEGRITY CHECK (cont)</u>	
	PGA	9. Monitor PGA cuff gage for 60 seconds; exercise suit joints during pressure decay period.	<p>If suit pressure decay is excessive, ARS/PGA pressure integrity is compromised:            SUIT CIRCUIT RELIEF vlv - AUTO            CABIN GAS RETURN vlv - AUTO            PRESS REC A vlv - EGRESS            PRESS REC B vlv - EGRESS</p> <p>When undocked:            PRESS REC A vlv - CABIN            PRESS REC B vlv - CABIN</p> <p>C02 comp cautions go on when C02 CANISTER SEL vlv - SEC. Pressure drop can be expected when switching between C02 canisters, due to volume change. If secondary C02 canister check is not required, omit steps 11 through 16.</p> <p>C02 comp cautions off when C02 CANISTER SEL vlv-PRIM.</p> <p>If integrity check has been performed for EVA, following ARS purge, SUIT CIRCUIT RELIEF vlv must be closed when ECS: SUIT PRESS ind - 5.5 psia. ARS pressure must be maintained above cabin pressure to preclude violating purge until cabin is depressurized to 3.5 psia, at which time SUIT CIRCUIT RELIEF vlv - AUTO.</p> <p>Returns suit circuit to approximate cabin pressure in 60 seconds. CS1 02 supply makeup is 5.0±0.2 psia. LM 02 supply makeup is 4.8±0.2 psia.</p> <p>Steps 19 and 20 are not required for EVA preparation.</p>
	ECS	10. Verify pressure decay <0.3 psig.	
	ECS	11. C02 CANISTER SEL vlv - SEC	
	PGA	12. ECS: PART PRESS C02 ind - decays to zero	
	PGA	13. If pressure falls below 3.7 psig, repeat steps 7 & 8.	
	PGA	14. Monitor PGA cuff gage for 60 seconds; exercise suit joints during decay period.	
	ECS	15. Verify pressure decay <0.3 psig.	
	ECS	16. C02 CANISTER SEL vlv - PRIM	
	ECS	17. SUIT CIRCUIT RELIEF vlv - AUTO	
2	ECS	18. ECS: SUIT PRESS ind - decays to cabin pressure	
LMP	ECS	19. CABIN GAS RETURN vlv - AUTO	
	ECS	20. SUIT GAS DIVERTER vlv - PUSH CABIN	

**LMA790-3-LM**  
**APOLLO OPERATIONS HANDBOOK**

CREW- MAN	PNL	PROCEDURES	REMARKS
		<p>4.2.16 <u>ARS/PGA PRESSURE INTEGRITY CHECK (cont)</u></p> <p>21. When LM pressure is regulated by CM or during EVA preparation: PRESS REG B vlv - EGRESS PRESS REG A vlv - EGRESS</p> <p>22. During mission phases other than CM O2 regulation or EVA preparation: PRESS REG B vlv - CABIN PRESS REG A vlv - CABIN</p> <p>23. CB ECS: CABIN FAN - open</p> <p>24. Perform final inspection of EMU; adjust PLSS straps as required.</p> <p>4.2.17 <u>VHF Activation &amp; Checkout</u></p> <p style="text-align: center;">CAUTION</p> <p>CB COMM: SE AUDIO must be closed to transmit on VHF A and/or operate DSEA. CB must be opened when LMP connects or disconnects LM comm cable &amp; COMM: TLM BIOMED sw - OFF or LEFT.</p> <p>CB COMM: CDR AUDIO must be closed to transmit voice on VHF B. CB must be opened when CDR connects or disconnects LM comm cable &amp; COMM: TLM BIOMED sw - OFF or RIGHT.</p>	<p>Steps 23 and 24 are required during EVA preparation (cabin depressurization and hatch opening).</p> <p>Assumptions: (1) Crewman is wearing PGA, (2) ECS Activation &amp; Checkout (para 4.2.13) has been completed, and (3) crewman is connected to LM ECS. Immediately after VHF activation and checkout, crewman should disconnect from transfer oxygen umbilical.</p>
CDR	11		
	12	<p>1. COMM: VHF A XMTR sw - VOICE VHF A RCVR sw - ON VHF B XMTR sw - DATA TLM PCH sw - LO</p>	VHF transceiver warmup is instantaneous.

SUBSY  
ACT

**LMA790-3-LM  
APOLLO OPERATIONS HANDBOOK**

CREW-MAN	PNL	PROCEDURES	REMARKS
		<p>4.2.17 <u>VHF Activation &amp; Checkout (cont)</u></p>	
LMP		<p>2. COMM ANT: VHF sel - FWD</p>	CSM select VHF ANT - SM LEFT
CDR		<p>3. Unstow LMP outboard armrest. or Unstow CDR inboard armrest.</p>	Ensure communications cable is not powered.  Do not adjust with CSM carrier present.
8/12		<p>4. AUDIO: VHF A sw - T/R ICS T/R sw - ICS T/R COMM: TLM BIOMED sw - OFF VHF A SQUELCH tv - noise + 1 div</p>	
12		<p>5. Verify CSM configured for VHF simplex A.</p>	
		<p>6. Request CSM remove transfer umbilical suit power.</p>	
		<p>7. When headset sounds cease, disconnect transfer umbilical comm cable from PGA &amp; connect LM comm cable to PGA.</p>	
LMP	16	<p>8. CB COMM: SE AUDIO - close or</p>	CB COMM: SE AUDIO and CB COMM: CDR AUDIO supplies power to respective crewman's communication carrier.
CDR	11	<p>CB COMM: CDR AUDIO - close</p>	
		<p>9. Perform VHF comm check with CSM, using PTT on ACA, and PTT/keyer on umbilical.</p>	
		<p>10. Request verification of CSM reception of LM LBR data, if desired.</p>	CSM verification of LM LBR data is as follows: CSM receives data via VHF B, data are recorded on DSE, and recorded data are dumped to MSFN, where they are re-recorded then played back. (CSM has no onboard verification capability.)
		<p>11. Perform intercom check.</p>	Audio volume, VOX sensitivity, and squelch controls should be adjusted, as required, for best results under mission conditions.
		<p>12. AUDIO: MODE sw - VOX</p>	
		<p>13. Perform comm check with CSM, using VOX.</p>	
8/12		<p>14. AUDIO: MODE sw - ICS/PTT.</p>	



# LMA790-3-LM APOLLO OPERATIONS HANDBOOK

CREW- MAN	PNL	PROCEDURES	REMARKS
		<p>4.2.18 <u>VHF B SIMPLEX CHECK</u></p> <p style="text-align: center;">CAUTION</p> <p>CB COMM: SE AUDIO must be closed to transmit on VHF A and/or operate DSEA. CB must be opened when LMP connects or disconnects LM comm cable &amp; COMM: TLM BIOMED sw - OFF or LEFT.</p> <p>CB COMM: CDR AUDIO must be closed to transmit voice on VHF B. CB must be opened when CDR connects or disconnects LM comm cable &amp; COMM: TLM BIOMED sw - OFF or RIGHT.</p>	
LMP	12	<p>1. Request CSM configure for VHF simplex A &amp; B.</p> <p>2. COMM: VHF B XMITR sw - VOICE VHF B RCVR sw - ON</p>	
CDR, LMP	8,12	<p>3. AUDIO: VHF A sw - OFF VHF B sw - T/R</p> <p>4. COMM: VHF B SQUELCH tw - noise + 1 div</p>	
CDR, LMP		<p>5. Perform comm check with CSM. (Identify channel as B.) Adjust volume controls as required.</p> <p>6. Request CSM return to VHF simplex A only.</p>	
CDR, LMP	8,12	<p>7. AUDIO: VHF A sw - T/R VHF B sw - OFF</p>	
LMP	12	<p>8. COMM: VHF B XMITR sw - DATA VHF B RCVR sw - OFF</p>	
CDR, LMP		<p>9. Perform comm check with CSM.</p>	

SUBS  
AC

**LMA790-3-LM**  
**APOLLO OPERATIONS HANDBOOK**

LM 3223

CREW-MAN	PNL	PROCEDURES	REMARKS
LMP	12	4.2.19 <u>S-BAND ACTIVATION &amp; CHECKOUT, USING OMNI ANTENNA</u>	Selection of antenna depends on vehicle attitude with respect to earth. Antenna selection to be determined by MSFN.
LMP	12	1. COMM ANT: S BAND sel - FWD or AFT	
CDR, LMP	8,12	2. AUDIO: S BAND T/R sw - S BAND T/R	
LMP	16	3. Verify CB COMM: PRIM S BD PWR AMPL - close	
LMP	12	4. COMM: S BAND XMTR/RCVR sw - SEC S BAND PWR AMPL sw - PRIM  S BAND VOICE sw - DN VOICE BU S BAND PCM sw - PCM TLM BIONED sw - OFF  TLM PCM sw - LO	S-band transceivers require 30-second warmup time. S-band power amplifiers require 60-second warmup and will lock up within that period. Recycle time for power amplifiers is 20 seconds from resumption of RF drive. Higher gain at lunar distance.  This switch, in either LEFT or RIGHT position, applies power to selected crewman's bioinstrumentation assembly. Power to this switch is supplied through CB COMM: PMP.  Only LBR telemetry data can be transmitted from S-band omni antennas at lunar distance.  SIGNAL STRENGTH ind is applicable as indication of uplink phase lock.
CDR, LMP		5. Perform S-band voice & data check with MSFN. Adjust volume and squelch controls as required.	
LMP	12	6. COMM: VHF B XMTR sw - OFF	CSM will deactivate LBR data recording.
LMP		7. Inform CSM of VHF B data transmission deactivation.	This procedure points S-band steerable antenna at earth center and verifies lock-on.
LMP		4.2.20 <u>S-BAND STEERABLE ANTENNA ACTIVATION AND CHECKOUT</u>	Assumption: MSFN is receiving telemetered ICPU angles in sufficient time to permit MSFN computation of S-band steerable antenna gimbal angles, if necessary (earth orbit only).  Steerable antenna position indicators should be used for gross position indications and direction of antenna movement only.

**LMA790-3-LM**  
**APOLLO OPERATIONS HANDBOOK**

CREW-MAN	PNL	PROCEDURES	REMARKS
		<p>4.2.20 <u>S-BAND STERILIZABLE ANTENNA ACTIVATION AND CHECKOUT (cont)</u></p> <p>LGC Power-Up (required)</p> <p>LGC Self-Test (desired)</p> <p>IMU Power-Up (LGC Operating) (required)</p> <p>IMU Orientation Determination Program (P51) (required)</p> <p>DAP Data Load Routine (R03) (required)</p>	<p>Ref para 4.6.1.1.</p> <p>Ref para 4.6.1.13.</p> <p>Ref para 4.6.1.3</p> <p>Ref para 4.9.1.1.</p> <p>Ref para 4.6.1.8 (recommend <math>\pm 5^\circ</math> deadband).</p> <p>Ref para 4.5.1.3.</p>
CDR	1 3	<p>1. Establish PCNCS attitude hold/rate command mode: GUID CONT sw - PCNS S/C: PCNS sw - ATT HOLD PITCH, ROLL, &amp; YAW sw - MDDE CONT</p>	<p>Ref para 4.13.2.1. COMM ANT: S BAND sel setting depends on LM attitude with respect to earth.</p>
LMP	12	<p>2. Controls - Communications Basic, except: COMM ANT: S BAND sel - FWD or AFT COMM: S BAND VOICE sw - DN VOICE BU TLM PCM sw - LO TLM BIOMED sw - LEFT or RIGHT</p> <p>3. Perform S-band voice &amp; LBR data check with MSFN.</p> <p>4. COMM: S BAND FWR AMPL sw - OFF TLM BIOMED sw - OFF</p> <p>5. Perform S-band voice &amp; LBR data check with MSFN.</p> <p>6. Perform S-Band Antenna Routine (R05) &amp; omit steps 7 &amp; 8. If R05 cannot be called at this time, perform steps 7 through 10.</p>	<p>Ref para 4.13.2.7.</p> <p>Ref para 4.6.1.30.</p>

SUBS  
ACT

**LMA790-3-LM**  
**APOLLO OPERATIONS HANDBOOK**

CREW- MAN	PNI	PROCEDURES	REMARKS
		<p>4.2.20 <u>S-BAND STEERABLE ANTENNA ACTIVATION AND CHECKOUT (cont)</u></p> <p>7. Display ICDU angles &amp; transmit to MSFN: Key V16 N20E R1 OGA XXX.XX° R2 IGA XXX.XX° R3 MGA XXX.XX° Key KEY REL</p> <p>8. Request MSFN transmit S-band steerable antenna pitch &amp; yaw gimbal angles required to point antenna at earth center.</p> <p>9. CB/AC BUS B: S BD ANT - close CB COM1: S BD ANT - close</p> <p>10. Initial activation: Communications Basic, except: COMM ANT: PITCH cont - -75° YAW cont - -12° TRACK MODE sw - SLEW (wait 30 sec)</p> <p style="text-align: center;">NOTE</p> <p>To ensure main-lobe acquisition, signal strength indication of &gt;3 is required without peaking COMM ANT: PITCH &amp; YAW cont.</p>	<p>MSFN uses N20 ICDU angles to compute pitch and yaw gimbal angles. Computation may take up to 15 minutes. Deadband of +0.3° is assumed to be acceptable for acquisition period when LM is undocked. When LM and CSM are docked, deadband for LM-CSM is assumed acceptable at +0.5°. Return to deadband of +5° after acquisition. (Ref para 4.6.1.8.)</p> <p>Assumption: There is no change in vehicle inertial attitude after step 8.</p> <p>Tests/analysis indicate that antenna track may be achieved at beam angles up to 16.5° from bore-sight at lunar range, using 30-foot MSFN dish (worst case). This angle corresponds to 3 volts on SIGNAL STRENGTH ind.</p> <p>Antenna shall not be permitted to drive into gimbal stops in either automatic or manual track mode. In automatic track mode, antenna will drive into gimbal stops if up-link signal is interrupted by vehicle maneuvering, orbit behind moon, or ground equipment failure. Condition may also exist in automatic track mode when antenna, in trying to accommodate changes in vehicle attitude, reaches gimbal stop. (This condition is not anticipated.) If any of above occurs, COMM ANT: TRACK MODE sw must be set to OFF and communications resumed via omni antennas. Steerable antenna shall remain in off mode for 10 minutes before reactivating, to permit cooldown.</p>
	11 16		
LMP	12		

**LMA790-3-LM**  
**APOLLO OPERATIONS HANDBOOK**

SUBS  
ACT

CREW MAN	PNL	PROCEDURES	REMARKS
		<p>4.2.20 <u>S-BAND STEERABLE ANTENNA ACTIVATION AND CHECKOUT (cont)</u></p> <p style="margin-left: 40px;">PITCH cont - _____ (ccw)            YAW cont - _____ (ccw)            S BAND sel - SLEW            SIGNAL STRENGTH ind - &gt;3            TRACK MODE sw - AUTO            SIGNAL STRENGTH ind - approx ≥4.0</p> <p style="text-align: center;">NOTE</p> <p style="margin-left: 40px;">To ensure main-lobe acquisition, verify increase in SIGNAL STRENGTH ind reading before proceeding with comm check.</p> <p>COMM:            S BAND VOICE sw - VOICE            TLM PCM sw - HI            TLM BIONED sw - as required</p> <p>11. Perform S-band voice &amp; HBR data check with MSFN.</p> <p>12. COMM:            S BAND VOICE sw - DN VOICE BU            TLM PCM sw - LO            TLM BIONED sw - as required</p> <p>13. Perform S-band voice &amp; LBR data check with MSFN.</p>	<p>Operation at stops for periods in excess of 3 minutes may result in degraded reliability or failure due to possible overheating. Caution and warning temperature sensor is not expected to react rapidly enough to reflect this thermal transient condition.</p> <p>If uplink signal is interrupted during station handover, depending on length of interruption, antenna may drive to a stop. To prevent this, precautions should be taken against losing carrier during handover.</p> <p>Computed angles from MSFN.</p>

**LMA790-3-LM**  
**APOLLO OPERATIONS HANDBOOK**

CREW- MAN	PNL	PROCEDURES	REMARKS
		<p>4.2.20 <u>S-BAND STEERABLE ANTENNA ACTIVATION AND CHECKOUT (cont)</u></p> <p>14. Acquisition procedure for lunar orbit:            COMM ANT:            PITCH cont - _____ (ccw)            YAW cont - _____ (ccw)            S BAND sel - SLEW            SIGNAL STRENGTH ind - &gt;3.0            TRACK MODE sw - AUTO            SIGNAL STRENGTH ind - approx &gt;4.0</p> <p>15. Before MSPN LOS:            COMM ANT:            PITCH cont - +90°            YAW cont - 0°            COMM:            TLM BIONED sw - OFF            TLM PCM sw - LO            S BAND VOICE sw - DN VOICE BU            COMM ANT:            TRACK MODE sw - OFF            S BAND sel - AFT or FWD            TRACK MODE sw - SLEW            PITCH cont - _____ (ccw)            YAW cont - _____ (ccw)</p> <p>16. When comm check complete:            COMM ANT:            PITCH cont - +90°            YAW cont - 0°            TRACK MODE sw - SLEW, then OFF when antenna reaches assigned position            When MSPN LOS:            COMM ANT:            PITCH cont - +90°            YAW cont - 0°            TRACK MODE sw - SLEW            S BAND sel - FWD or AFT</p>	<p>Previously computed angles from MSPN. If uplink signal is interrupted during station handover, depending on length of interruption, antenna may drive to a stop. To prevent this, precautions should be taken against losing carrier during handover.</p> <p>Computed angles from MSPN.</p>

LMA790-3-LM  
 APOLLO OPERATIONS HANDBOOK

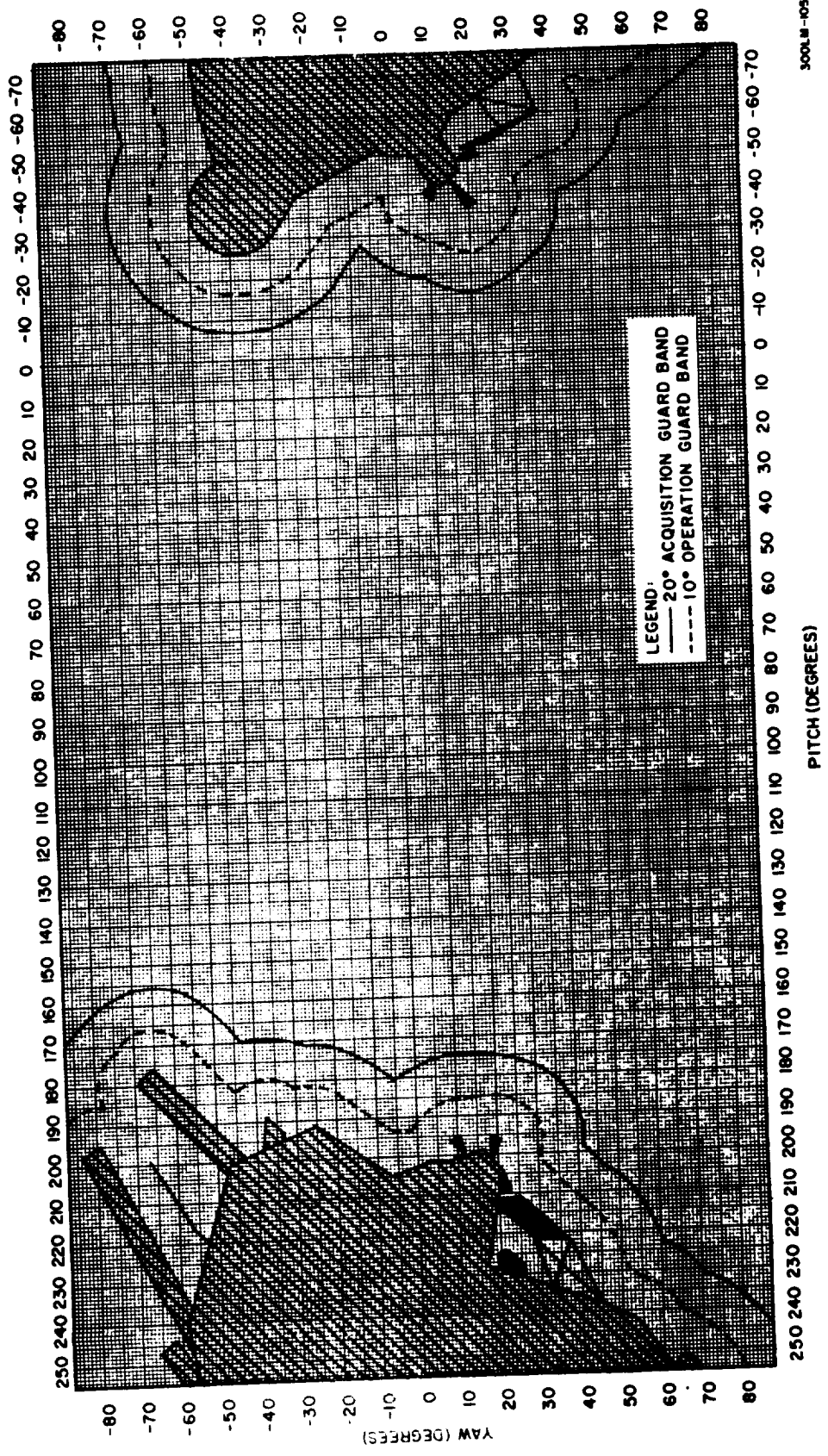

Figure 4-7. S-Band Steerable Antenna Vehicle Blockage Diagram (Relative to RF Boresight)

**LMA790-3-LM**  
**APOLLO OPERATIONS HANDBOOK**

CREW- MAN	PNL	PROCEDURES	REMARKS
		<p>4.2.21 <u>LOW-POWER S-BAND BACKUP VOICE, LBR CHECK WITH STEERABLE ANTENNA</u></p> <p>LGC Power-Up (required)</p> <p>LGC Self-test (desired)</p> <p>DIU Power-Up (LGC Operating) (required)</p> <p>DIU Orientation Determination Program (P51) (required)</p> <p>DAP Data Load Routine (R03) (required)</p> <p>1. Establish PCNCS attitude hold/rate command mode GUID CONT sw - PCNS S/C: PCNS sw - ATT HOLD PITCH, ROLL, &amp; YAW sw - MODE CONT</p> <p>2. Controls - Communications Basic except: COMM ANT: S BAND sel - FWD or APT COMM: S BAND PWR AMPL sw - OFF S BAND VOICE sw - DN VOICE BU TLH PCM sw - LO TLH BIONED sw - OFF</p> <p>3. Perform S-band voice &amp; LBR data check with MSFN.</p> <p>4. Perform S-Band Antenna Routine (R05) &amp; skip steps 5 &amp; 6. If R05 cannot be called at this time, perform steps 5 through 10.</p> <p>5. Display ICPU angles &amp; transmit to MSFN: Key V16 N20E R1 OGA XXX.XX* R2 IGA XXX.XX* R3 MGA XXX.XX* Key KEY REL</p>	<p>This procedure points S-band steerable antenna at earth center and verifies lock-on.</p> <p>Assumption: MSFN is receiving telemetered ICPU angles in sufficient time to permit MSFN computation of S-band steerable antenna gimbal angles, if necessary (earth orbit only).</p> <p>Ref para 4.6.1.1.</p> <p>Ref para 4.6.1.13.</p> <p>Ref para 4.6.1.3.</p> <p>Ref para 4.9.1.1.</p> <p>Ref para 4.6.1.8 (recommended <math>\pm 5^\circ</math> deadband).</p> <p>Ref para 4.5.1.3.</p> <p>Ref para 4.13.2.1.</p> <p>COMM ANT: S-BAND sel setting depends on LM attitude with respect to earth.</p> <p>Ref para 4.13.2.7.</p> <p>Ref para 4.6.1.30.</p> <p>MSFN uses N20 ICPU angles to compute pitch and yaw gimbal angles. Computation may take up to 15 minutes. Deadband of <math>\pm 0.3^\circ</math> is assumed to be acceptable for acquisition period when LJI is undocked. When LM and CSM are docked, deadband for LM-CSM is assumed acceptable at <math>\pm 0.5^\circ</math>. Return to deadband of <math>\pm 5^\circ</math> after acquisition. (Ref para 4.6.1.8.)</p>
CDR	1 3		
LMP	12		
CDR	4		



**LMA790-3-LM**  
**APOLLO OPERATIONS HANDBOOK**

CREW MAN	PNL	PROCEDURES	REMARKS
LMP	12	<p>4.2.21 <u>LOW-POWER S-BAND BACKUP VOICE, LBR CHECK WITH STEERABLE ANTENNA (cont)</u></p> <p>6. Request MSFN transmit S-band steerable antenna pitch &amp; yaw gimbal angles required to point antenna at earth center.</p> <p>7. <span style="margin-left: 100px;">NOTE</span></p> <p style="margin-left: 40px;">To ensure main lobe acquisition, signal strength indication of &gt;3 is required without peaking COM ANT: PITCH &amp; YAW cont.</p> <p>COM ANT:            PITCH cont - _____ (ccw)            YAW cont - _____ (ccw)            S BAND sel - SLEW            SIGNAL STRENGTH ind - &gt;3            TRACK MODE sw - AUTO            SIGNAL STRENGTH ind - approx &gt;4.0</p> <p style="margin-left: 100px;">NOTE</p> <p style="margin-left: 40px;">To ensure main lobe acquisition, verify increase in SIGNAL STRENGTH ind reading before proceeding with comm check.</p> <p>COM:            S BAND VOICE sw - VOICE            TLM PCM sw - HI            TLM BIOMED sw - as required</p> <p>8. COM ANT:            SIGNAL STRENGTH ind - &gt;3.0</p> <p style="margin-left: 100px;">NOTE</p> <p style="margin-left: 40px;">To ensure main-lobe acquisition, &gt;3.0 indication is obtained without peaking COM ANT: PITCH &amp; YAW cont.</p>	<p>Assumption: There is no change in vehicle inertial attitude after step 5.</p> <p>Computed angles from MSFN set in at previous LOS.</p>

SUBS  
ACT

# LMA790-3-LM APOLLO OPERATIONS HANDBOOK

CREW- MAN	PNI	PROCEDURES	REMARKS
		<p>4.2.21 <u>LOW-POWER S-BAND BACKUP VOICE, LBR CHECK WITH STEERABLE ANTENNA (cont)</u></p> <p>TRACK MODE sw - AUTO</p> <p style="margin-left: 40px;">SIGNAL STRENGTH ind - approx <math>&gt;4.0</math></p> <p style="margin-left: 40px;">COMM: S BAND VOICE sw - DN VOICE BU TLM PCI sw - LO</p> <p>9. Perform S-band voice &amp; HBR data check with MSFN.</p> <p>10. When comm check complete: COMM ANT: PITCH cont - +90° YAW cont - 0° TRACK MODE sw - SLEW, then OFF when antenna reaches assigned position When MSFN LOS: COMM ANT: PITCH cont - +90° YAW cont - 0° TRACK MODE sw - SLEW S BAND sel - FWD or AFT</p>	<p>Antenna shall not be permitted to drive into gimbal stops in either automatic or manual track mode. In automatic track mode, antenna will drive into gimbal stops if uplink signal is interrupted by vehicle maneuvering, orbit behind moon, or ground equipment failure. Condition may also exist in automatic track mode when antenna, in trying to accommodate changes in vehicle attitude, reaches gimbal stop. (This condition is not anticipated.) If any of above occurs, COMM ANT: TRACK MODE sw must be set to OFF and communications resumed via omni antennas. Steerable antenna shall remain in off mode for 10 minutes before reactivating, to permit cooldown.</p> <p>Operation at stops for periods in excess of 3 minutes may result in degraded reliability or failure due to possible overheating. Caution and warning temperature sensor is not expected to react rapidly enough to reflect this thermal transient condition.</p> <p>If uplink signal is interrupted during station handover, depending on length of interruption, antenna may drive to a stop. To prevent this, precautions should be taken against losing carrier during handover.</p>

**LMA790-3-LM**  
**APOLLO OPERATIONS HANDBOOK**

CREW- MAN	PNI	PROCEDURES	REMARKS
		<p>4.2.22 <u>S-BAND RANGING, VOICE, AND TELEMETRY CHECK</u></p> <p>S-Band Steerable Antenna Activation and Checkout</p> <p>1.           COMM:  S BAND XMTR/RCVR sw - SEC  S BAND PWR AMPL sw - PRIM  S BAND VOICE sw - VOICE  S BAND PCM sw - PCM  S BAND RANGE sw - RANGE  TLM BIOMED sw - LEFT or RIGHT  TLM PCM sw - HI</p> <p>2.           Verify ranging, voice, &amp; telemetry check.</p> <p>3.           When directed by MSFN:  COMM: S BAND RANGE sw - OFF/RESET</p> <p>4.2.23 <u>S-BAND FM CHECK</u></p> <p>S-Band Steerable Antenna Activation and Checkout</p> <p>1.           COMM:  S BAND MODULATE sw - FM  S BAND XMTR/RCVR sw - SEC  S BAND PWR AMPL sw - PRIM  S BAND VOICE sw - VOICE  S BAND PCM sw - PCM  TLM PCM sw - HI</p> <p>2.           Perform S-band voice &amp; HBR data check with MSFN.</p> <p>3.           COMM: S BAND MODULATE sw - FM</p> <p>4.           Perform S-band voice &amp; HBR data check with MSFN.</p>	<p>Ranging check is performed at MSFN direction. Check consists of transmission of PRN range code from MSFN and receipt of turnaround signal.</p> <p>Ref para 4.2.20.</p> <p>If MSFN does not transmit 30-kc subcarrier to LM during ranging, LM must set AUDIO: S BAND T/R sw (2) to OFF. (This is only necessary when COMM: UP LINK SQUELCH sw - OFF.)</p> <p>This switch, in either LEFT or RIGHT position, applies power to selected crewman's bioinstrumentation assembly. Power to this switch is supplied through CB COMM: PMP. SIGNAL STRENGTH ind is applicable as indication of uplink phaselock.</p> <p>Ref para 4.2.20.</p> <p>S-band transceiver warmup time is 5 seconds after change of modulation.</p>
LM 3223			

SUBS  
ACT

**LMA790-3-LM  
APOLLO OPERATIONS HANDBOOK**

LM 3223

CREW- MAN	PNI	PROCEDURES	REMARKS
		<p>4.2.24 <u>SECONDARY MODE S-BAND TRANSCIEVER &amp; POWER AMPLIFIER CHECK</u></p> <p>S-Band Steerable Antenna Activation and Checkout</p>	<p>Ref para 4.2.20.</p>
CDR	11	<p>1. Verify: CB COMM: SEC S BD XMTR/RCVR - close SEC S BD PWR AMPL - close</p>	
LMP	16	<p>2. Verify: CB COMM: PRIM S BD PWR AMPL - close PRIM S BD XMTR/RCVR - close</p>	
	12	<p>3. COMM: S BAND XMTR/RCVR sw - PRIM S BAND VOICE sw - VOICE</p>	<p>S-band transceivers require 30-second warmup time.</p>
		<p>4. Perform S-band voice &amp; HBR data check with MSFN.</p>	<p>S-band power amplifiers require 60-second warmup and will lock up within that period. Recycle time for power amplifiers is 20 seconds from resumption of RF drive.</p>
		<p>5. COMM: S BAND PWR AMPL sw - SEC</p>	<p>MSFN verifies power increase with power amplifier in operation.</p>
		<p>6. Perform S-band voice &amp; HBR data check with MSFN.</p>	
		<p>7. COMM: S BAND XMTR/RCVR sw - SEC S BAND PWR AMPL sw - PRIM</p>	
		<p>8. COMM: TLM PCM sw - HI</p>	
		<p>9. Perform S-band voice &amp; HBR data check with MSFN.</p>	

**LMA790-3-LM  
APOLLO OPERATIONS HANDBOOK**

CREW-MAN	PNL	PROCEDURES	REMARKS
		<p align="center"><u>4.2.25 S-BAND BACKUP VOICE &amp; KEYING CHECK</u></p> <p>1. COMM: S BAND MODULATE sw - PM S BAND PWR AMPL sw - PRIM S BAND VOICE sw - DN VOICE BU S BAND PCH sw - OFF ILM BIOMED sw - OFF COMM ANT: S BAND sel - FWD or AFT</p> <p>2. Perform S-band voice check with MSFN.</p> <p>3. COMM: S BAND PWR AMPL sw - OFF S BAND PCH sw - KEY</p> <p>4. CB COMM: PMP - open</p> <p>5. Perform code check with MSFN, using PTT/keyer on umbilical. Request (via code) that MSFN verify, on up voice, that code is received.</p> <p>6. CB COMM: PMP - close</p> <p>7. Perform S-band Steerable Antenna Activation and Checkout</p> <p align="center"><u>4.2.26 ASCENT BATTERY ACTIVATION &amp; CHECKOUT</u></p> <p>1. CB EPS: ASC ECA CONT - close ASC ECA - close</p> <p>2. CB EPS: ASC ECA - close ASC ECA CONT - close</p>	<p>Hot mike condition exists on S-band when operating in S-band backup voice mode.</p> <p>If COMM: S BAND MODULATE sw - FM and COMM: S BAND VOICE sw - DN VOICE BU, PMP automatically switches to PM mode. If FM mode is desired for normal voice operations after backup voice check, and COMM: S BAND MODULATE sw has been left in FM position, switch must be cycled through PM and back to FM to reset transmitter modulator.</p> <p>All down voice and PCM transmission capability is lost. CW (key) signal transmission capability exists only when CB COMM: PMP - open.</p> <p>Ref para 4.2.20.</p> <p>Load of 40 amperes should be on line before performing this task.</p>

LM 3237A

Basic Date 26 September 1971

Change Date \_\_\_\_\_

Page 4.2-45

SUBSYS  
ACT

**LMA790-3-LM  
APOLLO OPERATIONS HANDBOOK**

LM 3203, LM 3237A

CREW MAN	PNL	PROCEDURES	REMARKS
		<p>4.2.26 ASCENT BATTERY ACTIVATION &amp; CHECKOUT (cont)</p> <p align="center">CAUTION</p> <p>Verify that high-voltage tap of descent batteries has been selected before placing ascent batteries on line.</p> <p>3. Check Lunar battery and place both ascent batteries on line: EPS: POWER/TEMP MON sel - LUNAR BAT VOLTS ind - 37.0 to 37.2 vdc AMPS ind - 0 amp LMP LUNAR BAT sw - OFF/RESET; tb - bp, then ON; tb - LMP POWER/TEMP MON sel - LUNAR BAT VOLTS ind - 28.0 to 32.5 vdc AMPS ind - TBD LMP LUNAR BAT sw - OFF/RESET; tb - bp POWER/TEMP MON sel - BAT 5 VOLTS ind - 37.0 to 37.2 vdc AMPS ind - 0 amp BAT 5 NORMAL LMP FEED sw - ON; tb - gray VOLTS ind - 28.0 to 32.5 vdc AMPS ind - TBD LMP BAT 1 HI V sw - OFF/RESET; tb - bp CDR LUNAR BAT sw - OFF/RESET; tb - bp, then ON; tb - CDR POWER/TEMP MON sel - LUNAR BAT VOLTS ind - 28.0 to 32.5 vdc AMPS ind - TBD CDR LUNAR BAT sw - OFF/RESET; tb - bp POWER/TEMP MON sel - BAT 6 VOLTS ind - 37.0 to 37.2 vdc AMPS ind - 0 amp BAT 6 NORMAL CDR FEED sw - ON; tb - gray VOLTS ind - 28.0 to 32.5 vdc AMPS ind - TBD CDR BAT 4 HI V sw - OFF/RESET; tb - bp PWR/TEMP MON sel - Lmp bus, then CDR bus VOLTS ind - 26.5 to 32.5 vdc</p>	<p>Due to reverse current, BATTERY cautions may go on when ascent and descent batteries are paralleled. This is not to be regarded as malfunction symptom unless light remains on longer than approximately 15 seconds.</p>

**LMA790-3-LM**  
**APOLLO OPERATIONS HANDBOOK**

CREW-MAN	PNL	PROCEDURES	REMARKS
		<p>LM 3203, LM 3237A</p> <p>4.2.26 <u>ASCENT BATTERY ACTIVATION &amp; CHECKOUT (cont)</u></p> <p style="text-align: center;">CAUTION</p> <p>To avoid transients, remove descent batteries, one at a time, from line at intervals of no less than 3 sec.</p> <p>4. Check backup feed path from both ascent batteries: EPS: BAT 5 BACK UP CDR FEED sw - ON; tb - gray BAT 6 BACK UP LMP FEED sw - ON; tb - gray BAT 5 NORMAL LMP FEED sw - OFF/RESET; tb - bp BAT 6 NORMAL CDR FEED sw - OFF/RESET; tb - bp POWER/TEMP MDN sel - CDR BUS then LMP bus VOLTS ind - 26.5 to 32.5 vdc</p> <p>5. Place all four descent batteries on line: EPS: LMP BAT 1 HI VOLT &amp; 2 sw - ON; tb - gray CDR BAT 3 &amp; 4 HI VOLT sw - ON; tb - gray POWER/TEMP MDN sel - BAT 1 AMPS ind - TBD Repeat for BAT 2, BAT 3 &amp; BAT 4</p> <p>6. Remove both ascent batteries from line: EPS: BAT 5 BACK UP CDR FEED sw - OFF/RESET; tb - bp BAT 6 BACK UP SE FEED sw - OFF/RESET; tb - bp</p>	<p style="text-align: center;">•</p> <p>Ascent battery will be placed on line for minimum of 5 minutes or until battery current is stabilized, to check load-carrying capability if open-circuit voltage &lt; 32 vdc.</p> <p>To obtain proper current measurements when monitoring descent battery, divide indicator reading by 2.</p> <p>Electrical Power Subsystem is now in normal descent battery configuration.</p>

SUBSV  
ACT

**LMA790-3-LM**  
**APOLLO OPERATIONS HANDBOOK**

LM 3237A

CREW-MAN	P/NL	PROCEDURES	REMARKS
		4.2.26 <u>ASCENT BATTERY ACTIVATION &amp; CHECKOUT (cont)</u>	
16		7. CB EPS: ASC ECA CONT - open	
CDR	11	8. CB EPS: ASC ECA CONT - open	
		4.2.27 <u>APS TEMP/PRESS PREPRESSURIZATION CHECK</u>	
		1. HELIUM MDN sel - PRESS 1 MPS: HELIUM ind - 2800 to 3500 psia	Assumption: Circuit Breaker Activation (para 4.2.4) is completed. Procedure is performed before lunar launch.
		2. HELIUM MDN sel - PRESS 2 MPS: HELIUM ind - 2800 to 3500 psia	Ascent helium tank pressure values as a function of time remain approximately the same as initial tank loading conditions. For expected tank pressure as function of tank temperature and initial loading conditions, see figure 4-8.
		3. PRPLNT TEMP/PRESS MDN sw - ASC MPS: FUEL TEMP ind - 50° to 90° F OXID TEMP ind - 50° to 90° F FUEL PRESS ind - 108 to 172 psia OXID PRESS ind - 71 to 143 psia	



**LMA790-3-LM**  
**APOLLO OPERATIONS HANDBOOK**

CREW MAN	PNL	PROCEDURES	REMARKS
CDR	1	<p>4.2.28 <u>DPS TEMP/PRESS PREPRESSURIZATION CHECK</u></p> <p>1. HELIUM MON sel - AMB PRESS MPS: HELIUM ind - 1490 to 1750 psia</p> <p>2. HELIUM MON sel - SUPCRIT PRESS MPS: HELIUM ind - 750 to 1320 psia</p> <p>3. HELIUM MON sel - AMB PRESS</p> <p>4. PRPLNT TEMP/PRESS MON sw - DES 2 MPS: FUEL TEMP ind - 50° to 75° F OXID TEMP ind - 50° to 75° F FUEL PRESS ind - 70 to 122 psia OXID PRESS ind - 41 to 78 psia</p> <p>5. PRPLNT TEMP/PRESS MON sw - DES 1 MPS: FUEL TEMP ind - 50° to 75° F OXID TEMP ind - 50° to 75° F FUEL PRESS ind - 70 to 122 psia OXID PRESS ind - 41 to 78 psia</p> <p>6. PRPLNT QTY MON sw - DES 1 MPS: FUEL QUANTITY ind - 95% or less OXID QUANTITY ind - 95% or less Verify readings are within 0.5% of telemetry values.</p> <p>7. PRPLNT QTY MON sw - DES 2 Repeat procedure of step 6.</p> <p>8. PRPLNT QTY MON sw - OFF</p>	<p>Assumption: Circuit Breaker Activation (para 4.2.4) is completed.</p> <p>This pressure range represents minimum-to-maximum descent ambient helium bottle pressures before pressurization, as function of helium temperature and loading mass. For other bottle pressure values, see figure 4-9.</p> <p>This pressure range is based on supercritical helium loading temperature of -453°F and mass of 48 pounds at 120 psia. Specific pressure before pressurization is function of total elapsed time from tank loading to pressurization, multiplied by expected pressure rise (6 to 10 psia/hr.) For other tank pressures, see figure 4-10. The supercritical helium tank burst-disk rupture pressure is 1881 to 1967 psia.</p> <p>Due to increased DPS propellant loading, and therefore decreased ullage space, DPS regulator can be damaged during pressurization if FUEL or OXID TEMP ind - &gt;75°F.</p> <p>Due to increased DPS propellant loading, and therefore decreased ullage space, DPS regulator can be damaged during pressurization if FUEL or OXID TEMP ind - &gt;75°F.</p> <p>Exact values cannot be predetermined due to propellant sloshing under zero g.</p>

SUBSYS  
ACT

**LMA790-3-LM**  
**APOLLO OPERATIONS HANDBOOK**

CREW-MAN	PNL	PROCEDURES	REMARKS
		<p>4.2.28 <u>DPS TEMP/PRESS PREPRESSURIZATION CHECK (cont)</u></p> <p>9. PRPLNT TEMP/PRESS MON sw - DES 1</p> <p>10. DES He REG 1 tb - gray DES He REG 2 tb - bp</p> <p>4.2.29 <u>DPS PRESSURIZATION &amp; CHECKOUT</u></p> <p>1. ED: MASTER ARM sw - ON DES PRPLNT ISOL VLV sw - FIRE DES START He PRESS sw - FIRE MASTER ARM sw - OFF</p> <p>2. HELIUM MON sel - AMB PRESS MPS: HELIUM ind - 200 to 1100 psia</p> <p>3. HELIUM MON sel - SUPCRIT PRESS MPS: HELIUM ind - 750 to 1320 psia</p> <p>4. PRPLNT TEMP/PRESS MON sw - DES 1 MPS: FUEL TEMP ind - 50° to 90° F OXID TEMP ind - 50° to 90° F FUEL PRESS ind - 200 to 250 psia OXID PRESS ind - 200 to 250 psia</p> <p>5. PRPLNT TEMP/PRESS MON sw - DES 2 MPS: FUEL TEMP ind - 50° to 90° F OXID TEMP ind - 50° to 90° F FUEL PRESS ind - 200 to 250 psia OXID PRESS ind - 200 to 250 psia</p> <p>6. PRPLNT TEMP/PRESS MON sw - DES 1</p>	<p>DES He REG latching valve is open when tb - gray. DES He REG latching valve is closed when tb - bp.</p> <p>Assumption: Prepressurization check of DPS and APS has been performed at appropriate time in mission.</p> <p>Possible MASTER ALARM - on when ED: MASTER ARM sw - OFF, due to relay race removing CMEA inhibit.</p> <p>Following values apply to pressure relief valve assembly: Burst-disk rupture pressure - 260 to 275 psia Reset pressure - 254 psia Relief valve cracking pressure - 260 psia Below 40°F, engine operation is rough. Above 100°F, oxidizer decomposes, driving oxidizer-fuel ratio out of tolerance. Engine will not operate with smooth and efficient combustion with <math>\Delta T P/O &gt; 10^\circ F</math>. Due to increased DPS propellant loading, and therefore decreased ullage space, DPS regulator can be damaged during pressurization if FUEL or OXID TEMP ind - <math>&gt; 75^\circ F</math>.</p> <p>Due to increased DPS propellant loading, and therefore decreased ullage space, DPS regulator can be damaged during pressurization if FUEL or OXID TEMP ind - <math>&gt; 75^\circ F</math>.</p>

LMA790-3-LM  
APOLLO OPERATIONS HANDBOOK

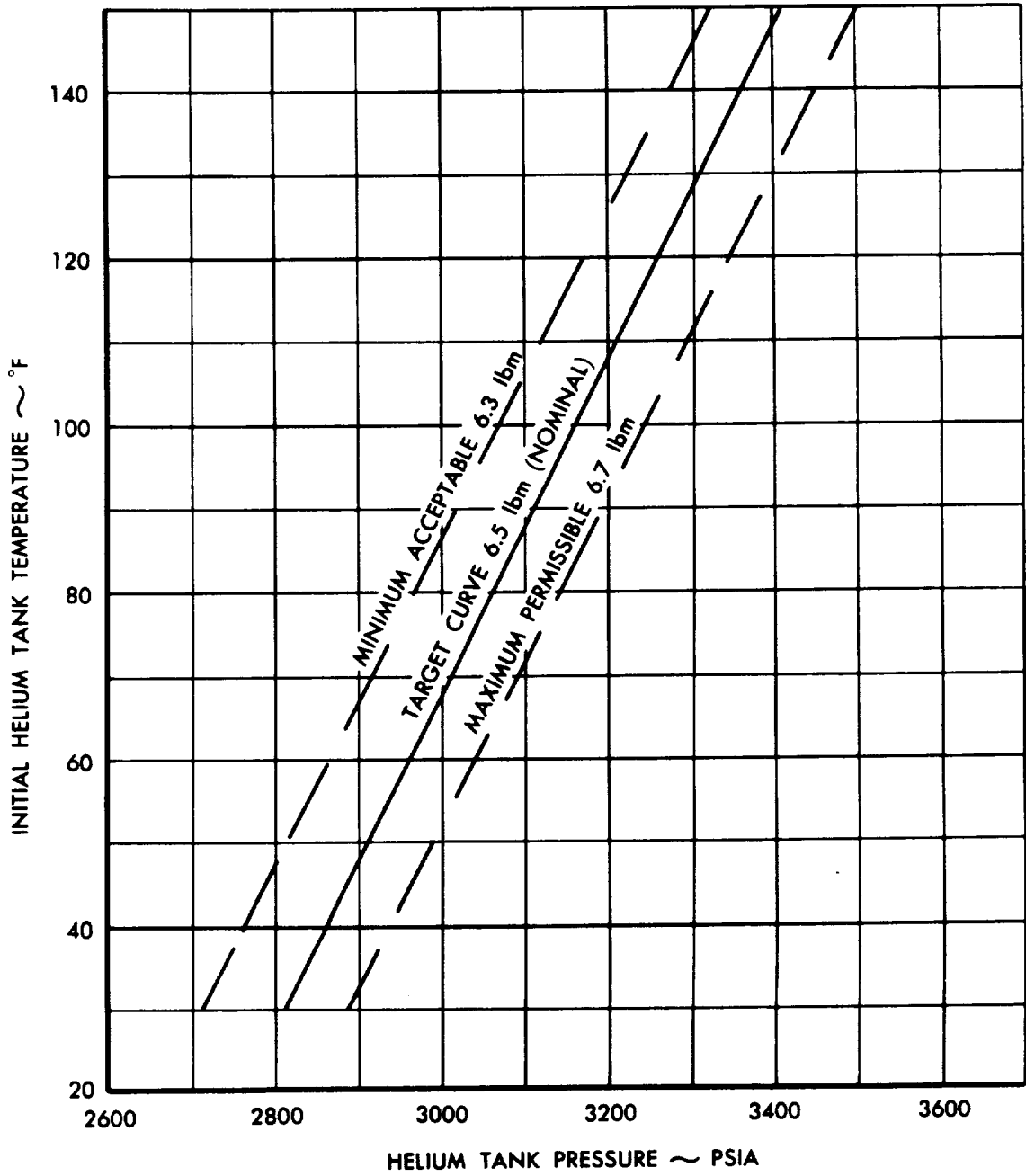

300LM4-557

Figure 4-8. Ascent Helium Loading

LMA790-3-LM  
 APOLLO OPERATIONS HANDBOOK

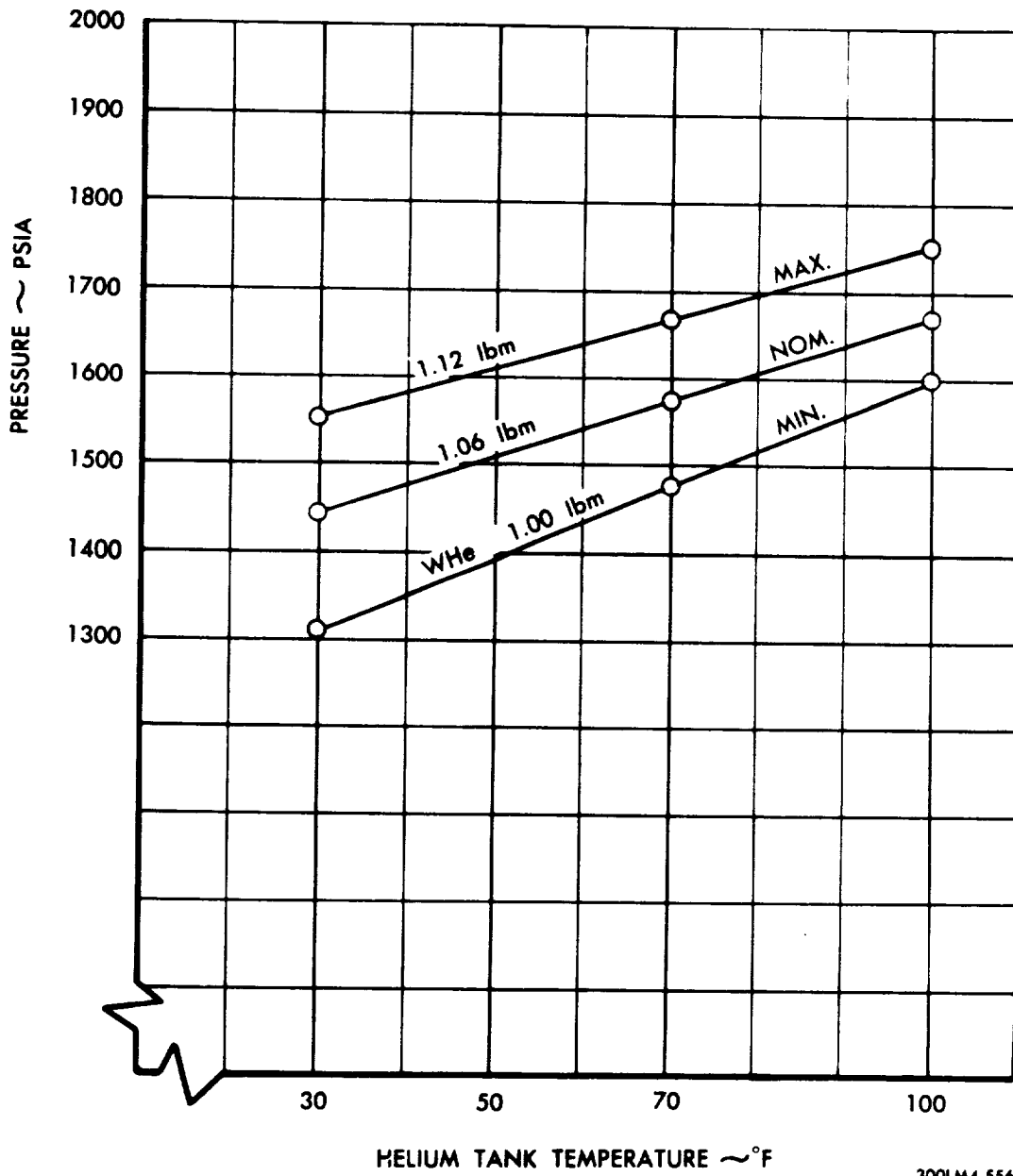

300LM4-556

Figure 4-9. Descent Ambient Helium Bottle Loading

LMA790-3-LM  
 APOLLO OPERATIONS HANDBOOK

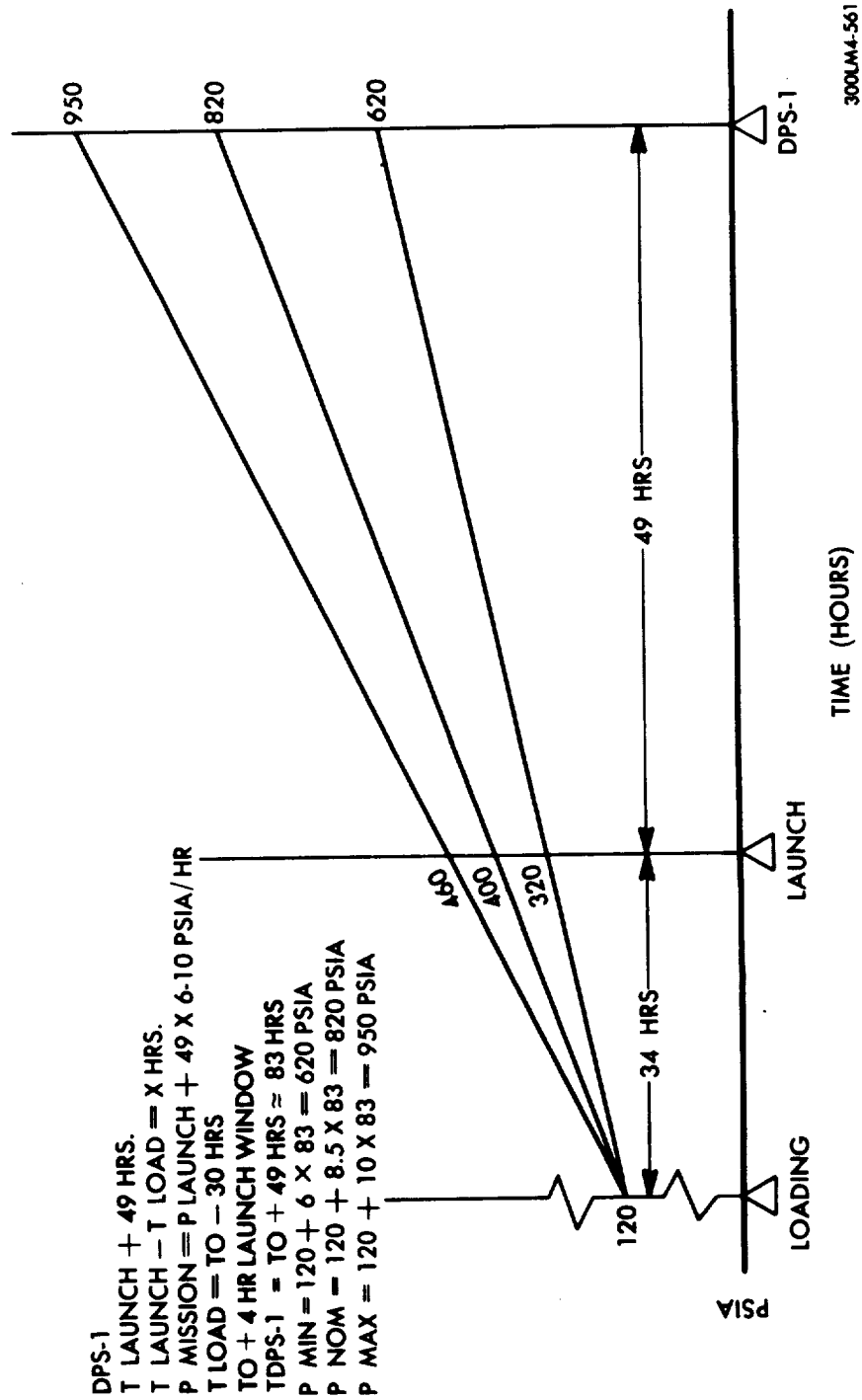

Figure 4-10. Theoretical Supercritical Helium Prepressurization

**LMA790-3-LM**  
**APOLLO OPERATIONS HANDBOOK**

CREW-MAN	PNL	PROCEDURES	REMARKS
LMP	3	<p>4.2.30 <u>RCS PRESSURIZATION</u></p> <p>1. HTR CONT: TEMP MON sel - RCS QUAD 1, 2, 3, &amp; 4 TEMP ind - 120° to 145°F (for each quad)</p> <p>2. RCS: A &amp; B QUANTITY ind - 100Z</p> <p>3. RCS: TEMP/PRESS MON sel - He A &amp; B PRESS ind - 2820 to 3280 psia</p> <p>4. RCS: TEMP/PRESS MON sel - PRLNT A &amp; B TEMP ind - 40° to 100°F A &amp; B PRESS ind - 10 to 50 psia</p> <p>5. RCS: TEMP/PRESS MON sel - FUEL MANF A &amp; B PRESS ind - 25 to 90 psia</p> <p>6. RCS: TEMP/PRESS MON sel - OXID MANF A &amp; B PRESS ind - 25 to 90 psia</p> <p style="text-align: center;">CAUTION</p> <p>RCS SYS A &amp; B ASC FEED 2 vlvs must be closed immediately after ED: RCS He PRESS sw - FIRE, to prevent possible propellant transfer between APS &amp; RCS.</p>	<p>This procedure is applicable if LM is launched with all main SOV's open. After 5-hour cold soak, warmup time for RCS thrusters before firing is approximately 1 hour with both sets of heaters operating; 3.2 hours if only one set is operating.</p> <p>CB RCS SYS B: PQCS/DISP must be closed for 1 minute to obtain valid readings. Quantity display remains at 100% until propellants in lines are used. Overall quantity accuracy (including propellant quantity measuring device accuracy) is <u>+ 9%</u>.</p> <p>This range represents minimum-to-maximum RCS theoretical helium bottle loading envelope pressure, before pressurization, as function of helium temperature and loading mass. For other bottle pressure values, see figure 4-11.</p> <p>During RCS pressurization, it is possible for ascent feed 2 valve to become unseated, allowing propellant transfer between APS &amp; RCS. Closing RCS system A &amp; B ascent feed 2 valves ensures that they are still closed after pressurization.</p>

LMA790-3-LM  
 APOLLO OPERATIONS HANDBOOK

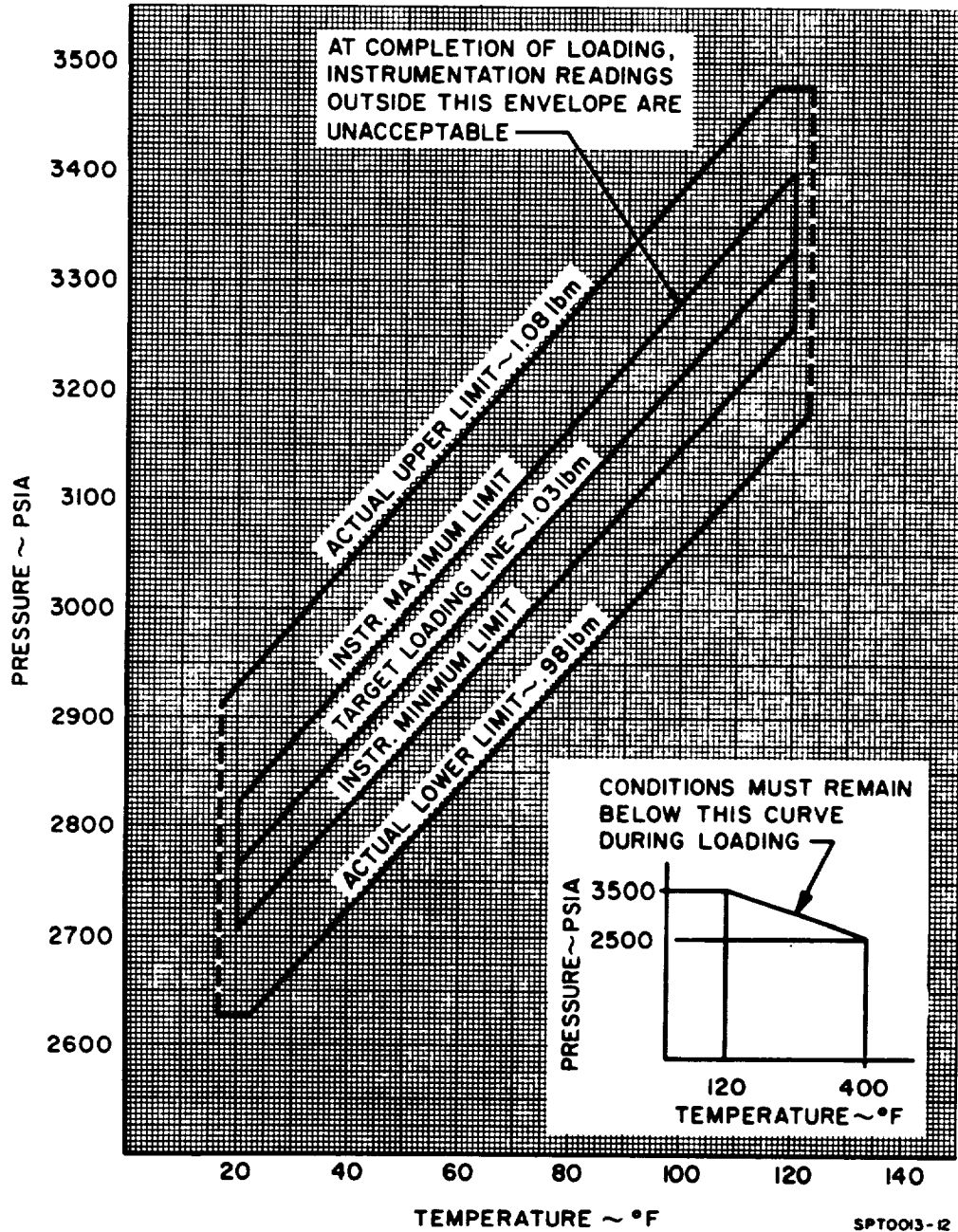

Figure 4-11. RCS Theoretical Helium Bottle Loading Envelope, Pressure vs Temperature

**LMA790-3-LM**  
**APOLLO OPERATIONS HANDBOOK**

CREW-MAN	PNL	PROCEDURES	REMARKS
		<p>4.2.30 <u>RCS PRESSURIZATION (cont)</u></p> <p>7. CB ED: LOGIC PWR B - open ED: MASTER ARM sw - ON RCS He PRESS sw - FIRE RCS: SYS A ASC FEED 2 sw - CLOSE SYS B ASC FEED 2 sw - CLOSE ED: MASTER ARM sw - OFF CB ED: LOGIC PWR B - close</p> <p style="text-align: center;">CAUTION</p> <p>CB ED: LOGIC PWR A &amp; LOGIC PWR B must be closed at completion of this task.</p> <p>RCS A REG warn lt - off RCS B REG warn lt - off</p> <p>8. RCS: SYS A ASC FEED 1 sw - ASC FEED 1 SYS B ASC FEED 1 sw - ASC FEED 1 CRSPD sw - CLOSE; tb - bp</p> <p>9. RCS: TEMP/PRESS MON sel - OXID MANF A &amp; B PRESS ind - 175 to 188 psia</p> <p>10. RCS: TEMP/PRESS MON sel - FUEL MANF A &amp; B PRESS ind - 175 to 188 psia</p> <p>11. RCS: TEMP/PRESS MON sel - PRELNT A &amp; B TEMP ind - 40° to 100° F A &amp; B PRESS ind - 178 to 188 psia</p>	<p>Permits verification of ED system A.</p> <p>Procedure confirms that all valves are actually open. When valve control switch is in center position, associated tb correctly indicates valve position. When switch is in an off-center position:</p> <p>a. CRSPD, &amp; MAIN SOV tb's are gray. b. ASC FUEL &amp; ASC OXID tb's are gray unless unenergized ASC FEED valves in same system are closed; then tb's are bp.</p> <p>Fuel and oxidizer nominal operating pressure is 178 to 188 psia. Burst disks rupture at 220+7 psia. Relief valves crack at 232+8 psia and reset at 212 psia.</p>
LMP	16 8 2 8 16		
	1 2		
	2		



**LMA790-3-LM  
APOLLO OPERATIONS HANDBOOK**

CREW: MAN	PNL	PROCEDURES	REMARKS
		<p>4.2.30 <u>RCS PRESSURIZATION (cont)</u></p> <p>12. RCS: TEMP/PRESS MON sel - He A &amp; B PRESS ind - 2750 to 3200 psia</p> <p>13. RCS: A QUANTITY ind - record Z remaining <u>    </u> Z B QUANTITY ind - record Z remaining <u>    </u> Z</p> <p>4.2.31 <u>RCS HOT/COLD FIRING CHECK</u></p> <p align="center">CAUTION</p> <p>Docking tunnel pressure (CSM side) must be zero psia. CSM roll jet commands must be inhibited to prevent possible simultaneous opposing jets firing.</p> <p>Communications Basic (required - near earth)</p> <p>S-Band Steerable Antenna Activation and Checkout (required)</p> <p>LGC Power-Up (required)</p> <p>IMU Power-Up (LGC Operating) (required)</p> <p>Circuit Breaker Activation (required)</p>	<p>Nominal helium tank pressure before pressurization is 3050 psia at +70°F.</p> <p>This procedure can be used before undocking and before lunar lift-off.</p> <p>This procedure performs TTCA (PGNS and AGS) Cold Fire, PGNS Rate Command Cold Fire, AGS Pulse Cold Fire, AGS Rate Command Cold Fire, Four-Jet Secondary Coil Hot Fire, and PGNS Minimum Impulse Hot Fire. It must be performed during MSFN contact to verify:</p> <ol style="list-style-type: none"> <li>TTCA continuity</li> <li>2.5° contacts in ACA</li> <li>12° hardover contact in ACA</li> <li>ACA transducer operation</li> <li>ACA continuity</li> <li>LGC inbits and outbits</li> <li>Operation of primary preamplifiers</li> <li>Operation of primary and secondary coils</li> <li>Inputs to ATCA jet select logic</li> </ol> <p>This procedure only checks CDR's ACA and TTCA systems.</p> <p>Ref para 4.13.2.1.</p> <p>Ref para 4.2.20.</p> <p>Ref para 4.6.1.1.</p> <p>Ref para 4.6.1.3.</p> <p>Ref para 4.2.4.</p>

SUBSYS  
ACT

**LMA790-3-LM  
APOLLO OPERATIONS HANDBOOK**

LM 2012

CREW-MAN	PNL	PROCEDURES	REMARKS
		<p>4.2.31 <u>RCS HOT/COLD FIRING CHECK (cont)</u></p>	
	3	<p>1. Verify quad temperature: HTR CONT: TEMP MON sel - RCS QUAD 1, 2, 3, &amp; 4 TEMP ind - 120° to 190° F</p> <p align="center">CAUTION</p> <p>HEATER cautions must be off for 25 minutes before firing RCS thrusters.</p>	
CDR LMP	11 16	<p>2. CB RCS SYS A: QUAD 1, 2, 3, 4 TCA - open CB RCS SYS B: QUAD 1, 2, 3, 4 TCA - open</p>	
	1	<p>3. GUID CONT sw - PGNS ACA PROP sw (CDR) - ENABLE S/C:</p>	
	3	<p>ROLL, PITCH, &amp; YAW sw - PULSE PGNS sw - ATT HOLD AGS sw - ATT HOLD</p>	<p>Poss MASTER ALARM, RCS TCA warn lt - on, tb - red during steps 3 thru 6.</p>
	4	<p>ACA/4 JET sw (CDR) - DISABLE TTCA/TRANSL sw (CDR) - ENABLE THROTTLE/JETS cont (BOTH) - JETS</p>	
TTCA		<p>Verify HBR with MSFN: CSM WIDE DEADBAND, ATT HOLD</p>	
	4	<p>4. TTCA cold fire check: Key V76E V11 N10E, 5E</p>	<p>Displays contents of channel No. 5 to verify presence of LGC jet-on commands (up and down firing).</p>
TTCA		<p>TTCA (CDR) - deflect, release Monitor DSKY R1: Up (+X) - R1 00252 Down (-X) - R1 00125 Repeat Up, down deflection using LMP's TTCA</p>	<p>MSFN verifies presence of AGS translational commands via GH1240.</p>

**LMA790-3-LM  
APOLLO OPERATIONS HANDBOOK**

CREW-MAN	PNL	PROCEDURES	REMARKS
	4	<p>4.2.31 <u>RCS HOT/COLD FIRING CHECK (cont)</u></p> <p>Key E6E</p> <p>TTCa (CDR) - deflect, release Monitor DSKY R1: Right (+Y) - R1 00220 Left (-Y) - R1 00140 Forward (+Z) - R1 00011 Aft (-Z) - R1 00006</p>	<p>Displays contents of channel No. 6 to verify presence of LGC jet-on commands (right, left, forward, and aft firing).</p> <p>MSPN verifies presence of AGS translational commands via GH1241 and GH1242.</p>
CDR	11 4	<p>5. PGNS Rate Command Cold Fire, AGS Pulse Cold Fire CB S/C: ATT DIR CONT - close Key V77E Key V15 N01E 42E</p>	<p>Displays octal content of LGC rate command counters in R1, R2, and R3.</p>
	ACA	<p>ACA (CDR) - to soft stop, pause (2 sec) at null Roll right - R3 00045 to 00057 Roll left - R3 77720 to 77732 Pitch up - R1 00045 to 00057 Pitch down - R1 77720 to 77732 Yaw right - R2 77720 to 77732 Yaw left - R2 00045 to 00057</p>	<p>MSPN verifies presence of AGS pulse mode commands via GH1247, GH1248, and GH1249.</p>
	1 3 ACA	<p>6. AGS Rate Command Cold Fire, Four-Jet Secondary Coil Hot Fire GUID CONT sw - AGS S/C: ROLL, PITCH, &amp; YAW sw - MODE CONT Verify RCS quad temperature <math>\geq 120^{\circ}F</math> for 25 min before proceeding. ACA (CDR) - deflect slowly to hardover, pause (2 sec) at null Roll right Roll left Pitch up Pitch down Yaw right Yaw left</p>	<p>MSPN monitors thrust chamber pressure (GR5031 through GR5046) to verify hardover contact closure and secondary coil operation; also verifies presence of AGS rate command output via GH1247, GH1248, and GH1249.</p>

SUBSY  
ACT

**LMA790-3-LM**  
**APOLLO OPERATIONS HANDBOOK**

LM 3231

CREW- MAN	PNL	PROCEDURES	REMARKS
		4.2.31 RCS HOT/COLD FIRING CHECK (cont)	
	1 4	7. PGNS Minimum Impulse Hot Fire GUID CONT sw - PGNS Key V76E Key V48E FL V04 N46 Verify DAP configuration - 32022 Key PRO Key V34E CB RCS SYS A: QUAD 4, 3, 2, & 1 TCA - close CB RCS SYS B: QUAD 1, 2, 3, & 4 TCA - close CB INST: CMEA - open, then close RCS: SYS A & B QUAD 1, 2, 3, & 4 tb (8) - gray Key V11 N10E 31E Verify: RI 67777 ACA (CDR) - deflect 2.5°, pause (2 sec) at null Roll right - RI 27757 Roll left - RI 27737 Yaw right - RI 27767 Yaw left - RI 27773 Yaw left - RI 27773 Key V48E FL V04 N46 Establish DAP configuration - Key V21E 31022E Key PRO Key V34E ACA (CDR) - deflect 2.5°, pause (2 sec) at null Pitch up - RI 27776 Pitch down - RI 27775 S/C: ROLL, PITCH, & YAW sw - PULSE GUID CONT sw - AGS Key V77E	Ref para 4.6.1.1.8.  Displays contents of channel No. 31 to check presence of minimum impulse inhibits. MSFN monitors jet driver output (GHI418 through GHI433) and thrust chamber pressure (GR5031 through GR5046) to verify primary coil operation. Four yaw maneuvers ensures firing of all eight horizontal RCS jets.  MSFN monitors jet driven output (GHI418 through GHI433) and thrust chamber pressure (GR5031 through GR5046) to verify primary coil operation.
CDR LMP	11 16 2 4 ACA		
	3 1 4		

**LMA790-3-LM**  
**APOLLO OPERATIONS HANDBOOK**

CREW-MAN	PNL	PROCEDURES	REMARKS
CDR	11	<p>4.2.32 <u>LANDING GEAR DEPLOY</u></p> <p>1. CB ED: LDG GEAR FLAG - close LOGIC PWR A - open</p> <p>2. ED: MASTER ARM sw - ON LDG GEAR DEPLOY sw - FIRE; th - gray</p> <p>3. CB ED: LOGIC PWR A - close</p> <p>4. ED: LDG GEAR DEPLOY sw - FIRE; th - gray MASTER ARM sw - OFF</p> <p style="text-align: center;">CAUTION</p> <p>CB ED: LOGIC PWR A &amp; B must be closed at completion of this task.</p> <p>5. Observe +2 landing gear through forward windows.</p> <p>6. After separation from CSM, request CSM to confirm all landing gears deployed &amp; locked.</p> <p>7. CB ED: LDG GEAR FLAG - open ED: LDG GEAR DEPLOY th - bp</p>	<p>Permits verification of ED system B.</p> <p>Possible MASTER ALARM - on when ED: MASTER ARM sw - OFF, due to relay race removing CWFA inhibit.</p>

SUBSYS  
ACT



# LMA790-3-LM APOLLO OPERATIONS HANDBOOK

PRELAUN  
CLOSEOU

LM 2011, LM 3235

CREW-MAN	PNL	PROCEDURES	REMARKS
	1	<p>4.1 PRELAUNCH CLOSEOUT CHECK (cont)</p> <p>SHFT/TRUN <math>\chi</math> sw - +50°            RATE SCALE sw - 25°/SEC            ACA PROP sw - ENABLE            ENG THR CONT:              THR CONT sw - AUTO              MAN THROT sw - CDR              ENG ARM sw - OFF              ATT/TRANSL sw - 4 JETS              BAL CPL sw - ON            ASC He REG 1 sw - center; tb - gray            ASC He REG 2 sw - center; tb - gray            DES He REG 1 sw - center; tb - gray            DES He REG 2 sw - center; tb - bp            PRPLNT QTY MON sw - OFF            PRPLNT TEMP/PRESS MON sw - ASC            HELIUM MON sel - OFF            ABORT pb - reset            ABORT STAGE pb - reset            RNG/ALT MON sw - ALT/ALT RT            MODE SEL sw - LDG RADAR            GUID CONT sw - PGNS</p>	<p>Switch guard covering ASC position</p> <p>ASC He REG latching valve - open            ASC He REG latching valve - open            DES He REG latching valve - open            DES He REG latching valve - closed</p>
	3	<p>8.</p> <p>ENG GMBL sw - ENABLE            DES ENG CMD OVRD sw - OFF            RADAR:              LDC ANT sw - AUTO              TEST sw - OFF              TEST/MON sel - ALT XMTR            RNDZ RADAR:              SLEW RATE sw - HI              SLEM sw - center              RNDZ RADAR sel - SLEW            S/C:              DEAD BAND sw - MIN              GYRO TEST ROLL sw - ROLL              GYRO TEST POS RT sw - OFF              ROLL sw - MODE CONT              PITCH sw - MODE CONT              YAW sw - MODE CONT              PGNS sw - OFF              AGS sw - OFF              IMU CAGE sw - OFF</p>	<p>Switch guard at side position</p>

**LMA790-3-LM  
APOLLO OPERATIONS HANDBOOK**

CREW-MAN	PNL	PROCEDURES	REMARKS
		<p>4.1 <u>PRELAUNCH CLOSEOUT CHECK (cont)</u></p> <p>HTR CONT:            TEMP MON sel - LDG RADAR            RCS SYS A/B 2 QUAD 1, 4, 2, &amp; 3 sw - OFF</p> <p>EVRT TRG:            RESET/COUNT sw - UP            THR CONT sw - STOP            SLEW CONT MIN sw - center            SLEW CONT SEC sw - center</p> <p>LTG:            SIDE PANELS sw - OFF            FLOOD sw - OFF            FLOOD cont - BRIGHT            LAMP/TONE TEST sel - OFF            EXTERIOR LTG sw - DOCK            X POINTER SCALE sw - HI MULT</p> <p>4 9. ACA/4 JET sw (CDR) - ENABLE            TTCA/TRANSL sw (CDR) - ENABLE            ACA/4 JET sw (LMP) - ENABLE            TTCA/TRANSL sw (LMP) - ENABLE</p> <p>AOT 10. Azimuth cont - CL            AOT ind - 000.0°            Eye guard assembly &amp; density filter - removed            MARK X pb - not depressed            MARK Y pb - not depressed            REJECT pb - not depressed            RR GTRO SEL sw - PRIM</p> <p>11. Verify rendezvous radar antenna restraint is not released.</p> <p>2 12. RCS:</p> <p style="text-align: right;">SYS A ASC FEED 1 sw - center</p>	<p>Status of fuel and oxidizer interconnect valves cannot be determined via ASC FUEL and ASC OXID tb's when tb's are unpowered. When powered, tb's - bp indicates that one set of fuel and oxidizer interconnect valves is closed while other set is open. When displays are not powered, talk-backs for main shutoff valves and crossfeed valve are not necessarily indicative of valve position. These valves should be in their nominal position; i.e., main shutoff valves open and crossfeed valve closed.</p> <p>ACS FEED 1 valves (primary) - open</p>



# LMA790-3-LM APOLLO OPERATIONS HANDBOOK

PRELAUNCH  
CLOSEOUT

CREW-MAN	PNL	PROCEDURES	REMARKS
		<p>4.1 PRELAUNCH CLOSEOUT CHECK (cont)</p> <p>SYS A ASC FEED 2 sv - center            SYS A ASC FUEL tb - bp            SYS A ASC OXID tb - bp            SYS B ASC FEED 1 sv - center            SYS B ASC FEED 2 sv - center            SYS B ASC FUEL tb - bp            SYS B ASC OXID tb - bp            SYS A QUAD 1, 4, 2, &amp; 3 sv - ENABLE; tb - gray            SYS B QUAD 1, 4, 2, &amp; 3 sv - ENABLE; tb - gray            CRSFD sv - center; tb - bp            SYS A MAIN SOV sw - center; tb - gray            SYS B MAIN SOV sw - center; tb - gray            TEMP/PRESS MON sel - He            ACA PROP sv - ENABLE            MASTER ALARM pb/lt - not depressed            RATE/ERR MON sw - LDG RDR/CHPTR            ATTITUDE MON sw - PGNS            GLYCOL sel - PUMP 2            SUIT FAN sel - 1            O2/H2O QTY MON sel - ASC 2</p>	<p>ASC FEED 2 valves (secondary) - closed</p> <p>ASC FEED 1 valves (primary) - open            ASC FEED 2 valves (secondary) - closed</p> <p>CRSFD valves - closed            SYS A MAIN SOV - open            SYS B MAIN SOV - open</p>
	TTCA	<p>13. THROTTLE/JETS cont (LMP) - JETS            Throttle friction cont (LMP) - as desired</p>	
	6	<p>14. Eng STOP pb/lt - reset            AGS STATUS sw - OFF</p>	
	ACA	<p>15. PTT pb (LMP) - not depressed</p>	
	16	<p>16. All cb's - open, except:            CB LTC: FLOOD - close            CB S/C: ASA - close            CB HTR:                MESA - close                S BD ANT - close            CB EPS:                DC BUS VOLT - close                DES ECA - close                CROSS TIE BAL LOADS - close                BAT FEED TIE (2) - close            Verify cb status per Prelaunch Closeout Check.</p>	See figure 4-2.

L\*2011

16

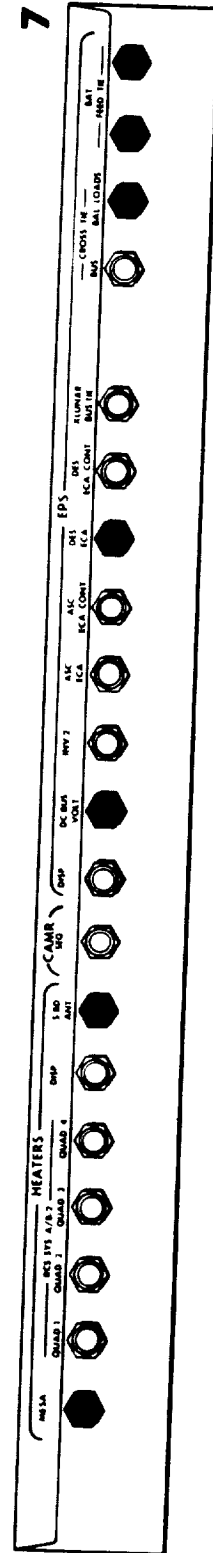
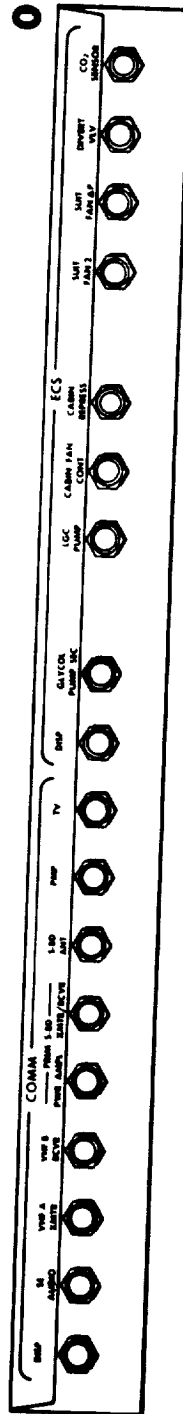
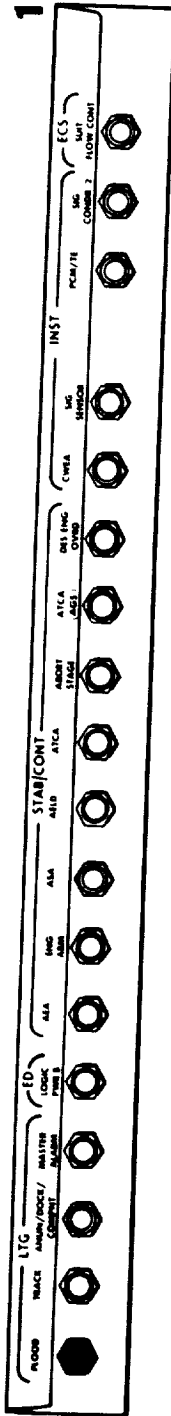
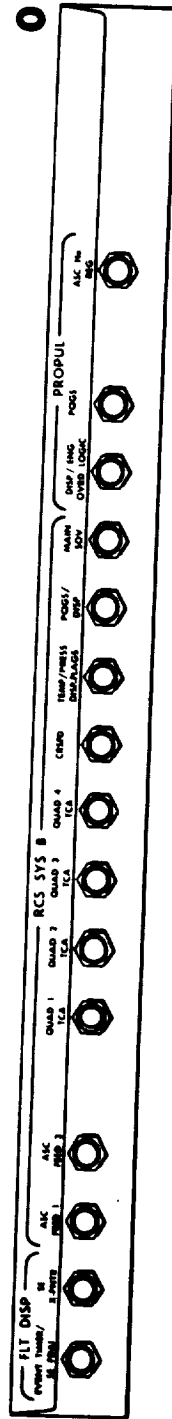

300LM10-1061-2

Figure 4-2. Prelaunch Closeout Check (Panel 16)





**LMA790-3-LM**  
**APOLLO OPERATIONS HANDBOOK**

SUBSYS  
ACT

CREW-MAN	PNL	PROCEDURES	REMARKS
		<p>4.2.1 <u>INITIAL ENTRY STATUS CHECK (cont)</u></p> <p>4. DES H20 vlv - OPEN</p> <p>4.2.2 <u>EPS ACTIVATION &amp; CHECKOUT</u></p> <p>1. LTG: ANUN/NUM cont - adjust CB EPS: DISP - close XLUNAR BUS TIE - close DES ECA CONT - close CB INST: SIG SENSOR - close PCM/TE - close SIG CONDR 2 - close CB EPS: XLUNAR BUS TIE - close DES ECA CONT - close CB INST: SIG CONDR 1 - close</p> <p>2. Check d-c bus voltage: EPS: LMP BAT 1 tb - LO LMP BAT 2 tb - bp CDR BAT 3 tb - bp CDR BAT 4 tb - LO LUNAR BAT tb - bp DES BATS tb - gray BAT 5 NORMAL LMP FEED tb - bp BAT 5 BACK UP CDR FEED tb - bp BAT 6 NORMAL CDR FEED tb - bp BAT 6 BACK UP LMP FEED tb - bp</p>	<p>FDAI pwr tb (2) - OFF (in view) C/W PWR caut lt - on</p>
	ECS		
	5 16		
	11		
	14		

**LMA790-3-LM  
APOLLO OPERATIONS HANDBOOK**

CREW-MAN	PNI	PROCEDURES	REMARKS																				
	11 16 3 16 3	<p>4.2.2 <u>EPS ACTIVATION &amp; CHECKOUT (cont)</u></p> <p>3. Activate RCS heaters:            CB HTR RCS SYS A/B 1: QUAD 4, 3, 2, &amp; 1 - close            CB HTR RCS SYS A/B 2: QUAD 1, 2, 3, &amp; 4 - close            HTR CONT: RCS SYS A/B 2 QUAD 1, 4, 2, &amp; 3 sw - AUTO            CB HTR: DISP - close            HTR CONT: TEMP MON sel - RCS QUAD 1, 2, 3, 4            Determine time for lowest temperature quad to reach 120°F.</p> <p align="center">CAUTION</p> <p>RCS quad temperatures must be &gt; 120° F            for 25 minutes before firing RCS thrusters.</p> <p>LTC: EXTERIOR LTC sw - OFF</p> <p align="center">CAUTION</p> <p>Do not proceed to step 4 if bus voltage &gt;27 vdc.            If bus voltage &gt;27 vdc, continue EPS activation            until bus voltage &lt;27 vdc, then perform step 4.</p>	<p>Time for quad temperature to reach 120°F is given in following table.</p> <table border="1" data-bbox="402 327 748 869"> <thead> <tr> <th>Initial Temperature (°F)</th> <th>Time for Quad to Reach 120°F (min)</th> </tr> </thead> <tbody> <tr><td>20</td><td>70</td></tr> <tr><td>30</td><td>60</td></tr> <tr><td>40</td><td>50</td></tr> <tr><td>50</td><td>40</td></tr> <tr><td>60</td><td>30</td></tr> <tr><td>70</td><td>20</td></tr> <tr><td>80</td><td>15</td></tr> <tr><td>90</td><td>10</td></tr> <tr><td>100</td><td>5</td></tr> </tbody> </table> <p>(Times given are to insure that quad is properly warmed up if one heater system has failed off. Warmup time for no failures is about one-half of times given.)</p>	Initial Temperature (°F)	Time for Quad to Reach 120°F (min)	20	70	30	60	40	50	50	40	60	30	70	20	80	15	90	10	100	5
Initial Temperature (°F)	Time for Quad to Reach 120°F (min)																						
20	70																						
30	60																						
40	50																						
50	40																						
60	30																						
70	20																						
80	15																						
90	10																						
100	5																						

# LMA790-3-LM APOLLO OPERATIONS HANDBOOK

CREW-MAN	PNL	PROCEDURES	REMARKS
		<p>4.2.2 EPS ACTIVATION &amp; CHECKOUT (cont)</p> <p>4. Turn on high voltage:            CB EPS: CROSS TIE BUS - close            EPS:              LMP BAT 1 HI V sw - OFF/RESET; tb - bp, then ON;              tb - gray              CDR BAT 4 HI V sw - OFF/RESET; tb - bp, then ON;              tb - gray            CB EPS:              CROSS TIE BUS - open              CROSS TIE BAL LOADS - open            EPS:              POWER/TEMP MON sw - BAT 1              When AMPS ind - &gt;15 amps:              LMP BAT 2 sw - OFF/RESET; tb - bp, then ON; tb - gray              POWER/TEMP MON sw - BAT 4              When AMPS ind - &gt;15 amps:              CDR BAT 3 sw - OFF/RESET; tb - bp, then ON; tb - gray</p> <p>5. Complete EPS activation:            CB/AC BUS B:              BUS TIE INV 2 - close              BUS TIE INV 1 - close            CB/AC BUS A:              BUS TIE INV 2 - close              BUS TIE INV 1 - close            AC BUS VOLT - close            CB EPS:              INV 1 - close              INV 2 - close</p> <p>6. CB INST: CWEA - close</p>	<p>If monitoring voltage and current while performing this step, first battery will furnish reverse current into other battery that has not been switched to high-voltage tap. Reverse current will cease as soon as battery is removed from line.</p> <p>CB EPS: INV 1 is closed for checkout. Inverter draws power while this circuit breaker is closed.</p> <p>C/W PWR caut lt - off            CWEA status indications are:              CES AC warn lt - on              CES DC warn lt - on              LGC warn lt - on              RCS A REG warn lt - on              RCS B REG warn lt - on              PRE AMPS caut lt - on              ECS caut lt - on (assuming ECS has not been activated)              GLYCOL caut lt - on (if ECS: GLYCOL temp ind &gt;50°F)</p>
	11,16 14		
	11,16		
	14		
	11		
	16		

SUBSYS  
ACT

**LMA790-3-LM**  
**APOLLO OPERATIONS HANDBOOK**

CREW-MAN	PNL	PROCEDURES	REMARKS
		<p>4.2.2 EPS ACTIVATION &amp; CHECKOUT (cont)</p>	
14	7.	<p>Initial EPS check: EPS: POWER/TEMP MON sel - AC BUS INVERTER sw - 1 VOLTS ind - green band INVERTER sw - 2 VOLTS ind - green band POWER/TEMP MON sel - LMP BUS VOLTS ind - 28.0 to 32.5 vdc POWER/TEMP MON sel - CDR BUS VOLTS ind - 28.0 to 32.5 vdc POWER/TEMP MON sel - BAT 4 VOLTS ind - 28.0 to 32.5 vdc AMPS ind - TBD Repeat for BAT 3, 2, 1. POWER/TEMP MON sel - ED/OFF ED VOLTS sw - BAT A VOLTS ind - 35.0 to 37.8 vdc ED VOLTS sw - BAT B VOLTS ind - 35.0 to 37.8 vdc</p>	<p>Component caution status indications are: H2O SEP comp caut lt - on GLYCOL comp caut lt - on MASTER ALARM - off (because panel 16 CB LTG: MASTER ALARM is not closed) These indications should not be regarded as malfunction symptoms. As subsequent tasks are performed, the caution and warning lights go off.</p> <p>Green band represents 112 to 118 vac.</p>
11	8.	<p>CB EPS: INV 1 - open</p>	<p>To obtain proper current measurement when monitoring descent battery, divide indicator reading by 2.</p> <p>Nominal open-circuit voltage for each ED battery is 37.1 vdc.</p>
14	9.	<p>EPS: POWER.TEMP MON sel - AC BUS</p>	<p>Opening CB EPS: INV 1 prevents unnecessary power consumption.</p>
11	10.	<p>CB/AC BUS B: SE WIND HTR - close</p>	<p>Assumption: Window shades are in stowed position when checking heaters. Heaters can also be checked in helmets-and-gloves-off configuration by placing crewmen's bare hand on window.</p>
14		<p>EPS: VOLTS ind - voltage drop CB/AC BUS B: SE WIND HTR - open</p>	<p>Voltage drop indicates LMP window heater turn-on.</p>



# LMA790-3-LM APOLLO OPERATIONS HANDBOOK

CREW-MAN	PNL	PROCEDURES	REMARKS
LM 3250		<p><u>4.2.2 EPS ACTIVATION &amp; CHECKOUT (cont)</u></p> <p>11. CB/AC BUS A: CDR WIND HTR - close EPS: VOLTS ind - voltage drop</p> <p>12. CB/AC BUS B: SE WIND HTR - close</p> <p>13. CB HTR: DOCK WINDOW - close</p> <p>14. CB S/C: ASA - close</p> <p><u>4.2.3 PRIMARY GLYCOL LOOP ACTIVATION</u></p> <p>2 1. ECS: PRESS ind pwr fail lt - on GLYCOL ind pwr fail lt - on QUANTITY ind pwr fail lt - on GLYCOL comp caut lt - on</p> <p>11 2. Verify: CB ECS: GLYCOL PUMP 1 - open GLYCOL PUMP 2 - open GLYCOL PUMP AUTO TRNFR - open</p> <p>16 3. CB ECS: DISP - close</p> <p>2 4. GLYCOL sel - PUMP 1 ECS: GLYCOL press ind - record: _____ GLYCOL sel - INST (SEC) ECS: GLYCOL press ind - record: _____</p> <p>11 5. GLYCOL sel - PUMP 2</p> <p>6. CB ECS: GLYCOL PUMP AUTO TRNFR - close GLYCOL PUMP 1 - close GLYCOL PUMP AUTO TRNFR - open</p>	<p>Voltage drop indicates CDR window heater turn-on.</p> <p>Docking window heater turn-on cannot be detected by voltage on EPS: VOLTS ind.</p> <p>Following indicator power failure lights - off when CB ECS: DISP is closed: ECS: PRESS GLYCOL QUANTITY</p> <p>Discharge pressure of primary and secondary glycol loops is necessary to determine CMEA instrumentation failure or leak in loop.</p>

SUBS  
AC

**LMA790-3-LM**  
**APOLLO OPERATIONS HANDBOOK**

LM 3216

CREW- MAN	P/NL	PROCEDURES	REMARKS
		<p>4.2.3 <u>PRIMARY GLYCOL LOOP ACTIVATION (cont)</u></p> <p>7. GLYCOL sel - PUMP 1</p> <p>8. CB ECS: GLYCOL PUMP 2 - close</p> <p>9. ECS: GLYCOL press ind - 21 to 37 psia GLYCOL comp caut lt - off</p> <p>4.2.4 <u>CIRCUIT BREAKER ACTIVATION</u></p> <p>1. X pointer ind pwr fail lt - on THRUST ind pwr fail lt - on MPS: PRESS ind pwr fail lt - on RCS: PRESS ind pwr fail lt - on QUANTITY ind pwr fail lt - on X pointer ind pwr fail lt - on FDAI pwr tb (2) - OFF (in view)</p>	<p>Primary glycol loop circulation starts, but primary sublimator has not been activated.</p> <p>Indicator power failure lights - off as circuit breaker for associated indicator power is closed.</p> <p><u>Pwr Fail Lt</u></p> <p>X pointer ind                      CB FLT DISP: CDR X PNTR</p> <p>THRUST ind                              CB FLT DISP: THRUST</p> <p>MPS: PRESS ind                      CB PROPUL: DISP/ENG OVRD LOGIC</p> <p>RCS: PRESS ind                      CB RCS SYS B: TEMP/PRESS DISP FLAGS</p> <p>RCS: QUANTITY ind                  CB RCS SYS B: PQGS/DISP</p> <p>X pointer ind                          CB FLT DISP: SE X PNTR</p> <p>FDAI pwr tb (2) - OFF (in view)                      CB FLT DISP: CDR FDAI</p> <p>CB FLT DISP: SE EVNT TMR/SE FDAI</p>

Basic Date 26 September 1971

Change Date \_\_\_\_\_

**LMA790-3-LM  
APOLLO OPERATIONS HANDBOOK**

CREW-MAN	PNL	PROCEDURES	REMARKS
		<p>4.2.4 <u>CIRCUIT BREAKER ACTIVATION (cont)</u></p> <p>2. Enable ATCA:</p> <p align="center">CAUTION</p> <p>Before closing CB S/C: ATCA, ensure:  GUID CONT sw - PGNS  S/C: PGNS &amp; AGS sw - OFF</p> <p>CB S/C: ENG CONT - open  CB A/C BUS A: DECA GMBL - open  CB S/C: ENG ARM - open  ATCA - close</p> <p>3. All cb's - close, except:  CB/AC BUS B:  SE WIND HTR - as required  AOT LAMP - open  CB/AC BUS A:  CDR WIND HTR - as required  AOT LAMP - open  RNDZ RDR - open  CB RCS SYS A: QUAD 4, 3, 2, &amp; 1 TCA - open</p> <p align="center">CAUTION</p> <p>CB/AC BUS A: RNG/RNG RT must be closed  before CB FLT DISP: RNG/RNG RT</p> <p>CB FLT DISP: RNG/RNG RT - open  CB HTR:  URINE LINE - as required  RNDZ RDR STBY - open (required)  DOCK WINDOW - as required  CB S/C:  AEA - open  AELD - open  CB ECS:  SUIT FAN 1 - open  CABIN FAN - open  CB COMM: CDR AUDIO - open</p>	<p>Verification of these controls and closing of CB S/C: ATCA before closing related circuit breakers ensures against inadvertent RCS jet firing or possible driving of DPS engine gimbal.</p> <p>When crew is monitoring windows and can detect fogging, heater operation is at crew discretion. (Use if condensation is noticed.)</p>

SUBSYS  
ACT

**LMA790-3-LM**  
**APOLLO OPERATIONS HANDBOOK**

LM 2010

CREW- MAN	PNI	PROCEDURES	REMARKS
1		<p>4.2.4 <u>CIRCUIT BREAKER ACTIVATION (cont)</u></p> <p>CB PGNS: LDC RDR - open RNDZ RDR - open RNG/ALT ind pwr/sig fail lt - on</p>	<p>RNG/ALT ind pwr/sig fail lt - on when CB/AC BUS A: RNG/RNG RT - close. RNG/ALT ind pwr/sig fail lt remains on due to lack of good range/altitude and rate signals when CB FLT DISP: RNG/RNG RT - close. Light goes off after good range/altitude and rate signals are present from selected input source. LGC warn lt - on due to LGC startup transient conditions. Light remains on until capacitor discharges. LGC warn lt was on previously because CB PGNS: LCC/DSKY was open.</p>
11		<p>LGC warn lt - on (up to 20 sec) CB PGNS: IMU OPR - open CB EPS: CROSS TIE BUS - open ASC ECA CONT - open INV 1 - open FDAI pwr tb (2) - OFF (in view)</p>	<p>Closing CB FLT DISP: RNG/RNG RT after CB/AC BUS A: RNG/RNG RT applies drive power to tapemeter after logic power. This prevents erratic driving, and possible off-scale condition, of tapemeter during power-up. See figure 4-5.</p>
1, 2		<p>4. CB FLT DISP: RNG/RNG RT - close</p>	<p>FUEL VENT latching valve is open when tb - gray. OXID VENT latching valve is open when tb - gray.</p>
11		<p>Verify cb status per Circuit Breaker Activation</p>	
8		<p>DES PROPUL: FUEL VENT tb - gray OXID VENT tb - gray ED: LDC GEAR DEPLOY tb - bp</p>	
1		<p>6. THRUST ind pwr fail lt - off X pointer ind pwr fail lt - off FDAI pwr tb - on (out of view)</p>	

**LMA790-3-LM**  
**APOLLO OPERATIONS HANDBOOK**

	CREW-MAN	PNL	PROCEDURES	REMARKS
LM 201c		16	<p>7. All cb's - close, except:            CB RCS SYS B: QUAD 1, 2, 3, &amp; 4 TCA - open            CB LTG: MASTER ALARM - open            CB S/C:                AEA - open                ENG ARM - open                AELD - open            CB COMM:                SE AUDIO - open                S BD ANT - open                TV - open</p>	<p>ECS caut lt and SUIT FAN comp caut lt - on when CB ECS:            SUIT FAN ΔP - close.</p>

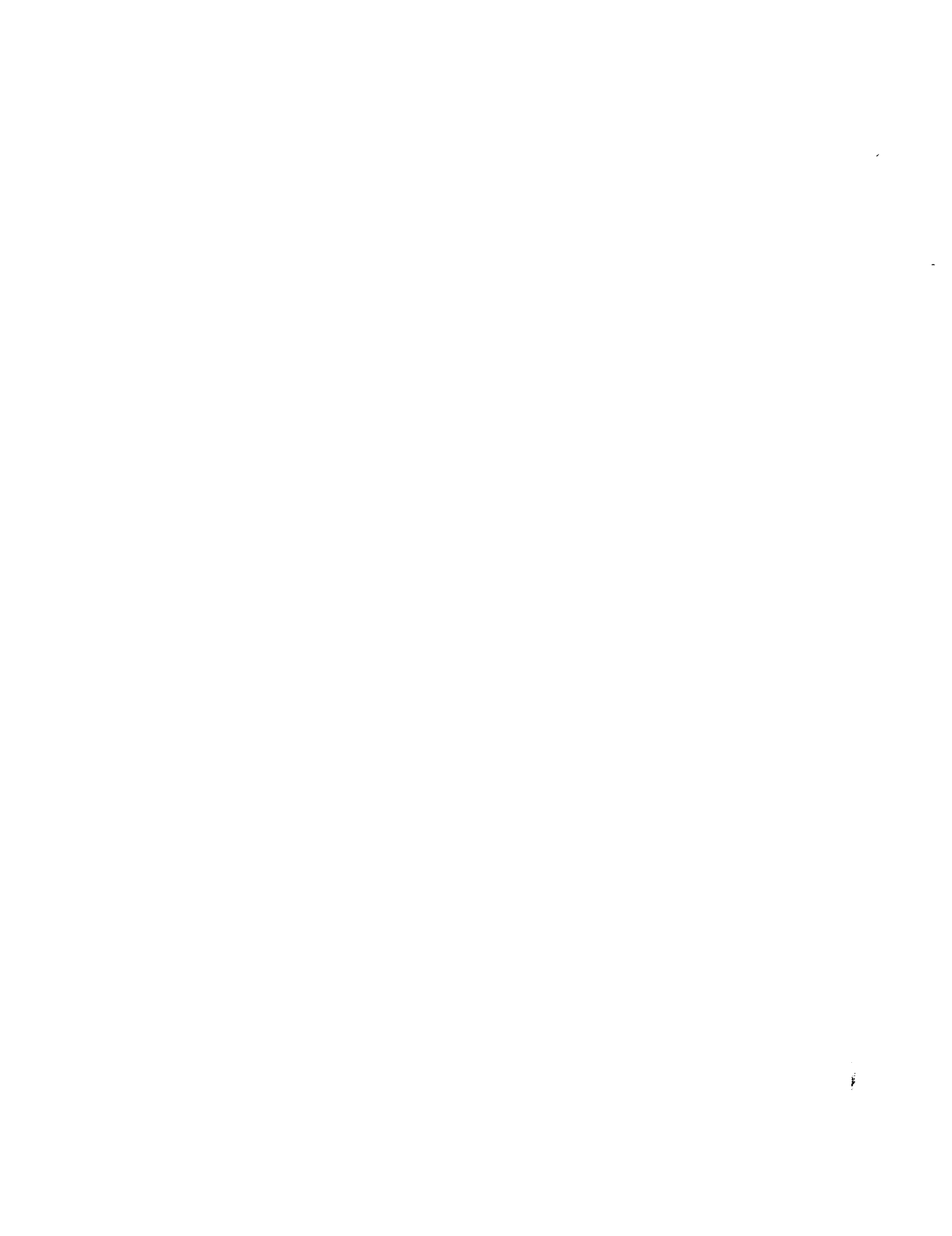

**LMA790-3-LM**  
**APOLLO OPERATIONS HANDBOOK**

PARA	TITLE	PAGE
4.3	Subsystem Deactivation . . . . .	4.3-2
4.3.1	Preparation For Sublimator Dryout . . . . .	4.3-2
4.3.2	Sublimator Dryout . . . . .	4.3-10
4.3.3	Final Subsystem Deactivation . . . . .	4.3-12
4.3.4	LM Transfer to CSM Power . . . . .	4.3-21
4.3.4.1	LM Transfer to CSM Power (Unstaged) . . . . .	4.3-21
4.3.4.2	LM Transfer to CSM Power (Staged) . . . . .	4.3-22
4.3.5	LM Transfer to LM LV Power (Backup) . . . . .	4.3-24
4.3.6	CSM Transfer to LM Power . . . . .	4.3-25
4.3.6.1	LM Initial Power-Up (CSM Powered Down) . . . . .	4.3-25
4.3.6.2	CSM Transfer to LM Power (Staged) . . . . .	4.3-26
4.3.6.3	CSM Transfer to LM Power (Unstaged) . . . . .	4.3-27
4.3.6.4	CSM Transfer to LM Power (Staged) - Lifeboat . . . . .	4.3-28
4.3.7	LM-to-CSM Power Transfer (Unstaged) (Power Removal from CSM/LM Umbilical) . . . . .	4.3-28

**LMA790-3-LM  
APOLLO OPERATIONS HANDBOOK**

CREW-MAN	PNL	PROCEDURES	REMARKS
		<p><u>4.3 SUBSYSTEM DEACTIVATION</u></p> <p>Subsystem deactivation consists of tasks performed by the crew to place LM subsystems into a powered-down condition that reproduces, to the extent practicable, LM prelaunch closeout status.</p> <p><u>4.3.1 PREPARATION FOR SUBLIMATOR DRYOUT</u></p> <ol style="list-style-type: none"> <li>1. Perform LGC Power-Down Program (P06).</li> <li>2. ORDEAL:           <ul style="list-style-type: none"> <li>FDAL 1&amp;2 sw - INRTL</li> <li>EARTH/LUNAR sw - PWR OFF</li> <li>LTG sw - OFF</li> <li>MODE sw - HOLD/FAST</li> <li>SLEM sw - center</li> <li>ALT SET cont - TBD na</li> </ul> </li> <li>3. DES PROPUL:           <ul style="list-style-type: none"> <li>FUEL VENT sw - center; tb - gray</li> <li>OXID VENT sw - center; tb - gray</li> </ul>           ED:           <ul style="list-style-type: none"> <li>DES PRPLNT ISOL VLV sw - SAFE</li> <li>MASTER ARM sw - OFF</li> <li>DES VENT sw - SAFE</li> <li>ASC He SEL sw - BOTH</li> <li>LDC GEAR DEPLOY sw - SAFE; tb - bp</li> <li>RCS He PRESS sw - SAFE</li> <li>DES START He PRESS sw - SAFE</li> <li>ASC He PRESS sw - SAFE</li> <li>STAGE sw - SAFE</li> <li>STAGE RELAY sw - OFF</li> </ul>           AUDIO:           <ul style="list-style-type: none"> <li>S BAND T/R sw - OFF</li> <li>ICS T/R sw - OFF</li> <li>RELAY ON sw - RELAY OFF</li> <li>MODE sw - ICS/PTT</li> <li>AUDIO CONT sw - NORM</li> <li>VHF A sw - OFF</li> <li>VHF B sw - OFF</li> </ul> </li> </ol>	<p>Assumptions: (1) One crewman is in LM, (2) PCA is donned, (3) crewman is receiving oxygen through GSM transfer umbilical, and (4) cabin repressurization system is enabled. Ref para 4.14.5.</p> <p>Ref para 4.6.1.2. Program 06 transfers ISS/LGC from operate to standby.</p> <p>FUEL VENT latching valve is open when tb - gray. OXID VENT latching valve is open when tb - gray.</p>



**LMA790-3-LM**  
**APOLLO OPERATIONS HANDBOOK**

CREW-MAN	PNL	PROCEDURES	REMARKS
		<p>4.3.1 <u>PREPARATION FOR SUBLIMATOR DRYOUT (cont)</u></p> <p>4. THROTTLE/JETS cont (CDR) - JETS Throttle friction cont (CDR) - TBD</p> <p>5. DES RATE sw - center Eng STOP pb/lt - reset Eng START pb/lt - not depressed +X TRANSL pb - not depressed MSN TMR: THR CONT sw - STOP SLEW CONT HOURS sw - center SLEW CONT MIN sw - center SLEW CONT SEC sw - center LTG: OVERRIDE ANUN sw - OFF OVERRIDE NUM sw - OFF OVERRIDE INTEGRAL sw - OFF SIDE PANELS sw - OFF FLOOD cont - BRIGHT ANUN/NUM cont - DIM INTEGRAL cont - DIM</p> <p>6. PTT pb (CDR) - not depressed</p> <p>1 7. X POINTER SCALE sw - HI MULT MASTER ALARM pb/lt - not depressed RATE/ERR MON sw - LDG RDR/CMPT ATTITUDE MON sw - PGNS SHFT/TRUN X sw - +50° RATE/SCALE sw - 25°/SEC ACA PROP sw - DISABLE ENG THR CONT: THR CONT sw - AUTO MAN THROT sw - CDR ENG ARM sw - OFF ATT/TRANSL sw - 2 JETS BAL CPL sw - ON ASC He REG 1 sw - center; tb - gray ASC He REG 2 sw - center; tb - gray DES He REG 1 sw - center; tb - gray DES He REG 2 sw - center; tb - bp PRPLNT QTY MON sw - OFF</p>	<p>ASC He REG latching valve is open when tb - gray. ASC He REG latching valve is open when tb - gray. DES He REG latching valve is open when tb - gray. DES He REG latching valve is closed when tb - bp.</p>

SUBSYS  
DEACT

**LMA790-3-LM  
APOLLO OPERATIONS HANDBOOK**

CREW- MAN	PNI	PROCEDURES	REMARKS
		<p>4.3.1 <u>PREPARATION FOR SUBLIMATOR DRYOUT (cont)</u></p> <p>PRPLNT TEMP/PRESS MON sw - ASC            HELIUM MON sel - OFF            ABOKT pb - reset            ABOKT STAGE pb - reset            ENG/ALT MON sw - ALT/ALT RT            MODE SEL sw - LDG RDR            GUID CONT sw - PGNS</p> <p>8.            ENG GMEL sw - ENABLE            DES ENG CMD OVRD sw - OFF            RADAR:              LDG ANT sw - AUTO              TEST sw - OFF              TEST MON sel - ALT XMTR            RNDZ RADAR:              SLEW RATE sw - HI              SLEW sw - center            RNDZ RADAR sel - AUTO TRACK            S/C:              DEAD BAND sw - MIN              GYRO TEST ROLL sw - ROLL              GYRO TEST POS RT sw - OFF              ROLL sw - MODE CONT              PITCH sw - MODE CONT              YAW sw - MODE CONT              PGNS sw - OFF              AGS sw - OFF              IMU CAGE sw - OFF            HTR CONT: TEMP MON sel - LDG RADAR            EVRT THR:              RESET/COUNT sw - DOWN              THR CONT sw - STOP              SLEW CONT MIN sw - center              SLEW CONT SEC sw - center            HTR CONT: RCS SYS A/B 2 QUAD 1, 2, 3, &amp; 4 sw - OFF            LTG:              SIDE PANELS sw - OFF              FLOOD sw - OFF              FLOOD cont - BRIGHT              EXTERIOR LTG sel - OFF              LAMP/TONE TEST sel - OFF (ccw)              X POINTER SCALE sw - HI MULT</p>	

**LMA790-3-LM**  
**APOLLO OPERATIONS HANDBOOK**

CREW-MAN	PNL	PROCEDURES	REMARKS
		<p>4.3.1 PREPARATION FOR SUBLIMATOR DRYOUT (cont)</p>	
	4	<p>ACA/4 JET sw (CDR) - DISABLE TTCA/TRANSL sw (CDR) - DISABLE ACA/4 JET sw (LMP) - DISABLE TTCA/TRANSL sw (LMP) - DISABLE</p>	
	AOT	<p>10. Azimuth cont - CL Eye guard assembly and density filter - removed MARK X pb - not depressed MARK Y pb - not depressed REJECT pb - not depressed</p>	
	2	<p>11. RCS: SYS A ASC FEED 1 &amp; 2 sw - center SYS A ASC FUEL &amp; OXID tb - bp SYS B ASC FEED 1 &amp; 2 sw - center SYS B ASC FUEL &amp; OXID tb - bp SYS A QUAD 1, 4, 2, &amp; 3 sw - center; tb - gray SYS B QUAD 1, 4, 2, &amp; 3 sw - center; tb - gray CRSFD sw - center; tb - bp SYS A MAIN SOV sw - center; tb - gray SYS B MAIN SOV sw - center; tb - gray TEMP/PRESS MON sel - He ACA PROP sw - DISABLE MASTER ALARM pb/lc - not depressed RATE/ERR MON sw - LDC RDR/CMPT ATTITUDE MON sw - AGS O2/H2O QTY MON sel - DES 2</p>	
	TTCA	<p>12. THROTTLE/JETS cont (LMP) - JETS Throttle friction cont (LMP) - TBD</p>	
	6	<p>13. Eng STOP pb/lc - reset ACS STATUS sw - OFF</p>	
	ACA	<p>14. PTT pb (LMP) - not depressed</p>	
	14	<p>15. COMM: UPLINK SQUELCH sw - ENABLE</p>	
	12	<p>16. UP DATA LINK sw - OFF AUDIO: AUDIO CONT sw - NORM S BAND T/R sw - OFF</p>	

SUBS  
DEAC

**LMA790-3-LM  
APOLLO OPERATIONS HANDBOOK**

CREW- MAN	PNI	PROCEDURES	REMARKS
		<p>4.3.1 PREPARATION FOR SUBLIMATOR DRYOUT (cont)</p> <p>ICS T/R sw - OFF            RELAY ON sw - RELAY OFF            MODE sw - ICS/PTT            VHF A sw - OFF            VHF B sw - OFF            COMM:</p> <p>S BAND MODULATE sw - PH            S BAND XMTR/RCVR sw - PRIM            S BAND PWR AMPL sw - PRIM            S BAND VOICE sw - OFF            S BAND PCM sw - PCM            S BAND RANGE sw - OFF/RESET            VHF A XMTR sw - OFF            VHF A RCVR sw - OFF            VHF B XMTR sw - OFF            VHF B RCVR sw - OFF            TLM BIONED sw - OFF            TLM PCM sw - HI            RECORDER sw - OFF            RECORDER TAPE tb - bp            COMM ANT:</p> <p>VHF sel - as required            TRACK MODE sw - AUTO            FITCH cont - as required            YAW cont - as required            S BAND sel - SLEW</p>	<p>High-bit-rate telemetry is required to monitor glycol temperature in real time.</p>
		<p>17. SUIT TEMP vlv - COLD</p> <p>18. LIQUID GARMENT COOLING vlv - COLD</p> <p>19. CB LTG: MASTER ALARM - open</p> <p>20. CB/AC BUS B:            He/PQCS PROPUL DISP - open            S BD ANT - close            ORDEAL - open            AGS - open            AOT LAMP - open            SE FDAI - open</p>	<p>If Sublimator Dryout Procedure is performed on lunar surface, using erectable antenna: TRACK MODE sw - OFF and S BAND sel - LUNAR STAY. If Sublimator Dryout procedure is performed on lunar surface using steerable antenna: TRACK MODE sw - SLEW and S BAND sel - SLEW.</p>
		<p>16</p> <p>11</p>	<p>CB LTG: MASTER ALARM - open out of sequence to prevent erroneous failure signals from activating master alarm.</p>

**LMA790-3-LM  
APOLLO OPERATIONS HANDBOOK**

CREW-MAN	PNL	PROCEDURES	REMARKS
		<p>4.3.1 PREPARATION FOR SUBLIMATOR DRYOUT (cont)</p> <p>CB/AC BUS A:            TAPE RCDR - open            AOT LAMP - open            RNDZ RDR - open            DECA GMBL - open            CB RCS SYS A:            MAIN SOV - open            ASC FEED 2 - open            ASC FEED 1 - open            CB FLT DISP: THRUST - open            THRUST ind pwr fail lt - on            CB FLT DISP: CDR X PNTR - open            X pointer ind pwr fail lt - on            CB FLT DISP: RNG/RNG RT - open            RNG/ALT ind pwr/sig fail lt - on            CB FLT DISP:            CDR FDAI - open            COAS - open            ORDEAL - open            CB AC BUS A:            RNG/RNG RT - open            CDR FDAI - open            CB HTR:            URINE LINE - open            RNDZ RDR SIDBY - close            RNDZ RDR OPR - open            DOCK WINDOW - open            AOT - open            CB S/C:            ABORT STAGE - open            ATCA (PGNS) - open            PRE AMPS caut lt - on            CB S/C:            AELD - open            ATT DIR CONT - open            ENG START OVRD - open            CB ED:            LDG GEAR FLAG - open            LOGIC PWR A - open            CB HTR RCS SYS A/B 1: QUAD 4, 3, 2, &amp; 1 - open</p>	<p>Opening CB FLT DISP: RNG/RNG RT before opening CB/AC BUS A: RNG/RNG RT removes drive power from tapemeter before logic power. This prevents erratic driving, and possible off-scale condition, of tapemeter during power-down.</p>

SUBSYS  
DEACT

**LMA790-3-LM**  
**APOLLO OPERATIONS HANDBOOK**

LM 3231

CREW-MAN	PNL	PROCEDURES	REMARKS
		<p><u>4.3.1 PREPARATION FOR SUBLIMATOR DRYOUT (cont)</u></p> <p>CB ECS:            SUIT FAN 1 - open            CABIN FAN - open            ECS caut lt - on            SUIT FAN comp caut lt - on            H2O SEP comp caut lt - on (delayed)            CB COMW:            UP DATA LINK - open            VHF B XMTR - open            VHF A RCVR - open            CB PCNS:            SIG STR DISP - open            LDG RDR - open            RNDZ RDR - open            LGC/DSKY - open            IMU OPR - open            CB EPS:            ASC ECA CONT - open            ASC ECA - open            INV 1 - open            CB PROPUL: DES He REG/VENT - open            Verify cb status per Preparation for Sublimator Dryout</p>	<p>Light on when water separator speed &lt; 800 rpm.</p> <p>LGC warn lt discrete is normally closed contact; therefore, light is on whenever CMEA is powered up and LGC is not powered up.</p> <p>See figure 4-12.</p>
	16	21. CB FLT DISP: EVNT TMR/SE FDAI - open SE X PNTR - open X pointer ind pwr fail lt - on FDAI pwr tb - OFF (in view) CB RCS SYS B: ASC FEED 1 - open ASC FEED 2 - open CRSFD - open TEMP/PRESS DISP FLAGS - open RCS: PRESS ind pwr fail lt - on CB RCS SYS B: PQGS/DISP - open RCS: QUANTITY ind pwr fail lt - on CB RCS SYS B: MAIN SOV - open CB PROPUL: DISP/ENG OVRD LOGIC - open MPS: PRESS ind pwr fail lt - on CB PROPUL: PQGS - open ASC He REG - open	

Basic Date 26 September 1971

Change Date \_\_\_\_\_

Page 4.3-8

LMA790-3-LM  
 APOLLO OPERATIONS HANDBOOK

LM3216

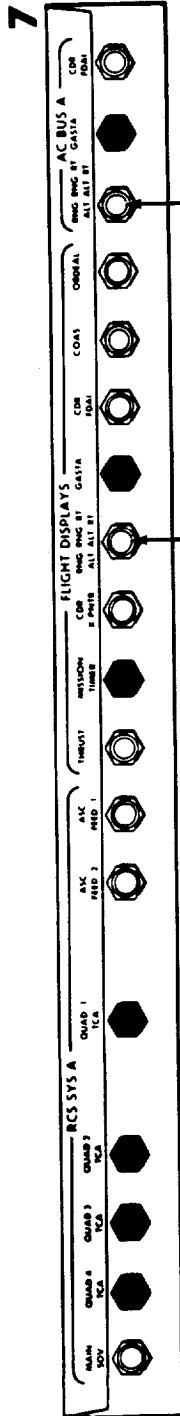
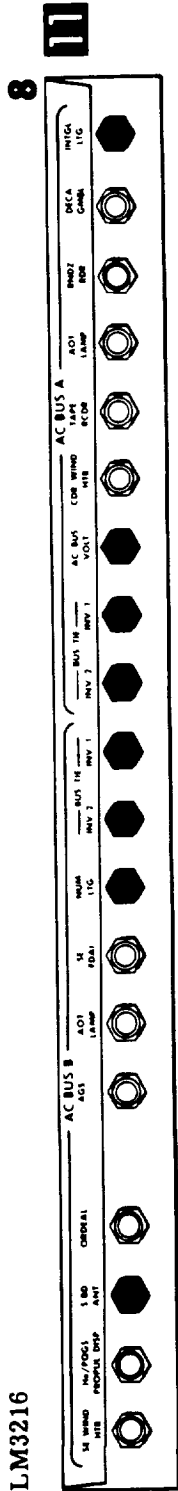

OPEN 1ST  
 OPEN 2ND

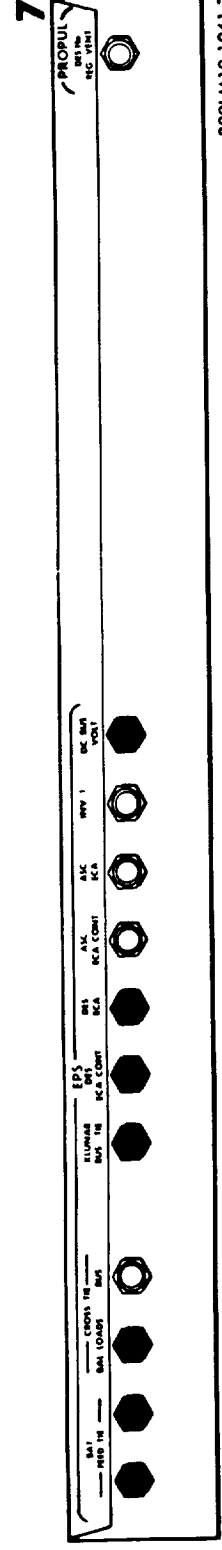
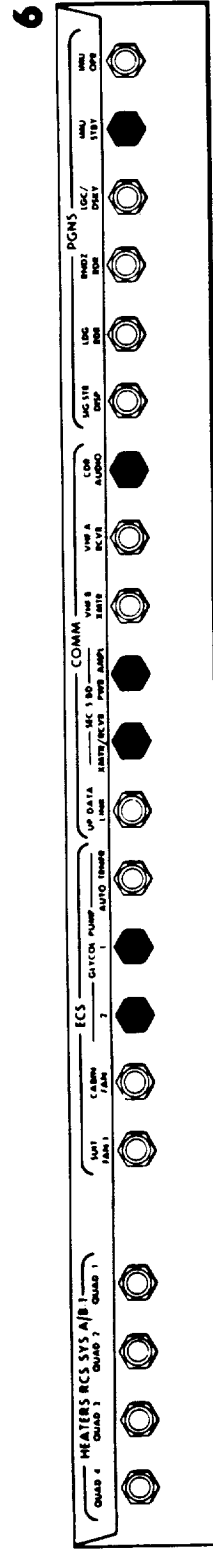
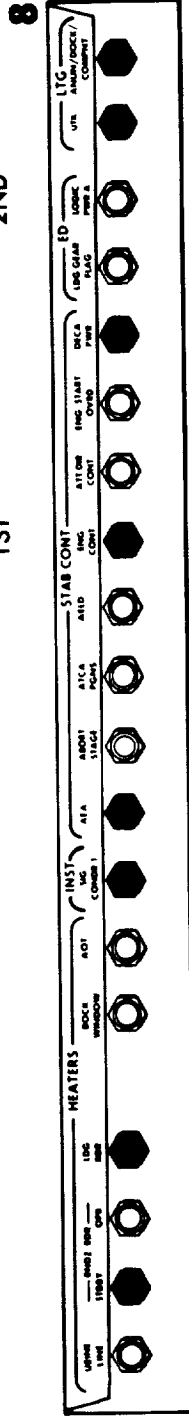

300LM10-1061-7

**LMA790-3-LM  
APOLLO OPERATIONS HANDBOOK**

LM 3204

CREW-MAN	PNL	PROCEDURES	REMARKS
		<p><u>4.3.1 PREPARATION FOR SUBLIMATOR DRYOUT (cont)</u></p> <p>CB LTG: TRACK - open            CB ED: LOGIC PMR B - open            CB S/C:                AEA - open                ENG ARH - open                AELD - open                ABORT STAGE - open                ATCA (AGS) - open                DES ENG OVRD - open            CB ECS: SUIT FLOW CONT - open            CB COMM:                VHF A XMTR - open                VHF B RCVR - open                S BD ANT - open                TV - open            CB ECS:                GLYCOL PUMP SEC - open                CABIN FAN CONT - open                SUIT FAN 2 - open                SUIT FAN AP - open                SUIT FAN comp caut lt - OFF            CB ECS:                DIVERT VLV - open                CO2 SENSOR - open                CB HTR RCS SYS A/B 2: QUAD 1, 2, 3, &amp; 4 - open                CB CAMR: SEQ - open            CB EPS:                ASC ECA - open                ASC ECA CONT - open            Verify cb status per Preparation for Sublimator Dryout.</p>	
	2 16		See figure 4-13.
	ECS	<p><u>4.3.2 SUBLIMATOR DRYOUT</u></p> <p>1. PRI EVAP FLOW #1 vlv - CLOSE            2. ECS: GLYCOL temp ind - monitor</p>	GLYCOL caut lt - on when ECS: GLYCOL temp ind >50°F.



4

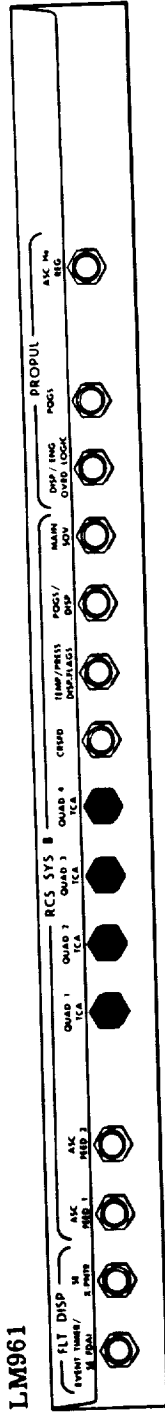

8

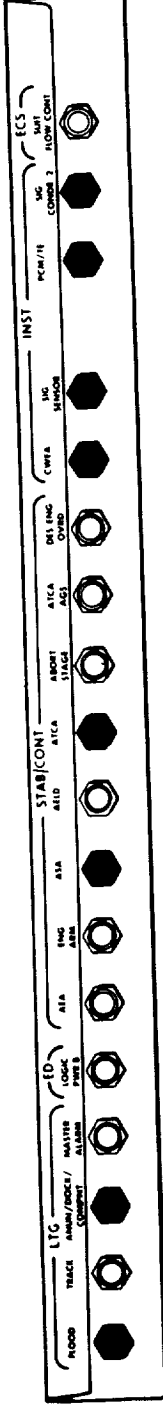

8

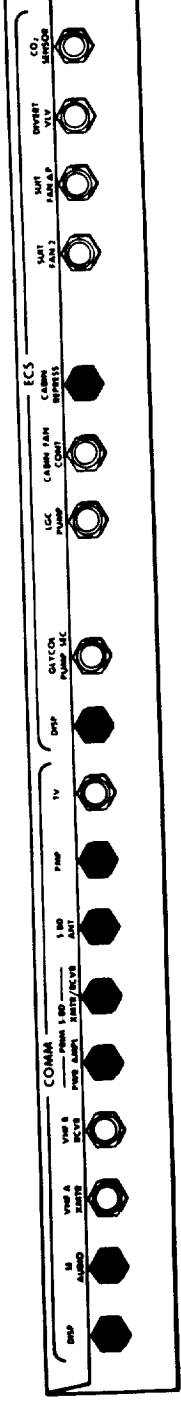

11

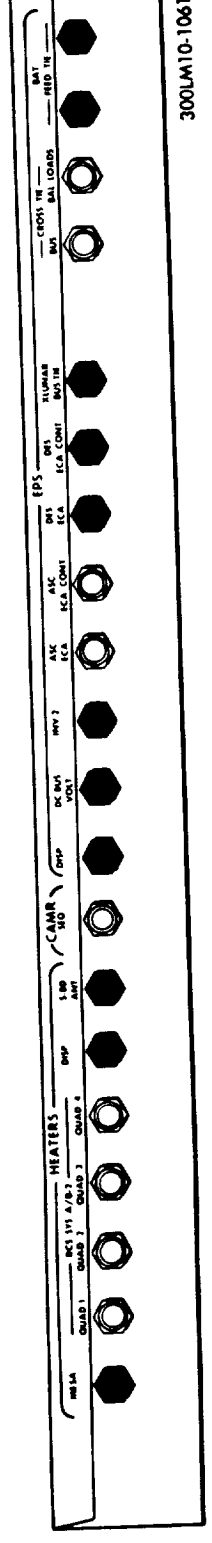

300LM10-1061-8

16

Figure 4-13. Preparation For Sublimator Dryout (Panel 16)

**LMA790-3-LM**  
**APOLLO OPERATIONS HANDBOOK**

CREW-MAN	PNL	PROCEDURES	REMARKS
		<p><u>4.3.3 FINAL SUBSYSTEM DEACTIVATION</u></p> <p style="text-align: center;">NOTE</p> <p>See figure 4-14 for time since PRI EVAP FLOW #1 vlv - CLOSE (para 4.3.2, step 1) before proceeding.</p> <p>1. CB INST: CWEA - open C/W PWR caut lt - on</p> <p>2. CB/AC BUS B: SE WIND HTR - open BUS TIE INV 1 - open CB/AC BUS A: BUS TIE INV 1 - open AC BUS VOLT - open CDR WIND HTR - open CB RCS SYS A: QUAD 4 TCA - open QUAD 3 TCA - open QUAD 2 TCA - open QUAD 1 TCA - open CB FLT DISP MSN TMR - open GASTA - open CB/AC BUS A: GASTA - open CB INST: SIG CONDR 1 - open CB S/C: DECA PWR - open CB LTC: UTIL - open ANUN/DOCK/COMPNT - open CB ECS: CABIN FAN - open CB CONM: SEC S BD XNTR/RCVR - open SEC S BD PWR AMPL - open CDR AUDIO - open CB EPS: CROSS TIE BUS - open X LUNAR BUS TIE - open DC BUS VOLT - open</p> <p style="text-align: right;">Verify cb status per Final Subsystem Deactivation</p>	<p>CB INST: CWEA - open out of sequence to prevent erroneous failure signals from activating CWEA and overloading LCA as subsequent circuit breakers are opened.</p>

See figure 4-15 (Sheet 1 of 4).

LMA790-3-LM  
APOLLO OPERATIONS HANDBOOK

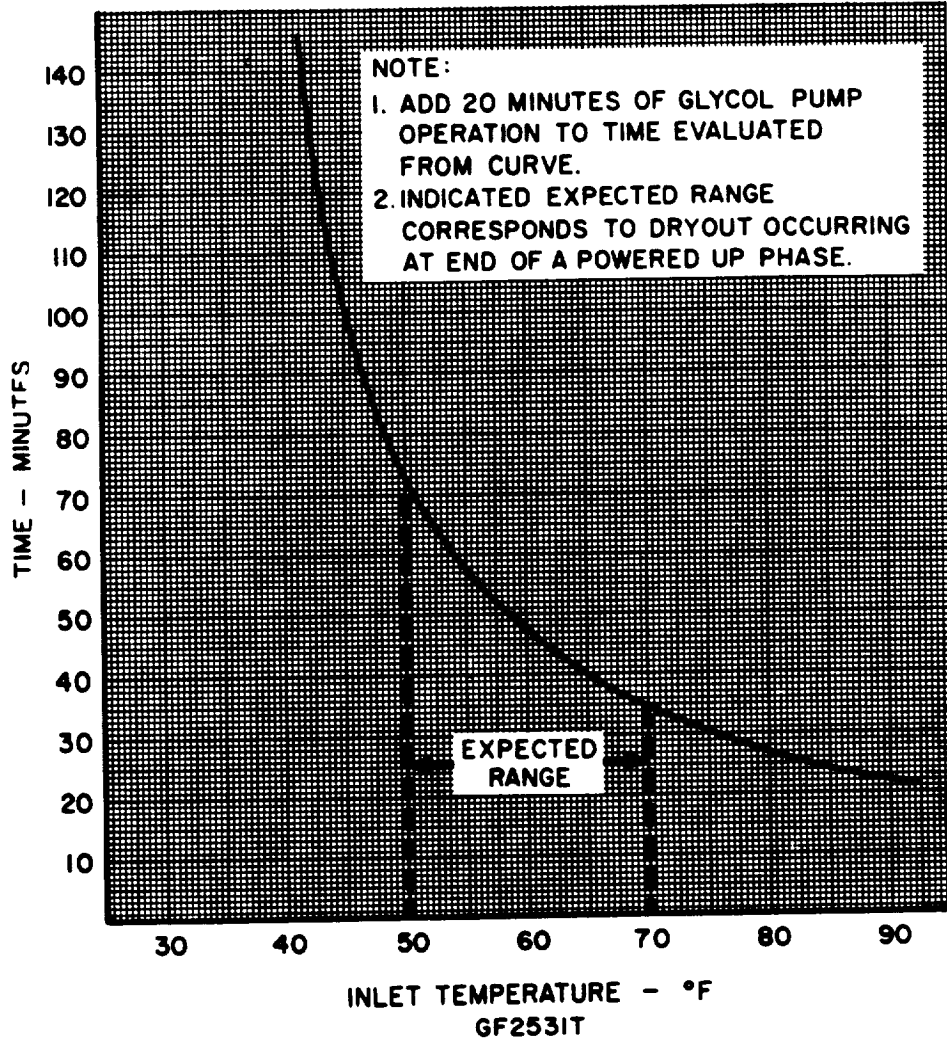

300LM5-1050

Figure 4-14. Sublimator Dryout Time Required vs Initial Inlet Temperature

LMA790-3-LM  
 APOLLO OPERATIONS HANDBOOK

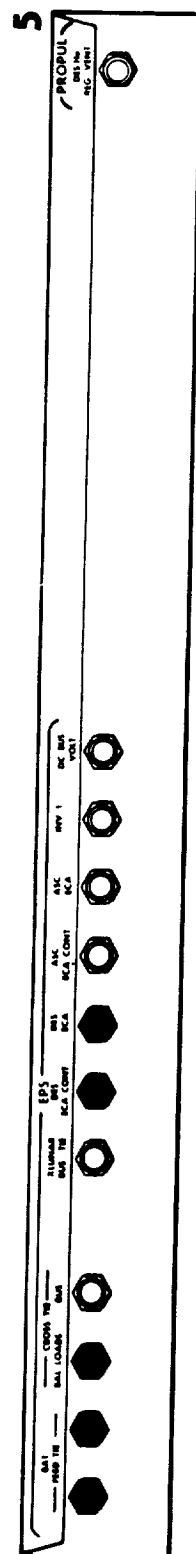
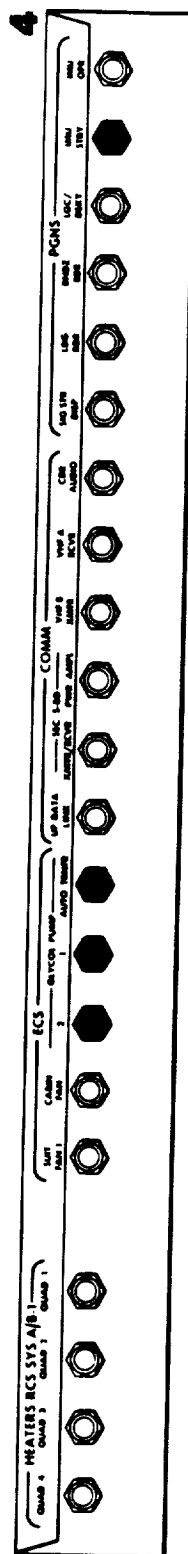
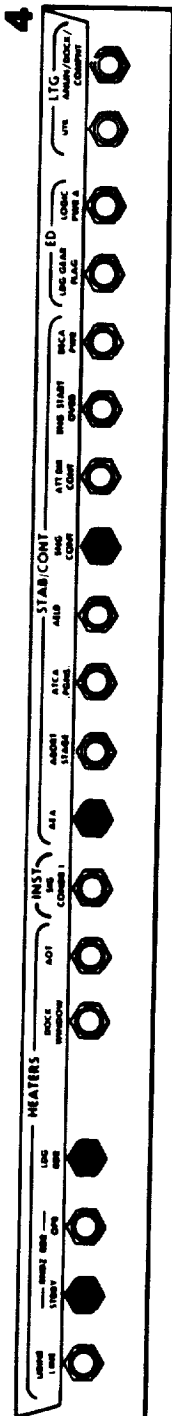
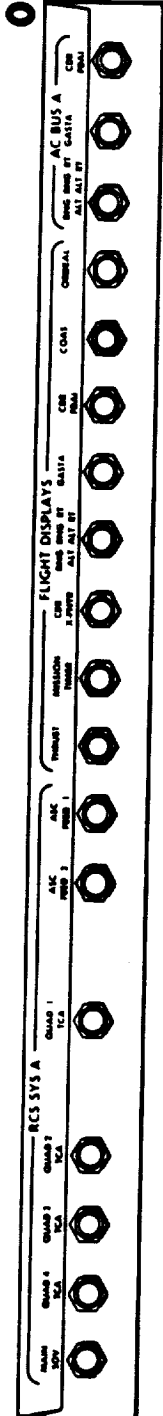
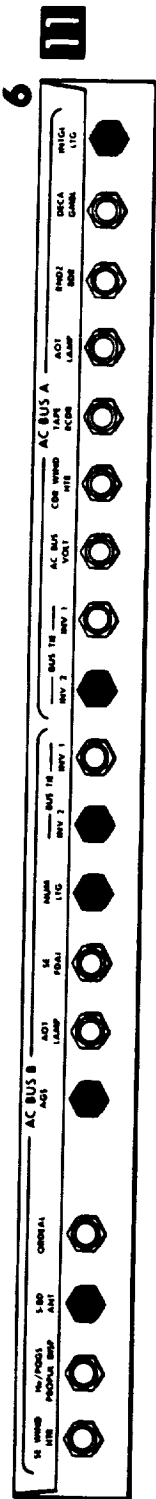

300LM10-1061-9

Figure 4-15. Final Subsystem Deactivation, Panel 11 (Sheet 1 of 4)

**LMA790-3-LM**  
**APOLLO OPERATIONS HANDBOOK**

CREW-MAN	PNL	PROCEDURES	REMARKS
	16	<p>4.3.3.3 FINAL SUBSYSTEM DEACTIVATION (cont)</p> <p>3. CB RCS SYS B:            QUAD 1 TCA - open            QUAD 2 TCA - open            QUAD 3 TCA - open            QUAD 4 TCA - open            CB LTG: ANUN/DOCK/COMPNT - open            CB S/C:            ATCA - open            ATCA (AGS) - open            CB INST:            SIG SENSOR - open            PCM/TE - open            CB COMM:            DISP - open            SE AUDIO - open            PRIM S BD PWR AMPL - open            PRIM S BD XMTR/RCVR - open            PMP - open            CB ECS: DISP - open            CB EPS:            DC BUS VOLT - open            X LUNAR BUS TIE - open            CROSS TIE BUS - open            Verify cb status per Final Subsystem Deactivation.</p>	<p>C/W PWR caut lt, all component caution lights, and all indicator power failure lights go off.</p>
	ECS	<p>4. ECS closeout:            Overhead floodlight (LMP) - rotate aft            SUIT GAS DIVERTER vlv - PULL EGRESS            LO PLSS FILL vlv - CLOSE            PRESS REC A vlv - CLOSE            PRESS REC B vlv - CLOSE            #1 ASC O2 vlv - CLOSE            #2 ASC O2 vlv - CLOSE            SUIT ISOL vlv (LMP) - SUIT DISC            SUIT ISOL vlv (CDR) - SUIT DISC            ASC H2O vlv - CLOSE            SEC EVAP FLOW vlv - CLOSE            DES H2O vlv - CLOSE            PRI EVAP FLOW #1 vlv - CLOSE            WATER TANK SELECT vlv - DES            LIQUID GARMENT COOLING vlv - COLD            CABIN GAS RETURN vlv - AUTO</p>	<p>See figure 4-15 (Sheet 2 of 4).</p> <p>When PRESS REC A and/or B vlv - CLOSE, ensure handle is rotated to full hard stop position.</p>

SUBSYS  
DEACT

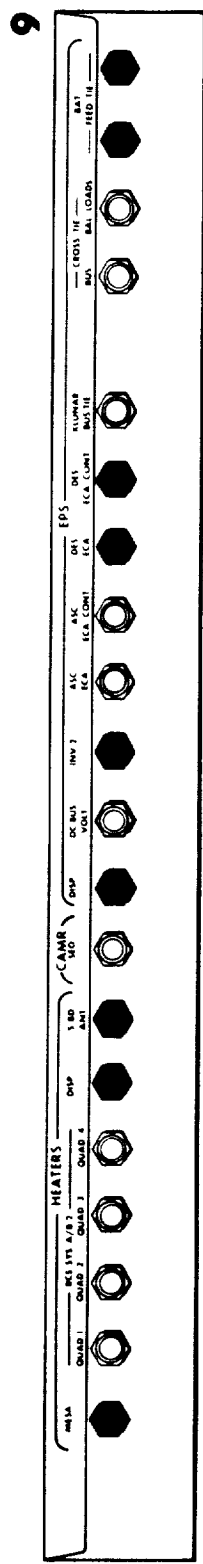
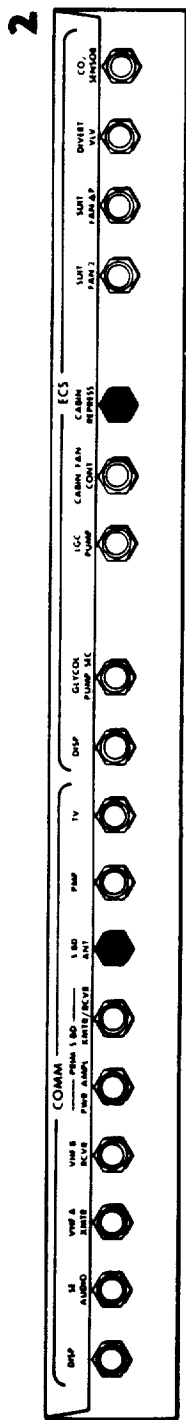
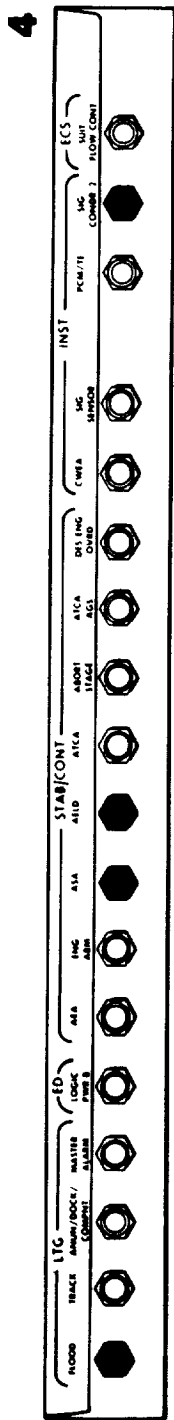
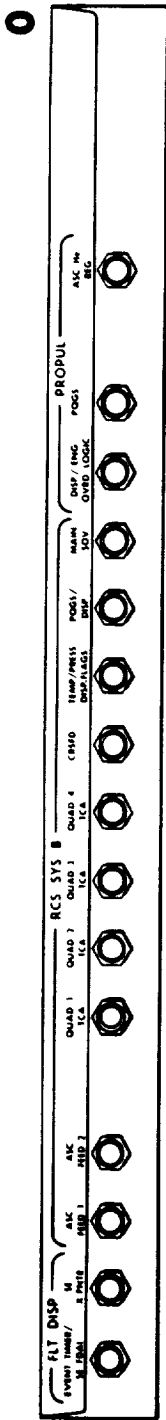

300LM10-1061-10

Figure 4-15. Final Subsystem Deactivation, Panel 16 (Sheet 2 of 4)

**LMA790-3-LM**  
**APOLLO OPERATIONS HANDBOOK**

CREW/ MAN	PNL	PROCEDURES	REMARKS
		<p>4.3.3 FINAL SUBSYSTEM DEACTIVATION (cont)</p> <p>CO2 CANISTER SEL vlv - PRIM            SUIT CIRCUIT RELIEF vlv - AUTO            PRIM CO2 CANISTER cover - CLOSE            SEC CO2 CANISTER cover - CLOSE            WATER SEP SEL vlv - PULL SEP 2            Overhead floodlight (LMP) - rotate forward            SUIT FAN sel - 1            GLYCOL sel - PUMP 2            O2/H2O QTY MON sel - ASC 2            Cabin relief &amp; dump vlv (fwd) - AUTO            HI PLSS O2 FILL vlv - CLOSE</p>	
	2		
	ECS +Z27		
	14	<p>5. EPS closeout:            EPS:            ED VOLTS sw - OFF            POWER/TEMP MON sel - ED/OFF</p>	
	16	<p>All cb's - open, except:            CB LTG: FLOOD - close            CB S/C: ASA - close            CB INST: SIG CONDR 2 - close            CB ECS: CABIN REPRESS - close            CB HTR: S BD ANT - close            CB EPS:            DISP - close            INV 2 - close            DES ECA - close            DES ECA CONT - close            CROSS TIE BUS - close            CROSS TIE BAL LOADS - close            BAT FEED TIE (2) - close</p>	
	11	<p>NOTE</p> <p>See figure 4-14 for time since PRI            EVAP FLOW #1 vlv - CLOSE (para            4.3.2, step 1) before proceeding.</p> <p>CB ECS:            GLYCOL PUMP AUTO TRNFR - open            GLYCOL PUMP 1 - open            GLYCOL PUMP 2 - open</p>	<p>To avoid setting automatic transfer circuit, CB ECS:            GLYCOL PUMP AUTO TRNFR - open before CB ECS: GLYCOL PUMP            1 - open.</p>

SUBSYS  
DEACT

**LMA790-3-LM  
APOLLO OPERATIONS HANDBOOK**

CREW- MAN	PNI	PROCEDURES	REMARKS
		<b>4.3.3 FINAL SUBSYSTEM DEACTIVATION (cont.)</b>	
	11	<p>All cb's - open, except:            CB/AC BUS B:            NUM LTG - close            BUS TIE INV 2 - close            CB/AC BUS A:            BUS TIE INV 2 - close            INTGL LTG - close            CB HTR:            RNDZ RDR STBY - close            LDG RDR - close            CB PCNS: IMU STBY - close            CB EPS:            BAT FEED TIE (2) - close            CROSS TIE BAL LOADS - close            CROSS TIE BUS - close            DES ECA CONT - close            DES ECA - close            EPS:            LMP BAT 2 sw - OFF/RESET; tb - bp            CDR BAT 3 sw - OFF/RESET; tb - bp            CDR BAT 4 LO V sw - OFF/RESET; tb - bp, then ON; tb - LO            LMP BAT 1 LO V sw - OFF/RESET; tb - bp, then ON; tb - LO            CB INST: SIG CONDR 2 - open            CB EPS:            DISP - open            CROSS TIE BUS (2) - open</p>	Switching all descent stage batteries from high to low voltage must be completed in <1 minute due to reverse current.
	14		
	16		
	11,16		
	16		
	14		
	11		
	16		
	11		
	10.	<p>Disable LM cabin repressurization system.</p>	See figure 4-15 (Sheets 3 of 4 and 4 of 4). Ref para 4.14.6.







**LMA790-3-LM**  
**APOLLO OPERATIONS HANDBOOK**

CREW-MAN	PNL	PROCEDURES	REMARKS
		<p>4.3.3 <u>FINAL SUBSYSTEM ACTIVATION (cont)</u></p> <p>11. Perform Intravehicular Transfer to CSM.</p> <p>12. CSM transfer power from LM to CSM.</p>	<p>Ref para 4.14.4.</p> <p>Power may be momentarily interrupted due to transfer effects. Online equipment should not suffer degradation. Equipment remaining on line via translunar bus:</p> <ul style="list-style-type: none"> <li>S-band steerable antenna heater</li> <li>Landing radar heater</li> <li>IMU heater</li> <li>ASA heater</li> <li>DES ECA cont (2)</li> </ul> <p>Overhead floodlights remain on while overhead hatch is open.</p>
		<p>4.3.4 <u>LM TRANSFER TO CSM POWER</u></p> <p>4.3.4.1 <u>LM Transfer to CSM Power (Unstaged)</u></p>	<p>Assumptions: (1) Descent batteries are on low-voltage taps, (2) LMP is receiving life support via transfer umbilical, (3) procedure is performed just before LMP intravehicular transfer to CSM, and (4) open-circuited reset line between CSM reset switch and LM relay junction box (RJB) prohibits descent battery HV/LV off signal.</p>
	16	<p>1. CB EPS: XLUNAR BUS TIE - close CB INST: SIG CONDR 2 - close CB EPS:</p>	
	11	<p>DISP - close DES ECA CONT - close CROSS TIE BUS - open XLUNAR BUS TIE - open DES ECA CONT - open ASC ECA CONT - open ASC ECA - open INV 1 - open DC BUS VOLT - open</p>	
	14	<p>2. EPS: CDR BAT 3 sw - OFF/RESET; tb - bp CDR BAT 4 LO V sw - OFF/RESET; tb - bp LMP BAT 1 HI V sw - OFF/RESET; tb - bp, then ON; tb - gray LMP BAT 2 sw - OFF/RESET; tb - bp</p>	
		<p>3. Coordinate transfer of power with CSM crewman.</p>	

SUBSYS  
DEACT

**LMA790-3-LM  
APOLLO OPERATIONS HANDBOOK**

LM 971

CREW- MAN	PNI	PROCEDURES	REMARKS
		<p>4.3.4.1 <u>LM Transfer to CSM Power (Unstaged) (cont)</u></p> <p style="text-align: center;">CAUTION</p> <p>Step 4 causes loss of vehicle lighting until power transfer to CSM is completed.</p> <p>16 4. CB EPS: BAT FEED TIE (2) - open</p> <p>5. Request CSM crewman to transfer power from LM to CSM.</p> <p>6. When lighting is restored: EPS: LMP BAT 1 HI V sw - OFF/RESET; tb - bp</p> <p>16 7. CB INST: SIG CONDR 2 - open CB EPS: DISP - open DES ECA CONT - open XLUNAR BUS TIE - open BAT FEED TIE (2) - close</p> <p>11 8. CB EPS: DES ECA CONT - open</p> <p>4.3.4.2 <u>LM Transfer to CSM Power (Staged)</u></p> <p>14 1. EPS: ED VOLTS sw - OFF POWER/TEMP MON sel - ED/OFF INVERTER sw - OFF</p> <p>16 2. All cb's - open, except: CB LTG: FLOOD - close CB S/C: ASA - close CB INST: SIG CONDR 2 - close CB HTR: S BD ANT - close CB EPS: DISP - close ASC ECA - close ASC ECA CONT - close XLUNAR BUS TIE - close BAT FEED TIE (2) - close</p>	

LMA790-3-LM  
**APOLLO OPERATIONS HANDBOOK**

LM 323

CREW- MAN	PNL	PROCEDURES	REMARKS
	11	<p>4.3.4.2 LM Transfer to CSM Power (Staged) (cont)</p> <p>3. All cb's - open, except:            CB LTC: UTIL - close            CB PGNS: IMU STBY - close            CB EPS:                BAT FEED TIE (2) - close                CROSS TIE BAL LOADS - close                ASC ECA CONT - close</p> <p style="text-align: center;">CAUTION</p> <p>Step 4 causes loss of vehicle utility lights until power transfer to CSM is completed.</p>	
	14.	<p>4. EPS: BAT 6 NORMAL CDR FEED sw - OFF/RESET; tb - bp</p> <p>5. Coordinate power transfer with CSM crewman.</p> <p>6. Request CSM crewman to transfer power from LM to CSM.</p> <p style="text-align: center;">CAUTION</p> <p>Step 7 causes loss of vehicle floodlights until power transfer to CSM is completed.</p>	
	16	<p>7. When utility lighting is restored:            EPS: BAT 5 NORMAL LMP FEED sw - OFF/RESET; tb - bp</p> <p>8. CB EPS: CROSS TIE BAL LOADS - close</p> <p>9. CB INST: SIG CONDR 2 - open            CB EPS:                DISP - open                ASC ECA - open                ASC ECA CONT - open                XLUNAR BUS TIE - open</p>	<p>Vehicle floodlights are restored.</p> <p>Equipment remaining on line via CSM-LM electrical umbilical:            S-band steerable antenna heater            IMU heater            ASA heater            Overhead floodlights remain on while overhead hatch is open.</p>

SUBSYS  
 DEACT

**LMA790-3-LM  
APOLLO OPERATIONS HANDBOOK**

CREW-MAN	PNL	PROCEDURES	REMARKS
		<p>4.3.4.2 LM Transfer to CSM Power (Staged) (cont)</p> <p>10. CB EPS: ASC ECA CONT - open</p> <p>11. CB LTG: UTIL - open</p> <p>12. Perform Intravehicular Transfer to CSM.</p> <p>4.3.5 LM TRANSFER TO LM LV POWER (BACKUP)</p> <p>1. CB EPS: XLUNAR BUS TIE - close            CB INST: SIG CONDR 2 - close            CB EPS:                DISP - close                DES ECA CONT - close                BAT FEED TIE (2) - open</p> <p>2. EPS: LMP BAT 1 HI V sw - ON; tb - stay</p> <p>3. Coordinate power transfer with CSM crewman.</p> <p style="text-align: center;">CAUTION</p> <p>Step 4 causes loss of vehicle lighting until power transfer to LM is completed. Keep fingers on panel 16 CB EPS: BAT FEED TIE (2).</p> <p>4. Request CSM crewman to remove CSM power.</p> <p style="text-align: center;">WARNING</p> <p>Do not perform step 5 until vehicle lights are off.</p> <p>16 5. CB EPS: BAT FEED TIE (2) - close</p> <p>14 6. EPS:            LMP BAT 2 sw - OFF/RESET; tb - bp, then ON; tb - gray            LMP BAT 1 LO V sw - OFF/RESET; tb - bp, then ON; tb - LO            CDR BAT 3 sw - OFF/RESET; tb - bp            CDR BAT 4 LO V sw - ON, tb - LO            LMP BAT 2 sw - OFF/RESET; tb - bp</p>	<p>Ref para 4.14.4.</p> <p>Assumptions: (1) Crewman is in LM, (2) CSM maintains power to LM, and (3) short-circuited set line between CSM power switch and LM deadface relay (DFR) prevents setting descent battery low-voltage set coil from CSM.</p> <p style="text-align: right;">Lighting is restored.</p>

**LMA790-3-LM**  
**APOLLO OPERATIONS HANDBOOK**

CREW-MAN	PNL	PROCEDURES	REMARKS
	16	<p><u>4.3.5 LM TRANSFER TO LM LV POWER (BACKUP) (cont)</u></p> <p>7. CB INST: SIG CONDR 2 - open CB EPS: DISP - open DES ECA CONT - open XLUNAR BUS TIE - open</p> <p><u>4.3.6 CSM TRANSFER TO LM POWER</u></p> <p><u>4.3.6.1 LM Initial Power-Up (CSM Powered Down)</u></p> <p>1. CB INST: SIG CONDR 2 - close CB EPS: DISP - close ASC ECA CONT - close</p> <p>2. EPS: BAT 5 NORMAL LMP FEED sw - ON; tb - gray</p> <p>3. CB EPS: DES ECA CONT - close XLUNAR BUS TIE - close</p> <p>EPS: LMP BAT 1 LO V sw - ON; tb - LO BAT 5 NORMAL LMP FEED sw - OFF/RESET; tb - bp LMP BAT 2 sw - ON; tb - gray CDR BAT 3 sw - ON; tb - gray CDR BAT 4 LO V sw - ON; tb - LO DES BATS tb - gray BAT 5 BACKUP CDR FEED tb - bp BAT 6 NORMAL CDR FEED tb - bp BAT 6 BACKUP LMP FEED tb - bp CB EPS: ASC ECA CONT - open</p> <p>4. Perform EPS Activation &amp; Checkout.</p>	Ref para 4.2.2.
	14		
	11,16		
	14		
	16		

SUBSYS  
DEACT

**LMA790-3-LM**  
**APOLLO OPERATIONS HANDBOOK**

LM 980, LM 3191, LM 3201

CREW-MAN	PNL	PROCEDURES	REMARKS
		<p>4.3.6.2 CSM Transfer to LM Power (Staged)</p> <p>1. CB LTG: UTIL - close</p> <p>2. CB EPS: XLUNAR BUS TIE - close</p> <p>3. CB INST: SIG CONDR 2 - close            CB EPS:            DISP - close            ASC ECA - close            ASC ECA CONT - close</p> <p style="text-align: center;">CAUTION</p> <p>Step 4 causes loss of vehicle floodlights until power transfer to LM is completed.</p> <p>4. CB EPS: CROSS TIE BAL LOADS - open            EPS: BAT 5 NORMAL LMP FEED sw - ON; tb - gray</p> <p style="text-align: center;">CAUTION</p> <p>Do not use Lunar Bat.</p> <p>5. Coordinate power transfer with CSM crewman.</p> <p style="text-align: center;">CAUTION</p> <p>Step 6 causes loss of vehicle utility lights until power transfer to LM is completed.</p> <p>6. Request CSM crewman to transfer power from CSM to LM.</p> <p>7. EPS: BAT 6 NORMAL CDR FEED sw - ON; tb - gray            CB EPS: CROSS TIE BAL LOADS - close</p> <p>8. CB EPS:            ASC ECA - close            ASC ECA CONT - close            XLUNAR BUS TIE - close</p>	
	11		
	16		
	16 14		
	14 16		
	11		



# LMA790-3-LM APOLLO OPERATIONS HANDBOOK

CREW-MAN	PNL	PROCEDURES	REMARKS
		<p>LM 980., LM 3191, LM 3201</p> <p>4.3.6.3 CSM Transfer to LM Power (Unstaged)</p> <p>1. CB INST: SIG CONDR 2 - close CB EPS:</p> <p style="padding-left: 20px;">DISP - close X-LUNAR BUS TIE - close DES ECA - close DES ECA CONT - close ASC ECA CONT - close ASC ECA - close CROSS TIE BAL LOADS - close CROSS TIE BUS - close CROSS TIE BAL LOADS - close EPS: BAT 6 NORMAL CDR FEED sw - ON; tb - gray</p> <p>2. Connect LM/CSM umbilicals.</p> <p>3. CSM configure for LM power transfer.</p> <p>4. After receiving "GO" from CSM: EPS: BAT 1, 2, 3, &amp; 4 tb - gray If not: EPS: LTP BAT 1 HI V sw - ON; tb - gray (LMP BAT 2 sw - ON; tb - gray) (CDR BAT 3 sw - ON; tb - gray) (CDR BAT 4 HI V sw - ON; tb - gray)</p> <p>5. CB INST: SIG CONDR 2 - open CB EPS: DISP - open</p> <p>6. EPS: BAT 6 NORMAL CDR FEED sw - OFF/RESET; tb - bp CB EPS: ASC ECA CONT - open</p>	
	16		
	11,16		
	11,16		
	16,11 14		
	14		
	16		
	14		
	11,16		
			Circuit breakers limit current to 15 amperes.

SUBSYS  
DEACT

**LMA790-3-LM  
APOLLO OPERATIONS HANDBOOK**

LM 980, LM 3191, LM 3202

CREW- MAN	PNL	PROCEDURES	REMARKS
		<u>4.3.6.4 CSM Transfer to LM Power (Staged) - Lifeboat</u>	
11		1. CB LIG: UTIL - close	
16		2. CB EPS: XLUNAR BUS TIE - close	
		3. CB INST: SIG CONDR 2 - close CB EPS: DISP - close ASC ECA - close ASC ECA CONT - close ASC ECA CONT - close CB EPS: ASC ECA - close ASC ECA CONT - close XLUNAR BUS TIE - close	
16		4. CB EPS: CROSS TIE BAL LOADS - open	
14		EPS: BAT 5 NORMAL LMP FEED sw - ON; tb - gray	
14		5. Request CSM crewman to transfer power to CSM power.	
16		6. EPS: BAT 6 NORMAL CDR FEED sw - ON; tb - gray CB EPS: CROSS TIE BAL LOADS - close	
		<u>4.3.7 LM-TO-CSM POWER TRANSFER (UNSTAGED) (POWER REMOVAL FROM CSM/LM UMBILICAL)</u>	
16		1. CSM configure for LM power removal.	
		2. CB INST: SIG CONDR 2 - close CB EPS: CROSS TIE BAL LOADS - close DISP - close	
14		3. Descent batteries still available - EPS: LMP LUNAR BAT sw - OFF/RESET, then ON; tb - LMP Descent batteries not available - EPS: BAT 1 (2, 3, 4, & LUNAR BAT) tb - bp CB EPS: BAT FEED TIE (2) - open EPS: LMP LUNAR BAT sw - OFF/RESET, then ON; tb - LMP EPS: LMP LUNAR BAT sw - OFF/RESET; tb - bp CB EPS: BAT FEED TIE (2) - close	
16		4. CB INST: SIG CONDR 2 - open CB EPS: DISP - open	
			Circuit breakers limit current to 15 amperes.
			Assumption: One ascent battery is feeding power to CDR bus.
			Full LM power is now removed from CSM.
			Full LM power is now removed from CSM.

Basic Date 26 September 1971

Change Date \_\_\_\_\_

Page 4.3-28

**LMA790-3-LM**  
**APOLLO OPERATIONS HANDBOOK**

PARA	TITLE	PAGE
4.4	G&C Reference Data . . . . .	4.4-2
4.4.1	LGC/DSKY Restrictions . . . . .	4.4-2
4.4.2	AEA/DEDA Restrictions . . . . .	4.4-5
4.4.3	Jet Select Logic . . . . .	4.4-8
4.4.4	LGC Programs . . . . .	4.4-10
4.4.5	LGC Routines . . . . .	4.4-11
4.4.6	Verb List . . . . .	4.4-12
4.4.7	Noun List . . . . .	4.4-14
4.4.8	Star/Planet List . . . . .	4.4-26
4.4.9	Checklist Reference Codes (V50 N25) . . . . .	4.4-28
4.4.10	Option Codes (V04 N06, V04 N12 or V05 N06) . . . . .	4.4-28
4.4.11	Alarm Codes (V05 N09) . . . . .	4.4-29
4.4.12	AOT Detent/LPD/COAS Codes (N70, N71) . . . . .	4.4-32
4.4.13	Flagwords . . . . .	4.4-33
4.4.14	AGS Selector Logic . . . . .	4.4-49
4.4.15	DEDA Input List . . . . .	4.4-51
4.4.16	DEDA Output List . . . . .	4.4-54
4.4.17	DEDA Accessible Parameters List . . . . .	4.4-57

APOLLO OPERATIONS HANDBOOK

LM 3231

CREW-MAN	PNL	PROCEDURES	REMARKS
		<p>4.4 G&amp;C REFERENCE DATA</p> <p>4.4.1 LGC/DSKY RESTRICTIONS</p> <p>The following restrictions apply to use of the LGC and DSKY:</p> <ol style="list-style-type: none"> <li>a. For display verbs 01 through 07, monitor verbs 11 through 17, and load verbs 21 through 25, the number of components of the verb must not exceed the number of components of the noun being used. If this restriction is not observed, the OPR ERR lt goes on.</li> <li>b. Mixing of octal and decimal data in multicomponent load verbs is not permitted. Data components must be all decimal or all octal.</li> <li>c. Loaded machine addresses must be in octal form.</li> <li>d. The magnitude of data being loaded should not exceed that of the noun being used. If this restriction is not observed, OPR ERR lt goes on.</li> <li>e. Decimal data must be preceded by a sign (+ or -). Leading zeroes need not be loaded when loading decimal data.</li> <li>f. When loading time-only nouns, three data words (three registers) must be loaded (for hours, minutes, and seconds).</li> <li>g. All data loads must be verified before pressing ENTR pb for the last register being loaded. If any data are incorrect, the register can be cleared by pressing CLR pb. Each successive pressing of the CLR pb clears the preceding register. This backing-up action occurs only on components called by the load verb.</li> <li>h. Only one of the following extended verbs can be running at a time: 41, 42, 43, 47, 48, 49, 55, 63, 64, 67, 70, 71, 72, 73, 82, 83, 85, 89, 90, 91, and 92. Each of these verbs call Extended Verb Interlock Routine (R76). If an extended verb from R76 is running when another is selected, OPR ERR lt will go on.</li> <li>i. Flashing VERB/NOUN requires operator action. The program in process is halted until appropriate action is taken.</li> <li>j. Nouns 40, 44, 45, 61, 62, 64, 66, 68, 74, 75, 77, and 78 cannot be loaded by V24 or V25 or have components that cannot be loaded. Channel No. 7 cannot be loaded via noun 07 or 10. Channel No. 77 cannot be loaded via noun 07.</li> <li>k. Most nouns contain useful data only when relevant computations are running. The following are exceptions: 1, 2, 3, 8, 9, 10, 15, 20, 21, 26, 27, 36, 38, 47, 65, 72 (if RR mode-LGC), R1 of 45, R2 of 46, and R2 of 66.</li> </ol>	

**LMA790-3-LM**  
**APOLLO OPERATIONS HANDBOOK**

CREW-MAN	PNL	PROCEDURES	REMARKS
		<p>4.4.1 <u>LGC/DSKY RESTRICTIONS (cont)</u></p> <p>1. If verb 37 is attempted within approximately 15 seconds of a fresh start or ISS turn-on, a PIPA failure will go undetected. To correct this condition, select P00 and reset IMODES 30, bit 5 (key V37E 00E; key V25 N07E 1277E, 20E, E).</p> <p>m. Final Automatic Request Terminate Routine (ROO) is not executed if V37 is flashing, until a proper response is made keying in two digits (program number), then ENTR.</p> <p>n. Performing ICDU Zero (para 4.6.1.21) during LM Rendezvous Navigation Program (P20) (para 4.8.2.1) may result in a bad mark or designate.</p> <p>o. An efficient attitude hold/rate command mode is not provided when docked with the CSM.</p> <p>p. KALCMANU maneuver rate &gt;0.5°/sec should not be used when docked with the CSM.</p> <p>q. A 1°/sec loss of attitude results if a +X-jet fails on or off and is undetected.</p> <p>r. A hardware restart removes track enable. If LM Rendezvous Navigation Program (P20) is in process, P20 is forced back to the beginning of RR Designate Routine (R21) and calls Preferred Tracking Attitude Routine (R61).</p> <p>s. Deleted</p> <p>t. Deleted</p> <p>u. Deleted</p> <p>v. Any program can be terminated as follows: (1) via V34E at any flashing display except at N25 in P06; N49 in P20; N88 in P51, P52, or P57; N64 in P64; N60 in P66; (V34 response to an extended verb display will terminate the extended verb and not the program running underneath) of (2) via V37E XXE at any flashing or nonflashing display, except N25 in P06.</p> <p>w. Deleted</p> <p>x. Restarts will terminate automatic attitude maneuvers and cause RESTART lt or PROG lt to come on with FL V50 N18. To recover, key PRO and continue.</p> <p>y. Deleted</p> <p>z. Deleted</p> <p>aa. If P20 or P22 is incorporating a mark, another program should not be selected via V37 until mark counter is incremented in V16 N45 display. If this is not desired, V95 can be used to stop updating. Wait 15 seconds before selecting another program. V80 or V81 must be entered to start state vector updating again.</p>	

RC 1600, LM 3231

G & C  
REF  
DATA

## APOLLO OPERATIONS HANDBOOK

CREW- MAN	PML	PROCEDURES	REMARKS
RC 1599	4.4.1	<p><u>LGC/DSKY RESTRICTIONS (cont)</u></p> <p>ab. VC or AV displays in control coordinates, N85 or N83 are based on reading accelerometers every 2 seconds. Displays, however, are asynchronous one-second monitors; therefore, result is a possible 0.5- to 1.5-second delay between application of AV and visible result.</p> <p>ac. When loading decimal data, ENTR may change last digit of loaded data. Data shown on DSKY may be displayed modulo maximum value allowed or may be data from a previous calculation stored into cells picked up for display. The crew is encouraged to always write over data with desired information.</p> <p>ad. During periods of high computer activity, selection of certain extended verbs (notably V67, V82, V83, V85, V90) may result in program alarms 31201 or 31202. Extended verb activity is lost and verb must be reselected.</p> <p>ae. KEY REL lt remains on after V37 until new program is started. DSKY should not be used until KEY REL lt goes off and new program number is displayed.</p> <p>af. VEC POINT routine may compute large OGA when +X-axis must be rotated approximately 180°. Sensitivity to such changes becomes greater as magnitude approaches 180°. If desired, maneuver manually in pitch approximately 30° and then have solution recomputed by keying PRO on PL V50 N18 while not in PGNSC automatic mode.</p> <p>ag. No crew initiated verb/noun is restart protected.</p> <p>ah. A restart will terminate extended verbs.</p> <p>ai. PRO pb must be depressed for minimum of 120 milliseconds for proceed function. If PRO pb fails, use V33E for proceed functions.</p> <p>aj. PRO pb is ignored when VERB ind displays V21, V22, or V23 and OPR ERR lt is lit. To accomplish a proceed function in response to a flashing load verb, V PRO should be used.</p> <p>ak. If V37E XXE, ABORT pb, or ABORT STAGE pb is used or if software restart occurs when RR/LR is being read, a 520 alarm may occur. Data that was being read is not used. To recover, key RSET and continue.</p> <p>al. Deleted</p> <p>am. If an extended verb has been selected during a mission program, with normal displays, the extended verb logic initially blanks the DSKY. Any response during the time the DSKY is blank would do one of the following: (1) respond to a normal mission program display underneath the extended verb or (2) respond to the first display in the extended verb, which could be initiated simultaneously with crew response. In general, do not key a response (PRO, ENTR, V32E, V33E, V34E) to either a blank DSKY or a nonflashing display.</p> <p>an. Do not select P20 in the update mode before completion of P66. W-matrix initialization will destroy the erasable memory (E-memory) descent targets.</p>	

**LMA790-3-LM**  
**APOLLO OPERATIONS HANDBOOK**

RC 1599	<b>CREW- MAN</b>	<b>PNL</b>	<b>PROCEDURES</b>	<b>REMARKS</b>
		<p>4.4.1 <u>LGC/DSKY RESTRICTIONS (cont)</u></p> <p>so. V92, which calls IMU performance test program (P07), is for ground use only and is inhibited by the NODOPO7 flag. The flag is set by V37 logic. If this restriction is not observed, the OPR ERR It goes on.</p>		

G &  
RE  
DA





**LMA790-3-LM**  
**APOLLO OPERATIONS HANDBOOK**

CREW-MAN	PNL	PROCEDURES	REMARKS
		<p>4.4.1 <u>LGC/DSKY RESTRICTIONS (cont)</u></p> <p>ap. To avoid computational errors of up to 1.1 degrees, in use of STAR/PLANET codes 46, 47, 50 (for sun, earth, moon respectively) (digits DE of R1 in N70, 71) if the sun, earth or moon are to be sighted on select code 00 (planet), and have MSFN uplink unit vectors.</p> <p>aq. If an 8 or 9 is pushed while loading a register which was not preceded by a plus or minus sign, OPR ERR 1c will be lit and the 8 or 9 is rejected. Remaining characters may then be supplied or register cleared and loading begun again.</p> <p>4.4.2 <u>AEA/DEDA RESTRICTIONS</u></p> <p>The following restrictions apply to use of the AEA and DEDA:</p> <ol style="list-style-type: none"> <li>a. The CLR pb must be pressed before every DEDA entry.</li> <li>b. All addresses are in octal form. They must not be less than 26 (lowest numbered accessible address) nor greater than 704 (highest numbered accessible address).</li> <li>c. A sign (+ or -) must be entered after the address when loading data.</li> <li>d. An octal quantity with a digit greater than 7 or a number greater than the allowable range of the address must not be entered.</li> <li>e. A DEDA entry of -00000 should not be made unless specified in a particular procedure.</li> <li>f. If more than 4 hours elapse with the AGS operating and no thrust along the X-axis, perform one of the following to prevent overflow of the accumulated velocity counter: <ul style="list-style-type: none"> <li>Staged: Key DEDA C 404+00000E</li> <li>Unstaged: Key DEDA C 404-12345E</li> </ul> </li> </ol> <p>8. If an accelerometer malfunctions, all AGS equations function properly and all guidance modes can be used as long as thrusting is performed orthogonal to the axis of the failed accelerometer, and the scale factor and bias compensation constant of the failed accelerometer are set to zero as follows:</p> <ul style="list-style-type: none"> <li>X-axis: Key DEDA C 534+00000E</li> <li>          C 540+00000E</li> <li>Y-axis: Key DEDA C 535+00000E</li> <li>          C 541+00000E</li> <li>Z-axis: Key DEDA C 536+00000E</li> <li>          C 542+00000E</li> </ul>	

RC 1601

P. 6

LMA790-J-LM  
 APOLLO OPERATIONS HANDBOOK

CREW- MAN	PHIL	PROCEDURES	REMARKS
		<p>4.4.2 <u>AEA/DEDA RESTRICTIONS (cont)</u></p>	
		<p>h. In attitude hold (400+00000) and guidance steering (400+10000), X-axis override can be accomplished through any desired angle. In Z-axis steering (400+20000), Z-axis override can be accomplished through any desired angle. If override of any other steering channel is desired, attitude excursion should be &lt;90° from AGS-computed orientation.</p> <p>i. Do not enter +00000 into address 414. This is done automatically after completion of any navigation initialization. If this entry is made manually, it is treated as a +10000 and causes the program to search the PGNCS downlink for an identification word which, when located, could destroy LM and CSM state vectors. If +10000 is entered manually into address 414, PGNCS downlink search can be eliminated by keying DEDA C 563+00000E.</p> <p>j. If lunar surface flag is inadvertently set during earth orbit, reset lunar surface flag as follows:                      Key DEDA C 604+00000 (only the sign is significant)</p> <p>k. DEDA quantities which are displayed in octal have a least quantization four times the internal computer scaling.</p> <p>l. When keying DEDA, each pushbutton should be depressed to its limit of travel to ensure making good switch contact.</p> <p>m. The scaling of certain DEDA values is mission-dependent. When these values appear in the DEDA listings of paragraphs 4.4.15, 4.4.16, and 4.4.17, quantization is given. When these values appear in the body of this document, quantization is defined with lunar scaling first, followed by earth scaling (e.g., 0.1/1 fps).</p> <p>n. All thrusting under AGS control must be done using External ΔV guidance routine (410+50000), or Orbit Insertion guidance routine (410+00000).</p> <p>o. To preclude any DEDA operation problem due to computer timing, the following rules should be observed:                      1. At least 0.6 second shall elapse between the pressing of any two DEDA control pushbuttons (CLR, ENTR, READOUT, or HOLD), except when pressing the CLR pb to erase the previous operation.                      2. After a DEDA entry, do not press the ENTR or READOUT pb within 1.5 seconds of the time the DEDA display has gone blank after pressing the ENTR pb.</p> <p>p. DEDA address 277 is angle between Z body axis and local horizon projected into U1-V1 plane (U1 is LM local vertical, V1 is downrange and parallel to CSM orbit plane). This quantity will agree with PGNCS angle only when LM yaw angle is 0° or 180°.</p> <p>q. DEDA should not be used to enter data while CB/AC BUS A: RNDZ RDR or CB/AC BUS A: GASTA or CB ECS: GLYCOL PUMP 1 (or 2) is being opened or closed nor while LTC: OVERRIDE INTEGRAL sw or GLYCOL SEL is being operated.</p> <p>r. The DEDA detects certain operator errors. The OPR ERR lt on the face of the DEDA goes on when these errors occur. False OPR ERR lt indications resulting from EMI on discrete lines may also occur. The light remains on until the CLR pb is pushed. The DEDA is then ready for a new instruction.</p>	

LMA790-3-LM  
 APOLLO OPERATIONS HANDBOOK

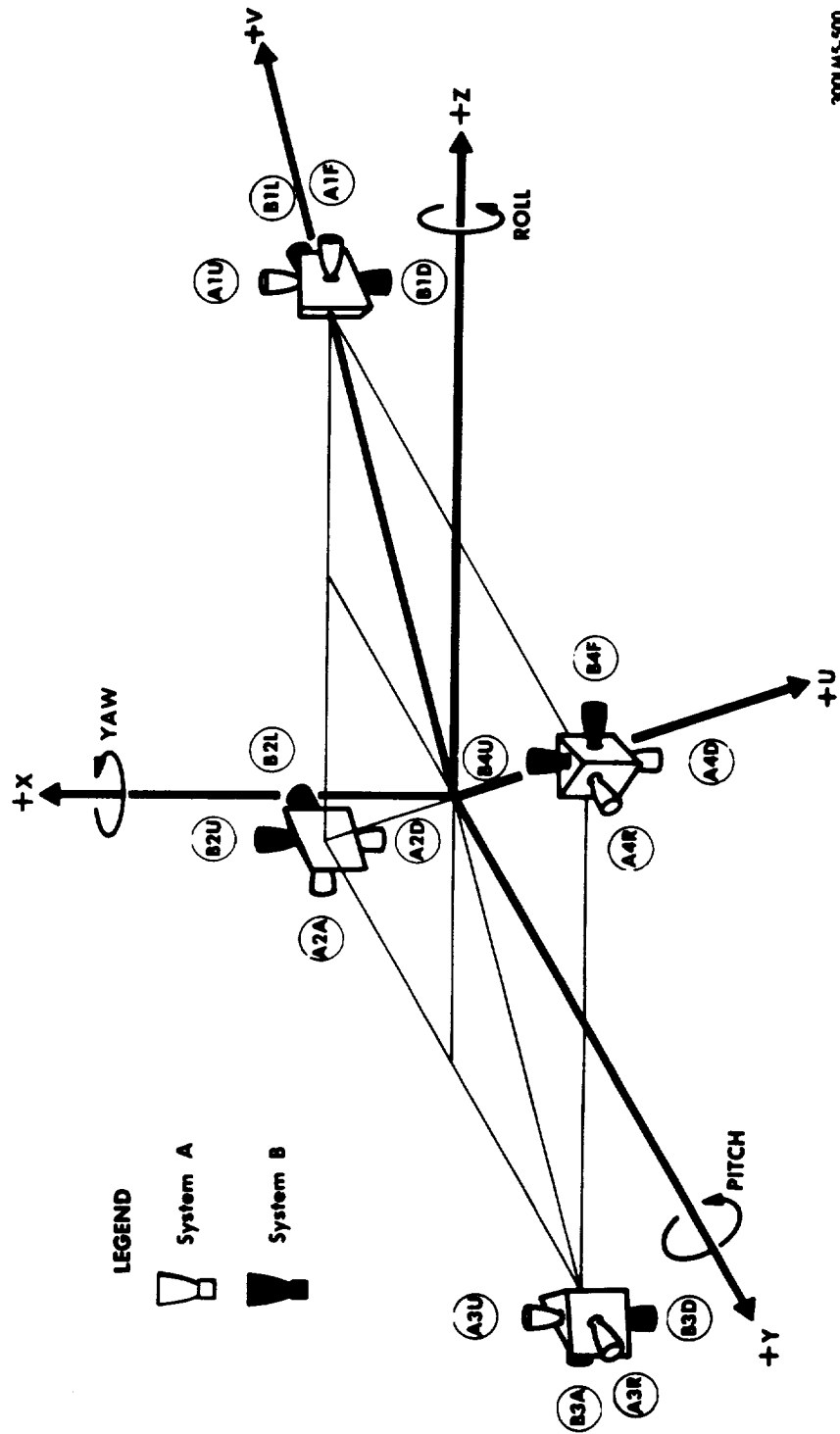

300LMS-500

Figure 4-16. RCS Thruster Geometry

**LMA790-3-LM**  
**APOLLO OPERATIONS HANDBOOK**

CREW MAN	PNL	PROCEDURES	REMARKS																																																												
		<p><b>4.4.3 JET SELECT LOGIC</b></p> <p>Table 4-1 is a general listing of the basic RCS engine logic for DAP-controlled translation and rotation maneuvers of the LM. Under DAP control, the jets selected for a particular maneuver are arranged so that the first entry is the optimum selection for the specified maneuver.</p>																																																													
		<p>Table 4-1. RCS Jet Select Logic</p>																																																													
		<table border="1" style="width: 100%; border-collapse: collapse;"> <thead> <tr> <th style="width: 15%;">Maneuver</th> <th style="width: 10%;">B A B A 4 4 4 4 U D P R</th> <th style="width: 10%;">A B B A 3 3 3 3 U D A R</th> <th style="width: 10%;">B A A B 2 2 2 2 U D A L</th> <th style="width: 10%;">A B A B 1 1 1 1 U D P L</th> </tr> </thead> <tbody> <tr> <td><b>A. DAP JET SELECTION - ROTATION</b></td> <td></td> <td></td> <td></td> <td></td> </tr> <tr> <td>+P (Yaw left), four-jet two-jet</td> <td>X</td> <td>X</td> <td>X</td> <td>X</td> </tr> <tr> <td colspan="5">Alternating pulses between A4R, B2L &amp; A1P, B3A</td> </tr> <tr> <td>-P (Yaw right), four-jet two-jet</td> <td>X</td> <td>X</td> <td>X</td> <td>X</td> </tr> <tr> <td colspan="5">Alternating pulses between B4P, A2A &amp; B1L, A3R</td> </tr> <tr> <td>+P (Alternative)*, two-jet</td> <td>X</td> <td>X</td> <td>X</td> <td>X</td> </tr> <tr> <td>-P (Alternative)*, two-jet</td> <td>X</td> <td>X</td> <td>X</td> <td>X</td> </tr> <tr> <td>+U (Pitch up, roll right)**, two-jet</td> <td>X</td> <td>X</td> <td>X</td> <td>X</td> </tr> <tr> <td>-U (Pitch down, roll left)**, two-jet</td> <td>X</td> <td>X</td> <td>X</td> <td>X</td> </tr> <tr> <td>+V (Pitch down, roll right)**, two-jet</td> <td>X</td> <td>X</td> <td>X</td> <td>X</td> </tr> <tr> <td>-V (Pitch up, roll left)**, two-jet</td> <td>X</td> <td>X</td> <td>X</td> <td>X</td> </tr> </tbody> </table>	Maneuver	B A B A 4 4 4 4 U D P R	A B B A 3 3 3 3 U D A R	B A A B 2 2 2 2 U D A L	A B A B 1 1 1 1 U D P L	<b>A. DAP JET SELECTION - ROTATION</b>					+P (Yaw left), four-jet two-jet	X	X	X	X	Alternating pulses between A4R, B2L & A1P, B3A					-P (Yaw right), four-jet two-jet	X	X	X	X	Alternating pulses between B4P, A2A & B1L, A3R					+P (Alternative)*, two-jet	X	X	X	X	-P (Alternative)*, two-jet	X	X	X	X	+U (Pitch up, roll right)**, two-jet	X	X	X	X	-U (Pitch down, roll left)**, two-jet	X	X	X	X	+V (Pitch down, roll right)**, two-jet	X	X	X	X	-V (Pitch up, roll left)**, two-jet	X	X	X	X	
Maneuver	B A B A 4 4 4 4 U D P R	A B B A 3 3 3 3 U D A R	B A A B 2 2 2 2 U D A L	A B A B 1 1 1 1 U D P L																																																											
<b>A. DAP JET SELECTION - ROTATION</b>																																																															
+P (Yaw left), four-jet two-jet	X	X	X	X																																																											
Alternating pulses between A4R, B2L & A1P, B3A																																																															
-P (Yaw right), four-jet two-jet	X	X	X	X																																																											
Alternating pulses between B4P, A2A & B1L, A3R																																																															
+P (Alternative)*, two-jet	X	X	X	X																																																											
-P (Alternative)*, two-jet	X	X	X	X																																																											
+U (Pitch up, roll right)**, two-jet	X	X	X	X																																																											
-U (Pitch down, roll left)**, two-jet	X	X	X	X																																																											
+V (Pitch down, roll right)**, two-jet	X	X	X	X																																																											
-V (Pitch up, roll left)**, two-jet	X	X	X	X																																																											
			<p>* Alternative two-jet policies when a P rotational jet fails. ** If one U or V rotational jet fails, the other jet completes rotation.</p>																																																												

**LMA790-3-LM**  
**APOLLO OPERATIONS HANDBOOK**

CREW: MAN	PNL	PROCEDURES	REMARKS																				
4.4.3 JET SELECT LOGIC (cont)																							
Table 4-1. RCS Jet Select Logic (cont)																							
		Maneuver																					
		B. DAP JET SELECTION - TRANSLATION																					
		+X-Translation, four-jet two-jet	<table border="1" style="width: 100%; border-collapse: collapse;"> <tr> <td style="width: 10%;">B A B A</td> <td style="width: 10%;">A B B A</td> <td style="width: 10%;">B A A B</td> <td style="width: 10%;">A B A B</td> </tr> <tr> <td>4 4 4 4</td> <td>3 3 3 3</td> <td>2 2 2 2</td> <td>1 1 1 1</td> </tr> <tr> <td>U D F R</td> <td>U D A R</td> <td>U D A L</td> <td>U D F L</td> </tr> <tr> <td style="text-align: center;">X</td> <td style="text-align: center;">X</td> <td style="text-align: center;">X</td> <td style="text-align: center;">X</td> </tr> <tr> <td style="text-align: center;">X</td> <td style="text-align: center;">X</td> <td style="text-align: center;">X</td> <td style="text-align: center;">X</td> </tr> </table>	B A B A	A B B A	B A A B	A B A B	4 4 4 4	3 3 3 3	2 2 2 2	1 1 1 1	U D F R	U D A R	U D A L	U D F L	X	X	X	X	X	X	X	X
B A B A	A B B A	B A A B	A B A B																				
4 4 4 4	3 3 3 3	2 2 2 2	1 1 1 1																				
U D F R	U D A R	U D A L	U D F L																				
X	X	X	X																				
X	X	X	X																				
		-X-Translation, four-jet two-jet	<table border="1" style="width: 100%; border-collapse: collapse;"> <tr> <td style="width: 10%;">B A B A</td> <td style="width: 10%;">A B B A</td> <td style="width: 10%;">B A A B</td> <td style="width: 10%;">A B A B</td> </tr> <tr> <td>4 4 4 4</td> <td>3 3 3 3</td> <td>2 2 2 2</td> <td>1 1 1 1</td> </tr> <tr> <td>U D F R</td> <td>U D A R</td> <td>U D A L</td> <td>U D F L</td> </tr> <tr> <td style="text-align: center;">X</td> <td style="text-align: center;">X</td> <td style="text-align: center;">X</td> <td style="text-align: center;">X</td> </tr> <tr> <td style="text-align: center;">X</td> <td style="text-align: center;">X</td> <td style="text-align: center;">X</td> <td style="text-align: center;">X</td> </tr> </table>	B A B A	A B B A	B A A B	A B A B	4 4 4 4	3 3 3 3	2 2 2 2	1 1 1 1	U D F R	U D A R	U D A L	U D F L	X	X	X	X	X	X	X	X
B A B A	A B B A	B A A B	A B A B																				
4 4 4 4	3 3 3 3	2 2 2 2	1 1 1 1																				
U D F R	U D A R	U D A L	U D F L																				
X	X	X	X																				
X	X	X	X																				
		+Y-Translation	<table border="1" style="width: 100%; border-collapse: collapse;"> <tr> <td style="width: 10%;">B A B A</td> <td style="width: 10%;">A B B A</td> <td style="width: 10%;">B A A B</td> <td style="width: 10%;">A B A B</td> </tr> <tr> <td>4 4 4 4</td> <td>3 3 3 3</td> <td>2 2 2 2</td> <td>1 1 1 1</td> </tr> <tr> <td>U D F R</td> <td>U D A R</td> <td>U D A L</td> <td>U D F L</td> </tr> <tr> <td style="text-align: center;">X</td> <td style="text-align: center;">X</td> <td style="text-align: center;">X</td> <td style="text-align: center;">X</td> </tr> <tr> <td style="text-align: center;">X</td> <td style="text-align: center;">X</td> <td style="text-align: center;">X</td> <td style="text-align: center;">X</td> </tr> </table>	B A B A	A B B A	B A A B	A B A B	4 4 4 4	3 3 3 3	2 2 2 2	1 1 1 1	U D F R	U D A R	U D A L	U D F L	X	X	X	X	X	X	X	X
B A B A	A B B A	B A A B	A B A B																				
4 4 4 4	3 3 3 3	2 2 2 2	1 1 1 1																				
U D F R	U D A R	U D A L	U D F L																				
X	X	X	X																				
X	X	X	X																				
		-Y-Translation	<table border="1" style="width: 100%; border-collapse: collapse;"> <tr> <td style="width: 10%;">B A B A</td> <td style="width: 10%;">A B B A</td> <td style="width: 10%;">B A A B</td> <td style="width: 10%;">A B A B</td> </tr> <tr> <td>4 4 4 4</td> <td>3 3 3 3</td> <td>2 2 2 2</td> <td>1 1 1 1</td> </tr> <tr> <td>U D F R</td> <td>U D A R</td> <td>U D A L</td> <td>U D F L</td> </tr> <tr> <td style="text-align: center;">X</td> <td style="text-align: center;">X</td> <td style="text-align: center;">X</td> <td style="text-align: center;">X</td> </tr> <tr> <td style="text-align: center;">X</td> <td style="text-align: center;">X</td> <td style="text-align: center;">X</td> <td style="text-align: center;">X</td> </tr> </table>	B A B A	A B B A	B A A B	A B A B	4 4 4 4	3 3 3 3	2 2 2 2	1 1 1 1	U D F R	U D A R	U D A L	U D F L	X	X	X	X	X	X	X	X
B A B A	A B B A	B A A B	A B A B																				
4 4 4 4	3 3 3 3	2 2 2 2	1 1 1 1																				
U D F R	U D A R	U D A L	U D F L																				
X	X	X	X																				
X	X	X	X																				
		+Z-Translation	<table border="1" style="width: 100%; border-collapse: collapse;"> <tr> <td style="width: 10%;">B A B A</td> <td style="width: 10%;">A B B A</td> <td style="width: 10%;">B A A B</td> <td style="width: 10%;">A B A B</td> </tr> <tr> <td>4 4 4 4</td> <td>3 3 3 3</td> <td>2 2 2 2</td> <td>1 1 1 1</td> </tr> <tr> <td>U D F R</td> <td>U D A R</td> <td>U D A L</td> <td>U D F L</td> </tr> <tr> <td style="text-align: center;">X</td> <td style="text-align: center;">X</td> <td style="text-align: center;">X</td> <td style="text-align: center;">X</td> </tr> <tr> <td style="text-align: center;">X</td> <td style="text-align: center;">X</td> <td style="text-align: center;">X</td> <td style="text-align: center;">X</td> </tr> </table>	B A B A	A B B A	B A A B	A B A B	4 4 4 4	3 3 3 3	2 2 2 2	1 1 1 1	U D F R	U D A R	U D A L	U D F L	X	X	X	X	X	X	X	X
B A B A	A B B A	B A A B	A B A B																				
4 4 4 4	3 3 3 3	2 2 2 2	1 1 1 1																				
U D F R	U D A R	U D A L	U D F L																				
X	X	X	X																				
X	X	X	X																				
		-Z-Translation	<table border="1" style="width: 100%; border-collapse: collapse;"> <tr> <td style="width: 10%;">B A B A</td> <td style="width: 10%;">A B B A</td> <td style="width: 10%;">B A A B</td> <td style="width: 10%;">A B A B</td> </tr> <tr> <td>4 4 4 4</td> <td>3 3 3 3</td> <td>2 2 2 2</td> <td>1 1 1 1</td> </tr> <tr> <td>U D F R</td> <td>U D A R</td> <td>U D A L</td> <td>U D F L</td> </tr> <tr> <td style="text-align: center;">X</td> <td style="text-align: center;">X</td> <td style="text-align: center;">X</td> <td style="text-align: center;">X</td> </tr> <tr> <td style="text-align: center;">X</td> <td style="text-align: center;">X</td> <td style="text-align: center;">X</td> <td style="text-align: center;">X</td> </tr> </table>	B A B A	A B B A	B A A B	A B A B	4 4 4 4	3 3 3 3	2 2 2 2	1 1 1 1	U D F R	U D A R	U D A L	U D F L	X	X	X	X	X	X	X	X
B A B A	A B B A	B A A B	A B A B																				
4 4 4 4	3 3 3 3	2 2 2 2	1 1 1 1																				
U D F R	U D A R	U D A L	U D F L																				
X	X	X	X																				
X	X	X	X																				
		+U (+Z & +Y) Translation	<table border="1" style="width: 100%; border-collapse: collapse;"> <tr> <td style="width: 10%;">B A B A</td> <td style="width: 10%;">A B B A</td> <td style="width: 10%;">B A A B</td> <td style="width: 10%;">A B A B</td> </tr> <tr> <td>4 4 4 4</td> <td>3 3 3 3</td> <td>2 2 2 2</td> <td>1 1 1 1</td> </tr> <tr> <td>U D F R</td> <td>U D A R</td> <td>U D A L</td> <td>U D F L</td> </tr> <tr> <td style="text-align: center;">X</td> <td style="text-align: center;">X</td> <td style="text-align: center;">X</td> <td style="text-align: center;">X</td> </tr> <tr> <td style="text-align: center;">X</td> <td style="text-align: center;">X</td> <td style="text-align: center;">X</td> <td style="text-align: center;">X</td> </tr> </table>	B A B A	A B B A	B A A B	A B A B	4 4 4 4	3 3 3 3	2 2 2 2	1 1 1 1	U D F R	U D A R	U D A L	U D F L	X	X	X	X	X	X	X	X
B A B A	A B B A	B A A B	A B A B																				
4 4 4 4	3 3 3 3	2 2 2 2	1 1 1 1																				
U D F R	U D A R	U D A L	U D F L																				
X	X	X	X																				
X	X	X	X																				
		-U (-Z & -Y) Translation	<table border="1" style="width: 100%; border-collapse: collapse;"> <tr> <td style="width: 10%;">B A B A</td> <td style="width: 10%;">A B B A</td> <td style="width: 10%;">B A A B</td> <td style="width: 10%;">A B A B</td> </tr> <tr> <td>4 4 4 4</td> <td>3 3 3 3</td> <td>2 2 2 2</td> <td>1 1 1 1</td> </tr> <tr> <td>U D F R</td> <td>U D A R</td> <td>U D A L</td> <td>U D F L</td> </tr> <tr> <td style="text-align: center;">X</td> <td style="text-align: center;">X</td> <td style="text-align: center;">X</td> <td style="text-align: center;">X</td> </tr> <tr> <td style="text-align: center;">X</td> <td style="text-align: center;">X</td> <td style="text-align: center;">X</td> <td style="text-align: center;">X</td> </tr> </table>	B A B A	A B B A	B A A B	A B A B	4 4 4 4	3 3 3 3	2 2 2 2	1 1 1 1	U D F R	U D A R	U D A L	U D F L	X	X	X	X	X	X	X	X
B A B A	A B B A	B A A B	A B A B																				
4 4 4 4	3 3 3 3	2 2 2 2	1 1 1 1																				
U D F R	U D A R	U D A L	U D F L																				
X	X	X	X																				
X	X	X	X																				
		+V (+Z & -Y) Translation	<table border="1" style="width: 100%; border-collapse: collapse;"> <tr> <td style="width: 10%;">B A B A</td> <td style="width: 10%;">A B B A</td> <td style="width: 10%;">B A A B</td> <td style="width: 10%;">A B A B</td> </tr> <tr> <td>4 4 4 4</td> <td>3 3 3 3</td> <td>2 2 2 2</td> <td>1 1 1 1</td> </tr> <tr> <td>U D F R</td> <td>U D A R</td> <td>U D A L</td> <td>U D F L</td> </tr> <tr> <td style="text-align: center;">X</td> <td style="text-align: center;">X</td> <td style="text-align: center;">X</td> <td style="text-align: center;">X</td> </tr> <tr> <td style="text-align: center;">X</td> <td style="text-align: center;">X</td> <td style="text-align: center;">X</td> <td style="text-align: center;">X</td> </tr> </table>	B A B A	A B B A	B A A B	A B A B	4 4 4 4	3 3 3 3	2 2 2 2	1 1 1 1	U D F R	U D A R	U D A L	U D F L	X	X	X	X	X	X	X	X
B A B A	A B B A	B A A B	A B A B																				
4 4 4 4	3 3 3 3	2 2 2 2	1 1 1 1																				
U D F R	U D A R	U D A L	U D F L																				
X	X	X	X																				
X	X	X	X																				
		-V (-Z & +Y) Translation	<table border="1" style="width: 100%; border-collapse: collapse;"> <tr> <td style="width: 10%;">B A B A</td> <td style="width: 10%;">A B B A</td> <td style="width: 10%;">B A A B</td> <td style="width: 10%;">A B A B</td> </tr> <tr> <td>4 4 4 4</td> <td>3 3 3 3</td> <td>2 2 2 2</td> <td>1 1 1 1</td> </tr> <tr> <td>U D F R</td> <td>U D A R</td> <td>U D A L</td> <td>U D F L</td> </tr> <tr> <td style="text-align: center;">X</td> <td style="text-align: center;">X</td> <td style="text-align: center;">X</td> <td style="text-align: center;">X</td> </tr> <tr> <td style="text-align: center;">X</td> <td style="text-align: center;">X</td> <td style="text-align: center;">X</td> <td style="text-align: center;">X</td> </tr> </table>	B A B A	A B B A	B A A B	A B A B	4 4 4 4	3 3 3 3	2 2 2 2	1 1 1 1	U D F R	U D A R	U D A L	U D F L	X	X	X	X	X	X	X	X
B A B A	A B B A	B A A B	A B A B																				
4 4 4 4	3 3 3 3	2 2 2 2	1 1 1 1																				
U D F R	U D A R	U D A L	U D F L																				
X	X	X	X																				
X	X	X	X																				
		+Y-Tack Translation***	<table border="1" style="width: 100%; border-collapse: collapse;"> <tr> <td style="width: 10%;">B A B A</td> <td style="width: 10%;">A B B A</td> <td style="width: 10%;">B A A B</td> <td style="width: 10%;">A B A B</td> </tr> <tr> <td>4 4 4 4</td> <td>3 3 3 3</td> <td>2 2 2 2</td> <td>1 1 1 1</td> </tr> <tr> <td>U D F R</td> <td>U D A R</td> <td>U D A L</td> <td>U D F L</td> </tr> <tr> <td style="text-align: center;">X</td> <td style="text-align: center;">X</td> <td style="text-align: center;">X</td> <td style="text-align: center;">X</td> </tr> <tr> <td style="text-align: center;">X</td> <td style="text-align: center;">X</td> <td style="text-align: center;">X</td> <td style="text-align: center;">X</td> </tr> </table>	B A B A	A B B A	B A A B	A B A B	4 4 4 4	3 3 3 3	2 2 2 2	1 1 1 1	U D F R	U D A R	U D A L	U D F L	X	X	X	X	X	X	X	X
B A B A	A B B A	B A A B	A B A B																				
4 4 4 4	3 3 3 3	2 2 2 2	1 1 1 1																				
U D F R	U D A R	U D A L	U D F L																				
X	X	X	X																				
X	X	X	X																				
		-Y-Tack Translation***	<table border="1" style="width: 100%; border-collapse: collapse;"> <tr> <td style="width: 10%;">B A B A</td> <td style="width: 10%;">A B B A</td> <td style="width: 10%;">B A A B</td> <td style="width: 10%;">A B A B</td> </tr> <tr> <td>4 4 4 4</td> <td>3 3 3 3</td> <td>2 2 2 2</td> <td>1 1 1 1</td> </tr> <tr> <td>U D F R</td> <td>U D A R</td> <td>U D A L</td> <td>U D F L</td> </tr> <tr> <td style="text-align: center;">X</td> <td style="text-align: center;">X</td> <td style="text-align: center;">X</td> <td style="text-align: center;">X</td> </tr> <tr> <td style="text-align: center;">X</td> <td style="text-align: center;">X</td> <td style="text-align: center;">X</td> <td style="text-align: center;">X</td> </tr> </table>	B A B A	A B B A	B A A B	A B A B	4 4 4 4	3 3 3 3	2 2 2 2	1 1 1 1	U D F R	U D A R	U D A L	U D F L	X	X	X	X	X	X	X	X
B A B A	A B B A	B A A B	A B A B																				
4 4 4 4	3 3 3 3	2 2 2 2	1 1 1 1																				
U D F R	U D A R	U D A L	U D F L																				
X	X	X	X																				
X	X	X	X																				
		+Z-Tack Translation***	<table border="1" style="width: 100%; border-collapse: collapse;"> <tr> <td style="width: 10%;">B A B A</td> <td style="width: 10%;">A B B A</td> <td style="width: 10%;">B A A B</td> <td style="width: 10%;">A B A B</td> </tr> <tr> <td>4 4 4 4</td> <td>3 3 3 3</td> <td>2 2 2 2</td> <td>1 1 1 1</td> </tr> <tr> <td>U D F R</td> <td>U D A R</td> <td>U D A L</td> <td>U D F L</td> </tr> <tr> <td style="text-align: center;">X</td> <td style="text-align: center;">X</td> <td style="text-align: center;">X</td> <td style="text-align: center;">X</td> </tr> <tr> <td style="text-align: center;">X</td> <td style="text-align: center;">X</td> <td style="text-align: center;">X</td> <td style="text-align: center;">X</td> </tr> </table>	B A B A	A B B A	B A A B	A B A B	4 4 4 4	3 3 3 3	2 2 2 2	1 1 1 1	U D F R	U D A R	U D A L	U D F L	X	X	X	X	X	X	X	X
B A B A	A B B A	B A A B	A B A B																				
4 4 4 4	3 3 3 3	2 2 2 2	1 1 1 1																				
U D F R	U D A R	U D A L	U D F L																				
X	X	X	X																				
X	X	X	X																				
		-Z-Tack Translation***	<table border="1" style="width: 100%; border-collapse: collapse;"> <tr> <td style="width: 10%;">B A B A</td> <td style="width: 10%;">A B B A</td> <td style="width: 10%;">B A A B</td> <td style="width: 10%;">A B A B</td> </tr> <tr> <td>4 4 4 4</td> <td>3 3 3 3</td> <td>2 2 2 2</td> <td>1 1 1 1</td> </tr> <tr> <td>U D F R</td> <td>U D A R</td> <td>U D A L</td> <td>U D F L</td> </tr> <tr> <td style="text-align: center;">X</td> <td style="text-align: center;">X</td> <td style="text-align: center;">X</td> <td style="text-align: center;">X</td> </tr> <tr> <td style="text-align: center;">X</td> <td style="text-align: center;">X</td> <td style="text-align: center;">X</td> <td style="text-align: center;">X</td> </tr> </table>	B A B A	A B B A	B A A B	A B A B	4 4 4 4	3 3 3 3	2 2 2 2	1 1 1 1	U D F R	U D A R	U D A L	U D F L	X	X	X	X	X	X	X	X
B A B A	A B B A	B A A B	A B A B																				
4 4 4 4	3 3 3 3	2 2 2 2	1 1 1 1																				
U D F R	U D A R	U D A L	U D F L																				
X	X	X	X																				
X	X	X	X																				

Alternating pulses between B2L, B4F & A2A, B2L  
 Alternating pulses between B1L, A1F & B1L, B3A  
 Alternating pulses between A4R, B4F & A4R, A2A  
 Alternating pulses between A3R, B3A & A3R, A1F  
 Alternating pulses between B3A, A3R & B3A, B1L  
 Alternating pulses between A2A, B2L & A2A, A4R  
 Alternating pulses between B4F, A4R & B4F, B2L  
 Alternating pulses between A1F, A3R & A1F, B1L

\*\*\* Y- and Z-tack translations are commanded when conventional Y or Z two-jet translations are not available (jet failure).  
 Tacking alternations are done every 0.1 second.

G & C  
REF  
DATA





**LMA790-3-LM**  
**APOLLO OPERATIONS HANDBOOK**

CREW-MAN	PNI	PROCEDURES	REMARKS
		<p>4.4.6 <u>VERB LIST</u></p> <p style="text-align: center;"><u>No.</u>                      <u>Regular Verbs</u></p> <p>01 Display octal component 1 in R1            02 Display octal component 2 in R1            03 Display octal component 3 in R1            04 Display octal components 1, 2 in R1, R2            05 Display octal components 1, 2, 3 in R1, R2, R3            06 Display decimal in R1; or R1, R2; or R1, R2, R3            07 Display double precision decimal in R1, R2            11 Monitor octal component 1 in R1            12 Monitor octal component 2 in R1            13 Monitor octal component 3 in R1            14 Monitor octal components 1, 2 in R1, R2            15 Monitor octal components 1, 2, 3 in R1, R2, R3            16 Monitor decimal in R1; or R1, R2; or R1, R2, R3            17 Monitor double precision decimal in R1, R2            21 Load component 1 into R1            22 Load component 2 into R2            23 Load component 3 into R3            24 Load components 1, 2 into R1, R2            25 Load components 1, 2, 3 into R1, R2, R3            27 Display fixed memory            30 Request executive            31 Request waitlist            32 Recycle program            33 Proceed without DSKY input            34 Terminate function            35 Test lights            36 Request fresh start            37 Change program</p> <p style="text-align: center;"><u>Extended Verbs</u></p> <p>40 Zero CDU            41 Coarse-align CDU            42 Fine-align IMU            43 Load IMU attitude error meters            44 Terminate RR continuous designate            47 Initialize ACS (R47)            48 Start DAP Data Load Routine (R03)            49 Start crew-defined maneuver (R62)            50 Please perform            52 Mark cursor</p>	<p>Test only</p> <p>Test only</p> <p>Use in POO only.</p> <p>Major mode</p> <p>Specify N20 or N72 Specify N20 or N72</p> <p>Test only V41 N72, option 2</p> <p>Paragraph 4.6.1.21, 4.6.1.22 4.9.1.3, 4.6.3.3 4.9.1.4 4.6.1.23 4.6.3.6 4.6.1.18 4.6.1.8 4.6.1.9 N/A N/A</p>



# LMA790-3-LM APOLLO OPERATIONS HANDBOOK

CREW-MAN	PNL	PROCEDURES	REMARKS																																																																																																																		
		<p><u>4.4.6 VERB LIST (cont.)</u></p> <p style="text-align: center;"><u>Extended Verbs</u></p> <table style="width: 100%; border-collapse: collapse;"> <thead> <tr> <th style="text-align: left;">No.</th> <th style="text-align: left;">Procedure</th> <th style="text-align: left;">Paragraph</th> </tr> </thead> <tbody> <tr><td>53</td><td>Mark spiral</td><td>N/A</td></tr> <tr><td>54</td><td>Mark X or Y reticle</td><td>N/A</td></tr> <tr><td>55</td><td>Increment LGC time (decimal)</td><td>4.6.1.24</td></tr> <tr><td>56</td><td>Terminate tracking (R56)</td><td>N/A</td></tr> <tr><td>57</td><td>Permit LR update</td><td>N/A</td></tr> <tr><td>58</td><td>Inhibit LR update</td><td>4.6.3.9</td></tr> <tr><td>59</td><td>Command LR to position 2</td><td>N/A</td></tr> <tr><td>60</td><td>Display LM attitude rates on FDAI error needles</td><td>4.6.1.32</td></tr> <tr><td>61</td><td>Display DAP attitude error</td><td>4.6.1.33</td></tr> <tr><td>62</td><td>Display total attitude error</td><td>4.6.3.2, 4.6.3.8</td></tr> <tr><td>63</td><td>RR/LR self-test (R04)</td><td>4.6.1.30</td></tr> <tr><td>64</td><td>Start S-band antenna routine (R05)</td><td>N/A</td></tr> <tr><td>65</td><td>Disable U &amp; V jets during DPS burn</td><td>4.6.1.35</td></tr> <tr><td>66</td><td>Vehicles attached; move this vehicle state vector to other vehicle.</td><td>4.6.1.34</td></tr> <tr><td>67</td><td>V-matrix ras error display</td><td>N/A</td></tr> <tr><td>68</td><td>Bypass lunar terrain model computations</td><td>4.6.1.29</td></tr> <tr><td>69</td><td>Restart</td><td>4.6.1.7</td></tr> <tr><td>70</td><td>Update liftoff time</td><td>4.6.1.7</td></tr> <tr><td>71</td><td>Universal update, block address</td><td>4.6.1.7</td></tr> <tr><td>72</td><td>Universal update, single address</td><td>4.6.1.7</td></tr> <tr><td>73</td><td>Update LGC time (octal)</td><td>4.6.1.7</td></tr> <tr><td>74</td><td>Initialize erasable dump via downlink (42 sec)</td><td>4.6.1.25</td></tr> <tr><td>75</td><td>Enable U &amp; V jets during DPS burn</td><td>N/A</td></tr> <tr><td>76</td><td>Minimum impulse command mode</td><td>N/A</td></tr> <tr><td>77</td><td>Rate command and attitude hold mode</td><td>N/A</td></tr> <tr><td>78</td><td>Start LR spurious return test (R77)</td><td>4.6.3.10</td></tr> <tr><td>79</td><td>Stop LR spurious return test (R77)</td><td>N/A</td></tr> <tr><td>80</td><td>Update LM state vector</td><td>N/A</td></tr> <tr><td>81</td><td>Update CSM state vector</td><td>N/A</td></tr> <tr><td>82</td><td>Request orbit parameter display (R30)</td><td>4.8.1.2</td></tr> <tr><td>83</td><td>Request rendezvous parameter display (R31)</td><td>4.6.1.11</td></tr> <tr><td>85</td><td>Display RR LOS azimuth &amp; elevation</td><td>N/A</td></tr> <tr><td>89</td><td>Start rendezvous final attitude maneuver (R63)</td><td>4.6.1.10</td></tr> <tr><td>90</td><td>Request rendezvous out-of-plane display (R36)</td><td>4.7.2.1</td></tr> <tr><td>91</td><td>Show Banksum</td><td>4.6.1.12</td></tr> <tr><td>92</td><td>Start IMU performance tests</td><td>N/A</td></tr> <tr><td>93</td><td>Enable V-Matrix Initialization</td><td>4.6.1.26</td></tr> </tbody> </table>	No.	Procedure	Paragraph	53	Mark spiral	N/A	54	Mark X or Y reticle	N/A	55	Increment LGC time (decimal)	4.6.1.24	56	Terminate tracking (R56)	N/A	57	Permit LR update	N/A	58	Inhibit LR update	4.6.3.9	59	Command LR to position 2	N/A	60	Display LM attitude rates on FDAI error needles	4.6.1.32	61	Display DAP attitude error	4.6.1.33	62	Display total attitude error	4.6.3.2, 4.6.3.8	63	RR/LR self-test (R04)	4.6.1.30	64	Start S-band antenna routine (R05)	N/A	65	Disable U & V jets during DPS burn	4.6.1.35	66	Vehicles attached; move this vehicle state vector to other vehicle.	4.6.1.34	67	V-matrix ras error display	N/A	68	Bypass lunar terrain model computations	4.6.1.29	69	Restart	4.6.1.7	70	Update liftoff time	4.6.1.7	71	Universal update, block address	4.6.1.7	72	Universal update, single address	4.6.1.7	73	Update LGC time (octal)	4.6.1.7	74	Initialize erasable dump via downlink (42 sec)	4.6.1.25	75	Enable U & V jets during DPS burn	N/A	76	Minimum impulse command mode	N/A	77	Rate command and attitude hold mode	N/A	78	Start LR spurious return test (R77)	4.6.3.10	79	Stop LR spurious return test (R77)	N/A	80	Update LM state vector	N/A	81	Update CSM state vector	N/A	82	Request orbit parameter display (R30)	4.8.1.2	83	Request rendezvous parameter display (R31)	4.6.1.11	85	Display RR LOS azimuth & elevation	N/A	89	Start rendezvous final attitude maneuver (R63)	4.6.1.10	90	Request rendezvous out-of-plane display (R36)	4.7.2.1	91	Show Banksum	4.6.1.12	92	Start IMU performance tests	N/A	93	Enable V-Matrix Initialization	4.6.1.26	
No.	Procedure	Paragraph																																																																																																																			
53	Mark spiral	N/A																																																																																																																			
54	Mark X or Y reticle	N/A																																																																																																																			
55	Increment LGC time (decimal)	4.6.1.24																																																																																																																			
56	Terminate tracking (R56)	N/A																																																																																																																			
57	Permit LR update	N/A																																																																																																																			
58	Inhibit LR update	4.6.3.9																																																																																																																			
59	Command LR to position 2	N/A																																																																																																																			
60	Display LM attitude rates on FDAI error needles	4.6.1.32																																																																																																																			
61	Display DAP attitude error	4.6.1.33																																																																																																																			
62	Display total attitude error	4.6.3.2, 4.6.3.8																																																																																																																			
63	RR/LR self-test (R04)	4.6.1.30																																																																																																																			
64	Start S-band antenna routine (R05)	N/A																																																																																																																			
65	Disable U & V jets during DPS burn	4.6.1.35																																																																																																																			
66	Vehicles attached; move this vehicle state vector to other vehicle.	4.6.1.34																																																																																																																			
67	V-matrix ras error display	N/A																																																																																																																			
68	Bypass lunar terrain model computations	4.6.1.29																																																																																																																			
69	Restart	4.6.1.7																																																																																																																			
70	Update liftoff time	4.6.1.7																																																																																																																			
71	Universal update, block address	4.6.1.7																																																																																																																			
72	Universal update, single address	4.6.1.7																																																																																																																			
73	Update LGC time (octal)	4.6.1.7																																																																																																																			
74	Initialize erasable dump via downlink (42 sec)	4.6.1.25																																																																																																																			
75	Enable U & V jets during DPS burn	N/A																																																																																																																			
76	Minimum impulse command mode	N/A																																																																																																																			
77	Rate command and attitude hold mode	N/A																																																																																																																			
78	Start LR spurious return test (R77)	4.6.3.10																																																																																																																			
79	Stop LR spurious return test (R77)	N/A																																																																																																																			
80	Update LM state vector	N/A																																																																																																																			
81	Update CSM state vector	N/A																																																																																																																			
82	Request orbit parameter display (R30)	4.8.1.2																																																																																																																			
83	Request rendezvous parameter display (R31)	4.6.1.11																																																																																																																			
85	Display RR LOS azimuth & elevation	N/A																																																																																																																			
89	Start rendezvous final attitude maneuver (R63)	4.6.1.10																																																																																																																			
90	Request rendezvous out-of-plane display (R36)	4.7.2.1																																																																																																																			
91	Show Banksum	4.6.1.12																																																																																																																			
92	Start IMU performance tests	N/A																																																																																																																			
93	Enable V-Matrix Initialization	4.6.1.26																																																																																																																			
			<p>For ground use only.</p>																																																																																																																		

LM 3231

G  
R  
E  
E  
D  
A  
T

LMA790-3-LM  
 APOLLO OPERATIONS HANDBOOK

CREW-MAN	PNL	PROCEDURES	REMARKS																																																									
		<p>4.4.6 <u>VERB LIST (cont)</u></p> <p><u>No.</u>                      <u>Extended Verbs</u></p> <p>95    No update of either state vector</p> <p>96    Interrupt integration and go to P00</p> <p>97    Perform engine fail procedure</p> <p>99    Enable engine ignition</p> <p>4.4.7 <u>NOUN LIST</u></p> <table border="0"> <thead> <tr> <th><u>No.</u></th> <th><u>Description/Component</u></th> <th><u>Scale</u></th> </tr> </thead> <tbody> <tr> <td>01</td> <td>Specify address (fraction)</td> <td></td> </tr> <tr> <td></td> <td>R1</td> <td>.XXXX</td> </tr> <tr> <td></td> <td>R2</td> <td>.XXXX</td> </tr> <tr> <td></td> <td>R3</td> <td>.XXXX</td> </tr> <tr> <td>02</td> <td>Specify address (whole)</td> <td></td> </tr> <tr> <td></td> <td>R1</td> <td>XXXX</td> </tr> <tr> <td></td> <td>R2</td> <td>XXXX</td> </tr> <tr> <td></td> <td>R3</td> <td>XXXX</td> </tr> <tr> <td>03</td> <td>Specify address (degree)</td> <td></td> </tr> <tr> <td></td> <td>R1</td> <td>XX.XX°</td> </tr> <tr> <td></td> <td>R2</td> <td>XX.XX°</td> </tr> <tr> <td></td> <td>R3</td> <td>XX.XX°</td> </tr> <tr> <td>04</td> <td>R1 Gravity error angle</td> <td>XX.XX°</td> </tr> <tr> <td></td> <td>R2</td> <td>---</td> </tr> <tr> <td></td> <td>R3</td> <td>---</td> </tr> <tr> <td>05</td> <td>R1 Sighting angle difference</td> <td>XX.XX°</td> </tr> <tr> <td></td> <td>R2</td> <td>---</td> </tr> <tr> <td></td> <td>R3</td> <td>---</td> </tr> </tbody> </table>	<u>No.</u>	<u>Description/Component</u>	<u>Scale</u>	01	Specify address (fraction)			R1	.XXXX		R2	.XXXX		R3	.XXXX	02	Specify address (whole)			R1	XXXX		R2	XXXX		R3	XXXX	03	Specify address (degree)			R1	XX.XX°		R2	XX.XX°		R3	XX.XX°	04	R1 Gravity error angle	XX.XX°		R2	---		R3	---	05	R1 Sighting angle difference	XX.XX°		R2	---		R3	---	<p>Ref para 4.6.1.31. Do not use during P20 when CSM state vector is being updated (V81) or after responding to FL V37 when leaving a program where average g was on.</p>
<u>No.</u>	<u>Description/Component</u>	<u>Scale</u>																																																										
01	Specify address (fraction)																																																											
	R1	.XXXX																																																										
	R2	.XXXX																																																										
	R3	.XXXX																																																										
02	Specify address (whole)																																																											
	R1	XXXX																																																										
	R2	XXXX																																																										
	R3	XXXX																																																										
03	Specify address (degree)																																																											
	R1	XX.XX°																																																										
	R2	XX.XX°																																																										
	R3	XX.XX°																																																										
04	R1 Gravity error angle	XX.XX°																																																										
	R2	---																																																										
	R3	---																																																										
05	R1 Sighting angle difference	XX.XX°																																																										
	R2	---																																																										
	R3	---																																																										

**LMA790-3-LM  
APOLLO OPERATIONS HANDBOOK**

CREW- MAN	PNI	PROCEDURES	REMARKS																											
		<p><u>4.4.7 NOUN LIST (cont)</u></p> <table border="0"> <thead> <tr> <th style="text-align: center;"><u>No.</u></th> <th style="text-align: center;"><u>Description/Component</u></th> <th style="text-align: center;"><u>Scale</u></th> </tr> </thead> <tbody> <tr> <td style="text-align: center;">06</td> <td>Option code R1 Code R2 Desired option R3</td> <td>Octal Octal Octal</td> </tr> <tr> <td style="text-align: center;">07</td> <td>Channel/Flagword/Erasable operator R1 ECADR R2 Bit Identification R3 Action</td> <td>Octal Octal Octal</td> </tr> <tr> <td style="text-align: center;">08</td> <td>Alarm data R1 Address R2 BBCON R3 ERCOUNT</td> <td>Octal Octal Octal</td> </tr> <tr> <td style="text-align: center;">09</td> <td>Alarm codes R1 First R2 Second R3 Last</td> <td>Octal Octal Octal</td> </tr> <tr> <td style="text-align: center;">10</td> <td>Channel to be specified R1 R2 R3</td> <td>Octal ----- -----</td> </tr> <tr> <td style="text-align: center;">11</td> <td>TIG (CSI) R1 R2 R3</td> <td>00XX hr 000X min 0XX.XX sec</td> </tr> <tr> <td style="text-align: center;">12</td> <td>Option code R1 Code R2 Desired option R3</td> <td>Octal Octal -----</td> </tr> <tr> <td style="text-align: center;">13</td> <td>TIG (CDH) R1 R2 R3</td> <td>00XX hr 000X min 0XX.XX sec</td> </tr> </tbody> </table>	<u>No.</u>	<u>Description/Component</u>	<u>Scale</u>	06	Option code R1 Code R2 Desired option R3	Octal Octal Octal	07	Channel/Flagword/Erasable operator R1 ECADR R2 Bit Identification R3 Action	Octal Octal Octal	08	Alarm data R1 Address R2 BBCON R3 ERCOUNT	Octal Octal Octal	09	Alarm codes R1 First R2 Second R3 Last	Octal Octal Octal	10	Channel to be specified R1 R2 R3	Octal ----- -----	11	TIG (CSI) R1 R2 R3	00XX hr 000X min 0XX.XX sec	12	Option code R1 Code R2 Desired option R3	Octal Octal -----	13	TIG (CDH) R1 R2 R3	00XX hr 000X min 0XX.XX sec	<p>R3 contains DATCODE during P57. Except channels 7 and 77.</p> <p>All except channel 7. (Which may be read but not loaded via N10)</p> <p>Used by extended verbs only</p>
<u>No.</u>	<u>Description/Component</u>	<u>Scale</u>																												
06	Option code R1 Code R2 Desired option R3	Octal Octal Octal																												
07	Channel/Flagword/Erasable operator R1 ECADR R2 Bit Identification R3 Action	Octal Octal Octal																												
08	Alarm data R1 Address R2 BBCON R3 ERCOUNT	Octal Octal Octal																												
09	Alarm codes R1 First R2 Second R3 Last	Octal Octal Octal																												
10	Channel to be specified R1 R2 R3	Octal ----- -----																												
11	TIG (CSI) R1 R2 R3	00XX hr 000X min 0XX.XX sec																												
12	Option code R1 Code R2 Desired option R3	Octal Octal -----																												
13	TIG (CDH) R1 R2 R3	00XX hr 000X min 0XX.XX sec																												

G & C  
REF  
DATA

**LMA790-3-LM  
APOLLO OPERATIONS HANDBOOK**

CREW-MAN	P/NL	PROCEDURES	REMARKS																								
		<p>4.4.7 <u>NOUN LIST (cont)</u></p> <table border="0"> <thead> <tr> <th><u>No.</u></th> <th><u>Description/Component</u></th> <th><u>Scale</u></th> </tr> </thead> <tbody> <tr> <td>14</td> <td>Deleted</td> <td></td> </tr> <tr> <td>15</td> <td>Increment address R1 R2 R3</td> <td>Octal ----- -----</td> </tr> <tr> <td>16</td> <td>Time of event R1 R2 R3</td> <td>00XX hr 00XX min 0XX.XX sec</td> </tr> <tr> <td>18</td> <td>Desired automatic maneuver FDAI angles R1 Roll R2 Pitch R3 Yaw</td> <td>XXX.XI° XXX.XI° XXX.XI°</td> </tr> <tr> <td>20</td> <td>Present ICDU angles R1 Outer gimbal R2 Inner gimbal R3 Middle gimbal</td> <td>XXX.XI° XXX.XI° XXX.XI°</td> </tr> <tr> <td>21</td> <td>PIPA's R1 X R2 Y R3 Z</td> <td>XXXXX pulses XXXXX pulses XXXXX pulses</td> </tr> <tr> <td>22</td> <td>Desired ICDU angles R1 Outer gimbal R2 Inner gimbal R3 Middle gimbal</td> <td>XXX.XI° XXX.XI° XXX.XI°</td> </tr> </tbody> </table>	<u>No.</u>	<u>Description/Component</u>	<u>Scale</u>	14	Deleted		15	Increment address R1 R2 R3	Octal ----- -----	16	Time of event R1 R2 R3	00XX hr 00XX min 0XX.XX sec	18	Desired automatic maneuver FDAI angles R1 Roll R2 Pitch R3 Yaw	XXX.XI° XXX.XI° XXX.XI°	20	Present ICDU angles R1 Outer gimbal R2 Inner gimbal R3 Middle gimbal	XXX.XI° XXX.XI° XXX.XI°	21	PIPA's R1 X R2 Y R3 Z	XXXXX pulses XXXXX pulses XXXXX pulses	22	Desired ICDU angles R1 Outer gimbal R2 Inner gimbal R3 Middle gimbal	XXX.XI° XXX.XI° XXX.XI°	<p>Used by extended verbs only</p>
<u>No.</u>	<u>Description/Component</u>	<u>Scale</u>																									
14	Deleted																										
15	Increment address R1 R2 R3	Octal ----- -----																									
16	Time of event R1 R2 R3	00XX hr 00XX min 0XX.XX sec																									
18	Desired automatic maneuver FDAI angles R1 Roll R2 Pitch R3 Yaw	XXX.XI° XXX.XI° XXX.XI°																									
20	Present ICDU angles R1 Outer gimbal R2 Inner gimbal R3 Middle gimbal	XXX.XI° XXX.XI° XXX.XI°																									
21	PIPA's R1 X R2 Y R3 Z	XXXXX pulses XXXXX pulses XXXXX pulses																									
22	Desired ICDU angles R1 Outer gimbal R2 Inner gimbal R3 Middle gimbal	XXX.XI° XXX.XI° XXX.XI°																									

**LMA790-3-LM  
APOLLO OPERATIONS HANDBOOK**

CREW- MAN	PNL	PROCEDURES	REMARKS																											
		<p>4.4.7 <u>NOUN LIST (cont)</u></p> <table style="width: 100%; border-collapse: collapse;"> <thead> <tr> <th style="text-align: left;"><u>No.</u></th> <th style="text-align: left;"><u>Description/Component</u></th> <th style="text-align: left;"><u>Scale</u></th> </tr> </thead> <tbody> <tr> <td>24</td> <td>ALGC clock time R1 R2 R3</td> <td>00XX hr 00XX min 0XX.XX sec</td> </tr> <tr> <td>25</td> <td>Checklist reference code (used with V50) R1 Code R2 R3</td> <td>XXXX ---- ----</td> </tr> <tr> <td>26</td> <td>Priority/delay, address, BBCON R1 R2 R3</td> <td>Octal Octal Octal</td> </tr> <tr> <td>27</td> <td>Self-test switch (on/off) R1 R2 R3</td> <td>XXXX ---- ----</td> </tr> <tr> <td>32</td> <td>Time from perigee R1 R2 R3</td> <td>00XX hr 00XX min 0XX.XX sec</td> </tr> <tr> <td>33</td> <td>TIG R1 R2 R3</td> <td>00XX hr 00XX min 0XX.XX sec</td> </tr> <tr> <td>34</td> <td>Time of event R1 R2 R3</td> <td>00XX hr 00XX min 0XX.XX sec</td> </tr> <tr> <td>35</td> <td>Time from event R1 R2 R3</td> <td>00XX hr 00XX min 0XX.XX sec</td> </tr> </tbody> </table>	<u>No.</u>	<u>Description/Component</u>	<u>Scale</u>	24	ALGC clock time R1 R2 R3	00XX hr 00XX min 0XX.XX sec	25	Checklist reference code (used with V50) R1 Code R2 R3	XXXX ---- ----	26	Priority/delay, address, BBCON R1 R2 R3	Octal Octal Octal	27	Self-test switch (on/off) R1 R2 R3	XXXX ---- ----	32	Time from perigee R1 R2 R3	00XX hr 00XX min 0XX.XX sec	33	TIG R1 R2 R3	00XX hr 00XX min 0XX.XX sec	34	Time of event R1 R2 R3	00XX hr 00XX min 0XX.XX sec	35	Time from event R1 R2 R3	00XX hr 00XX min 0XX.XX sec	<p>Ref para 4.6.1.13.</p>
<u>No.</u>	<u>Description/Component</u>	<u>Scale</u>																												
24	ALGC clock time R1 R2 R3	00XX hr 00XX min 0XX.XX sec																												
25	Checklist reference code (used with V50) R1 Code R2 R3	XXXX ---- ----																												
26	Priority/delay, address, BBCON R1 R2 R3	Octal Octal Octal																												
27	Self-test switch (on/off) R1 R2 R3	XXXX ---- ----																												
32	Time from perigee R1 R2 R3	00XX hr 00XX min 0XX.XX sec																												
33	TIG R1 R2 R3	00XX hr 00XX min 0XX.XX sec																												
34	Time of event R1 R2 R3	00XX hr 00XX min 0XX.XX sec																												
35	Time from event R1 R2 R3	00XX hr 00XX min 0XX.XX sec																												

G &  
REF  
DATA

**LMA790-3-LM**  
**APOLLO OPERATIONS HANDBOOK**

CREW- MAN	PNI	PROCEDURES	REMARKS			
4.4.7 MOUN LIST (cont)		<table border="0"> <tr> <td style="text-align: center;"><u>No.</u></td> <td style="text-align: center;"><u>Description/Component</u></td> <td style="text-align: center;"><u>Scale</u></td> </tr> </table>	<u>No.</u>	<u>Description/Component</u>	<u>Scale</u>	
<u>No.</u>	<u>Description/Component</u>	<u>Scale</u>				
		<table border="0"> <tr> <td style="text-align: center;">36</td> <td>Time of LGC clock R1 R2 R3</td> <td style="text-align: center;">00XX hr 00XX min 0X.XX sec</td> </tr> </table>	36	Time of LGC clock R1 R2 R3	00XX hr 00XX min 0X.XX sec	
36	Time of LGC clock R1 R2 R3	00XX hr 00XX min 0X.XX sec				
		<table border="0"> <tr> <td style="text-align: center;">37</td> <td>TIG (TPI) R1 R2 R3</td> <td style="text-align: center;">00XX hr 00XX min 0X.XX sec</td> </tr> </table>	37	TIG (TPI) R1 R2 R3	00XX hr 00XX min 0X.XX sec	
37	TIG (TPI) R1 R2 R3	00XX hr 00XX min 0X.XX sec				
		<table border="0"> <tr> <td style="text-align: center;">38</td> <td>State vector integration time (TET) R1 R2 R3</td> <td style="text-align: center;">00XX hr 00XX min 0X.XX sec</td> </tr> </table>	38	State vector integration time (TET) R1 R2 R3	00XX hr 00XX min 0X.XX sec	To monitor progress of state vector integration, time associated with progressing (regressing) state vector is available by keying V16 N38E. TET is time (GET) to which state vector integration process has presently calculated state vector.
38	State vector integration time (TET) R1 R2 R3	00XX hr 00XX min 0X.XX sec				
		<table border="0"> <tr> <td style="text-align: center;">40</td> <td>R1 TPI/TPC R2 VC R3 AV (Accumulated)</td> <td style="text-align: center;">XXXX min-sec XXX.X fps XXX.X fps</td> </tr> </table>	40	R1 TPI/TPC R2 VC R3 AV (Accumulated)	XXXX min-sec XXX.X fps XXX.X fps	
40	R1 TPI/TPC R2 VC R3 AV (Accumulated)	XXXX min-sec XXX.X fps XXX.X fps				
		<table border="0"> <tr> <td style="text-align: center;">41</td> <td>Navigation base R1 Azimuth R2 Elevation R3</td> <td style="text-align: center;">XX.XI° XX.XX° -----</td> </tr> </table>	41	Navigation base R1 Azimuth R2 Elevation R3	XX.XI° XX.XX° -----	System test
41	Navigation base R1 Azimuth R2 Elevation R3	XX.XI° XX.XX° -----				
		<table border="0"> <tr> <td style="text-align: center;">42</td> <td>R1 Ha R2 Hp R3 AV</td> <td style="text-align: center;">XXX.X nm XXX.X nm XXX.X fps</td> </tr> </table>	42	R1 Ha R2 Hp R3 AV	XXX.X nm XXX.X nm XXX.X fps	
42	R1 Ha R2 Hp R3 AV	XXX.X nm XXX.X nm XXX.X fps				
		<table border="0"> <tr> <td style="text-align: center;">43</td> <td>R1 Latitude R2 Longitude R3 Altitude</td> <td style="text-align: center;">XX.XI° XX.XX° XXX.X nm</td> </tr> </table>	43	R1 Latitude R2 Longitude R3 Altitude	XX.XI° XX.XX° XXX.X nm	A + display indicates north A + display indicates east
43	R1 Latitude R2 Longitude R3 Altitude	XX.XI° XX.XX° XXX.X nm				
		<table border="0"> <tr> <td style="text-align: center;">44</td> <td>R1 Ha R2 Hp R3 TFF</td> <td style="text-align: center;">XXX.X nm XXX.X nm XXX min-sec</td> </tr> </table>	44	R1 Ha R2 Hp R3 TFF	XXX.X nm XXX.X nm XXX min-sec	
44	R1 Ha R2 Hp R3 TFF	XXX.X nm XXX.X nm XXX min-sec				

RC 1586

**LMA790-3-LM**  
**APOLLO OPERATIONS HANDBOOK**

CREW- MAN	PNL	PROCEDURES		REMARKS
		4.4.7	<u>NOUN LIST (cont)</u>	
		45	<u>No.</u> Description/Component Scale R1 M                    XXXXX marks R2 TPI                 XXBXX min-sec R3 MGA                 XXX.XX°	
		46	R1 DAP configuration    Octal R2 Switch Function      Octal Fail Code                ----- R3	Ref para 4.6.1.8 (R03). R1 may be displayed or changed effectively only in R03. R2 may be displayed and changed either in R03 or otherwise.
		47	R1 LM weight             XXXXX lb R2 CSM weight          XXXXX lb R3	
		48	R1 Gimbal pitch trim    XXX.XX° R2 Gimbal roll trim     XXX.XX° R3	
		49	R1 AR                     XXX.XX nm R2 ΔV                    XXXX.X fps R3 Source Code         0000X	R3 indicates out-of-tolerance parameter X = 1, RR range        X = 3, RR shaft angle X = 2, RR range rate   X = 4, RR trunnion angle
		51	S-band antenna R1 Pitch                 XXX.XX° R2 Yaw                    XXX.XX° R3	
		52	R1 Central angle of active vehicle    XXX.XX° R2 R3	
		54	R1 Range                 XXX.XX nm R2 Range rate          XXXX.X fps R3 θ                        XXX.XX°	

G &  
RE  
DA

RC 1597, LM 3231

**LMA790-3-LM  
APOLLO OPERATIONS HANDBOOK**

CREW-MAN	PNI	PROCEDURES	REMARKS																								
		4.4.7 <u>NOON LIST (cont)</u>																									
		<table style="width: 100%; border-collapse: collapse;"> <thead> <tr> <th style="width: 5%;"><u>No.</u></th> <th style="width: 60%;"><u>Description/Component</u></th> <th style="width: 35%;"><u>Scale</u></th> </tr> </thead> <tbody> <tr> <td>55</td> <td>R1 N (apsidal crossings) R2 E R3 CENTANG</td> <td>XXXX XXX.XX° XX.XX°</td> </tr> <tr> <td>56</td> <td>R1 RR LOS azimuth R2 RR LOS elevation R3</td> <td>XX.XX° XXX.XX° ---</td> </tr> <tr> <td>58</td> <td>R1 hp (Post-TPI) R2 AV (TPI) R3 AV (TPF)</td> <td>XXX.X nm XXX.X fps XXX.X fps</td> </tr> <tr> <td>59</td> <td>AV (LOS) R1 LOS 1 R2 LOS 2 R3 LOS 3</td> <td>XXX.X fps XXX.X fps XXX.X fps</td> </tr> <tr> <td>60</td> <td>R1 V (Forward) R2 H rate R3 H</td> <td>XXX.X fps XXX.X fps XXXX ft</td> </tr> <tr> <td>61</td> <td>R1 TG R2 TPI R3 Crossrange</td> <td>XXXX min-sec XXXX min-sec XXX.X nm</td> </tr> <tr> <td>62</td> <td>R1 VI R2 TPI R3 AV (Accumulated)</td> <td>XXX.X fps XXXX min-sec XXX.X fps</td> </tr> </tbody> </table>	<u>No.</u>	<u>Description/Component</u>	<u>Scale</u>	55	R1 N (apsidal crossings) R2 E R3 CENTANG	XXXX XXX.XX° XX.XX°	56	R1 RR LOS azimuth R2 RR LOS elevation R3	XX.XX° XXX.XX° ---	58	R1 hp (Post-TPI) R2 AV (TPI) R3 AV (TPF)	XXX.X nm XXX.X fps XXX.X fps	59	AV (LOS) R1 LOS 1 R2 LOS 2 R3 LOS 3	XXX.X fps XXX.X fps XXX.X fps	60	R1 V (Forward) R2 H rate R3 H	XXX.X fps XXX.X fps XXXX ft	61	R1 TG R2 TPI R3 Crossrange	XXXX min-sec XXXX min-sec XXX.X nm	62	R1 VI R2 TPI R3 AV (Accumulated)	XXX.X fps XXXX min-sec XXX.X fps	
<u>No.</u>	<u>Description/Component</u>	<u>Scale</u>																									
55	R1 N (apsidal crossings) R2 E R3 CENTANG	XXXX XXX.XX° XX.XX°																									
56	R1 RR LOS azimuth R2 RR LOS elevation R3	XX.XX° XXX.XX° ---																									
58	R1 hp (Post-TPI) R2 AV (TPI) R3 AV (TPF)	XXX.X nm XXX.X fps XXX.X fps																									
59	AV (LOS) R1 LOS 1 R2 LOS 2 R3 LOS 3	XXX.X fps XXX.X fps XXX.X fps																									
60	R1 V (Forward) R2 H rate R3 H	XXX.X fps XXX.X fps XXXX ft																									
61	R1 TG R2 TPI R3 Crossrange	XXXX min-sec XXXX min-sec XXX.X nm																									
62	R1 VI R2 TPI R3 AV (Accumulated)	XXX.X fps XXXX min-sec XXX.X fps																									



**LMA790-3-LM  
APOLLO OPERATIONS HANDBOOK**

CREW- MAN	PMS	PROCEDURES	REMARKS				
		<p>4.4.7 <u>NOUN LIST (cont)</u></p> <table border="0"> <tr> <td style="vertical-align: top;"> <p><u>No.</u></p> <p>63</p>   <p>64</p>   <p>65</p>   <p>66</p>   <p>67</p>   <p>68</p>   <p>69</p> </td> <td style="vertical-align: top;"> <p><u>Description/Component</u></p> <p>R1 ΔH (LR alt minus LGC alt above landing site radius)</p> <p>R2 H rate</p> <p>R3 H</p>   <p>R1 TR/LPD</p> <p>R2 H rate</p> <p>R3 H</p>   <p>Sampled LGC time</p> <p>R1</p> <p>R2</p> <p>R3</p>   <p>R1 LR slant range</p> <p>R2 LR position</p> <p>R3</p>   <p>LR velocities</p> <p>R1 X</p> <p>R2 Y</p> <p>R3 Z</p>   <p>R1 Horizontal range to landing site</p> <p>R2 TC</p> <p>R3 VI</p>   <p>ARLS</p> </td> <td style="vertical-align: top;"> <p><u>Scale</u></p> <p>XXXX ft</p> <p>XXXX.X fps</p> <p>XXXX ft</p>   <p>XXXX sec-deg</p> <p>XXXX.X fps</p> <p>XXXX ft</p>   <p>00XXX hr</p> <p>000XX min</p> <p>0XX.XX sec</p>   <p>XXXX ft</p> <p>0000X</p> <p>----</p>   <p>XXXX fps</p> <p>XXXX fps</p> <p>XXXX fps</p>   <p>XXXX.X nm</p> <p>XXXX min-sec</p> <p>XXXX.X fps</p>   <p>XXXX ft</p> <p>XXXX ft</p> <p>XXXX ft</p> </td> <td style="vertical-align: top;"> <p>Patched in interrupt</p>   <p>X = 1 or 2</p> </td> </tr> </table>	<p><u>No.</u></p> <p>63</p> <p>64</p> <p>65</p> <p>66</p> <p>67</p> <p>68</p> <p>69</p>	<p><u>Description/Component</u></p> <p>R1 ΔH (LR alt minus LGC alt above landing site radius)</p> <p>R2 H rate</p> <p>R3 H</p> <p>R1 TR/LPD</p> <p>R2 H rate</p> <p>R3 H</p> <p>Sampled LGC time</p> <p>R1</p> <p>R2</p> <p>R3</p> <p>R1 LR slant range</p> <p>R2 LR position</p> <p>R3</p> <p>LR velocities</p> <p>R1 X</p> <p>R2 Y</p> <p>R3 Z</p> <p>R1 Horizontal range to landing site</p> <p>R2 TC</p> <p>R3 VI</p> <p>ARLS</p>	<p><u>Scale</u></p> <p>XXXX ft</p> <p>XXXX.X fps</p> <p>XXXX ft</p> <p>XXXX sec-deg</p> <p>XXXX.X fps</p> <p>XXXX ft</p> <p>00XXX hr</p> <p>000XX min</p> <p>0XX.XX sec</p> <p>XXXX ft</p> <p>0000X</p> <p>----</p> <p>XXXX fps</p> <p>XXXX fps</p> <p>XXXX fps</p> <p>XXXX.X nm</p> <p>XXXX min-sec</p> <p>XXXX.X fps</p> <p>XXXX ft</p> <p>XXXX ft</p> <p>XXXX ft</p>	<p>Patched in interrupt</p> <p>X = 1 or 2</p>	
<p><u>No.</u></p> <p>63</p> <p>64</p> <p>65</p> <p>66</p> <p>67</p> <p>68</p> <p>69</p>	<p><u>Description/Component</u></p> <p>R1 ΔH (LR alt minus LGC alt above landing site radius)</p> <p>R2 H rate</p> <p>R3 H</p> <p>R1 TR/LPD</p> <p>R2 H rate</p> <p>R3 H</p> <p>Sampled LGC time</p> <p>R1</p> <p>R2</p> <p>R3</p> <p>R1 LR slant range</p> <p>R2 LR position</p> <p>R3</p> <p>LR velocities</p> <p>R1 X</p> <p>R2 Y</p> <p>R3 Z</p> <p>R1 Horizontal range to landing site</p> <p>R2 TC</p> <p>R3 VI</p> <p>ARLS</p>	<p><u>Scale</u></p> <p>XXXX ft</p> <p>XXXX.X fps</p> <p>XXXX ft</p> <p>XXXX sec-deg</p> <p>XXXX.X fps</p> <p>XXXX ft</p> <p>00XXX hr</p> <p>000XX min</p> <p>0XX.XX sec</p> <p>XXXX ft</p> <p>0000X</p> <p>----</p> <p>XXXX fps</p> <p>XXXX fps</p> <p>XXXX fps</p> <p>XXXX.X nm</p> <p>XXXX min-sec</p> <p>XXXX.X fps</p> <p>XXXX ft</p> <p>XXXX ft</p> <p>XXXX ft</p>	<p>Patched in interrupt</p> <p>X = 1 or 2</p>				

G & C  
REF  
DATA

**LMA790-3-LM  
APOLLO OPERATIONS HANDBOOK**

LM 3231

CREW-MAN	P/NL	PROCEDURES	REMARKS																											
		4.4.7 <u>NOUJN LIST (Cont)</u>																												
		<table border="0" style="width: 100%;"> <thead> <tr> <th style="text-align: left;">NO.</th> <th style="text-align: left;">Description/Component</th> <th style="text-align: left;">Scale</th> </tr> </thead> <tbody> <tr> <td>70</td> <td>R1 AOT detent/star code (before mark) R2 R3</td> <td>00CDE ----- -----</td> </tr> <tr> <td>71</td> <td>R1 AOT detent/star code (after mark) R2 X marks R3 Y marks</td> <td>00CDE Z000X Z000Y</td> </tr> <tr> <td>72</td> <td>RR angles R1 Trunnion R2 Shaft R3</td> <td>XXX.XX° XXX.XX° -----</td> </tr> <tr> <td>73</td> <td>Desired RR angles R1 Trunnion R2 Shaft R3</td> <td>XXX.XX° XXX.XX° -----</td> </tr> <tr> <td>74</td> <td>R1 TPI R2 Yaw R3 Pitch</td> <td>XXBX min-sec XXX.XX° XXX.XX°</td> </tr> <tr> <td>75</td> <td>R1 AH (CDH) R2 AT (CDH-GSI or TPI-CDH) R3 AT (TPI-CDH or TPI-nom TPI)</td> <td>XXXX.X nm XXBX min-sec XXBX min-sec</td> </tr> <tr> <td>76</td> <td>R1 Desired downrange velocity R2 Desired radial velocity R3 Crossrange</td> <td>XXXX.X fps XXXX.X fps XXXX.X nm</td> </tr> <tr> <td>77</td> <td>R1 TG R2 VGY (LM) R3 VI</td> <td>XXBX min-sec XXXX.X fps XXXX.X fps</td> </tr> </tbody> </table>	NO.	Description/Component	Scale	70	R1 AOT detent/star code (before mark) R2 R3	00CDE ----- -----	71	R1 AOT detent/star code (after mark) R2 X marks R3 Y marks	00CDE Z000X Z000Y	72	RR angles R1 Trunnion R2 Shaft R3	XXX.XX° XXX.XX° -----	73	Desired RR angles R1 Trunnion R2 Shaft R3	XXX.XX° XXX.XX° -----	74	R1 TPI R2 Yaw R3 Pitch	XXBX min-sec XXX.XX° XXX.XX°	75	R1 AH (CDH) R2 AT (CDH-GSI or TPI-CDH) R3 AT (TPI-CDH or TPI-nom TPI)	XXXX.X nm XXBX min-sec XXBX min-sec	76	R1 Desired downrange velocity R2 Desired radial velocity R3 Crossrange	XXXX.X fps XXXX.X fps XXXX.X nm	77	R1 TG R2 VGY (LM) R3 VI	XXBX min-sec XXXX.X fps XXXX.X fps	R2 and R3 are modularized to the hour; e.g. Modulo 60 minutes.
NO.	Description/Component	Scale																												
70	R1 AOT detent/star code (before mark) R2 R3	00CDE ----- -----																												
71	R1 AOT detent/star code (after mark) R2 X marks R3 Y marks	00CDE Z000X Z000Y																												
72	RR angles R1 Trunnion R2 Shaft R3	XXX.XX° XXX.XX° -----																												
73	Desired RR angles R1 Trunnion R2 Shaft R3	XXX.XX° XXX.XX° -----																												
74	R1 TPI R2 Yaw R3 Pitch	XXBX min-sec XXX.XX° XXX.XX°																												
75	R1 AH (CDH) R2 AT (CDH-GSI or TPI-CDH) R3 AT (TPI-CDH or TPI-nom TPI)	XXXX.X nm XXBX min-sec XXBX min-sec																												
76	R1 Desired downrange velocity R2 Desired radial velocity R3 Crossrange	XXXX.X fps XXXX.X fps XXXX.X nm																												
77	R1 TG R2 VGY (LM) R3 VI	XXBX min-sec XXXX.X fps XXXX.X fps																												

**LMA790-3-LM  
APOLLO OPERATIONS HANDBOOK**

CREW-MAN	PNL	PROCEDURES	REMARKS																											
		<p>4.4.7 <u>NOUN LIST (cont)</u></p> <table style="width: 100%; border-collapse: collapse;"> <thead> <tr> <th style="text-align: left; width: 10%;"><u>No.</u></th> <th style="text-align: left; width: 50%;"><u>Description/Component</u></th> <th style="text-align: left; width: 40%;"><u>Scale</u></th> </tr> </thead> <tbody> <tr> <td>78</td> <td>R1 RR range R2 RR range rate R3 TPI</td> <td>XXX.XX nm XXX.X fps XXBX min-sec</td> </tr> <tr> <td>79</td> <td>R1 Cursor angle R2 Spiral angle R3 Position code</td> <td>XXX.XX° XXX.XX° 0000X</td> </tr> <tr> <td>80</td> <td>R1 Data indicator R2 <math>\Omega</math> R3</td> <td>XXXXX XXX.XX° -----</td> </tr> <tr> <td>81</td> <td><math>\Delta V</math> (LV) R1 X R2 Y R3 Z</td> <td>XXX.X fps XXX.X fps XXX.X fps</td> </tr> <tr> <td>82</td> <td><math>\Delta V</math> (LV) R1 X R2 Y R3 Z</td> <td>XXX.X fps XXX.X fps XXX.X fps</td> </tr> <tr> <td>83</td> <td><math>\Delta V</math> (LM) R1 X R2 Y R3 Z</td> <td>XXX.X fps XXX.X fps XXX.X fps</td> </tr> <tr> <td>84</td> <td><math>\Delta V</math> (CSH) R1 X R2 Y R3 Z</td> <td>XXX.X fps XXX.X fps XXX.X fps</td> </tr> <tr> <td>85</td> <td><math>\Delta V</math> (LM) R1 X R2 Y R3 Z</td> <td>XXX.X fps XXX.X fps XXX.X fps</td> </tr> </tbody> </table>	<u>No.</u>	<u>Description/Component</u>	<u>Scale</u>	78	R1 RR range R2 RR range rate R3 TPI	XXX.XX nm XXX.X fps XXBX min-sec	79	R1 Cursor angle R2 Spiral angle R3 Position code	XXX.XX° XXX.XX° 0000X	80	R1 Data indicator R2 $\Omega$ R3	XXXXX XXX.XX° -----	81	$\Delta V$ (LV) R1 X R2 Y R3 Z	XXX.X fps XXX.X fps XXX.X fps	82	$\Delta V$ (LV) R1 X R2 Y R3 Z	XXX.X fps XXX.X fps XXX.X fps	83	$\Delta V$ (LM) R1 X R2 Y R3 Z	XXX.X fps XXX.X fps XXX.X fps	84	$\Delta V$ (CSH) R1 X R2 Y R3 Z	XXX.X fps XXX.X fps XXX.X fps	85	$\Delta V$ (LM) R1 X R2 Y R3 Z	XXX.X fps XXX.X fps XXX.X fps	
<u>No.</u>	<u>Description/Component</u>	<u>Scale</u>																												
78	R1 RR range R2 RR range rate R3 TPI	XXX.XX nm XXX.X fps XXBX min-sec																												
79	R1 Cursor angle R2 Spiral angle R3 Position code	XXX.XX° XXX.XX° 0000X																												
80	R1 Data indicator R2 $\Omega$ R3	XXXXX XXX.XX° -----																												
81	$\Delta V$ (LV) R1 X R2 Y R3 Z	XXX.X fps XXX.X fps XXX.X fps																												
82	$\Delta V$ (LV) R1 X R2 Y R3 Z	XXX.X fps XXX.X fps XXX.X fps																												
83	$\Delta V$ (LM) R1 X R2 Y R3 Z	XXX.X fps XXX.X fps XXX.X fps																												
84	$\Delta V$ (CSH) R1 X R2 Y R3 Z	XXX.X fps XXX.X fps XXX.X fps																												
85	$\Delta V$ (LM) R1 X R2 Y R3 Z	XXX.X fps XXX.X fps XXX.X fps																												

G &  
REF  
DAT

**LMA790-3-LM  
APOLLO OPERATIONS HANDBOOK**

CREW-MAN	PNI	PROCEDURES	REMARKS																											
		4.4.7 <u>NOUN LIST (cont)</u>																												
		<table style="width: 100%; border-collapse: collapse;"> <thead> <tr> <th style="text-align: left;">No.</th> <th style="text-align: left;">Description/Component</th> <th style="text-align: left;">Scale</th> </tr> </thead> <tbody> <tr> <td>86</td> <td>VG (LV) R1 X R2 Y R3 Z</td> <td>XXX.X fps XXX.X fps XXX.X fps</td> </tr> <tr> <td>87</td> <td>Backup optics LOS R1 Azimuth R2 Elevation R3</td> <td>XX.XX° XX.XX° -----</td> </tr> <tr> <td>88</td> <td>Celestial body position R1 X R2 Y R3 Z</td> <td>.XXXX .XXXX .XXXX</td> </tr> <tr> <td>89</td> <td>Landmark R1 Latitude R2 Longitude/2 R3 Altitude</td> <td>XX.XXX° XX.XXX° XX.XX nm</td> </tr> <tr> <td>90</td> <td>Rendezvous out-of-plane parameters R1 Y R2 Y rate R3 <math>\psi</math></td> <td>XX.XX nm XXX.X fps XX.XX°</td> </tr> <tr> <td>91</td> <td>R1 Altitude R2 V R3 Flight path angle</td> <td>XXXX nmX10 XXXX fps XX.XX°</td> </tr> <tr> <td>92</td> <td>R1 Desired auto throttle R2 H rate R3 H</td> <td>XXXXX XXX.X fps XXXXX ft</td> </tr> <tr> <td>93</td> <td><math>\Delta</math> Gyro angles R1 X R2 Y R3 Z</td> <td>XX.XXX° XX.XXX° XX.XXX°</td> </tr> </tbody> </table>	No.	Description/Component	Scale	86	VG (LV) R1 X R2 Y R3 Z	XXX.X fps XXX.X fps XXX.X fps	87	Backup optics LOS R1 Azimuth R2 Elevation R3	XX.XX° XX.XX° -----	88	Celestial body position R1 X R2 Y R3 Z	.XXXX .XXXX .XXXX	89	Landmark R1 Latitude R2 Longitude/2 R3 Altitude	XX.XXX° XX.XXX° XX.XX nm	90	Rendezvous out-of-plane parameters R1 Y R2 Y rate R3 $\psi$	XX.XX nm XXX.X fps XX.XX°	91	R1 Altitude R2 V R3 Flight path angle	XXXX nmX10 XXXX fps XX.XX°	92	R1 Desired auto throttle R2 H rate R3 H	XXXXX XXX.X fps XXXXX ft	93	$\Delta$ Gyro angles R1 X R2 Y R3 Z	XX.XXX° XX.XXX° XX.XXX°	Celestial body unit vector
No.	Description/Component	Scale																												
86	VG (LV) R1 X R2 Y R3 Z	XXX.X fps XXX.X fps XXX.X fps																												
87	Backup optics LOS R1 Azimuth R2 Elevation R3	XX.XX° XX.XX° -----																												
88	Celestial body position R1 X R2 Y R3 Z	.XXXX .XXXX .XXXX																												
89	Landmark R1 Latitude R2 Longitude/2 R3 Altitude	XX.XXX° XX.XXX° XX.XX nm																												
90	Rendezvous out-of-plane parameters R1 Y R2 Y rate R3 $\psi$	XX.XX nm XXX.X fps XX.XX°																												
91	R1 Altitude R2 V R3 Flight path angle	XXXX nmX10 XXXX fps XX.XX°																												
92	R1 Desired auto throttle R2 H rate R3 H	XXXXX XXX.X fps XXXXX ft																												
93	$\Delta$ Gyro angles R1 X R2 Y R3 Z	XX.XXX° XX.XXX° XX.XXX°																												

**LMA790-3-LM  
APOLLO OPERATIONS HANDBOOK**

LM 32-

CREW-MAN	PNL	PROCEDURES	REMARKS															
		<p>4.4.7 <u>NOUN LIST (cont)</u></p> <table style="width: 100%; border-collapse: collapse;"> <thead> <tr> <th style="text-align: center;"><u>No.</u></th> <th style="text-align: center;"><u>Description/Component</u></th> <th style="text-align: center;"><u>Scale</u></th> </tr> </thead> <tbody> <tr> <td style="text-align: center;">94</td> <td>R1 VGX (LM) R2 H rate R3 H</td> <td>XXXX.X fps XXXX.X fps XXXX ft</td> </tr> <tr> <td style="text-align: center;">97</td> <td>System test input R1 R2 R3</td> <td>XXXX XXXX XXXX</td> </tr> <tr> <td style="text-align: center;">98</td> <td>System results and inputs R1 R2 R3</td> <td>XXXX .XXXX XXXX</td> </tr> <tr> <td style="text-align: center;">99</td> <td>R1 RSS in position R2 RSS in velocity R3 RSS in bias</td> <td>XXXX ft XXXX.X fps XXXX mrad</td> </tr> </tbody> </table>	<u>No.</u>	<u>Description/Component</u>	<u>Scale</u>	94	R1 VGX (LM) R2 H rate R3 H	XXXX.X fps XXXX.X fps XXXX ft	97	System test input R1 R2 R3	XXXX XXXX XXXX	98	System results and inputs R1 R2 R3	XXXX .XXXX XXXX	99	R1 RSS in position R2 RSS in velocity R3 RSS in bias	XXXX ft XXXX.X fps XXXX mrad	
<u>No.</u>	<u>Description/Component</u>	<u>Scale</u>																
94	R1 VGX (LM) R2 H rate R3 H	XXXX.X fps XXXX.X fps XXXX ft																
97	System test input R1 R2 R3	XXXX XXXX XXXX																
98	System results and inputs R1 R2 R3	XXXX .XXXX XXXX																
99	R1 RSS in position R2 RSS in velocity R3 RSS in bias	XXXX ft XXXX.X fps XXXX mrad																

G & C  
REF  
DATA

**LMA790-3-LM  
APOLLO OPERATIONS HANDBOOK**

LM 3231

CREW-MAN	PNL	PROCEDURES	REMARKS																																																																																																																																																																																																																																													
		<p><b>4.4.8 STAR/PLANET LIST</b> <u>Alphabetical</u></p> <table style="width: 100%; border-collapse: collapse;"> <thead> <tr> <th style="width: 70%;"></th> <th style="width: 10%; text-align: center;"><u>Octal Code</u></th> <th style="width: 10%; text-align: center;"><u>Vis Mag</u></th> </tr> </thead> <tbody> <tr><td>Acmar</td><td style="text-align: center;">6</td><td style="text-align: center;">3.4</td></tr> <tr><td>( α Eridani)</td><td></td><td></td></tr> <tr><td>Achernar</td><td style="text-align: center;">4</td><td style="text-align: center;">0.6</td></tr> <tr><td>( α Eridani)</td><td></td><td></td></tr> <tr><td>Acrux</td><td style="text-align: center;">25</td><td style="text-align: center;">1.6</td></tr> <tr><td>( α Crucis)</td><td></td><td></td></tr> <tr><td>Aldebaran</td><td style="text-align: center;">11</td><td style="text-align: center;">1.1</td></tr> <tr><td>( α Tauri)</td><td></td><td></td></tr> <tr><td>Alkaid</td><td style="text-align: center;">27</td><td style="text-align: center;">1.9</td></tr> <tr><td>( η Ursae Majoris)</td><td></td><td></td></tr> <tr><td>Alphard</td><td style="text-align: center;">21</td><td style="text-align: center;">2.2</td></tr> <tr><td>( α Hydrae)</td><td></td><td></td></tr> <tr><td>Alphecca</td><td style="text-align: center;">32</td><td style="text-align: center;">2.3</td></tr> <tr><td>( α Coroneae Borealis)</td><td></td><td></td></tr> <tr><td>Alpheratz</td><td style="text-align: center;">1</td><td style="text-align: center;">2.1</td></tr> <tr><td>( α Andromedae)</td><td></td><td></td></tr> <tr><td>Altair</td><td style="text-align: center;">40</td><td style="text-align: center;">0.9</td></tr> <tr><td>( α Aquilae)</td><td></td><td></td></tr> <tr><td>Antares</td><td style="text-align: center;">33</td><td style="text-align: center;">1.2</td></tr> <tr><td>( α Scorpii)</td><td></td><td></td></tr> <tr><td>Arcturus</td><td style="text-align: center;">31</td><td style="text-align: center;">0.2</td></tr> <tr><td>( α Bootis)</td><td></td><td></td></tr> <tr><td>Atria</td><td style="text-align: center;">34</td><td style="text-align: center;">1.9</td></tr> <tr><td>( α Trianguli Australis)</td><td></td><td></td></tr> <tr><td>Canopus</td><td style="text-align: center;">14</td><td style="text-align: center;">-0.9</td></tr> <tr><td>( α Carinae)</td><td></td><td></td></tr> <tr><td>Capella</td><td style="text-align: center;">13</td><td style="text-align: center;">0.2</td></tr> <tr><td>( α Aurigae)</td><td></td><td></td></tr> <tr><td>Dabih</td><td style="text-align: center;">41</td><td style="text-align: center;">3.2</td></tr> <tr><td>( β Capricorni)</td><td></td><td></td></tr> <tr><td>Deneb</td><td style="text-align: center;">43</td><td style="text-align: center;">1.3</td></tr> <tr><td>( α Cygni)</td><td></td><td></td></tr> <tr><td>Denebola</td><td style="text-align: center;">23</td><td style="text-align: center;">2.2</td></tr> <tr><td>( β Leonis)</td><td></td><td></td></tr> <tr><td>Diphda</td><td style="text-align: center;">2</td><td style="text-align: center;">2.2</td></tr> <tr><td>( β Ceti)</td><td></td><td></td></tr> <tr><td>Dnoces</td><td style="text-align: center;">20</td><td style="text-align: center;">3.1</td></tr> <tr><td>( ι Ursae Majoris)</td><td></td><td></td></tr> <tr><td>Enif</td><td style="text-align: center;">44</td><td style="text-align: center;">2.5</td></tr> <tr><td>( ε Pegasi)</td><td></td><td></td></tr> <tr><td>Fomalhaut</td><td style="text-align: center;">45</td><td style="text-align: center;">1.3</td></tr> <tr><td>( α Piscis Austrini)</td><td></td><td></td></tr> <tr><td>Gienah</td><td style="text-align: center;">24</td><td style="text-align: center;">2.8</td></tr> <tr><td>( γ Corvi)</td><td></td><td></td></tr> <tr><td>Menkar</td><td style="text-align: center;">7</td><td style="text-align: center;">2.8</td></tr> <tr><td>( α Ceti)</td><td></td><td></td></tr> <tr><td>Menkent</td><td style="text-align: center;">30</td><td style="text-align: center;">2.3</td></tr> <tr><td>( θ Centauri)</td><td></td><td></td></tr> <tr><td>Mirfak</td><td style="text-align: center;">10</td><td style="text-align: center;">1.9</td></tr> <tr><td>( α Persei)</td><td></td><td></td></tr> <tr><td>Navi</td><td style="text-align: center;">3</td><td style="text-align: center;">2.2</td></tr> <tr><td>( γ Cassiopeiae)</td><td></td><td></td></tr> <tr><td>Nunki</td><td style="text-align: center;">37</td><td style="text-align: center;">2.1</td></tr> <tr><td>( α Sagittarii)</td><td></td><td></td></tr> <tr><td>Peacock</td><td style="text-align: center;">42</td><td style="text-align: center;">2.1</td></tr> <tr><td>( α Pavonis)</td><td></td><td></td></tr> <tr><td>Polaris</td><td style="text-align: center;">5</td><td style="text-align: center;">2.1</td></tr> <tr><td>( α Ursae Minoris)</td><td></td><td></td></tr> <tr><td>Procyon</td><td style="text-align: center;">16</td><td style="text-align: center;">0.5</td></tr> <tr><td>( α Canis Minoris)</td><td></td><td></td></tr> <tr><td>Rasalhague</td><td style="text-align: center;">35</td><td style="text-align: center;">2.1</td></tr> <tr><td>( α Ophiuchi)</td><td></td><td></td></tr> <tr><td>Rigor</td><td style="text-align: center;">17</td><td style="text-align: center;">1.9</td></tr> <tr><td>( γ Velorum)</td><td></td><td></td></tr> <tr><td>Regulus</td><td style="text-align: center;">22</td><td style="text-align: center;">1.3</td></tr> <tr><td>( α Leonis)</td><td></td><td></td></tr> <tr><td>Rigel</td><td style="text-align: center;">12</td><td style="text-align: center;">0.3</td></tr> <tr><td>( β Orionis)</td><td></td><td></td></tr> <tr><td>Sirius</td><td style="text-align: center;">15</td><td style="text-align: center;">-1.6</td></tr> <tr><td>( α Canis Majoris)</td><td></td><td></td></tr> <tr><td>Spica</td><td style="text-align: center;">26</td><td style="text-align: center;">1.2</td></tr> <tr><td>( α Virginis)</td><td></td><td></td></tr> <tr><td>Vega</td><td style="text-align: center;">36</td><td style="text-align: center;">0.1</td></tr> <tr><td>( α Lyrae)</td><td></td><td></td></tr> <tr><td>Planet</td><td style="text-align: center;">00</td><td></td></tr> <tr><td>Sun</td><td style="text-align: center;">46</td><td></td></tr> <tr><td>Earth</td><td style="text-align: center;">47</td><td></td></tr> <tr><td>Moon</td><td style="text-align: center;">50</td><td></td></tr> </tbody> </table>		<u>Octal Code</u>	<u>Vis Mag</u>	Acmar	6	3.4	( α Eridani)			Achernar	4	0.6	( α Eridani)			Acrux	25	1.6	( α Crucis)			Aldebaran	11	1.1	( α Tauri)			Alkaid	27	1.9	( η Ursae Majoris)			Alphard	21	2.2	( α Hydrae)			Alphecca	32	2.3	( α Coroneae Borealis)			Alpheratz	1	2.1	( α Andromedae)			Altair	40	0.9	( α Aquilae)			Antares	33	1.2	( α Scorpii)			Arcturus	31	0.2	( α Bootis)			Atria	34	1.9	( α Trianguli Australis)			Canopus	14	-0.9	( α Carinae)			Capella	13	0.2	( α Aurigae)			Dabih	41	3.2	( β Capricorni)			Deneb	43	1.3	( α Cygni)			Denebola	23	2.2	( β Leonis)			Diphda	2	2.2	( β Ceti)			Dnoces	20	3.1	( ι Ursae Majoris)			Enif	44	2.5	( ε Pegasi)			Fomalhaut	45	1.3	( α Piscis Austrini)			Gienah	24	2.8	( γ Corvi)			Menkar	7	2.8	( α Ceti)			Menkent	30	2.3	( θ Centauri)			Mirfak	10	1.9	( α Persei)			Navi	3	2.2	( γ Cassiopeiae)			Nunki	37	2.1	( α Sagittarii)			Peacock	42	2.1	( α Pavonis)			Polaris	5	2.1	( α Ursae Minoris)			Procyon	16	0.5	( α Canis Minoris)			Rasalhague	35	2.1	( α Ophiuchi)			Rigor	17	1.9	( γ Velorum)			Regulus	22	1.3	( α Leonis)			Rigel	12	0.3	( β Orionis)			Sirius	15	-1.6	( α Canis Majoris)			Spica	26	1.2	( α Virginis)			Vega	36	0.1	( α Lyrae)			Planet	00		Sun	46		Earth	47		Moon	50		
	<u>Octal Code</u>	<u>Vis Mag</u>																																																																																																																																																																																																																																														
Acmar	6	3.4																																																																																																																																																																																																																																														
( α Eridani)																																																																																																																																																																																																																																																
Achernar	4	0.6																																																																																																																																																																																																																																														
( α Eridani)																																																																																																																																																																																																																																																
Acrux	25	1.6																																																																																																																																																																																																																																														
( α Crucis)																																																																																																																																																																																																																																																
Aldebaran	11	1.1																																																																																																																																																																																																																																														
( α Tauri)																																																																																																																																																																																																																																																
Alkaid	27	1.9																																																																																																																																																																																																																																														
( η Ursae Majoris)																																																																																																																																																																																																																																																
Alphard	21	2.2																																																																																																																																																																																																																																														
( α Hydrae)																																																																																																																																																																																																																																																
Alphecca	32	2.3																																																																																																																																																																																																																																														
( α Coroneae Borealis)																																																																																																																																																																																																																																																
Alpheratz	1	2.1																																																																																																																																																																																																																																														
( α Andromedae)																																																																																																																																																																																																																																																
Altair	40	0.9																																																																																																																																																																																																																																														
( α Aquilae)																																																																																																																																																																																																																																																
Antares	33	1.2																																																																																																																																																																																																																																														
( α Scorpii)																																																																																																																																																																																																																																																
Arcturus	31	0.2																																																																																																																																																																																																																																														
( α Bootis)																																																																																																																																																																																																																																																
Atria	34	1.9																																																																																																																																																																																																																																														
( α Trianguli Australis)																																																																																																																																																																																																																																																
Canopus	14	-0.9																																																																																																																																																																																																																																														
( α Carinae)																																																																																																																																																																																																																																																
Capella	13	0.2																																																																																																																																																																																																																																														
( α Aurigae)																																																																																																																																																																																																																																																
Dabih	41	3.2																																																																																																																																																																																																																																														
( β Capricorni)																																																																																																																																																																																																																																																
Deneb	43	1.3																																																																																																																																																																																																																																														
( α Cygni)																																																																																																																																																																																																																																																
Denebola	23	2.2																																																																																																																																																																																																																																														
( β Leonis)																																																																																																																																																																																																																																																
Diphda	2	2.2																																																																																																																																																																																																																																														
( β Ceti)																																																																																																																																																																																																																																																
Dnoces	20	3.1																																																																																																																																																																																																																																														
( ι Ursae Majoris)																																																																																																																																																																																																																																																
Enif	44	2.5																																																																																																																																																																																																																																														
( ε Pegasi)																																																																																																																																																																																																																																																
Fomalhaut	45	1.3																																																																																																																																																																																																																																														
( α Piscis Austrini)																																																																																																																																																																																																																																																
Gienah	24	2.8																																																																																																																																																																																																																																														
( γ Corvi)																																																																																																																																																																																																																																																
Menkar	7	2.8																																																																																																																																																																																																																																														
( α Ceti)																																																																																																																																																																																																																																																
Menkent	30	2.3																																																																																																																																																																																																																																														
( θ Centauri)																																																																																																																																																																																																																																																
Mirfak	10	1.9																																																																																																																																																																																																																																														
( α Persei)																																																																																																																																																																																																																																																
Navi	3	2.2																																																																																																																																																																																																																																														
( γ Cassiopeiae)																																																																																																																																																																																																																																																
Nunki	37	2.1																																																																																																																																																																																																																																														
( α Sagittarii)																																																																																																																																																																																																																																																
Peacock	42	2.1																																																																																																																																																																																																																																														
( α Pavonis)																																																																																																																																																																																																																																																
Polaris	5	2.1																																																																																																																																																																																																																																														
( α Ursae Minoris)																																																																																																																																																																																																																																																
Procyon	16	0.5																																																																																																																																																																																																																																														
( α Canis Minoris)																																																																																																																																																																																																																																																
Rasalhague	35	2.1																																																																																																																																																																																																																																														
( α Ophiuchi)																																																																																																																																																																																																																																																
Rigor	17	1.9																																																																																																																																																																																																																																														
( γ Velorum)																																																																																																																																																																																																																																																
Regulus	22	1.3																																																																																																																																																																																																																																														
( α Leonis)																																																																																																																																																																																																																																																
Rigel	12	0.3																																																																																																																																																																																																																																														
( β Orionis)																																																																																																																																																																																																																																																
Sirius	15	-1.6																																																																																																																																																																																																																																														
( α Canis Majoris)																																																																																																																																																																																																																																																
Spica	26	1.2																																																																																																																																																																																																																																														
( α Virginis)																																																																																																																																																																																																																																																
Vega	36	0.1																																																																																																																																																																																																																																														
( α Lyrae)																																																																																																																																																																																																																																																
Planet	00																																																																																																																																																																																																																																															
Sun	46																																																																																																																																																																																																																																															
Earth	47																																																																																																																																																																																																																																															
Moon	50																																																																																																																																																																																																																																															

**LMA790-3-LM**  
**APOLLO OPERATIONS HANDBOOK**

LM 3231

CREW- MAN	PNL	PROCEDURES	REMARKS
		4.4.8 STAR/PLANET LIST (cont)	
		Numerical	
		Octal Code	
		1 Alpheratz	2.1 ( α Andromedae)
		2 Diphda	2.2 ( β Ceti)
		3 Navi	2.2 ( γ Cassiopeiae)
		4 Achernar	0.6 ( α Eridani)
		5 Polaris	2.1 ( α Ursae Minoris)
		6 Acamar	3.4 ( θ Eridani)
		7 Menkar	2.8 ( α Ceti)
		10 Mirfak	1.9 ( α Persei)
		11 Aldebaran	1.1 ( α Tauri)
		12 Rigel	0.3 ( β Orionis)
		13 Capella	0.2 ( α Aurigae)
		14 Canopus	-0.9 ( α Carinae)
		15 Sirius	-1.6 ( α Canis Majoris)
		16 Procyon	0.5 ( α Canis Minoris)
		17 Regor	1.9 ( γ Velorum)
		20 Dnoces	3.1 ( ι Ursae Majoris)
		21 Alpherat	2.2 ( α Hydrae)
		22 Regulus	1.3 ( α Leonis)
		23 Denebola	2.2 ( β Leonis)
		24 Gienah	2.8 ( γ Corvi)
		25 Acrux	1.6 ( α Crucis)
		26 Spica	1.2 ( α Virginis)
		27 Alkaid	1.9 ( η Ursae Majoris)
		30 Menkent	2.3 ( θ Centauri)
		31 Arcturus	0.2 ( α Bootis)
		32 Alphecca	2.3 ( α Coronae Borealis)
		33 Antares	1.2 ( α Scorpii)
		34 Atria	1.9 ( α Trianguli Australis)
		35 Rasalhague	2.1 ( α Ophiuchi)
		36 Vega	0.1 ( α Lyrae)
		37 Munki	2.1 ( σ Sagittarii)
		40 Altair	0.9 ( α Aquilae)
		41 Dabih	3.2 ( β Capricorni)
		42 Peacock	2.1 ( α Pavonis)
		43 Deneb	1.3 ( α Cygni)
		44 Enif	2.5 ( ε Pegasi)
		45 Fomalhaut	1.3 ( α Piscis Austrini)
		46 Sun	
		47 Earth	
		50 Moon	
		00 Planet	

G & C  
REF  
DATA

**LMA790-3-LM**  
**APOLLO OPERATIONS HANDBOOK**

RC 1589

CREW- MAN	PNI	PROCEDURES	REMARKS
		<p>4.4.9 <u>CHECKLIST REFERENCE CODES (V50 N25)</u></p> <p><u>R1 Display</u></p> <p>00013 Key in normal or gyro torque coarse align            00014 Key in fine alignment option            00015 Perform celestial body acquisition            00016 Unprocessed Mark Sets            00062 Switch LGC power down            00201 Switch RR mode to automatic (LGC)            00203 Switch to PGNS automatic mode</p> <p>00205 Perform manual acquisition of CSM with RR            00500 Switch LR antenna to position 1</p> <p>4.4.10 <u>OPTION CODES (V04 N06, V04 N12, or V05 N06)</u></p> <p><u>R1 Display</u></p> <p>00001 - Specify IMU orientation            1 = Preferred            2 = Nominal            3 = REFSMAT            4 = Land site</p> <p>00002 - Specify vehicle            1 = LM            2 = CSM</p> <p>00003 - Specify tracking attitude            1 = Preferred            2 = Other</p> <p>00004 - Specify radar            1 = RR            2 = LR</p> <p>00005 - Specify SOR phase            1 = First            2 = Second</p> <p>00006 - Specify RR coarse align option            1 = Lock on            2 = Continuous designation</p>	<p>"Switch" denotes position change of a panel switch.            "Perform" denotes start or end of a task.            "Key in" denotes data entry through DSKY.</p> <p>R2 contains number of unused sets</p> <p>GUID CONT sw - PGNS; S/C: PGNS sw - AUTO; and ENG THR            CONT: THR CONT sw - AUTO</p> <p>Option code is displayed in R1 in conjunction with V04 N06, V04 N12, or V05 N06. Astronaut keys desired option into R2.</p>



**LMA790-3-LM**  
**APOLLO OPERATIONS HANDBOOK**

RC 1587, LM 3231

CREW-MAN	PNL	PROCEDURES	REMARKS
		<p>4.4.10 <u>OPTION CODES (V04 N06, V04 N12, or V05 N06) (cont)</u></p> <p><u>R1 Display</u></p> <p>00010 - Specify alignment mode</p> <p style="margin-left: 40px;">0 = Any time</p> <p style="margin-left: 40px;">1 = REFSMAT and lunar-g determination</p> <p style="margin-left: 40px;">2 = 2 bodies (star/planet)</p> <p style="margin-left: 40px;">3 = 1 body and lunar-g determination</p> <p><u>R2 Load</u></p> <p style="margin-left: 40px;">1 = No orbit change</p> <p style="margin-left: 40px;">2 = Change orbit to pass over LM</p> <p>00012 - Specify CSM orbit option</p> <p>4.4.11 <u>ALARM CODES (V05 N09)</u></p> <p><u>R1, R2, R3</u></p> <p>00111 Mark missing</p> <p>00112 Mark or mark reject not being accepted (V52, V53, V54 not flashing), or rod input and Ave-G off.</p> <p>00113 No inbits</p> <p>00115 No marks to reject</p> <p>00206 Zero encode not allowed with coarse-align + gimbal lock</p> <p>00207 ISS turn-on request not present for 90 sec</p> <p>00210 IMU not operating</p> <p>00211 Coarse align error</p> <p>00212 PIPA failed, but PIPA not in use</p> <p>00213 IMU not operating with turn-on request</p> <p>00214 Program using IMU when IMU turned off</p> <p>00217 Bad return from IMUSTALL</p> <p>00220 Bad REFSMAT</p> <p>00401 Desired gimbal angles &gt;X°</p> <p>00402 FINDCDUW routine not controlling attitude because of inadequate pointing vectors</p>	<p>Maximum of three alarm codes may be displayed simultaneously.</p> <p>R1 is first alarm to occur after last reset, R2 is second alarm to occur after last reset, R3 is most recent alarm (not reset by RSET pb).</p> <p>Alarms prefixed with 2 denote program goes into R00 (POOD00)</p> <p>Alarms prefixed with 3 denote software restart is generated (Ballout).</p> <p>M indicates main alarm.</p> <p>P indicates priority alarm.</p> <p>In-flight align, X = 60°; FINDCDUW, X = 70°.</p>

**G &  
RE  
DAT**

**LMA790-3-LM  
APOLLO OPERATIONS HANDBOOK**

RC 1587, LM 3231

CREW-MAN	PNL	PROCEDURES	REMARKS
		<p>4.4.11 <u>ALARM CODES (V05 N09) (cont.)</u></p> <p><u>R1, R2, R3</u></p> <p>00404M Specified star not available in any detent            00405M Two stars not available            00421 W-matrix overflow            00501M,P Radar antenna out of limits            00502 Bad radar gimbal angle input            00503M,P Radar antenna designate fail            00510 Radar automatic discrete not present            00511 Neither or both LR antenna position                      discretes present for more than 10 sec                      (high gate, 20 sec)                      RR goes out of automatic mode while in                      use            00514M,P RR CDU fail discrete present            00515 RADARUPT not expected at this time            00520            00522 LR position change            00523 LR did not achieve position 2            00525M,P Δθ&gt;3°            00526 Range &gt;400 nm            00527 LOS not in mode-2 coverage on lunar surface                      or maneuver is required            00530M,P LOS not in mode 2 coverage on lunar surface                      after 600 sec            00600M Imaginary roots on first iteration            00601M Hp (CSI) &lt;85 nm (earth orbit) or &lt;35,000 ft                      (lunar orbit)            00602M Hp (CDH) &lt;85 nm (earth orbit) or &lt;35,000 ft                      (lunar orbit)            00603M CSI to CDH time &lt;10 minutes            00604M CDH to TPI time &lt;10 minutes or computed CDH                      time &gt; input TPI time.            00605M Number of iterations exceeds loop maximum            00606M ΔV exceeds maximum            00611M No TIC for given elevation angle            00701M Illegal option code selected            00777 PIPA fail caused ISS warning            01102 LCC self-test error            01105 Downlink too fast</p>	<p>Alarm occurs only in V59 with average g off.</p>

**LMA790-3-LM**  
**APOLLO OPERATIONS HANDBOOK**

G & C  
REF  
DATA

LM 3231

CREW-MAN	PNL	PROCEDURES	REMARKS
		<p>4.4.11 <u>ALARM CODES (V05 N09) (cont)</u></p> <p><u>RL, R2, R3</u></p> <p>01106 Uplink too fast</p> <p>01107 Phase table failure. Assume erasable memory destroyed</p> <p>01301 ARCSIN-ARCCOS input angle too large</p> <p>01406 Bad return from ROOTPSRS</p> <p>01407 VC increasing (<math>\Delta V</math> accumulated at 90° from desired thrust vector)</p> <p>01410 Unintentional overflow in guidance</p> <p>01412 Descent ignition algorithm nonconverging</p> <p>01466 &lt;TOOFW engine throttle commands computed since last omitted throttle computation. V37 request not permitted at this time</p> <p>01520 Overflow in drift test</p> <p>01600 Bad IMU torque</p> <p>01601 Too close to ignition, slip TIC</p> <p>01703 Incorrect program selected for vehicle configuration</p> <p>01706M</p> <p>02001 Jet failures disabled Y-Z translation</p> <p>02002 Jet failures disabled X-translation</p> <p>02003 Jet failures disabled P-rotations</p> <p>02004 Jet failures disabled U-V rotations</p> <p>03777 ICDU failure caused ISS warning</p> <p>04777 ICDU, PIPA failure caused ISS warning</p> <p>07777 IMU failure caused ISS warning</p> <p>10777 IMU, PIPA failure caused ISS warning</p> <p>13777 IMU, ICDU failure caused ISS warning</p> <p>14777 IMU, ICDU, PIPA failure caused ISS warning</p> <p>20430 Acceleration overflow in integration</p> <p>20607 No solution from time - <math>\theta</math> or time radius</p> <p>21103 Unused CCS branch executed</p> <p>21204 Waitlist, variable delay, fix delay, long call, or delay job called with zero or negative <math>\Delta</math> time.</p> <p>21302 SQRT called with negative argument</p> <p>21406 Bad return from ROOTPSRS during ignition algorithm</p> <p>21501 DSKY alarm during internal use</p> <p>31104 Delay routine busy</p> <p>31201 Executive overflow, no VAC areas</p> <p>31202 Executive overflow, no core sets</p>	

**LMA790-3-LM  
APOLLO OPERATIONS HANDBOOK**

CREW-MAN	PNL	PROCEDURES	REMARKS																		
		<p>4.4.11 <u>ALARM CODES (V05 N09) (cont)</u></p> <p>31203 Waitlist overflow, too many tasks            31206 Second job attempts to go to sleep via DSKY program.            31207 No VAC area for marks            31210 Two programs using device at same time            31211 Illegal interrupt of extended verb            31502 Illegal flashing display            32000 DAP still in progress at next T5RUPT</p> <p>4.4.12 <u>AOT DETENT/LPD/COAS CODES (N70, N71)</u></p> <p style="text-align: center;"><u>R1</u></p> <p>LPD/COAS calibration    000DE            Lf - Left front        001DE            F - Front                002DE            Rf - Right front       003DE            Rr - Right rear        004DE            CL - Close              005DE            Lr - Left rear         006DE            COAS                    007DE</p> <p>Alternative LOS definition values N87</p> <p>COAS (overhead window)</p> <table style="width: 100%; border: none;"> <tr> <td style="width: 80%;">R1 Azimuth</td> <td style="width: 20%; text-align: right;">000.00°</td> </tr> <tr> <td>R2 Elevation</td> <td style="text-align: right;">090.00°</td> </tr> <tr> <td>R3</td> <td style="text-align: right;">-----</td> </tr> </table> <p>COAS (forward window)</p> <table style="width: 100%; border: none;"> <tr> <td style="width: 80%;">R1 Azimuth</td> <td style="width: 20%; text-align: right;">000.00°</td> </tr> <tr> <td>R2 Elevation</td> <td style="text-align: right;">000.00°</td> </tr> <tr> <td>R3</td> <td style="text-align: right;">-----</td> </tr> </table> <p>LPD</p> <table style="width: 100%; border: none;"> <tr> <td style="width: 80%;">R1 Azimuth</td> <td style="width: 20%; text-align: right;">000.00°</td> </tr> <tr> <td>R2 Elevation</td> <td style="text-align: right;">320.00°</td> </tr> <tr> <td>R3</td> <td style="text-align: right;">-----</td> </tr> </table>	R1 Azimuth	000.00°	R2 Elevation	090.00°	R3	-----	R1 Azimuth	000.00°	R2 Elevation	000.00°	R3	-----	R1 Azimuth	000.00°	R2 Elevation	320.00°	R3	-----	<p>IMU mode switch</p> <p>Zero/zero values given are nominal. After realignment, using AOT, and possibly an alignment check, IMU Realign Program (P52) (para 4.9.1.2) can be used to calibrate COAS. (Calibration is valid until COAS is reinstalled.)</p> <p>Values given do not include ground test calibration values. After realignment, using AOT, and possibly an alignment check, IMU Realign Program (P52) (para 4.9.1.2) can be used to flight-calibrate LPD.</p>
R1 Azimuth	000.00°																				
R2 Elevation	090.00°																				
R3	-----																				
R1 Azimuth	000.00°																				
R2 Elevation	000.00°																				
R3	-----																				
R1 Azimuth	000.00°																				
R2 Elevation	320.00°																				
R3	-----																				

**LMA790-3-LM**  
**APOLLO OPERATIONS HANDBOOK**

CREW-MAN	PNL	PROCEDURES				REMARKS		
		Flag	Name	Register Address	Flagword	Bit		
		<u>4.4.13 FLACHORDS</u>						
		Needle 2 flag	NEED2FLG	0074	0	15	<p style="text-align: center;"><u>Set</u></p> <p>Error needles are driven with LGC DAP computed body rates.</p> <p style="text-align: center;"><u>Reset</u></p> <p>Error needles are driven with attitude errors.</p>	
		J switch	JSWITCH	0074	0	14	Integration of W-matrix. Integration of state vector.	
		MID flag	MIDFLAG	0074	0	13	Integration with secondary body & solar perturbations. (Should remain zero in Lunar.) Integration without solar perturbations.	
		Moon flag	MOONFLAG	0074	0	12	Moon is sphere of influence. Earth is sphere of influence.	
		P21 flag	P21FLAG	0074	0	11	Use base vectors already calculated.	
		First pass flag	FSPASFLG	0074	0	10	First pass Succeeding pass	
		P25 flag	P25 FLAG	0074	0	9	P25 is operating (preferred tracking attitude) P25 is not operating	
		IMUSE flag	IMUSE	0074	0	8	IMU is in use IMU is not in use	
		Rendezvous flag	RNDVZFLG	0074	0	7	P20 or P22 is running (RR in use) P20 or P22 is not running	
		Rendezvous radar NB switch	RRNBSW	0074	0	6	RR target is in navigation-base coordinates. RR target is in stable-member coordinates.	
		Lock-on flag	LOKONSW	0074	0	5	Radar lock-on is desired Radar lock-on is not desired	
		Needle flag	NEEDLFLG	0074	0	4	Total attitude error is displayed DAP following error is displayed	

G & C  
REF  
DATA

LM 3231

**LMA790-3-LM  
APOLLO OPERATIONS HANDBOOK**

LM 3231

CREW- MAN	PNI	PROCEDURES				REMARKS
Flag	Name	Register Address	Flagword	Bit		
<u>4.4.13 FLAGWORDS (cont.)</u>						
Free Flag	FREEFLAG	0074	0	3	<div style="display: flex; justify-content: space-between;"> <div style="width: 45%;"> <p><u>Set</u></p> <p>Temporary flag used for utility purposes by P51 &amp; P52 in many routines and by lunar and solar ephemerides.</p> </div> <div style="width: 45%;"> <p><u>Reset</u></p> <p>Temporary flag used for utility purposes by P51 &amp; P52 in many routines and by lunar and solar ephemerides.</p> </div> </div>	
R10 flag	R10FLAG	0074	0	2	<div style="display: flex; justify-content: space-between;"> <div style="width: 45%;"> <p><u>Set</u></p> <p>R10 data output to ALT &amp; ALT RATE ind and inertial lateral velocity to X-pointer ind.</p> </div> <div style="width: 45%;"> <p><u>Reset</u></p> <p>R10 data output to ALT &amp; ALT RATE ind and to forward &amp; lateral velocity of X-pointer ind.</p> </div> </div>	
P66 PRO flag	P66PROFL	0074	0	1	<div style="display: flex; justify-content: space-between;"> <div style="width: 45%;"> <p><u>Set</u></p> <p>P66 is entered for first time (in R13) as a directive to continue P66 horizontal nulling.</p> </div> <div style="width: 45%;"> <p><u>Reset</u></p> <p>Proceed on flashing V06 N60 after touchdown (specifies stop to P66 horizontal nulling).</p> </div> </div>	
Number of jets flag	NJETSFLG	0075	1	15	<div style="display: flex; justify-content: space-between;"> <div style="width: 45%;"> <p><u>Set</u></p> <p>Two-jet RCS burn</p> </div> <div style="width: 45%;"> <p><u>Reset</u></p> <p>Four-jet RCS burn</p> </div> </div>	
DID flag	DIDFLAG	0075	1	14	<div style="display: flex; justify-content: space-between;"> <div style="width: 45%;"> <p><u>Set</u></p> <p>Inertial data are available</p> </div> <div style="width: 45%;"> <p><u>Reset</u></p> <p>Perform data display initialization functions</p> </div> </div>	
ERAD flag	ERADFLAG	0075	1	13	<div style="display: flex; justify-content: space-between;"> <div style="width: 45%;"> <p><u>Set</u></p> <p>Compute earth radius for Fischer ellipsoid; use stored moon radius. (Never set in Luminary.)</p> </div> <div style="width: 45%;"> <p><u>Reset</u></p> <p>Compute moon radius; use stored earth radius (pad radius) (latitude-longitude routines)</p> </div> </div>	
MOD flag	MODFLAG	0075	1	12	<div style="display: flex; justify-content: space-between;"> <div style="width: 45%;"> <p><u>Set</u></p> <p>Rate-of-descent mode is in process; normal operation continues.</p> </div> <div style="width: 45%;"> <p><u>Reset</u></p> <p>Rate-of-descent mode (P66) is not in process or, if in process, restart occurred.</p> </div> </div>	
No terrain flag	NOTERFLG	0075	1	11	<div style="display: flex; justify-content: space-between;"> <div style="width: 45%;"> <p><u>Set</u></p> <p>Lunar terrain model computations inhibited.</p> </div> <div style="width: 45%;"> <p><u>Reset</u></p> <p>Lunar terrain model computations permitted.</p> </div> </div>	
R61 flag	R61FLAG	0075	1	10	<div style="display: flex; justify-content: space-between;"> <div style="width: 45%;"> <p><u>Set</u></p> <p>Run R61.</p> </div> <div style="width: 45%;"> <p><u>Reset</u></p> <p>Run R65.</p> </div> </div>	

**LMA790-3-LM**  
**APOLLO OPERATIONS HANDBOOK**

RC 1588

CREW-MAN	PNL	PROCEDURES				REMARKS
		Flag	Name	Register Address	Flagword	Bit
<u>4.4.13 FLAGWORDS (cont)</u>						
		Vehicle update flag	VEHUPFLG	0075	1	8
		Update flag	UPDATFLG	0075	1	7
		No update flag	NOUPFLAG	0075	1	6
		Track flag	TRACKFLG	0075	1	5
		First time flag	FRSTIME	0075	1	4
		Iterate	SLOPESH	0075	1	3
		Iteration value	GUESSH	0075	1	2
		Drift flag	DRIPTFLG	0076	2	15
		Search flag	SRCHOPTN	0076	2	14
		Acquisition mode flag	ACHODFLG	0076	2	13
		LOS compute flag	LOSCMFLG	0076	2	12
		Steering flag	STERSH	0076	2	11
		Impulse flag	IMPULSH	0076	2	9
		External ΔV flag	XDELVFLG	0076	2	8

Set

Reset

CSM state vector being updated.  
LM state vector being updated.

State vector updates from tracking allowed.  
State vector updates from tracking not allowed.

Neither CSM nor LM state vector may be updated.  
Either CSM or LM state vector may be updated.

Tracking allowed.  
Tracking not allowed.

First time thru pre-position routine.  
Not first time thru pre-position routine.

Iterate with bias method in iterator.  
Iterate with regula falsi method in iterator.

No starting value for iteration.  
Starting value for iteration exists.

T3RUPT calls gyro compensation.  
T3RUPT does no gyro compensation.

RR in automatic search option (R24).  
RR not in automatic search option.

Manual acquisition by RR.  
Automatic acquisition by RR.

LOS is being computed.  
LOS is not being computed.

Powered flight steering is enabled (sufficient thrust is present).  
Powered flight steering is off (insufficient thrust present).

Minimum impulse burn (cutoff time specified).  
Steering burn (no cutoff) time available.)

External ΔV VC computation.  
Lambert (aimpoint) VC computation.

G &  
REF  
DATA

**LMA790-3-LM**  
**APOLLO OPERATIONS HANDBOOK**

CREW-MAN	PNI	PROCEDURES				REMARKS
		<u>4.4.13</u> <u>FLAGWORDS (cont)</u>				
		<u>Flag</u>	<u>Name</u>	<u>Register Address</u>	<u>Flagword</u>	<u>Bit</u>
		E & TPI flag	ETPIFLAG	0076	2	7
		Final flag	FINALFLG	0076	2	6
		Active vehicle flag	AVFLAG	0076	2	5
		Preferred attitude flag	PFRATFLG	0076	2	4
		Calculate maneuver 3	CALCMAN3	0076	2	3
		Calculate maneuver 2	CALCMAN2	0076	2	2
		Program select	NODOFLAG	0076	2	1
		POO flag	POOHFLAG	0077	3	15
		Gimbal lock fail	GLOKFAIL	0077	3	14
		REFSMAT flag	REFSMFLG	0077	3	13
		Lunar flag	LUNAFLAG	0077	3	12
		NO DO PO7 flag	NODOPO7	0077	3	11



**LMA790-3-LM**  
**APOLLO OPERATIONS HANDBOOK**

CREW-MAN	PNI	PROCEDURES	REMARKS																																																																																											
		4.4.13 <u>FLAGWORDS (cont)</u>																																																																																												
		<table border="1" style="width: 100%; border-collapse: collapse;"> <thead> <tr> <th style="text-align: left;">Flag</th> <th style="text-align: left;">Name</th> <th style="text-align: left;">Register Address</th> <th style="text-align: left;">Flagword</th> <th style="text-align: left;">Bit</th> </tr> </thead> <tbody> <tr> <td>View flag</td> <td>VFLAG</td> <td>0077</td> <td>3</td> <td>10</td> </tr> <tr> <td>RO4 flag</td> <td>RO4FLAG</td> <td>0077</td> <td>3</td> <td>9</td> </tr> <tr> <td>Precision integration flag</td> <td>PRECIFLG</td> <td>0077</td> <td>3</td> <td>8</td> </tr> <tr> <td>Occult flag</td> <td>CULTFLAG</td> <td>0077</td> <td>3</td> <td>7</td> </tr> <tr> <td>W-matrix orbital flag</td> <td>ORBWFLAG</td> <td>0077</td> <td>3</td> <td>6</td> </tr> <tr> <td>State vector flag</td> <td>STATEFLG</td> <td>0077</td> <td>3</td> <td>5</td> </tr> <tr> <td>Integration type flag</td> <td>INTYPLG</td> <td>0077</td> <td>3</td> <td>4</td> </tr> <tr> <td>State vector integration flag</td> <td>VINTFLAG</td> <td>0077</td> <td>3</td> <td>3</td> </tr> <tr> <td>W-dimension flag</td> <td>D6OR9FLG</td> <td>0077</td> <td>3</td> <td>2</td> </tr> <tr> <td>W-matrix use flag</td> <td>DIMWFLAG</td> <td>0077</td> <td>3</td> <td>1</td> </tr> <tr> <td>Mark display flag</td> <td>MRKIDFLG</td> <td>0100</td> <td>4</td> <td>15</td> </tr> <tr> <td>Priority display flag</td> <td>PRIODFLG</td> <td>0100</td> <td>4</td> <td>14</td> </tr> </tbody> </table>	Flag	Name	Register Address	Flagword	Bit	View flag	VFLAG	0077	3	10	RO4 flag	RO4FLAG	0077	3	9	Precision integration flag	PRECIFLG	0077	3	8	Occult flag	CULTFLAG	0077	3	7	W-matrix orbital flag	ORBWFLAG	0077	3	6	State vector flag	STATEFLG	0077	3	5	Integration type flag	INTYPLG	0077	3	4	State vector integration flag	VINTFLAG	0077	3	3	W-dimension flag	D6OR9FLG	0077	3	2	W-matrix use flag	DIMWFLAG	0077	3	1	Mark display flag	MRKIDFLG	0100	4	15	Priority display flag	PRIODFLG	0100	4	14	<table border="1" style="width: 100%; border-collapse: collapse;"> <thead> <tr> <th style="text-align: left;">Set</th> <th style="text-align: left;">Reset</th> </tr> </thead> <tbody> <tr> <td>Star pair is not in field of view</td> <td>Star pair is in field of view</td> </tr> <tr> <td>RO4 is running</td> <td>RO4 is not running</td> </tr> <tr> <td>Normal integration in P00.</td> <td>Engage 4-time step (P00) logic in integration.</td> </tr> <tr> <td>Star is occulted.</td> <td>Star is not occulted.</td> </tr> <tr> <td>W-matrix valid for orbital navigation. (Not used in Luminary.)</td> <td>W-matrix invalid for orbital navigation. (Not used in Luminary.)</td> </tr> <tr> <td>Permanent state vector updated.</td> <td>Permanent state vector not updated.</td> </tr> <tr> <td>Conic integration.</td> <td>Encke integration.</td> </tr> <tr> <td>CSM state vector being integrated.</td> <td>LM state vector being integrated.</td> </tr> <tr> <td>Dimension of W is 9 for integration.</td> <td>Dimension of W is 6 for integration.</td> </tr> <tr> <td>W-matrix is to be used.</td> <td>W-matrix is not to be used.</td> </tr> <tr> <td>Mark display in ENDIDLE.</td> <td>No mark display in ENDIDLE.</td> </tr> <tr> <td>Priority display in ENDIDLE.</td> <td>No priority display in ENDIDLE.</td> </tr> </tbody> </table>	Set	Reset	Star pair is not in field of view	Star pair is in field of view	RO4 is running	RO4 is not running	Normal integration in P00.	Engage 4-time step (P00) logic in integration.	Star is occulted.	Star is not occulted.	W-matrix valid for orbital navigation. (Not used in Luminary.)	W-matrix invalid for orbital navigation. (Not used in Luminary.)	Permanent state vector updated.	Permanent state vector not updated.	Conic integration.	Encke integration.	CSM state vector being integrated.	LM state vector being integrated.	Dimension of W is 9 for integration.	Dimension of W is 6 for integration.	W-matrix is to be used.	W-matrix is not to be used.	Mark display in ENDIDLE.	No mark display in ENDIDLE.	Priority display in ENDIDLE.	No priority display in ENDIDLE.
Flag	Name	Register Address	Flagword	Bit																																																																																										
View flag	VFLAG	0077	3	10																																																																																										
RO4 flag	RO4FLAG	0077	3	9																																																																																										
Precision integration flag	PRECIFLG	0077	3	8																																																																																										
Occult flag	CULTFLAG	0077	3	7																																																																																										
W-matrix orbital flag	ORBWFLAG	0077	3	6																																																																																										
State vector flag	STATEFLG	0077	3	5																																																																																										
Integration type flag	INTYPLG	0077	3	4																																																																																										
State vector integration flag	VINTFLAG	0077	3	3																																																																																										
W-dimension flag	D6OR9FLG	0077	3	2																																																																																										
W-matrix use flag	DIMWFLAG	0077	3	1																																																																																										
Mark display flag	MRKIDFLG	0100	4	15																																																																																										
Priority display flag	PRIODFLG	0100	4	14																																																																																										
Set	Reset																																																																																													
Star pair is not in field of view	Star pair is in field of view																																																																																													
RO4 is running	RO4 is not running																																																																																													
Normal integration in P00.	Engage 4-time step (P00) logic in integration.																																																																																													
Star is occulted.	Star is not occulted.																																																																																													
W-matrix valid for orbital navigation. (Not used in Luminary.)	W-matrix invalid for orbital navigation. (Not used in Luminary.)																																																																																													
Permanent state vector updated.	Permanent state vector not updated.																																																																																													
Conic integration.	Encke integration.																																																																																													
CSM state vector being integrated.	LM state vector being integrated.																																																																																													
Dimension of W is 9 for integration.	Dimension of W is 6 for integration.																																																																																													
W-matrix is to be used.	W-matrix is not to be used.																																																																																													
Mark display in ENDIDLE.	No mark display in ENDIDLE.																																																																																													
Priority display in ENDIDLE.	No priority display in ENDIDLE.																																																																																													

G &  
RE  
DAT

**LMA790-3-LM**  
**APOLLO OPERATIONS HANDBOOK**

CREW- MAN	PNI	PROCEDURES				REMARKS	
		4.4.13 <u>FLAGWORDS (cont)</u>					
		<u>Flag</u>	<u>Name</u>	<u>Register Address</u>	<u>Flagword</u>	<u>Bit</u>	<u>Reset</u>
		Normal display flag	MEMIDFLG	0100	4	13	Normal display in ENDIDLE.
		Mark display wait flag	MMAITFLG	0100	4	11	No higher priority display operating when mark display initiated.
		Normal display wait flag	MMAITFLG	0100	4	10	No higher priority display operating when normal display initiated.
		Mark NV flag	MKMNVFLG	0100	4	9	Astronaut not using DSKY when mark display initiated.
		Normal NV flag	MNMNVFLG	0100	4	8	Astronaut not using DSKY when normal display initiated.
		Priority NV flag	PRMNVFLG	0100	4	7	Astronaut not using DSKY when priority display initiated.
		Existing display interfered	PIMBEFLG	0100	4	6	Astronaut has not interfered with existing display.
		Mark display interrupt flag	MMDUPTFLG	0100	4	5	Mark display not interrupted by priority display.
		Normal display interrupt flag	MNDUPTFLG	0100	4	4	Normal display not interrupted by priority or mark display.

**LMA790-3-LM**  
**APOLLO OPERATIONS HANDBOOK**

LM 3231 CREW- MAN	PNL	PROCEDURES				REMARKS	
		Flag	Name	Register Address	Flagword	Bit	
		<u>4.4.13 FLAGWORDS (cont)</u>					
		Mark display over normal display	MNOVFLAG	0100	4	3	<u>Set</u> Mark display over normal.
		Mark display flag	XDSPFLAG	0100	4	1	<u>Reset</u> Priority display over mark or normal.
		DSKY flag	DSKYFLAG	0101	5	15	Mark display may be interrupted.
		Priority display flag	PDSPFLAG	0101	5	14	No displays sent to DSKY.
		U&V jets	SNUFFER	0101	5	13	Leave as normal display.
		No throttle flag	NOTHROTL	0101	5	12	P20 set so as to turn normal display into priority display in R60.
		R77 flag	R77FLAG	0101	5	11	U&V jets disabled during DPS burns (V65).
		RR range scale flag	RNGSCFLG	0101	5	10	Inhibit full throttle.
		Dimension flag	DMENFLG	0101	5	9	R77 is on. Suppress all radar alarms and tracker failures.
		Zoom flag	ZOOMFLAG	0101	5	8	Scale change occurred during RR reading.
		Engine on flag	ENGONFLG	0101	5	7	Dimension of W is 9 for incorporation.
		3-axis flag	3AXISFLG	0101	5	6	Throttle up and start guidance.
		Yaw axis flag	AORBSFLG	0101	5	5	Engine is turned on.





**LMA790-3-LM**  
**APOLLO OPERATIONS HANDBOOK**

CREW MAN	PNL	PROCEDURES				REMARKS	
		4.4.13 <u>FLAGWORDS (cont)</u>	<u>Register Address</u>	<u>Flagword</u>	<u>Bit</u>	<u>Set</u>	<u>Reset</u>
		<u>Flag</u>	<u>Name</u>				
		Gimbal drive switch	GMBDRVSW	6	10	Gimbal trim over.	Gimbal trim not over.
		MIN FLAG	MINFLAG	6	8	Servicer calls MUNRVG.	Servicer calls CALCRVG.
		Redesignation flag	REDFLAG	6	6	Landing site redesignation permitted.	Landing site redesignation not permitted.
		AV overwrite at TPI or TPIH	NTARGFLG	6	3	Astronaut did overwrite AV at TPI or TPIH (P34, P35, P74, P75).	Astronaut did not overwrite AV at TPI or TPIH.
		AUX flag	AUXFLAG	6	2	If IDLEFLAG is not set, servicer will exercise DVMON on next pass.	Servicer will skip DVMON on its next pass even if IDLEFLAG is not set. It will then set AUXFLAG.
		Attitude flag	ATTFLAG	6	1	LM attitude exists in moon-fixed coordinates.	No LM attitude exists in moon-fixed coordinates.
		TPI time	ITSWICH	7	15	TPI time to be computed (P34 and P74).	TPI time has been computed.
		Maneuver flag	MANUFLAG	7	14	Attitude maneuver during RR search. (Not used in Luminary.)	No attitude maneuver during RR search. (Not used in Luminary.)
		Ignition flag	IGNFLAG	7	13	TIG has arrived.	TIG has not arrived.

D R G

**LMA790-3-LM**  
**APOLLO OPERATIONS HANDBOOK**

CREW MAN	PNL	PROCEDURES				REMARKS	
		Flag	Name	Register Address	Flagword	Bit	
		<u>4.4.13 FLAGWORDS (cont)</u>					
		Astronaut flag	ASTNFLAG	0103	7	12	<u>Set</u> Astronaut has OK'd ignition. Astronaut has not OK'd ignition.
		Analog displays	SWANDISP	0103	7	11	<u>Reset</u> Landing analog displays suppressed.
		Normal switch	NORMSW	0103	7	10	Unit normal input to Lambert. Lambert computes its own unit normal.
		Compute state vector	RVSW	0103	7	9	Do not compute final state vector in time $\theta$ Compute final state vector in time $\theta$
		V67 flag	V67FLAG	0103	7	8	Astronaut overwrites W-matrix initial values. Astronaut does not overwrite W-matrix initial values.
		$\Delta V$ Monitor flag	IDLEFLAG	0103	7	7	No $\Delta V$ monitor. Connect $\Delta V$ monitor.
		V37 flag	V37FLAG	0103	7	6	Average g (servicer) running. Average g (servicer) off.
		Average g flag	AVEGFLAG	0103	7	5	Average g (servicer) desired. Average g (servicer) not desired.
		Uplink flag	UPLOCK FL	0103	7	4	$\overline{KKK}$ fail No $\overline{KKK}$ fail
		VERI FLAG	VERIFLAG	0103	7	3	Inverted by V33 at end of P27.
		Orbit parameter flag	V82EMFLG	0103	7	2	Moon vicinity Earth vicinity
		TFP switch	TFPSW	0103	7	1	Calculate T-perigee. Calculate TFF.
		RPQ flag	RPQFLAG	0104	8	15	RPQ not computed (RPQ = vector between secondary body and primary body) RPQ computed

# LMA790-3-LM

## APOLLO OPERATIONS HANDBOOK

CREW- MAN	PNL	PROCEDURES				REMARKS
		Flag	Name	Register Address	Flagword	Bit
		4.4.13 <u>FLAGWORDS (cont)</u>				
		Integration flag	NEWIFLG	0104	8	13
		CSM moon flag	CMOONFLG	0104	8	12
		LM moon flag	LMOONFLG	0104	8	11
		Guidance display flag	FLUNDISP	0104	8	10
		Surface flag	SURFFLAG	0104	8	8
		Infinity flag	INFINFLG	0104	8	7
		Order switch	ORDERSW	0104	8	6
		Apocenter-pericenter range select switch	APSESW	0104	8	5
		COGA flag	COGAFLAG	0104	8	4
		Initial align flag	INITALGN	0104	8	2
		360° switch	360SW	0104	8	1

G  
M  
R  
M

**LMA790-3-LM**  
**APOLLO OPERATIONS HANDBOOK**

RC 1586

CREW-MAN	PNI	PROCEDURES				REMARKS
		4.4.13 <u>FLAGS</u> (cont)				
		<u>Flag</u>	<u>Name</u>	<u>Register Address</u>	<u>Flagword</u>	<u>Bit</u>
		Vertical rise flag	FLVR	0105	9	14
		P70/P71 flag	P70/P71FLG	0105	9	13
		Position control	FLPC	0105	9	12
		Pregnition	FLPI	0105	9	11
		RCS	FLRCS	0105	9	10
		Abort enable flag	LETABORT	0105	9	9
		APS abort continuation flag	FLAP	0105	9	8
		Abort target-flag flag	ABTTGFLG	0105	9	7
		Rotation flag	ROTFLAG	0105	9	6
		Quit flag	QUITFLAG	0105	9	5
		Flight 59 flag	FLT59FLG	0105	9	4
		Integrate time flag	MIDIFLAG	0105	9	3
		MID to AV integration	MIDAVFLG	0105	9	2

Basic Date 26 September 1971

Change Date \_\_\_\_\_

Page 4.4-44



# LMA790-3-LM APOLLO OPERATIONS HANDBOOK

RC 1588, LM 3231

CREW-MAN	PNL	PROCEDURES				REMARKS
		Flag	Name	Register Address	Flagword	Bit
		<u>4.4.13 FLAGWORDS (cont)</u>				
		AVE to MID W-matrix integration	AVEMIDSW	0105	9	1
		Integration flag	INTFLAG	0106	10	14
		Ascent/descent stage flag	APSFLAG	0106	10	13
		Restart integration flag	REINTFLG	0106	10	7
		Control flag	CONTRFL	0106	10	2
		Not PCMC flag	NPCMCFL	0106	10	1
		LR bypass	LRBYPASS	0107	11	15
		Velocity fail test flag	VFAILFLG	0107	11	14
		Altitude fail test flag	HFAILFLG	0107	11	13
		VX inhibit flag	VXINH	0107	11	12

<u>Set</u>	<u>Reset</u>
AVE to MID calling for W-matrix integration. Do not write over RN, VN, or PIPTIME.	No AVE to MID W-matrix integration. Allow setup of RN, VN, and PIPTIME.
Integration in process	Integration not in process
Ascent stage (protected from fresh start)	Descent stage (protected from fresh start)
Integration routine to be restarted	Integration routine not to be restarted
DAP in control	DAP not in control
Last active DAP pass done with an AGS indication	Last active DAP pass done with PCMC indication
Bypass all LR updates	Do not bypass LR updates
When corresponding radar reading has failed velocity LR data reasonability test.	When corresponding radar reading has passed velocity LR data reasonability test.
When corresponding radar reading has failed altitude LR data reasonability test.	When corresponding radar reading has passed altitude LR data reasonability test.
If Z-velocity data unreasonable, bypass X-velocity update on next pass.	Update X-axis velocity.

G  
R  
E  
D

**LMA790-3-LM  
APOLLO OPERATIONS HANDBOOK**

BC 1588, LM 3231

CREW- MAN	PNL	PROCEDURES	REMARKS																				
		<p><u>4.4.13 FLAGWORDS (cont)</u></p> <table style="width: 100%; border-collapse: collapse;"> <thead> <tr> <th style="text-align: left;"><u>Flag</u></th> <th style="text-align: left;"><u>Name</u></th> <th style="text-align: left;"><u>Register Address</u></th> <th style="text-align: left;"><u>Flagword</u></th> <th style="text-align: left;"><u>Bit</u></th> </tr> </thead> <tbody> <tr> <td>Past high gate</td> <td>FSTHIGAT</td> <td>0107</td> <td>11</td> <td>11</td> </tr> <tr> <td>No LR read</td> <td>NOLRREAD</td> <td>0107</td> <td>11</td> <td>10</td> </tr> <tr> <td>X-axis override inhibit flag</td> <td>XORFLG</td> <td>0107</td> <td>11</td> <td>9</td> </tr> </tbody> </table>	<u>Flag</u>	<u>Name</u>	<u>Register Address</u>	<u>Flagword</u>	<u>Bit</u>	Past high gate	FSTHIGAT	0107	11	11	No LR read	NOLRREAD	0107	11	10	X-axis override inhibit flag	XORFLG	0107	11	9	<p style="text-align: center;"><u>Set</u></p> <p>Past high gate</p> <p>LR repositioning; bypass update.</p> <p>Below limit; inhibit X-axis override.</p> <p style="text-align: center;"><u>Reset</u></p> <p>Pre high gate</p> <p>LR not repositioning</p> <p>Above limit; do not inhibit X-axis override.</p>
<u>Flag</u>	<u>Name</u>	<u>Register Address</u>	<u>Flagword</u>	<u>Bit</u>																			
Past high gate	FSTHIGAT	0107	11	11																			
No LR read	NOLRREAD	0107	11	10																			
X-axis override inhibit flag	XORFLG	0107	11	9																			

**LMA790-3-LM**  
**APOLLO OPERATIONS HANDBOOK**

CREW-MAN	PNI	PROCEDURES				REMARKS	
		4.4.13 <u>FLAGWORDS (cont)</u>					
		<u>Flag</u>	<u>Name</u>	<u>Register Address</u>	<u>Flagword</u>	<u>Bit</u>	<u>Set</u> <u>Reset</u>
		LR permit flag	LRINH	0107	11	8	Permits LR data incorporation into state vector.  Inhibits LR data incorporation into state vector.
		LR velocity data	VELDATA	0107	11	7	LR velocity measurement not made
		LR altitude data	RNGEDATA	0107	11	4	LR altitude measurement not made
		R12 read flag	R12RDFLG	0107	11	3	LR not being read. (Complete set of five velocity data readings for particular velocity beam are not available.)
		LR velocity fail lamp flash flag	VFLSHFLG	0107	11	2	LR velocity fail; VEL It should be flashing
		LR altitude fail lamp flash flag	HFLSHFLG	0107	11	1	LR altitude has not failed; ALT It should not flash
		Continuous designate flag	CDESFLG	0110	12	15	LCC commands RR without lock-on
		Remode flag	REMODFLG	0110	12	14	Change in antenna mode was requested or is in process (remode)
		RR CDU zero flag	RCDUOFLG	0110	12	13	RR CDU's are not being zeroed.
		RR antenna mode flag	ANTENFLG	0110	12	12	RR antenna in mode 1

RADMODES = Flagword 12

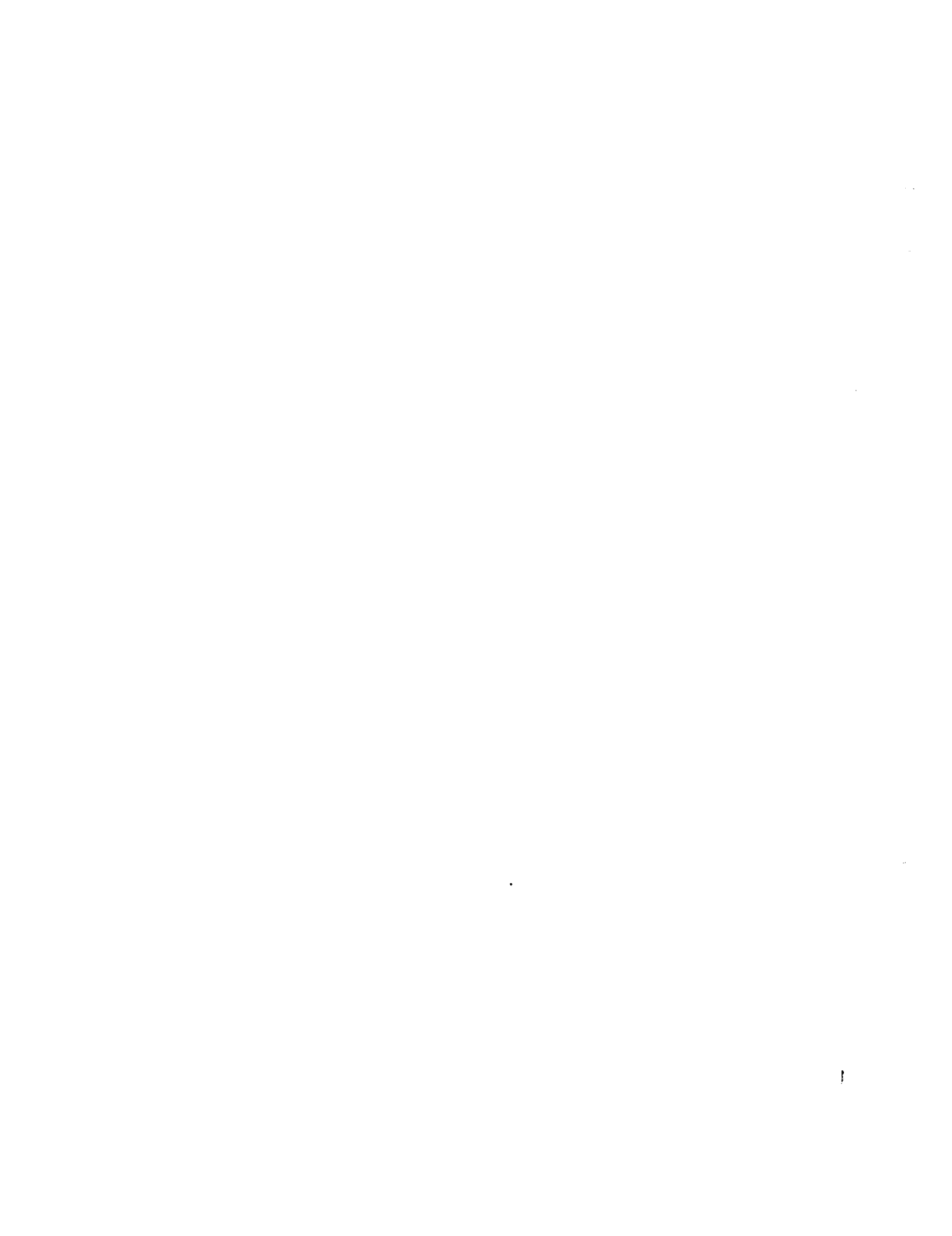

**LMA790-3-LM**  
**APOLLO OPERATIONS HANDBOOK**

RC 1588, LM 3231

CREW-MAN	PNI	PROCEDURES				REMARKS		
		Flag	Name	Register Address	Flagword	Bit		
		<u>4.4.13 FLAGWORDS (cont)</u>						
		Reposition flag	REPOSOM	0110	12	11	RR reposition in process  <u>Set</u> RR reposition in process  <u>Reset</u> No RR reposition in process	
		RR designate flag	DESIGFLG	0110	12	10	RR designate was requested or is in process RR designate was not requested & is not in process	
		LR altitude scale	ALTSCALE	0110	12	9	LR altitude reading is on high scale LR altitude reading is on low scale	
		LR velocity data fail flag	LRVELFLG	0110	12	8	LR velocity data fail No LR velocity data fail	
		No RR CDU fail flag	RCDUFAIL	0110	12	7	No RR CDU fail RR CDU fail	
		LR position flag	LRPOSFLG	0110	12	6	LR position 2 is desired LR position 1 is desired	
		LR altitude data fail flag	LRALTFLG	0110	12	5	LR altitude data fail; cannot be read successfully No LR altitude data fail	
		RR data fail flag	RRDATAFL	0110	12	4	RR data fail; cannot be read successfully No RR data fail	
		RR range scale flag	RRRFLAG	0110	12	3	RR range reading on high scale RR range reading on low scale	
		RR auto-matic mode	AUTOMODE	0110	12	2	RR not in auto mode. Automatic mode discrete is not present. RR in auto mode	
		RR turn-on flag	TURNONFL	0110	12	1	RR turn-on sequence in process. No RR turn-on sequence in process.	
		Minimum impulse flag	PULSEFLG	0111	13	15	Minimum impulse command made in attitude hold (V76) Not in minimum impulse command mode (V77)	
							DAPBOOLS = Flagword 13	

G & C  
REF  
DATA

**LMA790-3-LM**  
**APOLLO OPERATIONS HANDBOOK**

RC 1588

CREW-MAN	PNL	PROCEDURES				REMARKS
		4.4.13	FLAGWORDS (cont)			
		Flag	Name	Register Address	Flagword	Bit
		Gimbal flag	USEQRFLG	0111	13	14
		CSM docked flag	CSMDKFLG	0111	13	13
		Current rate command flag	OURRCFLG	0111	13	12
		4/2-jet X-axis translation flag	ACC4-2PL	0111	13	11
		A/B system translation flag	AORBITFLG	0111	13	10
		X-axis override flag	XOVINFLG	0111	13	9
		Drift flight	DRIFTDFL	0111	13	8
		ACA scale flag	RHCSCFLG	0111	13	7
		Ullage flag	ULLAGFLG	0111	13	6
		Deadband select 2 flag	DBSL2FLG	0111	13	5
		Deadband select flag	DBSELFLG	0111	13	4

Set	Reset
Gimbal unusable; use RCS jets only.	Trim gimbal can be used
CSM docked to LM; use backup DAP.	CSM not docked to LM
Current DAP pass is rate command.	Current DAP pass is not rate command.
4-jet X-axis translation requested	2-jet X-axis translation requested
Use RCS system B for X-translation.	Use RCS system A for X-translation (preferred).
X-axis override is locked out.	X-axis override is permitted.
Assume zero offset; drifting flight	Use offset acceleration estimate.
Normal ACA scaling requested	Fine ACA scaling requested
Ullage requested by program	No internal ullage request
Bits 5 and 4 of DAPBOOLS (flagword 13) are used together to indicate astronaut-selected deadband limits as follows:	
Bit 5 0 (reset)	Bit 4 0 (reset)
0	1
1	0
1	1
DAP Deadband	
+ 0.3°	
+ 1.0°	
+ 5.0°	
+ 5.0°	

**LMA790-3-LM**  
**APOLLO OPERATIONS HANDBOOK**

RC 1. , RC 1588, LM 3231

CREW-MAN	PNL	PROCEDURES	REMARKS																																																			
		<p><u>4.4.13 FLAGWORDS (cont)</u></p> <table border="1" style="width: 100%; border-collapse: collapse;"> <thead> <tr> <th style="width: 15%;">Flag</th> <th style="width: 15%;">Name</th> <th style="width: 15%;">Register Address</th> <th style="width: 15%;">Flagword</th> <th style="width: 10%;">Bit</th> </tr> </thead> <tbody> <tr> <td>Accelerations OK flag</td> <td>ACCOKFLG</td> <td>0111</td> <td>13</td> <td>3</td> </tr> <tr> <td>Automatic rate 2 flag</td> <td>AUTR2FLG</td> <td>0111</td> <td>13</td> <td>2</td> </tr> <tr> <td>Automatic rate 1 flag</td> <td>AUTR1FLG</td> <td>0111</td> <td>13</td> <td>1</td> </tr> </tbody> </table>	Flag	Name	Register Address	Flagword	Bit	Accelerations OK flag	ACCOKFLG	0111	13	3	Automatic rate 2 flag	AUTR2FLG	0111	13	2	Automatic rate 1 flag	AUTR1FLG	0111	13	1	<p style="text-align: center;"><u>Set</u>                      <u>Reset</u></p> <p>Computed accelerations are probably correct.      Computed accelerations are probably incorrect.</p> <p>Bits 2 &amp; 1 of DAPBOOLS (flagword 13) are used together to indicate astronaut-selected KALCMANU maneuver rates, as follows:</p> <table border="1" style="width: 100%; border-collapse: collapse;"> <thead> <tr> <th style="width: 15%;"></th> <th style="width: 15%;">Bit 2</th> <th style="width: 15%;">Bit 1</th> <th style="width: 55%;"></th> </tr> </thead> <tbody> <tr> <td>0 (reset)</td> <td>0</td> <td>0</td> <td>(reset) = 0.2°/sec</td> </tr> <tr> <td>0</td> <td>1</td> <td>1</td> <td>= 0.5°/sec</td> </tr> <tr> <td>1</td> <td>0</td> <td>0</td> <td>= 2.0°/sec</td> </tr> <tr> <td>1</td> <td>1</td> <td>1</td> <td>= 10.0°/sec</td> </tr> </tbody> </table> <p style="text-align: center;"><u>Submodes of operation</u></p> <p>Ref para 4.9.2.1 Ref para 4.9.3.2 Ref para 4.9.2.2, 4.9.2.3 Ref para 4.6.2.5 In-flight only. Ref para 4.6.2.14</p> <p>Guidance routines. Ref para 4.7.3.1 Ref para 4.7.1.2 Ref para 4.7.1.3 Ref para 4.7.1.4 Ref para 4.7.1.4 Ref para 4.7.1.1</p>		Bit 2	Bit 1		0 (reset)	0	0	(reset) = 0.2°/sec	0	1	1	= 0.5°/sec	1	0	0	= 2.0°/sec	1	1	1	= 10.0°/sec											
Flag	Name	Register Address	Flagword	Bit																																																		
Accelerations OK flag	ACCOKFLG	0111	13	3																																																		
Automatic rate 2 flag	AUTR2FLG	0111	13	2																																																		
Automatic rate 1 flag	AUTR1FLG	0111	13	1																																																		
	Bit 2	Bit 1																																																				
0 (reset)	0	0	(reset) = 0.2°/sec																																																			
0	1	1	= 0.5°/sec																																																			
1	0	0	= 2.0°/sec																																																			
1	1	1	= 10.0°/sec																																																			
		<p><u>4.4.14 AGS SELECTOR LOGIC</u></p> <table border="1" style="width: 100%; border-collapse: collapse;"> <thead> <tr> <th style="width: 15%;">Address</th> <th style="width: 15%;">Entry</th> <th style="width: 70%;"></th> </tr> </thead> <tbody> <tr> <td>400</td> <td>+00000</td> <td>Attitude hold</td> </tr> <tr> <td>400</td> <td>+10000</td> <td>Guidance steering</td> </tr> <tr> <td>400</td> <td>+20000</td> <td>Z-body-axis steering</td> </tr> <tr> <td>400</td> <td>+30000</td> <td>PGNS-to-AGS align</td> </tr> <tr> <td>400</td> <td>+40000</td> <td>Lunar align</td> </tr> <tr> <td>400</td> <td>+50000</td> <td>Body-axis align</td> </tr> <tr> <td>400</td> <td>+60000</td> <td>Gyro and accelerometer calibration</td> </tr> <tr> <td>400</td> <td>+70000</td> <td>Accelerometer only calibration</td> </tr> <tr> <td>410</td> <td>+00000</td> <td>Orbit insertion</td> </tr> <tr> <td>410</td> <td>+10000</td> <td>Coelliptic sequence initiation</td> </tr> <tr> <td>410</td> <td>+20000</td> <td>Constant Δh</td> </tr> <tr> <td>410</td> <td>+30000</td> <td>Terminal phase initiate search</td> </tr> <tr> <td>410</td> <td>+40000</td> <td>Terminal phase initiate execute</td> </tr> <tr> <td>410</td> <td>+50000</td> <td>External ΔV</td> </tr> <tr> <td>411</td> <td>+00000</td> <td>Do not perform automatic radar updating from PGNS downlink</td> </tr> <tr> <td>411</td> <td>+10000</td> <td>Select automatic radar updating from PGNS downlink</td> </tr> </tbody> </table>	Address	Entry		400	+00000	Attitude hold	400	+10000	Guidance steering	400	+20000	Z-body-axis steering	400	+30000	PGNS-to-AGS align	400	+40000	Lunar align	400	+50000	Body-axis align	400	+60000	Gyro and accelerometer calibration	400	+70000	Accelerometer only calibration	410	+00000	Orbit insertion	410	+10000	Coelliptic sequence initiation	410	+20000	Constant Δh	410	+30000	Terminal phase initiate search	410	+40000	Terminal phase initiate execute	410	+50000	External ΔV	411	+00000	Do not perform automatic radar updating from PGNS downlink	411	+10000	Select automatic radar updating from PGNS downlink	
Address	Entry																																																					
400	+00000	Attitude hold																																																				
400	+10000	Guidance steering																																																				
400	+20000	Z-body-axis steering																																																				
400	+30000	PGNS-to-AGS align																																																				
400	+40000	Lunar align																																																				
400	+50000	Body-axis align																																																				
400	+60000	Gyro and accelerometer calibration																																																				
400	+70000	Accelerometer only calibration																																																				
410	+00000	Orbit insertion																																																				
410	+10000	Coelliptic sequence initiation																																																				
410	+20000	Constant Δh																																																				
410	+30000	Terminal phase initiate search																																																				
410	+40000	Terminal phase initiate execute																																																				
410	+50000	External ΔV																																																				
411	+00000	Do not perform automatic radar updating from PGNS downlink																																																				
411	+10000	Select automatic radar updating from PGNS downlink																																																				

G & C  
REF  
DATA

**LMA790-3-LM**  
**APOLLO OPERATIONS HANDBOOK**

RC 1581, LM 3231

CREW-MAN	PNL	PROCEDURES	REMARKS																										
		4.4.14 AGS SELECTOR LOGIC (cont)																											
		<table border="0"> <thead> <tr> <th style="text-align: left;"><u>Address</u></th> <th style="text-align: left;"><u>Entry</u></th> </tr> </thead> <tbody> <tr> <td>412</td> <td>+00000</td> </tr> <tr> <td>413</td> <td>+10000</td> </tr> <tr> <td>414</td> <td>+00000</td> </tr> <tr> <td>414</td> <td>+10000</td> </tr> <tr> <td>414</td> <td>+20000</td> </tr> <tr> <td>414</td> <td>+30000</td> </tr> <tr> <td>415</td> <td></td> </tr> <tr> <td>416</td> <td>+10000</td> </tr> <tr> <td>416</td> <td>+30000</td> </tr> <tr> <td>417</td> <td>+00000</td> </tr> <tr> <td>417</td> <td>+10000</td> </tr> <tr> <td>507</td> <td>+00000</td> </tr> </tbody> </table>	<u>Address</u>	<u>Entry</u>	412	+00000	413	+10000	414	+00000	414	+10000	414	+20000	414	+30000	415		416	+10000	416	+30000	417	+00000	417	+10000	507	+00000	<p>Ref para 4.6.2.3. Self-test readouts: +00000 - Test not completed +10000 - Test successfully completed +30000 - Logic test failure +40000 - Memory test failure +70000 - Logic and memory test failure</p> <p>Readout only. A +00000 entry is treated as a +10000 entry. Ref para 4.6.1.18</p> <p>Ref para 4.6.2.7</p> <p>Ref para 4.6.2.9</p> <p>A +10000 entry is suggested.</p> <p>Reset automatically to +00000 after initialization</p>
<u>Address</u>	<u>Entry</u>																												
412	+00000																												
413	+10000																												
414	+00000																												
414	+10000																												
414	+20000																												
414	+30000																												
415																													
416	+10000																												
416	+30000																												
417	+00000																												
417	+10000																												
507	+00000																												
		<p>Reinitiate in-flight AGS self-test</p> <p>Any entry into 413 (+10000 is suggested) will store lunar azimuth and set lunar surface flag.</p> <p>Navigation initialization complete LM and CSM navigation initialization via PGNCS downlink</p> <p>LM navigation initialization via DEDA</p> <p>CSM navigation initialization via DEDA</p> <p>Any entry in this cell causes Z-body axis direction cosines, last computed range, and range rate to be stored in appropriate cells for use in radar filter</p> <p>Compute CSI maneuver with CDH maneuver occurring at 0.5 orbital period following CSI</p> <p>Compute CSI maneuver with CDH maneuver occurring at 1.5 orbital periods following CSI</p> <p>Normal value of radar initialization command</p> <p>Initialize radar filter</p> <p>Orient Z-body-axis to direction of CSM (Z-body-axis steering commanded)</p>																											



# LMA790-3-LM APOLLO OPERATIONS HANDBOOK

RC 1582

CREW MAN	PNL	PROCEDURES	REMARKS																																																																																																																																																																		
		<p>4.4.14 <u>AGS SELECTOR LOGIC (cont)</u></p> <table style="width: 100%; border-collapse: collapse;"> <thead> <tr> <th style="text-align: left;">Address</th> <th style="text-align: left;">Entry</th> <th style="text-align: left;">Description</th> </tr> </thead> <tbody> <tr> <td>623</td> <td>+00000</td> <td>Orient Z-body-axis parallel to CSM orbit plane (guidance steering commanded)</td> </tr> <tr> <td>623</td> <td>+10000</td> <td>Orient Z-body-axis parallel to plane defined by Wb vector (guidance steering commanded)</td> </tr> </tbody> </table>	Address	Entry	Description	623	+00000	Orient Z-body-axis parallel to CSM orbit plane (guidance steering commanded)	623	+10000	Orient Z-body-axis parallel to plane defined by Wb vector (guidance steering commanded)																																																																																																																																																										
Address	Entry	Description																																																																																																																																																																			
623	+00000	Orient Z-body-axis parallel to CSM orbit plane (guidance steering commanded)																																																																																																																																																																			
623	+10000	Orient Z-body-axis parallel to plane defined by Wb vector (guidance steering commanded)																																																																																																																																																																			
		<p>4.4.15 <u>DEDA INPUT LIST</u></p> <table style="width: 100%; border-collapse: collapse;"> <thead> <tr> <th rowspan="2" style="text-align: left;">Symbol</th> <th rowspan="2" style="text-align: left;">Address</th> <th colspan="2" style="text-align: center;">Quantization</th> <th rowspan="2" style="text-align: left;">Description</th> <th rowspan="2" style="text-align: center;">OI</th> <th rowspan="2" style="text-align: center;">CSI</th> <th rowspan="2" style="text-align: center;">CDH</th> <th rowspan="2" style="text-align: center;">TPI</th> <th rowspan="2" style="text-align: center;">XDV</th> </tr> <tr> <th style="text-align: center;">Lunar</th> <th style="text-align: center;">Earth</th> </tr> </thead> <tbody> <tr> <td>Sin δL</td> <td>047</td> <td></td> <td>Octal</td> <td>Sine of landing azimuth angle</td> <td>1</td> <td>1</td> <td>1</td> <td>1</td> <td>1</td> </tr> <tr> <td>Cosin δL</td> <td>053</td> <td></td> <td>Octal</td> <td>Cosine of landing azimuth angle</td> <td>1</td> <td>1</td> <td>1</td> <td>1</td> <td>1</td> </tr> <tr> <td>25J</td> <td>223</td> <td>100 ft</td> <td>1000 ft</td> <td>DEDA altitude update during descent</td> <td>1</td> <td>1</td> <td>1</td> <td>1</td> <td>1</td> </tr> <tr> <td>7J</td> <td>224</td> <td>100 ft</td> <td>1000 ft</td> <td>Term in semi major axis computation, δL (OI)</td> <td>1</td> <td>1</td> <td>1</td> <td>1</td> <td>1</td> </tr> <tr> <td>8J</td> <td>225</td> <td>100 ft</td> <td>1000 ft</td> <td>One-half lower limit on apolune radius</td> <td>1</td> <td>1</td> <td>1</td> <td>1</td> <td>1</td> </tr> <tr> <td>10J</td> <td>226</td> <td>100 ft</td> <td>1000 ft</td> <td>Retarget value for 7J when central angle exceeds 12J (OI)</td> <td>1</td> <td>1</td> <td>1</td> <td>1</td> <td>1</td> </tr> <tr> <td>5J</td> <td>231</td> <td>100 ft</td> <td>1000 ft</td> <td>Radial distance of landing site from center of attracting body</td> <td>1</td> <td>1</td> <td>1</td> <td>1</td> <td>1</td> </tr> <tr> <td>16J</td> <td>232</td> <td>100 ft</td> <td>1000 ft</td> <td>Targeted injection altitude at orbit insertion</td> <td>1</td> <td>1</td> <td>1</td> <td>1</td> <td>1</td> </tr> <tr> <td>21J</td> <td>233</td> <td>100 ft</td> <td>1000 ft</td> <td>Vertical pitch steering altitude threshold</td> <td>1</td> <td>1</td> <td>1</td> <td>1</td> <td>1</td> </tr> <tr> <td>1J1</td> <td>240</td> <td>100 ft</td> <td>1000 ft</td> <td>X-component of LM position used in LM initialization</td> <td>1</td> <td>1</td> <td>1</td> <td>1</td> <td>1</td> </tr> <tr> <td>1J2</td> <td>241</td> <td>100 ft</td> <td>1000 ft</td> <td>Y-component of LM position used in LM initialization</td> <td>1</td> <td>1</td> <td>1</td> <td>1</td> <td>1</td> </tr> <tr> <td>1J3</td> <td>242</td> <td>100 ft</td> <td>1000 ft</td> <td>Z-component of LM position used in LM initialization</td> <td>1</td> <td>1</td> <td>1</td> <td>1</td> <td>1</td> </tr> <tr> <td>2J1</td> <td>244</td> <td>100 ft</td> <td>1000 ft</td> <td>X-component of CSM position used in CSM initialization</td> <td>1</td> <td>1</td> <td>1</td> <td>1</td> <td>1</td> </tr> <tr> <td>2J2</td> <td>245</td> <td>100 ft</td> <td>1000 ft</td> <td>Y-component of CSM position used in CSM initialization</td> <td>1</td> <td>1</td> <td>1</td> <td>1</td> <td>1</td> </tr> <tr> <td>2J3</td> <td>246</td> <td>100 ft</td> <td>1000 ft</td> <td>Z-component of CSM position used in CSM initialization</td> <td>1</td> <td>1</td> <td>1</td> <td>1</td> <td>1</td> </tr> </tbody> </table>	Symbol	Address	Quantization		Description	OI	CSI	CDH	TPI	XDV	Lunar	Earth	Sin δL	047		Octal	Sine of landing azimuth angle	1	1	1	1	1	Cosin δL	053		Octal	Cosine of landing azimuth angle	1	1	1	1	1	25J	223	100 ft	1000 ft	DEDA altitude update during descent	1	1	1	1	1	7J	224	100 ft	1000 ft	Term in semi major axis computation, δL (OI)	1	1	1	1	1	8J	225	100 ft	1000 ft	One-half lower limit on apolune radius	1	1	1	1	1	10J	226	100 ft	1000 ft	Retarget value for 7J when central angle exceeds 12J (OI)	1	1	1	1	1	5J	231	100 ft	1000 ft	Radial distance of landing site from center of attracting body	1	1	1	1	1	16J	232	100 ft	1000 ft	Targeted injection altitude at orbit insertion	1	1	1	1	1	21J	233	100 ft	1000 ft	Vertical pitch steering altitude threshold	1	1	1	1	1	1J1	240	100 ft	1000 ft	X-component of LM position used in LM initialization	1	1	1	1	1	1J2	241	100 ft	1000 ft	Y-component of LM position used in LM initialization	1	1	1	1	1	1J3	242	100 ft	1000 ft	Z-component of LM position used in LM initialization	1	1	1	1	1	2J1	244	100 ft	1000 ft	X-component of CSM position used in CSM initialization	1	1	1	1	1	2J2	245	100 ft	1000 ft	Y-component of CSM position used in CSM initialization	1	1	1	1	1	2J3	246	100 ft	1000 ft	Z-component of CSM position used in CSM initialization	1	1	1	1	1	
Symbol	Address	Quantization			Description	OI							CSI	CDH	TPI	XDV																																																																																																																																																					
		Lunar	Earth																																																																																																																																																																		
Sin δL	047		Octal	Sine of landing azimuth angle	1	1	1	1	1																																																																																																																																																												
Cosin δL	053		Octal	Cosine of landing azimuth angle	1	1	1	1	1																																																																																																																																																												
25J	223	100 ft	1000 ft	DEDA altitude update during descent	1	1	1	1	1																																																																																																																																																												
7J	224	100 ft	1000 ft	Term in semi major axis computation, δL (OI)	1	1	1	1	1																																																																																																																																																												
8J	225	100 ft	1000 ft	One-half lower limit on apolune radius	1	1	1	1	1																																																																																																																																																												
10J	226	100 ft	1000 ft	Retarget value for 7J when central angle exceeds 12J (OI)	1	1	1	1	1																																																																																																																																																												
5J	231	100 ft	1000 ft	Radial distance of landing site from center of attracting body	1	1	1	1	1																																																																																																																																																												
16J	232	100 ft	1000 ft	Targeted injection altitude at orbit insertion	1	1	1	1	1																																																																																																																																																												
21J	233	100 ft	1000 ft	Vertical pitch steering altitude threshold	1	1	1	1	1																																																																																																																																																												
1J1	240	100 ft	1000 ft	X-component of LM position used in LM initialization	1	1	1	1	1																																																																																																																																																												
1J2	241	100 ft	1000 ft	Y-component of LM position used in LM initialization	1	1	1	1	1																																																																																																																																																												
1J3	242	100 ft	1000 ft	Z-component of LM position used in LM initialization	1	1	1	1	1																																																																																																																																																												
2J1	244	100 ft	1000 ft	X-component of CSM position used in CSM initialization	1	1	1	1	1																																																																																																																																																												
2J2	245	100 ft	1000 ft	Y-component of CSM position used in CSM initialization	1	1	1	1	1																																																																																																																																																												
2J3	246	100 ft	1000 ft	Z-component of CSM position used in CSM initialization	1	1	1	1	1																																																																																																																																																												

G & C  
REF  
DATA



**LMA790-3-LM**  
**APOLLO OPERATIONS HANDBOOK**

RC 158z

CREW- MAN	PNL	PROCEDURES	REMARKS																																																																															
		4.4.15 <u>DEDA INPUT LIST (cont)</u>																																																																																
		<table border="0" style="width: 100%; border-collapse: collapse;"> <thead> <tr> <th style="text-align: left; border-bottom: 1px solid black;">Symbol</th> <th style="text-align: left; border-bottom: 1px solid black;">Address</th> <th style="text-align: left; border-bottom: 1px solid black;">Quantization Lunar      Earth</th> </tr> </thead> <tbody> <tr> <td>TAL</td> <td>377</td> <td>0.1 min</td> </tr> <tr> <td>Vdx</td> <td>404</td> <td>N/A</td> </tr> <tr> <td>28J1</td> <td>450</td> <td>0.1 fps    1 fps</td> </tr> <tr> <td>28J2</td> <td>451</td> <td>0.1 fps    1 fps</td> </tr> <tr> <td>28J3</td> <td>452</td> <td>0.1 fps    1 fps</td> </tr> <tr> <td>22J</td> <td>464</td> <td>0.1 fps    1 fps</td> </tr> <tr> <td>23J</td> <td>465</td> <td>0.1 fps    1 fps</td> </tr> <tr> <td>17J</td> <td>503</td> <td>0.1 fps    1 fps</td> </tr> <tr> <td>Wbx</td> <td>514</td> <td>Octal</td> </tr> <tr> <td>Wby</td> <td>515</td> <td>Octal</td> </tr> <tr> <td>Wbz</td> <td>516</td> <td>Octal</td> </tr> <tr> <td>LK18</td> <td>534</td> <td>Octal</td> </tr> <tr> <td>LK20</td> <td>535</td> <td>Octal</td> </tr> <tr> <td>LK22</td> <td>536</td> <td>Octal</td> </tr> <tr> <td>LK19</td> <td>540</td> <td>0.001/0.01 fps sq</td> </tr> <tr> <td>LK21</td> <td>541</td> <td>0.001/0.01 fps sq</td> </tr> <tr> <td>LK23</td> <td>542</td> <td>0.001/0.01 fps sq</td> </tr> <tr> <td>LK1</td> <td>544</td> <td>0.01°/hr</td> </tr> <tr> <td>LK6</td> <td>545</td> <td>0.01°/hr</td> </tr> <tr> <td>LK11</td> <td>546</td> <td>0.01°/hr</td> </tr> <tr> <td>Δ6</td> <td>547</td> <td>Octal</td> </tr> <tr> <td>ZJ</td> <td>605</td> <td>Octal</td> </tr> </tbody> </table>	Symbol	Address	Quantization Lunar      Earth	TAL	377	0.1 min	Vdx	404	N/A	28J1	450	0.1 fps    1 fps	28J2	451	0.1 fps    1 fps	28J3	452	0.1 fps    1 fps	22J	464	0.1 fps    1 fps	23J	465	0.1 fps    1 fps	17J	503	0.1 fps    1 fps	Wbx	514	Octal	Wby	515	Octal	Wbz	516	Octal	LK18	534	Octal	LK20	535	Octal	LK22	536	Octal	LK19	540	0.001/0.01 fps sq	LK21	541	0.001/0.01 fps sq	LK23	542	0.001/0.01 fps sq	LK1	544	0.01°/hr	LK6	545	0.01°/hr	LK11	546	0.01°/hr	Δ6	547	Octal	ZJ	605	Octal	<p>0 = not available 1 = available</p> <p style="text-align: center;"> <table border="0" style="margin: auto;"> <tr> <td style="text-align: center;">OI</td> <td style="text-align: center;">CSI</td> <td style="text-align: center;">CDH</td> <td style="text-align: center;">TPI</td> <td style="text-align: center;">XDY</td> </tr> <tr> <td style="text-align: center;">1</td> <td style="text-align: center;">1</td> <td style="text-align: center;">1</td> <td style="text-align: center;">1</td> <td style="text-align: center;">1</td> </tr> </table> </p> <p>                     AGS computer time                      Accumulated ΔV in X-body-axis direction minus descent engine capability (updated every 0.040 sec)                      Component of external ΔV input in direction parallel to CSM orbit plane. (Positive value indicates velocity to be added in postgrade direction.)                      Component of external ΔV input in direction perpendicular to CSM orbit plane (positive value indicates velocity to be added opposite to LM angular momentum vector)                      Component of external ΔV input in radial direction (positive value indicates velocity to be added toward attracting body)                      Vertical pitch steering altitude rate threshold                      Target radial rate at orbit intersection                      Radar range rate                      Guidance steering unit vector (X)                      Guidance steering unit vector (Y)                      Guidance steering unit vector (Z)                      X-accelerator scale factor                      Y-accelerator scale factor                      Z-accelerator scale factor                      X-axis accelerometer bias compensation                      Y-axis accelerometer bias compensation                      Z-axis accelerometer bias compensation                      X-gyro drift compensation constant                      Y-gyro drift compensation constant                      Z-gyro drift compensation constant                      Lunar align azimuth correction                      Desired cotangent of LOS angle between LM and CSM at desired TPI time used in CSI computation                 </p>	OI	CSI	CDH	TPI	XDY	1	1	1	1	1
Symbol	Address	Quantization Lunar      Earth																																																																																
TAL	377	0.1 min																																																																																
Vdx	404	N/A																																																																																
28J1	450	0.1 fps    1 fps																																																																																
28J2	451	0.1 fps    1 fps																																																																																
28J3	452	0.1 fps    1 fps																																																																																
22J	464	0.1 fps    1 fps																																																																																
23J	465	0.1 fps    1 fps																																																																																
17J	503	0.1 fps    1 fps																																																																																
Wbx	514	Octal																																																																																
Wby	515	Octal																																																																																
Wbz	516	Octal																																																																																
LK18	534	Octal																																																																																
LK20	535	Octal																																																																																
LK22	536	Octal																																																																																
LK19	540	0.001/0.01 fps sq																																																																																
LK21	541	0.001/0.01 fps sq																																																																																
LK23	542	0.001/0.01 fps sq																																																																																
LK1	544	0.01°/hr																																																																																
LK6	545	0.01°/hr																																																																																
LK11	546	0.01°/hr																																																																																
Δ6	547	Octal																																																																																
ZJ	605	Octal																																																																																
OI	CSI	CDH	TPI	XDY																																																																														
1	1	1	1	1																																																																														

G & C  
REF  
DATA

**LMA790-3-LM**  
**APOLLO OPERATIONS HANDBOOK**

RC 1583

CREW-MAN	PNI	PROCEDURES	REMARKS																																																																																																											
		4.4.15 <u>DEDA INPUT LIST (cont)</u>																																																																																																												
		<table style="width: 100%; border-collapse: collapse;"> <thead> <tr> <th style="width: 10%;"><u>Symbol</u></th> <th style="width: 10%;"><u>Address</u></th> <th style="width: 10%;"><u>Quantization</u></th> <th style="width: 70%;"></th> </tr> <tr> <td></td> <td></td> <td style="text-align: center;"><u>Lunar</u>      <u>Earth</u></td> <td></td> </tr> </thead> <tbody> <tr> <td>K55</td> <td>607</td> <td>Octal</td> <td>h rate display scale factor</td> </tr> <tr> <td>3K4</td> <td>613</td> <td>Octal</td> <td>Sine of TPI interdict region</td> </tr> <tr> <td>6J1</td> <td>640</td> <td>Octal</td> <td>Negative of X inertial component of lunar rotation rate vector</td> </tr> <tr> <td>6J2</td> <td>641</td> <td>Octal</td> <td>Negative of Y inertial component of lunar rotation rate vector</td> </tr> <tr> <td>6J3</td> <td>642</td> <td>Octal</td> <td>Negative of Z inertial component of lunar rotation rate vector</td> </tr> <tr> <td>4K10</td> <td>662</td> <td>Octal</td> <td>Constant in linear expression for <math>\alpha</math>-L (OI)</td> </tr> <tr> <td>11J</td> <td>673</td> <td>Octal</td> <td>Retarget values for 4K10 when central angle exceeds 12J (OI)</td> </tr> </tbody> </table>	<u>Symbol</u>	<u>Address</u>	<u>Quantization</u>				<u>Lunar</u> <u>Earth</u>		K55	607	Octal	h rate display scale factor	3K4	613	Octal	Sine of TPI interdict region	6J1	640	Octal	Negative of X inertial component of lunar rotation rate vector	6J2	641	Octal	Negative of Y inertial component of lunar rotation rate vector	6J3	642	Octal	Negative of Z inertial component of lunar rotation rate vector	4K10	662	Octal	Constant in linear expression for $\alpha$ -L (OI)	11J	673	Octal	Retarget values for 4K10 when central angle exceeds 12J (OI)	<p>0 = not available 1 = available</p> <table style="width: 100%; border-collapse: collapse;"> <thead> <tr> <th style="width: 10%;"><u>OI</u></th> <th style="width: 10%;"><u>CSI</u></th> <th style="width: 10%;"><u>CDH</u></th> <th style="width: 10%;"><u>TPI</u></th> <th style="width: 10%;"><u>XDV</u></th> </tr> </thead> <tbody> <tr><td>1</td><td>1</td><td>1</td><td>1</td><td>1</td></tr> <tr><td>1</td><td>1</td><td>1</td><td>1</td><td>1</td></tr> <tr><td>1</td><td>1</td><td>1</td><td>1</td><td>1</td></tr> <tr><td>1</td><td>1</td><td>1</td><td>1</td><td>1</td></tr> <tr><td>1</td><td>1</td><td>1</td><td>1</td><td>1</td></tr> <tr><td>1</td><td>1</td><td>1</td><td>1</td><td>1</td></tr> <tr><td>1</td><td>1</td><td>1</td><td>1</td><td>1</td></tr> <tr><td>1</td><td>1</td><td>1</td><td>1</td><td>1</td></tr> </tbody> </table>	<u>OI</u>	<u>CSI</u>	<u>CDH</u>	<u>TPI</u>	<u>XDV</u>	1	1	1	1	1	1	1	1	1	1	1	1	1	1	1	1	1	1	1	1	1	1	1	1	1	1	1	1	1	1	1	1	1	1	1	1	1	1	1	1																										
<u>Symbol</u>	<u>Address</u>	<u>Quantization</u>																																																																																																												
		<u>Lunar</u> <u>Earth</u>																																																																																																												
K55	607	Octal	h rate display scale factor																																																																																																											
3K4	613	Octal	Sine of TPI interdict region																																																																																																											
6J1	640	Octal	Negative of X inertial component of lunar rotation rate vector																																																																																																											
6J2	641	Octal	Negative of Y inertial component of lunar rotation rate vector																																																																																																											
6J3	642	Octal	Negative of Z inertial component of lunar rotation rate vector																																																																																																											
4K10	662	Octal	Constant in linear expression for $\alpha$ -L (OI)																																																																																																											
11J	673	Octal	Retarget values for 4K10 when central angle exceeds 12J (OI)																																																																																																											
<u>OI</u>	<u>CSI</u>	<u>CDH</u>	<u>TPI</u>	<u>XDV</u>																																																																																																										
1	1	1	1	1																																																																																																										
1	1	1	1	1																																																																																																										
1	1	1	1	1																																																																																																										
1	1	1	1	1																																																																																																										
1	1	1	1	1																																																																																																										
1	1	1	1	1																																																																																																										
1	1	1	1	1																																																																																																										
1	1	1	1	1																																																																																																										
		4.4.16 <u>DEDA OUTPUT LIST</u>																																																																																																												
		<table style="width: 100%; border-collapse: collapse;"> <thead> <tr> <th style="width: 10%;"><u>Symbol</u></th> <th style="width: 10%;"><u>Address</u></th> <th style="width: 10%;"><u>Quantization</u></th> <th style="width: 70%;"></th> </tr> <tr> <td></td> <td></td> <td style="text-align: center;"><u>Lunar</u>      <u>Earth</u></td> <td></td> </tr> </thead> <tbody> <tr> <td>y</td> <td>211</td> <td>100 ft</td> <td>Present LM out-of-plane distance</td> </tr> <tr> <td>Vpy</td> <td>263</td> <td>0.1 fps</td> <td>Predicted out-of-CSM-plane velocity at t<sub>ig</sub> in CSI, CDH, or TPI; present LM out-of-plane velocity in OI</td> </tr> <tr> <td>Vyo</td> <td>270</td> <td>0.1 fps</td> <td>Present LM out-of-CSM-plane velocity</td> </tr> <tr> <td>1J</td> <td>275</td> <td>0.1 min</td> <td>Nominal time of TPI maneuver</td> </tr> <tr> <td>ξ</td> <td>277</td> <td>0.01°</td> <td>In-plane angle between Z-body-axis and local horizontal</td> </tr> <tr> <td>θ LOS</td> <td>303</td> <td>0.01°</td> <td>Predicted LOS angle at TPI</td> </tr> <tr> <td>θ f</td> <td>303</td> <td>0.01°</td> <td>LM to CSM phase angle: valid for t<sub>ig</sub> of CSI or CDH, present time in OI</td> </tr> <tr> <td>4J</td> <td>306</td> <td>0.01 min</td> <td>Time of node prior to nominal rendezvous time</td> </tr> <tr> <td>6J</td> <td>307</td> <td>0.01 min</td> <td>Time from TPI to rendezvous</td> </tr> <tr> <td>TΔ</td> <td>310</td> <td>0.01 min</td> <td>Time from present to next maneuver</td> </tr> <tr> <td>Tr</td> <td>311</td> <td>0.01 min</td> <td>Time to go until rendezvous in TPI</td> </tr> </tbody> </table>	<u>Symbol</u>	<u>Address</u>	<u>Quantization</u>				<u>Lunar</u> <u>Earth</u>		y	211	100 ft	Present LM out-of-plane distance	Vpy	263	0.1 fps	Predicted out-of-CSM-plane velocity at t <sub>ig</sub> in CSI, CDH, or TPI; present LM out-of-plane velocity in OI	Vyo	270	0.1 fps	Present LM out-of-CSM-plane velocity	1J	275	0.1 min	Nominal time of TPI maneuver	ξ	277	0.01°	In-plane angle between Z-body-axis and local horizontal	θ LOS	303	0.01°	Predicted LOS angle at TPI	θ f	303	0.01°	LM to CSM phase angle: valid for t <sub>ig</sub> of CSI or CDH, present time in OI	4J	306	0.01 min	Time of node prior to nominal rendezvous time	6J	307	0.01 min	Time from TPI to rendezvous	TΔ	310	0.01 min	Time from present to next maneuver	Tr	311	0.01 min	Time to go until rendezvous in TPI	<p>0 = not available 1 = available</p> <table style="width: 100%; border-collapse: collapse;"> <thead> <tr> <th style="width: 10%;"><u>OI</u></th> <th style="width: 10%;"><u>CSI</u></th> <th style="width: 10%;"><u>CDH</u></th> <th style="width: 10%;"><u>TPI</u></th> <th style="width: 10%;"><u>XDV</u></th> </tr> </thead> <tbody> <tr><td>1</td><td>1</td><td>1</td><td>1</td><td>1</td></tr> <tr><td>1</td><td>1</td><td>1</td><td>1</td><td>1</td></tr> <tr><td>1</td><td>1</td><td>1</td><td>1</td><td>1</td></tr> <tr><td>1</td><td>1</td><td>1</td><td>1</td><td>1</td></tr> <tr><td>0</td><td>0</td><td>0</td><td>1</td><td>0</td></tr> <tr><td>0</td><td>1</td><td>1</td><td>0</td><td>0</td></tr> <tr><td>0</td><td>0</td><td>0</td><td>1</td><td>0</td></tr> <tr><td>1</td><td>1</td><td>1</td><td>1</td><td>1</td></tr> <tr><td>0</td><td>1</td><td>1</td><td>1</td><td>1</td></tr> <tr><td>0</td><td>0</td><td>0</td><td>0</td><td>0</td></tr> </tbody> </table>	<u>OI</u>	<u>CSI</u>	<u>CDH</u>	<u>TPI</u>	<u>XDV</u>	1	1	1	1	1	1	1	1	1	1	1	1	1	1	1	1	1	1	1	1	0	0	0	1	0	0	1	1	0	0	0	0	0	1	0	1	1	1	1	1	0	1	1	1	1	0	0	0	0	0
<u>Symbol</u>	<u>Address</u>	<u>Quantization</u>																																																																																																												
		<u>Lunar</u> <u>Earth</u>																																																																																																												
y	211	100 ft	Present LM out-of-plane distance																																																																																																											
Vpy	263	0.1 fps	Predicted out-of-CSM-plane velocity at t <sub>ig</sub> in CSI, CDH, or TPI; present LM out-of-plane velocity in OI																																																																																																											
Vyo	270	0.1 fps	Present LM out-of-CSM-plane velocity																																																																																																											
1J	275	0.1 min	Nominal time of TPI maneuver																																																																																																											
ξ	277	0.01°	In-plane angle between Z-body-axis and local horizontal																																																																																																											
θ LOS	303	0.01°	Predicted LOS angle at TPI																																																																																																											
θ f	303	0.01°	LM to CSM phase angle: valid for t <sub>ig</sub> of CSI or CDH, present time in OI																																																																																																											
4J	306	0.01 min	Time of node prior to nominal rendezvous time																																																																																																											
6J	307	0.01 min	Time from TPI to rendezvous																																																																																																											
TΔ	310	0.01 min	Time from present to next maneuver																																																																																																											
Tr	311	0.01 min	Time to go until rendezvous in TPI																																																																																																											
<u>OI</u>	<u>CSI</u>	<u>CDH</u>	<u>TPI</u>	<u>XDV</u>																																																																																																										
1	1	1	1	1																																																																																																										
1	1	1	1	1																																																																																																										
1	1	1	1	1																																																																																																										
1	1	1	1	1																																																																																																										
0	0	0	1	0																																																																																																										
0	1	1	0	0																																																																																																										
0	0	0	1	0																																																																																																										
1	1	1	1	1																																																																																																										
0	1	1	1	1																																																																																																										
0	0	0	0	0																																																																																																										

**LMA790-3-LM  
APOLLO OPERATIONS HANDBOOK**

CREW-MAN	PNL	PROCEDURES		REMARKS
		Symbol	Address	
4.4.16 DEDA OUTPUT LIST (cont)				
			Quantization Lunar Earth	
		3J	0.01 min	Target offset time
		6r	0.1 nm	Differential orbital altitude along LM radial at CSI time
		qa	0.1 nm	Apofocus altitude of LM trajectory
		RR	0.01 nm	Computed range from LM to CSM
		h	0.1 nm	LM altitude
		rx	100 ft	X-component of LM position
		ry	100 ft	Y-component of LM position
		rz	100 ft	Z-component of LM position
		rcx	100 ft	X-component of CSM position
		rcy	100 ft	Y-component of CSM position
		rcz	100 ft	Z-component of CSM position
		rf	100 ft	Predicted LM orbit radial distance at tig (at burnout in OI)
		Vx	0.1 fps	X-component of LM velocity
		Vy	0.1 fps	Y-component of LM velocity
		Vz	0.1 fps	Z-component of LM velocity
		Vcx	0.1 fps	X-component of CSM velocity
		Vcy	0.1 fps	Y-component of CSM velocity
		Vcz	0.1 fps	Z-component of CSM velocity
		r	0.1 fps	LM altitude rate
		VG	0.1 fps	Magnitude of velocity to be gained
		VF	0.1 fps	Braking velocity required to rendezvous (TPI mode only)
		TAO	0.1 min	Coast time from CSI to CDH
		tig	0.1 min	Absolute time of next maneuver. Des-ignations tigA, tigB, and tigC (absolute times of CSI, CDH, and TPI maneuvers, respectively) are retained for procedural clarity.
		TAL	0.1 min	ACS computer time
		Ar	0.1 nm	Predicted differential altitude after CDH
		qlD	0.1 nm	Perifocus altitude of predicted LM trajectory
		qlT	0.1 nm	Perifocus altitude of LM trajectory
		if	0.1 fps	Desired final value of altitude rate

0 = not available  
1 = available

OI    CSI    CDH    TPI    XDV  
1    1    1    1    1

G & C  
REF  
DATA

RC 1583

**LMA790-3-LM**  
**APOLLO OPERATIONS HANDBOOK**

RC 1583

CREW-MAN	PNL	PROCEDURES			REMARKS					
		Symbol	Address	Quantization Lunar      Earth						
4.4.16 DEDA OUTPUT LIST (cont.)										
		V	433	0.1 fps 1 fps	Magnitude of LM velocity Range rate between LM and CSM (negative value indicates LM closing on CSM)	0I	CSI	CDH	TPI	XDV
		R	440	0.1 fps 1 fps		1	1	1	1	1
		VDX	470	0.1 fps 1 fps	Accumulated total sensed velocity increment in X-body direction	1	1	1	1	1
		VDY	471	0.1 fps 1 fps	Accumulated total sensed velocity increment in Y-body direction	1	1	1	1	1
		VDZ	472	0.1 fps 1 fps	Accumulated total sensed velocity increment in Z-body direction	1	1	1	1	1
		tA	477	0.1 fps 1 fps	Radial velocity at tig (at present in OI)	1	1	1	1	1
		ΔVgx	500	0.1 fps 1 fps	Velocity to be gained in X-body-axis direction	1	1	1	1	1
		ΔVgy	501	0.1 fps 1 fps	Velocity to be gained in Y-body-axis direction	1	1	1	1	1
		ΔVgz	502	0.1 fps 1 fps	Velocity to be gained in Z-body-axis direction	1	1	1	1	1
		1K18	534	Octal	X-accelerometer scale factor (fps/ pulse)	1	1	1	1	1
		1K20	535	Octal	Y-accelerometer scale factor (fps/ pulse)	1	1	1	1	1
		1K22	536	Octal	Z-accelerometer scale factor (fps/ pulse)	1	1	1	1	1
		1K19	540	0.001 fps sq 0.01 fps sq	X-accelerometer bias compensation	1	1	1	1	1
		1K21	541	0.001 fps sq 0.01 fps sq	Y-accelerometer bias compensation	1	1	1	1	1
		1K23	542	0.001 fps sq 0.01 fps sq	Z-accelerometer bias compensation	1	1	1	1	1
		1K1	544	0.01°/hr	X-gyro drift compensation coefficient	1	1	1	1	1
		1K6	545	0.01°/hr	Y-gyro drift compensation coefficient	1	1	1	1	1
		1K11	546	0.01°/hr	Z-gyro drift compensation coefficient	1	1	1	1	1
		62	574	N/A	Descent section staging flag	1	1	1	1	1
		621	604	N/A	Lunar surface flag	1	1	1	1	1
		μ6	612	Octal	Staging sequence counter	1	1	1	1	1
		μ8	614	1 count	Ullage counter	1	1	1	1	1
		1K9	616	1 count	Ullage counter value for ullage completion	1	1	1	1	1
		μ19	621	Split integer	Radar update counter displays	1	1	1	1	1



**LMA790-J-LM**  
**APOLLO OPERATIONS HANDBOOK**

RC 1584

CREW- MAN	PNL	PROCEDURES				REMARKS
		Symbol	Address	Quantization Lunar Earth		
4.4.17 DEDA ACCESSIBLE PARAMETERS LIST (cont)						
		Dry	105	Octal	LM position remainder (ft) (Y)	0 1 - not available 1 - available
		Drz	106	Octal	LM position remainder (ft) (Z)	0 1 - not available 1 - available
		ØP	107	Octal	PGCS Ø (pulses)	0 1 - not available 1 - available
		DIGX	110	Octal	Predicted change in integrated gravity (fps) (X)	0 1 - not available 1 - available
		DIGY	111	Octal	Predicted change in integrated gravity (fps) (Y)	0 1 - not available 1 - available
		DIGZ	112	Octal	Predicted change in integrated gravity (fps) (Z)	0 1 - not available 1 - available
		ψP	113	Octal	PGCS ψ (pulses)	0 1 - not available 1 - available
		GKDT	114	Octal	Gravity times major cycle time (fps) (X)	0 1 - not available 1 - available
		GYDT	115	Octal	Gravity times major cycle time (fps) (Y)	0 1 - not available 1 - available
		GZDT	116	Octal	Gravity times major cycle time (fps) (Z)	0 1 - not available 1 - available
		ØP	117	Octal	PGCS Ø (pulses)	0 1 - not available 1 - available
		Δvsx	120	Octal	Resolved sensed ΔV along inertial axis (fps) (X)	0 1 - not available 1 - available
		Δvsy	121	Octal	Resolved sensed ΔV along inertial axis (fps) (Y)	0 1 - not available 1 - available
		Δvsz	122	Octal	Resolved sensed ΔV along inertial axis (fps) (Z)	0 1 - not available 1 - available
		SIGA	123	Octal	Sine of FDI ΔY	0 1 - not available 1 - available
		RRX	124	Octal	Computed LM-CSM range (ft) (X)	0 1 - not available 1 - available
		RRY	125	Octal	Computed LM-CSM range (ft) (Y)	0 1 - not available 1 - available
		RRZ	126	Octal	Computed LM-CSM range (ft) (Z)	0 1 - not available 1 - available
		COGA	127	Octal	Cosine of FDI ΔY	0 1 - not available 1 - available
		A11	130	Octal	XB direction cosine	0 1 - not available 1 - available
		A12	131	Octal	XB direction cosine	0 1 - not available 1 - available
		A13	132	Octal	XB direction cosine	0 1 - not available 1 - available
		A31	134	Octal	ZB direction cosine	0 1 - not available 1 - available
		A32	135	Octal	ZB direction cosine	0 1 - not available 1 - available
		A33	136	Octal	ZB direction cosine	0 1 - not available 1 - available
		A21	140	Octal	YB direction cosine	0 1 - not available 1 - available
		A22	141	Octal	YB direction cosine	0 1 - not available 1 - available
		A23	142	Octal	YB direction cosine	0 1 - not available 1 - available
		δ10	147	Octal	TPI logic flag	0 1 - not available 1 - available





# LMA790-3-LM APOLLO OPERATIONS HANDBOOK

RC 1584

CREW- MAN	PNL	PROCEDURES	REMARKS																																																																																																																																																																																																																																																																																																																																										
		4.4.17 DEDA ACCESSIBLE PARAMETERS LIST (cont)																																																																																																																																																																																																																																																																																																																																											
		<table style="width: 100%; border-collapse: collapse;"> <thead> <tr> <th style="width: 10%; text-align: left;">Symbol</th> <th style="width: 10%; text-align: left;">Address</th> <th style="width: 10%; text-align: left;">Lunar</th> <th style="width: 10%; text-align: left;">Earth</th> <th style="width: 10%;"></th> <th style="width: 10%;"></th> <th style="width: 10%;"></th> <th style="width: 10%;"></th> <th style="width: 10%;"></th> <th style="width: 10%;"></th> </tr> <tr> <th colspan="2"></th> <th colspan="2" style="text-align: center;">Quantization</th> <th style="text-align: center;">OI</th> <th style="text-align: center;">CSI</th> <th style="text-align: center;">CDH</th> <th style="text-align: center;">TPI</th> <th style="text-align: center;">XDV</th> <th></th> </tr> </thead> <tbody> <tr> <td>8J</td> <td>225</td> <td>100 ft</td> <td>1000 ft</td> <td>1</td> <td>1</td> <td>1</td> <td>1</td> <td>1</td> <td>One-half lower limit of apolune radius</td> </tr> <tr> <td>10J</td> <td>226</td> <td>100 ft</td> <td>1000 ft</td> <td>1</td> <td>1</td> <td>1</td> <td>1</td> <td>1</td> <td>Retarget value for 7J</td> </tr> <tr> <td>4K5</td> <td>227</td> <td>100 ft</td> <td>1000 ft</td> <td>1</td> <td>1</td> <td>1</td> <td>1</td> <td>1</td> <td>Nominal burnout altitude in OI</td> </tr> <tr> <td>2K19</td> <td>230</td> <td>100 ft</td> <td>1000 ft</td> <td>1</td> <td>1</td> <td>1</td> <td>1</td> <td>1</td> <td>Ap limiter</td> </tr> <tr> <td>5J</td> <td>231</td> <td>100 ft</td> <td>1000 ft</td> <td>1</td> <td>1</td> <td>1</td> <td>1</td> <td>1</td> <td>Nominal lunar landing site radius</td> </tr> <tr> <td>16J</td> <td>232</td> <td>100 ft</td> <td>1000 ft</td> <td>1</td> <td>1</td> <td>1</td> <td>1</td> <td>1</td> <td>Targeted orbit insertion altitude</td> </tr> <tr> <td>21J</td> <td>233</td> <td>100 ft</td> <td>1000 ft</td> <td>1</td> <td>1</td> <td>1</td> <td>1</td> <td>1</td> <td>Vertical pitch steering altitude threshold</td> </tr> <tr> <td>1J1</td> <td>240</td> <td>100 ft</td> <td>1000 ft</td> <td>1</td> <td>1</td> <td>1</td> <td>1</td> <td>1</td> <td>LM ephemeris position (X-component)</td> </tr> <tr> <td>1J1</td> <td>241</td> <td>100 ft</td> <td>1000 ft</td> <td>1</td> <td>1</td> <td>1</td> <td>1</td> <td>1</td> <td>LM ephemeris position (Y-component)</td> </tr> <tr> <td>1J3</td> <td>242</td> <td>100 ft</td> <td>1000 ft</td> <td>1</td> <td>1</td> <td>1</td> <td>1</td> <td>1</td> <td>LM ephemeris position (Z-component)</td> </tr> <tr> <td>2J1</td> <td>244</td> <td>100 ft</td> <td>1000 ft</td> <td>1</td> <td>1</td> <td>1</td> <td>1</td> <td>1</td> <td>CSM ephemeris position (X-component)</td> </tr> <tr> <td>2J2</td> <td>245</td> <td>100 ft</td> <td>1000 ft</td> <td>1</td> <td>1</td> <td>1</td> <td>1</td> <td>1</td> <td>CSM ephemeris position (Y-component)</td> </tr> <tr> <td>2J3</td> <td>246</td> <td>100 ft</td> <td>1000 ft</td> <td>1</td> <td>1</td> <td>1</td> <td>1</td> <td>1</td> <td>CSM ephemeris position (Z-component)</td> </tr> <tr> <td>ØR</td> <td>252</td> <td>0.01°</td> <td></td> <td>0</td> <td>1</td> <td>1</td> <td>1</td> <td>1</td> <td>RR trunnion angle</td> </tr> <tr> <td>ØR</td> <td>253</td> <td>0.01°</td> <td></td> <td>0</td> <td>1</td> <td>1</td> <td>1</td> <td>1</td> <td>RR shaft angle</td> </tr> <tr> <td>ØR</td> <td>254</td> <td>0.01 nm</td> <td></td> <td>0</td> <td>1</td> <td>1</td> <td>1</td> <td>1</td> <td>RR range</td> </tr> <tr> <td>1J7</td> <td>254</td> <td>0.1 min</td> <td></td> <td>1</td> <td>1</td> <td>1</td> <td>1</td> <td>1</td> <td>LM epoch</td> </tr> <tr> <td>ØM</td> <td>255</td> <td>0.1 fps</td> <td>1 fps</td> <td>0</td> <td>1</td> <td>1</td> <td>1</td> <td>1</td> <td>RR range rate</td> </tr> <tr> <td>Ø46</td> <td>256</td> <td>Octal</td> <td></td> <td>0</td> <td>1</td> <td>1</td> <td>1</td> <td>1</td> <td>Range scaling &amp; data received indicator</td> </tr> <tr> <td>1J4</td> <td>260</td> <td>0.1 fps</td> <td>1 fps</td> <td>0</td> <td>1</td> <td>1</td> <td>1</td> <td>1</td> <td>X-component of LM velocity used in LM initialization</td> </tr> <tr> <td>1J5</td> <td>261</td> <td>0.1 fps</td> <td>1 fps</td> <td>1</td> <td>1</td> <td>1</td> <td>1</td> <td>1</td> <td>Y-component of LM velocity used in LM initialization</td> </tr> <tr> <td>1J6</td> <td>262</td> <td>0.1 fps</td> <td>1 fps</td> <td>1</td> <td>1</td> <td>1</td> <td>1</td> <td>1</td> <td>Z-component of LM velocity used in LM initialization</td> </tr> <tr> <td>Vpy</td> <td>263</td> <td>0.1 fps</td> <td>1 fps</td> <td>1</td> <td>1</td> <td>1</td> <td>1</td> <td>1</td> <td>Out-of-plane velocity at t<sub>ig</sub>; at present in OI</td> </tr> <tr> <td>2J4</td> <td>264</td> <td>0.1 fps</td> <td>1 fps</td> <td>1</td> <td>1</td> <td>1</td> <td>1</td> <td>1</td> <td>X-component of CSM velocity used in CSM initialization</td> </tr> <tr> <td>2J5</td> <td>265</td> <td>0.1 fps</td> <td>1 fps</td> <td>1</td> <td>1</td> <td>1</td> <td>1</td> <td>1</td> <td>Y-component of CSM velocity used in CSM initialization</td> </tr> <tr> <td>2J6</td> <td>266</td> <td>0.1 fps</td> <td>1 fps</td> <td>1</td> <td>1</td> <td>1</td> <td>1</td> <td>1</td> <td>Z-component of CSM velocity used in CSM initialization</td> </tr> <tr> <td>Vyo</td> <td>270</td> <td>0.1 fps</td> <td>1 fps</td> <td>1</td> <td>1</td> <td>1</td> <td>1</td> <td>1</td> <td>LM present out-of-plane velocity</td> </tr> <tr> <td>Vyofs</td> <td>271</td> <td>0.1 fps</td> <td>1 fps</td> <td>1</td> <td>1</td> <td>1</td> <td>1</td> <td>1</td> <td>Maximum V<sub>YO</sub> displayable</td> </tr> <tr> <td>2J7</td> <td>272</td> <td>0.1 min</td> <td></td> <td>1</td> <td>1</td> <td>1</td> <td>1</td> <td>1</td> <td>CSM epoch</td> </tr> <tr> <td>7K1</td> <td>274</td> <td>0.1 min</td> <td></td> <td>1</td> <td>1</td> <td>1</td> <td>1</td> <td>1</td> <td>TIC offset</td> </tr> <tr> <td>1J</td> <td>275</td> <td>0.1 min</td> <td></td> <td>1</td> <td>1</td> <td>1</td> <td>1</td> <td>1</td> <td>Desired time of TPI maneuver for CSI</td> </tr> </tbody> </table>	Symbol	Address	Lunar	Earth									Quantization		OI	CSI	CDH	TPI	XDV		8J	225	100 ft	1000 ft	1	1	1	1	1	One-half lower limit of apolune radius	10J	226	100 ft	1000 ft	1	1	1	1	1	Retarget value for 7J	4K5	227	100 ft	1000 ft	1	1	1	1	1	Nominal burnout altitude in OI	2K19	230	100 ft	1000 ft	1	1	1	1	1	Ap limiter	5J	231	100 ft	1000 ft	1	1	1	1	1	Nominal lunar landing site radius	16J	232	100 ft	1000 ft	1	1	1	1	1	Targeted orbit insertion altitude	21J	233	100 ft	1000 ft	1	1	1	1	1	Vertical pitch steering altitude threshold	1J1	240	100 ft	1000 ft	1	1	1	1	1	LM ephemeris position (X-component)	1J1	241	100 ft	1000 ft	1	1	1	1	1	LM ephemeris position (Y-component)	1J3	242	100 ft	1000 ft	1	1	1	1	1	LM ephemeris position (Z-component)	2J1	244	100 ft	1000 ft	1	1	1	1	1	CSM ephemeris position (X-component)	2J2	245	100 ft	1000 ft	1	1	1	1	1	CSM ephemeris position (Y-component)	2J3	246	100 ft	1000 ft	1	1	1	1	1	CSM ephemeris position (Z-component)	ØR	252	0.01°		0	1	1	1	1	RR trunnion angle	ØR	253	0.01°		0	1	1	1	1	RR shaft angle	ØR	254	0.01 nm		0	1	1	1	1	RR range	1J7	254	0.1 min		1	1	1	1	1	LM epoch	ØM	255	0.1 fps	1 fps	0	1	1	1	1	RR range rate	Ø46	256	Octal		0	1	1	1	1	Range scaling & data received indicator	1J4	260	0.1 fps	1 fps	0	1	1	1	1	X-component of LM velocity used in LM initialization	1J5	261	0.1 fps	1 fps	1	1	1	1	1	Y-component of LM velocity used in LM initialization	1J6	262	0.1 fps	1 fps	1	1	1	1	1	Z-component of LM velocity used in LM initialization	Vpy	263	0.1 fps	1 fps	1	1	1	1	1	Out-of-plane velocity at t <sub>ig</sub> ; at present in OI	2J4	264	0.1 fps	1 fps	1	1	1	1	1	X-component of CSM velocity used in CSM initialization	2J5	265	0.1 fps	1 fps	1	1	1	1	1	Y-component of CSM velocity used in CSM initialization	2J6	266	0.1 fps	1 fps	1	1	1	1	1	Z-component of CSM velocity used in CSM initialization	Vyo	270	0.1 fps	1 fps	1	1	1	1	1	LM present out-of-plane velocity	Vyofs	271	0.1 fps	1 fps	1	1	1	1	1	Maximum V <sub>YO</sub> displayable	2J7	272	0.1 min		1	1	1	1	1	CSM epoch	7K1	274	0.1 min		1	1	1	1	1	TIC offset	1J	275	0.1 min		1	1	1	1	1	Desired time of TPI maneuver for CSI	
Symbol	Address	Lunar	Earth																																																																																																																																																																																																																																																																																																																																										
		Quantization		OI	CSI	CDH	TPI	XDV																																																																																																																																																																																																																																																																																																																																					
8J	225	100 ft	1000 ft	1	1	1	1	1	One-half lower limit of apolune radius																																																																																																																																																																																																																																																																																																																																				
10J	226	100 ft	1000 ft	1	1	1	1	1	Retarget value for 7J																																																																																																																																																																																																																																																																																																																																				
4K5	227	100 ft	1000 ft	1	1	1	1	1	Nominal burnout altitude in OI																																																																																																																																																																																																																																																																																																																																				
2K19	230	100 ft	1000 ft	1	1	1	1	1	Ap limiter																																																																																																																																																																																																																																																																																																																																				
5J	231	100 ft	1000 ft	1	1	1	1	1	Nominal lunar landing site radius																																																																																																																																																																																																																																																																																																																																				
16J	232	100 ft	1000 ft	1	1	1	1	1	Targeted orbit insertion altitude																																																																																																																																																																																																																																																																																																																																				
21J	233	100 ft	1000 ft	1	1	1	1	1	Vertical pitch steering altitude threshold																																																																																																																																																																																																																																																																																																																																				
1J1	240	100 ft	1000 ft	1	1	1	1	1	LM ephemeris position (X-component)																																																																																																																																																																																																																																																																																																																																				
1J1	241	100 ft	1000 ft	1	1	1	1	1	LM ephemeris position (Y-component)																																																																																																																																																																																																																																																																																																																																				
1J3	242	100 ft	1000 ft	1	1	1	1	1	LM ephemeris position (Z-component)																																																																																																																																																																																																																																																																																																																																				
2J1	244	100 ft	1000 ft	1	1	1	1	1	CSM ephemeris position (X-component)																																																																																																																																																																																																																																																																																																																																				
2J2	245	100 ft	1000 ft	1	1	1	1	1	CSM ephemeris position (Y-component)																																																																																																																																																																																																																																																																																																																																				
2J3	246	100 ft	1000 ft	1	1	1	1	1	CSM ephemeris position (Z-component)																																																																																																																																																																																																																																																																																																																																				
ØR	252	0.01°		0	1	1	1	1	RR trunnion angle																																																																																																																																																																																																																																																																																																																																				
ØR	253	0.01°		0	1	1	1	1	RR shaft angle																																																																																																																																																																																																																																																																																																																																				
ØR	254	0.01 nm		0	1	1	1	1	RR range																																																																																																																																																																																																																																																																																																																																				
1J7	254	0.1 min		1	1	1	1	1	LM epoch																																																																																																																																																																																																																																																																																																																																				
ØM	255	0.1 fps	1 fps	0	1	1	1	1	RR range rate																																																																																																																																																																																																																																																																																																																																				
Ø46	256	Octal		0	1	1	1	1	Range scaling & data received indicator																																																																																																																																																																																																																																																																																																																																				
1J4	260	0.1 fps	1 fps	0	1	1	1	1	X-component of LM velocity used in LM initialization																																																																																																																																																																																																																																																																																																																																				
1J5	261	0.1 fps	1 fps	1	1	1	1	1	Y-component of LM velocity used in LM initialization																																																																																																																																																																																																																																																																																																																																				
1J6	262	0.1 fps	1 fps	1	1	1	1	1	Z-component of LM velocity used in LM initialization																																																																																																																																																																																																																																																																																																																																				
Vpy	263	0.1 fps	1 fps	1	1	1	1	1	Out-of-plane velocity at t <sub>ig</sub> ; at present in OI																																																																																																																																																																																																																																																																																																																																				
2J4	264	0.1 fps	1 fps	1	1	1	1	1	X-component of CSM velocity used in CSM initialization																																																																																																																																																																																																																																																																																																																																				
2J5	265	0.1 fps	1 fps	1	1	1	1	1	Y-component of CSM velocity used in CSM initialization																																																																																																																																																																																																																																																																																																																																				
2J6	266	0.1 fps	1 fps	1	1	1	1	1	Z-component of CSM velocity used in CSM initialization																																																																																																																																																																																																																																																																																																																																				
Vyo	270	0.1 fps	1 fps	1	1	1	1	1	LM present out-of-plane velocity																																																																																																																																																																																																																																																																																																																																				
Vyofs	271	0.1 fps	1 fps	1	1	1	1	1	Maximum V <sub>YO</sub> displayable																																																																																																																																																																																																																																																																																																																																				
2J7	272	0.1 min		1	1	1	1	1	CSM epoch																																																																																																																																																																																																																																																																																																																																				
7K1	274	0.1 min		1	1	1	1	1	TIC offset																																																																																																																																																																																																																																																																																																																																				
1J	275	0.1 min		1	1	1	1	1	Desired time of TPI maneuver for CSI																																																																																																																																																																																																																																																																																																																																				



**LMA790-3-LM**  
**APOLLO OPERATIONS HANDBOOK**

RC 1584

CREW-  
MAN

**PROCEDURES**

**REMARKS**

**4.4.17 DEDA ACCESSIBLE PARAMETERS LIST (cont)**

Symbol	Address	Quantization		OI	CSI	CDH	TPI	XDV
		Lunar	Earth					
Vcz	366	0.1 fps	1 fps	1	1	1	1	1
h	367	0.1 fps	1 fps	1	1	1	1	1
VG	370	0.1 fps	1 fps	1	1	1	1	1
VF	371	0.1 fps	1 fps	1	1	1	1	1
TAO	372	0.1 min		0	0	0	1	0
t18	373	0.1 min		0	1	0	0	0
TAL	377	0.1 min		1	1	1	1	1
SO	400	Octal		1	1	1	1	1
DISCIC	401	Octal		1	1	1	1	1
AH	402	0.1 nm		1	1	1	1	1
q1DEDA	402	0.1 nm		0	1	1	0	0
qL7ELE	403	0.1 nm		0	0	0	1	0
66	407	Octal		1	1	1	1	1
S10	410	Octal		1	1	1	1	1
S11	411	Octal		1	1	1	1	1
S12	412	Octal		1	1	1	1	1
S13	413	Octal		1	1	1	1	1
S14	414	Octal		1	1	1	1	1
S15	415	Octal		1	1	1	1	1
R*	415	Octal		1	1	1	1	1
S16	416	Octal		1	1	1	1	1
S17	417	Octal		1	1	1	1	1
Vex	420	0.1 fps	1 fps	1	1	1	1	1
Vey	421	0.1 fps	1 fps	1	1	1	1	1
Vez	422	0.1 fps	1 fps	1	1	1	1	1
if	423	0.1 fps	1 fps	1	1	1	1	1
Vox	424	0.1 fps	1 fps	1	1	1	1	0
Voy	425	0.1 fps	1 fps	1	1	1	1	1
Voz	426	0.1 fps	1 fps	1	1	1	1	1
VH	427	0.1 fps	1 fps	1	1	1	1	1
V	433	0.1 fps	1 fps	1	1	1	1	1

0 = not available  
1 = available

Z-component of present CSM inertial velocity vector  
LM altitude rate  
Magnitude of velocity to be gained  
TPI braking velocity  
Time from CSI to CDH  
Absolute time of next maneuver  
AGS absolute time  
AGS function selector  
Discrete word one  
LM-CSM differential altitude after CDH  
LM transfer orbit pericythion altitude  
LM present pericythion altitude  
Flag to initiate alignment prior to calibration  
Guidance mode selector  
Auto radar update selector  
In-flight self-test status indicator  
Store/no-store lunar azimuth selector  
Navigation initialization  
Radar gimbal null (enter only)  
Range rate at time of mark (read only)  
Number of LM half-orbits from CSI to CDH  
Radar filter initialization  
CSM epoch velocity vector (X)  
CSM epoch velocity vector (Y)  
CSM epoch velocity vector (Z)  
Desired altitude rate  
Velocity vector input to orbit parameter subroutine (X)  
Velocity vector input to orbit parameter subroutine (Y)  
Velocity vector input to orbit parameter subroutine (Z)  
Present LM horizontal velocity  
Present LM velocity

# LMA790-3-LM APOLLO OPERATIONS HANDBOOK

RC 1584

CREW- MAN	PNL	PROCEDURES	REMARKS																																																																														
		<p>4.4.17 <u>DEDA ACCESSIBLE PARAMETERS LIST (cont)</u></p> <table style="width: 100%; border-collapse: collapse;"> <thead> <tr> <th style="text-align: left;"><u>Symbol</u></th> <th style="text-align: left;"><u>Address</u></th> <th style="text-align: left;"><u>Quantization</u> <u>Lunar</u>      <u>Earth</u></th> <th style="text-align: left;"><u>Estimated range rate between LM and CSM (negative value indicates LM closing on CSM)</u></th> <th style="text-align: left;"><u>Range rate at time of radar update</u></th> <th style="text-align: left;"><u>Engine cutoff compensation</u></th> <th style="text-align: left;"><u>ΔV downrange (XDV input)</u></th> <th style="text-align: left;"><u>ΔV crossrange (XDV input)</u></th> <th style="text-align: left;"><u>OI</u></th> <th style="text-align: left;"><u>CSI</u></th> <th style="text-align: left;"><u>CDH</u></th> <th style="text-align: left;"><u>TPI</u></th> <th style="text-align: left;"><u>XDV</u></th> </tr> </thead> <tbody> <tr> <td>RR</td> <td>440</td> <td>0.1 fps    1 fps</td> <td></td> <td></td> <td></td> <td></td> <td></td> <td>1</td> <td>1</td> <td>1</td> <td>1</td> <td>1</td> </tr> <tr> <td>R</td> <td>441</td> <td>0.1 fps</td> <td></td> <td></td> <td></td> <td></td> <td></td> <td>1</td> <td>1</td> <td>1</td> <td>1</td> <td>1</td> </tr> <tr> <td>4K25</td> <td>446</td> <td>0.1 fps</td> <td></td> <td></td> <td></td> <td></td> <td></td> <td>1</td> <td>1</td> <td>1</td> <td>1</td> <td>1</td> </tr> <tr> <td>28J1</td> <td>450</td> <td>0.1 fps</td> <td></td> <td></td> <td></td> <td></td> <td></td> <td>0</td> <td>1</td> <td>1</td> <td>0</td> <td>1</td> </tr> <tr> <td>28J2</td> <td>451</td> <td>0.1 fps</td> <td></td> <td></td> <td></td> <td></td> <td></td> <td>0</td> <td>1</td> <td>1</td> <td>0</td> <td>1</td> </tr> </tbody> </table>	<u>Symbol</u>	<u>Address</u>	<u>Quantization</u> <u>Lunar</u> <u>Earth</u>	<u>Estimated range rate between LM and CSM (negative value indicates LM closing on CSM)</u>	<u>Range rate at time of radar update</u>	<u>Engine cutoff compensation</u>	<u>ΔV downrange (XDV input)</u>	<u>ΔV crossrange (XDV input)</u>	<u>OI</u>	<u>CSI</u>	<u>CDH</u>	<u>TPI</u>	<u>XDV</u>	RR	440	0.1 fps    1 fps						1	1	1	1	1	R	441	0.1 fps						1	1	1	1	1	4K25	446	0.1 fps						1	1	1	1	1	28J1	450	0.1 fps						0	1	1	0	1	28J2	451	0.1 fps						0	1	1	0	1	<p>0 - not available 1 - available</p>
<u>Symbol</u>	<u>Address</u>	<u>Quantization</u> <u>Lunar</u> <u>Earth</u>	<u>Estimated range rate between LM and CSM (negative value indicates LM closing on CSM)</u>	<u>Range rate at time of radar update</u>	<u>Engine cutoff compensation</u>	<u>ΔV downrange (XDV input)</u>	<u>ΔV crossrange (XDV input)</u>	<u>OI</u>	<u>CSI</u>	<u>CDH</u>	<u>TPI</u>	<u>XDV</u>																																																																					
RR	440	0.1 fps    1 fps						1	1	1	1	1																																																																					
R	441	0.1 fps						1	1	1	1	1																																																																					
4K25	446	0.1 fps						1	1	1	1	1																																																																					
28J1	450	0.1 fps						0	1	1	0	1																																																																					
28J2	451	0.1 fps						0	1	1	0	1																																																																					

G & C  
REF  
DATA



# LMA790-3-LM APOLLO OPERATIONS HANDBOOK

CREW- MAN	PNI	PROCEDURES	REMARKS																																																																																											
		<p>4.4.17 <u>DEDA ACCESSIBLE PARAMETERS LIST (cont)</u></p> <table style="width: 100%; border-collapse: collapse;"> <thead> <tr> <th style="text-align: left;"><u>Symbol</u></th> <th style="text-align: left;"><u>Address</u></th> <th style="text-align: left;"><u>Quantization</u> <u>Lunar</u></th> <th style="text-align: left;"><u>Earth</u></th> </tr> </thead> <tbody> <tr> <td>...</td> <td>505</td> <td>Octal</td> <td></td> </tr> <tr> <td>4K12</td> <td>506</td> <td>Octal</td> <td></td> </tr> <tr> <td>S307</td> <td>507</td> <td>Octal</td> <td></td> </tr> <tr> <td>C1</td> <td>513</td> <td>Octal</td> <td></td> </tr> <tr> <td>Wbx</td> <td>514</td> <td>Octal</td> <td></td> </tr> <tr> <td>Wby</td> <td>515</td> <td>Octal</td> <td></td> </tr> <tr> <td>Wbz</td> <td>516</td> <td>Octal</td> <td></td> </tr> <tr> <td>6K10</td> <td>517</td> <td>Octal</td> <td></td> </tr> </tbody> </table>	<u>Symbol</u>	<u>Address</u>	<u>Quantization</u> <u>Lunar</u>	<u>Earth</u>	...	505	Octal		4K12	506	Octal		S307	507	Octal		C1	513	Octal		Wbx	514	Octal		Wby	515	Octal		Wbz	516	Octal		6K10	517	Octal		<p>0 = not available 1 = available</p> <table style="width: 100%; border-collapse: collapse;"> <thead> <tr> <th style="text-align: left;"><u>OI</u></th> <th style="text-align: left;"><u>CSI</u></th> <th style="text-align: left;"><u>CDH</u></th> <th style="text-align: left;"><u>TPI</u></th> <th style="text-align: left;"><u>XDV</u></th> </tr> </thead> <tbody> <tr> <td>1</td> <td>0</td> <td>0</td> <td>0</td> <td>0</td> </tr> <tr> <td>1</td> <td>1</td> <td>1</td> <td>1</td> <td>1</td> </tr> <tr> <td>1</td> <td>1</td> <td>1</td> <td>1</td> <td>1</td> </tr> <tr> <td>0</td> <td>0</td> <td>0</td> <td>1</td> <td>0</td> </tr> <tr> <td>1</td> <td>1</td> <td>1</td> <td>1</td> <td>1</td> </tr> <tr> <td>1</td> <td>1</td> <td>1</td> <td>1</td> <td>1</td> </tr> <tr> <td>1</td> <td>1</td> <td>1</td> <td>1</td> <td>1</td> </tr> <tr> <td>1</td> <td>1</td> <td>1</td> <td>1</td> <td>1</td> </tr> <tr> <td>1</td> <td>1</td> <td>1</td> <td>1</td> <td>1</td> </tr> <tr> <td>1</td> <td>1</td> <td>1</td> <td>1</td> <td>1</td> </tr> </tbody> </table> <p>Desired out-of-plane jerk (fps cubed) Acceleration check for RD3DTL in OI Orient Z-body-axis to thrust axis Rendezvous angle cosine Unit vector input for commanding YAW when S00=1(X) Unit vector input for commanding YAW when S00=1(Y) Unit vector input for commanding YAW when S00=1(Z) Radar range rate null</p>	<u>OI</u>	<u>CSI</u>	<u>CDH</u>	<u>TPI</u>	<u>XDV</u>	1	0	0	0	0	1	1	1	1	1	1	1	1	1	1	0	0	0	1	0	1	1	1	1	1	1	1	1	1	1	1	1	1	1	1	1	1	1	1	1	1	1	1	1	1	1	1	1	1	1
<u>Symbol</u>	<u>Address</u>	<u>Quantization</u> <u>Lunar</u>	<u>Earth</u>																																																																																											
...	505	Octal																																																																																												
4K12	506	Octal																																																																																												
S307	507	Octal																																																																																												
C1	513	Octal																																																																																												
Wbx	514	Octal																																																																																												
Wby	515	Octal																																																																																												
Wbz	516	Octal																																																																																												
6K10	517	Octal																																																																																												
<u>OI</u>	<u>CSI</u>	<u>CDH</u>	<u>TPI</u>	<u>XDV</u>																																																																																										
1	0	0	0	0																																																																																										
1	1	1	1	1																																																																																										
1	1	1	1	1																																																																																										
0	0	0	1	0																																																																																										
1	1	1	1	1																																																																																										
1	1	1	1	1																																																																																										
1	1	1	1	1																																																																																										
1	1	1	1	1																																																																																										
1	1	1	1	1																																																																																										
1	1	1	1	1																																																																																										

G & C  
REF  
DATA







**LMA790-3-LM**  
**APOLLO OPERATIONS HANDBOOK**

RC 1584

CREW-MAN	PNL	PROCEDURES	REMARKS																																																																																																											
4.4.17 DEDA ACCESSIBLE PARAMETERS LIST (cont.)																																																																																																														
		<table border="0" style="width: 100%;"> <tr> <td style="text-align: center;"><u>Symbol</u></td> <td style="text-align: center;"><u>Address</u></td> <td style="text-align: center;"><u>Quantization</u></td> <td></td> </tr> <tr> <td></td> <td></td> <td style="text-align: center;"><u>Lunar</u></td> <td style="text-align: center;"><u>Earth</u></td> </tr> </table>	<u>Symbol</u>	<u>Address</u>	<u>Quantization</u>				<u>Lunar</u>	<u>Earth</u>																																																																																																				
<u>Symbol</u>	<u>Address</u>	<u>Quantization</u>																																																																																																												
		<u>Lunar</u>	<u>Earth</u>																																																																																																											
		<table border="0" style="width: 100%;"> <tr> <td style="text-align: center;">m8</td> <td style="text-align: center;">614</td> <td style="text-align: center;">1 count</td> <td></td> </tr> <tr> <td style="text-align: center;">1K9</td> <td style="text-align: center;">616</td> <td style="text-align: center;">1 count</td> <td></td> </tr> <tr> <td style="text-align: center;">1K30</td> <td style="text-align: center;">617</td> <td style="text-align: center;">1 count</td> <td></td> </tr> <tr> <td style="text-align: center;">2K17</td> <td style="text-align: center;">620</td> <td style="text-align: center;">1 count</td> <td></td> </tr> <tr> <td style="text-align: center;">μ19</td> <td style="text-align: center;">621</td> <td style="text-align: center;">Split integer</td> <td></td> </tr> <tr> <td style="text-align: center;">4K23</td> <td style="text-align: center;">622</td> <td style="text-align: center;">1 count</td> <td></td> </tr> <tr> <td style="text-align: center;">S623</td> <td style="text-align: center;">623</td> <td style="text-align: center;">Octal</td> <td></td> </tr> <tr> <td style="text-align: center;">1K4</td> <td style="text-align: center;">624</td> <td style="text-align: center;">Octal</td> <td></td> </tr> <tr> <td style="text-align: center;">1K24</td> <td style="text-align: center;">625</td> <td style="text-align: center;">Octal</td> <td></td> </tr> <tr> <td style="text-align: center;">1K26</td> <td style="text-align: center;">626</td> <td style="text-align: center;">Octal</td> <td></td> </tr> <tr> <td style="text-align: center;">1K27</td> <td style="text-align: center;">627</td> <td style="text-align: center;">Octal</td> <td></td> </tr> <tr> <td style="text-align: center;">1K28</td> <td style="text-align: center;">630</td> <td style="text-align: center;">Octal</td> <td></td> </tr> <tr> <td style="text-align: center;">1K29</td> <td style="text-align: center;">631</td> <td style="text-align: center;">Octal</td> <td></td> </tr> <tr> <td style="text-align: center;">1K33</td> <td style="text-align: center;">632</td> <td style="text-align: center;">Octal</td> <td></td> </tr> <tr> <td style="text-align: center;">1K34</td> <td style="text-align: center;">633</td> <td style="text-align: center;">Octal</td> <td></td> </tr> <tr> <td style="text-align: center;">1K35</td> <td style="text-align: center;">634</td> <td style="text-align: center;">Octal</td> <td></td> </tr> <tr> <td style="text-align: center;">1K36</td> <td style="text-align: center;">635</td> <td style="text-align: center;">Octal</td> <td></td> </tr> <tr> <td style="text-align: center;">2K1</td> <td style="text-align: center;">636</td> <td style="text-align: center;">Octal</td> <td></td> </tr> <tr> <td style="text-align: center;">2K2</td> <td style="text-align: center;">637</td> <td style="text-align: center;">Octal</td> <td></td> </tr> <tr> <td style="text-align: center;">6J1</td> <td style="text-align: center;">640</td> <td style="text-align: center;">Octal</td> <td></td> </tr> <tr> <td style="text-align: center;">6J2</td> <td style="text-align: center;">641</td> <td style="text-align: center;">Octal</td> <td></td> </tr> <tr> <td style="text-align: center;">6J3</td> <td style="text-align: center;">642</td> <td style="text-align: center;">Octal</td> <td></td> </tr> <tr> <td style="text-align: center;">P21</td> <td style="text-align: center;">644</td> <td style="text-align: center;">Octal</td> <td></td> </tr> <tr> <td style="text-align: center;">P22</td> <td style="text-align: center;">645</td> <td style="text-align: center;">Octal</td> <td></td> </tr> <tr> <td style="text-align: center;">P23</td> <td style="text-align: center;">646</td> <td style="text-align: center;">Octal</td> <td></td> </tr> <tr> <td style="text-align: center;">μ7</td> <td style="text-align: center;">647</td> <td style="text-align: center;">Octal</td> <td></td> </tr> <tr> <td style="text-align: center;">7K2</td> <td style="text-align: center;">650</td> <td style="text-align: center;">Octal</td> <td></td> </tr> </table>	m8	614	1 count		1K9	616	1 count		1K30	617	1 count		2K17	620	1 count		μ19	621	Split integer		4K23	622	1 count		S623	623	Octal		1K4	624	Octal		1K24	625	Octal		1K26	626	Octal		1K27	627	Octal		1K28	630	Octal		1K29	631	Octal		1K33	632	Octal		1K34	633	Octal		1K35	634	Octal		1K36	635	Octal		2K1	636	Octal		2K2	637	Octal		6J1	640	Octal		6J2	641	Octal		6J3	642	Octal		P21	644	Octal		P22	645	Octal		P23	646	Octal		μ7	647	Octal		7K2	650	Octal	
m8	614	1 count																																																																																																												
1K9	616	1 count																																																																																																												
1K30	617	1 count																																																																																																												
2K17	620	1 count																																																																																																												
μ19	621	Split integer																																																																																																												
4K23	622	1 count																																																																																																												
S623	623	Octal																																																																																																												
1K4	624	Octal																																																																																																												
1K24	625	Octal																																																																																																												
1K26	626	Octal																																																																																																												
1K27	627	Octal																																																																																																												
1K28	630	Octal																																																																																																												
1K29	631	Octal																																																																																																												
1K33	632	Octal																																																																																																												
1K34	633	Octal																																																																																																												
1K35	634	Octal																																																																																																												
1K36	635	Octal																																																																																																												
2K1	636	Octal																																																																																																												
2K2	637	Octal																																																																																																												
6J1	640	Octal																																																																																																												
6J2	641	Octal																																																																																																												
6J3	642	Octal																																																																																																												
P21	644	Octal																																																																																																												
P22	645	Octal																																																																																																												
P23	646	Octal																																																																																																												
μ7	647	Octal																																																																																																												
7K2	650	Octal																																																																																																												

 Ullage counter (2 second count)  Ullage counter threshold (2 second count)  Gyro calibrate time duration (2 sec count)  Number of p iterations -3  Range/rate rate mark counter since last filter initialization  Steering delay after staging (40 msec count)  Crew selection of steering vector  Altitude and altitude rate display constant  Singularity threshold, FDAI compensation (rad)  X-axis alignment gain constant (1/rad)  Lunar align constant (rad/fps)  Lunar align constant (1/rad)  Lunar align stop criterion (rad)  Calibrate gain constant  Calibrate gain constant (1/20 ms)  Navigation sensed accelerometer bias threshold (fps)  Accelerometer calibration gain constant  Gravitational constant (ft cubed/sec sq)  Gravitational constant reciprocal  Negative lunar rate about X inertial axis (rad/20 ms)  Negative lunar rate about Y inertial axis (rad/20 ms)  Negative lunar rate about Z inertial axis (rad/20 ms)  ΔV sum for acceleration calibration (X)  ΔV sum for acceleration calibration (Y)  ΔV sum for acceleration calibration (Z)  Calibration counter  Noise in P-Matrix diagonals ||  |  |  | |                   |    |     |     |     |     | |-------------------|----|-----|-----|-----|-----| | 0 = not available | 01 | CSI | CDH | TPI | XDV | | 1 = available     | 1  | 1   | 1   | 1   | 1   | |





**LMA790-3-LM**  
**APOLLO OPERATIONS HANDBOOK**

PARA	TITLE	PAGE
4.5	G&C Reference Modes . . . . .	4.5-2
4.5.1	Attitude Control Modes . . . . .	4.5-2
4.5.1.1	RCS Primary Coil Enable . . . . .	4.5-2
4.5.1.2	PGNCS Automatic . . . . .	4.5-2A
4.5.1.3	PGNCS Attitude Hold/Rate Command . . . . .	4.5-4
4.5.1.4	PGNCS Minimum Impulse . . . . .	4.5-4A
4.5.1.5	AGS Automatic . . . . .	4.5-6
4.5.1.6	AGS Attitude Hold/Rate Command . . . . .	4.5-8
4.5.1.7	AGS Pulse . . . . .	4.5-10
4.5.1.8	AGS Direct . . . . .	4.5-12
4.5.1.9	ACA Hardover . . . . .	4.5-14
4.5.2	Translation Control Modes . . . . .	4.5-14
4.5.2.1	Descent Engine On/Off Control . . . . .	4.5-14
4.5.2.2	Ascent Engine On/Off Control . . . . .	4.5-19
4.5.2.3	Descent Engine Throttle Control . . . . .	4.5-22
4.5.2.4	GDA Enable . . . . .	4.5-27
4.5.2.5	RCS Translation . . . . .	4.5-28
4.5.3	Dynamic Display Modes . . . . .	4.5-30
4.5.3.1	PGNCS Total Attitude Display . . . . .	4.5-30
4.5.3.2	PGNCS Attitude Rate/Error Display . . . . .	4.5-32
4.5.3.3	AGS Total Attitude Display . . . . .	4.5-33
4.5.3.4	AGS Attitude Error Display . . . . .	4.5-34
4.5.3.5	Attitude Rate Display . . . . .	4.5-34
4.5.3.6	RR Shaft Angle/Trunnion Angle Display . . . . .	4.5-35
4.5.3.7	RR Azimuth Rate/Elevation Rate Display . . . . .	4.5-36
4.5.3.8	Forward Velocity/Lateral Velocity Display . . . . .	4.5-36
4.5.3.9	Altitude/Altitude Rate Display . . . . .	4.5-37
4.5.3.10	Range/Range Rate Display . . . . .	4.5-37
4.5.3.11	Thrust Display . . . . .	4.5-38
4.5.3.12	Radar Signal Strength Display . . . . .	4.5-39
4.5.3.13	Heater Control Temperature Monitor Display . . . . .	4.5-39
4.5.3.14	RR LOS Azimuth and Elevation Display (V85) . . . . .	4.5-40

**LMA790-3-LM**  
**APOLLO OPERATIONS HANDBOOK**

CREW-MAN	PNL	PROCEDURES	REMARKS
		<p><u>4.5 G4C REFERENCE MODES</u></p> <p>The G4C reference modes cover basic G4C functions in terms of related subsystem operating prerequisites and switch positions, and are limited in their scope to independent subsystem functions. The modes may be repeated and, in general, apply to G4C procedures; they are not intended as complete or self-contained procedures. Because some procedures do not require all operating prerequisites or switch positions in a given reference mode, they are accomplished without referring to that mode.</p> <p>When a G4C reference mode refers to another reference mode, reference is made by title and paragraph number and, where applicable, options are recommended.</p> <p>During time-critical procedures, reference to other sections or paragraphs of this handbook cannot be accommodated. Because time-critical procedures must be self-contained, information normally referred to by section or paragraph number is repeated within those procedures.</p> <p><u>4.5.1 ATTITUDE CONTROL MODES</u></p> <p><u>4.5.1.1 RCS Primary Coil Enable</u></p> <p>11    1.    CB RCS SYS A: QUAD 4 TCA - close</p> <p>         2.    CB RCS SYS A: QUAD 3 TCA - close</p> <p>         3.    CB RCS SYS A: QUAD 2 TCA - close</p> <p>         4.    CB RCS SYS A: QUAD 1 TCA - close</p> <p>16    5.    CB RCS SYS B: QUAD 1 TCA - close</p> <p>         6.    CB RCS SYS B: QUAD 2 TCA - close</p> <p>         7.    CB RCS SYS B: QUAD 3 TCA - close</p> <p>         8.    CB RCS SYS B: QUAD 4 TCA - close</p>	<p>Provides d-c power to primary coils of oxidizer and fuel valves of RCS systems A and B. This mode alone is not sufficient to allow RCS jets to fire via primary coils.</p> <p>Provides d-c power to primary coils of oxidizer and fuel valves of RCS system A, jets 4R and 4D.</p> <p>Provides d-c power to primary coils of oxidizer and fuel valves of RCS system A, jets 3R and 3U.</p> <p>Provides d-c power to primary coils of oxidizer and fuel valves of RCS system A, jets 2A and 2D.</p> <p>Provides d-c power to primary coils of oxidizer and fuel valves of RCS system A, jets 1F and 1U.</p> <p>Provides d-c power to primary coils of oxidizer and fuel valves of RCS system B, jets 1L and 1D.</p> <p>Provides d-c power to primary coils of oxidizer and fuel valves of RCS system B, jets 2L and 2U.</p> <p>Provides d-c power to primary coils of oxidizer and fuel valves of RCS system B, jets 3A and 3D.</p> <p>Provides d-c power to primary coils of oxidizer and fuel valves of RCS system B, jets 4F and 4U.</p>

**LMA790-3-LM**  
**APOLLO OPERATIONS HANDBOOK**

LM 3231, LM 3235

CREW-MAN	PNL	PROCEDURES	REMARKS
		<p>4.5.1.2 <u>PGNS Automatic</u></p> <p>LGC Power-Up (required)</p> <p>IMU Power-Up (LGC operating) (required)</p> <p>DAP Data Load Routine (R03) (required)</p> <p>RCS Primary Coil Enable (required)</p>	<p>In PGNS automatic mode, LGC provides following: Automatic steering (three-axis rotation) Automatic ullage Automatic rate compensation Attitude hold to program-defined attitude. X-axis override, whereby astronaut commands X-axis attitude rates proportional to ACA displacement, is available. Attained yaw attitude is maintained by LGC. (Maximum commanded rate is either 4° or 20°/second if docked as selected in DAP Data Load Routine).</p> <p>Ref para 4.6.1.1.1.</p> <p>Ref para 4.6.1.1.3. CB PGNS: IMU OPR also supplies d-c power to PSA, which develops 28v, 800-cps, single phase for ACA proportional excitation and TTCA throttling.</p> <p>Ref para 4.6.1.1.8.</p> <p>Most programs, and extended verbs that perform maneuvers, require P51 and check for it via R02.</p> <p>Ref para 4.5.1.1.1.</p>
	<p>11</p>	<p>1. CB RCS SYS A: QUAD 2 TCA - open (if docked with CSM)</p> <p>2. CB S/C: ATCA (PGNS) - close</p> <p style="text-align: center;">CAUTION</p> <p>To prevent inadvertent RCS jet firing, S/C: PGNS sw - OFF before CB S/C: ATCA (PGNS) - close</p>	<p>This step disables jet pair A2A/A2D to produce fewer jet firings, less bending excitation, and slight RCS propellant saving.</p> <p>Provides d-c power for selecting PGNS operation via GUID CONT sw - PGNS, bias to ATCA out-of-detent relay, and enable voltage to ATCA primary preamplifiers via S/C: PGNS sw - AUTO or ATT HOLD.</p>

G &  
REF  
MODE





**LMA790-3-LM**  
**APOLLO OPERATIONS HANDBOOK**

LM 3231, LM 3235

CREW MAN	PNL	PROCEDURES	REMARKS
	<p>1</p> <p>3</p>	<p>4.5.1.2 <u>PGNS Automatic (cont)</u></p> <p>3. Establish PGNS automatic control: GUID CONT sw - PGNS S/C: PGNS sw - AUTO</p>	<p>Sets bank of relays required for PGNS operation and for routing followup signal to AEA. Provides automatic discrete to LCC and routes +28-vdc enable signal to ATCA primary preamplifiers through contact closure established when GUID CONT sw - PGNS. When S/C: PGNS sw is moved out of OFF position to ATT HOLD or AUTO move switch guard to cover OFF position.</p>

C  
R  
M

**LMA790-3-LM**  
**APOLLO OPERATIONS HANDBOOK**

CREW- MAN	PNI	PROCEDURES	REMARKS
		<p>4.5.1.2 <u>PGNCS Automatic (cont)</u></p> <p>S/C: ROLL, PITCH, &amp; YAW sw - MODE CONT or PULSE</p> <p>4. Establish X-axis override capability: ACA PROP sw (2) - ENABLE</p> <p>5. ACA - maneuver as desired (X-axis only)</p> <p>4.5.1.3 <u>PGNCS Attitude Hold/Rate Command</u></p> <p>LGC Power-Up (required)</p> <p>IMU Power-Up (LGC Operating) (required)</p> <p>DAP Data Load Routine (ROJ) (required)</p> <p>IMU Orientation Determination (P51) (required)</p> <p>RCS Primary Coil Enable (required)</p> <p>1. CB RCS SYS A: QUAD 2 TCA - open (if docked with CSM)</p> <p>2. CB S/C: ATCA (PGNS) - close</p> <p style="text-align: center;">CAUTION</p> <p>To prevent inadvertent RCS jet firing, S/C: PGNS sw - OFF before CB S/C: ATCA (PGNS) - close.</p>	<p>Switches do not affect PGNCS attitude when set to MODE CONT or PULSE; if set to DIR, with ACA 2.5° out of detent, RCS jets will fire via secondary coils in addition to firing via primary coils. This results in acceleration to greater rate than commanded. LGC will attempt to maintain commanded rate by firing opposing jets.</p> <p>Provides 800-cps power to ACA proportional primary windings.</p> <p>LGC will ignore commands, via ACA, to fire RCS jets, except in X-axis.</p> <p>In PGNCS attitude hold/rate command mode, LGC provides LH stabilization and automatic rate damping. Attitude can be changed using ACA. When ACA is returned to detent, LGC DAP damps rate, stores attitude after rate damping, and holds to new attitude.</p> <p>Ref para 4.6.1.1.</p> <p>Ref para 4.6.1.3.</p> <p>CB PGNS: IMU OPR also supplies d-c power to PSA, which develops 28v, 800-cps, single phase for ACA proportional excitation and ITCA throttling.</p> <p>Ref para 4.6.1.8.</p> <p>Ref para 4.9.1.1.</p> <p>Ref para 4.5.1.1.</p> <p>This step disables jet pair A2A/A2D to produce fewer jet firings, less bending excitation, and slight RCS propellant savings.</p> <p>Provides d-c power for selecting PGNCS operation via GUID CONT sw - PGNS, bias to ATCA out-of-detent relay, and enable voltage to ATCA primary preamplifiers via S/C: PGNS sw - AUTO or ATT HOLD.</p>

**LMA790-3-LM**  
**APOLLO OPERATIONS HANDBOOK**

LM 3207, -M 3231, LM 3235

CREW-MAN	PNL	PROCEDURES	REMARKS
		<p>4.5.1.3 <u>PGNCS Attitude Hold/Rate Command (cont)</u></p> <p>3. Establish PGNCS attitude hold control: GUID CONT sw - PGNCS</p> <p>S/C: PGNS sw - ATT HOLD</p> <p>ROLL, PITCH, &amp; YAW sw - MODE CONT or PULSE</p>	<p>Sets bank of relays for PGNCS operation and for routing followup signal to AEA.</p> <p>Provides attitude hold discrete to LGC and routes +28-vdc enable signal to ATCA primary preamplifiers through contact closure established when GUID CONT sw - PGNCS.</p> <p>When S/C:PGNS sw is moved out of OFF position to ATT HOLD or AUTO move switch guard to cover OFF position.</p> <p>Switches do not affect PGNCS attitude control when set to MODE CONT or PULSE; if set to DIR, with ACA 2.5° out of detent, RCS jets will fire via secondary coils in addition to firing via primary coils. This results in acceleration to greater rate than commanded. LGC will attempt to maintain commanded rate by firing opposing jets.</p>
	1, 2	<p>4. Establish rate command capability: ACA PROP sw (2) - ENABLE</p> <p>Key V77E No DAP lt - off</p>	<p>Provides 800-cps power to ACA proportional primary winding.</p> <p>Required to establish rate command capability. Commanded rate is proportional to ACA displacement. Maximum commanded rate is either 4° or 20°/sec, as indicated in DAP Data Load Routine (R03). Ref para 4.6.1.8.</p>
	ACA	<p>5. ACA - maneuver as desired</p> <p>4.5.1.4 <u>PGNCS Minimum Impulse</u></p> <p>LGC Power-Up (required)</p> <p>IMU Power-Up (LGC Operating) (required)</p>	<p>Releases attitude hold on LM (free drift) and allows one impulse per each ACA displacement &gt;2.5° from detent.</p> <p>Ref para 4.6.1.1.</p> <p>Ref para 4.6.1.3.</p> <p>CB PGNCS: IMU OPR also supplies d-c power to PSA, which develops 28v, 800-cps, single phase for ACA proportional excitation and ITCA throttling.</p>

C &  
REF  
MOD



**LMA790-3-LM**  
**APOLLO OPERATIONS HANDBOOK**

LM 3207, LM 3231, LM 3235

CREW: MAN	PNL	PROCEDURES	REMARKS
		<p>4.5.1.4 <u>PGNS Minimum Impulse (cont)</u></p> <p>DAP Data Load Routine (R03) (required)</p> <p>IMU Orientation Determination (P51) (required)</p> <p>RCS Primary Coil Enable (required)</p> <p>1. CB S/C: ATCA (PGNS) - close</p> <p style="text-align: center;">CAUTION</p> <p>To prevent inadvertent RCS jet firing, S/C: PGNS sw - OFF before CB S/C: ATCA (PGNS) - close.</p> <p>2. Establish PGNS minimum impulse control: GUID CONT sw - PGNS</p> <p>S/C: PGNS sw - ATT HOLD</p> <p style="text-align: center;">ROLL, PITCH, &amp; YAW sw - MODE CONT</p> <p>Key V76E No DAP lt - on</p> <p>3. ACA - maneuver as desired</p>	<p>Ref para 4.6.1.8.</p> <p>Ref para 4.9.1.1.</p> <p>Ref para 4.5.1.1.</p> <p>Provides d-c power for selecting PGNS operation via GUID CONT sw - PGNS, bias to ATCA out-of-detent relay, and enable voltage to ATCA primary preamplifiers via S/C: PGNS sw - AUTO or ATT HOLD.</p> <p>Sets bank of relays for PGNS operation and for routing followup signal to AEA.</p> <p>Permits LGC to accept all ACA inputs. Provides attitude hold discrete to LGC and routes +28-vdc enable to ATCA primary preamplifiers through contact closure established when GUID CONT sw - PGNS.</p> <p>When S/C:PGNS sw is moved out of OFF position to ATT HOLD or AUTO move switch guard to cover OFF position.</p> <p>Switches must be set to MODE CONT to get minimum impulse.</p> <p>Establishes minimum impulse control and removes attitude hold capability. V77E, V36E, or ignition sequence in P12, P40, P41, P42, P63, P70, P71, and R40 terminates minimum impulse control and reestablishes attitude hold and rate command capabilities. (No DAP lt - off)</p>

G &  
RE  
MOD

LMA790-3-LM  
**APOLLO OPERATIONS HANDBOOK**

LM 3207, LM 3235

CREW-MAN	PNL	PROCEDURES	REMARKS
		<p>4.5.1.5 <u>AGS Automatic</u></p> <p>AGS Power-Up (required)</p> <p>AGS Checkout (desired)</p>	<p>Provides AEA automatic attitude control. In this mode, guidance steering (X-axis) (address 400+100000) and Z-axis steering (acquisition steering) (address 400+200000) should not be selected, unless specified by particular procedure. Selection of either steering mode at other times, while AGS automatic mode is in control, may cause LM attitude rate changes of 10°/second in pitch and 5°/second in roll and yaw.</p> <p>Ref para 4.6.2.1.</p> <p>Ref para 4.6.2.4.</p>

G & C  
 REF  
 MODES

**LMA790-3-LM**  
**APOLLO OPERATIONS HANDBOOK**

CREW: MAN	PNL	PROCEDURES	REMARKS
		<p>4.5.1.5 <u>AGS Automatic (cont)</u></p> <p>AGS LM/CSM state vector valid (required)</p> <p>PGNCS/AGS Align (required)</p> <p>RCS Primary Coil Enable (required)</p> <p>1. CB S/C: ATCA - close ATCA (AGS) - close</p> <p style="text-align: center;">CAUTION</p> <p>To prevent inadvertent RCS jet firing, S/C: AGS sw - OFF before CB S/C: ATCA (AGS) - close.</p> <p>2. Establish AGS automatic control: GUID CONT sw - AGS</p> <p>S/C: AGS sw - AUTO</p> <p>ROLL, PITCH, &amp; YAW sw - MODE CONT</p>	<p>AGS Initialization Routine (R47) (para 4.6.1.18), or AGS Manual LM State Vector Update/Initialization (para 4.6.2.7) and AGS Manual CSM State Vector Update/Initialization (para 4.6.2.9).</p> <p>Ref para 4.9.2.1. AGS initialization and alignment are required for guidance steering and Z-axis steering, but are not required when LM is holding attitude in AGS automatic mode.</p> <p>Ref para 4.5.1.1.</p> <p>Provides d-c power to ATCA power supply. Provides d-c power for selecting AGS operation via GUID CONT sw - AGS, bias for ATCA out-of-detent relay, and enable voltage to ATCA abort preamplifiers via S/C: AGS sw - AUTO or ATT HOLD.</p> <p>Sets bank of relays for AGS operation.</p> <p>Provides automatic discrete to AEA and routes +28-vdc enable voltage to ATCA abort preamplifiers through contact closure established when GUID CONT sw - AGS. Automatic DPS and APS engine-off signal path is established for AEA-generated engine-off commands.</p> <p>Switches route AEA attitude commands to ATCA and enable ATCA gimbal trim commands to be routed to DECA via GUID CONT sw - AGS. ATCA limits attitude rates, except when LM is staged and in wide deadband. In this configuration attitude rates of 29.6°/second could be attained, which are greater than AGS ability to follow and could result in loss of valid attitude rate data.</p>

G  
R  
M

**LMA790-3-LM**  
**APOLLO OPERATIONS HANDBOOK**

CREW- MAN	PNL	PROCEDURES	REMARKS
	1	<p>4.5.1.5 <u>AGS Automatic (cont)</u></p> <p>ENG THR CONT: BAL CPL sw - ON</p>	<p>Routes +28-vdc enable signal, provided via S/C: AGS sw - AUTO, to ATCA four up-firing abort preamplifiers. ENG THR CONT: BAL CPL sw - ON during all mission phases, except during APS engine burns. This permits RCS to add to net thrust when under AGS control.</p>
	3	<p>S/C: DEAD BAND sw - MAX or MIN</p>	<p>In MAX position, attitude deadband in roll, pitch, and yaw is 5°. In MIN position, attitude deadband in pitch and roll is 0.3°; in yaw, 0.4°. Minimum deadband is automatically provided during MPS thrusting, as backup to S/C: DEAD BAND sw. Attitude rate deadband, when unstaged, is <math>\pm 0.2^\circ/\text{second}</math> (narrow) and <math>\pm 3.33^\circ/\text{second}</math> (wide). Attitude rate deadband, when staged, is <math>\pm 0.75^\circ/\text{second}</math> (narrow) and <math>\pm 12.5^\circ/\text{second}</math> (wide).</p>
	1	<p>ATT/TRANSL sw - 2 JETS or 4 JETS</p>	<p>Selects either two- or four-jet operation for X-translation or pitch and roll attitude maneuvers.</p>
		<p>4.5.1.6 <u>AGS Attitude Hold/Rate Command</u></p>	<p>Provides automatic stabilization signals from ABA when ACA is in detent, and permits attitude changes with CES rate stabilization when ACA is moved out of detent.</p>
		<p>AGS Power-Up (required)</p>	<p>Ref para 4.6.2.1.</p>
		<p>AGS Checkout (desired)</p>	<p>Ref para 4.6.2.4.</p>
		<p>RCS Primary Coil Enable (required)</p>	<p>Ref para 4.5.1.1.</p>
	16	<p>1. CB S/C: ATCA - close</p> <p>ATCA (AGS) - close</p> <p style="text-align: center;">CAUTION</p> <p>To prevent inadvertent RCS jet firing, S/C: AGS sw - OFF before CB S/C: ATCA (AGS) - close.</p>	<p>Provides d-c power to ATCA power supply.</p> <p>Provides d-c power for selecting AGS operation via GUID CONT sw - AGS, bias for ATCA out-of-detent relay, and enable voltage to ATCA abort preamplifiers via S/C: AGS sw - AUTO or ATT HOLD.</p>
	1	<p>2. Establish AGS attitude hold control: GUID CONT sw - AGS</p>	<p>Sets bank of relays for AGS operation.</p>



# LMA790-3-LM

## APOLLO OPERATIONS HANDBOOK

CREW-MAN	PNI	PROCEDURES	REMARKS
		<p>4.5.1.1.6 <u>AGS Attitude Hold/Rate Command (cont)</u></p> <p>S/C: AGS sw - ATT HOLD</p> <p>ROLL, PITCH, &amp; YAW sw - MODE CONT</p> <p>ENG THR CONT: BAL CPL sw - ON</p> <p>S/C: DEAD BAND sw - MAX or MIN</p> <p>ATT/TRANSL sw - 2 JETS or 4 JETS</p> <p>3. Establish rate command capability: ACA PROP sw (2) - ENABLE</p> <p>4. ACA - maneuver as desired</p>	<p>Provides followup discrete (attitude hold and ACA out of detent) to AEA and routes +28-vdc enable signal to ATCA abort preamplifiers through contact closure established when GUID CONT sw - AGS.</p> <p>Switches route AEA attitude commands to ATCA and enable ATCA gimbal trim commands to be routed to DECA via GUID CONT sw - AGS.</p> <p>Routes +28-vdc enable signal, provided via S/C: AGS sw - ATT HOLD, to ATCA four up-firing abort preamplifiers.</p> <p>ENG THR CONT: BAL CPL sw - ON during all mission phases, except during APS engine burns. This permits RCS to add to net thrust when under AGS control.</p> <p>In MAX position, attitude deadband in roll, pitch, and yaw is 5°. In MIN position, attitude deadband in pitch and roll is 0.3°; in yaw, 0.4°. Minimum deadband is automatically provided during MPS thrusting, as backup to DEAD BAND sw. Attitude rate deadband, when unstaged, is <math>\pm 0.2^\circ/\text{second}</math> (narrow) and <math>\pm 3.33^\circ/\text{second}</math> (wide). Attitude rate deadband, when staged, is <math>\pm 0.75^\circ/\text{second}</math> (narrow) and <math>\pm 12.5^\circ/\text{second}</math> (wide).</p> <p>Selects either two- or four-jet operation for X-translation or pitch and roll attitude maneuvers. When switch is in 4 JETS position, high rate limit cycling can result when LM is in light ascent weight configuration. Switch to 4 JETS position only when failed jets prevent roll, pitch, or X-axis translation.</p> <p>Provides 800-cps power to ACA proportional primary windings.</p> <p>Commanded rate is proportional to ACA deflection. Maximum commanded rate is <math>20^\circ/\text{second}</math>.</p>
	3		
	1		
	3		
	1		
	1, 2 ACA		

LM 3231

G  
R  
E  
M  
O  
D

**LMA790-3-LM**  
**APOLLO OPERATIONS HANDBOOK**

CREW-MAN	P/NL	PROCEDURES	REMARKS
		<p>4.5.1.7 <u>AGS Pulse</u></p> <p>If all axes are not placed under AGS pulse mode:</p> <p>AGS Power-Up (required)</p> <p>AGS Checkout (desired)</p> <p>PGMCS/AGS Align (required)</p> <p>AGS state vector valid (required)</p>	<p>Permits manual initiation of angular acceleration commands through low-frequency pulsing of RCS jets by CES on individual-axis basis. In selected axis(es), automatic rate damping and AEA attitude control are lost (open-loop acceleration).</p> <p>Ref para 4.6.2.1.</p> <p>Ref para 4.6.2.4.</p> <p>Ref para 4.9.2.1.</p> <p>AGS Initialization Routine (R47) (para 4.6.1.18) or AGS Manual LM State Vector Update/Initialization procedure (para 4.6.2.7) and AGS Manual GSN State Vector Update/Initialization procedure (para 4.6.2.9). AGS initialization and alignment are required for guidance steering and Z-axis steering, but are not required when LM is holding attitude in AGS automatic mode.</p>
	16	<p>1. Following are required for AGS pulse control: RCS Primary Coil Enable CB S/C: ATCA - close</p> <p>ATCA (AGS) - close</p> <p style="text-align: center;">CAUTION</p> <p>To prevent inadvertent RCS jet firing, S/C: AGS sw - OFF before CB S/C: ATCA (AGS) - close.</p>	<p>Ref para 4.5.1.1.</p> <p>Provides d-c power to ATCA power supply.</p> <p>Provides d-c power for selecting AGS operation via GUID CONT sw - AGS, bias for ATCA out-of-detent relay, and enable voltage to ATCA abort preamplifiers via S/C: AGS sw - AUTO or ATT HOLD.</p>
	1	<p>2. Establish AGS pulse control: GUID CONT sw - AGS</p>	<p>Sets bank of relays for AGS operation.</p>

**LMA790-3-LM**  
**APOLLO OPERATIONS HANDBOOK**

CREW-MAN	PNL	PROCEDURES	REMARKS
	3	<p>4.5.1.7 <u>AGS Pulse (cont)</u></p> <p>S/C: AGS sw - AUTO</p> <p>or select:</p> <p>S/C: AGS sw - ATT HOLD</p> <p>DEAD BAND sw - MAX or MIN</p> <p>ENG THR CONT: BAL CPL sw - ON</p> <p>CB S/C: ATT DIR CONT - close</p> <p>S/C: ROLL, PITCH, &amp; YAW sw - PULSE (selectable on individual-axis basis)</p>	<p>If all axes are not wanted under pulse control, remaining axis(es) can be controlled with S/C: AGS sw - AUTO or ATT HOLD. Do not set S/C: AGS sw - OFF. S/C: AGS sw - AUTO provides automatic discrete to AZA and routes enable voltage to ATCA abort preamplifiers through contact closure established when GUID CONT sw - AGS. If AUTO position is selected, guidance steering (X-axis) (address 400+10000) and Z-axis steering (address 400+20000) should not be selected, unless specified by particular procedure. Selection of either steering mode while in AGS automatic mode could result in vehicle attitude rates of 10°/second in all three axes.</p> <p>Provides followup discrete (attitude hold and ACA out of detent) to AZA and routes +28-vdc enable signal to ATCA abort preamplifiers through contact closure established when GUID CONT sw - AGS.</p> <p>Deadband is not in effect in axis(es) selected for pulse control. Minimum deadband is automatically provided during MPS thrusting. In MAX position, deadband in roll, pitch, and yaw is 5°. In MIN position, deadband in pitch and roll is 0.3°; in yaw, 0.4°.</p> <p>Routes +28-vdc enable signals, provided via S/C: AGS sw - ATT HOLD or AUTO, to ATCA four up-firing abort preamplifiers. ENG THR CONT: BAL CPL sw - ON during all mission phases, except during APS engine burns. This permits RCS to add to net thrust when under AGS control.</p> <p>Provides d-c power to S/C: ROLL, PITCH, &amp; YAW sw for direct and pulse mode operation.</p> <p>Inhibits AZA attitude errors and ACA rate commands to ATCA (selected axis only). Inhibits rate damping (open-loop acceleration in selected axis only). Inhibits routing of ATCA gimbal commands to DECA (selected axis only). Routes ACA pulse commands to ATCA jet logic.</p>
	1		
	11		
	3		

**LMA790-3-LM**  
**APOLLO OPERATIONS HANDBOOK**

CREW-MAN	PNL	PROCEDURES	REMARKS
		<p style="text-align: center;"><u>4.5.1.7 AGS Pulse (cont)</u></p> <p style="text-align: center;"><b>CAUTION</b></p> <p>If manual override about any axis (except X-axis when in attitude hold or in guidance steering, or Z-axis when in Z-body-axis steering) is commanded, oscillations can build up in other axes. If this occurs in attitude hold, ACA should be momentarily taken out of detent.</p>	<p>If manual override is required as a backup in one or more axes, with AGS in automatic control, it is assumed that computed attitude errors will be kept near null manually; therefore, oscillation problem will not occur.</p>
	ACA	<p>3. ACA - maneuver as desired</p> <p style="text-align: center;"><u>4.5.1.8 AGS Direct</u></p> <p>If all axes are not placed under AGS direct mode:</p> <p>AGS Power-Up (required)</p> <p>AGS Checkout (desired)</p> <p>RCS Primary Coil Enable (required)</p> <p>PCMCS/AGS Align (required)</p> <p>AGS state vector valid (required)</p>	<p>As long as ACA is held 2.5° out of detent, ATCA issues pulse commands of approximately 0.016 second duration at rate of approximately 4.3 pulses/second.</p> <p>Permits manual initiation of angular acceleration commands through on-off firing of RCS jets (two-jet operation direct to secondary coils) on individual-axis basis. In selected axis(es), automatic rate damping and AZA attitude control are lost (open-loop acceleration).</p> <p>Ref para 4.6.2.1.</p> <p>Ref para 4.6.2.4.</p> <p>Ref para 4.5.1.1.</p> <p>Ref para 4.9.2.1.</p> <p>AGS Initialization Routine (RA7) (para 4.6.1.18), or AGS Manual LM State Vector Update/Initialization procedure (para 4.6.2.7) and AGS Manual CSM State Vector Update/Initialization procedure (para 4.6.2.9). AGS initialization and alignment are required for guidance steering and Z-axis steering, but are not required when LM is holding attitude in AGS automatic mode.</p> <p>Provides d-c power to ATCA power supply.</p>
	16	<p>CB S/C:  ATCA - close  ATCA (AGS) - close</p>	<p>Provides d-c power for selecting AGS operation via GUID CONT sw - AGS, bias to ATCA out-of-detent relay, and enable voltage for ATCA abort preamplifiers via S/C:  AGS sw - AUTO or ATT HOLD.</p>



**LMA790-3-LM**  
**APOLLO OPERATIONS HANDBOOK**

LM 3231

CREW- MAN	PNI	PROCEDURES	REMARKS
	3	<p>4.5.1.8 <u>ACS Direct (cont)</u></p> <p>S/C: ROLL, PITCH, &amp; YAW sw - DIRECT (selectable on individual-axis basis)</p> <p style="text-align: center;">CAUTION</p> <p>If manual override about any axis (except X-axis when in attitude hold or in guidance steering, or Z-axis when in 2-body-axis steering) is commanded, oscillations can build up in other axes. If this occurs in attitude hold, ACA should be momentarily taken out of detent.</p>	<p>Inhibits AEA attitude error and ACA rate commands to ATCA (selected axis only). Inhibits rate damping (open-loop acceleration in selected axis only). Inhibits ATCA gimbal commands to DECA (selected axis only) and routes +28 vdc to DIRECT contact of ACA.</p> <p>If manual override is required as backup in one or more axes, with AGS in automatic control, it is assumed that computed attitude errors will be kept near null manually; therefore, oscillation problem will not occur.</p>
ACA		4. ACA - maneuver as desired	As long as ACA is held 2.5° out of detent, RCS jets will fire continuously.
		4.5.1.9 <u>ACA Hardover</u>	Provides override of attitude control by routing CES on-off commands to RCS secondary coils for four-jet operation.
11		1. CB S/C: ATT DIR CONT - close	Provides 28 vdc to ACA 12° switch (hardover) via ACA/4 JET sw - ENABLE.
	4	2. Establish hardover control: ACA/4 JET sw (CDR/LMP) - ENABLE	Routes 28 vdc to ACA 12° switch (hardover) from CB/SC: ATT DIR CONT.
ACA		ACA (CDR/LMP) - maneuver as desired	Hardover command is initiated when ACA is moved 12° out of detent (12° switches close) and 28 vdc is routed to RCS secondary coils.
		4.5.2 <u>TRANSLATION CONTROL MODES</u>	Provides configuration for starting and stopping descent engine, using PGCS, AGS, and manual control.
		4.5.2.1 <u>Descent Engine On/Off Control</u>	
	1.	PGCS control: LGC Power-Up (required) IMU Power-Up (LGC Operating) (required) PGCS Prethrust Program (required)	Ref para 4.6.1.1. Ref para 4.6.1.3. Ref para 4.7.1 or P63.

Basic Date 26 September 1971

Change Date \_\_\_\_\_

**LMA790-3-LM**  
**APOLLO OPERATIONS HANDBOOK**

CREW: MAN	PNI	PROCEDURES	REMARKS
		4.5.2.1 <u>Descent Engine On/Off Control (cont)</u>	
	11	a. Eng on: CB S/C: DECA PWR - close	Provides d-c power to descent engine-arming and engine-on relays in DECA.
	16	CB S/C: ENG ARM - close	Provides d-c power for automatic engine-on logic and energizes relays for routing arming and engine-on commands via ENG THR CONT: ENG ARM sw - DES.
	11	CB S/C: ATCA (PGNS) - close	Provides d-c power for selecting PGNS operation via GUID CONT sw - PGNS.
	1	ABORT STAGE pb - reset	Prevents descent engine-on relays from becoming deenergized.
	5, 6	Eng STOP pb/lit - reset	Completes signal path to engine-arming relays from ENG THR CONT: ENG ARM sw - DES.
	1	GUID CONT sw - PGNS	Sets bank of relays required for PGNS operation and for routing followup signal to AEA.
		ENG THR CONT: ENG ARM sw - DES	Routes d-c power to engine-arming relays through engine STOP pb/lit - reset.
		LCC eng-on command	Issued by LCC after both of following conditions are met: (1) ullage is acknowledged by PRO response to FL V99 (ullage translation is automatic) and (2) nominal ignition time is reached.
	11	b. Eng off: CB S/C: ATCA (PGNS) - close	Provides d-c power for selecting PGNS operation via GUID CONT sw - PGNS.
	16	CB S/C: ENG ARM - close	Provides d-c power for automatic engine-off logic.

G &  
RE  
MOD

**LMA790-3-LM**  
**APOLLO OPERATIONS HANDBOOK**

CREW-MAN	PNI	PROCEDURES	REMARKS
		<b>4.5.2.1 Descent Engine On/Off Control (cont)</b>	
	1	GUID CONT sw - PCNS	Sets bank of relays required for automatic engine-off command.
	3	S/C: PCNS sw - AUTO	Provides automatic discrete to LGC and establishes automatic descent engine-off signal path for LGC-generated engine-off commands.
		LGC eng-off command	Issued by LGC when shutoff criteria are reached.
		or select:	
	5, 6	Eng STOP pb/lt - push	Provides backup, manual descent engine-off control by removing descent engine-arming signal.
	1	ENG THR CONT: ENG ARM sw - OFF	
		or select:	
	5, 6	Eng STOP pb/lt - push	
	1	ABORT pb - reset	Removes redundant power and arming signal path to descent engine-arming relays.
		ENG THR CONT: ENG ARM sw - OFF	
		2. AGS control:	
		AGS Power-Up (required)	Ref para 4.6.2.1.
		AGS Prethrust Program (required)	Ref para 4.7.1.
		RCS Translation (required)	Ref para 4.5.2.5.
		a. Eng on:	RCS translation required for ullage.
	11	CB S/C: ENG CONT - close	Provides d-c power to descent engine-arming and engine-on relays in DECA.
	16	CB S/C: ENG ARM - close	Provides d-c power for automatic engine-on logic and energizes relays for routing arming and engine-on commands via ENG THR CONT: ENG ARM sw - DES.
	11	CB S/C: DECA PWR - close	Provides d-c power to descent engine-arming and engine-on relays in DECA



**LMA790-3-LM**  
**APOLLO OPERATIONS HANDBOOK**

CREW-MAN	PNL	PROCEDURES	REMARKS
		4.5.2.1 Descent Engine On/Off Control (cont.)	
	16	CB S/C: ATCA (AGS) - close	Provides d-c power for selecting AGS operation via GUID CONT sw - AGS.
	1	ABORT STAGE pb - reset	Prevents descent engine-on relays from becoming deenergized.
	5, 6	Eng STOP pb/lc - reset	Completes signal path to engine-arming relays when ABORT pb - push or ENG THR CONT: THR CONT sw - DES.
	1	GUID CONT sw - AGS	Sets bank of relays required for AGS operation.
	3	S/C: AGS sw - AUTO	Provides automatic discrete to AEA, required for automatic engine-on command. Automatic DPS and APS engine-off signal path is established.
	1	ABORT pb - push	Provides abort discrete to AEA, required for automatic engine-on command and routes d-c power to engine-arming and engine-on relays.
		ENG THR CONT: ENG ARM sw - DES	Provides redundant d-c power to descent engine-arming and engine-on relays.
		AEA eng-on command	Issued by AEA after manual ullage translation has been performed.
	16	b. Eng off: CB S/C: ENG ARM - close	Provides d-c power for automatic engine-off logic.
		ATCA (AGS) - close	Provides d-c power for selecting AGS operation via GUID CONT sw - AGS.
	1	ABORT pb - push	Provides abort discrete to AEA, which provides automatic off command by AEA.
		GUID CONT sw - AGS	Sets bank of relays required for AGS operation.
	3	S/C: AGS sw - AUTO	Provides automatic discrete to AEA, which provides automatic off command and establishes automatic DPS and APS engine-off signal path for AEA-generated engine-off commands.
	1	AEA eng-off command ENG THR CONT: ENG ARM sw - OFF	Issued by AEA when shutoff criteria are reached.

G  
RE  
MO

**LMA790-3-LM**  
**APOLLO OPERATIONS HANDBOOK**

CREW-MAN	PNI	PROCEDURES	REMARKS
		4.5.2.1 Descent Engine On/Off Control (cont)	
		3. Manual control:	
	16	a. Eng on: CB S/C: ENG ARM - close	Provides d-c power for energizing relays for routing engine-arming and engine-on commands via ENG THR CONT: ENG ARM sw - DES.
	11	CB S/C: ENG START OVRD - close	Provides d-c power for setting manual start relay via eng START pb/lt - push.
		DECA FWR - close	Provides d-c power to descent engine-arming and engine-on relays in DECA.
		ENG CONT - close	Provides d-c power for energizing manual engine-on relays via ENG THR CONT: ENG ARM sw - DES.
	1	ABORT STAGE pb - reset	Prevents descent engine-on command relays from being reset.
	5, 6	Eng STOP pb/lt - reset	Completes signal path to engine-arming relays when ENG THR CONT: ENG ARM sw - DES.
	TTCA	THROTTLE/JETS cont (CDR or LMP) - JETS	Selects X-axis jets.
	1	ENG THR CONT: ENG ARM sw - DES	Routes d-c power to engine-arming relays and to manual start relay.
	TTCA	ITCA (CDR or LMP) - move up or +X TRANSL pb - push & hold	Provides required ullage control.
	5	Eng START pb/lt - push	Momentary pushbutton, which energizes manual descent engine start relays.
	11	b. Eng off: CB S/C: ENG CONT - close	Provides d-c power to manual descent engine stop relay when eng STOP pb/lt - push.
	5, 6	Eng STOP pb/lt - push	Routes d-c power to manual descent engine stop relay and removes d-c power from descent engine-arming relay.
	1	ENG THR CONT: ENG ARM sw - OFF	Provides backup, manual stop by deenergizing manual descent engine start relay.

**LMA790-3-LM**  
**APOLLO OPERATIONS HANDBOOK**

CREW/ MAN	PNL	PROCEDURES	REMARKS
		<p>4.5.2.2 <u>Ascent Engine On/Off Control</u></p> <p>1. PGNS control:</p> <p style="padding-left: 20px;">LGC Power-Up (required)</p> <p style="padding-left: 20px;">IMU Power-Up (LGC Operating) (required)</p> <p style="padding-left: 20px;">PGNS Prethrust Program (required)</p> <p style="padding-left: 20px;">a. Eng on: CB S/C: ATCA (PGNS) - close</p> <p style="padding-left: 20px;">16 CB S/C: ENG ARM - close</p> <p style="padding-left: 20px;">ATCA - close</p> <p style="padding-left: 20px;">CB S/C: AELD - close</p> <p style="padding-left: 20px;">Eng STOP pb/lt - reset</p> <p style="padding-left: 20px;">GUID CONT sw - PGNS</p> <p style="padding-left: 20px;">ENG THR CONT: ENG ARM sw - ASC</p> <p style="padding-left: 20px;">LGC eng-on command</p> <p style="padding-left: 20px;">b. Eng off: CB S/C: ENG ARM - close</p> <p style="padding-left: 20px;">11 CB S/C: ATCA (PGNS) - close</p> <p style="padding-left: 20px;">1 GUID CONT sw - PGNS</p>	<p>Provides configuration for starting and stopping ascent engine, using PGNS, AGS, and manual control.</p> <p>Ref para 4.6.1.1.1.</p> <p>Ref para 4.6.1.1.3.</p> <p>Ref para 4.7.1.1.</p> <p>Provides d-c power for selecting PGNS operation via GUID CONT sw - PGNS.</p> <p>Provides d-c power for automatic engine-on logic and energizes relays for routing arming and engine-on commands via ENG THR CONT: ENG ARM sw - ASC.</p> <p>Provides d-c power to ATCA power supply, which develops power for automatic ascent engine on-off logic.</p> <p>Provides redundant d-c power for engine-on commands.</p> <p>Completes signal path required for energizing automatic engine-on relays.</p> <p>Sets bank of relays required for PGNS operation and for routing followup signal to AEA.</p> <p>Routes d-c power to engine-arm relays.</p> <p>Issued by LGC after both of following conditions are met: (1) ullage is acknowledged by PRO response to FL V99 (ullage translation is automatic) and (2) nominal ignition time is reached.</p> <p>Provides d-c power for automatic engine-off logic.</p> <p>Provides d-c power for selecting PGNS operation via GUID CONT sw - PGNS.</p> <p>Sets bank of relays required for PGNS automatic engine-off command.</p>

G &  
REF  
MODE

**LMA790-3-LM**  
**APOLLO OPERATIONS HANDBOOK**

CREW-MAN	PNL	PROCEDURES	REMARKS
	3	<p>4.5.2.2 Ascent Engine On/Off Control (cont)</p> <p>S/C: PGNS sw - AUTO</p> <p>LGC eng-off command</p> <p>ENG THR CONT: ENG ARM sw - OFF</p>	<p>Provides automatic discrete to LGC and establishes signal path for LGC-generated engine-off commands.</p> <p>Issued by LGC when shutoff criteria are reached.</p> <p>Removes backup arming function and issues ascent engine stop discrete to ascent engine.</p>
	1	<p>2. AGS control:</p> <p>AGS Power-Up (required)</p> <p>AGS Prethrust (required)</p> <p>RCS Translation (required)</p>	<p>Ref para 4.6.2.1.</p> <p>Ref para 4.7.1.</p> <p>Ref para 4.5.2.5.</p> <p>RCS translation required for ullage.</p>
	16	<p>a. Eng on: CB S/C: ENG ARM - close</p> <p>ATCA - close</p>	<p>Provides d-c power for automatic ascent engine-on logic and energizes automatic engine-on relays via ENG THR CONT: ENG ARM sw - ASC.</p> <p>Provides d-c power to ATCA power supply, which develops power for automatic ascent engine on-off logic.</p>
	11 16	<p>CB ED: LOGIC A - close CB ED: LOGIC B - close</p>	<p>Provides d-c power for APS pressurization and staging sequence relays when ABORT STAGE pb - push.</p>
	11,16	<p>CB S/C: AELD - close</p>	<p>Provides redundant d-c power for engine-on commands.</p>
	16	<p>CB S/C: ATCA (AGS) - close</p>	<p>Provides d-c power for selecting AGS operation via GUID CONT sw - AGS.</p>
	11,16	<p>CB S/C: ABORT STAGE - close</p>	<p>Provides d-c power for arming relays and abort stage discrete relays when ABORT STAGE pb - push.</p>
	5, 6	<p>Eng STOP pb/lc - reset</p>	<p>Completes signal path required for energizing automatic engine-on relays.</p>
	1	<p>GUID CONT sw - AGS</p>	<p>Sets bank of relays required for AGS operation.</p>

**LMA790-3-LM**  
**APOLLO OPERATIONS HANDBOOK**

CREW: MAN	PNI	PROCEDURES	REMARKS
	3	<p>4.5.2.2 <u>Ascent Engine On/Off Control (cont)</u></p> <p>S/C: AGS sw - AUTO</p>	<p>Provides automatic discrete to AEA, required for issuance of automatic engine-on command. Automatic DPS and APS engine-off signal path is established.</p>
	1	<p>ABORT STAGE pb - push</p> <p>ENG THR CONT: ENG ARM sw - ASC</p> <p>AEA eng-on command</p> <p>b. Eng off: CB S/C: ABORT STAGE - close</p>	<p>Routes d-c power to arming and abort stage discrete relays. Abort stage discrete to AEA is required for automatic engine-on command.</p> <p>Provides redundant d-c power to ascent engine-arming relay.</p> <p>Issued by AEA after manual ullage translation has been performed.</p> <p>Provides redundant power to abort stage discrete relays when ABORT STAGE pb - push. Abort stage discrete is required by AEA to issue automatic engine-off command.</p>
	16	<p>CB S/C: ENG ARM - close</p> <p>ATCA (AGS) - close</p>	<p>Provides d-c power for automatic engine-off logic.</p> <p>Provides d-c power for selecting AGS operation via GUID CONT sw - AGS.</p>
	1	<p>ABORT STAGE pb - push</p>	<p>Provides abort stage discrete to AEA, required for automatic engine-off command.</p>
	3	<p>GUID CONT sw - AGS</p> <p>S/C: AGS sw - AUTO</p>	<p>Sets bank of relays required for AGS operation.</p> <p>Provides automatic discrete to AEA, required for AEA automatic engine-off command, and establishes automatic DPS and APS engine-off signal path for AEA-generated engine-off commands.</p>
	1	<p>AEA eng-off command</p> <p>ENG THR CONT: ENG ARM sw - OFF</p> <p>ABORT STAGE pb - reset</p>	<p>Issued by AEA when shutoff criteria are reached.</p> <p>Removes d-c power to arming and abort stage discrete relays.</p>

G &  
RE  
MOD

**LMA790-3-LM**  
**APOLLO OPERATIONS HANDBOOK**

CREW- MAN	PNL	PROCEDURES	REMARKS
		<p><u>4.5.2.2 Ascent Engine On/Off Control (cont)</u></p> <p>3. Manual control:</p> <p style="padding-left: 20px;">a. Eng on: CB S/C: AKLD - close</p> <p style="padding-left: 20px;">CB S/C: ENG START OVRD - close</p> <p style="padding-left: 20px;">Eng STOP pb/lt - reset</p> <p style="padding-left: 20px;">ENG THR CONT: ENG ARM sw - ASC</p> <p style="padding-left: 20px;">Eng START pb/lt - push</p> <p style="padding-left: 20px;">b. Eng off: CB S/C: ENG CONT - close</p> <p style="padding-left: 20px;">Eng STOP pb/lt - push</p> <p style="padding-left: 20px;">ENG THR CONT: ENG ARM sw - OFF</p> <p><u>4.5.2.3 Descent Engine Throttle Control</u></p> <p>1. FCWCS control:</p> <p style="padding-left: 20px;">a. Automatic throttling: LCC Power-Up (required)</p>	<p>Provides redundant d-c power for engine-on commands.</p> <p>Provides d-c power for ascent engine-arming and start relays via ENG THR CONT: ENG ARM sw - ASC.</p> <p>Prevents ascent engine-arming and start relays from being reset.</p> <p>Routes d-c power to ascent engine-arming and start relays.</p> <p>Momentary pushbutton, which energizes arming and start relays.</p> <p>Provides d-c power for energizing relay that resets manual arming and start relays.</p> <p>Removes engine-on command by routing d-c power to relay that resets manual arming and start relays.</p> <p>Provides backup, manual stop command by deenergizing start relays.</p> <p>Establishes configuration for FCWCS (automatic and manual) and AGS (manual only) throttling control of descent engine and provides steps for switching from automatic to manual and from manual to automatic throttling control.</p> <p>Ref para 4.6.1.1.</p>
	11, 16		
	11		
	5, 6		
	1		
	5		
	11		
	5, 6		
	1		

**LMA790-3-LM**  
**APOLLO OPERATIONS HANDBOOK**

CREW-MAN	PNL	PROCEDURES	REMARKS
		<p>4.5.2.3 <u>Descent Engine Throttle Control (cont)</u></p> <p>CB S/C:            ATCA - close            ENG ARM - close            CB/AC BUS A: DECA GMBL - close</p> <p>Establish PCNGS automatic throttling control:            GUID CONT sw - PCNS            S/C: PCNS sw - AUTO            ENG THR CONT: THR CONT sw - AUTO</p>	<p>Provides d-c power to ATCA power supply, which develops power for automatic throttling circuits.</p> <p>Sets relays for PCNGS operation.</p> <p>Routes automatic thrust discrete to LGC and permits automatic throttling commands from LGC to be routed to throttle valve actuator assembly. With ENG THR CONT: THR CONT sw - AUTO, manual commands from ITCA's may also be routed to throttle valve actuator. Manual command voltage will be added to automatic command voltage in descent engine throttle actuator; resultant effective command voltage will be sum of two voltages.</p>
	16	<p>b. Manual throttling:            CB PCNS: IMU OPR - close            CB FLT DISP: THRUST - close</p>	<p>Provides d-c power to PSA, which develops 28v, 800 cps, for TTCA throttling excitation.</p>
	11	<p>Following provides backup d-c power to manual throttling circuits:            CB S/C: ENG ARM - close</p>	<p>Provides d-c power to ATCA power supply, which develops power for manual throttling circuits.</p>
	16	<p>ABORT pb - reset</p> <p>ENG THR CONT: ENG ARM sw - DES</p>	<p>Provides d-c power for energizing automatic engine-on relays.</p> <p>Completes return path to CB S/C: ENG ARM.</p>
	1	<p>CB/AC BUS A: DECA GMBL - close</p>	<p>Routes 28-vdc power to energize arming relays, which route 400-cps power to DECA auxiliary power supply.</p>
	11	<p>Establish PCNGS manual throttling control:            GUID CONT sw - PCNS</p>	<p>Provides 400-cps power to DECA auxiliary power supply, which provides backup voltage for manual throttling circuits.</p>
	1		<p>Routes 800-cps power from PSA to ITCA.</p>

G & C  
REF  
MODES

**LMA790-3-LM**  
**APOLLO OPERATIONS HANDBOOK**

LH 3231

CREW: MAN	PNI	PROCEDURES	REMARKS
		<p>4.5.2.3 <u>Descent Engine Throttle Control (cont)</u>            ENG THR CONT: MAN THROT sw - CDR or SE</p> <p>THRITTLE/JETS cont (CDR and/or LMP) - THROTTLE            Throttle friction cont (CDR/LMP) - adjust as desired</p> <p>ENG THR CONT: THR CONT sw - MAN</p> <p>TTCA (CDR/LMP) - move as desired</p> <p style="text-align: center;">CAUTION</p> <p>Operation in transient region (65% to 92.5%) causes excessive eng erosion.</p> <p>Rough combustion may be expected at start of DPS burns, due to gas ingestion in propellants. Roughness can last as long as 25 sec, depending on how quickly eng is throttled up. There is no constraint on throttling due to this roughness.</p> <p>c. Automatic to manual throttle switchover:            CB FLI DISP: THRUST - close</p> <p>Establish configuration for PGNC manual throttle control, except as follows:            ENG THR CONT: THR CONT sw - AUTO</p> <p>TTCA (CDR/LMP) - slowly increase throttle command</p>	<p>Provides manual throttling control authority to CDR or LMP and routes 800-cps power to TTCA and to manual throttling circuits.</p> <p>Enables TTCA throttling capability.</p> <p>Each control varies force required to move associated TTCA in +X-direction. They are operative only when associated THROTTLE/JETS cont - THROTTLE. Force required to move TTCA varies from 0.25 to 1 pound (minimum force) to 2.5 to 3.5 pounds (maximum force).</p> <p>Permits crew to monitor manual throttling commands on CMD THRUST ind and removes automatic throttling commands.</p> <p>Throttle control varies from 10% to 92.5% (based upon 100% = 10,500-pound thrust), with capability of selective throttling from 10% to 65%.</p> <p>Assumption: DPS automatic throttle control was initiated. Switchover procedure is required to attain smooth transition in throttling authority.</p> <p>As TTCA thrust command is increased (when LCC thrust commands are in throttleable region), every 2 seconds in P63, and P64, and every 1 second in P66, LCC commands decrease correspondingly so that effective thrust level is returned to desired level. Avoid unnecessary operation in region from 65% to 92.5%.</p>



**LMA790-3-LM**  
**APOLLO OPERATIONS HANDBOOK**

LM 3231 CREW- MAN	PNL	PROCEDURES	REMARKS
	1	<p>4.5.2.3 <u>Descent Engine Throttle Control (cont)</u></p> <p>CMD &amp; ENG THRUST ind - monitor When thrust = 10% &amp; eng pressures show slight increase: ENG THR CONT: THR CONT sw - MAN</p>	<p>Due to internal bias, CMD THRUST ind cannot read less than 10%. Full manual authority is established when ENG THRUST ind remains at increase in response to TTCA increase. Only at this point can ENG THR CONT: THR CONT sw be set to MAN without subjecting DPS to minus A thrust command. ENG THR CONT: THR CONT sw - MAN removes automatic throttling commands and permits crew to monitor manual throttling commands on CMD THRUST ind. Automatic DPS shutdown is still enabled.</p>
	TTCA	<p>TTCA - adjust thrust level as desired</p> <p>d. Manual to automatic throttling switchover: Establish configuration for PCNCS automatic throttling control:</p> <p>TTCA - slowly decrease to minimum thrust position</p>	<p>Assumption: DPS manual throttling mode was initiated. When ENG THR CONT: THR CONT sw - AUTO, LGC may command thrust level greater than existing thrust level.</p> <p>Gradually decrease TTCA to minimum position. LGC will increase thrust commands correspondingly (when LGC thrust commands are in throttlable region) at 2-second intervals for P63, and P64 and 1-second intervals for P66 if existing thrust level is to be maintained. Under automatic throttling control, thrust level cannot be less than that commanded by TTCA. If manual DPS start was used, manual DPS shutdown is required.</p>
		<p style="text-align: center;"><b>CAUTION</b></p> <p>Operation in transient region (65% to 92.5%) causes excessive eng erosion.</p> <p>Rough combustion may be expected at start of DPS burns, due to gas ingestion in propellants. Roughness can last as long as 25 sec, depending on how quickly eng is throttled up. There is no constraint on throttling due to this roughness.</p>	

M  
G  
O

**LMA790-3-LM**  
**APOLLO OPERATIONS HANDBOOK**

CREW-MAN	PNL	PROCEDURES	REMARKS
		<p>4.5.2.3 Descent Engine Throttle Control (cont)</p> <p>2. AGS control (manual throttling only):</p> <p>CB S/C: ATCA - close</p> <p>Following provides backup d-c power to manual throttling circuits:            CB S/C: ENG ARM - close            ABORT pb - reset            ENG THR CONT: ENG ARM sw - DES            CB/AC BUS A: DECA GMBL - close</p> <p>Establish AGS manual throttling control:            GUID CONT sw - AGS            ENG THR CONT: MAN THROT sw - CDR or SE</p> <p>THRITTLE/JETS cont (CDR/LMP) - THRITTLE            Throttle friction cont (CDR/LMP) - adjust as desired</p> <p>ENG THR CONT: THR CONT sw - MAN            TTCA (CDR/LMP) - move as desired</p>	<p>Provides d-c power to ATCA power supply, which develops e-c and d-c power for manual throttling circuits.</p> <p>Provides d-c power for energizing engine-arming relays. Completes return path to CB S/C: ENG ARM.</p> <p>Routes 28-vdc power to energize relay, which routes 400-cps power to DECA auxiliary power supply.</p> <p>Furnishes 400-cps power to DECA auxiliary power supply, which provides backup voltage for manual throttling circuits.</p> <p>Routes 800-cps power from ATCA power supply to TTCA.</p> <p>Provides manual throttle control authority to CDR or LMP and routes 800-cps power to ATCA and to manual throttling circuits.</p> <p>Enables TTCA throttling capability.</p> <p>Each control varies force required to move associated TTCA in +X-direction. They are operative only when associated THRITTLE/JETS cont - THRITTLE. Force required to move TTCA varies from 0.25 to 1 pound (minimum force) to 2.5 to 3.5 pounds (maximum force).</p> <p>Permits crew to monitor manual throttle commands on CMD THRUST ind and removes automatic throttle commands.</p> <p>Throttle control varies from 10% to 92.5% (based upon 100% = 10,500-pound thrust), with capability of selective</p>
	16		
	1		
	11		
	1		
	TTCA		
	1		
	TTCA		

**LMA790-3-LM**  
**APOLLO OPERATIONS HANDBOOK**

CREW: MAN	PNL	PROCEDURES	REMARKS
		<p><u>4.5.2.3 Descent Engine Throttle Control (cont)</u></p> <p style="text-align: center;">CAUTION</p> <p>Operation in transient region (65% to 92.5%) causes excessive eng erosion.</p> <p>Rough combustion may be expected at start of DPS burns due to gas ingestion in propellants. Roughness can last as long as 25 sec, depending on how quickly eng is throttled up. There is no constraint on throttling due to this roughness.</p> <p><u>4.5.2.4 GDA Enable</u></p>	<p>Throttling from 10% to 65%. Thrust changes from 65% to 92.5%, or from 92.5% to 65%, are not selected under normal conditions.</p> <p>Establishes configuration for enabling pitch and roll gibal drive assembly and associated failure-detection circuitry. Assumption: LGC gibal commands or ATCA gibal commands are present.</p> <p>Provides 115v, 400-cps power for GDA pitch and roll transducer and to DECA internal circuits.</p> <p>Provides d-c power for energizing GDA relay coils.</p> <p>Provides d-c power for energizing arming relays.</p> <p>Completes return path to CB S/C: ENG ARM.</p> <p>Routes 28-vdc power to energize relays, which route a-c and d-c power to GDA circuits.</p> <p>Provides d-c power for energizing relays.</p> <p>Routes 28-vdc power to energize relays, which route a-c and d-c power to GDA circuits.</p> <p>Enables 400-cps power to GDA pitch and roll switches.</p>
	11	1. CB/AC BUS A: DECA CHBL - close	
	16	CB S/C: DECA PWR - close	
	1	CB S/C: ENG ARM - close	
		ABORT pb - reset	
		ENG THR CONT: ENG ARM sw - DES	
		or select:	
	11	CB S/C: ENG CONT - close	
	1	ABORT pb - push	
	3	2. ENG CHBL sw - ENABLE	

P  
R  
M

**LMA790-3-LM**  
**APOLLO OPERATIONS HANDBOOK**

LM 3231

CREW- MAN	PNI	PROCEDURES	REMARKS
		<p>4.5.2.5 <u>ECS Translation</u></p> <p>1. FGMS manual translation control:                      LCC Power-Up (required)                      DMU Power-Up (required)</p> <p>DAP Data Load Routine (required)</p> <p>ECS Primary Coil Enable (required)</p> <p>CB S/C: ATCA (FGMS) - close</p> <p style="text-align: center;">CAUTION</p> <p>To prevent inadvertent ECS jet firing, S/C: FGMS sw - OFF before CB S/C: ATCA (FGMS) - close.</p> <p>Establish FGMS translation control:                      GUID CONT sw - FGMS</p> <p style="text-align: right;">S/C: FGMS sw - AUTO or ATT HOLD</p> <p style="text-align: right;">TTCA/TRANSL sw (CDR/LMP) - ENABLE</p>	<p>Establishes configuration for initiating FGMS or AGS manual translation maneuvers and +X-axis translation override control.</p> <p>Ref para 4.6.1.1.1.</p> <p>Ref para 4.6.1.3. CB FGMS: IMU OPR also supplies d-c power to PSA, which develops 28v, 800 cps, for ACA proportional excitation.</p> <p>Ref para 4.6.1.8. This routine establishes two- or four-jet X-axis translation.</p> <p>Ref para 4.5.1.1.1.</p> <p>Provides d-c power for selecting FGMS operation via GUID CONT sw - FGMS, bias voltage to ATCA, out-of-detent relay power, and enable voltage to ATCA primary preamplifiers via S/C: FGMS sw - AUTO or ATT HOLD.</p> <p>Sets bank of relays for FGMS operation. When LM configuration includes heavy descent stage (FGMS in control), Y- and Z axis translations, when commanded, should be performed sequentially to avoid loss of vehicle attitude control. Word "heavy" is referenced to both ascent and descent propellant loading conditions.</p> <p>Routes 28-vdc enable signal to ATCA primary preamplifiers.</p> <p>Routes X-, Y-, or Z-axis translation command discrete to LCC when TTCA is actuated.</p>
	11		
	1		
	3		
	4		

# LMA790-3-LM

## APOLLO OPERATIONS HANDBOOK

CREW-MAN	PNI	PROCEDURES	REMARKS
	TTCA	<p>4.5.2.5 <u>RCS Translation (cont)</u></p> <p>THROTTLE/JETS cont (CDR/LMP) - JETS            TTCA - move in desired direction of thrust</p> <p>If docked &amp; attitude control lost:            TTCA - release until attitude error in deadband</p> <p>If heavy descent stage or docked &amp; ΔVY or ΔVZ required, reorient &amp; translate along X-axis.</p>	<p>Enables TTCA X-axis translation capability.</p> <p>Steady Y-command or Z-command produces more pitch or roll torque than can be controlled by RCS jets.</p> <p>Y- or Z-axis translation consumes double theoretical minimum RCS propellant because significant pitch or roll torquing is required to balance remote center of mass.</p>
	16	<p>2. AGS manual translation control:            RCS Primary Coil Enable (required)</p> <p>CB S/C:            ATCA - close</p> <p>ATCA (AGS) - close</p> <p style="text-align: center;">CAUTION</p> <p>To prevent inadvertent RCS jet firing, S/C:            AGS sw - OFF before CB S/C: ATCA (AGS) - close.</p> <p>Establish AGS translation control:            GUID CONT sw - AGS</p>	<p>Ref para 4.5.1.1.</p> <p>Provides d-c power to ATCA power supply.</p> <p>Provides d-c power for selecting AGS operation via GUID CONT sw - AGS, bias for ATCA out-of-detent relay, and enable voltage to ATCA abort preamplifiers via S/C:            AGS sw - AUTO or ATT HOLD.</p>
	1	<p>S/C: AGS sw - AUTO or ATT HOLD</p>	<p>If GUID CONT sw - AGS and S/C: AGS sw - AUTO, AEA may steer LM. Set DEDA address 400+00000 (attitude hold); or initialize flight program properly, including a valid LM state vector and PGNCS/AGS alignment. Observe proper attitude hold restrictions before AGS orientation to initial computed steering attitude. Ref para 4.6.2.13.</p>
	3	<p>S/C: AGS sw - AUTO or ATT HOLD</p>	<p>Routes 28-vdc enable signal to ATCA abort preamplifiers.</p>

C &  
REF  
MOD

**LMA790-3-LM**  
**APOLLO OPERATIONS HANDBOOK**

CREW- MAN	PNI	PROCEDURES	REMARKS
		<p>4.5.2.5 <u>RCS Translation (cont)</u></p> <p>ENG THR CONT: BAL CPL sw - ON</p> <p>TTCA/TRANSL sw (CDR/LMP) - ENABLE</p> <p>THROTTLE/JETS cont (CDR/LMP) - JETS</p> <p>ENG THR CONT: ATT/TRANSL sw - 4 JETS or 2 JETS</p> <p>TTCA (CDR/LMP) - move in desired direction of thrust</p> <p>3. +X-axis translation override control:</p> <p>CB S/C: ATT DIR CONT - close</p> <p>+X TRANSL pb - push &amp; hold (continuous firing); push &amp; release (short bursts)</p> <p>4.5.3 <u>DYNAMIC DISPLAY MODES</u></p> <p>4.5.3.1 <u>PGNCS Total Attitude Display</u></p> <p>1. Inertial display:</p>	<p>Routes 28-vdc enable voltage, via S/C: AGS sw - ATT HOLD or AUTO, to ATCA four up-firing abort preamplifiers.</p> <p>ENG THR CONT: BAL CPL sw - ON during all mission phases, except during AFS engine burns. This permits RCS to add to net engine thrust, if under AGS control.</p> <p>Routes X-, Y-, or Z-axis translation commands to ATCA when TTCA is actuated.</p> <p>Enables TTCA X-axis translation capability.</p> <p>Selects four- or two-jet X-axis translation. When switch is in 4 JETS position, high rate limit cycling can result when LM is in light ascent weight configuration. Switch to 4 JETS position only when failed jets prevent roll, pitch, or X-axis translation.</p> <p>Provides four-jet +X-axis translation via RCS secondary coils.</p> <p>Provides +28 vdc to +X TRANSL pb for energizing RCS secondary coils.</p> <p>Routes +28 vdc to secondary coils of jets BID, AZD, B3D, and A4D. Jets fire continuously as long as pushbutton is pushed. If pushbutton fails closed, CB S/C: ATT DIR CONT - open; this prevents use of all secondary coils.</p> <p>Displays PGNCS total attitude data (inertial) on CDR and/or LMP FDAI. First line of each step gives configuration for CDR FDAI; second line, configuration for LMP FDAI.</p>

**LMA790-3-LM**  
**APOLLO OPERATIONS HANDBOOK**

CREW-MAN	PNL	PROCEDURES	REMARKS
		<p><u>4.5.3.1 FCNCS Total Attitude Display (cont)</u></p> <p>a. Power up FDAI:            CB/AC BUS A: CDR FDAI - close            CB/AC BUS B: SE FDAI - close            CB FLT DISP: CDR FDAI - close            CB FLT DISP: EVNT TMR/SE FDAI - close</p> <p>b. Power up GASTA:            CB/AC BUS A: GASTA - close</p> <p>CB FLT DISP: GASTA - close</p> <p>c. Select display configuration:            ATTITUDE MON sw (2) - FCNS</p> <p>ORDEAL:            FDAI 1 sw - INRTL            FDAI 2 sw - INRTL</p> <p>2. ORDEAL:</p> <p>a. Power up FDAI:            CB/AC BUS A: CDR FDAI - close            CB/AC BUS B: SE FDAI - close            CB FLT DISP: CDR FDAI - close            CB FLT DISP: EVNT TMR/SE FDAI - close</p> <p>b. Power up GASTA:            CB/AC BUS A: GASTA - close</p> <p>CB FLT DISP: GASTA - close</p>	<p>Provides a-c power to FDAI sphere drive system.</p> <p>Provides d-c power to FDAI and to parts of auxiliary relay switching box.</p> <p>Applicable to both FDAI's for FCNCS total attitude display. Provides a-c power to GASTA.</p> <p>Applicable to both FDAI's for FCNCS total attitude display. Provides d-c power to GASTA.</p> <p>Routes FCNCS roll and yaw attitude to both FDAI's; pitch attitude, to ORDEAL assembly.</p> <p>Bypasses ORDEAL resolvers and routes FCNCS pitch attitude directly to both FDAI's.</p> <p>Displays FCNCS total attitude data (orbital rate) on CDR and/or LMP FDAI. Only pitch axis is affected. First line of each step gives configuration for CDR FDAI; second line, configuration for LMP FDAI.</p> <p>Provides a-c power to FDAI sphere drive system.</p> <p>Provides d-c power to FDAI and to parts of auxiliary relay switching box.</p> <p>Applicable to both FDAI's for FCNCS ORDEAL display mode. Provides a-c power to GASTA.</p> <p>Applicable to both FDAI's for FCNCS ORDEAL display mode. Provides d-c power to GASTA.</p>

G 2  
RE  
MOD

**LMA790-3-LM**  
**APOLLO OPERATIONS HANDBOOK**

LM 3231

CREW-MAN	P/NL	PROCEDURES	REMARKS
		<p>4.5.3.1 <u>PGNS Total Attitude Display (cont)</u></p> <p>c. Power up ORDEAL: CB/AC BUS B: ORDEAL - close</p> <p>CB FLT DISP: ORDEAL - close ORDEAL: EARTH/LUNAR sw - EARTH or LUNAR</p> <p>LTC sw - BRT or DIM</p> <p>d. Select display configuration: ATTITUDE MON sw (2) - PGNS</p> <p>ORDEAL: FDAI 1 sw - ORB RATE FDAI 2 sw - ORB RATE</p> <p>4.5.3.2 <u>PGNS Attitude Rate/Error Display</u></p> <p>1. Power up FDAI: CB FLT DISP: CDR FDAI - close CB FLT DISP: EVNT THR/SE FDAI - close</p> <p>1A. Enable DAP: S/C: PGNS sw - ATT HOLD or AUTO</p> <p>1B. Deleted.</p> <p>2. Select display configuration: ATTITUDE MON sw (2) - PGNS</p> <p>RATE/ERR MON sw (2) - LDG RDR/CMPTTR Key V60E for LGC attitude rate display</p>	<p>Provides a-c power to ORDEAL resolvers.</p> <p>Provides d-c power to ORDEAL assembly.</p> <p>Routes a-c and d-c power to ORDEAL assembly. Provides proper orbital rate scaling.</p> <p>Controls brightness of ORDEAL EL panel lighting.</p> <p>Routes PGNS roll and yaw attitude to both FDAI's; pitch attitude, to ORDEAL assembly.</p> <p>Routes pitch attitude to ORDEAL resolvers, then to FDAI's.</p> <p>Displays PGNS attitude rate/error data with roll, pitch, and yaw rate/error needles of CDR and/or LMP FDAI. Error-needle scaling is set at +5°. Rate needle scaling is set at 1.25°/second full scale. First line of each step gives configuration for CDR FDAI; second line, configuration for LMP FDAI.</p> <p>Provides d-c power to FDAI and to parts of auxiliary relay switching box.</p> <p>Enables digital autopilot computations.</p> <p>Routes LGC attitude rate/error signals to roll, pitch, and yaw rate/error needles of both FDAI's when RATE/ERR MON sw - LDG RDR/CMPTTR.</p> <p>Completes signal path for routing LGS attitude rate/error to FDAI rate/error needles.</p> <p>V60 rate displays will be incorrect if PGNS is not actually controlling.</p>
	1,2		
	11 16		
	1,2		



# LMA790-3-LM

## APOLLO OPERATIONS HANDBOOK

LM 3231

CREW-MAN	PNL	PROCEDURES	REMARKS
		<p>4.5.3.2 <u>PGCS Attitude Rate/Error Display (cont)</u></p> <p>or Key V61E for mode I attitude error display or Key V62E for mode II attitude error display</p> <p>4.5.3.3 <u>AGS Total Attitude Display</u></p> <p>1. Inertial display:</p> <p>a. Power up FDAI: CB/AC BUS A: CDR FDAI - close CB/AC BUS B: SE FDAI - close CB/AC BUS B: AGS - close CB FLT DISP: CDR FDAI - close CB FLT DISP: EVNT TMR/SE FDAI - close</p> <p>b. Select display configuration: ATTITUDE MON sw (2) - AGS</p> <p>ORDEAL: FDAI 1 sw - INRTL FDAI 2 sw - INRTL</p> <p>2. ORDEAL (local horizontal attitude):</p> <p>a. Power up FDAI: CB/AC BUS A: CDR FDAI - close CB/AC BUS B: SE FDAI - close CB/AC BUS B: AGS - close CB FLT DISP: CDR FDAI - close CB FLT DISP: EVNT TMR/SE FDAI - close</p> <p>b. Power up ORDEAL: CB/AC BUS B: ORDEAL - close</p>	<p>Mode I - DAP following errors.</p> <p>Mode II - total attitude errors with respect to N22 angles (gimbal angles; display is scale limited). Mode II is automatically selected by LGC program and routine (such as R60).</p> <p>Displays AGS total attitude data (inertial) on CDR and/or LMP FDAI. First line of each step gives configuration for CDR FDAI; second line, configuration for LMP FDAI.</p> <p>Provides a-c power to FDAI sphere drive system. Applies a-c power for FDAI drive signals from AEA. Provides d-c power to FDAI and to parts of auxiliary relay switching box.</p> <p>Routes AGS roll and yaw attitude to both FDAI's; pitch attitude, to ORDEAL assembly.</p> <p>Bypasses ORDEAL resolvers and routes AGS pitch attitude directly to both FDAI's.</p> <p>Displays AGS total attitude data (orbital rate) on CDR and/or LMP FDAI. Only pitch axis is affected. First line of each step gives configuration for CDR FDAI; second line, configuration for LMP FDAI.</p> <p>Provides a-c power to FDAI sphere drive system. Applies a-c power for FDAI drive signals from AEA. Provides d-c power to FDAI and to parts of auxiliary relay switching box.</p> <p>Provides a-c power to ORDEAL resolvers.</p>

G & C  
REF  
MODES

**LMA790-3-LM  
APOLLO OPERATIONS HANDBOOK**

CREW-MAN	PNL	PROCEDURES	REMARKS
		<p><u>4.5.3.3 AGS Total Attitude Display (cont)</u></p> <p>CB FLT DISP: ORDEAL - close</p> <p>ORDEAL: EARTH/LUNAR sw - EARTH or LUNAR</p> <p>LTC sw - BRT or DIM</p> <p>c. Select display configuration: ATTITUDE MON sw - AGS</p> <p>ORDEAL: FDAI 1 sw - ORB RATE FDAI 2 sw - ORB RATE</p> <p><u>4.5.3.4 AGS Attitude Error Display</u></p> <p>1. Power up FDAI: CB FLT DISP: CDR FDAI - close CB FLT DISP: EVMT TMR/SE FDAI - close</p> <p>2. Select display range: S/C: DEAD BAND sw - MAX or MIN</p> <p>3. Select display configuration: ATTITUDE MON sw (2) - AGS</p> <p>RATE/ERR MON sw (2) - LDG RDR/CMFTR</p> <p><u>4.5.3.5 Attitude Rate Display</u></p>	<p>Provides d-c power to ORDEAL assembly.</p> <p>Routes a-c and d-c power to ORDEAL assembly. Provides proper orbital rate scaling.</p> <p>Controls brightness of ORDEAL EL panel lighting.</p> <p>Routes ACS roll and yaw attitude to FDAI; pitch attitude, to ORDEAL assembly.</p> <p>Routes pitch attitude to ORDEAL resolvers, then to FDAI.</p> <p>Displays ACS attitude error data with roll, pitch, and yaw error needles of CDR and/or LMP FDAI. First line of each step gives configuration for CDR FDAI; second line, configuration for LMP FDAI.</p> <p>Provides d-c power to FDAI and to parts of auxiliary relay switching box.</p> <p>Provides FDAI error-needle scaling of <math>\pm 14.4^\circ</math> (maximum) or <math>\pm 1.7^\circ</math> (minimum).</p> <p>Routes ACS attitude error signals to roll, pitch, and yaw error needles of both FDAI's when RATE/ERR MON sw - LDG RDR/CMFTR.</p> <p>Completes signal path for routing ACS attitude errors to both FDAI error needles.</p> <p>Displays rate gyro assembly data on FDAI roll, pitch, and yaw rate ind. This display mode is independent of PCNCS and ACS operation. First line of each step gives configuration for CDR FDAI; second line, configuration for LMP FDAI.</p>
	1,2		
	11 16		
	3		
	1,2		

**LMA790-3-LM**  
**APOLLO OPERATIONS HANDBOOK**

CREW- MAN	PNI	PROCEDURES	REMARKS
		<b>PROCEDURES</b>	
		<u>4.5.3.5 Attitude Rate Display (cont)</u>	
	11 16	1. Power up FDAI: CB FLI DISP: CDR FDAI - close CB FLI DISP: EVNT THR/SE FDAI - close	Provides d-c power to FDAI and to parts of auxiliary relay switching box.
	1	2. Select display range: RATE SCALE sw - 25°/SEC or 5°/SEC	Applicable to rate indicator on both FDAI's. Selects 25°/sec or 5°/sec full scale for rate indicator.
		<u>4.5.3.6 RR Shaft Angle/Trunnion Angle Display</u>	
	11 16	1. Power up FDAI: CB FLI DISP: CDR FDAI - close CB FLI DISP: EVNT THR/SE FDAI - close	Displays RR LX resolver trunnion angles with pitch and yaw error needles of CDR and/or LMP FDAI. First line of each step gives configuration for CDR FDAI; second line, configuration for LMP FDAI.
	1	2. Select display range: SHFT/TRUN § sw - +50° or +5°	Provides d-c power to FDAI and to parts of auxiliary relay switching box.
	1,2	3. Select display source: RATE/ERR MON sw - RNDZ RADAR	Provides scaling for both FDAI's. Set to +50°, full-scale deflection of FDAI pitch and yaw error needles indicates shaft and trunnion angles of +50° or -50°, or greater. Set to +5°, full-scale deflection of FDAI pitch and yaw error needles indicates shaft and trunnion angles of +5° or -5°, or greater.
			Routes shaft and trunnion angles from RR to pitch and yaw error needles of both FDAI's. Establishes RR azimuth rate/elevation rate display mode (para 4.5.3.7).

G  
R  
M

**LMA790-3-LM**  
**APOLLO OPERATIONS HANDBOOK**

CREW-MAN	PNI	PROCEDURES	REMARKS
		<p>4.5.3.7 <u>RR Azimuth Rate/Elevation Rate Display</u></p>	<p>Displays RR LOS azimuth and elevation rates on CDR and/or LMP X pointer ind. First line of each step gives configuration for CDR X pointer ind; second line, configuration for LMP X pointer ind.</p>
11 16		<p>1. Power up X pointer ind: CB FLT DISP: CDR X PNTR - close CB FLT DISP: SE X PNTR - close</p>	<p>Provides d-c power to both X pointer ind and to parts of auxiliary relay switching box.</p>
1,3		<p>2. Select display range: X POINTER SCALE sw (2) - HI MULT or LO MULT</p>	<p>Set to HI MULT, provides display scale of +20 mrad/sec-ond. Set to LO MULT, illuminates X.1 multiplier and provides scale of +2 mrad/sec.</p>
1,2		<p>3. Select display source: RATE/ERR MON sw (2) - RNDZ RADAR</p>	<p>Routes azimuth and elevation rates to X pointer ind and illuminates AZ RT and ELEV RT on X pointer ind.</p>
		<p>4.5.3.8 <u>Forward Velocity/Lateral Velocity Display</u></p>	<p>Displays forward and lateral velocity on CDR and/or LMP X pointer ind. First line of each step gives configuration for CDR X pointer ind; second line, configuration for LMP X pointer ind.</p>
11 16		<p>1. Power up X pointer ind: CB FLT DISP: CDR X PNTR - close CB FLT DISP: SE X PNTR - close</p>	<p>Provides d-c power to both X pointer ind and to parts of auxiliary relay switching box.</p>
1,3		<p>2. Select display range: X POINTER SCALE sw (2) - HI MULT or LO MULT</p>	<p>Set to HI MULT, illuminates X10 multiplier on X pointer ind and provides display scale of +200 fps. Set to LO MULT, provides display scale of +20 fps.</p>
1,2		<p>3. Select display configuration: RATE/ERR MON sw - LDG RDR/CHPTR</p>	<p>Routes forward and lateral velocity data to X pointer ind.</p>
1		<p>MODE SEL sw - LDG RADAR or FGNS or AGS</p>	<p>Set to LDG RADAR routes forward and lateral velocity data to one or both X pointer ind. Set to FGNS, routes LGC-computed forward and lateral velocity to X pointer ind. Set to AGS, routes AEA-computed lateral velocity to X pointer ind.</p>

**LMA790-3-LM**  
**APOLLO OPERATIONS HANDBOOK**

CREW-MAN	PNL	PROCEDURES	REMARKS
		<p>4.5.3.8 <u>Forward Velocity/Lateral Velocity Display (cont)</u></p> <p>4.5.3.9 <u>Altitude/Altitude Rate Display</u></p> <p>1. Power up ALT &amp; ALT RATE ind: CB/AC BUS A: RNG/RNG RT - close</p> <p>CB FLT DISP: RNG/RNG RT - close</p> <p>2. Select display configuration: RNG/ALT MDN sw - ALT/ALT RT</p> <p>MODE SEL sw - LDC RADAR or PCNS or AGS</p> <p>4.5.3.10. <u>Range/Range Rate Display</u></p>	<p>Lateral Velocity displayed on X pointer ind will not be the same for PCNS and AGS. PCNS outputs minus velocity for velocity along LM +Y-body-axis; AGS outputs plus velocity for velocity in direction of CSM angular momentum vector.</p> <p>Displays altitude and altitude rate data on ALT &amp; ALT RATE ind. Display ranges are as follows: Altitude - 0 to 60,500 feet Altitude rate - <math>\pm</math> 700 fps</p> <p>Provides a-c power to ALT and ALT RATE ind.</p> <p>Provides d-c power to ALT and ALT RATE ind.</p> <p>Routes data from source selected with MODE SEL sw to ALT and ALT RATE ind.</p> <p>Set to LDC RADAR, routes LR altitude and altitude rate data to ALT and ALT RATE ind. Set to PCNS, routes LDC-computed altitude and altitude rate data to ALT and ALT RATE ind. Set to AGS, routes AEA-computed altitude and altitude rate data to ALT and ALT RATE ind.</p> <p>Displays range and range rate data on RANGE and RANGE RATE ind. Display ranges are as follows: Range - 0 to 400 nm Range rate - 0 to <math>\pm</math>700 fps</p> <p>Range rate is limited by display hardware. Range rate reading of 100 fps can mean rate of 100, 1100, 2100, etc., fps. Also, if rate is between 701 and 999 fps, 1700 and 1999 fps, etc., display will read 700 fps and recycle to zero when rate becomes 1000 fps, 2000 fps, etc</p>

LM 3231

FORM NO.

**LMA790-3-LM**  
**APOLLO OPERATIONS HANDBOOK**

CREW-MAN	PNI	PROCEDURES	REMARKS
		<p>4.5.3.10 <u>Range/Range Rate Display (cont)</u></p> <p>1. Power up RANGE &amp; RANGE RATE ind: CB/AC BUS A: RNG/RNG RT - close</p> <p>CB FLT DISP: RNG/RNG RT - close</p> <p>2. Select display source: RNG/ALT MON sw - RNG/RNG RT</p>	<p>Provides a-c power to RANGE and RANGE RATE ind.</p> <p>Provides d-c power to RANGE and RANGE RATE ind.</p> <p>Routes RR range and range rate data to RANGE and RANGE RATE ind.</p>
		<p>4.5.3.11 <u>Thrust Display</u></p> <p>1. Power up ENG THRUST &amp; CMD THRUST ind: CB FLT DISP: THRUST - close</p> <p>2. Select display source:</p> <p>a. Display automatic thrust commands: ENG THR CONT: THR CONT sw - AUTO</p> <p>b. Display manual thrust commands: CB S/C: ENG CONT - close</p> <p>ENG THR CONT: THR CONT sw - MAN</p>	<p>Displays engine and commanded thrust levels. Scaling is 0% to 100% in 5% increments.</p> <p>Provides d-c power to ENG THRUST and CMD THRUST ind.</p> <p>Engine thrust level is displayed regardless of setting of ENG THR CONT: THR CONT sw.</p> <p>Routes accumulated LCC throttling commands from DECA to CMD THRUST ind.</p> <p>Provides d-c power for energizing relay, which routes manual thrust commands to ENG THRUST and CMD THRUST ind.</p> <p>Routes manual thrust commands from ITCA (CDR or LMP) to CMD THRUST ind.</p> <p>Following DSKY display is available during powered landing, to support manual throttle operations. (Automatic command is not available for display on CMD THRUST ind during manual throttle.)</p> <p>V16 N92E</p> <p>R1 Desired auto throttle XXXXX (may be &gt;100% of FTP thrust)</p> <p>R2 H rate XXXX.x fps</p> <p>R3 H XXXXX ft</p>

**LMA790-3-LM**  
**APOLLO OPERATIONS HANDBOOK**

CREW- MAN	PNI	PROCEDURES	REMARKS
		<p>4.5.3.12 <u>Radar Signal Strength Display</u></p> <p>1. Power up RADAR: SIGNAL STRENGTH ind: CB PCNS: SIG STR DISP - close</p> <p>2. Select display source from following: RADAR: TEST MON sel - ALT XMTR</p> <p style="text-align: center;">VEL XMTR</p> <p style="text-align: center;">ACC</p> <p style="text-align: center;">XMTR PWR</p> <p style="text-align: center;">SHAFT ERR</p> <p style="text-align: center;">TRUN ERR</p> <p>4.5.3.13 <u>Heater Control Temperature Monitor Display</u></p> <p>1. Power up HTR COMT: TEMP ind: CB HTR: DISP - close</p>	<p>Displays LR and RR test and flight data on RADAR: SIGNAL STRENGTH ind.</p> <p>Provides d-c power to RADAR: SIGNAL STRENGTH ind.</p> <p>Routes LR altitude transmitter power output to RADAR: SIGNAL STRENGTH ind during testing and flight operations.</p> <p>Routes LR velocity transmitter power output to RADAR: SIGNAL STRENGTH ind during testing and flight operations.</p> <p>During testing, specific value (TBD) of RR receiver signal strength is displayed. During flight operations signal varies.</p> <p>Displays specific value of transmitter output power during flight operations.</p> <p>During testing, displays angle error signals as needle fluctuations of equal amplitude. During flight operations, these error signals are displayed as needle fluctuations, which represent smoothness of servo tracking and are usually of unequal amplitude.</p> <p>Same as shaft error.</p> <p>Displays radar antenna assembly, RCS quad, or S-band antenna temperature.</p> <p>Provides d-c power to HTR COMT: TEMP ind.</p>
	11		
	3		
	3		
	16		

G & C  
REF  
MODES

**LMA790-3-LM**  
**APOLLO OPERATIONS HANDBOOK**

LM 3231

CREW- MAN	P/NL	PROCEDURES	REMARKS
		<p>4.5.3.13 <u>Heater Control Temperature Monitor Display (cont)</u></p> <p>2. Select display source from following: HTR CONT: TEMP MON sel - RNDZ RADAR</p> <p style="padding-left: 40px;">LDG RADAR</p> <p style="padding-left: 40px;">RCS QUAD 1 (QUAD 2, QUAD 3, QUAD 4)</p> <p style="padding-left: 40px;">S BAND</p>	<p>Routes RR antenna assembly temperature to HTR CONT: TEMP ind. Display range is -100° to +200° F.</p> <p>Routes LR antenna assembly temperature to HTR CONT: TEMP ind. Display range is -100° to +200° F.</p> <p>Routes selected RCS quad temperature to HTR CONT: TEMP ind. Quad temperature display range is -60° to 260° F.</p> <p>Routes S-band antenna temperature to HTR CONT: TEMP ind. Display range is -100° to +200° F.</p> <p>Displays RR LOS azimuth and elevation angles on DSKY.</p>
3		<p>4.5.3.14 <u>RR LOS Azimuth and Elevation Display (V85)</u></p> <p>1. RNDZ RADAR sel - LCC</p> <p>2. Key V85E Poss OPR ERR lt - on Exit V85, Key RSET</p> <p>3. FL V16 M56 - RR LOS R1 Azimuth XXX.XX° R2 Elevation XXX.XX° R3 _____ To terminate: Key FMO, V3AE or V3ZE Exit V85</p>	<p>OPR ERR lt - on if another extended verb from R76 is active.</p> <p>+000.00° to 360.00° about +Z. +000.00° to 360.00° about +Y.</p>



**LMA790-3-LM**  
**APOLLO OPERATIONS HANDBOOK**

PARA	TITLE	PAGE
4.6	G&C General . . . . .	4.6-3
4.6.1	PGNS . . . . .	4.6-3
4.6.1.1	LGC Power-Up . . . . .	4.6-3
4.6.1.2	LGC Power-Down Program (P06) . . . . .	4.6-4
4.6.1.3	IMU Power-Up (LGC Operating) . . . . .	4.6-4
4.6.1.4	IMU Power-Up (LGC Off) . . . . .	4.6-4
4.6.1.5	IMU Power-Down . . . . .	4.6-5
4.6.1.6	LGC Idling Program (P00) . . . . .	4.6-5
4.6.1.7	LGC Update Program (P27) . . . . .	4.6-6
4.6.1.8	DAP Data Load Routine (R03) . . . . .	4.6-8
4.6.1.9	Crew-Defined Maneuver Routine (R62) . . . . .	4.6-11
4.6.1.10	Rendezvous Final Attitude Routine (R63) . . . . .	4.6-13
4.6.1.11	Rendezvous Parameter Display Routine (R31) . . . . .	4.6-16
4.6.1.12	Show Banksum . . . . .	4.6-17
4.6.1.13	LGC Self-Test . . . . .	4.6-17
4.6.1.14	DSKY Light Test . . . . .	4.6-19
4.6.1.15	LGC/CMC Clock Synchronization Routine (R33) . . . . .	4.6-20
4.6.1.16	PIPA Bias Measurement & Loading . . . . .	4.6-21
4.6.1.17	Rate of Descent Controller/LGC Interface Check . . . . .	4.6-23
4.6.1.18	AGS Initialization Routine (R47) . . . . .	4.6-23
4.6.1.19	Preferred Tracking Attitude Program (P25) . . . . .	4.6-26
4.6.1.20	Fresh Start . . . . .	4.6-29
4.6.1.21	ICDU Zero . . . . .	4.6-30
4.6.1.22	RR CDU Zero . . . . .	4.6-31
4.6.1.23	Load IMU Attitude Error Meters . . . . .	4.6-31
4.6.1.24	Increment LGC Time . . . . .	4.6-32
4.6.1.25	Initialize Erasable Dump Via Downlink . . . . .	4.6-32
4.6.1.26	Enable W-Matrix Initialization . . . . .	4.6-33
4.6.1.27	ORDEAL Initialization . . . . .	4.6-33
4.6.1.28	LGC Erasable Memory Display/Update . . . . .	4.6-35
4.6.1.29	Restart . . . . .	4.6-36
4.6.1.30	S-Band Antenna Routine (R05) . . . . .	4.6-37
4.6.1.31	Interrupt Integration . . . . .	4.6-38
4.6.1.32	Mode I Attitude Error Display . . . . .	4.6-38
4.6.1.33	Mode II Attitude Error Display . . . . .	4.6-38
4.6.1.34	W-Matrix Error Display . . . . .	4.6-39
4.6.1.35	Move This Vehicle State Vector to Other State Vector. . . . .	4.6-39
4.6.1.36	Final Automatic Request Terminate Routine (R00) . . . . .	4.6-40
4.6.1.37	Erasable Modification Routine (R01) . . . . .	4.6-41
4.6.1.38	Input ΔRLS for Pinpoint Landing . . . . .	4.6-41
4.6.1.39	DSKY 88888 Clear . . . . .	4.6-42
4.6.2	AGS/CES . . . . .	4.6-42A
4.6.2.1	AGS Power-Up . . . . .	4.6-42A
4.6.2.2	AGS Power-Down . . . . .	4.6-44
4.6.2.3	AEA Self-Test . . . . .	4.6-45
4.6.2.4	AGS Checkout . . . . .	4.6-46
4.6.2.5	AGS Gyro & Accelerometer Calibration . . . . .	4.6-46
4.6.2.6	AGS Manual Absolute Time Initialization . . . . .	4.6-49
4.6.2.7	AGS Manual LM State Vector Update/Initialization . . . . .	4.6-50
4.6.2.8	Load AGS Contingency LM Lunar Touchdown State Vector. . . . .	4.6-51
4.6.2.9	AGS Manual CSM State Vector Update/Initialization . . . . .	4.6-52
4.6.2.10	Deleted . . . . .	4.6-53
4.6.2.11	Rate Gyro Check . . . . .	4.6-54
4.6.2.12	AEA Readiness Check . . . . .	4.6-55
4.6.2.13	AGS Orientation to Initial Computed Steering Attitude . . . . .	4.6-56
4.6.2.14	AGS Accelerometer Calibration . . . . .	4.6-58
4.6.2.15	AGS Wb Vector Update . . . . .	4.6-59
4.6.2.16	AGS Lunar Surface Gyro Calibration . . . . .	4.6-60
4.6.2.17	AGS Lunar Azimuth Store . . . . .	4.6-61

**LMA790-3-LM**  
**APOLLO OPERATIONS HANDBOOK**

PARA	TITLE	PAGE
4.6.2.18	AGS Rescaling From Lunar to Earth Mission . . . . .	4.6-61
4.6.2.19	AGS Power-Up From AGS Partial Power-Down . . . . .	4.6-63
4.6.2.20	AGS Partial Power-Down . . . . .	4.6-63
4.6.3	Radar . . . . .	4.6-64
4.6.3.1	Rendezvous Radar Power-Up . . . . .	4.6-64
4.6.3.2	Rendezvous Radar Initial Activation & Checkout . . . . .	4.6-64A
4.6.3.3	Rendezvous Radar Coarse Align . . . . .	4.6-69
4.6.3.4	Rendezvous Radar Manual Designation to Mode II . . . . .	4.6-70
4.6.3.5	Rendezvous Radar Manual Side-Lobe Acquisition Check & Main-Lobe Acquisition Verification . . . . .	4.6-71
4.6.3.6	Terminate Rendezvous Radar Continuous Designate . . . . .	4.6-79
4.6.3.7	Landing Radar Power-Up . . . . .	4.6-79
4.6.3.8	Landing Radar Checkout . . . . .	4.6-80
4.6.3.9	Command Landing Radar to Position 2 . . . . .	4.6-82
4.6.3.10	Landing Radar Spurious Test Routine (R77) . . . . .	4.6-82
4.6.3.11	Landing Radar Power-Down . . . . .	4.6-83

**LMA790-3-LM**  
**APOLLO OPERATIONS HANDBOOK**

LM 3207

CREW-MAN	PNL	PROCEDURES	REMARKS
		<p>4.6 <u>G&amp;C GENERAL</u></p> <p>The G&amp;C general procedures are usually performed during orbital flight and involve both PGNS and AGS/CES procedures. Being basic for G&amp;C operations, they are variously referred to or included as part of the more comprehensive G&amp;C procedures in paragraphs 4.7 through 4.12. In addition, applicable G&amp;C reference modes (para 4.5) are referenced throughout the G&amp;C procedures.</p> <p>Two assumptions are made before initiating any G&amp;C procedure: (1) Circuit Breaker Activation (para 4.2.4) has been completed and (2) RCS Pressurization (para 4.2.30) and RCS Hot/Cold Firing Check (para 4.2.31) have been completed.</p> <p>4.6.1 <u>PGNS</u></p> <p>4.6.1.1 <u>LGC Power-Up</u></p> <p>11 1. CB PGNS: LGC/DSKY - close</p> <p>1 Poss LGC warn lt - on (up to 20 sec)</p> <p>1,2</p> <p>4 Poss RESTART lt - on Key RSET, and/or Poss PROG: lt - on Key RSET Poss NO DAP lt - on</p> <p>2. Key PRO for 3 sec FL V37 (P06 static) If LGC reverts to standby after PRO is keyed, repeat step 2. Key RSET Poss NO DAP lt - on</p> <p>3. Perform Fresh Start.</p>	<p>Purpose of LGC Power-Up procedure is to bring LGC from off mode to operate mode or from standby mode to operate mode. Step 2 is not required if step 1 is performed.</p> <p>LGC warn lt - on due to LGC startup transient conditions. Light stays on until capacitor discharges. LGC warn lt discrete is normally closed contact; therefore, light is on when CMEA is powered up and LGC is not.</p> <p>RESTART lt and/or PROG lt may go on due to LGC startup transients.</p> <p>If alarm 01105 (downlink too fast) occurs, key RSET and ignore alarm.</p> <p>NO DAP lt - on if IMU powered down</p> <p>NO DAP lt - on if IMU powered down</p> <p>Ref para 4.6.1.20.</p>

**G & C  
GENERAL**

**LMA790-3-LM**  
**APOLLO OPERATIONS HANDBOOK**

LM 3207

CREW-MAN	PNL	PROCEDURES	REMARKS
		<p>4.6.1.2 <u>LGC Power-Down Program (P06)</u></p> <p>LGC Power-Up (required)</p> <p>1. Key V37E 06E</p> <p>2. FL V50 N25 - Checklist reference            R1 00062 - Switch LGC power down            R2 -----            R3 -----            Key PRO until STBY lt - on</p> <p>3. (Optional)            CB PGNS: LGC/DSKY - open            MASTER ALARM - on            LGC warn lt - on            MASTER ALARM pb/lt - reset</p>	<p>Purpose of LGC Power-Down Program (P06) is to transfer LGC from operate mode to standby mode. In order for LGC to maintain accurate value of GET, it must be brought to operate condition once every 23 hours.</p> <p>Ref para 4.6.1.1.</p> <p>Exit from P06 cannot be accomplished without putting LGC into standby mode, or keying V69E or V96E.</p> <p>Removes power from LGC/DSKY; IMU may be left on for total attitude reference.            LGC warn lt discrete is normally closed contact; therefore, light is on when CMEA is powered up and LGC is not.</p> <p>If computer power is switched off, it will be necessary to perform Fresh Start (V36) procedure (para 4.6.1.20) after power-up.</p> <p>Purpose of IMU Power-Up procedure is to transfer IMU from standby mode to operate mode, with LGC operating.</p> <p>Ref para 4.6.1.1.</p> <p>For PIPA stabilization, IMU should be on for at least 15 minutes.</p> <p>This is backup procedure, to be used only when LGC is off or failed and IMU is desired as attitude reference only.</p> <p>Ref para 4.5.3.1. Allows monitoring of IMU power-up.            Energizes IMU cage relays and applies gyro-wheel power.</p>
	11 1,2 1 1/2	<p>4.6.1.3 <u>IMU Power-Up (LGC Operating)</u></p> <p>LGC Power-Up (required)</p> <p>1. CB PGNS: IMU OPR - close</p> <p>NO ATT lt - on for 90 sec, then off</p> <p>NO DAP lt - off</p>	
	11	<p>4.6.1.4 <u>IMU Power-Up (LGC Off)</u></p> <p>1. CB PGNS: IMU STBY - close</p> <p>2. Select PGNS Total Attitude Display mode.</p> <p>3. CB PGNS: IMU OPR - close</p>	

**LMA790-3-LM**  
**APOLLO OPERATIONS HANDBOOK**

CREW-MAN	PNL	PROCEDURES	REMARKS
		<p>4.6.1.4 <u>IMU Power-Up (LGC Off) (cont)</u></p> <p>4. Wait approx 90 sec.</p> <p>5. S/C: IMU CAGE sw - ON (momentarily)</p> <p>4.6.1.5 <u>IMU Power-Down</u></p>	<p>Causes IMU to go inertial with present body-axis as reference.</p> <p>Purpose of IMU Power-Down procedure is to reduce IMU power from operate to standby condition. If LGC is in operate mode and is using IMU, IMU should not be powered down.</p>
	11	<p>1. CB PGNS: IMU OPR - open</p> <p style="text-align: center;">CAUTION</p> <p>When GUID CONT sw - PGNS, CB PGNS: IMU OPR - open will disable 800-cps excitation to ACA &amp; JTCA throttling.</p> <p>2. If LGC operating: NO DAP It - on Key V37E --E</p> <p style="text-align: center;">CAUTION</p> <p>Only in case of emergency shall IMU be powered down beyond standby. CB PGNS: IMU STRY - open. If standby power is removed for more than 20 min, ISS calibration is no longer valid.</p> <p>4.6.1.6 <u>LGC Idling Program (POO)</u></p> <p>LGC Power-Up (required)</p> <p>IMU Power-Up (LGC Operating) (desired)</p>	<p>Select desired programs not requiring IMU.</p> <p>Purpose of LGC Idling Program (POO) is to maintain LGC in state of readiness for any other program entry. POO is automatically selected by extended verb 96 in Interrupt Integration procedure (para 4.6.1.31).</p> <p>Ref para 4.6.1.1.</p> <p>Ref para 4.6.1.3. Enables crew maneuver via DAP operation. ISS should be on 15 minutes before thrusting maneuver.</p>



LM 3207

**LMA790-3-LM**  
**APOLLO OPERATIONS HANDBOOK**

LM 3231

CREW-MAN	PNL	PROCEDURES	REMARKS
		<p>4.6.1.1.6 <u>LGC Idling Program (P00)</u> (cont)</p> <p>1. Key V37E 00E</p>	<p>During this program, coasting integration routine will periodically update LM and CSM state vectors to approximately current time. Capability of selecting LGC program (V37E --E) is inhibited by LGC during this integration. Use of V37 at this time will result in program alarm (1520). Before state vector initialization, V96E should be used to prevent meaningless integration from tying up LGC.</p>
		<p>4.6.1.1.7 <u>LGC Update Program (P27)</u></p> <p>LGC Power-Up (required)</p> <p>DNA Enable (required)</p> <p>Communications Basic (required - near earth)</p> <p>Lunar telemetry (required - lunar distance)</p>	<p>Purpose of LGC Update Program (P27) is to insert information into LGC via digital uplink from MSFN or via DSKY input.</p> <p>Ref para 4.6.1.1.1.</p> <p>Ref para 4.13.2.11.</p> <p>Ref 4.13.2.1.</p> <p>S-Band Steerable Antenna Activation and Checkout (para 4.2.20).</p>
		<p>1. Key V37E 00E</p>	<p>P00 is automatically selected by extended verb 96 in Interrupt Integration procedure (para 4.6.1.31).</p> <p>This step is performed to prevent erroneous data being taken by AGS.</p>
		<p>2. If AGS is operating: Key DEDA C 563+0000E</p>	
		<p>3. If update is automatic (via digital uplink): UPLINK ACTY lt - on; go to step 8 If update is manual: Receive &amp; record data.</p>	
		<p>4. Desired update alternatives: a. Key V70E - Update lift-off time (P27) b. Key V71E - Load data block (P27) c. Key V72E - Load singular data (P27) d. Key V73E - Octal time increment (P27)</p> <p>Poss OPR ERR lt - on Exit P27, Key RSET; or If P27 not displayed, reselect P00, repeat step 4.</p>	<p>V71 may be used to update state vector, REFSMNT, or landing site. V72 may be used to update DAP data.</p> <p>OPR ERR lt - on if another extended verb from R76 is active.</p>

**LMA790-J-LM**  
**APOLLO OPERATIONS HANDBOOK**

CREW- MAN	PNL	PROCEDURES	REMARKS
LM 3231		<p>4.6.1.7 LGC Update Program (P27) (cont)</p> <p>5. FL V21 N01 (if V71 or V72 entered)  R1 -----  R2 Unchanged XXXXX  R3 UPBUFF Octal  Accept: Key XXXXE index word (displayed in R1)  Reject: Key V34E - Terminate</p> <p>6. FL V21 N01 - Data load request  R1 -----  R2 Unchanged  R3 AAAAA - Calculated machine address  Accept:  Key XXXXE update data  Repeat data load until all components are loaded.  Reject: Key V34E - Terminate</p> <p>7. FL V21 N02 - Load octal identifier  R1 -----  R2 Unchanged  R3 UPTMP</p> <p>Accept alternatives:  a. Key V33E - Use data</p>	<p>Load octal index word and display UPBUFF. UPBUFF is address of erasable memory location (initially 1173) used for temporary storage of index word to be loaded next. V70 and V73 do not require index word. Twenty locations are available for V71 and V72. Index word represents total number of quantities to be loaded including index word, addresses, and data. For V71 and V72, 3C index word (octal). Difference between verbs is that V72 requires index word that must be odd. With V71, single address describes where block of data will go; 22 (octal) locations are available for update parameters in addition to index word and block address. With V72, separate address is needed for each data word, and each block consists of index word, and up to nine pair of address and data words in successive even-odd numbered locations. An index word is not required for either V70 or V73.</p> <p>Flashing continues until all data components are loaded. In this step, data can mean either a machine address or actual update data. For V71, first entry is always calculated address (specified in R3) followed by update components. For V72, first entry is calculated address followed alternately by update data, next address, update data, etc. For V70 and V73, only update data are entered.</p> <p>UPTMP is erasable location (1166) for octal identifier. After last word in block being loaded is entered, noun changes to 02 to permit loading octal identifier of previously loaded block. This permits reloading block if MSFN detects previous value to be in error. If index word is to be changed, program should be terminated and reselected.</p> <p>Zerose channel 77 (restart monitor) (only if completed a state vector update).</p>



**LMA790-3-LM**  
**APOLLO OPERATIONS HANDBOOK**

LM 3231

CREW-MAN	PNL	PROCEDURES	REMARKS
		<p>4.6.1.7 <u>LGC Update Program (P27) (cont)</u></p> <p>b. Key XXE - Octal Identifier for data to be updated, return to step 6 Reject: Key V34E - Terminate</p> <p>8. Automatic update complete: UPLINK ACTY 1t - off</p> <p>9. If update was automatic, DSKY may indicate alarm because of transient condition. Perform DVA Disable.</p> <p>10. Exit P27, P00 is selected.</p> <p>4.6.1.8 <u>DAP Data Load Routine (R03)</u></p> <p>LGC Power-Up (required)</p> <p>1. Key V48E Poss OPR ERR 1t - on Exit R03, key RSET</p> <p>2. FL V04 N46 R1 DAP configuration/response data code ABCDE R2 Channel 30 backup code 0001J R3 ----- A = 1 - Ascent stage only A = 2 - Ascent &amp; Descent stages A = 3 - Ascent &amp; Descent stages docked with CSM B = 0 - Two-jet translation &amp; roll/pitch minimum impulse (RCS system A) B = 1 - Two-jet translation &amp; roll/pitch minimum impulse (RCS system B)</p>	<p>Loading octal identifier recycles program to step 6. After value is loaded, program continues to step 7, permitting additional MSFN changes to be made.</p> <p>Ref para 4.13.2.12.</p> <p>Purpose of DAP Data Load Routine (R03) is to load and verify DAP data, channel 30 backup codes, and DPS gimbal trim angles and to perform engine gimbal trim. (An optional throttle test may also be performed.)</p> <p>Routine 03 should not be selected during powered flight (or when average g is on) to avoid difficulties in setting attitude deadband and mass settings.</p> <p>Ref para 4.6.1.1.</p> <p>OPR ERR 1t - on if another extended verb from R76 is active.</p> <p>Two-jet system B X-axis translation should be selected in CSM-docked and LM-unstaged configurations, to avoid jet A2D impingement on descent stage and resulting torque</p>



**LMA790-3-LM**  
**APOLLO OPERATIONS HANDBOOK**

CREW- MAN	PNL	PROCEDURES	REMARKS										
RC 1537, LM 3231		<p>4.6.1.8 DAP Data Load Routine (R03) (cont)</p> <p>B = 2 - Four-jet translation (Minimum impulse/RSC sys A)                      B = 3 - Four-jet translation (Minimum impulse/RSC sys B)                      C = 0 - Fine scaling ACA - 4°/sec (LM only)                                - 0.4°/sec (LH &amp; CSM)</p> <p>C = 1 - Normal scaling ACA - 20°/sec (LM only)                                - 2.0°/sec (LH &amp; CSM)</p> <p>D = 0 - Attitude deadband 0.3° (Subject to                      D = 1 - Attitude deadband 1.0° programmed                      D = 2 - Attitude deadband 5.0° deadband conditions)</p>	<p>loss. When docked with CSM, avoid +X-translation of more than 10 seconds duration with jet A2D to avoid bending and possible damage to docking tunnel.</p> <p>Manual maneuvers using 4°/second ACA scaling are more efficient (i.e., propellant-time product is lower) than manual maneuvers using 20°/second scaling.</p> <p>If D=3, 5° attitude deadband is selected by default. Programmed exceptions to the crew selected deadband in R03 occur during portions (or all) of the following with deadbands as indicated:</p> <table border="1" style="width: 100%; border-collapse: collapse;"> <thead> <tr> <th style="width: 80%;">Condition</th> <th style="width: 20%;">Deadband</th> </tr> </thead> <tbody> <tr> <td>P64; P41 (R60 through burn); P12, P70, P71 (RCS trim); P40, P41, P42 (RCS trim); P66 (if preceded by P64); R61, R65 (during R60 maneuver); R23</td> <td style="text-align: center;">0.3°</td> </tr> <tr> <td>P63, P40, P42 (R60 through MPS burn); P12, P70, P71, P66 (if selected from P63)</td> <td style="text-align: center;">1.0°</td> </tr> <tr> <td>CSM docked DAP code (A = 3 in RL of N46)</td> <td style="text-align: center;">1.4°</td> </tr> <tr> <td>Fresh start</td> <td style="text-align: center;">5.0°</td> </tr> </tbody> </table> <p>Other programmed exceptions to crew selected data load in N46:                      A CSM DOCKED                        AFSFLAG                   Set by P42 (@ TIG-30), P71, P68                      B ACC4-2FL                        AORTRAN                   Set by P12, P70, P71 (selects four Jet)                                                    Switched by R40 (@ ENTER to V97) (reverses sys A or B selection)</p>	Condition	Deadband	P64; P41 (R60 through burn); P12, P70, P71 (RCS trim); P40, P41, P42 (RCS trim); P66 (if preceded by P64); R61, R65 (during R60 maneuver); R23	0.3°	P63, P40, P42 (R60 through MPS burn); P12, P70, P71, P66 (if selected from P63)	1.0°	CSM docked DAP code (A = 3 in RL of N46)	1.4°	Fresh start	5.0°
Condition	Deadband												
P64; P41 (R60 through burn); P12, P70, P71 (RCS trim); P40, P41, P42 (RCS trim); P66 (if preceded by P64); R61, R65 (during R60 maneuver); R23	0.3°												
P63, P40, P42 (R60 through MPS burn); P12, P70, P71, P66 (if selected from P63)	1.0°												
CSM docked DAP code (A = 3 in RL of N46)	1.4°												
Fresh start	5.0°												





# LMA790-3-LM APOLLO OPERATIONS HANDBOOK

CREW-MAN	PNL	PROCEDURES	REMARKS
		<p>4.6.1.8 DAP Data Load Routine (R03) (cont)</p> <p>E - KALCMANU rate            0 - 0.2°/sec            1 - 0.5°/sec            2 - 2.0°/sec            3 - 10.0°/sec</p> <p>I = 0 - Test channel 30, bit 5 for AUTO THROTTLE discrete &amp; act accordingly            I = 1 - Ignore AUTO THROTTLE discrete &amp; assume auto throttle is desired.</p> <p>J = 0 - Test channel 30, bits 1 &amp; 4 for ABORT &amp; ABORT STAGE discrettes &amp; act accordingly.            J = 1 - Ignore ABORT &amp; ABORT STAGE discrettes.</p> <p>Accept: Key PRO            Reject: Key V21, V22, or V24 - Load desired DAP data code and/or channel 30 back-up code</p> <p>3. FL V06 N47            R1 LM weight XXXX lb            R2 CSM weight XXXX lb            R3 -----            Accept: Key PRO - If DPS has been staged, exit R03</p> <p>Reject: Key V24E - Load desired parameters            If descent stage is attached, proceed to step 4.</p> <p>4. FL V06 N48 - Gimbal trim parameters            R1 Pitch trim XXX.XX°            R2 Roll trim XXX.XX°            R3 -----            To accept displayed parameters &amp; enable gimbal drive to trim:            CB S/C: DECA PWR - close (if open)            S/C: PGNS sw - AUTO or ATT HOLD            GUID CONT sw - PGNS</p>	<p>-----            None; see table above</p> <p>-----</p> <p>If docked with CSM, KALCMANU rate loaded should be 0.2°/second or 0.5°/second and 2.0°/second or 10°/second must not be selected (would result in excessive RCS propellant consumption and impingement).</p> <p>In light ascent stage configuration, it is possible to encounter high-rate attitude limit cycle. To correct this condition, load minimum LM weight of 5000 pounds in step 3. Minimum mass values are as follows:            Ascent stage only - 4,850 pounds            Descent stage attached - 14,462 pounds            CSM - 9,060 pounds</p> <p>Do not load zero or negative value in R1 or R2 of N48 otherwise PROG It - on with FL V37 and alarm code 21204 stored in N09 will result.            GDA Enable (para 4.5.2.4).</p>

LM 3231



**LMA790-3-LM**  
**APOLLO OPERATIONS HANDBOOK**

LH 3231

CREW- MAN	PNL	PROCEDURES	REMARKS
		<p>4.6.1.8 DAP Data Load Routine (R03) (cont)</p> <p style="text-align: center;">CAUTION</p> <p>To prevent overheating descent engine throttling actuators, following control configuration must be established before arming descent eng.</p> <p>CB PGNS: IMU OPR - close NO ATT lt - on for 90 seconds, then off THRITTLE/JETS cont (CDR) - THRITTLE ENG THR CONT: MAN THROT sw - CDR or: THRITTLE/JETS cont (LMP) - THRITTLE ENG THR CONT: MAN THROT sw - LMP</p> <p>Eng STOP pb/lt - push ENG THR CONT: ENG ARM sw - DES MASTER ALARM - on DES REG warn lt - on MASTER ALARM pb/lt - reset ENG GMBL sw - ENABLE Key PRO</p> <p>Within 60 seconds: MASTER ALARM - on ENG GMBL caut lt - on MASTER ALARM pb/lt - reset To reject: Key V24E - Load desired parameters, return to beginning of step 4 To exit R03, Key V34E</p>	<p>Required to prevent throttle valve actuator from overheating.</p> <p>Light remains on until: (1) Normal pressures are established by DPS pressurization, (2) CB INST: CMEA is cycled which resets logic if ENG THR CONT: ENG ARM sw - OFF, or (3) staging occurs.</p> <p>When gimbal stops are reached, ENG GMBL caut lt goes on within 60 seconds and remains on until ENG THR CONT: ENG ARM sw or ENG GMBL sw - OFF in step 6. This should not be regarded as malfunction indication.</p>
	11 4 TTCA 1		
	TTCA		
	5 1 1,2 1 1/2 3		
	1,2 2 1/2		
	5.	<p>Optional throttle test: TTCA (CDR) - minimum CMD THRUST ind - approx 10% TTCA (CDR) - soft stop CMD THRUST ind - approx 60% TTCA (CDR) - maximum CMD THRUST ind - approx 100%</p>	<p>Optional throttle test may be performed during gimbal drive to trim position.</p>
	6.	<p>FL V50 N48 - Continue interrupted program R1 XXX.XX* R2 XXX.XX*</p>	<p>If RESTART lt - on and this display does not occur, gimbal drive process has been permanently interrupted; routine must be recalled and/or trim process repeated.</p>

# LMA790-3-LM APOLLO OPERATIONS HANDBOOK

CREW MAN	PNL	PROCEDURES	REMARKS
		<b>PROCEDURES</b>	
		<u>4.6.1.8 DAP Data Load Routine (R03) (cont)</u>	
	1	<p>R3 XXX.XX*            Disable gimbal drive:            ENG THR CONT: ENG ARM sw - OFF            Reset eng STOP pb/lt:            a. Release tab - push            b. Verify eng STOP pb/lt - on            c. If eng STOP pb/lt - off, verify that lights are functioning by performing Caution &amp; Warning Array Checkout, steps 3 &amp; 4.            If lights are functioning, inadvertent reset has taken place &amp; engine is enabled. Steps d, e, &amp; f should not be performed.            d. Eng STOP pb/lt - push            e. Release tab - push            f. Verify eng STOP pb/lt - off            ENG GMBL caut lt - off            Key PRO, ENTER, or V34E (terminate) - Exit R03</p>	<p>Display indicates gimbal trim drive has been completed. Flashing display of V50 N48 will not occur until 1 minute minimum (2 minutes in worst case) has elapsed after PRO, step 4.</p> <p>Ref para 4.2.10.</p>
	2	<p style="text-align: center;"><u>4.6.1.9 Crew-Defined Maneuver Routine (R62)</u></p> <p>LGC Power-Up (required)            LGC Self-Test (desired)            IMU Power-Up (LGC Operating) (required)</p>	<p>Purpose of Crew-Defined Maneuver Routine (R62) is to provide crew with means of specifying final vehicle attitude when using LGC-controlled attitude maneuver. This routine can be entered only from P00.</p> <p>Ref para 4.6.1.1.            Ref para 4.6.1.13.            Ref para 4.6.1.3. ISS should be on 15 minutes before thrusting maneuver.            Most programs and extended verbs that perform maneuvers, require P51 and check for it via R02.            Ref para 4.6.1.8.</p>
	1, 2	<p>DAP Data Load Routine (R03) (required)</p> <p>1. Enable PGNS attitude control:            GUID CONT sw - PGNS            S/C:            PGNS sw - ATT HOLD            ROLL, PITCH, YAW sw - MODE CONT            ACA/4 JET sw (2) - ENABLE            ACA PROP sw (2) - ENABLE</p>	

G 2  
GENE

LM 3231

**LMA790-3-LM**  
**APOLLO OPERATIONS HANDBOOK**

CREW- MAN	P/NL	PROCEDURES	REMARKS
		<p>4.6.1.9 <u>Crew-Defined Maneuver Routine (R62) (cont)</u></p> <p>2. Establish PGNS total attitude &amp; attitude rate/error display: ATTITUDE MON sw - PGNS RATE/ERR MON sw (2) - LDG RDR/CMPT</p> <p>3. Key V49E Poss OPR ERR lt - on Exit R62, Key RSET</p> <p>4. FL V06 W22 R1 OGA XXX.XX° R2 IGA XXX.XX° R3 MGA XXX.XX° Accept: Key PRO Reject: Key V25E - Load new gimbal angles for R60</p> <p>5. Attitude Maneuver Routine (R60)</p> <p>FL V50 N18 - Perform desired automatic maneuver to final FDAI angles R1 Roll XXX.XX° R2 Pitch XXX.XX° R3 Yaw XXX.XX°</p> <p>To reject attitude maneuver: When within DAP deadband limits, &amp; further adjustment about desired vector is not desired, Key ENTR, exit R60/R62</p> <p>To perform attitude maneuver: a. To adjust vehicle attitude &amp; have LGC recompute gimbal angles, Select desired attitude control mode - ACA - maneuver as desired S/C: PGNS sw - ATT HOLD Key PRO Return to beginning of step 5.</p> <p>b. To perform attitude maneuver manually: Select desired attitude control mode - ACA - maneuver manually to required attitude Key PRO Return to beginning of step 5.</p>	<p>Ref para 4.5.3.1 and 4.5.3.2.</p> <p>OPR ERR lt - on if another extended verb from R76 is active or if LGC Idling Program (P00) is not in process.</p> <p>Automatic attitude maneuvers are more efficient (i.e., propellant-time product is lower) than manual attitude maneuvers.</p> <p>If final computed FDAI angles result in +90° yaw, trans-formation from IMU to FDAI angles in roll and pitch is indeterminate; R1 and R2 will be zero.</p> <p>Adjustment is not possible in all cases, including roll attitude adjustment. Ref para 4.5.1.</p> <p>If GUID CONT sw - PGNS and S/C: PGNS sw - AUTO, LGC commands automatic attitude maneuver. Ref para 4.5.1.</p>
	ACA 3		
	ACA		

**LMA790-3-LM**  
**APOLLO OPERATIONS HANDBOOK**

CREW-MAN	PNL	PROCEDURES	REMARKS
LM 3158		<p>4.6.1.9 <u>Crew-Defined Maneuver Routine (R62) (cont)</u></p> <p>c. To perform attitude maneuver automatically: GUID CONT sw - PGNS S/C: PGNS sw - AUTO Key PRO Go to step 6.</p> <p>6. If PGNS Automatic selected: DSKY displays are blanked until completion of automatic maneuver. Monitor FDAI belly band, with respect to color band on roll bezel, to avoid gimbal lock.</p> <p>To stop LM motion if gimbal lock is approached: S/C: PGNS sw - ATT HOLD If manual override &amp; completion of maneuver is desired: Select desired attitude control mode - ACA - maneuver manually Return to step 5.</p> <p>4.6.1.10 <u>Rendezvous Final Attitude Routine (R63)</u></p> <p>LGC Power-Up (required) LGC Self-Test (desired) IMU Power-Up (LGC Operating) (required) IMU Orientation Determination Program (P51) (required) DAP Data Load Routine (R03) (required) LGC state vector valid (required)</p>	<p>Automatic trim maneuver is to be considered essential for maneuvering to thrusting attitudes.</p> <p>If desired, Key extended verbs or Key V16 N18 - Final FDAI angles R1 Roll XXX.XX° R2 Pitch XXX.XX° R3 Yaw XXX.XX° Key KEY REL</p> <p>Belly band covers separation between hemispheres of FDAI ball. Belly band, in color bands on each side of FDAI roll bezel, would indicate IMU middle gimbal angle &gt;75°.</p> <p>During this maneuver, LGC will terminate automatic maneuver if S/C: PGNS sw is switched out of AUTO.</p> <p>Ref para 4.5.1.</p> <p>Purpose of Rendezvous Final Attitude Routine (R63) is to calculate and display final FDAI angles required to point +Z-axis or +X-axis at CSM and to call Attitude Maneuver Routine (R60) for automatic maneuver capability. This routine is selected only during LGC Idling Program (P00).</p> <p>Ref para 4.6.1.1. Ref para 4.6.1.13. Ref para 4.6.1.3. ISS should be on 15 minutes before thrusting maneuver. Ref para 4.9.1.1. Ref para 4.6.1.8. LGC Update Program (P27) (para 4.6.1.7).</p>



**LMA790-3-LM**  
**APOLLO OPERATIONS HANDBOOK**

CREW- MAN	P/NL	PROCEDURES	REMARKS
		<p>4.6.1.10 <u>Rendezvous Final Attitude Routine (R63) (cont)</u></p> <p>1. Enable PCNCS attitude control: GUID CONT sw - PCNS S/C:     FGNS sw - ATT HOLD     ROLL, PITCH, &amp; YAW sw - MODE CONT     ACA/4 JET sw (2) - ENABLE     ACA PROP sw (2) - ENABLE</p> <p>2. Establish PCNCS total attitude &amp; attitude rate/error display: ATTITUDE MON sw - PCNS RATE/ERR MON sw (2) - LDG RDR/CHPTR</p> <p>3. Key V89E Poss OPR ERR lt - on Exit R63, key RSET Poss PROG lt - on Key V05 M09E - Call alarm 00210 - IMU not on 00220 - ISS orientation not known</p> <p>Key KEY REL &amp; RSET FL V37 N-- Key XLE, exit R63</p> <p>4. FL V04 N12 - Option R1 00003 - Specify tracking attitude R2 00001 - Attitude option (+Z) R3 ----- R2 00001 = Preferred (+Z) 00002 = +X-axis Accept: Key PRO Reject: Key V22E - Key 2E (+X)</p> <p>5. FL V06 N18 - FDAI angles at track attitude R1 Roll XXX.XX° R2 Pitch XXX.XX° R3 Yaw XXX.XX° Update display: Key V32E Automatic attitude maneuver: Key PRO Terminate: Key V34E</p>	<p>Ref para 4.5.1.1.</p> <p>Ref para 4.5.3.1 and 4.5.3.2.</p> <p>OPR ERR lt - on if LGC Idling Program (P00) is not in process or if another extended verb from R76 is active.</p> <p>Perform IMU Power-Up (LGC Operating) procedure (para 4.6.1.3). Perform IMU Orientation Determination Program (P51) (para 4.9.1.1).</p>



**LMA790-3-LM**  
**APOLLO OPERATIONS HANDBOOK**

LM 3158	CREW-MAN	PNL	PROCEDURES	REMARKS
			<p>4.6.1.10 Rendezvous Final Attitude Routine (R63) (cont)</p> <p>6. Attitude Maneuver Routine (R60)</p> <p>FL V50 N18 - Perform desired automatic maneuver to final FDAI angles  R1 Roll XXX.XX°  R2 Pitch XXX.XX°  R3 Yaw XXX.XX°</p> <p>To reject attitude maneuver:  When within DAP deadband limits, &amp; further adjustment about desired vector is not desired,  Key ENTER, exit R60/R63</p> <p>To perform attitude maneuver:  a. To adjust vehicle attitude &amp; have LGC recompute gimbal angles,  Select desired attitude control mode -  ACA - maneuver as desired  S/C: PGNS sw - ATT HOLD  Key PRO</p> <p>b. Return to beginning of step 6.  To perform attitude maneuver manually:  Select desired attitude control mode -  ACA - maneuver manually to required attitude  Key PRO</p> <p>c. Return to beginning of step 6.  To perform attitude maneuver automatically:  GUID CONT sw - PGNS  S/C: PGNS sw - AUTO  Key PRO  Go to step 7.</p> <p>7. If PGNS automatic selected:  DSKY displays are blanked until completion of automatic maneuver. Monitor FDAI belly band, with respect to color band on roll bezel, to avoid gimbal lock.</p>	<p>Automatic attitude maneuvers are more efficient (i.e., propellant-time product is lower) than manual attitude maneuvers.  If final computed FDAI angles result in <math>\pm 90^\circ</math> yaw, trans-formation from IMU to FDAI angles in roll and pitch is indeterminate; R1 and R2 will be zero.</p> <p>Adjustment is not possible in all cases, including roll attitude adjustment.  Ref para 4.5.1.</p> <p>If GUID CONT sw - PGNS and S/C: PGNS sw - AUTO, LGC commands automatic attitude maneuver.</p> <p>Ref para 4.5.1.</p> <p>Automatic trim maneuver is to be considered essential for maneuvering to thrusting attitudes,</p> <p>If desired, Key extended verbs  or  Key V16 N18 - Final FDAI angles  R1 Roll XXX.XX°  R2 Pitch XXX.XX°  R3 Yaw XXX.XX°  Key KEY REL</p> <p>Belly band covers separation between hemispheres of FDAI ball. Belly band, in color bands on each side of FDAI roll bezel, would indicate IMU middle gimbal angle <math>&gt; 75^\circ</math>.</p>

**G & C**  
**GENERAL**



**LMA790-3-LM**  
**APOLLO OPERATIONS HANDBOOK**

LM 3158	CREW: MAN	PNI	<p style="text-align: center;"><b>PROCEDURES</b></p> <p>4.6.1.10 <u>Rendezvous Final Attitude Routine (R63) (cont)</u></p> <p>To stop LM motion if gimbal lock is approached: S/C: PGNS sw - ATT HOLD If manual override &amp; completion of maneuver is desired: Select desired attitude control mode - ACA - maneuver manually Return to step 6.</p>	<p style="text-align: center;"><b>REMARKS</b></p> <p>During this maneuver, LGC will terminate automatic maneuver if S/C: PGNS sw is switched out of AUTO.  Ref para 4.5.1.1.</p>
---------	--------------	-----	----------------------------------------------------------------------------------------------------------------------------------------------------------------------------------------------------------------------------------------------------------------------------------------------------------------------------------------------------------------------------	------------------------------------------------------------------------------------------------------------------------------------------------------------------------------------------

**G & C**  
**GENERAL**

**LMA790-3-LM**  
**APOLLO OPERATIONS HANDBOOK**

LM 3231

CREW-MAN	PNL	PROCEDURES	REMARKS
		<p>4.6.1.1.1 <u>Rendezvous Parameter Display Routine (R31)</u></p> <p>LGC Power-Up (required)</p> <p>LGC Self-Test (desired)</p> <p>IMU Power-Up (LGC Operating) (required)</p> <p>IMU Orientation Determination Program (P51) (required)</p> <p>1. Key V83E Press OPR ERR lt - on Exit R31, key RSET</p> <p>2. FL V16 N54 - Rendezvous parameters R1 Range XXX.XX nm R2 Range rate XXXX.X fps R3 0 XXX.XX° Display update every 0.5 sec. To terminate display: Key PRO, exit R31</p>	<p>Purpose of Rendezvous Parameter Display Routine (R31) is to display, at request of astronaut, LGC-calculated rendezvous parameters (range, range rate, and <math>\theta</math>).</p> <p>Ref para 4.6.1.1.1.</p> <p>Ref para 4.6.1.1.3.</p> <p>Ref para 4.6.1.3. ISS should be on 15 minutes before thrusting maneuver.</p> <p>Ref para 4.9.1.1.1.</p> <p>To monitor progress of state vector integration, time (GET) to which state vector integration process has presently calculated state vector is available as follows: Key V16 N38E - TET R1 00XXX hr R2 000XX min R3 0XX.XX sec To release display: Key KEY REL</p> <p>OPR ERR lt - on if another extended verb from R76 is active. Effects of marks on state vectors will not be exhibited in display of range and range rate if navigation marks are made after R31 is selected and running. If R31 is run for long time during coast flight, range and range rate data in N54 will begin to degenerate because of conic extrapolation of state vector. Range rate display may degrade considerably at range &lt;0.5 nm, depending on navigation accuracy. If V83 is called while on lunar surface, R3 of N54 will read approximately 180°, whereas it might be expected to read 0°. This is attributable to computational method and should be ignored.</p>

**LMA790-3-LM**  
**APOLLO OPERATIONS HANDBOOK**

CREW-MAN	PNL	PROCEDURES	REMARKS
		<p>4.6.1.1.2 <u>Show Banksum</u></p> <p>LGC Power-Up (required)</p> <p>LGC Idling Program or Fresh Start (required)</p> <p>1. Key V91E Press OPR ERR lt - on Exit V91, key RSET FL V05 N01</p> <p style="padding-left: 40px;">R1 Sum of bank AAAXX R2 Actual bank number 000YY R3 Bugger word 22ZZZ</p> <p>Verify Banksum equals bank number or its 7's complement Key V32E to recheck Banksum display Proceed: Key PRO - Go to next step in cycle Terminate: Key V34E - Exit Show Banksum</p> <p>2. If discrepancy appears, record bank number for transmittal to MSPN &amp; terminate use of LGC after completion of test.</p> <p>4.6.1.1.3 <u>LGC Self-Test</u></p> <p>LGC Power-Up (required)</p> <p>1. Key V21 N27E OE (Set SMODE for backup idle mode.)</p> <p>2. Zero SCOUNT, SCOUNT +1, &amp; ERCOUNT registers: Key V25 N01E 1365E E - (ERCOUNT) E - (SCOUNT) E - (SCOUNT +1)</p>	<p>Purpose of Show Banksum (V91) procedure is to verify contents of fixed memory. Recommended: Show Banksum procedure should be completed before LGC Self-Test procedure (para 4.6.1.1.3), if it is desired to leave self-test running.</p> <p>Ref para 4.6.1.1.1.</p> <p>Ref para 4.6.1.6 or 4.6.1.20.</p> <p>At start of Show Banksum, +0 is put in SMODE register and forces LGC Self-Test into backup idle loop.</p> <p>OPR ERR lt - on if not in POO or if another extended verb is active.</p> <p>Bugger word is value which, when added to Banksum, makes result equal bank number or its 7's complement.</p> <p>Bank number starts at zero and increments to next highest bank until Banksum repeats cycle from zero.</p> <p>Purpose of this procedure is to initiate and monitor LGC Self-Test, leaving self-test running in background; i.e., when LGC is not otherwise employed. Selection of POO before self-test tends to maximize LGC time available for self-test.</p> <p>Ref para 4.6.1.1.1.</p> <p>Steps 1, 2, and 3 are optional.</p> <p>ERCOUNT - Error counter SCOUNT - Self-test counter SCOUNT +1 - Erasable memory, cycle, and shift registers check good counter.</p>



**LMA790-3-LM**  
**APOLLO OPERATIONS HANDBOOK**

LM 2019, LM 3231

CREW-MAN	PROCEDURES	REMARKS																																				
	<p>4.6.1.13 LGC Self-Test (cont)</p> <p>3. Alternative to step 1: Key V36E - Fresh Start Observe DSKY blanks.</p> <p>4. Start monitoring of ERCOUNT, SCOUNT, &amp; SCOUNT +1: Key V15 N01E 1365E</p> <p>5. Key V21 N27E AAAAAE where AAAAA (SMODE) = one of five-digit codes listed below</p> <table border="1" data-bbox="438 976 909 1816"> <thead> <tr> <th>One cycle</th> <th>Cycles</th> <th>Check</th> </tr> </thead> <tbody> <tr> <td>00001(+1)</td> <td>77776 (-1)</td> <td>Perform +4 &amp; +5.</td> </tr> <tr> <td>00002(+2)</td> <td>77775 (-2)</td> <td>Perform +4 &amp; +5.</td> </tr> <tr> <td>00003(+3)</td> <td>77774 (-3)</td> <td>Perform +4 &amp; +5.</td> </tr> <tr> <td>00004(+4)</td> <td>77773 (-4)</td> <td>Perform ERASCHK, CNTRCHK, &amp; CYCLSHFT</td> </tr> <tr> <td>00005(+5)</td> <td>77772 (-5)</td> <td>if no new job is waiting Perform ROPECHK if no new job is waiting.</td> </tr> <tr> <td>00006(+6)</td> <td>77771 (-6)</td> <td>Perform +4 &amp; +5.</td> </tr> <tr> <td>00007(+7)</td> <td>77770 (-7)</td> <td>Perform +4 &amp; +5.</td> </tr> <tr> <td>00010(+10)</td> <td>77767 (-10)</td> <td>Perform +4 &amp; +5.</td> </tr> <tr> <td>00011 to 37777 (&gt;+10)</td> <td>77766 to 40000 (&lt;-10)</td> <td>Change to +0.</td> </tr> <tr> <td>00000(+0)</td> <td>-</td> <td>Perform backup idle mode; looks for new job.</td> </tr> <tr> <td>-</td> <td>77777 (-0)</td> <td>Perform +4 &amp; +5.</td> </tr> </tbody> </table> <p>6. Monitor register R2 (SCOUNT) Normal indication: 00001 for approx 13 sec 00002 for approx 52 sec 00003 for approx 13 sec, etc</p> <p>Abnormal indication: PROG 1c - on If SMODE (-) non-zero, key VERB</p> <p>7. Record R1 (ERCOUNT) R2 (SCOUNT) R3 (SCOUNT +1) Key V05 N09E - Call alarm</p>	One cycle	Cycles	Check	00001(+1)	77776 (-1)	Perform +4 & +5.	00002(+2)	77775 (-2)	Perform +4 & +5.	00003(+3)	77774 (-3)	Perform +4 & +5.	00004(+4)	77773 (-4)	Perform ERASCHK, CNTRCHK, & CYCLSHFT	00005(+5)	77772 (-5)	if no new job is waiting Perform ROPECHK if no new job is waiting.	00006(+6)	77771 (-6)	Perform +4 & +5.	00007(+7)	77770 (-7)	Perform +4 & +5.	00010(+10)	77767 (-10)	Perform +4 & +5.	00011 to 37777 (>+10)	77766 to 40000 (<-10)	Change to +0.	00000(+0)	-	Perform backup idle mode; looks for new job.	-	77777 (-0)	Perform +4 & +5.	<p>Fresh Start procedure also sets SMODE and ERCOUNT to +0.</p> <p>If LGC detects error during one cycle selection (+ non-zero), LGC goes to backup idle (+0). If no error is detected, test is repeated. If LGC detects error during repeated cycles (- non-zero), LGC tries test again. If no error is detected, test is repeated. If -0 is detected and error is detected, test continues from failed location.</p> <p>LGC self-test continues until SMODE is changed by DSKY entry or error is detected. However, once it is started, self-test runs only in background (when LGC is idling). Times quoted are minimum and are highly dependent upon present computer activity (e.g. with digital autopilot on, total time could be as long as 95 seconds).</p> <p>Verb pb is used to momentarily inhibit updating of DSKY by running monitor. Other DSKY pb's which will also freeze DSKY display are NOUN, CLEAR, +, -, or any digit.</p> <p>Alarm can occur any time after step 5.</p>
One cycle	Cycles	Check																																				
00001(+1)	77776 (-1)	Perform +4 & +5.																																				
00002(+2)	77775 (-2)	Perform +4 & +5.																																				
00003(+3)	77774 (-3)	Perform +4 & +5.																																				
00004(+4)	77773 (-4)	Perform ERASCHK, CNTRCHK, & CYCLSHFT																																				
00005(+5)	77772 (-5)	if no new job is waiting Perform ROPECHK if no new job is waiting.																																				
00006(+6)	77771 (-6)	Perform +4 & +5.																																				
00007(+7)	77770 (-7)	Perform +4 & +5.																																				
00010(+10)	77767 (-10)	Perform +4 & +5.																																				
00011 to 37777 (>+10)	77766 to 40000 (<-10)	Change to +0.																																				
00000(+0)	-	Perform backup idle mode; looks for new job.																																				
-	77777 (-0)	Perform +4 & +5.																																				

**LMA790-3-LM**  
**APOLLO OPERATIONS HANDBOOK**

CREW-MAN	PNL	PROCEDURES	REMARKS
RC 1606		<p>4.6.1.1.13 <u>LGC Self-Test (cont)</u></p> <p>R1 XXXX R2 XXXX R3 XXXX If 01102 appears: Key V05 N08E - Alarm data R1 Octal - ALMCADR R2 Octal - ALMCADR +1 R3 Octal - ERCOUNT Record R1 (ALMCADR). If 01102 does not appear: Attend to alarm &amp; continue. If SCOUNT was odd number when PROG lt came on: a. Key V01 N01E 1374E, record R1 (SKEEP 4) b. Key ENTER 1377E, record R1 (SKEEP 7) c. Transmit ALMCADR, SKEEP 4, &amp; SKEEP 7 to MSFN. d. Terminate use of LGC (erasable memory problem). If SCOUNT was even number when PROG lt came on: a. Perform Show Banksum procedure (para 4.6.1.1.12). b. Transmit number of failed bank to MSFN. c. Terminate use of LGC (fixed memory problem).</p> <p>4.6.1.1.14 <u>DSKY Light Test</u></p> <p>LGC Power-Up (required)</p> <p>1. Key V35E - DSKY lights test Press OPR ERR lt - on Exit V35, key RSET</p> <p>2. UPLINK ACTY lt - on NO ATT lt - on STBY lt - on KEY REL lt - on (flashing) OPR ERR lt - on (flashing) PRIO DISP lt - on NO DAP lt - on TEMP lt - on GIMBAL LOCK lt - on PROG lt - on RESTART lt - on TRACKER lt - on ALT lt - on VEL lt - on</p>	<p>ALMCADR - Contents of SPAIL = 1 + address of failure ALMCADR +1 - BBOON of SELFCHK ERCOUNT - Amount of self-check failures since last crew-initiated fresh start or manual zero of ERCOUNT.</p> <p>Purpose of DSKY Light Test procedure is to verify correct illumination of all DSKY lights, except CHPTR ACTY. Ref para 4.6.1.1.1.</p> <p>OPR ERR lt - on if DSKY light test (V35) is not performed in POO.</p>

G & C  
GENERAL

**LMA790-3-LM  
APOLLO OPERATIONS HANDBOOK**

RC 1606

CREW- MAN	PNL	PROCEDURES	REMARKS
		<p>4.6.1.14 <u>DSKY Light Test (cont)</u></p> <p>PROG ind - 88            VERB ind - 88 (flashing)            NOUN ind - 88 (flashing)            R1 +88888            R2 +88888            R3 +88888</p> <p>ISS warn lt - on            LGC warn lt - on            MASTER ALARM - on            MASTER ALARM pb/lt - reset</p> <p>3. After 5 sec:            UPLINK ACTY lt - off            NO ATT lt - off            Key RSET            STBY lt - off            KEY REL lt - off            OPR ERR lt - off            PRIO DISP lt - off            NO DAP lt - off            TEMP lt - off            GIMBAL LOCK lt - off            PROG lt - off            RESTART lt - off            TRACKER lt - off            ALT lt - off            VEL lt - off            PROG ind - 00            VERB ind - --            NOUN ind - --            R1 -----            R2 -----            R3 -----            ISS warn lt - off            LGC warn lt - off</p> <p>4.6.1.15 <u>LGC/CMC Clock Synchronization Routine (R33)</u></p>	<p>Purpose of LGC/CMC Clock Synchronization Routine (R33) is to determine time differential between LGC clock and CMC clock.</p>



**LMA790-3-LM**  
**APOLLO OPERATIONS HANDBOOK**

CREW- MAN	PNL	PROCEDURES	REMARKS
		<p>4.6.1.15 <u>LGC/CMC Clock Synchronization Routine (R33)</u> <u>(cont)</u></p> <p>LGC Power-Up (required)</p> <ol style="list-style-type: none"> <li>1. If precise value (difference between LGC &amp; CMC clocks) is available from MSFN, go to step 7.</li> <li>2. Confirm selection of Routine 33 in CSM.</li> <li>3. Key V06 N65 (Do not enter.)</li> <li>4. Perform countdown with CMP &amp; key ENTR on mark command.</li> <li>5. V06 N65 - LGC clock time               <ul style="list-style-type: none"> <li>R1 00XX hr</li> <li>R2 00XX min</li> <li>R3 0X.XX sec</li> </ul>               Record LGC clock time.                Obtain CMC clock time from CSM crewmember.                Compute clock-time difference.                If more clock-time difference data points are desired, return to step 4 &amp; repeat procedures.                To discontinue procedure, key KEY REL                To complete procedure, go to step 6.             </li> <li>6. Determine average of all clock-time differences.</li> <li>7. Key V55E (increment LGC time) Poss OPR ERR lt - on</li> <li>8. FL V21 N24 Key clock hr-difference FL V22 N24 Key clock min-difference FL V23 N24 Key clock sec-difference (0.01 sec)</li> <li>9. If clock check is desired, repeat steps 3 through 5.</li> </ol>	<p>Ref para 4.6.1.1. and CMC clock</p> <p>OPR ERR lt - on if another extended verb from R76 is active.</p> <p>Polarity is plus (+) if LGC gives lower clock indication.</p>

RC 1606

G &  
GENE

**LMA790-3-LM**  
**APOLLO OPERATIONS HANDBOOK**

LM 3231

CREW-MAN	PNL	PROCEDURES	REMARKS
		<p>4.6.1.1.16 <u>PIPA Bias Measurement &amp; Loading</u></p> <p>LGC Power-Up (required)</p> <p>IMU Power-Up (LGC Operating) (required)</p> <p>1. Establish Attitude Rate Display mode.</p> <p>2. Establish desired attitude control mode.</p> <p>Ensure attitude rates are &lt;0.1°/sec.</p> <p>3. Set EVNT TMR ind - 00:00</p> <p>4. S/C: PGNS sw - OFF</p> <p>5. Key V25 N21E E, E Key ENTER &amp; start EVNT TMR ind simultaneously</p> <p>6. Key V06E When EVNT TMR ind - 01:20: Key ENTER Record final PIPA counts R1 X ----- pulses R2 Y ----- pulses R3 Z ----- pulses</p> <p>7. Calculate PIPA bias: <math display="block">\frac{\text{Final count} - \text{PIPA bias}}{1000}</math></p> <p>8. Key V06 N01E - Present bias 1452E - Record R1 X Bias + ---- 1454E - Record R1 Y Bias + ---- 1456E - Record R1 Z Bias + ----</p> <p>9. Update PIPA bias: Key V21 N01E 14XXE (applicable bias) +.XXXXXE - Calculated value</p>	<p>Ref para 4.6.1.1.1.</p> <p>Ref para 4.6.1.3. ISS should be on 15 minutes before thrusting maneuver.</p> <p>Ref para 4.5.3.5.</p> <p>Ref para 4.5.1.</p> <p>Ref para 4.13.6.</p> <p>Zeros PIPA pulse registers.</p> <p>Time shown is for 80-second (01:20) bias check. If very short check is desired, perform step 6 at EVNT TMR ind - 00:08 and use divisor of 100 for step 7.</p> <p>PIPA pulses are displayed as + integers in right-hand digits of readout. Formula for calculating PIPA bias compensation results in decimal fraction (with decimal point on left).</p>

**LMA790-3-LM**  
**APOLLO OPERATIONS HANDBOOK**

CREW-MAN	PNI	PROCEDURES	REMARKS
		<p>4.6.1.1.17 <u>Rate of Descent Controller/LGC Interface Check</u></p> <p>LGC Power-Up (required)</p> <p>1. Key V11 N10E 16E - Monitor input channel 16  R1 XXCDX - Rate-of-descent inhibit configuration  R2 -----  R3 -----</p> <p>2. DES RATE sw - center  Verify C = 0 &amp; D &lt; 4</p> <p>3. DES RATE sw - +1 FPS (plus)  Verify D &gt; 3  PROG It - on</p> <p>4. DES RATE sw - -1 FPS (minus)  Verify C = 1</p> <p>4.6.1.1.18 <u>AGS Initialization Routine (R47)</u></p> <p>LGC Power-Up (required)</p> <p>LGC Self-Test (desired)</p> <p>IMU Power-Up (LGC Operating) (required)</p> <p>IMU Orientation Determination Program (P51) (required)</p> <p>AGS Power-Up (required)</p>	<p>Ref para 4.6.1.1.1.</p> <p>Alarm code 00112 stored if DES RATE sw activated with average g off and not in P52 or P57.</p> <p>Purpose of AGS Initialization Routine (R47) is to initialize AGS absolute time and/or to initialize/update AGS LM/CSM state vector.</p> <p>CSM state vector must be updated after each CSM thrust maneuver.</p> <p>If this routine is called from P00 or P3X (with P20 not in operation), LGC will send CDU zero discrete and disable DAP for approximately 12 seconds.</p> <p>Ref para 4.6.1.1.1.</p> <p>Ref para 4.6.1.1.3.</p> <p>Ref para 4.9.1.1.1.</p> <p>Ref para 4.6.2.1.1.</p>

LM 3231

C  
P  
GENE

**LMA790-3-LM**  
**APOLLO OPERATIONS HANDBOOK**

LM 999, LM 3231

CREW-MAN	PNL	PROCEDURES	REMARKS
		<p>4.6.1.18 <u>AGS Initialization Routine (R47) (cont)</u></p> <p>AGS Checkout (desired)</p> <p>Set Mission Timer</p> <p>LCC/CMC Clock Synchronization Routine (R33)</p> <p>Communications Basic (desired - near earth)</p> <p>S-Band Steerable Antenna Activation and Checkout (desired - lunar distance)</p> <p>1. Select AGS Initialization Routine (R47): Key V47E If only AGS LM/CSM state vector update is performed, omit step 3.</p> <p>Poss OPR ERR lt - on Exit RA7, key RSET</p> <p>Poss PROG lt - on Key V05 NO9E - Call alarm 00220 - REFSMFLG not set Key KEY REL &amp; RSET, exit R47 Perform IMU Orientation Determination Program (P51) Return to beginning of step 1.</p> <p>2. FL V06 N16 R1 00XX hr R2 00XX min R3 0XX.XX sec</p> <p>3. Initialization of AGS time: a. Option I: AEA clock zero Key DEDA C 377+00000 (Do not enter.) Key DSKY V32 (Do not enter.) Key ENTR on DSKY &amp; DEDA simultaneously.</p>	<p>Ref para 4.6.2.4.</p> <p>Ref para 4.2.12.</p> <p>Ref para 4.6.1.15.</p> <p>Ref para 4.13.2.1.</p> <p>Ref para 4.2.20.</p> <p>OPR ERR lt - on if another extended verb from R76 is active.</p> <p>Ref para 4.9.1.1.</p> <p>Before first AEA clock initialization, V06 N16 contains meaningless value. After AEA clock initialization, V06 N16 contains stored GET of AEA clock zero (K). (GET of AEA clock zero is MIT/DL expression for AGS time bias.) AGS time bias is required because AGS time is limited to approximately 72 hours. GET - AGS time bias (K) = AGS time.</p> <p>AEA clock is set to zero and simultaneously, present GET is set into V06 N16 by entering V32.</p>

**LMA790-3-LM**  
**APOLLO OPERATIONS HANDBOOK**

LM 3207

CREW- MAN	PNL	PROCEDURES	REMARKS
		<p>4.6.1.18 <u>AGS Initialization Routine (R47) (cont)</u></p> <p>b. Option II: Selection of specific AGS time bias (K)</p> <p>Key DEDA C 377+XXXX (0.1 min)</p> <p>Key DEDA ENTR            If only time initialization is performed, omit steps 5 &amp; 8 thru 11.</p> <p>4. Verify AGS time is incrementing from XXXXX value entered in step 3:            Key DEDA C 377R</p> <p>5. Command LM/CSM state vector update via PGNC S downlink:            Key DEDA C 414+10000E</p> <p align="center">CAUTION</p> <p>6. Check V06 N16            If value is not satisfactory, or if option "b" selected in step 3:            Key in correct value.            Record K, Key PRO</p> <p>7. V06 N16            R1 00XXX hr            R2 000XX min            R3 0XX.XX sec</p> <p>8. FL V50 N16            R1 00XXX hr            R2 000XX min            R3 0XX.XX sec</p>	<p>To simplify computation of AGS time, value for GET of AEA clock zero (K) can be determined that:</p> <ol style="list-style-type: none"> <li>Can be readily subtracted from GET to obtain AGS time</li> <li>Has occurred in recent past</li> <li>Is easy to remember</li> </ol> <p>Positive value of XXXXX and GET of AEA ENTR must be determined so that GET of AEA ENTR less XXXXX equals predetermined AGS time bias (K).</p> <p>Entry to be made at GET of AEA ENTR.</p> <p>If +00000 or +10000 is inadvertently entered into address 414, search of PGNC S downlink for identification word can be eliminated by keying C 563+00000E.</p> <p>MSFN can obtain precise value of K by comparing LGC and AEA downlink and can correct for uncertainties in processing pushbutton depression.</p> <p>After keying PRO (step 6), display is static until AEA downlink list is transmitted 10 times at 2 seconds per transmission (20 seconds). Then, if IMU is not in use, CDU, LGC, and AEA gimbal-angle counters are zeroed and DAP is disabled and NO DAP lit - on for approximately 12 seconds. The flashing V50 N16 display, which follows (after either approximately 20 seconds, or approximately 32 seconds if CDU zero is performed), indicates completion of downlink navigation update (and CDU Zero if performed).</p>

G &  
GENE

**LMA790-3-LM**  
**APOLLO OPERATIONS HANDBOOK**

LM 3231

CREW- MAN	PNI	PROCEDURES	REMARKS
		<p>4.6.1.18 <u>AGS Initialization Routine (R47) (cont)</u></p> <p>9. Verify AGS initialization complete: Key DEDA C 414R+0000 To terminate: Key PR0, V32E, or V34E</p> <p>10. If update accuracy verification is desired: Display LGC remasvous parameters (R31) - Key V83E Pos OPR ERR lt - on Exit R31, key RSET FL V16 N54 R1 Range    XXX.XX nm R2 Range rate   XXX.X fps R3 0        XXX.XX°</p> <p>11. Read out AGS range rate: Key DEDA C 440R XXXX (0.1/1 fps) Compare PCNCS &amp; AGS values of range rate. Values should be within 10 fps. To terminate R31: Key PR0</p> <p>4.6.1.19 <u>Preferred Tracking Attitude Program (P25)</u></p> <p>LGC Power-Up (required) LGC/CMC Clock Synchronization Program (R33) (required) IMU Power-Up (LGC Operating) (required) LGC Update Program (P27) (desired) IMU Orientation Determination Program (P51) (required) DAP Data Load Routine (R03) (required)</p>	<p>Occurs within 2 seconds.</p> <p>OPR ERR lt - on if another extended verb from R76 is in process. Range rate comparison is usable up to 8,388,000 feet (1380 nm) in lunar orbit; up to 33,554,000 feet (5,518 nm) in earth orbit.</p> <p>If IMU orientation has changed since last AGS alignment, perform PCNCS/AGS Align (para 4.9.2.1). Wait at least 30 seconds after CDU zero. Parenthetical quantization notation: lunar mission/earth mission.</p> <p>Purpose of Preferred Tracking Attitude Program (P25) is to compute LM preferred tracking attitude that will enable GSM tracking of LM beacon and to perform maneuver to preferred tracking attitude.</p> <p>Ref para 4.6.1.1. Ref para 4.6.1.15. Ref para 4.6.1.3. ISS should be on 15 minutes before thrusting maneuver. Ref para 4.6.1.7. Ref para 4.9.1.1. Ref para 4.6.1.8.</p>

**LMA790-3-LM**  
**APOLLO OPERATIONS HANDBOOK**

CREW- MAN	PNL	PROCEDURES	REMARKS
		<p>4.6.1.19 Preferred Tracking Attitude Program (P25) (cont)</p> <p>1. Enable PGNC attitude control: GUID CONT sw - PGNS S/C: PGNS sw - ATT HOLD ROLL, PITCH, &amp; YAW sw - MODE CONT ACA/4 JET sw (2) - ENABLE ACA PROP sw (2) - ENABLE</p> <p>2. Establish PGNC total attitude &amp; attitude rate/error display: ATTITUDE MON sw - PGNS RATE/ERR MON sw - LDG RDR/CHPTR</p> <p>3. Select P25: Key V37E 25E Pos PROG lt - on Key V05 N09E - Call alarm 00210 - IMU not on 00220 - ISS orientation not known</p> <p>Key KEY REL &amp; RSET FL V37 N-- Key XKB, exit P25</p> <p>Fine Preferred Tracking Attitude Routine (R65)</p> <p>4. Attitude Maneuver Routine (R60)</p>	<p>Ref para 4.5.3.1 and 4.5.3.2.</p> <p>Perform IMU Power-Up (LGC Operating) procedure (para 4.6.1.3). Perform IMU Orientation Determination Program (P51) (para 4.9.1.1).</p> <p>Fine Preferred Tracking Attitude Routine (R65) silently performs automatic trim to tracking attitude if maneuver &lt;15°. If limits are exceeded, crew is notified via FL V50 N18 (R60) that attitude maneuver is required. The roll attitude about LM Z-axis is undefined, but maintained at orientation resulting from maneuver. The crew may select roll attitude, such as heads up, in response to FL V50 N18.</p> <p>Asterisk (*) indicates priority display. Two-second delay is required before LGC will accept crew response.</p> <p>Automatic attitude maneuvers are more efficient (i.e., propellant-time product is lower) than manual attitude maneuvers.</p>

G & C  
GENER

**LMA790-3-LM**  
**APOLLO OPERATIONS HANDBOOK**

LH 3158, LM 3231

CREW-MAN	P/NL	PROCEDURES	REMARKS
		<p>4.6.1.19 Preferred Tracking Attitude Program (P25) (cont)</p> <p>*FL V50 N18 - Perform desired automatic maneuver to final FDAI angles            R1 Roll XXX.XX°            R2 Pitch XXX.XX°            R3 Yaw XXX.XX°            To reject attitude maneuver:            When within DAP deadband limits, &amp; further adjustment about desired vector is not desired,            Key ENTR, exit R60            To perform attitude maneuver:            a. To adjust vehicle attitude &amp; have LGC recompute gimbal angles:            ACA - maneuver as desired            S/C: PGNS sv - ATT HOLD            Key PRO            Return to beginning of step 4.            b. To perform attitude maneuver manually:            Select desired attitude control mode -            ACA - maneuver as desired            Key PRO            Return to beginning of step 4.            c. To perform attitude maneuver automatically:            GUID CONT sv - PGNS            S/C: PGNS sv - AUTO            Key PRO            Go to step 5.</p> <p>5. If PGNS automatic selected:            DSKY displays are blanked until completion of automatic maneuver. Monitor FDAI belly band, with respect to color band on roll bezel, to avoid gimbal lock.</p>	<p>If final computed FDAI angles result in +90° yaw, trans-formation from IMU to FDAI angles in roll and pitch is indeterminate; R1 and R2 will be zero.</p> <p>Adjustment is not possible in all cases, including roll attitude adjustment.            Ref para 4.5.1.</p> <p>If GUID CONT sv - PGNS and S/C: PGNS sv - AUTO, LGC commands automatic attitude maneuver.</p> <p>Ref para 4.5.1.</p> <p>Automatic trim maneuver is to be considered essential for maneuvering to thrusting attitudes.</p> <p>If desired, Key extended verbs            or            Key V16 N18 - Final FDAI angles            R1 Roll XXX.XX°            R2 Pitch XXX.XX°            R3 Yaw XXX.XX°            Key KEY REL</p> <p>Belly band covers separation between hemispheres of FDAI ball. Belly band, in color bands on each side of FDAI roll bezel, would indicate IMU middle gimbal angle &gt; 75°.</p>
3			
1 3			



**LMA790-3-LM  
APOLLO OPERATIONS HANDBOOK**

LM 315B, LM 3231	CREW- MAN	PNL	PROCEDURES	REMARKS
			<p>4.6.1.19 Preferred Tracking Attitude Program (P25) (cont)</p> <p>5. To stop LM motion if gimbal lock is approached:  S/C: PGNS sw - ATT HOLD  If manual override &amp; completion of maneuver is desired:  Select desired attitude control mode -  ACA - maneuver manually  Return to step 4.</p>	<p>During this maneuver, LGC will terminate automatic maneuver if S/C: PGNS sw is switched out of AUTO.  Ref para 4.5.1.</p>

G &  
GENER



**LMA790-3-LM**  
**APOLLO OPERATIONS HANDBOOK**

CREW-MAN	PNL	PROCEDURES	REMARKS
	<p>LM 3207, LM 3231</p>	<p>4.6.1.19 Preferred Tracking Attitude Program (P25) (cont)</p> <p>6. To terminate P25:</p> <p>a. To terminate P25 only: Key V56E, go to other program in process.</p> <p>b. To terminate all current programs &amp; routines: Key V34E FL V37 N--- Key V37E 00E, go to LGC Idling Program (P00)</p> <p>4.6.1.20 Fresh Start</p> <p>LGC Power-Up (required)</p> <p>1. Key V36E Press NO DAP lit - on (momentary) Observe DSKY blanks.</p> <p>2. Confer with MSFN to determine whether erasable memory restoration is required.</p> <p>3. Perform LGC Update Program (P27) if erasable memory restoration is required. Perform IMU Orientation Determination Program (P51) if REFSMAT is not acceptable.</p>	<p>Purpose of Fresh Start procedure is to establish computer memory configuration from which normal activity can proceed. (V36 can be used to recover from transient malfunctions.)</p> <p>Ref para 4.6.1.1.</p> <p>Fresh Start can be initiated as follows: Via program if phase table disagreement is detected following restart. (Alarm code 01107 is stored.); via program if self-check is interrupted by restart during its erasable memory check and erasable memory is suspect; by simultaneously pushing mark REJECT pb and RSET pb during restart (GOJAM) (command engine off); or by DSKY enter of V36E (Commands engine off).</p> <p>If V36 interrupted state vector integration, present state vector may not be valid. P27 can be used to re-store state vector.</p> <p>Some initialization settings can be changed by performing DAP Data Load Routine (RO3) if desired. These settings are as follows (states set by Fresh Start): Undocked, unstaged configuration 2-jet translation (RCS system B) Normal ACA scaling Maximum deadband 2.0°/sec KALCMANU rate</p> <p>Ref para 4.6.1.7. Ref para 4.9.1.1.</p>



**LMA790-3-LM**  
**APOLLO OPERATIONS HANDBOOK**

LM 3207, LM 3231

CREW-MAN	PNL	PROCEDURES	REMARKS
		<p>4.6.1.20 <u>Fresh Start (cont)</u></p> <p>Perform DAP Data Load Routine (R03) if desired. Key V76E if desired.</p> <p>Reload HIASCENT: Key V21 N01E 3000E 2324E</p> <p>4.6.1.21 <u>ICDU Zero</u></p> <p>LGC Power-Up (required)</p> <p>1. Key V40 N20E Pos OPR ERR lt - on Exit V40, key RSET NO DAP lt - on Pos PROG lt - on Key V05 M09E - Call alarm 00206 - Zero encode not allowed with coarse align &amp; gimbal lock Key KEY REL Perform ISS Coarse Align</p> <p>2. NO ATT lt - off NO DAP lt - off Pos PROG lt - on Key V05 M09E - Call alarm 00210 - IMU not on Key KEY REL &amp; RSET, exit V40 Pos ISS warn lt - on</p>	<p>Ref para 4.6.1.8. DAPBOOLS (Flagwood 13) is set to 21322 (para 4.4.13). If this is not satisfactory, select R03 and reload DAP data. V36E will destroy stored erasable values, which therefore must be reloaded. V36E also zeroes channel 77 (restart monitor).</p> <p>Purpose of ICDU Zero procedure is to ensure synchronization of IMU CDU counters in LGC, to terminate IMU coarse align mode, and enter inertial mode.</p> <p>ICDU Zero disables DAP for approximately 12 seconds.</p> <p>Attempts to use V37 to change program during 10.56 seconds after ICDU zero, during which DAP is disabled, will cause PROG lt - on with alarm code 01520 (V37 request not permitted at this time) stored for display with V05 M09E. DAP remains disabled if hardware or software restart occurs while DAP is disabled. To recover, repeat V40 N20E.</p> <p>Ref para 4.6.1.1.</p> <p>Pos OPR ERR lt - on if mode change or if gyro torquing is in process.</p> <p>Ref para 4.9.1.3.</p> <p>NO ATT lt - off indicates that ISS is not in coarse align mode</p> <p>ISS warn lt logic is updated at this time. (IMU and ICDU fail discretely previously inhibited are reset.)</p>

# LMA790-3-LM

## APOLLO OPERATIONS HANDBOOK

LM 3207, LM 3231, LM 3235

CREW-MAN	PNL	PROCEDURES	REMARKS
		<p>4.6.1.22 <u>RR CDU Zero</u></p> <p>LGC Power-Up (required) LGC Self-Test (desired)</p> <p>1. Key V40 N72E</p> <p>Poss OPR ERR 1t - on Exit V40 N72, key RSET</p> <p>2. When TRACKER 1t is updated, it will go on if any of following has occurred.</p> <p>a. RR CDU fails while in RR automatic mode b. RR data fail</p> <p>Poss PROG 1t - on Key V05 N09E - Call alarm 00510 - Radar automatic discrete not present Key KEY REL &amp; RSET</p> <p>4.6.1.23 <u>Load IMU Attitude Error Meters</u></p> <p>LGC Power-Up (required)</p> <p>1. Establish PGNS Attitude Rate/Error Display mode: ATTITUDE MON sw - PGNS RATE /ERR MON sw - LDG RDR/CHPTR</p> <p>3. S/C: PGNS sw - OFF NO DAP 1t - on</p> <p>3. Key V43E Poss OPR ERR 1t - on Exit V43, key RSET</p>	<p>Purpose of RR CDU Zero procedure is to zero rendezvous radar CDU's, determine (internally) RR antenna mode, and update TRACKER 1t.</p> <p>Ref para 4.6.1.1.1. Ref para 4.6.1.1.13.</p> <p>RR CDU Zero procedure terminates if RR is in process of being turned on or if reposition flag is set.</p> <p>OPR ERR 1t - on if read sequence of either radar or RR designate is in process or if another program or routine is using either radar or TRACKFLG is set.</p> <p>Alarm 00510 is called only when RNDZ RADAR sel is not set to LGC.</p> <p>Purpose of Load IMU Attitude Error Meters procedure is to display crew-specified angles by FDAI error needles. Procedure can be selected only during LGC Idling Program (P00).</p> <p>Ref para 4.6.1.1.1. Ref para 4.5.3.2.</p> <p>Switch must be off, for V43 procedure to continue. Switch guard may be moved to side position for duration of time S/C: PGNS sw - OFF.</p> <p>All registers are initially blank.</p> <p>OPR ERR 1t - on if S/C: PGNS sw - ATT HOLD or AUTO, IMU is in coarse align, P00 is not operating, or if another extended verb is active.</p>

G & G  
GENE

**LMA790-3-LM**  
**APOLLO OPERATIONS HANDBOOK**

LM 3231

CREW-MAN	PNI	PROCEDURES	REMARKS
		<p>4.6.1.23 <u>Load IMU Attitude Error Meters (cont)</u></p> <p>FL V21 N22 - Load error angles  R1 OGA    XXX.XX°  R2 IGA    XXX.XX°  R3 MGA    XXX.XX°  Load desired angles  To terminate:  Key V34E</p> <p>4.    V43 - Error meter load verb  Verify specified error angles displayed by FDAI error needles.</p> <p>4.6.1.24 <u>Increment LGC Time</u></p> <p>LGC Power-Up (required)</p> <p>1.    Key V55E  Press OPR ERR lt - on  Exit V55, key RSET</p> <p>2.    FL V21 N24 - Load Δ clock time  R1 00XXX hr  R2 000XX min  R3 0XX.XX sec  Accept: Load desired time increments  Reject: Key V33E or V34E, exit V55</p> <p>4.6.1.25 <u>Initialize Erasable Dump Via Downlink</u></p> <p>LGC Power-Up (required)</p> <p>Communications Basic (required - near earth)</p> <p>S-Band Steerable Antenna Activation and Checkout (required - lunar distance)</p>	<p>Maximum angle loaded should be <math>\pm 5^\circ</math>. Any value exceeding <math>\pm 5^\circ</math> will peg error needles.</p> <p>Purpose of Increment LGC Time procedure is to change LGC clock time, using increments loaded by crew.</p> <p>Ref para 4.6.1.1.</p> <p>OPR ERR lt - on if another extended verb from R76 is active.</p> <p>All registers are initially blank.</p> <p>Purpose of Initialize Erasable Dump Via Downlink procedure is to perform nondestructive dump of erasable memory to MSFN.</p> <p>Ref para 4.6.1.1.</p> <p>Ref para 4.13.2.1.</p> <p>Ref para 4.2.20.</p>

**LMA790-3-LM**  
**APOLLO OPERATIONS HANDBOOK**

CREW-MAN	PNL	PROCEDURES	REMARKS
		<p>4.6.1.1.25 <u>Initialize Erasable Dump Via Downlink (cont)</u></p> <p>1. Initialize erasable dump: Key V74E</p> <p>4.6.1.1.26 <u>Enable W-Matrix Initialization</u></p> <p>1. LGC Power-Up (required) Key V93E</p> <p>4.6.1.1.27 <u>ORDEAL Initialization</u></p> <p>LGC Power-Up (required for use with PCNCS)</p> <p>IMU Power-Up (LGC Operating) (required for use with PCNCS)</p> <p>IMU Orientation Determination Program (P51) (required for use with PCNCS)</p> <p>AGS Power-Up (required for use with AGS)</p> <p>AGS alignment valid (required for use with AGS)</p> <p>AGS state vector valid (required)</p>	<p>V74 should not be selected during AGS Initialization Routine (R47). V74 will always deliver two complete dumps.</p> <p>Purpose of Enable W-Matrix Initialization procedure is to request reinitialization of rendezvous W-matrix.</p> <p>Enable W-Matrix Initialization procedure resets RENDW FLC, which then causes LGC to reinitialize rendezvous W-matrix before next use. Flag is set, following initialization, indicating that it can be used again.</p> <p>Initialization is required after period of tracking to ensure nonzero rendezvous radar data weighting. Wait for navigation update for limited period of time.</p> <p>Ref para 4.6.1.1.1.</p> <p>Purpose of ORDEAL Initialization procedure is to align one or both FPAI's to local vertical coordinates. Procedure can be accomplished using PCNCS or AGS data.</p> <p>Ref para 4.6.1.1.1.</p> <p>Ref para 4.6.1.3. ISS should be on 15 minutes before thrusting maneuver.</p> <p>Ref para 4.9.1.1.1.</p> <p>Ref para 4.6.2.1.1.</p> <p>PCNCS/AGS Align (desired) Ref para 4.9.2.1 or AGS Lunar Align (para 4.9.3.2), AGS Initialization Routine (R47) (para 4.6.1.18), AGS Manual State Vector Update/Initialization (para 4.6.2.7/4.6.2.9).</p> <p>IMU and/or AGS must be aligned with +Y-axis of reference along (VXR), where V is velocity vector and R is position vector from center of earth or moon.</p>

LM 3231



**LMA790-3-LM**  
**APOLLO OPERATIONS HANDBOOK**

CREW- MAN	PNI	PROCEDURES	REMARKS
		<p>4.6.1.27 <u>ORDEAL Initialization (cont)</u></p> <ol style="list-style-type: none"> <li>1. Establish total attitude display &amp; ORDEAL controls.</li> <li>2. Obtain attitude setting by selecting one of following: Orbit Parameter Display Routine (R30)  Ground Track Determination Program (P21) Obtain attitude setting from MSFN. Use AGS altitude:     Key DEDA C 577R (0.1 nm)     AGS (hp address 403) (ha address 315)</li> <li>3. ORDEAL: ALT SET cont - adjust to setting determined in step 2</li> <li>4. Damp LM rates - select desired attitude control mode</li> <li>5. Obtain pitch angle to local horizontal. If FCNCS data required:     Key V83E - Request Rendezvous Parameter Display Routine (R31)</li> <li>6. Press OPR ERR lt - on (if another extended verb running) Exit R31, key RSET FL V16 N54     R1 Range     XXX.XX nm     R2 Range rate   XXX.X fps     R3 <math>\theta</math>       XXX.XX°     To terminate R31: Key PRO     If AGS data desired:     Key DEDA C 277R (0.01°)</li> <li>7. ORDEAL:     MODE sw - HOLD/FAST     SLEW sw - UP, center, DOWN (as required for coarse alignment of proper angles at right)</li> <li>8. ORDEAL:     MODE sw - OPR/SLOW     SLEW sw - UP, center, DOWN (fine-adjust FDAI precisely)</li> </ol>	<p>Ref para 4.5.3.1 and/or 4.5.3.3.</p> <p>Ref para 4.8.1.2 (average ha and hp). When R30 is used to determine altitude to be set in step 3, average of ha and hp should be performed. Ref para 4.8.1.1 (for circular orbit).</p> <p>Ref para 4.5.1.</p> <p>Ref para 4.6.1.11.</p> <p><math>\theta</math> (LCC) and <math>\xi</math> (DEDA) is angle between +Z-axis and local horizontal plane.</p> <p><math>\theta</math> or <math>\xi</math> is from 0° to 360°. (Fast rate is approximately X200 orbit rate.)</p>



**LMA790-3-LM  
APOLLO OPERATIONS HANDBOOK**

CREW-MAN	PNL	PROCEDURES	REMARKS
		<p>4.6.1.28 <u>LGC Erasable Memory Display/Update</u></p> <p>LGC Power-Up (required)</p> <p>LGC Self-Test (desired)</p> <ol style="list-style-type: none"> <li>1. Key V37E 00E</li> <li>2. Review erasable memory: Key V01 N01E FL V01 N01 R1 ----- R2 ----- R3 ----- Key desired register address (octal) Key ENTR</li> <li>3. V01 N01 R1 Register content R2 ----- R3 Register address</li> <li>4. To review next register: Key N15E</li> <li>5. V01 N15 R1 Register content R2 ----- R3 Register address Key ENTR for each succeeding register</li> <li>6. To change data in erasable memory: Key V21 N01E FL V21 N01 R1 ----- R2 ----- R3 ----- Key desired register address (octal) Key ENTR</li> </ol>	<p>This procedure may be performed in P00 only.</p> <p>Ref para 4.6.1.1.1.</p> <p>Ref para 4.6.1.1.3.</p>

G & C  
GENERAL

**LMA790-3-LM**  
**APOLLO OPERATIONS HANDBOOK**

LM 999, LM 3207, LM 3231

CREW-MAN	PNI	PROCEDURES	REMARKS
		<p>4.6.1.28 <u>LGC Erasable Memory Display/Update (cont)</u></p> <p>7. V21 N01  R1 Register content  R2 -----  R3 Register address  Load desired data.  Key ENTR</p> <p>8. To change next register:  Key N15E</p> <p>9. V21 N15  R1 Register content  R2 -----  R3 Register address  Load desired data  Key ENTR for each succeeding register.</p> <p>10. Repeat steps 2 thru 5 to verify correct loading of data.</p> <p>4.6.1.29 <u>Restart</u></p> <p>LGC Power-Up (required)</p> <p>1. Key V69E - Restart  RESTART lt - on  NO DAP lt - on (momentary)</p> <p>Poss PROG lt - on  Key V05 N09E  01107 - Bad phase table</p> <p>2. Confer with MSFN to determine whether restoration of erasable memory is required.</p> <p>3. To restore erasable memory:  Select LGC Update Program (P27).</p>	<p>R1 blank until loaded</p> <p>R1 blank until loaded</p> <p>Purpose of Restart procedure is to cause computer re-start.  Ref para 4.6.1.1.</p> <p>V69E does not select restart directly. Instead, it brings about "hardware" restart; i.e., it executes too many consecutive TC instructions (tight loop). Initially, all registers are blank unless restartable display is present when restart occurs.</p> <p>If alarm code is 01107, Fresh Start is automatically initiated. (Ref para 4.6.1.20.)</p> <p>Ref para 4.6.1.7.</p>

**LMA790-3-LM**  
**APOLLO OPERATIONS HANDBOOK**

LM 3.

CREW-MAN	PNL	PROCEDURES	REMARKS
		<p>4.6.1.29 <u>Restart (cont)</u></p> <p>4. Perform IMU Orientation Determination Program (P51) &amp; IMU Realign Program (P52), if required.</p> <p>5. Deleted</p> <p>4.6.1.30 <u>S-Band Antenna Routine (R05)</u></p> <p>LGC Power-Up (required) LGC Self-Test (desired) LGC time valid (required)</p> <p>LGC state vector valid (required)</p> <p>IMU Power-Up (LGC operating) (required)</p> <p>IMU Orientation Determination Program (P51) (required)</p> <p>1. Key V64E Press OPR ERR lt - on Exit R05, key RSET</p> <p>2. FL V06 N51 R1 Pitch   XXX.XX° R2 Yaw     XXX.XX° R3           -----</p> <p>Evaluate pitch &amp; yaw angles with respect to vehicle obstruction to antenna, LOS to earth center. To exit R05: Key PRO To obtain more desirable antenna angles: Maneuver vehicle, using ACA.</p> <p>3. Set S-band antenna to displayed angles: Key PRO</p>	<p>Ref para 4.9.1.1; reestablishes REFSMAT. Ref para 4.9.1.2.</p> <p>Purpose of S-Band Antenna Routine (R05) is to compute and display the two steerable S-band antenna gimbal angles, which will point it toward center of earth (for use in lunar orbit).</p> <p>Ref para 4.6.1.1. Ref para 4.6.1.13. LGC/CMC Clock Synchronization Routine (R33) (para 4.6.1.15) LGC Update Program (P27) (para 4.6.1.7) and, when possible, LM Rendezvous Navigation Program (P20) (para 4.8.2.1). (If P20 is operating, radar sighting marks will automatically be made approximately once per minute.) Ref para 4.6.1.3. ISS should be on 15 minutes before thrusting maneuver. Ref para 4.9.1.1.</p> <p>OPR ERR lt - on if another extended verb from R76 is active.</p> <p>&lt;-90° = &lt;+270° (pitch angle). &lt;-90° &amp; &lt;+90° (yaw angle). Display limits are angle conventions, not hardware limits.</p> <p>Ref para 4.2.20.</p>



**LMA790-3-LM**  
**APOLLO OPERATIONS HANDBOOK**

LM 3231

CREW-MAN	PNI	PROCEDURES	REMARKS
		<p>4.6.1.1.31 <u>Interrupt Integration</u></p> <p>LGC Power-Up (required)</p> <p>1. Key V96E</p> <p>Verify PROG ind - 00</p>	<p>Purpose of Interrupt Integration procedure is to suspend state vector integration.</p> <p>Ref para 4.6.1.1.1.</p> <p>Selecting Interrupt Integration procedure terminates program in process and selects P00. P00 state vector integration is bypassed until new program is selected.</p> <p>This does not maintain state vector synchronization; therefore, incorrect W-matrix extrapolation may occur if V96E is performed: (1) during P20 mark processing, but only if CSM state vector is being updated (V81 in effect) or (2) during AVETOMID, i.e., after responding to FL V37 when leaving program where average-g was on, but before program lights change. To recover: for item (1) - none required, for item (2) key V93E.</p>
		<p>4.6.1.1.32 <u>Mode I Attitude Error Display</u></p> <p>LGC Power-Up (required)</p> <p>IMU Power-Up (LGC Operating) (required)</p> <p>1. Select PGNS Attitude Rate/Error Display: ATTITUDE MON sv - PGNS RATE/ERR MON sv - LDC RDR/CHPTR</p> <p>2. Key V61E</p>	<p>Mode I displays DAP following attitude errors on FDAI error needles (difference between current CDU angles and DAP commanded angles).</p> <p>Ref para 4.6.1.1.1.</p> <p>Ref para 4.6.1.1.3.</p> <p>Ref para 4.5.3.2.</p>
		<p>4.6.1.1.33 <u>Mode II Attitude Error Display</u></p> <p>LGC Power-Up (required)</p> <p>IMU Power-Up (LGC Operating) (required)</p>	<p>Mode II displays total attitude error (N22-N20) on FDAI error needles. Mode II is automatically selected by LGC program and routine; e.g., (R60).</p> <p>Ref para 4.6.1.1.1.</p> <p>Ref para 4.6.1.1.3.</p>

**LMA790-3-LM  
APOLLO OPERATIONS HANDBOOK**

LM 3231

CREW-MAN	PNL	PROCEDURES	REMARKS
		<p>4.6.1.1.33 <u>Mode II Attitude Error Display (cont)</u></p> <p>1. Select PGNS Attitude Rate/Error Display: ATTITUDE MON sw - PGNS RATE/ERR MON sw - LDG RDR/CMPTTR</p> <p>2. Key V62E</p> <p>4.6.1.1.34 <u>W-Matrix Error Display</u></p> <p>LGC Power-Up (required)</p> <p>1. Key V67E Poss OPR ERR lt - on Exit V67, key RSET</p> <p>2. FL V06 N99 - Position &amp; velocity errors R1 RSS in position XXXXX ft R2 RSS in velocity XXXX.X fps R3 RSS in bias XXXXX mrad Reject: Key V25E - Load desired values, or key V34E Accept: Key PRO</p> <p>4.6.1.1.35 <u>Move This Vehicle State Vector to Other State Vector</u></p> <p>LGC Power-Up (required)</p> <p>1. Key V66E Poss OPR ERR lt - on Exit V66, key RSET</p>	<p>Ref para 4.5.3.2.</p> <p>The purpose of this procedure is to display W-matrix error information and provide means of reinitializing W-matrix if desired.</p> <p>Ref para 4.6.1.1.</p> <p>OPR ERR lt - on if another extended verb from R76 is active.</p> <p>Position, velocity, and bias values are initialization values for each diagonal element of the appropriate submatrix.</p> <p>If new data are loaded and accepted, W-matrix is reinitialized, using loaded data.</p> <p>This extended verb transfers CSM state vector data (in LCC) to LM state vector. Meaningful only when spacecraft are docked or station-keeping.</p> <p>Ref para 4.6.1.1.</p> <p>OPR ERR lt - on if this extended verb is used when on lunar surface.</p>

G & C  
GENERAL

**LMA790-3-LM**  
**APOLLO OPERATIONS HANDBOOK**

CREW- MAN	P/NL	PROCEDURES	REMARKS
		<p>4.6.1.36 <u>Final Automatic Request Terminate Routine (ROO)</u></p> <p>LGC Power-Up (required)</p> <p>1. If ROO is selected by LGC: FL V37 N--- Please perform change of program R1 ----- R2 ----- R3 ----- Key XXE Flashing terminates upon receipt of XXE. Go to step 3.</p> <p>2. If ROO is selected by crew: Key V37E XXE</p> <p>3. If desired program is P70 or P71: Exit ROO (Go to desired program.)</p> <p>4. If desired program is not P70 or P71: Press PROG It - on Key V05 N09E - Call alarm 01520</p> <p>Exit ROO Key KEY REL &amp; RSET PROG It - off</p>	<p>Purpose of Final Automatic Request Terminate Routine (ROO) is to provide standard exit for programs, and option to select any desired program. This procedure also provides description of activity following any V37E XXE.</p> <p>Ref para 4.6.1.1.1.</p> <p>Assumption: Calling program has successfully completed all its functions or crewman has prematurely terminated program.</p> <p>Alarm 01520 indicates (1) IMU is being initialized or (2) program other than POO has been selected and change of program is disallowed at this time.</p>

**LMA790-3-LM  
APOLLO OPERATIONS HANDBOOK**

RC 1604, LM 3231

CREW- MAN	PNI	PROCEDURES	REMARKS
		<p>4.6.1.37 <u>Erasable Modification Routine (RO)</u></p> <p>1. Key V25 N07E  R1 (octal) ECADR of erasable location  R2 (octal) Bit identification - five digits specifying bits in word to be modified  R3 (octal) Action positive nonzero (or nonblank) indicates "1" is to be set into bit positions specified in R2. Zero or blank indicates "0".</p> <p>4.6.1.38 <u>Input ARLS for Pinpoint Landing</u></p> <p>LGC Power Up (required)  LGC state vector and landing site vector valid (required)  Communication with MSFN (required)</p> <p>1. Receive &amp; record ARLS from MSFN.</p> <p>2. Load ARLS  Key V25 N69E  R1 AZ XXXXX ft  R2 AY XXXXX ft  R3 AX XXXXX ft</p>	<p>Purpose of Erasable Modification Routine is to provide manual capability of changing flagword and channel bits. It is not restricted to flagwords, but can modify any legitimate erasable location.</p> <p>R1 is channel location if 30g or below.</p> <p>Octal representation of binary word using binary 1's in bit positions to be modified.  Specifically: octal numbers (0000) 1 through 37777 are interpreted as positive nonzero and cause one(s) to be set in bit positions specified in R2; and octal numbers 77777 through 40000 are interpreted as negative and they as well as (0000) 0 and blank cause zero(s) to be set in bit positions specified in R2.</p> <p>Purpose of this procedure is to provide a flexible method for crew modification of RLS (in stable member (SM) coordinates, based on latest state vector data) for pinpoint landing.</p> <p>Ref para 4.6.1.1.</p> <p>LGC Update Program (P27) (para 4.6.1.7)</p> <p>May be performed as follows:</p> <ol style="list-style-type: none"> <li>1. Before selection of P63 (ignition time will be adjusted).</li> <li>2. In P63 before throttle-up (inputs must be moderate in magnitude - possible small attitude transient at throttle-up).</li> <li>3. In P63 after throttle-up (inputs must be moderate in magnitude - possible small attitude transient).</li> </ol> <p>AZ - downrange in SM coordinates.  AY - crossrange in SM coordinates.  AX - approximate altitude in SM coordinates.</p> <p>If P63 is reselected, above procedure must be repeated.</p>

G & C  
GENERAL

**LMA790-3-LM  
APOLLO OPERATIONS HANDBOOK**

LM 3231

CREW MAN	P/NL	PROCEDURES	REMARKS
		<p>4.6.1.39 <u>DSKY 8888 Clear</u></p> <p>1. Perform following DSKY entries:</p> <p>V99 N99 V25 N01E 00000E +99999E +99999E +99999 CLR, CLR, CLR 00000E 00000E 00000E</p> <p>In event of operator error or if DSKY does not clear, repeat procedure.</p>	<p>This procedure attempts to clear DSKY relay contamination that is possible cause of short that could light all segments of the DSKY EL numbers (appearing as 8's and +'s).</p>



# LMA790-3-LM APOLLO OPERATIONS HANDBOOK

CREW-MAN	PNL	PROCEDURES	REMARKS
		<p>4.6.2 <u>AGS/CES</u></p> <p>4.6.2.1 <u>AGS Power-Up</u></p> <p style="text-align: center;">CAUTION</p> <p>Do not power up AGS if LMP bus voltage &lt;26.5 vdc. Allow at least 1 second between settings of AGS STATUS sw and CB S/C: AEA.</p> <p>1. CB S/C: AEA - open            CB S/C: AEA - open            AGS STATUS sw - OFF            Disable AGS attitude control:            GUID CONT sw - PGNS or            S/C:                AGS sw - OFF                or                ROLL, PITCH, &amp; YAW sw - PULSE or DIRECT</p>	<p>Purpose of AGS Power-Up procedure is to power up AGS and to allow for ASA warmup and stabilization.            CB S/C: ASA - close (required from prelaunch).</p> <p>DC BUS warn lt - on if LMP bus voltage is &lt;26.5 vdc.            Rapid cycling could destroy AEA memory.</p> <p>Avoids possible attitude transients during power-up.</p> <p>LM is free to drift.            LM is free to drift.</p>

G &  
GENER



**LMA790-3-LM**  
**APOLLO OPERATIONS HANDBOOK**

LM 3250

CREW-MAN	PNI	PROCEDURES	REMARKS
LMP CDR	6 1 1, 2 1/2	<p>4.6.2.1 <u>AGS Power-Up (cont)</u></p> <p>2. AGS STATUS sw - STAND BY  AGS warn lt - on  MASTER ALARM - on  MASTER ALARM pb/lt - reset</p> <p>3. CB S/C: AEA - close</p> <p>Note time or start EVNT TMR ind.</p>	<p>AGS CMEA inhibit is removed and ASA voltage is low due to absence of AEA clock.</p> <p>Within 20 seconds, AEA can accept CDU discrete from PCNCS and can integrate PCNCS Euler angle increments.</p> <p>Following CB S/C: AEA - close, ASA requires 25 minutes of operation with AGS STATUS sw - STAND BY or OPERATE to stabilize sufficiently for nominal AGS operation.</p> <p>Under emergency conditions, AGS operation with degraded performance is available:</p> <p>Five minutes after ASA activation (CB S/C: AEA close and AGS STATUS SW - STANDBY or OPERATE) provided that, prior to this time, the CB S/C ASA had been closed and AGS STATUS SW - OFF (defined as warm-up mode) for at least 8.5 minutes with coolant flowing (and the ASA initially assumed at the coolant temperature of 40°F). Only 4 minutes are required in the warm-up mode prior to ASA activation for no coolant flow (with an initial assumed nominal ASA temperature of at least 60°F). For this case coolant flow must be initiated at or before ASA activation.</p>
LMP	16		
CDR	1	<p>AGS warn lt - off</p>	
	11	<p>4. Positioning of AEA backup power cb:  If PCNCS operating normally:  CB S/C: AEA - open  If PCNCS fails:  CB S/C: AEA - close</p>	<p>AEA backup cb should normally be open to prevent sneak path for transient or loss of both power buses due to a single failure; it should be closed if PCNCS fails.</p>
	11	<p>5. 25 min after step 3:  CB/AC BUS B: AGS - close</p>	

G &  
GENE

**LMA790-3-LM**  
**APOLLO OPERATIONS HANDBOOK**

LH 3231

CREW-MAN	PNI	PROCEDURES	REMARKS
LMP	6 1,2 1/2 1	<p>4.6.2.1 <u>AGS Power-Up (cont)</u></p> <p>AGS STATUS sw - OPERATE            MASTER ALARM - on            MASTER ALARM pb/lt - reset            AGS warn lt - on</p>	<p>AGS warn lt latches on (caused initially by core-priming operation, which, when performed, interferes with program inhibit of hardware alarm). AEA initial state:</p> <ol style="list-style-type: none"> <li>1. Engine-off is present.</li> <li>2. 400, and 410 through 417, are set to 00000.</li> </ol>
LMP	2	<p>02/H2O QTY MON sel - C/W RESET</p>	<p>02/H2O QTY MON sel should not remain in C/W RESET position. It performs its reset function only at time it is switched into C/W RESET position.</p>
LMP	1 2	<p>AGS warn lt - off            02/H2O QTY MON sel - previous position</p> <p>Key DEDA C 412R+10000</p>	<p>412+10000 indicates self-test was successful.</p>
CDR	6	<p>6. Perform AEA Readiness Check.</p>	<p>Ref para 4.6.2.12.</p>
LMP	16 11	<p>4.6.2.2 <u>AGS Power-Down</u></p> <p>AGS Power-Up (required)</p>	<p>Ref para 4.6.2.1</p>
CDR	1 1,2	<p>1. CB S/C: AEA - open            CB S/C: AEA - open</p>	<p>CB S/C: AEA is to be opened before AGS STATUS sw - STAND BY. This eliminates detrimental effects of switch closure bounce.</p>
LMP	1 1,2	<p>AGS warn lt - on            MASTER ALARM - on</p>	<p>AGS warn lt - on because ASA voltage is low due to absence of AEA clock.</p>
LMP	1/2	<p>MASTER ALARM pb/lt - reset</p>	
LMP	6	<p>2. AGS STATUS sw - STAND BY</p>	
CDR	11	<p>3. AGS STATUS sw - OFF            AGS warn lt - off</p>	
CDR	11	<p>4. CB/AC BUS B: AGS - open</p>	

**LMA790-3-LM**  
**APOLLO OPERATIONS HANDBOOK**

CREW-MAN	PNI	PROCEDURES	REMARKS
		<p>4.6.2.3 <u>AEA Self-Test</u></p> <p>AGS Power-Up (required)</p> <p>1. Check AEA self-test status: CB S/C: AEA - close CB S/C: AEA - open Key DEDA C 412R+10000</p> <p>If +10000 displayed, go to step 3.</p> <p>2. Reinitiate AEA self-test: Key DEDA C 412+00000E Repeat readout after approx 15 sec: Key DEDA C 412R</p> <p style="text-align: center;">CAUTION</p> <p>If +10000 is not stored &amp; displayed within 15 sec, AGS computer operations are not recommended. If +10000 remains after 15 sec, test is not being executed.</p> <p>3. Check AEA self-test/CWEA interface: Provide AEA self-test output to CWEA - Key DEDA C 412+70000E MASTER ALARM pb/lt - reset AGS warn lt - on 02/H20 QTY MDN sel - C/W RESET AGS warn lt - off 02/H20 QTY MDN sel - previous position</p> <p>4. Reinitiate AEA self-test: Key DEDA C 412+00000E Key DEDA C 412R+10000</p> <p>5. Test AEA backup power system: CB S/C: AEA - close CB S/C: AEA - open AGS warn lt - off</p>	<p>Purpose of AEA Self-Test procedure is to verify correct operation of AEA self-test/CWEA interface, and AEA normal and backup d-c power systems.</p> <p>Ref para 4.6.2.1.1.</p> <p>X = 1, X = 3, X = 4, X = 7</p> <p>AGS warn lt - on within 5 to 30 seconds of initializing or reinitializing self-test (412+00000) if self-test result code stored in 412 is not +10000.</p> <p>AGS is operating correctly if self-test output is 412+10000.</p>
LMP CDR	16 11		
CDR LMP CDR	11 16 1		<p>AGS warn lt - on and latched indicates failure in AEA backup power system.</p>

G &  
GENE

**LMA790-3-LM**  
**APOLLO OPERATIONS HANDBOOK**

CREW-MAN	PNI	PROCEDURES	REMARKS
		<b>4.6.2.3 AEA Self-Test (cont)</b>	
LMP CDR	16 11	6. Configure AEA d-c backup power: If PGMCs operating normally: CB S/C: AEA - close CB S/C: AEA - open If PGMCs fails: CB S/C: AEA - close CB S/C: AEA - close	AEA backup cb should normally be open; it should be closed if PGMCs fails.
LMP CDR	16 11	<b>4.6.2.4 AGS Checkout</b>	Purpose of AGS Checkout procedure is to verify correct operation of AEA and DEDA electroluminescent displays and pushbutton lights.  Ref para 4.6.2.1.
		<b>AGS Power-Up (required)</b>	
		1. Perform EL lamp check: Key DEDA C 000+88888 Verify: OPR ERR lt - on 000 in address indicator +88888 in data indicator	OPR ERR lt - on because more than nine pushbuttons have been keyed since last keying CLR pb.
		2. Complete pushbutton check: Key DEDA C 123-45679C OPR ERR lt - off	
		3. Perform AEA Readiness Check.	Ref para 4.6.2.12.
		<b>4.6.2.5 AGS Gyro &amp; Accelerometer Calibration</b>	
		<b>LGC Power-Up (required)</b>	
		<b>IMU Power-Up (LGC Operating)/IMU Power-Up (LGC Off)</b>	Purpose of AGS Gyro and Accelerometer Calibration procedure is to perform in-flight gyro and accelerometer calibration with PGMCs IMU operating. AGS alignment in-flight calibration may be performed provided IMU has been aligned (IMU Orientation Determination Program, P51).  Ref para 4.6.1.1.
		<b>IMU Orientation Determination Program (P51) (desired)</b>	Ref para 4.6.1.3/4.6.1.4. ISS should be on 15 minutes before thrusting maneuver.
		<b>AGS Power-Up (required)</b>	Ref para 4.9.1.1.  Ref para 4.6.2.1.

LMA790-3-LM  
**APOLLO OPERATIONS HANDBOOK**

CREW: MAN	PNI	PROCEDURES	REMARKS
		<p>LM 3207, LM 3231</p> <p>4.6.2.5 <u>ACS Gyro &amp; Accelerometer Calibration (cont)</u></p> <p>ACS Checkout (desired)</p> <p>Communications Basic (desired - near earth)</p> <p>S-Band Steerable Antenna Activation and Checkout (desired - lunar distance)</p> <p>1. Establish desired attitude control mode from following:</p> <p>a. ACS Attitude Hold/Rate Command:            GUID CONT sw - ACS            S/C:            ACS sw - ATT HOLD            ROLL, PITCH, &amp; YAW sw - MODE CONT            ENG THR CONT: BAL CPL sw - ON            S/C: DEAD BAND sw - MAX</p> <p>b. PGNS Attitude Hold/Rate Command            GUID CONT sw - PGNS            S/C:            PGNS sw - ATT HOLD            ROLL, PITCH, &amp; YAW sw - MODE CONT            Key V77E            NO DAP lt - off</p> <p>c. During docked flight, request that CSM maintain attitude hold. Establish attitude control mode -            ACS pulse:            GUID CONT sw - ACS            S/C: ACS sw - AUTO or ATT HOLD            ROLL, PITCH, &amp; YAW sw - PULSE            ENG THR CONT: BAL CPL sw - ON</p> <p>ACS direct:            GUID CONT sw - ACS            S/C: ACS sw - AUTO or ATT HOLD            ROLL, PITCH, &amp; YAW sw - DIR            ENG THR CONT: BAL CPL sw - ON</p> <p>PGNS minimum impulse:            GUID CONT sw - PGNS            S/C: PGNS sw - ATT HOLD            ROLL, PITCH, &amp; YAW sw - MODE CONT            Key V76E</p>	<p>Ref para 4.6.2.4.</p> <p>Ref para 4.13.2.1.</p> <p>Ref para 4.2.20.</p> <p>Ref para 4.5.1.6.</p> <p>Ref para 4.5.1.3.</p> <p>Ref para 4.5.1.7.</p> <p>Ref para 4.5.1.8.</p> <p>Ref para 4.5.1.6.</p>

G & C  
 GENER





LMA790-3-LM  
 APOLLO OPERATIONS HANDBOOK

CREW: MAN	PNL	PROCEDURES	REMARKS
		<p>4.6.2.5 <u>AGS Gyro &amp; Accelerometer Calibration (cont)</u></p> <p>2. Read out &amp; record gyro and accelerometer bias-compensation coefficients:            X-accelerometer                Key DEDA C 540R (0.001/0.01 fps sq)            Y-accelerometer                Key DEDA C 541R (0.001/0.01 fps sq)            Z-accelerometer                Key DEDA C 542R (0.001/0.01 fps sq)            X-gyro                Key DEDA C 544R (0.01°/hr)            Y-gyro                Key DEDA C 545R (0.01°/hr)            Z-gyro                Key DEDA C 546R (0.01°/hr)</p>	<p>Parentetical quantization notation: lunar mission/earth mission.</p>

G & C  
 GENERAL

LMA 3207, LM 3231

**LMA790-3-LM**  
**APOLLO OPERATIONS HANDBOOK**

LM 3207, LM 3208

CREW- MAN	PNL	PROCEDURES	REMARKS
		<p>4.6.2.5 AGS Gyro &amp; Accelerometer Calibration (cont)</p> <p>3. Establish attitude control mode from following:</p> <p>a. AGS pulse</p> <p>    GUID COMT sw - AGS</p> <p>    S/C:</p> <p>        AGS sw - AUTO or ATT HOLD</p> <p>        ROLL, PITCH, &amp; YAW sw - PULSE</p> <p>        DEAD BAND sw - MAX or MIN</p> <p>        ENG THR COMT: BAL CFL sw - ON</p> <p>b. AGS direct</p> <p>    GUID COMT sw - AGS</p> <p>    S/C:</p> <p>        AGS sw - AUTO or ATT HOLD</p> <p>        ROLL, PITCH, &amp; YAW sw - DIRECT</p> <p>        DEAD BAND sw - MAX or MIN</p> <p>        ENG THR COMT: BAL CFL sw - ON</p> <p>c. PCMS minimum impulse</p> <p>    GUID COMT sw - PCMS</p> <p>    S/C:</p> <p>        PCMS sw - ATT HOLD</p> <p>        ROLL, PITCH, &amp; YAW sw - MODE CONT</p> <p>    Key V76Z</p> <p>    NO DAP lt - on</p> <p>d. During docked flight, request that CSM maintain drifting flight.</p> <p>4. Establish attitude &amp; exercise ICDU fine-align switches.</p> <p>a. Monitor ICDU angles</p> <p>    Key V16 W20E</p> <p>        R1 OGA XXX.XI°</p> <p>        R2 IGA XXX.XI°</p> <p>        R3 MGA XXX.XI°</p> <p>b. Obtain desired ICDU angles by either of following:</p> <p>    (1) Maneuver LM via ACA until DSKY display of ICDU angles reads approx 22.5° or desired odd multiple of 22.5°.</p> <p>    (2) Request that CSM maneuver until DSKY display of ICDU angles reads approx 22.5° or desired odd multiple of 22.5°.</p> <p>c. Perform ICDU Zero procedure.</p> <p>d. Establish free drift rate of &lt;0.075°/sec for docked flight; &lt;0.1°/sec, for undocked flight.</p> <p>    Display LM attitude rates on FDAI error needles:</p> <p>    Key V60E</p>	<p>In first 30 seconds of this mode, AGS accelerometers are calibrated; this requires that RCS be inhibited for best performance. RCS can be inhibited by S/C: AGS sw - OFF.</p> <p>Ref para 4.5.1.7.</p> <p>Ref para 4.5.1.8.</p> <p>Ref para 4.5.1.4.</p> <p>This step eliminates possibility of degraded AGS gyro calibration due to coarse or fine ICDU switching transients.</p> <p>Ref para 4.6.1.21.</p>

**LMA790-3-LM**  
**APOLLO OPERATIONS HANDBOOK**

CREW-MAN	PNL	PROCEDURES	REMARKS
		<p>4.6.2.5 <u>AGS Gyro &amp; Accelerometer Calibration (cont)</u></p> <p>5. Command gyro-accelerometer calibration: Key DEDA C400+60000E</p> <p>6. Display one gyro bias compensation coefficient from following: X-gyro Key DEDA C 544R (0.01°/hr) Y-gyro Key DEDA C 545R (0.01°/hr) Z-gyro Key DEDA C 546R (0.01°/hr)</p> <p>7. Verify calibration complete: Key DEDA C 400R+00000</p> <p>8. Read out &amp; record gyro &amp; accelerometer bias-compensations coefficients: X-accelerometer Key DEDA C 540R (octal) Y-accelerometer Key DEDA C 541R (octal) Z-accelerometer Key DEDA C 542R (octal) X-gyro Key DEDA C 544R (0.01°/hr) Y-gyro Key DEDA C 545R (0.01°/hr) Z-gyro Key DEDA C 546R (0.01°/hr)</p> <p>4.6.2.6 <u>AGS Manual Absolute Time Initialization</u></p> <p>AGS Power-Up (required) AGS Checkout (desired) MSFN receiving AGS telemetry (LM in LOS to MSFN) Communications Basic (required - near earth)</p>	<p>If AGS is removed from calibrate mode before 32 seconds, initial value of accelerometer constants will be maintained.</p> <p>Readout of gyro bias-compensation coefficient places this quantity on AGS downlink (if lunar telemetry is established and COMM: ILM PCM sv - HI) to aid ground evaluation of calibration.</p> <p>Display should appear within 302 seconds.</p> <p>If AGS is removed from calibrate mode before 302 seconds, updated gyro constants will be used by AGS. If calibrate mode is exited before 180 seconds, reload initial gyro-calibration constants.</p> <p>Readout of these quantities places them on AGS downlink.</p> <p>If prelaunch specified failure limits on change in bias-compensation coefficients are exceeded, reload initial bias-compensation coefficients after concurrence from MSFN.</p> <p>Purpose of AGS Manual Absolute Time Initialization procedure is to provide specific base time value from which time incrementing continues (LGC not operating).</p> <p>Ref para 4.6.2.1 Ref para 4.6.2.4 Ref para 4.13.2.1.</p>

LH 3231



**LMA790-3-LM**  
**APOLLO OPERATIONS HANDBOOK**

LM 3231, LM 3233

CREW-MAN	PNL	PROCEDURES	REMARKS
		<p><u>4.6.2.6 AGS Manual Absolute Time Initialization (cont)</u>  <u>S-Band Steerable Antenna Activation (High Power)</u>                      (required - lunar distance)</p> <p>1. Enter initial value in AGS time address:                      Key DEDA C 377+XXXX (0.1 min)</p> <p style="text-align: center;">Key DEDA ENTR</p> <p>2. Receive &amp; record AGS time bias from MSFN                      (GET minus AGS time).</p> <p><u>4.6.2.7 AGS Manual LM State Vector Update/Initialization</u>                      AGS Power-Up (required)                      AGS Checkout (desired)                      AGS Calibration/AGS Initialization Routine (R47) (required)</p> <p>1. Obtain LM state vector &amp; epoch time from MSFN, and reset                      DEL 32 (Downlink Initialize Flag) C563 + 00000E</p> <p style="text-align: center;">CAUTION</p> <p style="text-align: center;">State vector is invalid if LM                      thrusting occurs between epoch                      point &amp; update time, or if this                      time exceeds 136.5 min.</p> <p>2. Enter X-component of LM position:                      Key DEDA C 240+XXXXE (100/1000 ft)</p> <p>3. Enter Y-component of LM position:                      Key DEDA C 241+XXXXE (100/1000 ft)</p> <p>4. Enter Z-component of LM position:                      Key DEDA C 242+XXXXE (100/1000 ft)</p> <p>5. Enter X-component of LM velocity:                      Key DEDA C 260+XXXXE (0.1/1 fps)</p>	<p>Ref para 4.2.20.</p> <p>Select convenient AGS time bias (e.g., in tens of hours), subtract AGS time bias from planned time of AEA ENTR (in GET), and convert remainder to tenths of minutes for DEDA entry of initial value (XXXXX).</p> <p>Entry to be made at planned time of AEA ENTR.</p> <p>MSFN obtains difference via ground checks and AGS telemetry.</p> <p>Ref para 4.6.2.1.                      Ref para 4.6.2.4.</p> <p>Ref para 4.6.2.5 or 4.6.1.18. AEA clock overflows 4396 minutes (approximately 73 hours) after initialization at zero.</p> <p>Minus is set, plus is reset. Resetting DEL 32 and completing manual state vector update before re-initializing AGS automatic rendezvous radar LM state vector update (Raw Data Transfer via LGC) para 4.8.2.3 avoids possible anomalous state vector update.</p> <p>Parentetical quantization notation: lunar mission/earth mission.</p>

**LMA790-3-LM**  
**APOLLO OPERATIONS HANDBOOK**

CREW- MAN	PNI	PROCEDURES	REMARKS
		<p>4.6.2.7 <u>AGS Manual LM State Vector Update/Initialization (cont)</u></p> <p>6. Enter Y-component of LM velocity: Key DEDA C 261+XXXXX (0.1/1 fps)</p> <p>7. Enter Z-component of LM velocity: Key DEDA C 262+XXXXX (0.1/1 fps)</p> <p>8. Enter LM epoch time: Key DEDA C 254+XXXXX (0.1 min)</p> <p style="text-align: center;">CAUTION</p> <p>Epoch data should be valid for exact AGS time indicated. Epoch time for updates when LM is on lunar surface should be within 0.5 hr of nominal lift-off.</p> <p>9. Command AEA to update LM state vector: Key DEDA C 414+20000E</p> <p>10. Verify LM state vector update complete: Key DEDA C 414R+00000</p> <p>4.6.2.8 <u>Load AGS Contingency LM Lunar Touchdown State Vector</u></p> <p>AGS Power-Up (required)</p> <p>AGS Checkout (desired)</p> <p>AGS time valid (required)</p> <p>1. Read out landing site radius: Key DEDA C 231R (100 ft)</p>	<p>Entry errors (steps 2 through 8) may be corrected any time before step 9. If data are not valid for exact 0.1 minute indicated, errors of 3 miles (lunar mission) or 12 miles (earth mission) or more could result.</p> <p>Display should appear within 2 seconds after step 9.</p> <p>This procedure shall be performed approximately 7 minutes before PDI (after state vector update), to prepare AGS for immediate ascent after LM touchdown (accomplished by keying DEDA C 414+20000E to update AGS state vector to values in procedure). This procedure may also be performed at any time on lunar surface when LGC is not available for AGS state vector update (R47).</p> <p>Ref para 4.6.2.1.</p> <p>Ref para 4.6.2.4.</p> <p>AGS Manual Absolute Time Initialization (para 4.6.2.6) or AGS Initialization Routine (R47) (para 4.6.1.18).</p>

G &  
GENERAL

LMA790-3-LM  
**APOLLO OPERATIONS HANDBOOK**

LH 3233

CREW-MAN	P/NL	PROCEDURES	REMARKS
		<p>4.6.2.8 <u>Load ACS Contingency LM Lunar Touchdown State Vector (cont)</u></p> <p>Enter contents of address 231 into X-component of LM position:            Key DEDA C 240+XXXXX (100 ft)</p> <p>Enter estimated time of touchdown +6 min. (ACS absolute time of landing +X for TD+X aborts):            Key DEDA C 254+XXXXX (0.1 min)</p> <p>Enter lunar rotation rate:            Key DEDA C 261+YYYYY (0.1 fps)            Key DEDA C 262-ZZZZZ (0.1 fps)</p> <p>4.6.2.9 <u>ACS Manual CSM State Vector Update/Initialization</u></p> <p>ACS Power-Up (required)            ACS Checkout (desired)            ACS Calibration/ACS Initialization Routine (R47) (required)</p> <p>1. Obtain CSM state vector &amp; epoch time from MSPN, and reset DEL 32 (Downlink Initialize Flag) C563+0000E</p> <p style="text-align: center;">CAUTION</p> <p>State vector is invalid if CSM thrusting occurs between epoch point &amp; update time, or if time exceeds 136.5 min.</p> <p>2. Enter X-component of CSM position:            Key DEDA C 244+XXXXX (100/1000 ft)</p> <p>3. Enter Y-component of CSM position:            Key DEDA C 245+XXXXX (100/1000 ft)</p> <p>4. Enter Z-component of CSM position:            Key DEDA C 246+XXXXX (100/1000 ft)</p> <p>5. Enter X-component of CSM velocity:            Key DEDA C 264+XXXXX (0.1/1 fps)</p> <p>6. Enter Y-component of CSM velocity:            Key DEDA C 265+XXXXX (0.1/1 fps)</p>	<p>To achieve satisfactory pericyathion, value entered in 254 should be +6 minutes of lift-off.</p> <p>YYYYY=15.2 sin (i)            ZZZZZ=15.2 cos (i)            i=angle (measured clockwise) from west to ACS Z-axis</p> <p>Ref para 4.6.2.1.            Ref para 4.6.2.4.            Ref para 4.6.2.5/4.6.1.18. AEA clock overflows 4396 minutes (approximately 73 hours) after initialization at zero.            Minus is set, plus is reset. Resetting DEL 32 and completing manual state vector update before re-initializing ACS automatic rendezvous radar LM state vector update (Raw Data Transfer via LCC) para 4.8.2.3. avoids possible anomalous state vector update.</p> <p>Parentetical quantization notation: lunar mission/earth mission.</p>

**LMA790-3-LM**  
**APOLLO OPERATIONS HANDBOOK**

CREW- MAN	PNI	PROCEDURES	REMARKS
		<p>4.6.2.9 <u>AGS Manual CSM State Vector Update/Initialization (cont)</u></p> <p>7. Enter Z-component of CSM velocity: Key DEDA C 266+XXXXXE (0.1/1 fps)</p> <p>8. Enter CSM epoch time: Key DEDA C 272+XXXXXE (0.1 min)</p> <p style="text-align: center;">CAUTION</p> <p>CSM epoch time must be a valid past-AGS time at multiple of 0.1 min.</p> <p>9. Command AZA to update CSM state vector: Key DEDA C 414+30000E</p> <p>10. Verify CSM state vector update complete: Key DEDA C 414R+00000</p> <p>4.6.2.10 <u>Deleted</u></p>	<p>Entry errors (steps 2 through 8) may be corrected any time before step 9.</p> <p>Display should appear within 2 seconds after step 9.</p>

**G & C**  
**GENERAL**

**LMA790-3-LM**  
**APOLLO OPERATIONS HANDBOOK**

LM 2013

CREW-MAN	PNL	PROCEDURES	REMARKS
		4.6.2.11 <u>Rate Gyro Check</u>	Rate Gyro Check procedure is to be accomplished only under PGNS control.
	16	1. Set controls for checkout: CB S/C: ATCA (AGS) - close RATE SCALE sw - 25°/SEC S/C: GYRO TEST POS RT sw - OFF	Complete checkout if abnormal condition is noted at any point. Check any additional abnormalities before proceeding to malfunction diagnostic.
	1,2 3 1,2 3 1,2	2. S/C: GYRO TEST ROLL sw - ROLL GYRO TEST POS RT sw - POS RT & HOLD FDAI roll rate ind - +5° S/C: GYRO TEST ROLL sw - FITCH FDAI pitch rate ind - +5° S/C: GYRO TEST ROLL sw - YAW FDAI yaw rate ind - +5°	
	3 1,2 3 1,2 1,2 3	S/C: GYRO TEST POS RT sw - NEG RT & HOLD FDAI yaw rate ind - -5° S/C: GYRO TEST ROLL sw - FITCH FDAI pitch rate ind - -5° S/C: GYRO TEST ROLL sw - ROLL FDAI roll rate ind - -5° S/C: GYRO TEST POS RT sw - OFF	
	1 3 1,2 3 1,2 3 1,2	3. RATE SCALE sw - 5°/SEC GYRO TEST POS RT sw - POS RT & HOLD FDAI roll rate ind - +5° S/C: GYRO TEST ROLL sw - FITCH FDAI pitch rate ind - +5° S/C: GYRO TEST ROLL sw - YAW FDAI yaw rate ind - +5°	



**LMA790-3-LM**  
**APOLLO OPERATIONS HANDBOOK**

CREW- MAN	PNL	PROCEDURES	REMARKS
		<p>4.6.2.11 <u>Rate Gyro Check (cont)</u></p> <p>S/C: GYRO TEST POS RT sw - NEG RT &amp; HOLD            FDAI yaw rate ind - -5°            S/C: GYRO TEST ROLL sw - PITCH            FDAI pitch rate ind - -5°            S/C GYRO TEST ROLL sw - ROLL            FDAI roll rate ind - -5°            S/C: GYRO TEST POS RT sw - OFF</p> <p>4.6.2.12 <u>AEA Readiness Check</u></p> <p>AGS Power-Up (required)            AGS Self-Test (required)</p> <p>1. Descent section staging flag status check:            Key DEDA C 574R            Negative number = staged; positive number = unstaged            If incorrect:            Key DEDA C 574+0000E (if unstaged); or            -0000E (if staged)</p> <p>2. Lunar surface flag status check:            Key DEDA C 604R            Negative number = on lunar surface; positive number =            not on lunar surface            If incorrect; Key DEDA C 604+0000E if not on lunar            surface; or -0000E if on lunar surface.</p> <p>3. Staging sequence counter status check:            Key DEDA C 612R            If unstaged &amp; +00000 not displayed:            Key DEDA C 612+0000E            If staged &amp; +00006 not displayed:            Key DEDA C 612+00007E</p>	<p>Purpose of AEA Readiness Check procedure is to verify status of AEA descent-section staging flag, lunar surface flag, and staging sequence counter.</p> <p>Ref para 4.6.2.1.            Ref para 4.6.2.3.</p> <p>-00000 - on lunar surface            +00000 - not on lunar surface</p>

G & C  
GENERAL

LM 2013

**LMA790-3-LM**  
**APOLLO OPERATIONS HANDBOOK**

CREW-MAN	PNL	PROCEDURES	REMARKS
		<p>4.6.2.13 <u>AGS Orientation to Initial Computed Steering Attitude</u></p> <p>AGS Power-Up (required)</p> <p>AGS alignment valid (required)</p> <p>AGS LM state vector valid (required)</p> <p>AGS CSM state vector valid (required)</p> <p>AGS Wb Vector Update (required if applicable to mission)</p> <p>AGS Manual Rendezvous Radar LM State Vector Update (required)</p> <p>1. Establish AGS Attitude Error Display mode: RATE/ERR MON sw - LDG RDR/CMPT</p> <p>2. Establish attitude control mode AEA attitude hold submode - Key DEDA C 400+00000E</p>	<p>Purpose of AGS Orientation to Initial Computed Steering Attitude procedure is to offer crew minimum fuel option or minimum time option for AGS orientation to initial computed steering attitude. The normally used minimum fuel option is presented first in a continuous and complete format. The minimum time option and other available procedural choices are presented in a format relating to the minimum fuel option procedure.</p> <p>Ref para 4.6.2.1.</p> <p>Backup AGS Alignment (AGS body axis alignment and PGNCS IMU) (para 4.9.2.2) Backup AGS Alignment (AGS body axis alignment and AOT) (para 4.9.2.3) AGS Lunar Alignment (para 4.9.3.2).</p> <p>AGS Initialization Routine (R47) (para 4.6.1.18), AGS Manual LM State Vector Update/Initialization, procedure (para 4.6.2.7), or AGS Manual Rendezvous Radar LM State Vector Update procedure (para 4.8.2.2)</p> <p>AGS Initialization Routine (R47) (para 4.6.1.18), AGS Manual CSM State Vector Update/Initialization procedure (para 4.6.2.9)</p> <p>Ref para 4.6.2.15.</p> <p>Ref para 4.8.2.2.</p> <p>Valid AGS LM state vector is not applicable when this procedure is used as part of AGS Manual Rendezvous Radar LM State Vector Update.</p> <p>Ref para 4.5.3.4. If total attitude display is desired, establish AGS Total Attitude Display mode (para 4.5.3.3).</p> <p>AEA attitude hold submode configuration is normally established after maneuver in which ABORT or ABORT STAGE pb was used.</p>

**LMA790-3-LM**  
**APOLLO OPERATIONS HANDBOOK**

CREW-MAN	PNL	PROCEDURES	REMARKS
		<p>4.6.2.13 AGS Orientation to Initial Computed Steering Attitude (cont)</p> <p>GUID CONT sw - AGS S/C: ROLL, PITCH, &amp; YAW sw - MODE CONT AGS Attitude Hold/Rate Command Mode: S/C: AGS sw - ATT HOLD S/C: DEAD BAND sw - MAX Select guidance steering from following: X-axis guidance steering, Z-axis parallel to CSM orbit plane - Key DEDA C 623+00000E Key DEDA C 400+10000E; or With yaw orientation specified by Wb vector - Key DEDA C 623+10000E Key DEDA C 400+10000E; or Acquisition Z-axis steering - Key DEDA C 507+00000E Key DEDA C 400+20000E; or Thrust guidance Z-axis steering - Key DEDA C 507+10000E Key DEDA C 400+20000E</p> <p>3. Orient LM to computed steering attitude:</p> <p>a. Manual: S/C: ROLL, PITCH, &amp; YAW sw - PULSE or DIRECT DEADBAND sw - MIN S/C: AGS sw - AUTO ACA - null attitude errors S/C: ROLL, PITCH, &amp; YAW sw - MODE CONT</p> <p style="text-align: center;">CAUTION</p> <p>Orientation in auto (minimum time option) with maximum deadband (after staging) can overload AEA counters &amp; lose AEA alignment.</p> <p>b. Automatic: S/C: DEAD BAND sw - MIN S/C: AGS sw - AUTO</p>	<p>Ref para 4.5.1.6.</p> <p>Wb vector is provided for S-band LOS angle for ascent from far western lunar landing sites. Checkout and/or other use of Wb vector is possible for earth-orbital flights.</p> <p>Minimum fuel option - preferred method for AGS orientation of LM.</p> <p>Attitude error needles must be nulled by "flying-to" needles. A "fly-from" null will be a false null and will result in large attitude excursions when vehicle is returned to automatic control. Avoid IMU gimbal lock.</p> <p>Minimum time option (ABRUPT 5° and/or 10°/sec maneuver)</p>

LM 3231



**LMA790-3-LM**  
**APOLLO OPERATIONS HANDBOOK**

LM 3207

CREW- MAN	PNL	PROCEDURES	REMARKS
		<p>4.6.2.14 <u>AGS Accelerometer Calibration</u></p> <p style="text-align: center;">CAUTION</p> <p>AGS accelerometer calibration requires unaccelerated flight, &amp; rotation rates <math>&lt; 0.1^\circ/\text{sec}</math>.</p> <p>AGS Power-Up (required)</p> <p>AGS Checkout (desired)</p> <p>Communications Basic (desired - near earth)</p> <p>S-Band Steerable Antenna Activation and Checkout (desired lunar distance)</p> <p>1. Establish Attitude Rate Display mode: RATE SCALE sw - 5°/SEC</p> <p>2. Establish desired attitude control mode from following:</p> <p>a. AGS Pulse: GUID CONT sw - AGS S/C: AGS sw - AUTO or ATT HOLD ROLL, PITCH, &amp; YAW sw - PULSE DEAD BAND sw - MAX or MIN ENG THR CONT: BAL CPL sw - ON</p> <p>b. AGS Direct: GUID CONT sw - AGS S/C: AGS sw - AUTO or ATT HOLD ROLL, PITCH, &amp; YAW sw - DIRECT DEAD BAND sw - MAX or MIN ENG THR CONT: BAL CPL sw - ON</p> <p>c. PGNS Attitude Hold/Rate Command GUID CONT sw - PGNS S/C: PGNS sw - ATT HOLD ROLL, PITCH, &amp; YAW sw - MODE CONT Key V77E NO DAP lt - off</p>	<p>Purpose of AGS Accelerometer Calibration procedure is to calibrate AGS accelerometers without using PGNS IMJ.</p> <p>Time to complete procedure is approximately 302 seconds.</p> <p>Ref para 4.6.2.1.</p> <p>Ref para 4.6.2.4.</p> <p>Ref para 4.13.2.1.</p> <p>Ref para 4.2.20.</p> <p>Ref para 4.5.3.5.</p> <p>Ref para 4.5.1.7.</p> <p>Ref para 4.5.1.8.</p> <p>Ref para 4.5.1.3. In-flight accelerometer-only calibration is acceptable with RCS not inhibited, but calibration accuracy may be degraded.</p>

**LMA790-3-LM**  
**APOLLO OPERATIONS HANDBOOK**

CREW- MAN	PNL	PROCEDURES	REMARKS
LM 3231		<p>4.6.2.14 <u>AGS Accelerometer Calibration (cont)</u></p> <p>d. During docked flight, request that CSM maintain drifting flight.</p> <p>3. Read out &amp; record accelerometer bias-compensation coefficients:            X-Accelerometer              Key DEDA C 540R (0.001/0.01 fps sq)            Y-Accelerometer              Key DEDA C 541R (0.001/0.01 fps sq)            Z-Accelerometer              Key DEDA C 542R (0.001/0.01 fps sq)</p> <p>4. Command accelerometer calibration:              Key DEDA C 400+70000E              Note time or start EVNT THR ind</p> <p>5. 35 seconds after beginning step 4.              Resume attitude control:              Key DEDA C 400+00000E              Establish desired attitude control mode</p> <p>6. Repeat step 3</p> <p>4.6.2.15 <u>AGS Wb Vector Update</u></p> <p>AGS Power-Up (required)            AGS Checkout (desired)</p> <p>1. Receive &amp; record Wb vector components from MSFN, &amp; enter Wb vector components:            X-component              Key DEDA C 514+XXXXXE (octal)            Y-component              Key DEDA C 515+XXXXXE (octal)            Z-component              Key DEDA C 516+XXXXXE (octal)</p>	<p>Parentetical quantization notation: lunar mission/earth mission.</p> <p>Although AGS accelerometer calibration requires only approximately 32 seconds to complete, AEA remains in calibrate mode for 302 seconds. Calibration may be manually terminated after 35 seconds by keying DEDA C 400+00000E (attitude hold).</p> <p>Readout of these quantities places them on AGS downlink.</p> <p>Purpose of AGS Wb Vector Update procedure is to maintain S-band LOS angles for ascent from far western lunar landing sites. Checkout or other use of yaw orientation is possible for earth-orbital flights.</p> <p>Ref para 4.6.2.1.            Ref para 4.6.2.4.            Nominally, appropriate Wb vector is loaded before launch.</p>

**G & C  
GENERAL**

**LMA790-3-LM**  
**APOLLO OPERATIONS HANDBOOK**

CREW-MAN	PNI	PROCEDURES	REMARKS
		<p>4.6.2.16 <u>AGS Lunar Surface Gyro Calibration</u></p> <p>AGS Power-Up (required)</p> <p>AEA Self-Test (desired)</p> <p>AGS Lunar Azimuth Store (required)</p> <p>AGS alignment (required)</p> <p>S-Band Steerable Antenna Activation and Checkout (desired)</p> <p>1. Read out &amp; record gyro-drift-compensation coefficients: Key DEDA C 544R (0.01°/hr) C 545R (0.01°/hr) C 546R (0.01°/hr)</p> <p>2. Enter appropriate lunar rotational rate information: Key DEDA C 640+XXXX (octal) C 641+XXXX (octal) C 642+XXXX (octal)</p> <p>3. Command gyro calibration: Key DEDA C 400+60000E</p> <p>4. Read out gyro calibration status: C 400R</p> <p>5. Read out &amp; record gyro-drift-compensation coefficients after completion of calibration: Key DEDA: C 544R (0.01°/hr) C 545R (0.01°/hr) C 546R (0.01°/hr) Compare with previous values</p>	<p>Purpose of AGS Lunar Surface Gyro Calibration procedure is to reestimate gyro-drift-compensation coefficients on lunar surface.</p> <p>Ref para 4.6.2.1.</p> <p>Ref para 4.6.2.3.</p> <p>Ref para 4.6.2.17.</p> <p>PGNCS/AGS Align procedure (para 4.9.2.1) or AGS Lunar Align (400+40000) (para 4.9.3.2).</p> <p>Ref para 4.2.20. Required to downlink calibration data</p> <p>Readout of coefficients places them on AGS downlink.</p> <p>AGS Flight Program 7 (FP-7) includes routines for calibrating gyros without restriction on lunar latitude or spacecraft alignment.</p> <p>Readout automatically changes to zero after 302 seconds of calibration, to indicate completion of calibration.</p> <p>Allowable differences: +0.90°/hr prelaunch to in-flight ±0.70°/hr in-flight to in-flight (&lt;24 hours)</p>

**LMA790-3-LM  
APOLLO OPERATIONS HANDBOOK**

CREW-MAN	PNL	PROCEDURES	REMARKS																																																
		<p>4.6.2.17 <u>AGS Lunar Azimuth Store</u></p> <p>AGS Power-Up (required)</p> <p>AGS Self-Test (desired)</p> <p>PGNCS/AGS Align</p> <p>1. Immediately after touchdown, command store lunar azimuth: Key DEDA C 413+10000E</p> <p>4.6.2.18 <u>AGS Rescaling From Lunar to Earth Mission</u></p> <p align="center">NOTE</p> <p>Not included in the following list are modified targeting J constants. New values will be determined when a backup mission is established.</p> <table border="0"> <thead> <tr> <th><u>DEDA Address</u></th> <th><u>Entry</u></th> <th><u>Parameter</u></th> </tr> </thead> <tbody> <tr><td>651</td><td>+20000</td><td>B13VSF</td></tr> <tr><td>653</td><td>+32756</td><td>B23RSF</td></tr> <tr><td>656</td><td>+15367</td><td>B22RSF</td></tr> <tr><td>677</td><td>+20305</td><td>B23SF</td></tr> <tr><td>304</td><td>+07839</td><td>3K4</td></tr> <tr><td>446</td><td>+00034</td><td>4K25</td></tr> <tr><td>454</td><td>+00100</td><td>4K26</td></tr> <tr><td>466</td><td>+00015</td><td>5K26</td></tr> <tr><td>473</td><td>-07332</td><td>4K27</td></tr> <tr><td>526</td><td>+13560</td><td>2K11</td></tr> <tr><td>607</td><td>+12000</td><td>K55</td></tr> <tr><td>634</td><td>+00020</td><td>1K35</td></tr> <tr><td>636</td><td>+62026</td><td>2K1</td></tr> <tr><td>637</td><td>+50732</td><td>2K2</td></tr> <tr><td>660</td><td>+00100</td><td>4K34</td></tr> </tbody> </table>	<u>DEDA Address</u>	<u>Entry</u>	<u>Parameter</u>	651	+20000	B13VSF	653	+32756	B23RSF	656	+15367	B22RSF	677	+20305	B23SF	304	+07839	3K4	446	+00034	4K25	454	+00100	4K26	466	+00015	5K26	473	-07332	4K27	526	+13560	2K11	607	+12000	K55	634	+00020	1K35	636	+62026	2K1	637	+50732	2K2	660	+00100	4K34	<p>Purpose of AGS Lunar Azimuth Store procedure is to store azimuth angle for possible later use by AGS Lunar Align procedure and to indicate to AGS that LM is on lunar surface. (Lunar surface flag is set by this procedure.)</p> <p>Ref para 4.6.2.1.</p> <p>Ref para 4.6.2.3.</p> <p>Ref para 4.9.2.1.</p> <p>Any entry (+10000 is suggested) causes lunar azimuth to be stored and lunar surface flag to be set.</p> <p>Purpose of AGS Rescaling From Lunar to Earth Mission procedure is to provide method of modifying scaling in AEA program when mission changes from lunar to earth.</p> <p>DEDA scale factors; to be entered first because they are for use in input-processing other DEDA entries.</p> <p>Sine of TPI central angle limit Eng cutoff compensation ΔVG threshold VG threshold Descent stage bias VF limit Altitude rate scaling Accelerometer bias threshold Gravity constant 1/2K1 aT lower limit</p>
<u>DEDA Address</u>	<u>Entry</u>	<u>Parameter</u>																																																	
651	+20000	B13VSF																																																	
653	+32756	B23RSF																																																	
656	+15367	B22RSF																																																	
677	+20305	B23SF																																																	
304	+07839	3K4																																																	
446	+00034	4K25																																																	
454	+00100	4K26																																																	
466	+00015	5K26																																																	
473	-07332	4K27																																																	
526	+13560	2K11																																																	
607	+12000	K55																																																	
634	+00020	1K35																																																	
636	+62026	2K1																																																	
637	+50732	2K2																																																	
660	+00100	4K34																																																	

LM 3248

**S & C  
GENERAL**

**LMA790-3-LM**  
**APOLLO OPERATIONS HANDBOOK**

LM 3248

CREW- MAN	PNL	PROCEDURES	REMARKS																																																
		<p>4.6.2.18 <u>AGS Rescaling From Lunar to Earth Mission (cont)</u></p> <table border="0"> <tr> <td style="text-align: center;"><u>DEDA Address</u></td> <td style="text-align: center;"><u>Entry</u></td> <td style="text-align: center;"><u>Parameter</u></td> </tr> <tr> <td>661</td> <td>+00007</td> <td>4K35</td> </tr> <tr> <td>674</td> <td>-15752</td> <td>2K4</td> </tr> <tr> <td>534</td> <td>(Accelerometer</td> <td>1K18</td> </tr> <tr> <td>535</td> <td>scale factors)</td> <td>1K20</td> </tr> <tr> <td>536</td> <td></td> <td>1K22</td> </tr> <tr> <td>540</td> <td>(Accelerometer</td> <td>1K19</td> </tr> <tr> <td>541</td> <td>bias compensa-</td> <td>1K21</td> </tr> <tr> <td>542</td> <td>tion constants)</td> <td>1K23</td> </tr> <tr> <td>657</td> <td>(DEDA scale</td> <td>BACCSF</td> </tr> <tr> <td></td> <td>factor)</td> <td></td> </tr> <tr> <td></td> <td>+23420</td> <td></td> </tr> <tr> <td>537</td> <td>(X-gyro mass</td> <td>1K14</td> </tr> <tr> <td></td> <td>unbalanced</td> <td></td> </tr> <tr> <td></td> <td>compensation</td> <td></td> </tr> <tr> <td></td> <td>constant)</td> <td></td> </tr> </table>	<u>DEDA Address</u>	<u>Entry</u>	<u>Parameter</u>	661	+00007	4K35	674	-15752	2K4	534	(Accelerometer	1K18	535	scale factors)	1K20	536		1K22	540	(Accelerometer	1K19	541	bias compensa-	1K21	542	tion constants)	1K23	657	(DEDA scale	BACCSF		factor)			+23420		537	(X-gyro mass	1K14		unbalanced			compensation			constant)		<p>Ullage threshold -2(2K1)</p> <p>Accelerometer scale factors; octal number must be replaced by number equal to one-fourth of previous value as follows:</p> <ol style="list-style-type: none"> <li>1. Read existing value.</li> <li>2. Convert octal readout to binary.</li> <li>3. Round constant by adding 1 to second least significant bit.</li> <li>4. Drop two least significant bits and add two bits at most significant end of word. Bits added are zeros if readout was plus; ones, if readout was minus. Regroup as five octal digits.</li> <li>5. Enter into original address with original sign.</li> </ol> <p>Accelerometer bias-compensation constants (decimal quantities, scaled at 0.001 fps sq) are rescaled as follows:</p> <ol style="list-style-type: none"> <li>1. Readout and record accelerometer bias compensation constants</li> <li>2. Change BACCSF - Key DEDA C657+23420</li> <li>3. Round accelerometer bias-compensation constant by adding 0.005</li> <li>4. Reenter accelerometer bias constant - Key DEDA C 540 (541, 542) +XXXX (0.01 fps sq)</li> </ol> <p>Existing octal number must be replaced by number equal to four times its former value. Following is method for obtaining new value:</p> <ol style="list-style-type: none"> <li>1. Read existing value.</li> <li>2. Convert octal readout to binary.</li> <li>3. Drop two most significant bits and add two zeros at least significant end of word. Regroup as five octal digits.</li> <li>4. Enter new value into original location with original sign.</li> </ol>
<u>DEDA Address</u>	<u>Entry</u>	<u>Parameter</u>																																																	
661	+00007	4K35																																																	
674	-15752	2K4																																																	
534	(Accelerometer	1K18																																																	
535	scale factors)	1K20																																																	
536		1K22																																																	
540	(Accelerometer	1K19																																																	
541	bias compensa-	1K21																																																	
542	tion constants)	1K23																																																	
657	(DEDA scale	BACCSF																																																	
	factor)																																																		
	+23420																																																		
537	(X-gyro mass	1K14																																																	
	unbalanced																																																		
	compensation																																																		
	constant)																																																		



**LMA790-3-LM**  
**APOLLO OPERATIONS HANDBOOK**

CREW/ MAN	PNL	PROCEDURES	REMARKS
CDR LMP	11 6 1,2 1/2 1	<p>4.6.2.19 <u>AGS Power-Up From AGS Partial Power-Down</u></p> <p>1. CB/AC BUS B: AGS - close AGS STATUS sw - OPERATE MASTER ALARM - on MASTER ALARM pb/lt - reset AGS warn lt - on</p>	<p>AGS warn lt latches on (caused initially by core priming operation which, when performed, interferes with program inhibit of hardware alarm).</p> <p>AEA initial state: 1. Engine-off is present. 2. Addresses 400 and 410 through 417 are set to 00000.</p>
	2	<p>O<sub>2</sub>/H<sub>2</sub>O QTY MON sel - C/W RESET</p>	<p>O<sub>2</sub>/H<sub>2</sub>O QTY MON sel should not remain in C/W RESET position. It performs its reset function only at time it is switched into C/W RESET position.</p>
	1 2 6	<p>AGS warn lt - off O<sub>2</sub>/H<sub>2</sub>O QTY MON sel - previous position Key DEDA C 412R +10000</p>	<p>For AGS to operate correctly, 412 output must be 10000.</p>
		<p>2. Perform AEA Readiness Check</p>	<p>Ref Para 4.6.2.12</p>
		<p>4.6.2.20 <u>AGS Partial Power-Down</u></p>	<p>AGS Partial Power Down procedure may be used for lunar stay to eliminate possibility of bias shift resulting from complete power-down.</p>
LMP	16	<p>AGS Power-Up (required)</p> <p>1. CB S/C: AEA - open</p>	<p>Ref para 4.6.2.1.1. CB S/C: AEA - open before AGS STATUS sw - STAND BY. This eliminates detrimental effects of switch closure bounce.</p>
	1 1,2 1/2	<p>AGS warn lt - on</p> <p>MASTER ALARM - on MASTER ALARM pb/lt - reset</p>	<p>AGS warn lt - on because of improper ASA power outputs due to absence of AEA clock.</p>
	6 16	<p>2. AGS STATUS sw - STAND BY CB S/C: AEA - close AGS warn lt - off or AGS warn lt - on</p>	
	2	<p>O<sub>2</sub>/H<sub>2</sub>O QTY MON sel - C/W RESET &amp; return to previous position AGS warn lt - off</p>	<p>Opening CB S/C: AEA in step 1 may cause AEA to issue test-failure signal, which causes AGS warn lt to latch on.</p>
CDR	11	<p>3. CB/AC BUS B: AGS - open</p>	



**LMA790-3-LM**  
**APOLLO OPERATIONS HANDBOOK**

CREW- MAN	PNI	PROCEDURES	REMARKS												
	11	<p>4.6.3 <u>RADAR</u></p> <p>4.6.3.1 <u>Rendezvous Radar Power-Up</u></p> <p>CB HTR: RNDZ RDR OPR - close (required) CB HTR: RNDZ RDR STBY - open (required)</p>	<p>Assumption: Rendezvous Radar Initial Activation &amp; Check-out procedure has been completed. Para 4.6.3.2.</p> <p>Circuit breaker shall be closed for at least 1 hour 45 minutes prior to operation (time required to warm up high power multiplier (HPM) from cold soak to normal operating temperature (-40°F to +10°F) with LM bus voltage of 29 volts.) Circuit breaker shall be closed for at least 45 minutes prior to self test (time required to warm up HPM from cold soak to minimum operating temperature (-40°F to -5°F) with LM bus voltage of 29 volts). Adequate RR accuracy for an abort from the lunar surface can be assured with the following warmup (28 volts at antenna).</p> <table border="1" style="width: 100%; border-collapse: collapse;"> <tr> <td style="width: 30%;">Lunar Surface Antenna Position</td> <td style="width: 30%;">Lunar Surface Warmup Time using operate heaters only (-40°F to +10°F, HPM)</td> <td style="width: 40%;">Lunar Surface Warmup time using operate heaters until HPM reaches -5°F and using concurrent heater/electronics operation to complete warmup (-40°F to +10°F, HPM)</td> </tr> <tr> <td>AOT Alignment</td> <td style="text-align: center;">45 minutes</td> <td>32 minutes (activate electronics after 25 minutes, HPM at -5°F)</td> </tr> <tr> <td>Boresight LM +X</td> <td style="text-align: center;">32 1/2 minutes</td> <td>26 minutes (activate electronics after 20 minutes, HPM at -5°F)</td> </tr> <tr> <td>Boresight at sun</td> <td style="text-align: center;">20 minutes</td> <td>18 minutes (activate electronics after 14 minutes, HPM at -5°F)</td> </tr> </table>	Lunar Surface Antenna Position	Lunar Surface Warmup Time using operate heaters only (-40°F to +10°F, HPM)	Lunar Surface Warmup time using operate heaters until HPM reaches -5°F and using concurrent heater/electronics operation to complete warmup (-40°F to +10°F, HPM)	AOT Alignment	45 minutes	32 minutes (activate electronics after 25 minutes, HPM at -5°F)	Boresight LM +X	32 1/2 minutes	26 minutes (activate electronics after 20 minutes, HPM at -5°F)	Boresight at sun	20 minutes	18 minutes (activate electronics after 14 minutes, HPM at -5°F)
Lunar Surface Antenna Position	Lunar Surface Warmup Time using operate heaters only (-40°F to +10°F, HPM)	Lunar Surface Warmup time using operate heaters until HPM reaches -5°F and using concurrent heater/electronics operation to complete warmup (-40°F to +10°F, HPM)													
AOT Alignment	45 minutes	32 minutes (activate electronics after 25 minutes, HPM at -5°F)													
Boresight LM +X	32 1/2 minutes	26 minutes (activate electronics after 20 minutes, HPM at -5°F)													
Boresight at sun	20 minutes	18 minutes (activate electronics after 14 minutes, HPM at -5°F)													
	3	<p>1. Select display mode: HTR CONT: TEMP MON sel - RNDZ RADAR</p>	<p style="text-align: center;">CAUTION</p> <p>HPM may be damaged if operated at temperatures below -5°F</p> <p>Ref para 4.5.3.13.</p>												

**LMA790-3-LM**  
**APOLLO OPERATIONS HANDBOOK**

CREW-MAN	PNL	PROCEDURES	REMARKS
		<p>4.6.3.1 <u>Rendezvous Radar Power-Up (cont)</u></p> <p>2. Verify rendezvous radar temperature: HTR CONT: TEMP Ind - <math>\gt</math> +10°F</p> <p>3. CB/AC BUS A: RNDZ RDR - close Wait 30 sec. CB PGNS: RNDZ RDR - close RNDZ RADAR: NO TRACK lt - on</p> <p>4.6.3.2 <u>Rendezvous Radar Initial Activation &amp; Checkout</u></p> <p>LGC Power-Up (required) LGC Self-Test (desired) ATCA Power-Up (required)</p> <p>CB HTR: RNDZ RDR OFR - close (required) CB HTR: RNDZ RDR STBY - open (required)</p> <p>1. Select displays: SHFT/TRUN <math>\bar{x}</math> sw - +50° RATE/ERR MON sw - RNDZ RADAR RNG/ALT MON sw - RNG/RNG RT</p> <p>2. RR GYRO SEL sw - PRIM</p>	<p>Wait until HTR CONT: TEMP ind - <math>\gt</math> +10°F before continuing procedure.</p> <p>Prevents: (1) Probable high-rate driving of antenna into stops and (2) probable unpredictable performance during gyro spin-up.</p> <p>This light is normally on when radar is energized but is not tracking.</p> <p>Ref para 4.6.1.1. Ref para 4.6.1.13. Ref para 4.2.4.</p> <p>Circuit breaker shall be closed for at least 45 minutes prior to self test (time required to warm up HPF from cold soak to minimum operating temperature (-40°F to -5°F) with LM bus voltage of 29 volts).</p> <p>Ref para 4.5.3.6.</p> <p>To avoid possible gyro logic voting problems, use PRIM position at all times unless primary gyro fails, at which time SEC should be selected. Failure of primary gyro while in mode I is indicated by gyration of FDAI shaft and trunnion needles.</p>
	11		
	11		
	1		
	12		

G & C  
GENERAL

LM 3231



**LMA790-3-LM**  
**APOLLO OPERATIONS HANDBOOK**

CREW-MAN	PNL	PROCEDURES	REMARKS
		<p>4.6.3.2 <u>Rendezvous Radar Initial Activation &amp; Checkout (cont)</u></p>	
	3	<p>3. HTR CONT: TEMP MON sel - RNDZ RADAR</p> <p>HTR CONT: TEMP ind - <math>\geq +10^{\circ}\text{F}</math></p>	<p>Ref para 4.5.3.13.</p> <p>Wait until HTR CONT: TEMP ind - <math>\geq +10^{\circ}\text{F}</math> before continuing procedure.</p>
		<p>4. RNDZ RADAR sel - SLEW</p>	<p>Data-no-good signal to CWEA is inhibited.</p>
		<p>5. Release rendezvous radar antenna restraining device:</p> <ol style="list-style-type: none"> <li>Remove locking PIP pin from T-handle mechanism on left side of AOT guard.</li> <li>Pull T-handle down to release antenna &amp; take up cable slack until detent is engaged.</li> <li>Reinsert locking PIP pin.</li> </ol>	<p>RR antenna must remain stowed or in <math>0^{\circ}</math> trunnion angle, <math>283^{\circ}</math> shaft angle before undocking, to prevent CSM RCS plume-impingement damage.</p>
	11	<p>6. Apply power to rendezvous radar: CB/AC BUS A: RNDZ RDR - close (after 30 sec.) CB FGNS: RNDZ RDR - close</p>	<p>Prevents: (1) Probable high-rate driving of antenna into stops and (2) probable unpredictable performance during gyro spin-up.</p>
	3 1	<p>7. RNDZ RADAR: NO TRACK lt - on RNG/ALT ind pwr/sig fail lt - on</p>	
	3	<p>8. Bring rendezvous radar antenna to mode I with shaft &amp; trunnion angles at <math>0^{\circ}</math>: RNDZ RADAR: SLEW RATE sw - HI Hold RNDZ RADAR: SLEW sw - LEFT (trunnion angle display on FDAI deflects to right &amp; returns to <math>0^{\circ}</math>.) RNDZ RADAR SLEW RATE sw - LO Hold RNDZ RADAR: SLEW sw - DOWN (Shaft angle display on FDAI reaches <math>0^{\circ}</math>.)</p>	<p>Trunnion slew at low rate can result in large amplitude oscillation near <math>90^{\circ}</math>.</p>
		<p>9. If docked with CSM, verify: CSM RCS thruster B-3 - off RNDZ RDR transponder - off</p>	
		<p>10. Select rendezvous radar display: X POINTER SCALE sw - HI</p>	
		<p>11. RNDZ RADAR: SLEW RATE sw - HI</p>	
		<p>12. Verify: RADAR: NO TRACK lt - on RNG/ALT ind pwr/sig fail lt - on</p>	<p>Ref para 4.5.3.7.</p>

**G & C**  
**GENERAL**

**LMA790-3-LM  
APOLLO OPERATIONS HANDBOOK**

LH 3249

CREW- MAN	PNI	PROCEDURES	REMARKS																																				
		4.6.3.2 Rendezvous Radar Initial Activation & Checkout (cont)																																					
		13. RNDZ RADAR: SLEW RATE sw - LO																																					
AOT		14. Confirm nulling can be achieved with: RR GYRO SEL sw - AUTO & SEC.																																					
3		15. RR GYRO SEL sw - PRIM																																					
		16. Hold RNDZ RADAR: SLEW sw - UP or DOWN, as required, until shaft angle display on FDAI reaches 0°.																																					
		17. RNDZ RADAR sel - AUTO TRACK																																					
		CAUTION																																					
		Monitor FDAI & prevent trunnion angle from exceeding 50° meter limit. Performance monitoring above meter limit is not possible. If trunnion is permitted to drift above meter limit, unstable performance may occur.																																					
		18. RADAR TEST sw - RNDZ	RR antenna will cycle and drift during self-test. Track lockup takes approximately 12 seconds.																																				
		RADAR: TEST/MON sel - positions indicated in chart, & observe values given for each radar.	Values given are extremes of tolerance for each function.																																				
		<table border="1" data-bbox="938 352 1214 1738"> <thead> <tr> <th>Rendezvous Radar Electronics Assembly*</th> <th>Antenna Assembly</th> <th>AGC</th> <th>Xmtr Pwr</th> <th>Shaft Err</th> <th>Trun Err</th> </tr> </thead> <tbody> <tr> <td>27</td> <td>34</td> <td>1.3 to 1.7</td> <td>2.3 to 2.7</td> <td>2.2 to 2.6</td> <td>2.2 to 2.6</td> </tr> <tr> <td>34</td> <td>40</td> <td>1.5 to 1.9</td> <td>2.8 to 3.2</td> <td>2.2 to 2.6</td> <td>2.2 to 2.6</td> </tr> <tr> <td>36</td> <td>42</td> <td>1.2 to 1.6</td> <td>2.8 to 3.2</td> <td>2.2 to 2.6</td> <td>2.2 to 2.6</td> </tr> <tr> <td>40</td> <td>23</td> <td>1.4 to 1.8</td> <td>2.8 to 3.2</td> <td>2.2 to 2.6</td> <td>2.2 to 2.6</td> </tr> <tr> <td>42</td> <td>44</td> <td>1.4 to 1.8</td> <td>2.5 to 2.9</td> <td>2.2 to 2.6</td> <td>2.2 to 2.6</td> </tr> </tbody> </table>	Rendezvous Radar Electronics Assembly*	Antenna Assembly	AGC	Xmtr Pwr	Shaft Err	Trun Err	27	34	1.3 to 1.7	2.3 to 2.7	2.2 to 2.6	2.2 to 2.6	34	40	1.5 to 1.9	2.8 to 3.2	2.2 to 2.6	2.2 to 2.6	36	42	1.2 to 1.6	2.8 to 3.2	2.2 to 2.6	2.2 to 2.6	40	23	1.4 to 1.8	2.8 to 3.2	2.2 to 2.6	2.2 to 2.6	42	44	1.4 to 1.8	2.5 to 2.9	2.2 to 2.6	2.2 to 2.6	
Rendezvous Radar Electronics Assembly*	Antenna Assembly	AGC	Xmtr Pwr	Shaft Err	Trun Err																																		
27	34	1.3 to 1.7	2.3 to 2.7	2.2 to 2.6	2.2 to 2.6																																		
34	40	1.5 to 1.9	2.8 to 3.2	2.2 to 2.6	2.2 to 2.6																																		
36	42	1.2 to 1.6	2.8 to 3.2	2.2 to 2.6	2.2 to 2.6																																		
40	23	1.4 to 1.8	2.8 to 3.2	2.2 to 2.6	2.2 to 2.6																																		
42	44	1.4 to 1.8	2.5 to 2.9	2.2 to 2.6	2.2 to 2.6																																		
		*Assignment of rendezvous radar electronics assemblies to vehicles as of 8/31/71 is: LM11 - RREA 36; LM12 - RREA 40; spares - RREA 34, 42; hold - RREA 27																																					

**LMA790-3-LM**  
**APOLLO OPERATIONS HANDBOOK**

CREW-MAN	PNL	PROCEDURES	REMARKS
		<p>LM 3214, LM 3231</p> <p>4.6.3.2 Rendezvous Radar Initial Activation &amp; Checkout (cont.)</p> <p>RADAR: NO TRACK lt - off RNG/ALT Ind pwr/sig fail lt - off</p> <p>19. To set No RR Monitor flag: Key V25 N07E - Load flagword generator R1 101E - ECADR of No RR Monitor flag R2 10E - Bit identification, bit 4 R3 1E - Set bit (to reset load 0)</p> <p>3 20. RNDZ RADAR sel - LGC</p> <p>21. Perform RR/LR Self-Test (R04), steps 22 through 25.</p> <p>22. Key V63E</p> <p>Poss OPR ERR lt - on Exit R04, key R5ET</p> <p>23. FL V04 N12 R1 Option code for assumed test 00004 R2 LGC assumed option (RR) 00001 R3 ----- Key PRO</p> <p>24. FL V16 N72 - RR CDU angles R1 Trunnion XXX.XX° R2 Shaft XXX.XX° R3 ----- Verify trunnion &amp; shaft angles with FDAI Key PRO</p> <p>25. FL V16 N78 R1 XXX.XX mm Range R2 XXX.X fps Range rate R3 XXXX min-sec TPI Verify: R1 - XXX.XX +/-0.2 mm R2 - -0XXX.X +1-20 fps Key V34E - Terminate Exit R04</p>	<p>Enables display of RR data on DSKY in all RR antenna positions.</p> <p>Because LM RR self-test cannot be performed with CSM RR transponder radiating, it is assumed that CSM has disabled its transponder. OPR ERR lt - on if another extended verb from R76 is active or if another program or routine is using either radar, or TRACKFLG is set.</p> <p>RR CDU angles will change at 0.5 hertz due to RR antenna cycling and drift during self-test.</p> <p>Values are flight values. All pad values will be decrement of these. Tolerance shall be +/-0.20 mm of range at ambient temperature and +20.0 fps of range rate at ambient temperature. Initial abnormal values loaded in rendezvous radar range output shift register during rendezvous radar power-up (-9899.5 fps typical) may be ignored.</p>







**LMA790-3-LM  
APOLLO OPERATIONS HANDBOOK**

LM 3249

**CREW-  
MAN**

**PROCEDURES**

**REMARKS**

**4.6.3.2 Rendezvous Radar Initial Activation & Checkout (cont)**

Rendezvous Radar Electronics Assembly*		R DSKY (nm)	R ind (nm)	R dot DSKY (fps)	R dot ind (fps)
27	34	195.40+/-0.2	196+/-2	-489.0+/-20	-487+/-20
34	40	195.30+/-0.2	195+/-2	-490.5+/-20	-488+/-20
36	42	194.88+/-0.2	195+/-2	-499.5+/-20	-497+/-20
40	23	195.64+/-0.2	196+/-2	-502.5+/-20	-500+/-20
42	44	195.6 +/-0.2	196+/-2	-498.0+/-20	-496+/-20

\*Assignment of rendezvous radar electronics assemblies to vehicles as of 8/31/71 is: LM10 - RREA 38; LM11 - RREA 36; LM12 - RREA 40; Spares - RREA 34, 42; hold - RREA 27.

26. RADAR: TEST/MON sel - SHAFT ERR
27. RADAR: SIGNAL STRENGTH ind - verify needle deflection at 0.5 hertz from 2.2 to 2.6 VDC (nominal)
28. RADAR: TEST/MON sel - TRUN ERR
29. Repeat step 27.
30. RNDZ RADAR sel - SLEW  
RNDZ RADAR: NO TRACK lt - on  
RNG/ALT ind pwr/sig fail lt - on
31. RNDZ RADAR: SLEW sw - null shaft & trunnion angles
32. RNDZ RADAR sel - AUTO TRACK
33. RNDZ RADAR: NO TRACK lt - off  
RNG/ALT ind pwr/sig fail lt - off
34. Allow approx 15 sec for lock-on. Verify rendezvous radar lock-on.



**LMA790-3-LM  
APOLLO OPERATIONS HANDBOOK**

LM 3214

CREW-MAN	PNL	PROCEDURES	REMARKS
	1	<p>4.6.3.2 <u>Rendezvous Radar Initial Activation &amp; Checkout (cont)</u></p> <p>35. Verify reversals every two seconds, of the following:            FDAI shaft and trunnion 2° to 8° in amplitude, until beyond display range due to drift.            X pointer ind AZ RT &amp; ELEV RT - full scale (both polarities)</p> <p align="center"><b>CAUTION</b></p> <p>Monitor FDAI &amp; prevent trunnion angle from exceeding 50° meter limit (by going to next step). Performance monitoring above meter limit is not possible. If trunnion is permitted to drift above meter limit, unstable performance may occur.</p>	<p>Needle motion will be barely perceptible at <math>\pm 50^\circ</math>.</p>
3	1,2 2 1/2	<p>36. RADAR TEST sw - OFF            MASTER ALARM - on            RNDZ RDR caut lt - on            MASTER ALARM pb/lt - reset</p>	<p>If docked to CSM, position antenna to 0° -0°, RNDZ RADAR: SLEW RATE sw - HI, slew shaft downward for 15 seconds (to mechanical stop), CB PCNS: RNDZ RDR - open, then CB/AC BUS A: RNDZ RDR - open.</p>

**LMA790-3-LM**  
**APOLLO OPERATIONS HANDBOOK**

CREW-MAN	PNL	PROCEDURES	REMARKS								
		<p>4.6.3.3 <u>Rendezvous Radar Coarse Align</u></p> <p>LGC Power-Up (required)</p> <p>LGC Self-Test (desired)</p> <p>Rendezvous Radar Power-Up or Initial Activation and Checkout (required)</p> <p>Key V41 N72E</p> <p>Posn OPR ERR 1t - on</p> <p>Exit V41 N72, key RSET</p> <p>1. FL V21 N73 - Load New RR angles</p> <p>2. R1 Trunnion      XXX.XX°</p> <p>    R2 Shaft        XXX.XX°</p> <p>    R3                -----</p> <p>    Accept: Load desired angles</p> <p>    Reject: Key V34E</p> <p>3. FL V04 N12 - Option</p> <p>    R1 00006 - Assumed RR designate mode</p> <p>    R2 00002 - LGC assumed option (continuous designate)</p> <p>    R3 -----</p> <p>    R2 1 - Lock-on</p> <p>    2 - Continuous designate</p> <p>    Accept: Key PRO</p> <p>    Reject: Key V22E - Key 1E (lock-on)</p>	<p>Purpose of Rendezvous Radar Coarse Align procedure is to drive rendezvous radar shaft and trunnion to angles specified by crew. Procedure can be performed only when no other extended verb is active, or when P20 is not in process. Continuous designate mode inhibits RR Gimbal Monitor Routine (25).</p> <p>Ref para 4.6.1.1.</p> <p>Ref para 4.6.1.13.</p> <p>Ref para 4.6.3.1 and para 4.6.3.2.</p> <p>If remodng or repositioning, delay until complete before proceeding to step 2.</p> <p>OPR ERR 1t - on if another extended verb is active, P20/P22 in use, or designate or read sequence in process, or TRACKFLC is set.</p> <p>All registers initially blank. For AOT, docking, and lunar-stay operations, stow RR antennas as follows:</p> <table style="margin-left: 40px; border-collapse: collapse;"> <tr> <td style="padding-right: 20px;">Sub-Solar Point</td> <td style="border-bottom: 1px solid black;"></td> </tr> <tr> <td style="padding-right: 20px;">AOT</td> <td style="border-bottom: 1px solid black;">90°</td> </tr> <tr> <td style="padding-right: 20px;">Shaft</td> <td style="border-bottom: 1px solid black;">-77°(+283) -50°(+310)</td> </tr> <tr> <td style="padding-right: 20px;">Trunnion</td> <td style="border-bottom: 1px solid black;">0°                    180°</td> </tr> </table> <p>Stow position for impingement or for lunar stay with nominal sun conditions is same as AOT position.</p> <p>Trunnion angle must be less than +50° to prevent excessive heating due to servo-loop oscillation.</p> <p>The antenna is stowed to provide minimum optical obstruction, maximum clearance, and acceptable RR temperature limits (&gt;-50° and &lt; +150°F).</p> <p>Limits for continuous designate are extended additional 15° in shaft (mode I) beyond normal (-85° to -70° or +275° to +290°).</p> <p>Continuous designate mode must be terminated by DSKY entry V44E. If rendezvous radar antenna position remote or reposition is in process, it will be completed before continuous designate is terminated.</p>	Sub-Solar Point		AOT	90°	Shaft	-77°(+283) -50°(+310)	Trunnion	0°                    180°
Sub-Solar Point											
AOT	90°										
Shaft	-77°(+283) -50°(+310)										
Trunnion	0°                    180°										

LM 3231

G &  
GENE

**LMA790-3-LM  
APOLLO OPERATIONS HANDBOOK**

CREW-MAN	PNL	PROCEDURES	REMARKS
		<p>4.6.3.3 <u>Remdesvous Radar Coarse Align (cont)</u></p> <p>4. V41 - Coarse-align CDU's To monitor RR trunnion &amp; shaft angles during coarse align: Key V16 N72E</p> <p style="margin-left: 20px;">R1 Trunnion           XXX.XI° R2 Shaft             XXX.XI° R3                     -----</p> <p>When finished with display: Key KEY REL</p> <p>5. Poss PNDG lt - on Key V05 M09E - Call alarm 00502 - Bad angle inputs 00503 - No data-good discrete in 30-sec designate Key KEY REL &amp; RSET</p> <p>4.6.3.4 <u>Remdesvous Radar Manual Designation to Mode II</u></p> <p>Remdesvous Radar Power-Up (required)</p> <p>Remdesvous Radar Initial Activation &amp; Checkout (required)</p> <p>Remdesvous Radar Coarse Align (required)</p> <p>1 1. RATE/ERR MON sw - ENDZ/RADAR</p> <p>3 2. ENDZ RADAR: SLEW RATE sw - HI SLEW sw - RIGHT until trunnion angle jumps to zero from extreme right of scale</p>	<p>Ref para 4.6.3.1.</p> <p>Ref para 4.6.3.2.</p> <p>Ref para 4.6.3.3.</p>

**LMA790-3-LM  
APOLLO OPERATIONS HANDBOOK**

LM 3231

CREW-MAN	PNL	PROCEDURES	REMARKS
		<p>4.6.3.5 <u>Rendezvous Radar Manual Side-Lobe Acquisition Check &amp; Main-Lobe Acquisition Verification</u></p> <p>COAS Lighting Check</p> <p>Rendezvous Radar Power-Up (required)</p> <p>or</p> <p>Rendezvous Radar Initial Activation &amp; Checkout (required)</p> <p>CSM maintaining preferred tracking attitude</p> <p>Communications Basic (required - near earth)</p> <p>S-Band Steerable Antenna Activation and Checkout (required - lunar distance)</p>	<p>Ref para 4.2.9.</p> <p>Ref para 4.6.3.1.</p> <p>Ref para 4.6.3.2.</p> <p>Ref para 4.13.2.1.</p> <p>Ref para 4.2.20.</p> <p>This procedure is normally entered from LM Rendezvous Navigation Program (P20) (para 4.8.2.1) or AGS Manual Rendezvous Radar LM State Vector Update procedure; therefore, requirements and switch settings for these procedures are not repeated in this procedure.</p> <p>Figure 4-12 data are taken from rendezvous radar P-23, figures 4-17 through 4-21 are from test data compiled on RR electronic assembly No. 9 and antenna assembly No. 7, and per transponder simulator LSW410-3070. Transponder simulator doubles true single-path attenuation and exaggerates AGC differences between side-and main-lobe peaks.</p>
		<p>1. Select RR display: SHFT/TRUN <math>\bar{x}</math> sw - +50° RATE/ERR MON sw - RNDZ RADAR RNG/ALT MON sw - RNG/RNG RT RADAR: TEST/MON sel - AGC</p>	<p>Ref para 4.5.3.6.</p>
		<p>2. If CSM is not visible, go to step 4. Turn on COAS: Remove COAS from overhead position. Set COAS detent for forward (left window) position. Install COAS in forward position. COAS sw - FWD ACA - maneuver LM to bring CSM to center of COAS reticle COAS sw - OFF</p>	<p>Ref para 4.5.3.10.</p>
		<p>8</p>	

G & G  
GENE

**LMA790-3-LM**  
**APOLLO OPERATIONS HANDBOOK**

CREW: MAN	PNL	PROCEDURES	REMARKS
		<p>4.6.3.5 <u>Kendzvous Radar Manual Side-Lobe Acquisition Check &amp; Main-Lobe Acquisition Verification (cont)</u></p> <p>3. If shaft &amp; trunnion angles are not nulled and RNDZ RADAR: NO TRACK lt - on: RNDZ RADAR sel - SLEW RNDZ RADAR: SLEW sw - slew to null shaft &amp; trunnion angles RNDZ RADAR sel - LGC or AUTO TRACK</p> <p>4. RNDZ RADAR: NO TRACK lt - off (after approx 15 sec) If RNDZ RADAR: NO TRACK lt - on, go to step 6 RANGE ind - note range</p> <p>3 RADAR: SIGNAL STRENGTH ind - note AGC level (See figure 4-17 for main lobe).</p>	<p>Approximately 15 seconds are required for lockup.</p> <p>Selection is based on procedure referencing this procedure.</p> <p>At low AGC levels (approximately 0.5 vdc), RANGE ind will display unstable sequence of range values. In this case, acquisition is likely to have been made on side lobe.</p> <p>Figure 4-17 is a nomogram illustrating nominal AGC level versus range. Adjustment for RR transponder gain (if CSM attitude is off-nominal) or RR transponder transmitter output power degradation can be made using signal strength in dbm.</p> <p>RR electronic assembly and RR transponder temperatures as they affect RR AGC are not compensated for in the nomograph. However, Apollo 9 AGC tracked "ambient" curve closely; therefore, RR P-18 ambient curve was selected for this nomogram.</p> <p>AGC values 12 to 18 db down from nominal indicate probable side-lobe acquisition.</p> <p>Variations in AGC values are due to several variables: CSM orientation produces +6-db variation, CSM transponder output produces variations, and RR temperature also produces variations. Therefore, signal strength versus range may not always discriminate between main- and side-lobe lockup.</p>

**LMA790-3-LM**  
**APOLLO OPERATIONS HANDBOOK**

CREW: MAN	PNL	PROCEDURES	REMARKS
LM 3231	1	<p>4.6.3.5 <u>Rendezvous Radar Manual Side-Lobe Acquisition Check &amp; Main-Lobe Acquisition Verification (cont)</u></p> <p>RANGE ind - verify AGC is nominal for display range</p> <p>If AGC is not nominal:</p> <ol style="list-style-type: none"> <li>a. Verify transponder signal strength receiver on LM AGC indicator. Determine LOS angles from LM to CSM using voice and/or COAS.</li> <li>b. Determine AGC variation as a function of CSM transponder altitude with respect to LOS to LM.</li> <li>c. Determine if AGC maximum value reflects side lobe or main lobe acquisition.</li> </ol>	
	3	<p>5. Acquire main lobe from side lobe: If shaft &amp; trunnion angles on FDAI are not at null: S/C: PGNS sw (or AGS sw) - ATT HOLD ACA - maneuver to null shaft &amp; trunnion angles RNDZ RADAR sel - SLEW RNDZ RADAR: SLEW sw - slew (in shaft or trunnion) to find symmetric stable lock-on peak</p> <p>Determine middle point between twin peaks.</p> <p>RNDZ RADAR: SLEW sw - slew in other axis to find higher AGC peak. RNDZ RADAR sel - LGC or AUTO TRACK</p> <p>RNDZ RADAR: NO TRACK lt - off (after approx 15 sec)</p>	<p>Figure 4-19 shows projected view of shaft and trunnion angles vs. AGC angles for RR main and side lobes.</p> <p>Lowest dip between twin peaks (middle point) is based on approximately 4-second slewing from peak to peak or on splitting difference between shaft (or trunnion) angles at two peaks.</p> <p>Selection is based on procedure referencing this procedure.</p> <p>Approximately 15 seconds are required for lockup.</p>
		<p>6. To obtain initial lock-on: RNDZ RADAR sel - SLEW RNDZ RADAR: SLEW sw - slew to null shaft &amp; trunnion angles</p> <p>7. When AGC response is observed: RNDZ RADAR: SLEW sw - search for highest peak or pair of peaks; note shaft &amp; trunnion angles RNDZ RADAR sel - LGC or AUTO TRACK</p>	<p>Note any AGC peaks in event AGC is zero at shaft and trunnion null.</p> <p>Selection is based on procedure referencing this procedure.</p>

G &  
GENER

LMA790-3-LM  
 APOLLO OPERATIONS HANDBOOK

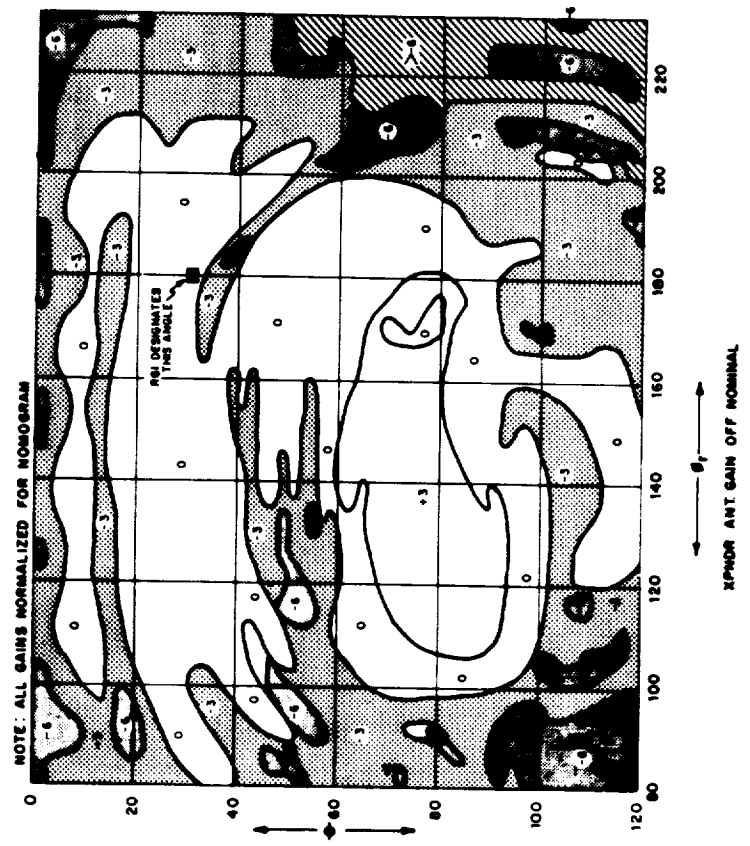
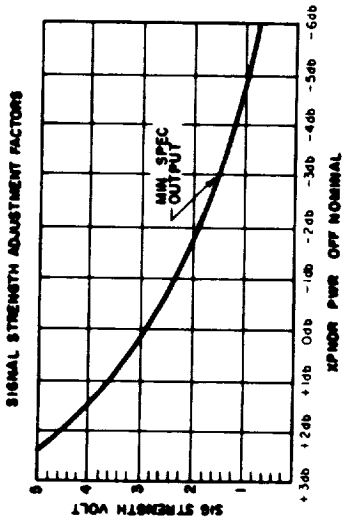

300LM5-620

Figure 4-17. Nomogram for Interpretation of Rendezvous Radar AGC (Normalized to -109 dbm 400 nm)

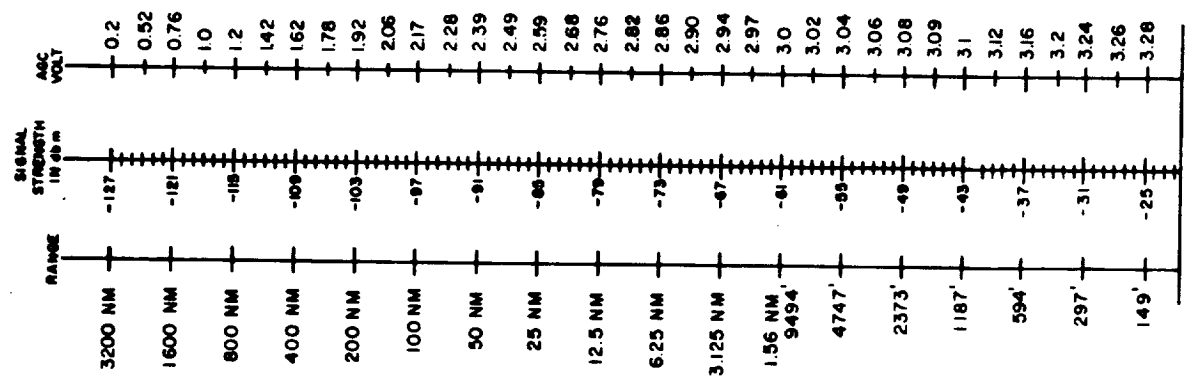



LMA790-3-LM  
 APOLLO OPERATIONS HANDBOOK

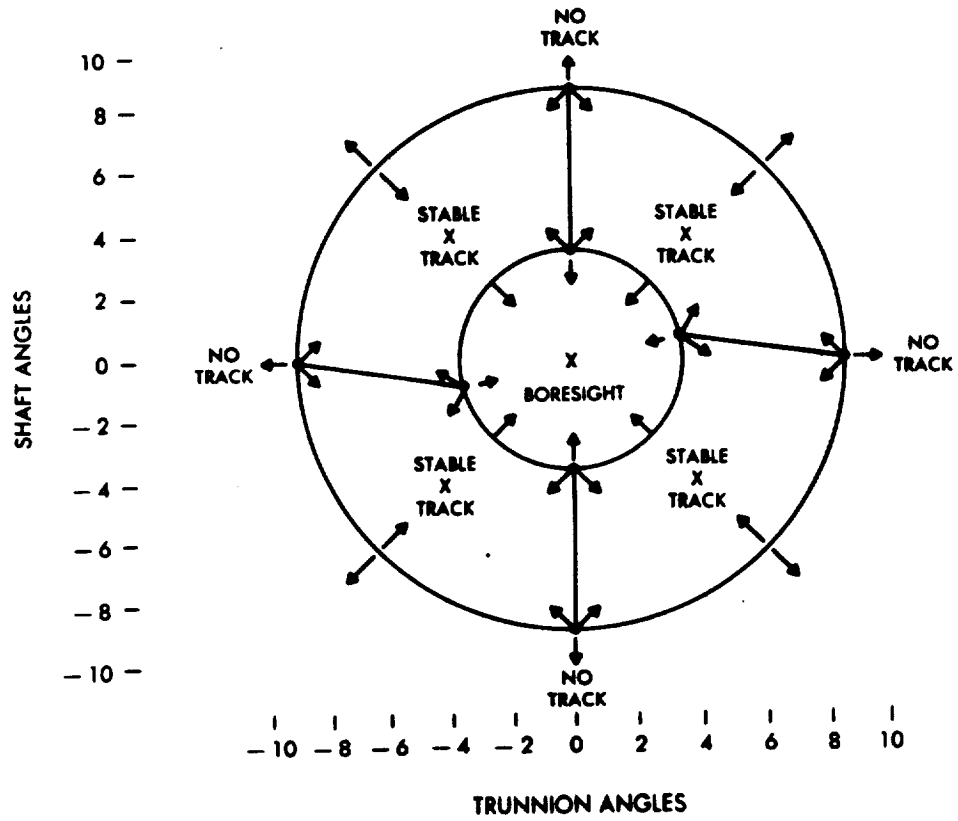

300LM5-603

Figure 4-18. Test Data, Designation Loci To Stable Tracking Angles

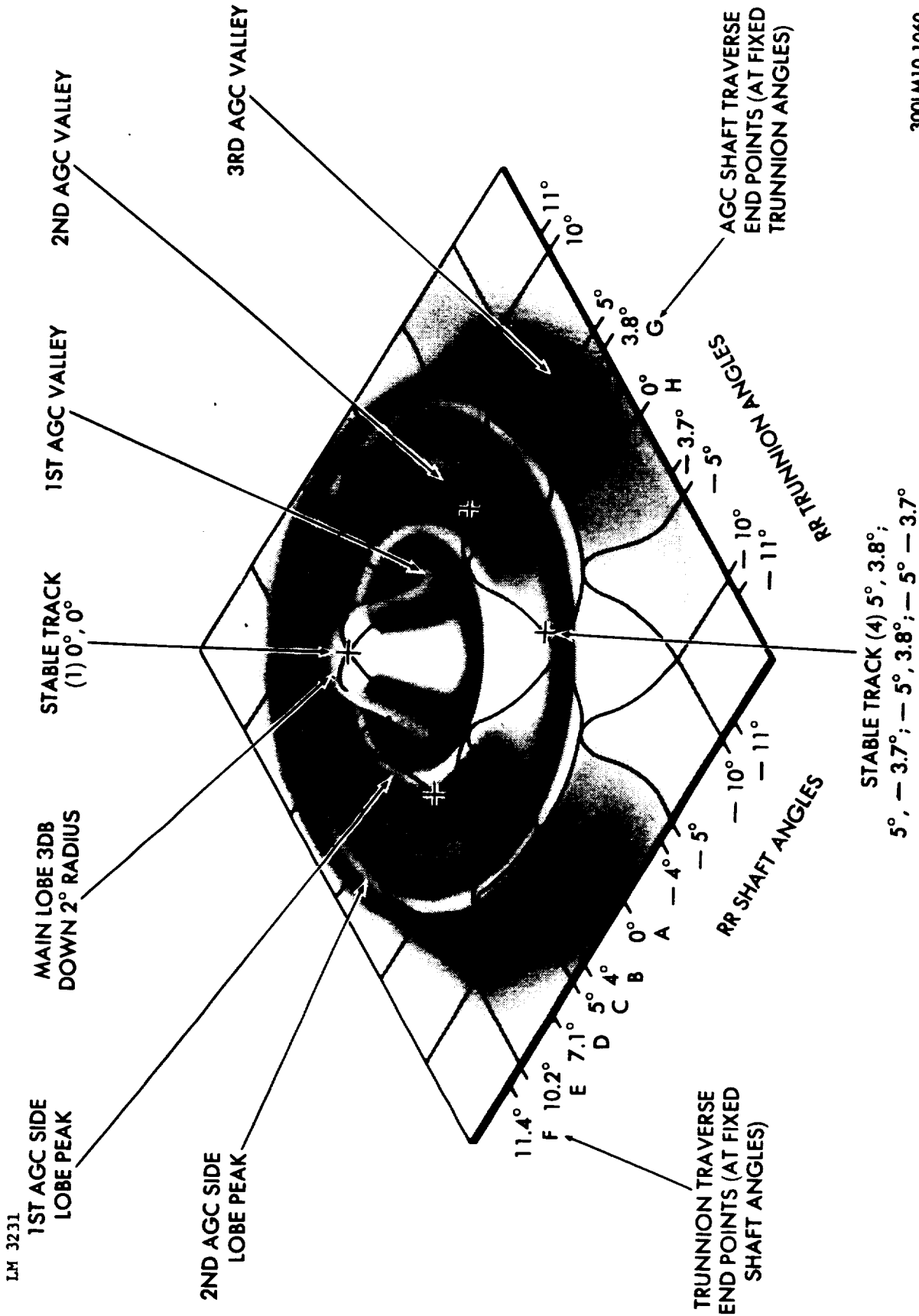

300LM10-1060

Figure 4-19. Test Data, ACC Signal Surface at Close Range (< 4 nm)

LMA790-3-LM  
 APOLLO OPERATIONS HANDBOOK

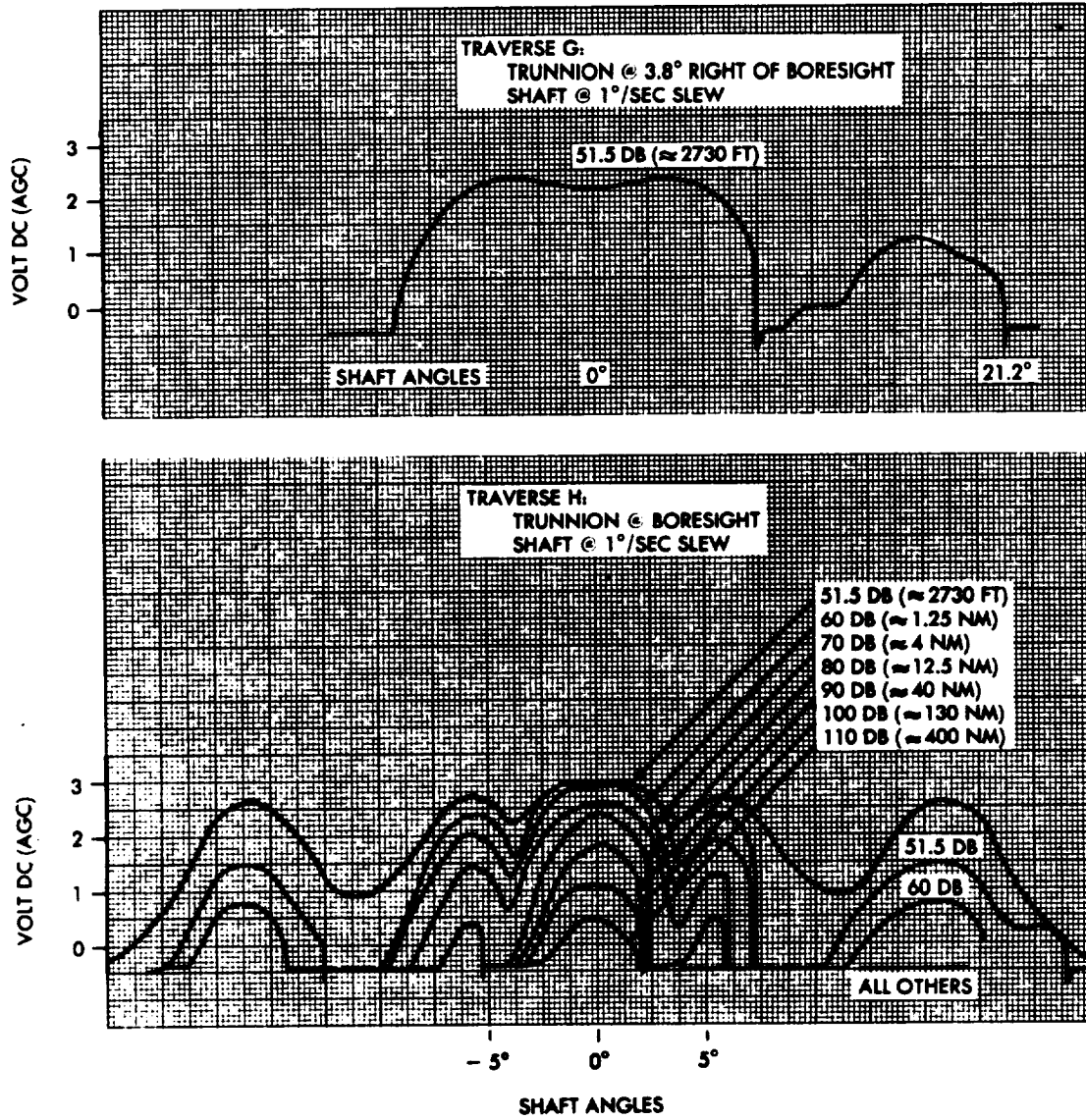

A-300LMS-605

Figure 4-20. Test Data, Rendezvous Radar Shaft Traverses at Fixed Trunnion Values

LMA790-3-LM  
 APOLLO OPERATIONS HANDBOOK

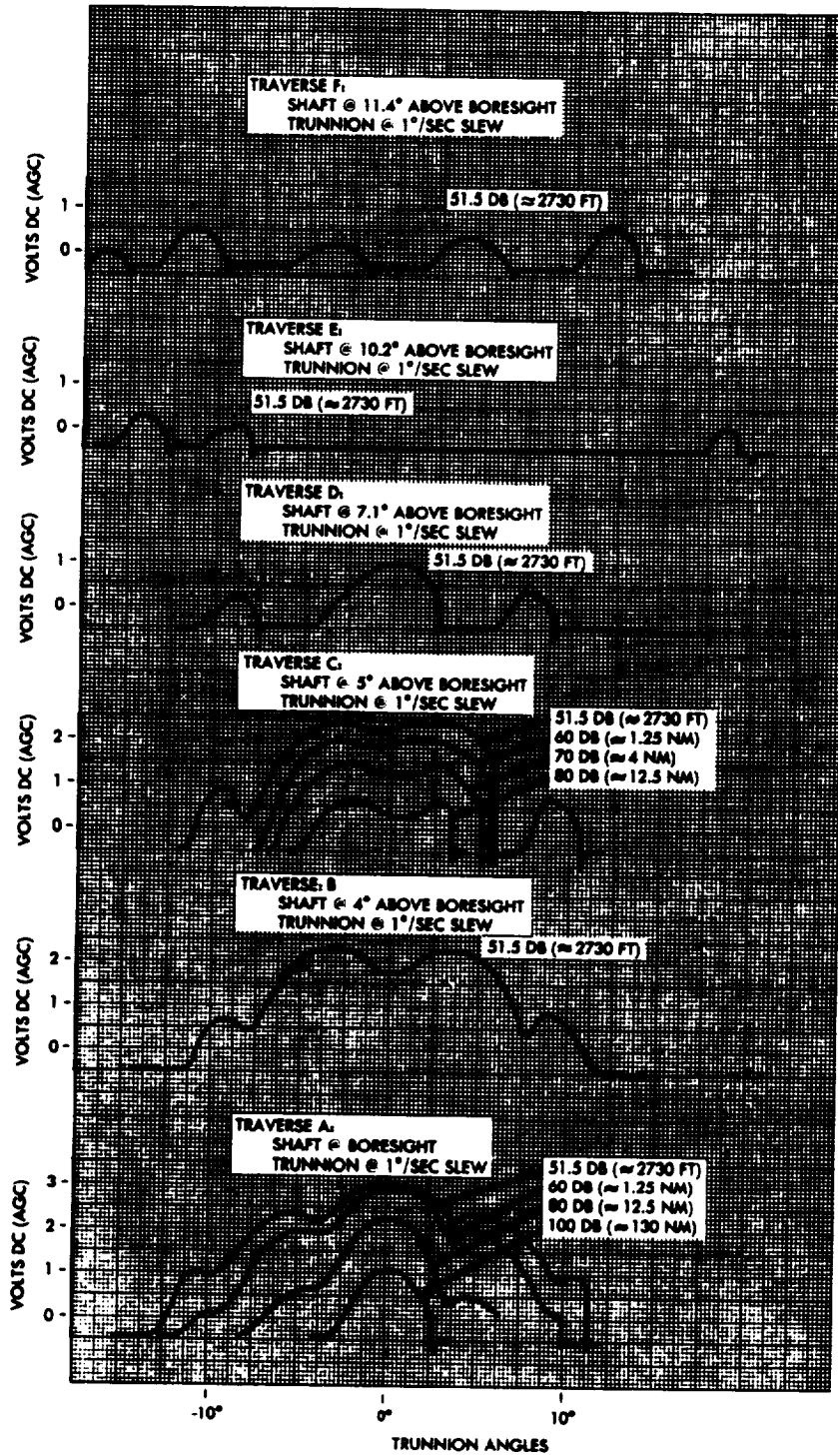

Figure 4-21. Test Data, Rendezvous Radar Trunnion Traverses at Fixed Shaft Values

# LMA790-3-EM

## APOLLO OPERATIONS HANDBOOK

	CREW: MAN	PNL	PROCEDURES	REMARKS
LM 3231			<p>4.6.3.5 <u>Rendezvous Radar Manual Side Lobe Acquisition Check &amp; Main-Lobe Acquisition Verification (cont)</u></p> <p>RNDZ RADAR: NO TRACK lt - off (after 15 sec)</p> <p>If RNDZ RADAR: NO TRACK lt - on, return to step 4</p> <p>RNDZ RADAR sel - SLEW</p> <p>RNDZ RADAR: SLEW sw - slew to previous shaft &amp; trunnion angle; search for higher AGC peak in other axis, starting from highest peak previously found or from bisection of pair of highest peaks previously found</p> <p>Return to beginning of step 7.</p> <p>4.6.3.6 <u>Terminate Rendezvous Radar Continuous Designate</u></p> <p>LCC Power-up (required)</p> <p>1. Key V44E</p> <p>4.6.3.7 <u>Landing Radar Power-Up</u></p> <p>1. Select displays mode &amp; verify landing radar temperature: HTR CONT: TEMP MON sel - LDC RADAR Monitor HTR CONT: TEMP ind</p> <p>2. CB PGNS: LDC RDR - close</p> <p>3. Monitor velocity transmitter power: RADAR: TEST MON sel - VEL XMTR SIGNAL STRENGTH ind - &gt;2.1 vdc</p> <p>4. Monitor altimeter transmitter power: RADAR: TEST MON sel - ALT XMTR SIGNAL STRENGTH ind - &gt;2.1 vdc</p>	<p>Approximately 15 seconds are required for lockup.</p> <p>No lock-on implies AGC peaks were from second side lobe (second side-lobe lock-on is not possible at &gt;0.5 nm range) or from first side lobe at range too great for lock-on. (See figure 4-17.)</p> <p>Purpose of Terminate Rendezvous Radar Continuous Designate procedure is to clear continuous designate and designate (internal) flags, disable RR CDU error counters, and enable RR Monitor Routine (R25). Procedure may be selected at any time, but has no effect unless Rendezvous Radar Coarse Align (option 2) is in process. If remote or reposition is in process, termination will be delayed until remote or repositioning is completed.</p> <p>Ref para 4.6.1.1.1.</p> <p>Temperature limits are determined by management curves and are mission dependent.</p> <p>Signal strength noted in OCP testing: approximately 3.0 vdc. (Transmitter power is temperature-dependent.)</p> <p>Signal strength noted in OCP testing: approximately 3.0 vdc. (Transmitter power is temperature-dependent.)</p>

G &  
GENER

**LMA790-3-LM  
APOLLO OPERATIONS HANDBOOK**

LM 3231

CREW-MAN	PNL	PROCEDURES	REMARKS
		<p>4.6.3.8 Landing Radar Checkout</p> <p>LGC Power-Up (required)</p> <p>LGC Self-Test (desired)</p> <p>Landing Radar Power-Up (required)</p> <p>1. Select landing radar display: RATE/ERR MON sw - LDG RDR/CHPTR MODE SEL sw - LDG RADAR RNG/ALT MON sw - ALT/ALT RT X POINTER SCALE sw - HI MULT</p> <p>2. Select self-test mode: RADAR TEST sw - LDG</p> <p>3. Verify self-test signal values: ALT ind - 7700 to 8100 ft ALT RATE ind - 478 to - 482 fps X pointer ind - off scale, to right and up</p> <p>4. Perform LR/RR Self-Test (RO4): Key V63E Poss OPR ERR lt - on Exit RO4, key RSET</p> <p>5. FL V04 N12 R1 00004 - Option code for assumed test R2 00001 - LGC assumed option (RR) R3 ----- Key Reject: V22E, 2E (load LR option), PRO</p> <p>6. FL V16 N66 R1 Range XXXXX ft R2 LR position 0000X R3 ----- R2 0000X - 1 - LR position 1 0000X - 2 - LR position 2</p> <p>Verify R1 is 08276 to 08296 ft <math>\pm</math> 2 counts on LGC (approximately 11 ft) If antenna position change check is not desired: Key PRO, go to step 12.</p>	<p>Ref para 4.6.1.1.</p> <p>Ref para 4.6.1.13.</p> <p>Ref para 4.6.3.7.</p> <p>Record self-test signal for mission evaluation (to nearest 50 feet). Nominal altitude display is 8000 ft. Nominal altitude rate is -480 fps.</p> <p>OPR ERR lt - on if another extended verb from R76 is active or if another program or routine is using either radar, or TRACKFLC is set.</p> <p>LGC supplies LR parameters to MSFN via downlink.</p> <p>Self-test simulated slant range to lunar surface.</p> <p>Record for mission evaluation, nominal range: 08286 ft.</p>

**LMA790-3-LM**  
**APOLLO OPERATIONS HANDBOOK**

CREW-MAN	PNI	PROCEDURES	REMARKS
		<p>4.6.3.8 <u>Landing Radar Checkout (cont)</u></p> <p>7. RADAR: LDG ANT sw - AUTO R2 - 00001</p> <p>8. RADAR: LDG ANT sw - DES R2 - 00001</p> <p>9. RADAR: LDG ANT sw - HOVER R2 - 00002 PROG lt - on Key V05 N09E - Call alarm 00522 - LR position change Key KEY REL &amp; RSET</p> <p>10. RADAR: LDG ANT sw - DES R2 - 00001</p> <p>11. RADAR: LDG ANT sw - AUTO R2 - 00001 Key PRO</p> <p>12. FL V16 N67 - Simulated velocities R1 X XXXXX fps R2 Y XXXXX fps R3 Z XXXXX fps Verify R1 is -00493 to -00497 Verify R2 is +01860 to +01864 Verify R3 is +01329 to +01333</p> <p>13. RADAR TEST sw - OFF ALT lt - on VEL lt - on RSET pb - push ALT lt - off VEL lt - off</p> <p>14. To terminate R04: Key V34E</p>	<p>LR position change during LR read cycle.</p> <p>ALT and VEL lts - on since date-good is lost when RADAR TEST sw - OFF in R04.</p>

G &  
GENER

**LMA790-3-LM**  
**APOLLO OPERATIONS HANDBOOK**

LM 3231

CREW/ MAN	PNL	PROCEDURES	REMARKS
		<p>4.6.3.9 <u>Command Landing Radar to Position 2</u></p> <p>LGC Power-Up (required)</p> <p>Landing Radar Power-Up (required)</p> <p>1. Key V59E            Poss OPR ERR lt - on            Exit V59, Key RSET            Poss PROG lt - on            Key V05 N09E - Call alarm            00523 - LR did not achieve position 2            Key KEY REL &amp; RSET</p> <p>4.6.3.10 <u>Landing Radar Spurious Test Routine (R77)</u></p> <p>LGC Power-Up (required)</p> <p>LGC Self-Test (desired)</p> <p>Landing Radar Power-Up (required)</p> <p>Landing Radar Checkout (desired)</p> <p>Communications Basic (required - near earth)</p> <p>S-Band Steerable Antenna Activation and Checkout (required - lunar distance)</p>	<p>Purpose of this extended verb is to drive LR antenna to position No. 2 (final approach and landing) and to cause HIGATJOB (high rate) to occur within 2 seconds if LR is stuck in position number 2 during P63 powered flight.</p> <p>Ref para 4.6.1.1.</p> <p>Ref para 4.6.3.7.</p> <p>OPR ERR lt - on if average g is off and TRACKFLG is set another program or routine is using either radar, or if average g is on and P63, P64, or P66 is not in progress.</p> <p>Alarm occurs only with average g off.</p> <p>The purpose of Landing Radar Spurious Test Routine (R77) is to provide landing radar range and velocity data for input on LGC downlink at one/second rate (when desired). Landing radar data are placed on downlink regardless of status of landing radar range-data-good and Velocity-data-good discrettes. Some portion of test (minimal) must be performed while MSFN is receiving LGC downlink telemetry data.</p> <p>Ref para 4.6.1.1.</p> <p>Ref para 4.6.1.13.</p> <p>Ref para 4.6.3.7.</p> <p>Ref para 4.6.3.8.</p> <p>Ref para 4.13.2.1.</p> <p>Ref para 4.2.20.</p>



**LMA790-3-LM**  
**APOLLO OPERATIONS HANDBOOK**

CREW-MAN	PNI	PROCEDURES	REMARKS
		<p>4.6.3.10 <u>Landing Radar Spurious Test Routine (R77) (Cont)</u></p> <ol style="list-style-type: none"> <li>1. Key V78E                Poss OPR ERR lt - on                Exit R77, key RSET</li> <li>2. To terminate routine:                Key V79E</li> </ol> <p>4.6.3.11 <u>Landing Radar Power-Down</u></p> <ol style="list-style-type: none"> <li>1. CB PGNS: LDG RDR - open</li> </ol>	<p>Routine may be called only when no other program or routine is using either radar, or TRACKFLC is set.</p>

LM 3231

G & C  
GENERAL



**LMA790-3-LM**  
**APOLLO OPERATIONS HANDBOOK**

PARA	TITLE	PAGE
4.7	Prethrust . . . . .	4.7-2
4.7.1	PGNCS/AGS . . . . .	4.7-2
4.7.1.1	External AV (LGC P30, AEA 410+50000) . . . . .	4.7-2
4.7.1.2	Coelliptic Sequence Initiation (LGC P32, AEA (410+10000) . . . . .	4.7-7
4.7.1.3	Constant $\Delta$ Altitude (LGC P33, AEA 410+20000) . . . . .	4.7-14
4.7.1.4	Transfer Phase Initiation (LGC P34, AEA 410+30000, Search; & 410+40000, Execute) . . . . .	4.7-20
4.7.1.5	Transfer Phase Midcourse (LGC P35, AEA 410+40000) . . . . .	4.7-28
4.7.2	PGNCS . . . . .	4.7-32
4.7.2.1	Rendezvous Out-Of-Plane Display Routine (R36) . . . . .	4.7-32
4.7.2.2	Target $\Delta V$ Program (CSM) (P76) . . . . .	4.7-33
4.7.2.3	Target $\Delta V$ Program (LM) (P77) . . . . .	4.7-34
4.7.3	AGS . . . . .	4.7-34A
4.7.3.1	AGS Out-Of-Plane Maneuver . . . . .	4.7-34A
4.7.3.2	AGS Orbit Insertion . . . . .	4.7-36
4.7.4	CSM Backup . . . . .	4.7-38
4.7.4.1	CSM Coelliptic Sequence Initiation Targeting Program (P72) . . . . .	4.7 38
4.7.4.2	CSM Constant $\Delta$ Altitude Targeting Program (P73) . . . . .	4.7-41
4.7.4.3	CSM Transfer Phase Initiation Targeting Program (P74) . . . . .	4.7-43
4.7.4.4	CSM Transfer Phase Midcourse Targeting Program (P75) . . . . .	4.7-46

**LMA790-3-LM**  
**APOLLO OPERATIONS HANDBOOK**

CREW-MAN	PNL	PROCEDURES	REMARKS
	<p>4.7 <u>PRETHRUST</u></p> <p>4.7.1 <u>PGNCS/AGS</u></p> <p>Prethrust PGNCS/AGS procedures are in a two-column format to facilitate presenting these procedures as separate PGNCS or AGS procedures, and as integrated PGNCS and AGS procedures: LGC in control and AEA in a followup condition ready to assume control. The left column presents the PGNCS procedures; the right column, AGS procedures.</p> <p>4.7.1.1 <u>External AV (LGC P30, AEA 410+50000)</u></p>	<p>Purpose of PGNCS External AV (P30) procedure is to accept targeting parameters from source(s) external to LGC and, from these data, compute velocity and other initial conditions required by LGC for desired maneuver. PGNCS-required parameters are TIC and AV vector.</p> <p>AGS External AV (410+50000) procedure accepts targeting parameters externally or from CSI, CDH, or TPI guidance routines. This procedure is used for all AGS-controlled thrusts, except AGS Orbit Insertion.</p> <p>Rendezvous Out-of-Plane Display Routine (R36) (para 4.7.2.1) may be used with External AV and RCS Thrust Program (P41) With AGS Followup/In Control procedure (para 4.10.1.3) for plane-change initiation (PCI) maneuver. This is accomplished by obtaining AVY targeting of external AV, followed by plus or minus Y-axis translation PCI maneuver using RCS. PCI is targeted to occur at approximately 30 minutes, or 90° phase angle, before CDH. It forces node at CDH and allows out-of-plane component of AV at CDH to achieve coplanar orbits.</p> <p>Ref para 4.6.1.1. Ref para 4.6.1.13.</p>	<p>LGC Power-Up (required)</p> <p>LGC Self-Test (desired)</p>

**LMA790-3-LM**  
**APOLLO OPERATIONS HANDBOOK**

CREW-MAN	PNL	PROCEDURES	REMARKS
		<p>4.7.1.1 External <math>\Delta V</math> (LGC P30, AEA 410+50000) (cont.)</p> <p>LGC time valid (required)</p> <p>LGC state vector valid (required)</p> <p>External <math>\Delta V</math> data received (required)</p> <p>IMU Power-Up (LGC Operating) (desired)</p> <p>IMU Orientation Determination Program (P51) (desired)</p>	<p>LGC/CMC Clock Synchronization Routine (R33) (para 4.6.1.15)</p> <p>LGC Update Program (P27) (para 4.6.1.7)</p> <p>LGC Update Program (P27) (para 4.6.1.7)</p> <p>Ref para 4.6.1.3. ISS should be on 15 minutes before thrusting maneuver.</p> <p>Ref para 4.9.1.1.1.</p> <p>Ref para 4.6.2.1.1.</p> <p>Ref para 4.6.2.3.</p> <p>AGS Manual Absolute Time Initialization procedure (para 4.6.2.6) or AGS Initialization Routine (R47) (para 4.6.1.18)</p> <p>AGS Initialization Routine (R47) (para 4.6.1.18) or AGS Manual LM State Vector Update/Initialization procedure (para 4.6.2.7) and AGS Manual CSM State Vector Update/Initialization (para 4.6.2.9)</p> <p>If GUID CONT sw - AGS, select AEA attitude hold: Key DEDA C 400+00000E, or S/C: AGS sw - ATT HOLD. Prevents possible attitude maneuver change of 5° and/or 10°/sec if AEA attitude hold not selected when in AGS control.</p> <p>AGS Wb Vector Update (para 4.6.2.15). Valid Wb vector is required if</p>
		<p>AGS Power-Up (required)</p> <p>AEA Self-Test (desired)</p> <p>AGS time valid (required)</p> <p>AGS LM/CSM state vector valid (required)</p>	
		<p>AGS Wb vector valid (desired)</p>	

PRETHR

**LMA790-3-LM**  
**APOLLO OPERATIONS HANDBOOK**

LM 323

CREW MAN	PNL	PROCEDURES	REMARKS
		<p>4.7.1.1 External AV (LGC P30, AEA 410+50000) (cont)</p> <p>AGS Alignment valid (desired)</p> <ol style="list-style-type: none"> <li>If targeting parameters are not computed by CSI, CDH, or TPI guidance routines, receive &amp; record targeting parameters from MSFN.</li> <li>Select external AV routine: Key DEDA C 410+50000E</li> </ol>	<p>steering selector address 623 - +10000.</p> <p>PCNCS/AGS Align (para 4.9.2.1), Backup AGS Alignment (Using AGS Body-Axis Alignment and FGMS IMU) (para 4.9.2.2), or Backup AGS Alignment (Using AGS Body-Axis Alignment and AOT) (Para 4.9.2.3)</p> <p>Initiate P30 at least 15 minutes before TIG.</p> <p>External AV routine must be selected before entering targeting parameters because Orbit Insertion, CSI, CDH, and TPI routines use some AEA memory locations that contain external AV and tig targeting parameters</p> <p>External AV components are given in local vertical coordinate frame at time of ignition (tigD). At TIG time bias (external AV) (7K1) (nominally 30 seconds) before targeted ignition time, no change in AV targeting parameters may be entered. In addition, thrust should not be initiated before 7K1 seconds before targeted ignition time.</p> <p>Stored components of impulsive AV along LM local vertical axes at TIG.</p>
		<ol style="list-style-type: none"> <li>Key V37E 30E</li> </ol>	
		<ol style="list-style-type: none"> <li> <p>FL V06 N33 - TIG</p> <p>R1 00XX hr</p> <p>R2 00XX min</p> <p>R3 0X.XX sec</p> <p>Accept: Record TIG</p> <p>Key PRO</p> <p>Reject: Key V25E - Load desired TIG</p> </li> </ol>	
		<ol style="list-style-type: none"> <li> <p>FL V06 N81 - AV (LV)</p> <p>R1 X XXX.X fps</p> <p>R2 Y XXX.X fps</p> <p>R3 Z XXX.X fps</p> <p>Accept: Key PRO</p> <p>Reject: Key V25E - Load desired AV data</p> </li> </ol>	

# LMA790-3-LM APOLLO OPERATIONS HANDBOOK

CREW-MAN	PNL	PROCEDURES	REMARKS
		<p>4.7.1.1 External AV (LGC P30, AEA 410+50000) (cont)</p>	<p>Parenthetical quantization notation: lunar mission/earth mission.</p> <p>Positive value of <math>\Delta V_x</math> indicates component of velocity-to-be-gained in postgrade direction.</p> <p>Positive value of <math>\Delta V_y</math> indicates component of velocity-to-be-gained opposite to CSM angular momentum vector.</p> <p>Positive value of <math>\Delta V_z</math> indicates component of velocity-to-be-gained toward gravitational source.</p> <p>Apofocus and perifocus altitudes are measured above launch pad radius in earth orbit; above lunar radius at most recently defined landing site, in lunar orbit. <math>\Delta V</math> is magnitude of velocity to be gained at TIC.</p> <p>Maximum altitude display value is 9999.9 nm.</p>
		<p>3. If targeting parameters are received from MSFN (step 1), enter components of external <math>\Delta V</math> and <math>\text{tigD}</math>: Horizontal component <math>\Delta V_x</math> - Key DEDA C 450+XXXXX (0.1/1 fps)</p> <p>Out-of-CSM plane component <math>\Delta V_y</math> - Key DEDA C 451+XXXXX (0.1/1 fps)</p> <p>Radial component <math>\Delta V_z</math> - Key DEDA C 452+XXXXX (0.1/1 fps)</p> <p><math>\text{tigD}</math> - Key DEDA C 373+XXXX.XE (0.1 min)</p>	
		<p>4. FL V06 N42 - Calculated thrusting parameters R1 Ha XXXX.X nm R2 Hp XXXX.X nm R3 AV XXXX.X fps Coordinate data with MSFN, if available. Accept: Key PR0 Reject alternatives: a. Key V34E - reselect P30 &amp; adjust aim parameters. b. Key V34E - select P27 &amp; load new aim parameters via up-link.</p> <p>5. FL V16 N45 - Maneuver data R1 M XXXX R2 TFI XXXX min-sec R3 MGA XXX.XX°</p>	<p>M will be 00000 because RR tracking data are normally not taken during P30. TFI is minus before TIC and plus after. Maximum TFI reading is 59:59. MGA at TIC if LM +X-axis is aligned to initial thrust direction, using current IMU alignment; -00002 if IMU orientation is unknown.</p>

PRETHRU

**LMA790-3-LM  
APOLLO OPERATIONS HANDBOOK**

CREW-MAN	PNI	PROCEDURES	REMARKS
		<p>4.7.1.1.1 <u>External AV (LCC P30, AEA 410+50000) (cont)</u></p> <p>6. Begin countdown to TIC: Set EVNT THR ind to count-down Load TIC into EVNT THR ind a. Use TPI from step 5 or b. Use MSFN time Key PRO</p> <p>7. FL V37 N-- Key XXE</p>	<p>If MGA is not satisfactory, P52 may be selected by keying V37E 52E.</p> <p>Ref para 4.13.6.</p> <p>Ref para 4.13.6.</p>
		<p>4. Begin countdown to TIC: Set EVNT THR ind to count-down. Load time-to-go to ignition into EVNT THR ind: a. Key DEDA C310R TA or b. Use MSFN time.</p>	



**LMA790-3-LM**  
**APOLLO OPERATIONS HANDBOOK**

CREW-MAN	PNL	PROCEDURES	REMARKS
		<p>4.7.1.2 Coelliptic Sequence Initiation (LGC P32, AEA 410+10000)</p> <p>LGC Power-Up (required)</p> <p>LGC Self-Test (desired)</p> <p>LGC time valid (required)</p> <p>LGC state vector valid (required)</p> <p>IMU Power-Up (LGC Operating) (desired)</p> <p>IMU Orientation Determination Program (P51) (desired)</p> <p>AGS Power-Up (required)</p> <p>AEA Self-Test (desired)</p> <p>AGS time valid (required)</p> <p>AGS LM/CSM state vector valid (required)</p>	<p>Ref para 4.6.1.1.</p> <p>Ref para 4.6.1.13.</p> <p>LGC/CMC Clock Synchronization Routine (R33) (para 4.6.1.15)</p> <p>LGC Update Program (P27) (para 4.6.1.7) and, when possible, LM Rendezvous Navigation Program (P20) (para 4.8.2.1). If P20 is operating, radar sighting marks are automatically made approximately once per minute. Number of marks (M) is displayed in RI with N45.</p> <p>Ref para 4.6.1.3. ISS should be on 15 minutes before thrusting maneuver.</p> <p>Ref para 4.9.1.1. Display of actual MGA in R3, with N45 during final pass, will not occur if LMW orientation is not known.</p> <p>Ref para 4.6.2.1.</p> <p>Ref para 4.6.2.3.</p> <p>AGS Manual Absolute Time Initialization procedure (para 4.6.2.6) or AGS Initialization Routine (R47) (para 4.6.1.18)</p> <p>AGS Initialization Routine (R47) (para 4.6.1.18) or AGS Manual LM State Vector Update/Initialization procedure (para 4.6.2.7) and AGS Manual CSM State Vector Update/Initialization procedure (para 4.6.2.9). AGS Manual Rendezvous Radar LM State Vector Update Ref para 4.8.2.2.</p>

PRETHR

**LMA790-3-LM**  
**APOLLO OPERATIONS HANDBOOK**

CREW- MAN	PNL	PROCEDURES	REMARKS
		<p>4.7.1.2 Coelliptic Sequence Initiation (LGC P32, AEA 410+10000) (cont)</p>	<p>If GUID CONT sw - AGS, select AEA attitude hold: Key DEDA C 400+0000E, or S/C: AGS sw - ATT HOLD</p> <p>If AEA attitude hold not selected when in AGS control, attitude maneuvers at 5° and/or 10°/second may occur.</p> <p>AGS Wb Vector Update (para 4.6.2.15). Valid Wb vector is required if steering selector address 623 = +10000.</p> <p>Ref para 4.5.3.9.</p> <p>Initial display is always zero. Negative or zero value causes time of apoapsis display. (Useful after abort.)</p>
1		<p>AGS Wb vector valid (desired)</p> <p>1. Establish altitude/altitude rate display: RNG/ALT MON sw - ALT/ALT RT MODE SEL sw - AGS</p>	
		<p>1. Key V37E 32E</p> <p>2. FL V06 N11 -- TIG (CSI) R1 00XX hr R2 00XX min R3 0XX.XX sec Alternatives: a. To display time of apoapsis with initial zeroes, Key PRO or Key V25E &amp; load any negative value b. To accept nonzero &amp; non-negative TIG (CSI) computed in response to a. above: Record TIG (CSI) Key PRO c. To reject TIG (CSI): Key V25E - Load desired TIG (CSI) Key PRO</p>	

**LMA790-3-LM**  
**APOLLO OPERATIONS HANDBOOK**

CREW-MAN	PNL	PROCEDURES	REMARKS
		<p>4.7.1.1.2 <u>Coelliptic Sequence Initiation (LGC P32, AEA 410+10000) (cont)</u></p> <p>2. Select CSI guidance mode: Key DEDA C 410+10000E</p> <p style="text-align: center;">CAUTION</p> <p>Time overflow will occur if selected earlier than 136 min before ignition time.</p> <p>3. <b>FL V06 N55</b> R1 N XXXX R2 E XXX.XX* R3 (R1 code) 00000 Accept: Record values. Key PRO Reject: Key V25E - Load desired parameters</p> <p>4. <b>FL V06 N37 TIC (TPI)</b> R1 00XX hr R2 00XX min R3 0X.XX sec Accept: Record TIC (TPI) Key PRO Reject: Key V25E - Load desired TIC (TPI)</p>	<p>Enter targeting before selecting CSI routine. If new targeting or new navigational updates are entered, reinitialize CSI routine by entering 410+00000, then 410+10000. Valid CSI solution should not be attempted earlier than 136 minutes before tIGA.</p> <p>If R3 = 0: When R1 is 00001, TIC (CDH) should occur at first apsidal crossing; when R1 is 00002, second apsidal crossing; etc.</p> <p>If R3 ≠ 0: TIC (CDH) at CSI + (180°) (R1)</p> <p>AGS Initialization Routine (R47) (para 4.6.1.18).</p>
		<p>3. Receive targeting data from MSFN or if PGNS P32 is in process obtain targeting data as follows:</p> <p>a. Obtain: TIG (CSI) step 2 PGNS column TIG (TPI) step 4 PGNS column K from last performance of R47.</p> <p>b. Compute: tIGA = TIG (CSI)-K tIGC = TIG (TPI)-K</p> <p>4. Enter targeting data: AGS time of CSI (tIGA) Key DEDA C 373+XXXXX (0.1 min) AGS time of TPI (tIGC) Key DEDA C 275+XXXXX (0.1 min) Select apsidal crossing for CDH</p>	

PRETHRU

**LMA790-3-LM**  
**APOLLO OPERATIONS HANDBOOK**

CREW-MAN	PNL	PROCEDURES	REMARKS										
		<p>4.7.1.2 Coelliptic Sequence Initiation (LCC P32, AEA 410+10000) (cont)</p> <p>5. FL V16 M45            R1 M           XXXXX            R2 TPI        XXBXX min-sec            R3 MGA       -00001</p> <p>R3 displays -00001 at any time other than last pass through program; -00002 during last pass if IMU is not aligned. MGA XXX.XX is displayed on last pass if IMU is aligned.</p> <p>Options:</p> <p>a. To continue mark process:            Key V32E - Go to step 6</p> <p>b. To terminate mark process, do final pass through program:            Key PRO</p>											
		<p>Key DEDA C 416+X0000E</p> <p>X = 1 - CDH transfer at 0.5 orbital period after CSI</p> <p>X = 3 - CDH transfer at 1.5 orbital periods after CSI</p> <p>Zero out-of-plane velocity to be gained:            Key DEDA C 451+00000E</p> <p>If thrusting is to be along X-axis:            Key DEDA C 623+X0000E</p> <p>X = 0 - Z-axis parallel to CSM orbit plane</p> <p>X = 1 - Z-axis specified by Wb vector</p> <p>5. Enter LOS angle at TPI (octal B7 cotangent):            Key DEDA C 605+XXXXXE</p>	<p>Nominal value is +00777 (preloaded before launch). Range is +01277 to +00135.</p> <p>Cotangents of angles in octal form with binary shift (B7):</p> <table style="margin-left: auto; margin-right: auto;"> <tr> <td style="text-align: right;"><u>Angle</u></td> <td style="text-align: left;"><u>Cotangent (Octal B7; DEDA load is + sign and five digits)</u></td> </tr> <tr> <td style="text-align: right;">20</td> <td style="text-align: left;">01277</td> </tr> <tr> <td style="text-align: right;">26.6</td> <td style="text-align: left;">00777</td> </tr> </table> <p>26.6° is nominal value between LOS to CSM and local horizontal at de-sired TPI time, as used in CSI computations (LM below and behind CSM).</p> <table style="margin-left: auto; margin-right: auto;"> <tr> <td style="text-align: right;">28.3</td> <td style="text-align: left;">00733</td> </tr> <tr> <td style="text-align: right;">70</td> <td style="text-align: left;">00135</td> </tr> </table>	<u>Angle</u>	<u>Cotangent (Octal B7; DEDA load is + sign and five digits)</u>	20	01277	26.6	00777	28.3	00733	70	00135
<u>Angle</u>	<u>Cotangent (Octal B7; DEDA load is + sign and five digits)</u>												
20	01277												
26.6	00777												
28.3	00733												
70	00135												

**LMA790-3-LM**  
**APOLLO OPERATIONS HANDBOOK**

CREW- MAN	PNL	PROCEDURES	REMARKS
		<p>4.7.1.1.2 Coelliptic Sequence Initiation (LGC P32, AEA 410+10000) (cont)</p> <p>6. Read out predicted radial velocity at CSI Key DEDA C 477R (0.1/1 fps)</p> <p>7. Check CSI solution after CSI solution is found (approx 2 sec): Total velocity-to-be-gained magnitude for CSI maneuver: Key DEDA C 370R (+0.1/1 fps)</p> <p>Downrange velocity to be gained in CSI maneuver - Key DEDA C 450R (+0.1/1 fps)</p> <p>Differential altitude at predicted time of CDH - Key DEDA C 402R (+0.1 mm)</p> <p>Predicted coast time from CSI to CDH - Key DEDA C 372R (+0.1 min)</p> <p>LM-to-CSM phase angle at CSI - Key DEDA C 303R (0.01°)</p> <p>Δr at CSI - Key DEDA C 314R (0.1 mm)</p> <p>If step 7 indicates acceptable CSI solution, go to step 9; if not, perform step 8.</p>	<p>Parenthetical quantization notation: lunar mission/earth mission.</p> <p>Exclusive of out-of-plane velocity unless address 451 ≠ 00000.</p> <p>Negative value indicates LM is higher than CSM.</p> <p>Sixty or eighty minutes are currently suggested approximate values for this time.</p>

PRETHR

**LMA790-3-LM**  
**APOLLO OPERATIONS HANDBOOK**

CREW-MAN	PNI	PROCEDURES	REMARKS
		<p>4.7.1.2 Coelliptic Sequence Initiation (LGC P32, AEA 410+10000) (cont)</p> <p>6. Poss FL V05 N09 - Alarm in up to three registers  R1 00XXX  R2 00XXX  R3 00XXX  PROC lt - on  Possible alarms:  00600 - Imaginary roots on first iteration  00606 - ΔV exceeds maximum (1000 fps)  00605 - Number of iterations exceed loop maximum (15)  00601 - CSI Hp &lt;85 nm (earth orbit) or 35,000 ft (lunar orbit)  00602 - CDH Hp &lt;85 nm (earth orbit) or 35,000 ft (lunar orbit)  00603 - CSI to CDH time &lt;10 min  00604 - CDH to TPI time &lt;10 min  Key RSET &amp; V32E - recycle to step 2, adjust input parameters</p> <p>7. FL V06 N75  R1 Aalt (CDH) XXXX.X nm  R2 AT (CSI/CDH) XXBX min-sec  R3 AT (CDH/TPI) XXBX min-sec  Record values  Key PRO</p> <p>8. Recompute CSI maneuver:  a. Receive new targeting parameters from MSFN.  or  b. Generate new TPI time.</p> <p>9. If thrusting is to be along Z-body-axis:  Key DEDA C 507+10000E  Key DEDA C 400+20000E</p>	<p>If lighting is important consideration in rendezvous, new TPI time would probably be present TPI plus one orbital period.</p> <p>Times shown in R2 and R3 are modulo 60 minutes, i.e., remainder in minutes and seconds after dividing time in seconds by 3600 (60 times 60) seconds. TIG(CDH) is available, key V06 N13E.</p>

**LMA790-3-LM  
APOLLO OPERATIONS HANDBOOK**

CREW- MAN	PNL	PROCEDURES	REMARKS
		<p>4.7.1.1.2 Coelliptic Sequence Initiation (LGC 732, AEA 410+10000) (cont)</p> <p>8. FL V06 N81 - CSI ΔV(LV)  R1 X XXXX.X fps  R2 Y XXXX.X fps  R3 Z XXXX.X fps  Accept: Record values  Key PRO  Reject: Key V25E - Load desired data</p> <p>9. FL V06 N82 - CDH ΔV(LV)  R1 X XXXX.X fps  R2 Y XXXX.X fps  R3 Z XXXX.X fps  Record values  Key PRO</p> <p>10. FL V16 N45  R1 M XXXX  R2 IFI XXXX min-sec  R3 MGA XXX.XX°  R3 will display:  a. -00001 if this is not last pass through program  b. -00002 if this is last pass &amp; IMU is not aligned  c. XXX.XX° MGA with + X-axis aligned with thrust vector</p>	<p>New value of ΔVY based on use of R36 may be substituted to obtain out-of-plane corrections (para 4.7.2.1). For AGS Out-of-Plane maneuver, ref para 4.7.3.1.</p> <p>If ΔV(LV) for CSI has been modified by crew, modification will not be reflected in LGC-computed values for CDH ΔV(LV). Unlike ΔV(LV) for CSI, these values cannot be written over.</p> <p>R1 display of M will be 00000 if RR data are not taken.</p> <p>MGA (XXX.XX°) is displayed on last pass if IMU is aligned.</p>
		<p>10. Read out time to maneuver:  Key DEDA C 310R (0.01 min)</p>	

**LMA790-3-LM  
APOLLO OPERATIONS HANDBOOK**

LM 3231

CREW- MAN	PNL	PROCEDURES	REMARKS
		<p><u>4.7.1.2 Coelliptic Sequence Initiation (LGC P32, AEA 410+10000) (cont)</u></p> <p>Options:</p> <p>a. If this was not last pass through program: (1) To terminate mark process &amp; accomplish final pass - Key PRO - Return to step 6 (2) To continue mark process - Key V32E, recycle to step 6</p> <p>b. If this was last pass through program: Set EVNT TMR ind to TFI.</p>	<p>If radar data are entered into AEA after switching to External ΔV or if navigation update is made, repeat ACS step 2.</p>
		<p>11. Transmit maneuver parameters CSI ΔV(LV) (N81) to CSH. Key PRO</p>	<p>Ref para 4.13.6.</p>
		<p>11. Set EVNT TMR ind to time to maneuver. ver.</p>	<p>Ref para 4.13.6.</p>
		<p>12. FL V37 N-- Select appropriate thrust procedure. XXE - Exit P32</p>	<p>Ref para 4.7.1.1. To permit monitoring of CSI parameters, it is suggested that External ΔV guidance routine not be selected until 4 or 5 minutes before ignition.</p>
		<p>13. Perform appropriate thrust procedure.</p>	<p>Ref para 4.10.</p>
		<p><u>4.7.1.3 Constant Δ Altitude (LGC P33, AEA 410+20000)</u></p>	<p>Purpose of Constant Δ Altitude procedure is to calculate parameters, based on maneuver data approved and keyed into LGC/AEA, for CDH; to display dependent variables for CDH maneuver; to display to, and receive approval from, astronaut/MSFN; and to store CDH target parameters for use by desired thrusting procedure.</p>
		<p>LGC Power-Up (required)</p>	<p>Ref para 4.6.1.1.</p>
		<p>LGC Self-Test (desired)</p>	<p>Ref para 4.6.1.13.</p>
		<p>LGC time valid (required)</p>	<p>LGC/CMC Clock Synchronization Routine (R33) (para 4.6.1.15)</p>



**LMA790-3-LM**  
**APOLLO OPERATIONS HANDBOOK**

CREW-MAN	PNL	PROCEDURES	REMARKS
		<p>4.7.1.1.3 Constant <math>\Delta</math> Altitude (LGC P33, AEA 410+20000) (cont)</p> <p>LGC state vector valid (required)</p> <p>IMU Power-Up (LGC Operating) (desired)</p> <p>IMU Orientation Determination Program (P51) (desired)</p> <p>Coelliptic Sequence Initiation (LGC P32, AEA 410+10000) (required)</p> <p>AGS Power-Up (required)</p> <p>AEA Self-Test (desired)</p> <p>AGS time valid (required)</p> <p>AGS LM/CSM state vector valid (required)</p>	<p>LGC Update Program (P27) (para 4.6.1.7) and, when possible, LM Rendezvous Navigation Program (P20) (para 4.8.2.1). If P20 is operating, radar sighting marks are made automatically about once per minute. Number of marks (M) is displayed in R1 with N45.</p> <p>Ref para 4.6.1.3. ISS should be on 15 minutes before thrusting maneuver.</p> <p>Ref para 4.9.1.1. Display of actual MGA in R3, with N45 during final pass, will not occur if IMU orientation is not known.</p> <p>Ref para 4.7.1.2.</p> <p>Ref para 4.6.2.1.</p> <p>Ref para 4.6.2.3.</p> <p>AGS Manual Absolute Time Initialization procedure (para 4.6.2.6) or AGS Initialization Routine (R47) (para 4.6.1.18)</p> <p>AGS Initialization Routine (R47) (para 4.6.1.18) or AGS Manual LM State Vector Update/Initialization (para 4.6.2.7) and AGS Manual CSM State Vector Update/Initialization procedure (para 4.6.2.9). AGS Manual Rendezvous Radar LM State Vector Update (para 4.8.2.2).</p>

PRETHRUS

**LMA790-3-LM**  
**APOLLO OPERATIONS HANDBOOK**

CREW- MAN	PNL	PROCEDURES	REMARKS
		<p>4.7.1.3 <u>Constant Δ Altitude (LCC P33, AEA 410+20000) (cont)</u></p> <p>Wb vector valid (desired)</p> <ol style="list-style-type: none"> <li>1. Establish altitude/altitude rate display: RNG/ALT MON sw - ALT/ALT RT MODE SEL sw - AGS</li> <li>2. Select CDH routine: Key DEDA C 410+20000E</li> <li>3. Zero out-of-plane velocity to be gained: Key DEDA C 451+00000E</li> <li>4. Perform AGS targeting:               <ol style="list-style-type: none"> <li>a. If CSI (but not PCI) was performed before CDH, &amp; CDH was selected before LM &amp; CSM navigation update, no targeting is required.</li> <li>b. Otherwise obtain tigrB from MSFN &amp; enter into AEA: Key DEDA C 373+XXXXXE (0.1 min)</li> </ol> </li> </ol>	<p>If GUID CONT sw - AGS, select AEA attitude hold: Key DEDA C 400+00000E, or S/C: AGS sw - ATT HOLD</p> <p>If AEA attitude hold is not selected when in AGS control, attitude maneuver at 5° and/or 10°/second may occur.</p> <p>AGS Wb Vector Update (para 4.6.2.15) Valid Wb vector is required if steering selector address 623 = +10000.</p> <p>Ref para 4.5.3.9.</p> <p>CDH solution will be invalid before tigrB minus 136 minutes. This initially invalid solution could occur when CDH is to be performed at 1.5 orbital periods after CSI.</p>

# LMA790-3-LM APOLLO OPERATIONS HANDBOOK

CREW- MAN	PNL	PROCEDURES	REMARKS
		<p>4.7.1.3 Constant <math>\Delta</math> Altitude (LGC P33, AEA 410+20000) (cont)</p> <ol style="list-style-type: none"> <li>1. Key V37E 33E</li> <li>2. FL V06 N13 - TIG (CDH)  R1 00XX hr  R2 00XX min  R3 0XX.XX sec  Accept: Record data.  Key PRO - Go to step 6  Reject: Key V25E - Load desired data</li> <li>3. Poss FL V05 N09 - Alarm  00611 - No solution for given CDH parameters  PROG lt - on  Key RSET  Options:  a. Key V32E - Recycle to step 2, readjust TIG (CDH)  b. Key PRO - Proceed with inaccurate data  c. Key V34E - Terminate  FL V37 N--  Key XXE</li> <li>4. FL V06 N75  R1 <math>\Delta</math> alt (CDH) XXXX.X mm  R2 <math>\Delta</math>T (CDH/TPI) XXBX min-sec  R3 <math>\Delta</math>T (TPI/nomTPI)XXBX min-sec  Record values.  Key PRO</li> <li>5. Verify solutions:  Display <math>\Delta</math>r  Key DEDA 402R (0.1 mm)  Compare with R1 <math>\Delta</math> alt</li> </ol>	<p>Parentetical quantization notation:  lunar mission/earth mission.</p>

PRETHRU

**LMA790-3-LM**  
**APOLLO OPERATIONS HANDBOOK**

LM 3231

CREW-MAN	PNL	PROCEDURES	REMARKS
		<p>4.7.1.1.3 Constant Δ Altitude (LGC P33, AEA 410+20000) (cont)</p> <p>5. FL V06 N81 - CDH ΔV(LV)  R1 X XXXX.X fps  R2 Y XXXX.X fps  R3 Z XXXX.X fps  Accept: Record values  Key PRO  Reject: Key V25E - Load desired  ΔV(LV)</p> <p>6. FL V16 M45  R1 M XXXXX  R2 TFI XXXX min-sec  R3 MGA XXX.XX°</p> <p>R3 will display:  a. -00001 if not last pass through program  b. -00002 if this is last pass &amp; IMU is not aligned  c. XXX.XX° MGA with +X-axis aligned with thrust vector</p> <p>Options:  a. If not last pass through program:  (1) To terminate mark process perform final pass, key PRO, &amp; go to step 3.</p>	<p>Negative value indicates retrograde attitude, Z-axis up (for X-axis thrust).</p> <p>New ΔVY value, based on use of R36 (V90), may be used to obtain out-of-plane corrections. Ref para 4.7.2.1 For AGS out-of-CSM-plane burn, ref para 4.7.3.1.</p> <p>R1 display of M will be 00000 if RR data are not taken.</p> <p>MGA (XXX.XX°) is displayed on last pass if IMU is aligned.</p>

**LMA790-3-LM**  
**APOLLO OPERATIONS HANDBOOK**

CREW-MAN	PNL	PROCEDURES	REMARKS
		<p>4.7.1.3 Constant <math>\Delta</math> Altitude (LGC P33, AEA 410+20000) (cont)</p> <p>7. If thrusting is along X-axis: Key DEDA C 623+X0000E X = 0 - Z-axis parallel to CSM orbit plane X = 1 - Z-axis specified by Wb vector</p> <p>If thrusting is along Z-axis: Key DEDA C 507+10000E Key DEDA C 400+20000E</p> <p>(2) To continue mark process - Key V32E - Recycle to step 3</p> <p>b. If this was last pass through program - Set EVNT TMR ind to TFI (in R2), transmit maneuver parameters CDH <math>\Delta</math>V (LV) (N81) to CSM, key PRO, go to step 7</p> <p>7. FL V37 N-- Select appropriate thrust procedure, Key XXE - Exit P33.</p>	<p>If radar data are entered into AEA after switching to External <math>\Delta</math>V or if navigation update is made, repeat AGS step 2.</p> <p>Ref para 4.13.6.</p> <p>Ref para 4.7.1.1. To permit monitoring of CDH parameters, it is suggested that External <math>\Delta</math>V guidance routine not be selected until 4 or 5 minutes before ignition time.</p> <p>Ref para 4.10.</p>
		<p>8. Set EVNT TMR ind to TA.</p> <p>9. Select External <math>\Delta</math>V guidance routine: Key DEDA C 410+50000E</p> <p>10. Select appropriate thrust procedure.</p>	

PRETHRU



# LMA790-3-LM APOLLO OPERATIONS HANDBOOK

CREW-MAN	PNI	PROCEDURES	REMARKS
		<p>4.7.1.6 Transfer Phase Initiation (LGC P34, AEA 410+30000, Search: &amp; 410+40000, Execute) (cont)</p> <p>IMU Power-Up (LGC Operating) (desired)</p> <p>IMU Orientation Determination Program (P51) (desired)</p>	<p>Ref para 4.6.1.3. ISS should be on 15 minutes before thrusting maneuver.</p> <p>Ref para 4.9.1.1. Display of actual MGA in R3, with N45 during final pass, will not occur if IMU orientation is not known.</p> <p>Ref para 4.6.2.1.</p> <p>Ref para 4.6.2.3.</p> <p>AGS Manual Absolute Time Initialization procedure (para 4.6.2.6) or AGS Initialization Routine (R47) (para 4.6.1.18)</p> <p>AGS Initialization Routine (R47) (para 4.6.1.18) or AGS Manual LM State Vector Update/Initialization procedure (para 4.6.2.7) and AGS Manual CSM State Vector Update/Initialization procedure (para 4.6.2.9). AGS Manual Rendezvous Radar LM State Vector Update Ref para 4.8.2.2.</p> <p>If GUID CONT sw - AGS, select AEA attitude hold: Key DEDA C 400+0000E, or S/C: AGS sw - ATT HOLD</p> <p>If AEA attitude hold is not selected when in AGS control, attitude maneuver at 5° and/or 10° sec may occur.</p>
		<p>AGS Power-Up (required)</p> <p>AEA Self-Test (desired)</p> <p>AGS time valid (required)</p> <p>AGS LM/CSM state vector valid (required)</p>	

PRETHRUS

**LMA790-3-LM**  
**APOLLO OPERATIONS HANDBOOK**

CREW-MAN	PNL	PROCEDURES	REMARKS
		<p>4.7.1.4 Transfer Phase Initiation (LCC P34, AEA 410+30000, Search; &amp; 410+40000, Execute) (cont)</p> <p>Wb vector valid (desired)</p> <ol style="list-style-type: none"> <li>1. Enter initial targeting data:               <ol style="list-style-type: none"> <li>a. Enter number of minutes before rendezvous that node occurrence is desired - Key DEDA C 306+XXXXXE (0.01 min)</li> <li>b. Enter time duration of transfer - Key DEDA C 307+XXXXXE (0.01 min)</li> </ol> <div style="border: 1px solid black; padding: 2px; margin: 5px 0;">If AGS in control, go to step 3.</div> </li> <li>2. Select mode &amp; target for AGS in followup (if search mode is not desired):               <ol style="list-style-type: none"> <li>a. Select TPI execute - Key DEDA C 410+40000E</li> <li>b. Enter TPI (tigC) - Key DEDA C 373+XXXXXE (0.1 min)</li> <li>c. Go to steps 3e &amp; 3f and verify solution.</li> </ol> </li> </ol> <p style="text-align: right;">1. Key V37E 34E</p>	<p>AGS Wb Vector Update (para 4.6.2.15). Valid Wb vector is required if steering selector address 623 = +10000</p> <p>Zero initial input will allow valid readout of Vp (DEDA address 371, step 4d).</p> <p>To avoid indeterminate values at 0°, 180°, and 360°, address 307 must not contain following values: Earth orbit: &lt;00500 04200 to &lt;05300 09000 to &lt;10000 &gt;13000</p> <p>Lunar orbit: &lt;00350 05700 to &lt;06500 &gt;11900</p> <p>tigC = TIC (TPI) - K.</p>



**LMA790-3-LM**  
**APOLLO OPERATIONS HANDBOOK**

CREW-MAN	PNL	PROCEDURES	REMARKS
		<p>4.7.1.4 Transfer Phase Initiation (LGC P34, AEA 410+30000, Search; &amp; 410+40000, Execute) (cont)</p> <p>2. FL V06 N37 - TIG (TPI)  R1 00XXX hr  R2 000XX min  R3 0XX.XX sec  Accept: Key PRO  Reject: Key V25E - Load desired  TIG (TPI)</p> <p>3. FL V06 N55  R1 N XXXXX  R2 E XXX.XX*  R3 CENTANG XXX.XX*</p> <p>Alternatives:  a. To accept present values of N, E, and CENTANG - Record values Key PRO - Go to step 9  b. To reject present values of N, E, or CENTANG - Key V25E, load N, E, &amp; CENTANG as desired.  Key PRO - Go to step 9  c. If program is to be terminated:  Key V34E  FL V37 N--  Key XXE, exit P34</p>	<p>P34 requires initial value of TIG (TPI) to be within 30 minutes of actual TPI time.</p> <p>N is defined as follows:  N = 0 (initial display is +00000)- specifies Kepler conic integration with no target offset (faster than precision integration)  N ≠ 0 - specifies precision integration with N target offsets (useful in earth orbit)  E is elevation angle between LM/CSM LOS and LM local horizontal at TIG (TPI) referenced to direction of flight. Initial Display is +000.00*.  A zero value in R2 requests that E be calculated based on previous display of TIG (TPI); a nonzero value of E, that TIG (TPI) be calculated based on E. CENTANG is orbital central angle of passive vehicle during transfer from TIG (TPI) to time of intercept.</p>

LM 3231

PRETHRU

**LMA790-3-LM**  
**APOLLO OPERATIONS HANDBOOK**

CREW- MAN	PNL	PROCEDURES	REMARKS
		<p>4.7.1.4 Transfer Phase Initiation (LGC P34, AEA 410+30000, Search; &amp; 410+40000, Execute) (cont)</p> <p>4. Poss FL V05 N09 - Alarm 00611 - No TIG for given E</p> <p>PROG It - on Key RSET &amp; PRO - Go to step 2</p>	<p>Address 310 must be entered after selecting TPI search mode (410+30000); otherwise, entry is lost. Valid solution should not be attempted earlier than 136 minutes before targeted rendezvous time. (Targeted rendezvous time is tIGC + 6J.)</p>
		<p>3. Select modes &amp; targeting for AGS in control (or using search mode):</p> <p>a. Select TPI search mode - Key DEDA C 410+30000E</p> <p>b. Enter Δ time from TPI execute (counted down to ignition) - Key DEDA C 310+XXXXXE (0.01 min)</p> <p>c. Read out θ LOS - Key DEDA C 303R (0.01°) When θ LOS = preselected value (approximately PGNC5 E):</p> <p>d. Select TPI execute mode - Key DEDA C 410+40000E</p> <p>e. Read out time to ignition - Key DEDA C 310R (0.01 min)</p> <p>f. Set EVNT THR ind to count-down to time to ignition using value in address 310.</p>	<p>Ref para 4.13.6.</p>
		<p>5. FL V06 N37 - TIG (TPI)</p> <p>R1 00XX hr R2 00XX min R3 0XX.XX sec Record TIG (TPI) Key PRO - Go to step 7</p>	
		<p>6. FL V06 N55</p> <p>R1 N XXXXX R2 E XXX.XX* R3 CENTANG XXX.XX* Record data. Key PRO</p>	

**LMA790-3-LM**  
**APOLLO OPERATIONS HANDBOOK**

CREW-MAN	PNL	PROCEDURES	REMARKS
		<p>4.7.1.1.4 Transfer Phase Initiation (LGC P34, AEA 410+30000, Search; &amp; 410+40000, Execute) (cont)</p> <p>7. FL V06 N58  R1 Hp  R2 ΔV(TPI)  R3 ΔV(TPF)  Record data.  Key PRO</p> <p>XXXX.X nm  XXXX.X fps  XXXX.X fps</p> <p>4. Verify TPI solution:  a. Read out time to rendezvous -  Key DEDA C 311R (0.01 min)</p> <p>b. Read out LOS angle -  Key DEDA C 303R (0.01°)</p> <p>c. Read out ΔV to be gained -  Key DEDA C 370R (0.1/1 fps)</p> <p>d. Read out braking velocity (VF) -  Key DEDA C 371R (0.1/1 fps)</p> <p>e. Read out TPI time -  Key DEDA C 373R (0.1 min)</p> <p>f. Read out transfer orbit peri-focus -  Key DEDA C 402R (0.1 nm)</p>	<p>Hp is altitude of perifocus above launch pad radius in earth orbit; above lunar radius at most recently defined landing site, in lunar orbit. ΔV(TPF) is required impulsive ΔV to accomplish intercept maneuver (TPF) at calculated time of intercept.</p> <p>To verify central angle of active vehicle is not within 170° to 190°:  Key V06 N52E  R1 XXX.XX ACTCENT (active vehicle central angle)  R2 -----  R3 -----  Key KEY REL  If within 170° to 190°, reenter program &amp; adjust input.</p> <p>Parentetical quantization notation: lunar mission/earth mission.</p>

PRETHRU

**LMA790-3-LM**  
**APOLLO OPERATIONS HANDBOOK**

LM 3231

CREW- MAN	PNL	PROCEDURES	REMARKS
		<p>4.7.1.1.4 <u>Transfer Phase Initiation (LGC F34, AEA 410+30000, Search; &amp; 410+40000, Execute) (cont)</u></p> <p>8. If desired, enter nonzero number of minutes before rendezvous that node occurrence is desired Key DEDA C 306 +XXXXXE (0.01 min)</p> <p>h. Read out TPI rendezvous offset time - Key DEDA C 312R (0.01 min)</p> <p>i. Read out transfer time to rendezvous - Key DEDA C 307R (0.01 min)</p> <p>j. Read out local level <math>\Delta V</math> components of TPI solution - Key DEDA C450R (0.1/1 fps) C451R (0.1/1 fps) C452R (0.1/1 fps)</p>	<p>New <math>\Delta VY</math> value, based on use of R36 (V90), may be used to obtain out-of-plane corrections. Ref para 4.7.2.1</p> <p><math>\Delta V</math> (LOS) are components of required impulsive <math>\Delta V</math> in orthogonal coordinate system oriented along LM-to-CSM LOS.</p> <p>LOS 1 is component along unit I LOS 2 is component along unit (HxI)xI LOS 3 is component along unit (HxI) Where, I = unit vector along LOS to CSM H = unit vector along LM orbital momentum vector.</p>
		<p>8. FL V06 N81 - <math>\Delta V</math> (LV) R1 X XXXX.X fps R2 Y XXXX.X fps R3 Z XXXX.X fps Accept: Record data. Key PRO Reject: Key V25E - Load desired values</p>	

# LMA790-3-LM

## APOLLO OPERATIONS HANDBOOK

CREW-MAN	PNI	PROCEDURES	REMARKS
		<p>LM 3225, LM 3235</p> <p>4.7.1.4 Transfer Phase Initiation (LGC P34, AEA 410+30000, Search; &amp; 410+40000, Execute) (cont)</p> <p>9. FL V16 N45  R1 H XXXXX  R2 TFI XXXXX min-sec  R3 MGA XXX.XX°</p> <p>Alternatives:</p> <p>a. Continue marks:  Key V32E (recycle), go to  (1) Step 6 if LGC is to calculate E</p> <p>or</p> <p>(2) Step 4 if LGC is not to calculate E</p> <p>b. Terminate marks:  Key PRO  (1) If not final pass, go to  (a) Step 6 if LGC is to calculate E  or  (b) Step 4 if LGC is not to calculate E  (2) If this was last pass,  FL V37 N--  Key XXE, exit P34</p> <p>Transmit maneuver parameters  TPI ΔV (LV)(N81) to CSM.  Terminate program:  Key V34E  FL V37 N--  Key XXE, exit P34</p>	<p>M is number of marks made since last thrust maneuver or P20 initiation. TPI is time from TIC (TPI). Sign is - before, + after, TIC (TPI). Maximum reading is 59859. MGA is middle gimbal angle at TIC (TPI) if LM +X-axis is aligned with initial thrust direction. Sign is +, except:</p> <p>a. When displayed at any time other than last pass through program, value is -00001.  b. On last pass, when IMU is not aligned, value is -00002.</p> <p>If desired:  V06 N59E  R1 ΔV (LOS 1) XXXX.X fps  R2 ΔV (LOS 2) XXXX.X fps  R3 ΔV (LOS 3) XXXX.X fps  Record data.  Key KEY REL</p> <p>If AGS is in followup, before keying PRO after last pass, perform AGS Initialization Routine (R47) (para 4.6.1.18).</p> <p>If radar data are entered into AEA after switching to External ΔV or if navigation update is made, repeat AGS step 3d.</p>
		<p>5. If thrusting is along X-axis:  Key DEDA C 62+X0000E  X = 0 - Z-axis parallel to CSM orbit plane  X = 1 - axis specified by Wb vector</p> <p>If thrusting is along Z-axis:  Key DEDA C 507+10000E  Key DEDA C 400+20000E</p>	

PRETHRU

**LMA790-3-LM**  
**APOLLO OPERATIONS HANDBOOK**

LM 3231

CREW- MAN	PNL	PROCEDURES	REMARKS
		<p>4.7.1.4 <u>Transfer Phase Initiation (LGC P34, AEA 410+30000, Search; &amp; 410+40000, Execute) (Cont)</u></p> <p>6. Select External AV guidance routine: Key DEEDA C 410+50000E</p>	<p>Ref para 4.7.1.1. To permit monitoring of TPI parameters, it is suggested that External AV guidance routine not be selected until 4 or 5 minutes before ignition time.</p>
		<p>4.7.1.5 <u>Transfer Phase Midcourse (LGC P35, AEA 410+40000)</u></p> <p style="text-align: center;">CAUTION</p> <p>AGS uses direct transfer equations for midcourse corrections (also used for TPI); therefore, guidance mode must not change for this procedure. State vector updates provide information for computing midcourse corrections.</p> <p>LGC Power-Up (required) LGC Self-Test (desired) LGC time valid (required) LGC state vector valid (required) IMU Power-Up (desired) IMU Orientation Determination Program (P51) (desired) TPI program (P34) (required)</p>	<p>Purpose of Transfer Phase Midcourse procedure is to calculate required AV and other initial conditions for TPM maneuver during LM active rendezvous.</p> <p>Ref para 4.6.1.1. Ref para 4.6.1.13. LGC/CMC Clock Synchronization Routine (R33) (para 4.6.1.15) LGC Update Program (P27) (para 4.6.1.7) and LM Rendezvous Navigation Program (P20) (para 4.8.2.1) Ref para 4.6.1.3. ISS should be on 15 minutes before thrust maneuver. Ref para 4.9.1.1. Display of actual MGA in R3, with N45 during final pass, will not occur if IMU orientation is not known. Ref para 4.7.1.4. Stores time of intercept in LGC Ref para 4.6.2.1. Ref para 4.6.2.3.</p>
		<p>AGS Power-Up (required) AEA Self-Test (desired)</p>	

**LMA790-3-LM**  
**APOLLO OPERATIONS HANDBOOK**

CREW-MAN	PNL	PROCEDURES	REMARKS
		<p>4.7.1.5 Transfer Phase Midcourse (LGC P35, AEA 410+40000) (cont)</p>	
		<p>AGS time valid (required)</p>	<p>AGS Manual Absolute Time Initialization procedure (para 4.6.2.6) or AGS Initialization Routine (R47) (para 4.6.1.18)</p>
		<p>AGS LM/CSM state vector valid (required)</p>	<p>AGS Initialization Routine (R47) (para 4.6.1.18) or AGS Manual LM State Vector Update/Initialization procedure (para 4.6.2.7) and AGS Manual CSM State Vector Update/Initialization procedure (para 4.6.2.9) or AGS Manual Rendezvous Radar LM State Vector Update procedure (para 4.8.2.2)</p>
		<p>Wb vector valid (desired)</p>	<p>If GUID CONT sw - AGS, select AEA attitude hold: Key DEDA - C 400+00000E, or S/C: AGS sw - ATT HOLD</p>
		<p>1. Reselect TPI Execute: Key DEDA C 410+40000E</p>	<p>If AEA attitude hold is not selected when in AGS control, attitude maneuvers at 5° and/or 10°/second may occur.</p>
		<p>2. Deleted</p>	
		<p>3. Determine targeted time of TPI burn &amp; time duration of transfer. Original time of rendezvous can be preserved by specifying new targeted time of TPI burn &amp; adjusting duration of transfer.</p>	<p>AGS Wb Vector Update (para 4.6.2.15). A valid Wb vector is required if address 623 = +10000</p>
		<p>a. Read out AGS computer time of TPI Key DEDA C 373R (0.1 min) Record tfgC.</p>	
		<p>1. Key V37E 35E Go to step 3.</p>	

PRETHRU

**LMA790-3-LM**  
**APOLLO OPERATIONS HANDBOOK**

CREW-MAN	PNL	PROCEDURES	REMARKS
		<p>4.7.1.5 <u>Transfer Phase Midcourse (LGC P3j, AEA 410+40000) (cont)</u></p> <p>b. Read out time from TPI to rendezvous - Key DEDA C 307R (0.01 min) Record value</p> <p>c. Enter time of midcourse - Key DEDA C 373+XXXXE (0.1 min)</p> <p>d. Enter adjusted time duration of transfer - Key DEDA C 307+XXXXE (0.01 min)</p> <p>e. Set node time prior to nominal rendezvous to zero - Key DEDA C 306+00000E (0.01 min)</p> <p>f. Read out VG - Key DEDA C 370R (0.1/1 fps)</p> <p>2. FL V06 N81 - AV(LV) R1 X XXXX.X fps R2 Y XXXX.X fps R3 Z XXXX.X fps Accept: Record data Key PRO Reject: Key V25E - Load desired AV(LV)</p>	<p>Use timeline values, compute new value, or receive from MSFN.</p> <p>Setting address 306 to zero avoids possibility of thrusting during invalid 2-second computer cycle.</p> <p>Rendezvous Out-of-Plane Display Routine (R36) may be used to define out-of-plane velocity corrections to be achieved by altering AVI.</p> <p>If desired: V06 N59E R1 AV(LOS 1) XXXX.X fps R2 AV(LOS 2) XXXX.X fps R3 AV(LOS 3) XXXX.X fps Record data Key KEY REL</p>



**LMA790-3-LM**  
**APOLLO OPERATIONS HANDBOOK**

LM 3231

CREW-MAN	PNL	PROCEDURES	REMARKS
		<p>4.7.1.5 Transfer Phase Midcourse (LGC P35, AEA 410+40000) (cont)</p> <p>4. If thrusting is along X axis: Key DEDA C 623+X0000E X = 0 - Z-axis parallel to CSM orbit plane X = 1 - Z-axis specified by Wb vector</p> <p>If thrusting along Z axis: Key DEDA C 507+10000E Key DEDA C 400+20000E</p> <p>5. Select External ΔV guidance routine.</p> <p>6. Select RCS thrust.</p>	<p>To verify central angle of active vehicle is not within 170° to 190°: Key V06 N52E R1 XXX.XX* ACTCENT (active vehicle central angle) R2 ----- R3 -----</p> <p>If within 170° to 190°, wait as necessary. Key KEY REL</p> <p>Ref para 4.7.1.1. To permit monitoring of IFM parameters, it is suggested that External ΔV not be selected until 4 or 5 minutes before ignition.</p> <p>Ref para 4.10.1.3.</p> <p>R3 will display: a. -00001 if this is not last pass. b. -00002 if this is last pass and IMU orientation is not known. c. XXX.XX MGA with +X-axis aligned with thrust vector.</p> <p>If midcourse correction is not required (ΔV &lt; TBD fps), continue marks.</p>
		<p>3. FL V16 N45 R1 M XXXXX R2 TFI XXBXX min-sec R3 MGA XXX.XX*</p> <p>a. Continue marks - Key V32E - Go to step 2 b. To terminate mark &amp; do final pass - Key PRO - Go to step 2 (If final pass go to step 4).</p> <p>4. FL V37 N-- Key XXE - Exit P35</p>	

PRETHR

**LMA790-3-LM  
APOLLO OPERATIONS HANDBOOK**

CREW- MAN	P/NL	PROCEDURES	REMARKS
		<p>4.7.2 <u>PCICS</u></p> <p>4.7.2.1 <u>Rendezvous Out-Of-Plane Display Routine (R36)</u></p> <p>LGC Power-Up (required)</p> <p>LGC Self-Test (desired)</p> <p>LGC time valid</p> <p>LGC state vector valid</p>	<p>Purpose of Rendezvous Out-of-Plane Display Routine (R36) is to display LGC-calculated rendezvous out-of-plane parameters. This routine may be used to target plane change <math>\Delta V</math> at nominal burns or with External <math>\Delta V</math> (LGC P30, AEA 410+50000) (para 4.7.1.1) and RCS Thrust Program (P41) With AGS Followup/In Control (para 4.10.1.3) for additional plus or minus Y-axis translations, such as PCI maneuver.</p> <p>Ref para 4.6.1.1.</p> <p>Ref para 4.6.1.3.</p> <p>LGC/CMC Clock Synchronization Routine (R33) (para 4.6.1.1.15)</p> <p>LGC Update Program (P27) (para 4.6.1.7)</p> <p>To monitor progress of state vector integration, time (GET) to which state vector integration process has presently calculated state vector is available as follows:</p> <p>Key V16 N38E - TET  R1 00XX hr  R2 00XX min  R3 0X.XX sec  To release DSKY: Key KEY RKL</p> <p>This routine should not be called while average G is running. OPR ERR lt - on if average g is on or if another extended verb from R76 is active.</p> <p>T (Event) is initialized to present TIC as defined by program in process.</p>
		<p>1. Key V90E  Pos OPR ERR lt - on  Exit R36, Key RSET</p> <p>2. FL V06 N16 - T (Event)  R1 00XX hr  R2 00XX min  R3 0X.XX sec  Accept: Key PRO  Reject: Key V25E - Load new T (Event)</p>	

**LMA790-3-LM**  
**APOLLO OPERATIONS HANDBOOK**

CREW MAN	PNL	PROCEDURES	REMARKS
		<p style="text-align: center;"><b>PROCEDURES</b></p> <p>4.7.2.1 <u>Rendezvous Out-Of-Plane Display Routine (R36) (cont.)</u></p> <p>3. FL V06 N90 - Out-of-plane parameters  R1 Y   XXX.XX nm  R2 Y rate XXX.XX fps  R3 Y   XXX.XX°</p> <p>a. To receive another data point:  Key V32E - Go to step 2</p> <p>b. To terminate:  Key PRO, exit R36</p> <p>4.7.2.2 <u>Target ΔV Program (CSM) (P76)</u></p> <p>LGC Power-Up (required)</p> <p>LGC time valid (required)</p> <p>LGC CSM state vector valid  (Premaneuver) (required)</p> <p>1. Key V37E 76E</p> <p>2. FL V06 N33 - TIG (CSM)  R1 00XXX hr  R2 000XX min  R3 0XX.XX sec  Accept: Key PRO  Reject: Key V25E - Load correct TIG (CSM)</p>	<p>R1 and R2 display out-of-plane position and velocity; R3 displays angle between LOS and forward direction, measured in local horizontal plane.</p> <p>Y = distance between CSM orbit plane and LM measured along line defined by <math>\underline{V} \times \underline{R}</math> of CSM where:</p> <p><math>\underline{V}</math> = CSM initial velocity vector  <math>\underline{R}</math> = CSM radial position vector</p> <p>Y rate = rate of change of Y with following sign convention:  + if Y is increasing algebraically  - if Y is decreasing algebraically  (If this parameter is to be nulled, magnitude of Y rate is used, but with opposite sign, in prethrust program; i.e., P30 and P32 through P35.)</p> <p><math>\gamma</math> = angle of LM orbital plane and projection of LOS to CSM onto LM horizontal plane.</p> <p>Purpose of Target ΔV Program (CSM) (P76) is to notify LGC of orbital parameter changes by CSM and to provide, to LGC, ΔV for CSM impulsive state velocity update.</p> <p>Ref para 4.6.1.1.</p> <p>LGC/CMC Clock Synchronization Routine (R33) (para 4.6.1.15)</p> <p>LGC Update Program (P27) (para 4.6.1.7) or LM Rendezvous Navigation Program (P20) (para 4.8.2.1) or Lunar Surface Navigation Program (P22) (para 4.8.3.1) with valid LM state vector and P20 or P22 updating CSM state vector.</p>

LM 32.21

PRETHRU

**LMA790-3-LM**  
**APOLLO OPERATIONS HANDBOOK**

LM 3231

CREW-MAN	PNI	PROCEDURES	REMARKS
		<p>4.7.2.2 <u>Target AV Program (CSM) (P76) (cont)</u></p> <p>3. FL V06 N84 -- AV(CSM) at TIG (CSM)  R1 X XXXX.X fps  R2 Y XXXX.X fps  R3 Z XXXX.X fps  Accept: Key PRO</p> <p>Reject: Key V25E - Load desired AV</p> <p>4. FL V37 N--  Key XIE - Exit P76</p> <p>4.7.2.3 <u>Target AV Program (LM) (P77)</u></p> <p>LGC Power-Up (required)  LGC time valid (required)</p> <p>LGC LM state vector valid (premaneuver) (required)</p> <p>1. Key V37E 77E</p> <p>2. FL V06 N33 - TIG (LM)  R1 00XX hr  R2 00XX min  R3 0XX.XX sec  Accept: Key PRO  Reject: Key V25E - Load correct TIG (LM)</p>	<p>N84 is available as an optional display in subsequent use of P3X or P72 through P75.  NODOFLAG is set after PRO is keyed causing 1520 alarm (V37 request is not permitted at this time) if V37E xxE, with xx ≠ 00 is attempted during integration.  NODOFLAG is reset after completion of integration.</p> <p>Data loaded should be actual ΔV at TIG (CSM).</p> <p>To resume P20 RR state vector updating, select an orbital prethrust program (P30 to P35, P72 to P75).  If Rendezvous Navigation Program (P20) or Lunar Surface Navigation Program (P22) is in process, P76 must be selected before CSM thrusting maneuver.</p> <p>Purpose of Target AV Program (LM) (P77) is to notify LGC of orbital parameter changes by LM and to provide, to LGC, ΔV for LM impulsive state velocity update.</p> <p>Ref para 4.6.1.1.</p> <p>LGC/CMC Clock Synchronization Routine (R33) (para 4.6.1.15)</p> <p>LGC Update Program (P27) (para 4.6.1.7) or LM Rendezvous Navigation Program (P20) with valid CSM State Vector and P20 updating LM state vector (para 4.8.2.1).</p>

**LMA790-3-LM**  
**APOLLO OPERATIONS HANDBOOK**

CREW-MAN	PNL	PROCEDURES	REMARKS
		<p>4.7.2.3 <u>Target ΔV Program (LM) (P77) (cont)</u></p> <p>3. FL V06 N81 - ΔV (LV) at TIC (LM)  R1 X XXXX.X fps  R2 Y XXXX.X fps  R3 Z XXXX.X fps  Accept: Key PRO</p> <p>Reject: Key V25E - Load desired ΔV</p> <p>4. FL V37 N--  Key XXE - Exit P77</p> <p>4.7.3 <u>AGS</u></p> <p>4.7.3.1 <u>AGS Out-of-Plane Maneuver</u></p> <p>AGS Power-Up (required)  AEA Self-Test (desired)  AGS time valid (required)</p> <p>AGS LM/CSM state vector valid (required)</p>	<p>ΔV in N81 is also written into N84 by LGC so that it is available as an optional display in subsequent use of P3X or P72 through P75. (N81 is overwritten by referenced programs.)</p> <p>NODOFLAG is set after PRO is keyed causing 1520 alarm (V37 request is not permitted at this time) if V37E xxE, with xx#00 is attempted during integration. NODOFLAG is reset after completion of integration.</p> <p>Data loaded should be actual ΔV at TIC (LM).</p> <p>To resume P20 RR state vector updating, select an orbital prethrust program (P30 to P35, P72 to P75).</p> <p>If Rendezvous Navigation Program (P20) is in process, P77 must be selected before LM thrusting maneuver.</p> <p>Ref para 4.6.2.1.  Ref para 4.6.2.3.</p> <p>AGS Manual Absolute Time Initialization Procedure (para 4.6.2.6) or AGS Initialization Routine (R47) (para 4.6.1.18)</p> <p>AGS Initialization Routine (R47) (para 4.6.1.18) or AGS Manual LM State Vector Update/Initialization procedure (para 4.6.2.7) and AGS Manual CSM State Vector Update/Initialization procedure (para 4.6.2.9). AGS Manual Rendezvous Radar LM State Vector Update. Ref para 4.8.2.2</p> <p>If GUID CONT sw - AGS, select AEA attitude hold:  Key DEDA C 400+0000E, or  S/C: AGS sw - ATT HOLD</p> <p>If AEA attitude hold is not selected when in AGS control, attitude maneuvers at 5° and/or 10°/sec may occur.</p>
	1.	<p>Select External ΔV:  Key DEDA C 410+5000E</p>	

PRETHRU

LM 3231

**LMA790-3-LM  
APOLLO OPERATIONS HANDBOOK**

CREW- MAN	PNL	PROCEDURES	REMARKS
		<p>4.7.3.1 <u>AGS Out-of-Plane Maneuver (cont)</u></p> <p>2. After CSI solution has converged &amp; solution checks made, or CDH solution checks made, read out-of-plane velocity: Key DEDA C 263R (0.1/1 fps)</p> <p>Go to step 4 for PCI translation.</p> <p>3. Determine proportion of out-of-plane velocity, with appropriate algebraic sign (same sign to decrease out-of-plane angle), to be entered in AVY (obtain from MSFN): Key DEDA C 451+XXXXX (0.1/1 fps) Read out in-plane horizontal velocity - Key DEDA C 450R (0.1/1 fps)</p>	<p>Parentetical quantization notation: lunar mission/earth mission.</p> <p>Two components of AV (AVX and AVZ) for external AV option are computed by CSI and CDH routines. Other component is read out on DEDA (address 263) and a proportion (dependent on desired effect on LM/CSM orbit out-of-plane angle and/or phasing on LM/CSM orbit nodes) is entered in address 451. Three components of AV are computed (and stored) by TPI and TPH routines. External AV option is used for CSI, CDH, TPI, TPM or PCI burns.</p>

**LMA790-3-LM**  
**APOLLO OPERATIONS HANDBOOK**

CREW- MAN	PNL	PROCEDURES	REMARKS
		<p>4.7.3.1 <u>AGS Out-of-Plane Maneuver (cont)</u></p> <p>Read out radial velocity - Key DEDA C 452R (0.1/1 fps) Go to step 5.</p> <p>4. For PCI maneuver: Select CSI Routine - Key DEDA C 410+10000E</p> <p>Load absolute time of PCI - Key DEDA C 373+XXXXXE (0.1 min)</p> <p>Read out time to PCI (TA) - Key DEDA C 310R (0.01 min)</p> <p>Set EVNT TMR ind to TA</p> <p>Select External AV - Key DEDA C 410+50000E</p> <p>Read out Vpy - Key DEDA C 263R (0.1/1fps) Record Vpy</p> <p>Enter Vpy as crossrange ΔV (with sign of Vpy) - Key DEDA C 451+XXXXXE(0.1/1fps)</p> <p>Enter zeros in ΔV downrange &amp; ΔV radial velocities - Key DEDA C 450+00000E (0.1/1 fps) Key DEDA C 452+00000E (0.1/1 fps)</p> <p>5. Select thrust procedure.</p>	<p>Verify flight program has stored downrange component. Radial velocity should be zero for horizontal maneuver.</p> <p>Ref para 4.10.</p>

PRETHRU

**LMA790-3-LM  
APOLLO OPERATIONS HANDBOOK**

CREW-MAN	PNL	PROCEDURES	REMARKS
		<p>4.7.3.2 <u>AGS Orbit Insertion</u></p> <p align="center"><b>CAUTION</b></p> <p>Use of AGS orbit insertion routine is not recommended in earth orbit, since large terminal altitude rate errors could result. It is recommended that earth orbit insertion burns be performed under control of External AV routine.</p> <p>AGS Power-Up (required)</p> <p>AEA Self-Test (desired)</p> <p>AGS time valid (required)</p> <p>AGS LM/CSM state vector valid (required)</p>	<p>Purpose of AGS Orbit Insertion procedure is to enter orbit injection parameters into AEA to place LM into desired orbit.</p> <p>Ref para 4.6.2.1.</p> <p>Ref para 4.6.2.3.</p> <p>AGS Manual Absolute Time Initialization procedure (para 4.6.2.6) or AGS Initialization Routine (R47) (para 4.6.1.18)</p> <p>AGS Initialization Routine (R47) (para 4.6.1.18) or AGS Manual LM State Vector Update/Initialization procedure (para 4.6.2.7) and AGS Manual CSM State Vector Update/Initialization procedure (para 4.6.2.9). AGS Manual Rendezvous Radar State Vector Update. Ref para 4.8.2.2.</p> <p>If GUID CONT sw - AGS, select AEA attitude hold:            Key DEDA C 400+00000E, or            S/C: AGS sw - ATT HOLD</p> <p>If AEA attitude hold is not selected when in AGS control, attitude maneuvers at 5° and/or 10°/sec may occur.</p> <p>During thrust maneuver, it is possible to read out predicted burnout radius, DEDA address 347 (100 ft).</p> <p>Amount of out-of-plane errors removed in Orbit Insertion can be varied by changing DEDA-accessible constants 5K16 (address 561) and 5K17 (address 611).</p>
		<p>1. Select Orbit Insertion mode:            Key DEDA C 410+00000E</p> <p align="center"><b>NOTE</b></p> <p>Orbit insertion targeting data are entered before launch and include variable targeting parameters. For launch after T2 when variable targeting does not apply, perform step 2A; otherwise, perform step 2.</p>	



**LMA790-3-LM**  
**APOLLO OPERATIONS HANDBOOK**

CREW-MAN	PNL	PROCEDURES	REMARKS
		<p>4.7.3.2 <u>AGS Orbit Insertion (cont)</u></p> <p>2. Enter targeting data:</p> <p style="text-align: center;">CAUTION</p> <p>Targeting for LM/CSM phase angles &gt;90° (absolute value) should not be attempted; range overflow may result. (Typically, range overflow occurs at angles of approximately +115°.)</p> <p>Injection altitude - Key DEDA C 232+XXXXXE (100/1000 ft)</p> <p>Injection altitude rate lower limit (23J) - Key DEDA C 465+XXXXXE (0.1/1 fps)</p> <p>Semimajor axis targeting term (7J) - Key DEDA C 224+XXXXXE (100/1000 ft)</p> <p>One half of lower limit of apolune radius (8J) - Key DEDA C 225+XXXXXE (100/1000 ft)</p> <p>Retarget value (10J) for 7J when central angle exceeds 12J - Key DEDA C 226+XXXXXE (100/1000 ft)</p> <p>Retarget value (11J) for 4K10 when central angle exceeds 12J - Key DEDA C 673+XXXXXE (octal)</p> <p>Phase angle limit (12J) for retargeting - Key DEDA C 305+XXXXXE (0.01°)</p> <p>Freeze TIG for post-insertion trim maneuver: Read out and record present AGS time Key C 377R (0.1 min) Load present AGS time in as tigd Key C 373+XXXXXE (0.1 min)</p> <p>3. Enter retargeting data: Key DEDA C 305+20000E Key DEDA C 662+00000E</p>	<p>Parenthetical quantization notation: lunar mission/earth mission.</p> <p style="text-align: right;">Step is necessary for launch after T2 when variable targeting does not apply. Avoids retargeting on phase angle. Eliminates phase angle dependency.</p>

PRETHRU

**LMA790-3-LM**  
**APOLLO OPERATIONS HANDBOOK**

CREW-MAN	PNI	PROCEDURES	REMARKS
		<p>4.7.3.2 <u>AGS Orbit Insertion (cont)</u></p> <p>Load desired semimajor axis 7J -  Key DEDA C 224+XXXXE (100/1000 ft)</p> <p>4. Perform desired thrusting procedure.</p> <p>4.7.4 <u>CSM BACKUP</u></p> <p>4.7.4.1 <u>CSM Coelliptic Sequence Initiation Targeting Program (P72)</u></p> <p>LGC Power-Up (required)</p> <p>LGC Self-Test (desired)</p> <p>LGC time valid (required)</p> <p>LGC state vector valid (required)</p> <p>1. Key V37E 72E</p> <p>2. FL V06 N11 - TIG (CSI)  R1 00XX hr  R2 00XX min  R3 0XX.XX sec  Accept: Record TIG (CSI).  Key PRO  Reject: Key V25E - Load desired TIG (CSI)</p> <p>3. FL V06 N55  R1 N XXXX  R2 E XX.XX*  R3 CENTANG +00000</p>	<p>Ref para 4.10.</p> <p>Purpose of CSM Coelliptic Sequence Initiation Targeting Program is to calculate parameters, based on maneuver data approved and keyed into LGC, for CSI and CDH; to display dependent variables to, and receive approval from, astronaut/MSFN; and to store and transmit CSI target parameters for use by desired CSM thrust program.</p> <p>Ref para 4.6.1.1.</p> <p>Ref para 4.6.1.13.</p> <p>LGC/CMC Clock Synchronization Routine (R33)  (para 4.6.1.15)</p> <p>LGC Update Program (P27) (para 4.6.1.7) and, when possible, LM Rendezvous Navigation Program (P20) (para 4.8.2.1). If P20 is operating, radar sighting marks are made automatically about once per minute. Number of marks (M) is displayed in R1 with N45.</p> <p>Initial display is always zero. Negative or zero value causes display of time of aposapsis (useful after abort).</p> <p>If R3 = 0:  When R1 is 00001, TIG (CDH) should occur at first apsidal crossing; when R1 is 00002, second apsidal</p>

**LMA790-3-LM**  
**APOLLO OPERATIONS HANDBOOK**

CREW-MAN	PNI	PROCEDURES	REMARKS
		<p>4.7.4.1 <u>CSM Coelliptic Sequence Initiation Targeting Program (P72)</u></p> <p>Accept: Record values Key PRO Reject: Key V25E - Load desired parameters</p> <p>4. FL V06 N37 TIG (TPI) R1 00XXX hr R2 000XX min R3 0XX.XX sec Accept: Record TIG (TPI) Key PRO Reject: Key V25E - Load desired TIG (TPI)</p> <p>5. FL V16 N45 R1 H XXXX R2 TPI XXXX min-sec R3 MGA -00001 Options: a. To continue mark process: Key V32E - Go to step 6 b. To terminate mark process &amp; do final pass through program: Key PRO</p> <p>6. Poss FL V05 N09 - Alarm in up to three registers R1 00XXX R2 00XXX R3 00XXX PROG lt - on Possible alarms: 00600 - Imaginary roots on first iteration 00606 - AV exceeds maximum (1000 fps) 00605 - Number of iterations exceed loop maximum (15) 00601 - CSI Hp &lt;35,000 ft (lunar orbit) or &lt;85 mm (earth orbit) 00602 - CDH Hp &lt;35,000 ft (lunar orbit) or &lt;85 mm (earth orbit) 00603 - CSI to CDH time &lt;10 min 00604 - CDH to TPI time &lt;10 min Key RSET &amp; V32E - Recycle to step 2, adjust input parameters</p>	<p>crossing; etc. If R3 ≠ 0: TIG (CDH) at CSI + (180°) (R1)</p>

PRETHRU

**LMA790-3-LM**  
**APOLLO OPERATIONS HANDBOOK**

LM 3231

CREW-MAN	PNL	PROCEDURES	REMARKS
		<p>4.7.4.1 CSM Coelliptic Sequence Initiation Targeting Program (P72) (cont)</p> <p>7. FL V06 N75  R1 Alt (CDH) XXXX.Xnm  R2 AT (CSI/CDH) XXBX min-sec  R3 AT (CDH/TPI) XXBX min-sec  Record values  Key PRO</p> <p>8. FL V06 N81 - CSI AV(LV)  R1 X XXXX.X fps  R2 Y XXXX.X fps  R3 Z XXXX.X fps  Accept: Record values  Key PRO  Reject: Key V25E - Load desired data</p> <p>9. FL V06 N82 - CDH AV(LV)  R1 X XXXX.X fps  R2 Y XXXX.X fps  R3 Z XXXX.X fps  Record values  Key PRO</p> <p>10. FL V16 N45  R1 M XXXX  R2 TFI XXBX min-sec  R3 MGA 0000X</p> <p>R3 will display:  a. -00001 if this is not last pass through program  b. -00002 if this is last pass  Options:  a. If this was not last pass through program:  (1) To terminate mark process &amp; accomplish final pass -  Key PRO - Return to step 6  (2) To continue mark process -  Key V32E - Recycle to step 6  b. If this was last pass through program:  Set EWNT TMR ind to TFI.</p>	<p>Times shown in R2 and R3 are modulo 60 minutes, i.e., remainder in minutes and seconds after dividing time in seconds by 3600 (60 times 60) seconds. TIG (CDH) is available, key V06 N13E.</p> <p>New value of AVY, based on use of R36 (V90), may be substituted to obtain out-of-plane corrections. (Ref para 4.7.2.1). However, R36 calculations are based on LM being active.</p> <p>If AV(LV) for CSI has been modified by crew, modification will not be reflected in LGC-computed values for CDH AV(LV). Unlike AV(LV) for CSI, these values cannot be written over.</p> <p>R1 display of M will be 00000 if RR data are not taken.</p> <p>Ref para 4.13.6.</p>

**LMA790-3-LM**  
**APOLLO OPERATIONS HANDBOOK**

CREW- MAN	PNI	PROCEDURES	REMARKS
		<p>4.7.4.1 <u>CSM Coelliptic Sequence Initiation Targeting Program (P72) (cont)</u></p> <p>11. Transmit maneuver parameters CSI AV(LV) (N81) to CSM Key PRO</p> <p>12. FL V37 N-- Key XXE - Exit P72</p> <p>4.7.4.2 <u>CSM Constant Δ Altitude Targeting Program (P73)</u></p>	<p>Purpose of CSM Constant Δ Altitude Targeting procedure is to calculate parameters, based on maneuver data approved and keyed into LGC for CDH; to display dependent variables for CDH maneuver to, and receive approval from astronaut/MSFN; and to store and transmit CDH target parameters for use by desired CSM thrusting procedure.</p> <p>Ref para 4.6.1.1.1.</p> <p>Ref para 4.6.1.1.3.</p> <p>LGC/CMC Clock Synchronization Routine (R33) (para 4.6.1.15)</p> <p>LGC Update Program (P27) (para 4.6.1.7) and, when possible, LM Rendezvous Navigation Program (P20) (para 4.8.2.1). If P20 is operating, radar sighting marks are made automatically about once per minute. Number of marks (M) is displayed in R1 with N45.</p> <p>Ref para 4.7.4.1.</p>
		<p>1. Key V37E 73E</p> <p>2. FL V06 N13 - TIG (CDH) R1 00XX hr R2 00XX min R3 0XX.XX sec Accept: Record data Key PRO - Go to step 6 Reject: Key V25E - Load desired data</p>	

PRETHRU

**LMA790-3-LM**  
**APOLLO OPERATIONS HANDBOOK**

CREW- MAN	PNL	PROCEDURES	REMARKS
		<p>4.7.4.2 <u>CSM Constant Δ Altitude Targeting Program (P73) (cont)</u></p> <p>3. Poss FL V05 N09 - Alarm 00611 - No solution for given CDH parameters PRG 1t - on Key RSET</p> <p>Options: a. Key V32E - Recycle to step 2, readjust TIG(CDH) b. Key PRO - Proceed with inaccurate data c. Key V34E - Terminate FL V37 N-- Key XKE</p> <p>4. FL V06 N75 R1 Aalt (CDH) XXXX.X nm R2 ΔT (CDH/TPI) XXXX min-sec R3 ΔT (TPI/nomTPI) XXXX min-sec Record values Key PRO</p> <p>5. FL V06 N81 - CDH ΔV(LV) R1 X XXXX.X fps R2 Y XXXX.X fps R3 Z XXXX.X fps Accept: Record values Key PRO Reject: Key V25E - Load desired ΔV(LV)</p> <p>6. FL V16 N45 R1 M XXXX R2 TPI XXXX min-sec R3 MGA 0000X</p> <p>R3 will display: a. -0001 if this is not last pass through program b. -0002 if this is last pass</p> <p>Options: a. If this was not last pass through program: (1) To terminate mark process &amp; accomplish final pass- Key PRO, and go to step 3</p>	<p>Negative value indicates retrograde attitude, Z-axis up (for X-axis thrust). New ΔV value, based on use of R36 (V90), may be used to obtain out-of-plane corrections. (Ref para 4.7.2.1.) However, R36 calculations are based on LM being active.</p> <p>R1 display of M will be 00000 if RR data are not taken.</p>

**LMA790-3-LM**  
**APOLLO OPERATIONS HANDBOOK**

LM 3231

CREW-MAN	PNL	PROCEDURES	REMARKS
		<p>4.7.4.2 <u>CSM Constant Δ Altitude Targeting Program (P73) (cont)</u></p> <p>(2) To continue mark process:            Key V32E - Recycle to step 3            b. If this was last pass through program:            Set EVNT TMR ind to TFI (in R2).</p> <p>7. Transmit maneuver parameters CDH ΔV (N81) to CSM:            Key PRO</p> <p>8. FL V37 N--            Key XIE - Exit P73</p> <p>4.7.4.3 <u>CSM Transfer Phase Initiation Targeting Program (P74)</u></p>	<p>Ref para 4.13.6.</p> <p>Purpose of CSM Transfer Phase Initiation Targeting Program is to calculate and transmit required ΔV and other initial conditions required by CMC for CSM execution of TPI maneuver given:</p> <p>a. Time of ignition, TIG (TPI), or elevation angle (E) of CSM/LM LOS at TIG (TPI)</p> <p>b. Central angle of transfer of passive vehicle (LM) from TIG (TPI) to time of intercept.</p> <p>TPI also calculates TIG (TPI) given E, or E given TIG (TPI).</p> <p>TPI procedure may be performed concurrently with P20. If P20 is operating, radar marks are made automatically, approximately once per minute, when enabled by track and update flags.</p> <p>Ref para 4.6.1.1.1.</p> <p>Ref para 4.6.1.1.13.</p> <p>LGC/CMC Clock Synchronization Routine (R33) (para 4.6.1.15)</p> <p>LGC Update Program (P27) (para 4.6.1.7) and when possible LM Rendezvous Navigation Program (P20) (para 4.8.2.1) If P20 is operating, radar marks are made automatically about once per minute. Number of marks (M) is displayed in R1 with N45.</p>
		<p>LGC Power-Up (required)</p> <p>LGC Self-Test (desired)</p> <p>LGC time valid (required)</p> <p>LGC state vector valid (required)</p>	

PRETHR

**LMA790-3-LM**  
**APOLLO OPERATIONS HANDBOOK**

LM 3231

CREW-MAN	PNL	PROCEDURES	REMARKS
		<p>4.7.4.3 <u>CSM Transfer Phase Initiation Targeting Program (P74) (cont)</u></p> <ol style="list-style-type: none"> <li>1. Key V37E 74E</li> <li>2. FL V06 N37 - TIG (TPI)               <ul style="list-style-type: none"> <li>R1 00000 hr</li> <li>R2 00000 min</li> <li>R3 000.00 sec</li> </ul>               Accept: Key PRO                Reject: Key V25E - Load desired TIG (TPI)             </li> <li>3. FL V06 N55               <ul style="list-style-type: none"> <li>R1 N XXXXX</li> <li>R2 E XXX.XX°</li> <li>R3 CENTANG XXX.XX°</li> </ul> </li> </ol> <p>Alternatives:</p> <ol style="list-style-type: none"> <li>a. To accept present values of N, E, and CENTANG - Record values                Key PRO - Go to step 9</li> <li>b. To reject present values of N, E, or CENTANG                Key V25E Load N, E, and CENTANG as desired                Key PRO - Go to step 9</li> <li>c. If program is to be terminated:                Key V34E                FL V37 N--                Key XXE, exit P74</li> </ol> <ol style="list-style-type: none"> <li>4. Press FL V05 N09 - Alarm                00611 - No TIG for given E                PROC lt - on                Key RSET &amp; PRO - Go to step 2</li> </ol>	<p>P74 requires initial value of TIG (TPI) to be within 30 minutes of actual TPI time.</p> <p>N is defined as follows:            N = 0 (initial display is +00000) - specifies Kepler conic integration with no target offset (faster than precision integration)            N ≠ 0 - specifies precision integration with N target offsets (useful in earth orbit)            E is elevation angle between CSM/LM LOS and CSM local horizontal at TIG (TPI) referenced to direction of flight. Initial display is -000.00°. Zero value in R2 requests that E be calculated based on previous display of TIG (TPI); nonzero value of E, that TIG (TPI) be calculated based on E.            CENTANG is orbital central angle of passive vehicle during transfer from TIG (TPI) to time of intercept.</p>



**LMA790-3-LM**  
**APOLLO OPERATIONS HANDBOOK**

LM 3231

CREW: MAN	PNL	PROCEDURES	REMARKS
		<p>4.7.4.3 CSM Transfer Phase Initiation Targeting Program (P/4) (cont)</p> <p>5. FL V06 N37 - TIC (TPI) R1 0000X hr R2 0000X min R3 0XX.XX sec Record TIC (TPI). Key PRO - Go to step 7</p> <p>6. FL V06 N55 R1 N XXXX R2 E XXX.XX* R3 CENTANG XXX.XX* Record data Key PRO</p> <p>7. FL V06 N58 R1 Hp XXXX. R2 AV(TPI) XXXX.X fps R3 AV(TPF) XXXX.X fps Record data. Key PRO</p> <p>8. FL V06 N81 - AV(LV) R1 X XXXX.X fps R2 Y XXXX.X fps R3 Z XXXX.X fps Accept: Record data Key PRO Reject: Key V25E - Load desired AV(LV)</p>	<p>To verify central angle of active vehicle is not within 170° to 190°: Key V06 N52E R1 XXX.XX* ACTCENT (active vehicle central angle) R2 ----- R3 ----- Key KEY REL If within 170° to 190°, reenter program &amp; adjust input.</p> <p>Hp is altitude of perifocus above launch pad radius in earth orbit; above lunar radius at most recently defined landing site, in lunar orbit. AV(TPF) is required impulsive ΔV to accomplish intercept maneuver (TPF) at calculated time of intercept.</p> <p>New ΔVY value, based on use of R36 (V90), may be used to obtain out-of-plane corrections. (Ref para 4.7.2.1) However, R36 calculations are based on LM being active.</p> <p>If desired: V06 N59E R1 ΔV (LOS 1) XXXX.X fps R2 ΔV (LOS 2) XXXX.X fps R3 ΔV (LOS 3) XXXX.X fps Record data. Key KEY REL</p>

PRETHR



**LMA790-3-LM**  
**APOLLO OPERATIONS HANDBOOK**

CREW-MAN	PNI	PROCEDURES	REMARKS
		<p>4.7.4.3 <u>CSM Transfer Phase Initiation Targeting Program</u>  <u>(P74) (cont)</u></p>	<p>AV (LOS) are components of required impulsive <math>\Delta V</math> in orthogonal coordinate system oriented along CSM-to-LM LOS.          LOS 1 is component along unit I          LOS 2 is component along unit <math>(H \times I) \times I</math>          LOS 3 is component along unit <math>(H \times I)</math>          Where,          I = unit vector along LOS to LM          H = unit vector along CSM orbital momentum vector</p>

**LMA790-3-LM**  
**APOLLO OPERATIONS HANDBOOK**

CREW- MAN	PNI	PROCEDURES	REMARKS
		<p>4.7.4.3 <u>CSM Transfer Phase Initiation Targeting Program (P74) (cont)</u></p> <p>9. FL V16 N45  R1 H XXXX  R2 TPI XIBX  R3 MGA -0000X</p> <p>Alternatives:</p> <p>a. Continue marks:  Key V32E, (recycle), go to:  (1) Step 6 if LGC is to calculate E  or  (2) Step 4 if LGC is not to calculate E</p> <p>b. Terminate marks:  Key PR0  (1) If not final pass, go to:  (a) Step 6 if LGC is to calculate E  or  (b) Step 4 if LGC is not to calculate E  (2) If this was last pass  FL V37 N--  Key XIE, exit P74  Transmit maneuver parameters TPI ΔV (LV) (N81)  to CSM.</p> <p>c. Terminate program:  Key V34E  FL V37 N--  Key XIE, exit P74</p> <p>4.7.4.4 <u>CSM Transfer Phase Midcourse Targeting Program (P75)</u></p> <p>LGC Power-Up (required)  LGC Self-Test (desired)</p>	<p>M is number of marks made since last thrust maneuver or P20 initiation.  TPI is time from TIG (TPI).  Sign is - before, + after, TIG (TPI).  Maximum reading is 59559.</p> <p>MGA is not pertinent to this program. R3 will display:  -00001 if this is not last pass through program  -00002 if this is last pass</p> <p>Purpose of CSM Transfer Phase Midcourse Targeting Program is to calculate and transmit required ΔV and other initial conditions for TPM maneuver during CSM active rendezvous.</p> <p>Ref para 4.6.1.1.1.  Ref para 4.6.1.1.3.</p>

# LMA790-3-LM

## APOLLO OPERATIONS HANDBOOK

CREW-MAN	PNL	PROCEDURES	REMARKS
		<p>4.7.4.4 CSM Transfer Phase Midcourse Targeting Program (P75) (cont)</p> <p>LGC time valid (required)</p> <p>LGC state vector valid (required)</p> <p>Time of intercept stored in LGC by CSM TPI Program (P74).</p> <ol style="list-style-type: none"> <li>1. Key V37E 75E Go to step 3.</li> <li>2. FL V06 N81 - <math>\Delta V(LV)</math> R1 X XXXX.X fps R2 Y XXXX.X fps R3 Z XXXX.X fps Accept: Record data. Key PRO Reject Key V25E - Load desired <math>\Delta V(LV)</math></li> </ol>	<p>LGC/CMC Clock Synchronization Routine (R33) (para 4.6.1.15)</p> <p>LGC Update Program (P27) (para 4.6.1.7) and LM Rendezvous Navigation Program (P20) (para 4.8.2.1)</p> <p>Ref para 4.7.4.3.</p> <p>Rendezvous Out-of-Plane Display Routine (R36) may be used to define out-of-plane velocity corrections to be achieved by altering <math>\Delta V</math>. However, R36 calculations are based on LM being active.</p> <p>If desired: V06 N59E R1 <math>\Delta V</math> (LOS 1) XXXX.X fps R2 <math>\Delta V</math> (LOS 2) XXXX.X fps R3 <math>\Delta V</math> (LOS 3) XXXX.X fps Record data. Key KEY REL</p> <p>To verify central angle of active vehicle is not within <math>170^\circ</math> to <math>190^\circ</math>: Key V06 N52E R1 XXX.XX° ACTCENT (active vehicle central angle) R2----- R3----- Key KEY REL If within <math>170^\circ</math> to <math>190^\circ</math>, wait as necessary. Key KEY REL</p> <p><math>\Delta V</math> (LOS) are components of required impulsive <math>\Delta V</math> in orthogonal coordinate system oriented along LM-to-CSM LOS. LOS 1 is component along unit I LOS 2 is component along unit (HxI)xI LOS 3 is component along unit (HxI) Where, I = unit vector along LOS to LM H = unit vector along CSM orbital momentum vector</p>

PRETHRU

LM 32-1

**LMA790-3-LM  
APOLLO OPERATIONS HANDBOOK**

LH 3231

CREW-MAN	P/NL	PROCEDURES	REMARKS
		<p>4.7.4.4 CSM Transfer Phase Midcourse Targeting Program (P75) (cont)</p> <p>3. FL V16 M45  R1 M XXXX  R2 TFI XXXX min-sec  R3 MGA 0000X  a. Continuous marks -  Key V32E - Go to step 2  b. To terminate mark &amp; do final pass -  Key PMD - Go to step 2 (If final pass go to step 4)</p> <p>4. FL V37 M---  Key XIE - Exit P75  Transmit maneuver parameters TFM AV (LV) (N81) to CSM.</p>	<p>R3 will display:  -00001 if this is not last pass  -00002 if this is last pass</p> <p>If midcourse correction is not required (<math>\Delta V</math> less than TBD) continue marks.</p>

**LMA790-3-LM**  
**APOLLO OPERATIONS HANDBOOK**

PARA	TITLE	PAGE
4.8	Navigation . . . . .	4.8-2
4.8.1	Orbital Navigation . . . . .	4.8-2
4.8.1.1	Ground Track Determination Program (P21) . . . . .	4.8-2
4.8.1.2	Orbit Parameter Display (PGCS R30 & AGS) . . . . .	4.8-3
4.8.2	LM Rendezvous Navigation . . . . .	4.8-6
4.8.2.1	LM Rendezvous Navigation Program (P20) . . . . .	4.8-6
4.8.2.2	AGS Manual Rendezvous Radar LM State Vector Update . . . . .	4.8-19
4.8.2.3	AGS Automatic Rendezvous Radar LM State Vector Update (Raw Data Transfer Via LGC) . . . . .	4.8-22
4.8.3	Lunar Surface Navigation . . . . .	4.8-22B
4.8.3.1	Lunar Surface Navigation Program (P22) . . . . .	4.8-22B

**LMA790-3-LM**  
**APOLLO OPERATIONS HANDBOOK**

CREW- MAN	P/N	PROCEDURES	REMARKS
		<p>4.8 NAVIGATION</p> <p>4.8.1 ORBITAL NAVIGATION</p> <p>4.8.1.1 <u>Ground Track Determination Program (P21)</u></p> <p>1. LGC Power-Up (required) Key V37E 21E</p> <p>2. FL V04 N06 - Option R1 00002 - Specify vehicle R2 00001 (LM) R3 ----- X = 1 - LM = 2 - CSM Accept: Key FMO Reject: Key V22E - 2E (CSM)</p> <p>3. FL V06 N34 - T (Event) R1 00XX hr R2 00XX min R3 0XX.XX sec Accept: Key FMO Reject: Key V25E - Load desired time or all zeros for present time</p> <p>4. FL V06 N43</p> <p>R1 Latitude (+North) XXX.XX° R2 Longitude (+East) XXX.XX° R3 Altitude XXXX.X nm</p> <p>a. Recycle: Key V32E, go to step 3 or b. Terminate program: Key PRO</p> <p>5. FL V37 N-- Key XXE</p>	<p>Purpose of Ground Track Determination Program (P21) is to compute ground track parameters associated with LM or CSM, based on time loaded in step 3. Ref para 4.6.1.1.</p> <p>LGC will assume CSM for all options other than 00001, 00000, or 77776.</p> <p>T (Event) is time (GET) at which latitude and longitude of vehicle position are desired. Display registers R1, R2, and R3 will initially read 00000.</p> <p>Additional parameters may be called as follows: Key V06 N91E R1 Altitude XXXX (10 nm) R2 V XXXX fps R3 Flight path angle XXX.XX° To terminate N91: Key KEY REL Altitude for earth orbit is above launch pad radius; for lunar orbit, above landing site radius.</p> <p>T (Event) is incremented by 10 minutes.</p> <p>Select desired program.</p>





**LMA790-3-LM**  
**APOLLO OPERATIONS HANDBOOK**

CREW/ MAN	PML	PROCEDURES	REMARKS
	<p>4.8.1.2 <u>Orbit Parameter Display (PGMS R30 &amp; AGS) (cont)</u></p> <p>1. Key V82E            Press OPR E2R 1t - on            Exit R30, key R8HT</p> <p>Press PL V04 N12 - Option code            R1 00002 - Specify vehicle            R2 0000X - Assumed option (LM)            R3 _____            X = 1 - LM                  = 2 - CSM</p> <p>Accept: Key PR0            Reject: Key V22E - 2E (CSM)</p> <p>2. PL V16 M44 - Orbit parameters            R1 Ha XXXX.X mm            R2 Hp XXXX.X mm            R3 TFF XXXX min-sec</p> <p>To repeat orbit-parameter calculations if average-g integration is not in process:            Key V32E            If TFF = -59B59 &amp; display of time to perifocus is desired, go to step 3; otherwise:            Key PR0, exit R30</p>	<p>AGS CSM state vector valid (required)</p> <p>1. Read out apofocus altitude:            Key DEDA C 315R (0.1 mm)            Compare with N44 Ha.</p> <p>2. Read out perifocus altitude:            Key DEDA C 403R (0.1 mm)            Compare with N44 Hp.</p>	<p>AGS Initialization Routine (R47) (para 4.6.1.1B) or AGS Manual CSM State Vector Update/Initialization procedure (para 4.6.2.9)</p> <p>OPR E2R 1t - on if another extended verb from R76 is active.</p> <p>If average-g integration is in process (powered flight), option code will not be called.</p> <p>Orbit parameters are automatically updated every 2 seconds while average-g integration is in process. For lunar orbit, if Hp &gt;35,000 feet, TFF = -59B59 (or earth orbit, if Hp &gt;300,000 feet). TFF is time of free fall to 35,000 feet for lunar orbit (or to 300,000 feet for earth orbit). TFF counts down if average-g integration is not in process. Maximum altitude display value is 9999.9 mm</p>

**LMA790-3-LM  
APOLLO OPERATIONS HANDBOOK**

CREW- MAN	PNI	PROCEDURES	REMARKS
		<p>4.8.1.2 <u>Orbit Parameter Display (PGNS R30 &amp; AGS) (cont)</u></p> <p>3. Key N32E - Time from perifocus  R1 00XX hr  R2 00XX min  R3 0XX.XX sec  When finished with display:  Key KEY REL, PRO, exit R30</p>	



**LMA790-3-LM  
APOLLO OPERATIONS HANDBOOK**

LM 3231

CREW-MAN	PNL	PROCEDURES	REMARKS
		<p style="text-align: center;"><b>4.8.2 LM RENDEZVOUS NAVIGATION</b></p> <p><b>4.8.2.1 LM Rendezvous Navigation Program (P20)</b></p>	<p>Purpose of LM Rendezvous Navigation Program (P20) is to acquire and track CSM transponder by positioning RR antenna and/or LM +Z-axis along LOS to CSM, and to update LM or CSM state vectors from tracking data. Program may be used to point LM tracking light at CSM. Three state vector update options exist:</p> <ol style="list-style-type: none"> <li>1. LM state vector update (V80E)</li> <li>2. CSM state vector update (V81E)</li> <li>3. No state vector update (V95E)</li> </ol> <p>If P20 is selected before landing phase of lunar landing mission, operation must be in no-update mode.</p> <p>When this program has been completed, it will continue to operate automatically and simultaneously with another program until terminated by crew selection of LCC Idling Program (P00), V56E or V34E in response to flashing P20 display. Keying in V34E in response to P20 display when LM Prethrust Program (P3X) is operating in foreground will not terminate prethrust program. If V56E or V34E (terminate P20) is keyed in during P32, P33, P34, or P35 computations (except on a noun 49 display), these computations will be restarted from the beginning.</p> <p>Hardware restart removes track enable and forces P20 to beginning of RR Designate Routine (R21), which calls Preferred Tracking Attitude Routine (R61).</p> <p>Ref para 4.6.1.1.</p> <p>Ref para 4.6.1.3. ISS should be on 15 minutes before thrusting maneuver.</p> <p>Ref para 4.6.1.13.</p> <p>Ref para 4.9.1.1.</p> <p>Ref para 4.6.2.1.</p> <p>Ref para 4.6.2.4.</p>
		<p>LCC Power-Up (required)</p> <p>IMU Power-Up (LCC Operating) (required)</p> <p>LCC Self-Test (desired)</p> <p>IMU Orientation Determination (required)</p> <p>AGS Power-Up (desired)</p> <p>AGS Checkout (desired)</p>	

**LMA790-3-LM**  
**APOLLO OPERATIONS HANDBOOK**

CREW: MAN	PNL	PROCEDURES	REMARKS
	<p>4.8.2.1 LM Rendezvous Navigation Program (P20) (cont)</p> <p>LGC time valid (desired)</p> <p>LGC state vector valid (required)</p> <p>Rendezvous Radar Initial Activation &amp; Checkout (required)</p> <p>CSM RR Transponder Activation (required)</p> <p>CSM maintaining preferred tracking attitude (required)</p> <p>1. Verify/set controls as follows:</p> <p>1 RATE/ERR MON sw - RNDZ RADAR</p> <p>ATTITUDE MON sw - PGNS</p> <p>GUID CONT sw - PGNS</p> <p>RNG/ALT MON sw - RNG/RNG RT</p> <p>RADAR TEST sw - OFF</p> <p>RNDZ RADAR sel - SLEW (if choice of LGC auto or manual acquisition is desired)</p> <p>RNDZ RADAR sel - LCC (if auto acquisition is desired)</p> <p>S/C:</p> <p>ROLL, PITCH, &amp; YAW sw - MODE CONT</p> <p>PGNS sw - ATT HOLD</p> <p>2. Key V37E 20E</p> <p>Pos PROG lt - on</p> <p>Key V05 N09E - Call alarm</p> <p>00210 - IMU not on</p> <p>00220 - Bad REFSMMAT (ISS orientation not known)</p>	<p>LGC/CMC Clock Synchronization Routine (R33) (para 4.6.1.15)</p> <p>AGS required to perform AGS acquisition steering as backup to Preferred Tracking Attitude Routine.</p> <p>LGC Update Program (P27) (para 4.6.1.7)</p> <p>Ref para 4.6.3.2. Rendezvous radar heaters must be turned on 2.5 hours before use.</p> <p>During attitude maneuvers, crew may desire to switch to LDG RDR/CMPTR for display of attitude errors.</p> <p>RNG/ALT ind pwr/sig fail lt may flash randomly at range rates below 10 fps when displaying rendezvous radar data. This is inherent in detection logic of indicator and does not indicate malfunction. Data are good and random flashing light should be disregarded.</p> <p>Crew will not be given option to acquire target manually if RNDZ RADAR sel - LCC.</p> <p>Allow 10 seconds between RNDZ RADAR sel-LGC and step 2 (Key V37E20E) to help avoid a software restart during LGC RR CDU zero. A restart (Hardware or software) during LGC "RR turn on" sequence can cause later erratic designate behavior. Recovery: RNDZ RADAR sel-LGC-to-SLEW-to-LGC.</p> <p>Perform IMU Power-Up (LGC Operating) procedure (para 4.6.1.3).</p> <p>Perform IMU Orientation Determination Program (P51) (para 4.9.1.1).</p>	

RC 159 >



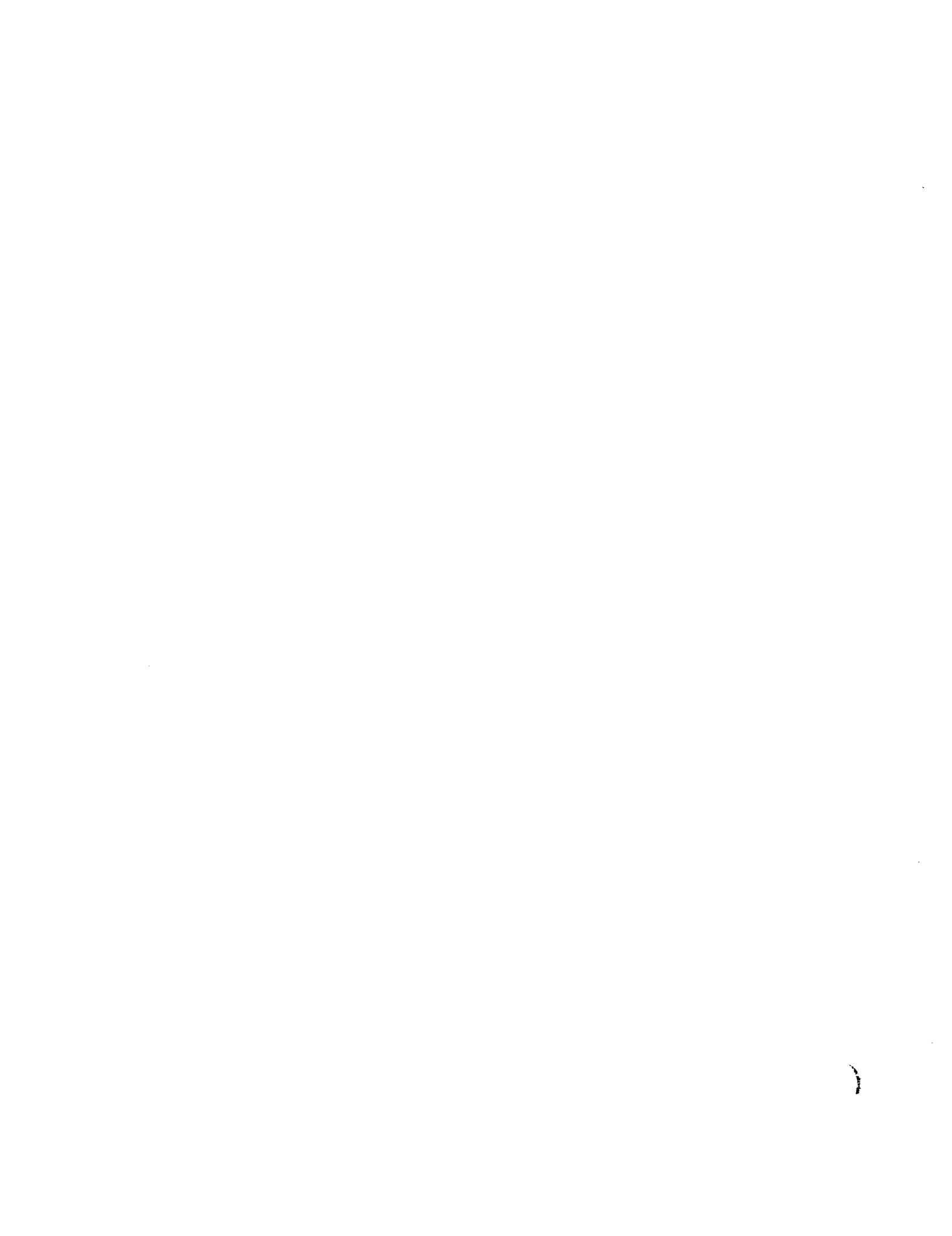

# LMA790-3-LM APOLLO OPERATIONS HANDBOOK

RC 1595, LM 3199, LM 3231

CREW-MAN	PNL	PROCEDURES	REMARKS
		<p>4.8.2.1 LM Rendezvous Navigation Program (P20) (cont.)</p> <p>Key KEY REL &amp; RSET            FL V37 N-- Perform change of program            Key XXE            Exit P20</p> <p>2A. Poss PROG lt - on            Key V05 N09E - Call alarm            00526 - Range &gt;400 nm            RNDZ RADAR: NO TRACK lt - on            Key RSET            Alternatives to alarm:            a. Wait until range &lt;400 nm - Key V32E, go to step 3               or            b. Key V56E perform Terminate Tracking Routine               (R56) - Terminate P20, exit to other program in               process or P00</p> <p>3. To change state vector to be updated:            a. Key V81E - Update CSM state vector               or            b. Key V95E - No state vector update</p> <p>4. Attitude Maneuver Routine (R61/R60)            If pointing error &lt;15°, maneuver will occur without            displays. Go to step 11 if RNDZ RADAR sel - LGC;            otherwise, go to step 6.            PRIO DISP lt - on            *FL V50 N18 - Perform desired automatic maneuver to final            FDAI angles            R1 Roll   XXX.XX°            R2 Pitch  XXX.XX°            R3 Yaw    XXX.XX°</p>	<p>Reselect P20.</p> <p>Go to program selected.</p> <p>To obtain optional display of range &amp; range rate:            Key V16 N54E            R1 range   XXX.XX nm   (999.99 will be displayed            R2 range rate XXXX.X fps   for values ≥ 999.99 nm)            R3 00000            If no other program is in process, R00 is automatically            entered.</p> <p>At beginning of program, LGC automatically sets state            vector to be updated to LM, but does not override pre-            vious V95E. Option may be changed at any time later by            DSKY entry.</p> <p>Automatic attitude maneuvers are more efficient (i.e.,            propellant-time product is lower) than manual attitude            maneuvers.</p> <p>If final computed FDAI angles result in +90° yaw,            transformation from IMU to FDAI angles in roll and            pitch is indeterminate and R1 and R2 will be zero.            Asterisk (*) indicates priority display. Two-second            delay is required before LGC will accept crew response.</p>

NAV

**LMA790-3-LM**  
**APOLLO OPERATIONS HANDBOOK**

LM 3158, LM 3199, LM 3231

CREW- MAN	PNI	PROCEDURES	REMARKS
		<p>4.8.2.1 <u>LM Rendezvous Navigation Program (P20) (cont)</u></p> <p>To reject attitude maneuver: When within DAP deadband limits, &amp; further adjustment about desired vector is not desired - Key ENTR, exit R60 - Go to step 12 if RNDZ RADAR sel - LGC, otherwise, go to step 6 PRIO DISP lt - off To perform attitude maneuver: a. To adjust vehicle attitude &amp; have LGC recompute gimbal angles: Select desired attitude control mode - ACA - maneuver as desired S/C: PGNS sw - ATT HOLD Key PRO  PRIO DISP lt - off Return to beginning of step 4.</p> <p>b. To perform attitude maneuver manually: Select desired attitude control mode - ACA - maneuver manually to required attitude Key PRO PRIO DISP lt - off Return to beginning of step 4.</p> <p>c. To perform attitude maneuver automatically: GUID CONT sw - PGNS S/C: PGNS sw - AUTO Key PRO PRIO DISP lt - off Go to step 5.</p> <p>5. If PGNS automatic attitude maneuver selected: DSKY displays are blanked until completion of automatic maneuver. Monitor FDAI belly band, with respect to color band on roll bezel, to avoid gimbal lock.</p>	<p>Adjustment is not possible in all cases, including roll attitude adjustment. Ref para 4.5.1.</p> <p>If GUID CONT sw - PGNS and S/C: PGNS sw - AUTO, LGC commands automatic attitude maneuver.</p> <p>Ref para 4.5.1.</p> <p>Automatic trim maneuver is to be considered essential for maneuvering to thrusting attitudes.</p> <p>If desired, Key extended verbs or Key V16 N18 - Final FDAI angles R1 Roll XXX.XX° R2 Pitch XXX.XX° R3 Yaw XXX.XX° Key KEY REL</p>
ACA	3		
ACA			
1 3			



**LMA790-3-LM**  
**APOLLO OPERATIONS HANDBOOK**

LM 3158, LM 3199

CREW MAN	PNL	PROCEDURES	REMARKS
		<p>4.8.2.1 LM Rendezvous Navigation Program (P20) (cont)</p> <p>Monitor return of preceding display, indicating automatic maneuver is complete. To stop LM motion if gimbal lock is approached:</p> <p>S/C: PCNS sw - ATT HOLD If manual override &amp; completion of maneuver is desired: Select desired attitude control mode - ACA - maneuver manually</p> <p>Return to step 4.</p> <p>6. *Poss FL V05 N09 - Alarm (only if another program is in process) PRIO DISP lt - on 00514 - RR goes out of automatic mode while in use PRG lt - on Alarm alternatives: a. RNDZ RADAR sel - LGC Key RSET &amp; PRO or V32E, go to step 11 PRIO DISP lt - off or b. Key RSET &amp; V56E or V34E, exit P20 PRIO DISP lt - off</p>	<p>Belly band covers separation between hemispheres of FDAI ball. Belly band, in color bands on each side of FDAI roll bezel, would indicate IMU middle gimbal angle <math>&gt;75^\circ</math>. During this maneuver, LGC will terminate automatic maneuver if S/C: PCNS sw is switched out of AUTO.</p> <p>Ref para 4.5.1.</p> <p>Asterisk (*) indicates priority display. Two-second delay is required before LGC will accept crew response.</p>

NAV

**LMA790-3-LM**  
**APOLLO OPERATIONS HANDBOOK**

CREW- MAN	PNL	PROCEDURES	REMARKS
		<p>4.8.2.1 LM Rendezvous Navigation Program (P20) (cont.)</p>	
		<p>7. Poss FL V50 N25 - Checklist reference (only if P20 is running alone)            R1 00201 - Perform RR automatic mode            R2 -----            R3 -----            Accept:            RNDZ RADAR sel - LGC            Key PRO - Go to step 11 (R21)            Reject: Key ENTR - Perform R23, steps 8 through 10</p>	<p>This display is called only when RNDZ RADAR sel is not set to LGC.</p> <p>Manual acquisition can be called from this display only by keying ENTR.</p> <p>LGC selects minimum deadband at this time.</p>
3		<p>8. RR Manual Acquisition Routine (R23)            FL V50 N25 - Checklist reference            R1 00205 - Perform manual acquisition of CSM            R2 -----            R3 -----</p>	<p>RR Manual Acquisition Routine (R23) may only be selected if P20 is not running in conjunction with another program.</p>
1 3		<p>Verify RATE/ERR MON sw - RNDZ RADAR            RNDZ RADAR: SLEW RATE sw - LO            RADAR: TEST/MON sel - AGC            Verify RR antenna is in mode No. 1.</p> <p>If shaft &amp; trunnion angles are zero &amp; stay at zero when RNDZ RADAR: SLEW sw - LEFT, hold sw until trunnion deflects right &amp; returns to zero.</p> <p>Perform square search pattern for CSM:            RNDZ RADAR: SLEW sw - RIGHT 2.5°, stop                              SLEW sw - UP 2.5°, stop                              SLEW sw - LEFT 5°, stop                              SLEW sw - DOWN 5°, stop                              SLEW sw - RIGHT 5°, stop</p> <p>Continue square search pattern to max increase of 10° until AGC signal increases on RADAR: SIGNAL STRENGTH ind.</p>	<p>When RNDZ RADAR sel - SLEW, RR range tracker is inhibited. RR range data are not usable.</p> <p>Hold at each stop 5 seconds.</p> <p>If electromagnetic interference in system is identified as caused by tracking light (regular pulses on audio channel or indicated on SIGNAL STRENGTH ind at approximate frequency of 1 pps), tracking light may be turned off until transmission or reception is complete.</p>
3		<p>RNDZ RADAR: SLEW sw - LEFT &amp; RIGHT for AGC peak on RADAR: SIGNAL STRENGTH ind            RNDZ RADAR: SLEW sw - UP &amp; DOWN for AGC peak on RADAR: SIGNAL STRENGTH ind</p>	

LM 3231

**LMA790-3-LM**  
**APOLLO OPERATIONS HANDBOOK**

LM 3199, LM 3231

CREW-MAN	PNL	PROCEDURES	REMARKS
		<p>4.8.2.1 <u>LM Rendezvous Navigation Program (P20) (cont)</u></p> <p>Perform Rendezvous Radar Manual Side-Lobe Acquisition Check &amp; Main-Lobe Acquisition Verification.</p> <p>a. When CSM acquisition achieved:  RNDZ RADAR sel - LGC  Verify RDNZ RADAR: NO TRACK lt - off after 15 seconds</p> <p>Key PRO - Exit R23  Go to step 17 (R22) unless:  *Poss FL V05 N09 - Alarm  00501 - RR antenna out of limits  PROG lt - on  RNDZ RADAR: NO TRACK lt - on  Key RSET</p> <p>Alternatives to alarm:</p> <p>1. Maneuver again to preferred tracking attitude -  Key V32E, go to step 9 (R61)  or</p> <p>2. Key V34E or V56E - Terminate R23 &amp; P20  FL V37 N -- - Perform change of program  Key XXE - Exit R23 &amp; P20</p> <p>b. If CSM acquisition is not obtained or is by side lobe:  Key ENTR - Perform preferred tracking attitude routine (R61), steps 9 and 10.</p> <p>c. If unable to acquire CSM manually:  Perform Rendezvous Radar Checkout.  Request CSM perform transponder test.  Key V34E - Terminate P20 &amp; R23  FL V37 N-- - Perform change of program  Key XXE - Exit P20 &amp; R23</p> <p>9. Attitude Maneuver Routine (R61/R60)  If pointing error &lt;15°, maneuver will occur without displays. Return to step 8.  PRIO DISP lt - on  *FL V50 N18 - Perform desired automatic maneuver to final  FDAI angles  R1 Roll   XXX.XX°  R2 Pitch   XXX.XX°  R3 Yaw    XXX.XX°</p>	<p>Ref para 4.6.3.5.</p> <p>Up to 15 seconds may elapse before range tracker locks on and data-good discrete is issued.</p> <p>Asterisk (*) indicates priority display. Two-second delay is required before LCC will accept crew response.</p> <p>Go to program selected.</p> <p>Ref para 4.6.3.2.</p> <p>Automatic attitude maneuvers are more efficient (i.e., propllant-time product is lower) than manual attitude maneuvers.</p> <p>If final computed FDAI angles result in +90° yaw, transformation from IMU to FDAI angles in roll and pitch is indeterminate and R1 and R2 will be zero.</p>



**LMA790-3-LM**  
**APOLLO OPERATIONS HANDBOOK**

LM 3158, LM 3199

CREW- MAN	PROCEDURES	REMARKS
<p>PNL</p>	<p>4.8.2.1 <u>LM Rendezvous Navigation Program (P20) (cont)</u></p> <p>To reject attitude maneuver: When within DAP deadband limits &amp; further adjustment about desired vector is not desired: Key ENTR, exit R60 - Return to step 8 PRIO DISP lt - off</p> <p>To perform attitude maneuver:</p> <p>a. To adjust vehicle attitude &amp; have LGC recompute gimbal angles: Select desired attitude control mode - ACA - maneuver as desired S/C: PGNS sw - ATT HOLD Key PRO PRIO DISP lt - off Return to beginning of step 9.</p> <p>b. To perform attitude maneuver manually: Select desired attitude control mode - ACA - maneuver manually to required attitude Key PRO PRIO DISP lt - off Return to beginning of step 9.</p> <p>c. To perform attitude maneuver automatically: GUID CONT sw - PGNS S/C: PGNS sw - AUTO Key PRO PRIO DISP lt - off Go to step 10</p> <p>10. If PGNS automatic attitude maneuver selected: DSKY displays are blanked until completion of automatic maneuver. Monitor FDAI belly band, with respect to color band on roll bezel, to avoid gimbal lock.</p> <p>Monitor return of preceding display, indicating automatic maneuver is complete.</p>	<p>Adjustment is not possible in all cases, including roll attitude adjustment. Ref para 4.5.1.</p> <p>If GUID CONT sw - PGNS and S/C: PGNS sw - AUTO, LGC commands automatic attitude maneuver.</p> <p>Ref para 4.5.1.</p> <p>Automatic trim maneuver is to be considered essential for maneuvering to thrusting attitudes.</p> <p>If desired, Key extended verbs or Key V16 N18 - Final FDAI angles R1 Roll XXX.XX° R2 Pitch XXX.XX° R3 Yaw XXX.XX° Key KEY REL</p> <p>Belly band covers separation between hemispheres of FDAI ball. Belly band, in color bands on each side of FDAI roll bezel, would indicate IMU middle gimbal angle &gt;75°. During this maneuver, IGC will terminate automatic maneuver if S/C: PGNS sw is switch out of AUTO.</p>

# LMA790-3-LM APOLLO OPERATIONS HANDBOOK

LM 3158, LM 3199, LM 3231

CREW-MAN	PNL	PROCEDURES	REMARKS
	ACA	<p>4.8.2.1 LM Rendezvous Navigation Program (P20) (cont.)</p> <p>To stop LM motion if gimbal lock is approached; S/C: PCMS sw - ATT HOLD If manual override &amp; completion of maneuver is desired: Select desired attitude control mode - ACA - maneuver manually</p> <p>Return to step 9.</p> <p>11. RR automatic acquisition (RR Designate Routine R21) If acquisition is successful (no alarms), go to step 16.</p> <p>*Poss FL V50 N18 - Perform automatic maneuver PRIO DISP lt - on Return to steps 4 &amp; 5.</p> <p>*Poss FL V05 N09 - Alarm PRIO DISP lt - on 00503 - RR unable to acquire target RNDZ RADAR: NO TRACK lt - on Key RSET Alternatives to alarm: a. Key V32E - Recycle to start of R21, step 11 to redesignate RR PRIO DISP lt - off or b. Key PRO - Initiate RR Search Routine (R24), steps 12 through 15 PRIO DISP lt - off or c. Key V14E or V56E, perform Terminate Tracking Routine (R56) - Terminate R21 &amp; P20 PRIO DISP lt - off Key R56</p>	<p>Ref para 4.5.1.</p> <p>Routine 21 points rendezvous radar at CSM until target is acquired or until alarm 00503 is generated. Designate process is automatic unless attitude maneuver is requested by LGC or program alarm occurs. When acquisition is accomplished in R21, crew confirmation of main-lobe lock on is requested (step 16). If acquisition is confirmed, RR Data Read Routine (R22), step 17, is performed; if not confirmed, P20 is terminated. Preferred Tracking Attitude Routine (R61) is called if LOS is not within antenna limits after reorienting LM, P20 automatically reselects R21, step 11.</p> <p>RR search process can be entered only from this alarm. Asterisk (*) indicates priority display. Two-second delay is required before LGC will accept crew response.</p>





**LMA790-3-LM**  
**APOLLO OPERATIONS HANDBOOK**

LM 3199, LM 3231

CREW-MAN	PNL	PROCEDURES	REMARKS
		<p>4.8.2.1 <u>LM Rendezvous Navigation Program (P20) (cont)</u></p> <p>12. Rendezvous radar search acquisition - Perform RR Search Routine (R24)</p> <p>    Poss PROG lt - on     Key V05 N09E - Call alarm     00527 - Attitude maneuver required     Key KEY REL</p> <p>    *FL V16 N80     PRIO DISP lt - on     R1 XXXX (initially 00000)     R2 <math>\Omega</math> XX.XX° (initially 00000 until designation begins)     R3 -----     If <math>\Omega</math> does not approach 30°, go to step 15.</p> <p>    If <math>\Omega</math> exceeds 30° any time during R24 -     To continue: Key V32E, Preferred Tracking Attitude Routine (R61), steps 13 &amp; 14.     PRIO DISP lt - off     To terminate: Key V34E or V56E, perform Terminate Tracking Routine (R56) - exit R24 &amp; P20     PRIO DISP lt - off</p>	<p>Confirm, by voice, that CSM is in preferred attitude and that transponder is active.</p> <p><math>\Omega</math> = angle between RR boresight and LM +Z axis</p> <p>R1 displays 11111 after search is successfully completed.</p>

**LMA790-3-LM**  
**APOLLO OPERATIONS HANDBOOK**

LM 3199

CREW- MAN	P/NL	PROCEDURES	REMARKS
		<p>4.8.2.1 <u>LM Rendezvous Navigation Program (P20) (cont)</u></p> <p>13. Attitude Maneuver Routine (R61/R60) If pointing error &lt;15°, maneuver will occur without displays. Return to step 12. PRIO DISP lt - on *FL V50 N18 - Perform desired automatic maneuver to final FDAI angles R1 Roll XXX.XX° R2 Pitch XXX.XX° R3 Yaw XXX.XX°</p> <p>To reject attitude maneuver: When within DAP deadband limits &amp; further adjustment about desired vector is not desired: Key ENTR, exit R60 - Return to step 12 PRIO DISP lt - off</p> <p>To perform attitude maneuver:</p> <p>a. To adjust vehicle attitude &amp; have LCC recompute gimbal angles: Select desired attitude control mode - ACA - maneuver as desired S/C: PGNS sw - ATT HOLD Key PRO PRIO DISP lt - off Return to beginning of step 13.</p> <p>b. To perform attitude maneuver manually: Select desired attitude control mode - ACA - maneuver manually to required attitude Key PRO PRIO DISP lt - off Return to beginning of step 13.</p> <p>c. To perform attitude maneuver automatically: GUID CONT sw - PGNS S/C: PGNS sw - AUTO Key PRO Go to step 14.</p>	<p>Automatic attitude maneuvers are more effective (i.e., propellant-time product is lower) than manual attitude maneuvers.</p> <p>If final computed FDAI angles result in ±90° yaw, trans-formation from IMU to FDAI angles in roll and pitch is indeterminate and R1 and R2 will be zero.</p> <p>Adjustment is not possible in all cases, including roll attitude adjustment. Ref para 4.5.1.</p> <p>If GUID CONT sw - PGNS and S/C: PGNS sw - AUTO, LGC commands automatic attitude maneuver.</p> <p>Ref para 4.5.1.</p> <p>Automatic trim maneuver is to be considered essential for maneuvering to thrusting attitudes.</p>



**LMA790-3-LM**  
**APOLLO OPERATIONS HANDBOOK**

RC 1593, LM 3158, LM 3199, LM 3231

CREW-MAN	PNL	PROCEDURES	REMARKS
		<p>4.8.2.1 LM Rendezvous Navigation Program (P20) (cont)</p> <p>14. If PGNS Automatic selected: Pre-R60 displays return until completion of automatic maneuver. Monitor FDAI belly band, with respect to color band on roll bezel, to avoid gimbal lock.</p> <p>Monitor return of preceding display, indicating automatic maneuver is complete. To stop LM motion if gimbal lock is approached: S/C: PGNS sw - ATT HOLD If manual override &amp; completion of maneuver is desired: Select desired attitude control mode - ACA - maneuver manually Return to step 13.</p> <p>15. Permit RR to search until V16 N80, R1 displays 11111. When search is successfully completed, verify CSM acquisition is not by side lobe: Key PRO - Return to step 2A If CSM acquisition is by side lobe, manually reacquire CSM in main lobe: RNDZ RADAR sel - LGC RNDZ RADAR: NO TRACK lt - off Key PRO - Return to step 2A If CSM is not acquired: Key V34E or V56E - Terminate R24 &amp; P20, reselect P20, &amp; at step 7 select R23</p> <p>16. PRIO DISP lt - on *FL V50 N72 R1 Trunnion XXX.XX* R2 Shaft XXX.XX* R3 -----</p> <p>If main-lobe lock-on has been achieved: Key PRO PRIO DISP lt - off</p>	<p>If desired, Key extended verbs or Key V16 N18 - Final FDAI angles R1 Roll XXX.XX* R2 Pitch XXX.XX* R3 Yaw XXX.XX* Key KEY REL</p> <p>Belly band covers separation between hemispheres of FDAI ball. Belly band, in color bands on each side of FDAI roll bezel, would indicate IMU middle gimbal angle &gt;75°. During this maneuver, LGC will terminate automatic maneuver if S/C: PGNS sw is switched out of AUTO.</p> <p>Ref para 4.5.1.</p> <p>R1 displays 11111 if RR search has been successful. Ref para 4.6.3.5.</p> <p>Key PRO only on display of 11111 is R1 of N80 (indicating lockon achieved), a PRO on 00000 results in an infinite RR designate loop. Recovery: Reselect P20 and redo R24.</p> <p>Large RR shaft and trunnion angles, or COAS LOS not optically on target, indicate side-lobe lock on has been achieved. Asterisk (*) indicates priority display. Two-second time delay is required before LGC will accept crew response.</p>
	ACA		
	3		



**LMA790-3-LM**  
**APOLLO OPERATIONS HANDBOOK**

LM 3199

CREW-MAN	PNL	PROCEDURES	REMARKS
		<p>4.8.2.1 LM Rendezvous Navigation Program (P20) (cont)</p> <p>If main-lobe lock-on was not achieved and is desired, manually reacquire CSM in main-lobe:            RNDZ RADAR sel - LGC            RNDZ RADAR: NO TRACK lt - off            Key PRO            PRIO DISP lt - off</p> <p>If main-lobe lock-on was not achieved and is not desired:            Key V34E or V56E - Perform Terminate Tracking Routine (R56) - Exit P20            PRIO DISP lt - off</p> <p>17. RR Data Read Routine (R22)</p> <p>LR/RR Read Routine (R20)</p> <p>Poss PROG lt - on            Poss RNDZ RADAR: NO TRACK lt - on            Poss TRACKER lt - on</p> <p>Key V05 N09E - Call alarm            00520 - RADARUPT not expected at this time            or no radar sampling requested at this time            Key KEL REL &amp; RSET - Return to step 11 (R21) for automatic reacquisition            *Poss FL V05 N09 - Alarm            PRIO DISP lt - on            00525 - Δθ &gt;3°            PROG lt - on            To terminate P20:            Key RSET &amp; V34E or V56E, perform Terminate Tracking Routine (R56)            PRIO DISP lt - off</p>	<p>RR Data Read Routine (R22) processes RR mark data to update LM or CSM or neither state vector, as defined in step 3. Process is automatic unless attitude maneuver is requested by LGC, or program alarm occurs.</p> <p>Purpose of LR/RR Read Routine (R20) is to read LR/RR parameters requested by the calling routine (R22), to perform various checks to ensure that system is operating correctly, and to ensure an alarm if errors occur in RR reading.</p> <p>TRACKER lt indicates program is unable to obtain good radar samples on each required pass.</p> <p>RADARUPT: LGC interrupt.</p> <p>Δθ = difference between RR indicated LOS and state-vector-indicated LOS.            Asterisk (*) indicates priority display. Two-second delay is required before LGC will accept crew response.</p>

**LMA790-3-LM**  
**APOLLO OPERATIONS HANDBOOK**

LM 319.

CREW-MAN	PNL	PROCEDURES	REMARKS
		<p>4.8.2.1 LM Rendezvous Navigation Program (P20) (cont)</p> <p>To continue: Key RSET &amp; PRO PRIO DISP lt - off PRIO DISP lt - on *FL V06 N05 R1 Δθ XXX.XX° R2 ----- R3 ----- To accept Δθ for state vector update: Key PRO PRIO DISP lt - off If LOS not within 30° of LM +Z axis, go to step 18. To reject: Key V32E - Recycle to step 11 (R21) for automatic reacquisition PRIO DISP lt - off To terminate P20: Key V34E or V56E, perform Terminate Tracking Routine (R56) PRIO DISP lt - off</p> <p>Fine Preferred Tracking Attitude Routine (R65)</p> <p>18. Poss Attitude Maneuver Routine (R61/R60) If pointing error &lt;15°, maneuver will occur without displays. Return to step 17. PRIO DISP lt - on *FL V50 N18 - Perform desired automatic maneuver to final FDAI angles R1 Roll XXX.XX° R2 Pitch XXX.XX° R3 Yaw XXX.XX° To reject attitude maneuver: When within DAP deadband limits, &amp; further adjustment about desired vector is not desired, Key ENTR, exit R60 - Return to step 17 PRIO DISP lt - off To perform attitude maneuver: a. To adjust vehicle attitude &amp; have LGC recompute gimbal angles: Select desired attitude control mode -</p>	<p>Display is flashed only when alarm 00525 appears and PRO is keyed.</p> <p>Automatic attitude maneuvers are more efficient (i.e., propellant-time product is lower) than manual attitude maneuvers.</p> <p>If final computed FDAI angles result in +90° yaw, transformation from IMU to FDAI angles in roll and pitch is indeterminate and R1 and R2 will be zero.</p> <p>Adjustment is not possible in all cases, including roll attitude adjustment. Ref para 4.5.1</p>

NAV

**LMA790-3-LM**  
**APOLLO OPERATIONS HANDBOOK**

LM 3158, LM 3199

CREW-MAN	PROCEDURES	REMARKS
	<p>4.8.2.1 LM Rendezvous Navigation Program (P20) (cont)</p>	
ACA	<p>ACA - maneuver as desired S/C: PGNS sw - ATT HOLD Key PRO PRIO DISP lt - off Return to beginning of step 18.</p> <p>b. To perform attitude maneuver manually: Select desired attitude control mode - ACA - maneuver manually to required attitude Key PRO PRIO DISP lt - off Return to beginning of step 18.</p> <p>c. To perform attitude maneuver automatically: GUID CONT sw - PGNS S/C: PGNS sw - AUTO Key PRO Go to step 19.</p>	<p>If GUID CONT sw - PGNS and S/C: PGNS sw - AUTO, LGC commands automatic attitude maneuver.</p> <p>Automatic trim maneuver is to be considered essential for maneuvering to thrusting attitudes.</p>
ACA	<p>19. If PGNS Automatic selected: Pre-R60 displays return until completion of automatic maneuver. Monitor FDAI belly band, with respect to color band on roll bezel, to avoid gimbal lock.</p> <p>To stop LM motion if gimbal lock is approached: S/C: PGNS sw - ATT HOLD</p> <p>If manual override &amp; completion of maneuver is desired: Select desired attitude control mode ACA - maneuver manually Return to step 18.</p>	<p>If desired, Key extended verbs or Key V16 N18 - Final FDAI angles R1 Roll XXX.XX° R2 Pitch XXX.XX° R3 Yaw XXX.XX° Key KEY REL</p> <p>Belly band covers separation between hemispheres of FDAI ball. Belly band, in color bands on each side of FDAI roll bezel, would indicate IMU middle gimbal angle &gt;75°. During this maneuver, LGC will terminate automatic maneuver if S/C: PGNS sw is switched out of AUTO.</p> <p>Ref para 4.5.1.</p>
ACA		

**LMA790-3-LM  
APOLLO OPERATIONS HANDBOOK**

CREW-MAN	PNI	PROCEDURES	REMARKS
		<p>LM 3158, LM 3199</p> <p>4.8.2.1 LM Rendezvous Navigation Program (P20) (cont.)</p> <p>20. *Pos FL V06 N49 - Out-of-tolerance update parameters            PRIO DISP lt - on            R1 AR XXX.XX nm            R2 AV XXXX.X fps            R3 OOOOX Source code            To accept update: Key PRO (incorporate mark data),            return to step 17            PRIO DISP lt - off            Reject options:            a. Reject data from source specified by source code               only:               Key V32E - Return to step 17               PRIO DISP lt - off               or               Reject all data from this mark:               Key V34E - Return to step 17               PRIO DISP lt - off               or            c. Terminate R22 &amp; P20:               Key V56E - Reselect P20 &amp; acquire manually               PRIO DISP lt - off</p>	<p>Asterisk (*) indicates priority display. Two-second delay is required before LGC will accept crew response.</p> <p>X = 1 - RR range            X = 2 - RR range rate            X = 3 - RR shaft angle            X = 4 - RR trunnion angle</p>

NAV



**LMA790-3-LM**  
**APOLLO OPERATIONS HANDBOOK**

RC 160c

CREW-MAN	PNL	PROCEDURES	REMARKS
		<p>4.8.2.1 <u>LM Rendezvous Navigation Program (P20) (cont)</u></p> <p>21. RR Monitor Routine (R25) - is called every 0.48 sec whenever LGC is on            Poss PROG lt - on            RNDZ RADAR: NO TRACK lt - on            TRACKER lt - on            Key V05 N09E - Call alarm            00515 - RR CDU failure            Key KEY REL &amp; RSET            Attempt to continue P20, using V06 N49 display, any additional alarm codes, &amp; MSFN to evaluate CDU performance.            If CDU performance is unsatisfactory:            Key V56E - Terminate</p> <p>22. To terminate P20:            Key V56E, perform Terminate Tracking Routine (R56)            exit to other program in process, or            If no other program in process:            FL V37 N--            Key XXE</p> <p>4.8.2.2 <u>AGS Manual Rendezvous Radar LM State Vector Update</u></p> <p>AGS Power-Up (required)            AGS Checkout (desired)            AGS alignment valid with X-Z inertial reference plane within 10° of CSM orbit plane            AGS time valid (required)</p>	<p>Routine 25 monitors RR gimbal angles and commands gimbal angles to one of two reference positions (dependent on antenna mode) if gimbals exceed predefined limits.            Routine 25 zeroes RR CDU when RR is first put into automatic mode and monitors RR CDU for possible failure.</p> <p>Ref para 5.2.2, malfunction procedures, Primary Guidance &amp; Navigation Section.</p> <p>RR use under LGC control is not possible. RR can be used in slew or automatic track modes.</p> <p>Select desired program.</p> <p>Purpose of AGS Manual Rendezvous Radar LM State Vector Update procedure is to update AGS LM state vector, using rendezvous radar range, range rate, and LOS data.</p> <p>Due to program rescaling limitations, rendezvous radar navigation state vector updating capability does not exist when AGS FP 8 is used in earth orbit.</p> <p>Ref para 4.6.2.1.            Ref para 4.6.2.4.</p> <p>PGNCS/AGS Align procedure (para 4.9.2.1), AGS Lunar Align procedure (para 4.9.3.2), or Backup AGS Alignment Procedure (para 4.9.2.2/4.9.2.3).</p> <p>AGS Manual Absolute Time Initialization procedure (para 4.6.2.6) or AGS Initialization Routine (para 4.6.1.18) AEA clock will overflow 4396 minutes (approximately 73 hours) after initialization at zero.</p>

NAV

**LMA790-3-LM  
APOLLO OPERATIONS HANDBOOK**

LH 3231

CREW- MAN	PNL	PROCEDURES	REMARKS
		<p>4.8.2.2 AGS Manual Rendezvous Radar LM State Vector Update (cont)</p> <p>AGS LM/CSM state vector valid (required)</p> <p>Rendezvous Radar Power-Up (required)</p> <p>Rendezvous Radar Checkout (required)</p> <p>1. RADAR TEST sw - OFF</p> <p>2. Establish range/range rate display mode: RNG/ALT MON sw - RNG/RNG RT</p> <p>3. Compute CSM acquisition maneuver. Select normal acquisition steering: Key DEDA C 5074-00000E Command acquisition steering computations: Key DEDA C 400+20000E</p> <p>4. Perform AGS Orientation to Initial Computed Steering Attitude, using acquisition Z-axis steering.</p> <p>5. Establish RR contact with CSM: Establish RR shaft/trunnion angle &amp; azimuth/elevation rate displays: SHFT/TRUN <math>\dot{\gamma}</math> sw - +5° X POINTER SCALE sw - as desired RATE/ENR MON sw - RNDZ RADAR Establish radar signal strength display: RADAR: TEST/MON sel - AGC Establish manual control of RR antenna: RNDZ RADAR sel - SLEW RNDZ RADAR: SLEW RATE sw - as desired Slew RR antenna to null RR shaft &amp; trunnion angle display one axis at a time. As second axis approaches null, observe RADAR: SIGNAL STRENGTH ind to determine &amp; lock onto strongest lobe. Slew antenna to check first axis for strongest lobe. Perform further main-lobe acquisition verification as required.</p>	<p>AGS Initialization Routine (R47) (para 4.6.1.18) or AGS Manual LM State Vector Update/Initialization and AGS Manual CSM State Vector Update/Initialization (para 4.6.2.7 and 4.6.2.9)</p> <p>Ref para 4.6.3.1.</p> <p>Ref para 4.6.3.2.</p> <p>Disables RR test signals.</p> <p>Ref para 4.5.3.10.</p> <p>AEA computes attitude errors to point LM +Z body-axis in direction of AEA-estimated LM-CSM LOS.</p> <p>Ref para 4.6.2.13.</p> <p>Ref para 4.5.3.6 and 4.5.3.7.</p> <p>Ref para 4.5.3.12.</p> <p>Rendezvous Radar Manual Side-Lobe Acquisition Check &amp; Main-Lobe Acquisition Verification (para 4.6.3.15)</p>



**LMA790-3-LM**  
**APOLLO OPERATIONS HANDBOOK**

CREW-MAN	PNL	PROCEDURES	REMARKS
		<p>4.8.2.2 <u>AGS Manual Rendezvous Radar LM State Vector Update (cont)</u></p> <p>6. Establish RR tracking of CSM:            RNDZ RADAR sel - AUTO TRACK            RNDZ RADAR: NO TRACK lt - off            Establish AGS attitude command mode:            S/C: AGS sw - ATT HOLD            DEAD BAND sw - MAX            or            ROLL, PITCH, &amp; YAW sw - PULSE or DIR</p> <p>7. Initialize radar filter:            Key DEDA C 417+1000E</p> <p>8. Perform RR range update:            S/C: ROLL, PITCH, &amp; YAW sw - MODE CONT, PULSE, or DIR            Enter RR range data:            a. Store Z-body-axis direction cosines -            (1) Key DEDA 415+10000 (Do not enter.)            (2) S/C: DEAD BAND sw - MIN            (3) ACA - rotate LM to null shaft &amp; trunnion angle display            (4) When RR shaft &amp; trunnion angles null, command AEA to store Z-body-axis direction cosines:            Key DEDA ENTR</p> <p>b. Obtain &amp; load range data:            (1) Note RR range on RANGE ind.            (2) Enter range value -            Key DEDA C 316+XXXXE (0.01/0.1)</p> <p>c. S/C: DEAD BAND sw - MAX</p>	<p>Ref para 4.5.1.6.</p> <p>This is necessary to conserve fuel, in case of delay to next step.</p> <p>Before taking each set of radar data, DEDA address 417 must be set to +10000, to initialize radar filter. It is recommended that radar data entry schedule consist of sequence of at least six range and five range rate entries in alternating order (beginning and ending with range entry). At long ranges (pre-CSE), radar data entry schedule should consist of a sequence of at least nine range and eight range rate entries in alternating order. Time between range updates should be maintained relatively constant in any updating sequence, and should be between 2 and 6 minutes. It is desirable that total time interval between first and last range entry in a given sequence be large in order to take advantage of changing geometry.</p> <p>At least 16 seconds must elapse between last entry of range or range rate and entry into 415.</p> <p>If gimbal angles are not zeroed when ENTR is keyed, repeat step 8a.</p> <p>Range data should be entered within 30 seconds of step 8a(4). Parenthetical quantization notation: lunar mission/earth mission.</p>
	ACA		
	1		
	3		



**LMA790-3-LM**  
**APOLLO OPERATIONS HANDBOOK**

LH 983, LM 3181A, LM 3231

CREW- MAN	PNI	PROCEDURES	REMARKS
		<p>4.8.2.2 <u>AGS Manual Rendezvous Radar LM State Vector Update (cont)</u></p> <p>9. Enter range rate data:</p> <p>a. Store Z body-axis direction cosines - (1) Key DEDA C 415+10000 (Do not enter)</p> <p>(2) Key DEDA ENTR</p> <p>b. Load RR range rate value - Key DEDA C 503+XXXXXE (0.1/1 fps)</p>	<p>One range rate entry is recommended between every pair of range entries.</p> <p>No special orientation is necessary; it is only necessary for rendezvous radar to be locked onto CSM. At least 4 seconds must elapse between last entry of range or range rate and entry into 415.</p> <p>If range rate data are not satisfactory, repeat step 9a.</p> <p>Range rate data should be entered within 30 seconds of step 9a(2).</p> <p>Parentetical quantization notation: lunar mission/earth mission. If range rate value is displayed on black portion of RANGE RATE ind tape, positive range rate DEDA entry is indicated; negative is closing rate.</p>
		<p>10. Repeat steps 8 &amp; 9 in sequence &amp; total number as described in remark opposite step 7.</p>	
		<p>4.8.2.3 <u>AGS Automatic Rendezvous Radar LM State Vector Update (Raw Data Transfer Via LGC)</u></p>	<p>Purpose of AGS Automatic Rendezvous Radar LM State Vector Update (Raw Data Transfer Via LGC) procedure is to update AGS LM state vector using rendezvous radar range, range rate and LOS data extracted from the PCNCS Rendezvous and Pre-thrust Downlist.</p>
		<p>AGS Power up (required)</p> <p>AGS Checkout (desired)</p> <p>AGS alignment valid with X-Z inertial reference plane within 10° of CSM orbit plane</p> <p>AGS time valid (required)</p>	<p>Ref para 4.6.2.1.</p> <p>Ref para 4.6.2.4.</p>
		<p>AGS LM/CSM State Vector Valid (required)</p>	<p>PCNCS/AGS Align procedure (para 4.9.2.1), AGS Lunar Align procedure (para 4.9.3.2), or Backup AGS Alignment procedure (para 4.9.2.2/4.9.2.3).</p> <p>AGS Manual Absolute Time Initialization procedure (para 4.6.2.6) or AGS Initialization Routine (para 4.6.1.18) AEA clock will overflow 4396 minutes (approximately 72 hours) after initialization at zero.</p> <p>AGS Initialization Routing (R47) (para 4.6.1.18) or AGS Manual LM/CSM State Vector Update/Initialization (para 4.6.2.7 &amp; 4.6.2.9).</p>

**LMA790-3-LM**  
**APOLLO OPERATIONS HANDBOOK**

LM 983, LM 3181A, LM 3231

CREW-MAN	PNL	PROCEDURES	REMARKS
		<p>4.8.2.3 AGS Automatic Rendezvous Radar LM State Vector Update (Raw Data Transfer Via LGC) (cont.)</p> <p>LGC Power-Up (required)</p> <p>LGC Self-Test (desired)</p> <p>TLM PCM sw - HI</p> <p>Rendezvous Radar Initial Activation &amp; Checkout (required)</p> <p>CSM RR Transponder Activation (required)</p> <p>Rendezvous Radar locked on to CSM transponder (required)</p> <p>PGNCS outputting - Rendezvous &amp; Prethrust List</p>	<p>Ref para 4.6.1.1.</p> <p>Ref para 4.6.1.13.</p> <p>S-band Steerable Antenna Activation and Checkout (para 4.2.20).</p> <p>Ref para 4.6.3.2.</p> <p>LM Rendezvous Navigation Program P20 (para 4.8.2.1), AGS Manual Rendezvous Radar LM State Vector Update (para 4.8.2.2). Rendezvous Radar Coarse Align (para 4.6.3.3).</p> <p>The PGNCS outputs the rendezvous and prethrust list during the following programs:</p> <p>P20, 21, 25</p> <p>P30, 32, 33, 34, 35</p> <p>P72, 73, 74, 75, 76</p> <p>(except during erasable memory dump via downlink V74).</p> <p>Disables RR test signals.</p> <p>Before taking each set of radar data, DEDA address 417 must be set to +10000, to initialize radar filter. It is recommended that the radar data entry schedule consist of a sequence of at least six range entries. At long ranges (such as pre-CSI), a radar data entry schedule should consist of a sequence of at least nine range entries. It is recommended that the automatic procedure be used whenever the PGNCS is in operation.</p> <p>In the automatic RR updating mode, range updates will be approximately two minutes apart (with range rate updates at alternate minutes).</p> <p>During the updating period, the radar shaft and truncation angles should be maintained at about 5° or less and the</p>
		<p>1. RADAR TEST sw - OFF</p> <p>2. Initialize radar filter Key DEDA C 417+10000E</p> <p>3. Command automatic RR update mode. Key DEDA C411+10000E</p>	

**LMA790-3-LM  
APOLLO OPERATIONS HANDBOOK**

RC 1607

CREW-MAN	PNI	PROCEDURES	REMARKS
		<p>4.8.2.3 <u>AGS Automatic Rendezvous Radar LM State Vector Update (Raw Data Transfer Via LGC) (cont)</u></p> <p>4. Monitor update mark counter Key DEDA C621R IX0YI</p> <p>5. The following additional displays are available is desired:</p> <ul style="list-style-type: none"> <li>a. Range/range rate update next - C 606R - (+00000/-XXXXX)</li> <li>b. AGS range - C 317R (0.01/0.1 nm)</li> <li>c. AGS range rate - C 440R (0.1 fps)</li> </ul> <p>4.8.3 <u>LUNAR SURFACE NAVIGATION</u></p> <p>4.8.3.1 <u>Lunar Surface Navigation Program (P22)</u></p>	<p>vehicle rate should be kept reasonably low (0.1 to 0.2 deg/sec.) When the shaft or trunnion angle exceeds 11.25°, the radar data transmitted via the PGCS downlink will not be accepted.</p> <p>To terminate automatic RR update mode; Key DEDA C411+00000E</p> <p>It is considered good practice to begin and terminate automatic RR update mode only during PGCS Rendezvous &amp; Pre-thrust downlist. Actual updating occurs only when all pre-requisites are met.</p> <p>Address 621 reset by C417+10000E XX - member of range updates YY - member of range rate updates</p> <p>Parenthetical quantization notation: lunar mission/ earth mission</p> <p>Purpose of Lunar Surface Navigation Program (P22) is to acquire and track CSM by positioning RR antenna along LOS to CSM. At beginning of program, state vector option is automatically set to CSM, but does not override previous V95E; this option can be inhibited any time and restored at later time by following entries:</p> <ul style="list-style-type: none"> <li>1. No state vector update (V95E)</li> <li>2. CSM state vector update (V81E)</li> </ul> <p>This program tracks CSM with RR in mode 2; therefore, antenna coverage is less than horizon to horizon.</p>

**LMA790-3-LM  
APOLLO OPERATIONS HANDBOOK**

LM 983, LM 3181A, LM 3231

CREW: MAN	PNL	PROCEDURES	REMARKS
		<p>4.8.3.1 Lunar Surface Navigation Program (P22) (cont)</p> <p>LGC Power-Up (required)</p> <p>IMU Power-Up (LGC Operating) (required)</p>	<p>Ref para 4.6.1.1.1.</p> <p>Ref para 4.6.1.3. ISS should be on 15 minutes before thrusting maneuver.</p>

NAV

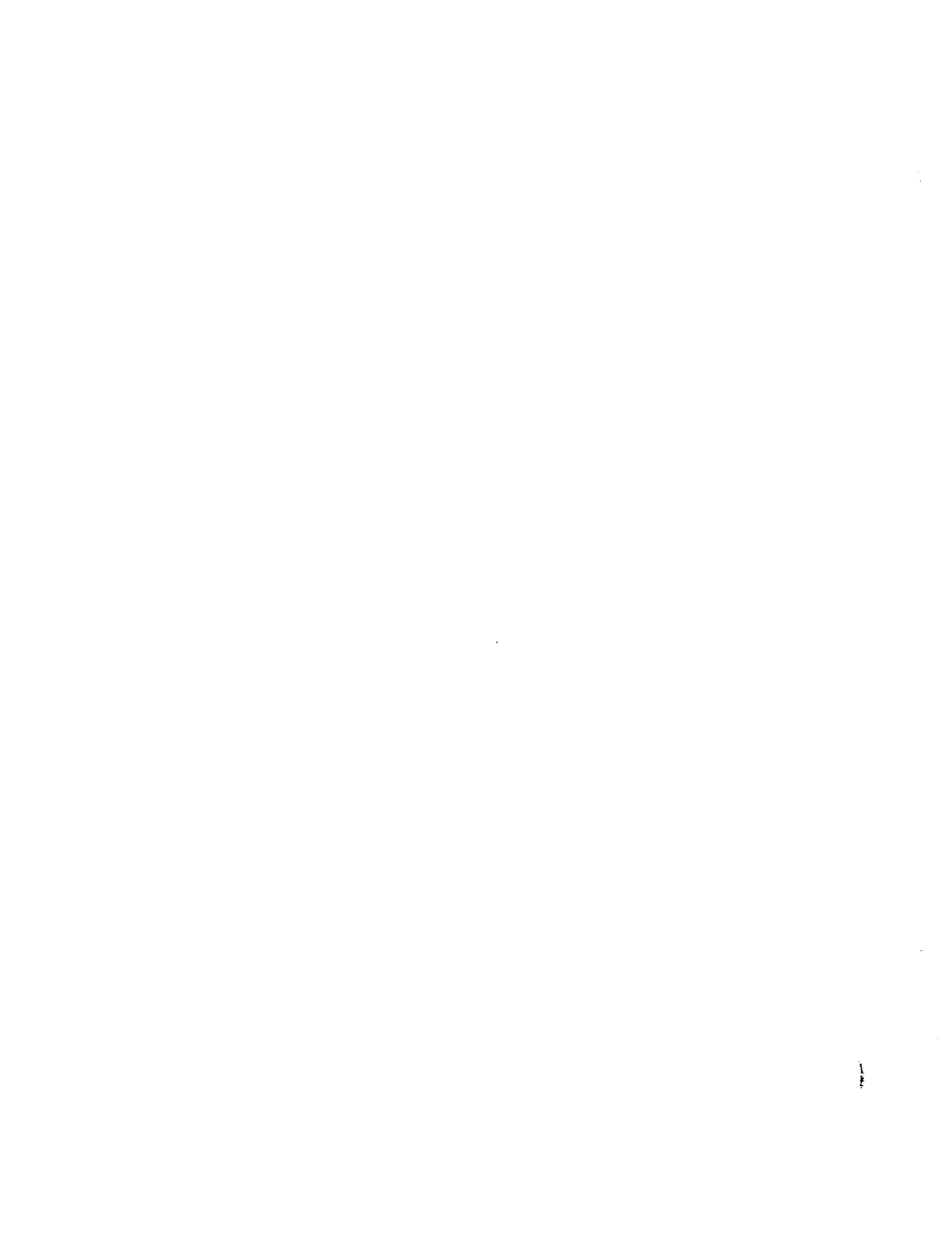

**LMA790-3-LM**  
**APOLLO OPERATIONS HANDBOOK**

CREW-MAN	PNL	PROCEDURES	REMARKS
RC 1595		<p>4.8.3.1 Lunar Surface Navigation Program (P22) (cont)</p> <p>LGC Self-Test (desired)</p> <p>LGC/CMC Clock Synchronization (R33) (desired)</p> <p>Rendezvous Radar Initial Activation &amp; Checkout (required)</p> <p>CSM RR Transponder Activation (required)</p> <p>1. Verify/set controls as follows: GUID CONT sw - PGNS RNG/ALT MON sw - RNG/RNG RT RADAR TEST sw - OFF</p> <p>2. Key V37E 22E</p> <p>3. FL V04 N06 - Option R1 00012 - CSM orbit option R2 00001 - LGC assumed option (CSM will not change present orbit) R3 ----- R2 = 1 - CSM will not change present orbit    = 2 - CSM will change present orbit to go over LM position Accept: Key PRO, 80 to step 5 Reject: Key V22E - Key 2E, go to step 4 (CSM will change present orbit to go over LM position)</p> <p>4. If desired option not 00001: FL V06 N33 - TIC R1 00XXX hr R2 000XX min R3 0XX.XX sec Accept: Key PRO Reject: Key V25E - Load desired TIC</p>	<p>Ref para 4.6.1.13.</p> <p>Ref para 4.6.1.15.</p> <p>Ref para 4.6.3.2. Rendezvous radar must be turned on 2.5 hours before use.</p> <p>Display of RR LOS azimuth and elevation (para 4.5.3.14) is available throughout program.</p> <p>When range/altitude rate input is &lt;5 fps, RNG/ALT ind pwr/sig fail it goes on. This does not represent malfunction, but condition inherent in detection circuitry. This will occur when CSM overpasses LM position and RR range rate goes through zero.</p> <p>Allow 10 seconds between RNDZ RADAR sel-LGC and step 2 (Key V37E20E) to help avoid a software restart during LGC RR CDU zero. A restart (Hardware or software) during LGC "RR turn on" sequence can cause later erratic designate behavior. Recovery: RNDZ RADAR sel-LGC-to-SLEW-to-LGC.</p> <p>Estimated launch time is displayed; CSM orbit change, option 2, is selected.</p>

**LMA790-3-LM**  
**APOLLO OPERATIONS HANDBOOK**

LM 3199, LM 3231

CREW-MAN	PNL	PROCEDURES	REMARKS
		<p>4.8.3.1 Lunar Surface Navigation Program (P22) (cont)</p> <p>5. Poss PROC lt - on Key V05 N09E - Call alarm 00210 - IMU not on 00220 - Bad REFSHMAT (ISS orientation not known)</p> <p>Key KEY REL &amp; RSET FL V37 N-- Key XIXE Exit R02 &amp; P22</p> <p>Poss V16 N54 R1 range     XXX.XX nm (999.99 will be displayed) R2 range rate XXXX.X fps for values &gt; 999.99nm) R3 000000 Poss FL V37</p> <p>6. To terminate CSM state vector update: Key V95E - No state vector update</p> <p>7. Poss FL V50 N25 - Checklist reference R1 00201 - Switch to RR automatic mode R2 ----- R3 ----- RNDZ RADAR sel - LGC Key PRO</p> <p>8. RR automatic acquisition (RR Designate Routine, R21) If acquisition is successful (no alarm), go to step 11. Lunar Surface RR Predesignate Routine (R26) PRIO DISP lt - on *FL V05 N09 - Alarm 00530 - LOS not in mode 2 coverage on lunar surface after 10 min</p> <p>Perform time check for P22 recall Key PRO - Exit R26, R21, &amp; P22 PRIO DISP lt - off FL V37 N-- Key XIXE</p> <p>*Poss FL V05 N09 - Alarm PRIO DISP lt - on 00503 - RR unable to acquire CSM</p>	<p>Perform IMU Power-Up (LGC Operating) procedure (para 4.6.1.1.3) Perform PGNGS Lunar Surface Align Program (P57) (para 4.9.3.1)</p> <p>Reselect P22.</p> <p>Display appears while range is &gt;400 nm and is decreasing. The display is recalculated every 5 seconds.</p> <p>FL V37 occurs if range &gt;400 nm and is increasing.</p> <p>At beginning of program, LGC automatically sets state vector to be updated to CSM, but does not override previous V95E.</p> <p>This display is called only when RNDZ RADAR sel is not set to LGC.</p> <p>Asterisk (*) indicates priority display. Two-second delay is required before LGC will accept crew response.</p>



**LMA790-3-LM**  
**APOLLO OPERATIONS HANDBOOK**

CREW-MAN	PNL	PROCEDURES	REMARKS
		<p>4.8.3.1 Lunar Surface Navigation Program (P22) (cont)</p> <p>PROG lt - on            RNDZ RADAR: NO TRACK lt - on            Key RSET            Alternatives to alarm:            a. Key V32E - Recycle to start of step 8, R21, to re-designate RR            PRIO DISP lt - off            Key PRO - Initiate RR Search Routine (R24), steps 9 &amp; 10.            PRIO DISP lt - off            c. Key V34E or V56E, perform Terminate Tracking Routine (R56) - Terminate R21 &amp; P22            PRIO DISP lt - off            FL V37 N--            Key XXE</p> <p>9. Rendezvous radar search acquisition - Perform RR Search Routine (R24)            Pos PROG lt - on            Key V05 N09E - Call alarm            00527 - CSM out of RR mode II limits            Key V56E, perform Terminate Tracking Routine (R56) - exit R24 &amp; P22            PRIO DISP lt - on            *FL V16 N80            R1 XXXXX (initially 00000)            R2 <math>\Omega</math> XXX.XX* (initially 00000 until designation begins)            R3 -----</p> <p>10. Permit RR to search until V16 N80, R1 displays 11111.            Key PRO - Return to step 5            PRIO DISP lt - off            If CSM is not acquired:            Key V34E - Exit R24 &amp; P22            PRIO DISP lt - off</p> <p>11. RR Data Read Routine (R22), steps 11 &amp; 12.</p>	<p>Confirm, by voice, that CSM is in preferred attitude and that transponder is active.</p> <p>Asterisk (*) indicates priority display. Two-second delay is required before LGC will accept crew response. R1 displays 11111 after RR Search Routine (R24) is successfully completed.  <math>\Omega</math> = angle between RR boresight and LM +Z axis.</p> <p>RR Data Read Routine (R22) processes RR mark data to update CSM state vector, defined in step 6.            If M (number of marks) is desired:            Key V16 N45E            R1 M XXXXX marks            R2 TFI XXXXX min-sec            R3 MGA XXX.XX</p>

RC 1606

NAV

**LMA790-3-LM  
APOLLO OPERATIONS HANDBOOK**

LM 3199, LM 3231

CREW-MAN	P/NL	PROCEDURES	REMARKS
		<p>4.8.3.1 <u>Lunar Surface Navigation Program (P22) (cont)</u></p> <p>LR/RR Read Routine (R20)</p> <p>Poss PROG lt - on            Poss RNDZ RADAR: NO TRACK lt - on            Poss TRACKER lt - on</p> <p>Key V05 N09E - Call alarm            00520 - RADARUPT not expected at this time            or            No radar sampling requested at this time            Key KEY REL &amp; RSET - Return to step 8 (R21) for            automatic reacquisition</p> <p>*Poss FL V05 N09 - Alarm            PRIO DISP lt - on            00525 - A0 &gt;3°            PROG lt - on            To terminate P22:            Key RSET &amp; V34E or V56E, perform Terminate Tracking            Routine (R56)            PRIO DISP lt - off            To continue:            Key RSET &amp; PRO            PRIO DISP lt - off</p> <p>PRIO DISP lt - on            *FL V06 N05            R1 A0 XXX.XX°            R2 -----            R3 -----            To accept A0 for state vector update: Key PRO            PRIO DISP lt - off</p>	<p>When finished with display, key KEY REL            TPI and MGA displays are meaningless.</p> <p>Purpose of LR/RR Read Routine (R20) is to read LR/RR            parameters requested by calling routine (R22), to per-            form various checks to ensure that system is operating            correctly, and to ensure an alarm if errors occur in RR            reading.</p> <p>TRACKER lt indicates program is unable to obtain "good"            radar samples on each required pass.</p> <p>RADARUPT: LGC interrupt.</p> <p>Asterisk (*) indicates priority display. Two-second delay            is required before LGC will accept crew response.</p> <p>Display is flashed only when alarm 00525 appears and            PRO is keyed.</p>

**LMA790-3-LM**  
**APOLLO OPERATIONS HANDBOOK**

LM 3199

CREW-MAN	PNL	PROCEDURES	REMARKS
		<p>4.8.3.1 Lunar Surface Navigation Program (P22) (cont)</p> <p>To reject:</p> <p>a. Verify acquisition is not by side lobe Key V32E - Recycle to step 8 (R21) for automatic reacquisition PRIO DISP lt - off</p> <p>b. Key V34E or V56E, perform Terminate Tracking Routine (R56) - Terminate R22 &amp; P22 PRIO DISP lt - off FL V37 N-- Key XXE</p> <p>12. *Poss FL V06 N49 - Out-of-tolerance update parameters PRIO DISP lt - on R1 AR XXX.XX mm R2 AV XXXX.X fps R3 0000X Source Code R3 X = 1 - range X = 2 - range rate To accept update: Key PRO PRIO DISP lt - off Reject options: a. Reject data from source specified by source code only: Key V32E - Return to step 11 PRIO DISP lt - off or b. Reject all data from this mark: Key V34E - Return to step 11 PRIO DISP lt - off or c. Terminate R22 &amp; P22 Key V56E PRIO DISP lt - off FL V37 N-- Key XXE</p> <p>13. RR Monitor Routine (R25) is called every 0.48 second whenever LGC is on.</p>	<p>Routine 25 monitors RR gimbal angles and commands gimbal angles to reference position if gimbal angles exceed predefined limits. Routine 25 zeroes RR CDU when RR is first put into automatic mode and monitors RR CDU for possible failure.</p>

NAV

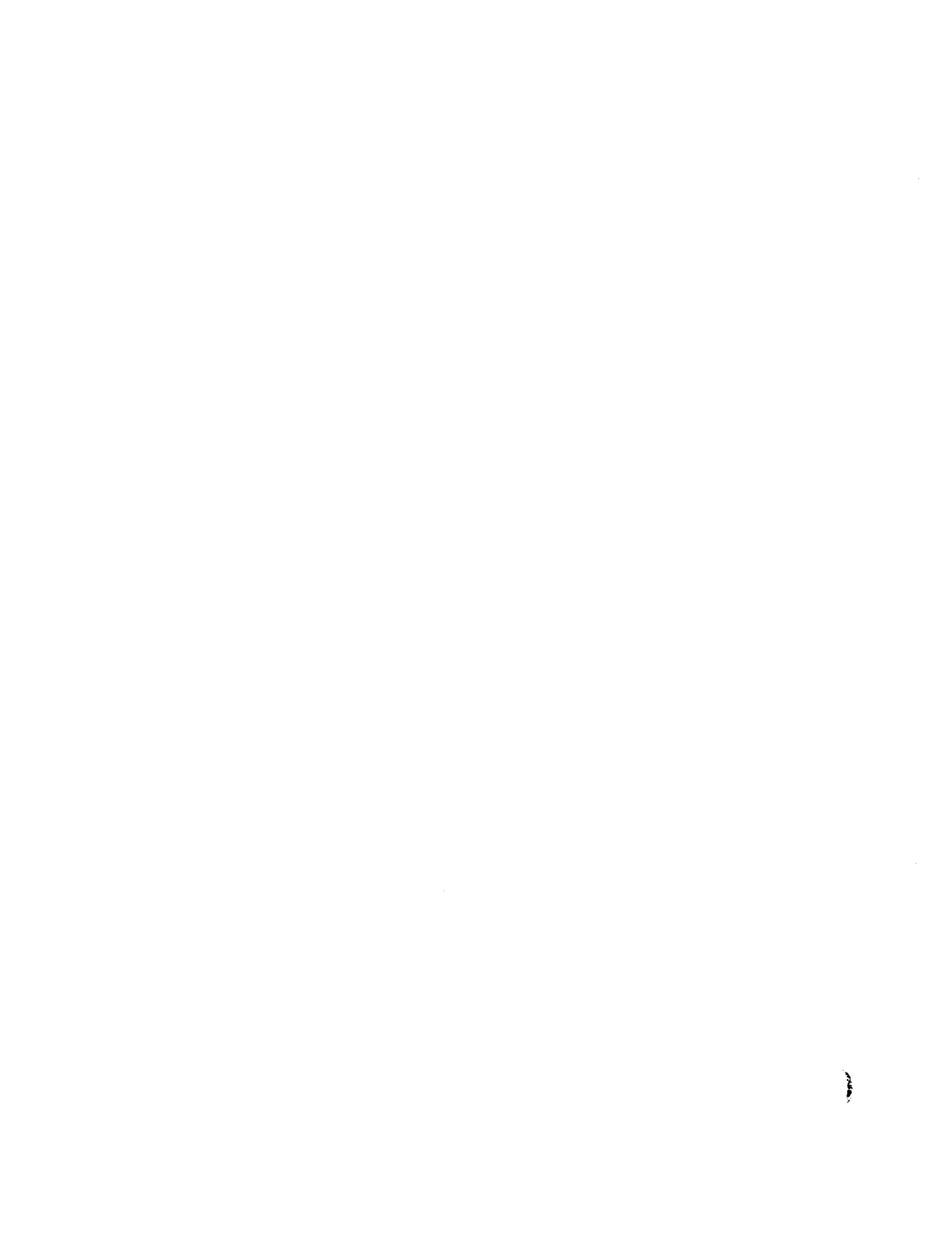

**LMA790-3-LM  
APOLLO OPERATIONS HANDBOOK**

LM 3199	CREW- MAN	PNI	<p style="text-align: center;"><b>PROCEDURES</b></p> <p>4.8.3.1 <u>Lunar Surface Navigation Program (P22) (cont)</u></p> <p>Poss PROG lt - on          RNDZ RADAR: NO TRACK lt - on          TRACKER lt - on          Key V05 N09E - Call alarm          00515 - RR CDU failure          Key KEY REL &amp; RSET</p>	<p style="text-align: center;"><b>REMARKS</b></p>
---------	--------------	-----	-----------------------------------------------------------------------------------------------------------------------------------------------------------------------------------------------------------------------------------------------------------------------------------------------------------------------------------------	---------------------------------------------------

NA

**LMA790-3-LM  
APOLLO OPERATIONS HANDBOOK**

CREW- MAN	P/NL	PROCEDURES	REMARKS
		<p>4.8.3.1 <u>Lunar Surface Navigation Program (P22) (cont)</u></p> <p>Attempt to continue P22. If initial acquisition or reacquisition is required (after failure) and if CDU performance is unsatisfactory (in this case preventing such acquisition), follow procedures for 00503 alarm in step 8 (and possibly step 10) above.</p> <p>14. To terminate P22:            Key V56E, perform Terminate Tracking Route (R56)            FL V37N--            Key XXZ</p>	

**LMA790-3-LM**  
**APOLLO OPERATIONS HANDBOOK**

PARA	TITLE	PAGE
4.9	Alignment . . . . .	4.9-2
4.9.1	PGNCS . . . . .	4.9-2
4.9.1.1	IMU Orientation Determination Program (P51) . . . . .	4.9-2
4.9.1.2	IMU Realign Program (P52) . . . . .	4.9-5
4.9.1.3	ISS Coarse Align . . . . .	4.9-14
4.9.1.4	Torque Gyros . . . . .	4.9-14A
4.9.1.5	Docked Manual IMU Coarse Alignment . . . . .	4.9-16
4.9.1.6	Crescent Alignment of PGNCS (IMU) . . . . .	4.9-16A
4.9.1.7	LM IMU Alignment to CSM Gyro Display Coupler (GDC) . . . . .	4.9-16C
4.9.2	AGS . . . . .	4.9-17
4.9.2.1	PGNCS/AGS Align . . . . .	4.9-17
4.9.2.2	Backup AGS Alignment (Using AGS Body-Axis Alignment and PGNS IMU) . . . . .	4.9-19
4.9.2.3	Backup AGS Alignment (Using AGS Body-Axis Alignment and AOT) . . . . .	4.9-20
4.9.2.4	Crescent Alignment to AGS (ASA) . . . . .	4.9-22
4.9.2.5	AGS Alignment of CSM Gyro Display Coupler or CSM Primary System . . . . .	4.9-22A
4.9.3	Lunar Surface Alignment . . . . .	4.9-22B
4.9.3.1	PGNCS Lunar Surface Align Program (P57) . . . . .	4.9-22B
4.9.3.2	AGS Lunar Align (400+40000) . . . . .	4.9-29

**LMA790-3-LM**  
**APOLLO OPERATIONS HANDBOOK**

CREW-MAN	PNL	PROCEDURES	REMARKS
		<p>4.9 <u>ALIGNMENT</u></p> <p>4.9.1 <u>PGMCS</u></p> <p>4.9.1.1 <u>IMU Orientation Determination Program (P51)</u></p>	<p>Time and RCS fuel may be saved and subsequent IMU realignment decisions simplified if IMU is left inertially stabilized as close as possible to orientation required by future LGC programs. If docked with CSM, CSM should relinquish attitude control. P51 determines inertial orientation of IMU and provides attitude control and total attitude monitoring capability.</p>
		LGC Power-Up (required)	Ref para 4.6.1.1.1.
		IMU Power-Up (LGC Operating) (required)	Ref para 4.6.1.3. ISS should be on 15 minutes before thrusting maneuver.
		DAP Data Load Routine (R03) (required)	Ref para 4.6.1.8.
		AGS Power-Up (desired)	Ref para 4.6.2.1.
		Rendezvous Radar Antenna in AOT position (desired)	Rendezvous Radar Coarse Align (para 4.6.3.3).
	11	1. Verify CB HTR: AOT - close	AOT heater should be turned on at least 25 minutes before selecting this procedure, to prevent fogging of AOT lens.
	1	2. Select total attitude display: ATTITUDE MON sw - as desired	
	11	3. CB/AC BUS A: AOT LAMP - close	CB/AC BUS B: AOT LAMP and CB/AC BUS A: AOT LAMP are redundant. If a-c bus A loading is large, CB/AC BUS B: AOT LAMP can be closed. Never close both cb's at same time.
	AOT	Adjust reticle brightness of CCRD. AOT ind - 000.0° Azimuth cont - F	
	4.	Key V37E 51E Press PROG It - on Key V05 N09E - Call alarm 00210 - IMU not on Perform IMU Power-Up. Key RSET & KEY REL FL V37 N— Key 51E	Ref para 4.6.1.3.



# LMA790-3-LM APOLLO OPERATIONS HANDBOOK

CREW- MAN	PNI	PROCEDURES	REMARKS
		<p>4.9.1.1 <u>IMU Orientation Determination Program (P51) (cont)</u></p> <p>5. FL V50 N25 - Checklist reference  R1 00015 - Star acquisition  R2 -----  R3 -----  If necessary, select desired attitude control mode.</p> <p>Maneuver to acquire desired stars.  To bypass coarse alignment: Key PRO</p> <p>To coarse-align IMU to LM axes:  Key MSTR  V41 N22 - Coarse align  R1 OGA 000.00°  R2 IGA 000.00°  R3 MEA 000.00°  MO ATT lt - on, then off,  Return to beginning of step 5.</p> <p>6. In-Flight Sighting Mark Routine (R53, steps 6 through 8):  Press PROG lt - on  Key V05 M09E - Call alarm  31207 - No VAC area for marks  31211 - Illegal interrupt of extended verb  Key MSET &amp; KEY REL  FL V01 N71  R1 00CDE - Detent/star code  R2 -----  R3 -----  Accept: Key PRO  Reject: Key V21E - Load desired codes  If detent code 7 (backup optics) is being used, go to step 7; otherwise, go to step 8.</p> <p>7. FL V06 N87  R1 Azimuth XXX.XX°  R2 Elevation XXX.XX°  R3 -----</p>	<p>V16 N20E may be keyed to monitor IMU gimbal angles.</p> <p>Ref para 4.5.1.</p> <p>Star pairs should be separated by at least 50°.</p> <p>MOT detent/LPD/COAS codes (para 4.4.12).  Star/planet list (para 4.4.8).</p> <p>Azimuth is defined as angle measured from LM +Z-axis to LOS projected on LM Y-Z plane; +, for negative rotation about LM +X-axis (yaw right).</p>

LM 3231



**LMA790-3-LM**  
**APOLLO OPERATIONS HANDBOOK**

CREW- MAN	PNI	PROCEDURES	REMARKS
		<p>4.9.1.1 IMU Orientation Determination Program (P51) (cont)</p> <p>Accept: Key PBO Reject: Key V24E - Load desired data</p> <p>8. FL V54 N71 - Please mark X or Y R1 00CDE - Detent/Star code R2 Z000X - X marks R3 Z000Y - Y marks</p> <p>Select desired attitude control mode:</p> <p>Maneuver so target crosses near center of reticle (either ADT or COAS).</p> <p>Mark X or Y, as appropriate (at least one of each required).</p> <p>To change mark reject option: Key ENTR To change Detent/Star code: Key V32E, return to step 6 To terminate: Key V34E FL V37 N-- Key XIE</p> <p>MARKRUPT ROUTINE (R57) Possible program alarms: PROG lt - OM Key V05 M09E - Call alarm 00111 - Mark missing 00112 - Mark or mark reject not being accepted 00113 - No inbits 00115 - No marks to reject Key KEY REL &amp; RSET</p> <p>To have LCC calculate LOS to star after marking sequence is complete: Key PRO If star code 00, go to step 9; otherwise, go to step 6 to mark on second star. After marking second star, go to step 10 or if second target was planet (star code 00), go to step 9.</p>	<p>Elevation is defined as angle measured from LOS to LM Y-Z plane; +, for LOS above LM Y-Z plane.</p> <p>Maximum value for X or Y is 5; additional marks overwrite fifth mark. Z=1 in R2/R3 indicates which mark is enabled for rejecting. Mark reject is enabled for only one axis at a time. Normally, Z=1 for last axis marked; however, mark reject enable may be switched back and forth between X and Y axes by keying ENTR.</p> <p>Ref para 4.5.1.1. PGCS minimum impulse mode (V76E) (NO DAP lt - on) is recommended, but AGS pulse or direct may also be used. PGCS minimum impulse is disabled by keying V77E. (NO DAP lt - off)</p> <p>To reduce possible error induced by ICDU transients, three to five pairs of marks (X &amp; Y) should be made on each star.</p> <p>To reject X or Y mark as indicated in R2/R3 of N71, REJECT pb - push</p>

LM 3207, LM 3231

**LMA790-3-LM**  
**APOLLO OPERATIONS HANDBOOK**

CREW-MAN	PNL	PROCEDURES	REMARKS
		<p>4.9.1.1 <u>IMU Orientation Determination Program (P51) (cont)</u></p> <p>9. Celestial Body Definition Routine (R58)            FL V06 N88 - Components of planet unit position vector            R1 X .XXXXXX            R2 Y .XXXXXX            R3 Z .XXXXXX            Accept: Key PRO - Go to step 6 to mark on second star or if this was second target, go to step 10.            Reject: Key V25E - Load desired components</p> <p>10. Sighting Data Display Routine (R54):            FL V06 M05            R1 XXX.XX° - Sighting angle difference            R2 -----            R3 -----            Accept: Key PRO            Reject: Key V32E - Go to step 5.</p> <p>11. FL V37 M---            Key XIB</p> <p>12. Remove power from ADT as desired:            CB/AC BUS A: ADT LAMP - open            CB/AC BUS B: ADT LAMP - open</p> <p>4.9.1.2 <u>IMU Realign Program (P52)</u></p> <p>LGC Power-Up (required)            IMU Power-Up (LGC Operating) (required)            IMU Orientation Determination Program (P51) (required)            DAP Data Load Routine (R03) (required)</p>	<p>Components defined at GET in reference coordinates. Components may be computed manually onboard or received from MSPN.</p> <p>M05 is defined as difference between indicated angle (from marks) and actual angle (stored ephemeris data). LGC responds to PRO by calculating REFSMAT and setting REFSMPLG.</p> <p>Select desired program.</p> <p>If docked with CSM, CSM should relinquish attitude control. Purpose of IMU Realign Program (P52) is to align IMU from known orientation to one of four orientations selected by crew:</p> <ol style="list-style-type: none"> <li>1. Preferred</li> <li>2. Nominal</li> <li>3. REFSMAT</li> <li>4. Landing site</li> </ol> <p>Ref para 4.6.1.1.            Ref para 4.6.1.3. ISS should be on 15 minutes before thrusting maneuver.            Ref para 4.9.1.1.            Ref para 4.6.1.8.</p>

LM 3231



**LMA790-3-LM**  
**APOLLO OPERATIONS HANDBOOK**

LM 3231

CREW-MAN	PNL	PROCEDURES	REMARKS
		<p>4.9.1.2 <u>IMU Realign Program (P52) (cont)</u></p> <p>AGS Power-Up (desired) Rendezvous radar antenna in AOT position (desired)</p> <p>1. Verify CB HTR: AOT - close</p> <p>2. Enable PCNS attitude control GUID CONT sw - PCNS S/C: PCNS sw - ATT HOLD ROLL, PITCH, YAW sw - MODE CONT ACA/4 JET sw (2) - ENABLE ACA PROP sw (2) - ENABLE</p> <p>3. Select total attitude display: ATTITUDE MON sw - as desired</p> <p>4. CB/AC BUS A: AOT LAMP - close</p> <p>Adjust reticle brightness on CCRD. AOT ind - 000.0° Azimuth cont - F</p> <p>5. Key V37E 52E Pos PROG It - on Key V05 N09E - Call alarm 00210 - IMU not on 00220 - IMU orientation not known</p> <p>Key KEY REL &amp; RSET FL V37 N-- Key XXE</p> <p>6. FL V04 N06 - Option R1 00001 - Specify IMU orientation R2 00003 - REFSMAT option R3 ----- Accept: Key PRO Reject: Key V22E - Load desired option:</p>	<p>Ref para 4.6.2.1. Rendezvous Radar Coarse Align (para 4.6.3.3). AOT heaters should be turned on 25 to 30 minutes before selecting this procedure, to prevent fogging of AOT lens.</p> <p>Ref para 4.5.1.</p> <p>Allows monitoring of IMU coarse alignment or LM attitude on FDAI's.</p> <p>CB/AC BUS B: AOT LAMP and CB/AC BUS A: AOT LAMP are redundant. If a-c bus A loading is large, CB/AC BUS B: AOT LAMP can be closed. Never close both cb's at same time.</p> <p>Select P51 after IMU Power-Up (LGC Operating) (para 4.6.1.3). Reselect P52 after performing IMU Orientation Determination Program (P51).</p> <p>Select desired program.</p> <p>If preferred attitude has been computed, R2 will read 00001.</p>

**LMA790-3-LM**  
**APOLLO OPERATIONS HANDBOOK**

LM 3231

CREW-MAN	PNI	PROCEDURES	REMARKS
		<p>4.9.1.2 IMU Realign Program (P52) (cont)</p> <p>1 - Preferred 2 - Nominal 3 - REFSMAT 4 - Landing site</p> <p>If preferred selected, go to step 9. If REFSMAT selected, go to step 11.</p> <p>7. FL V06 N34 - T (Event) R1 00XX hr R2 00XX min R3 0XX.XX sec</p>	<p>If nominal orientation (00002) was selected in step 6, Time (GET) at which LM state vector is to be defined for nominal orientation. T (Event) will initially be displayed as 00000, 00000, 00000, indicating, if accepted, that present time (GET) will be entered as T (Event).</p>

ALIGN



# LMA790-3-LM APOLLO OPERATIONS HANDBOOK

CREW- MAN	PNI	PROCEDURES	REMARKS
		<p>LM 979A, LM 3231</p> <p>4.9.1.1.2 <u>IMU Realign Program (P52) (cont.)</u></p> <p>Accept: Key PRO            Reject: Key V25E - Load desired time            If nominal selected, go to step 9.</p> <p>8. FL V06 N89            R1 Latitude XX.XXX°            R2 Longitude/2 XX.XXX°            R3 Altitude XXX.XX nm            Accept: Key PRO            Reject: Key V25E - Load desired coordinates</p> <p>9. FL V06 N22 - ICDU gimbal angles            R1 OGA XXX.XX°            R2 IGA XXX.XX°            R3 MGA XXX.XX°            Check MGA &lt;60°            Accept: Key PRO - IMU coarse align            Reject:            Select desired attitude control mode.            Maneuver LM to suitable attitude.            Key V32E            or            Key V34E - Terminate P52            FL V37 N--</p> <p>FL V50 N25 - Perform coarse align &amp; optical sighting.            R1 00013            R2 ----            R3 ----</p> <p>Accept: Key PRO - Go to step 10            Reject: Key ENTR</p> <p>V16 N20            R1 OGA XXX.XX°            R2 IGA XXX.XX°            R3 MGA XXX.XX°</p> <p>Monitor gimbal angles during pulse torquing, to avoid gimbal lock until realignment is completed.</p> <p>Go to step 36.</p>	<p>If landing site orientation (00004) was selected in step 6, T (Event) is defined as T (Land).</p> <p>Gimbal angles for present LM attitude and selected IMU orientation.</p> <p>If MGA &gt;60°, PROG lit - on; alarm code 00401 stored.</p> <p>Ref para 4.5.1.</p> <p>V32E recycles to update gimbal-angle display.</p> <p>Select desired program.</p> <p>Time (in seconds) to pulse torque for reject option: sum of gimbal angle changes times 2.</p> <p>Error (in degrees) introduced by reject option: sum of gimbal angle changes times 0.002.</p> <p>LM reorientation during pulse torquing is permissible.            If S/C: PGNS sw - AUTO, or ATT HOLD and V77 in effect, DAP will maneuver LM to follow IMU as it moves.</p> <p>Crew should maneuver to avoid gimbal lock during pulse torquing, if gimbal lock appears likely.</p>



**LMA790-3-LM**  
**APOLLO OPERATIONS HANDBOOK**

LM 3166A, LM 979A

CREW-MAN	PNL	PROCEDURES	REMARKS
		<p>4.9.1.2 IMU Realign Program (P52) (cont)</p> <p>10. Coarse Align Routine (R50)</p> <p>Verify completion of coarse alignment: Monitor FDAI ball motion. NO ATT lt - on, then off</p> <p>Press PROG lt - on Key V05 M09E - Call alarm 00211 - Coarse align error 00217 - Bad return from stall routines Key KEY REL &amp; RSET</p> <p>11. In-Flight Fine Align Routine (R51), steps 11 through 36 FL V50 N25 R1 00015 Select star acquisition mode R2 ----- R3 ----- Select desired attitude control mode. Maneuver LM to acquire stars: a. Key V34E to terminate P52, FL V37 N--, Key XXE b. Key V32E to select cursor/spiral marking &amp; bypass star-selection routine. Go to step 20. c. Key ENTR to bypass star selection routine or d. Key PRO</p> <p>Press FL V05 M09 - Alarm 00405 - Two stars not available in cone of view</p> <p>PROG lt - on a. Key V32E &amp; RSET - Recycle to beginning of step 11 or b. Maneuver LM to acquire two stars in cone of view. Key PRO &amp; RSET</p> <p>12. Automatic Optics Positioning Routine (R52) FL V01 N70 - Detent/star codes R1 000CDE R2 ----- R3 -----</p>	<p>If all gibal angle changes are &lt;1°, R50 is not performed. Once coarse alignment is complete, LGC will reset preferred orientation flag.</p> <p>If, at end of Coarse Align routine, gimbals are not within 2° of desired values, PROG lt will go on.</p> <p>Star pairs should be separated by at least 50°.</p> <p>Ref para 4.5.1.</p> <p>Star selection routine considers only those stars within AOT forward detent field of view.</p> <p>Star pairs should be separated by at least 50°. AOT detent/LPD/COAS codes (para 4.4.12) Star/planet list (para 4.4.8)</p>



# LMA790-3-LM APOLLO OPERATIONS HANDBOOK

LM 3148A

CREW-MAN	PNI	PROCEDURES	REMARKS
		<p>4.9.1.1.2 <u>IMU Realign Program (P52) (cont)</u></p> <p>C = Detent code DE = Star/planet code</p> <p>If AOT detent &amp; star code display are correct &amp;</p> <p>a. If not LPD/COAS calibration or</p> <p>b. If unsatisfactory LPD/COAS calibration: Key PRO</p> <p>If display unsatisfactory: Key V21E - Load desired values</p> <p>If this was satisfactory LPD/COAS calibration: Key V34E - Terminate R52 FL V37 N--- Key XXE</p> <p>If detent code is 0 (LPD/COAS calibration) or 7 (backup optics), go to step 13; if star code 00, go to step 14; otherwise, go to step 15.</p> <p>13. FL V06 N87 R1 Azimuth XXX.XX° R2 Elevation XXX.XX° R3 ----- Accept: Key PRO Reject: Key V24E - Load desired data</p> <p>If star code is 00, go to step 14, otherwise go to step 15.</p> <p>14. FL V06 N88 - Components of planet unit position vector R1 X .XXXX R2 Y .XXXX R3 Z .XXXX Accept: Key PRO Reject: Key V25E - Load desired components</p>	<p>All detent and LPD/COAS codes may be used in conjunction with automatic optics (LM) positioning.</p> <p>Attitude required to position specified optics LOS, along LOS to celestial body, will be computed during R60.</p> <p>Azimuth and elevation, with respect to LM, of specified LOS. Azimuth is defined as angle measured from LM +Z-axis to LOS projected to LM Y-Z plane. Polarity is + for negative rotation about LM +X-axis (yaw right). Elevation is defined as angle measured from LOS to LM Y-Z plane. Polarity is + for LOS above LM Y-Z plane.</p> <p>If LPD recalibration is required: Key V21 N03E, 3373E, AZBIAS, E V21 N03E, 1353E, ELBIAS, E</p> <p>Components of planet unit position vector defined at GET in reference coordinates. Components may be computed manually onboard or received from MSFN.</p>

ALL

**LMA790-3-LM**  
**APOLLO OPERATIONS HANDBOOK**

LM 3158

CREW-MAN	P/NL	PROCEDURES	REMARKS
		<p>4.9.1.2 <u>IMU Realign Program (P52) (cont)</u></p> <p>15. Attitude Maneuver Routine (R60)</p> <p>FL V50 N18 - Perform desired automatic maneuver to final FDAI angles  R1 Roll   XXX.XX°  R2 Pitch  XXX.XX°  R3 Yaw    XXX.XX°</p> <p>To reject attitude maneuver:  If within DAP deadband limits, &amp; further adjustment about desired vector is not desired,  Key ENTR, go to step 17, exit R60/R52</p> <p>If AOT detent position code was 0 (LPD/COAS calibration), exit R60 only &amp; go to step 12.</p> <p>To perform attitude maneuver:  a. To adjust vehicle attitude &amp; have LGC recompute gimbal angles:  Select desired attitude control mode -  ACA - maneuver as desired  S/C: PCNS sw - ATT HOLD  Key PRO  Return to beginning of step 15.</p> <p>b. To perform attitude maneuver manually:  Select desired attitude control mode -  ACA - maneuver to required attitude  Key PRO  Return to beginning of step 15.</p> <p>c. To perform attitude maneuver automatically:  GUID CONT sw - PCNS  S/C: PCNS sw - AUTO  Key PRO  Go to step 16.</p>	<p>Automatic attitude maneuvers are more efficient (i.e., propellant-time product is lower) than manual attitude maneuvers.  If final computed FDAI angles result in +90° yaw, transmission from IMU to FDAI angles in roll and pitch is indeterminate and R1 and R2 will be zero.</p> <p>Adjustment is not possible in all cases, including roll attitude adjustment.  Ref para 4.5.1.</p> <p>If GUID CONT sw - PCNS and S/C: PCNS sw - AUTO, LGC commands automatic attitude maneuver.  Ref para 4.5.1.</p> <p>Automatic trim maneuver is to be considered essential for maneuvering to thrusting attitudes.</p>

**LMA790-3-LM**  
**APOLLO OPERATIONS HANDBOOK**

CREW-MAN	PNI	PROCEDURES	REMARKS
		<p>4.9.1.2 <u>IMU Realign Program (P52)</u> (cont)</p> <p>16. If PCNCS automatic attitude maneuver selected: DSKY displays are blanked until completion of automatic maneuver. Monitor FDAI belly band, with respect to color band on roll bezel, to avoid gimbal lock.</p>	<p>If desired, Key extended verbs  or  Key V16 N18 - Final FDAI angles  R1 Roll XXX.XX°  R2 Pitch XXX.XX°  R3 Yaw XXX.XX°  Key KEY REL</p> <p>Belly band covers separation between hemispheres of FDAI ball. Belly band, in color bands on each side of FDAI roll bezel, would indicate IMU middle gimbal angle <math>&gt; 75^\circ</math>.</p>

LM 3158

ALIC



**LMA790-3-LM**  
**APOLLO OPERATIONS HANDBOOK**

LM 315b, LM 979A, LM 3231

CREW: MAN	PNI	PROCEDURES	REMARKS
	ACA	<p>4.9.1.2 <u>IMU Realign Program (P52) (cont)</u></p> <p>Monitor return of preceding display, indicating automatic maneuver is complete. To stop LM motion if gimbal lock is approached: S/C: PGNS sw - ATT HOLD Select desired attitude control mode - ACA - maneuver to required attitude</p> <p>Return to step 15.</p> <p>17. In-Flight Sighting Mark Routine (R53) Poss PROG It - on Key V05 N09E - Call alarm 31207 - No VAC area for marks 31211 - Illegal interrupt of extended verb Key KEY REL &amp; RSET</p> <p>FL V01 N71 - Detent/star codes R1 00CDE R2 ----- R3 ----- Accept: Key PRO Reject: Key V21E - Load desired codes</p> <p>If detent code 7 (backup optics) is being used, go to step 18; otherwise, go to step 19.</p> <p>18. FL V06 N87 R1 Azimuth XXX.XX° R2 Elevation XXX.XX° R3 ----- Accept: Key PRO Reject: Key V24E - Load desired data</p>	<p>During this maneuver, LGC will terminate automatic maneuver if S/C: PGNS sw is switched out of AUTO.</p> <p>Ref para 4.5.1.</p> <p>Star pairs should be separated by at least 50°.</p> <p>AOT detent/LPD/COAS codes (para 4.4.12). Star/planet list (para 4.4.8).</p> <p>Azimuth and elevation, with respect to LM, of specified LOS. Azimuth is defined as angle measured from LM +Z-axis to LOS projected to LM Y-Z plane. Polarity is + for negative rotation about LM +X-axis (yaw right). Elevation is defined as angle measured from LOS to LM Y-Z plane. Polarity is + for LOS above LM Y-Z plane.</p>

ALIGN

LM 979A, LM 3166A, LM 3207, LM 3231

CREW-MAN	PNI	PROCEDURES	REMARKS
		<p>4.9.1.2 IMU Realign Program (P52) (cont)</p> <p>19. FL V54 N71 - Please mark X or Y                      R1 00DSS - Detent/Star codes                      R2 2000X - X marks                      R3 2000Y - Y marks</p> <p>Select desired attitude control mode.</p> <p>Maneuver for target crossing near center of reticle (AOT or COAS). Mark X or Y, as appropriate (at least one of each required).</p> <p>To change mark reject option:                      Key ENTER                      To change Detent/Star code:                      Key V32E, return to step 17                      To terminate:                      Key V34E                      FL V37 N--                      Key XII</p> <p>MARKRUPT Routine (R57)                      Pose PROG lt - on                      To display alarm code:                      Key V05 W09E - Call alarm                      00111 - Mark missing                      00112 - Mark or mark reject not being accepted                      00113 - No inbits                      00115 - No marks to reject                      Key KEY REL &amp; RSET</p> <p>To have LGC calculate LOS to star after marking sequence is complete:                      Key PR0                      If star code 00, go to step 33; otherwise, go to step 12 if this was first star or go to step 34 if this was second star.</p>	<p>Maximum value for X or Y is 5; additional marks overwrite fifth mark. Z=1 in R2/R3 indicates which mark is enabled for rejecting. Mark reject is enabled for only one axis at a time. Normally, Z=1 for last axis marked; however, mark reject enable may be switched back and forth between X and Y axes by keying ENTER.</p> <p>Ref para 4.5.1.1. PGNCS minimum impulse mode (V76E) (NO DAP lt - on) is recommended, but AGS pulse or direct may also be used. PGNCS minimum impulse is disabled by keying V77E. (NO DAP lt - off) To reduce possible error induced by ICDU transients, three to five pairs of marks (X and Y) should be made on each star.</p> <p>To reject X or Y mark as indicated in R2/R3 of N71, REJECT pb - push</p>

**LMA790-3-LM**  
**APOLLO OPERATIONS HANDBOOK**

CREW- MAN	PNL	PROCEDURES	REMARKS
		<p>LM 979A, LM 3166A, LM 3207, LM 3231</p> <p>4.9.1.2 IMU Realign Program (P52) (cont)</p> <p>20. Lunar Surface Sighting Mark Routine (R59)            FL V01 N70 - AOT detent/star code            R1 00DSS            R2 -----            R3 -----            C - AOT detent code            DE - Star/planet code            Accept: Key PR0            Reject: Key V21E - Load desired codes</p> <p>21. Celestial Body Definition Routine (R58)            If star/planet code is 00 (planet) (can be used for non-LGC cataloged stars)            FL V06 N88 - Celestial body unit position vector components at GET            R1 .XXXXX            R2 .XXXXX            R3 .XXXXX            Accept: Key PR0            Reject: Key V25E - Load correct position vector components</p> <p>22. Poss FL V05 N09 - Alarm            00404 - Star LOS not within 30° of optical axis for any AOT detent position            Accept without acquisition data: Key PR0 - Go to step 16            Reject: Key V32E - Recycle to step 12</p> <p>23. FL V06 N79            R1 Cursor angle XX.XX°            R2 Spiral angle XX.XX°            R3 AOT position 0000X            X = 1, 2, 3 - Forward positions              = 4, 5, 6 - Rear positions            Accept: Key PR0            Reject: Key V32E - Recycle to step 12</p>	<p>Ref para 4.4.12.            Ref para 4.4.8.</p>



**LMA790-3-LM**  
**APOLLO OPERATIONS HANDBOOK**

LM 979A, LM 3166A, LM 3207, LM 3231

CREW- MAN	PNI	PROCEDURES	REMARKS
		<p>4.9.1.2 <u>IMU Realign Program (P52) (cont)</u></p> <p>24. Sighting Mark Routine (R53)            Poss PNOG It - on            Key V05 M09E - Call alarm            31207 - NO VAC area for marks            31211 - Illegal interrupt of extended verb            Key KEY REL &amp; RSET            FL V01 N71</p> <p>R1 OODSS - AOT detent/star code            R2 -----            R3 -----</p> <p>C - AOT detent code            DE - Star/planet code            Accept: Key PNO            Reject: Key V21E - Load desired codes</p> <p>25. Celestial Body Definition Routine (R58)            If star/planet code is 00 (planet) and Cursor/Spiral            option in step 11 (V32E) was selected: (can be used            for non-LGC cataloged stars)            FL V06 N08 - Celestial body unit position vector            components at CRT</p> <p>R1 .XXXX            R2 .XXXX            R3 .XXXX</p> <p>Accept: Key PNO            Reject: Key V25E - Load correct position vector com-            ponents</p> <p>26. FL V52 N71 - Please mark cursor            R1 AOT detent/star code OODSS            R2 Cursor marks Z000C            R3 Spiral marks Z000S</p>	<p>Ref para 4.4.12.            Ref para 4.4.8.</p> <p>Maximum value of C or S is 5; additional marks overwrite            fifth mark. Z=1 or 0; one, and only one, of the Z's            equals 1 at any one time. Z=1 indicates which type of            reticle mark or mark reject is enabled. Enable can be            switched back and forth by keying ENTER.</p>



**LMA790-3-LM  
APOLLO OPERATIONS HANDBOOK**

CREW-MAN	PNI	PROCEDURES	REMARKS
LM 979A	LM 3166A, LM 3207, LM 3231	<p>4.9.1.2 IMU Realign Program (P52) (cont)</p> <p>Reticule cont - center target in cursor To reset detent/star code: Key V32E - return to step 24 To switch mark reject enable &amp; request spiral marks: Key ENTR - go to step 29 To indicate marks complete: Key PRO - go to step 32 To mark: Key MARK X or MARK Y Pos PROC lt - on To display alarm code: Key V05 N09E - Call alarm 00111 - Mark missing 00112 - Mark or mark reject not being accepted 00113 - No inbits (in channel 17)</p> <p>27. FL V21 N79 - Load cursor angle R1 Cursor ----- R2 ----- R3 ----- Key XXX.XX°E - cursor angle</p> <p>28. FL V06 N79 - Verify cursor angle R1 Cursor XXX.XX° R2 ----- R3 ----- To reload: Key V21E XXX.XX°E To continue: Key PRO - return to step 26</p> <p>29. FL V53 N71 - Please mark spiral R1 AOT detent/star code 00DSS R2 Cursor marks 2000C R3 Spiral marks 2000S</p>	<p>To reject cursor marks, key REJECT. Cursor marks may be rejected as long as any remain. DES RATE sw may be used as a backup mark device in event of a MARK X or MARK Y failure.</p> <p>To load same CURSOR angle previously loaded KEY V33E or V, PRO</p> <p>Maximum value of C or S is 5; additional marks overwrite fifth mark. Z=1 or 0; one, and only one, of the Z's equals 1 at any one time. Z=1 indicates which type of reticule mark or mark reject is enabled. Enable can be switched back and forth by keying ENTR.</p>



**LMA790-3-LM**  
**APOLLO OPERATIONS HANDBOOK**

LM 979A, LM 3166A, LM 3207, LM 3231

CREW- MAN	PNI	PROCEDURES	REMARKS
	AOT	<p>4.9.1.2 <u>IMU Realign Program (P52) (cont)</u></p> <p>Reticle cont - center target in spiral To reselect detent/star code: Key V32E - return to step 24 To switch mark reject enable &amp; request cursor marks: Key ENTR - return to step 26 To indicate marks complete: Key PRO - go to step 32 To mark: Key MARK X or MARK Y Press PROG lt - on To display alarm code: Key V05 W09E - Call alarm 00111 - Mark missing 00112 - Mark or mark reject not being accepted 00113 - No inbits (in channel 1)</p> <p>30. FL V22 W79 - Load spiral angle R1 _____ R2 Spiral _____ R3 _____ Key XXX.XX°E - spiral angle</p> <p>31. FL V06 W79 - Verify spiral angle R1 _____ R2 Spiral XXX.XX° R3 _____ To reload: Key V22E XXX.XX°E To continue: Key PRO - return to step 29</p> <p>32. Press FL V50 W25 R1 00016 R2 0000X Number of mark data sets rejected during computation (if any) To take more marks: Key ENTR - return to step 24 To continue: Key PRO</p> <p>33. FL V06 W88 - Components of planet unit position vector If star code 00, go to step 33; otherwise go to step 24, if this was first star, or go to step 34, if this was second star.</p>	<p>To reject spiral marks, key REJECT. Spiral marks may be rejected as long as any remain.</p> <p>DES RATE sw may be used as a backup mark device in event of a MARK X or MARK Y failure.</p> <p>To load same SPIRAL angle as previously loaded KEY V33E, or V, PRO</p> <p>Data would be rejected if: a. Star is within 2° of AOT optical axis. b. Star is beyond 28.5° from AOT optical axis. c. More than 28 iterations are required to converge to a solution. d. Sign of iteration step changes more than once.</p> <p>Components of planet unit position vector defined at GET in reference coordinates. Components may be computed manually onboard or received from MSFN.</p>

**LMA790-3-LM**  
**APOLLO OPERATIONS HANDBOOK**

CREW- MAN	PNL	PROCEDURES	REMARKS
		<p>LM 979A, LM 3166A, LM 3231</p> <p>4.9.1.2 IMU Realign Program (P52) (cont.)</p> <p>R1 X .XXXX R2 Y .XXXX R3 Z .XXXX Accept: Key PRO Go to step 12 or step 24 if cursor/spiral if this was first star or Go to step 34 if this was second star Reject: Key V25E - Load desired components</p> <p>34. Sighting Data Display Routine (R54) FL V06 N05 R1 Sighting angle difference XXX.XX* R2 ----- R3 ----- Accept: Key PRO Reject: Key V32E - Go to step 36</p> <p>35. Gyro Torquing Routine (R55) FL V06 N93 - Gyro torquing angles R1 X XX.XXX* R2 Y XX.XXX* R3 Z XX.XXX* Accept: Key V76E, PRO Reject: Key V32E - Go to step 36</p> <p>36. FL V50 N25 - Checklist reference R1 00014 - Perform fine align R2 ----- R3 ----- Accept: Key PRO - Go to step 11 Reject: Key ENTR</p> <p>37. FL V37 N-- Key XXE, V77E</p> <p>38. Remove power from AOT as desired: CB/AC BUS A: AOT LAMP - open CB/AC BUS B: AOT LAMP - open</p>	<p>N05 is defined as difference between indicated angle (from marks) and actual angle (stored ephemeris data).</p> <p>If GUID CONT sw - PGNS and if either S/C: PGNS sw - AUTO or if V77 (rate command) is in effect and S/C: PGNS sw - ATT HOLD, DAP will maneuver LM to follow IMU as it moves.</p> <p>PRO allows gyro torquing to be performed before step 36.</p> <p>Select desired program.</p>
	11		



**LMA790-3-LM**  
**APOLLO OPERATIONS HANDBOOK**

LM 3207

CREW- MAN	FNL	PROCEDURES	REMARKS
		<p>4.9.1.3 <u>ISS Coarse Align</u></p> <p>1. Key V41 N20E Poss OPR ERR lt - on (if any other extended verb is active or if gyro torquing or mode switching is in process) Exit V41 N20, Key ESET</p> <p>2. FL V21 N22 - Load CDU angles R1 OG XXX.XI° R2 IG XXX.XI° R3 MG XXX.XI° To continue: Load desired CDU angles To terminate: Key V34E</p> <p>3. V41 - Coarse-align CDU's Exit if ISS turn-on or caging is in process (with or without NO ATT lt - on). NO ATT lt - on NO DAP lt - on Exit, if PROG lt - off</p> <p>Poss PROG lt - on Key V05 N09E - Call alara 00211 - Coarse align error (not within 2° of desired angles) If ISS malfunction is not indicated, compare actual with desired gimbal angles: Key V16 N22E - Desired ICDU angles R1 OG XXX.XI° R2 IG XXX.XI° R3 MG XXX.XI°</p> <p>Key N20E - ICDU angles R1 OG XXX.XI° R2 IG XXX.XI° R3 MG XXX.XI° Reset coarse align: Key KEY REL &amp; RSET</p>	<p>Purpose of ISS Coarse Align procedure is to align IMU to gimbal angles specified by astronaut.</p> <p>All registers initially blank; therefore, V33E option in response to display should not be used because it will cause coarse align to angles that are probably not known to astronaut.</p> <p>NO ATT lt remains on after gimbals have been driven to specified angles. Light may be extinguished and coarse-align mode terminated by V40 N20E (Zero CDU's, para 4.6.1.21) or V42E (Torque Gyros, para 4.9.1.4).</p>

**LMA790-3-LM**  
**APOLLO OPERATIONS HANDBOOK**

CREW-MAN	PNL	PROCEDURES	REMARKS
		<p>4.9.1.1.4 <u>Torque Gyros</u></p> <p>LGC Power-Up (required)</p> <p>IMU Power-Up (LGC Operating) (required)</p> <p>1. To load <math>\Delta</math> gyro angles <math>&gt; +99.999^\circ</math>, load three double precision LGC registers:</p> <p>Key V21 N01E 02737E  XXXXXXXX  N15E  XXXXX, E  YYYYY, E  YYYYY, E  ZZZZZ, E  ZZZZZ</p> <p>Otherwise: Go to step 2.</p> <p>2. Key V42E  Poss OPR ERR lt - on  Exit V42, Key ESET</p> <p>3. FL V21 N93 - <math>\Delta</math> gyro angles  R1 X XX.XXX  R2 Y XX.XXX  R3 Z XX.XXX  If step 1 not performed: Load desired <math>\Delta</math> gyro angles  If step 1 performed: Key V33E only if gyro torquing registers loaded before keying V42E.</p> <p>4. V42 - Fine align</p> <p>5. NO ATT lt - off (if on previously)</p>	<p>Purpose of Torque Gyros procedure is to fine-align stable member by torquing Gyros. Care should be taken to avoid middle gimbal angles <math>&gt;70^\circ</math> (no programmed test for middle gimbal angles before torquing).</p> <p>Ref para 4.6.1.1.1.</p> <p>Ref para 4.6.1.3. ISS should be on 15 minutes before thrusting maneuver.</p> <p>Loading angles <math>&gt;90^\circ</math> is intended for ground use only. Bit 14 of high-order word represents <math>180^\circ</math>; bit 13, <math>90^\circ</math> etc.</p> <p>Maximum negative gyro torquing angle is 37777, 37743; maximum positive gyro torquing angle is 40000, 40034. Any angle <math>&gt;</math> maximum will produce commanded torquing angle of zero.</p> <p>Middle gimbal angle should be <math>&lt;70^\circ</math>.</p> <p>OPR ERR lt - on if another extended verb from R76 is active or if mode switching or gyro torquing is in process.</p> <p>All registers initially blank.  If GUID CONT sv - FCNS and if either S/C: FCNS sv - AUTO or if V77 (rate command) is in effect and S/C: FCNS sv - ATT HOLD, DAP will maneuver LM to follow IMU as it moves.  Middle gimbal angle should be <math>&lt;70^\circ</math>.</p>

LM 3231





**LMA790-3-LM**  
**APOLLO OPERATIONS HANDBOOK**

CREW- MAN	PNI	PROCEDURES	REMARKS
		<p>4.9.1.1.4 <u>Torque Gyros (cont)</u></p> <p>6. Key V16 N93E Monitor Δ gyro angles countdown to zero during torquing. Key KEY REL or Perform step 7</p> <p>7. Alternative monitor procedure: Key V16 N20E - Monitor gimbal angles during torquing R1 OG XXX.XX° R2 IG XXX.XX° R3 MG XXX.XX° Key KEY REL</p>	<p>As each axis is torqued (in Y, Z, X sequence), data displayed in N93 for that axis is divided by 64 and counted down.</p>

ALIGN

**LMA790-3-LM**  
**APOLLO OPERATIONS HANDBOOK**

LH 3231

CREW MAN	FVA	PROCEDURES	REMARKS
		<p>4.9.1.5 Docked Manual IMU Coarse Alignment</p> <p>LGC Power-Up (required)</p> <p>IMU Power-Up (LGC Operating) (required)</p> <ol style="list-style-type: none"> <li>1. Request CSM select narrow deadband attitude hold in attitude convenient for manual transfer coarse alignment.</li> <li>2. Request docking interface roll calibration angle (<math>\Delta \theta</math>).</li> <li>3. Request &amp; record present CSM ICDU angles.</li> <li>4. Calculate &amp; record LM ICDU angles:  <math display="block">\begin{array}{l} \text{LM} \\ \text{CSM} \\ \text{(Y) OC} = + \Delta \theta - 60^\circ \\ \text{(P) IG} = - \text{IG} + 180^\circ \\ \text{(R) MC} = - \text{MC} \end{array}</math> </li> <li>5. Key V41 W20E - Coarse-align ICDU                      Press OPR ERR lt - on                      Exit V41 W20, key RSET                      FL V71 W22                      R1 OG XXX.XX°                      R2 IG XXX.XX°                      R3 MC XXX.XX°                      Load desired CDU angles.                      V41 - Coarse-align (CDU's)                 </li> <li>6. NO ATT lt - on                       Press PROG lt - on                      Key V05 W09E - Call alarm                      O0211 - Gimbals did not drive to desired angles                      Key KEY MEL &amp; RSET                      Reselect coarse align, step 5                 </li> <li>7. Key V16 W20E - Monitor ICDU coarse alignment                      R1 OG XXX.XX°                      R2 IG XXX.XX°                      R3 MC XXX.XX°                 </li> </ol>	<p>Ref para 4.6.1.1.</p> <p>Ref para 4.6.1.3. ISS should be on 15 minutes before thrusting maneuver.</p> <p>OPR ERR lt - on if another extended verb from R76 is active or if mode switching or gyro torquing is in process.</p>



**LMA790-3-LM  
APOLLO OPERATIONS HANDBOOK**

CREW-MAN	PNL	PROCEDURES	REMARKS
		<p>4.9.1.5 <u>Docked Manual IMU Coarse Alignment (cont)</u></p> <p>Record final LM ICDO angles Key KEY REL</p> <p>8. Perform ICDO Zero procedure</p> <p>9. Request &amp; record 18 reference stable member matrix (REFSMAT) values from GSN.</p> <p>10. Key V21 N01E 1731E</p> <p>Key first component XXXXE Key N15E, second component XXXXE, E Key third component XXXXE, E Key fourth through 18th component -----E, E</p> <p>11. Procedure for setting REFSMFLG: Key V25 N07E R1 77E R2 10000E R3 1E</p> <p>4.9.1.6 <u>Crescent Alignment of PGNCSS (IMU)</u></p> <p>Appropriate CB activation (required)</p> <p>LGC Power-Up (required for steps 5 thru 10)</p> <p>IMU Power-Up (LGC Operating) (required if LGC Powered up)</p> <p>1. Establish PGNCSS total attitude display: ATTITUDE MON sw - PGNS ORDEAL: FDAI 1 sw - INKRL FDAI 2 sw - INKRL</p>	<p>Ref para 4.6.1.21.</p> <p>Use LGC Update Program (P27) as alternative method of loading REFSMAT. Index value, 24 (octal); ECADR is 1731.</p> <p>Setting REFSMFLG indicates to LGC that REFSMAT is valid. REFSMAT defines IMU orientation in inertial space.</p> <p>Purpose of this procedure is to align PGNCSS (IMU) in contingency situation, using either AOT, LPD, or COAS, to earth's crescent.</p> <p>Assumptions: (1) LGC and IMU are capable of operation and (2) vehicle configuration may be LM/CSM or LM/CM.</p> <p>Ref para TBD.</p> <p>Ref para 4.6.1.1.</p> <p>Ref para 4.6.1.3.</p> <p>Ref para 4.5.3.1.</p>

LM 3231

ALIGN

LMA790-3-LM  
**APOLLO OPERATIONS HANDBOOK**

LM 3231

CREW /MAN	PROCEDURES	REMARKS
<p>11 8 AOT 11</p>	<p>4.9.1.6 <u>Crescent Alignment of FGCS (IMU) (cont)</u></p> <p>2. Select desired optical system:            a. COAS - install in CDR's window            CB FLT DISP: COAS - close            COAS sw - FWD            b. Azimuth cont - F            CB HTR: AOT - close            CB/AC BUS B: AOT LAMP - close            c. LPD reference axis</p> <p>3. Maneuver to acquire earth in optical systems field of view.</p> <p>4. Maneuver to align reference line along &amp; intersecting points of crescent. If LCC is not available (i.e., turned off or failed), go to step 11.</p> <p>5. Key V41 N20E - Coarse-align ICPU            FL V21 N22            Key required data</p>	<p>Either LM or CSM may maneuver if docked. This procedure requires no restriction on means of maneuvering.</p> <p>MSFN will update desired +X-axis direction to be either toward, or away from, sun. See diagrams below, which imply use of AOT and COAS.</p> <div data-bbox="714 210 1055 882" style="text-align: center;"> </div> <p>Data may be:            a. COAS: CDR window - 0°, 0°, 0°            b. AOT (Azimuth cont - F): 0°, 315°, 0°            Verb 41 noun 20 uses coarse align relay, which remains energized until released by step 7. (IMU is fixed with respect to LM body.)</p> <p style="text-align: right;">300LMS-2061</p>

**LMA790-3-LM**  
**APOLLO OPERATIONS HANDBOOK**

CREW- MAN	PNL	PROCEDURES	REMARKS
		<p>4.9.1.6 <u>Crescent Alignment of PGCS (IMU) (cont)</u></p> <p>6. If further accuracy is required: Key V41 N20E, V33E</p> <p>7. Key V40 N20 Verify reference line is properly aligned. Key ENTR Wait 15 sec before keying V37.</p> <p>8. Set REFSMAT flag: Key V25 N07E 77E 10000E 1E</p> <p>9. Set DRIFT flag: Key V37E 51E PRO V37E 00E</p> <p>10. If AGS is operational &amp; AGS alignment is desired: Key DEDA C 400+30000E If LGC is available, skip steps 11 &amp; 12.</p> <p>11. CB PGCS: IMU STRY - close (verify) IMU OPR - close Wait 90 sec.</p> <p>12. S/C: IMU CAGE sw - ON (momentarily)</p> <p>4.9.1.7 <u>LM IMU Alignment to CSM Gyro Display Coupler (GDC)</u></p> <p>Appropriate CB activation (required) LGC Power-Up (required) IMU Power-Up (LGC Operating) (required)</p>	<p>MSPN may request that REFSMAT be unlinked and subsequent P52 (IMU Realign Program) option 3 be performed.</p> <p>Energizes IMU cage relay and initiates gyro spin-up. Allows gyros to come up to speed.</p> <p>Releases platform at present vehicle orientation.</p> <p>Purpose of this procedure is to provide steps to be taken in contingency situation, for aligning LM IMU to CSM GDC.</p> <p>Assumptions: (1) LGC and IMU are capable of operation and (2) vehicle configuration may be LM/CSM or LM/CH.</p> <p>Ref para TBD. Ref para 4.6.1.1. Ref para 4.6.1.3.</p>



**LMA790-3-LM**  
**APOLLO OPERATIONS HANDBOOK**

CREW-MAN	PNI	PROCEDURES	REMARKS
		<p>4.9-1.7 LM IMU Alignment to CSM Gyro Display Coupler (GDC) (cont)</p>	
1/2		<p>1. Establish PCNCS total attitude display: ATTITUDE NOW sw - PCNCS ORDEAL:   FDAI 1 sw - INRTL   FDAI 2 sw - INRTL</p> <p>2. Request CSM go to minimum deadband attitude hold. Request 6 copy CSM GDC ATT SET dials (R, P, Y).</p> <p>3. Calculate LM ICPU angles:   LM (CG) = <math>300^\circ + \Delta \theta - CH</math> (R)   LM (IG) = <math>180^\circ + CH</math> (P)   LM (MG) = <math>360^\circ - CH</math> (Y)</p> <p>4. Key V41 N20E   FL V21 N22-Load calculated LM angles from step 3.</p> <p>5. Key V41 N20E, V33E</p> <p>6. Key V40 N20   Verify CSM at proper attitude   Key ENTR</p> <p>7. Notify CSM that minimum deadband attitude hold is no longer required.</p> <p>8. Set REFSMAT flag:   Key V25 N07E     77E     10000E     1E</p> <p>9. Set DRIFT flag:   Key V37E 51E   PRO   V37E 00E</p> <p>10. If desired, request MSFN uplink REFSMAT.</p>	<p>Ref para 4.5.3.1.</p> <p><math>\Delta \theta</math> = CSM roll index docking angle.</p> <p>Coarse-aligns LM IMU to input angles.</p> <p>Increases accuracy of coarse alignment.</p> <p>Releases LM IMU.</p> <p>Allows P52 (IMU Realign Program) option 3 to be performed with automatic optics.</p>

**LMA790-3-LM**  
**APOLLO OPERATIONS HANDBOOK**

CREW- MAN	PNL	PROCEDURES	REMARKS
		<p>4.9.2 AGS</p> <p>4.9.2.1 <u>PGNCS/AGS Align</u></p> <p>AGS Power-Up (required)</p> <p>AGS Checkout (desired)</p> <p>LGC Power-Up (required)</p> <p>IMU Power-Up (LGC Operating) (required)</p> <p>AGS Initialization Routine (R47) (required)</p> <p>1. Exercise ICDU fine-align switches:</p>	<p>Ref para 4.6.2.1.</p> <p>Ref para 4.6.2.4.</p> <p>Ref para 4.6.1.1.</p> <p>Ref para 4.6.1.3. ISS should be on 15 minutes before thrusting maneuver.</p> <p>Must be repeated when PGNS is aligned to new inertial reference (ref para 4.6.1.18).</p> <p>This step eliminates possibility that transients resulting from actuation of ICDU fine-align switches will degrade performance of AGS alignment to PGNCS IMU and prevents possibility of a coarse align transient jeopardizing AGS ability to achieve clear pericynthion in event of AGS abort from lunar surface.</p>

ALIGN

**LMA790-3-LM**  
**APOLLO OPERATIONS HANDBOOK**

LM 3207

CREW-MAN	P/NL	PROCEDURES	REMARKS
		<p>4.9.2.1 <u>PGNS/AGS Align (cont)</u></p> <p>a. Establish attitude control mode:            (1) AGS attitude hold/rate command - GUID CONT sw - AGS            S/C: AGS sw - ATT HOLD            ROLL, PITCH, &amp; YAW sw - MODE CONT            DEAD BAND sw - MAX            ENG THR CONT: BAL CPL sw - ON</p> <p>(2) PGNS attitude hold/rate command - GUID CONT sw - PGNS            S/C: PGNS sw - ATT HOLD            ROLL, PITCH, &amp; YAW sw - MODE CONT or PULSE</p> <p>(3) During docked flight, request that CSM maintain attitude hold. Establish attitude control mode - AGS pulse:            GUID CONT sw - AGS            S/C: AGS sw - AUTO or ATT HOLD            ROLL, PITCH, &amp; YAW sw - PULSE            ENG THR CONT: BAL CPL sw - ON</p> <p>AGS direct:            GUID CONT sw - AGS            S/C: AGS sw - AUTO or ATT HOLD            ROLL, PITCH, &amp; YAW sw - DIR            ENG THR CONT: BAL CPL sw - ON</p> <p>PGNS minimum impulse:            GUID CONT sw - PGNS            S/C: PGNS sw - ATT HOLD            ROLL, PITCH, &amp; YAW sw - MODE CONT            Key V76E            No DAP lt - on</p> <p>(4) On lunar surface, go to step 1d.</p> <p>b. Monitor ICDU angles:            Key V16 N20E            R1 OGA XXX.XX°            R2 ICA XXX.XX°            R3 MGA XXX.XX°</p> <p>If all three registers read &gt;11.25°, go to step 1d.</p>	<p>Ref para 4.5.1.6.</p> <p>Ref para 4.5.1.3.</p> <p>Ref para 4.5.1.7.</p> <p>Ref para 4.5.1.8.</p> <p>Ref para 4.5.1.4.</p> <p>ICDU angles correspond to following LM rotations:            R1 OGA - Yaw            R2 ICA - Pitch            R3 MGA - Roll</p>

Basic Date 26 September 1971

Change Date \_\_\_\_\_

**LMA790-3-LM**  
**APOLLO OPERATIONS HANDBOOK**

CREW- MAN	PNI	PROCEDURES	REMARKS
		<p>4.9.2.1 <u>PGNCS/AGS Align (cont)</u></p> <p>c. Obtain desired ICDU angles: If undocked, maneuver LM via ACA until all three DSKY registers read &gt;11.25°</p> <p>d. Perform ICDU Zero.</p> <p>2. Command PGNCS/AGS Align: Key DEDA C 400+3000E</p> <p>3. Verify alignment complete: Key DEDA C 400R</p> <p>4. Verify alignment accuracy: a. In flight (1) Establish AGS total attitude display on one FDAI- ATTITUDE MON sw - AGS ORDEAL: FDAI 1 sw - INRTL FDAI 2 sw - INRTL (2) Establish PGNCS total attitude display on other FDAI (3) Compare total attitude display of FDAI's. FDAI's should agree within 2°.</p> <p>b. Lunar surface (1) Key DEDA C 132R + ABCDE (octal) (2) Repeat steps 2, 3, &amp; 4b(1). (3) If D of address 132 changes more than two octal digits, repeat PGNCS/AGS Align procedure.</p> <p>4.9.2.2 <u>Backup AGS Alignment (Using AGS Body-Axis Alignment and PGNCS IMU)</u></p> <p>DAP Data Load Routine (required) (minimum deadband)</p> <p>AGS Power-Up (required)</p> <p>AGS Checkout (required)</p> <p>LGC Power-Up (required)</p> <p>IMU Power-Up (LGC Operating) (required)</p>	<p>Ref para 4.6.1.21.</p> <p>+00000 should appear within 2 seconds after step 2.</p> <p>Ref para 4.5.3.3.</p> <p>Ref para 4.5.3.1.</p> <p>This procedure is to be used if, for any reason, PGNCS alignment cannot be transferred to AGS via CDU.</p> <p>Ref para 4.6.1.8.</p> <p>Ref para 4.6.2.1.</p> <p>Ref para 4.6.2.4.</p> <p>Ref para 4.6.1.1.</p> <p>Ref para 4.6.1.3.</p>

ALIGN

**LMA790-3-LM  
APOLLO OPERATIONS HANDBOOK**

CREW-MAN	P/NL	PROCEDURES	REMARKS
		<p>4.9.2.2 Backup AGS Alignment (Using AGS Body-Axis Alignment and FGNS IMU) (cont)</p> <p>IMU Orientation Determination Program (P51) (required)</p> <ol style="list-style-type: none"> <li>1. Perform Crew-Defined Maneuver Routine (R62) to zero outer, inner, and middle gimbal angles of IMU (N22).</li> <li>2. Command body-axis alignment: Key DEDA C 400+50000E</li> <li>3. Terminate alignment: Key DEDA C 400+00000E</li> <li>4. Verify alignment accuracy:               <ol style="list-style-type: none"> <li>a. Establish AGS total attitude display mode on one FDAI- ATTITUDE MON sw - AGS ORDEAL: FDAI 1 sw - INRTL FDAI 2 sw - INRTL</li> <li>b. Establish PCNCS total attitude display mode on other FDAI- ATTITUDE MON sw - PCNCS</li> <li>c. Compare total attitude display of FDAI's. FDAI's should agree within 2°.</li> </ol> </li> </ol> <p>4.9.2.3 Backup AGS Alignment (Using AGS Body-Axis Alignment and AOT)</p> <p>AGS Power-Up (required) AGS Checkout (desired) AGS Total Attitude Display Communications Basic (required - near earth) or S-Band Steerable Antenna Activation (High Power) (required - lunar distance) Rendezvous Radar antenna in AOT position (desired)</p> <ol style="list-style-type: none"> <li>11 1. CB HTR: AOT - close  CB/AC BUS A: AOT LAMP - close</li> </ol>	<p>Ref para 4.9.1.1. Ref para 4.6.1.9.</p> <p>Ref para 4.5.3.1.</p> <p>Ref para 4.6.2.1. Ref para 4.6.2.4. Ref para 4.5.3.3. Ref para 4.13.2.1. Ref para 4.2.20. Rendezvous Radar Coarse Align (para 4.6.3.3). AOT heater should be turned on at least 25 minutes before selecting this procedure, to prevent fogging of AOT lens. CB/AC BUS B: AOT LAMP and CB/AC BUS A: AOT LAMP are redundant. If a-c bus A loading is large, CB/AC BUS B: AOT LAMP can be closed. Never close both cb's at same time.</p>



**LMA790-3-LM**  
**APOLLO OPERATIONS HANDBOOK**

LM 979A, LM 3207

CREW-MAN	PNL	PROCEDURES	REMARKS
	AOT	<p>4.9.2.3 Backup AGS Alignment (Using AGS Body-Axis Alignment and AOT)(cont)</p> <p>RETICLE BRIGHTNESS cont - adjust Azimuth cont - F</p> <p>2. Determine star pair &lt;30° apart. Record.</p> <p>3. Center prime star in AOT: S/C: AGS sw - ATT HOLD ROLL, PITCH, &amp; YAW sw - MODE CONT DEAD BAND sw - MIN GUID CONT sw - AGS ENG THR CONT: BAL CPL sw - ON ACA - maneuver LM to bring prime star to center of reticle</p> <p>4. Rotate reticle to place +X-line or +Y-line on second star. Record AOT ind - XXX.X° &amp; line identification.</p> <p>5. Perform body-axis align: Key DEDA C 400+50000E Immediately key DEDA C 400+00000E</p> <p>6. Report recorded data to MSFN.</p> <p>7. Pass new FDAI attitude angles provided by MSFN: ACA - maneuver as required Key DEDA C 400+50000E Key DEDA C 400+00000E</p> <p>8. Reinitialize LM &amp; CSM state vectors.</p>	<p>Stars must be included in RTCC list (data stored in RTCC memory). Spread between chosen stars should be as close to 30° as practicable.</p> <p>Because of restrictions on AEA computations, LM Y-axis must be &gt;10° from LM orbit plane.</p> <p>Body-axis align. Release align (attitude hold).</p> <p>LM must be within LOS of MSFN at time of report.</p> <p>AGS Attitude Hold/Rate Command (para 4.5.1.6).</p> <p>AGS manual LM/CSM State Vector Update (para 4.6.2.7 and 4.6.2.9). If LGC portion of PGCS is usable, uplink AGS state vectors to LGC via P27 (para 4.6.1.7) and perform AGS Initialization Routine (R47) (para 4.6.1.18).</p>

ALIGN

# LMA790-3-LM APOLLO OPERATIONS HANDBOOK

LM 3231

CREW- MAN	PNI	PROCEDURES	REMARKS
		<p>4.9.2.4 <u>Crescent Alignment of AGS (ASA)</u></p> <p>Appropriate CB activation (required)</p> <p>AGS Power-Up (required)</p> <p>AGS Checkout (desired)</p> <p>1. Establish AGS total attitude display: ATTITUDE NON sw - AGS ORDEAL:</p> <p style="margin-left: 20px;">FDAL 1 sw - INRTL FDAL 2 sw - INRTL</p> <p>2. Select desired optical system:</p> <p style="margin-left: 20px;">a. COAS - install in CDR's window CB FLT DISP: COAS - close COAS sw - FWD</p> <p style="margin-left: 20px;">b. Azimuth cont - F CB HTR: AOT - close CB/AC BUS B: AOT LAMP - close</p> <p style="margin-left: 20px;">c. LPD reference axis</p> <p>3. Maneuver to acquire earth in optical systems field of view.</p> <p>4. Maneuver to align reference line along &amp; intersecting points of earth's crescent.</p>	<p>Purpose of this procedure is to align AGS (ASA) in contingency situation, using either AOT, LPD, or COAS, to earth's crescent.</p> <p>Assumptions: (1) AEA and ASA are capable of operation and (2) vehicle configuration may be LM/CSM or LM/CH. Ref para TBD.</p> <p>Ref para 4.6.2.1. Ref para 4.6.2.4. Ref para 4.5.3.3.</p> <p>Either LM or CSM may maneuver if docked. This procedure required no restriction on means of maneuvering. MSPN will update desired +X-Axis direction to be either toward, or away from, sun. See diagrams below, which imply use of AOT or COAS.</p>
	1/2		
	11 8 AOT 11		

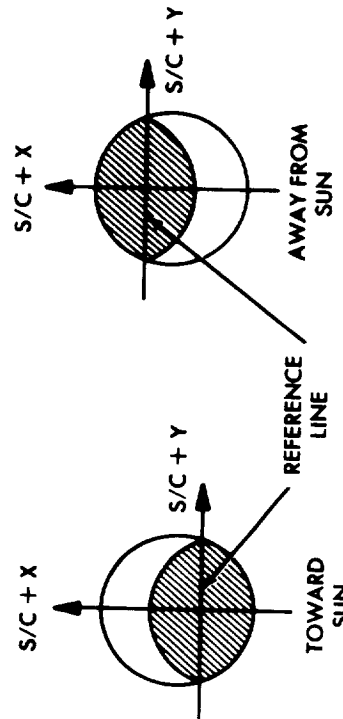

300LM8-2061

**LMA790-3-LM**  
**APOLLO OPERATIONS HANDBOOK**

CREW-MAN	PNL	PROCEDURES	REMARKS
		<p>4.9.2.4 <u>Crescent Alignment of ACS (ASA) (cont)</u></p> <p>5. Key DEDA C 400+50000E C 400+00000 (verify attitude) ENTR</p> <p>6. If AOT is used: Pitch up 45° on FDAI. Key DEDA C 400+50000E followed immediately by C 400+00000E</p> <p>4.9.2.5 <u>ACS Alignment to CSM Gyro Display Coupler</u> <u>or CSM Primary System</u></p> <p style="text-align: center;">Appropriate CB activation (required)</p> <p style="text-align: center;">ACS Power-Up (required)</p> <p>1. Establish ACS total attitude display: ATTITUDE MON sw - ACS ORDEAL: FDAI 1 sw - INRTL FDAI 2 sw - INRTL</p> <p>2. S/C: ROLL, PTICH, YAW sw - PULSE ACS sw - ATT HOLD</p> <p>3. Request CSM maneuver to: Roll (CSM) = 300° +Δθ Pitch (CSM) = 180° Yaw (CSM) = 0°</p> <p>4. Key DEDA C 400+50000E</p> <p>5. Key DEDA C 400+00000 On CSM mark: Key ENTR</p>	<p>Releases ASA platform.</p> <p>Purpose of this procedure is to provide steps to be taken in contingency situation, for aligning ACS (ASA) to orientation defined by either CSM IMU or GDC.</p> <p>Assumptions: (1) AEA and ASA are capable of operation, (2) vehicle configuration may be LM/CSM or LM/CM, and (3) CSM will perform any maneuvering.</p> <p>Ref para TBD.</p> <p>Ref para 4.6.2.1.</p> <p>Ref para 4.5.3.3.</p> <p>Δθ = CSM roll index docking angle.</p> <p>Body-axis alignment.</p> <p>CSM mark will be given when CMP verifies vehicle configuration at proper attitude.</p> <p>If use of ACS External ΔV routine is desired, MSFN will provide state vectors for loading into AEA.</p>

ALIG

**LMA790-3-LM**  
**APOLLO OPERATIONS HANDBOOK**

CREW-MAN	PNL	PROCEDURES	REMARKS
		<p>4.9.3 <u>LUNAR SURFACE ALIGNMENT</u></p> <p>4.9.3.1 <u>PGMCS Lunar Surface Align Program (P57)</u></p>	<p>Purpose of PGMCS Lunar Surface Align Program (P57) is to align or realign IMU to one of three orientations selected by crew:</p> <ol style="list-style-type: none"> <li>1. Preferred</li> <li>2. REFSMAT</li> <li>3. Landing site</li> </ol> <p>Program 57 can be used to provide IMU alignment in time-critical emergencies before ascent.</p> <p>Ref para 4.6.1.1.</p> <p>Ref para 4.6.1.13.</p> <p>Ref para 4.6.1.3. ISS should be on 15 minutes before thrusting maneuver.</p> <p>Rendezvous Radar Coarse Align (para 4.6.3.3).</p> <p>AOT heaters should be turned on at least 25 minutes before selecting this procedure, to prevent fogging of AOT lens.</p> <p>CB/AC BUS A: AOT LAMP and CB/AC BUS B: AOT LAMP are redundant. If a-c bus A loading is large, CB/AC BUS B: AOT LAMP can be closed instead. Never close both cb's at same time.</p> <p>Ref para 4.6.1.3.</p> <p>Nominal option cannot be selected on lunar surface. If preferred orientation is selected, but one has not been defined, no alarm will result, but alignment will be worthless.</p>
	11	<p>LGC Power-Up (required)</p> <p>LGC Self-Test (desired)</p> <p>IMU Power-Up (LGC Operating) (required)</p> <p>Rendezvous radar antenna in AOT position (desired)</p>	
	11	<p>1. Verify CB HTR: AOT - close</p>	
	AOT	<p>2. CB/AC BUS A: AOT LAMP - close</p> <p>RETICLE BRIGHTNESS cont - adjust AOT ind - 000.0° Azimuth cont - Y</p>	
		<p>3. Key V37E 57E Pos PRDG lt - on Key V05 W09E - Call alarm 00210 - IMU not on Perform IMU Power-Up (LGC Operating) procedure. Key KEY REL &amp; RSET FL V37 N-- Key XYE - Exit P57</p>	
		<p>4. FL V04 N06 - Option code R1 00001 - Specify IMU orientation R2 00003 - REFSMAT option R3 -----</p>	

**LMA790-3-LM**  
**APOLLO OPERATIONS HANDBOOK**

CREW: MAN	PNL	PROCEDURES	REMARKS
		<p>4.9.3.1 PGNCS Lunar Surface Align Program (P57) (cont)</p> <p>R2 1 = Preferred 2 = Nominal 3 = REFSMAT 4 = Landing site</p> <p>Accept: Key PRO - If R2 = 3 or 1 go to step 6 Reject: Key V22E - Load desired option</p> <p>5. FL V06 N34 - T (Align) R1 00XX hr R2 00XX min R3 0X.XX sec Accept: Key PRO Reject: Key V25E - Load desired T (Align) or all zeros.</p> <p>6. FL V05 N06 - Option code R1 00010 - Assumed alignment mode R2 00000 - Option (any time) R3 00C00 - Data code R2 0 - Any time (time critical) 1 = REFSMAT &amp; Lunar-g determination 2 = Two bodies (star/planet) 3 = One body &amp; lunar-g determination R3 C = 0 - REFSMAT not defined C = 1 - REFSMAT defined D = 0 - Stored LM attitude not available D = 1 - Stored LM attitude available. Accept: Key PRO Reject: Key V22E - Load desired option</p> <p>7. If option code 00000 or 00001 was selected in step 6: Poss FL V05 N09 - Alarm 00701 - Neither present REFSMAT nor stored LM attitude available Alarm alternatives: a. Key V32E - Recycle to step 6 and select another option or b. Key V34E - Terminate P57 FL V37 N-- Key XXE</p>	<p>Display initialized to contents of N33. If P12 was partially performed after landing, N33 was defined as TIG (AS). If all zeros are accepted, T (Align) is present time.</p>

LM 32.

ALIGN

**LMA790-3-LM**  
**APOLLO OPERATIONS HANDBOOK**

CREW/ MAN	P/NL	PROCEDURES	REMARKS
	1/2	<p>4.9.3.1 <u>PCMS Lunar Surface Align Program (P57) (cont)</u></p> <p>8. If option code 00000 or 00002 was selected in step 6, go to step 11.</p> <p>9. ATTITUDE MON sw - PCMS</p> <p>IMU first position: Desired gimbal angles set at            OG = +42°, IG = -42°, MG = +35 1/4°            NO ATT lt - on            Posn PROG lt - on            Key V05 M09E - Call alarm            00211 - Gimbals did not drive to within 2° of desired angles            00217 - Bad return from stall routines            Key KEY REL &amp; RSET            NO ATT lt - off</p> <p>IMU second position: Calculated, based on vehicle attitude after landing &amp; rotating 180° around gravity vector.            Repeat procedure of first position.</p> <p>10. FL V06 M04 - Gravity error angle            R1 XXX.XX°            R2 -----            R3 -----</p> <p>Accept: Key PRO            Reject: Key V32E, return to step 9 or            Key V34E - Terminate P57            FL V37 N---            Key XIX</p> <p>11. Define this to be first pass. If, in step 6, option code 00002 or 00003 was selected and data code was all zeros, perform steps 12 through 24, otherwise go to step 26; if option code 00000 or 00001 was selected, go to step 26.</p> <p>12. Lunar Surface Sighting Mark Routine (R59)            FL V01 N70 - AOT detent/star code            R1 OODSS            R2 -----            R3 -----</p>	<p>FDAI &amp; N20 (present ICPU angles) are available to monitor IMU changes.</p> <p>NO ATT lt - on while IMU is coarse-aligning to first position.</p> <p>NO ATT lt - off indicates IMU is inertial.            Completion of second position alignment completes determination of new gravity vector G.</p> <p>Until this step (in first execution of P57), LGC assumes lunar gravity vector to be parallel to LGC's currently stored value of radius-landing site (RLS), the landing site vector, if P68 was previously performed. If P68 was not previously performed, display is meaningless on first pass.</p>

**LMA790-3-LM**  
**APOLLO OPERATIONS HANDBOOK**

CREW: MAN	PNL	PROCEDURES	REMARKS
		<p>4.9.3.1 <u>PCNCS Lunar Surface Align Program (P57) (cont)</u></p> <p>C - AOT detent code DE - Star/planet code Accept: Key PRO Reject: Key V21E - Load desired codes</p> <p>13. Celestial Body Definition Routine (R58) If star/planet code is 00 (planet) (can be used for non-LGC cataloged stars) FL V06 N88 - Celestial body unit position vector components at GET R1 .XXXXX R2 .XXXXX R3 .XXXXX Accept: Key PRO Reject: Key V25E - Load correct position vector components</p> <p>14. Pos FL V05 N09 - Alarm 00404 - Star LOS not within 30° of optical axis for any AOT detent position Accept without acquisition data: Key PRO - Go to step 16 Reject: Key V32E - Recycle to step 12</p> <p>15. FL V06 N79 R1 Cursor angle XXX.XX° R2 Spiral angle XXX.XX° R3 AOT position 0000X X = 1, 2, 3 - Forward positions = 4, 5, 6 - Rear positions Accept: Key PRO Reject: Key V32E - Recycle to step 12</p> <p>16. Sighting Mark Routine (R53) Pos PROG lt - on Key V05 N09E - Call alarm 31207 - No VAC area for marks 31211 - Illegal interrupt of extended verb</p>	<p>Ref para 4.4.12. Ref para 4.4.8.</p>

LM 32.

ALIGN

**LMA790-3-LM  
APOLLO OPERATIONS HANDBOOK**

LM 3231

CREW-MAN	PNL	PROCEDURES	REMARKS
		<p>4.9.3.1 <u>PGNCS Lunar Surface Align Program (P57) (cont)</u></p> <p>Key KEY REL &amp; RSET            FL V01 N71            R1 OODSS - AOT detent/star code            R2 -----            R3 -----            C - AOT detent code            DE - Star/planet code            Accept: Key PRO            Reject: Key V21E - Load desired codes</p> <p>17. FL V52 N71 - Please mark cursor            R1 OODSS - AOT detent/star code            R2 cursor marks Z000C            R3 spiral marks Z000S            Reticule cont - center target in cursor            To re-select detent/star code:            Key V32E - return to previous step            To switch mark reject enable and request spiral marks:            Key ENTR - go to step 20            To indicate marks complete:            Key PRO - go to step 23            To MARK:            Key MARK X or MARK Y            Posn PROC lt - on            To display alarm code:            Key V05 N09E - Call alarm            00111 - Mark missing            00112 - Mark or mark reject not being accepted            00113 - No inbits (in channel 16)            00115 - No marks to reject            Key KEY REL &amp; RESET</p> <p>18. FL V21 N79 Load cursor angle            R1 Cursor -----            R2 -----            R3 -----            Key XXX.XX'E cursor angle</p>	<p>Ref para 4.4.12.            Ref para 4.4.8.</p> <p>Maximum value of C or S is 5; additional marks overwrite fifth mark. Z = 1 or 0, only one of Z's equals 1 at any one time. Z = 1 indicates which type of reticle mark reject is enabled. Enable can be switched back and forth by keying ENTR.</p> <p>To reject cursor marks - key REJECT. Cursor marks may be rejected as long as any remain.</p> <p>DES RATE sv may be used as a backup for, or in place of, MARK devices.</p>



**LMA790-3-LM**  
**APOLLO OPERATIONS HANDBOOK**

CREW-MAN	PNL	PROCEDURES	REMARKS
		<p>4.9.3.1 <u>PGNCS Lunar Surface Align Program (P57) (cont)</u></p> <p>19. FL V06 N79 Verify cursor angle  R1 Cursor XXX.XX  R2 -----  R3 -----  To reload: Key V21E XXX.XX°E  To continue: Key PRO - return to step 17</p> <p>20. FL V53 N71 - Please mark spiral  R1 OODSS AOT detent/star code  R2 cursor marks Z000C  R3 spiral marks Z000S  Retical cont - center target in spiral  To reselect detent/star code:  Key V32E - return to step 16  To switch mark reject enable and request cursor marks:  Key ENTR - return to step 17  To indicate marks complete:  Key PRO - go to step 23  To MARK:  Key MARK X or MARK Y  Poss PROG lt - on  To display alarm code:  Key V05 N09E call alarm  00111 - Mark missing  00112 - Mark or Mark reject not being accepted  00113 - No inbits (in channel 16)  00115 - No marks to reject  Key KEY REL &amp; RESET</p> <p>21. FL V22 N79 Load spiral angle  R1 -----  R2 Spiral -----  R3 -----  Key XXX.XX°E Spiral angle</p> <p>22. FL V06 N79 Verify spiral angle  R1 -----  R2 Spiral XXX.XX°  R3 -----  To reload: Key V22E XXX.XX E  To continue: Key PRO - return to step 20.</p>	<p>To reject spiral marks - Key REJECT. Spiral marks may be rejected as long as any remain.  DES RATE sw may be used as a backup for, or in place of, MARK devices.</p>

LM -

ALIGN

**LMA790-3-LM  
APOLLO OPERATIONS HANDBOOK**

LM 979A, LM 3207

CREW-MAN	PNI	PROCEDURES	REMARKS
		<p>4.9.3.1 <u>FGNCS Lunar Surface Align Program (P57) (cont)</u></p> <p>23. Poss FL V50 N25  R1 00016  R2 0000X Number of mark data sets rejected  To take more marks:  Key ENTR - return to step 16  To continue:  Key PRO</p> <p>24. Celestial Body Definition Routine (R58)  If star/planet code is 00 (planet):  FL V06 N88 - Celestial body unit position vector components at GET  R1 X .XXXX  R2 Y .XXXX  R3 Z .XXXX  Accept: Key PRO  Reject: Key V25E - Load correct position vector components</p> <p>25. Repeat steps 12 thru 24 for second celestial body (if option code 00002 was selected in step 6).</p> <p>26. Poss FL V06 N22 - Desired ICDU angles  R1 OG XXX.XX*  R2 IC XXX.XX*  R3 MG XXX.XX*  Key PRO  Poss NO ATT lt - on  No DAP lt - on  Poss PROG lt - on  Key V05 N09E - Call alarm  00211 - Gimbals did not drive to within 2° of desired angles  00217 - Bad return from stall routines  Key KEY REL &amp; RSET  NO ATT lt - off  No DAP lt - off</p>	<p>Data would be rejected if:</p> <ol style="list-style-type: none"> <li>Star is within 2° of AOT optical axis</li> <li>Star is beyond 28.5° from AOT optical axis</li> <li>More than 28 iterations are required to converge on a solution</li> <li>Sign of iteration step changes more than once.</li> </ol> <p>If gyro torquing angle exceeded 5° and on first pass.</p> <p>NO ATT lt - on while IMU is in coarse-align mode if gyro torquing angle exceeded 5° on any pass.</p> <p>NO ATT lt - off indicates IMU is inertial.</p>

# LMA790-3-LM

## APOLLO OPERATIONS HANDBOOK

CREW-MAN	PNL	PROCEDURES	REMARKS
LM 3.	LM 3231	<p>4.9.3.1.1 PGCS Lunar Surface Align Program (P57) (cont)</p> <p>27. If option code was 00000 in step 6, go to step 32. If this was first pass and option code was 00002 or 00003, perform steps 12 through 24, and define this to be second pass.</p> <p>28. Sighting Data Display Routine (R54)            FL V06 N05            R1 Sighting angle difference XXX.XX°            R2 -----            R3 -----            Accept: Key PRO            Reject: Key V32E - Go to step 32</p> <p>29. FL V06 N93 - Gyro torquing angles            R1 X XX.XXX°            R2 Y XX.XXX°            R3 Z XX.XXX°            Accept: Key PRO            Reject: Key V32E - Go to step 32</p> <p>30. Poss NO ATT lt - on            NO DAP lt - on            Poss PROG lt - on            Key V05 N09E - Call alarm            00211 - Gimbals did not drive to within 2° of desired angles            00217 - Bad return from stall routines            Key KEY REL &amp; RSET            NO ATT lt - off            NO DAP lt - off</p> <p>31. Deleted</p> <p>32. FL V50 N25 - Checklist reference            R1 00014 - Perform fine align            R2 -----            R3 -----            Accept fine align: Key PRO - Return to step 11            Reject fine align:            If option code was not 00002: Key ENTR or V34E, exit P57            FL V37 N--            Key XXE            If option code was 00002: Key ENTR</p>	<p>Sighting angle difference (NO5) is defined as difference between indicated angle (from marks) and actual angle (from ephemeris data).</p> <p>PRO allows gyro torquing to be performed before step 30. If any torquing angle &gt;5°, LGC will coarse-align IMU.</p> <p>NO ATT lt - on while IMU is in coarse-align mode if gyro torquing angle exceeded 5° on any pass.</p> <p>NO ATT lt - off indicates IMU is inertial.</p>



**LMA790-3-LM  
APOLLO OPERATIONS HANDBOOK**

CREW: MAN	P/NL	PROCEDURES	REMARKS
		<p>4.9.3.1 <u>FGNCS Lunar Surface Align Program (P57) (cont)</u></p> <p>FL V06 N89 - Computed landing site coordinates            R1 Latitude XX.XXX°            R2 Longitude/2 XI.XIX°            R3 Altitude XXX.XX m            Reject: Key V25E &amp; load desired coordinates            Accept option: Key PRO - Update stored RLS, exit P57            Terminate option: Key V34E - Terminate, exit P57            FL V37 N--            Key XII</p> <p>33. Remove power from AOT:            CB/AC BUS A: AOT LAMP - open            CB/AC BUS B: AOT LAMP - open</p>	
	11		

**LMA790-3-LM**  
**APOLLO OPERATIONS HANDBOOK**

CREW-MAN	PNI	PROCEDURES	REMARKS
		<p>4.9.3.2 <u>AGS Lunar Align (400+40000)</u></p> <p style="text-align: center;">CAUTION</p> <p>AGS Lunar Align routine is constrained to a maximum tilt angle of either X or Y body-axis to local horizontal plane of 30°. At higher tilt angles, possible AGS overflow can occur, resulting in incorrect alignment.</p> <p>AGS Power-Up (required)</p> <p>APA Self-Test (desired)</p> <p>Receive &amp; enter azimuth correction (<math>\Delta \delta</math>) (for corrections <math>&lt;5^\circ</math>) or cos <math>\delta L</math>, sin <math>\delta L</math> (with <math>\delta = 0</math>) (for corrections <math>&gt;5^\circ</math>), for lunar rotation &amp; CSM plane change from MSFN if available.</p> <p>Key DEDA C 547+XXXXXE (octal) <math>\Delta \delta</math> and/or C 053+XXXXXE (octal) Cos <math>\delta L</math> and C 047+XXXXXE (octal) Sin <math>\delta L</math></p> <p>2. Start lunar align: Key DEDA C 400+40000E</p> <p>3. If desired, take star sighting on known star, using AOT, communicate reticle counter values &amp; AOT detent to MSFN as follows: CB/AC BUS A: AOT LAMP - close</p> <p>Locate known star or planet (known to RTCC) visible through AOT (AOT detent as required). Rotate reticle control to center target in cursor lines, observe reticle counter value, &amp; transmit value to MSFN verbally. Rotate reticle cont to center target in spiral lines, observe reticle control value, &amp; verbally, transmit value to MSFN. Transmit AOT detent position to MSFN verbally.</p>	<p>Purpose of AGS Lunar Align (400+40000) procedure is to align AGS, using lunar gravity to find local vertical, and stored lunar azimuth angle.</p> <p>Ref para 4.6.2.1. Ref para 4.6.2.3.</p> <p>Minimum of 3 minutes is required to perform lunar align. Final lunar align should not be terminated until within <math>\pm 4</math> minutes of nominal lift-off time (by keying in C 400+00000E or C 400+10000E). Early exit from lunar align results in alignment error accumulation at rate of approximately 1.5°/hr (lunar rotation rate).</p> <p>CB/AC BUS B: AOT LAMP and CB/AC BUS A: AOT LAMP are redundant. If a-c bus A loading is large, CB/AC BUS B: AOT LAMP can be closed. Never close both cb's at same time.</p>

ALIGN

**LMA790-3-LM  
APOLLO OPERATIONS HANDBOOK**

<b>CREW- MAN</b>		<b>PNL</b>		<b>PROCEDURES</b>	<p>4.9.3.2 <u>AGS Lunar Align (400+40000) (cont)</u></p> <p>CS/AC BUS A: AOT LAMP - open          Key DEDA C 400+0000E (attitude hold submode)          Repeat steps 1 &amp; 2.</p>	<b>REMARKS</b>	
----------------------	--	------------	--	-------------------	---------------------------------------------------------------------------------------------------------------------------------------------------------------------------------------------	----------------	--

**LMA790-3-LM**  
**APOLLO OPERATIONS HANDBOOK**

PARA	TITLE	PAGE
4.10	Thrust . . . . .	4.10-2
4.10.1	Orbital Thrust . . . . .	4.10-2
4.10.1.1	DPS Thrust Program (P40) With AGS Followup/In Control .	4.10-2
4.10.1.2	APS Thrust Program (P42) With AGS Followup/In Control .	4.10-22
4.10.1.3	RCS Thrust Program (P41) With AGS Followup/In Control .	4.10-38
4.10.1.4	Thrust Monitor Program (P47) . . . . .	4.10-49
4.10.1.5	AGS RCS Axis-by-Axis Thrust . . . . .	4.10-51
4.10.1.6	RCS Burn for Lunar Impact (Unmanned Ascent Stage) . . .	4.10-53
4.10.1.7	Docked DPS Thrust Program (P40) With AGS Followup . . .	4.10-61
4.10.2	Powered Descent . . . . .	4.10-73
4.10.2.1	Braking Phase Program (P63) With AGS Preparation for Orbit Insertion (410+00000) . . . . .	4.10-73
4.10.2.2	Approach Phase Program (P64) . . . . .	4.10-86
4.10.2.3	Landing Phase (ROD) Program (P66) . . . . .	4.10-88
4.10.2.4	Landing Confirmation Program (P68) . . . . .	4.10-91
4.10.3	Powered Ascent . . . . .	4.10-92
4.10.3.1	Powered Ascent Program (P12) With AGS Followup/In Control . . . . .	4.10-92
4.10.3.2	DPS Abort (LGC, P70, AEA 410+00000) . . . . .	4.10-106
4.10.3.3	APS Abort (P71, AEA 410+00000) . . . . .	4.10-116

**LMA790-3-LM  
APOLLO OPERATIONS HANDBOOK**

CREW-MAN	PNI	PROCEDURES	REMARKS
		<p><u>4.10 THRUST</u></p> <p>The following procedures include DPS, APS, and RCS thrust, and powered ascent programs arranged in two-column format as separate PCMCS or ACS procedures. Together, PCMCS in the left column and AGS in the right, they provide an integrated PCMCS/AGS procedure; when one computer is in control (PCMCS or AGS), the other is at followup status ready to assume control. PCMCS-controlled, powered descent programs, with the AGS prepared for orbit insertion, are also included in this section.</p> <p><u>4.10.1 ORBITAL THRUST</u></p> <p><u>4.10.1.1 DPS Thrust Program (P40) With ACS Followup/In Control</u></p>	<p>Do not use this procedure for docked DPS burn. For docked DPS burn, use Docked DPS Thrust Program (P40) With AGS Followup (para 4.10.1.7).</p> <p>Purpose of DPS Thrust Program (P40) With ACS Followup/In Control procedure is to compute preferred IMU orientation and LM attitude for DPS thrust maneuver and to maneuver LM to thrusting attitude. This procedure controls PCMCS/ACS during countdown, ignition, thrusting, and thrust termination.</p> <p>Thrust vector at engine start may not be directed through LM center of gravity; therefore, normal start profile for all descent engine starts is at 10% throttle for 26 seconds to permit corrective gim-baling. If descent engine is started at high thrust, RCS propellant must be used to stabilize vehicle; extreme, momentary unbalance may exceed RCS compensating capability.</p>



**LMA790-3-LM**  
**APOLLO OPERATIONS HANDBOOK**

CREW-MAN	PNL	PROCEDURES	REMARKS
		<p>4.10.1.1.1 <u>DPS Thrust Program (P40) With AGS Followup/In Control(cont)</u></p>	<p>Descent engine must not be operated in throttling range of 60% to 92.5%, where operation of cavitating venturis in flow control valves becomes unpredictable and may cause incorrect fuel-oxidizer mixture ratio. Operation in 60% to 92.5% range will cause excessive engine erosion and early combustion chamber buru-through.</p> <p>Following sequence of procedures may cause problems:</p> <ol style="list-style-type: none"> <li>1. P3X, followed by P47, followed by P40, P41, or P42; prethrust computations may be overwritten by P47. To recover: Perform P3X, followed by P40, P41, or P42.</li> <li>2. Deleted</li> </ol>

LM 3231

THRU

**LMA790-3-LM**  
**APOLLO OPERATIONS HANDBOOK**

CREW-MAN	PROCEDURES	REMARKS
	<p>4.10.1.1 <u>DPS Thrust Program (P40) With AGS Followup/In Control (cont)</u></p>	
	<p>MPS Basic (Unstaged) (required)</p> <p>ECS Basic (Unstaged) (required)</p> <p>EPS Preparation for DPS Burn (if required)</p> <p>DPS Pressurization and Checkout (required)</p> <p>Communications Basic (required - near earth)</p> <p>S-Band Steerable Antenna Activation (High Power) (required - lunar distance)</p> <p>LGC Power-Up (required)</p> <p>LGC Self-Test (desired)</p> <p>LGC time valid (required)</p> <p>LGC state vector valid (required)</p> <p>IMU Power Up (LGC Operating) (required)</p> <p>IMU Orientation Determination Program (P51) (required)</p> <p>DAP Data Load Routine (R03) (required)</p> <p>Appropriate prethrust program (required)</p>	<p>Ref para 4.13.3.1.1.</p> <p>Ref para 4.13.1.1.1.</p> <p>Ref para 4.13.4.3.</p> <p>Ref para 4.2.29.</p> <p>Ref para 4.13.2.1.1.</p> <p>Ref para 4.2.20.</p> <p>Ref para 4.6.1.1.1.</p> <p>Ref para 4.6.1.13.</p> <p>LGC/CMC Clock Synchronization Routine (R33) (para 4.6.1.15)</p> <p>LGC Update Program (P27) (para 4.6.1.7) or LM Rendezvous Navigation Program (P20) (para 4.8.2.1)</p> <p>Ref para 4.6.1.3. ISS should be on 15 minutes before thrusting maneuver.</p> <p>Ref para 4.9.1.1.1.</p> <p>Ref para 4.6.1.8. If docked with CSM, KALCFMANU maneuver rate loaded in R03 should be 0.5° or 0.2°/second</p> <p>Ref para 4.7.</p>

**LMA790-3-LM**  
**APOLLO OPERATIONS HANDBOOK**

CREW-MAN	PNL	PROCEDURES	REMARKS
		<p>4.10.1.1.1 <u>DPS Thrust Program (P40) With AGS Followup/In Control (cont)</u></p> <p>AGS Power-Up (required)</p> <p>AEA Self-Test (desired)</p> <p>AGS time valid (required)</p> <p>AGS LM state vector valid (required)</p> <p>AGS CSM state vector valid (required)</p> <p>AGS alignment valid (required)</p> <p>AGS Wb Vector Update (required if mission warrants)</p> <p>Appropriate prethrust procedure (required)</p>	<p>Ref para 4.6.2.1.</p> <p>Ref para 4.6.2.3.</p> <p>AGS Manual Absolute Time Initialization procedure (para 4.6.2.6) or AGS Initialization Routine (RA7) (para 4.6.1.18)</p> <p>AGS Initialization Routine (RA7) (para 4.6.1.18) or AGS Manual LM State Vector Update/Initialization procedure (para 4.6.2.7) or AGS Manual Rendezvous Radar LM State Vector Update procedure (para 4.8.2.2)</p> <p>AGS Initialization Routine (RA7) (para 4.6.1.18) or AGS Manual CSM State Vector Update procedure (para 4.6.2.9)</p> <p>FCMCS/AGS Align (para 4.9.2.1), Backup AGS Alignment (Using AGS Body-Axis Alignment and FCMS IMU) (para 4.9.2.2), or Backup AGS Alignment (Using AGS Body-Axis Alignment and AOT) (para 4.9.2.3)</p> <p>Ref para 4.6.2.15.</p> <p>Ref para 4.7. If AGS TPI search prethrust procedure was used, TPI execute must have been selected subsequent to that procedure.</p>

THR

**LMA790-3-LM  
APOLLO OPERATIONS HANDBOOK**

CREW MAN	PNL	PROCEDURES	REMARKS
	<p>4.10.1.1.1 <u>DPS Thrust Program (P40) With AGS Followup/In Control (cont)</u></p> <p>1. Prepare PQGS for thrust monitoring:            PRPLNT QTY MON sw - DES 1            If DES QTY warn lt - on, it can be turned off after ullage settling has been established by cycling PRPLNT QTY MON sw - OFF, then DES 1.</p> <div style="border: 1px solid black; padding: 5px; margin: 10px 0;"> <p>If FGCS in followup, go to step 6.</p> </div> <p>2. Establish attitude control:            GUID CONT sw - FGCS            S/C:                PGNS sw - AUTO                AGS sw - AUTO                ROLL, PITCH, &amp; YAW sw - MODE CONT</p> <p>3. Establish FGCS total attitude &amp; attitude rate/error display:            ATTITUDE MON sw (1) - FGNS            ATTITUDE MON sw (1) - AGS            RATE/ERR MON sw (2) - LDG RDR/CHPTR</p> <p>4. Enable ACA/TTCA:            ACA/4 JET sw (2) - ENABLE            TTCA/TRANSL sw (2) - ENABLE            THROTTLE/JETS cont (1) - JETS            THROTTLE/JETS cont (1) - THROTTLE            ENG THR CONT: ATT/TRANSL sw - 4 JETS            ACA PROP sw (2) - ENABLE</p> <p>5. Prepare controls for DPS burn:            ENG THR CONT:                THR CONT sw - as required                MAN THROT sw - as required                ENG ARM sw - OFF                ABORT pb - reset</p>	<p>PQGS low-level detection circuit will latch up in low-quantity position if sensor probes are not immersed in propellant due to lack of ullage settling. PQGS should be in operation 15 minutes before start of thrust, but should not be operated continuously more than 45 minutes.</p> <p>Ref para 4.5.1.</p> <p>Ref para 4.5.3.1 and 4.5.3.2.</p> <p>ENG THR CONT: MAN THROT sw - CDR (SE) when CDR (LMP) THROTTLE/JETS cont - THROTTLE.</p>	

**LMA790-3-LM**  
**APOLLO OPERATIONS HANDBOOK**

CREW-MAN	PNL	PROCEDURES	REMARKS
	<p>4.10.1.1.1 <u>DPS Thrust Program (P40) With AGS Followup/In Control (cont)</u></p> <p>ABORT STAGE pb - reset Eng START pb/lit - off Eng STOP pb/lit (2) - reset DES ENG CMD OVRD sw - OFF ENG CRBL sw - ENABLE ENG THR CONT: BAL CPL sw - ON S/C: DEAD BAND sw - MIN CB S/C: DECA PWR - close DES ENG OVRD - close</p>	<p>If AGS in followup, go to step 7.</p> <p>2. Establish attitude control: Key DEDA C 400+0000E GUID CONT sw - AGS S/C: AGS sw - AUTO PGNS sw - AUTO ROLL, PITCH, &amp; YAW sw - MODE CONT</p> <p>3. Establish AGS attitude error &amp; total attitude display: ATTITUDE MON sw (1) - AGS ATTITUDE MON sw (1) - PGNS RATE/ERR MON sw (2) - LDG RDR/CHPTR</p> <p>4. Enable ACA/TTCA: ACA/4 JET sw (2) - ENABLE TTCA/TRANSL sw (2) - ENABLE THROTTLE/JETS cont (1) - THROTTLE THROTTLE/JETS cont (1) - JETS ENG THR CONT: ATT/TRANSL sw - 4 JETS ACA PROP sw (2) - ENABLE</p> <p>5. Prepare controls for DPS burn: ENG THR CONT: THR CONT sw - MAN MAN THROT sw - as required ENG ARM sw - OFF ABORT pb - reset ABORT STAGE pb - reset Eng START pb/lit - off Eng STOP pb/lit (2) - reset DES ENG CMD OVRD sw - OFF ENG CRBL sw - ENABLE ENG THR CONT: BAL CPL sw - ON S/C: DEAD BAND sw - MIN CB S/C: DECA PWR - close DES ENG OVRD - close</p>	<p>Prevents possible attitude maneuver at 5° and/or 10°/second.</p> <p>Ref para 4.5.3.4 and 4.5.3.3.</p> <p>ENG THR CONT: MAN THROT sw - CDR (SE) when CDR (LMP) THROTTLE/JETS cont - THROTTLE.</p>

THRU

**LMA790-3-LM  
APOLLO OPERATIONS HANDBOOK**

CREW MAN	PNL	PROCEDURES	REMARKS																					
		<p>4.10.1.1.1 <u>DPS Thrust Program (P40) With AGS Followup/In Control (cont)</u></p> <p>6. Confirm ullage threshold: Key DEDA C 616R Modify ullage threshold: Key DEDA C 616+000YYE Go to AGS step 9.</p> <p>7. Select desired guidance steering: a. Z-axis parallel to CSM orbit plane - Key DEDA C 623+00000E C 400+10000E or b. Z-axis specified by Wb vector Key DEDA C 623+10000E C 400+10000E</p> <p>8. Deleted</p> <div style="border: 1px solid black; padding: 5px; margin-top: 10px;"> <p>To switch to AGS: ENG THR CONT: THR CONT sw - MAN CB S/C: AEA (pal 11) - close Go to AGS step 9.</p> </div>	<p>Ullage time is 2YY seconds depending on ullage volume. YY is determined from following:</p> <table style="margin-left: auto; margin-right: auto;"> <thead> <tr> <th style="text-align: left;"><u>Remaining Fuel</u></th> <th style="text-align: center;"><u>2 Jets</u> <u>(B)</u></th> <th style="text-align: center;"><u>4 Jets</u></th> </tr> </thead> <tbody> <tr> <td>100% to 25%</td> <td style="text-align: center;">4</td> <td style="text-align: center;">3</td> </tr> <tr> <td>20%</td> <td style="text-align: center;">7</td> <td style="text-align: center;">5</td> </tr> <tr> <td>15%</td> <td style="text-align: center;">8</td> <td style="text-align: center;">6</td> </tr> <tr> <td>10%</td> <td style="text-align: center;">11</td> <td style="text-align: center;">8</td> </tr> <tr> <td>6%</td> <td style="text-align: center;">12</td> <td style="text-align: center;">8</td> </tr> <tr> <td>3%</td> <td style="text-align: center;">13</td> <td style="text-align: center;">9</td> </tr> </tbody> </table>	<u>Remaining Fuel</u>	<u>2 Jets</u> <u>(B)</u>	<u>4 Jets</u>	100% to 25%	4	3	20%	7	5	15%	8	6	10%	11	8	6%	12	8	3%	13	9
<u>Remaining Fuel</u>	<u>2 Jets</u> <u>(B)</u>	<u>4 Jets</u>																						
100% to 25%	4	3																						
20%	7	5																						
15%	8	6																						
10%	11	8																						
6%	12	8																						
3%	13	9																						

**LMA790-3-LM**  
**APOLLO OPERATIONS HANDBOOK**

CREW- MAN	PNL	PROCEDURES	REMARKS
		<p>4.10.1.1.1 <u>DPS Thrust Program (P40) With AGS Followup/In Control (cont.)</u></p> <p>5. Select P40: Key V37E 40E</p> <p>Poss FL V05 M09 - Alarm 01706 - Loaded LM configuration indicates DPS staged PRDG lt - on Key V34E &amp; ESET FL V37 M-- Key X3E - Exit P40 Poss PRDG lt - on Key V05 M09E - Call alarm 00210 - IMU not operation</p> <p>00220 - ISS orientation not known</p> <p>Key KEY MEL &amp; ESET FL V37 M-- Key X3E - Exit P40</p> <p>7. Attitude Maneuver Routine (M60) FL V50 M18 - Perform automatic maneuver to final FDAI angles R1 Roll XXX.XI° R2 Pitch XXX.XI° R3 Yaw XXX.XI°</p>	<p>Do not select P40 if VC &lt;45000/ weight, to avoid main engine burn of 0.01 second, which may cause DPS helium/fuel heat exchanger freeze-up.</p> <p>Perform IMU Power-Up (LCC Operating) procedure (para 4.6.1.3). Perform IMU Orientation Determina- tion Program (P51) (para 4.9.1.1). To obtain optional display of VC (LV): Key V06 M86E R1 X XXXX.X fps R2 Y XXXX.X fps R3 Z XXXX.X fps</p> <p>LCC sets attitude errors to zero at this time.</p> <p>Automatic attitude maneuvers are more efficient (i.e., propellant- time product is lower) than manual attitude maneuvers.</p> <p>If final computed FDAI angles result in +90° yaw, transformation from IMU to FDAI angles in roll and pitch is indeterminate and R1 and R2 will be zero.</p>

**LMA790-3-LM  
APOLLO OPERATIONS HANDBOOK**

CREW-MAN	PROCEDURES	REMARKS
	<p>4.10.1.1.1 <u>DPS Thrust Program (P40) With AGS Followup/In Control (cont.)</u></p> <p>If desired, before continuing R60, crew may alter values of parameters DWTURUSH, DVCNTR, TDECAV+1 as follows:            Key V21 MOLE (01250E, 03515E, or 03741E, respectively), (new data)E</p> <div style="border: 1px solid black; padding: 2px; width: fit-content;"> <p>If PCNCS in followup: Key ENTR, exit R60, go to PCNCS step 9.</p> </div> <p>Accept automatic attitude maneuver:            GUID CONT sw - PCNS            S/C: PCNS sw - AUTO            Key PRO - Go to step 8</p> <p>Reject alternatives (exit R60 via 7c):</p> <ol style="list-style-type: none"> <li>a. Perform manual attitude maneuver:                ver:                Select desired attitude control mode - ACA - maneuver manually                Key PRO - Return to beginning of step 7</li> <li>b. To recompute gimbal angles:                S/C: PCNS sw - AIT HOLD                Key PRO - Return to beginning of step 7</li> <li>c. When present attitude is satisfactory:                Null AGS yaw attitude error.                Monitor yaw attitude error on FDAI error needle.                ACA - null yaw error (X-axis override)                S/C: PCNS sw - AUTO                Key ENTR - Exit R60, go to step 8A</li> </ol>	<p>Decision to alter these values and desired new values would be coordinated with, and received from, MSFN. Some or all values are octal and complemented values.</p> <p>Automatic trim maneuver is considered essential for maneuvers to thrusting attitude.</p> <p>Ref para 4.5.1.</p> <p>With AGS guidance steering, AGS orients LM Z-axis in specified direction, PCNCS R60 does not drive LM Z-axis to any specified orientations; therefore, PCNCS-to-AGS switchover could result in large yaw excursion. Consider FDAI attitude error needles as fly-to needles. Needles can be nulled by flying from them. However, this results in false null and switchover to AGS will result in 180° yaw maneuver.</p>



**LMA790-3-LM**  
**APOLLO OPERATIONS HANDBOOK**

CREW-MAN	PNL	PROCEDURES	REMARKS
		<p>4.10.1.1.1 <u>DPS Thrust Program (P40) With ACS Followup/In Control (cont)</u></p> <p>8. If PGCS automatic attitude maneuver selected:            DSKY displays are blanked until completion of automatic maneuver.            Monitor FDAI belly band, with respect to color band on roll bezel, to avoid gimbal lock.</p> <p>Monitor return of preceding display, indicating automatic maneuver is complete.            To stop LM motion if gimbal lock is approached:            S/C: PGNS sw - ATT HOLD</p> <p>If manual override &amp; completion of attitude maneuver desired:            Select desired attitude control mode            ACA - maneuver manually</p> <p>Return to step 7.</p> <div style="border: 1px solid black; padding: 5px; margin-top: 10px;"> <p>To switch to ACS:              GUID CONT sw - ACS              S/C: ACS sw - AUTO              ENG THR CONT: THR CONT sw - MAN              CB (11) S/C: AEA - close              Go to ACS step 10.</p> </div>	<p>If desired, Key extended verbs or            Key V16 N18 - Final FDAI angles            R1 Roll XXX.XX°            R2 Pitch XXX.XX°            R3 Yaw XXX.XX°            Key KEY REL</p> <p>Belly band covers separation between hemispheres of FDAI ball. Belly band, in color bands on each side of FDAI roll bezel, would indicate IMU middle gimbal angle <math>\geq 75^\circ</math>.</p> <p>During this maneuver, LGC will terminate automatic maneuver if S/C: PGNS sw is switched out of AUTO.</p> <p>Ref para 4.5.1.</p>
		<p>9. Perform ACS Orientation to Initial Computed Steering Attitude.</p>	<p>Refer para 4.6.2.13.</p>

LM 3150

THRUST

**LMA790-3-LM**  
**APOLLO OPERATIONS HANDBOOK**

CREW- MAN	PNI	PROCEDURES	REMARKS
		<p>4.10.1.1.1 <u>DPS Thrust Program (P40) With ACS Followup/In Control (cont)</u></p> <p>10. Monitor X-axis component of velocity to be gained: Key DEDA C 500R (0.1/1 fps)</p> <div style="border: 1px solid black; padding: 5px; margin: 10px auto; width: fit-content;"> <p>To switch to PGNS: GUID CONT sv - PGNS ENG THR CONT: THR CONT sv - as desired Go to PGCS step 9.</p> </div> <p>8A. Pose FL V50 N25 - Checklist reference R1 00203 - Switch to PGNS automatic mode R2 ----- R3 -----</p> <p>If PGCS automatic mode desired: GUID CONT sv - PGNS S/C: PGNS sv - AUTO ENG THR CONT: THR CONT - AUTO Key PRO If PGCS automatic mode was selected: Key ENTR</p> <p>9. V06 N40 R1 TFI            XXBX min-sec R2 VG            XXXX.X fps R3 ΔV<sub>m</sub>        XXXX.X fps</p> <p>CMPTR ACTY lt - on Monitor PROG lt from TFI = -00B50 to -00B35. If PROG lt - on: Key V05 N09E - Call alarm</p>	<p>Parenthetical quantization notation: lunar mission/earth mission. Readout will equal total velocity to be gained if LM is properly oriented for DPS burn.</p> <p>TFI is time from DPS ignition in minutes and seconds to nearest second. Sign is - before normal TIC; + after.</p> <p>R3 displays 00000 until TFI = -00B30. V06 N40 displays are blanked from TFI = -00B35 to -00B30. If alarm 01703 occurs, beginning and duration of blanking cannot be defined.</p> <p>CMPTR ACTY lt - on during State Vector Integration Routine (N41). To monitor progress of state vector integration, time (CET) to which state vector integration process has presently calculated state vector is available as follows:</p>

**LMA790-3-LM  
APOLLO OPERATIONS HANDBOOK**

CREW- MAN	PNI	PROCEDURES	REMARKS
		<p>4.10.1.1 <u>DPS Thrust Program (P40) With AGS Followup/In Control (cont)</u></p> <p>01703 - TIG slipped</p> <p>Key KEY REL &amp; RSET CMPTR ACTY lt - off</p> <p>Update EVNT TMR ind if required.</p>	<p>Key V16 N38E - TET R1 00XX hr R2 00XX min R3 0XX.XX sec</p> <p>To terminate display: Key KEY REL TIG will be slipped, as required, to get state vector integration to new TIG -30 seconds.</p> <p>State vector integration complete.</p> <p>If alarm 01703 occurs: 1. PGCS in control and AGS in followup:</p>

THRUST



**LMA790-3-LM**  
**APOLLO OPERATIONS HANDBOOK**

CREW-MAN	PNL	PROCEDURES	REMARKS
		<p>4.10.1.1.1 <u>DPS Thrust Program (P40) With ACS Followup/In Control (cont)</u></p>	<p>ACS solution will not provide expected results if AGS is in orbit insertion or external AV guidance modes. If switchover to AGS occurs, affect on expected results will not be large if velocity to be gained is nulled.</p> <p>2. AGS in control and PCNCS in followup:</p> <ol style="list-style-type: none"> <li>a. If switchover to PCNCS occurs before burn, proper burn will occur X seconds later.</li> <li>b. If switchover to PCNCS occurs during or after burn, PCNCS will attempt to perform burn X seconds later. Therefore, if AGS remains in control up to ignition time, PCNCS backup capability is lost.</li> <li>c. If EVNT TMR ind is reset per PCNCS procedures and AGS remains in control, results stated in 1, above, will follow.</li> </ol> <p>If alarm 01703 occurs, following are recommended:</p> <ol style="list-style-type: none"> <li>1. If PCNCS in control and AGS in followup, reset EVNT TMR ind and proceed normally.</li> <li>2. If AGS in control and PCNCS in followup:             <ol style="list-style-type: none"> <li>a. Reset EVNT TMR ind and burn X seconds later under AGS control.</li> <li>or</li> <li>b. Switch to PCNCS and burn X seconds later.</li> </ol> </li> </ol>

THRU

**LMA790-3-LM**  
**APOLLO OPERATIONS HANDBOOK**

RC 1596, LM 3231

CREW- MAN	PNI	PROCEDURES	REMARKS
		<p>4.10.1.1.1 <u>DPS Thrust Program (P40) With AGS Followup/In Control (cont)</u></p> <p>10. TTCA - minimum thrust</p> <p>11. If docked with CSM: Key V65E</p> <p>12. When TFI = -00B29: V06 N40 R1 TFI XXXXX min-sec R2 VG XXXX.X fps R3 AVm XXXX.X fps Verify AVm &lt;0.5 fps from TFI = -00B30 to -00B15 If AVm &gt;0.5 fps, perform one of following:</p> <p>a. Switch to AGS: GUID CONT sw - AGS ENG THR CONT: THR CONT sw - MAN Go to AGS step 11.</p> <p>or</p> <p>b. If PGNCs in followup or AGS capability not available: Key V37E XIE - Exit P40</p> <p>If PGNCs in followup, go to PGNCs step 15.</p> <p>13. If first DPS burn, enable super-critical He pressurization: ED: MASTER ARM sw - ON</p> <p>14. When TFI = -00B07 monitor start of ullage.</p> <p style="text-align: center;">CAUTION</p> <p style="text-align: center;">DES ENG CMD OVRD sw - OFF</p> <p>ENG THR CONT: ENG ARM sw - DES</p>	<p>Inhibiting X-axis RCS jets during DPS burns is recommended to minimize thermal impingement problems with descent stage and CSM.</p> <p>AVm &gt;0.5 fps indicates excessive PIPA bias error.</p> <p>Do not Key V37E within approximately 50 microseconds before ullage (if necessary to Key V37E, do it before TIC-10 seconds or after ullage comes on) to avoid continuous ullage with average g off.</p> <p>If DES ENG CMD OVRD sw is set to ON, engine will start upon arming.</p>

**LMA790-3-LM**  
**APOLLO OPERATIONS HANDBOOK**

LM 3231 CREW- MAN	PNL	PROCEDURES	REMARKS
		<p>4.10.1.1.1 <u>DPS Thrust Program (P40) With AGS Followup/In Control (cont)</u></p> <p>13. When EVNT THR ind = 00:XX, initiate ullage maneuver: TTCA - move up until DPS start Immediately upon initiation of ullage maneuver, enable AGS eng control &amp; arm descent eng: ABORT pb - push ENG THR CONT: ENG ARM sw - DES</p> <p>15. When TFI = -00B05: FL V99 M40 - Engine-on enable R1 TFI XXXX min-sec R2 VC XXXX.X fps R3 AVm XXXX.X fps Accept: When AVm &gt; XXXX.X fps, Key PRO</p> <div style="border: 1px solid black; padding: 5px; margin: 10px 0;"> <p>If PGMS in followup, select accept option, go to PGMS step 19.</p> </div> <p>Reject alternatives: a. To perform thrust with RCS: Key ENTR, go to PGMS step 23 ENG THR CONT: ENG ARM sw - OFF ENG CHBL sw - ENABLE or b. Key V34E - Terminate FL V37 N-- Key XYE - Exit P40 ENG THR CONT: ENG ARM sw - OFF ENG CHBL sw - ENABLE</p>	<p>XX = 2YY; YY is initially set to 3, but may be reset in step 6.</p> <p>If redundant engine arming is desired.</p> <p>GDA is now fully enabled and will be driven by any ACA and/or AGS attitude error commands.</p> <p>Response to FL V99 M40 should be made as soon as possible to decrease possibility of violating descent stage thermal constraint (approximately 15 seconds).</p> <p>During FL V99 M40, brief FL V06 may appear intermittently; this should be disregarded.</p>

THRU

**LMA790-3-LM**  
**APOLLO OPERATIONS HANDBOOK**

LM 3231

CREW-MAN	PNI	PROCEDURES	REMARKS
		<p>4.10.1.1 <u>DPS Thrust Program (P40) With AGS Followup/In Control (cont)</u></p> <p>16. If TFI is negative &amp; nonzero:            V06 N40            R1 TFI XXXX min-sec            R2 VC XXX.X fps            R3 AVm XXX.X fps</p> <p>17. When TFI = -0000, monitor thrust.            If no DPS burn:            Eng START pb/lt - push</p> <p style="text-align: center;">CAUTION</p> <p>If DPS burn is manually initiated (eng START pb/lt), automatic eng shutoff will not occur. When shutoff criteria are reached, eng STOP pb/lt - push.</p> <p>Rough combustion may be expected at start of DPS burns due to gas ingestion in propellants. Roughness may last as long as 25 sec, depending on how quickly eng is throttled up. There is no constraint on throttling due to this roughness.</p> <p>18. DPS/APS Thrust Fail Routine (R40)</p> <p>If LGC detects thrust fail:            FL V97 NXX - Perform engine fail procedures (noun &amp; registers do not change)            R1 XXXX            R2 XXXX            R3 XXXX</p> <p>Alternatives to fail procedure:            a. Verify LGC interpretation of thrust failure.            Key PRO</p> <p>b. Attempt completion of maneuver:            Key ENTR, return to step 15</p>	<p>If TFI is not negative and nonzero, DPS engine is commanded on when PRO is keyed in step 15.</p> <p>R40 is called at ignition time and remains active until engine cutoff. R40 monitors PIPA outputs and initiates engine failure procedures if thrust failure is detected. Engine thrust fails when PIPA detects <math>\Delta V</math> of <math>&lt;0.394</math> fps (12 cm/sec) (docked) or <math>&lt;1.18</math> fps (36 cm/sec) (undocked) for five consecutive sampling periods of 2 seconds each, after ignition time. Engine thrust also fails if, during thrusting period, <math>\Delta V</math> is less than this threshold for two consecutive sampling periods of 2 seconds each. During FL V97 NXX, brief FL V06 may appear intermittently; this should be disregarded.</p>



# LMA790-3-LM

## APOLLO OPERATIONS HANDBOOK

CREW-MAN	PNL	PROCEDURES	REMARKS
		<p>4.10.1.1.1 <u>DPS Thrust Program (P40) With AGS Followup/In Control (cont)</u></p> <p>c. Terminate:            Key V34E - Exit P40            FL V37 N--            Key XKE            ENG THR CONT: ENG ARM sw - OFF            ENG CHBL sw - ENABLE</p> <p>19. V06 N40            R1 TFC XXXX min-sec            R2 VG XXXX.X fps            R3 AVm XXXX.X fps            TFC &amp; VG decreasing, AVm increasing;            Monitor FDAI.            Poss PROG lt - on            Key V05 W09E - call alarm            01407 - VC increasing (angle between actual thrust vector and desired thrust vector &gt;90°)            Key KEY REL &amp; RSET            Terminate burn or go to backup alternative b.</p> <div style="border: 1px solid black; padding: 5px; margin: 5px 0;">             If PCMCs in followup, go to PCMCs step 23.           </div> <p>Backup alternatives:            a. ENG THR CONT: THR CONT sw - MAN               TTCA - move up as desired            or            b. Switch to AGS:               GUID CONT sw - AGS               ABORT pb - push               ENG THR CONT: THR CONT sw - MAN               TTCA - move up as desired               Go to AGS step 16.</p>	<p>TFC is discontinuous and AVm becomes fairly constant for 4 to 5 seconds. AVgx will begin to count-down at engine ignition.</p> <p>If VG is found to be increasing by LCC, engine-off command will not be generated.</p>
		<p>15. Monitor AVgx.            If AGS in followup, go to AGS step 21.</p>	

LM 3231

THR

**LMA790-3-LM**  
**APOLLO OPERATIONS HANDBOOK**

CREW-MAN	PNI	PROCEDURES	REMARKS
		<p>4.10.1.1.1 <u>DPS Thrust Program (P40) With AGS Followup/In Control (cont)</u></p> <p>20. When EVNT THR ind = 00:26:            a. Manual thrust -            TTCA - move up as required</p> <p>b. Automatic thrust -            If burn duration &gt;95 sec:            ENG THRUST ind - approx 100Z            CND THRUST ind - approx 100Z</p> <p>20A. If propellant quantity &gt;29Z:            DES He REG 1 sw - OPEN; tb - gray</p> <p>21. If first DPS burn:            ED: MASTER ARM sw - OFF</p> <p>21A. When propellant quantity = 29Z            or            At TFC-10 sec (&lt;86Z):            DES He REG 1 sw - CLOSE; tb - bp</p> <p>22. Monitor thrust cutoff:            a. Early cutoff -            Return to step 18.            b. Late or manual cutoff-            Eng STOP pb/lt - push            Wait 3 sec            ENG THR CONT: ENG ARM sw - OFF            Reset eng STOP pb/lt:            (1) Release tab - push            (2) Eng STOP pb/lt - on.</p>	<p>If burn duration &lt;95 seconds, no-throttle flag is set to inhibit throttle command from going maximum, preventing inaccurate engine-cutoff computations when engine thrust level varies, and entire burn is performed at 10Z thrust level. At this time, TFC will start counting down.</p> <p>Manual throttle to approximately 40Z after 15 seconds at 10Z may be nominal for LM controlled DOI.</p> <p>Poss MASTER ALARM - on when ED:            MASTER ARM sw - OFF due to relay race removing CMEA inhibit.</p> <p>Early cutoff - cutoff has occurred early with respect to computed time of cutoff. Late cutoff - LGC or AEA did not terminate engine burn at computed time of cutoff. Normal cutoff - engine shutdown occurred at computed time of cutoff.</p> <p>ENG THR CONT: ENG ARM sw -            OFF removes arming signal to</p>
		<p>16. When EVNT THR ind = 00:26:            TTCA - move up (maximum)</p> <p>17. If first DPS burn:            ED: MASTER ARM sw - OFF</p> <p>18. Monitor thrust cutoff when AVgx = 00000 fps:            a. Late or manual cutoff -            Eng STOP pb/lt - push            Wait 3 sec            ENG THR CONT: ENG ARM sw - OFF            ABORT pb - reset            Reset eng STOP pb/lt:            (1) Release tab - push            (2) Eng STOP pb/lt - on</p>	

**LMA790-3-LM**  
**APOLLO OPERATIONS HANDBOOK**

CREW- MAN	PNI	PROCEDURES	REMARKS
		<p>4.10.1.1.1 <u>DPS Thrust Program (P40) With AGS Followup/In Control (cont)</u></p> <p>(3) If eng STOP pb/lt - off, verify that lights are functioning by performing Caution &amp; Warning Array Checkout, steps 3 &amp; 4 (para 4.2.10). If lights are functioning, inadvertent reset has taken place &amp; eng is enabled. Steps (4), (5), &amp; (6) should not be performed.</p>	<p>throttle actuator, causing throttle to move to fully open position. To avoid possible transient thrust surge, pause 3 seconds after pushing Eng STOP pb/lt. This ensures that all engine valves have time to close.</p>

THRUST

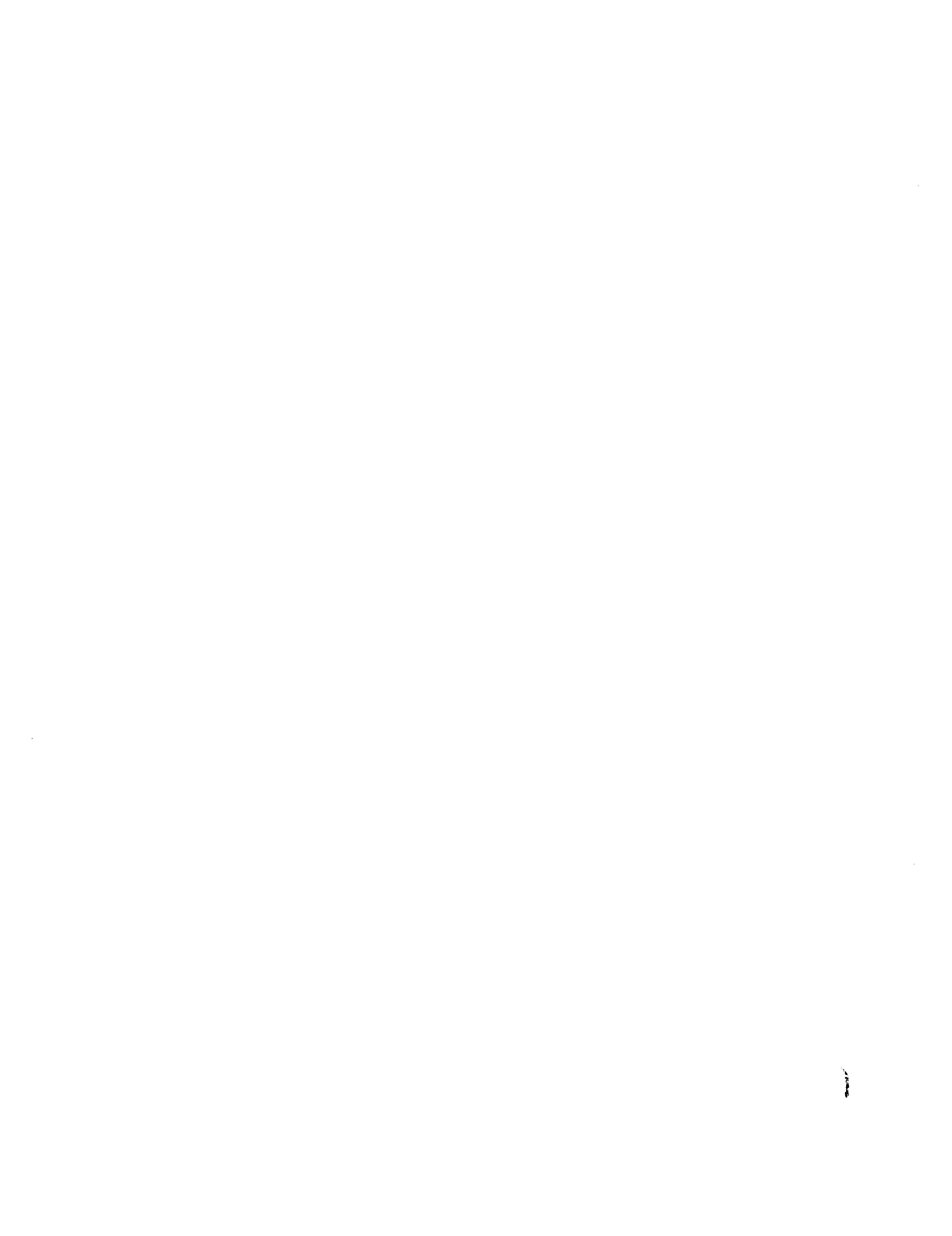

**LMA790-3-LM**  
**APOLLO OPERATIONS HANDBOOK**

CREW-MAN	PNL	PROCEDURES	REMARKS
		<p>4.10.1.1 DPS Thrust Program (P40) With AGS Followup/In Control (cont)</p> <p>(4) Eng STOP pb/lt - push (5) Release tab - push (6) Eng STOP pb/lt - off ENG CHBL sw - ENABLE</p> <p>c. Normal cutoff - ENG THR CONT: ENG ARM sw - OFF ENG CHBL sw - ENABLE</p> <div style="border: 1px solid black; padding: 5px; margin: 10px 0;"> <p>To switch to AGS: GUID CONT sw - AGS CB (11) S/C: AEA - close Go to AGS step 19.</p> </div> <p>23. If V65 was keyed before: Key V75E</p> <p>24. FL V16 M40 R1 TFC XXXX.X min-sec R2 VC XXXX.X fps R3 AVa XXXX.X fps</p> <p>Record final thrust parameters Key PR0 Record final propellant quantity noted during thrust PRELFT QTY MON sw - OFF</p> <p>25. FL V16 M85 - VG (LM) R1 X XXXX.X fps R2 Y XXXX.X fps R3 Z XXXX.X fps</p> <div style="border: 1px solid black; padding: 5px; margin: 10px 0;"> <p>If PGMS in followup, go to PGMS step 26.</p> </div>	
		<p>(4) Eng STOP pb/lt - push (5) Release tab - push (6) Eng STOP pb/lt - off ENG CHBL sw - ENABLE</p> <p>b. Early or normal cutoff - ABORT pb - reset ENG THR CONT: ENG ARM sw - OFF ENG CHBL sw - ENABLE</p> <div style="border: 1px solid black; padding: 5px; margin: 10px 0;"> <p>To switch to PGMS: GUID CONT sw - PGMS Go to PGMS step 24.</p> </div> <p>19. Record final propellant quantity noted during thrust PRELFT QTY MON sw - OFF</p>	<p>At this time, LGC zeroes attitude error and sets 0.3° deadband in RCS DAP.</p>

**LMA790-3-LM**  
**APOLLO OPERATIONS HANDBOOK**

CREW- MAN	PNI	PROCEDURES	REMARKS
		<p>4.10.1.1 <u>DPS Thrust Program (P40) With AGS Followup/In Control (cont)</u></p> <p>If nulling of VC is desired: S/C: PCRS sw - ATT HOLD THROTTLE/JETS cont (CDR) - JETS ACA/TTCA - null VCI, VCY, VCZ</p>	<p>If this trim maneuver is performed after use of orbit insertion routine, it should be performed immediately after engine shutdown. Orbit Insertion routine drives LM to specific point on desired orbit and residual AV's will increase naturally after engine shutdown.</p>
		<p>20. Trim AV residual -</p> <p>If not in Orbit Insertion (410+00000) select External AV: Key DEDA C 410+50000E</p> <p>Verify AEA attitude hold submode: Key DEDA C 400R If +00000 not displayed: Key DEDA C 400+00000E S/C: DEAD BAND sw - MIN</p> <p>Read and record: AVgx Key DEDA C 500R (0.1/1 fps) AVgy Key DEDA C 501R (0.1/1 fps) AVgz Key DEDA C 502R (0.1/1 fps)</p> <p>Read out and null AVg residuals in order of magnitude, largest first.</p> <p>S/C: DEAD BAND sw - MAX</p>	<p>Null AVgx by moving TTCA up or down. Up TTCA nulls positive AVgx.</p> <p>Null AVgy by moving TTCA right or left. Right TTCA nulls positive AVgy.</p> <p>Null AVgz by moving TTCA in or out. In TTCA nulls positive AVgz.</p>

**LMA790-3-LM**  
**APOLLO OPERATIONS HANDBOOK**

CREW-MAN	PNL	PROCEDURES	REMARKS
		<p>4.10.1.1.1 <u>DPS Thrust Program (P40) With ACS Followup/In Control (cont)</u></p> <p>21. Read out predicted perifocus altitude: Key DEDA C 403R (0.1 nm) Compare with PCNCS Hp value.</p> <p>22. Read out apofocus altitude: Key DEDA C 315R (0.1 nm) Compare with PCNCS Ha value.</p> <p>26. Terminate P40 or select Orbit Parameter Display Routine (R30): a. Terminate: Key PRO FL V37 N-- Key XIE - Exit P40 or b. Select R30: Key V76E &amp; verify/set NO DAP It - on S/C: PCNS sw - AIT HOLD to conserve RCS propellant by overriding LCC-selected deadband (0.3°) Key V82E FL V16 N44 R1 Ha XXXX.X nm R2 Hp XXXX.X nm R3 TFF XXXX min-sec Key PRO when finished with display to reestablish N85 display. Exit R30 Key PRO FL V37 N-- Key XIE - Exit P40</p> <p>27. Turn off ascent batteries: EPS: BAT 5 NORMAL LMP FEED sw - OFF/ RESET; tb - bp BAT 6 NORMAL CDR FEED sw - OFF/RESET; tb - bp</p> <p>28. Perform EPS check, Post DPS Burn.</p>	<p>While average g is in process, orbit parameters are automatically recomputed every 2 seconds.</p> <p>At this time, LCC restores crew-specified (R03) deadband limits in RCS DAP.</p> <p>Ref para 4.13.4.4.</p>
		<p>23. Turn off ascent batteries: EPS: BAT 5 NORMAL LMP FEED sw - OFF/ RESET; tb - bp BAT 6 NORMAL CDR FEED sw - OFF/RESET; tb - bp</p> <p>24. Perform EPS check, Post-DPS Burn.</p>	

LM 3207

**LMA790-3-LM**  
**APOLLO OPERATIONS HANDBOOK**

CREW- MAN	PNL	PROCEDURES	REMARKS
		<p>4.10.1.2 <u>APS Thrust Program (P42) With ACS Followup/In Control (cont)</u></p> <p>MFS Basic (Staged) (required)            ECS Prestaging Check (required)            EPS Basic (Staged) (required - if staged)            EPS Prestaging Check (required - if unstaged)            ED Prestaging Check (desired)</p> <p>MFS Basic (Staged) (required)            ECS Prestaging Check (required)            EPS Basic (Staged) (required - if staged)            EPS Prestaging Check (required - if unstaged)            ED Prestaging Check (desired)</p>	<p>Purpose of APS Thrust (P42) with ACS Followup/In Control procedure is to compute preferred IMJ orientation and LM attitude for APS thrust maneuver and to maneuver LM to thrusting attitude. This procedure controls PGMS/AGS during countdown, ignition, thrusting, and thrust termination.</p> <p>Following sequence of procedures may cause problems:</p> <ol style="list-style-type: none"> <li>1. P3X, followed by P47, followed by P40, P41, or P42; prethrust computations may be overwritten by P47.            To recover:            Perform P3X, followed by P40, P41, or P42</li> <li>2. Deleted            Ref para 4.13.3.2.            Ref para 4.12.7.            Ref para 4.13.4.2.            Ref para 4.12.5.            Ref para 4.12.6</li> </ol>

L.M. 1231



# LMA790-3-LM

## APOLLO OPERATIONS HANDBOOK

CREW-MAN	PNL	PROCEDURES	REMARKS
		<p>4.10.1.2 <u>APS Thrust Program (P42) With AGS Followup/In Control (cont)</u></p> <p>APS Pressurization &amp; Checkout (required)</p> <p>LGC Power-Up (required)</p> <p>LGC Self-Test (desired)</p> <p>LGC time valid (required)</p> <p>LGC state vector valid (required)</p> <p>IMU Power-Up (LGC Operating) (required)</p> <p>IMU Orientation Determination Program (P51) (required)</p> <p>DAP Data Load Routine (R03) (required)</p> <p>Appropriate prethrust program (required)</p>	<p>Ref para 4.12.3.</p> <p>Ref para 4.6.1.1.</p> <p>Ref para 4.6.1.13.</p> <p>LGC/CMC Clock Synchronization Routine (R33) (para 4.6.1.15)</p> <p>LGC Update Program (P27) (para 4.6.1.7) or Rendezvous Navigation Program (P20)</p> <p>Ref para 4.6.1.3. ISS should be on 15 minutes before thrusting maneuver.</p> <p>Ref para 4.9.1.1.</p> <p>Ref para 4.6.1.8. N46 (R1) = IBCOE recommended</p> <p>Ref para 4.7.</p> <p>Ref para 4.6.2.1.</p> <p>Ref para 4.6.2.3.</p> <p>AGS Manual Absolute Time Initialization Procedure (para 4.6.2.6) or AGS Initialization Routine (R47) (para 4.6.1.18)</p> <p>AGS Initialization Routine (R47) (para 4.6.1.18) or AGS Manual LM State Vector Update/Initialization Procedure (para 4.6.2.7) or AGS Manual Rendezvous Radar LM State Vector Update procedure (para 4.8.2.2)</p>
		<p>AGS Power-Up (required)</p> <p>AEA Self-Test (desired)</p> <p>AGS time valid (required)</p> <p>AGS LM state vector valid (required)</p>	

LM 3251

THRU

**LMA790-3-LM**  
**APOLLO OPERATIONS HANDBOOK**

LM 3231

CREW-MAN	PNL	PROCEDURES	REMARKS
		<p>4.10.1.1.2 <u>APS Thrust Program (P42) With AGS Followup/In Control (cont)</u></p> <div style="border: 1px solid black; padding: 5px; margin: 10px 0;"> <p>If PCNCS in followup, go to step 5.</p> </div> <ol style="list-style-type: none"> <li>1. Establish attitude control: GUID CONT sw - PCNS S/C: PCNS sw - AUTO AGS sw - AUTO ROLL, PITCH, YAW sw - MODE CONT</li> <li>2. Establish PCNCS total attitude &amp; attitude rate/error display: ATTITUDE MON sw (1) - PCNS ATTITUDE MON sw (1) - AGS RATE/ERR MON sw (2) - LDG RDR/CHPTR</li> <li>3. Enable ACA/TTCA: ACA/4 JET sw (2) - ENABLE TTCA/TRANSL sw (2) - ENABLE THROTTLE/JETS cont (2) - JETS ENG THR CONT: ATT/TRANSL sw - 4 JETS ACA PROP sw (2) - ENABLE</li> <li>4. Prepare controls for APS burn: ENG THR CONT: ENG ARM sw - OFF ABORT pb - reset ABORT STAGE pb - reset Eng START pb/lit - off Eng STOP pb/lit (2) - reset ENG THR CONT: BAL CPL sw - ON S/C: DEAD BAND sw - MIN CB (11) S/C: AELD - close CB (16) S/C: AELD - close</li> </ol>	<p>AGS Initialization Routine (R47) (para 4.6.1.18) or AGS Manual CSM State Vector Update (para 4.6.2.9)</p> <p>PCNCS/AGS Align (para 4.9.2.1), Back-up AGS Alignment (Using AGS Body-Axis Alignment and PCNS IMU) (para 4.9.2.2), Backup AGS Alignment (Using AGS Body-Axis Alignment and AOT) (para 4.9.2.3), or AGS Lunar Align (para 4.9.3.2)</p> <p>Ref para 4.6.2.15.</p> <p>Ref para 4.7. If AGS TPI search prethrust procedure was used, TPI execute must have been selected subsequent to that procedure.</p> <p>Ref para 4.5.3.1 and 4.5.3.2.</p>
		<p>AGS CSM state vector valid (required)</p> <p>AGS alignment valid (required)</p> <p>AGS Wb Vector Update (required if mission warrants) Appropriate prethrust procedure (required)</p>	

**LMA790-3-LM  
APOLLO OPERATIONS HANDBOOK**

CREW-MAN	PNL	PROCEDURES	REMARKS
		<p>4.10.1.1.2 APS Thrust Program (P42) With AGS Followup/In Control (cont)</p> <p>If AGS in followup, go to AGS step 5.</p> <ol style="list-style-type: none"> <li>Establish attitude control: Key DEDA C 400+0000E GUID CONT sw - AGS S/C: AGS sw - AUTO PGNS sw - AUTO ROLL, PITCH, YAW sw - MODE CONT</li> <li>Establish AGS attitude error &amp; total attitude display: ATTITUDE MON sw (1) - AGS ATTITUDE MON sw (1) - PGNS RATE/ERR MON sw (2) - LDG RDR/CMPTK</li> <li>Enable ACA/TTCA: ACA/4 JET sw - ENABLE TTCA/TRANSL sw (2) - ENABLE THROTTLE/JETS cont (2) - JETS ENG THR CONT: ATT/TRANSL sw - 4 JETS ACA PROP sw (2) - ENABLE</li> <li>Prepare controls for APS burn: ENG THR CONT: ENG ARM sw - OFF ABORT pb - reset ABORT STAGE pb - reset Eng START pb/lt - off Eng STOP pb/lt (2) - reset ENG THR CONT: BAL CPL sw - ON S/C: DEAD BAND sw - MIN CB (11) S/C: AELD - close CB (16) S/C: AELD - close Go to AGS step 7.</li> </ol>	<p>Prevents possible attitude maneuver change of 5° and/or 10°/second.</p> <p>Ref para 4.5.3.4 and 4.5.3.3.</p>

THRU

**LMA790-3-LM**  
**APOLLO OPERATIONS HANDBOOK**

CREW-MAN	PNL	PROCEDURES	REMARKS																																
		<p>4.10.1.2 <u>APS Thrust Program (P42) With AGS Followup/In Control (cont)</u></p> <p>5. Select desired guidance steering:            a. Z-axis parallel to CSM orbit plane:               Key DEDA C 623+00000E               Key DEDA C 400+10000E            or            b. Z-axis specified by Wb vector:               Key DEDA C 623+10000E               Key DEDA C 400+10000E</p> <p>6. Deleted</p> <div style="border: 1px solid black; padding: 2px; margin: 5px 0;">If AGS in followup, go to AGS step 9.</div> <div style="border: 1px solid black; padding: 2px; margin: 5px 0;">To switch to PGNCs, go to PGNCs step 5.</div> <p>7. Confirm ullage threshold:               Key DEDA C 616 R            Modify ullage threshold:               Key DEDA C +00000E</p>	<p>Do not select P42 if VG &lt; 45000/weight.</p> <p>Ullage time is 2Y seconds depending on ullage volume. Y is determined from following:</p> <table style="margin-left: auto; margin-right: auto;"> <thead> <tr> <th style="text-align: left;">Remaining Fuel</th> <th style="text-align: left;">Total Burn Time (sec)</th> <th style="text-align: left;">2 Jets</th> <th style="text-align: left;">4 Jets</th> </tr> <tr> <th></th> <th></th> <th style="text-align: center;">(B)</th> <th></th> </tr> </thead> <tbody> <tr> <td>100% to</td> <td>0 to</td> <td>2</td> <td>2</td> </tr> <tr> <td>50%</td> <td>228</td> <td></td> <td></td> </tr> <tr> <td>40%</td> <td>274</td> <td>4</td> <td>3</td> </tr> <tr> <td>30%</td> <td>319</td> <td>5</td> <td>4</td> </tr> <tr> <td>20%</td> <td>365</td> <td>6</td> <td>4</td> </tr> <tr> <td>10%</td> <td>410</td> <td>7</td> <td>5</td> </tr> </tbody> </table>	Remaining Fuel	Total Burn Time (sec)	2 Jets	4 Jets			(B)		100% to	0 to	2	2	50%	228			40%	274	4	3	30%	319	5	4	20%	365	6	4	10%	410	7	5
Remaining Fuel	Total Burn Time (sec)	2 Jets	4 Jets																																
		(B)																																	
100% to	0 to	2	2																																
50%	228																																		
40%	274	4	3																																
30%	319	5	4																																
20%	365	6	4																																
10%	410	7	5																																
		<div style="border: 1px solid black; padding: 2px; margin: 5px 0;">To switch to AGS: CB (11) S/C: AEA - close Go to AGS step 8.</div> <p>5. Key V37E 42E</p> <p>Poss FL V05 N09 - Alarm            01706 - Loaded LM configuration indicates DPS not staged            PROG lt - on</p>																																	

**LMA790-3-LM**  
**APOLLO OPERATIONS HANDBOOK**

CREW- MAN	PNL	PROCEDURES	REMARKS
		<p>4.10.1.1.2 APS Thrust Program (P42) With AGS Followup/In Control (cont.)</p> <p>Alternatives:            a. To continue: Key PRO &amp; RESET            or            b. To terminate: Key V34E &amp; RESET</p> <p>FL V37 N--            Key XXE - Exit P42</p> <p>Poss PROG lt - on            Key V05 N09E - Call alarm            00210 - IMU not on /</p> <p>00220 - ISS orientation not known            Key KEY REL &amp; RSET</p> <p>FL V37 N--            Key XXE - Exit P42</p> <p>6. Attitude Maneuver Routine (R60)            FL V50 N18 - Perform automatic maneuver to final FDAI angles            R1 Roll XXX.XX*            R2 Pitch XXX.XX*            R3 Yaw XXX.XX*</p>	<p>Although DPS has not been staged, staging will occur after TIG-30 seconds and before ignition (when average-g integration is being performed).</p> <p>Perform IMU Power-Up (LGC Operating) Procedure (para 4.6.1.3).            Perform IMU Orientation Determination Program (P51) (para 4.9.1.1).</p> <p>Manual selection of VG(LV) can be performed by following:            Key V06 N86E            R1 X XXXX.X fps            R2 Y XXXX.X fps            R3 Z XXXX.X fps</p> <p>At this time, LGC zeroes attitude error and sets 1° deadband in RCS DAP.</p> <p>Automatic attitude maneuvers are more efficient (i.e., propellant-time product is lower) than manual attitude maneuvers.            If final computed FDAI angles result in +90° yaw, transformation from IMU to FDAI angles in roll and pitch is indeterminate and R1 and R2 will be zero.</p>

LM 999, LM 3231

THRU

**LMA790-3-LM**  
**APOLLO OPERATIONS HANDBOOK**

LM 3231

CREW-MAN	PNL	PROCEDURES	REMARKS
		<p>4.10.1.2 APS Thrust Program (P42) With AGS Followup/In Control (cont)</p> <p>If desired, before continuing R60, crew may alter values of parameters DVTHRUSH, DVCNTR, TDECAY+1 as follows: Key V21 NO1E (01250E, 03515E, or 03741E, respectively), (new data)E</p> <div style="border: 1px solid black; padding: 5px; width: fit-content;"> <p>If PGNS in followup, key ENTR, exit R60, go to PGNS step 8.</p> </div> <p>Accept automatic attitude maneuver: GUID CONT sw - PGNS S/C: PGNS Sw - AUTO Key PRO - Go to step 7</p> <p>Reject alternatives (exit R60 via 6c):</p> <ol style="list-style-type: none"> <li>a. Perform manual attitude maneuver: Select desired attitude control mode ACA - maneuver manually Key PRO - Return to beginning of step 6</li> <li>b. To recompute gimbal angles: S/C: PGNS sw - ATT HOLD Key PRO - Return to beginning of step 6</li> <li>c. When present attitude is satisfactory: Null AGS yaw attitude error. Monitor yaw attitude error on FPAI error needle. ACA - null yaw error (X-axis override)</li> </ol>	<p>Decision to alter these values and desired new values would be coordinated with, and received from, MSFN. Some or all values are octal and complemented values.</p> <p>Automatic trim maneuver is considered essential for maneuvers to thrusting attitude.</p> <p>Ref para 4.5.1.</p> <p>With AGS guidance steering, AGS orients LM Z-axis in specified direction. PGNS R60 does not drive LM Z-axis to any specified orientation; therefore PGNS-to-AGS</p>

To switch to PGNS:  
GUID CONT sw - PGNS  
Go to PGNS step 6 & select automatic attitude maneuver.

**LMA790-3-LM**  
**APOLLO OPERATIONS HANDBOOK**

CREW-MAN	PNL	PROCEDURES	REMARKS
		<p>4.10.1.2 APS Thrust Program (P42) With AGS Followup/In Control (cont)</p> <p>S/C: PGNS sw - AUTO            Key ENTR - Exit R60.            Go to step 7A</p> <p>7. If PGNS automatic attitude maneuver selected:            DSKY displays are blanked until completion of automatic maneuver.            Monitor FDAI belly band, with respect to color band on roll bezel, to avoid gimbal lock.</p> <p>Monitor return of preceding display, indicating automatic maneuver complete.            To stop LM motion if gimbal lock is approached:            S/C: PGNS sw - ATT HOLD</p> <p>If manual override &amp; completion of attitude maneuver desired:            Select desired attitude control mode            ACA - maneuver manually            Return to step 6.</p> <p>7A. Poss FL V50 N25 - Checklist reference            R1 00203 - Switch to PGNS automatic mode            R2 -----            R3 -----</p>	<p>switchover could result in large yaw excursion. Consider FDAI attitude error needles as fly-to needles. Needles can be nulled by flying from them. However, this results in false null and switchover to AGS will result in 180° yaw maneuver.</p> <p>If desired, Key extended verbs or            Key V16 N18 - Final FDAI angles            R1 Roll XXX.XX°            R2 Pitch XXX.XX°            R3 Yaw XXX.XX°            Key KEY REL</p> <p>Belly band covers separation between hemispheres of FDAI ball. Belly band, in color bands on each side of FDAI roll bezel, would indicate IMU middle gimbal angle <math>\geq 75^\circ</math>.</p> <p>During this maneuver, LGC will terminate automatic maneuver if S/C: PGNS sw is switched out of AUTO.</p> <p>Ref para 4.5.1.</p> <p>Ref para 4.6.2.13.</p>

LM 3158, LM 3231

THRUS

**LMA790-3-LM**  
**APOLLO OPERATIONS HANDBOOK**

CREW-MAN	PNL	PROCEDURES	REMARKS
		<p>4.10.1.2 APS Thrust Program (P42) With AGS Followup/In Control (cont)</p> <p>If PGNS automatic mode desired: GUID CONT sw - PGNS S/C: PGNS sw - AUTO ENG THR CONT: THR CONT sw - AUTO</p> <p>Key PRO If PGNS automatic mode was selected: Key ENTR</p> <p>8. V06 N40 R1 TPI    XXBX min-sec R2 VG     XXX.X fps R3 AVm    XXX.X fps</p> <div style="border: 1px solid black; padding: 5px; margin: 10px 0;"> <p>To switch to PGNS: GUID CONT sw - PGNS ENG THR CONT: THR CONT sw - as desired Go to PGNS step 8.</p> </div> <p>CMPTR ACTY lt - on Monitor PROG lt from TPI = -00B50 to -00B35. If PROG lt - on: Key V05 N09E - Call alarm 01703 - TIG slipped</p> <p>Key KEY REL &amp; RSET CMPTR ACTY lt - off</p> <p>Update EVNT TMR ind if required.</p>	<p>R3 displays 0000 until TPI = -00B30 V06 N40 displays are blanked from TPI = -00B35 to -00B30. If alarm 01703 occurs, beginning and duration of blanking cannot be defined. To monitor progress of state vector integration, time (GET) to which state vector integration process has presently calculated state vector is available as follows: Key V16 N38E - TET R1 00XX hr R2 00XX min R3 0XX.XX sec To terminate display: Key KEY REL</p> <p>CMPTR ACTY lt - on during State Vector Integration Routine (R41).</p> <p>TIG will be slipped, as required, to get state vector integration to new TIG -30 seconds.</p> <p>State vector integration complete.</p> <p>If alarm 01703 occurs: 1. PGNS in control and AGS in followup:</p>



**LMA790-3-LM**  
**APOLLO OPERATIONS HANDBOOK**

CREW-MAN	PNL	PROCEDURES	REMARKS
		<p>4.10.1.1.2 APS Thrust Program (P42) With AGS Followup/In Control (cont)</p> <div style="border: 1px solid black; padding: 5px; margin: 10px 0;"> <p>To switch to AGS: GUID CONT sw - AGS S/C: AGS sw - AUTO CB S/C: AEA (pn1 11) - close Go to AGS step 9.</p> </div>	<p>AGS solution will not provide expected results if AGS is in orbit insertion or external ΔV guidance modes. If EVNT TMR ind is reset and velocity to be gained is nulled, deviation from expected results will not be large.</p> <p>2. AGS in control and PGCS in followup:</p> <ol style="list-style-type: none"> <li>a. If switchover to PGCS occurs before burn, proper burn will occur X seconds later (under PGCS control).</li> <li>b. If switchover to PGCS occurs during or after burn, PGCS will command engine off and attempt to perform burn X seconds later. Thus, if AGS remains in control up to ignition time and EVNT TMR ind is not reset, PGCS backup capability is lost.</li> <li>c. If EVNT TMR ind is reset per PGCS procedure and AGS remains in control, results stated in 1, above, will follow.</li> </ol> <p>If alarm 01703 occurs, following are recommended:</p> <ol style="list-style-type: none"> <li>1. If PGCS in control and AGS in followup, reset EVNT TMR ind and proceed normally.</li> </ol>

THRUS

**LMA790-3-LM**  
**APOLLO OPERATIONS HANDBOOK**

RC 1596, LM 3231

CREW- MAN	PNL	PROCEDURES	REMARKS
		<p>4.10.1.2 APS Thrust Program (P42) With AGS Followup/In Control (cont)</p>	<p>2. If AGS in control and PGCS in followup, reset EVNT TMR ind and burn X seconds later under AGS control, or switch to PGCS and burn X seconds later.</p> <p>Readout will equal total velocity to be gained if LM is properly oriented for burn.</p> <p>Parentetical quantization notation: lunar mission/earth mission.</p> <p><math>\Delta V_m &gt; 0.5</math> fps indicates excessive PIPA bias error</p> <p>Ref para 4.12.8 (steps 13-15)</p> <p>Do not Key V37E within approximately 50 microseconds before ullage (if necessary to Key V37E, do it before TIC-10 seconds or after ullage comes on) to avoid continuous ullage with average g off.</p> <p>During FL V99 N40, brief FL V06 may appear intermittently; this should be disregarded.</p> <p>XX = 2Y; Y is initially set to 3 but may be reset in step 7. Ullage time and <math>\Delta V</math> depends on real-time ullage volume.</p>
		<p>9. Monitor X-axis component of velocity to be gained Key DEDA C 500R (0.1/1 fps) S/C: DEAD BAND sw - MIN</p> <p style="border: 1px solid black; padding: 2px;">If AGS in followup, go to AGS step 12.</p>	
		<p>9. When TFI = -00B29: V06 N40 R1 TFI XXBXX min-sec R2 VG XXXX.X fps R3 <math>\Delta V_m</math> XXXX.X fps Verify <math>\Delta V_m &lt; 0.5</math> fps from TFI = -00B30 to -00B15 Perform RCS staging if not previously performed If <math>\Delta V_m &gt; 0.5</math> fps: a. Switch to AGS - GUID CONT sw - AGS S/C: AGS sw - AUTO Go to AGS step 10. b. If PGCS in followup or AGS capability not available: Key V37E XXE - Exit P42</p>	
		<p>10. When TFI = -00B06, monitor ullage <math>\Delta V</math>. FL V99 N40 - Engine-on enable R1 TFI XXBXX min-sec R2 VG XXXX.X fps R3 <math>\Delta V_m</math> XXXX.X fps ENG THR CONT: ENG ARM sw - ASC Accept: when <math>\Delta V_m &gt; XXXX.X</math> fps, Key PRO</p>	<p>10. When EVNT TMR ind = 00:XX, initiate ullage maneuver: TTCA - move up until APS start Immediately on ullage initiation: ABORT STAGE pb - push</p>

# LMA790-3-LM APOLLO OPERATIONS HANDBOOK

CREW-MAN	PNL	PROCEDURES	REMARKS
		<p>4.10.1.1.2 APS Thrust Program (P42) With ACS Follow/Up In control (cont)</p> <div style="border: 1px solid black; padding: 5px; margin: 10px 0;"> <p>If PGNCs in followup, select accept option and go to PGNCs step 13.</p> </div> <p>Reject alternatives:            a. To perform thrust with RCS:               Key ENTR - Go to PGNCs step 18               ENG THR CONT: ENG ARM sw - OFF</p> <p>b. To terminate:               Key V34E               FL V37 N--               Key XXE - Exit P42               ENG THR CONT: ENG ARM sw - OFF</p> <p>11. If TFI is negative and nonzero:               V06 N40               R1 TFI XXBX min-sec               R2 VG XXXX.X fps               R3 Δv XXXX.X fps</p> <p>12. When TFI = -00B00:               Monitor APS thrust.               If no APS burn,               Eng START pb/lt - push</p> <p style="text-align: center;">CAUTION</p> <p style="text-align: center;">If APS burn is manually initiated, automatic engine shutoff will not occur. When shutoff criteria are reached, eng STOP pb/lt must be pushed.</p>	<p>Complete protection against effects of single-point failures, which would cause engine to start as soon as it is armed, is not achieved unless ullage maneuver is completed before arming engine.</p> <p>Provides redundant engine power.</p>
		<p>ENG THR CONT: ENG ARM sw - ASC</p>	
		<p>11. When EVNT TMR ind = 00:00               Monitor APS thrust.               If no APS burn,               Eng START pb/lt - push</p>	

THRUST

**LMA790-3-LM  
APOLLO OPERATIONS HANDBOOK**

RC 1581, LM 3231

CREW-MAN	PNL	PROCEDURES	REMARKS
		<p>4.10.1.2 APS Thrust Program (P42) With AGS Followup/In Control (cont)</p>	
		<p>13. DPS/APS Thrust Fail Routine (R40)</p> <p>If LGC detects thrust fail:            FL V97 NXX - Perform engine fail procedure (noun and registers do not change)            R1 XXXXX            R2 XXXXX            R3 XXXXX</p> <p>Alternatives to fail procedure:            a. Verify LGC interpretation of thrust failure:            Key PRO</p> <p>b. Attempt completion of maneuver:            Key ENTR, return to step 10</p> <p>c. Terminate:            Key V34E - Exit P42            FL V37 N--            Key XXE            ENG THR CONT: ENG ARM sw - OFF</p>	<p>R40 is called at nominal ignition time and remains active until engine cutoff. R40 monitors PIPA outputs and initiates engine fail procedures if thrust fail is detected. Engine thrust fails when PIPA detects <math>\Delta V</math> of &lt;10.1 fps (308 cm/sec) for five consecutive sampling periods of 2 seconds each, after nominal ignition time. Engine thrust also fails if, during thrusting period, <math>\Delta V</math> is less than this threshold for two consecutive sampling periods of 2 seconds each.</p> <p>During FL V97 NXX, brief FL V06 may appear intermittently; this should be disregarded.</p>
		<p>14. V06 N40</p> <p>R1 TFC XXBXX min-sec            R2 VG XXXX.X fps            R3 <math>\Delta V_m</math> XXXX.X fps</p> <p>TFC &amp; VG decreasing, <math>\Delta V_m</math> increasing            Monitor FDAI.</p> <p>Poss PROC lt - on            Key V05 N09E - call alarm            01407 - VG increasing (angle between actual thrust vector and desired thrust vector &gt;90°)</p> <p>Key KEY REL &amp; RSET            Terminate burn or switch to AGS (see switchover box)</p> <div style="border: 1px solid black; padding: 5px; margin-top: 10px;"> <p>To switch to AGS:              GUID CONT sw - AGS              ABORT STAGE pb - push              CB (11) S/C: AEA - close              Go to AGS step 13.</p> </div>	<p>TFC is discontinuous and <math>\Delta V_m</math> becomes fairly constant for 4 to 5 seconds.</p> <p><math>\Delta V_{gx}</math> begins to count-down at engine ignition.</p> <p>If VG is found to be increasing by LGC, engine-off command will not be generated.</p> <p>ENG THR CONT: BAL CPL sw - OFF            reduces propellant consumption, however, in the event of single point failures of downward firing RCS jets            ENG THR CONT: BAL CPL sw - ON is required to maintain attitude control.</p> <p>ENG THR CONT: BAL CPL sw - ON is desirable for the entirety of short APS burns (of a few seconds duration) or until vehicle attitude is stabilized after APS startup.</p>
		<p>12. Monitor <math>\Delta V_{gx}</math>:            ENG THR CONT: BAL CPL sw - OFF</p> <div style="border: 1px solid black; padding: 5px; margin-top: 10px;"> <p>If AGS in followup, go to AGS step 18.</p> </div> <div style="border: 1px solid black; padding: 5px; margin-top: 10px;"> <p>To switch to PGNGS:              GUID CONT sw - PGNS              Go to PGNS step 15.</p> </div>	

**LMA790-3-LM**  
**APOLLO OPERATIONS HANDBOOK**

CREW-MAN	PNL	PROCEDURES	REMARKS
		<p>4.10.1.2 APS Thrust Program (P42) With AGS Followup/In Control (cont)</p> <p>If PGNS in followup, go to PGNCs step 18.</p> <p>15. Perform APS/RCS Propellant Interconnect, steps 1 through 3.</p> <p>16. When IFC = TBD, perform APS/RCS Propellant Interconnect, steps 4 &amp; 5.</p> <p>17. Monitor thrust cutoff:  a. Early cutoff:  Return to step 13.  b. Late or manual cutoff:  Eng STOP pb/lt - push  ENG THR CONT: ENG ARM sw - OFF</p> <p>Reset eng STOP pb/lt:  (1) Release tab - push  (2) Eng STOP pb/lt - on  (3) If eng STOP pb/lt - off, verify that lights are functioning by performing Caution &amp; Warning Array Checkout, steps 3 &amp; 4 (para 4.2.10). If lights are functioning, inadvertent reset has taken place, eng is enabled, &amp; steps (4), (5), &amp; (6) should not be performed.  (4) Eng STOP pb/lt - push  (5) Release tab - push  (6) Eng STOP pb/lt - off</p> <p>c. Normal cutoff:  ENG THR CONT: ENG ARM sw - OFF</p>	<p>Ref para 4.13.3.3.</p> <p>Ref para 4.13.3.3.</p> <p>Poss FL V97 NXX if LCC did not recognize fulfillment of cutoff criteria.</p>
		<p>13. Perform APS/RCS Propellant Interconnect, steps 1 through 3.</p> <p>14. When <math>\Delta V_{gx} &lt; \text{TBD}</math>, perform APS/RCS Propellant Interconnect, steps 4 &amp; 5.</p> <p>15. When <math>\Delta V_{gx} = 00000</math>, monitor thrust cutoff.</p> <p>If thrust cutoff does not occur:  Eng STOP pb/lt - push</p> <p>16. Disarm APS engine &amp; disable AGS engine control:  a. Early or normal cutoff:  ABORT STAGE pb - reset  ENG THR CONT: ENG ARM sw - OFF  b. Late cutoff:  ABORT STAGE pb - reset  ENG THR CONT: ENG ARM sw - OFF</p>	

THRUST

**LMA790-3-LM**  
**APOLLO OPERATIONS HANDBOOK**

CREW-MAN	PNL	PROCEDURES	REMARKS
		<p>4.10.1.2 APS Thrust Program (P42) With AGS Followup/In Control (cont)</p> <p>Reset eng STOP pb/lc:            (1) Release tab - push            (2) Eng STOP pb/lc - on            (3) If eng STOP pb/lc - off, verify that lights are functioning by performing Caution &amp; Warning Array Checkout, steps 3 &amp; 4 (para 4.2.10). If lights are functioning, inadvertent reset has taken place, eng is enabled, &amp; steps (4), (5), &amp; (6) should not be performed.            (4) Eng STOP pb/lc - push            (5) Release tab - push            (6) Eng STOP pb/lc - off</p> <div style="border: 1px solid black; padding: 5px; width: fit-content; margin: 10px auto;"> <p>To switch to AGS:              GUID CONT sw - AGS              CB (11) S/C: AEA - close              Go to AGS step 17.</p> </div> <p style="text-align: center; margin: 10px 0;"><b>CAUTION</b></p> <p>Avoid touching ascent eng cover top or side with bare hand or glove from 5 min to 7.5 hr after APS burn. Maximum temperature of 220°F will be reached 1.5 hr after APS burn.</p> <p>18. FL V16 N40            R1 TFC XXXX min-sec            R2 VC XXXX.X fps            R3 AVm XXXX.X fps            Record thrust parameters at their final value:            Key PRO</p> <div style="border: 1px solid black; padding: 5px; width: fit-content; margin: 10px auto;"> <p>To switch to PGCS:              GUID CONT sw - PGNS              Go to PGCS step 18.</p> </div>	<p>At this time, LGC zeroes attitude error and sets 0.3° deadband in RCS DAP.</p>

**LMA790-3-LM**  
**APOLLO OPERATIONS HANDBOOK**

CREW-MAN	PNL	PROCEDURES	REMARKS
	<p>4.10.1.2 APS Thrust Program (P42) With ACS Followup/In Control (cont)</p> <p>19. FL V16 N85 - VG(LM) R1 X XXXX.X fps R2 Y XXXX.X fps R3 Z XXXX.X fps</p> <div style="border: 1px solid black; padding: 2px; width: fit-content;"> <p>If PGNS in followup, go to PGNCs step 20.</p> </div> <p>If nulling of VG is desired: S/C: PGNS sw - ATT HOLD ACA/TTCA - null VGX, VGY, VGZ</p>	<p>17. Trim <math>\Delta V</math> residual:</p> <p>If not in Orbit Insertion (410+00000), select External <math>\Delta V</math>: Key DEDA C 410+50000E</p> <p>Verify AEA attitude hold submode: Key DEDA C 400R If +00000 not displayed: Key DEDA C 400+00000E S/C: DEAD BAND sw - MIN ENG THR CONT: BAL CPL sw - ON</p> <p>Read and record: <math>\Delta V_{gx}</math> Key DEDA C 500R (0.1/1 fps) <math>\Delta V_{gy}</math> Key DEDA C 501R (0.1/1 fps) <math>\Delta V_{gz}</math> Key DEDA C 502R (0.1/1 fps)</p> <p>Read out and null <math>\Delta V_{g}</math> residuals in order of magnitude, largest first.</p>	<p>If trim maneuver is performed after use of orbit insertion routine, it should be performed immediately after engine shutdown. Orbit insertion routine drives LM to specific point on desired orbit, and residual <math>\Delta V_{gx}</math> will increase naturally after engine shutdown.</p> <p>Null <math>\Delta V_{gx}</math> by moving TTCA up or down. Up TTCA nulls positive <math>\Delta V_{gx}</math>. Null <math>\Delta V_{gy}</math> by moving TTCA right or left. Right TTCA nulls positive <math>\Delta V_{gy}</math>. Null <math>\Delta V_{gz}</math> by moving TTCA in or out. In TTCA nulls positive <math>\Delta V_{gz}</math>.</p>

THRUST

**LMA790-3-LM**  
**APOLLO OPERATIONS HANDBOOK**

LM 3207

CREW- MAN	PNL	PROCEDURES	REMARKS
		<p>4.10.1.2 <u>APS Thrust Program (P42) With AGS Followup/In Control (cont)</u></p> <p>18. Read out predicted perifocus altitude: Key DEDA C 403R (0.1 nm) Compare with PGNSC Hp value.</p> <p>19. Readout apofocus altitude: Key DEDA C 315R (0.1 nm) Compare with PGNSC Ha value.</p> <p>20. Terminate P42 or select Orbit Parameter Display Routine (R30): a. Terminate: Key PRO FL V37 N-- Key XXE - Exit P42 or b. Select R30: Key V76E and verify/set No DAP lit - on S/C: PGNSC sw - ATT HOLD to conserve RCS propellant by overriding LGC selected deadhand (0.3°). Key V82E FL V16 N44 R1 Ha XXXX.X nm R2 Hp XXXX.X nm R3 TFF XXBX min-sec Key PRO, when finished with display to reestablish N85 display Exit R30 FL V37 N-- Key XXE - Exit P42</p>	<p>At this time, LGC restores crew-specified (R03) deadband limits in RCS DAP.</p> <p>Orbit parameters are automatically recomputed every 2 seconds while average g is in process.</p> <p>Maximum TFF reading is 59859.</p>
		<p>4.10.1.3 <u>RCS Thrust Program (P41) With AGS Followup/In Control</u></p>	<p>Purpose of RCS Thrust Program (P41) With AGS Followup/In Control procedure is to compute preferred IMU orientation and LM attitude for RCS thrust maneuver and to maneuver LM to thrusting attitude. This procedure provides suitable displays for manual execution of thrust maneuver.</p>



**LMA790-3-LM  
APOLLO OPERATIONS HANDBOOK**

LM 3231

CREW-MAN	PNL	PROCEDURES	REMARKS
		<p>4.10.1.3 RCS Thrust Program (P41) With ACS Followup/In Control (cont.)</p> <p>ECS Basic (Staged or Unstaged) (required)</p> <p>LCC Power-Up (required)</p> <p>LCC Self-Test (desired)</p> <p>LCC time valid (required)</p> <p>LGC state vector valid (required)</p> <p>IMU Power-Up (LGC Operating) (required)</p>	<p>Following sequence of procedures may cause problems:</p> <p>1. P3X, followed by P47, followed by P40, P41, or P42; prethrust computations may be overwritten by P47.</p> <p>To recover: Perform P3X, followed by P40, P41, or P42</p> <p>2. Deleted</p> <p>Ref para 4.13.1.1.</p> <p>Ref para 4.6.1.1.</p> <p>Ref para 4.6.1.13.</p> <p>LGC/CMC Clock Synchronization Routine (R33) (para 4.6.1.15)</p> <p>LGC Update Program (P27) (para 4.6.1.7)</p> <p>Ref para 4.6.1.3. ISS should be on 15 minutes before thrusting maneuver.</p>

THRUS

**LMA790-3-LM**  
**APOLLO OPERATIONS HANDBOOK**

LM 3231

CREW MAN	PNL	PROCEDURES	REMARKS
		<p>4.10.1.3 <u>ECS Thrust Program (P41) With AGS Followup/In Control (cont)</u></p> <p>IMU Orientation Determination Program (P51) (required)</p> <p>DAP Data Load Routine (M03) (required)</p> <p>Appropriate prethrust program (required)</p>	<p>Ref para 4.9.1.1.1.</p> <p>Ref para 4.6.1.1.8.</p> <p>Ref para 4.7.</p> <p>Ref para 4.6.2.1.1.</p> <p>Ref para 4.6.2.3.</p> <p>AGS Manual Absolute Time Initialization procedure (para 4.6.2.6) or AGS Initialization Routine (M47) (para 4.6.1.1.18)</p> <p>AGS Initialization Routine (M47) (para 4.6.1.18) or AGS Manual LM State Vector Update/Initialization procedure (para 4.6.2.7) or AGS Manual Rendezvous Radar LM State Vector Update (para 4.8.2.2)</p> <p>AGS Initialization Routine (M47) (para 4.6.1.18) or AGS Manual CSM State Vector Update procedure (para 4.6.2.9)</p> <p>PGNCS/AGS Align (para 4.9.2.1.1), Backup AGS Alignment (Using AGS Body-Axis Alignment and PGNS IMU) (para 4.9.2.2), Backup AGS Alignment (Using AGS Body-Axis Alignment and AOT) (para 4.9.2.3), or AGS Lunar Align (para 4.9.3.2).</p> <p>Ref para 4.6.2.1.5.</p>
		<p>AGS Power-Up (required)</p> <p>AEA Self-Test (desired)</p> <p>AGS time valid (required)</p> <p>AGS LM state vector valid (required)</p> <p>AGS CSM state vector valid (required)</p> <p>AGS alignment valid (required)</p> <p>AGS Wb Vector Update (required if mission warrants)</p>	

**LMA790-3-LM**  
**APOLLO OPERATIONS HANDBOOK**

LM 3207

CREW-MAN	PNL	PROCEDURES	REMARKS
		<p>4.10.1.3 RCS Thrust Program (P41) With AGS Followup/In Control (cont.)</p> <p>Appropriate prethrust procedure (required)</p> <p>If PGNCs in followup, go to PGNCs step 4.</p> <p>1. Establish attitude control: GUID CONT sw - PGNS S/C: PGNS sw - AUTO or ATT HOLD AGS sw - AUTO or ATT HOLD ROLL, PITCH, YAW sw - MODE CONT If No DAP It - on: Key V77E, No DAP It - off</p> <p>2. Establish PGNCs total attitude &amp; attitude rate/error display: ATTITUDE MON sw (1) - PGNS ATTITUDE MON sw (1) - AGS RATE/ERR MON sw (2) - LDG RDR/CHPTR</p> <p>3. Enable ACA/TTCA: ACA/4 JET sw (2) - ENABLE TTCA/TRANSL sw (2) - ENABLE THROTTLE/JETS cont (2) - JETS ENG THR CONT: ATT/TRANSL sw - 4 JETS BAL CPL sw - ON S/C: DEAD BAND sw - MIN ACA PROP sw (2) - ENABLE</p> <p>If AGS in followup, go to AGS step 4.</p> <p>1. Establish attitude control: Key DEDA C 400+0000E GUID CONT sw - AGS S/C: AGS sw - AUTO or ATT HOLD PGNS sw - AUTO ROLL, PITCH, YAW sw - MODE CONT</p>	<p>Ref para 4.7. If AGS TPI search prethrust procedure was previously selected, TPI execute must have been selected subsequent to that procedure.</p> <p>Ref para 4.5.1. Attitude hold is used for PCI.</p> <p>Ref para 4.5.3.1 and 4.5.3.2.</p> <p>Attitude hold is used for PCI.</p>

THRUS

**LMA790-3-LM**  
**APOLLO OPERATIONS HANDBOOK**

LM 3182

CREW- MAN	PNL	PROCEDURES	REMARKS
		<p>4.10.1.3 RCS Thrust Program (P41) With AGS Followup/In Control (cont)</p> <p>2. Establish AGS attitude error &amp; total attitude display:            ATTITUDE MON sw (1) - AGS            ATTITUDE MON sw (1) - PCNS            RATE/ERR MON sw (2) - LDG RDR/CMPT</p> <p>3. Enable ACA/ITCA:            ACA/4 JET sw (2) - ENABLE            ITCA/TRANSL sw (2) - ENABLE            ACA PROP sw (2) - ENABLE            THROTTLE/JETS cont (2) - JETS            ENG THR CONT:            ATT/TRANSL sw - 4 JETS            BAL CPL sw - ON            S/C: DEAD BAND sw - MIN            Go to step 6.</p> <p>4. Select desired guidance steering:            a. Z-axis parallel to CSM orbit plane:               Key DEDA C 623+10000E               C 400+10000E            or            b. Z-axis specified by Wb vector:               Key DEDA C 623+10000E               C 400+10000E</p> <p>5. Deleted</p> <div style="border: 1px solid black; padding: 2px; margin: 5px 0;">If AGS in followup, go to AGS step 7.</div> <p style="text-align: right;">To switch to PCNCS:            GUID CONT sw - PCNS            Go to PCNCS step 4.</p>	<p>Ref para 4.5.3.3 and 4.5.3.4.</p>
		<div style="border: 1px solid black; padding: 2px; margin: 5px 0;">To switch to AGS, go to AGS step 6.</div> <p>4. Key V37E 41E</p>	

**LMA790-3-LM**  
**APOLLO OPERATIONS HANDBOOK**

CREW-MAN	PNI	PROCEDURES	REMARKS
		<p>4.10.1.1.3 <u>RCS Thrust Program (P41) With AGS Followup/In Control (cont)</u></p> <p>Poss PROC lt - on Key V05 N09E - Call alarm 00210 - IMU not operating</p> <p>00220 - ISS orientation not known</p> <p>Key KEY REL &amp; RSET FL V37 N-- Key XIE - Exit P41</p>	<p>Perform IMU Power-Up (LGC Operating) procedure (para 4.6.1.3).</p> <p>Perform IMU Orientation Determination Program (P51) (para 4.9.1.1).</p> <p>To obtain optional display of TFI, VG, AV accumulated (before TIG-35 sec):</p> <p>Key V16 N40E R1 TFI            XXIX min-sec R2 VG            XXX.X fps R3 AV accumulated XXX.X fps (0000.0 until TIG-30 sec)</p> <p>If V16 N40E is used to monitor TFI and displaces N85, key V16 N85E if VG display is desired again.</p> <p>To obtain optional display of TFE (before TIG-35 sec):</p> <p>Key V16 N35E - Time from event R1 00XX hr R2 000X min R3 0XX.XX sec</p> <p>To obtain optional display of VG(LV) Key V06 N86E, N81E R1 X XXX.X fps R2 Y XXX.X fps R3 Z XXX.X fps</p> <p>N81 display will now differ from N81 display in prethrust programs P3X because of rotation of VG vector (to compensate for nonimpulsive burn duration).</p> <p>LCC sets attitude errors to zero at this time.</p>

THRU

**LMA790-3-LM**  
**APOLLO OPERATIONS HANDBOOK**

CREW-MAN	PNL	PROCEDURES	REMARKS
		<p>4.10.1.3. <u>RCS Thrust Program (P41) With AGS Followup/In Control (cont)</u></p> <p>5. Attitude Maneuver Routine (R60)            FL V50 N18 - Perform automatic maneuver to final FDAI angles            R1 Roll   XXX.XX°            R2 Pitch  XXX.XX°            R3 Yaw    XXX.XX°</p> <p>If PGNS in followup or for PCI:            Key ENTR, exit R60,            Go to PGNS step 7.</p> <p>Accept automatic attitude maneuver:            GUID CONT sw - PGNS            S/C: PGNS sw - AUTO            Key PRO - Go to step 6</p> <p>Reject alternatives (exit R60 via 5c):</p> <p>a. Perform manual attitude maneuver:            Select desired attitude control mode -            ACA - maneuver manually            Key PRO - Return to beginning of step 5</p> <p>b. To recompute gimbal angles:            S/C: PGNS sw - ATT HOLD            Key PRO - Return to beginning of step 5</p> <p>c. When present attitude satisfactory:            Null AGS yaw attitude error.            Monitor yaw attitude error on FDAI error needle.            ACA - null yaw error (X-axis override)</p>	<p>If final computed FDAI angles result in +90° yaw, transformation from IMU to FDAI angles in roll and pitch is indeterminate and R1 and R2 will be zero.</p> <p>Automatic trim maneuver is considered essential for maneuvers to thrusting attitude.</p> <p>Ref para 4.5.1</p> <p>With AGS guidance steering, AGS orients LM Z-axis in specified direction. PGNS-to-AGS switchover could result in large yaw excursion. Consider FDAI attitude error needles as</p>

**LMA790-3-LM**  
**APOLLO OPERATIONS HANDBOOK**

CREW-MAN	PNL	PROCEDURES	REMARKS
		<p>4.10.1.3 RCS Thrust Program (P41) with AGS Follow/up In Control (cont)</p> <p>S/C PCNS sw - AUTO Key ENTR - Exit R60, go to step 7</p> <p>6. If PCNS automatic attitude maneuver selected: DSKY displays are blanked until completion of automatic maneuver. Monitor FDAI belly band, with respect to color band on roll bezel, to avoid gimbal lock.</p> <p>Monitor return of preceding display, indicating automatic maneuver is complete. To stop LM motion if gimbal lock is approached: S/C: PCNS sw - ATT HOLD If manual override &amp; completion of attitude maneuver desired: Select desired attitude control mode - ACA - maneuver manually Return to step 5</p> <div style="border: 1px solid black; padding: 5px; width: fit-content;"> <p>To switch to AGS: GUID CONT sw - AGS S/C: AGS sw - AUTO Go to AGS step 7.</p> </div>	<p>fly-to-needles. Needles can be nullified by flying from them. However, this results in false null and switchover to AGS will result in 180° yaw maneuver.</p> <p>If desired, Key extended verbs or Key V16 N18 - Final FDAI angles R1 Roll XXX.XX° R2 Pitch XXX.XX° R3 Yaw XXX.XX° Key KEY REL</p> <p>Belly band covers separation between hemispheres of FDAI ball. Belly band, in color bands on each side of FDAI roll bezel, would indicate IMU middle gimbal angle &gt;75°. During this maneuver, LGC will terminate automatic maneuver if S/C: PCNS sw is switched out of AUTO.</p> <p>Ref para 4.5.1</p> <p>Ref para 4.6.2.13</p>
		<p>6. Perform AGS Orientation to Initial Computed Steering Attitude procedure or maintain attitude for PCI.</p>	

THRUST

LM 31..., LM 3231





**LMA790-3-LM**  
**APOLLO OPERATIONS HANDBOOK**

LM 3.1.08, LM 3231

CREW-MAN	PNL	PROCEDURES	REMARKS
		<p>4.10.1.3 <u>RCS Thrust Program (P41) with ACS Follow/up In control (cont)</u></p> <p>7. V16 N85 - VG(LM)  R1 X XXXX.X fps  R2 Y XXXX.X fps  R3 Z XXXX.X fps</p> <p>7. Monitor velocity to be gained VG:  Key DEDA C 370R (0.1/1 fps)  Determine whether value of VG is  &gt; 15 fps for step 9 procedure.</p>	<p>Parentetical quantization notation:  lunar mission/earth mission.</p> <p>Displays are blanked from TFI =  -00B35 to -00B30. Beginning and  duration of blanking cannot be de-  fined if alarm 01703 occurs.  Use of extended verb will blank V16  N85 display. Display will return at  approximately TIG-29 or at TIG. If</p>

THRUS

**LMA790-3-LM  
APOLLO OPERATIONS HANDBOOK**

LM 3231

CREW-MAN	PNL	PROCEDURES	REMARKS
		<p>4.10.1.3 RCS Thrust Program (P41) With AGS Followup/In Control (cont)</p> <p>CHPTR ACTY lt - on</p> <p>Monitor PROG lt from TPI = -00B50 to -00B35. If PROG lt - on: Key V05 M09E - Call alarm 01703 - TIG slipped</p> <p>Key KEY REL and RSET CHPTR ACTY lt - off</p> <p>At TIG-30 sec: V16 N85 - VG (LM) R1 X XXXX.X fps R2 Y XXXX.X fps R3 Z XXXX.X fps</p> <p>8. Display velocity to be gained in desired direction: a. X-axis Key DEDA C 500R (0.1/1 fps) b. Y-axis Key DEDA C 501R (0.1/1 fps) c. Z-axis Key DEDA C 502R (0.1/1 fps)</p> <div style="border: 1px solid black; padding: 5px; width: fit-content;"> <p>If AGS in followup, monitor ΔVgx and go to AGS step 14.</p> </div>	<p>display is desired before TIG-35 or between TIG-29 and TIG: Key V16 N85E Key KEY REL at or before KEY REL lt flashes at TIG</p> <p>CHPTR ACTY lt - on during State Vector Integration Routine (R41).</p> <p>To monitor progress of state vector integration, time (GET) to which state vector integration process has presently calculated state vector is available as follows: Key V16 N38E - TET R1 00XX hr R2 00XX min R3 0XX.XX sec To terminate display: Key KEY REL</p> <p>TIG will be slipped, as required, to get state vector integration to new TIG-30 seconds.</p> <p>State vector integration complete.</p>

**LMA790-3-LM**  
**APOLLO OPERATIONS HANDBOOK**

CREW-MAN	PNL	PROCEDURES	REMARKS
		<p>4.10.1.1.3 RCS Thrust Program (P41) With AGS Followup/In Control (cont)</p> <div style="border: 1px solid black; padding: 2px; margin-bottom: 10px;"> <p>To switch to AGS: GUID CONT sw - AGS Go to AGS step 9.</p> </div> <p>8. When EVNT TMR ind = 00:00: PL V16 N85 - VG(LM) R1 X XXXX.X fps R2 Y XXXX.X fps R3 Z XXXX.X fps</p>	
		<p>9. When EVNT TMR ind = 00:10:</p> <p>a. If VG was &gt;15 fps in step 7: S/C: DEAD BAND sw - MIN Eng STOP pb/lt - push ABORT pb - push Go to step 10.</p> <p>b. If VG was &lt;15 fps, or for Y translations: S/C: DEAD BAND sw - MIN S/C: AGS sw - ATT HOLD</p> <div style="border: 1px solid black; padding: 2px; margin-top: 10px;"> <p>To switch to PGNS: GUID CONT sw - PGNS Go to PGNS step 9.</p> </div>	<p>When X-axis VG reaches 15 fps, automatic selection of AEA attitude hold submode is produced, thus preventing gross attitude maneuvers as VC approaches zero fps and equations become unstable.</p> <p>There is no AEA attitude hold provision for VG &lt;15 fps; therefore, manual attitude hold is required. For PCI maneuver, manual Y-translation is required; therefore, ATT HOLD is selected.</p> <p>LGC sets attitude errors to zero at this time.</p> <p>When LM configuration includes a heavy descent stage, PGNS in control, 4 jet -Y and -Z translations, when commanded, should be performed sequentially to avoid loss of vehicle attitude control. The word "heavy" is referenced to both ascent and descent propellant loading conditions.</p>

THRU

**LMA790-3-LM**  
**APOLLO OPERATIONS HANDBOOK**

LM 3231

CREW-MAN	PNL	PROCEDURES	REMARKS
		<p>4.10.1.3 RCS Thrust Program (P41) With AGS Followup/In Control (cont)</p> <div style="border: 1px solid black; padding: 5px; margin: 5px 0;"> <p>If PGNS in followup, go to PGNS step 9.</p> </div> <p>S/C: PGNS sw - ATT HOLD ACA/TTCA - maneuver to null VG components</p>	
		<p>10. When EVNT TMR ind = 00:00:  a. X-axis selected -  TTCA - move up or down  b. Y-axis selected -  TTCA - move left or right  c. Z-axis selected -  TTCA - move in or out</p> <p>11. When <math>\Delta V_{gz} = 15</math> fps:  S/C: AGS sw - ATT HOLD</p> <p>12. When <math>\Delta V_{gx}</math>, <math>\Delta V_{gy}</math> or <math>\Delta V_{gz} = +00000</math>:  TTCA - release</p> <p>13. Null Vg residuals:  Repeat AGS step 8a, b, &amp; c, &amp; record quantities.  Repeat AGS step 10a, b, &amp; c, nulling <math>\Delta V_g</math> residuals in order of magnitude (largest first).</p> <p>14. If step 9 a was selected:  ABORT pb - reset  Eng STOP pb/lt - reset</p> <p>15. Read out predicted perifocus altitude:  Key DEDA C 403R (0.1 nm)  Compare with PGNS Hp value.</p> <p>16. Read out apofocus altitude:  Key DEDA C 315R (0.1 nm)  Compare with PGNS Ha value.</p>	<p>This maneuver is manual. Since both PGNS and AGS calculate <math>\Delta V</math> values, either DAP or CES can be used for stabilization and translation, using either computer readout of <math>\Delta V</math>.</p> <p>For positive translation, TTCA is moved up.</p> <p>For positive translation, TTCA is moved right.</p> <p>For positive translation, TTCA is moved in.</p>

**LMA790-3-LM**  
**APOLLO OPERATIONS HANDBOOK**

CREW-MAN	PNI	PROCEDURES	REMARKS
		<p>4.10.1.3 <u>RCS Thrust Program (P41) With ACS Followup/In Control (cont)</u></p> <p>9. Terminate P41 or select Orbit Parameter Display Routine (R30):</p> <p>a. Terminate:</p> <p style="padding-left: 20px;">Key PRO FL V37 N-- Key XXE - Exit P41</p> <p>or</p> <p>b. Select R30: Key V82E</p> <p>Poss OPR ERR lt - on Key RSET, exit R30 FL V16 N44</p> <p style="padding-left: 20px;">R1 Ha XXXX.X nm R2 Hp XXXX.X nm R3 TFF XXXX min-sec</p> <p>Key PRO when finished with display to reestablish N85 display: Exit R30: Key PRO FL V 37 N-- Key XXE - Exit P41</p>	<p>At this time, LGC restores crew-specified (R03) deadband limits in RCS DAP.</p> <p>Orbit parameters are automatically recomputed every 2 seconds while average g is in process. OPR ERR lt - on if another extended verb from R76 is active.</p>
		<p>4.10.1.4 <u>Thrust Monitor Program (P47)</u></p> <p>LGC Power-Up (required)</p> <p>LGC Self-Test (desired)</p> <p>LGC time valid (required)</p> <p>LGC state vector valid (required)</p> <p>IMU Power-Up (LGC Operating) (required)</p>	<p>Purpose of Thrust Monitor Program (P47) is to monitor LM acceleration during ACS-controlled burns or manual RCS translations and to display ΔV's resulting from thrusting maneuvers.</p> <p>Ref para 4.6.1.1.</p> <p>Ref para 4.6.1.13.</p> <p>LGC/CMC Clock Synchronization Routine (R33) (para 4.6.1.15)</p> <p>LGC Update Program (para 4.6.1.7) and, when appropriate, Rendezvous Navigation Program (P20) (para 4.8.2.1)</p> <p>Ref para 4.6.1.3. ISS should be on 15 minutes before thrusting maneuver.</p>



**LMA790-3-LM**  
**APOLLO OPERATIONS HANDBOOK**

LM 3231

CREW- MAN	PML	PROCEDURES	REMARKS
		<p>4.10.1.4 Thrust Monitor Program (P47)(cont)</p> <p>IMU Orientation Determination Program (P51) (required)</p> <p>DAP Data Load Routine (R03) (required)</p> <p>1. Select total attitude display: ATTITUDE MON sw - PCNS ORDEAL:   FDAI 1 sw - as desired   FDAI 2 sw - as desired</p> <p>2. Key V37E 47E Poss PROG lt - on Key V05 N09E - Call alarm</p> <p>00210 - IMU not on</p> <p>00220 - IMU orientation not known Key KEY REL &amp; MSET FL V37N-- Key XZE-Exit P47 CHPTR ACTY lt - on</p> <p>CHPTR ACTY lt - off</p> <p>FL V16 N83 - ΔV (LM) R1 X XXXX.X fps R2 Y XXXX.X fps R3 Z XXXX.X fps</p>	<p>Ref para 4.9.1.1.</p> <p>Ref para 4.6.1.8.</p> <p>Ref para 4.5.3.1.</p> <p>P47 should be selected immediately before planned thrusting maneuver and terminated as soon as possible after maneuver to keep errors associated with average-g integration at minimum. Perform IMU Power-Up (LGC Operating) procedure (para 4.6.1.3) Perform IMU Orientation Program (P51) (para 4.9.1.1)</p> <p>CHPTR ACTY lt - on during State Vector Integration Routine (R41). To monitor progress of state vector integration, time (GET) to which state vector integration process has presently calculated state vector is available as follows: Key V16 N38E - TET R1 XXXX hr R2 000X min R3 0XX.XX sec To terminate display: Key KEY REL</p> <p>State vector integration complete. (20 seconds minimum)</p> <p>Registers display 0000.0, except for PIPA bias accumulation, until thrusting maneuver is started. N83 is updated every 2 seconds.</p>

# LMA790-3-LM

## APOLLO OPERATIONS HANDBOOK

CREW MAN	PNL	PROCEDURES	REMARKS
		<p>4.10.1.4 <u>Thrust Monitor-Program (P47) (cont)</u></p> <p>4. Perform desired thrusting maneuver, monitoring FDAI to avoid gimbal lock.</p> <p>5. To zero displays for monitoring another burn: Key V32E To terminate monitoring: Key PRO or V34E</p> <p>6. FL V37 N-- Key XXE - Exit P47</p> <p>4.10.1.5 <u>AGS RCS Axis-by-Axis Thrust</u></p> <p>AGS Power-Up (required) AEA Self-Test (desired) AGS time valid (required)</p> <p>AGS LM state vector valid (required)</p> <p>AGS CSM state vector valid (required)</p>	<p>Rendezvous Parameter Display Routine (R31) may be called during this program to display range, range rate, and <math>\theta</math>.</p> <p>If electromagnetic interference in system is identified as caused by tracking light (regular pulses on audio channel or indicated on SIGNAL STRENGTH ind at approximate frequency of 1 pps), tracking light may be turned off until transmission or reception is complete.</p> <p>When the LM configuration includes a "heavy" descent stage, PCMS in control, 4 jet -Y &amp; -Z translations when commanded should be performed sequentially to avoid loss of vehicle attitude control. The word "heavy" is referenced to both ascent and descent propellant loading conditions.</p> <p>RCS fuel is used more efficiently when burn is done along velocity-to-be-gained vector. However, this procedure can be used to perform burns of small <math>\Delta V</math> magnitude where orientation attitude maneuver is large.</p> <p>Ref para 4.6.2.1. Ref para 4.6.2.3.</p> <p>AGS Initialization Routine (R47) (para 4.6.1.18) or AGS Manual Absolute Time Initialization procedure (para 4.6.2.6)</p> <p>AGS Initialization Routine (R47) (para 4.6.1.18) or AGS Manual LM State Vector Update/Initialization procedure (para 4.6.2.7) or AGS Manual Rendezvous Radar LM State Vector Update procedure (para 4.8.2.2)</p> <p>AGS Initialization Routine (R47) (para 4.6.1.18) or AGS Manual CSM State Vector Update/Initialization procedure (para 4.6.2.9)</p>

THRUST

LMA790-3-LM  
 APOLLO OPERATIONS HANDBOOK

LM 3231

CREW-MAN	PNL	PROCEDURES	REMARKS
		<p>4.10.1.5 <u>AGS RCS Axis-by-Axis Thrust (cont.)</u></p> <p>AGS alignment valid (required)</p> <p>Appropriate prethrust procedure performed (required)</p> <p>1. Enable ACA/TICA:            ACA/4 JET sw (2) - ENABLE            TICA/TRANSL sw (2) - ENABLE            THROTTLE/JETS cont (2) - JETS            ENG THR CONT: ATT/TRANSL sw - 2 JETS            ACA PNDP sw (2) - ENABLE</p> <p>2. Prepare thrust controls for RCS burn:            ENG THR CONT: ENG ARM sw - OFF            ABORT pb - reset            ABOVE STAGE pb - reset            Eng START pb/lit - off            Eng STOP pb/lit (2) - reset</p> <p>3. Select desired attitude control mode:            a. GUID CONT sw - ACS            S/C:            ACS sw - ATT HOLD            ROLL, PITCH, YAW sw - MODE CONT            DEAD BAND sw - MIN            ENG THR CONT: BAL CPL sw - ON</p> <p>or</p> <p>b. Select AEA attitude hold submode:            Key DEDA C 400+00000E            Establish ACS automatic mode:            GUID CONT sw - ACS            S/C:            ACS sw - AUTO            ROLL, PITCH, YAW sw - MODE CONT            DEAD BAND sw - MIN            ENG THR CONT: BAL CPL sw - ON</p>	<p>PGNS/AGS Align (para 4.9.2.1), Backup AGS Alignment (Using AGS Body-Axis and PGNS IMU) (para 4.9.2.2), Backup AGS Alignment (Using AGS Body-Axis Alignment and AOT) (para 4.9.2.3), or AGS Lunar Align (para 4.9.3.2)</p> <p>Ref para 4.7.</p> <p>Ref para 4.5.1.</p>



**LMA790-3-LM**  
**APOLLO OPERATIONS HANDBOOK**

CREW-MAN	PNI	PROCEDURES	REMARKS
		<p>4.10.1.5 <u>AGS RCS Axis-by-Axis Thrust (cont)</u></p> <p>4. If trimming on orbit-insertion burn:</p> <ol style="list-style-type: none"> <li>a. If mode has been changed: Key DEDA C 410+0000E - Orbit Insertion Mode</li> <li>b. If trim ignition time not yet targeted: Read out present AGS time &amp; record Key C 377R (0.1 min) Load present time as tigd Key C 373+XXXXE (0.1 min)</li> <li>c. Select External AV: Key DEDA C410+0000E</li> <li>d. Go to step 7.</li> </ol> <p>5. If trimming an in-orbit burn: Go to step 7.</p> <p>6. If targeted specifically for axis-by-axis thrust: Go to step 8.</p> <p>7. Read and record: AVgx Key DEDA C 500 R (0.1/1 fps) AVgy Key DEDA C 501 R (0.1/1 fps) AVgz Key DEDA C 502 R (0.1/1 fps)</p> <p>8. Read out and null AVg residuals, in order of magnitude, largest first.</p> <p>4.10.1.6 <u>RCS Burn for Lunar Impact (Unmanned Ascent Stage)</u></p>	<p>Null AVgx by moving TTCA up or down. Up TTCA nulls positive AVgx.</p> <p>Null AVgy by moving TTCA right or left. Right TTCA nulls positive AVgy.</p> <p>Null AVgz by moving TTCA in or out. In TTCA nulls positive AVgz.</p> <p>L4 RCS jets will be used to cause ascent stage to impact moon, near seismometer. An erasable memory RCS thrust program may be loaded via P27 and utilized to perform deorbit maneuver.</p>

THRUS

**LMA790-3-LM**  
**APOLLO OPERATIONS HANDBOOK**

LM 3231

CREW-MAN	PNI	PROCEDURES	REMARKS
		<p>4.10.1.6 RCS Burn for Lunar Impact (Unmanned Ascent Stage)(cont)</p> <p>LGC Power-Up (required)</p> <p>LGC Self-Test (desired)</p> <p>LGC time valid (desired)</p> <p>LGC state vector valid (desired)</p> <p>DMU Power-Up (LGC Operating) (required)</p> <p>DMU Orientation Determination (P51) (required)</p> <p>DAP Data Load Routine (R03) (desired)</p> <p>DUA Enable (required)</p> <p>AGS Power-Up (desired)</p> <p>AEA Self-Test (desired)</p> <p>AGS Time Valid (desired)</p> <p>AGS LM State Vector Valid (desired)</p> <p>PGNCS/AGS Align (desired)</p> <p>1. Target LGC (with AEA follow-up), using data provided by MSFN. Deorbit maneuver is initiated and terminated, using an uplinked- or DSKY-loaded erasable memory program (such as Guided RCS Thrust Erasable Memory Program, P99).</p>	<p>Ref para 4.6.1.1.</p> <p>Ref para 4.6.1.13.</p> <p>LGC/CMC Clock Synchronization Routine (R33) (para 4.6.1.15).</p> <p>LGC Update Program (P27) (para 4.6.1.7) and, when appropriate, LM Rendezvous Navigation Program (P20) (para 4.8.2.1).</p> <p>Ref para 4.6.1.3. ISS should be on 15 minutes before thrusting maneuver.</p> <p>Ref para 4.9.1.1.</p> <p>Ref para 4.6.1.8.</p> <p>Ref para 4.13.2.11.</p> <p>Ref para 4.6.2.1.</p> <p>Ref para 4.6.2.3.</p> <p>AGS Manual Absolute Time Initialization (para 4.6.2.6) or AGS Initialization Routine (R47) (para 4.6.1.18).</p> <p>AGS Initialization Routine (R47) (para 4.6.1.18) or AGS Manual LM State Vector Update/Initialization (para 4.6.2.7) or AGS Manual Rendezvous Radar LM State Vector Update (para 4.8.2.2).</p> <p>Ref para 4.9.2.1.</p> <p>PGNS prerequisites identified as being desired can be performed by MSFN after start of this procedure, but must be accomplished at some time. AGS prerequisites support monitoring via AGS.</p> <p>MSFN can provide external ΔV and time of ignition for use with LGC Program 30 and AEA 410+50000 (ref para 4.7.1.1) (if onboard data must be updated), or can target LGC, load erasable program, and initiate it via uplink.</p>

**LMA790-3-LM**  
**APOLLO OPERATIONS HANDBOOK**

RC 1590, LM 3197, LM 3231

CREW-MAN	PNL	PROCEDURES	REMARKS																																																																																													
		<p>4.10.1.6 <u>RCS Burn for Lunar Impact (Unmanned Ascent Stage)(cont)</u></p> <p>2. If desired, perform Crew Defined Maneuver Routine (R62).</p> <p>2A. Stop integration &amp; go to P00 Key V96E Load erasable memory program &amp; associated routines (such as P99) via LGC Update Program (P27).</p>	<p>Ref para 4.6.1.9.</p> <p>P99 uplink - Program number is specified by the contents of location 3421 (underlined below). Addresses are valid for Luminary 1E.</p> <table style="width: 100%; border: none;"> <tr> <td style="text-align: center;"><u>Load 1</u></td> <td style="text-align: center;"><u>Load 2</u></td> <td style="text-align: center;"><u>Load 4</u></td> </tr> <tr> <td>V71E</td> <td>V71E</td> <td>V71E</td> </tr> <tr> <td>FL V21 N01</td> <td>FL V21 N01</td> <td>FL V21 N01</td> </tr> <tr> <td>24E</td> <td>12E</td> <td>6E</td> </tr> <tr> <td>3404E</td> <td>3734E</td> <td>3426E</td> </tr> <tr> <td>1450E</td> <td>26E</td> <td>10636E</td> </tr> <tr> <td>12324E</td> <td>30605E</td> <td>56246E</td> </tr> <tr> <td>5520E</td> <td>151E</td> <td>77650E</td> </tr> <tr> <td>161E</td> <td>5214E</td> <td>75202E</td> </tr> <tr> <td>1400E</td> <td>OE</td> <td>FL V21 N02</td> </tr> <tr> <td>12150E</td> <td>OE</td> <td>V33E</td> </tr> <tr> <td>5656E</td> <td>15400E</td> <td></td> </tr> <tr> <td>3667E</td> <td>OE</td> <td></td> </tr> <tr> <td>74066E</td> <td>FL V21 N02</td> <td><u>Load 5</u></td> </tr> <tr> <td>12404E</td> <td>V33E</td> <td>V72E</td> </tr> <tr> <td>12433E</td> <td></td> <td>FL V21 N01</td> </tr> <tr> <td>1406E</td> <td></td> <td>15E</td> </tr> <tr> <td>5313E</td> <td><u>Load 3</u></td> <td>3455E</td> </tr> <tr> <td>143E</td> <td>V71E</td> <td>1404E</td> </tr> <tr> <td>36266E</td> <td>FL V21 N01</td> <td>1250E</td> </tr> <tr> <td>54333E</td> <td>3400E</td> <td>OE</td> </tr> <tr> <td>6060E</td> <td>5520E</td> <td>3515E</td> </tr> <tr> <td>77634E</td> <td>312E</td> <td>4E</td> </tr> <tr> <td>FL V21 N02</td> <td>5263E</td> <td>2371E</td> </tr> <tr> <td>V33E</td> <td>FL V21 N02</td> <td>13001E</td> </tr> <tr> <td></td> <td>V33E</td> <td>2372E</td> </tr> <tr> <td></td> <td></td> <td>1420E</td> </tr> <tr> <td></td> <td></td> <td>2373E</td> </tr> <tr> <td></td> <td></td> <td>12067E</td> </tr> <tr> <td></td> <td></td> <td>FL V21 N02</td> </tr> <tr> <td></td> <td></td> <td>V33E</td> </tr> </table>	<u>Load 1</u>	<u>Load 2</u>	<u>Load 4</u>	V71E	V71E	V71E	FL V21 N01	FL V21 N01	FL V21 N01	24E	12E	6E	3404E	3734E	3426E	1450E	26E	10636E	12324E	30605E	56246E	5520E	151E	77650E	161E	5214E	75202E	1400E	OE	FL V21 N02	12150E	OE	V33E	5656E	15400E		3667E	OE		74066E	FL V21 N02	<u>Load 5</u>	12404E	V33E	V72E	12433E		FL V21 N01	1406E		15E	5313E	<u>Load 3</u>	3455E	143E	V71E	1404E	36266E	FL V21 N01	1250E	54333E	3400E	OE	6060E	5520E	3515E	77634E	312E	4E	FL V21 N02	5263E	2371E	V33E	FL V21 N02	13001E		V33E	2372E			1420E			2373E			12067E			FL V21 N02			V33E
<u>Load 1</u>	<u>Load 2</u>	<u>Load 4</u>																																																																																														
V71E	V71E	V71E																																																																																														
FL V21 N01	FL V21 N01	FL V21 N01																																																																																														
24E	12E	6E																																																																																														
3404E	3734E	3426E																																																																																														
1450E	26E	10636E																																																																																														
12324E	30605E	56246E																																																																																														
5520E	151E	77650E																																																																																														
161E	5214E	75202E																																																																																														
1400E	OE	FL V21 N02																																																																																														
12150E	OE	V33E																																																																																														
5656E	15400E																																																																																															
3667E	OE																																																																																															
74066E	FL V21 N02	<u>Load 5</u>																																																																																														
12404E	V33E	V72E																																																																																														
12433E		FL V21 N01																																																																																														
1406E		15E																																																																																														
5313E	<u>Load 3</u>	3455E																																																																																														
143E	V71E	1404E																																																																																														
36266E	FL V21 N01	1250E																																																																																														
54333E	3400E	OE																																																																																														
6060E	5520E	3515E																																																																																														
77634E	312E	4E																																																																																														
FL V21 N02	5263E	2371E																																																																																														
V33E	FL V21 N02	13001E																																																																																														
	V33E	2372E																																																																																														
		1420E																																																																																														
		2373E																																																																																														
		12067E																																																																																														
		FL V21 N02																																																																																														
		V33E																																																																																														

THRUST

**LMA790-3-LM  
APOLLO OPERATIONS HANDBOOK**

LM 3196, LM 3231

CREW-MAN	PNI	PROCEDURES	REMARKS
		<p>4.10.1.6 <u>RCS Burn for Lunar Impact (Unmanned Ascent State)</u>(cont)</p> <p>2B. Select mode II attitude error display &amp; disarm engine. Key V62E ENG THR CONT: ENG ARM sv - OFF</p> <p>2C. Select erasable memory program: Key V30E - Verify program number</p> <p>Poss OPR ERR lt - on Exit V30, Key RSET Repeat step 2A</p> <p>FL V50 N18</p> <p>R1 Roll   XXX.XX° R2 Pitch   XXX.XX° R3 Yaw    XXX.XX°</p> <p>If CSM orientation maneuver-to-burn attitude is completed: Key ENTR V06 N40</p> <p>R1 TFI    XIXX min-sec R2 VG    XXX.X fps R3 ΔVM   XXX.X fps</p>	<p>Ref para 4.5.3.2.</p> <p>MSFN can perform all of erasable memory program or continue orientation maneuver by keying V33E after LH jettison. OPR ERR lt - on if R1 of N26 = 0</p>

**LMA790-3-LM  
APOLLO OPERATIONS HANDBOOK**

CREW-MAN	PNI	PROCEDURES	REMARKS
		4.10.1.6 RCS Burn for Lunar Impact (Unmanned Ascent Stage) (cont)	
CDR	1	3. GUID CONT sw - PGNS	<p>Positions of switches not constrained by requirements of this task and positions of momentary-contact switches are not listed.</p> <p>LTC: FLOOD sw - OFF before leaving LM or when flood-lighting is no longer required. Overhead/forward flood-lights remain on while overhead hatch is open; they go off at closing of hatch.</p>
CDR	1	4. ASC He REC 1 & 2 tb - gray	
LMP	2	5. RCS: SYS A & B ASC FUEL & ASC OXID tb(4) - bp SYS A & B QUAD 1,2,3 & 4 tb(8) - gray CRSFD tb - bp SYS A & B MAIN SOV tb(2) - gray	
		6. GLYCOL sel - PUMP 1	
CDR	3	7. S/C: ROLL, PITCH & YAW sw - MODE CONT PGNS sw - AUTO	
		8. LTC: FLOOD sw - ALL EXTERIOR LTC sw - TRACK	
CDR	4	9. ACA/4 JET sw (2) - DISABLE TTCA/TRANSL sw (2) - DISABLE ACA PROP sw (2) - DISABLE	
	1,2		
	5,6	10. Eng STOP pb/1t (2) - reset	

THRU

LMA790-3-LM  
 APOLLO OPERATIONS HANDBOOK

CREW-MAN	PNL	PROCEDURES	REMARKS
		4.10.1.6 RCS Burn for Lunar Impact (Unmanned Ascent Stage) (cont)	
LHP	12	11. COMM: UP DATA LINK sw - DATA S BAND MODULATE sw - PH S BAND XMTX/RCVR sw - PRIM S BAND PWR AMPL sw - PRIM S BAND VOICE sw - OFF S BAND PCH sw - PCH S BAND RANGE sw - RANGE VHF A XMTX sw - OFF VHF A RCVR sw - OFF VHF B XMTX sw - OFF VHF B RCVR sw - OFF TLM BIONED sw - OFF TLM PCH sw - HI RECORDER sw - OFF COMM ANTI: TRACK MODE sw - SLEW PITCH cont - (ccw) YAW cont - (ccw) S BAND sel - SLEW	
	14	12. EFS: POWER/TEMP MON sel - ED/OFF INVERTER sw - 2	
CDR	11	13. All cb's - open, except: CB AC BUS B: S BD ANTI - close ACS - close BUS TIE INV 2 & 1 - close CB AC BUS A: BUS TIE INV 2 & 1 - close AC BUS VOLT - close CB RCS SYS A: QUAD 4, 3, 2, & 1 TCA - close CB INST: SIG CONDR 1 - close CB S/C: AEA - close ATCA (FCNS) - close CB HTR RCS SYS A/B 1: QUAD 4, 3, 2, & 1 - close	Computed angles from MSPN approached in ccw direction.

**LMA790-3-LM**  
**APOLLO OPERATIONS HANDBOOK**

CREW-MAN	PNL	PROCEDURES	REMARKS
		<p>4.10.1.6 <u>RCS Burn for Lunar Impact (Unmanned Ascent Stage)</u> (cont)</p> <p>CB ECS:            SUIT FAN 1 - close            GLYCOL PUMP 2 - close            GLYCOL PUMP 1 - close            GLYCOL PUMP AUTO TRNFR - close</p> <p>CB COMM:            UP DATA LINK - close</p> <p>CB PCRS:            LGC/DSKY - close            IMU STBY - close            IMU OPR - close</p> <p>CB EPS:            BAT FEED TIE (2) - close            CROSS TIE MAL LOADS - close            CROSS TIE BUS - close            ASC ECA CONT - close            XLUNAR BUS TIE - close            ASC ECA - close            INV 1 - close            DC BUS VOLT - close</p> <p>Verify cb status per RCS Burn for Lunar Impact</p>	
LMP	16	<p>14. All cb's - open, except:            CB RCS SYS B:            QUAD 1, 2, 3, &amp; 4 TCA - close            PQGS/DISP - close</p> <p>CB LTG:            TRACK - close            FLOOD - close</p> <p>CB S/C:            AEA - close            ASA - close            ATCA - close            ATCA (AGS) - close</p> <p>CB INST:            CWEA - close            SIG SENSOR - close            PCM/TE - close            SIG CONDR 2 - close</p>	<p>See fig 4-22.</p> <p>RCS and MPS display circuit breakers must not be opened until status of RCS and ascent solenoid valves has been verified. CB RCS SYS B: PQGS/DISP must be left closed to enable telemetry transmission to MSFN.</p>

THRU

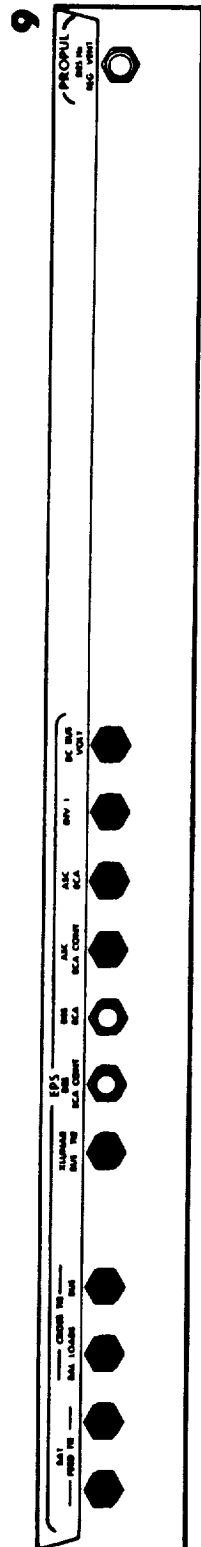
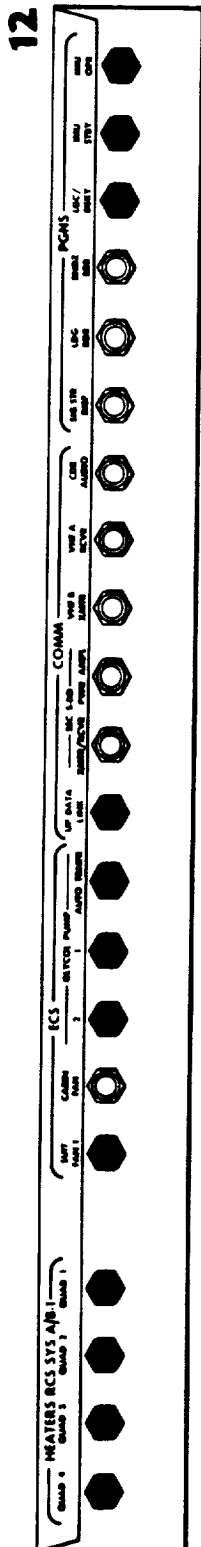
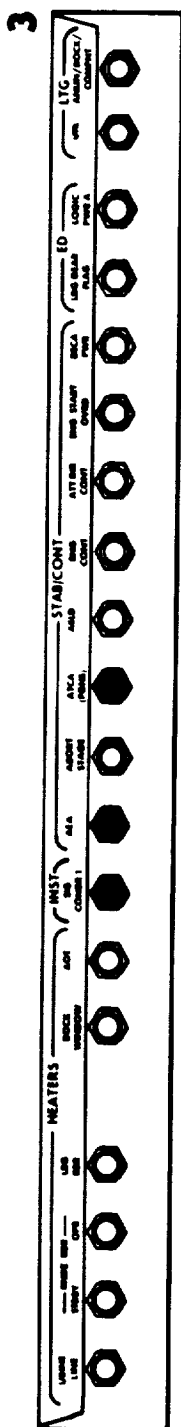
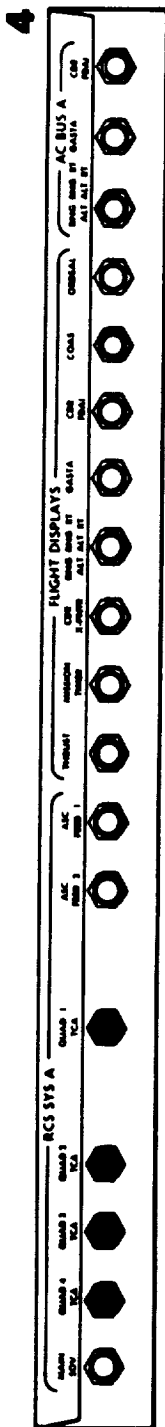
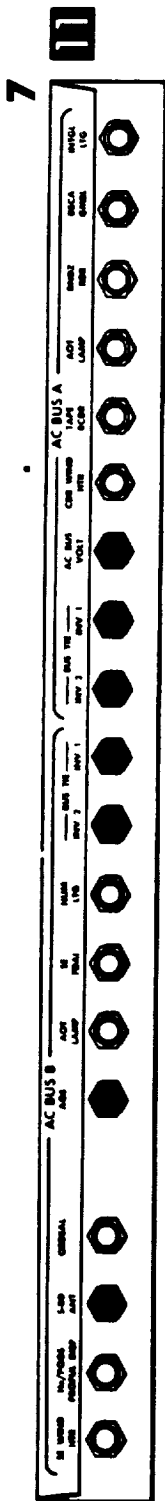

300LM10-1061-13

Figure 4-22. RCS Burn for Lunar Impact (Panel 11)



**LMA790-3-LM**  
**APOLLO OPERATIONS HANDBOOK**

CREW-MAN	PNL	PROCEDURES	REMARKS
		<p>4.10.1.6 RCS Burn for Lunar Impact (Unmanned Ascent Stage) (cont)</p> <p>CB COMN:            DISP - close            VHF A XMTR - close            VHF B RCVR - close            PRIM S BD PWR AMPL - close            PRIM S BD XMTR/RCVR - close            S BD ANT - close            PMP - close</p> <p>CB ECS:            CABIN REPRESS - close            SUIT FAN AP - close            CO2 SENSOR</p> <p>CB HTR RCS SYS A/B 2: QUAD 1, 2, 3, &amp; 4 - close            CB HTR: S BD ANT - close            CB EPS:            DISP - close            DC BUS VOLT - close            INV 2 - close            ASC ECA - close            XLUNAR BUS TIE - close            BAT FLED TIE (2) - close</p> <p>Verify cb status per RCS Burn for Lunar Impact.</p>	
	14	15. EPS:	See fig 4-23.
	16	BAT 5 BACK UP CDR FEED sw - ON; tb - gray BAT 6 BACK UP LMP FEED sw - ON; tb - gray CB EPS: DISP - open	This step places ascent batteries on alternative feed paths.
	1	16. ENG THR CONT: ENG ARM sw - OFF	
	11	17. CB ECS: SUIT FAN 1 - open  Perform Intravehicular Transfer to CSM.	Ref para 4.14.4.  Preparation for jettison, and jettison, are controlled from CSM.  Postjettison coast can be monitored visually from CSM.  LM is controlled by MSFN via uplink commands to DUA.

THRUST

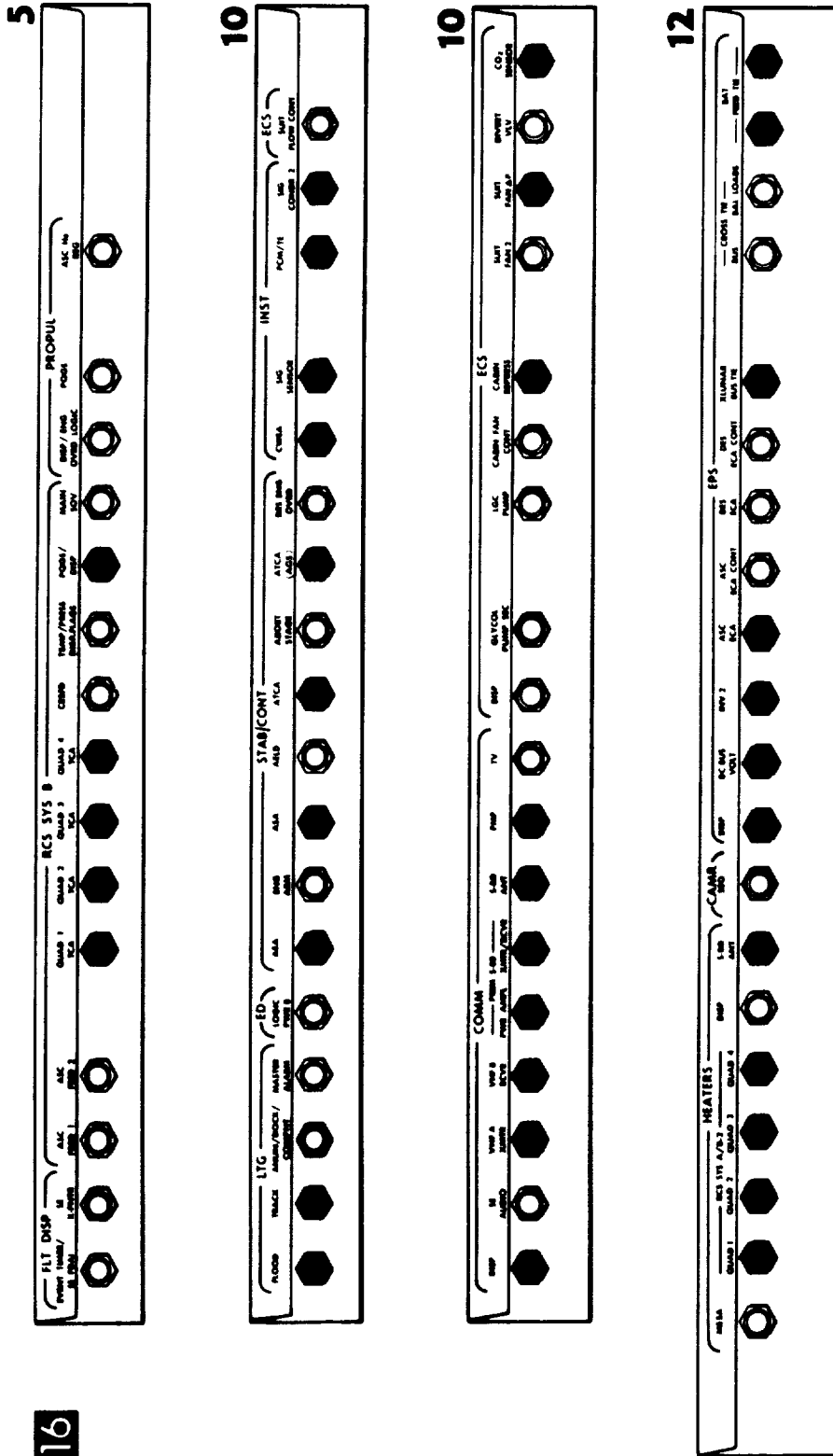

300LM10-1061-14

Figure 4-23. RCS Burn for Lunar Impact (Panel 16)

**LMA790-3-LM**  
**APOLLO OPERATIONS HANDBOOK**

CREW-MAN	P/NL	PROCEDURES	REMARKS
		<p>4.10.1.7 <u>Docked DPS Thrust Program (P40) With AGS Followup</u></p> <p style="text-align: center;">CAUTION</p> <p>Do not select this procedure unless VG is greater than <math>\Delta V_m</math> resulting from ullage maneuver.</p>	<p>Purpose of Docked DPS Thrust (P40) With AGS Followup procedure is to compute preferred IMU orientation and LM attitude for DPS thrust maneuver. This procedure controls PGNCS during countdown, ignition, thrusting, and thrust termination. Docked DPS thrust is to be performed under PGNCS control only, because CES cannot stabilize combined vehicles during thrusting. Therefore, switching to AGS automatic control during this procedure is prohibited; AGS is used only to monitor performance.</p> <p>Descent engine must not be operated in throttling range of 65% to 92.5%, where operation of cavitating venturis in flow control valves becomes unpredictable and may cause incorrect fuel-oxidizer mixtures ratio. Operation in 60% to 92.5% range will cause excessive engine erosion and early combustion chamber burn-through.</p> <p>Ref para 4.13.3.1. Ref para 4.13.1.1. Ref para 4.13.4.3. Ref para 4.2.29.</p> <p>Ref para 4.6.1.1. Ref para 4.6.1.13. LGC/CMC Clock Synchronization (R33) (para 4.6.1.15) LGC Update (P27) (para 4.6.1.7) Ref para 4.6.1.3. ISS should be on 15 minutes before thrusting maneuver. Ref para 4.9.1.1.</p> <p>Ref para 4.6.1.8. If docked with CSM, KALCMANU maneuver rate loaded in R03 should be 0.5°/second or</p>
	<p>MPS Basic (Unstaged) (required) ECS Basic (Unstaged) (required) EPS Preparation for DPS Burn (required) DPS Pressurization and Checkout (required)</p> <p>LGC Power-Up (required) LGC Self-Test (desired) LGC time valid (required)</p> <p>LGC state vector valid (required) IMU Power-Up (LGC Operating) (required) IMU Orientation Determination (P51) (required) DAP Data Load Routine (R03) (required)</p>	<p>MPS Basic (Unstaged) (required) ECS Basic (Unstaged) (required) EPS Preparation for DPS Burn (required) DPS Pressurization and Checkout (required)</p>	

THRUST

**LMA790-3-LM  
APOLLO OPERATIONS HANDBOOK**

CREW MAN	PNL	PROCEDURES	REMARKS
		<p>4.10.1.7 <u>Docked DPS Thrust Program (P40) with AGS Followup (cont)</u></p> <p>Appropriate prethrust program (required)</p> <p>AGS Power-Up (required)            AEA Self-Test (desired)            AGS time valid (desired)</p> <p>AGS LM state vector valid (desired)</p> <p>AGS CSM state vector valid (desired)</p> <p>AGS Alignment valid (required)</p> <p>AGS Mb Vector Update (required if mission warrants)            Appropriate prethrust procedure (required)</p>	<p>0.2°/second. During docked DPS burns, two-jet system B ullage should be selected.</p> <p>Rate command rates in docked configuration are one-tenth those of undocked configuration for same DAP load bit.</p> <p>Docked deadband is 1.4°.</p> <p>Ref para 4.7.</p> <p>Ref para 4.6.2.1.            Ref para 4.6.2.3.            AGS Manual Absolute Time Initialization (para 4.6.2.6) or AGS Initialization Routine (R47) (para 4.6.1.18)</p> <p>AGS Initialization Routine (R47) (para 4.6.1.18), or AGS Manual LM State Vector Update/Initialization (para 4.6.2.7), or AGS Manual Rendezvous Radar LM State Vector Update (para 4.8.2.2)</p> <p>AGS Initialization Routine (R47) (para 4.6.1.18) or AGS Manual CSM State Vector Update/Initialization (para 4.6.2.7)</p> <p>PCNCS/AGS Align (para 4.9.2.1), Backup AGS Alignment (using AGS Body-Axis Alignment and PCMS IMU) (para 4.9.2.2), Backup AGS Alignment (using AGS Body Axis Alignment and AOT) (para 4.9.2.3), or AGS Lunar Align (para 4.9.3.2)</p> <p>Ref para 4.6.2.15.</p> <p>Ref para 4.7. If AGS TPI search prethrust procedure was used, TPI execute must have been selected subsequent to that procedure.</p>

**LMA790-3-LM**  
**APOLLO OPERATIONS HANDBOOK**

CREW-MAN	PNL	PROCEDURES	REMARKS
		<p>4.10.1.7 Docked DPS Thrust Program (P40) With AGS Followup (cont)</p> <p style="text-align: center;">CAUTION</p> <p>PGCS should be in operation 15 min before start of thrust but should not be operated continuously for more than 45 min, to prevent equipment damage due to electronics overheating.</p> <ol style="list-style-type: none"> <li>1. Prepare PGCS for thrust monitoring: PRPLNT QTY MON sw - DES 1 If DES QTY warn lt - on, it can be extinguished after ullage settling has been established by cycling PRPLNT QTY MON sw to OFF, then DES 1.</li> <li>2. Establish attitude control: GUID CONT sw - PGNS S/C: PGNS sw - ATT HOLD AGS sw - ATT HOLD Key V76E No DAP lt - on S/C: ROLL, PITCH, YAW sw - MODE CONT</li> <li>3. Establish PGNS total attitude &amp; attitude rate/error display: ATTITUDE MON sw (1) - PGNS RATE/ERR MON sw (2) - LDC RDR/CMFTR</li> <li>4. Enable ACA/ITCA: THROTTLE/JETS cont (1) - JETS THROTTLE/JETS cont (1) - THROTTLE ENG THR CONT: ATT/TRANSL sw - 2 JETS ACA PROP sw (2) - ENABLE</li> <li>5. Prepare controls for DPS burn: ENG THR CONT: THR CONT sw - MAN MAN THROT sw - as required ENG ARM sw - OFF</li> </ol>	<p>Ref para 4.5.1. Do not use attitude hold/rate command mode when docked with CSM.</p> <p>PGCS low-level detection circuit will latch up in low-quantity position if sensor probes are not immersed in propellant because of lack of ullage settling.</p> <p>Ref para 4.5.3.1 and 4.5.3.2</p>

LM 3207

THRU

**LMA790-3-LM**  
**APOLLO OPERATIONS HANDBOOK**

CREW-MAN	PNL	PROCEDURES	REMARKS
		<p>4.10.1.1.7 <u>Docked DPS Thrust Program (P40) With AGS Followup (cont)</u></p> <p>ABORT pb - reset            ABORT STAGE pb - reset            Eng START pb/lit - off            Eng STOP pb/lit (2) - reset            DES ENG CMD OVRD sw - OFF            ENG CRBL sw - ENABLE            ENG THR CONT: BAL CPL sw - ON            S/C: DEAD BAND sw - MIN</p>	
		<p style="text-align: center;">CAUTION</p> <p>PQCS should be in operation 15 min before start of thrust but should not be operated continuously for more than 45 min, to prevent equipment damage due to electronics overheating.</p> <ol style="list-style-type: none"> <li>1. Prepare PQCS for thrust monitoring:              PRPLNT QTY MON sw - DES 1              If DES QTY warn lt - on, it can be extinguished after ullage settling has been established by cycling PRPLNT QTY MON sw to OFF, then DES 1.</li> <li>2. Select desired guidance steering:               <ol style="list-style-type: none"> <li>a. Z-axis parallel to CSM orbit plane -                    Key DEDA C 623+00000E                    Key DEDA C 400+100000E</li> <li>or</li> <li>b. Z-axis specified by Wb vector -                    Key DEDA C 623+10000E                    Key DEDA C 400+10000E</li> </ol> </li> <li>3. Deleted</li> </ol>	<p>PGNS low-level detection circuit will latch up in low-quantity position if sensor probes are not immersed in propellant because of lack of ullage settling.</p>
		<p>6. Select P40:            Key V37E 40E            Poss FL V05 N09 - Alarm</p>	

**LMA790-3-LM**  
**APOLLO OPERATIONS HANDBOOK**

LM 3231

CREW-MAN	PNI	PROCEDURES	REMARKS
		<p>4.10.1.1.7 Docked DPS Thrust Program (P40) With AGS Followup (cont.)</p> <p>01706 - Loaded configuration indicates DPS staged            PROG It - on            Key V34E &amp; RSET            FL V37 N--            Key XXE, exit P40 &amp; reload DAP            Poss PROG It - on            Key V05 N09E - Call alarm            00210 - IMU not operating</p> <p>00220 - ISS orientation not known            Key KEY REL &amp; RSET            FL V37 N--            Key XXE, exit P40            To obtain optional display of VG (LV):            Key V06 N86E              R1 X XXXX.X fps              R2 Y XXXX.X fps              R3 Z XXXX.X fps            To terminate display:            Key KEY REL</p> <p>7. Attitude Maneuver Routine (R60)            FL V50 N18 - Perform automatic maneuver to final FDAI angles              R1 Roll   XXX.XX°              R2 Pitch  XXX.XX°              R3 Yaw   XXX.XX°            If desired, before continuing R60, crew may alter values of parameters DWTTHRUSH, DVCNTR, TDECAY+1 as follows:            Key V21 N01E (01250E, 03515E, or 03741E, respectively), (new data)E</p>	<p>Perform IMU Power-UP (LGC Operating) (para 4.6.1.1.3).            Perform IMU Orientation Determination (P51) (para 4.9.1.1.1).</p> <p>If final computed FDAI angles result in +90° yaw, transformation from IMU to FDAI angles in roll and pitch is indeterminate and R1 and R2 will be zero.            Decision to alter these values and desired new values would be coordinated with, and received from MSFN.            Some or all values are octal and complemented values.</p>

THR

**LMA790-3-LM**  
**APOLLO OPERATIONS HANDBOOK**

LM 3158

CREW MAN	PNL	PROCEDURES	REMARKS
		<p><b>4.10.1.7 Docked DFS Thrust Program (P40) With AGS Followup (cont)</b></p> <p>After CSM maneuver to thrust attitude -</p> <p>a. Accept automatic attitude maneuver: GUID CONT sw - PGNS S/C: PGNS sw - AUTO Key PRO - go to step 8</p> <p>b. When present attitude satisfactory: Null AGS yaw attitude error. Monitor yaw attitude error on FDAI error needle. ACA - null yaw error (X-axis override) Key ENTR - Exit R60, go to step 9</p> <p>B. If PGNS automatic attitude maneuver selected: DSKY displays are blanked until completion of automatic maneuver. Monitor FDAI belly band, with respect to color band on roll bezel, to avoid gimbal lock.</p> <p style="text-align: right;">Return to step 7.</p>	<p>For docked DPS burns, CSM initially maneuvers to thrust attitude and LM performs automatic trim maneuver in step 8.</p> <p>If desired, Key extended verbs or Key V16 N18 - Final FDAI angles R1 Roll XXX.XX° R2 Pitch XXX.XX° R3 Yaw XXX.XX° Key KEY REL</p> <p>Belly band covers separation between hemispheres of FDAI ball. Belly band, in color bands on each side of FDAI roll bezel, would indicate DMU middle gimbal angle &gt;75°. During this maneuver, LGC will terminate automatic maneuver if S/C: PGNS sw is switched out of AUTO.</p>



**LMA790-3-LM**  
**APOLLO OPERATIONS HANDBOOK**

CREW-MAN	PNL	PROCEDURES	REMARKS
		<p>4.10.1.1.7 <u>Docked DPS Thrust Program (P40) With AGS Followup (cont)</u></p> <p>4. Monitor X-axis component of velocity to be gained: Key DEFA C 500R (0.1/1 fps)</p> <p>9. Poss FL V50 N25 - Checklist reference R1 00203 - Switch to PGNC auto-matic mode R2 ---- R3 ----</p>	<p>Parenthetical quantization notation: lunar mission/earth mission. Readout will equal total velocity to be gained if LM is properly oriented for DPS burn.</p> <p>Inhibiting X-axis RCS jets during DPS burn is recommended, to minimize thermal impingement problems with descent stage and CSM.</p>

THRUST



**LMA790-3-LM**  
**APOLLO OPERATIONS HANDBOOK**

CREW-MAN	PNL	PROCEDURES	REMARKS
		<p>4.10.1.1.7 <u>Docked DPS Thrust Program (P40) With AGS Followup (cont)</u></p> <p>If PCNCS automatic mode desired:  GUID CONT sw - PCNS  S/C: PCNS sw - AUTO  ENG THR CONT: THR CONT sw - AUTO  Key PRO</p> <p>If PCNCS automatic mode was selected or not desired: Key ENTR  Key V65E - Disable U &amp; V jets</p> <p>10. V06 N40 -  R1 TFI <u>XXBXX</u> min-sec  R2 VG <u>XXX.X</u> fps  R3 AVm <u>XXX.X</u> fps</p> <p>CMPTR ACTY lt - on  Monitor PROG lt from TFI = -00B50 to -00B35. If PROG lt - on:  Key V05 N09E - Call alarm  01703 - TIG slipped</p> <p>Key KEY REL &amp; RSET  CMPTR ACTY lt - off  Update EVNT TMR ind if required.</p> <p>11. Verify TTCA - minimum thrust  CB S/C: DECA PWR - close (if open)</p> <p>12. When TFI = -00B29:  V06 N40  R1 TFI <u>XXBXX</u> min-sec  R2 VG <u>XXX.X</u> fps  R3 AVm <u>XXX.X</u> fps  Verify AVm <math>\leq</math> 0.5 fps from  TFI = -00B30 to -00B15</p> <p>13. If first DPS burn, enable supercritical He pressurization:  ED: MASTER ARM sw - ON</p>	<p>R3 displays 00000 until TFI = -00B30. V06 N40 displays are blanked from TFI = -00B35 to -00B30. If alarm 01703 occurs, beginning and duration of blanking cannot be defined.</p> <p>CMPTR ACTY lt - on during State Vector Integration Routine (R41).</p> <p>TIG will be slipped, as required, to get state vector integration to new TIG-30 seconds.</p> <p>State vector integration complete.</p> <p>AVm &gt; 0.5 fps indicates excessive PIPA bias error.</p>

THRUST

**LMA790-3-LM  
APOLLO OPERATIONS HANDBOOK**

CREW-MAN	PNL	PROCEDURES	REMARKS
		<p>4.10.1.7 <u>Docked DPS Thrust Program (P40) With AGS Followup (cont)</u></p> <p>14. When TFI = -00B10: Initiate ullage maneuver: TICA - move up until TFI = -00B05</p> <p style="text-align: center;">CAUTION</p> <p style="text-align: center;">DES ENG CMD OVRD sw - OFF</p> <p>ENG THR CONT: ENG ARM sw - DES</p> <p>15. When TFI = -00B05 FL V99 N40 - Engine-on enable R1 TFI XXXX min-sec R2 VG XXXX.X fps R3 ΔV<sub>m</sub> XXXX.X fps Accept: When ΔV<sub>m</sub>&gt;XXXX.X fps Key PRO Reject: Key V34E FL V37 N--- Key XXE, exit P40 ENG THR CONT: ENG ARM sw - OFF</p> <p style="text-align: center;">CAUTION</p> <p>Do not select rate command attitude hold mode during docked DPS burns. This can result in loss of attitude control.</p> <p>16. If TFI is negative &amp; nonzero: V06 N40 R1 TFI XXXX min-sec R2 VG XXXX.X fps R3 ΔV<sub>m</sub> XXXX.X fps</p> <p>17. When TFI = -00B00, monitor thrust. If no DPS burn: Eng START pb/lt - push</p>	<p>If DES ENG CMD OVRD sw - ON, engine will start upon arming.</p> <p>During FL V99 N40, brief FL V06 may appear intermittently; this should be disregarded. Response to FL V99 N40 should be made as soon as possible, to decrease possibility of violating descent stage thermal constraint (approximately 15 seconds).</p> <p>If TFI is not negative and nonzero, DPS engine is commanded on when PRO is keyed in step 15.</p>

**LMA790-3-LM**  
**APOLLO OPERATIONS HANDBOOK**

CREW-MAN	PNL	PROCEDURES	REMARKS
		<p>4.10.1.7 <u>Docked DPS Thrust Program (P40) With ACS Followup (cont)</u></p> <p>18. Poss DES QTY warn lt            MASTER ALARM pb/lt - reset            PRPLANT QTY MON sw-cycle OFF, then DES I            DES QTY warn lt - off</p> <p style="text-align: center;">CAUTION</p> <p>If DPS burn is manually initiated (eng START pb/lt), automatic eng shutoff will not occur. When shutoff criteria are reached, eng STOP pb/lt must be pushed.</p> <p>Rough combustion may be expected at start of DPS burns due to gas ingestion in propellants. Roughness may last as long as 25 sec, depending on how quickly eng is throttled up. There is no constraint on throttling due to this roughness.</p> <p>5. Monitor <math>\Delta V_{gx}</math></p> <p>19. V06 N40            R1 TFC    XXXX min-sec            R2 VC    XXX.X fps            R3 AVm    XXX.X fps            When EVNT ind - 00:05:            TTCA - increase to 40%            TFC &amp; VG decreasing, <math>\Delta V_m</math> increasing            Monitor FDAL            Poss PROG lt - on            Key V05 N09E - Call alarm            01407 - VC increasing            Key KEY REL &amp; RSET            Terminate burn.</p> <p>19A. If propellant quantity &gt;29%:            DES He REG 1 sw - OPEN; cb - gray</p> <p>20. If first DPS burn:            ED: MASTER ARM sw - OFF            MASTER ALARM - on            MASTER ALARM pb/lt - reset</p>	<p><math>\Delta V_{gx}</math> will begin to count-down at engine ignition.            TFC is discontinuous and <math>\Delta V_m</math> becomes fairly constant for 4 to 5 seconds.</p> <p>If VC is found to be increasing by LCC, engine-off command will not be generated.</p> <p>MASTER ALARM - on when ED: MASTER ARM sw - OFF, due to relay race removing CMEA inhibit.</p>

THRUS

**LMA790-3-LM**  
**APOLLO OPERATIONS HANDBOOK**

CREW- MAN	PNL	PROCEDURES	REMARKS
		<p>4.10.1.7 <u>Docked DPS Thrust Program (P40) With AGS Followup (cont)</u></p> <p>21. <u>DPS/APS Thrust Fail Routine (R40)</u></p> <p>If LGC detects thrust fail:            FL V97 N40 - Perform engine fail procedures</p> <p>R1 TFC XXXX min-sec            R2 VC XXXX.X fps            R3 AVm XXXX.X fps</p> <p>Alternatives to fail procedure:            a. Verify LGC interpretation of thrust failure:                Key PRO</p> <p>b. Attempt completion of maneuver:                Key ENTR, return to step 15</p> <p>c. Terminate:                Key V34E - Exit P40                FL V37 N---                Key XXE</p> <p>21A. When propellant quantity = 29%            or            At TFC-10 sec (&lt;86Z):            DES He REG 1 sw - CLOSE; tb - bp</p> <p>22. When EVENT TMR ind = 00:26:            ENG THRUST ind - approx 100Z            CMD THRUST ind - approx 70Z            Unless TG &lt;95 sec</p> <p>23. Monitor thrust cutoff when TFC = 00B00.            Eng STOP pb/lt - push after automatic cutoff or if cutoff does not occur            ENG THR CONT: ENG ARM sw - OFF            If cutoff is early, return to step 21.</p>	<p>R40 is called at nominal ignition time and remains active until engine cutoff. R40 monitors PIPA outputs and initiates engine fail procedures if thrust fail is detected. Engine thrust fails when PIPA detects AV of &lt;0.394 fps (12 cm/sec) (docked configuration) for five consecutive sampling periods of 2 seconds each, after nominal ignition time. Engine thrust also fails if, during thrusting period, AV is less than this threshold for two consecutive sampling periods of 2 seconds each.</p> <p>During FL V97 N40, brief FL V06 may appear intermittently; this should be disregarded.</p> <p>When EVENT TMR ind = 00:26 = TIG+26 seconds, throttle is commanded to maximum. If TB &lt;95 seconds, no-throttle flag is set to inhibit throttle command from going maximum, to prevent inaccurate engine-cutoff computations when engine thrust level varies.</p>

**LMA790-3-LM**  
**APOLLO OPERATIONS HANDBOOK**

LM

CREW-MAN	PNL	PROCEDURES	REMARKS
		<p>4.10.1.7 Docked DPS Thrust Program (P40) With AGS Followup (cont)</p> <p>24. S/C: PGNS sw - ATT HOLD</p> <p>25. Key V75E - Reenable U &amp; V jets</p> <p>26. FL V16 N40  R1 TFC            XXBX min-sec  R2 VG            XXX.X fps  R3 ΔV<sub>m</sub>        XXX.X fps  Record thrust parameters at their final value:  Key PRO  Record final propellant quantity noted during thrust.  PRPLNT QTY MON sw - OFF</p> <p>27. FL V16 N85 - VG (LM)  R1 X XXXX.X fps  R2 Y XXXX.X fps  R3 Z XXXX.X fps  If nulling of VG is desired:  Key V77E  NO DAP lt - off  THROTTLE/JETS cont (CDR) - JETS  ACA/TTCA - null VGY, VGY, VGY</p> <p>28. Key V76E when maneuver is completed.  NO DAP lt - on</p> <p>29. Terminate P40 or select Orbit Parameter Display Routine (R30):  a. Terminate:  Key PRO  FL V37 N--  Key XXE, exit P40  or  b. Select R30:  Key V82E  FL V16 N44  R1 Ha            XXX.X nm  R2 Hp            XXX.X nm  R3 TFF           XXX min-sec</p>	<p>6. Read out predicted perifocus altitude:  Key DEDA C 403R (0.1 nm)  Compare with PGNS Hp value.</p> <p>7. Read out apofocus altitude:  Key DEDA C 315R (0.1 nm)  Compare with PGNS Ha value.</p>
			<p>While average g is in process, orbit parameters are automatically recomputed every 2 seconds.</p>

THRUST

**LMA790-3-LM**  
**APOLLO OPERATIONS HANDBOOK**

CREW- MAN	PNL	PROCEDURES	REMARKS
		<p>4.10.1.1.7 <u>Docked DPS Thrust Program (P40) With AGS Followup (cont)</u></p> <p>Key PMO when finished with display to reestablish N85 display, exit R30</p> <p>Key PMO FL V37 N-- Key XXE, exit P40</p> <p>30. Key V66E Turn off ascent batteries: EPS: BAT 5 NORMAL LMP FEED sw - OFF; tb - bp BAT 6 NORMAL CDR FEED sw - OFF; tb - bp</p> <p>31. Perform EPS check, Post-DPS Burn.</p>	<p>For docked DPS burn, CSM state vector should be updated via V66 before separation, because LGC assumed that CSM was in coasting orbit during burn.</p> <p>Ref para 4.13.4.4.</p>

RC 1606



**LMA790-3-LM**  
**APOLLO OPERATIONS HANDBOOK**

LM 3231

CREW- MAN	PNL	PROCEDURES	REMARKS
		<p>4.10.2 <u>POWERED DESCENT</u></p> <p>4.10.2.1 <u>Braking Phase Program (P63) With AGS Preparation for Orbit Insertion (410+00000)</u></p>	<p>Purpose of Braking Phase Program (P63) is to calculate required time of DPS ignition.</p> <p>This procedure controls PGNS during countdown, ignition, and thrusting of powered landing maneuver, to obtain desired aim conditions for braking phase. Successful accomplishment of braking phase aim conditions (high gate) is indicated to crew by automatic selection of Approach Phase Program (P64). P63 must be selected at least 20 minutes before nominal TIG for powered landing.</p> <p>This procedure prepares AGS to steer LM by changing DPS thrust vector from retrograde (PGNS braking phase) to postgrade to achieve orbit insertion.</p> <p>Landing Analog Displays Routine (R10) is enabled near start of average g in P63 and is terminated when average g is terminated.</p> <p>U-jets and V-jets may be disabled (V65E) or enabled (V75E). This capability is intended to be used during Docked DPS Thrust Program (P40) with AGS Followup only. However, this capability is available during P63.</p> <p>Following DSKY display is available during powered landing, to support manual throttle operations. (Auto command is not available for display on THRUST ind during manual throttle.)</p> <p>V16 N92E R1 Desired auto throttle XXXXX (may be &gt;100% of FTP thrust) R2 H rate XXXX.X fps R3 H XXXXX fps</p> <p>ENG THR CONT: THR CONT sw - MAN is permitted at any time during powered descent. However, (in P63, P64) whenever GUID CONT sw - PGNS and S/C:PGNS sw - AUTO, care should be exercised that manual command does not exceed LCC desired thrust more than briefly; otherwise, LCC may invert LM in attempting to achieve targeted trajectory.</p>

THRU

**LMA790-3-LM**  
**APOLLO OPERATIONS HANDBOOK**

CREW-MAN	PNL	PROCEDURES	REMARKS
		<p>4.10.2.1 <u>Braking Phase Program (P63) With AGS Preparation for Orbit Insertion (410-00000) (cont)</u></p> <p>MPS Basic (Unstaged) (required)</p> <p>ECS Basic (Unstaged) (required)</p> <p>EPS Preparation for DPS Burn (required)</p> <p>DPS P Pressurization &amp; Checkout (required)</p> <p>S-Band Steerable Antenna Activation (High Power) (required)</p> <p>LGC Power-Up (required)</p> <p>LGC Self-Test (required)</p> <p>LGC time valid (required)</p> <p>LM &amp; CSM state vectors valid</p> <p>Landing site position &amp; nominal landing time at designated landing site valid (required)</p> <p>IMU Power-Up (LGC Operating) (required)</p> <p>IMU aligned to landing site orientation for designated landing site &amp; nominal time of landing (required)</p> <p>DAP Data Load Routine (R03) (required)</p> <p>AGS Power-Up (required)</p> <p>AEA Self-Test (required)</p> <p>AGS time valid (required)</p> <p>AGS LM &amp; CSM state vectors valid (required)</p> <p>PGNCS/AGS Align (required)</p>	<p>Ref para 4.13.3.1.</p> <p>Ref para 4.13.1.1.</p> <p>Ref para 4.13.4.3.</p> <p>Ref para 4.2.29.</p> <p>Ref para 4.2.20.</p> <p>Ref para 4.6.1.1.</p> <p>Ref para 4.6.1.13.</p> <p>LGC/CMC Clock Synchronization Routine (R33) (para 4.6.1.15)</p> <p>LGC Update Program (P27) (para 4.6.1.7)</p> <p>LGC Update Program (P27) (para 4.6.1.7)</p> <p>Ref para 4.6.1.3. ISS should be on 15 minutes before thrusting.</p> <p>IMU Realign Program (P52) (para 4.9.1.2)</p> <p>Ref para 4.6.1.8.</p> <p>Ref para 4.6.2.1.</p> <p>Ref para 4.6.2.3.</p> <p>AGS Initialization Routine (R47) (para 4.6.1.18)</p> <p>AGS Initialization Routine (R47) (para 4.6.1.18)</p> <p>Ref para 4.9.2.1.</p>

**LMA790-3-LM**  
**APOLLO OPERATIONS HANDBOOK**

CREW- MAN	P/NL	PROCEDURES	REMARKS
		<p>4.10.2.1 <u>Braking Phase Program (P63) With AGS Preparation for Orbit Insertion (410+00000) (cont)</u></p> <p>AGS Wb Vector Update (required if mission warrants)</p> <p>AGS Orbit Insertion (required)</p> <p>AGS Gyro &amp; Accelerometer Calibration (desired)</p> <p>Landing Radar Power-Up (required)</p> <p>Landing Radar Checkout (required)</p> <p>Rendezvous Radar Power-Up (desired)</p> <p>Rendezvous Radar Checkout (desired)</p> <p>EVMT IMR 1nd set to count-up to zero at TIG, based on HSTN-provided data (required)</p> <p>CSM in preferred tracking attitude (required)</p> <p>Aim conditions required for braking phase stored in LGC before launch (required)</p> <p>1. Prepare PQGS for thrust monitoring:</p> <p style="text-align: center;">CAUTION</p> <p>PQGS should be in operation 15 min before start of thrust but should not be operated continuously for more than 45 min, to prevent equipment damage due to electronics overheating.</p> <p>PRPLNT QTY MON sw - DES 1 If DES QTY warn lt - on: PRPLNT QTY MON sw - OFF, then DES 1 (after ullage settling)</p> <p>2. Establish attitude control: GUID CONT sw - PGNS S/C: PGNS sw - AUTO ROLL, PITCH, YAW sw - MODE CONT</p>	<p>Ref para 4.6.2.15. (Required for orbit insertion from far westerly lunar landing sites.)</p> <p>Ref para 4.7.3.2.</p> <p>Ref para 4.6.2.5.</p> <p>Ref para 4.6.3.7.</p> <p>Ref para 4.6.3.8. Assumption: Procedure leaves antenna in position No. 1.</p> <p>Ref para 4.6.3.1.</p> <p>Ref para 4.6.3.2.</p> <p>Ref para 4.13.6.</p> <p>PQGS low-level detection circuitry will latch up in low-quantity position if sensor probes are not immersed in propellant due to lack of ullage settling.</p> <p>Ref para 4.5.1.</p>



**LMA790-3-LM  
APOLLO OPERATIONS HANDBOOK**

LM 2014

CREW-MAN	PNI	PROCEDURES	REMARKS
		4.10.2.1 Braking Phase Program (P63) With AGS Preparation for Orbit Insertion (410+00000) (cont)	
	1	3. Select displays: MODE SEL sw - AGS ATTITUDE MON sw (1) - AGS ATTITUDE MON sw (1) - FGNS RATE/ERR MON sw (2) - LDG PDR/CHPTR	
	4	4. Enable ACA/ TTCA: ACA/4 JET sw (2) - ENABLE TTCA/TRANSL sw (2) - ENABLE THROTTLE/JETS cont (2) - THROTTLE TTCA (CDR) - minimum position TTCA (LMP) - soft stop ENG THR CONT: ATT/TRANSL sw - 4 JETS ACA PROP sw (2) - ENABLE	
	1 1,2 11 ULP	5. CB LIG: UTIL - close CDR UTILITY LIGHT sw - BRIGHT LMP UTILITY LIGHT sw - BRIGHT	
	1	6. Prepare controls for DPS burn: ENG THR CONT: THR CONT sw - AUTO MAN THROT sw - CDR ENG ARM sw - OFF ABORT pb - reset ABORT STAGE pb - reset RNDZ RADAR sel - AUTO TRACK Eng START pb/lit - off Eng STOP pb/lit (2) - reset DES ENG CMD OVRD sw - OFF ENG GMBL sw - ENABLE ENG THR CONT: BAL CPL sw - ON S/C: DEAD BAND sw - MIN CB S/C: AELD - close CB S/C: AELD - close	
	3 5 5,6 3		
	1 3 11 16		
	7.	Deleted	

**LMA790-3-LM  
APOLLO OPERATIONS HANDBOOK**

CREW-MAN	PNL	PROCEDURES	REMARKS
LM 3231		<p>4.10.2.1 <u>Braking Phase Program (P63) With AGS Preparation for Orbit Insertion (410+00000) (cont)</u></p> <p>8. Prepare AGS for followup:  a. Select guidance steering from following  (1) X-axis guidance steering, Z-axis parallel to CSM orbital plane -  Key DEDA C 400+10000E  Key DEDA C 623+00000E  or  (2) Yaw orientation specified by Wb vector -  Key DEDA C 400+10000E  Key DEDA C 623+10000E  b. S/C: AGS sw - ATT HOLD or AUTO  c. CB S/C: AEA - close  CB S/C: AEA - open</p> <p>9. Key V37E 63E  Pos PRDC lt - on  Key V05 N9E - Call alarm</p>	<p>Wb vector is provided for S-band LOS angle for orbit insertion from far westerly lunar landing sites.</p> <p>AEA backup d-c power circuit breaker should be open, except when PGNCS fails.</p> <p>If P68 is inadvertently selected instead of P63:  a. Reset APSFLAG and SURFFLAG-  Key V37E 00E  V25 N07E, 104E, 200E, E  V25 N07E, 106E, 10000E, E  b. Perform P27 update of RLS (values TBD) via DSKY or uplink  Key V71E (confirm P27 established)  FL V21 N01  Key 12E, 02020E,  XXXXXE (most significant part of RLSz)  XXXXXE (least significant part of RLSz)  XXXXXE (most significant part of RLSy)  XXXXXE (least significant part of RLSy)  XXXXXE (most significant part of RLSz)  XXXXXE (least significant part of RLSz)  XXXXXE (most significant part of TLAND)  XXXXXE (least significant part of TLAND)  FL V21 N02  Key V PR0  c. Reselect P63 - Key V37E 63E</p> <p>If it is desired to change altitude at which LR updates are inhibited, from stored value of 50 feet (scaled in meters at B-10), new octal value may be loaded at this time as follows: V21 N01E 3451E XXXXXE</p>

THRU

**LMA790-3-LM**  
**APOLLO OPERATIONS HANDBOOK**

LM 3231

CREW-MAN	PNL	PROCEDURES	REMARKS
		<p>4.10.2.1 Braking Phase Program (P63) With ACS Preparation for Orbit Insertion (410+00000) (cont)</p> <p>00210 - IMU not on</p> <p>00220 - IMU orientation not known</p> <p>Key KEY REL &amp; RSET FL V37 N-- Key XXE - Exit P63 Poss PROG lt - on Key V05 N09E - Call alarm 01412 - Descent ignition algorithm not converging Key KEY REL &amp; RSET Key V96E or V37E XXE - Exit P63</p> <p>10. FL V06 N61 - Maneuver parameters R1 TC -XXBXX min-sec</p> <p>R2 TFI XXBXX min-sec R3 Crossrange +XXXX.X nm</p> <p>Reset EVNT TMR ind to TFI Key PRO</p>	<p>Perform IMU Power-Up (LGC Operating) procedure (para 4.6.1.3). Perform IMU Orientation Determination Program (P51) (para 4.9.1.1.1).</p> <p>TC - Initial value - Estimated time of full thrust flight to accomplish aim condition of high gate. TC will count-down (based on actual thrust) after full thrust is commanded. TFI - Time from ignition Crossrange - Out-of-plane distance between initial LM orbital plane and presently designated landing site. Plus indicates plane is south; minus indicates plane is north of landing site.</p> <p>Visual confidence check, using estimate of surface range from known landmark close to planned time of ignition and present LM position, can be performed at this time.</p>

**LMA790-3-LM**  
**APOLLO OPERATIONS HANDBOOK**

CREW- MAN	PNI	PROCEDURES	REMARKS
		<p>4.10.2.1 Braking Phase Program (P63) With ACS Preparation for Orbit Insertion (410+00000) (cont)</p> <p>11. Deleted</p> <p>12. Attitude Maneuver Routine (R60) FL V50 N18 - Perform automatic maneuver to final FDAI angles: R1 Roll   XXX.XX° R2 Pitch  XXX.XX° R3 Yaw    XXX.XX°</p> <p>If desired, before continuing R60, crew may alter values of parameters DVTHRUSH or DVCNTR as follows: Key V21 N01E (01250E or 03515E respectively), (new data) E</p> <p>Accept automatic attitude maneuver: GUID CONT sw - PGNS S/C: PGNS sw - AUTO Key PRO - Go to step 13</p> <p>Reject alternatives: a. Perform manual attitude maneuver:   Select desired attitude control mode -   ACA - maneuver manually   Key PRO - Return to beginning of step 12   To recompute gimbal angles:   S/C: PGNS sw - ATT HOLD   Key PRO - Return to beginning of step 12</p> <p>b. When present attitude satisfactory:   ACA - adjust yaw as required for S-band track (X-axis override)   Key ENTR - Exit R60, go to step 14</p> <p>13. If PGNS automatic attitude maneuver selected: Pre-R60 displays return until completion of automatic maneuver. Monitor FDAI belly band, with respect to color band on roll bezel, to avoid gimbal lock.</p>	<p>LGC automatically sets 1° deadband in RCS DAP. If final computed FDAI angles result in +90° yaw, transformation from IMU to FDAI angles in roll and pitch is indeterminate and R1 and R2 will be zero.</p> <p>Decision to alter these values and desired new values would be coordinated with, and received from, MSFN. Some or all values are octal and complemented values.</p> <p>Automatic trim maneuver is considered essential for maneuvers to thrusting attitude.</p> <p>Ref para 4.5.1.</p> <p>PDI yaw attitude, to maintain S-band track, is landing site dependent.</p> <p>If desired, Key extended verbs or Key V16 N18 - Final FDAI angles R1 Roll   XXX.XX° R2 Pitch  XXX.XX° R3 Yaw    XXX.XX° Key KEY REL</p> <p>Belly band covers separation between hemispheres of FDAI ball. Belly band, in color bands on each side of FDAI roll bezel, would indicate IMU middle gimbal angle &gt;75°.</p>

LM 3197, LM 3231

THRU





# LMA790-3-LM APOLLO OPERATIONS HANDBOOK

RC 1596, LM 999, LM 3231

CREW-MAN	PNL	PROCEDURES	REMARKS
		<p>4.10.2.1 Braking Phase Program (P63) With AGS Preparation for Orbit Insertion (410+00000) (cont)</p> <p>16. V06 N62  R1 VI XXXX.X fps  R2 TFI XXXX min-sec  R3 AVm 0000.0 fps</p> <p>CHPTR ACTY lt - on  Monitor PROG lt from TFI = 00B50 to -00B35.  If PROG lt - on:  Key V05 N09E - Call alarm  01703 - TIG slipped</p> <p>Key KEY REL &amp; RSET  CHPTR ACTY lt - off  TTCA (CDR &amp; LMP) - minimum (hardstop)  At TFI = -00B29:  Poss ALT lt - on (R20)  Poss VEL lt - on (R20)</p> <p>V06 N62  R1 VI XXXX.X fps  R2 TFI XXXX min-sec  R3 AVm XXXX.X fps  Verify AVm &lt; 0.5 fps from TFI = -00B30 to -00B15.  If AVm &gt; 0.5 fps: TBD  Verify VI in R1 is within ±5 fps of MSFN value of LM inertial velocity.  Poss FL VEL lt</p>	<p>Displays are blanked from TFI = -00B35 to -00B30. Beginning and duration of blanking cannot be defined if alarm 01703 occurs.</p> <p>CHPTR ACTY lt - on during State Vector Integration Routine (R41).</p> <p>TIG will be slipped, as required, to get state vector integration to new TIG-30 seconds.</p> <p>State Vector Integration complete.</p> <p>ALT lt - on steady if LR range data-good discrete not present.  VEL lt - on steady if LR velocity data-good discrete not present.</p> <p>AVm &gt; 0.5 fps indicates excessive PIPA bias error.</p> <p>VEL lt - flashing if two or more of last four consecutive values of AV exceed data test limits (reasonability test).</p> <p>Do not Key V37E within approximately 50 micro seconds before ullage (If necessary to Key V37E, do it before TIG-10 seconds or after ullage comes on) to avoid continuous ullage with average g off.</p>

**LMA790-3-LM**  
**APOLLO OPERATIONS HANDBOOK**

LM 3231

CREW- MAN	PNI	PROCEDURES	REMARKS
		<p>4.10.2.1 <u>Braking Phase Program (P63) With AGS Preparation for Orbit Insertion (410+00000) (cont)</u></p>	
	1	<p>17. When TFI = -00B07: Monitor start of automatic ullage</p> <p style="text-align: center;">CAUTION</p> <p>DES ENG CMD OVRD sv - OFF ENG THR CONT: ENG ARM sv - DES CMD THRUST ind = 10Z If &gt;10Z, do not continue P63.</p>	
	1	<p>18. When TFI = -00B05: FL V99 N62 - Engine-on enable R1 VI XXXX.X fps R2 TFI XXXX min-sec R3 ΔV XXXX.X fps To permit engine ignition: When ΔV<sub>m</sub> &gt; XXXX.X fps, Key PRO To reject ignition: ENG THR CONT: ENG ARM sv - OFF Key V34E - Terminate P63 FL V37 N-- Key XZE</p> <p style="text-align: center;">CAUTION</p> <p>Rough combustion may be expected at start of DPS burns due to gas ingestion in propellants. Roughness may last as long as 25 sec, depending on how quickly eng is throttled up. There is no constraint on throttling due to this roughness.</p>	<p>During FL V99 N62, brief FL V06 may appear intermittently; this should be disregarded.</p>
		<p>19. If TFI is negative and nonzero: V06 N62 R1 VI XXXX.X fps R2 TFI XXXX min-sec R3 ΔV XXXX.X fps When TFI = 00B00: Monitor ENG THRUST ind - 10Z If no thrust: TBD</p>	<p>If TFI is not negative and nonzero, DPS engine is commanded on when PRO is keyed in step 18.</p>

**LMA790-3-LM**  
**APOLLO OPERATIONS HANDBOOK**

CREW-MAN	PNI	PROCEDURES	REMARKS
		<p>4.10.2.1 <u>Braking Phase Program (P63) With AGS Preparation for Orbit Insertion (410+0000) (cont)</u></p> <p>20. DPS/APS Thrust Fail Routine (R40) is called at nominal ignition time &amp; remains active until engine cutoff.</p> <p>LGC detects thrust fail:            FL V97 NXK - Perform engine fail procedure            R1 XXXX            R2 XXXX            R3 XXXX</p> <p>Alternatives to fail procedure:            a. Verify LGC interpretation of thrust failure               Key PRO               Terminate:                  Key V34E - Exit R40 &amp; P63                  FL V37 N--                  XXE</p> <p>21. Zero AGS ullage counter threshold:            Key DEDA C 616+0000E</p> <p>22. FL V06 N63            R1 ΔH       XXXX ft            R2 H rate   XXXX.X fps            R3 H        XXXX ft</p> <p>Observe at TIC + X sec -            CMD THRUST ind - approx 100Z            ENG THRUST ind - approx 100Z</p>	<p>Purpose of R40 is to monitor PIPA outputs and initiate engine fail procedures if thrust fail is detected. Engine thrust fails when PIPA detects ΔV of &lt;1.18 fps (36 cm/sec) for five consecutive sampling periods of 2 seconds each, after nominal ignition time. Engine thrust also fails if, during thrusting period, ΔV is less than this threshold for two consecutive sampling periods of 2 seconds each.</p> <p>During FL V97 NXK, brief FL V06 may appear intermittently; this should be disregarded.</p> <p>ΔH - LR altitude minus LGC altitude above terrain model or landing site radius. +99999 is displayed prior to LR data good. Verb-noun flash occurs only in P63. A PRO, V32E, or V34E response to N63 will be ignored.            H rate - Altitude rate: -, descent; +, ascent            H - Altitude; +, above landing site radius</p> <p>X is approximately 26 seconds. Exact time is loaded before launch or by LGC Update Program (P27).</p>
	1		

THRUST

**LMA790-3-LM**  
**APOLLO OPERATIONS HANDBOOK**

LM 3197, LM 3231

CREW- MAN	PNI	PROCEDURES	REMARKS
		<p>4.10.2.1 <u>Braking Phase Program (P63) With AGS Preparation for Orbit Insertion (410+00000) (cont)</u></p>	<p>Landing Auto Modes Monitor Routine (RL3) is called by P63 at DPS throttle up and selects P66 if S/C: PGNS sw - ATT HOLD and LM crew commands net change in rate of descent. If S/C: PGNS sw - ATT HOLD but DES RATE sw has not been operated since change to attitude hold mode, present PGNS program, P63, or P64 is maintained and crew has manual control of LM attitude. PGNS continues to command DPS throttle and display LGC-computed attitude errors on FDAI error needles.</p> <p>If PROG lt comes on due to 01406 alarm (bad return from ROOTPSRS) or 01410 alarm (unintentional overflow in guidance), all LM attitude rates will stop but program will continue. Large attitude errors, which may have developed during manual attitude maneuvers, will no longer lead to loss of landing programs.</p> <p>DPS performance can be monitored at this time by verifying CMD THRUST ind &gt;50%, T/W ind &gt;1.0 g.</p> <p>Following checks should be performed at 90-second intervals.</p> <ol style="list-style-type: none"> <li>a. Alternate and compare PGNS and AGS attitude error inputs between FDAI's.</li> <li>b. Compare PGNS altitude, altitude rate, and lateral velocity with AGS-derived parameters on ALT/ALT RATE ind and X pointer ind.</li> </ol> <p>S-band track verification should be made after yaw up maneuver.</p> <p>Time of nulling of yaw angle is landing site dependent.</p>
	3	<p>DES ENG CMD OVRD sw - ON</p> <p>24. When H = 45,000 ft or at PDI+2 min (whichever occurs first) if LM in window down orientation: ACA - manually yaw LM right at 2°/sec to window-up orientation. or When H = 30,000 ft, X-axis override is removed &amp; LGC commands LM to specified attitude. or At PDI +3 min if LM in yaw angle for S-band track ACA - manually null yaw angle (yaw override)</p>	

**LMA790-3-LM**  
**APOLLO OPERATIONS HANDBOOK**

LM 3231

CREW- MAN	PNI	PROCEDURES	REMARKS
		<p>4.10.2.1 <u>Braking Phase Program (P63) With AGS Preparation for Orbit Insertion (410+00000) (cont)</u></p> <p>25. Descent State Vector Update Routine (R12)</p> <p>To enable use of LR data (and disable N63 flash in P63): Key V57E</p> <p>Poss PROC lt - on Key V05 M09E - Call alarm 00511 - Neither or both LR antenna position discretes present for more than 10 sec. Key KEY REL &amp; RSET</p> <p>To perform manual altitude update of AEA: Key DEDA C 223+XXXXXE (100 ft)</p> <p>LR/RR Read Routine (R20)</p> <p>Poss PROC lt - on Key V05 M09E - Call alarm 00520 - RADARUPT not expected at this time or no radar sampling requested at this time Key KEY REL &amp; RSET</p>	<p>Routine R12 is called every 2 seconds once average g is turned on and terminates when average g terminates. Lunar terrain model computations (for LR update adjustments) in R12 are bypassed when V68 is executed or Landing Phase Program (P66) is entered.</p> <p>Two verbs are available for manual control of LR data for state vector updating: V57 - Enable use of LR data (and disable N63 verb-noun flash in P63) V58 - Inhibit use of LR data (and re-enable N63 verb-noun flash in P63)</p> <p>If desired: Key V16 N68E R1 Horizontal range (to landing site) XXXX.X nm R2 TG XXXX min-sec R3 VI (Inertial velocity) XXXX.X fps</p> <p>XXXX must be nonzero. Address contents are reset to zero by AEA within 2 seconds, thus allowing later updates.</p> <p>Purpose of LR/RR Read Routine (R20) is to read LR/RR parameters requested by calling routine (R12), to perform various checks to ensure that system is operating correctly, and to ensure an alarm if errors occur in RR reading.</p> <p>RADARUPT: LGC interrupt.</p>



**LMA790-3-LM**  
**APOLLO OPERATIONS HANDBOOK**

LM 3231

CREW-MAN	PNI	PROCEDURES	REMARKS
		<p>4.10.2.2 <u>Approach Phase Program (P64)</u></p> <p style="text-align: center;">WARNING</p> <p>DES QTY warn it will not be accompanied by MASTER ALARM; therefore, crewman must monitor MPS: FUEL &amp; OXID QUANTITY ind.</p>	<p>Purpose of Approach Phase Program (P64) is to control PGNS during thrusting, from completion of high gate aim conditions until completion of low-gate aim conditions; to control LM thrust and attitude in manner to provide visibility of presently designated landing site; and to provide landing site redesignation capability. Successful accomplishment of low-gate aim conditions is indicated by automatic selection of Landing Phase (ROD) Program (P66).</p> <p>If desired: Key V16 N68E R1 Horizontal range (to landing site) XXXX.X mm R2 TC XXXX min-sec R3 VI (Inertial velocity) XXXX.X fps</p> <p>Following DSKY display is available during powered landing, to support manual throttle operations. (Auto command is not available for display on THRUST ind during manual throttle.)</p> <p>V16 N92E R1 Desired auto throttle XXXXX (may be &gt;100% of FTP thrust) R2 H rate XXXX.X fps R3 H XXXXX feet</p> <p>ENG THR CONT: THR CONT sw - MAN is permitted at any time during powered descent. However, (in P63, P64) whenever GUID CONT sw - PGNS and S/C:PGNS sw - AUTO, care should be exercised</p>

**LMA790-J-LM**  
**APOLLO OPERATIONS HANDBOOK**

CREW-MAN	PNI	PROCEDURES	REMARKS
		<p>4.10.2.2 Approach Phase Program (P64) (cont)</p> <p>1. PROG Ind - 64</p> <p>Poss FL ALT lt</p> <p>2. FL V06 N64 R1 TR/LPD XXXX sec-deg R2 H rate XXXX.X fps R3 H XXXXX ft</p> <p>Descent State Vector Update Routine (R12)</p> <p>Poss PROG lt - on Key V05 N09E - Call alarm 00511 - Neither or both LR antenna position discretes present for more than 10 seconds.</p> <p>RADAR: LDG ANT sw - HOVER Key KEY REL &amp; RSET</p> <p>3. Monitor FPAI &amp; observe LGC-controlled pitchover through forward window.</p> <p>LGC commands yaw rotation to bring designated landing site in line with landing point designator scale on CDR's forward window. Approximate look angle is in RI.</p> <p>To perform manual altitude update of AEA: Key DEDA C 223+XXXXX (100 ft)</p> <p>4. Select one of following: a. If presently designated landing site is acceptable, continue monitoring N64 &amp; descent toward presently designated landing site. b. If presently designated landing site is not acceptable: Key PR0 V06 N64</p>	<p>that manual command does not exceed LGC desired thrust more than briefly; otherwise, LGC may invert LM in attempting to achieve targeted trajectory.</p> <p>Attitude deadband is automatically set to 0.3° at this time.</p> <p>ALT lt - flashing if two or more of last four consecutive values of ΔH exceed data test limits (reasonability test)</p> <p>TR is defined as estimated time remaining until end of redesignation capability.</p> <p>LPD is defined as angle below LM +Z-axis to LOS of presently designated landing site.</p> <p>R12 continues to run throughout powered descent until P68.</p> <p>When LR antenna has been commanded to position No. 2, 10 seconds elapse before LGC starts monitor for position No. 2. Alarm code 00511 will be generated after 10 additional seconds elapse pending absence or presence of both position discretes.</p> <p>Nominally, pitchover occurs approximately 8 minutes after start of powered descent at approximate altitude 8,635 ft.</p> <p>Nominal look angle after pitchover is 39° to 44°.</p> <p>XXXXX must be nonzero. Address contents are reset to zero by AEA within 2 seconds, thus allowing later updates.</p> <p>For site redesignation: a. Plus pitch reduces visibility of nominal landing site. b. Large redesignations should be made early in approach phase to conserve propellant and minimize attitude transients.</p>

**LMA790-3-LM**  
**APOLLO OPERATIONS HANDBOOK**

CREW-MAN	PNL	PROCEDURES	REMARKS
		<p>4.10.2.2 <u>Approach Phase Program (P64) (cont)</u></p> <p>ACA - manually align new landing site on CDR's window LPD scale            ACA deflections in pitch (+) will result in 1° change in elevation from present LM landing site LOS.</p> <p>ACA deflections in roll (+) will result in 1° change in azimuth from present LM landing site LOS.</p> <p>4.10.2.3 <u>Landing Phase (ROD) Program (P66)</u></p>	<p>c. No LPD redesignations when TR (P64) equals zero seconds.            d. Refer to onboard data for nominal altitude rate vs altitude.</p> <p>Purpose of Landing Phase (ROD) Program (P66) is to modify LM rate of descent in response to manual inputs, via DES RATE sw, to LGC, and to modify inertial attitude in response to manual inputs via ACA. In absence of manual control inputs, constant rate of descent and inertial attitude are maintained. P66 updates LM state vector with acceleration and landing radar data but inhibits landing radar updates below approximately 50 feet. S/C: PGNS sw - AUTO causes LGC to null horizontal velocity by tilting thrust vector of vehicle up to 20°.</p> <p>With S/C: PGNS sw - ATT hold, the desired attitude to arrest the horizontal velocities is displayed on the FDAI attitude error needles (modulo 20°).</p> <p>If desired:            Key V06 N68E            R1 Horizontal range (to landing site) XXXX.X nm            R2 TG XXXX min-sec            R3 VI (Inertial velocity) XXXX.X fps</p> <p>Following DSKY display is available during powered landing, to support manual throttle operations. (Auto command is not available for display on THRUST ind during manual throttle.)</p> <p>V16 N92E            R1 Desired auto throttle XXXXX (may be &gt;100% of FTP thrust)            R2 H rate XXXX.X fps            R3 H XXXXX feet</p> <p>This allows backup ROD method, whereby LGC-calculated thrust required to achieve descent rate commanded by DES RT sw can be displayed on DSKY for manual implementation (by either crewman) if required.</p>

RC 1594



**LMA790-3-LM**  
**APOLLO OPERATIONS HANDBOOK**

CREW: MAN	PNL	PROCEDURES	REMARKS
		<p>4.10.2.3 Landing Phase (ROD) Program (P66) (cont)</p> <p>1. Observe PROG ind - 66</p> <p>2. FL V06 N60  R1 V (forward) XXXX.X fps  R2 H rate XXXX.X fps  R3 H XXXXX ft  Poss PROG lt - on  Key RSET  Key V05 M09E (if feasible)  01466 - &lt; TOOFW engine throttle commands computed since last omitted throttle computation  Key KEY REL</p> <p>3. To perform manual altitude update of AEA:  Key DEDA C 223+XXXXXE (100 ft)</p> <p>5. Monitor descent:  DES RATE sv - effect desired rate of descent</p> <p>ACA - rotate to desired attitude and/or landing site</p> <p align="center">WARNING</p> <p>DES QTY warn lt will not be accompanied by MASTER ALARM; therefore, crewmen must monitor MPS: FUEL &amp; OXID QUANTITY ind.</p>	<p>P66 is automatically called during any phase of powered descent if S/C: PCNS sv - AIT HOLD and DES RATE sv - +1 FPS or -1 FPS, or from P64 when time TTF&gt;TENDAPPR. Altitude rate at entry to P66 is maintained until modified by DES RATE sv inputs.</p> <p>TOOFW is padloaded erasable quantity.</p> <p>XXXX must be nonzero. Address contents are reset to zero by AEA within 2 seconds, thus allowing later updates.</p> <p>DES RATE sv establishes rate of descent in fixed increments; down (-) increases rate, up (+) decreases rate. Each actuation results in LGC change of 1 fps in rate of descent.</p> <p>Tilting descent engine thrust vector via ACA accelerates LM horizontally to rate that is maintained when thrust vector is returned to vertical.</p>

THRUST

**LMA790-3-LM**  
**APOLLO OPERATIONS HANDBOOK**

LM 3213, LM 3231

CREW- MAN	P/NL	PROCEDURES	REMARKS
		4.10.2.3 Landing Phase (ROD) Program (P66) (cont)	
1		4. Monitor CMD THRUST ind - ensure LGC throttle command is not >XXZ	Only in extreme cases of negative rates and/or LM attitude with respect to local vertical will throttle setting be >XXZ.
		5. If manual throttle control is desired: TICA - move up until CMD THRUST ind - 10Z ENG THR CONT: THR CONT sw - MAN	To reestablish LGC - controlled rate of descent: ENG THR CONT: THR CONT sw - AUTO X-axis override is available.
		6. If LGC nulling of horizontal velocity is desired: S/C: PGNS sw - AUTO	
		7. To return to manual control in pitch & roll: S/C: PGNS sw - ATT HOLD	
		8. When forward & lateral velocities <XX fps: VEL lt - on ALT lt - on	VEL and ALT lts - on as result of zero Doppler (tracking loss) when velocities are <XX fps, causing loss of velocity and range data-good.
1,3		9. Monitor touchdown: LUNAR CONTACT lt - on Eng STOP pb/lt - push Stand by to abort stage if: LM tilt angle >XX° or LM tilt angle changing at >X°/sec	LUNAR CONTACT lt - on when LM is 5.6 feet above lunar surface.
3		10. After LM is stabilized: ENG THR CONT: ENG ARM sw - OFF S/C: PGNS sw - ATT HOLD ACA - out of detent momentarily (to deactivate RCS thrusters if required) Record LM attitude. Key DEDA C 413+1000E (store AGS azimuth & set lunar surface flag) Perform Lunar Align: Key DEDA C 400+4000E	At this time, first lunar-stay/no-stay decision is made.  For immediate emergency aborts on AGS, following landing shock that causes loss of AGS inertial reference, lunar alignment must be maintained for minimum of 30 seconds. (Azimuth would not be corrected. Safe pericyynthion would be achieved.) Update assumes LM state vector and epoch time for nominal landing +X minutes have been previously loaded, Ref para 4.6.2.8.
		Update AGS LM state vector to nominal landing site: Key DEDA C 414+2000E	

**LMA790-3-LM**  
**APOLLO OPERATIONS HANDBOOK**

LM 3207, LM 3213

CREW-MAN	PNL	PROCEDURES	REMARKS
		<p>4.10.2.3 <u>Landing Phase (ROD) Program (P66) (cont)</u></p> <p>If not finished with FL V06 N60 display (to zero attitude errors): Key P80</p> <p>When Lunar-stay decision is made: Key V37E 68E</p> <p>4.10.2.4 <u>Landing Confirmation Program (P68)</u></p> <p>Requirements &amp; switch positions for P68 are established in Braking Phase Program (P63) &amp; subsequent powered-descent program.</p> <p>1. Key V37E 68E</p> <p>2. FL V06 N43 - LM landing position R1 Latitude XXX.XI° R2 Longitude XXX.XI° R3 Altitude XXXX.X nm Record LM landing position data. Key P80 FL V37 N-- Key XXE</p> <p>3. DES ENG CMD OVRD sv - OFF Reset eng STOP pb/lt a. Release tab - push b. Eng STOP pb/lt - on</p>	<p>Landing Confirmation Program (P68) (para 4.10.2.4)</p> <p>Purpose of Landing Confirmation Program (P68) is to terminate landing programs and initialize LGC for lunar surface operation. LGC zeroes attitude error, selects 5° deadband, computes and displays LM landing position, and commands DPS off.</p> <p>P68 is selected only after LM has landed on lunar surface in P66.</p> <p>This program places DAP in minimum impulse command mode. If S/C: PGNS sv is kept in ATT HOLD, RCS jet firings will not occur even if platform is being Gyro-torqued. NO DAP lt - on</p> <p>Display of RR LOS azimuth and elevation angles (para 4.5.3.14) is available throughout program.</p> <p>+ is north. + is east. Altitude above landing site; should = 0000.0 nm At this time, second lunar-stay/no-stay decision is made.</p>

THRUST

**LMA790-3-LM**  
**APOLLO OPERATIONS HANDBOOK**

CREW-MAN	PNL	PROCEDURES	REMARKS
		<p>4.10.2.4 <u>Landing Confirmation Program (P68) (cont)</u></p> <p>c. If eng STOP pb/lt - off, verify that lights are functioning by performing Caution &amp; Warning Array Checkout, steps 3 &amp; 4 (para 4.2.10). If lights are functioning, inadvertent reset has taken place, eng is enabled, &amp; steps d, e, &amp; f should not be performed.</p> <p>d. Eng STOP pb/lt - push</p> <p>e. Release tab - push</p> <p>f. Eng STOP pb/lt - off</p> <p>4.10.3 <u>POWERED ASCENT</u></p> <p>4.10.3.1 <u>Powered Ascent Program (P12) With AGS Followup/In Control</u></p>	<p>Purpose of Powered Ascent Program (P12) with AGS Followup/In Control is to display to crew, before ascent engine ignition: (a) certain LGC-stored parameters associated with powered ascent, for possible modification and (b) certain FDAI readings associated with early phases of powered ascent. P12 controls FGMS during countdown, ignition, thrust, and thrust termination of powered ascent maneuver from lunar surface.</p> <p>P12 is to be selected at least 5 minutes before lift-off.</p> <p>Landing Analog Display Routine (R10) is enabled shortly after average g computations start. R10 is terminated on termination of average g.</p> <p>R36, called by V90, is a coasting flight routine. If called during average g, it will cause OPR ERR lt - on.</p>

**LMA790-3-LM**  
**APOLLO OPERATIONS HANDBOOK**

CREW-MAN	PNL	PROCEDURES	REMARKS
		<p>4.10.3.1 Powered Ascent Program (P12) High AGS Followup/In Control (cont)</p> <p>APS Basic (Staged) (required)</p> <p>ECS Basic (Staged) (required)</p> <p>ECS Periodic Monitoring (staged) (required)</p> <p>EPS Prestaging Check (required)</p> <p style="text-align: center;"><b>CAUTION</b></p> <p>EPS Prestaging Check must be initiated 30 min before APS burn.</p> <p>APS Pressurization &amp; Checkout (required)</p> <p>APS/RCS Propellant Interconnect (desired)</p> <p>LGC Power-Up (required)</p> <p>LGC Self-Test (required)</p> <p>LGC time valid (required)</p> <p>LGC state vector valid (required)</p> <p>IMU Power-Up (LGC Operating) (required)</p> <p>PGNCS Lunar Surface Align Program (P57) (required)</p> <p>DAP Data Load Routine (R03) (required)</p>	<p>Ref para 4.13.3.2.</p> <p>Ref para 4.13.1.1.</p> <p>Ref para 4.13.1.3.</p> <p>Ref para 4.12.5.</p> <p>EPS Prestaging Check must be initiated 30 minutes before APS burn to provide conditioning of ascent batteries. This minimizes possibility of transients due to removal of descent batteries from line.</p> <p>Ref para 4.12.3.</p> <p>Ref para 4.13.3.3 or RCS Hot Firing Check procedure (para 4.2.31)</p> <p>Ref para 4.6.1.1.</p> <p>Ref para 4.6.1.13.</p> <p>LGC/CMC Clock Synchronization Routine (R33) (para 4.6.1.15)</p> <p>LGC Update Program (P27) (para 4.6.1.7) or Lunar Surface Navigation Program (P22) (para 4.8.3.1)</p> <p>Ref para 4.6.1.3. ISS should be on 15 minutes before thrusting maneuver.</p> <p>Ref para 4.9.3.1.</p> <p>Ref para 4.6.1.8.</p>

THRUST

LM 3251

**LMA790-3-LM**  
**APOLLO OPERATIONS HANDBOOK**

CREW-MAN	PNL	PROCEDURES	REMARKS
		<p>4.10.3.1 <u>Powered Ascent Program (P12) With AGS Followup/In Control (cont)</u></p> <p>LGC targeted for orbital insertion before earth launch (required)</p>	<p>Ref para 4.6.2.1.</p> <p>Ref para 4.6.2.3.</p> <p>AGS Manual Absolute Time Initialization procedure (para 4.6.2.6) or AGS Initialization Routine (R47) (para 4.6.1.18)</p> <p>AGS Initialization Routine (R47) (para 4.6.1.18) or AGS Manual LM State Vector Update/Initialization procedure (para 4.6.2.7)</p> <p>AGS Initialization Routine (R47) (para 4.6.1.18) or AGS Manual CSM State Vector Update/Initialization procedure (para 4.6.2.9)</p> <p>AGS Lunar Align procedure (para 4.9.3.2) PGNCS/AGS Align (para 4.9.2.1)</p> <p>Ref para 4.6.2.15. (required for ascent from far westerly lunar landing sites.)</p> <p>Ref para 4.6.2.16</p> <p>During this program, crew may monitor following: Key V16 N76E R1 VHP +XXXX.X fps R2 H rate F +XXXX.X fps R3 AR +XXXX.X mm</p>
		<p>AGS Power-Up (required)</p> <p>AEA Self-Test (required)</p> <p>AGS time valid (required)</p> <p>AGS LM state vector valid (required)</p> <p>AGS CSM state vector valid (required)</p> <p>AGS alignment valid (required)</p> <p>AGS Wb Vector Update (required if mission warrants)</p> <p>AGS Lunar Surface Gyro Calibration (desired)</p>	

**LMA790-3-LM**  
**APOLLO OPERATIONS HANDBOOK**

CREW-MAN	PNL	PROCEDURES	REMARKS
		<p>4.10.3.1 <u>Powered Ascent Program (P12) With AGS Followup/In Control (cont)</u></p> <p>1. Establish attitude control: GUID CONT sw - PGNS S/C: PGNS sw - AUTO AGS sw - AUTO ROLL, PITCH, YAW sw - MODE CONT</p> <p>2. Establish PGNS total attitude &amp; attitude error display: ATTITUDE MON sw (1) - PGNS ATTITUDE MON sw (1) - AGS RATE/ERR MON sw (2) - LDG RDR/CMPT Key V61E for mode I attitude error display or Key V62E for mode II attitude error display</p> <p>3. Establish velocity &amp; altitude displays: RING/ALT MON sw - ALT/ALT RT MODE SEL sw - PGNS or AGS</p> <p>4. Enable ACA/TTCA: ACA/4 JET sw (2) - ENABLE TTCA/TRANSL sw (2) - ENABLE THROTTLE/JETS cont (2) - JETS ACA PROP sw (2) - ENABLE ENG THR CONT: ATT/TRANSL sw - 4 JETS</p>	<p>VHF = Downrange velocity at injection H rate F = Radial velocity at injection AR = Crossrange distance to be removed to injection Ref para 4.5.1.</p> <p>Ref para 4.5.3.1 and 4.5.3.2.</p> <p>Mode I - DAP following errors.</p> <p>Mode II - Total attitude errors with respect to N22 angles (gimbal angles; display is scale limited). Ref para 4.5.3.8 and 4.5.3.9.</p>

THRUST

**LMA790-3-LM**  
**APOLLO OPERATIONS HANDBOOK**

LM 3235

CREW-MAN	PNL	PROCEDURES	REMARKS
		<p>4.10.3.1 Powered Ascent Program (P12) With <u>AGS Followup/In Control (cont)</u></p> <p>5. Prepare controls for APS burn: ENG THR CONT: ENG ARM sw - OFF Move switch guard to cover DES position Eng START pb/lit - off Eng STOP pb/lit (2) - reset ENG THR CONT: BAL CPL sw - ON S/C: DEAD BAND sw - MIN</p>	
		<p>1. Prepare AEA backup d-c power: a. If PGCS is in control: CB (16) S/C: AEA - close CB (11) S/C: AEA - open b. If AGS is in control: CB (16) S/C: AEA - close CB (11) S/C: AEA - close If AGS in followup, go to AGS step 7.</p> <p>2. Establish AGS attitude error &amp; total attitude display: ATTITUDE MON sw (1) - AGS RATE/ERR MON sw (2) - LDG RDR/CMPT</p> <p>3. Enable ACA/ITCA: ACA/4 JET sw (2) - ENABLE ITCA/TRANSL sw (2) - ENABLE THROTTLE/JETS cont (2) - JETS ACA PROP sw - ENABLE ENG THR CONT: ATT/TRANSL sw - 2 JETS</p> <p>4. Establish velocity &amp; altitude displays: RNG/ALT MON sw - ALT/ALT RT MODE SEL sw - PGNS or AGS</p> <p>5. Establish attitude control: GUID CONT sw - AGS S/C: AGS sw - AUTO ROLL, PITCH, YAW sw - MODE CONT</p> <p>6. Prepare controls for APS burn: ENG THR CONT: ENG ARM sw - OFF Eng START pb/lit - off</p>	<p>AEA backup d-c power circuit breaker should be open unless PGCS has failed.</p> <p>AEA backup d-c power circuit breaker should be closed if PGCS has failed.</p> <p>Ref para 4.5.3.3 and 4.5.3.4.</p> <p>Ref para 4.5.3.8 and 4.5.3.9.</p>



**LMA790-3-LM**  
**APOLLO OPERATIONS HANDBOOK**

CREW- MAN	PHL	PROCEDURES	REMARKS
		<p>4.10.3.1 <u>Powered Ascent Program (P12) With AGS Followup/In Control (cont)</u></p> <p>Eng STOP pb/lt (2) - reset ENG THR CONT: BAL CPL sw - ON S/C: DEAD BAND sw - MIN</p> <p>7. Select desired yaw steering: a. Z-axis parallel to CSM orbit plane - Key DEDA C 623+00000E or b. Z-axis specified by Wb vector - Key DEDA C 623+10000E</p> <p>8. Deleted</p> <p>9. Verify orbit insertion mode: Key DEDA C 410+00000E</p> <p>10. If AGS not in followup: Perform AGS Lunar Align 4 minutes before lift-off.</p> <p>11. Select guidance steering within 4 minutes of nominal lift-off time: Key DEDA C 400+10000E</p> <p>12. Display AVgx: Key DEDA C 500R (0.1/1 fps)</p>	
		<p>6. Key V37E 12E Poss PROC lt - on Key V05 N09E - Call alarm 00210 - IMU not on</p> <p>00220 - ISS orientation not known Key KEY REL &amp; RSET FL V37 N-- Key XE - Exit P12 If desired crew may alter values of parameters DVTHRUSH &amp; DVCNTR as follows: Key V21 N01E (01250E or 03515E respectively), (new data)E</p>	<p>Ref para 4.9.3.2.</p> <p>If AGS Lunar Align procedure (para 4.9.3.2) was selected, it is terminated by this step.</p> <p>Parentetical quantization notation: lunar mission/earth mission.</p> <p>Perform IMU Power-Up (LGC Operating) procedure (para 4.6.1.3) Perform FGCS Lunar Surface Align Program (P57) (para 4.9.3.1)</p> <p>Decision to alter these values and desired new values would be coordinated with, and received from, MSFN. Some or all values are octal and complemented values.</p>

LM 3231

**LMA790-3-LM**  
**APOLLO OPERATIONS HANDBOOK**

LM 3231

CREW-MAN	PNL	PROCEDURES	REMARKS
		<p>4.10.3.1 Powered Ascent Program (P12) With AGS Followup/In Control (cont)</p> <p>7. FL V06 N33 - TIG (AS)  R1 00XX hr  R2 00XX min  R3 0XX.XX sec  Accept: Record value.  Key PRO  Reject: Key V25E - Load desired  TIG (AS)</p> <p>8. FL V06 N76  R1 VHF +XXX.X fps  R2 H rate F +XXX.X fps  R3 AR +XXX.X nm</p> <p>Accept: Coordinate with MSFN, key PRO  Reject: Key V23E or V24E - Load desired values (coordinate with MSFN)</p> <p>9. Poss FL V50 N25 - Checklist  R1 00203 - Switch to PGCS auto-matic mode  R2 -----  R3 -----  Redundant request or to reject:</p>	<p>VHF = Downrange velocity at injection.  H rate F = Radial velocity at injection.  ΔR = Crossrange distance to be removed to injection.  Initial value of VHF is +5509.5 fps; initial value of H rate F is +19.5 fps.</p> <p>19.5 fps is (mission value for non-nominal lift-off time; + 32 fps is mission value loaded for nominal lift-off time).</p> <p>LGC zeroes attitude errors and sets 1° deadband in DAP at this time.</p> <p>Discrete in or to LGC may have failed.</p>

**LMA790-3-LM**  
**APOLLO OPERATIONS HANDBOOK**

CREW-MAN	PNI	PROCEDURES	REMARKS
		<p>4.10.3.1 <u>Powered Ascent Program (P12) With AGS Followup/In Control (cont)</u></p> <p>Key ENTR Proper request and to accept: GUID CONT sw - PGNS S/C: PGNS sw - AUTO Key PRO</p> <p>10. V06 N74 R1 TFI    XXBXX min-sec R2 Yaw    XXX.XX° R3 Pitch  XXX.XX°</p>	<p>Yaw and pitch angles are predicted FDAI angles at completion of yaw and pitch maneuvers during ascent. Yaw is angle at completion of yaw maneuver, which brings +Z-axis down-range, during vertical rise phase. Pitch is angle at completion of pitch maneuver during pitchover phase.</p> <p>Displays are blanked from TFI -00B35 to -00B30. Beginning and duration of blanking cannot be defined if alarm 01703 occurs.</p> <p>CHPTR ACTY lt - on during State Vector Integration Routine (R41).</p>
		<p>CHPTR ACTY lt - on</p> <p>Monitor PROG lt from TFI = -00B50 to -00B35. If PROG lt - on: Key V05 N09E - Call alarm 01703 - TIG slipped</p> <p>Key KEY REL &amp; RSET CHPTR ACTY lt - off</p> <p>Record yaw &amp; pitch</p> <p>Update EVNT TMR ind if desired or if TFI was slipped.</p> <p>Check CMEA status.</p>	<p>TIG will be slipped as required, to get state vector integration to new TIG-30 seconds.</p> <p>State vector integration complete.</p>

**LMA790-3-LM  
APOLLO OPERATIONS HANDBOOK**

LH 3231

CREW- MAN	PNL	PROCEDURES	REMARKS
		<p>4.10.3.1 <u>Powered Ascent Program (P12) With AGS Followup/In Control (cont)</u></p> <p>ED: MASTER ARM sw - ON CB (11) S/C: AELD - close CB (16) S/C: AELD - close</p> <p>11. At TFI = -00B35: VERB ind, NOUN ind, R1, R2, &amp; R3 blank for 5 sec</p> <p>12. At TFI = -00B29 V06 N74 R1 TFI 00BXX min-sec R2 Yaw XXX.XX° R3 Pitch XXX.XX°</p> <p>13. At TFI = -00B05 FL V99 N74 - Perform eng-on enable R1 TFI 00BXX min-sec R2 Yaw XXX.XX° R3 Pitch XXX.XX° To terminate: Key V34E</p> <p>To enable eng on: ENG THR CONT: ENG ARM sw - ASC Key PRO</p> <p>If thrust has failed after partial orbit insertion, complete maneuver with RCS. Key ENTR - Go to step 25.</p> <p>14. If TFI is negative and nonzero: V06 N74 R1 TFI 00BXX min-sec R2 Yaw XXX.XX° R3 Pitch XXX.XX°</p> <p>15. ABORT STAGE pb - push</p> <p>16. When TFI = 00B00: Monitor APS thrust</p>	<p>Average-g integration has started.</p> <p>During FL V99 N74, brief FL V06 may appear intermittently; this should be disregarded.</p> <p>Provides redundant arming signal and establishes conditions for auto-matic shutdown with eng START pb lt pressed.</p>

**LMA790-3-LM**  
**APOLLO OPERATIONS HANDBOOK**

CREW-MAN	PNL	PROCEDURES	REMARKS
		<p>4.10.3.1 <u>Powered Ascent Program (P12) With AGS Followup/In Control (cont)</u></p> <p>When thrust is detected: Eng START pb/lt - push</p> <p>15. Initiate AGS-controlled lift-off at nominal lift-off time: ABORT STAGE pb - push When thrust is detected: Eng START pb/lt - push</p> <p>17. DPS/APS Thrust Fail Routine (R40)</p> <p>If LGC detects thrust fail: FL V97 NXX - Perform engine fail procedure R1 XXXX R2 XXXX R3 XXXX</p> <p>Alternatives to fail procedure: a. Verify LGC interpretation of thrust failure. Key PRO b. Attempt completion of maneuver: Key ENIR, return to step 13 c. Terminate: Key V34E - Exit P12 FL V37 N-- Key XXE</p> <p>To switch to AGS: GUID CONT sw - AGS Go to AGS step 16.</p> <p>18. V06 N94 R1 VGX (LM) XXXX.X fps R2 H rate XXXX.X fps R3 H XXXXX ft</p> <p>Monitor FDAI &amp; N94 displays.</p> <p>Observe LM X-axis comes to local vertical.</p> <p>Observe LM yaw maneuver to recorded yaw angle.</p>	<p>Protects against single-point engine shutdown failure.</p> <p>R40 is called at nominal ignition time and remains active until engine cutoff. R40 monitors PIPA outputs and initiates engine fail procedures if thrust fail is detected. Engine thrust fails when PIPA detects <math>\Delta V</math> of &lt;10.1 fps (308 cm/sec) for five consecutive sampling periods of 2 seconds each, after nominal ignition time. Engine thrust also fails if, during thrusting period, <math>\Delta V</math> is less than this threshold for two consecutive sampling periods of 2 seconds each.</p> <p>During FL V97 NXX, brief FL V06 may appear intermittently. This should be disregarded.</p> <p>VGX (LM) - Velocity to be gained in X-body coordinate.</p> <p>X-axis override is inhibited.</p> <p>Yaw maneuver brings +Z-axis down-range.</p>
		<p>16. Monitor FDAI, ALT/ALT RT ind, &amp; <math>\Delta V_{gx}</math>.</p> <p>Observe LM X-axis comes to local vertical.</p> <p>Observe LM yaw maneuver to recorded yaw angle.</p>	

LM 3231

THRUS

**LMA790-3-LM**  
**APOLLO OPERATIONS HANDBOOK**

LM 3198, LM 3229, LM 3231

CREW-MAN	PNI	PROCEDURES		REMARKS
		<p>4.10.3.1 Powered Ascent Program (P12) With AGS Followup/In Control (cont.)</p> <p>When H rate &gt; +40:</p> <p>Observe LM pitch maneuver to recorded pitch angle.</p> <p>At lift-off + 1 min, yaw right as required for S-band track.</p> <p>Continue monitoring N94 displays &amp; FDAI:</p> <p>VI should be increasing. H rate should increase to approximately 200 fps &amp; then decrease to 32/19.5 fps.</p> <p>Attitude errors should be &lt;XX°.</p> <p>Attitude rates should be &lt;XX°/sec.</p>	<p>When ALT RATE ind - &gt; 50 fps: Observe LM pitchover maneuver.</p> <p>At lift-off + 1 min, Key DEDA C623+1000E</p> <p>17. Continue monitoring ΔVgx, ALT/ALT RATE ind, &amp; FDAI: ΔVgx should be decreasing. ALT RATE ind should increase to approximately 200 fps &amp; then decrease to 32/19.5 fps. ALT ind should be increasing Attitude errors should be &lt;XX°. Attitude rates should be &lt;XX°/sec. If AGS in followup, go to AGS step 25.</p> <p>18. When ΔVgx &lt;500 fps, perform APS/RCS Propellant Interconnect, steps 4 &amp; 5.</p>	<p>H rate of +40 fps is achieved approximately 12 seconds after lift-off.</p> <p>Twelve seconds after pitchover maneuver begins, X-axis override is enabled. LM yaw angle, to maintain S-band track, is landing site dependent</p> <p>If desired, additional LGC parameters may be displayed: Key V16 N77E R1 TG        XXXX min-sec R2 VGY (LM)  XXXX.X fps R3 VI        +XXXX.X fps</p> <p>TG = Estimated time of flight from present time to accomplishment of ascent injection conditions. VGY (LM) = Velocity to be gained in Y-body coordinate. VI = Inertial velocity. When finished with display: Key KEY REL Key N76E R1 VHF       +XXXX.X fps R2 H rate F  +XXXX.X fps R3 ΔR        +XXXX.X nm</p> <p>VHF = Downrange velocity at injection H rate F = Radial velocity at injection ΔR = Crossrange distance to be removed to injection Key KEY REL</p> <p>Ref para 4.13.3.3.</p>
19.				
20.		<p>When TG &lt;00B25 min-sec, perform APS/RCS Propellant Interconnect, steps 4 &amp; 5.</p>		

**LMA790-3-LM**  
**APOLLO OPERATIONS HANDBOOK**

CREW-MAN	PNL	PROCEDURES	REMARKS																												
		<p>4.10.3.1 Powered Ascent Program (PI2) With AGS Followup/In Control (cont)</p> <p>21. ENG THR CONT: ENG ARM sw - OFF</p> <p>22. Monitor N94 or N77 for automatic shutdown. Shutdown should occur when TC &lt; 1 sec If shutdown does not occur: ABORT STAGE pb - reset</p> <p>23. After automatic shutdown: Eng STOP pb/lt - push</p> <p>24. Disarm eng &amp; remove ED power: ABORT STAGE pb - reset Reset eng STOP pb/lt: a. Release tab - push b. Verify eng STOP pb/lt - on that lights are functioning by performing Caution &amp; Warning Array Checkout, Steps 3 &amp; 4 (para 4.2.10). If lights are functioning, inadvertent re-set has taken place, engine is enabled, &amp; steps d, e, &amp; f should not be performed.</p> <p>d. Eng STOP pb/lt - push e. Release tab - push</p>	<p>Removes manual engine-on signal and thus enables automatic shutdown.</p>																												
		<p>19. ENG THR CONT: ENG ARM sw - OFF</p> <p>20. Monitor Vgx for automatic shutdown. Shutdown should occur when Vgx &lt; 10 fps If shutdown does not occur: ABORT STAGE pb - reset</p> <p>21. Reestablish ullage counter threshold: Key DEDA C 616+0000YE</p> <p>22. After automatic shutdown: Eng STOP pb/lt - push</p> <p>23. Disarm eng &amp; remove ED power: ABORT STAGE pb - reset Reset eng STOP pb/lt: a. Release tab - push b. Eng STOP pb/lt - on c. If eng STOP pb/lt - off, verify that lights are functioning by performing Caution &amp; Warning Array Checkout, steps 3 &amp; 4 (para 4.2.10). If lights are functioning, inadvertent reset has taken place, &amp; engine is enabled, &amp; steps d, e, &amp; f should not be performed.</p> <p>d. Eng STOP pb/lt - push e. Release tab - push</p>	<p>Y is determined from following:</p> <table style="margin-left: auto; margin-right: auto;"> <thead> <tr> <th style="text-align: left;">Remaining Fuel</th> <th style="text-align: left;">Total Burn Time (sec)</th> <th style="text-align: left;">2 Jets</th> <th style="text-align: left;">4 Jets</th> </tr> </thead> <tbody> <tr> <td>100% to</td> <td>0 to</td> <td>2</td> <td>2</td> </tr> <tr> <td>50%</td> <td>228</td> <td></td> <td></td> </tr> <tr> <td>40%</td> <td>274</td> <td>4</td> <td>3</td> </tr> <tr> <td>30%</td> <td>319</td> <td>5</td> <td>4</td> </tr> <tr> <td>20%</td> <td>365</td> <td>6</td> <td>4</td> </tr> <tr> <td>&lt;10%</td> <td>&gt;410</td> <td>7</td> <td>5</td> </tr> </tbody> </table> <p>Required to reset manual engine start relays.</p>	Remaining Fuel	Total Burn Time (sec)	2 Jets	4 Jets	100% to	0 to	2	2	50%	228			40%	274	4	3	30%	319	5	4	20%	365	6	4	<10%	>410	7	5
Remaining Fuel	Total Burn Time (sec)	2 Jets	4 Jets																												
100% to	0 to	2	2																												
50%	228																														
40%	274	4	3																												
30%	319	5	4																												
20%	365	6	4																												
<10%	>410	7	5																												



**LMA790-3-LM**  
**APOLLO OPERATIONS HANDBOOK**

CREW-MAN	PNL	PROCEDURES	REMARKS
		<p>4.10.3.1 Powered Ascent Program (P12) With AGS Followup/In Control (cont)</p> <p>f. Verify eng STOP pb/lt - off CB ED: LOGIC PWR A - open CB ED: LOGIC PWR B - open</p> <p style="text-align: center;">CAUTION</p> <p>Avoid touching ascent engine cover top or side with bare hand or glove from 5 min to 7.5 hr after APS burn. Maximum temperature of 220°F will be reached 1.5 hr after APS burn.</p> <p>25. FL V16 N94 R1 VGX (LM) XXXX.X fps R2 H rate XXXX.X fps R3 H +XXXX ft Record values. Key PRO</p> <p>26. FL V16 N85 - VC (LM) R1 X XXXX.X fps R2 Y XXXX.X fps R3 Z XXXX.X fps</p> <p>If nulling of VC is desired: S/C: PGNS sw - ATT HOLD ACA &amp; TTCA - null VGX, VGY, VGZ</p>	<p>CB ED: LOGIC PWR A and B are opened to remove power from EDS since ED: MASTER ARM sw is left on to inhibit spurious CWEA indications.</p> <p>VGX (LM) - Velocity to be gained in X-body coordinate.</p> <p>LGC zeroes attitude errors and sets 0.3° deadband in DAP at this time.</p> <p>Two-jet translation is recommended to be selected through R03. If not selected through R03, translation will be four-jet. If trim maneuver is performed after use of orbit insertion routine, it should be performed immediately after engine shutdown. Orbit insertion routine drives LM to specific point on desired orbit, and residual ΔV<sub>EX</sub> will increase naturally after engine shutdown.</p>
		<p>24. Trim ΔV residual: Verify AEA attitude hold submode: Key DEDA C 400R If +00000 not displayed: Key DEDA C 400+00000E S/C: DFAD BAND sw - MVV ENG THR CONT: BAL CPL sw - ON</p> <p>Read and record: ΔV<sub>EX</sub> Key DEDA C 500R (0.1/1 fns) ΔV<sub>GY</sub> Key DEDA C 501R (0.1/1 fns) ΔV<sub>YZ</sub></p>	



**LMA790-3-LM**  
**APOLLO OPERATIONS HANDBOOK**

CREW-MAN	PNI	PROCEDURES	REMARKS
		<p>4.10.3.1 Powered Ascent Program (P12) With ACS Followup/In Control (cont)</p> <p>Key DEDA C 502R (0.1/1 fps)</p> <p>Read out and null <math>\Delta Vg</math> residuals in order of magnitude, largest first.</p> <p>25. Read out predicted perifocus altitude: Key DEDA C 403R (0.1 nm) Compare with PGNCs Hp value.</p> <p>26. Read out apofocus altitude: Key DEDA C 315R (0.1 nm) Compare with PGNCs Ha value.</p> <p>27. Terminate P12 or select Orbit Parameters Display Routine (R30):</p> <p>a. Terminate: Key PRO FL V37 N-- Key XXE - Exit P12</p> <p>or</p> <p>b. Select R30: Key V82E Press OPR ERR 1t - on Exit R30 - Key RSET - FL V16 N44 R1 Ha XXXX.X nm R2 Hp XXXX.X nm R3 TFF XXBX min-sec When finished with display: Key PRO, exit R30 Reestablish N85 display Key PRO FL V37 N-- Key XXE - Exit P12</p>	<p>Null <math>\Delta Vg</math> by moving TTCA up or down. Up TTCA nulls positive <math>\Delta Vg</math>.</p> <p>Null <math>\Delta Vg</math> by moving TTCA right or left. Right TTCA nulls positive <math>\Delta Vg</math>.</p> <p>Null <math>\Delta Vg</math> by moving TTCA in or out. In TTCA nulls positive <math>\Delta Vg</math>.</p> <p>At this time, LGC restores crew-specified (R03) deadband limits in RCS DAP.</p> <p>Orbit parameters are automatically recomputed every 2 seconds while average g is in process.</p> <p>OPR ERR 1t - on if another extended verb from R76 is active.</p> <p>Maximum TFF reading is 59B59.</p> <p>After final PRO, deadband selected by R03 is restored.</p>

THRU

APOLLO OPERATIONS HANDBOOK

LN 3245

CREW-MAN	PNL	PROCEDURES	REMARKS
		<p>4.10.3.1 <u>Powered Ascent Program (P12) With AGS Followup/In Control (cont)</u></p> <p>28. Deleted</p> <p>27. Deleted</p> <p>4.10.3.2 <u>DPS Abort (LGC P70, AEA 410+00000)</u></p> <p>Prerequisites are same as for Braking Phase Program (P63) With AGS Preparation for Orbit Insertion (410+00000).</p> <p>Switching configuration is same as that established during powered descent, from which this procedure is entered.</p>	<p>Purpose of this procedure is to control LM during DPS abort/orbit insertion from powered descent. P70 and 410+00000 provide PGCS-/AGS-controlled DPS abort from powered descent (P63, P64, or P66).</p> <p>Ref para 4.10.2.1.</p> <p>During this program, crew may monitor following: Key V16 N76E</p> <p>R1 VHF +XXXX.X fps R2 H rate F +XXXX.X fps R3 ΔR +XXXX.X nm VHF = Downrange velocity at injection H rate F = Radial velocity at injection ΔR = Crossrange distance to be removed to injection. Maximum allowable crossrange value is constrained to 0.5° (approximately 8 nm).</p> <p>When aborting on AGS, AEA backup d-c cb should be closed to guard against AEA restart.</p>
		<p>1. To initiate DPS abort on AGS: GUID CONT sw - AGS CB (11) S/C: AEA - close</p> <div style="border: 1px solid black; padding: 2px; width: fit-content;"> <p>If AGS in followup, go to AGS step 5.</p> </div>	

**LMA790-3-LM**  
**APOLLO OPERATIONS HANDBOOK**

LM 3231

CREW-MAN	PNL	PROCEDURES	REMARKS
		<p>4.10.3.2 DPS Abort (LGC P70, AEA 410+00000) (cont)</p> <div style="border: 1px solid black; padding: 5px; margin: 10px 0;"> <p>If S/C: AGS sw - AUTO, go to AGS step 3.</p> </div> <p>2. If S/C: AGS sw - ATT HOLD:</p> <ul style="list-style-type: none"> <li>a. ACA - maneuver +X-axis above horizontal</li> <li>b. TTCA - move up to FTP MODE SEL sw - AGS ATTITUDE MON sw - AGS</li> <li>c. ACA - maneuver +X-axis to local vertical</li> </ul> <div style="border: 1px solid black; padding: 5px; margin: 10px 0;"> <p>If desired to continue in AGS automatic, go to AGS step 3.</p> </div> <ul style="list-style-type: none"> <li>d. When altitude &gt;25,000 ft or altitude rate &gt;50 fps, ACA - pitchover to local horizontal (posigrade)</li> <li>e. S/C: AGS sw - AUTO go to AGS step 4.</li> </ul>	<p>Following conditions were established in powered descent and should be reestablished if modified for any reason:</p> <ul style="list-style-type: none"> <li>a. 410+00000 (Orbit Insertion)</li> <li>b. 400+10000 (Guidance Steering)</li> <li>c. S/C: DEADBAND sw - MIN ROLL, PITCH, YAW sw - MODE CONT</li> <li>d. DES ENG CMD OVRD sw - ON This condition (d) may not have been established if abort occurred early in powered descent. Establishing this condition would eliminate a possible AGS-commanded engine-off in step 4.</li> </ul>

THRU

**LMA790-3-LM**  
**APOLLO OPERATIONS HANDBOOK**

LM 3221, LM 3228

CREW-MAN	PNL	PROCEDURES	REMARKS
		<p>4.10.3.2 DPS Abort (LGC P70, AEA 410+00000) (cont)</p>	
		<p>1. To initiate DPS abort on PGNS:</p> <p style="text-align: center;">Program 70 may be called in two ways:</p> <p style="text-align: center;">CAUTION</p> <p>If channel 30 backup code (R2 of R46) has been set (000 X 1) to ignore ABORT (&amp; ABORT STAGE) discrete(s) do both a &amp; b below:</p> <p>a. ABORT pb - push or b. Key V37E 70E     Poss OPR ERR lt - on, exit P70 TTCA - move up to FTP ENG THR CONT: THR CONT sw - AUTO S/C: PGNS sw - AUTO</p>	
		<p>3. If S/C: ACS sw - AUTO</p> <p>a. Monitor +X-axis above horizontal</p> <p>b. TTCA - move up to FTP MODE SEL sw - ACS ATTITUDE MON sw - ACS</p> <p>c. Monitor +X-axis to local vertical</p> <p>d. When altitude <math>\geq 25,000</math> ft or altitude rate <math>&gt; 50</math> fps: Monitor pitchover to local horizontal (posigrade)</p>	<p>If total thrust failure has occurred, manual translation must be applied before selecting P70 and must remain applied until P70 automatically commands engine on.</p> <p>Detected by Abort Discretes Monitor Routine (R11). R11 then calls P70.</p>
		<p>4. ABORT pb - push Poss DPS shutdown (if very early in powered descent and DES ENG CMD OVRD sw - OFF)</p> <p>a. Perform ACS Orientation to Initial Computed Steering Attitude</p> <p>b. Perform step 9.b.</p>	<p>Program incorrectly selected.</p> <p>Attitude deadband is automatically set to <math>1.0^\circ</math> at this time.</p> <p>Considered possible, but unlikely because of choice of parameters in variable horizontal velocity targeting.</p> <p>Ref para 4.6.2.13.</p>

**LMA790-3-LM**  
**APOLLO OPERATIONS HANDBOOK**

RC 15% , LM 3231

CREW- MAN	PNL	PROCEDURES	REMARKS
		<p>4.10.3.2 DPS Abort (LGC P70, AEA 410+00000) (cont)</p> <p>3. DPS/APS Thrust Fail Routine (R40)            If LGC detects thrust fail:            FL V97 NXX - Perform engine fail procedures                R1 XXXXX                R2 XXXXX                R3 XXXXX</p> <p>Alternatives to fail procedure:            a. Verify LGC interpretation of thrust failure:                Key PRO</p> <p>b. Attempt completion of maneuver                Key ENTR                FL V99 - Perform engine-on enable                    R1 XXXXX                    R2 XXXXX                    R3 XXXXX                To enable main engine burn:                Key PRO, exit R40                TTCA - adjust as desired after ignition                To attempt completion of maneuver by RCS:                Key ENTR go to step 13.</p>	<p>In case of premature engine shutdown or <math>\Delta V</math> of &lt;11.68 fps (356 cm/sec) for one 2 second cycle, when configured: GUID CONT sw - PGNS and S/C: PGNS sw - AUTO, LM will enter mode of free drift rather than maintaining its last attitude.            S/C: PGNS sw - ATT HOLD will not eliminate free drift condition. This is due to LCC repeatedly setting CDU desired equal to CDU actual. This mode of operation is continued until thrust-fail procedure of 3b or 3c is followed, if due to premature shutdown; or until thrust is increased to bring acceleration above the threshold, if due to low manual throttle setting.</p> <p>R40 is called a nominal ignition time and remains active until engine cutoff. R40 monitors PIPA outputs and initiates engine fail procedures if thrust failure is detected. Engine thrust fails when PIPA detects <math>\Delta V</math> to be &lt;1.18 fps (36 cm/sec) for five consecutive sampling periods of 2 seconds each after nominal ignition time. Engine thrust also fails if, during thrusting period, <math>\Delta V</math> is less than this threshold for two consecutive sampling periods of 2 seconds each.</p> <p>During FL V97 N63, a brief FL V06 or V99 may appear intermittently. This should be disregarded.</p> <p>DPS automatic throttle is now set to minimum. Any further DPS throttle control must be performed manually.</p>

THRUS

**LMA790-3-LM  
APOLLO OPERATIONS HANDBOOK**

CREW-MAN	PNL	PROCEDURES	REMARKS
		<p>4.10.3.2 DPS Abort (LGC P70, AEA 410+00000) (cont)</p> <p>c. Terminate: Key V34E - Terminate FL V37 N-- or ABORT STAGE pb - push Exit P70 and R40, go to APS Abort (LGC P71, AEA 410+00000)</p> <p>4. DES ENG CMD OVRD sw - ON</p> <p>5. Pos FL V50 N25 R1 00203 - Switch guidance control to PCNS/automatic mode R2 ----- R3 -----</p> <p>a. GUID CONT sw - PCNS S/C: PCNS sw - AUTO ENG THR CONT: THR CONT sw - AUTO Key PRO</p> <p>b. If mode already selected: Key ENTR</p> <p>6. V06 N94 R1 VGX (LM) XXXX.X fps R2 H rate XXXX.X fps R3 H XXXXX ft</p> <p>7. Monitor thrusting: VI should be increasing. H rate should remain positive and increase to = XXX fps, then decrease to 19.5 fps. H should be increasing. CMD THRUST ind - 10Z ENG THRUST ind - FTP FDAI - Attitude errors should be &lt;XX* - Attitude rates should be &lt;XXX*/sec</p>	<p>Ref para 4.10.3.3. Provides redundant engine-on signal.</p> <p>VGX (LM) - Velocity to be gained in X-body coordinate. H rate - Altitude rate; - indicates descent, + indicates ascent H - Altitude with respect to land- ing site radius; + indicates altitude greater than radius. If H &gt;25,000 feet, LGC will maneu- ver LM to orbit insertion atti- tude. If H &lt;25,000 feet, LGC will inhibit X-axis override and maneuver LM to local vertical with +Z-axis downrange until H &gt;25,000 feet or until H rate &gt;40 fps, then pitch to orbit insertion attitude and restore X-axis override.</p>

# LMA790-3-LM APOLLO OPERATIONS HANDBOOK

LM 3231

CREW- MAN	PNL	PROCEDURES	REMARKS
		<p>4.10.3.2 DPS Abort (LGC P70, AEA 410+00000) (cont)</p> <p>5. Key DEDA C 500R (0.1 fps) &amp; continue monitoring ΔVgx, ALT &amp; ALT RATE ind, &amp; FDAI: ΔVgx should be decreasing. ALT RATE ind should increase to approx 200 fps, then decrease to 19.5 fps. ALT ind should be increasing. Attitude errors should &lt;XX°. Attitude rates should &lt;XX°/sec.</p> <p>6. Check propellant remaining against propellant required &amp; make staging decision. Note quantity (Z) remaining: MPS: FUEL QUANTITY ind ___ Z MPS: OXID QUANTITY ind ___ Z At 5.6Z remaining: DES QTY warn lt - on</p>	<p>Propellant flow rate at FTP is 5.5 seconds per 1Z change (or 11 seconds per 2Z change).</p> <p>Stage if:</p> <ol style="list-style-type: none"> <li>1. Malfunction is detected in DPS.</li> <li>2. Propellant depletion occurs.</li> <li>3. Engine cutoff occurs with ΔVg larger than that which can be trimmed by RCS.</li> </ol> <p>TC - Estimated time of flight from present time to accomplishment of ascent injection conditions, polarity is minus (-). VGY(LM) - Velocity to be gained in Y-body coordinate. VI - Inertial velocity. VGX(LM) - Velocity to be gained in X-body coordinate. VG (LM) - Velocity to be gained.</p>
		<p>8. Check propellant remaining against propellant required &amp; make staging decision. Note quantity (Z) remaining: MPS: FUEL QUANTITY ind ___ Z MPS: OXID QUANTITY ind ___ Z At 5.6Z remaining: DES QTY warn lt - on</p> <p>9. If desired: Key V16 N77E R1 TG XXBX min-sec R2 VGT(LM) XXXX.X fps R3 VI +XXXX.X fps</p> <p>To terminate display: Key KEY REL V06 N94 R1 VGX(LM) XXXX.X fps R2 H rate XXXX.X fps R3 H XXXXX ft Key V16 N85E VC (LM) R1 X XXXX.X fps R2 Y XXXX.X fps R3 Z XXXX.X fps</p> <p>To terminate display: Key KEY REL</p>	

THRU

**LMA790-3-LM  
APOLLO OPERATIONS HANDBOOK**

CREW-MAN	PNL	PROCEDURES	REMARKS
		<p>4.10.3.2 DPS Abort (LGC P70, AEA 410+00000) (cont)</p> <p>7. If DPS propellant is sufficient to achieve orbit insertion: Monitor for normal automatic DPS shutdown.</p> <p>Read out desired parameters: Horizontal velocity - Key DEDA C 427R (0.1 fps)</p> <p>Altitude rate - Key DEDA C 367R (0.1 fps)</p> <p>Altitude Key DEDA C 337R (0.1 nm)</p> <p>Monitor ΔVgx Key DEDA C 500R (0.1 fps)</p> <p>8. When horizontal velocity approaches shutoff criterion: DES ENG CMD OVRD sw - OFF</p>	<p>At automatic shutdown: Horizontal velocity is variable. Altitude rate is 19.5 fps. ΔVgx (500) = 0 fps.</p>
		<p>10. Before TG &lt; 1 sec: DES ENG CMD OVRD sw - OFF</p> <p>11. If engine automatic shutdown does not occur when TG &lt; 1 sec: Eng STOP pb/lt - push</p> <p>12. After shutdown, disarm DPS: ABORT pb - reset ENG THR CONT: ENG ARM sw - OFF Reset eng STOP pb/lt: a. Release tab - push b. Eng STOP pb/lt - on c. If Eng STOP pb/lt - off, verify light is functioning by performing Caution &amp; Warning Array Checkout, steps 3 &amp; 4. If light is functioning, inadvertent reset has taken place, eng is enabled &amp; steps d, e, &amp; f should not be performed.</p>	<p>Enables automatic engine shutdown.</p> <p style="text-align: right;">Ref para 4.2.10.</p>



**LMA790-3-LM**  
**APOLLO OPERATIONS HANDBOOK**

CREW-MAN	PNL	PROCEDURES	REMARKS
		<p>4.10.3.2 <u>DPS Abort (LGC P70, AEA 410+000000) (cont)</u></p> <p>d. Eng STOP pb/lt - push e. Release tab - push f. Eng STOP pb/lt - off</p> <p>13. FL V16 N94 R1 VGX (LM)            XXXX.X fps R2 H rate            XXXX.X fps R3 H                    XXXXX ft Key PRO</p> <p>14. FL V16 N85 VG (LM) R1 X XXXX.X fps R2 Y XXXX.X fps R3 Z XXXX.X fps</p> <p>If nulling of VG is desired: S/C: PGNS sw - ATT HOLD THROTTLE/JETS cont (CDR &amp; LMP) - JETS ACA/TTCA - null VGX, VGY, VGZ</p> <p>9. Cutoff possibilities: a. If cutoff does not occur at appropriate point (late cutoff): Eng STOP pb/lt - push ABORT pb - reset ENG Thr CONT: ENG ARM sw - OFF Reset eng STOP pb/lt: a. Release tab - push b. Eng STOP pb/lt - on c. If eng STOP pb/lt - off, verify light is functioning by performing Caution &amp; Warning Array Checkout, steps 3 &amp; 4. If light is functioning, an inadvertent reset has taken place, eng is enabled, &amp; steps d, e, &amp; f should not be performed. d. Eng STOP pb/lt - push e. Release tab - push f. Eng STOP pb/lt - off</p>	<p>VGX (LM) - Velocity to be gained in X-body coordinate.</p> <p>LGC zeroes attitude errors and sets 0.3° deadband in DAP at this time.</p> <p>Two-jet translation is recommended to be selected through R03. If not selected via R03, translation will be four-jet.</p> <p>Ref. para. 4.2.10.</p>

THRU

**LMA790-3-LM  
APOLLO OPERATIONS HANDBOOK**

LM 3209

CREW MAN	PNI	PROCEDURES	REMARKS																					
		<p>4.10.3.2 <u>DPS Abort (LGC P70, AEA 410+00000) (cont)</u></p> <p>b. If cutoff is early:</p> <p>1) To perform DPS burn: Key DEDA 616+000YY E ITCA - move up for 2YY+1 sec Eng START pb/lt - push</p> <p>2) If DPS start does not occur or to perform APS burn: Go to APS Abort (LGC P71, AEA 410+00000) with AGS in control</p> <p>3) To perform RCS burn: Go to AGS step 10</p> <p>c. If cutoff occurs at normal point: ENG THR CONT: ENG ARM sw - OFF ABORT pb - reset</p> <p>10. Trim ΔV residual. Verify AEA attitude hold submode. Key DEDA C 400R If +00000 not displayed: Key DEDA C 400+00000E S/C: DEAD BAND sw - MIN</p>	<p>Ullage time is 2Y seconds depending on ullage volume. Y is determined from the following chart:</p> <table border="1" data-bbox="406 231 617 672"> <thead> <tr> <th>Remaining fuel</th> <th>2 Jets (B)</th> <th>4 Jets</th> </tr> </thead> <tbody> <tr> <td>100% to 25%</td> <td>4</td> <td>3</td> </tr> <tr> <td>20%</td> <td>7</td> <td>5</td> </tr> <tr> <td>15%</td> <td>8</td> <td>6</td> </tr> <tr> <td>10%</td> <td>11</td> <td>8</td> </tr> <tr> <td>6%</td> <td>12</td> <td>8</td> </tr> <tr> <td>3%</td> <td>13</td> <td>9</td> </tr> </tbody> </table> <p>Do not restart MPS if ΔVg is &lt;30 fps.</p> <p>Engine must be stopped with ENG STOP pb/lt if it is started with ENG START pb/lt.</p> <p>If this trim maneuver is performed after use of orbit insertion routine, it should be performed immediately after engine shutdown. Orbit insertion routine drives LM to specific point on desired orbit and residual ΔVgx will increase naturally after engine shutdown.</p>	Remaining fuel	2 Jets (B)	4 Jets	100% to 25%	4	3	20%	7	5	15%	8	6	10%	11	8	6%	12	8	3%	13	9
Remaining fuel	2 Jets (B)	4 Jets																						
100% to 25%	4	3																						
20%	7	5																						
15%	8	6																						
10%	11	8																						
6%	12	8																						
3%	13	9																						

**LMA790-3-LM**  
**APOLLO OPERATIONS HANDBOOK**

LM 320., LM 3231

CREW-MAN	PNL	PROCEDURES	REMARKS
		<p>4.10.3.2 <u>DPS Abort (LGC P70, AEA 410+00000)</u> (cont)</p> <p>Read and record:            ΔVgx            Key DEDA C 500R (0.1/1 fps)            ΔVgy            Key DEDA C 501R (0.1/1 fps)            ΔVgz            Key DEDA C 502R (0.1/1 fps)</p> <p>Read out and null ΔVg residuals in order of magnitude, largest first.</p> <p style="text-align: center;">S/C: DEAD BAND sw - MAX</p>	<p>Null ΔVgx by moving TTCA up or down. Up TTCA nulls positive ΔVgx.</p> <p>Null ΔVgy by moving TTCA right or left. Right TTCA nulls positive ΔVgy.</p> <p>Null ΔVgz by moving TTCA in or out. In TTCA nulls positive ΔVgz.</p> <p>Ha - apolune altitude            Hp - perilune altitude            TFF - Time of free fall to 35,000 feet. If Hp &gt;35,000 ft, TFF = -59859.</p>
		<p>15. Terminate P70 or select Orbit Parameter Display Routine (R30):</p> <p>a. Terminate:            Key PRO            FL V37 N--            Key XXE, exit P70</p> <p>or</p> <p>b. Select R30:            To minimize RCS propellant usage in LGC selected narrow deadband, select minimum impulse            Key V76E            No DAP 1t - on            S/C: PGNS sw - ATT HOLD</p> <p>Key V82E            FL V16 N44            R1 Ha XXXX.X mm            R2 Hp XXXX.X mm            R3 TFF XX8XX min-sec</p>	

THRUST

**LMA790-3-LM  
APOLLO OPERATIONS HANDBOOK**

CREW-MAN	PNL	PROCEDURES	REMARKS
		<p>4.10.3.2 <u>DPS Abort (LGC P70, AEA 410+00000) (cont)</u></p> <p>If display of time Hp is desired:            Key N32E            R1 00XX hr            R2 00XX min            R3 0XX.XX sec</p> <p>When finished with display:            Key KEY REL            Key PRO to reestablish N85 display, exit R30</p> <p>Key PRO            F1 V37 N--            Key XE, exit P70</p>	<p>Orbit parameters are automatically recomputed every 2 seconds while average g is in process.</p>
		<p>11. Read out perflune altitude:            Key DEDA C 403R (0.1 nm)            Compare with PGNS Hp value.</p> <p>12. Readout apolune altitude:            Key DEDA C 315R (0.1 nm)            Compare with PGNS Ha value.</p>	
		<p>4.10.3.3 <u>APS Abort (LGC P71, AEA 410+00000)</u></p> <p>Prerequisites are same as for Braking Phase Program (P63) with AGS Preparation for Orbit Insertion (410+00000).</p> <p>Switching configuration is same as that established during powered descent, from which this procedure was entered.</p>	<p>Purpose of this procedure is to control LM during APS abort/orbit insertion from powered landing descent or continuation of abort begun on DPS. P71/410+00000 provides PGNS/AGS controlled abort from powered descent (P63, P64, P66, or P70).             Ref para 4.10.2.1.</p>

**LMA790-3-LM  
APOLLO OPERATIONS HANDBOOK**

CREW-MAN	PNI	PROCEDURES	REMARKS
		<p>4.10.3.3 APS Abort (LCC P71, AEA 410+00000) (cont)</p> <div style="border: 1px solid black; padding: 5px; margin: 10px 0;"> <p>If AGS in followup, go to AGS step 3.</p> <p align="center">or</p> <p>If continuing AGS abort started on DPS, go to step 1c.</p> </div> <ol style="list-style-type: none"> <li>1. To initiate APS abort on AGS:               <ol style="list-style-type: none"> <li>a. GUID CONT sw - AGS CB (11) S/C: AEA - close</li> <li>b. S/C: AGS sw - AUTO</li> <li>c. ABORT STAGE pb - push To achieve ullage: TTCA (LMP) - move up</li> <li>d. Monitor +X-axis above horizontal</li> </ol> </li> </ol>	<p>During this program, crew may monitor following: Key V16 N76E</p> <p>R1 VHF XXXX.X fps R2 H rate F XXXX.X fps R3 AR XXXX.X mm</p> <p>VHF - Downrange velocity at injection. H rate F - Radial velocity at injection ΔR - Crossrange distance to be removed to injection. Maximum allowable crossrange value is constrained to 0.5° (approximately 8 mm).</p> <p>Following conditions were established in powered descent and should be reestablished if modified for any reason:</p> <ol style="list-style-type: none"> <li>a. 410+00000 (Orbit Insertion)</li> <li>b. 400+10000 (Guidance Steering)</li> <li>c. S/C: DEAD BAND sw - MIN ROLL, PITCH, YAW sw - MODE CONT</li> </ol> <p>When aborting on AGS, AEA backup d-c cb should be closed to guard against AEA restart.</p>

THRU

**LMA790-3-LM**  
**APOLLO OPERATIONS HANDBOOK**

RC 1606

CREW- MAN	PNL	PROCEDURES	REMARKS
		<p>4.10.3.3 APS Abort (LGC P71, AEA 410+00000) (cont)</p> <p>e. MODE SEL sw - AGS ATTITUDE MON sw - AGS</p> <p>f. If initiating abort on APS: monitor +X-axis to local vertical</p> <p>g. When altitude &gt; 25,000 ft or altitude rate &gt; 50 fps, monitor pitchover to local horizontal (Posigrade)</p>	<p>Detected by Abort Discretes Monitor Routine (R11) which then calls P71.</p> <p>Steps lb.1 and lb.2 must be performed before keying in P71.</p> <p>Eng STOP pb/lt is pushed to shut-down DPS.</p>
		<p>1. P71 may be called in three ways: If channel 30 backup code (R2 of 146) has been set (000 X 1) to ignore (ABORT 6) ABORT STAGE discrete(s) do a, below (otherwise do b or c).</p> <p>a. ABORT STAGE pb - push Key V37E 71E</p> <p>or</p> <p>b. ABORT STAGE pb - push</p> <p>or</p> <p>c. Backup to ABORT STAGE pb &amp; its functions: 1) Eng STOP pb/lt - push ED: MASTER ARM sw - ON ASC He SEL sw - BOTH ASC He PRESS sw - FIRE ENG THR CONT: ENG ARM sw - ASC</p> <p>2) Reset eng STOP pb/lt: a. Release tab - push b. Eng STOP pb/lt - on</p>	

# LMA790-3-LM APOLLO OPERATIONS HANDBOOK

	CREW-MAN	PNI	PROCEDURES	REMARKS
RC 16			<p>4.10.3.3 APS Abort (LGC P71, AEA 410+00000) (cont.)</p> <ul style="list-style-type: none"> <li>c. If eng STOP pb/lt - off, inadvertent reset has taken place, eng is enabled, &amp; steps d, e, &amp; f should not be performed.</li> <li>d. Eng STOP pb/lt - push</li> <li>e. Release tab - push</li> <li>f. Eng STOP pb/lt - off</li> </ul>	

THRUST





**LMA790-3-LM**  
**APOLLO OPERATIONS HANDBOOK**

LM 3231

CREW- MAN	PNL	PROCEDURES	REMARKS
		<p>4.10.3.3 APS Abort (LGC P71, AEA 410+00000) (cont)</p> <p>3) THROTTLE/JETS cont (CDR)-JETS TTCA (CDR) - move up &amp; hold while keying DSKY V37E 71E Poss OPR ERR lt - on, exit P71</p> <p>2. S/C: PGNS sw - AUTO</p> <p>3. DPS/APS Thrust Fail Routine (R40) If LGC detects thrust fail:</p> <p>FL V97 NXK - Perform engine fail procedures R1 XXXXX R2 XXXXX R3 XXXXX</p> <p>Alternative to fail procedure: a. Verify LGC interpretation of thrust failure: Key PRO</p> <p>b. Attempt completion of maneuver: Key ENTR FL V99 NXK - Perform engine-on enable R1 XXXXX R2 XXXXX R3 XXXXX</p>	<p>Program incorrectly selected. (Either previous program not P63, P64, P66, or P70; or LGC failure - If latter: go to AGS step 1.)</p> <p>Attitude deadband is automatically set to 1.0° at this time.</p> <p>In case of premature engine shut- down, when configured: GUID CONT sw - PGNS and S/C: PGNS sw - AUTO, LM will enter mode of free drift rather than maintaining its last attitude. S/C: PGNS sw - ATT HOLD will not eliminate free drift con- dition. This is due to LGC repeatedly setting CDU desired equal to CDU actual. This mode of opera- tion is continued until thrust-fail procedure of 4b or 4c is followed.</p> <p>During FL V97 N63, a brief FL V06 or V99 may appear intermittently. This should be disregarded.</p> <p>R40 is called at nominal ignition time and remains active until en- gine cutoff. R40 monitors PIPA outputs and initiates engine fail procedures if thrust failure is detected. Engine thrust fails when PIPA detects <math>\Delta V</math> to be &lt;10.1 fps (308 cm/sec) for five consecutive sampling periods of 2 seconds each after nominal ignition time. En- gine thrust also fails if, during thrusting period, <math>\Delta V</math> is less than</p>

THRU

# LMA790-3-LM APOLLO OPERATIONS HANDBOOK

RC 1606

CREW- MAN	PNL	PROCEDURES	REMARKS
		<p>4.10.3.3 <u>APS Abort (LGC P71, AEA 410+00000) (cont)</u></p> <p>To enable main engine burn: Key PRO, exit R40 To attempt completion of ma- neuver by RCS: Key ENTR, go to step 15</p> <p>c. Terminate: Key V34E - Terminate FL V37 N-- Key XXE, exit P71 and R40 ENG THR CONT: ENG ARM sw - OFF</p> <p>4. ENG THR CONT: ENG ARM sw - ASC Eng START pb/lt - push</p> <p style="text-align: center;">CAUTION</p> <p>If P71 initiated by step 1.c, automatic shutoff will not occur, but will have to be terminated manually (step 12).</p> <p>5. Poss FL V50 N25 R1 00203 - Switch guidance control to PGNS Automatic mode R2 ----- R3 -----</p> <p>a. GUID CONT sw - PGNS S/C: PGNS sw - AUTO Key PRO</p> <p>b. If mode already selected: Key ENTR</p> <p>6. V06 N94 R1 VGX(LM) XXXX.X fps R2 H rate XXXX.X fps R3 H XXXXX ft</p>	<p>this threshold for two consecutive sampling periods of 2 seconds each.</p> <p>Provides redundant arming engine- on signals.</p> <p>ABORT STAGE pb functions are inoperative. No redundant arming signal is available.</p> <p>VGX(LM) - Velocity to be gained in X-body coordinate. H rate - Altitude rate; - indicates descent and + indicates ascent</p>
		<p>2. ENG THR CONT: ENG ARM sw - ASC Eng START pb/lt - push</p>	

**LMA790-3-LM**  
**APOLLO OPERATIONS HANDBOOK**

CREW-MAN	PNI	PROCEDURES	REMARKS
		<p>4.10.3.3 APS Abort (LGC P71, AEA 410+00000) (cont)</p> <p>6. Monitor thrusting: VI should be increasing H rate should remain positive and increase to approximately 200 fps &amp; then decrease to 19.5 fps. H should be increasing. FDAI - Attitude errors should be &lt;XX° - Attitude rates should be &lt;XX°/sec</p> <p>8. Perform APS/RCS Propellant Interconnect, steps 1 through 3.</p> <p>9. If desired: Key V16 N77E R1 TG            XXXX min-sec R2 VGY(LM)    XXXX.X fps R3 VI            +XXXX.X fps To terminate display: Key KEY REL</p>	<p>H - Altitude with respect to landing site radius; + indicates altitude greater than radius If H &gt;25,000 feet, LGC will maneuver LM to orbit insertion attitude. If H &lt;25,000 feet, LGC will inhibit X-axis override and maneuver LM to local vertical with +Z-axis downrange until H &gt;25,000 feet or until H rate &gt;40 fps, then pitch to orbit insertion attitude and restore X-axis override. Ref para 4.13.3.3.</p> <p>Ref para 4.13.3.3.</p> <p>Ref para 4.13.3.3.</p> <p>TC - Estimated time of flight from present time to accomplishment of ascent injection conditions; polarity is minus (-). VGY(LM) - Velocity to be gained in Y-body coordinate. VI - Inertial velocity.</p>

THRUS

**LMA790-3-LM**  
**APOLLO OPERATIONS HANDBOOK**

CREW-MAN	PNL	PROCEDURES	REMARKS
		<p>4.10.3.3 APS Abort (LCC P71, AEA 410+00000) (cont)</p> <p>V06 N94  R1 VGX(LM) XXXX.X fps  R2 H rate XXXX.X fps  R3 H XXXX ft</p> <p>Key V16 N85E - VG (LM)  R1 X XXXX.X fps  R2 Y XXXX.X fps  R3 Z XXXX.X fps</p> <p>To terminate display:  Key KEY REL</p> <p>10. When TC is approx 10 sec:  Perform APS/RCS Propellant Inter-connect steps 4 &amp; 5</p> <p style="text-align: center;">CAUTION</p> <p>Do not perform step 11 if program not initiated by ABORT STAGE pb - push</p> <p>11. Before TC &lt; 1 Sec:  ENG THR CONT: ENG ARM sw - OFF</p>	<p>VGX(LM) - Velocity to be gained in X-body coordinate.</p> <p>Ref para 4.13.3.3.</p> <p>At automatic shutdown:  Horizontal velocity is variable.  Altitude rate is 19.5 fps.  ΔVgx (500) = 0 fps.</p> <p>Removes normal engine-on signal and thus enables automatic shut down.</p>
		<p>5. When ΔVgx is approx 200 fps  Perform APS/RCS Propellant Inter-connect, steps 4 &amp; 5.</p> <p>6. Readout parameters as desired:  Horizontal velocity -  Key DEDA C 427R (0.1 fps)</p> <p>Altitude rate -  Key DEDA C 367R (0.1 fps)</p> <p>Altitude -  Key DEDA C 337R (0.1 nm)  Monitor ΔVgx -  Key DEDA C 500R (0.1 fps)</p> <p>7. When horizontal velocity approaches shutoff criterion:  ENG THR CONT: ENG ARM sw - OFF</p>	

**LMA790-3-LM**  
**APOLLO OPERATIONS HANDBOOK**

RC 16.

CREW-MAN	PNL	PROCEDURES	REMARKS
		<p>4.10.3.3 APS Abort (LGC P71, AFA 410+0000P) (cont)</p> <p>12. If automatic engine shutdown does not occur when TG &lt; 1 sec; ABORT STAGE pb - reset Poss MASTER ALARM - on MASTER ALARM pb/lt - reset Eng STOP pb/lt - push</p> <p>If program initiated by alternative method (step 1.c) ENG THR CONT: ENG ARM sw - OFF</p> <p>13. ED: MASTER ARM sw - ON CB ED: LOGIC PWR A - open CB ED: LOGIC PWR B - open</p> <p>14. After automatic shut down, disarm APS and reset manual start relays: ABORT STAGE pb - reset Poss MASTER ALARM - on MASTER ALARM pb/lt - reset Eng STOP pb/lt - push Reset eng STOP pb/lt: a. Release tab - push b. Eng STOP pb/lt - on c. If eng STOP pb/lt - off, verify light is functioning by performing Caution &amp; Warning Array Checkout, steps 3 &amp; 4. If light is functioning, an inadvertent reset has taken place, eng is enabled, &amp; steps d, e, &amp; f should not be performed d. Eng STOP pb/lt - push e. Release tab - push f. Eng STOP pb/lt - off</p>	<p>Reset shuts engine off. MASTER ALARM - on when ABORT STAGE pb - reset, due to relay race removing CWEA inhibit. Required to reset manual start relays.</p> <p>Leaving ED: MASTER ARM sw - ON places inhibit on ED CWEA preventing spurious master alarm indications (all pyros have been fired at this time). Opening cb's conserves power.</p> <p>Ref para 4.2.10.</p>

THRU

**LMA790-3-LM**  
**APOLLO OPERATIONS HANDBOOK**

CREW-MAN	PNL	PROCEDURES	REMARKS																								
		<p>4.10.3.3 APS Abort (LGC P71, AEA 410+00000) (cont)</p> <p>15. FL V16 N94  R1 - VGX(LM) XXXX.X fps  R2 - H rate XXXX.X fps  R3 - H XXXX ft  Key PRO</p> <p>16. FL V16 N85 - VG (LM)  R1 X XXXX.X fps  R2 Y XXXX.X fps  R3 Z XXXX.X fps  If nulling of VG is desired:  S/C: PGNS sw - ATT HOLD  THROTTLE/JETS cont (CDR &amp; LMP) -  JETS  ACA/TTCA - null VGX, VGY, VGZ</p>	<p>VGX(LM) - Velocity to be gained in X-body coordinate.</p> <p>LGC zeroes attitude errors and sets 0.3° deadband in DAP at this time.</p> <p>Two-jet translation is recommended to be selected through R03. If not selected via R03, translation will be four-jet.</p>																								
		<p>8. Cutoff possibilities:</p> <p>a. If cutoff does not occur at appropriate point (late cutoff):  ABORT STAGE pb - reset  MASTER ALARM - on  MASTER ALARM pb - reset  go to 8c.2.</p> <p>b. If cutoff is before appropriate point:  1) To perform APS burn:  Reestablish ullage counter threshold:  Key DEDA C 616+0000YE  To perform ullage &amp; manual start:  TTCA (CDR) - move up for 2Y + 1 seconds  ENR START pb/lt - push.  If APS start does not occur, go to step 9.</p> <p>2) To perform RCS burn, go to step 9</p>	<p>Ullage time is 2Y seconds depending on ullage volume.</p> <p>Y is determined from the following chart:</p> <table style="margin-left: auto; margin-right: auto;"> <tr> <td>Remaining Total Burn</td> <td>2 Jets</td> <td>4 Jets</td> </tr> <tr> <td>Fuel Time in Sec (B)</td> <td>2</td> <td>2</td> </tr> <tr> <td>100% to</td> <td>0</td> <td>228</td> </tr> <tr> <td>50%</td> <td>274</td> <td>4</td> </tr> <tr> <td>40%</td> <td>319</td> <td>5</td> </tr> <tr> <td>30%</td> <td>365</td> <td>6</td> </tr> <tr> <td>20%</td> <td>410</td> <td>7</td> </tr> <tr> <td>10%</td> <td></td> <td>5</td> </tr> </table>	Remaining Total Burn	2 Jets	4 Jets	Fuel Time in Sec (B)	2	2	100% to	0	228	50%	274	4	40%	319	5	30%	365	6	20%	410	7	10%		5
Remaining Total Burn	2 Jets	4 Jets																									
Fuel Time in Sec (B)	2	2																									
100% to	0	228																									
50%	274	4																									
40%	319	5																									
30%	365	6																									
20%	410	7																									
10%		5																									

**LMA790-3-LM**  
**APOLLO OPERATIONS HANDBOOK**

LM 3209

CREW-MAN	PNL	PROCEDURES	REMARKS
		<p>4.10.3.3.3 APS Abort (LGC P71, AEA 410+00001) (cont)</p> <p>c. If cutoff occurs at normal point:</p> <ol style="list-style-type: none"> <li>1) ABORT STAGE pb - reset MASTER ALARM - on MASTER ALARM pb - reset</li> <li>2) Reset manual start relays: Eng STOP pb/lt - push</li> <li>3) Reset Eng STOP pb/lt:               <ol style="list-style-type: none"> <li>a) Release tab - push</li> <li>b) Eng STOP pb/lt - on</li> <li>c) If eng STOP pb/lt - off, verify that lights are functioning by performing Caution and Warning Array Checkout steps 3 &amp; 4. If lights are functioning, an inadvertent reset has taken place, engine is enabled, and steps d, e, &amp; f should not be performed</li> <li>d) Eng STOP pb/lt - push</li> <li>e) Release tab - push</li> <li>f) Eng STOP pb/lt - off</li> </ol> </li> </ol> <p>9. Trim <math>\Delta V</math> residual. Verify AEA attitude hold submode. Key DEDA C 400R If +00000 not displayed: Key DEDA C 400+0000E S/C: DEAD BAND sw - MIN</p> <p>Read and record: <math>\Delta V_{gx}</math> Key DEDA C 500R (0.1/1 fps) <math>\Delta V_{gy}</math> Key DEDA C 501R (0.1/1 fps) <math>\Delta V_{gz}</math> Key DEDA C 502R (0.1/1 fps)</p>	<p>Do not restart MPS if <math>\Delta Vg</math> is &lt;30 fps.</p> <p>Ref para 4.2.10.</p> <p>If this trim maneuver is performed after use of orbit insertion routine, it should be performed immediately after engine shutdown. Orbit insertion routine drives LM to specific point on desired orbit and residual <math>\Delta V_{gx}</math> will increase naturally after engine shutdown.</p>

THRU

**LMA790-3-LM**  
**APOLLO OPERATIONS HANDBOOK**

LM3207, LM3231

CREW-MAN	PNL	PROCEDURES	REMARKS
		<p>4.10.3.3 APS Abort (LGC P71, AGS 410+00000) (cont)</p> <p>17. Terminate P71 or select Orbit Parameter Display Routine (R30):</p> <p>a. Terminate: Key PRO FL V37 N-- Key XXE, exit P71</p> <p>or</p> <p>b. Select R30: To minimize RCS propellant usage in LGC selected narrow deadband, select minimum impulse. verify/set: S/C: PGNS sw - ATT HOLD Key V76E NO DAP lt - on Key V82E FL V16 344 R1 Ha XXXX.X nm R2 Hp XXXX.X nm R3 TFF XXBXX min-sec</p> <p>If display of time to lip is desired: Key N32E R1 00XX hr R2 00XX min R3 0XX.XX sec</p> <p>When finished with display: Key KEY REL Key PRO to reestablish N85 display, exit R30 Key PRO FL V37 N-- Key XXE, exit P71</p>	<p>Null ΔVgx by moving TTCA up or down. Up TTCA nulls positive ΔVgx.</p> <p>Null ΔVgy by moving TTCA right or left. Right TTCA nulls positive ΔVgy.</p> <p>Null ΔVgz by moving TTCA in or out. In TTCA nulls positive ΔVgz.</p> <p>If Hp &gt;35,000 ft, TFF = -59B59 Orbit parameters are automatically recomputed every 2 seconds while average g is in process.</p> <p>Ha = apolune altitude Hp = perilune altitude TFF = Time of free fall to 35,000 feet. If Hp&gt;35,000 ft, TFF = -59B59.</p>
		<p>Read out and null ΔVg residuals in order of magnitude, largest first.</p> <p>S/C: DEAD BAND sw - MAX</p>	



**LMA790-3-LM**  
**APOLLO OPERATIONS HANDBOOK**

CREW-MAN	PNL	PROCEDURES	REMARKS
		<p>4.10.3.3 APS Abort (LGC P71, AGS 410+000000) (cont)</p> <p>10. Read out perilume altitude: Key DEDA C 403R (0.1 nm) Compare with PGNGS Hp value.</p> <p>11. Read out spolume altitude: Key DEDA C 315R (0.1 nm) Compare with PGNGS Ha value.</p>	

THRUST



**LMA790-3-LM  
APOLLO OPERATIONS HANDBOOK**

PARA	TITLE	PAGE
4.11	Undocking & Docking . . . . .	4.11-2
4.11.1	LM Undocking From CSM . . . . .	4.11-2
4.11.2	LM Docking . . . . .	4.11-6

SEP  
&  
DOCK

**LMA790-3-LM**  
**APOLLO OPERATIONS HANDBOOK**

LM 3231

CREW-MAN	PNL	PROCEDURES	REMARKS
		<p>4.11 <u>UNDOCKING &amp; DOCKING</u></p> <p>Undocking and docking procedures are arranged in a two-column format as separate PGNCs or AGS procedures, one guidance computer in control and the other in a followup condition ready to assume control; together, PGNCs in the left column and AGS in the right, they provide an integrated procedure.</p> <p>4.11.1 <u>LM UNDOCKING FROM CSM</u></p> <p>LGC Power-Up (required)</p> <p>LGC Self-Test (desired)</p> <p>LGC time valid (required)</p> <p>LGC state vector valid (required)</p> <p>IMU Power-Up (LGC Operating) (required)</p> <p>IMU Orientation Determination Program (P51) (required)</p> <p>DAP Data Load Routine (R03) (required)</p>	<p>This procedure describes LM active undocking. It should not be confused with maneuver commonly called separation, which is preceded by period of station-keeping following undocking. This procedure is incomplete until properly integrated with corresponding CSM procedure.</p> <p>Ref para 4.6.1.1.1.</p> <p>Ref para 4.6.1.1.13.</p> <p>LGC/CMC Clock Synchronization Routine (R33) (para 4.6.1.15)</p> <p>LGC Update Program (para 4.6.1.7) and, when appropriate, Rendezvous Navigation Program (P20) (para 4.8.2.1)</p> <p>Ref para 4.6.1.3. ISS should be on 15 minutes before thrusting maneuver.</p> <p>Ref para 4.9.1.1.1.</p> <p>Ref para 4.6.1.8. (R1) N46 = 21002</p> <p>Ref para 4.6.2.1.1.</p> <p>Ref para 4.6.2.3.</p> <p>AGS Manual Absolute Time Initialization procedure (para 4.6.2.6) or AGS Initialization Routine (R47) (para 4.6.1.18)</p>
			<p>AGS Power-Up (required)</p> <p>AEA Self-Test (desired)</p> <p>AGS time valid (required)</p>

# LMA790-3-LM

## APOLLO OPERATIONS HANDBOOK

LM 3231, LM 3235

CREW-MAN	PNI	PROCEDURES	REMARKS
		<p>4.11.1 LM UNDOCKING FROM CSM (cont)</p> <p>1. EPS Basic (Unstaged) (required) Select attitude control: GUID CONT sw - PGNS S/C: ROLL, PITCH, YAW sw - MODE CONT PGNS sw - OFF AGS sw - OFF DEAD BAND sw - MIN</p> <p>2. Enable ACA/TTCA: TTCA/TRANSL sw (2) - ENABLE ACA/4 JET sw (2) - ENABLE THROTTLE/JETS cont - JETS ENG THR CONT: BAL CPL sw - ON ATT/TRANSL sw - 2 JETS ACA PROP sw (2) - ENABLE</p> <p>3. Select total attitude &amp; attitude rate/error displays: FDAI 1 sw - as desired FDAI 2 sw - as desired ATTITUDE MON sw (1) - PGNS ATTITUDE MON sw (1) - AGS RATE/ERR MON sw (2) - LDG RDR/CHPTR Key V60E for attitude rate display or</p>	<p>AGS Initialization Routine (R47) (para 4.6.1.18) or AGS Manual LM State Vector Update/Initialization procedure (para 4.6.2.7) and AGS Manual CSM State Vector Update/Initialization procedure (para 4.6.2.9)</p> <p>AGS Alignment to PGNS IMU (para 4.9.2.1) or Backup AGS Alignment procedures (para 4.9.2.2 and 4.9.2.3). Valid attitude data are required when guidance steering is desired; e.g., for thrusting maneuvers.</p> <p>Ref para 4.13.4.1.</p> <p>Ref para 4.5.1.3.</p> <p>Switch guard may be moved to side position for duration of time S/C: PGNS sw - OFF.</p> <p>Ref para 4.5.1.6 and 4.5.2.5.</p> <p>Ref para 4.5.3.1 and 4.5.3.2.</p> <p>Ref para 4.5.3.4.</p>
		<p>AGS LM/CSM state vector valid (required)</p> <p>AGS attitude data valid (required)</p> <p>1. Select attitude control: S/C: AGS sw - OFF PGNS sw - OFF ROLL, PITCH, YAW sw - MODE CONT DEAD BAND sw - MIN GUID CONT sw - AGS</p> <p>2. Enable ACA/TTCA: TTCA/TRANSL sw (2) - ENABLE ACA/4 JETS sw - ENABLE THROTTLE/JETS cont (2) - JETS ENG THR CONT: BAL CPL sw - ON ATT/TRANSL sw - 2 JETS ACA PROP sw (2) - ENABLE</p> <p>3. Select total attitude &amp; attitude rate/error displays: FDAI 1 sw - as desired FDAI 2 sw - as desired ATTITUDE MON sw (1) - AGS ATTITUDE MON sw (1) - PGNS RATE/ERR MON sw - LDG RDR/CHPTR</p>	

SEP  
&  
DOC

**LMA790-3-LM  
APOLLO OPERATIONS HANDBOOK**

CREW-MAN	PNL	PROCEDURES	REMARKS
		<p>4.11.1 <u>LM UNDOCKING FROM CSM (cont)</u></p> <p>Key V61E for mode I attitude error display or Key V62E for mode II attitude error display</p>	<p>Mode I - DAP following errors.</p> <p>Mode II - total attitude errors with respect to N22 angles (gimbal angles display is scale limited) (preferred)</p>
		<p>4. Select attitude rate displays: RATE SCALE sw - as desired</p> <p>5. Request CSM verify CSM/LM electrical umbilical power sw set to off.</p> <p>6. Disconnect &amp; stow CSM/LM electrical umbilical.</p> <p>7. Install drogue (LM side).</p> <p>8. Close overhead hatch (LM side).</p> <p>9. Perform ECS Basic.</p> <p>10. Perform Heaters Status Check.</p>	<p>Select attitude rate displays: RATE SCALE sw - as desired</p> <p>Request CSM verify CSM/LM electrical umbilical power sw set to off.</p> <p>Disconnect &amp; stow CSM/LM electrical umbilical.</p> <p>Install drogue (LM side).</p> <p>Close overhead hatch (LM side).</p> <p>Perform ECS Basic.</p> <p>Perform Heaters Status Check.</p>
		<p>11. Perform Cabin Leak Check.</p> <p>12. Set EVNT TMR ind to count down to separation time.</p> <p>13. Verify CMP installed preloaded docking probe.</p> <p>14. Verify CMP released docking latches.</p>	<p>Ref para 4.13.1.9.</p> <p>Ref para 4.13.6.</p> <p>Assumption: Spring force of pre-loaded docking probe is sufficient to undock LM from CSM if desired.</p>
		<p style="text-align: center;">CAUTION</p> <p>RCS quad temperature must be &gt;120°F for 25 minutes before firing RCS thrusters.</p>	<p>Ref para 4.13.1.1. SUIT GAS DIVER-TER vlv is set to PULL EGRESS during MPS burns.</p> <p>Ref para 4.13.5.</p>

**LMA790-3-LM**  
**APOLLO OPERATIONS HANDBOOK**

LM 3207

CREW-MAN	PNI	PROCEDURES	REMARKS
		<p>4.11.1 LM UNDOCKING FROM CSM (cont)</p> <p>15. LTG: EXTERIOR LTG sw - DOCK</p> <p>16. Verify COAS installed in overhead window.</p> <p>17. Select Thrust Monitor Program (P47): Key V37E 47E Poss PROG It - on Key V05 N09E - Call alarm 00210 - IMU not on 00220 - IMU orientation not known Key KEY REL &amp; RSET FL V37 N-- Key XXE, exit P47</p> <p>18. FL V16 N83 - AV (LH) R1 X XXXX.X fps R2 Y XXXX.X fps R3 Z XXXX.X fps</p> <p>19. Secure self &amp; cabin. Key V76E (min impulse) NO DAP It - on S/C: PGNS sw - ATT HOLD Key V77 (do not key enter)</p> <p>20. Coordinate undocking countdown with CMP.</p> <p>21. Monitor undocking when EVNT TMR ind - 00:00. RCS: TEMP/PRESS MON sel - FUEL MANF A &amp; B PRESS ind - 178 to 188 psia TEMP/PRESS MON sel - OXID MANF A &amp; B PRESS ind - 175 to 188 psia TEMP/PRESS MON sel - He</p>	<p>P47 should be selected immediately before planned thrusting maneuver and terminated as soon as possible after maneuver, to keep errors associated with average g integration at a minimum.</p> <p>Registers display all zeros, except for PIPA bias accumulation, until thrust maneuver is started.</p> <p>Probe extension occurs at this time.</p> <p>Verification of normal RCS propellant manifold pressures after undocking insures that RCS: SYS A &amp; B SOV's are open.</p>
		<p>15. LTG: EXTERIOR LTG sw - DOCK</p> <p>16. Verify COAS installed in overhead window.</p> <p>17. Prepare AGS to display thrust: Key DEDA C 404 + 00000E C 405 + 00000E C 406 + 00000E C 470R</p> <p>18. Secure self &amp; cabin.</p> <p>19. Coordinate undocking countdown with CMP.</p> <p>20. Monitor undocking when EVNT TMR ind - 00:00. RCS: TEMP/PRESS MON sel - FUEL MANF A &amp; B PRESS ind - 178 to 188 psia TEMP/PRESS MON sel - OXID MANF A &amp; B PRESS ind - 175 to 188 psia TEMP/PRESS MON sel - He</p>	

SEE  
&  
DOC

**LMA790-3-LM**  
**APOLLO OPERATIONS HANDBOOK**

LM 3207

CREW-MAN	PNL	PROCEDURES	REMARKS
		<p>4.11.1 <u>LM UNDOCKING FROM CSM (cont)</u></p> <p>22. When separated desired number of feet: Key ENTR</p> <p>23. Terminate P47: Key PRO FL V37 N-- Key XXE, exit P47</p> <p>4.11.2 <u>LM DOCKING</u></p> <p>LGC Power-Up (required)</p> <p>LGC Self-Test (desired)</p> <p>LGC time valid (required)</p> <p>LGC state vector valid (required)</p> <p>IMU Power-Up (LGC Operating) (required)</p> <p>IMU Orientation Determination (P51) (required)</p> <p>DAP Data Load Routine (R03) (required)</p> <p>LGC monitoring thrust (required)</p> <p>COAS prepared for docking (required)</p>	<p>Undocking station-keeping distance is mission-dependent. (NO DAP lt - off)</p> <p>This is a mutually cooperative LM/CSM docking procedure, which is incomplete until properly integrated with corresponding CSM procedure.</p> <p>Ref para 4.6.1.1.</p> <p>Ref para 4.6.1.13.</p> <p>LGC/CMC Clock Synchronization Routine (R33) (para 4.6.1.15)</p> <p>LGC Update Program (P27) (para 4.6.1.7) and, when appropriate, Rendezvous Navigation Program (P20) (para 4.8.2.1)</p> <p>Ref para 4.6.1.3. ISS should be on 15 minutes before thrusting maneuver.</p> <p>Ref para 4.9.1.1.</p> <p>Ref para 4.6.1.8.</p> <p>Thrust Monitor Program (P47) (para 4.10.1.4)</p> <p>COAS lighting check (para 4.2.9), steps 1 through 9.</p> <p>Ref para 4.6.2.1.</p>
			<p>21. When separated desired number of feet: S/C: ACS sw - ATT HOLD</p> <p>ACS Power-Up (required)</p>



# LMA790-3-LM

## APOLLO OPERATIONS HANDBOOK

LM 3231, LM 3231

CREW-MAN	PNL	PROCEDURES	REMARKS
		<p>4.11.2 <u>LM DOCKING (cont)</u></p>	<p>Ref para 4.6.2.3.            AGS Manual Absolute Time Initialization procedure (para 4.6.2.6) or AGS Initialization Routine (R47) (para 4.6.1.18)</p> <p>AGS Initialization Routine (R47) (para 4.6.1.18) or AGS Manual LM State Vector Update/Initialization procedure (para 4.8.2.7) and AGS Manual CSM State Vector Update/Initialization procedure (para 4.6.2.9)</p> <p>AGS Alignment to PGNS IMU (para 4.9.2.1) or Backup AGS Alignment procedures (para 4.9.2.2/4.9.2.3), or AGS Lunar align (400 + 40000) (para 4.9.3.2).            Valid attitude data are required when guidance steering is desired; e.g., for thrusting maneuvers.</p> <p>COAS lighting check (para 4.2.9, steps 1 through 9).            Ref para 4.5.3.6.</p> <p>Ref para 4.5.3.7.            Ref para 4.5.3.10.</p> <p>Ref para 4.5.1.3.</p> <p>Ref para 4.5.1.4.</p>
		<p>AEA Self-Test (desired)            ACS time valid (required)</p> <p>AGS LM/GSM state vector valid (required)</p> <p>AGS attitude data valid (required)</p> <p>COAS prepared for docking (required)</p> <p>1. Select RR displays:            SHFT/TRUN I sw - as desired            RATE/ERR MON sw (1) - RNDZ RADAR            X POINTER SCALE sw - HI MULT            RNG/ALT MON sw - RNG/RNG KI</p> <p>2. Select attitude control:            Key V77E            NO DAP lt - off            GUID CONT sw - PGNS            S/C:            ROLL, PITCH, YAW sw - MODE CONT            PGNS sw - ATT HOLD            ACS sw - ATT HOLD            or            Same switch settings, except:            Key V76E            NO DAP lt - on</p>	

SEP  
&  
DOCK

**LMA790-3-LM  
APOLLO OPERATIONS HANDBOOK**

CREW-MAN	PML	PROCEDURES	REMARKS
		<p>4.11.2 LM DOCKING (cont)</p> <p>3. Enable ACA &amp; TTCA: TTCA/TRANSL sw (2) - ENABLE ACA/4 JET sw (2) - ENABLE THROTTLE/JETS cont (2) - JETS ENG THR CONT: BAL CPL sw - ON ATT/TRANSL sw - 2 JETS ACA PROP sw (2) - ENABLE</p> <p>4. Select total attitude display: ORDEAL: FDAI 1 sw - as desired FDAI 2 sw - as desired ATTITUDE MON sw (1) - PGNS ATTITUDE MON sw (1) - AGS</p>	<p>Ref para 4.5.2.5.</p>
		<p>5. Select attitude rate displays: RATE SCALE sw - as desired</p> <p>6. COAS sw - FWD LIG: EXTERIOR LIG sw - DOCK Verify CMP has installed docking target.</p> <p>7. Radar technique: ACA - yaw &amp; pitch, as required, to null shaft &amp; trunnion angles on FDAI. TTCA - translate along X &amp; Y body-axes to null LOS rates on X pointer ind (X pointer ind is</p>	<p>Ref para 4.5.3.3.</p>
		<p>2. Enable ACA &amp; TTCA: TTCA/TRANSL sw (2) - ENABLE ACA/4 JET sw (2) - ENABLE THROTTLE/JETS cont (2) - JETS ENG THR CONT: BAL CPL sw - ON ATT/TRANSL sw - 2 JETS ACA PROP sw (2) - ENABLE</p> <p>3. Select attitude control: S/C: AGS sw - ATT HOLD PGNS sw - ATT HOLD ROLL, PITCH, YAW sw - MODE CONT DEAD BAND sw - MIN</p> <p>4. Select total attitude display: ORDEAL: FDAI 1 sw - as desired FDAI 2 sw - as desired ATTITUDE MON sw (1) - AGS ATTITUDE MON sw (1) - PGNS</p> <p>5. Select attitude rate displays: RATE SCALE sw - as desired</p> <p>6. COAS sw - FWD LIG: EXTERIOR LIG sw - DOCK Verify CMP has installed docking target.</p> <p>7. Radar technique: ACA - yaw &amp; pitch, as required, to null shaft &amp; trunnion angles on FDAI. TTCA - translate along X &amp; Y body-axes to null LOS rates on X pointer (X pointer ind</p>	<p>Ref para 4.5.3.1.</p> <p>Ref para 4.5.1.6. AGS pulse and direct modes of attitude control are not recommended for docking.</p> <p>Ref para 4.5.3.5.</p> <p>Select display scaling ranges as desired for coarse and fine nulling. RNG/ALT ind pwr/sig fail lt may flash randomly for range rates below 10 fps when displaying RR data. This is inherent in detection logic of</p>

**LMA790-3-LM**  
**APOLLO OPERATIONS HANDBOOK**

CREW-MAN	PNI	PROCEDURES	REMARKS
		<p>4.11.2 <u>LM DOCKING (cont)</u> fly-to display.)</p> <p>Translate along Z-body-axis to bring range rate to -5 fps.</p> <p>8. Monitor: Between range of 500 &amp; 110 ft, maintain null of shaft &amp; trunnion angles &amp; LOS rates. Maintain range rate at -5 fps.</p> <p>9. TTCA - at 110 ft, translate to null range rate so that, at range of 80 ft, range rate is zero</p> <p>10. Select PGNC attitude rate display: RATE/ERR MON sw - LDC RDR/CMFTR Key V60E</p> <p>11. ACA &amp; TTCA - rotate &amp; translate to acquire face-to-face orientation (LM Z-axis aligned with CSM X-axis and COAS aligned with docking target) &amp; null LOS &amp; range rates</p> <p>12. Prepare for docking: RNDZ RADAR sel - SLEW SHFT/TRUN X sw - +50° RNDZ RADAR: SLEW sw - LEFT or RIGHT to null trunnion</p>	<p>indicator and does not indicate system malfunction. Data are good and randomly flashing light should be disregarded.</p> <p>Steps 7 and 8 outline approach from 500 to 110 feet using radar or visual (out-of-window) displays, respectively.</p> <p>If range track is broken and reacquisition occurs at true range of less than 500 feet, readout of approximately 405 nm can occur. This anomaly does not affect accuracy of range rate or angle data.</p> <p>When range and altitude input is equal to zero feet or range and altitude rate is equal to zero fps. RNC/ALT ind pwr/sig fail it goes on. This does not represent malfunction; condition is inherent in detection circuitry.</p> <p>Establish PGNC attitude rate/error display, ref para 4.5.3.2.</p>
		<p>is fly-to display.)</p> <p>Translate along Z-body-axis to bring range rate to -5 fps.</p> <p>8. Monitor: Between range of 500 &amp; 110 ft, maintain null of shaft &amp; trunnion angles &amp; LOS rates. Maintain range rate at -5 fps.</p> <p>9. TTCA - at 110 ft, translate to null range rate so that, at range of 80 ft, range rate is zero</p> <p>10. ACA &amp; TTCA - rotate &amp; translate to acquire face-to-face orientation (LM Z-axis aligned with CSM X-axis and COAS aligned with docking target) &amp; null LOS &amp; range rates</p> <p>11. Prepare for docking: RNDZ RADAR sel - SLEW SHFT/TRUN X sw - +50° RNDZ RADAR: SLEW sw - LEFT or RIGHT to null trunnion</p>	<p>Ref para 4.6.3.6 for alternate procedure for stowing RR antenna.</p>

SEP  
&  
DOCK

**LMA790.3-LM**  
**APOLLO OPERATIONS HANDBOOK**

LM 3207

CREW-MAN	PNI	PROCEDURES	REMARKS
		<p>4.11.2 <u>LM DOCKING (cont)</u></p> <p>RNDZ RADAR: SLEW sw - DOWN until shaft angle = 50° CB/AC BUS A: RNDZ RDR - open Install COAS in overhead window. COAS sw - OVRD</p> <p>13. ACA - pitch down 90° &amp; view CSM through overhead window</p> <p>14. ACA - yaw left 120° until COAS reticle is aligned with CSM stand-off target.</p> <p>15. For CSM active docking, go to step 16.</p> <p>16. TTCA - make final approach along +X-axis at closing rate of 0.25 to 0.5 fps</p> <p>17. At contact, apply +X-thrust.</p> <p>18. Terminate +X-thrust on receipt of capture verification. If in minimum impulse: Key V77E NO DAP lt - off</p> <p>20. Receive indication of docking-latch operation from CSM and/or by audible &amp; tactile cues.</p> <p>21. Maintain attitude control during retraction.</p>	<p>RNDZ RADAR: SLEW sw - DOWN until shaft angle = 50° CB/AC BUS A: RNDZ RDR - open Install COAS in overhead window. COAS sw - OVRD</p> <p>12. ACA - pitch down 90° &amp; view CSM through overhead window</p> <p>13. ACA - yaw left 120° until COAS reticle is aligned with CSM stand-off target.</p> <p>14. For CSM active docking, go to step 15.</p> <p>15. TTCA - make final approach along +X-axis at closing rate to 0.25 to 0.5 fps</p> <p>16. At contact, apply +X-thrust.</p> <p>17. Terminate +X-thrust on receipt of capture verification.</p> <p>18. Receive indication of docking-latch operation from CSM and/or by audible &amp; tactile cues.</p> <p>19. Maintain attitude control during retraction.</p>
			<p>Yaw instructions are for head-to-head initial conditions (such as both vehicles heads down or heads up) before 90° pitch, after CSM roll (if any). For one vehicle heads up and other heads down, yaw right 60°.</p> <p>Actual LOS to CSM will be approximately 3° below +X-axis.</p> <p>Contact is indicated by audible or tactile cues, voice link from CMP, and/or COAS observation.</p> <p>CMP provides voice verification.</p> <p>LM must be in attitude hold after capture to permit CSM realignment and retraction.</p> <p>Retraction is automatically initiated when capture latches engage drogue. Ten-inch retraction stroke should take approximately 5 seconds.</p>

**LMA790-3-LM  
APOLLO OPERATIONS HANDBOOK**

LM 3435

CREW-MAN	PNL	PROCEDURES		REMARKS
		<p>4.11.2 <u>LM DOCKING (cont)</u></p> <p>22. S/C: PGNS sw - OFF</p> <p>23. LTG: FLOOD sw - OVHD/FWD</p> <p>24. Pressurize LM/CSM interlock</p> <p>25. LTG: EXTERIOR LTG sw - OFF</p>	<p>20. S/C: AGS sw - OFF</p> <p>21. LTG: FLOOD sw - OVHD/F</p> <p>22. Pressurize LM/CSM interlock</p> <p>23. LTG: EXTERIOR LTG sw - OFF</p>	<p>Switch guard may be moved to side position for duration of time S/C: PGNS sw - OFF.</p>

SEP  
&  
DOCK

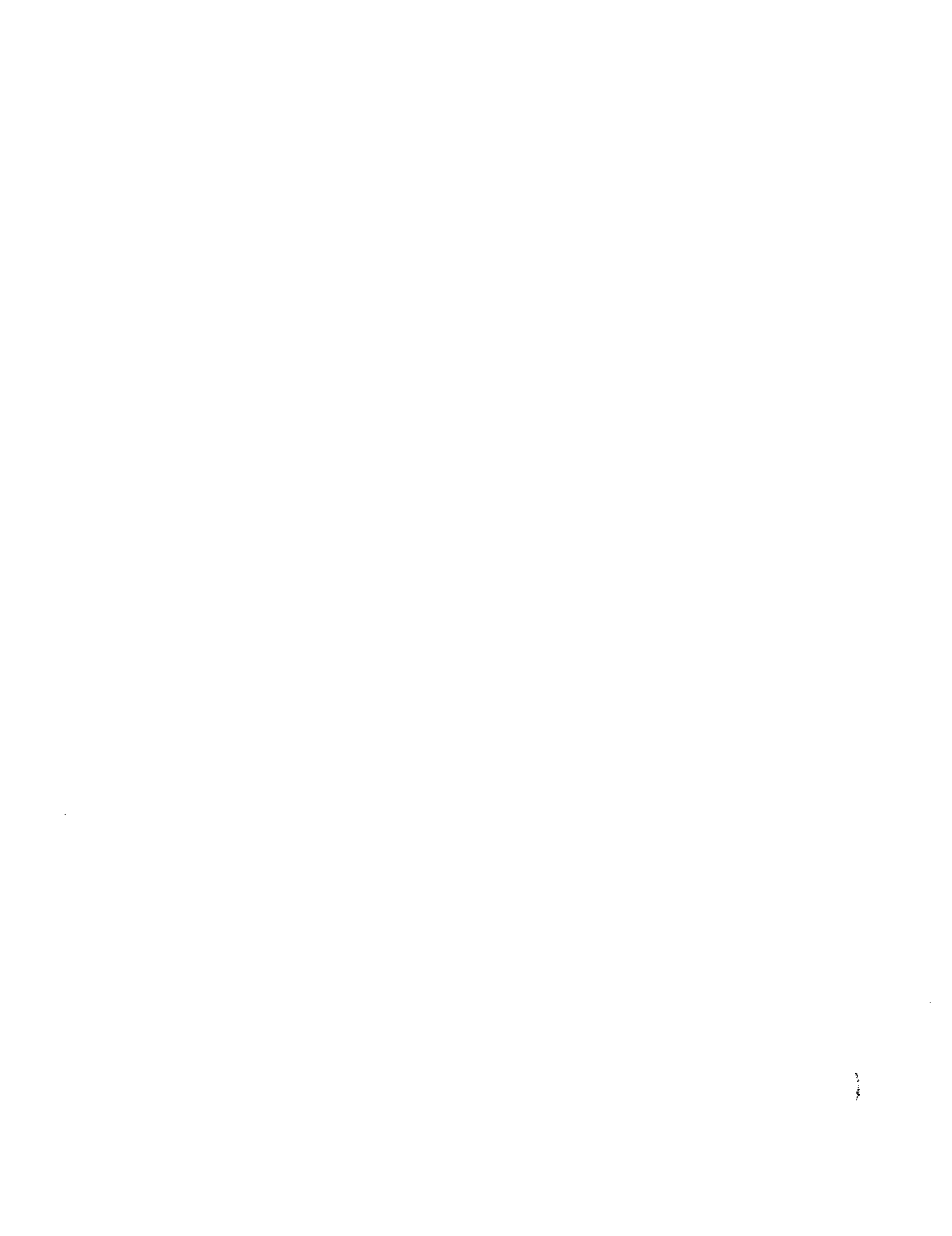

**LMA790-3-LM**  
**APOLLO OPERATIONS HANDBOOK**

PARA	TITLE	PAGE
4.12	Staging . . . . .	4.12-2
4.12.1	DPS Propellant Tank Venting . . . . .	4.12-2
4.12.2	DPS Supercritical He Venting (Lunar Surface Only) . . . . .	4.12-2A
4.12.3	APS Pressurization & Checkout . . . . .	4.12-3
4.12.4	APS Pressurization & Checkout (Alternate) . . . . .	4.12-4
4.12.5	EPS Prestaging Check . . . . .	4.12-6
4.12.6	ED Prestaging Check . . . . .	4.12-8
4.12.7	ECS Prestaging Check . . . . .	4.12-8
4.12.8	EPS Postaging Check . . . . .	4.12-8
4.12.9	RCS Staging . . . . .	4.12-9
4.12.10	AGS FITH . . . . .	4.12-14

**LMA790-3-LM**  
**APOLLO OPERATIONS HANDBOOK**

CREW-MAN	PNI	PROCEDURES	REMARKS
		4.12 <u>STAGING</u>	
		4.12.1 <u>DPS PROPELLANT TANK VENTING</u>	
CDR	1	1. Controls - MPS Basic (Unstaged)	<p>This task will be performed prior to staging or after last DPS burn, depending on specific mission profile.</p> <p>Ref para 4.13.3.1</p> <p>OXID VENT latching valve is open when tb - gray. FUEL VENT latching valve is open when tb - gray.</p> <p>Possible MASTER ALARM pb/lt - when ED: MASTER ARM sv - OFF due to relay race removing CMEA inhibit.</p> <p>MASTER ALARM lt and DES REG warn lt go on when pressure drops below 220 psia. DES REG warn lt remains on until staging or until CB INST: CMEA is cycled.</p> <p>OXID VENT latching valve is closed when tb-bp. FUEL VENT latching valve is closed when tb - bp.</p> <p>After long DPS abort or contingency burn, venting may be required if descent stage is to be retained, to avoid excessive pressure buildup in propellant tanks due to heat soakback. DPS relief valves cannot protect tanks from hot spots, which can exceed fracture-mechanics limits defined in SODB.</p> <p>Propellants reaching vent valves may close them or valves may vent propellants instead of helium. (Ref para 4.2.30.)</p>
	8	2. DES He REG 1 sv - CLOSE; tb - bp DES He REG 2 tb - bp	
	1	3. Vent propellant tanks. DES PROPUL: OXID VENT - tb - gray FUEL VENT - tb - gray ED: MASTER ARM sv - ON DES VENT sv - FIRE MASTER ARM sv - OFF MPS: OXID & FUEL PRESS ind - verify fuel & oxidizer pressures decreasing DES REG warn lt - on MASTER ALARM lt - on MASTER ALARM pb/lt - reset	
	8	4. For lunar-surface venting only - When MPS: OXID PRESS ind - 20 to 40 psia: DES PROPUL: OXID VENT sv - CLOSE; tb-bp When MPS: FUEL PRESS ind - <8 psia: DES PROPUL: FUEL VENT sv - CLOSE; tb-bp	
	11	5. For zero-g venting only -  If vent stops on its own or if pressure decrease <1 psia/10 sec: CB S/C: ATT DIR CONT - close	
	5	+X TRANSL pb - push and hold Wait 2 sec, then:	



**LMA790-3-LM**  
**APOLLO OPERATIONS HANDBOOK**

CREW- MAN	PNL	PROCEDURES	REMARKS
8		<p>4.12.1 <u>DPS PROPELLANT TANK VENTING (cont)</u></p> <p>DES PROPUL:            OXID VENT sw - OPEN; tb - gray            FUEL VENT sw - OPEN; tb - gray            Terminate translation after 10 sec:            +X TRANSL pb - release            When MPS: OXID PRESS ind - (TBD by MSFN):</p> <p>DES PROPUL: OXID VENT sw - CLOSE; tb - bp            When MPS: FUEL PRESS ind - (TBD by MSFN):            DES PROPUL: FUEL VENT sw - CLOSE; tb - bp</p>	<p>Vent-termination pressure is a function of many variables; MSFN must provide this data to crew.</p>
1 8		<p>4.12.2 <u>DPS SUPERCRITICAL He VENTING (LUNAR SURFACE ONLY)</u></p> <p>1. Vent supercritical helium:            HELIUM MON sel - SUPCRIT PRESS            PRELNT TEMP/PRESS MON sw - DES 1            DES PROPUL:            FUEL VENT sw - OPEN; tb - gray            OXID VENT sw - OPEN; tb - gray            DES He REG 1 sw - OPEN; tb - gray            DES He REG 2 sw - OPEN; tb - gray            CB PROPUL: DES He REG/VENT - open</p>	<p>DPS Propellant Tank Venting (para 4.12.1) is prerequisite to this procedure.</p>
1 8		<p>2. Verify supercritical helium pressure decreasing.</p>	<p>FUEL VENT latching valve is open when tb - gray            OXID VENT latching valve is open when tb - gray.            REG 1 &amp; 2 SOV's and vent valves will be left open to insure that descent supercritical helium, fuel and oxidizer tanks will be at minimum pressure when ascent engine FIIT occurs.</p>

STAGN

**LMA790-3-LM**  
**APOLLO OPERATIONS HANDBOOK**

CREW- MAN	PNI	PROCEDURES	REMARKS
	1	<p>4.12.3 <u>APS PRESSURIZATION &amp; CHECKOUT (cont)</u></p> <p>5. PRLNT TEMP/PRESS MON sw - ASC MPS: FUEL TEMP ind - 50° to 90° F OXID TEMP ind - 50° to 90° F FUEL PRESS ind - 172 to 203 psia OXID PRESS ind - 172 to 203 psia</p> <p>6. HELIUM MON sel - PRESS 2 MPS: HELIUM ind - 2700 to 3450 psia HELIUM MON sel - PRESS 1 MPS: HELIUM ind - 2700 to 3450 psia</p> <p>4.12.4 <u>APS PRESSURIZATION &amp; CHECKOUT (ALTERNATE)</u></p> <p>1. Controls - MPS Basic (Staged)</p> <p>2. HELIUM MON sel - PRESS 1 MPS: HELIUM ind - 2800 to 3500 psia</p> <p>3. HELIUM MON sel - PRESS 2 MPS: HELIUM ind - 2800 to 3500 psia</p> <p>4. PRLNT TEMP/PRESS MON sw - ASC MPS: FUEL TEMP ind - 50° to 90° F OXID TEMP ind - 50° to 90° F FUEL PRESS ind - 108 to 172 psia OXID PRESS ind - 71 to 143 psia</p> <p>5. ASC He REG 1 sw - CLOSE; tb - bp</p>	<p>Below 40°F, engine operation is rough. Above 100°F, oxidizer decomposes, driving oxidizer-fuel ratio out of tolerance. Engine will not operate with smooth and efficient combustion with AT P/O &gt;10°F.</p> <p>This optional procedure provides checks for helium regulators independently, before pressurization. Ascent helium tank pressure values, as function of time will remain approximately the same as for initial tank loading conditions. See figure 4-8. Ascent Helium Loading, for expected tank pressure as function of tank temperature and initial loading conditions. ASC PRESS warn lt goes on when helium tank pressure decreases to 2773 psia. ASC He REG primary solenoid latching valve is closed when tb - bp.</p> <p>Ref para 4.13.3.2.</p> <p>ASC He REG primary latching valve is closed when tb - bp.</p>

**LMA790-3-LM**  
**APOLLO OPERATIONS HANDBOOK**

CREW-MAN	PNL	PROCEDURES	REMARKS
		<p>4.12.3 <u>APS PRESSURIZATION &amp; CHECKOUT</u></p> <ol style="list-style-type: none"> <li>1. Controls - MPS Basic (Staged)</li> <li>2. HELIUM MON sel - PRESS 1 MPS: HELIUM ind - 2800 to 3500 psia</li> <li>3. HELIUM MON sel - PRESS 2 MPS: HELIUM ind - 2800 to 3500 psia</li> <li>4. ED: ASC He SEL sw - BOTH MASTER ARM sw - ON</li> </ol> <p>ASC He PRESS sw - FIRE</p> <p>MASTER ARM sw - OFF</p> <p>ASC PRESS warn it - on (if helium pressure &lt;2773 psia after pressurization)</p>	<p>Ascent helium tank pressure values, as function of time will remain approximately the same as for initial tank loading conditions. See figure 4-8. Ascent Helium Loading, for expected tank pressure as function of tank temperature and initial loading conditions. ASC PRESS warn lt goes on when helium tank pressure decreases to 2773 psia.</p> <p>Ref para 4.13.3.2.</p> <p>Select TANK 1 or TANK 2 if pressure readings in step 2 or 3 are below TBD, or a leak is suspected. APS helium tank design limit is 3500 psia, which corresponds to +160° F tank temperature. If this limit is approached, pressurize APS from affected tank(s).</p> <p>APS must not remain activated, i.e. compatibility squib valves fired, more than 24 hours before termination of use.</p> <p>Possible MASTER ALARM - on when ED: MASTER ARM sw - OFF due to relay race removing CHEA inhibit.</p> <p>Light goes off when staging occurs</p> <p>Following values apply to pressure relief valve assembly:          Burst-disk rupture pressure - 226 to 250 psia          Reseat pressure - 225 psia          Relief valve cracking pressure - 245 psia          Pressure fluctuations must settle out before proceeding to step 5.</p>

STAGING

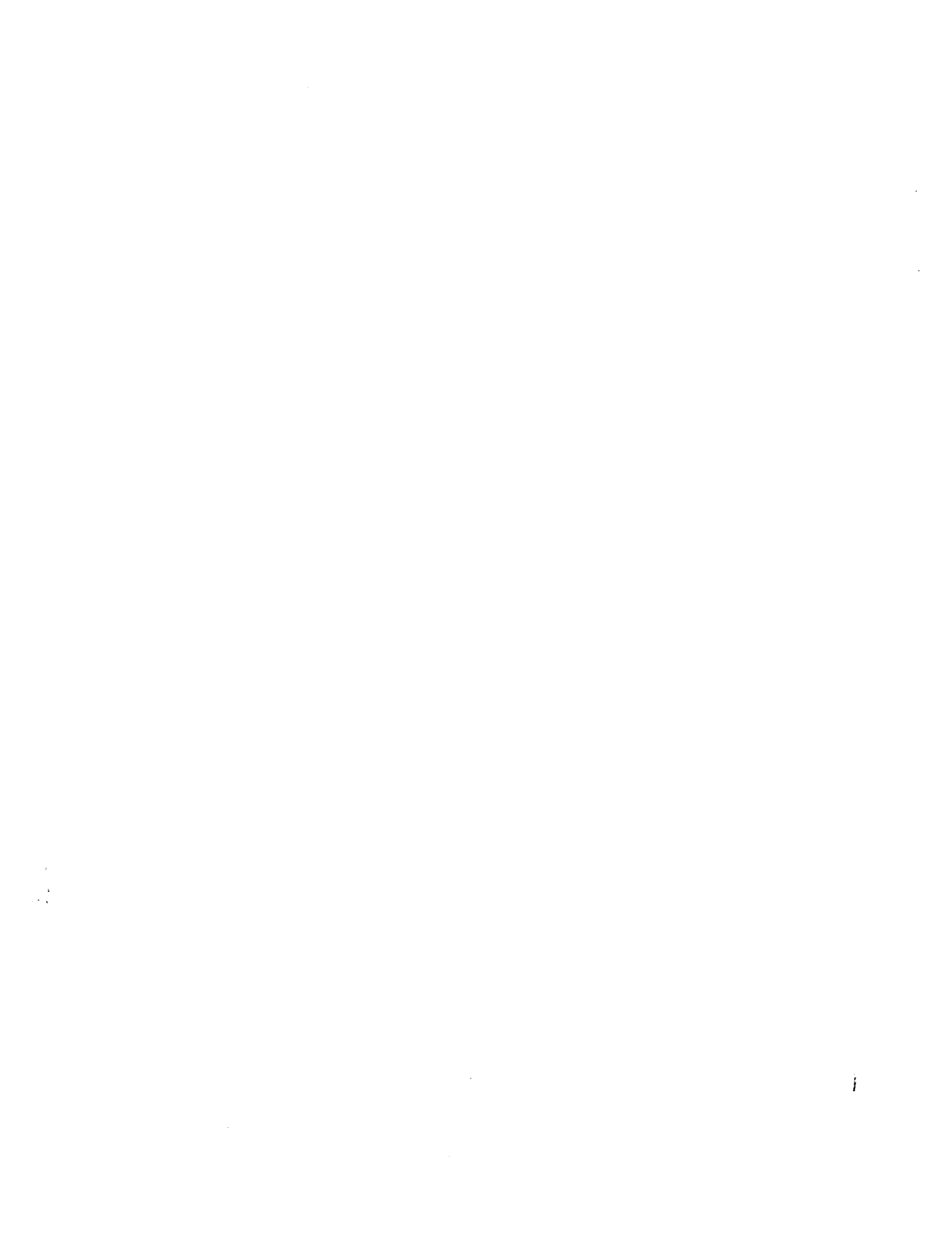

**LMA790-3-LM**  
**APOLLO OPERATIONS HANDBOOK**

CREW-MAN	PNL	PROCEDURES	REMARKS
	8	<p>4.12.4 APS PRESSURIZATION &amp; CHECKOUT (ALTERNATE) (cont)</p> <p>6. ED: ASC He SEL sw - BOTH MASTER ARM sw - ON</p> <p>ASC He PRESS sw - FIRE</p> <p>MASTER ARM sw - OFF</p>	<p>Select TANK 1 or TANK 2 if pressures indicated in step 2 or 3 are below TBD or if there is possibility of leak. APS helium tank design limit is 3500 psia, which corresponds to +160°F tank temperature. If this limit is approached, pressurize APS from affected tank(s). APS must not remain activated, i.e. compatibility squib valves fired, more than 24 hours before termination of use.</p> <p>Possible MASTER ALARM - on when ED: MASTER ARM sw - OFF due to relay race removing CWEA inhibit.</p> <p>Following values apply to pressure relief valve assembly: Burst-disk rupture pressure - 226 to 250 psia Reset pressure - 225 psia Relief valve cracking pressure - 245 psia Pressure fluctuations should settle out before proceeding to step 9.</p>
	1	<p>7. PRPLNT TEMP/PRESS MON sw - ASC MPS FUEL TEMP ind - 50° to 90° F OXID TEMP ind - 50° to 90° F</p> <p>FUEL PRESS ind - 172 to 203 psia OXID PRESS ind - 172 to 203 psia</p>	<p>Below 40°F, engine operation is rough. Above 100°F, oxidizer decomposes, driving oxidizer-fuel ratio out of tolerance. Engine will not operate with smooth and efficient combustion with AT F/O &gt;10°F.</p> <p>Regulated pressure range in secondary leg is as follows: 172 to 180 psia (primary) and 178 to 186 psia (secondary). Maximum lockup pressure is 203 psia. Generally, lockup pressure is about 10 to 12 psia higher than nominal regulated pressure for each regulator.</p>
CDR	1	<p>8. ASC He REG 1 sw - OPEN; tb - gray</p> <p>9. PRPLNT TEMP/PRESS MON sw - ASC MPS: FUEL TEMP ind - 50° to 90° F OXID TEMP ind - 50° to 90° F FUEL PRESS ind - 180 to 203 psia OXID PRESS ind - 180 to 203 psia</p>	<p>ASC He REG primary latching valve is open when tb - gray.</p> <p>Regulated pressure range in primary leg is as follows: 180 to 188 psia (primary) and 186 to 194 psia (secondary). Maximum lockup pressure is 203 psia. Generally, lockup pressure is about 10 to 12 psia higher than nominal regulated pressure for each regulator.</p>

STAGING

**LMA790-3-LM  
APOLLO OPERATIONS HANDBOOK**

LM 992

CREW-MAN	PNL	PROCEDURES	REMARKS
		<p>4.12.4 <u>APS PRESSURIZATION &amp; CHECKOUT (ALTERNATE) (cont)</u></p> <p>10. HELIUM MON sel - PRESS 2 MPS: HELIUM ind - 2700 to 3450 psia HELIUM MON sel - PRESS 1 MPS: HELIUM ind - 2700 to 3450 psia</p> <p>4.12.5 <u>EPS PRESTAGING CHECK</u></p> <p style="text-align: center;">CAUTION</p> <p>Fifteen minutes before staging, ascent batteries must be placed on line in parallel with descent batteries. Descent batteries No. 1 &amp; 3 must be removed from line at this time.</p> <p>1. Deleted</p> <p>2. EPS:</p> <p style="padding-left: 20px;">POWER/TEMP MON sel - BAT 5 VOLTS ind - 31.5 to 37.2 vdc BAT 5 NORMAL LMP FEED sw - ON; tb - gray VOLTS ind - 28.0 to 32.5 vdc AMPS ind - TBD</p> <p style="padding-left: 20px;">POWER/TEMP MON sel - BAT 6 VOLTS ind - 31.5 to 37.2 vdc BAT 6 NORMAL CDR FEED sw - ON; tb - gray VOLTS ind - 28.0 to 32.5 vdc AMPS ind - TBD</p> <p style="padding-left: 20px;">LMP BAT 1 HI V sw - TBD; tb - TBD CDR BAT 3 sw - TBD; tb - TBD</p> <p>3. CB/AC BUS A: DECA GMBL - open CB PROPUL: DES He REG/VENT - open CB S/C: DECA PWR - open CB ED: LDG GEAR FLAG - open CB HTR: LDG RDR - open CB FLT DISP: THRUST - open CB PGNS: LDG RDR - open CB EPS: INV 1 - close</p>	
CDR LMP	14		
CDR	11		

**LMA790-3-LM  
APOLLO OPERATIONS HANDBOOK**

CREW/MAAN	PNL	PROCEDURES	REMARKS
		<p>4.12.5 <u>EPS PRESTAGING CHECK (cont)</u></p> <p align="center">CAUTION</p> <p>Five minutes before staging, descent batteries No. 2 &amp; 4 must be removed from line &amp; CB EPS: CROSS TIE BAL LOADS (2) must be opened.</p>	
LMP	14	<p>4. EPS: LMP BAT 2 sw - OFF/RESET; tb - bp CDR BAT 4 HI V sw - OFF/RESET; tb - bp</p>	
CDR LMP	11 16	<p>5. CB EPS: CROSS TIE BAL LOADS - close CB EPS: CROSS TIE BAL LOADS - open</p>	
LMP	14	<p>6. EPS: INVERTER sw - 1 POWER/TEMP MON sel - AC BUS VOLTS ind - green band INVERTER sw - 2 VOLTS ind - green band POWER/TEMP MON sel - LMP BUS VOLTS ind - 26.5 to 32.5 vdc POWER/TEMP MON sel - CDR BUS VOLTS ind - 26.5 to 32.5 vdc</p>	Green band represents 112 to 118 vac.
		<p>7. EPS: LMP BAT 1 HI V sw - ON; tb - gray CDR BAT 4 HI V sw - ON; tb - gray LMP BAT 2 sw - ON; tb - gray CDR BAT 3 sw - ON; tb - gray</p>	If staging is to occur soon after this task, omit step 7; otherwise omit step 8.
		<p>8. EPS: DES BATS sw - DEADFACE; tb - bp</p>	

STAGE

**LMA790-3-LM**  
**APOLLO OPERATIONS HANDBOOK**

CREW-MAN	PNL	PROCEDURES	REMARKS
		4.12.6 <u>ED PRESTAGING CHECK</u>	Purpose of ED Prestaging Check procedure is to check open circuit voltage of ED batteries A and B before vehicle staging.
CDR	11	1. Verify CB ED: LOGIC PWR A - close	
LMP	16	2. Verify CB ED: LOGIC PWR B - close	
	14	3. EPS: POWER/TEMP MON sel - ED/OFF ED VOLTS sw - BAT A VOLTS ind - 35.0 to 37.8 vdc ED VOLTS sw - BAT B VOLTS ind - 35.0 to 37.8 vdc ED VOLTS sw - OFF POWER/TEMP MON sel - CDR BUS	
		4.12.7 <u>ECS PRESTAGING CHECK</u>	Nominal open-circuit voltage for each ED battery is 37.1 vdc.
		1. Perform ECS Basic (Staged).	
		2. Perform ECS Periodic Monitoring (Staged).	Ref para 4.13.1.1.
		4.12.8 <u>EPS POSTSTAGING CHECK</u>	Ref para 4.13.1.3.
CDR	11	1. Perform EPS Basic (Staged), except: CB ED: LOGIC PWR A - open	Ref para 4.13.4.2.
LMP	16	CB S/C: ABORT STAGE - open CB ED: LOGIC PWR B - open	
	14	2. EPS: POWER/TEMP MON sel - BAT 5 VOLTS ind - 28.0 to 32.5 vdc AMPS ind - TBD	
		3. EPS: POWER/TEMP MON sel - BAT 6 VOLTS ind - 28.0 to 32.5 vdc AMPS ind - TBD	
		4. EPS: POWER/TEMP MON sel - AC BUS VOLTS ind - green band	



**LMA790-3-LM**  
**APOLLO OPERATIONS HANDBOOK**

CREW-MAN	PNI	PROCEDURES	REMARKS
		<p>4.12.9 <u>RCS STAGING</u></p> <p>LGC Power-Up (required)</p> <p>LGC Self-Test (desired)</p> <p>LGC time valid (required)</p> <p>LGC state vector valid (required)</p> <p>IMU Power-Up (LGC Operating) (required)</p> <p>IMU Orientation Determination (PSI) (required)</p> <p>DAP Data Load Routine (R03) (required)</p> <p>EPS Prestaging Check (required)</p> <p>ECS Prestaging Check (required)</p> <p>ED Prestaging Check (desired)</p> <p>AGS Power-Up (required)</p> <p>AEA Self-Test (desired)</p> <p>AGS time valid (required)</p> <p>AGS LM/CSM state vector valid (required)</p>	<p>Purpose of RCS Staging procedure is to perform manual staging of ascent and descent stages, using RCS translation maneuver.</p> <p>Ref para 4.6.1.1.1.</p> <p>Ref para 4.6.1.1.13.</p> <p>LGC/CMC Clock Synchronization Routine (R33) (para 4.6.1.15)</p> <p>LGC Update Program (P27) (para 4.6.1.7) and, when appropriate, Rendezvous Navigation Program (P20) (para 4.8.2.1)</p> <p>Ref para 4.6.1.1.3. ISS should be on 15 minutes before thrusting maneuver</p> <p>Ref para 4.9.1.1.1.</p> <p>Ref para 4.6.1.1.8.</p> <p>Ref para 4.12.5.</p> <p>Ref para 4.12.7.</p> <p>Ref para 4.12.6.</p> <p>Ref para 4.6.2.1.1.</p> <p>Ref para 4.6.2.3.</p> <p>AGS Manual Absolute Time Initialization procedure (para 4.6.2.6) or AGS Initialization Routine (R47) (para 4.6.1.18)</p> <p>AGS Initialization Routine (R47) (para 4.6.1.18) or AGS Manual LM State Vector Update/Initialization procedure (para 4.6.2.7) and AGS</p>

STAGING

**LMA790-3-LM**  
**APOLLO OPERATIONS HANDBOOK**

LM 3207, LM 3231

CREW- MAN	PNI	PROCEDURES	REMARKS
	<p>4.12.9 <u>RCS STAGING (cont)</u></p> <p>1. Select attitude control: GUID CONT sw - PGNS S/C: ROLL, PITCH, YAW sw - MODE CONT PGNS sw - ATT HOLD AGS sw - ATT HOLD DEAD BAND sw - MIN Key V77E No DAP lt - off</p> <p>2. Enable ACA/TTCA: TTCA/TRANSL sw (2) - ENABLE ACA/4 JET sw (2) - ENABLE THROTTLE/JETS cont (2) - JETS ENG THR CONT: BAL CPL sw - on ATT/TRANSL sw - 4 JETS ACA PROP sw (2) - ENABLE</p> <p>3. Select total attitude &amp; attitude rate/error displays: ORDEAL: FDAI 1 sw - as desired FDAI 2 sw - as desired ATTITUDE MON sw (1) - PGNS ATTITUDE MON sw (1) - AGS RATE/ERR MON sw (2) - LDG RDR/CMPT Key V60E for LGC attitude rate display or Key V61E for mode I attitude error display or</p>	<p>PGNS/AGS Align (required)</p> <p>EPS Prestaging Check (required)</p> <p>ECS Prestaging Check (required)</p> <p>ED Prestaging Check (required)</p> <p>1. Select attitude control: GUID CONT sw - AGS S/C: ROLL, PITCH, YAW sw - MODE CONT AGS sw - ATT HOLD PGNS sw - ATT HOLD DEAD BAND sw - MIN</p> <p>2. Enable ACA/TTCA: TTCA/TRANSL sw (2) - ENABLE ACA/4 JET sw (2) - ENABLE THROTTLE/JETS cont (2) - JETS ENG THR CONT: BAL CPL sw - ON ATT/TRANSL sw - 4 JETS ACA PROP sw (2) - ENABLE</p>	<p>Manual CSM State Vector Update/Initialization procedure (para 4.6.2.9)</p> <p>Ref para 4.9.2.1.</p> <p>Ref para 4.12.5.</p> <p>Ref para 4.12.7.</p> <p>Ref para 4.12.6.</p> <p>Ref para 4.5.1.6 and 4.5.2.5.</p> <p>Ref para 4.5.3.1.</p> <p>Ref para 4.5.3.2</p> <p>Mode I - DAP following errors</p>

**LMA790-3-LM  
APOLLO OPERATIONS HANDBOOK**

LM 3431

CREW-MAN	PNL	PROCEDURES	REMARKS
	<p>4.12.9 <u>RCS STAGING (cont)</u></p> <p>Key V62E for mode II attitude error display</p>	<p>3. Select total attitude &amp; attitude error display: ORDEAL:     FDAI 1 sw - as desired     FDAI 2 sw - as desired     ATTITUDE MON sw - ACS     ATTITUDE MON sw - PCNS     RATE/ERR MON sw (2) - LDG     RDR/CMPTTR</p> <p>4. Select attitude rate display:     RATE SCALE sw - as desired</p> <p>5. Secure self &amp; cabin.</p> <p>6. Set EVNT TMR ind to stage time.</p>	<p>Mode II - total attitude errors with respect to N22 angles (gimbal angles; display is scale limited)</p> <p>Ref para 4.5.3.3.</p> <p>Ref para 4.5.3.4.</p> <p>Ref para 4.5.3.5.</p>
	<p>4. Select attitude rate display:     RATE SCALE sw - as desired</p> <p>5. Secure self &amp; cabin.</p> <p>6. Set EVNT TMR ind to stage time.</p> <p>7. When EVNT TMR ind - 02:00 min:     Key V48E</p> <p>8. FL V01 N46 - DAP configuration/     response data code</p> <p>R1 ABCDE R2 000XX R3 ----- A = 1 - Ascent stage only A = 2 - Ascent and descent stages A = 3 - Ascent and descent stages docked with CSM B = 0 - Two-jet translation (RCS system A alone)</p>	<p>3. Select total attitude &amp; attitude error display: ORDEAL:     FDAI 1 sw - as desired     FDAI 2 sw - as desired     ATTITUDE MON sw - ACS     ATTITUDE MON sw - PCNS     RATE/ERR MON sw (2) - LDG     RDR/CMPTTR</p> <p>4. Select attitude rate display:     RATE SCALE sw - as desired</p> <p>5. Secure self &amp; cabin.</p> <p>6. Set EVNT TMR ind to stage time.</p>	<p>Purpose of Digital Autopilot Data Load Routine (R03) at this time is to preload DAP with ascent configuration information before staging, to assure stable-vehicle condition immediately following staging.</p> <p>R03 should not be entered while average g integration process is on.</p> <p>1BCOE is recommended.</p>

STAGING

**LMA790-3-LM  
APOLLO OPERATIONS HANDBOOK**

CREW- MAN	PNL	PROCEDURES	REMARKS
		<p>4.12.9 <u>RCS STAGING (cont.)</u></p> <p>B = 1 - Two-jet translation (RCS system B alone)            B = 2 - Four-jet translation (RCS systems A &amp; B)            C = 0 - Fine scaling ACA - 4°/sec max            C = 1 - Normal scaling ACA - 20°/sec max            D = 0 - Attitude deadband 0.3°            D = 1 - Attitude deadband 1.0°            D = 2 - Attitude deadband 5.0°            E = KALCMANU rate                0 = 0.2°/sec                1 = 0.5°/sec                2 = 2.0°/sec                3 = 10.0°/sec            Accept: Key PRO            Reject: Key V21E - Load desired            DAP data code</p> <p>9. FL V06 N47            R1 LM weight XXXX lb            R2 CSH weight XXXX lb            R3 -----            Accept: Key V34E - Exit R03            Reject: -Key V21E - Load desired parameter</p> <p>10. Select thrust:            Monitor P47:            Key V37E 47E</p> <p>    Poss PROG lt - on            Key V05 N09E - Call alarm            00210 - IMU not on            00220 - Bad REFSMAT            (orientation not known)            Key KEY REL &amp; RSET            FL V37 N---            Key XXE, exit P47</p>	
			<p>Load ascent weight is supplied by MSFN.</p> <p>P47 should be selected immediately before planned thrusting maneuver, to keep errors associated with average-8 integration at a minimum.</p>
			<p>7. Zero &amp; readout VDX:            Key DEDA            C 404 + 00000E            C 405 + 00000E            C 406 + 00000E            C 470R (0.1/1 fps)</p>

**LMA790-3-LM**  
**APOLLO OPERATIONS HANDBOOK**

CREW-MAN	PNL	PROCEDURES	REMARKS
		<p>4.12.9 <u>RCS STAGING (cont)</u></p> <p>11. FL V16 N83 - ΔV (LM)  R1 X XXXX.X fps  R2 Y XXXX.X fps  R3 Z XXXX.X fps</p> <p>To switch to AGS  control:  GUID CONT sw - AGS</p> <p>12. ACA - maneuver to desired thrusting attitude  Monitor FDAI to avoid gimbal lock.</p> <p>13. EPS:  LMP BAT 1 HI V sw - OFF/RESET;  tb - bp  LMP BAT 2 sw - OFF/RESET;  tb - bp  CDR BAT 3 sw - OFF/RESET;  tb - bp  CDR BAT 4 HI V sw - OFF/RESET;  tb - bp  DES BATS sw - DEADFACE; tb - bp  ED: MASTER ARM sw - ON</p> <p>14. When EVNT TMR ind - 00:00:  TTCA - move down &amp; hold  When ΔVX = -2 fps:  TTCA - center  ED: STAGE sw - FIRE  TTCA - move up &amp; hold  When ΔVX = 0:  TTCA - center</p> <p>15. CB ED: LOGIC PWR A - open  CB ED: LOGIC PWR B - open</p> <p>16. Key PRO or V34E to terminate ΔV monitoring.</p>	<p>Registers display all zeros, except for PIPA bias accumulation, until thrust maneuver is started. N83 is updated every 2 seconds.</p>
		<p>To switch to PGNS  control:  GUID CONT sw - PGNS</p> <p>8. ACA - maneuver to desired thrusting attitude  Monitor FDAI to avoid gimbal lock.</p> <p>9. EPS:  LMP BAT 1 HI V sw - OFF/RESET;  tb - bp  LMP BAT 2 sw - OFF/RESET;  tb - bp  CDR BAT 3 sw - OFF/RESET;  tb - bp  CDR BAT 4 HI V sw - OFF/RESET;  tb - bp  DES BATS sw - DEADFACE; tb - bp  ED: MASTER ARM sw - ON</p> <p>10. When EVNT TMR ind - 00:00:  TTCA - move down &amp; hold  When ΔVX = -2 fps:  TTCA - center  ED: STAGE sw - FIRE  TTCA - move up &amp; hold  When ΔVX = 0:  TTCA - center</p> <p>11. CB ED: LOGIC PWR A - open  CB ED: LOGIC PWR B - open</p>	<p>Leaving ED: MASTER ARM sw - ON places inhibit on ED CWEA preventing spurious master alarm indications (all pyros have been fired at this point). Opening CB's conserves electrical power.</p> <p>Orbital Parameter Display Routine (R30) (para 4.8.1.2) may be called at this time.</p>

STAGIN

**LMA790-3-LM**  
**APOLLO OPERATIONS HANDBOOK**

CREW-MAN	PNL	PROCEDURES	REMARKS
		<p>4.12.9 <u>RCS STAGING (cont)</u></p> <p>17. FL V37 N-- Key XZE, Exit P47</p> <p>4.12.10 <u>AGS FIFTH</u></p> <p>LGC Power-Up (required)</p> <p>LGC Self-Test (desired)</p> <p>LGC time valid (required)</p> <p>LGC state vector valid (required)</p> <p>IMU Power-Up (LGC Operating) (required)</p> <p>IMU Orientation Determination (P51) (required)</p> <p>DAP Data Load Routine (R03) (required)</p> <p>Appropriate prethrust program (required)</p> <p>MPS Basic (Staged) (required)</p> <p>ECS Prestaging Check (required)</p> <p>ED Prestaging Check (desired)</p>	<p>Purpose of AGS FIFTH procedure is to compute preferred IMU orientation and LM attitude for APS thrust maneuver and to maneuver LM to thrusting attitude. This procedure controls PCNCS/AGS during countdown, ignition, staging, thrusting, and thrust termination.</p> <p>Ref para 4.6.1.1.1.</p> <p>Ref para 4.6.1.1.3.</p> <p>LGC/CMC Clock Synchronization Routine (R33) (para 4.6.1.1.15)</p> <p>LGC Update Program (P27) (para 4.6.1.7) or LM Rendezvous Navigation Program (P20) (para 4.8.2.1)</p> <p>Ref para 4.6.1.3. ISS should be on 15 minutes before thrusting maneuver</p> <p>Ref para 4.9.1.1.</p> <p>Ref para 4.6.1.8.</p> <p>Ref para 4.7.</p> <p>Ref para 4.13.3.2.</p> <p>Ref para 4.12.7.</p> <p>Ref para 4.12.6.</p>

**LMA790-3-LM**  
**APOLLO OPERATIONS HANDBOOK**

CREW-MAN	PNL	PROCEDURES	REMARKS
		<p>4.12.10 <u>AGS FITH (cont)</u></p> <p>EPS Prestaging Check (required)</p> <p>APS Pressurization &amp; Checkout (required)</p>	<p>Ref para 4.12.5.</p> <p>Ref para 4.12.3 or 4.12.4.</p> <p>Ref para 4.6.2.1.</p> <p>Ref para 4.6.2.3.</p> <p>AGS Initialization Routine (R47) (para 4.6.1.18) or AGS Manual Abort Time Initialization procedure (para 4.6.2.6).</p> <p>AGS Initialization Routine (R47) (para 4.6.1.18) or AGS Manual Rendezvous Radar LM State Vector Update (para 4.8.2.2).</p> <p>AGS Initialization Routine (R47) (para 4.6.1.18) or AGS Manual CSM State Vector Update/Initialization procedure (para 4.6.2.9).</p> <p>Ref para 4.9.2.1.</p> <p>Ref para 4.6.2.15.</p> <p>Ref para 4.7. If AGS TPI search prethrust was used, TPI excute must have been selected subsequently to be used here.</p> <p>Ref para 4.13.3.2.</p> <p>Ref para 4.12.7.</p> <p>Ref para 4.12.6.</p> <p>Ref para 4.12.5.</p> <p>Ref para 4.12.3 or 4.12.4.</p>

STAGING

**LMA790-3-LM  
 APOLLO OPERATIONS HANDBOOK**

CREW-MAN	PNL	PROCEDURES	REMARKS
		<p>4.12.10 AGS FITH (cont)</p> <p>1. Establish attitude control:                      Key DEDA C 400+00000E                      GUID CONT sw - AGS                      S/C:                          AGS sw - AUTO                          PCNS sw - AUTO                          ROLL, PITCH, YAW sw - MODE CONT</p> <p>2. Establish AGS total attitude &amp; attitude error display:                      ATTITUDE MON sw (1) - AGS                      ATTITUDE MON sw (1) - PCNS                      RATE/ERR MON sw (2) - LDC RDR/                      CMPTR</p> <p>3. Enable ACA &amp; TTCA:                      ACA/4 JET sw (2) - ENABLE                      TTCA/TRANSL sw (2) - ENABLE                      THROTTLE/JETS cont (2) - JETS                      ENG THR CONT: ATT/TRANSL sw -                          4 JETS                      ACA PROP sw (2) - ENABLE</p> <p>4. Prepare thrust controls for APS burn:                      ENG THR CONT: ENG ARM sw - OFF                      ABORT pb - reset                      ABORT STAGE pb - reset                      Eng START pb/lt - off                      Eng STOP pb/lt - reset</p> <p>5. Deleted</p>	<p>Ref para 4.5.3.3 and 4.5.3.4.</p>
		<p>1. Select P42:                      Key V37E 42E                      Poss FL V05 N09 - Alarm                      01706 - Loaded DAP configur-                      ation indicates DPS has not                      staged.                      PROC lt - on                      To continue:                      Key PRO &amp; RSET</p>	



**LMA790-3-LM**  
**APOLLO OPERATIONS HANDBOOK**

CREW-MAN	PNL	PROCEDURES	REMARKS
		<p>4.12.10 <u>AGS FITH (cont)</u></p> <p>To terminate: Key RSET &amp; V34E FL V37N-- Key XXE, Exit P42</p> <p>Poss PROG lt - on Key V05 N09E - Call alarm 00210 - IMU not on 00220 - ISS orientation not known</p> <p>Key KEY REL &amp; RSET FL V37 N-- Key XXE, Exit P42</p> <p>2. Attitude Maneuver Routine (R60)</p> <p>FL V50 N18 - Perform automatic maneuver to final FDAI angles R1 Roll XXX.XX° R2 Pitch XXX.XX° R3 Yaw XXX.XX° Key ENTR</p> <p>2A. FL V50 N25 - Checklist reference R1 00203 Switch to PGNC automatic mode R2 ----- R3 ----- Key ENTR</p> <p>3. V06 N40 - R1 TFI XXBX min-sec R2 VG XXXX.X fps</p>	<p>Perform IMU Power-Up (LGC Operating) (para 4.6.1.3). Alarm 220, perform IMU Orientation Determination Program (para 4.9.1.1).</p> <p>To obtain optional display of VG (LV), perform following: Key V06 N86E R1 X XXXX.X fps R2 Y XXXX.X fps R3 Z XXXX.X fps At this time, LGC zeroes attitude error and sets 1° deadband in RCS DAP.</p> <p>If computed final FDAI angles result in +90° yaw, transformation from IMU to FDAI angles in roll and pitch is indeterminate and R1 and R2 will be zero.</p> <p>Ref para 4.6.2.13.</p>

STAGN

**LMA790-3-LM**  
**APOLLO OPERATIONS HANDBOOK**

CREW-MAN	PNL	PROCEDURES	REMARKS
		<p>4.12.10 <u>AGS FITH (cont)</u></p> <p>R3 AVm XXXX.X fps CMPTR ACTY lt - on Monitor PROG lt from TFI = -00B50 to -00B35. If PROG lt - on: Key V05 N09E - Call alarm 01703 - TIG slipped</p> <p>Key KEY REL &amp; RSET CMPTR ACTY lt - off Update EVNT TMR ind if required.</p> <p>4. When TFI = -00B29: V06 N40 R1 TFI XXBX min-sec R2 VC XXXX.X fps R3 AVm XXXX.X fps</p>	<p>R3 displays 00000 until TFI = -00B30, V06 N40 displays are blanked from TFI = -00B35 to -00B30. CMPTR ACTY lt - on during State Vector Integration Routine (N41). If alarm 1703 occurs, beginning and duration of blanking cannot be defined.</p> <p>a. If switchover to PGCS occurs during or after burn, PGCS will command engine off and attempt to perform burn XX seconds later. Thus, if AGS remains in control up to ignition time and EVNT TMR ind is not reset, PGCS backup capability is lost.</p> <p>b. If EVNT TMR ind is reset per PGCS procedure and AGS remains in control, results stated in "a" will follow.</p> <p>If alarm 1703 occurs and AGS is in control and PGCS in followup, reset EVNT TMR ind and burn XX seconds later under AGS control, or switch to PGCS and burn XX seconds after PRO.</p> <p>Value will equal total velocity to be gained if LM is properly oriented for burn.</p> <p>7. Monitor X-axis component of velocity to be gained (AVgx): Key DEDA C 500R (0.1/1 fps) S/C: DEAD BAND sw - MIN</p>

**LMA790-3-LM**  
**APOLLO OPERATIONS HANDBOOK**

CREW-MAN	PNI	PROCEDURES	REMARKS
		<p>4.12.10 <u>AGS FITH (cont)</u></p> <p>Verify <math>\Delta V_m &lt; 0.5</math> fps from TFI = -00B30 to 00B15.</p> <p>If <math>\Delta V_m &gt; 0.5</math> fps, terminate P42: Key V37E XXE, exit P42</p> <p>5. When TFI = -00B05 FL V99 N40 - Engine on enable R1 TFI XXBXX min-sec R2 VC XXXX.X fps R3 <math>\Delta V_m</math> XXXX.X fps</p> <p>Accept: when <math>\Delta V_m &gt; XXXX.X</math> fps Key PRO</p> <p>Reject alternatives (in event of recycle to TIG -5 sec after staging):</p> <p>a. Perform thrust with RCS Key ENTR, go to PCNGS step 12</p> <p>or</p> <p>b. Terminate Key V34E FL V37 N-- Key XXE, exit P42</p> <p>6. V06 N40 R1 TFI XXBXX min-sec</p>	<p><math>\Delta V_m &gt; 0.5</math> fps indicates excessive PIPA bias error.</p> <p>Ullage time and <math>\Delta V</math> depends on real- time ullage volume. During FL V99 N40, brief FL V06 may appear intermittently; this should be disregarded.</p> <p>Complete protection against effects of single-point failure, which would cause engine to start as soon as it is armed, is not achieved unless ul- lage is completed before arming en- gine.</p> <p>8. ED: MASTER ARM sw - ON</p> <p>9. When EVNT TMR ind = 00:08, initiate ullage maneuver with one of following:</p> <p>a. TTCA - move up until APS start</p> <p>b. +X TRANSL pb - push until APS start</p> <p>Immediately on initiating ullage: ABORT STAGE pb - push ENG THR CONT: ENG ARM sw - ASC</p>

STAGING

**LMA790-3-LM**  
**APOLLO OPERATIONS HANDBOOK**

LM 3231

CREW-MAN	PNL	PROCEDURES	REMARKS
		<p>4.12.10 AGS FITH (cont)</p> <p>R2 VG XXXX.X fps R3 ΔV<sub>m</sub> XXXX.X fps</p> <p>7. When TFI = -00800, monitor thrust.</p> <p>7A. If no APS burn: Perform engine fail procedure (R40) If LGC detect thrust fail: FL V97 NXX - Perform engine fail procedure (noun &amp; registers do not change) R1 XXXXX R2 XXXXX R3 XXXXX Key ENTR, return to step 5</p> <p>8. V06 N40 R1 TFC XXBXX min-sec R2 VG XXXX.X fps R3 ΔV<sub>m</sub> XXXX.X fps</p> <p>TFC &amp; VG decreasing, ΔV<sub>m</sub> increasing: Monitor FDAI. Poss PROG lt - on Key V05 N09E - call alarm 01407 - VG increasing (angle between actual thrust vector and desired thrust vector &gt;90°) Key KEY REL &amp; RSET</p> <p>To switch to AGS control: GUID CONT sw - AGS ABORT STAGE pb - push Go to AGS step 12.</p> <p>If PGCS in followup: Go to PGCS step 12.</p> <p>9. Perform APS/RCS Propellant Interconnect (para 4.13.3.3), steps 1 through 3.</p>	
		<p>10. When EWNT TMR Ind = 00.00, monitor thrust. If no APS burn: Eng START pb/lt - push</p>	
		<p>11. Monitor ΔV<sub>gx</sub> display on DEDA ENG THR CONT: BAL CPL sw - OFF</p>	<p>ΔV<sub>gx</sub> begins to count down at engine ignition. If VG is found to be increasing by LGC, engine-off command will not be generated.</p>
		<p>To switch to PGCS control: GUID CONT sw - PGNS Go to PGCS step 9.</p> <p>12. Perform APS/RCS Propellant Interconnect, (para 4.13.3.3), steps 1 through 3.</p>	<p>TFC is discontinuous and ΔV<sub>m</sub> becomes fairly constant for 4 to 5 seconds.</p>

**LMA790-3-LM  
APOLLO OPERATIONS HANDBOOK**

CREW-MAN	PNL	PROCEDURES	REMARKS
		<p>4.12.10 ACS FITH (cont)</p> <p>10. When IFC = TBD: Perform APS/RCS Propellant Interconnect (para 4.13.3.3), steps 4 &amp; 5.</p> <p>11. Monitor thrust cutoff.</p> <p>a. Early cutoff: Return to step 7A.</p> <p>b. Late or manual cutoff Eng STOP pb/lt - push ABORT STAGE pb - reset ENG THR CONT: ENG ARM sw - OFF Eng STOP pb/lt - reset CB ED: LOGIC PWR A - open CB ED: LOGIC PWR B - open</p> <p>c. Normal cutoff: ABORT STAGE pb - reset ENG THR CONT: ENG ARM sw - OFF</p>	<p>13. When <math>\Delta V_{gx}</math> = TBD: Perform APS/RCS Propellant Interconnect (para 4.13.3.3), steps 4 &amp; 5.</p> <p>14. Monitor thrust cutoff when <math>\Delta V_{gx}</math> display on DEDA reads -00000. If cutoff does not occur: Eng STOP pb/lt - push</p> <p>15. Disarm eng &amp; disable ACS eng control:</p> <p>a. Early or normal cutoff: ABORT STAGE pb - reset ENG THR CONT: ENG ARM sw - OFF Eng STOP pb/lt - reset CB ED: LOGIC PWR A - open CB ED: LOGIC PWR B - open</p> <p>or</p> <p>b. Late cutoff: ABORT STAGE pb - reset ENG THR CONT: ENG ARM sw - OFF Eng STOP pb/lt - reset CB ED: LOGIC PWR A - open CB ED: LOGIC PWR B - open</p> <p>Leaving ED: MASTER ARM sw - ON places inhibit on ED CMEA, preventing spurious master alarm indications (all pyros have been fired at this point). Opening CB's conserves electrical power.</p>

LM 3231

STAGM

**LMA790-3-LM**  
**APOLLO OPERATIONS HANDBOOK**

CREW-MAN	PNI	PROCEDURES	REMARKS	
		<p>4.12.10 ACS FITH (cont)</p> <div style="border: 1px solid black; padding: 2px; margin-bottom: 10px;">                     To switch to ACS control:                      GUID CONT sw - AGS                      Go to ACS step 16.                 </div> <p>12. FL V16 N40                      R1 TFC XXBX min-sec                      R2 VG XXXX.X fps                      R3 ΔV<sub>m</sub> XXXX.X fps                      Record thrust parameters at their final value                      Key PRO</p> <p>13. FL V16 N85 - VG (LM)                      R1 X XXXX.X fps                      R2 Y XXXX.X fps                      R3 Z XXXX.X fps</p> <div style="border: 1px solid black; padding: 2px; margin-bottom: 10px;">                     If PGCS in followup:                      Go to PGCS step 14.                 </div> <p>If nulling of VG components is desired:                      S/C: PGNS sw - ATT HOLD                      ACA/TTCA - null VGX, VGY, &amp; VGZ</p>	<div style="border: 1px solid black; padding: 2px; margin-bottom: 10px;">                     To switch to PGCS control:                      GUID CONT sw - PGNS                      Go to PGCS step 12.                 </div> <p>16. Trim ΔV residual:                      Verify AGS attitude hold submode:                      Key DEDA C 400R                      If +00000 not displayed:                      Key DEDA C 400+00000E                      S/C: DEAD BAND sw - MIN                      ENG THR CONT: BAL CPL sw - ON</p> <p>Read and record:                      ΔV<sub>gx</sub>                      Key DEDA C 500R (0.1/1 fps)                      ΔV<sub>gy</sub>                      Key DEDA C 501R (0.1/1 fps)                      ΔV<sub>gz</sub>                      Key DEDA C 502R (0.1/1 fps)</p> <p>Read out and null ΔV<sub>g</sub> residuals in order of magnitude, largest first.</p>	<p>At this time, LGC zeroes attitude error and sets 0.3° deadband in RCS DAP.</p> <p>If trim maneuver is performed after use of orbit insertion routine, it should be performed immediately after engine shutdown. Orbit insertion routine drives LM to specific point on desired orbit and residual ΔV<sub>gx</sub> will increase naturally after engine shutdown.</p> <p>Null ΔV<sub>gx</sub> by moving TTCA up or down.                      Up nulls positive ΔV<sub>gx</sub>.</p>

**LMA790-3-LM**  
**APOLLO OPERATIONS HANDBOOK**

CREW-MAN	PNL	PROCEDURES	REMARKS
		<p>4.12.10 <u>AGS FIH (cont)</u></p> <p>14. Terminate P42 or select Orbit Parameter Display Routine (R30):</p> <p>a. Terminate            Key PRO            FL V37 N--            Key XXE, exit P42</p> <p>b. Initiate R30:            Key V82E            Poss OPR ERR lt - on            Exit R30, key RSET            FL V16 N44              R1 Ha XXXX.X nm              R2 Hp XXXX.X nm              R3 TFF XXBXX min-sec</p> <p>Key PRO when finished with R30 to reestablish P42 N85 displays &amp; exit R30.</p> <p>Key PRO            FL V37 N--            Key XXE, exit P42</p>	<p>Null ΔVgy by moving TTCA right or left. Right nulls positive ΔVgy.</p> <p>Null ΔVgz by moving TTCA in or out. In nulls positive ΔVgz.</p> <p>S/C: DEAD BAND sw - MAX</p> <p>17. Read out predicted perifocus altitude:            Key DEDA C 403R (0.1 nm)            Compare with PGNCs Hp.</p> <p>Read out apofocus altitude:            Key DEDA C 315R (0.1 nm)            Compare with PGNCs Ha.</p> <p>At this time, LGC restores crew-specified (R03) deadband limits in RCS DAP.</p> <p>OPR ERR lt - on if another extended verb from R76 is in process.</p> <p>Orbit parameters are recomputed every 2 seconds while average g routine is running.            Maximum TFF reading is 59:59.</p>

STAGING





**LMA790-3-LM**  
**APOLLO OPERATIONS HANDBOOK**

PARA	TITLE	PAGE
4.13	Subsystem Management . . . . .	4.13-3
4.13.1	ECS . . . . .	4.13-3
4.13.1.1	ECS Basic (Unstaged & Staged) . . . . .	4.13-3
4.13.1.2	ECS Periodic Monitoring (Unstaged) . . . . .	4.13-5
4.13.1.3	ECS Periodic Monitoring (Staged) . . . . .	4.13-7
4.13.1.4	Secondary Coolant Loop (HTS) Activation . . . . .	4.13-8
4.13.1.5	Primary LiOH Cartridge Replacement . . . . .	4.13-9
4.13.1.6	Secondary LiOH Cartridge Replacement . . . . .	4.13-10
4.13.1.7	Cabin Depressurization . . . . .	4.13-11
4.13.1.8	Cabin Re-pressurization . . . . .	4.13-13
4.13.1.9	Cabin Leak Check . . . . .	4.13-14
4.13.1.10	LCG Recharge . . . . .	4.13-14
4.13.1.11	Reverse O2 Umbilicals for PGA Cooling . . . . .	4.13-15
4.13.1.12	H2O Dispenser Activation . . . . .	4.13-16
4.13.1.13	Cabin Atmosphere Filtering . . . . .	4.13-17
4.13.2	Communications . . . . .	4.13-17
4.13.2.1	Communications Basic . . . . .	4.13-17
4.13.2.2	S-Band Configuration for LOS . . . . .	4.13-19
4.13.2.3	Relay Mode: EVA (Two-Man EVA) . . . . .	4.13-20
4.13.2.4	Relay Mode: EVA (One-Man EVA) . . . . .	4.13-21
4.13.2.5	Relay Mode: CSM Voice to MSFN . . . . .	4.13-22
4.13.2.6	VHF B Data Enable . . . . .	4.13-23
4.13.2.7	S-Band LBR Data Enable . . . . .	4.13-23
4.13.2.8	S-Band CNEA Enable . . . . .	4.13-23
4.13.2.9	DSEA Check . . . . .	4.13-23
4.13.2.10	VHF Ranging Check . . . . .	4.13-24
4.13.2.11	DUA Enable . . . . .	4.13-25
4.13.2.12	DUA Disable . . . . .	4.13-25
4.13.2.13	DUA Backup Voice Enable . . . . .	4.13-26
4.13.2.14	DUA Backup Voice Disable . . . . .	4.13-26
4.13.2.15	S-Band Antenna Cooldown . . . . .	4.13-26
4.13.2.16	S-Band Operation in PTC Mode . . . . .	4.13-26
4.13.3	Propulsion . . . . .	4.13-28
4.13.3.1	MPS Basic (Unstaged) . . . . .	4.13-28
4.13.3.2	MPS Basic (Staged) . . . . .	4.13-28
4.13.3.3	APS/RCS Propellant Interconnect . . . . .	4.13-29
4.13.3.4	DPS Periodic Monitoring . . . . .	4.13-30
4.13.3.5	APS Periodic Monitoring . . . . .	4.13-31
4.13.3.6	RCS Periodic Monitoring . . . . .	4.13-34
4.13.4	EPS . . . . .	4.13-35
4.13.4.1	EPS Basic (Unstaged) . . . . .	4.13-35
4.13.4.2	EPS Basic (Staged) . . . . .	4.13-36
4.13.4.3	EPS Preparation for DPS Burn . . . . .	4.13-36
4.13.4.4	EPS Check, Post-DPS Burn . . . . .	4.13-38
4.13.4.5	EPS Periodic Monitoring (Unstaged) . . . . .	4.13-38
4.13.4.6	EPS Periodic Monitoring (Staged) . . . . .	4.13-40
4.13.4.7	LCA Duty Cycle During Secondary Coolant Loop Operation . . . . .	4.13-40
4.13.4.8	Lunar Stay Battery Management . . . . .	4.13-41
4.13.5	Heaters Status Check . . . . .	4.13-44
4.13.6	Set Event Timer . . . . .	4.13-44
4.13.7	Waste Management . . . . .	4.13-44
4.13.7.1	Transfer Urine to D/S Waste Container (Prime Mode) . . .	4.13-45
4.13.7.2	Transfer Urine to D/S Waste Container (Alternative Mode) . . . . .	4.13-46
4.13.7.3	Transfer Urine to Small Urine Collection Assembly . . .	4.13-47
4.13.7.4	Emesis Disposal . . . . .	4.13-48
4.13.7.5	Deleted . . . . .	4.13-49/4.13-50
4.13.7.6	Defecation Disposal . . . . .	4.13-49/4.13-50
4.13.8	Installation of 16-MM Sequence Camera Wedge . . . . .	4.13-49/4.13-50
4.13.9	Window Shades (CDR, LMP, & Docking) . . . . .	4.13-51/4.13-52

**LMA790-3-LM**  
**APOLLO OPERATIONS HANDBOOK**

PARA	TITLE	PAGE
4.13.9.1	Deploy Shades . . . . .	4.13-51/4.13-52
4.13.9.2	Stow Shades . . . . .	4.13-51/4.13-52
4.13.10	Crash Bar Deployment . . . . .	4.13-51/4.13-52
4.13.10.1	Unstow Crash Bar . . . . .	4.13-51/4.13-52
4.13.10.2	Stow Crash Bar . . . . .	4.13-51/4.13-52

**LMA790-3-LM**  
**APOLLO OPERATIONS HANDBOOK**

CREW-MAN	PNL	PROCEDURES	REMARKS
		<p>4.13 <u>SUBSYSTEM MANAGEMENT</u></p> <p>Subsystem management procedures are a compilation of procedures that are common to more than one mission phase. The procedures involve basic switch configurations, integrity and status checks, servicing, and periodic monitoring. The procedures consist of the following:</p> <p style="padding-left: 40px;">Basic switch configurations of the ECS, communications, propulsion, and EPS</p> <p style="padding-left: 40px;">Integrity checks of cabin pressure, water separator, water separator, communications relay modes, data transmission and TV operation, and heaters status check.</p> <p style="padding-left: 40px;">Servicing of primary and secondary CO2 canisters</p> <p style="padding-left: 40px;">Periodic monitoring of ECS, DPS, AFS, and RCS.</p> <p>4.13.1 <u>ECS</u></p> <p>4.13.1.1 <u>ECS Basic (Unstaged &amp; Staged)</u></p> <p style="padding-left: 40px;">CAUTION</p> <p style="padding-left: 40px;">Due to interlock, #1 ASC 02 vlv cannot be set to OPEN before DES 02 vlv is set to CLOSE.</p> <p style="padding-left: 40px;">If DES 02 vlv cannot be set to CLOSE: INTLK OVRD pb - push #1 ASC 02 vlv - OPEN</p> <p style="padding-left: 40px;">Do not override this interlock until after vehicle is staged. To do otherwise would cause excessive loss of O2.</p> <p style="padding-left: 40px;">Do not perform ECS staged configuration prior to 30 minutes before staging. To do otherwise would unnecessarily deplete ascent stage consumables.</p> <p style="padding-left: 40px;">When PRESS REG A and/or B vlv - CLOSE, ensure handle is rotated to full hard stop position.</p> <p style="padding-left: 40px;">When positioning any faucet-type ECS valve to CLOSE position, ensure handle is rotated to full hard stop position.</p>	

SUBSYSTEM  
MCM

**LMA790-3-LM**  
**APOLLO OPERATIONS HANDBOOK**

CREW-MAN	PNL	PROCEDURES	REMARKS
		<p>4.13.1.1 <u>ECS Basic (Unstaged &amp; Staged) (cont)</u></p> <p style="text-align: center;"><u>Unstaged</u>                      <u>Staged</u></p>	
	ECS	<p>1. SUIT GAS DIVERTER vlv                      PUSH CABIN    PULL EGRESS</p> <p style="text-align: center;">CAUTION</p> <p>Rapid switching of CABIN REPRESS vlv from AUTO to CLOSE, or CLOSE to AUTO, causes loud bang. This does not damage valve. To change CABIN REPRESS vlv position, smooth, slow movement is recommended.</p> <p>CABIN REPRESS vlv                      AUTO                      CLOSE</p> <p>LO PLS FILL vlv                      CLOSE</p> <p>PRESS REG A vlv                      CABIN</p> <p>PRESS REG B vlv                      CABIN</p> <p>DES O2 vlv                      OPEN</p> <p>#1 ASC O2 vlv                      CLOSE</p> <p>#2 ASC O2 vlv                      CLOSE</p> <p>SUIT ISOL vlv (LMP)                      SUIT FLOW</p> <p>SUIT ISOL vlv (CDR)                      SUIT FLOW</p> <p>SEC EVAP FLOW vlv                      CLOSE</p> <p>PRI EVAP FLOW #2 vlv                      CLOSE</p> <p>WATER TANK SELECT vlv                      DES</p> <p>SUIT TEMP vlv                      adjust</p> <p>ASC H20 vlv                      adjust</p> <p>DES H20 vlv                      OPEN</p> <p>PRI EVAP FLOW #1 vlv                      CLOSE</p> <p>CABIN GAS RETURN vlv                      OPEN</p> <p>CO2 CANISTER SEL vlv                      EGRESS</p> <p>SUIT CIRCUIT RELIEF vlv                      PRIM</p> <p>PRIM CO2 CANISTER cover                      AUTO</p> <p>SEC CO2 CANISTER cover                      AUTO</p> <p>WATER SEP SEL vlv                      CLOSE</p> <p>LIQUID GARMENT COOLING vlv                      PUSH SEP I</p> <p>HI PLS O2 FILL vlv                      PUSH SEP I</p> <p style="text-align: right;">+Z27</p>	<p>During unstaged main engine burn: SUIT GAS DIVERTER vlv - PULL EGRESS CABIN GAS RETURN vlv - EGRESS</p> <p>This step should be performed before selecting ascent O2 consumables, to prevent unnecessary use of ascent O2.</p> <p>During staging and ascent engine burn: PRESS REG A &amp; B vlv - EGRESS</p>
		<p>2. Cabin relief &amp; dump vlv (ovhd)</p> <p>Cabin relief &amp; dump vlv (fwd)</p>	

**LMA790-3-LM  
APOLLO OPERATIONS HANDBOOK**

LM 3216

CREW-MAN	PNL	PROCEDURES	REMARKS
		4.13.1.1 ECS Basic (Unstaged & Staged) (cont)	
CDR	11	3. CB ECS: SUIT FAN 1 CABIN FAN GLYCOL PUMP 2 GLYCOL PUMP 1 GLYCOL PUMP AUTO TRNFR	GLYCOL PUMP AUTO TRNFR closed during lunar surface operation.
LMP	2	4. GLYCOL sel SUIT FAN sel O2/H2O QTY MON sel ECS: PRESS ind pwr fail lt GLYCOL ind pwr fail lt QUANTITY ind pwr fail lt GLYCOL comp caut lt SUIT FAN comp caut lt CO2 comp caut lt H2O SEP comp caut lt	
	16	5. CB ECS: SUIT FLOW CONT DISP GLYCOL PUMP SEC LCG PUMP  CABIN FAN CONT CABIN REPRESS SUIT FAN 2 SUIT FAN AP DIVERT VLV CO2 SENSOR	CB ECS: LCG PUMP - open at least 30 minutes before sleep period.  Assumption: ECS Basic (Unstaged).
	2	4.13.1.2 ECS Periodic Monitoring (Unstaged)  1. ECS: CABIN TEMP ind - 42° to 90°F PRESS ind pwr fail lt - off SUIT PRESS ind - 4.6 to 5.0 psia CABIN PRESS ind - 4.6 to 5.0 psia PART PRESS CO2 ind - <7.6 mm Hg	MASTER ALARM, ECS caut lt, and CO2 comp caut lt go on when 2.274+0.025 volts is sensed at CWEA comparator.

SUBSYS  
MGMT

**LMA790-3-LM**  
**APOLLO OPERATIONS HANDBOOK**

CREW/ MAN	P/NL	PROCEDURES	REMARKS
	2	<p>4.13.1.2 ECS Periodic Monitoring (Unstaged) (cont)</p> <p>GLYCOL ind pwr fail lt - off            GLYCOL temp ind - 33° to 49°F            GLYCOL press ind - 21 to 37 psia            GLYCOL comp caut lt - off            SUIT FAN comp caut lt - off            C02 comp caut lt - off            H2O SEP comp caut lt - off</p> <p>2. 02/H2O QTY MON sel - DES 2            ECS:            QUANTITY ind pwr fail lt - off            02 QUANTITY ind - TBDZ            H2O QUANTITY ind - TBDZ</p> <p>3. 02/H2O QTY MON sel - DES 1            ECS:            QUANTITY ind pwr fail lt - off            02 QUANTITY ind - TBDZ            H2O QUANTITY ind - TBDZ</p> <p>4. 02/H2O QTY MON sel - ASC 1            ECS:            02 QUANTITY ind - approx 100Z            H2O QUANTITY ind - approx 76Z</p> <p>5. 02/H2O QTY MON sel - ASC 2            ECS:            02 QUANTITY ind - approx 100Z            H2O QUANTITY ind - approx 76Z</p> <p>6. 02/H2O QTY MON sel - DES 2</p>	<p>When sensed at 5.0 psia, actual C02 partial pressure could be between 4.06 and 9.30 mm Hg when MASTER ALARM, ECS caut lt, and C02 comp caut lt go on. ECS: PART PRESS C02 ind will read nominally 7.6 mm Hg at this time.</p> <p>When sensed at 3.7 psia, actual C02 partial pressure could be between 5.21 and 12.6 mm Hg when MASTER ALARM, ECS caut lt, and C02 comp caut lt go on. ECS: PART PRESS C02 ind will read nominally 7.6 mm Hg at this time.</p> <p>Quantity of consumables displayed is function of mission elapsed time.</p> <p>Quantity of consumables displayed is function of mission elapsed time.</p> <p>Assumption: H2O tank fill ratio is 0.75.</p> <p>Assumption: H2O tank fill ratio is 0.75.</p>

**LMA790-3-LM**  
**APOLLO OPERATIONS HANDBOOK**

CREW-MAN	PNL	PROCEDURES	REMARKS
LJP	2	<p>4.13.1.3 ECS Periodic Monitoring (Staged)</p> <p>1. ECS:            CABIN TEMP ind - 42° to 90°F            PRESS ind pwr fail lt - off            SUIT PRESS ind - 4.6 to 5.0 psia            CABIN PRESS ind - 4.6 to 5.0 psia            PART PRESS CO2 ind - &lt;7.6 mm Hg</p>	<p>MASTER ALARM, ECS caut lt, and CO2 comp caut lt go on when 2.274±0.025 volts is sensed at CMEA comparator. When CO2 partial pressure is sensed as 5.0 psia, actual CO2 partial pressure could be between 5.35 and 8.25 mm Hg.</p> <p>When sensed at 5.0 psia, actual CO2 partial pressure could be between 4.06 and 9.30 mm Hg when MASTER ALARM, ECS caut lt, and CO2 comp caut lt go on. ECS: PART PRESS CO2 ind will read nominally 7.6 mm Hg at this time.</p> <p>When sensed at 3.7 psia, actual CO2 partial pressure could be between 5.21 and 12.6 mm Hg when MASTER ALARM, ECS caut lt, and CO2 comp caut lt go on. ECS: PART PRESS CO2 ind will read nominally 7.6 mm Hg at this time.</p>
		<p>2</p> <p>GLYCOL ind pwr fail lt - off            GLYCOL temp ind - 33° to 49°F            GLYCOL press ind - 21 to 37 psia            GLYCOL comp caut lt - off            SUIT FAN comp caut lt - off            CO2 comp caut lt - off            H2O SEP comp caut lt - off</p> <p>2. O2/H2O QTY MON sel - ASC 1            ECS:            QUANTITY ind pwr fail lt - off            O2 QUANTITY ind - TBDZ            H2O QUANTITY ind - TBDZ</p> <p>3. O2/H2O QTY MON sel - ASC 2            ECS:            O2 QUANTITY ind - approx 100Z            H2O QUANTITY ind - TBDZ</p> <p>4. O2/H2O QTY MON - ASC 1</p>	<p>Quantity of consumables displayed is function of mission elapsed time.</p>

SUBSYS  
MGMT

**LMA790-3-LM**  
**APOLLO OPERATIONS HANDBOOK**

CREW-MAN	PNL	PROCEDURES	REMARKS
		4.13.1.4 <u>Secondary Coolant Loop (HTS) Activation</u>	Activation of heat transport section secondary coolant loop assumes either failure of both primary glycol pumps, loss of primary glycol, or inability to maintain primary glycol loop temperature below +50°F.
			GLYCOL comp caut lt remains on after secondary coolant loop is activated.
			Following are not cooled by secondary coolant loop: LGC CDU PTA DSEA PSA GASTA LCA Descent batteries Cabin Descent ECA (2) IMU
	ECS 16	1. WATER TANK SELECT vlv - SEC	
LMP	2	2. CB ECS: GLYCOL PUMP SEC - close	
	ECS 11	3. GLYCOL sel - INST (SEC) ECS caut lt - off	
	ECS 11	4. SEC EVAP FLOW vlv - open	
CDR		5. CB ECS: GLYCOL PUMP 2 - open GLYCOL PUMP 1 - open GLYCOL PUMP AUTO TRNFR - open	
LMP	ECS 16	6. PRI EVAP FLOW #1 vlv - CLOSE PRI EVAP FLOW #2 vlv - CLOSE ASC H2O vlv - OPEN DES H2O vlv - CLOSE	
CDR	11	7. CB ECS: LCG PUMP - open CABIN FAN - open	



**LMA790-3-LM**  
**APOLLO OPERATIONS HANDBOOK**

CREW- MAN	PNL	PROCEDURES	REMARKS
		<p>4.13.1.5 <u>Primary LiOH Cartridge Replacement</u></p> <p style="text-align: center;">CAUTION</p> <p>If LiOH cartridge is replaced while cabin is depressurized, perform steps 1 &amp; 2.</p> <p>1. Verify following: CB ECS: SUIT FLOW CONT - close CABIN REPRESS - open</p> <p>2. CABIN REPRESS vlv - AUTO</p> <p>3. CO2 CANISTER SEL vlv - SEC CO2 comp caut lt - on ECS caut lt - off</p> <p>4. ECS: PART PRESS CO2 ind - monitor</p> <p>5. PRIM CO2 CANISTER VENT pb - push</p> <p>6. Grasp primary CO2 canister cover handle. press latch trigger with thumb &amp; hold.</p> <p>7. Rotate primary CO2 canister cover counterclockwise to detent, so that index on handle covers index on canister cover &amp; aligns with OPEN index on canister rim. Release latch trigger.</p> <p>8. Verify cover is in OPEN detent &amp; remove from canister.</p> <p>9. Rotate &amp; remove LiOH cartridge from canister.</p> <p>10. Open primary LiOH stowage container &amp; remove unused cartridge. Insert used cartridge in stowage container &amp; secure cover.</p> <p>11. Insert unused cartridge in primary CO2 canister. align lugs, &amp; rotate cartridge to secure in canister.</p> <p>12. Install primary CO2 canister &amp; verify index on handle covers index on canister cover (OPEN detent position).</p> <p>13. Align indexes on canister cover with index on canister rim.</p>	<p>Ascent engine cover must be cleared of stowed equipment to gain access to LiOH cartridge.</p> <p>ECS: PART PRESS CO2 ind should indicate pressure decay to zero mm Hg. Step 5 vents ΔP across canister.</p>
LMP	16		
LMP	ECS		
LMP	ECS 2		
LMP	ECS		
LMP			

SUBSY  
MGMT

**LMA790-3-LM**  
**APOLLO OPERATIONS HANDBOOK**

CREW-MAN	PNI	PROCEDURES	REMARKS
		<p>4.13.1.5 <u>Primary LiOH Cartridge Replacement (cont)</u></p> <p>14. Grasp primary CO2 canister cover handle press latch trigger, &amp; rotate cover clockwise.</p> <p>15. Release trigger, verify primary CO2 canister cover is in CLOSED detent &amp; handle index is aligned with CLOSE index on canister rim.</p> <p>16. CO2 CANISTER SEL vlv - PRIM</p> <p>17. CO2 comp caut lt - off</p> <p>18. ECS: PART PRESS CO2 ind - monitor</p> <p>4.13.1.6 <u>Secondary LiOH Cartridge Replacement</u></p> <p style="text-align: center;">CAUTION</p> <p>If LiOH cartridge is replaced while cabin is depressurized, perform steps 1 &amp; 2. If depressurized &amp; staged, omit step 2.</p> <p>1. Verify following CB ECS: SUIT FLOW CONT - close CABIN REPRESS - open</p> <p>2. CABIN REPRESS vlv - AUTO</p> <p>3. CO2 CANISTER SEL vlv - PRIM CO2 comp caut lt - off</p> <p>4. SEC CO2 CANISTER VENT pb - push</p> <p>5. Grasp secondary CO2 canister cover handle, press latch trigger with thumb &amp; hold.</p> <p>6. Rotate cover counterclockwise to detent, so that index on handle covers index on cover &amp; aligns with OPEN index on canister rim. Release latch trigger.</p> <p>7. Verify cover is in OPEN detent &amp; remove from canister.</p>	<p>Perform ARS/PGA Pressure Integrity Check procedure (para 4.2.16).</p> <p>Ascent engine cover must be cleared of stowed equipment to gain access to LiOH cartridge.</p> <p>There is no spare secondary LiOH cartridge in cabin until spare from descent stage is stowed in cabin after lunar touchdown.</p> <p>PLSS LiOH cartridge must be used as replacement in ECS, if replacement is attempted in orbit.</p> <p>Step 4 vents ΔP across canister.</p>

**LMA790-3-LM**  
**APOLLO OPERATIONS HANDBOOK**

CREW-MAN	PNL	PROCEDURES	REMARKS
		<p>4.13.1.1.6 <u>Secondary LiOH Cartridge Replacement (cont)</u></p> <p>8. Rotate &amp; remove LiOH cartridge from canister.</p> <p>9. Insert fresh secondary LiOH cartridge in canister, align lugs &amp; rotate cartridge to secure in canister.</p> <p>10. Install canister cover &amp; verify index on handle covers index on cover (OPEN detent position).</p> <p>11. Align indexes on cover with index on canister rim.</p> <p>12. Grasp cover handle, depress latch trigger &amp; rotate cover clockwise.</p> <p>13. Release trigger. Verify cover is in close detent position, with handle index aligned with CLOSE index on canister rim.</p> <p>14. CO2 CANISTER SEL vlv - SEC</p> <p>15. CO2 comp caut lt - on</p> <p>16. ECS: PART PRESS CO2 ind - &lt;7.6 mm Hg</p> <p>4.13.1.1.7 <u>Cabin Depressurization</u></p> <p>1. Verify ECS Basic (Unstaged)</p> <p>2. Perform ARS/PGA Pressure Integrity Check.</p> <p>3. PRESS REG A &amp; B vlv - EGRESS</p> <p style="text-align: center;">CAUTION</p> <p>Rapid switching of CABIN REPRESS vlv from AUTO to CLOSE, or CLOSE to AUTO, causes loud bang. This does not damage valve. To change CABIN REPRESS vlv position, smooth, slow movement is recommended.</p> <p>4. CABIN REPRESS vlv - AUTO</p> <p>5. SUIT GAS DIVERTER vlv - PULL EGRESS</p> <p>6. CABIN GAS RETURN vlv - EGRESS</p>	<p>Ref para 4.13.1.1.</p> <p>Ref para 4.2.16.</p> <p>This automatically deactivates cabin fan.</p>
LMP			
CDR/ LMP			
LMP			

SUBSYS  
MGM

**LMA790-3-LM**  
**APOLLO OPERATIONS HANDBOOK**

CREW-MAN	PNL	PROCEDURES	REMARKS
CDR		<p>4.13.1.7 <u>Cabin Depressurization (cont)</u></p> <p>7. Cabin relief &amp; dump vlv (ovhd) - OPEN (applicable for docked vehicle only)</p> <p>8. CB ECS: CABIN FAN - open</p> <p>9. CB ECS: CABIN REPRESS - open</p> <p>10. Cabin relief &amp; dump vlv (fwd or ovhd) - Cycle from AUTO to OPEN until cabin pressure is reduced to approx 3.2 psia</p> <p>11. Cabin relief &amp; dump vlv (fwd &amp; ovhd) - AUTO</p> <p>12. ECS: SUIT PRESS ind - 3.6 to 4.3 psia</p> <p>13. Cabin relief &amp; dump vlv (fwd or ovhd) - OPEN &amp; reduce cabin pressure to zero psia</p> <p>14. CB ECS: SUIT FLOW CONT - open (one-man EVA only)</p> <p>15. Cabin relief &amp; dump vlv (fwd) - AUTO</p> <p>16. Cabin relief &amp; dump vlv (ovhd) - AUTO</p> <p style="text-align: center;">CAUTION</p> <p>Rapid switching of CABIN REPRESS vlv from AUTO to CLOSE, or CLOSE to AUTO, causes loud bang. This does not damage valve. To change CABIN REPRESS vlv position, smooth, slow movement is recommended.</p> <p>17. CABIN REPRESS vlv - CLOSE</p>	<p>Depressurizes docking tunnel during cabin depressurization.</p> <p>Prevents activation of cabin fan in depressurized cabin.</p> <p>Forward or overhead cabin relief and dump valve may be used to depressurize cabin, if undocked (forward only if docked).</p> <p>During cabin depressurization, SUIT CIRCUIT RELIEF vlv closes when ARS pressure drops to 4.3 psia. To verify proper operation (closure) of valve, cabin pressure must be below 4.3 psia.</p> <p>Forward hatch can be opened within 2 minutes after cabin relief and dump vlv (fwd or ovhd) - OPEN (cabin pressure &lt;0.08 psia).</p>

**LMA790-3-LM**  
**APOLLO OPERATIONS HANDBOOK**

CREW-MAN	PNL	PROCEDURES	REMARKS
CDR	ECS	<p>4.13.1.8 <u>Cabin Repressurization</u></p> <p>1. Cabin relief &amp; dump vlv (fwd) - AUTO</p> <p>2. Cabin relief &amp; dump vlv (ovhd) - AUTO</p> <p style="text-align: center;">CAUTION</p> <p>Rapid switching of CABIN REPRESS vlv from AUTO to CLOSE, or CLOSE to AUTO, causes loud bang. This does not damage valve. To change CABIN REPRESS vlv position, smooth, slow movement is recommended.</p>	<p>Assumption: LM is unstaged.</p>
LMP	16 1.2 1 ECS	<p>3. CABIN REPRESS vlv - AUTO CB ECS: CABIN REPRESS - close MASTER ALARM - on CABIN warn lt - on CABIN REPRESS vlv opens</p>	<p>PLSS high O2 flow warning tone - on (3000-cps warble) if active PLSS is connected to PGA.</p>
CDR	1	4. PRESS REC A vlv - CABIN	
LMP	ECS	5. MASTER ALARM pb/lt - reset	
	1	6. PRESS REC B vlv - CABIN	
	1	7. CABIN warn lt - off	<p>CABIN REPRESS vlv closes and CABIN warn lt goes off when pressure reaches 4.4 to 5.0 psia.</p>
		8. Verify cabin pressure stabilizes at 4.8±0.2 psia.	<p>Cabin pressure stabilizes approximately 2 minutes after CABIN REPRESS vlv closes.</p>
	ECS	9. Return to ECS Basic (Unstaged), except: CABIN GAS RETURN vlv - AUTO before SUIT GAS DIVERTER vlv - PUSH CABIN	<p>Ref para 4.13.1.1. Reversing this sequence may cause suit fan to stall and water separator to slow down, causing: MASTER ALARM - on ECS caut lt - on SUIT FAN comp caut lt - on H2O SEP comp caut lt - on</p>



**LMA790-3-LM**  
**APOLLO OPERATIONS HANDBOOK**

CREW-MAN	PNL	PROCEDURES	REMARKS
LMP	ECS	<p>4.13.1.9 <u>Cabin Leak Check</u></p> <p>1. PRESS REG A &amp; B vlv - EGRESS</p> <p>2. ECS: CABIN PRESS ind - monitor periodically (2 hours)</p> <p>3. ECS: CABIN PRESS ind - decay &lt;0.6 psia</p> <p>4. Controls - ECS Basic (Unstaged)</p>	<p>Assumptions: (1) ECS Basic (Unstaged) and (2) undocked LM. Task can be accomplished in parallel with other non-ECS tasks, to save time.</p> <p>Action sets SUIT GAS DIVERTER vlv to PULL EGRESS and turns off cabin fan. If operation of cabin fan is desired: CB ECS: CABIN FAN CONT - open</p> <p>A 0.6-psia pressure decay is based on cabin free volume of 235 cubic feet, cabin initially at 4.8 psia and leaking 0.2 pound of O2 per hour. Corrections must be made for fluctuations in cabin temperature and for metabolic consumption. MSFN can verify specified leakage rates with only 30 minutes of monitoring cabin pressure.</p> <p>Ref para 4.13.1.1. When performing ECS Basic procedure, CABIN GAS RETURN vlv - AUTO before SUIT GAS DIVERTER vlv - PUSH CABIN. Reversing this sequence may cause suit fan to stall and water separator to slow down causing: MASTER ALARM - on ECS caut lt - on SUIT FAN comp caut lt - on H2O SEP comp caut lt - on</p>
		<p>4.13.1.10 <u>Contingency LCG Recharge</u></p> <p style="text-align: center;">WARNING</p> <p>Do not perform LCG recharge until MSFN verifies LM water pressure is &lt;37 psia.</p> <p>1. Verify with MSFN that sufficient water is available to perform LCG recharge.</p> <p>2. Verify RCU pump, fan and mode select switches - OFF.</p> <p>3. Connect RCU to PLSS.</p> <p>4. Connect PLSS water hose to PGA water connector.</p>	<p>Assumptions: (1) LCG leak has been isolated and corrective action taken, and (2) crewman is wearing LCG and PGA.</p> <p>The LCG will be subjected to LM water tank pressure which may be as high as 48 psia.</p> <p>PLSS must be upright, conformal side facing crewman.</p>

LM 2018

**LMA790-3-LM**  
**APOLLO OPERATIONS HANDBOOK**

LM 4.13-3

CREW-MAN	PNL	PROCEDURES	REMARKS
		4.13.1.10 <u>Contingency LGC Recharge (cont)</u>	
	PLSS	5. H2O DIVERTER vlv - MAX (aft)	
	PLSS	6. H2O SHUTOFF AND RELIEF vlv - CLOSED (fwd)	
	ECS	7. DES H2O vlv - CLOSE	
		8. Disconnect water dispenser & stow.	
		9. Connect LM water recharge hose to PLSS H2O fill connector.	
	ECS	10. DES H2O vlv - OPEN	
	PLSS	11. PUMP sw - ON	
		12. Activate PLSS gas trap by depressing button until water flows through vent hole, then release button; wait 10 seconds then repeat. Continue button depress cycle until water flows <u>immediately</u> upon depressing button.	
	PLSS	13. PUMP sw - OFF	LGC is full when water flows immediately upon depressing button.
	ECS	14. DES H2O vlv - CLOSE	
		15. Disconnect PLSS water hose from PGA.	
		16. Disconnect LM water recharge hose from PLSS.	
		17. Disconnect PLSS water hose from PGA.	
		18. Verify RCU pump, fan and mode select switches - OFF.	
		19. Disconnect RCU from PLSS.	
		20. Connect water dispenser to LM water recharge hose.	
	ECS	21. DES H2O vlv - OPEN	

SUBSYS  
MGMT

**LMA790-3-LM**  
**APOLLO OPERATIONS HANDBOOK**

LM 2018, LM 3215

CREW-MAN	PNI	PROCEDURES	REMARKS
CDR/ LMP		<p>4.13.1.11 <u>Reverse O2 Umbilicals for PGA Cooling</u></p> <p style="text-align: center;">WARNING</p> <p>Umbilicals must not be reversed for normal helmet-on operations.</p> <ol style="list-style-type: none"> <li>1. Remove helmet &amp; gloves.</li> <li>2. SUIT ISOL vlv - SUIT DISC</li> <li>3. Disconnect LM O2 umbilicals from PGA.</li> <li>4. Connect LM O2 umbilicals to PGA (red to blue, blue to red).</li> <li>5. SUIT ISOL vlv - SUIT FLOW &amp; verify O2 flow</li> <li>5a. SUIT GAS DIVERTER vlv - PULL EGRESS CABIN GAS RETURN vlv - EGRESS PGA DIVERTER vlvs - horizontal</li> <li>6. When activity is completed: SUIT ISOL vlv - SUIT DISC</li> <li>7. Disconnect LM O2 umbilicals from PGA.</li> <li>8. Connect LM O2 umbilicals to PGA (red to red, blue to blue).</li> <li>9. SUIT ISOL vlv - SUIT FLOW &amp; verify O2 flow.</li> <li>9a. CABIN GAS RETURN vlv - AUTO SUIT GAS DIVERTER vlv - PUSH CABIN</li> <li>10. Don helmet &amp; gloves.</li> </ol> <p>4.13.1.12 <u>H2O Dispenser Activation</u></p>	<p>Purpose of Reverse O2 Umbilicals for PGA Cooling procedure is to provide body cooling during periods necessitating helmet-off operations.</p> <p>For water separator speed control.</p> <p>Assumption: H2O dispenser is connected to spacecraft H2O hose before launch.</p> <p>H2O dispenser serves as fire extinguisher when slide safety is disengaged and fire extinguisher valve is actuated.</p>



**LMA790-3-LM  
APOLLO OPERATIONS HANDBOOK**

CREW-MAN	PNL	PROCEDURES	REMARKS
	ECS	<p>4.13.1.12 <u>H2O Dispenser Activation (cont)</u></p> <ol style="list-style-type: none"> <li>1. Unstow H2O dispenser.</li> <li>2. DES H2O vlv - OPEN (unstaged) or ASC H2O vlv - OPEN (staged)</li> <li>3. Use H2O dispenser as required.</li> <li>4. Stow H2O dispenser.</li> </ol>	<p>Both valves must be closed before disconnecting H2O dispenser from H2O hose.</p>

LM 32L

SUBSYS  
MGMT



**LMA790-3-LM**  
**APOLLO OPERATIONS HANDBOOK**

LM 3223

CREW-MAN	PNI	PROCEDURES	REMARKS
		<p>4.13.1.13 <u>Cabin Atmosphere Filtering</u></p> <p style="text-align: center;">CAUTION</p> <p>Limit fan operating time to 2 hours maximum after lunar ascent.</p> <p>1. Fan Activation:            CB ECS: CABIN FAN CONT - open            CB ECS: CABIN FAN - close</p> <p>2. Fan Deactivation:            CB ECS: CABIN FAN - open</p> <p>4.13.2 <u>COMMUNICATIONS</u></p> <p>4.13.2.1 <u>Communications Basic</u></p> <p style="text-align: center;">CAUTION</p> <p>CB COMM: SE AUDIO must be closed to transmit on VHF A and/or operate DSEA. CB must be opened when LMP connects or disconnects LM comm cable &amp; COMM: TLM BIONED sw - OFF or LEFT.</p> <p>CB COMM: CDR AUDIO must be closed to transmit voice on VHF B. CB must be opened when CDR connects or disconnects LM comm cable &amp; COMM: TLM BIONED sw - OFF or RIGHT.</p>	<p>Assumptions: (1) Cabin is pressurized to 4.8±0.2 psia and (2) free-floating lunar dust is present in cabin.</p> <p>Allows fan operation regardless of O2 demand regulators settings.</p> <p>Assumption: Initial communications checks complete.</p> <p>If electromagnetic interference in system is identified as caused by tracking light (regular pulses on audio channel or indicated on SIGNAL STRENGTH ind at approximate frequency of 1 pps), tracking light may be turned off until transmission or reception is complete.</p>
CDR	11	<p>1. CB/AC BUS B: S BD ANT - close            CB/AC BUS A: TAPE RCDR - close</p> <p>CB COMM:            UP DATA LINK - close            SEC S BD XTR/RCVR - close            SEC S BD PWR/AMPL - close            VHF B XTR - close            VHF A RCVR - close            CDR AUDIO - Close</p>	<p>COMM: S BAND PWR AMPL sw controls transmitted FM carrier modulation index for both subcarriers (1.024 and 1.25 mc).</p>

SUBSYS  
MGMT

**LMA790-3-LM  
APOLLO OPERATIONS HANDBOOK**

LM 3223

CREW- MAN	PNL	PROCEDURES	REMARKS																								
		<p>4.13.2.1 <u>Communications Basic (cont)</u></p>																									
8		<p>2. AUDIO: S BAND T/R sw - S BAND T/R ICS T/R sw - ICS T/R RELAY ON sw - RELAY OFF MODE sw - ICS /FTT AUDIO CONT sw - NORM VHF A sw - T/R VHF B sw - OFF</p>	<table border="1"> <caption>Subcarrier Modulation Index vs Switch position</caption> <thead> <tr> <th>SW POS</th> <th>PRIM</th> <th>OFF</th> <th>SEC</th> </tr> </thead> <tbody> <tr> <td>SUBCAR</td> <td>High</td> <td>Low</td> <td>High</td> </tr> <tr> <td>1.024 mc</td> <td>High</td> <td>Low</td> <td>High</td> </tr> <tr> <td>1.25 mc</td> <td>Low</td> <td>High</td> <td>Low</td> </tr> <tr> <td>1.25 mc</td> <td>Low</td> <td>Low</td> <td>Low</td> </tr> <tr> <td>low power</td> <td>CB COMM: PRIM S BD PWR AMPL - open</td> <td>-</td> <td>CB COMM: SEC S BD PWR AMPL - open</td> </tr> </tbody> </table>	SW POS	PRIM	OFF	SEC	SUBCAR	High	Low	High	1.024 mc	High	Low	High	1.25 mc	Low	High	Low	1.25 mc	Low	Low	Low	low power	CB COMM: PRIM S BD PWR AMPL - open	-	CB COMM: SEC S BD PWR AMPL - open
SW POS	PRIM	OFF	SEC																								
SUBCAR	High	Low	High																								
1.024 mc	High	Low	High																								
1.25 mc	Low	High	Low																								
1.25 mc	Low	Low	Low																								
low power	CB COMM: PRIM S BD PWR AMPL - open	-	CB COMM: SEC S BD PWR AMPL - open																								
16		<p>3. CB COMM: DISP - close SE AUDIO - close VHF A XMTTR - close VHF B RCVR - close PRIM S BD PWR AMPL - close PRIM S BD XMTTR/RCVR - close S BD ANT - close PMP - close TV - open CB HTR: S BD ANT - close CB CAMR: SEQ - open</p>	<p>Opening CB COMM: DISP while communicating via S-band causes apparent drop in receiver signal strength read by MSFN (GT0994), due to change in telemetry AGC.</p>																								
14		<p>4. COMM: UPLINK SQUELCH sw - as desired</p>																									
12		<p>5. UP DATA LINK sw - OFF AUDIO: S BAND T/R sw - S BAND T/R ICS T/R sw - ICS T/R RELAY ON sw - RELAY OFF MODE sw - ICS/FTT AUDIO CONT sw - NORM VHF A sw - T/R VHF B sw - OFF</p>																									
		<p>6. COMM: S BAND MODULATE sw - PH S BAND XMTTR/RCVR sw - SEC S BAND PWR AMPL sw - PRIM S BAND VOICE sw - VOICE</p>																									

**LMA790-3-LM**  
**APOLLO OPERATIONS HANDBOOK**

CREW- MAN	PNL	PROCEDURES	REMARKS
		<p>4.13.2.1 <u>Communications Basic (cont)</u></p> <p>S BAND PCM sw - PCM S BAND RANGE sw - OFF/RESET VHF A XTR sw - VOICE VHF A RCVR sw - ON VHF B XTR sw - OFF VHF B RCVR sw - OFF TLM BIOMED sw - as required TLM PCM sw - HI RECORD sw - OFF</p> <p style="text-align: center;">NOTE</p> <p>Recorder, when enabled, runs continuously when AUDIO: MODE sw is set to ICS/PTI. Total running time is 10 hours.</p>	
LMP	12	<p>7. Verify COMM ANT: TRACK MODE sw - AUTO PITCH cont - computed angle YAW cont - computed angle S BAND sel - SLEW VHF sel - AFT or FWD</p>	<p>Ref para 4.2.21 for AOS procedure. Computed angles are set before switching to AUTO.</p>
LMP	12	<p>4.13.2.2 <u>S-Band Configuration for LOS</u></p> <p>1. Immediately before LOS, configure: COMM ANT: PITCH cont - 90° YAW cont - 0° COMM: TLM PCM sw - LO S BAND VOICE sw - DN VOICE BU TLM BIOMED sw - OFF COMM ANT: TRACK MODE sw - OFF S BAND sel - AFT or FWD TRACK MODE sw - SLEW</p>	<p>Antenna shall not be permitted to drive into gimbal stops. If left in automatic track mode, antenna will drive into gimbal stops when signal is lost during lunar orbit (LOS). Operation at stops for periods longer than 3 minutes may result in degraded reliability or failure due to possible overheating. Caution and warning temperature sensor is not expected to react rapidly enough to reflect this thermal transient condition. Steerable antenna shall remain in off mode for 10 minutes before reactivating, to permit cooldown. If antenna drives to, and remains in stops for period of 3 minutes or longer, antenna must be deactivated for period of 10 minutes to allow temperature to decay to acceptable limits of operation. Ref para 4.13.2.15.</p>

SUBS  
MCM

**LMA790-3-LM**  
**APOLLO OPERATIONS HANDBOOK**

CREW-MAN	PNL	PROCEDURES	REMARKS
		<p>4.13.2.2 <u>S-Band Configuration for LOS (cont)</u></p> <p>PITCH cont - computed angle YAW cont - computed angle</p>	<p>Computed angle from MSFN.</p>
		<p>4.13.2.3 <u>Relay Mode: EVA (Two-Man EVA)</u></p> <p style="text-align: center;">CAUTION</p> <p>CB COMM: SE AUDIO must be closed to transmit on VHF A and/or operate DSEA. CB must be opened when LMP connects or disconnects LM comm cable &amp; COMM: TLM BIOMED sw - OFF or LEFT.</p> <p>CB COMM: CDR AUDIO must be closed in order to transmit voice on VHF B. CB must be opened when CDR connects or disconnects LM comm cable &amp; COMM: TLM BIOMED sw - OFF or RIGHT.</p>	<p>Task provides full conference capability between EVA, LM, CSM, and MSFN.</p>
CDR	8	<p>1. Controls - Communications Basic, except: AUDIO: VHF A sw - OFF MODE sw - VOX VOX SENS tv - 9</p>	
LMP	12	<p>AUDIO: VHF B sw - RCV RELAY ON sw - RELAY ON MODE sw - VOX VOX SENS tv - 9</p>	
		<p>2. COMM: VHF B RCVR sw - ON VHF A SQUELCH tv - noise threshold + 1-1/2 div VHF B SQUELCH tv - noise threshold + 1-1/2 div TLM BIOMED sw - OFF RECORDER sw - as desired</p>	
		<p>3. Assure EVA antenna is deployed.</p>	

**LMA790-3-LM  
APOLLO OPERATIONS HANDBOOK**

CREW- MAN	PNL	PROCEDURES	REMARKS
		<p>4.13.2.3 <u>Relay Mode: EVA (Two-Man EVA) (cont)</u></p> <p>4. COMM ANT: VHF sel - EVA S BAND sel - SLEW (LUNAR STAY when erectable antenna is deployed)</p> <p>5. On completion of Relay Mode: EVA (Two-Man EVA), return to Communications Basic.</p> <p>4.13.2.4 <u>Relay Mode: EVA (One-Man EVA)</u></p> <p align="center">CAUTION</p> <p>CB COMM: SE AUDIO must be closed to transmit on VHF A and/or operate DSEA. CB must be opened when LMP connects or disconnects LM comm cable &amp; COMM: TLM BIOMED sw - OFF or LEFT.</p> <p>CB COMM: CDR AUDIO must be closed to transmit voice on VHF B. CB must be opened when CDR connects or disconnects LM comm cable &amp; COMM: TLM BIOMED sw - OFF or RIGHT</p> <p>1. Controls - Communications Basic, except: AUDIO: VHF B sw - RCV MODE sw - VOX VOX SENS tv - 9 AUDIO: VHF B sw - RCV MODE sw - VOX VOX SENS tv - 9 RELAY ON sw - RELAY ON</p>	<p>Assumption: Both extravehicular astronauts returned to vehicle together. Ref para 4.13.2.1.</p>
	12	<p>2. COMM: VHF B RCVR sw - ON VHF A SQUELCH tv - noise threshold + 1-1/2 div VHF B SQUELCH tv - noise threshold + 1-1/2 div TLM BIOMED sw - non-EVA crewman RECORDER sw - as desired</p>	

SUBS  
MCM

**LMA790-3-LM  
APOLLO OPERATIONS HANDBOOK**

LM 3193

CREW- MAN	P/NL	PROCEDURES	REMARKS
		<p>4.13.2.4 <u>Relay Mode: EVA (One-Man EVA) (cont)</u></p> <p>3. Ensure EVA antenna is deployed.</p> <p>4. COMM ANT: VHF sel - EVA S BAND sel - SLEW</p> <p>5. On completion of Relay Mode: EVA (One-Man EVA), return to Communications Basic.</p>	Ref para 4.13.2.1.
		<p>4.13.2.5 <u>Relay Mode: CSM Voice to MSFN</u></p> <p style="text-align: center;">CAUTION</p> <p>CB COMM: SE AUDIO must be closed to transmit on VHF A and/or operate DSEA.</p> <p>CB COMM: CDR AUDIO must be closed in order to transmit voice on VHF B.</p>	
CDR	8	<p>1. Controls - Communications Basic, except: AUDIO: VHF B sw - RCV MODE sw - VOX</p>	
LMP	12	<p>AUDIO: VHF B sw - RCV S BAND T/R sw - RCV RELAY ON sw - ON MODE sw - VOX</p> <p>COMM: VHF A XMITR sw - VOICE/RING VHF A RCVR sw - OFF VHF B XMITR sw - OFF VHF B RCVR sw - ON</p>	
		<p>2. On completion of Relay Mode: CSM Voice to MSFN, return to Communications Basic</p>	Ref para 4.13.2.1.



**LMA790-3-LM**  
**APOLLO OPERATIONS HANDBOOK**

CREW-MAN	PNL	PROCEDURES	REMARKS
CDR	11	<p>4.13.2.6 <u>VHF B Data Enable</u></p> <p>1. CB COMM: VHF B XMTR - close</p>	
LMP	12	<p>2. COMM: VHF B XMTR sw - DATA TLM PCM sw - LO</p>	
LMP	12	<p>4.13.2.7 <u>S-Band LBR Data Enable</u></p> <p>1. Controls - Communications Basic, except: COMM: S BAND VOICE sw - DN VOICE BU TLM PCM sw - LO TLM BIONED sw - OFF COMM ANT: S BAND sel - FWD or AFT</p> <p>2. On completion of S-Band LBR Data Enable, return to Communications Basic.</p>	<p>Ref para 4.13.2.1.</p>
LMP	12	<p>4.13.2.8 <u>S-Band CWEA Enable</u></p> <p>Communications Basic (required)</p> <p>1. COMM: S BAND RANGE sw - RANGE, OFF/RESET, TV/CWEA ENABLE</p> <p>2. When S-band CWEA function is no longer needed: COMM: S BAND RANGE sw - OFF/RESET</p>	<p>Ref para 4.13.2.1. Switch must be cycled to prevent false MASTER ALARM.</p>
		<p>4.13.2.9 <u>DSEA Check</u></p> <p style="text-align: center;">CAUTION</p> <p>CB COMM: SE AUDIO must be closed to transmit on VHF A and/or operate DSEA. CB COMM: CDR AUDIO must be closed to transmit voice on VHF B.</p> <p>1. Controls - Communications Basic, except: COMM: RECORDER sw - ON</p>	

SUBSYS  
MGMT

**LMA790-3-LM**  
**APOLLO OPERATIONS HANDBOOK**

CREW-MAN	PNL	PROCEDURES	REMARKS
		<p>4.13.2.9 <u>DSEA Check (cont)</u></p> <p>2. Transmit voice (VOX or PTT).</p> <p>3. COMM: RECORDER TAPE tb - gray during voice transmissions</p> <p style="text-align: center;">CAUTION</p> <p>When operating DSEA with either AUDIO: MODE sw - VOX, do not set either switch to ICS/PTT while talking; DSEA may stop. If DSEA stops, COMM: RECORDER sw - cycle.</p> <p>4. On completion of DSEA Check, return to Communications Basic.</p> <p>4.13.2.10 <u>VHF Ranging Check</u></p> <p style="text-align: center;">CAUTION</p> <p>CB COMM: SE AUDIO must be closed to transmit on VHF A and/or operate DSEA.</p> <p>CB COMM: CDR AUDIO must be closed to transmit voice on VHF B.</p> <p>1. At CSM request, controls - Communications Basic, except:</p> <p>COMM: VHF A XMTTR sw - VOICE/RNG VHF B RCVR sw - ON</p> <p>2. AUDIO: VHF A sw - OFF</p> <p style="text-align: center;">NOTE</p> <p>Voice comm must be disabled during acquisition, by setting AUDIO: VHF A sw - OFF.</p>	<p>With ICS/PTT selected on either audio center, DSEA will run continuously when COMM: RECORDER sw - ON.</p> <p>Talkback will be gray under following conditions:</p> <ol style="list-style-type: none"> <li>1. First 4 seconds of power application</li> <li>2. While recording (speaking) on track 1</li> <li>3. Any time that tape is in motion on other than track 1, providing corresponding section of track 1 has voice recorded on it.</li> </ol> <p>Ref para 4.13.2.1.</p> <p>VHF Ranging check is performed at CSM direction. Check consists of CSM transmission of VHF signal to LM, and CSM receipt of turnaround signal.</p> <p>LM is undocked from CSM.</p> <p>Effective range limits: Minimum - 500 feet Maximum - 200 nm</p> <p>Hot mike condition exists on VHF A when AUDIO: VHF A sw - T/R during VHF ranging operations. Phase-lock acquisition requires 14 seconds after CSM initiation.</p> <p>Activation of VHF ranging significantly reduces VHF voice capability. If unsatisfactory VHF voice communications are experienced and voice communication is required, VHF ranging should be disabled on CSM and LM.</p>

**LMA790-3-LM**  
**APOLLO OPERATIONS HANDBOOK**

CREW-MAN	PNL	PROCEDURES	REMARKS
		<p>4.13.2.10 <u>VHF Ranging Check (cont)</u></p> <p>3. AUDIO: VHF B sw - RCV</p> <p>4. At CSM request: COMM: VHF A XMTR sw - VOICE VHF B RCVR sw - OFF</p> <p>5. AUDIO: VHF A sw - T/R</p> <p>6. On completion of VHF Ranging Check, return to Communications Basic.</p>	<p>Refer para 4.13.2.1.</p>
		<p>4.13.2.11 <u>DVA Enable</u></p> <p>LGC Power-Up (required)</p> <p>1. Coordinate uplink requirements with MSFN</p> <p>2. CB COMM: UP DATA LINK - close UP DATA LINK sw - DATA</p> <p>3. Clear inlink counter before initial MSFN uplink transmission Key V21 NOIE, 00045E, 00000E</p>	<p>Ref para 4.6.1.1.</p> <p>MSFN can also clear and reset inlink counter.</p>
		<p>4.13.2.12 <u>DVA Disable</u></p> <p>LGC Power-Up (required)</p> <p>1. UP DATA LINK sw - OFF</p> <p>2. Key RSET &amp; CLR to reset any LGC-initiated alarms.</p>	<p>Ref para 4.6.1.1.</p>
CDR	11 12		
CDR	12		

SUBSYS  
MGMT

**LMA790-3-LM**  
**APOLLO OPERATIONS HANDBOOK**

CREW/ MAN	PNI	PROCEDURES	REMARKS
CDR	11	4.13.2.13 <u>DUA Backup Voice Enable</u> 1. CB COMM: UP DATA LINK - close	Prevents retransmission of DUA backup voice to MSFN.
LMP	12 14	2. UP DATA LINK sw - VOICE BU COMM: UPLINK SQUELCH sw - ENABLE	
CDR, LMP	8,12	3. AUDIO: MODE sw - ICS/PTT	
		4. AUDIO: ICS T/R sw - ICS T/R	
		5. Verify reception of MSFN voice.	
LMP	12	4.13.2.14 <u>DUA Backup Voice Disable</u> 1. UP DATA LINK sw - OFF	When antenna has operated "in stops" for 3 minutes or longer, it requires cooldown to allow electronics to reach safe operating temperature. Soakback period has been determined to be 10 minutes.
CDR	11	2. CB COMM: UP DATA LINK - open	
	12	4.13.2.15 <u>S-Band Antenna Cooldown</u> 1. COM ANT: TRACK MODE sw - OFF PITCH cont - 90° (ccw) YAW cont - 0° (ccw)	
		2. Following 10-minute shutdown: COM ANT: TRACK MODE se - SLEW	Ref para 4.2.20.
LMP	14	3. Perform S-Band Steerable Antenna Activation & Checkout 4.13.2.16 <u>S-Band Operation in PTC Mode</u> 1. COMM: UPLINK SQUELCH sw - OFF	
	12	2. When noise level increases: COM ANT: S-BAND sel - FWD or AFT (as required)	

**LMA790-3-LM  
APOLLO OPERATIONS HANDBOOK**

LM 3223

Communications Basic Configuration	Prior To Docking	Prep For Undocking	LOS Procedure	AOS Procedure	LM Relay With VHF Beeping	CSM Relay	Lunar Stay	PLS/EVCS With TV (EVA)
Panel 11 All COMM cb's - close								
Panel 9 - AUDIO (CDE)								
S BAND T/R sw - S BAND T/R						S BAND RCY		
ICS T/R sw - ICS T/R								
RELAY ON sw - RELAY OFF						RELAY ON		
MODE sw - ICS/PTT					VOX	VOX		VOX
AUDIO CONT sw - NORM								
VHF A sw - T/R					OFF		OFF	
VHF B sw - OFF	RCV	RCV	RCV		RCV		RCV	
VOX SENS sw - max								
Panel 16 All COMM cb's - close CS COMM: TV - open								close
Panel 14 - COMM UPLINK SQUELCH sw - as desired	ENABLE	ENABLE	ENABLE		ENABLE	OFF	OFF*	ENABLE
Panel 12 UPDATA LINK sw - OFF								
Panel 12 - AUDIO (LMP)								
S BAND T/R sw - S BAND T/R						S BAND RCY	OFF	
ICS T/R sw - ICS T/R								
RELAY ON sw - RELAY OFF						RELAY ON		RELAY ON
MODE sw - ICS/PTT					VOX	VOX		VOX
AUDIO CONT sw - NORM								
VHF A sw - T/R					OFF		OFF	
VHF B sw - OFF	RCV	RCV	RCV		RCV	RCV	RCV	RCV
VOX SENS - max								
Panel 12 - COMM								
S BAND MODULATE sw - FM								FM
S BAND XMITR/RCVR sw - SEC								
S BAND PWR AMPL sw - PRIM								
S BAND VOICE sw - VOICE			ON VOICE BU					
S BAND PCM sw - PCM								
S BAND RANGE sw - OFF/RESET		RANGE					as required	
VHF A XMITR sw - VOICE	VOICE/RNG				VOICE or VOICE/RNG		OFF	
VHF A RCVR sw - ON					OFF		OFF	
VHF B XMITR sw - OFF		DATA	DATA			OFF	ON	
VHF B RCVR sw - OFF	ON	ON			ON	ON	ON	ON
VHF A SQUELCH sw - norm								NT + 1 1/2
VHF B SQUELCH sw - norm								NT + 1 1/2
TLM BOMED sw - as required	BRIGHT	BRIGHT	OFF		OFF			OFF
TLM PCM sw - HI		LO	LO					
RECORDER sw - OFF								ON
Panel 12 - COMM ANT								
TRACK MODE sw - AUTO			OFF, then SLEW	SLEW, then AUTO			SLEW	OFF
PTCH cont - computed angle			90					
YAW cont - computed angle			0					
S BAND ant - SLEW			AFT or FWD	SLEW				as required
VHF ant - AFT or FWD								EVA

\*During EVA - ENABLE

SRM116-1003

Table 4-2. Communications Modes

**LMA790-3-LM**  
**APOLLO OPERATIONS HANDBOOK**

CREW-MAN	PNL	PROCEDURES	REMARKS
		<p>4.13.3 <u>PROPULSION</u></p> <p>4.13.3.1 <u>MPS Basic (Unstaged)</u></p>	
CDR	11	1. CB/AC BUS B: He/PQGS PROPUL DISP - close CB PROPUL: DES He REG/VENT - close	
LMP	16	2. CB PROPUL: DISP/ENG OVRD LOGIC - close PQGS - close ASC He REG - close	
CDR	1	3. PRELNT QTY MON sw - OFF HELIUM MON sel - SUPCRIT PRESS PRELNT TEMP/PRESS MON sw - DES 1 DES He REG 1 tb - gray DES He REG 2 tb - bp ASC He REG 1 tb - gray ASC He REG 2 tb - gray	
CDR	8	4. DES PROPUL: FUEL VENT tb - gray OXID VENT tb - gray	
		4.13.3.2 <u>MPS Basic (Staged)</u>	
CDR	11	1. CB/AC BUS B: He/PQGS PROPUL DISP - close CB PROPUL: DES He REG/VENT - open	
LMP	16	2. CB PROPUL: DISP/ENG OVRD LOGIC - close PQGS - open ASC He REG - close	
CDR	1	3. PRELNT QTY MON sw - OFF HELIUM MON sel - PRESS 2 PRELNT TEMP/PRESS MON sw - ASC ASC He REG 1 tb - gray ASC He REG 2 tb - gray	ASC He REG latching valve is open when tb - gray ASC He REG latching valve is open when tb - gray

**LMA790-3-LM**  
**APOLLO OPERATIONS HANDBOOK**

CREW/ MAN	PNL	PROCEDURES	REMARKS
	<p>4.13.3.3 <u>APS/RCS Propellant Interconnect</u></p> <p style="text-align: center;">WARNING</p> <p>Ullage settling requirements for APS propellant must be met before opening interconnect (thrusting maneuver or +g field). Interconnect must be closed before termination of thrusting maneuver to prevent helium injection into RCS causing RCS engine damage.</p>	<p>1. Thrust for TBD seconds.</p> <p>2. RCS:            SYS A ASC FEED 1 &amp; 2 sw - ASC FEED 1 &amp; 2            SYS A ASC FUEL &amp; ASC OXID tb - gray            SYS A MAIN SOV sw - CLOSE; tb - bp            TEMP/PRESS MON sel - FUEL MANT            A PRESS ind - 172 to 203 psia            TEMP/PRESS MON sel - OXID MANT            A PRESS ind - 172 to 203 psia</p> <p>3. RCS:            SYS B ASC FEED 1 &amp; 2 sw - ASC FEED 1 &amp; 2            SYS B ASC FUEL &amp; ASC OXID tb - gray            SYS B MAIN SOV sw - CLOSE tb - bp            TEMP/PRESS MON sel - OXID MANT            B PRESS ind - 172 to 203 psia            TEMP/PRESS MON sel - FUEL MANT            B PRESS ind - 172 to 203 psia</p> <p>4. TBD seconds before termination of APS thrust:</p> <p>RCS:            SYS A &amp; B MAIN SOV sw - OPEN; tb - gray            SYS A &amp; B ASC FEED 2 sw - CLOSE</p> <p>SYS A &amp; B ASC FUEL &amp; ASC OXID tb - bp</p>	<p>Assumptions: (1) Ascent propulsion section is pressurized, (2) ascent propellants settled in tanks, and (3) +X-axis RCS thrusters are firing.</p> <p>APS/RCS interconnect can be used for +X-axis translation maneuver using APS propellants, as long as required RCS ullage maneuver has been completed and +X-axis translation has not been interrupted.</p> <p>Time for propellant to settle is dependent upon vehicle configuration and weight.</p> <p>RCS: SYS A ASC FUEL and ASC OXID tb - gray indicates primary and secondary fuel and oxidizer ascent feed interconnect valves have opened.</p> <p>RCS: SYS B ASC FUEL and ASC OXID tb - gray indicate primary and secondary fuel and oxidizer ascent feed interconnect valves have opened.</p> <p>Procedure for closing APS/RCS interconnect.</p> <p>Ascent feed valves can be opened after ascent engine has been shut down, provided +X-axis RCS thrusters are firing before reopening valves.</p> <p>RCS: SYS A and B ASC FUEL and ASC OXID tb - bp indicates primary or secondary fuel and oxidizer ascent feed valves are closed.</p>

SUB  
M

**LMA790-3-LM**  
**APOLLO OPERATIONS HANDBOOK**

CREW-MAN	PNL	PROCEDURES	REMARKS
		<p>4.13.3.3 <u>APS/RCS Propellant Interconnect (cont)</u></p> <p>If tb - gray:            SYS A or SYS B (depending on which tb - gray) ASC FEED            1 sw - CLOSE            SYS A &amp; B ASC FUEL &amp; ASC OXID tb - bp            SYS A or SYS B (depending on which tb - gray) ASC            FEED 2 sw - OPEN            SYS A &amp; B ASC FUEL &amp; ASC OXID tb - bp            TEMP/PRESS MON sel - FUEL MANT            A &amp; B PRESS ind - 175 to 188 psia            TEMP PRESS MON sel - OXID MANT            A &amp; B PRESS ind - 175 to 188 psia</p> <p>5. RCS: TEMP/PRESS sel - He</p> <p>4.13.3.4 <u>DPS Periodic Monitoring</u></p> <p>1. HELIUM MON sel - SUPCRIT PRESS            MFS: HELIUM ind - 500 to 1320 psia</p> <p>2. MFS PRESS ind pwr fail lt - off</p> <p>3. PREPLANT TEMP/PRESS MON sw - DES 1            MFS:            FUEL TEMP ind - 50° to 90° F            OXID TEMP ind - 50° to 90° F            FUEL PRESS ind - 242 to 253 psia            OXID PRESS ind - 242 to 253 psia</p> <p>4. PREPLANT TEMP/PRESS MON sw - DES 2            MFS:            FUEL TEMP ind - 50° to 90° F            OXID TEMP ind - 50° to 90° F            FUEL PRESS ind - 242 to 253 psia            OXID PRESS ind - 242 to 253 psia</p> <p>5. PREPLANT TEMP/PRESS MON sw - DES 1</p>	<p>This procedure checks status of propellants and helium before each burn and at intervals during coast periods. Range of supercritical helium pressures will be based upon information provided in figure 4-10.</p> <p>Light goes on when power to MFS: FUEL and OXID PRESS ind is interrupted.</p> <p>Following values apply to pressure relief valve assembly:            Burst-disk rupture pressure - 260 to 275 psia            Reseat pressure - 254 psia            Relief valve cracking pressure - 260 psia</p>



**LMA790-3-LM**  
**APOLLO OPERATIONS HANDBOOK**

CREW-MAN	PNL	PROCEDURES	REMARKS
CDR	1	<p>4.13.3.5 <u>APS Periodic Monitoring</u></p> <p>1. HELIUM MON sel - PRESS 1 MPS: HELIUM ind - 2800 to 3500 psia (pre pressurization), 2700 to 3450 psia (post pressurization), &amp; 600 to 800 psia (post lunar ascent)</p> <p>2. HELIUM MON sel - PRESS 2 MPS: HELIUM ind - 2800 to 3500 psia (pre pressurization), 2700 to 3450 psia (post pressurization), &amp; 600 to 800 psia (post lunar ascent)</p> <p>3. MPS: PRESS ind pwr fail lt - off</p> <p>4. PRPLNT TEMP/PRESS MON sw - ASC MPS: FUEL TEMP ind - 50° to 90° F OXID TEMP ind - 50° to 90° F FUEL PRESS ind - 172 to 203 psia OXID PRESS ind - 172 to 203 psia</p> <p>5. If unstaged: PRPLNT TEMP/PRESS MON sw - DES 1 HELIUM MON sel - SUPCRIT PRESS</p>	<p>This procedure checks status of propellants and helium before each burn and at intervals during coast periods.</p> <p>Helium pressure drops are expected during APS use. See figure 4-25 for APS helium tank pressures during burn.</p> <p>Ascent helium tank pressure varies as function of time and is dependent on same as initial tank loading conditions. See figure 4-8 for expected helium tank pressure before pressurization.</p> <p>ASC PRESS warn lt-on when helium tank pressure &lt;2773 psia; it is inhibited after staging.</p> <p>Light goes on when power to MPS: FUEL and OXID PRESS ind is interrupted.</p>

SUBS  
MGM

**LMA790-3-LM  
APOLLO OPERATIONS HANDBOOK**

**Deleted**

**Figure 4-24. Predicted APS Helium Tank Temperature During Burn**

LMA790-3-LM  
APOLLO OPERATIONS HANDBOOK

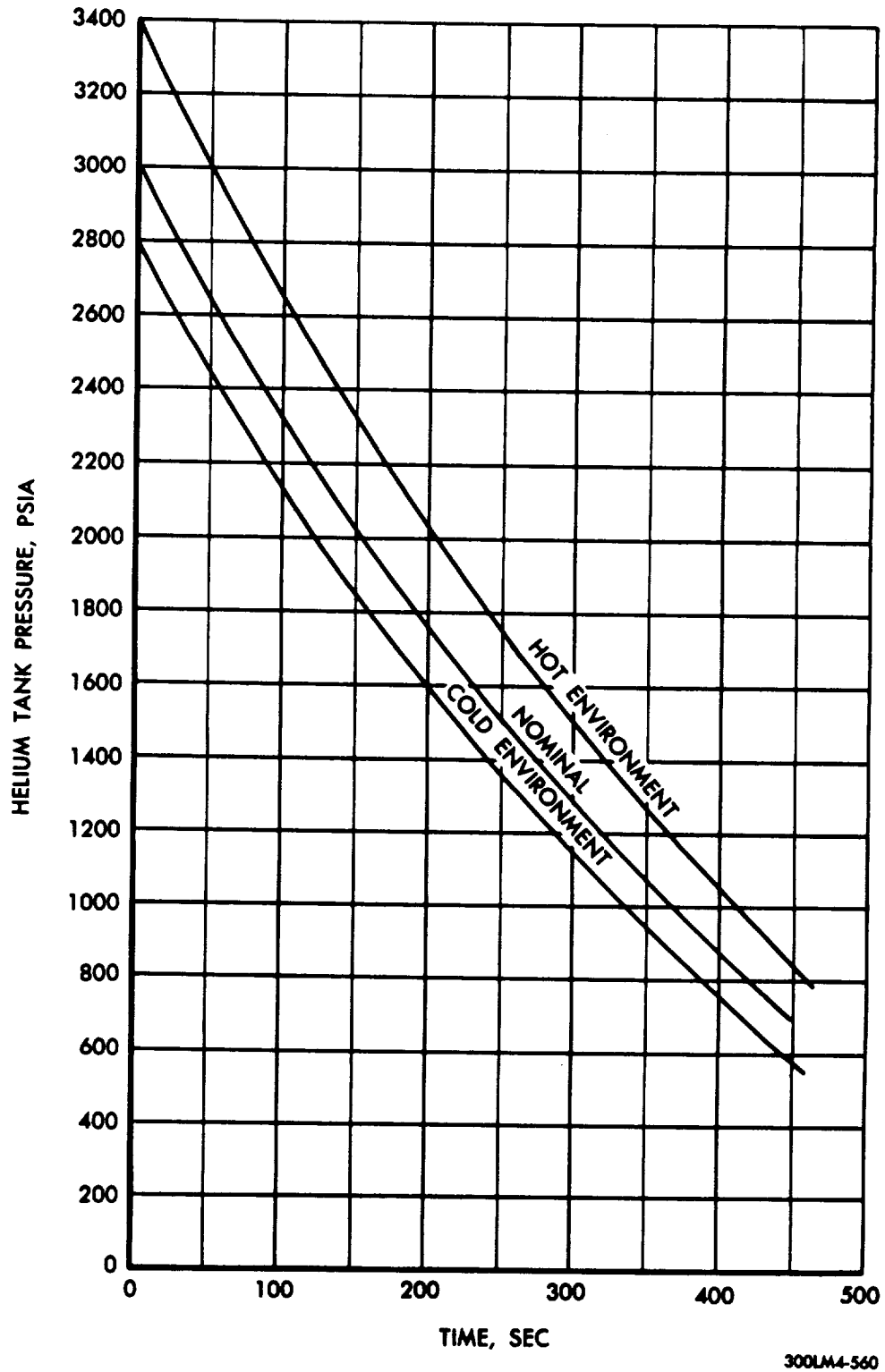

Figure 4-25. Predicted APS Helium Tank Pressure During Burn

**LMA790-3-LM**  
**APOLLO OPERATIONS HANDBOOK**

CREW-MAN	PNL	PROCEDURES	REMARKS
LMP	2	<p>4.13.3.6 <u>RCS Periodic Monitoring</u></p> <p>1. RCS: PRESS ind pwr fail lt - off QUANTITY ind pwr fail lt - off</p> <p>2. RCS: A &amp; B QUANTITY ind - monitor &amp; record percentage of usable propellant remaining: A <u>    </u> % B <u>    </u> %</p> <p>3. RCS: TEMP/PRESS MON sel - He A &amp; B PRESS ind - monitor &amp; record: A <u>    </u> psia B <u>    </u> psia</p> <p>4. RCS: TEMP/PRESS MON sel - PRLPLNT A &amp; B TEMP ind - 40° to 100° F A &amp; B PRESS ind - 178 to 188 psia</p> <p>5. RCS: TEMP/PRESS MON sel - FUEL MANF A &amp; B PRESS ind - 175 to 188 psia</p> <p>6. RCS: TEMP/PRESS MON sel - OXID MANF A &amp; B PRESS ind - 175 to 188 psia</p> <p>7. RCS: TEMP/PRESS MON sel - He (other than lunar stay) or FUEL (OXID) MANF (lunar stay only)</p> <p>8. RCS: SYS A ASC FUEL tb - bp SYS A ASC OXID tb - bp SYS B ASC FUEL tb - bp SYS B ASC OXID tb - bp SYS A QUAD 1, 4, 2, 3, tb - gray SYS B QUAD 1, 4, 2, 3, tb - gray ' CRSFD tb - bp SYS A &amp; B MAIN SOV tb - gray</p>	<p>Purpose of RCS Periodic Monitoring procedure is to check status of propellants, helium, and valve positions before each burn and at intervals during coast periods.</p> <p>During vehicle deactivation when CB RCS SYS B: TEMP/PRESS DISP FLAGS and CB RCS SYS B: PQGS/DISP - open, RCS: PRESS ind pwr fail lt and RCS: QUANTITY ind pwr fail lt - on.</p> <p>Usable propellant remaining in either system is <math>\geq</math> meter reading less 14%.</p>

**LMA790-3-LM**  
**APOLLO OPERATIONS HANDBOOK**

CREW- MAN	PNI	PROCEDURES	REMARKS
	3	<p>4.13.3.6 <u>RCS Periodic Monitoring (cont)</u></p> <p>9. Verify RCS quad temperature readings: HTR CONT: TEMP MON sel - QUAD 1, 2, 3, 4 TEMP ind - 120° to 190° F (each quad) RCS SYS A/B 2 QUAD 1, 2, 3, 4 sw - AUTO</p>	
		<p>4.13.4 <u>EPS</u></p> <p>4.13.4.1 <u>EPS Basic (Unstaged)</u></p>	
CDR	11	<p>1. All EPS cb's - close, except: CB EPS: INV 1 - open ASC ECA CONT - open</p>	
LMP	16	<p>2. All EPS cb's - close, except: CB EPS: ASC ECA CONT - open CROSS TIE BUS - open CROSS TIE BAL LOADS - open</p>	
	14	<p>3. EPS: POWER/TEMP MON sel - CDR BUS INVERTER sw - 2 LMP BAT 1 &amp; 2 tb - gray CDR BAT 3 &amp; 4 tb - gray DES BATS tb - gray LUNAR BAT tb - bp BAT 5 NORMAL LMP FEED tb - bp BAT 5 BACK UP CDR FEED tb - bp BAT 6 NORMAL CDR FEED tb - bp BAT 6 BACK UP LMP FEED tb - bp</p>	<p>Panel 16 CB EPS: CROSS TIE BAL LOADS will be closed during lunar stay, to provide load sharing.</p>

SUBSY  
MCM

**LMA790-3-LM**  
**APOLLO OPERATIONS HANDBOOK**

LM 992

CREW- MAN	P/NL	PROCEDURES	REMARKS
CDR	11	<p>4.13.4.2 <u>EPS Basic (Staged)</u></p> <p>1. All EPS cb's - close, except:            CB EPS:              CROSS TIE BUS - open              DES ECA CONT - open              DES ECA - open              ASC ECA CONT - open</p>	
LMP	16	<p>2. All EPS cb's - close, except:            CB EPS:              DES ECA - open              DES ECA CONT - open              CROSS TIE BUS - open              CROSS TIE BAL LOADS - open              ASC ECA CONT - open</p>	<p>Panel 16 CB EPS: CROSS TIE BAL LOADS should only be closed if orbital contingency occurs.</p>
	14	<p>3. EPS:            POWER/TEMP MON sel - CDR BUS            INVERTER sv - 2            LMP BAT 1 &amp; 2 tb - bp            CDR BAT 3 &amp; 4 tb - bp            DES BATS tb - bp            LUNAR BAI tb - bp            BAT 5 NORMAL LMP FEED tb - gray            BAT 5 BACK UP CDR FEED tb - bp            BAT 6 NORMAL CDR FEED tb - gray            BAT 6 BACK UP LMP FEED tb - bp</p>	
CDR	11	<p>4.13.4.3 <u>EPS Preparation for DPS Burn</u></p> <p>1. Perform EPS Basic (Unstaged), except:            CB EPS: INV 1 - close</p>	<p>Ref para 4.13.4.1.</p>
LMP	14	<p>2. Check a-c voltage from inverter No. 1:            EPS:              POWER/TEMP MON sel - AC BUS              INVERTER sv - 1              VOLTS ind - green band</p>	<p>Green band represents 112 to 118 vac.</p>

**LMA790-3-LM**  
**APOLLO OPERATIONS HANDBOOK**

CREW-MAN	PNL	PROCEDURES	REMARKS
		<p>4.13.4.3 <u>EPS Preparation for DPS Burn (cont)</u></p> <p style="text-align: center;">CAUTION</p> <p>Twenty minutes before start of DPS burn, ascent batteries must be placed on-line in parallel with descent batteries. CB EPS: CROSS TIE BAL LOADS (2) must remain closed until just before start of burn.</p> <p>3. Place both ascent batteries on line: EPS: POWER/TEMP MON sel - BAT 5 VOLTS ind - 31, 5 to 37.2 vdc AMPS ind - 0 amps BAT 5 NORMAL LMP FEED sw - ON; tb - gray VOLTS ind - 28.0 to 32.5 vdc AMPS ind - TBD POWER/TEMP MON sel - BAT 6 VOLTS ind - 31.5 to 37.2 vdc AMPS ind - 0 amps BAT 6 NORMAL CDR FEED sw - ON; tb - gray VOLTS ind - 28.0 to 32.5 vdc AMPS ind - TBD</p> <p>4. Check voltage of all six batteries: EPS: POWER/TEMP MON sel - BAT 1 VOLTS ind - 28.0 to 32.5 vdc Repeat check for BAT 2, 3, 4, 5, &amp; 6</p> <p>5. Check d-c voltage on both buses: EPS: POWER/TEMP MON sel - LMP BUS VOLTS ind - 26.5 to 32.5 vdc</p> <p>6. EPS: POWER/TEMP MON sel - CDR BUS</p>	<p>Due to reverse current, BATTERY cautions may go on when ascent and descent batteries are paralleled. This is not to be regarded as malfunction symptom unless light is on longer than approximately 15 seconds.</p>
LMP	14		

SUBS  
MCM

**LMA790-3-LM**  
**APOLLO OPERATIONS HANDBOOK**

CREW/ MAN	P/NL	PROCEDURES	REMARKS
CDR	11	<p>4.13.4.4 <u>EPS Check, Post-DPS Burn</u></p> <p>1. CB EPS: ASC ECA CONT - close</p>	<p>This task should be performed soon after any DPS burn during which ascent batteries were in parallel with descent batteries.</p>
LMP	16	<p>2. CB EPS: ASC ECA CONT - close</p>	
	14	<p>3. Remove ascent batteries from line: EPS: BAT 5 NORMAL LMP FRED sw - OFF/RESET; tb - bp BAT 6 NORMAL CDR FRED sw - OFF/RESET; cb - bp</p>	
		<p>4. Check voltage &amp; current of descent batteries: EPS: POWER/TEMP MON sel - BAT 1 VOLTS ind - 28.0 to 32.5 vdc AMPS ind - TBD Repeat for BAT 2, 3, &amp; 4.</p>	<p>Verify load-sharing of descent batteries. To obtain proper current measurement for descent batteries, divide indicator reading by 2.</p>
CDR	11	<p>5. CB EPS: ASC ECA CONT - open</p>	
LMP	16	<p>6. CB EPS: ASC ECA CONT - open</p>	
	14	<p>7. Check e-c voltage from inverter No. 1: EPS: POWER/TEMP MON sel - AC BUS INVERTER sw - 1 VOLTS ind - green band INVERTER sw - 2 VOLTS ind - green band POWER/TEMP MON sel - CDR BUS</p>	<p>Green band represents 112 to 118 vac.</p>
CDR	11	<p>8. CB EPS: INV 1 - open</p>	
		<p>4.13.4.5 <u>EPS Periodic Monitoring (Unstaged)</u></p>	<p>Ref para 4.13.4.1.</p>
		<p>1. Verify EPS Basic (Unstaged).</p>	
	14	<p>2. Check voltage on d-c buses: EPS: POWER/TEMP MON sel - CDR BUS VOLTS ind - 26.5 to 32.5 vdc Repeat for LMP BUS.</p>	
	11	<p>3. CB EPS: INV 1 - close</p>	<p>CB EPS: INV 1 is closed for checkout. Inverter No. 1 draws power while this circuit breaker is closed.</p>



**LMA790-3-LM**  
**APOLLO OPERATIONS HANDBOOK**

CREW-MAN	PNL	PROCEDURES	REMARKS
		<p>4.13.4.5 <u>EPS Periodic Monitoring (Unstaged) (cont)</u></p> <p>4. Check voltage on a-c buses: EPS: POWER/TEMP MON sel - AC BUS INVERTER sw - 1 VOLTS ind - green band INVERTER sw - 2 VOLTS ind - green band</p> <p>5. CB EPS: INV 1 - open</p> <p>6. Check voltage &amp; current of descent batteries: EPS: POWER/TEMP MON sel - BAT 1 VOLTS ind - 28.0 to 32.5 vdc. AMPS ind - TBD Repeat for BAT 2, 3, 4, &amp; LUN battery.</p> <p>7. Check open-circuit voltage &amp; current of ascent batteries: EPS: POWER/TEMP MON sel - BAT 5 VOLTS ind - 31.5 to 37.2 vdc. AMPS ind - 0 amp Repeat for BAT 6.</p> <p>8. Check open-circuit voltage of ED batteries: EPS: POWER/TEMP MON sel - ED/OFF ED VOLTS sw - BAT A VOLTS ind - 35.0 to 37.8 volts Repeat for BAT B.</p> <p>9. EPS: POWER/TEMP MON sel - CDR BUS</p>	<p>Green band represents 112 to 118 vac.</p> <p>Opening CB EPS: INV 1 prevents unnecessary power consumption.</p> <p>To obtain proper current measurements for descent batteries, divide indicator readings by 2.</p> <p>Nominal open-circuit voltage for each ED battery is 37.1 vdc.</p>



**LMA790-3-LM  
APOLLO OPERATIONS HANDBOOK**

CREW- MAN	PNL	PROCEDURES	REMARKS
		<p><u>4.13.4.6 EPS Periodic Monitoring (Staged)</u></p> <p>1. Verify EPS Basic (Staged).</p> <p>2. Check voltage on d-c buses: EPS: POWER/TEMP MON sel - CDR BUS VOLTS ind - 26.5 to 32.5 vdc Repeat for LMP BUS.</p> <p>3. CB EPS: INV 1 - close</p> <p>4. Check voltage on e-c buses: EPS: POWER/TEMP MON sel - AC BUS INVERTER sw - 1 VOLTS ind - green band INVERTER sw - 2 VOLTS ind - green band</p> <p>5. Check voltage &amp; current of ascent batteries: EPS: POWER/TEMP MON sel - BAI 5 VOLTS ind - 28.0 to 32.5 vdc AMPS ind - TBD Repeat for BAI 6.</p> <p>6. EPS: POWER/TEMP MON sel - CDR BUS</p> <p><u>4.13.4.7 LCA Duty Cycle During Secondary Coolant Loop Operation</u></p> <p>1. LTG: OVERRIDE INTEGRAL sw - ON</p> <p>2. CB/AC BUS B: NUM LTG - open CAUTION CB/AC BUS B: NUM LTG must be closed during engine burns &amp; rendezvous &amp; docking maneuvers. It must be opened at completion of these periods.</p> <p>3. CB LTG: MASTER ALARM - close</p>	<p>Ref para 4.13.4.2.</p> <p>Green band represents 112 to 118 vac.</p> <p>This procedure must be performed to limit total maximum on time of LCA, with full load, to 45 minutes during extended periods (45 minutes or more) of secondary coolant loop operation.</p> <p>Overhead floodlighting will be used to provide panel illumination.</p>
CDR	5		
	11		
LMP	16		

**LMA790-3-LM**  
**APOLLO OPERATIONS HANDBOOK**

CREW- MAN	P/NL	PROCEDURES	REMARKS
		<p>4.13.4.7 <u>LCA Duty Cycle During Secondary Coolant Loop Operation (cont)</u></p> <p>4. CB LTG: ANUN/DOCK/COMPNT - open CB LTG: ANUN/DOCK/COMPNT - open</p> <p style="text-align: center;">CAUTION</p> <p>If subsystem failure occurs, MASTER ALARM will be activated. CB LTG: ANUN/DOCK/COMPNT (2) must be closed &amp; necessary corrective action taken, then circuit breakers must be opened.</p>	
		<p>4.13.4.8 <u>Lunar Stay Battery Management</u></p> <p>1. Lunar battery on CDR bus with battery No. 4 CB EPS: CROSS TIE BAL LOADS - as required</p> <p>EPS: POWER/TEMP MON sel - LUN BAT VOLTS ind - 31.5 to 37.2 vdc AMPS ind - 0 amp CDR BAT 3 sw - OFF/RESET; tb - bp CDR LUNAR BAT sw - ON; tb - CDR POWER/TEMP MON sel - LMP BUS VOLTS ind - 26.5 to 32.5 vdc Repeat for CDR bus.</p> <p>2. Lunar battery off CDR bus EPS: POWER/TEMP MON sel - BAT 3 VOLTS ind - 31.5 to 37.2 vdc AMPS ind - 0 amp CDR LUNAR BAT sw - OFF/RESET; tb - bp CDR BAT 3 sw - ON; tb - gray POWER/TEMP MON sel - LMP BUS VOLTS ind - 26.5 to 32.5 vdc Repeat for CDR bus. CB EPS: CROSS TIE BAL LOADS - close</p> <p>3. Lunar battery on LMP bus with battery No. 1 CB EPS: CROSS TIE BAL LOADS - as required</p>	<p>Circuit breaker can be opened or closed, depending on charge condition of batteries No. 1 and 2.</p> <p>Perform this step if step 1 opened circuit breaker. Circuit breaker can be opened or closed, depending on charge condition of batteries No. 3 and 4.</p>

SUBS  
MCM

**LMA790-3-LM  
APOLLO OPERATIONS HANDBOOK**

CREW- MAN	PNI	PROCEDURES	REMARKS
		<b>4.13.4.8 Lunar Stay Battery Management (cont)</b>	
	14	<p>EPS:            POWER/TEMP MON sel - LUN BAT            VOLTS ind - 31.5 to 37.2 vdc            AMPS ind - 0 amp            LMP BAT 2 sw - OFF/RESET; tb - bp            LMP LUNAR BAT sw - ON; tb - LMP            POWER/TEMP MON sel - LMP BUS            VOLTS ind - 26.5 to 32.5 vdc            Repeat for CDR bus.</p>	
	14	<p>4. Lunar battery off LMP bus            EPS:            POWER/TEMP MON sel - BAT 2            VOLTS ind - 31.5 to 37.2 vdc            AMPS ind - 0 amp            LMP LUNAR BAT sw - OFF/RESET; tb - bp            LMP BAT 2 sw - ON; tb - gray            POWER/TEMP MON sel - LMP BUS            VOLTS ind - 26.5 to 32.5 vdc            Repeat for CDR bus.            CB EPS: CROSS TIE BAL LOADS - close</p>	<p>Perform this step if step 3 opened circuit breaker.</p>
	16	<p>5. Lunar battery on CDR bus alone            CB EPS: CROSS TIE BAL LOADS - as required</p>	<p>Circuit breaker can be opened or closed, depending on charge condition of batteries No. 1 and 2.</p>
	14	<p>EPS:            POWER/TEMP MON sel - LUN BAT            VOLTS ind - 31.5 to 37.2 vdc            AMPS ind - 0 amp            CDR BAT 3 sw - OFF/RESET; tb - bp            CDR LUNAR BAT sw - ON; tb - CDR            CDR BAT 4 HI V sw - OFF/RESET; tb - bp            POWER/TEMP MON sel - LMP BUS            VOLTS ind - 26.5 to 32.5 vdc            Repeat for CDR bus.</p>	

**LMA790-3-LM**  
**APOLLO OPERATIONS HANDBOOK**

CREW-MAN	PNI	PROCEDURES	REMARKS
		<p>4.13.4.8 <u>Lunar Stay Battery Management (cont.)</u></p>	
	14	<p>6. Lunar battery off CDR bus EPS: POWER/TEMP MON sel - BAT 4 VOLTS ind - 31.5 to 37.2 vdc AMPS ind - 0 amp CDR BAT 4 HI V sw - ON; tb - gray POWER/TEMP MON sel - BAT 3 VOLTS ind - 31.5 to 37.2 vdc AMPS ind - 0 amp CDR LUNAR BAT sw - OFF/RESET; tb - bp CDR BAT 3 sw - ON; tb - gray POWER/TEMP MON sel - LMP BUS VOLTS ind - 26.5 to 32.5 vdc Repeat for CDR bus. CB EPS: CROSS TIE BAL LOADS - close</p>	<p>Perform this step if step 5 opened circuit breaker.</p> <p>Circuit breaker can be open or closed, depending on charge condition of batteries No. 3 and 4.</p>
	16	<p>7. Lunar battery on LMP bus alone CB EPS: CROSS TIE BAL LOADS - as required</p>	
	14	<p>8. Lunar battery off LMP bus EPS: POWER/TEMP MON sel - LUN BAT VOLTS ind - 31.5 to 37.2 vdc AMPS ind - 0 amp LMP BAT 2 sw - OFF/RESET; tb - bp LMP LUNAR BAT sw - ON; tb - LMP LMP BAT 1 HI V sw - OFF/RESET; tb - bp POWER/TEMP MON sel - LMP BUS VOLTS ind - 26.5 to 32.5 vdc Repeat for CDR bus.</p>	
	14	<p>8. Lunar battery off LMP bus EPS: POWER/TEMP MON sel - BAT 1 VOLTS ind - 31.5 to 37.2 vdc AMPS ind - 0 amp LMP BAT 1 HI V sw - ON; tb - gray POWER/TEMP MON sel - BAT 2 VOLTS ind - 31.5 to 37.2 vdc AMPS ind - 0 amp</p>	

SUBSYS  
MGMT

**LMA790-3-LM**  
**APOLLO OPERATIONS HANDBOOK**

CREW-MAN	PNL	PROCEDURES	REMARKS
		<p>4.13.4.8 <u>Lunar Stay Battery Management (cont)</u></p> <p>LMP LUNAR BAT sw - OFF/RESET; tb - bp  LMP BAT 2 sw - ON; tb - gray  POWER/TEMP MON sel - LMP BUS  VOLTS ind - 26.5 to 32.5 vdc  Repeat for CDR bus.  CB EPS: CROSS TIE BAL LOADS - close</p>	
	16		<p>Perform this step if step 7 opened circuit breaker.</p>
		<p>4.13.5 <u>HEATERS STATUS CHECK</u></p> <p>1. HTR CONT:  TEMP MON sel - LDG RADAR  TEMP ind - -19° to +148° F  TEMP MON sel - RCS QUAD 1, 2, 3, &amp; 4  TEMP ind - +119 to +190° F (each quad)  TEMP MON sel - S BAND  TEMP ind - -64° to +153° F  TEMP MON sel - RNDZ RADAR  TEMP ind - -54° to +148° F  TEMP MON sel - LDG RADAR</p>	<p>This procedure is performed before LM/CSM separation and during LM manned coasting periods, to verify that all heater temperatures are within tolerance. Assumption: All heater circuit breakers are closed.</p>
	3		
LMP	3	<p>4.13.6 <u>SET EVENT TIMER</u></p> <p>1. EVNT TMR:  RESET/COUNT sw - RESET  RESET/COUNT sw - UP or DOWN  SLEW CONT MIN sw - TENS  SLEW CONT MIN sw - UNITS  SLEW CONT SEC sw - TENS  SLEW CONT SEC sw - UNITS  TMR CONT sw - START</p>	<p>Flashing 9's can be seen as ghost background to normally displayed numbers if ambient lighting is very low and display brightness is at high level. Flashing-digit condition is normal and should not be regarded as malfunction indication.</p>
		<p>4.13.7 <u>WASTE MANAGEMENT</u></p> <p style="text-align: center;">WARNING</p> <p>If germicide pouch is accidentally ruptured, proceed as follows:</p>	

**LMA790-3-LM**  
**APOLLO OPERATIONS HANDBOOK**

RC . . . LM 3244

CREW- MAN	PNL	PROCEDURES	REMARKS
		<p><u>4.13.7 WASTE MANAGEMENT (cont)</u></p> <p>Germicide on LM surface or hardware - Wipe up with tissue.</p> <p>Germicide on crewman's skin - Blot with tissue &amp; flush with water.</p> <p>Germicide in crewman's eyes - Flush with water from water gun &amp; blot with tissue.</p> <p>Germicide ingested - take high-protein food; do not induce vomiting.</p> <p><u>4.13.7.1 Transfer Urine to D/S Waste Container (Prime Mode)</u></p> <ol style="list-style-type: none"> <li>1. Five min before urine transfer: CB HTR: URINE LINE - close HTR CONT: URINE LINE sw - HTR 1</li> <li>2. Remove urine receptacle &amp; transfer hose from storage.</li> <li>3. Remove protective cap and plug from urine receptacle, and safety cap from transfer hose.</li> <li>4. Connect urine receptacle to transfer hose.</li> <li>5. Urine receptacle vlv - open</li> <li>6. Accomplish task.</li> <li>7. Urine receptacle vlv - close</li> <li>7A. Unstow water dispenser.</li> <li>7B. Flush urine receptacle with water.</li> </ol>	<p>Assumptions: (1) Cabin is pressurized and (2) PGA is doffed.</p> <p>Prevents freezing of urine.</p> <p>Urine receptacle protective cap &amp; plug prevents water, residual urine, and odor from entering the cabin</p> <p>Waste management tank nominal pressure is 2.5 psi.</p> <p>If urine does not flow: HTR CONT: URINE LINE sw - HTR 2 and wait 5 minutes</p>

SUBSYS  
MGMT

**LMA790-3-LM  
APOLLO OPERATIONS HANDBOOK**

RC 1605, LM 3244

CREW- MAN	P/NL	PROCEDURES	REMARKS
		<p>4.13.7.1 <u>Transfer Urine to D/S Waste Container (Prime Mode) (cont)</u></p> <p style="text-align: center;">NOTE</p> <p style="padding-left: 40px;">Do not insert water gun into urine receptacle.</p> <p>7C. Rotate urine receptacle.</p> <p style="text-align: center;">NOTE</p> <p style="padding-left: 40px;">Blot excess water with paper towel.</p> <p>7D. Urine receptacle vlv - open</p> <p>7E. Shake urine receptacle</p> <p>7F. Urine receptacle vlv - close</p> <p style="text-align: center;">CAUTION</p> <p style="padding-left: 40px;">To prevent loss of O2 from cabin after urine transfer, urine receptacle valve must be closed</p> <p>7G. Stow water dispenser</p> <p>8. Install protective cap and plug on urine receptacle.</p> <p>9. Disconnect urine receptacle from transfer hose.</p> <p>10. Install safety cap on transfer hose.</p> <p>11. Stow equipment.</p> <p>12. HTR CONT: URINE LINE sv - OFF CB HTR: URINE LINE - open</p> <p>4.13.7.2 <u>Transfer Urine to D/S Waste Container (Alternative Mode)</u></p> <p>1. Five min before urine transfer:</p>	<p>Urine receptacle protective cap &amp; plug prevents water, residual urine, and odor from entering the cabin</p> <p>Assumption: PGA is donned.</p> <p>Prevents freezing of urine.</p>



**LMA790-3-LM**  
**APOLLO OPERATIONS HANDBOOK**

RC 160D, LM 3244

CREW-MAN	PNI	PROCEDURES	REMARKS
	11 8	<p>4.13.7.2 <u>Transfer Urine to D/S Waste Container (Alternative Mode) (cont)</u></p> <p>CB HTR: URINE LINE - close  HTR CONT: URINE LINE sw - HTR 1</p> <p>2. Remove transfer hose from stowage.</p>	

SUBSY  
MGMT



**LMA790-3-LM**  
**APOLLO OPERATIONS HANDBOOK**

CREW- MAN	PNL	PROCEDURES	REMARKS
		<p>4.13.7.2 <u>Transfer Urine to D/S Waste Container (Alternative Mode) (cont)</u></p> <ol style="list-style-type: none"> <li>3. Remove safety plug from transfer hose.</li> <li>4. Remove cover from PGA urine transfer connector.</li> <li>5. Connect transfer hose to PGA urine transfer connector.</li> <li>6. Monitor flow through urine sight glass.</li> <li>7. After flow has stopped, disconnect transfer hose from PGA urine transfer connector.</li> <li>8. Install safety plug into transfer hose.</li> <li>9. Install cover on PGA urine transfer connector.</li> <li>10. Stow transfer hose.</li> <li>11. HTR CONT: URINE LINE sv - OFF CB HTR: URINE LINE - open</li> </ol> <p>4.13.7.3 <u>Transfer Urine to Small Urine Collection Assembly</u></p> <p style="text-align: center;">CAUTION</p> <p>Urine should not be transferred until at least 40 min after water sublimator startup.</p> <ol style="list-style-type: none"> <li>1. Remove small urine collection assembly from stowage.</li> <li>2. Expose PGA urine transfer connector &amp; attach collection assembly to PGA.</li> </ol>	<p>Waste management tank nominal pressure is 2.5 psi. If urine does not flow: HTR CONT: URINE LINE sv - HTR 2 and wait 5 minutes.</p> <p>This is backup procedure for use if waste management system fails. Assumption: Both crewmen are wearing helmets and gloves.</p> <p>Alternative method of transferring urine from PGA is to manually squeeze fluid from UCTA. If this method is used, omit steps 3 through 6.</p>

SUBS  
MGM

**LMA790-3-LM**  
**APOLLO OPERATIONS HANDBOOK**

CREW-MAN	PNI	PROCEDURES	REMARKS
		<p>4.13.7.3 <u>Transfer Urine to Small Urine Collection Assembly (cont)</u></p>	
ECS		<p>3. SUIT GAS DIVERTER vlv - PULL EGRESS</p> <p>CABIN GAS RETURN vlv - EGRESS            SUIT CIRCUIT RELIEF vlv - CLOSE            PRESS REC A vlv - DIRECE 02</p>	<p>Sequence in steps 3 and 6 should be performed as given. If sequence is changed, suit fan may stall and water separator may slow down, causing:</p> <p>MASTER ALARM - on            ECS caut lt - on            SUIT FAN comp caut lt - on            H2O SFP comp caut lt - on</p>
2		<p>4. ECS: SUIT PRESS ind - 0.5 to 0.75 psia &gt; CABIN PRESS ind</p>	<p>PRESS REC B vlv can be used in lieu of PRESS REC A vlv.</p>
ECS		<p>5. PRESS REC A vlv - CABIN</p> <p>6. When urine transfer is completed:            SUIT CIRCUIT RELIEF vlv - AUTO            CABIN GAS RETURN vlv - AUTO            SUIT GAS DIVERTER vlv - PUSH CABIN</p>	
		<p>7. Remove small urine collection assembly from PGA &amp; install cap on PGA connector.</p> <p>8. Stow small urine collection assembly.</p>	
		<p>4.13.7.4 <u>Emesis Disposal</u></p>	
		<p>1. Remove fecal/emesis (F/E) bag from stowage.</p> <p>2. Open germicide pouch &amp; insert into inner F/E bag.</p>	
16 ECS		<p>3. CB ECS: CABIN REPRESS - close            CABIN REPRESS vlv - AUTO            PRESS REC A vlv - CABIN            PRESS REC B vlv - CABIN</p> <p>4. Doff helmet &amp; gloves.</p> <p>5. SUIT ISOL vlv - SUIT DISC</p>	<p>Assumptions: (1) Cabin is pressurized and (2) Steps 3, 4, 5, 7, and 8 must be performed if PGA is donned.</p> <p>Unstaged vehicle only.</p>

**LMA790-3-LM  
APOLLO OPERATIONS HANDBOOK**

LM 3211

CREW-MAN	PNL	PROCEDURES	REMARKS
	ECS	<p>4.13.7.4 <u>Emesis Disposal (cont)</u></p> <ol style="list-style-type: none"> <li>6. Perform task</li> <li>7. SUIT ISOL vlv - SUIT FLOW</li> <li>8. Don helmet &amp; gloves.</li> <li>9. Seal inner F/E bag.</li> <li>10. Insert inner F/E bag into outer F/E bag &amp; seal.</li> <li>11. Stow outer F/E bag.</li> </ol> <p>4.13.7.5 Deleted</p> <p>4.13.7.6 <u>Defecation Disposal</u></p> <ol style="list-style-type: none"> <li>1. Remove defecation device from storage.</li> <li>2. Insert inner bag into unit.</li> <li>3. Open germicide pouch &amp; insert into inner F/E bag.</li> <li>4. Perform task.</li> <li>5. Seal inner bag.</li> <li>6. Place inner bag into outer F/E bag &amp; seal outer bag.</li> <li>7. Knead contents.</li> <li>8. Stow bag.</li> </ol> <p>4.13.8 <u>INSTALLATION OF 16-MM SEQUENCE CAMERA WEDGE</u></p> <ol style="list-style-type: none"> <li>1. Remove 16-mm camera from window mount.</li> <li>2. Remove wedge from 16-mm camera bag in RHSSC; stow bag in midsection.</li> <li>3. Install wedge on window mount.</li> <li>4. Reinstall camera.</li> </ol>	<p>Assumptions: (1) Cabin is pressurized &amp; (2) PGA is doffed.</p> <p>Germicide pouch is inserted before performing task for defecation.</p>





**LMA790-3-LM**  
**APOLLO OPERATIONS HANDBOOK**

CREW-MAN	PNL	PROCEDURES	REMARKS
		<p>4.13.9 WINDOW SHADES (CDR, LMP, &amp; DOCKING)</p> <p>4.13.9.1 <u>Deploy Shades</u></p> <ol style="list-style-type: none"> <li>1. Pull shade from container &amp; unroll (window covered).</li> <li>2. Tack Velcro.</li> </ol> <p>4.13.9.2 <u>Stow Shades</u></p> <ol style="list-style-type: none"> <li>1. Untack Velcro.</li> <li>2. Guide shade to stowed position (window uncovered).</li> </ol> <p>4.13.10 <u>CRASH BAR DEPLOYMENT</u></p> <p>4.13.10.1 <u>Unstow Crash Bar</u></p> <ol style="list-style-type: none"> <li>1. Release crash bar from stowage bracket &amp; swivel out &amp; up across window.</li> <li>2. Lock bar into upper bracket.</li> </ol> <p>4.13.10.2. <u>Stow Crash Bar</u></p> <ol style="list-style-type: none"> <li>1. Remove crash bar from upper bracket &amp; swivel out &amp; down.</li> <li>2. Lock bar into stowage bracket.</li> </ol>	<p>Shades must be deployed during unmanned phases of mission. During manned periods, shade position is at discretion of crew.</p> <p>Procedure to be used before all engine burns and all lunar-surface cabin activity.</p>

SUBSY  
MGM





**LMA790-3-LM  
APOLLO OPERATIONS HANDBOOK**

PARA	TITLE	PAGE
4.14	Intravehicular Operations . . . . .	4.14-2
4.14.1	Initial Intravehicular Transfer to LM . . . . .	4.14-2
4.14.2	Intravehicular Transfer to LM (Second Crewman) . . . . .	4.14-3
4.14.3	Prepare for LM-to-CSM Transfer . . . . .	4.14-3
4.14.4	Intravehicular Transfer to CSM . . . . .	4.14-5
4.14.5	Enable LM Cabin Repressurization System . . . . .	4.14-5
4.14.6	Disable LM Cabin Repressurization System . . . . .	4.14-6
4.14.7	Connect to LM ECS & Communications . . . . .	4.14-6
4.14.8	Disconnect From LM ECS & Communications . . . . .	4.14-8
4.14.9	Open Overhead Hatch (LM Side) . . . . .	4.14-9
4.14.10	Open Overhead Hatch (CSM Side) . . . . .	4.14-9
4.14.11	Close Overhead Hatch (LM Side) . . . . .	4.14-10
4.14.12	Close Overhead Hatch (CSM Side) . . . . .	4.14-10
4.14.13	Install Drogue (LM Side) . . . . .	4.14-11
4.14.14	Install Drogue (CSM Side) . . . . .	4.14-11
4.14.15	Remove Drogue (LM Side) . . . . .	4.14-11
4.14.16	Remove Drogue (CSM Side) . . . . .	4.14-12
4.14.17	Tunnel Pressure Equalization From LM . . . . .	4.14-12
4.14.18	Tunnel Pressurization From LM, Without Using LM Consumables . . . . .	4.14-12
4.14.19	Tunnel Pressurization From LM, Using LM Consumables . . . . .	4.14-13
4.14.20	Vacuum Brush Operation . . . . .	4.14-14

INTRA  
VEHICULAR  
OPERATIONS

**LMA790-3-LM  
APOLLO OPERATIONS HANDBOOK**

LM 3231

CREW MAN	P/NL	PROCEDURES	REMARKS
		<p>4.14 <u>INTRAVEHICULAR OPERATIONS</u></p> <p>4.14.1 <u>INITIAL INTRAVEHICULAR TRANSFER TO LM</u></p> <ol style="list-style-type: none"> <li>1. Perform Open Overhead Hatch (CSM Side) procedure.</li> <li>2. Verify that LM cabin overhead floodlights are on with hatch open.</li> <li>3. Read relative roll indication on docking ring &amp; transmit reading to CSM.</li> <li>4. Enter LM cabin, head first &amp; facing forward.</li> <li>5. Maneuver into cabin above ascent engine cover, grasp assist bar forward of hatch fitting in LM ceiling, pull self into cabin &amp; walk backward down open hatch, ascent engine cover, &amp; midsection bulkhead until feet are on cabin floor. Stow window shades (3) as required.</li> <li>6. DES H20 vlv - OPEN</li> <li>7. Unstow water dispenser to check that there is no water leakage, then stow.</li> <li>8. Overhead floodlights - adjust for forward illumination</li> <li>9. Remove utility lights from interim stowage assembly &amp; place in operational locations.</li> <li>10. Remove interim stowage assembly from front panel &amp; place over PLSS in recharge station.</li> <li>11. Unstow checklist &amp; DEDA desk; place checklist on desk.</li> </ol>	<p>Assumptions: (1) Docking tunnel is clear; (2) CSM, LM, and docking tunnel are pressurized; and (3) transfer umbilical is connected to PGA.</p> <p>Only one crewman at a time can transfer, because there is only one transfer umbilical.</p> <p>Ref para 4.14.10.</p>

**LMA790-3-LM**  
**APOLLO OPERATIONS HANDBOOK**

LM 3240

CREW: MAN	PNL	PROCEDURES	REMARKS
	3	<p>4.14.1 <u>INITIAL INTRAVEHICULAR TRANSFER TO LM (cont)</u></p> <p style="text-align: center;">CAUTION</p> <p>Do not exceed 14.4-amp power limitation through CSM/LM electrical umbilicals.</p> <p>12. LTC: FLOOD sw - ALL EXTERIOR LTC sw - OFF</p> <p>13. Unstow mirror &amp; mount on panel 4.</p> <p>14. Attach inboard restraint cables to PGA.</p> <p>15. Move mirror to panel 16.</p> <p>4.14.2 <u>INTRAVEHICULAR TRANSFER TO LM (SECOND CREWMAN)</u></p> <p>1. Enter LM cabin, head first &amp; facing forward.</p> <p>2. Maneuver into cabin above ascent engine cover, grasp assist bar forward of hatch fitting in LM ceiling, pull self into cabin &amp; walk backward down open hatch, ascent engine cover, &amp; midsection bulkhead until feet are on cabin floor.</p> <p>3. Stand in flight station, face forward, &amp; attach restraints.</p> <p>4.14.3 <u>PREPARE FOR LM-TO-CSM TRANSFER</u></p> <p>1. Verify that CSM has pressurized docking tunnel.</p> <p>2. Cabin relief &amp; dump vlv (ovhd) - OPEN</p> <p>3. Overhead hatch - UNLOCK, open, &amp; secure to ascent engine cover</p> <p>4. Verify that tunnel is clear.</p>	<p>Mirror is used to assist in securing restraints to PGA.</p> <p>Use restraints, as required during flight.</p> <p>Mirror mounts on panels 4, 11, and 16 are to be used as required during flight.</p> <p>Assumptions: (1) Equipment transfer to CSM, if required, must be accomplished before connection to transfer umbilical, and (2) PGA is donned.</p> <p>If vacuum transfer is required, omit steps 1 and 2.</p> <p>If probe and drogue are in tunnel, crew must remove and stow. CSM crewman may connect CSM/LM electrical umbilical during this time. LM crewman may reach transfer umbilical stowage himself.</p>
CDR			

INTRA-  
VEHICULAR  
OPERATIONS

**LMA790-3-LM**  
**APOLLO OPERATIONS HANDBOOK**

CREW-MAN	PNI	PROCEDURES	REMARKS
		<p>4.14.3 <u>PREPARE FOR LM-TO-CSM TRANSFER (cont)</u></p> <p>5. Receive transfer umbilical from CSM.</p> <p>6. Verify that O2 is not flowing in transfer umbilical.</p> <p>7. Remove plugs from PGA O2 connectors &amp; stow.</p> <p>8. Connect transfer umbilical O2 hoses to PGA, inlet to inlet (blue to blue), outlet to outlet (red to red).</p> <p>9. Request CSM to verify no transfer umbilical suit power.</p> <p>10. COMM: TLM BIONED sw - OFF or LEFT or COMM: TLM BIONED sw - OFF or RIGHT</p> <p>11. CB COMM: SE AUDIO - open or CB COMM: CDR AUDIO - open</p> <p>12. Disconnect LM comm cable from PGA &amp; connect transfer umbilical comm cable to PGA.</p> <p>13. Signal CSM to apply transfer umbilical suit power.</p> <p>14. Request CSM to start O2 flow through transfer umbilical.</p> <p>15. SUIT ISOL vlv (LMP) - SUIT DISC or SUIT ISOL vlv (CDR) - SUIT DISC</p> <p>16. Verify O2 flow to PGA through transfer umbilical.</p> <p>17. Disconnect LM umbilical O2 hoses from PGA.</p> <p>18. Remove plugs from stowage &amp; place in PGA.</p> <p>19. Stow LM umbilical.</p>	<p>Steps 10 and 11 are performed to ensure that crewman communications cable is not powered.</p> <p>Step 11 results in loss of communications.</p> <p>This constitutes communications check via transfer umbilical communications cable.</p>

**LMA790-3-LM**  
**APOLLO OPERATIONS HANDBOOK**

CREW-MAN	PNL	PROCEDURES	REMARKS
LM 3231	LMP	<p>4.14.4 <u>INTRAVEHICULAR TRANSFER TO CSM</u></p> <ol style="list-style-type: none"> <li>1. Unstow &amp; install interim stowage assembly over panels 1 &amp; 2.</li> <li>2. Overhead floodlights - rotate aft Deploy window shades (3) if previously stowed.</li> <li>3. DES H2O vlv - CLOSE</li> <li>4. Release hatch from ascent engine cover.</li> <li>5. Cabin relief &amp; dump vlv (ovhd) - AUTO</li> <li>6. Perform Close Overhead Hatch (CSM Side) procedure.</li> </ol>	
	ECS	<p>4.14.5 <u>ENABLE LM CABIN REPRESSURIZATION SYSTEM</u></p> <p align="center">NOTE</p> <p>This procedure enables LM ECS to operate in conjunction with CM ECS in event of cabin puncture (loss of cabin pressure) while vehicles are docked, pressurized, &amp; tunnel hatches are open.</p> <ol style="list-style-type: none"> <li>1. DES O2 vlv - OPEN</li> </ol> <p align="center">CAUTION</p> <p>Rapid switching of CABIN REPRESS vlv from AUTO to CLOSE, or CLOSE to AUTO, causes loud bang. This does not damage valve. To change CABIN REPRESS vlv position, smooth, slow movement is recommended.</p> <ol style="list-style-type: none"> <li>2. CABIN REPRESS vlv - AUTO</li> <li>3. CB ECS: CABIN REPRESS - close</li> </ol>	<p>Ref para 4.14.12.</p> <p>Assumptions: (1) Initial Intravehicular Transfer to LM (para 4.14.1) has been performed and (2) LM PRESS REG A and B vlv - CLOSE.</p>
	ECS		
	16		

INTRA-VEHICULAR OPERATIONS

**LMA790-3-LM  
APOLLO OPERATIONS HANDBOOK**

CREW- MAN	PNL	PROCEDURES	REMARKS
		<p><u>4.14.6 DISABLE LM CABIN REPRESSURIZATION SYSTEM</u></p>	<p>Procedure to be performed by last crewman leaving LM.</p>
ECS		<p>1. DES 02 vlv - CLOSE</p> <p align="center">CAUTION</p> <p>Rapid switching of CABIN REPRESS vlv from AUTO to CLOSE, or CLOSE to AUTO, causes loud bang. This does not damage valve. To change CABIN REPRESS vlv position, smooth, slow movement is recommended.</p>	
	16	<p>2. CABIN REPRESS vlv - CLOSE</p> <p>3. CB ECS: CABIN REPRESS - open</p>	
		<p><u>4.14.7 CONNECT TO LM ECS &amp; COMMUNICATIONS</u></p> <p align="center">CAUTION</p> <p>CB COMM: SE AUDIO must be closed to transmit on VHF A and/or operate DSEA. CB must be opened when LMP connects or disconnects LM comm cable &amp; COMM: TLM BIONED sw - OFF or LEFT.</p> <p>CB COMM: CDR AUDIO must be closed to transmit voice on VHF B. CB must be opened when CDR connects or disconnects LM comm cable &amp; COMM: TLM BIONED sw - OFF or RIGHT.</p>	<p>Assumptions: (1) LM ECS and communications are configured to support crewman, (2) procedure to be used at any time other than initial entry, and (3) procedure is used for pressurized or depressurized cabin.</p>
ECS		<p>1. Unstow LM umbilical.</p> <p>2. Verify that PCA 02 connectors clear.</p> <p>3. Connect 02 hoses to PCA 02 connectors, inlet to inlet (blue to blue), outlet to outlet (red to red).</p>	
LMP		<p>4. SUIT ISOL vlv (LMP) - SUIT FLOW</p> <p align="center">or</p> <p>SUIT ISOL vlv (CDR) - SUIT FLOW</p>	
CDR			

**LMA790-3-LM**  
**APOLLO OPERATIONS HANDBOOK**

CREW- MAN	PNL	PROCEDURES	REMARKS
		4.14.7 <u>CONNECT TO LM ECS &amp; COMMUNICATIONS (cont)</u>	
		5. Terminate flow from PLSS or CSM.	
		6. Verify 02 flow to PGA from LM ARS.	
LMP	12	7. Verify: COMM: TLM BIONED sw - OFF or LEFT or COMM: TLM BIONED sw - OFF or RIGHT	
CDR			
LMP	16	8. Verify: CB COMM: SE AUDIO - open or CB COMM: CDR AUDIO - open	
CDR	11		
	RCU	9. EVC-1 (EVC-2) MODE SEL sw - 0 or Request CSM to remove comm cable power & verify noise level change in headset.	Removes communications power from PLSS cable.  Removes communications power from transfer umbilical.
		10. Disconnect PLSS or CSM comm cable from PGA.	
LMP	16	11. Connect LM comm cable to PGA.	
CDR	11	12. CB COMM: SE AUDIO - close or CB COMM: CDR AUDIO - close	
CDR/ LMP		13. Disconnect PLSS or CSM 02 hoses.	
		14. Unstow LCG H20 umbilical.	
		15. Verify that PGA multiple water connection is clear.  CAUTION  Do not connect LM LCG H20 umbilical to PGA if LCC accumulator bob was found to be bottomed during Initial Entry status check.	
	16	16. Connect LCG H20 umbilical to PGA connector.	
		17. CB ECS: LCG PUMP - close (as required)	

**LMA790-3-LM  
APOLLO OPERATIONS HANDBOOK**

CREW- MAN	PNI	PROCEDURES	REMARKS
		<p>4.14.8 <u>DISCONNECT FROM LM ECS &amp; COMMUNICATIONS</u></p> <p style="text-align: center;">CAUTION</p> <p>CB COMM: SE AUDIO must be closed to transmit on VHF A and/or operate DSEA. CB must be opened when LMP connects or disconnects LM comm cable &amp; COMM: TLM BIOMED sw - OFF or LEFT.</p> <p>CB COMM: CDR AUDIO must be closed to transmit voice on VHF B. CB must be opened when CDR connects or disconnects LM comm cable &amp; COMM: TLM BIOMED sw - OFF or RIGHT.</p>	<p>Assumptions: (1) Each crewman is in position to observe and assist other crewman and (2) procedure is used for pressurized or depressurized cabin.</p>
LMP	ECS	<ol style="list-style-type: none"> <li>Verify that PCA 02 connectors clear.</li> <li>Connect PLSS (or CSM) 02 hoses to PCA 02 connectors, inlet to inlet (blue to blue), outlet to outlet (red to red).</li> <li>Initiate flow from PLSS (or CSM)</li> <li>SUIT ISOL vlv (LMP) - SUIT DISC; verify flow from PLSS (or CSM) or SUIT ISOL vlv (CDR) - SUIT DISC; verify flow from PLSS (or CSM)</li> </ol>	
	RCU	<ol style="list-style-type: none"> <li>Disconnect LM 02 hoses from PCA.</li> <li>EVC-1 (EVC-2) MODE SEL sw - 0 or Request CSM to remove comm cable power &amp; verify noise level change in headset.</li> </ol>	<p>Removes communications power from PLSS cable.</p> <p>Removes communications power from transfer umbilical.</p>
LMP	12	<p>COMM: TLM BIOMED sw - OFF or LEFT or COMM: TLM BIOMED sw - OFF or RIGHT</p>	
CDR	16	<p>CB COMM: SE AUDIO - open or CB COMM: CDR AUDIO - open</p>	
LMP	11		



**LMA790-3-LM**  
**APOLLO OPERATIONS HANDBOOK**

CREW- MAN	PNL	PROCEDURES	REMARKS
		<p>4.14.8 <u>DISCONNECT FROM LM EGS &amp; COMMUNICATIONS (cont)</u></p> <p>9. Disconnect comm cable from PGA.</p> <p>10. Connect PLSS (or CSM) comm cable to PGA.</p> <p>11. Stow LM umbilical.</p> <p>12. CB EGS: LCG PUMP - open</p> <p>13. Disconnect LCG H2O umbilical from PGA</p> <p>14. Stow LCG H2O umbilical.</p> <p>15. Unstow &amp; replace PGA/LCG plug.</p> <p>4.14.9 <u>OPEN OVERHEAD HATCH (LM SIDE)</u></p> <p>1. Grasp hatch handle &amp; push.</p> <p>2. Rotate handle counterclockwise to UNLOCK &amp; pull hatch open.</p> <p>3. Cabin relief &amp; dump vlv (ovhd) - AUTO</p> <p>4. Guide hatch to ascent engine cover.</p> <p>5. Latch hatch flange to ascent-engine-cover fitting to secure hatch open.</p> <p>4.14.10 <u>OPEN OVERHEAD HATCH (CSM SIDE)</u></p> <p>1. Cabin relief &amp; dump vlv (ovhd) - PULL TO DUMP</p> <p>2. Grasp hatch handle &amp; pull.</p> <p>3. Rotate handle clockwise to UNLOCK.</p> <p>4. Open hatch &amp; guide inward to LM ascent engine cover.</p> <p>5. Push hatch so that hatch flange latches to ascent-engine-cover fitting.</p>	<p>To be performed before last crewman disconnects from LCG H2O umbilicals.</p> <p>Assumptions: (1) CSM has pressurized docking tunnel and (2) Tunnel Pressure Equalization From LM procedure (para 4.14.17) has been performed.</p> <p>CSM must verify docking-tunnel and LM-cabin pressure equalization.</p> <p>External handle of cabin relief and dump vlv (ovhd) is spring loaded to allow return to automatic, when released.</p>
LMP / CDR	16		

INTRA  
VEHICULAR  
OPERATION

**LMA790-3-LM  
APOLLO OPERATIONS HANDBOOK**

CREW-MAN	PNL	PROCEDURES	REMARKS
		<p><u>4.14.11 CLOSE OVERHEAD HATCH (LM SIDE)</u></p> <ol style="list-style-type: none"> <li>1. Unlatch hatch flange from ascent-engine-cover fitting.</li> <li>2. Guide hatch to closed position.</li> <li>3. Grasp handle &amp; push.</li> <li>4. Rotate handle clockwise to LOCK.</li> <li>5. Verify that handle pops out of detent, then release.</li> <li>6. Cabin relief &amp; dump vlv (ovhd) - AUTO</li> </ol> <p><u>4.14.12 CLOSE OVERHEAD HATCH (CSM SIDE)</u></p> <ol style="list-style-type: none"> <li>1. Unlatch hatch flange from ascent-engine-cover fitting.</li> <li>2. Cabin relief &amp; dump vlv (ovhd) - AUTO</li> <li>3. Enter LM/CSM tunnel, feet first.</li> <li>4. Grasp hatch handle &amp; guide hatch to closed position.</li> <li>5. Pull handle &amp; rotate counterclockwise to LOCK.</li> <li>6. Verify that handle pops out of detent, then release.</li> </ol> <p><u>4.14.13 INSTALL DROGUE (LM SIDE)</u></p> <ol style="list-style-type: none"> <li>1. Verify that drogue support-locking fitting is in unlocked position.</li> <li>2. Request CMP to pass drogue through tunnel.</li> <li>3. Receive drogue &amp; grasp by handles.</li> <li>4. Align drogue lugs with LM drogue support-fitting ramps.</li> <li>5. Push drogue toward CSM until drogue lugs engage support fitting.</li> <li>6. Rotate drogue clockwise through full travel.</li> </ol>	<p>Lever parallel to LM Y-Z plane and rotated clockwise against tunnel wall.</p> <p>Full travel is approximately 5°.</p>

**LMA790-3-LM**  
**APOLLO OPERATIONS HANDBOOK**

CREW-MAN	PNI	PROCEDURES	REMARKS
		<p>4.14.13 <u>INSTALL DROGUE (LM SIDE) (cont)</u></p> <p>7. Lock drogue in place by rotating lever counterclockwise, perpendicular to tunnel wall, then rotating lever parallel to LM X-axis.</p> <p>4.14.14 <u>INSTALL DROGUE (CSM SIDE)</u></p> <ol style="list-style-type: none"> <li>1. Verify that drogue support-locking fitting is in unlocked position.</li> <li>2. Retrieve drogue from stowage</li> <li>3. Insert drogue into tunnel past drogue support fittings, using drogue handles to control movement through tunnel.</li> <li>4. Rotate drogue 180° &amp; grasp drogue forward edge with both hands.</li> <li>5. Align drogue lugs with LM drogue support-fitting ramps.</li> <li>6. Pull drogue toward CSM until lugs engage support fittings.</li> <li>7. Rotate drogue counterclockwise through full travel.</li> <li>8. Lock drogue in place by rotating lever clockwise perpendicular to tunnel wall &amp; push into detent.</li> </ol> <p>4.14.15 <u>REMOVE DROGUE (LM SIDE)</u></p> <ol style="list-style-type: none"> <li>1. Unlock drogue by rotating lever upward &amp; parallel to LM Y-Z plane; rotate clockwise against tunnel wall.</li> <li>2. Grasp drogue handles &amp; rotate drogue counterclockwise through full travel.</li> <li>3. Pull drogue until lugs disengage from support fittings.</li> <li>4. Rotate drogue so that CMP can grasp drogue handles &amp; pull drogue into CSM.</li> </ol>	<p>Lever out of detent and rotated counterclockwise against tunnel wall.</p> <p>Full travel is approximately 5°.</p> <p>Full travel is approximately 5°.</p> <p>Assumption: CMP is in position to assist LM crewman.</p>

**LMA790-3-LM  
APOLLO OPERATIONS HANDBOOK**

CREW- MAN	PNI	PROCEDURES	REMARKS
		<p>4.14.16 <u>REMOVE DROGUE (CSM SIDE)</u></p> <ol style="list-style-type: none"> <li>1. Pull drogue locking lever out of detent &amp; rotate counter-clockwise to tunnel wall.</li> <li>2. Grasp drogue forward edge with both hands &amp; rotate clockwise through full travel.</li> <li>3. Push drogue toward LM until lugs have disengaged from drogue support fittings.</li> <li>4. Rotate drogue 180° &amp; grasp both drogue handles.</li> <li>5. Guide drogue through tunnel into CSM.</li> </ol>	<p>Full travel is approximately 5°.</p>
		<p>4.14.17 <u>TUNNEL PRESSURE EQUALIZATION FROM LM</u></p> <ol style="list-style-type: none"> <li>1. PRESS REG A vlv - EGRESS PRESS REG B vlv - EGRESS</li> <li>2. SUIT GAS DIVERTER vlv - FULL EGRESS</li> <li>3. Cabin relief &amp; dump vlv (ovhd) - OPEN</li> </ol>	<p>Prevents LM from supplying oxygen to both LM and CSM while interconnecting tunnel is open.</p>
		<p>4.14.18 <u>TUNNEL PRESSURIZATION FROM LM, WITHOUT USING LM CONSUMABLES</u></p> <ol style="list-style-type: none"> <li>1. PRESS REG A vlv - EGRESS PRESS REG B vlv - EGRESS</li> <li>2. SUIT GAS DIVERTER vlv - FULL EGRESS</li> <li>3. Cabin relief &amp; dump vlv (ovhd) - OPEN</li> <li>2. ECS: CABIN PRESS ind - approx 4.6 psia</li> </ol>	<p>This is backup procedure. Pressurization of tunnel is normally CSM task.</p> <p>Assumption: ECS Basic (Unstaged).</p> <p>Prevents LM from supplying oxygen to both LM and CSM while interconnecting tunnel is open.</p> <p>Cabin pressure will decrease approximately 0.2 psia, based on following: (1) LM free volume - 235 cu ft, (2) combined docking tunnel volume - 11.5 cu ft, and (3) initial LM pressure - 4.8 psia.</p>

**LMA790-3-LM**  
**APOLLO OPERATIONS HANDBOOK**

CREW/ MAN	PNL	PROCEDURES	REMARKS
		<p>4.14.18 <u>TUNNEL PRESSURIZATION FROM LM WITHOUT USING LM CONSUMABLES (cont)</u></p> <p>4.14.19 <u>TUNNEL PRESSURIZATION FROM LM, USING LM CONSUMABLES</u></p>	<p>CSM must equalize pressure with tunnel at 4.6 psia. Final pressure decay will be function of how long LM maintains tunnel pressure. Initial tunnel leakage (during initial seal latching) is 0.25 lb/hr at 5 psia. After completion of final seal latching, leakage is 0.1 lb/hr at 5 psia.</p> <p>This is backup procedure. Pressurization of tunnel is normally CSM task.</p> <p>Assumptions: (1) ECS Basic (Staged), (2) ascent oxygen tanks No. 1 and 2 have sufficient usable oxygen remaining and (3) this is last pressurization before crew transfer and LM jettison.</p> <p>Cabin pressure will decrease approximately 0.2 psia, based on following: (1) LM free volume - 235 cu ft, (2) combined docking tunnel volume - 11.5 cu ft, and (3) initial LM pressure - 4.8 psia.</p>
LMP	ECS	1. PRESS REG A vlv - EGRESS PRESS REG B vlv - EGRESS	
	ECS	2. SUIT GAS DIVERTER vlv - PULL EGRESS CABIN GAS RETURN vlv - AUTO	
		3. Cabin relief & dump vlv (ovhd) - OPEN	
	2	4. ECS: CABIN PRESS ind - approx 4.4 psia	
		CAUTION	
		Rapid switching of CABIN REPRESS vlv from AUTO to CLOSE, or CLOSE to AUTO, causes loud bang. This does not damage valve. To change CABIN REPRESS vlv position, smooth, slow movement is recommended.	
	ECS	5. CABIN REPRESS vlv - MANUAL until ECS: CABIN PRESS ind - 5.0 psia, then - CLOSE	

INTRA  
VEHICULAR  
OPERATION

**LMA790-3-LM**  
**APOLLO OPERATIONS HANDBOOK**

CREW-MAN	PNI	PROCEDURES	REMARKS
		4.14.20 <u>VACUUM BRUSH OPERATION</u>	<p>Assumptions: (1) LM ascent stage docked with CSM after lunar launch, (2) LM/CSM docking hatches are open and tunnel is clear, and (3) crew have doffed helmets and gloves.</p>
CDR		1. Receive vacuum brush equipment from CSM.	
LMP	ECS	2. SUIT GAS DIVERTER vlv - PULL EGRESS CABIN GAS RETURN vlv - EGRESS SUIT CIRCUIT RELIEF vlv - CLOSE	
CDR, LMP		3. Disconnect red O2 hose from PGA.	
LMP		4. Connect red hose to O2 umbilical interconnect.	
CDR		5. Connect red hose to vacuum.	
CDR/ LMP		6. Vacuum equipment as necessary.	
CDR		7. Disconnect vacuum from hose and stow.	
LMP		8. Disconnect hose from O2 umbilical interconnect.	
CDR, LMP		9. Connect red O2 hose to PGA.	
LMP		10. SUIT CIRCUIT RELIEF vlv - AUTO	

**LMA790-3-LM**  
**APOLLO OPERATIONS HANDBOOK**

PARA	TITLE	PAGE
4.15	Lunar Stay Operations . . . . .	4.15-2
4.15.1	Cabin Operations . . . . .	4.15-2
4.15.1.1	EPS Check, Post-Lunar-Landing . . . . .	4.15-2
4.15.1.2	Lunar Stay Subsystems Check . . . . .	4.15-3
4.15.1.3	Open Forward Hatch (Cabin Side) . . . . .	4.15-13
4.15.1.4	Open Forward Hatch (Outside) . . . . .	4.15-13
4.15.1.5	Close Forward Hatch (Cabin Side) . . . . .	4.15-13
4.15.1.6	Close Forward Hatch (Outside) . . . . .	4.15-14
4.15.1.7	ARS Purge (EVA Preparation) . . . . .	4.15-14
4.15.1.8	Subsystem Configuration for EVA Preparation . . . . .	4.15-15
4.15.1.9	PLSS/EVCS Electrical Checkout, Two-Man EVA . . . . .	4.15-17
4.15.1.10	PLSS/EVCS Electrical Checkout, One-Man EVA . . . . .	4.15-20
4.15.1.11	Final Subsystems Configuration for Egress . . . . .	4.15-23
4.15.1.12	ECS Status (Two Men on Lunar Surface) . . . . .	4.15-24
4.15.1.13	Post-EVA Final Subsystems Configuration . . . . .	4.15-26A
4.15.1.14	Cooling H2O Changeover, PLSS H2O to LM H2O (LCG) . . . . .	4.15-28
4.15.1.15	Cooling H2O Changeover, LM H2O (LCG) to PLSS H2O . . . . .	4.15-28
4.15.1.16	PLSS Recharge . . . . .	4.15-28
4.15.1.16.1	Oxygen Recharge . . . . .	4.15-28
4.15.1.16.2	Feedwater Reservoir and Auxiliary Tank Recharge, Gravity Environment . . . . .	4.15-29
4.15.1.17	Raise EVA Antenna . . . . .	4.15-32
4.15.1.18	Stow EVA Antenna . . . . .	4.15-32
4.15.1.19	Sleep Station . . . . .	4.15-32
4.15.1.19.1	Deploy Sleep Station . . . . .	4.15-32
4.15.1.19.2	Stow Sleep Station . . . . .	4.15-33
4.15.1.20	Buddy Umbilical Stowage Bag Removal . . . . .	4.15-34
4.15.1.21	PGA Protective Stowage . . . . .	4.15-34
4.15.2	Extravehicular Activity . . . . .	4.15-34
4.15.2.1	MESA Operations . . . . .	4.15-34
4.15.2.1.1	MESA Remote Deployment . . . . .	4.15-34
4.15.2.1.2	MESA Manual Deployment . . . . .	4.15-35
4.15.2.1.3	MESA Height Adjustment . . . . .	4.15-35
4.15.2.1.4	MESA Exterior Blanket Removal . . . . .	4.15-35
4.15.2.1.5	TV Camera Deployment . . . . .	4.15-36
4.15.2.1.6	MESA Equipment Handling and Transfer . . . . .	4.15-36
4.15.2.1.7	SRC Removal . . . . .	4.15-37
4.15.2.2	LRV Deployment . . . . .	4.15-37
4.15.2.3	ALSEP Operations . . . . .	4.15-37
4.15.2.3.1	Open Scientific Equipment (SEQ) Bay . . . . .	4.15-37
4.15.2.3.2	Pallet Assembly Remote Deployment . . . . .	4.15-38
4.15.2.3.3	Pallet Assembly Manual Deployment . . . . .	4.15-39
4.15.2.3.4	Pallet Assembly Manual Deployment in Low Attitude . . . . .	4.15-40
4.15.2.3.5	Removal of RTG Fuel Element . . . . .	4.15-41
4.15.2.4	Deleted . . . . .	4.15-42
4.15.2.5	TV Camera Operation . . . . .	4.15-42
4.15.2.6	Lunar Launch Contingency Stowage . . . . .	4.15-42

**LMA790-3-LM**  
**APOLLO OPERATIONS HANDBOOK**

CREW- MAN	PNL	PROCEDURES	REMARKS	
		4.15 <u>LUNAR STAY OPERATIONS</u>		
		4.15.1 <u>CABIN OPERATIONS</u>		
		4.15.1.1 <u>EPS Check, Post-Lunar-Landing</u>		
CDR	11	1. CB EPS: ASC ECA CONT - close	This task should be performed soon after any DPS burn during which ascent batteries were in parallel with descent batteries.	
LMP	16	2. CB EPS: ASC ECA CONT - close		
	14	3. Remove ascent batteries from line: EPS: BAT 5 NORMAL LMP FEED sw - OFF/RESET; tb - bp BAT 6 NORMAL CDR FEED sw - OFF/RESET; tb - bp		
		4. Check voltage & current of descent batteries: EPS: POWER/TEMP MON sel - BAT 1 VOLTS ind - 28.0 to 32.5 vdc AMPS ind - TBD Repeat for BAT 2, 3, & 4.		
CDR	11	5. CB EPS: CROSS TIE BAL LOADS - close ASC ECA CONT - open		Verify load-sharing of descent batteries. To obtain proper current measurement for descent batteries, divide indicated reading by 2.
LMP	16	6. CB EPS: ASC ECA CONT - open CROSS TIE BAL LOADS - close		
	14	7. Check a-c voltage from inverter No. 1: EPS: POWER/TEMP MON sel - AC BUS INVERTER sw - 1 VOLTS ind - green band INVERTER sw - 2 VOLTS ind - green band POWER/TEMP MON sel - CDR BUS		Green band represents 112 to 118 volts ac.
	11	8. CB EPS: INV 1 - open		



**LMA790-3-LM**  
**APOLLO OPERATIONS HANDBOOK**

CREW-MAN	PNL	PROCEDURES	REMARKS
	11	<p>4.15.1.1.2 Lunar Stay Subsystems Check</p> <p>1. All cb's open, except:            CB/AC BUS B:            SE WIND HTR - as required            He/PQGS PROFUL DISP - close            S BD ANT - close            NUM LTG - close            BUS TIE INV 2 - close            BUS TIE INV 1 - close            CB/AC BUS A:            BUS TIE INV 2 - close            BUS TIE INV 1 - close            AC BUS VOLT - close            CDR WIND HTR - as required            TAPE RCDR - close            INTGL LTG - close            CB FLT DISP: MSN TMR - close            CB HTR:            URINE LINE - as required            RNDZ RDR STBY - close            DOCK WINDOW - as required            CB INST: SIG CONDR 1 - close            CB S/C:            ABORT STAGE - close            AICA (FGNS) - close            CB LTG:            UTIL - close            ANUN/DOCK/COMPNT - close            CB HTR RCS SYS A/B 1:            QUAD 4 - close            QUAD 3 - close            QUAD 2 - close            QUAD 1 - close            CB ECS:            SUIT FAN 1 - close            GLYCOL PUMP 2 - close            GLYCOL PUMP 1 - close            GLYCOL PUMP AUTO TRNFR - close            CB COMM:            UP DATA LINK - close            SEC 5 BD XMTR/RCVR - close</p>	<p>Assumptions: (1) This check occurs after DPS venting of helium and propellant and (2) GSM is not in LOS.</p> <p>When crew is monitoring windows and can detect fogging, heater operation is at crew discretion (use if condensation is noticed). When crew is not monitoring windows (sleep periods), window heaters are required to prevent condensation on windows if sun is less than 20° angle to window. (Solar angle with respect to LM coordinate systems can be determined by MSFN with aid of IMU gimbal angles.)</p> <p>If abort stage function is required, CB ED: LOGIC PWR A and B must be closed. (They are kept open to minimize current drain on batteries.)</p>

**LMA790-3-LM  
APOLLO OPERATIONS HANDBOOK**

CREW- MAN	PNL	PROCEDURES	REMARKS
		<p>4.15.1.2 Lunar Stay Subsystems Check (cont)</p> <p>SEC S BD PWR AMPL - close  VHF B XMTR - close  VHF A RCVR - close  CDR AUDIO - close  CB PCNS:    LGC/DSKY - close    DMU STBY - close  CB EPS:    BAT FEED TIE (2) - close    CROSS TIE BAL LOADS - close    XLUNAR BUS TIE - close    DES ECA CONT - close    DES ECA - close    ASC ECA - close    DC BUS VOLT - close  Verify cb status per Lunar Stay Subsystems Check.</p> <p>8 2. DES PROPUL:  FUEL VENT sw - center; tb - bp  OXID VENT sw - center; tb - bp  HTR CONT:    MESA sw - HI    URINE LINE sw - as required  ED:    DES PRPLNT ISOL VLV sw - SAFE    MASTER ARM sw - OFF    DES VENT sw - SAFE    ASC He SEL sw - BOTH    LDG GEAR DEPLOY sw - SAFE; tb - bp    RCS He PRESS sw - SAFE    DES START He PRESS sw - SAFE    ASC He PRESS sw - SAFE    STAGE sw - SAFE (guarded)    STAGE RELAY sw - OFF  AUDIO:    S BAND T/R sw - S BAND T/R    ICS T/R sw - ICS T/R    RELAY ON sw - RELAY OFF    MODE sw - ICS/PTT    AUDIO CONT sw - NORM    VHF A sw - OFF    VHF B sw - OFF    COAS sw - OFF</p>	<p style="text-align: center;">See figure 4-26.</p> <p style="text-align: right;">Volume, squelch, and sensitivity controls will be adjusted as required.</p>

LMA790-3-LM  
 APOLLO OPERATIONS HANDBOOK

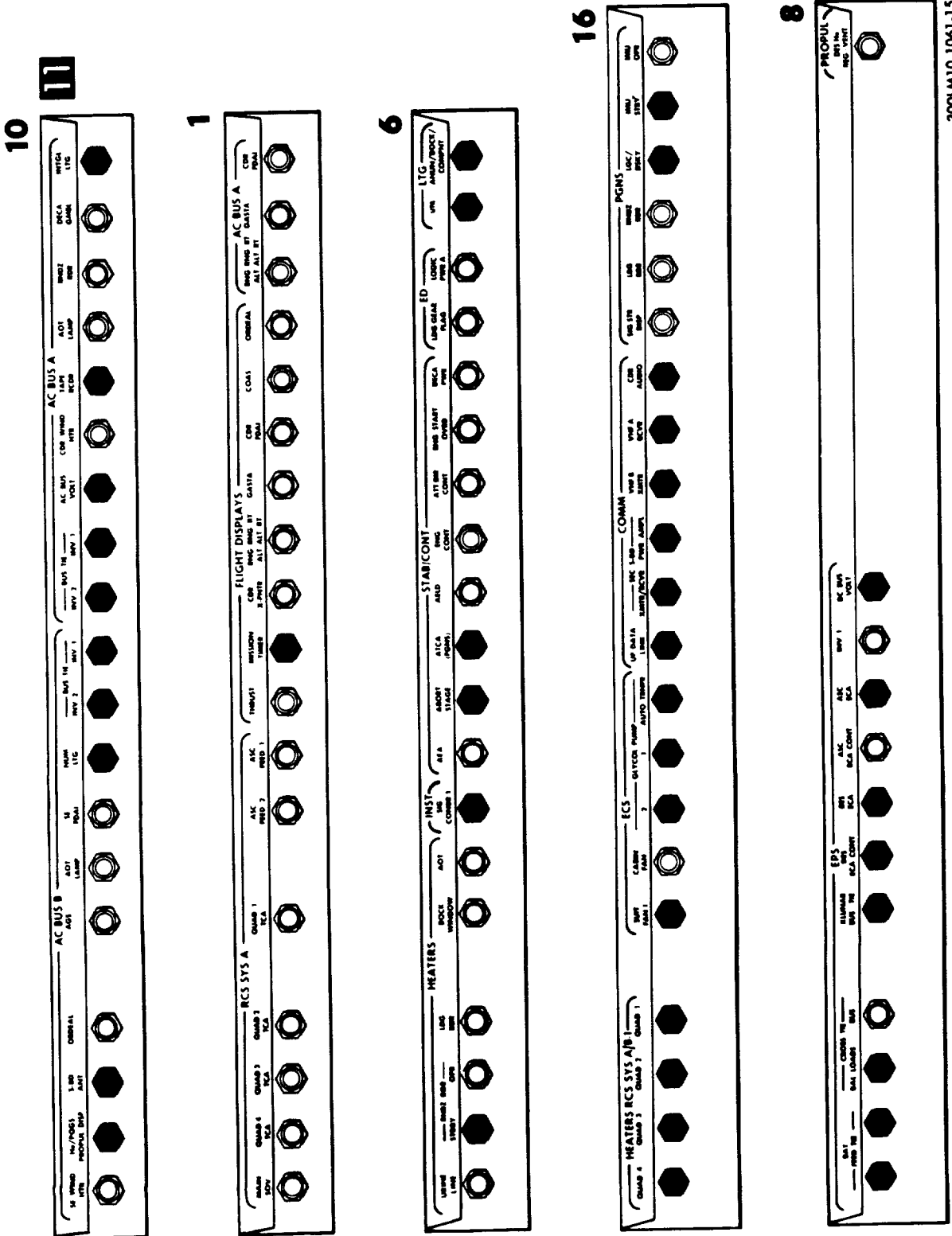

Figure 4-26. Lunar Stay Subsystems Check (Panel 11)

300LMI0-1061-15

**LMA790-3-LM  
APOLLO OPERATIONS HANDBOOK**

CREW- MAN	PNL	PROCEDURES	REMARKS
		<p>4.15.1.1.2 Lunar Stay Subsystems Check (cont)</p> <p>3. ORDEAL:            FDAI 1 sw - INRTL            FDAI 2 sw - INRTL            EARTH/LUNAR sw - PWR OFF            LTG sw - OFF            MODE sw - HOLD/FAST            SLEW sw - center</p> <p>4. THROTTLE/JETS cont (CDR) - JETS</p> <p>5. Eng STOP pb/lt - reset            Eng START pb/lt - not depressed            +X TRANSL pb - not depressed            MSN THR: THR CONT sw - START            LTG:              OVERRIDE ANUN sw - OFF              OVERRIDE NUM sw - OFF              OVERRIDE INTEGRAL sw - OFF              SIDE PANELS sw - OFF              FLOOD cont - BRIGHT              ANUN/NUM cont - DIM              INTEGRAL cont - DIM</p> <p>1 6. FDAI pwr tb - OFF (in view)            X pointer ind pwr fail lt - on            THRUST ind pwr fail lt - on            RNG/ALT ind pwr/sig fail lt - on            X POINTER SCALE sw - HI MULT            MASTER ALARM - off            RATE/ERR MON sw - LDC RDR/CHPTR            ATTITUDE MON sw - PGNS            SHFT/TRUN <math>\frac{1}{2}</math> sw - +50°            RATE SCALE sw - 25°/SEC            Eng THR CONT:              THR CONT sw - AUTO              MAN THROT sw - CDR              ENG ARM sw - OFF              ATT/TRANSL sw - 2 JETS              BAL CPL sw - ON              ASC He REG 1 &amp; 2 sw - center; tb - gray              DES He REG 1 sw - center; tb - gray              DES He REG 2 sw - center; tb - bp              ACA PROP sw - ENABLE</p>	

**LMA790-3-LM  
APOLLO OPERATIONS HANDBOOK**

CREW MAN	PNL	PROCEDURES	REMARKS
		<p>4.15.1.1.2 Lunar Stay Subsystems Check (cont)</p> <p>PRPLNT QTY MON sw - OFF            PRPLNT TEMP/PRESS MON sw - ASC            HELIUM MON sel - PRESS 1            ABORT pb - reset            ABORT STAGE pb - reset            RING/ALT MON sw - ALT/ALT RT            MODE SEL sw - PCNS            GUID CONT sw - PCNS</p> <p>3 7. ENG GMBL sw - OFF            DES ENG CHD OVRD sw - OFF            RADAR:            LDG ANT sw - AUTO            RADAR TEST sw - OFF            TEST/MON sel - AGC            RNDZ RADAR: SLEW RATE sw - HI            RNDZ RADAR sel - LGC            S/C:            DEAD BAND sw - MIN            GYRO TEST ROLL sw - ROLL            GYRO TEST POS RT sw - OFF            ROLL sw - MODE CONT            PITCH sw - MODE CONT            YAW sw - MODE CONT            PCNS sw - OFF            AGS sw - OFF            IMU CAGE sw - OFF            HTR CONT:            TEMP MON sel - RNDZ RDR            RCS SYS A/B 2 QUAD 1, 2, 3, 4 sw - AUTO            EVNT TMR: RESET/COUNT sw - UP            LTG:            SIDE PANELS sw - OFF            FLOOD sw - OVHD/FWD            FLOOD cont - RRIGHT            LAMP/TONE TEST sel - OFF            EXTERIOR LTG sw - OFF            X POINTER SCALE sw - HI MULT</p> <p>4 8. ACA/4 JET sw (CDR) - ENABLE            TTCA/TRANSL sw (CDR) - ENABLE            ACA/4 JET sw (LMP) - ENABLE            TTCA/TRANSL sw (LMP) - ENABLE</p>	

**LMA790-3-LM  
APOLLO OPERATIONS HANDBOOK**

CREW- MAN	PNL	PROCEDURES	REMARKS
		4.15.1.1.2 Lunar Stay Subsystems Check (cont)	
	AOT	9. Azimuth cont - CL Eye guard & density filter - removed MARK X pb - not depressed MARK Y pb - not depressed REJECT pb - not depressed	
	2	10. RCS: SYS A ASC FEED 1 & 2 sw - center SYS A ASC FUEL & OXID tb - bp SYS B ASC FEED 1 & 2 sw - center SYS B ASC FUEL & OXID tb - bp SYS A QUAD 1, 4, 2, 3 sw - center; tb - gray SYS B QUAD 1, 4, 2, 3 sw - center; tb - gray CRSPD sw - center; tb - bp SYS A MAIN SOV sw - center; tb - gray SYS B MAIN SOV sw - center; tb - gray TEMP/PRESS MON sel - He ACA PROP sw - ENABLE MASTER ALARM - off RATE/ERR MON sw - LDG RDR/CHPTR ATTITUDE MON sw - AGS GLYCOL sel - PUMP 1 SUIT FAN sel - 1 O2/H2O QTY MON sel - DES 2	
	TTCA	11. THROTTLE/JETS cont (LMP) - JETS	
	6	12. Eng STOP pb/lt - reset AGS STATUS sw - STAND BY	
	16	13. All cb's open except: X pointer ind pwr fail lt - on FDAI pwr tb - OFF (in view) CB RCS SYS B: TEMP/PRESS DISP FLAGS - close PQGS/DISP - close CB PROPUL: DISP/ENG OVRD LOGIC - close ASC He REG - close CB LTC: FLOOD - close ANUN/DOCK/COMPNT - close MASTER ALARM - close	Power failure light and talkback are activated when FLT DISP circuit breakers are opened.

**LMA790-3-LM**  
**APOLLO OPERATIONS HANDBOOK**

CREW-MAN	PNL	PROCEDURES	REMARKS
		<p>4.15.1.1.2 <u>Lunar Stay Subsystems Check (cont)</u></p> <p>CB S/C:</p> <ul style="list-style-type: none"> <li>AEA - close</li> <li>ASA - close</li> <li>AFLD - close</li> <li>ATCA - close</li> <li>ABORT STAGE - close</li> <li>ATCA (AGS) - close</li> </ul> <p>CB INST:</p> <ul style="list-style-type: none"> <li>CMEA - close</li> <li>SIG SENSOR - close</li> <li>PCM/TE - close</li> <li>SIG CONDR 2 - close</li> </ul> <p>CB ECS: SUIT FLOW CONT - close</p> <p>CB COMM:</p> <ul style="list-style-type: none"> <li>DISP - close</li> <li>SE AUDIO - close</li> <li>VHF A XMTR - close</li> <li>VHF B RCVR - close</li> <li>PRIM S BD PMR AMPL - close</li> <li>PRIM S BD XMTR/RCVR - close</li> <li>S BD ANT - close</li> <li>PMP - close</li> </ul> <p>CB ECS:</p> <ul style="list-style-type: none"> <li>DISP - close</li> <li>LCC PUMP - as required</li> <li>CABIN FAN CONT - close</li> <li>CABIN REPRESS - close</li> <li>SUIT FAN 2 - close</li> <li>SUIT FAN AP - close</li> <li>DIVERT VLV - close</li> <li>CO2 SENSOR - close</li> <li>CB HTR: MESA - close</li> <li>CB HTR RCS SYS A/B 2:</li> <li>QUAD 1 - close</li> <li>QUAD 2 - close</li> <li>QUAD 3 - close</li> <li>QUAD 4 - close</li> </ul> <p>CB HTR:</p> <ul style="list-style-type: none"> <li>DISP - close</li> <li>S BD ANT - close</li> </ul> <p>CB EPS:</p> <ul style="list-style-type: none"> <li>DISP - close</li> </ul>	
	16		

**LMA790-3-LM**  
**APOLLO OPERATIONS HANDBOOK**

CREW-MAN	PNL	PROCEDURES	REMARKS
		<p>4.15.1.2 Lunar Stay Subsystems Check (cont)</p> <p>DC BUS VOLT - close            INV 2 - close            ASC ECA - close            DES ECA - close            DES ECA CONT - close            XLUNAR BUS TIE - close            CROSS TIE BAL LOADS - close            BAT FEED TIE (2) - close            Verify cb status per Lunar Stay Subsystems Check.</p> <p>14. EPS:            ED VOLTS sw - OFF            POWER/TEMP MON sel - CDR BUS            INVERTER sw - 2            LMP BAT 1 tb - gray            LMP BAT 2 tb - TBD            CDR BAT 3 tb - TBD            CDR BAT 4 tb - gray            LUNAR BAT tb - TBD            DES BATS tb - gray            BAT 5 NORMAL LMP FEED tb - bp            BAT 5 BACK UP CDR FEED tb - bp            BAT 6 NORMAL CDR FEED tb - bp            BAT 6 BACK UP LMP FEED tb - bp            COMM: UPLINK SQUELCH sw - as desired</p> <p>12. 15. UP DATA LINK sw - OFF            AUDIO:            AUDIO CONT sw - NORM            S BAND T/R sw - S BAND T/R            ICS T/R sw - ICS T/R            RELAY ON sw - RELAY OFF            MODE sw - ICS/PTT            VHF A sw - OFF            VHF B sw - OFF            COMM:            S BAND MODULATE sw - PM            S BAND XMTR/RCVR sw - PRIM            S BAND PWR AMPL sw - PRIM            S BAND VOICE sw - VOICE            S BAND PCH sw - PCH            S BAND RANGE sw - OFF/RESET            VHF A XMTR sw - OFF (when in LOS - VOICE)</p>	<p>See figure 4-27.</p> <p>Volume, squelch, and sensitivity controls will be adjusted as required.</p> <p>Ref para 4.15.1.9 for EVA operation.</p>



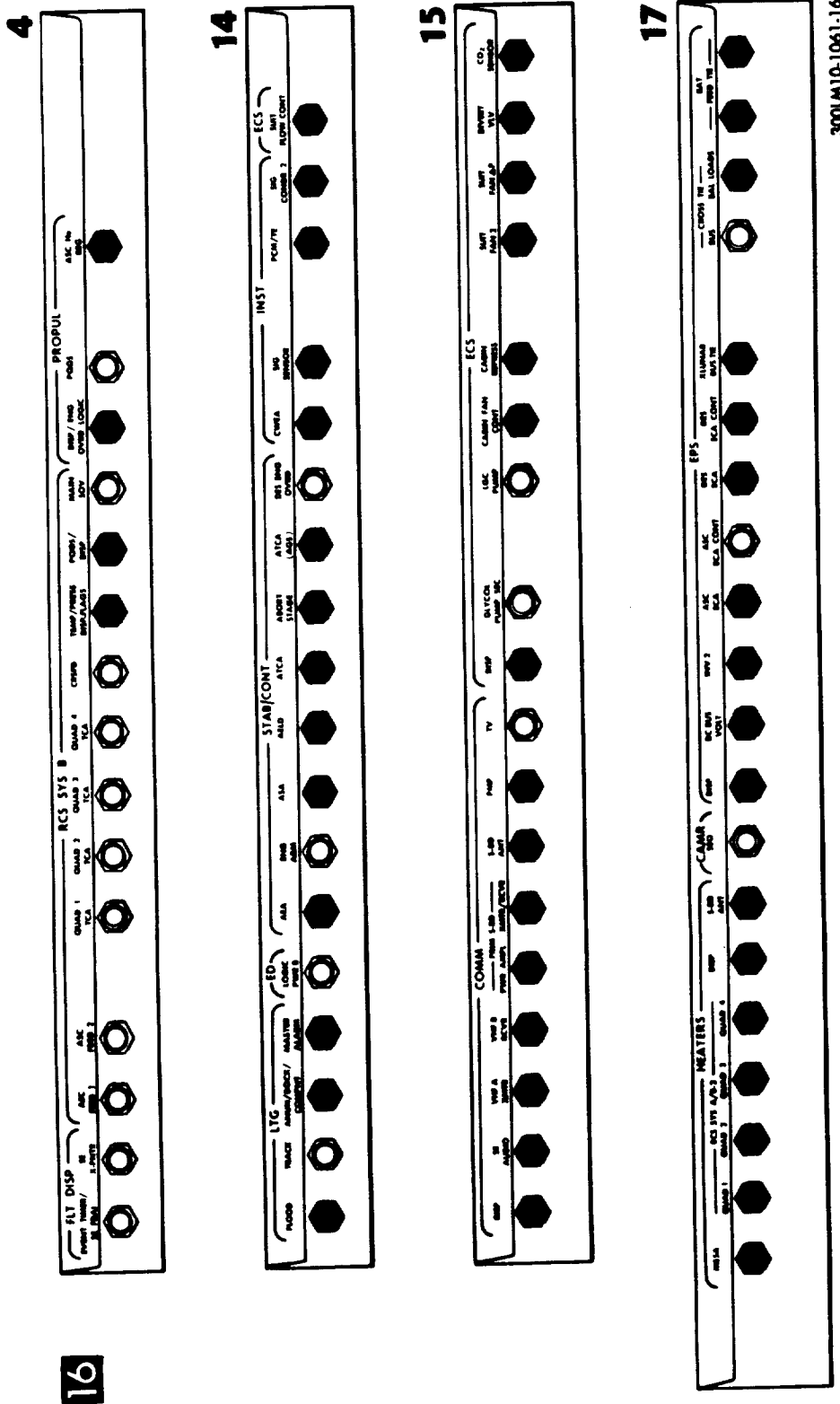

Figure 4-27. Lunar Stay Subsystems Check (Panel 16)

**LMA790-3-LM  
APOLLO OPERATIONS HANDBOOK**

CREW MAN	PNL	PROCEDURES	REMARKS
		<p>4.15.1.2 Lunar Stay Subsystems Check (cont)</p> <p>VHF A RCVR sw - OFF (when in LOS - ON)  VHF B XNTR sw - OFF  VHF B RCVR sw - OFF  TLM BIOMED sw - as required  TLM PCM sw - HI  RECORDER sw - OFF; tb - bp  COM ANT:</p> <p>VHF sel - FWD or AFT  TRACK MODE sw - SLEW  PITCH cont - as required  YAW cont - as required  S BAND sel - SLEW</p>	
		<p>16. Overhead floodlights (CDR &amp; LMP) - as required</p>	
	UTL	<p>17. CDR UTILITY LIGHT sw - as required  LMP UTILITY LIGHT sw - as required</p>	
	ECS	<p>18. SUIT GAS DIVERTER vlv - PUSH CABIN  CABIN REPRESS vlv - AUTO  LO PLSS FILL vlv - CLOSE  PRESS REG A vlv - CABIN  PRESS REG B vlv - CABIN  DES 02 vlv - OPEN  #1 ASC 02 vlv - CLOSE  #2 ASC 02 vlv - CLOSE  SUIT ISOL vlv (CDR) - SUIT FLOW  SUIT ISOL vlv (LMP) - SUIT FLOW  ASC H20 vlv - CLOSE  SEC EVAP FLOW vlv - CLOSE  PRI EVAP FLOW #2 vlv - CLOSE  DES H20 vlv - OPEN  PRI EVAP FLOW #1 vlv - OPEN  WATER TANK SELECT vlv - DES  SUIT TEMP vlv - adjust  LIQUID GARMENT COOLING vlv - COLD  CABIN GAS RETURN vlv - AUTO  SUIT CIRCUIT RELIEF vlv - AUTO  CO2 CANISTER SEL vlv - PRIM  PRIM CO2 CANISTER cover - CLOSE  SEC CO2 CANISTER cover - CLOSE  WATER SEP SEL vlv - PUSH SEP 1  Cabin relief &amp; dump vlv (ovhd) - AUTO</p>	

**LMA790-3-LM**  
**APOLLO OPERATIONS HANDBOOK**

CREW: MAN	PNL	PROCEDURES	REMARKS
	+227	<p>4.15.1.2 <u>Lunar Stay Subsystems Check (cont)</u></p> <p>Cabin relief &amp; dump vlv (fwd) - AUTO HI PLSS O2 FILL vlv - CLOSE</p> <p>4.15.1.3 <u>Open Forward Hatch (Cabin Side)</u></p> <ol style="list-style-type: none"> <li>1. Verify/set cabin relief &amp; dump vlv (fwd) - OPEN</li> <li>2. Grasp forward hatch handle &amp; push.</li> <li>3. Rotate hatch handle counterclockwise to UNLOCK.</li> <li>4. Pull hatch open.</li> </ol> <p>4.15.1.4 <u>Open Forward Hatch (Outside)</u></p> <ol style="list-style-type: none"> <li>1. Grasp forward hatch handle &amp; pull.</li> <li>2. Rotate hatch handle clockwise to UNLOCK.</li> <li>3. Push hatch open.</li> </ol> <p>4.15.1.5 <u>Close Forward Hatch (Cabin Side)</u></p> <ol style="list-style-type: none"> <li>1. Guide forward hatch to closed position.</li> <li>2. Grasp hatch handle &amp; push.</li> <li>3. Rotate hatch handle clockwise to LOCK.</li> <li>4. Verify that hatch handle pops out of detent, then release.</li> <li>5. Cabin relief &amp; dump vlv (fwd) - AUTO</li> </ol>	<p>Assumption: Cabin is depressurized.</p> <p>Forward hatch is self-securing in any open position.</p> <p>Forward hatch is self-securing in any open position. If hatch cannot be opened, cabin relief and dump vlv (fwd) - PULL TO DUMP and hold, to bleed off any accumulated pressure. External handle of cabin relief and dump vlv (fwd) is spring-loaded to return to automatic when released.</p> <p>No special constraints or protection required for hatch seal. Crewman may wipe seal with gloved finger to verify that there is no debris on seal.</p>

**LMA790-3-LM**  
**APOLLO OPERATIONS HANDBOOK**

CREW-MAN	PNL	PROCEDURES	REMARKS
		<p>4.15.1.6 <u>Close Forward Hatch (Outside)</u></p> <ol style="list-style-type: none"> <li>1. Grasp forward hatch handle &amp; guide hatch to closed position.</li> <li>2. Pull hatch handle &amp; rotate counterclockwise to LOCK.</li> <li>3. Verify that hatch handle pops out of detent, then release.</li> </ol> <p>4.15.1.7 <u>ARS Purge (EVA Preparation)</u></p> <p style="text-align: center;">CAUTION</p> <p>If cabin pressure fails during purging:            SUIT CIRCUIT RELIEF vlv - AUTO            CABIN GAS RETURN vlv - EGRESS            PRESS REC A &amp; B vlv - EGRESS</p> <ol style="list-style-type: none"> <li>1. SUIT GAS DIVERTER vlv - FULL EGRESS</li> <li>2. SUIT CIRCUIT RELIEF vlv - CLOSE</li> <li>3. CABIN GAS RETURN vlv - OPEN</li> <li>4. CO2 CANISTER SEL vlv - midposition</li> <li>5. PRESS REC A vlv - EGRESS</li> <li>6. PRESS REC B vlv - DIRECT O2 for 2 minutes, then EGRESS</li> <li>7. CABIN GAS RETURN vlv - EGRESS</li> <li>8. CO2 CANISTER SEL vlv - PRIM</li> <li>9. FAN sw - ON</li> <li>10. SUIT ISOL vlv (LMP) - SUIT DISC</li> <li>11. Perform ARS/PGA Pressure Integrity Check.</li> </ol>	<p>Assumptions: (1) Both crewmen are on ARS and (2) EVA crewman is connected to PLSS.</p> <p>Crew monitor and maintains ARS pressure &gt; cabin pressure, but not &gt;5.5 psia.</p> <p>Ref para 4.2.16.</p>

**LMA790-3-LM**  
**APOLLO OPERATIONS HANDBOOK**

CREW-MAN	PNL	PROCEDURES	REMARKS
		<p>4.15.1.7 <u>ARS Purge (EVA Preparation) (cont)</u></p> <p style="text-align: center;">CAUTION</p> <p>To preclude violating ARS purge, SUIT CIRCUIT RELIEF vlv must be closed following CDR's ARS/PGA Pressure Integrity Check &amp; ARS pressure maintained above cabin pressure until cabin pressure is dumped to 3.5 psia, at which time SUIT CIRCUIT RELIEF vlv - AUTO.</p>	
		<p>4.15.1.8 <u>Subsystem Configuration for EVA Preparation</u></p>	<p>Purpose of Subsystem Configuration for EVA Preparation procedure is to verify status of LM controls at start of EVA period of operations. It is to be used as baseline for ensuing EVA operations.</p> <p>Assumptions: (1) CSM controls attitude in docked EVA operation (orbital flight), (2) because EVA occurs at sunrise all cabin lighting shall be adjusted to BRIGHT levels for optimum interior visibility and adaptation at egress, and (3) all LM subsystems have operated nominally up to this point in mission timeline.</p> <p>Ref para 4.13.1.1.1.</p>
LMP	ECS	<p>1. Verify ECS Basic (Unstaged). Critical control/display status is as follows: CABIN REPRESS vlv - AUTO DES O2 vlv - OPEN WATER TANK SELECT vlv - DES CO2 CANISTER SEL vlv - PRIM PRIM CO2 CANISTER cover - CLOSE SEC CO2 CANISTER cover - CLOSE CB ECS:</p>	
CDR	11	<p>GLYCOL PUMP 2 - close GLYCOL PUMP 1 - close</p>	
LMP	2	<p>GLYCOL PUMP AUTO TRNFR - close GLYCOL sel - PUMP 1 SUIT FAN sel - 1 O2/H2O QTY MON sel - DES 2 ECS: PRESS ind pwr fail lt - off GLYCOL ind pwr fail lt - off QUANTITY ind pwr fail lt - off GLYCOL comp caut lt - off SUIT FAN comp caut lt - off</p>	

**LMA790-3-LM  
APOLLO OPERATIONS HANDBOOK**

CREW-MAN	PNL	PROCEDURES	REMARKS
		4.15.1.8 <u>Subsystem Configuration for EVA Preparation (cont)</u>	
LMP	16	C02 comp caut lt - off H2O SEP comp caut lt - off CB ECS: SUIT FLOW CONT - close GLYCOL PUMP SEC - open SUIT FAN 2 - close SUIT FAN ΔP - close C02 SENSOR - close CB HTR: MESA - close	
CDR	14	2. Verify EPS Basic (Unstaged). Critical displays as follows: EPS: LMP BAT 1 tb - gray LMP BAT 2 tb - TBD CDR BAT 3 tb - TBD CDR BAT 4 tb - gray LUNAR BAT tb - TBD DES BATS tb - gray BAT 5 NORMAL LMP FEED tb - bp BAT 5 BACKUP CDR FEED tb - bp BAT 6 NORMAL CDR FEED tb - bp BAT 6 BACKUP LMP FEED tb - bp	Ref para 4.13.4.1.
CDR	11	3. CB S/C: ATT DIR CONT - open	
	8	4. HTR CONT: MESA sw - HI URINE LINE sw - OFF ED: MASTER ARM sw - OFF STAGE sw - SAFE	
	1	5. ENG THR CONT: ENG ARM sw - OFF	
	8	ED: LDG GEAR DEPLOY tb - gray	
	1	GUID CONT sw - PGNS	
		ABORT pb - reset	
		ABORT STAGE pb - reset	
	3	6. DES ENG CMD OVRD sw - OFF	
		S/C: ROLL, PITCH, YAW sw - MODE CONT PGNS sw - OFF	

**LMA790-3-LM**  
**APOLLO OPERATIONS HANDBOOK**

CREW- MAN	PNL	PROCEDURES	REMARKS
		<p>4.15.1.8 <u>Subsystem Configuration for EVA Preparation (cont)</u></p> <p>7. Perform LGC Power-Down Program (P06).</p> <p>8. Verify Communications Basic</p> <p>4.15.1.9 <u>PLSS/EVCS Electrical Checkout, Two-Man EVA</u></p> <p>1. COMM: S BAND MODULATE sw - FN</p> <p>2. CB COMM: TV - close</p> <p>3. Verify voice comm with MSFN.</p> <p>4. AUDIO: S BAND T/R sw - S BAND T/R ICS T/R sw - ICS T/R RELAY ON sw - RELAY ON MODE sw - VOX VOX SENS tv - 9 VHF A sw - T/R VHF B sw - RCV</p> <p>5. AUDIO: S BAND T/R sw - S BAND T/R ICS T/R sw - ICS T/R RELAY ON sw - RELAY OFF MODE sw - VOX VOX SENS tv - 9 VHF A sw - T/R VHF B sw - RCV</p> <p>6. Ensure LM EVA antenna deployed.</p> <p>7. COMM ANT: VHF sel - EVA</p> <p>8. COMM: VHF A XMTR sw - VOICE VHF A RCVR sw - ON VHF B XMTR sw - OFF VHF B RCVR sw - ON VHF A SQUELCH tv - noise threshold + 1-1/2 div VHF B SQUELCH tv - noise threshold + 1-1/2 div</p>	<p>Ref para 4.6.1.2</p> <p>Ref para 4.13.2.1</p> <p>Assumption: Volume controls will be adjusted as required.</p>
LMP	12		
	16		
	12		
CDR	8		
	12		
LMP			

**LMA790-3-LM**  
**APOLLO OPERATIONS HANDBOOK**

CREW-MAN	PNL	PROCEDURES	REMARKS
		<p>4.15.1.9 <u>PLSS/EVCS Electrical Checkout, Two-Man EVA (cont)</u></p> <p>TLM BIOMED sw - OFF</p> <p>RECORDER sw - as desired</p> <p style="text-align: center;">CAUTION</p> <p>All LM &amp; PLSS electrical connectors must be deadfaced before mating or demating.</p>	<p>COMM: TLM BIOMED sw - OFF removes biomed signal power from crew communications cables.</p>
	16	<p>9. CB COMM: SE AUDIO - open</p>	<p>CB COMM: SE AUDIO - open removes LMP mike power and earphone signal; intercom function is lost. Removes power from SE audio center, DSEA, and VHF A transmitter key.</p>
	RCU	<p>10. Disconnect LM cable from PGA.</p> <p>11. Secure LM comm cable.</p> <p>12. EVC-2 MODE SEL sw - 0</p> <p>13. Connect EVC-2 electrical umbilical to PGA electrical connector.</p>	
	16	<p>14. CB COMM: SE AUDIO - close</p>	<p>CB COMM: SE AUDIO - close restores SE audio center power.</p>
	RCU	<p>15. PTT sw - MAIN EVC-2 MODE SEL sw - A</p> <p>16. Verify voice with CDR.</p> <p style="text-align: center;">NOTE</p> <p>Unstow PLSS antenna if it transmits garbled voice communications and/or loses telemetry.</p> <p style="text-align: center;">CAUTION</p> <p>All LM &amp; PLSS electrical connectors must be deadfaced before mating or demating.</p>	<p>Low PGA pressure and low vent will cause 10-second warning tone each time EVC-2 MODE SEL sw is repositioned. LMP will have RF sidetone via LM.</p>



**LMA790-3-LM**  
**APOLLO OPERATIONS HANDBOOK**

CREW/ MAN	PNL	PROCEDURES	REMARKS
CDR	11	<p>4.15.1.9 <u>PLSS/EVCS Electrical Checkout, Two-Man EVA (cont)</u></p> <p>17. CB COMM: CDR AUDIO - open</p>	<p>CB COMM: CDR AUDIO - open removes CDR mike power and earphone signal; intercom function is lost. Removes power from CDR audio center and VHF B transmitter key.</p>
RCU		<p>18. Disconnect LM cable from PGA.</p> <p>19. Secure LM comm cable.</p> <p>20. EVC-1 MODE SEL sw - 0</p> <p>21. Connect PLSS/EVC-1 electrical umbilical to PGA electrical connector.</p>	
	11	<p>22. CB COMM: CDR AUDIO - close</p>	<p>CB COMM: CDR AUDIO - close restores CDR audio center power.</p>
	8	<p>23. AUDIO: VHF A sw - OFF VHF B sw - OFF</p>	
RCU		<p>24. PTT sw - MAIN EVC-1 MODE SEL sw - B</p>	
LMP		<p>25. Verify voice with LMP.</p>	<p>CDR cannot hear MSFN at this time.</p>
CDR		<p>26. EVC-2 MODE SEL sw - B</p>	
		<p>27. EVC-1 MODE SEL sw - A</p>	
CDR/ LMP	RCU	<p>28. Verify voice with LMP.</p> <p>29. EVC-1 &amp; -2 MODE SEL sw - AR</p>	<p>LMP cannot hear MSFN at this time.</p>
LMP	16	<p>30. Verify voice with each other.</p> <p>31. Verify voice &amp; telemetry comm with MSFN.</p> <p>32. CB COMM: TV - open</p>	

**LMA790-3-LM  
APOLLO OPERATIONS HANDBOOK**

LM 3193

CREW-MAN	PNL	PROCEDURES	REMARKS
		<p>4.15.1.9 <u>PLSS/EVCS Electrical Checkout, Two-Man EVA (cont)</u></p> <p style="text-align: center;">NOTE</p> <p>Perform following steps if comm check with MSFN fails due to weak signal.</p> <p>33. COMM S BAND MODULATE sw - FM</p> <p>34. Verify voice &amp; telemetry comm with MSFN.</p> <p>35. CB COMM: TV - close</p> <p>36. COMM: S BAND MODULATE sw - FM</p> <p>4.15.1.10 <u>PLSS/EVCS Electrical Checkout, One-Man EVA</u></p> <p>1. COMM: S BAND MODULATE sw - FM</p> <p>2. CB COMM: TV - close</p> <p>3. Verify voice comm with MSFN.</p> <p>4. AUDIO:  S BAND T/R sw - S BAND T/R  ICS T/R sw - ICS T/R  RELAY ON sw - RELAY OFF  MODE sw - VOX  VOX SENS tw - 9  VHF A sw - RCV  VHF B sw - T/R</p>	
CDR	8	<p>5. AUDIO:  S BAND T/R sw - S BAND T/R  ICS T/R sw - ICS T/R  RELAY ON sw - RELAY ON</p>	

Assumption: Volume controls will be adjusted as required.

**LMA790-3-LM**  
**APOLLO OPERATIONS HANDBOOK**

CREW-MAN	PNL	PROCEDURES	REMARKS
		<p>4.15.1.10 <u>PLSS/EVCS Electrical Checkout, One-Man EVA (cont)</u></p> <p>MODE sw - VOX VOX SENS tv - 9 VHF A sw - RCV VHF B sw - T/R</p> <p>6. Ensure LM EVA antenna deployed.</p> <p>7. COMM ANT: VHF sel - EVA</p> <p>8. COMM: VHF A XMITR sw - OFF VHF A RCVR sw - ON VHF B XMITR sw - VOICE VHF B RCVR sw - ON VHF A SQUELCH tv - noise threshold + 1 1/2 div VHF B SQUELCH tv - noise threshold + 1 1/2 div TLM BIOMED sw - LEFT or RIGHT</p> <p>RECORDER sw - as desired</p> <p style="text-align: center;">CAUTION</p> <p>All electrical connectors must be deadfaced before mating or demating.</p> <p>9. CB COMM: CDR AUDIO - open</p> <p>10. Disconnect LM comm cable from PGA.</p> <p>11. Secure LM comm cable.</p> <p>12. EVC-1 MODE SEL sw - 0</p> <p>13. Connect PLSS/EVC electrical umbilical to PGA electrical connector.</p> <p>14. CB COMM: CDR AUDIO - close</p>	<p>COMM: TLM BIOMED sw - LEFT if CDR in LM; RIGHT, if LMP in LM. COMM: TLM BIOMED sw - OFF removes biomed signal power from crew communications cables.</p>
LMP	12		
CDR	11		
CDR	11		

**LMA790-3-LM  
APOLLO OPERATIONS HANDBOOK**

LM 3193

CREW-MAN	PNL	PROCEDURES	REMARKS
		4.15.1.10 PLSS/EVCS Electrical Checkout, One-Man EVA (cont)	
	RCU	15. PIT sw - MAIN EVC-1 MODE SEL sw - B	
LMP	12	16. Verify voice comm with LMP & MSFN.	Low PGA pressure and low vent will cause 10-second warning tone each time EVC-1 MODE SEL sw is repositioned. CDR will have RF sidetone via LM.
CDR	8	17. AUDIO: VHF A sw - T/R VHF B sw - RCV	
LMP	12	18. AUDIO: VHF A sw - T/R VHF B sw - RCV	
CDR	RCU	19. COMM: VHF A XMTR sw - VOICE VHF B XMTR sw - OFF	
		20. EVC-1 MODE SEL sw - A	
		21. Verify voice with LMP.	
		22. Verify voice & telemetry comm with MSFN.	
		NOTE	
		Perform following steps if comm check with MSFN fails due to weak signal.	
LMP	12	23. COMM: S BAND MODULATE sw - PM	
		24. Verify voice & telemetry comm with MSFN.	
	16	25. CB COMM: TV - close	
		26. COMM: S BAND MODULATE sw - FM	

**LMA790-3-LM**  
**APOLLO OPERATIONS HANDBOOK**

CREW/ MAN	PNL	PROCEDURES	REMARKS
		<p>4.15.1.11 <u>Final Subsystems Configuration for Egress</u></p>	<p>Purpose of Final Subsystems Configuration for Egress procedure is to verify status of LM controls before cabin depressurization. Crew have donned PLSS and are receiving PLSS oxygen.</p>
ECS		<p>1. SUIT GAS DIVERTER v1v - PULL EGRESS</p> <p>PRESS REC A v1v - EGRESS</p> <p>PRESS REC B v1v - EGRESS</p> <p>DES O2 v1v - OPEN</p> <p>SUIT ISOL v1v (LMP) - SUIT DISC</p> <p>SUIT ISOL v1v (CDR) - SUIT DISC</p> <p>CABIN GAS RETURN v1v - EGRESS</p> <p>CO2 CANISTER SEL v1v - PRIM</p> <p>SUIT CIRCUIT RELIEF v1v - AUTO</p>	<p>For ECS controls not listed, refer to ECS Basic (Unstaged) procedure (para 4.13.1.1).</p>
16		<p>2. CB ECS:</p> <p>SUIT FAN AP - open</p> <p>SUIT FAN 2 - open</p> <p>SUIT FLOW CONT - close</p> <p>LCG PUMP - open</p> <p>CABIN REPRESS - open</p> <p>CABIN FAN CONT - close</p> <p>CB HTR: MESA - close</p>	
11		<p>3. CB ECS:</p> <p>CABIN FAN - open</p> <p>GLYCOL PUMP 2 - close</p> <p>GLYCOL PUMP 1 - close</p> <p>GLYCOL PUMP AUTO TRNFR - close</p>	
2		<p>4. GLYCOL sel - PUMP 1</p> <p>SUIT FAN sel - 2</p> <p>O2/H2O QTY MON sel - DES 2</p> <p>ECS:</p> <p>PRESS ind pwr fail lt - off</p> <p>GLYCOL ind pwr fail lt - off</p> <p>QUANTITY ind pwr fail lt - off</p> <p>GLYCOL comp caut lt - off</p> <p>SUIT FAN comp caut lt - off</p> <p>CO2 comp caut lt - off</p> <p>H2O SEP comp caut lt - on</p> <p>ECS caut lt - on</p>	
		<p>5. Verify EPS Basic (Unstaged).</p>	<p>ECS caut lt and H2O SEP comp caut lt - on when separator speed &lt;800 rpm.</p> <p>Ref para 4.13.4.1.</p>

**LMA790-3-LM  
APOLLO OPERATIONS HANDBOOK**

CREW-MAN	PNL	PROCEDURES	REMARKS
		<p>4.15.1.11 <u>Final Subsystems Configuration for Egress (cont)</u></p> <p>6. Critical displays are as follows:            EPS:            LMP BAT 1 tb - gray            LMP BAT 2 cb - TBD            CDR BAT 3 cb - TBD            CDR BAT 4 cb - gray            LUNAR BAT tb - TBD            DES BATS tb - gray            BAT 5 NORMAL LMP FEED tb - bp            BAT 5 BACK UP CDR FEED tb - bp            BAT 6 NORMAL CDR FEED tb - bp            BAT 6 BACK UP LMP FEED tb - bp</p>	
	14	<p>3 7. LTG: EXTERIOR LTC sel - OFF</p> <p>16 8. CB LTG: TRACK - open</p> <p>11 9. CB S/C: ATT DIR CONT - open</p> <p>8 10. ED:            MASTER ARM sw - OFF            STAGE sw - SAFE            HTR CONT: MESA sw - HI</p> <p>1 11. ENG THR CONT: ENG ARM sw - OFF</p> <p>3 12. S/C: PGNS &amp; AGS sw - OFF</p> <p>13. Verify Relay Mode: EVA (Two-Man EVA)</p>	
		<p>4.15.1.12 <u>ECS Status (Two Men on Lunar Surface)</u></p> <p>1. SUIT GAS DIVERTER vlv - PULL EGRESS            CABIN REPRESS vlv - CLOSE            LO FLSS FILL vlv - CLOSE            PRESS REG A vlv - EGRESS            PRESS REG B vlv - EGRESS            DES O2 vlv - OPEN            #1 ASC O2 vlv - CLOSE            #2 ASC O2 vlv - CLOSE            SUIT ISOL vlv (LMP) - SUIT DISC            SUIT ISOL vlv (CDR) - SUIT DISC</p>	<p>Ref para 4.13.2.3.</p> <p>SUIT GAS DIVERTER vlv - PULL EGRESS, during unstaged main engine firing.</p>

**LMA790-3-LM  
APOLLO OPERATIONS HANDBOOK**

CREW-MAN	PNL	PROCEDURES	REMARKS
		<p>4.15.1.1.12 <u>ECS Status (Two Men on Lunar Surface) (cont)</u></p> <p>SEC EVAP FLOW vlv - CLOSE            PRI EVAP FLOW #2 vlv - CLOSE            WATER TANK SELECT vlv - DES            SUIT TEMP vlv - adjust            ASC H2O vlv - CLOSE            DES H2O vlv - CLOSE            PRI EVAP FLOW #1 vlv - OPEN            CABIN GAS RETURN vlv - EGRESS            CO2 CANISTER SEL vlv - PRIM            SUIT CIRCUIT RELIEF vlv - AUTO            PRIM CO2 CANISTER cover - CLOSE            SEC CO2 CANISTER cover - CLOSE            WATER SEP SEL vlv - PUSH SEP 1            LIQUID GARMENT COOLING vlv - COLD            HI PLS FILL vlv - CLOSE</p>	
	+227	<p>2. Cabin relief &amp; dump vlv (ovhd) - AUTO            Cabin relief &amp; dump vlv (fwd) - OPEN</p>	
	16	<p>3. CB ECS:            SUIT FAN AP - open            SUIT FAN 2 - open</p>	
	11	<p>4. CB ECS:            SUIT FAN 1 - close            CABIN FAN - open            GLYCOL PUMP 2 - close            GLYCOL PUMP 1 - close            GLYCOL PUMP AUTO TRNPR - close</p>	
	2	<p>5. GLYCOL sel - PUMP 1            SUIT FAN sel - 2            O2/H2O QTY MON sel - DES 2            ECS:            PRESS ind pwr fail lt - off            GLYCOL ind pwr fail lt - off            QUANTITY ind pwr fail lt - off            GLYCOL comp caut lt - off            SUIT FAN comp caut lt - off            CO2 comp caut lt - off            H2O SEP comp caut lt - on            ECS caut lt - on</p>	

**LMA790-3-LM  
APOLLO OPERATIONS HANDBOOK**

CREW- MAN	PNI	PROCEDURES	REMARKS
		4.15.1.12 ECS Status (Two Men on Lunar Surface) (cont)	
16		6. CB ECS: DISP - close GLYCOL PUMP SEC - open LOG PUMP - open CABIN FAN CONT - close SUIT FAN 2 - open DIVERV VLV - close CO2 SENSOR - close	
2		7. ECS: PRESS ind pwr fail lt - off SUIT PRESS ind - 3.6 to 4.0 psia CABIN PRESS ind - 0 psia PART PRESS CO2 ind - 7.6 mm Hg GLYCOL ind pwr fail lt - off GLYCOL temp ind - 33° to 49° F GLYCOL press ind - 21 to 37 psia GLYCOL comp caut lt - off SUIT FAN comp caut lt - off CO2 comp caut lt - off H2O SEP comp caut lt - on ECS caut lt - on	
2		8. O2/H2O QTY MON sel - DES 2 ECS: QUANTITY ind pwr fail lt - off O2 QUANTITY ind - TBDX H2O QUANTITY ind - TBDX  CAUTION  Crewman must check following cb's immediately before egress: CB (11) PCNS: RNDZ RDR - open CB (11) ECS: CABIN FAN - open CB (16) ECS: GLYCOL PUMP SEC - open	Quantity of consumables displayed is function of mission elapsed time.



**LMA790-3-LM**  
**APOLLO OPERATIONS HANDBOOK**

CREW- MAN	PNL	PROCEDURES	REMARKS
LMP	ECS	<p>4.15.1.13 <u>Post-EVA Final Subsystems Configuration</u></p> <p>1. Verify ECS Basic (Unstaged) Critical control positions are as follows:            SUIT GAS DIVERTER vlv - PUSH CABIN</p> <p align="center">CAUTION</p> <p>Rapid switching of CABIN REPRESS vlv from AUTO to CLOSE, or CLOSE to AUTO, causes loud bang. This does not damage valve. To change CABIN REPRESS vlv position, smooth, slow movement is recommended.</p> <p>CABIN REPRESS vlv - AUTO            PRESS REC A vlv - CABIN            PRESS REC B vlv - CABIN            CABIN GAS RETURN vlv - AUTO            SUIT CIRCUIT RELIEF vlv - AUTO            Cabin relief &amp; dump vlv (ovhd) - AUTO            Cabin relief &amp; dump vlv (fwd) - AUTO</p>	<p>Purpose of Post-EVA Subsystems Configuration procedure is to verify/set LM controls after both crewmen have returned LM to nominal in-flight status.</p> <p>Ref para 4.13.1.1.1. SUIT FAN sel may remain in position 2 between lunar surface EVA's.            If helmets/gloves doffed,            Reverse O2 hoses R/B &amp; B/R</p> <p>Position:            SUIT GAS DIVERTER vlv - PULL EGRESS            CABIN GAS RETURN vlv - EGRESS            PCA DIVERTER vlv - Horizontal            For water separator speed control</p>
CDR	11	<p align="center">NOTE</p> <p>For sleep mode, stow LM O2 hoses R/R &amp; B/B.            Position both SUIT ISOL vlv - SUIT FLOW            SUIT GAS DIVERTER vlv - PUSH CABIN            CABIN GAS RETURN vlv - AUTO</p>	<p>ARS configuration required for noise control during crew sleep periods.</p>
LMP	16	<p>CB ECS:            CABIN FAN - open            SUIT FAN 1 - close</p> <p>CB ECS:            CABIN REPRESS - close            SUIT FAN 2 - close            SUIT FAN AP - close            DIVERT VLV - close</p>	

LM 2007, LM 3215

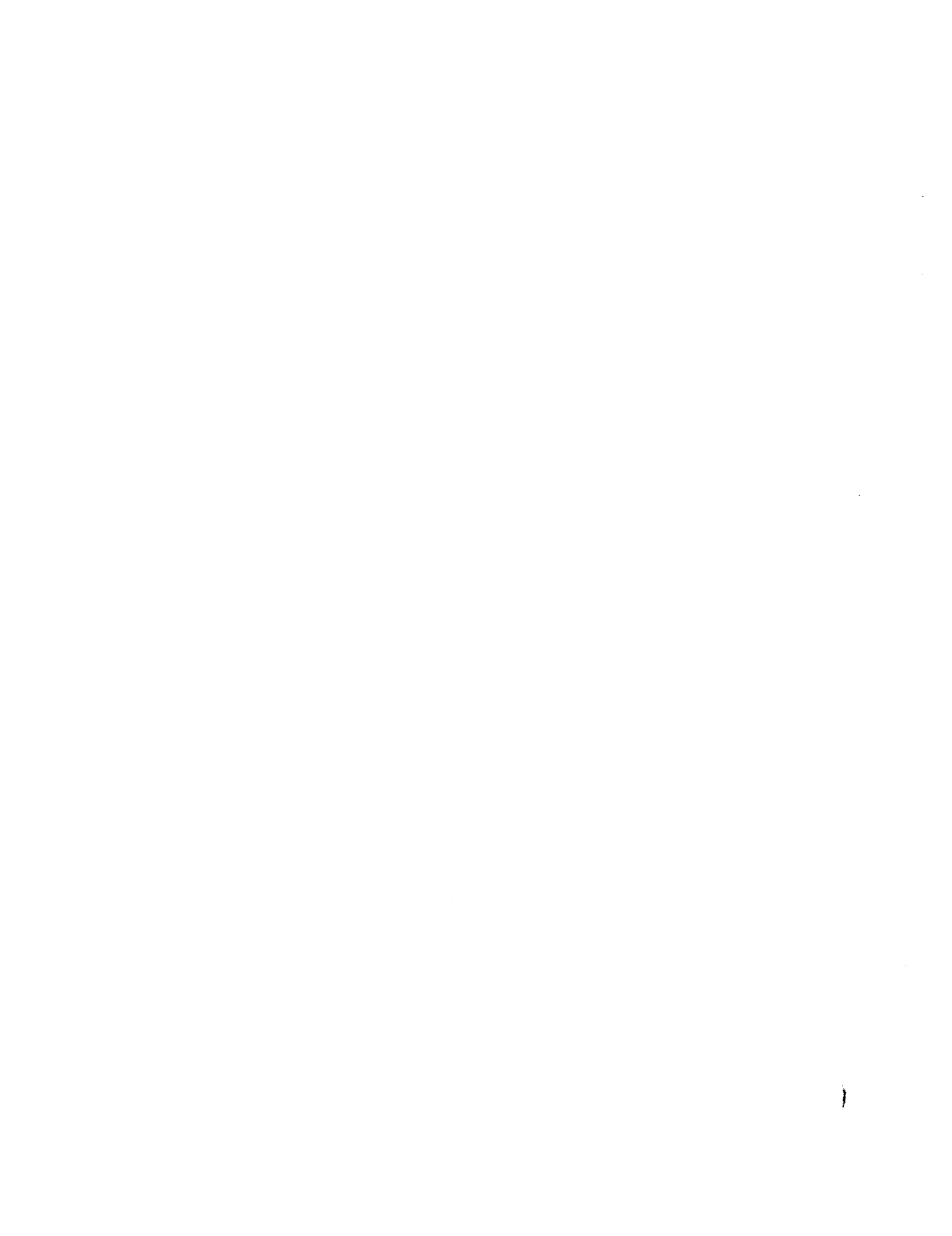

# LMA790-3-LM APOLLO OPERATIONS HANDBOOK

LM 3232

SYMPTOM	PROCEDURE	REMARKS
<p><b>4</b></p> <p><b>1</b></p> <p>Rate gyro test fails</p>	<p><b>1</b> Both FDAI rate ind agree?</p> <p>NO → <b>2</b> RATE NEEDLE FAILURE</p> <p>YES → <b>3</b> Any rate needle remains at zero?</p> <p>YES → <b>4</b> Needles at zero?</p> <p>NO → <b>6</b> Rate needles deflect in one direction only?</p> <p>YES → <b>7</b> GYRO TEST POS RT SW FAILED CLOSED</p> <p>NO → <b>9</b> All rate needles peg in both directions?</p> <p>YES → <b>12</b> RATE SCALE SW FAILED OFF</p> <p>NO → <b>10</b> Dynamic ck</p> <p style="margin-left: 20px;">                 ● GUID CONT - AGS                  ● MODE CONT (AGS) - ATT HOLD                  ● ATT CONT (3) - MODE CONT                  ● ACA - cmd mnvr in axis                  ● Monitor for smooth rate with damping             </p> <p>Response norm? YES → <b>11</b> GYRO TEST ROLL SW FAILED OPEN IN AFFECTED AXIS.</p> <p>NO → <b>13</b> RATE GYRO FAILED IN AFFECTED AXIS</p> <p style="margin-left: 20px;">                 ● ATT CONT (affected axis) - PULSE or DIR                  or                  ● GUID CONT - PCNS             </p> <p>ALL → <b>5</b> TEST VOLTAGE LOST OR GYRO TEST ROLL SW OR GYRO TEST POS RT SW FAILED OPEN</p> <p>ONE → <b>8</b> GYRO TEST ROLL SW FAILED INTO UNAFFECTED AXIS OR DOUBLE GYRO FAILURE</p> <p>TWO → <b>8</b> GYRO TEST ROLL SW FAILED INTO UNAFFECTED AXIS OR DOUBLE GYRO FAILURE</p>	<p><b>1</b> Test all three axes in both directions.</p> <p><b>2</b> Assumption: RATE SCALE - 25°/SEC but switch failed open when test was run. Failure results in selection of 5 /second scale</p> <p><b>3</b> AGS rate command lost for affected axis if roll or pitch. AGS DPS burn capability lost</p>
<p><b>5</b></p> <p>RNG/RNG RT pwr/sig fail lit</p> <p>Light on if: Signal lost. A-C or d-c power to ind lost 512 KHZ from timing equipment in PCMTEA lost</p>	<p><b>1</b> Ck for short.</p> <p>cb (11) FLT DISP: RNG/RNG RT or cb/AC BUS A: RNG/RNG RT - open &amp; cannot be reset?</p> <p>YES → <b>2</b> RNG/RNG RT IND SHORTED → <b>3</b> Remove power to ind.</p> <p>NO → <b>4</b> Ck for open.</p> <p>cb (11) FLT DISP: RNG/RNG RT - open</p> <p>Pwr/sig fail lit - off? YES → <b>8</b> RNG/RNG RT IND FAILED DUE TO OPEN → <b>7</b> RR range &amp; range rate can be displayed on DSKY as backup to RNG/RNG RT ind.</p> <p>NO → <b>5</b> cb (11) FLT DISP: RNG/RNG RT - close</p> <p>cb/AC BUS A: RNG/RNG RT - open</p> <p>Pwr/sig fail lit - off? YES → <b>8</b> RNG/RNG RT IND FAILED DUE TO OPEN → <b>7</b> RR range &amp; range rate can be displayed on DSKY as backup to RNG/RNG RT ind.</p> <p>NO → <b>6</b> Verify status of ind-driving source.</p> <p>● Radar - Ck xmt'r power signal strength</p> <p>● AEA - Ck operation via DEDA.</p> <p>Source operating normally? YES → <b>9</b> Select alt display source (when operating).</p> <p>For which display source is pwr/sig fail lit - off?</p> <p>LR &amp; AGS only → <b>10</b> RR output failed or open in data or selector line to RNG/RNG RT ind.</p> <p>RR only → <b>12</b> Failure between RNG/ALT MON sw and MODE SEL sw</p> <p>RR &amp; either LR or AGS → <b>13</b> LR or AGS output or selector line to RNG/RNG RT ind failed.</p> <p>LR only or AGS only → <b>14</b> Failure of indicator</p> <p>None → <b>15</b> Failure of mode select logic common line, or timing (from PCMTEA), or indicator.</p> <p>NO → <b>11</b> Correct source malfunction.</p>	<p><b>1</b> Light is normally on when power is supplied and indicator is not used by selected source (PCNS, AGS, LR, or RR). If either input signal goes to zero, light goes on. Light may flash randomly if range rate is - 10 fps. Neither condition indicates malfunction. Since PCNS output is supplied to indicator only during average g, at powered descent or ascent, PCNS is not considered in the malfunction analysis.</p> <p><b>2</b> RR range and range rate may be displayed if a and (b and/or c) are true.</p> <p>a. RR locked on to CSM</p> <p>b. P20 in process</p> <p>c. Monitor V16 N78</p> <p>R1 Range XXXX XX nm</p> <p>R2 Range rate XXXX X fps</p> <p><b>3</b> Alternative display sources</p> <p>a. RR range, range-rate - N78</p> <p>b. LGC range, range-rate. B - NS4 (if R31 in process by V83E)</p> <p>c. LGC latitude, longitude, altitude - N43 (if P21 in process)</p> <p>d. LM altitude (h) - DEDA 337</p> <p>e. Altitude rate (h) - DEDA 367</p> <p>f. LM - CSM range - DEDA 317</p> <p>g. LM - CSM range - rate - DEDA 440</p> <p>h. LGC altitude, altitude rate: N63 (during average g in powered descent) N94 (during average g in powered ascent)</p> <p style="text-align: right;">A: 300LMS-1016</p>

GUIDANCE & CONTROL FLIGHT DISPLAYS

LMA790-3-LM  
**APOLLO OPERATIONS HANDBOOK**

L.M. 3232

SYMPTOM	PROCEDURE	REMARKS
<p><b>2</b></p> <p>FDAI total att abnormal</p> <p><b>2a</b></p> <p>FDAI OFF flag appears</p>	<pre> graph TD     S1[FDAI total att abnormal] --&gt; P1{1 FDAI OFF flag visible?}     S2[FDAI OFF flag appears] --&gt; P1     P1 -- YES --&gt; P2[2 ORDEAL pni •FDAI 1 (2) affected FDAI - att position (ORB RATE or INRTL) FDAI moves?]     P1 -- NO --&gt; P6{6 ORDEAL operating?}     P2 -- YES --&gt; P3[3 Wait 1 min &amp; observe FDAI FDAI total att changes?]     P2 -- NO --&gt; P3     P3 -- YES --&gt; P4[4 FDAI FAILED]     P3 -- NO --&gt; P6     P6 -- YES --&gt; P7[7 ORDEAL pni •FDAI 1 &amp; 2 - INRTL Total att display norm?]     P6 -- NO --&gt; P8{8 Place FDAI's on all inertial sources Both FDAI's agree?}     P7 -- YES --&gt; P8     P7 -- NO --&gt; P8     P8 -- YES --&gt; P9[9 AUTO OR MANUAL MNVR PROBLEM]     P8 -- NO --&gt; P11{11 Abnormal total att?}     P9 --&gt; P11     P11 -- DONT KNOW --&gt; P12[12 Compare gymbal angles. •V49E •V16 M20E •Mnvr to 0, 0, 0 DSKY &amp; PGNS total att agree?]     P11 -- PGNS --&gt; P13[13 Switch input •ATT MON - AGS Total att norm?]     P11 -- AGS --&gt; P13     P12 -- YES --&gt; P15[15 Switch input •ATT MON - PGNS Total att norm?]     P12 -- NO --&gt; P15     P13 -- YES --&gt; P14[14 FDAI TOTAL ATT DISPLAY FAILED]     P13 -- NO --&gt; P15     P14 --&gt; P15     P15 -- YES --&gt; P16[16 AGS/IMU alignment just completed?]     P15 -- NO --&gt; P16     P16 -- YES --&gt; P17[17 Switch input to other FDAI •ATT MON - PGNS (other FDAI) Total att norm?]     P16 -- NO --&gt; P18[18 ONE FDAI TOTAL ATT DISPLAY INTERCONNECT FAILURE FROM PGNS]     P17 -- YES --&gt; P18     P17 -- NO --&gt; P21[21 IMU/FDAI INTERFACE FAILED]     P18 --&gt; P22[22 Switch input to other FDAI •ATT MON - AGS (other FDAI) Total att norm?]     P21 --&gt; P22     P22 -- YES --&gt; P23[23 ACA/FDAI INTERFACE FAILED]     P22 -- NO --&gt; P23     P23 --&gt; P24[24 ATT MON (2) - AGS]     P23 --&gt; P25[25 ONE FDAI TOTAL ATT DISPLAY INTERCONNECT FAILURE FROM AGS]     P24 --&gt; P25     P25 --&gt; P26[26 ATT MON (2) - PGNS]     P25 --&gt; P27[27 CAUTION FDAI that displays symptom can be driven from one source only.]     P26 --&gt; P27     P27 --&gt; P28[28 ATT MON (2) - AGS]     </pre>	<p><b>1</b> Orbital rate and inertial total attitude displays are identical 1 minute per orbital period. Waiting 1 minute resolves possible ambiguity.</p> <p><b>2</b> Failure may be confined to ORDEAL resolvers to only one FDAI.</p> <p><b>3</b> LM did not achieve desired automatic or manual maneuver.</p> <p><b>4</b> AGS - IMU alignment capability lost. Align AGS by backup method.</p> <p><b>5</b> Failure includes one of six IMU output lines or GASTA failure.</p> <p><b>6</b> Failure includes: One of six AEA output channels failed. One of three AEA return lines failed.</p>
<p><b>3</b></p> <p>Rate display abnormal</p>	<pre> graph TD     S1[Rate display abnormal] --&gt; P1{1 Both FDAI rate ind agree?}     P1 -- YES --&gt; P2[2 Stabilize LM via out-the-window indication. •Compare rate needles with vehicle motion. •RATE SCALE -5°/sec Ind rate &gt; LM motion?]     P1 -- NO --&gt; P5[5 FDAI RATE NEEDLE FAILURE]     P2 -- YES --&gt; P3[3 RATE SCALE - 25°/sec Ind rate &gt; LM motion?]     P2 -- NO --&gt; P4[4 Perform dynamic ck •GUID CONT - AGS •MODE CONT (AGS) - ATT HOLD •ATT CONT (3) - MODE CONT •ACA - cmd mnvr in affected axis Response norm?]     P3 -- YES --&gt; P6[6 RATE SCALE SW FAILED OPEN]     P3 -- NO --&gt; P4     P4 -- YES --&gt; P8[8 ATCA/FDAI INTERFACE FAILED OPEN]     P4 -- NO --&gt; P7[7 RATE GYRO FAILED ON]     P6 --&gt; P8     P7 --&gt; P9[9 CAUTION AGS may be selected only if ATT CONT (affected axis) - PULSE or DIR]     P8 --&gt; P9     P9 --&gt; P10[10 ATCA/RGA INTERFACE FAILED OPEN]     </pre>	<p><b>1</b> 5°/sec scale always in effect</p> <p><b>2</b> Rate display lost. Possible needle movement may be due to vibration.</p>

A-300LMS-1019

GUIDANCE & CONTROL FLIGHT DISPLAYS

Basic Date 26 September 1971

Change Date \_\_\_\_\_

# LMA790-3-LM APOLLO OPERATIONS HANDBOOK

LM981A, LM 3232

SYMPTOM	PROCEDURE	REMARKS
<p><b>1</b></p> <p>FDAl att error abnormal</p>	<p><b>1</b> ATT MON sw?</p> <p style="margin-left: 20px;">PGNS → <b>2</b> Switch input source. ●ATT MON - AGS Att error norm?</p> <p style="margin-left: 20px;">AGS → <b>5</b> Switch input source. ●ATT MON - PGNS Att error norm?</p> <p style="margin-left: 20px;">AGS → <b>8</b> Switch input to other FDAl. ATT MON - AGS (other FDAl) Att error norm?</p> <p style="margin-left: 20px;">PGNS → <b>3</b> Switch input to other FDAl ●ATT MON - PGNS (other FDAl) Att error norm?</p> <p style="margin-left: 20px;">NO → <b>6</b> FDAl ATT ERROR DISPLAY FAILED.</p> <p style="margin-left: 20px;">NO → <b>7</b> ONE OF THREE LGC ATT ERROR SIGNALS FAILED OPEN OR BIASED.</p> <p style="margin-left: 20px;">NO → <b>10</b> SIGNAL PATH FROM AGS TO ONE FDAl ATT ERROR DISPLAY FAILED</p> <p style="margin-left: 20px;">NO → <b>11</b> Needle failed at zero?</p> <p style="margin-left: 20px;">YES → <b>12</b> All axes?</p> <p style="margin-left: 20px;">NO → <b>13</b> ONE OF THREE AEA ATT ERROR CHAN FAILED OPEN.</p> <p style="margin-left: 20px;">YES → <b>15</b> GUID CONT sw?</p> <p style="margin-left: 20px;">PGNS → <b>16</b> AUTO DISCRETE (B4) FAILED OFF.</p> <p style="margin-left: 20px;">AGS → <b>17</b> MODE CONT (AGS) sw?</p> <p style="margin-left: 20px;">ATT HOLD → <b>18</b> ●DEDA C 400+00000E ●MODE CONT (AGS) - AUTO Att error zero?</p> <p style="margin-left: 20px;">AUTO → <b>20</b> LUNAR SURFACE FLAG FAILED SET.</p> <p style="margin-left: 20px;">YES → <b>21</b> FOLLOWUP DISCRETE FAILED ON.</p> <p style="margin-left: 20px;">NO → <b>22</b> All axes?</p> <p style="margin-left: 20px;">NO → <b>23</b> ONE OF THREE AEA ATT ERROR CHAN FAILED BIASED.</p> <p style="margin-left: 20px;">YES → <b>25</b> GUID CONT sw?</p> <p style="margin-left: 20px;">AGS → <b>26</b> Pulse or direct?</p> <p style="margin-left: 20px;">YES → <b>27</b> ●Att ACA - cmd mmvr Att error zero during mmvr?</p> <p style="margin-left: 20px;">NO → <b>28</b> ●GUID CONT - PGNS</p> <p style="margin-left: 20px;">NO → <b>32</b> ●DEDA C 400R +00000?</p> <p style="margin-left: 20px;">NO → <b>33</b> ●DEDA C 400+00000E Att error zero?</p> <p style="margin-left: 20px;">YES → <b>34</b> AUTO DISCRETE FAILED ON.</p> <p style="margin-left: 20px;">YES → <b>35</b> ●MODE CONT (AGS) - ATT HOLD ●ACA - out of detent Att error zero?</p> <p style="margin-left: 20px;">YES → <b>36</b> GUID CONT PATH OF FOLLOWUP DISCRETE FAILED OFF</p> <p style="margin-left: 20px;">NO → <b>37</b> FOLLOWUP DISCRETE FAILED OFF</p>	<p><b>1</b> Attitude error display lost for affected FDAl only for selected source</p> <p><b>2</b> Failure affects displays only</p> <p><b>3</b> FDAl attitude error display will show erroneous nonzero value in affected axis.</p> <p><b>4</b> AGS attitude error computations limited to attitude hold.</p> <p><b>5</b> AGS automatic start/stop of MPS lost AGS computations and displays are unaffected, except for attitude error</p> <p><b>6</b> AGS attitude hold capability remains only in automatic mode.</p> <p><b>7</b> All AGS attitude hold capabilities are lost.</p> <p><b>8</b> Check and reset lunar surface flag if flag failed set. AGS guidance steering lost.</p> <p><b>9</b> CAUTION GUID CONT - AGS will result in abnormal vehicle dynamics</p> <p><b>10</b> ●ATT MON (2) - PGNS ●GUID CONT - PGNS</p> <p><b>11</b> ●ATT MON (2) - PGNS ●GUID CONT - PGNS</p> <p><b>12</b> ●ATT MON (2) - PGNS ●GUID CONT - PGNS</p> <p><b>13</b> ●ATT MON (2) - PGNS ●GUID CONT - PGNS</p> <p><b>14</b> ●ATT MON (2) - PGNS ●GUID CONT - PGNS</p> <p><b>15</b> ●ATT MON (2) - PGNS ●GUID CONT - PGNS</p> <p><b>16</b> ●ATT MON (2) - PGNS ●GUID CONT - PGNS</p> <p><b>17</b> ●ATT MON (2) - PGNS ●GUID CONT - PGNS</p> <p><b>18</b> ●ATT MON (2) - PGNS ●GUID CONT - PGNS</p> <p><b>19</b> ●ATT MON (2) - PGNS ●GUID CONT - PGNS</p> <p><b>20</b> ●ATT MON (2) - PGNS ●GUID CONT - PGNS</p> <p><b>21</b> ●ATT MON (2) - PGNS ●GUID CONT - PGNS</p> <p><b>22</b> ●ATT MON (2) - PGNS ●GUID CONT - PGNS</p> <p><b>23</b> ●ATT MON (2) - PGNS ●GUID CONT - PGNS</p> <p><b>24</b> ●ATT MON (2) - PGNS ●GUID CONT - PGNS</p> <p><b>25</b> ●ATT MON (2) - PGNS ●GUID CONT - PGNS</p> <p><b>26</b> ●ATT MON (2) - PGNS ●GUID CONT - PGNS</p> <p><b>27</b> ●ATT MON (2) - PGNS ●GUID CONT - PGNS</p> <p><b>28</b> ●ATT MON (2) - PGNS ●GUID CONT - PGNS</p> <p><b>29</b> ●ATT MON (2) - PGNS ●GUID CONT - PGNS</p> <p><b>30</b> ●ATT MON (2) - PGNS ●GUID CONT - PGNS</p> <p><b>31</b> ●ATT MON (2) - PGNS ●GUID CONT - PGNS</p> <p><b>32</b> ●ATT MON (2) - PGNS ●GUID CONT - PGNS</p> <p><b>33</b> ●ATT MON (2) - PGNS ●GUID CONT - PGNS</p> <p><b>34</b> ●ATT MON (2) - PGNS ●GUID CONT - PGNS</p> <p><b>35</b> ●ATT MON (2) - PGNS ●GUID CONT - PGNS</p> <p><b>36</b> ●ATT MON (2) - PGNS ●GUID CONT - PGNS</p> <p><b>37</b> ●ATT MON (2) - PGNS ●GUID CONT - PGNS</p>
<p><b>1a</b></p> <p>AGS att error zero when it should be nonzero</p> <p>Normally nonzero when: GUID CONT - PGNS MODE CONT (AGS) - AUTO 400 = 10000 or 20000 or GUID CONT - AGS MODE CONT (AGS) - ATT HOLD ACA - neutral or GUID CONT - AGS MODE CONT (AGS) - AUTO</p>	<p><b>11</b> Needle failed at zero?</p> <p style="margin-left: 20px;">YES → <b>12</b> All axes?</p> <p style="margin-left: 20px;">NO → <b>13</b> ONE OF THREE AEA ATT ERROR CHAN FAILED OPEN.</p> <p style="margin-left: 20px;">YES → <b>15</b> GUID CONT sw?</p> <p style="margin-left: 20px;">PGNS → <b>16</b> AUTO DISCRETE (B4) FAILED OFF.</p> <p style="margin-left: 20px;">AGS → <b>17</b> MODE CONT (AGS) sw?</p> <p style="margin-left: 20px;">ATT HOLD → <b>18</b> ●DEDA C 400+00000E ●MODE CONT (AGS) - AUTO Att error zero?</p> <p style="margin-left: 20px;">AUTO → <b>20</b> LUNAR SURFACE FLAG FAILED SET.</p> <p style="margin-left: 20px;">YES → <b>21</b> FOLLOWUP DISCRETE FAILED ON.</p>	<p><b>3</b> FDAl attitude error display will show erroneous nonzero value in affected axis.</p> <p><b>4</b> AGS attitude error computations limited to attitude hold.</p> <p><b>5</b> AGS automatic start/stop of MPS lost AGS computations and displays are unaffected, except for attitude error</p> <p><b>6</b> AGS attitude hold capability remains only in automatic mode.</p> <p><b>7</b> All AGS attitude hold capabilities are lost.</p> <p><b>8</b> Check and reset lunar surface flag if flag failed set. AGS guidance steering lost.</p>
<p><b>1b</b></p> <p>AGS att error nonzero when it should be zero</p> <p>Normally zero when: GUID CONT - PGNS MODE CONT (AGS) - ATT HOLD or MODE CONT (AGS) - ATT HOLD ACA - out of detent or GUID CONT - PGNS 400 = 00000</p>	<p><b>22</b> All axes?</p> <p style="margin-left: 20px;">NO → <b>23</b> ONE OF THREE AEA ATT ERROR CHAN FAILED BIASED.</p> <p style="margin-left: 20px;">YES → <b>25</b> GUID CONT sw?</p> <p style="margin-left: 20px;">AGS → <b>26</b> Pulse or direct?</p> <p style="margin-left: 20px;">YES → <b>27</b> ●Att ACA - cmd mmvr Att error zero during mmvr?</p> <p style="margin-left: 20px;">NO → <b>28</b> ●GUID CONT - PGNS</p> <p style="margin-left: 20px;">NO → <b>32</b> ●DEDA C 400R +00000?</p> <p style="margin-left: 20px;">NO → <b>33</b> ●DEDA C 400+00000E Att error zero?</p> <p style="margin-left: 20px;">YES → <b>34</b> AUTO DISCRETE FAILED ON.</p> <p style="margin-left: 20px;">YES → <b>35</b> ●MODE CONT (AGS) - ATT HOLD ●ACA - out of detent Att error zero?</p> <p style="margin-left: 20px;">YES → <b>36</b> GUID CONT PATH OF FOLLOWUP DISCRETE FAILED OFF</p> <p style="margin-left: 20px;">NO → <b>37</b> FOLLOWUP DISCRETE FAILED OFF</p>	<p><b>9</b> Capability of changing AEA attitude hold inertial reference solely with ACA lost.</p> <p><b>10</b> If in PGNS, failure is applicable to Z-axis steering. If in AGS, attitude hold can be established only via DEDA.</p> <p><b>11</b> A new attitude can be established by: a. ATT CONT - PULSE b. MODE CONT (AGS) - ATT HOLD c. ACA - Maneuver to new attitude d. Key DEDA C575 + 00000E e. ATT CONT - MODE CONT</p>

GUIDANCE & CONTROL FLIGHT DISPLAYS

**LMA790-3-LM**  
**APOLLO OPERATIONS HANDBOOK**

5.2.1 GUIDANCE & CONTROL FLIGHT DISPLAYS

Table 5-1. G&C FLT DISP Procedure Entry Sheet

Symptom	Sym No.	Page No.
FDAI att error abnormal	1	5.2-4
AGS att error zero when it should be nonzero	1a	5.2-4
AGS att error nonzero when it should be zero	1b	5.2-4
FDAI total att abnormal	2	5.2-5
FDAI OFF flag appears	2a	5.2-5
Rate display abnormal	3	5.2-5
Rate gyro test fails	4	5.2-6
RNG/RNG RT pwr/sig fail lt	5	5.2-6

**LMA790-3-LM**  
**APOLLO OPERATIONS HANDBOOK**

**5.2 MALFUNCTION PROCEDURES**

The malfunction procedures enable recognition of subsystem malfunctions, determination of their cause, correction or isolation of the failure, and determination of the effect on the subsystem and the scheduled mission. The procedures cover all significant single failures. To prevent the procedures from becoming complex and unmanageable, double unrelated failures are not covered. The malfunction procedures are arranged by subsystem, or subsystem section (PGNS, AGS, CES, DPS, APS, etc), in a three-column format as follows:

Symptom Column. Symptom logic blocks in this column allow entry into the malfunction procedure. When applicable, data under these blocks explain and qualify the symptom or condition. The symptoms are arranged numerically within each subsystem or subsystem section.

Procedure Column. This column contains a step-by-step logic flow diagram, consisting primarily of action blocks, decision blocks, and failure blocks that enable failure correction and isolation. Caution and warning blocks are included for conditions, which, if not corrected, may degrade the operational integrity of a subsystem or may adversely affect crew safety. Remote event symbols refer to related remarks, to another step of the procedure, or to a step in another malfunction procedure.

Remarks Column. This column contains supplemental data related to, and referenced from, the logic blocks in the "SYMPTOM" and "PROCEDURE" column.

**LMA790-3-LM**  
**APOLLO OPERATIONS HANDBOOK**

GUIDANCE & CONTROL FLIGHT DISPLAYS

PRIMARY GUIDANCE & NAVIGATION SECTION

ABORT GUIDANCE SECTION

CONTROL ELECTRONICS SECTION

DESCENT PROPULSION SECTION

ASCENT PROPULSION SECTION

REACTION CONTROL SUBSYSTEM

ELECTRICAL POWER SUBSYSTEM

COMMUNICATIONS SUBSYSTEM

ENVIRONMENTAL CONTROL SUBSYSTEM

EXPLOSIVE DEVICES

HEATERS





**LMA790-3-LM**  
**APOLLO OPERATIONS HANDBOOK**

<b>REMARKS</b>	
<b>PROCEDURES</b>	5.1 ABORT PROCEDURES (To be supplied)
<b>PNL</b>	
<b>CREW- MAN</b>	



**LMA790-3-LM  
APOLLO OPERATIONS HANDBOOK**

**SECTION 5  
CONTINGENCY PROCEDURES**

**LMA790-3-LM**  
**APOLLO OPERATIONS HANDBOOK**

LM 3193

CREW-MAN	PNL	PROCEDURES	REMARKS
CDR		<p>4.15.2.4 Deleted</p> <p>4.15.2.5 <u>TV Camera Operation</u></p>	<p>Assumptions: (1) CDR is outside of cabin and (2) LMP is in cabin.</p>
LMP	12	<p>1. Confirm S-band steerable antenna high-power operation.</p> <p>2. Inform LMP of readiness to deploy MESA.</p> <p>3. COMM: S BAND MODULATE sv - FM</p>	<p>Five-second warmup period is required after modulation change.</p>
	16	<p>4. CB COMM: TV - close</p> <p>5. Deploy MESA</p> <p>6. Verify MSFN reception of TV signal.</p>	
	16 12	<p>7. When TV operation is completed: CB COMM: TV - open COMM: S BAND PWR AMPL sv - as required S BAND MODULATE sv - FM</p> <p>4.15.2.6 <u>Lunar Launch Contingency Storage</u></p>	<p>Five-second warmup period is required after modulation change.</p> <p>Assumptions: (1) Early lunar launch is required, (2) cabin cannot be depressurized for equipment jettison, and (3) three-EVA mission.</p>
		<p>In event of mission abort during lunar operations, following loose items must be stowed.</p>	
		<p>1. Post-EVA 1 GSRC - LHMSSC OPS (2) - SRC racks PLSS (1) - recharge station PLSS (1) - cabin floor RCU (2) - ISA SRC - aft of ascent engine cover PLSS batteries (2) - jettison bag PLSS LiOH (2) - jettison bag Lunar overshoes - jettison bag Jettison bag - ISA TSB - ISA ISA - aft bay rest station fittings HSB (2) - ascent engine cover</p>	

**LMA790-3-LM  
APOLLO OPERATIONS HANDBOOK**

CREW-MAN	PNI	PROCEDURES	REMARKS
		<p>4.15.2.3.5 <u>Removal of RTG Fuel Element</u></p> <ol style="list-style-type: none"> <li>1. Unstow lanyard &amp; open astronaut/RTG protective door.</li> <li>2. Unstow fuel cask lanyard from inboard surface of astronaut/RTG protective door.</li> <li>3. Move away from vehicle to position in front of cask.</li> </ol> <p style="text-align: center;"><b>WARNING</b></p> <p style="text-align: center;">Do not handle chain portion of lanyard. It is hot and may damage gloves.</p> <ol style="list-style-type: none"> <li>4. Pull fuel cask deployment lanyard to unlock pins &amp; actuate tilting mechanism.</li> <li>5. Continue pulling lanyard until fuel cask is tilted to desired fuel-removal attitude. Discard lanyard.</li> <li>6. Retrieve dome-removal tool from pallet No. 2.</li> <li>7. Remove dome (turn clockwise) from fuel cask.</li> <li>8. Discard dome &amp; dome-removal tool.</li> <li>9. Retrieve fuel transfer tool from pallet No. 2 &amp; withdraw fuel element.</li> <li>10. Insert tool into cask &amp; extract fuel element.</li> <li>11. Insert fuel element into RTG. Discard tool.</li> <li>12. Close astronaut/RTG protective door.</li> </ol>	

**LMA790-3-LM**  
**APOLLO OPERATIONS HANDBOOK**

CREW-MAN	PNI	PROCEDURES	REMARKS
		<p><u>4.15.2.3.4 Pallet Assembly Manual Deployment in Low Attitude</u></p> <ol style="list-style-type: none"> <li>1. Unstow extraction lanyard from pallet handle.</li> <li>2. Attach Velcro loop portion of black &amp; white striped lanyard to Velcro hooks on LM structure.</li> </ol> <p style="text-align: center;">CAUTION</p> <p style="text-align: center;">When pallet is in tilted-down position, it may slide out of compartment after unlatching.</p> <ol style="list-style-type: none"> <li>3. Pull white extraction lanyard to unlatch pallet, until lanyard falls free of latch bar mechanism.</li> <li>4. Disconnect pip pin from escapement mechanism (top).</li> <li>5. Remove pallet, using hockey stick &amp; extraction lanyard.</li> <li>6. Rotate pallet, using extraction lanyard, so that handle side is up.</li> <li>7. Release lanyard quick-release catch from forward lower edge of pallet.</li> <li>8. Stow lanyards in empty storage compartment.</li> <li>9. Repeat steps 1 through 8 for other pallet.</li> <li>10. Remove Velcro if used.</li> <li>11. Close SEQ bay door by pulling black door-actuation lanyard.</li> <li>12. Close astronaut/MIC protective door.</li> <li>13. Stow lanyards.</li> </ol>	

**LMA790-3-LM  
APOLLO OPERATIONS HANDBOOK**

CREW- MAN	PNL	PROCEDURES	REMARKS
		<p>4.15.2.3.3 <u>Pallet Assembly Manual Deployment</u></p> <ol style="list-style-type: none"> <li>1. Disconnect top pin from escapement mechanism.</li> <li>2. Release lanyard quick release catch from forward lower edge of pallet.</li> </ol> <p style="text-align: center;"><b>CAUTION</b></p> <p>If ALSEP is in position low, pull lanyard from top position. When ALSEP is in tilted-down position, pallet may slide out of compartment after unlatching.</p> <p style="text-align: center;"><b>NOTE</b></p> <p>Do not strike FLSS antenna against descent stage.</p> <ol style="list-style-type: none"> <li>3. Unstow lanyard from handle &amp; pull lanyard until it falls free from latch bar mechanism.</li> <li>4. Stow extraction lanyard to avoid interference with manual deployment.</li> <li>5. Grasp pallet handle &amp; pull to extract pallet from bay. Supporting pallet on bottom, remove pallet and lower it to surface (handle side up).</li> <li>6. Repeat steps 1 through 5 for other pallet.</li> <li>7. Close SEQ bay door by pulling black door-actuation lanyard.</li> <li>8. Close astronaut/ETC protective door.</li> <li>9. Stow lanyards.</li> </ol>	





**LMA790-3-LM  
APOLLO OPERATIONS HANDBOOK**

CREW: MAN	PNI	PROCEDURES	REMARKS
		<p><u>4.15.2.3.2 Pallet Assembly Remote Deployment</u></p> <ol style="list-style-type: none"> <li>1. Grasp extraction lanyard stowed on container handle.</li> <li>2. Move away from vehicle for approximately full length of lanyard.</li> <li>3. Pull white lanyard to unlatch pallet from LM.</li> <li>4. Continue pulling white lanyard until pallet falls free from guide rails &amp; boom is fully extended.</li> <li>5. Hold white lanyard taut to prevent pallet from swinging back against vehicle.</li> <li>6. Actuate black-&amp;-white-striped lanyard by series of short, sharp jerks to lower pallet to surface, handle side up.</li> <li>7. Release lanyard quick-release from forward edge of pallet.</li> <li>8. Stow lanyard.</li> <li>9. Remove ball-lock pin attached to container support strut.</li> <li>10. Pull black-&amp;-white-striped lanyard to retract boom into SEQ bay.</li> <li>11. Stow all loose lanyards in empty stowage compartment.</li> <li>12. Repeat steps 1 through 11 for other pallet.</li> <li>13. Close SEQ bay door by pulling black section of door-actuation lanyard.</li> <li>14. Close astronaut/ETC protective door.</li> <li>15. Stow lanyards.</li> </ol>	

**LMA790-3-LM**  
**APOLLO OPERATIONS HANDBOOK**

LM 3210

CREW-MAN	PNI	PROCEDURES	REMARKS
		<p>4.15.2.1.7 <u>SRC Removal</u></p> <ol style="list-style-type: none"> <li>1. Raise thermal blanket over SRC area.</li> <li>2. Remove SRC.</li> <li>3. Unstow SRC table.</li> <li>4. Mount SRC on table.</li> <li>5. Close thermal blanket.</li> </ol> <p>4.15.2.2 <u>LRV Deployment</u></p> <ol style="list-style-type: none"> <li>1. Move to position on ladder.</li> <li>2. Deleted</li> <li>3. Pull D-ring to release LRV release mechanism.</li> <li>4. Descend ladder to lunar surface.</li> </ol> <p>4.15.2.3 <u>ALSEP Operations</u></p> <p>4.15.2.3.1 <u>Open Scientific Equipment (SEQ) Bay</u></p> <ol style="list-style-type: none"> <li>1. Unfold thermal shield from right side of SEQ bay.</li> <li>2. Grasp door-actuation lanyard &amp; move away from vehicle.</li> <li>3. Pull white section of lanyard to open astronaut protective door (RTG fuel cask heat shield).</li> <li>4. Continue pulling lanyard to open SEQ bay door.</li> <li>5. Stow lanyard on secondary strut, to right of SEQ bay.</li> </ol>	<p>SRC's must be removed in numerical order.</p> <p>Weighbags and secondary structure must be removed before removal of SRC No. 3.</p> <p>Maximum open time of MESA thermal blankets per EVA: Center compartment - 15 minutes Outer compartments - 1 hour 15 minutes (1st EVA) and 15 min (subsequent EVA's)</p> <p>Assumption: Other crewman has previously deployed the deployment cable and the two reel operating tapes.</p> <p>This step completes GAC/GFE procedures. GAC/GFE procedures (deployment) are not supplied in LM AOR.</p>



LMA790-3-LM  
 APOLLO OPERATIONS HANDBOOK

CREW-MAN	PNI	PROCEDURES	REMARKS
LMP		4.15.2.1.5 <u>TV Camera Deployment</u> 1. Unstow & deploy camera tripod. 2. Remove camera from bracket. 3. Set up camera on tripod, facing pallet. 4. Unstow & play out TV cable until color coding is visible. 5. Move camera away from vehicle.	
CDR	MESA	4.15.2.1.6 <u>MESA Equipment Handling and Transfer</u> 1. Lift center thermal blanket to expose EVA pallet. 2. Unstow EVA pallet. 3. Unstow SRC table. 4. Mount pallet on table. 5. Restow thermal blanket.	Assumptions: (1) CDR is on lunar surface and (2) LMP is in cabin. S-band antenna to be unstowed before removal of EVA pallets No. 2 and 3. Step 3 to be performed after removal of EVA pallet No. 1, due to crewman reach constraint.
LMP		6. Place necessary equipment (MCS LiOH canister or stero return cassette container) on pallet, for transfer.	Maximum open time of MESA thermal blankets per EVA: Center compartment - 15 minutes Outer compartments - 1 hour 15 minutes (let EVA) and 15 min (subsequent EVA's)
CDR		7. Transfer pallet into ascent stage. 8. Receive, unload, & return pallet to CDR. 9. Discard pallet.	

LH 3231

**LMA790-3-LM**  
**APOLLO OPERATIONS HANDBOOK**

CREW- MAN	PNL	PROCEDURES	REMARKS
LMP		<p>4.15.2.1.2 <u>MESA Manual Deployment</u></p> <ol style="list-style-type: none"> <li>1. Move to MESA.</li> <li>2. Grasp manual deployment lanyard &amp; move away from vehicle.</li> <li>3. Pull on lanyard until pallet deploys.</li> </ol> <p>4.15.2.1.3 <u>MESA Height Adjustment</u></p> <ol style="list-style-type: none"> <li>1. Unstow olive strap &amp; draw out until fully deployed &amp; all straps are taut.</li> <li>2. Unstow black adjustment strap. Lift strap to disengage buckle leaf-lock.</li> <li>3. Increase lifting force to raise MESA. or Decrease lifting force to lower MESA.</li> <li>4. Engage buckle leaf-lock by maintaining holding force while simultaneously decreasing strap angle to bring black strap in line with olive strap.</li> </ol> <p>4.15.2.1.4 <u>MESA Exterior Blanket Removal</u></p> <ol style="list-style-type: none"> <li>1. Move to MESA &amp; adjust pallet to desired height.</li> <li>2. Loosen blanket around TV lens.</li> <li>3. Grasp strap on left half of blanket &amp; pull blanket to left, off MESA.</li> <li>4. Push blanket under MESA.</li> <li>5. Pull right half of blanket to right, lifting up &amp; over TV camera.</li> <li>6. Push blanket under MESA.</li> </ol>	<p>Assumption: Activation of MESA release mechanism resulted only in unlocking pallet; pallet did not deploy.</p> <p>Step 1 must be performed if MESA is resting on lunar surface following MESA Remote Deployment (para 4.15.2.1.1).</p> <p>Olive MESA deployment strap is drawn out from controlled strap-release mechanism (ratchet).</p> <p>This enables MESA to be raised or lowered.</p> <p>MESA adjustment strap draws through buckle at approximately 40 pounds of lifting force, at strap angle of approximately 75°. (Strap angle is 0° when black strap is in line with olive strap.)</p> <p>Ref para 4.15.2.1.3.</p>

**LMA790-3-LM**  
**APOLLO OPERATIONS HANDBOOK**

LM 3231, LM 3234

CREW-MAN	PNI	PROCEDURES	REMARKS
	+Z27	<p><u>4.15.1.20 Buddy Umbilical Storage Bag Removal</u></p> <ol style="list-style-type: none"> <li>1. Unfasten Velcro on external cover.</li> <li>2. Ensure buddy umbilical attachment straps clear pull-tabs.</li> <li>3. Unsnap internal compartment.</li> <li>4. Remove buddy umbilical storage bag &amp; secure external cover.</li> </ol> <p><u>4.15.1.21 PGA Protective Stowage</u></p> <ol style="list-style-type: none"> <li>1. Doff suits.</li> <li>2. Place one suit on left side of ascent engine cover, with neck ring near -Z27 netting &amp; legs extended down onto or near 233 deck (step).</li> <li>3. Place second suit on right side of ascent engine cover, with neck ring near -Z27 netting, shoulders overlapping those of other suit &amp; legs extended down onto or near 233 deck (step).</li> <li>4. Open empty jettison bag &amp; insert lower legs of suits (crew preference).</li> </ol> <p><u>4.15.2 EXTRAVEHICULAR ACTIVITY</u></p> <p><u>4.15.2.1 MESA Operations</u></p> <p><u>4.15.2.1.1 MESA Remote Deployment</u></p> <ol style="list-style-type: none"> <li>1. Move to position on ladder.</li> <li>2. Pull lanyard at platform side to release pip pin &amp; activate MESA release locking mechanism.</li> <li>3. Descend ladder to lunar surface.</li> <li>4. Stow LEC on ladder cleat.</li> </ol>	<p>Suits may be stowed, at crew preference, in one of following configurations:</p> <ol style="list-style-type: none"> <li>a. Connectors facing up</li> <li>b. Connectors facing down</li> <li>c. Suits placed back to back</li> </ol> <p>MESA should be manually deployed if automatic system does not release locking mechanism. (Ref para 4.15.2.1.2.)</p>

**LMA790-3-LM**  
**APOLLO OPERATIONS HANDBOOK**

CREW-MAN	PNI	PROCEDURES	REMARKS
		<p>4.15.1.19.1 <u>Deploy Sleep Station (cont)</u></p> <p>4. Pass LMP inboard center support strap to CDR (beneath LMP &amp; CDR umbilicals if connected).</p> <p>5. Attach strap to lower handrail on suit circuit assembly.</p> <p>6. Attach outboard center support strap to lower ISA fitting &amp; straddle hammock while facing CDR flight station.</p> <p>7. Position self in hammock, with head at LMP flight station.</p> <p>8. Attach aft fittings of CDR hammock to -Z27 attach points. Pass hammock (beneath umbilicals if connected) &amp; attach forward straps to panel 1 and 2 hammock fittings. Adjust tension on straps for desired hammock height.</p> <p>9. Attach outboard center support strap to vertical handrail above suit circuit assembly.</p> <p>10. Climb into hammock, with feet facing forward. Attach inboard center support strap to outboard PLSS downing station attachment &amp; pull downward on strap to maintain desired tension. Lie back in hammock.</p>	
		<p>4.15.1.19.2 <u>Stow Sleep Station</u></p> <p>1. Climb out of hammock &amp; detach all straps.</p> <p>2. Place all straps on hammock &amp; roll up hammock.</p> <p>3. Climb out of hammock &amp; detach center support straps &amp; the attach straps on LMP side of cabin.</p> <p>4. Place all straps on hammock &amp; roll up hammock.</p> <p>5. Return to CDR flight station &amp; stow CDR &amp; LMP hammocks.</p>	



**LMA790-3-LM**  
**APOLLO OPERATIONS HANDBOOK**

CREW: MAN	PNI	PROCEDURES	REMARKS
		<p>4.15.1.16.2 <u>Feedwater Reservoir and Auxiliary Tank Recharge, Gravity Environment (cont)</u></p> <p>23. HTR CONT: URINE LINE sw - OFF</p> <p>24. CB HTR: URINE LINE - open</p> <p>4.15.1.17 <u>Raise EVA Antenna</u></p> <ol style="list-style-type: none"> <li>1. Move to aft cabin bay.</li> <li>2. Grasp EVA antenna T-handle.</li> </ol> <p style="text-align: center;">CAUTION</p> <p style="text-align: center;">Rotate handle slowly to prevent vertical overshoot.</p> <ol style="list-style-type: none"> <li>3. Pull down &amp; rotate handle to detent; release handle.</li> </ol> <p>4.15.1.18 <u>Stow EVA Antenna</u></p> <ol style="list-style-type: none"> <li>1. Move to aft cabin bay.</li> <li>2. Grasp EVA antenna T handle.</li> <li>3. Pull down &amp; rotate handle to detent; release handle.</li> </ol> <p>4.15.1.19 <u>Sleep Station</u></p> <p>4.15.1.19.1 <u>Deploy Sleep Station</u></p> <ol style="list-style-type: none"> <li>1. Install sun filter on AOT.</li> <li>2. Unstow midsection hammock from storage at CDR station, &amp; move to aft equipment bay. Route umbilicals behind PCA, if required.</li> <li>3. Unroll LMP hammock from CDR side of crew compartment &amp; loosely attach hammock straps to hammock fittings at LMP flight station. Adjust tension on straps at CDR station for desired hammock height.</li> </ol>	<p>Full travel of handle rotation is approximately 225°. Direction of turn is counterclockwise.</p> <p>Full travel of handle rotation is approximately 225°. Direction of turn is clockwise.</p> <p>To prevent earthshine through telescope.</p>

**LMA790-3-LM**  
**APOLLO OPERATIONS HANDBOOK**

CREW-MAN	PNI	PROCEDURES	REMARKS
		<p>4.15.1.16.2 <u>Feedwater Reservoir and Auxiliary Tank Recharge, Gravity Environment (cont)</u></p>	
	ECS	<p>11. DES H2O vlv - OPEN</p> <p>12. DES H2O vlv - CLOSE</p> <p>13. Disconnect urine transfer hose from FLSS primary water tank vent fitting &amp; connect to FLSS auxiliary water tank vent fitting.</p> <p style="text-align: center;">NOTE</p> <p>Water is initially observed in vent flow indicator due to previous entrapment of water in vent tube. As gas is vented, water is no longer observed. Water is again observed when gas is completely vented and auxiliary tank is full.</p> <p>If water does not disappear within 10 sec after DES H2O vlv - OPEN, there is no gas in auxiliary tank. Proceed to next step of procedure.</p>	
	ECS	<p>14. DES H2O vlv - OPEN</p> <p>15. DES H2O vlv - CLOSE</p>	
	FLSS	<p>16. Disconnect urine transfer hose from FLSS auxiliary water tank vent fitting &amp; stow.</p> <p>17. DES H2O vlv - OPEN for 5 to 10 sec, then CLOSE</p> <p>18. FLSS AUX H2O SHUTOFF AND RELIEF vlv - CLOSE</p> <p>19. Disconnect all hoses &amp; install dust caps.</p> <p>20. Secure FLSS.</p> <p>21. Reconnect water dispenser to water recharge hose &amp; stow.</p>	Step 17 tops off FLSS water tanks.
	ECS	<p>22. DES H2O vlv - OPEN</p>	





**LMA790-3-LM**  
**APOLLO OPERATIONS HANDBOOK**

CREW-MAN	PNL	PROCEDURES	REMARKS
		<p>4.15.1.16.2 <u>Feedwater Reservoir and Auxiliary Tank Recharge, Gravity Environment (cont)</u></p> <p>2. Open PLS thermal insulation flap &amp; access door to expose H2O fill &amp; drain fittings &amp; vent fitting.</p> <p>3. Unstow urine transfer hose &amp; connect to PLS H2O drain fitting.</p> <p>4. DES H2O vlv - CLOSE</p> <p>5. Unstow water recharge hose &amp; disconnect from water dispenser.</p> <p>6. Connect hose to PLS H2O fill fitting.</p> <p>7. DES H2O vlv - OPEN</p> <p style="text-align: center;">NOTE</p> <p style="text-align: center;">During recharge, flow may be verified by observing intermittent bubbles in urine transfer hose flow indicator.</p> <p>8. Charge for minimum of 5 minutes.</p> <p>9. DES H2O vlv - CLOSE</p> <p>10. Disconnect urine transfer hose from PLS H2O drain fitting &amp; connect hose to PLS primary tank vent fitting.</p> <p style="text-align: center;">NOTE</p> <p style="text-align: center;">Water is initially observed in vent flow indicator due to previous entrapment of water in vent tube. As gas is vented, water is no longer observed. Water is again observed when gas is completely vented and feedwater bladder is full.</p> <p style="text-align: center;">If water does not disappear within 10 sec after DES H2O vlv - OPEN, there is no gas in feedwater bladder. Proceed to next step of procedure.</p>	<p style="text-align: center;">Time required to fill PLS feedwater bladder.</p>

LM 3242

**LMA790-3-LM**  
**APOLLO OPERATIONS HANDBOOK**

LM 9.

CREW- MAN	PNL	PROCEDURES	REMARKS
		4.15.1.16.1 <u>Oxygen Recharge (cont)</u>	
		3. Unstow LM 02 recharge hose.	
		4. Verify: LM 02 recharge hose connected to HI PRESS QD. or LM 02 recharge hose connected to LO PRESS QD.	HI PRESS QD is to be used as nominal mode.  LO PRESS QD is to be used as back-up or contingency mode only.
		5. Remove dust cap & connect LM 02 recharge hose to PLSS 02 fill fitting.	
	+Z27	6. HI PLSS 02 FILL vlv - OPEN or LO PLSS FILL vlv - OPEN	LO PLSS valve will provide 57% charge to PLSS tank if descent oxygen quantity >35%.
	ECS	7. Charge as required	While charging with oxygen, crewman may proceed to Feed-water Reservoir Recharge procedure (para 4.15.1.16.2).
	+Z27	8. HI PLSS 02 FILL vlv - CLOSE or LO PLSS FILL vlv - CLOSE	LO PLSS valve will provide 57% charge to PLSS tank if descent oxygen quantity >35%.
	ECS	9. Disconnect LM 02 recharge hose from PLSS 02 fill fitting. 10. Replace dust caps on fill fitting & hose. 11. Stow LM 02 recharge hose. 12. Close PLSS 02 access door & thermal insulation flap.	
		4.15.1.16.2 <u>Feedwater Reservoir and Auxiliary Tank Recharge, Gravity Environment</u>	
	11	1. Five min before transfer of PLSS condensate: CB HTR: URINE LINE - close HTR CONT: URINE LINE sw - HTR 1	Assumptions: (1) PLSS AUX H2O SHUTOFF AND RELIEF vlv - OPEN, (2) PLSS may be mounted in recharge station or on ascent engine cover, (3) PLSS PRIMARY H2O SHUTOFF AND RELIEF vlv - CLOSE, and (4) all dust caps are tethered, and removed as required.
	8		

Basic Date 26 September 1971

Change Date \_\_\_\_\_

Page 4.15-29

LUNAR  
STAY  
OPERATIONS

**LMA790-3-LM**  
**APOLLO OPERATIONS HANDBOOK**

CREW- MAN	P/NL	PROCEDURES	REMARKS
		<p>4.15.1.14 <u>Cooling H2O Changeover, PLSS H2O to LM H2O (LCG)</u></p> <ol style="list-style-type: none"> <li>1. Loosen torso tiedown.</li> <li>2. PUMP sw - OFF</li> <li>3. Disconnect PLSS H2O connector from PGA.</li> <li>4. Connect LM LCG H2O connector to PGA.</li> </ol>	<p>This should be performed by other crewman. PGA connector may inadvertently lock, in which case it must be unlocked before LCG H2O connector engagement.</p>
	16	<p>CB ECS: LCG PUMP - close</p> <p>4.15.1.15 <u>Cooling H2O Changeover, LM H2O (LCG) to PLSS H2O</u></p> <ol style="list-style-type: none"> <li>1. CB ECS: LCG PUMP - open</li> <li>2. Disconnect LM LCG H2O connector from PGA.</li> <li>3. Connect PLSS H2O connector to PGA.</li> <li>4. PUMP sw - ON</li> <li>5. Tighten torso tiedown as desired.</li> </ol>	
		<p>4.15.1.16 <u>PLSS Recharge</u></p> <p>GFE/GFE procedures (PLSS battery and LiOH cartridge replacement procedures) are not supplied in LM AOH.</p> <p>4.15.1.16.1 <u>Oxygen Recharge</u></p> <ol style="list-style-type: none"> <li>1. ECS: O2 QUANTITY ind - &gt;56% (descent tank 2)</li> <li>2. Open PLSS thermal insulation flap &amp; access door to expose O2 fill fitting. Remove dust cap.</li> </ol>	<p>Assumptions: (1) CDR and LMP are in their respective flight stations, (2) either crewman may perform all or any part of recharge procedures, (3) PLSS may be in donning station or on ascent engine cover, and (4) PLSS control unit is electrically connected to PLSS.</p> <p>Assumptions: (1) PLSS may be mounted in recharge station or on ascent engine cover, (2) PRIM O2 SHUTOFF vlv - OFF (fwd), (3) HI PLSS O2 FILL vlv - CLOSE, (4) LO PLSS FILL vlv - CLOSE, and (5) all dust caps are tethered.</p> <p>PLSS cannot be fully charged with oxygen if quantity &lt;56%.</p>

**LMA790-3-LM**  
**APOLLO OPERATIONS HANDBOOK**

LM 2007, LM 3215

CREW- MAN	PNI	PROCEDURES	REMARKS
CDR	11	<p>4.15.1.1.3 <u>Post-EVA Final Subsystems Configuration (cont)</u></p> <p>2. Verify EPS Basic (Unstaged)</p> <p>3. Verify Communications Basic.</p> <p>4. CB S/C: ATT DIR CONT - open</p> <p>5. ED: MASTER ARM sw - OFF STAGE sw - SAFE</p> <p>6. ENG THR CONT: ENG ARM sw - OFF</p> <p>7. S/C: PCNS sw - OFF</p>	<p>Ref para 4.13.4.1.</p> <p>Ref para 4.13.2.1. This verification may be performed simply by verifying voice and telemetry reception by MSFN.</p>

Basic Date 26 September 1971

Change Date \_\_\_\_\_

Page 4.15-27

LUNAR  
STAY  
OPERATION



**LMA790-3-LM**  
**APOLLO OPERATIONS HANDBOOK**

CREW-MAN	PNI	PROCEDURES	REMARKS
		<p>4.15.2.6 Lunar Launch Contingency Storage (cont)</p> <p>2. Post-EVA 2            PLSS (1) - recharge station            ECS LiOH - jettison bag            OPS (1) - upper SRC rack            SRC - lower SRC rack            RCU (2) - ISA            PLSS batteries (2) - jettison bag            PLSS LiOH (2) - jettison bag            Lunar overshoes - jettison bag            Stero cassette - RMSSC            Jettison bag - ISA            TSB - ISA            ISA - aft bay rest station fittings            HSB (2) - ascent engine cover            PLSS (1) - upside down in donning station            OPS (1) - cabin floor</p> <p>3. Post-EVA 3            PLSS (1) - recharge station            ECS LiOH - jettison bag            SRC - upper SRC rack            RCU (2) - ISA            PLSS batteries (2) - jettison bag            PLSS LiOH - jettison bag            Lunar overshoes - jettison bag            Comic ray detector - lower LHMSSC            Jettison bag - ISA            TSB - ISA            ISA - aft bay rest station fittings            HSB (2) - ascent engine cover            PLSS (1) - upside down in donning station            OPS (2) - cabin floor</p>	



**LMA790-3-LM  
APOLLO OPERATIONS HANDBOOK**

5.2.2 PRIMARY GUIDANCE & NAVIGATION SECTION

Table 5-2. PGNS Procedure Entry Sheet

Symptom	Sym No.	Page No.
TRACKER 1t	1	5.2-8
ISS warn 1t	2	5.2-8
TEMP 1t	3	5.2-9
GIMBAL LOCK 1t	4	5.2-9
LGC warn 1t	5	5.2-9
RESTART 1t	5a	5.2-9
ALT 1t	6	5.2-10
VEL 1t	7	5.2-10
RNDZ RDR caut 1t	8	5.2-11
NO TRACK 1t	8a	5.2-11
LGC test	SSR-1	5.2-12

# LMA790-3-LM APOLLO OPERATIONS HANDBOOK

LM3252, LM3259

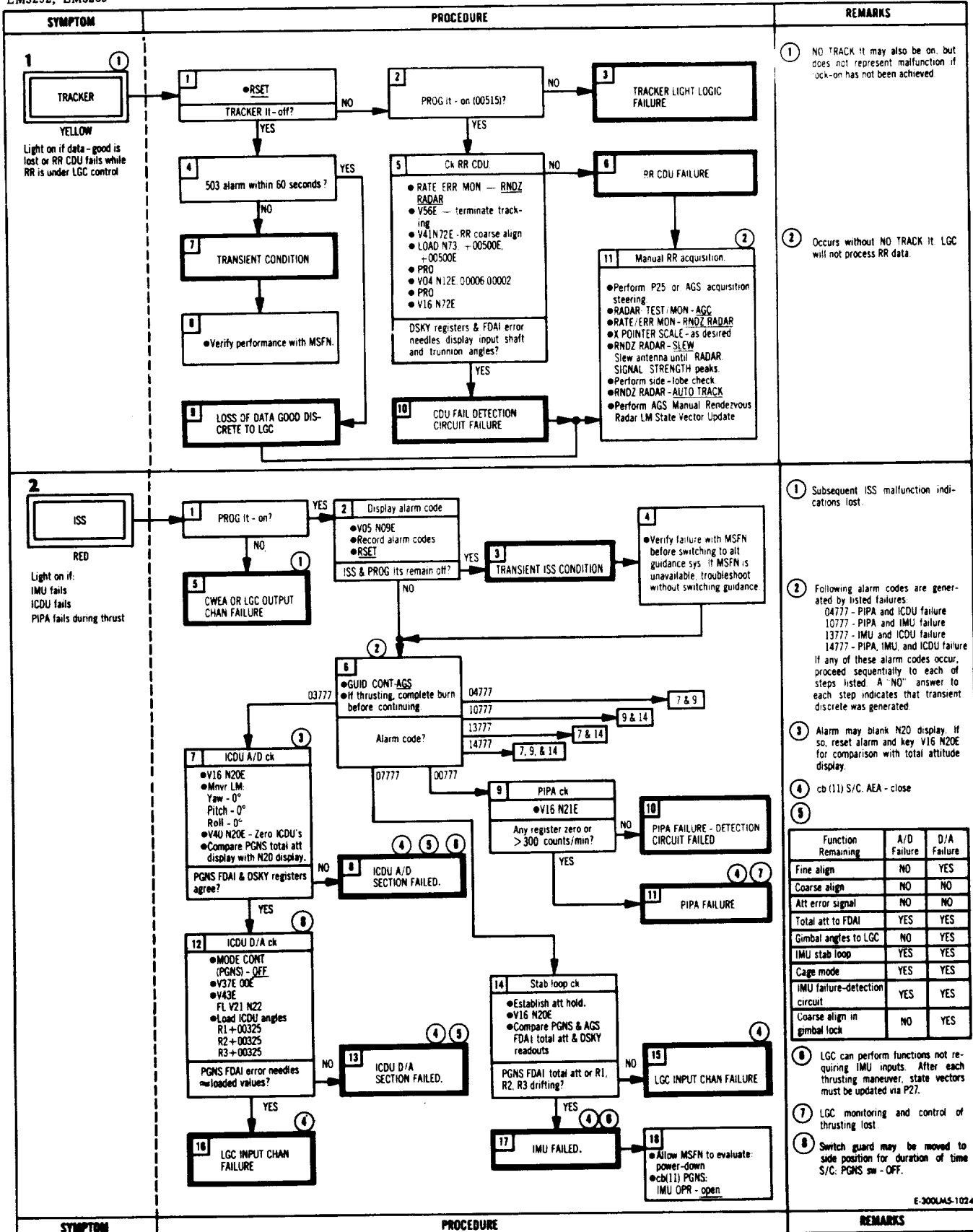

PRIMARY GUIDANCE & NAVIGATION SECTION

E-300LMS-1024



# LMA790-3-LM APOLLO OPERATIONS HANDBOOK

LM 3232

SYMPTOM	PROCEDURE	REMARKS																						
<p><b>3</b></p> <div style="border: 1px solid black; padding: 5px; margin-bottom: 5px;"> <p style="text-align: center;"><b>TEMP</b></p> <p style="text-align: center;">YELLOW</p> <p>Light on if IMU temp out of limits &lt;126 F &gt;134 F</p> </div>		<p>① R1 readout of 0, 1, 2, 3 indicates IMU temperature is within limits.</p> <p>② GN &amp; CS performance will be unaffected by IMU out-of-tolerance temperature for at least 15 minutes. Critical maneuvers can be conducted within this time. IMU stab loop and velocity measurements will be degraded after this time.</p> <p>③ Subsequent IMU out-of-tolerance temperature indications are lost.</p>																						
<p><b>4</b></p> <div style="border: 1px solid black; padding: 5px; margin-bottom: 5px;"> <p style="text-align: center;"><b>GIMBAL LOCK</b></p> <p style="text-align: center;">YELLOW</p> <p>Light on if MGA &gt; 70</p> </div>		<p>① LGC commands coarse align when MGA &gt; 85°</p> <p>② GIMBAL LOCK is unusable for monitoring</p> <p>③ Belly band covers separation between hemispheres of FDAI ball. Belly band, in color bands on each side of FDAI roll bezel, would indicate IMU middle gimbal angle &gt; 75°.</p>																						
<p><b>5</b></p> <div style="border: 1px solid black; padding: 5px; margin-bottom: 5px;"> <p style="text-align: center;"><b>LGC</b></p> <p style="text-align: center;">RED</p> <p>Light on if LGC prime power fails Scaler fails Counter fails</p> </div>		<p>① Transient condition could have existed either in LGC or CWEA</p> <p>② DSKY relay that turns on LGC it disables gyro torquing and PIPA capability. Hence, LGC monitoring and control of both TVC and RCS attitude maneuvers lost.</p> <p>③ Attempt repowering LGC by opening and reclosing cb (11) PGNS, LGC/DSKY.</p> <p>④ Readout of 0, 1, 4, 5 indicates LGC fail signal to CWEA.</p> <p>⑤ cb (11) S/C AEA - close</p> <p>⑥</p>																						
<p><b>5a</b></p> <div style="border: 1px solid black; padding: 5px; margin-bottom: 5px;"> <p style="text-align: center;"><b>RESTART</b></p> <p style="text-align: center;">YELLOW</p> <p>Lighted by Parity failure TRUPT lock TC trap Night watchman or Voltage failure</p> </div>		<p>①</p> <table border="1" style="width: 100%; border-collapse: collapse;"> <thead> <tr> <th style="width: 70%;">Alarm Source</th> <th style="width: 30%;">Channel 77 Code (Octal):</th> </tr> </thead> <tbody> <tr><td>*Parity fail (F-memory)</td><td>001</td></tr> <tr><td>*Parity fail (E-memory)</td><td>003</td></tr> <tr><td>TC trap</td><td>004</td></tr> <tr><td>RUPT lock</td><td>010</td></tr> <tr><td>Night watchman</td><td>020</td></tr> <tr><td>Voltage fail</td><td>040</td></tr> <tr><td>Counter fail</td><td>100</td></tr> <tr><td>Scaler fail</td><td>200</td></tr> <tr><td>Scaler: double frequency alarm</td><td>400</td></tr> <tr><td>*Allowable combinations of above alarms</td><td>Octal sum of above codes</td></tr> </tbody> </table> <p>*Parity fail will either be in E-memory or F-memory, but not in combination</p>	Alarm Source	Channel 77 Code (Octal):	*Parity fail (F-memory)	001	*Parity fail (E-memory)	003	TC trap	004	RUPT lock	010	Night watchman	020	Voltage fail	040	Counter fail	100	Scaler fail	200	Scaler: double frequency alarm	400	*Allowable combinations of above alarms	Octal sum of above codes
Alarm Source	Channel 77 Code (Octal):																							
*Parity fail (F-memory)	001																							
*Parity fail (E-memory)	003																							
TC trap	004																							
RUPT lock	010																							
Night watchman	020																							
Voltage fail	040																							
Counter fail	100																							
Scaler fail	200																							
Scaler: double frequency alarm	400																							
*Allowable combinations of above alarms	Octal sum of above codes																							

PRIMARY GUIDANCE & NAVIGATION SECTION

# LMA790-3-LM APOLLO OPERATIONS HANDBOOK

SYMPTOM	PROCEDURE	REMARKS
<p><b>6</b></p> <div style="border: 1px solid black; padding: 5px; width: fit-content;">ALT</div> <p style="text-align: center;">YELLOW</p> <p>Light on steady if: LR range data-good discrete not present when LGC tries to read LR altitude (R20) Expected at: High altitudes Off-nominal attitudes (including "belly down") Zero Doppler</p> <p>Light flashing if: LR altitude reasonableness test failed below high-gate (R12) Expected at: Lurain discontinuities Zero Doppler</p>	<p style="text-align: center;">①</p> <p>1 Condition? <span style="float: right;">②</span></p> <p style="margin-left: 40px;">FLASHING → 2 Preceded by steady ALT II &amp; VEL II - flashing</p> <p style="margin-left: 40px;">STEADY → 5 Before average g in P63? <span style="float: right;">⑧</span></p> <p style="margin-left: 40px;">5 YES → 6 DSKY RELAY FAILURE</p> <p style="margin-left: 40px;">5 NO → 8 ●RNG/ALT MON - ALT/ALT RT ●MODE SEL - LDG RADAR Altitude display on ALT/ALT RATE OK?</p> <p style="margin-left: 40px;">8 YES → 9 ●Monitor R1 ΔH in N63 ΔH changing?</p> <p style="margin-left: 40px;">8 NO → 10 LR/LGC INTERFACE FAILURE <span style="float: right;">⑦</span></p> <p style="margin-left: 40px;">9 YES → 11 DSKY RELAY FAILURE</p> <p style="margin-left: 40px;">9 NO → 10</p> <p style="margin-left: 40px;">8a ●cb PGNS LDG RDR - cycle Symptom remains after 20 sec?</p> <p style="margin-left: 40px;">8a YES → 12 ●RADAR TEST MON - ALT XMTR RADAR SIGNAL STRENGTH &gt; 2.1?</p> <p style="margin-left: 40px;">8a NO → 8b POSSIBLE ERRONEOUS LR LOW SCALE</p> <p style="margin-left: 40px;">12 YES → 13 ●RADAR TEST MON - VEL XMTR RADAR SIGNAL STRENGTH &gt; 2.1?</p> <p style="margin-left: 40px;">12 NO → 16 LR DEGRADED OR FAILED <span style="float: right;">④ ⑧</span></p> <p style="margin-left: 40px;">13 YES → 14 Do LR Self Test ●V58E ●RADAR TEST - LDG Test OK? (Monitor ALT/ALT RATE)</p> <p style="margin-left: 40px;">13 NO → 17 LR FAILED</p> <p style="margin-left: 40px;">14 YES → 15 ●RADAR TEST - OFF ●V57E <span style="float: right;">④</span></p> <p style="margin-left: 40px;">14 NO → 17</p> <p style="margin-left: 40px;">2 YES → 3 Do LR Self Test ●MODE SEL - LDG RADAR ●V58E ●RADAR TEST - LDG Self-test altitude correct (8000 ft on ALT/ALT RATE)?</p> <p style="margin-left: 40px;">2 NO → 3</p> <p style="margin-left: 40px;">3 YES → 4 ●RADAR TEST - OFF ●ALT II - on steady (≈ 6 sec?) ●Monitor R1 ΔH in N63 ●V57E when ΔH is satisfactory <span style="float: right;">④ ⑤</span></p> <p style="margin-left: 40px;">3 NO → 7 LR ALTITUDE FAILURE</p> <p style="margin-left: 40px;">7 PGNS YEL <span style="float: right;">⑦ ①</span></p>	<p>① Expected zero Doppler region LR antenna position No 1 - about 7000 to 5000 feet LR antenna position No 2 - about 350 to 150 feet</p> <p>② Altitude reasonableness test is performed only after high gate</p> <p>③ Time limitations below high gate may not permit test</p> <p>④ LR self-test cannot determine cause. Symptom may be temporary due to causes such as those listed in SYMPTOM column</p> <p>⑤ Possible data interface failure</p> <p>⑥ Assumption R04 is not running</p> <p>⑦ Capability of updating LGC with LR data is lost</p> <p>⑧ If transmitter corona is suspect, cb PGNS LDG RDR - cycle</p> <p>⑨ If transmitter power or receiver sensitivity for beams No 1, 2, or 4 is degraded, altitude data-good may be late</p>
<p><b>7</b></p> <div style="border: 1px solid black; padding: 5px; width: fit-content;">VEL</div> <p style="text-align: center;">YELLOW</p> <p>Light on steady if: LR velocity data-good discrete not present when LGC tries to read LR velocity (R20) Expected at: High altitudes Off-nominal attitudes (including "belly down") Zero Doppler</p> <p>Light on flashing if: LR velocity reasonableness tests failed (R12) Expected at: Lurain discontinuity Near-zero Doppler LR antenna stuck between positions (at higher attitudes)</p>	<p style="text-align: center;">①</p> <p>1 Condition? <span style="float: right;">②</span></p> <p style="margin-left: 40px;">FLASHING → 2 Preceded by steady VEL II or ALT II also flashing?</p> <p style="margin-left: 40px;">STEADY → 8 Before average g in P63? <span style="float: right;">⑧</span></p> <p style="margin-left: 40px;">2 YES → 3 POSSIBLE CROSS-LOBE LOCK-ON</p> <p style="margin-left: 40px;">2 NO → 5 Do LR Self Test ●V58 ●RATE ERR MON - LDG RDR CMPTR ●MODE SEL - LDG RADAR ●RNG/ALT MON - ALT/ALT RT ●RADAR TEST - LDG Altitude rate and/or horizontal velocities (on ALT/ALT RATE and/or X pointer) obviously bad?</p> <p style="margin-left: 40px;">5 YES → 7 LR VELOCITY FAILURE</p> <p style="margin-left: 40px;">5 NO → 6 ●RADAR TEST - OFF ●V57E <span style="float: right;">③ ④</span></p> <p style="margin-left: 40px;">8 YES → 12 DSKY RELAY FAILURE</p> <p style="margin-left: 40px;">8 NO → 9 ●RNG/ALT MON - ALT/ALT RT ●MODE SEL - LDG RADAR Altitude rate display changing?</p> <p style="margin-left: 40px;">9 YES → 13 DSKY RELAY FAILED OR LR/LGC INTERFACE FAILURE</p> <p style="margin-left: 40px;">9 NO → 16 LR VELOCITY FAILURE</p> <p style="margin-left: 40px;">8a ●cb PGNS LDG RDR - cycle Symptom remains after 20 sec?</p> <p style="margin-left: 40px;">8a YES → 10 ●RADAR TEST/MON - VEL XMTR RADAR SIGNAL STRENGTH &gt; 2.1?</p> <p style="margin-left: 40px;">8a NO → 9a POSSIBLE ERRONEOUS LR LOW SCALE</p> <p style="margin-left: 40px;">10 YES → 14 Do LR Self Test ●V58E ●RADAR TEST - LDG ●RATE ERR MON - LDG RDR/CMPTR Altitude rate and/or horizontal velocities (on ALT/ALT RATE and/or X pointer) obviously bad?</p> <p style="margin-left: 40px;">10 NO → 15 ●RADAR TEST - OFF ●V57E <span style="float: right;">③</span></p> <p style="margin-left: 40px;">3 Act-uate forced tracker search ●RADAR TEST - LDG Wait 1 sec ●RADAR TEST - OFF ●VEL II - on steady (≈ 6 sec), then off</p>	<p>① Expected zero Doppler regions LR antenna position No 1 - about 7000 to 5000 feet LR antenna position No 2 - about 350 to 150 feet</p> <p>② Velocity reasonableness test is performed when velocity &lt; 6000 fps all the time</p> <p>③ LR self-test cannot determine cause. Symptom may be temporary due to causes such as those listed in SYMPTOM column</p> <p>④ Possible data interface failure</p> <p>⑤ Possible impact on ability to use altitude data</p> <p>⑥ Assumption R04 is not running</p> <p>⑦ If transmitter power or receiver sensitivity for beam No 1, 2, or 3 is degraded, velocity data-good may be late. If beam No 1 and/or 2 is affected, altitude data will also be late</p> <p>⑧ If transmitter corona is suspect, cb PGNS LDG RDR - cycle</p> <p>⑨ There is no onboard capability for distinguishing between failures. Continue and monitor other data sources if data-good-discrete interface failed, LR data are not processed.</p> <p>⑩ Unless results are obvious, test is inconclusive without report of downlink from MSFN</p>

PRIMARY GUIDANCE & NAVIGATION SECTION

# LMA790-3-LM APOLLO OPERATIONS HANDBOOK

SYMPTOM	PROCEDURE	REMARKS
<p><b>RNDZ RDR</b></p> <p>YELLOW</p> <p>Light on if RR loses data good in AUTO TRACK</p> <p><b>8a</b></p> <p><b>NO TRACK</b></p> <p>YELLOW</p> <p>Light on if RR loses data good in AUTO TRACK &amp; LGC modes</p>	<pre> graph TD     Start(( )) --&gt; 1{1 NO TRACK lt - on?}     1 -- NO --&gt; 2{2 RNDZ RADAR - SLEW RNDZ RDR lt - off?}     2 -- YES --&gt; 3{3 NO TRACK lt - on?}     2 -- NO --&gt; 5{5 CWEA FAILURE}     3 -- YES --&gt; 4{4 RR FAIL DETECT CKT FAILURE}     3 -- NO --&gt; 6{6 NO TRACK LT FAILED OFF}     1 -- YES --&gt; 7{7 Range rate display OK? (AGC &gt; 0.6 vdc)}     7 -- NO --&gt; 8{8 RR xmtr ck RNDZ RADAR TEST/MON - XMTR PWR Signal strength &gt; 1.6?}     8 -- NO --&gt; 9{9 RR DEGRADED OR FAILED}     8 -- YES --&gt; 10{10 CSM ATT OR XPNDR PROBLEM}     10 -- NO --&gt; 11{11 CSM verifies att &amp; xpnder OK?}     11 -- YES --&gt; 14{14 Request CSM RNDZ XPNDR HEATER RADAR TEST-RNDZ (wait 15 sec) Range &amp; range rate display OK?}     11 -- NO --&gt; 13{13 CSM verifies att &amp; xpnder OK?}     13 -- YES --&gt; 16{16 Request CSM RNDZ XPNDR HEATER RADAR TEST-RNDZ (wait 15 sec) TEST OK?}     16 -- YES --&gt; 17{17 RADAR TEST - OFF Request CSM RNDZ XPNDR PWR}     16 -- NO --&gt; 18{18 RANGE TRACKER FAILURE}     17 --&gt; 18     14 -- YES --&gt; 15{15 RR FAILURE}     14 -- NO --&gt; 15     17 --&gt; 18     18 --&gt; 19{19 Mode?}     19 -- LGC --&gt; 20{20 Reacquire Attempt LGC acquisition via P20 NO TRACK lt - off?}     20 -- YES --&gt; 23{23 NO AUTO TRACK ENABLE FROM LGC}     20 -- NO --&gt; 23     19 -- AUTO TRACK --&gt; 21{21 GUID CONT?}     21 -- PGNS --&gt; 22{22 Reacquire Attempt AUTO &amp; MAN acquisition via P20 RNDZ RDR &amp; NO TRACK lts - off?}     22 -- YES --&gt; 23     22 -- NO --&gt; 25{25 RR FAILURE}     21 -- AGS --&gt; 24{24 Reacquire Attempt AGS acquisition steering &amp; manual lock on RNDZ RDR &amp; NO TRACK lts - off?}     24 -- YES --&gt; 23     24 -- NO --&gt; 25     19 --&gt; 26{26 MOMENTARY LOSS OF TRACK}     26 --&gt; 27{27 Mode?}     27 -- LGC --&gt; 20     27 -- AUTO TRACK --&gt; 28{28 RNDZ RADAR - SLEW then AUTO TRACK (wait 15 sec) Range display OK?}     28 -- NO --&gt; 16     28 -- YES --&gt; 30{30 NO TRACK lt - off?}     30 -- YES --&gt; 31{31 RNG CKT TRANSIENT (AND/OR RNDZ RDR LT FAILED OFF)}     30 -- NO --&gt; 33{33 Will N10E 33E R1 ABCDE D = 0, 2, 4, or 6?}     33 -- NO --&gt; 34{34 DATA GOOD CKTRY FAILURE}     33 -- YES --&gt; 35{35 DATA NO GOOD/NO TRACK CKT FAILURE}     </pre>	<p>① RNDZ RDR C/W monitor capability lost. Use NO TRACK lt.</p> <p>② Continue troubleshooting.</p> <p>③ If antenna is drifting or oscillating abnormally, a single gyro has failed RR GYRO SEL - SEC and reacquire.</p> <p>④ To check for possible rnz radar corona problem or frequency tracker lock-on to spurious radiation, cycle cb (11) PGNS. RNDZ RDR off for ~10 sec.</p> <p>⑤ Key Y95E (in LGC mode) before initiating self-test or go to AUTO TRACK.</p> <p>⑥ RR will maintain tracking and provide good range rate data, shaft and trunnion angles to FDAI error needles, and azimuth and elevation angle rates to X pointer ind.</p> <p>⑦ LGC cannot read Rndz radar</p> <p>⑧ All Rndz radar data OK but RR data good missing and LGC will not accept data</p> <p>⑨ Data OK to LGC and display. Use RNG/ALT pwr/sig fail lt, TRACKER lt, and AGC &gt; 0.6 vdc as substitute track indication.</p>

C-300LMS-1032

PRIMARY GUIDANCE & NAVIGATION SECTION

Basic Date 26 September 1971

Change Date \_\_\_\_\_

**LMA790-3-LM  
APOLLO OPERATIONS HANDBOOK**

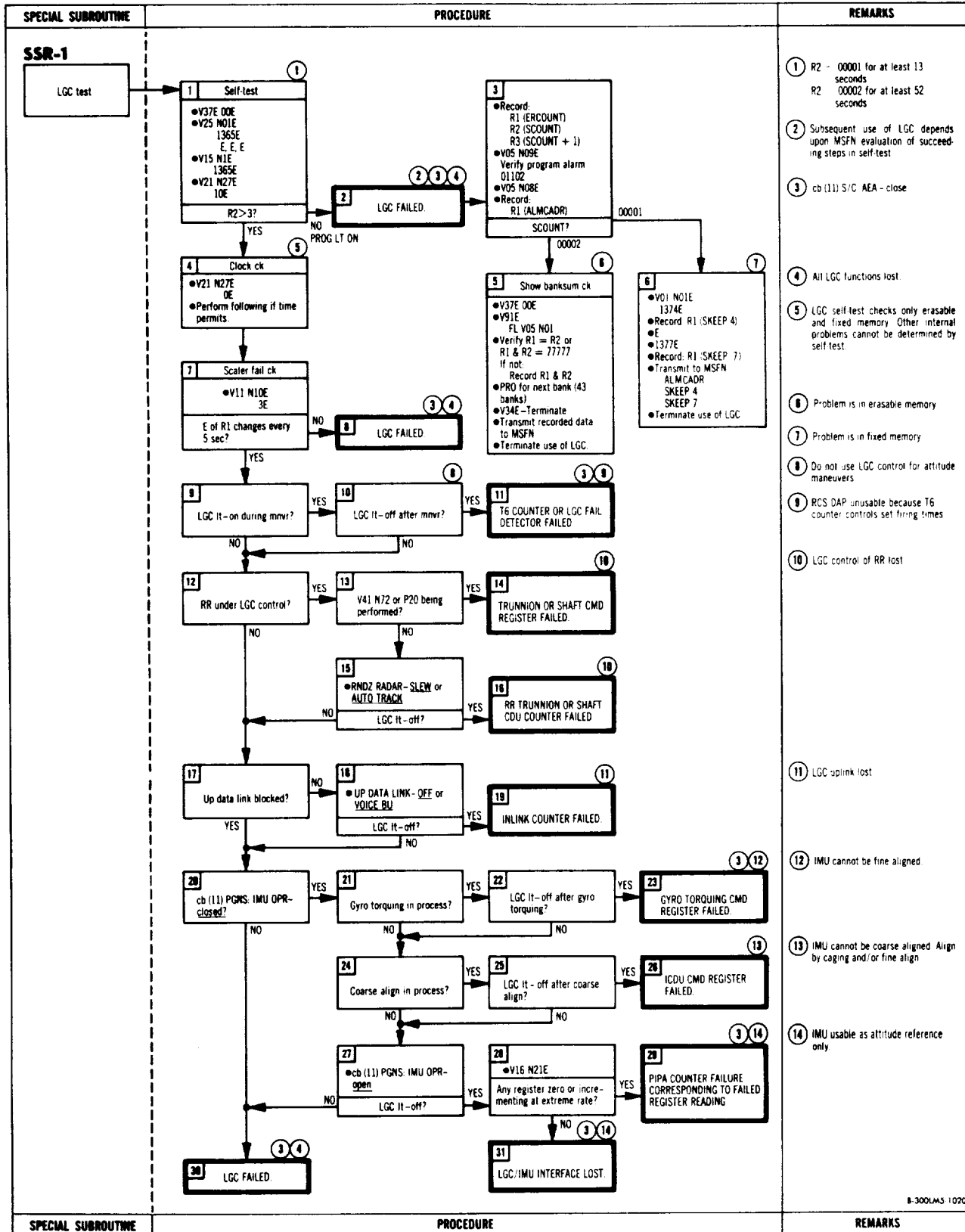

B-300LMS 1020

PRIMARY GUIDANCE & NAVIGATION SECTION

**LMA790-3-LM**  
**APOLLO OPERATIONS HANDBOOK**

5.2.3 ABORT GUIDANCE SECTION

Table 5-3. AGS Procedure Entry Sheet

Symptom	Sym No.	Page No.
AGS warn lt	1	5.2-14
DEDA response abnormal	2	5.2-14

# LMA790-3-LM APOLLO OPERATIONS HANDBOOK

L.M3257, L.M3258

SYMPTOM	PROCEDURE	REMARKS
<p><b>1</b></p> <div style="border: 1px solid black; padding: 5px; margin-bottom: 5px;"> <p style="text-align: center; margin: 0;"><b>AGS</b></p> <p style="text-align: center; margin: 0;">RED</p> </div> <p>Light on if:</p> <p>ASA power supplies out of tolerance</p> <p>ASA heater fails on (activated at 150° ± 5°F)</p> <p>AEA fails to complete minor cycle within 20 milliseconds</p> <p>AEA test mode discrete signals failure condition</p> <p>Light latches on when AEA failure is detected. O<sub>2</sub>/H<sub>2</sub>O QTY MON must be set to C/W RESET position to unlatch.</p>		<p>① AGS lost.</p> <p>② AGS self-test status 412 + X0000 X = 0 Test not complete X = 1 Test successful X = 3 Logic test failure X = 4 Memory test failure X = 7 Logic and memory test failure</p> <p>③ AGS operations not recommended.</p> <p>④ O<sub>2</sub>/H<sub>2</sub>O QTY MON performs latch-up release when set to C/W RESET</p> <p>⑤ For PGNS unavailable: C 400+70000 checks accelerometers only.</p> <p>⑥ AEA restart changes: 470 to - 80000, 400 and 410 through 417 to - 00000, 470 is incremented by accumulated ΔV<sub>x</sub> from an initial value at AEA start-up of - 8000.0 fps.</p> <p>⑦ Test Mode Fail (T.M.F.) must be reset to permit the appearance of the AGS warning light in the event of future AEA detected failures.</p>
<p><b>2</b></p> <div style="border: 1px solid black; padding: 5px; margin-bottom: 5px;"> <p style="text-align: center; margin: 0;">DEDA response abnormal</p> </div>		<p>① Readout and enter functions are lost. AGS flight displays are available, but will become less and less reliable due to inability to be updated, aligned or calibrated.</p> <p>② OPR ERR display lost.</p> <p>③ MSFN can confirm DEDA readouts.</p> <p>a. For following failures, AGS/DEDA capability is unaffected: EL segments HOLD pb open</p> <p>b. For following failure, readout and enter capability is lost: CLR pb closed Digit pb closed ENTR pb closed HOLD pb closed READOUT pb closed</p> <p>AGS flight displays are available, but will become less and less reliable due to inability to be updated, aligned, or calibrated.</p> <p>c. The pb capability is lost for following failures: Digit pb open ENTR pb open* + or - pb open*</p> <p>*AGS can no longer be aligned, updated, or calibrated. AEA routines via SIX entry are lost.</p>

**LMA790-3-LM**  
**APOLLO OPERATIONS HANDBOOK**

5.2.4 CONTROL ELECTRONICS SECTION

5.2.4.1 Abnormal Vehicle Dynamics

- Abnormal vehicle dynamics during coasting flight is defined as uncommanded vehicle acceleration by RCS, including limit cycling on edge of deadband. Abnormal vehicle dynamics during thrust includes unexpected acceleration or oscillation, or excessive RCS firing. Abnormal dynamics may not always be recognized on vehicle displays; it may be necessary to verify the symptom using other available cues.

Table 5-4. CES Procedure Entry Sheet

Symptom	Sym No.	Page No.
Abnormal vehicle dynamics (non-MPS)	1	5.2-16
LM drifts out of deadband	2	5.2-17
PGNS minimum impulse (V76) cmds abnormal	3	5.2-17
AGS pulse or direct cmds abnormal	4	5.2-18
Prop cmds abnormal	5	5.2-18
TTCA cmds abnormal	6	5.2-19
Abnormal Dynamics during MPS thrusting	7	5.2-19
ENG GMBL caut lt	8	5.2-20
No MPS shutdown	9	5.2-20
Premature MPS ignition	9a	5.2-20
No MPS ignition at TIC = 0	10	5.2-21
ENG THRUST & CMD THRUST ind do not agree/off schedule	11	5.2-21
PRE AMPS caut lt	12	5.2-22
CES AC warn lt	13	5.2-22
CES DC warn lt	14	5.2-22

LMA790-3-LM  
 APOLLO OPERATIONS HANDBOOK

LM3253, LM3260

SYMPTOM	PROCEDURE	REMARKS
<p><b>1</b> Abnormal vehicle dynamics (non-MPS)</p>	<p><b>1</b> Stabilize LM.                  ●ACA-hardover, if required                  ●GUID CONT - AGS (PGNS)                  ●MODE CONT (2) - ATT HOLD                  ●ATT CONT (3) - MODE CONT                  ●TTCA/TRANSL (2) - DISABLE                  ●DEAD BAND - MAX                  ●ACA - neutral                  LM stable within deadband?</p> <p>YES → <b>8</b> RCS TCA it on?                  YES → <b>4</b>   <b>1</b></p> <p>NO → <b>2</b> RCS TCA it on?                  YES → <b>3</b> JET DRIVER FAILED ON (PRIMARY COIL) → <b>4</b> Isolate failed jet.                  Affected quad ●RCS, SYS A (B) QUAD - DISABLE                  ●cb RCS SYS A (B): QUAD 1 (2, 3, 4) TCA - open</p> <p>NO → <b>5</b> ●ACA PROP (2) - DISABLE LM stable?                  YES → <b>6</b> ACA FAILED OUT OF DETENT → <b>7</b> ●ACA PROP - ENABLE individually, to isolate failed ACA</p> <p>NO → <b>9</b> ●ACA/4 JET (2) - DISABLE LM stable?                  YES → <b>12</b> ACA HARDOVER SW SHORTED → <b>13</b> ●ACA/4 JET - ENABLE individually, to isolate failed ACA</p> <p>NO → <b>10</b> + X TRANSL PB SHORTED → <b>11</b> ●cb (11) S/C ATT DIR CONT - open</p> <p>NO → <b>14</b> Symptom occurred in?                  PGNS → <b>15</b> DAP data load OK?                  YES → <b>18</b> ●GUID CONT - PGNS LM stable? → <b>17</b> TTCA FAILED → <b>7</b> Internal failure may be confined to LGC input/output channel, which can be determined from RCS cold-fire check.                  NO → <b>18</b> ●Reload correct DAP data load.</p> <p>AGS → <b>21</b> Rate needles abnormal?                  YES → <b>22</b> RGA FAILED → <b>8</b> Perform AEA self-test.</p> <p>NO → <b>23</b> AGS att error needles &gt; 0?                  YES → <b>24</b> ●GUID CONT - AGS LM stable?                  YES → <b>25</b> ●ATT CONT - individually DIR, then MODE CONT LM stable? → <b>26</b> ●TTCA/TRANSL - ENABLE individually LM stable? → <b>27</b> AEA FAILURE → <b>8</b> Perform AEA self-test.                  NO → <b>28</b> AGS - CES FAILURE → <b>10</b> ●GUID CONT - PGNS</p> <p>NO → <b>29</b> ACA 2.5° SW SHORTED → <b>4</b>   <b>11</b> ●ATT CONT (affected axis) - MODE CONT</p> <p>NO → <b>30</b> TTCA FAILED</p>	<p><b>1</b> For abnormal dynamics during commanded maneuvers, refer to symptom for associated mode.</p> <p><b>2</b> Single RCS jet failed on, when compensated for by opposing jets, consumes 0.12% / second of total RCS propellant.</p> <p><b>3</b> AGS attitude hold capability remains only in automatic mode.</p> <p><b>4</b> Alternative is to replace defective ACA with shorting plug. See CES symptom No. 5, remark No. 6.</p> <p><b>5</b> + X TRANSL pb, hardover, DIRECT mode, and PULSE mode lost.</p> <p><b>6</b> Hardover mode is lost.</p> <p><b>7</b> Internal failure may be confined to LGC input/output channel, which can be determined from RCS cold-fire check.</p> <p><b>8</b> AGS rate command and FDAI rate monitoring lost. If roll or pitch, AGS DPS burn capability lost.</p> <p><b>8</b> Perform AEA self-test.</p> <p><b>10</b> AGS MODE CONT and possibly PULSE mode lost. DIRECT mode is unaffected.</p> <p><b>11</b> DIRECT and PULSE modes lost for affected axis. PGNS minimum impulse mode may be lost in affected axis.</p>

D-300LMS-1023

CONTROL ELECTRONICS SECTION



**LMA790-3-LM**  
**APOLLO OPERATIONS HANDBOOK**

LM3254, LM3255, RC1608

SYMPTOM	PROCEDURE	REMARKS																
<p><b>2</b></p> <p>LW drifts out of deadband</p>		<p>① RCS control lost for affected pos of GUID CONT sw. If ATCA circuit breaker for associated guidance system opened, a return to that system for control is impossible.</p> <p>② Only AGS PULSE and DIRECT control are available in affected axis.</p>																
<p><b>3</b></p> <p>PGNS minimum impulse (V76) cmds abnormal</p>		<p>① Alternative procedure - Affected system: RCS: SYS (affected quad) - <u>DISABLE</u>; tb - bp Thruster disable discrete to LGC may be reset by recycling RCS: SYS (affected quad) - <u>ENABLE</u>; tb - gray</p> <p>② Octal code of failed jet:</p> <table border="1"> <tr> <td>1U - 100E</td> <td>4U - 1E</td> </tr> <tr> <td>1D - 200E</td> <td>4D - 2E</td> </tr> <tr> <td>1F - 4E</td> <td>4F - 2E</td> </tr> <tr> <td>1L - 200E</td> <td>4R - 100E</td> </tr> <tr> <td>2U - 20E</td> <td>3U - 4E</td> </tr> <tr> <td>2D - 40E</td> <td>3D - 10E</td> </tr> <tr> <td>2A - 10E</td> <td>3A - 1E</td> </tr> <tr> <td>2I - 20E</td> <td>3R - 40E</td> </tr> </table> <p>③ If problem is in pitch or roll, LPD is lost.</p> <p>④ LGC minimum impulse LPD, AGS PULSE, and one-half of DIRECT authority lost in one direction for affected ACA.</p>	1U - 100E	4U - 1E	1D - 200E	4D - 2E	1F - 4E	4F - 2E	1L - 200E	4R - 100E	2U - 20E	3U - 4E	2D - 40E	3D - 10E	2A - 10E	3A - 1E	2I - 20E	3R - 40E
1U - 100E	4U - 1E																	
1D - 200E	4D - 2E																	
1F - 4E	4F - 2E																	
1L - 200E	4R - 100E																	
2U - 20E	3U - 4E																	
2D - 40E	3D - 10E																	
2A - 10E	3A - 1E																	
2I - 20E	3R - 40E																	
SYMPTOM	PROCEDURE	REMARKS																

B-300LMS-1014

CONTROL ELECTRONICS SECTION

Basic Date 26 September 1971

Change Date \_\_\_\_\_

Page 5.2-17

# LMA790-3-LM APOLLO OPERATIONS HANDBOOK

LM3251, LM3255, RC1808

SYMPTOM	PROCEDURE	REMARKS
<p><b>4</b></p> <p>AGS pulse or direct cmds abnormal</p>		<p><b>1</b> Affected axis may be available in PGNS (if preamp failed).</p> <p><b>2</b> One-half of DIRECT authority lost in one direction for affected ACA.</p> <p><b>3</b> LGC minimum impulse LPD, AGS PULSE, and one-half of DIRECT authority lost in one direction for affected ACA.</p> <p><b>4</b> AGS PULSE mode lost for affected axis.</p>
<p><b>5</b></p> <p>Prop cmds abnormal</p>		<p><b>1</b> Prop control lost for affected ACA.</p> <p><b>2</b> Failure may be single or multi-axi.</p> <p><b>3</b> Failure could be open LGC output channel, summing amplifier, pulse rate module, or preamplifier.</p> <p><b>4</b> Prop control lost for affected guidance system DIRECT and PULSE control unaffected.</p> <p><b>5</b> If symptom is present in both guidance modes malfunction may be open circuit in one ACA.</p> <p><b>6</b> To remove ACA and replace with shorting plug:          •cb (11) S/C ATT DIR CONT - open          ATCA (PGNS) - open          •cb (16) S/C ATCA TAGS) - open          •cb (11) COMM: CDR - open (for CDR ACA) or          cb (16) COMM: SE - open (for LMP ACA)          •ACA PROP (2) - DISABLE          •AUDIO CONT (2) - NORM          On suspected ACA:          •P &amp; J 709 - disconnect          •P &amp; J 708 - disconnect          •Install jumper plug on J 709          •Install dust cap on J 708          •Close above cb's &amp; reconfigure switches</p> <p>Since vehicle attitude control is lost during switch over, use of this procedure during controlled flight is not recommended.</p> <p><b>7</b> PGNS and DIRECT control unaffected. PULSE control may be available in AGS.</p> <p><b>8</b> DIRECT control unaffected Prop control may be OK in alternative guidance system.</p> <p><b>9</b> FDAI rate displays lost.</p> <p><b>10</b> If PGNS guidance desired, inhibit jet per CES 3, step 7.</p> <p style="text-align: right;">C-300LMS-101*</p>

CONTROL ELECTRONICS SECTION

**LMA790-3-LM**  
**APOLLO OPERATIONS HANDBOOK**

LM3260

SYMPTOM	PROCEDURE	REMARKS
<p><b>6</b></p> <p>TTCA cmds abnormal</p>		<p>1 Abnormal response will be lack of (or subnormal) <math>\Delta V_m</math> or abnormal limit cycling.</p> <p>2 RCS control for affected guidance system lost.</p> <p>3 Resetting cb (16) INST: CWEA causes MASTER ALARM - on.</p> <p>4 If failed driver is for Y or Z jet, translation time will be at least twice nominal since translation is single-jet.</p> <p>5 LGC problem may be confined to input/output channel failure, which can be determined from RCS cold-fire test in step 5.</p> <p>6 Translation capability in AGS lost.</p> <p>7 Applicable to AGS control only.</p>
<p><b>7</b></p> <p>Abnormal dynamics during MPS thrusting</p>		<p>1 Assumption: All DPS burns are initiated in PGNS.</p> <p>2 Possible RCS TCA II.</p>

CONTROL ELECTRONICS SECTION

LMA790-3-LM  
**APOLLO OPERATIONS HANDBOOK**

SYMPTOM	PROCEDURE	REMARKS
<p><b>8</b></p> <div style="border: 1px solid black; padding: 5px; width: fit-content;"> <b>ENG GMBL</b>                      YELLOW                      Light on if there is discrepancy between gimbal drive signal &amp; gimbal response signal                 </div>		<p><b>1</b> Light is inhibited when ENG ARM - QFF.</p> <p><b>2</b> Mission rules dictate crew action. Continuation of powered descent will result in abnormal RCS fuel consumption and possible violation of thermal constraints.</p> <p><b>3</b> It is possible to distinguish between these failures by resetting ENG GMBL it. (ENG GMBL - QFF, then ENABLE.)</p> <p><b>4</b> C/W monitoring of GDA lost.</p> <p><b>5</b> It may be possible to reset gimbal position, using alternative guidance system and MSFN information.</p>
<p><b>9</b></p> <div style="border: 1px solid black; padding: 5px; width: fit-content;">                     No MPS shutdown                      ● Eng STOP pb - push                      ● ENG ARM - QFF                      ● Verify ABORT (ABORT STAGE) pb - reset                      Eng shuts down?                 </div> <p><b>9a</b></p> <div style="border: 1px solid black; padding: 5px; width: fit-content;"> <b>Premature MPS ignition</b> </div>		<p><b>1</b> Assumption: Burn was terminated on premature ignition (except during lunar ascent). Whether crew will reattempt burn at TIG will be mission rule.</p> <p><b>2</b> Failure of MPS to shut down automatically will also result from failure of cb (16) S/C ENG ARM. If this circuit breaker is open, manual starts and stops will be required for subsequent burns. Delay arming engine until TIG.</p> <p><b>3</b> AGS attitude hold and automatic on-off capability lost.</p> <p><b>4</b> AGS - controlled burns unaffected</p>
SYMPTOM	PROCEDURE	REMARKS

8-300LMS-102

CONTROL ELECTRONICS SECTION

**LMA790-3-LM  
APOLLO OPERATIONS HANDBOOK**

SYMPTOM	PROCEDURE	REMARKS
<p><b>10</b></p> <p>No MPS ignition at TIG = 0</p>	<pre> graph TD     S10[No MPS ignition at TIG = 0] --&gt; B1[1 Manual start • Eng START pb - push Eng starts?]     B1 -- YES --&gt; B2[2 AUTO ON - OFF CKTRY FAILURE.]     B1 -- NO --&gt; B4[4 Redundant arming signal • ABORT pb - push (DPS) • ABORT STAGE pb - push (APS) Eng starts?]     B4 -- YES --&gt; B5[5 ENG ARM SW CKTRY FAILED.]     B4 -- NO --&gt; B7[7 DECA POWER OR RELAY K10 FAILED.]     B2 --&gt; B3[3 Manual shutdown When burn complete: • Eng STOP pb - push • Eng ARM - OFF • Verify ABORT (ABORT STAGE) pb - reset]     B5 --&gt; B6[6 Subsequent burns: • DPS - Arm via ABORT pb. • APS - Arm via ABORT STAGE pb. • Use auto eng-on cmd for ignition.]     B7 --&gt; B8[8 Subsequent DPS burns: • DES ENG CMD OVRD - ON at TIG]             </pre>	<p>① Failure of MPS to start and stop automatically will also result from failure of cb (16) S/C. ENG ARM. If this circuit breaker is open, manual starts and stops will be required for subsequent burns. Delay arming engine until TIG.</p> <p>② MSFN will advise if maximum thrust /fixed gimbal DPS starts are expected. No APS burns are possible, due to double CES failure. If descent engine override is used to start first DPS burn, supercritical helium may not be pressurized.</p>
<p><b>11</b></p> <p>ENG THRUST &amp; CMD THRUST ind do not agree/off schedule &gt; 7%</p>	<pre> graph TD     S11[ENG THRUST &amp; CMD THRUST ind do not agree/off schedule &gt; 7%] --&gt; B1[1 FTP?]     B1 -- YES --&gt; B2[2 Early throttle down to 10%?]     B1 -- NO --&gt; B5[5 AUTO LOGIC OUTPUT LOW]     B2 -- YES --&gt; B3[3 CMD still FTP?]     B2 -- NO --&gt; B6[6 ENG THRUST &amp; CMD THRUST ind both low?]     B3 -- YES --&gt; B4[4 DECA RELAY FAILED]     B3 -- NO --&gt; B10[10 AUTO LOGIC FAILED TO 0]     B4 --&gt; B7[7 Throttle up &amp; attempt to match ENG THRUST &amp; CMD THRUST ind.]     B5 --&gt; B8[8 • Advance TTCA until ENG THRUST ind = FTP]     B6 -- YES --&gt; B12[12 TTCA FAILED]     B6 -- NO --&gt; B9[9 Use alt TTCA • MAN THROT - other position]     B9 -- YES --&gt; B12     B9 -- NO --&gt; B14[14 MANUAL LOGIC FAILED OR DEGRADED DPS/HARDWARE]     B10 --&gt; B11[11 Throttle up &amp; fly manual profile]     B12 --&gt; B13[13 Wait for throttle down]     B14 --&gt; B13     B13 --&gt; B15[15 Throttle down occur?]     B15 -- YES --&gt; B16[16 ENG THRUST, CMD THRUST, &amp; T/W ind remain static/off schedule?]     B15 -- NO --&gt; B24[24 CMD THRUST ind = FTP?]     B16 -- YES --&gt; B19[19 AUTO LOGIC FAILED]     B16 -- NO --&gt; B17[17 ENG THRUST or CMD THRUST ind static while other ind &amp; T/W ind norm?]     B17 -- YES --&gt; B18[18 IND FAILED]     B17 -- NO --&gt; B20[20 ENG THRUST/CMD THRUST ind readings?]     B20 --&gt; B21[21 Switch to manual throttle &amp; fly manual profile.]     B20 --&gt; B22[22 Use alt TTCA • MAN THROT - other position]     B22 -- YES --&gt; B23[23 TTCA FAILED]     B22 -- NO --&gt; B26[26 Throttle up CMD THRUST ind decr?]     B23 --&gt; B25[25 AUTO LOGIC FAILED TO FTP]     B24 -- YES --&gt; B25     B24 -- NO --&gt; B28[28 THROTTLE ACTUATOR FAILED OR MANUAL THROTTLE FAILED TO 100%]     B25 --&gt; B21     B26 -- YES --&gt; B30[30 DEGRADED DPS/HARDWARE]     B26 -- NO --&gt; B27[27 MANUAL LOGIC FAILED]             </pre>	<p>① DPS throat erosion is expected to decrease command thrust ≈ 1% below timeline and engine thrust ≈ 5% below timeline. With maximum abnormal propellant pressures, 7% difference could be nominal.</p> <p>② Desired auto throttle display available on DSKY in R1 of N92.</p> <p>③ MSFN monitors DPS performance.</p> <p>④ DPS should not be operated for more than 25 seconds in nonthrotttable range.</p>

A-300LMS-1021

CONTROL ELECTRONICS SECTION

**LMA790-3-LM  
APOLLO OPERATIONS HANDBOOK**

SYMPTOM	PROCEDURE	REMARKS
<p><b>12</b></p> <p><b>PRE AMPS</b></p> <p>YELLOW</p> <p>Light on if either -4.7-vdc power supply is out of tolerance</p>	<p>1 CES AC it-on?</p> <p>NO 2 ONE OR BOTH -4.7-VDC PREAMP BIAS POWER SUPPLIES FAILED.</p> <p>YES</p>	<p>1 Sporadic jet firings are possible if both power supplies failed.</p>
<p><b>13</b></p> <p><b>CES AC</b></p> <p>RED</p> <p>Light on if ATCA a-c power supplies are out of tolerance</p>	<p>1 Reset light &amp; perform rate gyro test.</p> <p>•GUID CONT - PGNS •GYRO TEST POS RT - POS RT •Observe rate needles &amp; light.</p> <p>CES AC it remains on?</p> <p>YES 4 CWEA FAILURE</p> <p>NO 2 Rate displays null?</p> <p>YES 3 SINGLE-PHASE ATCA POWER SUPPLY FAILED.</p> <p>NO 5 Reinitialize CWEA</p> <p>•cb (16) INST: CWEA - open, then close</p> <p>CES AC it remains off?</p> <p>YES 6 TRANSIENT CONDITION</p> <p>NO 6 Make small mnvr via PGNS rate mode.</p> <p>Rate inds &gt; 0?</p> <p>YES 7 POWER SUPPLY VOLTAGE OUT OF TOLERANCE (1φ OR 3φ) OR 1φ OF 3φ FAILED.</p> <p>NO 9 POWER TO RATE GYRO FAILED.</p>	<p>1 If AGS is in control, true CES a-c failure causes loss of damping.</p> <p>2 AGS control of LM lost, but AEA remains for computation purposes only.</p> <p>3 RR usable only in LGC mode. Shaft and trunnion power lost in SLEW and AUTO TRACK.</p> <p>4 Subsequent CES a-c monitoring lost.</p> <p>5 Resetting cb (16) INST: CWEA causes MASTER ALARM - on.</p> <p>6 Rate gyro assembly will probably not restart after shutdown.</p> <p>7 FDAI rate needles are invalid, but rates may be displayed on error needles via VSOE (full-scale deflection = ± 25°/sec).</p>
<p><b>14</b></p> <p><b>CES DC</b></p> <p>RED</p> <p>Light on if ATCA d-c power supplies are out of tolerance</p>	<p>1 Reset light.</p> <p>•GUID CONT - PGNS •GYRO TEST POS RT - POS RT</p> <p>CES DC it remains on?</p> <p>YES 5 CWEA FAILURE</p> <p>NO 2 Reinitialize CWEA</p> <p>•cb (16) INST: CWEA - open, then close</p> <p>CES DC it remains off?</p> <p>YES 6 TRANSIENT CONDITION</p> <p>NO 3 Staged?</p> <p>YES 4 ATCA POWER SUPPLY (-15V, ±6V AND/OR +4.3V) FAILED.</p> <p>NO 7 Enable throttle actuator.</p> <p>•Eng STOP pb - push •ENG ARM - DES</p> <p>MSFN reports throttle at max?</p> <p>YES 9 -15V OR +4.3V ATCA POWER SUPPLY FAILED.</p> <p>NO 8 ±6V ATCA POWER SUPPLY FAILED.</p>	<p>1 Resetting cb (16) INST: CWEA causes MASTER ALARM - on.</p> <p>2 AGS attitude control lost.</p> <p>3 Subsequent APS burns should be started manually.</p> <p>4 Subsequent CES d-c monitoring lost.</p> <p>5 This transient condition may have caused throttle to lock in 100% position. Cycle cb AC BUS A, DECA GMBL, and/or check throttle position with MSFN.</p> <p>6 DPS and APS operation is normal in PGNS.</p> <p>7 DPS fixed at maximum throttle with gimbal locked.</p>

B-300LMS-1013

**LMA790-3-LM**  
**APOLLO OPERATIONS HANDBOOK**

RC 96

5.2.5 DESCENT PROPULSION SECTION

5.2.5.1 General

- Double failures are not considered.
- During descent engine burns, continue the burn unless it becomes apparent that an explosion could occur.
- The DPS is loaded with helium and propellants according to prescribed values.
- The DPS has been checked before use.
- The status of all tb's has been checked and verified before entering the tb malfunction procedures.

5.2.5.2 Assumptions

5.2.5.2.1 Off-Nominal Helium Pressure, or Propellant Temperature or Pressure, Indication

- Large leaks are not considered.
- These are troubleshooting procedures intended to locate, identify, and isolate off-nominal conditions that do not trigger the CWEA or provide discrete malfunction indications.
- The crew does not enter into this symptom unless they have had an obvious off-nominal condition.
- Heat or cold-soak is not a malfunction.

5.2.5.2.2 DES REG Warning Light

- The DES REG warn lt CWEA logic has been enabled by the first descent engine arming, since CB INST: CWEA has been closed.
- The LM has not staged.

5.2.5.2.3 Deleted.

5.2.5.2.4 Abnormal PQGS Indication

- Quantity indications are not reliable until after ullage settling.

Table 5-5. DPS Procedure Entry Sheet

Symptom	Sym No.	Page No.
DES REG warn lt	1	5.2-24
Fuel/oxid press abnormal	1a	5.2-24
Fuel/oxid temp abnormal	2	5.2-25
He press abnormal	3	5.2-25
DES He REG 1 (2) tb - bp	4	5.2-25
DES He REG 2 (1) th - gray	5	5.2-25
DES QTY warn lt	6	5.2-26
PQGS ind abnormal	7	5.2-26
FUEL VENT (OXID VENT) tb - abnormal	8	5.2-26

LMA790-3-LM  
**APOLLO OPERATIONS HANDBOOK**

L.M 2005

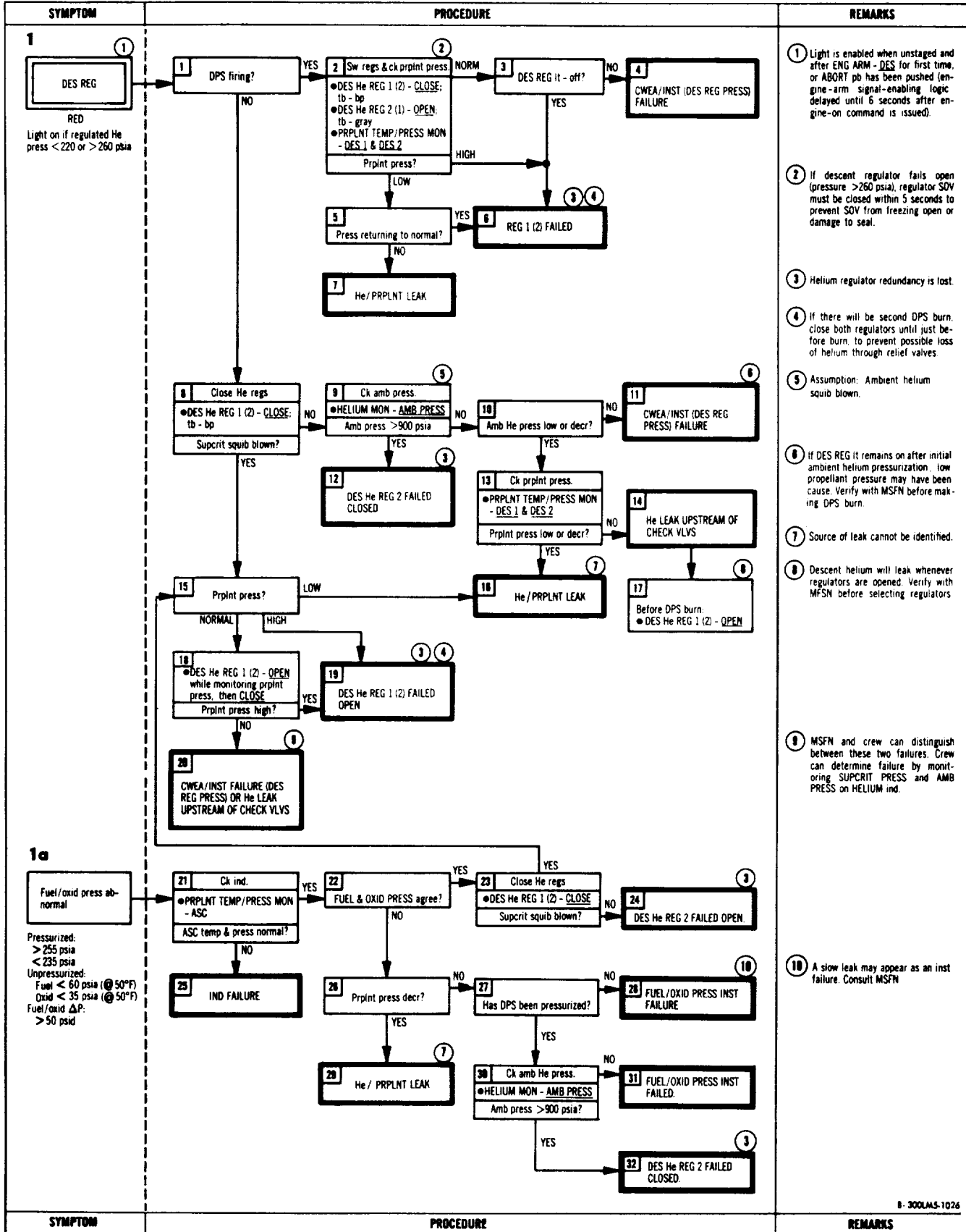

B-300LAS-1026

DESCENT PROPULSION SECTION



# LMA790-3-LM APOLLO OPERATIONS HANDBOOK

SYMPTOM	PROCEDURE	REMARKS
<p><b>2</b></p> <p>Fuel/oxid temp abnormal</p> <p>&gt;75°F (unpress) &gt;90°F (press) &lt;50°F Fuel/oxid Δt &gt;10°F</p>		<p>① Descent tanks No. 1 are located at + Y &amp; - Z. Descent tanks No. 2 are located at - Y &amp; + Z.</p> <p>② Use unaffected temp to estimate temp of failed tank sensor.</p>
<p><b>3</b></p> <p>He press abnormal</p> <p>Supcrit: &gt; or &lt; timeline Amb: &gt;1750 psia &lt;1300 psia (unpress) &lt;200 psia (press)</p>		<p>① MSFN can distinguish between these failures.</p> <p>② DES REG It and fuel/oxidizer pressure are only indications of abnormal helium pressure.</p> <p>③ Source of leak cannot be identified.</p> <p>④ He supply will not be depleted with descent regs closed. Open descent regs just prior to burn.</p> <p>⑤ If DES REG it comes on, failure is helium leak upstream of check valves.</p> <p>⑥ If ambient helium squib valves are fired, supercritical helium will be lost through same leak.</p> <p>⑦ Verify with MSFN before selecting regulators.</p>
<p><b>4</b></p> <p>DES He REG 1 (2) tp - bp</p> <p>BP abnormal when reg in use</p>		<p>① Helium regulator redundancy may be lost. Failure can be confirmed by decreasing fuel/oxidizer pressure during burn if DES He REG 2 is not opened.</p>
<p><b>5</b></p> <p>DES He REG 2 (1) tb - gray</p> <p>Gray abnormal when reg not in use</p>		<p>① DES He REG 2 SOV is open if ambient helium tank pressure is approximately equal to supercritical helium pressure after first descent engine burn has been initiated.</p>

C-300LMS-1031

DESCENT PROPULSION SECTION

LMA790-3-LM  
**APOLLO OPERATIONS HANDBOOK**

SYMPTOM	PROCEDURE	REMARKS
<p><b>6</b></p> <p><b>DES QTY</b></p> <p>RED</p> <p>Light on if burn time to prplnt depletion &lt; 2 min at 25% thrust</p>		<p>1 Light is inhibited when PRPLNT QTY MON - OFF or when staged.</p> <p>2 DES QTY lit should go on when PQGS reading is in 4% to 7% range</p> <p>3 If PQGS is turned on before propellants are settled, DES QTY lit will come on if a low level sensor is exposed.</p> <p>4 Low-level indication is erroneous. Monitor fuel/oxidizer numerics.</p>
<p><b>7</b></p> <p><b>PQGS ind abnormal</b></p>		<p>1 Quantity readouts are reliable only under +X-acceleration. Fuel reading may indicate up to 5% low for ~10 minutes after initial turn-on. PQGS duty cycle is 45 minutes on, 15 minutes off.</p> <p>2 Use good system to estimate quantity of failed tank</p> <p>3 DES QTY lit is unaffected</p> <p>4 DES QTY lit may be inoperative</p> <p>5 Use fuel/oxidizer to estimate quantity of failed system</p>
<p><b>8</b></p> <p><b>FUEL VENT (OXID VENT) tb - abnormal</b></p> <p>Abnormal if:          BP - before first venting or during venting.          Gray - after first venting</p>		<p>1 Not applicable to zero-g conditions.</p> <p>2 Fracture mechanics limits may be exceeded due to heat soakback after long burn, if fuel (oxid) tank is not vented.</p>

DESCENT PROPULSION SECTION

**LMA790-3-LM  
APOLLO OPERATIONS HANDBOOK**

5.2.6 ASCENT PROPULSION SECTION

5.2.6.1 General

- Double failures are not considered, except that in the ASC HI REG caut lt malfunction procedure a double failure (series-parallel regulators) causes the ASC HI REG caut lt to go on.
- During ascent engine burns, continue the burn unless it becomes apparent that an explosion could occur.
- The APS is loaded with helium and propellants according to prescribed values.
- The APS has been checked before use.
- The status of all tb's has been checked and verified before entering the tb malfunction procedures.

5.2.6.2 Assumptions

5.2.6.2.1 Off-Nominal Helium, or Propellant Temperature or Pressure, Indication

- Large leaks are not considered.
- These are troubleshooting procedures that cover off-nominal and anomalous conditions that do not trigger the CWEA or provide discrete malfunction indications.
- The crew does not enter into this symptom unless they have had an obvious off-nominal condition.
- Heat or cold-soak is not a malfunction.

5.2.6.2.2 ASC PRESS Warning Light

- If this light goes on during a non-mission critical burn, immediately shut down the engine.

5.2.6.2.3 ASC QTY Caution Light

- A malfunction does not exist if this light goes on at the nominal time.

Table 5-6. APS Procedure Entry Sheet

Symptom	Sym No.	Page No.
ASC PRESS warn lt	1	5.2-28
Fuel or oxid temp abnormal	2	5.2.28
Fuel or oxid press abnormal	2a	5.2.28
He press abnormal or decr	3	5.2-29
ASC QTY caut lt	4	5.2-29
ASC HI REG caut lt	5	5.2-29
ASC He REG 1 (2) tb - bp	6	5.2-29

# LMA790-3-LM APOLLO OPERATIONS HANDBOOK

SYMPTOM	PROCEDURE	REMARKS
<p><b>1</b></p> <div style="border: 1px solid black; padding: 5px; margin-bottom: 5px;"> <b>ASC PRESS</b>  <small>RED</small>  <small>Light on if either He press &lt; 2775 psia (before staging only)</small> </div>		<p>① Light may also have been triggered as a result of APS pressurization. MSFN can distinguish these causes.</p>
<p><b>2</b></p> <div style="border: 1px solid black; padding: 5px; margin-bottom: 5px;"> <small>Fuel or oxid temp abnormal</small>  <small>&gt; 90°F</small>  <small>&lt; 50°F</small>  <small>Fuel/oxid Δt &gt; 10°</small> </div> <p><b>2a</b></p> <div style="border: 1px solid black; padding: 5px;"> <small>Fuel or oxid press abnormal</small>  <small>Pressurized:</small>  <small>&gt; 203 psia</small>  <small>&lt; 170 psia</small>  <small>Unpressurized:</small>  <small>&lt; 110 psia (fuel) @ 50°F</small>  <small>&lt; 70 psia (oxid) @ 50°F</small>  <small>Fuel/oxid ΔP &gt; 10 psia</small> </div>		<p>① MSFN can distinguish between the failures</p> <p>② Helium supply will deplete if both squibs were fired</p> <p>③ Verify with MSFN before selecting regs.</p>
<b>SYMPTOM</b>	<b>PROCEDURE</b>	<b>REMARKS</b>

E-300LMS-1025

ASCENT PROPULSION SECTION

**LMA790-3-LM  
APOLLO OPERATIONS HANDBOOK**

SYMPTOM	PROCEDURE	REMARKS
<p>He press abnormal or decr &gt; 3300 psia &lt; 2900 psia</p>		<p>① MSFN can determine which condition exists.</p>
<p>4 ASC QTY YELLOW Light on when burn time &lt; 8 sec.</p>		<p>① C/W indication of when to close ASC FEED valves lost.</p>
<p>5 ASC HI REG YELLOW Light on if He mant press &gt; 220 psia</p>		
<p>6 ASC He REG 1 (2) tb - bp</p>		<p>① MSFN can distinguish between these two failures.</p>

C-300LMS-1027

ASCENT PROPULSION SECTION



**LMA790-3-LM**  
**APOLLO OPERATIONS HANDBOOK**

LM 3259

5.2.7 REACTION CONTROL SUBSYSTEM

5.2.7.1 General

- The integrity of the RCS is verified before entering the off-nominal condition indicated in the "symptom" column of each RCS malfunction procedure.

5.2.7.2 Assumptions

5.2.7.2.1 RCS Caution Light

- An RCS propellant leak can cause the RCS caution light to go on, but this will only happen if a leak occurs when the propellant quantity is very low or if the propellant tanks rupture. (The probability of the propellant tanks rupturing is very remote.)

5.2.7.2.2 RCS TCA Warning Light

- A translation maneuver must be completed before any action is taken regarding the RCS TCA warning light, except if two or more red test bulbs appear for the same RCS system (A or B). Appearance of the red test bulbs would indicate that the main SOV's or ascent feed valves unlatched or failed closed.
- Crossfeed valves are not open.
- Ascent feed valves are not open, except during +X-translation.

5.2.7.2.3 Talkback Anomaly

- The status of all test bulbs is checked and verified before entering the test bulb anomaly malfunction procedure.

5.2.7.2.4 PQMD Off Nominal

- Temp compensation of the PQMD pressure transducer has considerable time lag. During periods of high propellant use, the PQMD may indicate 5% to 10% low for several minutes.
- The PQMD malfunction procedure is primarily for detection of leaks and transducer failures. It is not applicable to off-nominal performance of the thrusters or digital autopilot.

5.2.7.2.5 Off-Nominal RCS Propellant or Helium Indication

- A helium regulator failure is not considered in this malfunction procedure because the RCS: A & B PRESS indicators are not sensitive enough to reflect regulated helium pressure changes less than 20 psia. However, the RCS A & B REG warning light alerts the crew to high and low regulated helium pressure.

Table 5-7. RCS Procedure Entry Sheet

Symptom	Sym No.	Page No.
RCS caution light	1	5.2-32
He pressure low or decrease	1a	5.2-32
PQMD abnormal	1b	5.2-32
RCS pressure or temp abnormal	2	5.2-32
RCS A (B) REG warning light	3	5.2-33
RCS TCA warning light	4	5.2-33
TB abnormal (QUAD)	5a	5.2-34
TB abnormal (MAIN SOV, CRSFD, ASC FEED)	5b	5.2-34

LMA790-3-LM  
**APOLLO OPERATIONS HANDBOOK**

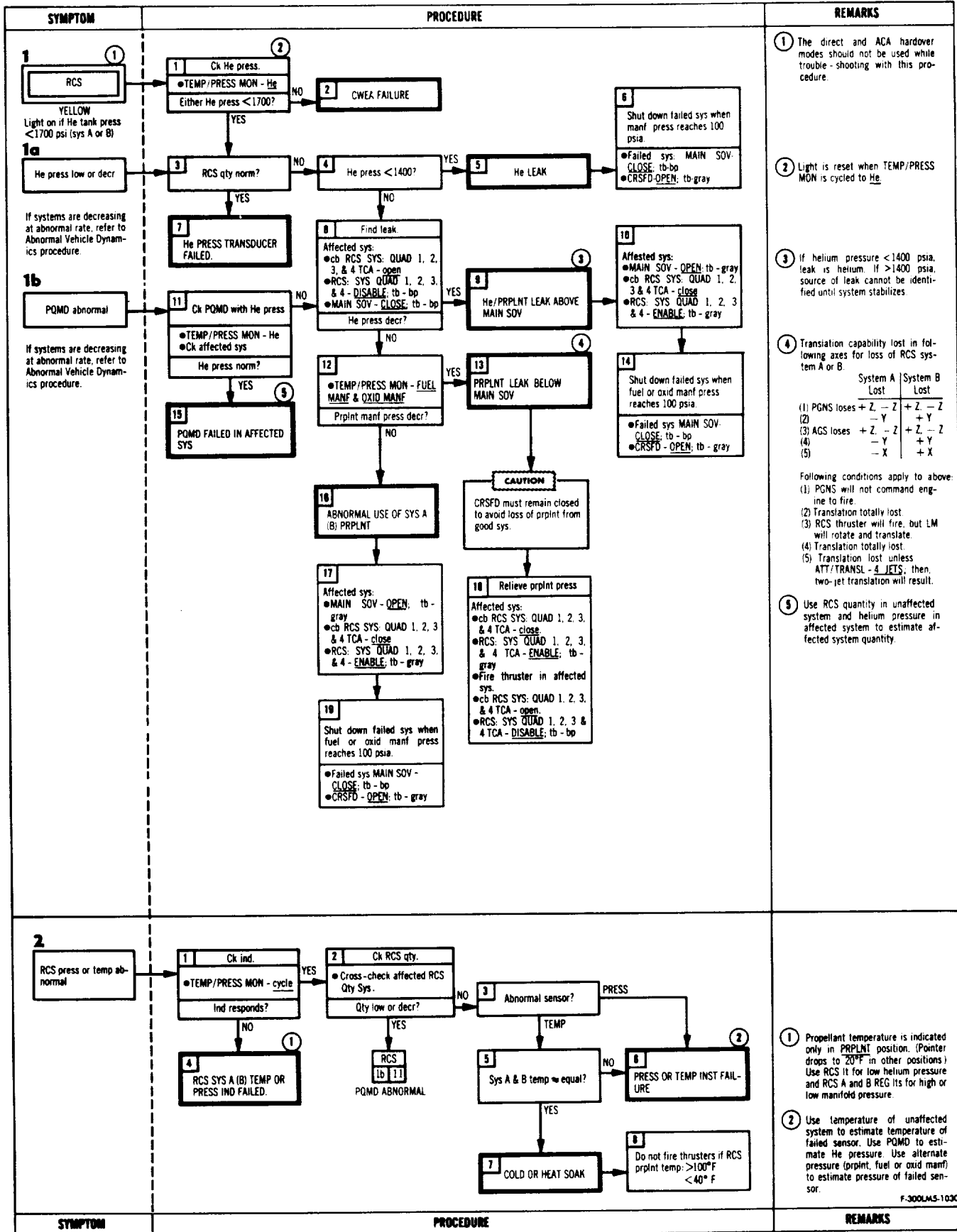

REACTION CONTROL SUBSYSTEM



LM3260

LM A790-3-LM  
**APOLLO OPERATIONS HANDBOOK**

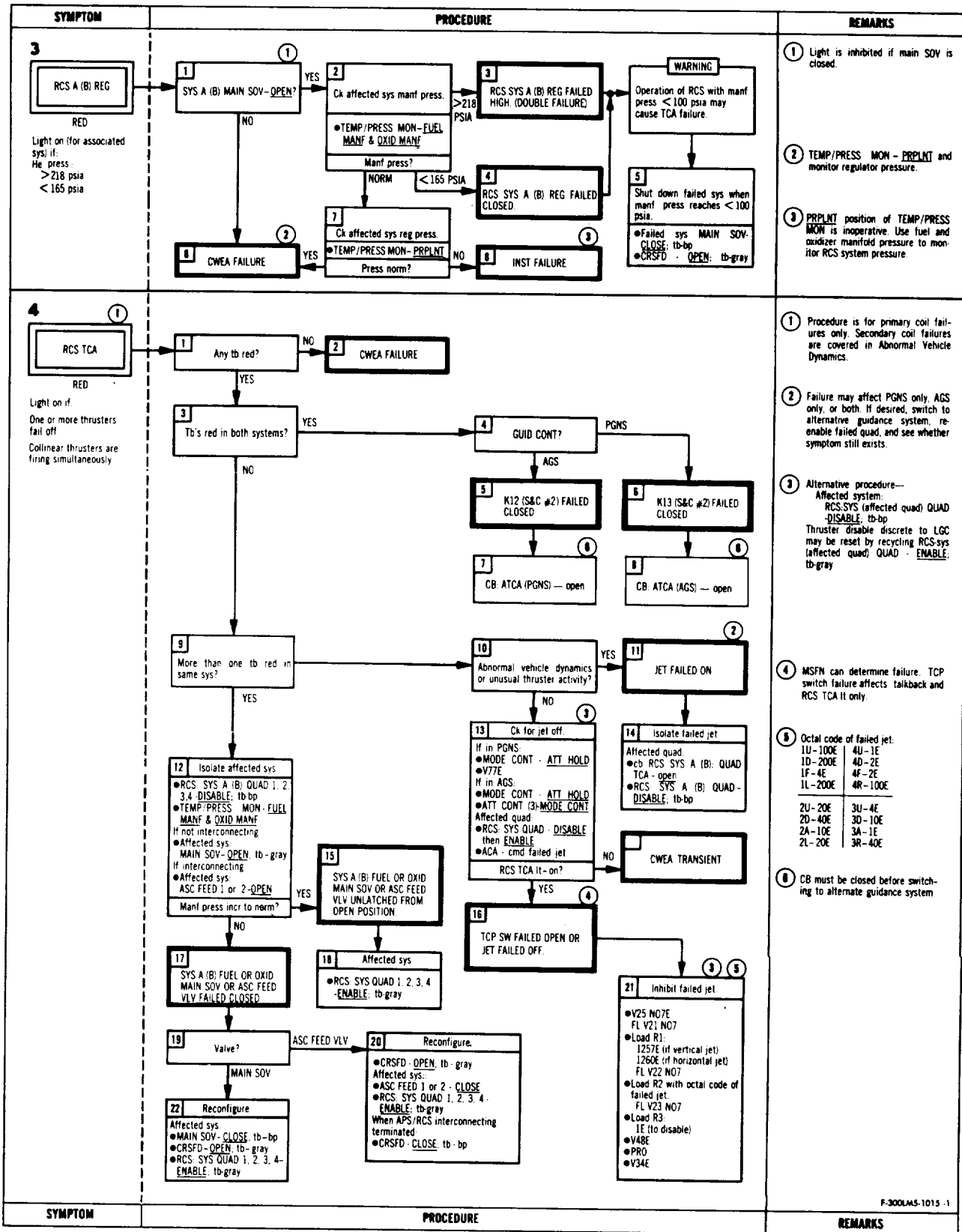

REACTION CONTROL SUBSYSTEM

Basic Date 26 September 1971

Change Date \_\_\_\_\_

Page 5.2-33

F-300LMS-1015-1

LMA790-3-LM  
**APOLLO OPERATIONS HANDBOOK**

LM3260

SYMPTOM	PROCEDURE	REMARKS
<p><b>5a</b></p> <p>TB abnormal QUAD</p> <p><b>5b</b></p> <p>TB abnormal MAIN SOV, CRSFD, ASC FEED</p>	<pre> graph TD     5a[TB abnormal QUAD] --&gt; 1{1 QUAD tb red?}     1 -- YES --&gt; 2[2 QUAD TB FAILURE]     1 -- NO --&gt; 3["3 Cycle sw &amp; leave in desired position. TB agrees?"]     3 -- YES --&gt; 5[5 VLV INADVERTENTLY OPENED OR CLOSED OR STICKY TB]     3 -- NO --&gt; 4[4 TB FAILURE OR FAILED VLV ①]     </pre>	<p>① When terminating APS/RCS interconnect:          if SYS A (B) MAIN SOV tb-bp. leave CRSFD <u>OPEN</u>.          if SYS A (B) ASC FUEL or ASC OXID tb-gray, SYS A (B) ASC FEED 1 - <u>CLOSE</u>, SYS A (B) ASC FEED 2 - <u>ASC FEED 2</u>.</p>
SYMPTOM	PROCEDURE	REMARKS

RCS

**LMA790-3-LM**  
**APOLLO OPERATIONS HANDBOOK**

**5.2.8 ELECTRICAL POWER SUBSYSTEM**

**5.2.8.1 Assumptions**

- Troubleshooting will be performed when mission phase and task loading permit. Accordingly, certain malfunction procedures will not be performed until a main engine burn or critical maneuver is completed.
- Malfunction procedures are entered from normal operational modes. Procedures for checkout modes are not included.
- Inverter No. 2 is on line.
- No a-c circuit breaker opened before entering these procedures.
- In the case of loss of bus, recovery procedures for equipment other than EPS are not included (except for certain critical ECS recovery procedures indicated in symptoms 1 and 2 and for a recovery procedure for regaining EL lighting in symptom 4).
- A partial short as referred to in these procedures: (1) Affects either CDR or SE bus in such a way as to cause the bus voltage to drop below 26.5 volts; (2) Does not draw current of sufficient magnitude to actuate the associated ECA overcurrent relay (150 to 200 amps per ECA).

Table 5-8. EPS Procedure Entry Sheet

Symptom	Sym No.	Page No.
DC BUS warn lt (UNSTAGED)	1	5.2-36
VOLTS - low	1a	5.2-36
DC BUS warn lt (STAGED)	2	5.2-38
BATTERY caut lt (STAGED or UNSTAGED)	3	5.2-39
Deleted	4	5.2-39
Bat tb abnormal (STAGED or UNSTAGED)	5a	5.2-40
5 BAT tb abnormal (UNSTAGED)	5b	5.2-40
5 Bat tb abnormal (UNSTAGED)	5c	5.2-40
INVERTER caut lt	6	5.2-41
A-C voltage high	6a	5.2-41
Bus functions lost	SSR-1	5.2-42

# LMA790-3-LM APOLLO OPERATIONS HANDBOOK

LM2015

SYMPTOM	PROCEDURE	REMARKS
<p><b>1 UNSTAGED</b></p> <div style="border: 1px solid black; padding: 5px; margin-bottom: 10px;"> <p><b>DC BUS</b></p> <p>RED</p> </div> <div style="border: 1px solid black; padding: 5px; margin-bottom: 10px;"> <p><b>BATTERY</b></p> <p>YELLOW</p> <p>Light on if either or both buses &lt; 26.5 volts and Bat overtemperature ≥ 145°</p> <p>Bat reverse current &gt; 10 amp for 4 to 6 sec</p> <p>Bat overcurrent &gt; 150 to 200 amp</p> </div>	<p style="text-align: center;">①</p> <p style="text-align: center;">②</p> <p style="text-align: center;">③</p> <p style="text-align: center;">④</p> <p style="text-align: center;">⑤</p> <p style="text-align: center;">⑥</p> <p style="text-align: center;">⑦</p> <p style="text-align: center;">⑧</p> <p style="text-align: center;">⑨</p> <p style="text-align: center;">⑩</p> <p style="text-align: center;">⑪</p> <p style="text-align: center;">⑫</p> <p style="text-align: center;">⑬</p> <p style="text-align: center;">⑭</p> <p style="text-align: center;">⑮</p> <p style="text-align: center;">⑯</p> <p style="text-align: center;">⑰</p> <p style="text-align: center;">⑱</p> <p style="text-align: center;">⑲</p> <p style="text-align: center;">⑳</p> <p style="text-align: center;">㉑</p> <p style="text-align: center;">㉒</p> <p style="text-align: center;">㉓</p> <p style="text-align: center;">㉔</p> <p style="text-align: center;">㉕</p> <p style="text-align: center;">㉖</p> <p style="text-align: center;">㉗</p> <p style="text-align: center;">㉘</p> <p style="text-align: center;">㉙</p> <p style="text-align: center;">㉚</p> <p style="text-align: center;">㉛</p> <p style="text-align: center;">㉜</p> <p style="text-align: center;">㉝</p> <p style="text-align: center;">㉞</p> <p style="text-align: center;">㉟</p> <p style="text-align: center;">㊱</p> <p style="text-align: center;">㊲</p> <p style="text-align: center;">㊳</p> <p style="text-align: center;">㊴</p> <p style="text-align: center;">㊵</p> <p style="text-align: center;">㊶</p> <p style="text-align: center;">㊷</p> <p style="text-align: center;">㊸</p> <p style="text-align: center;">㊹</p> <p style="text-align: center;">㊺</p> <p style="text-align: center;">㊻</p> <p style="text-align: center;">㊼</p> <p style="text-align: center;">㊽</p> <p style="text-align: center;">㊾</p> <p style="text-align: center;">㊿</p>	<p>① Assumption: CROSS TIE is open. If CDR BUS voltage is lost for &gt;20 minutes sublimator freeze up occurs.</p> <p>② DC FEEDER FAULT It may or may not be on.</p> <p>③ Short is on battery whose talkback is not bp Good battery was disconnected by overcurrent.</p> <p>④ Allow 5 minutes before closing cb PGNS, IMU OPR (IMU gyro constraint)</p> <p>⑤ If failure occurs after PDI refer to emergency procedure for CDR (LMP) BUS failure</p> <p>⑥ COMM will be lost for time required to bring up secondary S-band or while troubleshooting Option of remaining on primary S-Band, without COMM, until LMP BUS status is ascertained may be exercised</p> <p>⑦ Remove 2.5 ampere-hours from each ascent battery before dead-facing</p> <p>⑧ BAT 2 can not be placed ON.</p> <p>⑨ BAT 5 power is available through normal feed when deadfaced.</p> <p>⑩ BAT 6 (if CDR FEEDER shorted) or BAT 5 (if LMP FEEDER shorted) power is available only through back-up feed and should be so used before abort stage to preclude placing BAT 6 (5) on shorted feeder.</p>
SYMPTOM	PROCEDURE	REMARKS

ELECTRICAL POWER SUBSYSTEM

Basic Date 26 September 1971

Change Date \_\_\_\_\_

Page 5.2-38

300LM10-9028-1

LMA790-3-LM  
 APOLLO OPERATIONS HANDBOOK

L.M2025

SYMPTOM	PROCEDURE	REMARKS
	<p style="text-align: center;">1 (See sheet 1)</p> <div style="display: flex; justify-content: space-between;"> <div style="width: 45%;"> <p><b>23</b> (5)</p> <ul style="list-style-type: none"> <li>● SUIT FAN - 2, INV - 2</li> <li>● Power down PGNS</li> <li>● CDR BAT 4, HI V &amp; 3 or LUNAR CDR BAT - OFF/RESET; tb - bp</li> <li>● cb (11) EPS: BAT FEED TIE (2) - open</li> </ul> <p>DC FEEDER FAULT II - on?</p> <p>YES → <b>24</b></p> <p>NO → <b>26</b></p> <p><b>26</b></p> <p>LUNAR BAT CDR FEED on prior to malfunction?</p> <p>YES → <b>27</b></p> <p>NO → <b>28</b></p> <p><b>27</b></p> <ul style="list-style-type: none"> <li>● CDR LUNAR BAT - ON</li> <li>tb - CDR?</li> </ul> <p>YES → <b>29</b></p> <p>NO → <b>20</b></p> <p><b>28</b></p> <ul style="list-style-type: none"> <li>● POWER/TEMP MON - BAT 3 (4)</li> </ul> <p>Voltage normal?</p> <p>YES → <b>29</b></p> <p>NO → <b>31</b></p> <p><b>29</b></p> <ul style="list-style-type: none"> <li>● POWER/TEMP MON - BAT 3 (4)</li> </ul> <p>YES → <b>32</b></p> <p>NO → <b>31</b></p> <p><b>31</b></p> <p>SHORT BETWEEN ECA &amp; BAT 3 (4) WITH LOW VOLTAGE</p> <p>→ <b>34</b></p> <p><b>32</b></p> <p>CDR BUS SHORT</p> <p>→ <b>35</b></p> <p><b>34</b> Reconfigure</p> <ul style="list-style-type: none"> <li>● cb (11) EPS: BAT FEED TIE (2) - close</li> <li>● BAT 4 HI V (3) - ON; tb - gray</li> <li>● SUIT FAN - 1</li> <li>● Power up PGNS</li> </ul> <p><b>35</b> Reconfigure (12)</p> <ul style="list-style-type: none"> <li>● PRI EVAP FLOW <math>\neq</math> 1 vlv - CLOSE</li> <li>● BAT 6 BACK UP LMP FEED - ON; tb - gray</li> <li>● cb (16) EPS: ASC ECA CONT - close</li> <li>● GLYCOL - INST (SEC)</li> <li>● WATER TANK SELECT vlv - SEC</li> <li>● cb ECS GLYCOL PUMP SEC - close</li> <li>● SEC EVAP FLOW vlv - OPEN</li> <li>a. Immediately                     <ul style="list-style-type: none"> <li>● cb ECS LCG PUMP - open</li> <li>● LTG OVERRIDE INTEGRAL - ON</li> <li>● cb/AC BUS A - TAPE RCDR - open</li> <li>● cb/AC BUS B - NUM LTG - open (except during ene burn or mdr &amp; dockine)</li> <li>● cb (11 &amp; 16) LTG: ANUN/DOCK/COMPNT - open</li> </ul> </li> <li>b. For subsequent master alarms:                     <ul style="list-style-type: none"> <li>● cb (16) LTG: ANUN/DOCK/COMPNT - close</li> </ul> </li> <li>c. Within 2 hours:                     <ul style="list-style-type: none"> <li>● cb/AC BUS A: GASTA - open</li> </ul> </li> </ul> <p>→ <b>36</b></p> <p><b>36</b></p> <p>DES STAGE FEEDER SHORT BETWEEN ECA &amp; DFR (BATS 3, 4 &amp; LUNAR BAT CDR FEED LOST)</p> <p>NO → <b>38</b></p> <p><b>38</b> Reconfigure (13)</p> <ul style="list-style-type: none"> <li>● LMP BAT 1 HI V &amp; 2, CDR BAT 3 &amp; 4 HI V - OFF/RESET; tb - bp</li> <li>● cb (11) EPS: BAT FEED TIE (2) - close</li> <li>● BAT 6 BACK UP LMP FEED - OFF/RESET; tb - bp</li> <li>● BAT 6 NORMAL CDR FEED - ON; tb - gray</li> <li>● cb (16) EPS: CROSS TIE BUS - open</li> </ul> <p>→ <b>33</b></p> <p><b>33</b></p> <p>ASC STAGE FEEDER SHORT BETWEEN DRF &amp; BUS</p> <p>→ <b>37</b></p> <p><b>37</b> Reconfigure</p> <ul style="list-style-type: none"> <li>● DES BAT - CONNECT; tb - gray</li> <li>● BAT 6 BACK UP LMP FEED - OFF/RESET; tb - bp</li> <li>● BAT 5 NORMAL CDR FEED - OFF/RESET; tb - bp</li> </ul> <p>→ <b>30</b></p> <p><b>30</b> Determine if short is on ASC or DES feeder (7)</p> <ul style="list-style-type: none"> <li>● cb (16) EPS: ASC ECA CONT - close</li> <li>● BAT 6 BACK UP LMP FEED - ON; tb - gray</li> <li>● BAT 5 NORMAL LMP FEED - ON; tb - gray</li> <li>● DES BAT - DEADFACE</li> <li>tb - by</li> </ul> <p>DC FEEDER FAULT II - on?</p> <p>NO → <b>36</b></p> <p>YES → <b>33</b></p> <p><b>24</b> CDR ASC OR DES FEEDER SHORT</p> <p>→ <b>25</b></p> <p><b>25</b> Restore bus (4)</p> <ul style="list-style-type: none"> <li>● cb (11) LTG: UTL - open</li> <li>● ANUN/DOCK/COMPNT - open</li> <li>● cb (11) ECS: GLYCOL PUMP 1 - open</li> <li>● GLYCOL PUMP 2 - open</li> <li>● cb (11) COMM: SEC S BD XMTR/RCVR - open</li> <li>● SEC S BD PWR AMPL - open</li> <li>● VHF B XMTR - open</li> <li>● cb (1) PGNS: LDG RDR - open</li> <li>● RNDZ RDR - open</li> <li>● LGC/DSKY - open</li> <li>● IMU OPR - open</li> <li>● cb (11) EPS: INV T - open</li> <li>● cb (16) EPS: CROSS TIE BUS - close</li> <li>● Power up PGNS</li> <li>● cb (11) - close above cb's as required</li> </ul> </div> <div style="width: 45%;"> <p><b>11</b> BAT 3 can not be placed ON.</p> <p><b>12</b> PRIMARY GLYCOL LOOP is lost.</p> <p><b>13</b> BAT 6 power is available through normal feed when deadfaced.</p> </div> </div> <p style="text-align: center;">EPS SSR-1 BUS FUNCTIONS LOST</p>	
SYMPTOM	PROCEDURE	REMARKS

A-300UM10-9028-2

ELECTRICAL POWER SUBSYSTEM

Basic Date 26 September 1971

Change Date \_\_\_\_\_

Page 5.2-36A

# LMA790-3-LM APOLLO OPERATIONS HANDBOOK

L.M2022A, L.M2025

SYMPTOM	PROCEDURE	REMARKS
<p><b>UNSTAGED</b></p> <div style="border: 1px solid black; padding: 5px; margin-bottom: 10px;"> <p><b>DC BUS</b></p> <p>RED Light on if either or both buses &lt; 26.5 volts (Battery light not on)</p> </div>	<p style="text-align: center;">①</p> <p>1 Ck bus voltage ●POWER/TEMP MON - CDR BUS, then LMP BUS Bus volts low?</p> <p style="text-align: center;">②</p> <p>2 CWEA FAILURE</p> <p style="text-align: center;">③</p> <p>3 CK BATS 3 &amp; 4 ●POWER/TEMP MON - BAT 3, then 4 Bat volts &lt; 20 vdc?</p> <p style="text-align: center;">④</p> <p>4 ECI OPEN</p> <p style="text-align: center;">⑤</p> <p>5 Verify configuration LUNAR BAT CDR FEED on prior to malfunction</p> <p style="text-align: center;">⑥</p> <p>6 CK BAT 3 &amp; 4 amps ●POWER/TEMP MON - BAT 3, then 4 Amps high?</p> <p style="text-align: center;">⑦</p> <p>7 Power down CDR BUS ●SUIT FAN - 2, INV - 2 ●Power down PGNS ●CDR BAT 4 HI V &amp; 3 or CDR LUNAR BAT - OFF/RE-SET; tb - bp ●cb (11) EPS: BAT FEED TIE (2) - open</p> <p style="text-align: center;">⑧</p> <p>8 CDR BUS SHORT</p> <p style="text-align: center;">⑨</p> <p>9 DC FEEDER FAULT It - on?</p> <p style="text-align: center;">⑩</p> <p>10 Restore bus ●cb (11) UTIL - open ANUN/DOCK/COMPNT - open ●cb (11) ECS: GLYCOL PUMP 1 - open GLYCOL PUMP 2 - open ●cb (11) COMM: SEC S BD XMTR/RCVR - open SEC S BD PWR AMPL - open VHF B XMTR - open ●cb (11) PGNS: LDG RDR - open RNDZ RDR - open LGC/DSKY - open IMU OPR - open ●cb (11) EPS: INV 1 - open ●cb (16) EPS: CROSS TIE BUS - close ●Power up PGNS ●cb (11) - close above cb's as required</p> <p style="text-align: center;">⑪</p> <p>11 Reconfigure ●PRI EVAP ±1 viv - CLOSE ●BAT 6 BACK UP LMP FEED - ON; tb - gray ●cb (16) EPS: ASC ECA CONT - close ●GLYCOL - INST (SEC) ●WATER TANK SELECT viv - SEC ●cb ECS: GLYCOL PUMP SEC - close ●SEC EVAP FLOW viv - OPEN a. Immediately: ●cb ECS: LCG PUMP - open ●LTG: OVERRIDE INTEGRAL - ON ●cb/AC BUS A - TAPE RCOR - open ●cb/AC BUS B: NUM LTG - open (except during eng burn or rndz &amp; docking) ●cb (11 &amp; 16) LTG: DOCK/COMPNT - open b. For subsequent master alarms: ●cb (16) LTG: ANUN/DOCK/COMPNT - close c. Within 2 hours: ●cb/AC BUS A: GASTA - open</p> <p style="text-align: center;">⑫</p> <p>12 DFR OPEN</p> <p style="text-align: center;">⑬</p> <p>13 CDR ASC OR DES FEEDER SHORT</p> <p style="text-align: center;">⑭</p> <p>14 Lunar bat volts normal?</p> <p style="text-align: center;">⑮</p> <p>15 CDR BUS VOLTS SIG COND R FAILED</p> <p style="text-align: center;">⑯</p> <p>16 DEADFACE RELAY FAILED OPEN</p> <p style="text-align: center;">⑰</p> <p>17 Reconfigure ●SUIT FAN - 2, INV - 2 ●Power down PGNS ●CDR LUNAR BAT - OFF/RESET; tb - bp ●CDR BAT 4 HI V - ON; tb - gray Bus volts normal?</p> <p style="text-align: center;">⑱</p> <p>18 Reconfigure ●BAT 6 NORMAL CDR FEED - ON; tb - gray ●Power up PGNS</p> <p style="text-align: center;">⑲</p> <p>19 Reconfigure ●BAT 6 NORMAL CDR FEED - ON; tb - gray ●Power up PGNS</p> <p style="text-align: center;">⑳</p> <p>20 CK LUNAR BAT voltage ●POWER/TEMP MON - LUNAR BAT Voltage normal?</p> <p style="text-align: center;">㉑</p> <p>21 LUNAR BAT LOST</p> <p style="text-align: center;">㉒</p> <p>22 LUNAR BAT CDR - on tb - CDR?</p> <p style="text-align: center;">㉓</p> <p>23 TRANSIENT SCA FAILURE</p> <p style="text-align: center;">㉔</p> <p>24 Determine if ASC or DES feeder short ●cb (16) EPS: ASC ECA CONT - close ●BAT 6 BACK UP LMP FEED - ON; tb - gray ●BAT 5 NORMAL LMP FEED - ON; tb - bp ●DES BATS - DEADFACE; tb - bp DC FEEDER FAULT It - on?</p> <p style="text-align: center;">㉕</p> <p>25 DES STAGE FEEDER SHORT BETWEEN ECA &amp; DFR (BATS 3, 4, &amp; LUNAR BAT CDR FEED LOST)</p> <p style="text-align: center;">㉖</p> <p>26 Reconfigure ●LMP BAT 1 HI V &amp; 2 CDR BAT 3 &amp; 4 HI V - OFF/RE-SET; tb - bp ●cb (11) EPS: BAT FEED TIE (2) - close ●BAT 6 NORMAL CDR FEED - ON; tb - gray ●BAT 6 BACK UP LMP FEED - OFF/RESET; tb - bp ●cb (16) EPS: CROSS TIE BUS - open</p> <p style="text-align: center;">㉗</p> <p>27 ASC STAGE FEEDER SHORT BETWEEN DFR &amp; BUS (BAT 3, 4, AND LUNAR BAT CDR FEED LOST)</p> <p style="text-align: center;">㉘</p> <p>28 Reconfigure ●CDR BAT 3 - ON; tb - gray ●Power up PGNS</p> <p style="text-align: center;">㉙</p> <p>29 Reconfigure ●DES BATS - CONNECT; tb - gray</p> <p style="text-align: center;">㉚</p> <p>30 Reconfigure ●DES BATS - CONNECT; tb - gray</p>	<p>① Assumption: Cross tie circuit is open prior to entering this procedure.</p> <p>② DC BUS It remains on and subsequent low bus voltage C/W monitoring is lost.</p> <p>③ If failure occurs after PDI refer to emergency procedure for CDR BUS failure.</p> <p>④ PRIMARY GLYCOL loop is lost.</p> <p>⑤ BUS will lose power when LUNAR BAT OFF</p> <p>⑥ DE FEEDER FAULT It may or may not be on</p> <p>⑦ CDR BUS OK BATS 3, 4, and LUNAR BAT CDR FEED lost; LUNAR BAT LMP FEED still available</p> <p>⑧ Allow 5 minutes from time of PGNS power down before closing cb PGNS: IMU OPR (IMU GYRO constraint).</p> <p>⑨ Remove 2.5 ampere-hours from each ascent battery before deadfacing.</p> <p>⑩ BAT 6 power is available through normal feed only after deadfacing.</p> <p>⑪ LUNAR BAT CDR FEED lost; LUNAR BAT LMP FEED still available</p> <p>⑫ BAT 6 power is available only through back-up feed and should be so used before abort stage to preclude automatically placing BAT on the shorted feeder.</p> <p>⑬ O. C. RELAY failure prevents BAT 3 from being placed on</p> <p>⑭ LUNAR BAT is lost.</p> <p>⑮ To power both buses with descent batteries only, remove nonessential equipment until total load 50 amps.</p>

A-300L10-9029-1

**LMA790-3-LM  
APOLLO OPERATIONS HANDBOOK**

LM2025

SYMPTOM	PROCEDURE	REMARKS
		<p>16 LUNAR BAT LMP FEED lost LUNAR BAT CDR FEED still available.</p> <p>17 O. C. RELAY failure prevents BAT 2 from being placed on.</p> <p>18 LMP BUS OK. BAT 1, 2, and LUNAR BAT LMP FEED lost. LUNAR BAT CDR FEED still available.</p> <p>19 COMM will be lost for time required to bring up SEC S-BD or while trouble shooting. Option of remaining on PRI S-BD without COMM until LMP BUS status is ascertained may be exercised.</p> <p>20 If failure occurs after PDI, refer to emergency procedure for LMP BUS failure.</p> <p>21 BAT 5 power is available through normal feed only when deadlaced.</p> <p>22 BAT 5 power is available only through back-up feed and should be so used before abort stage to preclude automatically placing BAT 5 on the shorted feeder.</p>
SYMPTOM	PROCEDURE	REMARKS

A-300-LM10-9029-2

ELECTRICAL POWER SUBSYSTEM

Issue Date 26 September 1971

Change Date \_\_\_\_\_

Page 5.2-37

# LMA790-3-LM APOLLO OPERATIONS HANDBOOK

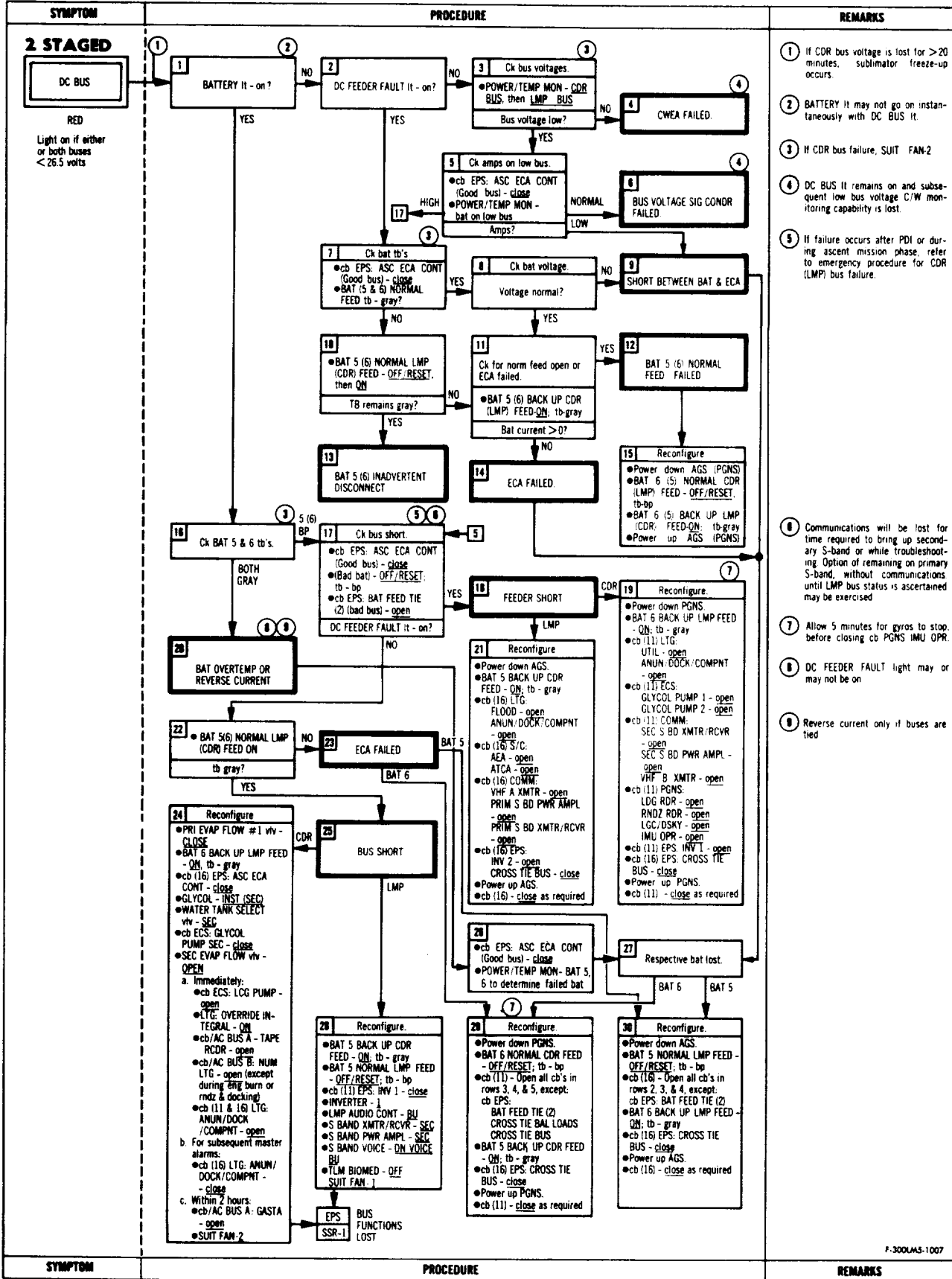

F-300LAS-1007



# LMA790-3-LM APOLLO OPERATIONS HANDBOOK

RC98, LM2021

SYMPTOM	PROCEDURE	REMARKS
<p><b>3 STAGED OR UNSTAGED</b></p> <p><b>BATTERY</b></p> <p>YELLOW</p> <p>Light on if: Bat overtemperature &gt; 145°</p> <p>Bat reverse current &gt; 10 amp for 4 to 6 sec</p> <p>Bat overcurrent &gt; 150 to 200 amp</p>	<pre> graph TD     1["1 Ck Bat FAULT ●PWR/TEMP MON - ALL BAT POSITIONS BAT FAULT It - on?"] -- NO --&gt; 2["2 CWEA FAILED"]     1 -- YES --&gt; 3["3 Is vehicle staged?"]     3 -- YES --&gt; 4["4 Bat amps &amp; volts norm?"]     3 -- NO --&gt; 5["5 Faulty bat - OFF/RESET: tb - bp Volts norm?"]     4 -- YES --&gt; 7["7 If Failed Bat is an ASC BAT If staging required: ● CB (11 &amp; 16) EPS: DES ECA - Open ● CB (16) EPS: CROSS TIE BUS - Close ● If time permits DES BAT OFF at 5 sec intervals ● Good ASC BAT backup FEED on"]     4 -- NO --&gt; 6["6 OVER TEMPERATURE OR REVERSED CURRENT. BAT LOST"]     5 -- YES --&gt; 8["8 Attempt reset ●Faulty bat - ON Bat stays on line?"]     5 -- NO --&gt; 6     8 -- YES --&gt; 8     8 -- NO --&gt; 11["11 ECA FAILED"]     6 --&gt; 7     7 --&gt; 10["10 INSTRUMENTATION PROBLEM"]     8 --&gt; 10     10 --&gt; 12["12 TRANSIENT ECA PROBLEM"]     </pre>	<p>1 Bat C/W monitoring capability is lost.</p> <p>2 Subsequent battery malfunction monitoring capability is lost. However, BAT FAULT It operates normally.</p> <p>3 Faulty bat may have tripped OFF - LINE.</p> <p>4 Hold battery switch to OFF/RESET for at least 4 seconds to ensure resetting of BATTERY caution light.</p> <p>5 Functions lost: 1. If failure associated with BAT 1, 2, 3 or 4 - BAT 1, 2, 3 or 4 is lost. 2. If failure associated with lunar bat - lunar bat is available on opposite feed path. Batt warning light may remain ON and other battery malfunctions will be inhibited.</p>
<p><b>4 STAGED</b></p>	<p>Deleted.</p>	<p>1 Deleted.</p>

F-300LM4-1009

# LMA790-3-LM APOLLO OPERATIONS HANDBOOK

SYMPTOM	PROCEDURE	REMARKS
<p><b>3a. STAGED OR UNSTAGED</b></p> <p>One bat tb abnormal (tp)</p>	<p>1. <b>CK amps</b> ●POWER/TEMP MON-affected bat Amps zero?</p> <p>2. <b>Attempt reset</b> ●Faulty bat - OFF/RESET, then ON Amps zero?</p> <p>3. <b>INADVERTENT BAT TRIP OR TRANSIENT ECA FAILURE</b></p> <p>4. <b>ECA RELAY CONTACT OR TB FAILURE</b></p> <p>5. <b>ECA FAILED</b></p>	
<p><b>5b. UNSTAGED</b></p> <p>① 5 DES BAT - tb - bp DES BATS - tb - bp and ASC BAT - tb (5) - gray</p> <p>Failure occurred when ascent battery was turned on.</p>	<p>6. <b>DID FAILURE OCCUR WHEN BAT 5 or 6 TURNED ON?</b></p> <p>7. <b>RELAY K1 CONTACT FAILED CLOSED</b></p> <p>8. <b>To put DES bats on line</b> ●BAT 6 NORMAL CDR FEED-ON tb-gray ●cb (16) EPS: DES ECA CONT - open ●cb (16) EPS: ASC ECA cont - close ●DES BATS - CONNECT ●LMP BAT 1 HI V &amp; LMP BAT 2 - ON ●CDR BAT 3 &amp; CDR BAT 4 HI V - ON ●cb (16) EPS: ASC ECA CONT - open</p> <p>9. <b>RELAY K2 CONTACT FAILED CLOSED</b></p> <p>10. <b>To put DES bats on line</b> ●BAT 5 NORMAL LMP FEED-ON tb-gray ●cb (11) EPS: DES ECA CONT - open ●cb (11) EPS: ASC ECA CONT - close ●DES BATS - CONNECT ●LMP BAT 1 HI V &amp; LMP BAT 2 - ON ●CDR BAT 3 &amp; CDR BAT 4 HI V - ON ●cb (11) EPS: ASC ECA CONT - open</p>	<p>① One bus will be lost if failure occurs when first ascent battery is turned on. Possible DC bus warning light.</p>
<p><b>5c. UNSTAGED</b></p> <p>5 DES BAT - tb - bp DES BATS - tb - bp and 2 ASC BAT - tb - gray</p>	<p>11. <b>LGC AND ACA ABORT STAGE DISCRETE PRESENT?</b></p> <p>12. <b>ABORT STAGE SWITCH CONTACT CONTAMINATED</b></p> <p>13. <b>cb (16) STAB/CONT: ABORT STAGE - open</b> ●LMP BAT 1 HI V - ON: tb - gray?</p> <p>14. <b>To restore DES bats</b> ●cb (11) EPS: DES ECA - open ●LMP BAT 1 HI V - ON LMP BAT tb - gray?</p> <p>15. <b>PCM ABORT STAGE DISCRETE ON?</b></p> <p>16. <b>cb (16) STAB/CONT: ABORT STAGE - open</b></p> <p>17. <b>cb (16) STAB/CONT: ABORT STAGE - close</b> ●cb (11) STAB/CONT: ABORT STAGE - open</p> <p>18. <b>RELAY K20 CONTACT FAILED CLOSED</b></p> <p>19. <b>cb (11) STAB/CONT: ABORT STAGE - open</b></p> <p>20. <b>RELAY K10 CONTACT FAILED OPEN</b></p> <p>21. <b>cb (11) EPS: DES ECA - close</b> ●cb (16) EPS: DES ECA - open ●LMP BAT 1 HI V - ON ●LMP BAT 2 - ON or LUNAR BAT LMP BUS - ON ●CDR BAT 3 - ON or LUNAR BAT CDR BUS - ON ●CDR BAT 4 HI V - ON ●cb (16) EPS: ASC ECA cont - close ●DES BATS - CONNECT ●cb (16) EPS: ASC ECA CONT - open</p> <p>22. <b>To restore DES BATS</b> ●LMP BAT 1 HI V - ON ●LMP BAT 2 - ON or LUNAR BAT LMP BUS - ON ●CDR BAT 3 - ON or LUNAR BAT CDR BUS - ON ●CDR BAT 4 HI V - ON ●cb (16) EPS: ASC ECA CONT - close ●DES BATS - CONNECT ●cb (16) EPS: ASC ECA CONT - open</p>	<p>② On the Lunar Surface when the ABORT CB's are open and computers are off, the failure could only be K10 or K20 relay contacts.</p>

C-300LM4-1010

LMA790-3-LM  
**APOLLO OPERATIONS HANDBOOK**

LM986A

SYMPTOM	PROCEDURE	REMARKS
<p><b>6</b></p> <div style="border: 1px solid black; padding: 5px; width: fit-content;"> <b>INVERTER</b>                      YELLOW                      Light on if:                      Bus A a-c voltage &lt; 112 volts                      Frequency &lt; 398 cps or &gt; 402 cps                 </div>  <p><b>6a</b></p> <div style="border: 1px solid black; padding: 5px; width: fit-content;">                     A-C voltage high,                      (out of green band)                 </div>		<p>① Assumption: Inverter No. 2 is on. If inverter No. 1 is operating, replace all references to inverter No. 2 with inverter No. 1.</p> <p>② INVERTER It remains on.</p> <p>③ Monitor a-c voltage on VOLTS ind.</p>
SYMPTOM	PROCEDURE	REMARKS

A-300LM10-9025

ELECTRICAL POWER SUBSYSTEM

# LMA790-3-LM APOLLO OPERATIONS HANDBOOK

LM 998A

## SPECIAL SUBROUTINE SSR-1

### Des functions lost

#### AC BUS B

AC BUS B: SE WIND HTR  
He/PGS PROPUL DISP  
He MON  
DES QTY  
S BD ANT  
Auto/man ant slew  
ORDEAL  
AGS  
AGS att mon & AGS ORB RATE  
ACT LAMP (R)  
SE FDAI  
NUM LGT  
BUS TIE INV 2  
BUS TIE INV 1

#### AC BUS A

AC BUS A: BUS TIE INV 2  
BUS TIE INV 1  
AC BUS VOLT  
AC bus monitor  
CDR WIND HTR  
TAPE RCDR  
AOT LAMP (R)  
RNDZ RDR  
Auto/man ant slew  
DECA GMBL  
GDA lock-up  
Limited manual throttle capability  
INTGL LTG  
CDR FDAI  
GASTA  
PGNS att & PGNS ORB RATE  
RNG/RNG RT ALT/ALT RT ind

#### CDR BUS

FLT DISP: ORDEAL  
COAS  
CDR FDAI & att needles  
GASTA  
PGNS att & rate needles  
RNG/RNG RT ALT/ALT RT meter  
CDR X - PWTR  
MISSION TIMER  
THRUST meter

#### RCS SYS A:

ASC FEED 1  
Last position  
ASC FEED 2  
Last position  
QUAD 1 TCA  
QUAD 2 TCA  
QUAD 3 TCA  
QUAD 4 TCA  
MAIN SOV  
Last position  
} Thrusters lost

#### CDR BUS (cont)

HTR: URINE LINE heaters  
RNDZ RDR STBY heaters  
RNDZ RDR OPR heaters  
LDG RDR heater  
DOCK window heater  
AOT heater

#### INST: SIG COND 1

Propellant tb's  
Some ind  
Some CWEA Its come on

#### STAB/CONT: ABORT STAGE (R, except no auto eng arm)

ATCA PGNS  
LGC control of RCS  
ability to switch from AGS to PGNS  
AELD (R)  
ENG CONT  
DPS on capability except override ENG  
STOP for DPS & APS AGS GMBL Trim  
ATT DIR CONT  
Secondary Coils AGS Pulse mode  
ENG START OVRD  
Manual start (DPS & APS)  
DECA PWR  
Auto & Manual DPS "on" & "off"  
(Override only available) DPS  
throttle (100%)

#### ED: LDG GEAR FLAG

LOGIC PWR A

UTL

#### LTG: ANUN/DOCK/COMPNT

Lighting (R)

#### PGNS: IMU OPR

IMU STBY  
LSC/DSRY  
RNDZ RDR  
LDG RDR  
SIG STR DISP

#### COMM: CDR AUDIO center

VHF A RCVR  
VHF B XMTR  
SEC S BD PWR AMPL  
SEC S BD XMTR/RCVR  
UP DATA LINK

#### ECS: GLYCOL PUMP AUTO TRNFR

GLYCOL PUMP 1  
GLYCOL PUMP 2  
CABIN FAN  
SUIT FAN 1

#### HTR RCS SYS A/B 1: QUAD 1 heater

QUAD 2 heater  
QUAD 3 heater  
QUAD 4 heater

#### EPS: DES ECA CONT (R)

DES ECA (R)  
ASC ECA CONT (R)  
ASC ECA (R)  
INV 1  
DC BUS VOLT

#### PROPUL: DES He REG/YENT

VENT - last position

#### LMP BUS

FLT DISP: EVENT TIMER/SE FDAI &  
rate needles  
SE X - PWTR

#### RCS SYS B: ASC FEED 1

Last position  
ASC FEED 2  
Last position

QUAD 1 TCA  
QUAD 2 TCA  
QUAD 3 TCA  
QUAD 4 TCA  
} Thrusters lost

CRSFD

Last position

TEMP/PRESS DISP FLAG

PGS DISP

RCS qty

MAIN SOV

Last position

#### PROPUL: DISP/ENG OVRD LOGIC

MPS ind inoperative  
PGNS  
FUEL  
FUEL/OXID qty  
ASC He REG  
Last position

#### INST: SIG COND 2

EPS tb's  
Some ind  
Some CWEA Its come on

#### PCM/TE

TM XMT

Timing signals

SIG SENSOR

CWEA

#### STAB/CONT: DES ENG OVRD

Override function  
ATCA (AGS)  
AGS stab cont ability to switch from  
PGNS to AGS  
ABORT STAGE  
ASC ENG "ON" & arming  
ATCA  
RR SLEW & AUTO TRACK Modes  
AGS stab Cont  
FDAI Rate needles  
Auto ASC ENG "on"  
DPS GmbL locked  
Throttle goes to 100%

AELD (R)

Auto APS commands

ASA

AGS

ENG ARM

Auto engine on/off  
(DPS & APS)

AEA

AGS

#### ED: LOGIC PWR B

Descent Engine override function

#### LTG: MASTER ALARM

ANUN/DOCK/COMPNT (R)

TRACK light

FLOOD lighting

#### COMM: DISP

S-bd ant  
SE AUDIO  
VHF A XMTR  
VHF B RCVR  
PRIM S BD PWR AMPL  
PRIM S BD XMTR/RCVR  
S BD ANT  
Auto/man ant slew  
PMP  
VHF rcv  
S-bd xmtr/rcv

TV

#### ECS: SUIT FLOW CONT

Torn-suit protection

DISP

GLYCOL PUMP SEC

CABIN FAN CONT

CABIN REPRESS

Auto repress

SUIT FAN 2

SUIT FAN ΔP

DIVERT VLV

Auto close

CO<sub>2</sub> SENSOR

#### EPS: DES ECA CONT (R)

DES ECA (R)

ASC ECA CONT (R)

ASC ECA (R)

INV 2

DC BUS VOLT

DISP

Volts/amps

Th's

#### CAMR: SEQ

HTR RCS SYS A/B 2: S-BD ANT heater

DISP

QUAD 4 heater

QUAD 3 heater

QUAD 2 heater

QUAD 1 heater

MESA heaters

8-300LMA-1039

**LMA790-3-LM  
APOLLO OPERATIONS HANDBOOK**

5.2.9 COMMUNICATIONS SUBSYSTEM

5.2.9.1 Assumptions

- Troubleshooting procedures such as checking sw's, cb's, redundant PTT pb's, redundant mode (VOX, PTT) alternative antennas, etc. are performed before entering malfunction procedures.
- These malfunction procedures do not assume a particular Communications Subsystem sw configuration other than that required to operate the equipment before entry into the procedures.
- Malfunction procedures are entered from normal operational modes. (Procedures are not included for checkout modes.)

Table 5-9. CS Procedure Entry Sheet

Symptom	Sym No.	Page No.
Loss of ICS	1	5.2-44
One crewman has abnormal (unselected) hot mike	2	5.2-44
Loss of VHF voice comm with CSM	3	5.2-44
Loss of S-band voice comm	4	5.2-45
S BD RCVR caut lt	5	5.2-46
Cannot acquire phaselock	5a	5.2-46
MSFN reports loss of PCM. S-band voice OK	6	5.2-46
Loss of voice comm with EVA (one man EVA)	7	5.2-47
CSM informs LM of VHF ranging loss	8	5.2-48

**LMA790-3-LM**  
**APOLLO OPERATIONS HANDBOOK**

SYMPTOM	PROCEDURE	REMARKS
<p><b>1</b></p> <p>Loss of ICS</p>		<p>① VOX mode may be available.</p>
<p><b>2</b></p> <p>One crewman has abnormal (unselected) hot mike.</p>		<p>① Hot mike in all modes. Continuous keying of S-band and simplex VHF when selected to T/R. Duplex VHF is available at expense of increased power. DSEA should be turned off when not recording.</p>
<p><b>3</b></p> <p>Loss of VHF voice comm with CSM</p>		<p>① Affects particular T/R function only.</p> <p>② All received VHF and S-band voice lost.</p> <p>③ Loss of VHF transmission from LM may be due to corona in the VHF transmitter. VHF A (B) XMTR - OFF for a period of 20 seconds and then ON may extinguish corona and restore use.</p> <p>④ Capability of simultaneously receiving up data and up voice lost.</p>

A-300LM4-1000

# LMA790-3-LM APOLLO OPERATIONS HANDBOOK

LM 3230

SYMPTOM	PROCEDURE	REMARKS
<p><b>4</b></p> <p>Loss of S-band voice comm</p> <p>MSFN not within VHF range</p>		<p><b>1</b> Loss or near loss of up voice is indicated by COMM ANT. SIGNAL STRENGTH &lt; 3.7 (steerable) or &lt; 2.5 (omni) and noise in headset if S-band squelch is off.</p> <p><b>2</b> Affects particular T/R function only</p> <p><b>3</b> Allow 30 seconds to reacquire phaselock.</p> <p><b>4</b> All S-band up voice is lost. Voice contact with MSFN is available through CSM relay mode.</p> <p><b>5</b> Requires ~3 minutes</p> <p><b>6</b> Up voice is available through up data link only. Simultaneous up voice and up data capability lost.</p> <p><b>7</b> Ranging lost while in FM.</p> <p><b>8</b> Down voice subcarrier operational instrumentation, PCM data, PM control, and FM control lost.</p> <p><b>9</b> Biomed data lost</p> <p><b>10</b> Emergency keying is still available (cb (16) COMM: PMP must be open).</p>
SYMPTOM	PROCEDURE	REMARKS

8-300LMS-1001

COMMUNICATIONS SUBSYSTEM

# LMA790-3-LM APOLLO OPERATIONS HANDBOOK

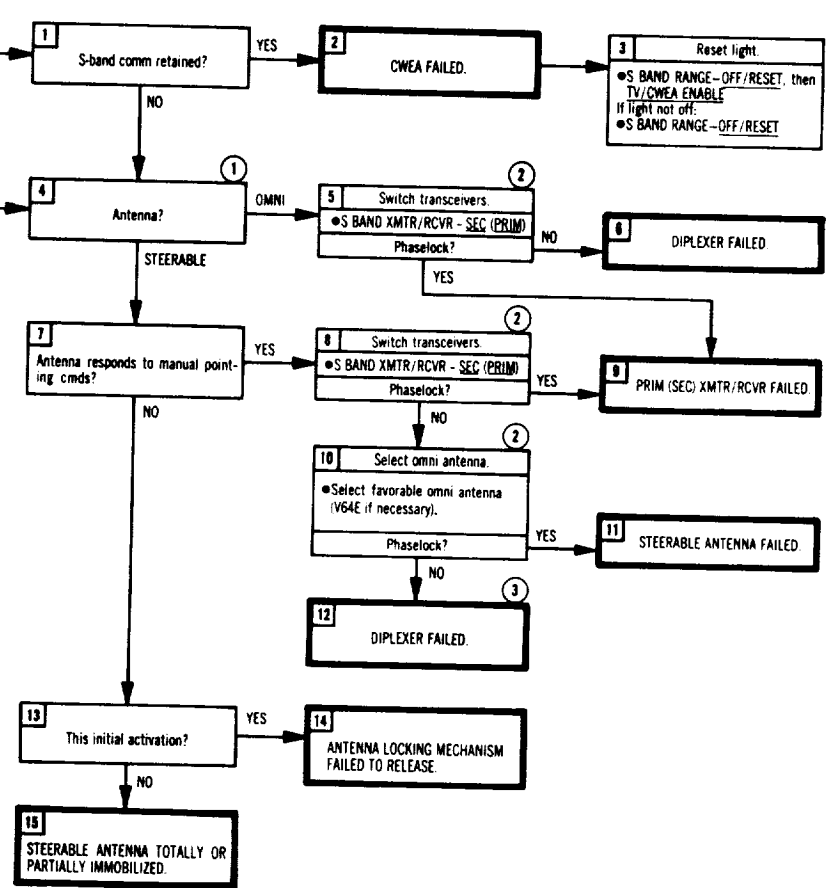
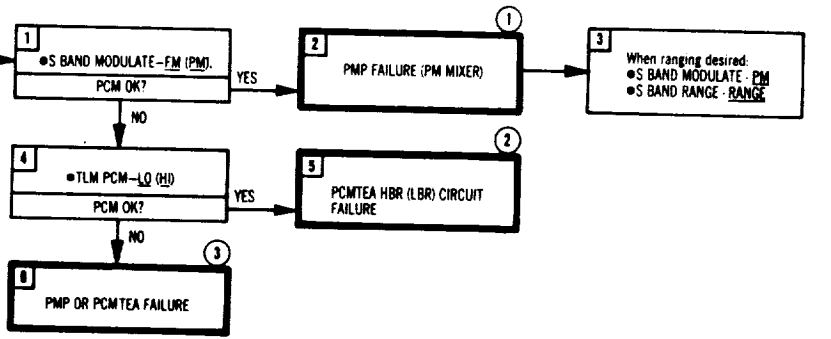
SYMPTOM	PROCEDURE	REMARKS
<p><b>5</b></p> <div style="border: 1px solid black; padding: 5px; margin-bottom: 10px;"> <p>S BD RCVR</p> <p>YELLOW</p> <p>Light on if AGC &lt; 1.0</p> </div> <p><b>5a</b></p> <div style="border: 1px solid black; padding: 5px;"> <p>Cannot acquire phase lock</p> <p>Signal strength &lt; 1.3</p> </div>		<p>① Assumption: VHF voice contacts with CSM were attempted.</p> <p>② Allow 30 seconds for phaselock acquisition.</p> <p>③ All S-band functions lost.</p>
<p><b>6</b></p> <div style="border: 1px solid black; padding: 5px;"> <p>MSFN reports loss of PCM. S-band voice OK</p> </div>		<p>① Simultaneous ranging and PCM capability lost.</p> <p>② HBR (LBR) PCM lost.</p> <p>③ S-band telemetry lost.</p>
SYMPTOM	PROCEDURE	REMARKS

300LMS-10X

COMMUNICATIONS SUBSYSTEM



LMA790-3-LM  
**APOLLO OPERATIONS HANDBOOK**

SYMPTOM	PROCEDURE	REMARKS
<p><b>7</b></p> <p>①            Loss of voice comm with EVA (one-man EVA)</p>	<p>① MSFN/LM comm OK?</p> <p>NO → ②</p> <p>YES → ⑤</p> <p>②</p> <ul style="list-style-type: none"> <li>• AUDIO CONT - BU</li> <li>• BU audio center:</li> <li>• RELAY ON (8 or 12) - RELAY OFF</li> </ul> <p>Comm OK?</p> <p>NO → ③</p> <p>YES → ⑥</p> <p>③</p> <ul style="list-style-type: none"> <li>• cb COMM: AUDIO (2) - open</li> <li>• Connect to alternate crewman's umbilical</li> <li>• cb COMM: AUDIO (2) - close</li> </ul> <p>Comm OK?</p> <p>YES → ④</p> <p>NO → ⑦</p> <p>④ UMBILICAL FAILURE</p> <p>⑥ AUDIO CENTER FAILURE</p> <p>⑦ COMM CARRIER OR SUIT HARNESS FAILURE</p> <p>⑤</p> <ul style="list-style-type: none"> <li>• Notify MSFN of problem BU audio center:</li> <li>• RELAY ON (12 or 8) - RELAY OFF</li> </ul> <p>Audio center:</p> <ul style="list-style-type: none"> <li>• AUDIO VHF B - T/R</li> <li>• COMM VHF B XMTR - VOICE</li> </ul> <p>Comm OK?</p> <p>YES → ⑧</p> <p>NO → ⑩</p> <p>⑧</p> <ul style="list-style-type: none"> <li>• LM XMTR A OR LM RCVR B OR EVA XMTR B OR EVA RCVR A FAILURE</li> </ul> <p>③</p> <ul style="list-style-type: none"> <li>• LM may be reconfigured to backup-relay mode if desired.</li> </ul> <p>⑩</p> <p>TOTAL VHF VOICE COMM FAILURE OF EVA OR LM (COMM CARRIER, EVA PWR SUPPLY, DIPLEXER, ETC)</p> <p>⑪</p> <ul style="list-style-type: none"> <li>• If MSFN originally reported no loss of EMU data, return to normal relay configuration.</li> </ul>	<p>① EVA will wait at least 3 minutes following communications loss before changing modes.</p> <p>② Configures LM for transmission and reception on both VHF frequencies.</p> <p>③ Loss of EMU data relay capability.</p>
SYMPTOM	PROCEDURE	REMARKS

A-300LMS-1051

COMMUNICATIONS SUBSYSTEM

**LMA790-3-LM  
APOLLO OPERATIONS HANDBOOK**

SYMPTOM	PROCEDURE	REMARKS
<p><b>8</b></p> <p>CSM informs LM of VHF ranging loss</p>	<pre> graph TD     Start[1] --&gt; Q1{Voice ok?}     Q1 -- NO --&gt; CS[CS 3 4]     Q1 -- YES --&gt; Q2{2 Is LM/CSM closing/opening rate &gt;1800 fps?}     Q2 -- YES --&gt; B3[3 MAXIMUM CAPABILITY OF EQUIPMENT HAS BEEN EX- CEEDED]     B3 --&gt; B4[4 Reattempt acquisition when rate is reduced.]     Q2 -- NO --&gt; Q3{5 Request CSM initiate VHF ranging reset Tones?}     Q3 -- NO --&gt; B6[6 CSM PROBLEM. RANGING TONES NOT TRANSMITTED TO LM]     Q3 -- YES --&gt; Q4{7 Request CSM verify ranging status Ranging OK?}     Q4 -- YES --&gt; B8[8 MOMENTARY LOSS OF TRACK]     Q4 -- NO --&gt; Q5{9 Recycle VHF A XMTR - OFF. then VOICE/RNG Request CSM initiate ranging reset. Ranging OK?}     Q5 -- YES --&gt; B10[10 RTTA PWR SUPPLY PROTECTIVE SHUTDOWN]     Q5 -- NO --&gt; Q6{11 Request CSM verify tone reception Tones?}     Q6 -- NO --&gt; B12[12 PROBABLE RTTA FAILURE]     Q6 -- YES --&gt; B13[13 FINE TONE PROBLEM IN RTTA OR CSM PROBLEM]     B12 --&gt; B14[14 VHF A XMTR - VOICE]     B13 --&gt; B14                     </pre>	<p>① If RTTA failure has resulted in 100% duty cycle on xmtr A, ranging operation, in excess of 2 min at temperatures &gt;67°F indicated on ECS; GLYCOL temp ind, may result in xmtr damage. 67°F on ECS; GLYCOL temp ind equals 100°F at ERA flange.</p> <p>② Switching out range capability will enhance voice capability.</p>
SYMPTOM	PROCEDURE	REMARKS

COMMUNICATIONS SUBSYSTEM

**LMA790-3-LM  
APOLLO OPERATIONS HANDBOOK**

5.2.10 ENVIRONMENTAL CONTROL SUBSYSTEM

Table 5-10. ECS Procedure Entry Sheet

Symptom	Sym No.	Page No.
H2O QUANTITY low or decr abnormally	1	5.2-50
CABIN warn lt	2	5.2-50A
CABIN PRESS - low or decr	2a	5.2-50A
CABIN PRESS - high	3	5.2-51
SUIT/FAN warn lt	4	5.2-52
SUIT PRESS - low	4a	5.2-52
SUIT PRESS - high (egress mode)	5	5.2-52
O2 QTY caut lt	6	5.2-53
O2 QUANTITY - low or decr	6a	5.2-53
ECS caut lt	7	5.2-54
SUIT FAN lt	7a	5.2-54
H2O SEP lt	7b	5.2-54
CO2 lt	7c	5.2-54A
PART PRESS CO2 - high	7d	5.2-54A
GLYCOL comp lt	7e	5.2-54A
GLYCOL caut lt	8	5.2-55
GLYCOL temp - high or incr	8a	5.2-55
GLYCOL comp lt	9	5.2-56
GLYCOL press - low or decr	10	5.2-56

**LMA790-3-LM  
APOLLO OPERATIONS HANDBOOK**

LM 2008A

SYMPTOM	PROCEDURE	REMARKS
<p><b>1</b> <b>H<sub>2</sub>O QUANTITY low or decr abnormally</b></p>	<p><b>1</b> Using ASC or DES H<sub>2</sub>O?</p> <p>ASC</p> <p><b>5</b> Ck H<sub>2</sub>O gun &amp; line Visible leak?</p> <p>NO</p> <p><b>8</b> Ck ASC #1 &amp; #2 H<sub>2</sub>O tanks O<sub>2</sub> / H<sub>2</sub>O QTY MON - ASC 1 then ASC 2</p> <p>NO</p> <p><b>10</b> One tank steady &amp; other tank decreasing?</p> <p>NO</p> <p><b>13</b> N<sub>2</sub> OR H<sub>2</sub>O LEAK OR SENSOR FAILURE IN LOW TANK</p> <p>NO</p> <p><b>16</b> LEAK IN H<sub>2</sub>O GUN OR LINE</p> <p>NO</p> <p><b>21</b> Ck H<sub>2</sub>O gun &amp; line Visible leak?</p> <p>NO</p> <p><b>25</b> LEAK IN H<sub>2</sub>O GUN OR LINE</p> <p>NO</p> <p><b>29</b> Ck H<sub>2</sub>O gun DES H<sub>2</sub>O vlv - CLOSE Disconnect &amp; reconnect gun check nozzle DES H<sub>2</sub>O vlv - OPEN If leak still present - CLOSE DES H<sub>2</sub>O vlv - CLOSE</p> <p>ASC</p> <p><b>2</b> Ck ASC #1 &amp; #2 H<sub>2</sub>O tanks O<sub>2</sub> / H<sub>2</sub>O QTY MON - ASC 1 then ASC 2 Both tanks &lt; full decal?</p> <p>NO</p> <p><b>6</b> One ASC tank &lt; full decal?</p> <p>NO</p> <p><b>9</b> Ck DES #1 &amp; #2 H<sub>2</sub>O tanks O<sub>2</sub> / H<sub>2</sub>O QTY MON - DES 1 then DES 2 Both tanks low?</p> <p>NO</p> <p><b>11</b> CLOGGED FEED LINE FROM STEADY TANK OR SENSOR FAILURE</p> <p>NO</p> <p><b>17</b> Ck H<sub>2</sub>O gun ASC H<sub>2</sub>O vlv - CLOSE Disconnect &amp; reconnect gun; check nozzle ASC H<sub>2</sub>O vlv - OPEN If leak still present - CLOSE ASC H<sub>2</sub>O vlv - CLOSE</p> <p>NO</p> <p><b>22</b> Ck for leak in feed line WATER TANK SELECT vlv - ASC DES H<sub>2</sub>O qty decreasing?</p> <p>NO</p> <p><b>26</b> H<sub>2</sub>O LEAK IN LINE UPSTREAM OF WATER TANK SELECT VLV</p> <p>NO</p> <p><b>30</b> Reselect DES H<sub>2</sub>O WATER TANK SELECT vlv - DES When glycol temp increases WATER TANK SELECT vlv - ASC DES H<sub>2</sub>O vlv - CLOSE ASC H<sub>2</sub>O vlv - OPEN</p> <p>DES</p> <p><b>3</b> PRI EVAP FLOW <math>\neq</math> 2 OR SEC EVAP FLOW vlv LEAKS IN CLOSED POSITION</p> <p>NO</p> <p><b>7</b> N<sub>2</sub> OR H<sub>2</sub>O LEAK OR SENSOR FAILURE IN LOW TANK</p> <p>NO</p> <p><b>12</b> H<sub>2</sub>O in cabin?</p> <p>NO</p> <p><b>14</b> Ck for leak in H<sub>2</sub>O tk WATER TANK SELECT vlv - ASC DES H<sub>2</sub>O qty decreasing?</p> <p>NO</p> <p><b>15</b> LEAK IN LINE TO SUBLIMATOR OR SUBLIMATOR BREAKTHROUGH</p> <p>NO</p> <p><b>18</b> LEAK UPSTREAM TANK SEL VLV</p> <p>NO</p> <p><b>20</b> Reconfigure WATER TANK SELECT vlv - DES When glycol temp increases WATER TANK SEL vlv - ASC DES H<sub>2</sub>O - CLOSE ASC H<sub>2</sub>O - OPEN</p> <p>NO</p> <p><b>23</b> Ck for leak in manifold WATER TANK SELECT vlv - DES PRI EVAP FLOW <math>\neq</math> 1 vlv - CLOSE DES H<sub>2</sub>O qty decreasing?</p> <p>NO</p> <p><b>24</b> H<sub>2</sub>O LEAK IN LINE DOWNSTREAM OF PRI EVAP FLOW VLV</p> <p>NO</p> <p><b>27</b> MANF LEAK BETWEEN WATER TANK SELECT VLV &amp; PRI EVAP FLOW <math>\neq</math> 1 VLV</p> <p>NO</p> <p><b>31</b> Select alt feedpath PRI EVAP FLOW <math>\neq</math> 2 vlv - OPEN WATER TANK SELECT vlv - SEC ASC H<sub>2</sub>O vlv - OPEN</p> <p>YES</p> <p><b>4</b> Cycle vlv PRI EVAP FLOW <math>\neq</math> 2 vlv - OPEN then CLOSE SEC EVAP FLOW vlv - OPEN then CLOSE O<sub>2</sub> / H<sub>2</sub>O QTY MON - ASC 1 &amp; 2 Monitor for decay</p>	<p><b>1</b> Assumption: No indicator failure. MSFN can verify indicator failure by reading pressure sensors via telemetry.</p> <p><b>2</b> MSFN can determine sensor failure when WATER TANK SELECT vlv - ASC for <math>\approx</math> 1 hour.</p> <p><b>3</b> Activate secondary glycol loop: PRI EVAP FLOW <math>\neq</math> 1 vlv - CLOSE WATER TANK SELECT vlv - SEC ASC H<sub>2</sub>O vlv - OPEN GLYCOL - INST (SEC) cb (16) ECS GLYCOL PUMP SEC - close SEC EVAP FLOW vlv - OPEN Immediately after activating secondary glycol loop: cb ECS LCG PUMP - open cb / AC BUS A: TAPE RCDR - open LTG: OVERRIDE INTEGRAL - ON cb / AC BUS B: NUM LTG - open, except during eng burn or rendezvous or docking maneuvers cb (11 &amp; 16) LTG: AMUN / DOCK / COMPNT - open For subsequent master alarms, one AMUN / DOCK / COMPNT cb must be closed momentarily to enable C/W lights b. At MSFN request: cb PGNS: IMU OPR - open LGC / DSKY - open c. Within 2 hours: cb / AC BUS A: GASTA - open cb FLT DISP: GASTA - open cb COMM: UP DATA LINK - open</p> <p><b>4</b> Close DES H<sub>2</sub>O valve prior to staging</p>

300LM10-9027

ENVIRONMENTAL CONTROL SUBSYSTEM

# LMA790-3-LM APOLLO OPERATIONS HANDBOOK

LM 2001, LM 2008A

SYMPTOM	PROCEDURE	REMARKS
<p><b>2</b></p> <div style="border: 1px solid black; padding: 5px; margin-bottom: 10px;"> <b>CABIN</b>                      RED                      Light on if cabin press &lt; 4.45 to 3.70 psia                 </div> <p><b>2a</b></p> <div style="border: 1px solid black; padding: 5px;">                     CABIN PRESS low or decr                      &lt; 4.6 psia                 </div>		<p>① C/W monitoring of cabin pressure is lost. Monitor CABIN PRESS.</p> <p>② Automatic cabin-repressurization capability lost. Automatic closing of SUIT GAS DIVERTER vlv lost. CABIN is inoperative.</p> <p>③ If unstaged, or if staged and ascent O<sub>2</sub> quantity is sufficient to make up cabin pressure:                      ● CABIN REPRESS vlv - <u>MANUAL</u> until cabin pressure is normal.                      If not, configure to egress mode per step 14.</p>
<b>SYMPTOM</b>	<b>PROCEDURE</b>	<b>REMARKS</b>

F-300LMS-1033

ENVIRONMENTAL CONTROL SUBSYSTEM



LMA790-3-LM  
**APOLLO OPERATIONS HANDBOOK**

L.M2030

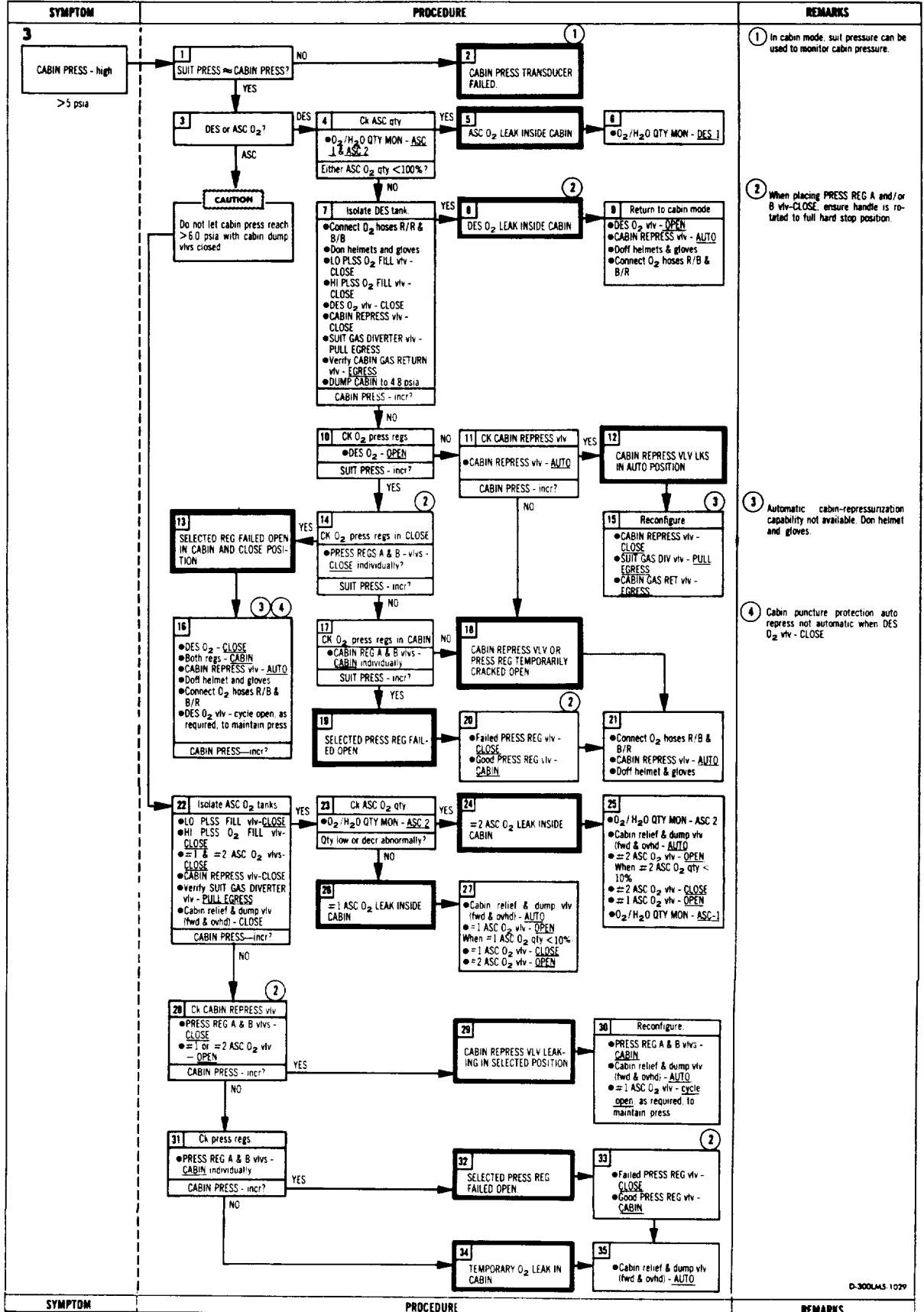

**LMA790-3-LM  
APOLLO OPERATIONS HANDBOOK**

LM 2001

SYMPTOM	PROCEDURE	REMARKS
<p><b>4</b></p> <p><b>SUIT/FAN</b> <sup>①</sup></p> <p>RED</p> <p>Light on if: Suit press &lt; 3.12 psia in egress mode Suit fan No. 2 fails while in use</p>	<p><b>1</b> PGA flow stopped?</p> <p>YES → <b>2</b> SUIT ISOL vlv - SUIT DISC?</p> <p>NO → <b>4</b> SUIT FAN comp It - on?</p> <p>YES → <b>3</b> SUIT FAN Δ P SW (INTERNAL) FAILED CLOSED</p> <p>NO → <b>9</b> PGA cuff gage low?</p> <p>YES → <b>10</b> PGA LEAK</p> <p>NO → <b>12</b> C/WEA/INST FAILURE</p> <p><b>2</b> SUIT ISOL vlv - SUIT DISC?</p> <p>YES → <b>7</b> Reconfigure ECS</p> <p><b>8</b> ● Ck PGA cuff gage. ● SUIT ISOL vlv (CDR &amp; LMP) - SUIT FLOW (hold) ● cb (16) ECS: SUIT FLOW CONT - open</p> <p><b>3</b> SUIT FAN NO. 2 FAILED.</p> <p><b>7</b> Reconfigure ECS</p> <p>● cb (16) ECS: SUIT FAN 2 - open ● cb (16) ECS: SUIT FAN Δ P - open ● Doff helmet &amp; gloves ● PRESS REG A &amp; B vlv - CABIN ● CABIN GAS RETURN vlv - AUTO ● SUIT GAS DIVERTER vlv - PUSH CABIN ● cb ECS: CABIN FAN - CLOSE ● PRESS REG A &amp; B vlv - DIRECT O<sub>2</sub> periodically, to purge cabin of CO<sub>2</sub></p>	<p><b>①</b> Assumptions: (1) Suit warning: suit fan No. 1 is in operation; and (2) fan warning: suit fan No. 1 is inoperative</p> <p><b>②</b> No suit/fan C/W inputs to SUIT FAN comp It, ECS It, and SUIT/FAN warn It.</p> <p><b>③</b> O<sub>2</sub> flow is only indication of fan operation. C/W monitoring of suit protection lost. SUIT FAN warn It inoperative. Use SUIT/FAN comp It as indication of fan failure.</p>
<p><b>4a</b></p> <p><b>SUIT PRESS - low</b></p> <p>&lt; 3.6 psia</p>	<p><b>5</b></p> <p><b>SUIT PRESS - high (egress mode)</b> <sup>①</sup></p> <p>&gt; 4.0 psia</p> <p><b>1</b> PGA cuff press &gt; 4.0 psi? <sup>②</sup></p> <p>YES → <b>2</b> Ck O<sub>2</sub> press reg. <sup>③</sup></p> <p>NO → <b>4</b> SUIT PRESS TRANSDUCER OR SIG COND FAILED. <sup>④</sup></p> <p><b>2</b> ● PRESS REG A vlv - CLOSE</p> <p>SUIT PRESS - decr? YES → <b>3</b> PRESS REG A VLV REGULATING HIGH OR FAILED OPEN. <sup>③</sup></p> <p>NO → <b>5</b> PRESS REG B VLV REGULATING HIGH OR FAILED OPEN. <sup>③</sup></p> <p><b>3</b> Reset PRESS REG A vlv.</p> <p>● PRESS REG B vlv - CLOSE ● PRESS REG A vlv - EGRESS</p>	<p><b>①</b> Assumption: Cabin is depressurized and CABIN REPRESS vlv - CLOSE.</p> <p><b>②</b> Suit loop pressure is limited to 4.3 psi by SUIT CIRCUIT RELIEF vlv.</p> <p><b>③</b> When placing PRESS REG A and/or B vlv - CLOSE, ensure handle is rotated to full hard stop position.</p> <p><b>④</b> SUIT PRESS is erroneous. Use PGA cuff pressure gage.</p>

C 300LMA-10C

ENVIRONMENTAL CONTROL SUBSYSTEM





LMA790-3-LM  
**APOLLO OPERATIONS HANDBOOK**

L.M 2002

SYMPTOM	PROCEDURE	REMARKS
<p><b>7</b></p> <p>ECS YELLOW</p> <p><b>7a</b> SUIT FAN YELLOW ECS It &amp; SUIT FAN comp It - on if suit fan ΔP &lt; 6 in H<sub>2</sub>O</p> <p><b>7b</b> H<sub>2</sub>O SEP ECS &amp; H<sub>2</sub>O Sep Lts - on if H<sub>2</sub>O Sep speed &lt; 800 rpm</p>	<p><b>1</b> ● SUIT FAN comp It - on?</p> <p>YES → <b>2</b> ● SUIT FAN - 2 Flow in suit loop stopped when failure noted?</p> <p>NO → <b>8</b> H<sub>2</sub>O SEP It - on?</p> <p>YES → <b>20</b> to (Sheet 2)</p> <p>NO → <b>3</b> SUIT FAN NO. 1 FAILED. ● cb (11) ECS: SUIT FAN 1 - open</p> <p>YES → <b>5</b> ● SUIT FAN comp It - on?</p> <p>NO → <b>9</b> SUIT FAN NO. 1 OUTPUT DEGRADED</p> <p>YES → <b>6</b> SUIT FAN ΔP SENSOR FAILED ● SUIT FAN - 1 ● cb (16) ECS: SUIT FAN ΔP - open</p> <p>NO → <b>10</b> ● WATER SEP SEL - all sep ● Verify SUIT GAS DIVERTER vlv - PULL EGRESS H<sub>2</sub>O SEP It - on &gt; 2 min?</p> <p>NO → <b>11</b> ● Monitor H<sub>2</sub>O sep performance H<sub>2</sub>O SEP It - on again?</p> <p>YES → <b>12</b> ORIG H<sub>2</sub>O SEP FAILED</p> <p>NO → <b>13</b> CO<sub>2</sub> CANISTER sel - SEC H<sub>2</sub>O SEP It - on &gt; 2 min?</p> <p>YES → <b>14</b> ● Select alt suit fan H<sub>2</sub>O SEP It - on &gt; 2 min?</p> <p>NO → <b>15</b> ORIG SUIT FAN DEGRADED ● Reselect prim LiOH cartridge ● Reselect orig H<sub>2</sub>O SEP</p> <p>NO → <b>17</b> ● Inspect Prim canister inlet screen &amp; flow limiter for debris, if none. ● Remove flow limiter ● Select prim LiOH Cartridge H<sub>2</sub>O SEP It - on &gt; 2 min?</p> <p>NO → <b>22</b> H<sub>2</sub>O SEP SPEED INSUFFICIENT WITH FLOW LIMITER INSTALLED</p> <p>YES → <b>18</b> Do not allow SUIT ISOL vlvs to remain in SUIT DISC for &gt; 1 min if helmets/gloves on. ● Both SUIT ISOL vlvs - SUIT DISC H<sub>2</sub>O SEP It - on at end of 1 min?</p> <p>YES → <b>19</b> PROBABLE H<sub>2</sub>O SEP INST FAILURE ● Both SUIT ISOL vlvs - SUIT FLOW ● Reselect prim LiOH cartridge ● Reselect orig H<sub>2</sub>O SEP</p> <p>NO → <b>21</b> H<sub>2</sub>O SEP SPEED INSUFFICIENT WITH HIGH SUIT ΔP ● Both SUIT ISOL vlvs - SUIT FLOW ● Verify Cabin press 4.8 ± 2 psia ● Remove helmets &amp; gloves ● CO<sub>2</sub> CANISTER SEL vlv - PRIM ● Stow O<sub>2</sub> hoses ● CABIN GAS RETURN vlv - AUTO ● SUIT GAS DIVERTED vlv - PUSH CABIN ● Examine PGA connectors for debris and clean as required then ● Connect O<sub>2</sub> hoses R/B &amp; B/R ● SUIT ISOL vlvs - SUIT FLOW ● Reselect prim LiOH cartridge ● Reselect orig H<sub>2</sub>O SEP ● CABIN GAS RETURN vlv - EGRESS ● SUIT GAS DIVERTER vlv - PULL EGRESS</p> <p>NO → <b>23</b> PRIM LiOH CARTRIDGE FAILURE ● CO<sub>2</sub> CANISTER sel - SEC ● Chg prim LiOH cartridge ● Reselect prim LiOH cartridge ● Reselect orig H<sub>2</sub>O SEP</p> <p>NO → <b>24</b> Reconfigure &amp; Evaluate</p>	<p><b>1</b> Assumption: Suit fan No. 1 in use.</p> <p><b>2</b> Suit fan input to CWEA inoperative. Fan failure detected by reduced suit flow and H<sub>2</sub>O SEP It.</p> <p><b>3</b> Use component caution lights and appropriate indicator for subsequent failure.</p> <p><b>4</b> Crew comfort is only indicator of H<sub>2</sub>O separator performance.</p> <p><b>5</b> H<sub>2</sub>O SEP component caution It &amp; ECS caution It will remain on, use component lts &amp; indicators for suit fan Glycol pump &amp; Hi CO<sub>2</sub> failures.</p> <p><b>6</b> H<sub>2</sub>O SEP It may come on again if excessive amount of debris was found in prim canister inlet screen during inspection.</p> <p><b>7</b> Consult MSFN if no debris is evident.</p>

C 300LMS-103

ENVIRONMENTAL CONTROL SUBSYSTEM

LMA790-3-LM  
**APOLLO OPERATIONS HANDBOOK**

LM 2002

SYMPTOM	PROCEDURE	REMARKS
<p><b>7c</b></p> <p>CO<sub>2</sub></p> <p>YELLOW</p> <p>ECS &amp; CO<sub>2</sub> lts - on if CO<sub>2</sub> partial press &gt;7.6 mm Hg</p> <p><b>7d</b></p> <p>PART PRESS CO<sub>2</sub> - high &gt; 7.6 mm Hg</p> <p><b>7e</b></p> <p>GLYCOL</p> <p>YELLOW</p> <p>ECS lt &amp; GLYCOL comp lt - on if pump ΔP &lt; 3 psid</p>	<pre> graph TD     Start(( )) --&gt; 26{26 CO2 lt - on?}     26 -- YES --&gt; 27{27 ● Ck PART PRESS CO2* ● CO2 CANISTER SEL vlv - SEC CO2 partial press before selecting SEC canister?}     26 -- NO --&gt; 28{28 ECS lt - off in &lt;1 min?}     27 -- &lt; 7.6 mm Hg --&gt; 28     27 -- &gt; 7.6 mm Hg --&gt; 30{30 ● cb (11) ECS CO2 SENSOR - open ECS lt - off?}     28 -- YES --&gt; 29{29 PART PRESS CO2 IND &amp; CARTRIDGE FAILURE}     28 -- NO --&gt; 30     29 --&gt; 31{31 ● Change primary LiOH cartridge.}     30 -- YES --&gt; 33{33 CWEA FAILURE}     30 -- NO --&gt; 36{36 PRIMARY LiOH CARTRIDGE SATURATED OR FAILED.}     31 --&gt; 34{34 ● CO2 CANISTER SEL vlv - PRIM}     33 --&gt; 34     36 --&gt; 37{37 ● Change primary LiOH cartridge.}     34 --&gt; 37     37 --&gt; 38{38 ● CO2 CANISTER SEL vlv - PRIM ● cb (16) ECS CO2 SENSOR - open}     38 --&gt; 39{39 ● CO2 CANISTER SEL vlv - PRIM ● cb (16) ECS CO2 SENSOR - open}     39 --&gt; 10(10)     39 --&gt; 11(11)     39 --&gt; 12(12)     40{40 GLYCOL comp lt - on?}     40 -- YES --&gt; 41{41 GLYCOL press &lt; 15 psi?}     40 -- NO --&gt; 44{44 CWEA FAILURE}     41 -- YES --&gt; 42{42 GLYCOL PUMP #1 FAILURE}     41 -- NO --&gt; 45{45 GLYCOL PUMP ΔP SW FAILED CLOSED.}     42 --&gt; 43{43 Reestablish glycol flow ● GLYCOL - PUMP 2}     43 --&gt; 12     </pre>	<p>⑧ CO<sub>2</sub> lt remains on while selector is in SEC position. CO<sub>2</sub> should drop to zero in &lt;1 minute</p> <p>⑩ Use ECS and CO<sub>2</sub> lts to detect high CO<sub>2</sub>.</p> <p>⑪ Normal life of primary canister is 41 man-hours; secondary canister, 16 man-hours.</p> <p>⑫ Change LiOH canister on time. CO<sub>2</sub> sensor usually fails high.</p> <p>⑬ If both glycol pumps failed, activate secondary glycol loop:          ● PRI EVAP FLOW #1 vlv - CLOSE          ● WATER TANK SELECT vlv - SEC          ● GLYCOL - INST (SEC)          ● cb (16) ECS: GLYCOL PUMP SEC - close          ● SEC EVAP FLOW vlv - OPEN          a. Immediately after activating secondary glycol loop:          ● cb ECS: LCG PUMP - open          ● cb/AC BUS A: TAPE RCOR - open          ● LTG: OVERRIDE INTEGRAL - ON          ● cb/AC BUS B: NUM LTG - open, except during eng burn or rendezvous or docking maneuvers          ● cb (11 &amp; 16) LTG: ANUN/DOCK/COMPNT - open          For subsequent master alarms, one ANUN/DOCK/COMPNT cb must be closed momentarily to enable C/W lights.          b. At MSFN request:          ● cb PGNS:          IMU OPR - open          LGC/DSKY - open          c. Within 2 hours:          ● cb/AC BUS A: GASTA - open          ● cb FLT DISP: GASTA - open          ● cb COMM: UP DATA LINK - open</p> <p>⑭ Assumption: cb (11) ECS: GLYCOL PUMP AUTO TRNFR - open</p>
SYMPTOM	PROCEDURE	REMARKS

C-300LMS-1035-2

ENVIRONMENTAL CONTROL SUBSYSTEM

Basic Date 26 September 1971

Change Date \_\_\_\_\_

Page 5.2-54A/5.2-54B



**LMA790-3-LM  
APOLLO OPERATIONS HANDBOOK**

SYMPTOM	PROCEDURE	REMARKS
<p><b>GLYCOL</b></p> <p><b>YELLOW</b></p> <p>Light on if: Prim glycol temp &gt;50° F Prim glycol accum &lt;10% Sec glycol accum &lt;10%</p> <p><b>8a</b> GLYCOL temp- high or incr &gt; 45° F</p>	<p><b>1</b> GLYCOL temp &gt;50° F?</p> <p><b>CAUTION</b> Sublimator freeze-up may occur if glycol pumps are of &gt;20 min</p> <p><b>2</b> Ck for leak in prim loop ●cb (11) ECS: GLYCOL PUMP AUTO TRNFR - open ●cb (11) ECS: GLYCOL PUMP 1 - open Is difference between glycol press discharge ≥ 2 psia from value recorded before pump start-up?</p> <p><b>3</b> Ck for leak in sec loop ●GLYCOL - INST (SEC) Is difference between glycol press discharge ≥ 2 psia from value recorded before pump start-up?</p> <p><b>4</b> CWEA OR ACCUMULATOR LOW - LEVEL SENSOR FAILURE</p> <p><b>5</b> LEAK IN PRIMARY GLYCOL LOOP</p> <p><b>6</b> LEAK IN SECONDARY GLYCOL LOOP</p> <p><b>7</b> Restart prim glycol loop ●GLYCOL - PUMP 1 ●cb (11) ECS: GLYCOL PUMP 1 - close ●cb (11) ECS: GLYCOL PUMP AUTO TRNFR - close</p> <p><b>8</b> Restart prim glycol loop ●cb (11) ECS: GLYCOL PUMP 1 - close ●cb (11) ECS: GLYCOL PUMP AUTO TRNFR - close ●When GLYCOL temp &gt;50° F or pump press fluctuates, proceed to next step.</p> <p><b>9</b> Activate sec glycol loop ●Verify PRI EVAP FLOW #1 &amp; #2 vlv - CLOSE ●WATER TANK SELECT vlv - SEC ●GLYCOL - INST (SEC) ●cb (16) ECS: GLYCOL PUMP SEC - close ●SEC EVAP FLOW vlv - OPEN ●Reconfigure electrical loads for secondary loop operation.</p> <p><b>10</b> GLYCOL temp- high or incr &gt; 45° F</p> <p><b>11</b> SUIT temp ≈ 10° F &gt; GLYCOL temp?</p> <p><b>12</b> GLYCOL temp-incr?</p> <p><b>13</b> ●PRI EVAP FLOW #1 vlv - CLOSE ●PRI EVAP FLOW #2 vlv - OPEN GLYCOL temp steady or decr within 5 min?</p> <p><b>14</b> PRIMARY SUBLIMATOR FAILURE</p> <p><b>15</b> THERMAL OVERLOAD ●Cycle electrical loads, as necessary, to maintain thermal loads within limits.</p> <p><b>16</b> Isolate sec H<sub>2</sub>O reg. ●PRI EVAP FLOW #2 vlv - CLOSE ●PRI EVAP FLOW #1 vlv - OPEN GLYCOL temp-incr again?</p> <p><b>17</b> PRIMARY H<sub>2</sub>O REG FAILED</p> <p><b>18</b> Reconfigure for ASC H<sub>2</sub>O feed ●WATER TANK SELECT vlv - SEC ●PRI EVAP FLOW #2 vlv - OPEN ●PRI EVAP FLOW #1 vlv - CLOSE</p> <p><b>19</b> TRANSIENT CONDITION</p>	<p><b>1</b> Assumption: (1) Primary glycol loop was operating with cb ECS: GLYCOL PUMP AUTO TRNFR closed. (2) Selected H<sub>2</sub>O tank has not been depleted.</p> <p><b>2</b> Glycol loop redundancy lost.</p> <p><b>3</b> Monitor system performance with GLYCOL caution inoperative.</p> <p><b>4</b> For loss of primary glycol loop: a. Immediately after activating secondary glycol loop: ●cb ECS: LCG PUMP - open ●cb/AC BUS A: TAPE RCDR - open ●LTG: OVERRIDE INTEGRAL - ON ●cb/AC BUS B: NUM LTG - open, except during eng burn or rendezvous or docking maneuvers ●cb (11 &amp; 16) LTG: ANUN/DOCK/COMPNT - open For subsequent master alarms, one ANUN/DOCK/COMPNT cb must be closed momentarily to enable C/W lights. b. At MSFN request: ●cb PGNS: IMU OPR - open LGC/DSKY - open c. Within 2 hours: ●cb/AC BUS A: GASTA - open ●cb FLT DISP: GASTA - open ●cb COMM: UP DATA LINK - open</p> <p><b>5</b> Descent H<sub>2</sub>O for cooling is lost.</p> <p><b>6</b> VHF ranging failure at glycol temperature above 67°F indicated in cabin may result in VHF transmitter damage.</p>
SYMPTOM	PROCEDURE	REMARKS

D:300LMS-1036

**LMA790-3-LM  
APOLLO OPERATIONS HANDBOOK**

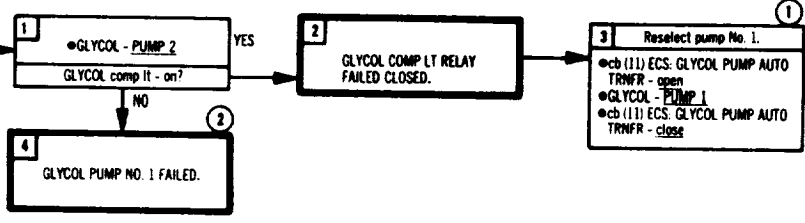
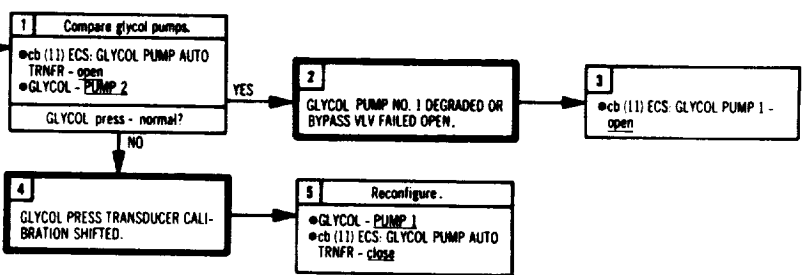
SYMPTOM	PROCEDURE	REMARKS
<p><b>9</b></p> <div style="border: 1px dashed black; padding: 5px; width: fit-content;"> <p align="center">GLYCOL</p>  <p align="center">YELLOW</p> <p>Light on if pump ΔP &lt; 3 psid</p> </div>	 <pre> graph TD     S1[1 GLYCOL - PUMP 2] -- YES --&gt; S2[2 GLYCOL COMP LT RELAY FAILED CLOSED.]     S1 -- NO --&gt; S4[4 GLYCOL PUMP NO. 1 FAILED.]     S2 --&gt; S3[3 Reselect pump No. 1.]     S3 --&gt; S1     </pre>	<p><b>1</b> Glycol pump automatic transfer is operable. Monitor GLYCOL ind. for pump failures.</p> <p><b>2</b> A temporary ΔP switch failure will result in automatic transfer. Confirm pump No. 1 failure by re-setting automatic transfer circuit and reselecting pump No. 1 while monitoring glycol pressure. Do not stop glycol flow for &gt;20 minutes if sublimator is operating.</p>
<p><b>10</b></p> <div style="border: 1px solid black; padding: 5px; width: fit-content;"> <p>GLYCOL press - low or decr</p> <p>&lt; 17 psia</p> </div>	 <pre> graph TD     S1[1 Compare glycol pumps.] -- YES --&gt; S2[2 GLYCOL PUMP NO. 1 DEGRADED OR BYPASS VLV FAILED OPEN.]     S1 -- NO --&gt; S4[4 GLYCOL PRESS TRANSDUCER CALIBRATION SHIFTED.]     S2 --&gt; S3[3 cb (11) ECS: GLYCOL PUMP 1 - open.]     S4 --&gt; S5[5 Reconfigure.]     </pre>	
SYMPTOM	PROCEDURE	REMARKS

A-300LAS-1G

**LMA790-3-LM**  
**APOLLO OPERATIONS HANDBOOK**

RC1604, LM3261, LM3262

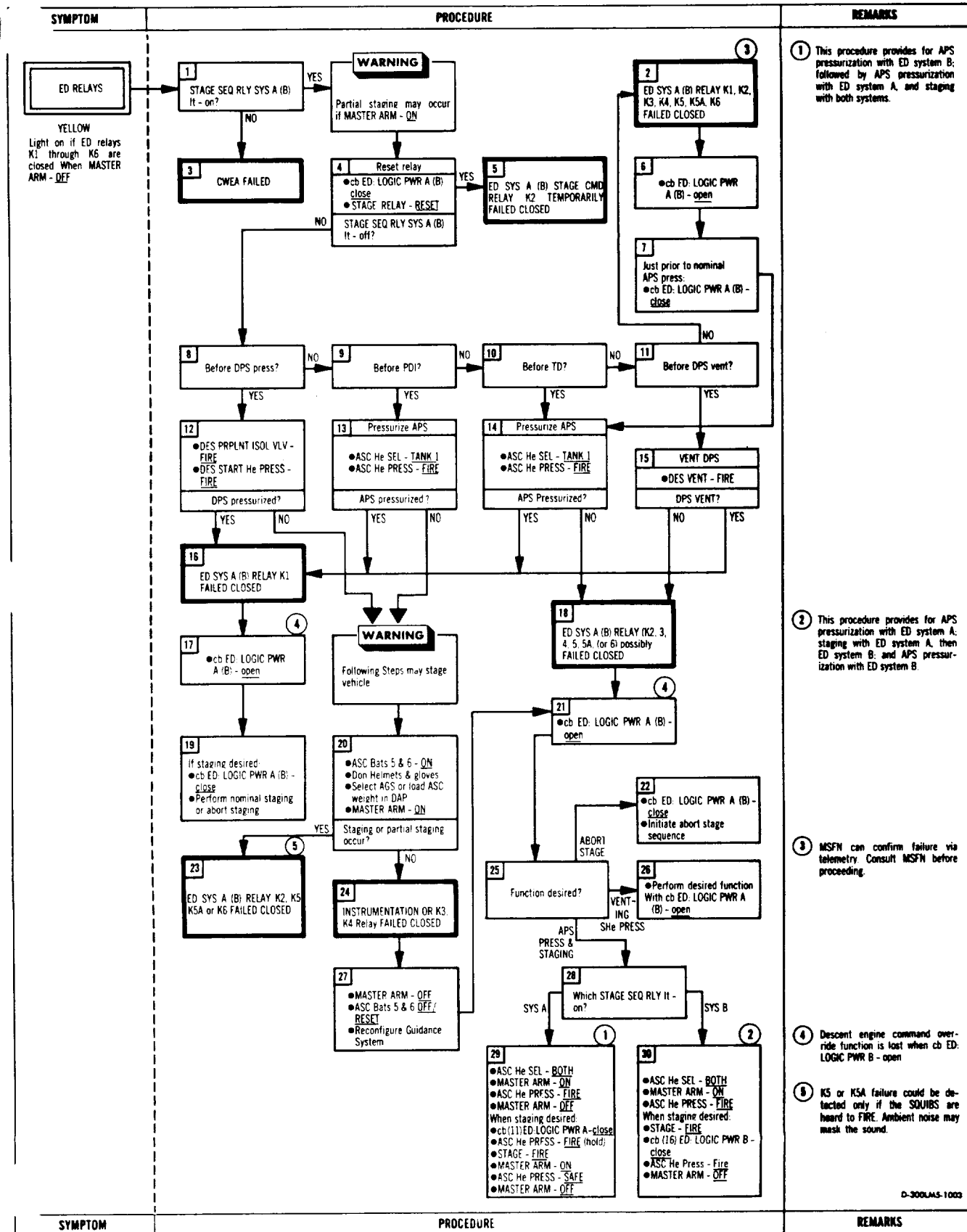

D-300LAS-1003

EXPLOSIVE DEVICES

**LMA790-3-LM**  
**APOLLO OPERATIONS HANDBOOK**

5.2.11 EXPLOSIVE DEVICES

Table 5-11. ED Procedure Entry Sheet

Symptom	Sym No.	Page No.
ED RELAYS cautions	1	5.2-58
STAGE SEQ RELAYS SYS A & B lights - off when MASTER ARM - ON	2	5.2-59
STAGE SEQ RELAYS SYS A & B light - off when MASTER ARM - ON	3	5.2-59
MSFN advises both SYS A & B K7-K15 FAILED	4a	5.2-60
MSFN advises both SYS A & B K7-K15 FAILED	4b	5.2-60



LMA790-3-LM  
 APOLLO OPERATIONS HANDBOOK

RC99, LM3262

SYMPTOM	PROCEDURE	REMARKS
<p><b>4a</b></p> <p>MSFN advises                      SYS A (B)                      K7 - K15 FAILED</p>	<p>1 DPS SHe press?</p> <p>NO → 2</p> <p>YES ↓</p> <p>2 CB ED: LOGIC                      PWR A (B) - open</p> <p>3 After SHe press:                      ● FUEL VENT - CLOSE                      ● OXID VENT - CLOSE                      ● CB ED LOGIC PWR                      A (B) - close</p> <p>4 Before DPS venting:                      ● CB ED LOGIC PWR                      A (B) - open                      ● MASTER ARM - on</p>	<p>Relay functions                      K7 - RCS press.                      K8 - LDG gear.                      K9 - DPS SHe press.                      K10 - ASC HE TANK 1.                      K11 - ASC HE TANK 2.                      K12 - ASC FUEL and OXID                      COMP vlv (SYS B only).                      K12a - ACS FUEL and                      OXID COMP vlv.                      K13 - DPS FUEL and                      OXID vent.                      K14 - DPS AMB HE                      K15 - DPS FUEL and                      OXID COMP vlv.</p>
<p><b>4b</b></p> <p>MSFN advises                      both SYS A &amp; B                      K7 - K15 FAILED</p>	<p>5 Before MASTER ARM - on:                      ● DES He REG 1 - CLOSE                      ● DES He REG 2 - CLOSE                      ● FUEL VENT - CLOSE                      ● OXID VENT - CLOSE                      If DPS not pressurized:                      ● DES PRPLNT ISOL VLV -                      FIRE &amp; hold until MASTER                      ARM - on</p> <p>6 At TIG of First DPS                      burn: DES He REG 1 -                      OPEN</p>	
SYMPTOM	PROCEDURE	REMARKS

A-300LM10-9026

EXPLOSIVE DEVICES

# LMA790-3-LM APOLLO OPERATIONS HANDBOOK

LM2024, LM3262

SYMPTOM	PROCEDURE	REMARKS
<p><b>2</b></p> <p>STAGE SEQ RLY SYS A &amp; B Its - off when MASTER ARM - ON</p>	<p><b>1</b> Recycle sw.</p> <ul style="list-style-type: none"> <li>●MASTER ARM - recycle</li> </ul> <p>STAGE SEQ RLY SYS A &amp; B It - on?</p> <p style="text-align: right;">NO → <b>2</b></p> <p style="text-align: center;">YES ↓</p> <p><b>4</b> TRANSIENT CONDITION</p> <p style="text-align: right;"><b>2</b> MASTER ARM SW FAILED OFF (DOUBLE FAILURE) → <b>3</b></p> <p><b>3</b> All method of arming ED bus</p> <ul style="list-style-type: none"> <li>●ASE He Sel - Tank-1</li> <li>●cb S/C ABORT STAGE (2) - open</li> <li>●ABORT STAGE pb - push</li> <li>ED RELAYS It - on</li> <li>●MASTER ALARM - on</li> <li>●MASTER ALARM - reset</li> <li>●ED (desired function) - FIRE</li> <li>●ABORT STAGE pb - reset</li> <li>●cb S/C ABORT STAGE (2) - close</li> </ul>	<p><b>1</b> This method pressurizes ASCENT Tank-1 as soon as ABORT STAGE pb is pushed.</p>
<p><b>3</b></p> <p>STAGE SEQ RLY SYS A(B) It - off when MASTER ARM - ON</p>	<p><b>1</b> Recycle sw.</p> <ul style="list-style-type: none"> <li>●MASTER ARM - recycle</li> </ul> <p>STAGE SEQ RLY SYS A(B) It - on?</p> <p style="text-align: right;">YES → <b>2</b></p> <p style="text-align: center;">NO ↓</p> <p><b>3</b> ●MASTER ARM - OFF</p> <ul style="list-style-type: none"> <li>●cb ED LOGIC PWR B(A) - open</li> <li>●MASTER ARM - ON</li> <li>●ED: (function desired) - FIRE</li> </ul> <p>Function performed?</p> <p style="text-align: right;">NO → <b>4</b></p> <p style="text-align: center;">YES ↓</p> <p><b>6</b> INSTRUMENTATION FAILURE</p> <p style="text-align: right;"><b>4</b> All arming method</p> <ul style="list-style-type: none"> <li>●ASC He SEL - TANK 1</li> <li>●cb S/C ABORT STAGE (2) - open</li> <li>●ABORT STAGE pb - push</li> </ul> <p>STAGE SEQ RLY SYS A(B) It - on?</p> <p style="text-align: right;">NO → <b>5</b></p> <p style="text-align: center;">YES ↓</p> <p><b>7</b> MASTER ARM SW FAILED FOR ED SYS A (B) → <b>8</b></p> <p><b>8</b> ●ED: (function desired) - FIRE</p> <ul style="list-style-type: none"> <li>●ABORT STAGE pb - reset</li> <li>●cb S/C ABORT STAGE (2) - close</li> <li>●MASTER ARM OFF</li> <li>●cb ED LOGIC PWR B(A) - close</li> <li>●ASC He SEL - TANK 2</li> </ul> <p style="text-align: right;"><b>9</b> ●MASTER ARM - OFF</p> <ul style="list-style-type: none"> <li>●cb ED LOGIC PWR B(A) - close</li> </ul> <p>DPS pressurized?</p> <p style="text-align: right;">NO → <b>11</b></p> <p style="text-align: center;">YES ↓</p> <p><b>10</b> NOTE: The following step not required if after TD and LM within safe manual staging attitude constraint.</p> <p style="text-align: right;"><b>11</b> ●DES START He PRESS - FIRE</p> <ul style="list-style-type: none"> <li>●if DPS does not press. continue</li> </ul> <p style="text-align: right;"><b>12</b> On Surface?</p> <p style="text-align: center;">NO ↓</p> <p style="text-align: right;">YES ↓</p> <p><b>13</b> ●ASC He PRESS - FIRE</p> <ul style="list-style-type: none"> <li>●if APS does not press continue</li> </ul> <p style="text-align: right;"><b>14</b> Continue Mission</p> <p style="text-align: right;"><b>5</b> ED SYS A(B) RELAY KI FAILED OPEN</p>	<p><b>1</b> MSFN can confirm failure. Consult MSFN before proceeding.</p> <p><b>2</b> Descent engine command override function is lost when cb ED LOGIC PWR B - open</p> <p><b>3</b> This method pressurizes ascent tank 1 as soon as abort stage pb is pushed.</p> <p><b>4</b> ABORT STAGE pb must be pushed for staging. This ensures staging with two pyro systems.</p>

B-300LMB

EXPLOSIVE DEVICES

LMA790-3-LM  
**APOLLO OPERATIONS HANDBOOK**

SYMPTOM	PROCEDURE	REMARKS
<p><b>HEATER</b></p> <p><b>YELLOW</b>                      Light on if:                      RR temp &gt; 148° or &lt; -54° F                      S-band temp &gt; 153° or &lt; -67° F</p> <p><b>1a</b></p> <p>RR temp abnormal                      &gt; timeline temp or 145 F                      &lt; -52° F (power down)                      &lt; 10° F (power up)</p>	<p>1 HTR CONT: TEMP MON - RNDZ RADAR                      HEATER II - off?</p> <p>2 HTR CONT: TEMP MON - S BAND                      HEATER II - off?</p> <p>3 CWEA FAILED</p> <p>4 Temp?</p> <p>5 RR operating?</p> <p>6 INST FAILURE</p> <p>7 cb (11) HTR: RNDZ RDR STBY - open                      cb (11) HTR: RNDZ RDR OPR - close                      Temp incr?</p> <p>8 RR STBY HEATER CKTRY FAILURE</p> <p>9 INST FAILURE</p> <p>10 Turn on RR when temp &gt; 10° F.</p> <p>11 Cool RR                      cb (11) HTR: RNDZ RDR STBY &amp; RNDZ RDR OPR - open                      Temp decr?</p> <p>12 RR operating?</p> <p>13 When RR not required:                      cb (11) PGNS: RNDZ RDR - open                      cb 7/AC BUS A: RNDZ RDR - open                      Temp decr?</p> <p>14 HEAT SOAK</p> <p>15 When temp &lt; 148 F or timeline                      cb (11) HTR: RNDZ RDR OPR - close                      Temp incr?</p> <p>16 RR OPR HEATER CKTRY FAILED ON</p> <p>17 INST FAILURE</p> <p>18 Restore heaters                      cb (11) HTR: RNDZ RDR STBY OR RNDZ RDR OPR - close</p> <p>19 RR STBY HEATER CKTRY FAILED ON</p> <p>20 Reconfigure heaters                      cb (11) HTR: RNDZ RDR OPR - open                      cb (11) HTR: RNDZ RDR STBY - close</p>	<p>1 Light goes off when HTR CONT: TEMP MON is set to affected heater position. HEATER II will not go on again for same failure or future faults of that heater until normal limits are established.</p> <p>2 C/W monitoring of heater operation is lost. Use HTR CONT: TEMP MON for heater monitoring.</p>
<p><b>1b</b></p> <p>S band antenna temp abnormal                      &gt; 135° F (TLC and lunar orbit)                      &gt; 150° F (lunar stay)                      &lt; -52° F</p>	<p>21 Antenna temp?</p> <p>22 Deactivate heater.                      cb (16) HTR: S BD ANT - open                      Antenna temp decr?</p> <p>23 S-BAND ANTENNA HEATER FAILED ON</p> <p>24 Manual temp control                      If needed:                      cb (16) HTR: S BD ANT - cycle to maintain temp at -50° to 100° F</p> <p>25 Antenna operating?</p> <p>26 Antenna operating?</p> <p>27 Deactivate antenna.                      When able, deactivate antenna:                      COMM ANT: TRACK MODE - OFF                      cb/AC BUS B: S BD ANT - open                      cb (16) COMM: S BD ANT - open                      Antenna temp decr?</p> <p>28 Power antenna                      cb/AC BUS B: S BD ANT - close                      cb (16) COMM: S BD ANT - close                      COMM ANT: TRACK MODE - SLEW                      Antenna temp incr?</p> <p>29 HEAT SOAK OR INST FAILURE</p> <p>30 HEAT SOAK</p> <p>31 INST FAILURE</p> <p>32 S-BAND ANTENNA HEATER FAILED OFF</p> <p>33 cb (16) HTR: S BD ANT - open</p>	<p>3 To power up RR (RR range data may not be reliable until 17 minutes after initial step):                      a. If RR temp &lt; +10° F:                      cb (11) HTR: RNDZ RDR OPR - close                      b. When RR temp ≥ +10° F:                      cb/AC BUS A: RNDZ RDR - close                      After 30 sec:                      cb (11) PGNS: RNDZ RDR - close                      c. If step a performed:                      cb (11) HTR: RNDZ RDR OPR - open</p>
SYMPTOM	PROCEDURE	REMARKS

8-300LMS-1004

HEATERS

**LMA790-3-LM  
APOLLO OPERATIONS HANDBOOK**

5.2.12 HEATERS

5.2.12.1 Assumptions

5.2.12.1.1 HEATER caut lt (RCS)

- Assume no action will be taken during a critical mission phase.
- One heat system (4/QUAD) can maintain temperature above 119°F.

Table 5-12. HTR Procedure Entry Sheet

Symptom	Sym No.	Page No.
HEATER caut lt	1	5.2-62
RR temp abnormal	1a	5.2-62
S-band antenna temp abnormal	1b	5.2-62
LR temp abnormal	2	5.2-63
RCS quad 1 (2, 3, 4) temp abnormal	3	5.2-63

LMA790-3-LM  
**APOLLO OPERATIONS HANDBOOK**

L.M3246

SYMPTOM	PROCEDURE	REMARKS
<p><b>2</b></p> <p>LR temp abnormal</p> <p>&gt;145° F or timeline temp                      &lt;60° F</p>		
<p><b>3</b></p> <p>RCS quad 1 (2, 3, 4) temp abnormal</p> <p>&gt;190 F                      &lt;125 F</p>		<p><b>1</b> Abnormal high temp is for periods of no thruster activity after temp soakback from previous activity (if any) has stabilized.</p> <p><b>2</b> For contingencies where QUAD temp <math>\geq 60^\circ\text{F}</math>, manual mode engine operation may be undertaken. If minimum pulse bit is required, QUAD warmup to <math>119^\circ\text{F}</math> may be accomplished by steady state engine operation. A 3-sec firing of each engine in cold QUAD will result in cluster temperature rise through thermal soak-back. After minimum temperature achieved, maintain operational temperature through heater and/or engine operation.</p>



**LMA790-3-LM**  
**APOLLO OPERATIONS HANDBOOK**

PARA	TITLE	PAGE
5.3	Emergency Procedures . . . . .	5.3-2
5.3.1	Excessive Cabin Leak . . . . .	5.3-2
5.3.2	Fire/Smoke in Cabin (Not in suit loop) . . . . .	5.3-3
5.3.3	Fire/Smoke in suit loop . . . . .	5.3-3
5.3.4	Suit Leak in Depressurized Cabin . . . . .	5.3-4
5.3.5	Vacuum Changeover - PLSS to LM . . . . .	5.3-5
5.3.6	Crewman Vacuum Transfer to CSM . . . . .	5.3-6
5.3.7	Emergency Transfer, Using OPS . . . . .	5.3-7
5.3.8	Emergency Forward Hatch Opening (Cabin Side) . . . . .	5.3-8
5.3.9	Contaminants In ARS/Cabin Atmosphere . . . . .	5.3-8
5.3.10	Smoke In Cabin (Crew Unsuitd) . . . . .	5.3-9
5.3.11	Loss of Descent Power . . . . .	5.3-11
5.3.12	Loss of CDR Bus During Powered Descent . . . . .	5.3-11
5.3.12.1	To Abort (DPS Engine) . . . . .	5.3-11
5.3.12.2	To Abort (APS Engine) . . . . .	5.3-12
5.3.12.3	Reconfigure . . . . .	5.3-13
5.3.13	Loss of LMP Bus During Powered Descent . . . . .	5.3-13
5.3.13.1	To Abort (DPS Engine) . . . . .	5.3-13
5.3.13.2	To Abort (APS Engine) . . . . .	5.3-14
5.3.13.3	Reconfigure . . . . .	5.3-14
5.3.14	Extravehicular Transfer (Staged Vehicle) . . . . .	5.3-15
5.3.14.1	Subsystem Preparation for Egress . . . . .	5.3-15
5.3.14.2	Final Subsystem Preparation for EVT . . . . .	5.3-16

**LMA790-3-LM  
APOLLO OPERATIONS HANDBOOK**

CREW/ MAN	PNL	PROCEDURES	REMARKS
		LM 3231	
		<p><u>5.3 EMERGENCY PROCEDURES</u></p> <p>Emergency procedures enable the crew to perform corrective action in the event of hazardous situations. These procedures require instant response on the part of the crew to prevent the situation from becoming worse. It is assumed that the crew are wearing helmets and gloves at all times. The procedures cover the following:</p> <ul style="list-style-type: none"> <li>a. Excessive cabin leak</li> <li>b. Fire/smoke in cabin (not in suit loop)</li> <li>c. Fire/smoke in suit loop</li> <li>d. Suit leak in depressurized cabin</li> <li>e. Vacuum changeover - PLSS to LM</li> <li>f. Crewman vacuum transfer to CSM</li> <li>g. Emergency transfer, using OPS</li> <li>h. Emergency forward hatch opening (cabin side)</li> <li>i. Contaminants in ARS/cabin atmosphere</li> <li>j. Loss of descent power</li> <li>k. Loss of CDR bus during powered descent</li> <li>l. Loss of LMP bus during powered descent</li> <li>m. Extravehicular transfer</li> </ul>	
		<p><u>5.3.1 EXCESSIVE CABIN LEAK</u></p> <p>1. When cabin pressure drops to &lt;4.45 to 3.7 psia, following occurs automatically:            MASTER ALARM - on            CABIN warn lt - on            CABIN REPRESS vlv opens            SUIT GAS DIVERTER vlv - PULL EGRESS</p> <p>2. PRESS REG A &amp; B vlv - EGRESS            CABIN warn lt - off            CABIN REPRESS vlv closes            Cabin fan goes off.</p> <p>3. CABIN REPRESS vlv - CLOSE</p> <p>4. CB ECS:            CABIN REPRESS - open            LCG PUMP - as required</p> <p>5. MASTER ALARM pb/lt - reset</p> <p>6. CB ECS: CABIN FAN - open</p>	<p>Assumption: ECS is in basic (unstaged) configuration when cabin leak occurs.</p> <p>CABIN REPRESS vlv will not open if vehicle is in ECS basic (staged) configuration.</p>
CDR/ LMP	1,2 1 ECS		
LMP	16		
CDR/ LMP	1/2		
CDR	11		



**LMA790-3-LM**  
**APOLLO OPERATIONS HANDBOOK**

CREW-MAN	PNI	PROCEDURES	REMARKS
		<u>5.3.2 FIRE/SMOKE IN CABIN (NOT IN SUIT LOOP)</u>	
	ECS	<ol style="list-style-type: none"> <li>1. PRESS REC A &amp; B vlv - EGRESS</li> <li>2. SUIT GAS DIVERTER vlv - PULL EGRESS</li> <li>3. Use EPS: POWER/TEMP MON sel to check for excessive current. Remove power from affected bus.</li> <li>4. Use fire extinguisher as required.</li> <li>5. Don helmets &amp; gloves.</li> <li>6. SUIT FAN sel - redundant fan if flow stops</li> </ol>	<p>When PRESS REC A and/or B vlv - CLOSE, ensure handle is rotated to full hard stop position.</p> <p>Alternative of donning helmets and gloves and using fire extinguisher is real-time decision. Order of items to be accomplished is dependent on crew assessment of situation.</p>
	2	<p style="text-align: center;"><b>WARNING</b></p> <p>Combustion products should be considered toxic. Smoke and contaminants must be removed from cabin before removing helmets, by purging or dumping cabin.</p> <p>7. If fire persists:            Prepare to dump cabin (if ascent stage only, insufficient O2 is available for repress)            Visually check suit integrity.            CABIN GAS RETURN vlv - EGRESS            CB ECS: CABIN REPRESS - open            Cabin relief &amp; dump vlv (fwd) - OPEN, then AUTO at 3.2 psia            ECS: SUIT PRESS ind - 3.6 to 4.0 psi            Cabin relief &amp; dump vlv - OPEN until ECS: CABIN PRESS ind - 0 psia</p>	
	ECS 16 2 ECS	<u>5.3.3 FIRE/SMOKE IN SUIT LOOP</u>	
	ECS	<ol style="list-style-type: none"> <li>1. SUIT ISOL vlv (CDR &amp; LMP) - SUIT DISC</li> <li>2. SUIT FAN sel - OFF</li> </ol>	

**LMA790-3-LM**  
**APOLLO OPERATIONS HANDBOOK**

CREW- MAN	PNI	PROCEDURES	REMARKS
		<p>5.3.3 <u>FIRE/SMOKE IN SUIT LOOP (cont)</u></p> <p>3. PRESS REG A &amp; B vlv - CLOSE</p> <p>4. Remove helmet &amp; gloves.</p> <p>5. SUIT CIRCUIT RELIEF vlv - CLOSE</p> <p>6. CABIN GAS RETURN vlv - EGRESS</p> <p>7. SUIT GAS DIVERter vlv - PULL EGRESS</p> <p>8. Isolate suit loop electrically:            CB ECS: SUIT FAN 1 - open            CB ECS:                SUIT FLOW CONT - open                SUIT FAN 2 - open                SUIT FAN AP - open                DIVERter VLV - open                CO2 SENSOR - open</p> <p>9. CABIN REPRESS vlv - MANUAL, as necessary to maintain cabin pressure &amp; replenish O2</p> <p>When fire goes out:</p> <p>10. If cabin is contaminated, purge as necessary.</p> <p>11. CABIN REPRESS vlv - MANUAL</p> <p>12. Cabin relief &amp; dump vlv (fwd) - AUTO</p> <p>13. If ascent stage only, closely monitor O2 supply.</p> <p>5.3.4 <u>SUIT LEAK IN DEPRESSURIZED CABIN</u></p>	<p>When PRESS REG A and/or B vlv - CLOSE, ensure handle is rotated to full hard stop position.</p>
CDR/ LMP	1,2 ECS	<p>1. MASTER ALARM - on            SUIT/FAN warn lt - on            SUIT ISOL vlv (CDR) - SUIT DISC            SUIT ISOL vlv (LMP) - SUIT DISC</p>	<p>These events occur simultaneously and automatically when ECS: SUIT PRESS ind falls below 3.1 psia.</p>

**LMA790-3-LM**  
**APOLLO OPERATIONS HANDBOOK**

CREW-MAN	PNL	PROCEDURES	REMARKS
		<p>5.3.4 <u>SUIT LEAK IN DEPRESSURIZED CABIN (cont)</u></p> <ol style="list-style-type: none"> <li>2. Forward hatch - close</li> <li>3. Forward hatch handle - LOCK</li> <li>4. Cabin relief &amp; dump vlv (fwd) - AUTO</li> <li>5. CABIN REPRESS vlv - AUTO CB ECS: CABIN REPRESS - close CABIN warn lt - on</li> <li>6. PRESS REG A vlv - CABIN</li> <li>7. PRESS REG B vlv - CABIN</li> <li>7A. CABIN GAS RETURN vlv - AUTO SUIT GAS DIVERTER vlv - PUSH CABIN</li> <li>8. SUIT ISOL vlv (CDR) - SUIT FLOW</li> <li>9. SUIT ISOL vlv (LMP) - SUIT FLOW</li> <li>10. MASTER ALARM pb/lt - reset</li> </ol>	<p>Crewman with intact suit will perform steps 2 through 10. Omit steps 2 through 4 if forward hatch is closed and forward cabin relief and dump valve is not set to OPEN.</p> <p>SUIT/FAN warn lt - off when suit pressure &gt;3.1 psia. CABIN warn lt - off when cabin pressure is between 4.4 and 5 psia.</p> <p>Steps 8 and 9 are performed when cabin pressure &gt;3.1 psia.</p> <p>Assumption: Cabin cannot be pressurized.</p>
		<p>5.3.5 <u>VACUUM CHANGEOVER - PLS5 TO LM</u></p> <ol style="list-style-type: none"> <li>1. Remove purge valve from PGA &amp; hand to CDR for stowage.</li> <li>2. Disconnect OPS 02 hose from PGA.</li> <li>3. Remove LM O2 umbilical from stowage &amp; hand to LMP.</li> <li>4. Connect LM O2 umbilical to PGA right-side connectors &amp; verify locked (red to red, blue to blue).</li> <li>5. FEEDWATER vlv - CLOSED</li> </ol>	<p>If PLS5 sublimator freeze-up is a problem, do not proceed until LCG liquid circulation temperature starts to rise.</p>

**LMA790-3-LM**  
**APOLLO OPERATIONS HANDBOOK**

CREW-MAN	PNL	PROCEDURES	REMARKS
		<p>5.3.5 <u>VACUUM CHANGEOVER - PLSS TO LM (cont)</u></p> <p>6. SUIT ISOL vlv (LMP) - SUIT FLOW</p> <p>7. VENTILATION DIVERTER vlv - IV (horizontal)</p> <p>8. FAN sw - OFF PUMP sw - OFF EVC-1 (or EVC-2) MODE SEL sw - 0</p> <p>9. Verify flow from LM ARS to PGA.</p> <p>10. Disconnect PLSS electrical connector from PGA &amp; connect LM comm cable to PGA.</p> <p>11. Disconnect PLSS O2 hoses from PGA.</p> <p>5.3.6 <u>CREWMAN VACUUM TRANSFER TO CSM</u></p> <p>1. Receive transfer umbilical from CSM.</p> <p>2. Verify that O2 is not flowing in transfer umbilical.</p> <p>3. Remove plugs from appropriate PGA O2 connectors &amp; stow.</p> <p>4. Connect transfer umbilical O2 hoses to PGA, inlet to inlet (blue to blue), outlet to outlet (red to red).</p> <p>5. Request CSM to verify no transfer of umbilical suit power.</p> <p>12. 6. COMM: TLM BIONED sw - LEFT or OFF (LMP) or COMM: TLM BIONED sw - RIGHT or OFF (CDR)</p> <p>11. 7. CB COMM: CDR AUDIO - open or CB COMM: SE AUDIO - open</p> <p>16. 8. Disconnect LM comm cable from PGA &amp; connect transfer umbilical comm cable to PGA.</p>	<p>Assumptions: (1) Overhead hatch is open and (2) tunnel is clear.</p> <p>Steps 6 and 7 ensure that crewman communications cables are not powered.</p> <p>CDR loses communications. LMP loses communications.</p>

**LMA790-3-LM**  
**APOLLO OPERATIONS HANDBOOK**

CREW-MAN	PNL	PROCEDURES	REMARKS
		<p>5.3.6 <u>CREWMAN VACUUM TRANSFER TO CSM (cont)</u></p> <p>9. Request CSM to apply transfer umbilical suit power.</p> <p>10. Request CSM to start O2 flow through transfer umbilical.</p> <p>11. SUIT ISOL vlv (CDR) - SUIT DISC or SUIT ISOL vlv (LMP) - SUIT DISC</p> <p>12. Verify O2 flow to PGA through transfer umbilical.</p> <p>13. CB ECS: LCG PUMP - open</p> <p>14. Disconnect LM LCG H2O hoses &amp; LM O2 hoses from PGA.</p> <p>15. Remove all plugs from stowage &amp; place in PGA connectors.</p> <p>16. Stow LM umbilical.</p> <p>17. Transfer into CSM.</p> <p>5.3.7 <u>EMERGENCY TRANSFER, USING OPS</u></p> <p>1. Cabin relief &amp; dump vlv (ovhd) - OPEN</p> <p>2. Cabin relief &amp; dump vlv (fed) - OPEN</p>	<p>This constitutes communications check via transfer umbilical communications cable.</p> <p>Assumptions: (1) LM or CSM cannot be pressurized and (2) CDR and LMP have OPS donned and activated.</p> <p>With two OPS's operating and each flowing O2 at rate of 8 lb/hr, cabin equilibrium pressure will be approximately 0.075 psia when exhausting through both cabin relief and dump valves. If LM and CSM are docked, both CSM hatches should be open to allow LM overhead cabin relief and dump valve to exhaust to vacuum. If exhausting is through one cabin relief &amp; dump valve, cabin equilibrium pressure will be approximately 0.15 psia, which may cause difficulty in opening hatch(es).</p>

**LMA790-3-LM**  
**APOLLO OPERATIONS HANDBOOK**

CREW- MAIN	PNL	PROCEDURES	REMARKS
		<p><u>5.3.8 EMERGENCY FORWARD HATCH OPENING (CABIN SIDE)</u></p> <p>1. If latch is jammed in LOCK position:            a. Pull lanyard to remove lockpin.            b. Rotate cam plate to uncover latch.            c. Grasp handle &amp; pull hatch open.</p> <p><u>5.3.9 CONTAMINANTS IN ARS/CABIN ATMOSPHERE</u></p> <p>Perform ARS purge:</p> <ol style="list-style-type: none"> <li>1. SUIT GAS DIVERTER vlv - PULL EGRESS</li> <li>2. SUIT CIRCUIT RELIEF vlv - AUTO</li> <li>3. CABIN GAS RETURN vlv - EGRESS</li> <li>4. CO2 CANISTER SEL vlv - midposition</li> </ol> <p style="text-align: center;">CAUTION</p> <p>Step 5 shall be performed consistent with amount of available O2.</p> <ol style="list-style-type: none"> <li>5. PRESS REC A vlv - DIRECT O2 for 5 minutes or until ARS is clear</li> <li>6. CO2 CANISTER SEL vlv - PRIM</li> </ol> <p style="text-align: center;">NOTE</p> <p>If cabin dump is required, omit steps 7 thru 11 and line 3 of step 15.</p> <ol style="list-style-type: none"> <li>7. Cabin relief &amp; dump vlv (fwd) - OPEN</li> <li>8. When ECS: CABIN PRESS ind - 4.5 psia: Cabin relief &amp; dump vlv (fwd) - AUTO</li> <li>9. PRESS REC A vlv - CABIN</li> </ol>	<p>Lanyard is to left of hatch latch, on hatch jamb.</p> <p>Selection of midposition allows contamination absorption by both primary and secondary LiOH canisters.</p> <p>ECS: SUIT PRESS ind will increase to approximately 5.8 psia.</p>
LMP	ECS		
CDR			
LMP			

**LMA790-3-LM**  
**APOLLO OPERATIONS HANDBOOK**

LM 2004

CREW-MAN	PNI	PROCEDURES	REMARKS
		<p>5.3.9 <u>CONTAMINANTS IN ARS/CABIN ATMOSPHERE. (cont)</u></p> <p style="text-align: center;">CAUTION</p> <p>Step 10 will degrade ARS pressure relief capability.</p> <p>10. When ECS: SUIT PRESS ind decreases to approximately 5 psia: SUIT CIRCUIT RELIEF vlv - CLOSE</p> <p>11. Maintain cabin pressure at 4.5 psia by cycling SUIT CIRCUIT RELIEF vlv - CLOSE, AUTO, CLOSE, as required.</p> <p style="text-align: center;">CAUTION</p> <p>Steps 12 &amp; subsequent are required only if toxic fumes are severe enough to require cabin dump.</p> <p>12. PRESS REG A &amp; B vlv - EGRESS</p> <p>13. CB ECS: CABIN REPRESS - open</p> <p>14. Cabin relief &amp; dump vlv (fwd) - OPEN</p> <p>15. Monitor ECS: SUIT &amp; CABIN PRESS ind. When cabin pressure decays to 4.0 psia: SUIT CIRCUIT RELIEF vlv - AUTO SUIT PRESS ind decay stops at 4.3 psia.</p> <p>16. Cabin relief &amp; dump vlv (fwd) - AUTO when cabin pressure = zero psia.</p> <p>5.3.10 <u>SMOKE IN CABIN (Crew Unsuited)</u></p> <p style="text-align: center;">NOTE</p> <p>Step 1 to be performed based on density and toxicity of smoke in cabin.</p>	<p>Required to prevent automatic actuation of CABIN REPRESS vlv at 3.7 to 4.45 psia. Limit cabin pressure to 4.6 psia to prevent violating purge.</p> <p>ARS/PGA Pressure Integrity Check (para 4.2.16) prior to step 12 is real-time decision.</p> <p>Assume ARS in "CABIN" mode with SUIT ISOL vlvs in SUIT FLOW, O<sub>2</sub> Hoses Stowed, SUIT FAN 2 in use.</p> <p>Assume crew have determined smoke source is not in the suit loop and performance of this procedure will not precipitate an uncontrolled fire.</p>

**LMA790-3-LM**  
**APOLLO OPERATIONS HANDBOOK**

CREW-MAN	PNL	PROCEDURES	REMARKS
		LM 2004	
LMP	ECS	<p>5.3.10 <u>SMOKE IN CABIN (Crew Unsuitd) (cont)</u></p> <p>1. Cabin Repress vlv - MANUAL for 1 minute then - CLOSE</p> <p style="text-align: center;">NOTE</p> <p>Cabin purge time of 1 minute may be extended depending on amount of available Descent O<sub>2</sub>.</p> <p>2. CB ECS: SUIT FAN Δ P - open</p> <p>3. CB ECS: SUIT FAN 2 - open</p> <p>4. SUIT CIRCUIT RELIEF vlv - AUTO (verify)</p> <p>5. Unstow Blue O<sub>2</sub> Hoses</p> <p>6. PRESS REGS A &amp; B vlv - DIRECT O<sub>2</sub></p> <p>7. DON PGA's (without LCG &amp; UCTA, if doffed) UCTA HOSE. LCG &amp; BIO BELT CONNECTIONS NOT REQD.</p> <p style="text-align: center;">NOTE</p> <p>Use Blue O<sub>2</sub> Hoses periodically to "wash" smoke from face, as required.</p> <p>8. Connect ECS umbilicals to PGA, O<sub>2</sub> hoses Blue/Blue, Red/Red</p> <p>9. Don helmets &amp; gloves</p> <p>10. PRESS REG B vlv - EGRESS</p> <p>11. SUIT GAS DIVERTER vlv - PULL EGRESS</p>	<p>Cabin pressure will increase to 5.4 to 5.85 psia before cabin pressure relief valve opens. Relief valve operation should be audible to crew.</p> <p>RCS Caution &amp; H<sub>2</sub>O Separator component lts ON when H<sub>2</sub>O speed decays to &lt;800 rpm.</p> <p>Provides O<sub>2</sub> flow to crew when suit fan off. Minimum allowable cabin pressure is 3.0 psia with Suit Isolation valves in Suit Disconnect, Press Regs A&amp;B in Direct O<sub>2</sub> and Suit Circuit Relief vlv in Auto.</p>
LMP	16		
LMP	16		
LMP	ECS		
LMP	ECS		
LMP	ECS		
CDR/ LMP			
LMP	ECS		



**LMA790-3-LM**  
**APOLLO OPERATIONS HANDBOOK**

RC 1606

CREW-MAN	PNL	PROCEDURES	REMARKS
		5.3.10 SMOKE IN CABIN (Crew Unsuitd) (cont)	
		12. CABIN GAS RETURN vlv - EGRESS  CAUTION  Step 13 terminates O2 flow to crew in order to purge the suit loop. Suit isol valve should not remain in Suit Disconnect >1 minute or crew asphyxiation may result. Perform steps 13 thru 16 within 1 minute.	
		13. SUIT ISOL vlv's (CDR & LMP) - SUIT DISCONNECT	
LMP	16	14. CB ECS: SUIT FAN 2 - close	Initiates ARS circulation for purging smoke. H2O Sep Component lt out when H2O Sep speed increases to >800 rpm.
LMP	16	15. CB ECS; SUIT FAN P - close	
LMP	ECS	16. SUIT ISOL vlv's (CDR & LMP) - SUIT FLOW	Reinitiates O2 flow to crew.
LMP	16	17. CB ECS: CABIN REPRESS - open	
CDR	ECS	18. Cabin relief & dump vlv (fwd or ovhd) - OPEN reduce cabin press to 3.5 psia then AUTO	Press REG A in DIRECT O2 until this step maintains suit loop pressure above cabin pressure.
LMP	ECS	19. PRESS REG A vlv - EGRESS	Assures Suit Circuit Relief vlv lockup and PGA/ARS integrity prior to cabin dump to 0 psia.
LMP	2	20. Verify SUIT PRESS 4.3 psia, monitor for 1 minute, verify stable.	
CDR	ECS	21. Cabin relief & dump vlv (fwd or ovhd) - OPEN (reduce cabin pressure to 0 psia) then AUTO	





**LMA790-3-LM**  
**APOLLO OPERATIONS HANDBOOK**

LM 2031

CREW-MAN	PNL	PROCEDURES	REMARKS
LMP	14	<p>5.3.11 <u>LOSS OF DESCENT POWER</u></p> <p>1. EPS: BAT 5 NORMAL SE FEED sw - ON BAT 6 NORMAL CDR FEED sw - ON</p> <p>2. DES 02 vlv - CLOSE #1 ASC 02 vlv - OPEN WATER TANK SELECT vlv - ASC DES H20 vlv - CLOSE</p> <p>3. Reconfigure electrical loads as required.</p> <p>4. Perform EPS Basic (Staged).</p> <p>5.3.12 <u>LOSS OF CDR BUS DURING POWERED DESCENT</u></p>	<p>Assumption: EPS is in basic (unstaged) configuration.</p> <p>Lighting and life support systems restored.</p> <p>Ref para 4.13.4.2.</p> <p>Symptom: MASTER ALARM - on, DC BUS and LGC warn lt - on, and EPS: DC FEEDER FAULT comp caut lt - on.</p> <p>Assumption: Inverter No. 1 is used during DPS burns.</p> <p>Results: 100% DPS thrust, loss of PGNS, GDA locked, loss of RCS, and loss of DPS automatic start, stop, and manual start. Engine will shut down unless DES ENG CMD OVRD sw - ON.</p>
3	1	<p>5.3.12.1 <u>To Abort (DPS Engine)</u></p> <p>1. Verify/set DES ENG CMD OVRD sw - ON</p> <p>2. GUID CONT sw - AGS</p> <p>3. S/C: AGS sw - AUTO</p> <p>4. ABORT pb - push</p> <p>5. SUIT FAN sel - 2</p> <p>6. EPS: INVERTER sw - 2</p> <p>7. Key DEDA C 500R (0.1 fps). Monitor Δ Vgx.</p> <p>7A. ENG THR CONT: ENG ARM sw - OFF</p>	<p>S/C: AGS sw - ATT HOLD could be used to provide manual maneuver to desired attitude, then AGS sw - AUTO.</p> <p>Integral and numerics lighting are restored when inverter No. 2 is selected.</p>

**LMA790-3-LM**  
**APOLLO OPERATIONS HANDBOOK**

CREW-MAN	PNL	PROCEDURES	REMARKS
		<p>5.3.12.1 <u>To Abort (DPS Engine) (cont)</u></p> <p>8. To terminate burn when ΔVgx goes to zero: DES ENG CMD OVRD sw - OFF</p> <p>9. Delete</p> <p>10. Reconfigure.</p> <p>5.3.12.2 <u>To Abort (APS Engine)</u></p> <p>1. GUID CONT sw - AGS</p> <p>3. S/C: AGS sw - AUTO</p> <p>1. ABORT STAGE pb - push</p> <p>4. ENG THR CONT: ENG ARM sw - ASC</p> <p style="text-align: center;">CAUTION</p> <p>Do not set ENG THR CONT: BAL CFL sw - OFF.</p> <p>TTCA 5. THROTTLE/JETS cont (CDR) - JETS</p> <p>6. If ullage threshold counter is not set to zero: TTCA - move up until eng starts</p> <p>7. SUIT FAN sel - 2</p> <p>14. EPS: INVERTER sw - 2</p> <p>6. Key DEDA C 500R (0.1 fps). Monitor ΔVgx.</p> <p>10. Monitor thrust cutoff. If not cutoff: Eng STOP pb/lit - push</p> <p>11. Reconfigure.</p>	<p>Ref para 5.3.12.3.</p> <p>Manual start capability is lost. S/C: AGS sw must be in AUTO position and eng STOP pb/lit must be in reset position. There will be large attitude excursion when S/C: AGS sw - AUTO. Expect attitude transient at staging.</p> <p>Ref para 5.3.12.3.</p>

LM 2031, LM 3243.

**LMA790-3-LM**  
**APOLLO OPERATIONS HANDBOOK**

CREW-MAN	PNL	PROCEDURES	REMARKS
		<p>5.3.12.3 <u>Reconfigure</u></p> <p>1. ABORT/ABORT STAGE pb - reset</p> <p>2. ENG THR CONT: ENG ARM sw - OFF</p> <p>3. AUDIO: AUDIO CONT sw - BU</p> <p>4. AUDIO: S BAND T/R sw - S BAND T/R ICS T/R sw - ICS T/R MODE sw - ICS/PTT VHF A sw - T/R VHF B sw - RCY</p> <p>5. FRI EVAP FLOW #1 vlv - CLOSE Activate secondary glycol loop.</p> <p>6. Use VHF ranging &amp; track light for rendezvous.</p> <p>7. Eng STOP pb/lc - reset</p> <p>5.3.13 <u>LOSS OF LMP BUS DURING POWERED DESCENT</u></p>	<p>Ref para 4.13.1.4.</p> <p>Ref para 4.13.2.10.</p> <p>Symptom: DC BUS and AGS warn lt, and EPS: DC FEEDER FAULT comp caut lt - on.</p> <p>Assumption: Inverter No. 1 is used for DPS burn.</p> <p>Results: 100% DPS thrust, loss of AGS, loss of DPS/APS automatic start and stop capability. GDA locked, DES ENG CMD OVRD lost.</p>
		<p>5.3.13.1 <u>To Abort (DPS Engine)</u></p> <p>3 1. S/C: PCNS sw - AUTO</p> <p>1 2. ABORT pb - push</p> <p>3. If manual backup is desired or if inverter No. 2 is in use: ED: MASTER ARM sw - ON Eng START pb/lc - push</p>	<p>Must be accomplished immediately, to prevent undesirable attitude transient when DPS thrust goes to 100%. DPS will shut down and must be manually started if inverter No. 2 is in use.</p>

**LMA790-3-LM  
APOLLO OPERATIONS HANDBOOK**

CREW- MAN	PNL	PROCEDURES	REMARKS
		<p>5.3.13.1 <u>To Abort (DPS Engine) (cont)</u></p> <p>4. To terminate burn when TG &lt; 1 sec: Eng STOP pb/lt - push</p> <p>5. Reconfigure.</p> <p>5.3.13.2 <u>To Abort (APS Engine)</u></p> <p>1. S/C: PGNS sw - AUTO</p> <p>2. ABORT STAGE pb - push</p> <p>3. ENG THR CONT: ENG ARM sw - ASC</p> <p>4. Eng START pb/lt - push</p> <p>5. EPS: INVERTER sw - 1</p> <p>6. To terminate burn when TG &lt; 1 sec: Eng STOP pb/lt - push</p> <p>7. Reconfigure.</p> <p>5.3.13.3 <u>Reconfigure</u></p> <p>1. ENG THR CONT: ENG ARM sw - OFF</p> <p>2. ABORT/ABORT STAGE pb - reset</p> <p>3. UP DATA LINK sw - VOICE BU AUDIO: AUDIO CONT sw - BU COMM: S BAND XMTR/RCVR sw - SEC S BAND PWR AMPL sw - SEC S BAND VOICE sw - DN VOICE BU S BAND RANGE sw - OFF/RESET VHF A RCVR sw - ON VHF B XMTR sw - VOICE COMM ANT: S BAND sel - FWD or AFT</p>	<p>Ref para 5.3.13.3.</p> <p>Normal configuration.</p> <p>Ref para 5.3.13.3.</p> <p>Reacquire S-band.</p>
	5/6		
	3		
	1		
	5		
	14		
	5/6		
	1		
	12		

**LMA790-3-LM**  
**APOLLO OPERATIONS HANDBOOK**

CREW-MAN	PNL	PROCEDURES	REMARKS
	12	<p>5.3.13.3 <u>Reconfigure (cont.)</u></p> <p>4. AUDIO: S BAND T/R sw - S BAND T/R ICS T/R sw - ICS T/R MODE sw - ICS/PIT VHF A sw - RCV VHF B sw - T/R</p>	
	5/6	<p>5. Eng STOP pb/lt - reset</p>	
		<p>5.3.14 <u>EXTRAVEHICULAR TRANSFER (STAGED VEHICLE)</u></p>	
		<p>5.3.14.1 <u>Subsystem Preparation for Egress</u></p> <p>ECS Periodic Monitoring (Staged) (required) EPS Periodic Monitoring (Staged) (required) LGC Power-Down (P06) (required)</p>	<p>Assumptions: (1) Crewman cannot perform IVT, (2) OPS are on cabin floor, and (3) vehicle staged.</p>
CDR	11	<p>1. CB S/C: ATT DIR CONT - open</p>	Ref para 4.13.1.3
	8	<p>2. ED: MASTER ARM sw - ON</p>	Ref para 4.13.4.6
	3.	<p>3. ED: • STAGE sw - SAFE (guarded) LDC GEAR DEPLOY cb - bp</p>	Ref para 4.6.1.2
	1	<p>4. ENG THR CONT: ENG ARM sw - OFF GUID CONT sw - PGNS ABORT pb - reset ABORT STAGE pb - reset</p>	Assumption: CSM is controlling attitude. Switch is left on to inhibit spurious CWZA indications.
	3	<p>5. DES ENG CMD OVRD sw - OFF S/C: ROLL, PITCH, YAW sw - MODE CONT PGNS sw - OFF</p>	
	11	<p>6. CB RCS SYS A: QUAD 1, 2, 3, 4 TCA - open CB ED: LOGIC PWR A - open</p>	

**LMA790-3-LM**  
**APOLLO OPERATIONS HANDBOOK**

CREW- MAN	PNI	PROCEDURES	REMARKS
LMP	16	<p>5.3.14.1 <u>Subsystem Preparation for Egress (cont)</u></p> <p>CB S/C: ABORT STAGE - open CB PGNS: LGC/DSKY - open</p> <p>7. CB RCS SYS B: QUAD 1, 2, 3, 4 TCA - open CB ED: LOGIC PWR B - open CB S/C: ABORT STAGE - open CB LTG: TRACK - open</p> <p>5.3.14.2 <u>Final Subsystem Preparation for EVT</u></p> <p>1. CB ECS: CABIN FAN - open</p> <p>2. CB ECS: LCG PUMP - open</p> <p>3. LTG: EXTERIOR LTG sw - OFF</p>	



**LMA790-3-LM**  
**APOLLO OPERATIONS HANDBOOK**

PARA	TITLE	PAGE
5.4	Contingency Management Procedures . . . . .	5.4-2
5.4.1	EPS Prestaging Check - Lunar Contingency (One Ascent Battery only) . . . . .	5.4-2
5.4.2	PLSS Makeup to LM Suit Loop via PGA Interface . . . . .	5.4-3
5.4.3	PLSS O2 Transfer to LM Suit Loop via Manifold . . . . .	5.4-4
5.4.4	PLSS H2O Transfer to LM Sublimator . . . . .	5.4-4
5.4.5	ARS Configuration for use of CM LiOH Cartridges . . . . .	5.4-5
5.4.6	AGS Passive Thermal Control (PTC) for LM/CM Configuration . . . . .	5.4-6
5.4.7	AGS Passive Thermal Control (PTC) for LM/CSM Configuration . . . . .	5.4-8
5.4.8	PGNCS Passive Thermal Control (PTC) for LM/CSM Configuration . . . . .	5.4-9
5.4.9	LM Staging While Docked with CM only . . . . .	5.4-11
5.4.10	LM/LGC-Controlled Spin Stabilization of CM . . . . .	5.4-13
5.4.11	LM/AGS-Controlled Spin Stabilization of CM . . . . .	5.4-14
5.4.12	Minimizing DPS Supercritical Helium Pressure Rise at Start of Burn . . . . .	5.4-15
5.4.12A	DPS Supercritical Helium Venting (Zero G, Docked Only). Deleted	5.4-16
5.4.13	Deleted	
5.4.14	DPS Supercritical Helium Vent During a Burn . . . . .	5.4-17
5.4.15	Loss of Both Ascent H2O Tanks . . . . .	5.4-19
5.4.16	Loss of Both Ascent O2 Tanks . . . . .	5.4-20
5.4.17	Loss of Both Press Regs (Failed Closed) . . . . .	5.4-21
5.4.18	Loss of Both Suit Fans . . . . .	5.4-22
5.4.19	Optimization of APS Helium Manifold Leak . . . . .	5.4-23
5.4.20	Ascent Stage Oxygen Tank Bleed-Down Procedure . . . . .	5.4-24A
5.4.21	Ascent Stage Oxygen Tank Top-Off Procedure . . . . .	5.4-24B
5.4.22	Descent O2 Venting . . . . .	5.4-24B
5.4-23	Loss of Manual and Auto APS Start Capability . . . . .	5.4-25
5.4-24	Loss of Manual and Auto APS Start Capability (with loss of one bus) . . . . .	5.4-31
5.4-25	Loss of ED Sub-system . . . . .	5.4-35

**LMA790-3-LM**  
**APOLLO OPERATIONS HANDBOOK**

CREW-MAN	PNI	PROCEDURES	REMARKS
		<p>5.4 <u>CONTINGENCY MANAGEMENT PROCEDURES</u></p> <p>5.4.1 <u>EPS PRESTAGING CHECK - LUNAR CONTINGENCY (ONE ASCENT BATTERY ONLY)</u></p> <p style="text-align: center;">CAUTION</p> <p>Thirty minutes before lunar launch, usable ascent battery must be placed on-line, on both normal &amp; backup feed paths. Descent batteries No. 1 &amp; 3 must be removed from line &amp; CB EPS: CROSS TIE BAL LOADS (2) opened at this time.</p> <p>1. EPS: POWER/TEMP MON sel - good BAT 5 (6) VOLTS ind - 31.5 to 37.2 volts BAT 5 (6) NORMAL SE (CDR) FEED sw - ON; tb - gray BAT 5 (6) BACK UP CDR (SE) FEED sw - ON; tb - gray VOLTS ind - 28.0 to 32.5 volts AMPS ind - TBD</p> <p>2. EPS: SE BAT 1 HI VOLT sw - OFF/RESET; tb - bp CDR BAT 3 HI VOLT sw - OFF/RESET; tb - bp</p> <p>3. CB EPS: CROSS TIE BAL LOADS - open</p> <p style="text-align: center;">CAUTION</p> <p>Twenty minutes before lunar launch, descent battery No. 2 must be removed from line. Final IMU alignment must not take place before removal of this battery.</p>	<p>Contingency management procedures provide "life-boat" support for the CSM, and long-term operation during a nonnominal vehicle situation.</p> <p style="text-align: right;">Ref para 4.9.3.1.</p>
LMP	14		
LMP	16		

**LMA790-3-LM**  
**APOLLO OPERATIONS HANDBOOK**

LM 3211

CREW-MAN	PNL	PROCEDURES	REMARKS
LMP	14	<p>5.4.1 <u>EPS PRESTAGING CHECK - LUNAR CONTINGENCY (ONE ASCENT BATTERY ONLY) (cont)</u></p> <p>4. EPS: SE BAT 2 HI VOLT sw - OFF/RESET; tb - bp</p> <p style="text-align: center;">CAUTION</p> <p>Seven minutes before lunar launch, descent battery No. 4 must be re-moved from line.</p> <p>5. EPS: CDR BAT 4 HI VOLT sw - OFF/RESET; tb - bp</p> <p>5.4.2 <u>FLSS MAKEUP TO LM SUIT LOOP VIA PGA INTERFACE</u></p>	<p>If unexpected transient occurs, torquing procedure (para 4.9.1.4 or 4.9.3.1) may be required at this time to re-align IMU.</p> <p>Procedure could provide 2.11 pounds of oxygen for -6 FLSS; 3.18 pounds for -7 FLSS.</p> <p>Assumptions: (1) Cabin is depressurized, (2) LM 02 is depleted, or (3) LM 02 must be conserved.</p>
	ECS	<p>1. Verify LM configured for egress mode: PRESS REG A &amp; B vlv's, EGRESS SUIT GAS DIVERTER vlv - FULL EGRESS CABIN GAS RETURN vlv - EGRESS SUIT ISOL vlv (CDR) - SUIT FLOW SUIT ISOL vlv (LMP) - SUIT FLOW CB ECS: CABIN FAN - open CB ECS: CABIN REPRESS - open LM 02 umbilicals connected to PGA (red to red, blue to blue).</p> <p>2. Don FLSS.</p> <p>3. Connect FLSS 02 hoses to PGA (red to red, blue to blue).</p>	
	11 16		
	FLSS	<p>4. PRIM 02 SHUTOFF vlv - LOCKED ON (aft)</p>	
	ECS	<p>5. DES 02 vlv - CLOSE</p>	
		<p>6. #1 ASC 02 vlv - CLOSE</p>	
		<p>7. #2 ASC 02 vlv - CLOSE</p>	
		<p>8. FLSS FILL vlv - CLOSE</p>	
		<p>9. PRESS REG A vlv - CLOSE</p>	
		<p>10. PRESS REG B vlv - CLOSE</p>	

**LMA790-3-LM**  
**APOLLO OPERATIONS HANDBOOK**

CREW-MAN	PMS	PROCEDURES	REMARKS
		<p>5.4.3 <u>PLSS O2 TRANSFER TO LM SUIT LOOP VIA MANIFOLD</u></p> <ol style="list-style-type: none"> <li>1. Open PLSS thermal insulation flap to expose O2 fill fitting. Remove dust cap.</li> <li>2. Unatow LM O2 recharge hose, remove dust cap, &amp; connect hose to PLSS O2 fill fitting.</li> <li>3. Don helmets &amp; gloves.</li> <li>4. SUIT GAS DIVERTER vlv - PUSH CABIN PRESS REG A &amp; B vlvs - CABIN CABIN REPRESS vlv - CLOSE CABIN GAS RETURN vlv - AUTO SUIT CIRCUIT RELIEF vlv - AUTO #1 &amp; #2 ASC O2 vlvs - CLOSE DES O2 vlv - CLOSE</li> <li>5. PLSS FILL vlv - OPEN</li> <li>6. Upon MSFN direction: PLSS FILL vlv - CLOSE</li> <li>7. Disconnect LM O2 recharge hose from PLSS O2 fill fitting &amp; install dust caps.</li> <li>8. Stow O2 recharge hose &amp; secure PLSS flap.</li> </ol> <p>5.4.4 <u>PLSS H2O TRANSFER TO LM SUBLIMATOR</u></p> <ol style="list-style-type: none"> <li>1. H2O SHUTOFF AND RELIEF vlv - CLOSED (fwd)</li> <li>2. Open PLSS thermal insulation flap to expose H2O fill &amp; drain fittings.</li> <li>3. Remove PLSS H2O drain fitting dust cap.</li> </ol>	<p>Extra oxygen provided by this procedure would be 2.11 pounds for -6 PLSS and 3.18 pounds for -7 PLSS.</p> <p>If PLSS H2O is to be expelled by PLSS O2, do not allow PLSS O2 quantity to decrease below 5% (approx 150 psia).</p> <p>MSFN monitors PLSS O2 pressure (GT8182P/GT8282P) to determine when PLSS O2 is depleted. MSFN can also monitor manifold pressure (GF3589P) to determine when PLSS O2 is depleted.</p> <p>Amount of extra water provided by this procedure would be 16.8 pounds for -6 PLSS and 21.6 pounds for -7 PLSS.</p>

**LMA790-3-LM  
APOLLO OPERATIONS HANDBOOK**

CREW MAN	PNL	PROCEDURES	REMARKS
		<p>5.4.4 <u>PLSS H2O TRANSFER TO LM SUBLIMATOR (cont)</u></p> <p>4. Vent PLSS H2O drain connector to cabin ambient, using connector from small urine collection assembly.</p> <p>5. When ECS: H2O QUANTITY ind readings are 10%, proceed to next step.</p> <p>6. ASC H2O vlv - CLOSE DES H2O vlv - CLOSE</p> <p>7. Unstow LM H2O recharge hose &amp; disconnect H2O dispenser.</p> <p>8. Remove dust cap from PLSS H2O fill fitting &amp; connect LM H2O recharge hose.</p> <p>9. ASC H2O vlv - OPEN When it has been determined (on signal from MSFN) that PLSS feedwater is near depletion, proceed with next step.</p> <p>10. ASC H2O vlv - CLOSE</p> <p>11. Disconnect LM H2O recharge hose from PLSS H2O fill fitting &amp; install dust cap.</p> <p>12. Remove venting connector from PLSS H2O drain connector &amp; install dust cap.</p> <p>13. Secure PLSS.</p> <p>14. Repeat steps 1 through 13 for second PLSS.</p> <p>15. Connect H2O dispenser to LM H2O recharge hose &amp; stow.</p>	<p>Hole must be cut into bag to vent cabin ambient.</p>

RC 1606

Basic Date 26 September 1971

Change Date \_\_\_\_\_

**LMA790-3-LM  
APOLLO OPERATIONS HANDBOOK**

EC 1606, LM 3247

CREW-MAN	PNL	PROCEDURES	REMARKS
	2	<p><u>5.4.5 ABS CONFIGURATION FOR USE OF CM L10H CARTRIDGES</u></p> <ol style="list-style-type: none"> <li>1. SUIT FAN sel - 1</li> <li>2. CO2 CANISTER SEL vlv - SEC (secondary cartridge removed)</li> <li>3. SUIT ISOL vlv (CDR &amp; LMP) - SUIT DISC</li> <li>4. SUIT GAS DIVERTER vlv - PULL EGRESS</li> <li>5. CABIN GAS RETURN vlv - EGRESS</li> <li>6. SUIT CIRCUIT RELIEF vlv - CLOSE</li> <li>7. Attach both LM O2 return (red) hoses to CM L10H cartridge adapters.</li> <li>8. Tape closed approx one-half of opening of each LM O2 supply (blue) hose.</li> <li>9. Position L10H cartridge adapters to preclude obstructing crew activities.</li> <li>10. Position LM O2 supply (blue) hoses to obtain desired direction of flow.</li> <li>11. SUIT ISOL vlv (CDR &amp; LMP) - SUIT FLOW</li> </ol>	<p>Assumptions: (1) CM and LM are docked, (2) LM L10H cartridges are expended, (3) CM L10H cartridges and adapters are available, and (4) LM O2 hoses are disconnected from PGA's.</p> <p>See figure 5-1.</p> <p>Simulates suit pressure drop.</p>

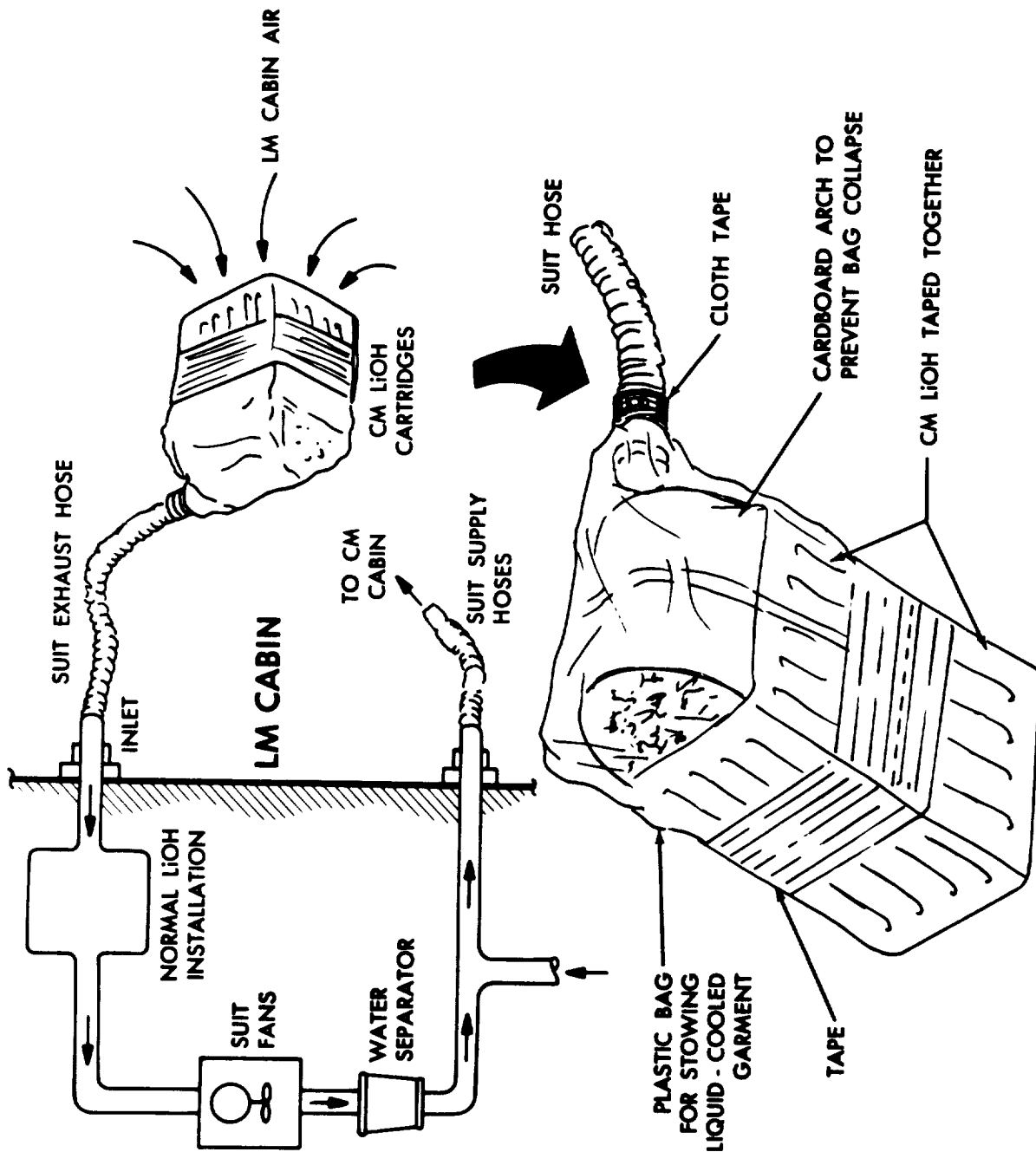

300UM8-2060

Figure 5-1. Supplemental Carbon Dioxide Removal System

**LMA790-3-LM  
APOLLO OPERATIONS HANDBOOK**

LM 3247

CREW/ MAN	PNI	PROCEDURES	REMARKS
		<p><b>5.4.6</b> <u>AGS PASSIVE THERMAL CONTROL (PTC) FOR LM/CH CONFIGURATION</u></p> <p>Appropriate subsystem activation</p> <p>AGS Power-Up (required)</p> <p>AGS Checkout (desired)</p> <p>AGS Alignment (required)</p>	<p>Procedure documents necessary steps for AGS-controlled PTC mode of LM/CH configuration.</p> <p>Determined by real time conditions</p> <p>Ref para 4.6.2.1.</p> <p>Ref para 4.6.2.4.</p> <p>Ref para 4.9.2. Any alignment may be used; i.e., body-axis alignment. Body-axis realignment at initial PTC attitude (step 3) may be desirable.</p> <p>Ref para 4.5.3.3 and 4.5.3.5.</p>
1,2		<p>1. Establish AGS total attitude &amp; attitude rate displays: ATTITUDE MON sw - AGS ORDEAL: FDAL 1 sw - INRTL FDAL 2 sw - INRTL RATE/ERR MON sw - LDG RDR/CRPTR RATE SCALE sw - 5°/SEC</p>	
1,2 1		<p>2. Configure for control mode: S/C: AGS sw - ATT HOLD ROLL, PITCH, YAW sw - MODE CONT DEAD BAND sw - MAX GUID CONT sw - AGS ENG THR CONT: BAL CFL sw - ON ATT/TRANSL sw - 2 JETS</p>	
3		<p>3. Maneuver via ACA to initial PTC attitude. S/C: ROLL, PITCH, YAW sw - MODE CONT</p>	
1		<p>4. Allow AGS to limit cycle for approx 20 min, then: S/C: ROLL, PITCH, YAW sw - PULSE</p>	<p>Provides automatic damping.</p>
ACA		<p>5. ACA - YAW for approx 2 sec (0.3°/sec)</p>	<p>Time depends on vehicle weight.</p>
		<p><b>5.4.7</b> <u>AGS PASSIVE THERMAL CONTROL (PTC) FOR LM/CSM CONFIGURATION</u></p> <p>Appropriate subsystem activation</p>	<p>Procedure documents necessary steps for AGS-controlled PTC mode of LM/CSM configuration.</p> <p>Determined by real time conditions</p>



**LMA790-3-LM**  
**APOLLO OPERATIONS HANDBOOK**

LM 324/

CREW-MAN	PNI	PROCEDURES	REMARKS
		<p>5.4.7 <u>AGS PASSIVE THERMAL CONTROL (PTC) FOR LM/CSM CONFIGURATION (cont)</u></p> <p>AGS Power-Up (required)</p> <p>AGS Checkout (desired)</p> <p>AGS Alignment (required)</p> <p>1. Establish AGS total attitude &amp; attitude rate displays: ATTITUDE MON sw - AGS ORDEAL:   FDAI 1 sw - INKTL   FDAI 2 sw - INKTL   RATE/SER MON sw - LDG MON/CMPT   RATE SCALE sw - 5°/SEC</p> <p>2. Configure for control mode: S/C:   ROLL, PITCH, YAW sw - PULSE   AGS sw - ATT HOLD   GUID CONT sw - AGS   ENG THR CONT:     BAL CFL sw - ON     ATT/TRANSL sw - 2 JETS   S/C: DEAD BAND sw - MIN   THROTTLE/JETS cont (CDR &amp; LMP) - JETS</p> <p>3. Maneuver via TTCA to initial PTC attitude. ACA - out of detent (momentarily) S/C: YAW sw - MODE COMT</p> <p>4. After vehicle rates become &lt;0.05°/sec: S/C: YAW sw - PULSE</p> <p>5. ACA - YAW for approx 2 sec (0.3°/sec)</p>	<p>Ref para 4.6.2.1.</p> <p>Ref para 4.6.2.4.</p> <p>Ref para 4.9.2. Any alignment may be used; i.e., body-axis alignment. Body-axis realignment at initial PTC attitude (step 4) may be desirable.</p> <p>Ref para 4.5.3.3 and 4.5.3.5.</p> <p>Rates may be determined by use of starfield in COAS or AOT fields of view or FDAI error needles appearing motionless.</p> <p>Time depends on vehicle weight.</p> <p>If CSM is unable to use SH RCS jets, this procedure may be used to initiate PTC mode.</p>
		<p>5.4.8 <u>PGNCS PASSIVE THERMAL CONTROL (PTC) FOR LM/CSM CONFIGURATION</u></p>	

**LMA790-3-LM**  
**APOLLO OPERATIONS HANDBOOK**

LM 3207, LM 3241

CREW- MAN	PROCEDURES	REMARKS
	<p><u>5.4.8 PGNS PASSIVE THERMAL CONTROL (PTC) FOR LH/GSM CONFIGURATION (cont)</u></p> <p>Appropriate subsystem activation</p> <p>LGC Power-Up (required)</p> <p>IMU Power-Up (LGC Operating) (required)</p> <p>IMU Alignment (required)</p> <p>DAP Data Load Routine (R03) (required)</p> <p>Establish PGNS total attitude &amp; attitude rate displays: ATTITUDE MON sw - PGNS ORDEAL:</p> <p>FDAL 1 sw - INKTL FDAL 2 sw - INKTL</p> <p>RATE/ERR MON sw - LDG RDR/CHPTR Key V60E RATE SCALE sw - 5°/SEC</p> <p>GUID CONT sw - PGNS S/C: ROLL, PITCH, YAW sw - MODE CONT PGNS sw - ATT HOLD Key V76E</p> <p>Maneuver via ITCA to PTC attitude.</p> <p>S/C: PGNS sw - AUTO Wait 10 min</p> <p>Key V25 N07E Key 1257E Key 252E Verify RCS: SYS A &amp; SYS B QUADswitches are set to ENABLE. Key 1E</p> <p>Establish new reference: a. Key V77E NO DAP It - off or b. S/C: PGNS sw - ATT HOLD, then AUTO</p>	<p>Determined by real time conditions</p> <p>Ref para 4.6.1.1.1.</p> <p>Ref para 4.6.1.1.3.</p> <p>Any IMU alignment will suffice; i.e., crescent alignment. (Ref para 4.9.1.6.)</p> <p>Ref para 4.6.1.8.</p> <p>Ref para 4.5.3.1, 4.5.3.2, and 4.5.3.5.</p> <p>PGNS attitude rates on error needles.</p> <p>Sets up LGC control mode for manual maneuver to initiate PTC attitude.</p> <p>MSFN can also determine vehicle rates.</p> <p>Prepares for disabling of downward firing RCS jets, which will reduce LGC jet-control authority.</p> <p>Next step will reduce deadband. This step ensures that vehicle will not be outside deadband, by establishing new reference.</p>
1,2	1.	
1,2	1,2	
1	1	
1 3	1 3	
	3.	
	4.	
	5.	
	6.	

**LMA790-3-LM**  
**APOLLO OPERATIONS HANDBOOK**

CREW-MAN	PNL	PROCEDURES	REMARKS
		<p>5.4.8 <u>PGNS PASSIVE THERMAL CONTROL (PTC) FOR LM/CSM CONFIGURATION (cont)</u></p> <p>7. Key V48E FL V06 N46 - DAP configuration Key V21E, 2X1XE Key PRO FL V06 N47 - Vehicle weights Key V34E</p> <p>8. Wait 15 min.</p> <p>9. Alternative PTC procedures: a. Manual: Key V76E NO DAP lt - on S/C: PGNS sw - ATT HOLD Yaw right approx 30 pulses</p> <p>b. Erasable memory programmed: Key V72E - Scatter E-memory update FL V21 N01 - Load number of DSKY loads Key 5E FL V21 N01 - Load address Key 3237E FL V21 N01 - Load value Key 77775E FL V21 N01 - Load address Key 3242E FL V21 N01 - Load value Key 0015E FL V21 N02 Key V33 - Jet activity begins when ENTR pb is keyed. S/C: PGNS sw - ATT HOLD Key V76E NO DAP lt - on</p> <p>5.4.9 <u>LM STAGING WHILE DOCKED WITH CM ONLY</u></p> <p>Appropriate subsystem activation</p>	<p>Step 7, when completed, transfers jet-failure data into DAP phase plane structure.</p> <p>Sets up LGC minimum impulse mode. Initiates vehicle rates of approximately 0.3°/second. Number of pulses depends on vehicle weight.</p> <p>E6 1637 in Luminary IE. Approximately 0.3°/second rate of change of CDU angle (DELCDUX).</p> <p>E6 1642 = P (yaw) axis desired attitude maneuver rate per Luminary IE. 0.3°/second rate.</p> <p>Prevents DAP firings after PTC is initiated.</p> <p>Purpose of LM Staging While Docked With CM Only procedure is to prepare for spin stabilization of CM via LM before reentry in contingency situation. Determined by real time conditions</p>

**LMA790-3-LM**  
**APOLLO OPERATIONS HANDBOOK**

LM 910B

CREW-MAN	P/NL	PROCEDURES	REMARKS
		<p>5.4.9 LM STAGING WHILE DOCKED WITH CH ONLY (cont)</p> <p>AGS Power-Up (required)</p> <p>AEA Self-Test (desired)</p> <p>LGC Power-Up (desired)</p> <p>LGC Self-Test (desired)</p> <p>IMU Power-Up (LGC Operating) (desired)</p> <p>MSFN update, applicable REFSMAT and state vector (required)</p> <p>EPS Prestaging Check (required)</p> <p>ED Prestaging Check (required)</p> <p>ECS Prestaging Check (required)</p> <p>DAP Data Load (RO3) (required if PGNS up)</p> <p>1. Select attitude control: GUID CONT sw - AGS S/C: ROLL, PITCH, YAW sw - MODE CONT AGS sw - AIT HOLD PGNS sw - AIT HOLD DEAD BAND sw - MIN</p> <p>2. Enable ACA/TTCA: TTCA/TRANSL sw (CDR &amp; LMP) - ENABLE THROTTLE/JETS cont (CDR &amp; LMP) - JETS ENG THR CONT: BAL CFL sw - ON ATT/TRANSL sw - 4 JETS ACA PROP sw - ENABLE</p> <p>3. Select attitude/attitude error display: ATTITUDE MON sw - AGS RATE/ERR MON sw - LDG RDR/CHPTR</p> <p>4. ACA - maneuver to staging attitude</p>	<p>Ref para 4.6.2.1.</p> <p>Ref para 4.6.2.3.</p> <p>Ref para 4.6.1.1.</p> <p>Ref para 4.6.1.13.</p> <p>Ref para 4.6.1.3.</p> <p>Ref para 4.6.1.7.</p> <p>Ref para 4.12.5.</p> <p>Ref para 4.12.6.</p> <p>Ref para 4.12.7.</p> <p>Ref para 4.6.1.8.</p> <p>AGS control avoids problems associated with DAP settings at staging.</p> <p>Ref para 4.5.2.5.</p>

LMA790-3-LM  
 APOLLO OPERATIONS HANDBOOK

CREW-MAN	PNL	PROCEDURES	REMARKS
LM		5.4.9 LM STAGING WHILE DOCKED WITH CM ONLY (cont)	
14		5. EPS: SE BAT 1 HI VOLT sw - OFF/RESET; tb - bp SE BAT 2 HI VOLT sw - OFF/RESET; tb - bp CDR BAT 3 HI VOLT sw - OFF/RESET; tb - bp CDR BAT 4 HI VOLT sw - OFF/RESET; tb - bp DES BATS sw - DEADFACE; tb - bp	
1		6. Set EVNT TMR ind. 7. Select Thrust Monitor Program: Key V37E 47E	
8.		FL V16 N83 - ΔV (LM) R1 X XXX.X fps R2 Y XXX.X fps R3 Z XXX.X fps	
9.		Call VDX: Key DEDA C 404+00000E C 405+00000E C 406+00000E C 470R	
ACA		10. ACA - out of detent	
8		11. ED: MASTER ARM sw - ON	
1		12. When EVNT TMR ind - 00:00:	
TTCA		TTCA - move down & hold When ΔVX = -0.3 to -0.5 fps: TTCA - center ED: STAGE sw - FIRE TTCA - move up & hold When ΔVX = 0: TTCA - center	Zeroes error needles.
11		13. CB ED: LOGIC PWR A - open	
16		CB ED: LOGIC PWR B - open	
14.		Key PRO or V34E to terminate ΔV monitoring FL V37 H— Key XKE, exit P47	

LMA790-3-LM  
 APOLLO OPERATIONS HANDBOOK

LM 3247

CREW- MAN	P/NL	PROCEDURES	REMARKS
		<p>5.4.10 <u>LM/LGC-CONTROLLED SPIN STABILIZATION OF CM</u></p> <p>Appropriate subsystem activation</p> <p>LGC Power-Up (required)</p> <p>IMU Power-Up (LGC Operating) (required)</p> <p>DAP Data Load Routine (R03) (required)</p> <p>1. Establish total attitude &amp; attitude rate displays:                      ATTITUDE MON sw - PCNS                      ORDEAL:                          FDAI 1 sw - INRTL                          FDAI 2 sw - INRTL                      RATE SCALE sw - 25°/SEC</p> <p>2. GUID CONT sw - PCNS                      S/C: PCNS sw - ATT HOLD                      Key V77E                      NO DAP lt - off</p> <p>3. Key V72E - Scatter E-memory update                      FL V21 N01 - Load number of DSKY loads                      Key 5E                      FL V21 N01 - Load address                      Key 3237E                      FL V21 N01 - Load value                      Key 77511E                      FL V21 N01 - Load address                      Key 3242E                      FL V21 N01 - Load value of desired rate                      Key 16162E                      FL V21 N02                      Key V33 - Jet activity commences when ENTR is keyed.</p>	<p>Procedure documents DSKY procedure for implementing LGC-controlled spin (20°/second) about LM X-axis.                      Assumptions: (1) SM has been staged, (2) LM has been staged (ref para TBD), and (3) LM and CM are stowed.</p> <p>Determined by real time conditions</p> <p>Ref para 4.6.1.1.</p> <p>Ref para 4.6.1.3.</p> <p>Ref para 4.6.1.8.</p> <p>N46                      R1 - 3XXX                      N47                      R1 = 14,462 pounds (minimum)                      R2 = actual weight</p> <p>Ref para 4.5.3.1 and 4.5.3.5.</p> <p>E6 1637 in Luminary 1E.</p> <p>E1642 = P (Yaw) axis desired attitude maneuver rate per Luminary 1E.</p> <p>Do not use ACA or DSKY after ENTR, because of possibility of LGC stopping rate.</p>

**LMA790-3-LM**  
**APOLLO OPERATIONS HANDBOOK**

CREW-MAN	PNL	PROCEDURES	REMARKS
		<p>5.4.10 <u>LM/LGC-CONTROLLED STABILIZATION OF CM (cont)</u></p> <p>4. Crew transfer to CM.</p> <p>5.4.11 <u>LM/AGS-CONTROLLED SPIN STABILIZATION OF CM</u></p> <p>Appropriate subsystem activation</p> <p>AGS Power-Up (required)</p> <p>AGS Checkout (desired)</p>	<p>Procedure documents method of implementing manual (AGS) 20°/second spin about LM X-axis.</p> <p>Determined by real time conditions</p> <p>Ref para 4.6.2.1.</p> <p>Ref para 4.6.2.4.</p>

LM





**LMA790-3-LM**  
**APOLLO OPERATIONS HANDBOOK**

CREW-MAN	PNL	PROCEDURES	REMARKS
		<p>LM 2040A</p> <p>5.4.11 <u>LM/AGS-CONTROLLED SPIN STABILIZATION OF CM (cont)</u></p> <p>1. S/C: YAW sw - DIR PITCH, ROLL sw - MODE CONT AGS sw - ATT HOLD RATE SCALE sw - 25°/SEC GUID CONT sw - AGS</p> <p>2. ACA - Yaw until 20°/sec attained</p> <p>3. Crew transfer to CM.</p> <p>5.4.12 <u>MINIMIZING DPS SUPERCRITICAL HELIUM PRESSURE RISE AT START OF BURN</u></p> <p>NOTE</p> <p>Add to any DPS thrusting procedure or powered descent.</p> <p>1. MPS: Initiate burn without ambient DPS pressurization if first burn.</p> <p>2. DES He REG 2 sw - OPEN; tb - gray</p> <p>3. Five seconds after ignition, vent SHe through vent valves: ED: MASTER ARM sw - ON DES VENT sw - FIRE MASTER ARM sw - OFF</p> <p>4. DES PROPUL: OXID VENT sw - OPEN; tb - gray FUEL VENT sw - OPEN; tb - gray</p> <p>5. When MPS: HELIUM ind - SHe press decreasing or after five seconds of venting (whichever is longer) DES PROPUL: OXID VENT sw - CLOSE; tb - bp FUEL VENT sw - CLOSE; tb - bp</p>	<p>This procedure is required if DPS supercritical helium (SHe) pressure exceeds 1700 psia at start of burn. Procedure prevents SHe burst disk from blowing shortly after start of burn and resultant complete loss of SHe.</p> <p>Ref para 4.2.29.</p> <p>Possible MASTER ALARM when ED: MASTER ARM sw - OFF, due to relay race removing CMEA inhibit.</p>

**LMA790-3-LM**  
**APOLLO OPERATIONS HANDBOOK**

LM 2020A

CREW-MAN	PNI	PROCEDURES	REMARKS
		<p>5.4.12 <u>MINIMIZING DPS SUPERCRITICAL HELIUM PRESSURE RISE AT START OF BURN (cont)</u></p>	
	1	6. DES He REG 2 sw - CLOSE; tb - bp	
		5.4.12A <u>DPS SUPERCRITICAL HE VENTING (ZERO G, DOCKED ONLY)</u>	
	1	1. GUID CONT sw - ACS	<p>This procedure is required if supercritical helium (SHe) pressure exceeds SHe burst disc range (1881 to 1967 psia) or fracture-mechanics limits as defined in SODR. Assumptions: (1) SHe squib has been blown, since pressure should never reach this high pressure case unless DPS has been burned and (2) RCS has also been pressurized, since there should have been at least one DPS burn.</p>
	3	2. S/C: ROLL, PITCH, YAW sw - PULSE DEADBAND sw - MAX ACS sw - ATT HOLD	<p>A+1°/sec pitch rate is established to settle DPS propellant to assure a gaseous vent. Rate will be maintained for 1 minute prior to venting to assure settling.</p>
		3. Establish +1°/sec pitch rate via ITCA (use +Z translation). Wait 1 min.	
		4. Controls - MPS Basic (Unstaged)	Ref para 4.13.3.1.
	1	5. DES He REG 1 sw - CLOSE; tb - bp	ULLAGE is to be vented without SHe flow.
	8	6. DES PROPUL: OXID VENT sw - OPEN; tb - gray FUEL VENT sw - OPEN; tb - gray	
		7. ED: MASTER ARM sw - ON DES VENT sw - FIRE MASTER ARM sw - OFF	<p>Possible MASTER ALARM when ED; MASTER ARM sw - OFF. During venting, PITCH rate will increase.</p>
	1	8. MPS: FUEL/OXID PRESS ind - verify ULLAGE press decreasing. When FUEL/OXID PRESS ind - 30 psia DES PROPUL:	<p>Vent termination SHe pressure is a function of several variables; MSFN must provide this data.</p>

**LMA790-3-LM**  
**APOLLO OPERATIONS HANDBOOK**

LM 2020A

CREW- MAN	PNL	PROCEDURES	REMARKS
		<p>5.4.12A <u>DPS SUPERCRITICAL HE VENTING (ZERO G, DOCKED ONLY)</u> (cont)</p> <p>FUEL VENT sw - CLOSE; tb - bp            OXID VENT sw - CLOSE; tb - bp</p> <p>9. DES He REG 1 sw - OPEN; tb - gray            DES He REG 2 sw - OPEN; tb - gray</p> <p>10. Null out Pitch Rate via ITCA            S/C: BOLL, PITCH, YAW sw - as desired</p> <p>5.4.13 Deleted</p>	<p>She is vented into propellant tanks. Can be verified by increasing ullage pressures. Should ullage pressure minus reg outlet press exceed 3 psi, the crew may be requested by MSFN to cycle open the FUEL and OXID VENT valves.</p>

**LMA790-3-LM  
APOLLO OPERATIONS HANDBOOK**

LM 2020A

CREW-MAN	PML	PROCEDURES	REMARKS
		<p><u>5.4.14 DPS SUPERCRITICAL HELIUM VENT DURING A BURN</u></p> <p style="text-align: center;">NOTE</p> <p>Assumes normal activation for a DPS burn (either 30 min or 2 hr).</p> <p>Add to any DPS thrusting procedure.</p> <p>1. MPS: Initiate burn without ambient DPS pressurization if first burn.</p> <p>2. DES He REG 2 sw - OPEN; tb - gray</p> <p>3. Five sec. after ignition, vent SHE through vent valves: ED: MASTER ARM sw - ON DES VENT sw - FIRE MASTER ARM sw - OFF</p> <p>4. DES PROPUL: OXID VENT sw - OPEN; tb - gray FUEL VENT sw - OPEN; tb - gray</p> <p>5. After 10D sec of venting SHE - DES PROPUL: OXID VENT sw - CLOSE; tb - bp FUEL VENT sw - CLOSE; tb - bp DES He REG 1 sw - CLOSE; tb - bp DES He REG 2 sw - CLOSE; tb - bp</p> <p>6. Stop burn no less than five seconds from termination of vent.</p>	<p>This procedure is required for any critical burn if the projected supercritical helium (SHe) pressure rise rate causes SHe pressure to exceed 1800 psi prior to that critical burn</p> <p>A 10 percent throttle setting should be used for burn.</p> <p>Ref para 4.2.31.</p> <p>Possible MASTER ALARM when ED: MASTER ARM sw - OFF, due to relay race removing CMEA inhibit</p> <p>Time of vent will be supplied by MSPN (every 5 sec - 1 lb. SHe).</p> <p>The DES REG SOVS are closed to prevent freezing the Fuel/He Heat Exchanger, should the vent valves take a while to fully seat.</p>

**LMA790-3-LM**  
**APOLLO OPERATIONS HANDBOOK**

LM 26-114

CREW MAN	PNL	PROCEDURES	REMARKS
		<p>5.4.15 <u>LOSS OF BOTH ASCENT H2O TANKS</u></p> <ol style="list-style-type: none"> <li>1. Lunar stay - no action required</li> <li>2. Preparation for lift-off - ECS Basic (Staged), except:               <ol style="list-style-type: none"> <li>a. Fill drink bags with descent water</li> <li>b. At lift-off -1 hour, activate secondary glycol loop:                   <ul style="list-style-type: none"> <li>CB ECS: GLYCOL PUMP SEC - close</li> <li>PRI EVAP FLOW #2 vlv - OPEN</li> <li>SEC EVAP FLOW vlv - OPEN</li> <li>LIQUID GARMENT COOLING vlv - COLD</li> <li>WATER TANK SELECT vlv - DES</li> </ul> </li> <li>c. Just before lift-off:                   <ul style="list-style-type: none"> <li>LIQUID GARMENT COOLING vlv - HOT</li> </ul> </li> </ol> </li> <li>3. Ascent -               <ol style="list-style-type: none"> <li>a. Insertion:                   <ul style="list-style-type: none"> <li>Perform normal insertion</li> </ul> </li> <li>b. Post insertion:                   <ul style="list-style-type: none"> <li>(1) PRI EVAP FLOW #1 &amp; #2 vlv - CLOSE</li> <li>(2) SEC EVAP FLOW vlv - CLOSE</li> <li>(3) Doff Helmets &amp; gloves</li> <li>(4) PRESS REG A &amp; B vlv - CABIN</li> <li>(5) CABIN GAS RETURN vlv - AUTO</li> </ul> </li> </ol> </li> </ol>	<p>This procedure provides for crew and spacecraft thermal control in event that both ascent H2O tanks are lost.</p> <p>Ref para 4.13.1.1.1.</p> <p>Ref para 4.13.1.1.4.</p> <p>Use as required.</p> <p>Water separator is now dead-headed. When H2O SEP comp caut lt - on, switch to other separator.</p>

**LMA790-3-LM**  
**APOLLO OPERATIONS HANDBOOK**

CREW-MAN	PANEL	PROCEDURES	REMARKS
	2	<p><u>5.4.15 LOSS OF BOTH ASCENT H2O TANKS (cont)</u></p> <p>(6) SUIT GAS DIVERTER vlv - PUSH CABIN (7) SUIT FAN sel - 2 When sublimators are dry: (8) SUIT FAN sel - OFF (Cycle suit fan on/off for CO2 level control) (9) SUIT ISOL vlv - SUIT DISC (crew preference) (10) Power down equipment per Loss-of-Cooling Timeline.</p> <p>c. Post CSI: Doff suits &amp; stow</p>	<p>Use cold fan to minimize water usage.</p>
	ECS	<p><u>5.4.16 LOSS OF BOTH ASCENT O2 TANKS</u></p> <p>1. Lunar stay pre-launch prep:</p> <p>a. CABIN REPRESS vlv - MANUAL until ECS: CABIN PRESS ind - 5.2 psia, then: CABIN REPRESS vlv - CLOSE</p> <p>b. Don OPS in CEVT configuration.</p> <p>c. Just before lift-off: FLSS FILL vlv - CLOSE #1 ASC O2 vlv - CLOSE #2 ASC O2 vlv - CLOSE DES O2 vlv - CLOSE</p>	<p>This procedure provides for O2 management in event that both ascent O2 tanks are lost.</p> <p>If cabin pressure is lost (zero psia), OPS O2 - OM.</p> <p>If failure occurs before final jettison, both FLSS's should be retained and recharged for possible later use.</p>
		<p>2. Ascent</p> <p>a. Perform normal insertion: #1 ASC O2 vlv - CLOSE CABIN GAS RETURN vlv - AUTO</p> <p>b. Post-Insertion: Doff helmet &amp; gloves CABIN GAS RETURN vlv - AUTO SUIT GAS DIVERTER vlv - PUSH CABIN</p>	<p>ECS Basic (Staged), ref para 4.13.1.1.</p> <p>Assuming a 0.23 lb/hour O2 use rate (0.06 + 0.17), it takes 5.6 hours to reach 4.0 psia. If use rate is such that cabin pressure would be below 3.5 psia before rndz/docking, a portion of each OPS bottle would be available for makeup.</p>

**LMA790-3-LM**  
**APOLLO OPERATIONS HANDBOOK**

CREW-MAN	PNL	PROCEDURES	REMARKS
		<p>5.4.17 <u>LOSS OF BOTH PRESS REGS (FAILED CLOSED)</u></p> <p>1. Failure occurred with cabin depressurized:</p> <p style="margin-left: 20px;">a. Cabin relief &amp; dump vlv (fwd) - AUTO</p> <p style="margin-left: 20px;">b. Cabin relief &amp; dump vlv (ovhd) - AUTO</p> <p style="margin-left: 20px;">c. CABIN REPRESS vlv - AUTO CB ECS: CABIN REPRESS - close MASTER ALARM - on CABIN warn lt - on CABIN GAS RETURN vlv - AUTO</p> <p style="margin-left: 20px;">d. CABIN warn lt - off</p> <p style="margin-left: 20px;">e. PRESS REG A &amp; B vlv - CABIN</p> <p style="margin-left: 20px;">f. SUIT GAS DIVERTER vlv - PULL EGRESS</p> <p>2. Failure occurred with cabin pressurized:</p> <p style="margin-left: 20px;">a. CABIN GAS RETURN vlv - AUTO</p> <p style="margin-left: 20px;">b. SUIT GAS DIVERTER vlv - PULL EGRESS</p> <p style="margin-left: 20px;">c. CABIN REPRESS vlv - AUTO</p> <p style="margin-left: 20px;">d. PRESS REG A &amp; B vlv - CABIN</p>	<p>This procedure provides for O2 control without automatic regulator capability.</p> <p>Assumption: LM configured for Cabin Depressurization, ref para 4.13.1.7.</p> <p>Supplies O2 to ARS when cabin pressure exceeds ARS pressure. Time to breathe ARS from 3.6 psia to 3.3 psia (min allowable) is approximately 3 minutes in a closed suit loop configuration. To prevent hypoxia, immediate activation of this procedure is essential.</p> <p>CABIN warn lt goes off when cabin pressure reaches 4.4 to 5.0 psia.</p> <p>Assumption: LM configured for ECS Basic (staged or unstaged), ref para 4.13.1.1.</p> <p>When CABIN REPRESS vlv is actuated, SUIT GAS DIVERTER vlv would automatically go to PULL EGRESS if it were in PUSH CABIN position.</p> <p>CABIN REPRESS vlv will keep cabin pressure above 3.7 psia minimum.</p>

**LMA790-3-LM**  
**APOLLO OPERATIONS HANDBOOK**

CREW-MAN	PNI	PROCEDURES	REMARKS
		<p>5.4.18 <u>LOSS OF BOTH SUIT FANS</u></p> <p>1. Failure during lunar stay -  a. PLSF available:  (1) Doff helmets &amp; gloves  (2) CB ECS: CABIN FAN - close  (3) Connect PLSF hose to PGA's (red to blue, blue to red)  (4) Don PLSF with RCU  (5) FAN sw - ON  b. PLSF not available:  (1) Doff helmets &amp; gloves  (2) PRESS REG A &amp; B vlvs - CABIN  (3) CABIN GAS RETURN vlv - AUTO  (4) SUIT GAS DIVERTER vlv - PUSH CABIN  (5) CB ECS: CABIN FAN - close  (6) PRESS REG A &amp; B vlvs - DIRECT O2 periodically, to purge cabin of CO2</p> <p>2. Failure when in lift-off configuration -  ECS Basic (Staged), except:  PRESS REG A &amp; B vlvs - CABIN  Doff helmets &amp; gloves</p> <p>3. Failure during Ascent -  a. Insertion:  (1) Doff helmets &amp; gloves  (2) If crew activity does not permit helmets &amp; gloves removed, perform following:  PRESS REG A - CABIN  PRESS REG B - DIRECT O2  b. Post-Insertion:  SUIT GAS DIVERTER vlv - PUSH CABIN  VENTILATION DIVERTER vlv - EV (vertical)</p> <p>PGA  ECS  11</p>	<p>This procedure provides for CO2 control in event that both suit fans are lost. As a result of this failure, CO2 sensor indications will be inaccurate.</p> <p>MSFN will provide required purge cycle.</p> <p>Ref para 4.13.1.1.</p> <p>DIRECT O2 supplies = 7 lb/hr O2 to suit loop when ASC O2 tank is full.</p> <p>MSFN will provide required purge cycles.</p>



**LMA790-3-LM**  
**APOLLO OPERATIONS HANDBOOK**

CREW- MAN	PNL	PROCEDURES	REMARKS
		<p><u>5.4.19 OPTIMIZATION OF APS HELIUM MANIFOLD LEAK</u></p> <ol style="list-style-type: none"> <li>1. If leak is detected before ignition - As soon as leak is detected: CB PROPUL: ASC He REG - close ASC He REG 1 &amp; 2 sw - CLOSE; tb - bp HELIUM MON sel - PRESS 1 PRPLNT TEMP/PRESS MON sw - ASC</li> <li>2. If leak is detected after ignition: Omit steps 2 &amp; 3.</li> <li>3. If leak is detected before pressurization - Pressurize with one helium bottle at ignition -5 sec: ED: ASC He SEL sw - TANK 1 MASTER ARM sw - ON ASC He PRESS sw - FIRE</li> <li>4. Immediately at APS ignition: ASC He REG 1 &amp; 2 - OPEN; tb - gray</li> </ol> <p style="text-align: center;">WARNING</p> <p>If during ignition +40 seconds, helium source decay rate is &gt;11 psia/sec (&gt;22 psia/sec for one bottle pressurization), isolate reg SOV that gives lesser decay rate and use it in lieu of both reg SOV's. If neither reg SOV selection decreases leak rate, go to step 4 only.</p> <p>4. At ignition +40 seconds:</p>	<p>This procedure is used in conjunction with nominal powered ascent procedures if helium manifold leak is detected.</p> <p>MSPN can detect such a leak with telemetry. This procedure utilizes fact that helium is continuously lost only while leak is being supplied with helium. By minimizing time leak is being supplied, amount of helium lost can be minimized.</p> <p>Forty seconds will ensure that sufficient ullage volume exists for first blowdown cycle.</p>

**LMA790-3-LM  
APOLLO OPERATIONS HANDBOOK**

CREW- MAN	PNI	PROCEDURES	REMARKS
		<p><u>5.4.19 OPTIMIZATION OF APS HELIUM MANIFOLD LEAK (cont)</u></p> <p>ASC He REG 1 &amp; 2 sw - CLOSE; tb - bp</p> <p>If helium source pressure stops decreasing, go to step 5. If helium source pressure continues to decrease, after regs are closed, perform following only.</p> <p>ASC He REG 1 &amp; 2 sw - OPEN; tb - gray</p> <p>If one bottle pressurization - When MPS: FUEL or OXID PRESS ind - 110 psia: ED: ASC He SEL sw - TANK 2 MASTER ARM sw - ON ASC He PRESS sw - FIRE</p> <p>5. When MPS: FUEL or OXID PRESS ind - 110 psia: ASC He REG 1 &amp; 2 sw - OPEN; tb - gray</p> <p>6. When MPS: FUEL or OXID PRESS ind - 170 psia: ASC He REG 1 &amp; 2 sw - CLOSE; tb - bp</p> <p>7. For one bottle pressurization: Continue to cycle between steps 5 &amp; 6.</p> <p>When MPS: HELIUM - 500 psia (PRESS 1): ED: ASC He SEL sw - TANK 2 MASTER ARM sw - ON ASC He PRESS sw - FIRE</p> <p>8. For two bottle pressurization: Continue to cycle between steps 5 &amp; 6 At ignition +340 sec: ASC He REG 1 &amp; 2 sw - OPEN; tb - gray</p>	
			<p>After 340 seconds, APS has sufficient blowdown capability if it is fully pressurized, so opening regulators assures final pressurization. Loss of He once tanks are fully pressurized, at this point, does not preclude a safe insertion.</p>

**LMA790-3-LM**  
**APOLLO OPERATIONS HANDBOOK**

LM 3217A

CREW-MAN	PNL	PROCEDURES	REMARKS
	ECS	<p>5.4.20 <u>ASCENT STAGE OXYGEN TANK BLEED-DOWN PROCEDURE</u></p> <ol style="list-style-type: none"> <li>1. Verify LM configured -               <ol style="list-style-type: none"> <li>a. Cabin relief and dump vlv (fwd) - AUTO</li> <li>b. SUIT CIRCUIT RELIEF vlv - AUTO</li> <li>c. CABIN GAS RETURN vlv - AUTO</li> <li>d. SUIT GAS DIVERTER vlv - PUSH CABIN</li> <li>e. LO PLSS FILL vlv - CLOSE</li> <li>f. HI PLSS O2 FILL vlv - CLOSE</li> <li>g. Correct O2 hoses R/R and B/B</li> <li>h. Don Helmets and Gloves</li> <li>i. DES O2 vlv - CLOSE</li> <li>j. CABIN REPRESS vlv - CLOSE</li> </ol> </li> <li>2. O2/H2O QTY MON sel - ASC 1 (2)</li> </ol> <p style="text-align: center;">NOTE</p> <p>Monitor cabin pressure during procedure and verify 4.6 - 5.8 psia. Cabin relief and dump valve will relieve to maintain cabin pressure at 5.25 - 5.8 psia.</p> <ol style="list-style-type: none"> <li>3. #1 (2) ASC O2 vlv - OPEN</li> <li>4. PRESS REG A vlv - DIRECT O2</li> <li>5. When ECS: O2 QUANTITY ind - 95 to 100%:               <ol style="list-style-type: none"> <li>a. #1 (2) ASC O2 vlv - CLOSE</li> <li>b. PRESS REG A vlv - CABIN</li> </ol> </li> <li>6. CABIN REPRESS vlv - AUTO</li> <li>7. DES O2 vlv - OPEN</li> <li>8. Doff Helmets and Gloves</li> <li>9. SUIT GAS DIV vlv - FULL EGRESS CABIN GAS RETURN vlv - EGRESS Correct O2 hoses R/B and B/R</li> <li>10. O2/H2O QTY MON sel DES 2</li> </ol>	<p>Assumption: Bleed-down to be performed if MSFN verifies necessity.</p> <p style="text-align: right;">Monitor</p>

**LMA790-3-LM**  
**APOLLO OPERATIONS HANDBOOK**

LM 3218, LM 3227A

CREW-MAN	PNL	PROCEDURES	REMARKS
		<p>5.4.21 <u>ASCENT STAGE OXYGEN TANK TOP-OFF PROCEDURE</u></p> <p style="padding-left: 40px;">To effect a refill ASC 02 TANK #1 (2)</p> <ol style="list-style-type: none"> <li>1. Verify #1 &amp; #2 ASC 02 vlv - CLOSE</li> <li>2. 02/H2O QTY MON sel - DES 1 02/H2O QTY MON sel - DES 2</li> <li>3. 02/H2O QTY MON sel - ASC 1 (2)</li> <li>4. Verify DES 02 vlv - OPEN</li> <li>5. INTLK OVRD pb - Push and hold</li> <li>6. #1 (2) ASC 02 vlv - OPEN</li> <li>7. #2 (2) ASC 02 vlv - CLOSE</li> <li>8. INTLK OVRD pb - Release</li> <li>9. 02/H2O QTY MON sel - DES 2</li> </ol> <p>5.4.22 <u>DESCENT 02 VENTING</u></p> <ol style="list-style-type: none"> <li>1. Retrieve 02 vent adapter from stowage.</li> <li>2. Cabin relief and dump vlv (fwd &amp; ovhd) - AUTO</li> <li>3. HI PLSS 02 FILL vlv - CLOSE</li> <li>4. Disconnect PLSS fill 02 hose from HI PRESS 02 QD.</li> <li>5. Connect 02 vent adapter to HI PRESS 02 QD.</li> <li>6. Connect PLSS fill 02 hose to LO PRESS 02 QD.</li> </ol>	<p>Assumptions:</p> <ol style="list-style-type: none"> <li>1. Necessity for tank recharge verified by MSFN.</li> <li>2. DES STAGE 02 TANK pressure sufficient to effect a top-off of a low ASC 02 TANK verified by MSFN.</li> </ol> <p>Note quantity of DES 1 02 Note quantity of DES 2 02 Monitor 02 quantity</p> <p>When ECS: 02 QUANTITY ind is 95 - 99 Z or ECS: 02 QUANTITY ind stabilizes.</p> <p>This procedure is required to vent DESCENT TANK no. 2 prior to performing manual staging while on lunar surface.</p>
	ECS		
	2		
	ECS		
	+227		

**LMA790-3-LM**  
**APOLLO OPERATIONS HANDBOOK**

LM 3227A

CREW-MAN	PNL	PROCEDURES	REMARKS
		<p>5.4.22 <u>DESCENT O2 VENTING (cont)</u></p> <p>7. O2/H2O QTY MON sel - DES 2</p> <p>8. HI PLSS O2 FILL vlv - OPEN</p> <p>9. HI PLSS O2 FILL vlv - CLOSE when directed by MSFN, or immediately after lift - off.</p>	<p>Cabin pressure will rise from 5.4 to 5.8 psia before cabin pressure relief valve opens.</p>

Basic Date 26 September 1971

Change Date \_\_\_\_\_

Page 5.4-24C/5.4-2

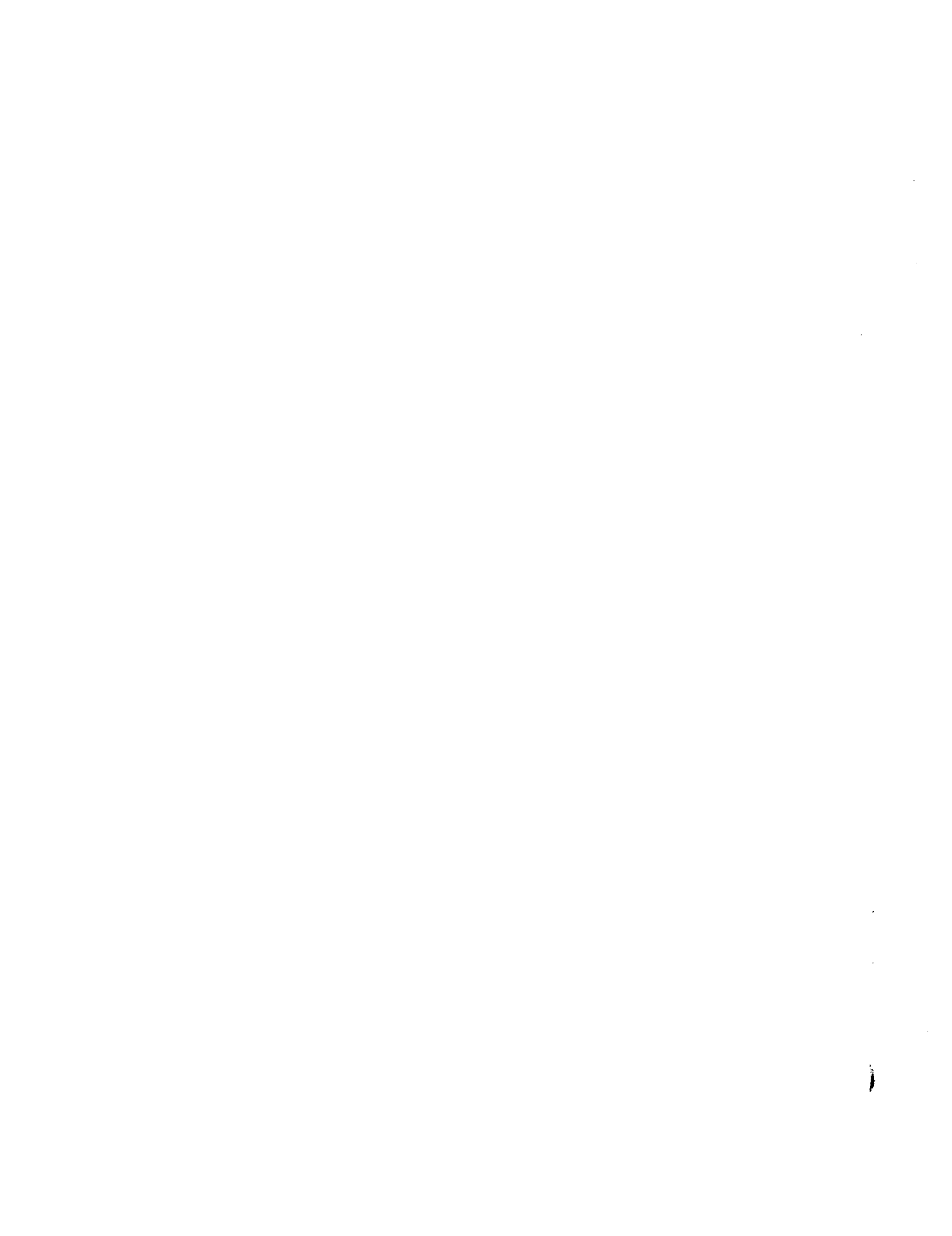

**LMA790-3-LM  
APOLLO OPERATIONS HANDBOOK**

CREW-MAN	PNL	PROCEDURES	REMARKS
		<p><u>5.4.23 LOSS OF MANUAL AND AUTO APS START CAPABILITY</u></p> <p>1. Eng STOP pb/lt - push Eng START pb/lt - off ENG THR CONT: ENG ARM sw - OFF ABORT STAGE pb - reset ED: Observe STAGE SEQ RELAYS lcs ED: MASTER ARM sw - OFF If staged: MASTER ALARM &amp; ED RELAY CAUTION LT - on Key V37E00E</p> <p>2. Remove and stow restraints (CDR's to floor fittings)</p> <p>3. If vehicle is unstaged, return to descent consumables: #1 ASC O2 vlv - CLOSE DES O2 vlv - OPEN WATER TANK SELECT vlv - DES ASC H2O vlv - CLOSE DES H2O vlv - OPEN PRESS REG A &amp; PRESS REG B vlvs - CABIN SUIT GAS DIVERTER vlv - PULL EGRESS CABIN GAS RETURN vlv - EGRESS Doff helmets and gloves SUIT ISOL vlvs (2) - SUIT DISC Reverse O2 hoses R/B and B/R PGA DIVERTER vlvs - IV (Horizontal) SUIT ISOL vlvs (2) - SUIT FLOW CABIN REPRESS vlv - AUTO CB EPS: DES ECA CONT - close DES ECA - close ASC ECA CONT - close EPS: DES BAT sw - CONNECT: tb - gray LMP BAT 2 sw - ON; tb - gray CDR BAT 4 HI-V sw - ON; tb - gray LMP BAT 1 HI-V sw - ON; tb - gray CDR BAT 3 sw - ON; tb - gray BAT 5 NORMAL LMP FEED sw - OFF; tb - bp BAT 6 NORMAL CDR FEED sw - OFF; tb - bp</p>	<p>Assumption: Vehicle is configured for normal ascent and manual staging has been approved by MSFN.</p> <p>If at least one lt has gone off, staging has occurred.</p>
	5		
	1		
	8		
	4		
	8		
	ECS		
	11,16		
	14		

LM 3240A

**LMA790-3-LM  
APOLLO OPERATIONS HANDBOOK**

CREW/ MAN	PNL	PROCEDURES	REMARKS
CDR	11	<p>5.4.23 <u>LOSS OF MANUAL AND AUTO APS START CAPABILITY (cont)</u></p> <p>4. Power down PJ45A: CB RCS SYS A: QUAD 4, 3, 2 and 1 TCA - open CB S/C: ATCA (PGNS) - open AELD - open</p>	
CDR	11	<p>5. Unsnap netting snaps from trevano ceiling aft of docking window at +Z27 bulkhead</p> <p>6. Expose PJ45A above trevano ceiling: a. Cut on line taped from +Z27 bulkhead to docking window b. Cut on line taped from top of PNL11 to docking window c. Bend trevano section down toward PNL11, snap off and discard</p> <p>7. Unstow connector coupling pliers from container aft of engine cover</p> <p>8. Demate PJ45A by rotating connector coupling counter clockwise</p> <p>9. Unstow LCG's and remove Ascent Engine T-Adapter cable from package.</p> <p>10. Mate P45X of T-cable to J45 at +Z27 bulkhead using pliers to initiate remating</p> <p>11. Mate J45X of T-cable to P45A</p> <p>12. If vehicle is unstaged, return to ascent consumables: BAT 5 NORMAL LMP FEED sw - ON; tb - gray BAT 6 NORMAL CDR FEED sw - ON; tb - gray CB EPS: ASC ECA CONT (2) - close DES H2O vlv - CLOSE ASC H2O vlv - OPEN WATER TANK SELECT vlv - ASC DES O2 vlv - CLOSE #1 ASC O2 - OPEN</p>	<p>Penlights may be used to illuminate work area if required</p> <p>Stowed below PLSS recharge station</p>
CDR	14		
CDR	11,16 ECS		

LM 3240A



**LMA790-3-LM**  
**APOLLO OPERATIONS HANDBOOK**

LM 3240A

CREW-MAN	PNL	PROCEDURES	REMARKS
		<p>5.4.23 <u>LOSS OF MANUAL AND AUTO APS START CAPABILITY</u> (cont)</p> <p>Reverse O2 hoses R/R and B/B Don helmets and gloves PRESS REG A &amp; PRESS REG B vlv - EGRESS SUIT GAS DIVERter vlv - PULL EGRESS CABIN GAS RETURN vlv - AUTO SUIT CIRCUIT RELIEF vlv - AUTO CABIN REPRESS vlv - CLOSE LMP BAT 1 HI-V sw - OFF/RESET; tb - bp CDR BAT 3 sw - OFF/RESET; tb - bp LMP BAT 2 sw - OFF/RESET; tb - bp CDR BAT 4 HI-V sw - OFF/RESET; tb - bp DES BAT sw - DEADFACE; tb - bp If tb - bp; CB EPS: DES ECA - open DES ECA CONT - open ASC ECA CONT - open</p>	
	14		
	11,16		
	11 16 8	<p>13. Manually stage: CB ED: LOGIC PWR A - close CB ED: LOGIC PWR B - close ED: MASTER ARM sw - ON STAGE sw - FIRE STAGE SEQ RELAYS lts - off</p>	<p>If staging prior to liftoff is not feasible, this step must be performed simultaneously with liftoff.</p>
LMP LMP	2 14 12	<p>14. Prepare for LMP Bus Power Down ECS: SUIT FAN sel - 1 EPS: INVERTER sw - 1 AUDIO: AUDIO CONT sw - BU COMM: S-BAND XMTR/RCVR sw - SEC S-BAND PWR AMPL sw - SEC S-BAND VOICE sw - DN VOICE BU S-BAND RANGE sw - OFF/RESET VHF A RCVR sw - ON VHF B XMTR sw - VOICE TLM BIOMED sw - OFF COMM ANT: S-BAND sel - FWD or AFT AUDIO: S-BAND T/R sw - S-BAND T/R</p>	<p>Reacquire S-BAND</p>

**LMA790-3-LM  
APOLLO OPERATIONS HANDBOOK**

LM 3240A

CREW- MAN	PNL	PROCEDURES	REMARKS
		<p>5.4.23 <u>LOSS OF MANUAL AND AUTO APS START CAPABILITY</u> (cont)</p> <p>ICS T/R sw - ICS T/R MODE sw - ICS/FTT VHF A sw - RCV VHF B sw - T/R</p>	
LMP	16	<p>15. Power down LMP Bus: CB EPS: CROSS TIE BUS - open CROSS TIE BAL LOADS - open BAT FEED TIE (2) - open</p>	
		<p>16. Unstow LCG's and remove ED Adapter Cable (20 ft) from package.</p>	Stowed below PLSS recharge station
LMP	16	<p>17. Remove dust cap from J166</p>	
LMP	16	<p>18. Mate P166/167 (align white stripe) of ED Adapter Cable to J166</p>	
CDR		<p>19. Mate P428 of ED Adapter Cable to J428X of T-cable</p>	
CDR		<p>20. Dress cables clear of PNL11</p>	
LMP	ECS	<p>21. PGA DIVERTER v1vs - IV (Horizontal)</p>	
	11	<p>22. Prepare PGNS for launch: CB AC BUS A: RNDZ RDR - close</p>	
	3	<p>CB PGNS: RNDZ RDR - close RR sel - LCC V41 N72E (+00000, +28300) N12 R2 00002, PRO V16 N72E</p>	
	11	<p>CB PGNS: RNDZ RDR - open CB AC BUS A: RNDZ RDR - open V44E</p>	
	11	<p>Window shades - deploy CB AC BUS A: AOT LAMP - close P57, R2 00004, PRO N34 Load LO Time, PRO N06 00010 00003 00110</p>	



**LMA790-3-LM  
APOLLO OPERATIONS HANDBOOK**

			PROCEDURES	REMARKS
LM 3240A	CREW-MAN	PNI	<p>5.4.23 <u>LOSS OF MANUAL AND AUTO APS START CAPABILITY</u> (cont)</p> <p>at TFI - 00800: CB EPS: BAT FEED TIE (2) - close</p> <p>24. When TG&lt;1 sec; CB EPS: BAT FEED TIE (2) - open</p>	
	LMP	16 16		

**LMA790-3-LM**  
**APOLLO OPERATIONS HANDBOOK**

CREW-MAN	PNL	PROCEDURES	REMARKS
		<p>LM 3240A</p> <p>5.4.24 <u>LOSS OF MANUAL AND AUTO APS START CAPABILITY (WITH LOSS OF ONE BUS)</u></p> <ol style="list-style-type: none"> <li>1. Eng STOP pb/lit - push Eng START pb/lit - off Eng THR CONT: ENG ARM sw - OFF ABORT STAGE pb - reset</li> <li>2. ED: Observe STAGE SEQ RELAYS lts ED: MASTER ARM sw - OFF if staged: MASTER ALARM &amp; ED RELAY CAUTION lt - on, If CDR bus is powered up: Key V37E 00E</li> <li>3. Power down PJ45A: CB RCS SYS A: QUAD 4, 3, 2 and 1 TCA - open CB S/C: ATCA (PGNS) - open AELD - open</li> <li>4. Unsnap netting snaps from trevano ceiling aft of docking window at +227 bulkhead</li> <li>5. Expose PJ45A above trevano ceiling:               <ol style="list-style-type: none"> <li>a. Cut on line taped from +227 bulkhead to docking window</li> <li>b. Cut on line taped from top of PNL11 to docking window</li> <li>c. Bend trevano section down toward PNL11, snap off and discard</li> </ol> </li> <li>6. Unstow connector coupling pliers from container aft of engine cover</li> <li>7. Demate PJ45A by rotating connector coupling counter clockwise</li> <li>8. Unstow Ascent Engine T-adapter cable from in-flight coverall garments</li> <li>9. Mate P45X of T-cable to J45 at +227 bulkhead using pliers to initiate remating</li> </ol>	<p>Assumption: Manual staging has previously been performed and vehicle is configured for normal one bus ascent.</p> <p>If at least one lt has gone off, staging has occurred</p> <p>Penlights may be used to illuminate work area if required</p> <p>Stowed below PLSS recharge station</p>

**LMA790-3-LM**  
**APOLLO OPERATIONS HANDBOOK**

CREW/MAN	PNI	PROCEDURES	REMARKS
		<p>5.4.24 <u>LOSS OF MANUAL AND AUTO APS START CAPABILITY</u> <u>(WITH LOSS OF ONE BUS)(cont)</u></p>	
		<p>10. Mate J45X of T-cable to P45A</p>	
		<p>11. If CDR bus is powered up: Key V37E 57E</p>	
		<p>12. Prepare PGNS for launch: If CDR bus is powered up: (If LMP bus is powered up, start with step 13) CB AC BUS A: RNDZ RDR - close CB PGNS: RNDZ RDR - close RR sel - LGC V41 N72E (+00000, +28300) N12 R2 00002, PRO V16 N72E CB PGNS: RNDZ RDR - open CB AC BUS A: RNDZ RDR - open V44E Window shades - deploy CB AC BUS A: AOT LAMP - close P57, R2 00004, PRO N34 Load LO Time, PRO N06 00010 00003 00110 PRO (No Att 1t - ON/OFF, Twice) N04 Grav Err (.01°) V32E (No Att 1t - ON/OFF, Twice) N04 Grav Err (.01°)</p>	
CDR	11		
	3		
	11		
	11		
		<p>PRO N22 ICDU Angles (.01°) PRO (No Att 1t - ON/OFF) N71 Star, 4 marks N05 Angle Diff (.01°)</p>	
		<p>PRO N93 Torque Angles (.001°) PRO N25 00014, ENTR POOE</p>	

LH 3240A

LMA790-3-LM  
**APOLLO OPERATIONS HANDBOOK**

LM 3240A

CREW-MAN	PNL	PROCEDURES	REMARKS
		<p>5.4.24 <u>LOSS OF MANUAL AND AUTO APS START CAPABILITY</u>            (WITH LOSS OF ONE BUS)(cont)</p> <p>CB AC BUS A: AOT LAMP - open            Window shades - stow            CB AC BUS A: RNDZ RDR - close            CB PGNS: RNDZ RDR - close            V41 N7ZE (+17500, +27500)            N12 R2 00002, PRO            V16 N7ZE            CB PGNS: RNDZ RDR - open            CB AC BUS A: RNDZ RDR - open            V44E            RR sel - SLEW            P12E            N33 : : TIG            PRO            N76 VH Final (+55408)            H Dot Final (+00320)            X Rng (+00000)            PRO            N74 TFI, Yaw, Pitch            Det - Set/ON</p> <p>13. Prepare AGS for launch:            If LMP bus is powered up:            C574+00000E (Unstaged)            C604-00000E (On Surface)            C400+60000E (AGS calibration)            C612R- to Att Hold at Abort Stage            C307-----AT Trans (+04300)            373-----TIG TPI (+01496)            C451+0AVY            C400R (+0 calibration complete)            C544R-----X            C545R-----Y            C546R-----Z            C400+4E Lunar Align            ATTITUDE MON sw - AGS            MODE SEL sw - AGS</p> <p>14. Unstow ED Adapter Cable (20 ft) from LCG's in lower left hand mid section</p>	
	11		
	11		
	11		
	3		

CDR





**LMA790-3-LM**  
**APOLLO OPERATIONS HANDBOOK**

LM 3240A

CREW-MAN	PNL	PROCEDURES	REMARKS
		<p>5.4.25 <u>LOSS OF ED SUB-SYSTEM</u></p> <p>1. Perform Subsystems Configuration for EVA preparation</p> <p>2. Perform PLSS/EVCS Electrical Checkout, One-Man EVA</p> <p>3. Connect to LM02, COMM and H2O Place gas connector plugs in PGA PGA DIVERTER vlv - HORIZONTAL</p> <p>4. Final Subsystems Configuration for Egress CB ECS:LGS PUMP - Close LGC - Cold, As required CB ECS: CABIN REPRESS vlv - Close (Verify) SUIT FLOW CONT - Open SUIT GAS DIVERTER vlv - PULL EGRESS (Verify) CABIN GAS RETAIN vlv - EGRESS (Verify) SUIT CIRCUIT RELIEF vlv - AUTO (Verify) Reverse O2 hoses, R/R and B/B Don helmets and gloves</p> <p>5. Perform ARS/PGA Pressure Integrity Check</p> <p>6. Unstow ED Adapter Cable (20 ft) from LGC's in the lower left-hand mid section</p> <p>7. Secure P166/167 to the hand hold between PNL's 12 and 14</p> <p>8. Secure scissors and connector coupling pliers via tethers to PGA D-ring and velcro to either side of RCU</p> <p>9. Attach P428 of ED Adapter Cable on PGA glove under velcro cover</p> <p>10. Perform Cabin Depressurization</p> <p>11. Remove the beta body from connector P428</p> <p>12. Exit cabin, descent ladder to surface, stow ED Adapter Cable, and approach parked LRV; or, descend ladder to last rung and navigate across secondary struts to left side of QUAD IV, after cutting MESA support strap - disregard steps 13 through 16</p>	<p>Ref para 4.15.1.8</p> <p>Ref para 4.15.1.10</p> <p>Ref para 4.2.16</p> <p>Ref para 4.13.1.7</p> <p>Depends on real-time descision regarding landing attitude</p>

**LMA790-3-LM**  
**APOLLO OPERATIONS HANDBOOK**

CREW-MAN	PNL	PROCEDURES	REMARKS
		<p>5.4.25 <u>LOSS OF ED SUB-SYSTEM (cont)</u></p> <p>13. Drive LRV and park adjacent to left hand side of MESA</p> <p>14. At MESA fold back blankets, away from left hand side</p> <p style="text-align: center;">CAUTION</p> <p style="padding-left: 40px;">Crewman must not stand on verticle members of the SRC support structure.</p> <p>15. Climb onto LRV from left hand seat and then onto left hand side of MESA</p> <p>16. Climb up MESA and stand on inboard area of MESA using the top of QUAD IV as support</p> <p style="text-align: center;">CAUTION</p> <p style="padding-left: 40px;">Inconel is very sharp at the edges and can cut into the PGA. Close scissors after use.</p> <p>17. Holding onto the top of QUAD IV with the right hand, tear away at the Inconel and thermal blankets on the left hand side with the scissors, by starting at the 5 inch taped opening in the left hand side of the Inconel blanket, exposing the ED relay box</p> <p>18. Verify access clear of the Inconel blanket to the ED relay box</p> <p style="text-align: center;">CAUTION</p> <p style="padding-left: 40px;">The front corner connector must not be demated.</p> <p style="text-align: center;">NOTE</p> <p style="padding-left: 40px;">Connector coupling pliers can be utilized if required</p>	<p>Assumption: MESA has previously been unstowed.</p> <p style="text-align: right;">Connector is color coded with brown tape.</p>

LM 3240A

**LMA790-3-LM**  
**APOLLO OPERATIONS HANDBOOK**

CREW-MAN	PNL	PROCEDURES	REMARKS
		<p>5.4.25 <u>LOSS OF ED SUB-SYSTEM (cont)</u></p> <p>19. Demate connectors required for access to the GSE dust cover without demating the front corner connector</p> <p>20. Demate the GSE dust cover</p> <p>21. Remove the ED adapter cable from the PGA glove</p> <p>22. Remove the dust cap from connector P428</p> <p>23. Mate the ED adapter cable to the GSE connector on the ED relay box, by observing alignment marks</p> <p>24. Pull the cable slightly taut</p> <p>25. Climb down from the LM via the MESA (or navigate back across the secondary struts to the ladder)</p> <p>26. Climb up the ladder and enter the cabin</p> <p>27. Power down the LMP bus and hook up the ED adapter cable (20 ft)</p> <p>28. Apply power to the ED adapter cable: CB EPS: BAT FEED TIE (2) - close</p> <p>29. Manually stage CB ED: LOGIC PWR A - close ED:     MASTER ARM sw - ON     STAGE SEQ RELAYS SYS A lt - on     STAGE sw - FIRE     STAGE SEQ RELAYS lts - off</p> <p>30. CB EPS: BAT FEED TIE (2) - open Demate P166/167 of adapter cable from J166 and jettison CB EPS: BAT FEED TIE (2) - close Close hatch</p> <p>31. Power up LMP bus:</p>	<p style="text-align: right;">Ref para 5.4.23, steps 15, 16, 17, 18, and 19</p>
LMP	16		
LMP	16		

LM 3240A

**LMA790-3-LM  
APOLLO OPERATIONS HANDBOOK**

LH 3240A

CREW- MAN	PNI	PROCEDURES	REMARKS
	ECS	<p>5.4.25 <u>LOSS OF ED SUB-SYSTEM (cont)</u></p> <p>32. Perform Cabin Repressurization with descent 02 if available:            PRESS REG A &amp; PRESS REG B vlvs - CLOSE            #1 ASC 02 vlv - CLOSE            DES 02 vlv - OPEN            CABIN REPRESS vlv - MANUAL            until Cabin pressure 3.5 psia, then CLOSE            CABIN GAS RETURN vlv - AUTO            CABIN REPRESS vlv - MANUAL            until Cabin pressure 4.6 to 5.0 psia, then CLOSE            DES 02 vlv - CLOSE            #1 ASC 02 vlv - OPEN            PRESS REG A AND PRESS REG B vlvs - EGRESS            If DES 02 not available:            CB(16) ECS: SUIT FLOW CONTROL - close</p>	<p>EVA crewman perform vacuum change over PLSS to LM            Ref para 5.3-5</p>

## APPENDIX D

Table D-1. Definitions of Symbols and Abbreviations

Symbol or Abbreviation	Definition
<u>A</u>	
AAP	Abort autopilot
abs	Absolute
ac	Alternating current (a-c, u.m.)
ACA	Attitude controller assembly
AEA	Abort electronics assembly
AEAA	Ascent engine arming assembly
AELD	Ascent engine latching device
AFC	Automatic frequency control
AGC	Automatic gain control
AGS	Abort guidance section
ALSEP	Apollo lunar surface experiment package
ALT	Altitude
amp	Ampere(s)
AMPL	Amplifier
ANT	Antenna
ANUN	Annunciator
AOT	Alignment optical telescope
APS	Ascent propulsion section
ARS	Atmosphere revitalization section
ASA	Abort sensor assembly
ASC	Ascent
ASD	Apollo standard detonator
ASI	Apollo standard initiator
ASSY	Assembly
ATA	Abort timing assembly

**LAA790-3-LM  
APOLLO OPERATIONS HANDBOOK**

Table D-1. Definitions of Symbols and Abbreviations (cont)

Symbol or Abbreviation	Definition
<u>A (cont)</u>	
ATCA	Attitude and translation control assembly
ATM	Altimeter transmitter multiplier
att	Attitude
auto	Automatic
AZEL	Azimuth-elevation unit
<u>B</u>	
bal	Balance
bat	Battery
bd	Band
biomed	Biomedical
bp	Barber pole
Btu	British thermal unit
BU	Backup
<u>C</u>	
caut lt	Caution light
CB	D-C circuit breaker
CB/AC	A-C circuit breaker
CBW	Constant bandwidth
CBX	C-band transponder
CCRD	Computer control and reticle dimmer assembly
CDH	Constant A altitude
CDR	Commander
CDU	Coupling data unit
CENTANG	Orbital central angle during transfer
CES	Control electronics section
cktry	Circuitry
CL	Close
CLR	Clear
CMC	Command Module Computer

**LMA790-3-LM**  
**APOLLO OPERATIONS HANDBOOK**

Table D-1. Definitions of Symbols and Abbreviations (cont)

Symbol or Abbreviation	Definition
<u>C (cont)</u>	
CMP	Command Module Pilot
CMPTR	Computer
Co	CSI iteration error (AGS)
COAS	Crewman optical alignment sight
comm	Communications
comp caut lt	Component caution light
cont	Continuous rotary control
CONT	Control
cos	Cosine
CO2	Carbon dioxide
CPL	Couple
cps	Cycles per second
CRD	Cosmic-ray detector
CRSFD	Crossfeed
CS	Communications Subsystem
CSI	Coelliptic sequence initiation
CSM	Command/Service Module
CSRC	Contingency sample return container
CW	Continuous-wave
C/W	Caution and warning
CWEA	Caution and warning electronics assembly
<u>D</u>	
Da	Alignment error signal (AGS)
D/A	Digital-to-analog
DAP	Digital autopilot
dbm	Decibel with respect to 1 milliwatt
dc	Direct current (d-c, u.m.)
DECA	Descent engine control assembly
decr	Decrease
DEDA	Data entry and display assembly

**LMA790-3-LM**  
**APOLLO OPERATIONS HANDBOOK**

LM 3231

Table D-1. Definitions of Symbols and Abbreviations (cont)

Symbol or Abbreviation	Definition
<u>D (cont)</u>	
DEMOD	Demodulator
DES	Descent
DET	Detector
DFR	Deadface relay
DID	Display inertial data (discrete)
DIF	Differential
DIG	Predicted change in integrated gravity (AGS)
DISC	Disconnect
DISP	Display
DIST	Distribution
DN	Down
DOI	Descent orbit insertion
DPS	Descent propulsion section
Dr	LM position remainder (AGS)
DRB	Deadface relay box
DSEA	Data storage electronics assembly
DSKY	Display and keyboard
DUA	Digital uplink assembly
DV	Differential velocity
DA	Lunar alignment correction (AGS)
<u>E</u>	
E	Elevation angle (angle between active vehicle LOS and local horizontal plane at TIG, measured from direction of flight)
ECA	Electrical control assembly
ECS	Environmental Control Subsystem
ECADR	Erasable complete address
ED	Explosive device
EDS	Explosive Devices Subsystem
EKG	Electrocardiograph
EL	Electroluminescent



**LMA790-3-LM**  
**APOLLO OPERATIONS HANDBOOK**

LM 3231

Table D-1. Definitions of Symbols and Abbreviations (cont)

Symbol or Abbreviation	Definition
<u>E (cont)</u>	
EMI	Electromagnetic interference
EMU	Extravehicular mobility unit
eng	Engine
ENTR	Enter
EOS	Emergency oxygen system
EPS	Electrical Power Subsystem
ERA	Electronic replaceable assembly
ERCOUNT	Error counter
ERR	Error
ETB	Equipment transfer bag
EV	Extravehicular
EVA	Extravehicular astronaut; extravehicular activity
EVC	Extravehicular communications
EVCS	Extravehicular communications system
EVVA	Extravehicular visor assembly
Ex	X-component of attitude error
Ey	Y-component of attitude error
Ez	Z-component of attitude error
<u>F</u>	
F	Fahrenheit
FCRA	Fecal collection receptacle assembly
FDAI	Flight director attitude indicator
FDBK	Feedback
F/E	Fecal/emesis
FITH	Fire-in-the-hole
FL	Flash
FM	Frequency modulation
F/O	Fuel-to-oxidizer ratio
FOV	Field of view
fps	Foot (feet) per second
ft	Foot (feet)
fwd	Forward

**LMA790-3-LM  
APOLLO OPERATIONS HANDBOOK**

Table D-1. Definitions of Symbols and Abbreviations (cont)

Symbol or Abbreviation	Definition
<u>G</u>	
g	Gravity
GASTA	Gimbal angle sequencing transformation assembly
gc	Gigacycle(s)
GDA	Gimbal drive actuator
GET	Ground elapsed time
GETI	Ground elapsed time of ignition
GMBL	Gimbal
GN&CS	Guidance, Navigation, and Control Subsystem
GOX	Gaseous oxygen
GSE	Ground support equipment
GSOP	Guidance Systems Operations Plan
GUID	Guidance
<u>H</u>	
h	LM altitude
h	LM altitude rate
H	Altitude of active vehicle
Ha	Apogee altitude
HBR	High bit rate
He	Helium
Hg	Mercury
Hp	Perigee altitude
Hrf	High (+) low (-) angular rate scaling (AGS)
HTR	Heater
HTS	Heat transport section
HV	High voltage
H2O	Water
H/X	Heat exchanger

**LMA790-3-LM  
APOLLO OPERATIONS HANDBOOK**

Table D-1. Definitions of Symbols and Abbreviations (cont)

Symbol or Abbreviation	Definition
<u>I</u>	
IAM	Incidental amplitude modulation
ICDU	Inertial portion of coupling data unit
ICS	Intercommunication system
ID	Identification
IF	Intermediate frequency
IG	Inner gimbal (pitch)
IGA	Inner gimbal angle
IMU	Inertial measurement unit
incr	Increase
ind	Indicator
ind pwr fail lt	Indicator power failure light
ind pwr/sig fail lt	Indicator power/signal failure light
inst	Instrumentation
ISA	Interim stowage assembly
ISS	Inertial subsection
IV	Intravehicular
IVT	Intravehicular transfer
<u>K</u>	
K	Ground elapsed time of AEA clock zero
KALCMANU	Maneuver calculation
kc	Kilocycle(s)
kmc	Kilomegacycle(s)
kpps	Kilopulse(s) per second
<u>L</u>	
lat	Lateral
LBR	Low bit rate
LCA	Liquid cooling assembly
LCC	Liquid-cooled garment
LCRU	Lunar communications relay unit
ldg	Landing
LGC	LM guidance computer

**LMA790-3-LM**  
**APOLLO OPERATIONS HANDBOOK**

Table D-1. Definitions of Symbols and Abbreviations (cont)

Symbol or Abbreviation	Definition
<u>L (cont)</u>	
LGEC	Lunar geological exploration camera
LH	Left-hand
LHMSSC	Left-hand midsection stowage compartment
LiOH	Lithium hydroxide
LM	Lunar Module
LMP	LM Pilot
LOR	Lunar orbital rendezvous
LOS	Line of sight; loss of signal
LPD	Landing point designator
LR	Landing radar
LRV	Lunar roving vehicle
LSD	Least significant digit
lt	Light
ltg	Lighting
LV	Local vertical; low voltage
LWHS	Lightweight headsets
<u>M</u>	
MAN	Manual
MANF	Manifold
max	Maximum
mc	Megacycle(s)
MESA	Modularized equipment stowage assembly
MET	Mobile equipment transporter
MG	Middle gimbal (roll)
MGA	Middle gimbal angle
MID	Midcourse
min	Minimum
mm	Millimeter(s)
MOD	Modulation
MON	Monitor
MPS	Main Propulsion Subsystem

**LMA790-3-LM**  
**APOLLO OPERATIONS HANDBOOK**

Table D-1. Definitions of Symbols and Abbreviations (cont)

Symbol or Abbreviation	Definition
<u>M (cont)</u>	
MPX	Multiplexer
MSD	Most significant digit
mrad	Milliradian
msec	Millisecond(s)
MSFN	Manned Space Flight Network
mv	Millivolt(s)
mw	Milliwatts(s)
<u>N</u>	
n	Mean orbital angular rate of LM in transfer orbit (rad/sec)
N	Noun; number of marks
N/A	Not applicable
NB	Navigation base
NC	Normally closed
nm	Nautical mile(s)
NO	Normally open
No.	Number
norm	Normal
NRZ	Nonreturn-to-zero
N2H4	Hydrazine
N2O4	Nitrogen tetroxide
<u>O</u>	
OCP	Operational checkout procedure
OG	Outer gimbal (yaw)
OGA	Outer gimbal angle
OI	Orbit insertion
OPR	Operate
OPR ERR	Operator error
OPS	Oxygen purge system
ORDEAL	Orbital rate display - earth and lunar
OSC	Oscillator

**LMA790-3-LM  
APOLLO OPERATIONS HANDBOOK**

Table D-1. Definitions of Symbols and Abbreviations (cont)

Symbol or Abbreviation	Definition
<u>O (cont)</u>	
OSCPCS	Oxygen supply and cabin pressure control section
OSS	Optical subsection
OVBD	Overboard
ovhd	Overhead
OVRD	Override
OXID	Oxidizer
O2	Oxygen
<u>P</u>	
P	Semilatus rectum (semiparameter) of LM transfer orbit (ft)
P	Previous value of p in the iteration (ft)
PA	Power amplifier
PAM	Pulse amplitude modulation
para	Paragraph
pb	Pushbutton switch (except pushbutton/light)
pb/lt	Pushbutton/light
PBW	Proportional bandwidth
PCA	Program coupler assembly
PCM	Pulse code modulation
PCMTEA	Pulse-code-modulation and timing electronics assembly
PDA	Power distribution assembly
PGA	Pressure garment assembly
PGNCS	Primary guidance, navigation, and control section
PGNS	Primary guidance and navigation section
Pi or $\pi$	3.1416
PIPA	Pulse integrating pendulous accelerometer
PLSS	Portable life support system
PM	Phase modulation
PMP	Premodulation processor
Poss	Possible
p-p	Peak-to-peak

**LMA790-3-LM  
APOLLO OPERATIONS HANDBOOK**

Table D-1. Definitions of Symbols and Abbreviations (cont)

Symbol or Abbreviation	Definition
<u>P (cont)</u>	
ppm	Pulse(s) per minute
pps	Pulse(s) per second
PQGS	Propellant quantity gaging system
PQMD	Propellant quantity measuring device
PRE	Program reader electronics
press	Pressure
PRF	Pulse repetition frequency
PRIM	Primary
PRM	Pulse ratio modulator
PRN	Pseudorandom noise
prplnt	Propellant
PS	Power supply
PSA	Power and servo assembly
psi	Pound(s) per square inch
psia	Pound(s) per square inch absolute
psid	Pound(s) per square inch differential
PSK	Phase-shift keyed
PT	Pressure transducer
PTA	Pulse torque assembly
PTT	Push-to-talk
PVT	Pressure-volume-temperature
pwr	Power
<u>Q</u>	
q	Perifocus (AGS)
q1D	Perifocus altitude of predicted LM trajectory (TPI only)
qa	Apofocus altitude of LM trajectory (AGS)
QI	Quantity indicator
qLT	Perifocus altitude of LM trajectory (AGS)

**LMA790-3-LM**  
**APOLLO OPERATIONS HANDBOOK**

LM 3231

Table D-1. Definitions of Symbols and Abbreviations (cont)

Symbol or Abbreviation	Definition
<u>Q (cont)</u>	
qty	Quantity
quad	Quadrant
<u>R</u>	
r	LM range rate
R	Rankine; radius vector; LM-to-CSM range (AGS)
$\dot{R}$	Range rate between LM and CSM (AGS)
RC	Resistance-capacitance
R/C	Reverse current
RCCA	Rough combustion cutoff assembly
RCR	Reverse-current relay
RCS	Reaction Control Subsystem
rcvr	Receiver
RCU	Remote control unit
rcx	X-component of CSM position (AGS)
rcy	Y-component of CSM position (AGS)
rcz	Z-component of CSM position (AGS)
RD	Relay driver; desired radial jerk (AGS)
RDR	Radar
Ref	Reference
REFSMAT	Reference stable member matrix
reg	Regulator
RES	Resolver
RF	Radio frequency
rf	Predicted orbit insertion burnout radius (AGS)
$\dot{r}_f$	Desired final value of altitude rate (AGS)
RGA	Rate gyro assembly
RH	Right-hand
RHSC	Right-hand side console
RJB	Relay junction box
rms	Root mean square



**LMA790-3-LM**  
**APOLLO OPERATIONS HANDBOOK**

LM 3231

Table D-1. Definitions of Symbols and Abbreviations (cont)

Symbol or Abbreviation	Definition
<u>R (cont)</u>	
RNDZ	Rendezvous
RNG	Range
ROD	Rate of descent
RR	Rendezvous radar; estimated range between LM and CSM (AG)
RR	Estimated range rate between LM and CSM (AGS)
RRE	Rendezvous radar electronics
RRS	Calculated range at time of radar range measurement
RT	Resistance thermometer
rx	X-component of LM position (AGS)
ry	Y-component of LM position (AGS)
rz	Z-component of LM position (AGS)
RZ	Return-to-zero
<u>S</u>	
SBPA	S-band power amplifier
SBX	S-band transponder
SC	Signal conditioner
S/C	Stabilization and control
SCEA	Signal-conditioning electronics assembly
S ΔE	Term proportional to sine of ΔE
SE	Systems Engineer
sec	Second(s); secondary
sel	Selector
SENS	Sensitivity
SEP	Separator
SEQ	Sequence; scientific equipment
SHe	Supercritical helium
SG	Signal generator
SHFT	Shaft
SIG	Signal

**LMA790-3-LM**  
**APOLLO OPERATIONS HANDBOOK**

LM 3231

Table D-1. Definitions of Symbols and Abbreviations (cont)

Symbol or Abbreviation	Definition
<u>S (cont)</u>	
sin	Sine
SOV	Shutoff valve
SPA	Signal processor assembly
STBY	Standby
SUBCAR	Subcarrier
SUPCRIT	Supercritical
sw	Switch
SWC	Solar wind composition (experiment)
sys	System
<u>T</u>	
t	AGS computer time (AGS)
T	Time
T (Align)	State vector time (GET) selected to define IMU and LM orientation
TAI	Absolute time (AGS)
TAo	Time from CSI to CDH (AGS)
tb	Talkback
TBD	To be determined
TCA	Thrust chamber assembly
tco	Predicted time from CDH to TPI (AGS)
TCP	Thrust chamber pressure
TΔ	Time to CDH, CSI, or TPI
TAV	Target ΔV (AGS)
TE	Timing electronics equipment
temp	Temperature
TET	State vector integration time
TFC	Time from engine cutoff
TFF	Time of free fall to 300,000 ft, earth orbit; 35,000 ft, lunar orbit
TFI	Time from TIG

**LMA790-3-LM  
APOLLO OPERATIONS HANDBOOK**

Table D-1. Definitions of Symbols and Abbreviations (cont)

Symbol or Abbreviations	Definition
<u>T (cont)</u>	
TF INT	Time from intercept
TG	Time-to-go to engine cutoff
THR	Thrust
T1	Time to CSI (AGS)
TIG	Time of ignition
tigA	AGS computer time of CSI maneuver (AGS)
tigB	Absolute time of CDH maneuver (AGS)
tigC	AGS computer time of TPI or midcourse maneuver (AGS)
TLE	Tracking light electronics
TLM	Telemetry
TPF	Transfer phase final maneuver
TPI	Transfer phase initiation
TPM	Transfer phase midcourse
Tr	Time to rendezvous (AGS)
TR	Redesignation time remaining (PGNS)
T/R	Transmitter/receiver
TRANSL	Translation
TRUN	Trunnion
TTCA	Thrust/translation controller assembly
TTI	Time to initiate
TTIG	Time to ignition
TV	Television
TVC	Thrust vector control
tw	Thumbwheel
TX	Telemetry transmitter
<u>U</u>	
U	LM rotational axis in Y-Z plane 45° from +Z
UCTA	Urine collection and transfer assembly

**LMA790-3-LM  
APOLLO OPERATIONS HANDBOOK**

LM 3231

Table D-1. Definitions of Symbols and Abbreviations (cont)

Symbol or Abbreviation	Definition
<u>U (cont)</u>	
UDMH	Unsymmetrical dimethylhydrazine
UHF	Ultrahigh frequency
URS	Urine receptacle system
usec	Microsecond(s)
<u>V</u>	
V	Verb; inertial velocity vector at TIG; LM velocity; LM rotational axis in Y-Z plane 315° from +Z
vac	Volts, alternating current
VCO	Voltage-controlled oscillator
Vcx	X-component of CSM velocity (AGS)
Vcy	Y-component of CSM velocity (AGS)
Vcz	Z-component of CSM velocity (AGS)
vdc	Volts, direct current
VDX	$\Delta V$ expended in X-body-axis direction minus descent engine capability
VDY	$\Delta V$ expended in Y-body-axis direction
VDZ	$\Delta V$ expended in Z-body-axis direction
VEL	Velocity
VG	Magnitude of velocity vector required by LM for transfer orbit injection (fps); magnitude of LM velocity to be gained
VGX (LM)	Component of VG vector resolved along present X-axis
VGX (LV)	Component of VG vector at TIG along (RxV)xR
VGY (LM)	Component of VG vector resolved along present Y-axis
VGY (LV)	Component of VG vector at TIG along VxR
VGZ (LM)	Component of VG vector resolved along present Z-axis
VGZ (LV)	Component of VG vector at TIG along -R
Vhw	Horizontal velocity (AGS)
VHF	Very high frequency
VI	Inertial velocity
vlv	Valve
Vo	$\Delta V$ for CSI maneuver (AGS)

**LMA790-3-LM  
APOLLO OPERATIONS HANDBOOK**

Table D-1. Definitions of Symbols and Abbreviations (cont)

Symbol or Abbreviation	Definition
<u>V (cont)</u>	
vol	Volume
VOX	Voice-operated relay
VPI	Valve position indicator
vpo	CDH maneuver $\Delta V$ (AGS)
Vpy	Velocity perpendicular to CSM orbit (AGS)
vrms	Volts root mean square
VSm	Velocity to be gained during burn (AGS)
VT	Total velocity required to rendezvous (direct interception only)
Vx	Velocity along X-axis; altitude rate
Vy	Lateral velocity; velocity along Y-axis
Vyo	LM velocity normal to CSM orbit plane (AGS)
Vz	Forward velocity; velocity along Z-axis
<u>W</u>	
warn lt	Warning light
Wbx	X-unit vector for commanding attitude (AGS)
Wby	Y-unit vector for commanding attitude (AGS)
Wbz	Z-unit vector for commanding attitude (AGS)
Wcx	X-unit vector normal to CSM orbit (AGS)
Wcy	Y-unit vector normal to CSM orbit (AGS)
Wcz	Z-unit vector normal to CSM orbit (AGS)
<u>X</u>	
X	LM vertical axis
XDV	External $\Delta V$
xmtr	Transmitter
xpndr	Transponder
XTAL	Crystal
<u>Y</u>	
Y	LM lateral axis; LM out-of-plane position (AGS)
Ycx	X-component of CSM position (AGS)

**LMA790-3-LM  
APOLLO OPERATIONS HANDBOOK**

Table D-1. Definitions of Symbols and Abbreviations (cont)

Symbol or Abbreviation	Definition
<u>Y (cont)</u>	
Ycy	Y-component of CSM position (AGS)
Ycz	Z-component of CSM position (AGS)
YD	Desired out-of-plane jerk
yf	Predicted value of out-of-CSM-orbit plane position (AGS)
Yx	X-component of LM position (AGS)
Yy	Y-component of LM position (AGS)
Yz	Z-component of LM position (AGS)
<u>Z</u>	
Z	LM fore-aft axis
<u>Δ</u>	
δL	Landing azimuth angle (AGS)
ΔE	Difference between initial and final eccentric anomalies of transfer orbit (rad)
Δh	Altitude differential
ΔH	Altitude between active and passive vehicle after CDH (AGS)
Δp	Change in p for next iteration (AGS)
ΔP	Pressure differential
ΔR	Magnitude of difference between position state vector before and after incorporation of mark data
Δro	Differential altitude in coelliptic orbit (AGS)
ΔT	Time differential
ΔTRANS	Time required for transfer from TIG (TPI) to time of intercept
ΔV	Velocity change (differential); magnitude of difference between state vector before and after incorporation of mark data
ΔV (CDH)	Required impulsive ΔV to accomplish CDH maneuver at TIG (CDH)
ΔV (CSI)	Required impulsive ΔV to accomplish CSI maneuver at TIG (CSI)
ΔVgx	ΔV in X-direction (AGS)
ΔVgy	ΔV in Y-direction (AGS)

**LMA790-3-LM**  
**APOLLO OPERATIONS HANDBOOK**

Table D-1. Definitions of Symbols and Abbreviations (cont)

Symbol or Abbreviation	Definition
<u><math>\Delta</math> (cont)</u>	
$\Delta V_{gz}$	$\Delta V$ in Z-direction (AGS)
$\Delta V_m$	Measured $\Delta V$ magnitude
$\Delta V$ (MID)	Required impulsive $\Delta V$ to accomplish next midcourse maneuver at TIG (MID)
$\Delta V$ (TPF)	Required impulsive $\Delta V$ to accomplish intercept (TPF) maneuver at calculated time of intercept
$\Delta V$ (TPI)	Required impulsive $\Delta V$ to accomplish TPI maneuver at TIG (TPI)
$\Delta V_y$	External $\Delta V$ component in horizontal direction perpendicular to CSM orbit plane (AGS)
$\Delta V_X$ (LM)	Component of integrated acceleration along LM +X-axis
$\Delta V_X$ (LV)	Component of $\Delta V$ applied at TIG along (RxV)xR
$\Delta V_Y$ (LM)	Component of integrated acceleration along LM +Y-axis
$\Delta V_Y$ (LV)	Component of $\Delta V$ applied at TIG along VxR
$\Delta V_Z$ (LM)	Component of integrated acceleration along LM +Z-axis
$\Delta V_Z$ (LV)	Component of $\Delta V$ applied at TIG along -R
$\Delta \theta$	Angular difference between RR indicated LOS and state vector LOS
$\chi$	Angle
$a$	Semimajor axis of transfer orbit (AGS)
$\theta$	Phase
$\infty$	Infinity
$\leq$	Less than or equal to
$\geq$	Greater than or equal to
$<$	Is less than
$>$	Is greater than
$\theta$	Angle between LM +Z-axis and local horizontal plane (pitch)
$\theta_f$	LM-to-CSM phase angle
$\theta_{LOS}$	Predicted LOS angle at TPI time (AGS TPI only)
$\xi$	Angle between LM +Z-axis and local horizontal plane (AGS)
$\theta$	Yaw
$\psi$	Roll; angle between LOS and forward direction
$\Omega$	Angle between RR LOS and LM +Z-axis

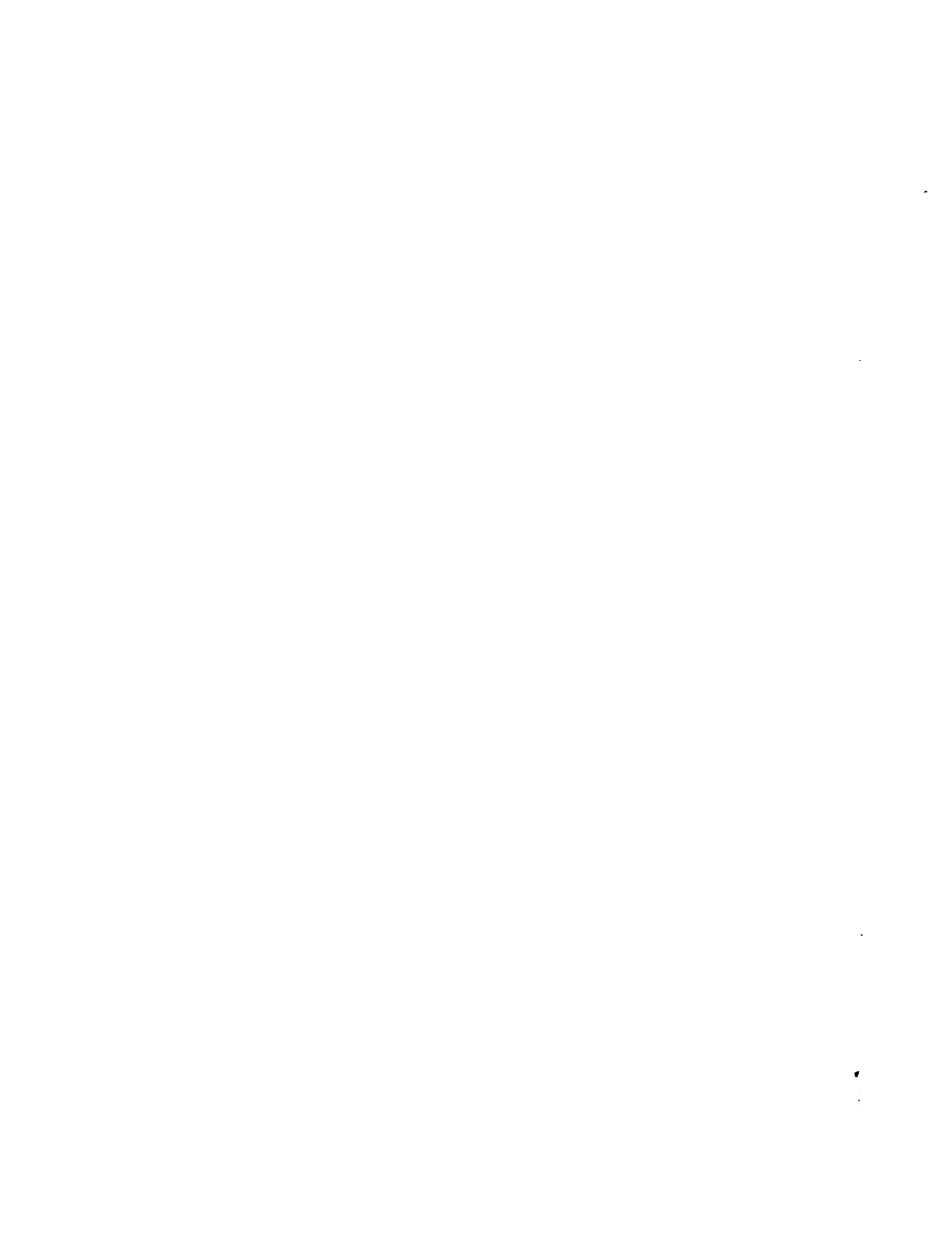



**APPENDIX E**  
**Controls and Displays**

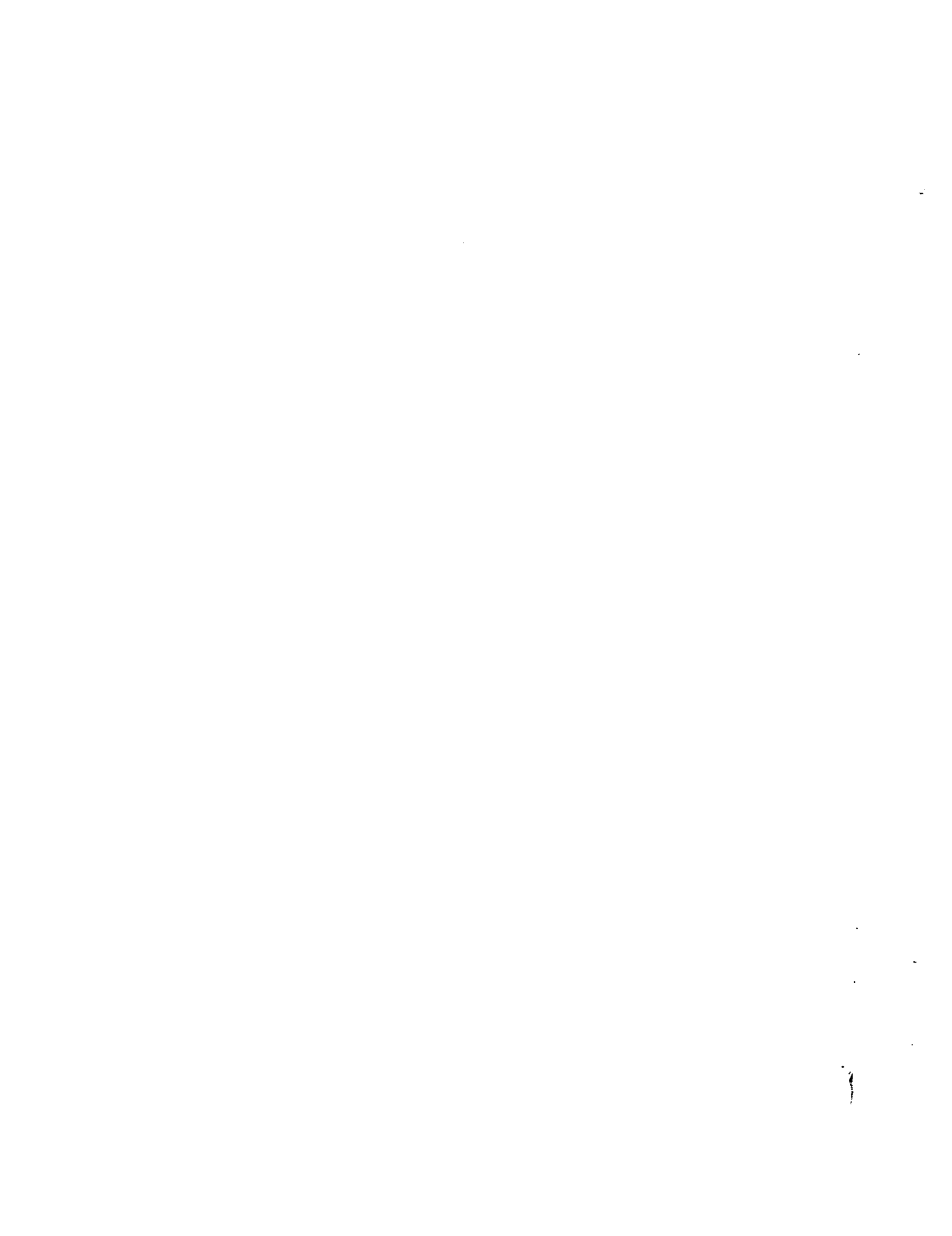



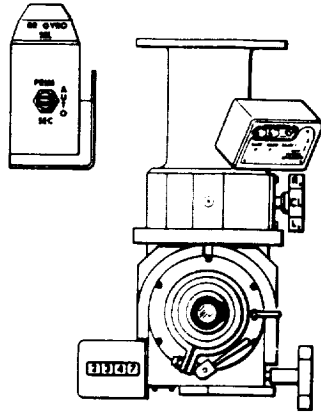
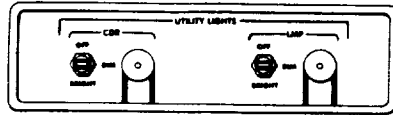
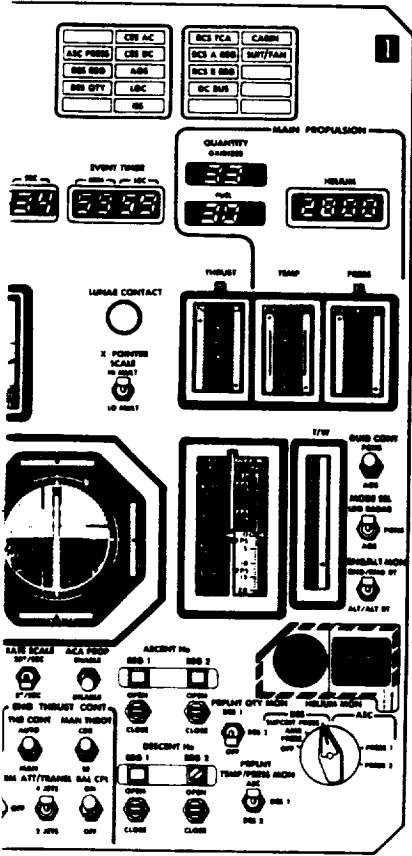

Alignment Optical Telescope (AOT)

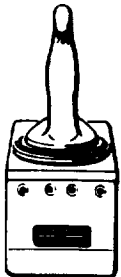
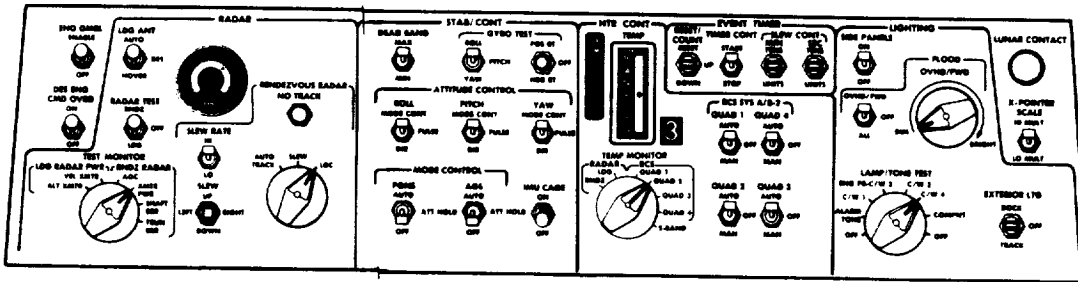
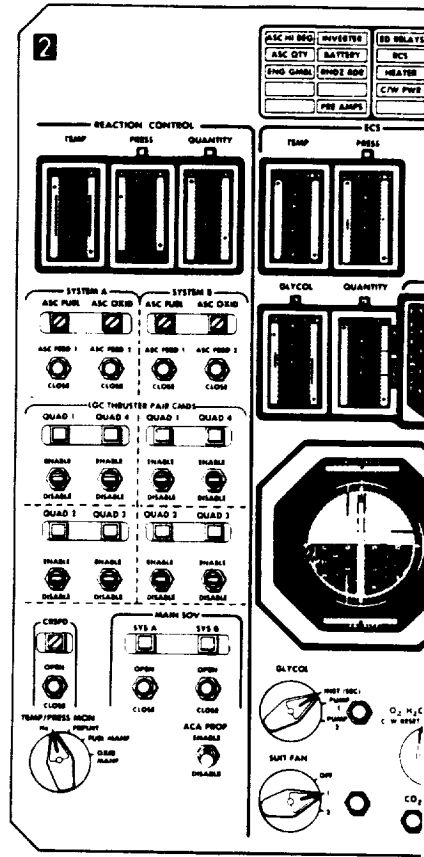

Attitude Controller Assembly (ACA)

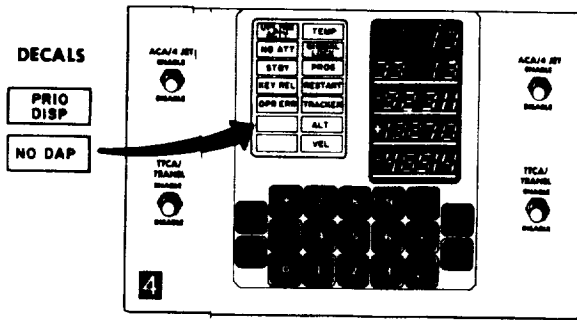

Thrust/Translation Control

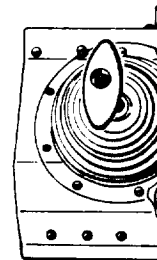

E-3/E-4-B

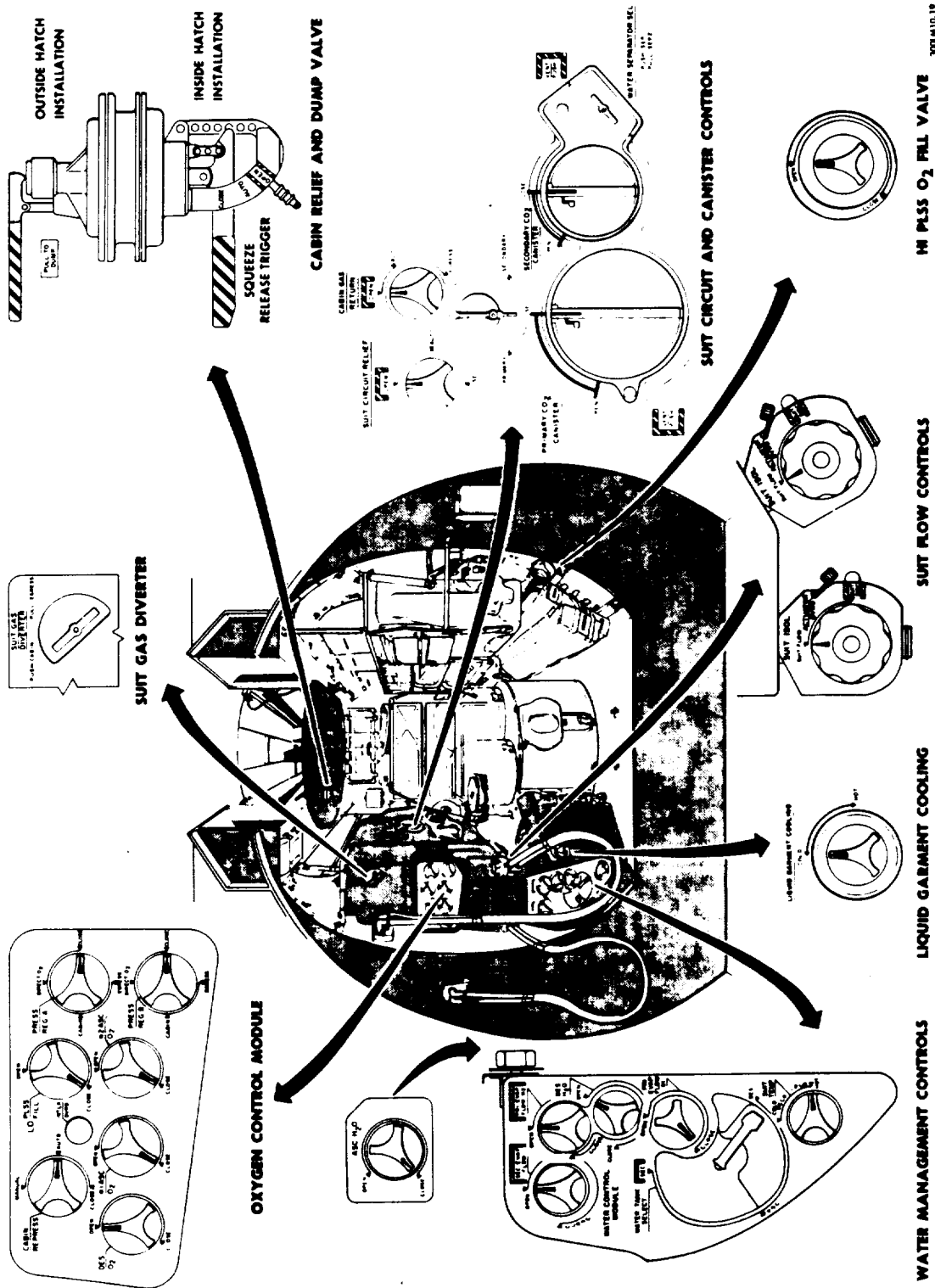

Figure E-2. ECS Aft Bulkhead Controls



**LMA790-3-LM  
 APOLLO OPERATIONS HANDBOOK**

**APPENDIX F**

**ALPHABETICAL INDEX**

**A**

	Page
Abbreviations, Definitions of Symbols and . . . . .	D-1
Abort Procedures . . . . .	5.1-1
APS Abort (LGC P71, AEA 410+00000) . . . . .	4.10-116
ACA Hardover . . . . .	4.5-14
Activation, Subsystem . . . . .	4.2-2
<b>AGS</b>	
AEA/DEDA Restrictions . . . . .	4.4-5
AEA Readiness Check . . . . .	4.6-55
AEA Self-Test . . . . .	4.6-45
AGS Accelerometer Calibration . . . . .	4.6-58
AGS (Alignment) . . . . .	4.9-17
AGS Alignment, Backup (Using AGS Body-Axis Alignment & AOT) . . . . .	4.9-20
AGS Alignment, Backup (Using AGS Body-Axis Alignment & PGNS IMU) . . . . .	4.9-19
AGS Attitude Error Display . . . . .	4.5-34
AGS Attitude Hold/Rate Command . . . . .	4.5-8
AGS Automatic . . . . .	4.5-6
AGS Automatic Rendezvous Radar LM State Vector Update (Raw Data Transfer Via LGC) . . . . .	4.8-22
AGS/CES . . . . .	4.6-42A
AGS Checkout . . . . .	4.6-46
AGS Contingency LM Lunar Touchdown State Vector, Load . . . . .	4.6-51
AGS Direct . . . . .	4.5-12
AGS FITH . . . . .	4.12-14
AGS Gyro & Accelerometer Calibration . . . . .	4.6-46
AGS Initialization Routine (R47) . . . . .	4.6-23
AGS Lunar Align (400+40000) . . . . .	4.9-29
AGS Lunar Azimuth Store . . . . .	4.6-61
AGS Lunar Surface Gyro Calibration . . . . .	4.6-60
AGS Manual Absolute Time Initialization . . . . .	4.6-49
AGS Manual CSM State Vector Update/Initialization . . . . .	4.6-52
AGS Manual LM State Vector Update/Initialization . . . . .	4.6-50
AGS Orbit Insertion . . . . .	4.7-36
AGS Orbital Steering . . . . .	4.6-53
AGS Orientation to Initial Computed Steering Attitude, . . . . .	4.6-56
AGS Out-of-Plane Maneuver . . . . .	4.7-34A
AGS Partial Power-Down . . . . .	4.6-63
AGS Power-Down . . . . .	4.6-42A
AGS Power-Up . . . . .	4.6-43
AGS Power-Up From AGS Partial Power-Down . . . . .	4.6-63
AGS (Prethrust) . . . . .	4.7-34A
AGS Pulse . . . . .	4.5-10
AGS RCS Axis-by-Axis Thrust . . . . .	4.10-51
AGS Rescaling From Lunar to Earth Mission . . . . .	4.6-61
AGS Selector Logic . . . . .	4.4-49
AGS Total Attitude Display . . . . .	4.5-33
AGS warn lt (malfunction procedure) . . . . .	5.2-14
AGS Wb Vector Update . . . . .	4.6-59
DEDA response abnormal (malfunctions procedure) . . . . .	5.2-14
PGNCS/AGS Align . . . . .	4.9-17
Rate Gyro Check . . . . .	4.6-54
Alarm Codes (V05 N09) . . . . .	4.4-29
<b>Alignment</b> . . . . .	4.9-2
AGS . . . . .	4.9-17
AGS Lunar Align (400+40000) . . . . .	4.9-29
Backup AGS Alignment (Using AGS Body-Axis Alignment & AOT) . . . . .	4.9-20
Backup AGS Alignment (Using AGS Body-Axis Alignment & PGNS IMU) . . . . .	4.9-19
Docked Manual IMU Coarse Alignment . . . . .	4.9-16
IMU Orientation Determination Program (P51) . . . . .	4.9-2
IMU Realign Program (P52) . . . . .	4.9-5
ISS Coarse Align . . . . .	4.9-14
Lunar Surface Alignment . . . . .	4.9-22

**LMA790-3-LM**  
**APOLLO OPERATIONS HANDBOOK**

ALPHABETICAL INDEX (cont)

	Page
PGNCS . . . . .	4.9-2
PGNCS/AGS Align . . . . .	4.9-17
PGNCS Lunar Surface Align Program (P57) . . . . .	4.9-22
Torque Gyros . . . . .	4.9-15
<b>ALSEP</b>	
<b>ALSEP Operations</b>	
Open Scientific Equipment (SEQ) Bay . . . . .	4.15-37
Pallet Assembly Remote Deployment . . . . .	4.15-37
Pallet Assembly Manual Deployment . . . . .	4.15-38
Pallet Assembly Manual Deployment in Low Attitude . . . . .	4.15-39
Removal of RTG Fuel Element . . . . .	4.15-40
Altitude/Altitude Rate Display . . . . .	4.15-41
AOT Detent/LPD/COAS Codes (N70, N71) . . . . .	4.5-37
AOT Lighting Check . . . . .	4.4-32
Approach Phase Program (P64) . . . . .	4.2-17
<b>APS</b>	4.10-86
APS Abort (LGC P71, AEA 410+00000) . . . . .	4.10-116
APS Periodic Monitoring . . . . .	4.13-31
APS Pressurization & Checkout . . . . .	4.12-3
APS Pressurization & Checkout (Alternate) . . . . .	4.12-4
APS/RCS Propellant Interconnect . . . . .	4.13-29
APS Temp/Press Prepressurization Check . . . . .	4.2-48
APS Thrust Program (P42) With AGS Followup/In Control . . . . .	4.10-22
Ascent Engine On/Off Control . . . . .	4.5-19
ASC He REG 1 (2) tb-bp (malfunction procedure) . . . . .	5.2-29
ASC HI REG caut lt (malfunction procedure) . . . . .	5.2-29
ASC PRESS warn lt (malfunction procedure) . . . . .	5.2-28
ASC QTY caut lt (malfunction procedure) . . . . .	5.2-29
Fuel or oxid press abnormal (malfunction procedure) . . . . .	5.2-29
Fuel or oxid temp abnormal (malfunction procedure) . . . . .	5.2-29
He press abnormal or decr (malfunction procedure) . . . . .	5.2-29
ARS/Cabin Atmosphere, Contaminants In . . . . .	5.3-8
ARS/PGA Pressure Integrity Check . . . . .	4.2-29
ARS Purge (EVA Preparation) . . . . .	4.15-14
Ascent Battery Activation & Checkout . . . . .	4.2-45
Ascent Stage Oxygen Tank Bleed-Down Procedure . . . . .	5.4-24A
Ascent Stage Oxygen Tank Top-Off Procedure . . . . .	5.4-24B
Attitude Control Modes . . . . .	4.5-2
Attitude Error Display, Mode I . . . . .	4.6-38
Attitude Error Display, Mode II . . . . .	4.6-38
Attitude Rate Display . . . . .	4.5-34

B

Braking Phase Program (P63) With AGS Preparation for Orbit Insertion (410+00000) . . . . .	4.10-73
--------------------------------------------------------------------------------------------	---------

C

Cabin Atmosphere Filtering . . . . .	4.13-17
Cabin Depressurization . . . . .	4.13-11
Cabin Leak Check . . . . .	4.13-14
Cabin Leak, Excessive . . . . .	5.3-2
Cabin Operations . . . . .	4.15-2
Cabin Repressurization . . . . .	4.13-13
Cabin Repressurization System, Disable LM . . . . .	4.14-6
Cabin Repressurization System, Enable LM . . . . .	4.14-5
<b>Calibration</b>	
AGS Accelerometer Calibration . . . . .	4.6-58
AGS Gyro & Accelerometer Calibration . . . . .	4.6-46
AGS Lunar Surface Gyro Calibration . . . . .	4.6-60
Camera Wedge, Installation of 16-MM Sequence . . . . .	4.13-50
Caution & Warning Array Checkout . . . . .	4.2-19



**LMA790-3-LM**  
**APOLLO OPERATIONS HANDBOOK**

ALPHABETICAL INDEX (cont)

	Page
<b>CES</b>	
Abnormal dynamics during MPS thrusting (malfunction procedure) . . . . .	5.2-19
Abnormal vehicle dynamics (non-MPS) (malfunction procedure) . . . . .	5.2-16
AGS pulse or direct cmds abnormal (malfunction procedure) . . . . .	5.2-18
CES AC warn lt (malfunction procedure) . . . . .	5.2-22
CES DC warn lt (malfunction procedure) . . . . .	5.2-22
ENG GMBL caut lt (malfunction procedure) . . . . .	5.2-20
ENG THRUST & CMD THRUST ind do not agree/off schedule (malfunction procedure) .	5.2-21
LM drifts out of deadband (malfunction procedure) . . . . .	5.2-17
No MPS ignition at TIG = 0 (malfunction procedure) . . . . .	5.2-21
No MPS shutdown (malfunction procedure) . . . . .	5.2-20
PGNS minimum impulse (V76) cmds abnormal (malfunction procedure) . . . . .	5.2-17
PRE AMPS caut lt (malfunction procedure) . . . . .	5.2-22
Premature MPS ignition (malfunction procedure) . . . . .	5.2-20
Prop cmds abnormal (malfunction procedure) . . . . .	5.2-18
TTCA cmds abnormal (malfunction procedure) . . . . .	5.2-19
Checklist Reference Codes (V50 N25) . . . . .	4.4-28
Circuit Breaker Activation . . . . .	4.2-10
COAS Lighting Check . . . . .	4.2-18
Coelliptic Sequence Initiation (LGC P32, AEA 410+10000) . . . . .	4.7-7
<b>Communications</b>	
Cannot acquire phaselock (malfunction procedure) . . . . .	5.2-46
Communications Basic . . . . .	4.13-17
Communications (Subsystem Management) . . . . .	4.13-17
Connect to LM ECS & Communications . . . . .	4.14-6
Disconnect From LM ECS & Communications . . . . .	4.14-8
DSEA Check . . . . .	4.13-23
DUA Backup Voice Disable . . . . .	4.13-26
DUA Backup Voice Enable . . . . .	4.13-26
DUA Disable . . . . .	4.13-25
DUA Enable . . . . .	4.13-25
Loss of ICS (malfunction procedure) . . . . .	5.2-44
Loss of S-band voice comm (malfunction procedure) . . . . .	5.2-45
Loss of VHF voice comm with CSM (malfunction procedure) . . . . .	5.2-44
Loss of voice comm with EVA (one man EVA) (malfunction procedure) . . . . .	5.2-47
Low-Power S-Band Backup Voice, LBR Check With Steerable Antenna . . . . .	4.2-40
MSFN reports loss of PCM. S-band voice OK. (malfunction procedure) . . . . .	5.2-46
One crewman has abnormal (unselected) hot mike (malfunction procedure) . . . . .	5.2-44
Relay Mode: CSM Voice to MSFN . . . . .	4.13-22
Relay Mode: EVA (One-Man EVA) . . . . .	4.13-21
Relay Mode: EVA (Two-Man EVA) . . . . .	4.13-20
S-Band Antenna Cooldown . . . . .	4.13-26
S-Band Configuration for LOS . . . . .	4.13-19
S-Band CWEA Enable . . . . .	4.13-23
S-Band LBR Data Enable . . . . .	4.13-23
S-Band Operation in PTC Mode . . . . .	4.13-26
S BD RCVR caut lt (malfunction procedure) . . . . .	5.2-46
VHF Ranging Check . . . . .	4.13-24
VHF B Data Enable . . . . .	4.13-23
Connect to LM ECS, Crewman . . . . .	4.2-28
Connect to LM ECS & Communications . . . . .	4.14-6
Constant Δ Altitude (LGC P33, AEA 410+20000) . . . . .	4.7-14
Consumables Check . . . . .	4.2-21
Controls and Displays . . . . .	E-1
Coolant Loop (HTS) Activation, Secondary . . . . .	4.13-8
Cooling H2O Changeover, LM H2O (LCG) to PLSS H2O . . . . .	4.15-28
Cooling H2O Changeover, PLSS H2O to LM H2O (LCG) . . . . .	4.15-28
Crash Bar Deployment . . . . .	4.13-51
Crash Bar, Stow . . . . .	4.13-51
Crash Bar, Unstow . . . . .	4.13-51
Crew-Defined Maneuver Routine (R62) . . . . .	4.6-11
Crewman Connect to LM ECS . . . . .	4.2-28
Crewman Disconnect Transfer Umbilical . . . . .	4.2-28A
CSM Backup . . . . .	4.7-38

**LMA790-J-LM**  
**APOLLO OPERATIONS HANDBOOK**

ALPHABETICAL INDEX (cont)

	Page
CSM Coelliptic Sequence Initiation Targeting Program (P72) . . . . .	4.7-38
CSM Constant $\Delta$ Altitude Targeting Program (P73) . . . . .	4.7-41
CSM Transfer Phase Initiation Targeting Program (P74) . . . . .	4.7-43
CSM Transfer Phase Midcourse Targeting Program (P75) . . . . .	4.7-46
CSM Transfer to LM Power (Unstaged) . . . . .	4.3-27
CSM Transfer to LM Power (Staged - Lifeboat) . . . . .	4.3-28
<b>D</b>	
DAP Data Load Routine (R03) . . . . .	4.6-8
Deactivation, Final Subsystem . . . . .	4.3-12
Deactivation, Subsystem . . . . .	4.3-2
DEDA Accessible Parameters List . . . . .	4.4-57
DEDA Input List . . . . .	4.4-51
DEDA Output List . . . . .	4.4-54
Defecation Disposal (Alternative Mode) . . . . .	4.13-49
Defecation Disposal (Prime Mode) . . . . .	4.13-48
Descent Engine On/Off Control . . . . .	4.5-14
Descent Engine Throttle Control . . . . .	4.5-22
Descent O <sub>2</sub> Venting . . . . .	5.4-24B
Disconnect From LM ECS & Communications . . . . .	4.14-8
Displays, Controls and . . . . .	E-1
Docking, LM . . . . .	4.11-6
<b>DPS</b>	
Descent Engine On/Off Control . . . . .	4.5-15
Descent Engine Throttle Control . . . . .	4.5-22
DES He REG 1 (2) tb - bp (malfunction procedure) . . . . .	5.2-25
DES He REG 2 (1) tb - gray (malfunction procedure) . . . . .	5.2-25
DES QTY warn lt (malfunction procedure) . . . . .	5.2-26
DES REG warn lt (malfunction procedure) . . . . .	5.2-24
DPS Abort (LGC P70, AEA 410+00000) . . . . .	4.10-106
DPS Periodic Monitoring . . . . .	4.13-30
DPS Pressurization & Checkout . . . . .	4.2-50
DPS Propellant Tank Venting . . . . .	4.12-2
DPS Supercritical He Venting (Lunar Surface Only) . . . . .	4.12-2A
DPS Temp/Press Prepressurization Check . . . . .	4.2-49
DPS Thrust Program (P40) With AGS Followup, Docked . . . . .	4.10-61
DPS Thrust Program (P40) With AGS Followup/In Control . . . . .	4.10-2
Fuel/oxid press abnormal (malfunction procedure) . . . . .	5.2-24
Fuel/oxid temp abnormal (malfunction procedure) . . . . .	5.2-25
FUEL VENT/OXID VENT tb - abnormal (malfunction procedure) . . . . .	5.2-26
He press abnormal (malfunction procedure) . . . . .	5.2-25
Loss of Descent Power . . . . .	5.3-11
PQGS ind abnormal (malfunction procedure) . . . . .	5.2-26
Drogue (CSM Side), Install . . . . .	4.14-11
Drogue (CSM Side), Remove . . . . .	4.14-12
Drogue (LM Side), Install . . . . .	4.14-10
Drogue (LM Side), Remove . . . . .	4.14-11
DSEA Check . . . . .	4.13-23
DSKY Light Test . . . . .	4.6-19
DUA Backup Voice Disable . . . . .	4.13-26
DUA Backup Voice Enable . . . . .	4.13-26
DUA Disable . . . . .	4.13-25
DUA Enable . . . . .	4.13-25
Dynamic Display Modes . . . . .	4.5-30
<b>E</b>	
<b>ED</b>	
ED Prestaging Check . . . . .	4.12-8
ED RELAYS caut lt (malfunction procedure) . . . . .	5.2-58
STAGE SEQ RELAYS SYS A & B lts - off when MASTER ARM - <u>ON</u> (malfunction procedure) . . . . .	5.2-58
STAGE SEQ RELAY SYS A or B lt - off when MASTER ARM - <u>ON</u> (malfunction procedure) . . . . .	5.2-59

**LMA790-3-LM**  
**APOLLO OPERATIONS HANDBOOK**

ALPHABETICAL INDEX (cont)

	Page
Emergency Procedures . . . . .	5.3-2
Contaminants In ARS/Cabin Atmosphere . . . . .	5.3-8
Emergency Forward Hatch Opening (Cabin Side) . . . . .	5.3-8
Emergency Transfer, Using OPS . . . . .	5.3-7
EPS Prestaging Check - Lunar Contingency (One Ascent Battery Only) . . . . .	5.3-10
Excessive Cabin Leak . . . . .	5.3-2
Extravehicular Transfer (Staged Vehicle) . . . . .	5.3-15
Final Subsystem Preparation for EVT . . . . .	5.3-16
Fire/Smoke in Cabin (Not in Suit Loop) . . . . .	5.3-3
Fire/Smoke in Suit Loop . . . . .	5.3-3
Loss of CDR Bus During Powered Descent . . . . .	5.3-11
Abort (DPS Engine), To . . . . .	5.3-11
Abort (APS Engine), To . . . . .	5.3-12
Reconfigure . . . . .	5.3-13
Loss of Descent Power . . . . .	5.3-11
Loss of ED Sub-system . . . . .	5.4-35
Loss of LMP Bus During Powered Descent . . . . .	5.3-13
Abort (DPS Engine), To . . . . .	5.3-13
Abort (APS Engine), To . . . . .	5.3-14
Reconfigure . . . . .	5.3-14
Loss of Manual and Auto APS Start Capability . . . . .	5.4-25
Loss of Manual and Auto APS Start Capability (with loss of one bus) . . . . .	5.4-31
Smoke in Cabin (Crew Unsuiting) . . . . .	5.3-9
Subsystem Preparation for Egress . . . . .	5.3-15
Suit Leak in Depressurized Cabin . . . . .	5.3-4
Vacuum Changeover - PLSS to LM . . . . .	5.3-5
Vacuum Transfer to CSM, Crewman . . . . .	5.3-6
ECS	
ARS/Cabin Atmosphere, Contaminants In . . . . .	5.3-8
ARS/PGA Pressure Integrity Check . . . . .	4.2-29
Cabin Atmosphere Filtering . . . . .	4.13-17
Cabin Depressurization . . . . .	4.13-11
Cabin Leak Check . . . . .	4.13-14
Cabin Leak, Excessive . . . . .	5.3-2
CABIN PRESS - high (malfunction procedure) . . . . .	5.2-51
CABIN PRESS - low or decr (malfunction procedure) . . . . .	5.2-50
Cabin Repressurization . . . . .	4.13-13
Cabin Repressurization System, Disable LM . . . . .	4.14-6
Cabin Repressurization System, Enable LM . . . . .	4.14-5
CABIN warn lt (malfunction procedure) . . . . .	5.2-50
Connect to LM ECS, Crewman . . . . .	4.2-28
Connect to LM ECS & Communications . . . . .	4.14-6
Consumables Check . . . . .	4.2-21
Coolant Loop (HTS) Activation, Secondary . . . . .	4.13-8
Cooling H2O Changeover, LM H2O, (LCG) to PLSS H2O . . . . .	4.15-28
Cooling H2O Changeover, PLSS H2O to LM H2O (LCG) . . . . .	4.15-28
CO2 lt (malfunction procedure) . . . . .	5.2-54
Disconnect From LM ECS & Communications . . . . .	4.14-8
ECS Activation & Checkout . . . . .	4.2-21
ECS Basic (Unstaged & Staged) . . . . .	4.13-23
ECS caut lt (malfunction procedure) . . . . .	5.2-54
ECS Periodic Monitoring (Staged) . . . . .	4.13-7
ECS Periodic Monitoring (Unstaged) . . . . .	4.13-5
ECS Prestaging Check . . . . .	4.12-8
ECS (Subsystem Management) . . . . .	4.13-3
ECS Status (Two Men on Lunar Surface) . . . . .	4.15-24
GLYCOL caut lt (malfunction procedure) . . . . .	5.2-54
GLYCOL comp lt (malfunction procedure) . . . . .	5.2-55
GLYCOL press - low or decr (malfunction procedure) . . . . .	5.2-56
Glycol Pump Check . . . . .	4.2-21
GLYCOL temp - high or incr (malfunction procedure) . . . . .	5.2-55
H2O Dispenser Activation . . . . .	4.13-16
H2O QUANTITY - low or decr abnormally (malfunction procedure) . . . . .	5.2-50
H2O SEP lt (malfunction procedure) . . . . .	5.2-54

**LMA790-3-LM**  
**APOLLO OPERATIONS HANDBOOK**  
 ALPHABETICAL INDEX (cont)

	Page
LCG Recharge Procedure . . . . .	4.13-14
02 Demand Regulator Checkout . . . . .	4.2-24
02 Demand Regulator Check (Alternative), In-Flight . . . . .	4.2-27
02 QTY caut lt (malfunction procedure) . . . . .	5.2-53
02 QUANTITY - low or descr (malfunction procedure) . . . . .	5.2-53
02 Supply Activation . . . . .	4.2-23
PART PRESS CO2 - high (malfunction procedure) . . . . .	5.2-54
Primary LiOH Cartridge Replacement . . . . .	4.13-9
Secondary LiOH Cartridge Replacement . . . . .	4.13-10
SUIT FAN lt (malfunction procedure) . . . . .	5.2-54
SUIT/FAN warn lt (malfunction procedure) . . . . .	5.2-52
Suit Fan Activation, Checkout, and Water Separator Check . . . . .	4.2-23
SUIT ISOL Valve Check . . . . .	4.2-22
Suit Leak in Depressurized Cabin . . . . .	5.3-4
SUIT PRESS - high (egress mode) (malfunction procedure) . . . . .	5.2-52
SUIT PRESS - low (malfunction procedure) . . . . .	5.2-52
Egress, Final Subsystem Configuration for . . . . .	4.15-23
Emesis Disposal . . . . .	4.13-48
Enable W-Matrix Initialization . . . . .	4.6-33
<b>EPS</b>	
A-C voltage high (malfunction procedure) . . . . .	5.2-40
Ascent Battery Activation & Checkout . . . . .	4.2-45
Bat tb abnormal (UNSTAGED) (malfunction procedure) . . . . .	5.2-39
BATTERY caut lt (STAGED) (malfunction procedure) . . . . .	5.2-39
BATTERY caut lt (UNSTAGED) (malfunction procedure) . . . . .	5.2-39
Bus functions lost (malfunction procedure) . . . . .	5.2-41
Circuit Breaker Activation . . . . .	4.2-10
DC BUS warn lt (STAGED) (malfunction procedure) . . . . .	5.2-38
DC BUS warn lt (UNSTAGED) (malfunction procedure) . . . . .	5.2-36
EPS Activation & Checkout . . . . .	4.2-5
EPS Basic (Staged) . . . . .	4.13-36
EPS Basic (Unstaged) . . . . .	4.13-35
EPS Check, Post-DPS Burn . . . . .	4.13-38
EPS Periodic Monitoring (Staged) . . . . .	4.13-40
EPS Periodic Monitoring (Unstaged) . . . . .	4.13-38
EPS Poststaging Check . . . . .	4.12-8
EPS Preparation for DPS Burn . . . . .	4.13-36
EPS Prestaging Check . . . . .	4.12-6
EPS Prestaging Check - Lunar Contingency (One Ascent Battery Only) . . . . .	5.4-2
EPS (Subsystem Management) . . . . .	4.13-35
INVERTER caut lt (malfunction procedure) . . . . .	5.2-40
LCA Duty Cycle During Secondary Coolant Loop Operation . . . . .	4.13-40
Loss of CDR Bus During Powered Descent . . . . .	5.3-11
Loss of LMP Bus During Powered Descent . . . . .	5.3-13
Lunar Stay Battery Management . . . . .	4.13-41
VOLTS - low (malfunction procedure) . . . . .	5.2-36
Erased Modification Routine (RO1) . . . . .	4.6-41
EVA Antenna, Raise . . . . .	4.15-32
EVA Antenna, Stow . . . . .	4.15-32
Event Timer, Set . . . . .	4.13-44
External AV (LGC P30, AEA 410+50000) . . . . .	4.7-2
Extravehicular Activity . . . . .	4.15-34
<b>F</b>	
Final Automatic Request Terminate Routine (RO0) . . . . .	4.6-40
Fire/Smoke in Cabin (Not in Suit Loop) . . . . .	5.3-3
Fire/Smoke in Suit Loop . . . . .	5.3-3
FITH, AGS . . . . .	4.12-14
Flagwords . . . . .	4.4-33
Forward Hatch (Cabin Side), Close . . . . .	4.15-13
Forward Hatch (Cabin Side), Open . . . . .	4.15-13

**LMA790-3-LM  
APOLLO OPERATIONS HANDBOOK**

ALPHABETICAL INDEX (cont)

	Page
Forward Hatch Opening (Cabin Side), Emergency . . . . .	5.3-8
Forward Hatch (Outside), Close . . . . .	4.15-14
Forward Hatch (Outside), Open . . . . .	4.15-13
Forward Velocity/Lateral Velocity Display . . . . .	4.5-36
Fresh Start . . . . .	4.6-29

G

G&C

AGS att error nonzero when it should be zero (malfunction procedure) . . . . .	5.2-4
AGS att error zero when it should be nonzero (malfunction procedure) . . . . .	5.2-4
FDAI att error abnormal (malfunction procedure) . . . . .	5.2-4
FDAI OFF flag appears (malfunction procedure) . . . . .	5.2-5
FDAI total att abnormal (malfunction procedure) . . . . .	5.2-5
G&C General . . . . .	4.6-3
G&C Reference Data . . . . .	4.4-2
G&C Reference Modes . . . . .	4.5-2
Rate display abnormal (malfunction procedure) . . . . .	5.2-5
Rate gyro test fails (malfunction procedure) . . . . .	5.2-6
RNG/RNG RT pwr/sig fail lt (malfunction procedure) . . . . .	5.2-6
GDA Enable . . . . .	4.5-27
Glycol Loop Activation, Primary . . . . .	4.2-9
Glycol Pump Check . . . . .	4.2-21
Ground Track Determination Program (P21) . . . . .	4.8-2

H

HEATERS

HEATER caut lt (malfunction procedure) . . . . .	5.2-62
Heater Control Temperature Monitor Display . . . . .	4.5-39
Heaters Status Check . . . . .	4.13-44
LR temp abnormal (malfunction procedure) . . . . .	5.2-63
RCS quad 1 (2, 3, 4) temp abnormal (malfunction procedure) . . . . .	5.2-63
RR temp abnormal (malfunction procedure) . . . . .	5.2-62
S-band antenna temp abnormal (malfunction procedure) . . . . .	5.2-62
H2O Dispenser Activation . . . . .	4.13-16
LCG Recharge . . . . .	4.13-14

I

ICDU Zero . . . . .	4.6-30
IMU Coarse Alignment, Docked Manual . . . . .	4.9-16
IMU Orientation Determination Program (P51) . . . . .	4.9-2
IMU Power-Down . . . . .	4.6-5
IMU Power-Up (LGC Off) . . . . .	4.6-4
IMU Power-Up (LGC Operating) . . . . .	4.6-4
IMU Realign Program (P52) . . . . .	4.9-5
Increment LGC Time . . . . .	4.6-32
In-Flight O2 Demand Regulator Check (Alternative) . . . . .	4.2-27
Initial Entry Status Check . . . . .	4.2-2
Initial Intravehicular Transfer to LM . . . . .	4.14-2
Initialize Erasable Dump Via Downlink . . . . .	4.6-32
Input Δ RLS for Pinpoint Landing . . . . .	4.6-41
Installation of 16-MM Sequence Camera Wedge . . . . .	4.13-49
Install Drogue (CSM Side) . . . . .	4.14-12

**LMA790-3-LM**  
**APOLLO OPERATIONS HANDBOOK**  
ALPHABETICAL INDEX (cont)

	Page
Install Drogue (LM Side) . . . . .	4.14-11
Interrupt Integration . . . . .	4.6-38
Intravehicular Operations . . . . .	4.14-2
Intravehicular Transfer to CSM . . . . .	4.14-5
Intravehicular Transfer to LM (Second Crewman) . . . . .	4.14-3
ISS Coarse Align . . . . .	4.9-14
J	
Jet Select Logic . . . . .	4.4-8
L	
Landing Confirmation Program (P68) . . . . .	4.10-92
Landing Gear Deploy . . . . .	4.2-61
Landing Phase (ROD) Program (P66) . . . . .	4.10-88
Landing Radar Checkout . . . . .	4.6-80
Landing Radar Power-Down . . . . .	4.6-83
Landing Radar Power-Up . . . . .	4.6-79
Landing Radar Spurious Test Routine (R77) . . . . .	4.6-82
Landing Radar to Position 2, Command . . . . .	4.6-82
LCA Duty Cycle During Secondary Coolant Loop Operation . . . . .	4.13-40
LGC Recharge . . . . .	4.13-14
LGC/CMC Clock Synchronization Routine (R33) . . . . .	4.6-20
LGC/DSKY Restrictions . . . . .	4.4-2
LGC Erasable Memory Display/Update . . . . .	4.6-35
LGC Idling Program (P00) . . . . .	4.6-5
LGC Power-Down Program (P06) . . . . .	4.6-4
LGC Power-Up . . . . .	4.6-3
LGC Programs . . . . .	4.4-10
P00 - LGC Idling . . . . .	4.6-5
P06 - LGC Power-Down . . . . .	4.6-4
P12 - Powered Ascent . . . . .	4.10-92
P20 - Rendezvous Navigation . . . . .	4.8-6
P21 - Ground Track Determination . . . . .	4.8-2
P22 - Lunar Surface Navigation . . . . .	4.8-22
P25 - Preferred Tracking Attitude . . . . .	4.6-26
P27 - LGC Update . . . . .	4.6-6
P30 - External AV . . . . .	4.7-2
P32 - Coelliptic Sequence Initiation (CSI) . . . . .	4.7-7
P33 - Constant $\Delta$ Altitude (CDH) . . . . .	4.7-14
P34 - Transfer Phase Initiation (TPI) . . . . .	4.7-20
P35 - Transfer Phase Midcourse (TPM) . . . . .	4.7-28
P40 - DPS Thrust . . . . .	4.10-2
P41 - RCS Thrust . . . . .	4.10-38
P42 - APS Thrust . . . . .	4.10-22
P47 - Thrust Monitor . . . . .	4.10-50
P51 - IMU Orientation Determination . . . . .	4.9-2
P52 - IMU Realign . . . . .	4.9-5
P57 - Lunar Surface Align . . . . .	4.9-22
P63 - Braking Phase . . . . .	4.10-73
P64 - Approach Phase . . . . .	4.10-86
P66 - Landing Phase (ROD) . . . . .	4.10-88
P68 - Landing Confirmation . . . . .	4.10-91
P70 - DPS Abort . . . . .	4.10-106
P71 - APS Abort . . . . .	4.10-116
P72 - CSM Coelliptic Sequence Initiation Targeting . . . . .	4.7-38
P73 - CSM Constant $\Delta$ Altitude Targeting . . . . .	4.7-41
P74 - CSM Transfer Phase Initiation Targeting . . . . .	4.7-43
P75 - CSM Transfer Phase Midcourse Targeting . . . . .	4.7-46
P76 - Target $\Delta V$ (CSM) . . . . .	4.7-33
P77 - Target $\Delta V$ (LM) . . . . .	4.7-34

**LMA790-3-LM**  
**APOLLO OPERATIONS HANDBOOK**

ALPHABETICAL INDEX (cont)

	Page
LGC Routines . . . . .	4.4-11
R00 - Final Automatic Request Terminate . . . . .	4.6-40
R01 - Erasable and Channel Modification . . . . .	4.6-41
R03 - DAP Data Load . . . . .	4.6-8
R04 - RR/LR Self-Test . . . . .	4.6-64,80
R05 - S-Band Antenna . . . . .	4.6-37
R30 - Orbit Parameter Display . . . . .	4.8-3
R31 - Rendezvous Parameter Display . . . . .	4.6-16
R33 - LGC/CMC Clock Synchronization . . . . .	4.6-20
R36 - Rendezvous Out-of-Plane Display . . . . .	4.7-32
R47 - AGS Initialization . . . . .	4.6-23
R60 - Attitude maneuver routine . . . . .	4.6-12,-15,-27;4.8-8,-11,-14,-17; 4.9-10;4.10-27,-44,-65,-79;4.12-17
R62 - Crew-Defined Maneuver . . . . .	4.6-11
R63 - Rendezvous Final Attitude . . . . .	4.6-13
R77 - LR Spurious Test . . . . .	4.6-82
LGC Self-Test . . . . .	4.6-17
LGC Update Program (P27) . . . . .	4.6-6
Lighting	
AOT Lighting Check . . . . .	4.2-17
Caution & Warning Array Checkout . . . . .	4.2-19
COAS Lighting Check . . . . .	4.2-18
DSKY Light Test . . . . .	4.6-19
Lighting Activation & Checkout . . . . .	4.2-16
L10H Cartridge Replacement, Primary . . . . .	4.13-9
L10H Cartridge Replacement, Secondary . . . . .	4.13-10
LM-to-CSM Power Transfer, Unstaged . . . . .	4.3-28
Load IMU Attitude Error Meters . . . . .	4.6-31
Low-Power S-Band Backup Voice, LBR Check With Steerable Antenna . . . . .	4.2-40
LRV Deployment . . . . .	4.15-37
Lunar Launch Contingency Stowage . . . . .	4.15-42
Lunar Stay Operations . . . . .	4.15-2
Lunar Surface Navigation . . . . .	4.8-22B
Lunar Surface Navigation Program (P22) . . . . .	4.8-22B

M

Malfunction Procedures . . . . .	5.2-1
Abort Guidance Section . . . . .	5.2-13
AGS warn lt . . . . .	5.2-14
DEDA response abnormal . . . . .	5.2-14
Ascent Propulsion Section . . . . .	5.2-27
ASC He REG 1 (2) tb - bp . . . . .	5.2-29
ASC HI REG caut lt . . . . .	5.2-29
ASC PRESS warn lt . . . . .	5.2-28
ASC QTY caut lt . . . . .	5.2-29
Fuel or oxid press abnormal . . . . .	5.2-29
Fuel or oxid temp abnormal . . . . .	5.2-29
He press abnormal or decr . . . . .	5.2-29
Communication Subsystem . . . . .	5.2-43
Cannot acquire phaselock . . . . .	5.2-46
Loss of ICS . . . . .	5.2-44
Loss of S-band voice comm . . . . .	5.2-45
Loss of VHF voice comm with CSM . . . . .	5.2-44
Loss of voice comm with EVA (one man EVA) . . . . .	5.2-47
MSFN reports loss of PCM. S-band voice OK . . . . .	5.2-46
One crewman has abnormal (unselected) hot mike . . . . .	5.2-44
S BD RCVR caut lt . . . . .	5.2-46

**LMA790-3-LM**  
**APOLLO OPERATIONS HANDBOOK**

ALPHABETICAL INDEX (cont)

	Page
Control Electronics Section . . . . .	5.2-15
Abnormal dynamics during MPS thrusting . . . . .	5.2-19
Abnormal vehicle dynamics (non-MPS) . . . . .	5.2-16
AGS Pulse or direct cmds abnormal . . . . .	5.2-18
CES AC warn lt . . . . .	5.2-22
CES DC warn lt . . . . .	5.2-22
ENG GMSL caut lt . . . . .	5.2-20
ENG THRUST & CMD THRUST ind do not agree/off schedule . . . . .	5.2-21
LM drifts out of deadband . . . . .	5.2-17
No MPS ignition at TIC = 0 . . . . .	5.2-21
No MPS shutdown . . . . .	5.2-20
PGNS minimum impulse (V76) cmds abnormal . . . . .	5.2-17
PRE AMPS caut lt . . . . .	5.2-22
Premature MPS ignition . . . . .	5.2-20
Prop cmds abnormal . . . . .	5.2-18
TTCA cmds abnormal . . . . .	5.2-19
Descent Propulsion Section . . . . .	5.2-23
DES He REG 1 (2) tb - bp . . . . .	5.2-25
DES He REG 2 (1) tb - gray . . . . .	5.2-25
DES QTY warn lt . . . . .	5.2-26
DES REG warn lt . . . . .	5.2-24
Fuel/oxid press abnormal . . . . .	5.2-24
Fuel/oxid temp abnormal . . . . .	5.2-25
FUEL VENT/OXID VENT tb - abnormal . . . . .	5.2-26
He press abnormal . . . . .	5.2-25
PQGS ind abnormal . . . . .	5.2-26
Electrical Power Subsystem . . . . .	5.2-35
A-C voltage high . . . . .	5.2-40
5 Bat tb abnormal (UNSTAGED) . . . . .	5.2-40
5 Bat tb abnormal (UNSTAGED) . . . . .	5.2-40
Bat tb abnormal (STAGED or UNSTAGED) . . . . .	5.2-40
BATTERY caut lt (STAGED or UNSTAGED) . . . . .	5.2-39
Bus functions lost . . . . .	5.2-42
DC BUS warn lt (STAGED) . . . . .	5.2-38
DC BUS warn lt (UNSTAGED) . . . . .	5.2-36
INVERTER caut lt . . . . .	5.2-40
VOLTS - low . . . . .	5.2-36
Environmental Control Subsystem . . . . .	5.2-49
CABIN press - high . . . . .	5.2-51
CABIN PRESS - low or decr . . . . .	5.2-50A
CABIN warn lt . . . . .	5.2-50A
CO2 lt . . . . .	5.2-54A
ECS caut lt . . . . .	5.2-54
GLYCOL caut lt . . . . .	5.2-55
GLYCOL comp lt . . . . .	5.2-54A
GLYCOL press - low or decr . . . . .	5.2-56
GLYCOL temp - high or incr . . . . .	5.2-55
H2O QUANTITY - low or decr abnormally . . . . .	5.2-50
H2O SEP lt . . . . .	5.2-54
O2 QTY caut lt . . . . .	5.2-53
O2 QUANTITY - low or decr . . . . .	5.2-53
PART PRESS CO2 - high . . . . .	5.2-54A
SUIT FAN lt . . . . .	5.2-54
SUIT/FAN warn lt . . . . .	5.2-52
SUIT PRESS - high (egress mode) . . . . .	5.2-52
SUIT PRESS - low . . . . .	5.2-52
Explosive Devices . . . . .	5.2-57
ED RELAYS caut lt . . . . .	5.2-58
STAGE SEQ RELAY SYS A or B lt - off when MASTER ARM - <u>ON</u> . . . . .	5.2-59
STAGE SEQ RELAYS SYS A & B lts - off when MASTER ARM - <u>ON</u> . . . . .	5.2-59
MSFN Advises Both Sys A & B K7-K15 Failed . . . . .	5.2-60



**LMA790-3-LM  
APOLLO OPERATIONS HANDBOOK**

ALPHABETICAL INDEX (cont)

	Page
Guidance & Control Flight Displays . . . . .	5.2-3
AGS att error nonzero when it should be zero . . . . .	5.3-4
AGS att error zero when it should be nonzero . . . . .	5.2-4
FDAI att error abnormal . . . . .	5.2-4
FDAI OFF flag appears . . . . .	5.2-5
FDAI total att abnormal . . . . .	5.2-5
Rate display abnormal . . . . .	5.2-5
Rate gyro test fails . . . . .	5.2-6
RNG/RNG RT pwr/sig fail lt . . . . .	5.2-6
Heaters . . . . .	5.2-61
HEATER caut lt . . . . .	5.2-62
LR temp abnormal . . . . .	5.2-63
RCS quad 1 (2, 3, 4) temp abnormal . . . . .	5.2-63
RR temp abnormal . . . . .	5.2-62
S-band antenna temp abnormal . . . . .	5.2-62
Primary Guidance & Navigation Section . . . . .	5.2-7
ALT lt . . . . .	5.2-10
GIMBAL LOCK lt . . . . .	5.2-9
ISS warn lt . . . . .	5.2-8
LGC test . . . . .	5.2-12
LGC warn lt . . . . .	5.2-9
NO TRACK lt . . . . .	5.2-11
RESTART lt . . . . .	5.2-9
RNDZ RDR caut lt . . . . .	5.2-11
TEMP lt . . . . .	5.2-9
TRACKER lt . . . . .	5.2-8
VEL lt . . . . .	5.2-10
Reaction Control Section . . . . .	5.2-31
He press low or decr . . . . .	5.2-32
PQMD abnormal . . . . .	5.2-32
RCS A (B) REG warn lt . . . . .	5.2-33
RCS caut lt . . . . .	5.2-32
RCS press or temp abnormal . . . . .	5.2-32
RCS TCA warn lt . . . . .	5.2-33
TB abnormal (QUAD) . . . . .	5.2-33
TB abnormal (MAIN SOV, CRSFD, ASC FEED) . . . . .	5.2-33
MESA Operation . . . . .	4.15-34
MESA Equipment Handling and Transfer . . . . .	4.15-36
MESA Exterior Blanket Removal . . . . .	4.15-35
MESA Height Adjustment . . . . .	4.15-35
MESA Manual Deployment . . . . .	4.15-35
MESA Remote Deployment . . . . .	4.15-34
SRC Removal . . . . .	4.15-37
TV Camera Deployment . . . . .	4.15-36
Mission Timer, Set . . . . .	4.2-20
Mode I Attitude Error Display . . . . .	4.6-38
Mode II Attitude Error Display . . . . .	4.6-38
MPS Basic (Staged) . . . . .	4.13-28
MPS Basic (Unstaged) . . . . .	4.13-28
N	
Navigation . . . . .	4.8-2
Navigation, LM Rendezvous . . . . .	4.8-5
Navigation, Lunar Surface . . . . .	4.8-22
Navigation, Orbital . . . . .	4.8-2
Noun List . . . . .	4.4-14

**LMA790-3-LM**  
**APOLLO OPERATIONS HANDBOOK**

ALPHABETICAL INDEX (cont)

	Page
O	
Option Codes (V04 N06, V04 N12, or V05 N06) . . . . .	4.4-28
Orbital Navigation . . . . .	4.8-2
Orbital Thrust . . . . .	4.10-2
Orbit Parameter Display (PGNCS R30 & AGS) . . . . .	4.8-3
ORDEAL Initialization . . . . .	4.6-33
Overhead Hatch (CSM Side), Close . . . . .	4.14-10
Overhead Hatch (CSM Side), Open . . . . .	4.14-9
Overhead Hatch (LM Side), Close . . . . .	4.14-10
Overhead Hatch (LM Side), Open . . . . .	4.14-9
O2 Demand Regulator Checkout . . . . .	4.2-24
O2 Demand Regulator Check (Alternative), In-Flight . . . . .	4.2-27
O2 Supply Activation . . . . .	4.2-23
P	
PGA Cooling, Reverse O2 Umbilicals for . . . . .	4.13-15
PGNCS	
AGS Initialization Routine (R47) . . . . .	4.6-23
Crew-Defined Maneuver Routine (R62) . . . . .	4.6-11
DAP Data Load Routine (R03) . . . . .	4.6-8
DSKY Light Test . . . . .	4.6-19
Erasable Modification Routine (R01) . . . . .	4.6-41
Enable W-Matrix Initialization . . . . .	4.6-33
Final Automatic Request Terminate Routine (R00) . . . . .	4.6-40
Fresh Start . . . . .	4.6-29
ICDU Zero . . . . .	4.6-30
IMU Power-Down . . . . .	4.6-5
IMU Power-Up (LGC Off) . . . . .	4.6-4
IMU Power-Up (LGC Operating) . . . . .	4.6-4
Increment LGC Time . . . . .	4.6-32
Initialize Erasable Dump Via Downlink . . . . .	4.6-32
Input ARLS For Pinpoint Landing . . . . .	4.6-41
Interrupt Integration . . . . .	4.6-38
LGC/CMC Clock Synchronization Routine (R33) . . . . .	4.6-20
LGC Erasable Memory Display/Update . . . . .	4.6-35
LGC Idling Program (P00) . . . . .	4.6-5
LGC Power-Down Program (P06) . . . . .	4.6-4
LGC Power-Up . . . . .	4.6-3
LGC Self-Test . . . . .	4.6-17
LGC Update Program (P27) . . . . .	4.6-6
Load IMU Attitude Error Meters . . . . .	4.6-31
Mode I Attitude Error Display . . . . .	4.6-38
Mode II Attitude Error Display . . . . .	4.6-38
Move This Vehicle State Vector to Other State Vector . . . . .	4.6-39
ORDEAL Initialization . . . . .	4.6-33
PGNCS/AGS . . . . .	4.7-2
PGNCS/AGS Align . . . . .	4.9-17
PGNCS (Alignment) . . . . .	4.9-2
PGNCS Attitude Hold/Rate Command . . . . .	4.5-4
PGNCS Attitude Rate/Error Display . . . . .	4.5-32
PGNCS Automatic . . . . .	4.5-2A
PGNCS Lunar Surface Align Program (P57) . . . . .	4.9-22
PGNCS Minimum Impulse . . . . .	4.5-4A
PGNCS (Prethrust) . . . . .	4.7-32
PGNCS Total Attitude Display . . . . .	4.5-30
PGNS . . . . .	4.6-3
PIPA Bias Measurement & Loading . . . . .	4.6-21
Preferred Tracking Attitude Program (P25) . . . . .	4.6-26
Rate of Descent Controller/LGC Interface Check . . . . .	4.6-23

**LMA790-3-LM  
APOLLO OPERATIONS HANDBOOK**

ALPHABETICAL INDEX (cont)

	Page
Rendezvous Final Attitude Routine (R63)	4.6-13
Rendezvous Parameter Display Routine (R31)	4.6-16
Restart	4.6-36
RR CDU Zero	4.6-31
S-Band Antenna Routine (R05)	4.6-37
Show Banksum	4.6-17
W-Matrix Error Display	4.6-39
PIPA Bias Measurement & Loading	4.6-21
PLSS	
Cooling H2O Changeover, LM H2O (LCG) to PLSS H2O	4.15-28
Cooling H2O Changeover, PLSS H2O to LM H2O (LCG)	4.15-28
PLSS/EVCS Electrical Checkout, One-Man EVA	4.15-20
PLSS/EVCS Electrical Checkout, Two-Man EVA	4.15-17
PLSS Recharge	4.15-28
Feedwater Reservoir and Auxiliary Tank Recharge, Gravity Environment	4.15-29
Oxygen Recharge	4.15-28
Vacuum Changeover - PLSS to LM	5.3-5
Post-EVA Final Subsystems Configuration	4.15-26A
Powered Ascent	4.10-92
Powered Ascent Program (P12) With AGS Followup/In Control	4.10-92
Powered Descent	4.10-73
Power Transfer, LM-to-CSM (Unstaged)	4.3-21
Preferred Tracking Attitude Program (P25)	4.6-26
Prelaunch Closeout Check	4.1-2
Prethrust	4.7-2
Primary Glycol Loop Activation	4.2-9
Primary Sublimator Activation	4.2-16
Propulsion (Subsystem Management)	4.13-28

R

Radar	4.6-64
Command Landing Radar to Position 2	4.6-82
Landing Radar Checkout	4.6-80
Landing Radar Power-Up	4.6-79
Landing Radar Power-Down	4.6-83
Landing Radar Spurious Test Routine (R77)	4.6-82
Radar Signal Strength Display	4.5-39
Rendezvous Radar Coarse Align	4.6-69
Rendezvous Radar Continuous Designate, Terminate	4.6-79
Rendezvous Radar Initial Activation & Checkout	4.6-64A
Rendezvous Radar LM State Vector Update, AGS Manual	4.8-19
Rendezvous Radar Manual Designation to Mode II	4.6-70
Rendezvous Radar Manual Side-Lobe Acquisition Check & Main-Lobe Acquisition Verification	4.6-71
Rendezvous Radar Power-Up	4.6-64
RR Azimuth Rate/Elevation Rate Display	4.5-36
RR CDU Zero	4.6-31
RR LOS Azimuth and Elevation Display (V85)	4.5-40
RR Shaft Angle/Trunnion Angle Display	4.5-35
Range/Range Rate Display	4.5-37
Rate Gyro Check	4.6-54
Rate of Descent Controller/LGC Interface Check	4.6-23
RCS Burn for Lunar Impact (Unmanned Ascent Stage)	4.10-53
RCS Hot/Cold Firing Check	4.2-57
RCS Periodic Monitoring	4.13-34
RCS Pressurization	4.2-54
RCS Primary Coil Enable	4.5-2
RCS Staging	4.12-9
RCS Thrust Program (P41) With AGS Followup/In Control	4.10-38
RCS Translation	4.5-28
Relay Mode: CSM Voice to MSFN	4.13-22
Relay Mode: EVA (One-Man EVA)	4.13-21
Relay Mode: EVA (Two-Man EVA)	4.13-20

**LMA790-3-LM  
APOLLO OPERATIONS HANDBOOK**

ALPHABETICAL INDEX (cont)

	Page
Rendezvous Final Attitude Routine (R63) . . . . .	4.6-13
Rendezvous Navigation, LM . . . . .	4.8-6
Rendezvous Navigation Program (P20), LM . . . . .	4.8-6
Rendezvous Out-of-Plane Display Routine (R36) . . . . .	4.7-32
Rendezvous Parameter Display Routine (R31) . . . . .	4.6-16
Restart . . . . .	4.6-36

S

S-Band Activation & Checkout, Using Omni Antenna . . . . .	4.2-34
S-Band Antenna Cooldown . . . . .	4.13-26
S-Band Antenna Routine (R05) . . . . .	4.6-37
S-Band Backup Voice & Keying Check . . . . .	4.2-45
S-Band Configuration for LOS . . . . .	4.13-19
S-Band CWEA Enable . . . . .	4.13-23
S-Band FM Check . . . . .	4.2-43
S-Band LBR Data Enable . . . . .	4.13-23
S-Band Ranging, Voice, and Telemetry Check . . . . .	4.2-43
S-Band Steerable Antenna Activation and Checkout . . . . .	4.2-34
Secondary S-Band Transceiver & Power Amplifier Check . . . . .	4.2-44
Set Mission Timer . . . . .	4.2-20
Shades, Deploy . . . . .	4.13-51
Shades, Stow . . . . .	4.13-51
Show Banksum . . . . .	4.6-17
Sleep Station . . . . .	4.15-32
Sleep Station, Deploy . . . . .	4.15-32
Sleep Station, Stow . . . . .	4.15-33
SRC Removal . . . . .	4.15-37
Staging . . . . .	4.12-2
Star/Planet List . . . . .	4.4-26
State Vector, Move This Vehicle State Vector to Other . . . . .	4.6-39
Sublimator Activation, Primary . . . . .	4.2-16
Sublimator Dryout . . . . .	4.3-10
Sublimator Dryout, Preparation for . . . . .	4.3-2
Subsystem Activation . . . . .	4.2-2
Subsystem Configuration for EVA Preparation . . . . .	4.15-15
Subsystem Deactivation . . . . .	4.3-2
Subsystem Deactivation, Final . . . . .	4.3-12
Subsystem Management . . . . .	4.13-3
Suit Fan Activation, Checkout, and Water Separator Check . . . . .	4.2-23
SUIT ISOL Valve Check . . . . .	4.2-22
Symbols and Abbreviations, Definitions of . . . . .	D-1

T

Target AV Program (P76) . . . . .	4.7-33
Thrust . . . . .	4.10-2
Thrust Display . . . . .	4.5-38
Thrust Monitor Program (P47) . . . . .	4.10-50
Thrust, Orbital . . . . .	4.10-2
Timer Electroluminescent (EL) Numeric Check . . . . .	4.2-20
Torque Gyros . . . . .	4.9-14A
Transfer Phase Initiation (LGC P34, AEA 410+30000, Search; & 410+40000, Execute) . . . . .	4.7-20
Transfer Phase Midcourse (LGC P35, AEA 410+40000) . . . . .	4.7-28
Transfer to CSM, Crewman Vacuum . . . . .	5.3-6
Transfer to CSM, Intravehicular . . . . .	4.14-5
Transfer to LM (Second Crewman), Intravehicular . . . . .	4.14-3
Transfer to LM, Initial Intravehicular . . . . .	4.14-2

**LMA790-3-LM**  
**APOLLO OPERATIONS HANDBOOK**

ALPHABETICAL INDEX (cont)

	Page
Transfer Umbilical, Crewman Disconnect . . . . .	4.2-28
Transfer, Using OPS, Emergency . . . . .	5.3-7
Translation Control Modes . . . . .	4.5-14
Tunnel Pressure Equalization From LM . . . . .	4.14-12
Tunnel Pressurization From LM, Using LM Consumables . . . . .	4.14-13
Tunnel Pressurization From LM, Without Using LM Consumables . . . . .	4.14-12
TV Camera Deployment . . . . .	4.15-36
TV Camera Operation . . . . .	4.15-42
U	
Undocking From CSM, LM . . . . .	4.11-2
Urine Collection Assembly, Transfer Urine to Small . . . . .	4.13-47
Utility Lights Activation & Checkout . . . . .	4.2-17
V	
Vacuum Brush Operation . . . . .	4.14-14
Vacuum Changeover - PLSS to LM . . . . .	5.3-5
Verbs	
Verb List . . . . .	4.4-12
V40 - Zero CDU (N20) . . . . .	4.6-30
V40 - Zero CDU (N72) . . . . .	4.6-31
V41 - Coarse-Align CDU (N20) . . . . .	4.9-14
V41 - Coarse-Align CDU (N72) . . . . .	4.6-69
V42 - Fine-Align IMU . . . . .	4.9-15
V43 - Load FDAI Error Needles . . . . .	4.6-31
V44 - Terminate RR Continuous Designate . . . . .	4.6-79
V47 - Initialize AGS (R47) . . . . .	4.6-23
V48 - Start DAP Data Load Routine (R03) . . . . .	4.6-8
V49 - Start Crew-Defined Maneuver (R62) . . . . .	4.6-11
V55 - Increment LGC Time . . . . .	4.6-32
V59 - Command LR to Position 2 . . . . .	4.6-82
V61 - Display DAP Attitude Error . . . . .	4.6-38
V62 - Display Total Attitude Error . . . . .	4.6-38
V63 - RR/LR Self-Test (R04) . . . . .	4.6-64, 80
V64 - Start S-Band Antenna Routine (R05) . . . . .	4.6-37
V66 - Vehicles Attached: Move This Vehicle State Vector to Other Vehicle . . . . .	4.6-39
V67 - W-Matrix RMS Error Display . . . . .	4.6-39
V69 - Restart . . . . .	4.6-36
V70 - Update Liftoff Time . . . . .	4.6-6
V71 - Universal Update, Block Address . . . . .	4.6-6
V72 - Universal Update, Single Address . . . . .	4.6-6
V73 - Update LGC Time . . . . .	4.6-6
V74 - Initialize Erasable Dump via Downlink . . . . .	4.6-32
V78 - Start LR Spurious Return Test (R77) . . . . .	4.6-82
V79 - Stop LR Spurious Return Test (R77) . . . . .	4.6-82
V82 - Request Orbit Parameter Display (R30) . . . . .	4.8-3
V83 - Request Rendezvous Parameter Display (R31) . . . . .	4.6-16
V89 - Start Rendezvous Final Attitude Maneuver (R63) . . . . .	4.6-13
V90 - Request Rendezvous Out-of-Plane Display (R36) . . . . .	4.7-32
V91 - Show Banksum . . . . .	4.6-17
V93 - Enable W-Matrix Initialization . . . . .	4.6-33
V96 - Interrupt Integration and go to POO . . . . .	4.6-38
VHF Activation & Checkout . . . . .	4.2-31
VHF B Data Enable . . . . .	4.13-23
VHF B Simplex Check . . . . .	4.2-33
VHF Ranging Check . . . . .	4.13-24

LMA790-3-LM  
APOLLO OPERATIONS HANDBOOK

ALPHABETICAL INDEX (cont)

	Page
W	
Waste Management . . . . .	4.13-44
Defecation Disposal . . . . .	4.13-49
Emesis Disposal . . . . .	4.13-48
Transfer Urine to D/S Waste Container (Alternative Mode) . . . . .	4.13-46
Transfer Urine to D/S Waste Container (Prime Mode) . . . . .	4.13-45
Transfer Urine to Small Urine Collection Assembly . . . . .	4.13-47
Water Separator Check . . . . .	4.2-23
W-Matrix Error Display . . . . .	4.6-39
Window Shades (CDR, LMP, & Docking) . . . . .	4.13-51