

Return to Dept 2013

MASSACHUSETTS INSTITUTE OF TECHNOLOGY

APOLLO

GUIDANCE, NAVIGATION AND CONTROL

LGC

GUIDANCE & NAVIGATION EQUATIONS

LUNAR LANDING MISSION GSOP

PRELIMINARY SECTION 5

JUNE 1967

**INSTRUMENTATION
LABORATORY**

CAMBRIDGE 39, MASSACHUSETTS

COPY # _____

MASSACHUSETTS INSTITUTE OF TECHNOLOGY
DEPARTMENT OF AERONAUTICS AND ASTRONAUTICS
INSTRUMENTATION LABORATORY
CAMBRIDGE, MASS 02139

C. S. DRAPER
DIRECTOR

June 19, 1967

THROUGH: National Aeronautics and Space Administration
Resident Apollo Spacecraft Program Office at MIT
Instrumentation Labroatory
75 Cambridge Parkway
Cambridge, Massachusetts 02142

TO: National Aeronautics and Space Administration
Manned Spacecraft Center
Houston, Texas 77058
Attn: Mr. T. F. Gibson - FS

FROM: N. E. Sears

SUBJECT: Preliminary GSOP Chapter 5 Guidance Equations for LGC
Lunar Landing Mission

Gentlemen:

This document is the fourth submittal of GSOP Chapter 5 guidance and navigation equations for MSC review. It represents the first complete Chapter 5 for the LGC lunar landing mission, and will later be incorporated in the GSOP for this mission.

With the exception of introductory and general comment sections, the following sections are being submitted for MSC review for the first time.

<u>Section</u>	<u>Title</u>	<u>Page</u>
5. 3. 4. 4. 6	LR Data Reasonableness Test Routine	5. 3-59
5. 4. 4. 7	Stable Orbit Rendezvous	5. 4-62
5. 4. 5	Abort Targeting	5. 4-69
5. 5. 5	Kepler Subroutine	5. 5-25
5. 5. 6	Lambert Subroutine	5. 5-28
5. 5. 7	Time-Theta Subroutine	5. 5-32

<u>Section</u>	<u>Title</u>	<u>Page</u>
5. 5. 8	Time-Radius Subroutine	5. 5-34
5. 5. 9	Apsides Subroutine	5. 5-37
5. 5. 10	Miscellaneous Subroutines	5. 5-39
5. 5. 11	Initial Velocity Subroutine	5. 5-48
5. 6. 4	Star Selection Routine	5. 6-44
5. 6. 7	Additional Rendezvous Displays	5. 6-51
5. 6. 10	Lunar Surface Checkout	5. 6-54
5. 6. 11	LGC Idling Program	5. 6-56
5. 6. 12	FDAI-IMU Transformations	5. 6-59
5. 6. 13	IMU Compensation	5. 6-62

The other sections of this document have been previously submitted and reviewed as follows:

<u>MIT Partial</u> <u>Submittal Date</u>	<u>MSC-MIT</u> <u>Review Date</u>
Feb. 6, 1967	Feb. 28, 1967
March 20, 1967	April 12, 1967
April 17, 1967	May 9, 1967

These sections were revised on the basis of the above reviews. In addition to the changes directed by these reviews, the routines of the following sections were further modified to improve LGC operating and storage requirements, and are subject to further MSC review.

<u>Section</u>	<u>Title and Major Modification</u>	<u>Page</u>
5. 3. 3. 3	Cross Product Steering Concept 1) The cross product steering constant c used in the SPS Backup TEI maneuver is no longer an uplink parameter, and is defined to be zero for all LGC cross product controlled maneuvers.	5. 3-5

<u>Section</u>	<u>Title and Major Modification</u>	<u>Page</u>
5. 3. 4	<p>Lunar Landing Guidance</p> <p>1) The lunar-fixed and the lunar-fixed trajectory-oriented coordinate systems have been eliminated from the landing guidance.</p> <p>2) The Ignition Computations Routine is based on range to landing site rather than time to maximum thrust.</p> <p>3) The ignition aim or target conditions have been eliminated.</p> <p>4) A simplified extrapolation computation is used in the initial ullage and DPS trim phase.</p>	5. 3-13
5. 3. 5	<p>Powered Ascent Guidance</p> <p>1) The vehicle attitude control about the thrust axis during the ascent guidance phase is now controlled by the astronaut using the X-axis override DAP mode rather than explicit command by the guidance equations.</p>	5. 3-103
5. 6. 2. 2	<p>Lunar Surface Alignment</p> <p>1) Three of the original seven options were eliminated without sacrificing flexibility.</p> <p>2) Gravity vector determination was substituted for local vertical erection.</p> <p>3) Two vectors describing the vehicle orientation in lunar coordinates are stored in place of the three IMU gimbal angles used for initial coarse alignment.</p>	5. 6-9

SECTION 5 GUIDANCE EQUATIONS

5. 1 INTRODUCTION

5. 1. 1 GENERAL COMMENTS

The purpose of this section is to present the Guidance and Navigation Computation Routines associated with the Apollo Lunar Landing Mission. These Routines are utilized by the Programs outlined in Section 4 which consider astronaut and other subsystem interface and operational requirements. The guidance and navigation equations and procedures presented in Section 5 are primarily concerned with mission type programs representing the current LM PGNCs Computer (LGC) capability. A restricted number of LGC service type program operations which involve computation requirements are also included.

The LM PGNCs Computer (LGC) guidance and navigation equations for the lunar landing mission are presented in the following five categories:

- Section 5. 2 Coasting Flight Navigation Routines
- Section 5. 3 Powered Flight Navigation and Guidance Routines
- Section 5. 4 Targeting Routines
- Section 5. 5 Basic Subroutines
- Section 5. 6 General Service Routines

A complete table of contents for Section 5 is presented in the following Section 5. 1. 2. 1. A cross reference between the LGC program and callable routine numbers of Section 4 that are described in Section 5 is listed in Section 5. 1. 2. 2.

5. 1. 2 TABLE OF CONTENTS

5. 1. 2. 1 Section 5 Table of Contents

<u>SECTION NO.</u>	<u>TITLE</u>	<u>PAGE</u>
<u>5. 1</u>	<u>Introduction</u>	
5. 1. 1	General Comments	5. 1-1
5. 1. 2	Table of Contents	5. 1-2
5. 1. 3	General Program Utilization	5. 1-10
5. 1. 4	Coordinate Systems	5. 1-19
<u>5. 2</u>	<u>Coasting Flight Navigation</u>	
5. 2. 1	General Comments	5. 2-1
5. 2. 2	Coasting Integration Routine	5. 2-11
5. 2. 2. 1	General Comments	5. 2-11
5. 2. 2. 2	Encke's Method	5. 2-11
5. 2. 2. 3	Disturbing Acceleration	5. 2-14
5. 2. 2. 4	Error Transition Matrix	5. 2-17
5. 2. 2. 5	Numerical Integration Method	5. 2-21
5. 2. 2. 6	Coasting Integration Logic	5. 2-23
5. 2. 3	Measurement Incorporation Routine	5. 2-31
5. 2. 4	Rendezvous Navigation Program	5. 2-38
5. 2. 4. 1	Target Acquisition Routine	5. 2-38
5. 2. 4. 2	Rendezvous Navigation Routine	5. 2-48
5. 2. 4. 3	RR Monitor Routine	5. 2-68

<u>SECTION NO.</u>	<u>TITLE</u>	<u>PAGE</u>
5. 2. 5	RR Lunar Surface Navigation Program	5. 2-70
5. 2. 5. 1	Target Acquisition Routine	5. 2-70
5. 2. 4. 2	Lunar Surface Navigation Routine	5. 2-74
<u>5. 3</u>	<u>Powered Flight Navigation and Guidance</u>	
5. 3. 1	General Comments	5. 3-1
5. 3. 2	Powered Flight Navigation-Average G Routine	5. 3-2
5. 3. 3	Descent Orbit Injection Guidance	5. 3-4
5. 3. 3. 1	General Objectives	5. 3-4
5. 3. 3. 2	Required Targeting Parameters	5. 3-4
5. 3. 3. 3	Cross Product Steering Concept	5. 3-5
5. 3. 3. 4	Initial Thrust Attitude Calculation	5. 3-9
5. 3. 3. 5	Engine -Off Criterion	5. 3-9
5. 3. 3. 6	Guidance Equations for Descent Orbit Injection	5. 3-10
5. 3. 4	Lunar Landing Guidance	5. 3-13
5. 3. 4. 1	General Comments	5. 3-13
5. 3. 4. 2	Coordinate Systems	5. 3-17
5. 3. 4. 3	Description of Overall Guidance and Navigation System	5. 3-23
5. 3. 4. 4	Powered Landing Routines	5. 3-34
5. 3. 4. 5	Summary of Operations for Different Phases of Landing Maneuver	5. 3-99

<u>SECTION NO.</u>	<u>TITLE</u>	<u>PAGE</u>
5. 3. 5	Powered Ascent Guidance	5. 3-105
5. 3. 5. 1	Guidance Objective	5. 3-105
5. 3. 5. 2	Ascent Guidance Coordinate Systems	5. 3-107
5. 3. 5. 3	Required Targeting Parameters	5. 3-109
5. 3. 5. 4	Ascent Guidance Equations	5. 3-112
5. 3. 6	Lambert Aim Point Maneuver Guidance	5. 3-126
5. 3. 6. 1	Rendezvous Intercept	5. 3-126
5. 3. 6. 2	Transearch Injection Backup	5. 3-134
5. 3. 7	External ΔV Maneuver Guidance	5. 3-137
<u>5. 4</u>	<u>Targeting Routines</u>	
5. 4. 1	General Comments	5. 4-1
5. 4. 2	Lunar Landing Time Prediction Routine	5. 4-3
5. 4. 2. 1	General	5. 4-3
5. 4. 2. 2	Determination of LM Descent Trajectory to Perilune	5. 4-7
5. 4. 2. 3	Determination of New Descent Orbit Injection Time	5. 4-7
5. 4. 2. 4	Program Outputs	5. 4-8
5. 4. 3	LM Launch Time Prediction Routine	5. 4-10
5. 4. 3. 1	General	5. 4-10
5. 4. 3. 2	CFP Launch Time Prediction	5. 4-16
5. 4. 3. 3	DT Launch Time Prediction	5. 4-20

<u>SECTION NO.</u>	<u>TITLE</u>	<u>PAGE</u>
5. 4. 4	Rendezvous Targeting	5. 4-22
5. 4. 4. 1	General	5. 4-22
5. 4. 4. 2	Pre-CSI Maneuver (MODE 1)	5. 4-24
5. 4. 4. 3	Pre-CDH Maneuver (MODE 2)	5. 4-39
5. 4. 4. 4	Pre-TPI Maneuver (MODE 3)	5. 4-45
5. 4. 4. 5	Rendezvous Midcourse Corrections (MODE 4)	5. 4-49
5. 4. 4. 6	TPI Search Program	5. 4-52
5. 4. 4. 7	Stable Orbit Rendezvous	5. 4-62
5. 4. 5	Abort Targeting	5. 4-69
5. 4. 5. 1	Abort From Powered Landing	5. 4-69
5. 4. 5. 2	Quick Abort Surface Targeting	5. 4-75
5. 5	<u>Basic Subroutines</u>	
5. 5. 1	General Comments	5. 5-1
5. 5. 1. 1	Solar System Subroutines	5. 5-1
5. 5. 1. 2	Conic Trajectory Subroutines	5. 5-2
5. 5. 2	Planetary Inertial Orientation Subroutine	5. 5-12
5. 5. 3	Latitude-Longitude Subroutine	5. 5-18
5. 5. 4	Lunar and Solar Ephemerides	5. 5-23
5. 5. 5	Kepler Subroutine	5. 5-25
5. 5. 6	Lambert Subroutine	5. 5-28
5. 5. 7	Time-Theta Subroutine	5. 5-32
5. 5. 8	Time-Radius Subroutine	5. 5-34
5. 5. 9	Apsides Subroutine	5. 5-37
5. 5. 10	Miscellaneous Subroutines	5. 5-39
5. 5. 11	Initial Velocity Subroutine	5. 5-48

<u>SECTION NO.</u>	<u>TITLE</u>	<u>PAGE</u>
5. 6	<u>General Service Routines</u>	
5. 6. 1	General Comments	5. 6-1
5. 6. 2	IMU Alignment Modes	5. 6-2
5. 6. 2. 1	Orbital Alignment	5. 6-2
5. 6. 2. 2	Lunar Surface Alignment	5. 6-9
5. 6. 3	IMU Routines	5. 6-22
5. 6. 3. 1	AOT Transformations	5. 6-22
5. 6. 3. 2	IMU Transformations	5. 6-31
5. 6. 3. 3	Gravity Vector Determination Routine	5. 6-36
5. 6. 3. 4	REFSMMAT Transformations	5. 6-40
5. 6. 4	Star Selection Routine	5. 6-44
5. 6. 5	Ground Track Routine	5. 6-46
5. 6. 6	S-Band Antenna Routine	5. 6-47
5. 6. 7	Additional Rendezvous Displays	5. 6-51
5. 6. 8	AGS Initialization Program	5. 6-52
5. 6. 9	LGC Initialization	5. 6-53
5. 6. 10	Lunar Surface Checkout	5. 6-54
5. 6. 11	LGC Idling Program	5. 6-56
5. 6. 12	FDAI - IMU Transformations	5. 6-59
5. 6. 13	IMU Compensation	5. 6-62

5. 1. 2. 2 Sections 4 and 5 Cross Reference

<u>PROGRAM NUMBER</u>	<u>TITLE</u>	<u>PRINCIPAL SECTION 5 SUBSECTION NQ</u>	<u>PAGE</u>
P-00	LGC Idling Program	5. 6. 11	5. 6-56
P-02	AGS Initialization Program	5. 6. 8	5. 6-52
P-04	PGNCS Lunar Surface Check-out Program	5. 6. 10	5. 6-54
P-10	Predicted Launch Time (CFP)	5. 4. 3.	5. 4-10
P-11	Predicted Launch Time (DT)	5. 4. 3.	5. 4-10
P-12	Powered Ascent Guidance	5. 3. 5	5. 3-105
P-17	TPI Search Program	5. 4. 4. 6	5. 4-52
P-20	Rendezvous Navigation Program	5. 2. 4	5. 2-38
P-21	Ground Track Determination Program	5. 6. 5	5. 6-46
P-22	RR Lunar Surface Navigation Program	5. 2. 5	5. 2-70
P-25	Preferred Tracking Attitude Program	5. 2. 4. 1. 1	5. 2-40
P-30	External ΔV Maneuver Guidance	5. 3. 7	5. 3-137
P-31	General Lambert Aim Point Guidance	5. 3. 6	5. 3-126
P-32	Coelliptic Sequence Initiation (CSI) Program	5. 4. 4. 2	5. 4-24
P-33	Constant Differential Altitude (CDH) Program	5. 4. 4. 3	5. 4-39
P-34	Transfer Phase Initiation (TPI) Program	5. 4. 4. 4	5. 4-45

<u>PROGRAM NUMBER</u>	<u>TITLE</u>	<u>PRINCIPAL SECTION 5 SUBSECTION NO.</u>	<u>PAGE</u>
P-35	Transfer Phase Midcourse (TPM) Program	5. 4. 4. 5	5. 4-49
P-38	Stable Orbit Rendezvous Program	5. 4. 4. 7. 1	5. 4-63
P-39	Stable Orbit Rendezvous Mid- course Program	5. 4. 4. 7. 2	5. 4-67
P-40	DPS Maneuver Program	5. 3. 3. 3-5	5. 3-5
P-41	RCS Maneuver Program	5. 3. 3. 3-5	5. 3-5
P-42	APS Maneuver Program	5. 3. 3. 3-5	5. 3-5
P-46	LM/ CSM Separation Monitor Program	5. 6. 2. 1. 2	5. 6-3
P-50	Docked IMU Coarse Alignment	5. 6. 2. 1. 1	5. 6-2
P-51	IMU Orientation Determination	5. 6. 2. 1. 3	5. 6-4
P-52	IMU Realignment Program	5. 6. 2. 1. 4	5. 6-4
P-53	IMU Orientation Determination Backup Program	5. 6. 2. 1. 5	5. 6-6
P-54	IMU Realignment Program Backup Program	5. 6. 2. 1. 6	5. 6-7
P-57	Lunar Surface Alignment	5. 6. 2. 2	5. 6-9
P-60	Predicted Lunar Landing Time Program	5. 4. 2	5. 4-3
P-61	Descent Orbit Injection Program	5. 3. 3. 6	5. 3-10
P-63	Braking Phase	5. 3. 4. 4. 1 to 5. 3. 4. 4. 14	5. 3-34
P-64	Approach Phase Guidance		
P-65	Automatic Landing Phase Guidance		
P-66	Rate of Descent (ROD) Landing Phase Guidance	5. 3. 4. 4. 15	5. 3-86

<u>PROGRAM NUMBER</u>	<u>TITLE</u>	<u>PRINCIPAL SECTION 5 SUBSECTION NO.</u>	<u>PAGE</u>
P-67	Manual Landing Phase Guidance	5. 3. 4. 4. 15	5. 3-86
P-70	DPS Abort Guidance	5. 4. 5. 1	5. 4-69
P-71	APS Abort Guidance		
P-72	CSM CSI Targeting	5. 4. 4. 2	5. 4-24
P-73	CSM CDH Targeting	5. 4. 4. 3	5. 4-39
P-74	CSM TPI Targeting	5. 4. 4. 4	5. 4-45
P-75	CSM TPM Targeting	5. 4. 4. 5	5. 4-49
P-78	CSM Stable Orbit Rendezvous Targeting	5. 4. 4. 7. 1	5. 4-63
P-79	CSM Stable Orbit Rendezvous Midcourse Targeting	5. 4. 4. 7. 2	5. 4-67

<u>CALLABLE ROUTINES</u>	<u>TITLE</u>	<u>SECTION 5 SUBSECTION NO.</u>	<u>PAGE</u>
R-05	S-Band Antenna Routine	5. 6. 6	5. 6-47
R-30	Orbit Parameter Display Routine	5. 5. 10	5. 5-39
R-31	Rendezvous Parameter Display Routine	5. 6. 7	5. 6-51
R-32	Target ΔV Routine	5. 2. 4. 2. 2	5. 2-67
R-61	Preferred Tracking Attitude Routine	5. 2. 4. 1. 1	5. 2-40

5. 1. 3 GENERAL PROGRAM UTILIZATION

The following outline is a brief summary of the major LGC programs that would be used in the principal phases of a lunar landing mission. This outline reflects the LGC capability for nominal and abort cases of such a mission.

I Lunar Orbit Phase Prior to LM Descent Orbit Injection

A) Nominal

- P - 27 LGC Update Program (Initialization)
- P - 60 Lunar Landing Time Prediction Program
- P - 02 AGS Initialization Program

- P - 46 LM / CSM Separation Monitor Program
- P - 20 Rendezvous Navigation Program
(Pre-DOI RR Check-out)

B) Aborts to Return to Earth Trajectory (SPS Backup)

- P - 47 Thrust Monitor Program
(Manual Re-docking)
- P - 27 LGC Update Program
- P - 31 Lambert Aim Point Maneuver Program
(TEI and cislunar MCC for SPS backup
with RTCC targeting)
- P - 40 DPS Thrust Program

I Lunar Orbit Phase Prior to LM Descent Orbit
Injection (cont)

C) Service Programs for Nominal and Abort Cases

P - 05 PGNCS Start Up
P - 50 Docked IMU Coarse Alignment
P - 52 IMU Realignment Program
R - 05 S-Band Antenna Routine
P - 21 Ground Track Program
R - 30 Orbit Parameter Display Routine
P - 00 LGC Idling Program
P-51 IMU Orientation Determination Program

II Descent Orbit Injection (DOI) and LM Descent Coast
Phase

A) Nominal

P - 61 Descent Orbit Injection Program
 (Pre-Thrust and Thrust Modes)

P - 25 Preferred Tracking Attitude Program
 (Descent Monitoring)

R - 31 Rendezvous Parameter Display Routine

R - 30 Orbit Parameter Display Routine

P - 63 Landing Maneuver Braking Maneuver
 Program (Pre-Ignition Mode)

P - 02 AGS Initialization Program

II Descent Orbit Injection (DOI) and LM Descent Coast
Phase (cont)

B) Aborts to Rendezvous Condition

1. LM Active Vehicle

- P - 20 Rendezvous Navigation Program
 (LGC navigation)
- P - 32 CSI Pre-Thrust Program
- P - 33 CDH Pre-Thrust Program
- P - 34 TPI Pre-Thrust Program
- P - 35 TPM Pre-Thrust Program
- P - 17 TPI Search Program
- P - 38 Stable Orbit Rendezvous Program
- P - 39 Stable Orbit Rendezvous Midcourse
 Program
- P - 40 }
P - 41 } DPS, RCS or APS Thrust Programs
P - 42 }
- (or)
- P - 25 Preferred Tracking Attitude Program
 (CMC navigation)
- (or)
- P - 27 LGC Update Program
 (RTCC navigation)
- P - 30 External ΔV Pre-Thrust Program
 (CMC or RTCC targeted)
- (or)
- P - 31 Lambert Aim Point Maneuver Pro-
 gram (RTCC targeted)

II

Descent Orbit Injection (DOI) and LM Descent Coast

Phase (cont)

B) Aborts to Rendezvous Condition

2. CSM Active Retrieval

- P - 20 Rendezvous Navigation Program
(LGC navigation)
- R - 32 Target ΔV Routine
- P - 72 CSM CSI Pre-Thrust Program
- P - 73 CSM CDH Pre-Thrust Program
- P - 74 CSM TPI Pre-Thrust Program
- P - 75 CSM TPF Pre-Thrust Program
- P - 78 CSM Stable Orbit Rendezvous Program
- P - 79 CSM Stable Orbit Rendezvous Midcourse
Program
- (or)
- P - 25 Preferred Tracking Attitude Program
(CMC navigation)

C) Service Programs for Nominal and Abort Cases

- P - 52 IMU Realignment Program
- R - 30 Orbit Parameter Display Routine
- R - 31 Rendezvous Parameter Display Routine
- P - 21 Ground Track Program
- R - 05 S-Band Antenna Routine
- P - 00 LGC Idling Program

III

Powered Landing Maneuver and Post Landing Phase

A) Nominal

P-63 Landing Braking Phase

P-64 Landing Approach Phase

P-65 Automatic Landing Phase Guidance

(or)

P-66 Rate of Descent Landing Guidance

(or)

P-67 Manual Landing Phase Guidance

P-57 Lunar Surface Alignment Program

P-02 AGS Initialization Program

R-05 S-Band Antenna Routine

B) Abort to Orbit

1. Aborts During Powered Landing Maneuver

P-70 DPS Abort Guidance Program

P-71 APS Abort Guidance Program

2. Aborts from the Lunar Surface (Anytime Launch Case)

P-05 PGNCS Start Up

P-57 Lunar Surface Alignment
(Fast Alignment Mode)

P-27 LGC Update Program

P-12 Powered Ascent Guidance Program

IV

Lunar Pre-Launch Phase (Final 3 CSM Orbits before
LM Launch)

A) Nominal

P - 27 LGC Update Program

(or)

P - 22 RR Lunar Surface Navigation Program

P - 10 Predicted Launch Time (CFP) Program

(or)

P - 11 Predicted Launch Time (DT) Program

P - 02 AGS Initialization Program

B) Service Programs

P - 05 PGNCS Start Up

P - 04 PGNCS Lunar Surface Check-out
Program

P - 57 Lunar Surface Alignment Program

R - 05 S-Band Antenna Routine

P - 00 LGC Idling Program

V LM Powered Ascent Phase

A) Nominal

 P - 12 Powered Ascent Guidance

B) Aborts

 None

VI Rendezvous Phase

A) Nominal

 P - 20 Rendezvous Navigation Program

 P - 32 CSI Pre-Thrust Program

 P - 33 CDH Pre-Thrust Program

 P - 34 TPI Pre-Thrust Program

 P - 35 TPM Pre-Thrust Program

 P - 17 TPI Search Program

 P - 38 Stable Orbit Rendezvous Program

 P - 39 Stable Orbit Rendezvous Midcourse
 Program

 P - 41 }
 P - 42 } RCS or APS Thrust Programs

 P - 02 AGS Initialization Program

Rendezvous Phase (cont)B) Aborts to Rendezvous1. LM Active (RR Failure)

P - 27 LGC Update Program

P - 25 Preferred Tracking Attitude Program
(CSM navigation)P - 30 External ΔV Pre-Thrust Program
(CSM or RTCC targeted)

P - 41	} RCS or APS Thrust Programs
P - 42	

2. CSM Active RetrievalP - 20 Rendezvous Navigation Program
(LGC navigation)R - 32 Target ΔV Routine

P - 72 CSM CSI Pre-Thrust Program

P - 73 CSM CDH Pre-Thrust Program

P - 74 CSM TPI Pre-Thrust Program

P - 75 CSM TPF Pre-Thrust Program

P - 78 CSM Stable Orbit Rendezvous Program

P - 79 CSM Stable Orbit Rendezvous Midcourse
Program

(or)

P - 25 Preferred Tracking Attitude Program
(CMC navigation)

C) Service Programs for Nominal and Abort Cases

- P - 52 IMU Realignment Program
- R - 05 S-Band Antenna Routine
- R - 30 Orbit Parameter Display Routine
- R - 31 Rendezvous Parameter Display
Routine
- P - 21 Ground Track Program
- P - 00 LGC Idling Program

5. 1. 4 COORDINATE SYSTEMS

There are five major coordinate systems used in the navigation and guidance programs. These five coordinate systems are defined individually in the following descriptions. Any additional coordinate systems used in particular LGC programs are defined in the individual section describing that program.

5. 1. 4. 1 Basic Reference Coordinate System

The Basic Reference Coordinate System is an orthogonal inertial coordinate system whose origin is centered at either the moon or the earth. The orientation of this coordinate system is defined by the line of intersection of the mean earth equatorial plane and the mean orbit of the earth (the ecliptic) at the beginning of the Besselian year which starts January 0, 525, 1969. The X-axis (\underline{u}_{XI}) is along this intersection with the positive sense in the direction of the ascending node of the ecliptic on the equator (the equinox), the Z-axis (\underline{u}_{ZI}) is along the mean earth north pole, and the Y-axis (\underline{u}_{YI}) completes the right-handed triad. In the lunar landing mission this coordinate system is normally moon-centered for the LGC. In some non-nominal or abort cases requiring LGC operation in cislunar space, the Basic Reference Coordinate System is shifted from moon-centered to earth-centered when the estimated vehicle position from the moon first exceeds a specified value r_{SPH} . This procedure is described in Section 5. 2. 2. 6 and Fig. 2. 2-3. During alternate earth-orbit missions in which the LM is active near the earth, the Basic Reference Coordinate System will be earth-centered. All navigation stars and lunar-solar ephemerides are referenced to this coordinate system. All vehicle state vectors are referenced to this system during coasting or free fall phases of the mission.

5. 1. 4. 2 IMU Stable Member or Platform Coordinates

The orthogonal inertial coordinate system defined by the PGNCS inertial measurement unit (IMU) is dependent upon the current IMU alignment. There are many possible alignments during a mission, but the primary IMU alignment orientations described in Section 5. 6. 3. 4 are summarized below and designated by the subscript SM:

1. Preferred Alignment

$$\begin{aligned} \underline{u}_{XSM} &= \text{UNIT}(\underline{x}_B) \\ \underline{u}_{YSM} &= \text{UNIT}(\underline{u}_{XSM} \times \underline{r}) \\ \underline{u}_{ZSM} &= \underline{u}_{XSM} \times \underline{u}_{YSM} \end{aligned} \tag{5. 1. 1}$$

where:

$$\left. \begin{array}{l} \underline{u}_{XSM} \\ \underline{u}_{YSM} \\ \underline{u}_{ZSM} \end{array} \right\} \begin{array}{l} \text{IMU stable member coordinate unit vec-} \\ \text{tors referenced to the Basic Reference} \\ \text{Coordinate System} \end{array}$$

$$\underline{x}_B = \text{vehicle or body X-axis}$$

$$\underline{r} = \text{current position vector in the Basic Reference Coordinate System}$$

2. Nominal Alignment (Local Vertical)

$$\begin{aligned} \underline{u}_{XSM} &= \text{UNIT}(\underline{r}) \text{ at } t_{\text{align}} \\ \underline{u}_{YSM} &= \text{UNIT}(\underline{v} \times \underline{r}) \\ \underline{u}_{ZSM} &= \underline{u}_{XSM} \times \underline{u}_{YSM} \end{aligned} \tag{5. 1. 2}$$

where \underline{r} and \underline{v} represent the vehicle state vector at the alignment time, t_{align} .

3. Lunar Landing Alignment

$$\begin{aligned} \underline{u}_{XSM} &= \text{UNIT}(\underline{r}_{LS}) \text{ at } t_L \\ \underline{u}_{ZSM} &= \text{UNIT}\left[(\underline{r}_C \times \underline{v}_C) \times \underline{u}_{XSM}\right] \\ \underline{u}_{YSM} &= \underline{u}_{ZSM} \times \underline{u}_{XSM} \end{aligned} \quad (5.1.3)$$

where \underline{r}_{LS} is the lunar landing site vector at the predicted landing time, t_L , and \underline{r}_C and \underline{v}_C are the CSM position and velocity vectors.

4. Lunar Launch Alignment

The same as that defined in Eq. (5.1.3) except that \underline{r}_{LS} is the landing or launch site at the predicted launch time t_L .

The IMU coordinate system is assumed to be centered at the same point that the Basic Reference Coordinate System is currently centered at.

5.1.4.3 Vehicle or Body Coordinate System

The vehicle or body coordinates (subscript B) are the general LM coordinates. The origin of this coordinate frame is at the PGNCS Navigation Base. The X-axis (\underline{u}_{XB}) is along the nominal spacecraft DPS-APS thrust axis, the Z-axis (\underline{u}_{ZB}) is normal to \underline{u}_{XB} and directed forward from the design eye. The Y-axis is orthogonal to the X and Z axes so as to form a right-handed system.

5. 1. 4. 4 Earth-Fixed Coordinate System

The Earth-fixed Coordinate System is an orthogonal rotating coordinate system centered at the earth. The Z-axis is along the true polar axis of the earth, the X-axis is along the intersection of the meridian of Greenwich and the equatorial plane of the earth, and the Y-axis is in the equatorial plane and completes the right-handed triad.

5. 1. 4. 5 Moon-Fixed Coordinate System

The Moon-fixed Coordinate System is an orthogonal rotating coordinate system centered at the moon. The Z-axis is along the true polar axis of the moon, the X-axis is along the intersection of the meridian of 0° longitude and the equatorial plane of the moon, and the Y-axis is in the equatorial plane and completes the right-handed triad.

5.2 COASTING FLIGHT NAVIGATION

5.2.1 GENERAL COMMENTS

The LGC Coasting Flight Navigation Routines which are presented in Sections 5.2.2 through 5.2.5 are used during non-thrusting phases of the Apollo mission. The basic objective of the navigation routines is to maintain estimates of the position and velocity vectors of both the CSM and the LM. Let \underline{r} and \underline{v} be the estimates of a vehicle's position and velocity vectors, respectively. Then, the six-dimensional state vector, \underline{x} , of the spacecraft is defined by

$$\underline{x} = \begin{pmatrix} \underline{r} \\ \underline{v} \end{pmatrix}$$

Coasting Flight Navigation is accomplished by extrapolating the state vector, \underline{x} , by means of the Coasting Integration Routine (Section 5.2.2), and updating or modifying this estimated state using Rendezvous Radar (RR) tracking data by the recursive method of navigation (Sections 5.2.3 - 5.2.5).

The Coasting Integration Routine (Section 5.2.2) is used by other navigation and targeting routines to extrapolate the following:

- 1) Present estimated LM state vector
- 2) Present estimated CSM state vector
- 3) An arbitrary specified state vector, such as the predicted result of a maneuver

The LGC idling program (Section 5.6.11) periodically uses the Coasting Integration Routine to advance the estimated CSM state vector (and the estimated LM state vector when the LM is not on the surface of the moon) to approximately current time. This procedure has the lowest priority of all programs, and is performed only when no other program is active. This periodic state vector extrapolation is not necessary from a theoretical point of view, but does have two practical purposes. First, it is advisable to maintain current (or at least nearly current) state vector estimates in case an emergency situation arises. Second, a significant amount of computation time is transferred from a period of high computer activity (navigation measurement processing, targeting, etc.) to a period of low activity.

State vector extrapolation is accomplished by means of Encke's method of differential accelerations. The motion of a spacecraft is dominated by the conic orbit which would result if the spacecraft were in a central force field. In Encke's method the differential equations for the deviations from conic motion are integrated numerically. This technique is in contrast to a numerical integration of the differential equations for the total motion, and it provides a more accurate orbit extrapolation. The numerical integration is accomplished by means of Nystrom's method which gives fourth-order accuracy while requiring only three computations of the derivatives per time step. The usual fourth-order Runge-Kutta integration methods require four derivative computations per time step.

Regardless of the accuracy of the state vector extrapolation, errors in the initial conditions will propagate and soon grow to intolerable size. Thus, it is necessary periodically to obtain additional data in the form of either new state vector estimates or modifications to the current state vector estimates. These state vector modifications are computed from navigation data obtained by means of navigation measurements.

The LM PGNCs uses RR tracking data to compute state vector changes, while the CSM GNCS uses optical angle data. Navigation measurement data are used to update state vector estimates during rendezvous and lunar surface navigation procedures. These two navigation procedures will be used normally during all LM-CSM lunar-orbit rendezvous phases and the LM lunar surface prelaunch phase, respectively, in the lunar landing mission. However, in order to provide for alternate mission capability, the rendezvous navigation procedure can be used near the moon or the earth.

Although the state vector of the LM is six-dimensional, it is not necessary that the quantities estimated during a particular navigation procedure be the position and velocity vectors of the LM. A variety of "estimated state vectors", not necessarily of six-dimensions, are used.

In order to achieve desired rendezvous objectives, it is necessary to expand the rendezvous navigation procedure to nine dimensions, and to include in the estimation the constant RR angle biases. The estimated state vector that is used in rendezvous navigation is given by

$$\underline{x} = \begin{pmatrix} \underline{r} \\ \underline{v} \\ \underline{\text{bias}} \end{pmatrix}$$

where \underline{r} and \underline{v} are the estimated position and velocity vectors of either the LM or the CSM, and $\underline{\text{bias}}$ is a vector whose components are the estimates of the RR angle biases. The selection of the vehicle

update mode is an astronaut option and will be based primarily upon which vehicle's state vector is most accurately known initially, and which vehicle is controlling the rendezvous maneuvers.

In order to estimate the RR angle biases, it is necessary to restrict the LM attitude during RR tracking. This attitude restriction involves controlling the LM +Z-axis to be within 30° of the tracking line-of-sight and is described in Section 5.2.4.1.

During the LM lunar surface prelaunch phase of the lunar landing mission RR tracking is used for navigation. In this mode, however, the previously mentioned LM attitude restriction obviously cannot be met, and only the RR range and range rate data are used. Also, since it is assumed that the landing site is well known, the estimated state vector that is used in lunar surface navigation is the standard six-dimensional CSM state vector.

Navigation data is incorporated into the state vector estimates by means of the Measurement Incorporation Routine (Section 5.2.3) which has both six- and nine-dimensional modes. The Measurement Incorporation Routine is a subroutine of the following navigation routines:

- 1) Rendezvous Navigation Routine (Section 5.2.4.2)
- 2) Lunar Surface Navigation Routine (Section 5.2.5.2)

Simplified functional diagrams of the navigation programs which use these routines are given in Figs. 2.1-1 and 2.1-2, respectively.

In rendezvous navigation, estimated LM and CSM position and velocity vectors are obtained at required times by means of the

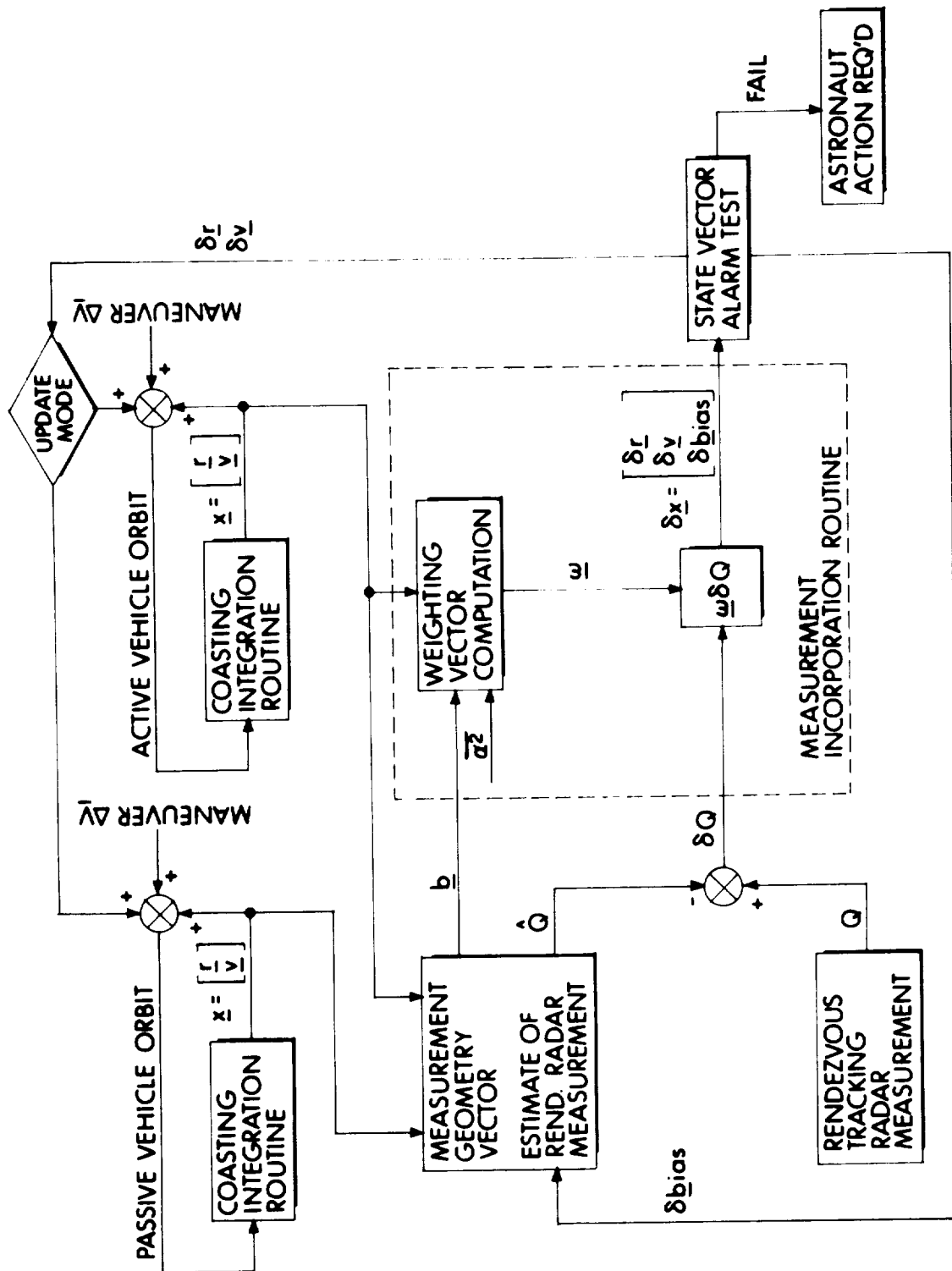

Figure 2.1-1 Simplified LGC Rendezvous Navigation Functional Diagram

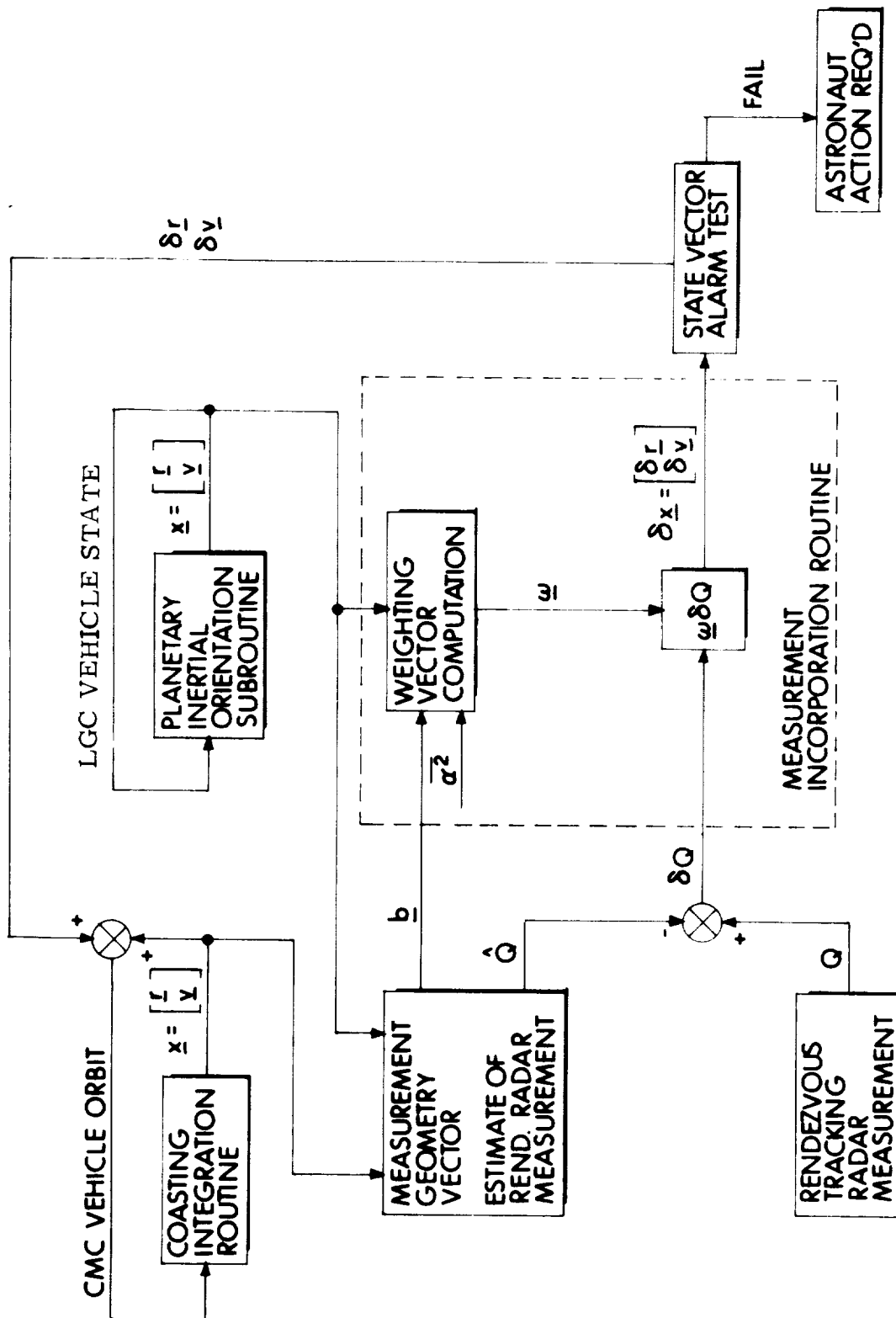

Figure 2.1-2 Simplified Lunar Surface Navigation Functional Diagram

Coasting Integration Routine (Section 5.2.2). The Measurement Incorporation Routine (Section 5.2.3) is used to incorporate the measurement data into the state vector estimates. In lunar surface navigation, the same process is performed except that the estimated LM state vector is obtained by means of the Planetary Inertial Orientation Subroutine (Section 5.5.2).

The updating procedure, which is illustrated in simplified form in Figs. 2.1-1 and 2.1-2, involves computing an estimated tracking measurement, \hat{Q} , based on the current state vector estimates. This estimated measurement is then compared with the actual tracking measurement Q (RR tracking data in the LGC) to form a measured deviation δQ . A statistical weighting vector, $\underline{\omega}$, is computed from statistical knowledge of state vector uncertainties and tracking performance, $\hat{\sigma}^2$, plus a geometry vector, \underline{b} , determined by the type of measurement being made. The weighting vector, $\underline{\omega}$, is defined such that a statistically optimum linear estimate of the deviation, $\underline{\delta x}$, from the estimated state vector is obtained when the weighting vector is multiplied by the measured deviation δQ . The vectors $\underline{\omega}$, \underline{b} and $\underline{\delta x}$ are of six or nine dimensions depending upon the dimension of the state vector being estimated.

In an attempt to prevent unacceptably large incorrect state vector changes, certain validity tests have been included in the LGC navigation routines.

In the Rendezvous and Lunar Surface Navigation Routines (Sections 5.2.4.2 and 5.2.5.2) measurement data is processed periodically (once or twice per minute), and it is desirable that the CSM be tracked during the entire rendezvous phase up to the manual terminal maneuver. If the magnitudes of the changes in the estimated position and velocity vectors, δr and δv , respectively, are both less than preset tracking alarm levels, then the selected vehicle's state vector is automatically updated by the computed deviation, $\underline{\delta x}$, and no special display is presented, except that the tracking

measurement counter is incremented by one. If either δr or δv exceeds its alarm level, then the state vector is not updated, and the astronaut is alerted to this condition by a special display of δr and δv .

In this case the astronaut should place the RR under manual control and make the necessary radar operating and side lobe checks to verify main lobe lock-on and tracking conditions. After the tracking has been verified, and navigation data has again been acquired, the astronaut has the option of commanding a state vector update if the tracking alarm is again exceeded, or of repeating further RR checks before incorporating the measurement data. If the astronaut cannot verify the tracking, then he can terminate the program and try to achieve tracking conditions at a later time.

The tracking alarm criterion is incorporated in the navigation routines to alert the astronaut to the fact that the state vector update is larger than normally expected, and to prevent the estimated state vector from automatically being updated in such cases. The update occurs only by specific command of the astronaut. The tracking alarm level beyond which updating is suspended is primarily chosen to avoid false acquisition and tracking conditions. There is a low probability that the alarm level will be exceeded in the LGC if the estimated state vectors are essentially correct, since the RR Designation and Data Read Routines have partial internal checks for side-lobe acquisition before tracking data are incorporated in the navigation routines. The most probable condition for the state vector update alarm level being exceeded in the LGC is, therefore, initial acquisition and tracking in the case where a poor estimate of either the CSM or LM state vector exists. In this case the astronaut would have to command the initial state vector update, after which

the tracking alarm level would seldom be exceeded during the remainder of the navigation phase. It should be noted that this statement is true only if the estimated state vector of the active vehicle performing a powered rendezvous maneuver is updated by the Average-G Routine in the case of the LM being the active vehicle, or by a DSKY entry (R-32) of the maneuver ΔV if the CSM is the active vehicle.

The displayed values of δr and δv which have not passed the tracking alarm test will depend upon the statistical parameters stored in the LGC and upon the following types of errors:

Type 1: Errors in the current state vector estimates

Type 2: Errors in alignment of the IMU

Type 3: Reasonable RR tracking performance errors

Type 4: A PGNCS or RR failure resulting in false acquisition

The existence of Type 1 errors is precisely the reason that the RR tracking is being done. It is the function of the navigation to decrease Type 1 errors in the presence of noise in the form of errors of Types 2 and 3. Since the RR tracking should not be performed unless the IMU is well aligned and the PGNCS and RR are functioning properly, it follows that the purpose of the state vector change validity check is to discover a Type 4 error. As previously mentioned, there is a low probability of this type of error occurring.

Based upon the last time that the state vector was updated and when the IMU last was realigned, very crude reasonable values for δr and δv can be generated by the astronaut. The LGC will provide no information to assist the astronaut in his estimates of reasonable values for δr and δv .

The parameters required to initialize the navigation routines (Sections 5.2.4.2 and 5.2.5.2) are the initial estimated CSM state vector, plus the initial estimated LM state vector for the Rendezvous Navigation Routine or the estimated landing site for the Lunar Surface Navigation Routine, initial state vector estimation error covariance matrices in the form of prestored diagonal error transition matrices (as defined in Section 5.2.2.4), and a priori measurement error variances. The basic input to the navigation routines is RR tracking data which is automatically acquired by the Data Read Routine. The primary results of the navigation routines are the estimated LM and CSM state vectors. The various guidance targeting modes outlined in Section 5.4 are based on the state vector estimates which result from these navigation routines.

5.2.2 COASTING INTEGRATION ROUTINE

5.2.2.1 General Comments

During all coasting phase navigation procedures, an extrapolation of position and velocity by numerical integration of the equations of motion is required. The basic equation may be written in the form

$$\frac{d^2}{dt^2} \underline{r}(t) + \frac{\mu_P^*}{r^3} \underline{r}(t) = \underline{a}_d(t) \quad (2.2.1)$$

where μ_P is the gravitational constant of the primary body, and $\underline{a}_d(t)$ is the vector acceleration which prevents the motion of the vehicle (CSM or LM) from being precisely a conic with focus at the center of the primary body. The Coasting Integration Routine is a precision integration routine in which all significant perturbation effects are included. The form of the disturbing acceleration $\underline{a}_d(t)$ depends on the phase of the mission.

An approximate extrapolation of a vehicle state vector in which the disturbing acceleration, $\underline{a}_d(t)$ of Eq. (2.2.1), is set to zero may be accomplished by means of the Kepler subroutine (Section 5.5.5).

5.2.2.2 Encke's Method

If \underline{a}_d is small compared with the central force field, direct integration of Eq. (2.2.1) is inefficient. Therefore, the extrapolation will be accomplished using the technique of differential accelerations attributed to Encke.

* In the remainder of Section 5.2 the subscripts P and Q will denote primary and secondary body, respectively. When the body is known, then the subscripts E, M, and S will be used for earth, moon, and sun, respectively. The vehicle will be indicated by the subscripts C for CSM and L for LM.

At time t_0 the position and velocity vectors, \underline{r}_0 and \underline{v}_0 , define an osculating conic orbit. The position and velocity vectors in the conic orbit, $\underline{r}_{\text{con}}(t)$ and $\underline{v}_{\text{con}}(t)$, respectively, will deviate by a small amount from the actual position and velocity vectors.

The conic position and velocity at time t are computed as shown in Section 5.5.5. Required in this calculation is the variable x which is the root of Kepler's equation. In order to minimize the number of iterations required in solving Kepler's equation, an estimate of the correct solution for x is obtained as follows:

Let

$$\tau = t - t_0 \quad (2.2.2)$$

During the previous computation cycle the values

$$\begin{aligned} \underline{r}' &= \underline{r}_{\text{con}} \left(\tau - \frac{\Delta t}{2} \right) \\ \underline{v}' &= \underline{v}_{\text{con}} \left(\tau - \frac{\Delta t}{2} \right) \end{aligned} \quad (2.2.3)$$

$$x' = x \left(\tau - \frac{\Delta t}{2} \right)$$

were computed. A trial value of $x(\tau)$ is obtained from

$$x_t = x' + s \left[1 - \gamma s (1 - 2\gamma s) - \frac{1}{6} \left(\frac{1}{r'} - \alpha \right) s^2 \right] \quad (2.2.4)$$

where

$$\begin{aligned} s &= \frac{\sqrt{\mu_P}}{r'} \left(\frac{\Delta t}{2} \right) \\ \gamma &= \frac{\underline{r}' \cdot \underline{v}'}{2r' \sqrt{\mu_P}} \end{aligned} \quad (2.2.5)$$

$$\alpha = \frac{2}{r_0} - \frac{v_0^2}{\mu_P}$$

After specification of \underline{r}_0 , \underline{v}_0 , x_t and τ , the Kepler subroutine (Section 5.5.5) is used to compute $\underline{r}_{\text{con}}(\tau)$, $\underline{v}_{\text{con}}(\tau)$, and $x(\tau)$. Because of the excellent initial approximation provided by Eq. (2.2.4), it has not been found necessary to iterate for x more than once (and frequently it is not necessary at all) in order to obtain a value of x for which $\tau - \tau(x)$ is less than the given tolerance level.

The true position and velocity vectors will deviate from the conic position and velocity since \underline{a}_d is not zero. Let

$$\underline{r}(t) = \underline{\delta}(t) + \underline{r}_{\text{con}}(t) \quad (2.2.6)$$

$$\underline{v}(t) = \underline{\nu}(t) + \underline{v}_{\text{con}}(t)$$

where $\underline{\delta}(t)$ and $\underline{\nu}(t)$ are the position and velocity deviations from the conic. The deviation vector $\underline{\delta}(t)$ satisfies the differential equation

$$\frac{d^2}{dt^2} \underline{\delta}(t) = - \frac{\mu_P}{r_{\text{con}}^3(t)} \left[f(q) \underline{r}(t) + \underline{\delta}(t) \right] + \underline{a}_d(t) \quad (2.2.7)$$

subject to the initial conditions

$$\underline{\delta}(t_0) = \underline{0}, \quad \underline{\nu}(t_0) = \underline{0} \quad (2.2.8)$$

where

$$q = \frac{(\underline{\delta} - 2\underline{r}) \cdot \underline{\delta}}{r^2} \quad (2.2.9)$$

$$f(q) = q \frac{3 + 3q + q^2}{1 + (1 + q)^{3/2}} \quad (2.2.10)$$

The first term on the right-hand side of Eq. (2.2.7) must remain small, i. e., of the same order as $\underline{a}_d(t)$, if the method is to be efficient. As the deviation vector $\underline{\delta}(t)$ grows in magnitude, this term will eventually increase in size. Therefore, in order to maintain the efficiency of the method, a new osculating conic orbit should be defined by the total position and velocity vectors $\underline{r}(t)$ and $\underline{v}(t)$. The process of selecting a new conic orbit from which to calculate deviations is called rectification. When rectification occurs, the initial conditions for the differential equation for $\underline{\delta}(t)$, as well as the variables τ and x , are again zero.

5.2.2.3 Disturbing Acceleration

The form of the disturbing acceleration $\underline{a}_d(t)$ that is used in Eq. (2.2.1) depends on the phase of the mission. In earth or lunar orbit, only the gravitational anomalies arising from the non-spherical shape of the primary body need be considered. Let \underline{a}_{dP} be the acceleration due to the non-spherical gravitational anomalies of the primary body. Then, for the earth

$$\underline{a}_{dE} = \frac{\mu_E}{r^2} \sum_{i=2}^4 J_{iE} \left(\frac{r_E}{r} \right)^i \left[P'_{i+1} (\cos \phi) \underline{u}_r - P'_i (\cos \phi) \underline{u}_z \right] \quad (2.2.11)$$

where

$$P_2'(\cos \phi) = 3 \cos \phi$$

$$P_3'(\cos \phi) = \frac{1}{2} (15 \cos^2 \phi - 3) \quad (2.2.12)$$

$$P_4'(\cos \phi) = \frac{1}{3} (7 \cos \phi P_3' - 4 P_2')$$

$$P_5'(\cos \phi) = \frac{1}{4} (9 \cos \phi P_4' - 5 P_3')$$

are the derivatives of Legendre polynomials,

$$\cos \phi = \underline{u}_r \cdot \underline{u}_z \quad (2.2.13)$$

and J_2, J_3, J_4 are the coefficients of the second, third, and fourth harmonics of the earth's potential function. The vectors \underline{u}_r and \underline{u}_z are unit vectors in the direction of \underline{r} and the polar axis of the earth, respectively, and r_E is the equatorial radius of the earth.

In the case of the moon

$$\begin{aligned} \underline{a}_{dM} = & \frac{\mu_M}{r^2} \left\{ \sum_{i=2}^4 J_{iM} \left(\frac{r_M}{r} \right)^i \left[P_{i+1}'(\cos \phi) \underline{u}_r - P_i'(\cos \phi) \underline{u}_z \right] \right. \\ & \left. + 3 J_{22M} \left(\frac{r_M}{r} \right)^2 \left[4 \frac{x_M y_M}{x_M^2 + y_M^2} (\underline{u}_r \times \underline{u}_z) + \frac{x_M^2 - y_M^2}{x_M^2 + y_M^2} ((5 \cos^2 \phi - 3) \underline{u}_r - 2 \cos \phi \underline{u}_z) \right] \right\} \end{aligned} \quad (2.2.14)$$

where r_M is the mean lunar radius, J_{22M} is the coefficient of the term in the moon's gravitational potential function which describes the asymmetry of the moon about its polar axis, and x_M and y_M are the X and Y components of \underline{r} expressed in moon-fixed coordinates. The other terms in Eq. (2. 2. 14) have definitions analogous to those in Eq. (2. 2. 11). The variables x_M , y_M , and \underline{u}_z are computed by means of the Planetary Inertial Orientation Subroutine (Section 5. 5. 2).

During cislunar-midcourse flight (translunar and transearth) the gravitational attraction of the sun and the secondary body Q (earth or moon) are relevant forces. The accelerations due to the secondary body and the sun are

$$\underline{a}_{dQ} = - \frac{\mu_Q}{r_{QC}^3} \left[f(q_Q) \underline{r}_{PQ} + \underline{r} \right] \quad (2. 2. 15)$$

$$\underline{a}_{dS} = - \frac{\mu_S}{r_{SC}^3} \left[f(q_S) \underline{r}_{PS} + \underline{r} \right] \quad (2. 2. 16)$$

where \underline{r}_{PQ} and \underline{r}_{PS} are the position vectors of the secondary body and the sun with respect to the primary body, r_{QC} and r_{SC} are the distances of the CSM from the secondary body and the sun, and the arguments q_Q and q_S are computed from

$$q_Q = \frac{(\underline{r} - 2 \underline{r}_{PQ}) \cdot \underline{r}}{r_{PQ}^2} \quad (2. 2. 17)$$

$$q_S = \frac{(\underline{r} - 2 \underline{r}_{PS}) \cdot \underline{r}}{r_{PS}^2} \quad (2. 2. 18)$$

The functions $f(q_Q)$ and $f(q_S)$ are calculated from Eq.(2. 2. 10).

The position vectors of the moon relative to the earth, \underline{r}_{EM} , and the sun relative to the earth, \underline{r}_{ES} , are computed as described in Section (5.5.4). Then,

$$\underline{r}_{PQ} = \begin{cases} \underline{r}_{EM} & \text{if } P = E \\ -\underline{r}_{EM} & \text{if } P = M \end{cases} \quad (2.2.19)$$

and

$$\underline{r}_{PS} = \begin{cases} \underline{r}_{ES} & \text{if } P = E \\ \underline{r}_{ES} - \underline{r}_{EM} & \text{if } P = M \end{cases} \quad (2.2.20)$$

Finally,

$$\underline{r}_{QC} = \underline{r} - \underline{r}_{PQ} \quad (2.2.21)$$

$$\underline{r}_{SC} = \underline{r} - \underline{r}_{PS}$$

5.2.2.4 Error Transition Matrix

The position and velocity vectors as maintained in the computer are only estimates of the true values. As part of the navigation technique it is necessary also to maintain statistical data in the computer to aid in the processing of navigation measurements.

If $\underline{\epsilon}(t)$ and $\underline{\eta}(t)$ are the errors in the estimates of the position and velocity vectors, respectively, then the six-dimensional correlation matrix $E(t)$ is defined by

$$E_6(t) = \begin{pmatrix} \overline{\underline{\epsilon}(t) \underline{\epsilon}(t)^T} & \overline{\underline{\epsilon}(t) \underline{\eta}(t)^T} \\ \overline{\underline{\eta}(t) \underline{\epsilon}(t)^T} & \overline{\underline{\eta}(t) \underline{\eta}(t)^T} \end{pmatrix} \quad (2. 2. 22)$$

In certain applications it becomes necessary to expand the state vector and the correlation matrix to more than six dimensions so as to include estimation of landmark locations in the CMC during orbit navigation, and rendezvous radar tracking biases in the LGC during the rendezvous navigation procedure. For this purpose a nine-dimensional correlation matrix is defined as follows :

$$E(t) = \begin{pmatrix} & & \overline{\underline{\epsilon}(t) \underline{\beta}^T} \\ & E_6(t) & \overline{\underline{\eta}(t) \underline{\beta}^T} \\ \overline{\underline{\beta} \underline{\epsilon}(t)^T} & \overline{\underline{\beta} \underline{\eta}(t)^T} & \overline{\underline{\beta} \underline{\beta}^T} \end{pmatrix} \quad (2. 2. 23)$$

where the components of the three-dimensional vector $\underline{\beta}$ are the errors in the estimates of three variables which are estimated in addition to the components of the spacecraft state vector.

In order to take full advantage of the operations provided by the interpreter in the computer, the correlation matrix will be restricted to either six or nine dimensions. If, in some navigation procedure, only one or two additional items are to be estimated, then a sufficient number of dummy variables will be added to the desired seven- or eight-dimensional state vector to make it nine-dimensional.

Rather than use the correlation matrix in the navigation procedure, it is more convenient to utilize a matrix $W(t)$, called the error transition matrix, and defined by

$$E(t) = W(t) W(t)^T \quad (2. 2. 24)$$

Extrapolation of the nine-dimensional matrix $W(t)$ is made by direct numerical integration of the differential equation

$$\frac{d}{dt} W(t) = \begin{pmatrix} O & I & O \\ G(t) & O & O \\ O & O & O \end{pmatrix} W(t) \quad (2. 2. 25)$$

where $G(t)$ is the three-dimensional gravity gradient matrix, and I and O are the three-dimensional identity and zero matrices, respectively. If the W matrix is partitioned as

$$W = \begin{pmatrix} \underline{w}_0 & \underline{w}_1 & \cdots & \underline{w}_8 \\ \underline{w}_9 & \underline{w}_{10} & \cdots & \underline{w}_{17} \\ \underline{w}_{18} & \underline{w}_{19} & \cdots & \underline{w}_{26} \end{pmatrix} \quad (2. 2. 26)$$

then,

$$\left. \begin{aligned} \frac{d}{dt} \underline{w}_i(t) &= \underline{w}_{i+9}(t) \\ \frac{d}{dt} \underline{w}_{i+9}(t) &= G(t) \underline{w}_i(t) \\ \frac{d}{dt} \underline{w}_{i+18}(t) &= \underline{0} \end{aligned} \right\} \quad i = 0, 1, \dots, 8 \quad (2.2.27)$$

The extrapolation may be accomplished by successively integrating the vector differential equations

$$\frac{d^2}{dt^2} \underline{w}_i(t) = G(t) \underline{w}_i(t) \quad i = 0, 1, \dots, 8 \quad (2.2.28)$$

The gravity gradient matrix $G(t)$ for earth or lunar orbit is given by

$$G(t) = \frac{\mu_P}{r^5(t)} \left[3 \underline{r}(t) \underline{r}(t)^T - r^2(t) I \right] \quad (2.2.29)$$

During cislunar-midcourse flight

$$\begin{aligned} G(t) &= \frac{\mu_P}{r^5(t)} \left[3 \underline{r}(t) \underline{r}(t)^T - r^2(t) I \right] \\ &+ \frac{\mu_Q}{r_{QC}^5(t)} \left[3 \underline{r}_{QC}(t) \underline{r}_{QC}(t)^T - r_{QC}^2(t) I \right] \end{aligned} \quad (2.2.30)$$

Thus, if D is the dimension of the matrix $W(t)$ for the given navigation procedure, the differential equations for the $\underline{w}_i(t)$ vectors are

$$\begin{aligned} \frac{d^2}{dt^2} \underline{w}_i(t) = & \frac{\mu_P}{r^3(t)} \left\{ 3 \left[\underline{u}_r(t) \cdot \underline{w}_i(t) \right] \underline{u}_r(t) - \underline{w}_i(t) \right\} \\ & + M \frac{\mu_Q}{r_{QC}^3(t)} \left\{ 3 \left[\underline{u}_{QC}(t) \cdot \underline{w}_i(t) \right] \underline{u}_{QC}(t) - \underline{w}_i(t) \right\} \end{aligned} \quad (2.2.31)$$

$i = 0, 1, \dots, D-1$

where $\underline{u}_r(t)$ and $\underline{u}_{QC}(t)$ are unit vectors in the directions of $\underline{r}(t)$ and $\underline{r}_{QC}(t)$, respectively, and

$$M = \begin{cases} 1 & \text{for cislunar midcourse flight} \\ 0 & \text{for earth or lunar orbit} \end{cases} \quad (2.2.32)$$

5.2.2.5 Numerical Integration Method

The extrapolation of navigational data requires the solution of a number of second-order vector differential equations, specifically Eqs. (2.2.7) and (2.2.31). These are all special cases of the form

$$\frac{d^2}{dt^2} \underline{y} = \underline{f}(\underline{y}, t) \quad (2.2.33)$$

Nystrom's method is particularly well suited to this form and gives an integration method of fourth-order accuracy. The second-order system is written

$$\frac{d}{dt} \underline{y} = \underline{z}$$

(2. 2. 34)

$$\frac{d}{dt} \underline{z} = \underline{f}(\underline{y}, t)$$

and the formulae are summarized below.

$$\underline{y}_{n+1} = \underline{y}_n + \underline{\phi}(\underline{y}_n) \Delta t$$

$$\underline{z}_{n+1} = \underline{z}_n + \underline{\psi}(\underline{y}_n) \Delta t$$

$$\underline{\phi}(\underline{y}_n) = \underline{z}_n + \frac{1}{6} (\underline{k}_1 + 2\underline{k}_2) \Delta t$$

(2. 2. 35)

$$\underline{\psi}(\underline{y}_n) = \frac{1}{6} (\underline{k}_1 + 4\underline{k}_2 + \underline{k}_3)$$

$$\underline{k}_1 = \underline{f}(\underline{y}_n, t_n)$$

$$\underline{k}_2 = \underline{f}\left(\underline{y}_n + \frac{1}{2} \underline{z}_n \Delta t + \frac{1}{8} \underline{k}_1 (\Delta t)^2, t_n + \frac{1}{2} \Delta t\right)$$

$$\underline{k}_3 = \underline{f}\left(\underline{y}_n + \underline{z}_n \Delta t + \frac{1}{2} \underline{k}_2 (\Delta t)^2, t_n + \Delta t\right)$$

For efficient use of computer storage as well as computing time the computations are performed in the following order:

Eq. (2. 2. 35). It is necessary to preserve the values of the vector \underline{r} at times t_n , $t_n + \Delta t/2$, $t_n + \Delta t$ for use in the solution of Eqs. (2. 2. 31).

- 2) Equations (2. 2. 31) are solved one-at-a-time using Eqs. (2. 2. 35) together with the values of \underline{r} which resulted from the first step.

The variable Δt is the integration time step and should not be confused with τ , the time since rectification. The maximum value for Δt which can be used for precision integration, Δt_{\max} , is given by the empirically determined formula

$$\Delta t_{\max} = \text{minimum} \left(\Delta t_{\text{lim}}, \frac{K r^{3/2}}{\sqrt{\mu_P}} \right) \quad (2. 2. 36)$$

where the calculation is truncated to the nearest two centiseconds and

$$\Delta t_{\text{lim}} = 4000 \text{ sec.} \quad (2. 2. 37)$$

$$K = 0.3$$

Because of the form of Eq. (2. 2. 36), it is possible for the Coasting Integration Routine to use an excessive amount of time to extrapolate a state vector if the resulting trajectory passes too close to the target planet. Furthermore, the capability of extrapolating a state vector to a desired radial distance may be a useful function. For these reasons, the desired final time and the desired final radius must be specified by the calling routine.

5. 2. 2. 6 Coasting Integration Logic

Estimates of the state vectors of two vehicles (CSM and LM) will be maintained in the computer. In various phases of the mission it will be required to extrapolate a state vector either alone or with an associated W matrix of dimension six or nine.

To accomplish all of these possible procedures, as well as to solve the computer restart problem, three state vectors will be maintained in the computer. Let \underline{x}_C and \underline{x}_L be the estimated CSM and LM state vectors, respectively, and let \underline{x} be a temporary state vector. The state vector \underline{x} is a symbolic representation of the following set of variables:

$$\begin{aligned}
 \underline{r}_0 &= \text{rectification position vector} \\
 \underline{v}_0 &= \text{rectification velocity vector} \\
 \underline{r}_{\text{con}} &= \text{conic position vector} \\
 \underline{v}_{\text{con}} &= \text{conic velocity vector} \\
 \underline{\delta} &= \text{position deviation vector} \\
 \underline{\nu} &= \text{velocity deviation vector} \\
 t &= \text{time associated with } \underline{r}_{\text{con}}, \underline{v}_{\text{con}}, \underline{\delta} \text{ and } \underline{\nu} \\
 \tau &= \text{time since rectification} \\
 x &= \text{root of Kepler's equation} \\
 P &= \text{primary body} = \begin{cases} + 1 \text{ for earth} \\ - \\ + 2 \text{ for moon} \\ - \end{cases}
 \end{aligned}
 \tag{2. 2. 38}$$

where the positive sign indicates cislunar-midcourse flight and the negative sign near-earth or near-lunar orbit.

The state vectors \underline{x}_C and \underline{x}_L represent an analogous set of variables.

The Coasting Integration Routine is controlled by the calling program by means of the two indicators D and V. The variable D indicates the dimension of the W matrix with

$$D = 0 \tag{2. 2. 39}$$

denoting that the state vector only is to be extrapolated. The variable V indicates the appropriate vehicle as follows:

$$V = \begin{cases} 1 & \text{for CSM} \\ 0 & \text{for LM} \\ -1 & \text{for state vector specified by calling program} \end{cases} \quad (2.2.40)$$

In addition, the calling program must set the desired final time t_F ; the desired final radius r_F ; and, for V equal to -1 , the desired state vector x .

A simplified functional diagram of the Coasting Integration Routine is shown in Fig. 2.2-1. In the figure the indicated state vector is being integrated to time t_F . The value of Δt for each time step is Δt_{\max} (Eq. (2.2.36)) or the total time-to-go whichever is smaller. The integration is terminated when the computed value of Δt is less than ϵ_t , or the magnitude of the position vector is less than r_F .

Figures 2.2-2, 2.2-3 and 2.2-4 illustrate in more detail the logic flow of this routine. In these figures certain items which have not been discussed fully in the text are explicitly illustrated. The following is a list of these items together with the number of the figure in which each occurs.

- 1) Saving of \underline{r} values for W matrix integration: Fig. 2.2-2.
- 2) Change in origin of coordinates: Fig. 2.2-3.
- 3) Rectification procedure: Fig. 2.2-3.
- 4) Selection of disturbing acceleration: Fig. 2.2-4.

The logic flow shown in these figures is controlled by the three switches or flags A, B, and F. Switch A is used in the determination

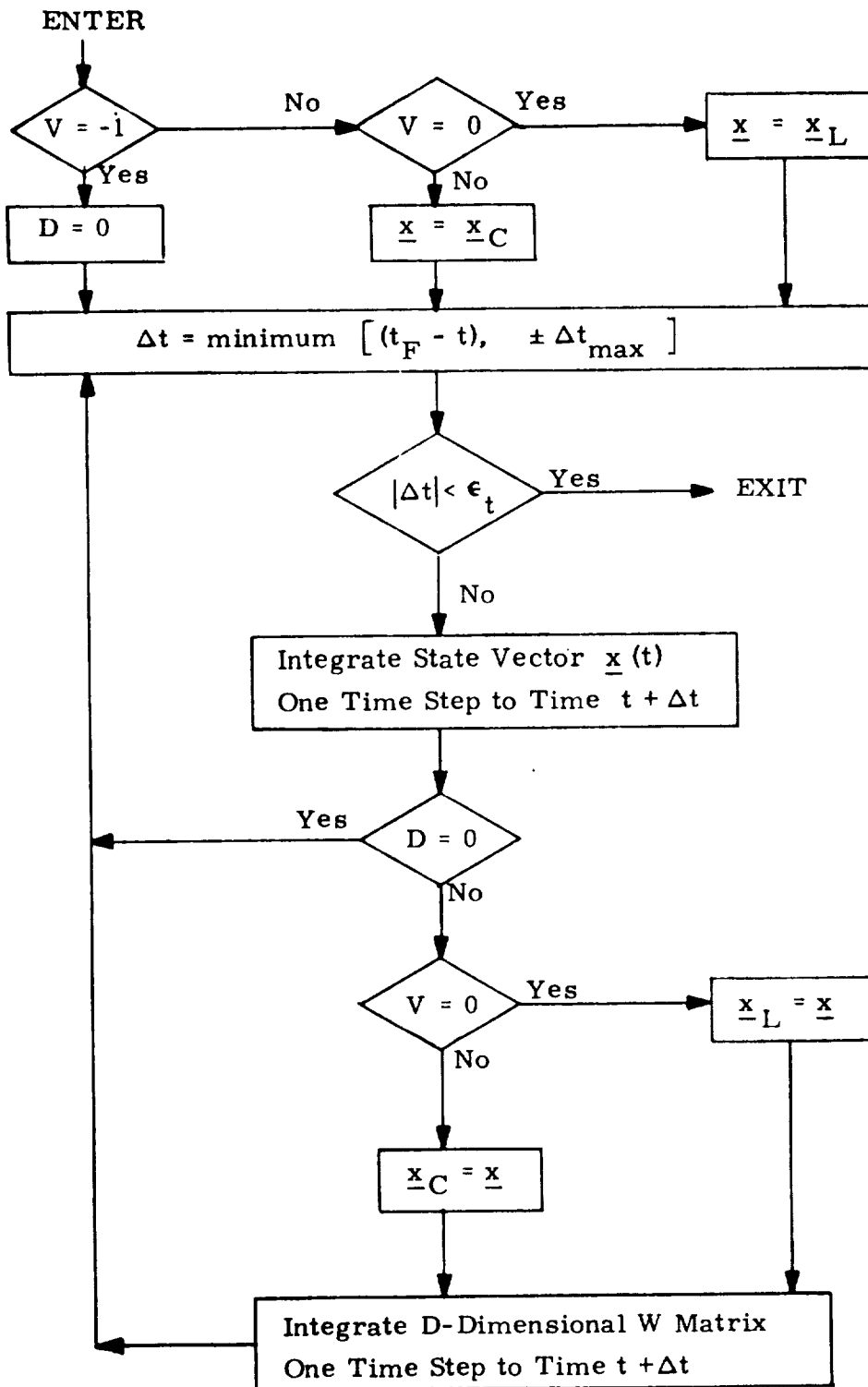

Figure 2. 2-1 Simplified Coasting Integration Routine Logic Diagram

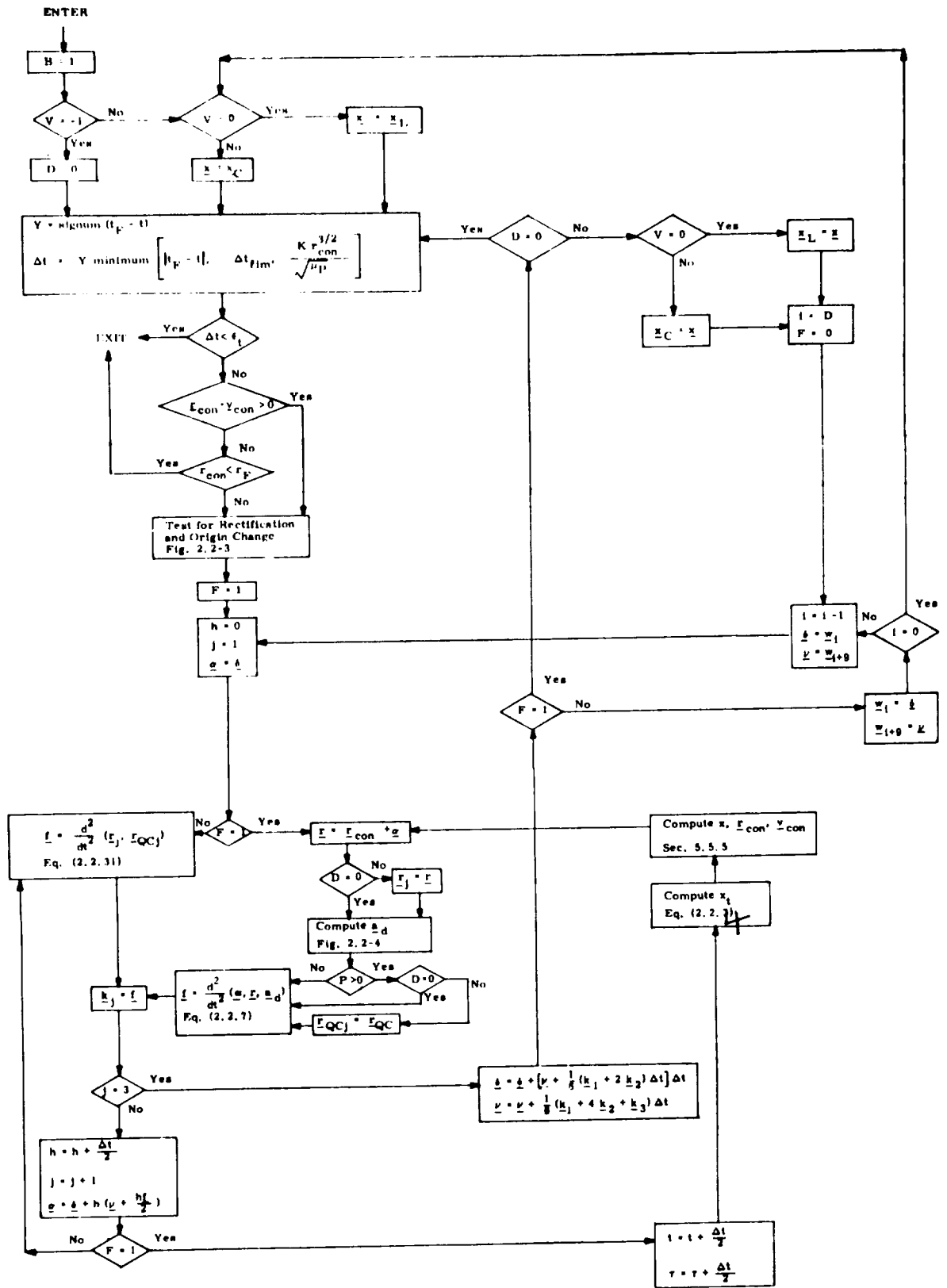

Figure 2.2-2 Coasting Integration Routine
Logic Diagram

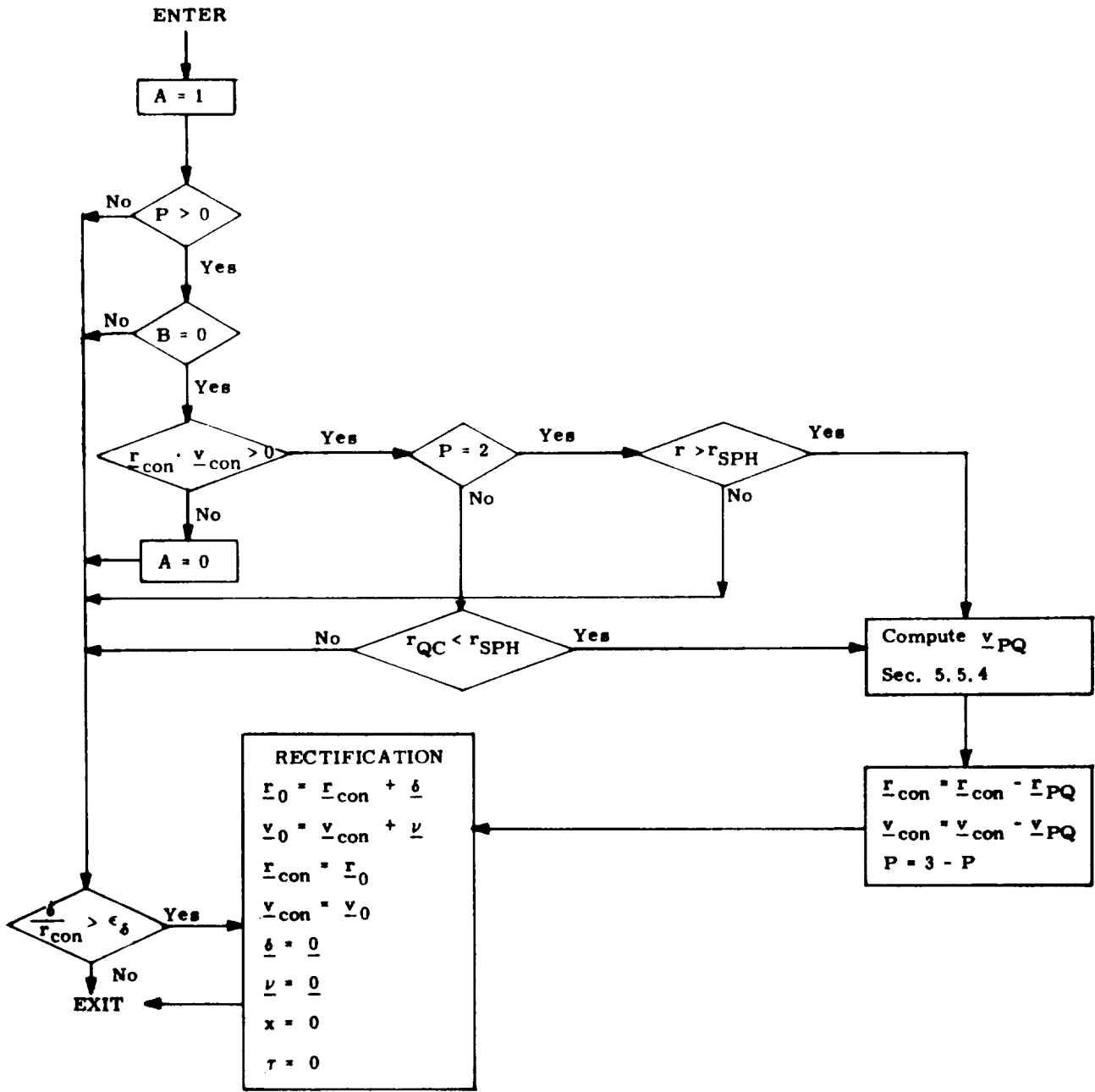

Figure 2.2-3 Rectification and Coordinate System Origin Change Logic Diagram

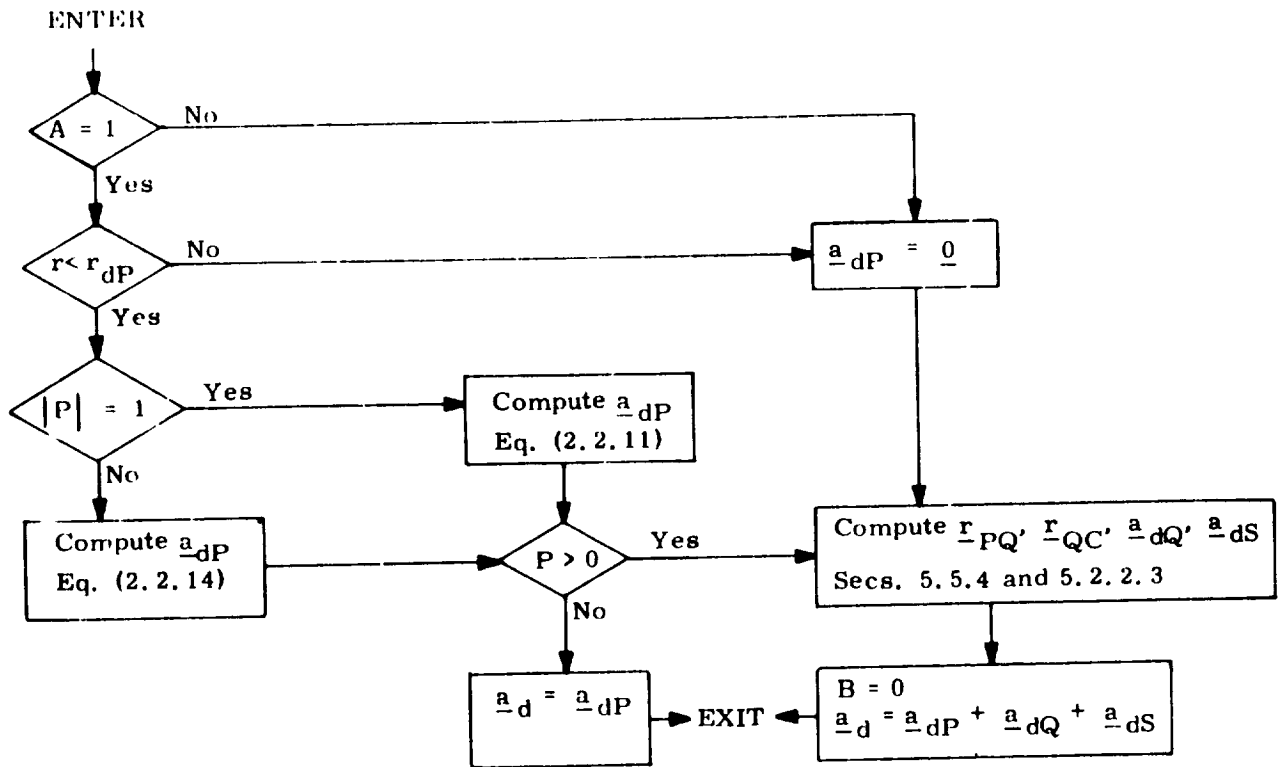

Figure 2. 2-4 Disturbing Acceleration Selection
Logic Diagram

of whether or not the acceleration due to the non-spherical gravitational anomalies of the primary planet, \underline{a}_{dP} , should be included in the disturbing acceleration. The acceleration \underline{a}_{dP} is relevant during earth and lunar orbit, and during that part of cislunar-mid-course flight in which the vehicle is both departing from the primary planet and is within the prescribed radius r_{dP} . Switch B inhibits the test for a change in the origin of the Basic Reference Coordinate System until the vector \underline{r}_{PQ} is available. Switch F is used to distinguish between state vector integration ($F = 1$) and W matrix integration ($F = 0$).

The definitions of the various control constants which appear in Figs. 2.2-1 to 2.2-4 are as follows:

- ϵ_t = integration time step criterion
- ϵ_δ = rectification criterion
- r_{SPH} = radius of lunar sphere of influence
- r_{dE} = radius of relevance for earth non-spherical gravitational anomalies
- r_{dM} = radius of relevance for moon non-spherical gravitational anomalies

5. 2. 3 MEASUREMENT INCORPORATION ROUTINE

Periodically it is necessary to update the estimated position and velocity vectors of the vehicle (CSM or LM) by means of navigation measurements. At the time a measurement is made, the best estimate of the state vector of the spacecraft is the extrapolated estimate denoted by \underline{x}' . The first six components of \underline{x}' are the components of the estimated position and velocity vectors. In certain situations it becomes necessary to estimate more than six quantities. Then, the state vector will be of nine dimensions. From this state vector estimate it is possible to determine an estimate of the quantity measured. When the predicted value of this measurement is compared with the actual measured quantity, the difference is used to update the indicated state vector as well as its associated error transition matrix as described in Section 5.2.1. The error transition matrix, W , is defined in Section 5.2.2.4.

This routine is used to compute deviations to be added to the components of the estimated state vector, and to update the estimated state vector by these deviations provided the deviations pass a state vector update validity test as described in Section 5.2.1.

Let D be the dimension (six or nine) of the estimated state vector. Associated with each measurement are the following parameters which are to be specified by the program calling this routine:

\underline{b} = Geometry vector of D dimensions

$\overline{\alpha^2}$ = A priori measurement error variance

δQ = Measured deviation, the difference between the quantity actually measured and the expected value based on the original value of the estimated state vector \underline{x}' .

The procedure for incorporating a measurement into the estimated state vector is as follows:

- 1 Compute a D-dimensional \underline{z} vector from

$$\underline{z} = W'^T \underline{b} \quad (2.3.1)$$

where W' is the error transition matrix associated with \underline{x}' .

- 2 Compute the D-dimensional weighting vector, $\underline{\omega}$, from

$$\underline{\omega}^T = \frac{1}{z^2 + \alpha^2} \underline{z}^T W'^T \quad (2.3.2)$$

- 3 Compute the state vector deviation estimates from

$$\delta \underline{x} = \underline{\omega} \delta Q \quad (2.3.3)$$

- 4 If the data pass the validity test, update the state vector and the W matrix by

$$\underline{x} = \underline{x}' + \delta \underline{x} \quad (2.3.4)$$

$$W = W' - \frac{\underline{\omega} \underline{z}^T}{1 + \sqrt{\frac{\alpha^2}{z^2 + \alpha^2}}} \quad (2.3.5)$$

In order to take full advantage of the three-dimensional vector and matrix operations provided by the interpreter in the computer, the nine-dimensional W matrix will be stored sequentially in the computer as follows :

$$\underline{w}_0, \underline{w}_1, \dots, \underline{w}_{26}$$

Refer to Section 5.2.2.4 for the definition of the W matrix. Define the three-dimensional matrices

$$W_0 = \begin{pmatrix} \underline{w}_0^T \\ \underline{w}_1^T \\ \underline{w}_2^T \end{pmatrix} \quad W_1 = \begin{pmatrix} \underline{w}_3^T \\ \underline{w}_4^T \\ \underline{w}_5^T \end{pmatrix} \quad \dots \quad W_8 = \begin{pmatrix} \underline{w}_{24}^T \\ \underline{w}_{25}^T \\ \underline{w}_{26}^T \end{pmatrix} \quad (2.3.6)$$

so that

$$W = \begin{pmatrix} W_0^T & W_1^T & W_2^T \\ W_3^T & W_4^T & W_5^T \\ W_6^T & W_7^T & W_8^T \end{pmatrix} \quad (2.3.7)$$

Let the nine-dimensional vectors $\underline{\delta x}$, \underline{b} , $\underline{\omega}$, and \underline{z} be partitioned as follows:

$$\underline{\delta x} = \begin{pmatrix} \underline{\delta x}_0 \\ \underline{\delta x}_1 \\ \underline{\delta x}_2 \end{pmatrix} \quad \underline{b} = \begin{pmatrix} \underline{b}_0 \\ \underline{b}_1 \\ \underline{b}_2 \end{pmatrix} \quad \underline{\omega} = \begin{pmatrix} \underline{\omega}_0 \\ \underline{\omega}_1 \\ \underline{\omega}_2 \end{pmatrix} \quad \underline{z} = \begin{pmatrix} z_0 \\ z_1 \\ \vdots \\ z_8 \end{pmatrix} = \begin{pmatrix} \underline{z}_0 \\ \underline{z}_1 \\ \underline{z}_2 \end{pmatrix} \quad (2.3.8)$$

Then, the computations shown in Eqs. (2.3.1) through (2.3.3) are performed as follows, using three-dimensional operations:

$$\underline{z}_i = \sum_{j=0}^{\frac{D}{3}-1} W'_{i+3j} \underline{b}_j$$

$$a = \sum_{j=0}^{\frac{D}{3}-1} \underline{z}_j \cdot \underline{z}_j + \alpha^2$$

(2.3.9)

$$\underline{\omega}_i^T = \frac{1}{a} \sum_{j=0}^{\frac{D}{3}-1} \underline{z}_j^T W'_{3i+j}$$

$$\delta \underline{x}_i = \delta Q \underline{\omega}_i \quad \left(i = 0, 1, \dots, \frac{D}{3} - 1 \right)$$

Equation (2.3.5) is written

$$\gamma = \frac{1}{1 + \sqrt{\alpha^2/a}}$$

(2.3.10)

$$\underline{w}_{i+9j} = \underline{w}'_{i+9j} - \gamma \underline{z}_i \underline{\omega}_j \quad \left(\begin{array}{l} i = 0, 1, \dots, D-1 \\ j = 0, 1, \dots, \frac{D}{3}-1 \end{array} \right)$$

The Measurement Incorporation Routine is divided into two subroutines, INCORP1 and INCORP2. The subroutine INCORP1 consists of Eqs. (2.3.9), while INCORP2 is composed of Eqs. (2.3.4) and (2.3.10). The method of using these subroutines is illustrated in Fig. 2.3-1.

Since the estimated position and velocity vectors are maintained in two pieces, conic and deviation from the conic, Eq. (2.3.4) cannot be applied directly. The estimated position and velocity deviations resulting from the measurement, $\delta \underline{x}_0$ and $\delta \underline{x}_1$, are added to the vectors $\underline{\delta}$ and \underline{v} , the position and velocity deviations from the conics, respectively. Since $\underline{\delta}$ and \underline{v} are maintained to much higher accuracy than the conic position and velocity vectors, a possible computation overflow situation exists whenever Eq. (2.3.4) is applied. If overflow does occur, then it is necessary to reinitialize the Coasting Integration Routine (Section 5.2.2) by the process of rectification as described in Section 5.2.2.2. The logic flow of the subroutine INCORP2 is illustrated in detail in Fig. 2.3-2.

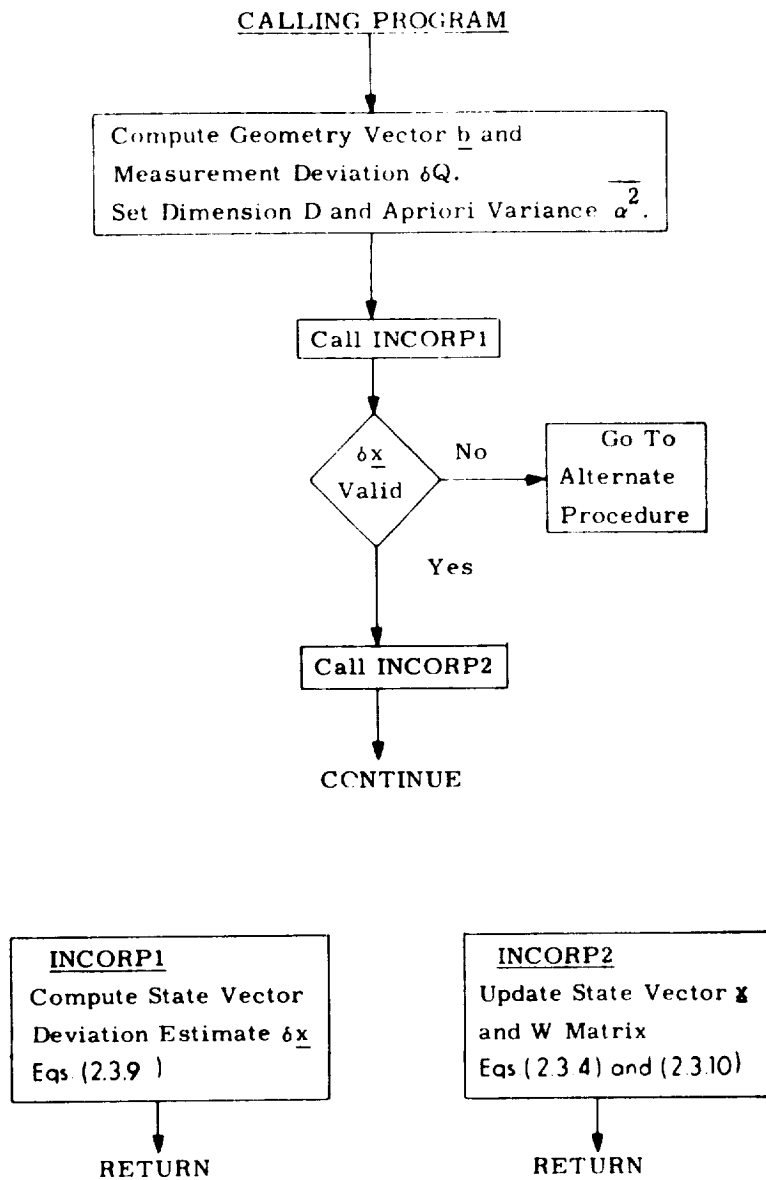

Fig. 2.3-1 Measurement Incorporation Procedure

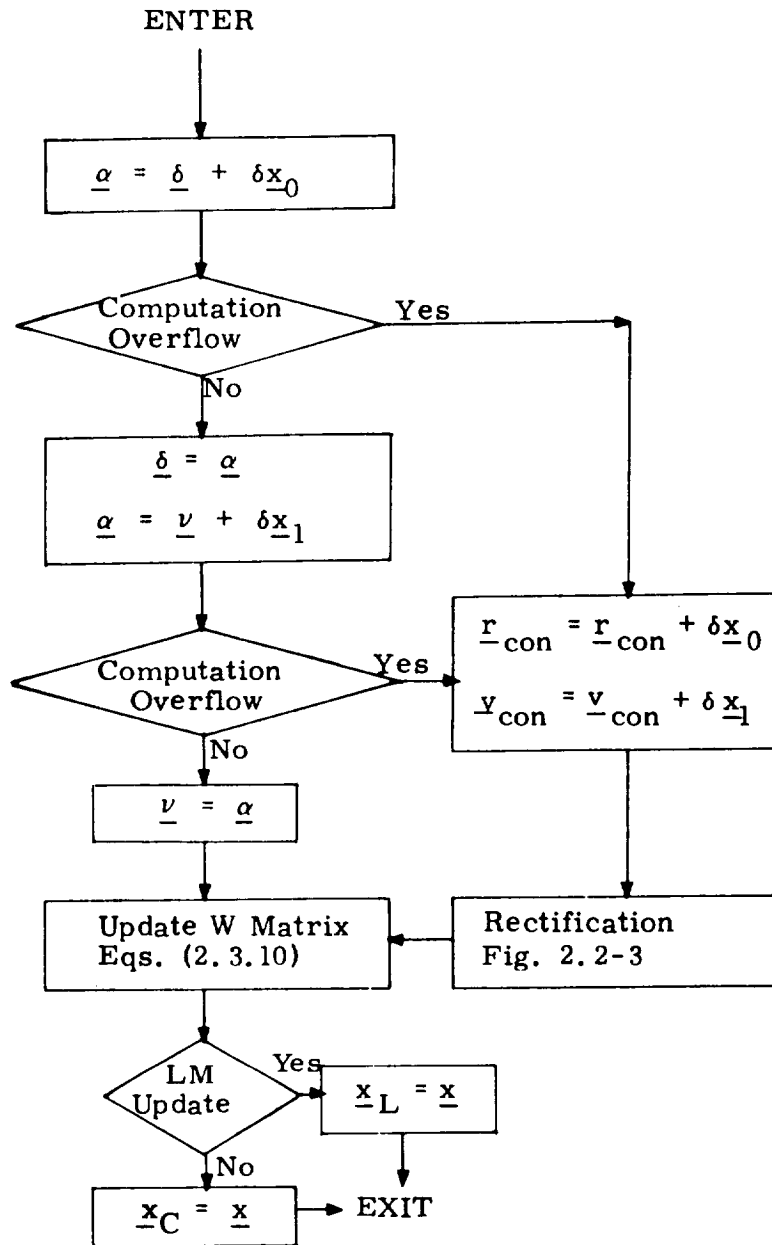

Fig. 2.3-2 INCORP2 Subroutine Logic Diagram

5.2.4 RENDEZVOUS NAVIGATION PROGRAM

5.2.4.1 Target Acquisition Routine

One of the first functions performed by the Rendezvous Navigation Program is to use the Target Acquisition Routine to establish lock-on of the LM Rendezvous Radar (RR) with the transponder on the CSM. Since the problem of acquiring the CSM with the RR is essentially the same for both the Rendezvous and Lunar Surface Navigation Programs (P-20 and P-22, respectively), the same Acquisition Routine is used for both except for minor differences in operation. As seen in Fig. 2.4-1, a different path is taken at various points in the routine if program P-22 is being used. For the moment, however, most of the operational details presented are for the case when the Rendezvous Navigation Program is being used. In Section 5.2.5.1 an explanation is given for the different paths taken by the routine when P-22 is being used. In either case it is assumed at the start of the routine that the RR is on and has been permitted to warm-up for at least 30 seconds.

Three modes are indicated at the top of Fig. 2.4-1 for controlling the RR in target acquisition. Normally the RR LGC Mode is used to control the RR for target acquisition. However, the astronaut may elect to use the RR Manual Mode by a verb-noun entry when calling either navigation program. The RR Search Mode, which is also indicated at the top of Fig. 2.4-1, is not used at the beginning of either navigation program, but can be called by the astronaut when an Alarm is issued by the corresponding Designate Routine.

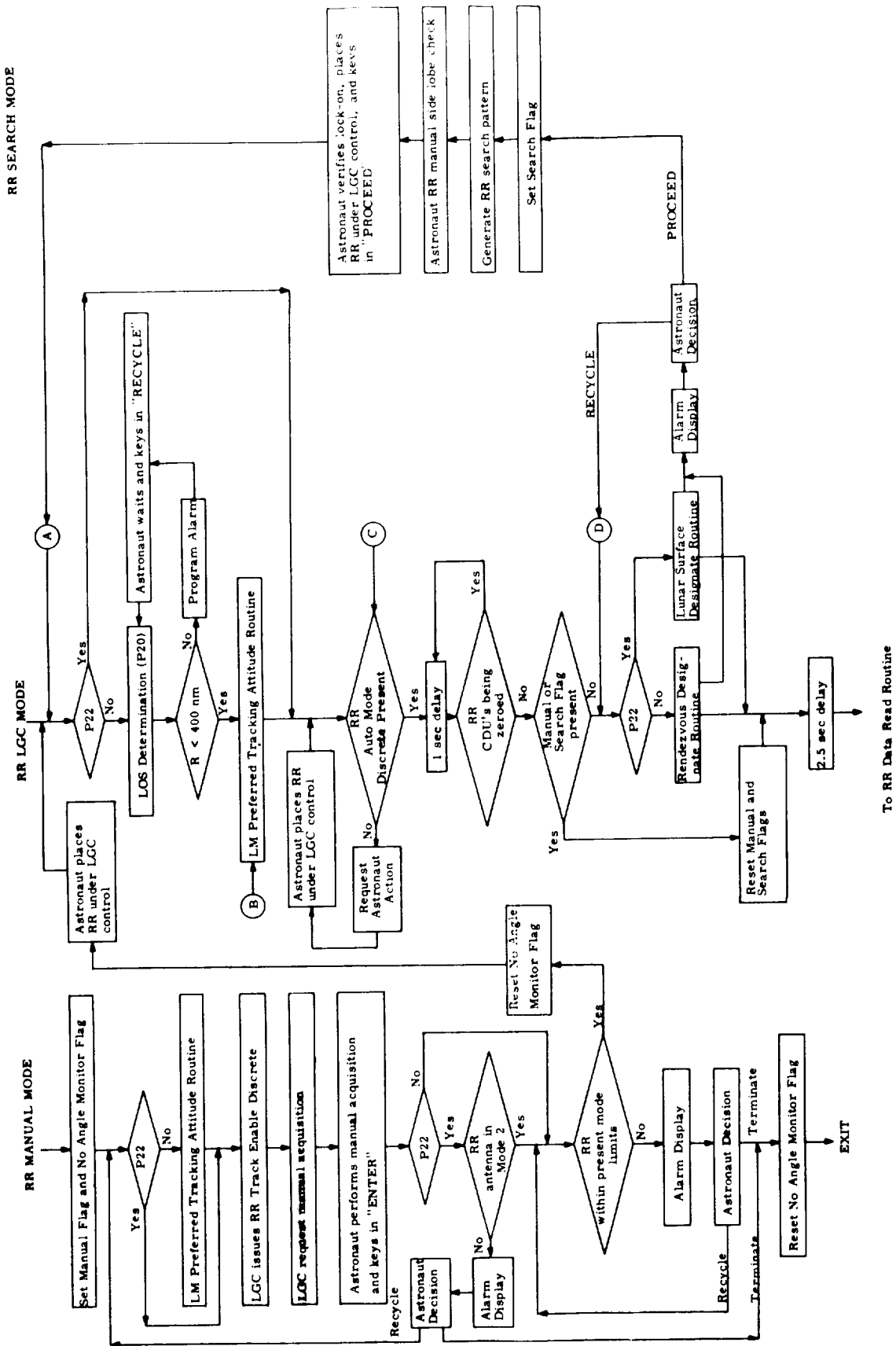

Figure 2.4-1 Target Acquisition Routine

5.2.4.1.1 Target Acquisition With the RR LGC Mode

LGC control of the RR is shown in the middle column of Fig. 2.4-1 where the first step is the determination of the line-of-sight (LOS) to the CSM. This is accomplished by taking the vector difference of the LM and CSM position vectors propagated to that time. If the range between the LM and CSM is greater than 400 nm, an alarm is issued since the RR is unable to provide correct range information to the LGC because of the ranging technique used in the radar. After successfully completing the range check, the LM Preferred Tracking Attitude Routine is used to align the LM + Z-axis with the LOS. The Preferred Tracking Attitude Routine automatically recomputes the LOS and then calls the KALCMANU Routine of Section 3 to align the LM + Z-axis along the LOS. At this point, if the astronaut should decide to manually change the attitude, such as to roll about the Z-axis, it is essential that he recall the Preferred Tracking Attitude Routine to insure that the Z-axis is aligned with the LOS before proceeding with the next step. This is done to insure a sufficient period of data taking for estimation of the RR angle biases before the angle between the RR antenna and the LM Z-axis reaches 30 degrees. During the RR data taking process the LM is controlled to hold an approximate inertially fixed attitude by use of the 5° limit cycle. The RR Data Read Routine, which is described in Section 5.2.4.2, is used to detect when the RR antenna is more than 30 degrees from the + Z-axis and causes the + Z-axis to be re-aligned with the LOS using the Preferred Tracking Attitude Routine. In addition to meeting the requirements for estimating RR angle biases, it is also essential that the above attitude constraints be used because of the limited radiation coverage of the LM optical beacon which must be directed towards the CSM so as to enable the astronaut in the CSM to optically sight upon it. The beacon is centered with respect to the LM + Z-axis and has a beamwidth of approximately 60 degrees.

Having completed the Preferred Tracking Attitude Routine in Fig. 2.4-1, the LGC checks to see if the RR Auto Mode discrete is being received from the RR. This discrete signifies that the RR is on and has been placed under LGC control by a switch associated with the radar. Afterwards, a check is made to insure that the RR CDU's are not being zeroed. These CDU's are zeroed by the RR Monitor Routine (R-25) of Section 5.2.4.3 whenever the RR is placed under LGC control. Next, a check is made to see if either the Manual or Search flag is present, signifying that the manual or search mode of acquisition is being used. Since the present mode is assumed to be the RR LGC Mode, these flags should not be present.

During rendezvous, the Rendezvous Designate Routine of Fig. 2.4-2 is used to designate the RR along the LOS to the CSM. Initially, the routine removes the RR Track Enable discrete, if it is present, to insure that the RR will respond to its designate commands. Next, a check is made to see if the target LOS is in the present RR antenna coverage mode, of which there are two as shown in Fig. 2.4-3. In the present case, the LOS should be in the Mode 1 coverage region since the Preferred Tracking Attitude Routine previously aligned the LM Z-axis along the LOS. If the RR antenna is not in this desired coverage mode (Mode 1), action is taken to place it there.

Afterwards, the designate routine starts designating the RR towards the LOS as shown in Fig. 2.4-2. The LOS is determined every two seconds by extrapolation of the CSM and LM state vectors. Every half second new rate commands, proportional to the angular difference between the RR and LOS, are issued to the gyros of the RR Antenna Servos. When the RR is within 0.5 degrees of the LOS, the RR Track Enable discrete is issued to the RR, enabling its angle tracking servos to track the target if its range and range-rate tracking networks have already acquired the target. The routine then terminates if the RR Data Good discrete, signifying RR lock-on, is received. However, if this discrete is not present, the routine will continue generating

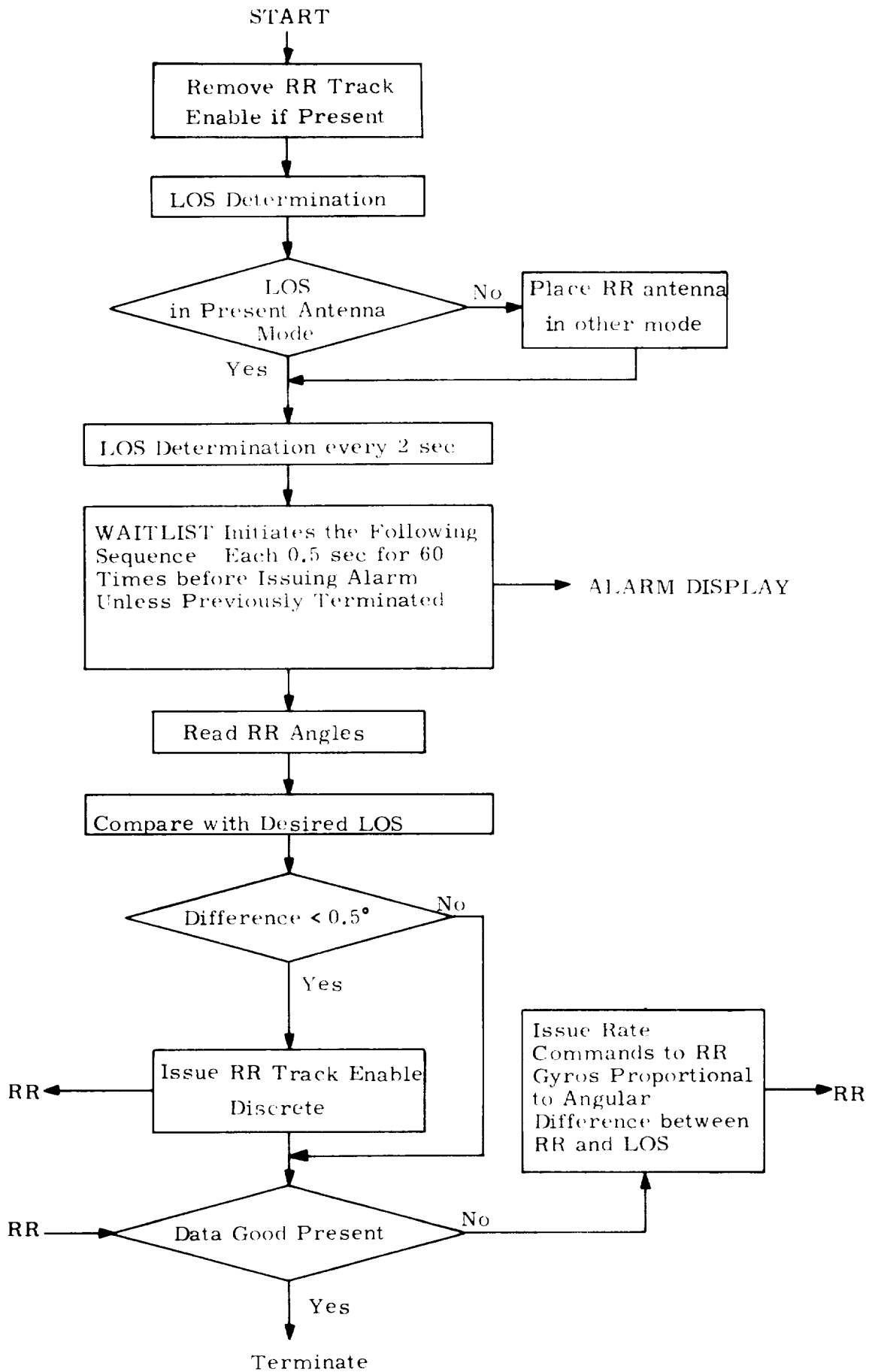

Figure 2.4-2 Rendezvous Designate Routine

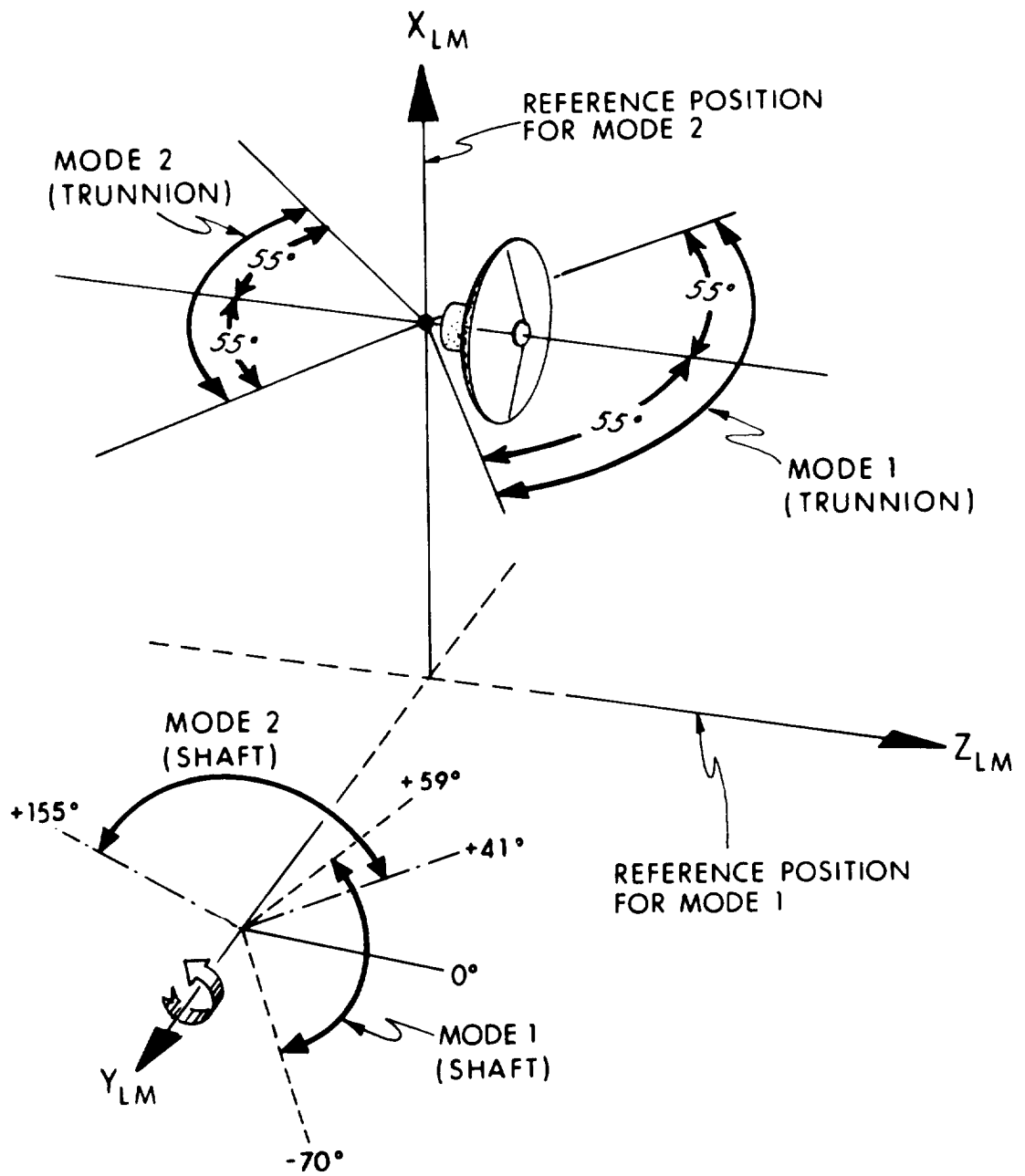

Figure 2.4-3 RR Antenna Shaft and Trunnion LOS Operating Regions

commands and checking for this discrete until the allotted time (approx. 30 seconds) has expired, at which time an Alarm is issued. At this point it is seen in Fig. 2.4-1 that the astronaut can either repeat the LGC designate process or proceed to the RR Search Mode.

Once lock-on is achieved, a 2.5 - second delay is introduced before going to the RR Data Read Routine. This delay permits any transients in the RR angle tracking servos to settle out before data is taken.

5.2.4.1.2 Target Acquisition With the RR Manual Mode

If the astronaut indicates when calling the Rendezvous Navigation Program that he wishes to manually acquire the CSM, the logic is that given in the left column of Fig. 2.4-1. The Manual and the No Angle Monitor flags are set and the attitude is established in the same manner as previously given for the RR LGC Mode. The No Angle Monitor flag is set during the RR Manual Mode so as to disable the angle monitor function of the RR Monitor Routine (see Section 5.2.4.3). Afterwards, the LGC issues the Track Enable discrete to the RR and requests the astronaut to manually acquire the target. Although the RR Track Enable discrete has no effect on manual control of the RR, it is issued at this time so that there will be no loss of RR tracking after the target has been manually acquired and the RR has been placed under LGC control.

After achieving lock-on manually, the astronaut keys in "ENTER" and the RR is checked to see if it is within the limits of the present coverage mode. If not, an alarm is displayed and the astronaut can either terminate the program or wait and recycle the limit check until the RR moves within the limits. After it has been established that the RR is within the mode limits, the No Angle Monitor flag is reset and the astronaut may then place the RR under LGC control. As seen in Fig. 2.4-1, the remaining steps are the same as for the RR LGC Mode except that the Designate Routines are by-passed.

5.2.4.1.3 Use of the RR Search Mode

In Fig. 2.4-1 it is seen that the RR Search Mode may be instigated by the astronaut if an Alarm has been issued by the Rendezvous or Lunar Surface Designate Routines. This mode causes the RR antenna to move in a hexagonal search pattern about the estimated LOS. The search pattern is a box with six sides where the side to side dimensions are 5.6° as shown in Fig. 2.4-4. At the beginning of this mode the RR is designated for six seconds along the estimated LOS to the target defined by the unit vector \underline{u}_{LOS} in Fig. 2.4-4. Afterwards, the LGC sequentially designates the RR to each corner of the hexagon for a period of six seconds. Having completed the designate to each corner, the LGC repeats the above process starting with a designate along \underline{u}_{LOS} for six seconds. The time required to generate this search pattern is approximately 42 seconds.

The logic flow used to generate the search pattern is shown in Fig. 2.4-5 and, for the moment, consideration will be given only to those logic steps taken during operation of the Rendezvous Navigation Program (P-20). Note that the LOS is updated every six seconds so as to keep the search pattern moving with the estimated target position. A more frequent update of the LOS is not considered necessary during rendezvous since the LOS angular rate seldom exceeds one milliradian per second. However, when the LOS is updated, it is determined three seconds into the future so as to minimize the LOS error. During the search operation, the Track Enable discrete is issued to the RR so that it may acquire the target. As seen in Fig. 2.4-5 a check is made every 6 seconds to see if the RR is within 30° of the LM + Z-axis. If this angle exceeds 30° , the LM Preferred Tracking Attitude Routine is used to re-establish the preferred attitude before commencing with the search pattern. A check is also made

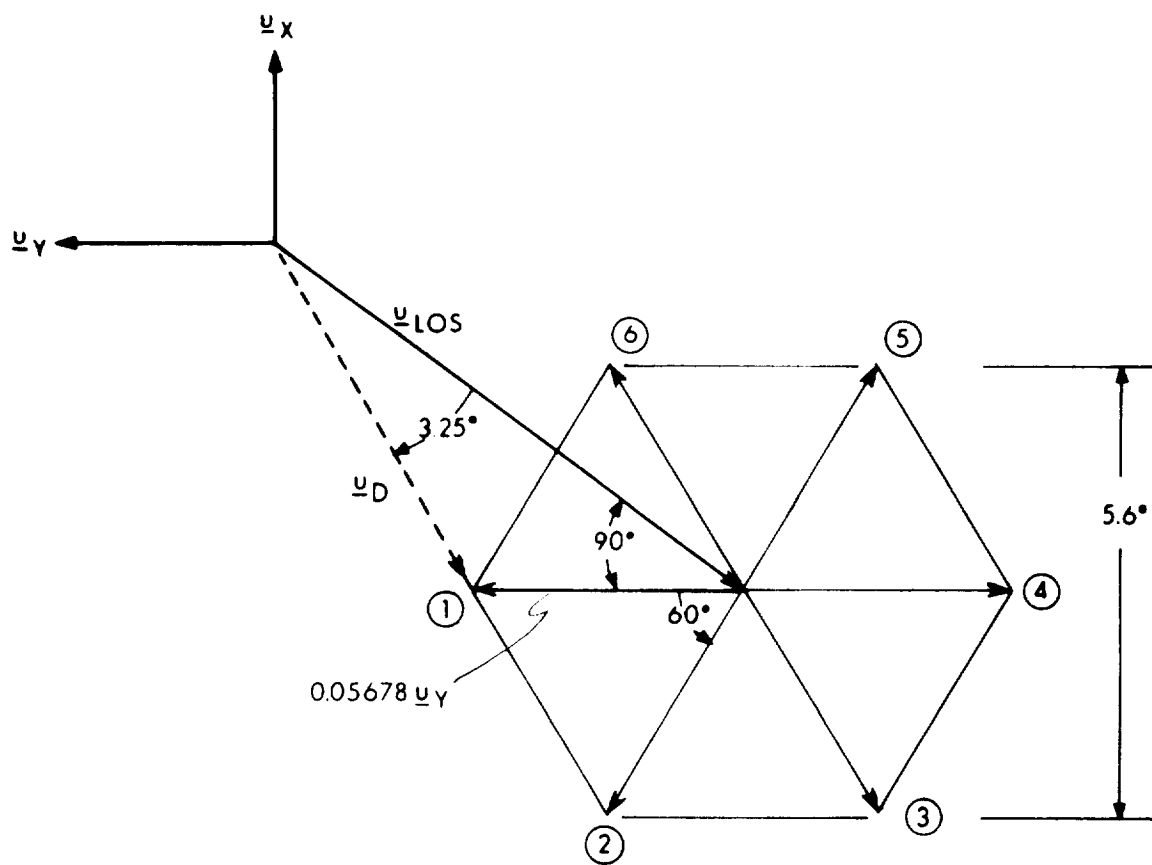

Fig. 2.4-4 RR Search Pattern

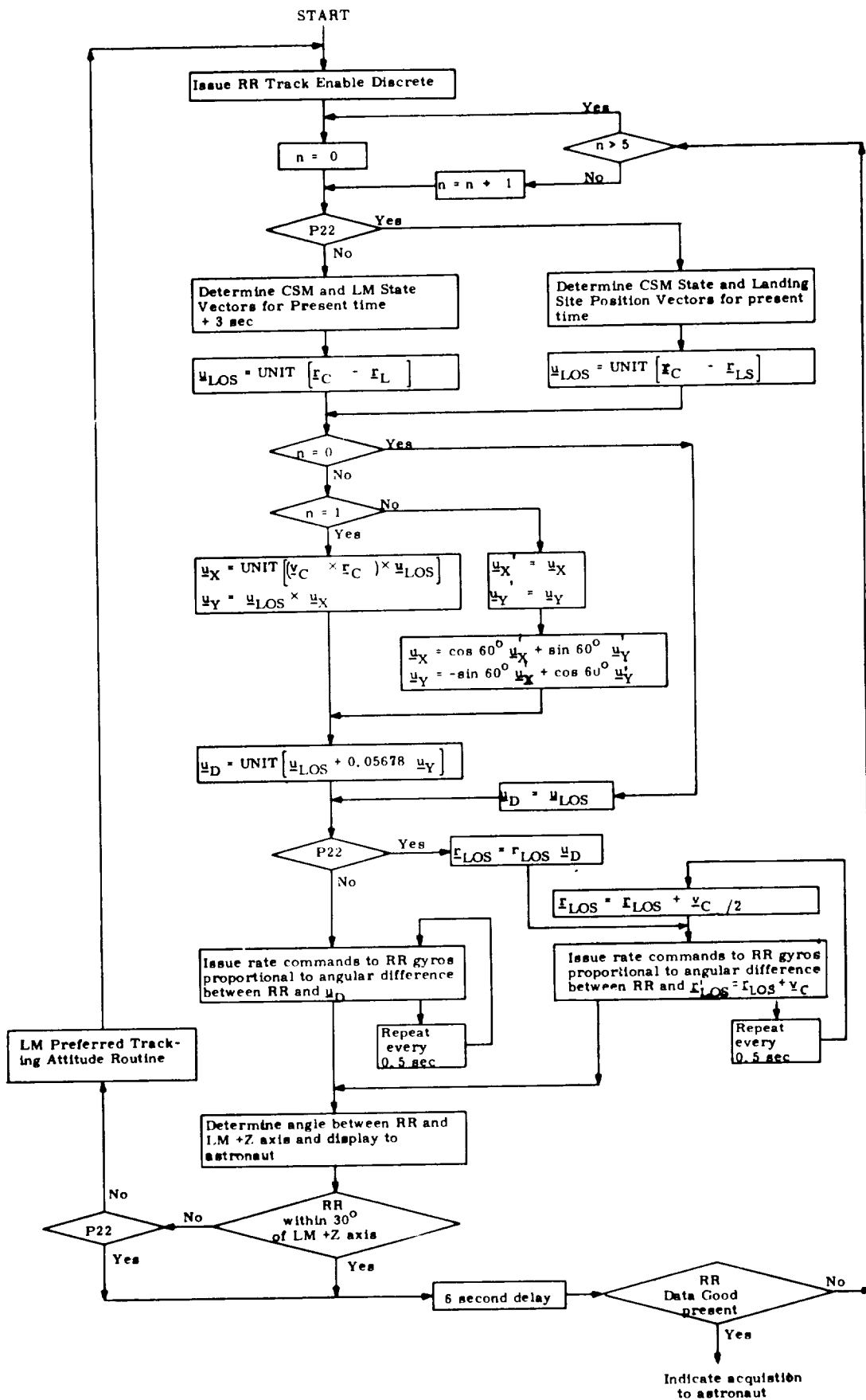

Figure 2.4-5 RR Search Pattern Generation

every six seconds to see if the LGC is receiving the RR Data Good discrete, signifying that the RR has acquired the target. If this discrete is present, the search pattern is stopped and the astronaut is notified. The astronaut then checks to see if acquisition was obtained with the main radiation lobe of the RR. By manually positioning the RR and observing the RR signal strength meter, he should be able to distinguish the main lobe from any side lobes. Having verified and achieved lock-on with the main radiation lobe, the astronaut places the RR under LGC control and enters a "PROCEED". The remaining steps are indicated in Fig. 2.4-1.

5.2.4.2 Rendezvous Navigation Routine

5.2.4.2.1 RR Data Read Routine

During operation of the Rendezvous Navigation Routine use is made of the RR Data Read Routine to obtain measurement data from the RR. The logic associated with the RR Data Read Routine is given in Fig. 2.4-6. Like the Target Acquisition Routine, this routine is used by both the Rendezvous and Lunar Surface Navigation Programs, with different paths being taken at various points in the routine depending on which program (P - 20 or P - 22) is in operation. The RR Data Read Routine periodically obtains a complete set of data from the RR (range, range rate, shaft angle, and trunnion angle) for purposes of navigation, although only range and range rate data is used for update during lunar surface navigation. The frequency of RR data requests made by the RR Data Read Routine is about once every minute during rendezvous navigation and about once every 30 seconds during lunar surface navigation.

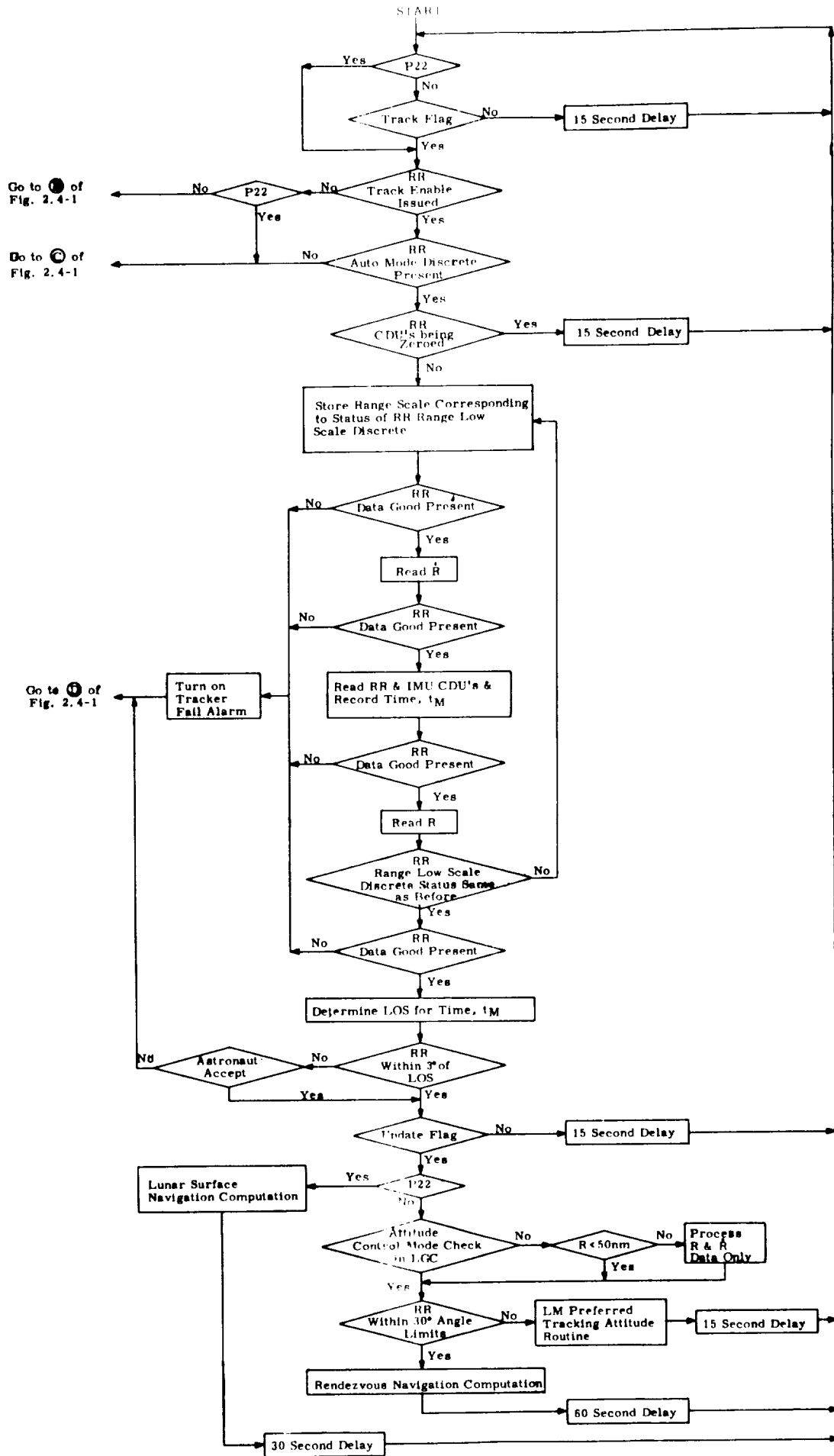

Figure 2.4-6 RR Data Read Routine

For the moment, an explanation will be given only for those logic steps in Fig. 2.4-6 associated with use of the Data Read Routine during rendezvous navigation. The different steps taken during operation with the Lunar Surface Navigation Program (P - 22) are explained in Section 5.2.5.2.

In Fig. 2.4-6, the first check made by the routine, after establishing that P-20 is being used, is to see if the Track flag is present. This flag is removed during the preparation and execution of a LM ΔV maneuver when there is no desire to have the routine request RR data or call any other routine such as the Rendezvous Designate and LM Preferred Tracking Attitude Routines. Note that a new request will be made for RR data 15 seconds later if the Track flag is absent.

If the Track flag is present, the routine next checks for issuance of the RR Track Enable discrete and reception of the RR Auto Mode discrete. The former discrete is removed and not re-issued by the RR Monitor Routine whenever the RR antenna angles exceed the limits in Fig. 2.4-3. Its absence therefore indicates a need to go back to input (B) of Fig. 2.4-1 to re-establish the LM preferred tracking attitude and re-designate the radar. Afterwards, a check is made to insure that RR data is not taken if the RR CDU's are being zeroed.

The sequence used by the routine for reading RR data is shown in Fig. 2.4-6 where frequent checks are made of the RR Data Good discrete to insure that no RR tracking interruptions have occurred during the read-out. Prior to and after reading the data, the routine checks the status of the Range Low Scale discrete to insure that the proper scaling will be applied to the range data. For ranges below 50.8 nautical miles, the RR issues the Range Low Scale discrete indicating to the LGC that the low scale factor should be used. If the status of this discrete should change during the data reading process, it is seen in Fig. 2.4-6 that a new data request is immediately made by the routine.

In order that a given set of RR data be usable for navigation update purposes, the data must all be referenced to one instant of time. Therefore, the time t_m when the CDU angles were recorded is used as the time tag for a complete set of RR data.

After the RR data is read, the LOS is determined for time t_m and compared with that indicated by the RR CDU's. This is done to insure against RR side-lobe lock-on. If the difference is more than 3 degrees, an alarm is issued to the astronaut who must then decide to go to the Rendezvous Designate Routine or request the LGC to proceed with the data.

Following the side-lobe check, the LGC checks to see if the Update flag is present. This flag is removed when there is no desire to use the RR data to update the navigation equations such as during the terminal phase of rendezvous. It is removed by the LGC during a LM ΔV maneuver, and by the Target Delta V Routine (R-32) when the CSM is performing a ΔV maneuver. The flag differs from the Track flag in that the presence of only the Track flag still permits the LGC to monitor RR tracking and read RR data for purposes other than navigation updates.

After the Update flag check, the LGC checks the LM attitude control mode to see if the 5° limit cycle is being used and that the attitude is not under manual control. This insures that the RR data will be satisfactory for update purposes.

The last check made by this routine is to determine if the RR antenna is less than 30 degrees from the LM + Z-axis. As mentioned previously, this is required in order for the LGC to perform a satisfactory determination of RR angle biases, and to also enable the LM Optical Beacon to be seen by the CSM.

The range obtained from the RR by the RR Data Read Routine is that measured by the RR between the LM and the CSM. This data is sent to the LGC from the RR as a binary data word R_{RR} . In the LGC the range r_{RR} in feet is obtained as follows:

$$r_{RR} = k_R R_{RR}$$

where k_R is the bit weight.

The range rate data obtained from the RR by the RR Data Read Routine is in the form of a binary data word S_{RR} which represents the count in the RR of a frequency comprising both the doppler frequency and a bias frequency (f_{BRR}) over a time interval τ_{RR} . At present, τ_{RR} is given as 80.000 milliseconds. To obtain the range rate (\dot{r}_{RR}) in feet per second, the following computation is made:

$$\dot{r}_{RR} = k_{RR} (S_{RR} - f_{BRR} \tau_{RR})$$

where k_{RR} is the scale factor required to obtain the range rate in feet per second and is of such a polarity as to make \dot{r}_{RR} positive in the above equation for increasing range.

A summary of the processing constants required by the LGC for RR operation is given as follows:

f_{BRR}	Range rate bias frequency
τ_{RR}	Counting interval in RR for range rate measurements
k_{RR}	Scale factor to convert the range rate count obtained from the RR to feet per second for the counting interval τ_{RR} . The scale factor polarity is such as to make the converted result positive for increasing range.
k_{R1}	Bit weight in feet for long range scale.
k_{R2}	Bit weight in feet for short range scale.

5.2.4.2.2 Rendezvous Navigation Computations

During rendezvous phases RR navigation data are obtained by means of automatic rendezvous radar tracking of the CSM from the LM. These data are used to update the estimated six-dimensional state vector of either the LM or the CSM. The option of which state vector is to be updated by the RR tracking data is controlled by the astronaut as described in Section 5.2.1 and illustrated in Fig. 2.1-1. This decision will be based upon which vehicle's state vector is most accurately known, and upon which vehicle is performing the rendezvous. This process requires that the constant RR tracking angle biases be compensated for by estimating these biases along with the selected vehicle's state vector such that subsequent RR tracking angle data can be modified as shown in simplified form Fig. 2.1-1.

This routine is used to process the CSM-tracking measurement data, and is used normally during lunar-orbit rendezvous in the lunar landing mission. The routine also can be used in earth orbit during alternate missions.

After the preferred LM attitude is achieved and RR tracking acquisition and lock-on is established (Section 5.2.4.1), the following tracking data are automatically acquired by the RR Data Read Routine (Section 5.2.4.2.1) at approximately one minute intervals:

- Measured range, R_M
- Measured range rate, \dot{R}_M
- Measured shaft angle, β_M
- Measured trunnion angle, θ_M

where the subscript M indicates the RR measured value. In addition to the above four measured quantities the time of the measurement and the three IMU gimbal angles are also recorded.

Although eight variables are estimated in the navigation procedure (six vehicle state-vector components and two RR angle biases), it is convenient to use the following nine-dimensional state vector:

$$\underline{x} = \begin{pmatrix} \underline{r} \\ \underline{v} \\ \delta\beta \\ \delta\theta \\ 0 \end{pmatrix} \quad (2.4.1)$$

where \underline{r} and \underline{v} are the estimated position and velocity vectors, respectively, of the selected vehicle (LM or CSM) which is being updated, $\delta\beta$ and $\delta\theta$ are the estimates of the biases in the RR shaft and trunnion angles, respectively, and the ninth coordinate is a dummy variable. This type of RR tracking angle bias is referred to as a boresight bias and is one of two types which may be defined. With the LM attitude restriction mentioned in Section 5.2.1, either type of angle bias (tilt or boresight) can be used, and the boresight type indicated in Eq. (2.4.1) is most convenient.

Let \underline{r}_L , \underline{v}_L , \underline{r}_C and \underline{v}_C be the estimated position and velocity vectors of the LM and CSM, respectively, at the time of the measurement. Then, the measurement error variances, $\overline{\alpha^2}$, the nine-dimensional geometry vectors, \underline{b} , and the measured deviations, δQ , for the range and range rate measurements are computed as follows:

Measured range, R_M

$$\underline{r}_{LC} = \underline{r}_C - \underline{r}_L$$

$$\underline{u}_{LC} = \text{UNIT}(\underline{r}_{LC})$$

$$\overline{\alpha^2} = \text{maximum}(\underline{r}_{LC}^2 \text{ var}_R, \text{ var}_{R\text{min}})$$

(2.4.2)

$$\underline{b}_0 = \overline{\alpha} \underline{u}_{LC}$$

$$\underline{b}_1 = \underline{0}$$

$$\underline{b}_2 = \underline{0}$$

$$\delta Q = R_M - r_{LC}$$

where var_R is the RR range error variance corresponding to a percentage error, and $\text{var}_{R\text{min}}$ is the minimum RR range error variance.

Measured range rate, \dot{R}_M

$$\underline{r}_{LC} = \underline{r}_C - \underline{r}_L$$

$$\underline{u}_{LC} = \text{UNIT}(\underline{r}_{LC})$$

$$\underline{v}_{LC} = \underline{v}_C - \underline{v}_L$$

(2.4.3)

$$\dot{r} = \underline{v}_{LC} \cdot \underline{u}_{LC}$$

$$\overline{\alpha^2} = \text{maximum}(\dot{r}^2 \text{ var}_V, \text{ var}_{V\text{min}})$$

Measured range rate, \dot{R}_M (Continued)

$$\underline{b}_0 = \mp \frac{1}{r_{LC}} (\underline{u}_{LC} \times \underline{v}_{LC}) \times \underline{u}_{LC}$$

$$\underline{b}_1 = \mp \underline{u}_{LC}$$

$$\underline{b}_2 = \underline{0}$$

$$\delta Q = \dot{R}_M - \dot{r}$$

(2.4.3 Continued)

where var_V is the RR range-rate error variance corresponding to a percentage error, and $\text{var}_{V_{\min}}$ is the minimum RR range-rate variance.

In Eqs. (2.4.2) and (2.4.3) the negative signs are selected if it is the LM state vector that is being updated, and the positive signs if it is the CSM state vector.

In order to process the RR angle data (β_M and θ_M), it is necessary to consider the relative orientations of the various coordinate systems. If \underline{u}_X , \underline{u}_Y and \underline{u}_Z are unit vectors along the X-, Y- and Z-axes, respectively, of the RR Measurement Coordinate System, then the measured shaft angle, β_M , and the measured trunnion angle, θ_M , are defined as shown in Fig. 2.4-7. In the figure, the vector \underline{r}_{XZ} is the projection of the measured LM-to-CSM line-of-sight vector on the XZ-plane.

It is assumed that the RR Measurement Coordinate System is coincident with the Navigation Base Coordinate System since all RR performance specifications are referenced to the PGNCS navigation base. The unit vectors \underline{u}_X , \underline{u}_Y and \underline{u}_Z are then given in the Basic Reference Coordinate System by

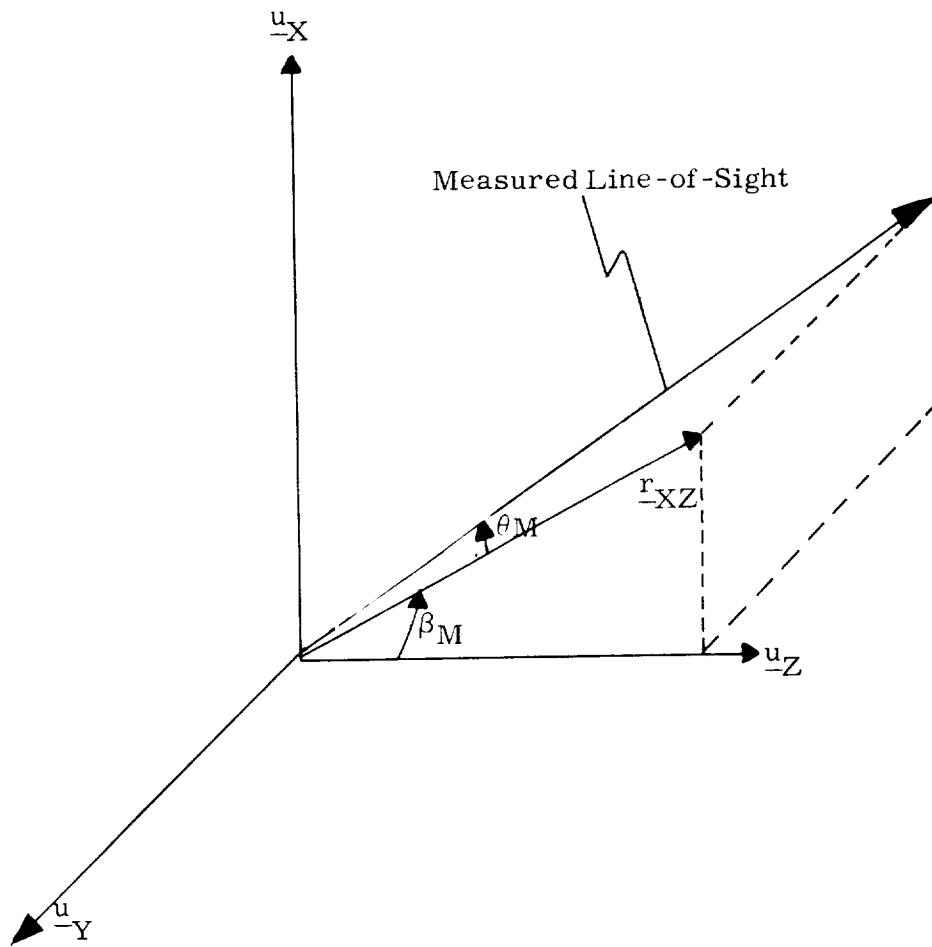

Figure 2.4-7 RR Measurement Coordinate System

$$\begin{pmatrix} \underline{u}_X^T \\ \underline{u}_Y^T \\ \underline{u}_Z^T \end{pmatrix} = \begin{bmatrix} \text{SMNB} \end{bmatrix} \begin{bmatrix} \text{REFSMMAT} \end{bmatrix} \quad (2.4.4)$$

where $\begin{bmatrix} \text{SMNB} \end{bmatrix}$ and $\begin{bmatrix} \text{REFSMMAT} \end{bmatrix}$ are transformation matrices as defined in Section 5.6.3, and the angles from which SMNB is determined are the values of the IMU gimbals which were recorded at the measurement time.

The measurement error variances, $\overline{\alpha^2}$, the nine-dimensional geometry vectors, \underline{b} , and the measured deviations, δQ , for the shaft and trunnion angle measurements are computed as follows:

Measured shaft angle, β_M

$$\underline{r}_{LC} = \underline{r}_C - \underline{r}_L$$

$$\underline{u}_{LC} = \text{UNIT}(\underline{r}_{LC})$$

$$S = -\underline{u}_{LC} \cdot \underline{u}_Y$$

$$r_{XZ} = r_{LC} \sqrt{1 - S^2}$$

$$\overline{\alpha^2} = \text{var}_\beta + \text{var}_{\text{IMU}} \quad (2.4.5)$$

$$\underline{b}_0 = \frac{1}{r_{XZ}} \text{UNIT}(\underline{u}_Y \times \underline{u}_{LC})$$

$$\underline{b}_1 = \underline{0}$$

$$\underline{b}_2 = \begin{pmatrix} 1 \\ 0 \\ 0 \end{pmatrix}$$

$$\delta Q = \beta_M - \tan^{-1} \left(\frac{\underline{u}_X \cdot \underline{u}_{LC}}{\underline{u}_Z \cdot \underline{u}_{LC}} \right) - \delta\beta$$

where var_β is the RR shaft-angle error variance and var_{IMU} is one-half the IMU angular error variance.

Measured trunnion angle, θ_M

$$\underline{r}_{\text{LC}} = \underline{r}_{\text{C}} - \underline{r}_{\text{L}}$$

$$\underline{u}_{\text{LC}} = \text{UNIT}(\underline{r}_{\text{LC}})$$

$$S = -\underline{u}_{\text{LC}} \cdot \underline{u}_{\text{Y}}$$

$$r_{\text{XZ}} = r_{\text{LC}} \sqrt{1 - S^2}$$

$$\overline{\alpha^2} = \text{var}_\theta + \text{var}_{\text{IMU}}$$

(2.4.6)

$$\underline{b}_0 = \mp \frac{1}{r_{\text{XZ}}} (\underline{u}_{\text{Y}} \times \underline{u}_{\text{LC}}) \times \underline{u}_{\text{LC}}$$

$$\underline{b}_1 = \underline{0}$$

$$\underline{b}_2 = \begin{pmatrix} 0 \\ 1 \\ 0 \end{pmatrix}$$

$$\delta Q = \theta_M - \sin^{-1}(S) - \delta\theta$$

where var_θ is the RR trunnion-angle error variance.

In Eqs. (2.4.5) and (2.4.6) the negative signs are used if it is the LM state vector that is being updated, and the positive signs if it is the CSM state vector.

The data are incorporated into the state vector estimates by means of four calls to the Measurement Incorporation Routine (Section 5.2.3). The updated components of the nine-dimensional state vector resulting from each incorporation are used as initial conditions for the next update in the sequence.

Included in each use of the Measurement Incorporation Routine is the state vector update validity check, as described in Section 5.2.1 and illustrated in Fig. 2.4-8.

The results of the processing of the RR measurement data are updated values of the estimated position and velocity vectors of the CSM or the LM and estimates of the RR angle biases. The two estimated vehicle state vectors are used to compute required rendezvous targeting parameters as described in Section 5.4.4.

For convenience of calculation in the LGC, Eqs. (2.4.5) and (2.4.6) are reformulated and regrouped as follows:

Preliminary Radar Angle Calculation

$$\begin{aligned}
 \underline{r}_{LC} &= \underline{r}_C - \underline{r}_L \\
 \underline{u}_{LC} &= \text{UNIT}(\underline{r}_{LC}) \\
 S &= -\underline{u}_{LC} \cdot \underline{u}_Y \\
 r_{XZ} &= r_{LC} \sqrt{1 - S^2}
 \end{aligned}
 \tag{2.4.7}$$

Measured shaft angle, β_M

$$\begin{aligned}
 \overline{\alpha^2} &= r_{XZ}^2 (\text{var}_{\beta} + \text{var}_{\text{IMU}}) \\
 \underline{b}_0 &= \mp \text{UNIT}(\underline{u}_Y \times \underline{u}_{LC}) \\
 \underline{b}_1 &= \underline{0} \\
 \underline{b}_2 &= \begin{pmatrix} r_{XZ} \\ 0 \\ 0 \end{pmatrix} \\
 \delta Q &= r_{XZ} \left[\beta_M - \tan^{-1} \left(\frac{\underline{u}_X \cdot \underline{u}_{LC}}{\underline{u}_Z \cdot \underline{u}_{LC}} \right) - \delta\beta \right]
 \end{aligned}
 \tag{2.4.8}$$

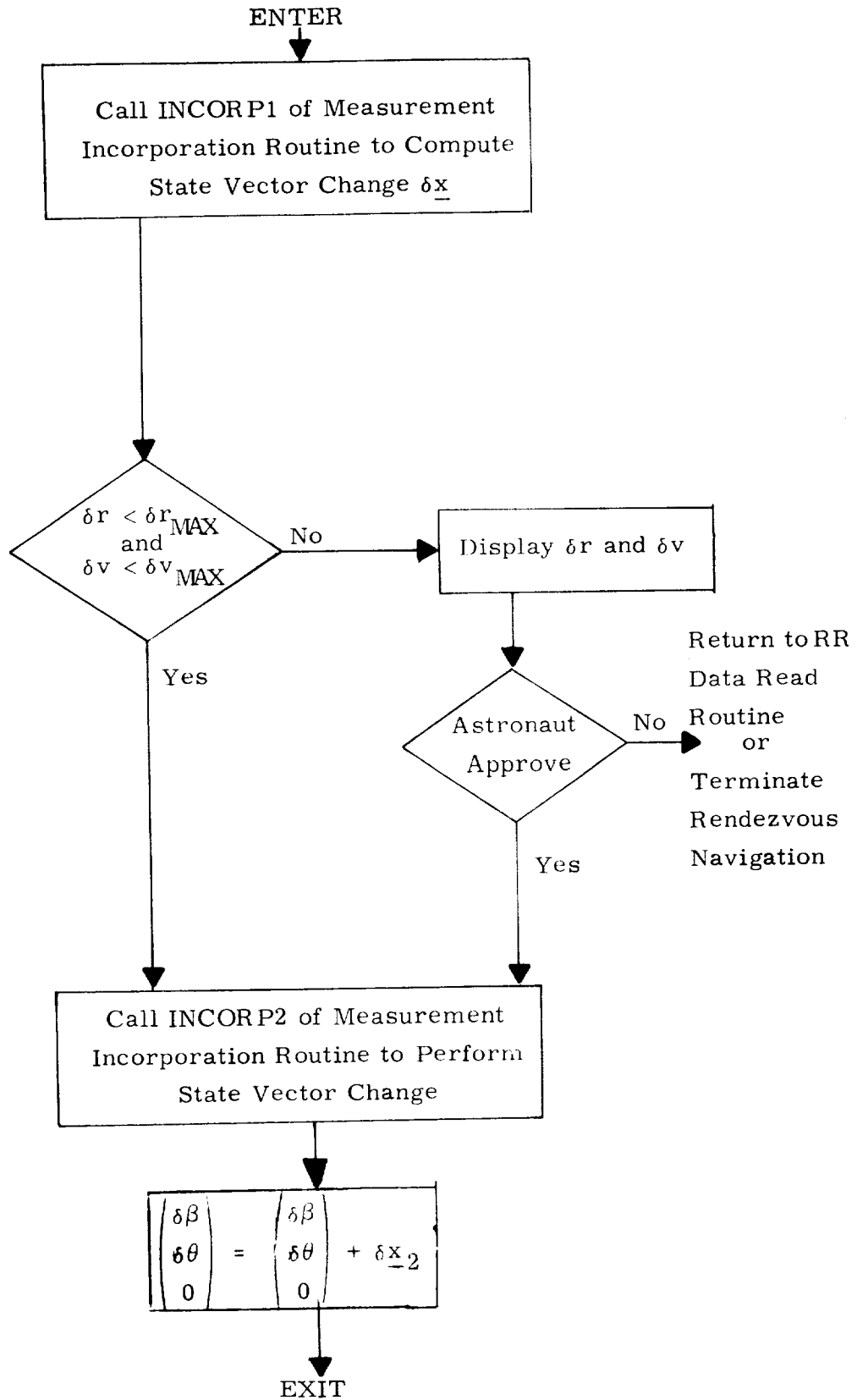

Figure 2.4-8 Rendezvous Navigation Measurement Incorporation Procedure

Measured trunnion angle, θ_M

$$\begin{aligned} \overline{\alpha^2} &= r_{XZ}^2 (\text{var}_{\theta} + \text{var}_{\text{IMU}}) \\ \underline{b}_0 &= \overline{r} (\underline{u}_Y \times \underline{u}_{LC}) \times \underline{u}_{LC} \\ \underline{b}_1 &= \underline{0} \\ \underline{b}_2 &= \begin{pmatrix} 0 \\ r_{XZ} \\ 0 \end{pmatrix} \\ \delta Q &= r_{XZ} \left[\theta_M - \sin^{-1}(S) - \delta\theta \right] \end{aligned} \tag{2.4.9}$$

The procedure for performing the rendezvous navigation computations is illustrated in Figs. 2.4-9 and 2.4-10. It is assumed that the following items are stored in erasable memory at the start of the computation shown in Fig. 2.4-9:

- \underline{x}_C = Estimated CSM state vector as defined in Section 5.2.2.6.
- \underline{x}_L = Estimated LM state vector.
- W = Six-dimensional error transition matrix associated with \underline{x}_C or \underline{x}_L as defined in Section 5.2.2.4.

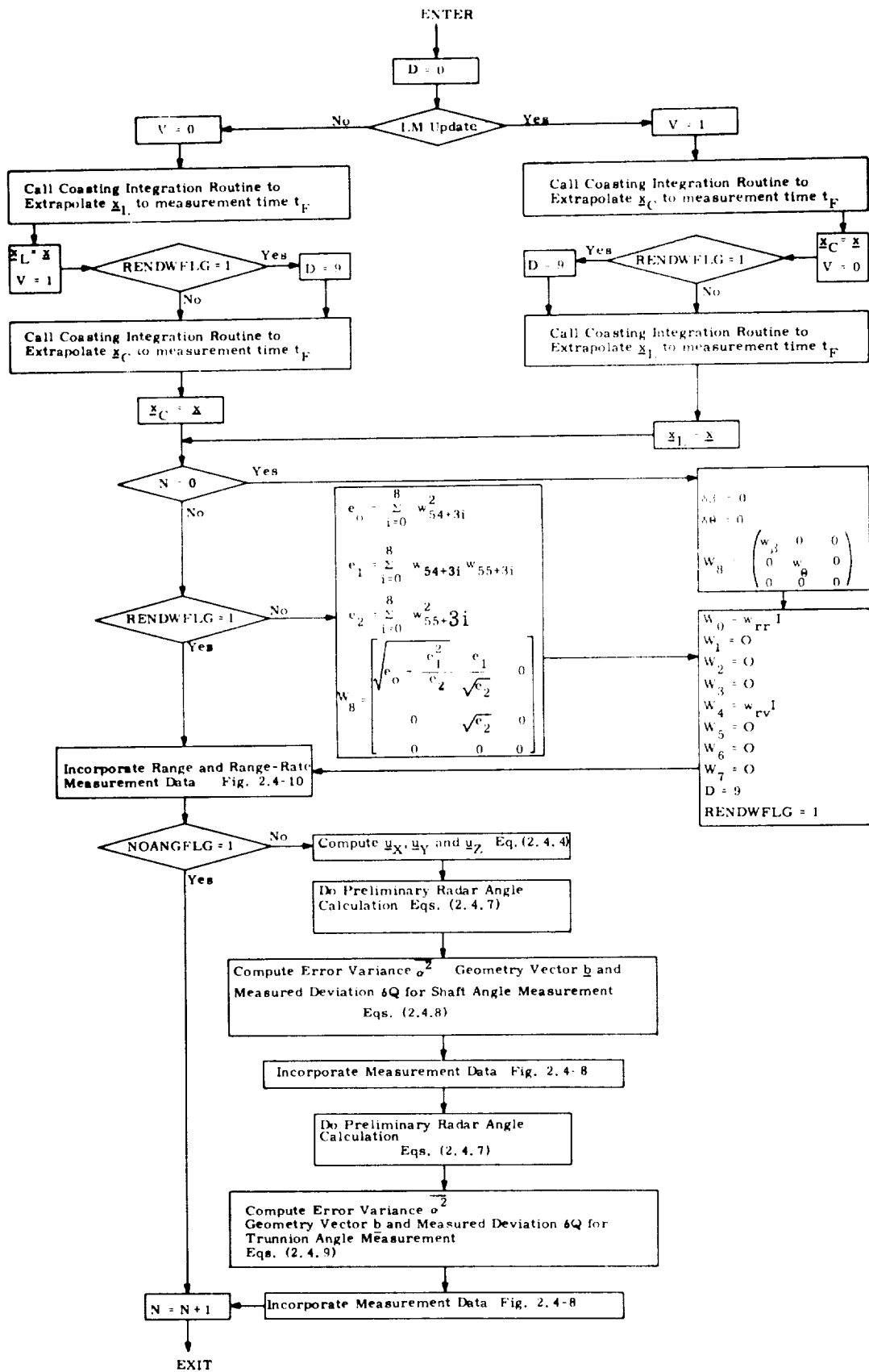

Fig. 2.4-9 Rendezvous Navigation Computation Logic Diagram

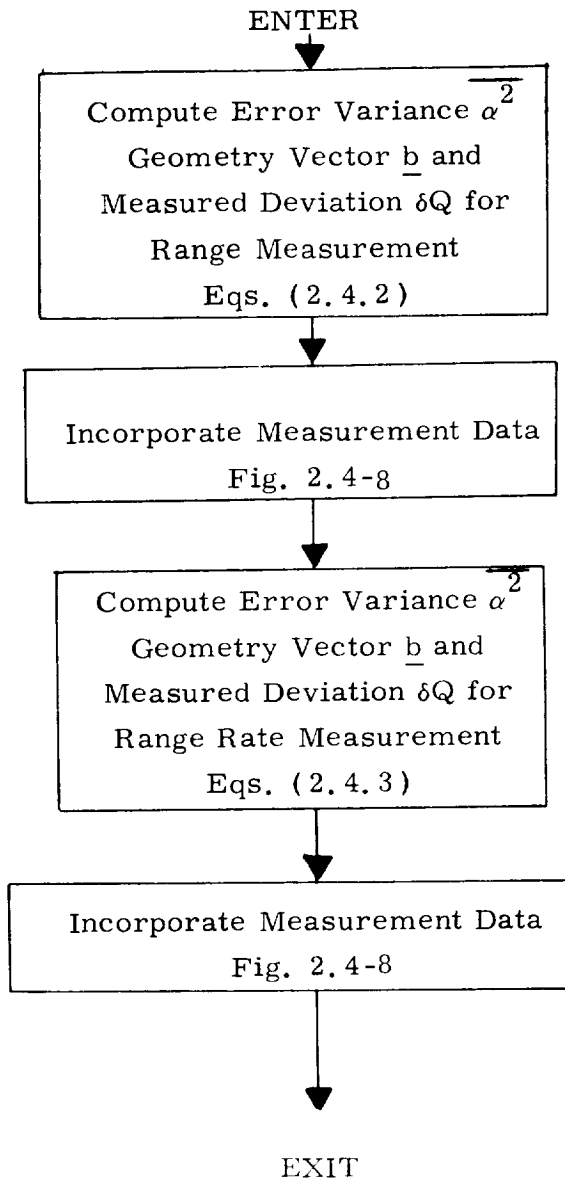

Fig. 2.4-10 RR Measured Range and ^{Range}Rate Rate Incorporation

$$\text{RENDWFLG} = \begin{cases} 1 \text{ for valid W matrix} \\ 0 \text{ for invalid W matrix} \end{cases}$$

This flag or switch is maintained by programs external to the Rendezvous Navigation Routine. It indicates whether or not the existing W matrix is valid for use in processing RR tracking data. The flag is set to zero after each of the following procedures:

- 1) Powered maneuver
- 2) State vector update from ground
- 3) Orbit navigation
- 4) Astronaut command

$[\text{REFSMMAT}] =$ Transformation Matrix: Basic Reference Coordinate System to IMU Stable Member Coordinate System.

$N =$ Number of sets of rendezvous navigation data already processed.

$t_F =$ Measurement time.

$R_M, \dot{R}_M, \beta_M, \theta_M =$ RR measurement data

$w_{rr}, w_{rv}, w_{\beta}, w_{\theta} =$ Preselected W matrix initial diagonal elements

Three IMU gimbal angles

Vehicle update mode

NOANGFLG = $\left\{ \begin{array}{l} 1 \text{ indicates RR angle measurements} \\ \quad (\beta_M \text{ and } \theta_M) \text{ are not to be used} \\ \\ 0 \text{ indicates RR angle measurements} \\ \quad (\beta_M \text{ and } \theta_M) \text{ are to be used} \end{array} \right.$

The variables D and V are indicators which control the Coasting Integration Routine (Section 5.2.2) as described in Section 5.2.2.6, and I and O are the three-dimensional identity and zero matrices, respectively.

The RR-measurement-data incorporation procedure outlined above is repeated at approximately one-minute intervals throughout the rendezvous phase except during powered maneuvers. If the LM is the passive vehicle, the CSM rendezvous maneuvers are voice-linked to the LM as an ignition time and three velocity components in a CSM local vertical coordinate system, and then entered as updates to the estimated CSM state vector in the LGC. Upon receipt of these data, RR tracking and data processing should be suspended until after the maneuver. The update is accomplished by means of the Target ΔV Routine, R-32. If the LM is the active vehicle, the estimated LM state vector is updated by means of the Average-G Routine (Section 5.3.2) during the maneuver.

5.2.4.3 RR Monitor Routine

The logic associated with the RR Monitor Routine (R-25) is given in Fig. 2.4-11. This routine is initiated every 0.48 seconds by T4RUPT and monitors various items such as the Auto Mode discrete, the RR CDU Fail discrettes, and the angular excursions of the RR antenna. In addition, it zeros the RR CDU's and determines the present RR antenna mode whenever the Auto Mode discrete appears. If there is an RR CDU failure when the Auto Mode discrete is present and P-20 or P-22 is in use, the Tracker Fail Alarm is turned on.

After checking for RR CDU failure, it is seen in Fig. 2.4-11 that a number of conditions must be met before the routine will check to see if the RR antenna angles are within the present mode limits (see Fig. 2.4-3). For example, the angles are not checked if the No Angle Monitor flag is present, signifying that the RR Manual Mode of target acquisition is being used. If all the conditions are met and the RR antenna is not within the present mode limits, the routine will issue an alarm, remove the RR Track Enable discrete from the RR, and cause the RR to be repositioned to the reference position (see Fig. 2.4-3) for the present mode.

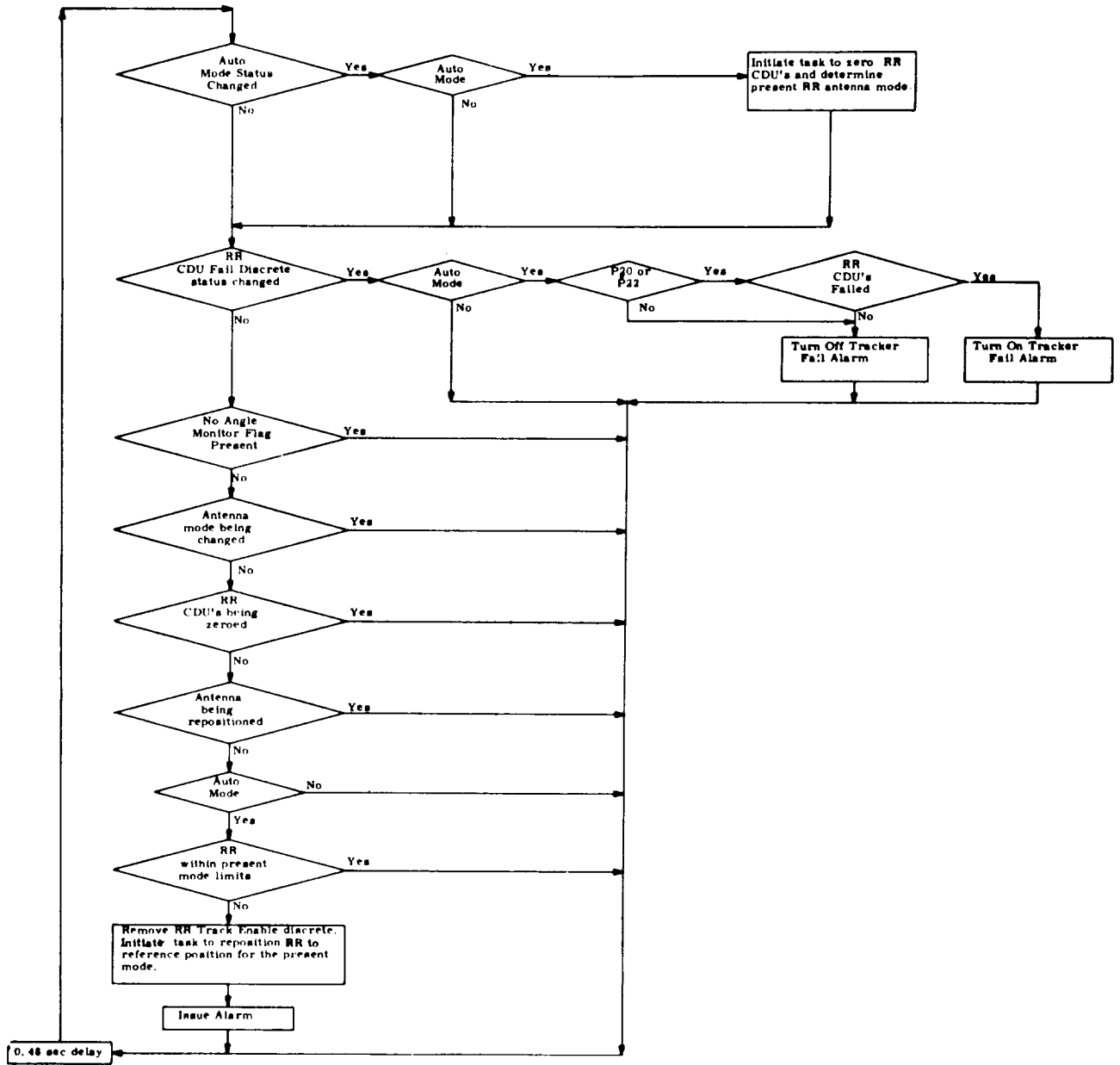

Figure 2.4-11 RR Monitor Routine

5.2.5 RR LUNAR SURFACE NAVIGATION PROGRAM

5.2.5.1 Target Acquisition Routine

Since acquisition of the CSM with the LM rendezvous radar (RR) during lunar surface navigation is essentially the same as during rendezvous navigation, the same Acquisition Routine (see Fig. 2.4-1) is used for both except for minor differences in operation. When the Lunar Surface Navigation Program (P-22) is in operation, it is seen in Fig. 2.4-1 that the RR LGC Mode does not make a 400 nm check or use the Preferred Tracking Attitude Routine. Also, the Lunar Surface Designate Routine is used in place of the Rendezvous Designate Routine while on the lunar surface in order to minimize the lag errors which could occur while designating the RR through the relatively large line-of-sight (LOS) angular rates experienced at that time. If the in-orbit technique of designation were used while on the lunar surface, the lag error could sometimes be twice as large as the LOS angular rate. This is primarily due to the fact that the present control system existing between the RR and the LGC is essentially a Type 1 servo control system. Although this type of control system is considered to be accurate enough for designating the RR during rendezvous where the LOS angular rate seldom exceeds one milliradian per second, it is not considered satisfactory for use on the lunar surface.

In order to compensate for lag errors when designating the RR on the lunar surface, the Lunar Surface Designate Routine shown in Fig. 2.5-1 is used. Initially, checks are made to insure that the RR Track Enable discrete is not being issued to the RR, the RR antenna is in Mode 2, and the target LOS is within the operating limits (see Fig. 2.4-3) of Mode 2. If the LOS is not within the above limits, an alarm code is displayed to the astronaut and he either repeats the limit check or terminates the program. Afterwards, the routine starts designating the RR to the CSM by issuing rate commands every half second to the RR gyros which are proportional to the

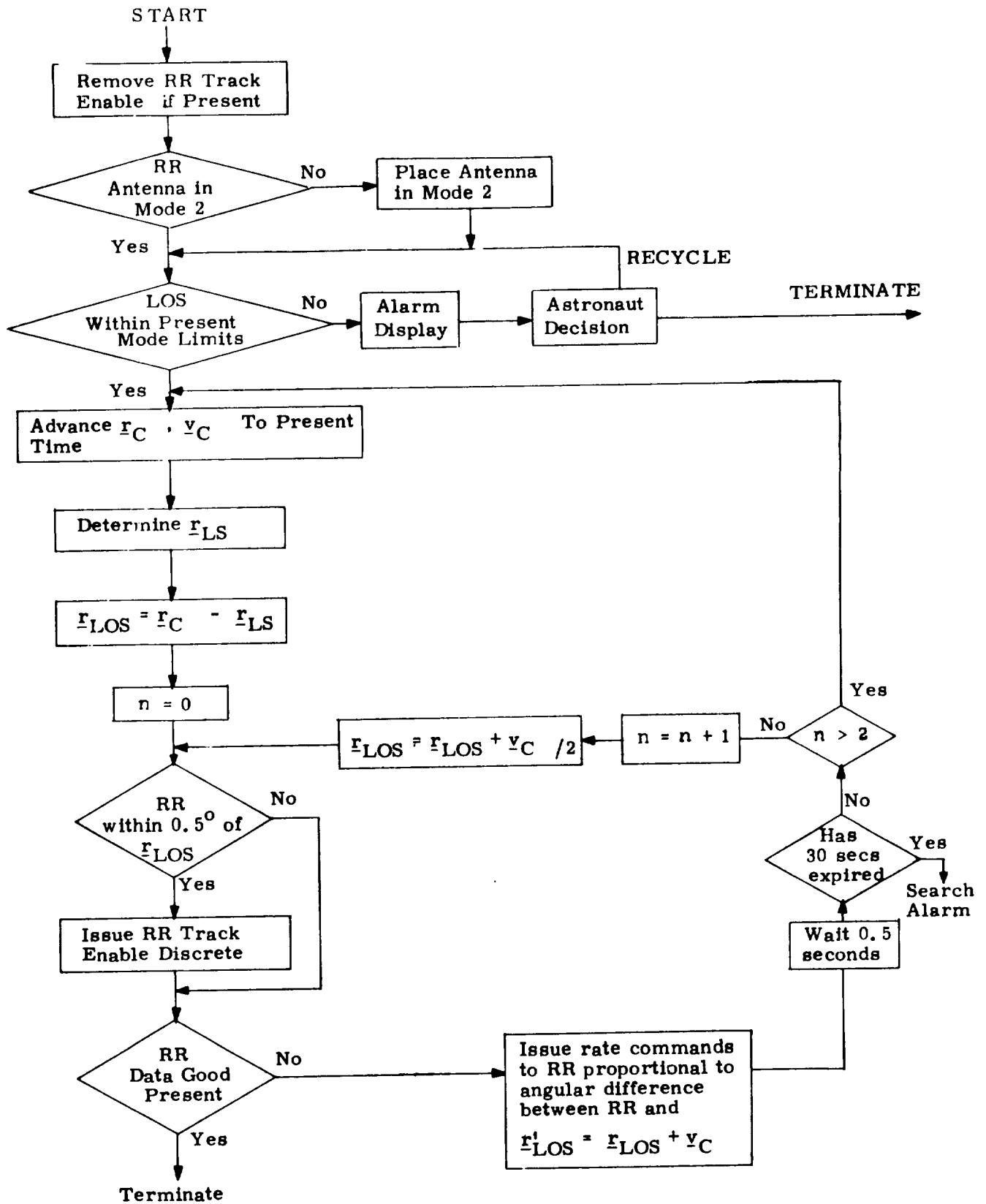

Figure 2.5-1 Lunar Surface Designate Routine

angular difference between the RR and

$$\underline{r}'_{LOS} = \underline{r}_{LOS} + \underline{v}_C \quad (2.5.1)$$

where \underline{r}_{LOS} is the present range vector to the CSM, \underline{v}_C is the CSM velocity vector, and \underline{r}'_{LOS} is essentially \underline{r}_{LOS} advanced one second into the future. This correction keeps the RR pointed along the estimated LOS to the CSM.

Note that the present range vector (\underline{r}_{LOS}) is determined by using the position vectors of the CSM and the landing site (\underline{r}_C and \underline{r}_{LS}) only once every two seconds. However, during the intermediate half seconds, it is updated by the following approximation:

$$\underline{r}_{LOS} = \underline{r}_{LOS} + \underline{v}_C / 2 \quad (2.5.2)$$

since it is less time consuming in LGC operation.

During the designate operation the routine checks every 0.5 seconds to see if the RR is within 0.5 degrees of the present estimated range vector (\underline{r}_{LOS}). Once the RR is within 0.5 degrees of \underline{r}_{LOS} , the RR Track Enable discrete is issued to the RR, enabling its angle tracking servos to track the target. A check is also made every 0.5 seconds to see if the RR Data Good discrete is being received from the RR. This discrete signifies that the RR range and range-rate tracking networks have acquired the target and that the RR Track Enable discrete has been received from the LGC. If the RR fails to achieve lock-on after 30 seconds of designation, an alarm is displayed, whereupon, the astronaut either repeats the designate process or proceeds with the RR Search Mode as indicated in Fig. 2.4-1. In Fig. 2.4-5 it is seen that a slightly different technique is used to generate the RR search pattern when program P-22 is being used. This is done in program P-22 primarily to compensate for the large lag errors

which could occur if the search pattern were generated on the lunar surface with the technique used with program P-20. The technique used to compensate for lag error is the same as that used in the Lunar Surface Designate Routine.

The logic given in Fig. 2.4-1 for the RR Manual Mode of acquisition when using program P-22 is fairly self-explanatory. It is seen that the Preferred Tracking Attitude Routine is bypassed and steps are taken after manual acquisition to insure that the RR antenna is within the operating limits of Mode 2.

5.2.5.2 Lunar Surface Navigation Routine

While the LM is on the surface of the moon, RR navigation data is used to update the estimated CSM state vector as described in Section 5.2.1.

After target acquisition has been accomplished (Section 5.2.5.1), data is obtained approximately every 30 secs. by means of the RR Data Read Routine (Section 5.2.4.2.1). In addition to reading RR data more often during this portion of the mission, the RR Data Read Routine omits the checks made on the Track Flag, the vehicle attitude control mode, and angular excursion of the RR with respect to the vehicle +Z-axis (30° limit check).

Although the RR Data Read Routine reads the RR angles along with the range and range rate, the angle data is not used for update purposes because of the uncertainties associated with the magnitude and nature of the RR angle biases which may be present during the large angular excursions of the RR with respect to the vehicle at this time. Thus, the estimated state vector in the Lunar Surface Navigation Routine is the six-dimensional CSM state vector, and only the range and range rate data (R_M and \dot{R}_M , respectively) are used in the navigation computations.

The computation logic for the Lunar Surface Navigation Routine is similar to the rendezvous navigation logic (Section 5.2.4.2) and is illustrated in Fig. 2.5-2. It is assumed that the following items are stored in erasable memory at the start of the procedure shown in the figure:

- \underline{x}_C = Estimated CSM state vector as defined in Section 5.2.2.6
- W = Six-dimensional error transition matrix associated with \underline{x}_C as defined in Section 5.2.2.4

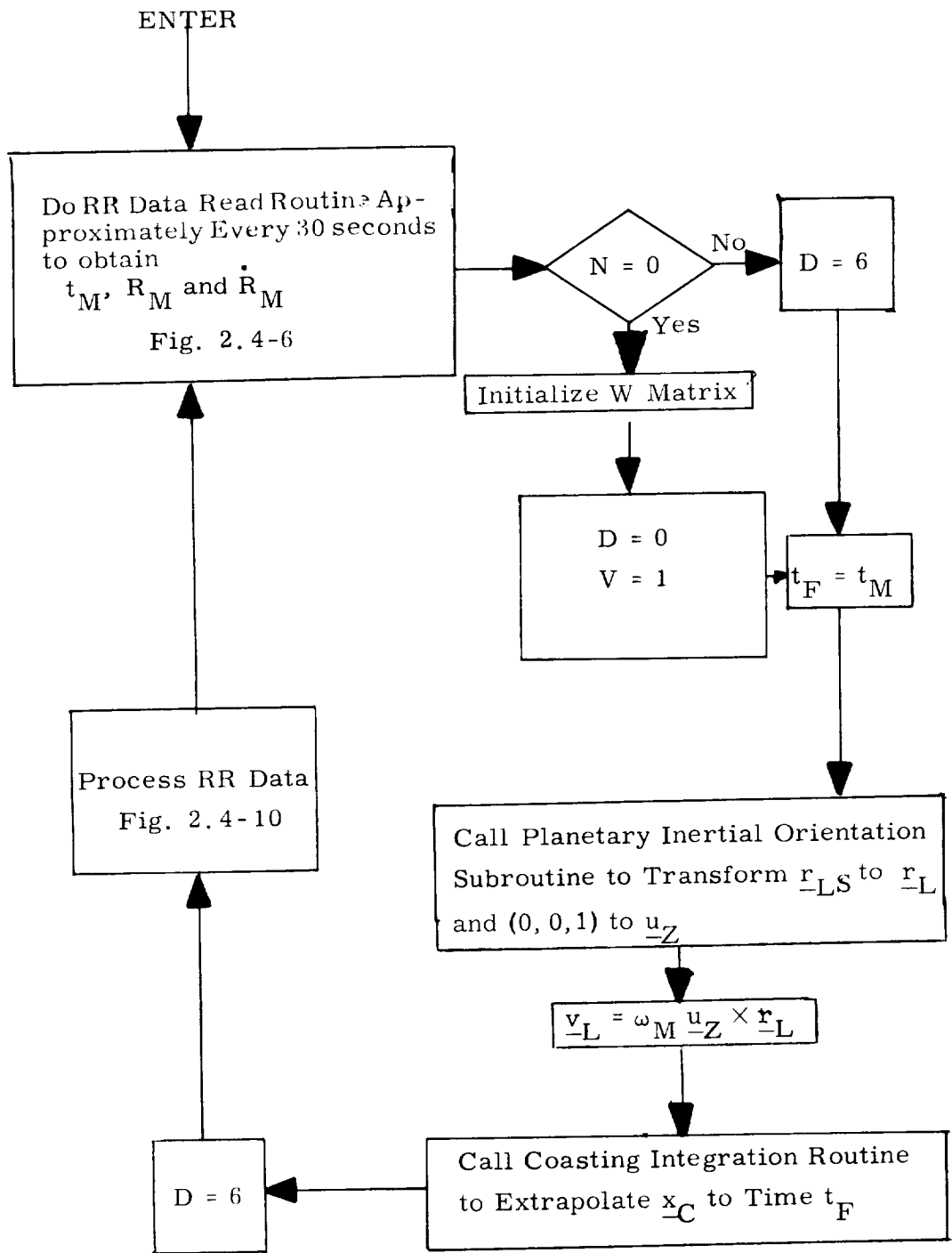

Fig. 2.5-2

Lunar Surface Navigation Routine Logic Diagram

\underline{r}_{LS} = Estimated landing site or LM position vector on the surface of the moon in moon-fixed coordinates.

N = Number of measurement data points already processed.

The variables D and V are indicators which control the Coasting Integration Routine (Section 5.2.2) as described in Section 5.2.2.6, \underline{u}_Z is a unit vector along the rotational axis of the moon, and ω_M is the lunar angular velocity.

5.3 POWERED FLIGHT NAVIGATION AND GUIDANCE

5.3.1 GENERAL COMMENTS

The objective of the powered flight guidance and navigation routines is to maintain an estimate of the LM state vector during thrusting maneuvers, and to control the thrust direction and duration such that the desired velocity cut-off conditions specified by the targeting routines of Section 5.4 are achieved. The powered flight navigation routine, used to maintain an estimate of the vehicle state vector during all thrusting conditions, is referred to as the Average-G Routine, and is presented in Section 5.3.2.

There are three basic powered flight guidance concepts used in the LGC. The first is a velocity-to-be-gained concept with cross product steering (Section 5.3.3.3) that is used in each of the three following programs:

- 1) Descent Orbit Injection Guidance (Section 5.3.3)
- 2) Lambert Aim Point Maneuver Guidance (Section 5.3.6)
- 3) External ΔV Maneuver Guidance (Section 5.3.7)

These three programs, based on the cross product steering concept, differ only in the unique generation of the desired velocity vector, \underline{v}_R .

The second basic guidance concept is the quadratic explicit guidance of Section 5.3.4 which is used for the powered lunar landing maneuver. This concept is used to control the throttleable LM Descent Propulsion System (DPS) such that specified target or aim point conditions are achieved during the various phases of the landing maneuver. The landing maneuver target conditions for each phase are chosen to satisfy various DPS throttle and visibility constraints.

The third LGC guidance concept is the linear explicit guidance of Section 5.3.5 used to control powered ascent maneuvers from the lunar surface to desired ascent injection conditions. This guidance concept is also used to control abort maneuvers initiated during the powered landing maneuver as described in Section 5.4.5.

5.3.2 POWERED FLIGHT NAVIGATION -- AVERAGE-G ROUTINE

During a powered flight maneuver, the state vector estimate will be maintained by numerical integration of the equations of motion using Average-G equations.

The information about the thrust acceleration comes from the IMU Pulsed Integrating Pendulous Accelerometers (PIPA) in the form of velocity increments ($\Delta \underline{v}$) over the time interval (Δt) corresponding to the time of repetitive computations (generally two seconds). The computations are, therefore, in terms of discrete increments of velocity rather than instantaneous accelerations.

If \underline{r}_{n-1} and \underline{v}_{n-1} are the position and velocity estimates at the beginning of the nth computational cycle, then \underline{r}_n and \underline{v}_n are computed from

$$\underline{r}_n = \underline{r}_{n-1} + \Delta t (\underline{v}_{n-1} + \underline{g}_{n-1} \Delta t / 2 + \Delta \underline{v} / 2) \quad (3.2.1)$$

$$\underline{v}_n = \underline{v}_{n-1} + .5 \Delta t (\underline{g}_{n-1} + \underline{g}_n) + \Delta \underline{v} \quad (3.2.2)$$

where \underline{g}_n is the gravitational acceleration. The gravitational acceleration outside the lunar sphere of influence is given by:

$$\underline{g}_n = - \frac{\mu_e}{r_n^2} \left\{ \underline{u}_{r_n} + \frac{3}{2} J_2 \left(\frac{r_{eq}}{r_n} \right)^2 \left[(1 - 5 \cos^2 \phi) \underline{u}_{r_n} + 2 \cos \phi \underline{u}_z \right] \right\} \quad (3.2.3)$$

where

$$\cos \phi = \underline{u}_{r_n} \cdot \underline{u}_z \quad (3.2.4)$$

The vectors \underline{u}_{r_n} and \underline{u}_z are unit vectors in the direction of r_n and the polar axis of the earth, respectively, μ_e is the gravitational constant of the earth, r_{eq} is the equatorial radius of the earth, and J_2 is the second-harmonic coefficient of the earth's potential function.

The gravitational acceleration within the lunar sphere of influence is determined by a simplification of Eq. (3.2.4) as follows:

$$\underline{g}_n = -\frac{\mu_M}{r_n^2} \underline{u}_{r_n} \quad (3.2.5)$$

where μ_M is the gravitational constant of the moon.

The $\Delta \underline{v}$ is compensated for instrument errors as described in Section 5.6.13. Further, the $\Delta \underline{v}$ is transformed into the Basic Reference Coordinate System since the navigation calculations are made in reference coordinates.

5.3.3 DESCENT ORBIT INJECTION GUIDANCE

5.3.3.1 General Objectives

The objective of the LGC Descent Orbit Injection program is to establish a 180 degree central angle transfer orbit from the CSM orbit to a desired powered landing maneuver ignition point. In the nominal lunar landing mission the descent orbit is between a near circular CSM orbit of 80 nm altitude and a landing maneuver ignition point (a radius vector of 50,000 feet altitude above the landing site with a specified central angle or ground range to the landing site).

The nominal mission calls for zero flight path angle relative to the local horizontal at the landing maneuver ignition point. This means that perilune of the descent orbit is at the landing maneuver ignition point and the apolune is on the CSM orbit. Furthermore, no plane change is made during this descent orbit injection.

5.3.3.2 Required Targeting Parameters

The targeting parameters required for the descent orbit injection guidance are:

- 1) t_{DI} = Desired injection cutoff time
- 2) h_P = Desired perilune altitude magnitude

These two parameters will nominally be determined by the Lunar Landing Time Prediction Routine of Section 5.4.2 which is also referred to as the DOI targeting routine. The descent orbit guidance will steer for a conic trajectory that will achieve the desired perilune. Since the perturbation on this conic due to the lunar non spherical gravity effects can decrease this perilune by as much as 10,000 feet, the value of h_P will be offset in the targeting routine to compensate for this effect.

5.3.3.3 Cross Product Steering Concept

The cross product steering concept is used to control the following maneuvers:

1. DOI (Descent Orbit Injection)
2. CSI (Coelliptic Sequence Initiation)
3. CDH (Constant Differential Altitude)
4. TPI (Transfer Phase Initiation, CFP and Stable Orbit Rendezvous)
5. MCC (Rendezvous Midcourse Corrections, CFP and Stable Orbit Rendezvous)
6. TEI (Transearth Injection SPS backup)
7. External ΔV

The objective of the cross product steering concept in the LM is to control the thrust direction along the velocity to be gained vector. The velocity to be gained vector (\underline{v}_G) is defined as

$$\underline{v}_G = \underline{v}_R - \underline{v} \quad (3.3.1)$$

where \underline{v}_R is the required velocity and \underline{v} is the current vehicle velocity.

The desired thrust direction \underline{a}_{TD} is defined such that

$$\underline{a}_{TD} \times \underline{v}_G = \underline{0} \quad (3.3.2)$$

If the actual thrust acceleration \underline{a}_T is along \underline{a}_{TD} , the equation

$$\underline{v}_G \times \underline{a}_T = \underline{0} \quad (3.3.3)$$

will be satisfied. In general, there is a directional error and the control system will rotate the vehicle so that the equation is satisfied.

To align the vehicle such that Eq. (3.3.3) is satisfied, a thrust axis command is generated as follows:*

$$\underline{u}_{TD} = \underline{u}_{VG} \quad (3.3.4)$$

where

$$\underline{u}_{VG} = \text{UNIT}(\underline{v}_G) \quad (3.3.5)$$

$$\underline{u}_{TD} = \text{unit vector in desired thrust direction}$$

The mechanization of this cross product steering concept is illustrated in Fig. 3.3-1. In the figure

$\Delta \underline{v}$ = velocity increment measured by the PIPA's

Δt = computing interval

As illustrated in Fig. 3.3-1, the velocity to be gained is normally computed by Eq. (3.3.1). If a new value of required velocity \underline{v}_R generated by the Lambert or DOI Routines is not available on any computation cycle, the velocity to be gained is computed as

$$\underline{v}_G = \underline{v}_G + \underline{b}\Delta t - \Delta \underline{v} \quad (3.3.6)$$

where $\underline{b}\Delta t$ is the equivalent velocity defined in Fig. 3.3-1 as

$$\Delta \underline{v}_R - \underline{g}\Delta t.$$

* Note that this pointing logic differs from that for the Command Module. This is because of differences in the LM and CSM digital autopilots.

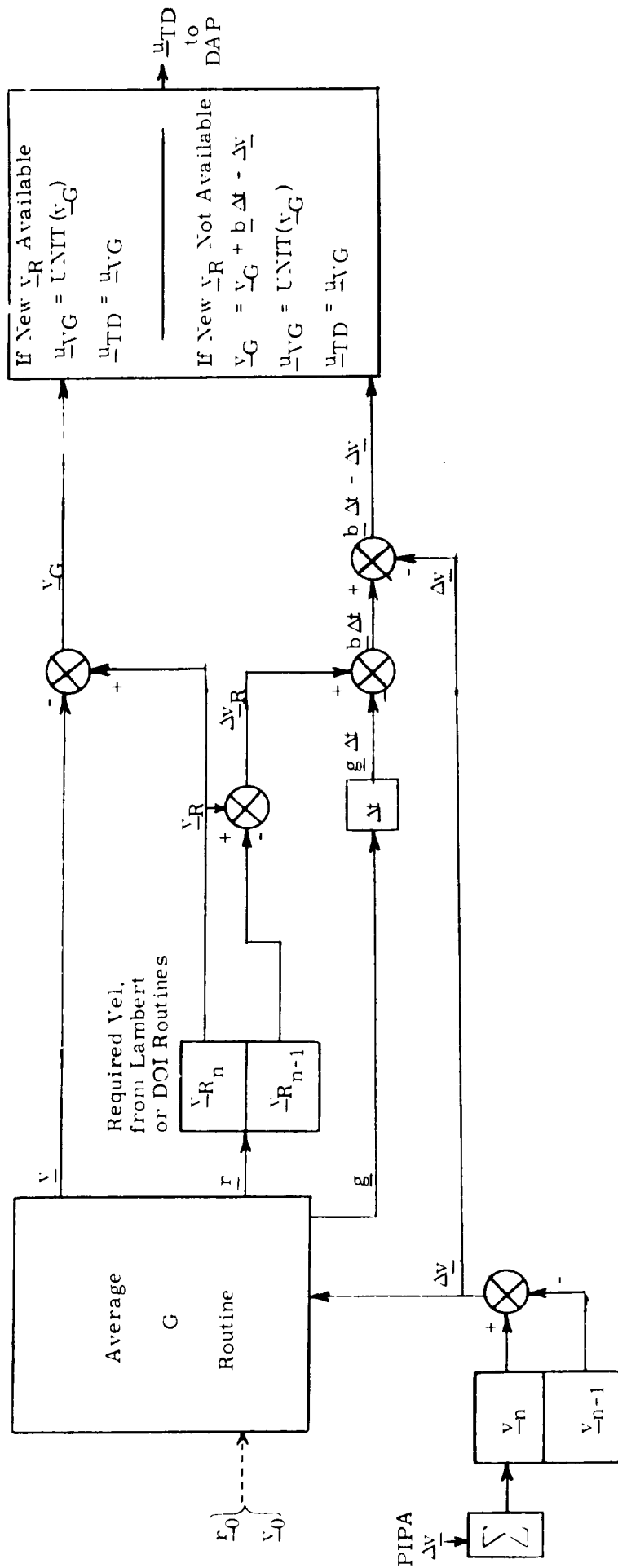

Figure 3.3-1 Cross Product Powered Flight Steering Block Diagram

An angular command for the digital autopilot is generated in the form of desired gimbal angles (CDUD) from the thrust axis command according to the following

$$\underline{CDUD} = \underline{CDU} + M_{SM, G} (\underline{u}_T \times \underline{u}_{TD}) \quad (3.3.7)$$

where

CDU = Present gimbal angles read by the CDU's

$$= \begin{Bmatrix} CDUX \\ CDUY \\ CDUZ \end{Bmatrix} = \begin{Bmatrix} \text{outer gimbal angle} \\ \text{inner gimbal angle} \\ \text{middle gimbal angle} \end{Bmatrix}$$

CDUD = desired gimbal angles

\underline{u}_T = thrust X-axis generated by a filter (in stable member coordinates)

$M_{SM, G}$ = non-orthogonal matrix relating body rates to gimbal rates

$$= \begin{Bmatrix} \cos(CDUY)/\cos(CDUZ) & 0 & -\sin(CDUY)/\cos(CDUZ) \\ -\cos(CDUY) \tan(CDUZ) & 1 & \sin(CDUY) \tan(CDUZ) \\ \sin(CDUY) & 0 & \cos(CDUY) \end{Bmatrix}$$

(3.3.8)

The rotation about the X-axis is held to zero by making a different command for the first component of $\underline{CDUD} - \underline{CDU} = \Delta \underline{CDUX}$ namely

$$\Delta \underline{CDUX} = -\sin(\underline{CDUZ}) \Delta \underline{CDUY} \quad (3.3.9)$$

where $\Delta \underline{CDUY}$ = second component of $\underline{CDUD} - \underline{CDU}$

The digital autopilot then nulls the difference between \underline{CDUD} and \underline{CDU} issuing commands at a rate of 10 per second.

5.3.3.4 Initial Thrust Attitude Calculation

The initial thrust attitude is in the direction of the velocity-to be gained. The initial value of u_{TD} is therefore found from Eq. (3.3.4).

5.3.3.5 Engine-off Criterion

The engine-off time t_{go} is estimated continuously from the Eq.

$$t_{go} = K_1 \left[\frac{\underline{v}_G \cdot \underline{\Delta v}}{\underline{\Delta v} \cdot \underline{\Delta v}} \right] \Delta t + \Delta t_{tail-off} \quad (3.3.10)$$

where

$$K_1 = 1 - \frac{1}{2} \left[\frac{|\underline{v}_G \cdot \underline{\Delta v}|}{gI_{SP} |\underline{\Delta v}|} \right]$$

I_{SP} = specific impulse of selected engine

g = 32.17405 fps²

$\Delta t_{\text{tail-off}}$ = a negative number representing the duration of burn at full or maximum thrust equivalent to the tail-off impulse after engine -off signal is issued, and computation delays.

When t_{go} falls, for the first time, below a value of 4.0 seconds, the engine-off signal is set to be issued t_{go} seconds later and no new attitude commands, \underline{u}_{TD} , are issued.

5.3.3.6 Guidance Equations for Descent Orbit Injection

The following guidance equations are used in the Descent Orbit Injection Program P-61 of Section 4.

Input Variables

1. $\underline{r}, \underline{v}, t$: Vehicle state vector at time t from the Orbit Navigation Routine
2. r_{LS} : Landing Site radius magnitude
3. t_{DI} : Descent injection cut-off time from targeting parameters
4. h_p : Desired perilune altitude from targeting parameters
5. DPS Throttle profile controlled by the DPS ON ROUTINE and a pre-stored thrust profile

Outputs

1. \underline{u}_{TD} Desired thrust vector in stable member coordinates.
2. Engine-off signal

Required Velocity for Orbital Descent Maneuver

The velocity vector, \underline{v}_R , required for the descent orbit is computed from

$$\underline{v}_R = (\underline{u}_R \times \underline{u}_Z) \left[\frac{2\mu r_{lp}}{r^2 + r r_{lp}} \right]^{1/2} \quad (3.3.11)$$

where

$r_{lp} = h_p + r_{LS} =$ perilune target altitude plus landing site radius

$\underline{u}_R =$ Unit vector along \underline{r}

$\underline{u}_Z =$ Unit $(\underline{u}_V \times \underline{u}_R)$ = unit vector normal to orbital plane

$\mu =$ Gravitational constant

Initial Thrust Attitude Calculation

In order to align the vehicle thrust axis along the desired acceleration vector, \underline{a}_{TD} , during the Pre-DOI phase (Program 61 of Section 4) the following computations are made:

- a) Vehicle state vector is integrated forward to the descent injection cut-off time, t_{DI} , by means of the Coasting Integration Routine (Section 5.2.2).
- b) The velocity-to-be-gained, \underline{v}_G , is computed from Eqs. (3.3.1) and (3.3.11).

c) The maneuver thrust time, t_T , in seconds is computed by the following expression

$$t_T = (26) + \frac{|\underline{v}_G| - (28.9)}{(9.43)} \quad (3.3.12)$$

The above expression is based on the thrust profile in which the initial DPS thrust of 10% is held for 26 seconds resulting in a velocity change of about 28.9 fps including ullage effects. The 9.43 factor is the acceleration for maximum DPS thrust.

d) The first DPS ignition time, t_{IG} , is then calculated from

$$t_{IG} = t_{DI} - t_T \quad (3.3.13)$$

e) The vehicle state vector is next integrated to time t_{IG} by means of the Coasting Integration Routine.

f) The velocity-to-be-gained which corresponds to the state at time t_{IG} is computed as shown in Section 5.3.3.3.

g) The initial thrust attitude is then set by

$$\underline{u}_{TD} = \text{UNIT}(\underline{v}_G)$$

5.3.4 LUNAR LANDING GUIDANCE

5.3.4.1 GENERAL COMMENTS

The basic function of the LM powered-landing guidance and navigation system is to control the LM from an initial altitude of 50,000 feet and velocity of about 5600 ft/sec., to a safe landing at a selected site on the moon with essentially zero velocity. The above-mentioned objective must be accomplished under the following conditions:

- (1) DPS propellant must be utilized in an efficient manner.
- (2) The selected landing site must be visible to the astronaut for at least 75 seconds.
- (3) The DPS must either operate at a fixed throttle setting corresponding to 92.5 percent of maximum thrust, or it can be operated as a continuously-throttleable engine between 10 and 58 percent of maximum thrust.
- (4) The astronaut must have the capability of manually redesignating the landing site during the interval when the site is visible.

The powered-landing maneuver is most conveniently divided into seven distinct phases, as shown in Table 3.4.1-1. The primary deceleration (i. e. braking) of the LM is accomplished during the braking phase, which is typically about 450 seconds in duration. The emphasis in the design of this phase is efficient utilization of fuel, i. e. minimum ΔV . The DPS is typically operated at the 92.5 percent throttle setting for the major part of the phase. The visibility phase is designed to satisfy the landing-maneuver visibility requirements and trajectory terminal constraints. During this phase, which is typically about 135 seconds in duration, the thrust vector (X-axis of vehicle) is typically elevated at least 45 degrees above the

Table 3.4.1-1 Powered Landing Maneuver Phases

Phase Number	Phase Name
-2	Pre-ignition
-1	DPS Ullage and Trim
0	Braking
1	Transition-I
2	Visibility
3	Transition-II
4	Final Descent

local horizontal plane. At the end of the phase the thrust-vector orientation is essentially parallel to the local-vertical direction. Throughout the visibility phase the DPS is operated in the continuously-throttleable (10-58 percent) region. Landing-site redesignations are permitted up to the last 20 seconds of the phase.

The pre-ignition phase is used to compute the appropriate ignition time and ignition orientation for the DPS. Prior to the start of the braking phase, there is an ullage maneuver followed by a trim phase during which the DPS is operated at 10 percent of maximum thrust for 26 seconds. A short transition phase (4 seconds long) is used between the braking and visibility phases, and also between the visibility and final descent phases in order to limit vehicle attitude rates between the phases. The final descent phase takes the vehicle from an altitude of about 100 feet down to the lunar surface with an essentially constant rate of descent.

The navigation of the LM is based solely on data from the IMU, i.e. PIPA output data, until the estimated LM altitude has decreased to 25,000 feet. At this time LR altitude measurements are taken, and are used to update the LM state estimates at 2-second intervals thereafter. After the estimated altitude is below 15000 ft, LR velocity-component measurements are used to update the state in addition to the altitude measurements. At each updating time an altitude measurement and a velocity-component measurement are processed in sequence, with the altitude measurement being processed first. The LR updatings of the state vector always take place immediately after the PIPA outputs have been processed, regardless of when the actual LR measurements are taken.

The present section of this document (Section 5.3.4) provides a detailed description of the various operations performed throughout the powered-landing maneuver for guidance and navigation of the LM. A description of the various coordinate systems used

in the powered-landing guidance and navigation system is given in Section 5.3.4.2. A general description of the overall system follows in Section 5.3.4.3. Then, in Section 5.3.4.4 the various operations involved in the landing maneuver are described in detail. For convenience the important operations or groups of operations have been subdivided into routines (or subroutines). Information-flow diagrams for the various routines are presented in Section 5.3.4.4. Finally, in Section 5.3.4.5 the major operations are traced out for the different phases of the landing maneuver.

5.3.4.2 COORDINATE SYSTEMS

5.3.4.2.1 General Information

There are five different coordinate systems used in the guidance and navigation of the LM during the powered landing maneuver. These coordinate systems and the unit vectors along their X, Y, Z axes are as follows:

- (1.) Inertial Coordinates --- \underline{u}_{XI} , \underline{u}_{YI} , \underline{u}_{ZI}
- (2.) IMU or Platform Coordinates --- \underline{u}_{XP} , \underline{u}_{YP} , \underline{u}_{ZP}
- (3.) Vehicle-Body Coordinates --- \underline{u}_{XB} , \underline{u}_{YB} , \underline{u}_{ZB}
- (4.) Guidance Coordinates --- \underline{u}_{XG} , \underline{u}_{YG} , \underline{u}_{ZG}
- (5.) LR Antenna Coordinates --- \underline{u}_{XA} , \underline{u}_{YA} , \underline{u}_{ZA}

Each of these coordinate systems is a rectilinear system with the individual axes defined so as to form a right-handed system.

Quantities referred to in the various coordinate systems will be subscripted in the following manner:

- I - inertial coordinates
- P - platform (IMU) coordinates
- B - vehicle-body (Nav. Base) coordinates

G - guidance coordinates

A - antenna coordinates

For convenience the subscript referring to the coordinate frame will always be placed last, when more than one subscript is used. As an example, the components of vehicle position in inertial coordinates would be referred to as r_{XI} , r_{YI} , and r_{ZI} .

For conciseness of notation in this section all rotational transformation matrices will be indicated by the symbol C. Two subscripts will always be used on C; the first indicates the coordinate frame that the quantity of interest is currently expressed in, the second indicates the coordinate frame into which the quantity is to be transformed. For example, the rotational matrix used to transform a quantity in platform coordinates (P) to inertial coordinates (I) will be represented as C_{PI} .

5.3.4.2.2 Inertial Coordinates

The inertial-coordinate system (subscript I) is the Basic Reference Coordinate system for the LGC computations. The origin of this system coincides with the center of the moon. The orientation of this coordinate system is defined by the line of intersection of the mean equatorial plane and the mean orbit of the earth (the ecliptic) at the nearest beginning of the Besselian year in which the mission takes place. The X-axis (\underline{u}_{XI}) is along the ascending node of the ecliptic on the equator (the equinox), the Z-axis (\underline{u}_{ZI}) is along the earth's mean north pole, and the Y-axis (\underline{u}_{YI}) completes a right-handed triad. All navigation stars and vehicle state vectors are referenced to this system.

5.3.4.2.3 IMU or Platform Coordinates

The IMU or platform coordinates (subscript P) are the IMU landing alignment orientation coordinates described in Section 5.1.4.2. The origin of this system is at the center of the moon. The X-axis (\underline{u}_{XP}) pierces the nominal site at the nominal landing time, the Z-axis (\underline{u}_{ZP}) is in the CSM orbit plane and points forward at the nominal landing time, and the Y-axis (\underline{u}_{YP}) completes a right-handed triad. The IMU coordinates are also referred to as stable member coordinates (subscript SM) in other sections of the document.

5.3.4.2.4 Vehicle-Body or Navigation-Base Coordinates

Vehicle-body or navigation-base coordinates (subscript B) are the generally accepted LM coordinates. The origin of the coordinate frame is at the PGNCS Navigation Base. The X-axis (\underline{u}_{XB}) is in the direction of the nominal thrust vector, the Z-axis (\underline{u}_{ZB}) is in the direction forward from the design eye, and the Y-axis (\underline{u}_{YB}) is orthogonal to the X and Z axes so as to form a right-handed system.

5.3.4.2.5 Guidance Coordinates

The guidance coordinate frame (subscript G) is a lunar-fixed frame whose origin is at the current landing site. The command acceleration computations for the guidance system are performed in the guidance coordinate frame.

The guidance-system X-axis (\underline{u}_{XG}) is along the direction from the center of the moon to the current landing site. The Y-axis (\underline{u}_{YG}) and Z-axis (\underline{u}_{ZG}), which are orthogonal to each other and to \underline{u}_{XG} , are oriented such that the LM velocity (\underline{v}_G), acceleration (\underline{a}_G), and jerk (\underline{j}_G) will all be coplanar (in the X-Z plane) at the time that the vehicle arrives at the current aim point. To accomplish this, the guidance frame is rotated about its X-axis (\underline{u}_{XG}) such that:

$$\underline{u}_{YGP} = \text{UNIT} (\underline{r}_{SP} \times [4\underline{r}_P + (\underline{v}_P - \underline{\omega}_P \times \underline{r}_P) t_{GO}]) \quad (3.4.2.1)$$

where \underline{u}_{YGP} is a unit vector along the guidance-frame Y-axis, expressed as components in the platform (IMU) coordinate frame. The quantities \underline{r}_{SP} , \underline{r}_P , and \underline{v}_P represent respectively the current site position, the LM position, and the LM velocity in the platform frame. The quantity $\underline{\omega}_P$ is the lunar rotational angular velocity, and t_{GO} is the estimated time-to-go to the current aim point. In effect, \underline{u}_{YGP} is set up to be normal to the trajectory plane at the time of arrival at the aim point. The guidance frame Z-axis (\underline{u}_{ZG}) is oriented perpendicular to the X and Y axes so as to form a right-handed system.

It is important to note that the position, velocity, and acceleration aim conditions (\underline{r}_{DG} , \underline{v}_{DG} , and \underline{a}_{DG}) are invariant in guidance coordinates for a given aim point. These aim conditions viewed in platform coordinates, however, will change during the powered maneuver. It should also be noted that the guidance-frame orientation and origin will change whenever the current landing site (\underline{r}_{SP}) is changed. The orientation and location of the guidance frame are recomputed at 2-second intervals throughout the braking and visibility phases until the phase time-to-go is less than 20 seconds.

In concluding this section it should be mentioned that the relation of Eq. (3.4.2.1) is predicated on the assumption that the LM's acceleration trajectory follows a quadratic function of time-to-go from the present state to the current aim point. This condition will be only approximately realized in the actual physical situation.

The LR antenna coordinate system (subscript A) is the coordinate system in which the velocity-component data used to update the LM navigation system are obtained. The antenna axes (\underline{u}_{XA} , \underline{u}_{YA} , and \underline{u}_{ZA}) are fixed with respect to the velocity beams, as shown in Fig. 3.4.2-1.

The X-axis (\underline{u}_{XA}) is oriented along the axis of symmetry of the radar beams, as in Fig. 3.4.2-1. The Z-axis (\underline{u}_{ZA}) is normal to the X-axis and directed forward, symmetrically oriented with respect to the rear velocity beams (see Fig. 3.4.2-1). The Y-axis is perpendicular to the X and Z axes, and directed so as to form a right-handed system. LR range data are referenced to the LR antenna coordinate system by the angle ξ as shown in Fig. 3.4.2-1.

The relationships between the five coordinate frames discussed in this section are shown below as a straight line diagram. The interpretation of this figure is as follows. In order to go from one coordinate frame to another, all the coordinate frames located between the two frames must be passed through. For example, to transform a quantity from the guidance frame (G) to the inertial frame (I) only a single transformation is required. However, if it is desired to go from the guidance frame to the antenna coordinate frame (A), then transformations must be made through the inertial frame (I), the platform frame (P) and the vehicle-body frame (B), in that order.

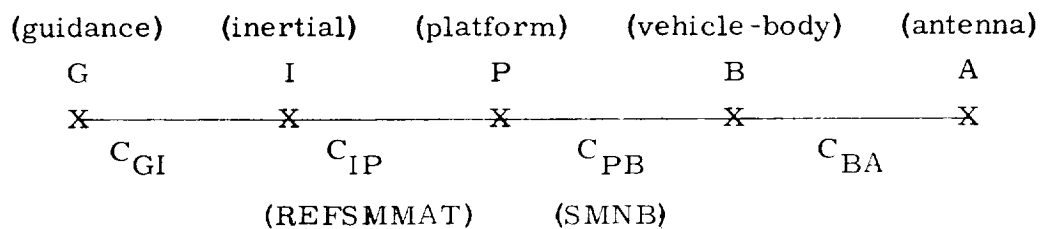

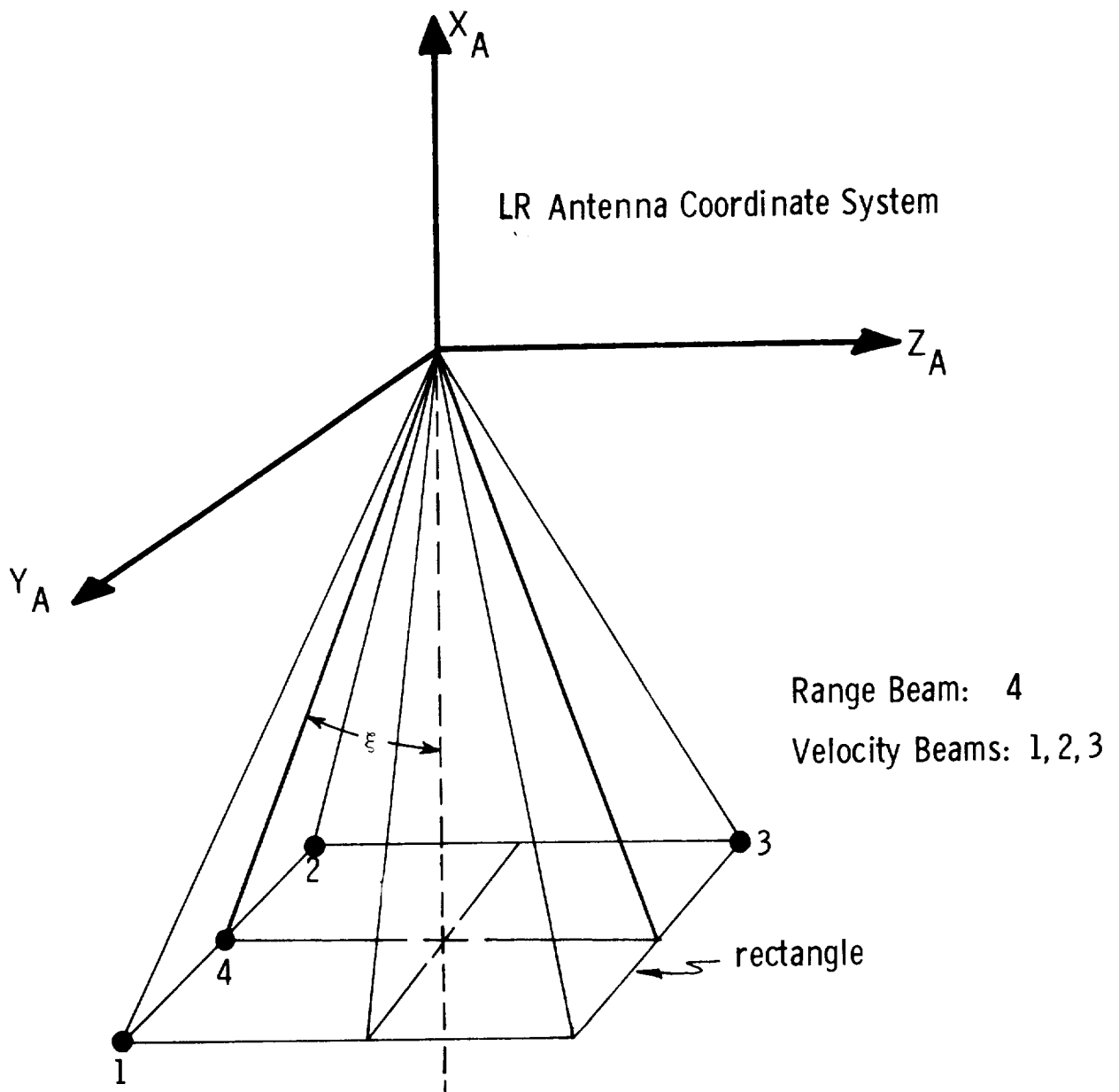

1. Range Beam 4 is in the $X_A - Z_A$ plane at an angle ξ from the $-X_A$ axis
2. LR velocity data to LGC is in Ant. Coord. System
3. LR Ant. Coord. System is related to the PGNCS Nav. Base by a specified set of Euler angles for each of the two LR antenna positions

Fig. 3.4.2-1 LR Antenna Coordinate System and Beam Configuration

5.3.4.3 DESCRIPTION OF OVERALL GUIDANCE AND NAVIGATION SYSTEM

5.3.4.3.1 General Information

The primary objectives for the guidance-and-navigation system during the powered landing maneuver are the computation of the following quantities:

- (1) Time of ignition of the descent propulsion system (DPS)
- (2) Required vehicle attitude commands (thrust direction and vehicle - orientation yaw angle about the thrust direction)
- (3) Required DPS throttle commands.
- (4) Time-to-go to the end of the current phase
- (5) Current LM state vector with LR updates
- (6) Landing-point designation (LPD) function

To accomplish these objectives, a large number of different operations must be performed in the LM guidance computer. For the purpose of describing these operations, it is most convenient to subdivide the various operations into routines, organized in terms of the particular operations being performed. The most important routines are the following:

- (1) Ignition-Computations Routine
- (2) State-Vector Update Routine
- (3) Guidance-Frame Computation
- (4) Guidance-and-Control Routine
- (5) Attitude-Command Routine
- (6) Throttle-Command Routine

In the present section, the operation of the overall system will be described in general terms, referring primarily to the above-mentioned major routines. The relevant system functional

diagram is shown in Fig. 3.4.3-1. In the following section (5.3.4.4) all the various routines will be considered in some detail. Finally, in Section 5.3.4.5 the sequence of operations for the powered maneuver is traced throughout its successive phases.

5.3.4.3.2 Phases of Powered Landing Maneuver

The powered landing maneuver is most conveniently divided into seven different phases, as indicated in Table 3.4.1-1. This section will briefly review the important characteristics of these phases and the operations performed during them.

- (1) The pre-ignition phase begins about 30 minutes before the nominal DPS ignition time. At this time the procedure for computing the proper DPS ignition time is begun, using the Ignition-Computations Routine. This routine in effect determines the time at which the ullage maneuver should be started, based on the down-range component of vehicle position relative to the landing site. The details of the routine are given in Section 5.3.4.4.2. During the pre-ignition phase the vehicle travels in free-fall (unpowered) flight. Under normal conditions the proper ignition time will be determined several minutes before the nominal ignition time.
- (2) The DPS ullage-and-trim phase consists of a 7.5-second interval during which 200 lbs. of thrust (RCS) are applied to the LM, followed by a 26-second interval at a thrust of 1050 pounds (DPS). The thrust-vector orientation during this period is held at the value predicted for the start of the braking phase from the Ignition-Computations Routine.

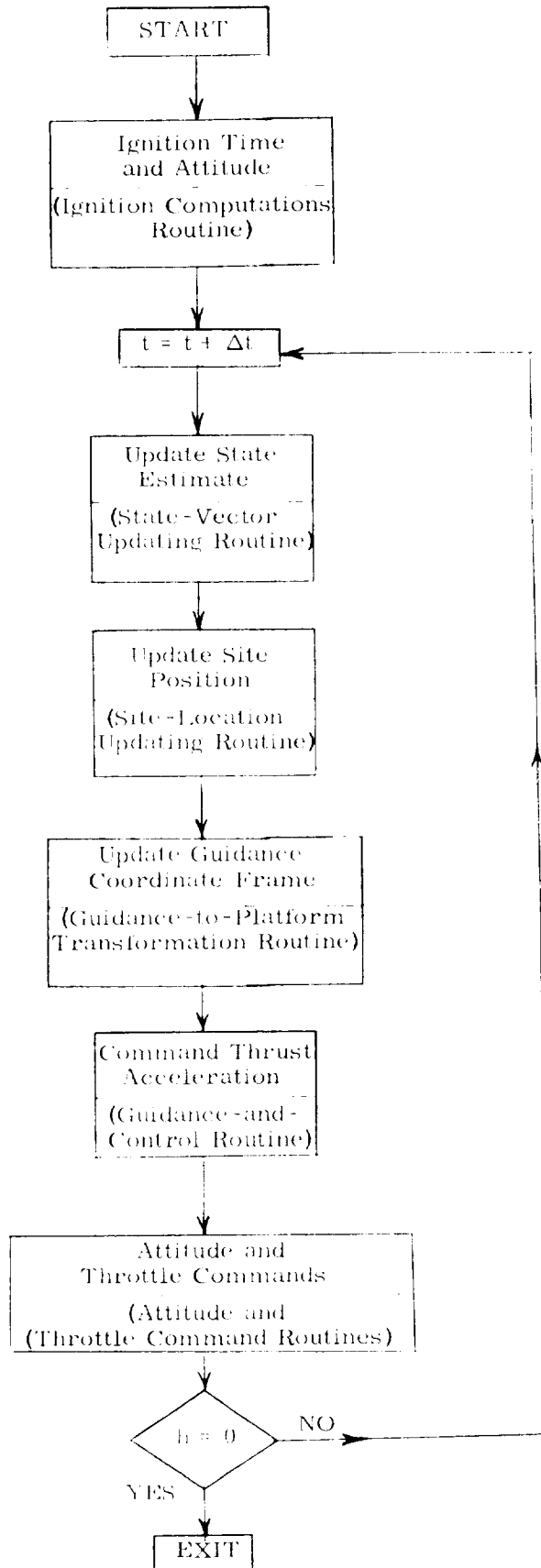

Figure 3.4.3-1 Powered Landing Guidance and Navigation System

- (3) The braking phase starts with the LM at an altitude of about 50,000 feet travelling towards the landing site with a velocity of about 5600 ft/sec. The duration of this phase is approximately 450 seconds. During this period the LM velocity and altitude are reduced to the High-Gate aim-condition values (e. g. 620 ft/sec. and 9500 feet respectively). The command thrust acceleration for the vehicle is computed so the actual vehicle acceleration program will be a quadratic function of the time-to-go to the current aim point. The detailed procedure for computing the thrust acceleration is given in the Guidance-and-Control Routine referred to in Fig. 3.4.3-1 and described in Section 5.3.4.4.11. During the initial part of the braking phase, the DPS throttle is set so as to provide about 92.5 percent of nominal rated thrust. Then, at about 120 seconds before the end of the phase, the engine is throttled down and operated thereafter in the continuously throttleable region (10-58 percent of nominal thrust).
- (4) The first transition phase, which is of 4 seconds duration, serves primarily to reorient the LM acceleration vector from its value at the end of the braking phase to the desired value at the start of the visibility phase. The LM acceleration is varied as a linear function of time during this interval.
- (5) The visibility phase starts with the vehicle at an altitude of about 9000 feet and travelling toward the selected site with a velocity of about 600 ft/sec. During the visibility phase, the vehicle is maintained in an orientation such that its X-axis is sufficiently close

to the vertical so that the selected site is visible to the astronaut for at least 75 seconds. It is possible for the astronaut to redesignate the landing site during this phase up to the last 20 seconds of the phase. Under nominal conditions with no site redesignations the visibility phase is about 135 seconds in duration. At the end of the visibility phase the vehicle is at the Low-Gate aim conditions (e. g. an altitude of about 100 feet and ~~is~~ moving toward the selected site with a velocity of about 5 ft/sec.)

- (6) The second transition phase, which is of 4 seconds duration, serves primarily to reorient the LM acceleration vector from its value at the end of the visibility phase to the desired value at the start of the final-descent phase. The LM acceleration is varied as a linear function of time during this interval.
- (7) The final-descent phase takes the vehicle from an initial altitude of about 100 feet down to touchdown on the surface. The thrust acceleration of the LM is controlled to provide an essentially constant-velocity vertical descent at a rate of 5 ft/sec. until the estimated altitude is 50 feet, and at 3 ft/sec. thereafter to touchdown.
- (8) A semi-manual mode referred to as the Rate of Descent (ROD) mode is available in which the LGC controls the DPS throttle to maintain the vertical velocity that existed when the mode was selected. The astronaut controls the attitude manually and can incrementally change the LGC controlled vertical velocity by discrete signal inputs.

- (9) A complete manual landing mode can also be selected in which the astronaut controls both vehicle attitude and DPS throttle. The LGC is used to update the vehicle state vector in this mode and provide various display functions.

5.3.4.3.3 Overall Guidance-and-Navigation System Operation

The major operations involved in the powered landing maneuver and the sequence in which they occur are shown in Fig. 3.4.3-1. This section will describe these operations in general terms. The details of the various routines used here will be given in Section 5.3.4.4.

First of all the DPS ignition time and thrust direction are computed, as described in detail in Section 5.3.4.4.2 for the Ignition-Computations Routine. In essence the ignition time (start of the ullage maneuver) is computed as the time when the vehicle is a preselected down-range distance from the landing site. The distance that the site is out of the descent-orbit plane, and deviations in descent-orbit starting altitude are accounted for in the ignition time test. The ignition attitude is computed by extrapolating the state estimate forward (from its value at the start of the ullage maneuver) over a time interval equivalent to the ullage-and-trim maneuver duration. The command specific force is then computed at this extrapolated state, using the Guidance-and-Control Routine, to obtain the desired ignition attitude.

After the DPS has been ignited, using the time determined from the Ignition-Computations Routine, the LM attitude and throttle commands are determined according to the procedure shown by the last five items on Fig. 3.4.3-1. The required guidance and navigation system outputs are the orientation of the thrust vector and the

magnitude of the required thrust. Up-to-date values for these quantities are computed at 2-second intervals throughout the powered landing maneuver.

The first step in the guidance-and-navigation computations cycle, as indicated in Fig. 3.4.3-1, is the updating of the LM state vector. The detailed procedure is described in Section 5.3.4.4 for the State-Vector Update Routine. A brief description of the procedure will next be given. The state vector is updated at 2-second intervals throughout the powered landing maneuver at precisely the times that the PIPA outputs are obtained. In the absence of LR measurements, the LM state vector is updated solely on the basis of PIPA data from the IMU, using an Average-G computation procedure. The state-vector updating is performed in the platform coordinate frame throughout the powered landing maneuver.

State-vector updating by LR measurements is begun when the estimated vehicle altitude has decreased below 25,000 feet. At this time altitude (range) updatings are started and are taken thereafter at 2-second intervals throughout the powered landing maneuver (except during the transition phases when no LR data are taken). Velocity component updating of the state vector is started as soon as the estimated LM altitude is less than 15000 ft. The velocity-component measurements (3 components) are processed as individual components with a 2-second interval between different components, and a 6-second interval between successive processings of the same velocity components. The state-vector corrections derived from the LR data are incorporated immediately after the PIPA outputs are processed. When both altitude and velocity-component data are processed, the altitude data are incorporated before the velocity data.

The state-vector updating by LR measurements is accomplished by computing a correction to the state based on the weighted difference between the current raw measurement (\tilde{q}) and its extrapolated estimate (q'). This correction is used to update the state vector along the direction of the measurement (in state space). The LR altitude-measurement weighting function is a pre-computed linear function of altitude; the velocity-component weighting functions are precomputed linear functions of speed. In general, the LR measurements will not be taken at the exact time that the PIPA outputs are processed. To circumvent this problem the LM state-vector estimates for the two previous updating times are stored in the computer and used to obtain the measurement-quantity estimate (q') for the same time that the measurement (\tilde{q}) was made. The difference ($\tilde{q} - q'$) is then used to update the LM state at the next PIPA-processing time.

The next step in the guidance-and-navigation computation cycle after the state-vector updating, as indicated in Fig. 3.4.3-1, is the updating of the site-position vector in platform coordinates (\underline{r}_{SP}). This updating is required to account for lunar-rotation effects and site redesignations commanded by the astronaut. The necessary computations are performed in the Site-Location Updating Routine.

Next, using the up-to-date values of the LM state estimate ($\underline{r}_P, \underline{v}_P$) and the site location, computations are made to determine the location and orientation of the guidance coordinate frame. These computations are performed in the Guidance-to-Platform Transformation Routine.

The next operation in the computation cycle is the command thrust-acceleration computation, which is performed by the Guidance-and-Control Routine. The detailed procedure is described in Section 5.3.4.4.11. Some of the important characteristics of the thrust-acceleration computation will next be described.

The thrust-acceleration command computation is basically performed in the guidance coordinate frame. For this reason the LM state vector, which is updated and extrapolated in platform coordinates, must first be transformed to the guidance frame. Then, depending on the particular phase of the landing maneuver and the time-to-go to the end of the phase, the appropriate command acceleration relation is selected.

If the vehicle is in the final-descent phase (Phase = 4), the required acceleration is directed so as to obtain a preselected vehicle descent velocity. If the vehicle is in one of the transition phases (Phase = 1, 3), the last 20 seconds of the braking phase (Phase = 0), or the last 10 seconds of the visibility phase (Phase = 2), then the command acceleration is computed so that the vehicle's acceleration is a linear function of the time-to-go to the end of the phase of interest.

At all other times during the powered landing-maneuver the command acceleration is computed so that the vehicle's acceleration profile is a quadratic function of the time-to-go to the end of the phase of interest. When the quadratic guidance law is used, the time-to-go is computed to provide a pre-selected value of jerk along the guidance-frame Z-axis (j_{DZG}) at the terminus of the phase of interest. The details of the time-to-go computation are given in Section 5.3.4.4.12. During the visibility phase (up to the last 20 seconds) it is permissible to redesignate the landing site, i. e. change the aim position (r_{DG}) used in the quadratic guidance equation. The magnitude of the allowable site redesignation displacement decreases as the end of the visibility phase is approached.

After the command specific force has been computed, the vehicle attitude commands are next determined. The detailed procedure for determining these commands is given in Section 5.3.4.4.13.

In regard to vehicle roll and pitch commands, the preferred orientation is simply the one that places the thrust vector along the direction of the command thrust acceleration, as computed in the Guidance-and-Control Routine. The yaw attitude command, on the other hand, will vary depending upon the particular phase of the landing that the vehicle is in. During all initial phases throughout the braking phase to altitudes greater than 30,000 feet, the yaw attitude is held at its previous position, or the astronaut can change the yaw attitude with the X-axis override DAP mode. For altitudes below 30,000 feet in the braking phase the window-up orientation is commanded for LR operation, and X-axis override is inhibited. During the visibility phase the yaw command will vary depending upon the location of the LOS to the site relative to the LM window. If it is determined that the site will be visible to the astronaut, then the LM will be yawed so that the LOS lies in the vehicle X-Z plane. If it is determined that the LOS is not near the window edge (i. e. the site cannot be seen), then a window-up orientation is commanded. If the LOS is near the LM window edge, an intermediate yaw attitude is commanded. During the final descent (phase 4), the X-axis override option is again activated.

The final step in the guidance-and-navigation computation cycle, as indicated in Fig. 3.4.3-1, is the computation of the LM throttle commands. Because of DPS erosion problems, the DPS must either be operated at a fixed throttle-setting corresponding to 92.5 percent of nominal maximum thrust, or it can be operated as a continuously throttleable engine between 10 and 58 percent of nominal maximum thrust. The logic for determining the proper throttle command is discussed in Section 5.3.4.4.14.

In effect, the throttle command is 92.5 percent of nominal maximum thrust (i. e. it is set at 9710 pounds) until the command thrust from the guidance equations is less than 50 percent of the maximum thrust (5250). At this time the throttle command is switched to operate the DPS in the continuously throttleable mode between 10 and 58 percent of maximum thrust (where the throttle command is equal to the computed command thrust). If the command thrust exceeds the 58-percent value at some later time, the

throttle command will switch back to the 92.5-percent value until the subsequent command thrust is less than 50 percent of the maximum value. The different throttle-command switching levels (58 and 50 percent) are used to minimize the number of switchings of the throttle between the 10-58 percent region and the 92.5 percent fixed setting.

The guidance-and-navigation cycle, as described here, is repeated at 2-second intervals throughout the powered landing maneuver until the LM finally touches down on the lunar surface.

5.3.4.4 POWERED LANDING ROUTINES

5.3.4.4.1 General Information

The powered-landing guidance-and-navigation system operation, as mentioned earlier, is most conveniently described if first subdivided into a series of so-called Powered-Landing Routines. Each of these routines in a sense corresponds to a particular operation or function relating to the landing maneuver. The present section will describe these routines in detail and provide information-flow diagrams for them. Four other routines referred to in Section 5.3.4.4 are the Coasting-Integration, Planetary-Inertial Orientation, REFSMMAT, and SMNB Routines; these routines are described in Sections 5.2.2, 5.5.2, 5.6.3.4, and 5.6.3.2 respectively.

5.3.4.4.2 Ignition-Computations Routine

The primary function of the Ignition-Computations Routine is to determine the time at which the DPS is to be ignited, and the preferred vehicle attitude during the ullage and DPS trim maneuvers. These computations are completed several minutes before the actual ignition time occurs. The information-flow diagram for this routine is shown on Fig. 3.4.4-1.

The first step in the Ignition-Computations Routine, as indicated in Fig. 3.4.4-1, is to extrapolate the LM state estimate ($\underline{r}_P, \underline{v}_P$) forward to a time about 180 seconds before the nominal ignition time t_B of Section 5.4.2.4. This time is for convenience referred to as the ignition-computations starting time. The state extrapolation is carried out by means of the Coasting Integration Routine, which is described in Section 5.2.2.

Next, the site position vector is computed in platform coordinates (\underline{r}_{SP}), using the Planetary-Inertial-Orientation (PIO) and Inertial-to-Platform-Transformation Routines. The PIO Routine provides the site position in inertial coordinates at the starting time (\underline{r}_{SI}). The Inertial-to-Platform Transformation Routine transforms the position vector to the platform frame.

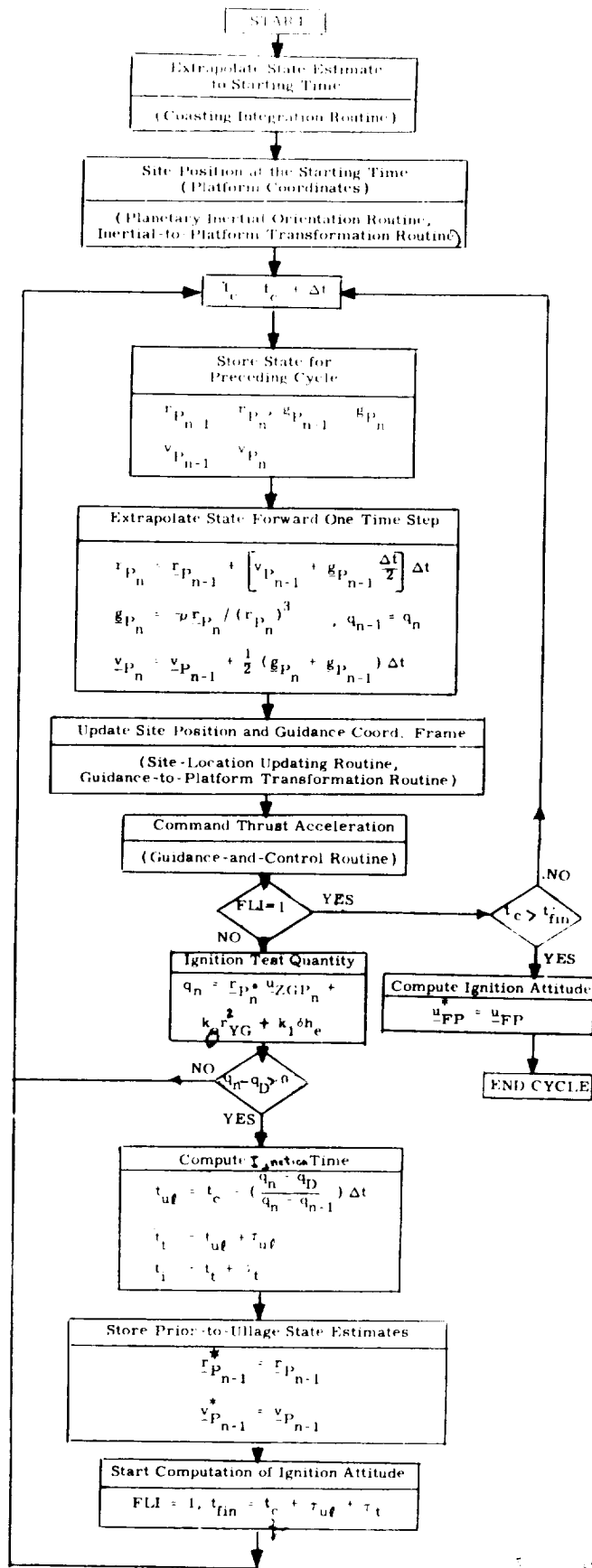

Figure 3. 4. 4-1 Ignition Computations Routine

At this time the ignition-computations cycle is begun, with the time used for the computations being incremented by two seconds on each cycle. The time used in the computation cycle is denoted by t_c rather than t , since it is actually several minutes ahead of real time.

The first operation in the ignition-computations cycle, as shown in Fig. 3.4.4-1, is to store the estimated values of LM position (\underline{r}_P), velocity (\underline{v}_P), and acceleration due to lunar gravitational force (\underline{g}_P) from the preceding computation cycle. The LM state vector estimates are next extrapolated forward one time step (Δt), as indicated in Fig. 3.4.4-1. The stored values of estimated LM position, velocity, and lunar gravitational acceleration from the preceding computation cycle ($\underline{r}_{P_{n-1}}$, $\underline{v}_{P_{n-1}}$, $\underline{g}_{P_{n-1}}$) are used in these computations.

Next, the site position vector estimate in platform coordinates (\underline{r}_{SP}) is updated to account for lunar-rotation effects, using the Site-Location Updating Routine. Using the up-to-date values of vehicle position (\underline{r}_P), vehicle velocity (\underline{v}_P), and site position (\underline{r}_{SP}) in the Guidance-to-Platform Routine, a computation is now made of the orientation and location of the guidance-coordinate frame axes (\underline{u}_{XGP} , \underline{u}_{YGP} , and \underline{u}_{ZGP}). An estimate of the time-to-go from the estimated state (\underline{r}_P , \underline{v}_P) to the High-Gate trajectory conditions, assuming a quadratic acceleration trajectory, is required in the guidance-frame computations.

The required LM command thrust acceleration at the estimated state (\underline{r}_P , \underline{v}_P) is next computed, assuming again that a quadratic acceleration trajectory is followed to the High-Gate point. This acceleration is computed in the Guidance-and-Control Routine.

At this time in the routine, the ignition test quantity (q_n) is computed. (The flag FII has a zero value at this time.) The major part of the test quantity (q_n) is the component of vehicle position (r_{P_n}) along the down-range guidance-frame Z-axis (u_{ZGP_n}). Terms are included in q_n to account for the ~~vehicle's out-of-plane~~ distance in the guidance frame ($r_{Y(G)}$), and deviations in vehicle altitude (δh_e) at the start of the free-fall trajectory from the CSM orbit. The quantities k_0 and k_1 are fixed coefficients whose values are determined from landing maneuver simulation runs.

The various operations in the ignition-computation cycle described thus far are repeated with the computation time (t_c) incremented in 2-second steps until the test quantity (q_n) exceeds a preselected value (q_D). At this point in the routine, the time to start the ullage maneuver ($t_{u\phi}$) is computed, using a linear interpolation as indicated in Fig. 3.4.4-1. The time to start the trim phase (t_t) and the braking phase (t_b) are also determined at this time, using the predetermined ullage and trim maneuver intervals ($\tau_{u\phi}$ and τ_t). Finally, the estimated values of the vehicle state on the PIPA-processing time prior to the start of the ullage maneuver ($r_{P_{n-1}}^*$, $v_{P_{n-1}}^*$) are next stored for future use as initial conditions in the State-Vector Updating Routine.

The ignition-attitude computation is next begun by setting the ignition flag (FII) at a unity value. The estimated LM state is then extrapolated forward from the present time (t_c) by the ullage-and-trim interval ($\tau_{u\phi} + \tau_t$) to the time t_{fin} at which the attitude computations are stopped. At each computation time step the command thrust acceleration (u_{FP}) is recomputed, as indicated by the procedure shown in Fig. 3.4.4-1. When the computation time (t_c) finally exceeds the final time (t_{fin}), the ignition attitude computations are stopped and the current attitude is stored for use in the ullage-and-trim maneuver (u_{FP}^*). The Ignition-Computation Routine is left at this time.

5.3.4.4.3 Inertial-to-Platform Transformation Routine

The transformations between the inertial (subscript I) and platform (subscript P) coordinate frames are accomplished by the Inertial-to-Platform Transformation Routine, as indicated in Fig. 3.4.4-2. The platform (IMU) coordinate-frame unit vectors are obtained in inertial coordinates ($\underline{u}_{XPI}, \underline{u}_{YPI}, \underline{u}_{ZPI}$) by means of the REFSMMAT Routine (Section 5.6.3.4). These vectors are the column-vectors of the IMU-to-inertial frame transformation matrix C_{PI} .

Figure 3.4.4-2

Transformation between Inertial and Platform Frames

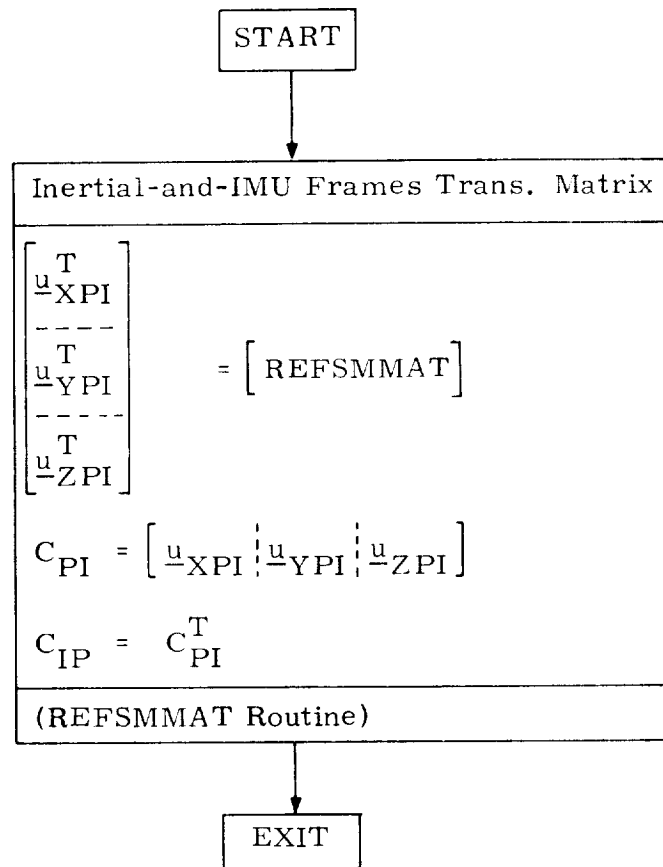

5.3.4.4.4 State-Vector Update Routine

The State-Vector Update Routine computes the current state of the vehicle ($\underline{r}_P, \underline{v}_P$) using output data from the IMU and the landing radar (LR). The state-vector updatings occur at 2-second intervals during the landing maneuver at the times that the PIPA outputs are processed. The state-vector updatings are performed in the platform frame (subscript P).

During the early part of the landing maneuver only the PIPA outputs are used to update the LM state vector. When the estimated LM altitude has dropped below 25,000 feet, range measurements (altitude) from the LR are used to update the state at 2-second intervals. When the estimated LM altitude has dropped below 15,000 feet, velocity-component measurements are used in addition to the range measurements. The three velocity-component measurements are processed individually at 2-second intervals immediately after the altitude measurements. The time between consecutive processings of the same velocity component is 6 seconds. It is important to note that the LR range and velocity measurements, in general, will not be taken at precisely the times that the PIPA outputs are processed. The state-vector updating, however, is done only at the PIPA-processing times. This requires that the difference between the raw measurement (\tilde{q}) and its extrapolated estimate (q') at the measurement time be carried over to the next PIPA-processing time for use in the state-vector updating procedure.

The information-flow diagram for the State-Vector Update Routine is given in Fig. 3.4.4-3. The sequence of operations involved in the procedure will next be described.

The first step in the updating cycle, as shown in Fig. 3.4.4-3, is to store the state-vector estimates in platform coordinates for the two previous cycles through the State Vector Update Routine ($\underline{r}_{n-1}, \underline{v}_{n-1}, \underline{r}_{n-2}, \underline{v}_{n-2}$). These stored values are used to obtain estimates of

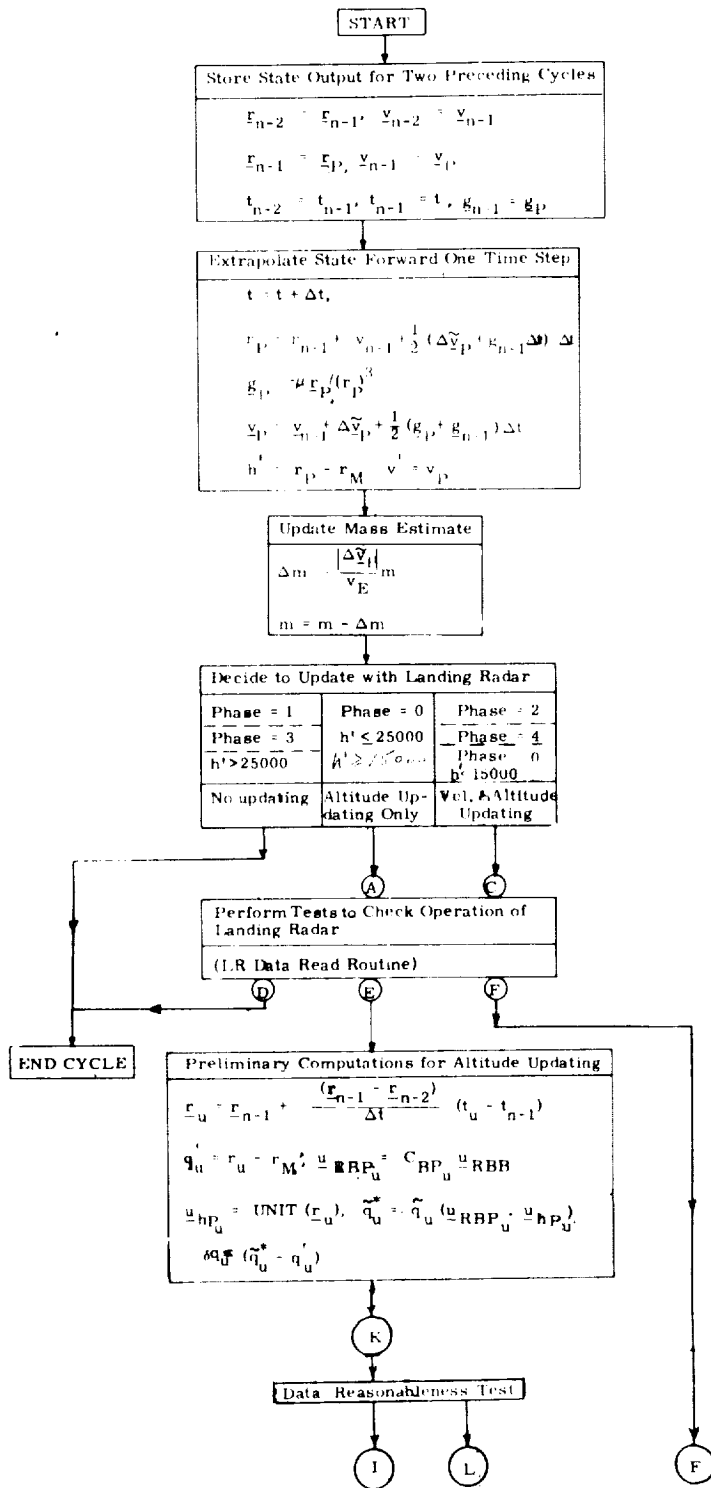

Figure 3. 4. 4-3 State Vector Update Routine (Page 1 of 2)

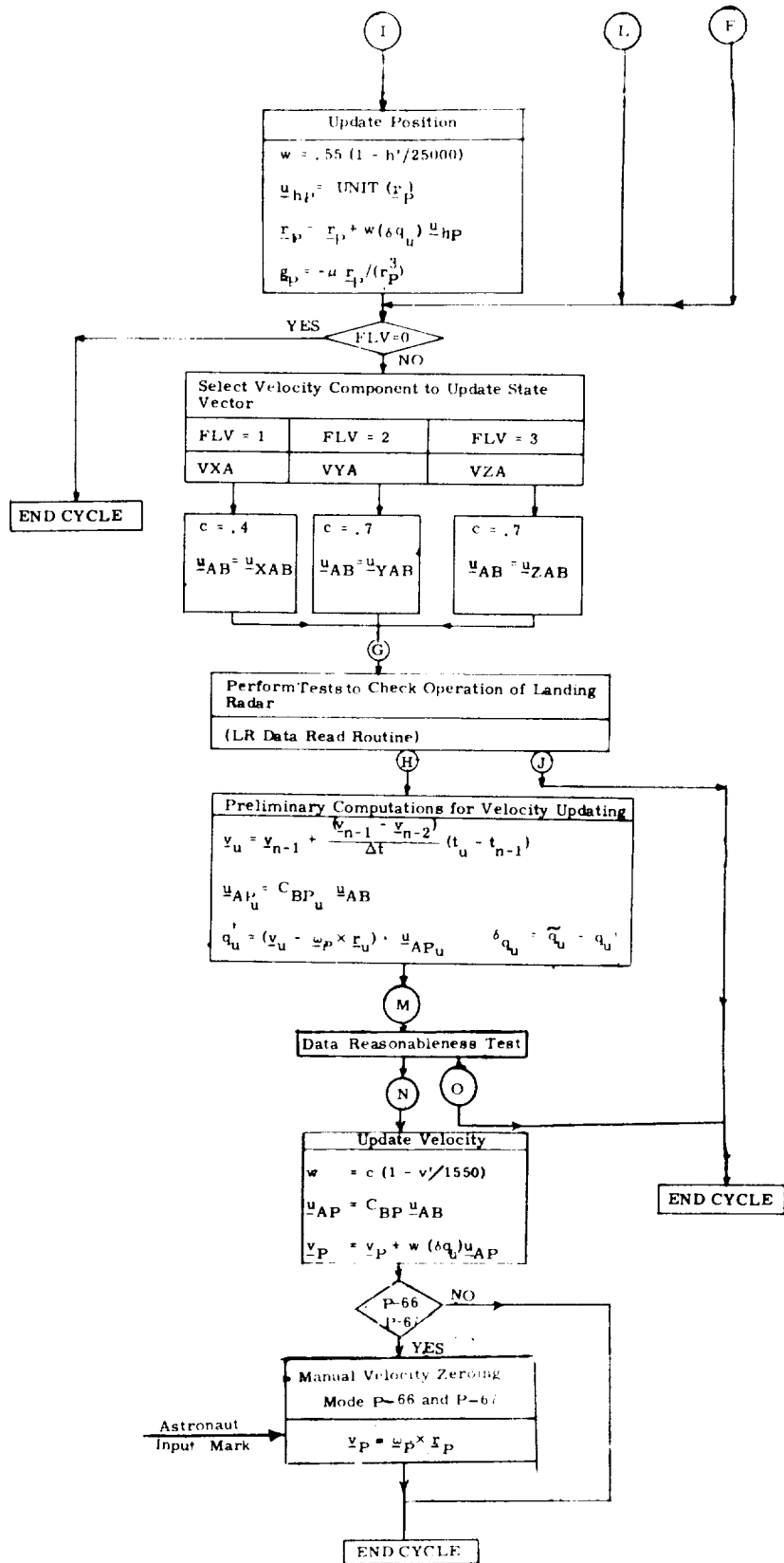

Figure 3. 4. 4-3 State Vector Update Routine (Page 2 of 2)

the LR measurement quantities (q') at the times the measurements are actually taken between the PIPA processing times.

Next the state of the LM from the previous cycle (r_{n-1} and v_{n-1}) is extrapolated forward to the present time using the PIPA output data ($\Delta\tilde{v}_P$) and the previous-cycle estimate of the LM acceleration due to the lunar gravitational field (\underline{g}_{n-1}). The extrapolation interval (which is 2 seconds) is denoted by Δt . Extrapolated values of LM altitude (h') and speed (v') are next obtained, using the value of radius of the moon at the initially-selected site (r_M) in the h' computations.

Using the PIPA output data, an up-to-date estimate of LM mass (m) is next obtained as shown in Fig. 3.4.4-3. The change in estimated mass, as can be seen, is a function of the present vehicle mass (m), the measured PIPA velocity change $|\Delta\tilde{v}_P|$, and the prestored exhaust velocity (v_E) for the DPS.

After the state extrapolation has been completed, the decision is made whether to update with LR measurements or not. The criteria are shown in Fig. 3.4.4-3. If the LM is in either of ~~the~~ the two transition phases (Phase = 1, 3) or if its altitude is greater than 25,000 feet, then no LR updates are attempted.

† To simplify notation the subscripts n , $n-1$, and $n-2$ are omitted wherever possible, if there is no ambiguity.

On the other hand, if the estimated LM altitude is less than 25,000 feet, then altitude data are used to update the state estimates. When the LM estimated altitude is less than 15,000 feet and the LM is in either the braking (Phase = 0), visibility (Phase = 2), or final-descent (Phase = 4) phases, then both altitude and velocity-component updatings are made.

At this point in the computation cycle the LR Data-Read Routine is entered for the first time. A detailed description of this routine is given in the following section (Section 5.3.4.4.5). Various tests are performed here to check the operation of the radar. The command to change the orientation of the LR antenna at the start of the visibility phase is also generated here. Finally, the velocity-measurement flag (FLV), which determines the LR velocity component to be processed on the current computation cycle is set at its proper value.

After the LR Data-Read Routine operations have been completed, the altitude-updating procedure is begun. A description of the altitude-updating procedure follows for the general case where the range (altitude) measurement is taken at time t_u (subscript u), which lies between the successive PIPA-output processing times t_{n-1} and t_n . The interval between successive readings of the PIPA output data (Δt) is 2 seconds. The first step in the altitude updating procedure, as shown on Fig. 3.4.4-3, is to obtain an estimate of the position of the LM at the time of the range measurement (\underline{r}_u). This is based on the position estimates for the two preceding updating cycles (\underline{r}_{n-1} and \underline{r}_{n-2}). Next, an estimate of LM altitude at the measurement time (q_u here) is obtained by subtracting the lunar

radius at the initial site (r_M) from the magnitude of the LM position vector (r_u). The actual raw measurement from the radar (\tilde{q}_u) is the slant range to the ground along the direction of the range beam (\underline{u}_{RBB}). In order to obtain a meaningful comparison between \tilde{q}_u and q'_u (as previously defined) it is necessary to use the component of \tilde{q}_u projected along the local vertical (i. e. measured altitude) rather than the measured slant range along the beam. This first requires that the orientation of the range beam at the measurement time in the platform frame (\underline{u}_{RBP_u}) be determined from the known range-beam orientation in vehicle (Nav. Base.) coordinates (\underline{u}_{RBB}), using the vehicle-to-platform transformation matrix (C_{BP_u}). It should be noted that the orientation of the range beam (\underline{u}_{RBB}) is changed at the start of the visibility phase (to \underline{u}'_{RBB}). The altitude measurement used in the updating procedure (\tilde{q}_u^*) is obtained by scaling-down the raw range measurement by the projection of the range beam (\underline{u}_{RBP_u}) along the computed local vertical at the measurement time (\underline{u}_{hP_u}).

The Data-Reasonableness-Test Routine is next entered to determine if the raw altitude measurement data appear to be satisfactory. The tests are described in detail in Section 5.3.4.4.6. If the altitude-data tests indicate the data are satisfactory, then the position estimate (r_P) is next updated using the weighted measurement difference ($\tilde{q}_u^* - q'_u$). If the data are not satisfactory, or the astronaut inhibits LR altitude updating, this operation is bypassed.

The difference between the altitude measurement at the measurement time (\tilde{q}_u^*) and its extrapolated estimate (q'_u) is used to update the LM position vector at the next PIPA-output processing time after the measurement. As can be seen in Fig. 3.4.4-3,

the weighted measurement difference is used to update the position component of the state vector (\underline{r}_P) along the direction estimated for the altitude measurement (\underline{u}_{hP}). The altitude-measurement weighting function (w), as can be seen, is stored as a linear function of the estimated LM altitude (h'). An updated computation of the vehicle acceleration due to the lunar gravitational field (\underline{g}_P) is made at this time.

At this point in the routine the velocity-measurement flag (FLV) is checked to determine whether a velocity-component updating is to be made. If the flag (FLV) is set at zero, no velocity measurement updatings are made on the current computation cycle. If, on the other hand, the velocity-measurement flag (FLV) is not zero, then the computations required for velocity-component updating are begun.

First of all, the constant used in the linear velocity-component weighting-function relations (c) is defined for the velocity component of interest. Next, the unit vector along the direction of the velocity component being processed (\underline{u}_{AB}) is determined in the vehicle coordinate frame. The unit vectors for the different velocity components, as shown in Fig. 3.4.4-3, are referred to as \underline{u}_{XAB} , \underline{u}_{YAB} , and \underline{u}_{ZAB} .

Now, the LR Data-Read Routine is entered for the second time during the computation cycle. Additional checks on the operation of the LR are made in the LR Data-Read Routine at this time, as described in Section 5.3.4.4.5. The raw velocity-component data are also smoothed at this time before incorporation into the state estimate.

If the tests performed in the LR Data-Read Routine are satisfied, then an estimate of vehicle velocity at the measurement time (\underline{v}_u) is now obtained, based on the updated velocity estimates from the two previous computation cycles (\underline{v}_{n-1} and \underline{v}_{n-2}).

Also, the orientation of the antenna axis for the velocity component being processed (\underline{u}_{AP_u}) is obtained in platform coordinates from \underline{u}_{AB} and the transformation matrix C_{BP_u} . Using \underline{v}_u and \underline{u}_{AP_u} , an estimate is now obtained of the magnitude of the velocity component being processed (q'_u). The difference between the raw measurement and the estimate (δq_u) is computed at this time.

The Data-Reasonableness-Test Routine is next entered to check the velocity measurement data. If the LR fails this test or LR velocity updating is inhibited by the astronaut, no velocity-component updatings are made and the computation cycle through the State-Vector Update Routine is completed. If, on the other hand, the data appear to be satisfactory or the astronaut overrides the velocity reasonableness test the velocity-updating procedure is continued.

The updated estimate of vehicle velocity (\underline{v}_p) is obtained, as shown in Fig. 3.4.4-3, by first computing the weighted difference between q'_u and the raw measurement \tilde{q}_u . The weighting function (w), as can be seen, is taken as a linear function of the estimated vehicle speed (v'). The weighted difference $w(\tilde{q}_u - q'_u)$ is then used to update the LM velocity vector at the next PIPA-output processing time along the direction of the measured velocity component (\underline{u}_{A1}).

It should be noted that the LR range weighting factor (w) and the velocity weighting factors (c) of Fig. 3.4.4-3 are preliminary values based on assumed LR performance and lunar terrain models. These weighting factors will be revised on the basis of more detailed LR performance and terrain specifications when they are available.

A check is now made to see whether either of the two terminal landing modes P66 or P67 are in current use. If these modes are not in use, then the State-Vector-Update Routine computation cycle is completed. If landing modes P66 or P67

are in current use, then the astronaut has the option of updating the velocity estimate (\underline{v}_P) to a zero value relative to the moon. This is accomplished upon command by the astronaut by setting \underline{v}_P equal to the lunar rotational velocity ($\underline{w}_P \times \underline{r}_P$). The State-Vector-Update Routine computation cycle is now complete.

5.3.4.4.5 LR Data Read Routine

The logic associated with the LR Data Read Routine is given in Fig. 3.4.4-4a. The dotted-line portions of this figure are those parts of the State Vector Update Routine (Fig. 3.4.4-3) which are associated with the LR Data Read Routine.

Requests for LR data are issued to this routine by the State Vector Update Routine once every two seconds during certain phases of the powered landing maneuver. These data request are made at either inputs (A) or (C) of Fig. 3.4.4-4a.

Input (A)

During the braking phase when the estimated altitude is less than 25,000 feet but more than 15,000 feet, LR data request are made at input (A) and only range is obtained from the LR. If the time-to-go (t_{GO}) is less than 6 seconds, the LR Position Command Routine is called to drive the LR antenna from position One to Two. Since the time required to change antenna positions can be as much as 10 seconds, this routine is called in advance so as to provide sufficient time for the antenna to reach position Two before initiation of the visibility phase. After checking t_{GO} , a check is made to insure that the LR Range Low Scale discrete is not being received from the LR since this discrete should not appear until the range is below 2,500 feet.

After the range scale check, the routine checks to see if the LR Position One discrete is being received from the LR, signifying that the antenna is in position One. Since it is assumed that the antenna has already been placed in position One prior to the

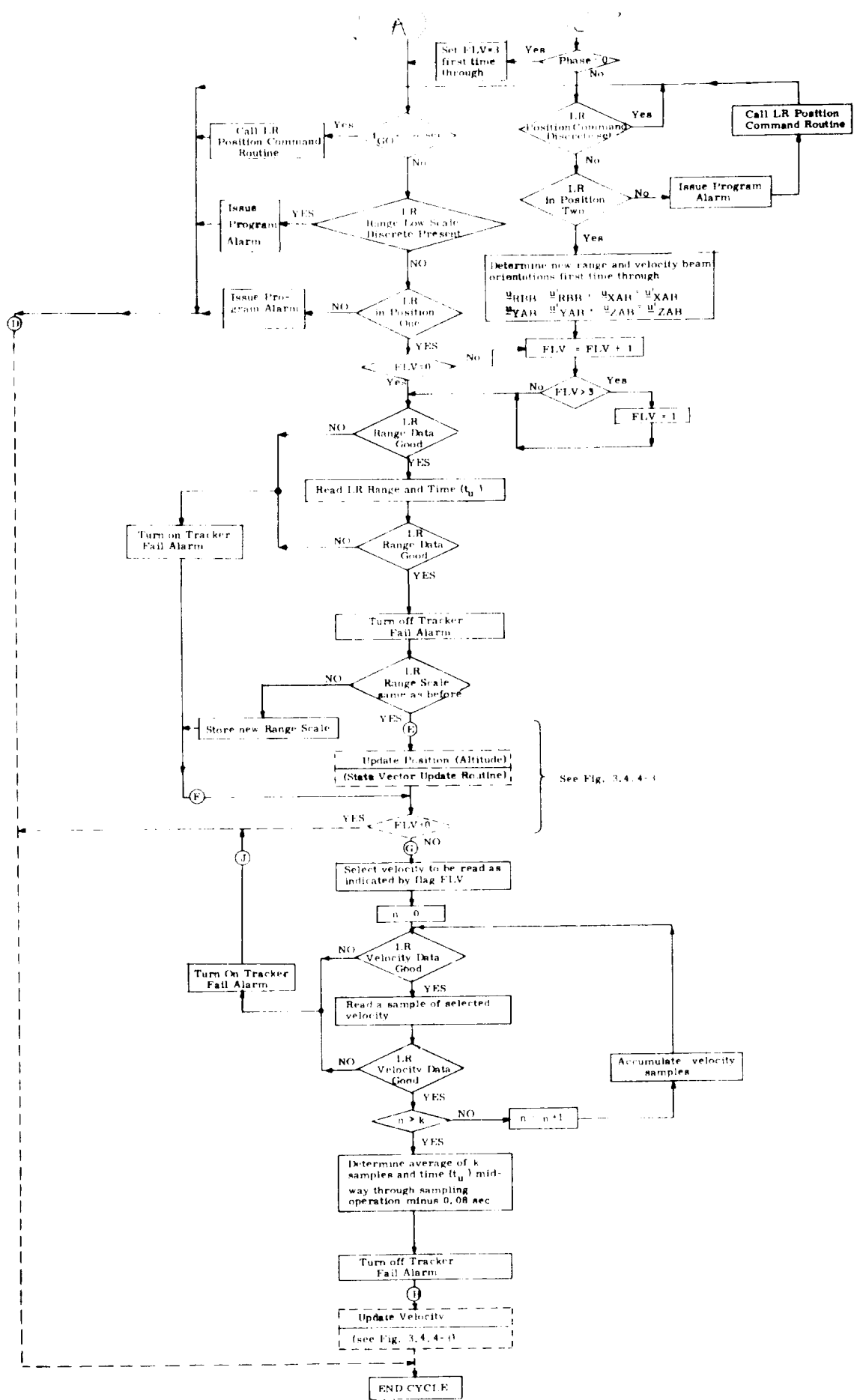

Figure 3.4.4-4a LR Data Read Routine

powered landing maneuver, this check is just a precautionary measure. Next, the routine checks to see if the velocity selection flag (FLV) is zero, which insures that only range data will be obtained from the LR. FLV is initially set to zero and remains at this value throughout the time that LR data requests are made at input (A).

The logic shown in Fig. 3.4.4-4a for obtaining range from the LR is fairly self-explanatory. Checks are made just before and after reading LR range to insure that the LR Range Data Good discrete is being received from the LR. This discrete signifies that the radar tracking loops associated with the LR range beam and the two rear LR velocity beams are locked-on and tracking satisfactorily. Absence of this discrete causes the Tracker Fail Alarm to be turned on, and no position update is made with LR data. If the alarm has been on since the previous request for LR data, it is turned off if the discrete is received during the present request. If the status of the LR Range Low Scale discrete has changed since the last range data request, the present range reading is not used, since a delay of at least one second is required after the LR range scale change to allow a counter in the LR to stabilize.

In Fig. 3.4.4-4a it is seen that after reading the LR range and updating the vehicle altitude, the State Vector Update Routine (dotted portion) bypasses the LR velocity reading portion of the LR Data Read Routine since FLV = 0.

Input (C)

During the latter portion of the braking phase (Phase = 0) when the estimated altitude is below 15,000 feet, and throughout the visibility and final descent phases (Phase = 2 or 4), requests are made at input (C) for both LR range and velocity data.

In Fig. 3. 4. 4-4a it is seen that the velocity selection flag FLV is set at 3 the first time a data request is made at input (C) during the braking phase. This enables the velocity selection flag FLV to be cycled. During this time both range and velocity data is obtained from the LR with its antenna remaining in position One. Note that FLV can now have only one of three values (1, 2, or 3), depending on which LR velocity component (X_A , Y_A , or Z_A) is to be used during a single request for LR data. After the routine reads the LR range for update of altitude as previously explained, one of the three components of LR velocity is read as indicated in Fig.3.4.4-4a. Note that the LR velocity reading used by the LGC for update purposes is actually the average of k successive readings (samples) of a given component of LR velocity. Each sample represents an 80 millisecond duration count in the LR of certain doppler frequencies. The total time required to obtain one sample from the LR is about 100 milliseconds. In reading out each velocity sample from the LR the routine checks before and after each sample to insure that the LR Velocity Data Good discrete is being received from the LR. This discrete signifies that all three velocity tracking loops are locked-on and tracking satisfactorily. The time tag t_u assigned to the averaged velocity reading corresponds to the midpoint of the k samples minus 0.08 seconds to account for lag in the LR velocity tracking loops. Although k + 1 samples of LR velocity are read during an LR data request, only the first k samples are averaged for the final result. As yet, the actual value of k which will be used during the mission is not known and will be specified later after certain LR performance test results have been obtained from Earth flight tests.

When LR data request are made at input (C) during the visibility and final descent phases (Phase = 2 or 4) it is seen in Fig. 3. 4. 4-4a that a check is initially made to see if the LR Position Command discrete is set signifying that the LR Position Command

Routine of Fig. 3.4.4-5 is still commanding the LR antenna from position One to Two. If the LR Position Command discrete is not set, the routine then checks to see if the LR Position Two discrete is present signifying that the LR antenna is in position Two. Absence of the discrete either indicates a possible malfunction or that the astronaut has terminated LGC control of the braking phase prior to $T_{GO}^t = 6$ seconds and had not finished placing the antenna in position Two with his separate manual slew controls. In either case a program alarm is issued before calling the LR Position Command Routine.

Assuming the LR antenna is in position Two, the vectors defining the new orientations of the range and velocity beams for position Two are established the first time through. Afterwards, the LR Data Read Routine reads the LR range and velocity data just as previously described for the latter portion of the braking phase (i. e. below 15,000 feet).

LR Velocity and Range Measurement Data

The velocity data obtained from the LR by the LR Data Read Routine is with respect to the LR antenna coordinate system of Fig. 3.4.2-1 and is in a form which is described as follows along with the various data processing steps the LGC performs to transform the data into the Navigation Base Coordinate System.

The velocity data furnished at the LGC interface by the LR comprises three binary data words of the following form:

$$\begin{aligned}
S_{XA} &= \left[(f_1 + f_3) / 2 + f_B \right] \tau_{LR} \\
S_{YA} &= \left[(f_1 - f_2) + f_B \right] \tau_{LR} \\
S_{ZA} &= \left[(f_3 - f_2) + f_B \right] \tau_{LR}
\end{aligned}
\tag{3.4.1}$$

where S_{XA} , S_{YA} , and S_{ZA} correspond, respectively, to the velocity components along the $-X_A$, $+Y_A$, and $+Z_A$ antenna axes of Fig. 3.4.2-1. The quantities f_1 , f_2 , and f_3 are the beam doppler frequencies, f_B is the bias frequency used in the LR, and τ_{LR} is the time interval used by the LR when counting the cycles of the above frequencies so as to produce the data words S_{XA} , S_{YA} , and S_{ZA} . The time interval, τ_{LR} is 30.001 milliseconds.

In the LGC the velocity along each antenna coordinate axis is computed from the above data words as follows:

$$\begin{aligned}
v_{XA} &= k_{XA} (S_{XA} - f_B \tau_{LR}) \\
v_{YA} &= k_{YA} (S_{YA} - f_B \tau_{LR}) \\
v_{ZA} &= k_{ZA} (S_{ZA} - f_B \tau_{LR})
\end{aligned}
\tag{3.4.2}$$

where v_{XA} , v_{YA} , and v_{ZA} are the LR measured velocities along the positive antenna coordinate axes, and k_{XA} , k_{YA} , and k_{ZA} are the corresponding scale factors used to obtain the above velocities in feet per second.

The velocity information expressed by v_{XA} , v_{YA} , and v_{ZA} is transformed from the antenna coordinate system to the Navigation Base Coordinate System using the angles α and β shown in Fig. 3.4.4-4b.

The range obtained from the LR by the LR Data Read Routine is that measured by the LR along the range beam shown in Fig. 3.4.2-1. This beam is in the $X_A - Z_A$ plane of the antenna coordinate system and is at an angle ξ from the $-X_A$ axis. The range data is sent to the LGC from the LR as a binary data word R_{LR} , which represents the count of a certain frequency in the LR during the time interval τ_{LR} . Within the LGC, the range r_{LR} along the range beam is computed as follows:

$$r_{LR} = k_{LR} R_{LR} \quad (3.4.3)$$

where k_{LR} is the bit weight in feet and R_{LR} is the range data word obtained from the LR for the counting interval τ_{LR} .

A summary of the processing constants required by the LGC for LR operation is given as follows:

f_B	Velocity bias frequency
τ_{LR}	Counting interval of the landing radar.
k_{XA}	Scale factor to convert $(S_{XA} - f_B \tau_{LR})$ to velocity along the LR antenna coordinate X_A (Fig. 3.4.2-1) in feet per second for the counting interval τ_{LR} .

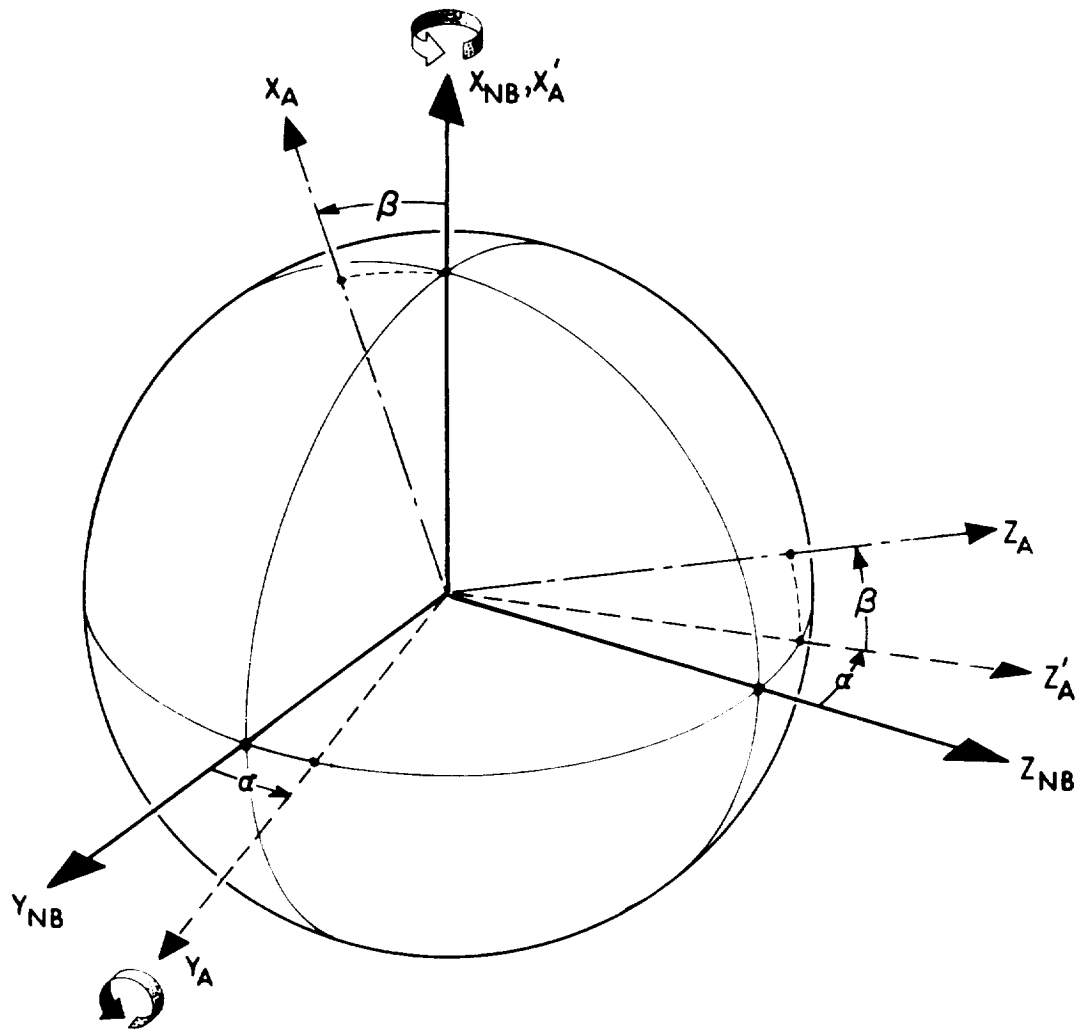

<u>ANGLE ORDER</u>	<u>AXIS OF ROTATION</u>
α	X_{NB}
β	Y_A

Figure 3.4.4-4b Angles Defining Orientation of LR Antenna Axes with Respect to the Navigation Base Coordinate System

k_{YA}	Scale factor to convert $(S_{YA} - f_B \tau_{LR})$ to velocity along the LR antenna coordinate Y_A in feet per second for the counting interval τ_{LR} .
k_{ZA}	Scale factor to convert $(S_{ZA} - f_B \tau_{LR})$ to velocity along the LR antenna coordinate Z_A in feet per second for the counting interval τ_{LR} .
α_1 β_1 }	Respective angles between the LR antenna coordinate system in position One and the navigation base coordinate system (Fig. 3.4.4-4b).
α_2 β_2 }	Respective angles between the LR antenna coordinate system in position Two and the navigation base coordinate system (Fig. 3.4.4-4b)
k_{LR1}	Bit weight in feet for long range scale
k_{LR2}	Bit weight in feet for short range scale
ξ	Angle of range beam with respect to the $-X_A$ axis of the LR antenna

LR Position Command Routine

The Landing Radar (LR) Position Command Routine is used by the LGC to command the LR antenna from positions One to Two during the lunar landing maneuver. The logic associated with the operation of this routine is shown in Fig. 3.4.4-5. Initially, the routine checks to see if the LR Position Two Discrete is being received from the LR, signifying that the antenna is

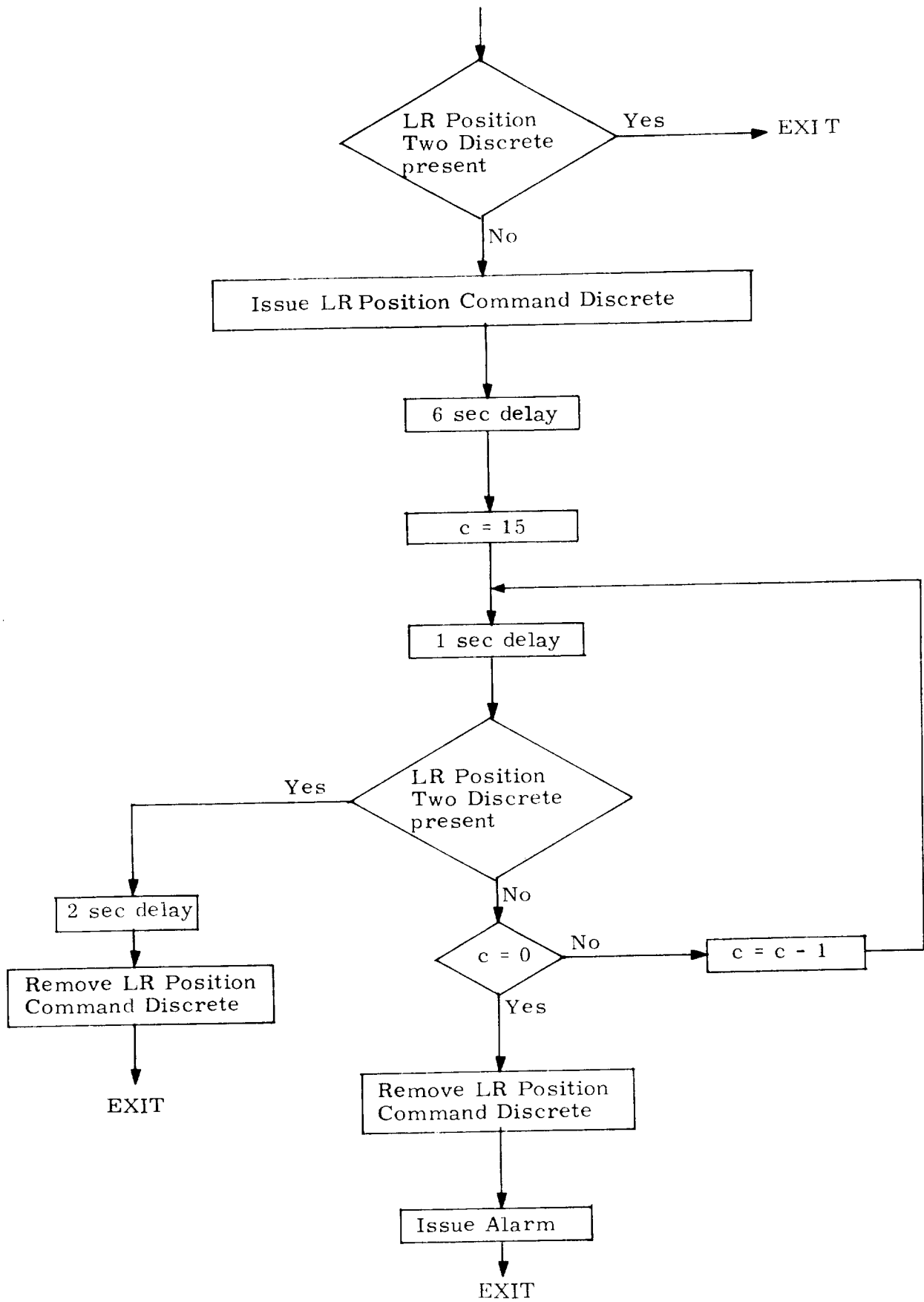

Figure 3.4.4-5 LR Position Command Routine

already in position Two. If the discrete is not present, the LR Position Command Discrete is issued to the LR causing its antenna to be driven to position Two. Seven seconds after the start of the routine, and each second thereafter, the routine checks to see if the LR Position Two Discrete is being received, until a period of 22 seconds has expired, at which time, the LR Position Command Discrete is removed and an alarm is issued. If the LR Position Two Discrete is received prior to the above time, the LR Position Command Discrete is removed after a 2 second delay. Under normal conditions the LR antenna should take no more than 10 seconds to go from positions One to Two.

5.3.4.4.6 LR Data Reasonableness Test Routine

The objective of the LR data reasonableness test is to detect and reject degraded LR data caused by cross-coupled side lobe or vibrating structure frequency tracker lock-up. In these situations the LR Data Good discretizes to the PGNCS will be present and the LGC would normally process the LR data to update the estimated state vector. The LR data reasonableness test must be applied to both range and velocity LR data with appropriate external control by the astronaut to inhibit or override the LR updating process.

The logic diagram for the LR Data Reasonableness Test Routine is presented in Fig. 3.4.4-6. This routine performs separate tests on derived altitude and velocity data from the LR as controlled by the LR Data Read Routine of Section 5.3.4.4.5. The dotted line portions of Fig. 3.4.4-6 are those parts of the State Vector Update Routine (Fig. 3.4.4-3) and LR Data Read Routine (Fig. 3.4.4-4a) which are associated with the LR Data Reasonableness Test Routine.

With reference to Fig. 3.4.4-6, the altitude difference δq_u as determined by the preliminary computation for altitude updating by the State Vector Update Routine, is used as the basic parameter for the LR altitude reasonableness test. The parameter, δq_u is the difference between the altitude as determined from the LR range data (\tilde{q}_u^* of Fig. 3.4.4-3) and that derived from the estimated state vector (q_u'). The LR altitude reasonableness test shown in Fig. 3.4.4-6 is a linear function of the estimated current altitude q_u' . If the altitude data test is passed, the Altitude Inhibit flag controlled by the astronaut must be absent before the LR range data is used to update the state vector. It

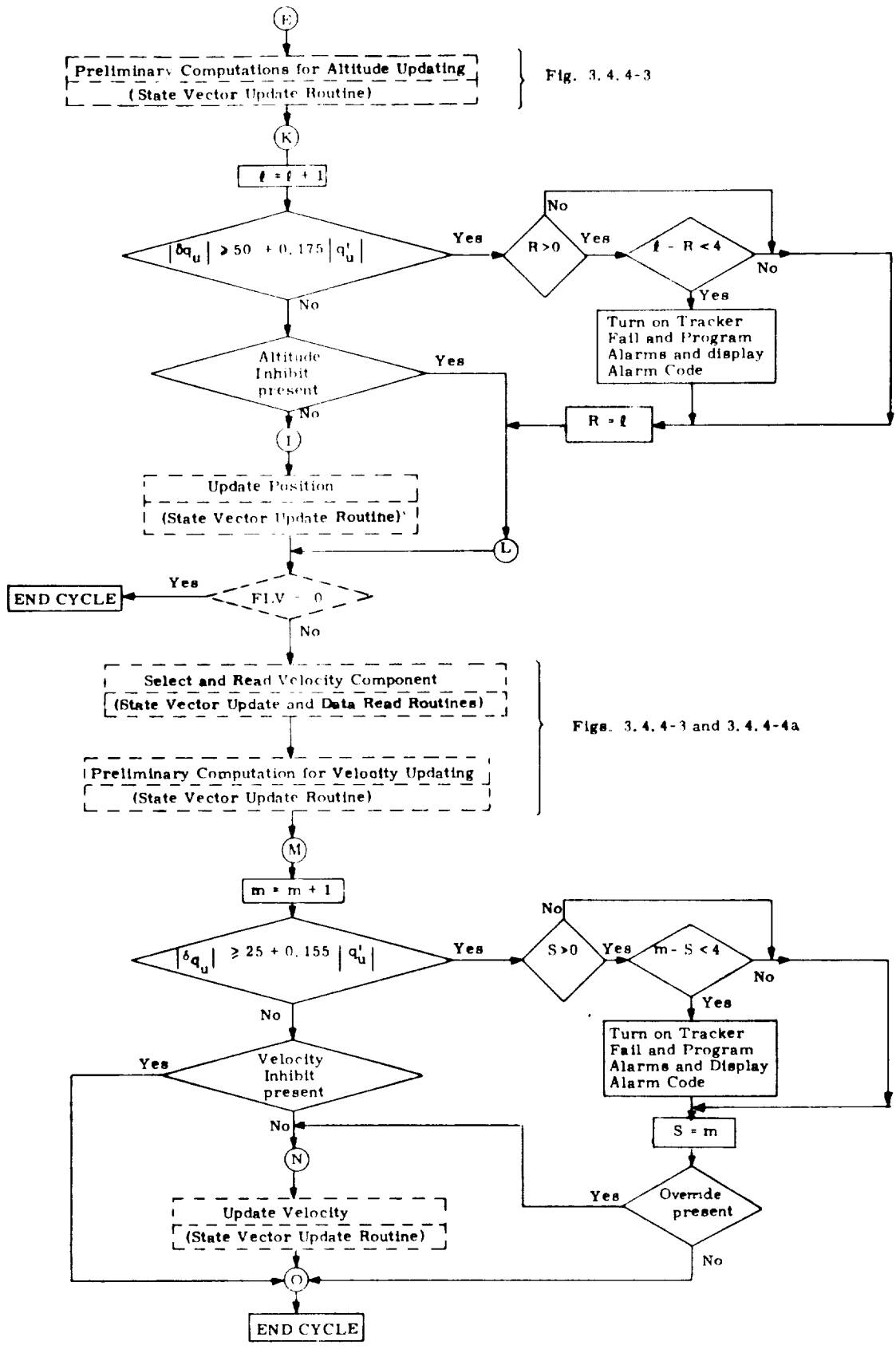

Fig. 3.4.4-3

Figs. 3.4.4-3 and 3.4.4-4a

Figure 3.4.4-6 LR Data Reasonableness Test Routine

should be noted that the Altitude Inhibit flag is initially set automatically in the landing program so that no LR altitude updating can start until commanded to do so by the astronaut.

If the altitude difference parameter δq_u exceeds the limits set by the altitude data test, the alarm logic shown in Fig. 3.4.4-6 is designed to activate the Tracker Fail and Program Alarm lights accompanied by an identifying DSKY alarm code if two or more of the last four consecutive LR altitude reasonableness test have failed.

If the LR Data Read Routine calls for a velocity update (FLV = 1, 2, or 3), the velocity difference δq_u as determined by the preliminary computation for the velocity updating in the State Vector Update Routine (Fig. 3.4.4-3) is used as the basic parameter in the LR velocity reasonableness test as was done with the altitude difference in the altitude test. In the velocity test case, δq_u is the difference between the LR indicated velocity component (\tilde{q}_u of Fig. 3.4.4-3) and that estimated from the state vector (q'_u). The LR velocity data reasonableness test is of similar form to the altitude test as shown in Fig. 3.4.4-6, and all three LR velocity components use the same velocity data reasonableness test. If the velocity difference passes the LR velocity reasonableness test and the velocity update is not inhibited by the astronaut, the state vector is automatically updated by the State Vector Update Routine. In contrast to the LR altitude data test and operation, the Velocity Inhibit flag is initially reset when the landing program is activated. Consequently, LR velocity updating is done automatically provided that the Velocity Data Good discrete is present and the velocity data reasonableness test is passed.

If the LR velocity data exceeds the limits of the velocity reasonableness test, it is seen in Fig. 3.4.4-6 that the same type of alarm criterion is used as with the altitude data test. If two or more of the last four LR velocity readings obtained by the Data Read Routine fail the velocity reasonableness test, the Tracker Fail and Program Alarm lights are activated and an identifying DSKY alarm code is displayed. It should be noted that S and m are initially set to zero in the landing program. The purpose of the Override flag following the alarm logic is to enable the astronaut to manually override the velocity data reasonableness test and force a velocity update with LR velocity data independent of the velocity data reasonableness test. Initially, the Override flag is reset by the landing program. Afterwards, whenever the flag is set by the astronaut, the Velocity Inhibit flag is reset, and vice versa. In other words, the astronaut is only able to set one of the two flags, which in turn causes the other to be reset. However, a third mode will be available to the astronaut in the velocity test whereby both flags are reset. This latter mode might be regarded as being the normal mode of operation since it permits a state vector update only if the velocity data passes the test.

It should also be noted that since the LR data reasonableness tests follow the LR Data Good discrete checks in the LR Data Read Routine, the data reasonableness alarm criterion is based on the last four LR readings which had passed the Data Good discrete check. The LR data reasonableness tests are independent of intermittent tracking and do not account for any data rejected because of failure to pass the LR data good tests.

5.3.4.4.7 Site-Location Updating Routine

The function of the Site-Location Updating Routine is to provide an up-to-date value of site position in platform coordinates (\underline{r}_{SP}). This requires that the site location be updated to account for the rotation of the moon, and also in response to hand-controller commands by the astronaut. The information-flow diagram is shown in Fig. 3.4.4-7.

The first operation in the Site-Location Updating Routine is to update the site position (\underline{r}_{SP}) by the effect of lunar-rotational velocity ($\underline{\omega}_p \times \underline{r}_{SP}$) over the computation-cycle interval (Δt). Then, using the new value of \underline{r}_{SP} and the up-to-date estimate of vehicle position (\underline{r}_P), new values of the line-of-sight to the current site ($\underline{\rho}_P$) and its unit vector (\underline{u}_{ρ_P}) are determined.

A test is next made to see if any hand-controller commands (n_e or n_a) have been stored. If there are no stored commands, the routine is left with no further computations on the present cycle. If stored commands are present, the desired landing-site perturbation computation is next begun.

The site-perturbation computation essentially rotates the line-of-sight (LOS) vector about a pair of axes that are essentially perpendicular to the current LOS (\underline{u}_{ρ_P}) and to each other. The axes referred to here are the vehicle Y axis (\underline{u}_{YBP}), which normally is held perpendicular to \underline{u}_{ρ_P} during the visibility phase, and the unit-vector \underline{u}_{AZP} which is perpendicular to both \underline{u}_{YBP} and \underline{u}_{ρ_P} . The perturbed LOS direction ($\underline{u}_{\rho_{NP}}$), as can be seen in Fig. 3.4.4-7, is computed as the sum of an azimuth perturbation ($n_a k_a$) along \underline{u}_{YBP} and an elevation perturbation ($n_e k_e$) along \underline{u}_{AZP} . The position vector from the vehicle to the perturbed site ($\underline{\rho}_{NP}$) is next computed using the components of $\underline{\rho}_P$ and $\underline{u}_{\rho_{NP}}$ along the platform-frame X-axis and the unit vector ($\underline{u}_{\rho_{NP}}$).

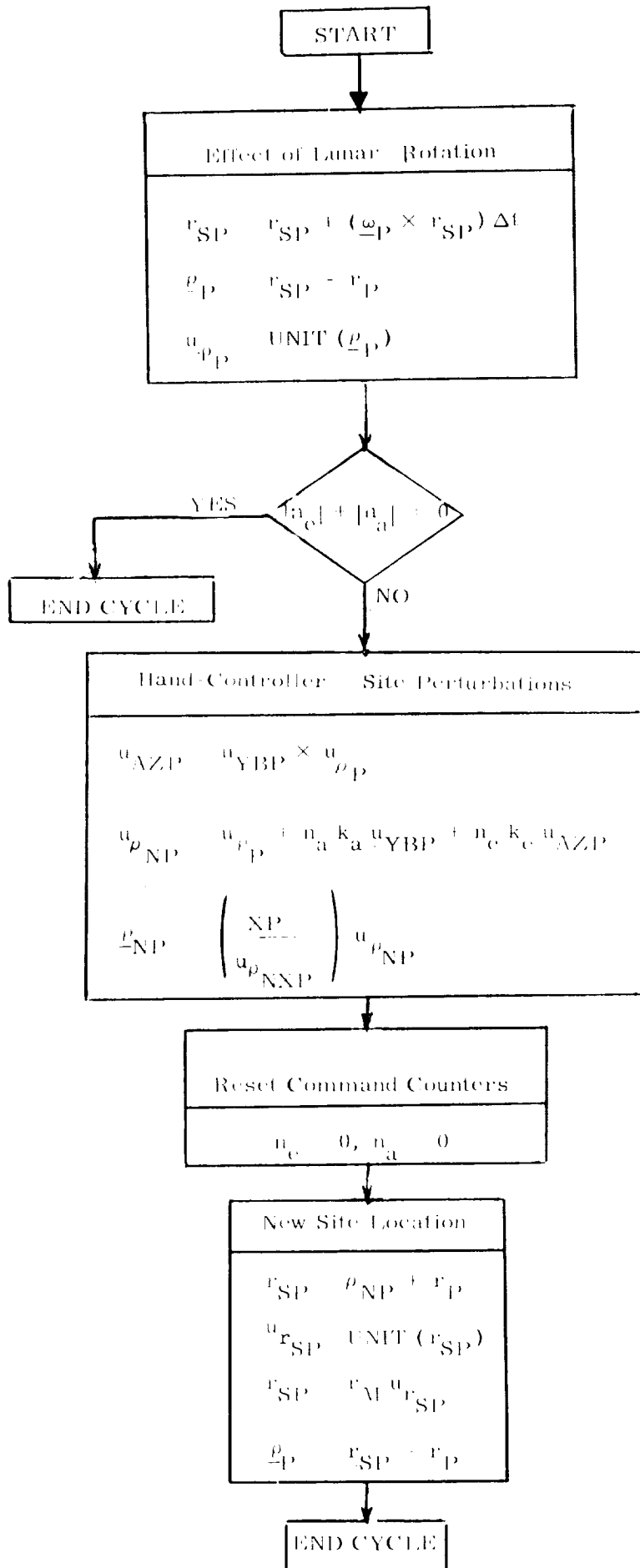

Figure 3.4.4-7 Site-Location Updating Routine

At this point in the routine the hand-controller command counts n_e and n_a are reset to zero values. The new site position vector is then computed, as shown in Fig. 3.4.4-7, using the new LOS position vector ($\underline{\rho}_{NP}$) and the current estimate of vehicle position (\underline{r}_P). The quantity r_M represents the radius of the moon at the initially selected site.

5.3.4.4.8 Guidance-to-Platform Transformation Routine

The command acceleration for the guidance system is computed in the guidance coordinate frame (subscript G). The vehicle state-vector estimate ($\underline{r}_P, \underline{v}_P$), on the other hand, is performed in the platform coordinate frame (subscript P). Likewise, the direction of the command thrust applied to the vehicle (\underline{u}_{FP}) must ultimately be computed in platform coordinates. The guidance-to-platform transformation routine shows how the required transformation matrices C_{GP} and its transpose C_{PG} can be computed. The information-flow diagram is given in Fig. 3. 4. 4-8.

The first step in the Guidance-to-Platform Transformation Routine is to compute the unit vector along the guidance-frame X-axis in platform coordinates (\underline{u}_{XGP}). This vector is directed along the up-to-date site-position (\underline{r}_{SP}), as obtained from the Site-Location Updating Routine.

The orientation of the guidance frame Y and Z axes are next determined by computing the vector distance \underline{d} which is a function of $\underline{r}_P, \underline{r}_{SP}, \underline{v}_P, \underline{\omega}_P, t_f$, and t , as shown in Fig. 3. 4. 4. 8. The vector \underline{d} is computed so as to be in the plane of the LM trajectory at the end of the current landing-maneuver phase. The unit vector \underline{u}_{XGP} is also in this plane. By taking the cross-product of \underline{u}_{XGP} and \underline{d} , the guidance-frame Y-axis (\underline{u}_{YGP}) is set up to be perpendicular to the vehicle-trajectory plane at the end of the phase. The guidance-frame Z-axis \underline{u}_{ZGP} is made perpendicular to the X and Y axes so as to form an orthogonal right-handed system.

The transformation matrix C_{GP} is then obtained as a matrix with $\underline{u}_{XGP}, \underline{u}_{YGP},$ and \underline{u}_{ZGP} as column vectors. The matrix C_{PG} is the transpose of C_{GP} , i. e. the vectors $\underline{u}_{XGP}, \underline{u}_{YGP},$ and \underline{u}_{ZGP} are its row vectors. It should be noted that the Guidance-to-Platform Routine is bypassed whenever the computed time-to-go (t_{GO}) for the current phase is less than or equal to ~~20~~ seconds.

1
I

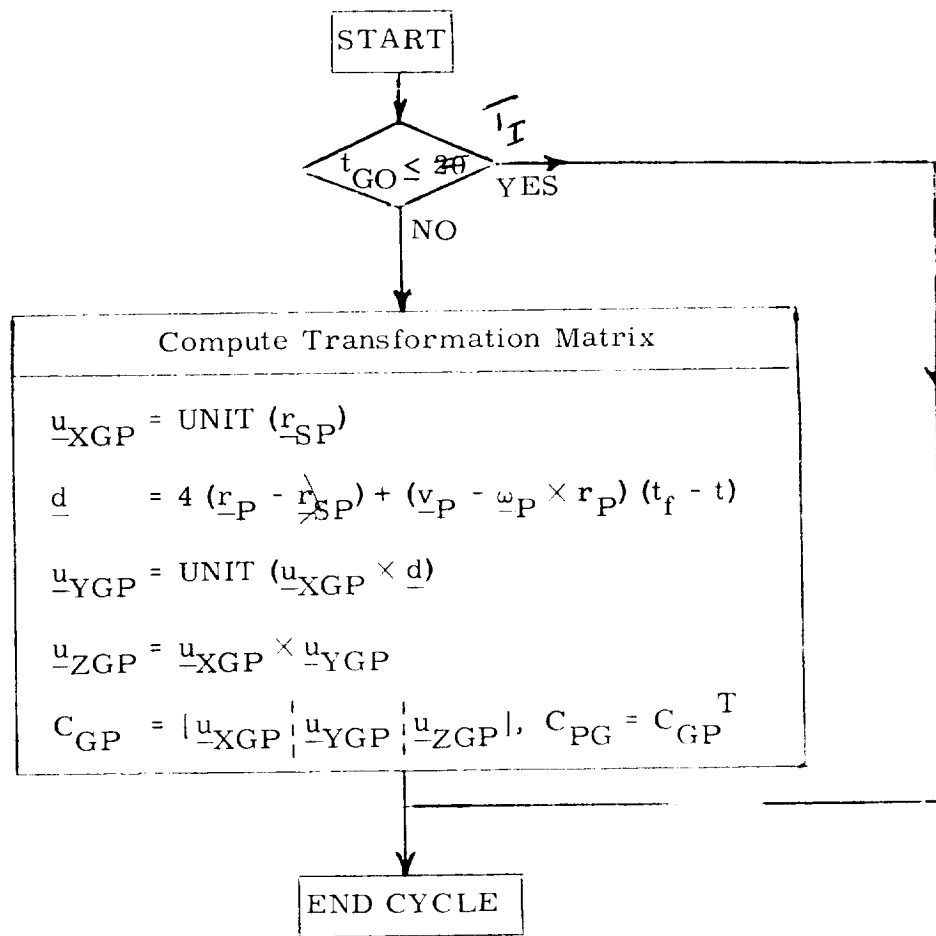

Figure 3.4.4-8 Guidance-to-Platform Transformation Routine

5.3.4.4.9 Vehicle-to-Platform Transformation Routine

In the powered landing guidance-and-navigation system it is necessary to transform quantities from vehicle (Nav. Base) coordinates to IMU (stable member) coordinates and vice-versa. The transformation matrices to accomplish this are C_{BP} (vehicle to IMU) and C_{PB} (IMU to vehicle).

The elements of C_{BP} , as shown in the diagram of Fig. 3. 4. 4-9, are the vehicle (Nav. Base) unit vectors expressed in the platform coordinate frame (\underline{u}_{XBP} , \underline{u}_{YBP} , \underline{u}_{ZBP}). The unit vectors \underline{u}_{XBP} , \underline{u}_{YBP} , \underline{u}_{ZBP} are obtained from the SMNB Routine (Sec. 5. 6. 2) as functions of the IMU gimbal angles.

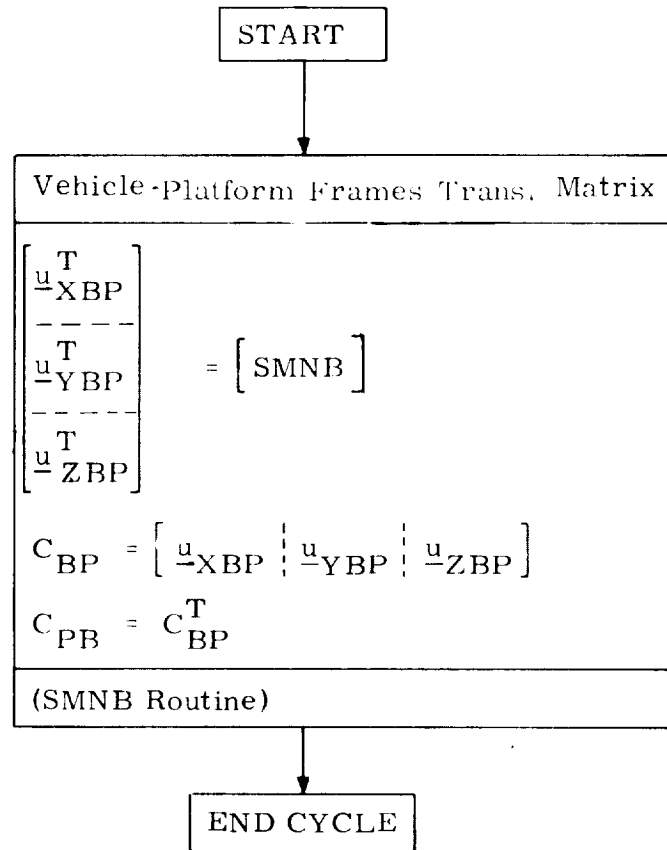

Figure 3. 4. 4-9 Transformation between Vehicle and Platform

5.3.4.4.10 Aim-Conditions Routine

The function of the Aim-Conditions Routine is to provide appropriate desired terminal values of LM position, velocity, acceleration, and jerk for the command acceleration relations, using the pre-stored aim conditions shown in Table 3.4.4-1. The Aim-Conditions Routine also provides an initial estimate for the terminal time of the current landing-maneuver phase.

The Aim-Conditions Routine is in effect a subroutine of the Guidance-and-Control Routine. The Aim-Conditions Routine, as can be seen on Fig. 3.4.4-11, is entered only when the aim-conditions flag (FLA) has a non-zero value. The mode selector in the Aim-Conditions Routine, as can be seen in Fig. 3.4.4-10, is a function of the phase of the landing maneuver and the setting of FLA. The values of FLA throughout the landing maneuver and the times at which FLA is reset are given in Table 3.4.4-2.

The Aim-Conditions Routine, as indicated in the information flow diagram of Fig. 3.4.4-10, has basically four different modes of operation. These will next be described in detail.

The first mode, shown on the far left-hand side of Fig. 3.4.4-10, is for the final-descent phase (Phase = 4). During this phase the velocity-following guidance law is used (see Fig. 3.4.4-11) in which the command specific force is determined so that the LM achieves a preselected desired velocity (v_{DG}). At the start of the final-descent phase the Aim-Conditions Routine is entered and the velocity is set at 5 ft/sec. downward along the local vertical direction (u_{rG}). Then, at an estimated altitude of 50 feet, the Aim-Conditions Routine is entered again and the desired descent velocity is reset to 3 ft/sec. During this mode the horizontal velocity is controlled to be zero.

Aim Conditions for Guidance System

1) Ullage-and-Trim Phase:

Aim Condition	Ullage Ph.	Trim Ph.
Specific Force	s_u	s_t
Time Duration	τ_{ul}	τ_t

2) Braking and Visibility Phases:

Aim Condition	High-Gate Point	Low-Gate Point
Position (G-Frame)	r_{OFG}	r_{2FG}
Velocity (G-Frame)	v_{OFG}	v_{2FG}
Acceleration (G-Frame)	a_{OFG}	a_{2FG}
Down-Range Jerk (G-Frame)	j_{OFZG}	j_{2FZG}
Initial Time-to-Go	τ_{OF}	τ_{2F}

3) Transition Phases:

Aim Condition	Trans. I	Trans. II
Acceleration (G-Frame)	a_{1FG}	a_{3FG}
Time Duration	τ_{tr1}	τ_{tr2}

4) Final Descent Phase:

Aim Condition	Alt. > 50 ft.	Alt. < 50 ft.
Rate of Descent	v_{v1}	v_{v2}

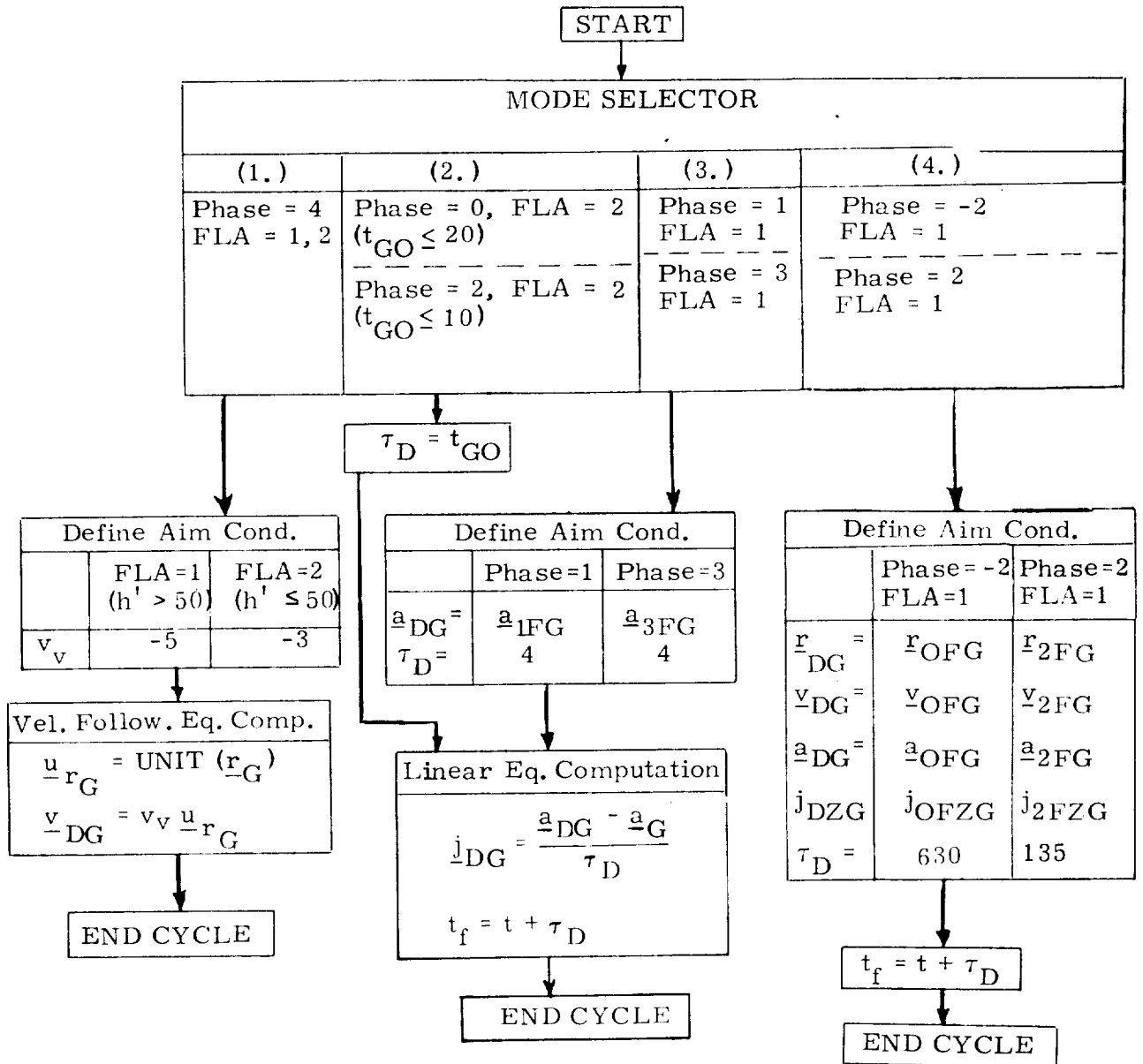

Figure 3.4.4-10 Aim Conditions Routine

Table 3. 4. 4-2 Values of FLA and Times at which it is Reset during Powered Landing Maneuver

Phase	Time of Change	New FLA
-2	Initial Setting	0
-2	$t_{ph} = 0$	1
-2	Next cycle after $t_{ph} = 0$	0
0	$t_{GO} \leq 20$	2
0	Next cycle after $t_{GO} \leq 20$	0
1	$t_{ph} = 0$	1
1	Next cycle after $t_{ph} = 0$	0
2	$t_{ph} = 0$	1
2	Next cycle after $t_{ph} = 0$	0
2	$t_{GO} \leq 10$	2
2	Next cycle after $t_{GO} \leq 10$	0
3	$t_{ph} = 0$	1
3	Next cycle after $t_{ph} = 0$	0
4	$t_{ph} = 0$	1
4	Next cycle after $t_{ph} = 0$	0
4	$h' < 50$	2
4	Next cycle after $h' < 50$	0

The next two modes in the Aim-Conditions Routine (second and third from left side of Fig. 3. 4. 4-10) relate to the linear command specific force guidance modes. The command acceleration in these modes (\underline{a}_G) is given by:

$$\underline{a}_G = \underline{a}_{DG} + \underline{j}_{DG} (t - t_f) \quad (3. 4. 4. 4)$$

where \underline{a}_{DG} and \underline{j}_{DG} are the desired terminal values of LM acceleration and jerk for the phase of interest, expressed in the guidance frame. The quantities t and t_f represent the present and terminal values of time for the phase of interest. The function of the Aim-Conditions Routine during these linear-guidance modes is to provide values for \underline{a}_{DG} , \underline{j}_{DG} , and t_f .

In the case of the linear-acceleration transition phases (Phase = 1, 3) the Aim-Conditions Routine is entered at the start of the phase to define the desired acceleration in guidance coordinates (\underline{a}_{DG}) and the duration of the phase (τ_D). The desired ~~terminal~~ jerk in guidance coordinates (\underline{j}_{DG}) is then obtained from \underline{a}_{DG} , τ_D , and the current LM command acceleration \underline{a}_G . The terminal time (t_f) is then obtained from the current time (t) and the phase duration (τ_D). In the case of the linear-acceleration periods at the ends of the braking and visibility phases, the Aim-Conditions Routine is entered at the start of the period, and \underline{a}_{DG} , \underline{j}_{DG} , and t_f are computed as for the transition phases. The only difference here is that the value used for τ_D is the current computed value of time-to-go (t_{GO}). It should be noted here that the values used for \underline{a}_{DG} in these two cases are those previously defined for the phases of interest.

The fourth mode of the Aim-Conditions Routine (the one on the right side of Fig. 3. 4. 4-10) relates to the quadratic command acceleration guidance modes. The command acceleration in these modes (\underline{a}_G) is given by the relation:

$$\underline{a}_G = \underline{a}_{DG} - \frac{6 (\underline{v}_G - \underline{v}_{DG})}{(t_f - t)} - \frac{12 (\underline{r}_G - \underline{r}_{DG})}{(t_f - t)^2} \quad (3.4.4.5)$$

where \underline{a}_{DG} , \underline{v}_{DG} , and \underline{r}_{DG} represent the desired terminal acceleration, velocity, and position in the guidance frame. The quantities \underline{r}_G and \underline{v}_G represent the LM position and velocity expressed in the guidance frame. The quantity t_f represents the terminal time for the phase of current interest, and t is the present time. The function of the Aim-Conditions Routine is to provide up-to-date values for \underline{a}_{DG} , \underline{v}_{DG} , \underline{r}_{DG} , and t_f in the current landing-maneuver phase.

The fourth mode of the Aim-Conditions Routine is entered at the start of the pre-ignition phase (Phase = -2, FLA = 1), and finally at the start of the visibility phase (Phase = 2, FLA = 1). The first operation performed after this mode is entered, as can be seen in Fig. 3.4.4-10, is to define the current phase position, velocity, and acceleration aim-conditions (\underline{r}_{DG} , \underline{v}_{DG} , and \underline{a}_{DG}). Then, values are defined for the component of desired terminal jerk along the guidance-frame Z-axis (j_{DZG}), and the duration of the current phase (τ_D). Finally, a computation is made of the terminal time for the phase of current interest (t_f).

5.3.4.4.11 Guidance-and-Control Routine

The Guidance-and-Control Routine computes the command specific force vector (\underline{s}_P) for the LM during the powered landing maneuver. From the command specific force (\underline{s}_P), the desired thrust-vector orientation (\underline{u}_{FP}) and the throttle commands (f_{th}) are obtained. The information-flow diagram for the Guidance-and-Control Routine is shown in Fig. 3.4.4-11.

The first step in the Guidance-and-Control Routine, as indicated in Fig. 3.4.4-11, is to update the aim conditions for the command-specific-force relations, and to recompute the orientation of the guidance-frame coordinate axes. These aim conditions are the desired values of position, velocity, acceleration, and down-range jerk ($\underline{r}_{DG}, \underline{v}_{DG}, \underline{a}_{DG}, j_{DZG}$). The decision to update aim conditions is controlled by the aim-conditions flag (FLA). It is only when FLA has a non-zero value that the aim-conditions routine (Section 5.3.4.4.10) is entered. The sequence of values for FLA during the landing maneuver is shown in Table 3.4.4-2. The updating procedure is described in Section 5.3.4.4.10.

The vehicle command acceleration (from which the command specific force is obtained) is computed in the guidance coordinate frame (subscript G). The LM state vector, on the other hand, as was noted in Sec. 5.3.4.4.4 is updated in the platform frame (subscript P). Accordingly, the next operation performed in the Guidance-and-Control Routine is to transform the current estimated state from the platform frame ($\underline{r}_P, \underline{v}_P$) to the guidance frame ($\underline{r}_G, \underline{v}_G$), as indicated in Fig. 3.4.4-11. The transformation matrix between guidance and platform coordinates (C_{GP}), as obtained from the ~~Aim-Conditions Routine~~ is used in this operation.

*Guidance to Platform Routine
(5.3.4.4.8)*

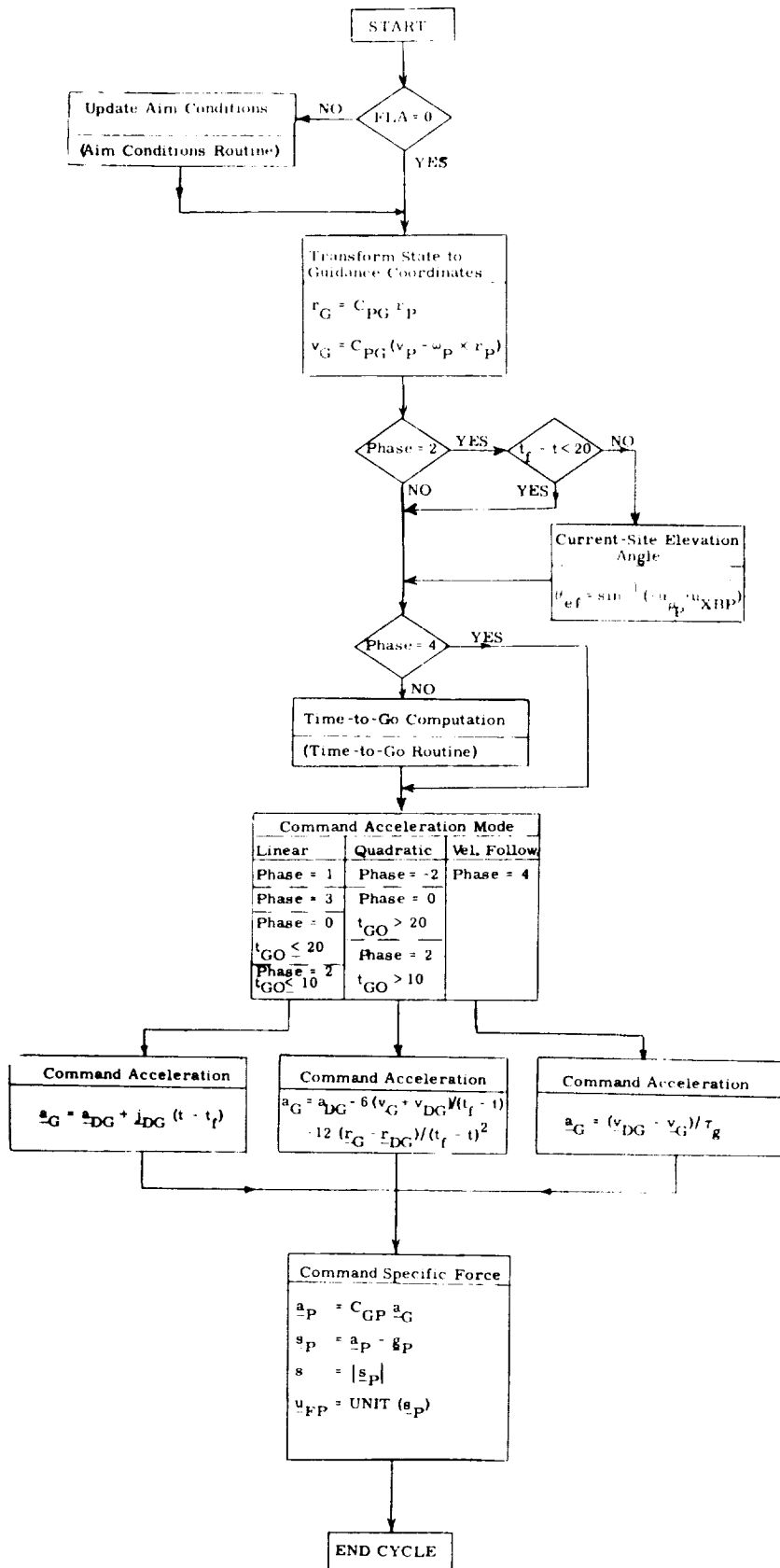

Figure 3. 4. 4-11 Guidance and Control Routine

At this point in the Guidance-and-Control Routine, a test is made to see if the LM is in the visibility phase of the landing maneuver. If the LM is in this phase and time remaining for the phase ($t_f - t$) is greater than 20 seconds, then a computation is made of the current-site elevation angle ($\theta_{e\ell}$) with respect to the plane defined by the vehicle Y and Z axes, as shown in Fig. 3. 4. 4-11. The direction of the line-of-sight to the current landing site ($\underline{u}_{\rho P}$) is used in this computation as obtained from the Site-Location Updating Routine. The quantity \underline{u}_{XBP} represents a unit vector along the vehicle's X-axis.

The next operation in the routine is to compute the time-to-go for the LM from its present location to the current aim point. This computation is required in the command-acceleration relations for all of the phases of the landing maneuver except the final descent phase. The time-to-go computation is performed in the Time-to-Go Routine (Sec. 5. 3. 4. 4. 12).

At this point in the routine the command-acceleration mode to be used in the current computation cycle is selected. Three different choices are possible: the acceleration (\underline{a}_G) may be computed to provide LM acceleration profiles that vary either as linear or quadratic functions of time-to-go for the phase, or \underline{a}_G may be computed to provide a constant LM velocity.

In the linear mode, the acceleration command (\underline{a}_G) is determined so that the vehicle acceleration is a linear function of the time-to-go to the end of the phase, as indicated in Fig. 3. 4. 4-11. The desired aim acceleration (\underline{a}_{DG}) and jerk (\underline{j}_{DG}) are obtained from the Aim-Conditions Routine (Sec. 5. 3. 4. 4. 10). The terminal time (t_f) is obtained from the Time-to-Go Routine (Sec. 5. 3. 4. 4. 12). The linear mode is used during both transition phases (Phase = 1, 3), the last 20 seconds of the braking phase (Phase = 0), and the last 10 seconds of the visibility phase (Phase = 2).

The command acceleration for the quadratic mode is computed to provide a LM acceleration profile that is a quadratic function of the time-to-go to the end of the phase of current interest. The required relation is shown in Fig. 3.4.4-11 in terms of the current vehicle state (\underline{r}_G , \underline{v}_G) and the desired aim conditions (\underline{r}_{DG} , \underline{v}_{DG} , and \underline{a}_{DG}). The terminal time (t_f) is computed in the Time-to-Go Routine so that a specified value of jerk along the guidance frame Z-axis at the end of the phase (j_{DZG}) is obtained. The quadratic guidance law is used throughout the pre-ignition phase, during the braking phase except for the last 20 seconds, and during the visibility phase except for the last 10 seconds.

In the velocity-following mode, as shown in Fig. 3.4.4-11, the acceleration command (\underline{a}_G) is determined so that the vehicle's velocity (\underline{v}_G) during the descent has a desired value (\underline{v}_{DG}) determined from the Aim-Conditions Routine. The coefficient in the command acceleration relation (τ_g) controls the rate at which the desired velocity is obtained during the descent phase. The velocity-following mode is used only in the final descent phase.

The command specific force in platform coordinates (\underline{s}_P) is obtained by first transforming the command acceleration from guidance coordinates (\underline{a}_G) to platform coordinates (\underline{a}_P). The transformation matrix from guidance to platform coordinates C_{GP} is used here. The computed acceleration of the vehicle due to the lunar gravitational field (\underline{g}_P) is then subtracted from (\underline{a}_P) to obtain the required command specific force (\underline{s}_P). The required thrust direction (\underline{u}_{FP}) is along the direction of \underline{s}_P .

5.3.4.4.12 Time-to-Go Routine

The command specific force equations, as shown in Fig. 3.4.4-11, require that the time-to-go-to the end of the current phase ($t_f - t$) be computed. The routine for accomplishing this is called the Time-To-Go Routine. The information-flow diagram for the routine is shown in Fig. 3.4.4-12.

Two different methods for computing time-to-go (t_{GO}) are employed. When the quadratic-acceleration guidance law is used, t_{GO} is computed by a Newton-Raphson iterative process so that the estimated component of jerk along the guidance-frame Z-axis at the end of the phase has a preselected value. This mode, as can be seen in Fig. 3.4.4-12, is used during the pre-ignition phase, the braking phase except for the last 20 seconds, and during the visibility phase except for the last 10 seconds. At all other times during the landing maneuver the time-to-go is simply obtained by taking the difference between the current estimate of terminal time for the phase (t_f) and the present time (t). The values used here for t_f during the transition phases are obtained from the aim-conditions routine (Section 5.3.4.4.10). During the last 20 seconds of the braking phase and last 10 seconds of the visibility phase, the value used for t_f is the one obtained on the last Newton-Raphson computation cycle.

The Newton-Raphson iterative procedure for computing t_{GO} and t_f will be next described. The incremental change in time-to-go (t_{GO}) is computed from the ratio of the difference between the predicted and desired down-range jerk components at the end of the phase ($j_{FZG} - j_{DZG}$) to the rate-of-change of predicted terminal jerk (j_{FZG}) with respect to time-to-go (i. e. $\partial j_{FZG} / \partial t_{GO}$). This quantity as shown in Fig. 3.4.4-12, is expressed as the ratio of two polynomial functions of t_{GO} . The quantities v_{DZG} , a_{DZG} and j_{DZG}

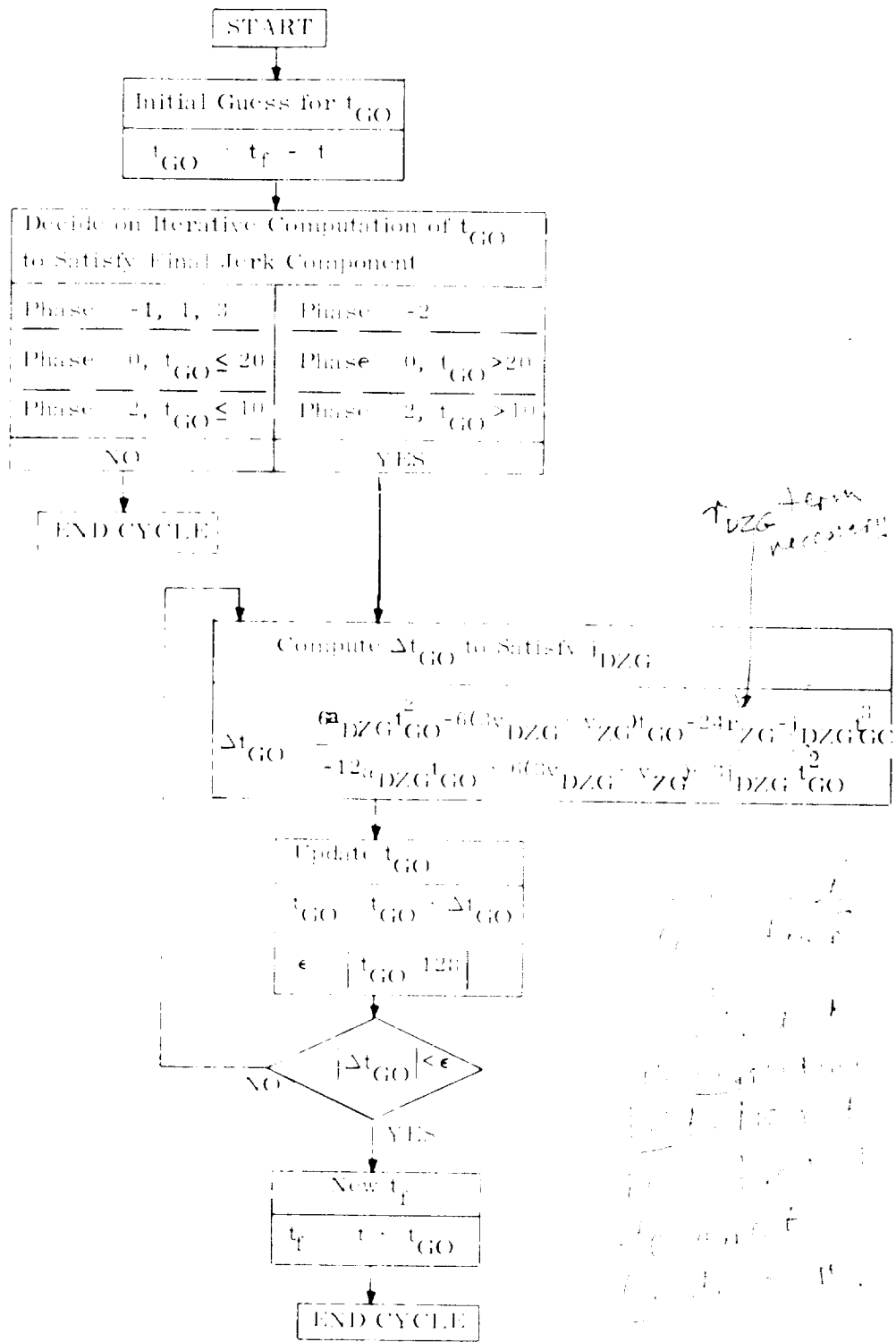

FIG. 3.4.4-12

Iterative Computation

represent the desired final values of velocity, acceleration, and jerk respectively for the phase of interest along the guidance-frame Z-axis. The quantities r_{ZG} and v_{ZG} represent the components of present vehicle position and velocity in the guidance frame along the Z-axis.

The up-to-date estimate of t_{GO} is obtained by adding the incremental change (Δt_{GO}) to the previous t_{GO} estimate. A check is then made to see if Δt_{GO} is less than $t_{GO}/128$. If the test is not satisfied, the iteration cycle is repeated until the test is finally satisfied. Usually this test is satisfied on the first iteration cycle, except for the first t_{GO} -computation cycle for a given phase. The up-to-date estimate of final time for the phase of interest (t_f) is now computed from t and t_{GO} , which completes the cycle through the Time-to-Go Routine.

5.3.4.4.13 Attitude Command Routine

The vehicle's orientation during the powered landing maneuver is determined by specifying the desired directions for the thrust vector (\underline{u}_{FP_d}) and the vehicle's Y-axis (\underline{u}_{YBP_d}). Both of these unit vectors, as can be seen, are in the IMU coordinate system (subscript P). By specifying the thrust direction, the X-axis orientation is also specified within the thrust-vector displacement required to correct c. g. offsets in the vehicle.

The primary computations performed in the Attitude-Command Routine, as can be seen from the information-flow diagram of Fig. 3.4.4-13, relate to the yaw-attitude command, i. e. the orientation of \underline{u}_{YBP_d} . The preferred thrust vector orientation (\underline{u}_{FP_d}) is simply along the direction of command specific force (\underline{u}_{FP}) computed in the Guidance-and-Control Routine (Section 5.3.4.4.11).

There are basically five different yaw-command modes in the Attitude-Command Routine. These modes are most conveniently referred to as follows:

- (1) Hold attitude
- (2) X-axis over-ride
- (3) Line-of-sight (LOS) in XB-ZB plane
- (4) Window up

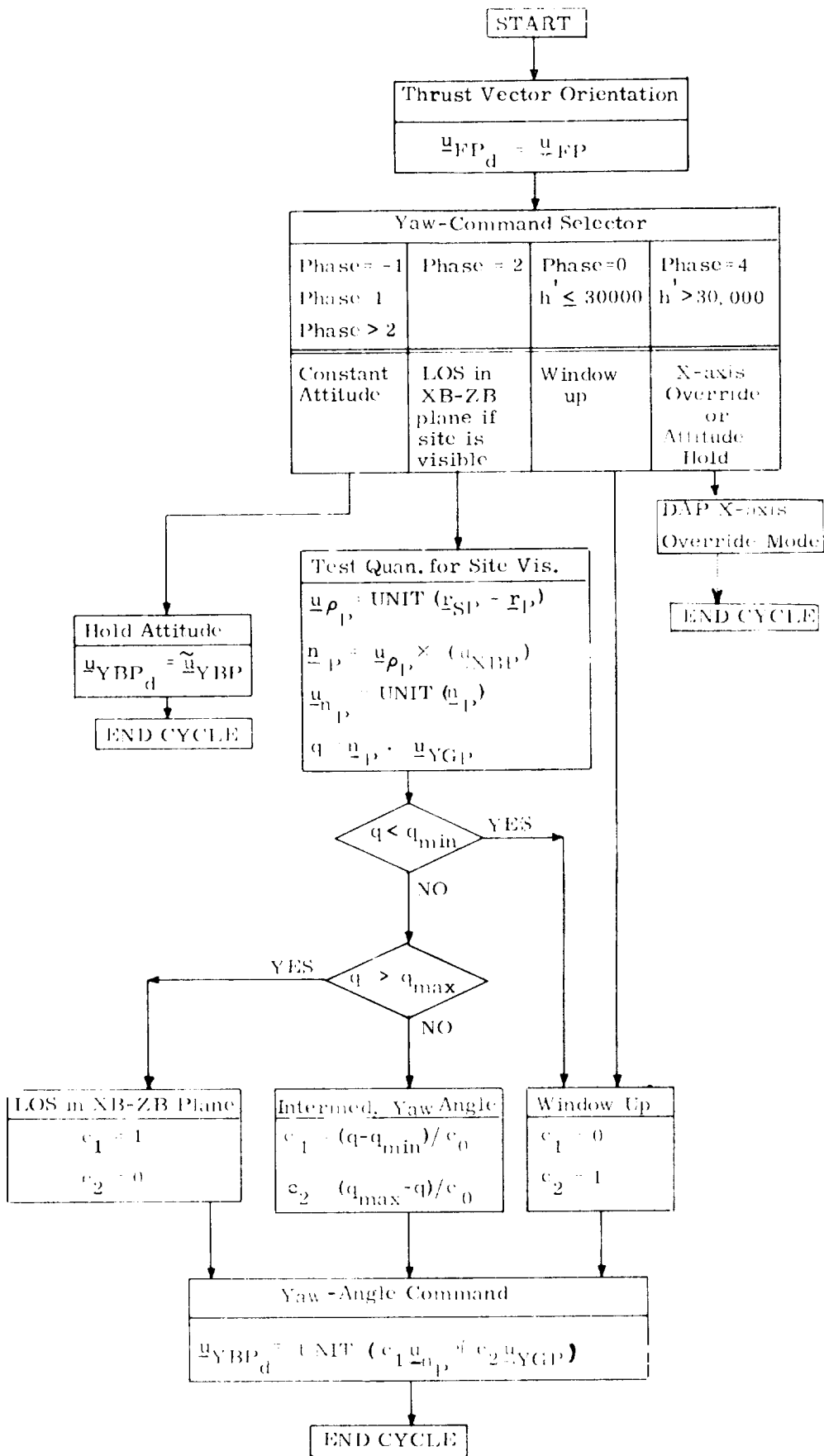

Fig. 3.4.4-13

Attitude Command Routine

(5) Intermediate yaw angle between LOS in XB-ZB plane and window-up orientation

The hold-attitude mode, as indicated in Fig. 3. 4. 4-13, is used in the ullage-and-trim phase, the two transition phases, and the final-descent phase (Phase = - 1, 1, 3, and 4). The present measured Y-axis orientation (\tilde{u}_{YBP}) is simply held fixed here.

The X-axis over-ride option is provided to the astronaut during the braking phase when the estimated LM altitude is greater than 30,000 feet. The X-axis over-ride flag (FLXOV) is used in Fig. 3. 4. 4-13 to indicate this option. The yaw command in this mode is simply that provided by the astronaut (u_{YBPc}).

During the visibility phase of the landing maneuver the vehicle may either be given a yaw command to hold the LOS in the XB-ZB plane, to hold the window up, or to yaw to an intermediate angle between the one for the LOS in XB-ZB plane and the window up. The choice of yaw command is based on the orientation of the LOS with respect to the edge of the LM window. This is determined in the Attitude-Command Routine of Fig. 3. 4. 4-13 by first computing the direction of the line-of-sight ($u_{\rho P}$). A vector related to the depression angle (n_P) of the line-of-sight below the vehicle X-axis (u_{XBP}) is next determined.

The test for yaw-control mode during the visibility phase is based on the projection of the depression-angle vector (i. e. n_P) along the guidance-frame Y-axis (u_{YGp}). If the test quantity q is less than a predetermined number q_{min} , then it is assumed that the LOS is not near the window edge. Under these conditions the window-up mode is used, which means that the coefficients c_1 and c_2 in Fig. 3. 4. 4-13 are set at 0 and 1, respectively. The resultant yaw-angle command (u_{YBPd}) in this case is to orient the vehicle

- Y-axis along the direction of the Y-axis of the guidance frame (\underline{u}_{YGP}), which is essentially a window-up orientation. The same window-up yaw command is used during the latter part of the braking phase when the estimated altitude (h') is less than 30,000 feet.

When the yaw-command test quantity (q) is greater than a preselected number q_{\max} (which is equal to the \sin of 25 degrees), it is deduced that the LOS will be visible to the astronaut in the window. In this case the coefficients c_1 and c_2 are set to 1 and 0, respectively. The resultant vehicle yaw command in this case orients the vehicle Y-axis parallel to the direction of \underline{n}_p , which causes the LOS to lie in the vehicle XB-ZB plane. The vector \underline{n}_p , as can be seen in Fig. 3.4.4-13, is perpendicular to the plane of the LOS and the vehicle X-axis.

Under conditions where the test quantity (q) lies between the preselected q_{\max} and q_{\min} , an intermediate yaw angle orientation which lies between the window-up and LOS in XB-ZB plane orientations is used. The coefficient c_0 in this case is equal to the difference $q_{\max} - q_{\min}$. The coefficients c_1 and c_2 will be between zero and one. The transition, in this case is smooth and continuous between the window-up and LOS in XB-ZB plane orientation modes.

5.3.4.4.14 Throttle-Command Routine

The Throttle-Command Routine determines the value of thrust at which the throttle should be set (f_{th}). The values used for f_{th} are different from those obtained from the command specific force equations because of operational restrictions on the descent propulsion system (DPS). The restrictions are that the DPS can either be operated at a constant thrust level corresponding to 92.5 percent of the nominal maximum thrust (i. e. at about 9710 pounds), or it can be continuously throttled in the range between 10 and 58 percent of nominal maximum thrust.

The throttle command logic used to operate the DPS under these restrictions is shown in Fig. 3. 4. 4-14. The essential elements of the throttle-command system are:

- (1) If f is greater than 6090 pounds, then f_{th} is 9710 pounds.
- (2) If f is less than 1050 pounds, then f_{th} is 1050 pounds.
- (3) If f lies between 1050 and 5250 pounds, then $f_{th} = f$.
- (4) If f lies between 5250 and 6090 pounds, then f_{th} can have one of two values, depending on the throttle-command flag (FLTH). If FLTH = 0, then $f_{th} = 9710$; if FLTH = 1, then $f_{th} = f$.

The throttle-setting flag (FLTH) starts with a zero value. It is set equal to unity thereafter whenever the command thrust (f) drops below 5250 pounds (if it is not already unity); it is reset to zero whenever the command thrust increases above 6090 pounds. By allowing the command thrust (f) to vary over a range of thrust value (between 5250 and 6090 pounds) before the flag FLTH is changed in value (i. e. reset), the number of times that f_{th} jumps between 9710 pounds and the permissible 10-58 percent continuously-throttleable region is minimized.

5.3.4.4.15 Rate of Descent and Manual Landing Modes

At any time during the lunar landing maneuver the astronaut can select a semi-manual control mode referred to as the Rate of Descent (ROD) Routine. This control mode is normally considered one of three alternate final landing modes initiated after, or near, the Low-Gate aim conditions. During the ROD mode, the astronaut manually controls the vehicle attitude and the LGC controls the DPS throttle such that the vertical velocity condition existing when the mode was initiated is automatically

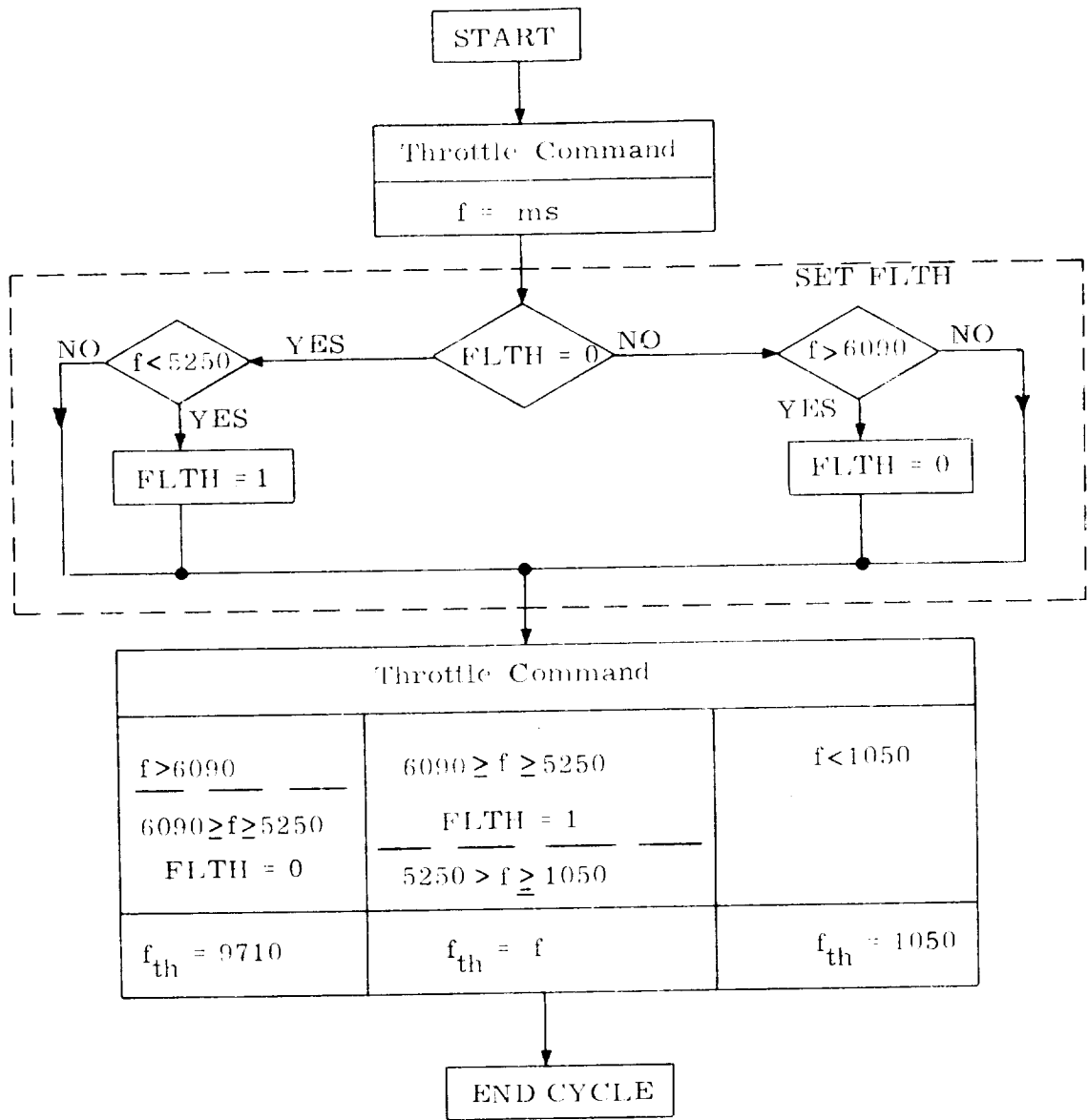

Fig. 3.4.4-14 Throttle Command Routine

maintained. The vertical velocity or rate of descent can be modified by astronaut inputs in the form of incremental discrete signals representing 1 ft/sec changes per signal.

The LGC information flow diagram for the ROD landing mode is shown in Fig. 3.4.4-15. The ROD mode is initiated during the landing maneuver when the astronaut changes the attitude control switch from Automatic to Attitude Hold, but leaves the DPS throttle switch in the Automatic position. As shown in Fig. 3.4.4-15, the LGC first determines the vertical velocity (ROD) when the mode was initiated at time t_0 , based on the last state vector estimate from the State Vector Update Routine of Section 5.3.4.4.4. It might be noted that this state vector may not be current by as much as the basic computation cycle (2 sec.).

The initial ROD, \dot{h}_0 , is determined as shown and is defined as negative for a downward velocity closing with the lunar surface. On the next computation cycle of the State Vector Update Routine the vehicle state vector is advanced to the current time and updated by LR data if acceptable. The current ROD, \dot{h} , is computed from this updated state vector and then compared with the desired ROD, \dot{h}_D . The desired ROD is the sum of the initial \dot{h}_0 and the input accumulated ROD switch increments $\Delta\dot{h}$ controlled by astronaut. The required commanded specific force, s , is then computed as shown in Fig. 3.4.4-15 where a_v is the required vertical acceleration over the control period τ_A . The quantities \underline{u}_{Fj} and \underline{u}_{hl} represent the thrust and vehicle position unit vectors respectively referenced to the platform coordinate system. The required DPS thrust acceleration is then used as the input to the Throttle Command Routine of Section 5.3.4.4.14. As illustrated in Fig. 3.4.4-15, the above computation sequence is repeated until the routine is stopped by an ENTER signal from the astronaut after lunar touchdown.

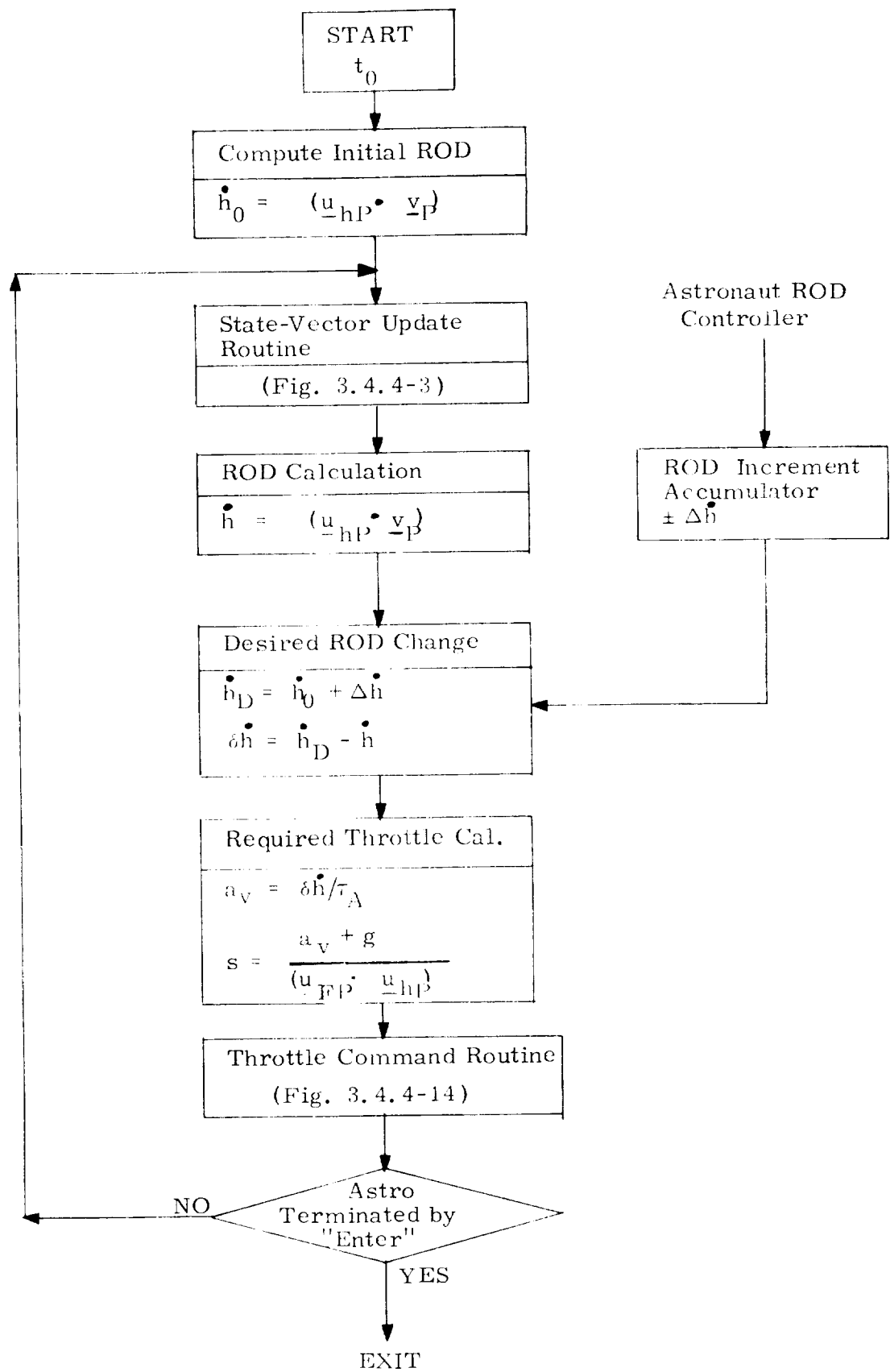

Fig. 3.4.4-15 Rate of Descent (ROD) Lunar Landing Mode

If the astronaut places the attitude control switch in the Attitude Hold position, and then the DPS throttle switch in the Manual position during the landing maneuver, the vehicle is under complete manual control. The only LGC function during this mode of operation is to update the vehicle state vector with the State-Vector Update Routine and provide required display functions described in the following section. During this manual mode of operation, LR data are used by the State-Vector Update Routine to update the state vector for abort and display functions. These functions are terminated at lunar landing by an astronaut ENTER command as in the ROD Routine.

During the ROD (P-66) and Manual (P-67) landing modes a special astronaut controlled state vector update function is available. This special update function sets all three of the vehicle velocity components relative to the lunar surface to zero when the astronaut achieves this condition by manual or semi-manual control and indicates the zero velocity condition to the LGC by a specific extended verb DSKY entry. This velocity nulling process is illustrated in Fig. 3.4.4-3 of the State-Vector Update Routine as the last computation function indicated.

It might be noted that once the ROD or manual landing modes (P66 and P67) have been selected, the astronaut can not return to the LGC automatic landing modes P63, P64 and P65 of Chapter 4.

5.3.4.4.16 Landing Maneuver Display Computations

During the lunar landing maneuver the LGC is required to provide digital displays on the DSKY and drive analog type vehicle meters.

DSKY Display Parameters

The following digital display parameters are required for the lunar landing programs P-63 to P-67 as automatic or callable DSKY displays as specified in Section 4.

1. TFI: Time from DPS ignition.
Time from DPS ignition is merely a total of the accumulated maneuver time.
2. t_{GO} : Time-to-Go
Time-to-go is the computed time remaining in a given mission phase as determined by the Time-to-Go Routine of Section 5.3.4.12.
3. ΔV_m : Measured or accumulated ΔV
Measured maneuver ΔV magnitude in ft/sec.
4. v : Inertial Velocity
Magnitude of vehicle inertial velocity
5. h : Altitude
Altitude above the landing site radius magnitude
6. \dot{h} : Altitude Rate
Altitude rate as derived from the current state vector

7. Δh : Altitude Difference

The quantity $(\tilde{q}'_u - q'_u)$ in the Update Position function of Fig. 3.4.4-3 where \tilde{q}'_u is the altitude derived from LR range data and q'_u is the estimated altitude from the state vector

8. LONG : Longitude

Vehicle lunar longitude computed from the Latitude Longitude Routine of Section 5.5.3 for the current state vector.

9. RANGE : Range to the Landing Site

Slant range from the LM to the landing site

$$\text{RANGE} = |\underline{\rho}_P|$$

where slant range $\underline{\rho}_P$ is defined in Section 5.3.4.4.7.

10. ΔV_R : ΔV Remaining

Approximate DPS characteristic velocity remaining, as computed from the following expression:

$$\Delta V_R = \Delta V_{REF} - \Delta V_m \quad (3.4.4.6)$$

where ΔV_{REF} = Maximum DPS ΔV allocated for the lunar landing maneuver.

11. LPD Angle

Elevation angle of the current landing site referenced to the Landing Point Designator. This parameter is θ_{el} of Fig. 3.4.4-11.

12. MARGIN - Hover Time Remaining

This parameter is displayed in P-64, and represents the approximate hover time in minutes and seconds that would be available if the current automatic landing maneuver were allowed to continue to completion. This parameter is computed as follows:

$$\text{MARGIN} = t_{\text{REF}} - k_1 \Delta\text{MAN} \quad (3.4.4.7)$$

where

t_{REF} = Initial nominal Phase 2 hover time

k_1 = 0.84

ΔMAN = $(t_{\text{HG}} + t_{\text{GO}}) - t_{\text{P2}}$

t_{HG} = current time from High Gate

t_{GO} = time to go from Section 5.3.4.4.12

t_{P2} = nominal maneuver time for Phase 2

This parameter is primarily useful in landing site redesignation cases using the LPD, and is displayed for a period of four seconds after the redesignation.

13. v_{HP} : Horizontal Velocity

The horizontal velocity component of the current velocity vector as derived in Eq. 3.4.4.9 for the analog display parameters.

14. Forward Velocity

The modified forward horizontal velocity component as computed by Eq. 3. 4. 4. 11 for the analog display parameters

15. Lateral Velocity

The modified lateral horizontal velocity component as computed by Eq. 3. 4. 4. 11 for the analog display parameters.

It might be noted that the above DSKY displays are updated approximately once every two seconds.

Analog Display Parameters

The LGC is required to drive four analog displays in all landing maneuver phases if selected to do so by the astronaut. A description of the LGC computational requirements for these analog displays is as follows:

1. h: Altitude

This parameter is the estimated local altitude as derived from the difference between the current position vector (see State-Vector Update Routine of Section 5. 3. 4. 4. 4) and the landing site radius value. The LGC drives a digital tape meter with this parameter scaled at 2. 34 feet per bit over a range of 0 to 60, 000 feet.

2. \dot{h} : Altitude Rate

The altitude rate is computed from the current velocity and position state vectors (Section 5.3.4.4.4). The LGC drives a digital tape meter with this parameter scaled at 0.5 ft/sec. per bit over a range of ± 500 ft/sec.

3. Forward Velocity and Lateral Velocity

The LGC drives two analog meters through the RR CDU digital to analog networks to provide an indication of horizontal velocity conditions. The coordinates and display requirements for this function are defined in ICD LIS-540-100001 Section 1.2.3. The two display parameters essentially represent the local horizontal velocity component resolved as a function of vehicle yaw angle from the initial LM descent plane. The LGC computations required for these displays are as follows:

The reference horizontal coordinates of the local vertical system are defined as:

$$\underline{u}_{\text{HYP}} = \text{UNIT} (\underline{v}_{0P} \times \underline{r}_{0P}) \quad (3.4.4.8)$$

$$\underline{u}_{\text{HZP}} = \text{UNIT} (\underline{r}_P \times \underline{u}_{\text{HYP}})$$

where \underline{r}_{0P} and \underline{v}_{0P} are the initial LM position and velocity vectors at DPS ignition referenced to the IMU or Platform Coordinate system, and \underline{r}_P is the current LM position vector.

The horizontal component of the current velocity vector, \underline{v}_{HP} is determined from:

$$\underline{u}_{HP} = \text{UNIT} \left[(\underline{u}_{RP} \times \underline{u}_{VP}) \times \underline{u}_{RP} \right] \quad (3.4.4.9)$$

$$\underline{v}_{HP} = \left[(\underline{v}_P - \underline{\omega}_P \times \underline{r}_P) \cdot \underline{u}_{HP} \right] \underline{u}_{HP}$$

where $\underline{\omega}_P$ is the lunar rotation rate used in the same manner as the LR state update computation of Section 5.3.4.4.4. The quantity \underline{u}_{VP} is a unit vector along the LM velocity vector.

The horizontal velocity expressed in the reference horizontal coordinates is:

$$v_{HZ} = \underline{v}_{HP} \cdot \underline{u}_{HZP} \quad (3.4.4.10)$$

$$v_{HY} = \underline{v}_{HP} \cdot \underline{u}_{HYP}$$

The display parameters are then computed as follows:

$$\text{Forward velocity} = v_{HZ} \cos \text{AOG} - v_{HY} \sin \text{AOG} \quad (3.4.4.11)$$

$$\text{Lateral Velocity} = v_{HZ} \sin \text{AOG} + v_{HY} \cos \text{AOG}$$

where AOG is the IMU outer-gimbal angle, which is representative of the vehicle yaw angle measured from the initial LM descent plane.

The forward and lateral velocity parameters are to be scaled for a range of ± 200 ft/sec.

The desired LGC update rate of the above four analog display parameters is once every two seconds in the braking phase (P63), once every second in the visibility phase (P64), and four times every second during the three possible terminal landing phases P65, P66, and P67. Display rates greater than once every two seconds will require the state vector extrapolation computation of the State-Vector Update Routine. At the present time it is not known if the LGC can update these display parameters at the desired rates due to computation time limits during the time-critical landing maneuver. The LGC display capability will be determined in hybrid-simulation evaluations during the landing program verification, and the above display update rates will be achieved if possible.

5.3.4.4.17 Post Landing Sequences and Procedures

The three terminal landing programs P65, P66, and P67 are all terminated by a DSKY ENTER signal after lunar touchdown. At this time all landing maneuver programs are terminated. The Average-G Routine is allowed to cycle to the next PIPA processing time to establish the landing condition vehicle state vector and reference time. This final LM state vector is then reinitialized to known lunar conditions by preserving the position vector components as determined by the Average-G Routine, and then setting the velocity components of the state vector to the lunar rotation velocity determined by:

$$\underline{v}_P = \underline{\omega}_P \times \underline{r}_P \quad (3.4.4.12)$$

where $\underline{\omega}_P$ is the lunar rotation rate vector used in the LR state update computation of Section 5.3.4.4.4. The reinitialized landing state vector and reference time are then stored for following prelaunch or abort programs.

The vehicle attitude in lunar fixed coordinates is determined by the Lunar Surface Alignment Program P-57 (Section 5.6.2.2) and stored. Before PGNCS power down, an IMU fine alignment is made and the vehicle attitude redefined and stored in place of the previous attitude. These vehicle attitude vectors are used in following nominal or emergency IMU alignment operations. An AGS initialization operation is normally performed prior to PGNCS power down.

5.3.4.5 SUMMARY OF OPERATIONS FOR DIFFERENT PHASES OF LANDING MANEUVER

5.3.4.5.1 Pre-Ignition Phase

At approximately 30 minutes before the nominal DPS ignition time the pre-ignition computations are begun. The purpose of these computations is to determine the ignition time and the desired LM ignition attitude.

The first operation performed is to extrapolate the LM state estimate forward to a time about 180 seconds before the nominal ignition time. Then, the state estimate is extrapolated forward in 2-second time increments until the down-range component of vehicle distance from the site, corrected for site out-of-plane distance and orbit ejection altitude deviations, is less than a preselected value (q_D). A linear interpolation is then performed to determine the exact time that the down-range distance test is satisfied. The ullage maneuver is started at this time.

The LM state estimate is next extrapolated forward in time over an interval equivalent to the ullage-and-trim phase interval. The required LM command thrust acceleration corresponding to this state is then computed, assuming a quadratic-acceleration trajectory to the High-Gate point. The resultant command thrust-acceleration attitude (\underline{u}_{FP}) is then used as the DPS ignition attitude.

5.3.4.5.2 Ullage-and Trim Phase

During the ullage-and-trim maneuver the vehicle is held a constant attitude corresponding to the direction of command specific force at ignition time determined in the ignition-computations.

procedure. The ullage-and-trim maneuver consists of a 7.5-second interval during which about 200 pounds of thrust are applied to LM, followed by a 26-second interval at a thrust of about 1050 pounds.

5.3.4.5.3 Braking Phase

During the braking phase the sequence of operations on a typical computation cycle involves first an updating of the state vector, then a computation of command specific force, and finally computations of attitude and throttle commands. New commands are computed at 2-second intervals throughout the phase, which is typically about 450 seconds in duration.

The state-vector updatings are based solely on IMU data until the vehicle's altitude has dropped to 25,000 feet. At this time LR altitude measurements are taken and used to update the vehicle's state at 2-second intervals. Velocity measurements are taken when the estimated altitude has dropped to 15000 feet.

During the major part of the braking phase the command specific force is determined so that the vehicle's acceleration en route to the High-Gate point is a quadratic function of the time-to-go to this point. The quadratic in time-to-go guidance law permits the specification of terminal position, velocity, and acceleration.

In order to minimize engine erosion problems, it is necessary to operate the DPS either at a fixed throttle setting corresponding to 92.5 percent of nominal maximum thrust, or it can be operated as a continuously throttleable engine in the 10-58 percent region. To utilize propellant efficiently, it is desirable to

operate the DPS at the high-throttle setting as long as possible. In order to permit the astronaut to have landing-site visibility for at least 75 seconds, it is necessary that the braking phase aim-conditions (position and velocity) be met with a reasonable accuracy. This requires that the DPS be operated in the continuously throttle-able range of thrust during the final part of the braking phase.

To accomplish the above objectives, a throttle-command logic is employed which will hold the throttle at the 92.5 percent position until the command specific force is less than 50 percent of the nominal maximum value. By properly selecting the braking-phase aim-conditions, this switching or throttling-down is made to occur at about 120 seconds before the end of the phase on a nominal trajectory.

Throughout the braking phase, attitude commands are generated to align the vehicle's thrust vector along the direction of the computed command specific force. During the early part of the braking phase when the LM altitude is greater than 30,000 feet, the astronaut may yaw the vehicle about its X-axis to observe the lunar terrain. When the altitude drops below 30,000 feet, however, a window-up yaw attitude is commanded in order to insure proper LR operation.

At approximately 20 seconds before the end of the braking phase the last specific-force command using updated state-vector estimates is made. Thereafter, the command specific force is determined such that the vehicle's acceleration is varied as a linear function of time-to-go from its present value to the desired terminal acceleration. The state vector is updated with LR measurements during these last 20 seconds, but the updated state is not utilized in the computation of specific force commands.

5.3.4.5.4 Transition-Phase-I

The first transition phase is four seconds in duration. During this period the specific force is commanded so that the vehicle's acceleration is varied as a linear function of time from its value at the end of the braking phase to the desired initial value for the visibility phase.

5.3.4.5.5 Visibility Phase

The initial and final state for the visibility phase along with its time duration are chosen so that the vehicle's X-axis (i. e. the thrust vector) is elevated sufficiently high above the local horizontal plane to permit landing-site visibility for at least 75 seconds. Typically these elevation angles are at least 45-50 degrees. The initial and terminal states are such that nominally the DPS is operated in the continuously-throttleable region throughout the visibility phase, which is typically 135 seconds long with no site redesignations.

The state vector of the LM is updated with both altitude and velocity-component LR measurements at 2-second intervals throughout the visibility phase. The updatings take place immediately after the PIPA output data are processed. An altitude measurement and a velocity-component measurement are processed sequentially at each updating time, with the velocity-component measurement following after the altitude measurement. The interval between successive processings for a given velocity component is 6 seconds. Pre-stored LR weighting functions are used in the processing of the LR data. The altitude weighting functions are stored as linear functions of altitude, the velocity-component weighting functions are stored as linear functions of speed.

During the major part of the visibility phase (except for the last 10 seconds) specific force commands are generated to provide a LM acceleration that is a quadratic function of the time-to-go to the desired terminal state. New steering specific-force commands are computed at 2-second intervals. The thrust commands for this phase, as mentioned earlier, are such that the DPS will normally be operated in the continuously throttleable region throughout the phase. When the time-to-go for the phase drops below 10 seconds, a linear time-to-go acceleration function is commanded for the vehicle. Throughout the visibility phase, attitude commands are computed to orient the thrust vector along the direction of the computed command specific force.

The astronaut has the option of manually redesignating the landing site by means of LPD switch commands. These commands are first stored in the computer, as obtained from the controller. Then, at 2-second intervals a computation is made of the desired site perturbation and the new site location. The depression angle of the line-of-sight to the current site below the vehicle's X-axis is computed and displayed to the astronaut throughout the visibility phase. Normally when the current site is visible in the window, attitude commands are generated to yaw the vehicle about its X-axis until the line-of-sight to the current site is in the plane of the vehicle X and Z axes, i. e. it is along the landing-point designator (LPD) index line. Using the computed site depression angle on the DSKY, the astronaut can look out the window and decide where and how to redesignate the landing site, if he so desires.

Transition-Phase-II

The second transition phase is four seconds in duration. During this period the specific force is commanded so that the vehicle's acceleration is varied as a linear function of time from its value at the end of the visibility phase to the desired initial value for the final-descent phase.

5.3.4.5.6 Final-Descent Phase

During the initial part of the descent phase the command specific force is computed so that the vehicle will descend at a constant velocity of 5 ft/sec. When the estimated LM altitude has dropped to 50 feet, the descent velocity is reduced to 3 ft/sec. LR updatings of the state-vector of the LM are made at 2-second intervals throughout the phase.

5.3.4.5.7 Rate of Descent Terminal Mode

The astronaut has the option of initiating this semi-manual control mode in which the vehicle attitude is manually controlled, and the LGC automatically commands the DPS throttle to maintain the initial vertical velocity. This reference vertical velocity can be manually incremented by the Rate of Descent Controller.

5.3.4.5.8 Manual Terminal Mode

This mode of operation can be selected at any time in the landing maneuver. The primary function of the LGC during this mode is to maintain the state vector updating with IMU and LR data, and provide display parameters.

5.3.5

POWERED ASCENT GUIDANCE

5.3.5.1

Guidance Objective

The objective of the Powered Ascent Guidance Program (P-12) is to control the LM ascent maneuver to an injection condition such that a specified velocity vector is achieved at a desired radial and cross range position. The specified injection altitude is with respect to the launch site radius vector magnitude, and the controlled injection cross range or lateral position is relative to the CSM orbital plane. In order to control the ascent maneuver to these three velocity and two position injection constraints, an explicit guidance concept is used which employs a linear control form. Since this guidance program is used with a fixed thrust or non-throttleable engine configuration, the velocity and position conditions along the radial (R) and cross range (Y) directions are explicitly controlled by two orthogonal thrust acceleration components varying linearly with time, while the third or remaining component of thrust acceleration is used to achieve the desired velocity in the down range (Z) direction by terminating the thrust at the proper time. The development of the ascent guidance equations is such that the best performance is achieved when the required maneuver is in the down range (Z) direction. In the lunar launch or abort maneuvers controlled by this program, all injection position and velocity parameters are therefore controlled with the exception of the position along the velocity vector referred to as the down range position.

The Powered Ascent Guidance Program can control LM ascent maneuvers initiated from non-coplanar launch conditions to be coplanar with the CSM orbital plane at injection, or parallel to the CSM orbital plane at a specified out-of-plane or cross range distance if the astronaut does not wish to remove all of the launch out-of-plane distance during the ascent maneuver. The program is able

designed to achieve ascent injection under some off nominal APS thrust conditions (e. g. a single APS helium tank failure), and to allow for RCS injection in cases of premature APS shut down.

The Powered Ascent Guidance Program consists of three major phases of operations. These phases are:

- 1) Pre-Ignition Phase
- 2) Vertical Rise Phase
- 3) Ascent Guidance Phase

The Powered Ascent Guidance presented in this section is also used to control abort maneuvers initiated during the powered lunar landing maneuver. These abort maneuvers can use either the DPS, APS, or a staged combination of the two to achieve the desired abort injection conditions. The abort programs and targeting used to control abort maneuvers using the Powered Ascent Guidance are presented in Section 5. 4. 5.

The ascent guidance equations are primarily based upon the concept that the vehicle equations of motion can be expressed as variables whose rates remain essentially fixed unless thrust acceleration is applied along their respective axes. Considering the kinematics of a vehicle in, or nearly in, orbit the radial rate and two components of velocity in the local horizontal plane are variables of this type. A Local Vertical Coordinate system is therefore used to define the velocity control portion of the ascent guidance. Since it is also required to measure vehicle position components that are time integrals of these rates, the vehicle radius magnitude and two arc lengths measured from two fixed planes are used. The coordinate system in which vehicle position is measured is referred to as the Target Coordinate System.

The Target and Local Vertical Coordinate systems for the ascent guidance program are illustrated in Fig. 3.5-1 and defined as follows:

Target Coordinate System

The target coordinate system is referenced to the CSM orbital plane and initial LM position by:

$$\begin{aligned}\underline{Q} &= \text{UNIT} (\underline{v}_C \times \underline{r}_C) \\ \underline{S} &= \text{UNIT} (\underline{r}_0 \times \underline{Q}) \\ \underline{P} &= \underline{Q} \times \underline{S}\end{aligned}\tag{3.5.1}$$

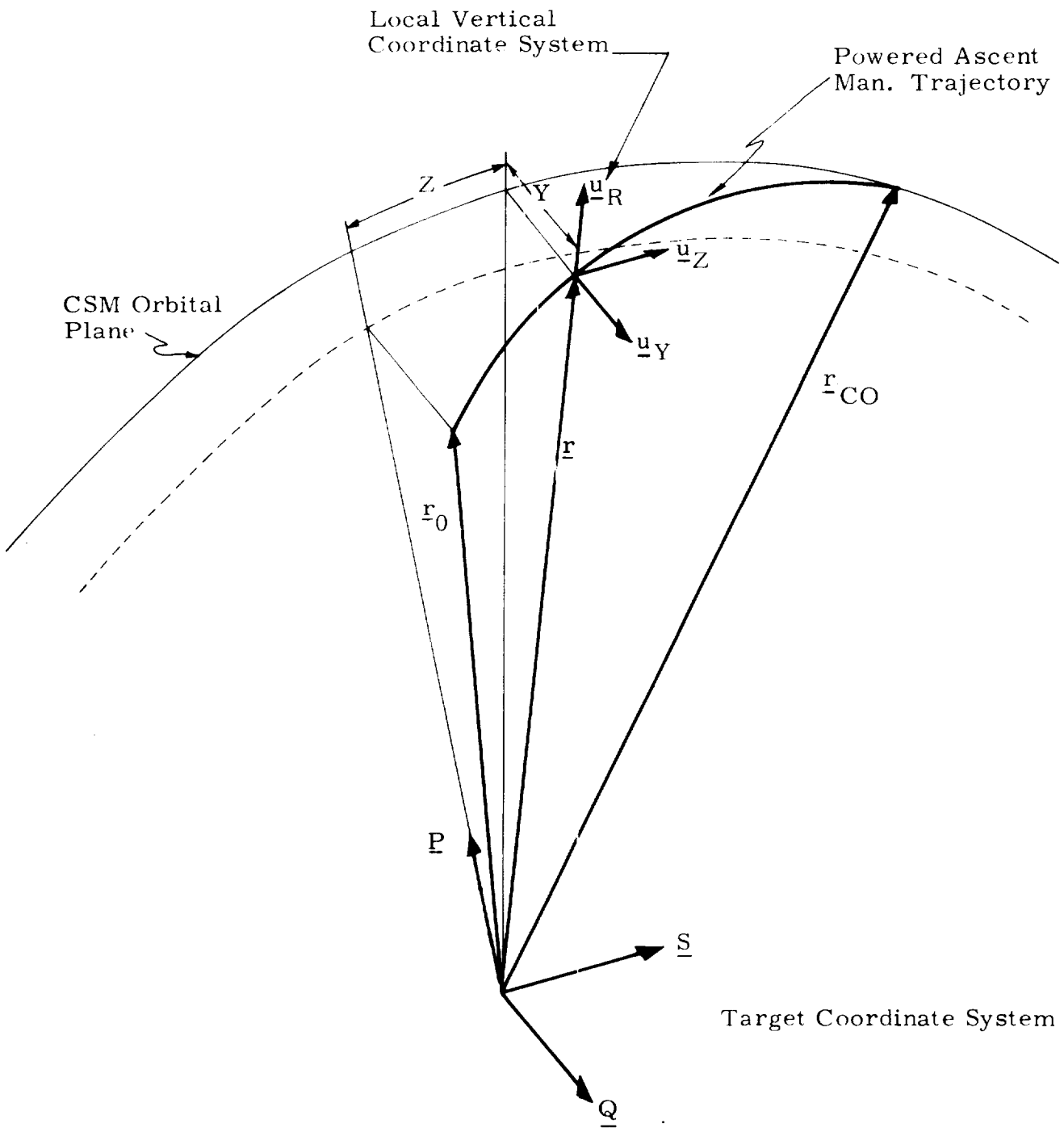

Fig. 3.5-1 Powered Ascent Guidance Coordinate Systems

where \underline{r}_C and \underline{v}_C are the CSM position and velocity vectors, and \underline{r}_0 is the initial LM position vector at t_{IG} . The vehicle Z and Y position is measured from the PQ and PS planes respectively as shown in Fig. 3.5-1.

Local Vertical Coordinate System

The local vertical coordinate system of Fig. 3.5-1 is defined by:

$$\begin{aligned}\underline{u}_R &= \text{UNIT}(\underline{r}) \\ \underline{u}_Z &= \text{UNIT}(\underline{u}_R \times \underline{Q}) \\ \underline{u}_Y &= \underline{u}_Z \times \underline{u}_R\end{aligned}\tag{3.5.2}$$

where \underline{r} is the current LM position vector. The vector \underline{r}_{CO} is the LM position vector at engine cut-off.

5.3.5.3 Required Targeting Parameters

Besides the CSM and LM state vectors normally stored and updated in the LGC, the following input parameters are required by the Ascent Guidance Program.

Input Parameters

1. t_{IG} Ignition time
2. R_D Desired injection radius (Nominally 60,000 ft. over the landing site radius)

3. Y_D Desired injection cross range distance
 measured from the CSM orbital plane
4. \dot{R}_D Desired injection radial rate
5. \dot{Y}_D Desired injection cross range rate
6. \dot{Z}_D Desired injection down range rate

It should be noted that for nominal lunar launch conditions, the desired ascent injection conditions listed under Items 2 to 6 are prestored values for the lunar mission under consideration. These prestored desired injection parameters will control the ascent maneuver to cut-off in the CSM orbital plane at an altitude of 60,000 ft. with a coplanar, horizontal velocity vector that will result in a 30 nm apolune altitude. The injection and trajectory apolune altitudes are measured with respect to the launch site radius magnitude. The astronaut can change the Y_D and \dot{Z}_D prestored target parameters prior to lunar launch if desired.

Output Parameters

The following parameters are the basic outputs of the Ascent Guidance Program:

1. $\underline{A}XISD$ Desired thrust attitude command to
 the LM digital autopilot (DAP)
2. $\Delta CDUX$ Attitude command about the vehicle
 thrust axis to the LM DAP during the
 vertical rise phase
3. Engine-off Signal

Pre-Ignition Phase

- a) t_{IG} Input ignition time initially displayed for verification
- b) ΔR Cross range distance from the launch site to the CSM orbital plane that will be taken out during the ascent maneuver
- c) V_Z Injection velocity target parameter \dot{Z}_D
- d) FDAI Yaw Angle } The yaw angle that should be present on the FDAI at the end of the vertical rise phase prior to pitch over
- e) FDAI Pitch Angle } The FDAI pitch angle that should be present after pitch over has been completed in the early portion of the ascent guidance phase.
- f) TFI Time from Ignition

Vertical Rise Phase

- a) V Inertial velocity magnitude
- b) h Altitude or radial position measured from the launch site radius
- c) \dot{h} Altitude Rate

Callable Display

- a) t_{go} Estimated time to ascent injection
- b) V_Y Current cross plane velocity \dot{Y}

Same displays as Vertical Rise Phase

5.3.5.4 Ascent Guidance Equations

The general computation diagram for the Ascent Guidance Program is illustrated in Fig. 3.5-2. There are three major phases to the nominal lunar ascent maneuver as listed in Section 5.3.5.1. These three phases are described with reference to Fig. 3.5-2 in the following sections along with the off-nominal condition involving RCS injection due to premature APS termination.

5.3.5.4.1 Pre-Ignition Phase

The pre-ignition phase computation sequence is controlled in Fig. 3.5-2 by the control flag FLPI = 1. With reference to this figure, the routine is first initialized with the following parameters:

$a_T = 10.5 \text{ fps}^2$	Initial APS thrust acceleration	
$\tau = 945 \text{ sec.}$	Initial APS mass to mass flow rate ratio	
$\left. \begin{array}{l} \frac{1}{\Delta V_0} = 0.0478 \text{ sec/ft} \\ \frac{1}{\Delta V_1} = 0.0476 \text{ sec/ft} \\ \frac{1}{\Delta V_2} = 0.0474 \text{ sec/ft} \end{array} \right\}$	Initial velocity parameters for the thrust filter computation (Section 5.3.5.4.2)	
$\Delta t_{\text{tail-off}}$		A negative time increment used to correct t_{go} for the APS tail-off and computation delays.
$t_{go} = 450 \text{ sec.}$		Initial estimate of the powered ascent maneuver duration to injection

The desired injection target conditions are next called from fixed memory. The target parameters shown in Fig. 3.5-2 are those for the nominal lunar launch condition resulting in the coplanar injection trajectory described in Section 5.3.5.3.

The LM state vector on the lunar surface is next advanced to the ignition time t_{IG} by the Planetary Inertial Orientation Routine. A dummy LM state vector is then generated by extrapolating the initial $\underline{r}(t_{IG})$ and $\underline{v}(t_{IG})$ through a nominal vertical rise phase as shown in Fig. 3.5-2. The target and local vertical coordinate systems of Section 5.3.5.2 are generated, and the velocity vector \underline{v} resolved into the local vertical system.

The effective gravity is next computed from the following expression:

$$g_{\text{eff}} = \frac{H^2}{r^3} - g_n \quad (3.5.3)$$

where $H^2 = |\underline{r} \times \underline{v}|^2$ and g_n is the nominal gravity as computed by the Average G Routine of Section 5.3.2.

The vehicle position R, Y and Z in the target coordinate system is computed as shown. The arcsine expressions in this computation may be evaluated by short series expansions.

t_{go} Estimation

As shown in Fig. 3.5-2, the current velocity to be gained, \underline{v}_G , is computed from the present and desired injection velocities. The time-to-go, t_{go} , is then determined from a truncated series expansion of the exponential expression for $t_{go}(v_G)$:

6

$$t_{go} = \tau \left(1 - e^{-\frac{v_G}{V_E}} \right) \quad (3.5.4)$$

The series expansion used to approximate the above expression is truncated at the second order term, and the coefficient of the second order term is replaced by a parameter, K_T , which can be adjusted to over or under estimate t_{go} in the early phases of the maneuver.

$$t_{go} = \tau \frac{v_G}{V_E} \left(1 - K_T \frac{v_G}{V_E} \right) + \Delta t_{tail-off} \quad (3.5.5)$$

where

$$\tau = \frac{\text{mass}}{\text{mass flow rate}}$$

V_E = Exhaust velocity from the Mass Monitor Routine

K_T = 0.34 (typical value)

$\Delta t_{tail-off}$ = A negative time increment used to correct t_{go} for the APS tail-off and computation delays.

Guidance Parameter Computations

With reference to Fig. 3.5-2, the time t_0 is the time at which the basic guidance parameters A, B, C and D are computed.

Since the LGC attitude commands to the LM autopilot are constant over the computation interval Δt , t_0 is made $\Delta t/2$ smaller so that the output command is that which corresponds to the middle of the control interval.

The control times t_2 and t_3 of Fig. 3.5-2 are used to regulate the guidance function as follows:

$t_2 = 2$ sec: Represents the time interval before engine cut-off during which all guidance parameters are held at their last computed values.

$t_3 = 10$ sec: The time interval before engine cut-off during which the guidance parameters B and D that control the injection position in the R and Y directions are set to zero. During this 10 second interval all position control is terminated and the guidance system attempts to achieve the desired injection velocity conditions until t_2 .

During the pre-ignition phase neither the t_2 or t_3 control conditions exist and the regular guidance parameter computation of A, B, C and D is carried out as shown.

Commanded Thrust Acceleration Vector Computation

The required acceleration components a_{TR} and a_{TY} are computed as shown in Fig. 3.5-2 for the R and Y injection parameters respectively. These two required acceleration components are then combined as

$$\underline{a}_H = a_{TY} \underline{u}_Y + a_{TR} \underline{u}_R \quad (3.5.6)$$

$$a_H = |\underline{a}_H| \quad (3.5.7)$$

and compared with $K_R a_T$ where a_T is the available thrust acceleration and K_R is a parameter which limits the percentage of a_T allowable for the commanded a_H . In some abort maneuver conditions it is desirable to maintain a small component of thrust in the Z direction making K_R less than 1. Under nominal lunar launch conditions K_R is set equal to unity. If a_H is greater than $K_R a_T$, the commanded a_H is reduced by a factor $K_R a_T / a_H$ and the remaining available acceleration, $(1 - K_R^2)^{1/2} a_T$, is directed along Z. If the required a_H is smaller than $K_R a_T$, the remainder $(a_T^2 - a_H^2)^{1/2}$ is directed along Z and \underline{a}_H is unchanged. In the computation of the commanded thrust acceleration vector, \underline{a}_T , the sense of the Z component of \underline{a}_T is determined by the sign of the velocity to be gained in this direction (SGN $\Delta \dot{Z}$).

Pre-Ignition Display and Control

With reference to Fig. 3.5-2 the following two commanded acceleration unit vectors are next computed in the pre ignition phase:

\underline{u}_{YAW} = The unit vector of the horizontal plane components of the commanded acceleration \underline{a}_T

\underline{u}_{TD} = Unit vector along \underline{a}_T

These two unit vectors are used to precompute the FDAI yaw angle at the end of the vertical rise phase assuming that attitude control about the thrust axis is completed in this phase, and the FDAI pitch angle early in the ascent guidance phase after pitch over transients have damped out. These FDAI angle display parameters are computed as follows:

$$\text{FDAI Yaw Angle} = -\cos^{-1} (\underline{u}_{\text{YAW}} \cdot \underline{u}_{\text{Z}}) \text{SGN} (\underline{u}_{\text{YAW}} \cdot \underline{u}_{\text{Y}}) \quad (3.5.8)$$

$$\text{FDAI Pitch Angle} = -\cos^{-1} (\underline{u}_{\text{TD}} \cdot \underline{u}_{\text{R}}) \quad (3.5.9)$$

In the first computation cycle it is assumed that the ascent maneuver will be controlled to a coplanar injection ($Y_{\text{D}} = 0$, $\dot{Y}_{\text{D}} = 0$). If the astronaut does not desire to have the entire launch out-of-plane distance taken out during the ascent maneuver he can specify by the ΔR DSKY entry how much out-of-plane distance should be achieved during the powered ascent. Injection conditions will then be parallel, but non-coplanar with respect to the CSM orbital plane. The magnitude of the horizontal injection velocity, \dot{Z}_{D} , is initially computed and prestored for 30 nm apolune altitude above the scheduled landing site radius. If the actual landing site radius is significantly different from that initially selected prior to earth launch, the astronaut can change the desired injection velocity magnitude \dot{Z}_{D} if available from an external source.

The final operations during the pre-ignition phase are to restore the LM state vector to its $t_{\text{IG}} - 30$ sec. values, $\underline{r}(t_{\text{IG}} - 30)$ and $\underline{v}(t_{\text{IG}} - 30)$, set the vertical rise phase flag FLVR, set the APS ignition for t_{IG} , and start the Average G Routine at $t_{\text{IG}} - 30$ sec.

With APS ignition at t_{IG} the ascent guidance computation is recycled to (A) of Fig. 3. 5-2. The primary objective of the vertical rise phase is to maintain a vertical thrust orientation until a specified vertical velocity of 50 fps has been achieved. The LM state vector is updated by the Average G Routine of Section 5. 3. 2 during all thrust phases of the ascent maneuver. The FLIC control flag of Fig. 3. 5-2 (pg 2 of 2) is for the initial computation cycle of lunar landing abort maneuvers of Section 5. 4. 5.

Thrust Filter Computation

The measured vehicle velocity increments, ΔV , by the PGNCS IMU integrating accelerometers (PIPA's) include noise not only from the main engine but also from the RCS jets used for attitude control. In order to estimate an accurate thrust acceleration performance (a_T and τ), several successive ΔV PIPA readings are averaged. Under the assumption of a constant mass flow engine, $1/a_T$ is a linear function of time. The ratio of mass to mass flow rate (τ) is then computed from four successive PIPA readings ΔV_0 , ΔV_1 , ΔV_2 and ΔV_3 as follows

$$\Sigma = \frac{1}{\Delta V_0} + \frac{1}{\Delta V_1} + \frac{1}{\Delta V_2} + \frac{1}{\Delta V_3} \quad (3. 5. 10)$$

$$\tau' = \frac{\Sigma}{4} V_E \Delta t - 2 \Delta t \quad (3. 5. 11)$$

Where Δt is the computation interval. In Eq. (3. 5. 11) the first term represents the estimate of τ' at the center of the series of time increments for which ΔV was measured, and the second term updates the estimate to current time. Additional smoothing may be accomplished by averaging this new value of τ' with the previous estimate of τ , updated by Δt .

$$\tau = \frac{1}{2} (\tau' + \tau - \Delta t) \quad (3.5.12)$$

The exhaust velocity V_E is normally computed by the Mass Monitor Routine. In the pre-ignition computation for lunar launch the three velocity increments $\frac{1}{\Delta V_0}$, $\frac{1}{\Delta V_1}$, and $\frac{1}{\Delta V_2}$ are prestored initialization constants.

The vehicle thrust acceleration magnitude is then computed by

$$a_T = \frac{V_E}{\tau} \quad (3.5.13)$$

Vertical Rise Phase Control

With reference to Fig. 3.5-2, the computation sequence uses the standard ascent guidance equations except that the engine-off signal cannot be set during the vertical rise phase. After the commanded acceleration vector \underline{a}_T has been computed, the vertical rise phase (FLVR = 1) sequence then determines the direction of \underline{a}_T in the horizontal plane designated as \underline{u}'_{YAW} . The vehicle attitude is rotated (yawed) about the thrust axis until the LM body Z axis coincides with \underline{u}'_{YAW} so that at the ascent guidance phase, the pitch-over maneuver will be about the LM body Y axis. The vehicle yaw attitude control parameter about the thrust axis is $\Delta CDUX$ in Fig. 3.5-2 where \underline{u}_{BY} is the unit vector along the LM +Y body axis. As shown in Fig. 3.5-2, the vertical rise phase cannot be terminated until the yaw attitude about the thrust axis is within 5 degrees of the desired orientation, and the vertical velocity is greater than 50 fps. The altitude check ($h > 25,000$) shown in Fig. 5.3-2 (pg 5 of 5) is used in abort programs of Section 5.4.5 to add an additional attitude constraint on the vertical rise phase.

5.3.5.4.3 Ascent Guidance Phase

During the ascent guidance phase the vehicle thrust attitude is controlled to be along the commanded acceleration vector \underline{a}_T . The vehicle attitude about the thrust axis is no longer controlled by the ascent guidance equations, and the X-axis override DAP mode is activated so that the astronaut can manually control vehicle yaw attitude for the duration of the powered ascent maneuver. The X-axis override is activated 10 seconds (t_{X0} of Fig. 3.5-2, page 5 of 5) after the termination of the vertical rise phase to allow for attitude stabilization after pitch over.

As previously described in Section 5.3.5.4.1, when the time to go, t_{go} , falls below 10 seconds (t_3) the injection position constraints are terminated and the Ascent Guidance Program only controls the injection velocity. When t_{go} falls below 4 seconds the engine-off command is set for t_{go} , and the guidance parameters are computed one more time when t_{go} is less than t_2 .

In the case of a single APS helium tank failure, the thrust acceleration will decrease over the last portion of the ascent maneuver, but no special operations in the ascent guidance equations are made for this off nominal case.

5.3.5.4.4 RCS Ascent Injection Conditions

If the APS is prematurely shut down prior to ascent injection, the Ascent Guidance Program can be used to aid in the manual control of the RCS to achieve the desired injection conditions. At APS termination the ΔV Monitor Routine places the vehicle in the attitude hold control mode. The astronaut can then command the Ascent Guidance Program to continue under the assumption of four jet RCS injection. At this time the ascent guidance equations are re-initialized with the nominal RCS values for \underline{a}_T , τ , ΔV_0 , ΔV_1 , ΔV_2 and V_E while the $\Delta t_{tail-off}$ and FLVR are set to zero. With reference to Fig. 3.5-2 an RCS injection also sets FLPC = 1 which eliminates injection position control from the guidance computations. In this mode of operation the velocity to be gained vector, \underline{v}_G , is displayed in body coordinates so that the astronaut can manually complete the ascent injection. The coordinate transformations REFSMMAT and SMNB used to compute \underline{v}_G in body coordinates are defined in Section 5.6.3.

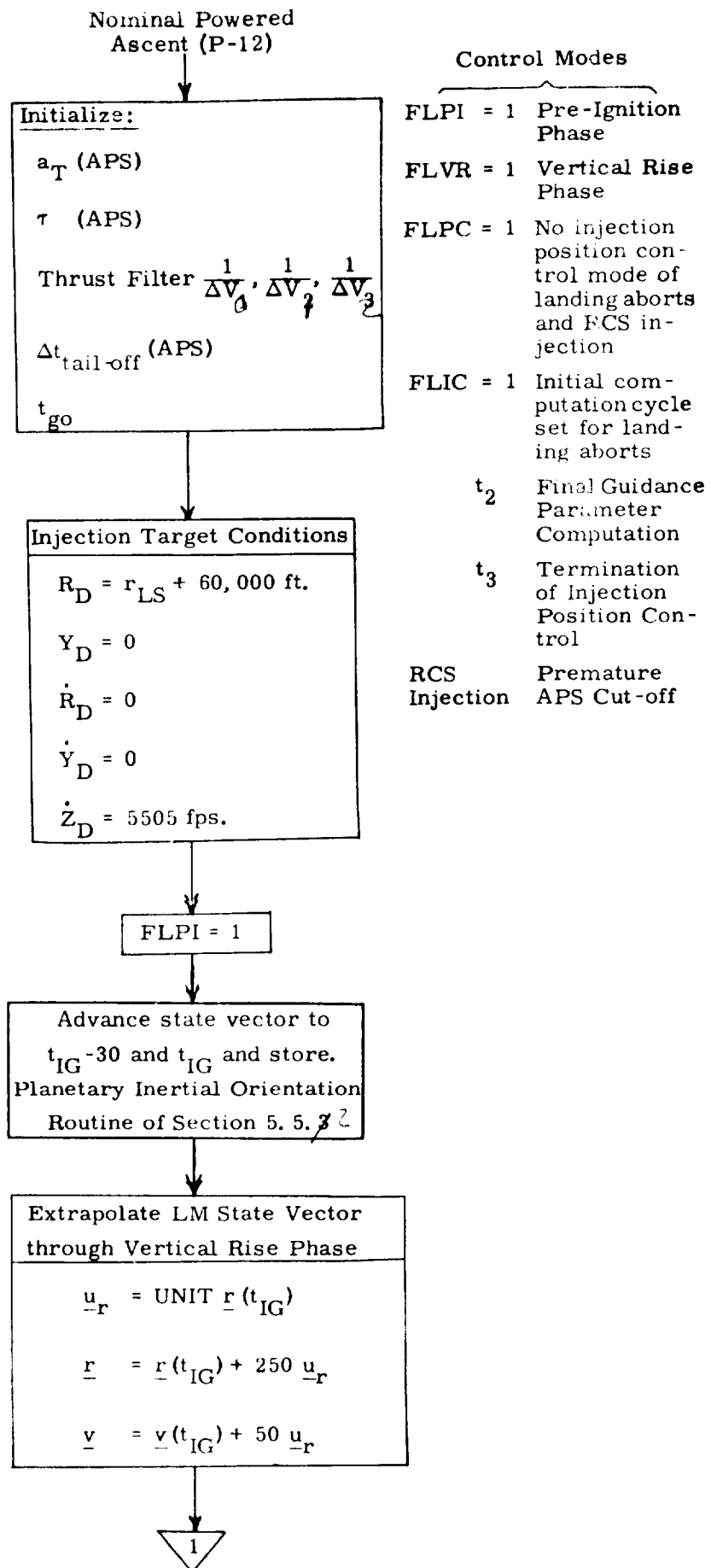

Figure 3.5-2 Powered Ascent Guidance Computation Sequence
(page 1 of 5)

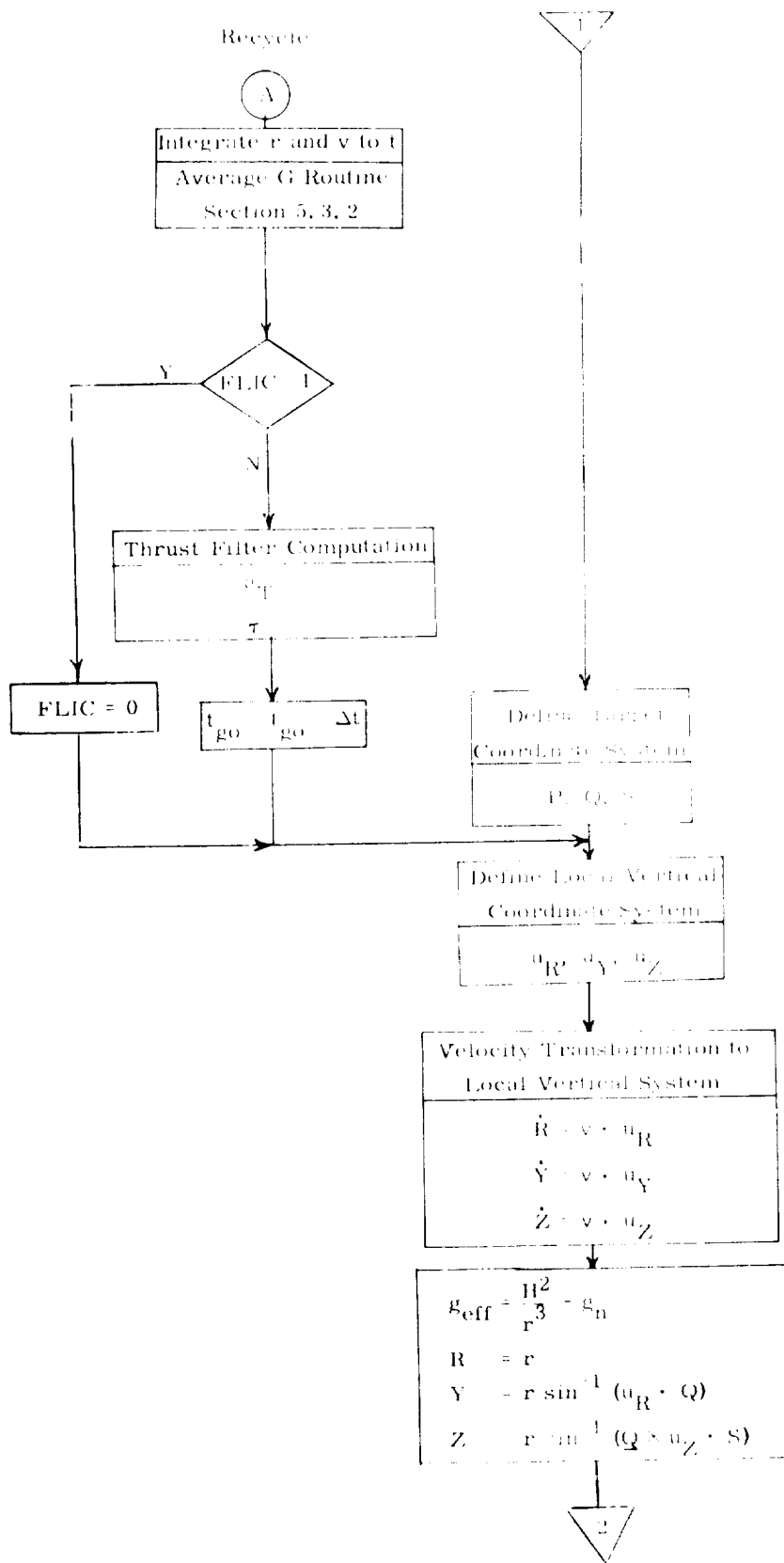

Figure 3.5-2 Powered Ascent Guidance Computation Sequence

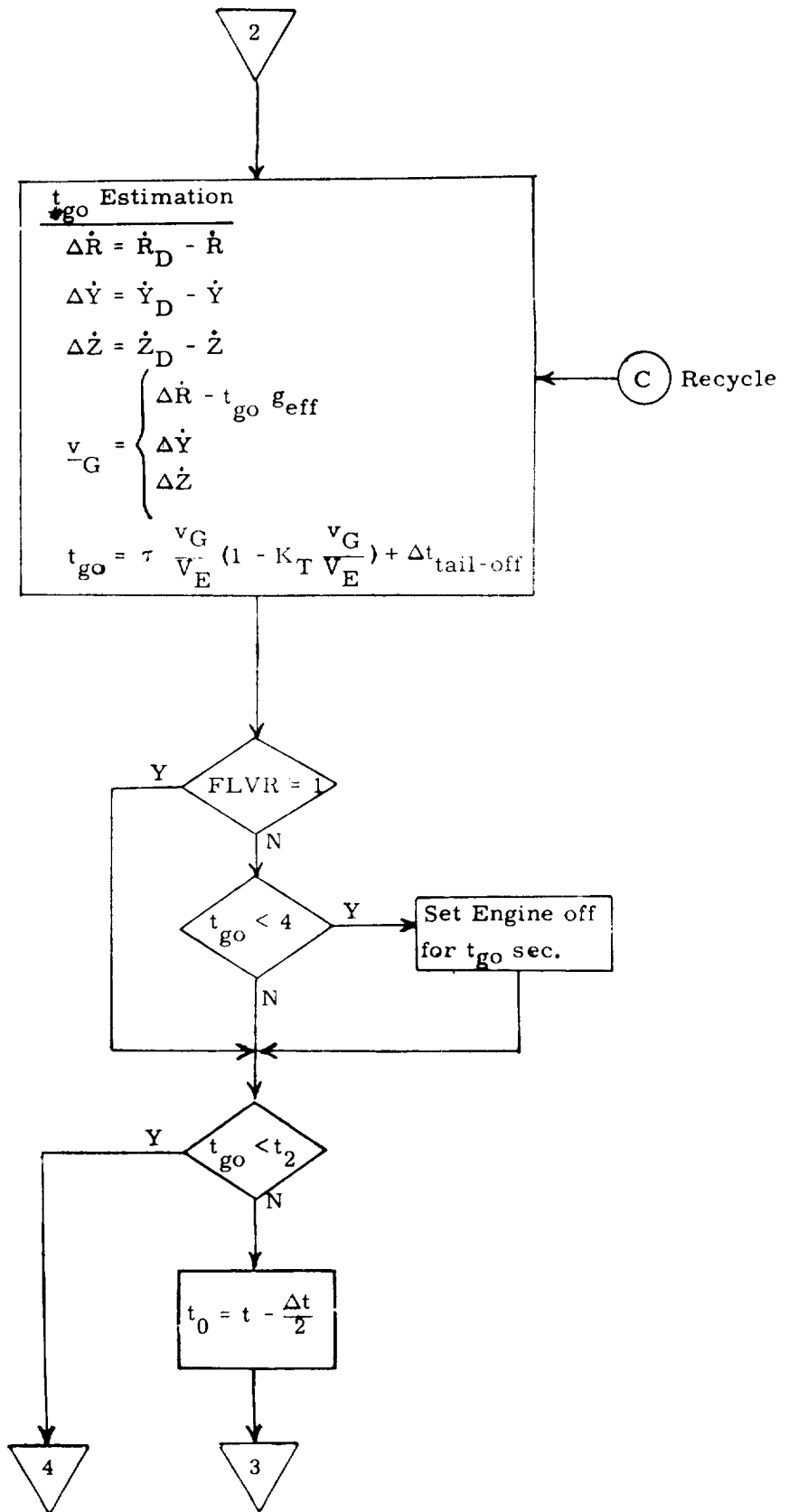

Figure 3.5-2 Powered Ascent Guidance Computation Sequence
(page 3 of 5)

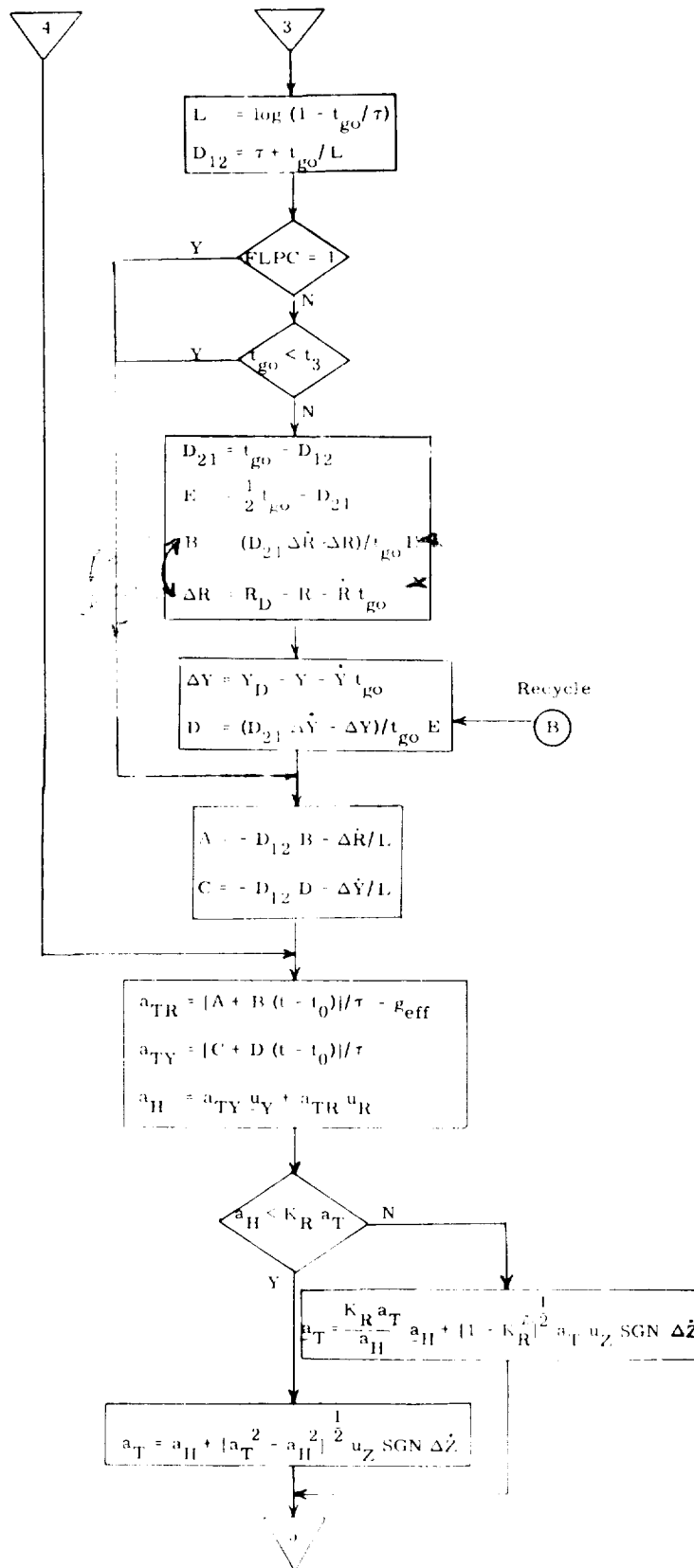

Figure 3.5-2 Powered Ascent Guidance Computation Sequence

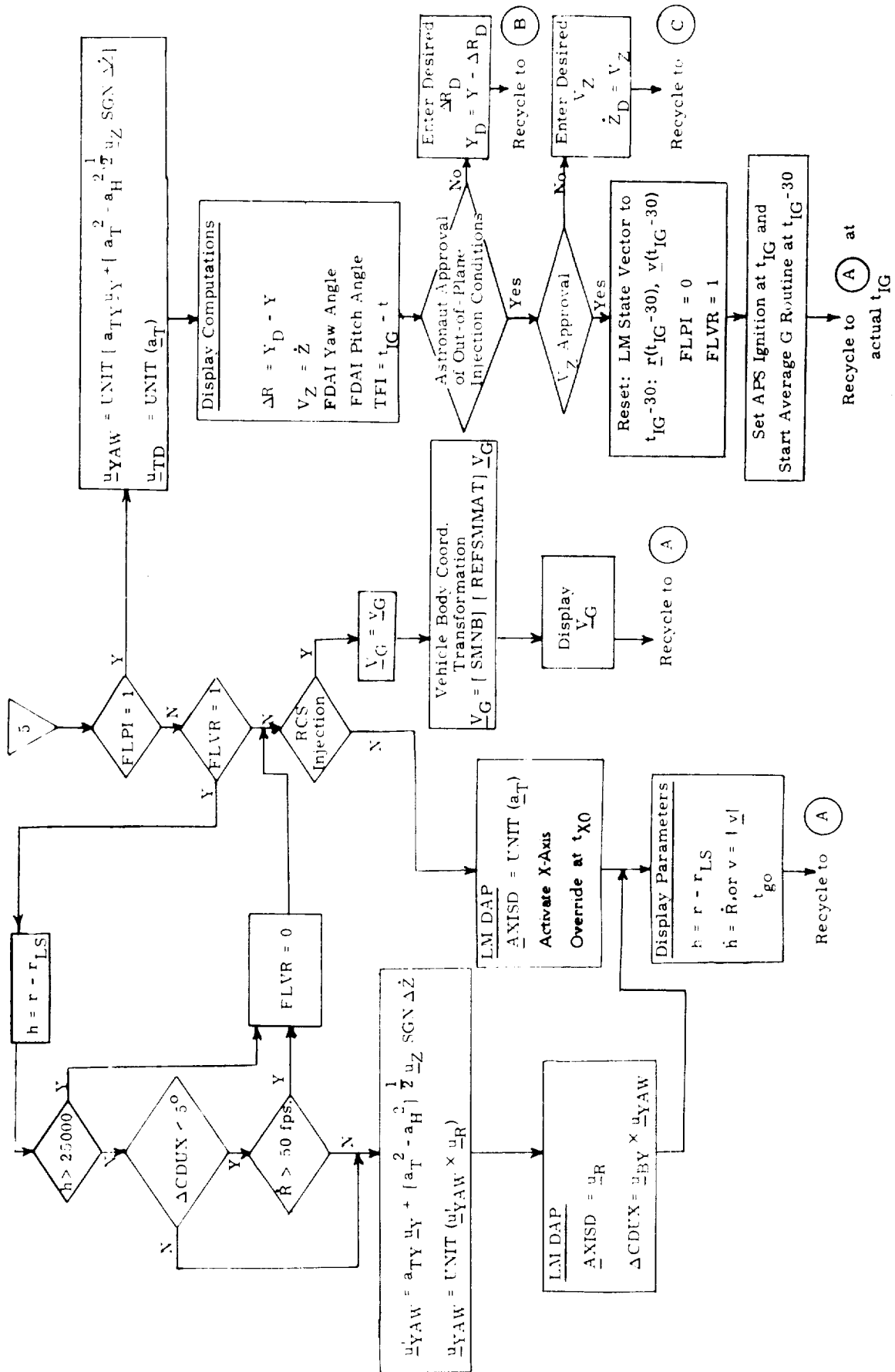

Figure 3.5-2 Powered Ascent Guidance Computation Sequence (page 5 of 5)

5.3.6 LAMBERT AIM POINT MANEUVER GUIDANCE

The objective of the Lambert Aim Point Maneuver Guidance program is to control the cut-off velocity vector such that the resulting trajectory intercepts a specified target position vector at a given time. This program is based upon the cross-product steering concept of Section 5.3.3.3 and the Lambert Subroutine of Section 5.5.6.

The Lambert Aim Point Maneuver Guidance is used to control the following maneuvers:

- 1) Rendezvous Intercept P34 and Midcourse Correction Maneuvers P-35
- 2) Stable Orbit Rendezvous TPI (P-38) and Midcourse (P-39).
- 3) TEI Backup Maneuver Guidance P-31

Either the CMC, LGC or RTCC can target Rendezvous Intercept Maneuvers. The targeting parameters for the TEI backup guidance maneuver must be determined by the RTCC.

5.3.6.1 Rendezvous Intercept Maneuver Guidance

This powered flight guidance routine is used to control the rendezvous Transfer Phase Initiation (TPI) and midcourse correction maneuvers in both the Concentric Flight Plan and the Stable Orbit Rendezvous technique. The required maneuver velocity is initially calculated before the ignition time using the Initial Velocity Subroutine (Section 5.5.11) which in turn uses the Lambert Subroutine (Section 5.5.6). During the maneuver the Lambert Subroutine is used to update the required maneuver velocity. This closed loop guidance concept, coupled with cross product steering (Section 5.3.3³), controls maneuvers such that the resulting trajectory intercepts a target aim point at a designated time.

The Rendezvous Intercept Maneuver Routine is used in program P - 42 when the APS is chosen for the maneuver, P - 41 when the LM RCS is chosen for the maneuver, P - 40 when the DPS is chosen. The required initial inputs and targeting for this routine are determined in programs P-34, P-35, P-38 and P-39 for the rendezvous maneuvers when the LM is the active vehicle.

Input Parameters

1. Ignition Time: t_{IG}
2. Time of flight to intercept (t_F) measured between TPI and intercept provided no terminal rendezvous maneuvers were made.
3. Target aim point: $\underline{r}_2(t_A)$ where t_A is the time of arrival at the target point.
4. Engine choice: DPS, APS or RCS

Outputs

1. \underline{u}_{TD} = unit vector in the desired thrust direction to the LM autopilot
2. APS Engine-off Signal (P - 42)
or
DPS Engine-off Signal (P - 40)
3. Display of velocity to be gained components in body axes for RCS controlled maneuvers (P - 41)

Guidance Computations

The rendezvous intercept maneuver guidance computation sequence is illustrated in Fig. 3.6-1. The velocity required to intercept the target aim point \underline{r}_2 at t_A is determined by the Lambert Subroutine. The associated velocity to be gained \underline{v}_G , is derived as shown in Fig. 3.6-1. The velocity to be gained is then used in the cross-product steering concept of Section 5.3.3.3 to determine the required steering command to the flight control system and the time for engine cut-off. The Lambert Subroutine (Section 5.5.6) will ordinarily be cycled at the same rate as the steering computations. If the computer work load prevents completion of the Lambert Subroutine at this rate the Lambert problem can be cycled at half the basic steering computation rate as illustrated in Fig. 3.6-1.

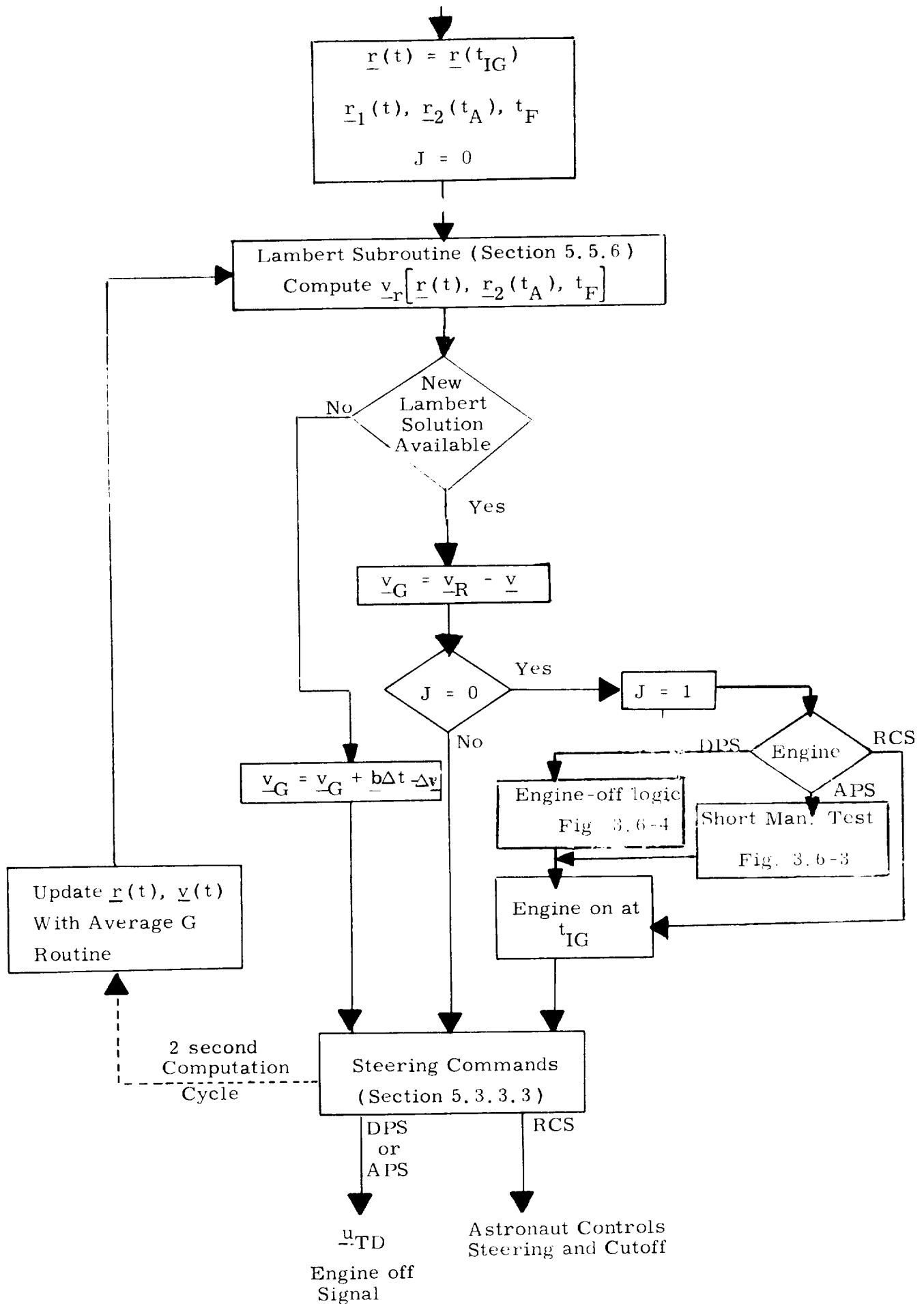

Figure 3.6-1 Rendezvous Intercept Maneuver Guidance

Short Maneuver Test

The steering computations are normally performed every two seconds; therefore a small time interval elapses before effective steering is achieved. If the APS burn time is less than a second there may be a requirement to set the engine-off signal before the Δv from the PIPA'S can be measured. Therefore, at the start of the steering computations an estimate of the time between the engine-on and engine-off signals is made based on the engine test data shown in Fig. 3.6-2.

If the estimate of engine-on time (t_{on}) is less than 6 seconds the engine is set to stay on for t_{on} seconds and the vehicle attitude is maintained at the pre-thrust alignment throughout the burn. The logic for the APS short maneuver steering is shown in Fig. 3.6-3. For APS maneuvers of 6 seconds or more the general engine-off criteria as shown in Fig. 3.6-4 is used.

For the case in which the RCS is selected for a maneuver, there is no automatic short maneuver test or engine cutoff computation. The entire maneuver is controlled manually.

The automatic portion of the DPS engine-off logic is shown in Fig. 3.6-4. Before the start of a DPS maneuver an estimate of the maneuver time is made using the input weight and assuming a 10% thrust level throughout the maneuver. If the estimated DPS maneuver time is less than 6 seconds, the engine-off signal is set at $t_{IG} + t_{PM}$ and the vehicle attitude is maintained at the pre-thrust alignment throughout the maneuver. If the predicted maneuver time, t_{PM} , is between 26 and 120 seconds the throttle will be automatically inhibited such that the entire maneuver is at the 10% thrust level.

Summarizing, the DPS should not be selected for maneuvers less than 6 seconds if accurate injection conditions are desired. If the initial estimated maneuver time, t_{PM} at the 10% thrust level is between 26 and 120 seconds the throttle will be automatically inhibited.

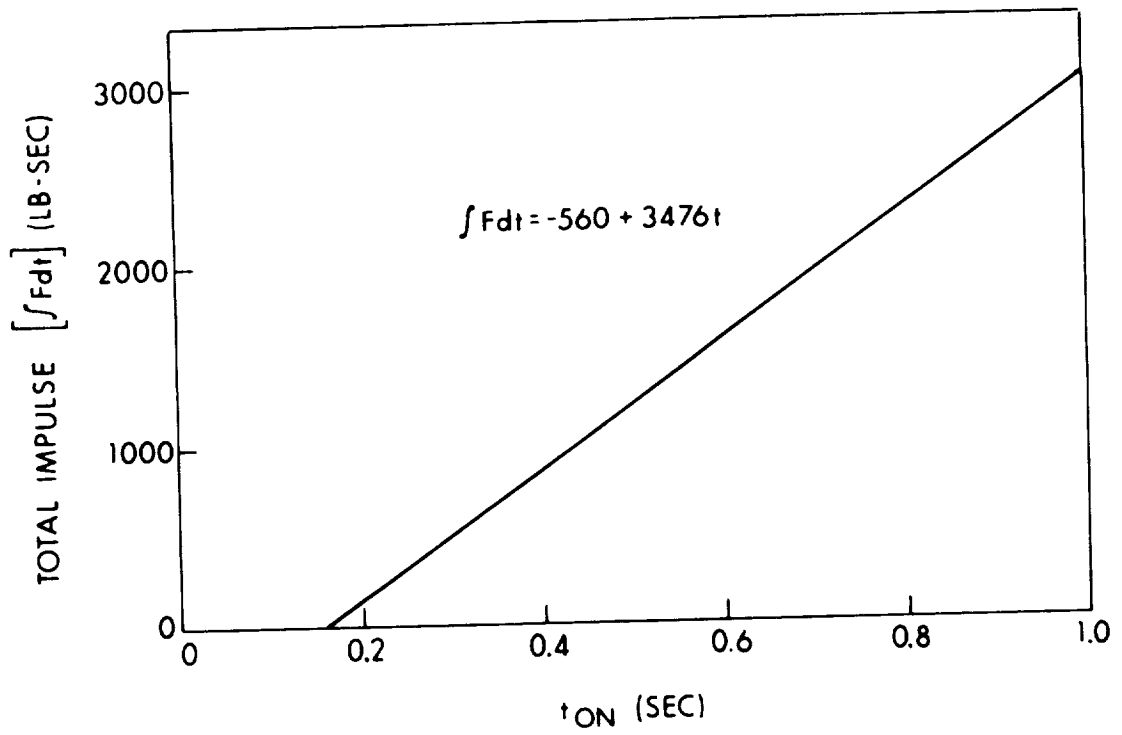

Figure 3.6-2 APS Minimum Impulse Test Data (NASA / MSC - Feb. 1, 1967)

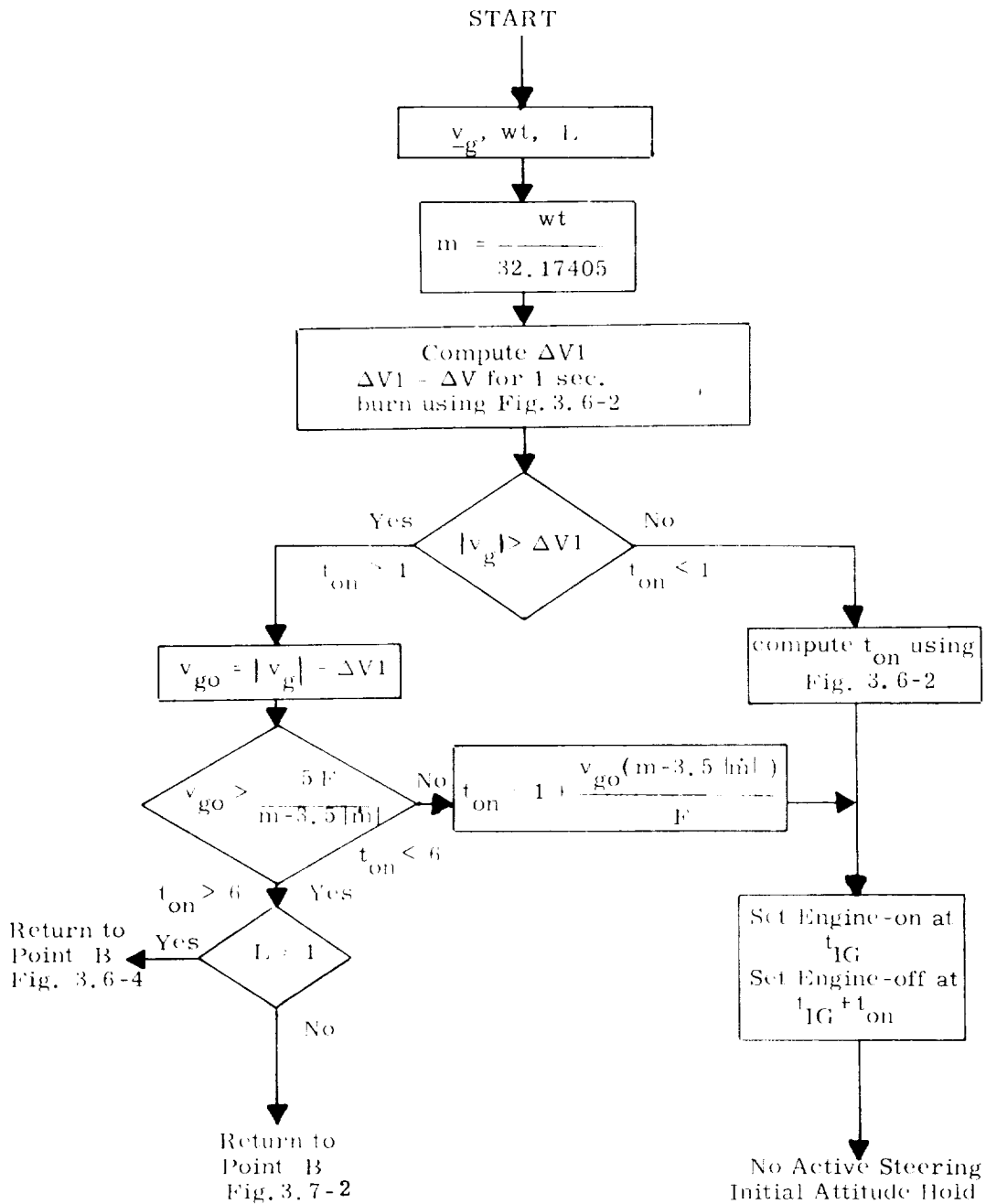

Figure 3.6-3 APS Short Maneuver Steering Logic

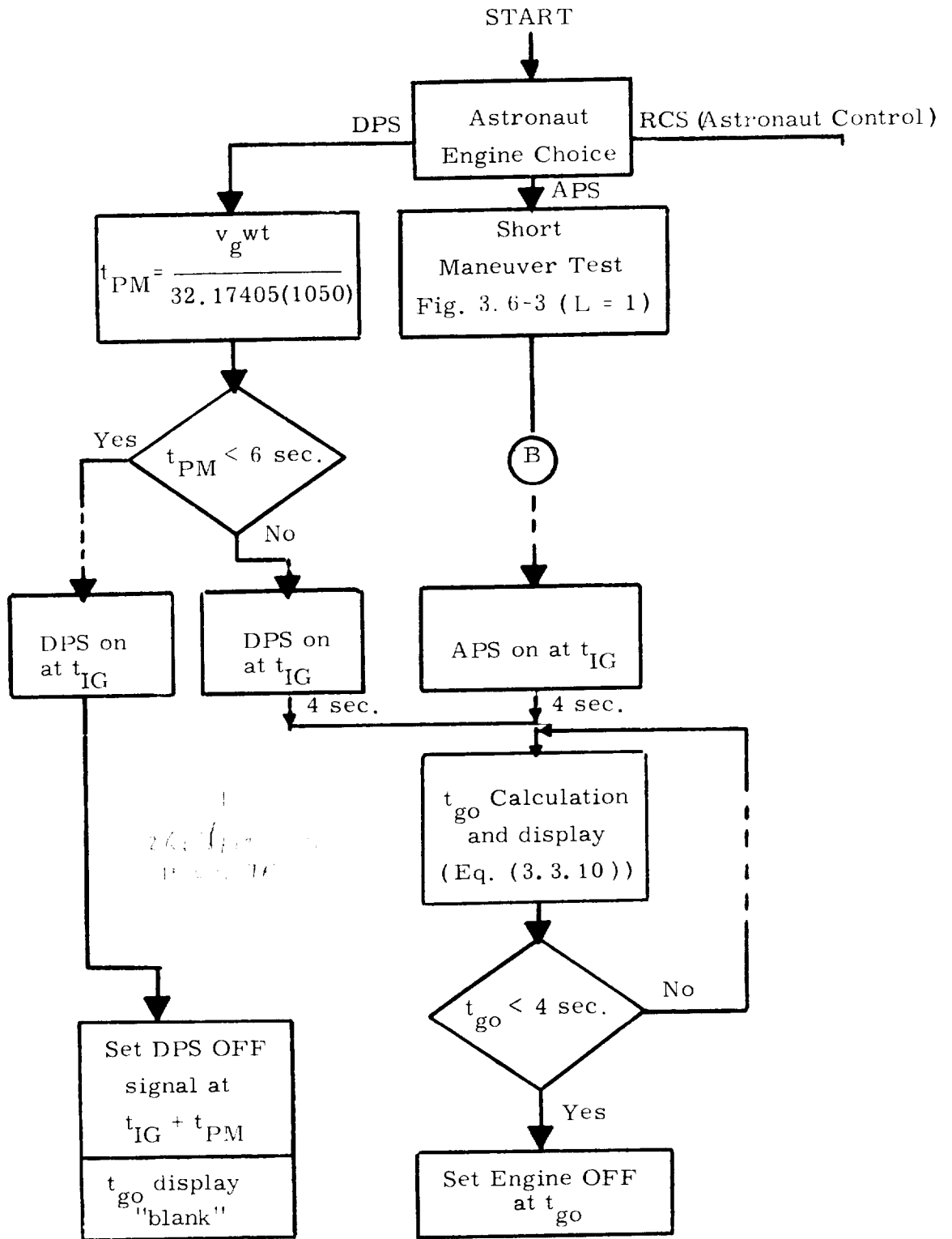

Figure 3.6-4 General LM Engine-off Calculation Logic

5.3.6.2 Transearch Injection Backup Guidance

This powered flight guidance maneuver is used to control an SPS backup maneuver in the event of an SPS failure for transearch injection (TEI) using the DPS. The basic steering concept is that presented in Section 5.3.3.3 with the input velocity to be gained being determined by the Lambert Subroutine of Section 5.5.6.

This maneuver must be targeted by the RTCC using the General Lambert Maneuver prethrust program P-31. In contrast to the CMC cross product steering concept, the cross product steering constant c determined by RTCC targeting must be assumed to be zero for LM maneuvers.

Input Parameters

1. Ignition Time (t_{IG})
2. Time of flight to conic target aim vector (t_F)
3. Conic target aim vector $\underline{r}_2(t_A)$

where $t_A = t_F + t_{IG}$

4. Engine - DPS

Output

1. \underline{u}_{TD} = unit vector in the desired thrust direction to the LM Flight Control System
2. DPS engine-off signal

Guidance Computations

The transearth backup guidance maneuver is illustrated in Fig. 3.6-5. The velocity required to intercept the target aim vector \underline{r}_2 at t_A is determined by the Lambert Subroutine and then the associated velocity to be gained \underline{v}_G is derived as shown in Fig. 3.6-5. If the Lambert Subroutine calculation is not completed due to computer work load, \underline{v}_G is computed as shown in Fig. 3.6-5 from previous solutions. The velocity to be gained is then used in the cross product steering concept of Section 5.3.3.3 to determine the required command signal to the flight control system, and the time for DPS engine cut-off. As indicated in Fig. 3.6-5 the Lambert Subroutine is cycled in the computation sequence at the same rate as steering computations or, as mentioned above, at half the rate.

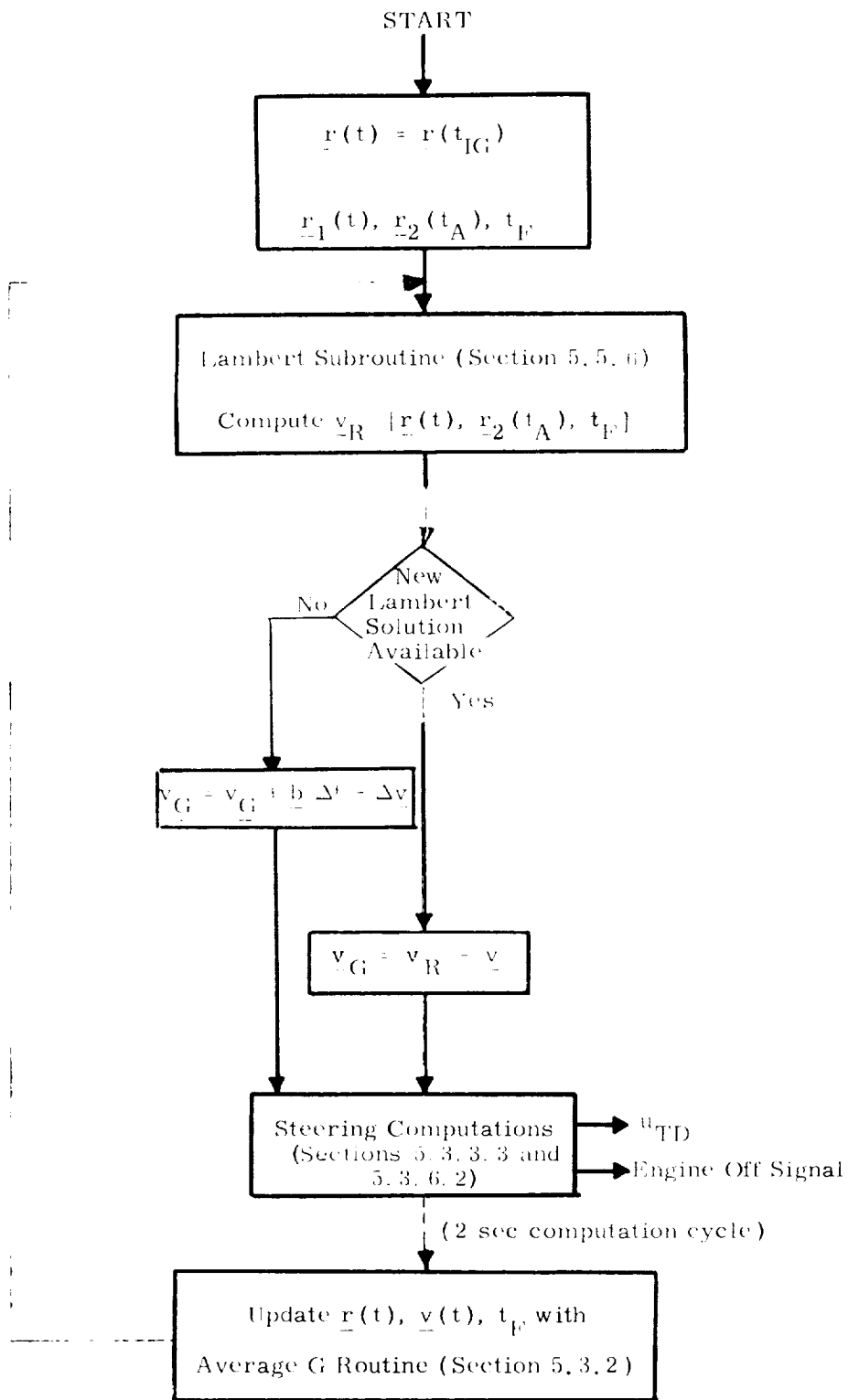

Figure 3.6-5 TEI Backup Maneuver Guidance

5.3.7 EXTERNAL ΔV MANEUVER GUIDANCE

External ΔV Maneuver Guidance is normally used to perform orbit maneuvers such as those prescribed by the con-centric flight plan. The guidance program accepts input data via the DSKY or the telemetry uplink in the form of 3 components of an impulsive $\Delta \underline{V}$. An approximate compensation for the finite maneuver time is made by rotating the $\Delta \underline{V}$ vector and the guidance program issues commands to the spacecraft control system so as to apply the compensated velocity increment along an inertially fixed direction defined at the ignition time.

Input Parameters

- 1) Time of ignition (t_{IG})
- 2) Specified velocity change ($\Delta \underline{V}_S$) in the local vertical coordinate system of the active vehicle at the time of ignition.
- 3) Anticipated magnitude of the vehicle weight, wt, in pounds
- 4) Engine choice; DPS, APS or RCS

Outputs

- 1) \underline{u}_{TD} = unit vector in the desired thrust direction to the LM autopilot
- 2) DPS Engine-off signal (P - 40)
or
APS Engine-off signal (P - 42)
- 3) Display of velocity to be gained components in vehicle body axes for RCS controlled maneuvers (P - 41)

Computations

The local vertical coordinate system is defined by:

$$\begin{aligned}\underline{X} &= \text{UNIT} \left[\underline{r}(t_{\text{IG}}) \times \underline{v}(t_{\text{IG}}) \right] \times \underline{r}(t_{\text{IG}}) \\ \underline{Y} &= \text{UNIT} \left[\underline{v}(t_{\text{IG}}) \times \underline{r}(t_{\text{IG}}) \right] \\ \underline{Z} &= -\text{UNIT} \left[\underline{r}(t_{\text{IG}}) \right]\end{aligned}\tag{3.7.1}$$

where $\underline{r}(t_{\text{IG}})$ and $\underline{v}(t_{\text{IG}})$ are the position and velocity vectors at the time of ignition respectively.

The input column vector $\Delta\underline{V}_S$ is first pre-multiplied by a matrix, the columns of which are \underline{X} , \underline{Y} , and \underline{Z} , to yield $\Delta\underline{V}_S$ in the inertial coordinate system.

The input $\Delta\underline{V}_S$ is the required impulsive velocity change. In order to compensate for the change in position during the maneuver, the input $\Delta\underline{V}_S$ is biased by half the estimated central angle of travel during the maneuver. The inplane velocity components of $\Delta\underline{V}_S$ are given by:

$$\Delta\underline{V}_P = \Delta\underline{V}_S - \left(\Delta\underline{V}_S \cdot \underline{u}_P \right) \underline{u}_P$$

where (3.7.2)

$$\underline{u}_P = \text{UNIT} \left[\underline{v}(t_{\text{IG}}) \times \underline{r}(t_{\text{IG}}) \right]$$

The approximate central angle, θ_T , traveled during the maneuver is given by:

$$\theta_T \cong \frac{|\underline{r} \times \underline{v}|}{r^2} \frac{\Delta V_S}{a'_T} \quad (3.7.3)$$

where a'_T is the estimated constant maneuver acceleration determined from

$$a'_T = \frac{F (32.17405)}{wt} \quad (3.7.4)$$

with F equal to a prestored nominal thrust in pounds based on the astronaut engine selection, and wt is the vehicle weight in pounds entered as a DSKY input parameter. The values of F are

$F = 9712.5$ pounds for the DPS

$F = 3500$ pounds for the APS

$F = 100$ pounds / jet for the RCS

The corrected inplane velocity-to-be-gained is defined as:

$$\Delta \underline{V}_C = \Delta V_P \left\{ \text{UNIT} (\Delta \underline{V}_P) \cos \frac{\theta_T}{2} + \text{UNIT} (\Delta \underline{V}_P \times \underline{u}_P) \sin \left(\frac{\theta_T}{2} \right) \right\} \quad (3.7.6)$$

and is illustrated in Fig. 3.7-1. The corrected velocity-to-be-gained during the powered flight is then given by:

$$\Delta \underline{V}_T = \Delta \underline{V}_C + (\Delta \underline{V}_S \cdot \underline{u}_P) \underline{u}_P \quad (3.7.7)$$

The general computational sequence for the External ΔV Maneuver Guidance is illustrated in Fig. 3.7-2. The input \underline{v}_G to the steering equations of Section 5.3.3.3 is initially set equal to $\Delta \underline{V}_T$ of Eq. (3.7.7). During the powered maneuver, \underline{v}_G is updated as shown in Fig. 3.7-2 by the accumulated $\Delta \underline{v}$ measured by the accelerometers.

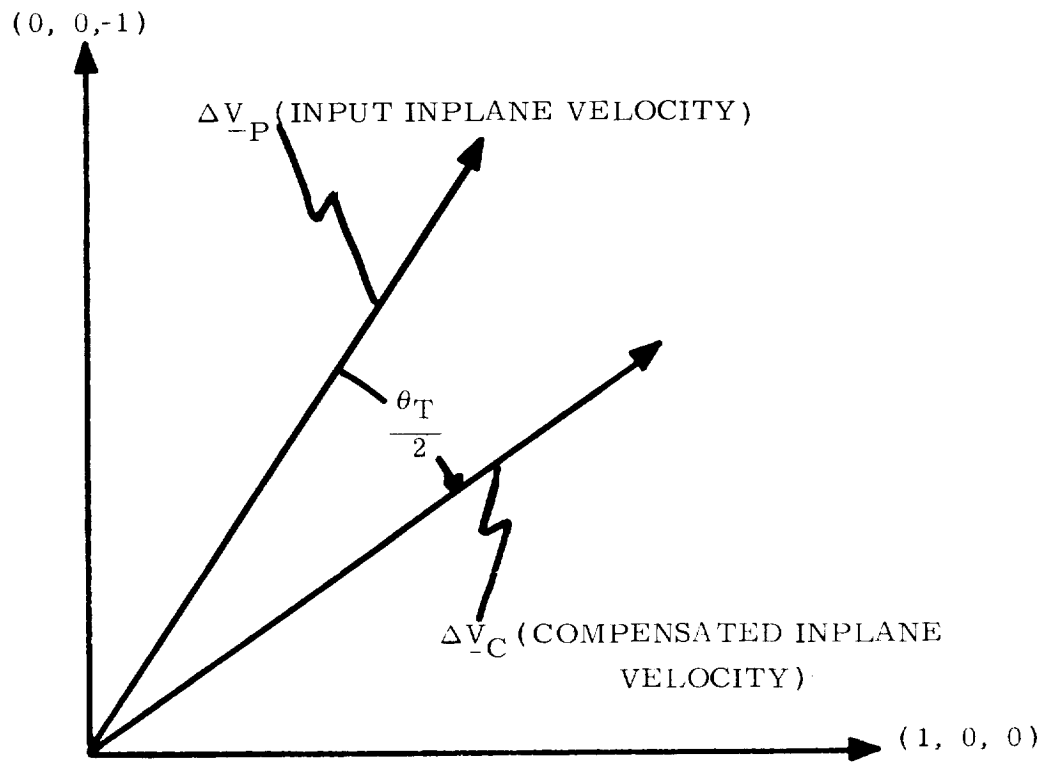

Figure 3.7-1 Inplane External ΔV Maneuver Time Compensation

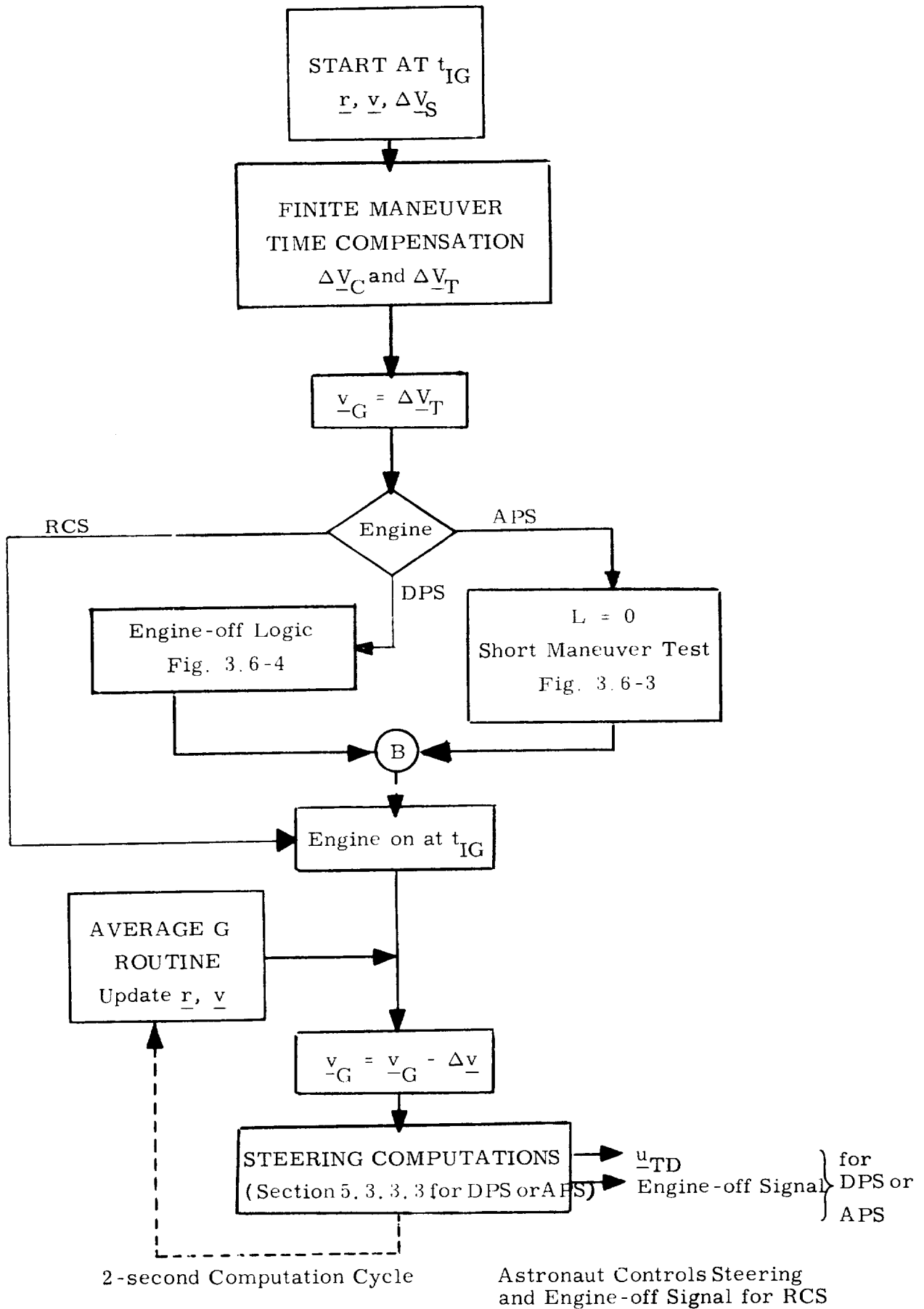

Figure 3.7-2 External ΔV Maneuver Guidance

5.4 TARGETING ROUTINES

5.4.1 GENERAL COMMENTS

The objectives of the targeting routines presented in this section are to provide the LGC capability to determine the required input target parameters and set control modes for the various powered flight guidance routines of Section 5.3. The LGC targeting capability represented by the programs in the following subsections is sufficient to complete the nominal LM phases of the lunar landing mission. These LGC targeting routines are summarized in the following subsections:

5.4.2 Lunar Landing Time Prediction Routine

5.4.3 LM Launch Time Prediction Routine

5.4.4 Rendezvous Targeting

These routines include the following rendezvous maneuver phases:

1. Pre-CSI
2. Pre-CDH
3. Pre-TPI
4. Rendezvous Midcourse Corrections
5. TPI Search Program
6. Stable Orbit Rendezvous

5.4.5 Abort Targeting from Lunar Landing

In some abort cases such as Transearth Injection SPS Backup, RTCC targeting is required.

All LGC targeting programs use the Basic Reference Coordinate System defined in Section 5.1.4.1. The Rendezvous Targeting Routines of Section 5.4.4 can be used in either earth or lunar orbits. The basic input parameters required by the targeting routines of this section are the vehicle state vector estimates determined by the navigation programs of Section 5.2.

5.4.2. LUNAR LANDING TIME PREDICTION ROUTINE

5.4.2.1 General

The main object of this program is to compute the lunar landing time for a Hohmann descent trajectory from the CSM orbit followed by a powered flight phase to the desired landing site. The input parameters to the program are:

1. $\underline{r}_D, \underline{v}_D, t_D$ Vehicle state vector at time t_D .
2. t, t_E Present time and earliest permissible deorbit time.
3. \underline{r}_{LSA}, t_A Position of the desired landing site at time t_A .
4. h_{DP}, θ_F, t_F Desired ignition altitude, nominal angle and time for the powered landing maneuver (see Fig. 4.2-1).

The program contains an iterative loop which insures that the landing position of the LM coincides with the desired landing site as specified in the LGC initialization when rotated into the CSM plane at the nominal landing time. Figure 4.2-1 defines the descent trajectory configuration and nomenclature and Fig. 4.2-2 illustrates the program logic.

The iterative loop starts with the updating of the CSM state vector to a new time and then advancing the LM through the Hohmann transfer and the powered landing maneuver phases. The landing position of the LM is then compared with the desired landing site at the LM landing time to obtain a basis for selecting a new descent orbit injection time.

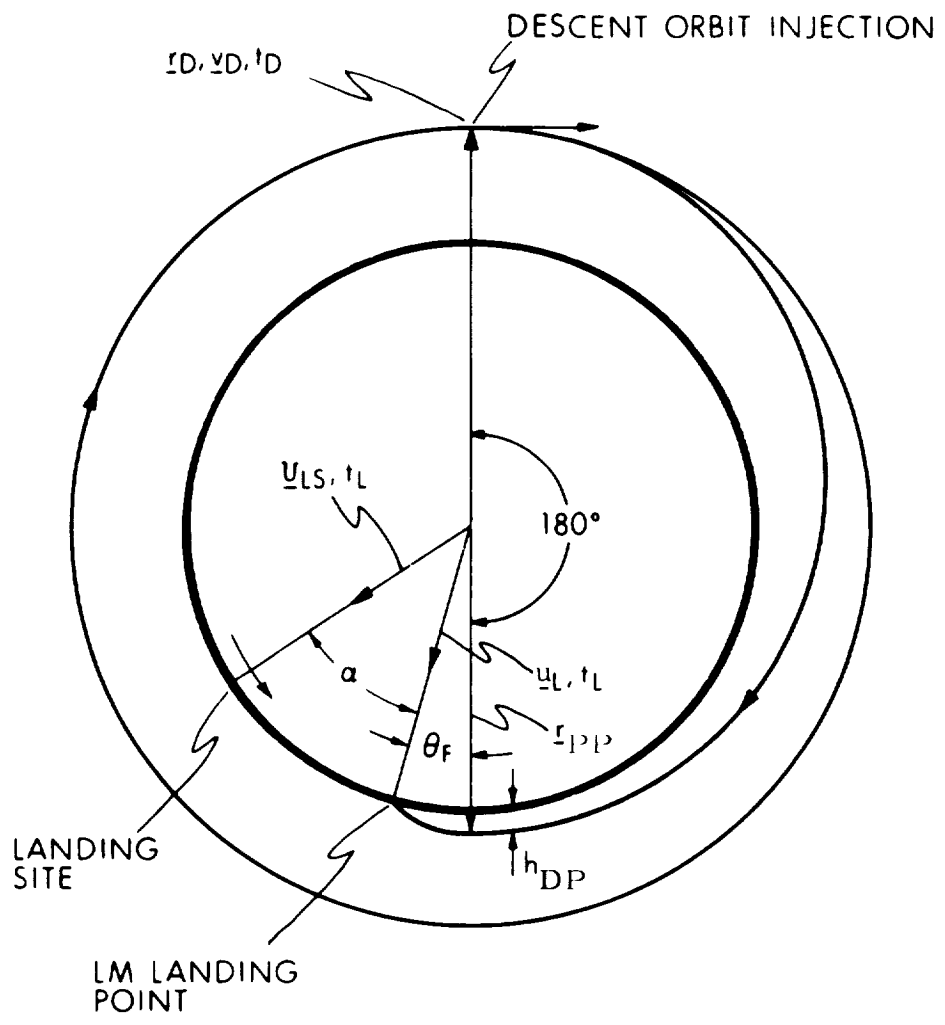

Fig. 4.2-1 Descent Trajectory Nomenclature

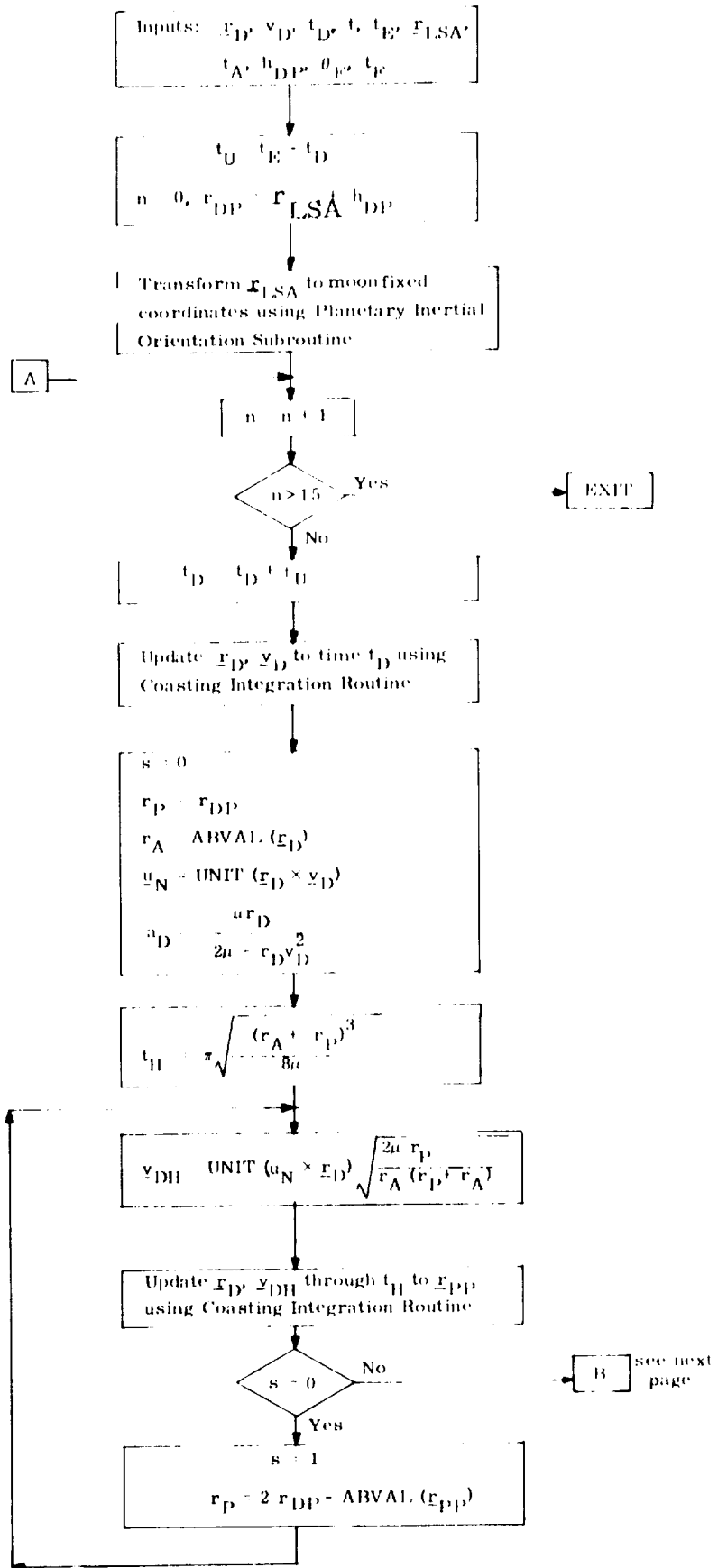

Figure 4.2-2 Lunar Landing Time Prediction Logic Diagram

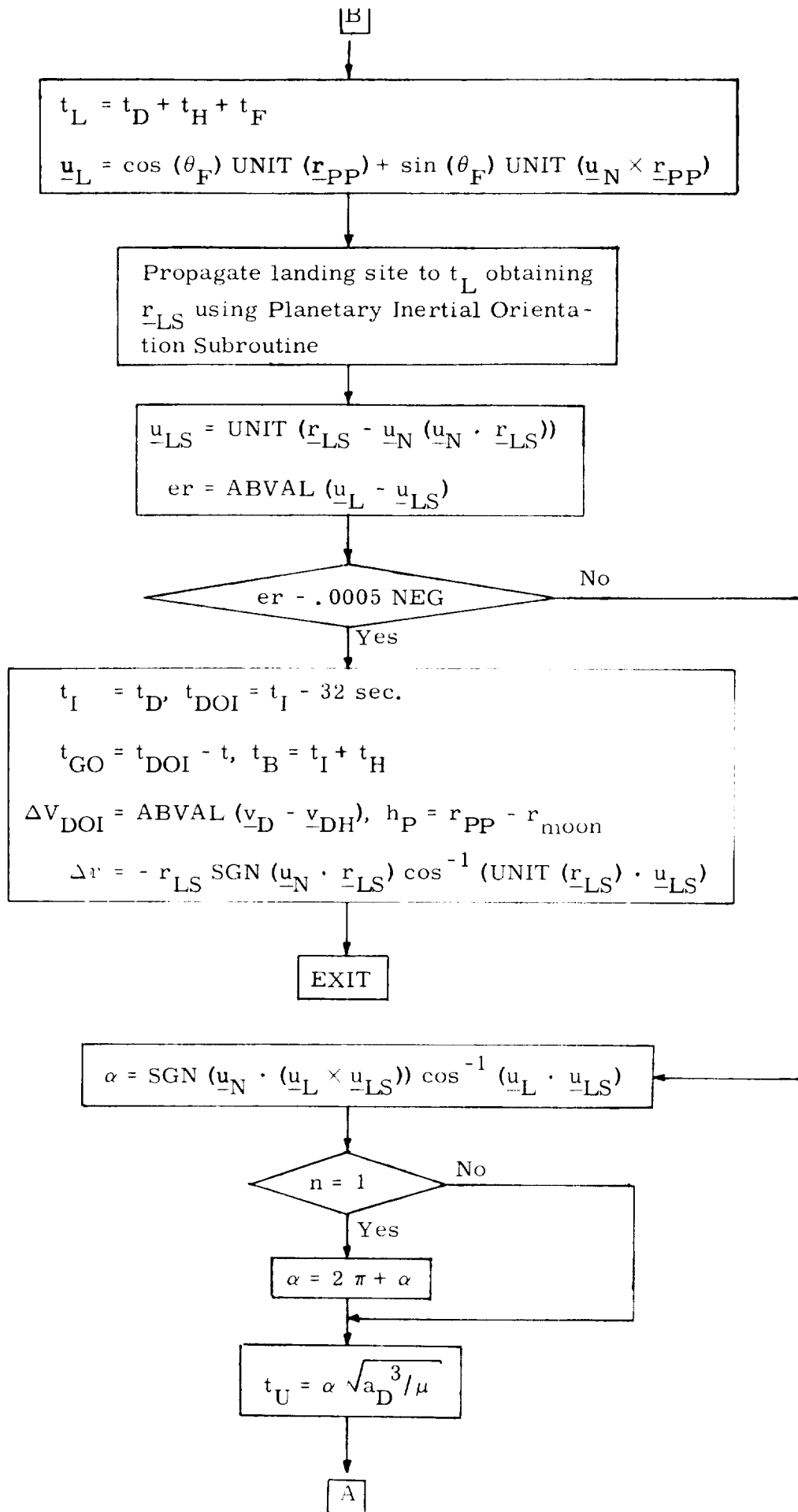

Figure 4. 2-2 Lunar Landing Time Prediction Logic Diagram (page 2 of 2)

5.4.2.2 Determination of the LM Descent Trajectory to Perilune

After the descent orbit injection maneuver, the LM should descend on a Hohmann transfer trajectory to the desired perilune altitude. However, due to the non-spherical gravity effects of the moon, the actual LM descent trajectory will only approximate the conic Hohmann transfer. An offset procedure is used to partially compensate for the non-spherical effects.

According to Fig. 4.2-2, the conic Hohmann transfer time t_H and velocity \underline{v}_{DH} are first computed. The LM state vector $(\underline{r}_D, \underline{v}_{DH})$ is then advanced through t_H using the Coasting Integration Routine. The perilune altitude is then offset and a new Hohmann velocity is computed. The LM state vector is again advanced through t_H which will result in approximately attaining the desired perilune conditions.

5.4.2.3 Determination of New Descent Orbit Injection Time

Once the LM landing time is obtained, the position vector of the desired landing site is determined and rotated into the LM descent orbit plane. The angle α between this vector and the LM landing point is computed in the following manner. On the first iteration ($n = 1$) α is measured from the LM to the desired landing site in the rotational direction of the LM. On subsequent iterations α is defined in the region $-\pi < \alpha < \pi$, with the positive error indicating that the landing site is ahead of the LM. When α is sufficiently small the iteration is terminated. Otherwise, the CSM state vector is updated through the time obtained by multiplying the mean motion of the CSM by α .

5.4.2.4 Program Outputs

The outputs of the program are:

t_I	Nominal time for descent orbit injection (assuming impulsive burn).
t_{DOI}	Approximate time of ignition for descent orbit injection ($t_I - 32$ secs.).
t_{GO}	Time-to-go to ignition time for the descent orbit injection maneuver.
t_B	Nominal time of ignition for the powered landing maneuver.
t_L	Nominal time of landing.
Δr	Cross track distance between the descent orbit and the landing site (plus if north of the descent orbital plane).
h_P	Descent orbit insertion target altitude.
ΔV_{DOI}	Required velocity for the descent orbit injection (impulsive burn) maneuver.

The landing site position vector at the predicted landing time, t_L , is used as the basic vector direction to which the LM IMU is aligned for the descent and landing maneuver phases. The CSM orbital plane is used to define the other IMU or stable member (SM) landing alignment parameters as follows:

$$\begin{aligned} \underline{x}_{SM} &= \text{UNIT} \left[\underline{r}_{LS} (t_L) \right] \\ \underline{y}_{SM} &= \text{UNIT} \left(\underline{z}_{SM} \times \underline{x}_{SM} \right) \end{aligned}$$

$$\underline{z}_{SM} = \text{UNIT} \left[(\underline{r}_C \times \underline{v}_C) \times \underline{x}_{SM} \right]$$

where \underline{r}_C and \underline{v}_C are the CSM position and velocity vectors, respectively.

The nominal descent orbit injection time, t_I , and the perilune target altitude, h_P , are the two primary input parameters for the DOI pre-thrust program. The output parameters, t_{DOI} and t_{GO} , are estimates of the DOI maneuver ignition time and time-to-go respectively which provide the astronaut with this major maneuver timing requirements before calling the DOI maneuver program. The output t_B is used as the nominal ignition time for the landing maneuver pre-ignition program. The Δr and ΔV_{DOI} are primary display outputs to the astronaut to determine if the landing maneuver and DOI maneuver targeted by this routine are within nominal DPS ΔV limits.

5. 4. 3 LM LAUNCH TIME PREDICTION ROUTINE

5. 4. 3. 1 General

The objective of the LM Launch Time Prediction Routine is to determine the lunar surface ascent ignition time. There are two operating modes of this routine. The first involves the concentric flight plan (CFP) rendezvous profile, and the second is used for direct transfer (DT) rendezvous trajectories. Both of these rendezvous profiles are initiated from the standard ascent injection trajectory which is normally coplanar with the CSM orbital plane with a perilune altitude above the landing site radius of 60,000 ft. and an apolune altitude of 30 n. m. The CFP rendezvous profile normally involves two intermediate parking orbits established by the CSI and CDH maneuvers before a final direct transfer or intercept trajectory is established by the TPI maneuver. In the DT rendezvous profile the final intercept trajectory to the CSM is established as soon as possible after the ascent injection. Since these two rendezvous profiles involve different vehicle phasing conditions at the intercept or TPI maneuver, different launch time calculations are required.

The CFP mode of the LM Launch Time Prediction Routine is controlled by program P-10 of Section 4. The CFP rendezvous profile (Sections 5. 4. 4.1 to 5. 4. 4. 4) involves an initial CSI maneuver nominally initiated about 30 minutes after ascent injection. Based on a knowledge of the CSM orbit, the desired radius of the CDH maneuver can be computed using a specified altitude difference between the CSM and LM orbits at the CDH point. The CSI maneuver can then be determined under the constraints that the CSI maneuver must be applied horizontally and that the apolune of the resulting trajectory must equal the CDH radius vector. The LM state vector is then advanced to this apolune point and the required CDH maneuver determined. The LM state is then again advanced along the resulting trajectory after the

CDH maneuver to the desired LM position at the TPI time. This position is found by integrating the CSM state vector to the specified TPI time and then using the line-of-sight constraint and altitude difference (at the CDH maneuver) to compute the desired LM position. The time that the LM arrives at this desired position is forced to the TPI time in this routine by iterating on the lunar launch time assuming a standard powered ascent trajectory.

The direct transfer (DT) rendezvous mode of this routine is controlled by program P-11 of Section 4. The DT rendezvous profile is initiated with the TPI maneuver as soon as possible (e. g. 10 minutes) after ascent injection with a specified central transfer angle and time of flight between the TPI maneuver and intercept point. The terminal rendezvous or intercept point is, therefore, fixed relative to the launch site for these conditions. The arrival times of the LM and CSM at the intercept point are equated in this routine by iterating on the LM launch time assuming a standard ascent trajectory and fixed time interval between ascent injection and the TPI maneuver.

The general targeting parameters used in the LM Launch Time Prediction Routine are illustrated in Fig. 4. 3-1.

The required input parameters for this routine are as follows:

- 1) $\underline{r}, \underline{v}, t$ CSM state vector at time t
- 2) \underline{r}_{LS}, t_A LM launch position vector at time t_A
- 3) t_1, θ_1, h_1 Nominal ascent injection maneuver time, transfer angle and injection altitude for the LM

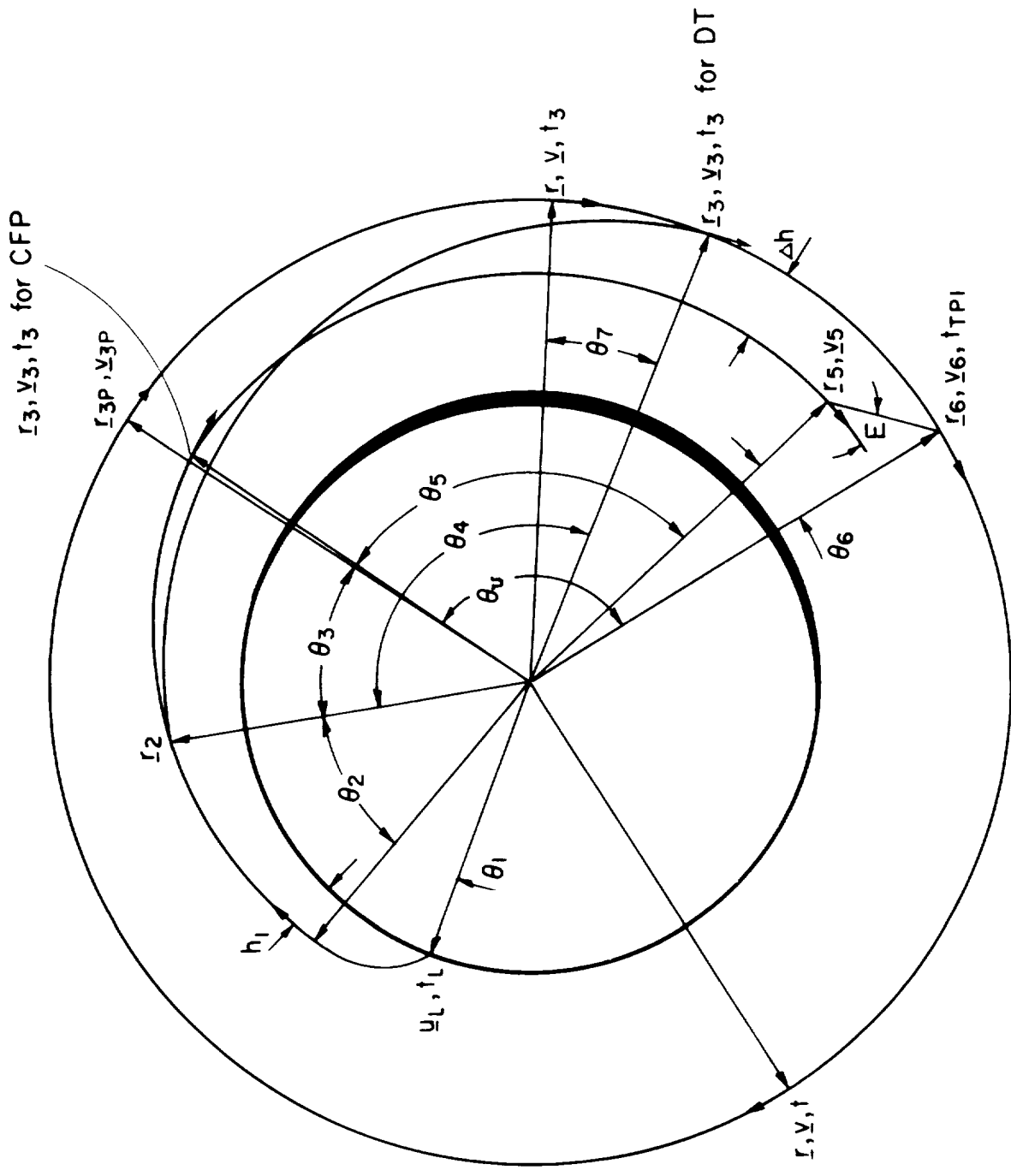

Fig. 4.3-1 LM Launch Time Prediction Nomenclature

- | | | |
|----|---------------------|--|
| 4) | v_{LV} , v_{LH} | LM vertical and horizontal target velocity at ascent maneuver injection |
| 5) | t_2 | Time from the end of powered ascent to the first rendezvous maneuver. (CSI for the CFP mode, and TPI for the DT mode represented by the angle θ_2 of Fig. 4.3-1). |
| 6) | t_L | Initial estimate of the LM launch time |
| 7) | s | Switch (0 for concentric flight plan rendezvous, and 1 for direct transfer rendezvous). |

In the CFP mode ($s = 0$) the following input parameters are also required:

- | | | |
|-----|------------|--|
| 8) | Δh | Altitude difference for the CDH maneuver (plus if LM is to be below the CSM at CDH). |
| 9) | E | Desired line-of-sight angle relative to the local horizontal at the TPI time ($\approx 26.5^\circ$ if LM is below the CSM, otherwise $\approx -153.5^\circ$) |
| 10) | t_{TPI} | Desired time of the TPI maneuver |
| 11) | t_F | The CFP transfer trajectory time-of-flight between TPI and the intercept point or TPF |

In the DT mode ($s = 1$) the following input parameters are required in addition to numbers 1 - 7 above:

- 12) θ_4, t_4 Central angle and time required for the direct transfer rendezvous trajectory between the TPI maneuver and intercept point.

The CSM state vector (Item 1 above) is obtained in one of three ways prior to calling this routine. These three possible CSM update techniques are:

- a) MSFN-RTCC CSM orbit determination and telemetry uplink to the LGC by program P-27
- b) CMC determination of the CSM orbit by the Orbit Navigation Routine P-22 (Section 5.2.4 of Vol. 1) and voice link transfer of this data to the LM
- c) LGC updating of the CSM orbit by the Rendezvous Radar (RR) Lunar Surface Navigation Routine, P-22 (Section 5.2.5 of Vol. 2) during the CSM overpass prior to LM launch.

The LM landing or launch position vector (Item 2) has been stored in the LGC since the LM state vector reinitialization after LM landing (Section 5.3.4.4.17). The powered ascent trajectory parameters listed in Items 3 and 4 are prestored values of the standard ascent maneuver. Items greater than and including number 5 in the above input list must be provided by astronaut inputs. It should be noted that in the CFP mode of this routine the launch time and rendezvous targeting are based upon the assumption that the CDH maneuver will be performed at the first apsidal crossing after the CSI maneuver.

The primary output of the LM Launch Time Prediction Routine is the ascent ignition time. This is one of the major input parameters to the Powered Ascent Guidance Routine (Section 5.3.5), and also determines the LM IMU launch alignment with the CSM orbital parameters. It might be noted that the LM Launch Time Prediction Routine does not include the computation of a launch window for either the CFP or DT modes. In addition to the launch ignition time the following parameters are displayed as outputs of this routine.

CFP Mode (s = 0)

1. ΔV_{CSI}
2. ΔV_{CDH}
3. ΔV_{TPI}
4. ΔV_{TPF}
5. t_{CSI}
6. t_{CDH}
7. t_{TPI}
8. t_{TPF}
9. Δr - Out of plane distance in nautical miles to be corrected during the powered ascent maneuver for a coplanar injection
10. t_{IG} - Time of ignition
11. TFI - Time from ignition

DT Mode (s = 1)

1. ΔV_{TPI}
2. ΔV_{TPF}

3. t_{TPI}
4. t_{TPF}
5. Δr - see No. 9 above
6. t_{IG} - Time of ignition
7. TFI - Time from ignition

It is possible to retarget both the CFP and DT rendezvous profiles after launch with parameters different from those used in the LM Launch Time Prediction Routine by the Pre-CSI Program P-32 (Section 5.4.3.1) for the CFP mode, or the TPI Search Program P-17 (Section 5.4.4.5) for the DT mode.

Since the concentric flight plan and the direct transfer rendezvous modes employ the same outer iterative loop as well as several common computations, the solutions are combined in one LGC program as outlined in Fig. 4.3-2.

5.4.3.2 CFP Launch Time Prediction

With reference to Fig. 4.3-2 with $s = 0$, a fictitious LM state vector is first created in order to determine the range angle θ_2 (Fig. 4.3-1) between the end of the powered ascent phase and the desired CSI point. After integrating the CSM state vector to the time t_{TPI} , the first estimate of the CDH maneuver radius r_A is found. The post CSI velocity vector \underline{v}_{2F} is then calculated on the basis that the CSI maneuver must be a horizontal application of velocity which results in an apolune at the CDH altitude. The range angle θ_3 and time t_3 to apolune are also obtained. This allows the total time t_S and central angle θ_S between the LM launch site and the CDH point to be computed.

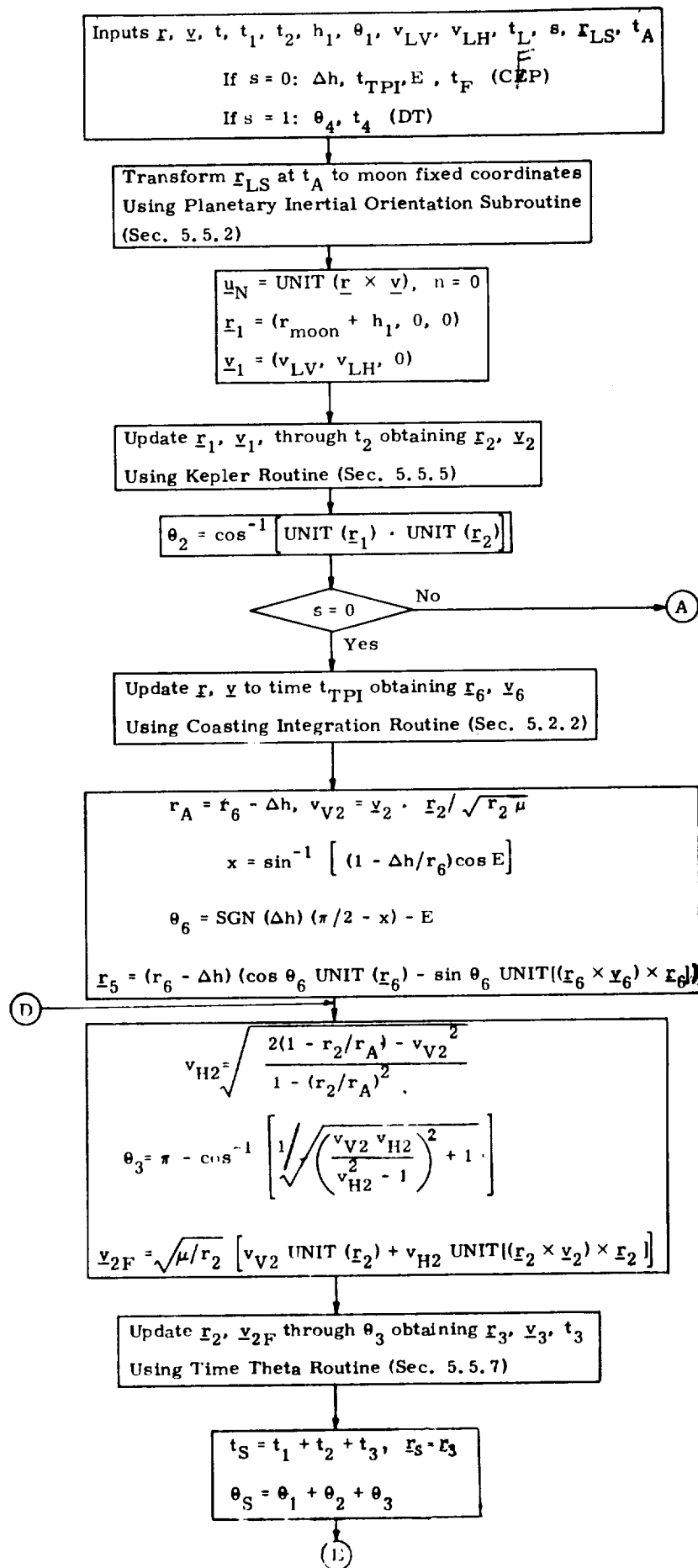

Figure 4.3-2 LM Launch Time Prediction Logic Diagram

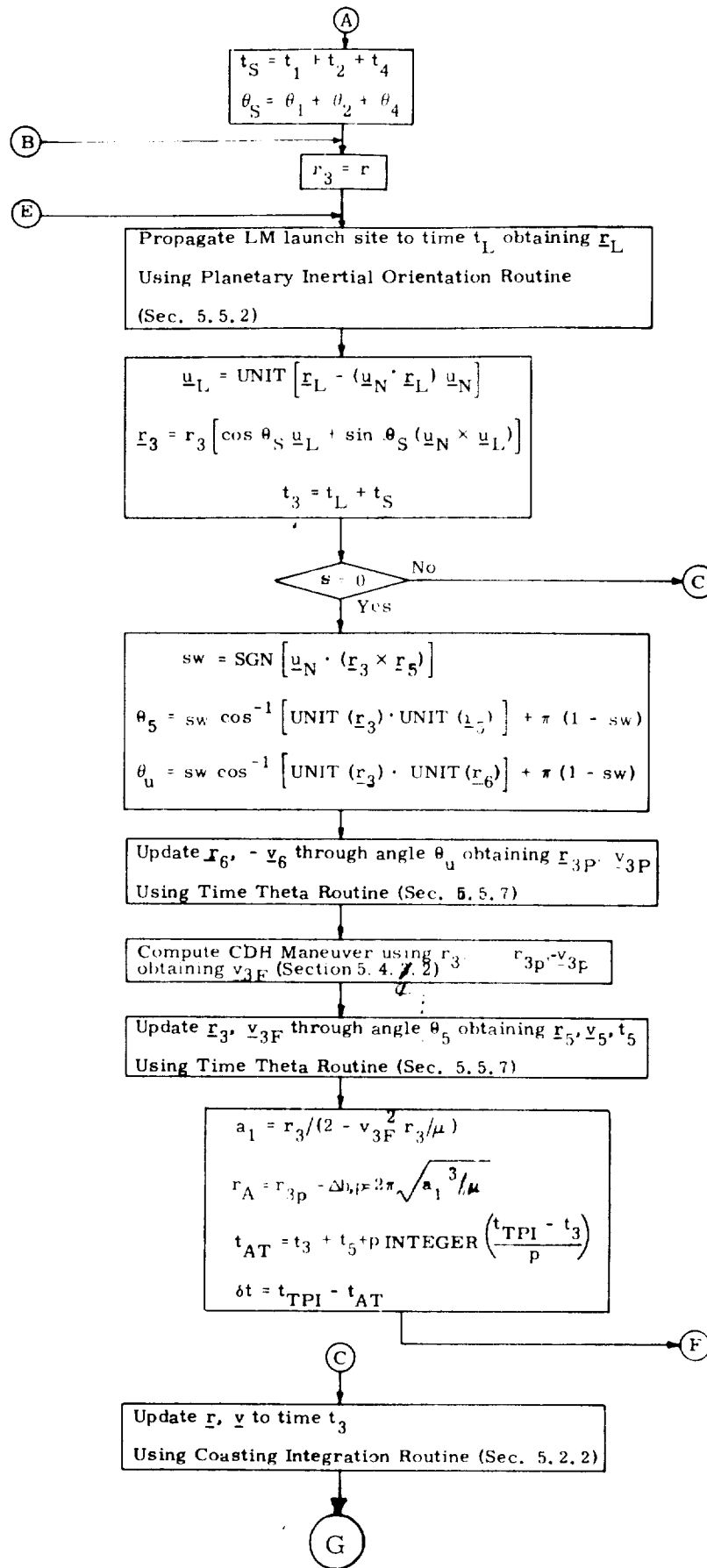

Figure 4.3-2 LM Launch Time Prediction Logic Diagram

(Page 2 of 3)

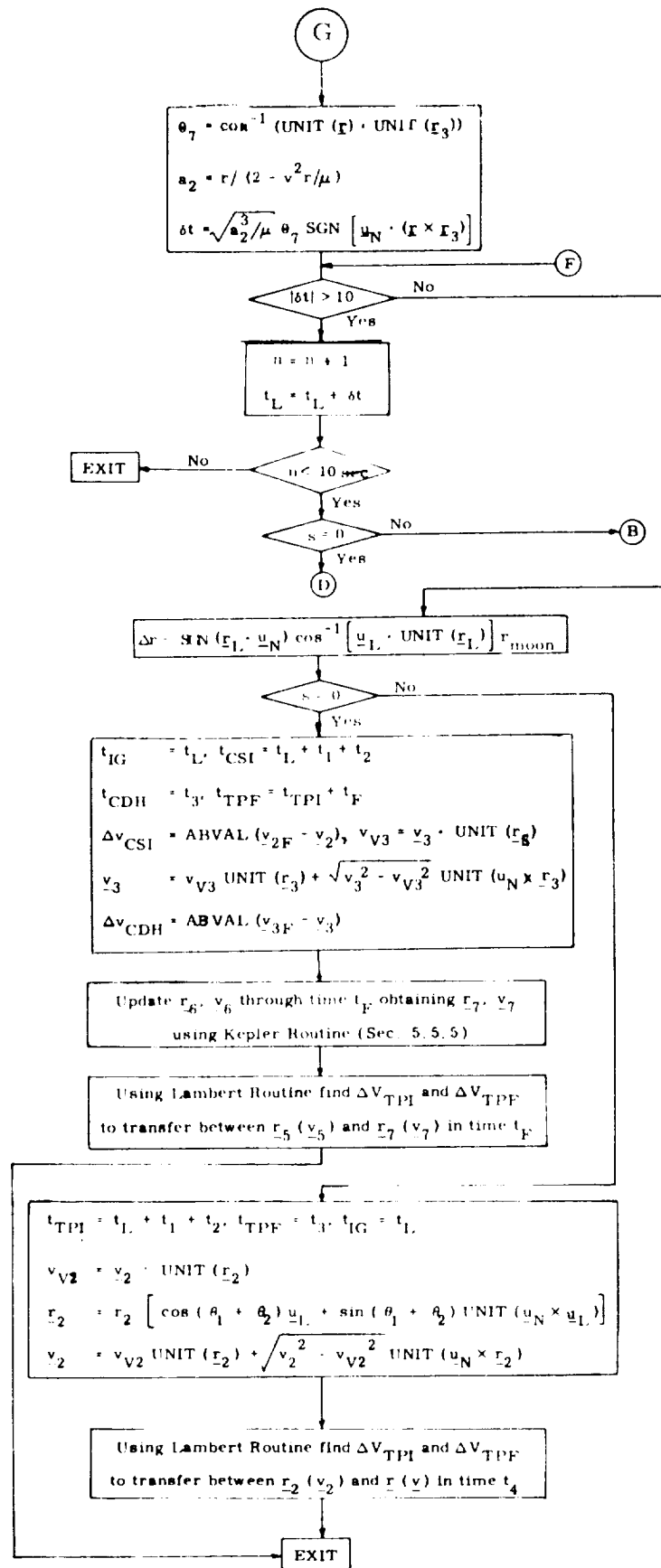

Figure 4.3-2 LM Launch Time Prediction Logic Diagram
(page 3 of 3)

At the TPI time, the line-of-sight from the LM to the CSM must form the angle E with respect to the local horizontal (see Fig. 4.3-1). The TPI geometry yields the angle θ_6 (negative if Δh is negative) between the two vehicles and the desired LM position vector \underline{r}_5 at the TPI time.

The remainder of the program consists of an iterative loop to determine the proper launch time t_L . Initially t_L is given as an input. After propagating the launch site to time t_L and rotating it into the CSM orbital plane obtaining \underline{u}_L , the CDH position \underline{r}_3 is obtained by rotating \underline{u}_L through the angle θ_S . In order to compute the CDH maneuver, and to obtain a new estimate of the CDH altitude, the CSM state vector is extrapolated by means of the Time-Theta Subroutine (Section 5.5.7) to \underline{r}_{3P} , a point directly above \underline{r}_3 . The CDH maneuver is calculated according to Section 5.4.3.2 obtaining the final velocity \underline{v}_{3P} . The period p of the orbit after the CDH maneuver has been made is also calculated. The LM is then extrapolated by means of the Time-Theta Subroutine (Section 5.5.7) through the angle θ_5 between the CDH position and the desired LM position \underline{r}_5 , obtaining the time t_5 . A time error δt is computed allowing for the possibility of multiple revolutions between CDH and TPI. After testing to see if δt is sufficiently small, t_L is set equal to t_L plus δt and the loop is repeated.

5.4.3.3 DT Launch Time Prediction

With reference to Figs. 4.3-1 and 4.3-2 the range angle θ_2 between the end of the powered ascent and the first maneuver (TPI) are calculated as in the CFP mode. The range angle θ_S and time t_S from the LM launch point to the rendezvous point \underline{r}_3 are found by summing the appropriate quantities θ_1 , θ_2 , and θ_4 of Fig. 4.3-1. After obtaining the inplane position \underline{u}_L of the

LM launch site at time t_L , \underline{u}_L is rotated through the angle θ_S . The CSM state vector is integrated to the time that the LM arrives at its rendezvous position. The time error is then obtained from the angular error θ_7 in position after approximating the CSM orbit with its mean motion. This error is then used to close the iteration loop, as in the CFP approach.

5. 4. 4 RENDEZVOUS TARGETING

5. 4. 4. 1 General

The Concentric Rendezvous Program in the LGC may be used in any of four different modes depending on the mission phase at the time the program is selected. It may be called up by the astronaut at any time before the Coelliptic Sequence Initiation (CSI), after the CSI maneuver has been performed and prior to the Constant Differential Altitude (CDH) maneuver, after completion of the CDH maneuver and before the Transfer Phase Initiation (TPI) maneuver, and during the mid-course phase. The program is designed such that it may be used for the nominal active LM rendezvous or for a CSM retrieval rendezvous provided an acceptable solution exists for the given initial conditions and program inputs entered by the astronaut.

A LM direct rendezvous capability is possible with the use of the final modes of the Concentric Rendezvous Program, the Transfer Phase Initiation, and the Midcourse Correction mode. In addition, the TPI Search Program provides a minimum fuel transfer capability. An alternate rendezvous procedure is available using the Stable Orbit Rendezvous Routines.

Used in the first mode (pre-CSI), the objective of the program is to use the latest estimates of the CSM and LM state vectors to establish two maneuvers prior to the Transfer Phase Initiation such that the following conditions are realized.

- (1) The first maneuver (CSI) must be such that the impulsive ΔV is in the active vehicle horizontal plane defined at the initiation of the maneuver.
- (2) The second maneuver (CDH), which occurs at an apsidal crossing of the active vehicle orbit specified by an astronaut input, is designed to make the active and passive vehicle orbits coelliptic as defined in (6) of Section 5. 4. 4. 2.

- (3) At a designated Transfer Phase Initiation (TPI) time, the line of sight (LOS) from the active vehicle to the passive vehicle is at a prescribed angle from the horizontal plane defined at the active vehicle position.
- (4) The time from CSI to CDH and the time from CDH to TPI must not be less than 10 minutes.
- (5) After each maneuver the resulting orbit must have a pericenter altitude which is not less than a prescribed value.

All computations performed in the Concentric Rendezvous Program are referenced to the Basic Reference Coordinate System defined in Section 5.1.4.

The program has a basic dependence on the state vector estimates which are obtained from the navigation routines discussed in Section 5.2 and 5.3.2.

For each of the routines in this section there are two associated program numbers based on whether the LM or the CSM is the active vehicle. If the astronaut elects to make the CSM active, the only change is the program number selected. All equations and program operations in Section 5.4.4 are identical for these two modes of operation.

5.4.4.2 Pre-CSI Maneuver (MODE 1)

This program mode corresponds to Program P-32 (LM active) or P-72 (CSM active) of Section 4.

Inputs

- 1) Choice of maneuvering vehicle. (P-32 LM, P-72 CSM)
- 2) Time of the CSI maneuver.
- 3) NA (If this number is 1, the CDH maneuver will take place at the first apsidal crossing of the active vehicle orbit, etc.).
- 4) Desired LOS angle at TPI (E)
- 5) Time of the TPI maneuver.
- 6) t_F of the final transfer trajectory. (The time, t_F , is the transfer trajectory time between TPI and intercept (TPF) and does not include effects of terminal rendezvous maneuvers.)

Program Operation

It is assumed, for the purpose of computing the CSI maneuver, that the targeting problem is entirely planar and that all vehicle orbits are conics. To use this assumption, the active vehicle state vector is rotated into the plane defined by the passive vehicle orbit. The CSI maneuver will therefore be parallel to the passive vehicle orbital plane.

An initial guess of the CSI maneuver is first made. The active vehicle can then be advanced through NA apses to obtain the CDH maneuver point and the passive vehicle advanced to a point

radially above the active vehicle. The coelliptic maneuver is computed and the active vehicle is advanced to the TPI time. A special measure of the terminal error which exists between the desired LOS angle and the line which connects the two vehicles at the TPI time is calculated. This error is driven to zero by iterating on the CSI maneuver magnitude using a Newton-Raphson iteration scheme. The logic of this procedure is illustrated in Fig. 4.4-1 with the important steps denoted by circled numbers which are discussed in detail below.

① Rotation of active vehicle state vector

The state vector of the active vehicle is rotated into the plane of the passive vehicle with the following equations

$$\underline{r}_{A1} = r_{A1} \text{ UNIT} \left[\underline{r}_{A1} - (\underline{r}_{A1} \cdot \underline{\text{UN}}) \underline{\text{UN}} \right] \quad (4.4.1) \quad *$$

$$\underline{v}_{A1} = v_{A1} \text{ UNIT} \left[\underline{v}_{A1} - (\underline{v}_{A1} \cdot \underline{\text{UN}}) \underline{\text{UN}} \right] \quad (4.4.2)$$

where

$$\underline{\text{UN}} = \text{UNIT} (\underline{r}_{P1} \times \underline{v}_{P1})$$

\underline{r}_{A1} = active vehicle position vector at CSI

\underline{v}_{A1} = active vehicle velocity vector at CSI

\underline{r}_{P1} = passive vehicle position vector at CSI

\underline{v}_{P1} = passive vehicle velocity vector at CSI

* In the remainder of Section 5.4.4 the subscripts A and P denote active and passive vehicle respectively.

- Inputs
- 1) Choice of Vehicle
 - 2) V_{CS1}
 - 3) T_{TP1}
 - 4) C_{DH} Apert (NA)
 - 5) Line of Sight Angle (LO)
 - 6) ΔV Signal Transfer

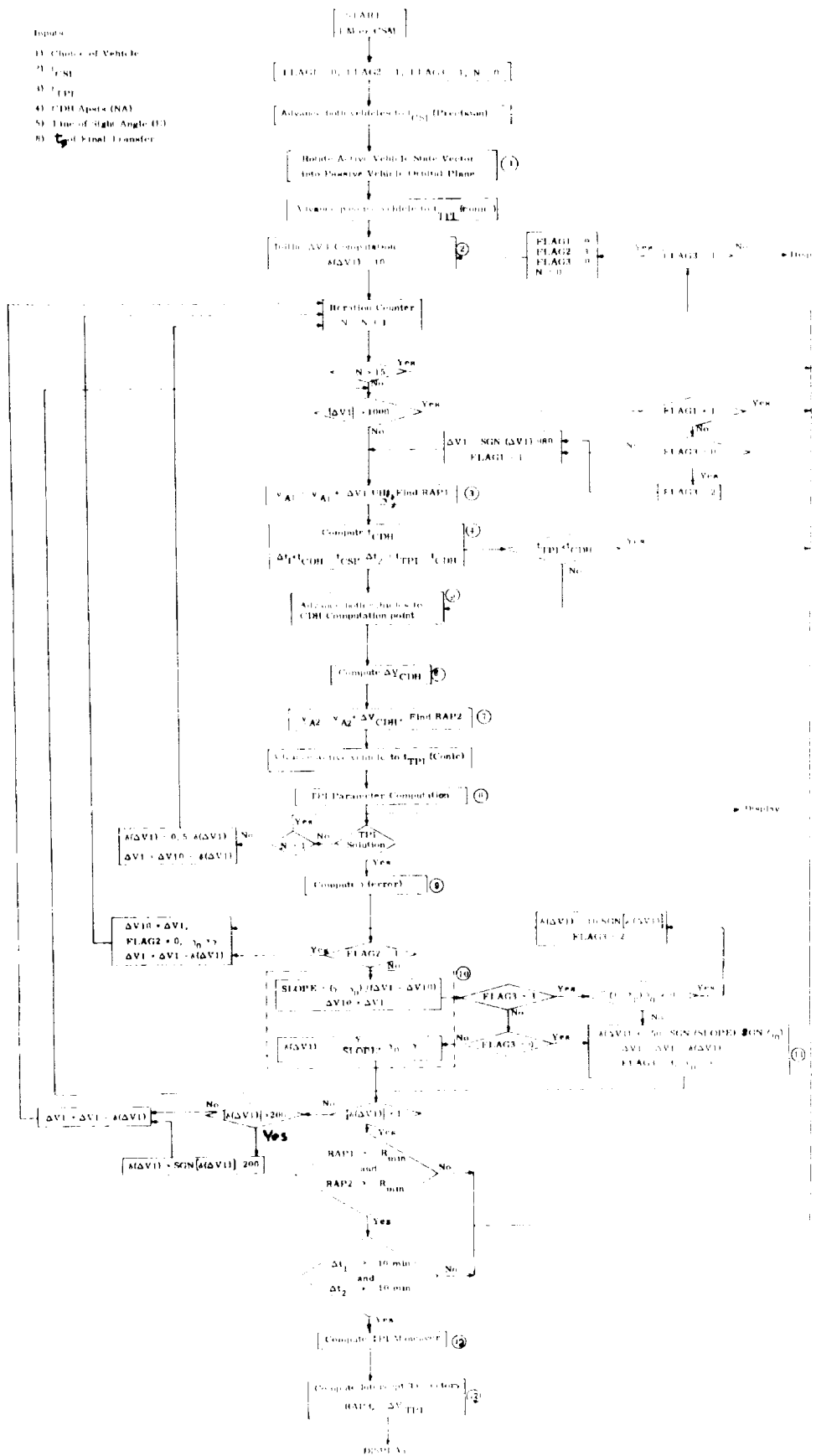

Fig. 4.4-1 Pre-CSI Maneuver Mode

2 Initial ΔV_1 Computation

The initial value of the CSI maneuver ΔV is given by:

$$\Delta V_1 = \sqrt{\frac{2\mu r_{P3}}{r_{A1} (r_{P3} + r_{A1})}} - \left(\underline{v}_{A1} \cdot \underline{U}_{H1} \right) \quad (4.4.3)$$

where

$$\underline{U}_{H1} = \text{UNIT} \left[(\underline{r}_{A1} \times \underline{v}_{A1}) \times \underline{r}_{A1} \right] \quad (4.4.4)$$

and r_{P3} is the magnitude of the passive vehicle position vector at t_{TPI} .

This impulse, when added to the velocity of the active vehicle in the direction of \underline{U}_{H1} , will result in the active vehicle attaining a radius of r_{P3} 180 degrees from the CSI point.

3 Computation of Pericenter Radius after CSI

Once ΔV_{CSI} has been computed, R_{AP1} , the pericenter radius of the active vehicle orbit after the maneuver, is computed using the Apsides Subroutine (Section 5.5.9).

4 Computation of t_{CDH}

In the general case when the active vehicle orbit is

elliptic, the time of flight Δt_1 between the CSI and CDH maneuvers is based on the following calculation of the true anomaly at the CSI point after ΔV_1 has been added to the vehicle's velocity.

$$\cos F = \left(\frac{h^2 - \mu r_{A1}}{\mu e r_{A1}} \right) \quad (4.4.5)$$

where h is the angular momentum and e is the eccentricity of the active vehicle orbit. The Time-Theta Routine (Section 5.5.7) is then used to compute the time of flight Δt_p between the CSI point and the nearest pericenter. The desired flight time Δt_1 is obtained from:

$$\Delta t_1 = \left\{ \begin{array}{l} \frac{NA T_2}{2} - \Delta t_p \quad \text{if } (\underline{r}_{A1} \cdot \underline{v}_{A1}) > 0 \\ \frac{(NA - 1)}{2} T_2 + \Delta t_p \quad \text{if } (\underline{r}_{A1} \cdot \underline{v}_{A1}) < 0 \end{array} \right\} \quad (4.4.6)$$

where T_2 is the period of the active vehicle orbit. Equation (4.4.6) is used to compute Δt_1 provided the active vehicle orbit, after the CSI maneuver, has an eccentricity greater than 10^{-4} and the vertical velocity is greater than .05 ft/sec. If either of these two conditions is not satisfied, then Δt_1 is obtained from

$$\Delta t_1 = \frac{NA T_2}{2} \quad (4.4.7)$$

The CDH maneuver time is

$$t_{CDH} = t_{CSI} + \Delta t_1$$

5 Advance Vehicles to CDH Point

The active vehicle is advanced through Δt_1 using the Kepler Subroutine (Section 5.5.5) to obtain \underline{r}_{A2} and \underline{v}_{A2} . The central angle between the passive vehicle at the CSI time and the active vehicle at the CDH time is found from

$$\theta = \pi - S \left[\cos^{-1} \left(\frac{\underline{r}_{A2} \cdot \underline{r}_{P1}}{r_{A2} r_{P1}} \right) - \pi \right] \quad (4.4.8)$$

where

$\underline{r}_{A2}, \underline{v}_{A2}$ = the active vehicle state vector at t_{CDH}

\underline{r}_{P1} = the passive vehicle position vector at t_{CSI}

$$S = \text{SIGN} \left[(\underline{v}_{A2} \times \underline{r}_{A2}) \cdot (\underline{r}_{P1} \times \underline{r}_{A2}) \right]$$

The passive vehicle at t_{CSI} is updated through the angle θ using the Time-Theta Subroutine (Section 5.5.7) obtaining \underline{r}_{P2} and \underline{v}_{P2} .

6 Computation of $\Delta \underline{V}_{CDH}$

To compute the CDH maneuver $\Delta \underline{V}$ it is necessary to find the passive vehicle's vertical component of velocity at \underline{r}_{P2} and the difference in altitude between the two vehicles at the CDH position. These are given by

$$v_{PV} = \frac{r_{A2} \cdot v_{P2}}{r_{A2}} \quad (4.4.9)$$

$$\Delta H = r_{P2} - r_{A2} \quad (4.4.10)$$

where

\underline{v}_{P2} = the passive vehicle velocity vector
at t_{CDH}

The CDH maneuver $\Delta \underline{V}$ is defined as the impulsive $\Delta \underline{V}$ which results in the active vehicle orbit having a semi-major axis and radial component of velocity at t_{CDH} which are given by Eqs. (4.4.11) and (4.4.12).

$$a_A = a_P - \Delta H \quad (4.4.11)$$

$$v_{AV} = v_{PV} \sqrt{\left(\frac{a_P}{a_A}\right)^3} \quad (4.4.12)$$

where a_P is found from

$$a_P = \frac{\mu r_{P1}}{2\mu - v_{P1}^2 r_{P1}} \quad (4.4.13)$$

The CDH maneuver ΔV is given by the following:

$$\Delta V_{CDH} = \sqrt{\mu \left(\frac{2}{r_{A2}} - \frac{1}{a_A} \right) - v_{AV}^2} U_{H2} + \frac{v_{AV}}{r_{A2}} r_{A2} - v_{A2} \quad (4.4.14)$$

where

$$U_{H2} = \text{UNIT} \left[(r_{A2} \times v_{A2}) \times r_{A2} \right]$$

7 CDH Maneuver

The ΔV_{CDH} computed from Eq. (4.4.14) is applied impulsively to the active vehicle and RAP2, the pericenter altitude of the resulting orbit, is computed using the Apsides Subroutine (Section 5.5.9).

8 TPI Computation

A circular orbit which passes through the passive vehicle position is constructed at the TPI time. A

unit vector which passes through the active vehicle position and is coincident with the desired TPI line of sight is found as follows (See Fig. 4. 4-2).

$$\underline{U} = \cos E \underline{U}_{H3} + \sin E \frac{\underline{r}_{A3}}{r_{A3}} \quad (4. 4. 15)$$

where E is typically 26.6° (-153.4°) and

$$\underline{U}_{H3} = \text{UNIT} \left[(\underline{r}_{A3} \times \underline{v}_{A3}) \times \underline{r}_{A3} \right]$$

The position vector of the intersections between the line and circular orbit is given by Eq. (4. 4. 16).

$$\underline{P} = \underline{r}_{A3} + K \underline{U} \quad (4. 4. 16)$$

where K is an unknown scalar multiplier which has two values in general.

Equating the magnitudes of \underline{P} and \underline{r}_{P3} results in a quadratic expression for K

$$K^2 + 2K \underline{r}_{A3} \cdot \underline{U} + r_{A3}^2 - r_{P3}^2 = 0 \quad (4. 4. 17)$$

If there are no real solutions to Eq. (4. 4. 17) the

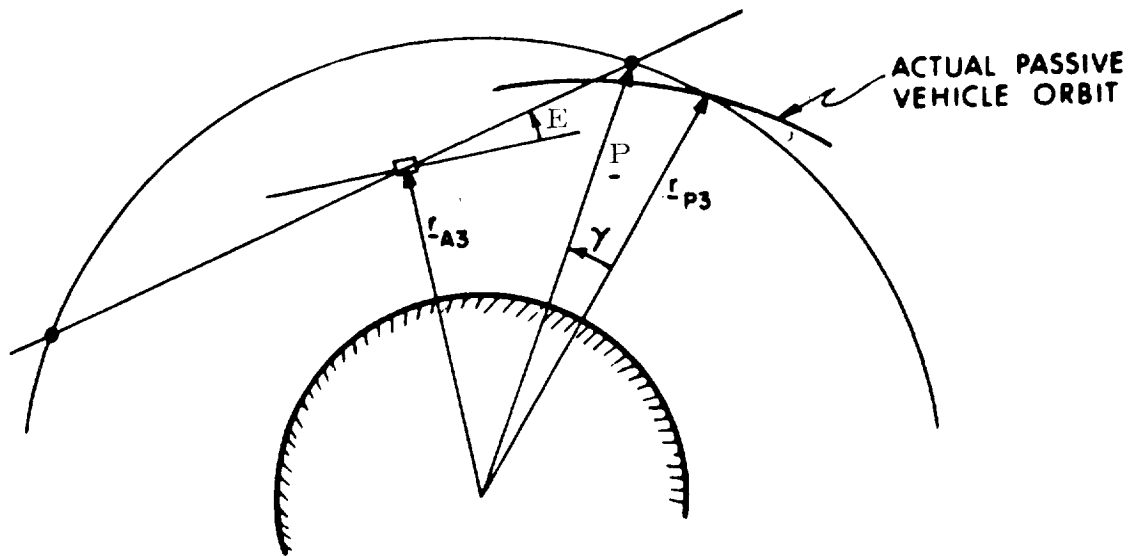

Fig. 4.4-2a TPI geometry, active vehicle below

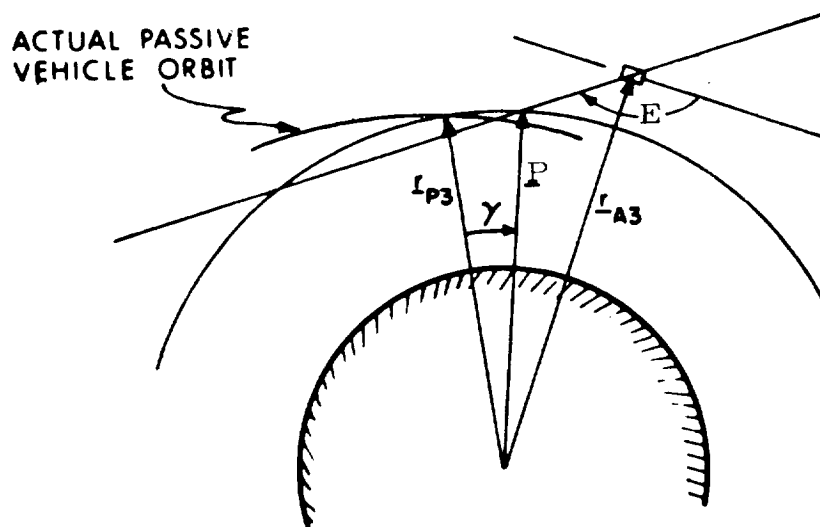

Fig. 4.4-2b TPI geometry, active vehicle above

TPI geometry has no solution, (i. e. \underline{U} does not intersect the circular orbit). Otherwise the K of minimum absolute value is chosen as the physically desirable TPI solution.

9 Computation of Error

An angle error is then defined by

$$\gamma = \cos^{-1} \left(\frac{\underline{P} \cdot \underline{r}_{P3}}{P r_{P3}} \right) \quad (4.4.18)$$

The sign of γ is positive if \underline{r}_{P3} is ahead of \underline{P} and is defined in the region from $-\pi$ to $+\pi$. This angular error is now used to close the iteration loop which is designed to converge to an acceptable ΔV_{CSI} if one exists.

10 Iteration Step Computation

In order to obtain a second value of ΔV_{CSI} , 10 ft/sec. is subtracted from the first value. Once two points have been found, a Newton-Raphson technique is employed to compute the iteration step. After each step the magnitude of the step is found and compared with a prescribed value. The iteration is terminated when the step size is less than the prescribed value.

If, after the first point is found, any of the iterations result in no solution of the TPI geometry, the next ΔV_{CSI} change is a fraction of the previous one. This process is repeated as necessary.

11 Second TPI Parameter Computation

Once an iteration loop has been established it is possible to cycle the program twice. If the first iteration fails to converge to an acceptable solution a second attempt is automatically initiated by modifying ΔV_{CSI} in the direction opposite to that initially taken during the first search. ΔV_{CSI} is incremented in steps of 50 ft/sec. until the error has undergone a sign change (e. g. has gone from $+\pi$ to $-\pi$). The second search then starts with the latest value of ΔV_{CSI} and an adjacent point in the direction of the 50 ft/sec. steps.

If an acceptable solution for ΔV_{CSI} and ΔV_{CDH} has been found (see checks below), the position vector of the passive vehicle is advanced using the Kepler Subroutine (Section 5.5.5) to the intercept time given by

$$t_{\text{TPF}} = t_{\text{TPI}} + t_{\text{F}} \quad (4.4.19)$$

12 Computation of Conic TPI Maneuver

The Initial Velocity Subroutine (Section 5.5.11) is used to determine the velocity impulse ΔV_{TPI} to transfer between the active and passive vehicle during the time t_F . This computation is done conically, requiring no offset procedure.

13 Computation of Conic TPF Maneuver

After application of ΔV_{TPI} the pericenter distance R_{AP3} of the trajectory which follows the TPI maneuver can be determined from the Apsides Subroutine (Section 5.5.9). The active vehicle is advanced through the time t_F using the Kepler Subroutine (Section 5.5.5) and the TPF maneuver found by subtracting the velocity vectors of the two vehicles at t_{TPF} .

Included in the pre-CSI thrust mode are seven program checks which are automatically made.

- 1) If on the first iteration there is no solution of the TPI geometry, the iteration cannot be established.
- 2) If on any iteration the magnitude of ΔV_{CSI} exceeds a maximum value, a ΔV slightly below the maximum value is used for the next iteration. If the following iteration also requires a ΔV which exceeds the maximum, the iteration is terminated.
- 3) An iteration counter is used to protect against unlimited looping. The counter is checked against a preset maximum value.
- 4) RAP1 is compared with a minimum acceptable pericenter radius.
- 5) RAP2 is compared with a minimum acceptable pericenter radius.
- 6) $t_{\text{CDH}} - t_{\text{CSI}}$ is compared to a minimum acceptable value (10 minutes).
- 7) $t_{\text{TPI}} - t_{\text{CDH}}$ is compared to a minimum acceptable value (10 minutes)

For the first check above, a check failure results in an

immediate program exit. However, for the other checks the program will be automatically recycled once.

For a particular set of vehicle state vectors and program inputs there may be more than one pair of maneuvers which satisfies all of the above checks. The program will converge to only one of these, and there is no method for detecting any other solutions if they exist. Also, there is no way in which the program will indicate that the solution found is the only one, nor that it is in any way an optimum.

Nominal Outputs (pre -CSI mode)

- 1) Magnitude of
 - a) ΔV_{CSI}
 - b) ΔV_{CDH}
 - c) ΔV_{TPI}
 - d) ΔV_{TPF}
- 2) Maneuver time of CDH, (t_{CDH})
- 3) Altitude of CDH
- 4) Differential altitude at t_{CDH}
- 5) Pericenter altitude after the TPI maneuver

In addition these nominal outputs there are seven ways in which the pre-CSI mode of the Concentric Rendezvous Program may exit. All seven of these are in the form of program alarms described in Section 4 and correspond to the seven checks described above.

5.4.4.3 Pre-CDH Maneuver (MODE 2)

This program mode corresponds to program P-33 (LM active) or P-73 (CSM active) of Section 4, and the computational sequence is illustrated in Fig. 4.4-3.

Inputs

- 1) Choice of maneuvering vehicle (P-33 LM, P-73 CSM)
- 2) Time of CDH Maneuver
- 3) TPI time or Elevation angle
- 4) t_F of final transfer trajectory

Program Operation

After the CSI maneuver has been completed and prior to the CDH time, the Concentric Flight Plan Program may be used in the following manner. Based on the input, t_{CDH} , and the estimated state vectors, both vehicles are advanced to the CDH time using the Coasting Integration Routine. The CDH maneuver is then computed and the parameters associated with the CDH maneuver are displayed. The third input is then used in the following manner.

If the astronaut has elected to input a desired elevation angle, the following iterative technique is used to compute TPI time.

MODE 2

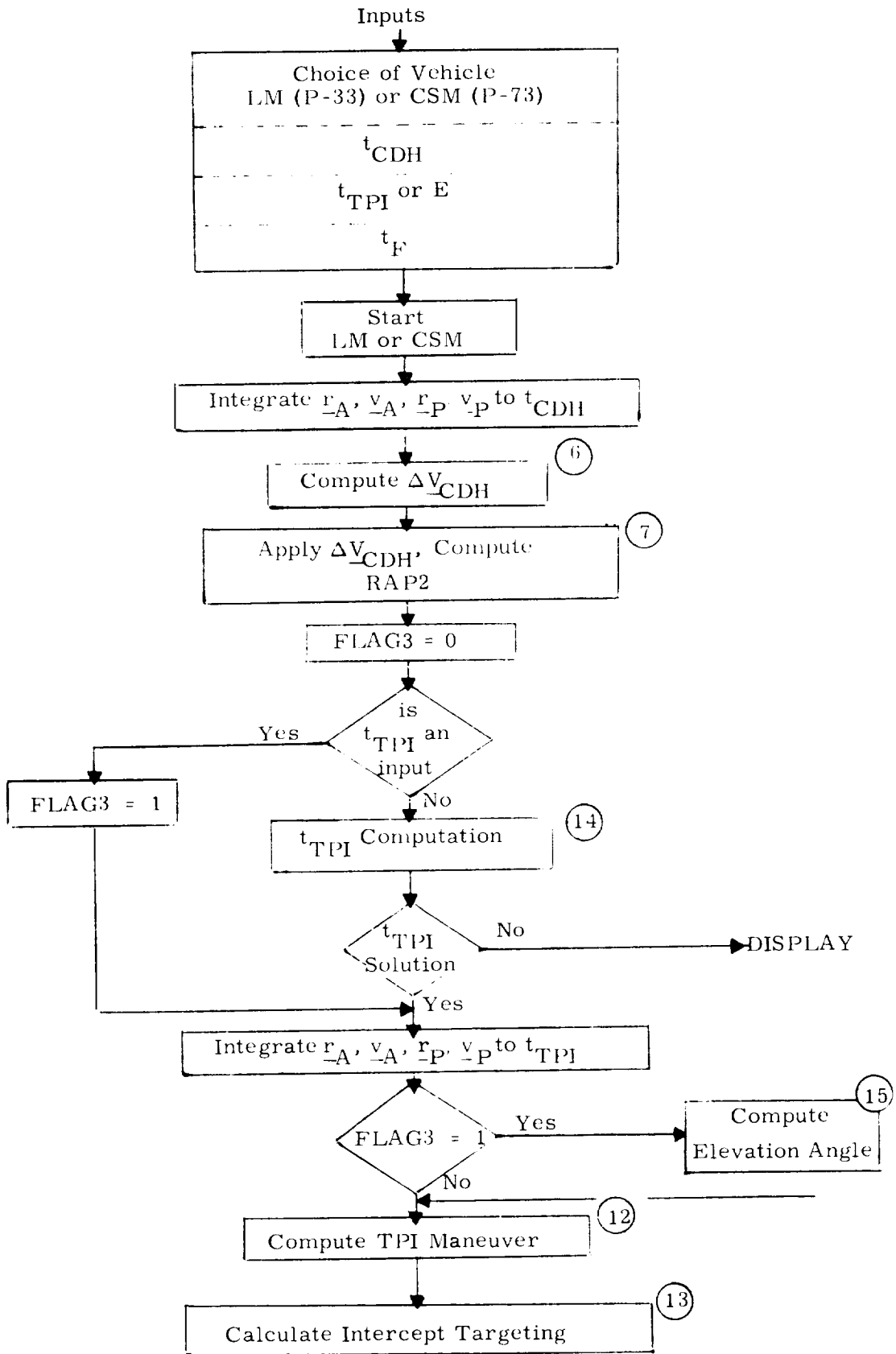

Figure 4. 4-3 Pre-CDH Maneuver Mode

14 TPI Computation

Both vehicles are advanced to the stored TPI time using the Coasting Integration Routine. If the difference between the true line-of-sight angle and the input TPI angle is greater than 0.1 degrees, the true TPI time is then calculated by making successive co-planar circular approximations to the current orbits (which are assumed to be no more than 5 degrees out of plane).

The time error to the true TPI for circular orbits is given by the equation:

$$TERR = \frac{ARCCOS [(RA/ RP) \cos E] - E - \lambda}{WP - WA} \quad (4.4.20)$$

where

RA, RP = the magnitude of the active and passive vehicle position vectors

E = desired TPI angle (4.4.21)

λ = central angle from RA to RP, positive when RP is ahead of RA.

WA, WP = the magnitudes of orbital angular velocities

It should be noted that the ARCCOS term in the above equation always gives rise to 2 solutions. If $RP > RA$ only one such solution is meaningful; however when $RA > RP$, both solutions are significant. In this case the solution corresponding to the shorter line of sight between vehicles is selected.

Both vehicles are then advanced to the time given by Eq. (4. 4.22) and the true line of sight angle rechecked.

$$t_{TPI} = t_{TPI} + TERR \quad (4. 4. 22)$$

This process is repeated until the line of sight error becomes less than 0.1 deg. An iteration counter is used to protect against excessive iterations. When there is no TPI time associated with the elevation angle, the counter will serve as a means of initiating a program alarm which indicates that no solution can be found.

If a desired t_{TPI} were selected as the input, the following procedure is used to compute the corresponding elevation angle.

⑮ Elevation Angle Computation

If a TPI time is one of the inputs, both vehicles are advanced to that time using the Coasting Integration Routine; and the elevation angle (defined in Fig. 4.4-4) which corresponds to the TPI time is computed using the following equations:

$$\underline{H3} = (\underline{r}_{A3} \times \underline{v}_{A3}) \times \underline{r}_{A3}$$

$$\underline{LOS} = \text{UNIT} (\underline{r}_{P3} - \underline{r}_{A3}) \quad (4. 4. 23)$$

$$\underline{UA3} = \text{UNIT} (\underline{r}_{A3})$$

$$E = \pi/2 - \cos^{-1} (\underline{UA3} \cdot \underline{LOS})$$

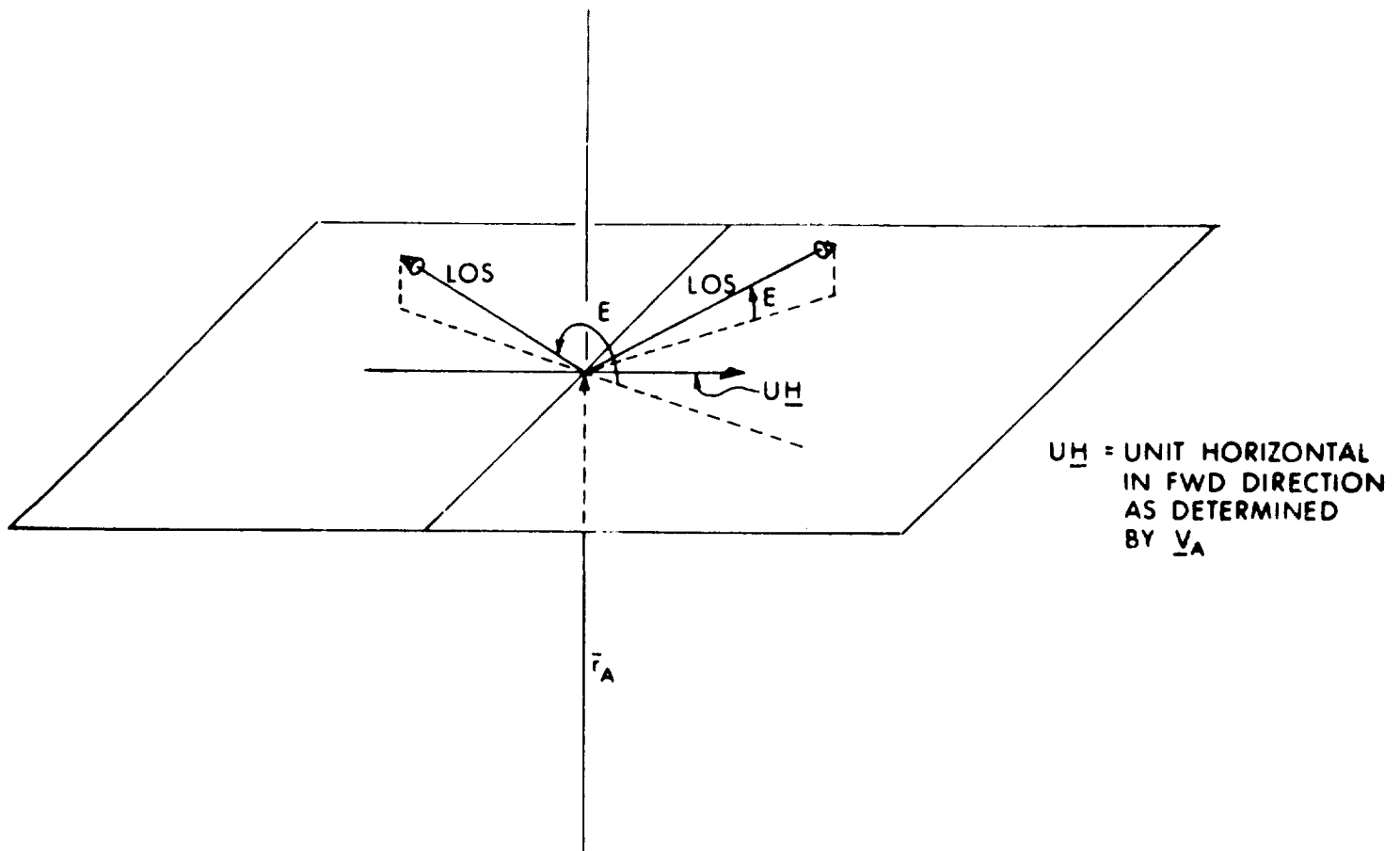

- 1) IF THE LOS PROJECTION ON \underline{UH} IS POSITIVE:
 - a) WHEN THE LOS IS ABOVE THE HORIZONTAL PLANE $0 < E < \pi/2$
 - b) WHEN THE LOS IS BELOW THE HORIZONTAL PLANE $-\pi/2 < E < 0$

- 2) IF THE LOS PROJECTION ON \underline{UH} IS NEGATIVE
 - a) WHEN THE LOS IS ABOVE THE HORIZONTAL PLANE $\pi/2 < E < \pi$
 - b) WHEN THE LOS IS BELOW THE HORIZONTAL PLANE $-\pi < E < -\pi/2$

Fig. 4.4-4 Definition of Elevation Angle, E

$$\text{If } (\underline{\text{LOS}} \cdot \underline{\text{H3}}) < 0; \text{E} = \pi - \text{E} \quad (4.4.24)$$

$$\text{XE} = |\text{E}| - \pi$$

$$\text{If } \text{XE} > 0; \text{E} = \text{XE} - \pi \quad (4.4.25)$$

The parameters associated with the transfer phase are computed using (12) and (13) of Section 5.4.4.2.

This mode of the Concentric Flight Plan provides a re-computation of the CDH maneuver as well as an updated prediction of the relative TPI geometry. The only program exit which does not give the nominal outputs will occur if there is no solution to the TPI geometry.

Nominal Outputs (pre-CDH mode)

- 1) Magnitude of
 - a) ΔV_{CDH}
 - b) ΔV_{TPI}
 - c) ΔV_{TPF}
- 2) Elevation angle or t_{TPI}
- 3) Altitude of CDH
- 4) Differential altitude at t_{CDH}

- 5) Pericenter altitude after the CDB maneuver
- 6) Pericenter altitude after the TPI maneuver

5.4.4.4 Pre-TPI Maneuver (MODE 3)

This program mode corresponds to Program P-34 (LM active) or P-74 (CSM active) of Section 4 and the computational sequence is illustrated in Fig. 4. 4-5.

Inputs

- 1) Choice of maneuvering vehicle (P-34 LM, P-74 CSM)
- 2) TPI time or elevation angle
- 3) t_F of final transfer trajectory

Program Operation

A procedure exactly analogous to that described in (14) and (15) of Section 5. 4. 4. 3 is used to compute the desired TPI geometry given the astronaut input of a TPI time or elevation angle.

If the final modes of the Concentric Rendezvous Program are used for a direct rendezvous maneuver, a nominal TPI time does not exist in the computer when the MODE 3 program (P-34 or P-74) is initiated. Therefore, if the astronaut wishes to specify an elevation angle it is necessary to input both the TPI time and E, the desired elevation angle. As discussed in Section 5. 4. 4. 3 a nominal t_{TPI} is needed to initialize the routine used to compute t_{TPI} for a given E. When the above input procedure is completed and the E option selected the TPI time associated with the desired elevation angle will be computed.

(16) Computation of TPI (or Midcourse) Maneuver

To compute the TPI (or Midcourse) Maneuver the Initial Velocity Subroutine (Section 5. 5. 11) is used with the proper switch set to allow for one target offset. Although the offset procedure, as well as the initialization for the Lambert Subroutine, is included in the Initial Velocity Subroutine the offset technique is repeated here for further clarity.

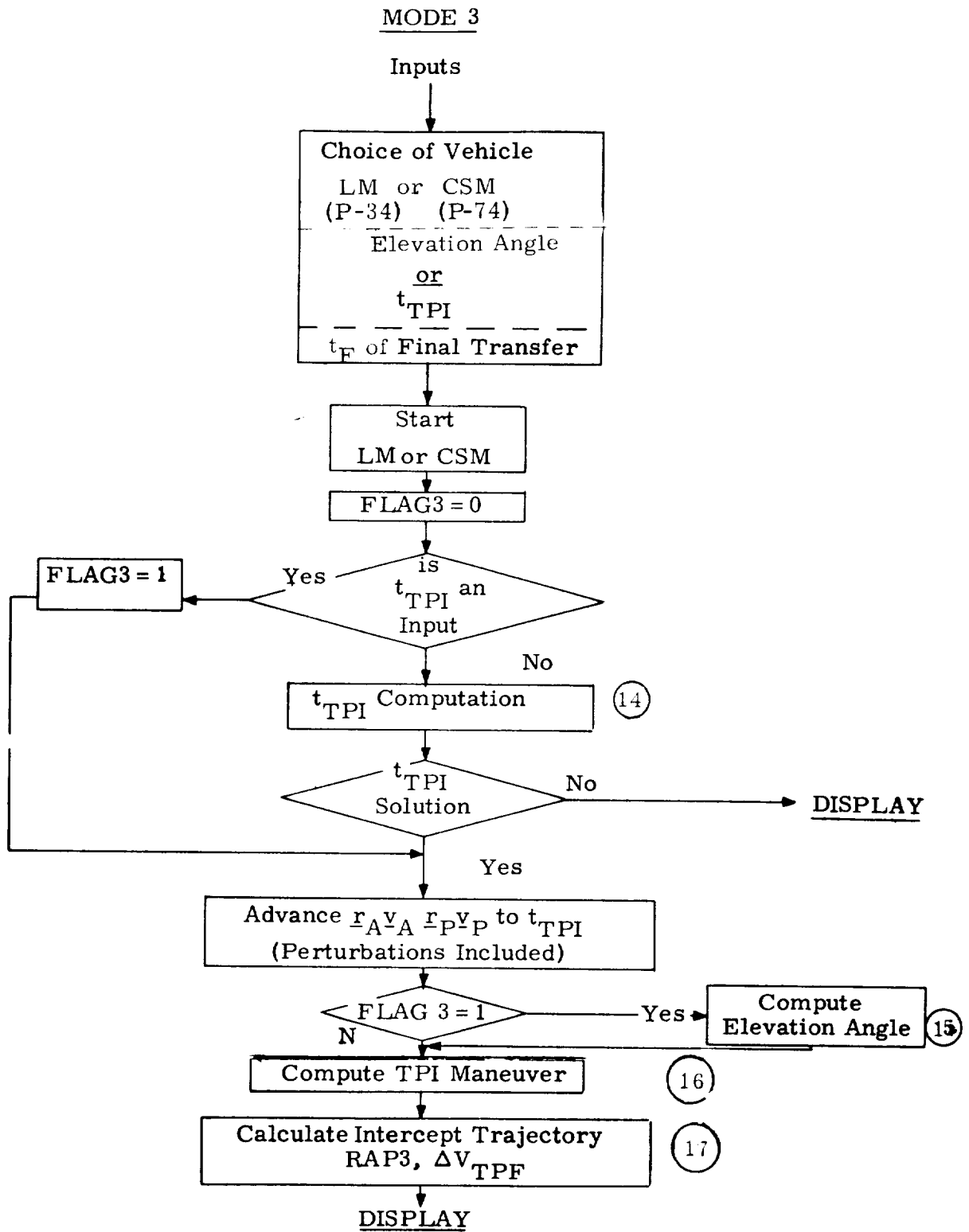

Fig. 4. 4-5 Pre-TPI Maneuver Mode

The estimate of both vehicle state vectors along with the t_F of the final transfer (an astronaut input) are used to compute an intercept aim point and the maneuver required to arrive at this aim point at the desired time. In calculating an offset target to be used by the Lambert Routine (See Section 5.5.6) for computing ΔV_{TPF} , the effects of non-spherical gravitational perturbations are considered in the following way.

The position vector of the passive vehicle is advanced to the intercept time with the Coasting Integration Routine using the input transfer trajectory t_F . The intercept time is given by Eq. (4.4.26).

$$t_{TPF} = t_{TPI} + t_F \quad (4.4.26)$$

The aimpoint for the initial ΔV calculation is the position vector of the passive vehicle at t_{TPF} , that is

$$\underline{r}_{AIM_0}(t_{TPF}) = \underline{r}_P(t_{TPF}) \quad (4.4.27)$$

The passive vehicle velocity vector at the intercept point, $\underline{v}_P(t_{TPF})$, is also obtained from the Coasting Integration Routine and stored.

The state vector of the active vehicle is advanced to t_{TPF} using the Lambert solution, resulting in $\underline{r}_A(t_{TPF})$. Due to non-spherical gravitational perturbations, the active vehicle will not intercept the target. The position deviation from the desired position $\underline{r}_P(t_{TPF})$ is given by

$$\delta \underline{r}_{-1} (t_{\text{TPF}}) = \underline{r}_{-A} (t_{\text{TPF}}) - \underline{r}_{-P} (t_{\text{TPF}}) \quad (4.4.28)$$

A new aimpoint is computed for the second iteration, by the following equation:

$$\underline{r}_{\text{AIM}_1} (t_{\text{TPF}}) = \underline{r}_{\text{AIM}_0} - \delta \underline{r}_{-1} (t_{\text{TPF}}) \quad (4.4.29)$$

A new $\Delta \underline{V}$ is then computed using $\underline{r}_{\text{AIM}_1} (t_{\text{TPF}})$, t_{F} , and $\underline{r}_{-A} (t_{\text{TPI}})$. Using the new $\Delta \underline{V}$, the state vector of the active vehicle is again advanced to t_{TPF} to obtain $\underline{r}_{-A} (t_{\text{TPF}})$ and $\underline{v}_{-A} (t_{\text{TPF}})$.

①7 Intercept Trajectory Computation

Once a $\Delta \underline{V}_{\text{TPI}}$ has been computed the Apsides Sub-routine (Section 5.5.9) is used to determine the pericenter altitude of the trajectory established by the TPI maneuver. The relative velocity at intercept, $\Delta \underline{V}_{\text{TPF}}$, is

$$\Delta \underline{V}_{\text{TPF}} = \underline{v}_{-P} (t_{\text{TPF}}) - \underline{v}_{-A} (t_{\text{TPF}}) \quad (4.4.30)$$

where $\underline{v}_{-A} (t_{\text{TPF}})$ and $\underline{v}_{-P} (t_{\text{TPF}})$ are both available from the above computations.

Nominal Outputs (pre-TPI mode)

- 1) Elevation angle or TPI time
- 2) Magnitude of
 - a) ΔV_{TPI}
 - b) ΔV_{TPF}
- 3) Pericenter altitude after the TPI maneuver

In addition to the nominal outputs (above) there is one other way in which the pre-TPI mode of the Concentric Rendezvous Program may exit. If there is no solution to the TPI time for an input elevation angle a program alarm will result, as mentioned in (15) of Section 5.4.4.3.

5.4.4.5 Rendezvous Mid-Course Maneuvers (MODE 4)

This program mode corresponds to program P-35 (LM active) or P-75 (CSM active) of Section 4 and the computational sequence is illustrated in Fig. 4.4-6. Normally rendezvous midcourse maneuvers, and consequently this program, should not be used if the time-to-go to intercept is less than 10 minutes.

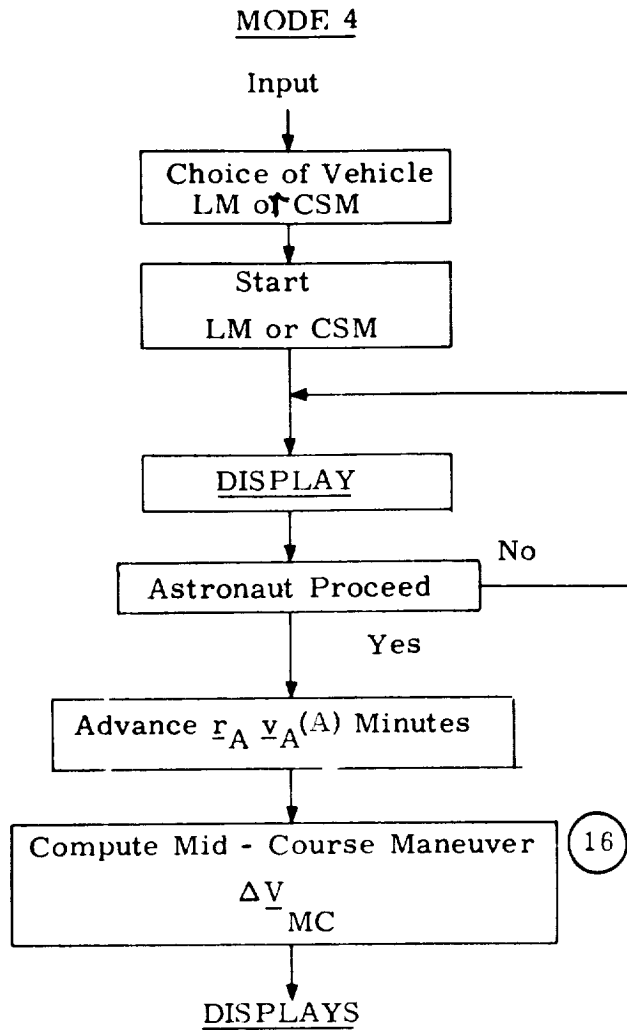

Fig. 4. 4-6 Rendezvous Mid-course Maneuver Mode.

Inputs

- 1) Choice of maneuvering vehicle
(P-35 LM, P-75 CSM)

Program Operation

The objective of this mode is to maintain an intercept trajectory with midcourse correction maneuvers so that the active vehicle will intercept the passive vehicle at the time and aimpoint established in the previous TPI mode. The midcourse mode of the Concentric Flight Plan may be called up by the astronaut at any time after the TPI maneuver. When the program is initiated the number of navigation measurements since the last maneuver and the time to intercept are displayed. Based on this information and additional displays discussed in Section 5.6.6, the astronaut may elect to proceed with a midcourse correction maneuver at any point. When he does so the program computes the midcourse correction which would take place (A) minutes from the current time. The time delay is the period required to prepare for a thrusting maneuver. To compute the midcourse correction, the active vehicle is advanced to a point (A) minutes from the present time and the passive vehicle is advanced to the intercept time using the Coasting Integration Routine. The correction required to intercept the passive vehicle at the intercept time defined by the TPI program is then computed using the techniques described in (16) of Section 5.4.4.4.

Nominal Outputs

- 1) Rendezvous Midcourse Maneuver ΔV_{MC}
- 2) ΔV_{TPF} if Midcourse Maneuver is performed

5.4.4.6 TPI Search Program

The objective of the TPI Search Program is to determine the minimum total velocity transfer trajectory from a specified TPI maneuver time within the constraint of a safe pericenter. The minimum total velocity determined during the transfer trajectory search function of this Program is the sum of the impulsive velocities for the TPI maneuver and the TPF or ideal rendezvous maneuver. This program is used to establish the target parameters for a direct intercept trajectory between the LM and CSM orbits controlled by a TPI maneuver. The manual terminal rendezvous maneuver is normally initiated from such an intercept trajectory. The TPI Search Program is designated as program P-17 in Section 4, and as the name suggests is used to provide the required TPI maneuver target parameters for either direct transfer (DT) rendezvous profiles or concentric flight plan (CFP) rendezvous TPI maneuvers if ΔV minimization is desired beyond nominal preselected astronaut input target parameters. This program can be used in both earth and lunar orbits. In the LGC the active vehicle referred to in the following discussion which establishes the intercept trajectory is the LM vehicle, and the CSM is the passive vehicle.

The following input parameter is required by the TPI Search Program.

- 1.) t_{TPI} desired time of transfer phase initiation (TPI)

The basic output parameters displayed to the astronaut are:

- 1.) $\pm \theta_0$ Initial relative phase angle between the two vehicles at t_{TPI} , + indicating that the active vehicle is ahead of the passive vehicle with respect to orbital motion.

2.) $\pm \Delta h$ Altitude difference between the two vehicles at t_{TPI} , + indicating that the passive vehicle has a larger radial magnitude than the active vehicle.
3.) K Preferred central angle search sector. $K = +1$ for central angles greater than 180° , and $K = -1$ for central angles less than 180° .
4.) ΔV_{TPI} Impulsive velocity required for the TPI maneuver.
5.) $\pm \Delta V_{TPF}$ Impulsive velocity required for the terminal rendezvous maneuver, + indicating that the active vehicle is ascending at TPF, - if descending.
6.) h_P Altitude of the pericenter above a reference radius vector.
7.) t_F Transfer time of the intercept trajectory between the TPI and TPF maneuvers.

In general non-coplanar transfer cases, there will normally be two minimum total ΔV intercept trajectories, one having a central angle greater than 180° and the other less than 180° . In the TPI

Search Program these two central angle sectors are searched separately. The Program initially selects the sector in which the most acceptable solution will probably be found based upon the relative position conditions existing at the selected TPI time and displays this choice to the astronaut. The astronaut may proceed with this choice or command the search sector by changing the above parameter K. Due to the excessive ΔV requirements for two-impulse transfers with 180 degree central angles in non-coplanar conditions, the central angle search sectors are limited away from 180° by an angle depending upon the magnitude of the non-coplanar angle between the active vehicle position vector at TPI and the passive vehicle orbital plane.

The general TPI Search Program target vectors and relative angles are illustrated in Fig. 4.4-7. The subscripts A and P refer to the active and passive vehicles, respectively.

Program Operation

The TPI Search Program logic diagram is shown in Fig. 4.4-8. With reference to this figure the following major computation sequences are described:

1. Upon selection and activation of the TPI Search Program the planetary body (earth or moon) is first confirmed by the SETMU Subroutine of Section 5.5.10, and the appropriate gravitational constant, μ , and minimum pericenter altitude h_{PLIM} are set for program operation. The following minimum pericenter altitude limits for the transfer trajectory are prestored:

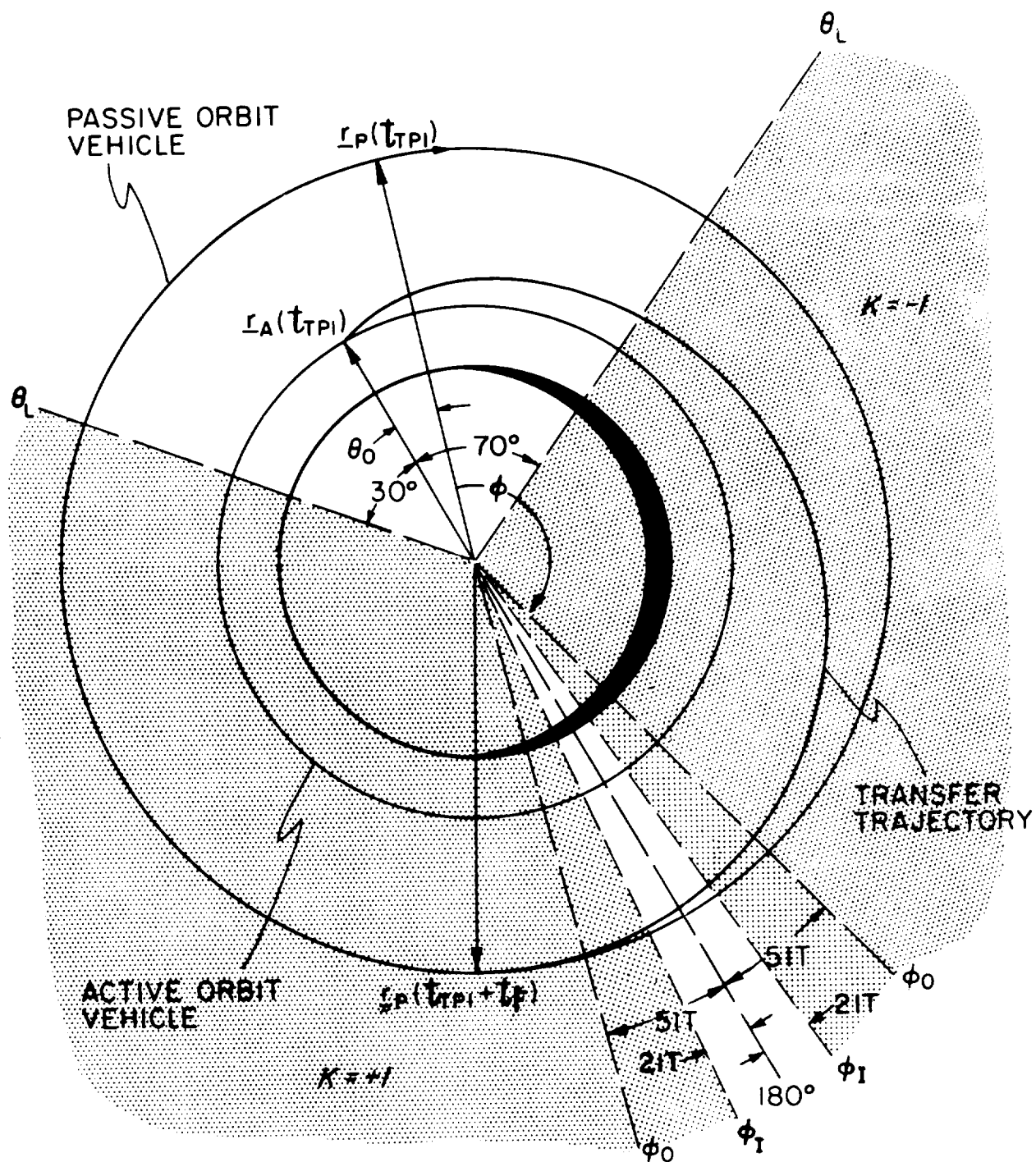

Figure 4.4-7 Central Angle Sectors for the TPI Search Program

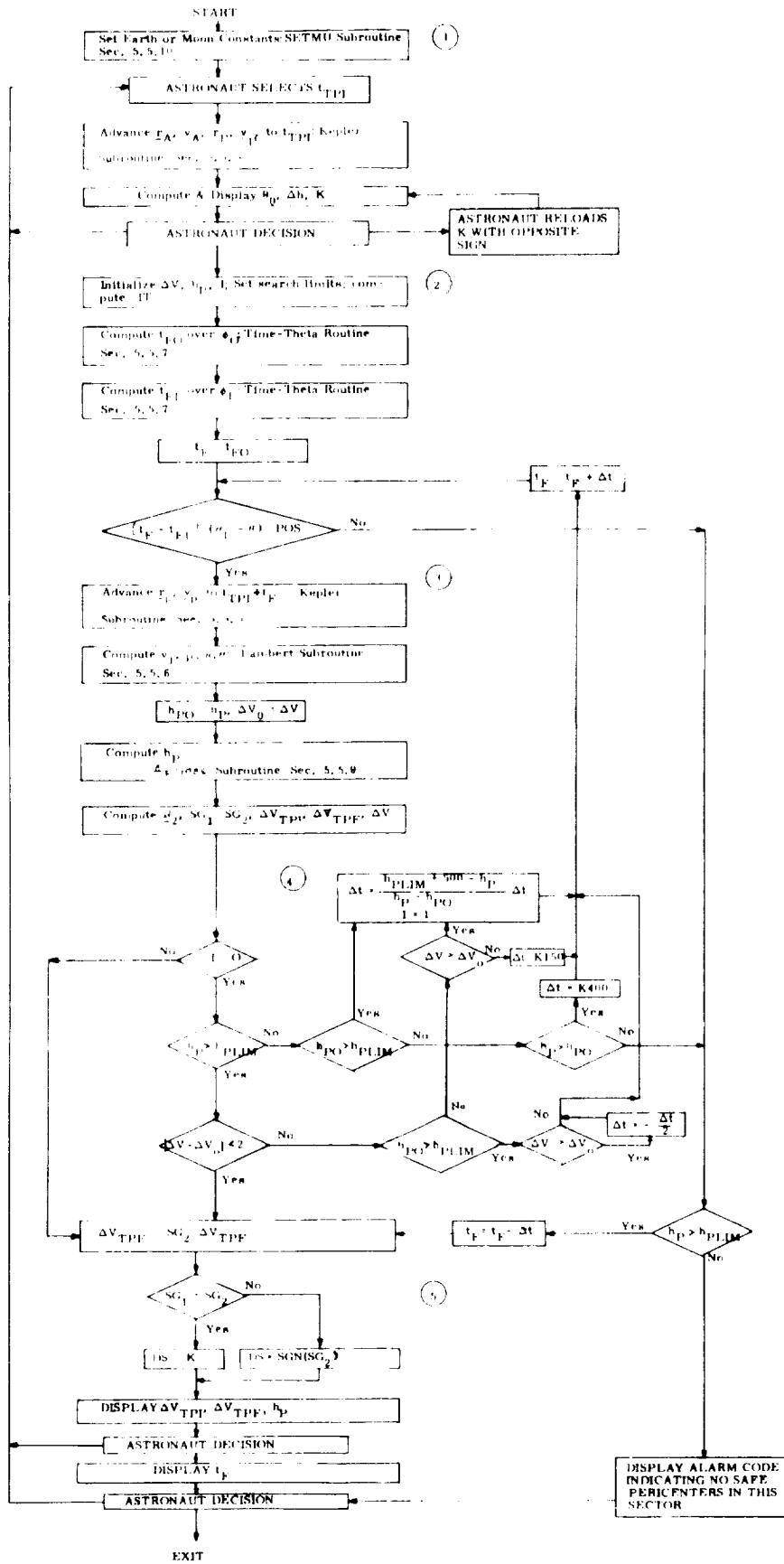

Figure 4.4-8 TPI Search Program Logic Diagram

Lunar Orbit Case : $h_{\text{PLIM}} = 35,000$ ft above the landing site radius magnitude.

Earth Orbit Case : $h_{\text{PLIM}} = 85$ nm above the launch pad radius.

The active and passive vehicle state vectors are next advanced to the specified TPI time by means of the Kepler Subroutine of Section 5.5.5. At this point the relative phase angle θ_0 , altitude difference Δh , and search sector flag K are computed as follows:

$$\underline{u}_{\text{HP}} = \text{UNIT}(\underline{r}_{\text{P}} \times \underline{v}_{\text{P}}) \quad (4.4.31)$$

$$\underline{r}_{\text{PA}} = \underline{r}_{\text{A}} - (\underline{r}_{\text{A}} \cdot \underline{u}_{\text{HP}})\underline{u}_{\text{HP}} \quad (4.4.32)$$

$$\theta_0 = \text{Sign}[(\underline{r}_{\text{P}} \times \underline{r}_{\text{A}}) \cdot \underline{u}_{\text{HP}}] \cos^{-1}[\text{UNIT}(\underline{r}_{\text{PA}}) \cdot \text{UNIT}(\underline{r}_{\text{P}})] \quad (4.4.33)$$

$$\Delta h = |\underline{r}_{\text{P}}| - |\underline{r}_{\text{A}}| \quad (4.4.34)$$

$$K = \text{Sign}[\Delta h] \quad (4.4.35)$$

The parameters θ_0 , Δh and K are then displayed to the astronaut and a response is requested. The astronaut may proceed, command the initial search to the other sector by changing K, or change the TPI time.

2. With reference to Fig. 4.4-8, the program next computes the parameter IT by:

$$IT = \left[\text{UNIT}(r_A) \cdot u_{HP} \right]^{\frac{1}{2}} \quad (4.4.36)$$

An initial guess ϕ_0 is then made of the transfer angle of the passive vehicle corresponding to a minimum ΔV for the active vehicle:

$$\phi_0 = 180^\circ + \theta_0 + K \cdot 5IT \quad (4.4.37)$$

and is used to start the search iteration. An inner transfer angle limit for the passive vehicle of

$$\phi_I = 180^\circ + \theta_0 + K \cdot 2IT \quad (4.4.38)$$

is set to avoid excessive ΔV conditions, and the outer search limits are set as follows:

$$\theta_L = 70^\circ \quad (K = -1) \quad (4.4.39)$$

$$\theta_L = 330^\circ \quad (K = +1)$$

The following initial values are next set to start the iterative procedure:

$$\begin{aligned} \Delta V &= 10^5 \quad (\text{fps}) \\ h_P &= -10^8 \quad (\text{ft}) \\ I &= 0 \end{aligned} \quad (4.4.40)$$

The Time Theta Subroutine of Section 5.5.7 is used to determine the passive vehicle transfer time between its position at the selected TPI time and both $\phi_0(t_{FO})$ and $\phi_I(t_{FI})$. The initial time of flight t_F is defined equal to t_{FO} .

3. The minimum ΔV trajectory search begins by advancing the passive vehicle to the initial aim point at $t_{TPI} + t_F$ by means of the Kepler Subroutine (Section 5.5.5) and storing the resulting passive vehicle state vector at this time. The Lambert Subroutine of Section 5.5.6 is then used to determine the required velocity \underline{v}_1 to establish an intercept trajectory to the aim point with a transit time of t_F . This subroutine also provides the trajectory orbit parameters p and a that are later used with the Apesides Subroutine of Section 5.5.9 to determine the transfer trajectory pericenter altitude h_P . In order to determine the velocity \underline{v}_2 of the active vehicle at the intercept point, the Time-Theta Subroutine (Section 5.5.7) is used. The following computations are then performed.

$$SG_1 = \text{Sign} \left[\underline{r}_A \cdot \underline{v}_A \right] \quad (4.4.41)$$

$$SG_2 = \text{Sign} \left[\underline{r}_P(t_{TPI} + t_F) \cdot \underline{v}_2 \right] \quad (4.4.42)$$

$$\Delta V_{TPI} = \left| \underline{v}_1 - \underline{v}_A \right| \quad (4.4.43)$$

$$\Delta V_{TPF} = \left| \underline{v}_2 - \underline{v}_P(t_{TPI} + t_F) \right| \quad (4.4.44)$$

$$\Delta V = \Delta V_{TPI} + \Delta V_{TPF} \quad (4.4.45)$$

4. The program enters a control sequence whose effect is as follows:

1. If the height of pericenter h_P and its previous value h_{PO} are both less than h_{PLIM} and furthermore h_P is less than h_{PO} an alarm is displayed indicating that there are no safe pericenters in the sector being searched.

2. If, as before, both $h_P < h_{PLIM}$ and $h_{PO} < h_{PLIM}$, but now $h_P > h_{PO}$ the program sets the time of flight increment Δt equal to $K 400$ sec., increments the time of flight, and continues searching.

3. If the pericenter changes from safe to unsafe, the program interpolates to find the time of flight at which the change occurred, and accepts this value as the solution, together with ΔV_{TPI} , ΔV_{TPF} , h_P

4. If the pericenter changes from unsafe to safe, the program also interpolates and accepts the solution provided ΔV is greater than its previous value ΔV_0 . If not it sets $\Delta t = K 150$ sec., increments the time of flight, and continues searching.

5. If the present pericenter is safe and $|\Delta V - \Delta V_0| < 2$ the present time of flight is accepted as the solution.

6. If none of the above conditions holds, the time of flight is incremented by Δt if $\Delta V < \Delta V_0$ or diminished by $\Delta t / 2$ if $\Delta V > \Delta V_0$, and the search function continues.

7. If the time of flight exceeds the bounds set in 2 a solution is assumed if a safe pericenter exists, otherwise the alarm code is displayed indicating no safe pericenters in the sector being searched.

5 A sign is affixed to ΔV_{TPF} and the solution set consisting of ΔV_{TPI} , $\pm \Delta V_{\text{TPF}}$, h_P is displayed to the astronaut. The order in which the above parameters are presented on the three display registers (R1, R2, R3) is dependent upon the polarity of the display sequence variable (DS) in Fig. 4.4-8 and indicates to the astronaut whether the pericenter of the transfer trajectory occurs between the TPI and TPF maneuvers (DS positive) or beyond the rendezvous point (DS negative) as follows:

R1	: ΔV_{TPI}	
R2	: h_P	pericenter between TPI and TPF
R3	: $\pm \Delta V_{\text{TPF}}$	

R1	: ΔV_{TPI}	
R2	: $\pm \Delta V_{\text{TPF}}$	pericenter beyond rendezvous point
R3	: h_P	

If the astronaut is satisfied with these trajectory parameters, he may request that the time of flight t_F be displayed to be recorded as an input parameter for the TPI Pre-thrust program P-34 along with the initial t_{TPI} . The other central angle sector may be searched by returning to (1) and changing K, or a new trajectory solution attempted by returning to (1) and changing the input TPI time until a satisfactory transfer trajectory has been found.

5.4.4.7 Stable Orbit Rendezvous

The Stable Orbit Rendezvous profile is defined by the following four orbital maneuvers. The first maneuver (initial Stable Orbit TPI) defines a transfer of the active vehicle to a point on the orbit of the passive vehicle, a given distance ahead of, or behind the passive vehicle, as measured along the passive vehicle orbital path. The second maneuver (Stable Orbit Rendezvous-SOR maneuver) is designed to place the active vehicle in the same orbit as the passive vehicle with a separation between the two vehicles determined by the first TPI maneuver. The position of the active vehicle relative to the passive vehicle after this second maneuver is referred to as the stable orbit point. The third and fourth maneuvers represent the final transfer from the stable orbit point (final TPI) and terminal rendezvous respectively, and are similar to the corresponding maneuvers in the final phase of the concentric rendezvous sequence.

The first two stable orbit rendezvous maneuvers will make use of program P-38 which is essentially the same as P-34 except for the following modifications. If P-38 is used for the initial Stable Orbit TPI maneuver, a special phantom target state vector is generated and used in place of the passive vehicle for targeting and Lambert steering. When P-38 is used for the stable orbit maneuver an ignition time bias is used in order to partially compensate for the finite maneuver time. Both of these modifications are discussed in detail below.

During the transfer to the stable orbit point and also during the final transfer phase a program (see Section 5.4.4.7.2) is available for computing any midcourse corrections required to intercept the target point.

All the orbital calculations required for the targeting in this program use the Coasting Integration Routine, a precision technique. The pre-thrust programs for the Stable Orbit Rendezvous (P-38, P-78, P-39, P-79) use the Lambert targeting concept with one offset aim point (see Section 5.4.4.4 and 5.5.6) and the cross-product steering of Section 5.3.3.3.

5.4.4.7.1 Stable Orbit TPI Program

The Stable Orbit TPI Program has two phases and is used to perform the first and the second maneuver described above. This program corresponds to P-38 or P-78 of Section 4. The logic flow is shown in Fig 4.4-9.

Input Parameters

- 1) Choice of maneuvering vehicle
(P-38 LM, P-78 CSM)
- 2) Ignition time of the maneuver, t_{TPI}
- 3) t_F , time of flight of transfer trajectory
- 4) Program Phase

PHASE = 1 TPI maneuver

PHASE = 2 SOR maneuver

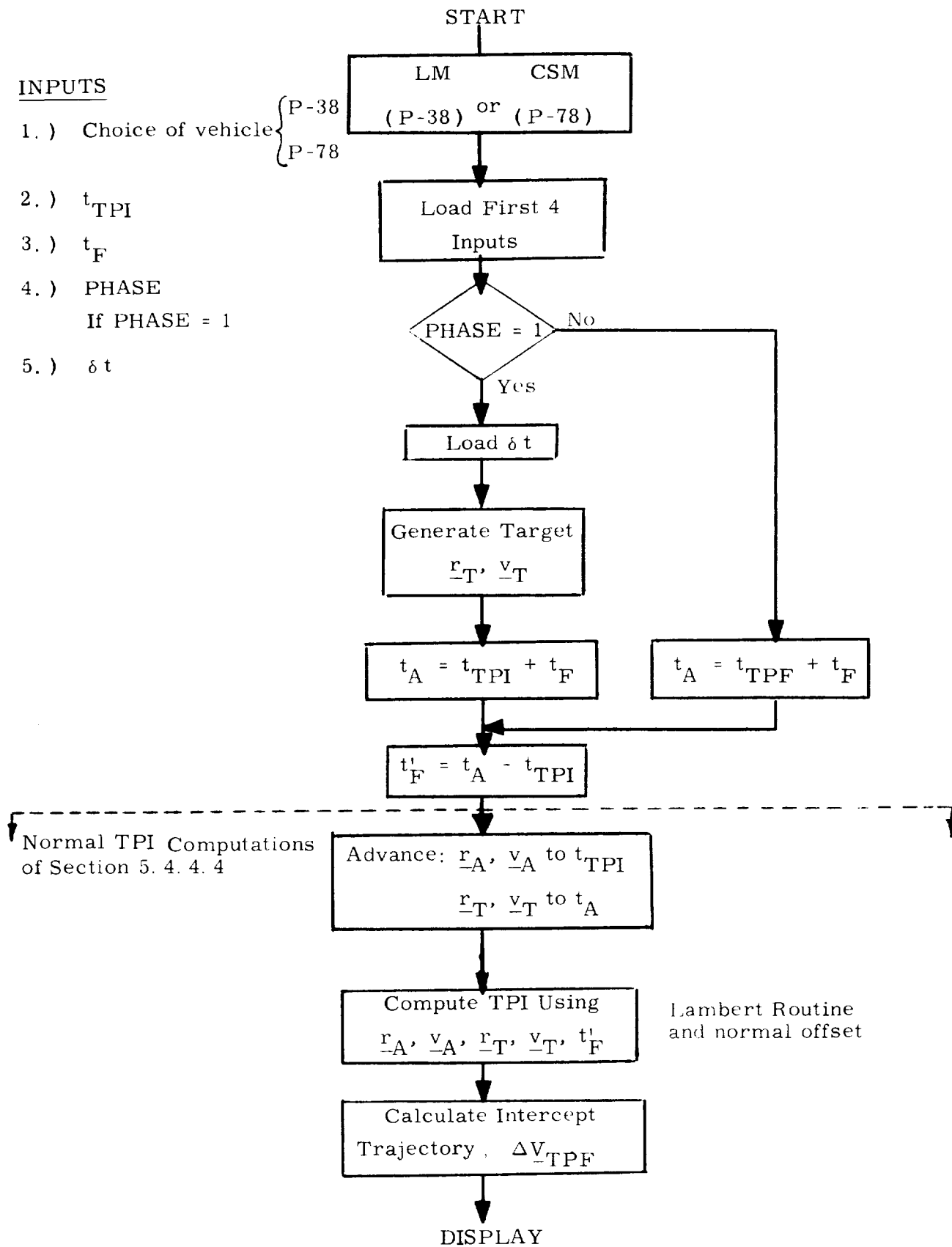

Figure 4. 4-9 Stable Orbit Rendezvous Program (TPI and SOR Modes)

If PHASE = 1, the following parameter (5) is also a required input:

- (5) δt , The offset of the stable orbit point specified as the time required for the passive vehicle to traverse the desired offset distance. Positive δt indicates that the stable orbit point is ahead of the passive vehicle, negative δt behind the passive vehicle.

Program Operation

If the program is used for the first TPI transfer (PHASE = 1) a phantom or offset target is generated using precision orbit integration. This offset state vector is displaced from the passive vehicle an amount specified by the δt input and represents a target in the same orbit as the passive vehicle. In both phases this program uses the phantom state vector to compute a transfer maneuver using the same logic as that in the pre-TPI maneuver targeting (Section 5.4.4.4). The portion of Fig. 4.4-9 below the dotted line is completely analogous to the targeting of the pre-TPI maneuver.

When this program is used for the second (SOR) maneuver in the stable orbit rendezvous sequence (PHASE = 2), the time of ignition is offset from the time corresponding to an impulsive maneuver. This offset is computed by the astronaut and the time of ignition, t_{TPI} is adjusted accordingly. In order to maintain the targeting which corresponds to an impulsive maneuver and thus provide an ignition bias, the time of arrival, t_A , required for the definition of the intercept trajectory is based on the impulsive maneuver time, t_{TPF} , which was computed in the PHASE = 1 operation of this program. The logic and equations required for this ignition offset are included in Fig. 4.4-9, and the definitions of the quantities used are presented in Fig. 4.4-10.

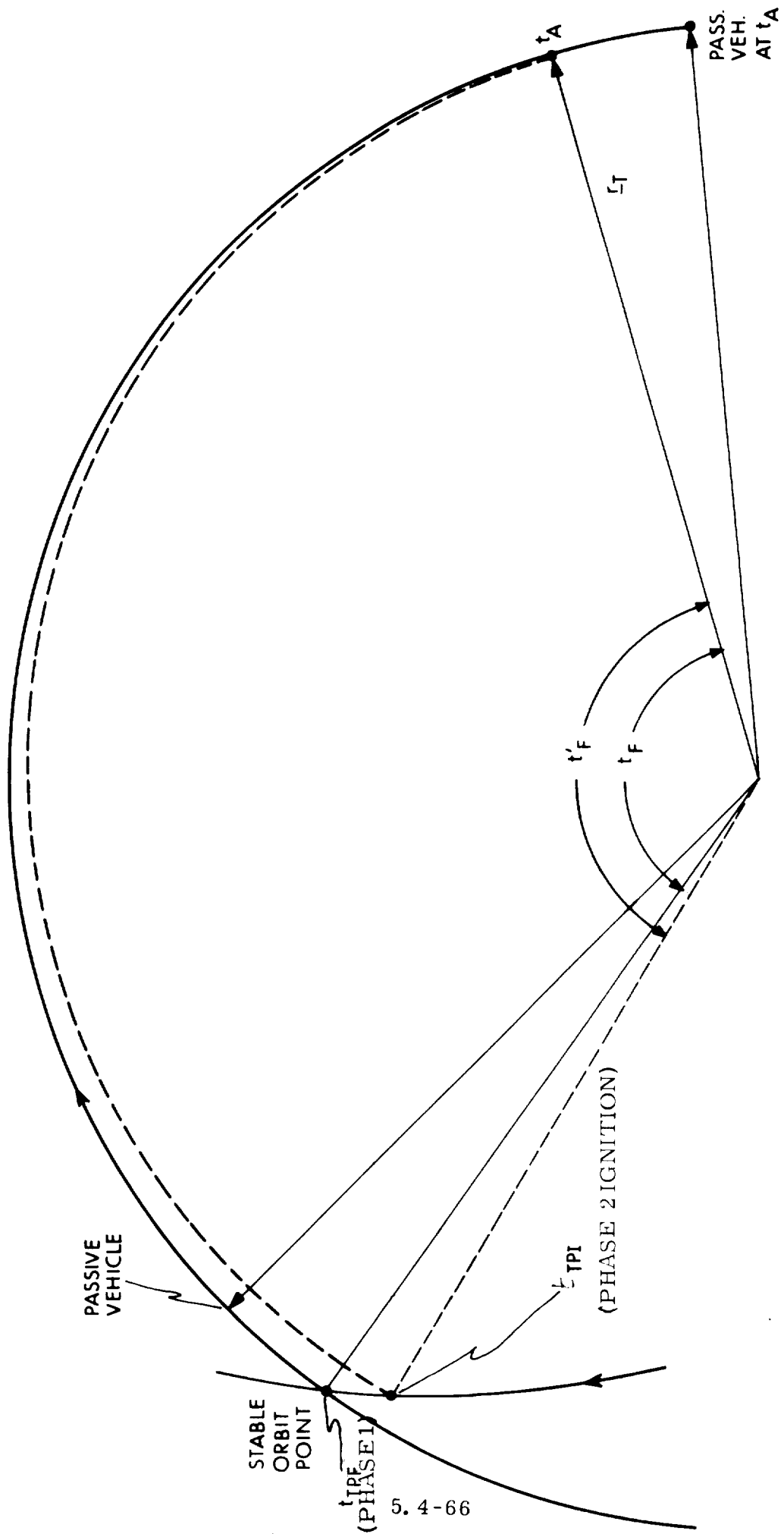

Figure 4. 4-10 Stable Orbit Rendezvous TPI - Phase 2

After the state vector of the stable orbit point has been matched by the active vehicle, the PHASE = 1 mode of this program may be used again to perform the final transfer to rendezvous by setting $\delta t = 0$. Alternately, P-34 or P-74 may be used to perform the TPI maneuver included in the concentric rendezvous sequence. In either case the final braking and docking maneuvers will be accomplished manually.

Outputs

- 1) ΔV of maneuver = $\left\{ \begin{array}{l} \Delta V_{TPI} \quad \text{PHASE} = 1 \\ \Delta V_{SOR} \quad \text{PHASE} = 2 \end{array} \right.$
- 2) ΔV_{TPF} , Relative velocity at target intercept
(Approximately zero for PHASE = 2)
- 3) Pericenter altitude after maneuver.

5.4.4.7.2 Stable Orbit Midcourse

Inputs

- 1) Choice of maneuvering vehicle
(P-39 LM, P-79 CSM)

Program Operation

This program has the same function and follows the same logic as P-35 or P-75 described in Section 5.4.4.5, except that the target used to compute the midcourse maneuver is the offset phantom state vector used in the computation of the Stable Orbit TPI or SOR maneuvers (Section 5.4.4.7).

Outputs

- 1) Midcourse maneuver, ΔV_{MC}
- 2) ΔV_{TPF} if midcourse maneuver is performed.

5. 4. 5 ABORT TARGETING

5. 4. 5. 1 Aborts from Powered Landing

5. 4. 5. 1. 1 General Objectives

The objective of the DPS and APS Abort Targeting and Control Programs, P-70 and P-71 respectively, is to control the abort maneuver from the powered landing maneuver such that a suitable injection trajectory is achieved from which a rendezvous profile can be accomplished. The abort programs P-70 and P-71 essentially use the Powered Ascent Guidance Program P-12 of Section 5. 3. 5 to control the abort maneuver to the desired prestored injection conditions. These desired abort injection conditions are a fixed horizontal velocity in the CSM orbital plane such that the resulting coplanar orbit would have perilune and apolune altitudes of 60, 000 ft. and 80 n. m. respectively if the injection occurred at a 60, 000 ft. altitude. The abort targeting and control operation is dependent upon which of three zones the abort was initiated at during the powered landing maneuver.

The first of these zones is between the landing maneuver DPS ignition point and 150 seconds (TFI-time from ignition) into the landing trajectory. During this interval the abort targeting program shuts the engine off while the vehicle is being re-oriented to the desired thrust direction for the abort maneuver. This thrust direction is determined by the Powered Ascent Guidance Program operating in the injection velocity control mode to achieve the desired horizontal injection velocity, but not controlling the altitude or lateral injection position conditions. When the desired thrust direction is achieved, the astronaut reignites the engine and the abort maneuver is then controlled by the Powered Ascent Guidance.

The second abort zone in the landing trajectory is between the landing maneuver time from ignition (TFI) point of 150 seconds to an altitude, h , of 25,000 feet. An abort initiated in this interval maintains engine ignition and immediately results in the standard Powered Ascent Guidance mode controlling both the desired injection velocity and two components of position. No initial vertical rise phase is incorporated in the abort maneuver initiated in this second zone.

The third abort zone is between a landing trajectory altitude of 25,000 ft. and lunar landing. If an abort is initiated during this final zone, the abort maneuver is first constrained to a vertical rise phase until either the vehicle altitude exceeds 25,000 ft. or the altitude rate exceeds 50 fps. After the vertical rise phase, the standard Powered Ascent Guidance mode controls the abort maneuver to the desired injection position and velocity conditions.

The DPS Abort Program P-70 is immediately initiated when the Abort Button is activated by the astronaut during the powered landing maneuver sending the abort discrete signal to the LGC. ^{by DSKY entry} The APS Abort Program P-71 is initiated by a DSKY entry calling this program or whenever the Abort Stage discrete signal is received by the LGC during the landing maneuver or abort maneuver. The required input parameters for the P-70 and P-71 abort programs from the landing maneuver programs P-63 thru 67 are as follows:

Input Parameters from Landing Maneuver Programs

1. $\underline{r}, \underline{v}$ at t_{abort} LM state vector at the abort time
2. $\underline{r}_C, \underline{v}_C$ CSM state vector at some previous time
3. TFI Time from landing maneuver DPS ignition

All other target and initialization parameters are prestored in the LGC.

The primary outputs of the P-70 and P-71 Abort Programs are the same as those for the Powered Ascent Guidance Program P-12 of Section 5.3.5. These outputs are LM digital autopilot (DAP) Attitude commands, the engine-off signal, and display parameters for the Vertical Rise and Ascent Guidance Phases (Section 5.3.5.3). When the vehicle attitude is under LGC control, the Powered Ascent Guidance Program controls the attitude about the thrust axis during a Vertical Rise Phase such that the LM Z-axis is in the initial abort trajectory plane. During the Ascent Guidance Phase, the vehicle attitude about the X thrust axis is controlled so that the LM Y-axis is horizontal with the Z-axis in a downward direction towards the moon. The astronaut can manually control the attitude about the thrust axis with the X-axis override DAP mode during the Ascent Guidance Phase, but cannot override the LGC yaw attitude commands during a Vertical Rise Phase.

5.4.5.1.2 Abort Targeting and Control

The functional logic diagram for the P-70 and P-71 Abort Programs is shown in Fig. 4.5-1. With reference to this figure the following initialization parameters are activated when the DPS Abort Program P-70 is initiated by the Abort Button.

P-70 DPS Abort Initialization Parameters

When a DPS controlled abort is initiated, the initial thrust acceleration is dependent upon the current vehicle mass and the DPS maximum thrust level. Both mass and maximum thrust levels vary during the landing maneuver due to propellant utilization and DPS throat erosion respectively. In order to initialize the Powered Ascent Guidance of Section 5.3.5 for an abort maneuver, the DPS performance

at maximum thrust must be estimated at any time during the landing maneuver. Since the exhaust velocity, V_E , is relatively constant and the main effect of DPS erosion is to change the mass flow rate, the output parameters of the Mass Monitor Routine (V_E , and mass m) are used to compute the DPS initialization parameters as follows:

$$a_T = \frac{\dot{m} V_E}{m} = \frac{V_E}{\tau} \quad (4.5.1)$$

$$\tau = \frac{m}{\dot{m}} = k_1 m + \frac{2}{m_0} \left(\frac{1}{\dot{m}_0} - k_1 \right) m^2 - \frac{1}{m_0^2} \left(\frac{1}{\dot{m}_0} - k_1 \right) m^3 \quad (4.5.2)$$

where

$$\begin{aligned} m_0 \text{ and } \dot{m}_0 &= \text{initial vehicle mass and mass flow rate} \\ \left. \begin{array}{l} V_E \\ m \end{array} \right\} &= \text{current exhaust velocity and vehicle mass} \\ &\text{from the Mass Monitor Routine} \\ k_1 &= \text{constant derived from DPS performance} \\ &\text{variations} \end{aligned}$$

The thrust filter initialization requires the following three parameters:

$$\begin{aligned} \frac{1}{\Delta V_1} &= \frac{1}{\Delta V_{IG}} + \frac{1}{2 V_E} \\ \frac{1}{\Delta V_2} &= \frac{1}{\Delta V_{IG}} + \frac{3}{2 V_E} \\ \frac{1}{\Delta V_3} &= \frac{1}{\Delta V_{IG}} + \frac{5}{2 V_E} \end{aligned} \quad (4.5.3)$$

where ΔV_{IG} is $a_T \Delta t$, a_T is the acceleration computed above, and Δt is the computation cycle time.

$\Delta t_{\text{tail-off}}$ A negative time increment used to correct t_{go} for the DPS tail-off and computation delays.

$t_{go} = \text{TFI}$ Landing maneuver time-from-ignition is used as the initial estimate of the abort maneuver time.

The following initialization parameters are activated when the APS Abort Program P-71 is initiated by the Abort Stage Button:

P-71 APS Abort Initialization Parameters

The engine-off signal is cleared in case it had been set during the previous DPS controlled phase of the abort maneuver prior to staging

$a_T = 10.5 \text{ fps.}^2$ Initial APS thrust acceleration

$\tau = 945 \text{ sec.}$ Initial APS mass to mass flow rate ratio

Thrust Filter Parameters:

$$\frac{1}{\Delta V_1} = 0.0478 \text{ sec/ft}$$

$$\frac{1}{\Delta V_2} = 0.0476 \text{ sec/ft}$$

$$\frac{1}{\Delta V_3} = 0.0474 \text{ sec/ft}$$

} Initial velocity parameters for the thrust filter computation (Section 5.3.5.4.2)

$\Delta t_{\text{tail-off}}$

A negative time increment used to correct t_{go} for the APS tail-off and computation delays.

The initial maneuver time-to-go, t_{go} , for P-71 is set equal to TFI in the case of an APS initiated abort, or equal to twice the previously computed time-to-go of P-70 for an abort stage condition.

The prestored target injection conditions listed in Fig. 4. 5-1 are for the coplanar injection trajectory with a 60,000 ft. perilune and 80 n. m. apolune, provided that the injection occurred at the desired 60,000 ft. altitude condition. These fixed injection target conditions are normally achieved for aborts initiated in the second and third zones described in Section 5. 4. 5. 1. 1. During the first abort zone (DPS landing ignition to a TFI of 150 sec.) no position control is exercised during the abort programs and the resulting injection trajectory apolune will be less than 80 n. m. due to the fixed \dot{Z}_D target parameter.

The Target Coordinate System definition shown in Fig. 4. 5-1 is the same as that used in the Powered Ascent Guidance Program (Section 5. 3. 5. 2) where \underline{v}_C and \underline{r}_C represent a CSM state vector, and \underline{r}_0 is the LM position vector at the time of abort.

The functional logic illustrated in Fig. 4. 5-1 (pg 2 of 2) represents the abort program control for the three abort zones previously described. During the first abort zone (TFI < 150 sec.) the DPS is immediately shut-down. The LM state vector is then advanced forward by 20 seconds by the Kepler Routine and the Powered Ascent Guidance Program cycled once to compute the required thrust direction for the abort maneuver. The LM is then oriented to this desired thrust direction by the KALCMANU routine and the engine reignited by the astronaut. As illustrated in Fig. 4. 5-1 and Section 4, the astronaut can delay engine reignition by recycling the free-fall computations with a new delay time δt . When the engine is restarted, the Powered Ascent Guidance of Fig. 3. 5-2 (pages 2 of 5 to 5 of 5) is used to control the abort maneuver to engine cut-off. During abort zone 1 no injection position control is used (FLPC = 1).

Aborts initiated during landing trajectory zones two and three (TFI > 150 sec) command to DPS to maximum thrust and immediately exit to the Powered Ascent Guidance point (A) of Fig. 3. 5-2 (pg 2 of 5). The abort programs then initiate the Vertical Rise Mode as shown in Fig. 3. 5-2 (page 5 of 5) until the altitude exceeds 25, 000 ft. or the vertical velocity exceeds 50 fps. The Powered Ascent Guidance of Fig. 3. 5-2 then controls the abort maneuver until engine cut-off.

5.4.5.2 Quick Abort Surface Targeting

Aborts initiated from the lunar surface are no different from nominal launch and ascent phases except in the case of an immediate or "quick" launch condition. In quick abort cases, a fast coarse IMU alignment is made (program P-57), and the Powered Ascent Guidance Program P-12 (Section 5. 3. 5) is immediately called. There is no special ascent targeting for the quick abort launch and the standard ascent injection parameters of Section 5. 3. 5. 3 are used unless the astronaut changes the injection out-of-plane position Y_D and horizontal velocity \dot{Z}_D by the pre-ignition procedures of program P-12.

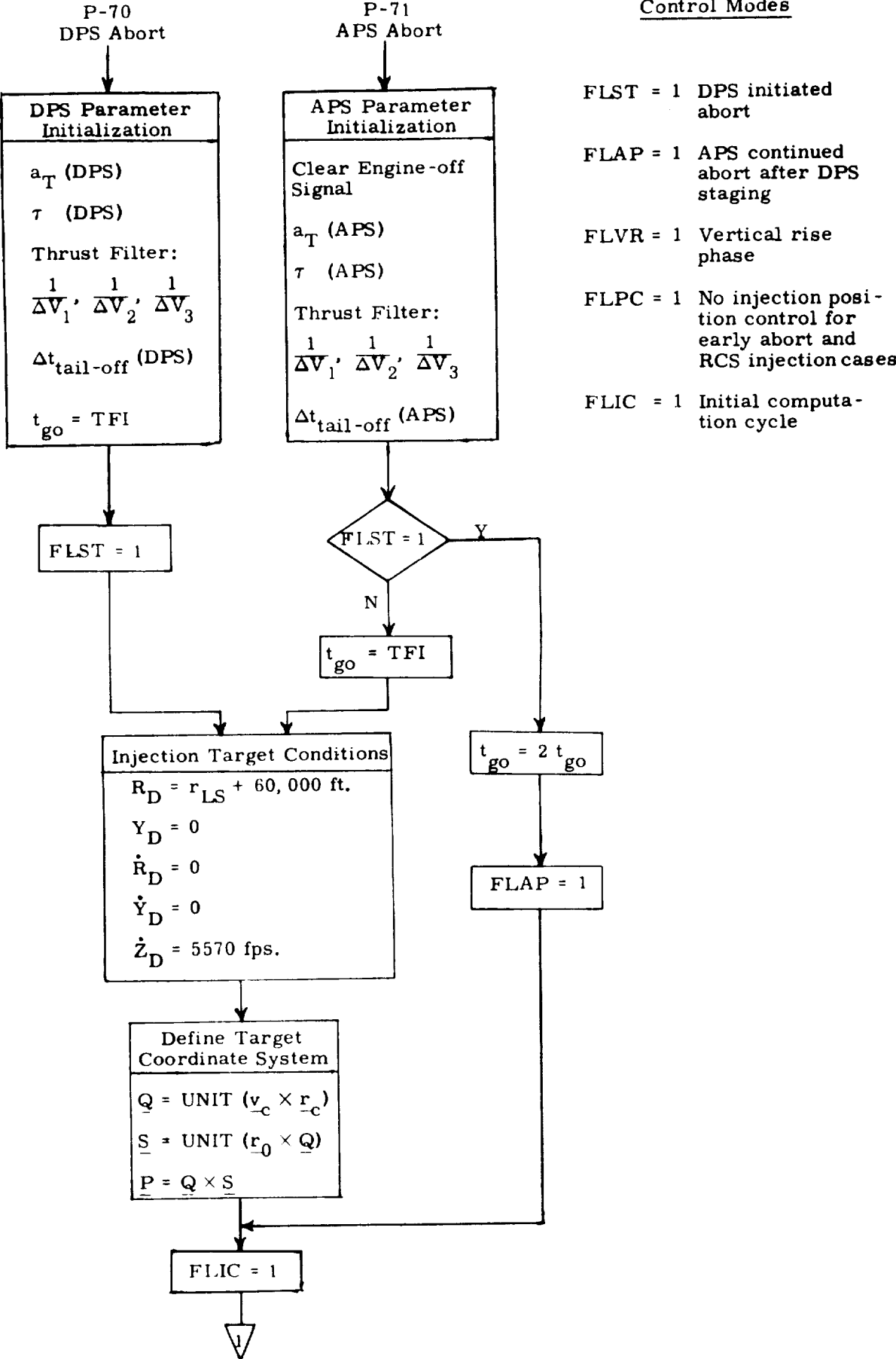

Fig. 4.5-1 Abort Targeting and Maneuver Control from Powered Lunar Landing

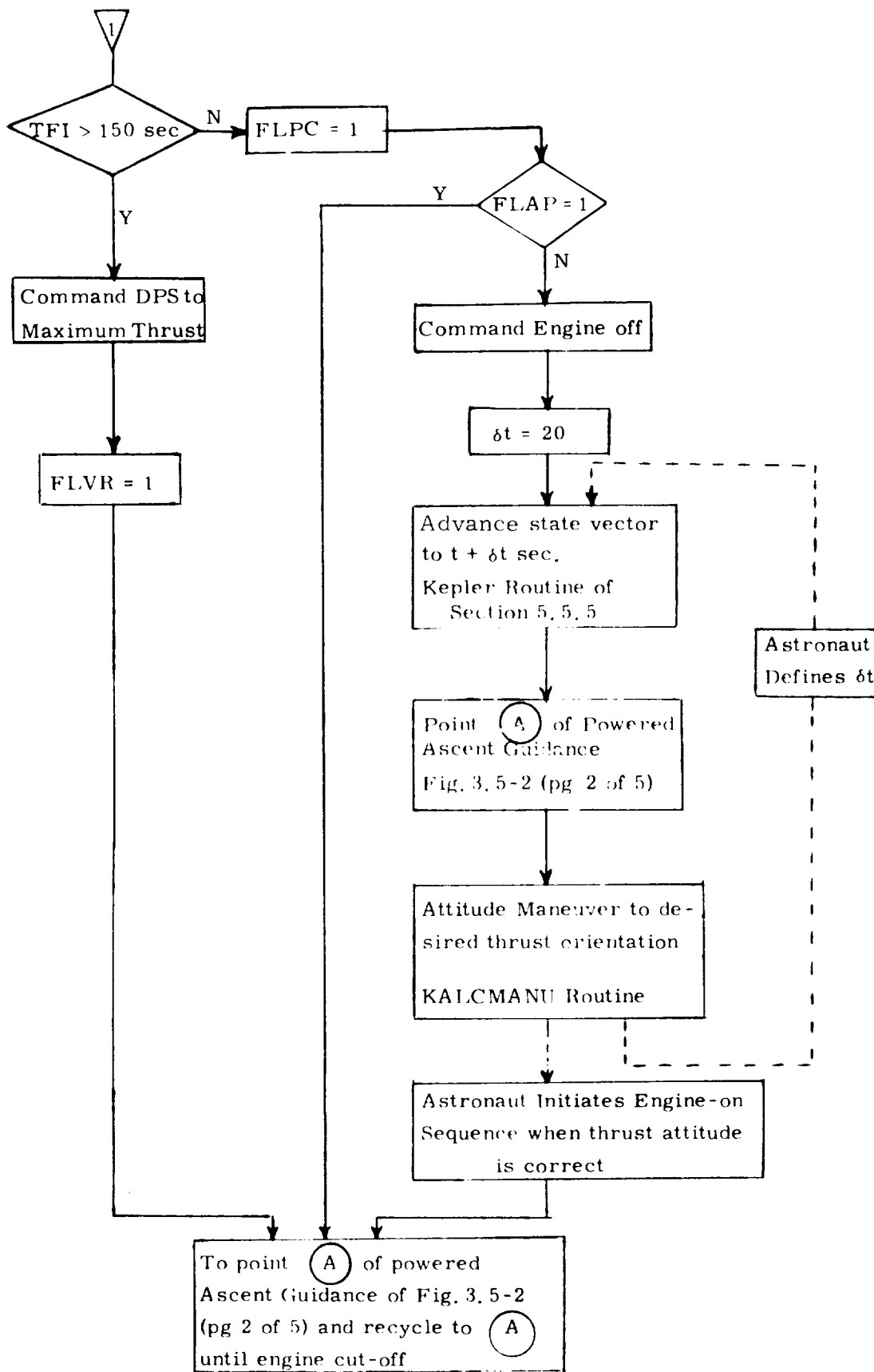

Fig. 4. 5-1 Abort Targeting and Maneuver Control from Powered Lunar Landing (cont)

(page 2 of 2)

5.5 BASIC SUBROUTINES

5.5.1 GENERAL COMMENTS

The basic solar system and conic trajectory sub-routines which are used by the various guidance and navigation routines are described in this section.

5.5.1.1 Solar System Subroutines

The subroutines used to determine the translation and rotation of the relevant solar system bodies (earth, moon and sun) are designed specifically for a fourteen day lunar landing mission. The method of computing the position and velocity of the moon and the sun relative to the earth is given in Section 5.5.4. The transformations between the Basic Reference Coordinate System and the Earth - and Moon-fixed Coordinate Systems are described in Section 5.5.2. The procedure for transforming between vectors in the Basic Reference Coordinate System and latitude, longitude, altitude coordinates is given in Section 5.5.3. Although these subroutines are normally used in the lunar landing mission, they are valid for use in any mission of not more than fourteen days duration in earth-moon space.

5.5 1.2 Conic Trajectory Subroutines

This is a description of a group of conic trajectory subroutines which are frequently used by higher level routines and programs in both the Command Module and the Lunar Module computers.

These subroutines, whose block diagrams are presented in Sections 5.5.5 to 5.5.10, provide solutions to the following conic problems. (See nomenclature which follows)

- (1) Given $\underline{r}(t_1)$, $\underline{v}(t_1)$, t_D ; solve for $\underline{r}(t_2)$, $\underline{v}(t_2)$
(Kepler Subroutine)
- (2) Given $\underline{r}(t_1)$, $\underline{r}(t_2)$, t_{D21}, δ_G ; solve for $\underline{v}(t_1)$
(Lambert Subroutine)
- (3) Given $\underline{r}(t_1)$, $\underline{v}(t_1)$, θ ; solve for t_{21} , $\underline{r}(t_2)$, $\underline{v}(t_2)$
(Time-Theta Subroutine)
- (4) Given $\underline{r}(t_1)$, $\underline{v}(t_1)$, $r(t_2), s_r$; solve for t_{21} , $\underline{r}(t_2)$, $\underline{v}(t_2)$
(Time-Radius Subroutine)
- (5) Given $\underline{r}(t)$, $\underline{v}(t)$; solve for r_P , r_A , e
(Apsides Subroutine)

In addition, the following useful subroutines are provided.

- (6) Conic Parameters Subroutine (See Fig. 5.10-1).
- (7) Geometric Parameters Subroutine (See Fig. 5.10-2).
- (8) Iterator Subroutine (See Fig. 5.10-3).

The solutions to the above set of conic problems have stringent accuracy requirements. Programming the fixed-point Apollo computer introduces two constraints which determine accuracy limitations: the 28 bit double precision word length, and the range of variables which is several orders of magnitude for the Apollo mission.

In order to maintain numerical accuracy when these subroutines are programmed into the Apollo computer, floating point programming techniques must be exercised. The effect is for even a simple equation to require a large number of computer instructions. The alternative to this is to separate the problem into phases, each with a different variable range. This, however, requires an even larger number of instructions. These considerations provide the incentive for efficiently organizing the conic equations as shown in the block diagrams.

In addition to the requirement for accuracy, the solution to the Kepler and Lambert Problems must be accomplished in a minimum of computation time in order that the guidance system operate satisfactorily in real time. This additional constraint dictates that a minimum of computer instructions be performed when solving the problem.

Method of Solution

To minimize the total number of computer instructions, the problems are solved in the "universal" form; i. e. only equations which are equally valid for the ellipse, parabola and hyperbola are used. Also these subroutines can be used with either the earth or the moon as the as the attracting body.

Kepler's equation, in the universal form, is utilized to relate transfer time to the conic parameters. All other necessary equations are also universal. The Kepler and Lambert problems are solved with a single iteration loop utilizing a simple first-order slope iterator. In the case of the Kepler problem a third order approximation is available to produce the initial guess for the independent variable (See Eq. (2.2.4) of Section 5.2.2.2).

Sections 5.5.5 thru 5.5.10 provide block diagrams of the detailed computational procedures for solving the various problems. The equations are presented in block diagram form with nomenclature below.

Range of Variables

As indicated previously, the programming of the conic subroutines requires a careful balance between accuracy, computational speed and number of instructions. This balance, in the Apollo Guidance Computer, leaves very little margin in any of these areas.

Since the values of problem variables are determined by the solution of the problem being solved and since the problem may originate from the ground system, it is essential that the variable range limitations be defined. The conic routines are incapable of handling problems when the solution lies outside of the range.

The following is a list of the maximum allowable numeric values of the variables. Note that, in addition to fundamental quantities such as position and velocity, there are limitations on intermediate variables and combinations of variables.

Scaling for Conic Subroutines (Sections 5.5.5 to 5.5.10)

<u>Parameter</u>	<u>Maximum Value*</u>	
	<u>Earth</u> <u>Primary Body</u>	<u>Moon</u> <u>Primary Body</u>
r	2^{29}	2^{27}
v	2^7	2^5
t	2^{28}	2^{28}
α^{**}	2^{-22}	2^{-20}
α_N^{**}	2^6	2^6
p_N	2^4	2^4
$\cot \gamma$	2^5	2^5
$\cot \frac{\theta}{2}$	2^5	2^5
x	2^{17}	2^{16}
$\xi = \alpha x^{2***}$	- 50 $+ 4\pi^2$	- 50 $+ 4\pi^2$
$c_1 = \frac{r \cdot v}{\sqrt{\mu}}$	2^{17}	2^{16}
$c_2 = r v^2 / \mu - 1$	2^6	2^6
$\lambda = r(t_1) / r(t_2)$	2^7	2^7
$\cos \theta - \lambda$	2^7	2^7

* All dimensional values are in units of meters and centiseconds.

** The maximum absolute value occurs for negative values of this parameter.

***Both the maximum and minimum values are listed since neither may be exceeded.

Parameter	Maximum Value*	
	Earth	Moon
e	2^3	2^3
x^2	2^{33}	2^{31}
$x^2 c(\xi)$	2^{33}	2^{31}
$x^3 s(\xi)/\sqrt{\mu}$	2^{28}	2^{28}
$c_1 x^2 c(\xi)$	2^{49}	2^{46}
$c_2 x^2 s(\xi)$	2^{35}	2^{33}
$x [c_2 x^2 s(\xi) + r(t_1)]$	2^{49}	2^{46}
$\xi s(\xi)$	2^7	2^7
$x^2 c(\xi)/r$	2^8	2^8
$\sqrt{\mu} x (\xi s(\xi) - 1)/r(t_2)$	2^{15}	2^{13}

* All dimensional values are in units of meters and centiseconds.

Nomenclature for Conic Subroutines (Sections 5.5.5 to 5.5.10)

$\underline{r}(t_1)$	initial position vector
$\underline{v}(t_1)$	initial velocity vector
$\underline{r}(t_2)$	terminal position vector
$\underline{v}(t_2)$	terminal velocity vector
\underline{u}_N	unit normal in the direction of the angular momentum vector
α	reciprocal of semi-major axis (negative for hyperbolas)
r_p	radius of pericenter
r_A	radius of apocenter
e	eccentricity
α_N	ratio of magnitude of initial position vector to semi-major axis
p_N	ratio to semi-latus rectum to initial position vector magnitude
γ	inertial flight path angle as measured from vertical
θ	true anomaly difference between $\underline{r}(t_1)$ and $\underline{r}(t_2)$
f	true anomaly of $\underline{r}(t_2)$

x	a universal conic parameter equal to the ratio of eccentric anomaly difference to $\sqrt{+\alpha}$ for the ellipse, or the ratio of the hyperbolic analog of eccentric anomaly difference to $\sqrt{-\alpha}$ for the hyperbola
x'	value of x from the previous Kepler solution
t_{21}	computed transfer time from Kepler's equation ($t_2 - t_1$)
t'_{21}	transfer time corresponding to the previous solution of Kepler's equation
t_D	desired transfer time through which the conic update of the state vector is to be made
t_{D21}	desired transfer time to traverse from $\underline{r}(t_1)$ to $\underline{r}(t_2)$
t_{ERR}	error in transfer time
ϵ_t	tolerance to which transfer time must converge
Δx	increment in x which will produce a smaller t_{ERR}
ϵ_x	value of Δx which will produce no significant change in t_{21}
$\Delta \cot \gamma$	increment in $\cot \gamma$ which will produce a smaller t_{ERR}
ϵ_c	value of $\Delta \cot \gamma$ which will produce no significant change in t_{21}

μ	product of universal gravitational constant and mass of the primary attracting body
x_{MAX}	maximum value of x
x_{MIN}	minimum value of x
\cot_{MAX}	maximum value of $\cot \gamma$
\cot_{MIN}	minimum value of $\cot \gamma$
ℓ_{MAX}	upper bound of general independent variable
ℓ_{MIN}	lower bound of general independent variable
x_{MAX1}	absolute upper bound on x with respect to the moon
x_{MAX0}	absolute upper bound on x with respect to the earth
k	a fraction of the full range of the independent variable which determines the increment of the independent variable on the first pass through the iterator
y	general dependent variable
y'	previous value of y
y _{ERR}	error in y
z	general independent variable

Δz	increment in z which will produce a smaller y_{ERR}
s_G	a sign which is plus or minus according to whether the true anomaly difference between $\underline{r}(t_1)$ and $\underline{r}(t_2)$ is to be less than or greater than 180 degrees
s_r	a sign which is plus or minus according to whether the desired radial velocity at $\underline{r}(t_2)$ is plus or minus
$\underline{\eta}_1$	general vector # 1
$\underline{\eta}_2$	general vector # 2
ϕ	angle between $\underline{\eta}_1$ and $\underline{\eta}_2$
f_1	a switch set to 0 or 1 according to whether a guess of $\cot \gamma$ is available or not
f_2	a switch set to 0 or 1 according to whether Lambert should determine \underline{u}_N from $\underline{r}(t_1)$ and $\underline{r}(t_2)$ or \underline{u}_N is an input
f_3	a tag set to 0 or 1 according to whether the iterator should use the "Regula Falsi" or bias method
f_4	a flag set to 0 or 1 according to whether the iterator is to act as a first order or a second order iterator
f_5	a flag set to 0 or 1 according to whether a feasible solution exists or not

- f_6 a switch set to 0 or 1 according to whether or not the new state vector is to be an additional output requirement of the Time-Theta or Time-Radius problems.
- f_7 a flag set to 1 if the inputs require that the conic trajectory must close through infinity
- f_8 a flag set to 1 if the Time-Radius problem was solved for pericenter or apocenter instead of $r(t_2)$

5. 5. 2 PLANETARY INERTIAL ORIENTATION SUBROUTINE

This subroutine is used to transform vectors between the Basic Reference Coordinate System and a Planetary (Earth-fixed or Moon-fixed) Coordinate System at a specified time. These three coordinate systems are defined in Section 5. 1. 4.

Let \underline{r} be a vector in the Basic Reference Coordinate System, \underline{r}_P the same vector expressed in the Planetary Coordinate System, and t the specified ground elapsed time (GET). Then,

$$\underline{r}_P = M(t) (\underline{r} - \underline{\ell} \times \underline{r}) \quad (5. 2. 1)$$

and

$$\underline{r} = M^T(t) (\underline{r}_P + \underline{\ell}_P \times \underline{r}_P) \quad (5. 2. 2)$$

where $M(t)$ is a time dependent orthogonal transformation matrix, $\underline{\ell}$ is a small rotation vector in the Basic Reference Coordinate System, and $\underline{\ell}_P$ is the same vector $\underline{\ell}$ expressed in the Planetary Coordinate System. The vector $\underline{\ell}$ is considered constant in one coordinate system for the duration of the mission. The method of computing $M(t)$ and $\underline{\ell}$ depends on whether the relevant planet is the earth or the moon.

Case I - Earth

For the earth, the matrix $M(t)$ describes a rotation about the polar axis of the earth (the Z-axis of the Earth-fixed Coordinate

System), and the vector $\underline{\ell}$ accounts for the precession and nutation of the polar axis (the deviation of the true pole from the mean pole).

Let A_X and A_Y be the small angles about the X- and Y-axes of the Basic Reference Coordinate System, respectively, that describe the precession and nutation of the earth's polar axis. The values of these two angles at the midpoint of the mission are included in the pre-launch erasable data load and are considered constant throughout the flight. Then,

$$\underline{\ell} = \begin{pmatrix} -A_X \\ -A_Y \\ 0 \end{pmatrix}$$

$$A_Z = A_{Z0} + \omega_E (t + t_0) \quad (5.2.3)$$

$$M(t) = \begin{pmatrix} \cos A_Z & \sin A_Z & 0 \\ -\sin A_Z & \cos A_Z & 0 \\ 0 & 0 & 1 \end{pmatrix}$$

$$\underline{\ell}_P = M(t) \underline{\ell}$$

where A_{Z0} is the angle between the X-axis of the Basic Reference Coordinate System and the X-axis of the Earth-fixed Coordinate System (the intersection of the Greenwich meridian and the equatorial plane of the earth) at July 1.0, 1968 universal time (i. e., midnight at Greenwich just prior to July 1, 1968), t_0 is the elapsed time between July 1.0, 1968 universal time and the time that the computer clock was zeroed, and ω_E is the angular velocity of the earth.

Case II - Moon

For the moon, the matrix $M(t)$ accounts for the difference in orientation of the Basic Reference and Moon-fixed Coordinate Systems in exact accordance with Cassini's laws, and the rotation vector $\underline{\ell}$ corrects for deviations from the above orientation because of physical libration.

Define the following three angles which are functions of time:

- B = the obliquity, the angle between the mean earth equatorial plane and the plane of the ecliptic.
- Ω_1 = the longitude of the node of the moon's orbit measured from the X-axis of the Basic Reference Coordinate System.
- F = the angle from the mean ascending node of the moon's orbit to the mean moon.

Let I be the constant angle between the mean lunar equatorial plane and the plane of the ecliptic ($1^\circ 32.1'$). Then, the sequence of rotations which brings the Basic Reference Coordinate System into coincidence with the Moon-fixed Coordinate System (neglecting libration) is as follows:

<u>Rotation</u>	<u>Axis of Rotation</u>	<u>Angle of Rotation</u>
1	X	B
2	Z	Ω_I
3	X	-I
4	Z	$\pi + F$

The transformation matrices for these rotations are, respectively,

$$M_1 = \begin{pmatrix} 1 & 0 & 0 \\ 0 & \cos B & \sin B \\ 0 & -\sin B & \cos B \end{pmatrix}$$

$$M_2 = \begin{pmatrix} \cos \Omega_I & \sin \Omega_I & 0 \\ -\sin \Omega_I & \cos \Omega_I & 0 \\ 0 & 0 & 1 \end{pmatrix}$$

$$M_3 = \begin{pmatrix} 1 & 0 & 0 \\ 0 & \cos I & -\sin I \\ 0 & \sin I & \cos I \end{pmatrix}$$

$$M_4 = \begin{pmatrix} -\cos F & -\sin F & 0 \\ \sin F & -\cos F & 0 \\ 0 & 0 & 1 \end{pmatrix}$$

(5.2.4)

The matrix $M(t)$ is then given by

$$M(t) = M_4 M_3 M_2 M_1 \quad (5.2.5)$$

The following approximate method is used to determine the transformation between the Basic Reference and Moon-fixed Coordinate Systems.

The angles B , Ω_I and F are computed as linear functions of time. Let $\underline{\ell}_M$ be the value of the vector libration $\underline{\ell}_P$ (expressed in the Moon-fixed Coordinate System) at the midpoint of the mission. The vector $\underline{\ell}_M$ is included in the pre-launch erasable data load and is considered constant throughout the flight. Then,

$$\begin{aligned} \underline{\ell}_P &= \underline{\ell}_M \\ t_M &= t + t_0 \\ B &= B_0 + \dot{B} t_M \\ \Omega_I &= \Omega_{I0} + \dot{\Omega}_I t_M \\ F &= F_0 + \dot{F} t_M \end{aligned}$$

$$\begin{aligned} \underline{a} &= \begin{pmatrix} \cos \Omega_I \\ \cos B \sin \Omega_I \\ \sin B \sin \Omega_I \end{pmatrix} \\ \underline{b} &= \begin{pmatrix} -\sin \Omega_I \\ \cos B \cos \Omega_I \\ \sin B \cos \Omega_I \end{pmatrix} \end{aligned} \quad (5.2.6)$$

$$\underline{c} = \begin{pmatrix} 0 \\ -\sin B \\ \cos B \end{pmatrix}$$

$$\underline{d} = \underline{b} C_I - \underline{c} S_I$$

$$\underline{m}_2 = \underline{b} S_I + \underline{c} C_I$$

$$\underline{m}_0 = -\underline{a} \cos F - \underline{d} \sin F \quad (5.2.6)$$

(cont.)

$$\underline{m}_1 = \underline{a} \sin F - \underline{d} \cos F$$

$$M(t) = \begin{pmatrix} \underline{m}_0^T \\ \underline{m}_1^T \\ \underline{m}_2^T \end{pmatrix}$$

$$\underline{f} = M^T(t) \underline{f}_P$$

where B_0 , Ω_{I0} , and F_0 are the values of the angles B , Ω_I and F , respectively, at July 1.0, 1968 universal time; \dot{B} , $\dot{\Omega}_I$ and \dot{F} are the rates of change of these angles; and C_I and S_I are the cosine and sine, respectively, of the angle I .

5. 5. 3 LATITUDE-LONGITUDE SUBROUTINE

For display and data load purposes, the latitude, longitude, and altitude of a point near the surface of the earth or the moon are more meaningful and more convenient to use than the components of a position vector. This subroutine is used to transform position vectors between the Basic Reference Coordinate System and Geographic or Selenographic latitude, longitude, altitude at a specified time.

In the case of the moon, the altitude is computed above either the landing site radius, r_{LS} , or the mean lunar radius, r_M . For the earth, the altitude is defined with respect to either the launch pad radius, r_{LP} or the radius of the Fisher ellipsoid, r_F , which is computed from

$$r_F^2 = \frac{b^2}{1 - \left(1 - \frac{b^2}{a^2}\right) (1 - \text{SINL}^2)} \quad (5.3.1)$$

where a and b are the semi-major and semi-minor axes of the Fischer ellipsoid, respectively, and SINL is the sine of the geocentric latitude.

The computational procedures are illustrated in Figs. 5.3-1, 5.3-2, and 5.3-3. The calling program must specify either a vector \underline{r} or latitude (Lat), longitude (Long), and altitude (Alt). In addition, the program must set the time t and the two indicators P and F where

$$P = \begin{cases} + 1 & \text{for earth} \\ + 2 & \text{for moon} \end{cases}$$

$$F = \begin{cases} 1 & \text{for Fischer ellipsoid or mean lunar radius} \\ 0 & \text{for launch pad or landing site radius} \end{cases}$$

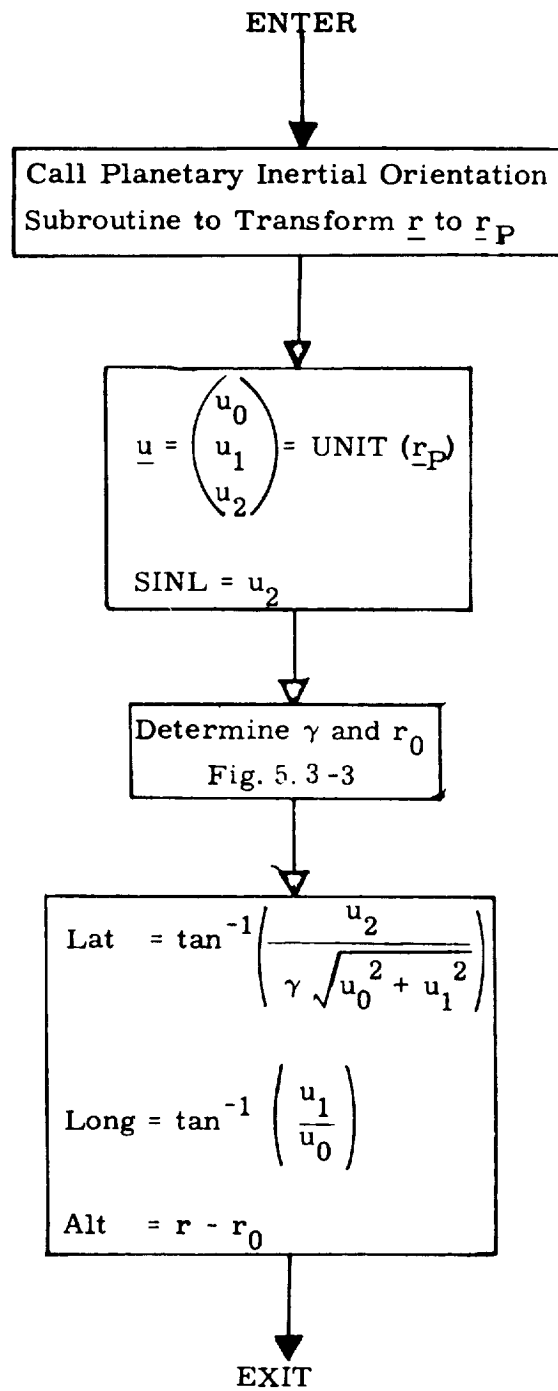

Fig. 5.3-1 Vector to Latitude, Longitude, Altitude Computation Logic Diagram

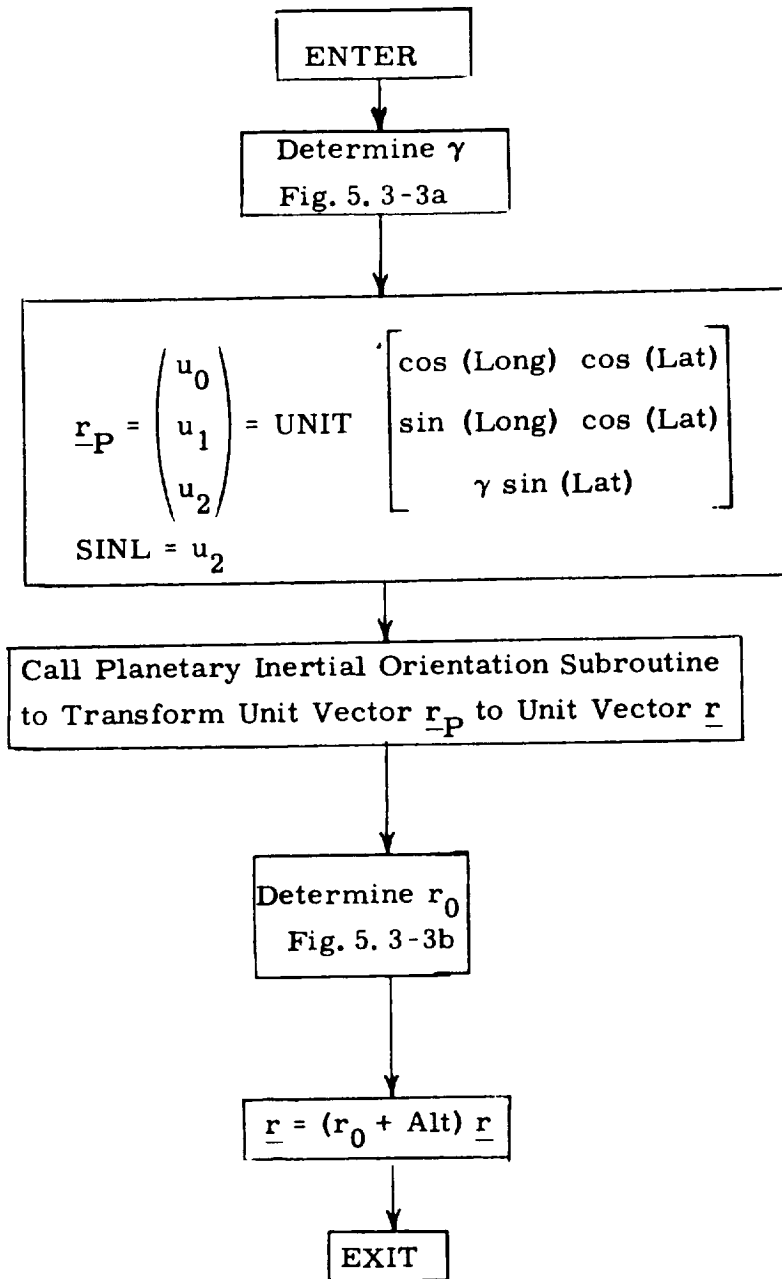

Fig. 5.3-2 Latitude, Longitude, Altitude to Vector Computation Logic Diagram

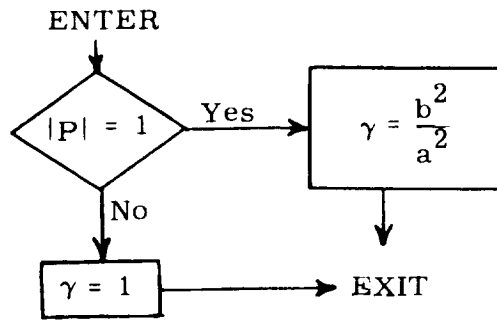

Figure 5.3-3a Determination of γ

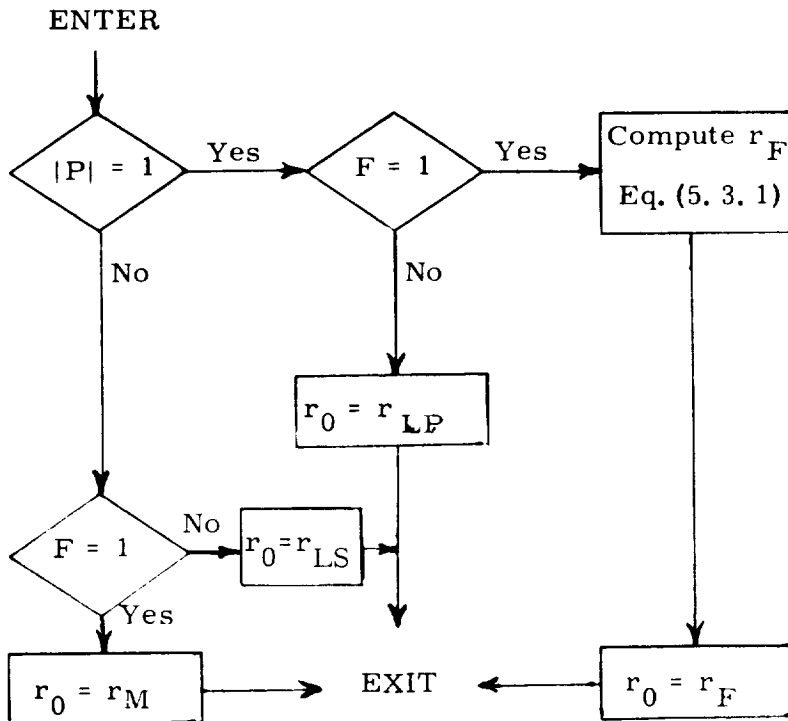

Figure 5.3-3b Determination of r_0

5. 5. 4 LUNAR AND SOLAR EPHEMERIDES

This subroutine is used to determine the position and velocity vectors of the sun and the moon relative to the earth. The position vectors of the moon and the sun are needed by the Coasting Integration Routine to compute gravity perturbations (Section 5. 2. 2. 3). The velocity of the moon is used by the Coasting Integration Routine when a change in the origin of the coordinate system is performed at the sphere of influence of the moon (Fig. 2. 2-3). The velocity of the sun is required, but not very accurately, to compute aberration corrections to optical sightings.

The position of the moon is stored in the computer in the form of a ninth-degree polynomial approximation which is valid over a 14. 5 day interval beginning at noon ephemeris time on the day of the launch. The following parameters are included in the pre-launch erasable data load:

t_{M0} = the elapsed time between July 1. 0, 1968 universal time and the time at the center of the range over which the lunar-position polynomial is valid. The value of t_{M0} will be an integral number of quarter days minus the difference between ephemeris time and universal time.

c_0 to c_9 = vector coefficients

Let t be the specified ground elapsed time (GET), and t_0 be the elapsed time between July 1. 0, 1968 universal time and the time that the computer clock was zeroed. Then, the approximate position and velocity of the moon are computed from

$$t_M = t + t_0 - t_{M0} \quad (5. 4. 1)$$

$$\underline{r}_{EM} = \sum_{i=0}^9 c_i t_M^i \quad (5.4.2)$$

$$\underline{v}_{EM} = \sum_{i=1}^9 i c_i t_M^{i-1} \quad (5.4.3)$$

The approximate position and velocity of the sun are computed from the following items which are included in the pre-launch erasable data load:

\underline{r}_{ES0} , \underline{v}_{ES0} = the position and velocity vectors of the sun relative to the earth at time t_{M0} .

ω_{ES} = the angular velocity of the vector \underline{r}_{ES0} at time t_{M0}

Then,

$$\begin{aligned} \underline{r}_{ES} = & \underline{r}_{ES0} \cos(\omega_{ES} t_M) \\ & + \left[\underline{r}_{ES0} \times \text{UNIT}(\underline{v}_{ES0} \times \underline{r}_{ES0}) \right] \sin(\omega_{ES} t_M) \end{aligned} \quad (5.4.4)$$

$$\underline{v}_{ES} = \underline{v}_{ES0} \quad (5.4.5)$$

5.5.5 KEPLER SUBROUTINE

The Kepler Subroutine solves for the two body position and velocity vectors at the terminal position given the initial position and velocity vectors and a transfer time to the terminal position.

This section contains information to aid the reader in understanding the less obvious aspects of the Kepler Subroutine block diagram depicted in Figs. 5.5-1 and 5.5-2. The subroutines referred to in these figures are presented in Section 5.5.10. Nomenclature is found in Section 5.5.1.2.

Prior to entering the Kepler Subroutine an initial estimate of x can be generated via Eq. (2.2.4) of Section 5.2.2.2 with $x_1 = x'$, $\tau_1 = t_{21}$, and $\tau = t_D$. However, x' and t_{21} are non-zero only if the subroutine is being used repetitively.

Although, theoretically, there is no upper bound on x , the practical bound is set to x_{MAX0} or x_{MAX1} to eliminate non-feasible trajectories and increase the accuracy to which x can be computed. In addition, αx^2 has a practical range of $-50 < \alpha x^2 < 2\pi$ which determines an independent upper bound on x . The x_{MAX} used, then, corresponds to the smaller of the two values.

The transfer time convergence criterion is approximately the same as the granularity of the time input. Since, for some of the problems to be solved, the sensitivity of time to x is so large that the granularity in x , ϵ_x , produces a change in time which exceeds the granularity in time, it is necessary to introduce ϵ_x as a redundant convergence criterion.

The Kepler Subroutine, provided the parameter range constraints are satisfied and t_D is less than one period, will always produce a solution.

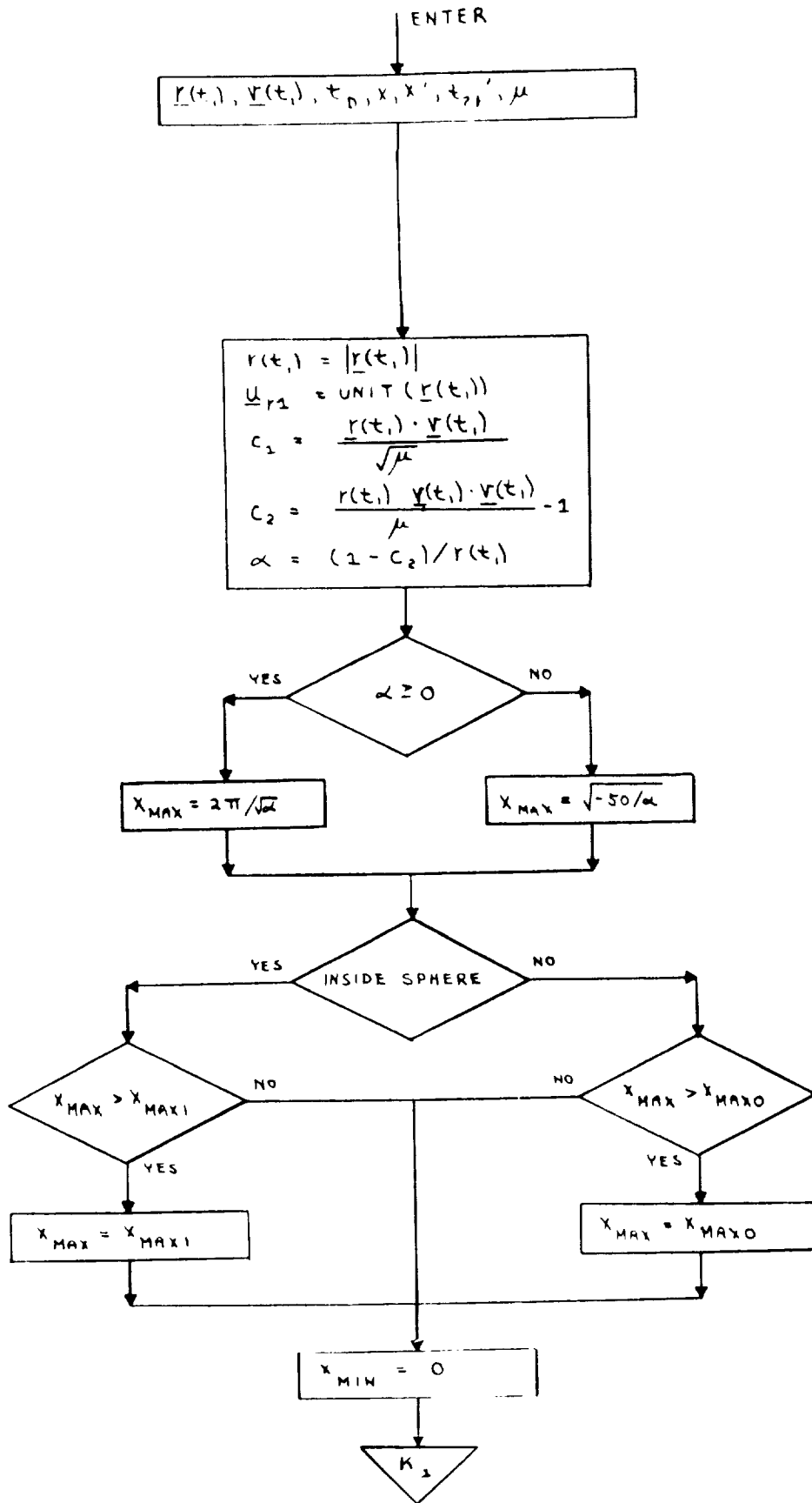

Figure 5.5-1 Kepler Subroutine

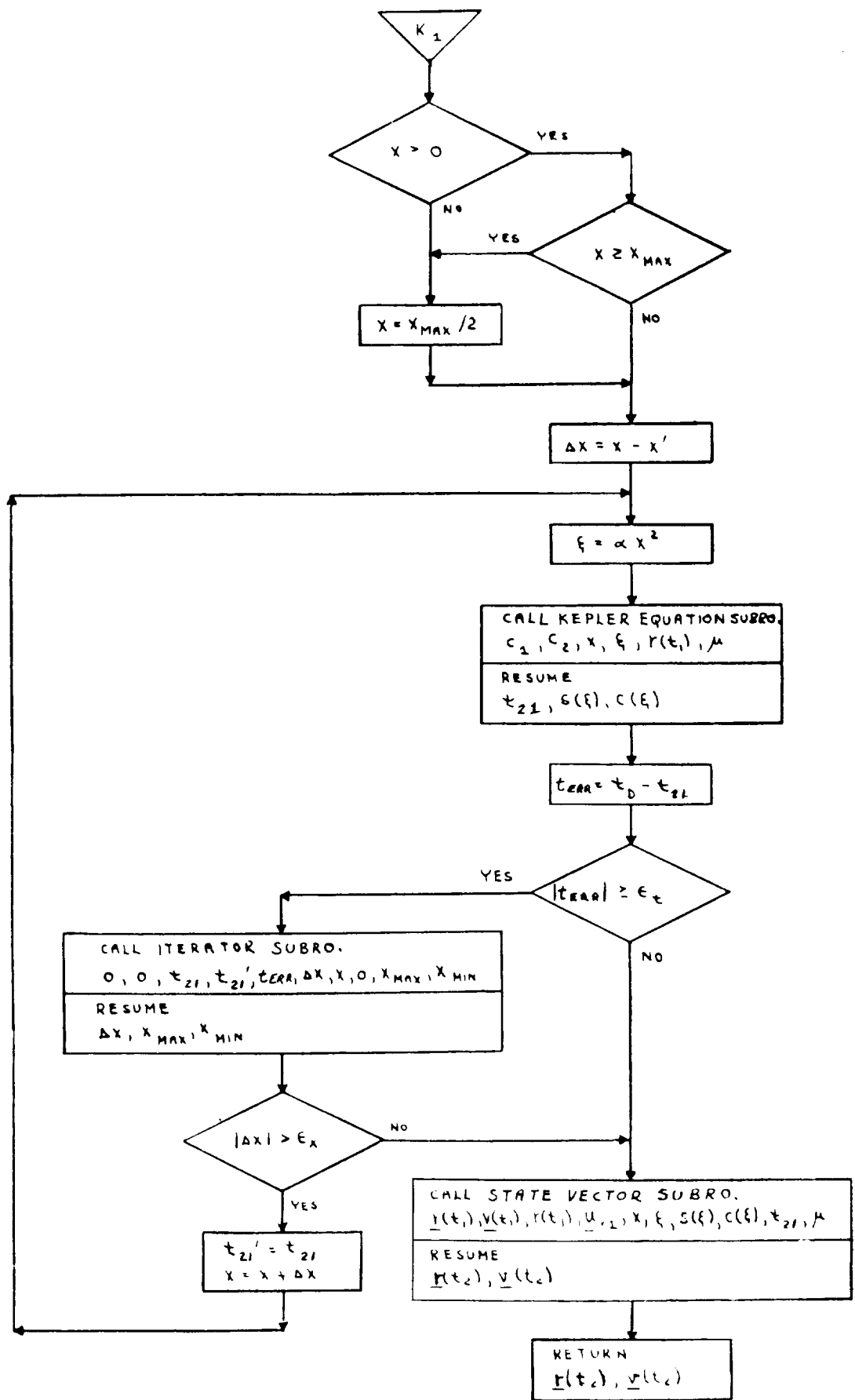

Figure 5.5-2 Kepler Subroutine

5.5.6 LAMBERT SUBROUTINE

The Lambert Subroutine solves for the two body initial velocity vector given the initial and terminal position vectors and a transfer time between the two.

This section contains information to aid the reader in understanding the less obvious aspects of the Lambert Subroutine block diagrams depicted in Figs. 5.6-1 and 5.6-2. The subroutines referred to in these figures are presented in Section 5.5.10. Nomenclature is found in Section 5.5.1.2.

If the Lambert Subroutine is used repetitively and rapid computation is required, the previous value of the independent variable, $\cot \gamma$, can be used as a starting point for the new iteration along with "k", a measure of the quality this guess is expected to have. Flag f_3 provides this option.

The Lambert Subroutine computes the normal to the trajectory, \underline{u}_N , using the two input position vectors. If these vectors are nearly colinear, it is desirable to specify the normal as an input rather than rely on the ill-defined normal based on the two input position vectors. Flag f_2 provides this option. The presence of the inputs in parentheses, therefore, is contingent upon the setting of these flags.

The theoretical bounds on the independent variable, $\cot \gamma$, correspond to the infinite energy hyperbolic path and the parabolic path which closes through infinity. These bounds are dynamically reset by the iterator to provide a more efficient iteration scheme. In addition, if during the course of the iteration, $\cot \gamma$ causes a parameter of the problem to exceed its maximum as determined by its allowable range, the appropriate bound is reset and the iterator continues trying to find an acceptable solution. (This logic does not appear in Figs. 5.6-1 and 2

as it is pertinent only to fixed-point programming). If no acceptable solution is reached, the transfer time input was too small to produce a practical trajectory between the input position vectors. When this happens, $\Delta \cot \gamma$ approaches its granularity limit ϵ_x before time converges to ϵ_t . However, this same granularity condition exists when the sensitivity problem described in the Kepler Subroutine, Section 5.5.5, occurs. In this case an acceptable solution does exist. This dual situation is resolved via a third convergence criterion. If the error in transfer time is greater than ϵ_t but less than a small percentage, k_1 , of the desired transfer time and $\Delta \cot \gamma$ is less than ϵ_x , then the solution is deemed acceptable and the required velocity is computed.

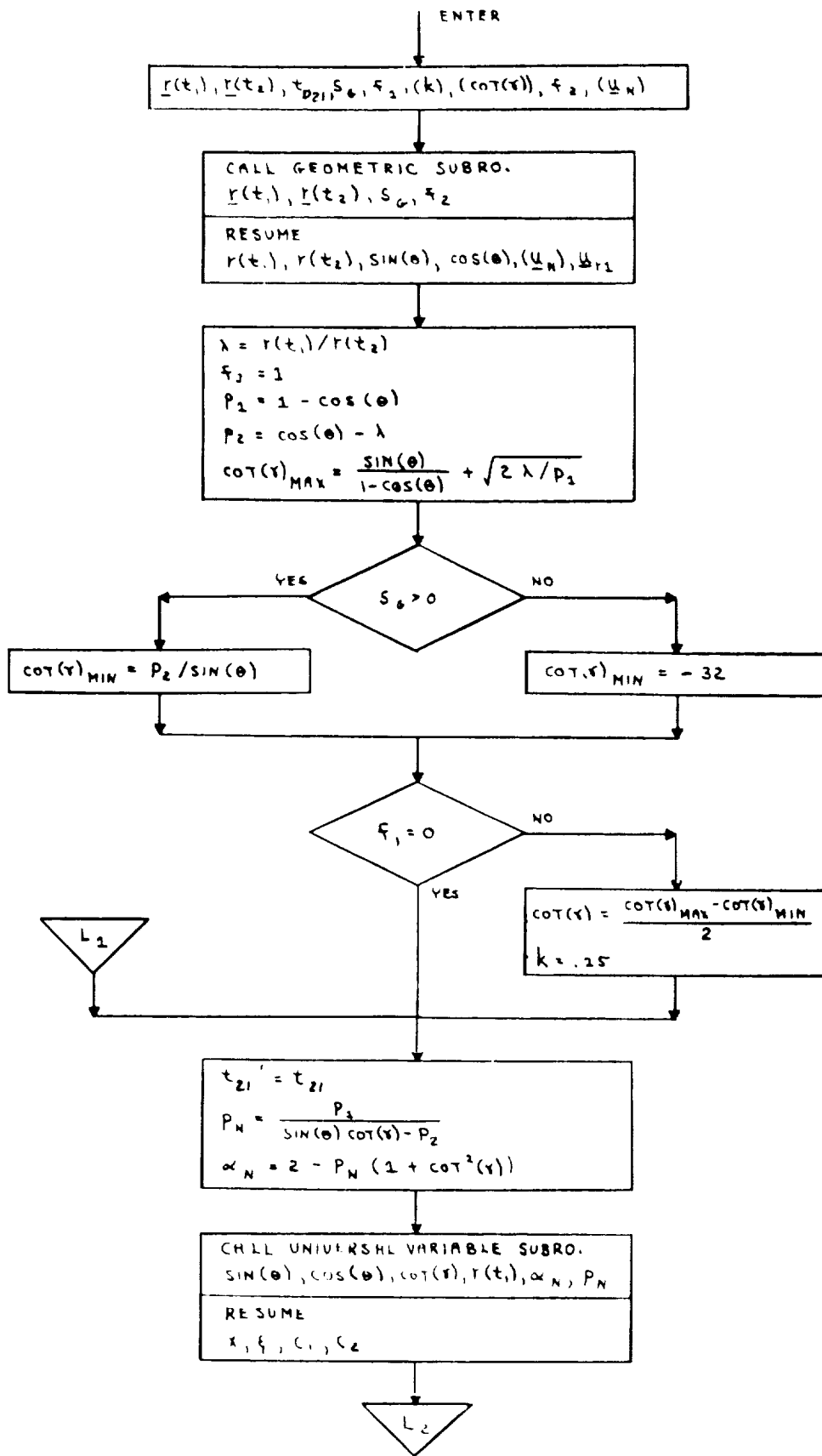

Figure 5.6-1 Lambert Subroutine

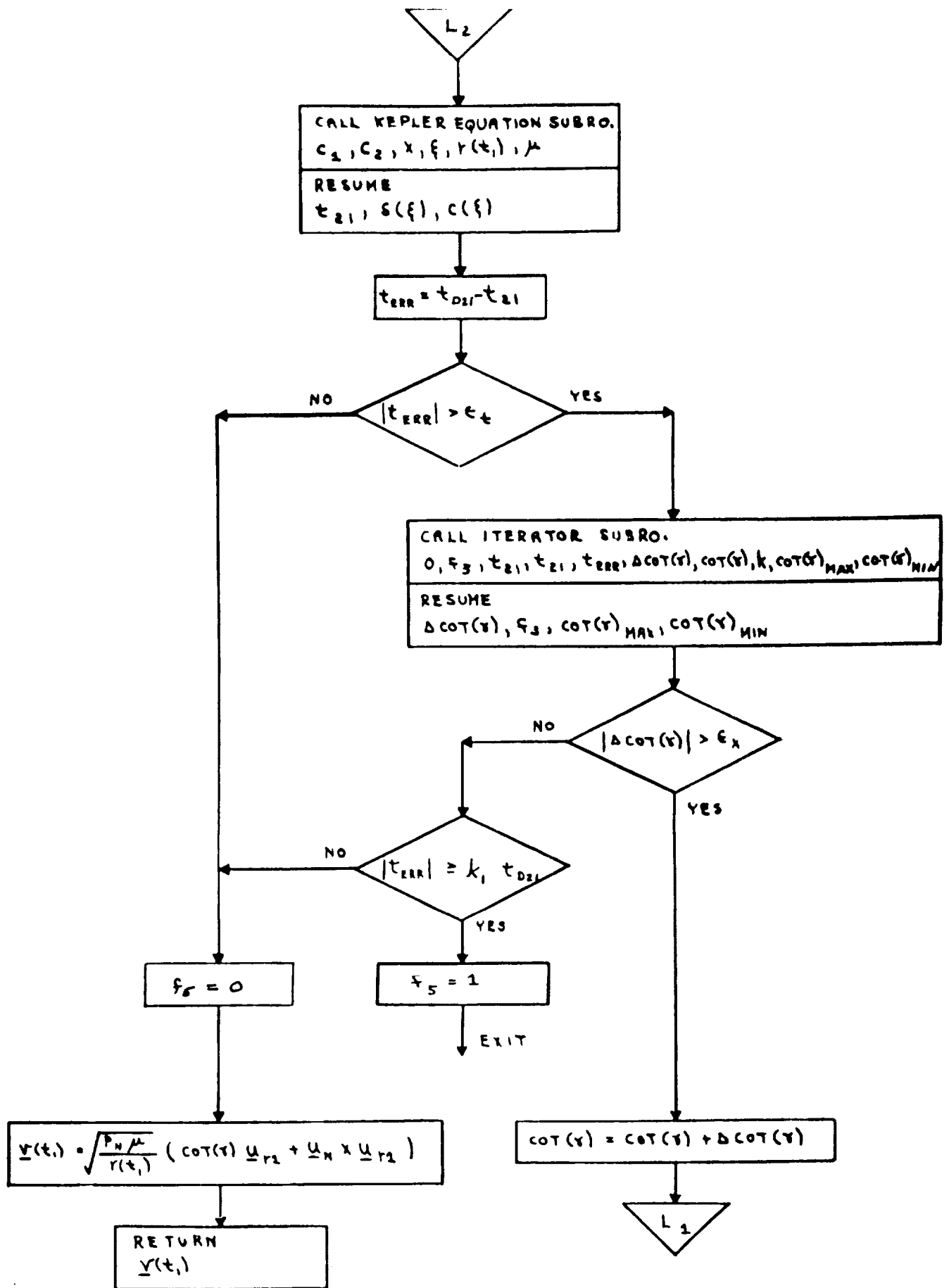

Figure 5.6-2 Lambert Subroutine

5.5.7 TIME-THETA SUBROUTINE

The Time-Theta Subroutine solves for the two body transfer time given the initial position and velocity vectors and the true anomaly difference (transfer angle) to the terminal position.

This section contains information to aid the reader in understanding the less obvious aspects of the Time-Theta Subroutine block diagram depicted in Fig. 5.7-1. The subroutines referred to in this figure are presented in Section 5.5.10. Nomenclature is found in Section 5.5.1.2.

The flag f_6 must be zero if the user desires computation of the terminal state vector in addition to the transfer time.

If the conic trajectory is a parabola or hyperbola and the desired transfer angle, θ , lies beyond the asymptote of the conic, f_7 will be set indicating that no solution is possible.

In addition to the parameter range constraints imposed on Kepler's equation, the additional restriction on Time-Theta that the trajectory must not be near rectilinear is indicated by the range of $\cot \gamma$.

The Time-Theta problem is not well defined for near rectilinear trajectories, i.e. the transfer angle θ is no longer a meaningful problem parameter. This will not cause difficulties provided the input variables are within the specified ranges.

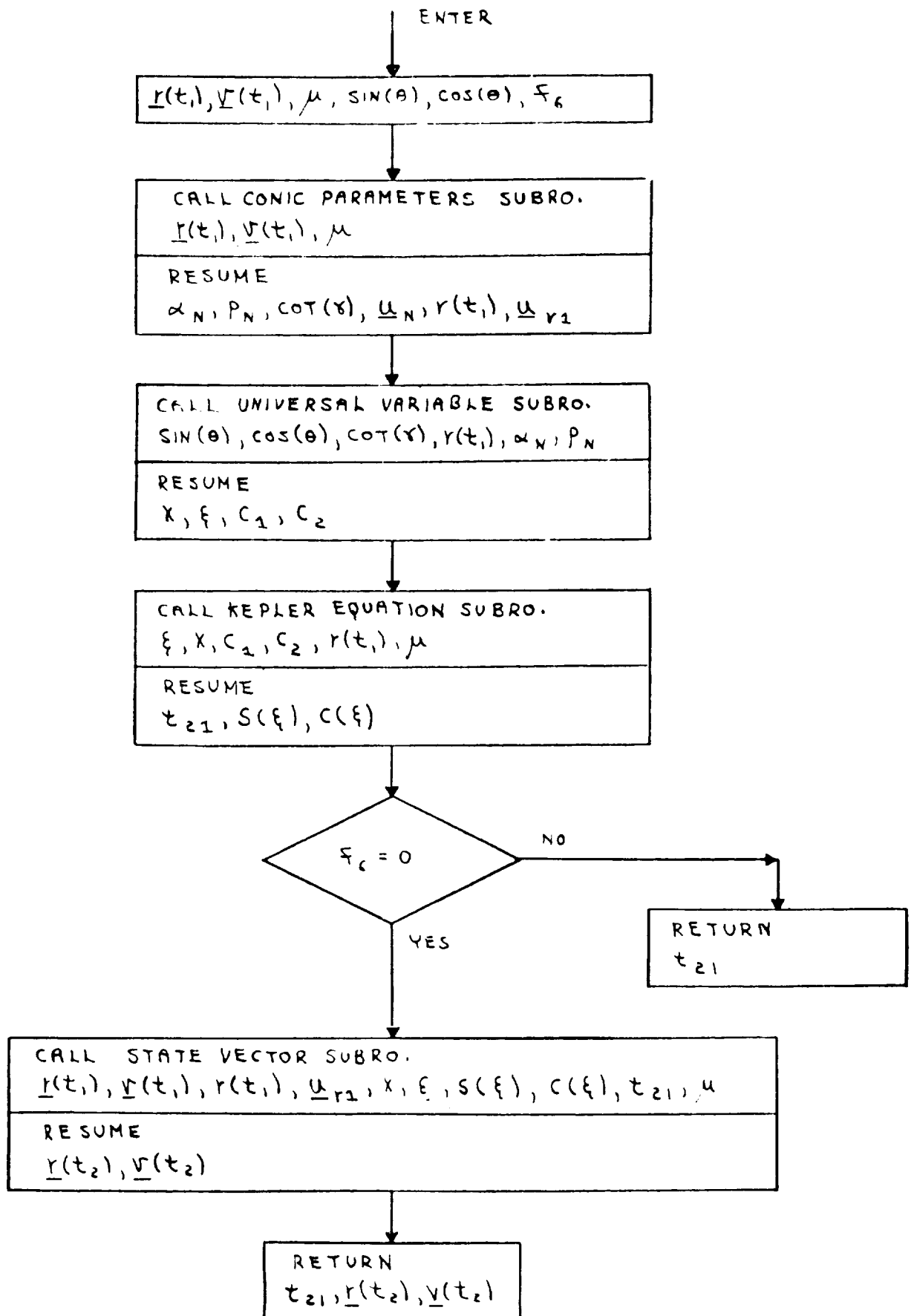

Figure 5.7-1 Time-Theta Subroutine

5. 5. 8 TIME-RADIUS SUBROUTINE

The Time Radius Subroutine solves for the two body transfer time to a specified radius given the initial position and velocity vectors and the radius magnitude.

This section contains information to aid the reader in understanding the less obvious aspects of the Time-Radius Subroutine block diagrams depicted in Figs. 5. 8-1 and 5. 8-2. The subroutines referred to in this figure are presented in Section 5. 5. 10. Nomenclature is found in Section 5. 5. 1. 2

Paragraphs 3, 4, and 5 of Section 5. 5. 7 apply to the Time-Radius Subroutine as well.

Since an inherent singularity is present for the circular orbit case, near-circular orbits result in a loss of accuracy in computing both the transfer time, t_{21} , and the final state vector. This is caused by the increasing sensitivity of t_{21} to $r(t_2)$ as the circular orbit is approached.

If $r(t_2)$ is less than the radius of pericenter or greater than the radius of apocenter, then $r(t_2)$ will be ignored and the pericenter or apocenter solution, respectively, will be computed. A flag, f_8 , will be set to indicate this.

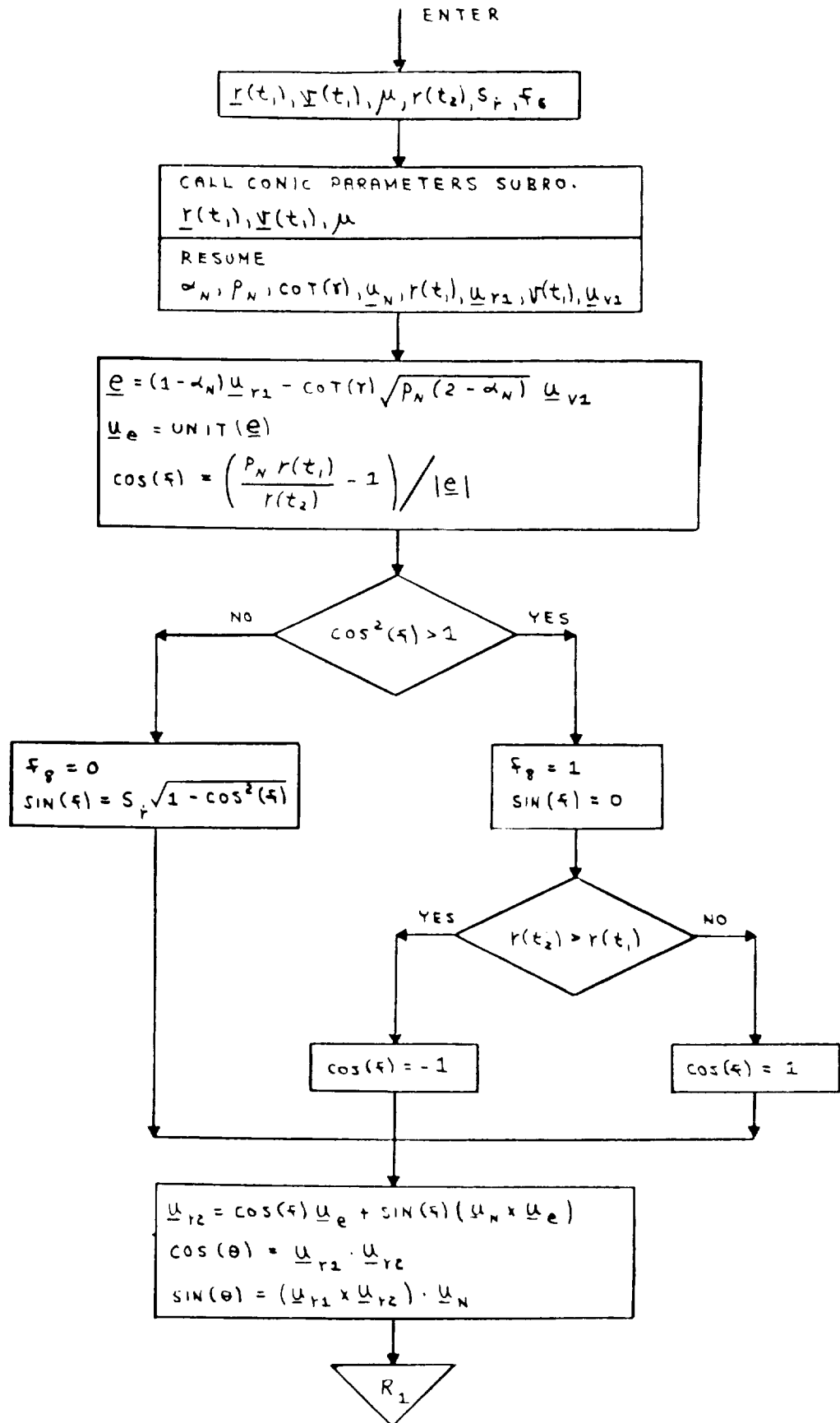

Figure 5. 8-1 Time-Radius Subroutine

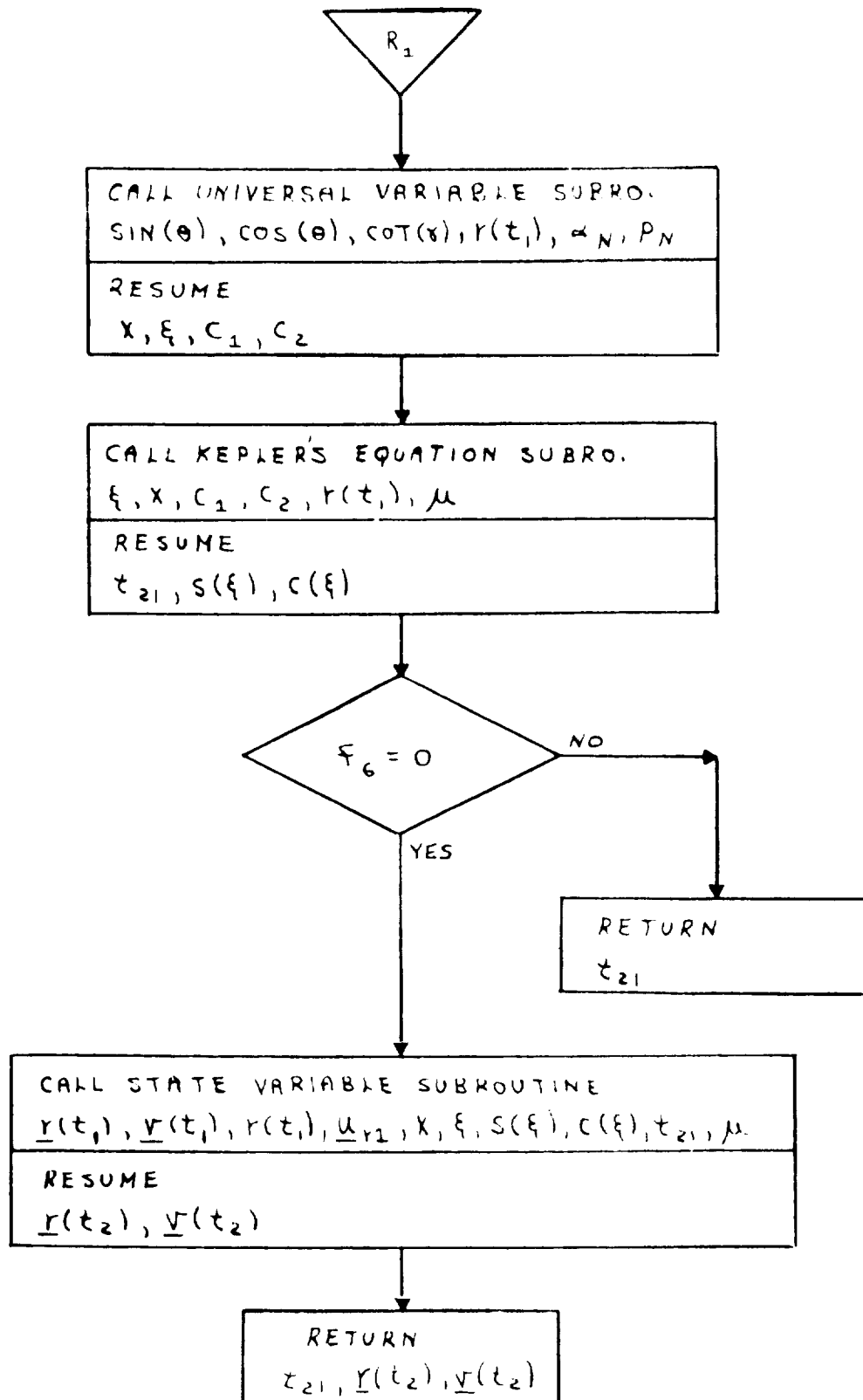

Figure 5.8-2 Time-Radius Subroutine

5.5.9 APSIDES SUBROUTINE

The Apsides Subroutine solves for the two body radii of apocenter and pericenter and the eccentricity of the trajectory given the position and velocity vectors for a point on the trajectory.

This subroutine is depicted in Fig. 5.9-1. The subroutines referred to in this figure are presented in Section 5.5.10. Nomenclature is found in Section 5.5.1.2.

It is characteristic of this computation that the apsides become undefined as the conic approaches a circle. This is manifested by decreasing accuracy. When the conic is nearly parabolic, or hyperbolic, the radius of apocenter is not defined. In this event the radius of apocenter will be set to the maximum positive value allowed.

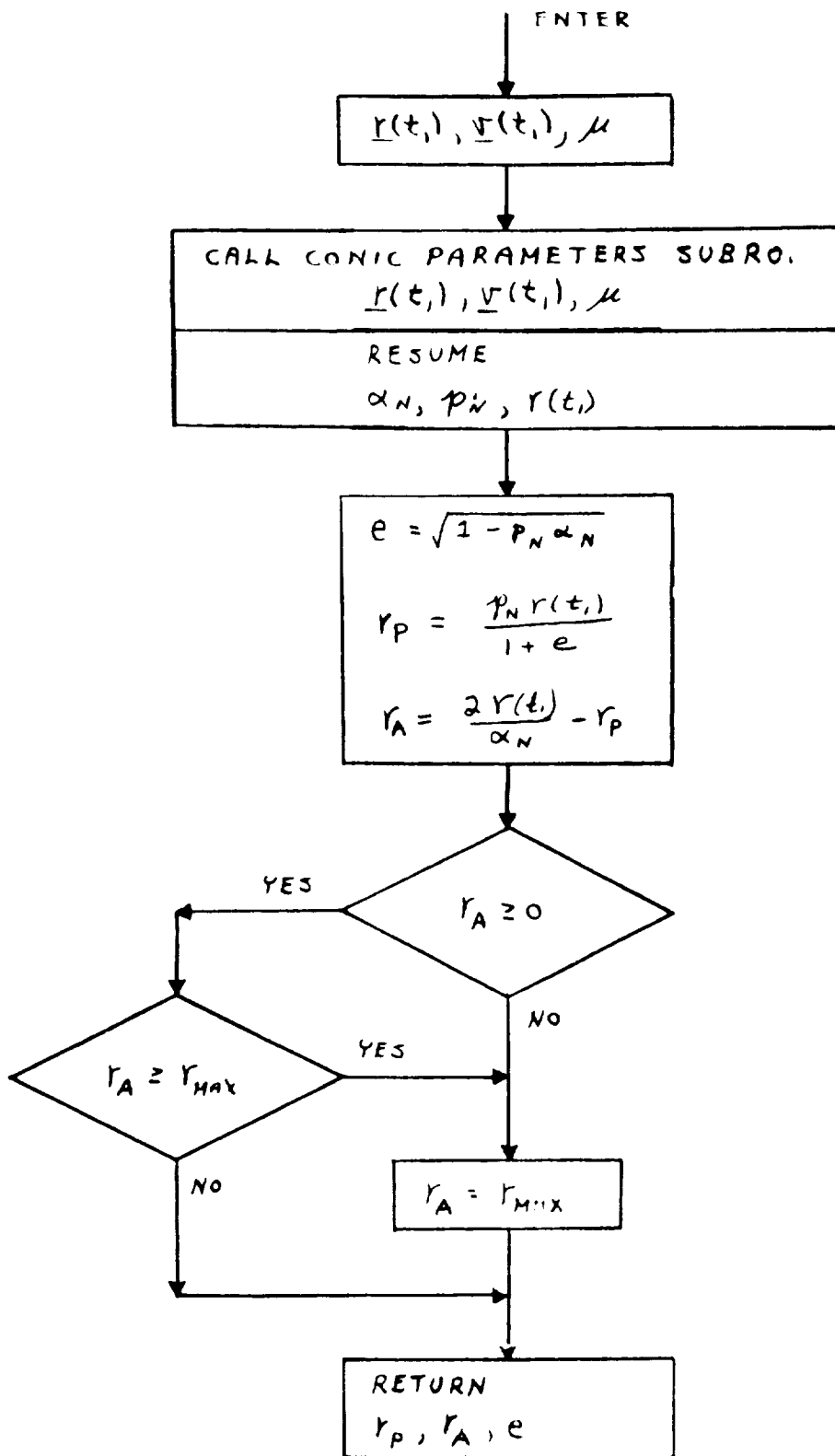

Figure 5.9-1 Apsides Subroutine

5. 5. 10 MISCELLANEOUS SUBROUTINES

There are, as part of the Conic Trajectory Subroutines, three subroutines which are useful in their own right. These are the Conic Parameters, the Geometric Parameters and the Iterator Subroutines which are depicted in Figs. 5. 10-1, 5. 10-2 and 5. 10-3, respectively.

The Conic Parameters and Geometric Parameters Subroutines are self explanatory.

The Iterator Subroutine serves several purposes. It is used when flag f_4 is set to zero to solve for the value of the independent variable which drives the error in the dependent variable to zero, provided the function is monotonically increasing. To improve convergence for functions whose derivative changes rapidly, the limits are reset as shown in the block diagram.

With f_4 set to 1, the Iterator seeks a minimum of the function, provided the first derivative is single-valued between the limits. The inputs are redefined so that "y" is the derivative of the independent variable with respect to the dependent variable, and "x" is the value at which the derivative was computed or approximated. Since the desired value of y is zero, $y_{ERR} = -y$.

Since the Iterator uses the "Regula Falsi" technique, it requires two sets of variables to begin iteration. If only one set is available, flag f_3 must be set to 1, causing the iterator to generate the independent variable increment from a percentage of the full range.

In addition to the above subroutines there are three other subroutines of primary interest to the five basic conic subroutines described in Sections 5.5.5 to 5.5.9. These are the Universal Variable Subroutine, the Kepler Equation Subroutine, and the State Vector Subroutine shown in Figs. 5.10-4, 5.10-5 and 5.10-6 respectively.

The Universal Variable Subroutine is utilized by the Lambert, the Time-Theta and the Time-Radius Subroutines to compute the universal parameter x required for the time equation. There are two different formulations required according to the size of the parameter w .

If the input to the subroutine requires the physically impossible solution that the trajectory "close through infinity", the problem will be aborted, setting flag f_7 .

The Kepler Equation Subroutine computes the transfer time given the variable x and the conic parameters.

The State Vector subroutine computes the position and velocity vectors at a point along the trajectory given an initial state vector, the variable x and the transfer time.

The final miscellaneous subroutine, the SETMU Subroutine, is depicted in Fig. 5.10-7. It sets μ to the appropriate primary body gravitational constant consistent with the estimated CSM state vector as defined in Section 5.2.2.6.

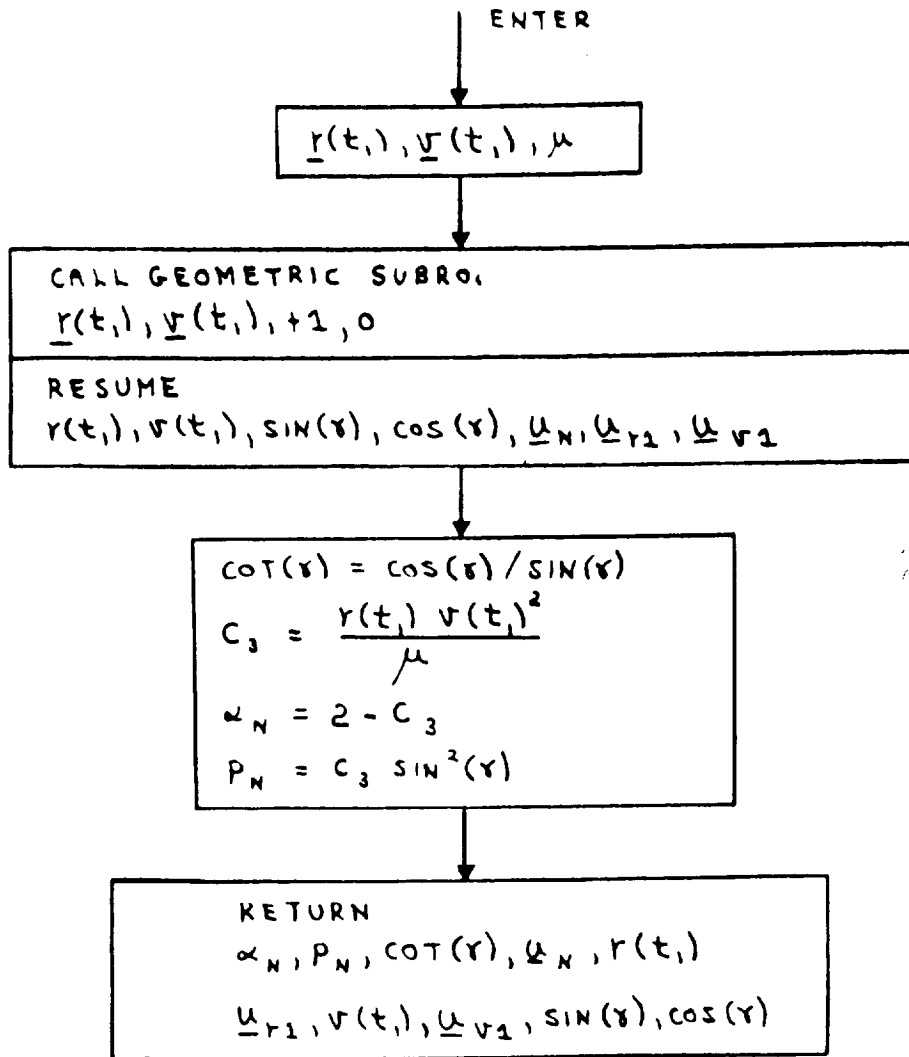

Figure 5. 10-1 Conic Parameters Subroutine

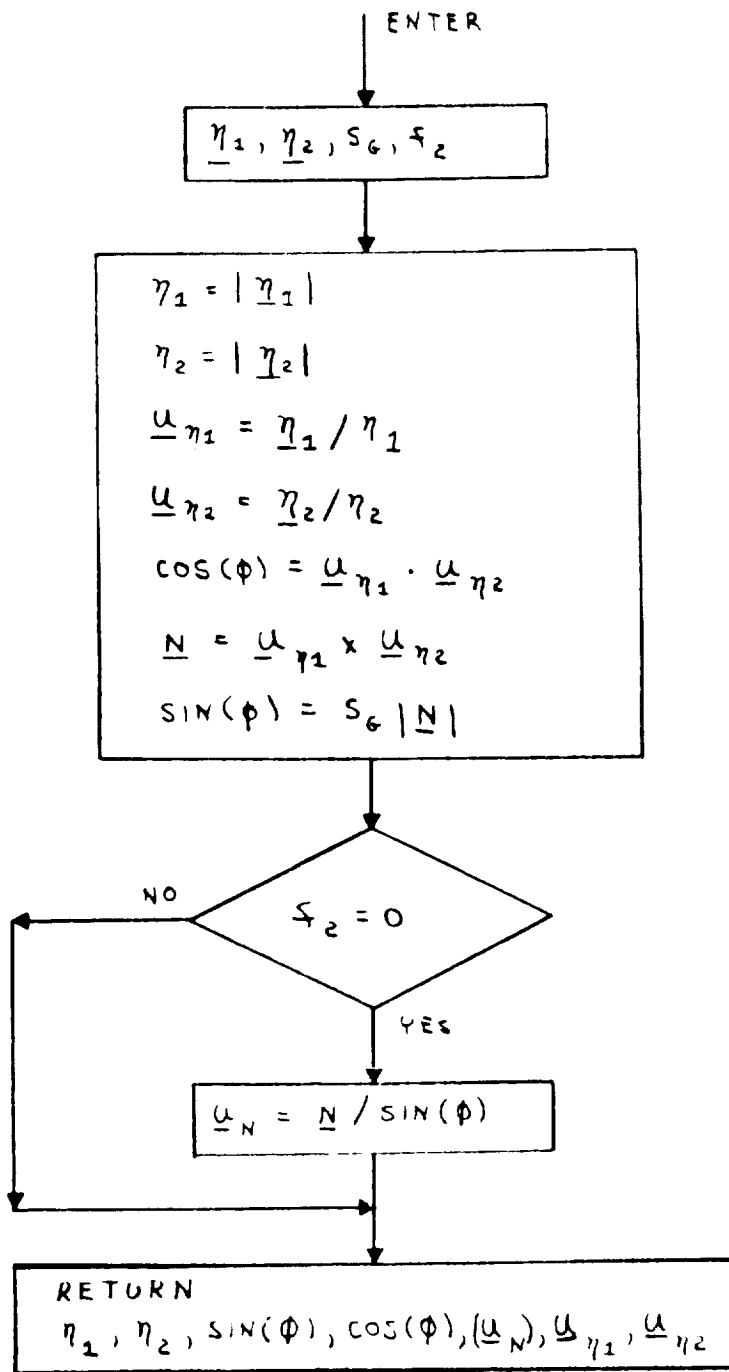

Figure 5.10-2 Geometric Parameters Subroutine

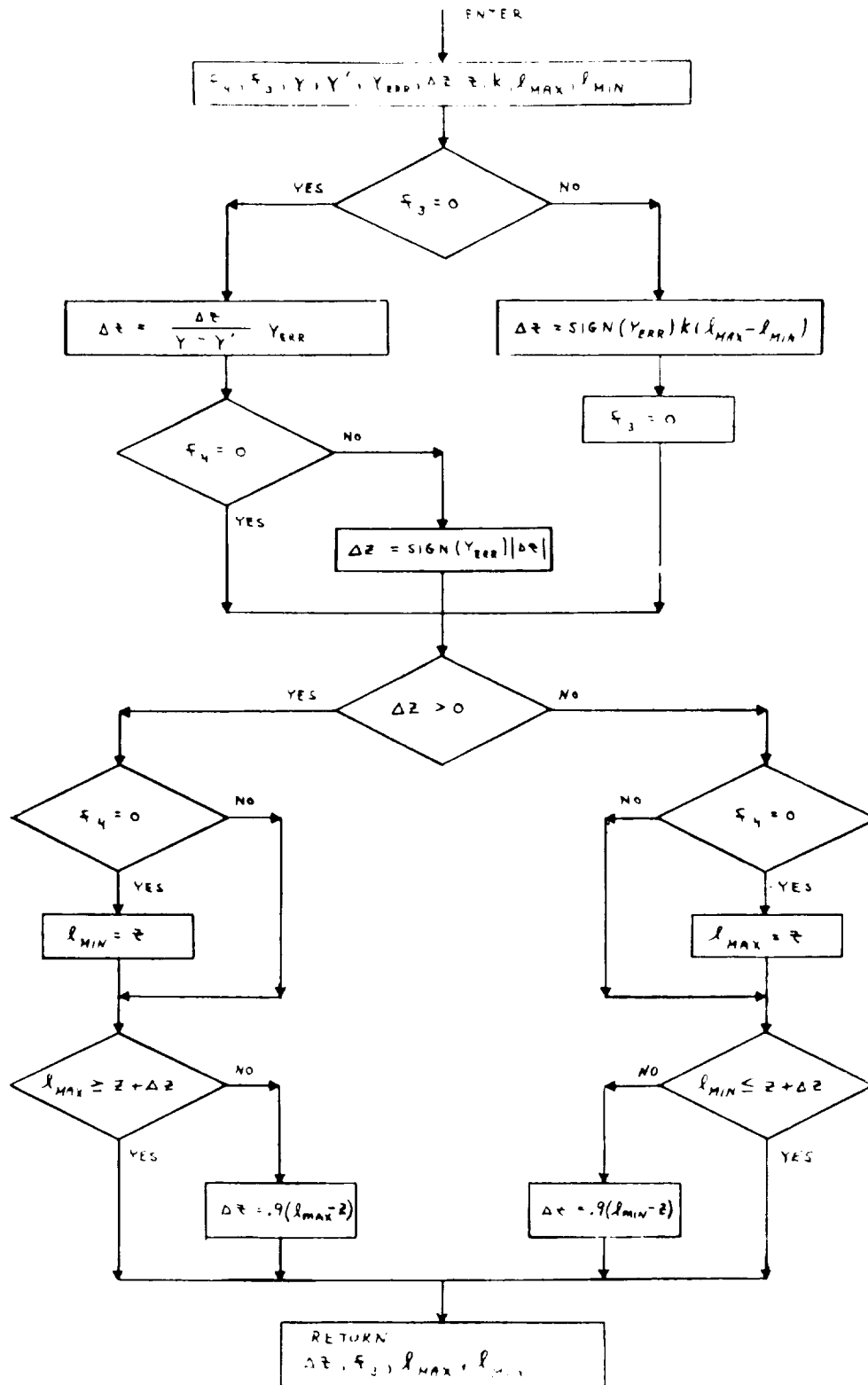

Figure 5.10-3 Iterator Subroutine

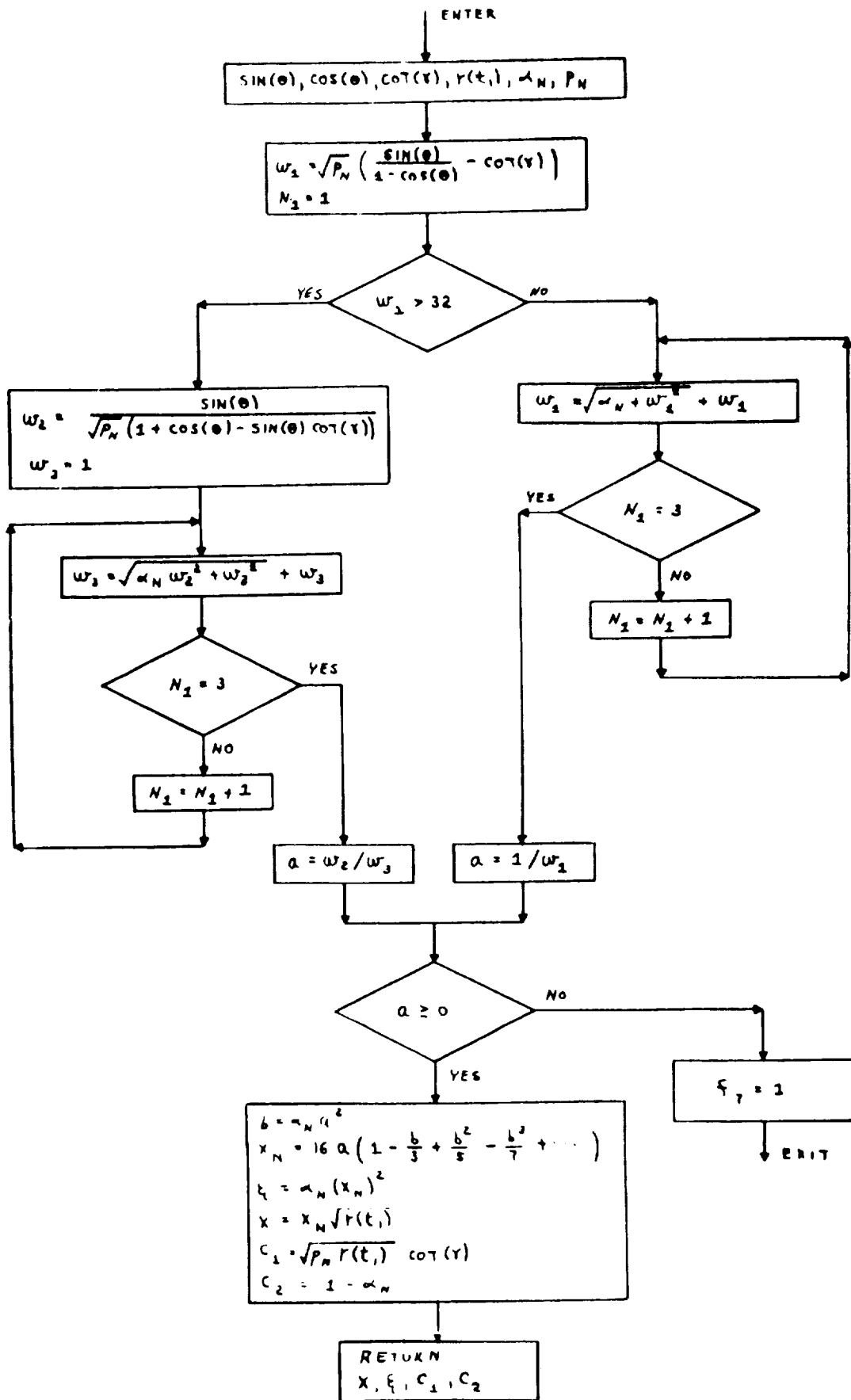

Figure 5.10-4 Universal Variable Subroutine

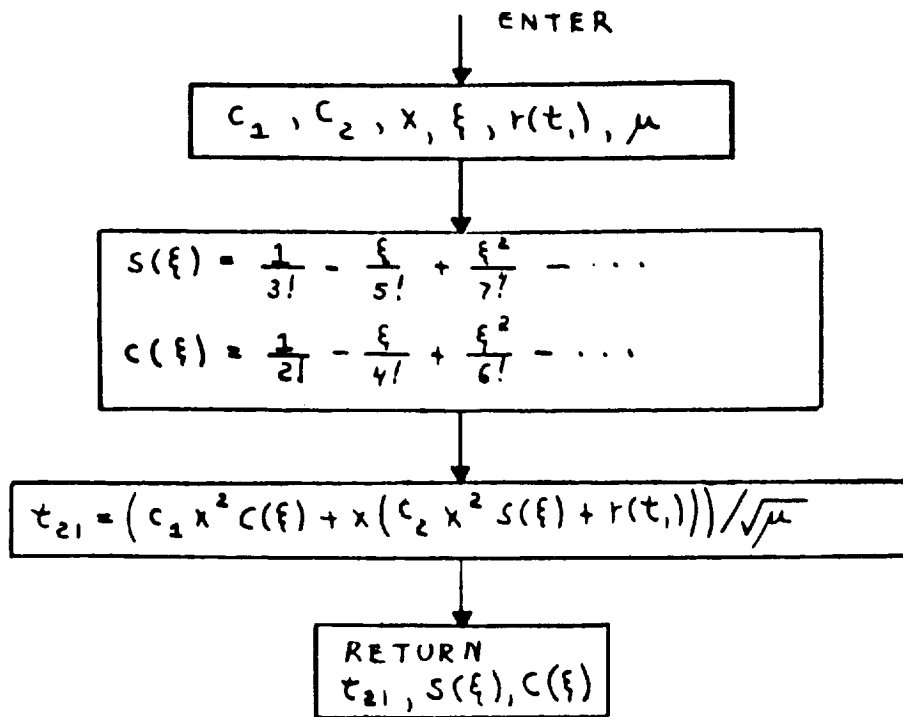

Figure 5.10-5 Kepler Equation Subroutine

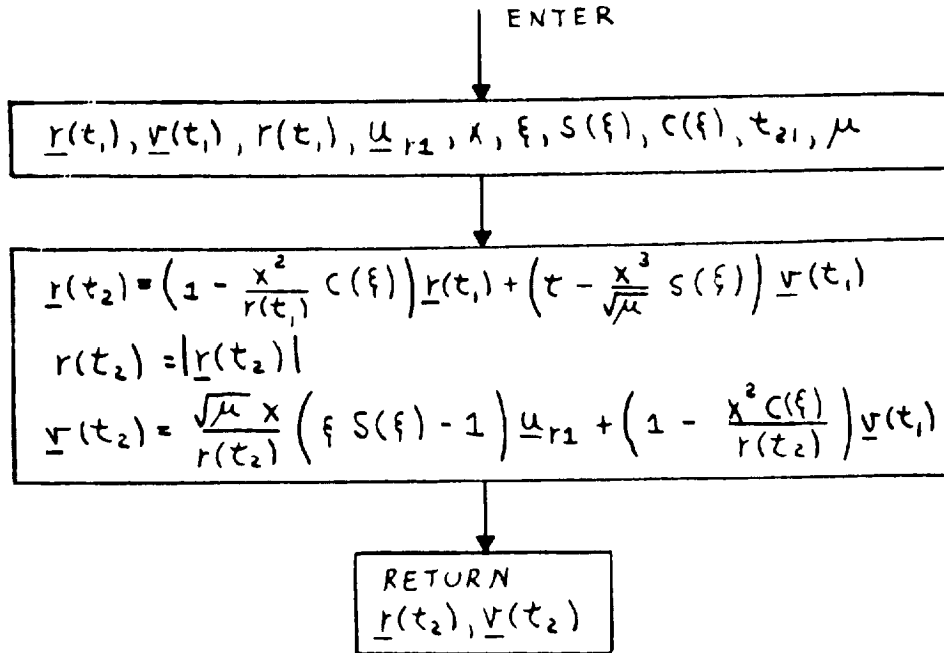

Figure 5.10-6 State Vector Subroutine

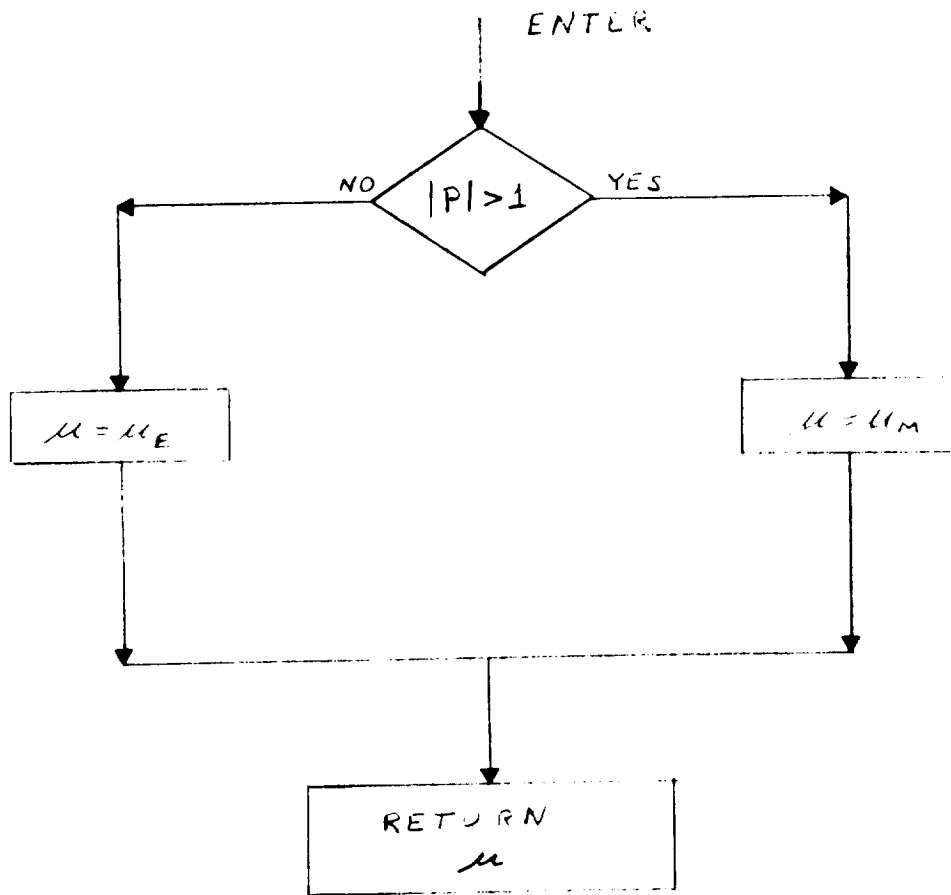

Figure 5.10-7 SETMU Subroutine

5.5.11 INITIAL VELOCITY SUBROUTINE

The Initial Velocity Subroutine computes the initial velocity vector for a trajectory of specified transfer time between specified initial and target position vectors. The trajectory may be either two body or precise depending on the number of iterations allowed within the subroutine.

In addition, at the users option, the target vector will be projected into the plane defined by the initial position vector and another arbitrary input vector. This option is exercised when the transfer angle between the initial and target position vectors is within a specified angle measured from 180 degrees.

This subroutine is depicted on Fig. 5.11-1. As shown on the figure the Lambert Subroutine, Section 5.5.6, is utilized to compute the two body initial velocity. The Coasting Integration Subroutine, Section 5.2.2, is utilized in computing the precise trajectory. This is an iterative process. An off-set target vector is used as input to the Lambert Subroutine which then provides the initial velocity for the Coasting Integration Subroutine.

Nomenclature for the Initial Velocity Subroutine

$\underline{r}(t_1)$	Initial position vector
$\underline{v}(t_1)$	Vector sometimes used to establish the trajectory plane - usually a velocity vector.
$\underline{r}_T(t_2)$	Target vector
t_D	Transfer time to target vector
N_1	Number of iterations allowed
ϵ	Angle to 180 degrees below which the target vector is rotated into an arbitrary plane
f_1	See nomenclature in Section 5.5.1.2
K	See nomenclature in Section 5.5.1.2
$\underline{v}_T(t_1)$	The initial velocity vector of the trajectory passing thru the target
$\underline{v}_T(t_2)$	The velocity vector at the target position

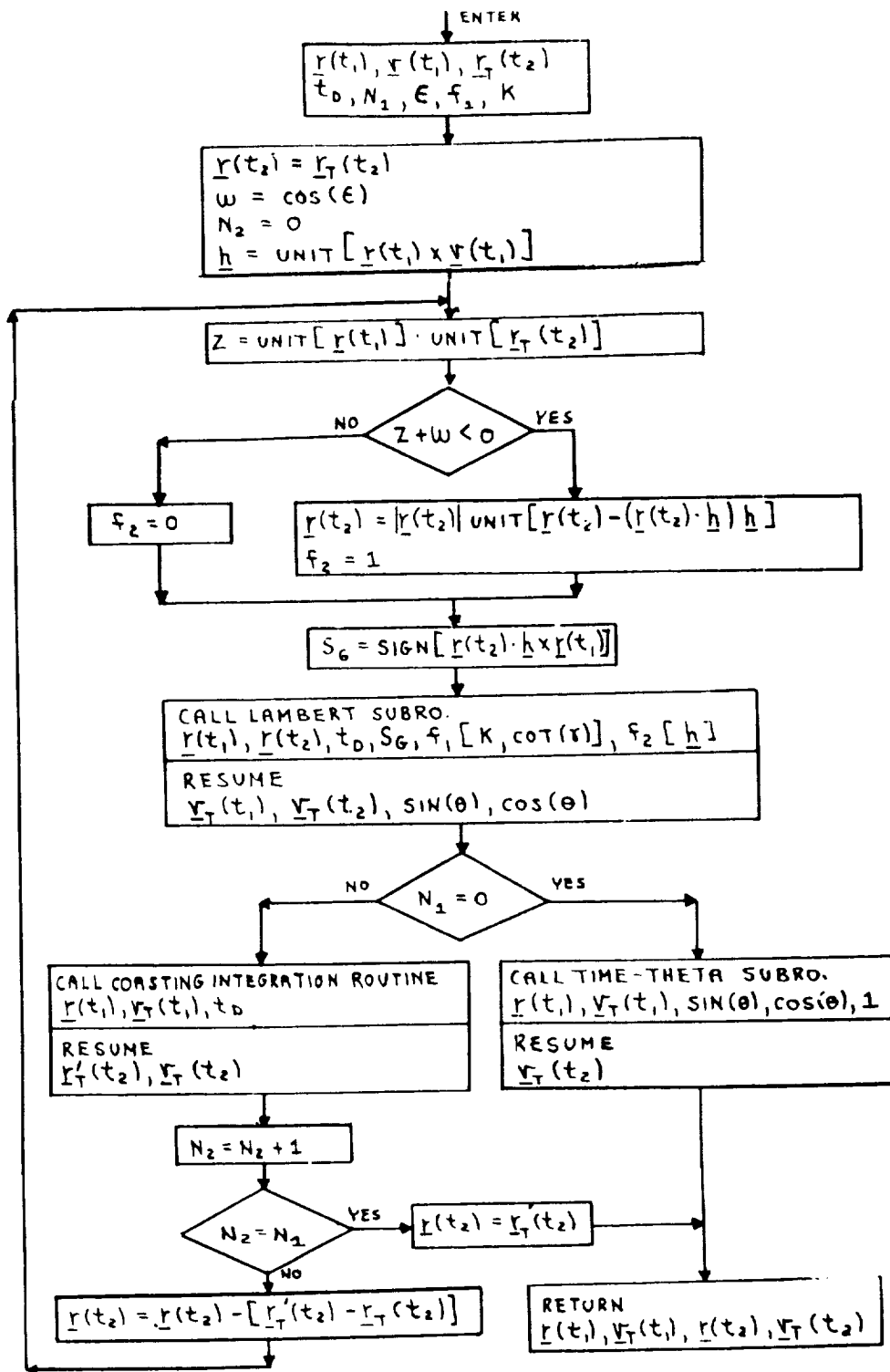

Figure 5. 11-1 Initial Velocity Subroutine

5. 6 GENERAL SERVICE ROUTINES

5. 6. 1 GENERAL COMMENTS

The routines presented in this section are used for the following general service functions:

- 1) IMU alignment modes
- 2) Basic Coordinate Transformations
- 3) Computer initialization procedures
- 4) Special display routines which can be called by the astronaut

5.6.2 IMU ALIGNMENT MODES

5.6.2.1 Orbital Alignment

5.6.2.1.1 Docked IMU Coarse Alignment Program

The Docked IMU Coarse Alignment Program (P - 50) is used to coarse align the LM IMU to the same inertial orientation as the CSM IMU while the vehicles are in the docked configuration. Prior to initiating this program it is assumed that the CSM IMU is aligned to the landing orientation defined in Section 5.6.3.4.4 for the nominal landing time T (L).

At the start of program P - 50 the astronaut establishes the proper fixed attitude of the docked configuration so as to avoid any possibility of gimbal lock. The astronaut then enters into the LGC the docking interface roll calibration angle ($\Delta\phi$) and the present CSM IMU gimbal angles. Using these angles the program computes the desired LM IMU gimbal angles as follows in order to place the LM IMU stable member at the same inertial orientation as the CSM IMU stable member:

$$MGA_{LM} = -MGA_{CSM}$$

$$IGA_{LM} = IGA_{CSM} + 180^{\circ} \quad (6.2.1)$$

$$OGA_{LM} = \Delta\phi - OGA_{CSM} - 60^{\circ}$$

where MGA, IGA, and OGA are the middle, inner, and outer gimbal angles, respectively.

The program then coarse aligns the LM IMU to the desired gimbal angles and displays the final angles to the astronaut in case he wishes to check them. If he is not satisfied with the angles, he must recall the program. Once this alignment is complete, it is assumed by the LGC that the LM IMU stable member is at the desired inertial landing orientation.

5.6.2.1.2 LM / CSM Separation Monitor Program

This program is designated as P - 46 and is used to monitor the manually controlled LM separation maneuver from the CSM when the LM IMU is only coarse aligned by program P - 50 prior to separation. The objective of the LM / CSM Separation Monitor Program is to update the LM state vector after the separation maneuver with sufficient accuracy to maintain the desired LM landing CEP.

The general functional operation of program P - 46 is as follows. The program is initiated after IMU alignment by program P - 50 and prior to separation of the LM from the CSM. The resulting velocity change due to the manual separation maneuver is then sensed by the PIPA's when the velocity readings exceed the threshold limits. This maneuver $\Delta \underline{V}$ and time t_{SEP} are then stored, and the automatic free-fall integration routine temporarily suspended. Immediately after the separation maneuver the LM IMU alignment is determined with P - 51 (IMU Orientation Determination Program) by making two successive star sighting operations. This operation determines the REFSMMAT transformation (Section 5.6.3) for the LM IMU during the separation maneuver. The LM state vector is then integrated to t_{SEP} by the Coasting Integration Routine and updated by the stored separation maneuver $\Delta \underline{V}$ and current REFSMMAT. The automatic state vector integration operation is next reinitiated after this separation maneuver update has been completed. The final operation is to then realign the LM IMU to the desired descent and landing phase alignment with program P - 52.

5.6.2.1.3 IMU Orientation Determination Program

The IMU Orientation Determination Program (P - 51) is used during free-fall to determine the present IMU stable member orientation with respect to the Basic Reference Coordinate System by sighting on two navigation stars with the Alignment Optical Telescope (AOT). These stars must be selected by the astronaut and sighted upon in the manner indicated in Section 5.6.3.1.1 and in the In-Flight Sighting Mark Routine (R - 53) of Section 4. Once the line-of-sight vectors to the two stars have been obtained in stable member coordinates, a test is made by the Star Data Test Routine (R - 54 of Section 4) to see if the angle between the two vectors is in close agreement with the angle between the corresponding line-of-sight vectors stored in basic reference coordinates. If the star vectors in stable member coordinates pass the test, they can be used with the corresponding vectors stored in basic reference coordinates to determine the present stable member orientation and REFSMMAT, using the procedure given in Section. 5.6.3.4.1.

It should be noted that the astronaut can also use program P-51 to determine the IMU orientation while on the lunar surface. This capability is automatically provided by the program whenever the LM is on the lunar surface, and is accomplished simply by substituting the Lunar Surface Sighting Mark Routine (R-59) for the Inflight Sighting Mark Routine (R-53)

5.6.2.1.4 IMU Realignment Program

The IMU Realignment Program (P - 52) is used during free-fall to align the IMU from a known orientation to one of the desired orientations given in Section 5.6.3.4 and in P - 52 of Section 4. Initially, the astronaut selects the desired stable member orientation, and the program computes and displays the IMU gimbal angles for the desired stable member orientation using the present vehicle attitude. If the computed gimbal angles are unsatisfactory, the astronaut maneuvers the vehicle to a more suitable attitude and has the program re-compute and display the new gimbal angles. Once satisfactory angles have been obtained,

the Coarse Alignment Routine (R - 50 of Section 4) is used to coarse align the IMU to the desired orientation. Afterwards, the astronaut maneuvers the vehicle to a desired attitude for star acquisition and the Star Selection Routine of Section 5.6.4 is used to select two stars. If the Star Selection Routine is unable to find two satisfactory stars at the present vehicle attitude, the astronaut either repeats the above process of changing the vehicle attitude and using the Star Selection Routine or selects his own stars. It should be noted that the Star Selection Routine only selects stars for the forward viewing position of the AOT. However, the astronaut may select stars with the intention of using either of the other two viewing positions described in Section 5.6.3.1.1.

After the stars have been selected, the Fine Alignment Routine (R - 51) is used to obtain the necessary star sightings and to align the IMU to the desired orientation. This routine accomplishes the above tasks by using various other routines. Prior to sighting on each star, the astronaut is given the option of either maneuvering the vehicle himself to place the star at the desired sighting location in one of the three fields-of-view (FOV) of the AOT or having the Auto Optics Positioning Routine (R - 52 of Section 4) command the vehicle attitude so as to place the star at the center of the forward FOV. Once the star is properly positioned, the In-Flight Sighting Mark Routine is used to perform sightings on the star.

After the sightings have been made on both stars, the Star Data Test Routine is used to check the angle between the two measured star directions, and the Gyro Torquing Routine (R - 55 of Section 4) is used to torque the IMU stable member to the desired orientation.

5.6.2.1.5 IMU Orientation Determination Backup Program

The IMU Orientation Determination Backup Program (P-53) provides the capability of using some optical device other than the Alignment Optical Telescope (AOT) to sight on stars for purposes of IMU orientation determination during free-fall. Possible devices which might be considered as backups to the AOT are the Crew Optical Alignment Sight (COAS) and the Landing Point Designator (LPD).

Program P-53 is identical to program P-51 except for a new mode of operation of the In-Flight Sighting Mark Routine (R-53) which is established by setting the AOT Backup flag at the start of program P-51. When the In-Flight Sighting Mark Routine is used in this mode, the astronaut first enters into the LGC the sighting coordinates (AZ and EL) of the optical device. These coordinates are defined in the same manner as those given for the AOT in Section 5.6.3.1. Next, the astronaut changes the LM attitude so that the star will cross the corresponding X and Y reticle lines of the optical device just as is done with the AOT. The astronaut depresses the X or Y mark button whenever the star crosses the corresponding reticle line. When the star coincides with one of the reticle lines, this defines a plane containing the star. The orientations of the two planes \underline{u}_{XP} and \underline{u}_{YP} in stable member coordinates are:

$$\underline{u}_{XP} = \begin{bmatrix} \text{NBSM} \\ \dots \\ \dots \\ \dots \end{bmatrix} \underline{u}'_{XPN} \quad (6.2.2)$$

$$\underline{u}_{YP} = \begin{bmatrix} \text{NBSM} \\ \dots \\ \dots \\ \dots \end{bmatrix} \underline{u}'_{YPN} \quad (6.2.3)$$

where $\overline{\text{NBSM}}_X$ and $\overline{\text{NBSM}}_Y$ are the transformation matrices based upon the IMU CDU readings stored during the X and Y marks. It should be noted that Eqs. (6.2.2) and (6.2.3) would be identical to those given for the AOT in Eqs. (6.3.7) and (6.3.8) of Section 5.6.3.1.1 if the AOT did not cause a rotation of the apparent field-of-view (i. e., R_N was always equal to zero in Eqs. (6.3.5) and (6.3.6)).

The vector \underline{s}_{SM} describing the line-of-sight to the star in stable member coordinates is given in Eq. (6.3.9) of Section 5.6.3.1.1. A multiple mark capability is provided just as with the AOT in order to achieve greater accuracy.

After sightings have been made on two stars, the star data test is performed and the orientation of the IMU stable member is determined.

5.6.2.1.6 IMU Realignment Backup Program

The IMU Realignment Backup Program (P-54) provides the capability of using some optical device other than the AOT to sight on stars for purposes of IMU realignment during free-fall. Basically, this program accomplishes this by establishing another mode of operation of the IMU Realignment Program (P-52). When program P-54 is called, the AOT Backup flag is set just as is done in the IMU Orientation Determination Backup Program (P-53).

Afterwards, program P-54 performs the same functions as program P-52 except that the presence of the AOT Backup flag causes the Auto Optics Positioning Routine to be by-passed in the Fine Alignment Routine. In addition the AOT Backup flag establishes

a new mode of operation in the In-Flight Sighting Mark Routine just as was done in program P-53 (Section 5.6.2.1.5). After sightings have been made on two stars, the star data test is performed and the IMU stable member is fine aligned to the desired inertial orientation by torquing the gyros.

5.6.2.2 Lunar Surface Alignment

5.6.2.2.1 General

There are several methods of IMU alignment available to the astronaut while on the lunar surface. These methods are selectable through various options offered in a single lunar surface IMU alignment program (P-57). Most of these methods are considered as back-ups to the preferred normal method of IMU alignment using optical sightings on two stars with the AOT. In addition, the astronaut has the option at the beginning of the program of having the IMU stable member aligned to the orientation required for launch at a specified time $T(L)$, which may be the time of lunar launch defined by one of the Ascent Prethrusting Programs (P-10 or P-11) or a time specified by himself. The manner in which this time specifies the launch orientation and its associated REFSMMAT is given in Section 5.6.3.4.4. It should be noted that any time $T(L)$ specified by the astronaut may be somewhat arbitrary and does not necessarily mean that a launch will take place at that time.

Whenever the IMU is aligned by one of the options in this program, the orientation of the LM is determined with respect to the Moon-Fixed Coordinate System and stored in erasable memory. This is done primarily for purposes of backup so that the IMU can be aligned at any later time using just the stored LM attitude data. It also provides a means for coarse alignment of the IMU prior to sighting on stars with the AOT. In addition to determining and storing the LM attitude after each alignment, the LM attitude is also determined and stored by the landing programs (P-65, P-66, and P-67) just prior to their termination by the astronaut, which occurs when the vehicle has come to rest on the lunar surface. This step is taken to insure that the data will be available in case the IMU is turned off without having been re-aligned after touchdown or it is found that a re-alignment cannot be made with the AOT.

The attitude of the LM is determined with respect to the Moon-Fixed Coordinate System by first obtaining the unit vectors \underline{u}_{YREF} and \underline{u}_{ZREF} which define the orientations of the vehicle (or navigation base) Y and Z axes with respect to the Basic Reference Coordinate System. These vectors are obtained from the following matrix.

$$\begin{bmatrix} \underline{u}_{XREF}^T \\ \underline{u}_{YREF}^T \\ \underline{u}_{ZREF}^T \end{bmatrix} = \begin{bmatrix} REFNB \end{bmatrix} = \begin{bmatrix} SMNB \end{bmatrix} \begin{bmatrix} REFSMMAT \end{bmatrix} \quad (6.2.4)$$

where $\begin{bmatrix} REFSMMAT \end{bmatrix}$ and $\begin{bmatrix} NBSM \end{bmatrix}$ are the transformation matrices defined in Sections 5.6.3.4 and 5.6.3.2.1, respectively. Note that any two of the three LM axes could have been used for this purpose and that only two axes are needed to define the vehicle attitude. Afterwards, the vectors are transformed to the Moon-Fixed Coordinate System as \underline{u}_{YMF} and \underline{u}_{ZMF} by the Planetary Inertial Orientation Routine of Section 5.5.2 and stored in erasable memory. The Attitude flag is then set to denote that the attitude has been stored. Once these vectors have been determined in the Moon-Fixed Coordinate System, they will always represent the correct orientation of the vehicle Y and Z axes with respect to the Moon-Fixed Coordinate System as long as there is no change in the vehicle attitude due to settling. To determine the orientation of these vectors with respect to the Basic Reference Coordinate System at a later time it is only necessary to transform the stored vectors to the Basic Reference Coordinate System using the Planetary Inertial Orientation Routine with the indicated time as one of the inputs.

The various options (methods) of IMU alignment available to the astronaut in the lunar surface alignment program are presented in the following sections. In considering the various options it is important to note that a program alarm is issued at the beginning of some options if the Attitude flag or REFSMFLAG is not set, since these are regarded as prerequisites for these options. The REFSMFLAG is a flag which is set whenever the computer knows the orientation of the IMU stable member with respect to the Basic Reference Coordinate System and implies that the computer has the correct matrix REFSMMAT for transforming vectors from the Basic Reference Coordinate System to the Stable Member Coordinate System. Since REFSMMAT should be set only if the IMU is on and at a known orientation, its presence at the start of an alignment program generally implies that the IMU has previously been aligned and has remained on until the start of the present alignment. However, it is possible that the correct REFSMMAT could have been determined on the earth in one of the backup situations described later and entered into the LGC without a previous alignment having been made with the Lunar Surface Alignment Program since the time the IMU was turned on.

The logic diagram in Fig. 6.2-1 presents most of the essential features of the Lunar Surface Alignment Program except for the steps performed at the beginning of the program such as checking the status of certain flags, selecting the alignment option, and selecting the desired IMU orientation by specifying the time $T(L)$. Sufficient details are given on these preliminary steps in program P-57 of Section 4. As seen in Fig. 6.2-1, the various options are integrated so that they share certain common operations.

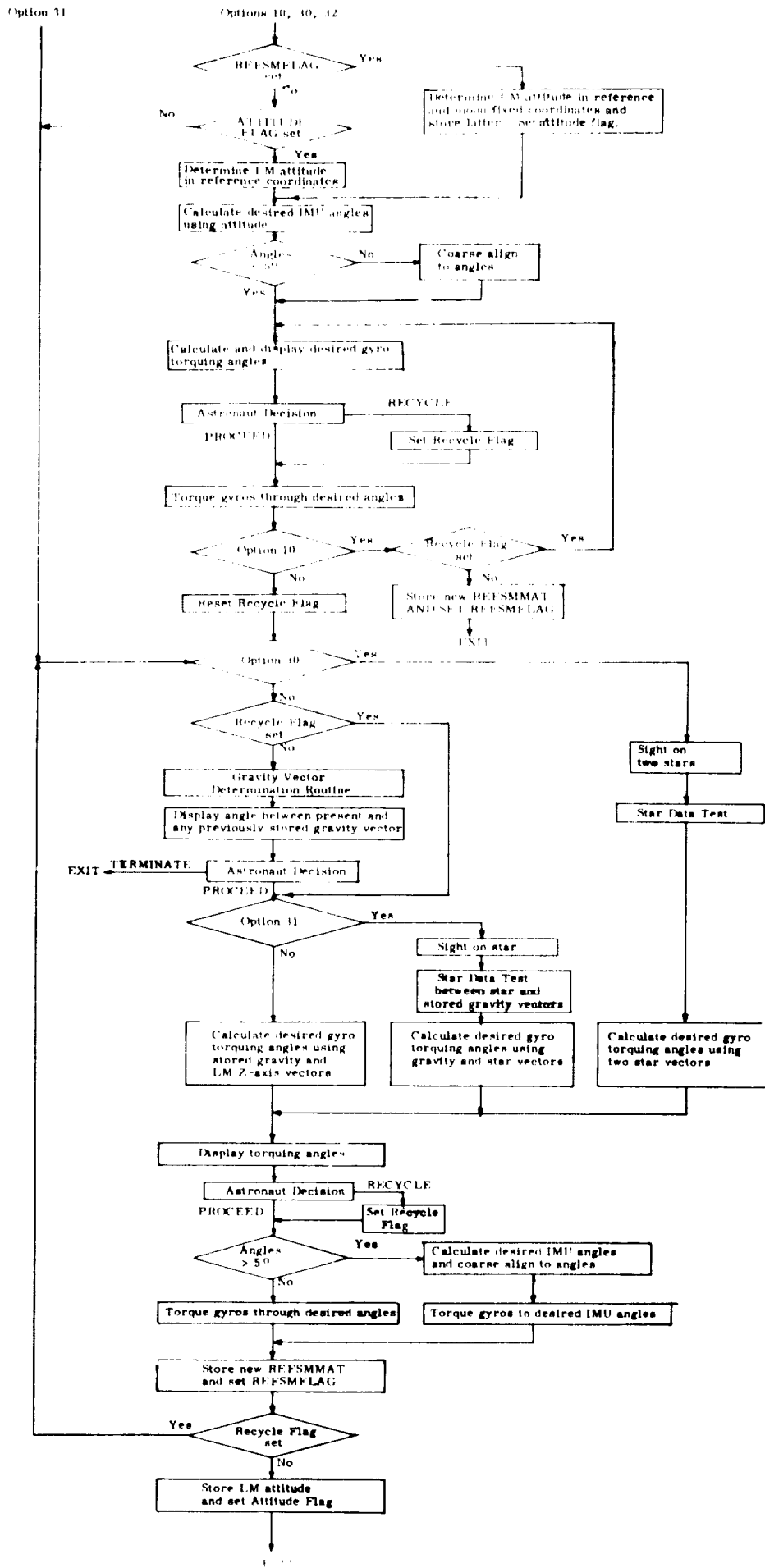

Figure 6.2-1 Lunar Surface Alignment Program
5.6-12

5.6.2.2.2 Option 10 - Anytime Alignment

Option 10 is selected by the astronaut if he wants the IMU to be driven to the desired orientation using only the stored LM attitude or the present REFSMMAT. This option provides a quick means of alignment for emergency launch in case there is no time to perform the alignment by other means. If neither the Attitudeflag or the REFSMFLAG is set at the beginning of this option, it is seen in program P-57 of Section 4 that a program alarm is issued. The alignment is accomplished by calculating the desired IMU gimbals angles using the stored LM attitude or the present REFSMMAT and aligning the IMU to these angles by driving the IMU gimbals (coarse alignment) and/or torquing the gyros. In Fig. 6.3-1 it is seen that the astronaut may repeat the gyro torquing process if he so desires. After completing the alignment, the new REFSMMAT is stored and REFSMFLAG is set.

To calculate the desired gimbal angles in Option 10, the unit vectors \underline{u}_{XREF} , \underline{u}_{YREF} , and \underline{u}_{ZREF} defining the orientation of the LM attitude axes (i. e. navigation base axes) with respect to the reference coordinate system are first determined using the stored LM attitude vectors (\underline{u}_{YMF} and \underline{u}_{ZMF}) in moon-fixed coordinates, or the present REFSMMAT.

If REFSMFLAG is set, the above LM attitude vectors are obtained from the present REFSMMAT as indicated in Eq. (6.2.4). In addition, the LM attitude vectors \underline{u}_{YREF} , \underline{u}_{ZREF} are used to establish new stored LM attitude vectors (\underline{u}_{YMF} and \underline{u}_{ZMF}) in moon-fixed coordinates by use of the Planetary Inertial Orientation Routine.

If REFSMFLAG is not set at the beginning of Option 10, but the Attitude flag is, the desired LM attitude vectors \underline{u}_{YREF} and \underline{u}_{ZREF} are obtained from the stored LM attitude vectors \underline{u}_{YMF} and \underline{u}_{ZMF} with the Planetary Inertial Orientation Routine, and \underline{u}_{XREF} is as follows:

$$\underline{u}_{XREF} = \underline{u}_{YREF} \times \underline{u}_{ZREF} \quad (6.2.5)$$

With vectors \underline{u}_{XREF} , \underline{u}_{YREF} , \underline{u}_{ZREF} , and those defining the desired orientation of the stable member with respect to the reference coordinate system, the routine CALCGA of Section 5.6.3.2.2 may be used to obtain the desired gimbal angles.

The desired gyro torquing angles in Option 10 are determined with the routine CALCGTA of Section 5.6.3.2.3 where the inputs to this routine are the vectors \underline{x}_D , \underline{y}_D , and \underline{z}_D which may be obtained from the following matrix:

$$\begin{bmatrix} \underline{x}_D^T \\ \underline{y}_D^T \\ \underline{z}_D^T \end{bmatrix} = [\text{REFSMMAT}]_D \left\{ \begin{bmatrix} \text{NBSM} \\ \text{REFNB} \end{bmatrix} \right\}^T \quad (6.2.6)$$

where $[\text{REFSMMAT}]_D$ is the desired REFSMMAT and $[\text{REFNB}]$ is defined in Eq. (6.2.4).

5.6.2.2.3 Option 30 - Total Alignment With the AOT

Option 30 is selected by the astronaut whenever a complete alignment or realignment is to be made by sighting on two celestial objects (usually stars) with the Alignment Optical Telescope (AOT). No program alarm is issued when selecting this option if the Attitude flag or REFSMFLAG is not set. However, if either of these flags is set, the IMU is first aligned as indicated for Option 10 in Fig. 6.2-1. If neither of these flags is set, the IMU stable member remains at its present orientation and sightings are made on two stars using the Lunar Surface Sighting Mark Routine (R-59) which is described in Section 5.6.3.1.2 and in routine R-59 of Section 4. Afterwards, the Star Data Test Routine (R-54) of Section 4 is used to test the angle between the unit vectors defining the measured directions of the two stars in the present stable member coordinate system.

To determine the desired gyro torquing angles the following procedure is used: Let \underline{s}_A and \underline{s}_B be the two measured unit star vectors in the present stable member coordinate system, and \underline{s}_A'' and \underline{s}_B'' are the unit vectors to the corresponding stars in the reference coordinate system, which are obtained from fixed memory. First, the unit star vectors \underline{s}_A' and \underline{s}_B' with respect to the desired stable member coordinate system are determined from \underline{s}_A'' and \underline{s}_B'' :

$$\begin{aligned}\underline{s}_A' &= \left[\text{REFSMMAT} \right]_D \underline{s}_A'' \\ \underline{s}_B' &= \left[\text{REFSMMAT} \right]_D \underline{s}_B''\end{aligned}\tag{6.2.7}$$

where $[\text{REFSMMAT}]_D$ is the desired REFSMMAT. The vectors \underline{s}_A , \underline{s}_B , \underline{s}'_A , and \underline{s}'_B are then used by the routine AXISGEN of Section 5.6.3.2.4 to obtain the orientations \underline{x} , \underline{y} , and \underline{z} of the desired stable member axes with respect to the present stable member coordinate system, which are required by the routine CALCGTA in order to calculate the desired gyro torquing angles.

In Fig. 6.2-1 it is seen that the gyro torquing angles are then displayed to the astronaut so that he may make a decision as to whether to set the Recycle flag or not. Afterwards, depending on the magnitude of the torquing angles, the IMU is aligned to the desired orientation either by torquing the gyros or by first coarse aligning the IMU and then torquing the gyros.

If a coarse alignment is to be made, the desired gimbal angles are calculated by the routine CALCGA using the following input vectors: \underline{x} , \underline{y} , \underline{z} , which were previously determined and defined the orientation of the desired stable member with respect to the present stable member coordinate system; and \underline{x}_{NB} , \underline{y}_{NB} , \underline{z}_{NB} , which define the orientation of the navigation base with respect to the present stable member coordinate system and may be obtained from the matrix $[\text{SMNB}]$.

If a coarse alignment is performed, the gyro torquing angles required afterwards may be determined by the routine CALCGTA using the vectors \underline{x} , \underline{y} , and \underline{z} which define the orientation of the desired stable member with respect to the present stable coordinate system and are given in the following matrix:

$$\begin{bmatrix} \underline{x}^T \\ \underline{y}^T \\ \underline{z}^T \end{bmatrix} = [\text{NBSM}]_D [\text{SMNB}] \quad (6.2.8)$$

where $\left[\text{NBSM} \right]_{\text{D}}$ is the desired navigation base to stable member transformation matrix determined by using the desired gimbal angles previously determined for coarse alignment.

After the desired alignment has been made, the new REFSMMAT is stored, the REFSMFLAG is set, and a check is made to see if the Recycle flag had been set by the astronaut. As seen in Fig. 6.2-1 the Recycle flag enables the astronaut to repeat most of the alignment options. If the Recycle flag is not set, the program terminates after determining and storing the LM attitude vectors $\underline{u}_{\text{YMF}}$ and $\underline{u}_{\text{ZMF}}$ in moon-fixed coordinates and setting the Attitude flag.

5.6.2.2.4 Option 31 - Total Alignment Using the Gravity Vector and the AOT

Option 31 is selected when the complete alignment is to be made by determining the lunar gravity vector with the accelerometers and sighting on a single celestial object with the AOT. As will be discussed later, this option may be selected by the astronaut if he is only interested in determining the direction of the gravity vector. No program alarm is issued by program P-57 when selecting this option if the Attitude flag or REFSMFLAG is not set.

In Fig. 6.2-1 it is seen that Option 31 does not cause an initial IMU alignment to be made using either the present REFSMMAT or stored LM attitude, but starts immediately with the Gravity Vector Determination Routine described in Section 5.6.3.3. This routine determines the direction of the gravity vector by monitoring the IMU accelerometers at two special

orientations of the stable member. The output is a stored unit vector \underline{u}_G defining the direction of the lunar gravity vector in vehicle (navigation base) coordinates. The angle between this vector and any previously stored gravity vector is displayed to the astronaut so that he may judge whether there has been any settling of the vehicle. At this point he may terminate the program if he is only interested in obtaining the gravity vector. However, if he is interested in making a complete IMU alignment, he next uses the Lunar Surface Sighting Mark Routine (R-59) of Section 4 to sight on one star with the AOT. The Star Data Test Routine (R-54) is then used to check the angle between the measured star direction and the stored gravity vector. This angle is compared with the angle between the corresponding star vector and the landing site position vector in reference coordinates.

Afterwards, the desired gyro torquing angles are calculated in the same manner as is done with the unit star vectors in Option 30 except that one of the star vectors in the present stable member coordinate system (say \underline{s}_A) is actually

$$\underline{s}_A = \left[\text{NBSM} \right] \underline{u}_G \quad (6.2.9)$$

and the corresponding star vector \underline{s}_A'' in the Basic Reference Coordinate System is

$$\underline{s}_A'' = \text{UNIT} \left\{ \underline{r}_{LS} \left[T(L) \right] \right\} \quad (6.2.10)$$

where \underline{r}_{LS} is the landing site position vector in the Basic Reference Coordinate System at the specified time $T(L)$.

The remaining steps in Option 31 are the same as described for Option 30. However, it should be noted that if the Recycle flag was set, the alignment is repeated without a new gravity vector being determined by the Gravity Vector Determination Routine since the recycle capability is mainly provided to check on optical sightings made with the AOT.

If the astronaut had terminated this option after having determined only the gravity vector with the Gravity Vector Determination Routine, this may have been done in order to implement another technique of aligning the IMU which involves having the rendezvous radar (RR) track the CSM and transmitting the RR and IMU CDU angles to earth via down-link. In addition, the stored gravity vector in vehicle (or navigation base) coordinates would have to be transmitted to the earth. It should be noted that the gravity vector could be transmitted by voice-link instead of down-link in such an improbable situation since the direction of gravity remains fixed in the navigation base coordinate system as long as there is no settling of the vehicle. With the above data and the knowledge of the positions of the CSM and the landing site, the present stable member orientation with respect to the reference coordinate system can be determined at the earth. The associated REFSMMAT can then be voice-linked to the astronaut and entered into the LGC. With this REFSMMAT, Option 10 can be used to align the IMU to the desired orientation.

5.6.2.2.5 Option 32 - Total Alignment Using the Gravity Vector and the Stored LM Attitude

Option 32 is selected when the complete alignment is to be made by using the stored LM attitude and determining the lunar gravity vector with the accelerometers. A program alarm is issued when selecting this option if the Attitude flag or REFSMFLAG is not set. Initially, the IMU is aligned to the desired orientation using the same procedure as in Option 10, although this particular alignment is unnecessary. The primary reason for using the Option 10 portion of the program is to insure that the LM attitude vectors \underline{u}_{YMF} and \underline{u}_{ZMF} are available later if REFSMFLAG is set but the Attitude flag is not.

Next, the Gravity Vector Determination Routine of Section 5.6.3.3 is used to obtain the gravity vector \underline{u}_G in navigation base coordinates. The gyro torquing angles are then calculated in the same manner as is done with the unit star vectors in Option 30 except that both of the star vectors (\underline{s}_A and \underline{s}_B) in the present stable coordinate system do not represent the directions of stars but are the directions of the gravity vector and the LM Z axis in the present stable member coordinate system, respectively. The vector \underline{s}_A is obtained from the following:

$$\underline{s}_A = \begin{bmatrix} \text{NBSM} \end{bmatrix} \underline{u}_G \quad (6.2.11)$$

where \underline{u}_G is the gravity vector stored in navigation base coordinates. The vector \underline{s}_B represents the third row of the matrix $\begin{bmatrix} \text{SMNB} \end{bmatrix}$. The corresponding unit vectors (\underline{s}_A'' and \underline{s}_B'') in the reference coordinate system are determined as follows:

\underline{s}_A'' is obtained from Eq. (6.2.10) and \underline{s}_B'' is obtained by transforming the stored LM Z-axis vector (\underline{u}_{ZMF}) from moon-fixed to reference coordinates with the Planetary Inertial Orientation Routine.

The remaining steps in Option 32 are the same as described for Option 30.

5. 6. 3 IMU ROUTINES

5. 6. 3. 1 AOT Transformations

5. 6. 3. 1. 1 Determination of the Star Line-of-Sight During Free-Fall

To perform IMU alignment during free-fall it is necessary to determine the line-of-sight to two separate navigation stars in stable member coordinates. This section presents the method used to determine the line-of-sight to a single star and must be repeated for the second star.

Optical sightings are made on a given star by varying the LM attitude so that the star will cross the X and Y reticle lines of the Alignment Optical Telescope (AOT). The astronaut depresses the X or Y mark button whenever the star crosses the corresponding reticle line. When the star coincides with one of the reticle lines, this defines a plane containing the star. Once the location of the star has been established in two separate planes, the line-of-sight to the star can be obtained by solving for the intersection of these two planes.

The AOT is a unity power telescope with a field-of-view (FOV) of 60 degrees and can be rotated to three distinct positions about an axis parallel to the navigation base X-axis. These positions are accurately obtained by the use of detents. The center of the FOV for each of the viewing positions is defined by the azimuth (AZ_N) and elevation (EL_N) angles shown in Fig. 6. 3-1 where the subscript N denotes the viewing position being used. The approximate values of these angles for the three viewing positions are:

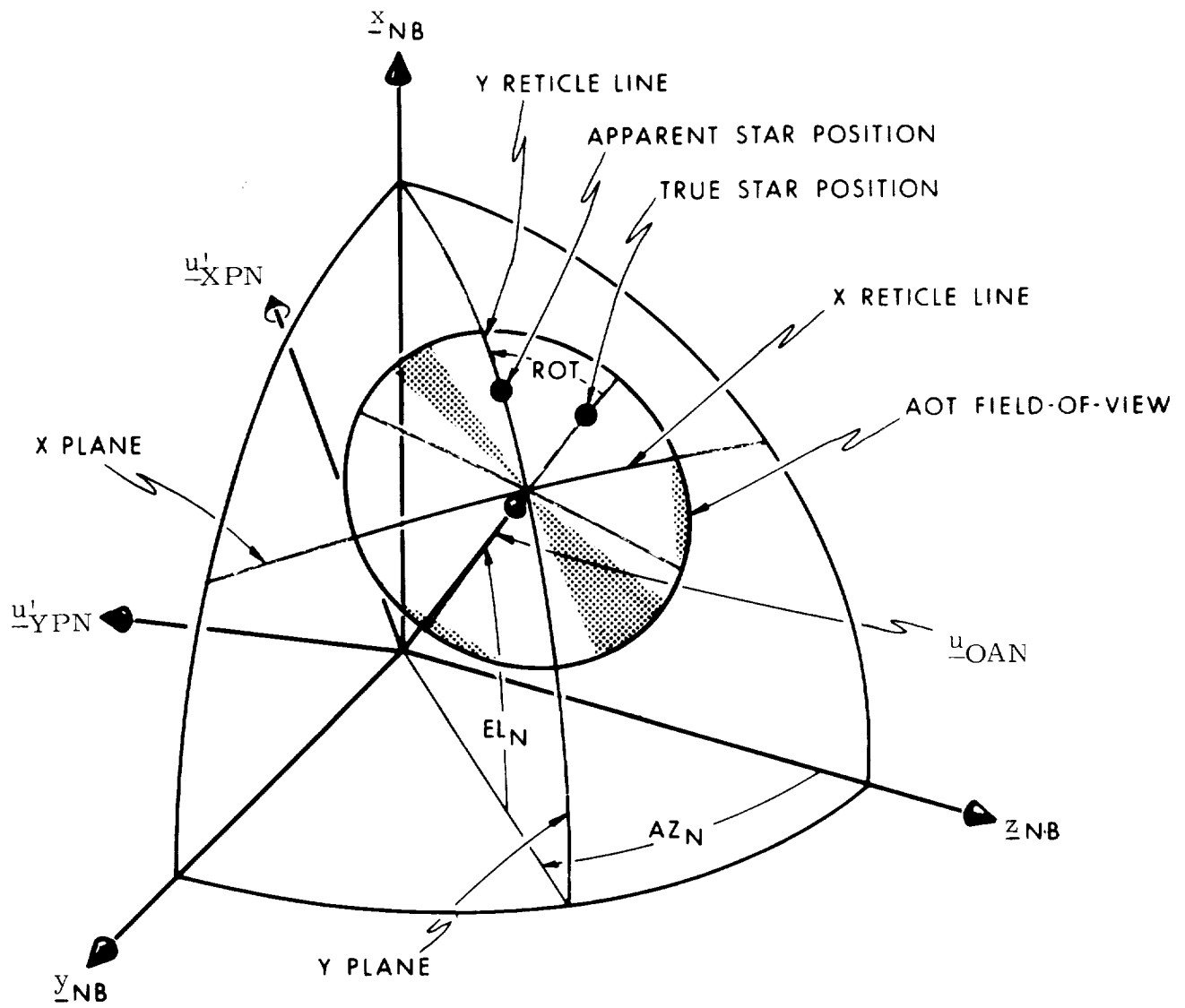

Fig. 6. 3-1 AOT Alignment Geometry

Position 1 (left)	$AZ_1 = -60^\circ,$	$EL_1 = 45^\circ$
Position 2 (forward)	$AZ_2 = 0^\circ,$	$EL_2 = 45^\circ$
Position 3 (right)	$AZ_3 = 60^\circ,$	$EL_3 = 45^\circ$

In the In-Flight Sighting Mark Routine (R53) the above viewing positions correspond to detents 1, 2, and 3, respectively. Since the exact values of AZ_N and EL_N vary slightly from one AOT to another, these values are not known until the final AOT installation. The values must therefore be stored in the erasable memory for each mission.

The direction of the center of the FOV (or optical axis) for each viewing position can be expressed in navigation base coordinates by the following unit vector:

$$\underline{u}_{OAN} = \begin{bmatrix} \sin (EL_N) \\ \cos (EL_N) \sin (AZ_N) \\ \cos (EL_N) \cos (AZ_N) \end{bmatrix} \quad (6.3.1)$$

In Fig. 6.3-1 the X and Y reticle lines of the AOT define two planes perpendicular to each other. The orientation of these planes with respect to the navigation base for each viewing position are given by the following unit vectors:

$$\underline{u}'_{YPN} = \text{UNIT} (\underline{u}_{OAN} \times \underline{u}_{XNB}) \quad (6.3.2)$$

$$\underline{u}'_{XPN} = \underline{u}'_{YPN} \times \underline{u}_{OAN} \quad (6.3.3)$$

where N denotes the viewing position and $\underline{u}_{XNB} = (1, 0, 0)$.

When the AOT is in the left or right viewing position, the apparent star field observed through the instrument differs from the true star field by an angle of rotation, ROT about the optical axis. The sense of this rotation for the right viewing position is shown in Fig. 6.3-1 and is reversed for the left viewing position. This effect is due to the optical design of the AOT and does not occur for the AOT reticle lines. Consequently, when a star coincides, for example, with the Y reticle line, as shown in Fig. 6.3-1, its true location is in a plane obtained by rotating the Y plane about the optical axis by an amount ROT in the reverse direction. If it is assumed that the azimuth angle, AZ_N , is positive as shown in Fig. 6.3-1, then the correct sense and magnitude of the rotation (R_N) which is applied to the X and Y planes for a given viewing position is

$$R_N = AZ_2 - AZ_N \quad (6.3.4)$$

Therefore, the correct orientation in navigation base coordinates of the planes represented by the X and Y reticle lines is

$$u_{XPN} = \cos (R_N) u'_{XPN} + \sin (R_N) u'_{YPN} \quad (6.3.5)$$

$$u_{YPN} = -\sin (R_N) u'_{XPN} + \cos (R_N) u'_{YPN} \quad (6.3.6)$$

Since the above planes (u_{XPN} and u_{YPN}) are fixed with respect to the navigation base coordinate system it is only necessary to compute them once when using a given viewing position; regardless of the number of marks made on a star.

The orientations of the planes u_{XP} and u_{YP} in stable member coordinates are

$$\underline{u}_{XP} = [\text{NBSM}]_X \underline{u}_{XPN} \quad (6.3.7)$$

$$\underline{u}_{YP} = [\text{NBSM}]_Y \underline{u}_{YPN} \quad (6.3.8)$$

where $[\text{NBSM}]_X$ and $[\text{NBSM}]_Y$ are the transformation matrices based upon IMU CDU readings stored during the X and Y marks and are defined in Section 5.6.3.2.1.

The vector describing the line-of-sight to the star in stable member coordinates is therefore:

$$\underline{s}_{SM} = \text{UNIT} (\underline{u}_{XP} \times \underline{u}_{YP}) \quad (6.3.9)$$

To achieve greater accuracy in determining the line-of-sight to a star, a multiple mark capability is provided, whereby the astronaut can continue to make sighting marks until he is satisfied that he has obtained a sufficient number of mark pairs. A running count of the number of pairs obtained during the marking operation is displayed to the astronaut. When each mark pair is received, it is processed to obtain a unit star vector \underline{s}_{SM} which is averaged with any previously obtained unit vectors for this star. The averaging process consists of taking the arithmetic mean of the rectangular components of the star vectors in stable member coordinates. During free fall it will be possible for the astronaut to enter into the LGC the coordinates of some other celestial body, such as the sun, for sighting purposes.

5.6.3.1.2 Determination of the Star LOS During Lunar Stay

When optical sightings are to be made during the lunar stay period for purposes of IMU alignment, the AOT is used in a manner different from that for free-fall. Instead of using the entire X and Y reticle lines, use is made of only half of the Y line and a spiral,

which also exist on the AOT reticle. The complete reticle pattern is shown at the left of Fig. 6.3-2. The spiral is so constructed as to depart radially from the center as a linear function of rotation about the center. Both the spiral and that half of the Y line used during the lunar stay period have been constructed as double lines to aid the astronaut in placing them on a star. The doubled portion of the Y line is sometimes referred to as the cursor. The entire reticle pattern can be rotated about its center by turning a knob near the eyepiece. A micrometer type readout is provided near the knob to indicate the amount of reticle rotation.

When optical sightings are made during free-fall the reticle rotation angle is set to zero. On the lunar surface, however, the astronaut must rotate the reticle pattern so as to establish coincidence of the star with both the cursor and the spiral as shown at the right of Fig. 6.3-2 and record the indicated angle of the micrometer dial for each. During these two measurements the X MARK button must be depressed once so that the LGC will store the IMU CDU angles for later use. After making the two measurements, the astronaut enters the two angles into the LGC.

The two angles, which are shown as YROT and SROT in Fig. 6.3-2, completely define the direction of the star with respect to the center of the field-of-view (FOV) of the AOT for the particular viewing position being used. The direction or azimuth of the star with respect to the center of the FOV is indicated by YROT. The angular separation between the star and the center of the FOV is given by

$$SEP = \frac{360^{\circ} + SROT - YROT}{12} \quad (6.3.10)$$

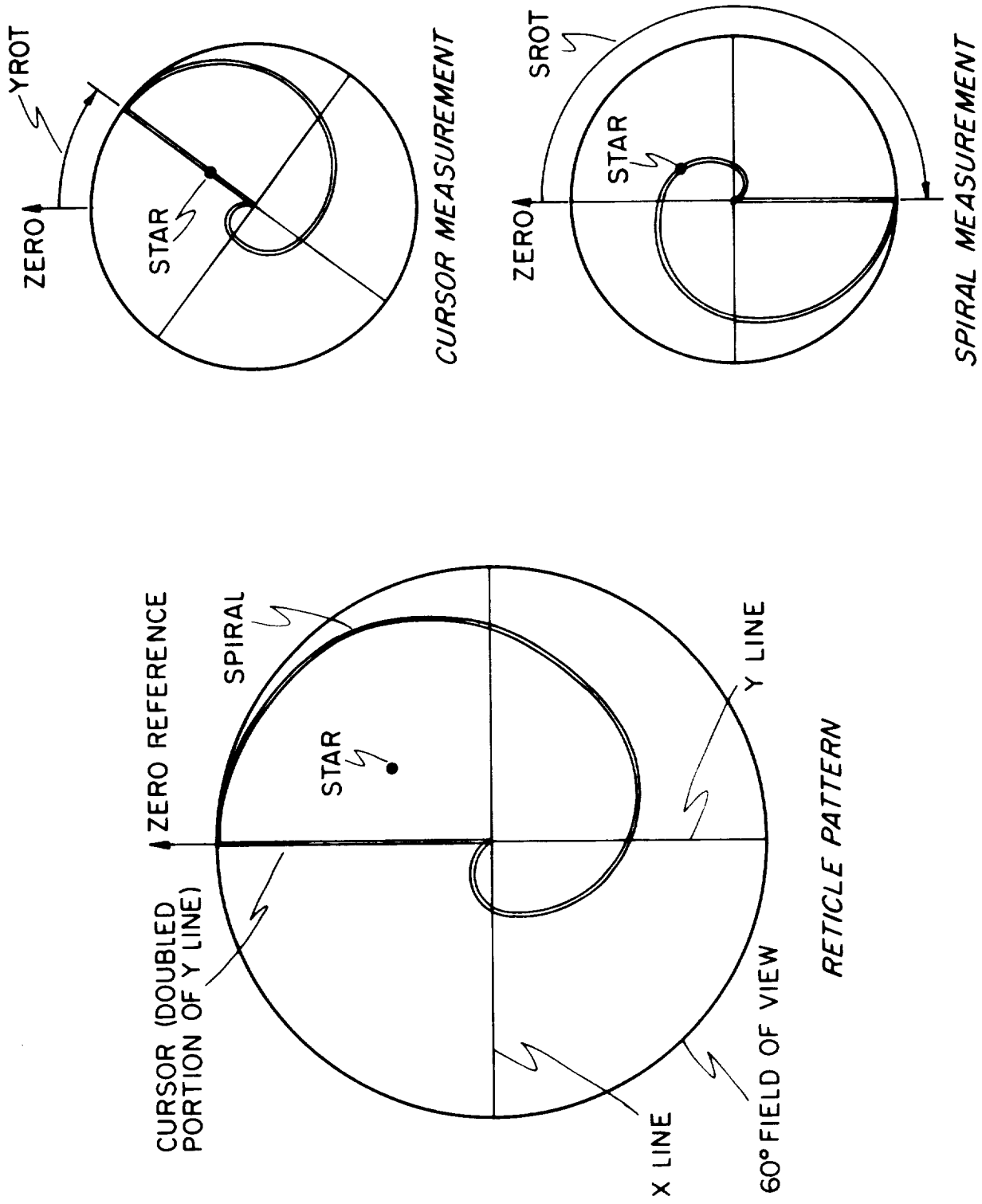

Fig. 6.3-2 AOT Reticle Pattern and Use on Lunar Surface

where 360° has been added to the numerator to insure that SEP will always be positive, although it may differ from the true separation by 360° .

To determine a unit vector \underline{s}_{NB} , which represents the direction of the star in navigation base coordinates, use is made of the vectors \underline{u}_{OAN} , \underline{u}_{YPN} , and \underline{u}_{XPN} given in Section 5.6.3.1.1 for the free-fall case. \underline{u}_{OAN} is the direction in navigation base coordinates of the center of the FOV for the particular AOT viewing position being used. \underline{u}_{YPN} and \underline{u}_{XPN} are normal to the planes associated with the Y and X reticle lines for the AOT viewing position being used and define the orientations of these planes in navigation base coordinates. However, it should be noted that the planes specified by \underline{u}_{YPN} and \underline{u}_{XPN} are correct only if the reticle rotation angle is zero.

If the reticle is rotated through the angle YROT in order to place the cursor on the star, the vector defining the orientation of the plane containing both the star and \underline{u}_{OAN} is

$$\underline{u}_{YPN}'' = -\sin(YROT) \underline{u}_{XPN} + \cos(YROT) \underline{u}_{YPN} \quad (6.3.11)$$

To obtain \underline{s}_{NB} it is only necessary to rotate \underline{u}_{OAN} about \underline{u}_{YPN}'' through the angle SEP:

$$\underline{s}_{NB} = \cos(SEP) \underline{u}_{OAN} + \sin(SEP) (\underline{u}_{YPN}'' \times \underline{u}_{OAN}) \quad (6.3.12)$$

The line-of-sight to the star in stable member coordinates is:

$$\underline{s}_{SM} = [NBSM]_X \cdot \underline{s}_{NB} \quad (6.3.13)$$

where $[NBSM]_X$ is the transformation matrix derived from using the IMU CDU angles stored when the X MARK button was depressed.

To achieve greater accuracy in determining the line-of-sight to a star during the lunar stay period, a multiple mark capability is provided just as during free-fall. Whenever a unit star vector \underline{s}_{SM} is obtained during the star sighting process, it is averaged with any previously obtained unit vectors for this star. The averaging consists of taking the arithmetic mean of the rectangular components of the star vectors in stable member coordinates. A running count of the number of star vectors obtained for a given star is displayed to the astronaut.

During the lunar stay it will also be possible for the astronaut to enter into the LGC the coordinates of some other celestial body such as the sun for sighting purposes. In addition, the astronaut will be able to use any of the three rear viewing positions of the AOT by loading the appropriate angles AZ and EL (see Section 5.6.3.1.1) in erasable memory.

5.6.3.2 IMU Transformations

5.6.3.2.1 Stable Member-Navigation Base

Let IGA, MGA, OGA be the IMU inner, middle and outer gimbal angles, respectively. Define the following matrices:

$$Q_1 = \begin{pmatrix} \cos \text{IGA} & 0 & -\sin \text{IGA} \\ 0 & 1 & 0 \\ \sin \text{IGA} & 0 & \cos \text{IGA} \end{pmatrix} \quad (6.3.14)$$

$$Q_2 = \begin{pmatrix} \cos \text{MGA} & \sin \text{MGA} & 0 \\ -\sin \text{MGA} & \cos \text{MGA} & 0 \\ 0 & 0 & 1 \end{pmatrix} \quad (6.3.15)$$

$$Q_3 = \begin{pmatrix} 1 & 0 & 0 \\ 0 & \cos \text{OGA} & \sin \text{OGA} \\ 0 & -\sin \text{OGA} & \cos \text{OGA} \end{pmatrix} \quad (6.3.16)$$

Stable Member to Navigation Base Transformation

$$\underline{u}_{\text{NB}} = Q_3 Q_2 Q_1 \underline{u}_{\text{SM}} \quad (6.3.17)$$

$$[\text{SMNB}] = Q_3 Q_2 Q_1$$

Navigation Base to Stable Member Transformation

$$\underline{u}_{SM} = Q_1^T Q_2^T Q_3^T \underline{u}_{NB}, \quad [NBSM] = Q_1^T Q_2^T Q_3^T \quad (6.3.18)$$

5.6.3.2.2 Calculation of Gimbal Angles (CALCGA)

Given a stable member orientation and a navigation base orientation both referred to the same coordinate system, the following procedure is used to compute the corresponding gimbal angles.

$$\begin{aligned} \underline{a}_{MG} &= \text{UNIT} (\underline{x}_{NB} \times \underline{y}_{SM}) \\ \cos \text{OGA} &= \underline{a}_{MG} \cdot \underline{z}_{NB} \\ \sin \text{OGA} &= \underline{a}_{MG} \cdot \underline{y}_{NB} \\ \text{OGA} &= \text{ARCTRIG} (\sin \text{OGA}, \cos \text{OGA}) \\ \cos \text{MGA} &= \underline{y}_{SM} \cdot (\underline{a}_{MG} \times \underline{x}_{NB}) \\ \sin \text{MGA} &= \underline{y}_{SM} \cdot \underline{x}_{NB} \\ \text{MGA} &= \text{ARCTRIG} (\sin \text{MGA}, \cos \text{MGA}) \\ \cos \text{IGA} &= \underline{a}_{MG} \cdot \underline{z}_{SM} \\ \sin \text{IGA} &= \underline{a}_{MG} \cdot \underline{x}_{SM} \\ \text{IGA} &= \text{ARCTRIG} (\sin \text{IGA}, \cos \text{IGA}) \end{aligned} \quad (6.3.19)$$

where the inputs are three vectors along the stable member axes and three vectors along the navigation base axes. In the above equations ARCTRIG implies computing the angle, choosing either \sin^{-1} or \cos^{-1} so as to yield maximum accuracy.

5.6.3.2.3 Calculation of Gyro Torquing Angles (CALCGTA)

In the fine align procedure, after the present platform orientation is determined, the torquing angles required to move the platform into the desired orientation must be computed. This is achieved as follows:

Let \underline{x}_D , \underline{y}_D , and \underline{z}_D be the desired stable member axes referred to present stable member orientation. The rotations are performed in three steps: (1) rotating through θ_y about the y axis, yielding \underline{x}'_D , \underline{y}_D , \underline{z}'_D ; (2) rotating through θ_z about the z' axis, yielding \underline{x}''_D , \underline{y}'_D , \underline{z}''_D ; (3) and finally rotating through θ_x about the x'' axis, yielding \underline{x}'''_D , \underline{y}''_D , \underline{z}'''_D . The relevant equations are as follows:

$$\underline{z}'_D = \text{UNIT}(-x_{D,3}, 0, x_{D,1})$$

$$\sin \theta_y = z'_{D,1}$$

$$\cos \theta_y = x_{D,1}$$

$$\theta_y = \text{ARCTRIG}(\sin \theta_y, \cos \theta_y)$$

$$\sin \theta_z = x_{D,2}$$

(6.3.20)

$$\cos \theta_z = z'_{D,3} x_{D,1} - z'_{D,1} x_{D,3}$$

$$\theta_z = \text{ARCTRIG}(\sin \theta_z, \cos \theta_z)$$

$$\cos \theta_x = \underline{z}'_D \cdot \underline{z}_D$$

$$\sin \theta_x = \underline{z}'_D \cdot \underline{y}_D$$

$$\theta_x = \text{ARCTRIG}(\sin \theta_x, \cos \theta_x)$$

The required inputs are the three coordinate axes of the desired stable member orientation referred to the present stable member orientation.

5.6.3.2.4 Coordinate Axes Generator (AXISGEN)

Given two unit vectors (usually star vectors), \underline{s}_A and \underline{s}_B , expressed in two coordinate systems, denoted by primed and unprimed characters, i. e., \underline{s}'_A , \underline{s}'_B , \underline{s}_A , \underline{s}_B , this routine computes the unit vectors \underline{x} , \underline{y} , \underline{z} which are the primed coordinate system axes referred to the unprimed coordinate system. This is accomplished by defining two ortho-normal coordinate sets, one in each system, in the following manner:

$$\begin{aligned}
 \underline{u}'_X &= \underline{s}'_A \\
 \underline{u}'_Y &= \text{UNIT}(\underline{s}'_A \times \underline{s}'_B) \\
 \underline{u}'_Z &= \underline{u}'_X \times \underline{u}'_Y \\
 \underline{u}_X &= \underline{s}_A \\
 \underline{u}_Y &= \text{UNIT}(\underline{s}_A \times \underline{s}_B) \\
 \underline{u}_Z &= \underline{u}_X \times \underline{u}_Y
 \end{aligned}
 \tag{6.3.21}$$

The primed coordinate system axes expressed in terms of the unprimed coordinate system axes are:

$$\begin{aligned}
 \underline{x} &= u'_{X1} \underline{u}_X + u'_{Y1} \underline{u}_Y + u'_{Z1} \underline{u}_Z \\
 \underline{y} &= u'_{X2} \underline{u}_X + u'_{Y2} \underline{u}_Y + u'_{Z2} \underline{u}_Z \\
 \underline{z} &= u'_{X3} \underline{u}_X + u'_{Y3} \underline{u}_Y + u'_{Z3} \underline{u}_Z
 \end{aligned}
 \tag{6.3.22}$$

It should be noted that vectors can be transformed from the unprimed to the primed coordinate systems by using the following matrix constructed with the output (Eq. (6.3.22)) of AXISGEN:

$$\begin{bmatrix} \underline{x}^T \\ \underline{y}^T \\ \underline{z}^T \end{bmatrix}
 \tag{6.3.23}$$

5.6.3.3 Gravity Vector Determination Routine

The gravity vector determination routine, see Fig. 6.3-3, measures the gravity vector twice, to minimize the error due to accelerometer bias. For the first measurement the IMU is coarse-aligned to gimbal angles of : OGA = 0⁰, MGA = -45⁰, IGA = 45⁰. In this orientation the accelerometer axes are at equal angles from the spacecraft X-axis, which should be roughly parallel to the gravity vector. The PIPA's are then monitored for 40 seconds, giving a gravity vector \underline{g} in stable member co-ordinates. The gravity vector is transformed to navigation base co-ordinates, using the SMNB routine, and stored as \underline{g}_1 .

A rotation matrix, Q, is then constructed, see Eqs. (6.3.24) and (6.3.25), which essentially defines the new orientation of the stable member axes with respect to the present stable member axes if the stable member were to be rotated 180⁰ about the gravity vector.

$$\underline{u}'_X = \text{UNIT}(\underline{g})$$

$$\underline{u}'_Y = \text{UNIT} \left[\underline{u}'_X \times (0, 1, 0) \right] \quad (6.3.24)$$

$$\underline{u}'_Z = \underline{u}'_X \times \underline{u}'_Y$$

$$Q = \begin{bmatrix} \underline{u}'_X & \underline{u}'_Y & \underline{u}'_Z \end{bmatrix} \begin{bmatrix} \underline{u}'_X^T \\ -\underline{u}'_Y^T \\ -\underline{u}'_Z^T \end{bmatrix} \quad (6.3.25)$$

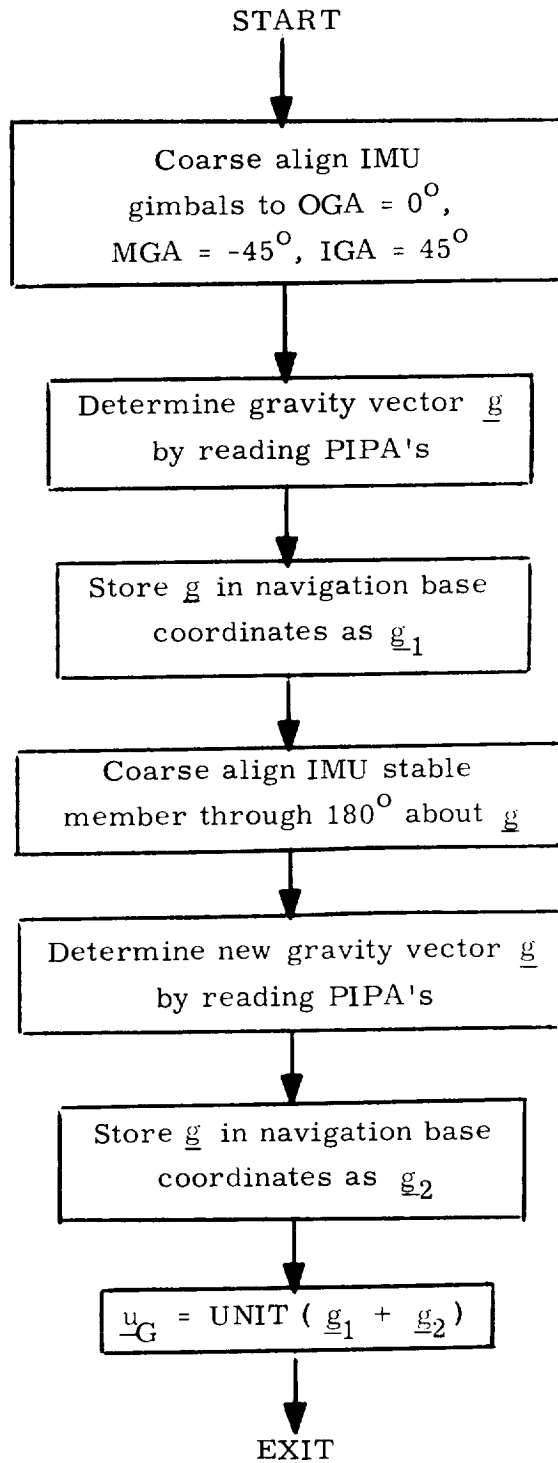

Figure 6.3-3 Gravity Vector Determination Routine

The coordinates of the desired stable member axes with respect to the present stable member axes are present in matrix Q:

$$Q = \begin{bmatrix} x_{SM}^T \\ y_{SM}^T \\ z_{SM}^T \end{bmatrix} \quad (6.3.26)$$

and the coordinates of the navigation base axes with respect to the present stable member axes are present in the following matrix:

$$SMNB = \begin{bmatrix} x_{NB}^T \\ y_{NB}^T \\ z_{NB}^T \end{bmatrix} \quad (6.3.27)$$

With the vectors in (6.3.26) and (6.3.27), the routine CALCGA can be used to determine the desired gimbal angles for the new orientation. The stable member is then coarse-aligned to this new orientation, and the PIPA's are again monitored for 40 seconds, giving another gravity vector in stable member co-ordinates. This gravity vector is transformed to navigation base co-ordinates with the SMNB routine, and stored as \underline{g}_2 .

The unit vector in the direction of the gravity vector is calculated from:

$$\underline{u}_G = \text{UNIT} (\underline{g}_1 + \underline{g}_2) \quad (6.3.28)$$

By using the above procedure, the error in estimating the direction of the gravity vector because of accelerometer biases is reduced.

5.6.3.4 REFSMMAT Transformations

The matrix required to transform a vector from the Basic Reference Coordinate System to the IMU Stable Member Coordinate System is referred to as REFSMMAT. This matrix can be constructed as follows with the unit vectors \underline{u}_{XSM} , \underline{u}_{YSM} , and \underline{u}_{ZSM} defining the orientations of the stable member axes with respect to the Basic Reference Coordinate System:

$$\text{REFSMMAT} = \begin{bmatrix} \underline{u}_{XSM}^T \\ \underline{u}_{YSM}^T \\ \underline{u}_{ZSM}^T \end{bmatrix} \quad (6.3.29)$$

5.6.3.4.1 Present REFSMMAT From Star Sightings

The present IMU stable member orientation with respect to the reference coordinate system, and the associated REFSMMAT, can be determined by sighting on two navigation stars with the AOT. If \underline{s}'_A and \underline{s}'_B are the unit vectors defining the measured directions of the two stars in the present stable member coordinate system, and \underline{s}_A and \underline{s}_B are the unit vectors to the corresponding stars as known in the reference coordinate system, then these vectors can be used as the input to the routine AXISGEN (Section 5.6.3.2.4) to obtain the present IMU orientation and REFSMMAT (Eqs. (6.3.22) and (6.3.23)).

5.6.3.4.2 Alignment for Thrusting Maneuvers (Preferred Orientation)

During certain thrusting maneuvers the IMU will be aligned according to the following equations.

$$\begin{aligned}\underline{u}_{XSM} &= \text{UNIT} (\underline{x}_B) \\ \underline{u}_{YSM} &= \text{UNIT} (\underline{x}_B \times \underline{r}) \\ \underline{u}_{ZSM} &= \underline{u}_{XSM} \times \underline{u}_{YSM}\end{aligned}\tag{6.3.30}$$

where \underline{x}_B is the LM X-axis and \underline{r} is the LM position vector.

The associated transformation matrix (REFSMMAT) is given by Eq.(6.3.29).

5.6.3.4.3 Alignment to Local Vertical in Orbit (Nominal Orientation)

The IMU stable member may be aligned to the local vertical at a specified time. For this type of orientation the stable member axes are found from the following.

$$\begin{aligned}\underline{u}_{XSM} &= \text{UNIT} (\underline{r}) \\ \underline{u}_{YSM} &= \text{UNIT} (\underline{v} \times \underline{r}) \\ \underline{u}_{ZSM} &= \text{UNIT} (\underline{u}_{XSM} \times \underline{u}_{YSM})\end{aligned}\tag{6.3.31}$$

where \underline{r} and \underline{v} are the position and velocity vectors of the LM at the specified time.

The REFSMMAT associated with this IMU orientation is found from Eq. (6.3.29).

5.6.3.4.4 Lunar Landing and Launch Orientations

The proper IMU orientation for lunar landing and launch is defined by the following equations:

$$\begin{aligned} \underline{u}_{XSM} &= \text{UNIT} \left\{ \underline{r}_{LS} \left[T(L) \right] \right\} \\ \underline{u}_{YSM} &= \underline{u}_{ZSM} \times \underline{u}_{XSM} \\ \underline{u}_{ZSM} &= \text{UNIT} \left\{ \underline{h}_C \times \underline{r}_{LS} \left[T(L) \right] \right\} \end{aligned} \quad (6.3.32)$$

where \underline{u}_{XSM} , \underline{u}_{YSM} , and \underline{u}_{ZSM} represent the directions of the respective stable member axes expressed in the Basic Reference Coordinate System.

\underline{h}_C is the orbital angular momentum vector of the CSM given by $(\underline{r}_C \times \underline{v}_C)$.

\underline{r}_{LS} is the landing site position vector in the Basic Reference Coordinate System at a specified time $T(L)$.

In Section 4 the time $T(L)$ may either be the nominal time of lunar landing referred to in IMU Realignment Program (P-52), the time of lunar ascent defined by one of the Ascent Prethrusting Programs (P-10 or P-11), or a time specified by the astronaut at the beginning of the Lunar Surface Alignment Program (P-57).

Since the landing site moves in the Basic Reference Coordinate System because of lunar rotation, it is more convenient to store its position vector r_{-LS} in the Moon-Fixed Coordinate System where it does not change with time. Whenever it is desired to express r_{-LS} in the reference coordinate system for a given time (i. e., $T(L)$) use is made of the Planetary Inertial Orientation Routine of Section 5.5.2.

The REFSMMAT associated with the landing site alignment in Eq. (6.3.32) is given by Eq. (6.3.29).

5.6.4 STAR SELECTION ROUTINE

The Star Selection Routine is used by the IMU Re-alignment Program (P - 52) to select the best pair of stars for fine alignment of the IMU. The logic diagram for this routine is shown in Fig. 6.4-1.

Each pair from the computer catalog of 37 stars is tested to see if either is occulted by the earth, moon, or sun, and that the angle of separation between them is 20 to 55 degrees. In addition, a check is made to see if both stars of a pair are within a 55 degree field-of-view cone centered with respect to the optical axis of the Alignment Optical Telescope (AOT) when in the forward viewing position. Although this cone is slightly smaller than the actual field-of-view (60 degrees) of the AOT, it is used to enhance the probability that a selected pair will remain visible during attitude limit cycle operation of the spacecraft, and to also allow for existing errors in stable member orientation.

The pair of stars passing the above tests and having the largest angular separation are chosen by this routine. If the routine is unable to find a satisfactory pair of stars after testing all combinations, an alarm code is displayed. In this latter case, it is seen in Program P - 52 of Section 4 that the astronaut can repeat the star selection process at a different spacecraft attitude, if he so desires.

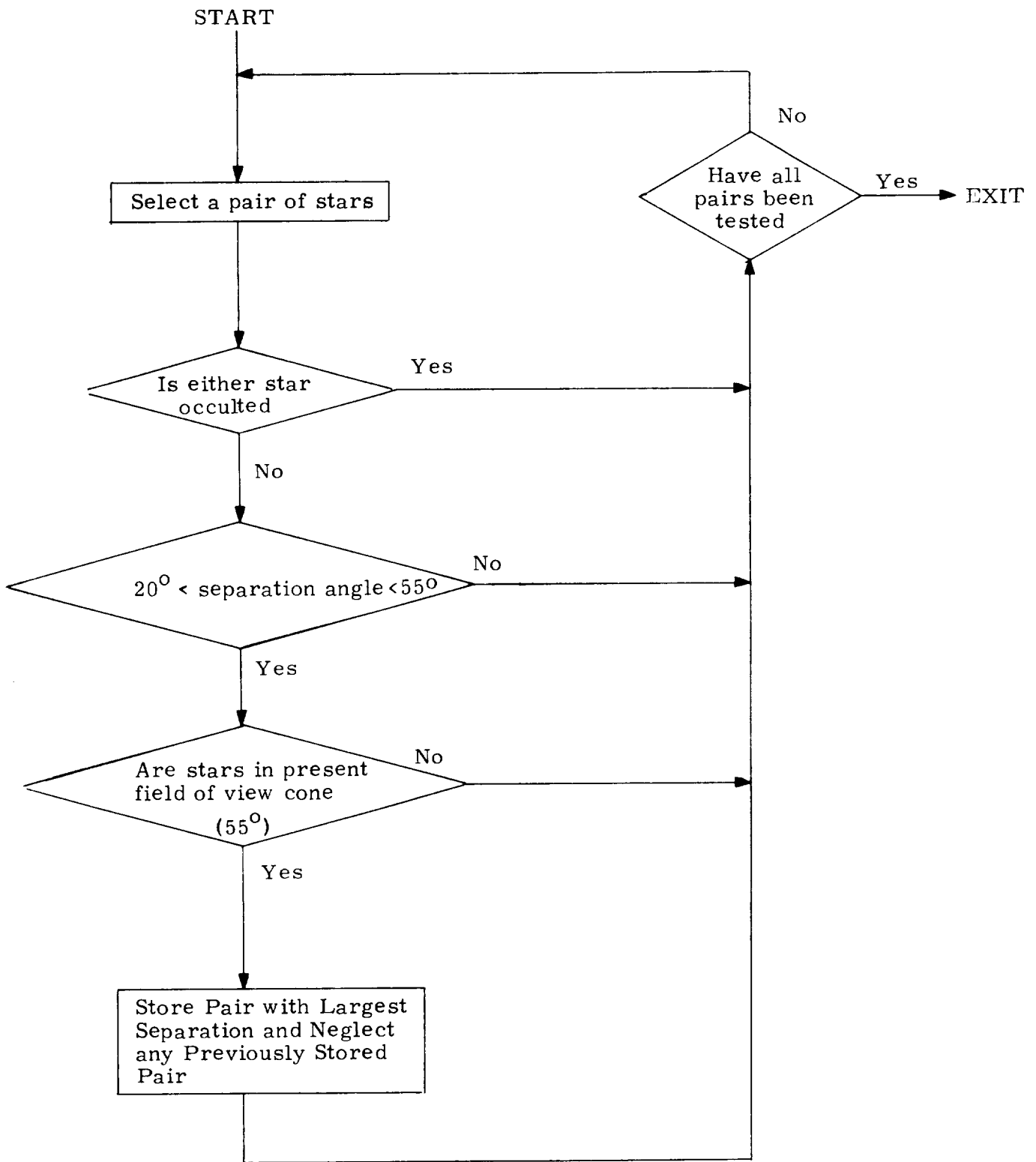

Fig. 6.4-1 Star Selection Routine

5.6.5 GROUND TRACK ROUTINE

This routine is used by the astronaut in near-earth or near-moon orbit to obtain CSM or LM trajectory information. The astronaut specifies a time (GET) and a vehicle (CSM or LM). The routine uses the Coasting Integration Routine (Section 5.2.2) to extrapolate the desired vehicle's state vector to the specified time. The resulting estimated position vector is converted to latitude, longitude, altitude coordinates by means of the Latitude-Longitude Subroutine (Section 5.5.3) and these data are displayed. Altitude is defined with respect to the landing site radius for lunar orbit, and the launch pad radius for earth orbit. The astronaut can request the state vector extrapolation to continue in ten minute steps, or to another specified time, and obtain additional displays of the coordinates of points in the spacecraft's orbit.

The S-Band Antenna Routine (R-05) in the LGC is used to compute and display the two antenna gimbal angles which will point the antenna toward the center of the Earth, using the present LM position and body attitude. The gimbal angle definitions and their relation to the LM body axes are shown in Fig. 6.6-1.

This routine can be initiated by the astronaut only during coasting flight or when the LM is on the lunar surface before the S-Band Erectable Antenna is used. It may be used only if the inertial system is operative and when computer activity is at a minimum. Once the program is initiated the computer will automatically update the display at a rate no less than once every three seconds. This update will continue until S-Band lock-on is achieved and so indicated by the astronaut via the DSKY. If the S-Band Antenna Routine is interrupted, the display and computation will be terminated until the astronaut reinitiates the routine.

The computational and display accuracy of the antenna gimbal angles is ± 1.0 degrees. This accuracy reflects only the level of accuracy of the displayed angles and does not indicate the pointing accuracy of the associated antenna alignment.

The angles computed and displayed (see Fig. 6.6-1) cover the entire range of possible gimbal angles. There is no attempt to restrict these angles to those constrained by gimbal limits or to indicate that a vehicle attitude change is required to achieve S-Band lock-on.

Rotation order α, β

α , pitch angle is rotation about the + Y LM body axis ($-90 < \alpha \leq 270$)

β , yaw angle is rotation about the yaw gimbal axis fixed to the antenna ($-90 < \beta < 90$)

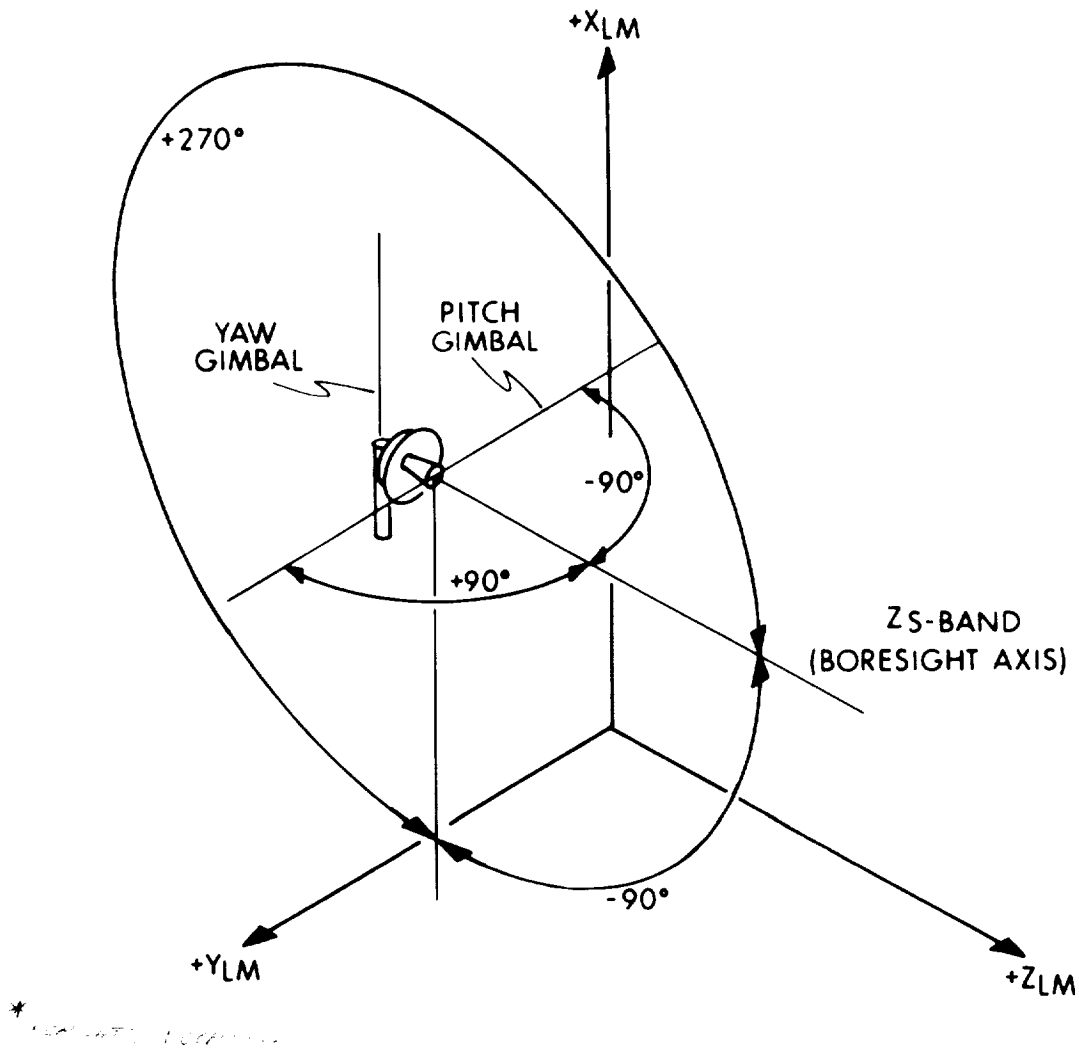

Figure 6. 6-1 Definition of LM S-Band Gimbal Angles

The equations and logic used to compute the LM antenna gimbal angles are shown in Fig. 6.6-2. It is assumed in this program that the S-Band Antenna Routine in the LGC will only be used when the LM is within the sphere of influence of the moon.

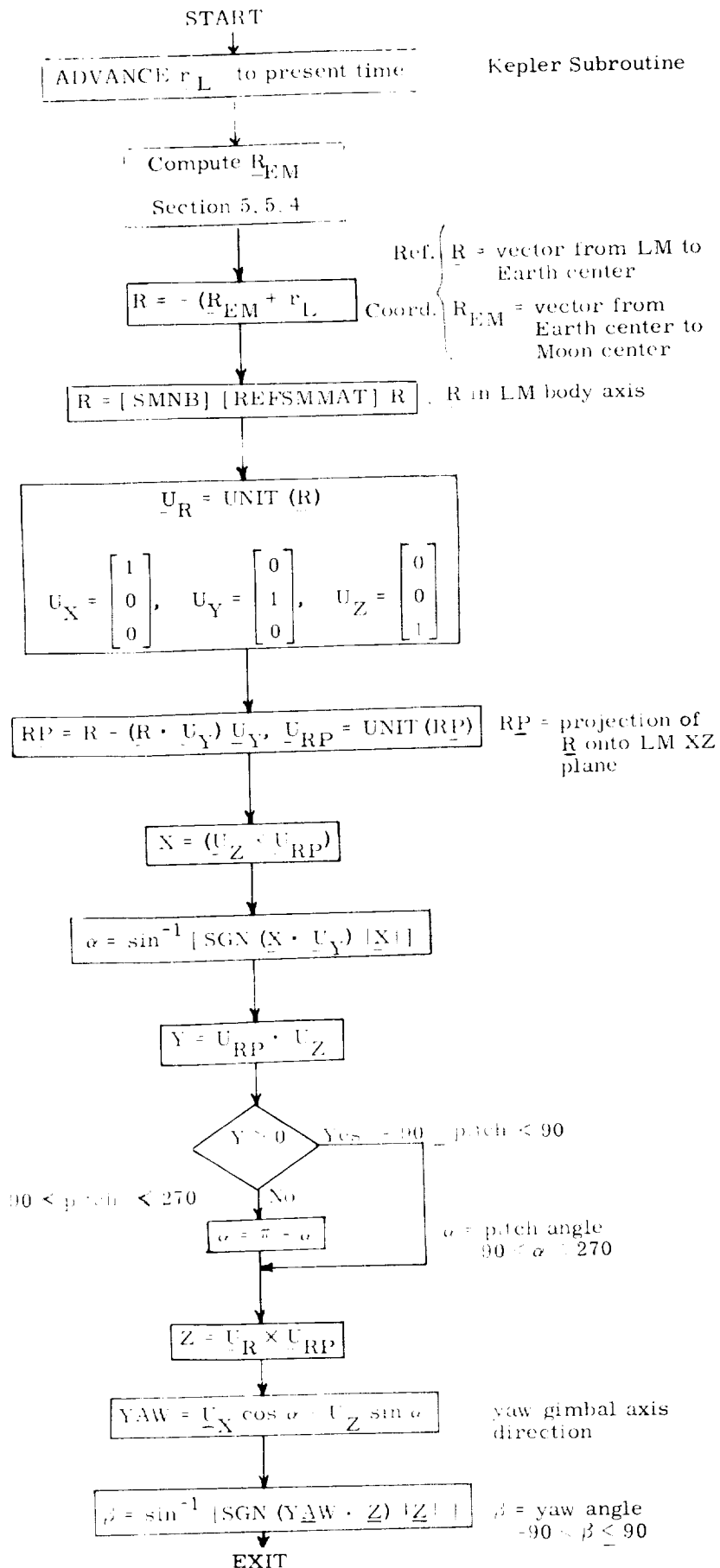

Figure 6.6-2 S-Band Angle Computations and Logic

5.6.7 ADDITIONAL RENDEZVOUS DISPLAYS

During the final phases of rendezvous the following routine, R-31 may be called by the astronaut for the purpose of computing and displaying the range and range rate between the two vehicles and also an angle θ shown in Fig. 6.7-1.

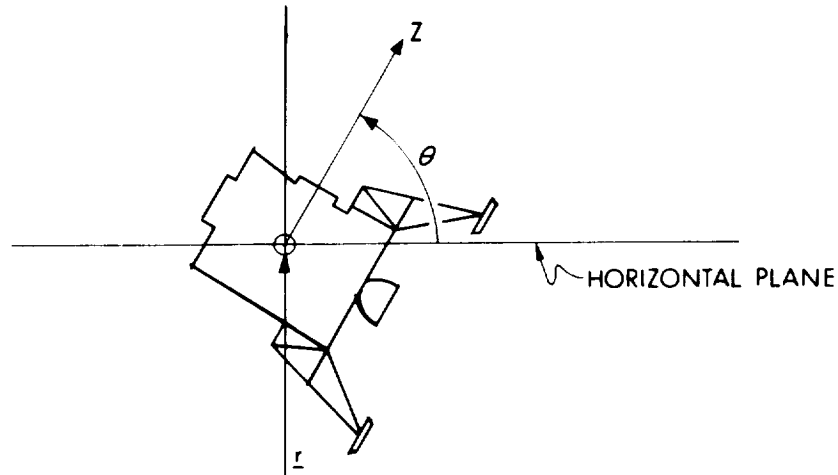

Figure 6.7-1 Definition of Theta

The angle θ represents the angle between the LM Z-body axis and the local horizontal plane. It, therefore, does not uniquely define the orientation of the LM Z axis, but only defines a cone above or below the horizontal plane on which the Z axis can be found. Theta is defined between $\pm 90^\circ$ with the sign positive when the Z axis is above the horizontal plane.

The three displays of R-31 are automatically updated every two seconds until R-31 is terminated by the astronaut.

5.6.8 AGS INITIALIZATION PROGRAM

The Abort Guidance System (AGS) initialization involves a separate program P-02 in the LGC that prepares a special telemetry downlink list with the required AGS initialization parameters. The AGS-LGC initialization interface is through the telemetry subsystem. At a desired GET, the astronaut simultaneously makes an "ENTER" in both LGC and AEA (Abort Electronic Assembly). The LGC stores the GET at this ENTER and subtracts this time from all state vector reference times used in the AGS initialization. There is also the option of loading an AGS initialization time obtained from an external source.

The AGS Initialization Program next integrates the CSM and LM state vectors to the AGS reference GET that was determined by the above ENTER operation or to the current GET if it is greater than the AGS reference GET. This state vector integration (Section 5.2.2) is based on the determination of the earth or lunar orbit condition by examining the primary body indicator P of Section 5.2.2.6. In the earth orbital condition, the CSM and LM state vectors are divided by a factor of four and these modified state vectors are put on the special down-link telemetry list after the AGS reference GET is subtracted from the state vector time. In the lunar orbit condition the CSM and LM state vectors are modified by only the subtraction of the AGS reference GET from the state vector time before being put on the down-link list. This special telemetry down-link list is then sent 10 consecutive times before the normal down-link format is resumed.

Subsequent AGS initializations do not normally require a new AGS time referencing operation involving the simultaneous LGC and AEA ENTER inputs. During AGS initializations following the first, the special initialization down-link is prepared by modifying the state vector times by subtracting the initial GET reference time determined in the first initialization.

The final operation is to zero the IMU CDU's for the AGS alignment procedure as described in Section 4.

5. 6. 9 LGC INITIALIZATION

The LGC initialization procedure prior to LM separation is a manual operation which does not involve a numbered LGC program. After the LGC is activated the first requirement is to synchronize the LGC clock with that of the CMC. This is a count-down and mark procedure described in R-30, CMC/LGC Clock Synchronization Routine of Section 4, to obtain an average clock difference which is then used to increment the LGC clock. The CMC and LGC clock synchronization can also be checked by the Mission Ground Control Center using telemetry down-link data, which can provide a more precise difference to increment the LGC clock.

In the lunar landing mission the following parameters are next voice-linked from the CSM and entered in the LGC as initialization parameters:

- 1) \underline{r}_C : CSM position vector
- 2) \underline{v}_C : CSM velocity vector
- 3) t_C : CSM state vector time
- 4) \underline{r}_{LS} : lunar landing site vector
- 5) t_{LS} : time \underline{r}_{LS} is valid
- 6) t_0 : time difference between zero GET and
 July 1.0, 1968 universal time.

In the above procedure, all parameters are entered in octal, and position and velocity vectors are double precision. In the lunar landing mission the above items 1 through 5 are normally determined by the CMC Orbit Navigation Program P-22.

5.6.10 LUNAR SURFACE CHECKOUT

The primary purpose of the PGNCS Checkout Program (P-04) is to verify the following while on the surface of the moon or earth.

- 1) The integrity of the IMU fine and coarse alignment interface with the LGC.
- 2) The integrity of the IMU accelerometers and gyros.
- 3) The accuracy of the present LGC stored accelerometer and gyro compensation parameters.

Initially the IMU gimbal angles, while being displayed to the astronaut, are coarse aligned to zero. If the angles are not within a certain threshold of zero, an alarm code is displayed, whereupon, the astronaut either repeats the coarse alignment or terminates the program.

Next, the LGC issues torquing commands to the gyros to drive the gimbal angles to zero while continuing to display these angles. If the final angles are not within a certain threshold of zero, an alarm code is displayed, and the astronaut either recycles the gyro torquing process or terminates the program.

Afterwards, the IMU gimbal angles, while being displayed, are coarse aligned to $OGA = 45^{\circ}$, $IGA = -45^{\circ}$, and $MGA = 45^{\circ}$. If the final angles are not within a certain threshold of the desired values, an alarm code is displayed, and the astronaut either recycles the process or terminates the program.

With the IMU in this final orientation, the program calculates the gravity vector \underline{g}_1 using the accumulated outputs of the PIPA's over a period of 10 seconds. Next, the PIPA outputs are used for 880 seconds to correct for drift of the IMU stable member, after which, a second gravity vector \underline{g}_2 is determined using the accumulated PIPA outputs for 10 seconds. The program then displays the magnitude of \underline{g}_2 , after which, it displays the horizontal component $\dot{\theta}$ of lunar or earth rotation rate at the present site as determined from the following:

$$\dot{\theta} \approx \left| \text{UNIT}(\underline{g}_1) \times \text{UNIT}(\underline{g}_2) \right| / \Delta t \quad (6.10.1)$$

where Δt is the elapsed time between the determination of \underline{g}_1 and \underline{g}_2 .

5.6.11 LGC IDLING PROGRAM

This program is used to maintain the LGC in a state of readiness for entry into any other program. While the idling program is in operation, the Coasting Integration Routine (Section 5.2.2) is used to advance the estimated CSM state vector (and the estimated LM state vector when the LM is not on the surface of the moon) to approximately current time. This procedure has the lowest priority of all programs, and is performed only when no other program is active. This periodic state vector extrapolation is not necessary from a theoretical point of view, but does have two practical purposes. First, it is advisable to maintain current (or at least nearly current) state vector estimates in case an emergency situation arises. Second, a significant amount of computation time is transferred from a period of high computer activity (navigation measurement processing, targeting, etc.) to a period of low activity.

In order to use the Coasting Integration Routine in an efficient manner, the maximum value for the integration time step, Δt_{\max} , is computed as described in Section 5.2.2.5. The value of Δt_{\max} is a function of radial distance and varies from step to step. Let t be the time associated with the estimated CSM state vector and t_1 be the current time. The estimated state vector(s) are extrapolated ahead when

$$t_1 > t + 4 \Delta t_{\max} \quad (6.11.1)$$

The integration is terminated when

$$t_1 < t + \Delta t_{\max} \quad (6.11.2)$$

In this manner no extra and smaller-than-maximum integration time steps are performed, and the periodic integration is accomplished most effeciently.

The logic for the periodic state vector extrapolation is illustrated in Fig. 6. 11-1. The variables D and V are indicators which control the Coasting Integration Routine. The quantities \underline{x}_C and \underline{x}_L are the estimated CSM and LM state vectors, respectively, and \underline{x} is a temporary state vector used for integration. Refer to Section 5. 2. 2. 6 for precise definitions of these items.

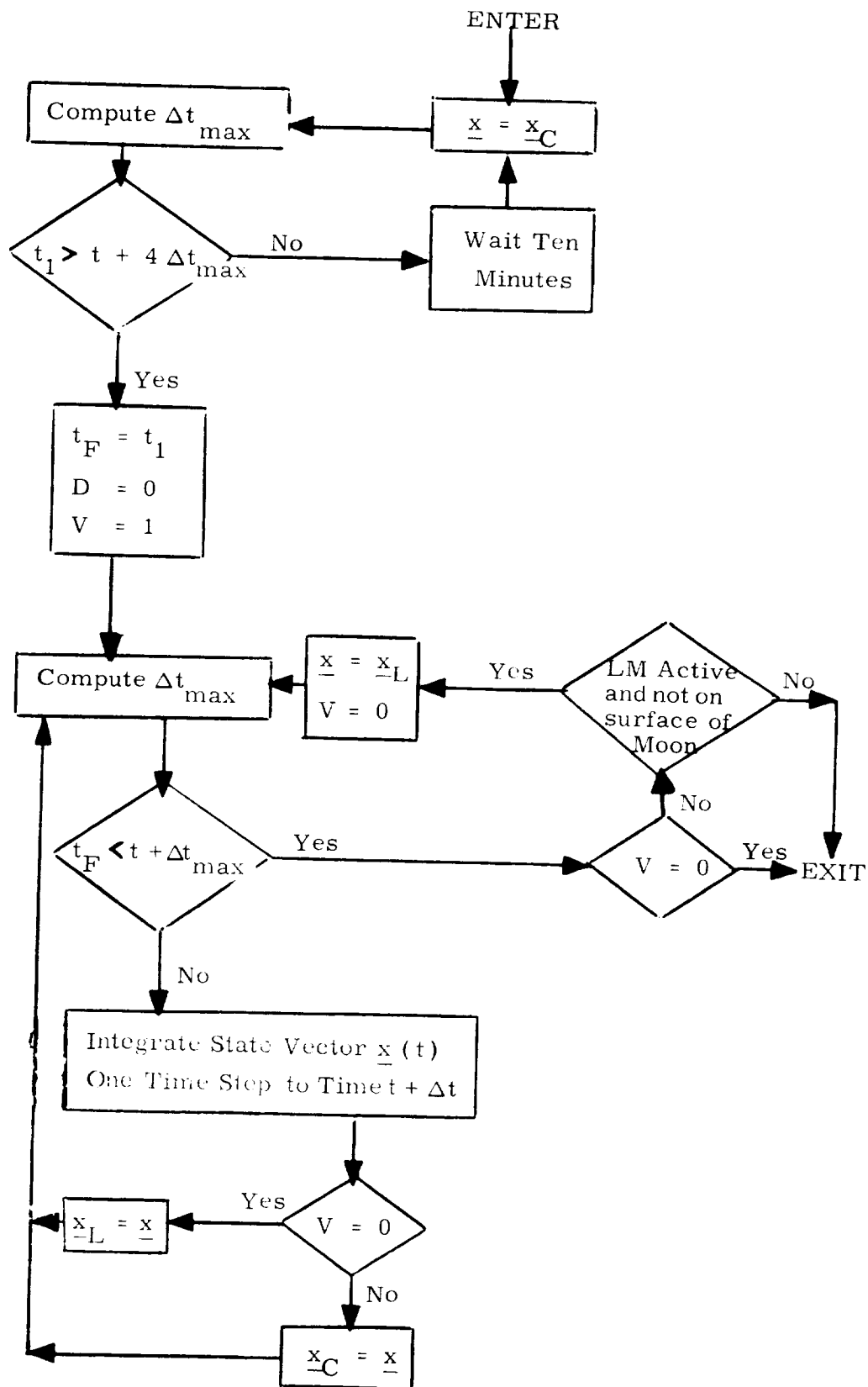

Figure 6.11-1 LGC Idling Program Logic Diagram

5.6.12 FDAI-IMU TRANSFORMATIONS

The following transformations are used to convert IMU gimbal angles to angles on the LM FDAI Ball. Each gimbal angle is that angle through which the designated gimbal must be rotated, in the conventional right-handed sense, with respect to its outer neighbor to make the X, Y, Z Coordinate Systems of both gimbals coincide.

Pitch

$$P = \sin^{-1} \left[\sin (IGA) \cos (OGA) + \cos (IGA) \sin (MGA) \sin (OGA) \right]$$

$$-\pi/2 < P < \pi/2 \quad (6.12.1)$$

Yaw

$$Y = 2\pi - \sin^{-1} \left[\frac{\cos (MGA) \sin (OGA)}{\cos P} \right]$$

$$= \cos^{-1} \left[\frac{\cos (IGA) \cos (OGA) - \sin (IGA) \sin (MGA) \sin (OGA)}{\cos P} \right]$$

$$(6.12.2)$$

Roll

$$R = \sin^{-1} \left[\frac{\cos (IGA) \sin (MGA) \cos (OGA) - \sin (IGA) \sin (OGA)}{\cos P} \right]$$
$$= \cos^{-1} \left[\frac{\cos (IGA) \cos (MGA)}{\cos P} \right] \quad (6.12.3)$$

where

- IGA = IMU inner gimbal angle
- MGA = IMU middle gimbal angle
- OGA = IMU outer gimbal angle

The gimbal angles are defined to be zero when the gimbal axes of rotation are mutually orthogonal.

For $P = \pm \pi / 2$ the above equations become indeterminate. In this case roll and yaw on the FDAI Ball also become meaningless and are not uniquely defined. However, the following equations give the relationship between the FDAI angles and the gimbal angles for this case.

If $IGA = \pi / 2$

- 1.) $OGA = 0 \longrightarrow R - Y = MGA$
 - 2.) $OGA = \pi \longrightarrow R + Y = \pi - MGA$
- (6.12.4)

If $\text{IGA} = -\pi/2$

1.) $\text{OGA} = 0 \longrightarrow \mathbf{R} + \mathbf{Y} = \text{MGA}$

2.) $\text{OGA} = \pi \longrightarrow \mathbf{R} - \mathbf{Y} = \pi - \text{MGA}$ (6.12.5)

5.6.13 IMU COMPENSATION

The IMU Compensation is designed to compensate for PIPA bias and scale factor error and at the same time accumulate gyro torquing commands necessary to compensate for the associated bias and acceleration caused gyro drifts. The correction to the PIPA's is

$$\text{PIPA}_C = (1 + \text{SFE}_I) \text{PIPA}_I + \text{BIAS}_I \Delta t$$

where

PIPA_C is the compensated data for the I^{th} PIPA denoted PIPAX_C , PIPAY_C , PIPAZ_C

$$\text{SFE} = \frac{\text{SF} - \text{SF}_{\text{nom}}}{\text{SF}_{\text{nom}}} \quad (\text{erasable load})^*$$

$$\text{SF} = \text{Scale-factor} \frac{\text{CM/Sec}}{\text{Pulse}}$$

BIAS_I is the bias for the I^{th} PIPA (an erasable load)

The compensated data is then used to compute the IRIG torquing necessary to cancel the NBD, ADIA, and ADSRA gyro coefficients. The computations are

$$\text{XIRIG} = -\text{ADIAX} \text{PIPAX}_C + \text{ADSRAX} \text{PIPAY}_C - \text{NBDX} \Delta t$$

$$\text{YIRIG} = -\text{ADIAY} \text{PIPAY}_C + \text{ADSRAY} \text{PIPAZ}_C - \text{NBDY} \Delta t$$

$$\text{ZIRIG} = -\text{ADIAZ} \text{PIPAZ}_C - \text{ADSRAZ} \text{PIPAY}_C + \text{NBDZ} \Delta t$$

*The term "erasable load" refers to data entered in LGC erasable memory just prior to launch.

where

XIRIG, YIRIG, ZIRIG are gyro drift compensations
NBDX, NBDY, NBDZ are gyro bias drifts (an erasable load)
ADSRAX, ADSRAY, ADSRAZ are gyro drifts due to acceleration in spin reference axis (an erasable load)
ADIAX, ADIAY, ADIAZ are gyro drifts due to acceleration in the input axis (an erasable load)

When the magnitude of any IRIG command exceeds two pulses, the commands are sent to the gyros.

During free-fall only the NBDX, NBDY, NBDZ are the relevant coefficients and the routine is so ordered that only these terms are calculated for the gyro compensation.

