

**CASE FILE
COPY**

NASA SP-238

APOLLO 11

Mission Report

PREPARED BY
MISSION EVALUATION TEAM
NASA MANNED SPACECRAFT CENTER



Scientific and Technical Information Office
NATIONAL AERONAUTICS AND SPACE ADMINISTRATION
1971
Washington, D.C.

100
100

PREFACE

On May 25, 1961, this nation made a commitment: to land men on the Moon before the end of the decade. On July 20, 1969, the commitment was met. American astronauts left the following message on the lunar surface: "Here men from the planet Earth first set foot upon the Moon, July 1969 A.D. We came in peace for all mankind."

The achievement belongs to all mankind. But those that made it possible deserve our special thanks. First, there are three especially brave men -- Neil Armstrong, Mike Collins, and Buzz Aldrin. They were backed up by thousands of men and women in NASA, in other government agencies, in industry and in universities, and in the Congress. All of them were dedicated to the cause of Apollo, and they proved that with skill and the desire to succeed -- above all, with dedication -- we as a nation can indeed meet the most difficult tasks we set for ourselves.

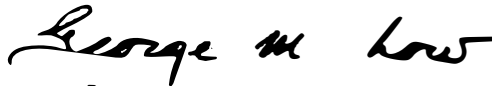

George M. Low
Acting Administrator
National Aeronautics and
Space Administration

CONTENTS

Section	Page
1. SUMMARY	1
2. INTRODUCTION	2
3. MISSION DESCRIPTION	2
4. PILOTS' REPORT	15
Prelaunch Activities	15
Launch	15
Earth Orbit Coast and Translunar Injection	15
Transposition and Docking	15
Translunar Coast	16
Lunar Orbit Insertion	17
Lunar Module Checkout	17
Descent Preparation	17
Undocking and Separation	19
Lunar Module Descent	19
Command Module Solo Activities	20
Lunar Surface Operations	21
Launch Preparation	25
Ascent	26
Rendezvous	26
Command Module Docking	27
Transearch Injection	27
Transearch Coast	27
Entry	28
Recovery	28
5. LUNAR DESCENT AND ASCENT	29
Descent Trajectory Logic	29
Preparation for Powered Descent	32

Section	Page
Powered Descent	34
Landing Dynamics	51
Postlanding Spacecraft Operations	52
Ascent	55
Rendezvous	60
6. COMMUNICATIONS	65
7. TRAJECTORY	70
Launch Phase	71
Earth Parking Orbit	71
Translunar Injection	71
Maneuver Analysis	72
Command Module Entry	79
Service Module Entry	79
Lunar Orbit Targeting	80
Lunar Orbit Navigation	81
8. PERFORMANCE OF THE COMMAND AND SERVICE MODULES	83
Structural and Mechanical Systems	83
Electrical Power	85
Cryogenic Storage	86
Very-High-Frequency Ranging	86
Instrumentation	86
Guidance, Navigation, and Control	87
Reaction Control	95
Service Propulsion	95
Environmental Control System	97
Crew Station	98
Consumables	98

Section	Page
9. PERFORMANCE OF THE LUNAR MODULE	102
Structural and Mechanical Systems	102
Thermal Control	102
Electrical Power	102
Communications Equipment	103
Instrumentation	103
Guidance and Control	104
Reaction Control	114
Descent Propulsion	115
Ascent Propulsion	119
Environmental Control System	120
Radar	120
Crew Station	121
Consumables	121
10. PERFORMANCE OF THE EXTRAVEHICULAR MOBILITY UNIT	125
11. THE LUNAR SURFACE	128
Lunar Geology Experiment	130
Lunar Soil Mechanics Experiment	144
Examination of Lunar Samples	147
Passive Seismic Experiment	148
Laser Ranging Retroreflector Experiment	154
Solar Wind Composition Experiment	154
Photography	155
12. BIOMEDICAL EVALUATION	158
Bioinstrumentation and Physiological Data	158
Medical Observations	160
Extravehicular Activity	162
Physical Examinations	164
Lunar Contamination and Quarantine	164

Section	Page
13. MISSION SUPPORT PERFORMANCE	168
Flight Control	168
Manned Space Flight Network Performance	168
Recovery Operations	169
14. ASSESSMENT OF MISSION OBJECTIVES	174
Location of the Landed Lunar Module	175
Lunar Field Geology	176
15. LAUNCH VEHICLE SUMMARY	177
16. ANOMALY SUMMARY	178
Command and Service Modules	178
Lunar Module	187
Government-Furnished Equipment	200
17. CONCLUSIONS	201
REFERENCES	202
APPENDIX A — APOLLO SPACECRAFT FLIGHT HISTORY	203
APPENDIX B — VEHICLE DESCRIPTIONS	205
APPENDIX C — GLOSSARY	216

SYMBOLS AND ABBREVIATIONS

A	ampere
ac	alternating current
AGS	abort guidance system
A-h	ampere-hour
ALDS	Apollo launch data system
APS	ascent propulsion system
arc sec	arc second
ARIA	Apollo range instrumentation aircraft
ASHUR	Apollo Spacecraft Hardware Utilization Requests
BDA	Bermuda
Btu	British thermal unit
CAPCOM	capsule communicator
CATS	command and telemetry system
c.d.t.	central daylight time
cm	centimeter
CM	command module
CMC	command module computer
CRO	Carnarvon, Australia
CSM	command and service modules
CYI	Canary Islands
D	down
dB	decibel
dc	direct current
deg	degree
DPS	descent propulsion system
D/T	delayed time
E	east
e.s.t.	eastern standard time

FM	frequency modulation
ft/sec	feet per second
g	gravity of earth
g.e.t.	ground elapsed time
G&N	guidance and navigation
GDS	Goldstone, California
G.m.t.	Greenwich mean time
HAW	Hawaii
hr	hour
HSK	Honeysuckle, Australia
Hz	hertz
I	inertia
in-lb	inch-pound
kpps	kilopulses per second
kWh	kilowatt-hour
lb/hr	pounds per hour
lb/ft ²	pounds per square foot
LGC	lunar module guidance computer
LM	lunar module
M	mega-
MAD	Madrid, Spain
mERU	milli-earth rate unit
mg	milligram
MILA	Merritt Island Launch Area, Florida
min	minute
mm	millimeter
msec	millisecond
MSFN	Manned Space Flight Network
N	north

NA	not available
P	pressure (transducer location)
PAM	pulse amplitude modulation
PCM	pulse code modulation
PGNCS	primary guidance, navigation, and control system
PM	phase modulation
ppm	parts per million
psf	pounds per square foot
psi	pounds per square inch
q	dynamic pressure
RCS	reaction control system
RED	Redstone tracking ship
REFSMAT	reference stable member matrix
S	south
S-IC, S-II, S-IVB	first, second, and third stages of Saturn V launch vehicle
SM	service module
T	temperature (transducer location)
TV	television
TAN	Tananarive
TCA	thrust chamber assembly
U.S.	United States
V	volt
VAN	Vanguard tracking ship
vhf	very high frequency
VOX	voice-operated transmitter
W	west
Wh	watt-hour
X, Y, Z	spacecraft axes
°C	degrees Centigrade

°F degrees Fahrenheit
α angle of attack
μ micro-

1. SUMMARY

The purpose of the Apollo 11 mission was to land men on the lunar surface and to return them safely to earth. The members of the crew were Neil A. Armstrong, Commander; Michael Collins, Command Module Pilot; and Edwin E. Aldrin, Jr., Lunar Module Pilot.

The space vehicle was launched from Kennedy Space Center, Florida, at 8:32:00 a.m. e.s.t., July 16, 1969. The activities during earth orbit checkout, translunar injection, transposition and docking, spacecraft ejection, and translunar coast were similar to those of the previous mission, a lunar orbit rendezvous flight. Only one midcourse correction, performed at approximately 27 hours g.e.t., was required during translunar coast.

The spacecraft was inserted into lunar orbit at approximately 76 hours g.e.t., and the circularization maneuver was performed two revolutions later. Initial checkout of the lunar module systems was satisfactory, and after a planned rest period, the Commander and Lunar Module Pilot entered the lunar module to prepare for descent.

The two spacecraft were undocked at approximately 100 hours g.e.t., followed by separation of the command and service modules from the lunar module. Descent orbit insertion was performed at approximately 101-1/2 hours g.e.t., and powered descent to the lunar surface began approximately 1 hour later. Operation of the guidance and descent propulsion systems was nominal. The lunar module was maneuvered manually to a landing approximately 1100 feet down range from the nominal landing point during the final 2-1/2 minutes of descent. The spacecraft landed in the Sea of Tranquility at 102:45:40 g.e.t. The landing coordinates were latitude 0°41'15" N and longitude 23°26' E. During the first 2 hours on the lunar surface, the two crewmen performed a postlanding checkout of all lunar module systems. Afterward, they ate their first meal on the moon and elected to perform the surface operations earlier than planned.

Considerable time was deliberately devoted to checkout and donning of the back-mounted portable life support and oxygen purge systems. The Commander egressed through the forward hatch and deployed an equipment module in the descent stage. A camera in this module provided live television coverage of the Commander descending the ladder to the surface, with first contact made at 109:24:15 g.e.t. (9:56:15 p.m. e.s.t., July 20, 1969). The Lunar Module Pilot egressed soon thereafter, and both crewmen used the initial period on the surface to become acclimated to the reduced gravity and unfamiliar surface conditions. A contingency sample was taken from the surface, and the television camera was deployed so that most of the lunar module was included in its view field. The crew activated the scientific experiments, which included a solar wind detector, a passive seismometer, and a laser retroreflector. The Lunar Module Pilot evaluated his ability to operate and move about and was able to translate rapidly and with confidence. Forty-seven pounds of lunar surface material were collected to be returned for analysis. The surface exploration was concluded in the allotted time of 2-1/2 hours, and the crew reentered the lunar module at 111-1/2 hours g.e.t.

Ascent preparation was conducted efficiently, and the ascent stage lifted off the surface at 124-1/4 hours g.e.t. A nominal firing of the ascent engine placed the vehicle into a 48- by 9-mile orbit. After a rendezvous sequence similar to that of Apollo 10, the two spacecraft were docked at 128 hours g.e.t. Following transfer of the crew, the ascent stage was jettisoned, and the command and service modules were prepared for trans-earth injection.

The return flight started with a 150-second firing of the service propulsion engine during the 31st lunar revolution at 135-1/2 hours g.e.t. As in the translunar flight, only one midcourse correction was required, and passive thermal control was exercised

for most of the transearth coast. Inclement weather necessitated moving the landing point 215 miles down range. The entry phase was normal, and the command module landed in the Pacific Ocean at 195-1/4 hours g.e.t. The landing coordinates, as determined from the onboard computer, were latitude 13°19' N and longitude 169°09' W.

After landing, the crew donned biological isolation garments. The crew was then retrieved by helicopter and taken to the primary recovery ship, U.S.S. Hornet. The crew and the lunar material samples were placed in the Mobile Quarantine Facility for transport to the Lunar Receiving Laboratory in Houston, Texas. The command module was taken aboard the U.S.S. Hornet approximately 3 hours after landing.

With the completion of the Apollo 11 mission, the national objective, landing men on the moon and returning them safely to earth before the end of the decade, had been accomplished.

2. INTRODUCTION

The Apollo 11 mission was the 11th in a series of flights using Apollo flight hardware and was the first lunar landing mission of the Apollo Program. It was also the fifth manned flight of the command and service modules and the third manned flight of the lunar module. The purpose of the mission was to perform a manned lunar landing and to return the men safely to earth. A history of the Apollo flights is presented in appendix A.

Because of the excellent performance of the entire spacecraft, only the systems performance that significantly differed from that of previous missions is reported. The ascent, descent, and landing portions of the mission are reported in section 5, and the lunar surface activities are reported in section 11.

In this report, all actual times are given as elapsed time from range zero (g.e.t.), which is established as the integral second before lift-off. Range zero for this mission was 13:32:00 G.m.t., July 16, 1969. All references to mileage distance are in nautical miles.

3. MISSION DESCRIPTION

The Apollo 11 mission accomplished the basic mission of the Apollo Program, that is, to land two men on the lunar surface and return them safely to earth. As a part of this first lunar landing, three basic experiment packages were deployed, lunar material samples were collected, and surface photographs were taken. Two of the experiments were a part of the early Apollo scientific experiment package that was developed for deployment on the lunar surface. The sequence of events and the flight plan of the Apollo 11 mission are shown in table 3-1 and figure 3-1, respectively.

The Apollo 11 space vehicle was launched on July 16, 1969, at 8:32 a.m. e.s.t., as planned. The spacecraft and the S-IVB were inserted into a 100.7- by 99.2-mile earth parking orbit. After a 2-1/2-hour checkout period, the spacecraft/S-IVB combination was injected into the translunar phase of the mission. Trajectory parameters after the translunar injection firing were nearly perfect, with the velocity within 1.6 ft/sec of that planned. Only one of the four options for midcourse corrections during the translunar phase was exercised. This correction, which was made with the service propulsion system at approximately 26-1/2 hours, provided a 20.9-ft/sec velocity change. During the remaining periods of free-attitude flight, passive thermal control was used to maintain spacecraft temperatures within desired limits. The Commander and Lunar Module Pilot transferred to the lunar module during the translunar phase to make an initial inspection and to prepare the lunar module for a systems check in lunar orbit.

The spacecraft was inserted into a 60- by 169.7-mile lunar orbit at approximately 76 hours. Four hours later, a lunar orbit circularization maneuver was performed to place the spacecraft in a 65.7- by 53.8-mile orbit. The Lunar Module Pilot entered the lunar module at approximately 81 hours for the initial power-up and systems checks. After the planned sleep period was completed at 93-1/2 hours, the crew donned their suits, transferred to the lunar module, and made final preparations for descent to the lunar surface. The lunar module was undocked on time at approximately 100 hours. After the exterior of the lunar module had been inspected from the command module, a separation maneuver was performed with the service module reaction control system.

A descent orbit insertion maneuver was performed by the descent propulsion system at 101-1/2 hours. Trajectory parameters following this maneuver were as planned, and powered descent initiation was on time at 102-1/2 hours. The descent maneuver lasted approximately 12 minutes, with engine shutdown occurring almost simultaneously with touchdown in the Sea of Tranquility. The coordinates of the actual landing point were latitude 0°41'15" N and longitude 23°26' E, compared with the planned landing point of latitude 0°43'53" N and longitude 23°38'51" E. These coordinates are referenced to Lunar Map ORL-II-6(100), first edition, dated December 1967.

A 2-hour postlanding checkout was completed, followed by a partial power-down of the spacecraft. A crew rest period was planned to precede the extravehicular activity for exploration of the lunar surface. However, the crew elected to perform the extravehicular portion of the mission prior to the sleep period because they were not overly tired and were adjusting easily to the 1/6-g environment. After the crew donned their portable life support systems and completed the required checkouts, the Commander egressed at approximately 109 hours. Prior to descending the ladder, the Commander deployed an equipment module in the descent stage. The television camera located in the equipment module operated satisfactorily and provided live television coverage of the Commander's descent to the lunar surface. The Commander collected the contingency lunar material samples. Approximately 20 minutes later, the Lunar Module Pilot egressed, and dual exploration of the lunar surface began.

During the exploration period, the television camera was deployed, and the American flag was raised on the lunar surface. The solar wind experiment also was deployed for later retrieval. Both crewmen evaluated their mobility on the lunar surface, deployed the passive seismic and laser retroreflector experiments, collected approximately 47 pounds of lunar material, and obtained photographic documentation of their activities and the conditions around them. The crewmen reentered the lunar module after approximately 2 hours 14 minutes of exploration.

After an 8-hour rest period, the crew began preparations for ascent. Lift-off from the lunar surface occurred on time at 124:22:00.8. The spacecraft was inserted into a 48.0- by 9.4-mile orbit, from which a rendezvous sequence similar to that for the previous mission was successfully performed.

Approximately 4-1/2 hours after lunar module ascent, the command and service modules completed a docking maneuver. The ascent stage was jettisoned in lunar orbit, and the command and service modules were prepared for transearth injection at 135-1/2 hours.

The activities during transearth coast were similar to those during translunar flight. The service module was separated from the command module 15 minutes before reaching the entry interface altitude of 400 000 feet. After an automatic entry sequence and landing system deployment, the command module landed in the Pacific Ocean at 195-1/2 hours. The postlanding procedures that involved the primary recovery ship U.S.S. Hornet included precautions to avoid back-contamination by any lunar organisms, and the crew and samples were placed in quarantine.

After reaching the NASA Manned Spacecraft Center, the spacecraft, crew, and samples entered the Lunar Receiving Laboratory quarantine area for continuation of the post-landing observation and analyses. No evidence of abnormal medical reactions was observed, and the crew and spacecraft were released from quarantine on August 10, 1969.

TABLE 3-I.- SEQUENCE OF EVENTS

Event	Time, hr:min:sec
Range zero - 13:32:00 G.m.t., July 16, 1969	
Lift-off	00:00:00.6
S-IC outboard engine cut-off	00:02:41.7
S-II engine ignition (command)	00:02:43.0
Launch escape tower jettison	00:03:17.9
S-II engine cut-off	00:09:08.3
S-IVB engine ignition (command)	00:09:12.2
S-IVB engine cut-off	00:11:39.3
Translunar injection maneuver	^a 02:44:16.2
Command and service module/S-IVB separation	03:17:04.6
First docking	03:24:03.1
Spacecraft ejection	04:16:59.1
Separation maneuver (from S-IVB)	^a 04:40:01.8
First midcourse correction	^a 26:44:58.6
Lunar orbit insertion	^a 75:49:50.4
Lunar orbit circularization	^a 80:11:36.8
Undocking	100:12:00
Separation maneuver (from lunar module)	^a 100:39:52.9
Descent orbit insertion	^a 101:36:14
Powered descent initiation	^a 102:33:05
Lunar landing	102:45:39.9
Egress (hatch opening)	109:07:33
Ingress (hatch closing)	111:39:13
Lunar lift-off	^a 124:22:00.8
Coelliptic sequence initiation	^a 125:19:35
Constant differential height maneuver	^a 126:17:49.6
Terminal phase initiation	^a 127:03:51.8
Docking	128:03:00
Ascent stage jettison	130:09:31.2
Separation maneuver (from ascent stage)	^a 130:30:01
Transearth injection maneuver	^a 135:23:42.3
Second midcourse correction	^a 150:29:57.4
Command module/service module separation	194:49:12.7
Entry interface	195:03:05.7
Landing	195:18:35

^aEngine ignition time.

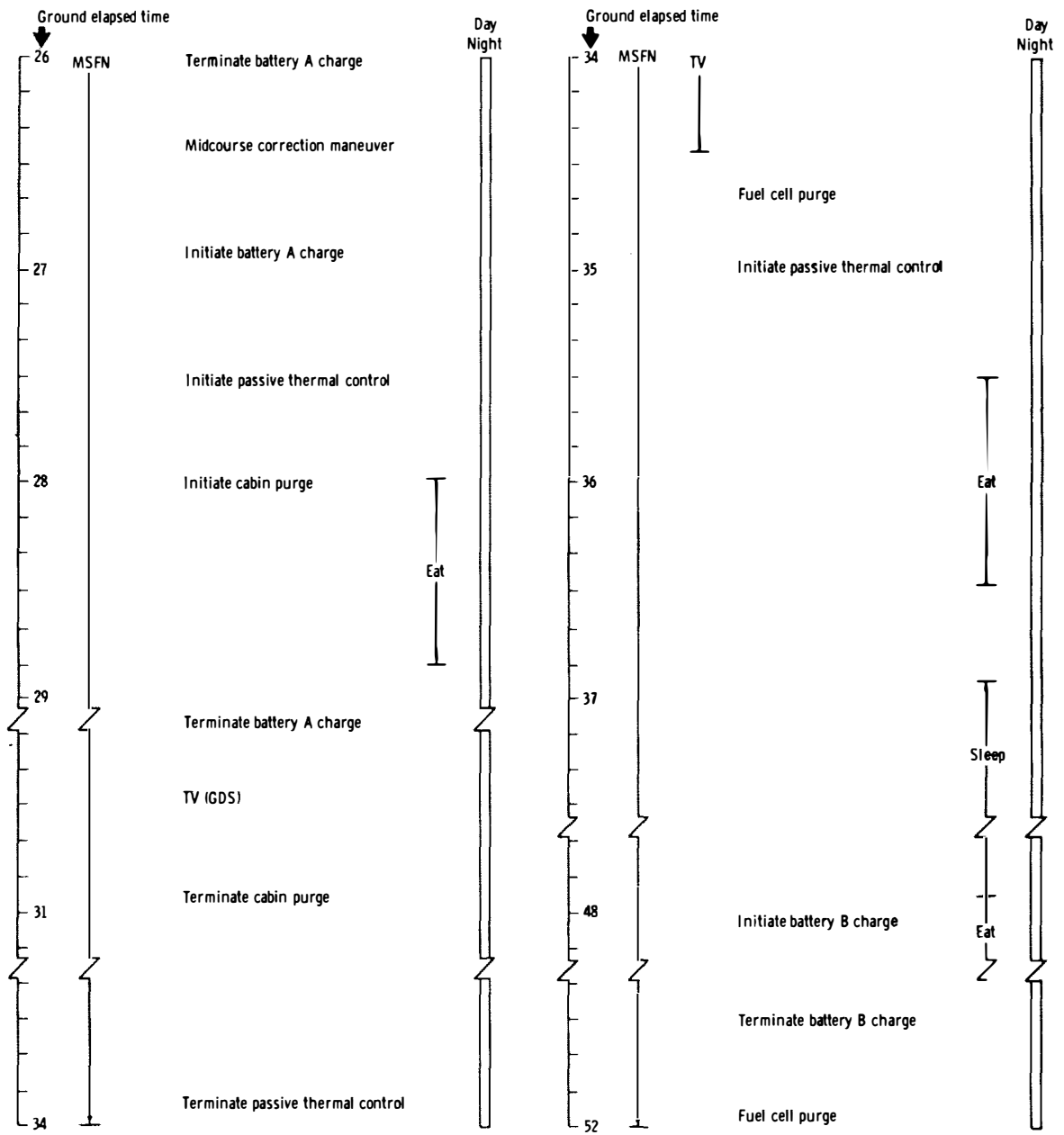

(b) 26 to 52 hours.

Figure 3-1.- Continued.

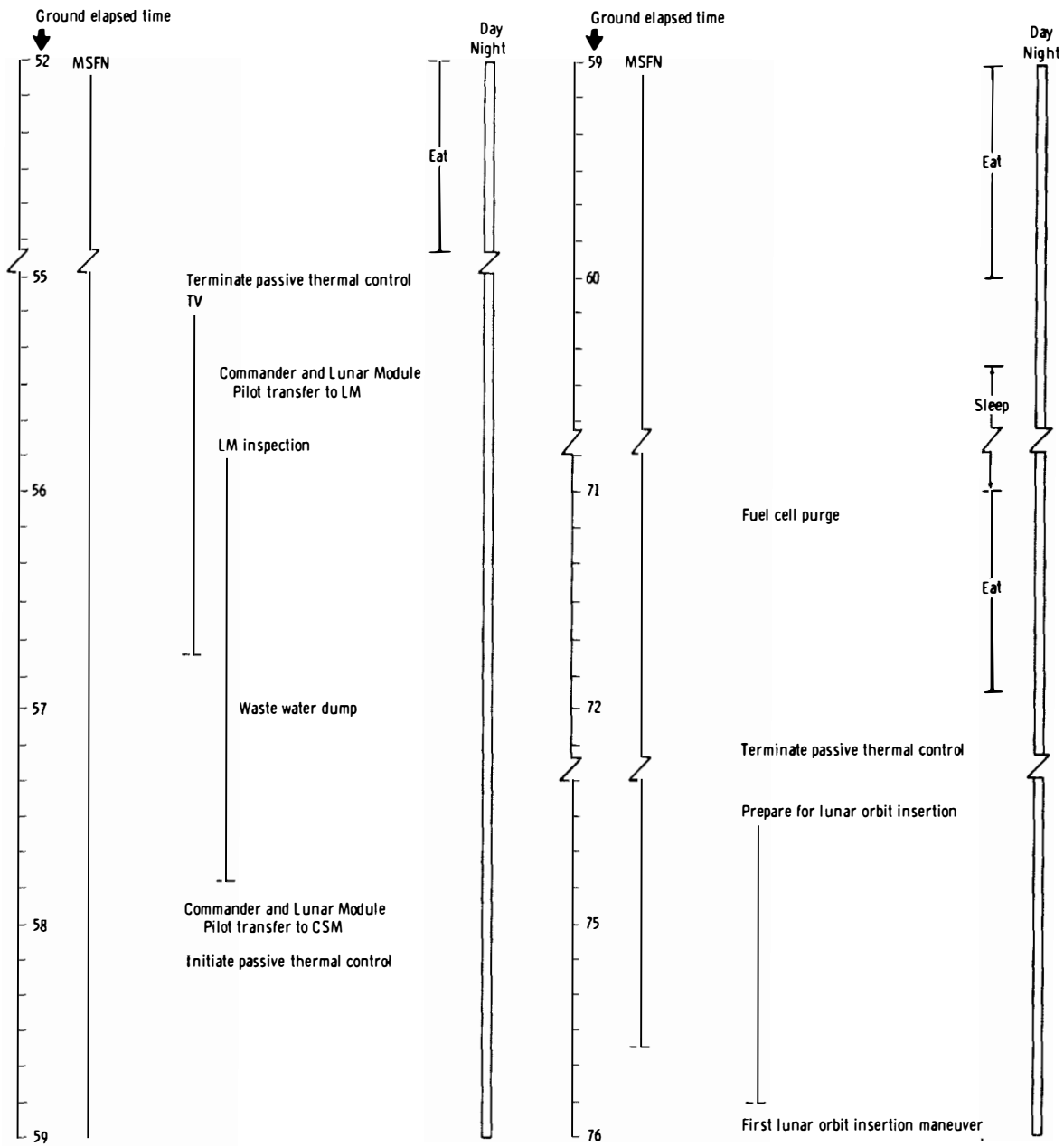

(c) 52 to 76 hours.

Figure 3-1.- Continued.

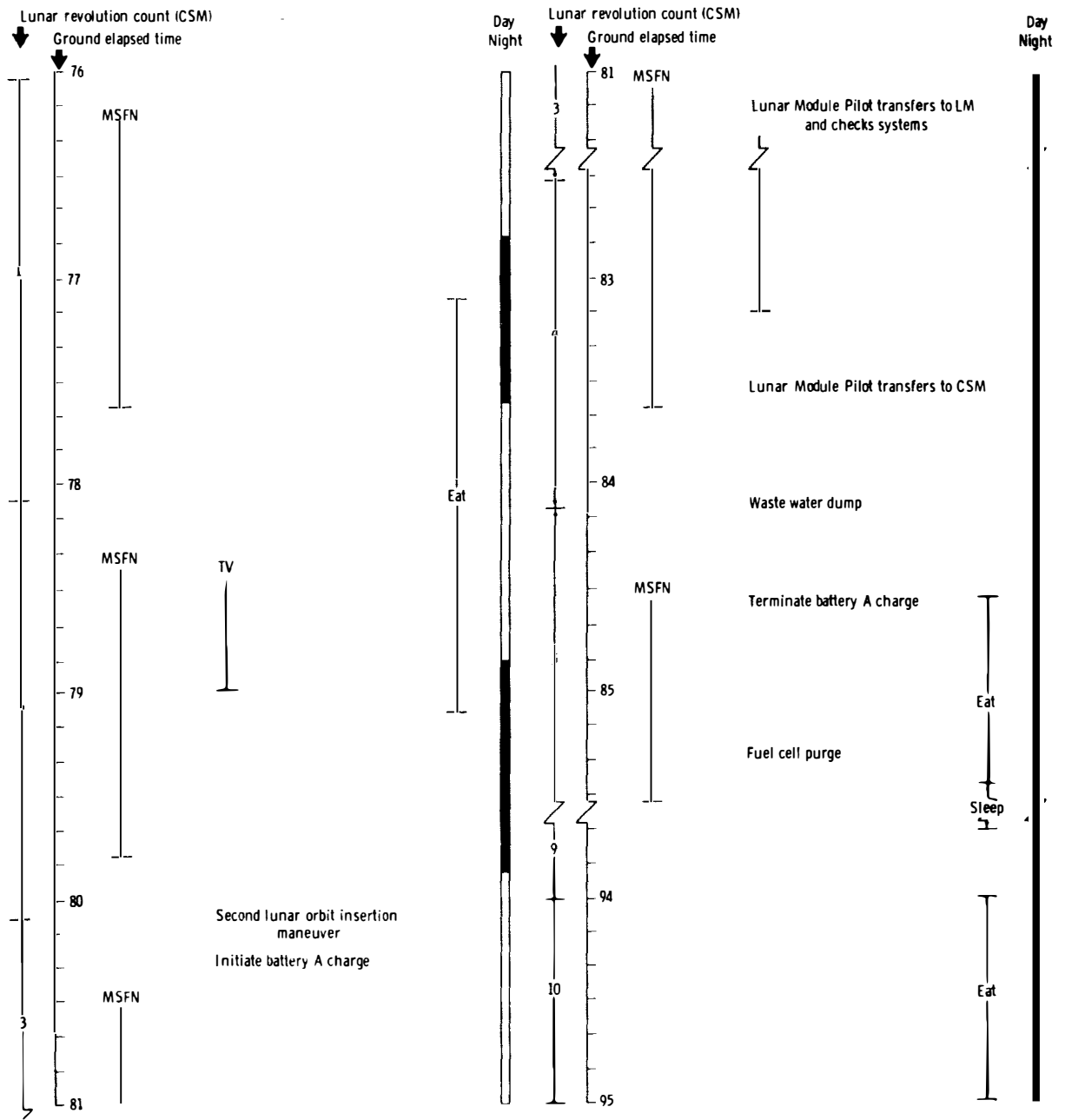

(d) 76 to 95 hours.

Figure 3-1.- Continued.

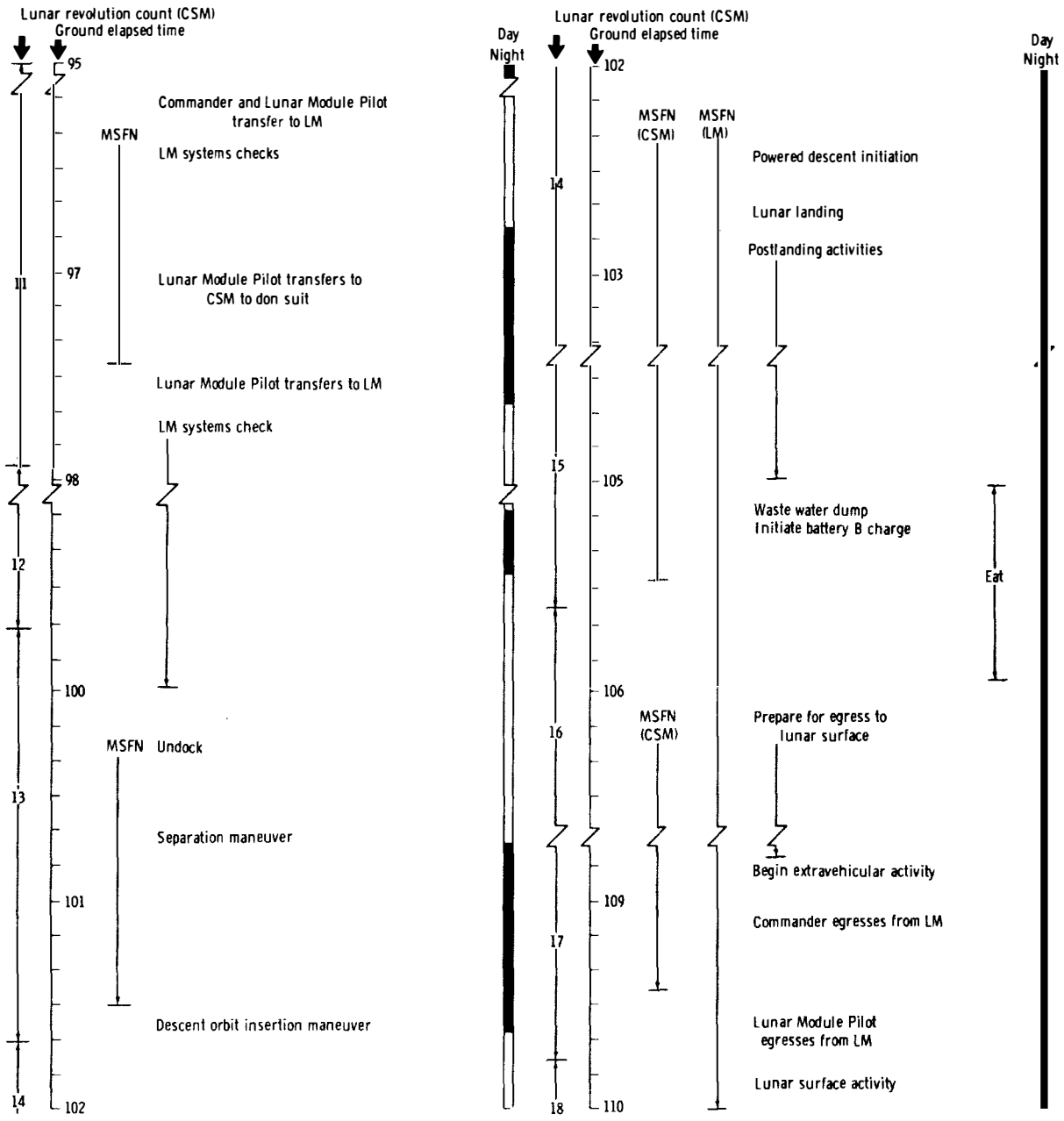

(e) 95 to 110 hours.

Figure 3-1.- Continued.

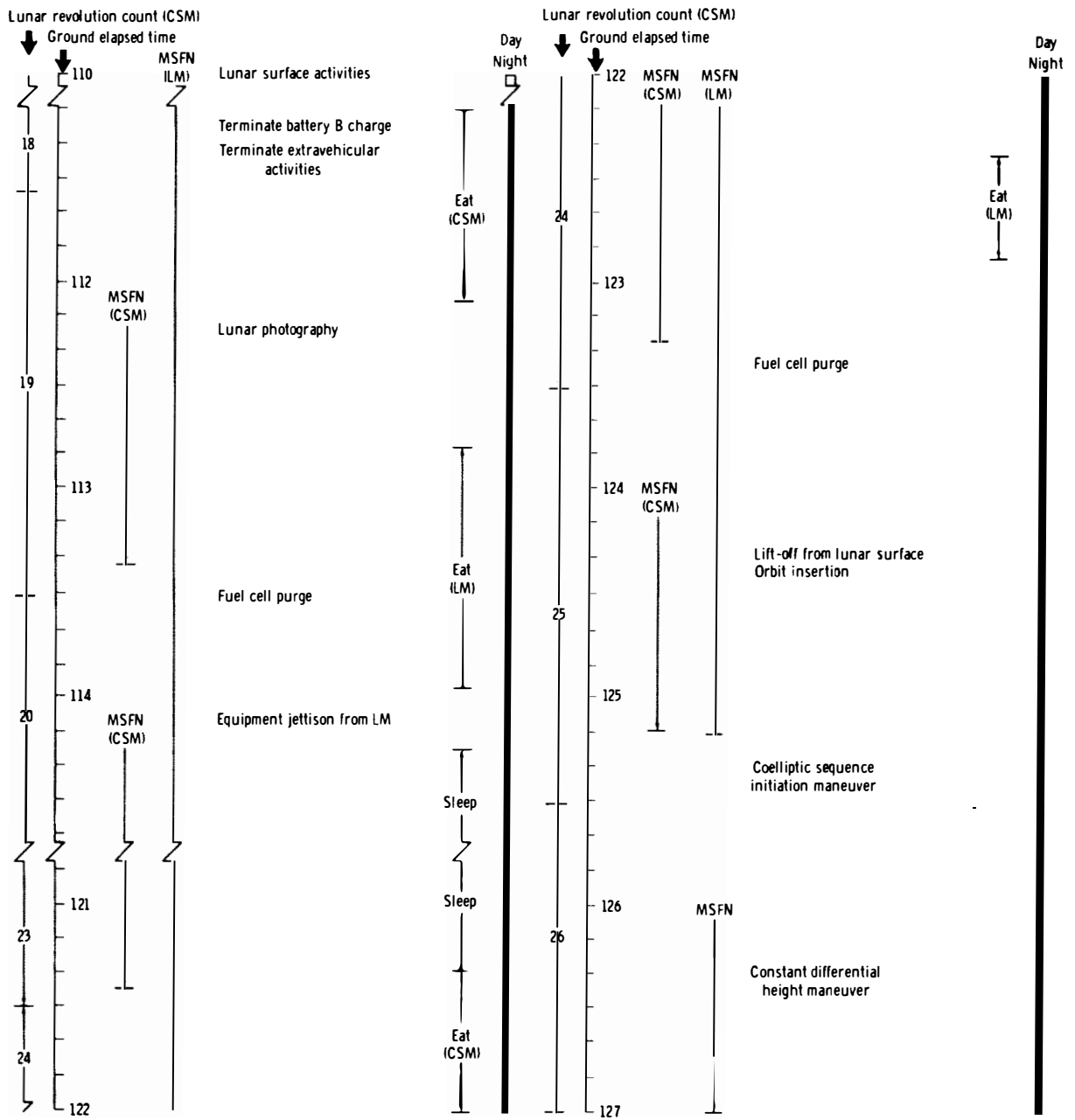

(f) 110 to 127 hours.

Figure 3-1.- Continued.

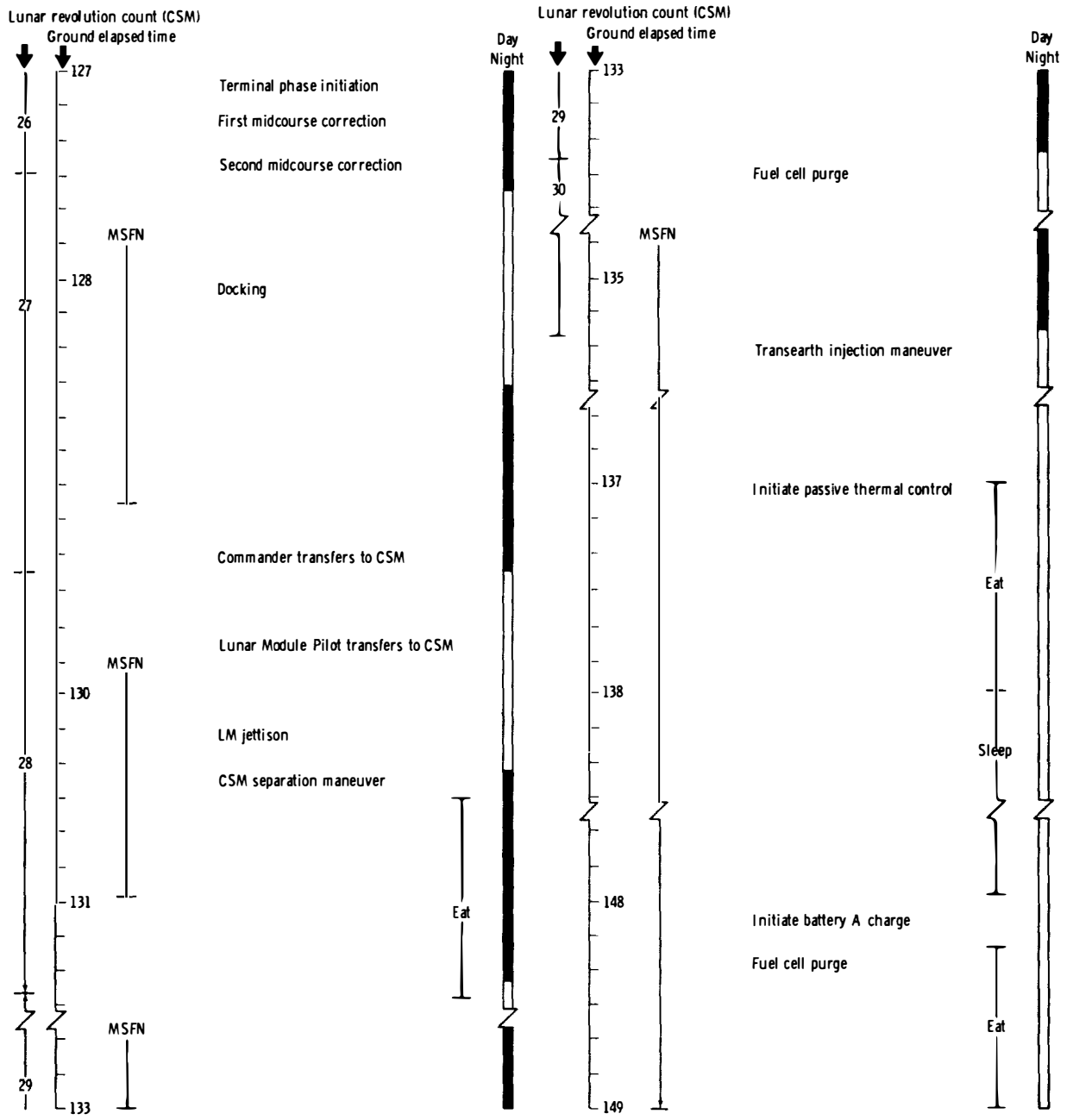

(g) 127 to 149 hours.
 Figure 3-1.- Continued.

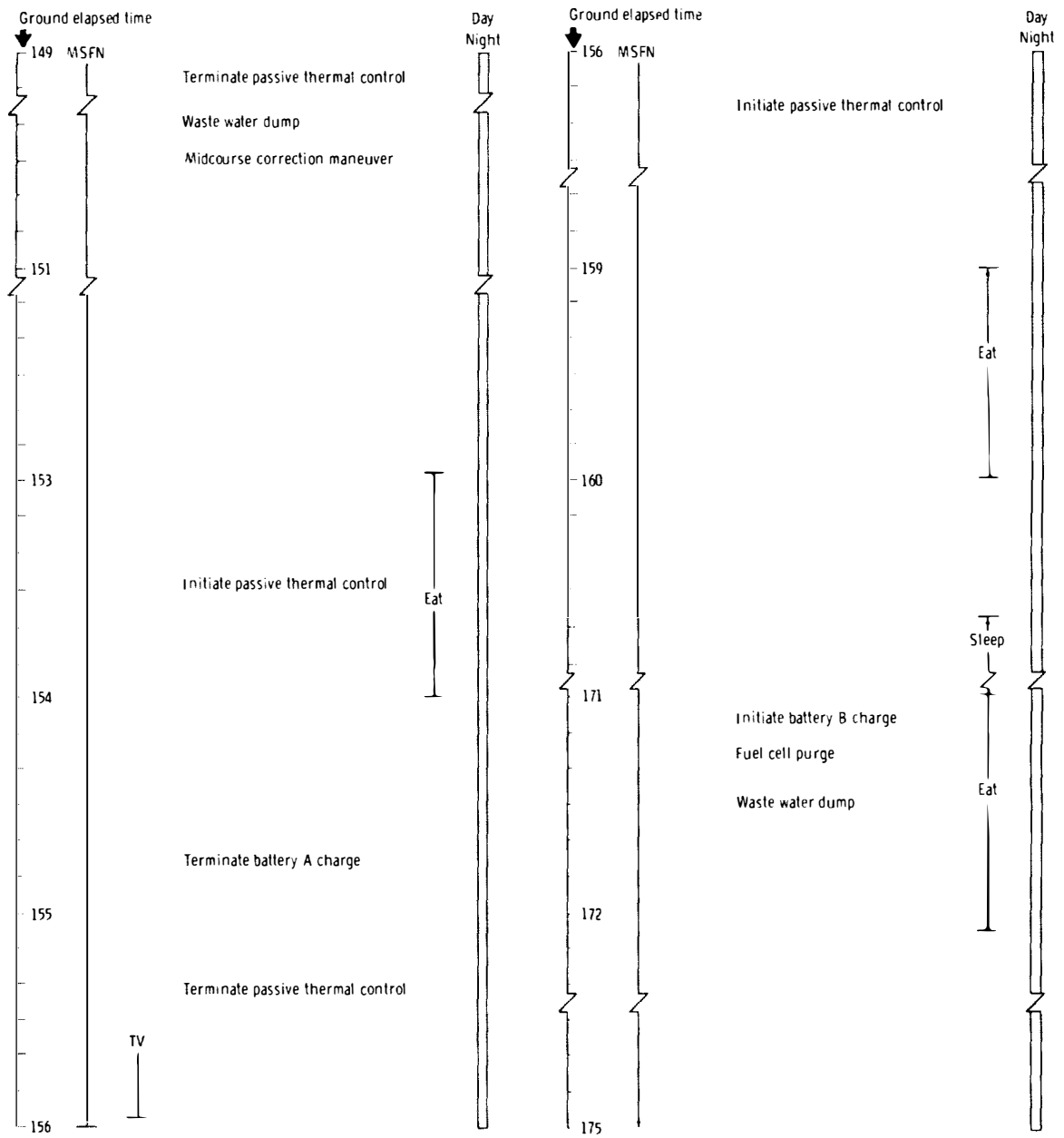

(h) 149 to 175 hours.

Figure 3-1.- Continued.

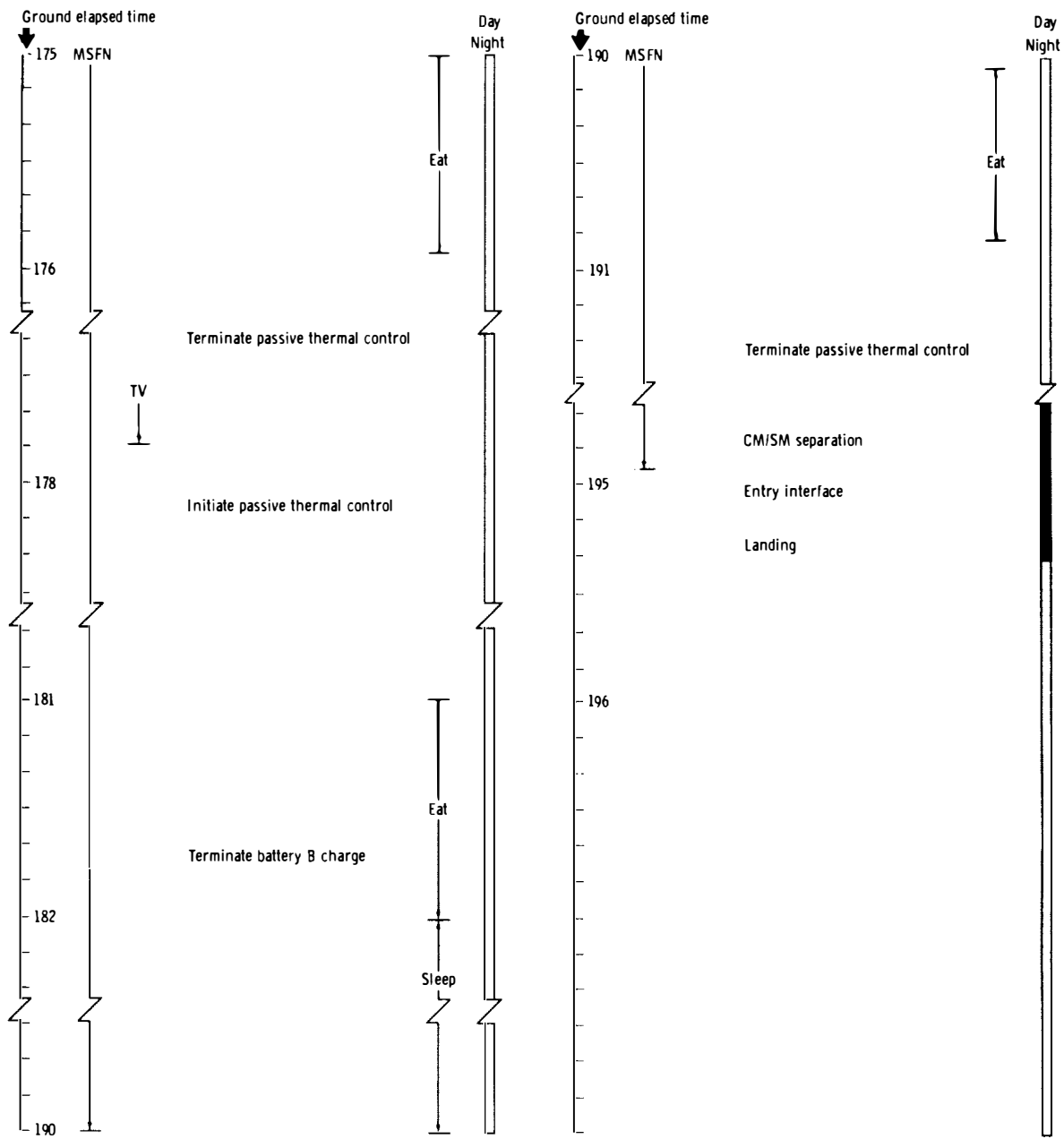

(i) 175 to 196 hours.

Figure 3-1.- Concluded.

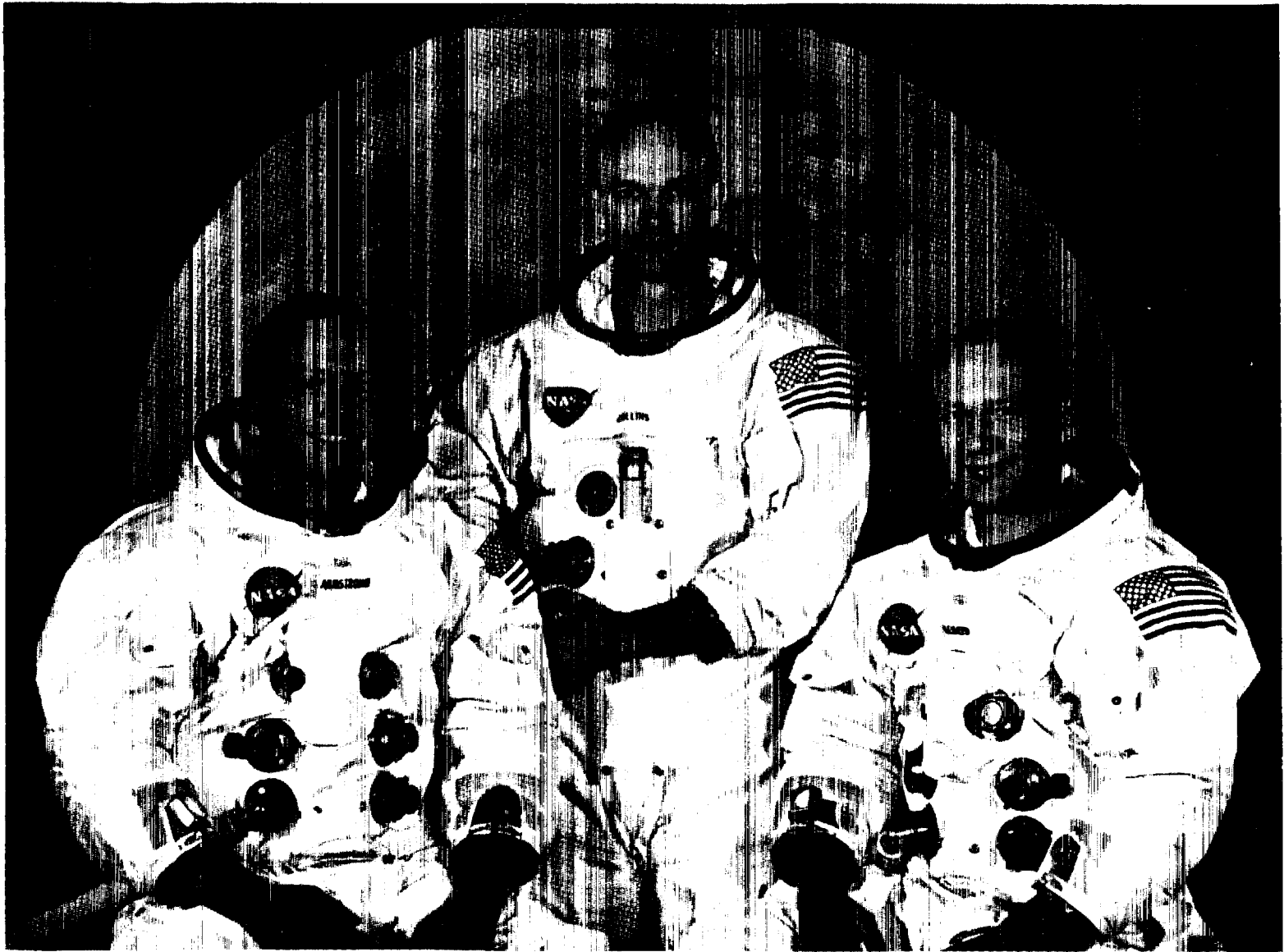

Commander Neil A. Armstrong, Command Module Pilot Michael Collins, and Lunar Module Pilot Edwin E. Aldrin, Jr.

4. PILOTS' REPORT

Prelaunch Activities

All prelaunch systems operations and checks were completed on time and without difficulty. The configuration of the environmental control system included operation of the secondary glycol loop and provided comfortable cockpit temperature conditions.

Launch

Lift-off occurred precisely on time with ignition accompanied by a low rumbling noise and moderate vibration that increased significantly at the moment of holddown release. The vibration magnitudes decreased appreciably at the time tower clearance was verified. The yaw, pitch, and roll guidance-program sequences occurred as expected. No unusual sounds or vibrations were noted during passage through the region of maximum dynamic pressure, and the angle of attack remained near zero. The S-IC/S-II staging sequence occurred smoothly and at the expected time.

The entire S-II stage flight was remarkably smooth and quiet, and the launch escape tower and boost protective cover were jettisoned normally. The mixture-ratio shift of the J2 engine in the S-II stage was accompanied by a noticeable acceleration decrease. The S-II/S-IVB staging sequence occurred smoothly and approximately at the predicted time. The S-IVB insertion trajectory was completed without incident, and the automatic guidance shutdown yielded an insertion-orbit ephemeris, from the command module computer, of 102.1 by 103.9 miles. Communications between the crewmembers and the Manned Space Flight Network were excellent throughout all launch stages.

Earth Orbit Coast and Translunar Injection

The insertion checklist was completed, and a series of spacecraft systems checks disclosed no abnormalities. All tests of the navigation equipment, including alignments and drift checks, were satisfactory. The service module reaction control thrusters were fired in the minimum-impulse mode and were verified by telemetry.

No abnormalities were noted during preparation for translunar injection. Initiation of translunar injection was accompanied by the proper onboard indications, and the S-IVB propellant tanks were repressurized on schedule.

The S-IVB stage reignited on time at 2:44:16 without ignition or guidance transients. An apparent 0.5° to 1.5° pitch-attitude error on the attitude indicators was not confirmed by the command module computer, which indicated that the attitude and the attitude rate duplicated the reference trajectory precisely. (See "Guidance, Navigation, and Control" in section 8.) The guided cut-off yielded a velocity very close to that expected, as indicated by the onboard computer. The entry monitor system further confirmed that the forward velocity error for the translunar injection maneuver was within 3.3 ft/sec.

Transposition and Docking

The digital autopilot was used for the transposition maneuver scheduled to begin 20 seconds after spacecraft separation from the S-IVB. The time delay was to allow the command and service modules to drift approximately 70 feet prior to thrusting back toward the S-IVB. The separation and the beginning of transposition were on time. To assure a pitchup maneuver for better visibility through the hatch window, pitch axis control was retained in a manual mode until after a pitchup rate of approximately 1 deg/sec was

attained. Control was then given to the digital autopilot to continue the combined pitch/roll maneuver. However, the autopilot stopped pitching up at this point, and it was necessary to reestablish manual control. (See "Guidance, Navigation, and Control" in section 8 for more discussion of the autopilot.) This control cycle was repeated several times before the autopilot continued the transposition maneuver. Consequently, additional time and reaction control fuel (18 pounds above the preflight nominal) were required, and the spacecraft reached a maximum separation distance of at least 100 feet from the S-IVB.

The subsequent closing maneuvers were made normally under digital autopilot control by using a 2-deg/sec rate and 0.5° deadband control mode. Contact was made at an estimated 0.1 ft/sec, without side velocity, but with a small roll misalignment. Subsequent tunnel inspection revealed a roll index angle of 2.0° and a contact mark on the drogue 4 inches long. Lunar module extraction was normal.

Translunar Coast

The S-IVB was targeted to achieve a translunar injection cut-off velocity 6.5 ft/sec in excess of that required to place the spacecraft on the desired free-return trajectory. This overspeed was then cancelled by a service propulsion correction of 20 ft/sec at 23 minutes after spacecraft ejection.

Two periods of cislunar midcourse navigation, using the command module computer program (P23), were planned and executed. The first determination, at 6 hours, was primarily to establish the apparent horizon altitude for optical marks in the computer. The first determination was begun at a distance of approximately 30 000 miles; while the second determination, at 24 hours, was designed to establish the optical bias errors accurately. Excess time and fuel were expended during the first period because of difficulty in locating the substellar point of each star. Ground-supplied gimbal angles were used rather than those from the onboard computer. This technique was devised because computer solutions are unconstrained about the optics shaft axis; therefore, the computer is unable to predict if the lunar module structure might block the line of sight to the star. The ground-supplied angles prevented the lunar module structure from occulting the star, but were not accurate in locating the precise substellar point, as evidenced by the fact that the sextant reticle pattern was not parallel to the horizon. Additional maneuvers were required to achieve a parallel reticle pattern near the point of horizon-star superposition.

The second period of navigation measurements was less difficult, largely because the earth appeared much smaller, and trim maneuvers to the substellar point could be made much more quickly and economically.

The digital autopilot was used to initiate the passive thermal control mode at a positive roll rate of 0.3 deg/sec, with the positive longitudinal axis of the spacecraft pointed toward the ecliptic North Pole during translunar coast. (The ecliptic South Pole was the direction used during transearth coast.) After the roll rate had been established, thruster firing was prevented by turning off all 16 switches for the service module thrusters. In general, this method was highly successful in that it maintained a satisfactory spacecraft attitude for long periods of time and allowed the crew to sleep without fear of either entering gimbal lock or encountering unacceptable thermal conditions. However, a procedural refinement in the form of a new computer routine is required to make the operation foolproof from an operator's viewpoint.¹ On several occasions and for several different reasons, an incorrect computer-entry procedure was used,

¹Editor's note: A new routine (routine 64) was available for Apollo 12.

resulting in a slight waste of reaction control propellants. Satisfactory platform alignments (program P52, option 3) using the optics in the resolved mode and medium speed were possible during rotation at 0.3 deg/sec.

Lunar Orbit Insertion

A 6-minute service propulsion maneuver was performed, and the spacecraft was inserted into a 169.9- by 60.9-mile orbit, as determined by the onboard computer. Procedurally, this firing was the same as all the other service propulsion maneuvers, except that it was started by using the bank B propellant valves instead of the bank A valves. The steering of the docked spacecraft was exceptionally smooth, and the control of the applied velocity change was extremely accurate, as evidenced by the fact that residuals were only 0.1 ft/sec in all axes.

The circularization maneuver was targeted for a 66- by 54-mile orbit, a change from the 60-mile circular orbit which had been executed in previous lunar flights. The firing was normally accomplished by using the bank A propellant valves only, and the onboard solution of the orbit was 66.1 by 54.4 miles. The ellipticity of this orbit was supposed to disappear slowly because of irregularities in the lunar gravitational field, such that the command module would be in a 60-mile circular orbit at the time of rendezvous. However, the onboard estimate of the orbit during the rendezvous was 63.2 by 56.8 miles, indicating that the ellipticity decay rate was less than expected. As a result, the rendezvous maneuver solutions differed from the preflight estimates.

Lunar Module Checkout

Two entries were made into the lunar module prior to the final activation on the day of landing. The first entry was made at approximately 57 hours g.e.t. on the day before lunar orbit insertion. Television and still cameras were used to document the hatch probe and drogue removal and the initial entry into the lunar module. The command module oxygen hoses were used to provide circulation in the lunar module cabin. A leisurely inspection period confirmed the proper positioning of all circuit breaker and switch settings and of all stowage items. All cameras were checked for proper operation.

Descent Preparation

Lunar module.- The crew was awakened according to the flight plan schedule. The liquid cooling garments and biomedical harnesses were donned. In anticipation of the donning, these items had been unstowed and prepositioned the evening before. Following a hearty breakfast, the Lunar Module Pilot transferred into the lunar module to accomplish initial activation before returning to the command module for suiting. This staggered suiting sequence served to expedite the final checkout and resulted in only two crewmembers being in the command module during each suiting operation.

The sequence of activities was essentially the same as that developed for Apollo 10, with only minor refinements. Numerous Manned Space Flight Network simulations and training sessions, including suited operations of this mission phase, ensured the completion of this exercise within the allotted time. As in all previous entries into the lunar module, the repressurization valve produced a loud "bang" when it was positioned to CLOSE or AUTO and when the cabin regulator was off. Transfer of power from the command module to the lunar module and then electrical power system activation were completed on schedule.

The primary glycol loop was activated approximately 30 minutes early, with a slow but immediate decrease in glycol temperature. The activation continued to progress

smoothly 30 to 40 minutes ahead of schedule. With the Commander entering the lunar module early, the Lunar Module Pilot had more than twice the normally allotted time to don his pressure suit in the command module.

The early power-up of the lunar module computer and inertial measurement unit enabled the ground to calculate the fine gyro torquing angles for aligning the lunar module platform to the command module platform before the loss of communications on the lunar far side. This early alignment added more than an hour to the planned time available for analyzing the drift of the lunar module guidance system.

After suiting, the Lunar Module Pilot entered the lunar module, the drogue and probe were installed, and the hatch was closed. During the ascent-battery checkout, the variations in voltage produced a noticeable pitch and intensity variation in the already loud noise of the glycol pump. Suit-loop pressure integrity and cabin regulator repressurization checks were accomplished without difficulty. Activation of the abort guidance system produced only one minor anomaly. An illuminated portion of one of the data readout numerics failed, and this failure resulted in some ambiguity in data readout. (See "Electroluminescent Segment on Display Inoperative" in section 16.)

Following command module landmark tracking, the lunar module was maneuvered to obtain steerable antenna acquisition, and state vectors were uplinked into the primary guidance computer. The landing-gear deployment was evidenced by a slight jolt to the spacecraft. The reaction control system, the descent propulsion system, and the rendezvous radar system were activated and checked out. Required pressurization was confirmed both audibly and by instrument readout.

The abort guidance system calibration was accomplished at the preplanned spacecraft attitude. As the command and service modules maneuvered both spacecraft to the undocking attitude, a final switch and circuit breaker configuration check was accomplished, followed by donning of helmets and gloves.

Command module.- Activities after lunar orbit circularization were routine, with the time being used primarily for photographing the lunar surface. The activation of the lunar module in preparation for descent was, from the viewpoint of the Command Module Pilot, a well-organized and fairly leisurely period. During the abort guidance system calibration, the command module was maintained at a fixed attitude for several minutes without firing thrusters. It was easy to stabilize the spacecraft with minimum-impulse control prior to the required period; therefore, no thruster firings were needed for at least 10 minutes.

The probe, drogue, and hatch all functioned perfectly; and the operations of closing out the tunnel, preloading the probe, and cocking the latches were done routinely. Previous practice with installation and removal of the probe and drogue during translunar coast was most helpful.

Two periods of orbital navigation (program P22) were scheduled with the lunar module attached. The first, at 83 hours, consisted of five marks on the Crater Kamp in the Foaming Sea. The technique used was to approach the target area in an inertial attitude hold mode, with the X-axis being roughly horizontal to the target when the spacecraft reached an elevation angle of 35° from the target, at which point a pitch-down of approximately 0.3 deg/sec was begun. This technique, which was necessary to assure a 2-1/2-minute mark period distributed evenly near the zenith, was performed without difficulty.

The second navigation exercise was performed on the following day, shortly prior to separation from the lunar module. A series of five marks was taken on a small crater on the inner north wall of crater 130. The previously described technique was used, except that two forward-firing thrusters (one yaw and one pitch) were inhibited to preclude

thrust impingement on the deployed rendezvous-radar and steerable antennas. The reduced pitch authority doubled the time required (to approximately 3 seconds when using acceleration command) to achieve a 0.3-deg/sec pitch-down rate. Because the Command Module Pilot was in the lower equipment bay, where rate instrumentation is not available, it was necessary in both cases to achieve the pitch rate by timing the duration of acceleration-command hand controller inputs.

To prevent the two spacecraft from slipping and hence upsetting the docked lunar module platform alignment, roll thruster firings were inhibited after the probe preload until the tunnel had been vented to approximately 1 psi. Only single roll jet authority was used after the 1-psi point was reached and until the tunnel pressure became zero.

Undocking and Separation

Particular care was exercised in the operation of both spacecraft throughout the undocking and separation sequences to ensure that the lunar module guidance computer maintained an accurate knowledge of position and velocity.

The undocking action imparted a velocity of 0.4 ft/sec to the lunar module, as measured by the lunar module primary guidance system. The abort guidance system disagreed with the primary system by approximately 0.2 ft/sec, which is well within the preflight limit. The velocity was nulled, since the primary system was assumed to be correct. The command module undocking velocity was maintained until the desired inspection distance of 40 feet was reached. At this distance, the command module velocity was visually nulled with respect to the lunar module.

A visual inspection by the Command Module Pilot during a lunar module 360° yaw maneuver confirmed proper landing-gear extension. The lunar module maintained position with respect to the command module at relative rates believed to be less than 0.1 ft/sec. To enter the planned equiperiod separation orbit, the 2.5-ft/sec radially downward separation maneuver was performed at approximately 100-1/2 hours with the command and service modules.

Lunar Module Descent

The first optical alignment of the inertial platform, in preparation for descent orbit insertion, was accomplished shortly after entering darkness and following separation. The torquing angles were approximately 0.3°, indicating either an error in the docked alignment or platform drift. A rendezvous-radar lock was achieved manually, and the radar boresight coincided with that of the crew optical sight. Radar range was substantiated by the vhf ranging in the command module.

Descent orbit insertion.- The descent orbit insertion maneuver was performed with the descent engine in the manual throttle configuration. Ignition at the minimum-throttle setting was smooth, with no noise or sensation of acceleration. After 15 seconds, the thrust level was advanced to 40 percent, as planned. Throttle response was smooth and free of oscillations. The guided cut-off left residuals of less than 1 ft/sec in each axis. The X- and Z-axis residuals were reduced to zero by using the reaction control system. The computer-determined ephemeris was 9.1 by 57.2 miles, as compared with the predicted value of 8.5 by 57.2 miles. The abort guidance system confirmed that the magnitude of the maneuver was correct. An additional evaluation was performed by using the rendezvous radar to check the relative velocity between the two spacecraft at 6 and 7 minutes subsequent to the maneuver. These velocity values corresponded to the predicted data within 0.5 ft/sec.

Alignment and navigation checks.- Just prior to powered descent, the angle between the line of sight to the sun and a selected axis of the inertial platform was compared

with the onboard computer prediction of that angle, and this comparison provided a check on inertial platform drift. Three such measurements were all within the specified tolerance, but the 0.08° spread between them was somewhat larger than expected.

Visual checks of down-range and cross-range position indicated that ignition for the powered descent firing would occur at approximately the correct location over the lunar surface. Based on measurements of the line-of-sight rate of landmarks, the estimates of altitudes converged on a predicted altitude of 52 000 feet at ignition. These measurements were slightly degraded because of a 10° to 15° yaw bias maintained to improve communications margins.

Powered descent.- Ignition for powered descent occurred on time at the minimum thrust level, and the engine was automatically advanced to the fixed-throttle point (maximum thrust) after 26 seconds. Visual position checks indicated the spacecraft was 2 or 3 seconds early over a known landmark, but with little cross-range error. A yaw maneuver to a faceup position was initiated at an altitude of about 45 900 feet approximately 4 minutes after ignition. The landing radar began receiving altitude data immediately. The altitude difference, as displayed from the radar and the computer, was approximately 2800 feet.

At 5 minutes 16 seconds after ignition, the first of a series of computer alarms indicated a computer overload condition. These alarms continued intermittently for more than 4 minutes, and although continuation of the trajectory was permissible, monitoring of the computer information display was occasionally precluded. (See "Computer Alarms During Descent" in section 16.)

Attitude-thruster firings were heard during each major attitude maneuver and intermittently at other times. Thrust reduction of the descent propulsion system occurred nearly on time (planned at 6 minutes 24 seconds after ignition) and contributed to the prediction that the landing would probably be down range of the intended point, inasmuch as the computer had not been corrected for the observed down-range error.

The transfer to the final-approach-phase program (P64) occurred at the predicted time. After the pitch maneuver and the radar antenna position change, the control system was transferred from the automatic to the attitude hold mode, and control response checked in pitch and roll. Automatic control was restored after the pitch and yaw errors had been reduced to zero.

After it became clear that an automatic descent would terminate in a boulder field surrounding a large sharp-rimmed crater, manual control was again assumed, and the range was extended to avoid the unsatisfactory landing area. The rate-of-descent throttle control mode (program P66) was entered in the computer to reduce the altitude rate so as to maintain sufficient height for landing-site surveillance.

Both the down-range and the cross-range positions were adjusted to permit final descent in a small, relatively level area bounded by a boulder field to the north and by sizable craters to the east and south. Surface obscuration caused by blowing dust was apparent at 100 feet and became increasingly severe as the altitude decreased. Although visual determination of horizontal velocity, attitude, and altitude rate were degraded, cues for these variables were adequate for landing. Landing conditions are estimated to have been 1 or 2 ft/sec left, 0 ft/sec forward, and 1 ft/sec down; no evidence of vehicle instability at landing was observed.

Command Module Solo Activities

The Command Module Pilot consolidated all known documentation requirements for a single volume, known as the Command Module Pilot Solo Book, which was very useful and

took the place of a flight plan, a rendezvous book, an updates book, a contingency extravehicular checklist, and so forth. Normally, this book was anchored to the Command Module Pilot by a clip attached to the end of his helmet tie-down strap. The sleep period was timed to coincide with that of the lunar module crew so that radio silence could be observed. The Command Module Pilot had complete trust in the various systems experts on duty in the Mission Control Center and therefore was able to sleep soundly.

The method used for target acquisition (program P22) while the lunar module was on the surface varied considerably from the method used when the spacecraft were docked. The optical alignment sight reticle was placed on the horizon image, and the resulting spacecraft attitude was maintained manually at the orbital rate in the minimum-impulse control mode. Once stabilized, the spacecraft maintained this attitude long enough to allow the Command Module Pilot to move to the lower equipment bay and take marks. He could also move from the equipment bay to the hatch window in a few seconds to cross-check the attitude. In general, this method of operation was satisfactory.

Despite the fact that the Command Module Pilot had several uninterrupted minutes each time he passed over the lunar module, he could never see the spacecraft on the surface. He was able to scan an area of approximately 1 square mile on each pass, and ground estimates of lunar module position varied by several miles from pass to pass. It is doubtful that the Command Module Pilot was ever looking precisely at the lunar module; he more likely was observing an adjacent area. Although it was not possible to assess the ability to see the lunar module from 60 miles, it was apparent there were no flashes of specular light to attract the Command Module Pilot's attention.

The visibility through the sextant was good enough to allow the Command Module Pilot to acquire the lunar module (in flight) at distances of more than 100 miles. However, the lunar module was lost in the sextant field of view just prior to powered descent initiation (120-mile range) and was not regained until after ascent insertion (at an approximate range of 250 miles), when it appeared as a blinking light in the night sky.

In general, more than enough time was available to monitor systems and perform all necessary functions in a leisurely fashion, except during the rendezvous phase. During that 3-hour period when hundreds of computer entries, as well as numerous marks and other manual operations, were required, the Command Module Pilot had little time to devote to analyzing any off-nominal rendezvous trends as they developed or to cope with any systems malfunctions. Fortunately, no additional attention to these details was required.

Lunar Surface Operations

Postlanding checkout.- The postlanding checklist was completed as planned. Venting of the descent oxidizer tanks was begun almost immediately. When the oxidizer tank pressure was vented to between 40 and 50 psi, fuel was vented to the same pressure level. Apparently, the pressure indications received on the ground were somewhat higher, and they increased with time. (See "High Fuel Interface Pressure after Landing" in section 16.) At ground request, the valves were reopened, and the tanks were vented to 15 psi.

Platform alignment and preparation for early lift-off were completed on schedule without significant problems. The mission timer malfunctioned and displayed an impossible number that could not be correlated with any specific failure time. After several unsuccessful attempts to recycle this timer, it was turned off for 11 hours to cool. The timer was turned on for ascent, and it operated properly and performed satisfactorily for the remainder of the mission. (See "Mission Timer Stopped" in section 16.)

Egress preparation.- The crew had given considerable thought to the advantage of beginning the extravehicular activity as soon as possible after landing instead of

following the flight plan schedule and having the surface operations between two rest periods. The initial rest period was planned to allow flexibility in the event of unexpected difficulty with postlanding activities. These difficulties did not materialize. The crewmen were not overly tired, and no problem was experienced in adjusting to the 1/6-g environment. Based on these facts, the decision was made at 104:40:00 to proceed with the extravehicular activity prior to the first rest period.

Preparation for extravehicular activity began at 106:11:00. The estimate of the preparation time proved to be optimistic. In simulations, 2 hours had been found to be a reasonable allocation; however, everything had also been laid out in an orderly manner in the cockpit, and only those items involved in the extravehicular activity were present. In actual use, checklists, food packets, monoculars, and other items interfered with an orderly preparation. All these items required some thought as to their possible interference or use in the extravehicular activity. This interference resulted in exceeding the time line estimate by a considerable amount. Preparation for egress was conducted slowly, carefully, and deliberately, and future missions should be planned and conducted with the same philosophy. The extravehicular activity preparation checklist was adequate and was followed closely. However, minor items that required a decision in real time or that had not been considered before flight required more time than anticipated.

An electrical connector on the cable that connects the remote control unit to the portable life support system gave some trouble in mating. (See "Mating of Remote Control Unit to Portable Life Support System" in section 16.) This problem had been encountered occasionally with the same equipment before flight. At least 10 minutes were required in order to connect each unit, and at one point it was thought the connection would not be successfully completed.

Considerable difficulty was experienced with voice communications when the extravehicular transceivers were used inside the lunar module. At times, communications between the ground and the lunar module were good, but at other times they were garbled for no obvious reason. Outside the vehicle, no appreciable communications problems occurred. Upon ingress from the surface, communications difficulties recurred, but under different conditions. That is, the voice dropouts to the ground were not repeatable in the same manner.

Depressurization of the lunar module was one aspect of the mission that had never been completely performed on the ground. In the various altitude chamber tests of the spacecraft and the extravehicular mobility unit, a complete set of authentic conditions was never present. The depressurization of the lunar module through the bacteria filter took much longer than had been anticipated. The indicated cabin pressure did not go below 0.1 psi, and some concern was experienced in opening the forward hatch against this residual pressure. The hatch appeared to bend on initial opening, and small particles appeared to be blown out around the hatch when the seal was broken. (See "Slow Cabin Decompression" in section 16.)

Lunar module egress.- Simulation work in both the water immersion facility and the 1/6-g environment in an airplane was reasonably accurate in preparing the crew for lunar module egress. Body positioning and arching-the-back techniques were performed in exiting the hatch, and no unexpected problems were experienced. The forward platform was more than adequate to allow changing the body position from that used in egressing the hatch to that required for getting on the ladder. The first ladder step was somewhat difficult to see and required caution and forethought. In general, the hatch, porch, and ladder operations were not particularly difficult and caused little concern. Operations on the platform could be performed without losing body balance, and adequate maneuvering room was available.

The initial operation of the lunar equipment conveyor in lowering the camera was satisfactory, but after the straps had become covered with lunar surface material, a

problem arose in transporting the equipment back into the lunar module. Dust from this equipment fell back onto the lower crewmember and into the cabin and seemed to bind the conveyor so that considerable force was required in order to operate the conveyor. Alternatives in transporting equipment into the lunar module had been suggested before flight, and although no opportunity was available to evaluate these techniques, the alternatives might have been an improvement over the conveyor.

Surface exploration.- Work in the 1/6-g environment was a pleasant experience. Adaptation to movement was not difficult, and movement seemed to be natural. Certain specific peculiarities, such as the effect of the mass as compared to the lack of traction, can be anticipated; but complete familiarization need not be pursued.

The most effective means of walking seemed to be the lope that evolved naturally. The fact that both feet were occasionally off the ground at the same time, plus the fact that the feet did not return to the surface as rapidly as on earth, required some anticipation before an attempt to stop. Noticeable resistance was provided by the suit, although movement was not difficult.

On future flights, crewmembers may want to consider kneeling in order to work with their hands. Getting to and from the kneeling position would be no problem, and being able to do more work with the hands would increase productive capability.

Photography with the Hasselblad cameras on the remote control unit mounts produced no problems. The first panorama was taken while the camera was hand-held; however, the camera was much easier to operate while on the mount. The handle on the camera was adequate, and few pictures were triggered inadvertently.

The solar wind experiment was easily deployed. As with the other operations involving lunar surface penetration, it was possible to penetrate the lunar surface material only approximately 4 or 5 inches. The experiment mount was not quite as stable as desired, but it stayed erect.

The television system presented no difficulty except that the cord was continually in the way. At first, the white cord showed up well, but it soon became covered with dust and was therefore more difficult to see. The cable had a "set" from being coiled around the reel, and it would not lie completely flat on the surface. Even when it was flat, however, a foot could still slide under it, and the Commander became entangled several times. (See "Television Cable Retained Coiled Shape" in section 16.)

Collecting the bulk sample required more time than anticipated because the modular-equipment-stowage-assembly table was in deep shadow, and collecting samples in that area was far less desirable than taking those in the sunlight. It was also desirable to take samples as far as possible from the exhaust plume and propellant contamination. An attempt was made to include a hard rock in each sample, and approximately 20 trips were required to fill the box. As in simulations, the difficulty of scooping up the material without throwing it out as the scoop became free created some problem. It was almost impossible to collect a full scoop of material, and the task required approximately double the planned time.

Several of the operations would have been easier in sunlight. Although it was possible to see in the shadows, time had to be allowed for dark adaptation when walking from the sunlight into the shadow. On future missions, a yaw maneuver just prior to landing would be advantageous so that the descent stage work area would be in sunlight.

The scientific experiment package was easily deployed manually, and some time was saved as a result. The package was easy to manage, but finding a level area was difficult. A good horizon reference was not available, and in the 1/6-g environment, physical cues were not as effective as in a one-g environment. Therefore, the selection of a

deployment site for the experiments caused some problems. The experiments were placed in an area between shallow craters in surface material which had the same consistency as the surrounding area and which was expected to be stable. Considerable effort was required to change the slope of one of the experiments. It was not possible to lower the equipment by merely forcing it down, and it was necessary to move the experiment back and forth to scrape away the excess surface material.

No abnormal conditions were noted during the lunar module inspection. The insulation on the secondary struts had been damaged from the heat, but the primary struts were only singed or covered with soot. There was much less damage than on the examples that had been seen before flight.

Obtaining the core tube sample presented some difficulty. It was impossible to force the tube more than 4 or 5 inches into the surface material, yet the material provided insufficient resistance to hold the extension handle in the upright position. Since the handle had to be held upright, both hands could not be used on the hammer. In addition, the resistance of the suit made it difficult to steady the core tube and swing the hammer with any great force. The hammer actually missed several times. The amount of force used was sufficient to make dents in the handle, but the core tube could be driven only to a depth of approximately 6 inches. Extraction offered little or virtually no resistance. Two samples were taken. Insufficient time remained to take the documented sample, although as wide a variety of rocks as possible was selected in the remaining time.

The performance of the extravehicular mobility unit was excellent. Neither crewman felt any thermal discomfort. The Commander used the minimum cooling mode for most of the surface operation. The Lunar Module Pilot switched to the maximum diverter valve position immediately after sublimator startup and operated at maximum position for 42 minutes before switching to the intermediate position. The Lunar Module Pilot's switch remained in the intermediate position for the duration of the extravehicular activity. The thermal effect of shadowed areas in comparison to sunlit areas was not detectable inside the suit.

The crewmen were kept physically cool and comfortable, and the ease of performing in the 1/6-g environment indicated that tasks requiring greater physical exertion may be undertaken on future flights. The Commander experienced some physical exertion while transporting the sample return container to the lunar module, but his physical limit had not been approached.

Lunar module ingress.- Ingress to the lunar module produced no problems. The capability to do a vertical jump was used to an advantage in making the first step up the ladder. By doing a deep knee bend, then springing up the ladder, the Commander was able to guide his feet to the third step. Movements in the 1/6-g environment were slow enough to allow deliberate foot placement after the jump. The ladder was somewhat slippery from the powdery surface material, but not dangerously so.

As previously stated, mobility on the platform was adequate for developing alternate methods of transferring equipment from the surface. The hatch opened easily, and the ingress technique developed before flight was satisfactory. At a point about halfway through the hatch, a concerted effort to arch the back was required in order to keep the forward end of the portable life support system low enough to clear the hatch. Little exertion was associated with transition to a standing position.

Because of the bulk of the extravehicular mobility unit, caution had to be exercised to avoid bumping into switches, circuit breakers, and other controls while moving around the cockpit. One circuit breaker was in fact broken as a result of contact (section 16).

Equipment jettison was performed as planned, and the time taken before flight in determining the items not required for lift-off was well spent. Considerable weight reduction and increase in space was realized. Discarding the equipment through the hatch was not difficult, and only one item remained on the platform. The post-ingress checklist procedures were performed without difficulty; the checklist was well-planned and was followed precisely.

Lunar rest period.- The rest period was almost completely unsatisfactory. The helmets and gloves were worn to relieve subconscious anxiety about a loss of cabin pressure, and they presented no problem. But noise, lighting, and a lower-than-desired temperature were annoying. The suits were uncomfortably cool, even with the waterflow disconnected. Oxygen flow was finally cut off, and the helmets were removed, but the noise from the glycol pumps was then loud enough to interrupt sleep. The window shades did not completely block out light, and the cabin was illuminated by a combination of light passing through the shades, warning lights, and display lighting. The Commander rested on the ascent engine cover and was bothered by the light entering through the telescope. The Lunar Module Pilot estimated that he slept fitfully for perhaps 2 hours, and the Commander did not sleep at all, even though body positioning was not a problem. Because of the reduced gravity, the positions on the floor and on the engine cover were both quite comfortable.

Launch Preparation

Alining the platform before lift-off was complicated by the limited number of stars available. Because of sun and earth interference, only two detents effectively remained from which to select stars. Accuracy is greater for stars close to the center of the field, but none were available at this location. A gravity/one-star alinement was successfully performed. A manual averaging technique was used to sample five successive cursor readings and then five spiral readings. The result was then entered into the computer. This technique appeared to be easier than taking and then entering five separate readings. Torquing angles were close to 0.7° in all three axes and indicated that the platform drifted.²

After the alinement, the navigation program was entered. It is recommended that future crews update the abort guidance system with the primary guidance state vector at this point and then use the abort guidance system to determine the command module location. The primary guidance system cannot be used to determine the command module range and range rate, and the radar will not lock on until the command module is within a 400-mile range. As this range is approached, the abort guidance system provides valid data.

A cold-fire reaction control system check and an abort guidance system calibration were performed, and the ascent pad was taken. Approximately 45 minutes prior to lift-off, another platform alinement was performed. The landing-site alinement option at ignition was used for lift-off. The torquing angles for this alinement were approximately 0.09° .

In accordance with ground instructions, the rendezvous radar was placed in the antenna SLEW position with the circuit breakers off for ascent to avoid recurrence of the alarms experienced during a descent.

Both crewmembers had forgotten to watch for the small helium pressure decrease indication that the Apollo 10 crew experienced when the ascent tanks were pressurized, and

²Editor's note: However, platform drift was within specification limits.

the crew initially believed that only one tank had been pressurized. This oversight was temporary, but it delayed the crew verification of proper pressurization of both tanks.

Ascent

The pyrotechnic noises at descent stage separation were loud, but ascent-engine ignition was inaudible. The yaw and pitch maneuvers were smooth. The pitch- and roll-attitude limit cycles were as expected and were not accompanied by physiological difficulties. Both the primary and the abort guidance systems indicated the ascent to be a duplicate of the planned trajectory. The guided cut-off yielded residuals of less than 2 ft/sec; and the inplane components were nulled to within 0.1 ft/sec with the reaction control system. Throughout the trajectory, the ground track could be visually verified, although a pitch attitude confirmation by use of the horizon in the overhead window was difficult because of the horizon lighting condition.

Rendezvous

At orbital insertion, the primary guidance system showed an orbit of 47.3 by 9.5 miles, as compared to the abort guidance system solution of 46.6 by 9.5 miles. Since radar range-rate data were not available, the Manned Space Flight Network quickly confirmed that the orbital insertion was satisfactory.

In the preflight planning, stars had been chosen that would be in the field of view and that would require a minimum amount of maneuvering to get through alignment and back in plane. This maintenance of a nearly fixed attitude would permit the radar to be turned on and the acquisition conditions to be designated so that marks for a coelliptic sequence initiation solution would be immediately available. During the simulations, these preselected stars had not been correctly located relative to the horizon, and time and fuel were wasted in first maneuvering to these stars, then failing to mark on them, and finally maneuvering to an alternate pair. Even with these problems, the alignment was finished approximately 28 minutes before the coelliptic sequence initiation, and it was possible to proceed with radar lock-on.

All four sources for the coelliptic sequence initiation solution agreed to within 0.2 ft/sec, an accuracy that had never been observed before. The Commander elected to use the primary guidance solution without any out-of-plane thrusting.

The coelliptic sequence initiation maneuver was accomplished by using the plus Z thrusters, and the radar lock-on was maintained throughout the firing. Continued navigation tracking by both spacecraft indicated a plane-change maneuver of approximately 2.5 ft/sec, but the crew elected to defer this small correction until terminal phase initiation. The small out-of-plane velocities that existed between the spacecraft orbits indicated a highly accurate lunar surface alignment. As a result of the higher-than-expected ellipticity of the command module orbit, backup chart solutions were not possible for the first two rendezvous maneuvers, and the constant-differential height maneuver had a higher-than-expected vertical component. The computers in both spacecraft agreed closely on the maneuver values, and the lunar module primary guidance computer solution was executed by using the minus X thrusters.

During the coelliptic phase, radar tracking data were inserted into the abort guidance system to obtain an independent intercept guidance solution. The primary guidance solution was 6-1/2 minutes later than planned. However, the intercept trajectory was nominal, with only two small midcourse corrections of 1.0 and 1.5 ft/sec. The line-of-sight rates were low, and the planned braking schedule was used to reach a station-keeping position.

In the process of maneuvering the lunar module to the docking attitude, while at the same time avoiding direct sunlight in the forward windows, the platform inadvertently reached gimbal lock. The docking was completed by using the abort guidance system for attitude control.

Command Module Docking

Pre-docking activities in the command module were normal in all respects, as was docking up to the point of probe capture. After the Command Module Pilot ascertained that a successful capture had occurred, as indicated by "barberpole" indicators, the CMC-FREE switch position was used and one retract bottle fired. A right yaw excursion of approximately 15° took place immediately for 1 or 2 seconds. The Command Module Pilot went back to the CMC-AUTO switch position and made hand-controller inputs to reduce the angle between the two vehicles to zero. At docking, thruster firings occurred unexpectedly in the lunar module when the retract mechanism was actuated, and attitude excursions of up to 15° were observed. The lunar module was manually realigned. While this maneuver was in progress, all 12 docking latches fired, and docking was completed successfully. (See "Guidance, Navigation, and Control" in section 8.)

Following docking, the tunnel was cleared, and the probe and drogue were stowed in the lunar module. The items to be transferred to the command module were cleaned by using a vacuum brush attached to the lunar module suit return hose. The suction was low, and as a result, the process was rather tedious. The sample return containers and film magazines were placed in appropriate bags to complete the transfer, and the lunar module was configured for jettison according to the checklist procedure.

Transearth Injection

The time between docking and transearth injection was more than adequate to clean all equipment contaminated with lunar surface material and to return it to the command module for stowage so that the necessary preparations for transearth injection could be made. The transearth injection maneuver, the last service propulsion engine firing of the flight, was nominal. The only difference between the transearth maneuver and previous firings was that without the docked lunar module, the start transient was apparent.

Transearth Coast

During transearth coast, faint spots or scintillations of light were observed within the command module cabin. These phenomena became apparent after the Commander and the Lunar Module Pilot became dark-adapted and relaxed.³

³Editor's note: The source or cause of the light scintillations is as yet unknown. One explanation involves primary cosmic rays with energies in the range of billions of electron volts bombarding an object in outer space. The theory assumes that numerous heavy and high-energy cosmic particles penetrate the command module structure, causing heavy ionization inside the spacecraft. When liberated electrons recombine with ions, photons in the visible portion of the spectrum are emitted. If a sufficient number of photons is emitted, a dark-adapted observer can detect the photons as a small spot or a streak of light. Two simple laboratory experiments were conducted to substantiate the theory, but no positive results were obtained in a 5-psi pressure environment because a high enough energy source was not available to create the radiation at that pressure. This level of radiation does not present a crew hazard.

Only one midcourse correction, a reaction control system firing of 4.8 ft/sec, was required during transearth coast. In general, the transearth coast period was characterized by a general relaxation on the part of the crew, with plenty of time available to sample the excellent variety of food packets and to take photographs of the shrinking moon and the growing earth.

Entry

Because of the presence of thunderstorms in the primary recovery area (1285 miles down range from the entry interface of 400 000 feet), the targeted landing point was moved to a range of 1500 miles from the entry interface. This change required the use of computer program P65 (skip-up control routine) in the computer, in addition to those programs used for the planned shorter range entry. This change caused the crew some apprehension because such entries had rarely been practiced in preflight simulations. However, during the entry, these parameters remained within acceptable limits. The entry was guided automatically and was nominal in all respects. The first acceleration pulse reached approximately 6.5g, and the second reached 6.0g.

Recovery

Upon landing, the 18-knot surface wind filled the parachutes and immediately rotated the command module into the apex down (stable II) flotation position prior to parachute release. Moderate wave-induced oscillations accelerated the uprighting sequence, which was completed in less than 8 minutes. No difficulties were encountered in completing the postlanding checklist.

The biological isolation garments were donned inside the spacecraft. Crew transfer into the raft was followed by hatch closure and by decontamination of the spacecraft and crewmembers by means of germicidal scrubdown.

Helicopter pickup was performed as planned, but visibility was substantially degraded because of moisture condensation on the biological isolation garment faceplate. The helicopter transfer to the aircraft carrier was performed as quickly as could be expected, but the temperature increase inside the suit was uncomfortable. Transfer from the helicopter into the mobile quarantine facility completed the voyage of Apollo 11.

5. LUNAR DESCENT AND ASCENT

Descent Trajectory Logic

The lunar descent trajectory, shown in figure 5-1, began with a descent orbit insertion maneuver targeted to place the spacecraft into a 60- by 8.2-mile orbit with the pericyynthion longitude located approximately 260 miles up range from the landing site. Powered descent, shown in figure 5-2, was initiated at pericynthion and continued through landing.

The powered descent trajectory was designed with factors considered such as optimum propellant usage, navigation uncertainties, landing-radar performance, terrain uncertainties, and crew visibility restrictions. The basic premise during trajectory design was to maintain near-optimum use of propellant during initial braking and to provide a standard final approach from which the landing area could be assessed and a desirable landing location selected. The onboard guidance capability allowed the crew to redesignate the desired landing position in the computer for automatic execution or, if late in the trajectory, to take over manually and fly the lunar module to the desired point. To provide these descent characteristics, compatibility between the automatic and manually controlled trajectories was required, as well as acceptable flying quality under manual control. Because of guidance dispersions, site-selection uncertainties, visibility restrictions, and undefined surface irregularities, measures were taken to provide the crew adequate flexibility in the terminal-approach technique, with the principal limitation being descent propellant quantity.

The major phases of powered descent are the braking phase (which terminates at an altitude of 7700 feet), the approach or visibility phase (to an altitude of approximately 500 feet), and the final landing phase. Three separate computer programs, one for each phase, in the primary guidance system execute the desired trajectory such that the various position, velocity, acceleration, and visibility constraints are satisfied. These programs provide an automatic guidance and control capability for the lunar module from powered descent initiation to landing. The braking phase program (P63) is initiated approximately 40 minutes before the descent engine ignition and controls the lunar module until the final approach phase program (P64) is automatically entered to provide proper trajectory conditions and optimum landing-site visibility.

If desired, during a nominal descent, the crew may select the manual landing phase program (P66) prior to completion of the final approach phase program (P64). If the manual landing phase program (P66) is not entered, the automatic landing phase program (P65) will be entered automatically when the time to go equals 12 seconds (at an altitude of approximately 150 feet). The automatic landing phase program (P65) initiates an automatic descent by nulling the horizontal velocity relative to the surface and maintaining the rate of descent at 3 ft/sec. The manual landing phase program (P66) is initiated when the crew changes the position of the primary guidance mode control switch from automatic to attitude-hold and then actuates the rate-of-descent control switch. Spacecraft attitude changes are then controlled manually by the crew; the descent engine throttle is under computer control; and the Commander can introduce 1-ft/sec increments into the descent rate by using the rate-of-descent switch.

To assure proper operation of the onboard systems throughout the descent phase, maximum use was made (both on board and on the ground) of all data, system responses, and cues, based on the spacecraft position with respect to the designated lunar features. The two onboard guidance systems provided the crew with a continuous check of selected navigation parameters. Comparisons were made on the ground between data from each of the onboard systems and comparable information derived from tracking data. A powered flight processor was used to simultaneously reduce Doppler tracking data from three or

more ground stations and to calculate the required parameters. A filtering technique was used to compute corrections to the Doppler tracking data and thereby define an accurate vehicle state vector. The ground data were used as a voting source in case of a slow divergence between the two onboard systems.

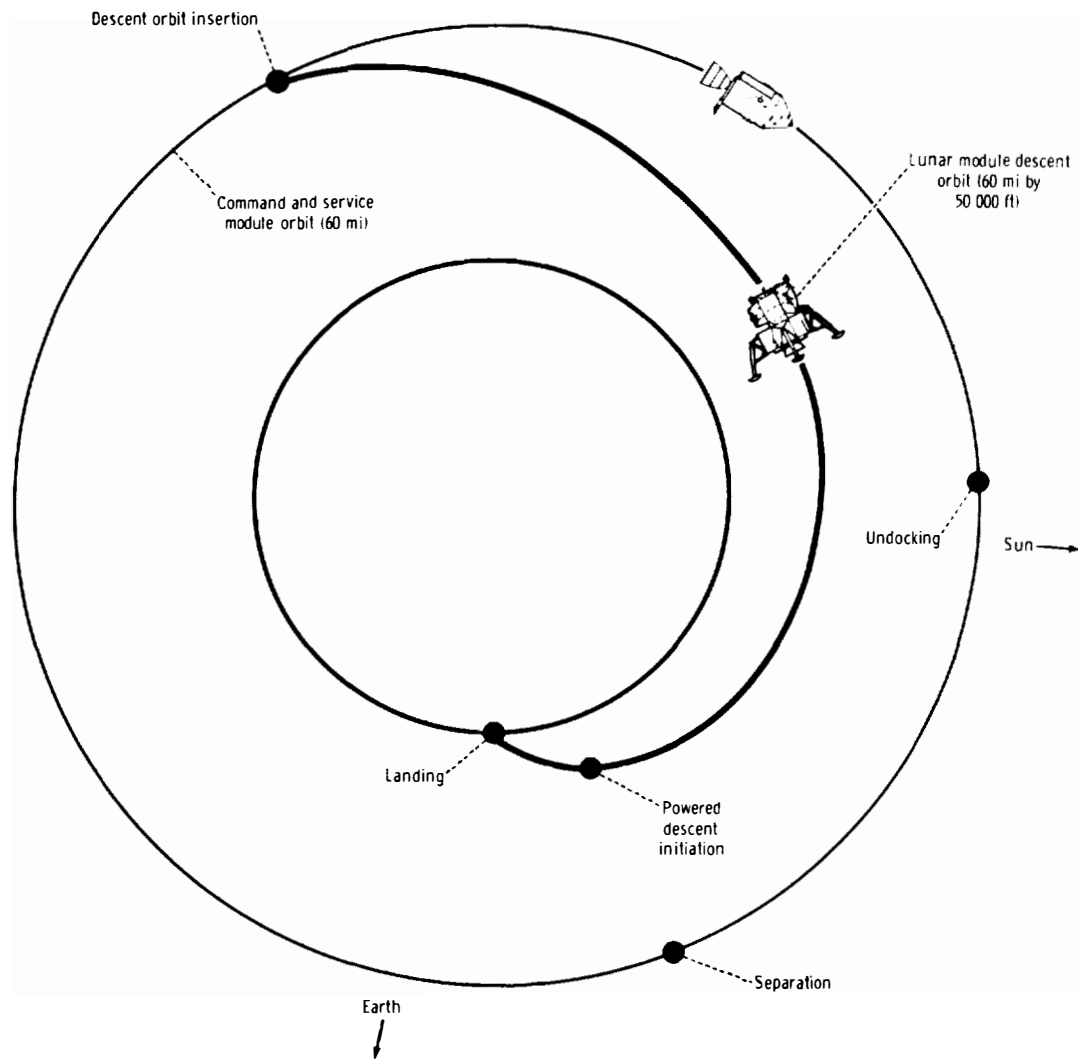
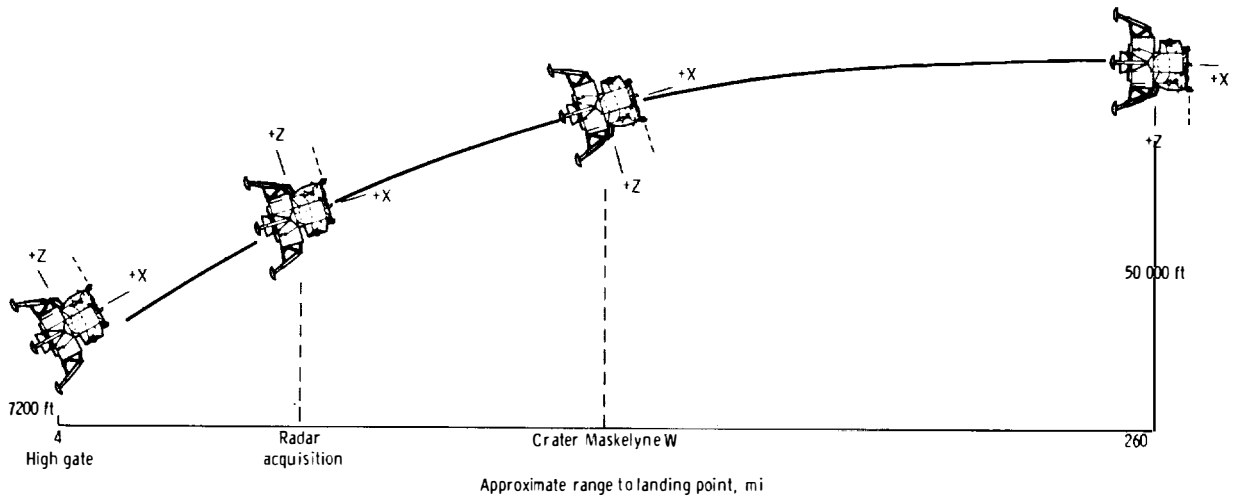
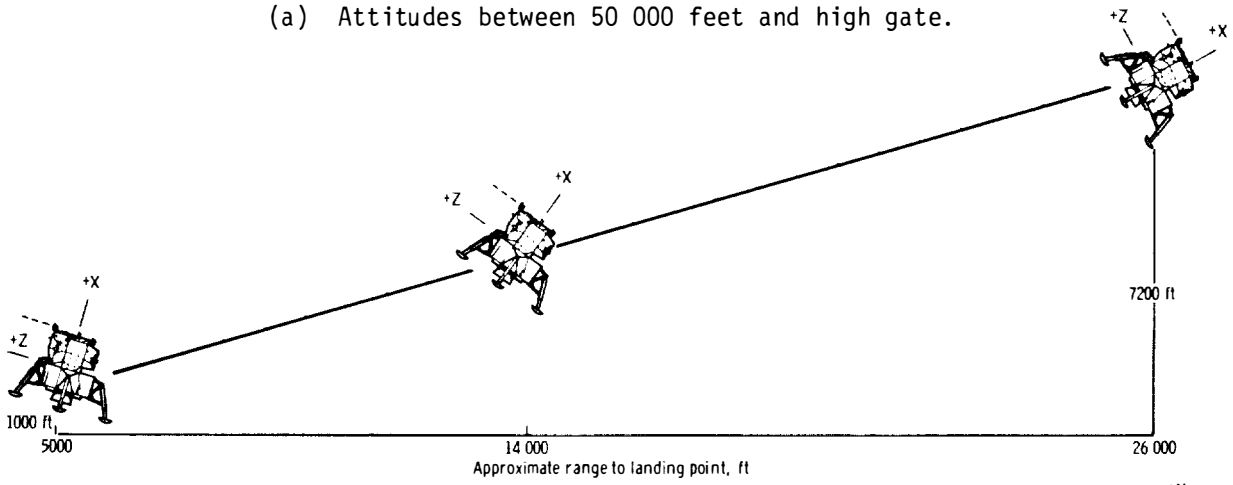

Figure 5-1.- Lunar module descent orbital events.



(a) Attitudes between 50 000 feet and high gate.



(b) Attitudes between high gate and attitude hold.

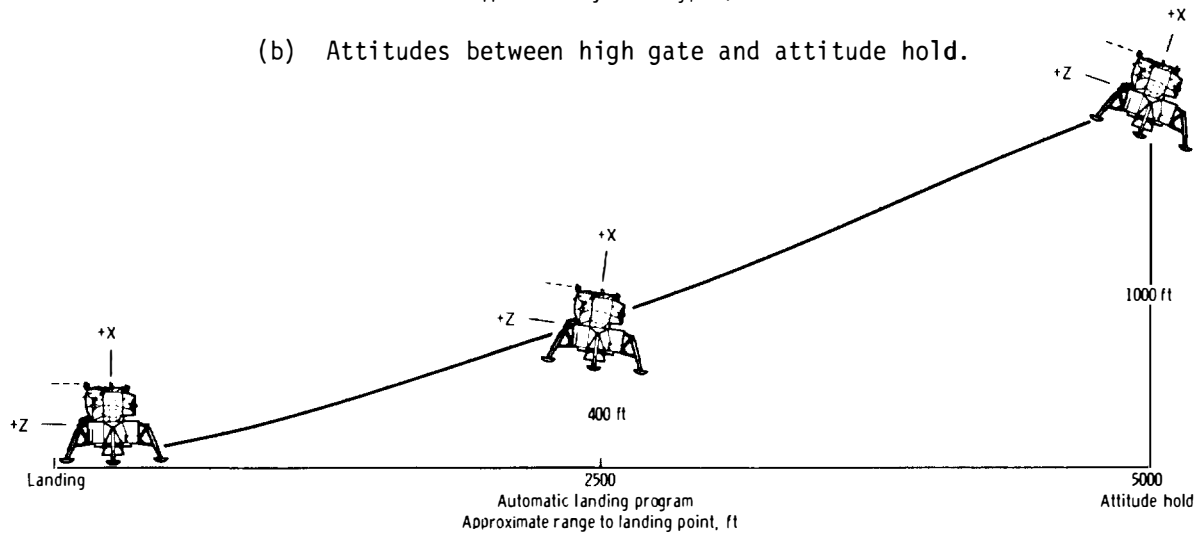

(c) Attitudes between attitude hold and landing.

Figure 5-2.- Spacecraft attitudes during powered descent.

Preparation for Powered Descent

Following the first sleep period in lunar orbit, the crew entered and began activation of the lunar module. (See "Descent Preparation" in section 4.) A listing of the significant events for lunar module descent is presented in table 5-I.

Undocking was accomplished on schedule just prior to acquisition of signal on lunar revolution 13. After the lunar module inspection by the Command Module Pilot, a separation maneuver was performed by the command and service modules; 20 minutes later, the rendezvous-radar and vhf ranging outputs were compared. The two systems agreed and indicated a 0.7-mile range. The inertial measurement unit was aligned optically for the first time, and the resulting gyro torquing angles were well within the platform drift criteria for a satisfactory primary system. Descent orbit insertion was performed on time approximately 8 minutes after Manned Space Flight Network loss of signal. Table 5-II contains the trajectory information on the descent orbit insertion, as reported by the crew following acquisition of signal on lunar revolution 14. An incorrectly loaded target vector caused a relatively large Z-axis residual for the abort guidance system. With this exception, the residuals were well within the three-sigma dispersion (± 0.6 ft/sec) predicted before flight.

Following descent orbit insertion, rendezvous-radar data were recorded by the Lunar Module Pilot and were used to predict that the pericyynthion point would be at an altitude of approximately 50 000 feet. Initial checks using the landing point designator capability produced close agreement by indicating an altitude of 52 000 feet. Following descent orbit insertion, the crew also reported that a solar sighting performed by using the alinement telescope was well within the powered descent initiation go/no-go criterion of 0.25° . The solar sighting consisted of acquiring the sun through the telescope and comparing the actual gimbal angles to those theoretically required and computed by the onboard computer for this observation. This check is an even more accurate indication of platform performance if the 0.07° bias correction for the telescope rear detent position is subtracted from the recorded data.

The comparison of velocity residuals between ground tracking data and the onboard system, as calculated along the earth-moon line-of-sight, provided an additional check on the performance of the primary guidance system. A 2-ft/sec residual was recorded at acquisition of signal and provided confidence that the onboard state vector would have altitude and down-range velocity errors of small magnitude at powered descent initiation. The Doppler residual was computed by comparing the velocity measured along the earth-moon line-of-sight by ground tracking with the same velocity component computed by the primary system. As the lunar module approached powered descent initiation, the Doppler residual began to increase in magnitude to approximately 13 ft/sec. Because the earth-moon line-of-sight vector was almost normal to the velocity vector at this point, the residual indicated that the primary system estimate of its state vector was approximately 21 000 feet up range of the actual state vector. This same error was also reflected in the real-time comparisons made by using the powered flight processor previously mentioned. Table 5-III is a comparison of the latitude, longitude, and altitude between the best-estimate trajectory state vector at powered descent initiation, the operational

trajectory, and the preflight calculated trajectory. The onboard state-vector errors at powered descent initiation resulted from a combination of the following conditions:

1. Uncoupled thruster firings during the docked landmark tracking exercise
2. Unaccounted-for velocity accrued during undocking and subsequent inspection and station-keeping activity
3. Descent orbit insertion residual
4. Propagated errors in the lunar potential function
5. Lunar module venting

TABLE 5-I.- LUNAR DESCENT EVENT TIMES

Time, hr:min:sec	Event
102:17:17	Acquisition of data
102:20:53	Landing radar on
102:24:40	Abort guidance alinement to primary guidance
102:27:32	Yaw maneuver to obtain improved communications
102:32:55	Altitude of 50 000 feet
102:32:58	Propellant-settling firing start
102:33:05	Descent engine ignition
102:33:31	Fixed throttle position (crew report)
102:36:57	Faceup yaw maneuver in process
102:37:51	Landing-radar data good
102:37:59	Faceup maneuver complete
102:38:22	1202 alarm (computer determined)
102:38:45	Radar updates enabled
102:38:50	Altitude less than 30 000 feet (inhibit X-axis override)
102:38:50	Velocity less than 2000 ft/sec (start landing-radar velocity update)
102:39:02	1202 alarm
102:39:31	Throttle recovery
102:41:32	Program P64 entered
102:41:37	Landing-radar antenna to position 2
102:41:53	Attitude-hold (handling qualities check)
102:42:03	Automatic guidance
102:42:18	1201 alarm (computer determined)
102:42:19	Landing-radar low scale (less than 2500 feet)
102:42:43	1202 alarm (computer determined)
102:42:58	1202 alarm (computer determined)
102:43:09	Landing-point redesignation
102:43:13	Attitude-hold
102:43:20	Abort guidance attitude update
102:43:22	Program P66 entered
102:44:11	Landing-radar data not good
102:44:21	Landing-radar data good
102:44:28	Redline low-level sensor light
102:44:59	Landing-radar data not good
102:45:03	Landing-radar data good
102:45:40	Landing
102:45:40	Engine off

TABLE 5-II.- DESCENT ORBIT INSERTION
MANEUVER RESIDUALS

Axis	Velocity residual, ft/sec	
	Before trimming	After trimming
X	-0.1	0.0
Y	-.4	-.4
Z	-.1	.0

TABLE 5-III.- POWERED DESCENT INITIATION STATE VECTORS

Parameter	Operational trajectory	Best-estimate trajectory	Primary guidance computer
Latitude, deg	0.9614	1.037	1.17
Longitude, deg	39.607	39.371	39.48
Altitude, ft	50 000	49 376	49 955

Powered Descent

The powered descent maneuver began with a 26-second thrusting period at minimum throttle. Immediately after ignition, S-band communications were interrupted momentarily but were reestablished when the antenna was switched from the automatic to the slew position. The descent maneuver was initiated in a facedown attitude to permit the crew to make time marks on selected landmarks. A landing point designator sighting on the crater Maskelyne W was approximately 3 seconds early, confirming the suspected down-range error. Following the landmark sightings, a yaw maneuver to faceup attitude was initiated at an indicated altitude of approximately 45 900 feet. The maneuver took longer than expected because of an incorrect setting of a rate display switch.

Landing-radar lock-on occurred before the end of the yaw maneuver, with the spacecraft rotating at approximately 4 deg/sec. The altitude difference between that calculated by the onboard computer and that determined by the landing radar was approximately 2800 feet, which agreed with the altitude error suspected from the Doppler residual comparison. Radar altitude updates of the onboard computer were enabled at 102:38:45, and the differences converged within 30 seconds. Velocity updates began automatically 4 seconds after the altitude update was enabled. Two altitude-difference transients occurred during computer alarms and were apparently associated with incomplete radar data readout operations. (See "Computer Alarms During Descent" in section 16.)

The reduction in throttle setting was predicted to occur 384 seconds after ignition; actual throttle reduction occurred at 386 seconds, which indicated nominal performance of the descent engine.

The first of five computer alarms occurred approximately 5 minutes after initiation of the descent. Occurrences of these alarms are indicated in table 5-I and are discussed in "Computer Alarms During Descent" in section 16. Although the alarms did not degrade the performance of any primary guidance or control function, they did interfere with an early assessment of the landing approach by the crew.

Arrival at high gate (end of braking phase) and the automatic switch to the final approach phase program (P64) occurred at 7129 feet at a 125-ft/sec descent rate. These values are slightly lower than predicted but are within acceptable boundaries. At approximately 5000 feet, the Commander switched his control mode from automatic to attitude-hold to check manual control in anticipation of the final descent.

After the pitchover at high gate, the landing point designator indicated that the approach path was leading into a large crater. An unplanned redesignation was introduced at this time. To avoid the crater, the Commander again switched from automatic to attitude-hold control and manually increased the flight-path angle by pitching to a nearly vertical attitude for range extension. Manual control began at an altitude of approximately 600 feet. Ten seconds later, at approximately 400 feet, the rate-of-descent mode was activated to control descent velocity. In this manner, the spacecraft was guided approximately 1100 feet down range from the initial aim point.

Figure 5-3 contains histories of altitude compared with altitude rate from the primary and abort guidance systems and from the Manned Space Flight Network powered flight processor. The altitude difference existing between the primary system and the Manned Space Flight Network at powered descent initiation can be observed in figure 5-3. All three sources are initialized to the primary guidance state vector at powered descent initiation. However, the primary system is updated by the landing radar, and the abort guidance system is not. As indicated in figure 5-3, the altitude read-outs from both systems gradually diverged so as to indicate a lower altitude for the primary system until the abort system was manually updated with altitude data from the primary system.

The powered flight processor data reflect both the altitude and down-range errors existing in the primary system at powered descent initiation. The radial velocity error is directly proportional to the down-range position error such that a 1000-foot down-range error will cause a 1-ft/sec radial velocity error. Therefore, the 20 000-foot down-range error existing at powered descent initiation was also reflected as a 20-ft/sec radial velocity residual. In figure 5-3, this error is apparent in the altitude region near 27 000 feet, where an error of approximately 20 ft/sec is evident. The primary-system altitude error in existence at powered descent initiation manifests itself at touchdown when the powered flight processor indicates a landing altitude below the lunar surface. Figure 5-4 contains a similar comparison of lateral velocity from the three sources. Again, the divergence noted in the final phases in the abort guidance system data was caused by a lack of radar updates.

Figure 5-5 contains a time history of spacecraft pitch attitude recorded by the primary and abort guidance systems. The scale is set up so that a pitch of 0° would place the X-axis of the spacecraft vertical at the landing site. Two separate designations of the landing site are evident in the phase after manual takeover. Figure 5-6 contains comparisons for the pitch and roll attitudes and indicates the lateral corrections made in the final phase.

Figure 5-7 is an enlarged photograph of the area adjacent to the lunar landing site and shows the final portions of the ground track to landing. Figure 5-8 is an area photograph, taken from a Lunar Orbiter flight, showing the landing-site ellipse and the ground track flown to the landing point. Figure 5-9 contains a preliminary attempt to reconstruct the surface terrain viewed during descent, based upon trajectory and radar data and upon known surface features. The coordinates of the landing point, as obtained

from the various real-time and postflight sources, are shown in table 5-IV. As shown in figure 5-10, the actual landing point was latitude 0°41'15" N and longitude 23°26' E, compared with the targeted landing point of latitude 0°43'53" N and longitude 23°38'51" E. In this report, figure 5-10 is the basic reference map for the location of the landing point. As noted, the landing point dispersion was caused primarily by errors in the on-board state vector prior to powered descent initiation.

Figure 5-11 is a time history of pertinent vehicle control parameters during the entire descent phase. Evidence of fuel slosh was detected in the attitude-rate information following the yaw maneuver. The slosh effect increased to the point where reaction control thruster firings were required to damp the rate prior to throttle recovery. The dynamic behavior at this point and through the remainder of the descent was comparable to that observed in simulations and indicates nominal control system performance.

Approximately 95 pounds of reaction control propellant were used during powered descent, as compared to the predicted value of 40 pounds. Plots of propellant consumption for the reaction control and descent propulsion systems are shown in figure 5-12. The reaction control propellant consumption while in the manual descent control mode was 51 pounds, approximately 1-1/2 times greater than that for the automatic mode. This increase in usage rate is attributed to the requirement for greater attitude and translation maneuvering in the final stages of descent. The descent propulsion system propellant usage was greater than predicted because of the additional time required for the landing-site redesignation.

TABLE 5-IV.- LUNAR LANDING COORDINATES^a

Data source for solution	Latitude, deg N (b)	Longitude, deg E	Radius of landing site 2, miles
Primary guidance onboard vector	0.649	23.46	937.17
Abort guidance onboard vector	.639	23.44	937.56
Powered flight processor (based on 4-track solution)	.631	23.47	936.74
Alinement optical telescope	.523	23.42	
Rendezvous radar	.636	23.50	937.13
Best-estimate trajectory acceler- ometer reconstruction	.647	23.505	937.14
Lunar module target	.691	23.72	937.05
Photography	.647 or ^c 0°41'51"	23.505 or ^c 23°26'00"	

^aFollowing the Apollo 10 mission, a difference was noted (from the landmark tracking results) between the trajectory coordinate system and the coordinate system on the reference map. In order to reference trajectory values to the 1:100,000 scale Lunar Map ORB-II-6 (100), dated December 1967, correction factors of +2'25" in latitude and -4'17" in longitude must be applied to the trajectory values.

^bAll latitude values are corrected for the estimated out-of-plane position error at powered descent initiation.

^cThese coordinate values are referenced to Lunar Map ORB-II-6 (100) and include the correction factors.

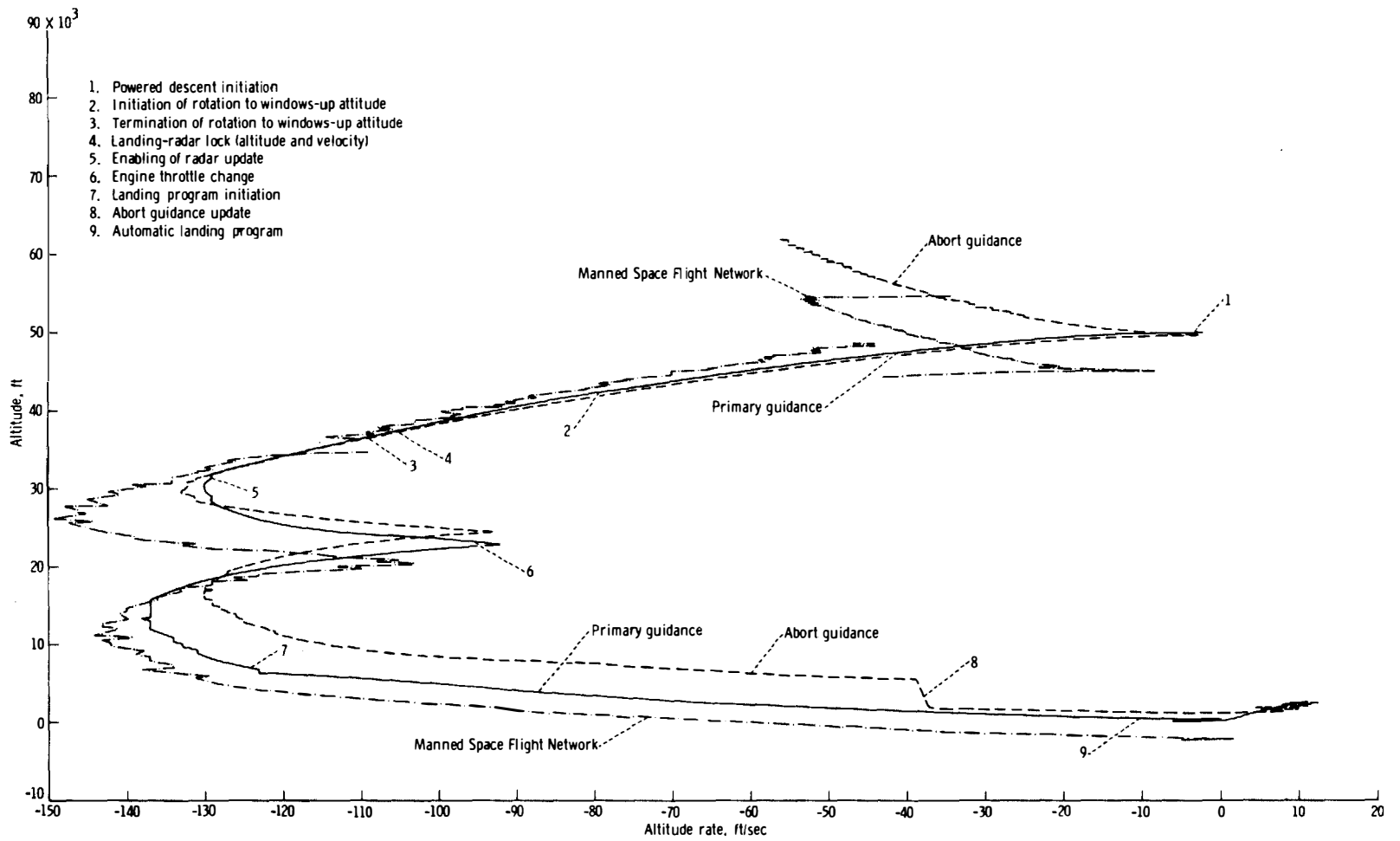

Figure 5-3.- Comparison of altitude and altitude rate during descent.

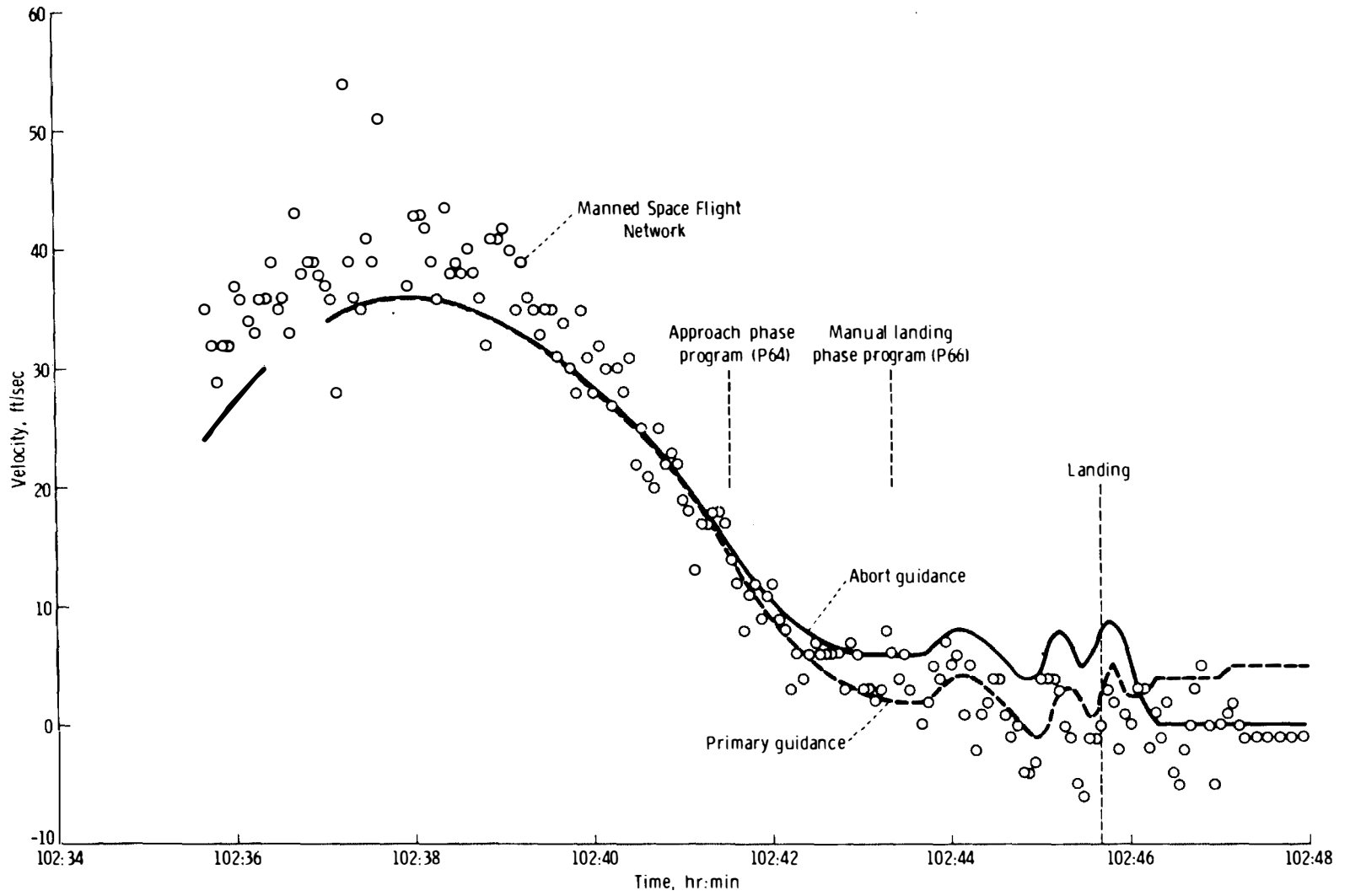

Figure 5-4.- Comparison of lateral velocity.

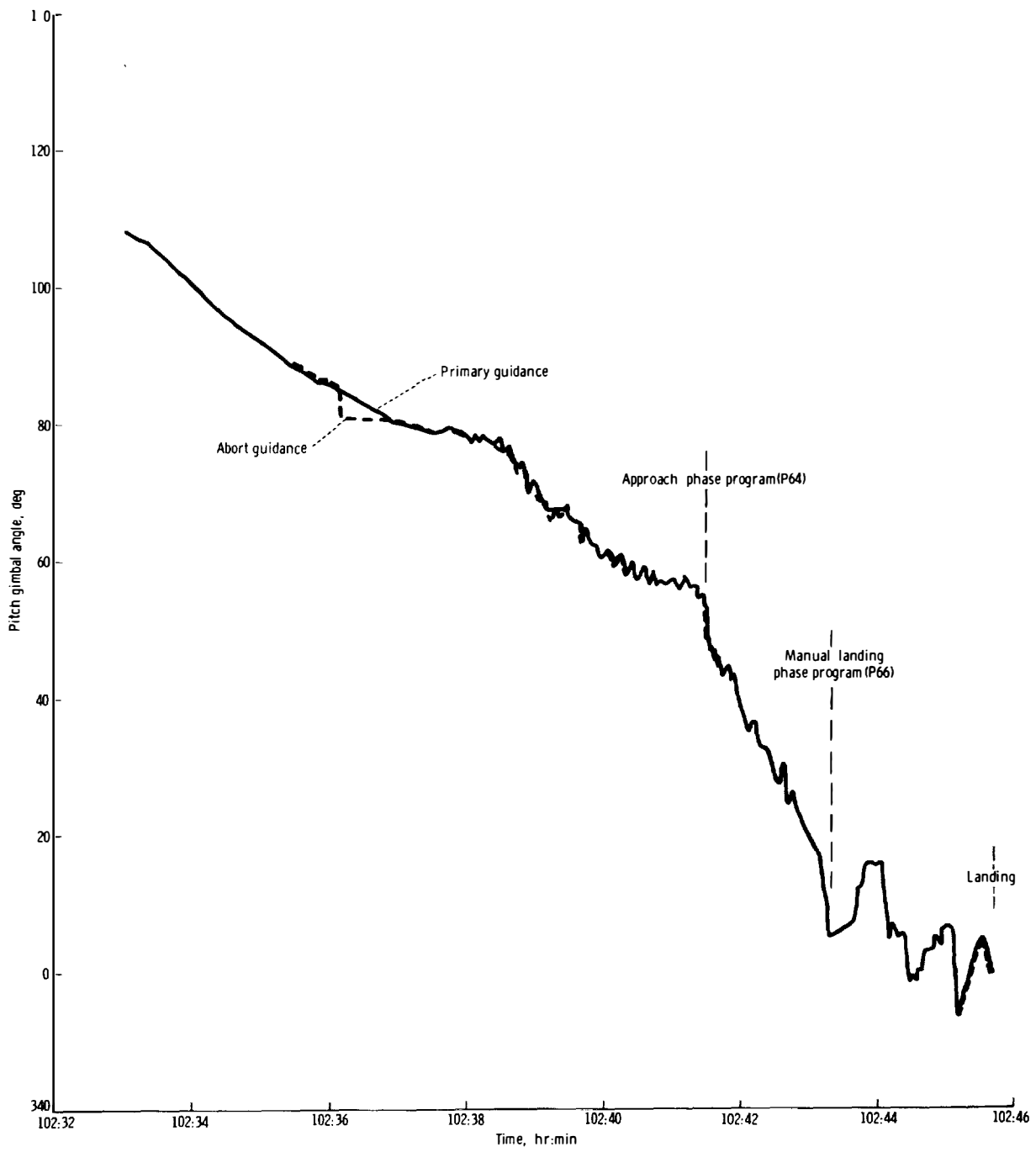
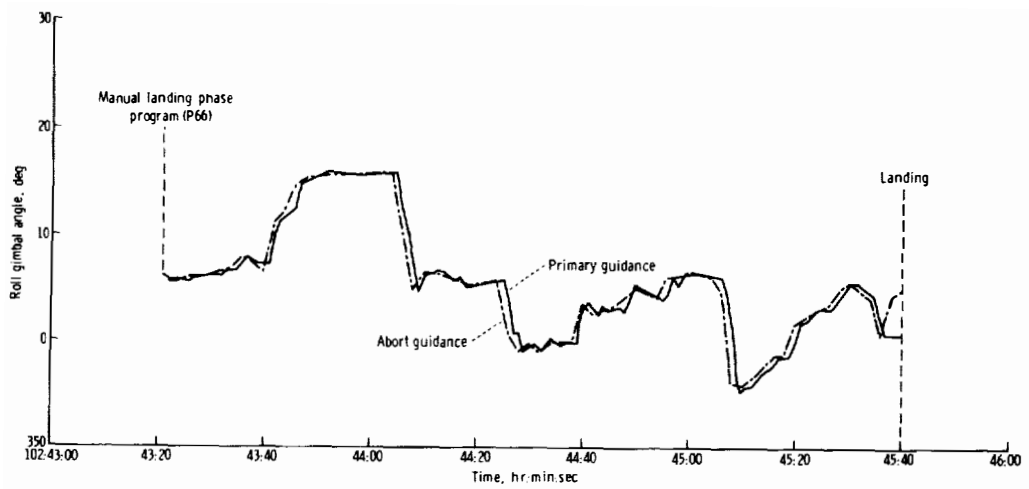
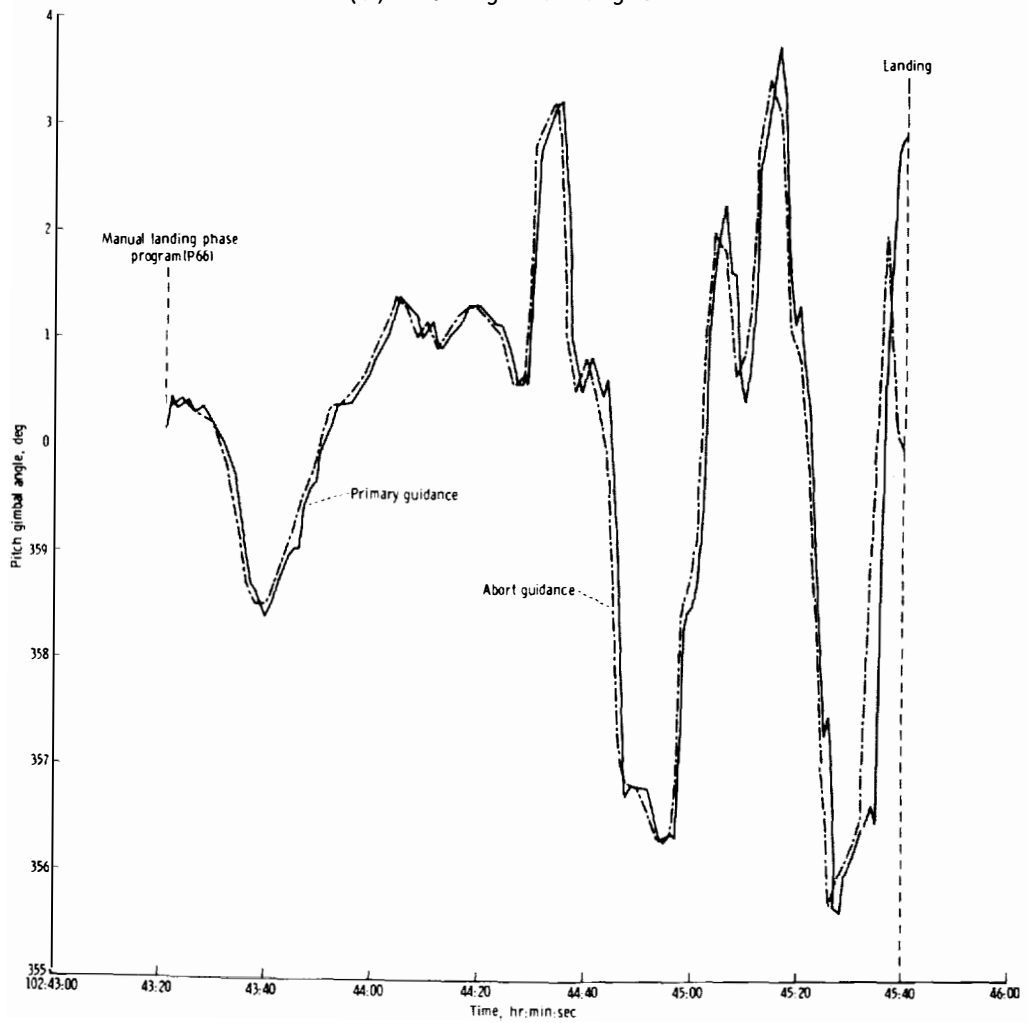

Figure 5-5.- Pitch attitude time history during descent.



(a) Roll gimbal angle.



(b) Pitch gimbal angle.

Figure 5-6.- Expanded pitch and roll attitude time histories near landing.

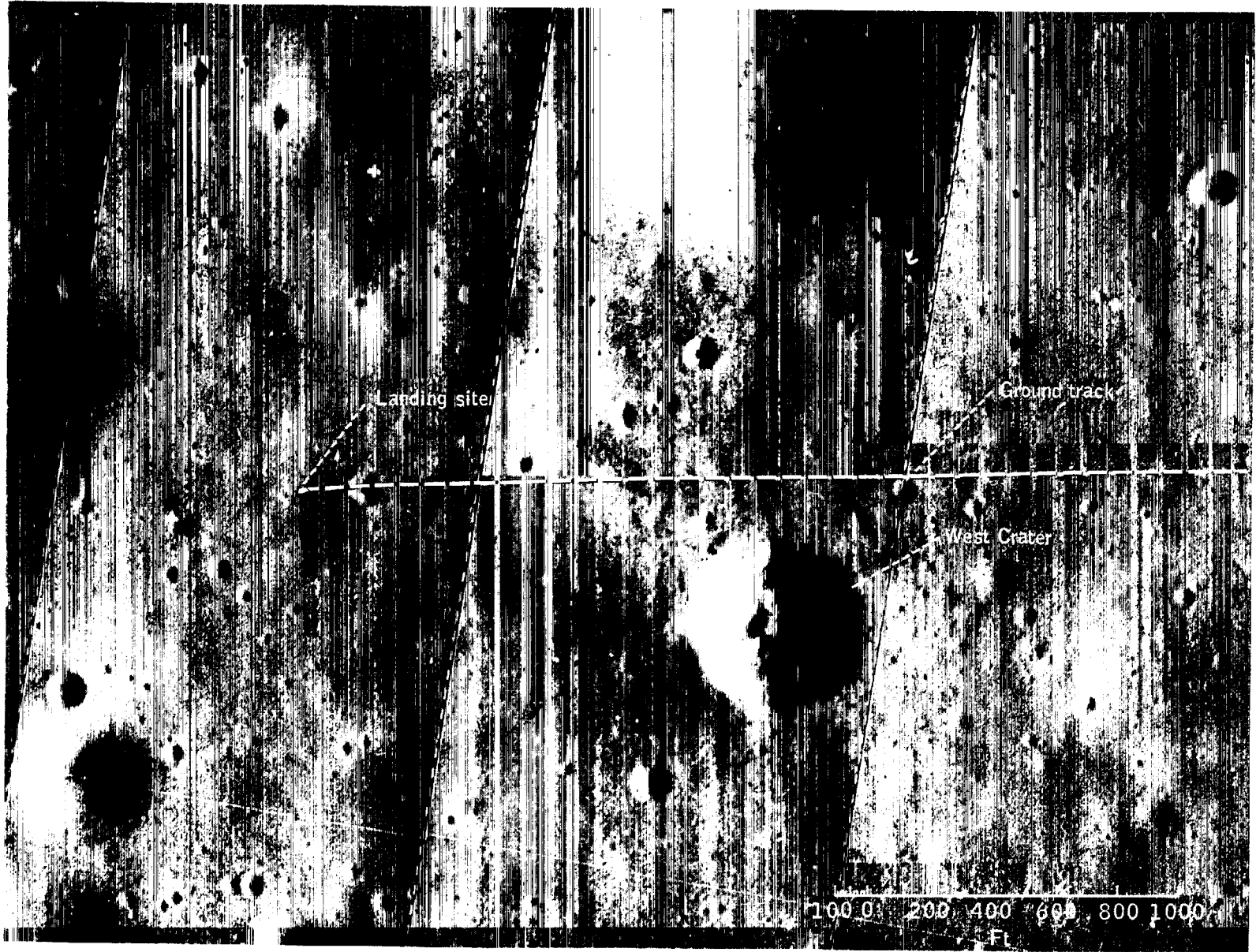
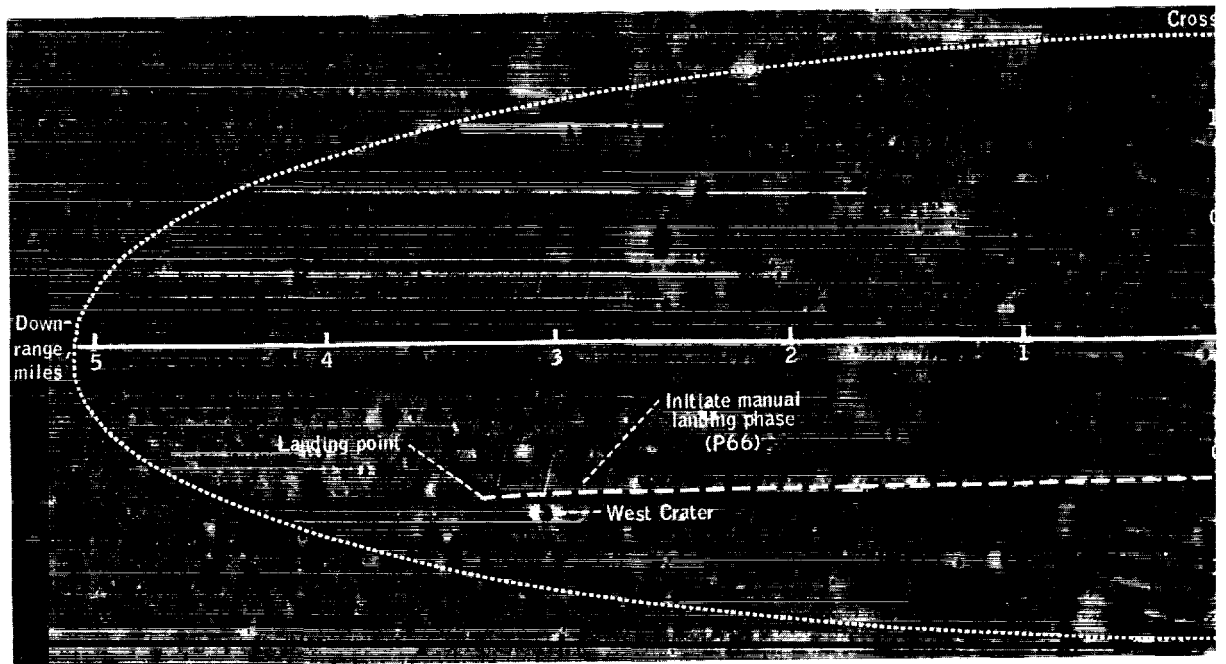

Figure 5-7.- Enlarged map of lunar landing area.



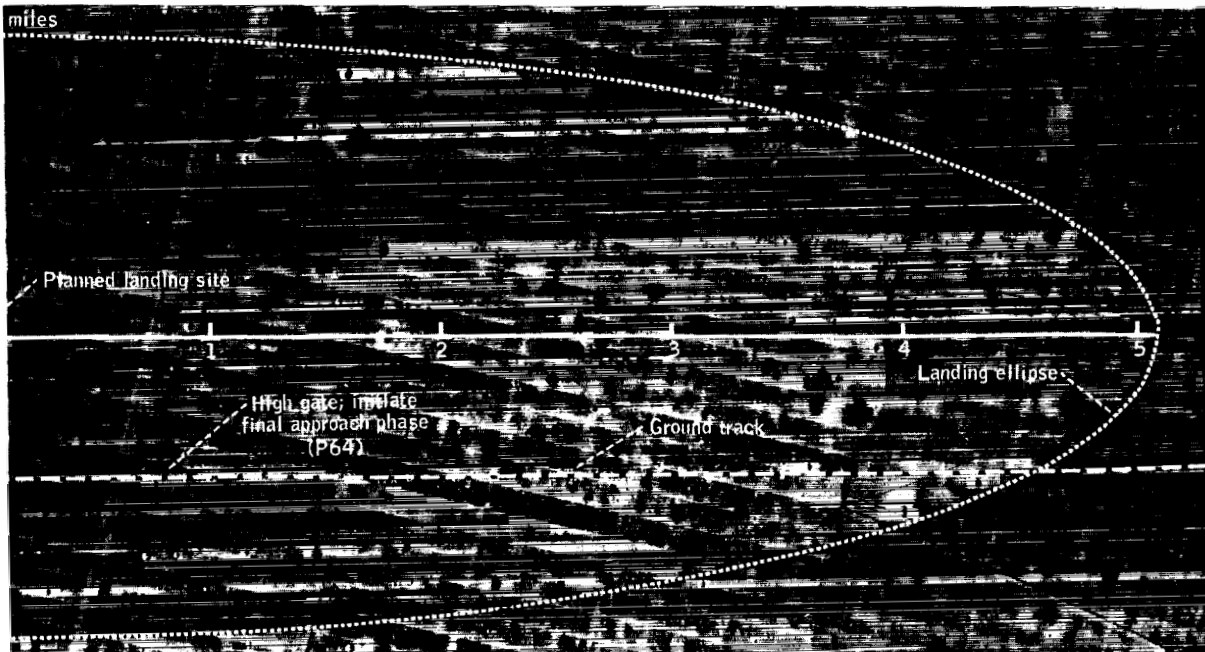
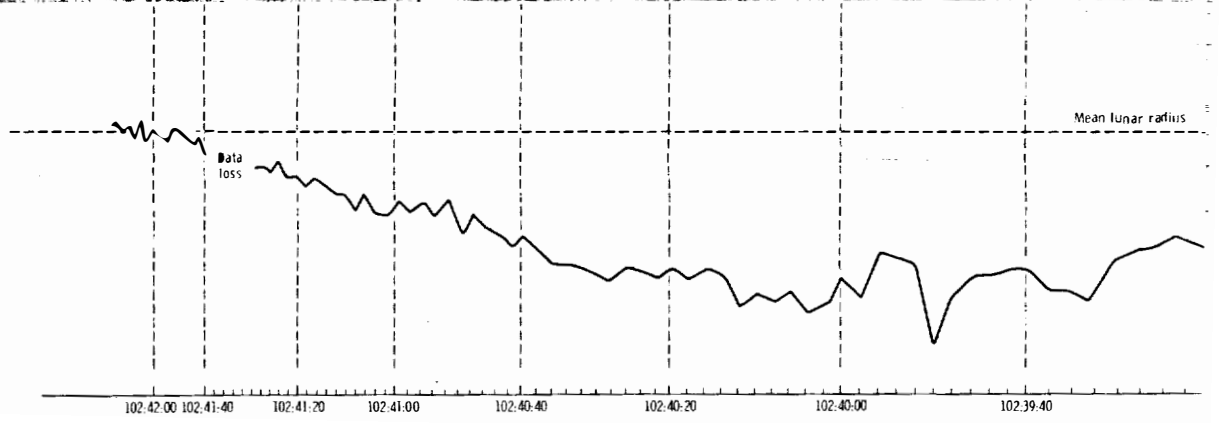
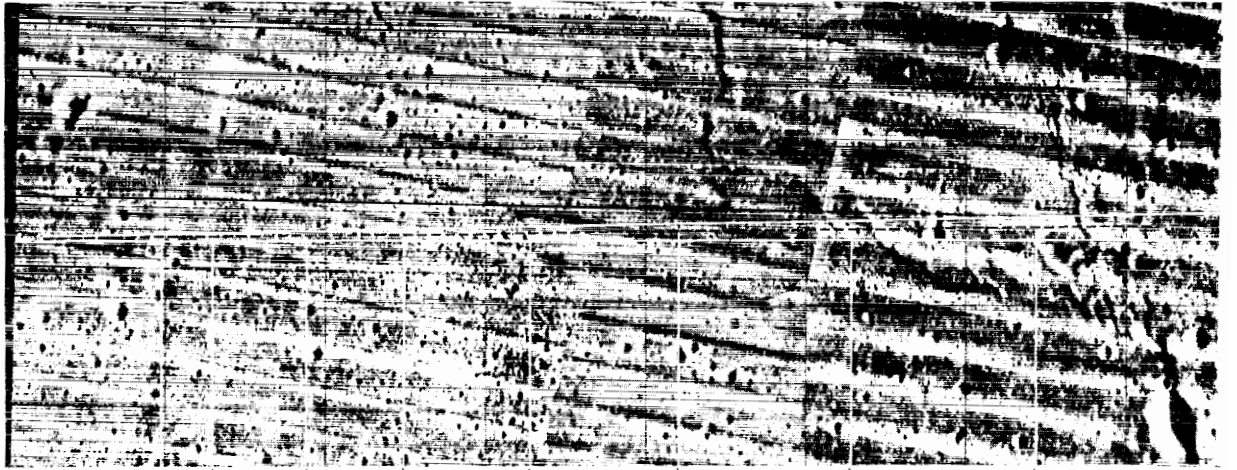

Figure 5-8.- Area photograph of landing-site ellipse showing ground track.



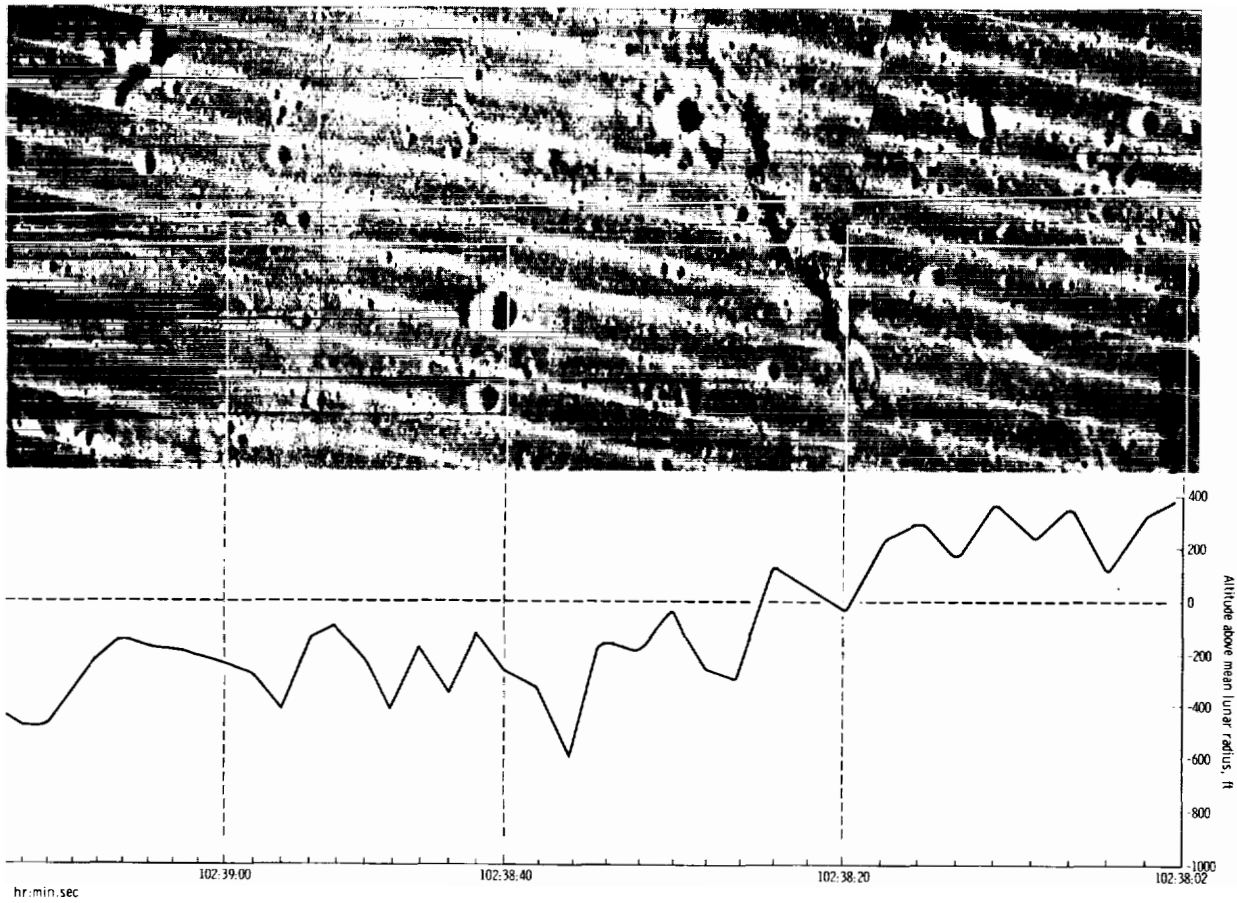
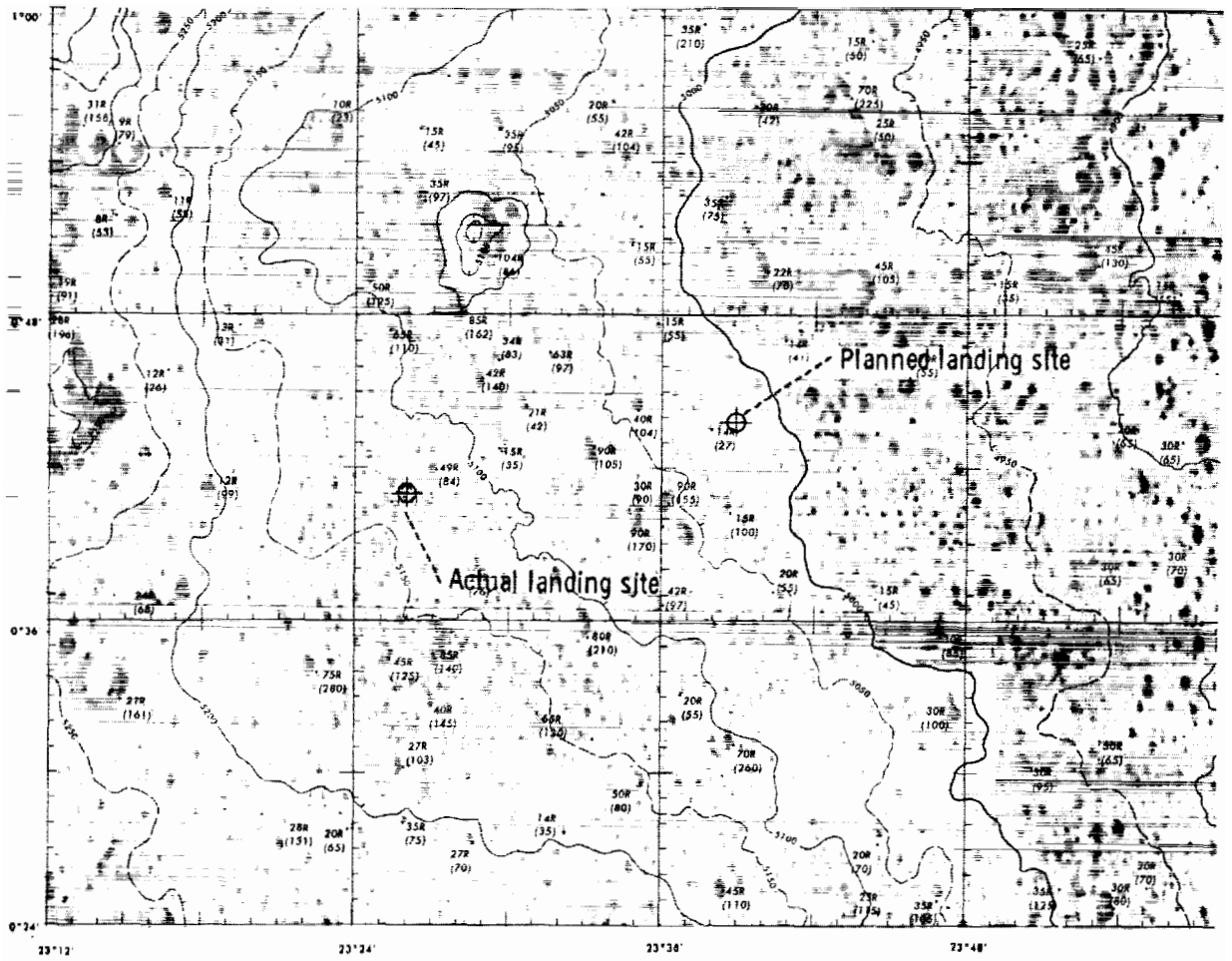

Figure 5-9.- Terrain indicated by landing radar.



PREPARED UNDER THE DIRECTION OF THE DEPARTMENT OF DEFENSE BY THE ARMY MAP SERVICE, CORPS OF ENGINEERS, U. S. ARMY FOR THE NATIONAL AERONAUTICS AND SPACE ADMINISTRATION

LEGEND

Elevation (reference to Datum)	_____	104
Elevation (reference to surrounding terrain)	_____	104R
Depth of Crater (rim to floor)	_____	(170)
Slope Ticks (downhill direction)	_____	
Index Contour	_____	5300
Intermediate Contour	_____	5200
Supplementary Contour	_____	5250
Excrescent	_____	

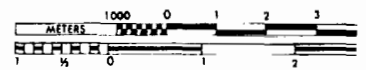

LUNAR MAP
ORB-II-6 (100)
1ST EDITION DEC. 1967

THIS MAP WAS PREPARED FROM LUNAR ORBITER II PHOTOGRAPHS SUPPLEMENTED BY PHOTOGRAPHS FROM MISSIONS I AND III

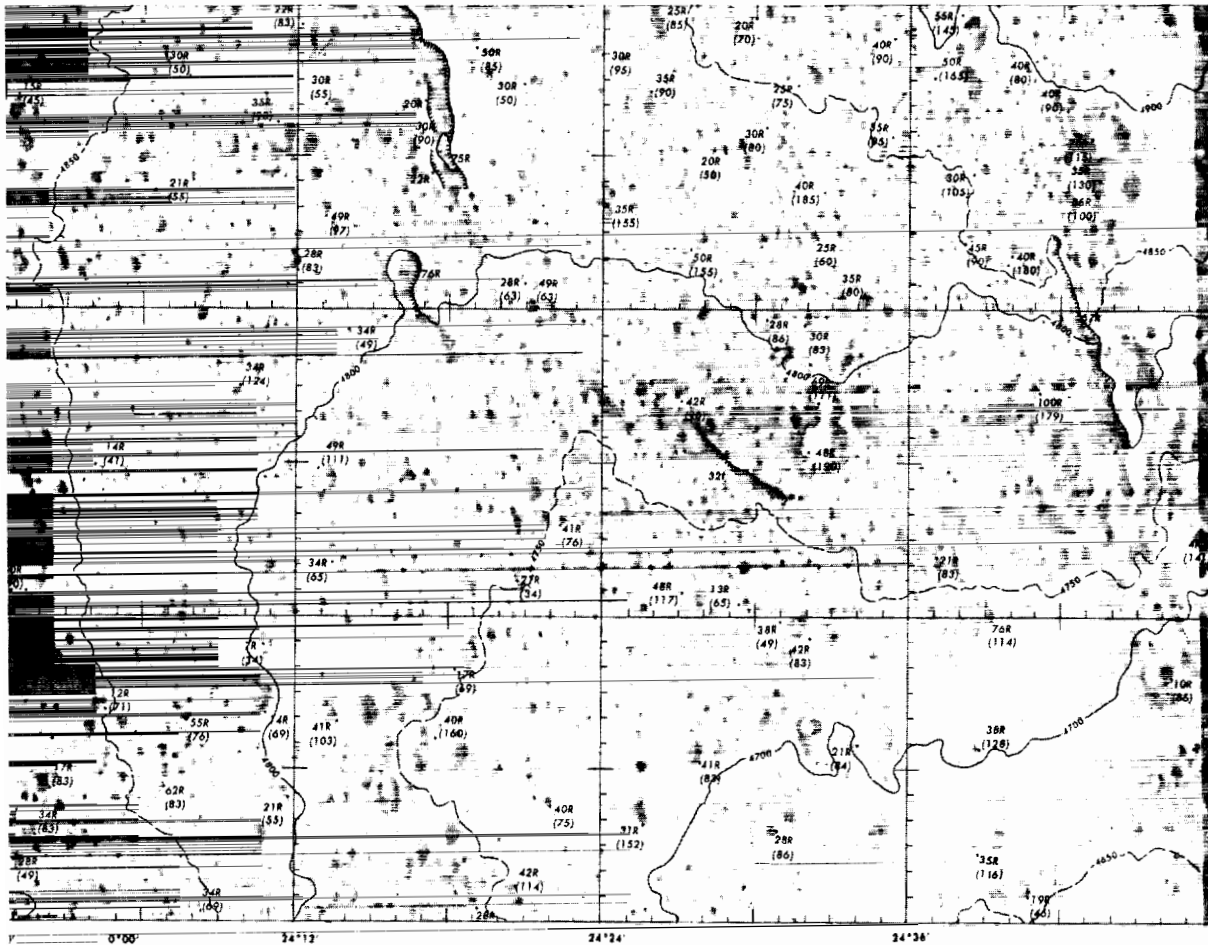

SCALE 1:100,000



CONTOUR INTERVAL 100 METERS
 SUPPLEMENTARY CONTOURS AT 50 METER INTERVALS

MERCATOR PROJECTION
 STANDARD PARALLELS AT 2°30'N AND 2°30'S LATITUDES

CONTOURS AND SPOT ELEVATIONS ARE EXPRESSED AS RADIUS VECTORS IN METERS WITH THE FIRST THREE DIGITS OMITTED. FOR EXAMPLE A RADIUS VECTOR OF 1735200 METERS IS DESIGNATED AS 5200 METERS

THE HORIZONTAL AND VERTICAL CONTROL WAS ESTABLISHED BY PHOTOGRAMMETRIC TRIANGULATION USING ORBIT CONSTRAINTS AND IS BASED ON LUNAR ORBITER II EPHEMERIS DATA

RELATIVE ERRORS EXPRESSED IN METERS (90 PERCENT PROBABILITY):
 HORIZONTAL _____ 88 METERS
 VERTICAL _____ 262 METERS

Figure 5-10.- Basic lunar reference map.

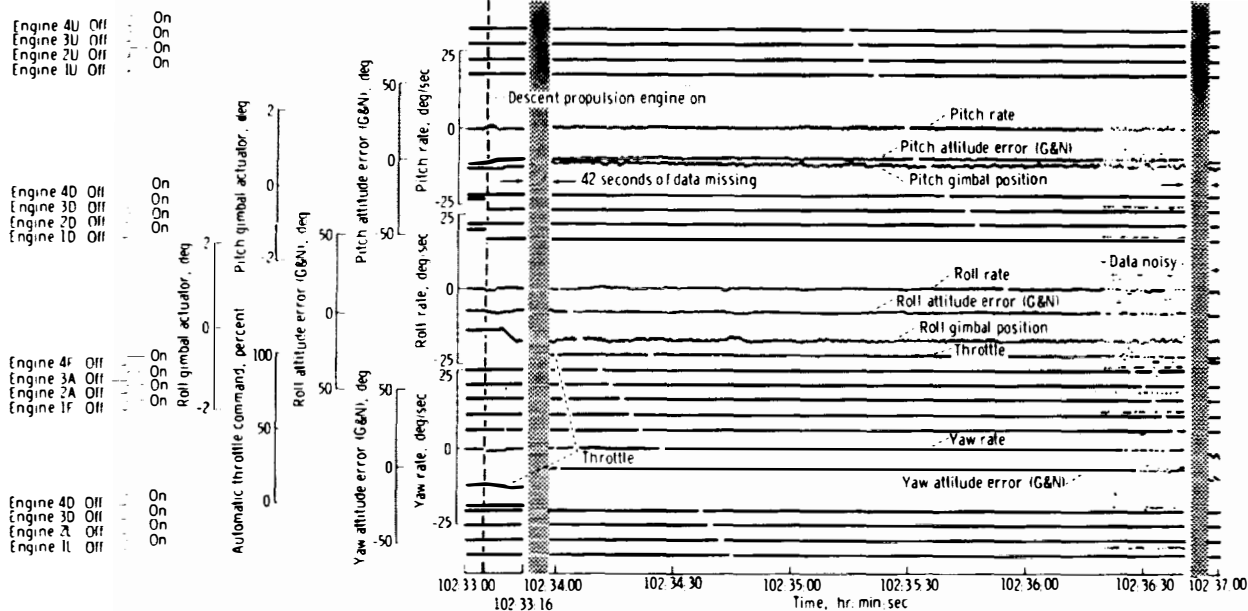

(a) 102:33:00 to 102:37:00.

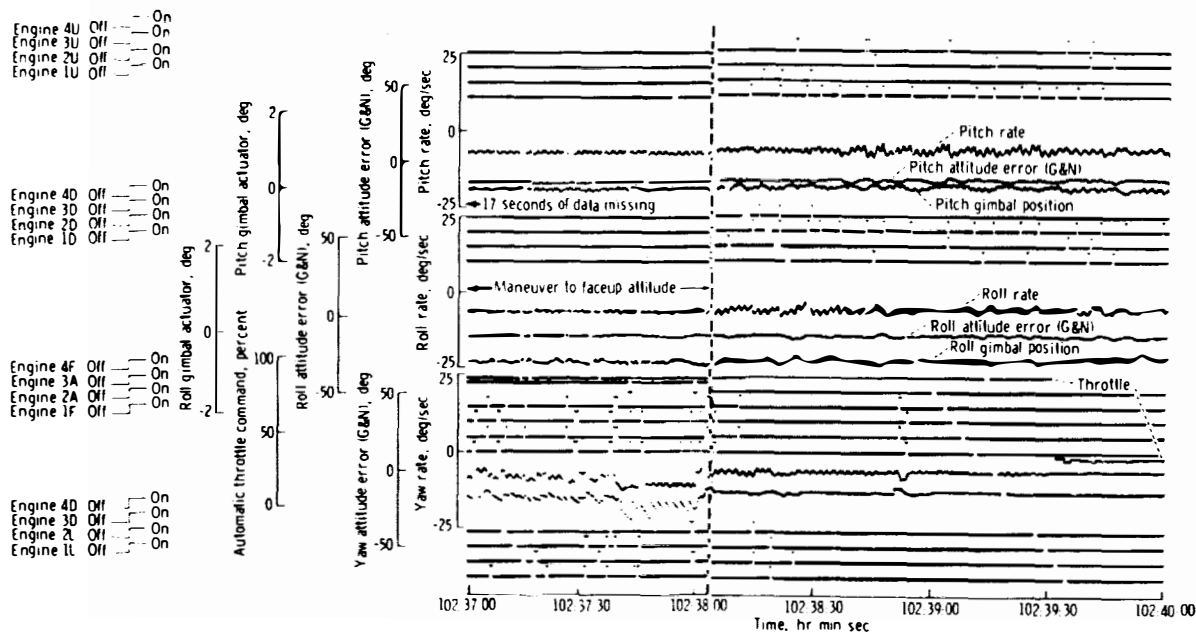

(b) 102:37:00 to 102:40:00.

Figure 5-11.- Spacecraft dynamics during descent.

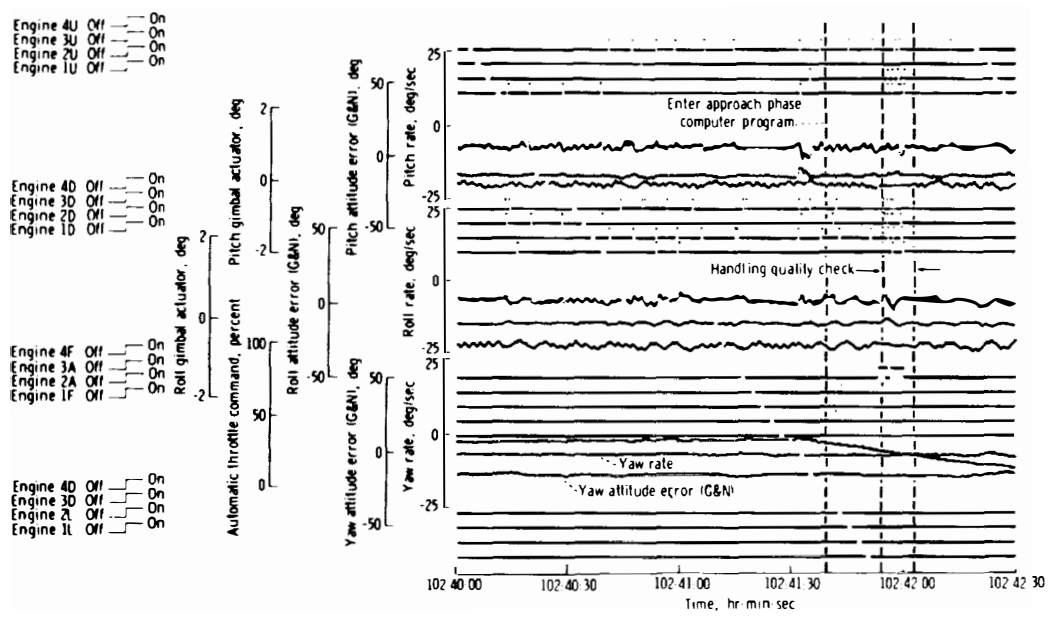

(c) 102:40:00 to 102:42:30.

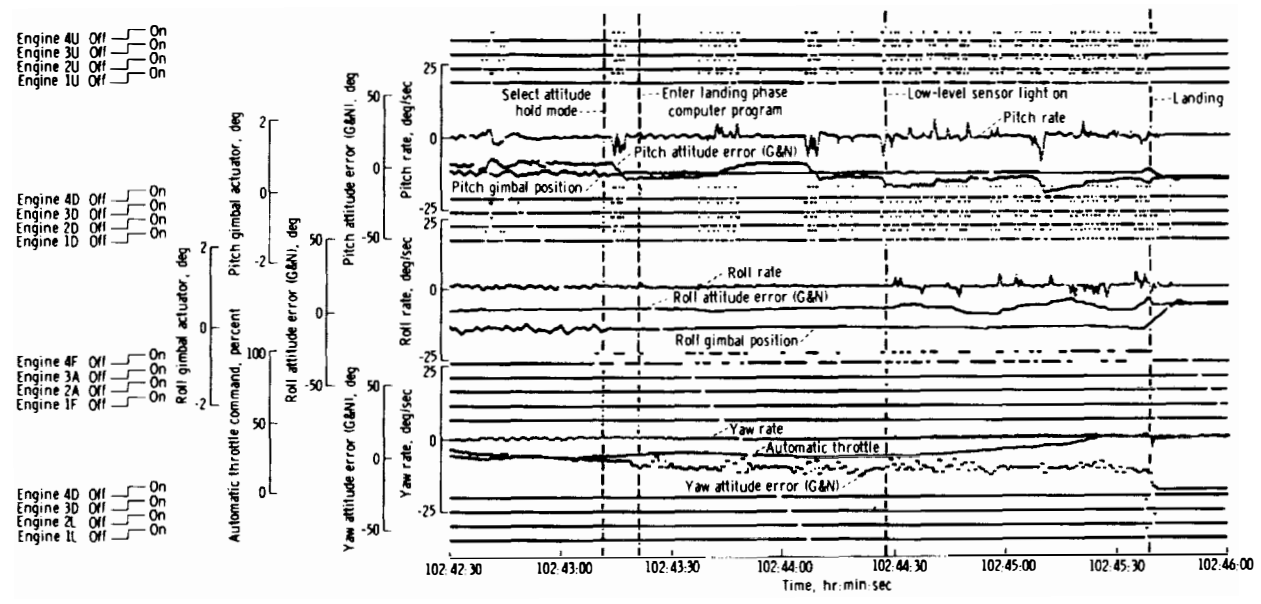

(d) 102:42:30 to 102:46:00.

Figure 5-11.- Concluded.

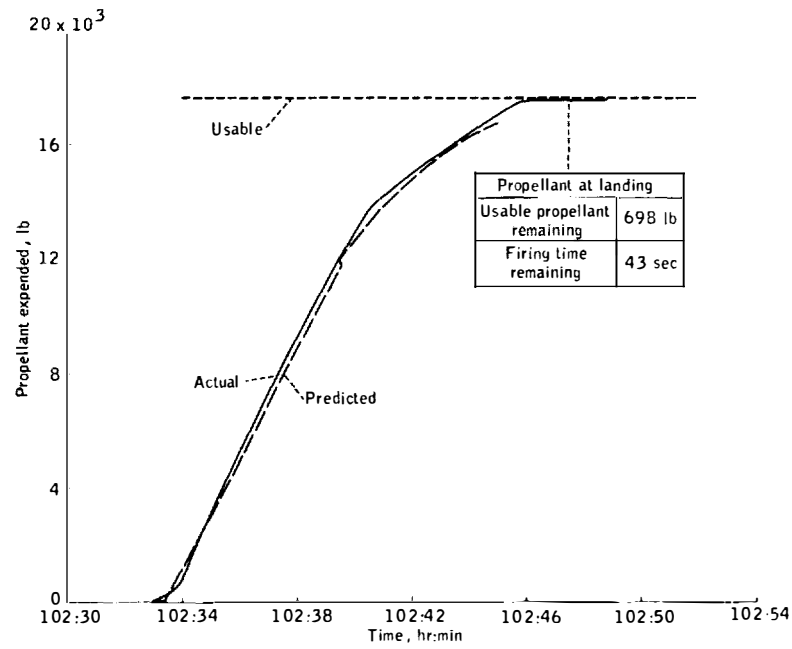

(a) Descent propulsion system.

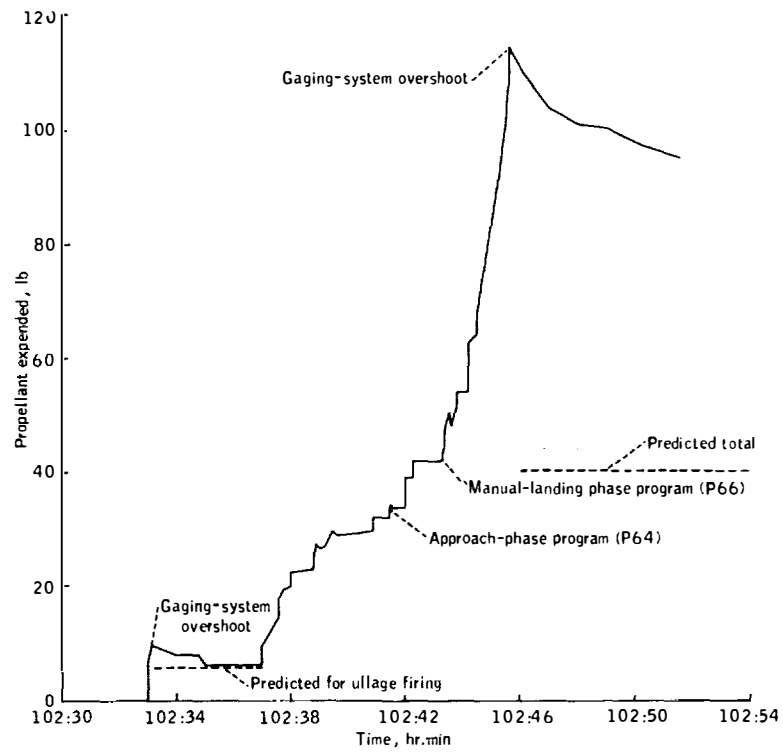

(b) Reaction control system.

Figure 5-12.- Propellant consumption.

Landing Dynamics

The landing on the lunar surface occurred at 102:45:39.9 with negligible forward velocity, approximately 2.1 ft/sec to the crew's left and 1.7 ft/sec vertically. Figure 5-13 shows the body-rate transients which indicate that the right and the forward landing gear touched almost simultaneously, giving the spacecraft a roll-left and a pitch-up motion. The left-directed lateral velocity resulted in a slight yaw-right transient at the point of touchdown. These touchdown conditions, obtained from attitude rates and integration of accelerometer data, were verified qualitatively by the at-rest positions of the lunar surface sensing probes and by surface buildup around the rims of the footpads. Figure 11-17 (in section 11) shows the probe boom nearly vertical on the inboard side of the minus Y footpad, indicating a velocity component in the minus Y direction. Built-up lunar material can be seen outboard of the pad, which also indicates a lateral velocity in this direction. The probe position and lunar material disturbance produced by the minus Z gear assembly (fig. 11-17) indicate a lateral velocity in the minus Y direction. Figure 11-16 (in section 11) shows in greater detail the surface material disturbance on the minus Y side of the minus Z footpad. The plus Y landing gear assembly supports the conclusion of a minus Y velocity because the probe was on the outboard side and material was piled in board of the pad.

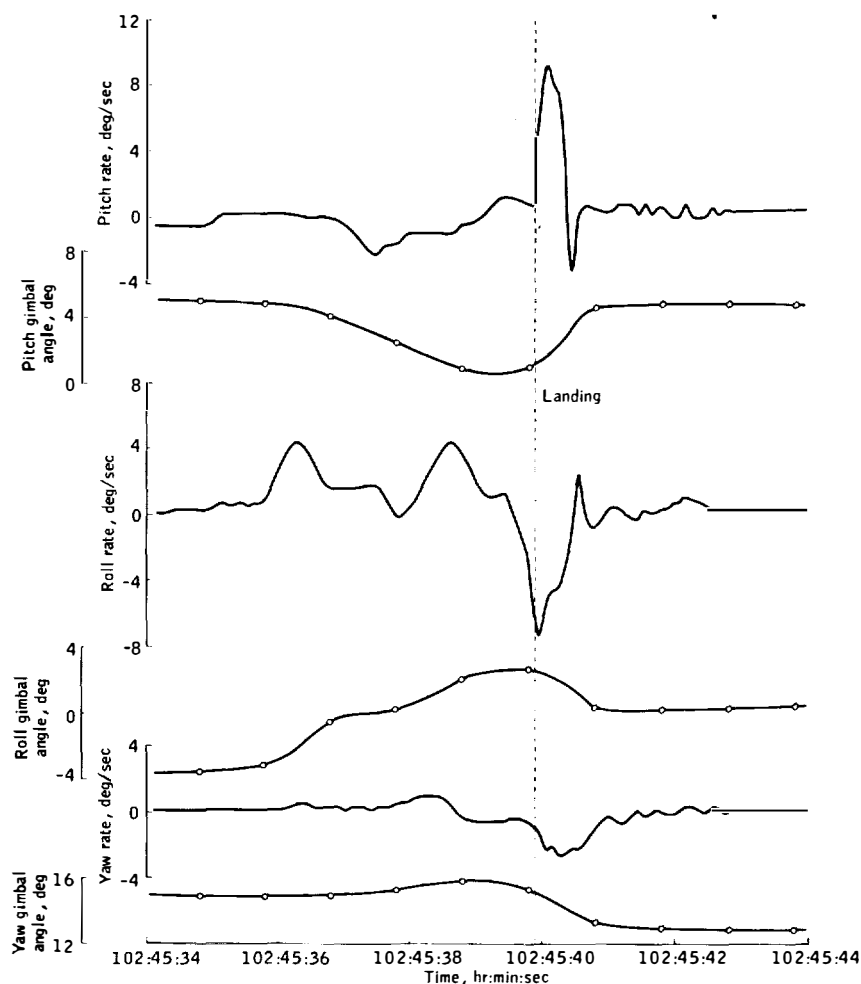

Figure 5-13.- Spacecraft dynamics during lunar touchdown.

The crew reported no sensation of rockup (postcontact instability) during the touch-down phase. A postflight simulation of the landing dynamics indicates that the maximum rockup angle was only approximately 2°, which is indicative of a stable landing. In the simulation, the maximum footpad penetration was 2.5 to 3.5 inches, with an associated vehicle slideout (skidding) of 1 to 3 inches. The landing gear struts stroked less than 1 inch, which represents about 10 percent of the energy absorption capability of the low-level primary-strut honeycomb cartridge. Examination of photographs indicates agreement with this analytical conclusion.

Postlanding Spacecraft Operations

Immediately after landing, the lunar module crew began a simulated launch countdown in preparation for the possibility of a contingency lift-off. Two problems arose during this simulated countdown. First, the mission timer had stopped and could not be restarted; therefore, the event timer was started by using a mark from the ground. Second, the descent stage fuel-helium heat exchanger froze, apparently with fuel trapped between the heat exchanger and the valves, causing the pressure in the line to increase. (See "Mission Timer Stopped" and "High Fuel Interface Pressure After Landing" in section 16 for further discussion of these problems.)

The inertial measurement unit was alined three times during this period by using each of the three available lunar surface alinement options. The alinements were satisfactory, and the results provided confidence in the technique. The simulated countdown was terminated at 104-1/2 hours, and a partial power-down of the lunar module was initiated.

During the lunar surface stay, the Command Module Pilot made several unsuccessful attempts to locate the lunar module through the sextant by using sighting coordinates transmitted from the ground. Estimates of the landing coordinates were obtained from the lunar module computer, the lunar surface gravity alinement of the platform, and the limited interpretation of the geological features during descent. Figure 5-14 shows the areas that were tracked and the times of closest approach that were used for the sightings. The actual landing site, as determined from films taken during the descent, did not lie near the center of the sextant field of view for any of the coordinates used; therefore, the ability to acquire the lunar module from a 60-mile orbit can neither be established nor denied. The Command Module Pilot reported that only one grid square could be scanned during a single pass.

Because of the unsuccessful attempts to sight the lunar module from the command module, the decision was made to track the command module from the lunar module by using the rendezvous radar. The command module was acquired at a 79.9-mile range and a 3236-ft/sec closing rate, and loss of track occurred at 85.3 miles with a receding range-rate of 3531 ft/sec (fig. 5-15).

The inertial measurement unit was successfully alined two more times prior to lift-off, once to obtain a drift check and once to establish the proper inertial orientation for lift-off. The drift check indicated normal system operation, as discussed in "Guidance and Control" in section 9. An abort guidance system alinement was also performed prior to lift-off; however, a procedural error caused an azimuth misalinement, which resulted in the out-of-plane velocity error discussed in "Guidance and Control" in section 9.

1:100,000

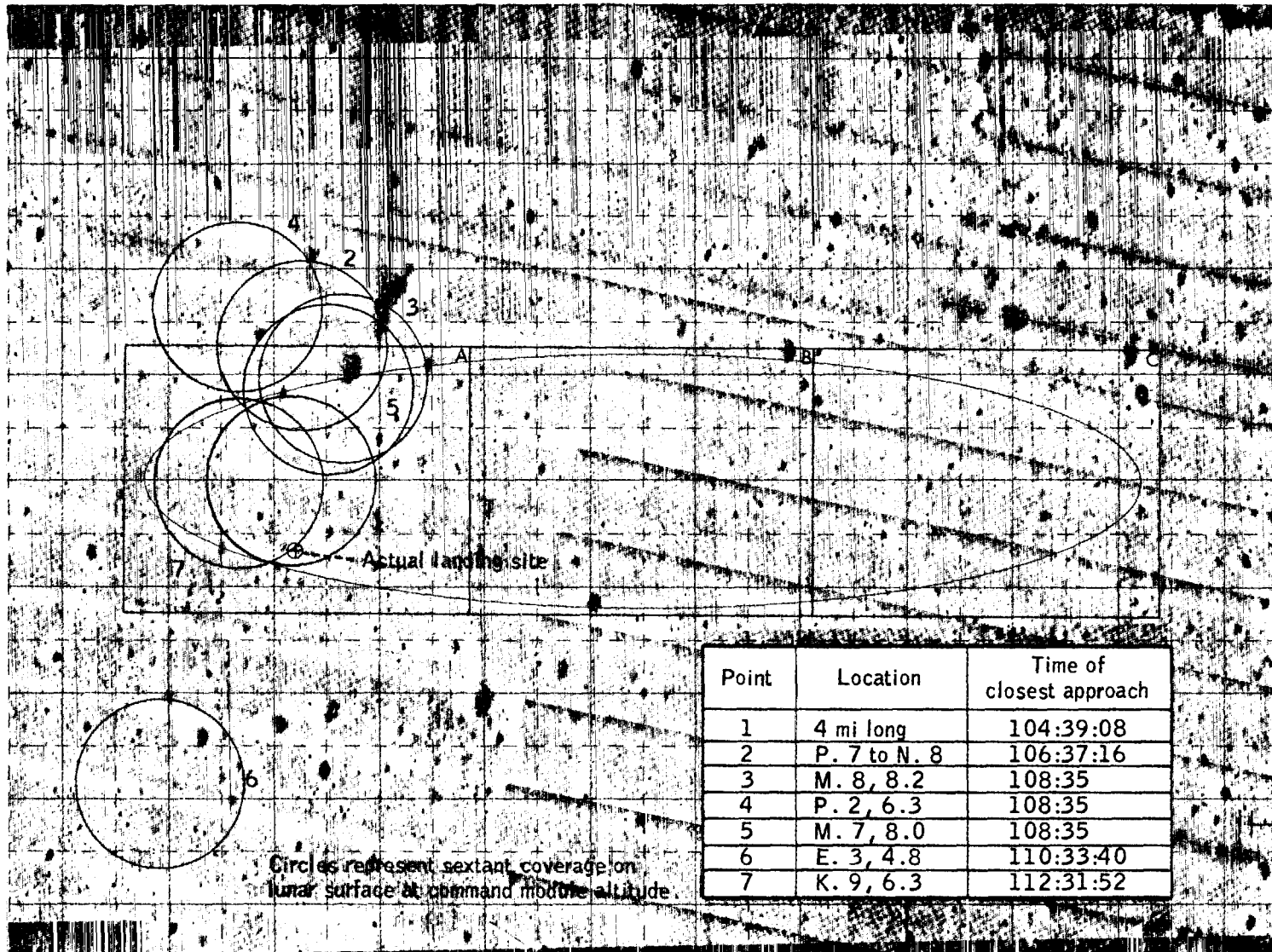

Figure 5-14.- Command module sighting history during lunar stay.

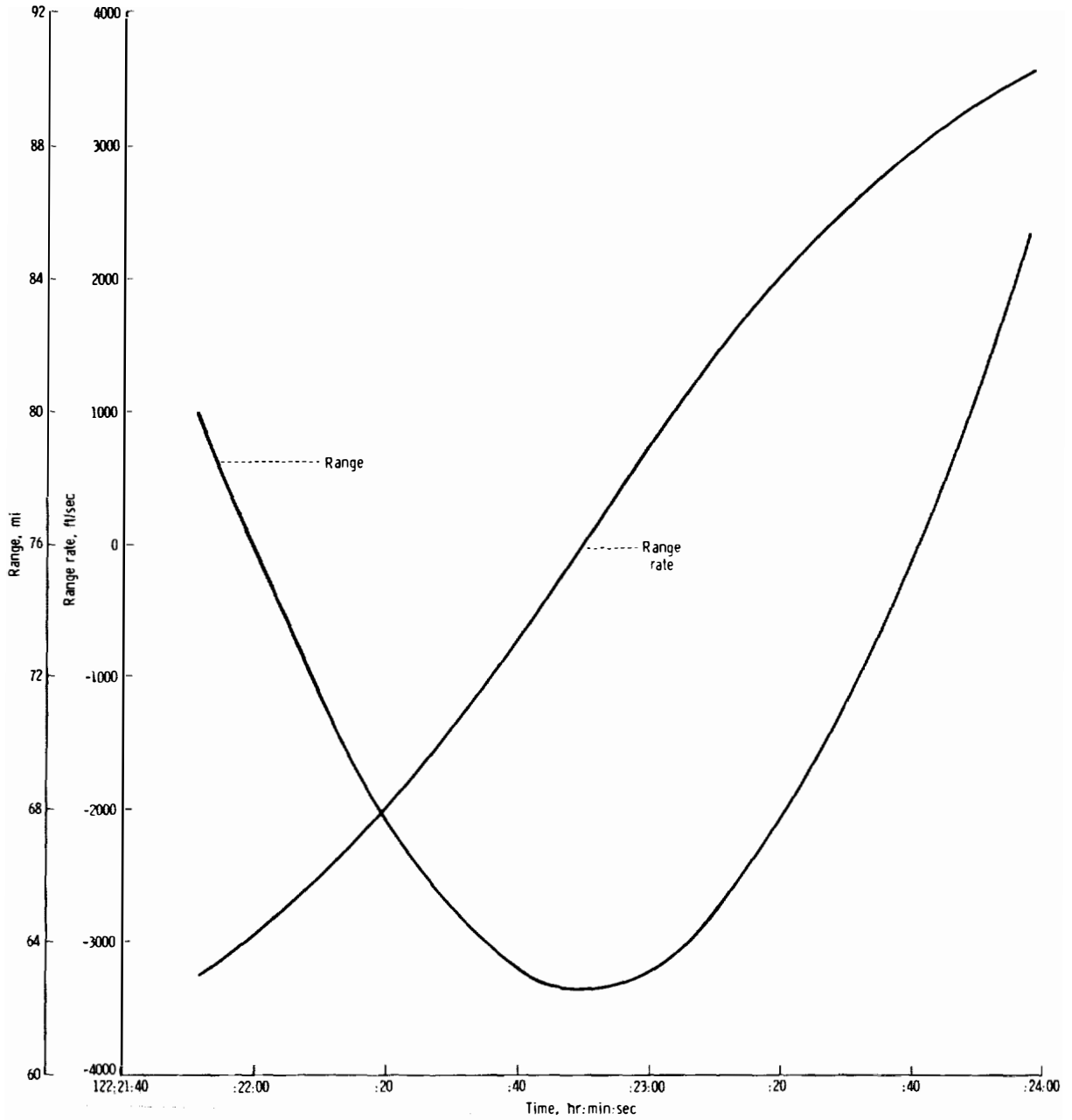

Figure 5-15.- Rendezvous-radar tracking of the command module while the lunar module was on the lunar surface.

Ascent

Preparations for ascent began after the end of the crew rest period at 121 hours. The command module state vector was updated from the ground, with coordinates provided for crater 130, a planned landmark. This crater was tracked by using the command module sextant on the revolution prior to lift-off to establish the target orbit plane. During this revolution, the rendezvous radar was used to track the command module, as previously mentioned, and the lunar surface navigation program (P22) was exercised to establish the location of the lunar module relative to the orbit plane. Crew activities during the preparation for launch were conducted as planned, and lift-off occurred on time.

The ascent phase was initiated by a 10-second period of vertical rise, which allowed the ascent stage to clear the descent stage and surrounding terrain obstacles safely and provided for rotation of the spacecraft to the correct launch azimuth. The pitch-over maneuver to a 50° attitude with respect to the local vertical began when the ascent velocity reached 40 ft/sec. Powered ascent was targeted to place the spacecraft in a 10- by 45-mile orbit to establish the correct initial conditions for the rendezvous. Figure 5-16 shows the planned ascent trajectory, as compared with the actual ascent trajectory.

The crew reported that the ascent was smooth, with normal reaction control thruster activity. The ascent stage appeared to "wallow" or traverse the attitude deadbands, as expected. Figure 5-17 contains a time history of selected control system parameters during the ascent maneuver. A data dropout occurred immediately after lift-off and made accurate determination of the fire-in-the-hole forces difficult. The body rates recorded just prior to the data dropout were small (less than 5 deg/sec) but were increasing in magnitude at the time of the dropout. However, crew reports and associated dynamic information during the data-loss period do not indicate that any rates exceeded the expected ranges.

The predominant disturbance torque during ascent was about the pitch axis and appears to have been caused by thrust vector offset. Figure 5-18 contains an expanded view of control system parameters during a selected period of the ascent phase. The digital autopilot was designed to control about axes offset approximately 45° from the spacecraft body axes and normally to fire only plus X thrusters during powered ascent. Therefore, down-firing thrusters 2 and 3 were used almost exclusively during the early phases of the ascent and were fired alternately to control the pitch disturbance torque. These jets induced a roll rate while counteracting the pitch disturbance; therefore, the accompanying roll motion contributed to the wallowing sensation reported by the crew. As the maneuver progressed, the center of gravity moved toward the thrust vector, and the resulting pitch disturbance torque and required thruster activity decreased until almost no disturbance was present. Near the end of the maneuver, the center of gravity moved to the opposite side of the thrust vector, and proper thruster activity to correct for this opposite disturbance torque can be observed in figure 5-17.

The crew reported that the velocity-to-be-gained indication in the abort guidance system differed 50 to 100 ft/sec from the primary-system indication near the end of the ascent maneuver. The reason for these differences appears to be unsynchronized data displayed from the two systems (section 9).

Table 5-V contains a comparison of insertion conditions between those calculated by various onboard sources and the planned values. Satisfactory agreement is indicated by all sources. The powered flight processor was again used and indicated performance well within the ranges expected for both systems.

TABLE 5-V.- INSERTION SUMMARY

Source	Altitude, ft	Radial velocity, ft/sec	Down-range velocity, ft/sec
Primary guidance ^a	60 602	33	5537.0
Abort guidance	60 019	30	5537.9
Network tracking	61 249	35	5540.7
Operational trajectory	60 085	32	5536.6
Reconstructed from accelerometers	60 337	33	5534.9
Actual (best-estimate trajectory)	60 300	32	5537.0
Target values ^b	60 000	32	5534.9

^aThe following velocity residuals were calculated by the primary guidance: $X = -2.1$ ft/sec, $Y = -0.1$ ft/sec, $Z = +1.8$ ft/sec. The orbit resulting after residuals were trimmed was apocynthion altitude = 47.3 miles and pericynthion altitude = 9.5 miles.

^bAlso, cross-range displacement of 1.7 miles was to be corrected.

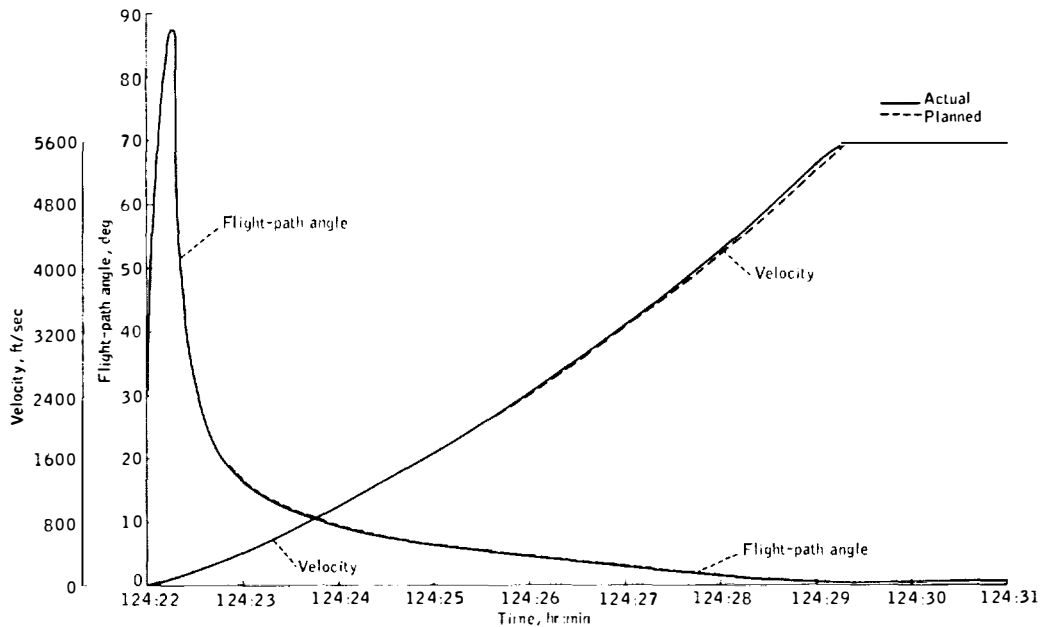

(a) Velocity and flight-path angle.

Figure 5-16.- Trajectory parameters for lunar ascent phase.

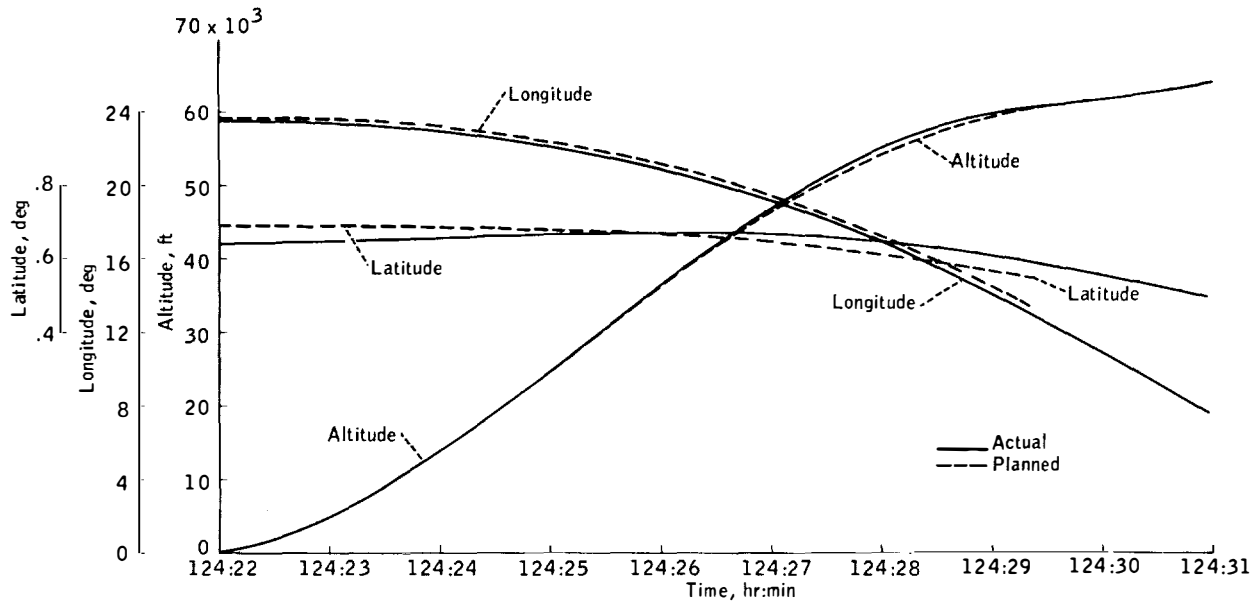

(b) Altitude, longitude, and latitude.

Figure 5-16.- Concluded.

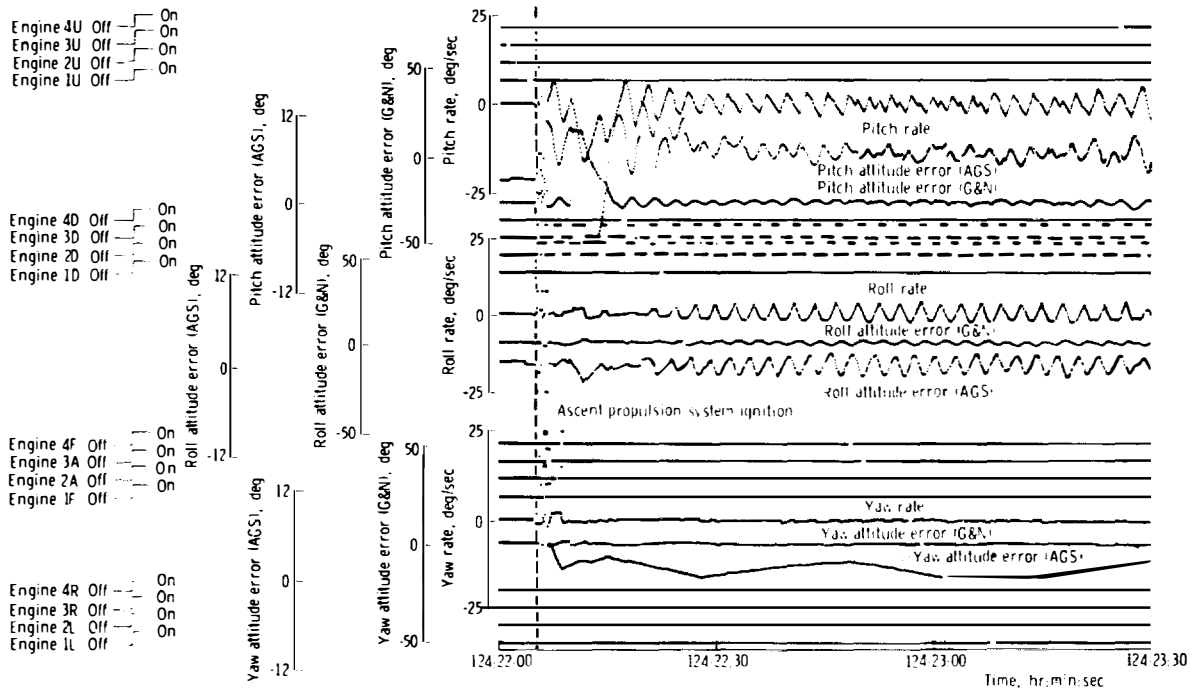

(a) 124:22:00 to 124:23:30.

Figure 5-17.- Spacecraft dynamics during ascent.

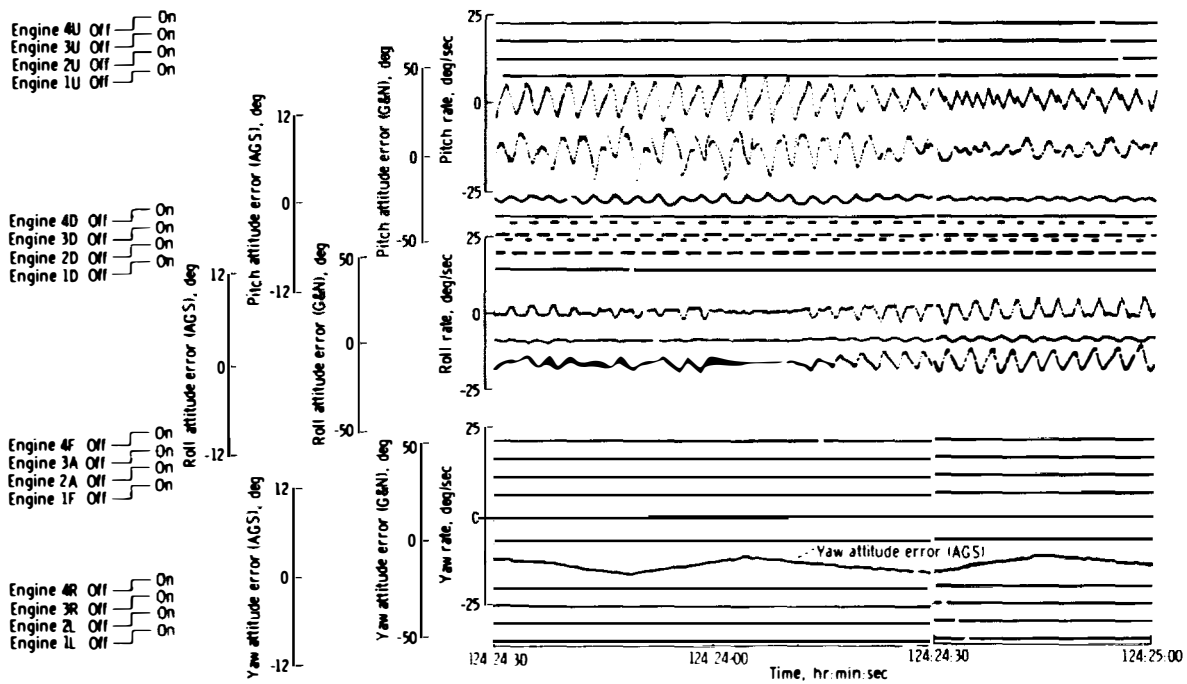

(b) 124:23:30 to 124:25:00.

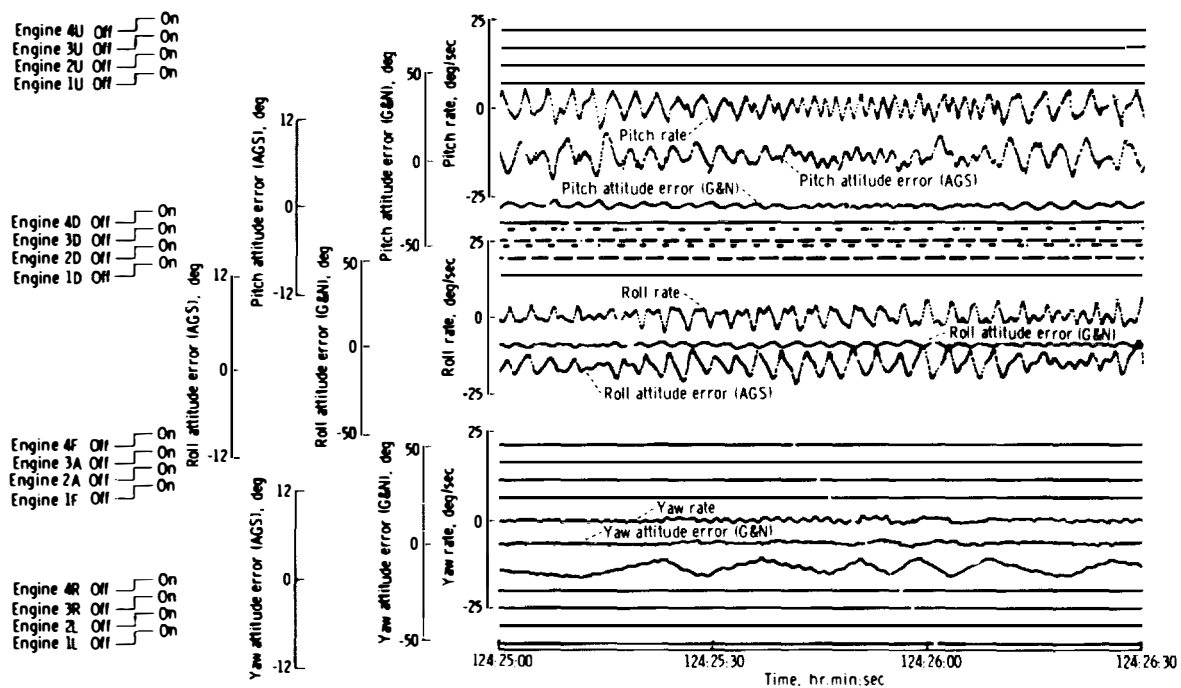

(c) 124:25:00 to 124:26:30.

Figure 5-17.- Continued.

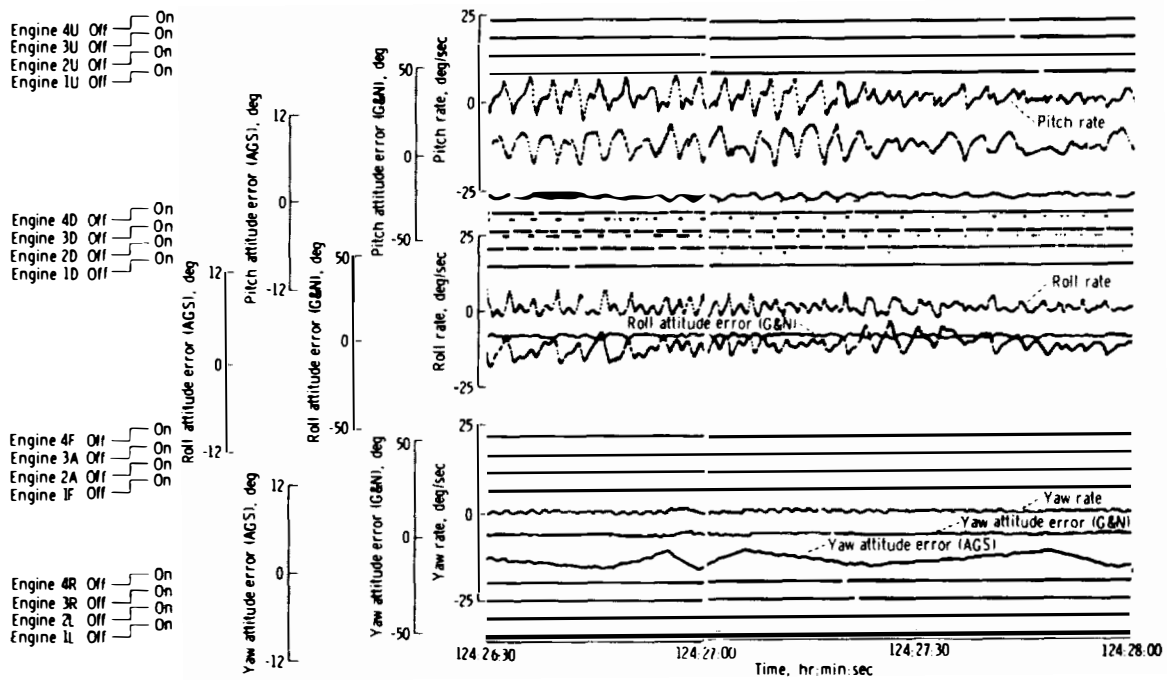

(d) 124:26:30 to 124:28:00.

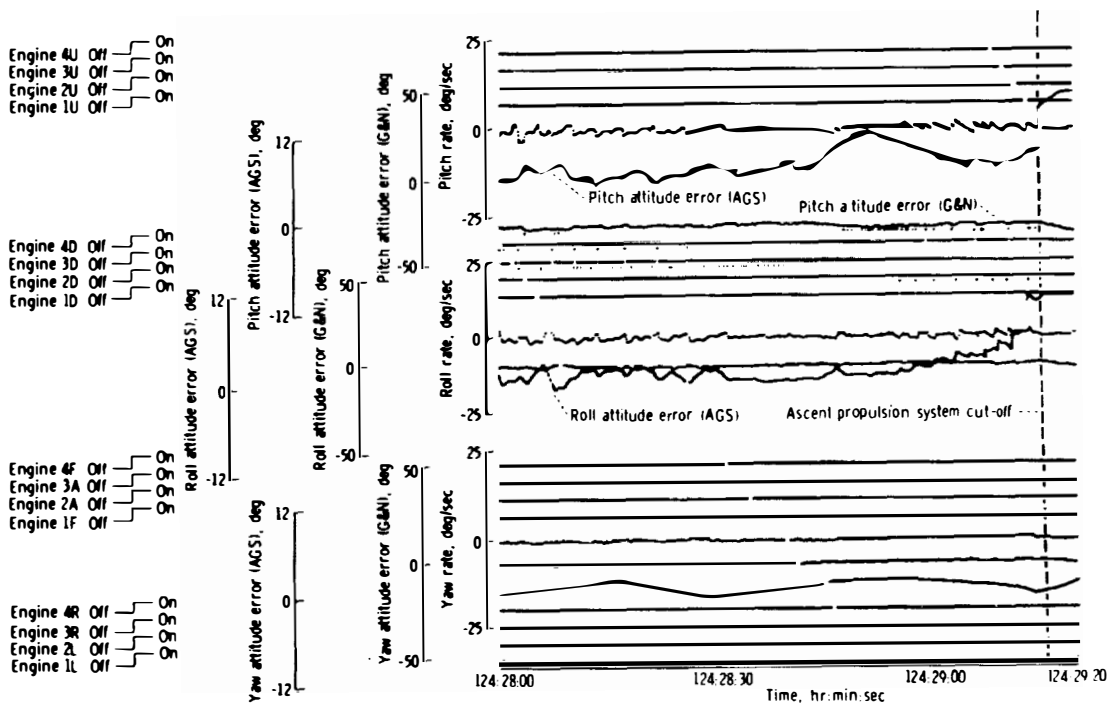

(e) 124:28:00 to 124:29:20.

Figure 5-17.- Concluded.

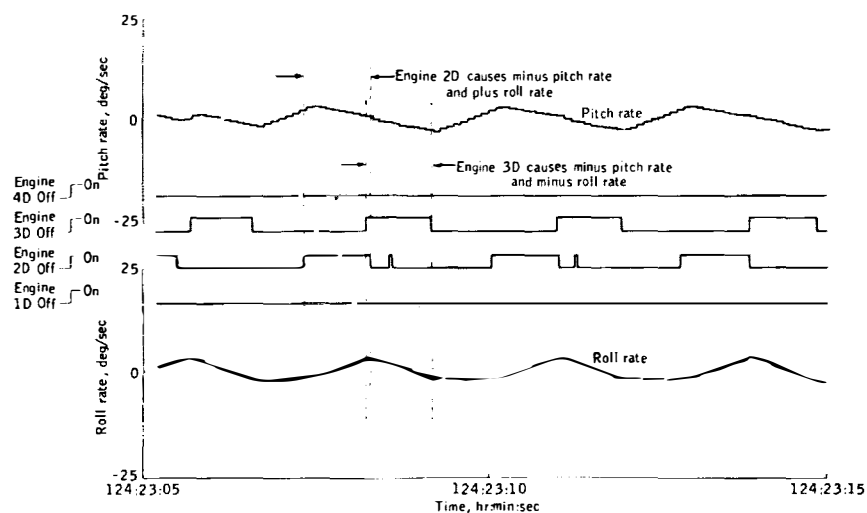

Figure 5-18.- Expanded time history of spacecraft rates during ascent.

Rendezvous

Immediately after ascent insertion, the Commander began a platform alignment by using the lunar module telescope. During this time, the ground relayed the lunar module state vector to the command module computer to permit execution of navigation updates by using the sextant and the vhf ranging system. The lunar module platform alignment took longer than expected; consequently, the coelliptic sequence initiation program was entered into the computer approximately 7 minutes later than planned. This delay allowed less than the nominal 18 radar navigation updates between insertion and the first rendezvous maneuver. Also, the first range-rate measurement for the backup solution was missed; however, this loss was not significant because both the lunar module and the command module guidance systems performed normally. Figure 5-19 shows the ascent and rendezvous trajectories and their relationship in lunar orbit.

Prior to the coelliptic sequence initiation, the lunar module out-of-plane velocity was computed by the command module to be -1.0 ft/sec, a value small enough to be deferred until terminal phase initiation. The final lunar module solution for coelliptic sequence initiation was a 51.5 -ft/sec maneuver to be performed with the Z-axis reaction control thrusters, with a planned ignition time of 125:19:34.7.

Following the coelliptic sequence initiation maneuver, the constant differential height program was called up in both spacecraft. Operation of the guidance systems continued to be normal, and successful navigation updates were obtained by using the sextant, the vhf ranging system, and the rendezvous radar. The Lunar Module Pilot reported that the backup range-rate measurement at 36 minutes prior to the constant differential height maneuver was outside the limits of the backup chart. Postflight trajectory analysis has shown that the off-nominal command module orbit (62 by 56 miles) caused the range-rate measurement to be approximately 60 ft/sec below nominal at the 36-minute data point. The command module was near pericynthion and the lunar module was near apocynthion at the measurement point. These conditions, which decreased the lunar module closure rate to below the nominal value, are apparent in figure 5-20, a relative motion plot of the two spacecraft between insertion and the constant differential height maneuver. Figure 5-20 was obtained by forward and backward integration of the last available lunar module state vector prior to loss of signal following insertion and the final constant differential height maneuver vector integrated backward to the coelliptic sequence initiation point.

The dynamic range of the backup charts has been increased for future landing missions. The constant differential height maneuver was accomplished at the lunar module primary guidance computer time of 126:17:49.6.

The constant differential height maneuver was performed with a total velocity change of 19.9 ft/sec. In a nominal coelliptic flight plan with a circular target orbit for the command module, the velocity change for this maneuver would be zero. However, the ellipticity of the command module orbit required a real-time change in the rendezvous plan prior to lift-off to include approximately 5 ft/sec (applied retrograde) to compensate for the change in differential height upon arriving at this maneuver point and approximately 11 ft/sec (applied vertically) to rotate the line of apsides to the correct angle. Actual execution errors in ascent insertion and coelliptic sequence initiation resulted in an additional velocity change requirement of approximately 8 ft/sec, which yielded the actual total of 19.9 ft/sec.

Following the constant differential height maneuver, the computers in both spacecraft were configured for terminal phase initiation. Navigation updates were made, and several computer recycles were performed to obtain an early indication of the maneuver time. The final computation was initiated 12 minutes prior to the maneuver, as planned. Ignition had been computed to occur at 127:03:39, or 6 minutes 39 seconds later than planned.

Soon after the terminal phase initiation maneuver, both spacecraft passed behind the moon. At the next acquisition, the spacecraft were flying in formation in preparation for docking. The crew reported that the rendezvous was nominal, with the velocity change for the first midcourse maneuver less than 1 ft/sec and for the second approximately 1.5 ft/sec. The midcourse maneuvers were performed by thrusting the body-axis components to zero, while the lunar module plus Z axis remained pointed at the command module. The line-of-sight rates were reported to be small, and the planned braking was used for the approach to station keeping. The lunar module and command module maneuver solutions are summarized in tables 5-VI and 5-VII, respectively.

During the docking maneuver, two unexpected events occurred. In the alignment procedure for docking, the lunar module was maneuvered through the platform gimbal-lock attitude, and the docking had to be completed by using the abort guidance system for attitude control. The off-nominal attitude resulted from an added rotation to avoid sunlight interference in the forward windows. The sun elevation was approximately 20° higher than planned because the angle for initiation of the terminal phase was reached approximately 6 minutes late.

The second unexpected event occurred after docking and consisted of relative vehicle alignment excursions of as much as 15° following initiation of the retract sequence. The proper docking sequence consists of (1) initial contact, (2) lunar module plus X thrusting from initial contact to capture latch, (3) switching of the command module control from the automatic to the manual mode, (4) relative motions to be damped to within $\pm 3^\circ$, and (5) initiation of retract to achieve hard docking. The Commander detected the relatively low velocity at initial contact and applied plus X thrusting; however, the thrusting was continued until after the misalignment excursion had developed because the Commander had received no indication of the capture event. The dynamics were complicated further when the Command Module Pilot also noticed the excursions and reversed the command module control mode from manual to automatic. At this time, both the lunar module and the command module were in the minimum-deadband attitude-hold mode, thereby causing considerable thruster firing until the lunar module was placed in maximum deadband. The spacecraft were stabilized by using manual control just prior to achieving a successful hard dock. The initial observed misalignment excursion is considered to have been caused by the continued lunar module thrusting following capture because the thrust vector does not pass through the center of gravity of the command and service modules.

The rendezvous was successful and was similar to that for Apollo 10, with all guidance and control systems operating satisfactorily. The Command Module Pilot reported that the vhf ranging broke lock approximately 25 times following ascent insertion; however, lock-on was reestablished each time, and navigation updates were successful. The lunar module reaction control propellant usage was nearly nominal.

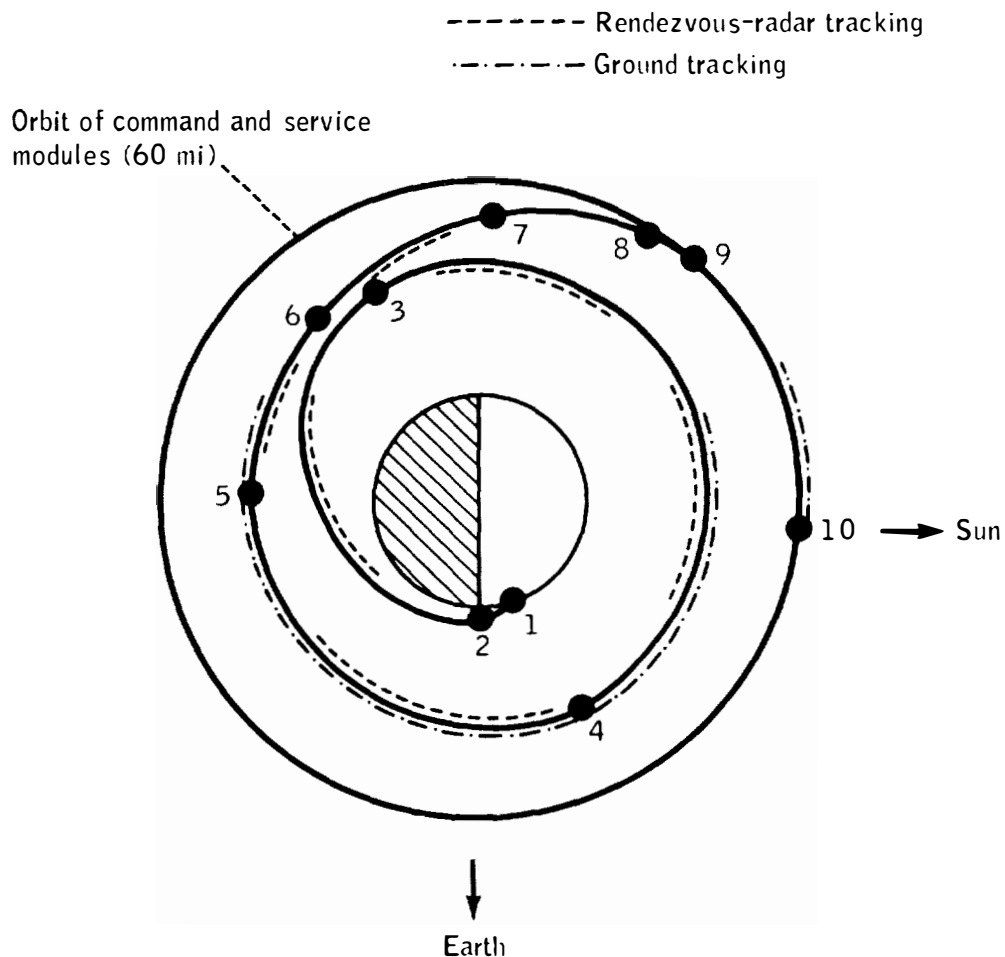

Event	Time
1 Lift-off	124:22:00.8
2 Lunar module insertion	124:29:15.7
3 Coelliptic sequence initiation	125:19:35.0
4 Constant differential height phase	126:17:49.6
5 Terminal phase initiation	127:03:51.8
6 First midcourse correction	127:18:30.8
7 Second midcourse correction	127:33:30.8
8 Beginning of braking	127:36:57.3
9 Beginning of station keeping	127:52:05.3
10 Docking	128:03:00.0

Figure 5-19.- Ascent and rendezvous trajectory.

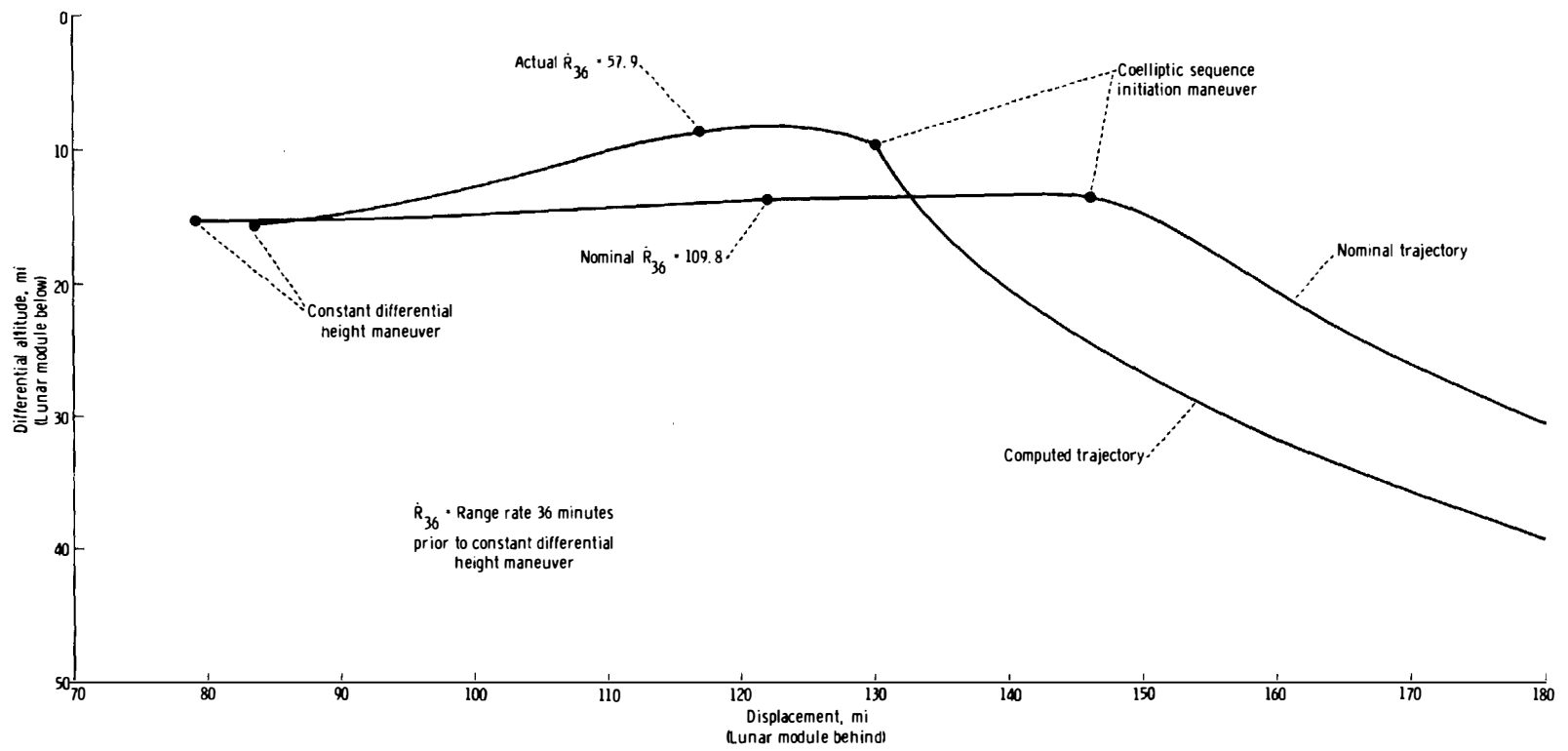

Figure 5-20.- Relative spacecraft motion during rendezvous.

TABLE 5-VI.- LUNAR MODULE MANEUVER SOLUTIONS

Maneuver	Primary guidance			Abort guidance		Real-time nominal		Actual	
	Solution	Time, hr:min:sec	Velocity, ft/sec	Time, hr:min:sec	Velocity, ft/sec	Time, hr:min:sec	Velocity, ft/sec	Time, hr:min:sec	Velocity, ft/sec
Coelliptic sequence initiation	Initial	125:19:35.48	49.4 posigrade	125:19:34.70	51.3 posigrade	125:19:35	52.9 posigrade	125:19:35	51.6 posigrade .7 south .1 down
	Final	125:19:35.48	51.5 posigrade						
Constant differential height	Initial	126:17:46.36	8.1 retrograde 1.8 south 17.7 up	(a)	(a)	126:17:42	5.1 retrograde 11.0 up	126:17:50	8.0 retrograde 1.7 south 18.1 up
	Final	126:17:46.36	8.1 retrograde 18.2 up						
Terminal phase initiation ^b	Initial	127:03:16.12	25.2 forward 1.9 right .4 down	127:03:39	23.4 total	126:57:00	22.4 posigrade .2 north 11.7 up	127:03:52	22.9 posigrade 1.4 north 11.0 up
	Final	127:03:31.60	25.0 forward 2.0 right .7 down						
First midcourse correction	Final	127:18:30.8	0.0 forward .4 right .9 down	(a)	(a)	127:12:00	0	(c)	(c)
Second midcourse correction	Final	127:33:30.8	0.1 forward 1.2 right .5 down	(a)	(a)	127:27:00	0	(c)	(c)

^aSolution not obtained.

^bBody-axis reference frame; all other solutions are for local-vertical reference frame. To compare the primary guidance solution for terminal phase initiation with the real-time nominal and actual values, the following components are equivalent to those listed but with a correction to a local-vertical reference frame: 22.7 posigrade, 1.5 north, and 10.6 up.

^cData not available because of moon occultation.

TABLE 5-VII.- COMMAND MODULE MANEUVER SOLUTIONS^a

Maneuver	Time, hr:min:sec	Solution, ft/sec
Coelliptic sequence initiation	125:19:34.70	51.3 retrograde 1.4 south 0 up/down
Constant differential height	126:17:46.00	9.1 posigrade 2.4 north 14.6 down
Terminal phase initiation	^b 127:02:34.50 ^c 127:03:30.8	22.9 retrograde 1.7 south 11.9 down
First midcourse correction	127:18:30.8	1.3 retrograde .6 south
Second midcourse correction	127:33:30.8	.1 retrograde 1.0 south .6 down

^aAll solutions are in the local-horizontal coordinate frame.

^bInitial computed time of ignition using nominal elevation angle of 208.3° for terminal phase initiation.

^cFinal solution using lunar module time of ignition.

6. COMMUNICATIONS

Performance of all communications systems (sections 8, 9, 10, and 13) — including those of the command module, lunar module, portable life support system, and Manned Space Flight Network — was generally as expected. This section presents only those aspects of communications systems performance which were unique to the Apollo 11 flight. The performance of these systems was otherwise consistent with that of previous flights. The S-band communications system provided good-quality voice, as did the vhf link within its range capability. The performance of command module and lunar module up-data links was nominal, and real-time and playback telemetry performance was excellent. Color television pictures of high quality were received from the command module. Good-quality black-and-white television pictures were received and converted to standard format during lunar surface operations. Excellent-quality tracking data were obtained for both the command and the lunar modules. The received up-link and down-link signal powers corresponded to preflight predictions. Communications systems management, including antenna switching, was generally good.

Two-way phase lock with the command module S-band equipment was maintained by the Merritt Island, Grand Bahama Island, Bermuda, and U.S.N.S. Vanguard stations through orbital insertion, except during S-IC/S-II staging, interstage jettison, and station-to-station handovers. A complete loss of up-link lock and command capability was encountered between 6 and 6-1/2 minutes after earth lift-off because the operator of the ground transmitter at the Grand Bahama Island station terminated transmission 30 seconds early. Full S-band communications capability was restored at the scheduled handover time when the Bermuda station established two-way phase lock. During the Merritt Island station coverage of the launch phase, PM and FM receivers were used to demodulate the received telemetry data. (Normally, only the PM data link is used.) The purpose of this configuration was to provide additional data on the possibility of improving telemetry coverage, by using the FM receiver, during S-IC/S-II staging and interstage jettison. There was no loss of data through the FM receiver at staging. On the other hand, the same event caused a 9-second loss of data at the PM receiver output (fig. 6-1). However, the loss of data at interstage jettison was approximately the same for both types of receivers.

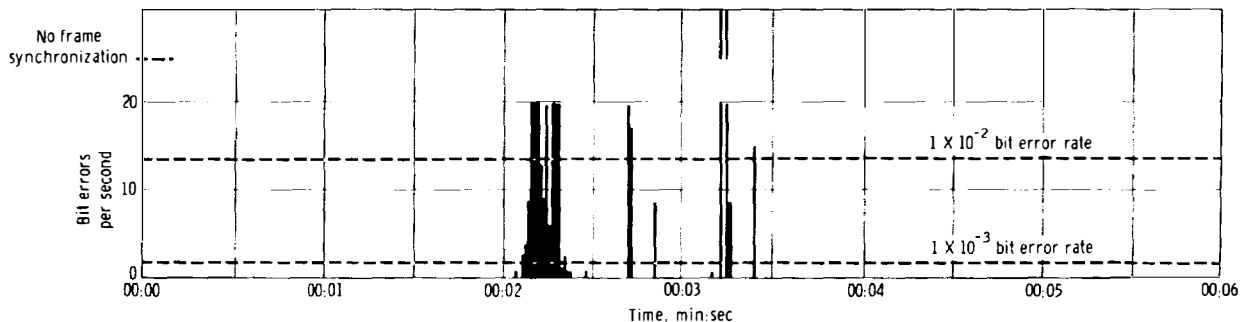

(a) PM telemetry performance.

Figure 6-1.- Communications systems performance (down link) during launch.

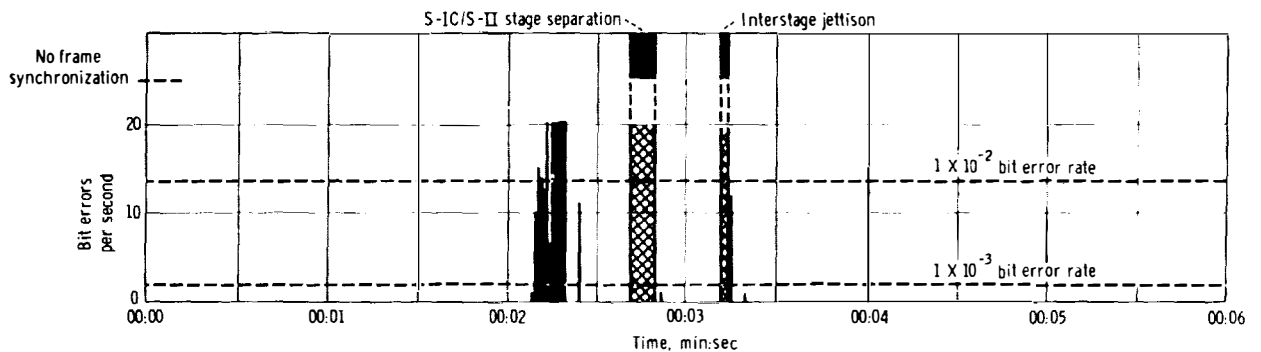

(b) FM telemetry performance.

Figure 6-1.- Concluded.

The television transmission attempted during the first pass over the Goldstone station was unsuccessful because of a shorted patch cable in the ground station television equipment. Also, the tracking coverage during this pass was limited to approximately 3 minutes by terrain obstructions. All subsequent transmissions provided high-quality television.

The U.S.N.S. Redstone and Mercury and the Hawaii station provided adequate coverage of translunar injection. A late handover of the command module and instrument unit up links from the U.S.N.S. Redstone to the U.S.N.S. Mercury and an early handover of both up links from the U.S.N.S. Mercury to the Hawaii station were performed because of command computer problems at the U.S.N.S. Mercury. Approximately 58 seconds of command module data were lost during these handovers. The loss of data during the handover from the U.S.N.S. Mercury to the Hawaii station was caused by terrain obstructions.

Communications between the command module and the ground were lost during a portion of transposition and docking because the crew failed to switch omnidirectional antennas during the pitch maneuver. Two-way phase lock was regained when the crew acquired the high-gain antenna in the narrow beamwidth. The telemetry data recorded on board the spacecraft during this phase were subsequently played back to the ground. Between 3-1/2 and 4 hours, the down-link voice received at the Mission Control Center was distorted by equipment failures within the Goldstone station.

During the fourth lunar orbit revolution, lunar module communications equipment was activated for the first time. Good-quality normal and backup down-voice and high- and low-bit-rate telemetry were received through the 210-foot antenna at Goldstone, California, while the spacecraft was transmitting through an omnidirectional antenna. As expected, telemetry decommutation frame synchronization could not be maintained in the high-bit-rate mode by using the 85-foot antenna at Goldstone for reception.

Between acquisition of the lunar module signal at 102:16:30 and the pitch-down maneuver during powered descent, valid steerable antenna autotrack could not be achieved, and received up-link and down-link carrier powers were 4 to 6 decibels less than nominal. Coincidentally, several losses of phase lock were experienced (fig. 6-2). Prior to the unscheduled yaw maneuver initiated at 102:27:22, the line of sight from the lunar module steerable antenna to earth was obstructed by a reaction control thruster plume deflector. (See "Steerable Antenna Acquisition" in section 16.) Therefore, in this attitude, the antenna was more susceptible to incidental phase and amplitude modulation resulting from

multipath effects off either the lunar module or the lunar surface. The sharp losses of phase lock were probably caused by the buildup of oscillations in the steerable antenna motion as the frequencies of the incidental amplitude and phase modulation approached multiples of the antenna switching frequency (50 hertz). After the yaw maneuver, auto-track with the correct steerable antenna pointing angles was not attempted until 102:40:12. Subsequently, valid autotrack was maintained throughout landing.

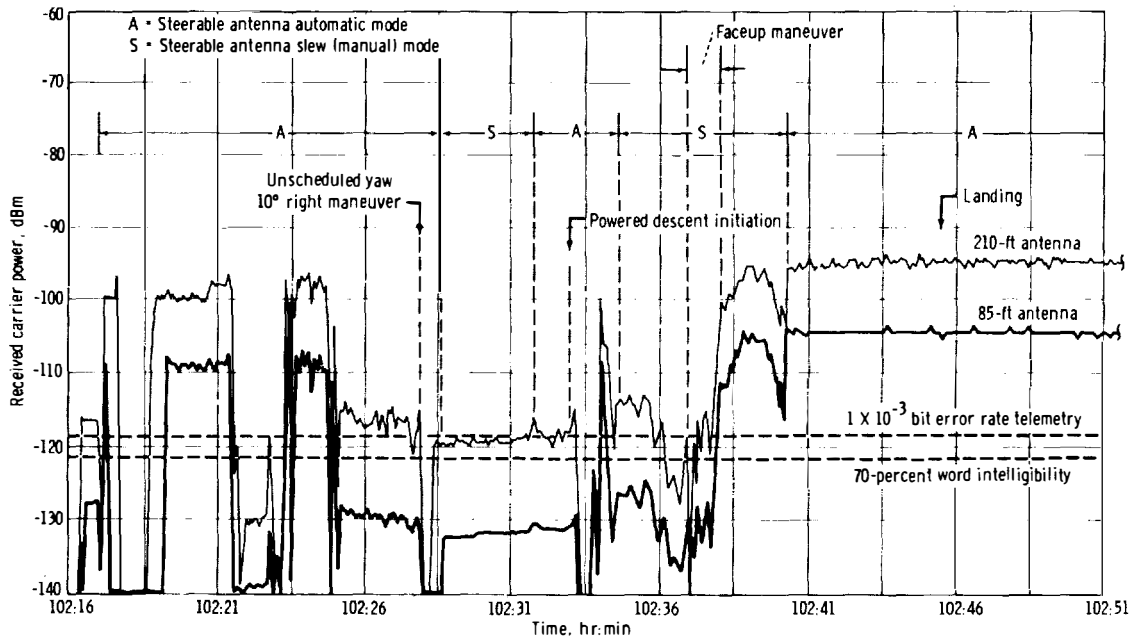

(a) Down-link power.

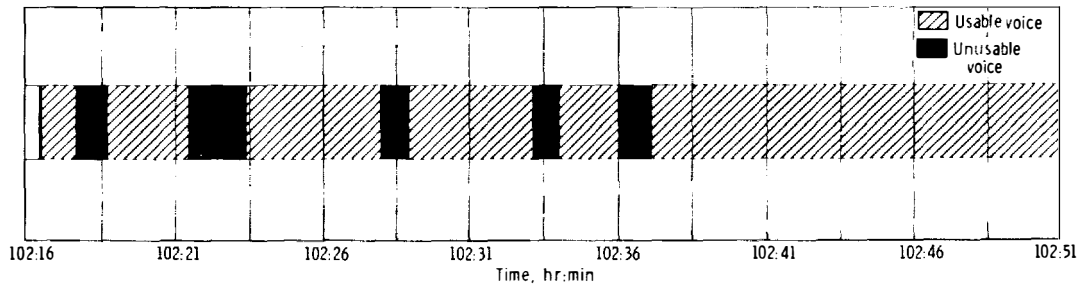

(b) Voice performance (210-foot antenna).

Figure 6-2.- Communications systems performance (down link) during final descent.

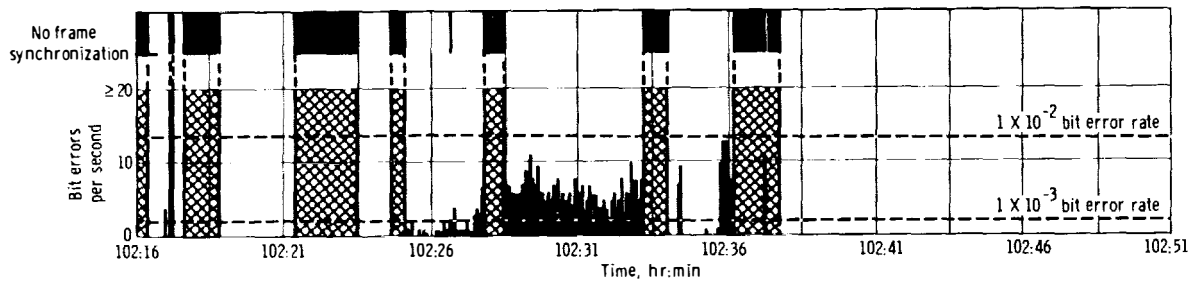

(c) Telemetry performance (210-foot antenna).

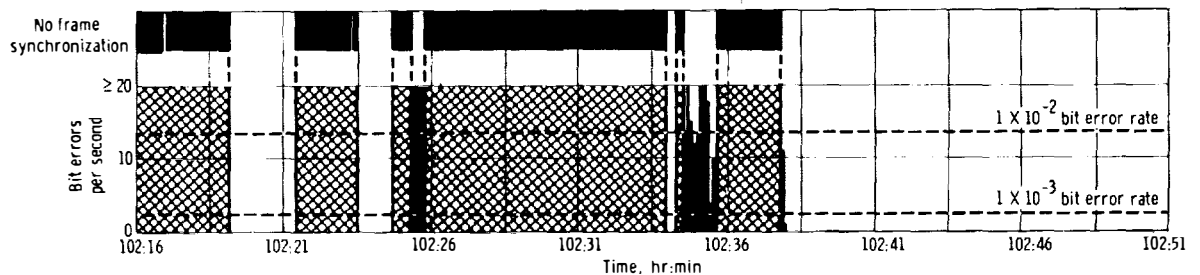

(d) Telemetry performance (85-foot antenna).

Figure 6-2.- Concluded.

As shown in figure 6-2, the performance of the down-link voice and telemetry channels was consistent with the received carrier power. The long periods of loss of PCM synchronization on data received at the 85-foot station distinctly illustrate the advantage of scheduling the descent maneuver during coverage by a 210-foot antenna.

After landing, the lunar module steerable antenna was switched to the slew (manual) mode and was used for all communications during the lunar surface stay. Also, the Manned Space Flight Network was configured to relay voice communications between the two spacecraft. This configuration provided good-quality voice while the command module was transmitting through the high-gain antenna. However, the lunar module crewmen reported that the noise associated with random keying of the voice-operated amplifier within the Manned Space Flight Network relay configuration was objectionable when the command module was transmitting through an omnidirectional antenna. This noise was expected with operation on an omnidirectional antenna, and the use of the two-way voice relay through the Manned Space Flight Network was discontinued, as planned, after the noise was reported. During the subsequent extravehicular activity, a one-way voice relay through the Manned Space Flight Network to the command module was utilized.

Primary coverage of the extravehicular activity was provided by the 210-foot antennas at Goldstone, California, and Parkes, Australia. Backup coverage was provided by the 85-foot antennas at Goldstone, California, and Honeysuckle Creek, Australia. Voice communications during this period were satisfactory; however, voice-operated-relay operations caused breakup of the voice received at the Manned Space Flight Network stations. (See "Network Performance" in section 13 and "Voice Breakup During Extravehicular Activity" in section 16.) This breakup was primarily associated with the Lunar Module Pilot. Throughout the lunar surface operation, an echo was heard on the ground 2.6 seconds after

the up-link transmissions because the up-link voice was turned around and transmitted on the lunar module S-band down link. (See the subsection of section 16 entitled "Echo During Extravehicular Activity.") The Parkes receiving station was largely used by the Mission Control Center as the primary receiving station for real-time television transmissions. The telemetry decommutation system and the PAM-to-PCM converter maintained frame synchronization on the lunar module telemetry data and the portable-life-support-system status data, respectively, throughout the lunar surface activities.

An evaluation of data recorded by the Honeysuckle station during lunar surface activities was accomplished to determine whether a station with an 85-foot antenna could have supported this mission phase without deployment of the lunar module erectable antenna. The results of the evaluation were compared with those of a similar evaluation recorded at the Goldstone station which used the 210-foot antenna. A comparison of slow-scan television signals received at the two stations shows that although there was a decibel difference in signal-to-noise ratios, there was no appreciable difference in picture quality. The differences in down-link voice intelligibility and telemetry data quality were not significant. There is no perceptible difference in the quality of biomedical data received at the 85- and 210-foot stations. Playback of portable-life-support-system status data for the Lunar Module Pilot shows that frame synchronization was maintained 88 and 100 percent of the time for the stations with the 85- and the 210-foot antennas, respectively. Based on these comparisons, it is believed that the ground station with the 85-foot antenna could have supported the lunar surface activities without deployment of the erectable antenna, with slightly degraded data.

The performance of the communications system during the ascent and rendezvous phases was nominal except for a 15-second loss of down-link phase lock at ascent engine ignition. The data indicate this loss can be attributed to rapid phase perturbations caused by transmission through the ascent engine plume. During future Apollo missions, a wider carrier tracking loop bandwidth will be selected by the Manned Space Flight Network stations prior to powered ascent. This change will minimize the possibility of loss of phase lock because of rapid phase perturbations.

7. TRAJECTORY

The analysis of the trajectory from lift-off to spacecraft/S-IVB separation was based on Marshall Space Flight Center results and Manned Space Flight Network tracking data. After separation, the actual trajectory information was based on the best-estimate trajectory generated after the flight from Manned Space Flight Network tracking and telemetry data.

The earth and moon models used for the trajectory analysis are described geometrically as follows: (1) The earth model is a modified seventh-order expansion containing geodetic and gravitational constants representative of the Fischer ellipsoid, and (2) the moon model is a spherical harmonic expansion containing the R2 potential function, which is defined in reference 1. Table 7-1 defines the trajectory and maneuver parameters.

TABLE 7-1.- DEFINITION OF TRAJECTORY AND ORBITAL PARAMETERS

Parameter	Definition
Geodetic latitude	Spacecraft position measured north or south from the equator of the earth to the local-vertical vector, deg
Selenographic latitude	Spacecraft position measured north or south from the true lunar equatorial plane to the local-vertical vector, deg
Longitude	Spacecraft position measured east or west from the prime meridian of the body to the local-vertical vector, deg
Altitude	Perpendicular distance from the reference body to the point of orbit intersect, ft or miles; altitude above the lunar surface is referenced to landing site 2
Space-fixed velocity	Magnitude of the inertial velocity vector referenced to the body-centered, inertial reference coordinate system, ft/sec
Space-fixed flight-path angle	Flight-path angle measured positive upward from the body-centered, local-horizontal plane to the inertial velocity vector, deg
Space-fixed heading angle	Angle of the projection of the inertial velocity vector onto the local body-centered, horizontal plane, measured positive eastward from north, deg
Apogee	Maximum altitude above the oblate earth model, miles
Perigee	Minimum altitude above the oblate earth model, miles
Apocynthion	Maximum altitude above the moon model, referenced to landing site 2, miles
Pericynthion	Minimum altitude above the moon model, referenced to landing site 2, miles
Period	Time required for spacecraft to complete 360° orbit rotation, min
Inclination	Acute angle formed at the intersection of the orbit plane and the equatorial plane of the reference body, deg
Longitude of the ascending node	Longitude where the orbit plane crosses the equatorial plane of the reference body from below, deg

Launch Phase

The launch trajectory was essentially nominal and was approximately identical to that of Apollo 10. A maximum dynamic pressure of 735 lb/ft^2 was experienced. The S-IC center and outboard engines and the S-IVB engine cut off within 1 second of the planned times, and the S-II outboard engine cut off 3 seconds early. At S-IVB cut-off, the altitude was high by 9100 feet, the velocity was low by 6.0 ft/sec, and the flight-path angle was high by 0.01° . All of these variations were within the expected dispersions.

Earth Parking Orbit

Earth parking orbit insertion occurred at 0:11:49.3. The parking orbit was perturbed by low-level hydrogen venting of the S-IVB stage until 2:34:38, the time of S-IVB restart preparation.

Translunar Injection

The S-IVB was reignited for the translunar ejection maneuver at 2:44:16.2, or within 1 second of the predicted time, and cut-off occurred at 2:50:03. All parameters were nominal, as shown in figure 7-1.

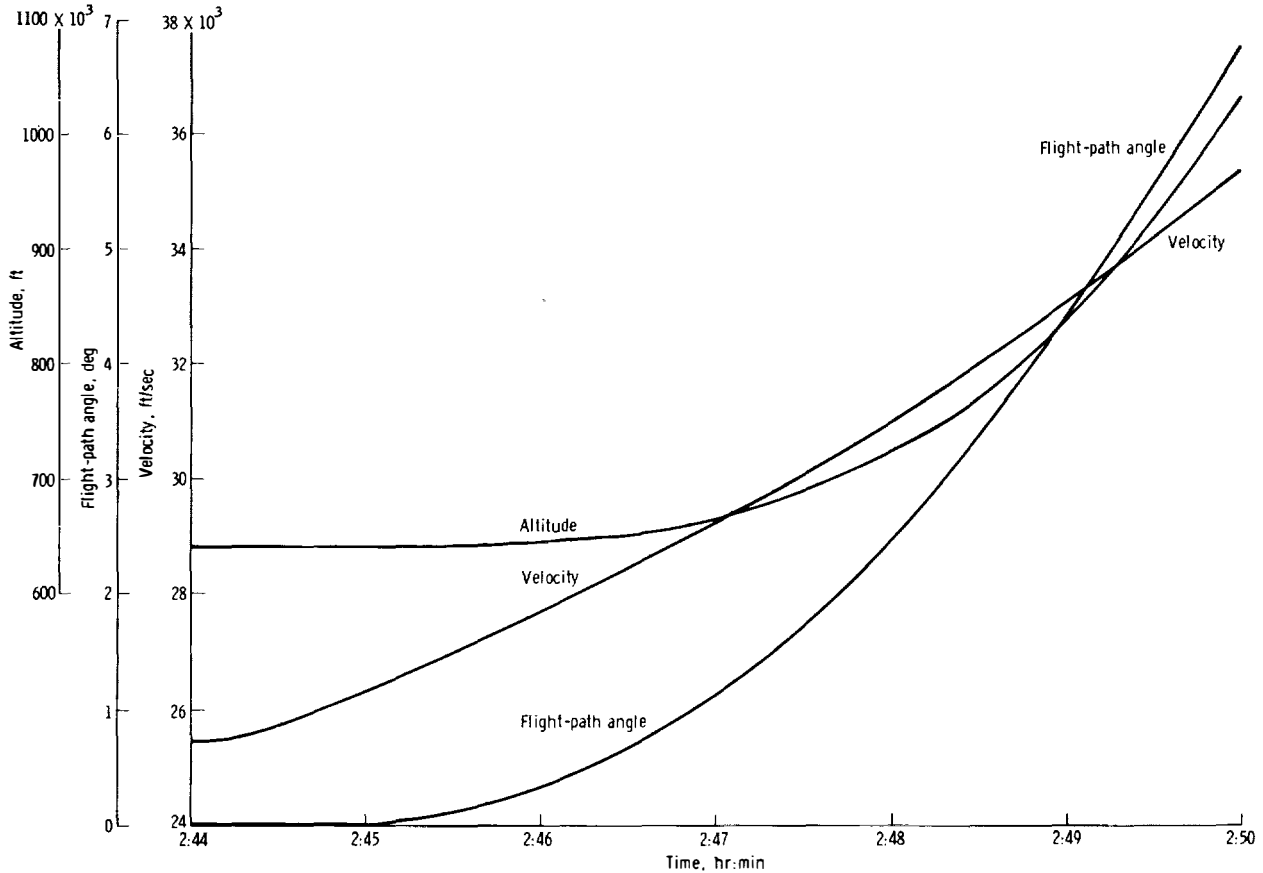

Figure 7-1.- Trajectory parameters during translunar injection firing.

Maneuver Analysis

The parameters derived from the best-estimate trajectory for each spacecraft maneuver executed during the translunar, lunar orbit, and transearth coast phases are presented in table 7-II. Tables 7-III and 7-IV present the respective pericyynthion and free-return conditions after each translunar maneuver. The free-return results indicate conditions at entry interface produced by each maneuver, assuming no additional orbit perturbations. Tables 7-V and 7-VI present the respective maneuver summaries for the lunar orbit and the transearth coast phases.

Translunar injection.- The pericyynthion altitude resulting from translunar injection was 896.3 miles, as compared with the preflight prediction of 718.9 miles. This altitude difference is representative of a 1.6-ft/sec accuracy in the injection maneuver. The associated free-return conditions show an earth capture of the spacecraft.

Separation and docking.- The command and service modules separated from the S-IVB and successfully completed the transposition and docking sequence. The spacecraft were ejected from the S-IVB at 3 hours 17 minutes. The effect of the 0.7-ft/sec ejection maneuver was a change in the predicted pericyynthion altitude to 827.2 miles. The separation maneuver performed by the service propulsion system was executed precisely and on time. The resulting trajectory conditions indicate a pericyynthion altitude reduction to 180.0 miles, as compared to the planned value of 167.7 miles. The difference indicates a 0.24-ft/sec execution error.

Translunar midcourse correction.- The computed midcourse correction for the first option point was only 17.1 ft/sec. A real-time decision was made, therefore, to delay the first midcourse correction until the second option point at translunar injection plus 24 hours because of the small increase to only 21.2 ft/sec in the corrective velocity required. The first and only translunar midcourse correction was initiated on time and resulted in a pericyynthion altitude of 61.5 miles, as compared with the desired value of 60.0 miles. Two other opportunities for midcourse correction were available during the translunar phase, but the velocity changes required to satisfy planned pericyynthion altitude and nodal position targets were well below the levels at which normal lunar orbit insertion can be retargeted. Therefore, no further translunar midcourse corrections were required. The translunar trajectory was similar to that of Apollo 10.

Lunar orbit insertion and circularization.- The lunar orbit insertion and circularization targeting philosophy for Apollo 11 differed from that of Apollo 10 in two ways. First, targeting for the landing-site latitude was biased to account for the orbit plane regression observed in Apollo 10, and second, the circularization maneuver was targeted for a noncircular orbit of 65.7 by 53.7 miles, as compared with the 60-mile circular orbit targeted for Apollo 10. A discussion of these considerations is presented in "Lunar Orbit Targeting" in section 7. The representative ground track of the spacecraft during the lunar orbit phase of the mission is shown in figure 7-2.

The sequence of events for lunar orbit insertion was initiated on time, and the orbit achieved as 169.7 by 60.0 miles. The firing duration was 4.5 seconds less than predicted because of higher-than-predicted thrust. (See "Service Propulsion" in section 8.)

The circularization maneuver was initiated two revolutions later and achieved the desired target orbit to within 0.1 mile. The spacecraft was placed into a 65.7-by-53.8-mile orbit, with pericyynthion at approximately 80° W, as planned. The R2 orbit prediction model predicted a spacecraft orbit at 126 hours (revolution 13) of 59.9 by 59.3 miles. However, the orbit did not circularize during this period (fig. 7-3). The effects of the lunar potential were sufficient to cause this prediction to be in error by approximately 2.5 miles. The actual spacecraft orbit at 126 hours was 62.4 by 56.6 miles.

Undocking and command module separation.- The lunar module was undocked from the command module during lunar revolution 13 at approximately 100 hours. The command and service modules then performed a three-impulse separation sequence, with an actual firing time of 9 seconds and a velocity change of 2.7 ft/sec. As reported by the crew, the lunar module trajectory perturbations resulting from undocking and station keeping were not compensated for in the descent orbit insertion maneuver one-half revolution later. These errors directly affected the lunar module state-vector accuracy at the initiation of powered descent.

Lunar module descent.- The descent orbit insertion maneuver was executed at 101.5 hours, and approximately 57 minutes later, the powered descent sequence began. The detailed trajectory analysis for the lunar module descent phase is presented in "Descent Trajectory Logic" in section 5. The trajectory parameters and maneuver results are presented in tables 7-II and 7-V.

Lunar module ascent and rendezvous.- The lunar module ascent stage lifted off the lunar surface at 124:22:00.8 after staying on the surface for 21 hours 36.35 minutes. The lunar orbit insertion and rendezvous sequence were normal. The terminal phase was completed by 128 hours. The detailed trajectory analysis for ascent and rendezvous is presented in "Ascent" and "Rendezvous" in section 5. Tables 7-II and 7-V present the trajectory parameters and maneuver results for these phases.

Transearth injection.- The transearth injection maneuver was initiated on time and achieved a velocity change of only 1.2 ft/sec less than planned. This maneuver exceeded the real-time planned duration by 3.4 seconds because of a slightly lower-than-expected thrust. (See "Service Propulsion" in section 8.) The transearth injection would not have achieved acceptable earth entry conditions. The resulting perigee altitude solution was 69.4 miles, as compared with the nominal value of 20.4 miles.

Transearth midcourse correction.- At the fifth midcourse-correction option point, the first and only transearth midcourse correction of 4.8 ft/sec was made with the reaction control system, and the trajectory was corrected to the predicted entry flight-path angle of -6.51°.

TABLE 7-II. - TRAJECTORY PARAMETERS

Event	Reference body	Time, hr:min:sec	Latitude, deg	Longitude, deg	Altitude, miles	Space-fixed velocity, ft/sec	Space-fixed flight-path angle, deg	Space-fixed heading angle, deg E of N
Translunar phase								
S-IVB second ignition	Earth	2:44:16.2	5.03 S	172.55 E	105.8	25 562	0.02	57.78
S-IVB second cut-off	Earth	2:50:03.2	9.52 N	165.61 W	173.3	35 567	6.91	59.93
Translunar injection	Earth	2:50:13.2	9.98 N	164.84 W	180.6	35 546	7.37	60.07
Command module/S-IVB separation	Earth	3:17:04.6	31.16 N	88.76 W	4 110.9	24 456.8	46.24	95.10
Docking	Earth	3:24:03.1	30.18 N	81.71 W	5 317.6	22 662.5	44.94	99.57
Spacecraft/S-IVB separation (ejection)	Earth	4:16:59.1	23.18 N	67.70 W	3 506.5	16 060.8	62.01	110.90
Separation maneuver								
Ignition	Earth	4:40:01.8	21.16 N	68.46 W	16 620.8	14 680.0	64.30	113.73
Cut-off	Earth	4:40:04.7	21.16 N	68.46 W	16 627.3	14 663.0	64.25	113.74
First midcourse correction								
Ignition	Earth	26:44:58.7	5.99 N	11.16 W	109 475.3	5 025.0	77.05	120.88
Cut-off	Earth	26:45:01.8	6.00 N	11.17 W	109 477.2	5 010.0	76.88	120.87
Lunar orbit phase								
Lunar orbit insertion								
Ignition	Moon	75:49:50.4	1.57 S	169.58 W	86.7	8 250.0	-9.99	-62.80
Cut-off	Moon	75:55:48.0	.16 N	167.13 E	60.1	5 479.0	-.20	-66.89
Lunar orbit circularization								
Ignition	Moon	80:11:36.8	.02 S	170.09 E	61.8	5 477.3	-.49	-66.55
Cut-off	Moon	80:11:53.5	.02 S	169.16 E	61.6	5 338.3	.32	-66.77
Undocking	Moon	100:12:00.0	1.11 N	116.21 E	62.9	5 333.8	.16	-89.13
Separation								
Ignition	Moon	100:39:52.9	.99 N	31.86 E	62.7	5 332.7	-.13	-106.89
Cut-off	Moon	100:40:01.9	1.05 N	31.41 E	62.5	5 332.2	-.16	-106.90
Descent orbit insertion								
Ignition	Moon	101:36:14.0	1.12 S	140.20 W	56.4	5 364.9	.10	-75.70
Cut-off	Moon	101:36:44	1.16 S	141.88 W	57.8	5 284.9	-.06	-75.19
Powered descent initiation	Moon	102:33:05	1.02 N	39.39 E	6.4	5 564.9	.03	-104.23
Lunar orbit engine cut-off	Moon	124:29:15.7	.73 N	12.99 E	10.0	5 537.9	.28	-108.15
Coelliptic sequence initiation								
Ignition	Moon	125:19:35.0	.98 S	147.12 W	47.4	5 328.1	.11	-77.98
Cut-off	Moon	125:20:22.0	.91 S	149.57 W	48.4	5 376.6	.09	-76.98
Terminal phase initiation								
Ignition	Moon	127:03:51.8	1.17 S	110.28 W	44.1	5 391.5	-.16	-93.16
Cut-off	Moon	127:04:14.5	1.17 S	111.46 W	44.0	5 413.2	-.03	-92.65
Terminal phase finalization	Moon	127:46:09.8	.80 N	118.61 E	7.6	5 339.7	.42	-70.45
Docking	Moon	128:03:00.0	1.18 N	67.31 E	60.6	5 341.5	.16	-87.63
Ascent stage jettison	Moon	130:09:31.2	1.10 N	41.85 E	61.6	5 335.9	.15	-97.81
Final separation								
Ignition	Moon	130:30:01.0	.08 N	20.19 W	62.7	5 330.1	-.05	-52.86
Cut-off	Moon	130:30:08.1	.19 N	20.58 W	62.7	5 326.9	-.02	-52.73
Transearth injection								
Ignition	Moon	135:23:42.3	.16 S	164.02 E	52.4	5 376.0	-.03	-62.77
Cut-off	Moon	135:26:13.7	.50 N	154.02 E	58.1	8 589.0	5.13	-62.60
Transearth coast phase								
Second midcourse correction								
Ignition	Earth	150:29:57.4	13.16 S	37.79 W	169 087.2	4 075.0	-80.34	129.30
Cut-off	Earth	150:30:07.4	13.16 S	37.83 W	169 080.6	4 074.0	-80.41	129.30
Command module/service module separation	Earth	194:49:12.7	35.09 S	122.54 E	1 778.3	29 615.5	-35.26	69.27

TABLE 7-III.- TRANSLUNAR MANEUVER SUMMARY

Maneuver	System	Ignition time, hr:min:sec	Firing time, sec	Velocity change, ft/sec	Resultant pericyynthion conditions				
					Altitude, miles	Velocity, ft/sec	Latitude, deg	Longitude, deg	Arrival time, hr:min:sec
Translunar injection	S-IVB	2:44:16.2	347.3	10 441.0	896.3	6640	0.11 S	174.13 W	75:05:21
Command and service modules/S-IVB separation	Reaction control	3:17:04.6	7.1	.7	827.2	6728	.09 S	174.89 W	75:07:47
Spacecraft/S-IVB separation	Service propulsion	4:40:01.8	2.9	19.7	180.8	7972	.18 N	175.97 E	75:39:30
First midcourse correc- tion	Service propulsion	26:44:58.7	3.1	20.9	61.5	8334	.17 N	173.57 E	75:53:35

TABLE 7-IV.- FREE-RETURN CONDITIONS FOR TRANSLUNAR MANEUVERS

Vector description	Vector time, hr:min:sec	Entry interface conditions				
		Velocity, ft/sec	Flight-path angle, deg	Latitude, deg	Longitude, deg	Arrival time, hr:min:sec
After translunar injection	2:50:03.0	36 076	-64.06	1.93 N	66.40 E	162:12:04
After command and service modules/S-IVB separation	4:40:01.0	36 079	-67.43	.19 S	98.05 E	160:32:27
After separation maneuver	11:28:00.0	36 139	-48.95	37.38 S	59.95 E	146:39:27
After first midcourse correction	26:45:01.5	36 147	-10.25	18.46 S	168.10 E	145:05:28
Before lunar orbit insertion	70:48:00	36 147	-9.84	17.89 S	169.01 E	145:04:32

TABLE 7-V.- LUNAR ORBIT MANEUVER SUMMARY

Maneuver	System	Ignition time, hr:min:sec	Firing time, sec	Velocity change, ft/sec	Resultant orbit	
					Apocynthion, miles	Pericynthion, miles
Lunar orbit insertion	Service propulsion	75:49:50.4	357.5	2917.5	169.7	60.0
Lunar orbit circularization	Service propulsion	80:11:36.8	16.8	158.8	66.1	54.5
Command module/lunar module separation	Service module reaction control	100:39:52.9	5.2	1.4	63.7	56.0
Descent orbit insertion	Descent propulsion	101:36:14.0	30.0	76.4	64.3	55.6
Powered descent initiation	Descent propulsion	102:33:05	756.3	6930	58.5	7.8
Lunar orbit insertion	Ascent propulsion	124:22:00.8	434.9	6070.1	48.0	9.4
Coelliptic sequence initiation	Lunar module reaction control	125:19:35	47.0	51.5	49.3	45.7
Constant differential height	Lunar module reaction control	126:17:49.6	17.8	19.9	47.4	42.1
Terminal phase initiation	Lunar module reaction control	127:03:51.8	22.7	25.3	61.7	43.7
Terminal phase finalization	Lunar module reaction control	127:46:09.8	28.4	31.4	63.0	56.5
Final separation	Lunar module reaction control	130:30:01.0	7.2	2.2	62.7	54.0

TABLE 7-VI.- TRANSEARTH MANEUVER SUMMARY

Event	System	Ignition time, hr:min:sec	Firing time, sec	Velocity change, ft/sec	Resultant entry interface conditions				
					Flight-path angle, deg	Velocity, ft/sec	Latitude, deg	Longitude, deg	Arrival time, hr:min:sec
Transearth injection	Service propulsion	135:23:42.3	151.4	3279.0	-0.70	36 195	4.29 N	180.15 E	195:05:57
Second midcourse correction	Service module reaction control	150:29:57.4	11.2	4.8	-6.46	36 194	3.17 S	171.99 E	195:03:08

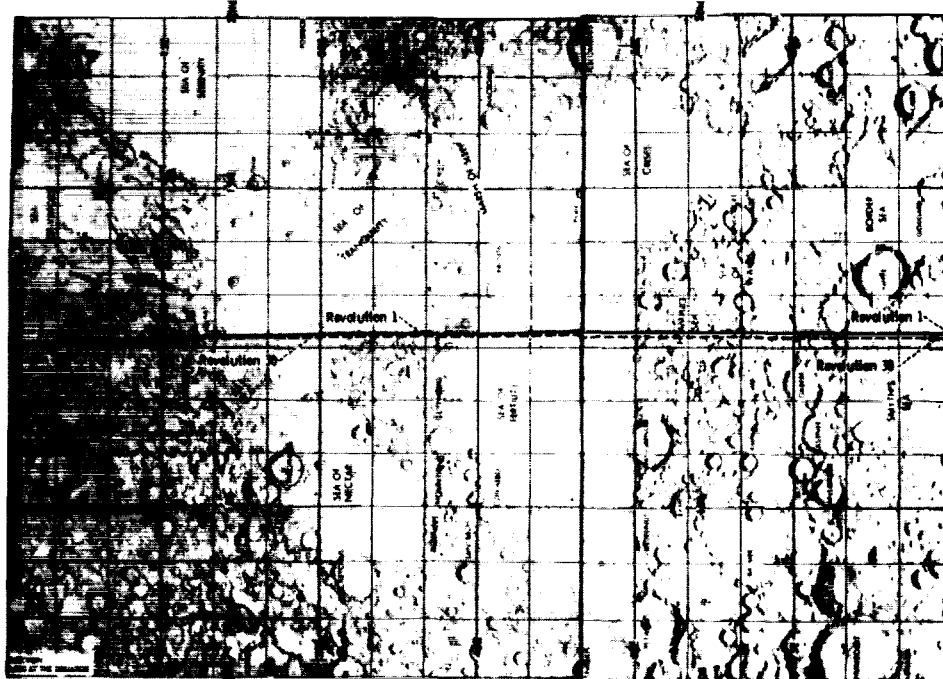

(c) 0° to 90° E.

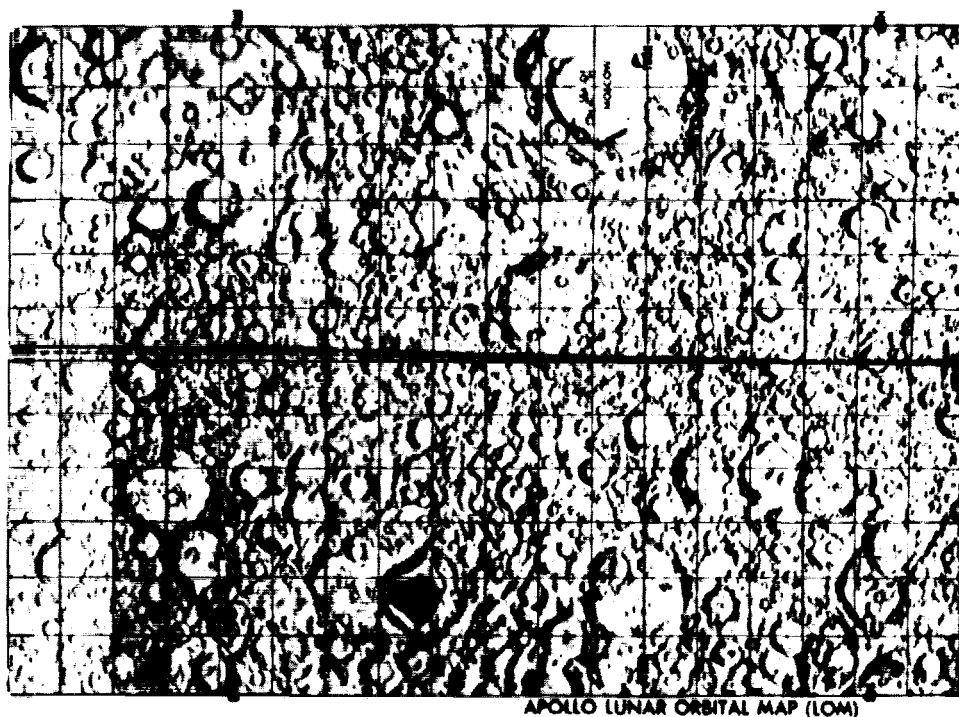

(d) 90° E to 180°.

Figure 7-2.- Concluded.

Command Module Entry

The best-estimate trajectory for the command module during entry was obtained from a digital postflight reconstruction. The onboard telemetry recorder was inoperative during entry, and, because the spacecraft experienced communications blackout during the first portion of entry, complete telemetry information was not recorded. An Apollo range instrumentation aircraft received a small amount of data soon after the entry interface was reached and again approximately 4 minutes into the entry. These data, combined with the best-estimate trajectory, produced the postflight data presented in this report. Table 7-VII presents the actual conditions at entry interface. The flight-path angle at entry was 0.03° shallower than predicted at the last midcourse correction, which caused a peak load factor of $6.56g$ that was slightly higher than planned. The spacecraft landed in the Pacific Ocean at longitude 169.15° W and latitude 13.30° N.

TABLE 7-VII.- ENTRY TRAJECTORY PARAMETERS

Entry interface (400 000-foot altitude):	
Time, hr:min:sec	195:03:05.7
Geodetic latitude, deg S	3.19
Longitude, deg E	171.96
Altitude, miles	65.8
Space-fixed velocity, ft/sec	36 194.4
Space-fixed flight-path angle, deg	-6.48
Space-fixed heading angle, deg E of N	50.18
Maximum conditions:	
Velocity, ft/sec	36 277.4
Acceleration, g	6.51
Drogue deployment:	
Time, hr:min:sec	195:12:06.9
Geodetic latitude, deg S	
Recovery ship report	13.25
Onboard guidance	13.30
Target	13.32
Longitude, deg W	
Recovery ship report	169.15
Onboard guidance	169.15
Target	169.15

Service Module Entry

The service module entry was recorded on film by aircraft. This film shows the service module entering the atmosphere of the earth and disintegrating near the command module. According to preflight predictions, the service module should have skipped out of the atmosphere into a highly elliptical orbit. The Apollo 11 crew observed the service module approximately 5 minutes after separation and indicated that the reaction control thrusters were firing and that the module was rotating. A more complete discussion of this anomaly is presented in "Service Module Entry" in section 16.

Lunar Orbit Targeting

The targeting philosophy for the lunar orbit insertion maneuver differed in two ways from that of Apollo 10. First, the landing-site latitude targeting was biased in an attempt to account for the orbit plane regression noted in Apollo 10. During Apollo 10, the lunar module passed approximately 5 miles south of the landing site on the low-altitude pass following descent orbit insertion. The Apollo 11 target bias of -0.37° in latitude was based on the Langley Research Center 13th-degree, 13th-order lunar gravity model. Of all gravity models investigated, this one came the closest to predicting the orbit inclination and longitude of ascending node rates observed from Apollo 10 data. During the lunar landing phase in revolution 14, the lunar module latitude was 0.078° north of the desired landing-site latitude. A large part of this error resulted because the targeted orbit was not achieved at lunar orbit insertion. The difference between the predicted and actual values was approximately 0.05° , which represents the prediction error from the 13th-degree, 13th-order model over 14 revolutions. However, the amount of lunar module plane change required during descent was reduced from the 0.337° that would have been required for a landing during Apollo 10 to 0.078° in Apollo 11 by biasing the lunar orbit insertion targeting. A comparison between Apollo 10 and 11 latitude targeting results is presented in table 7-VIII.

The second change from Apollo 10 targeting was that the circularization maneuver was targeted for a noncircular orbit of 53.7 by 65.7 miles. The R2 lunar potential model predicted this orbit would decay to a 60-mile circular orbit at nominal time for rendezvous, thereby conserving ascent stage propellants. Although the R2 model is currently the best for predicting inplane orbital elements, it cannot predict accurately over long intervals. Figure 7-3 shows that the R2 predictions, using the revolution 3 vector, matched the observed altitudes for approximately 12 revolutions. It should be noted that the service module reaction-control-system separation maneuver in lunar orbit was taken into account for both the circularization targeting and the R2 prediction. Estimates show that if the spacecraft had been placed into a nearly circular orbit, as in Apollo 10, a degenerated orbit of 55.7 by 67.3 miles would have resulted by the time of rendezvous. The velocity penalty at the constant differential height maneuver for the Apollo 10 approach would have been at least 23 ft/sec, as compared to the actual 8 ft/sec resulting from the executed circularization targeting scheme. A comparison between Apollo 11 and Apollo 10 circularization results is presented in table 7-IX.

TABLE 7-VIII.- LATITUDE TARGETING SUMMARY

Latitude	Landing-site latitude on the landing revolutions, deg	
	Apollo 10	Apollo 11
Desired	0.691	0.691
Actual	.354	.769
Error	.337 S	.078 N

TABLE 7-IX.- CIRCULARIZATION ALTITUDE TARGETING

Altitude	Orbit altitude, miles	
	Apollo 10	Apollo 11
At circularization:		
Desired	60.0 by 60.0	53.7 by 65.7
Actual	61.0 by 62.8	54.5 by 66.1
Error	1.0 by 2.8	.8 by .4
At rendezvous:		
Desired	60.0 by 60.0	60.0 by 60.0
Actual	58.3 by 65.9	56.5 by 62.6
Error	-1.9 by 5.9	-3.5 by 2.6

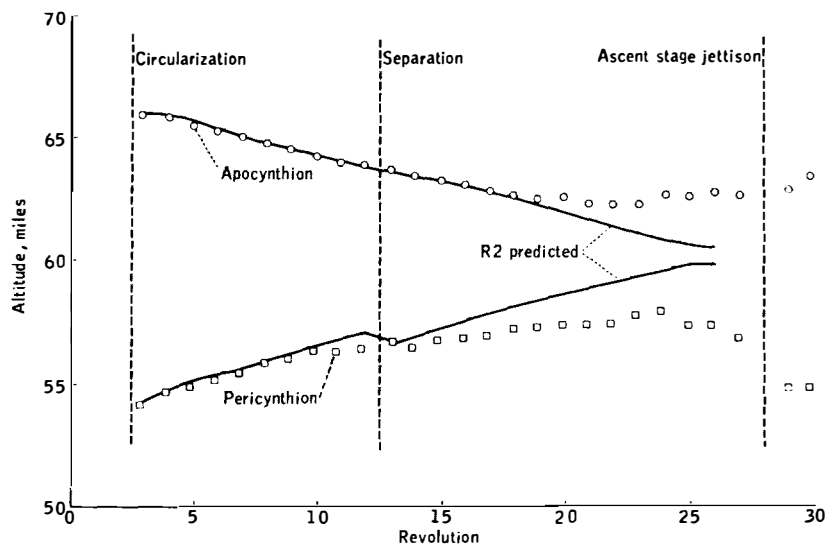

Figure 7-3.- Apocynthion-pericynthion history.

Lunar Orbit Navigation

The preflight plan for lunar orbit navigation, based on Apollo 8 and 10 postflight analyses, was to fit tracking data from two near-side lunar passes with the orbit plane constrained to the latest one-pass solution. For descent targeting, it was planned to use the landing-site coordinates determined from landmark sightings during revolution 12 if it appeared that the proper landmark had been tracked. If not, the best-estimate preflight coordinates from Lunar Orbiter data and Apollo 10 sightings were to be used. In addition, these coordinates were to be adjusted to account for a two-revolution propagation of radial errors determined in revolutions 3 to 10. The predicted worst-case estimate of navigation accuracy was approximately 3000 feet in both latitude and longitude.

Several unanticipated problems severely affected navigation accuracy. First, greater inconsistency and larger errors were observed in the one-pass orbit plane estimates than had been observed on any previous mission (fig. 7-4). These errors were the result of a known deficiency in the R2 lunar potential model. This condition should not occur on future missions because different lunar inclination angles will be flown.

A second problem, closely related to the first, was that the two-revolution propagation errors for crosstrack, or latitude, errors were extremely inconsistent. The average propagation error based on five samples at the end of revolution 10 was 2900 feet, but the uncertainty in this estimate was ± 9000 feet. Conversely, the propagation errors for radial and downtrack, or longitude, errors were within expected limits. No adjustment was made for either latitude or longitude propagation errors because of the large uncertainty in the case of latitude and the small correction (800 feet) required in the case of longitude.

The coordinates obtained from the landmark tracking during revolution 12 deviated from the best preflight estimate of the center of the landing-site ellipse by 0.097° N, 0.0147° E, and 0.038 mile below. These errors are attributed to the R2 potential model deficiencies. The large difference in latitude resulted from an error in the spacecraft state-vector estimate of the orbit plane; these were the data used to generate the sighting angles. The difference in longitude could also have been caused by an error in the estimated state vector or by tracking of the wrong landmark.

The third problem area was the large number of trajectory perturbations in revolutions 11 to 13 because of uncoupled attitude maneuvers, such as hot-firing tests of the lunar module thrusters, undocking impulse, station-keeping activity, sublimator operation and possibly tunnel and cabin venting. The net effect of these perturbations was a sizable down-range miss.

A comparison of the lunar landing point coordinates generated from various data sources is presented in table 5-IV. The difference, or miss distance, was 0.0444° S and 0.2199° E, or approximately 4440 and 21 990 feet, respectively. The miss in latitude was caused by neglecting the two-revolution orbit plane propagation error, and the miss in longitude resulted from the trajectory perturbations during revolutions 11 to 13.

The coordinates used for ascent targeting were the best preflight estimate of landing-site radius and the onboard-guidance estimate of latitude and longitude at touchdown (corrected for initial state-vector errors from ground tracking). The estimated errors in targeting coordinates were a radius 1500 feet less than desired and a longitude 4400 feet to the west.

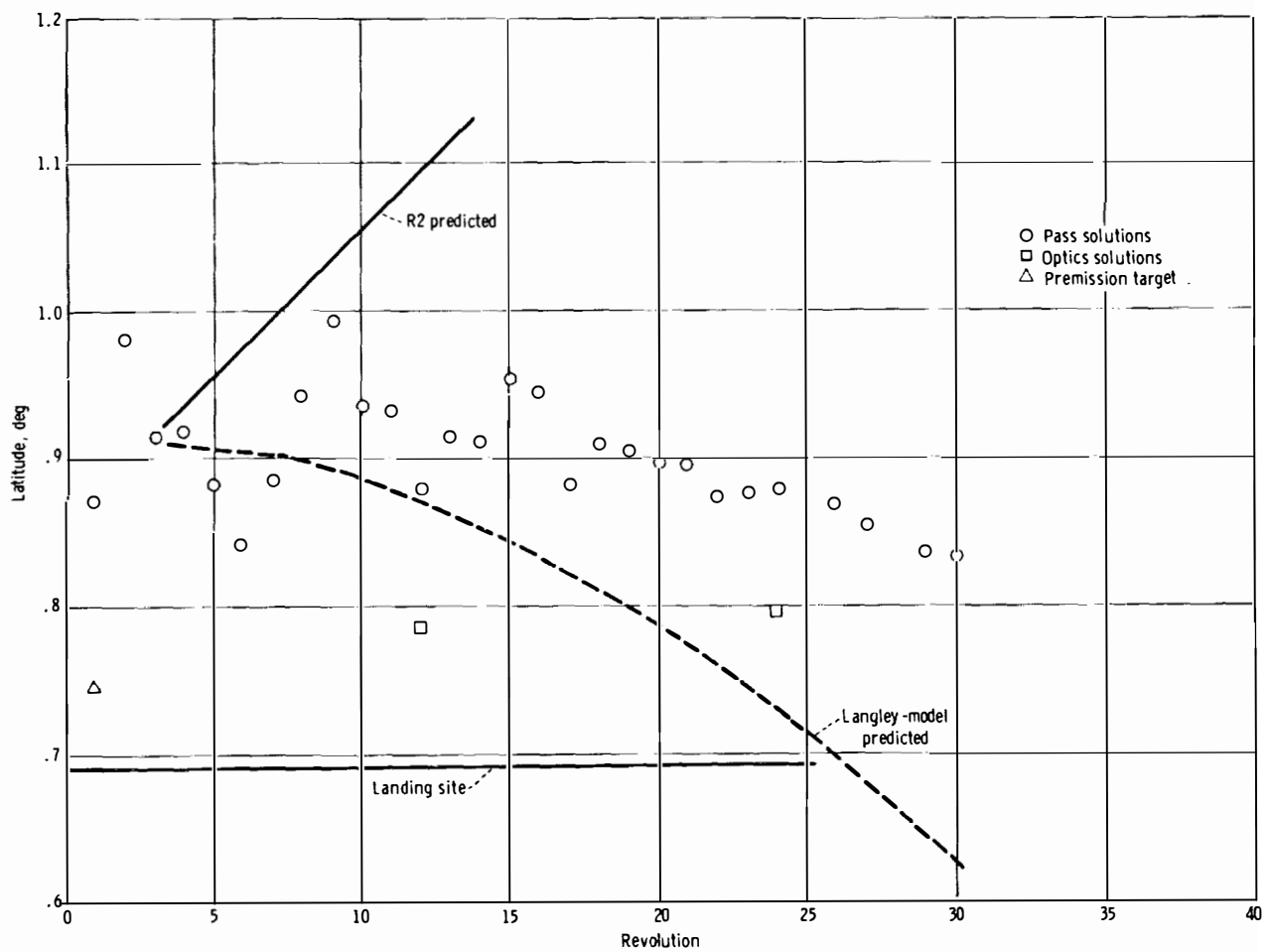

Figure 7-4.- Selenographic latitude estimates based on a one-pass solution using the R2 model.

8. PERFORMANCE OF THE COMMAND AND SERVICE MODULES

The performance of the command and service modules is discussed in this section. The sequential, pyrotechnic, thermal protection, earth landing, power distribution, and emergency detection systems operated as intended and are not discussed further. Discrepancies and anomalies are generally mentioned in this section, but are discussed in greater detail in section 16. Descriptive and historical information about the command and service modules is given in appendix B.

Structural and Mechanical Systems

At earth lift-off, measured winds, both at the 60-foot level and in the region of maximum dynamic pressure, indicated that structural loads were well below the established limits. During the first stage of flight, accelerations measured in the command module were nominal and similar to those measured during the Apollo 10 mission. The predicted and calculated spacecraft loads (1) at lift-off, (2) in the region of maximum dynamic pressure, (3) at the end of first-stage boost, and (4) during staging are shown in table 8-I.

Command module accelerometer data indicate that sustained low-frequency longitudinal oscillations were limited to 0.15g during S-IC boost. Structural loads during S-II and S-IVB boost, translunar injection, both docking operations, all service propulsion maneuvers, and entry were well within design limits.

As with all other mechanical systems, the docking system performed as required for both the translunar and the lunar orbit docking events. The information given in table 8-II concerning the two docking operations at contact is based upon crew comments. The probe retract time for both events was between 6 and 8 seconds. During the gas retract phase of the lunar orbit docking, the crew detected a relative yaw misalignment that was estimated to have been as much as 15°. (See "Rendezvous" in sections 4 and 5 for further discussion of the docking system.) The unexpected vehicle motions were not precipitated by the docking hardware and did not prevent accomplishment of a successful hard dock. Computer simulations of the lunar orbit docking event indicate that the observed vehicle misalignments can be caused by lunar module plus X thrusting after the command module is placed in an attitude-free control mode. (See "Guidance, Navigation, and Control" in this section.)

TABLE 8-I.- MAXIMUM SPACECRAFT LOADS DURING LAUNCH PHASE

(a) Predicted and calculated spacecraft loads

Interface	Load	Lift-off		Maximum q_{α}		End of first-stage boost		Staging	
		Calculated ^a	Predicted ^b	Calculated ^a	Predicted ^c	Calculated ^a	Predicted ^d	Calculated ^a	Predicted ^e
Launch escape system/command module	Bending moment, in-lb . . .	520 000	1 000 000	136 000	310 000	110 000	173 000	230 000	110 000
	Axial force, lb	^f -12 100	-11 000	-22 200	-24 000	-34 600	-36 000	5 000	8 000
Command module/service module	Bending moment, in-lb . . .	680 000	1 320 000	166 000	470 000	340 000	590 000	300 000	140 000
	Axial force, lb	-28 600	-36 000	-88 200	-88 000	-81 600	-89 600	11 000	19 000
Service module/adaptor	Bending moment, in-lb . . .			696 000	1 620 000	2 000 000	2 790 000	1 220 000	1 540 000
	Axial force, lb			-193 300	-200 000	-271 000	-296 000	34 000	60 000
Adaptor/instrument unit	Bending moment, in-lb . . .			2 263 000	4 620 000	2 600 000	5 060 000	1 400 000	1 440 000
	Axial force, lb			-297 800	-300 000	-415 000	-441 000	51 000	90 000

(b) Flight conditions at maximum q_{α} ^g

Condition	Measured	Predicted ^c
Flight time, sec	89.0	87.2
Mach number	2.1	1.9
Dynamic pressure, psf . . .	695	727
Angle of attack, deg	1.43	1.66

(c) Accelerations at the end of the first-stage boost

Acceleration	Measured	Predicted ^d
Longitudinal, g	3.88	4.0
Lateral, g06	.05

^aCalculated from flight data.^bPredicted Apollo 11 loads based on wind-induced launch vehicle bending moment measured prior to launch.^cPredicted Apollo 11 loads based on measured winds aloft.^dPredicted Apollo 11 loads for Block II spacecraft design verification conditions.^ePredicted Apollo 11 loads based on AS-506 static test thrust decay data.^fNegative axial force indicates compression.^gMeasured maximum q_{α} = 994 psf-deg; predicted maximum q_{α} = 1210 psf-deg.

TABLE 8-II.- TRANSLUNAR AND LUNAR ORBIT CONTACT CONDITIONS

Contact conditions	Translunar docking	Lunar orbit docking
Axial velocity, ft/sec	0.1 to 0.2	0.1
Lateral velocity, ft/sec . . .	0	0
Angular velocity, deg/sec . . .	0	0
Angular alinement, deg	0	0
Miss distance, in.	4	0

Electrical Power

Batteries.- The bus voltages of the entry and pyrotechnic batteries were maintained at normal levels, and battery charging was nominal. All three entry batteries contained the cellophane separators; whereas, only battery B used this type of separator for the Apollo 10 mission. The improved performance of the cellophane separators is evident from voltage/current data, which show, at a 15-ampere load, that the cellophane-type batteries maintain an output 1 to 2 volts higher than the Permion-type batteries.

The only departure from expected performance occurred when battery A was placed on main bus A for the translunar midcourse correction. During this maneuver, the normal current supplied by each battery is between 4 and 8 amperes, but the current from battery A was initially 25 amperes and gradually declined to approximately 10 amperes just prior to removal from the main bus. This occurrence can be explained by consideration of two conditions: (1) Fuel cell 1 on main bus A had a lower than average skin temperature (400° F), which caused it to deliver less current than usual, and (2) battery A had been fully charged just prior to the maneuver. Both these conditions combined to result in the higher-than-usual current delivery by battery A. Performance was normal thereafter. The total battery capacity was maintained continuously above 103 A-h until separation of the command module from the service module.

Fuel cells.- The fuel cells and radiators performed satisfactorily during the pre-launch and flight phases. All three fuel cells were activated 68 hours prior to launch, and after a 3.5-hour conditioning load, they were placed on open-circuit inline heater operation until 3 hours prior to launch. After that time, the fuel cells provided full spacecraft power.

During the 195 hours of the mission, the fuel cells supplied approximately 393 kWh of energy at an average spacecraft current of 68.7 amperes (22.9 amperes per fuel cell) and an average command module bus voltage of 29.4 volts. The maximum deviation from equal load sharing between individual fuel cells was an acceptable 4.5 amperes.

All thermal parameters, including condenser exit temperature, remained within normal operating ranges and agreed favorably with predicted flight values. The condenser exit temperature on fuel cell 2 fluctuated periodically every 3 to 8 minutes throughout the flight. This disturbance was similar to that noted on all other flights and has been shown to have no effect on fuel cell performance.

Cryogenic Storage

The cryogenic storage system satisfactorily supplied reactants to the fuel cells and metabolic oxygen to the environmental control system. At launch, the total oxygen quantity was 615 pounds (79 pounds above the minimum redline limit), and the hydrogen quantity was 54.1 pounds (1.0 pound above the minimum redline limit). The overall consumption from the system was nominal during the flight.

One heater in oxygen tank 2 was discovered to be inoperative. Records show that it had failed between the times of the countdown demonstration test and the actual countdown, and current measurements indicate that the element had an open circuit. This anomaly is discussed in detail in section 16.

Very-High-Frequency Ranging

The operation of the vhf ranging system was nominal during descent and from lunar lift-off until orbital insertion. Following insertion, several tracking dropouts were experienced. These dropouts resulted from negative circuit margins which were caused by the use of the lunar module aft vhf antenna instead of the forward vhf antenna. After the antennas were switched, vhf ranging operation returned to normal. A maximum range of 246 miles was measured, and a comparison of the vhf ranging data with rendezvous-radar data and the predicted trajectory showed close agreement.

Instrumentation

The instrumentation system — including the data storage equipment, the central timing equipment, and the signal conditioning equipment — supported the mission. The data storage equipment did not operate during entry because the circuit breaker was open. The circuit breaker that supplies ac power to the recorder also controls operation of the S-band FM transmitter. When the television camera and associated monitor were to be powered without transmitting to a ground station, the circuit breaker was opened to disable the S-band FM transmitter. This breaker was inadvertently left open after the last television transmission.

At approximately 5 hours 20 minutes into a scheduled cabin oxygen enrichment ("Low Oxygen Flow Rate" in section 16), the oxygen flow-rate transducer indicated a low oxygen flow rate. Comparison of the oxygen manifold pressure, oxygen-flow-restrictor differential pressures, and cryogenic oxygen values indicated that the flow-rate-transducer output calibration had shifted downward. To compensate for the uncertainties associated with the oxygen flow indications, cabin enrichment procedures were extended from 8 to 9 hours.

Guidance, Navigation, and Control

The command module guidance, navigation, and control system performance was satisfactory throughout the mission. Earth launch, earth orbit, and translunar injection monitoring functions were normal except that the crew reported a 1.5° pitch deviation from the expected flight director attitude indicator reading during the translunar injection maneuver. The procedure was designed for the crew to align the flight director attitude indicator/orbit-rate drive electronics assembly at approximately 4 deg/min while the launch vehicle maintained the local vertical. One error of 0.5° is attributed to the movement of the S-IVB while the flight director attitude indicator and the orbit-rate drive electronics were being aligned. An additional 0.2° error resulted from an error in orbit-rate drive electronics initialization. Furthermore, the reading accuracy of the flight director attitude indicator is 0.25° . An additional source of error for the Apollo 11 mission was a late trajectory modification that changed the ignition attitude by 0.4° . The accumulation of errors from these four sources accounts for the error reported by the crew. The present procedure is considered adequate; therefore, no change is being prepared for later missions.

Transposition and docking.- Two unexpected indications reported by the crew later proved to be the normal operation of the respective systems. The 180° pitch transposition maneuver was to be performed automatically under digital autopilot control with a manually initiated angular rate. The crew reported that each time the digital autopilot was activated, it stopped the manually induced rate and maintained a constant attitude. The cause of the apparent discrepancy was procedural; although the digital autopilot was correctly initialized for the maneuver, in each case, the rotational hand controller was moved out of detent prior to enabling of the digital autopilot. Normally, when the out-of-detent signal is received by the computer, the digital autopilot is switched from an automatic to an attitude-hold function until it is reenabled. After four attempts, the maneuver was initiated properly and proceeded according to plan.

The other discrepancy concerned the entry monitor system velocity counter. The crew reported biasing the counter to -100 ft/sec prior to separation, thrusting forward until the counter indicated 100.6, then thrusting aft until the counter indicated 100.5. After the transposition maneuver, the counter indicated 99.1 rather than the expected 100.5. The cause of this apparent discrepancy was also procedural. The transposition maneuver was made at an average angular velocity of 1.75 deg/sec. The entry monitor system is mounted approximately 12 feet from the center of rotation. The resulting centripetal acceleration integrated over the time necessary to move 180° yields a 1.2-ft/sec velocity change and accounts for the error observed. The docking maneuver following transposition was normal, with only small transients.

Inertial reference system alignments.- The inertial measurement unit was aligned as shown in table 8-III. Results were normal and comparable to those of previous missions.

Translation maneuvers.- A summary of pertinent parameters for each of the service propulsion maneuvers is contained in table 8-IV. All maneuvers were as expected, with very small residuals. Monitoring of these maneuvers by the entry monitor system was excellent, as shown in table 8-V. The velocity initializing the entry monitor velocity counter prior to each firing is biased by the velocity expected to be accrued during thrust tail-off. When in control of a maneuver, the entry monitor issues an engine-off discrete signal when the velocity counter reaches zero in order to avoid an overburn, and the bias includes an allowance for the predicted tail-off.

The crew was concerned about the duration of the transearth injection maneuver. When the firing appeared to be approximately 3 seconds longer than anticipated, the crew issued a manual engine-off command. Further discussion of this problem is contained in "Service Propulsion" in this section. The data indicate that a computer engine-off discrete signal appeared simultaneously with actual engine shutdown. Therefore, the manual input, which is not instrumented, was either later than, or simultaneous with, the automatic command.

Attitude control.- All attitude control functions were performed satisfactorily throughout the mission. The passive thermal control roll maneuver was used during translunar and transearth coast.

After entry into lunar orbit and while still in the docked configuration, the crew reported a tendency of the spacecraft to position itself along the local vertical with the lunar module positioned down. This effect was apparently a gravity gradient torque, which can be as large as 0.86 ft-lb when the longitudinal axis of the vehicle is oriented 45° from the local vertical. A thruster duty cycle of once every 15 to 18 seconds would be consistent with a disturbance torque of this magnitude.

Midcourse navigation.- Midcourse navigation using star/horizon sightings was performed during the translunar and transearth coast phases. The first two groups of sightings, at 43 600 miles and at 126 800 miles, were used to calibrate the height of the horizon for updating the computer. Although several procedural problems were encountered during early attempts, the apparent horizon altitude was determined to be 35 kilometers. Table 8-VI contains a synopsis of the navigation sightings performed.

Landmark tracking.- Landmark tracking was performed in lunar orbit as indicated in table 8-VII. The objective of the sightings was to eliminate part of the relative uncertainty between the landing site and the command module orbit and thus improve the accuracy of descent targeting. The sightings also provided an independent check on the overall targeting scheme. The pitch technique provided spacecraft control while the sextant was in use. The landmark tracking program was also used to point the optics in several unsuccessful attempts to locate and track the lunar module on the lunar surface. (See "Postlanding Spacecraft Operations" in section 5.)

Entry.- The entry was performed under automatic control, as planned. No telemetry data are available for the period during blackout; however, all indications are that the system performed as intended.

The onboard calculations for inertial velocity and flight-path angle at the entry interface, which were 36 195 ft/sec and -6.488°, respectively, compare favorably with the 36 194-ft/sec and -6.483° calculations determined from tracking. Figure 13-1 in section 13 shows a summary of landing-point data. The onboard computer indicated a landing at longitude 169°9' W and latitude 13°18' N, or 1.69 miles from the desired target point. Because no telemetry nor radar was available during entry, a final evaluation of navigation accuracy cannot be obtained. However, a simulated best-estimate trajectory shows a landing point 1.03 miles from the target and confirms the onboard solution. Indications are that the entry monitor system performed as intended.

Inertial measurement unit performance.- Preflight performance of the inertial components is summarized in table 8-VIII. This table also shows the average value of the accelerometer bias measurements and gyro null bias drift measurements made in flight and the accompanying updates.

The gyro drift compensation updates were not as successful as expected, probably because of the change in sign of the compensation values. With the change in the torquing current, a bias difference apparently occurred as a result of residual magnetization in the torquer winding. The difference was small, however, and had no effect on the mission.

Figure 8-1 contains a comparison of velocity measured by the inertial measurement unit with that from the launch vehicle guidance system during earth ascent. These velocity differences reflect the errors in the inertial component compensation values. One set of error terms that would cause these velocity errors is shown in table 8-IX. The divergence between the two systems is well within the expected limits and indicates excellent performance, although a momentary saturation of the launch vehicle guidance system Y-axis accelerometer caused an initial 5-ft/sec error between the two systems. The remainder of the divergence in this axis was caused primarily by a misalignment during gyrocompassing of the spacecraft guidance system. The 60-ft/sec out-of-plane velocity error at insertion is equivalent to a misalignment of 0.11° ; this is corroborated by the Z-axis gyro torquing angle calculated during the initial optical alignment in earth orbit.

Computer.- The computer performed as intended throughout the mission. A number of alarms occurred, but all were caused by procedural errors or were intended to caution the respective crewman.

Optics.- The sextant and the scanning telescope performed normally throughout the mission. After the coelliptic sequence maneuver, the Command Module Pilot reported that, after selecting the rendezvous tracking program (P20), the optics had to be "zeroed" before automatic tracking of the lunar module would begin. Data indicate that the optics mode switch was in the COMPUTER position when the command module was set up for the contingency mirror-image coelliptic sequence maneuver. In this maneuver program, the service propulsion engine gimbals are trimmed by the computer through the digital-to-analog converter outputs of the optics coupling data units. The same converters are used to drive the sextant shaft and trunnion when the optics are in COMPUTER mode. The telescope is mechanically linked to the sextant so that it is operated when the sextant is operated. To avoid driving the optics with a gimbal drive signal, or vice versa, the computer issues discrete signals which enable or disable the appropriate output. With the optics drive disengaged, the trunnion in the sextant was observed (during preflight testing) to drift toward the positive stop. The drift is caused by an antibacklash spring.

A register in the computer tracks trunnion position but is not large enough to provide an unambiguous value for the full range of allowable trunnion angles. Therefore, the register is biased to provide unambiguous readouts for the normally used range of -10° to $+64.7^\circ$. In this case, the trunnion drifted beyond 64.7° , the register overflowed, and the computer lost track of actual trunnion position. When the automatic optics positioning routine was entered after selection of the rendezvous tracking program (P20), the computer drive commands, based on the invalid counter contents, drove the trunnion to the positive stop. Zeroing the system reestablished synchronization and proper operation.

Entry monitor system.- Operation of the entry monitor system was normal, although one segment on the electroluminescent numerical display for the velocity counter failed to operate during the mission. (See "Loss of Electroluminescent Segment in Entry Monitor System" in section 16.)

TABLE 8-III.- PLATFORM ALINEMENT SUMMARY

Time, hr:min	Program option (a)	Star used	Gyro torquing angle, deg			Star angle difference, deg	Gyro drift, mERU			Comments
			X	Y	Z		X	Y	Z	
0:48	3	30 Menkent, 37 Nunki	+0.018	+0.033	+0.152	0.01	--	--	--	Check star 34 Atria
5:35	3	17 Regor, 34 Atria	-.172	-.050	-.060	.02	+2.4	+0.7	-0.8	Not torqued
5:39	3	17 Regor, 34 Atria	-.171	-.052	-.055	.02	+2.4	+0.7	-0.8	
9:36	1	30 Menkent, 32 Alphecca	+1.005	-.368	-.737	.01	--	--	--	Check star 33 Antares
24:14	3	36 Vega, 37 Nunki	-.493	-.191	-.024	.00	+2.3	+0.9	-.1	
53:00	3	10 Mirfak, 16 Procyon	+0.103	+0.366	-.004	.01	-1.1	-1.4	.0	
57:26	3	31 Arcturus, 35 Rasalhague	+0.111	+0.128	+0.014	.01	-1.7	-1.9	-.2	
73:08	3	40 Altair, 45 Fomalhaut	+0.285	+0.281	-.006	.01	-1.2	-1.2	.0	
73:33	1	6 Acamar, 42 Peacock	-.423	+0.508	+0.111	.01	--	--	--	
79:10	3	33 Antares, 41 Dabih	+0.100	+0.159	+0.044	.02	-1.2	-1.9	+0.5	Check star 33 Antares
81:05	3	37 Nunki, 44 Enif	+0.046	+0.051	-.028	.02	-1.6	-1.8	-1.0	
96:55	1	4 Achernar, 34 Atria	+0.170	+0.342	-.023	.00	-.7	-1.5	-.1	
101:15	3	1 Alpheratz, 6 Acamar	+0.084	+0.124	-.010	.01	-1.3	-1.9	-.2	
103:00	3	10 Mirfak, 12 Rigel	+0.032	+0.009	+0.001	.02	-1.2	-.3	.0	Check star 7 Menkar
107:30	3	43 Deneb, 44 Enif	+0.057	+0.166	-.022	.01	-.8	-2.4	-.3	
112:52	1	33 Antares, 41 Dabih	+0.057	+0.213	-.081	.00	--	--	--	
121:15	3	25 Acrux, 42 Peacock	+0.165	+0.186	-.039	.00	-1.3	-1.5	-.3	
124:41	3		+0.064	+0.100	+0.021		-1.2	-1.9	+0.4	
134:34	3	1 Alpheratz, 11 Aldebaran	+0.166	+0.212	-.019	.01	-1.1	-1.4	-.1	Check star 1 Alpheratz
136:51	1	1 Alpheratz, 43 Deneb	+0.469	-.217	+0.383	.02	--	--	--	
149:19	3	14 Canopus, 16 Procyon	+0.265	+0.268	+0.012	.01	-1.5	-1.5	+0.1	Check star 11 Aldebaran
171:16	3		+0.445	+0.451	+0.006	.01	-1.4	-1.4	.0	Check star 12 Rigel
192:12	1	2 Diphda, 4 Achernar	-1.166	-.690	+0.456	.00	--	--	--	Check stars 10 Mirfak, 1 Alpheratz, 45 Fomalhaut, 3 Navi
193:35	3	1 Alpheratz, 45 Fomalhaut	+0.016	-.040	-.010	.01	-.8	+1.9	-.5	

^a1 indicates preferred; 3 indicates REFSMMAT.

TABLE 8-IV.- MANEUVER SUMMARY

Parameter (a)	Service propulsion maneuver				
	Separation	First midcourse correction	Lunar orbit insertion	Lunar orbit circularization	Transearth injection
Time:					
Ignition, hr:min:sec	4:40:01.72	26:44:58.64	75:49:50.37	80:11:36.75	135:23:42.28
Cut-off, hr:min:sec	4:40:04.65	26:45:01.77	75:55:47.90	80:11:53.63	135:26:13.69
Duration, sec	2.93	3.13	357.53	16.88	151.41
Velocity (actual/desired), ft/sec:					
X-axis component	-9.76/-9.74	-14.19/-14.68	+327.12/+327.09	+92.53/+92.51	+932.77/+932.74
Y-axis component	+14.94/+14.86	+13.17/+13.14	+2361.28/+2361.29	+118.18/+118.52	-2556.06/-2555.81
Z-axis component	+8.56/+8.74	+7.56/+7.66	+1681.85/+1681.79	+51.61/+51.93	-1835.66/-1834.60
Velocity residual after trim- ming, ft/sec:					
X-axis component	0.0	+0.3	-0.1	+0.3	0.0
Y-axis component0	.0	.0	.0	+ .7
Z-axis component	-.1	+.5	+.1	-.1	+.1
Entry monitor system	-.3	-.5	+.5	-.7	-2.7
Engine gimbal position, deg:					
Initial					
Pitch	+0.93	+0.97	+0.97	+1.65	-0.55
Yaw	-.15	-.15	-.15	-.69	+ .69
Maximum excursion					
Pitch	+.40	+.30	+.30	+.31	-1.73
Yaw	-.46	-.42	-.38	-.33	+1.55
Steady-state					
Pitch	+1.15	+1.15	+1.23	+1.90	-.12
Yaw	-.06	-.02	-.06	-.32	+ .48
Cut-off					
Pitch	+1.28	+1.19	+2.03	+1.81	-.33
Yaw	-.19	-.19	-.57	-.44	-.94
Maximum rate excursion, deg/sec:					
Pitch	-0.08	+0.12	+0.07	-0.04	^b +1.00
Yaw	+.21	+.16	+.14	-.20	^b -1.00
Roll	-.14	-.21	-.18	-.13	^b -1.00
Maximum attitude error, deg:					
Pitch	Negligible	Negligible	0.2	-0.3	-0.4
Yaw	Negligible	-0.1	.2	+.2	+.5
Roll	Negligible	-.3	-5.0	+2.6	+5.0

^aVelocities are in earth- or moon-centered inertial coordinates; velocity residuals are in body coordinates.

^bSaturated.

TABLE 8-V.- ENTRY MONITOR SYSTEM VELOCITY SUMMARY

Maneuver	Total velocity to be gained along X-axis minus residual, ft/sec	Velocity set into entry monitor system counter, ft/sec	Planned residual, ft/sec	Actual residual, ft/sec	Corrected entry monitor error, ft/sec (a)
Separation	19.8	15.2	-4.6	-4.0	+0.6
First midcourse correction	20.9	16.8	-4.1	-3.8	+3
Lunar orbit insertion	2917.4	2910.8	-6.6	-6.8	-.2
Lunar orbit circularization	159.3	153.1	-6.2	-5.2	+1.0
Transearth injection	3283.2	3262.5	-20.7	-17.9	+2.8
Second midcourse correction	4.7	4.8	+1	+2	+1

^aA correction factor of 0.2 ft/sec was applied in order to determine the corrected error.

TABLE 8-VI.- MIDCOURSE NAVIGATION

Group	Set/marks	Star	Horizon	Time, hr:min	Distance from earth, miles	Remarks
1	1/4	2 Diphda	Earth near	6:36	43 600	The optics calibration was determined as -0.003°; it was not entered.
	^a 2/3	40 Altair	Earth far	--	--	Difficulty was encountered in locating the star because of procedural problems.
	3/6	45 Fomalhaut	Earth near	--	--	
	4/3	2 Diphda	Earth near	8:08	--	Sightings were misaligned up to 50° in the measurement plane; the misalignment resulted from improper instructions from the ground.
2	1/3	1 Alpheratz	Earth near	24:20	126 800	The optics calibration was zero and was therefore not entered. The automatic maneuver computed on board did not consider the lunar module; therefore, difficulty in locating the first star was encountered as the optics were pointed at the lunar module. The ground-computed maneuver was used, and the sightings proceeded satisfactorily.
	2/3	2 Diphda	Earth near	--	--	
	3/4	45 Fomalhaut	Earth far	25:20	--	

^aThe first sighting on star 40 was rejected; it had the wrong horizon.

TABLE 8-VII.- LANDMARK TRACKING

Time, hr:min:sec	Landmark identification	Number of marks	Optics mode
82:43:00	A1 (altitude landmark)	5	Sextant, manual — resolved
98:49:00	130	5	Sextant, manual — resolved
104:39:00	130	5	Sextant, manual — resolved
122:24:00	130	5	Sextant, manual — resolved

TABLE 8-VIII.- COMMAND MODULE INERTIAL COMPONENT PREFLIGHT HISTORY

Error	Sample mean	Standard deviation	No. of samples	Countdown value	Flight load	Flight average before update	Flight average after update
Accelerometers							
X-axis:							
Scale factor error, ppm	35	46	8	50	40	--	--
Bias, cm/sec ²	-.23	.07	9	-.25	-.26	-0.26	-0.26
Y-axis:							
Scale factor error, ppm	-22	56	8	-98	-80	--	--
Bias, cm/sec ²	-.05	.11	8	.04	^a -.13	+08	+08
Z-axis:							
Scale factor error, ppm	-43	50	8	-101	-30	--	--
Bias, cm/sec ²20	.14	8	.15	^b .14	.00	+01
Gyroscopes							
X-axis:							
Null bias drift, mERU	-1.2	1.7	9	0.4	^c -1.8	+2.4	-1.2
Acceleration drift, spin reference axis, mERU/g	-5.4	3.8	9	-3.3	-6.0		
Acceleration drift, input axis, mERU/g	13.7	3.9	9	14.4	15.0		
X-axis:							
Null bias drift, mERU	-1.5	1.1	9	-2.4	^d -.6	+7	-1.4
Acceleration drift, spin reference axis, mERU/g	1.7	2.0	8	1.3	3.0		
Acceleration drift, input axis, mERU/g	7.1	5.6	14	9.0	5.0		
Z-axis:							
Null bias drift, mERU	-.9	1.6	9	-2.3	^e -.2	-.6	-0.1
Acceleration drift, spin reference axis, mERU/g	8.4	6.6	8	20.4	5.0		
Acceleration drift, input axis, mERU/g8	6.4	9	-4.7	1.0		

^aUpdated to +0.08 at 31 hours.

^bUpdated to +0.02 at 31 hours.

^cUpdated to +0.44 at 31 hours.

^dUpdated to +0.26 at 31 hours.

^eUpdated to -0.31 at 31 hours.

TABLE 8-IX.- INERTIAL SUBSYSTEM ERRORS DURING LAUNCH

Error term	Uncompensated error	One-sigma specification
Offset velocity, ft/sec	4.2	--
Bias, cm/sec ² :		
X-axis	^a -.046	0.2
Y-axis	^a .150	--
Z-axis	^a .001	--
Null bias drift, mERU:		
X-axis	^a 2.4	2.0
Y-axis	^a .7	--
Z-axis	^a -.8	--
Acceleration drift, input axis, mERU/g:		
X-axis	-6.8	8.0
Y-axis	2.0	8.0
Z-axis	-.7	8.0
Acceleration drift, spin reference axis, mERU/g:		
Y-axis	-8.0	5.0
Acceleration drift, output axis, mERU/g:		
X-axis	-2.3	2 to 5
Y-axis8	2 to 5
Z-axis	-3.0	--
Uncorrelated platform misalignment about the X-axis, arc sec	-13	50
Uncorrelated platform misalignment about the Y-axis, arc sec	-26	50

^aAveraged for entire flight.

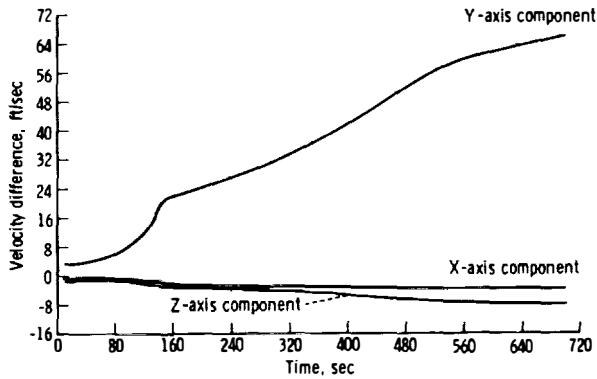

Figure 8-1.- Velocity comparison between instrument unit and spacecraft guidance during ascent.

Reaction Control

Service module.- Performance of the service module reaction control system was normal throughout the mission. The total propellant consumed prior to the command module/service module separation was 560 pounds, 30 pounds less than predicted. During all mission phases, the system pressures and temperatures remained well within their normal operating ranges.

At the time the command and service modules separated from the S-IVB, the crew reported that the propellant isolation valve indicators for quad B indicated the "barber-pole" position. This indication corresponds to at least one primary and one secondary valve being in the closed position. Twenty to 30 seconds after closure, the crew reopened the valves according to the checklist procedures, and no further problems were experienced. (See "Indicated Closure of Propellant Isolation Valves" in section 16.)

Command module.- After command module/service module separation, the crew reported that the minus-yaw engine in system 1 was not responding properly to firing commands through the automatic coils. Postflight data confirm that this engine produced low, but detectable, thrust when the automatic coils were activated. Also, the response to direct coil commands was normal, which indicates that, mechanically, the two valves were operating properly and that one of the two valves was operating when the automatic coils were energized. Postflight tests confirmed that an intermittent circuit existed on a terminal board in the valve electronics. ("Failure of Automatic Coil in One Thruster" in section 16 contains a discussion of this anomaly.)

All measured system pressures and temperatures were normal throughout the mission, and except for the problem with the yaw engine, both systems operated as expected during entry. Approximately 1 minute after command module/service module separation, system 2 was disabled, and system 1 was used for entry control, as planned. Forty-one pounds of propellant were used during entry.

Service Propulsion

Service propulsion system performance was satisfactory during each of the five maneuvers, with a total firing time of 531.9 seconds. The actual ignition times and firing durations are listed in table 8-IV. The longest engine firing was for 357.5 seconds during the lunar orbit insertion maneuver. The fourth and fifth service propulsion firings were preceded by a plus-X reaction control translation to effect propellant settling, and all firings were conducted under automatic control.

The steady-state performance during all firings was satisfactory. The steady-state pressure data indicate essentially nominal performance; however, the gaging system data indicate a mixture ratio of 1.55 rather than the expected ratio of 1.60 to 1.61.

The engine transient performance during all starts and shutdowns was satisfactory. The chamber pressure overshoot during the start of the spacecraft separation maneuver from the S-IVB was approximately 120 psia, which corresponds to the upper specification limit for starts requiring only one bank of propellant valves. On subsequent firings, the chamber pressure overshoots were all less than 120 psia. During the separation firing, minor oscillations in the measured chamber pressure were observed, beginning approximately 1.5 seconds after the initial firing signal. However, the magnitude of the oscillations was less than 30 psi (peak-to-peak), and by approximately 2.2 seconds after ignition, the chamber pressure data indicated normal steady-state operation.

The helium pressurization system functioned normally throughout the mission. All system temperatures were maintained within their redline limits without heater operation.

The propellant utilization and gaging system operated satisfactorily throughout the mission. The mode selection switch for the gaging system was set in the normal position for all service propulsion firings; as a result, only the primary system data were used. The propellant utilization valve was in the NORMAL position during the separation and first midcourse firings and for the first 76 seconds of the lunar orbit insertion firing. At that time, the valve was moved to the INCREASE position and remained there through the first 122 seconds of the transearth injection firing. The valve position was moved to NORMAL for approximately 9 seconds and then to DECREASE for most of the remainder of the transearth injection firing.

Figure 8-2 shows the indicated propellant unbalance, as computed from the data. The indicated unbalance history should reflect the unbalance history displayed in the cabin, within the accuracy of the telemetry system. As expected, based upon previous flights, the indicated unbalance following the start of the lunar orbit insertion firing showed decrease readings. The initial decrease readings were caused primarily by the oxidizer level in the sump tank exceeding the maximum gageable height. This condition occurs because oxidizer is transferred from the storage tank to the sump tank as a result of helium absorption from the sump tank ullage. This phenomenon, in combination with a known storage tank oxidizer gaging error, is known to cause both the initial decrease readings and a step increase in the unbalance at crossover. The crewmen were briefed on these conditions prior to flight and, therefore, expected both the initial decrease readings and a step increase of 150 to 200 pounds at crossover. When the unbalance started to increase (approach zero) prior to crossover, the crew, in anticipation of the increase, properly interpreted the unbalance meter movement as an indication of a low mixture ratio and moved the propellant utilization valve to the INCREASE position. As shown in figure 8-2, the unbalance then started to decrease in response to the valve change, and at crossover, the expected step increase occurred. At the end of the firing, the crew reported that the unbalance was a 50-pound increase, which agrees well with the telemetered data shown in figure 8-2. This early recognition of a lower mixture ratio and the movement of the propellant utilization valve to the INCREASE position during lunar orbit insertion resulted in a higher-than-predicted average thrust for the firing and in a duration of 4.5 seconds less than predicted.

The duration of the firing, as determined by Mission Control, was decreased to reflect the higher thrust level experienced on the lunar orbit insertion firing. However, during the transearth injection firing, the propellant utilization valve was cycled from the NORMAL to the DECREASE position twice. This transfer resulted in less than the expected thrust and consequently resulted in an overburn of 3.4 seconds beyond the recalculated transearth injection firing prediction.

Preliminary calculations, which were based on the telemetered gaging data and the predicted effects of propellant utilization valve position, yielded mixture ratios for the NORMAL valve position of approximately 1.55, compared to an expected range of 1.60 to 1.61. Less-than-expected mixture ratios were also experienced during the Apollo 9 and 10 missions, and sufficient preflight analyses were made prior to the Apollo 11 mission to verify that the propellant utilization and gaging system was capable of correcting for mixture-ratio shifts of the magnitudes experienced. The reason for the less-than-expected mixture ratios during the last three flights is still under investigation.

An abnormal decay in the secondary (system B) nitrogen pressure was observed during the lunar orbit insertion service propulsion firing, which indicated a leak in the system that operates the engine upper bipropellant valve bank. No further leakage was indicated during the remainder of the mission. (This anomaly is discussed in greater detail in "Service Propulsion Nitrogen Leak" in section 16.)

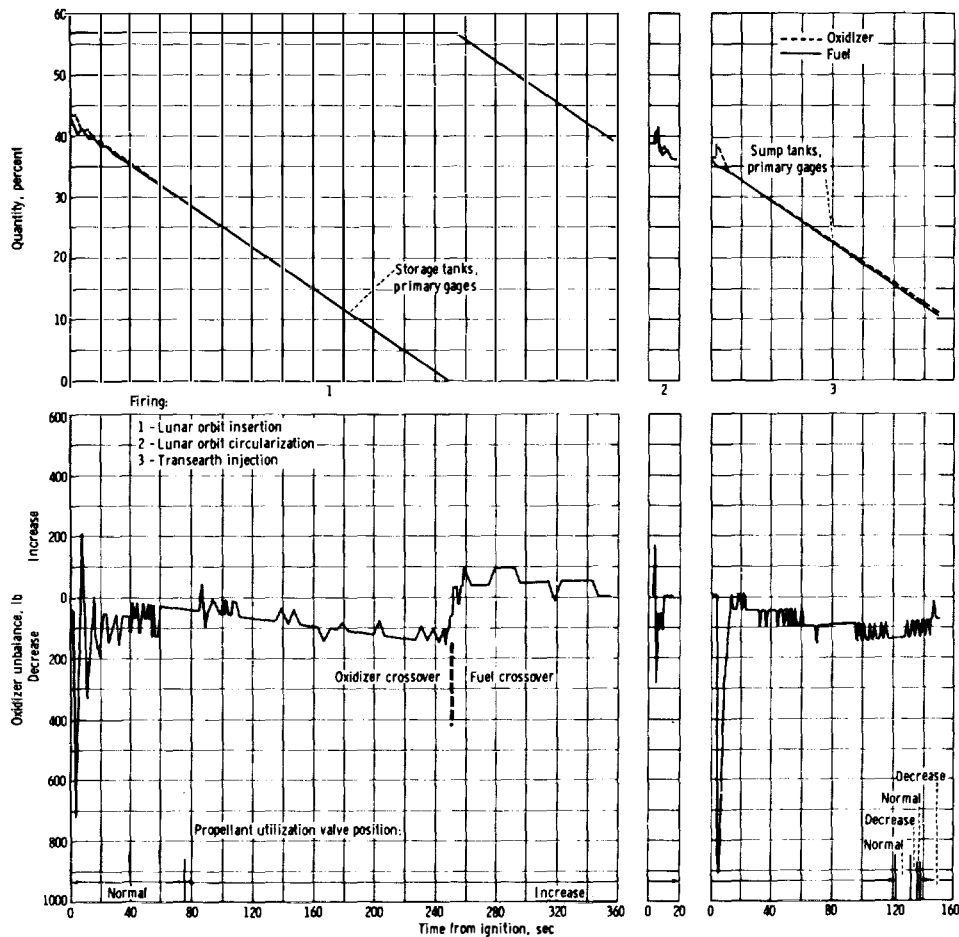

Figure 8-2.- Service propulsion propellant unbalance.

Environmental Control System

The environmental control system performed satisfactorily throughout the mission and provided a comfortable environment for the crew and adequate thermal control of spacecraft equipment.

Oxygen distribution.- The cabin pressure stabilized at 4.7 psia prior to translunar injection and returned to that value after initial lunar module pressurization. However, two master alarms indicating high oxygen flow occurred during lunar module pressurization when the oxygen flow rate was decreasing. This condition was also experienced during ground testing. Postflight analysis has shown that this condition was caused by a malfunction of the oxygen flow rate transducer. (See "Oxygen Flow Master Alarms" in section 16.)

Particulate backcontamination control.- The command module oxygen systems were used for particulate lunar surface backcontamination control from final command module docking until earth landing. At approximately 128 hours, the oxygen flow rate was adjusted to an indicated reading of approximately 0.6 lb/hr to establish a positive differential pressure between the two spacecraft; this adjustment caused the cabin pressure to increase to about 5.4 psia. The oxygen purge was terminated at 130 hours 9 minutes following the command module tunnel hatch leak check.

Thermal control.- The primary coolant system provided adequate thermal control for crew comfort and for the spacecraft equipment throughout the mission. The secondary coolant system was activated only during redundant component checks and the earth entry chilldown. The evaporators were not activated during lunar orbit coast because the radiators provided adequate temperature control.

At 105 hours 19 minutes, the primary evaporator outlet temperature had dropped to 31.5° F. Normally, the temperature is maintained above 42° F by the glycol temperature control valve during cold temperature excursions of the radiator. (This discrepancy is discussed in "Glycol Temperature Control Valve" in section 16.)

Water management.- Gas in the spacecraft potable water has been a problem on all manned Apollo flights. On the Apollo 11 mission, a two-membrane water/gas separator was installed on both the water gun and the outlet at the food preparation unit. The separators allow only gas to pass through one membrane into the cabin atmosphere, while the second membrane passes only gas-free water to the outlet port for crew consumption. The crew indicated that performance of the separators was satisfactory. Water in the food bags and from the water pistol was nearly free of gas. Two interface problems were experienced during use of the separators. There is no positive lock between the water pistol and the inlet port of the separator; thus, occasionally, the separator would not remain in place while the water pistol was being used to fill a food bag. Also, the crew commented that some provision for positively retaining the food bag to the separator outlet port would be highly desirable. For future spacecraft, a redesign of the separator will provide positive locking between the water pistol and the inlet port of the separator. Also, a change has been made in the separator outlet probe to provide an improved interface with the food bag.

Crew Station

The displays and controls were adequate except that the mission clock in the lower equipment bay ran slow, by less than 10 seconds over a 24-hour period, as reported by the crew. The mission clocks have a history of slow operation, which has been attributed to electromagnetic interference. In addition, the glass face was found to be cracked. This problem has also been experienced in the past and is caused by stress introduced in the glass during the assembly process.

The lunar module clock is identical to the command module clock. Because of the lunar module clock problem discussed in "Mission Timer Stopped" in section 16, an improved-design timer is being procured and will be incorporated in future command modules.

Consumables

The predictions for consumables usage improved from mission to mission such that for the Apollo 11 mission, all the command and service module consumable quantities were within 10 percent of the preflight estimates.

Service propulsion propellant.- The service propulsion propellant usage was within 5 percent of the preflight estimate for the mission. The deviations which were experienced have been attributed to the variations in firing times. (See "Service Propulsion" in this section.) In table 8-X, the loadings were calculated from gaging system readings and measured densities prior to lift-off.

Reaction control propellant.- Reaction control system propellant usage predictions and flight data agreed to within 5 percent.

Service module: The reaction control system propellant usage for the service module was higher than expected during transposition and docking and during the initial set of navigation sightings. This higher usage was balanced by efficient maneuvering of the command and service modules during the rendezvous sequence, in which the propellant consumption was less than predicted. The usages listed in table 8-XI were calculated from telemetered helium tank pressure data by using the relationship between pressure, volume, and temperature.

Command module: The reaction control system propellant usages for the command module (shown in table 8-XI) were calculated from pressure, volume, and temperature relationships.

Cryogenics.- The oxygen and hydrogen usages were within 5 percent of those predicted. This deviation was caused by the loss of an oxygen tank heater element and by a reduced reaction control system heater duty cycle. Usages listed in table 8-XII are based on the electrical power produced by the fuel cells.

Water.- Predictions concerning the amount of water consumed in the command and service modules are not generated for each mission because the system has an initial charge of potable water at lift-off, and additional water is generated in the fuel cells in excess of the demand. Also, some water is dumped overboard, and some is consumed. The water quantities loaded, consumed, produced, and expelled during the Apollo 11 mission are shown in table 8-XIII.

TABLE 8-X.- SERVICE PROPULSION PROPELLANT USAGE

Conditions	Actual usage, lb			Preflight planned usage, lb
	Fuel	Oxidizer	Total	
Loaded:				
In tanks	15 633	24 967		
In lines	79	124		
Total	15 712	25 091	40 803	40 803
Consumed	13 754	21 985	35 739	36 296
Remaining at command module/service module separation	1 958	3 106	5 064	4 507

TABLE 8-XI.- REACTION CONTROL SYSTEM PROPELLANT USAGE

(a) Service module

Condition	Actual usage, lb			Preflight planned usage, lb
	Fuel	Oxidizer	Total	
Loaded:				
Quad A	110	225	--	--
Quad B	110	225	--	--
Quad C	110	225	--	--
Quad D	110	225	--	--
Total	440	900	1340	1342
Consumed	191	369	560	590
Remaining at command module/service module separation	249	531	780	752

(b) Command module

Condition	Actual usage, lb			Preflight planned usage, lb
	Fuel	Oxidizer	Total	
Loaded:				
System A	44.8	78.4	--	--
System B	44.4	78.3	--	--
Total	89.2	156.7	245.9	245.0
Consumed:				
System A	15.0	26.8	--	--
System B	.0	.0	--	--
Total	15.0	26.8	40.8	39.3
Remaining at main parachute deployment:				
System A	30.8	51.6	--	--
System B	44.4	78.3	--	--
Total	75.2	129.9	205.1	205.7

TABLE 8-XII.- CRYOGENICS USAGE

Condition	Hydrogen usage, lb		Oxygen usage, lb	
	Actual	Planned	Actual	Planned
Available at lift-off:				
Tank 1	27.3	--	300.5	--
Tank 2	26.8	--	314.5	--
Total	54.1	56.4	615.0	634.7
Consumed:				
Tank 1	17.5	--	174.0	--
Tank 2	17.4	--	180.0	--
Total	34.9	36.6	354.0	371.1
Remaining at command module/ service module separation:				
Tank 1	9.8	--	126.5	--
Tank 2	9.4	--	134.5	--
Total	19.2	19.8	261.0	263.6

TABLE 8-XIII.- WATER USAGE

Condition	Quantity, lb
Loaded:	
Potable water tank	31.7
Waste water tank	28
Produced in flight:	
Fuel cells	315
Lithium hydroxide, metabolic	Not applicable
Dumped overboard (including urine)	325.7
Evaporated prior to command module/service module separation	8.7
Remaining at command module/service module separation:	
Potable water tank	36.8
Water waste tank	43.5

9. PERFORMANCE OF THE LUNAR MODULE

A discussion of the lunar module systems performance is presented in this section. The significant problems are discussed in detail in section 16. Descriptive and historical information about the lunar module is presented in appendix B.

Structural and Mechanical Systems

No structural instrumentation was installed on the lunar module; consequently, the structural performance evaluation was based on lunar module guidance and control data, cabin pressure data, command module acceleration data, photographs, and analytical results.

Based on measured command module accelerations and on simulations using measured wind data, the lunar module loads are inferred to have been within structural limits during the S-IC, S-II, and S-IVB launch phase firings and during the S-IVB translunar injection maneuvers. The loads during both dockings were also within structural limits. Command module accelerometer data show minimal structural excitation during the service propulsion maneuvers, which indicated that the lunar module loads were well within structural limits.

The structural loading environment during lunar landing was evaluated from motion picture film, still photographs, postflight landing simulations, and crew comments. The motion picture film from the onboard camera showed no evidence of structural oscillations during landing, and crew comments agree with this assessment. Flight data from the guidance and propulsion systems were used in conducting the simulations of the landing. (See "Landing Dynamics" in section 5.) The simulations and photographs indicate that the landing-gear-strut stroking was very small and that the external loads developed during landing were well within design values.

Thermal Control

The lunar module internal temperatures at the end of the translunar flight were nominal and within 3° F of the launch temperatures. During the active periods, temperature response was normal, and all antenna temperatures were within acceptable limits.

The crew inspected the descent stage thermal shielding after the lunar landing and observed no significant damage.

Electrical Power

The electrical power system performed satisfactorily. The dc bus voltage was maintained above 28.8 volts throughout the flight. The maximum observed load was 81 amperes during powered descent initiation. Both inverters performed as expected.

The knob on the ascent-engine-arm circuit breaker was broken, probably by the aft edge of the oxygen purge system hitting the breaker during preparations for extravehicular activity. In any event, this circuit breaker was closed without difficulty when required prior to ascent. (See "Broken Circuit Breaker Knob" in section 16.)

At staging, the descent batteries had supplied 1055 A-h of a nominal total capacity of 1600 A-h. The difference in load sharing at staging was 2 A-h on batteries 1 and 2 and 23 A-h on batteries 3 and 4; both of these values are acceptable.

At lunar module jettison, the two ascent batteries had delivered 336 A-h of a nominal total capacity of 592 A-h. The ascent batteries continued to supply power for a total of 680 A-h at 28 V dc or higher.

Communications Equipment

The overall performance of the S-band steerable antenna was satisfactory. However, some difficulties were experienced during descent of the lunar module. Prior to the scheduled 180° yaw maneuver, the signal strength dropped below the tracking level, and the antenna broke lock several times. After the maneuver was completed, new look angles were set, and the antenna acquired the up-link signal and tracked normally until landing. The most probable cause of the problem was a combination of vehicle blockage and multipath reflections from the lunar surface, as discussed in "Steerable Antenna Acquisition" in section 16.

During the entire extravehicular activity, the lunar module relay provided good voice and extravehicular mobility unit data. Occasional breakup of the Lunar Module Pilot's voice occurred in the extravehicular communications system relay mode. The most probable cause was that the sensitivity of the voice-operated relay of the Commander's audio center in the lunar module was inadvertently set at less than the maximum specified. (This anomaly is discussed in "Voice Breakup During Extravehicular Activity" in section 16.) Also, during the extravehicular activity, the Manned Space Flight Network received an intermittent echo of the up-link transmissions. This echo was most likely caused by signal coupling between the headset and microphone. (A detailed discussion of this anomaly is given in "Echo During Extravehicular Activity" in section 16.) After crew ingress into the lunar module, the voice link was lost when the portable life support system antennas were stowed; however, the data from the extravehicular mobility unit remained acceptable.

Television transmission was good during the entire extravehicular activity, both from the descent stage stowage unit and from the tripod on the lunar surface. The signal-to-noise ratios of the television link were good. The television was turned off after 5 hours 4 minutes of continuous operation.

Lunar module voice and data communications were normal during the lift-off from the lunar surface. The steerable antenna maintained lock and tracked throughout the ascent. Up-link signal strength remained stable at approximately -88 dBm.

Instrumentation

The performance of the operational instrumentation was satisfactory, with the exception of the data storage electronic assembly (onboard voice recorder). When the tape was played, no timing signal was evident, and the voice was weak and unreadable, with a 400-hertz hum and a wideband noise background. (For further discussion of this anomaly, see "Onboard Recorder Failure" in section 16.)

Guidance and Control

Power-up initialization.- The guidance and control system power-up sequence was nominal except that the crew reported an initial difficulty in alining the abort guidance system. The abort guidance system is alined in flight by transferring the inertial measurement unit gimbal angles from the primary guidance system, and from these angles establishing a direction cosine matrix. Prior to the first alinement after activation, the primary system coupling data units and the abort system gimbal angle registers must be zeroed to ensure that the angles accurately reflect the platform attitude. Failure to zero could cause the symptoms reported. Another possible cause of the difficulty is an incorrect setting of the orbital rate drive electronics mode switch. If this switch is set in the ORBITAL RATE position, even though the orbital rate drive unit is powered down, the pitch attitude displayed on the flight director attitude indicator will be offset by an amount corresponding to the orbital rate drive resolver. No data are available for the alinement attempt, and no pertinent information is contained in the data before and after the occurrence. Because of the success of all subsequent alinement attempts, hardware and software malfunctions are unlikely, and a procedural discrepancy is the most probable cause of the difficulty.

Attitude reference system alinements.- Pertinent data concerning each of the inertial measurement unit alinements are contained in table 9-I. The first alinement was performed before undocking, and the command module platform was used as a reference in correcting for the measured 2.05° misalinement of the docking interface. After undocking, the alinement optical telescope was used to realine the platform to the same reference, and a misalinement equivalent to the gyro torquing angles shown in table 9-I was calculated. These angles were well within the go/no-go limits established preflight.

TABLE 9-I.- LUNAR MODULE PLATFORM ALINEMENT SUMMARY

Time, hr:min	Type of alinement	Alinement mode		Telescope detent	Star used	Star angle difference, deg	Gyro torquing angle, deg			Gyro drift, mERU		
		Option (a)	Technique (b)				X-axis	Y-axis	Z-axis	X-axis	Y-axis	Z-axis
100:15	P52	3	NA	Front --	Acrux Antares	0.03	-0.292	0.289	-0.094	--	--	--
103:01	P57	3	1	NA	NA	.15	.005	-.105	-.225	--	--	--
103:47	P57	3	2	Left rear Right rear	Rigel Navi	.09	-.167	.186	.014	4.5	-5.0	0.4
104:16	P57	4	3	Left rear --	Rigel --	.08	.228	-.025	-.284	--	--	--
122:17	P57	3	3	Right rear --	Capella --	.07	-.699	.695	-.628	2.6	-2.6	-2.3
123:49	P57	4	3	Left front Right rear	Mirfak Capella	.11	.089	.067	-.041	-4.9	-3.2	-2.0
124:51	P52	3	NA	Front Front	Rigel Acrux	0	-.006	.064	.137	.4	-2.8	8.1

^a₃ indicates reference stable member matrix (REFSMMAT); 4 indicates landing site.

^b₁ indicates REFSMMAT plus g; 2 indicates two bodies; 3 indicates one body plus g.

After the descent orbit insertion maneuver, an alignment check was performed by making three telescope sightings on the sun. A comparison was made between the actual pitch angle required for the sun marks and the angle calculated by the onboard computer. The results were well within the allowable tolerance and again indicated a properly functioning platform.

The inertial measurement unit was aligned five times while on the lunar surface. All three alignment options were used successfully and are listed as follows: (1) an alignment using a gravity vector calculated by the onboard accelerometers and a prestored azimuth, (2) an alignment using the two vectors obtained from two different star sightings, and (3) an alignment using the calculated gravity vector and a single star sighting to determine an azimuth.

The Lunar Module Pilot reported that the optical sightings associated with these alignments were based on a technique in which the average of five successive sightings was calculated by hand and then inserted into the computer. An analysis of these successive sightings indicated that the random sighting error was small and that the only significant trend observed in the successive sightings was lunar rate.

The platform remained inertial during the 17.5-hour period between the third and fourth alignments. Because both of these alignments were to the same orientation, it is possible to make an estimate of gyro drift while on the lunar surface. Drift was calculated from three sources: the gyro torquing angles or misalignment, indicated at the second alignment; the gimbal angle change history in comparison to that predicted from lunar rate; and the comparison of the actual gravity tracking history of the onboard accelerometers with that predicted from lunar rate. The results from the alignments (table 9-II) indicate excellent agreement for the granularity of the data used.

TABLE 9-II.- LUNAR SURFACE GYRO DRIFT COMPARISON

Axis	Gyro drift, deg		
	Computer output (program P57)	Gimbal angle change	Computed from gravity
X	0.699	0.707	0.413
Y	-.696	-.73	-.76
Z	.628	.623	1.00

The abort guidance system was aligned to the primary system at least nine times during the mission (table 9-III). The alignment accuracy, as determined by the Euler angle differences between the primary and abort systems for the eight alignments available on telemetry, was within specification tolerances. In addition, the abort guidance system was independently aligned three times on the lunar surface by using gravity, as determined by the abort system accelerometers, and by using an azimuth derived from an external source. The resulting Euler angles are shown in table 9-IV. A valid comparison following the first alignment cannot be made because the abort guidance system azimuth was not updated. Primary guidance alignments following the second alignment were incompatible with the abort guidance system because the inertial measurement unit was not

aligned to the local vertical. A comparison of the Euler angles for the third alignment indicated an azimuth error of 0.08°. This error resulted from an incorrect azimuth value received from the ground and loaded manually in the abort guidance system. The resulting 0.08° azimuth error caused an out-of-plane velocity difference between the primary and abort systems at insertion. (See "Ascent" in section 5.)

TABLE 9-III.- GUIDANCE SYSTEM ALIGNMENT COMPARISON

Time, hr:min:sec	Indicated difference, gimbal minus abort electronics, deg		
	X-axis	Y-axis	Z-axis
Lunar surface			
102:52:01	-0.0081	0.0066	0.0004
103:15:29	-.0161	-.0271	.0004
103:50:29	-.0063	-.0015	.0028
122:36:00	-.0166	-.0025	.0028
122:53:00	-.0152	-.0071	-.0012
122:54:30	-.0071	-.0101	-.0012
Inflight			
100:56:20	-0.0019	-0.0037	0.0067
126:11:56	-.0369	.0104	-.0468

TABLE 9-IV.- LUNAR SURFACE ALIGNMENT COMPARISON

Angle	Abort guidance	Primary guidance	Difference
Yaw, deg	13.3194	13.2275	0.0919
Pitch, deg	4.4041	4.4055	-.0014
Roll, deg5001	.4614	.0387

Translation maneuvers.- All translation maneuvers were performed under the primary guidance system control, with the abort guidance system operating in a monitor mode. Significant parameters are contained in table 9-V. The dynamic response of the spacecraft was nominal during descent and ascent engine maneuvers, although the effect of fuel slosh during powered descent was greater than expected, based on preflight simulations. Slosh

oscillations became noticeable after the 180° yaw maneuver and gradually increased to the extent that thruster firings were required for damping (fig. 5-11 in section 5). The effect remained noticeable and significant until after the end of the braking phase, when the engine was throttled down to begin rate-of-descent control. The slosh response has been reproduced postflight by making slight variations in the slosh model damping ratio.

TABLE 9-V.- LUNAR MODULE MANEUVER SUMMARY^a

Condition	Maneuver					
	Descent orbit insertion (PGNCS/DPS)	Powered descent initiation (PGNCS/DPS)	Ascent (PGNCS/APS)	Coelliptic sequence initiation (PGNCS/RCS)	Constant-differential height (PGNCS/RCS)	Terminal phase initiation (PGNCS/RCS)
Time						
Ignition, ^b hr:min:sec	^c 101:36:14	102:33:05.01	124:22:00.79	^c 125:19:35	126:17:49.6	127:03:51.8
Cut-off, ^b hr:min:sec	101:36:44	102:45:41.40	124:29:15.67	125:20:22	126:18:29.2	127:04:14.5
Duration, sec	30.0	756.39	434.88	47.0	17.8	22.7
Velocity (desired/actual), ft/sec:		6775 (total)				
X-axis component	-75.8/ (d)		971.27/971.32	51.5/ (d)	2.04/2.05	-20.70/-20.62
Y-axis component	0/ (d)		.22/.18	1.0/ (d)	18.99/18.85	-13.81/-14.10
Z-axis component	9.8/ (d)		5550.05/5551.57	0/ (d)	6.6/6.17	-4.19/-4.93
Coordinate system	Local vertical		Stable platform	Local vertical	Earth-centered inertial	Earth-centered inertial
Velocity residual after trimming, ft/sec:						
X-axis component	^c 0	NA	.4	-.2	.1	-.2
Y-axis component	-.4		-1.0	-.7	-.1	0
Z-axis component	0		1.4	-.1	0	-.1
Gimbal drive actuator, in.:	(d)		NA	NA	NA	NA
Initial						
Pitch43				
Roll		-.02				
Maximum excursion						
Pitch03				
Roll		-.28				
Steady state						
Pitch59				
Roll		-.28				
Maximum rate excursion, deg/sec:	(d)			(d)		
Pitch8	-16.2		-.8	1.2
Roll		-.8	1.8		-.6	-.8
Yaw		-.6	2.0		-.2	-.2
Maximum attitude excursion, deg:	(d)			(d)		
Pitch		1.2	3.2		-1.6	-.4
Roll		-1.6	-2.0		.8	-.4
Yaw		-2.4	-2.0		-.4	-.8

^aRendezvous maneuvers after terminal phase initiation are discussed in section 5, based on crew reports.

^bIgnition and cut-off times are those commanded by the computer.

^cReported by crew.

^dNo data available.

The ascent maneuver was nominal, with the crew reporting the wallowing tendency inherent in the control technique used. As shown in table 9-V, the velocity at insertion was 2 ft/sec higher than planned. This higher velocity has been attributed to a difference in the predicted and actual tail-off characteristics of the engine.

The abort guidance system, as stated, was used to monitor all primary guidance system maneuvers. Performance was excellent except for some isolated procedural problems. The azimuth misalignment which was inserted into the abort guidance system prior to lift-off and which contributed to the out-of-plane error at insertion is discussed in "Attitude Reference System Alinements" in this section. During the ascent firing, the abort guidance system velocity to be gained was used to compare with and to monitor the primary system velocity to be gained. The crew reported that near the end of the insertion maneuver, the primary and abort system displays differed by 50 to 100 ft/sec. A

similar comparison of the reported parameter differences has been made postflight and is shown in figure 9-1. As indicated, the velocity difference was as large as 39 ft/sec and was caused by lack of time synchronization between the two sets of data. The calculations are made and displayed independently by the two computers, which have outputs that are not synchronized. Therefore, the time at which a given velocity is valid could vary as much as 4 seconds between the two systems. Both systems appear to have operated properly.

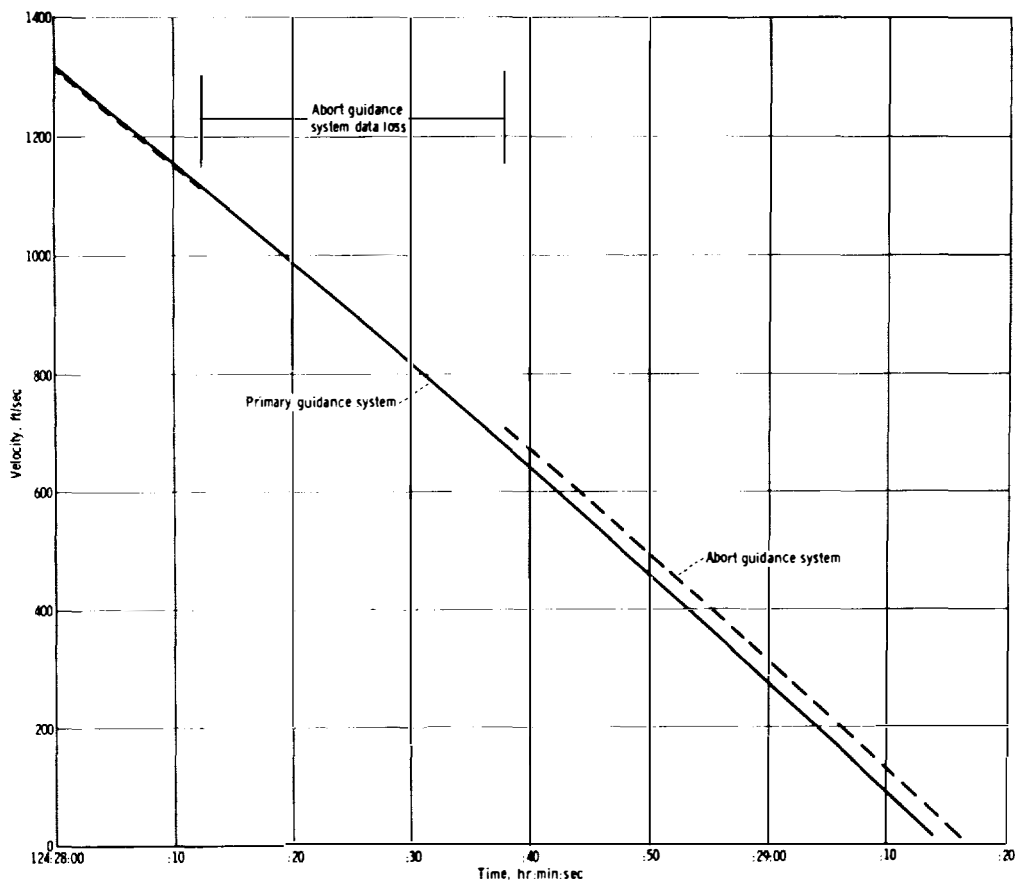

Figure 9-1.- Comparison of primary guidance and abort guidance system velocities during final ascent phase.

The abort guidance system performed satisfactorily during monitoring of rendezvous maneuvers, although residuals after the terminal phase initiation maneuver were somewhat large. The differences were caused by a 23-second-late initiation of the maneuver and by relatively large attitude excursions induced because of the incorrect selection of wide deadband in the primary system. The desired velocity vector in the abort guidance system is chosen for a nominal time of rendezvous. If the terminal phase initiation maneuver is begun at a time other than nominal and if the abort system is not retargeted, the maneuver direction and magnitude will not be correct.

Attitude control.- The digital autopilot was the primary source of attitude control during the mission, and it performed as designed. One procedural discrepancy occurred during the 180° yaw maneuver after the start of powered descent. The yaw maneuver was performed manually by using the proportional rate output of the rotational hand controller. Because a low rate scale was erroneously selected for display, the maneuver was begun and partially completed at less than the desired rate of 10 deg/sec. Continuing the maneuver on the low rate scale would have delayed landing-radar acquisition. After the problem was recognized, the high rate scale was selected, and the maneuver was completed as planned. The abort guidance system was used just prior to the second docking. Performance was as expected; however, some difficulty was experienced during the docking. (See "Rendezvous" in section 5.)

Primary guidance, navigation, and control system performance.- The inertial measurement unit was replaced 12 days before launch, and the new unit exhibited excellent performance throughout the mission. Table 9-VI contains the preflight history of the inertial components for the inertial measurement unit. The accelerometer bias history is shown in table 9-VII. An accelerometer bias update was performed prior to undocking, with the results as shown in table 9-VII.

TABLE 9-VI.- LUNAR MODULE INERTIAL COMPONENT PREFLIGHT HISTORY

Error	Sample mean	Standard deviation	Number of samples	Countdown value	Flight load
Accelerometers					
X-axis:					
Scale factor error, ppm	-155	111	4	-237	-270
Bias, cm/sec ²60	.09	4	.70	.66
Y-axis:					
Scale factor error, ppm	-1156	11	2	-1164	-1150
Bias, cm/sec ²08	.04	2	.05	.10
Z-axis:					
Scale factor error, ppm	-549	72	2	-600	-620
Bias, cm/sec ²14	.12	2	.22	.20
Gyroscopes					
X-axis:					
Null bias drift, mERU	-1.5	1.4	3	-1.3	-1.6
Acceleration drift, spin reference axis, mERU/g	5.7	0	2	5.7	6.0
Acceleration drift, input axis, mERU/g	12.8	3.5	2	15.2	10.0
Y-axis:					
Null bias drift, mERU	3.0	1.6	3	1.3	3.8
Acceleration drift, spin reference axis, mERU/g	-4.0	1.4	2	-3.1	-5.0
Acceleration drift, input axis, mERU/g	-2.3	6.1	2	2.0	3.0
Z-axis:					
Null bias drift, mERU	4.1	.6	3	3.5	4.4
Acceleration drift, spin reference axis, mERU/g	-4.7	.4	2	-4.4	-5.0
Acceleration drift, input axis, mERU/g	-9.3	7.7	2	-3.8	-3.0

TABLE 9-VII.- ACCELEROMETER BIAS FLIGHT HISTORY

Condition	Bias, cm/sec ²		
	X-axis	Y-axis	Z-axis
Flight load	0.66	0.10	0.20
Updated value	.66	.04	.03
Flight average before update	.63	.04	.03
Flight average after update	.67	.07	-.01

Visibility in orbit and on the lunar surface through the alinement optical telescope was as expected. Because of the relative position of the earth, the sun, and the reflections off the lunar surface, only the left and right rear telescope detent positions were usable after touchdown. Star recognition and visibility through these detents proved to be adequate. The sun angle had changed by the time of lift-off, and only the right rear detent was usable. This detent proved sufficient for the alinements made just prior to lift-off. (See "Ascent" in section 5.)

The lunar module guidance computer performed as designed, except for a number of unexpected alarms. The first alarm occurred during the power-up sequence when the display keyboard circuit breaker was closed, and a 520 alarm (RADAR RUPT), which was not expected at this time, was generated. This alarm, which has been reproduced on the ground, was caused by a random setting of logic gates during the turn-on sequence. The 520 alarm has a low probability of occurrence and is neither abnormal nor indicative of a malfunction.

The Executive overflow alarms that occurred during descent ("Powered Descent" in section 5) are now known to be normal for the existing situation and are indicative of the proper performance of the guidance computer. These alarms are discussed in "Computer Alarms During Descent" in section 16.

Abort guidance system performance.- Except for procedural errors which degraded performance to some extent, all required functions were satisfactory. Eight known state-vector transfers from the primary system were performed. The resulting position and velocity differences for three of the transfers are shown in table 9-VIII. With the exception of one incorrect difference caused by an incorrect K-factor used to time-synchronize the system, all state-vector updates were accomplished without difficulty.

TABLE 9-VIII.- ABORT GUIDANCE STATE-VECTOR UPDATES

Time, hr:min:sec	Abort minus primary guidance	
	Position, ft	Velocity, ft/sec
122:31:02	-137.6	0.05
124:09:12	-177.6	-.15
126:10:14	-301.3	-2.01

The preflight inertial component test history is shown in table 9-IX. The inflight calibration results were not recorded; however, just prior to the inflight calibration (before loss of data), the accelerometer biases were calculated from velocity data and known computer compensations. The shift between the preinstallation calibration data and the flight measurements is shown in table 9-X. (The capability estimate limits are based on current three-sigma capability estimates with expected measurement errors included.)

TABLE 9-IX.- ABORT GUIDANCE PREINSTALLATION CALIBRATION DATA

(a) Accelerometer bias

Axis	Sample mean, μg	Standard deviation, μg	Number of samples	Final calibration value, μg	Flight compensation value, μg
X	-53	42	15	1	0
Y	-22	9	15	-17	-23.7
Z	-79	22	15	-66	-71.2

(b) Accelerometer scale factor

Axis	Standard deviation, ppm	Number of samples	Final calibration value, ppm	Flight compensation value, ppm
X	14	9	-430	-463.5
Y	28	9	324	299.5
Z	12	9	1483	1453.4

(c) Gyro scale factor

Axis	Sample mean, deg/hr	Standard deviation, deg/hr	Number of samples	Final calibration value, deg/hr	Flight load value, deg/hr
X	-1048	-10	15	-1048	-1048
Y	-300	-47	15	-285	-285
Z	3456	16	15	3443	3443

TABLE 9-IX.- ABORT GUIDANCE PREINSTALLATION CALIBRATION DATA - Concluded

(d) Gyro fixed drift

Axis	Sample mean, ppm	Standard deviation, ppm	Number of samples	Final calibration value, ppm	Flight load value, ppm
X	0.33	0.05	15	0.27	0.27
Y	.04	.05	15	.03	.03
Z	.51	.07	15	.41	.41

(e) Gyro spin axis mass unbalance

Axis	Sample mean, deg/hr/g	Standard deviation, deg/hr/g	Number of samples	Final calibration value, deg/hr/g	Flight load value, deg/hr/g
X	-0.67	0.12	15	-0.65	-0.65

TABLE 9-X.- ACCELEROMETER STABILITY

(a) Preinstallation and flight measurements

Accelerometer	Accelerometer bias, μ g			
	Preinstallation calibration (June 6, 1969)	Freefall (July 20, 1969)	48-day shift	Capability estimate
X-axis	1	-65	-66	185
Y-axis	-17	-41	-24	185
Z-axis	-66	-84	-18	185

TABLE 9-X.- ACCELEROMETER STABILITY - Concluded

(b) Inflight measurements

Accelerometer	Accelerometer bias, μg			
	Before descent	After ascent	Shift	Capability estimate
X-axis	-34	-62	-28	60
Y-axis	-27	-31	-4	60
Z-axis	-41	-62	-21	60

When telemetered data were regained after the inflight calibration and after powered ascent, excellent accelerometer stability was indicated as shown in table 9-X. (The capability estimate limits are based upon current three-sigma capability estimates with expected measurement errors included.) Inflight calibration data on the gyros were reported, and two lunar surface gyro calibrations were performed with the results shown in table 9-XI. The degree of stability of the instruments was well within the expected values.

TABLE 9-XI.- GYRO CALIBRATION COMPARISON

Calibration	Gyro drift, deg/hr		
	X-axis	Y-axis	Z-axis
Preinstallation (June 2, 1969)	0.27	0.03	0.41
Final earth prelaunch (June 28, 1968)	.10	-.13	.35
Inflight (July 20, 1969)	.33	-.07	.38
First lunar surface (July 21, 1969)	.34	-.08	.47
Second lunar surface (July 21, 1969)	.41	-.04	.50

The only hardware discrepancy reported in the abort guidance system was the failure of an electroluminescent segment in one digit of the data entry and display assembly. (This failure is discussed in "Electroluminescent Segment on Display Inoperative" in section 16.)

Reaction Control

The performance of the reaction control system was satisfactory. The system pressurization sequence was nominal, and the regulators maintained acceptable outlet pressures (between 178 and 184 psia) throughout the mission.

The crew reported thrust chamber assembly warning flags for three engine pairs. The A2 and A4 flags occurred simultaneously during lunar module station-keeping prior to descent orbit insertion. The B4 flag appeared shortly thereafter and also twice just before powered descent initiation. The crew believed that these flags were accompanied by master alarms. The flags were reset by cycling of the caution and warning electronics circuit breaker. (See "Reaction Control System Warning Flags" in section 16 for further discussion of these warning flags.)

The chamber pressure switch in reaction control engine B1D failed in the closed mode approximately 8.5 minutes after powered descent initiation. The switch remained closed for 2 minutes 53 seconds, then opened and functioned properly for the remainder of the mission. The failure mode is believed to be the same as that on the Apollo 9 and 10 missions, that is, particulate contamination or propellant residue holding the switch closed. The only potential consequence of the failure would have been the inability to detect an engine failed in the off mode.

A master alarm was noted at 126:44:00, when seven consecutive pulses were commanded on engine A2A without a pressure switch response. Further discussion of this discrepancy is given in "Thrust Chamber Pressure Switches" in section 16.

Thermal characteristics were satisfactory, and all temperatures were within predicted values. The maximum quad temperature was 232° F on quad 1 subsequent to touchdown. The fuel tank temperatures ranged from 68° to 71° F.

Propellant usage, based on the propellant quantity measuring device, was 319 pounds, compared with a predicted value of 253 pounds and the total propellant load of 549 pounds. Approximately 57 of the 66 pounds in excess of the predictions were used during powered descent. Figures 9-2 and 9-3 include total and individual system propellant consumption profiles.

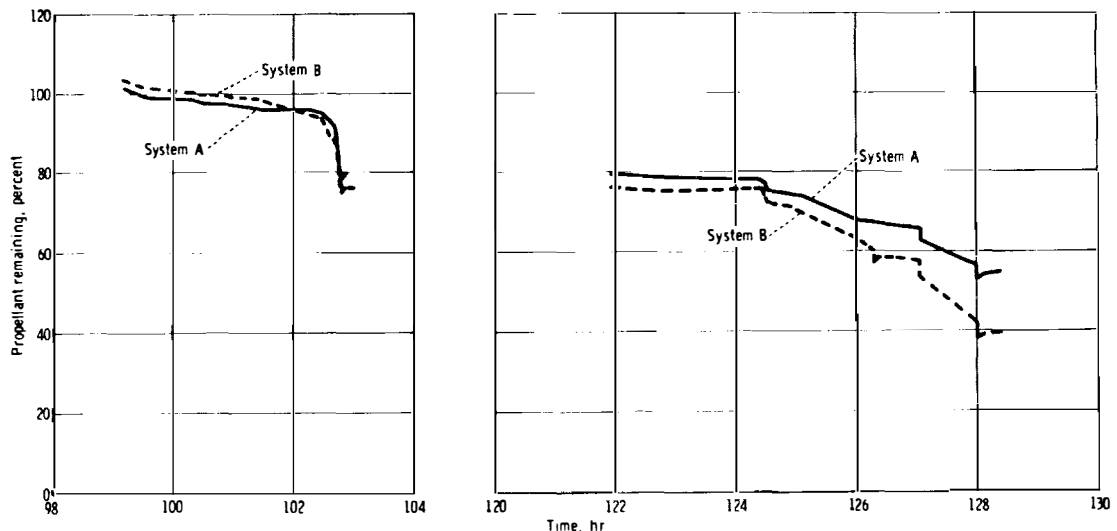

Figure 9-2.- Propellant consumption from each system.

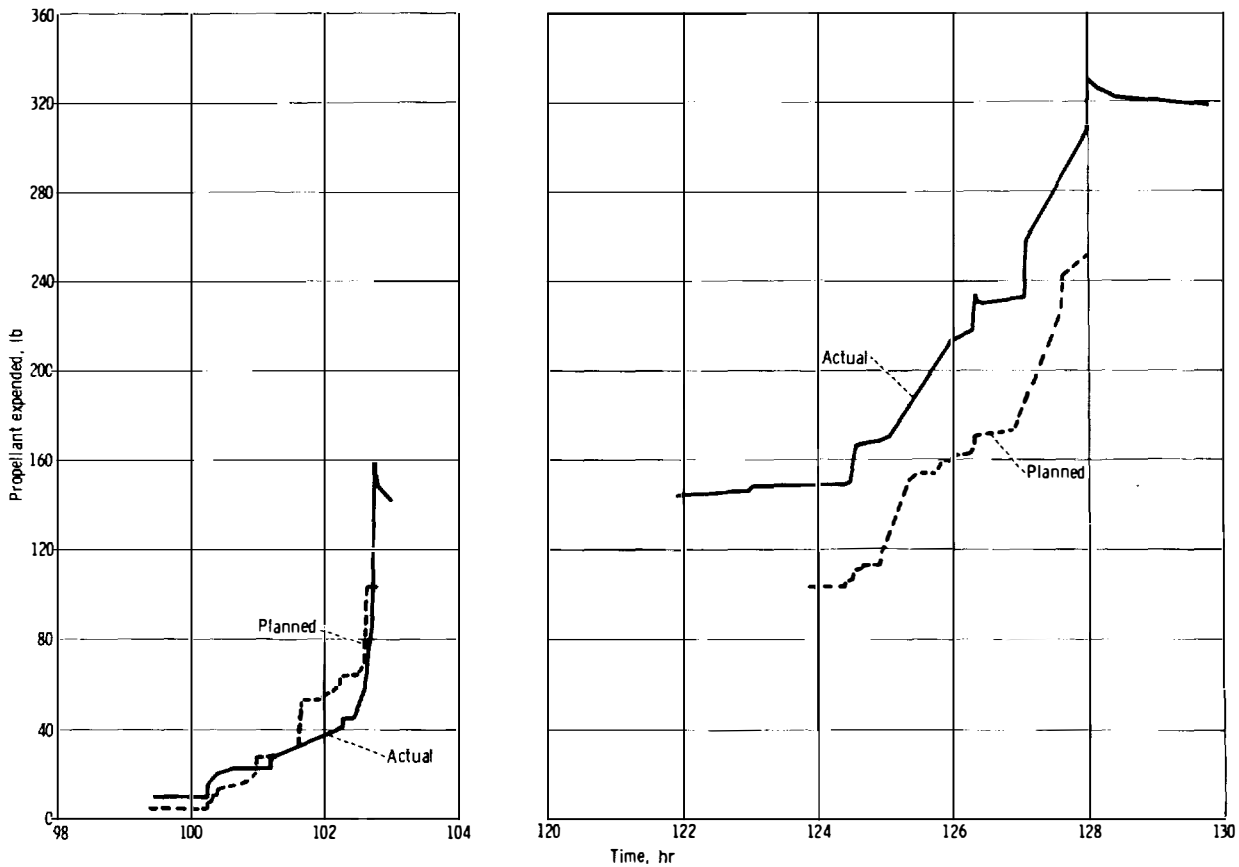

Figure 9-3.- Total propellant consumption.

During powered ascent, the reaction control system was used in the ascent interconnect mode. The reaction control system used approximately 69 pounds of propellant from the ascent propulsion tanks.

Descent Propulsion

The descent propulsion system operation was satisfactory for the descent orbit insertion and descent maneuvers. The engine transients and throttle response were normal.

Inflight performance.- The descent orbit insertion maneuver lasted 30 seconds; the resulting velocity change was 76.4 ft/sec. The engine was started at the minimum throttle setting of 13.0 percent of full thrust and, after approximately 15 seconds, was throttled to 40-percent thrust for the remainder of the firing.

The duration of the powered descent firing was 756.3 seconds, corresponding to a velocity change of approximately 6775 ft/sec. The engine was at the minimum throttle setting (13 percent) at the beginning of the firing and, after approximately 26 seconds, was advanced to full throttle. There was approximately a 45-second data dropout during

this period, but crew reports indicated that the throttle-up conditions were apparently normal. Figure 9-4 presents descent propulsion system pressures and throttle settings as a function of time. The data have been smoothed and do not reflect the data dropout and throttle fluctuations just before touchdown.

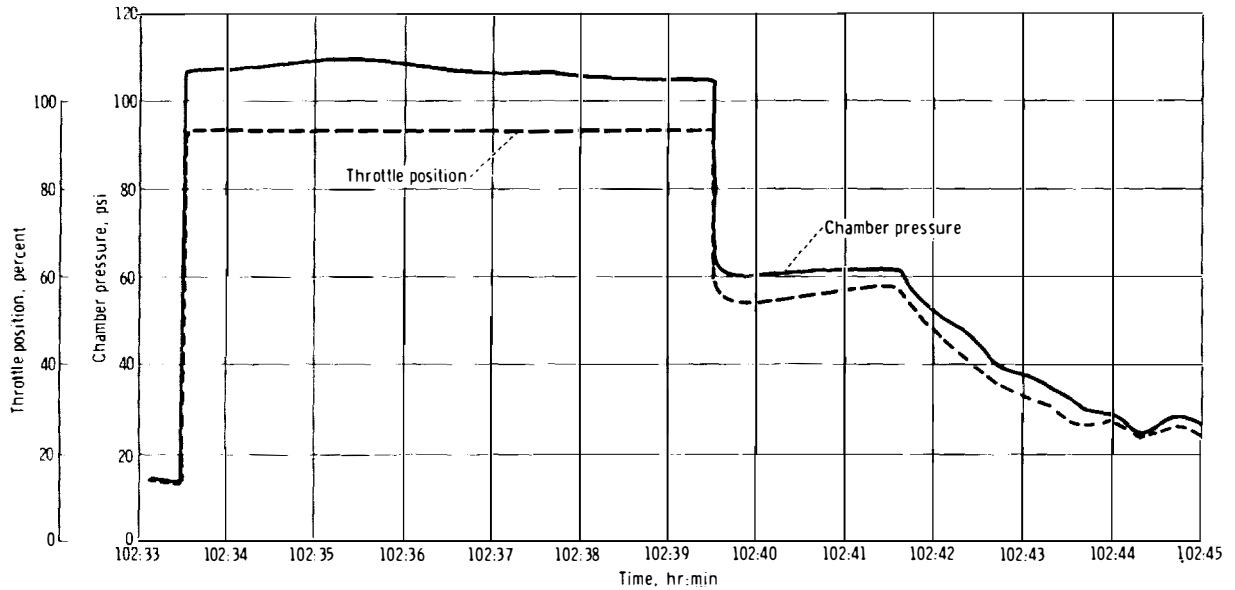

(a) Throttle position and chamber pressure.

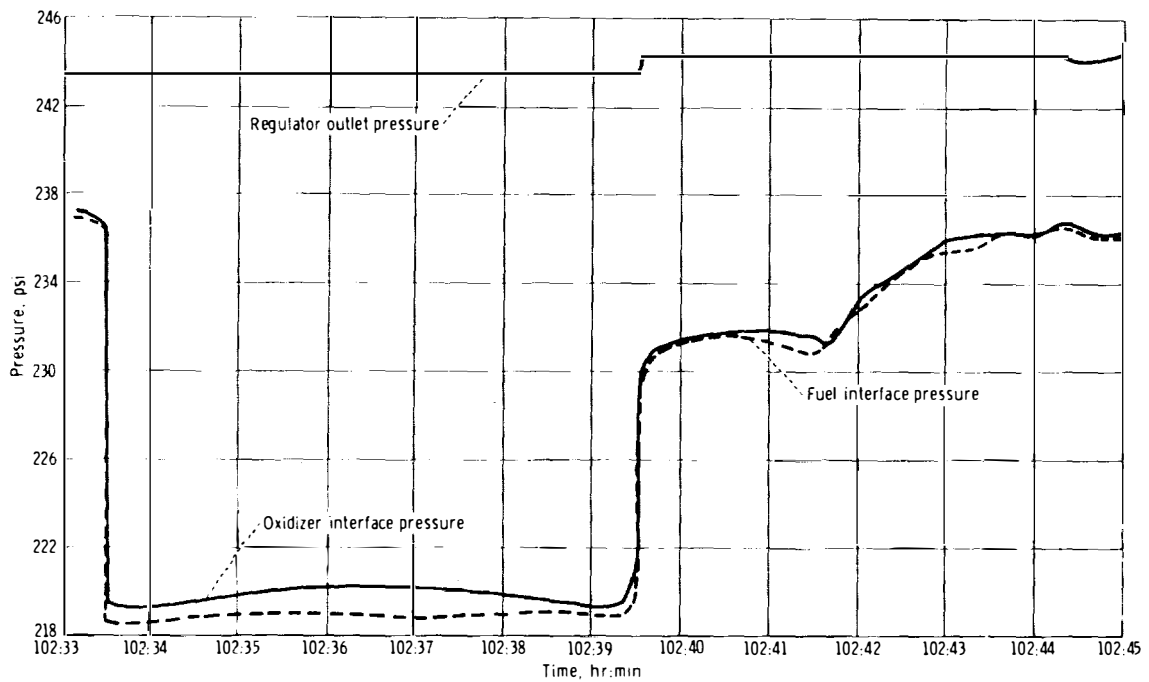

(b) Oxidizer interface, fuel interface, and regulator outlet pressures.

Figure 9-4.- Descent propulsion system performance.

During the powered descent maneuver, the oxidizer interface pressure appeared to oscillate as much as 67 psi peak to peak. The pressure continued to oscillate throughout the firing, although over a smaller range (fig. 9-5); the oscillations were most prominent at approximately 50-percent throttle. The fact that oscillations of this magnitude were not observed in the chamber pressure or the fuel interface pressure measurements indicates that they were not real. Engine performance was not affected. Oscillations of this type have been observed at the White Sands Test Facility on similar pressure measurement installations on numerous engines. The high-magnitude pressure oscillations observed during the White Sands Test Facility tests were amplifications of much lower pressure oscillations in the system. The phenomenon has been demonstrated in ground tests where small actual oscillations were amplified by cavity resonance of a pressure transducer assembly containing a tee with the transducer on one leg of the tee and a cap on another leg. This assembly is similar to the interface pressure transducer installation. The resonance conditions will vary with the amount of helium trapped in the tee and with the throttle setting.

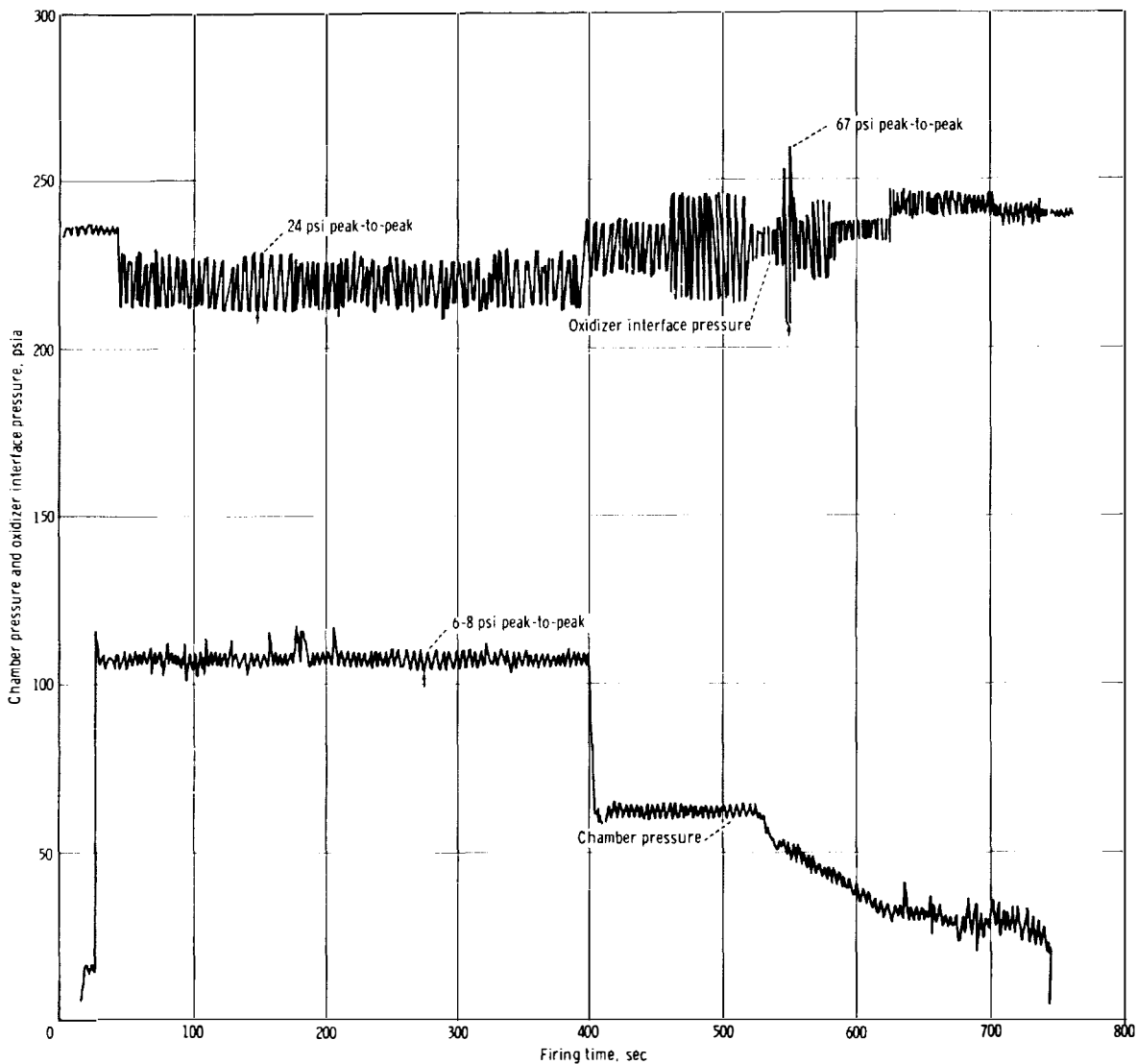

Figure 9-5.- Oxidizer interface pressure and chamber pressure oscillations.

System pressurization.- The oxidizer tank ullage pressure decayed from 158 to 95 psia during the period from lift-off to the first activation of the system at approximately 83 hours. During this period, the fuel tank ullage pressure decayed from 163 to 139 psia. These decays, which resulted from helium absorption into the propellants, were within the expected range.

The measured pressure profile in the supercritical helium tank was normal. The preflight and inflight pressure rise rates were 8.3 and 6.4 psi/hr, respectively.

During propellant venting after landing, the fuel interface pressure increased rapidly to an off-scale reading. The fuel line had frozen during venting of the supercritical helium, trapping fuel between the prevalve and the helium heat exchanger; and this fuel, when heated from engine soakback, caused the pressure rise. (See "High Fuel Interface After Landing" in section 16 for further discussion of this problem.)

Gaging system performance.- During the descent orbit insertion maneuver and the early portion of powered descent, the two oxidizer propellant gages indicated off-scale (greater than the maximum 95-percent indication), as expected. The fuel probes, however, indicated approximately 94.5 percent instead of reading off-scale. The propellant loaded was equivalent to approximately 97.3 and 96.4 percent for oxidizer and fuel, respectively. An initial low fuel reading had also occurred on the Apollo 10 mission. As the firing continued, the propellant gages began to indicate consumption correctly. The tank 1 and tank 2 fuel probe measurements agreed throughout the firing. The tank 1 and tank 2 oxidizer probe measurements agreed initially, but midway through the firing, they began to diverge until the difference was approximately 3 percent. For the remainder of the firing, the difference remained constant. The divergence was probably caused by oxidizer flowing from tank 2 to tank 1 through the propellant crossover line as a result of an offset in the spacecraft center of gravity.

The low-level light came on at 102:44:30.4, which indicated that approximately 116 seconds of total firing time remained, based on the sensor location. The propellant-remaining time line from the low-level light indication to the calculated propellant depletion is as follows.

Propellant low-level light on	Engine cut-off	Landing go/no-go decision point	Calculated propellant depletion
.	.	.	.
	.	.	.
.	.	.	.
.	.	.	.
116	45	20	0

Firing time remaining, sec

The indicated time of 45 seconds to propellant depletion compares favorably with the postflight calculated value of 50 seconds to oxidizer tank 2 depletion. The 5-second difference is within the measurement accuracy of the system. The low-level signal was triggered by the point sensor in either oxidizer tank 2 or fuel tank 2.

Ascent Propulsion

The ascent propulsion system was fired for 435 seconds from lunar lift-off to orbit insertion. All aspects of system performance were nominal.

The regulator outlet pressure, which was 184 psia during the firing, returned to the nominal lockup value of 188.5 psia after engine cut-off. Table 9-XII presents a comparison of the actual and predicted performance. Based on engine flow rate data, the engine mixture ratio was estimated to be 1.595. The estimated usable propellant remaining at engine shutdown was 174 pounds of oxidizer and 121 pounds of fuel; these quantities are equivalent to 25 seconds of additional firing time to oxidizer depletion.

TABLE 9-XII.- STEADY-STATE PERFORMANCE

Parameter	10 seconds after ignition		400 seconds after ignition	
	Predicted (a)	Measured (b)	Predicted (a)	Measured (b)
Regulator outlet pressure, psia	184	184.5	184	184
Oxidizer bulk temperature, °F	70	70.4	70	70.4
Fuel bulk temperature, °F	70	71.0	70	71.0
Oxidizer interface pressure, psia	170.6	170.0	169.6	169.5
Fuel interface pressure, psia	170.4	169.3	169.5	168.8
Engine chamber pressure, psia	122.6	122	122.5	122
Mixture ratio	1.604	--	1.595	--
Thrust, lb	3464	--	3439	--
Specific impulse, sec	309.4	--	308.8	--

^a Preflight prediction based on acceptance test data and assuming nominal system performance.

^b Actual flight data with known biases removed.

After ascent propulsion system cut-off and during lunar orbit, the fuel and interface pressures increased from their respective flow pressures to lockup and then continued to increase to approximately 3.6 psi for fuel and 11 to 12 psi for oxidizer. Loss of signal occurred approximately 39 minutes after engine shutdown as the vehicle went behind the moon. Pressure rises in the system were observed during both the Apollo 9 and the Apollo 10 missions. This initial pressure rise after shutdown was caused by a number of contributing factors, such as regulator lockup, heating of the ullage gas, and vaporization from the remaining propellants.

At reacquisition of signal (approximately 1 hour 29 minutes after shutdown), drops of approximately 6 and 3.6 psi had occurred in the oxidizer and fuel pressures, respectively. Thereafter, the pressure remained at a constant level for the 4.5 hours that the data were monitored. This behavior rules out leakage as a cause of the pressure drops. The apparent pressure drops had no effect on ascent propulsion system performance and were probably caused by a combination of ullage gas cooling, pressure transducer drift as a result of engine heat soakback, and instrumentation resolution. At temperatures higher than 200° F, the accuracy of the pressure transducer degrades to ±4 percent

(+10 psia) rather than the normal ± 2 percent. A permanent shift may also occur at high temperatures. Thermal analysis indicates that the peak soakback temperatures were 200° to 235° F. Errors which may be attributed to various sources include a transducer shift of 4 percent (equivalent to ± 10 psi), a pulse-code-modulation resolution of 2 counts (equivalent to 2 psi), and a 1-psi ullage pressure change which is effective only on the oxidizer side.

Environmental Control System

The environmental control system in the lunar module supported all lunar operations satisfactorily, with only the following minor exceptions.

Routine water/glycol sampling during prelaunch activities showed the presence of large numbers of crystals which were identified as benzothiazyl disulfide. These crystals were precipitated from a corrosion inhibitor in the fluid. The environmental control system was flushed and filtered repeatedly, but the crystallization continued. The fluid was then replaced with one containing a previously omitted additive (sodium sulfite), and the amount of crystallization decreased. A spacecraft pump package was run on a bench rig with the fluid containing crystals, and the pump performance was shown to be unaffected, even for long durations. During the test, the filter in the test package plugged, and the bypass valve opened. Pump disassembly revealed no deterioration. It was then demonstrated that the crystals, while presenting an undesirable contamination, were not harmful to environmental control system operation. The flight performance of the heat transport section was nominal. The investigation revealed that recently the corrosion inhibitor formulation was slightly modified. For future spacecraft, water/glycol with the original corrosion inhibitor formulation will be used.

Depressurization of the lunar module cabin through the bacteria filter during the extravehicular activity required more time than predicted. The data indicate that the cabin pressure transducer reading was high at the low end of its range; consequently, the crew could have opened the hatch sooner if the true pressure had been known.

During the sleep period on the lunar surface, the crew reported that they were too cold to sleep. Analysis of the conditions experienced indicated that once the crewmen were in a cold condition, there was not enough heat available in the environmental control system to return them to a comfortable condition. Ground tests have indicated that in addition to the required procedural changes which are designed to maintain heat in the suit circuit, blankets will be provided and the crew will sleep in hammocks.

Shortly after lunar module ascent, the crewmen reported that the carbon dioxide indicator was erratic; therefore, they switched to the secondary cartridge. The crewmen had also selected the secondary water separator because one crewman had reported water in his suit. Evaluation of the erratic carbon dioxide readings indicated that the carbon dioxide sensor had malfunctioned, and the circuit breaker was pulled. Erratic operation in the past has been caused by free water in the optical section of the sensor. Further discussion of both the erratic carbon dioxide readings and the water in the crewman's suit is contained in "Indication of High Carbon Dioxide Partial Pressure" and "Water in One Suit" in section 16.

Radar

Performance of the rendezvous and landing radars was satisfactory, and antenna temperatures were always within normal limits. Range and velocity were acquired by the landing radar at slant ranges of approximately 44 000 and 28 000 feet, respectively. The tracker was lost briefly at altitudes of 240 and 75 feet; these losses were expected and are attributed to zero-Doppler effects associated with manual maneuvering.

Crew Station

Displays and controls.- The displays and controls supported the mission satisfactorily, except that the mission timer stopped during the descent. After being deenergized for 11 hours, the timer was started again and operated properly throughout the remainder of the mission. The most probable cause of this failure was a cracked solder joint. This anomaly is discussed in greater detail in "Mission Timer Stopped" in section 16.

Crew provisions.- The Commander and Lunar Module Pilot were provided with communications carrier adapter eartubes (with molded earpieces) for use in the lunar module cabin. The purpose of these earphone adapters was to increase the audio level to the ear; use of the adapters is according to crewman preference. The Lunar Module Pilot used the adapters throughout the lunar module descent and landing phase, but after landing, he found the molded earpieces uncomfortable and removed them. The Commander did not use adapters because his preflight experience indicated that audio volume levels were adequate. The Apollo 10 Lunar Module Pilot had used the adapters during his entire lunar module operational period and had reported no discomfort. The Apollo 12 crewmembers were also provided adapters for optional use.

The crew commented that the inflight coverall garments would be more utilitarian if they were patterned after the standard one-piece summer flying suit. More pockets with a better method of closure, preferably zippers, were recommended and will be provided for evaluation by future crews.

The crew reported that the lunar module windows fogged repeatedly while the sunshades were installed. They transferred two of the command module tissue dispensers to the lunar module and used the tissues to clean the windows instead of using the window heaters for defogging. Tissue dispensers are being added to the lunar module stowage list.

Consumables

On the Apollo 11 mission, the actual usage of only three consumables deviated by as much as 10 percent from the preflight predictions. These consumables were the descent stage oxygen, ascent stage oxygen, and reaction control system propellant. The actual oxygen requirements were less than predicted because the leakage rate was lower than expected. The actual reaction control propellant requirement was greater than predicted because of the increased hover time during the descent phase.

The electrical power system consumables usage was within 5 percent of predicted flight requirements. The usage of current from the descent stage batteries was approximately 8 percent less than predicted, and the usage of current from the ascent stage batteries was approximately 3 percent more than predicted. The deviations appear to have resulted from uncertainties in the predicted usage for reaction control heater duty cycles. Electrical power consumption is discussed further in "Electrical Power" in this section.

Descent propulsion system propellant.- The higher-than-predicted propellant usage by the descent propulsion system was caused by the maneuvering to avoid a large crater during the final stages of descent. Until that time, propellant usage had been nominal. Allowance for manual hover and landing-point redesignation was in the preflight budget but was not considered part of the nominal usage.

The descent propulsion system propellant loading quantities given in table 9-XIII were calculated from readings and measured densities prior to lift-off.

TABLE 9-XIII.- DESCENT PROPULSION PROPELLANT USAGE

Condition	Actual usage, lb			Preflight planned usage, lb
	Fuel	Oxidizer	Total	
Loaded	6975	11 209	18 184	18 184
Consumed				
Nominal	--	--	--	17 010
Redesignation	--	--	--	103
Margin for manual hover	--	--	--	114
Total	6724	10 690	17 414	17 227
Remaining at engine cut-off				
Tanks	216	458	--	--
Manifold	35	61	--	--
Total	251	519	770	957

Ascent propulsion system propellant.- The actual ascent propulsion system propellant usage was within 5 percent of the preflight predictions. The loadings given in table 9-XIV were determined from measured densities prior to lift-off and from weights of offloaded propellants. A portion of the propellants was used by the reaction control system during ascent stage operations.

TABLE 9-XIV.- ASCENT PROPULSION PROPELLANT USAGE

Condition	Actual usage, lb			Preflight planned usage, lb
	Fuel	Oxidizer	Total	
Loaded	2020	3218	5238	5238
Consumed				
By ascent propulsion system prior to ascent stage jettison	1833	2934	--	--
By reaction control system	23	46	--	--
Total	1856	2980	4836	4966
Remaining at ascent stage jettison	164	238	402	272

Reaction control system propellant.- The increased hover time for lunar landing resulted in a deviation of over 10 percent in the reaction control system propellant usage, as compared with the preflight predictions. Propellant consumption (shown in table 9-XV) was calculated from telemetered helium tank pressure histories by using the relationships between pressure, volume, and temperature. The mixture ratio was assumed to be 1.94 for the calculations.

TABLE 9-XV.- LUNAR MODULE REACTION CONTROL SYSTEM PROPELLANT USAGE

Condition	Actual usage, lb			Preflight planned usage, lb
	Fuel	Oxidizer	Total	
Loaded				
System A	108	209	--	--
System B	108	209	--	--
Total	216	418	634	633
Consumed				
System A	46	90	--	--
System B	62	121	--	--
Total	108	211	319	253
Remaining at lunar module jettison				
System A	62	119	--	--
System B	46	88	--	--
Total	108	207	315	380

Oxygen.- The actual oxygen usage was lower than the preflight predictions because the oxygen leak rate from the cabin was less than the specification value. The actual rate was 0.05 lb/hr, as compared with the specification rate of 0.2 lb/hr. In table 9-XVI, the actual quantities loaded and consumed are based on telemetered data.

Water.- The actual water usage was within 10 percent of the preflight predictions. In table 9-XVII, the actual quantities loaded and consumed are based on telemetered data.

TABLE 9-XVI.- OXYGEN USAGE

Condition	Actual usage, lb	Preflight planned usage, lb
Loaded (at lift-off)		
Descent stage	48.2	48.2
Ascent stage		
Tank 1	2.5	2.4
Tank 2	2.5	2.4
Total	5.0	4.8
Consumed		
Descent stage	17.2	21.7
Ascent stage		
Tank 1	1.0	1.5
Tank 2	.1	0
Total	1.1	1.5
Remaining in descent stage at lunar lift-off	31.0	26.5
Remaining at ascent stage jettison		
Tank 1	1.5	.9
Tank 2	2.4	2.4
Total	3.9	3.3

TABLE 9-XVII.- LUNAR MODULE WATER USAGE

Condition	Actual usage, lb	Preflight planned usage, lb
Loaded (at lift-off)		
Descent stage	217.5	217.5
Ascent stage		
Tank 1	42.4	42.4
Tank 2	42.4	42.4
Total	84.8	84.8
Consumed		
Descent stage	147.0	158.6
Ascent stage		
Tank 1	19.2	17.3
Tank 2	18.1	17.3
Total	37.3	34.6
Remaining in descent stage at lunar lift-off	70.5	58.9
Remaining at ascent stage jettison		
Tank 1	23.2	25.1
Tank 2	24.3	25.1
Total	47.5	50.2

10. PERFORMANCE OF THE EXTRAVEHICULAR MOBILITY UNIT

Performance of the extravehicular-mobility-unit was excellent throughout both intravehicular and extravehicular lunar surface operations. Crew mobility was good during extravehicular activity, and an analysis of inflight cooling system data shows good correlation with ground data. The crew remained comfortable throughout the most strenuous surface operations. Because of the lower-than-expected metabolic rates, oxygen and water consumption was below predicted levels throughout the extravehicular activities.

The pressure garment assemblies, including helmet and intravehicular gloves, were worn during launch. The pressure garment assemblies of the Commander and Lunar Module Pilot had been reconfigured with new arm bearings which contributed to the relatively unrestricted mobility demonstrated during lunar surface operations.

The Command Module Pilot's pressure garment assembly did not fit in the lower abdomen and crotch areas; the incorrect fit was caused by the urine collection and transfer assembly flange. Pressure points resulted from insufficient size in the pressure garment assembly. On future flights, fit checks will be performed with the crewman wearing the urine collection and transfer assembly, the fecal containment system, and the liquid cooling garment, as applicable. In addition, the fit check will include a position simulating that which the crewman experiences during the countdown.

All three pressure garment assemblies and the liquid cooling garments for the Commander and Lunar Module Pilot were donned at approximately 97 hours in preparation for the lunar landing and lunar surface operations. Donning was accomplished normally with the crewmen helping each other, as required. The suit integrity check prior to undocking was completed successfully, with suit pressures decaying approximately 0.1 psi.

Wristlets and comfort gloves were taken aboard for optional use by the Commander and Lunar Module Pilot during the lunar stay. Because of the quick adaption to the 1/6-g environment, the light loads handled on this mission, and the short duration of the lunar surface activity, both crewmen elected to omit the use of the protective wristlets and comfort gloves. Without the protection of the wristlets, the Lunar Module Pilot's wrists were rubbed by the wrist rings, and the grasp capability of the Commander was reduced somewhat without the comfort gloves.

After attachment of the lunar module restraint, a pressure point developed on the instep of the Lunar Module Pilot's right foot because the restraint tended to pull him forward and out board rather than straight down. However, he compensated by moving his right foot forward and out board; this foot then took the majority of the load. After assessment of the Apollo 12 mission, a determination is to be made of whether corrective action is required.

Extravehicular activity preparations proceeded smoothly. However, more time was required than planned for completing the unstowage of equipment and performing other minor tasks not normally emphasized in training exercises.

The oxygen-purge-system checkout was performed successfully. During pre-egress activities, the crewmembers encountered difficulty in mating the remote-control-unit connector and were required to spend approximately 10 minutes in mating each connector. Each time the crewman thought the connector was aligned, the lock lever caused the connector to lean to one side and disengage. (This problem is discussed further in "Mating of Remote Control Unit to Portable Life Support System" in section 16.)

Another difficulty was the bulk of the portable life support system. One circuit breaker was broken, and the positions of two circuit breakers were changed when the

crewmembers accidentally bumped them with their portable life support systems as they performed the pre-egress activities.

While waiting for the cabin to depressurize, the members of the crew were comfortable, even though the inlet temperature of the liquid cooling garment reached approximately 90° F prior to sublimator startup. No thermal changes were noted at egress. The portable life support system and oxygen purge system were worn quite comfortably, and the back-supported mass was not objectionable in the 1/6-g environment.

Analysis of the extravehicular activity data shows a good correlation with data from previous training conducted in the Space Environmental Simulation Laboratory facility. As expected, the feedwater pressure during the mission was slightly higher than that indicated during simulations. The difference results from the lunar gravitational effect on the head of water at the sublimator and transducer, the high point in the system. The only other discernible differences were in temperature readouts, which generally indicated better performance (more cooling) than expected. Comfort in the liquid cooling garment was always adequate, although the data indicate a much higher temperature for the Commander's garment than for the Lunar Module Pilot's garment. This observation correlates with previous simulation experience which shows that the Commander had a strong preference for a warmer body temperature than that desired by the Lunar Module Pilot. This parameter is controlled by each crewman to meet his comfort requirements. Operation of the extravehicular mobility unit while in the extravehicular mode was uneventful. The only change necessary to the control settings for the portable life support system was that of the diverter valves, which both crewmen changed at their option for comfort.

Because of the lower-than-expected metabolic rates for the Lunar Module Pilot and especially for the Commander, the actual oxygen and feedwater quantities consumed were lower than predicted. Consumables data are shown in table 10-1.

TABLE 10-1.- APOLLO 11 CONSUMABLES DATA

Condition	Commander		Lunar Module Pilot	
	Actual	Predicted	Actual	Predicted
Metabolic rate, Btu/hr	800	1360	1100	1265
Time, min	191	160	186	160
Oxygen, lb				
Loaded	1.26	1.26	1.26	1.26
Consumed ^a54	.68	.60	.63
Remaining72	.58	.66	.63
Feedwater, lb				
Loaded	8.6	8.5	8.6	8.5
Consumed ^b	2.9	5.4	4.4	5.1
Remaining	5.7	3.1	4.2	3.4

^aApproximately 0.06 pound was required for the suit integrity check.

^bApproximately 0.6 pound was required for startup and as trapped water.

TABLE 10-I.- APOLLO 11 CONSUMABLES DATA - Concluded

Condition	Commander		Lunar Module Pilot	
	Actual	Predicted	Actual	Predicted
Power, Wh				
Initial charge ^C	270	270	270	270
Consumed	133	130	135	130
Remaining	137	140	135	140

^CMinimum prelaunch charge.

Crewman mobility and balance in the extravehicular mobility unit were sufficient to allow stable movement during performance of lunar surface tasks. The Lunar Module Pilot demonstrated the capability to walk, run, change direction while running, and stop movement without difficulty. He reported a tendency to tip backwards in the soft sand and noted that he had to be careful to compensate for the different location of the center of mass. The crewmen knelt down and contacted the lunar surface while retrieving objects. The crew stated that getting down on one or both knees to retrieve samples and allow closer inspection of the lunar surface should be a normal operating mode. Additional waist mobility would improve the ability to get closer to the lunar surface and, in addition, would increase downward visibility.

Each crewman raised his extravehicular visor assembly to various positions throughout the extravehicular activity and noted a back reflection of his face from the visor. The reflection was greatest with the sun shining approximately 90° from the front of the visor assembly. With this reflection, it was difficult to see into shaded areas. In addition, the continuous movement from sunlight into shadow and back into sunlight required extra time because of the necessary wait for adaptation to changes in light intensity. Use of the blinders on the visor assembly could have alleviated the reflection and adaptation problem to some extent.

11. THE LUNAR SURFACE

Preflight planning for the Apollo 11 mission included a lunar surface stay of approximately 22 hours, including 2 hours 40 minutes that were allotted to extravehicular activities.

After landing, the crew performed a lunar module checkout to ascertain launch capability and photographed the landing area from the lunar module. Then, following an extensive checkout of the extravehicular mobility unit, the crewmen left the lunar module to accomplish the following activities:

1. Inspection of the lunar module exterior
2. Collection of a contingency sample, a bulk sample, and documented samples of lunar surface materials
3. Evaluation of the physical characteristics of the lunar surface and its effects on extravehicular activity
4. Deployment of the solar wind composition experiment and, at the end of the extravehicular activities, retrieval of the experiment for return to earth
5. Deployment of the early Apollo scientific experiments package, consisting of the passive seismic experiment and the laser ranging retroreflector

Throughout the extravehicular activities, the crewmen made detailed observations and took photographs to document their activities and the lunar surface characteristics. A television camera provided real-time coverage of crew extravehicular activities. Although the crewmen were operating in a new environment, they were able to complete the activities at a rate very close to that predicted before flight (table 11-I).

Except for a portion of the planned documented sample collection not completed, the lunar surface activities were totally successful, and all objectives were accomplished. As had been anticipated prior to flight, there was insufficient time for exact performance of the documented sample collection. Two core samples and several loose rock samples were collected and returned. There was also insufficient time to fill the environmental and gas analysis sample containers, which were a part of the documented sampling.

Minor equipment malfunctions and operational discrepancies occurred during the extravehicular activity, but none prevented accomplishment of the respective tasks. Conversely, several operations were enhanced, and equipment performance increased because of unexpected influences of the lunar environment.

The planned time line of major surface activities compared with the actual time required is shown in table 11-I. Table 11-I lists the events sequentially, as presented in the Lunar Surface Operations Plan, and also includes several major unplanned activities. Crew rest periods, system checks, spontaneous observations, and unscheduled evaluations not necessarily related to the task being accomplished are not listed as separate activities but are included in the appropriate times.

During deployment of the television camera, several activities were accomplished, including some that were unplanned. The time line provided a minimum amount of time for the Commander to (1) remove the thermal blanket on the equipment compartment, (2) change the camera lens, (3) remove the tripod and camera from the compartment, and

TABLE 11-I.- COMPARATIVE TIMES FOR PLANNED LUNAR SURFACE EVENTS

Event	Planned time, min:sec	Actual time, min:sec	Difference, min:sec	Remarks
Final preparation for egress	10:00	20:45	+10:45	Approximately 8 min 30 sec from cabin pressure reading of 0.2 psia until hatch opening
Commander egress to surface	10:00	8:00	-2:00	
Commander environmental familiarization	5:00	2:05	-2:55	
Contingency sample collection	4:30	3:36	-0:54	Out of sequence with planned time line
Preliminary spacecraft checks	6:30	6:35	+0:05	Out of sequence
Lunar Module Pilot egress to surface	7:00	7:00	0:00	Approximately 2 min 10 sec for portable life support system checks
Commander photography and observation	0:00	2:40	+2:40	
Television camera deployment (partial)	4:00	4:50	+0:50	Deployment interrupted for activity with plaque
Lunar Module Pilot environmental familiarization	6:00	15:00	+9:00	Includes assisting Commander with plaque and television camera deployment
Television camera deployment (complete)	7:00	11:50	+4:50	Includes photography of solar composition experiment and comments on lunar surface characteristics
Solar wind composition experiment deployment	4:00	6:20	+2:20	
Bulk sample and extravehicular mobility unit evaluation (complete)	14:30	18:45	+4:15	
Lunar module inspection by Lunar Module Pilot	14:00	18:15	+4:15	
Lunar module inspection by Commander	15:30	17:10	+1:40	Includes closeup camera photographs
Experiment package offloading	7:00	5:20	-1:40	From door open to door closed
Experiment package deployment	9:00	13:00	+4:00	From selection of site to completion of photography; trouble leveling the equipment
Documented sample collection	34:00	17:50	-16:10	Partially completed
Lunar Module Pilot ingress	4:00	4:00	0:00	
Transfer of sample return container	14:00	9:00	-5:00	
Commander ingress	9:30	6:14	-3:16	Includes cabin repressurization

(4) move the tripod-mounted camera to a remote location. This time also included a few minutes for (1) viewing selected lunar features, (2) positioning the camera to cover the subsequent surface activities, and (3) returning to the compartment.

Throughout the extravehicular activity, both crewmen made observations and evaluations of the lunar environment, including lighting and surface features as well as other characteristics of scientific or operational interest. During the extravehicular activity, the sun angle ranged from 14.5° to 16° . Most of the observations and evaluations will provide valuable information for future equipment design, crew training, and flight planning.

The evaluation of lunar surface experiments is contained in the following paragraphs. Photographic results, including those related to specific experiments, are discussed both in the appropriate sections and in a general description of lunar surface photography. (See "Solar Wind Composition Experiment" in this section. Definitions of some scientific terms used in this section are contained in appendix C.)

Lunar Geology Experiment

Summary.- The Apollo 11 spacecraft landed in the southwestern part of Mare Tranquillitatis at latitude $0^\circ 41' 15''$ N and longitude $23^\circ 26'$ E (fig. 11-1), approximately 20 kilometers southwest of the crater Sabine D. This part of Mare Tranquillitatis is crossed by relatively faint, but distinct, north-northwest-trending rays (bright, whitish lines) associated with the crater Theophilus, which lies 320 kilometers to the southeast (ref. 2). The landing site is approximately 25 kilometers southeast of Surveyor V and 68 kilometers southwest of the impact crater formed by Ranger VIII. A fairly prominent north-northeast-trending ray lies 15 kilometers west of the landing site. This ray may be related to Alfraganus, 160 kilometers to the southwest, or to Tycho, approximately 1500 kilometers to the southwest. The landing site lies between major rays, but may contain rare fragments derived from Theophilus, Alfraganus, Tycho, or other distant craters.

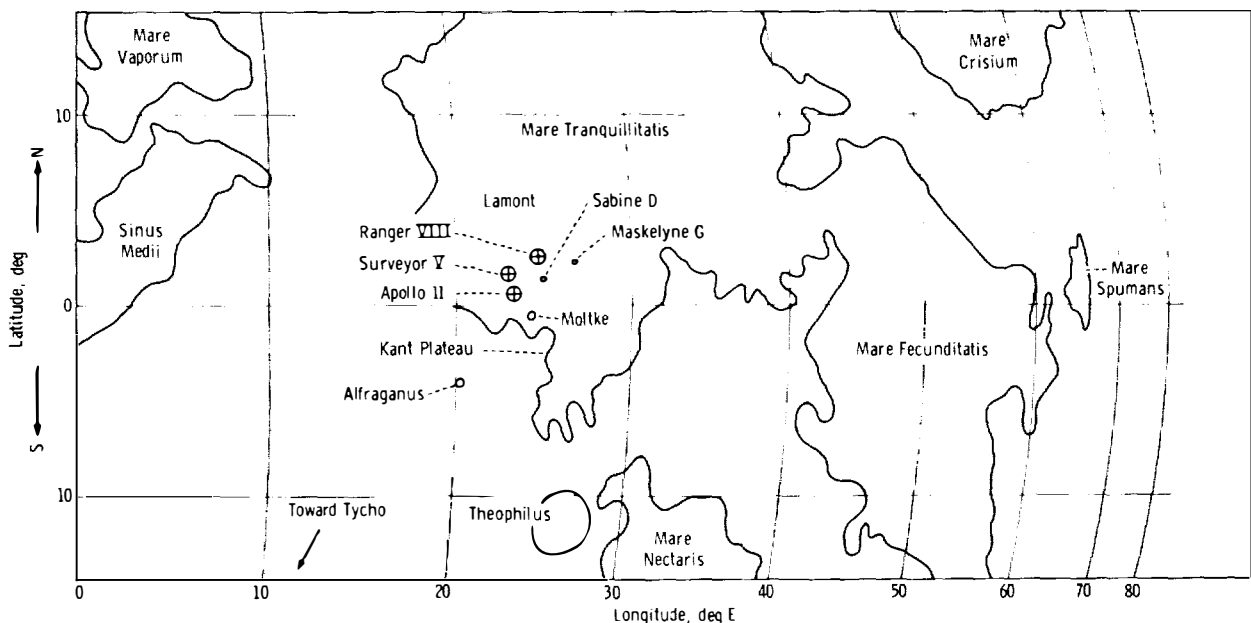

Figure 11-1.- Landing location relative to Surveyor V and Ranger VIII.

About 400 meters east of the landing point is a sharp-rimmed ray crater, approximately 180 meters in diameter and 30 meters deep, which was unofficially named West Crater. West Crater is surrounded by a blocky ejecta (material ejected from crater) apron that extends almost symmetrically outward approximately 250 meters from the rim crest. Blocks as large as 5 meters in diameter exist from on the rim to as far away from the rim as approximately 150 meters, as well as in the interior of the crater. Rays of blocky ejecta, with many fragments 0.5 to 2 meters across, extend beyond the ejecta apron west of the landing point. The lunar module landed between these rays in a path that is relatively free of extremely coarse blocks.

At the landing site, the lunar surface consists of fragmental debris ranging in size from particles too fine to be resolved by the naked eye to blocks 0.8 meter in diameter. This debris forms a layer that is called the lunar regolith. At the surface, the regolith (debris layer) is porous and weakly coherent. It grades downward into a similar, but more densely packed, substrate. The bulk of the regolith consists of fine particles, but many small rock fragments were encountered in the subsurface as well as on the surface.

In the vicinity of the lunar module, the mare surface has numerous small craters ranging in diameter from a few centimeters to several tens of meters. Just southwest of the lunar module is a double crater 12 meters long, 6 meters wide, and 1 meter deep, with a subdued raised rim. Approximately 50 meters east of the lunar module is a steep-walled, but shallow, crater 33 meters in diameter and 4 meters deep which was visited by the Commander near the end of the extravehicular period.

All of the craters in the immediate vicinity of the lunar module have rims, walls, and floors of relatively fine-grained material, with scattered coarser fragments that occur in about the same abundance as on the intercrater areas. These craters are up to a meter deep and, because of the lack of blocky ejecta, appear to have been excavated entirely in the regolith.

At the 33-meter-diameter crater east of the lunar module, the walls and rim have the same texture as the regolith elsewhere; however, a pile of blocks was observed on the floor of the crater. The crater floor may lie close to the base of the regolith. Several craters of about the same size — with steep walls and shallow, flat floors or floors with central humps — occur in the area around the landing site. From the depths of these craters, the thickness of the regolith is estimated to range from 3 to 6 meters.

Coarse fragments are scattered in the vicinity of the lunar module in about the same abundance as at the Surveyor I landing site in the Ocean of Storms at latitude 2°24.6' S and longitude 48°18' W. The coarse fragments are distinctly more abundant than at the other Surveyor landing sites on the maria, including the landing site of Surveyor V northwest of the lunar module. The Surveyor I landing site was near a fresh blocky-rim crater but beyond the apron of coarse blocky ejecta, as was the Apollo 11 site. It may be inferred that many rock fragments in the immediate vicinity of the spacecraft, at both the Surveyor I and the Apollo 11 landing sites, were derived from the nearby blocky-rim crater. Fragments derived from West Crater may have come from depths as great as 30 meters beneath the mare surface and may be direct samples of the bedrock from which the local regolith was derived.

Rock fragments at the Apollo 11 landing site have a wide variety of shapes, and most are embedded to varying degrees in the fine matrix of the regolith. Most of the rocks are rounded or partially rounded on their upper surfaces, but angular fragments of irregular shape are also abundant. A few rocks are rectangular slabs with a faint platy (parallel fractures) structure. Many of the rounded rocks, when collected, were found to be flat or of irregular angular shape on the bottom. The exposed part of one unusual rock, which was not collected, was described by the Commander as resembling an automobile

distributor cap. When this rock was dislodged, the sculptured "cap" was found to be the top of a much bigger rock, the buried part of which was larger in lateral dimensions and angular in form.

The evidence suggests that processes of erosion are taking place on the lunar surface and that this erosion is leading to the gradual rounding of the exposed surfaces of rocks. Several processes may be involved. On some rounded rock surfaces, the individual clasts (fragmented material) and grains that compose the rocks and the glassy linings of pits on the surfaces have been left in raised relief by general wearing away or ablation of the surface. This differential erosion is most prominent in microbreccia (rocks consisting of small sharp fragments embedded in a fine-grained matrix). The ablation may be caused primarily by small particles bombarding the surface.

Some crystalline rocks of medium grain size have rounded surfaces that have been produced by the peeling of closely spaced exfoliation (thin, concentric flakes) shells. The observed "distributor cap" form may have developed by exfoliation or by spalling of the free surfaces of the rock as a result of one or more energetic impacts on the top surface.

Minute pits from a fraction of a millimeter to approximately 2 millimeters in diameter and from a fraction of a millimeter to 1 millimeter deep occur on the rounded surfaces of most rocks. As described in "Geologic Photography and Mapping Procedures" in this section, many of these pits are lined with glass. The pits are present on a specimen of microbreccia which has been tentatively identified in photographs taken on the lunar surface and for which a preliminary orientation of the rock at the time of collection has been obtained. (An example is fig. 11-2.) The pits, which are found primarily on the upper side of the specimen, clearly have been produced by a process acting on the exposed surface. The pits do not resemble impact craters produced in the laboratory (at collision velocities of 7 km/sec and below), and their origin is yet to be explained.

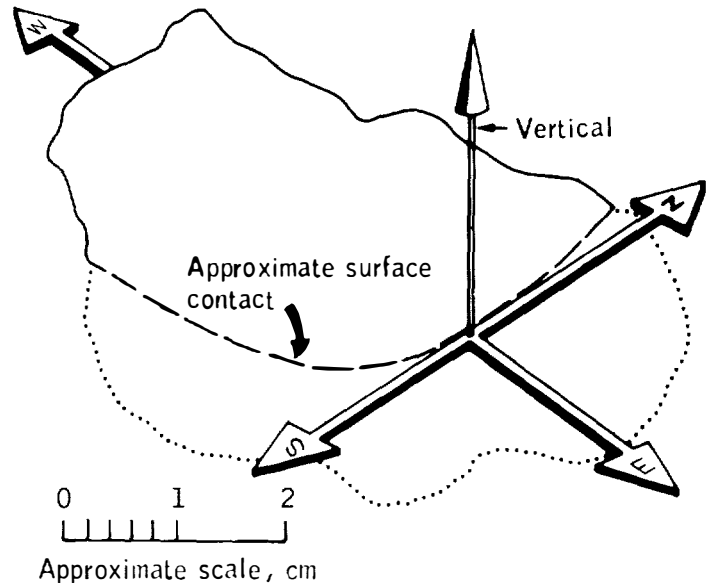

Figure 11-2. Lunar sample and relative position on lunar surface.

Regional geologic setting.- Mare Tranquillitatis has an irregular form (refs. 3 and 4). Two characteristics suggest that the mare material is relatively thin: (1) an unusual ridge ring, named Lamont, located in the southwest part of the mare, may be localized over the shallowly buried rim of a premare crater; and (2) no large positive gravity anomaly, like those over the deep mare-filled circular basins, is associated with Mare Tranquillitatis (ref. 5).

The southern part of Mare Tranquillitatis is crossed by relatively faint but distinct north-northwest-trending rays and prominent secondary craters associated with the crater Theophilus. Approximately 15 kilometers west of the landing site is a fairly prominent north-northeast-trending ray. The ray may be related to either of the craters Alfraganus or Tycho located 160 and 1500 kilometers, respectively, to the southwest.

A hill of highland-like material protrudes above the mare surface 52 kilometers east-southeast of the landing site. This structure suggests that the mare material is very thin in this region, perhaps no more than a few hundred meters thick.

Location of the landing site from transmitted geologic data.- The landing site was tentatively identified during the lunar surface stay on the basis of observations transmitted by the crew. The Commander reported avoiding a blocky crater the size of a football field during landing and observed a hill that he estimated to be from 0.5 to 1 mile west of the lunar module. The lunar module was tilted 4.5° E (backward) on the lunar surface.

During the first pass of the command and service modules after lunar module landing (approximately 1 to 1.5 hours after landing), the first of several different landing-site locations, computed from the onboard computer and from tracking data, was transmitted to the Command Module Pilot for visual search. (See section 5.) The first such estimate of the landing site was northwest of the planned landing ellipse. The only site near this computed location that could have matched the reported description was near North Crater at the northwest boundary of the landing ellipse. However, this region did not match the description very closely. Later, computed estimates indicated that the landing site was considerably south of the earlier determination, and the areas near West Crater most closely fit the description. These data were transmitted to the Command Module Pilot on the last pass before lunar module lift-off, but the Command Module Pilot's activities at this time did not permit visual search. The location just west of West Crater was confirmed by rendezvous-radar tracking of the command module by the lunar module near the end of the lunar stay period and by the descent photography.

The crater that was avoided during landing was reported by the crew to be surrounded by ejecta containing blocks up to 5 meters in diameter and which extended 100 to 200 meters from the crater rim, indicating a relatively fresh, sharp-rimmed ray crater. The only crater in the 100- to 200-meter size range that meets the description and is in the vicinity indicated by the radar is West Crater near the southwest edge of the planned landing ellipse. A description by the Commander of a double crater approximately 6 to 12 meters in size and south of the lunar module shadow, plus the identification of West Crater, the hill to the west, and the 21- to 24-meter crater reported behind the lunar module, formed a unique pattern from which the landing site was determined to within approximately 8 meters. The 21- to 24-meter crater has been since identified by photometry as being 33 meters in diameter. The returned sequence-camera descent photography confirmed the landing point location. The position corresponds to coordinates latitude 0°41'15" N and longitude 23°26'0" E on figure 5-10 (in section 5).

Geology from transmitted data.- The surface of the mare near the landing site is unusually rough and of greater geologic interest than expected before flight. Television pictures indicated a greater abundance of coarse fragmental debris than at any of the four Surveyor landing sites on the maria except that of Surveyor I (ref. 6). It is

likely that the observed fragments and the samples returned to earth had been derived from varying depths beneath the original mare surface and have had widely different histories of exposure on the lunar surface.

The major topographic features in the landing area are large craters a few hundred meters across, four of which are broad subdued features. The fifth large crater is West Crater located 400 meters east of the landing point. Near the lunar module, the surface is pocked by numerous small craters and strewn with fragmental debris, part of which may have been generated during the impact formation of West Crater.

Among the smaller craters, both sharp, raised-rim craters and relatively subdued craters are common. They range in size from a few centimeters to 20 meters. A slightly subdued, raised-rim crater (the reported 21- to 24-meter crater) 33 meters in diameter and 4 meters deep occurs approximately 50 meters east of the lunar module, and a double crater (the reported doublet crater) approximately 12 meters long and 6 meters wide lies 10 meters west of the lunar module at a 260° azimuth (fig. 5-8).

The walls and floors of most of the craters are smooth and uninterrupted by either outcrops or conspicuous stratification. Rocks present in the 33-meter crater are larger than any of those seen on the surface in the vicinity of the lunar module. The bulk of the surface layer consists of fine-grained particles which tended to adhere to the crewmen's boots and suits, as well as to equipment, and which was molded into smooth forms in the footprints.

The regolith is weak and relatively easily trenched to depths of several centimeters. At an altitude of approximately 30 meters prior to landing, the crewmen observed dust moving away from the center of the descent propulsion blast. The lunar module footpads penetrated to a maximum depth of 7 or 8 centimeters. The crewmen's boots left prints generally from 3 millimeters to 2 or 3 centimeters deep (fig. 11-3). Surface material



Figure 11-3.- Surface characteristics around footprints.

was easily dislodged when kicked. The flagpole and drive tubes were pressed into the surface to a depth of approximately 12 centimeters. At that depth, the regolith was not sufficiently strong to hold the core tubes upright. A hammer was used to drive the core tubes to depths of 15 to 20 centimeters. In places, during scooping operations, rocks were encountered in the subsurface.

The crewmen's boot treads were sharply preserved, and angles as large as 70° were maintained in the footprint walls (fig. 11-4). The surface disturbed by walking tended to break into slabs, cracking outward approximately 12 to 15 centimeters from the edges of the footprints.

The finest particles of the surface had some adhesion to boots, gloves, suits, hand-tools, and rocks on the lunar surface. On repeated contact, the coating on the boots thickened to the point that the color of the boots was completely obscured. When the fine particles were brushed off the suits, a stain remained.



Figure 11-4.- Footprint in surface material.

During the television panorama, the Commander pointed out several rocks west of the television camera, one of which was tabular and standing on edge, protruding 30 centimeters above the surface. Scattered fields of angular blocks, many more than 0.5 meter long, occur north and west of the lunar module. In general, the rocks tended to be rounded on top and flat or angular on the bottom. The cohesive strength of rock fragments varied, and in some cases the crew had difficulty in distinguishing aggregates, or clods of fine debris, from rocks.

Geologic photography and mapping procedures.- Television and photographic coverage of the lunar surface activities constitute most of the fundamental data for the lunar geology experiment and complement information reported by the crew. (Refer to "Photography" in this section for a discussion of lunar surface photography.)

Photographic documentation of the lunar surface was acquired with a 16-millimeter sequence camera, a closeup stereoscopic camera, and two 70-millimeter still cameras (one with an 80-millimeter lens and the other with a 60-millimeter lens). The camera with the 60-millimeter lens was intended primarily for gathering geologic data, and a transparent plate containing a five-by-five matrix of crosses was mounted in front of the film plane to define the coordinate system for the optical geometry.

Photographic procedures planned for the lunar geology experiment for use with the 70-millimeter Hasselblad and the 60-millimeter lens were the panorama survey, the sample area survey, and the single sample survey.

The panorama survey consists of 12 pictures taken at intervals of 30° in azimuth and aimed at the horizon with the lens focused at 22.5 meters. The resulting pictures, when matched together as a mosaic, form a continuous 360° view of the landing site from which relative azimuth angles can be measured between features of interest. The Commander took a partial panorama from the foot of the ladder immediately after he stepped to the lunar surface (fig. 11-5(a)). Also, three panoramas were taken from the vertexes of an imaginary triangle surrounding the lunar module (for example, figs. 11-5(b) and 11-5(c)).

The sample area survey consists of five or more pictures taken of an area 4 to 6 meters from the camera. The first picture was taken approximately down sun, and the succeeding three or more pictures were taken cross sun, with parallel camera axes at intervals of 1 to 2 meters.

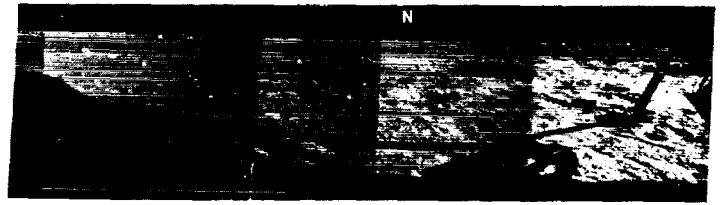

(a)

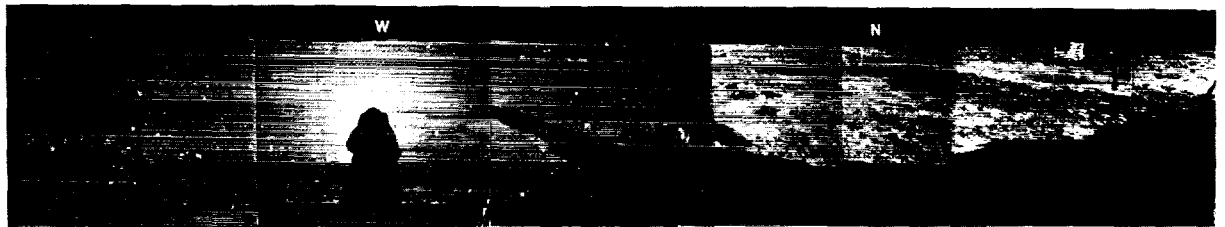

(b)

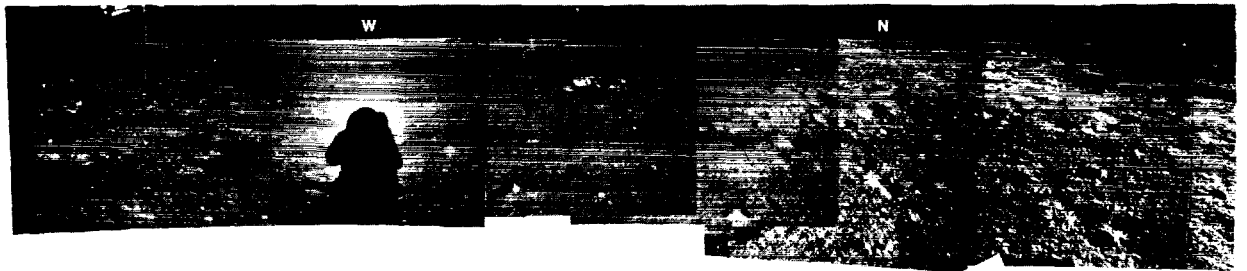

(c)

Figure 11-5.- Panoramic views.

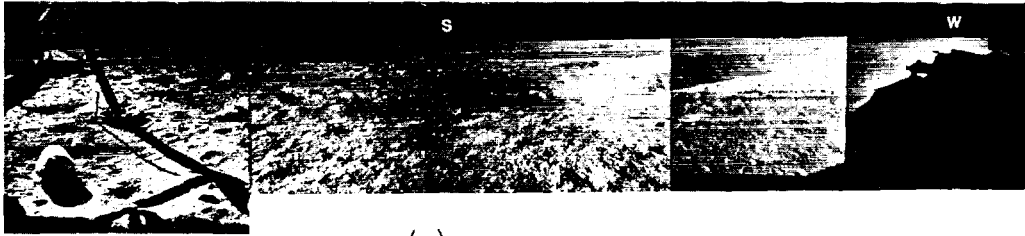

(a)

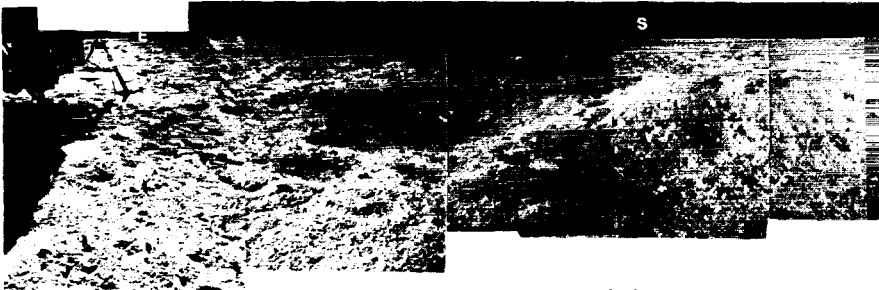

(b)

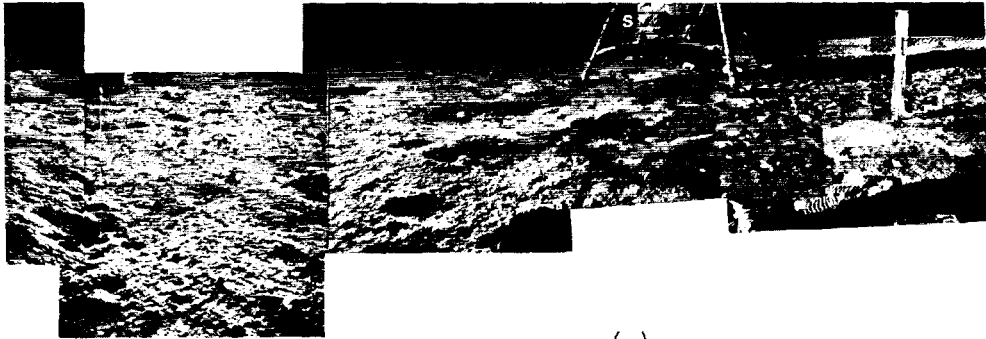

(c)

Figure 11-5.- Panoramic views.

The single sample survey was designed to record structures that were particularly significant to the crew. The area was photographed from a distance of 1.6 meters. As with the sample area survey, the first picture was taken approximately down sun, and the next two were taken cross sun.

Geologic study from photographs.- The lunar geology experiment includes a detailed study and comparison of photographs of the rock samples in the Lunar Receiving Laboratory with photographs taken on the lunar surface. The method of study involves drawings of geologic sketch maps of faces that show features of the rock unobscured by dust and detailed descriptions of the morphologic (relating to former structure), structural, and textural features of the rock, together with interpretation of the associated geologic features. The photographs and geologic sketches constitute a permanent record of the appearance of the specimens before subsequent destructive laboratory work.

A small rock 2 by 4 by 6 centimeters, which was collected in the contingency sample, has been tentatively located on the lunar surface photographs. Photographs of the rock show a fresh-appearing vesicular (with small cavities resulting from vaporization in a molten mass) lava, similar in vesicularity, texture, and crystallinity to many terrestrial basalts (fig. 11-2).

The third largest rock in the contingency sample was collected within 2 meters of the lunar module. The rock has an ovoid shape, tapered at one end, with a broadly rounded top and nearly flat bottom (fig. 11-6). This rock is approximately 5.5 centimeters long, 2 to 3 centimeters wide, and 1.5 to 2 centimeters thick. Parts of the top and sides of the rock are covered with fine dust, but the bottom and lower sides indicate a very fine-grained clastic rock containing scattered subrounded rock fragments up to 5 millimeters in diameter. The rounded ovoid shape of the top and sides of this specimen is irregular in detail. In the central part of the rock, a broad depression is formed by many coalescing shallow irregular cavities and round pits. Adjacent to the central part, toward the tapered front end, round deep pits are abundant and so closely spaced that some pits intersect others and indicate more than one generation of pitting. The bottom of the rock is marked by two parallel flat surfaces separated by an irregular longitudinal scarp approximately 0.5 to 1 millimeter high. A few small cavities are present, but no round pits of the type found on the top appear on the bottom of the rock. An irregular fracture pattern occurs on the bottom of the rock. The fractures are short, discontinuous, and largely filled with dust. On the top of the rock near the tapered end, a set of short fractures 3 to 9 millimeters long is largely dust filled and does not appear to penetrate far into the rock. On a few sides and corners, there are short curved fractures which may be exfoliation features. This rock is a breccia of small subangular lithic fragments in a very fine-grained matrix. The rock resembles the material of the surface layer as photographed by the stereoscopic closeup camera, except that this specimen is indurated.

Top and side view

Bottom and partial side view

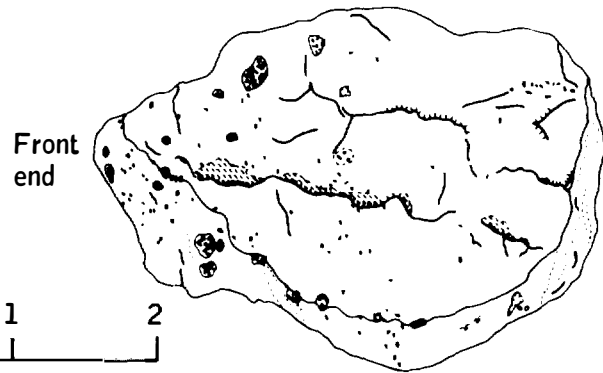

0 1 2
Approximate scale, cm



Sub-angular imbedded rock fragments showing lath-shaped white "crystals"



Fractures



White "crystals" and cleavage fragments in the matrix



Vertical irregularity, hachures indicate down side



Circular pits, many with raised rims; some with thin white halos



Faint layering visible on lower sides of specimen and locally on top



Irregular cavities



Shadow

Figure 11-6.- Detailed view of lunar rock.

Photometric evaluation.- The general photometric characteristics of the surface were not noticeably different from those observed at the Surveyor landing sites. See "Photography" in this section for a more detailed evaluation of the photography during lunar orbit and surface operations. The albedo of the lunar surface decreased significantly when the surface was disturbed or covered with a spray of fine-grained material kicked up by the crew. At low phase angles, the reflectance of the fine-grained material was increased noticeably, especially where it was compressed smoothly by the crewmen's boots.

Surface traverse and sampling logs.- The television pictures and lunar surface photographs were used to prepare a map of the locations of surface features, emplaced instruments, and samples (fig. 11-7). The most distant single traverse was made to the 33-meter-diameter crater east of the lunar module.

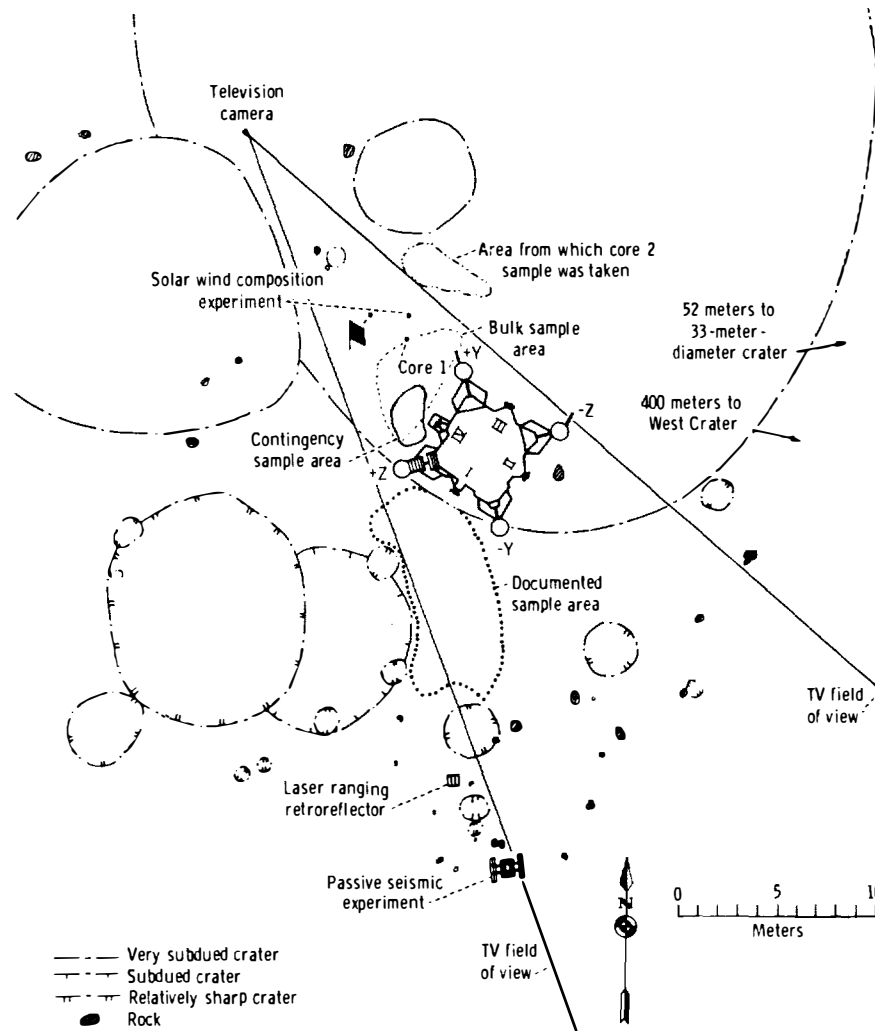

Figure 11-7.- Diagram of lunar surface activity areas.

The contingency sample was taken in view of the sequence camera just outside quad IV of the lunar module. Two scoopfuls filled the sample bag with approximately 1.03 kilograms of surface material. The areas where the samples were obtained have been accurately located on a frame (fig. 11-8) of the sequence film taken from the lunar module window. Both scoopfuls included small rock fragments (figs. 11-9 and 11-10) visible on the surface from the lunar module windows prior to sampling.

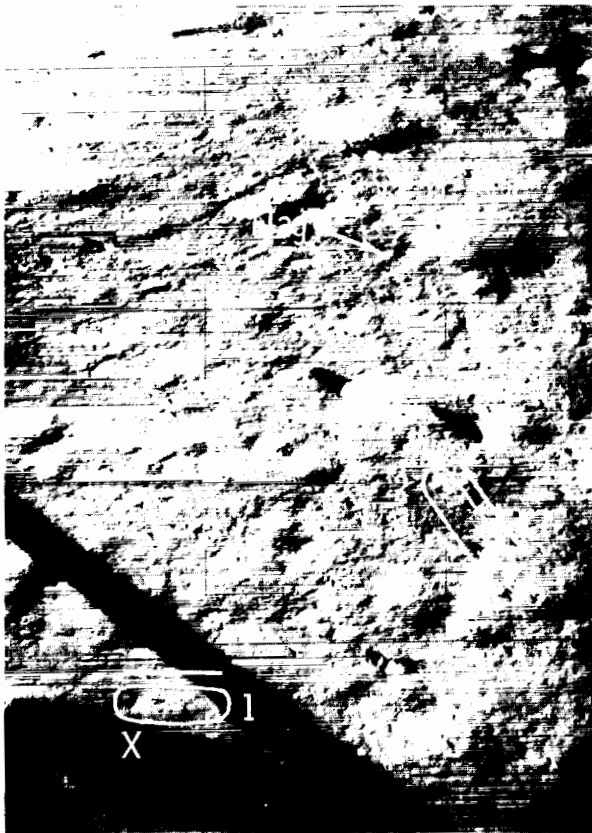

Figure 11-8.- Location of two contingency sample scoops.



Figure 11-9.- Rocks collected during first contingency sample scoop.

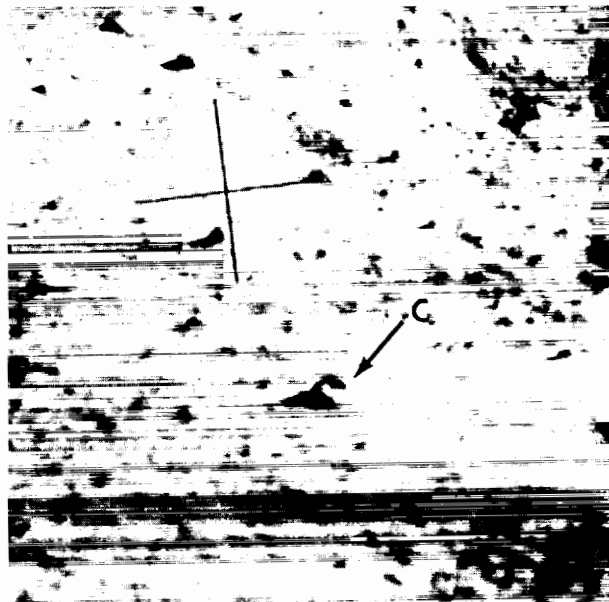

Figure 11-10.- Rock collected during second contingency sample scoop.

The Commander pushed the handle of the scoop apparatus 15 to 20 centimeters into the surface near the area of the first scoop. Collection of the bulk sample included 17 or 18 scoopfuls taken in full view of the television camera and at least five scoopfuls taken within the field of view of the sequence camera.

The two core-tube samples were taken in the vicinity of the solar wind composition experiment. The first core location was documented by the television camera and by two individual Hasselblad photographs. The second core-tube location, as reported by the crew, was in the vicinity of the solar wind composition experiment.

Approximately 20 selected, but unphotographed, grab samples (approximately 6 kilograms) were collected in the final minutes of the extravehicular activity. These specimens were collected in a region 10 to 15 meters south of the lunar module and near the east rim of the large double crater.

The sites of three of the contingency sample rocks have been located, and the locations of two rocks have been tentatively identified by comparing the shapes and sizes shown in the lunar module window and surface

photographs with photographs taken of the specimens at the Lunar Receiving Laboratory. Evidence for the identification and orientation of rock A (fig. 11-9) was obtained from the presence of a saddle-shaped notch on its exposed side. Rock C (fig. 11-10) was characterized by the pitlike depression visible on the photographs. Rock B (fig. 11-9) is approximately 2 centimeters wide and at this time has not been correlated with the specimens in the Lunar Receiving Laboratory. During bulk sampling, rock fragments were collected primarily on the northeast rim of the large double crater southwest of the lunar module.

Photographs taken of the documented sample locality (south of the plus Z footpad) before and after the extravehicular activity were examined for evidence of rocks that might have been included in the sample. Figures 11-11 and 11-12 illustrate that three rather large rocks (up to several tens of centimeters) were removed from their respective positions shown on the photographs taken before the extravehicular activity. A closer view of these three rocks was obtained during the extravehicular activity (fig. 11-13).



Figure 11-11.- Photograph taken before extravehicular activity, showing rocks collected (fig. 11-9).

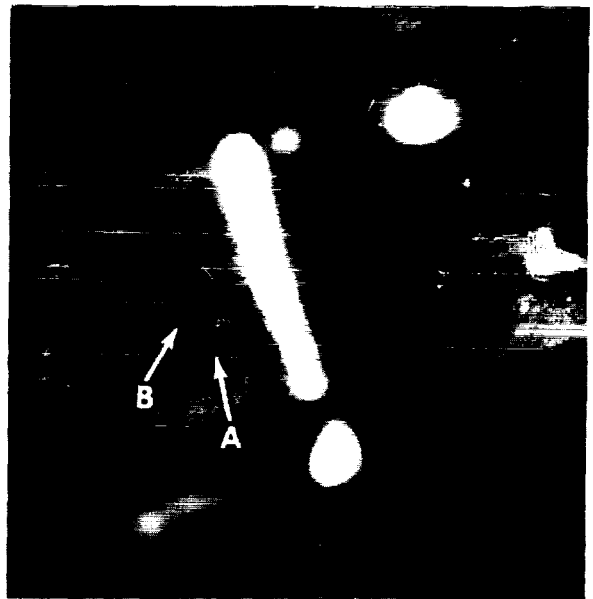

Figure 11-12.- Photograph of area shown in figure 11-11 after extravehicular activity.



Figure 11-13.- Photograph of area shown in figures 11-11 and 11-12, taken during extravehicular activity.

Geologic handtools.- The geologic handtools included the contingency sample container, a scoop, a hammer, an extension handle, two core tubes, tongs, two large sample bags, a weighing scale, two sample return containers, and the gnomon. Also included were small sample bags numbered for use in documentation. All handtools were used except the gnomon. The crew reported that, in general, the handtools worked well.

The large scoop attached to the extension handle was used primarily during bulk sampling to collect rocks and fine-grained material. The large scoop was used approximately 22 times in collecting the bulk sample. As expected from 1/6-g simulations, some lunar material tended to fall out of the scoop at the end of a scooping motion.

The hammer was used to drive the core tubes, which were attached to the extension handle. Blows hard enough to dent the top of the extension handle could be struck. The extension handle was attached to the large scoop for taking bulk samples and was attached to the core tubes for taking core samples.

Two core tubes were driven, and each collected a satisfactory sample. Each tube had an internally tapered bit that compressed the sample 2.2:1 inside the tube. One core tube contained 10 centimeters of sample, and the other contained 13 centimeters of sample. The tubes were difficult to drive deeper than approximately 20 centimeters. This difficulty may have been partially caused by the increasing density of the fine-grained material with depth or by other mechanical characteristics of the lunar regolith. The difficulty of penetration was also a function of the tapered bit, which caused greater resistance with increased penetration. One tube was difficult to attach to the extension handle. When this tube was detached from the extension handle, the butt end of the tube unscrewed and was lost on the lunar surface. The tubes were opened after the flight, and the split liners inside both tubes were found to be offset at the bit end. The Teflon

core follower in one tube was originally inserted upside down, and the follower in the other tube was inserted without the expansion spring which holds the follower snugly against the inside of the split tube.

The tongs were used to pick up the documented samples and to right the closeup stereoscopic camera when it fell over on the lunar surface. One of the large sample bags was used for stowage of documented samples. The other large bag, the weigh bag, was used for stowage of bulk samples. The weighing scale was used only as a hook to suspend the bulk sample bag from the lunar module during the collection of bulk samples.

Lunar Soil Mechanics Experiment

The lunar surface at the Apollo 11 landing site was similar in appearance, behavior, and mechanical properties to the surface observed at the Surveyor maria landing sites. Although the lunar surface material differs considerably in composition and in range of particle shapes from a terrestrial soil of the same particle size distribution, it does not appear to differ significantly in its engineering behavior.

A variety of data was obtained through detailed crew observations, photography, telemetered dynamic data, and examination of the returned lunar surface material and rock samples. This information permitted a preliminary assessment of the physical and mechanical properties of the lunar surface materials. Simulations based on current data are planned to gain further insight into the physical characteristics and mechanical behavior of lunar surface materials.

Observed characteristics.- The physical characteristics of lunar surface materials were first indicated during the lunar module descent. At that time, the crew noticed a transparent sheet of dust resembling a thin layer of ground fog that moved radially outward and caused a gradual decrease in visibility.

Inspection of the area below the descent stage after landing revealed no evidence of an erosion crater and little change in the apparent topography. The surface immediately underneath the engine skirt had a singed appearance and was slightly etched (fig. 11-14). The surface appearance indicated that the descent engine had caused a sculpturing effect that extended outward from the engine. Visible streaks of eroded material extended to a maximum distance of approximately 1 meter beyond the engine skirt.

During ascent, no visible signs of surface erosion were observed. The insulation blown off the descent stage generally moved outward on extended flight paths in a manner similar to that of the eroded surface particles during descent, although the crew reported that the insulation was, in some cases, blown for several miles.

The landing gear footpads penetrated the lunar surface 2 to 8 centimeters, and there was no discernible throwout from the footpads. Figures 11-15 to 11-18 show the footpads of the plus Y, minus Z, and minus Y struts. The same photographs show the postlanding condition of the lunar contact probes, which had dug into and were dragged through the lunar surface, as well as some surface bulldozing caused by the minus Z footpad in the direction of the left lateral motion during landing. The bearing pressure on each footpad was 1 or 2 psi.

The upper centimeters of lunar surface material in the vicinity of the landing site are characterized by a brownish, medium-gray, slightly cohesive granular material that is largely composed of bulky grains in the size range of silt to fine sand. Angular to subrounded rock fragments up to 1 meter in diameter are distributed throughout the area. Some of these fragments were observed to lie on the surface, some were partially buried, and others were barely exposed.



Figure 11-14.- Lunar surface under descent stage engine.

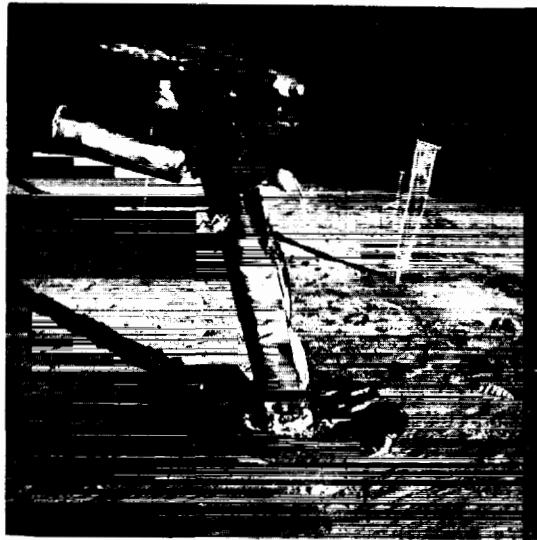

Figure 11-15.- Interaction of the plus Y footpad and contact probe with lunar surface.



Figure 11-16.- Interaction of the minus Z footpad with lunar surface.



Figure 11-17.- Interaction of the minus Y footpad and contact probe with lunar surface.

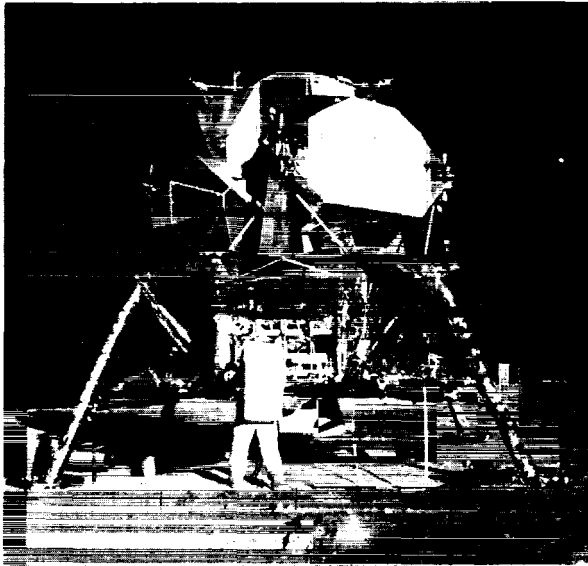

Figure 11-18.- Soil disturbance in the minus Y footpad area.

The lunar surface is relatively soft to depths of 5 to 20 centimeters. The surface can be easily scooped, offers low resistance to penetration, and provides slight lateral support for staffs, poles, and core tubes. Beneath this relatively soft surface, resistance to penetration increases considerably. The available data indicate that this increase is caused by an increase in the density of material at the surface rather than by the presence of rock fragments or bedrock.

Natural clods of fine-grained material crumbled under the crewmen's boots. The behavior of the clods, while not fully understood, indicates cementation or natural cohesion between the grains (or both). In nitrogen, returned lunar surface samples were also found to cohere to some extent after being separated, although to a lesser degree than observed on the lunar surface in the vacuum environment.

The lunar surface material was loose, powdery, and fine-grained and exhibited adhesive characteristics. As a result, the material tended to stick to any object with which it came in contact, including the crewmen's boots and suits, the television cable, and the lunar equipment conveyor. During operation of the lunar equipment conveyor, the powder adhering to it was carried into the spacecraft cabin. Also, sufficient fine-grained material collected on the equipment conveyor to cause binding.

The thin layer of material adhering to the crewmen's boot soles caused a tendency to slip on the ladder during ingress. Similarly, the powdery coating of the rocks on the lunar surface caused some slipping. (See section 4.) A fine dust confined between two relatively hard surfaces, such as a boot sole and a ladder run or a rock surface, would be expected to produce a tendency to slip. However, the lunar surface provided adequate bearing strength for standing, walking, loping, or jumping and sufficient traction for starting, turning, or stopping.

Small, fresh crater walls having slope angles of up to 15° could be readily negotiated by the crew. Going straight down or up was found to be preferable to traversing these slopes sideways. The footing was not secure because the varying thicknesses of unstable layer material tended to slide in an unpredictable fashion.

The material on the rims and walls of larger size craters, with wall slopes ranging up to 35° , appeared to be more compact and stable than that on the smaller craters.

Examination of lunar material samples.- Preliminary observations were made of the general appearance, structure, texture, color, grain-size distribution, consistency, compactness, and mechanical behavior of the fine-grained material sampled by the core tubes and collected during the contingency, bulk, and documented samplings. These investigations are reported in greater detail in other reports.

Examination of Lunar Samples

A total of 22 kilograms of lunar material was returned by the Apollo 11 crew; 11 kilograms were rock fragments more than 1 centimeter in diameter, and 11 kilograms were smaller particulate material. Because the crewman filled the documented sample container by picking up selected rocks with tongs, the container held a variety of large rocks (total weight, 6.0 kilograms). The total bulk sample weighed 14.6 kilograms.

The returned lunar material may be divided into the following four groups:

1. Type A: fine-grained crystalline igneous rock containing vesicles (cavities)
2. Type B: medium-grained vuggy (small cavity) crystalline igneous rock
3. Type C: breccia (rock consisting of sharp fragments imbedded in a fine-grained matrix) made of small fragments of gray rocks and fine material
4. Type D: fines (mixtures of very small particles of various sizes)

The major findings of a preliminary examination of the lunar samples are as follows:

1. Based on the fabric and mineralogy, the rocks can be divided into two groups: (a) fine- and medium-grained crystalline rocks of igneous origin, probably originally deposited as lava flows, then dismembered and redeposited as impact debris and (b) breccias of complex history.

2. The crystalline rocks are different from any terrestrial rock and from meteorites, as shown by the bulk chemistry studies and by analyses of mineral concentration in a specified area.

3. Erosion has occurred on the lunar surface, as indicated by the rounding on most rocks and by the evidence of exposure to a process which gives the rocks a surface appearance similar to sandblasted rocks. No evidence exists of erosion by surface water.

4. The probable presence of the assemblage iron-troilite-ilmenite and the absence of any hydrated phase suggest that the crystalline rocks were formed under extremely low partial pressures of oxygen, water, and sulfur (in the range of those in equilibrium with most meteorites).

5. The absence of secondary hydrated minerals suggests that there has been no surface water at Tranquility Base at any time since the rocks were exposed.

6. Evidence of shock or impact metamorphism is common in the rocks and fines.

7. All the rocks display glass-lined surface pits which may have been caused by the impact of small particles.

8. The fine material and the breccia contain large amounts of all noble gases with elemental and isotopic abundances that almost certainly were derived from the solar wind. The fact that interior samples of the breccias contain these gases implies that the breccias were formed at the lunar surface from material previously exposed to the solar wind.

9. The $^{40}\text{K}/^{40}\text{Ar}$ measurements on igneous rock indicate that those rocks crystallized 3 to 4 billion years ago. Cosmic-ray-produced nuclides indicate that the rocks have been within 1 meter of the surface for periods of 20 to 160 million years.

10. The level of indigenous volatilizable or pyrolyzable (or both) organic material appears to be extremely low (considerably less than 1 ppm).

11. The chemical analyses of 23 lunar samples show that all rocks and fines are generally similar chemically.

12. The elemental constituents of lunar samples are the same as those found in terrestrial igneous rocks and meteorites. However, several significant differences in composition occur: (a) Some refractory elements (such as titanium and zirconium) are notably enriched, and (b) the alkalis and some volatile elements are depleted.

13. Elements that are enriched in iron meteorites (that is, nickel, cobalt, and the platinum group) either were not observed or were low in abundance.

14. The chemical analysis of the fine material is in excellent agreement with the results of the alpha-backscattering measurement at the Surveyor V site.

15. Of 12 radioactive species identified, two were cosmogenic radionuclides of short half life (^{52}Mn which has a half life of 5.7 days and ^{48}V which has a half life of 16.1 days).

16. Uranium and thorium concentrations were near the typical values for terrestrial basalts; however, the potassium-to-uranium ratio determined for lunar surface material is much lower than such values determined for either terrestrial rocks or meteorites.

17. The observed high concentration of ^{26}Al is consistent with a long-cosmic-ray exposure age inferred from the rare-gas analysis.

18. To date, no evidence of biological material has been found in the samples.

19. The lunar surface material at the lunar module landing site is predominantly fine grained, granular, slightly cohesive, and incompressible. The hardness increases considerably at a depth of 6 inches. The soil is similar in appearance and behavior to the soil at the Surveyor landing sites.

Passive Seismic Experiment

The early Apollo scientific experiment package seismometer system met the requirements of the experiment for the first 2 weeks of its operation. No significant instrumental deficiencies were encountered, despite the fact that maximum operating temperatures exceeded those planned for the instrument by as much as 50° F.

Analysis of calibration pulses and signals received from various crew activities indicated that all four seismometers were operating properly. Instrument response curves derived from calibration pulses are shown in figure 11-19.

During the first lunar day, data were acquired at 11:40:39 p.m. e.s.t., July 20, 1969, and transmission was stopped by command from Mission Control Center at 06:58:46 a.m. e.s.t., August 3, 1969, when the predicted rate of solar panel output power drop occurred at lunar sunset. This output power drop occurred approximately 4 hours 40 minutes before the sunset time predicted for a flat surface, indicating an effective slope of 2°20' upward to the west at the deployment site.

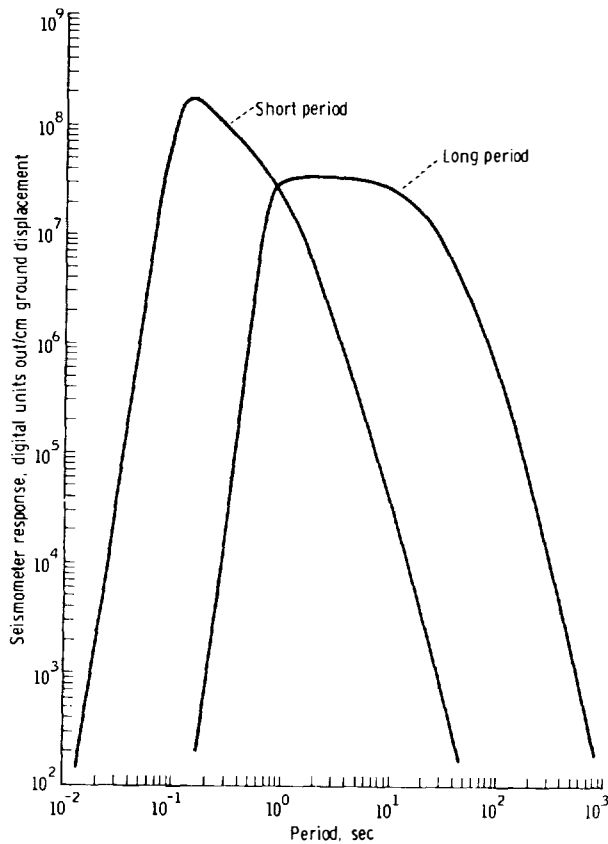

Figure 11-19.- Response from passive seismic experiment.

Except for the occasional occurrence of transient signals, the background seismic signal level on the long-period vertical-component seismometer is below system noise; that is, below 0.3 millimicron over the period range from 1 to 10 seconds (figs. 11-21 and 11-22). This level is between 100 and 10 000 times less than the average background levels observed on earth in the normal period range for microseisms (6 to 8 seconds).

Continuous background motions of relatively large amplitude (10 to 30 millimicrons peak to peak) were observed on the records from both horizontal-component seismometers. The amplitude of these motions decreased below the level of the 54-second oscillation for a 2- to 3-day interval centered near lunar noon when the rate of change of external temperature with time would be at a minimum. The signals were of low frequency (with a period of approximately 20 seconds to 2 minutes). It is assumed that these signals correspond to tilting of the instruments. The tilting is caused by a combination of thermal distortions of the metal pallet which serves as the instrument

Seismic background noise.- A histogram of seismic background level recorded by the short-period seismometer is shown in figure 11-20. Immediately after turn-on, the high-amplitude signal was produced in part by crew activities and in part by a signal generated within the lunar module, presumably by venting processes. The levels decreased steadily until the background signal had disappeared completely by July 29, 1969 (8 days after turn-on). Thus, the continuous seismic background signal near 1 hertz is less than 0.3 millimicron, which corresponds to system noise. Maximum signal levels of 1.2 microns at frequencies of 7 to 8 hertz were observed during the period when the crewmen were on the surface.

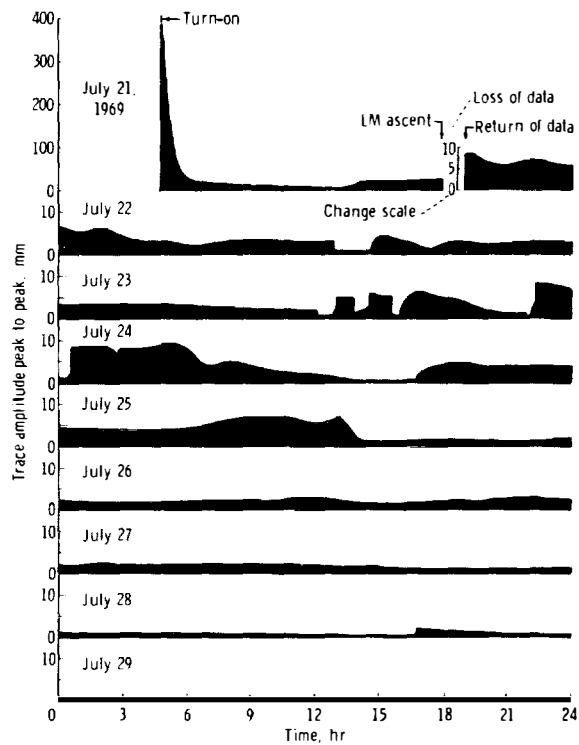

Figure 11-20.- Signal-level history from short-period Z-axis seismometer.

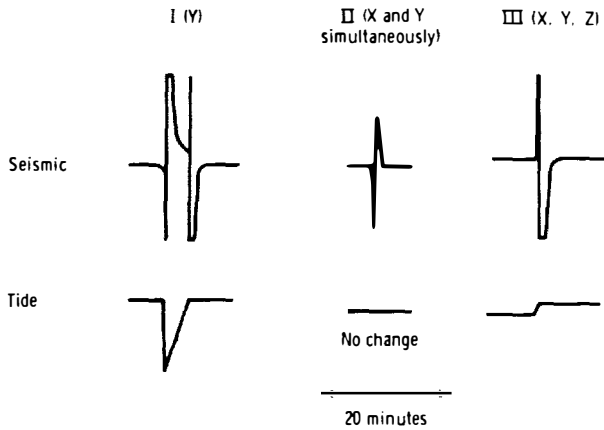

Figure 11-21.- Diagram showing types of noise transients observed on the seismic and tidal outputs from the long-period seismometers.

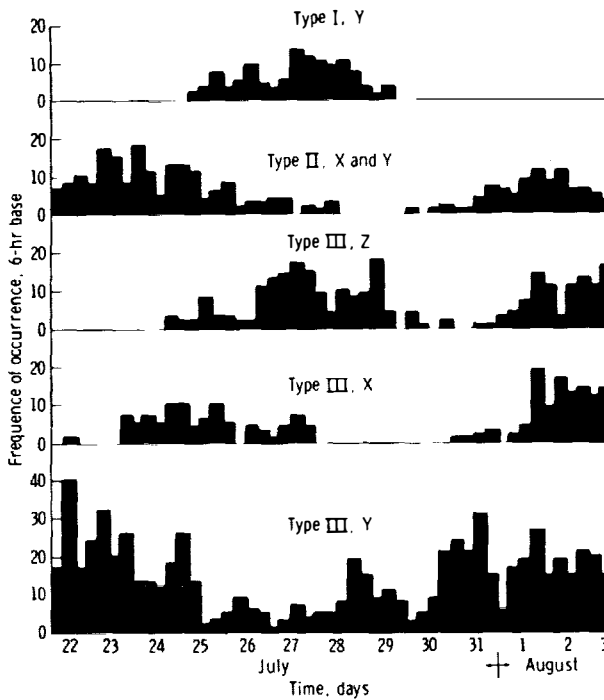

Figure 11-22.- Histogram of long-period noise transients.

mately equal to the fundamental resonant mode of vibration of the lunar module structure. For comparison, the spectrum of the signal generated when one of the portable life support systems, which weighed 75 pounds, struck the ground after being ejected from the lunar module is shown in figure 11-24. The spectrum again shows the 7.2-hertz peak; however, the two peaks at 11.3 and 12.3 hertz would be dominant if the spectrum were corrected for instrument response. The signal at 7.2 hertz was presumably generated because

base and a rocking motion of the pallet produced by thermal effects in the lunar surface material. However, the horizontal component of true lunar seismic background level at shorter periods (less than 10 seconds) also appears to be less than 0.3 millimicron.

Near seismic events.- Four types of high-frequency signals produced by local sources (within 10 to 20 kilometers of the seismic experiment package) have been tentatively identified. Signals of the first type, those produced by crew activities, were prominent on the short-period seismometer from initial turn-on until lunar module ascent. Such signals were particularly large when the crewmen were in physical contact with the lunar module. The signal produced when the Commander ascended the ladder to reenter the lunar module is shown in figure 11-23.

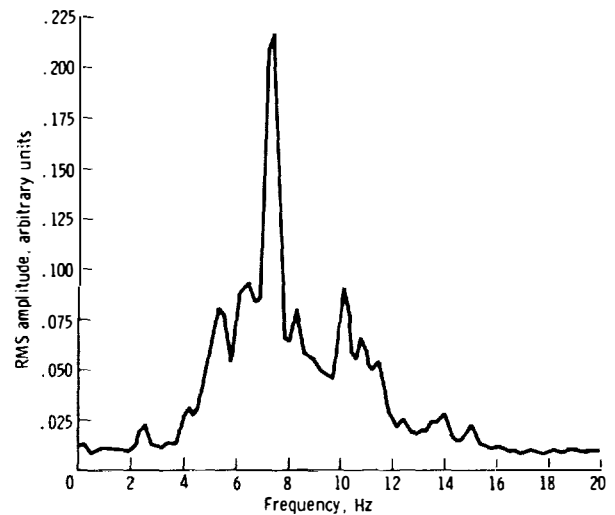

Figure 11-23.- Seismometer response while Commander was ascending ladder.

The predominant frequency of all of the signals produced by crew activities is 7.2 to 7.3 hertz. The spectrum of the signal produced by the Commander on the lunar module ladder, shown in figure 11-23, contains this prominent peak. This frequency is approxi-

the portable life support system struck the lunar module porch and the ladder as it fell to the surface.

The 7.2-hertz peak is shifted to 8.0 hertz in the spectra of signals generated after departure of the lunar module ascent stage. It is expected that resonances in the remaining descent stage structure shifted to higher frequencies when the mass of the ascent stage was removed.

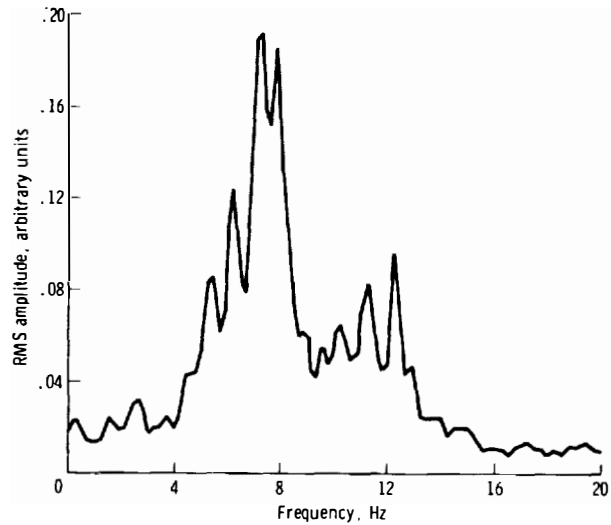

Figure 11-24.- Seismometer response from first portable life support system impacting lunar surface.

Some of the signals observed had the same characteristics that landslides have on earth. The signals have emergent onsets and last up to 7 minutes for the largest trains. Low frequencies (1/10 to 1/15 hertz) associated with the largest of these trains are also observed on the seismograms from the long-period vertical-component seismometer. As shown in figure 11-25, the events associated with these signals began on July 25, 1969 (2 days before lunar noon), subsided during the lunar noon period, and continued after lunar noon with more frequent and much smaller events. The activity is believed to be related in some way to thermal effects. More than 200 of these events were identified.

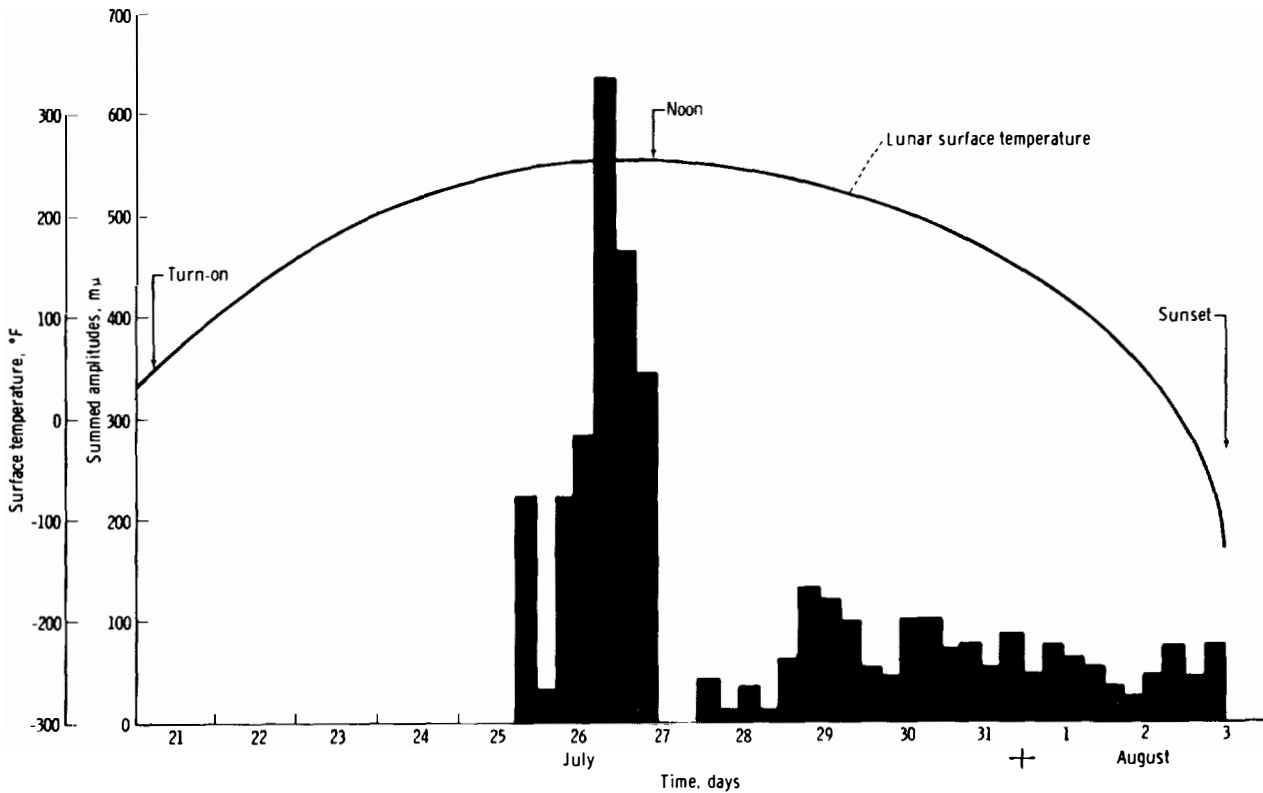

Figure 11-25.- Lunar surface temperature and seismometer output signals.

High-frequency signals from an undetermined source were observed. These signals began with large amplitudes on the short-period seismometer and gradually decreased over a period of 8 days until they disappeared completely on July 30, 1969. During the final stages of this activity, the signals became repetitive, with nearly identical structure from train to train. As mentioned previously, the predominant frequency of these signals was approximately 7.2 hertz before the lunar module ascent and 8.0 hertz after the lunar module ascent. The complete disappearance of these signals and their nearly identical form have led to the tentative conclusion that they were produced by the lunar module itself, presumably by venting processes.

Some of the observed high-frequency signals may have been from nearby meteoroid impacts. An analysis is being made of several high-frequency signals which may correspond to meteoroid impacts at ranges of a few kilometers or less from the passive seismic experiment package. Substantive remarks on these events cannot be made until spectra of the signals are computed.

Distant seismic events.- During the period July 22 to 24, 1969, three of the recorded signals appear to be surface waves, that is, seismic waves which travel along the surface of the moon in contrast to body waves which would travel through the interior of the moon. Body waves (compressional and shear waves) produced by a given seismic source normally travel at higher velocities than surface waves and, hence, are observed on the record before the surface waves. No body waves were observed for distant seismic events. The wave trains begin with short-period oscillations (2 to 4 seconds) which gradually increase in period to 16 to 18 seconds when the train dispersed.

A wave train having similar characteristics has been observed on the long-period vertical channel in association with a series of discrete pulses on the short-period vertical channel. In this case, the long-period wave train observed on the record is simply the summation of transients corresponding to these pulses and, hence, is of instrumental origin. A dispersion of this type is commonly observed on earth in various types of surface waves. The dispersion, or gradual transformation of an initial impulsive source to an extended oscillatory train of waves, is produced by propagation through a wave guide of some type. The events observed appear only on the horizontal-component seismometers. Such horizontally polarized waves, when observed on earth, would be called Love waves. On earth, surface waves which have a vertical component of motion (Rayleigh waves) are usually the most prominent waves on a record from a distant event. Several possibilities are presently under study to explain these waves.

Engineering evaluation.- From acquisition of initial data to turn-off, the passive seismic experiment package operated for 319 hours 18 minutes. The power and data subsystems performed extremely well, particularly in view of the abnormally high operating temperatures. The output of the solar cell array was within 1 to 2 watts of the expected value and was always higher than the 27-watt minimum design specification.

Approximately 99.8 percent of the data from the passive seismic experiment package are preserved on tape. Several occurrences of data dropout were determined to be caused by a source other than the seismic experiment system. The passive seismic experiment showed good response in detection of the crewmen's footsteps, the portable life support system ejection from the lunar module, and the movements by the crew in the lunar module prior to lift-off.

Data from the dust and thermal radiation engineering measurement were obtained continuously except for brief turn-off periods associated with power/thermal management. Nine hundred and sixteen commands were transmitted and accepted by the passive seismic experiment package. Most of these commands were used to level the equipment, thereby correcting for the thermal distortions of the supporting primary structure.

The down-link signal strength received from the passive seismic experiment package agrees with the predictions. For the 30-foot antennas, the strength ranged from -135 to -139 dBm, and for the 85-foot antennas, the strength ranged from -125 to -127 dBm.

Normal operation was initiated on the second lunar day by command from Mission Control Center at 1:00 a.m. e.s.t., August 19, 1969, approximately 20 hours after sunrise at Tranquility Base. Transmission stopped at 6:08 a.m. e.s.t., September 1, 1969, with the loss of solar panel output power at lunar sunset. The loss of transmission was disappointing; however, at the time of the loss, the passive seismic experiment package had exceeded the design objectives.

Data received, including seismometer measurements, were consistent with those recorded at corresponding sun elevation angles on the first lunar day. Operation continued until the data system did not respond to a transmitted command at 3:50 a.m. e.s.t., August 25, 1969 (approximately noon of the second lunar day). No command was accepted by the passive seismic experiment package after that time, despite repeated attempts under a wide variety of conditions. The initial impact of the loss of command capability was the inability to relevel the long-period seismic sensors. As a result, all three axes became so unbalanced that the data were meaningless; however, meaningful data continued to be received from the short-period seismic sensor.

Valid short-period seismic sensor and telemetry data continued to be received and recorded during the remainder of the second lunar day. Component temperatures and power levels continued to be nominal and corresponded to values recorded at the same sun angles on the first lunar day. The passive seismic experiment was automatically switched to the standby mode of operation when the power dropped at sunset.

Down-link transmission was acquired during the third lunar day at 5:27 p.m. e.s.t., September 16, 1969. Transmission stopped at 6:31 a.m. e.s.t., October 1, 1969, with the loss of power at lunar sunset. Efforts to restore command communications were unsuccessful. The passive seismic experiment remained in the standby mode of operation, with no seismic data output. Data from the dust and thermal radiation engineering measurement went off scale low at 10:00 p.m. e.s.t., September 16, 1969, and remained off scale throughout the day. The down-link signal strength, component temperatures, and power levels continued to be nominal and corresponded to values recorded at the same sun angles on previous days.

Engineering conclusions.- Tentative conclusions based on a preliminary analysis of data obtained during the first recording period (July 21 to August 3) are as follows:

1. The seismic background signal on the moon is less than the threshold sensitivity of the instrument (0.3 millimicron). Seismometers are able to operate on the lunar surface at 10 to 100 times higher sensitivity than is possible on earth.

2. Allowing for the difference in size between the earth and the moon, the occurrence of seismic events (moonquakes or impacts) on the moon is much less frequent than the occurrence of earthquakes on the earth.

3. Despite the puzzling features of the possible surface wave trains, an attempt is being made to find lunar models compatible with the data.

4. Erosional processes corresponding to landslides along crater walls may be operative within one or more relatively young craters located within a few kilometers of the passive seismic experiment package.

Laser Ranging Retroreflector Experiment

The laser ranging retroreflector was deployed approximately 14 meters south-southwest of the lunar module in a relatively smooth area (fig. 11-26). The bubble was not precisely in the center of the leveling device, but was between the center and the innermost division in the southwest direction. This misalignment indicated an off-level condition of less than 30 minutes of arc. The shadow lines and sun compass markings were clearly visible, and the crew reported that these devices showed that the alignment was precise.

On August 1, 1969, the Lick Observatory obtained reflected signals from the laser ranging retroreflector. The signal continued to appear for the remainder of the night. Between 5 and 8 J/pulse were transmitted at 6943 angstroms. When the 120-inch telescope was used, each returned signal contained, on the average, more than one photoelectron, a value that indicated that the condition of the retroreflector on the surface was entirely satisfactory.

On August 20, 1969, the McDonald Observatory obtained reflected signals from the retroreflector. The round-trip signal time was found to be 2.49596311 (± 0.00000003) seconds, an uncertainty equivalent to a distance variation of 4.5 meters.



Figure 11-26.- Laser ranging retroreflector deployed.

The Lick Observatory and McDonald Observatory observations, made a few days before lunar sunset and a few days after lunar sunrise, show that the thermal design of the retroreflector permits operation during sun-illuminated periods and that the retroreflector survived the lunar night satisfactorily. The observations also indicate that no serious degradation of optical performance occurred as a result of flaked insulation, debris, dust, or rocket exhaust products which scattered during the lunar module lift-off.

The scientific objectives of the laser ranging retroreflector experiment — studies of gravitation, relativity, and earth and lunar physics — can be achieved only by successfully monitoring the changes in the distances from stations on earth to the laser beam reflector on the moon with an uncertainty of approximately 15 centimeters over a period of many years. The McDonald Observatory is being instrumented to make daily observations with this accuracy, and it is expected that several other stations capable of this ranging precision will be established.

Solar Wind Composition Experiment

The solar wind composition experiment was designed to measure the abundance and the isotopic compositions of the noble gases in the solar wind (^3He , ^4He , ^{20}Ne , ^{21}Ne , ^{22}Ne , ^{36}Ar , and ^{38}Ar). The experiment consisted of a specially prepared aluminum foil with an effective area of 0.4 square meter (fig. 11-27). The experiment was deployed approximately 6 meters from the lunar module. The staff of the experiment penetrated 13.5 centimeters into the surface.

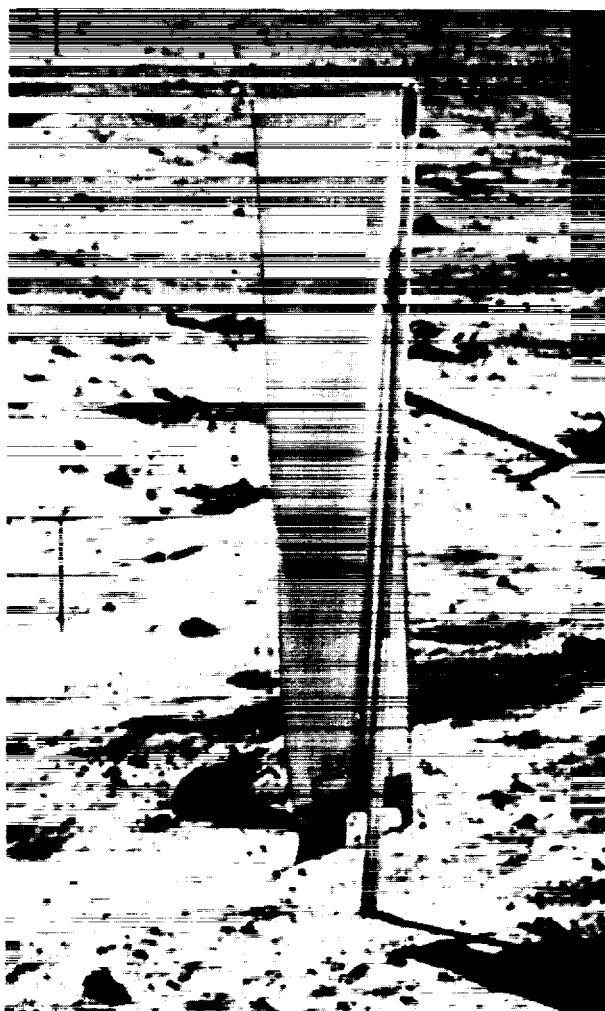

Figure 11-27.- Solar wind composition experiment deployed.

When exposed to the solar wind at the lunar surface, solar wind particles which arrived with velocities of a few hundred kilometers per second penetrated the foil to a depth of several millionths of a centimeter and became firmly trapped. The foil was retrieved after a 77-minute exposure to the lunar environment. The return unit was placed into a special Teflon bag and returned to earth in the lunar sample return container. A portion of the foil was cut out, placed into a metal gasket vacuum container, and heat sterilized at 125° C for 39 hours. The evolving atoms were then analyzed in statically operated mass spectrometers, and the absolute and isotopic quantities of the particles were determined.

Photography

During the mission, all nine of the 70-millimeter and all 13 of the 16-millimeter film magazines carried on board the spacecraft were exposed. Approximately 90 percent of the photographic objectives were accomplished, including approximately 85 percent of the requested lunar photography and approximately 46 percent of the target-of-opportunity photography.

Photographic objectives.- The lunar surface photographic objectives were as follows:

1. Long-distance coverage from the command module
2. Lunar mapping photography from orbit
3. Photography of the landed lunar module location
4. Sequence photography during descent, lunar stay, and ascent
5. Still photographs through the lunar module window
6. Still photographs on the lunar surface
7. Closeup stereoscopic photography

Film description and processing.- Special care was taken in the selection, preparation, calibration, and processing of the film to maximize returned information. The types of film included and exposed are listed in table 11-II.

TABLE 11-II.- FILM TYPES USED

Film type	Film size, mm	Magazines	ASA speed	Resolution, lines/mm	
				High contrast	Low contrast
S0-368, color	16	5	64	80	35
	70	2			
	35	1			
S0-168, color	16	8	(a)	63	32
	70	2			
3400, black and white	70	5	40	170	70

^aExposed and developed at ASA 1000 for interior photography and ASA 160 for lunar surface photography.

Photographic results.- Lunar photography from the command module consisted mainly of photographs of specified targets of opportunity, together with a short strip of vertical still photography from approximately 170° to 120° E longitude. Most of the other 70-millimeter command module photography was of the lunar surface features selected by the crew.

The 16-millimeter sequence camera photography was generally excellent. The descent film was used to determine the location of the landed lunar module. One sequence of 16-millimeter coverage taken from the lunar module window shows the lunar surface change from a light to a dark color wherever the crew walked.

The quantity and quality of still photographs taken through the lunar module window and on the lunar surface were very good. On some sequences, to ensure good photography, the crew varied the exposures one stop in either direction from the exposure indicated. The still photography on the surface indicates that the landing-site location determined by use of the 16-millimeter descent film is correct.

The closeup stereoscopic photography provides good-quality imagery of 17 areas, each 3 by 3 inches. These areas included various rocks, some ground surface cracks, and rocks which appear to have been partially melted or splattered with molten glass.

Photographic lighting and color effects.- When the lunar surface was viewed from the command module window, the color was reported to vary with the viewing angle. A high sun angle caused the surface to appear brown, and a low sun angle caused the surface to appear slate gray. From the command module, distinct color variations were seen in the maria, and these variations are very pronounced on the processed film. According to the crew, the 16-millimeter photographs are more representative of the true surface color than are the 70-millimeter photographs. However, prints from both film types have shown tints of green and other shades which are not realistic. Underexposure contributes to the green tint, and the printing process can increase this effect. Each generation away from the original copy will cause a further increase in this tinting. On the original film, the greenish tint in the dark, or underexposed, areas is a function of spacecraft

window transmission characteristics and low sun angles. For Apollo 12, the master film copies will be color corrected, which should greatly minimize unrealistic tinting.

A 16-millimeter film sequence from the lunar module window shows crew activities in both gray and light-brown areas. As the crewmen moved, the gray area, which is apparently softer, deeper material, turned almost black. The crewmen's feet visibly sank in this gray material as they kicked moderate quantities. The light-brown area did not appreciably change color with the crewmen's movement.

The color pictures in which the fine-grained parts of the lunar surface appear gray are properly exposed, while those pictures in which the lunar surface is light brown to light tan are generally overexposed. The rocks appear light gray to brownish gray in pictures that are properly exposed for the rocks and vary from light tan to an off white where overexposed. The crew reported that fine-grained lunar material and rocks appeared to be gray to dark gray. These materials appeared slightly brownish gray when observed near a zero phase angle. Small brownish, tan, and golden reflections were observed on rock surfaces.

The targets and associated exposure values for each frame of the lunar surface film magazines were carefully planned before flight. Nearly all of the photographs were taken at the recommended exposure settings.

Preflight simulations and training photography indicated that at shutter speeds of 1/125 second or longer, a suited crewman could induce excessive image motion during exposure. A shutter speed of 1/250 second was therefore chosen to reduce the unwanted motion to an acceptable level. Corresponding f-stops were then determined which would provide correct exposure under predicted lunar lighting conditions. At the completion of the training program, the crew was proficient at photographing different subjects under varying lighting conditions.

To simplify camera operations, f-stops of 5.6 and 11 were chosen for exposures in the cross-sun and down-sun directions, respectively. This exposure information was provided on decals attached to the film magazines and was used successfully.

The crewmen chose exposures for unusual lighting conditions. For example, the photographs of the Lunar Module Pilot descending the ladder were taken at an f-stop of 5.6 and a speed of 1/60 second, and the best photograph of the landing-leg plaque was taken at an exposure of 5.6 and a speed of 1/30 second. When a high depth of field was required, exposures were made with smaller apertures and correspondingly slower shutter speeds to maintain equivalent exposure values. The crewmen usually steadied the camera against the remote-control-unit brackets on their suits during these slower speed exposures.

A preliminary analysis of all lunar surface exposures indicates that the nominal shutter speed of 1/250 second appears to be a good compromise between depth of field and crew-induced image motion. In those specific instances where a slower shutter speed was required, either because of depth-of-field or lighting considerations, the crew was able to minimize image motion by steadying the camera. However, the selection of the 1/250-second speed will be reevaluated for continued general photography. Figures 11-3, 11-4, and 11-18 are representative of lunar surface photography.

12. BIOMEDICAL EVALUATION

This section is a summary of the Apollo 11 quarantine procedures and medical findings, based upon a preliminary analysis of biomedical data. More comprehensive evaluations will be published in separate medical reports.

The three crewmen accumulated 585 man-hours of space flight experience during the lunar landing mission, including 2 hours 14 minutes and 1 hour 42 minutes on the lunar surface for the Commander and the Lunar Module Pilot, respectively.

The crew's health and performance were excellent throughout the flight and the 18-day postflight quarantine period. No significant physiological changes were observed after this mission, as has been the case on all previous missions, and no effects attributable to lunar surface exposure have been observed.

Bioinstrumentation and Physiological Data

The biomedical data were of very good quality. Only two minor problems occurred, both late in the flight. Data from the Command Module Pilot's impedance pneumogram became unreadable, and the Lunar Module Pilot's electrocardiogram signal degraded because of drying of the electrode paste under the sensors. The Lunar Module Pilot replaced the electrocardiogram leads in his bioinstrumentation harness with the spare set from the medical kit, and proper readings were restored. No attempt was made to correct the Command Module Pilot's respiration signal, because of entry preparations. Physiological parameters were always within expected ranges, and sleep data were obtained on all three crewmen during most of the mission.

The average heart rates during the entire mission were 71, 60, and 67 beats/min for the Commander, Command Module Pilot, and Lunar Module Pilot, respectively. During the powered descent and ascent phases, the only data planned to be available were the Commander's heart rates, which ranged from 100 to 150 beats/min during descent and from 68 to 120 beats/min during ascent, as shown in figures 12-1 and 12-2, respectively.

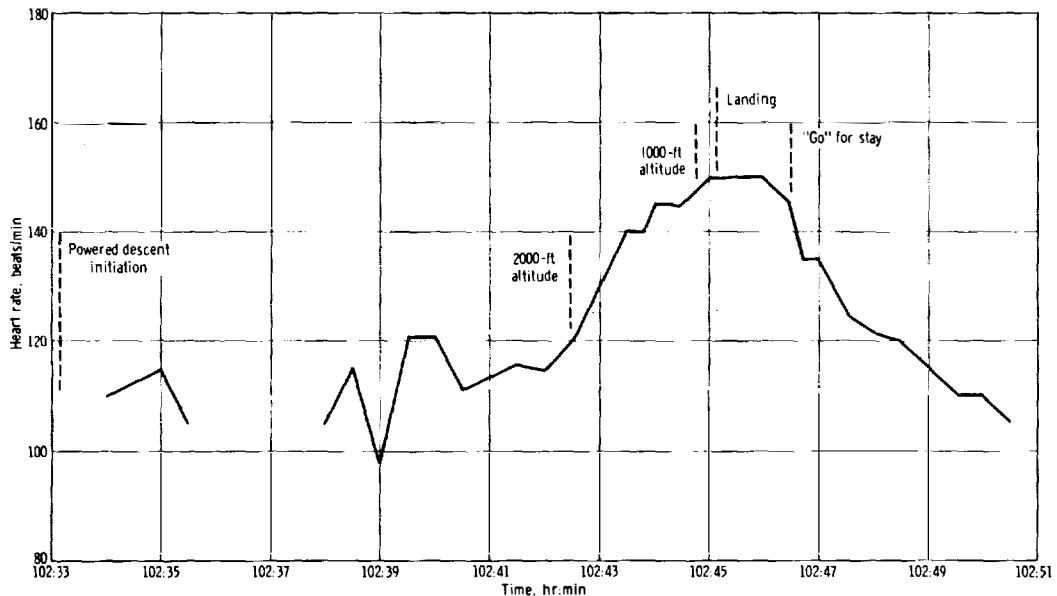

Figure 12-1.- Heart rates of the Commander during lunar descent.

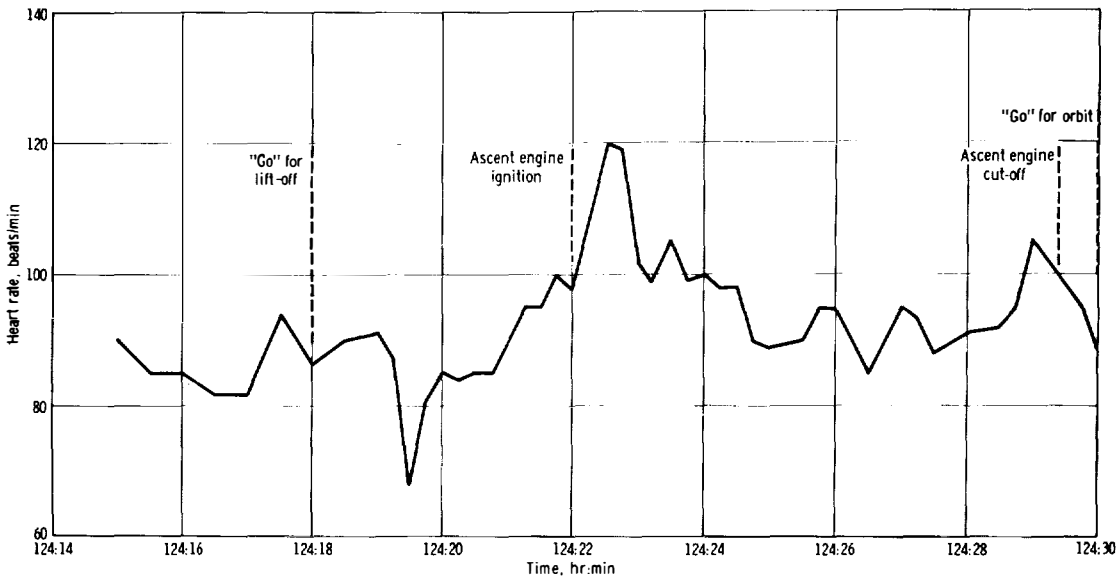
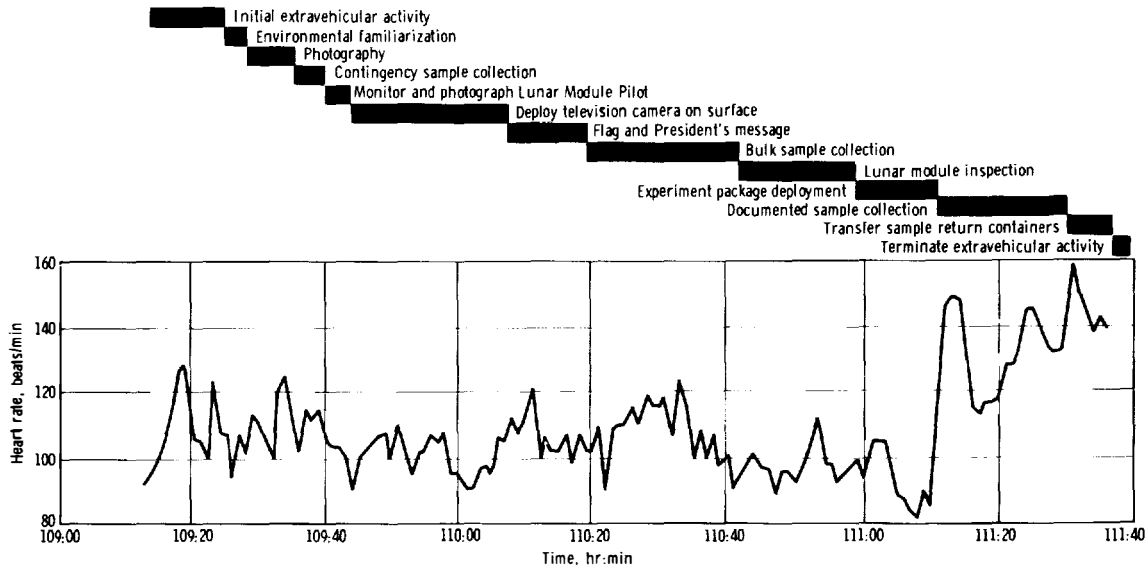

Figure 12-2.- Heart rates of the Commander during ascent.

Plots of heart rates during lunar surface exploration are shown in figure 12-3. The average heart rates were 110 beats/min for the Commander and 88 beats/min for the Lunar Module Pilot. The increase in the Commander's heart rate during the last phases of this activity is indicative of an increased workload and body heat storage. The metabolic production of each crewman during the extravehicular activity is reported in "Extravehicular Activity" in this section.



(a) Commander.

Figure 12-3.- Heart rates during extravehicular activities.

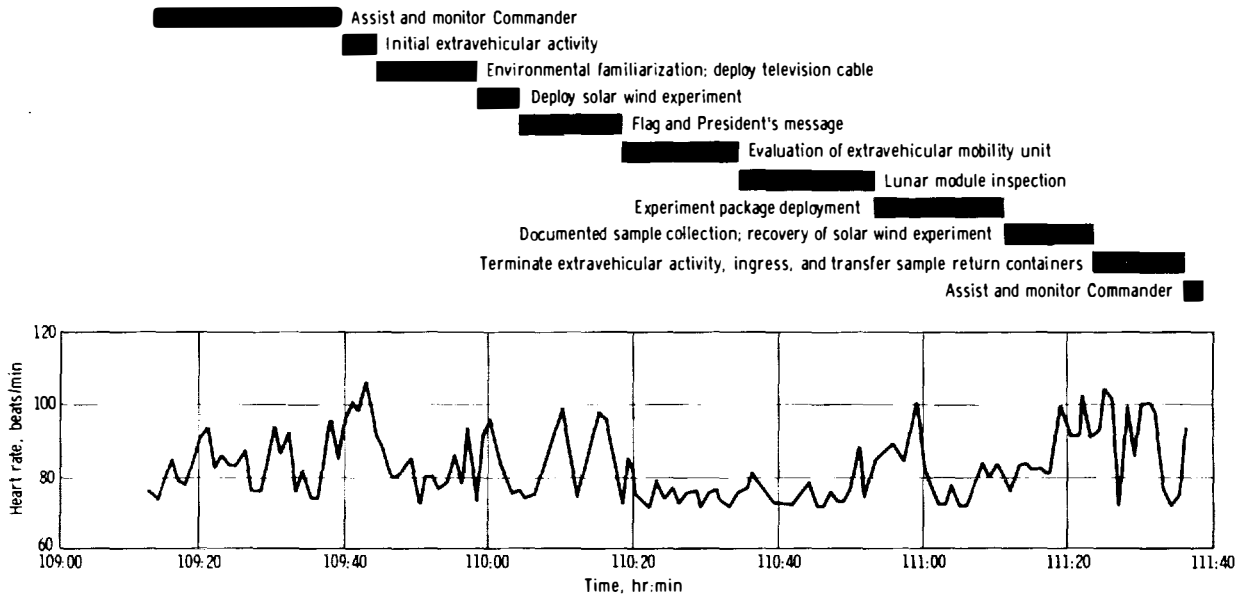

(b) Lunar Module Pilot.

Figure 12-3.- Concluded.

Medical Observations

Adaptation to weightlessness.- The Commander reported that he felt less zero-g effects, such as fullness of the head, than he had experienced on his previous flight. All three crewmen commented that the lack of a gravitational pull caused a puffiness underneath their eyes, and this condition caused them to squint somewhat. However, none felt ill effects associated with this puffiness. In donning and doffing the suits, the crewmen had no feeling of tumbling or the disorientation which has been described by the Apollo 9 crew.

During the first 2 days of the flight, the Command Module Pilot reported that half a meal was more than enough to satisfy his hunger, but his appetite subsequently returned.

Medications.- The Commander and the Lunar Module Pilot each took one Lomotil tablet prior to the sleep period to retard bowel movements before the lunar module activity. The Commander and Lunar Module Pilot each carried extra Lomotil tablets into the lunar module, but did not take them. At 4 hours before entry and again after splashdown, the three crewmen each took antinausea tablets containing 0.3 milligram of Hyoscine and 5.0 milligrams of Dexedrine. The crewmen also took aspirin tablets, but the number of tablets per individual was not recorded. The Lunar Module Pilot recalled that he had taken two aspirin tablets almost every night to aid his sleep.

Sleep.- It is interesting to note that the crewmen's subjective estimates of amount of sleep were less than those based upon telemetered biomedical data, as shown in table 12-I. By either count, the crewmen slept well in the command module. The simultaneous sleep periods during the translunar coast were carefully monitored, and the crew arrived on the lunar surface well rested. Therefore, it was not necessary to wait until after the first planned 4-hour sleep period before conducting the extravehicular activity.

The crewmen did not sleep well in the lunar module following the lunar surface activity. (See "Lunar Surface Operations" in section 4.) However, the crewmen slept well during all three transearth sleep periods.

TABLE 12-I.- ESTIMATED SLEEP DURATIONS

Time of crew report, hr:min	Estimated amount of sleep, hr:min					
	Telemetry			Crew report		
	Commander	Command Module Pilot	Lunar Module Pilot	Commander	Command Module Pilot	Lunar Module Pilot
23:00	10:25	10:10	8:30	7:00	7:00	5:30
48:15	9:40	10:10	9:15	8:00	9:00	8:00
71:24	9:35	(a)	9:20	7:30	7:30	6:30
95:25	6:30	6:30	5:30	6:30	6:30	5:30
Total	36:10	--	32:35	29:00	30:00	25:30

^aNo data available.

Radiation.- The personal radiation dosimeters were read at approximately 12-hour intervals, as planned. The total integrated, but uncorrected, doses were 0.25, 0.26, and 0.28 rad for the Commander, Command Module Pilot, and Lunar Module Pilot, respectively. The Van Allen belt dosimeter indicated total integrated doses of 0.11 rad for the skin reading and 0.08 rad for the depth reading during the entire mission. Thus, the total dose for each crewman is estimated to have been less than 0.2 rad, which is well below the medically significant level. Results of the radiochemical assays of feces and urine and an analysis of the onboard nuclear emulsion dosimeters will be presented in a separate medical report.

The crewmen were examined with a total body gamma-radioactivity counter on August 10, 1969, after release from quarantine. No induced radioactivity was detected, based on critical measurements and an integration of the total-body gamma spectrum. The examination for natural radioactivity revealed the levels of potassium-40 and cesium-137 to be within the normal range.

Inflight exercise.- The planned exercise program included isometric and isotonic exercises and the use of an exerciser. As in previous Apollo missions, a calibrated exercise program was not planned. The inflight exerciser was used primarily for crew relaxation. During transearth coast, the Lunar Module Pilot exercised vigorously for two 10-minute periods. His heart rate reached 170 and 177 beats/min, and the partial pressure of carbon dioxide increased approximately 0.6 mm Hg during these periods. The heart rates and the carbon dioxide readings rapidly returned to normal levels when exercise ceased.

Drug packaging.- Several problems concerning drug packaging developed during the flight. All the medications in tablet and capsule form were packaged in individually sealed plastic or foil containers. When the medical kit was unstowed in the command module, the packages were blown up like balloons because the air had not been sufficiently

evacuated during packaging. This ballooning increased the volume of the medical-kit contents after the kit was opened and thus prevented restowage until a flap was cut away from the kit. Venting of each of the plastic or foil containers will be accomplished for future flights and should prevent this problem from recurring. The Afrin nasal spray bubbled out when the cap was removed and was therefore unusable. The use of cotton in the spray bottle is expected to resolve this problem on future flights.

Water.- The eight inflight chlorinations of the command module water system were accomplished normally and essentially as scheduled. Analysis of the potable water samples obtained approximately 30 hours after the last inflight chlorination showed a free-chlorine residual of 0.8 milligram from the drinking dispenser port and 0.05 milligram from the hot-water port. The iodine level in the lunar module tanks, based on preflight sampling, was adequate for bacterial protection throughout the flight.

Chemical and microbiological analyses of the preflight water samples for both spacecraft showed no significant contaminants. Tests for coliform and anaerobic bacteria, as well as for yeasts and molds, were negative during the postflight water analysis, which was delayed because of quarantine restrictions.

A new gas/water separator was used with satisfactory results. The palatability of the drinking water was greatly improved over that of previous flights because of the absence of gas bubbles, which can cause gastrointestinal discomfort.

Food.- The food supply for the command module included rehydratable foods and beverages, wet-packed foods, foods contained in spoon-bowl packages, dried fruit, and bread. The new food items for this mission were candy sticks and jellied fruit candy; ham, chicken, and tuna salad spreads packaged in lightweight aluminum, easy-open cans; and cheddar cheese spread and frankfurters packaged in flexible foil as wet-packed foods. A new pantry-type food system allowed real-time selection of food items based upon individual preference and appetite. Four meal periods on the lunar surface were scheduled, and extra optional items were included with the normal meal packages.

Prior to flight, each crewman evaluated the available food items and selected his flight menus. The menus provided approximately 2300 kilocalories per man per day and included 1 gram of calcium, 0.5 gram of phosphorus, and 80 grams of protein. The crewmen were well satisfied with the quality and variety of the flight foods. They reported that their food intake met their appetite and energy requirements.

The preparation and eating of sandwiches presented no problems. The only criticisms of the food system were that the coffee was not particularly good and that the fruit-flavored beverages tasted too sweet. The new gas/water separator was effective in reducing the amount of gas in the water and greatly improved the taste of the rehydratable foods.

Extravehicular Activity

The integrated rates of Btu production and the accumulated Btu production during the intervals of planned activities are listed in table 12-II. The actual average metabolic production per hour was estimated to be 900 Btu for the Commander and 1200 Btu for the Lunar Module Pilot. These values are less than the preflight estimates of 1350 and 1275 Btu for the respective crewmen.

TABLE 12-II.- METABOLIC RATES DURING LUNAR SURFACE EXPLORATION^a

Event	Starting time, hr:min	Duration, min	Rate, Btu/hr	Estimated work, Btu	Cumulative work, Btu
Commander					
Initial extravehicular activity	109:13	11	900	165	165
Environmental familiarization	109:24	3	800	40	205
Photography	109:27	7	875	102	307
Contingency sample collection	109:34	5	675	56	363
Monitoring and photography of Lunar Module Pilot	109:39	4	850	57	420
Television camera deployment on surface	109:43	23	750	288	708
U.S. flag deployment and President's message	110:06	12	825	165	873
Bulk sample collection	110:18	23	850	326	1199
Lunar module inspection	110:41	18	675	203	1402
Experiment package deployment	110:59	12	775	155	1557
Documented sample collection	111:11	19	1250	396	1953
Transfer of sample return containers	111:30	7	1450	169	2122
Extravehicular activity termination	111:37	2	1400	48	2170
TOTAL		146			2170
Lunar Module Pilot					
Assistance and monitoring of Commander	109:13	26	1200	520	520
Initial extravehicular activity	109:39	5	1950	163	683
Environmental familiarization; television cable deployment	109:44	14	1200	280	963
Solar wind experiment deployment	109:58	6	1275	128	1091
U.S. flag deployment and President's message	110:04	14	1350	315	1406
Evaluation of extravehicular mobility unit	110:18	16	850	227	1633
Lunar module inspection	110:34	19	875	277	1910
Experiment package deployment	110:53	18	1200	360	2270
Documented sample collection; recovery of solar wind experiment	111:11	12	1450	290	2560
Extravehicular activity termination, ingress, and transfer of sample return containers	111:23	14	1650	385	2945
Assistance and monitoring of Commander	111:37	2	1100	37	2982
TOTAL		146			2982

^aValues are from the integration of three independent determinations of metabolic rate based on heart rate, decay of oxygen supply pressure, and liquid cooling garment thermodynamics.

Physical Examinations

Comprehensive medical evaluations were conducted on each crewman at 29, 15, and 5 days prior to the day of launch. Brief physical examinations were then conducted each day until launch.

The postflight medical evaluation included the following: microbiology studies, blood studies, physical examinations, orthostatic tolerance tests, exercise response tests, and chest X-rays.

The recovery-day examination revealed that all three crewmen were in good health and appeared to be well rested. They showed no fever and had lost no more than the expected amount of body weight. Each crewman had taken antimotion sickness medication 4 hours prior to entry and again after landing, and no seasickness or adverse symptoms were experienced.

Data from chest X-rays and electrocardiograms were within normal limits. The only positive findings were small papules beneath the axillary sensors on both the Commander and the Lunar Module Pilot. The Commander had a mild serous otitis media of the right ear, but could clear his ears without difficulty. No treatment was necessary.

The orthostatic tolerance test showed significant increases in the immediate post-flight heart-rate responses, but these increases were less than the changes seen in previous Apollo crewmembers. In spite of this apparent improvement, the return to preflight values was slower than had been observed for previous Apollo crewmembers. The reasons for this slower recovery are not clear at this time, but in general, these crewmembers exhibited less decrement in oxygen consumption and work performed than was observed in exercise response tests after previous Apollo flights.

Followup evaluations were conducted daily during the quarantine period in the Lunar Receiving Laboratory, and the immunohematology and microbiology analyses revealed no changes attributable to exposure to the lunar surface material.

Lunar Contamination and Quarantine

The two fundamental responsibilities of the lunar sample program were to preserve the integrity of the returned lunar samples in the original or near-original state and to make practical provisions to protect the earth from possible contamination by lunar substances that might be infectious, toxic, or otherwise harmful to man, animals, or plants.

The Public Laws and Federal Regulations concerning contamination control for lunar-sample-return missions are described in reference 7. An interagency agreement between the National Aeronautics and Space Administration; the Department of Agriculture; the Department of Health, Education, and Welfare; the Department of the Interior; and the National Academy of Sciences (ref. 8) confirmed the existing arrangements for the protection of the earth and defined the Interagency Committee on Back Contamination. The quarantine schemes for manned lunar missions were established by the Interagency Committee on Back Contamination (ref. 9).

The planned 21-day crew quarantine represented the period required in order to preclude the development of infectious disease conditions that could generate volatile epidemic events. In addition, early signs of latent infectious diseases with longer incubation periods would probably be detected through extensive medical and clinical pathological examinations. However, to provide additional assurance that no infectious

disease of lunar origin is present in the Apollo 11 crewmembers, an extensive epidemiological program will continue for 1 year after their release from quarantine.

Lunar exposure.- Although each crewman attempted to clean himself and the equipment before ingress, a fairly large amount of dust and grains of lunar surface material was brought into the cabin. When the crewmen removed their helmets, they noticed a distinct, pungent odor emanating from the lunar material. The texture of the dust was like powdered graphite, and both crewmen were very dirty after they removed their helmets, overshoes, and gloves. The crewmen cleaned their hands and faces with tissues and with towels that had been soaked in hot water. The Commander removed his liquid cooling garment in order to clean his body. One grain of material got into the Commander's eye, but was easily removed and caused no problem. The dustlike material could not be removed completely from beneath the crewmen's fingernails.

The cabin cleaning procedure involved the use of a vacuum-brush device and positive air pressure from the suit supply hoses to blow remote particles into the atmosphere for collection in the lithium hydroxide filters in the environmental control system.

The concern that particles remaining in the lunar module would float in the cabin atmosphere at zero-g after ascent caused the crew to remain helmeted to prevent contamination of the eyes and respiratory system. However, floating particles were not a problem. The cabin and equipment were further cleaned with the vacuum brush. The equipment from the surface and the pressure garment assemblies were placed in bags for transfer to the command module. Before transfer to the command module, the spacecraft systems were configured to cause a positive gas flow from the command module through the hatch dump/relief valve in the lunar module.

During the return to earth, the interior of the command module was cleaned at 24-hour intervals by using the vacuum brush and towels. In addition, the circulation of the cabin atmosphere through the lithium hydroxide filters continued to remove traces of particulate material.

Recovery procedures.- The recovery procedures were successfully conducted with no compromises of the planned quarantine techniques. The times of the major postlanding events are listed in "Recovery Operations" in section 13.

After the command module was uprighted, four biological isolation garments and the decontamination gear were lowered to one of two liferafts. One of the four swimmers donned a biological isolation garment. The second liferaft was then moved to the spacecraft. The protected swimmer retired with the second liferaft to the original upwind position. The hatch was opened, the crew's biological isolation garments were inserted into the command module, and the hatch was closed.

After donning the biological isolation garments, the crew egressed. The protected swimmer sprayed the upper deck and hatch areas with Betadine, a water-soluble iodine solution, as planned in the quarantine procedure. After the four men and the liferaft were wiped with a solution of sodium hypochlorite, the three swimmers returned to the vicinity of the spacecraft to stand by during the helicopter pickup of the flightcrew.

The crewmen were brought up into the helicopter without incident and remained in the aft compartment. As expected, a moderate amount of water was present on the floor after retrieval, and the water was wiped up with towels. The helicopter crewmen were also protected from possible contamination.

The helicopter was moved to the Mobile Quarantine Facility on the lower deck of the recovery vessel. The crewmen walked across the deck, entered the Mobile Quarantine Facility, and removed their biological isolation garments. The descent steps and the deck

area between the helicopter and the Mobile Quarantine Facility were sprayed with glutaraldehyde solution, which was mopped up after a 30-minute contact time.

After the crewmen had been picked up, the protected swimmer scrubbed the upper deck around the postlanding vents, the hatch area, and the flotation collar near the hatch with Betadine. The remaining Betadine was emptied into the bottom of the recovery raft. The swimmer removed his biological isolation garment and placed it in the Betadine in the liferaft. The disinfectant sprayers were dismantled and sunk. After a 30-minute contact time, the liferaft and remaining equipment were sunk.

Following egress of the flightcrew and a recovery surgeon from the helicopter, the hatch of the helicopter was closed and the vehicle was towed to the flight deck for decontamination with formaldehyde.

The crew became uncomfortably warm while they were enclosed in the biological isolation garments in the environment (90° F) of the helicopter cabin. On two of the garments, the visor fogged up because of the improper fit of the nose and mouth cup. To alleviate this discomfort on future missions, consideration is being given to (1) replacing the present biological isolation garment with a lightweight coverall, similar to whiteroom clothing, with respirator mask, cap, gloves, and booties and (2) using a liquid cooling garment under the biological isolation garment.

The command module was taken aboard the U.S.S. Hornet approximately 3 hours after landing and was attached to the Mobile Quarantine Facility through a flexible tunnel. The removal of lunar surface samples, film, data tape, and medical samples went well, with one exception. Two of the medical sample containers leaked within the inner biological isolation container. Corrective measures were promptly executed, and the quarantine procedure was not violated.

Transfer of the Mobile Quarantine Facility from the recovery ship to a C-141 aircraft and from the aircraft to the Lunar Receiving Laboratory at the NASA Manned Spacecraft Center was accomplished without any question of a quarantine violation. The transfer of the lunar surface samples and the command module into the Lunar Receiving Laboratory was also accomplished as planned.

Quarantine.- A total of 20 persons on the medical support teams were exposed, directly or indirectly, to lunar material for periods ranging from 5 to 18 days. Daily medical observations and periodic laboratory examinations showed no signs or symptoms of infectious disease related to lunar exposure.

No microbial growth was observed from the prime lunar samples after 156 hours of incubation on all types of differential media. No micro-organisms which could be attributed to an extraterrestrial source were recovered from the crewmen or the spacecraft.

None of the 24 mice injected intraperitoneally with lunar material showed visible shock reaction following injection, and all remained alive and healthy during the first 10 days of a 50-day toxicity test. During the first 7 days of testing of the prime lunar samples in germ-free mice, all findings were consistent with the decision to release the crew from quarantine.

Samples from the crewmen were injected into tissue cultures, suckling mice, mycoplasma media, and 6- and 10-day-old embryonated eggs. There was no evidence of viral replication in any of the host systems at the end of 2 weeks. During the first 8 days of testing the lunar material, all findings were compatible with crew release from quarantine.

No significant trends were noted in any biochemical, immunological, or hematological parameters in either the flightcrew or the medical support personnel.

The personnel in quarantine and in the Crew Reception Area of the Lunar Receiving Laboratory were approved for release from quarantine on August 10, 1969. Following decontamination with formaldehyde, the interior of the command module and the ground servicing equipment utilized in the decontamination procedures were approved for release from quarantine on August 10, 1969. The samples of lunar material and other items stored in the biological isolation containers in the Lunar Receiving Laboratory were released to principal scientific investigators in September 1969.

13. MISSION SUPPORT PERFORMANCE

Flight Control

Preflight simulations provided adequate flight control training for all mission phases. Also, the flight controllers on the descent team supplemented this training by conducting descent simulations with the Apollo 12 crew. Interfaces between Mission Control teammembers and the flightcrew were effective, and no major operational problems were encountered. The two-way flow of information between the flightcrew and the flight controllers was effective. The overloading of the lunar module guidance computer during powered descent was assessed accurately, and the information provided to the flightcrew permitted continuation of descent.

The flight control response to those problems identified during the mission was based on real-time data. Sections 8, 9, and 16 should be consulted for the postflight analyses of these problems. Three of the more pertinent real-time decisions are discussed in the following paragraphs.

At acquisition of signal after lunar orbit insertion, data showed that the indicated tank B nitrogen pressure was approximately 300 psi lower than expected and that the pressure had started to decrease at 80 seconds into the maneuver. (See "Service Propulsion Nitrogen Leak" in section 16.) To conserve nitrogen and to maximize system reliability for transearth injection, it was recommended that the circularization maneuver be performed, using tank A only. No further leak was apparent, and both tanks were used normally for transearth injection.

Five computer program alarms occurred between 5 and 10 minutes after initiation of powered descent. These alarms are symptoms of possible computer overloading. However, it had been decided before flight that bailout-type alarms such as these would not prevent continuation of the flight, even though the alarms could cause violations of other mission rules, such as velocity differences. The alarms did not occur continually, and proper computer navigation functions were being performed; therefore, a decision was given to continue the descent.

During the crew rest period on the lunar surface, two checklist changes were recommended, based on the events of the previous 20 hours: (1) the rendezvous radar would remain off during the ascent firing and (2) the MODE-SELECT switch would not be placed in the PRIMARY GUIDANCE position, thus preventing the computer from generating altitude and altitude rate for the telemetry display. The reason for these changes was to prevent computer overload during ascent, as had occurred during descent.

Manned Space Flight Network Performance

The Mission Control Center and the Manned Space Flight Network were placed on mission status on July 7, 1969, and supported the lunar landing mission satisfactorily. Hardware, communications, and computer support in the Mission Control Center was excellent. No major data losses were attributed to these systems, and the few failures that did occur had minimal impact on support operations. Air-to-ground communications were generally good during the mission; however, a number of significant problems were experienced as a result of procedural errors.

The support provided by the real-time computer complex was generally excellent, and only one major problem was experienced. During translunar coast, a problem in updating digital-to-television displays by the use of the primary computer resulted in the loss of all real-time television displays for approximately an hour. The problem was isolated to the interface between the computer and the display equipment.

Figure 13-1 depicts the U.S.S. Hornet and associated aircraft positions at the time of command module landing at 195:18:35 (16:50 G.m.t.). The command module landed at a point calculated by recovery forces to be latitude $13^{\circ}19' N$ and longitude $169^{\circ}9' W$.

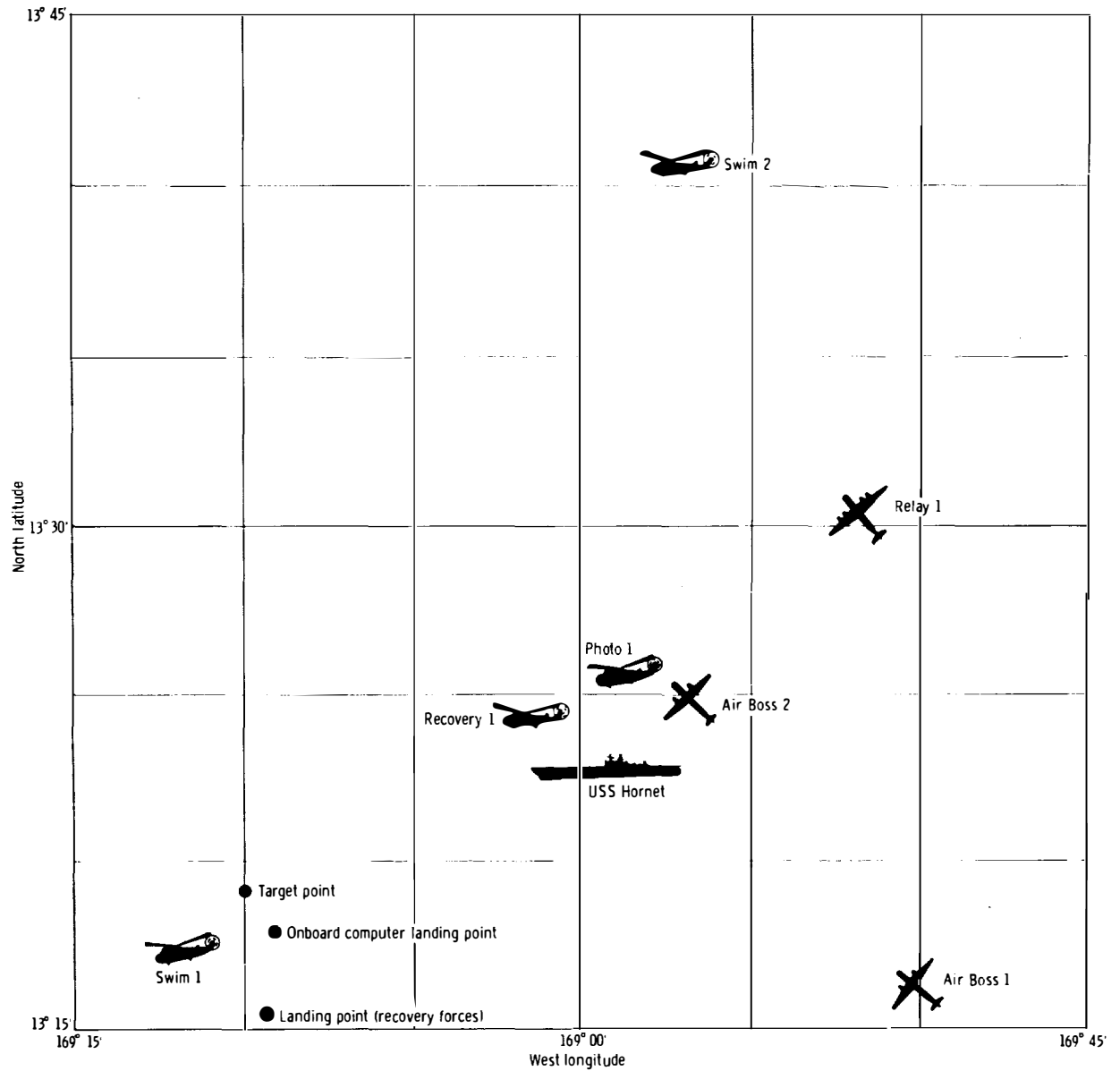

Figure 13-1.- Landing and recovery data.

Operations by the communications processors were excellent, and the few problems that did occur caused only minor losses of mission data.

Air-to-ground voice communications were generally good, although a number of ground problems caused temporary loss or degradation of communications. Shortly after landing on the lunar surface, the crew complained about the noise level on the S-band voice up linked from the Goldstone station. This problem occurred while the Goldstone station was configured in the Manned Space Flight Network relay mode. The source of the noise was isolated to a breaking of squelch control caused by high noise on the command module down link being subsequently up linked to the lunar module by way of the relay mode. The noise was eliminated by disabling the relay mode. On several occasions during the mission, spacecraft voice on the Goddard conference loop was degraded by the voice-operated gain-adjust amplifiers. In most cases, the problem was cleared by disabling the amplifier unit at the remote site.

Command operations were good throughout the mission. Of the approximately 3450 execution commands transmitted during the mission, only 24 were rejected by remote-site command computers, and 21 were lost for unknown reasons. Approximately 450 command loads were generated and successfully transferred to the Manned Space Flight Network stations, and 58 of these were up linked to the spacecraft.

Both C- and S-band tracking support were good. Loss of tracking coverage was experienced during translunar injection when the U.S.N.S. Mercury was unable to provide high-speed trajectory data because of a temporary problem in the central data processor. Some stations also experienced temporary S-band power amplifier failures during the mission.

The Manned Space Flight Network support of the scientific experiment package was good. A few hardware and procedural problems were encountered; however, the only significant data loss occurred when the S-band parametric amplifier at the Canary Island station failed only seconds before the lunar module ascent. Consequently, all seismic package data were lost during this phase, since no backup stations were available for support.

Television support provided by Manned Space Flight Network and Jet Propulsion Laboratory facilities, particularly that provided by the 210-foot stations at Parkes and Goldstone, was good throughout the mission.

Recovery Operations

The Department of Defense provided recovery support commensurate with the probability of landing within a specified area and with any special problems associated with such a landing. Recovery force deployment was nearly identical to that for Apollo 8 and 10.

Support for the primary landing area in the Pacific Ocean was provided by the U.S.S. Hornet. Air support consisted of four SH-3D helicopters from the U.S.S. Hornet, three E-1B aircraft, three Apollo range instrumentation aircraft, and two HC-130 rescue aircraft staged from Hickam Air Force Base, Hawaii. Two of the E-1B aircraft were designated as "Air Boss," and the third was a communications relay aircraft. Two of the SH-3D helicopters carried the swimmers and the required recovery equipment. The third SH-3D helicopter was used as a photographic platform, and the fourth, which carried the decontamination swimmer and the flight surgeon, was used for crew retrieval.

The command module immediately went to the stable II (apex down) flotation attitude after landing. The uprighting system returned the spacecraft to the stable I attitude 7 minutes 40 seconds later. One or 2 quarts of water entered the spacecraft while it was in the stable II position. The swimmers were deployed to install the flotation collar; the decontamination swimmer then passed the biological isolation garments to the flightcrew, assisted the crew into the liferaft, and decontaminated the exterior surface of the command module. (See "Lunar Contamination and Quarantine" in section 12.) After the command module hatch was closed and decontaminated, the flightcrew and decontamination swimmer washed each other with the decontaminate solution prior to being taken aboard the recovery helicopter. The crew arrived on board the U.S.S. Hornet at 17:53 G.m.t. and entered the Mobile Quarantine Facility 5 minutes later. The first lunar samples to be returned were flown to Johnston Island, placed aboard a C-141 aircraft, and flown to Houston. Approximately 6-1/2 hours later, the second sample shipment was flown from the U.S.S. Hornet directly to Hickam Air Force Base, Hawaii, and placed aboard a range instrumentation aircraft for transfer to Houston.

The command module and Mobile Quarantine Facility were offloaded in Hawaii on July 27, 1969. The Mobile Quarantine Facility was loaded aboard a C-141 aircraft and flown to Houston, Texas, where a brief ceremony was held. The flightcrew arrived at the Lunar Receiving Laboratory at 10:00 G.m.t. on July 28, 1969.

The command module was taken to Ford Island for deactivation. Upon completion of deactivation, the command module was shipped to Hickam Air Force Base, Hawaii, and flown on a C-133 aircraft to Houston. A postrecovery inspection showed no significant discrepancies in the spacecraft.

Table 13-I is a chronological listing of events during the recovery and quarantine operations.

TABLE 13-I.- RECOVERY AND QUARANTINE EVENTS

Event	Time, G.m.t.
July 24, 1969	
Visual contact by aircraft	16:39
Radar contact by U.S.S. Hornet	16:40
vhf voice and recovery-beacon contact	16:46
Command module landing (195:18:35 g.e.t.)	16:50
Flotation collar inflated	17:04
Command module hatch open	17:21
Crew egress in biological isolation garments	17:29
Crew aboard U.S.S. Hornet	17:53

TABLE 13-I.- RECOVERY AND QUARANTINE EVENTS - Continued

Event	Time, G.m.t.
July 24, 1969 - Continued	
Crew in Mobile Quarantine Facility	17:58
Command module lifted from water	19:50
Command module secured to Mobile Quarantine Facility transfer tunnel	19:58
Command module hatch reopened	20:05
Sample return containers 1 and 2 removed from command module	22:00
Sample return container 1 removed from Mobile Quarantine Facility	23:32
July 25, 1969	
Sample return container 2 removed from Mobile Quarantine Facility	00:05
Sample return container 2 and film launched to Johnston Island	05:15
Sample return container 1, film, and biological samples launched to Hickam Air Force Base, Hawaii	11:45
Sample return container 2 and film arrived in Houston	16:15
Sample return container 1, film, and biological samples arrived in Houston	23:13
July 26, 1969	
Command module decontaminated and hatch secured	03:00
Mobile Quarantine Facility secured	04:35

TABLE 13-I.- RECOVERY AND QUARANTINE EVENTS - Concluded

Event	Time, G.m.t.
July 27, 1969	
Mobile Quarantine Facility and command module offloaded	00:15
Safing of command module pyrotechnics completed	02:05
July 28, 1969	
Mobile Quarantine Facility arrived at Houston	06:00
Flightcrew in Lunar Receiving Laboratory	10:00
July 30, 1969	
Command module delivered to Lunar Receiving Laboratory	23:17

14. ASSESSMENT OF MISSION OBJECTIVES

The single primary mission objective for the Apollo 11 mission (as defined in the NASA Headquarters document OMSF M-D MA 500-11 (SE 010-000-1) entitled "Apollo Flight Mission Assignments" and prepared July 11, 1969) was to perform a manned lunar landing and return safely to earth. In addition to the single primary objective, 11 secondary objectives were delineated from the following two general categories:

1. To perform selenological inspection and sampling
2. To obtain data to assess the capability and limitations of a man and his equipment in the lunar environment

The 11 secondary objectives are listed in table 14-I and are described in detail in NASA Manned Spacecraft Center document SPD 9-R-038 (entitled "Mission Requirements, SA-506/CSM-107/LM-5, G Type Mission Lunar Landing," April 17, 1969).

The following experiments were assigned to the Apollo 11 mission:

1. Passive seismic experiment (S-031)
2. Lunar field geology (S-059)
3. Laser ranging retroreflector (S-078)
4. Solar wind composition (S-080)
5. Cosmic ray detection (S-151)

The single primary objective was met. All secondary objectives and experiments except for the following were fully satisfied:

1. Objective G: location of the landed lunar module
2. Experiment S-059: lunar field geology

These two items were not completely satisfied in the manner planned before flight. A discussion of the deficiencies appears in the following paragraphs. A full assessment of the Apollo 11 detailed objectives and experiments will be presented in separate reports.

TABLE 14-I.- DETAILED OBJECTIVES AND EXPERIMENTS

Description		Completed
Objectives:		
A	Contingency sample collection	Yes
B	Lunar surface extravehicular operations	Yes
C	Lunar surface operations with extravehicular mobility unit	Yes
D	Landing effects on lunar module	Yes
E	Lunar surface characteristics	Yes
F	Bulk sample collection	Yes
G	Location of the landed lunar module	Partial
H	Lunar environment visibility	Yes
I	Assessment of contamination by lunar material	Yes
L	Television coverage	Yes
M	Photographic coverage	Yes
Experiments:		
S-031	Passive seismic experiment	Yes
S-059	Lunar field geology	Partial
S-078	Laser ranging retroreflector experiment	Yes
S-080	Solar wind composition	Yes
S-151	Cosmic ray detection	Yes
T-029	Pilot description	Yes

Location of the Landed Lunar Module

It was planned to make a near-real-time determination of the location of the landed lunar module, based on crew observations. Observations by the lunar module crew during descent and after landing were to provide information for locating the landing point by using onboard maps. In addition, this information was to be transmitted to the Command Module Pilot, who was to use the sextant in an attempt to locate the landed lunar module. Furthermore, if it were not possible for the Command Module Pilot to resolve the lunar module in the sextant, he was to track a nearby landmark that had a known location relative to the landed lunar module (as determined by the lunar module crew or the ground team).

This near-real-time determination of the landed lunar module location by the lunar module crew was not accomplished because the crew's attention was confined to the cabin during most of the visibility phase of the descent. Consequently, their observations of the lunar features during descent were not sufficient to allow them to judge their position. The crew's observation of the large crater near the landing point did provide an important clue to their location, but this clue was not sufficient to locate the landing point with confidence.

On several orbital passes, the Command Module Pilot used the sextant in an attempt to locate the lunar module. His observations were directed to areas where ground data indicated the lunar module could have landed. These attempts to locate the lunar module were unsuccessful, and it is doubtful that the Command Module Pilot's observations were ever directed to the area where the lunar module was actually located.

Near the end of the lunar surface stay, the location of the landed lunar module was determined from the lunar module rendezvous-radar tracking data (confirmed postflight by using descent photographic data). However, the Command Module Pilot's activities did not permit his attempting another tracking pass after the lunar module location had been determined accurately.

Lunar Field Geology

For the Apollo 11 mission, the documented sample collection (Experiment S-059, lunar field geology) was assigned the lowest priority of any of the scientific objectives and was planned as one of the last activities during the extravehicular activity period. Two core-tube samples were collected as planned, and approximately 15 pounds of additional lunar samples were obtained as part of this objective. However, time constraints on the extravehicular activity precluded collection of these samples with the degree of documentation originally planned.

In addition, there was not sufficient time to allow the collection of a lunar environment sample or a gas analysis sample in the two special containers provided. Although these samples were not obtained in their special containers, it was possible to obtain the desired results by using other samples contained in the regular sample return containers.

15. LAUNCH VEHICLE SUMMARY

The trajectory parameters of the AS-506 launch vehicle from launch to translunar injection were all close to the expected values. The vehicle was launched on an azimuth 90° east of north. A roll maneuver was initiated at 13.2 seconds in order to place the vehicle on the planned flight azimuth of 72.058° east of north.

Following lunar module ejection, the S-IVB/instrument unit maneuvered to a slingshot attitude that was fixed relative to the local horizontal. The retrograde velocity necessary to perform the lunar slingshot maneuver was accomplished by a liquid oxygen dump, an auxiliary propulsion system firing, and liquid hydrogen venting. The closest approach of the vehicle to the lunar surface was 1825 miles at 78:42:00. A flight evaluation report containing additional data on the launch vehicle performance has been published by the NASA Marshall Space Flight Center (entitled "Saturn V Launch Vehicle Flight Evaluation Report AS-506, Apollo 11 Mission, "Report MPR-SAT-FE-69-9, Sept. 20, 1969).

16. ANOMALY SUMMARY

This section contains a discussion of the significant problems or discrepancies noted during the Apollo 11 mission.

Command and Service Modules

Service propulsion nitrogen leak.- During the lunar orbit insertion firing, the gaseous nitrogen in the redundant service propulsion engine actuation system decayed from 2307 to 1883 psia (fig. 16-1), which indicated a leak downstream of the injector prevalve. The normal pressure decay as experienced by the primary system is approximately 50 psia for each firing. Only one system was affected, and no performance degradation resulted. This actuation system was used during the transearth injection firing, and no leakage was detected.

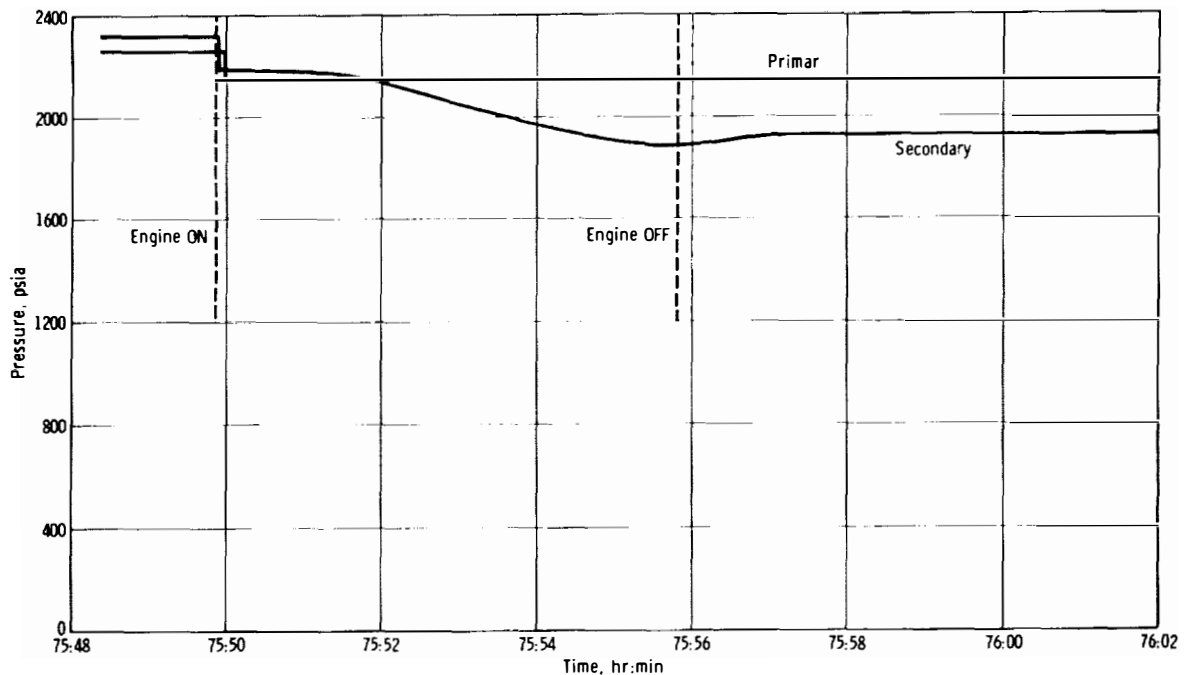

Figure 16-1.- Nitrogen pressure during initial lunar orbit insertion firing.

The fuel and oxidizer valves are controlled by actuators driven by nitrogen pressure. Figure 16-2 is representative of both nitrogen control systems. When power is applied to the service propulsion system in preparation for a maneuver, the injector preclude is opened; however, pressure is not applied to the actuators, because the solenoid control valves are closed. When the engine is commanded on, the solenoid control valves are opened, pressure is applied to the actuator, and the rack on the actuator shaft drives a pinion gear to open the fuel and oxidizer valves. When the engine is commanded off, the solenoid control valve vents the actuator and closes the fuel and oxidizer valves.

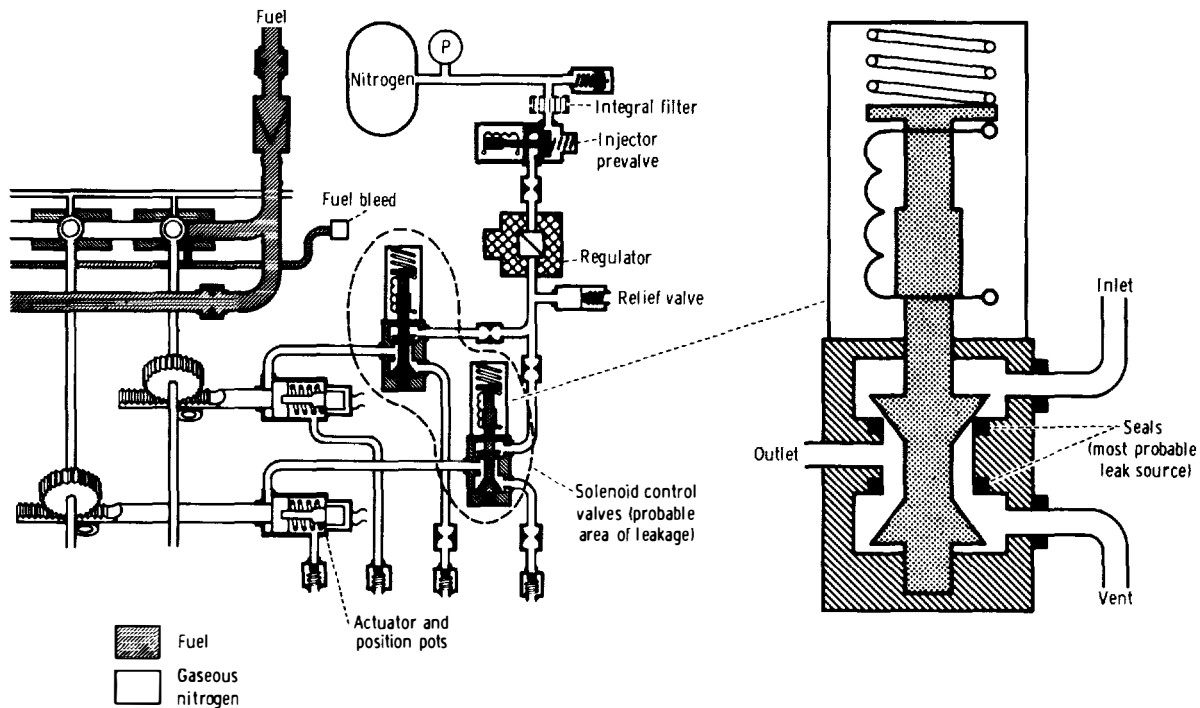

Figure 16-2.- Control for service propulsion propellants.

The most probable cause of the problem was contamination of one of the components downstream of the injector prevalue, which isolates the nitrogen supply during nonfiring periods. The injector prevalue was not considered a problem source because it was opened 2 minutes before ignition, and no leakage occurred during that period. The possibility that the regulator and relief valve were leaking was also eliminated because pressure was applied to these components when the prevalue was opened.

The solenoid control valves have a history of leakage, which has occurred either because of improper internal airgap adjustment or because of seal damage caused by contamination. The airgap adjustment could not have caused the leakage, because an improper airgap with the prevalues open would have caused the leak to remain constant. Both of the solenoid control valves in the leaking system had been found to be contaminated before flight and were removed from the system, rebuilt, and successfully retested during the acceptance test cycle.

It is concluded that the leakage was due to a contamination-induced failure of a solenoid control valve. The source of contamination is unknown; however, the contamination was apparently removed from the sealing surface during the valve closure for the first lunar orbit insertion maneuver (fig. 16-2). The suspected source is a contaminated facility manifold at the vendor's plant. Although an investigation of the prior failure indicated that the flight valve was not contaminated, the facility manifold is still considered a possible source of the contaminants.

Spacecraft for Apollo 12 and subsequent missions have integral filters installed, and the facility manifolds are controlled more closely; therefore, no further corrective action was taken.

This anomaly is closed.

Cryogenic heater failure.- The performance of the automatic pressure control system indicated that one of the two heater elements in oxygen tank 2 was inoperative. Data showing heater currents for prelaunch checkout verified that both heater elements were operational through the countdown demonstration test. However, the readings recorded for current during the tank pressurization in the launch countdown showed that one heater in oxygen tank 2 had failed. This information was not made known to proper channels for disposition prior to the flight because no specification limits were called out in the test procedure.

Manufacturing records for all Block II oxygen tanks showed that there have been no thermal-switch nor electrical-continuity failures in the program; two failures occurred during the insulation resistance tests. One failure was attributed to moisture in the connector. After this unit had been dried, it passed all acceptance tests. The other failure was identified in the heater assembly before it was installed in a tank. This failure, which was also an insulation problem, would not have prevented the heater from functioning normally.

The cause of the flight failure was probably an intermittent contact on a terminal board in the heater circuit. The 16-gage wiring at the board has exhibited intermit-tencies several times in the past. This board is the same type of terminal board that was found to be the cause of the control engine problem on Apollo 11. (See "Failure of Automatic Coil in One Thruster" in this section.) Since the oxygen tank heaters are redundant, no mission constraints were created other than a requirement for more frequent quantity balancing.

The launch-site test requirements were changed to specify the amperage level necessary to verify that both tank heaters were operational. Additionally, all launch-site procedures were reviewed to determine whether specification limits are required in other areas.

This anomaly is closed.

Failure of automatic coil in one thruster.- The minus-yaw engine in command module reaction control system 1 produced low and erratic thrust in response to firing commands through the automatic coils of the engine valves. The spacecraft rates verified that the engine performed normally when fired by using the direct coils.

Electrical continuity through at least one of the parallel automatic coils in the engine was evidenced by the fact that the stabilization and control system driver signals were normal. This behavior, along with the fact that at least some thrust was produced, indicates that one of the two valves was working normally.

At the launch site, another engine undergoing checkout had failed to respond to commands during the valve signature tests. The problem was isolated to a faulty terminal board connector. The faulty terminal board was replaced, and the systems were re-tested satisfactorily. Because of this incident and because of the previous history of problems with terminal boards, these connectors were prime suspects when engine problems occurred.

Postflight tests showed that two pins in the terminal board (fig. 16-3) were loose and caused intermittent continuity to the automatic coils of the engine valve. This type

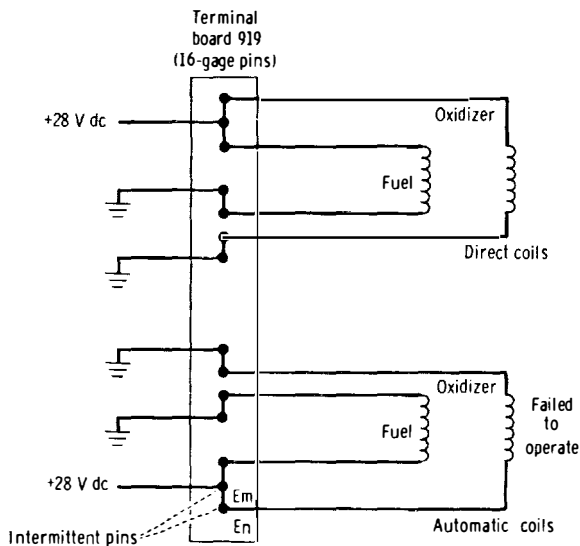

Figure 16-3.- Terminal board schematic for minus-yaw engine, command module reaction control system 1.

would not illuminate. The segment is independently switched through a logic network that activates a silicon-controlled rectifier to bypass the light when it is not illuminated. The power source is 115 volts, 400 hertz.

Four cases of similar malfunctions have been recorded. One case involved a segment that would not illuminate, and three cases involved segments that would not turn off. In each case, the cause was identified as misrouting of logic wires in the circuit controlling the rectifiers. The misrouting bent the wires across terminal strips containing sharp wire ends. These sharp ends punctured the insulation and caused shorts to ground or to +4 volts, turning the segment off or on, respectively.

A rework of the affected circuits took place in the process of soldering crimp joints that had been involved in an Apollo 7 anomaly. An inspection to detect misrouting was conducted at this time; however, because of potting restrictions, the inspection was limited. A number of other failure mechanisms exist in circuit elements and leads; however, there is no associated failure history. A generic or design problem is considered unlikely because of the number of satisfactory activations sustained to date.

The preflight checkout program was examined to identify possibilities for improvement in assuring proper operation of all segments throughout all operating conditions.

This anomaly is closed.

Oxygen flow master alarms.- During the initial lunar module pressurization, two master alarms were activated when the oxygen flow rate was decreasing from full scale. The same condition had been observed several times during altitude chamber tests and during subsequent troubleshooting. The cause of the problem could not be identified before launch, but the only consequence of the alarms was the nuisance factor. Figure 16-4 shows the basic elements of the oxygen flow sensing circuit. Note in figure 16-4 that, for a master alarm to occur, relay K1 must hold in for 16 seconds, after which time relays K2 and K3 will close, activating a master alarm.

of failure has been noted previously on terminal boards manufactured prior to November 1967. The faulty board was manufactured in 1966.

The intermittent contact was caused by improper clip position relative to the bus bar counterbore. The improper positioning resulted in loss of some side force and precluded proper contact pressure against the bus bar. A design change was made to the base gasket to ensure that the bus bar was correctly positioned.

Pre-November 1967 terminal boards were located from installation records, and it was determined that none were in circuits which would jeopardize crew safety. No action was taken for Apollo 12.

This anomaly is closed.

Loss of electroluminescent segment in the entry monitor system.- An electroluminescent segment on the numeric display of the entry monitor system velocity counter

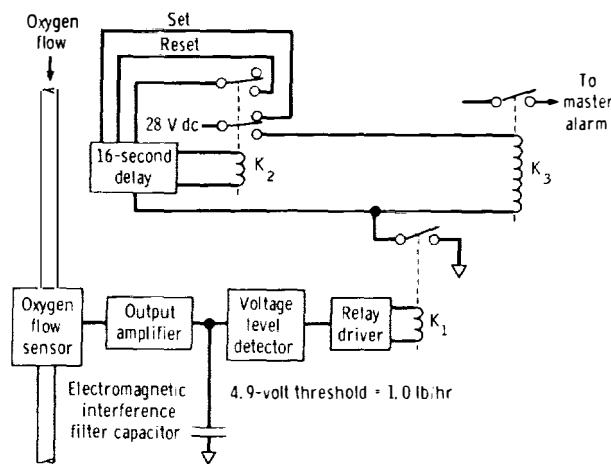

Figure 16-4.- Oxygen flow sensing circuit.

The capacitor shown in figure 16-4 is actually a part of an electromagnetic interference filter and is required to prevent fluctuation of the amplifier output to the voltage detector. Without the capacitor, a slow change in flow rate in the vicinity of the threshold voltage of relay K1 will cause relay K1 to open and close continuously (chatter). Relay K2 has a slower dropout time than relay K1; therefore, if relay K1 is chattering, relay K2 may not be affected, so that the 16-second time delay continues to time out. Consequently, master alarms can be initiated without resetting of the 16-second timer.

The filter capacitor was open during postflight tests, and the master alarms were duplicated with slow, decreasing flow rates.

There has been no previous failure history of these metalized Mylar capacitors associated with the flow sensors. No corrective action was required.

This anomaly is closed.

Indicated closure of propellant isolation valves.- The propellant isolation valves on quad B of the service module reaction control system closed during command and service module separation from the S-IVB. A similar problem was encountered on the Apollo 9 mission. Tests after Apollo 9 indicated that a valve with normal magnetic latch forces would close at shock levels as low as 87g with an 11-millisecond duration; however, with durations in the expected range of 0.2 to 0.5 millisecond, shock levels as high as 670g would not close the valves. The expected shock range is 180g to 260g.

Two valves having the nominal latching force of 7 pounds were selected for shock testing. It was found that shocks of 80g for 10 milliseconds to shocks of 100g for 1 millisecond would close the valves. The latching forces for the valves were reduced to 5 pounds, and the valves were shock tested again. The shock required to close the valves at this reduced latching force was 54g for 10 milliseconds and 75g for 1 millisecond. After completion of the shock testing, the valves were examined and tested, and no degradation was noted. Higher shock levels may have been experienced in flight, and further tests will be conducted.

A review of the checkout procedures indicates that the latching force can be degraded only if improper procedures are implemented, such as the application of reverse current or ac to the circuit. A special test on Apollo 12 indicated that the valve latching force was not degraded.

Because there was no valve degradation when the valve was shocked closed and because the crew checklist contained precautionary information concerning these valves, no further action was necessary.

This anomaly is closed.

Odor in docking tunnel.- An odor similar to burned wire insulation was detected in the tunnel when the hatch was first opened. No evidence of discoloration nor indications of overheating of the electrical circuits could be found when the circuits were examined by the crew during the flight. Several other sources of the odor were investigated,

including burned particles from tower jettison, outgassing of a silicone lubricant used on the hatch seal, and outgassing of other components used in the tunnel area. Odors from these sources were reproduced for the crew to compare with the odors detected during flight. The crew stated that the odor from a sample of the docking hatch ablator was similar to that detected in flight. Apparently, removal of the outer insulation (TG-15000) from the hatch of Apollo 11 (and of subsequent spacecraft) resulted in higher ablator temperatures and, therefore, a larger amount of outgassing odor than on previous flights.

This anomaly is closed.

Low oxygen flow rate.- Shortly after launch, the oxygen flow rate indication was at the lower limit of the instrumentation rather than at the nominal metabolic rate of 0.3 lb/hr. Also, during water separator cyclic accumulator cycles, the flow rate indication was less than the expected full measurement output of 1.0 lb/hr.

Analysis of associated data indicated that the oxygen flow was normal, but that the indicated flow rate was negatively biased by approximately 1.5 lb/hr. Postflight tests of the transducer confirmed this bias, and the cause was associated with a change in the heater winding resistance within the flow sensor bridge (fig. 16-5). The resistance of the heater had increased from 1000 to 1600 ohms, therefore changing the temperature of the hot wire element that supplies the reference voltage for the balance of the bridge. Further testing to determine the cause of the resistance change was not practical because of the minute size of the potted resistive element. Depotting of the element would destroy available evidence of the cause of failure. Normally, heater resistance changes occur early in the 100-hour burn-in period during which heater stability is achieved.

A design problem was not indicated; therefore, no action was taken.

This anomaly is closed.

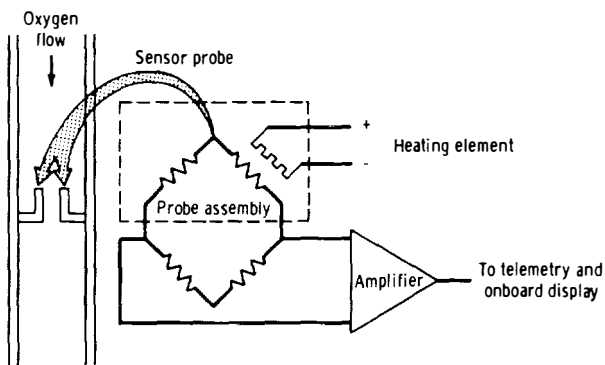
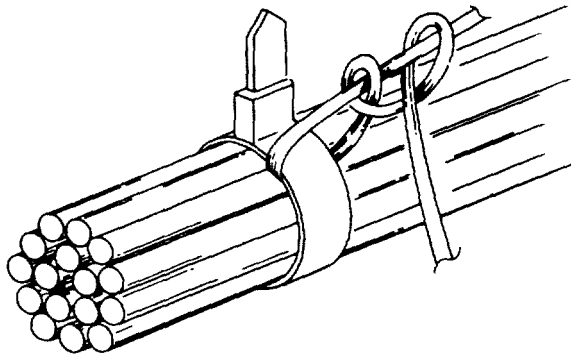

Figure 16-5.- Oxygen flow sensor.

Forward heat shield mortar lanyard untied.- During postflight examination of the Apollo 11 spacecraft, an apparent installation error was found on the mortar umbilical lanyard of the forward heat shield. That is, all but one of the tie-wrap knots were untied. This series of knots secures the tie-wraps around the electrical bundle, and its function is to break the wraps during heat shield jettison.

The knots should be two closely tied half-hitches that secure the tie-wrap to the lanyard (fig. 16-6). Examination of the Apollo 10 lanyard indicated that these knots were not two half-hitches but a clove hitch (fig. 16-6). Spacecraft 110 and 111 were examined, and it was found that a clove hitch was erroneously used on these vehicles also.

After the lanyard breaks the tie-wraps, if the fragment of tie-wrap pulls out of the knot, the clove hitch knot can untie, thus lengthening the lanyard. Lengthening this lanyard as the umbilical cable pays out can allow transfer of some loading into the umbilical disconnect fittings. Should a sufficient load be transferred to the disconnect fitting to cause shearpins to fail, the mortar umbilical of the forward heat shield could be disconnected prior to the mortar firing. This disconnection would prevent deployment of the forward heat shield separation-augmentation parachute, and there would be a possibility of forward heat shield recontact with the command module. Examination of the forward heat shield recovered from Apollo 10 confirmed that the mortar had fired and that the parachute was properly deployed.



(a) Proper.

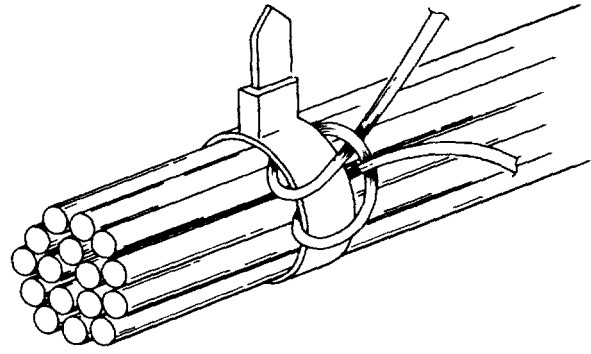

(b) Improper.

Figure 16-6.- Tie-wraps on lanyards.

A step-by-step procedure for correct lanyard knot tying and installation was developed for spacecraft 112. Apollo 12 and 13 were reworked accordingly.

This anomaly is closed.

Glycol temperature control valve.- During lunar orbit operations, the glycol temperature control valve did not control the evaporator inlet temperature. The temperature of the water/glycol entering the evaporator is normally maintained above 42° F by the glycol temperature control valve, which mixes hot water/glycol with water/glycol returning from the radiators (fig. 16-7). As the radiator outlet temperature decreases, the temperature control valve opens to allow more hot glycol to mix with the cold fluid returning from the radiator. This procedure is followed to maintain the evaporator inlet temperature at 42° to 48° F. The control valve starts to close as the radiator outlet temperature increases and closes completely at evaporator inlet temperatures above 48° F. If the automatic temperature control system fails, manual operation of the temperature control valve is available by deactivating the automatic mode. This deactivation is accomplished by positioning the glycol evaporator temperature inlet switch from AUTO to MANUAL, which removes power from the control circuit.

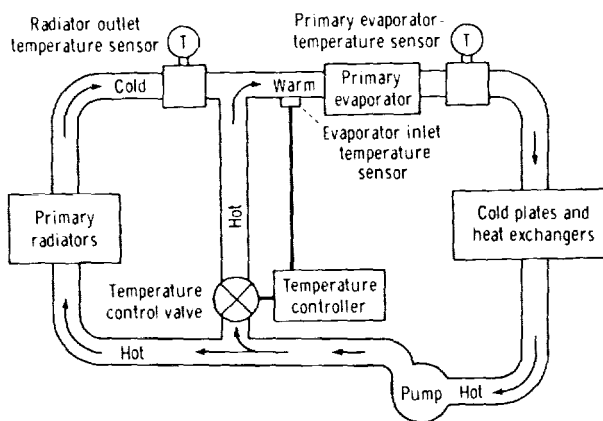

Figure 16-7.- Primary water/glycol coolant loop.

Two problems occurred on Apollo 11 during lunar orbit operations. First, as the temperature of the water/glycol returning from the radiators increased, the temperature control valve did not close fast enough; thus, an early rise was produced in evaporator outlet temperature. Second, the evaporator outlet temperature decreased to 31° F during revolution 15 as the radiator outlet temperature was rapidly decreasing (fig. 16-8). Figure 16-8 also shows normal operation of the valve and control system after the problem. Both anomalies disappeared at approximately the time during revolution 15 that the glycol evaporator temperature inlet switch was cycled by the crew. The temperature control valve and related control system continued to operate satisfactorily for the remainder of the mission.

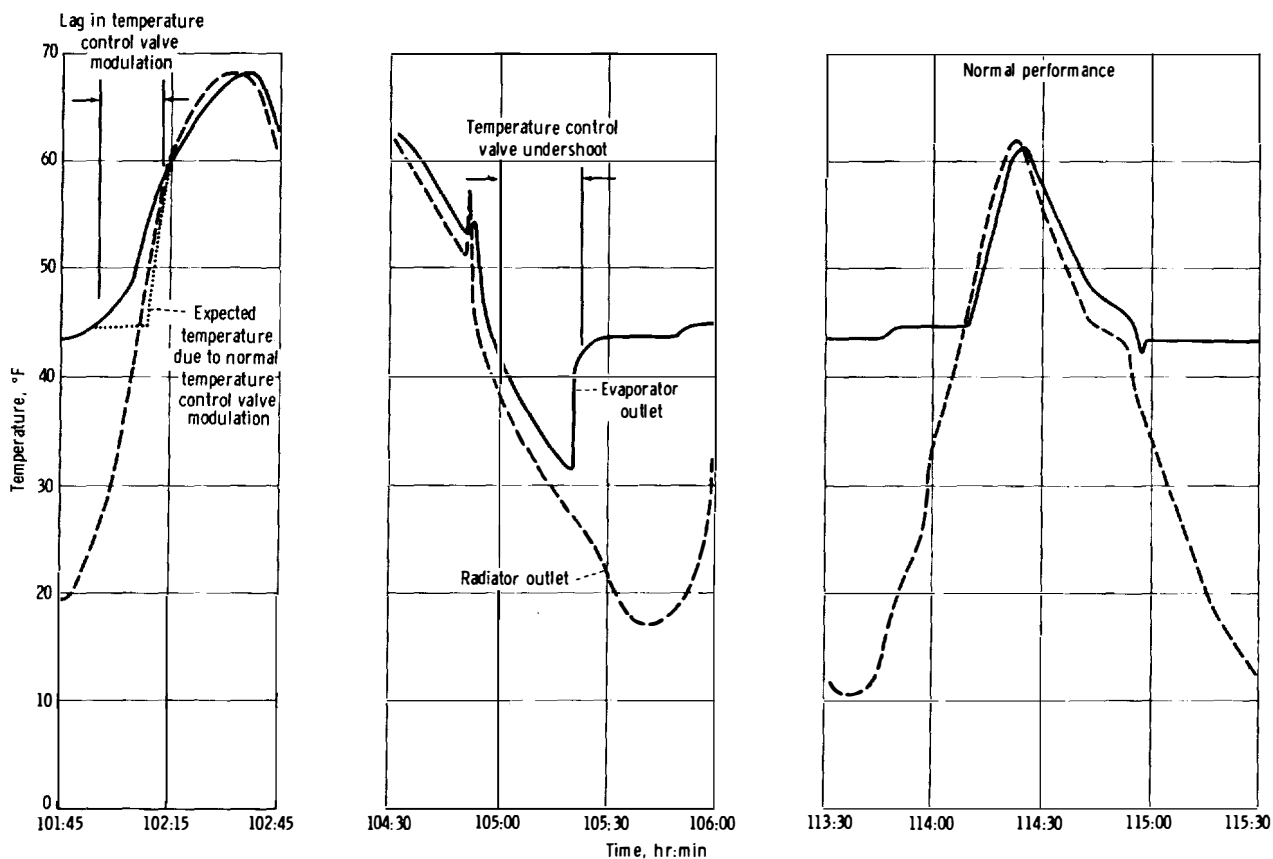

Figure 16-8.- Comparison of radiator and evaporator outlet temperatures.

The control valve was removed from the spacecraft, disassembled, and inspected. A bearing within the valve gear train was found to have its retainer disengaged from the race so that the retainer interfered with the worm gear travel (fig. 16-9).

The valve gear train is driven into mechanical stops and is stalled when the valve is commanded full open or closed. Analysis of the failed bearing and the gear train design indicates that high static thrust loads (74 pounds) applied to the bearing when the gear train is stalled caused the failure. The bearing is rated for 20 pounds of static thrust.

The capability to set the valve manually at a position that will maintain the normal temperature range of the system precludes the necessity of a redesign.

This anomaly is closed.

Service module entry.- The service module jettisoning sequence was designed with the intention that the service module, upon being jettisoned on a lunar return flight, would enter the atmosphere of the earth to between 300 and 400 thousand feet of altitude and then skip out into a highly elliptical earth orbit. Thus, the risk of recontact with the command module during entry would be eliminated. However, on the Apollo 8, 10, and 11 missions, the service module did not skip out as expected.

Tracking data obtained by C-band radar on the Apollo 11 mission indicated that the separation velocity was much less than that expected. During the Apollo 11 mission, the service module was seen by the crew approximately 5 minutes after it had been jettisoned; this sighting could not have occurred if the service module had followed its expected

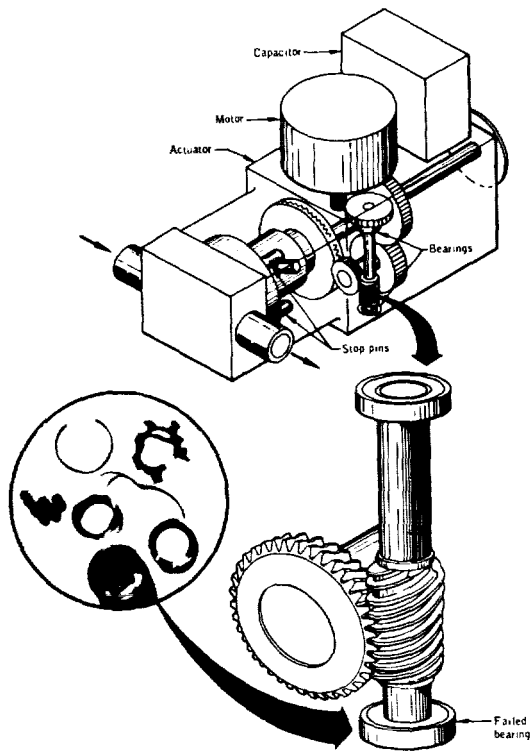

Figure 16-9.- Temperature control valve.

trajectory. (The crew noted at the time of the sighting that the reaction control system thrusters were still firing.) Photographs obtained from aircraft showed the service module entering the atmosphere of the earth and disintegrating near the command module.

The service module jettisoning sequence required that the four negative-X-translation reaction control system engines commence thrusting at separation and continue until propellant depletion. Two seconds after separation, four reaction control system roll engines fired for 5-1/2 seconds to spin stabilize the service module about its X-axis. A minimum separation velocity of approximately 300 ft/sec should have been obtained for a stable service module, and this separation velocity is more than sufficient to cause the service module to skip out. The separation velocity for the Apollo 10 mission was approximately 60 ft/sec (30 ft/sec less than the minimum velocity required for skip out.)

Hardware failure resulting in failure of one reaction control system engine or in early termination of thrusting is highly unlikely because of the redundancy in the control circuits and the consistency in successive missions of the occurrence of the failure of the service module to skip out.

Analysis of propellant sloshing shows, however, that the service module can become unstable, which results in low net separation velocities. Pictorial representation of the sloshing is shown in figure 16-10. The analyses indicate that tip-off moments applied to the service module at jettison cause the spin vector to precess about the service module X-axis. The precession excites longitudinal sloshing of the propellants in the tanks. Initial propellant locations are shown in heavy shading in figure 16-10. When the spin vector precesses to the other side of the X-axis, the propellants are driven to the other ends of the tanks, as shown in light shading. The sloshing then causes the spin vector to approach a position normal to the service module X-axis. The sloshing effects can cause a reduction in separation velocity, and during the 300-second thrusting period, the service module attitude can be reversed 180°. This condition introduces a remote possibility of recontact between the service module and the command module.

Analysis showed that the optimum separation velocity for a range of propellant loads can be obtained by restricting the roll thrusting to a period of 2 seconds and the X-axis thrusting to a period of 25 seconds. Therefore, beginning with the Apollo 13 mission, the service module jettison controller was modified to give the following jettison sequence.

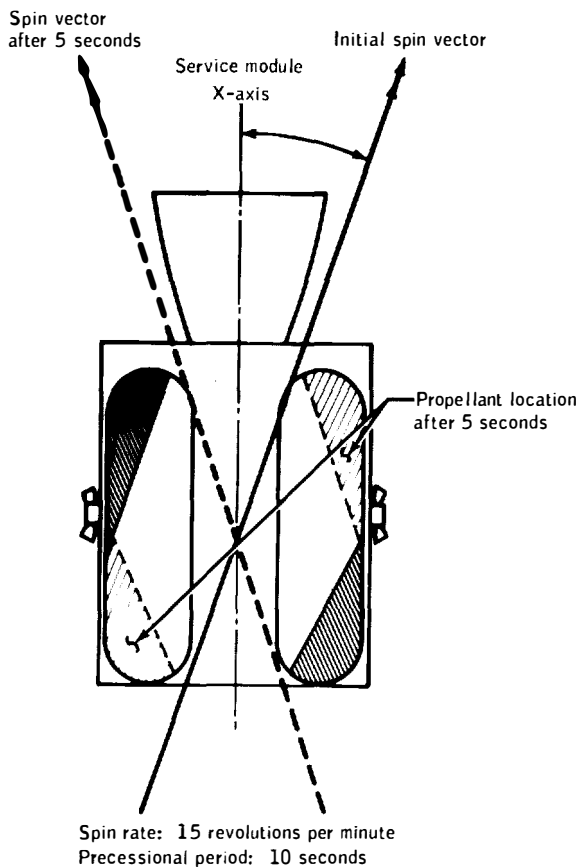

Figure 16-10.- Propellant sloshing effects.

is, electrical components (resistors, capacitors, diodes, etc.) were soldered between two circuit boards, and the void between the boards was filled with potting compound (fig. 16-11). The differential expansion between the potting compound and the component leads caused the solder joints to crack and break electrical contact. Presumably, the 11-hour period the timer was off allowed the timer to cool sufficiently for the cracked joint to make electrical contact, and the timer then operated normally.

There was no practical solution to the problem for units that were installed for the Apollo 12 mission. However, to decrease the probability of failure, a screening procedure (vibration and thermal test and 50 hours of operation) has been used to select timers for vehicle installation. The Apollo 11 timer was exposed to vibration and thermal tests and to 36 hours of operation prior to installation.

New mission timers and event timers that will be mechanically and electrically interchangeable with present timers are being developed. These new timers will use integrated circuits welded on printed circuit boards instead of the cordwood construction and will include design changes associated with the other timer problems such as cracked glass and electromagnetic interference susceptibility. The new timers will be incorporated into the spacecraft when qualification testing is complete.

This anomaly is closed.

Time after separation, sec	Event
0	Four negative-X-translation jets on
2	Four roll jets on
4	Four roll jets off
25	Four negative-X-translation jets off

This anomaly is closed.

Lunar Module

Mission timer stopped.- The crew reported shortly after lunar landing that the mission timer had stopped. They could not restart the clock at that time, and the power to the timer was turned off to allow the timer to cool. Eleven hours later, the timer was restarted and functioned normally for the remainder of the mission.

Based on the characteristic behavior of the mission timer and the similarity to previous timer failures, the most probable cause of the failure was a cracked solder joint. The reason for the cracked solder joint was the cordwood construction; that

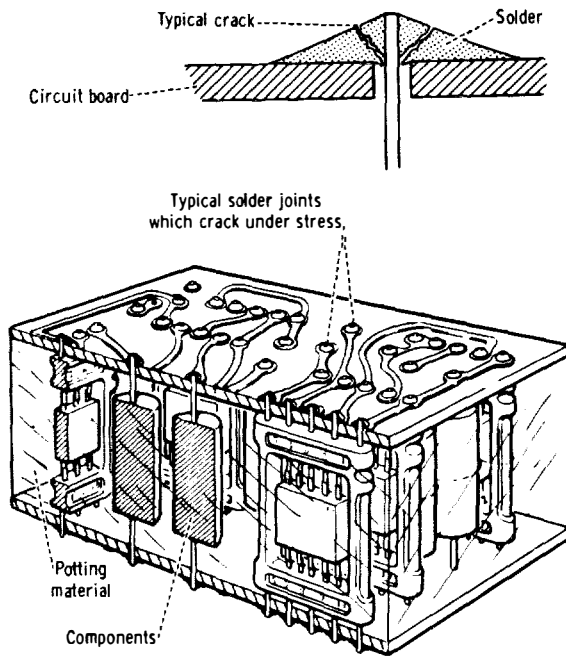

Figure 16-11.- Typical modular construction.

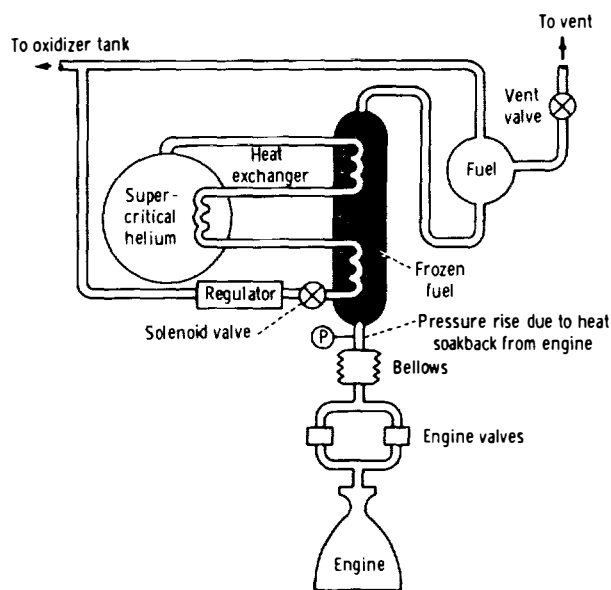

Figure 16-12.- Supercritical helium flow for descent propulsion system.

High fuel interface pressure after landing.- During simultaneous venting of the descent propellant and supercritical helium tanks, fuel in the fuel/helium heat exchanger was frozen by the helium flowing through the heat exchanger. Subsequent heat soakback from the descent engine caused expansion of the fuel trapped in the section of line between the heat exchanger and the engine shutoff valve (fig. 16-12). The result was a pressure rise in this section of line. The highest pressure in the line was probably in the range of 700 to 800 psia. (The interface pressure transducer range is 0 to 300 psia.) The weak point in the system is the bellows links, which yield at pressures greater than 650 psia and fail at approximately 800 to 900 psia. Failure of the links would allow the bellows to expand and relieve the pressure without external leakage. The heat exchanger, which is located in the engine compartment, thawed within approximately 0.5 hour and allowed the line pressure to decay.

On future missions, the solenoid valve (fig. 16-12) will be closed prior to fuel venting and opened some time prior to lift-off. This procedure will prevent freezing of fuel in the heat exchanger and will allow the supercritical helium tank to vent later. The helium pressure rise rate after landing is approximately 3 to 4 psi/hr and constitutes no constraint to presently planned missions. Appropriate changes will be made to operational procedures.

This anomaly is closed.

Indication of high carbon dioxide partial pressure.- Shortly after the lunar module ascent, the crew reported that the carbon dioxide partial pressure indication was high and erratic. The secondary lithium hydroxide canister was selected, with no effect on the indication. The primary canister was then reselected, and a caution and warning alarm was activated.

Prior to extravehicular activity, the environmental control system had been deactivated. This deactivation stopped the water separator and allowed the condensate that had collected in the separator to drain

into a tank (fig. 16-13). The drain tank contained a honeycomb material designed to retain the condensate. If the amount of condensate exceeded the effective surface of the honeycomb, water could have leaked through the vent line and into the system just up stream of the sensor. (Before the sensor became erratic, the Commander had noted water

in his suit.) Free water in the optical section of the sensor will cause erratic performance. The carbon dioxide content is sensed by measuring the light transmission across a stream of suit-loop gas. Any liquid in the element affects the light transmission and thus gives improper readings. To preclude water being introduced into the sensor from the drain tank, the vent line was relocated to an existing boss upstream of the fans, effective on Apollo 13 (fig. 16-13).

This anomaly is closed.

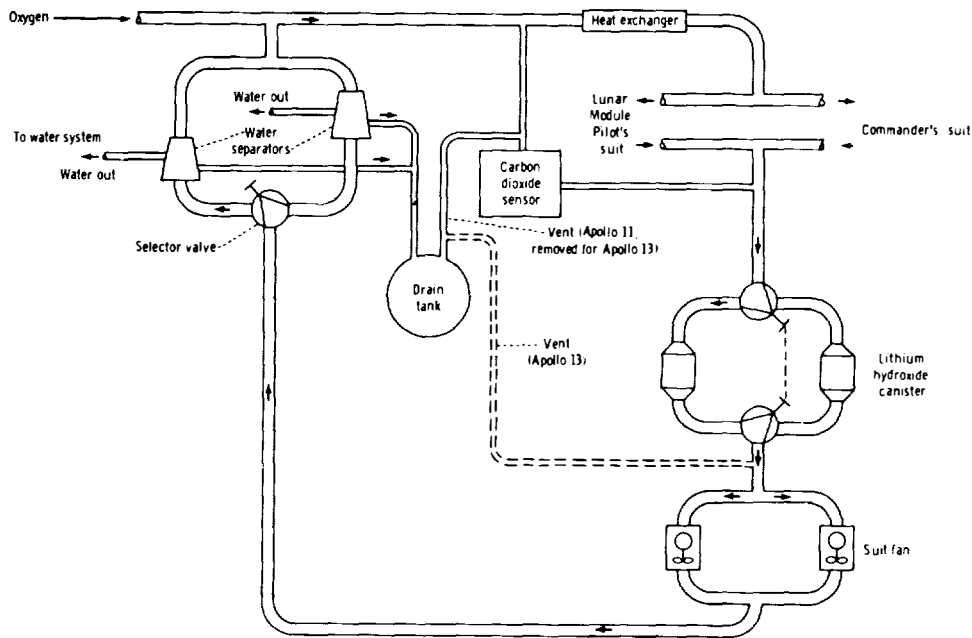

Figure 16-13.- Simplified suit-loop schematic.

Steerable antenna acquisition.- When the steerable antenna was selected after acquisition on revolution 14, difficulty was encountered in maintaining communications. The down-link signal strength was lower than predicted and several times decreased to the level at which lock was lost. However, the nominal performance of the steerable antenna before and after the time in question indicated that the antenna hardware operated properly.

For the pointing angles used, errors were discovered in the antenna coverage restriction diagram in the Spacecraft Operational Data Book. In addition, the diagram failed to include the thruster plume deflectors, which were added to the lunar module at the launch site. Figure 16-14 shows the correct blockage diagram and the diagram that was used in the Spacecraft Operational Data Book prior to flight. The pointing angles of the antenna were in an area of blockage or sufficiently close to blockage to affect the coverage pattern. As the antenna boresight approaches the vehicle structure, the on-boresight gain is reduced, the selectivity to incoming signals is reduced, and sidelobe interference is increased. Furthermore, a preflight analysis showed that the multipath signal, or reflected ray (fig. 16-15), from the lunar surface to the vehicle flight trajectory would be sufficient to cause some of the antenna tracking losses. Also, the reduction in antenna selectivity caused by vehicle blockage increases the probability of multipath interferences in the antenna tracking circuits. In conclusion, both the vehicle blockage and the multipath signals probably contributed to the reduced measured signal.

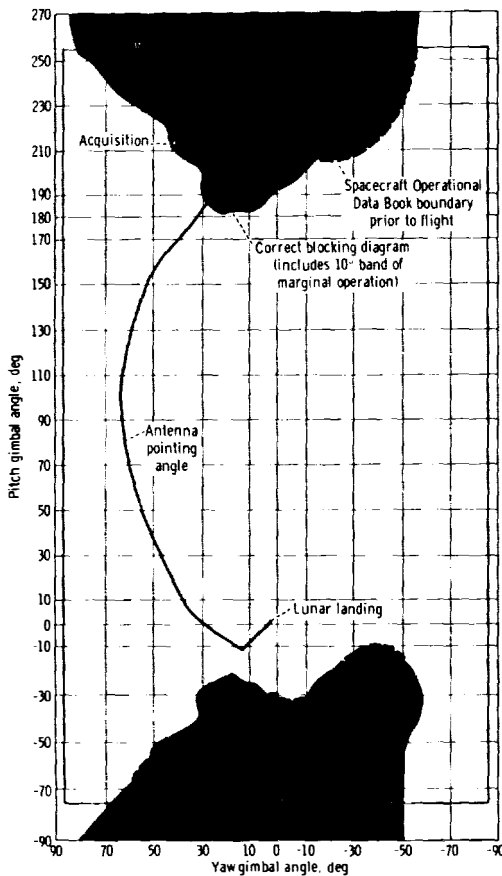

Figure 16-14.- Coverage restrictions for S-band steerable antenna.

For future missions, the correct vehicle blockage and multipath conditions will be determined for the predicted flight trajectory. Operational measures can be employed to reduce the probability of the recurrence of this problem by selecting vehicle attitudes that orient the antenna away from vehicle blockages and by selecting vehicle attitude hold with the antenna track mode switch in the SLEW or MANUAL position throughout the time periods when this problem may occur.

This anomaly is closed.

Computer alarms during descent.- Five computer program alarms occurred during descent prior to the low-gate phase of the trajectory. The performance of guidance and control functions was not affected.

The alarms were of the Executive overflow type, which signify that the guidance computer cannot accomplish all of the data processing requested in a computation cycle. The alarms indicated that more than 10 percent of the computation capacity of the computer was preempted by unexpected counter interrupts of the type generated by the coupling data units which interface with the rendezvous-radar shaft and trunnion resolvers (fig. 16-16).

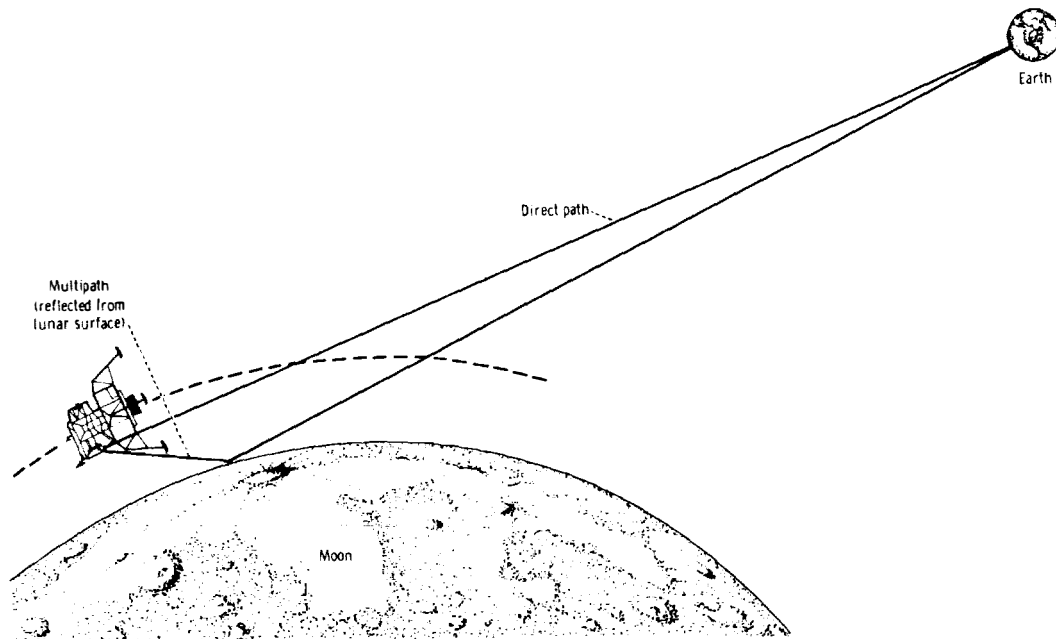

Figure 16-15.- Example of multipath.

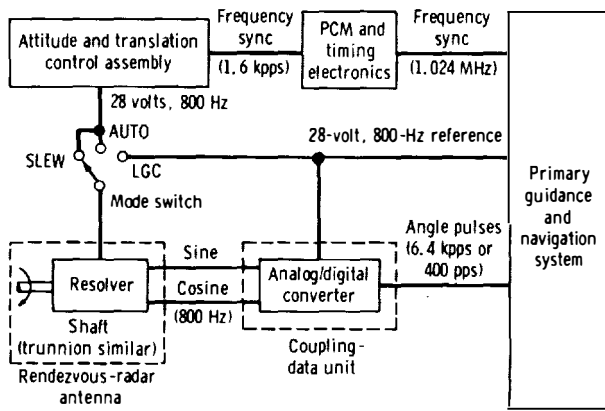

Figure 16-16.- Interfaces from rendezvous-radar antenna to primary guidance system.

The computer is organized such that input/output interfaces are serviced by a central processor on a time-shared basis with other processing functions. High-frequency data such as accelerometer and coupling data unit inputs are processed as counter interrupts, which are assigned the highest priority in the time-sharing sequence. Whenever one of these pulse inputs is received, any lower priority computation task being performed by the computer is temporarily suspended or interrupted for 11.72 microseconds while the pulse is processed; then, control is returned to the Executive program for resumption of routine operations.

The Executive program is the job-scheduling and job-supervising routine which allocates the required erasable memory storage for each job request and decides which job is given control of the central processor.

The Executive program schedules the various repetitive routines or jobs (such as Servicer, the navigation and guidance job which is done every 2 seconds) on an open-loop basis with respect to whether the job scheduled on the previous cycle was completed. Should the completion of a job be slowed because high-frequency counter interrupts usurp excessive central processor time, the Executive program will schedule the same job again and reserve another memory storage area for its use. When the Executive program is requested to schedule a job and all locations are assigned, a program alarm is displayed and a software restart is initiated. A review of the jobs that can run during descent led to the conclusion that multiple scheduling of the same job produced the program alarms. The cause for the multiple scheduling of jobs has been identified by analyses and simulations to be primarily counter interrupts from the rendezvous-radar coupling data unit.

The interrupts during the powered descent resulted from the configuration of the rendezvous-radar/coupling data unit/computer interface. A schematic of the interface is shown in figure 16-16. When the rendezvous-radar mode switch is in the AUTO or SLEW position, the excitation for the radar shaft and trunnion resolvers is supplied by a 28-volt, 800-hertz signal from the attitude and translation control assembly. When the switch is in the LGC position, the positioning of the radar antenna is controlled by the guidance computer, and the resolver excitation is supplied by a 28-volt, 800-hertz source in the primary guidance and navigation control system. The output signals of the shaft and trunnion resolvers interface with the coupling data units, regardless of the excitation source. The attitude and translation control assembly voltage is locked in frequency with the primary guidance and navigation control system voltage through control (by the primary guidance and navigation control system) of the PCM and timing electronics frequency, but it is not locked in phase. When a mode switch is not in LGC, the attitude and translation control assembly voltage is the source for the resolver output signals to the coupling data units, while the primary guidance and navigation control system 800-hertz voltage is used as a reference voltage in the analog-to-digital conversion portion of the coupling data unit. Any difference in phase or amplitude between the two 800-hertz voltages will cause the coupling data unit to recognize a change in shaft or trunnion position, and the coupling data unit will "slew" (digitally). The "slewing"

of the data unit results in the undesirable and continuous transmission of pulses representing incremental angular changes to the computer. The maximum rate for the pulses is 6.4 kpps, and the pulses are processed as counter interrupts. Each pulse received by the computer requires one memory cycle time (11.7 microseconds) to process. If a maximum of 12.8 kpps is received (two radar coupling data units), 15 percent of the available computer time will be spent in processing the radar interrupts. (The computer normally operates at approximately 90 percent of capacity during the peak activity of powered descent.) When the capacity of the computer is exceeded, some repetitively scheduled routines will not be completed prior to the start of the next computation cycle. The computer then generates a software restart and displays an Executive overflow alarm.

The meaningless counter interrupts from the rendezvous-radar coupling data unit will not be processed by the Luminary 1B program used on future missions. When the radar is not powered up or the mode switch is not in the LGC position, the data units will be zeroed, and counter interrupts will not be generated by the radar coupling data units. An additional change will permit the crew to monitor the descent without requiring as much computer time as was required in Luminary 1A.

This anomaly is closed.

Slow cabin decompression.- The decompression of the cabin prior to extravehicular activity required longer than had been anticipated. In analysis of the seriousness of this problem, it was determined that the crew cannot damage the hatch by trying to open it prematurely. Static tests show that a handle force of 78 pounds at 0.25 psid and 118 pounds at 0.35 psid is required to permit airflow past the seal. The hatch deflected only in the region of the handle. A handle pull of 300 pounds at 2 psid did not damage either the handle or the hatch. In addition, neutral buoyancy tests showed that suited subjects in a 1/6-g environment could pull a maximum of 102 pounds.

On Apollo 12 and subsequent vehicles, the bacteria filter was not to be used; thus, the time for decompression was reduced from approximately 5 minutes to less than 2 minutes. The altitude chamber test for Apollo 13 included a partial cabin vent procedure that verified satisfactory valve assembly operation without the bacteria filter installed.

This anomaly is closed.

Electroluminescent segment on display inoperative.- An electroluminescent segment on the numeric display of the abort guidance system data entry and display assembly was reported inoperative. The affected digit is shown in figure 16-17. With this segment inoperative, it was impossible to differentiate between the numerals 3 and 9. The crew was still able to use the particular digit; however, there was some ambiguity on the readout.

Each segment on the display is switched independently through a logic network that activates a silicon-controlled rectifier placed in series with the segments. In this respect, the control circuit is different from that used in the entry monitor system velocity counter, although both units are made by the same manufacturer. (See "Loss of Electroluminescent Segment in Entry Monitor System" in this section.) The power source is 115 volts, 400 hertz, and can be varied for intensity control.

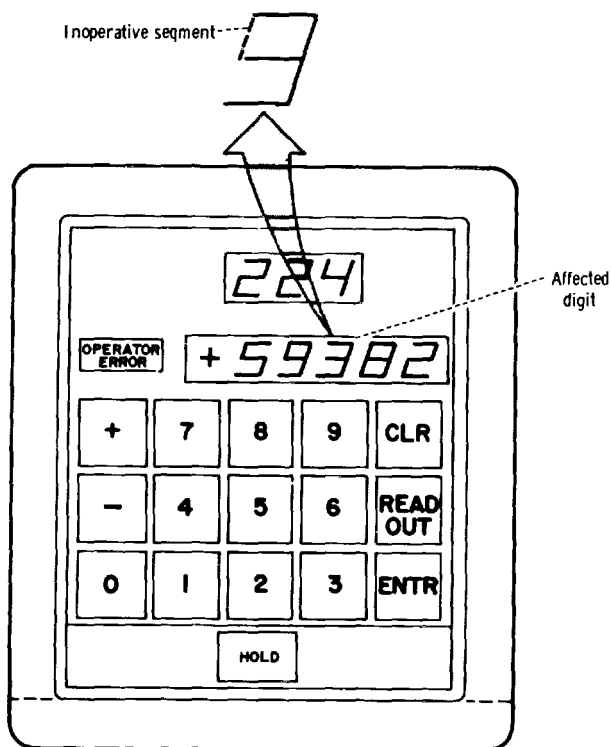

Figure 16-17.- Inoperative segment in one digit of the data entry and display assembly.

One similar failure occurred on a delta qualification unit. The cause was a faulty epoxy process which resulted in a cracked and open electrode in the light-emitting element. Circuit analysis shows several component and wiring failures that could account for the failure; however, there is no history of these types of failure. The number of satisfactory activations of all the segments does not indicate the existence of a generic problem. To ensure proper operation under all conditions, for future missions a prelaunch test will activate all segments; then, the intensity will be varied through the full range while the display is observed for faults.

This anomaly is closed.

Voice breakup during extravehicular activity.- Voice-operated relay operation during extravehicular activity caused breakup of voice received by the Manned Space Flight Network. This breakup was associated with both crewmen, but primarily with the Lunar Module Pilot.

In ground tests, the conditions experienced during the extravehicular activity were duplicated by decreasing the sensitivity of the lunar module down-link voice-operated keying control from 9 (maximum) to 8, a decrease of approximately 7 decibels. During chamber tests, lunar module keying by the extravehicular communications system was demonstrated when the sensitivity control was set at 9. The crew indicated that the pre-extravehicular activity adjustment should have been set in accordance with the onboard checklist (maximum increase). The crewmen also verified that they did not experience any voice breakup from each other or from the Manned Space Flight Network, which indicated that the breakup was probably caused by marginal keying of the voice-operated keying circuits of the lunar module down-link relay.

Voice tapes of the Apollo 11 crew obtained during altitude chamber tests were used in an attempt to duplicate the problem by simulating voice modulation characteristics and levels being fed into the lunar module communications system during the extravehicular activity. These voice tapes modulated a signal generator that was received by and relayed through a breadboard (mockup) of the lunar module communications system. No discernible breakup of the relayed voice occurred with the sensitivity control set at 9.

All analysis and laboratory testing to date indicates that the voice breakup experienced during the extravehicular activity was not an inherent system design problem. Testing has shown that any voice that will key the extravehicular communications system will also key the lunar module relay if the sensitivity control is set at 9.

The most probable cause of the problem is an inadvertent low setting of the Commander's sensitivity control. During extravehicular activity, both crewmen use the Commander's lunar module voice-operated circuit when talking to the ground. Other less likely causes are degraded modulation from the extravehicular communications system or

degradation of the lunar module circuit gain between the vhf receiver and the Commander's amplifier. However, no known previous failures have resulted in degraded extravehicular communications modulation levels or degraded lunar module keying performance.

This anomaly is closed.

Echo during extravehicular activity.- A voice turnaround (echo) was heard during extravehicular activity. At that time, the lunar module was operating in a relay mode. Up-link voice from the S-band was processed and retransmitted to the two extravehicular crewmen by means of the lunar module vhf transmitter. Crew voice and data were received by the lunar module vhf receiver and relayed to the earth by means of the lunar module S-band transmitter (fig. 16-18). The echo, which was duplicated in the laboratory, resulted from mechanical acoustical coupling between the communications carrier earphone

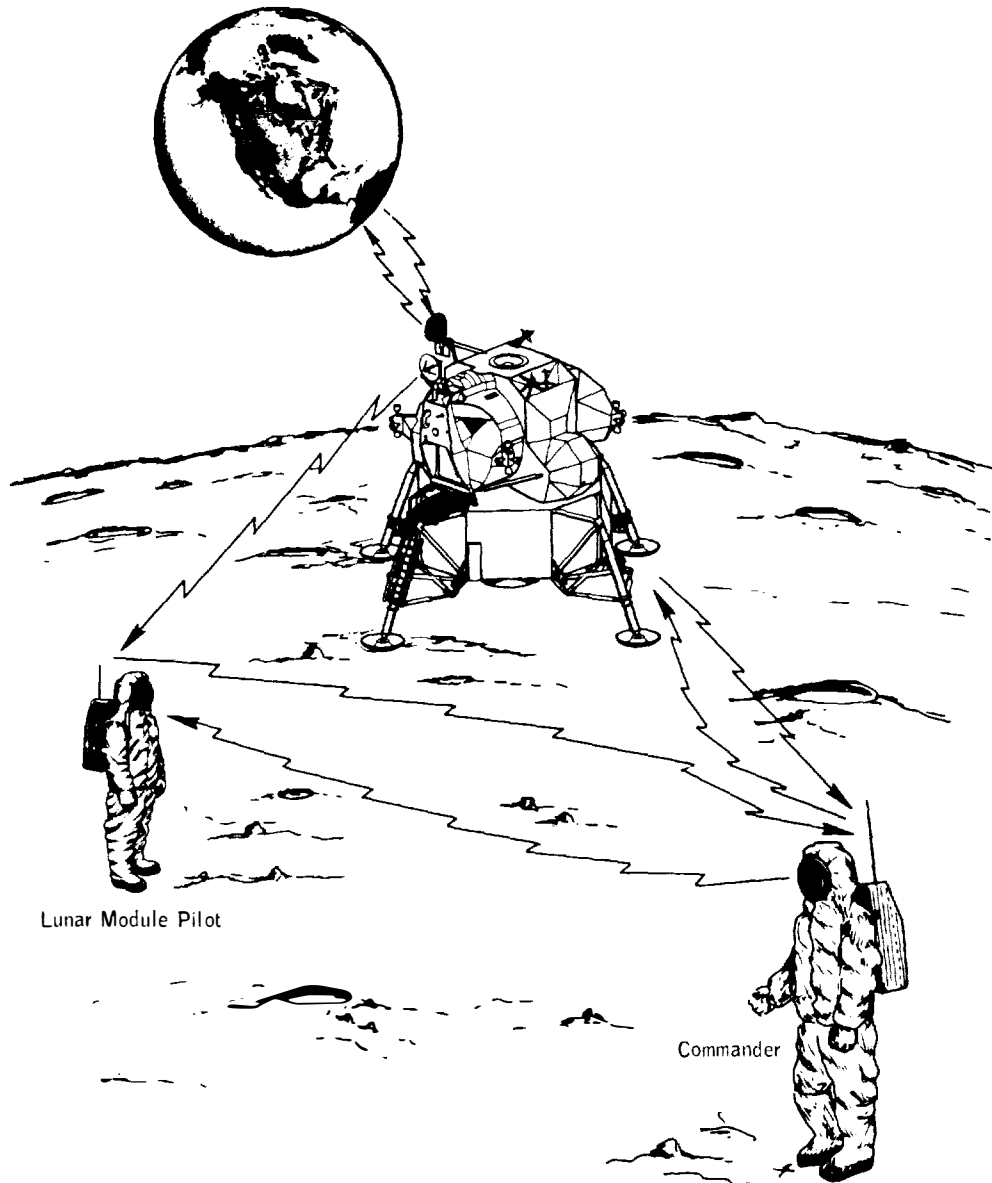

Figure 16-18.- Communications relays during extravehicular activity.

and microphone (fig. 16-19). The crewmen indicated that their volume controls were set at maximum during the extravehicular activity. This setting would provide a level of approximately +16 dBm into each crewman's earphones. Isolation between earphones and microphones, exclusive of airpath coupling, is approximately 48 decibels. Therefore, at the microphone output, the ground voice signal would appear at a level of approximately -32 dBm. If it is assumed that extravehicular communications keying was enabled, this signal would be processed and transmitted by the extravehicular communications system and would provide a level of approximately -12 dBm at the output of the lunar module vhf receiver. If the lunar module relay was enabled, this signal would be amplified and relayed to earth by means of the S-band at a nominal output level.

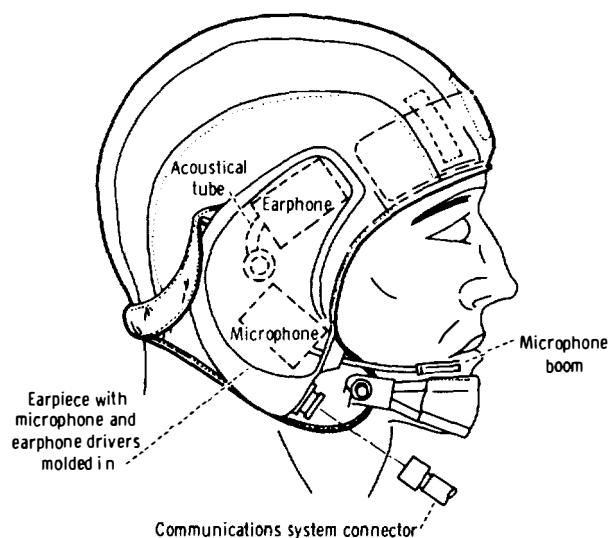

Figure 16-19.- Communications carrier.

When the lunar module voice-operated keying circuit is properly adjusted, any signal that keys the extravehicular communications system will also key the lunar module relay. There are indications that the lunar module voice-operated keying sensitivity was set below maximum, as evidenced by the relayed voice breakup experienced by the Lunar Module Pilot. (See "Voice Breakup During Extravehicular Activity" in this section.) Therefore, it would have been possible for the extravehicular communications system to have been keyed by breathing or by suit airflow without this background noise being relayed by the lunar module. However, the up-link turnaround voice could have provided the additional lunar-module-received audio signal level to operate the voice-operated keying circuits, which would have permitted the signal to be returned to earth. The crew indicated that the voice-operated keying circuits in the extravehicular communications system were activated by suit airflow for some positions of the head in the helmet.

Both voice-operated keying circuits were also keyed by bumping or rubbing of the communications carrier against the helmet. The random echo problem is inherent in the communications system design, and there does not appear to be any practical way to eliminate random voice-operated keying or to significantly reduce the acoustical coupling in the communications carrier.

A procedure to inhibit the remoting of down-link voice during periods of up-link voice transmissions will be accomplished to eliminate the echo. The capsule communicator's console will be modified to allow capsule-communicator simplex operation (up link only, down link disabled) during up-link transmissions as a backup mode of operation if the echo becomes objectionable. However, the ground system will still have the echo of the capsule communicator when the simplex mode is used.

This anomaly is closed.

Onboard recorder failure.- The data storage electronics assembly did not record properly in flight. Postflight playback of the tape revealed that the reference tone was recorded properly; however, the voice signal was low and recorded with a 400-hertz tone and strong background noise. Occasionally, the voice level was normal for short periods. In addition, only the 4.6-kilohertz timing signal was recorded. This signal should have switched between 4.2 and 4.6 kilohertz in order to record the timing code.

During postflight tests, the recorder functioned properly for the first 2 hours of operation. Then, the voice channel failed and recorded no voice or background noise, although timing and reference tones were recorded properly. This failure does not duplicate the flight results, which indicated that the failure did not exist in flight.

Tests with the recorder installed in a lunar module were performed to determine the vehicle wiring failures that could cause the signals found on the flight tape. An open circuit in both the timing signal return line and the voice signal line would duplicate the problem. Similar broken wires were found in LTA-8 during thermal/vacuum tests. The most probable cause of the failure was two broken wires (26 gage) in the vehicle harness to the recorder. For Apollo 12 to 15, the wire harness at the recorder connector will be wrapped with tape to stiffen the connector and provide protection against flexure damage. For Apollo 16 and subsequent missions, a sheet-metal cover will be added to protect the harness.

Preflight data from the launch-site checkout procedure show that both the timing inputs and the internally generated reference frequency were not within specification tolerances, which may be indicative of a preflight problem with the system. The procedure did not specify acceptable limits but has now been corrected.

This anomaly is closed.

Broken circuit breaker knob.- The crew reported after the completion of extravehicular activity that the knob on the engine arm circuit breaker was broken and that two other circuit breakers were closed. The engine arm circuit breaker was successfully closed when required for ascent, but loss of the knob would not allow manual opening of the breaker.

The most probable cause of the damage was impact with the oxygen purge system (aft edge) during preparation for extravehicular activities; such an impact was demonstrated in simulations in a lunar module. Circuit breaker guards will be installed on Apollo 12 and subsequent vehicles to prevent the oxygen purge system from impacting with the circuit breakers.

This anomaly is closed.

Thrust chamber pressure switches.- The switch used to monitor the quad 2 aft-firing engine (A2A) exhibited slow response to jet driver commands during most of the mission. During an 18-minute period just prior to terminal phase initiation, the switch failed to respond to seven consecutive minimum-impulse commands. This failure resulted in a master alarm and a thruster warning flag, both of which were reset by the crew. The engine operated normally, and the switch failure had no effect on the mission. The crew did not attempt any investigative procedures to determine whether the engine had actually failed. A section drawing of the switch is shown in figure 16-20.

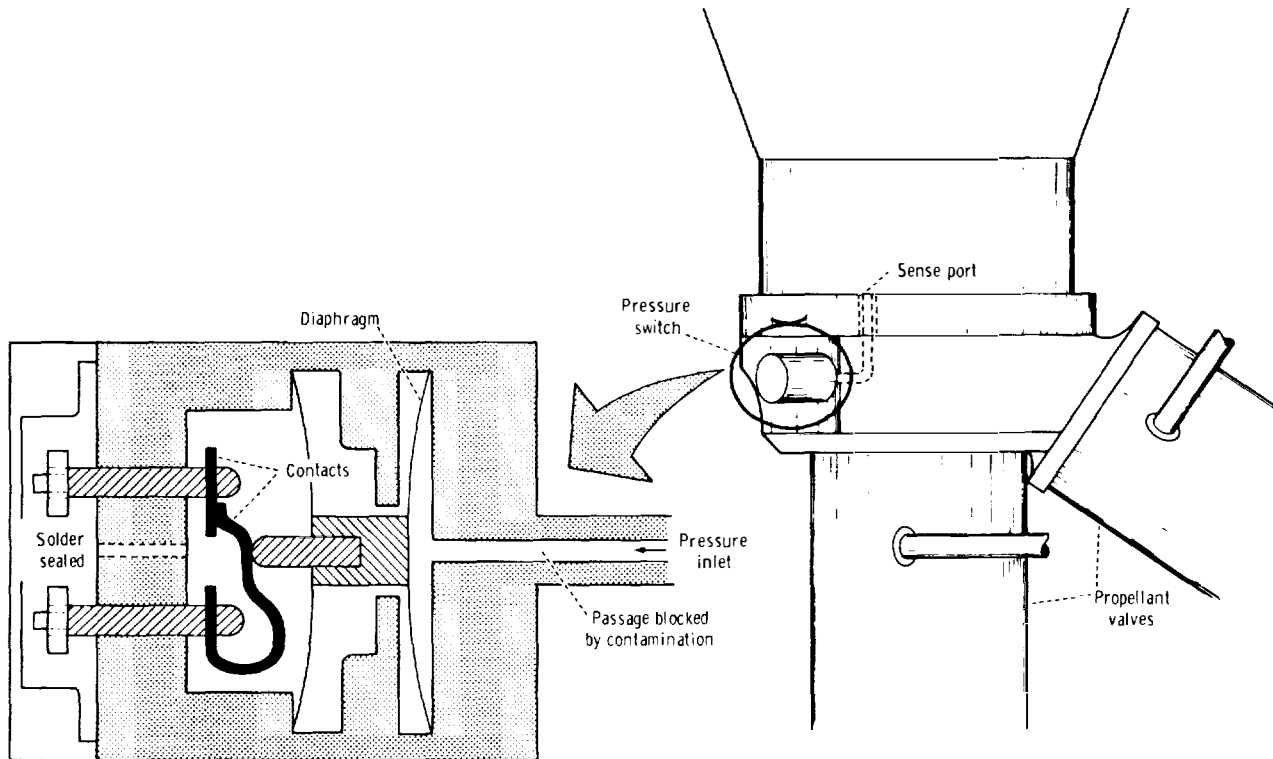

Figure 16-20.- Chamber pressure switch.

This failure was the first of its type to be observed in flight or in ground testing. The switch closing response (time of jet driver ON command to switch closure) appeared to increase from an average of approximately 15 to 20 milliseconds during station keeping to 25 to 30 milliseconds at the time of failure. Normal switch closing response is 10 to 12 milliseconds, based on ground test results. The closing response remained at the 25- to 30-millisecond level following the failure, and the switch continued to fail to respond to some minimum-impulse commands. The switch opening time (time from jet driver OFF command to switch opening) appeared to be normal throughout the mission. In view of these results, the most probable cause of the switch failure was particulate contamination in the inlet passage of the switch. Contamination in this area would reduce the flow rate of chamber gases into the diaphragm cavity, thereby reducing the switch closing response. However, the contamination would not necessarily affect switch opening response because normal chamber pressure tailoff requires approximately 30 to 40 milliseconds in order to decrease from approximately 30 psia to the normal switch opening pressure of approximately 4 psia. The 30- to 40-millisecond time would probably be sufficient to allow the gases in the diaphragm cavity to vent such that the switch would open normally. The crews for future missions will be briefed to recognize and handle similar situations.

This anomaly is closed.

Water in one suit.- After the lunar module achieved orbit, water (estimated to be 1 tablespoonful) began to enter the Commander's suit in spurts at approximately 1-minute intervals. The Commander immediately selected the secondary water separator, and the spurts stopped after 15 to 20 minutes. The spurts entered the suit through the suit half-vent duct when the crewmen were not wearing their helmets. The pressures in all liquid systems that interface with the suit loop were normal, which indicated no leakage.

The possible sources of free water in the suit loop are the water separator drain tank, an inoperative water separator, local condensation in the suit loop, and leakage through the water separator selector valve (fig. 16-13). An evaluation of each of these possible sources indicated that leakage through the water separator selector valve was the most probable source of the free water.

The flapper-type valve is located in a Y-duct arrangement and is used to select one of two water separators. Leakage of this valve would allow free water to pass through the idle water separator and subsequently enter the suit hose. This leakage would most probably result from a misalignment and binding in the slot of the selector valve actuation linkage (fig. 16-21).

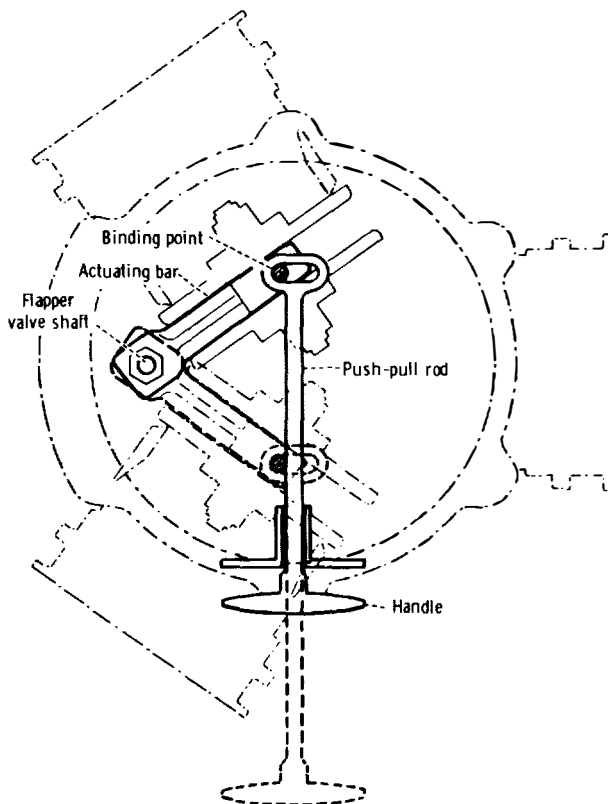

Figure 16-21.- Water separator selector valve.

The allowable actuation force after linkage rigging was 15 pounds. The usual actuation forces have been 7 to 8 pounds, but 12.5 pounds were required on the Apollo 11 mission. The allowable actuation force has been lowered to 10 pounds, and inspections for linkage binding have been incorporated into procedures at the factory and the launch site.

This anomaly is closed.

Reaction control system warning flags.- The crew reported thrust chamber assembly warning flags for three engine pairs. Quad 2 and quad 4 warning flags for system A occurred simultaneously during lunar module station keeping prior to descent orbit insertion. The quad 4 flag for system B appeared shortly thereafter and also twice just before powered descent initiation. The crew believed these flags were accompanied by master alarms. The flags were reset by cycling of the caution and warning electronics circuit breaker. Sufficient data are not available to confirm any of the reported conditions.

One of the following may have caused the flag indications:

1. The thrust chamber pressure switch may have failed to respond to thruster firings.
2. Firing of opposing thrusters may have caused a thrust-chamber-on failure indication.
3. Erroneous caution and warning system or display flag operation may have occurred.

The first two possible causes are unlikely because simultaneous multiple failures would have to occur and subsequently be corrected. The third possible cause is the most likely to have occurred where a single-point failure existed. Ten of the 16 engine pressure switch outputs are conditioned by the 10 buffers in one module in the signal conditioner electronics assembly (fig. 16-22). This module is supplied with +28 V dc through one wire. In addition, the module contains an oscillator that provides an

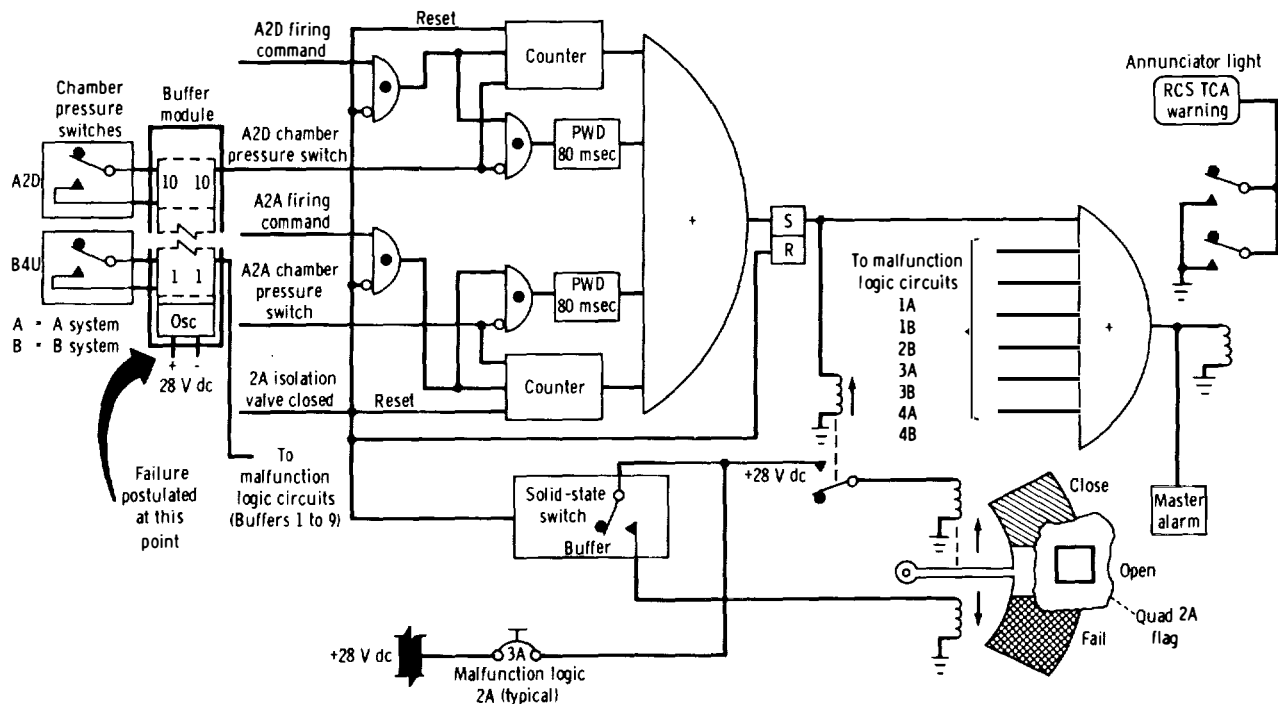

Figure 16-22.- Reaction control system malfunction-detection circuits.

ac voltage to each of the 10 buffers. If either the +28 V dc is interrupted or the oscillator fails, none of the 10 buffers will respond to pressure switch closures. If engines monitored by these buffers are then commanded on, the corresponding warning flags will appear, and a master alarm will occur.

If plus X translation were commanded (fig. 16-23), the down-firing engines in quads 2 and 4 of system A could fire, and flags 2A and 4A would appear. A subsequent minus X rotation could fire the forward-firing thruster in quad 4 of system B and the aft-firing thruster in quad 2 of system A, and flag 4B would appear. The aft-firing engine in quad 2 of system A (A2A) is not monitored as having failed. The failure, then, could have cleared itself. The response of the vehicle to thruster firings would have been normal under these conditions. There is no history of similar failures either at package or module level in the signal conditioner electronics assembly. No corrective action was taken.

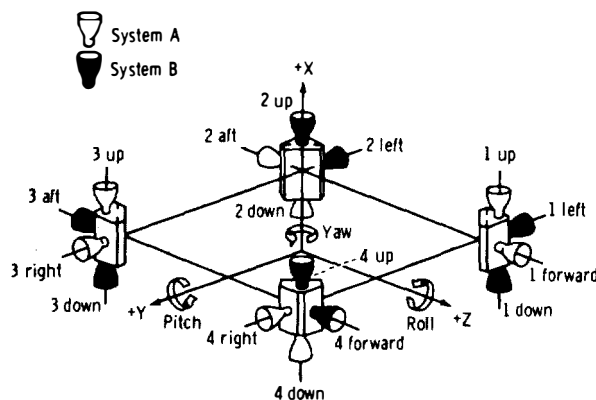

Figure 16-23.- Reaction control system geometry.

This anomaly is closed.

Government-Furnished Equipment

Television cable retained coiled shape.- The cable for the lunar surface television camera retained its coiled shape after being deployed on the lunar surface. Loops resulting from the coils represented a potential tripping hazard to the crew.

All the changes that have been investigated relative to changes in cable material and in stowage and deployment hardware have indicated only minimal improvement in deployed cable form, together with a weight penalty for the change. No hardware changes are planned.

This anomaly is closed.

Mating of remote control unit to portable life support system.- During preparation for extravehicular activity, the crew experienced considerable difficulty in mating the electrical connectors from the remote control unit to the portable life support system. For rotational polarization alignment, it was necessary to grasp the cable insulation because the coupling lock ring was free for unlimited rotation on the connector shell (fig. 16-24).

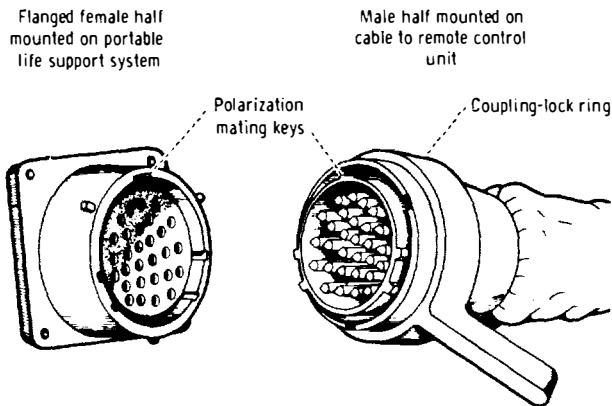

Figure 16-24.- Connector between remote control unit and portable life support system.

For future missions, the male half of the connector has been replaced with one that has a coupling lock ring with a positive rotational position with the connector shell and that can be grasped for firm alignment of the two halves. The ring is then rotated 90° in order to capture and lock the two halves. In addition, easier insertion has been attained with conical-tipped contact pins in place of hemispherical-tipped pins.

This anomaly is closed.

Difficulty in closing sample return containers.- The force required to close the sample return containers was much higher than expected. This high closing force, together with the instability of the descent stage work table and the lack of adequate retention provisions, made closing of the containers very difficult.

Because of the type of container seal, the force required to close the cover reduces with each closure. The crew had extensive training with a sample return container which had been opened and closed many times, resulting in closing forces lower than the maximum limit of 32 pounds.

The container used for the flight had not been exercised, as had the container used for training. In addition, the cleaning procedures used by the contractor before delivery removed all lubricant from the latch linkage sliding surfaces. Tests with similar containers have shown that the cleaning procedure caused an increase in the closing force of as much as 24 pounds.

A technique for burnishing on the lubricant after cleaning has been incorporated. As a result, containers now being delivered require closing forces no greater than 25 pounds. Overcenter locking mechanisms for retaining the containers on the work table will be installed on a mockup table and will be evaluated for possible incorporation on Apollo 13 and subsequent missions.

This anomaly is closed.

17. CONCLUSIONS

The Apollo 11 mission, which included a manned lunar landing and lunar surface exploration, was conducted with skill, precision, and relative ease. The excellent performance of the spacecraft in the preceding four flights and the thorough planning in all aspects of the program permitted the safe and efficient execution of this mission. The following conclusions are drawn from the information contained in this report.

1. The effectiveness of preflight training was reflected in the skill and precision with which the crew executed the lunar landing. Manual control while maneuvering to the desired landing point was satisfactorily exercised.

2. The planned techniques involved in the guidance, navigation, and control of the descent trajectory were good. Performance of the landing radar met all expectations in providing the information required for descent.

3. The extravehicular mobility units were adequately designed to enable the crew to conduct the planned activities. Adaptation to the 1/6-g environment was relatively quick, and mobility on the lunar surface was easy.

4. The two-man prelaunch checkout and countdown for ascent from the lunar surface were well planned and executed.

5. The time-line activities for all phases of the lunar landing mission were well within the crew's capability to perform the required tasks.

6. The quarantine operation from spacecraft landing until release of the crew, spacecraft, and lunar samples from the Lunar Receiving Laboratory was accomplished successfully and without any violation of the quarantine.

7. No micro-organisms from an extraterrestrial source were recovered from either the crew or the spacecraft.

8. The hardware problems experienced on the Apollo 11 mission, as on previous manned missions, were of a nature that did not unduly hamper the crew or result in the compromise of safety or mission objectives.

9. The Mission Control Center and the Manned Space Flight Network proved to be adequate for controlling and monitoring all phases of the flight, including the descent, surface activity, and ascent phases of the mission.

REFERENCES

1. Anon.: Lunar Gravitational Model Analysis for Apollo. Boeing Company (Seattle, Washington), Dec. 5, 1968.
2. Milton, D. J.: Geologic Map of Theophilus Quadrangle of the Moon. In Geologic Atlas of the Moon, U.S. Geological Survey, Scale 1:1,000,000. I-546(LAC-78), 1968.
3. Heacock, Raymond L.; Kuiper, C.; et al.: Ranger VII, Part II: Experimenters Analysis and Interpretations. Jet Propulsion Laboratory (California Institute of Technology, Pasadena, Calif.), JPL-TR-32-700, 1965. (Also available as NASA-CR-62347.)
4. McCord, Thomas B.: Color Differences on the Lunar Surface. J. Geophys. Res., Vol. 74, no. 12, June 15, 1969, pp. 3131-3142.
5. Muller, P. M.; and Sjogren, W. L.: Mascons: Lunar Mass Concentrations. Science, vol. 161, no. 3842, Aug. 16, 1968, pp. 680-684.
6. Shoemaker, E. M.; Moms, E. C.; et al.: 1968 Surveyor Project Final Report, Part II: Science Results, Section III: Television Observations from Surveyor. Jet Propulsion Laboratory (California Institute of Technology, Pasadena, Calif.), JPL-TR-32-1265, 1968, pp. 21-136.
7. Interagency Committee on Back Contamination: Excerpts of Federal Regulation Pertinent to Contamination Control for Lunar Sample Return Missions. GPO 927-742, 1967.
8. Anon.: Interagency Agreement Between the National Aeronautics and Space Administration; the Department of Agriculture; the Department of Health, Education, and Welfare; the Department of the Interior; and the National Academy of Sciences on the Protection of the Earth's Biosphere from Lunar Sources of Contamination. August 24, 1967.
9. Interagency Committee on Back Contamination: Quarantine Schemes for Manned Lunar Missions. GPO 927-741, 1967.

APPENDIX A

APOLLO SPACECRAFT FLIGHT HISTORY

Mission	Spacecraft	Description	Launch date	Launch site
PA-1	BP-6	First pad abort	Nov. 7, 1963	White Sands Missile Range, N. Mex.
A-001	BP-12	Transonic abort	May 13, 1964	White Sands Missile Range, N. Mex.
AS-101	BP-13	Nominal launch and exit environment	May 28, 1964	Cape Kennedy, Fla.
AS-102	BP-15	Nominal launch and exit environment	Sept. 18, 1964	Cape Kennedy, Fla.
A-002	BP-23	Maximum dynamic pressure abort	Dec. 8, 1964	White Sands Missile Range, N. Mex.
AS-103	BP-16	Micrometeoroid experiment	Feb. 16, 1965	Cape Kennedy, Fla.
A-003	BP-22	Low-altitude abort (planned high- altitude abort)	May 19, 1965	White Sands Missile Range, N. Mex.
AS-104	BP-26	Micrometeoroid experiment and service module RCS launch	May 25, 1965	Cape Kennedy, Fla.
PA-2	BP-23A	Second pad abort	June 29, 1965	White Sands Missile Range, N. Mex.
AS-105	BP-9A	Micrometeoroid experiment and service module RCS launch environment	July 30, 1965	Cape Kennedy, Fla.
A-004	SC-002	Power-on tumbling boundary abort	Jan. 20, 1966	White Sands Missile Range, N. Mex.
AS-201	SC-009	Supercircular entry with high heat rate	Feb. 26, 1966	Cape Kennedy, Fla.

APOLLO SPACECRAFT FLIGHT HISTORY - Concluded

Mission	Spacecraft	Description	Launch date	Launch site
AS-202	SC-011	Supercircular entry with high heat load	Aug. 25, 1966	Cape Kennedy, Fla.
Apollo 4	SC-017 LTA-10R	Supercircular entry at lunar return velocity	Nov. 9, 1967	Kennedy Space Center, Fla.
Apollo 5	LM-1	First lunar module flight	Jan. 22, 1968	Cape Kennedy, Fla.
Apollo 6	SC-020 LTA-2R	Verification of closed-loop emergency detection system	April 4, 1968	Kennedy Space Center, Fla.
Apollo 7	CSM 101	First manned flight; earth orbital	Oct. 11, 1968	Cape Kennedy, Fla.
Apollo 8	CSM 103	First manned lunar orbit flight; first manned Saturn V launch	Dec. 21, 1968	Kennedy Space Center, Fla.
Apollo 9	CSM 104 LM-3	First manned lunar module flight; earth orbit rendezvous; extra-vehicular activity	Mar. 3, 1969	Kennedy Space Center, Fla.
Apollo 10	CSM 106 LM-4	First lunar orbit rendezvous; low pass over lunar surface	May 18, 1969	Kennedy Space Center, Fla.
Apollo 11	CSM 107 LM-5	First lunar landing	July 16, 1969	Kennedy Space Center, Fla.

APPENDIX B

VEHICLE DESCRIPTIONS

The Apollo 11 space vehicle contained few changes from the Apollo 10 configuration. The launch escape system and the spacecraft/launch vehicle adapter were identical to those for Apollo 10. The few minor changes to the command and service modules, the lunar module, and the Saturn V launch vehicle are discussed in the following paragraphs. A description of the extravehicular mobility unit and the lunar surface experiment equipment and a listing of spacecraft mass properties are also presented.

Command and Service Modules

The insulation in the area of the command module forward hatch was modified to prevent the flaking which occurred during the Apollo 10 lunar module pressurization. The feedback circuit in the high-gain antenna was slightly changed to reduce servo dither. In the Apollo 10 command module, one of the three entry batteries was modified to make use of cellophane separators. The flight results proved this cellophane separator to be superior to the Permion-type separators previously used, and the Apollo 11 command module had the cellophane separators on all three entry batteries. The battery chargers were modified to produce a higher charging capacity. The secondary bypass valves for the fuel cell coolant loop were changed from an angle-cone seat design (block II) to a single-angle seat design (block I) to reduce the possibility of particulate contamination. As a replacement for the water/gas separation bag, which proved ineffective during Apollo 10, an in-line dual-membrane separation device was added to both the water gun and the food preparation unit.

Lunar Module

Structural changes.- The most significant structural change to the lunar module was the added provisions for the functional early Apollo scientific experiments package and the modular equipment stowage assembly, both of which housed the experiments and tools used during the lunar surface activities. Another change was the addition of the reaction control system plume deflectors.

Changes to the landing gear included (1) removing the lunar surface sensing probe on the plus Z gear and lengthening the remaining probes and (2) increasing the sliding clearance of the landing gear struts to permit full stroke at extreme temperature conditions.

Thermal changes.- A change from Kapton to Kel-F was made to the descent stage base heat shield to preclude the possibility of interference with the landing radar. Also, insulation was added to the landing gear and the probes to accommodate the requirement for descent engine firing until touchdown.

Communications systems changes.- The major modifications to the communications systems included the addition of an extravehicular activity antenna to the lunar module for lunar communications between the crew and the lunar module and the addition of an S-band erectable antenna to the lunar module to permit communications through the lunar module communications system (fig. 16-16) while the crew was on the surface. A television camera similar to that used on the Apollo 9 mission was stowed in the descent stage to provide television coverage of the lunar surface activities.

Guidance and control system changes.- The major difference in the guidance and control system was the redesign of the gimbal drive actuator to a constant damping system rather than a brake. The actuator was redesigned as a result of the brake failing in both the disengaged and the engaged positions. This change also required modification of the descent engine control assembly and the phase-correcting network to eliminate the possibility of inadvertent caution and warning alarms. The exterior tracking light had improvements in the flash head and in the pulse-forming network. The pushbuttons for the data entry and display assembly were rewired to preclude the erroneous caution and warning alarms that occurred on the Apollo 10 flight. The guidance and navigation optics system was modified by the addition of Teflon locking rings to the sextant and to the scanning telescope to prevent the rotation of eye guards under zero-g conditions. The deletion of unmanned control capability permitted removal of the ascent engine aiming assembly.

Ascent propulsion system changes.- The injector filter for the ascent propulsion system was modified because the fine mesh in the original filter caused a change in the mixture ratio. An additional change was the incorporation of a lightweight thrust chamber.

Environmental control system changes.- In the environmental control system, a suit cooling assembly and water hose umbilicals were added to the air revitalization section to provide additional crew cooling capability. As a result, the cabin air recirculation assembly, the cabin temperature control valve, and the regenerative heat exchanger were deleted. Also, a redundant water regulator was added to the secondary coolant loop in the water management section. In the environmental control system relay box in the oxygen and cabin pressure control section, a pressure transducer was replaced by a suit pressure switch to improve reliability.

Radar changes.- The landing-radar electronics assembly was reconfigured to protect against a computer strobing pulse that was providing what appeared to be two pulses to the radar. Another modification permitted the crew to break tracker lock and to start a search for the main beam in the event the radar pulse locked onto the structure or onto a side lobe. The lunar reflectivity attenuation characteristics were updated in the radar electronics to account for the updated Surveyor data and for landing-radar flight tests. For correlation between the Manned Space Flight Network and the inertial measurement unit of the primary guidance system, a logic change permitted the lateral velocity to be an output signal of the landing radar. A further design change was made to prevent the landing radar from accepting noise spikes as a pulse in the velocity bias error signal train.

The rendezvous-radar design changes included a new self-test segment to provide low-temperature stability with the low-frequency and mid-frequency composite signal. In addition, heaters were added to the gyro assembly and the cable wrap to accommodate the lunar-stay temperature requirements. A manual voting override switch permitted the crew to select either the primary or the secondary gyro inputs.

Display and control changes.- A circuit breaker was added for the abort electronics assembly to protect the dc bus, and another circuit breaker was added to accommodate the transfer of the utility light to the dc bus to provide redundant light.

The circuit breaker for the environmental control system suit and cabin repressurization function was deleted in conjunction with the modification of the suit cooling assembly. In addition, a low level caution and warning indication on the secondary water/glycol accumulator has been provided.

Changes to the caution and warning electronics assembly included the inhibition of the landing-radar temperature alarm and the prevention of a master alarm during inverter selection and master alarm switching.

Master alarm functions which were eliminated include the descent helium regulator warning prior to pressurization with the descent engine control assembly; the reaction-control-system thrust-chamber-assembly warning with quad circuit breakers open; the rendezvous-radar caution when the mode select switch is placed in the AUTO-TRACK position; and the reaction-control-system quad temperature alarm. Caution and warning functions which were deleted include the landing-radar velocity "data no good" warning and the descent propellant low-level quantity warning, which was changed to a low-level quantity indication light only.

A further change included the added capability of resetting the abort electronics assembly caution and warning channel with the water quantity test switch. A modification was made to the engine-stop-switch latching mechanism to ensure positive latching of the switch.

Crew provision changes.- The waste management system was changed to a one-large and five-small urine container configuration. Additional stowage included provisions for a second Hasselblad camera, for two portable life support systems and remote control units, for two pairs of lunar overshoes, and for a feedwater collection bag. The Commander had an attitude-controller-assembly lock mechanism added.

Extravehicular Mobility Unit

The extravehicular mobility unit provides life support in a pressurized or unpressurized cabin and up to 4 hours of extravehicular activity life support.

In its extravehicular configuration, the extravehicular mobility unit was a closed-circuit pressure vessel that enveloped the crewman. The environment inside the pressure vessel consisted of 100-percent oxygen at a nominal pressure of 3.75 psia. The oxygen was provided at a flow rate of 6 cubic feet per minute. The extravehicular life support equipment configuration is shown in figure B-1.

Liquid cooling garment.- The crewmen wore the liquid cooling garment while in the lunar module and during all extravehicular activity. The garment provided cooling during extravehicular and intravehicular activity by absorbing body heat and by transferring excessive heat to the sublimator in the portable life support system. The liquid cooling garment was a one-piece, long-sleeved, integrated stocking undergarment of netting material. It consisted of an inner liner of nylon chiffon to facilitate donning and an outer layer of nylon Spandex into which a network of Tygon tubing was woven. Cooled water, supplied from the portable life support system or from the environmental control system, was pumped through the tubing.

Pressure garment assembly.- The pressure garment assembly was the basic pressure vessel of the extravehicular mobility unit. This assembly would have provided a mobile life support chamber if cabin pressure had been lost because of leaks or puncture of the vehicle. The pressure garment assembly consisted of a helmet, a torso and limb suit, intravehicular activity gloves, and various controls and instrumentation to provide the crewman with a controlled environment.

Torso and limb suit.- The torso and limb suit was a flexible pressure garment that encompassed the entire body except the head and hands. It had four gas connectors, a multiple water receptacle, and electrical connector, and a urine transfer connector. The connectors had positive locking devices and could be connected and disconnected without assistance from another crewman. The gas connectors comprised an oxygen inlet and outlet connector on each side of the suit front torso. Each oxygen inlet connector had an integral ventilation diverter valve. The multiple water receptacle, mounted on the suit torso, served as the interface between the environmental control system water

supply and the water connectors for the liquid cooling garment and the portable life support system. The electrical connector, when mated with the vehicle or with the electrical umbilical of the portable life support system, provided a communications, instrumentation, and power interface to the pressure garment assembly. The urine transfer connector was used to transfer urine from the urine collection transfer assembly to the waste management system.

The urine transfer connector on the suit right leg permitted dumping of the urine collection bag without depressurizing the pressure garment assembly. A pressure relief valve on the suit sleeve, near the wrist ring, vented the suit in the event of overpressurization. The valve opened at approximately 4.6 psig and reseated at 4.3 psig. If the valve did not open, it could have been manually overridden. A pressure gage on the other sleeve indicated suit pressure.

Helmet.- The helmet was a Lexan (polycarbonate) shell with a bubble-type visor, a vent pad assembly, and a helmet-attaching ring. The vent pad assembly permitted a constant flow of oxygen over the inner front surface of the helmet. The helmet did not turn independently of the torso and limb suit; however, the crewman could turn his head within the helmet neck-ring area. The helmet had provisions on each side for mounting an extra-vehicular visor assembly.

Communications carrier.- The communications carrier was a polyurethane foam headpiece with two independent earphones and microphones which were connected to the suit 21-pin communications electrical connector. The communications carrier could be worn with or without the helmet during intravehicular operations. It was worn with the helmet during extravehicular operations.

Integrated thermal micrometeoroid garment.- The integrated thermal micrometeoroid garment, which was worn over the pressure garment assembly, protected the crewman from harmful radiation, heat transfer, and micrometeoroid activity. The integrated thermal micrometeoroid garment was a one-piece, form-fitting multilayered garment that was laced over the pressure garment assembly and remained with it. The extravehicular activity visor assembly, gloves, and boots were donned separately. From the outer layer in, the integrated thermal micrometeoroid garment consisted of a protective cover, a micrometeoroid-shielding layer, a thermal-barrier blanket (multiple layers of aluminized Mylar), and a protective liner. A zipper on the integrated thermal micrometeoroid garment permitted connection or disconnection of umbilical hoses. For extravehicular activity, the pressure garment assembly gloves were replaced with the extravehicular activity gloves. The extravehicular activity gloves were made of the same material as the integrated thermal micrometeoroid garment to permit handling of intensely hot or cold objects outside the cabin and for protection against lunar temperatures. The extravehicular activity boots were worn over the pressure garment assembly boots. They were made of the same material as the integrated thermal micrometeoroid garment. The soles had additional insulation for protection against intense temperatures.

Extravehicular activity visor assembly.- The extravehicular activity visor assembly provided protection against solar heat, space particles, and radiation and helped to maintain thermal balance. The two pivotal visors of the extravehicular activity visor assembly could be attached to a pivot mounting on the pressure garment assembly helmet. The lightly tinted (inner) visor reduced fogging in the helmet. The outer visor had a vacuum-deposited gold-film reflective surface, which provided protection against solar radiation and space particles. The extravehicular activity visor assembly was held snug to the pressure garment assembly helmet by a tab-and-strap arrangement that allowed the visors to be rotated approximately 90° up or down, as desired.

Portable life support system.- The portable life support system (fig. B-2) contained the expendable materials and the communications and telemetry equipment required for extravehicular operation. The system supplied oxygen to the pressure garment assembly and cooling water to the liquid cooling garment and removed solid and gas contaminants from returning oxygen. The suited crewman wore the portable life support system, attached with a harness, on his back. The total system contained an oxygen ventilating circuit, water feed and liquid transport loops, a primary oxygen supply, a main power supply, communications systems, displays and related sensors, switches, and controls. A cover encompassed the assembled unit, and the top of the portable life support system supported the oxygen purge system.

Remote control unit.- The remote control unit was a display and control unit, chest-mounted for easy access. The controls and displays consisted of a fan switch, pump switch, space-suit communication-mode switch, volume control, oxygen quantity indicator, and oxygen purge system actuator.

Oxygen purge system.- The oxygen purge system provided oxygen and pressure control for certain extravehicular emergencies and was mounted on top of the portable life support system. The system was self-contained, independently powered, and nonrechargeable. It was capable of 30 minutes of regulated (3.7 ± 0.3 psid) oxygen flow at 8 lb/hr to prevent excessive carbon dioxide buildup and to provide limited cooling. The system consisted of two interconnected spherical 2-pound oxygen bottles, an automatic temperature control module, a pressure regulator assembly, a battery, oxygen connectors, and the necessary checkout instrumentation. The oxygen purge system provided the hard mount for the vhf antenna.

Experiment Equipment

Solar wind composition.- The purpose of the solar wind composition experiment was to determine the elemental and isotopic composition of noble gases and other selected elements present in the solar wind. This objective was to be accomplished by trapping particles of the solar wind on a sheet of aluminum foil exposed on the lunar surface.

Physically, the experiment consisted of a metallic telescoping pole approximately 1.5 inches in diameter and approximately 16 inches in length when collapsed. When extended, the pole was approximately 5 feet long. In the stowed position, the foil was enclosed in one end of the tubing and rolled up on a spring-driven roller. Only the foil portion was recovered at the end of the lunar exposure period. The foil was rolled on the spring-driven roller and stowed in the sample return container for return to earth.

Laser ranging retroreflector.- The laser ranging retroreflector experiment (fig. B-3) was a retroreflector array of fused silica cubes. A folding support structure was used for aiming and alining the array toward earth. The purpose of the experiment was to reflect laser ranging beams from earth to their point of origin for precise measurement of earth-moon distances, the center of the lunar mass motion, and the lunar radius; for earth geophysical information; and for development of space communication technology.

Earth stations that can beam lasers to the experiment include the McDonald Observatory at Fort Davis, Texas; the Lick Observatory at Mount Hamilton, California; and the Catalina Station of the University of Arizona. Scientists in other countries also plan to bounce laser beams off the retroreflector.

Passive seismic experiment package.- The passive seismic experiment (fig. B-4) consisted of three long-period seismometers and one short-period vertical seismometer for measuring meteoroid impacts and moonquakes and for gathering information on the lunar interior (for example, whether a lunar core and mantle exist). The passive seismic experiment package had four basic subsystems: the structure/thermal subsystem to provide

shock, vibration, and thermal protection; the electrical power subsystem to generate 34 to 46 watts by solar panel array; the data subsystem to receive and decode Manned Space Flight Network up-link commands and down-link experiment data and to handle power switching tasks; and the passive seismic experiment subsystem to measure lunar seismic activity with long-period and short-period seismometers which could detect inertial mass displacement. Also included in the package were 15-watt radioisotope heaters to maintain the electronic package at a minimum of 60° F during the lunar night.

A solar panel array of 2520 solar cells provided approximately 40 watts to operate the instrument and the electronic components, including the telemetry data subsystem. Scientific and engineering data were to be telemetered down link while ground commands initiated from the Mission Control Center at the NASA Manned Spacecraft Center were to be transmitted up link by using Manned Space Flight Network remote sites.

Lunar field geology.- The primary aim of the Apollo lunar field geology experiment was to collect lunar samples. The tools described in the following paragraphs and shown in figure B-5 were provided for this purpose.

A calibrated Hasselblad camera and a gnomon were to be used to obtain the geometric data required to reconstruct the geology of the site in the form of geologic maps and to recover the orientation of the samples for erosion and radiation studies. The sample bags and camera frame numbers were provided to aid in identifying the samples and relating them to the crew's description.

Core tubes, in conjunction with hammers, were to provide samples in which the stratigraphy of the uppermost portion of the regolith would be preserved for return to earth. A sample scoop was provided for collecting particulate material and individual rock fragments and for digging shallow trenches for inspection of the regolith. The tongs were provided for collecting rock fragments and for retrieving tools that might have been dropped. Lunar environment and gas analysis samples were to be collected, sealed in special containers, and returned for analysis.

Launch Vehicle

Launch vehicle AS-506 was the sixth in the Apollo-Saturn V series and was the fourth manned Apollo-Saturn V vehicle. The AS-506 launch vehicle was configured the same as the AS-505 launch vehicle used for the Apollo 10 mission, except for the differences described in the following paragraphs.

In the S-IC stage, the pre-charge accumulator bottles were removed from the control pressure system, and various components of the research and development instrumentation system were removed or modified. In the S-II stage, the components of the research and development instrumentation system were removed, and excess weld doublers were removed from the liquid-oxygen-tank aft bulkhead.

In the S-IVB stage, five additional measurements were used to define the low-frequency vibration that had occurred during the Apollo 10 mission. In the propulsion system, a liner was added to the liquid hydrogen feed duct, an oxygen/hydrogen injector was changed, the shutoff valve on the pneumatic power control module was modified by the addition of a block point, and a new configuration of the cold helium shutoff and dump valves and a pneumatic shutoff valve solenoid were installed.

In the instrument unit, the FM/FM telemetry system was modified to accommodate the five added S-IVB structural vibration measurements. Tee sections, clamps, and thermal switch settings were minor modifications in the environmental control system. The flight program was changed to accommodate the requirements of the Apollo 11 mission.

Mass Properties

Spacecraft mass properties for the Apollo 11 mission are summarized in table B-I. These data represent the conditions as determined from postflight analyses of expendable loadings and usage during the flight. Variations in spacecraft mass properties are determined for each significant mission phase from lift-off through landing. Expendables usage is based on reported real-time and postflight data, as presented in other sections of this report. The weights and centers of gravity of the individual command and service modules and of the lunar module ascent and descent stages were measured prior to flight, and the inertial values were calculated. All changes incorporated after the actual weighing were monitored, and the spacecraft mass properties were updated.

TABLE B-I.- MASS PROPERTIES

Event	Weight, lb	Center of gravity, in.			Moment of inertia, slug-ft ²			Product of inertia, slug-ft ²		
		X _A	Y _A	Z _A	I _{XX}	I _{YY}	I _{ZZ}	I _{XY}	I _{XZ}	I _{YZ}
Lift-off	109 666.6	847.0	2.4	3.9	67 960	1 164 828	1 167 323	2586	8 956	3335
Earth orbit insertion	100 756.4	807.2	2.6	4.1	67 108	713 136	715 672	4745	11 341	3318
Transposition and docking										
Command and service modules	63 473.0	934.0	4.0	6.5	34 445	76 781	79 530	-1789	-126	3148
Lunar module	33 294.5	1236.2	.2	.1	22 299	24 826	24 966	-508	27	37
Total docked	96 767.5	1038.0	2.7	4.3	57 006	532 219	534 981	-7672	-9 240	3300
Separation maneuver	96 566.6	1038.1	2.7	4.3	56 902	531 918	534 766	-7670	-9 219	3270
First midcourse correction										
Ignition	96 418.2	1038.3	2.7	4.2	56 770	531 482	534 354	-7711	-9 170	3305
Cut-off	96 204.2	1038.4	2.7	4.2	56 667	531 148	534 113	-7709	-9 147	3274
Lunar orbit insertion										
Ignition	96 061.6	1038.6	2.7	4.2	56 564	530 636	533 613	-7785	-9 063	3310
Cut-off	72 037.6	1079.1	1.7	2.9	44 117	412 855	419 920	-5737	-5 166	382
Circularization										
Ignition	72 019.9	1079.2	1.8	2.9	44 102	412 733	419 798	-5745	-5 160	386
Cut-off	70 905.9	1081.5	1.6	2.9	43 539	407 341	413 864	-5403	-5 208	316
Separation	70 760.3	1082.4	1.8	2.8	44 762	407 599	414 172	-5040	-5 404	286
Docking										
Command and service modules	36 847.4	943.6	2.8	5.5	20 747	57 181	63 687	-2094	833	321
Ascent stage	5 738.0	1168.3	4.9	-2.4	3 369	2 347	2 873	-129	54	-354
Total after docking										
Ascent stage manned	42 585.4	973.9	3.1	4.5	24 189	113 707	120 677	-1720	-1 018	-50
Ascent stage unmanned	42 563.0	972.6	2.9	4.5	24 081	110 884	117 804	-2163	-811	-28
Total after ascent stage	37 100.5	943.9	2.9	5.4	20 807	56 919	63 417	-2003	730	305
Jettison										
Transearth injection										
Ignition	36 965.7	943.8	3.0	5.3	20 681	56 775	63 303	-1979	709	336
Cut-off	26 792.7	961.4	-1.1	6.8	15 495	49 843	51 454	-824	180	-232
Command and service module separation										
Before	26 656.5	961.6	.0	6.7	15 406	49 739	51 338	-854	228	-200
After										
Service module	14 549.1	896.1	.1	7.2	9 143	14 540	16 616	-837	885	-153
Command module	12 107.4	1040.4	-1.2	6.0	6 260	5 470	4 995	55	-403	-47
Entry	12 095.5	1040.5	-1.2	5.9	6 253	5 463	4 994	55	-400	-47
Drogue deployment	11 603.7	1039.2	-1.2	5.9	6 066	5 133	4 690	56	-375	-48
Main parachute deployment	11 318.9	1039.1	-1.1	5.2	5 933	4 947	4 631	50	-312	-28
Landing	10 873.0	1037.1	-1.1	5.1	5 866	4 670	4 336	45	-322	-27
Lunar module										
Lunar module at launch	33 297.2	185.7	0.2	0.2	22 304	25 019	25 018	228	454	77
Separation	33 683.5	186.5	.2	.7	23 658	26 065	25 922	225	705	73
Descent orbit insertion										
Ignition	33 669.6	186.5	.2	.8	23 649	26 045	25 899	224	704	71
Cut-off	33 401.6	186.5	.2	.8	23 480	25 978	25 871	224	704	71
Lunar landing	16 153.2	213.5	.4	1.6	12 582	13 867	16 204	182	555	74
Lunar lift-off	10 776.6	243.5	.2	2.9	6 808	3 475	5 971	20	214	45
Orbit insertion	5 928.6	255.3	.4	5.3	3 457	3 082	2 273	17	135	43
Coelliptic sequence initiation	5 881.5	255.0	.4	5.3	3 437	3 069	2 246	17	137	44
Docking	5 738.0	254.4	.4	5.4	3 369	3 044	2 167	18	141	50
Jettison	5 462.5	255.0	.1	3.1	3 226	3 039	2 216	28	119	35

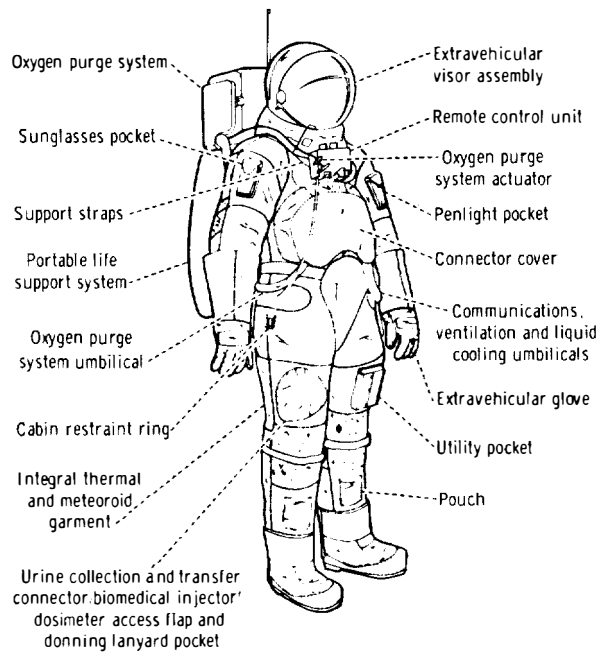

Figure B-1.- Extravehicular mobility unit.

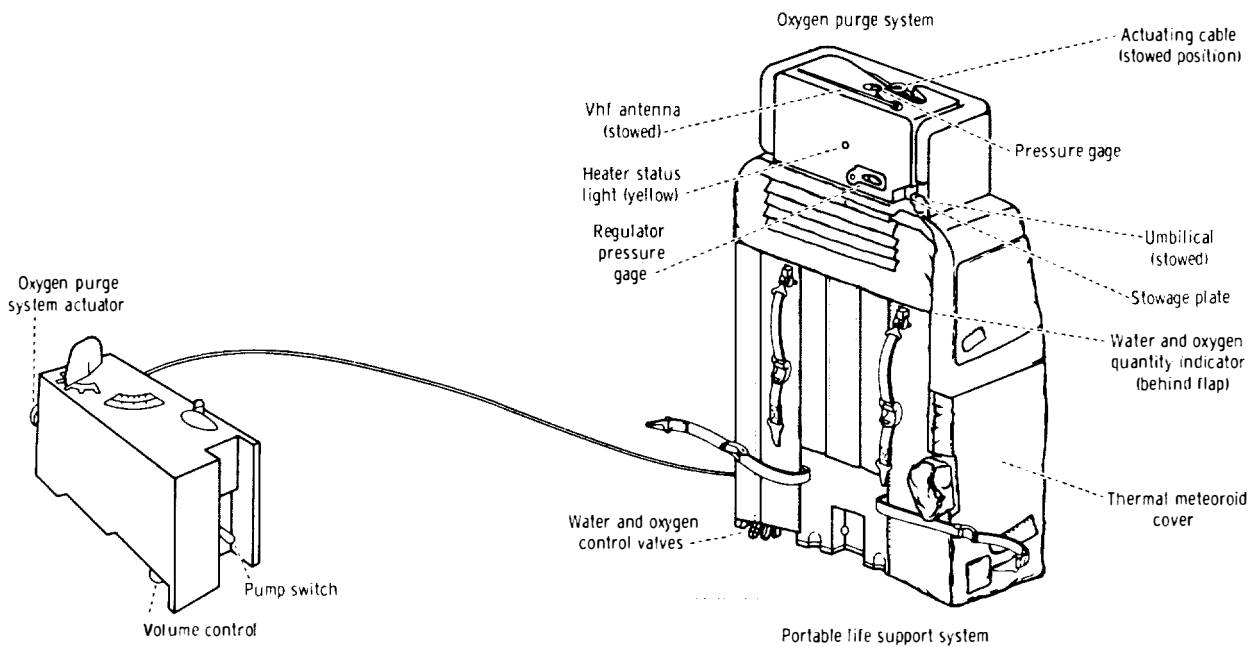

Figure B-2.- Portable life support system.

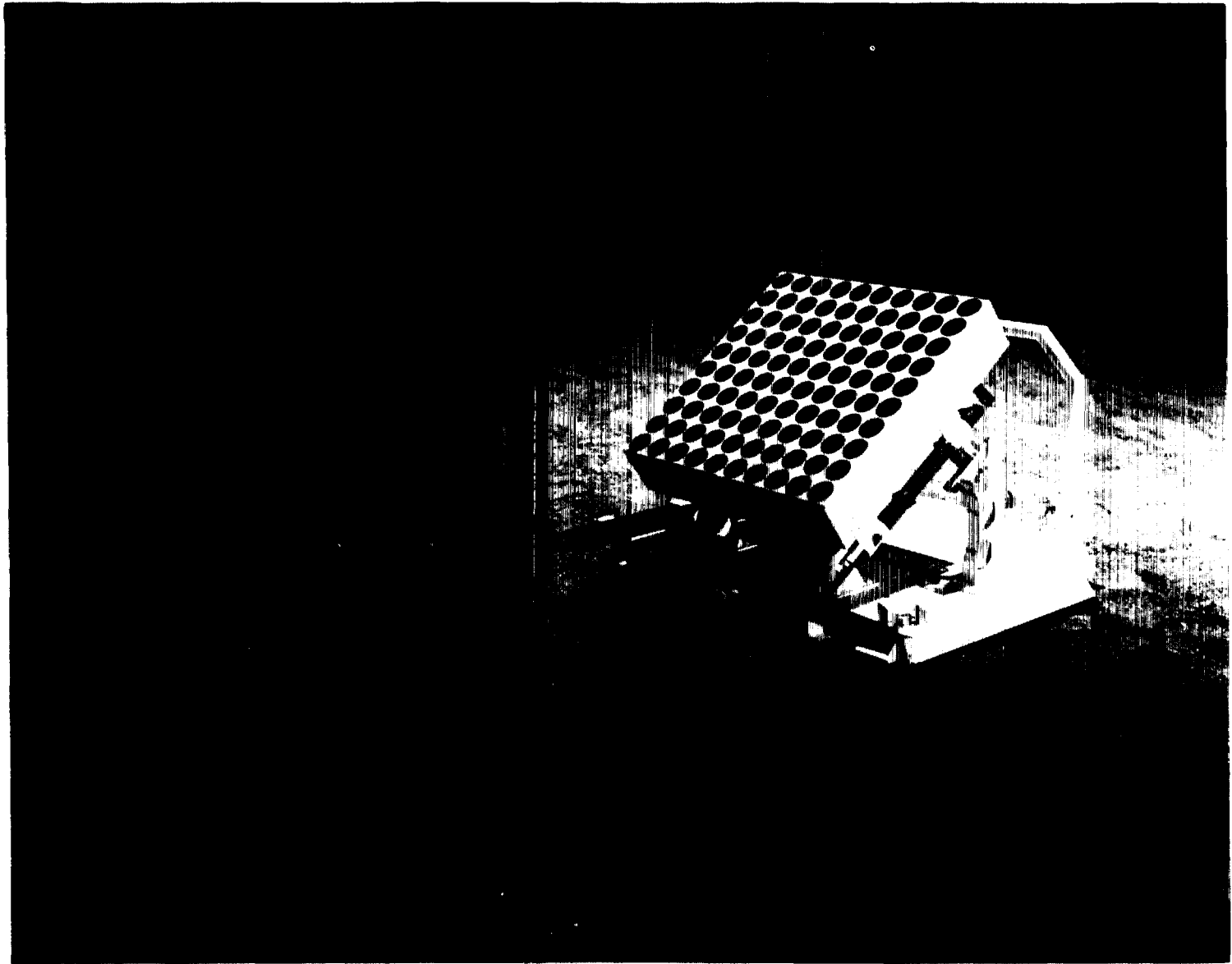

Figure B-3.- Laser reflector experiment deployment.

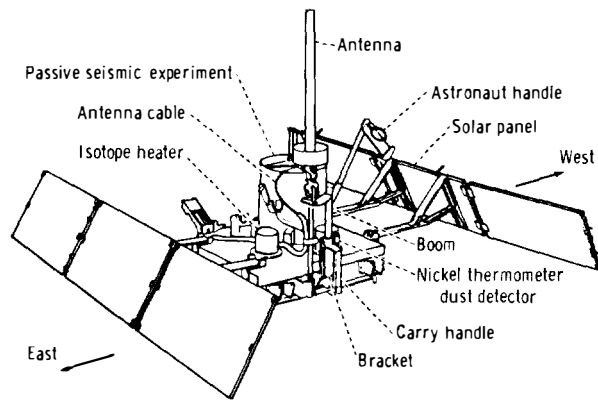

Figure B-4.- Passive seismic experiment package deployed configuration showing dust detector geometry.

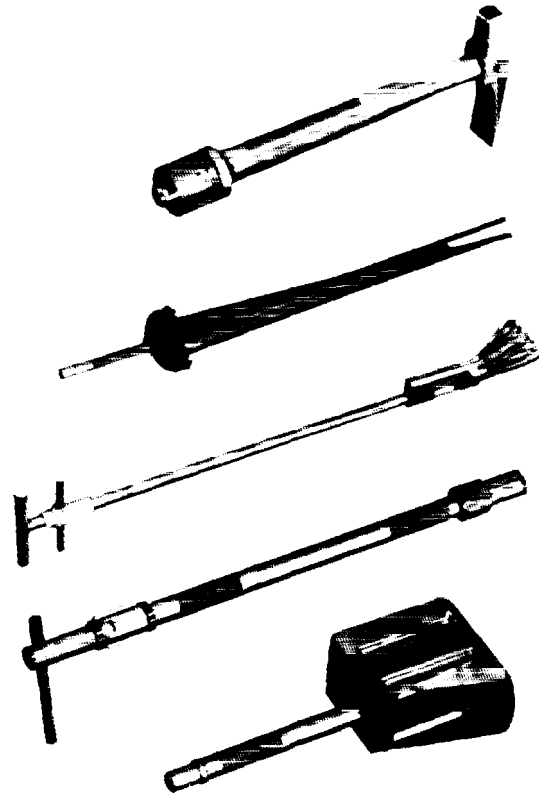

Figure B-5.- Geologic sampling handtools.

APPENDIX C

GLOSSARY

The following terms are used in section 11.

ablation	removal; wearing away
albedo	ratio of light reflected to light incident on a surface
basalt	generally, any fine-grained dark-colored igneous rock
breccia	see microbreccia
clast	rock composed of fragmental material of specified types
diabase	fine-grained, igneous rock of the composition of a gabbro, but having lath-shaped plagioclase crystals enclosed wholly or in part in later formed augite
ejecta	material thrown out (as from a volcano)
euhedral	having crystals whose growth has not been interfered with
exfoliation	process of breaking loose thin concentric shells or flakes from a rock surface
feldspar	any of a group of white, nearly white, flesh-red, bluish, or greenish minerals that are aluminum silicates with potassium, sodium, calcium, or barium
feldspathic	pertaining to feldspar
gabbro	medium- or coarse-grained basic igneous rock, forming intrusive bodies of medium or large size and consisting chiefly of plagioclase and pyroxene
gal	unit of acceleration equivalent to 1 cm/sec^2
gnomon	instrument used for size and color comparison with known standards
igneous	formed by solidification from a molten or partially molten state
induration	hardening
lithic	stonelike
microbreccia	rock consisting of small sharp fragments embedded in any fine-grained matrix
morphologic	study of form and structure in physical geography
olivine	mineral; a magnesium-iron silicate commonly found in basic igneous rocks
peridotites	any of a group of granitoid igneous rocks composed of olivine and usually other ferromagnesian minerals, but with little or no feldspar

plagioclase	triclinic feldspar
platy	consisting of plates or flaky layers
pyroxene	family of important rock-forming silicates
pyroxenites	igneous rock, free from olivine, composed essentially of pyroxene
ray	any of the bright, whitish lines seen on the moon and appearing to radiate from lunar craters
regolith	surface soil
terra	earth
vesicle	small cavity in a mineral or rock, ordinarily produced by expansion of vapor in the molten mass

