

# APOLLO

## GUIDANCE, NAVIGATION AND CONTROL

Approved: A. Laats Date: 1/8/69  
A. LAATS, DIRECTOR, SYSTEM TEST  
APOLLO GUIDANCE AND NAVIGATION PROGRAM

Approved: G. W. Cherry Date: 1/16/69  
G. CHERRY, LUMINARY PROJECT MANAGER  
APOLLO GUIDANCE AND NAVIGATION PROGRAM

Approved: R. H. Battin Date: 1/14/69  
R. H. BATTIN, DIRECTOR, MISSION DEVELOPMENT  
APOLLO GUIDANCE AND NAVIGATION PROGRAM

Approved: D. G. Hoag Date: 15 Jan 69  
D. G. HOAG, DIRECTOR  
APOLLO GUIDANCE AND NAVIGATION PROGRAM

Approved: R. R. Ragan Date: 15 Jan 69  
R. R. RAGAN, DEPUTY DIRECTOR  
INSTRUMENTATION LABORATORY

R-557

GUIDANCE SYSTEM OPERATIONS PLAN  
FOR MANNED LM EARTH ORBITAL MISSIONS  
USING PROGRAM SUNDANCE 306, AND  
PROGRAM LUMINARY 069

SECTION 1 PRELAUNCH  
(Rev. 1)

DECEMBER 1968

**MIT** INSTRUMENTATION  
LABORATORY  
CAMBRIDGE 39, MASSACHUSETTS

#### ACKNOWLEDGEMENT

This report was prepared under DSR Project 55-23870, sponsored by the Manned Spacecraft Center of the National Aeronautics and Space Administration through Contract NAS 9-4065 with the Instrumentation Laboratory, Massachusetts Institute of Technology, Cambridge, Mass.

R-557

GUIDANCE SYSTEM OPERATIONS PLAN  
FOR MANNED LM EARTH ORBITAL MISSIONS  
USING  
PROGRAM SUNDANCE  
SECTION 1 PRELAUNCH

Signatures appearing on this page designate approval of this document by NASA/MSC.

Approved:  Date: 8/12/68  
Thomas F. Gibson  
Asst. Chief, Flight Software Branch  
Manned Spacecraft Center, NASA

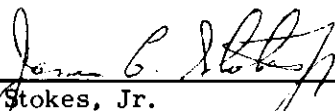
Approved:  Date: 8/12/68  
James C. Stokes, Jr.  
Chief, Flight Software Branch  
Manned Spacecraft Center, NASA

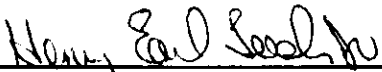
Approved:  Date: 8/12/68  
Lynwood C. Dunseith  
Chief, Flight Support Division  
Manned Spacecraft Center, NASA

Date: December 1968

REVISION INDEX COVER SHEET  
GUIDANCE SYSTEM OPERATION PLAN

GSOP #R-557 Title: For Manned LM Earth Orbital Missions Using  
Programs SUNDANCE (Rev 306), and LUMINARY (Rev 069)

Section #4 Title: Pre-launch (Rev. 1) December 1968

December

Date

Rev.

December 1968

1

Revision 1 incorporates the following NASA/MSC  
approved change and is published as a complete  
new document.

PCR 262 Section 1 Update

Rev. 1 of Section 1 of R-557 "Guidance System Operations Plan for Manned LM Earth Orbital Missions Using Program SUNDANCE (Revision 306) "Pre-launch" includes all of the material required to make the document completely applicable to those missions using Program LUMINARY (R-567). For this reason, no separate Section 1 for the LUMINARY GSOP will be published, and the SUNDANCE volume will be used in its place. If pre-launch test operations for LUMINARY (Rev 069) deviate from one-to-one correlation with those for SUNDANCE in the future, a LUMINARY Section 1 will be issued.



SUNDANCE (Rev 306)  
LUMINARY (Rev 069)  
Section 1 (Rev 1)

Table of Contents

- 1.1 Introduction
- 1.2 LGC Self Test
- 1.3 Performance Test Computations
  - 1.3.1 Gyro Drift Measurement
  - 1.3.2 Accelerometer Error Measurement
  - 1.3.3 Gyro Torquing Scale Factor Error Measurement
  - 1.3.4 AGS - IMU Alignment Check
- 1.4 Functional Description of System Performance Tests
  - 1.4.1 Gyro Drift and Accelerometer Error Test Description
  - 1.4.2 IRIG Scale Factor Test Description
  - 1.4.3 AGS - IMU Alignment Check Description
- 1.5 Performance Test Data Analysis
  - 1.5.1 IRIG Scale Factor Data
  - 1.5.2 Gyro Drift Data
  - 1.5.3 Accelerometer Scale Factor Error and Bias Error Data
  - 1.5.4 AGS Alignment





## 1.0 PRELAUNCH TEST PROGRAMS

1.1 The Guidance System Operations Plan is published as six separate volumes (sections) as listed below:

Section 1	Pre-Launch Test Programs
Section 2	Data Links
Section 3	Digital Auto-Pilots
Section 4	Operational Modes
Section 5	Guidance Equations
Section 6	Control Data

The purpose of this section is to present the program requirements and descriptions for the prelaunch calibration and test operations for a manned LM Apollo Earth Orbital or Lunar Missions.

These routines utilize the uplink capability (described in Section 2) of the LGC to load either variables or instructions for utilization or execution during the running of the tests.

The results of the gyro drift and accelerometer parameter tests are used to determine or confirm the IMU compensation parameters used for the mission. The compensation parameters will be loaded prior to launch and used during the mission to reduce the IMU alignment and specific force measurement errors.

This volume constitutes a control document to govern the test methods and data analysis equations to be used for prelaunch calibration and test.

Revisions to this plan which reflect changes in the above control items require NASA approval.

## 1.2 LGC SELF-CHECK and SHOW-BANKSUM

The version of AGC Block II SELF-CHECK found in the program SUNDANCE has been reduced to include only the erasable memory check, the fixed memory check and the SHOW-BANKSUM job.

### 1.2.1 Options Available in SELF-CHECK

The different options of SELF-CHECK are controlled by loading the appropriate numbers into the SMODE register. Placing a +0 into the SMODE register forces the computer to go into the backup idle loop where it continuously looks for a new job. Loading SMODE with  $\pm 11$  octal or greater causes SMODE to be changed to +0 and puts the computer into the backup idle loop. Loading SMODE with any other number less than  $\pm 11$  octal starts up one of the active SELF-CHECK options. These option numbers are as follows:

- $\pm 4$  octal checks erasable memory
- $\pm 5$  octal checks fixed memory
- $\pm 10$  octal performs both previous options
- $\pm 1, \pm 2, \pm 3, \pm 6, \pm 7$  same as  $\pm 10$  option
- 0 same as  $\pm 10$  until an error is detected.

The SMODE register is set to +0 by any FRESH START.

### 1.2.2 Procedure to Start SELF-CHECK

Noun 27 is assigned to the SMODE register, so to activate SELF-CHECK use the DSKY as follows:

V21N27E (option number) E

This loads the desired option number into SMODE, and starts that option.

### 1.2.3 SHOW-BANKSUM Operating Procedures

The SHOW-BANKSUM routine shows the sum of the bank in R1 of the DSKY (equal to plus or minus the bank number), the bank number in R2 of the DSKY, and the "bugger" word in R3 of the DSKY. The operating procedure consists of three steps: it is important to perform the last step to end this particular job.

#### Procedure to START SHOW-BANKSUM

This routine has its own Verb (91) so it is very easy to start. The

information for bank 00 appears in R1, R2, R3 of the DSKY immediately after starting SHOW-BANKSUM. Verb 05 Noun 01 is used to display this information. Starting SHOW-BANKSUM puts +0 in the SMODE register. This forces SELF-CHECK to go into the backup idle loop.

#### STARTING PROCEDURE V91E

(The computer must be in Programs 00, or a V36E should precede V91E.)

#### Procedure to Display Next Bank

The "proceed" verb is utilized to display the sum of the rest of the banks. Each time the proceed verb is entered from the DSKY, the information for the next higher bank appears in R1, R2, and R3 of the DSKY. If another "proceed verb enter" is performed after the last bank in a particular rope has been observed, the information for bank 00 will be displayed again. Continued proceed verb entries will allow you to observe all the banks a second time.

#### CONTINUE PROCEDURE V33E or PRO

#### Procedure to Stop BANK-SHOWSUM

The operator must punch in the "terminate" verb when he is through with SHOW-BANKSUM. This terminates the SHOW-BANKSUM routine in the EXECUTIVE.

#### TERMINATE PROCEDURE V34E

#### 1.2.4 Control of SELF-CHECK options (Figure 1.2.4-1)

The program starts at the entry point SELFCHK after which it stores the address of the ERASCHK routine in register SKEEP1. A check for a new job is made and if no job is waiting, proceed to test register SMODE. If the contents of SMODE is +0, idle by looping through the check for a new job or, if greater than  $\pm 10$  octal, change SMODE to +0 and idle. For any other contents of SMODE increment the SCOUNT register and test SMODE again, following with either A, B, or C below.

A. If the contents of SMODE is  $\pm 4$  perform ERASCHK, the check of erasable memory diagramed in Figure 1.2.6-1, CNTRCHK, the check of all counters and other special erasable registers (Figure 1.2.6-2), and CYCLSHFT, the check of the cycle and shift registers in Figure 1.2.6-3. Then increment SCOUNT+1 register, store the address of the ROPECHK routine in register SKEEP1 and check for a new job starting the erasable memory test option again. Normally the program continues to cycle as above until the content of SMODE is changed by DSKY or until an error is detected.

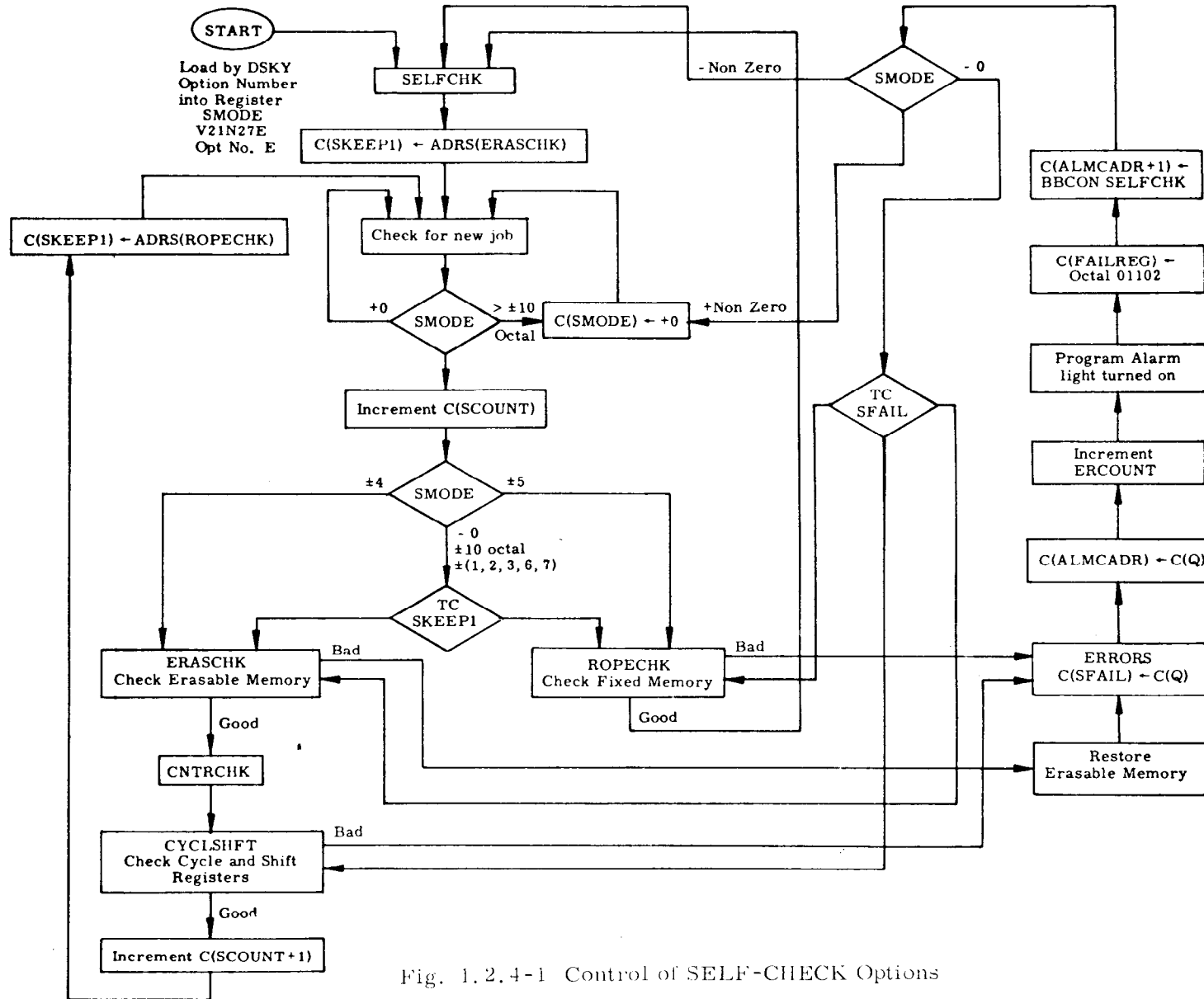

Fig. 1.2.4-1 Control of SELF-CHECK Options

- B. If the contents of SMODE is  $\pm 5$  perform ROPECHK, the check of fixed memory in Figure 1.2.7-1. The program then cycles back through the starting point SELFCHK and continues to cycle in a manner similar to that of option  $\pm 4$ , as described in the preceding paragraph.
- C. If the contents of SMODE is  $-0, \pm 10$  octal,  $\pm 1, \pm 2, \pm 3, \pm 6$ , or  $\pm 7$  branch to the routine indicated by the address in register SKEEP1. For the first pass this would be the address of ERASCHK. Complete the ERASCHK, CNTRCHK, CYCLSHFT loop. At the start of the second pass, the content of SKEEP1 has been changed to the address of ROPECHK. Therefore, after the second test in the loop of SMODE, the branch (TC SKEEP1) is to ROPECHK. At the end of ROPECHK the program loops through SELFCHK changing SKEEP1 to the address of ERASCHK for the third pass. This alternate cycling of ERASCHK and ROPECHK continues indefinitely until the content of SMODE is changed by DSKY or an error is detected. In the event that an error is detected, the program stores in register SFAIL the address of the location following the location in SELF-CHECK that detected the error. This address is also stored in the register ALMCADR for the ALARM routine. If ERASCHK is running, the program will also restore the contents of the erasable registers under test. The register ERCOUNT (set to +0 by DSKY FRESH START) is incremented and the ALARM routine is called. The ALARM routine turns on the program alarm light and loads into register FAILREG the alarm code for SELF-CHECK (octal 01102). The BBCON of SELF-CHECK is loaded into register ALMCADR +1 and returns control to the SELF-CHECK program. The contents of SMODE is then tested, followed by D, E or F.
- D. If SMODE is + Non-Zero, change the contents to +0 which puts the computer into the backup idle loop.
- E. If SMODE is - Non-Zero, start the option again from the beginning (at entry point SELFCHK).
- F. If SMODE is  $-0$ , branch on the contents of SFAIL to the location in SELF-CHECK immediately following the location where the error was detected and proceed with the option from that point.
- G. Alarm Display: A SELF-CHECK error initiates program alarm by calling subroutine ALARM2 with  $C(A) = C(Q) = C(ALMCADR) = (SFAIL)$  and ERCOUNT incremented by one. The alarm code for self check error is  $01102_8$ .

H. In the event that the check for a new job finds one waiting, the job will be executed and at the conclusion will return control to SELF-CHECK. Since SELF-CHECK is run as part of the backup idle loop it cannot run as long as there are any active jobs.

#### 1.2.5 Explanation of SHOW-BANKSUM (Figure 1.2.5-1)

SHOW-BANKSUM consists of a routine called SHOWSUM. This routine essentially does the same thing that the routine ROPECHK does; that is, add up the sum of separate banks in the rope. After this the similarity ends. ROPECHK makes sure the sum of the bank is plus or minus its own bank number while SHOWSUM displays the sum of the bank in R1 of the DSKY irrespective of what the sum may be. SHOWSUM also displays the bank number and the bugger word in R2 and R3 of the DSKY at the same time. The sum of the bank and bank number in R1 and R2 are shown as the least significant bit instead of bits 11-15 (the actual bank bits in the computer).

Undoubtedly the greatest use of this routine will be in restoring the confidence of personnel in the computer and in verifying that the correct rope modules for a particular mission are actually the ones in the computer package. Following is a short description of the SHOWSUM subroutine.

Each bank in the rope is summed separately; from the lowest address to the highest address used in that bank. The contents of a higher address are added to the sum of the previous addresses. If this creates an overflow condition, a +1 is added to the new sum; a -1 is added to the new sum if an underflow condition is created. The sum of each bank should be plus or minus its own bank number. The sum of the bank is displayed in R1 of the DSKY. The bank number (actual bank number used to sum the bank cycled 5 places left) is displayed in R2 and the bugger word is displayed in R3. Entering a proceed verb (33) from the DSKY will display the same information for the next higher bank. Entering a terminate verb (34) from the DSKY will end the SHOWSUM routine.

#### 1.2.6 ERASCHK (Figure 1.2.6-1)

This part of SELF-CHECK makes sure that it is possible to read a "1" and a "0" into and out of each bit position of erasable memory.

The RESTART program tests the contents of ERESTORE (the ERASCHK activity indicator) before proceeding with RESTART. The contents of ERESTORE (set to +0 any FRESH START) should be equal to the contents of SKEEP7 (address of the first of the pair of registers under check by ERASCHK)

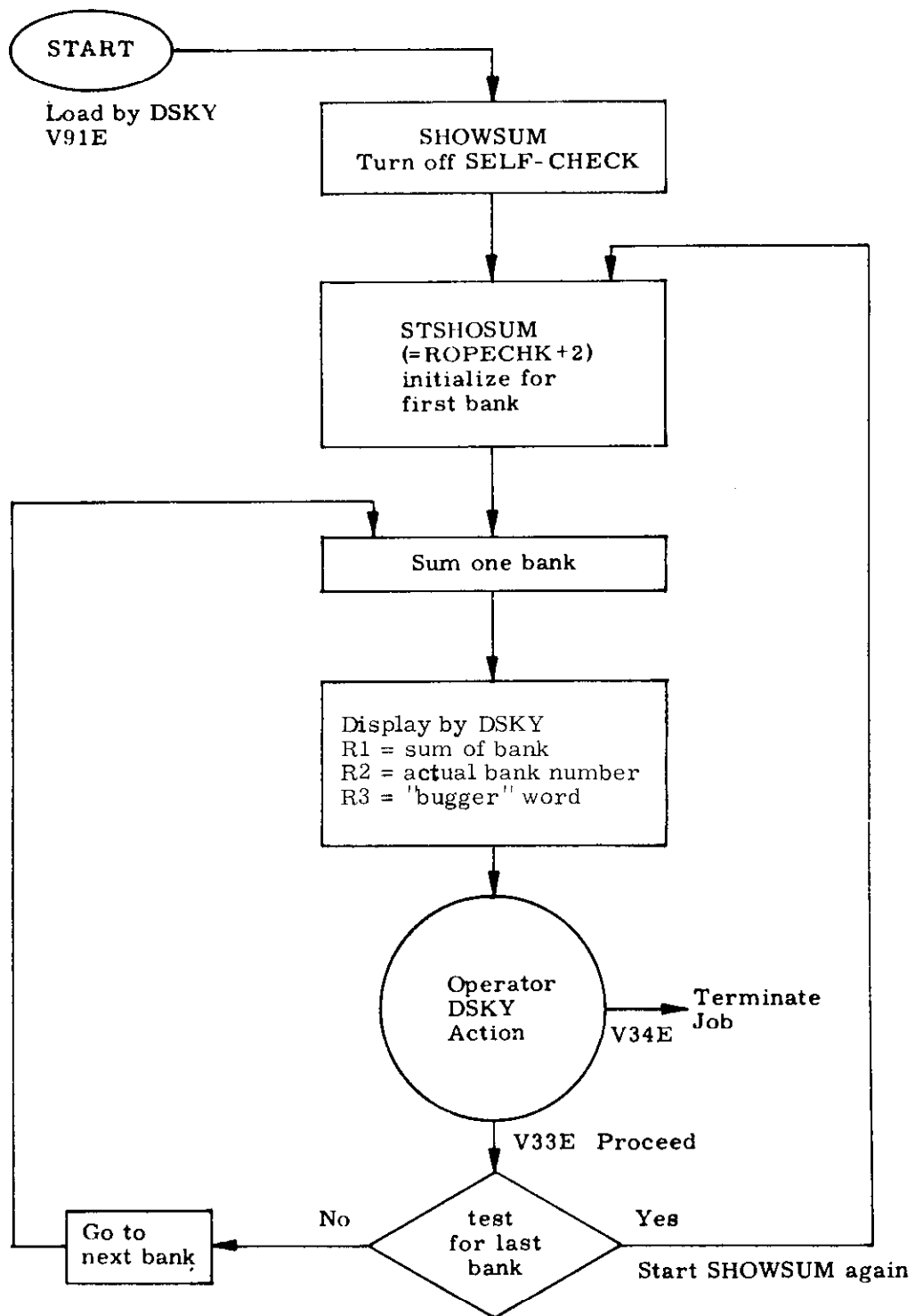

Fig. 1. 2. 5-1 Control of SHOW-BANKSUM

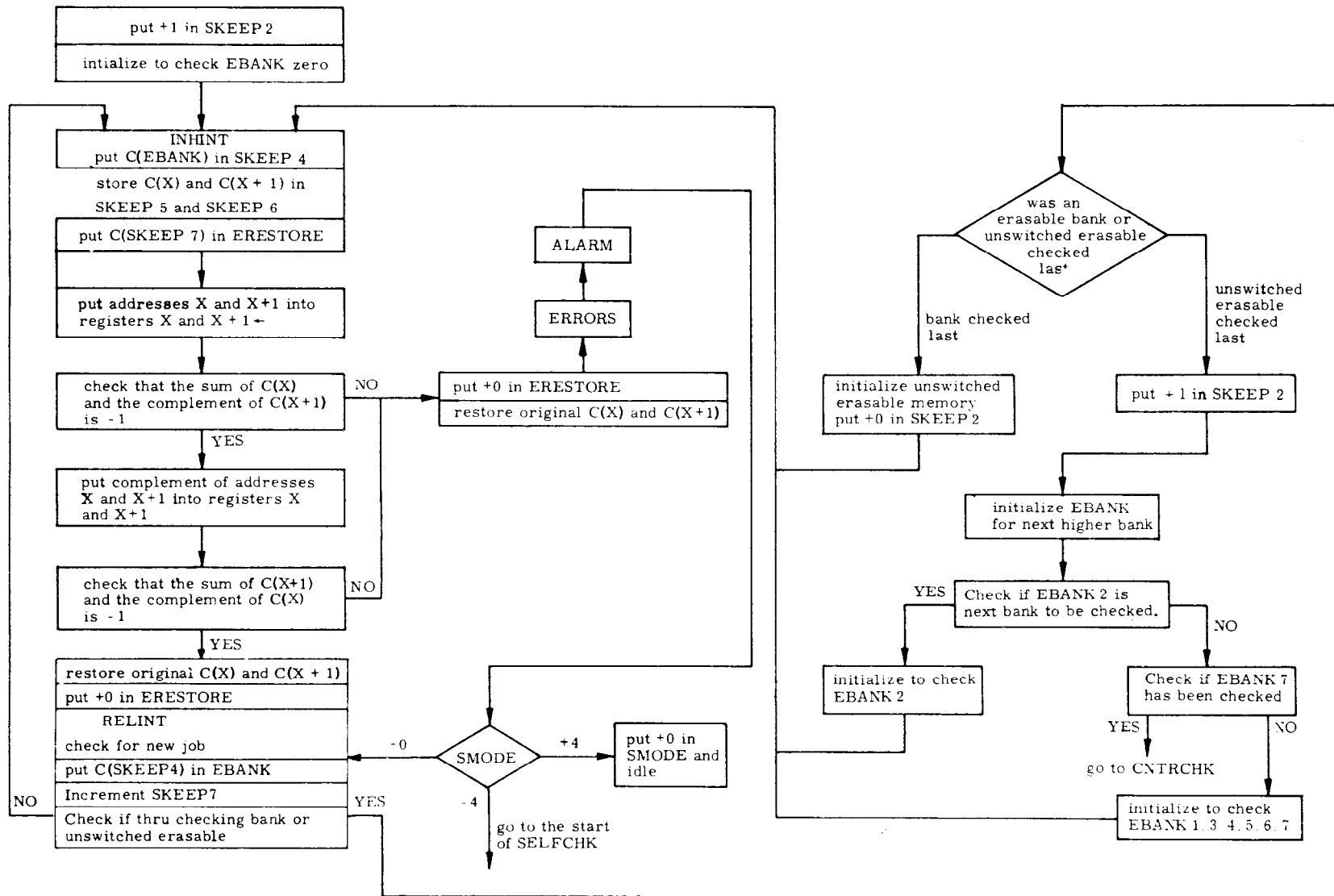

Fig. 1.2.6-1



or equal to positive zero if no pair of registers are being checked. If the test determines that the contents of ERESTORE is not "a positive number less than 2000 octal and equal to the contents of SKEEP7", the program switches to DOFSTART (programmed FRESH START). The reason for the DOFSTART is that the improper contents of register ERESTORE causes one to doubt the contents of erasable memory. (The exception occurs when ERESTORE itself is being tested.)

If the contents of ERESTORE are positive zero, do not restore erasable, proceed with RESTART. If the contents of ERESTORE are positive, less than 2000 octal, and equal to the contents of SKEEP7, then the original contents of the pair of registers under check are restored to those registers, ERESTORE is set to positive zero and the program proceeds with the RESTART.

The non-special erasable registers are checked for correct addressing and content by placing their own address in two successive registers and making sure there is a difference of -1 when the contents of the lower address register is added to the complement of the higher address register; if it is not, this subroutine branches to the PRERORS subroutine.

The previous contents of the erasable registers had been preserved and are restored to the two registers by PRERORS which then performs a TC to the ERRORS subroutine.

If the difference is -1, the contents of the two registers are complemented and the complement of the lower register added to the contents of the higher register; the result is checked for -1. If the result is not -1, TC to PRERORS as noted above. If the result is -1, restore the previous contents to the two registers, and proceed to the next iteration. The higher address register of the past iteration becomes the lower address register of the next iteration. The erasable memory banks are checked from zero through seven with common erasable (60-1373) being checked after each erasable bank.

#### CNTRCHK (Figure 1.2.6-2)

The CS instruction is performed on all erasable registers from octal 60 through octal 10. These include all counters and other special erasable registers. It is not feasible to put their own address in these registers and check their contents because of their special use.

#### CYCLSHFT (Figure 1.2.6-3)

The octal number 25252 is placed in the two cycle registers, the shift right register, and the EDOP register. The contents of these registers are then twice checked for correct contents.

CNTRCHK

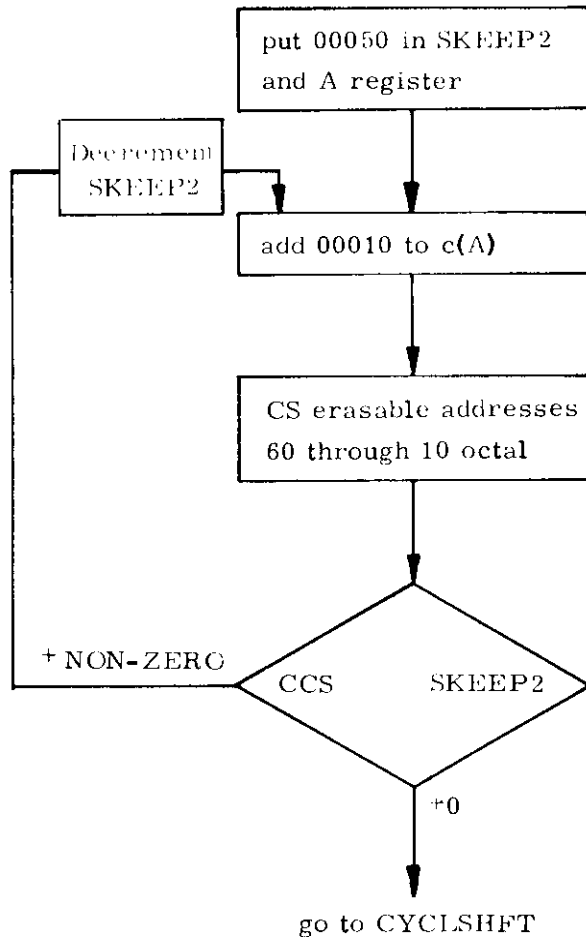

Fig. 1.2.6-2 CNTRCHK

CYCLSHFT

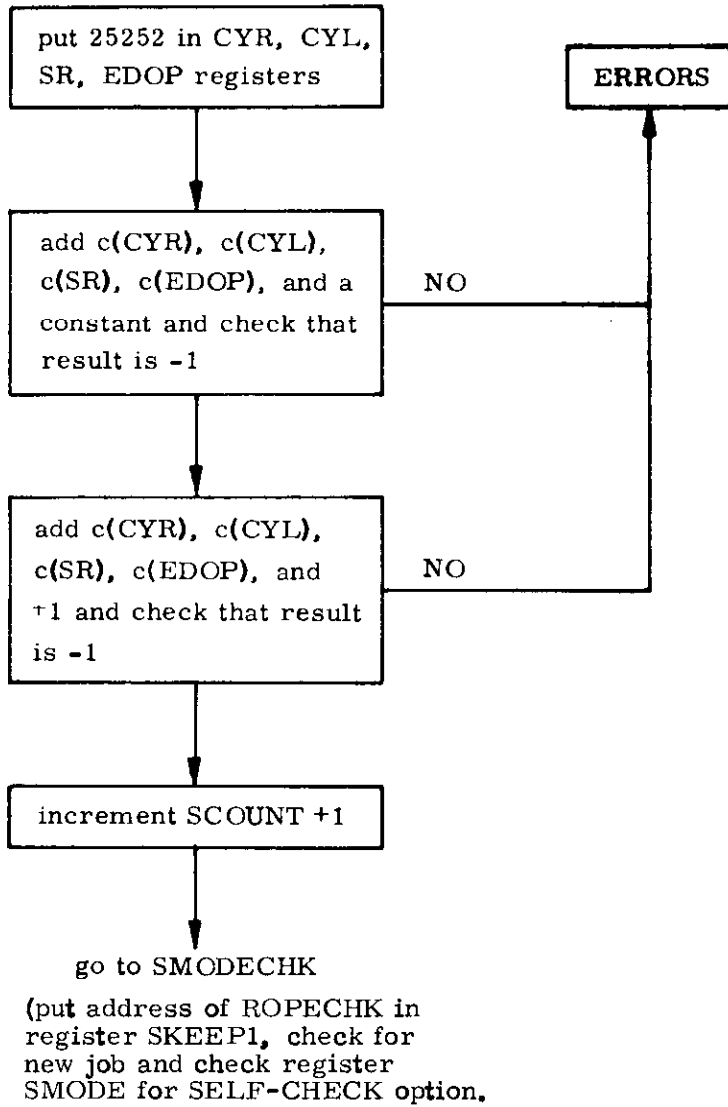

Fig. 1.2.6-3 CYCLSHFT

### 1.2.7 Check of Rope Memory (Figure 1.2.7-1)

The routine for checking the correct contents of a rope is called ROPECHK. Its purpose is twofold. First, it is a check on the computer. It makes sure all current drivers, sense amplifiers, and associated circuitry used in connection with the fixed memory are operating properly. Secondly, it is a check on the rope itself. It makes sure none of the sense or inhibit lines have become shorted or opened (essentially guarantees content of rope is correct and can be read correctly by the computer).

The sum of each bank should be the same as its bank number in the low order bits of the computer. A special word, which is called a "bugger" word, is added to the normal sum of the bank as the last word to be added. This "bugger" word forces the sum of the bank to be plus or minus the Bank Number. As an example, the sum of bank 33 octal may be 00033 or 77744. Two TC SELF words indicate the end of the summing process for each bank unless the bank is full. The "bugger" word immediately follows the second TC SELF word. If the bank is full, the "bugger" word is in the last address, and the two TC SELF words are not necessary to indicate the end of the summing process for that bank. Of course, all addresses in a bank up to and including the "bugger" word have to contain words of good parity. Following is a short description of the ROPECHK routine.

Each bank in the rope is summed separately; from the lowest address to the highest address used in that bank. The content of a higher address is added to the sum of the previous addresses. If this creates an overflow condition, a +1 is added to the new sum; a -1 is added to the new sum if an underflow condition is created. The sum of each bank should be plus or minus its own bank number. If the sum of the bank is its bank number, the subroutine proceeds on to checking the next bank. If the sum of the bank is not its bank number, SELF-CHECK goes to the error routine. The banks are checked in ascending order.

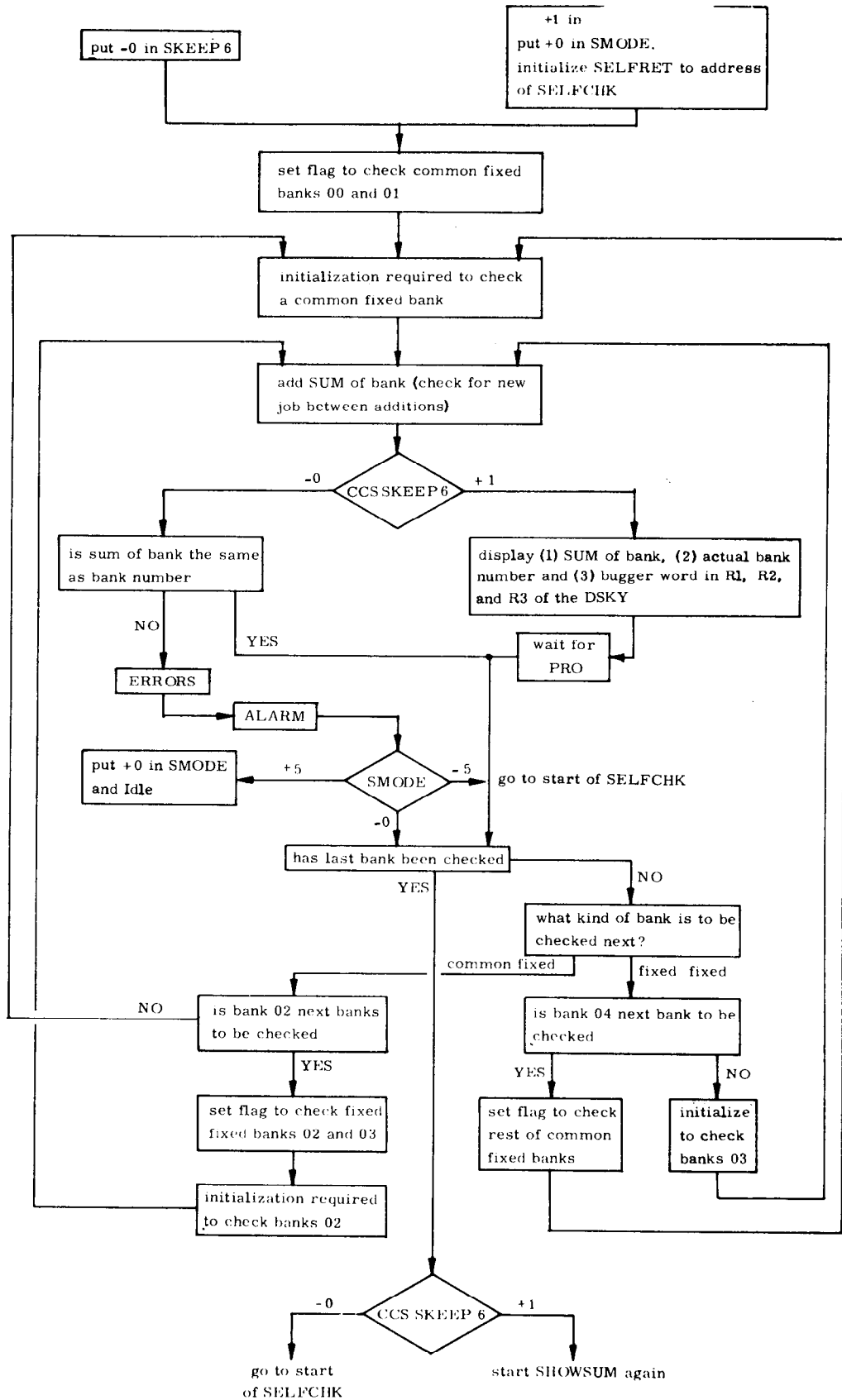

Fig. 1. 2. 7-1

## 1.3 Performance Test Computations

### 1.3.1 Gyro Drift Computation

The physical basis for gyro drift measurement during prelaunch operations is the detection of the vector rotation of the gravity reaction acceleration. The IMU accelerometers provide the necessary data. The data is corrupted by accelerations due to launch vehicle swaying motion and by quantization in the Pulsed Integrating Pendulous Accelerometer.

The effect of gyro drift on the vector rotation of gravity is small, therefore an optimum data processing method is required.

The data is processed by a simplified optimum filter which includes in its state vector estimates of the launch vehicle disturbances. The 13-dimensional state vector is described in Table I.

The simplified filter design recognizes that the gains for the optimum filter may be precomputed, since the measurement times will be the same for all trials and the a priori assumptions for the statistics of the initial state vector will not change.

The filter gains are precomputed by operating on a digital simulation of the system with a complete linear optimum filter. The gain functions are reconstructed piecewise in the LGC during the operation of the filter process using data loaded into the LGC erasable memory. The operation of the simplified optimum filter is depicted in Figure 1.3.1-1.

Figure 1.3.1.1 is a block diagram representing the following computations:

#### A. Measurement

The accelerometers are sampled every second. The sampled accelerometer outputs are transformed to the vertical, north and east reference coordinate system.

$$\begin{bmatrix} \Delta V_x \\ \Delta V_y \\ \Delta V_z \end{bmatrix}^T \begin{bmatrix} XSM \end{bmatrix}^T = 1/2 \begin{bmatrix} \Delta V_v \\ \Delta V_s \\ \Delta V_e \end{bmatrix}^T$$

Where  $\begin{bmatrix} XSM \end{bmatrix}$  is the transformation matrix from vertical, south, east earth reference to stable member coordinates.

The sign of the  $\Delta V_S$  is changed by  $\Delta V_S = - \Delta V_S$ .

The measurements are used to update estimates of south and east velocity. It is corrected for the effects of wind disturbance.

$$\begin{aligned}
po_s &= \hat{po}_s - C_1 \Delta V_s (2^9) & C_1 &= 0.13055869 \\
po_e &= \hat{po}_e - C_1 \Delta V_e (2^9) \\
\Delta M_1 &= 4(C_2 v_s) - po_s & C_2 &= -0.52223476 \\
\Delta M_2 &= 4(C_2 v_e) - po_e
\end{aligned}$$

### B. Filter gains

The filter gains are pre-determined in the design process of the simplified filter. The gains are updated every second. The following gains are used.

1.  $K_1$  multiplies the total pulse counts from the accelerometers ( $po$ ).
2.  $K_2$  multiplies the estimated east axis leveling angle ( $\gamma$ ).
3.  $K_3$  multiplies the estimated aximuth axis angle ( $\alpha$ ).
4.  $K_4$  multiplies the estimated vertical gyro drift ( $dx$ ).
5.  $K_5$  multiplies the estimated north-south gyro drift ( $dy$ ).
6.  $K_6$  Zero.
7.  $K_7$  wind induced sway velocity gain.
8.  $K_8$  wind induced sway accelerometer gain.

For the first 30 seconds  $K_1$  and  $K_2$  have the form  $Ae^{-t/\gamma}$  (see figure 1.3.1-2 and 1.3.1-3).

$$K_1 = 0.935e^{-0.0912t}$$

$$K_2 = 0.262e^{-0.208t}$$

The gains are modified at each sample as follows:

$$K_1 a_1 = K_1 \quad [K_1(0) = .93505870]$$

$$K_2 a_2 = K_2 \quad [K_2(0) = .26266423]$$

$K_3, K_4, K_5, K_6$  are zero initially, then modified as follows:

$$K_3 + a_3 = K_3$$

$$K_4 + a_4 = K_4$$

$$K_5 + a_5 = K_5$$

$$K_6 + a_6 = K_6$$

The values of  $a_1 - a_5$  are applicable over specified intervals. The values of  $a_1 - a_5$  and their applicable intervals are tabulated in Table 2.  $a_6$  is zero.

$$K_7 = 0.17329931$$

$$K_8 = -0.00835370$$

C. State vector update

The state vector variables are updated as follows:

$$\begin{aligned}\alpha + \Delta M_1 (K_3) &= \alpha \\ \beta + \Delta M_1 (K_2) &= \beta \\ \gamma + \Delta M_2 (K_2) &= \gamma \\ po_s + \Delta M_1 (K_1) &= po_s \\ po_e + \Delta M_2 (K_1) &= po_e \\ v_s + \Delta M_1 (2K_7) &= v_s \\ v_e + \Delta M_2 (2K_7) &= v_e \\ p_s &\left\{ \begin{array}{l} \text{These parameters are updated during} \\ \text{launch vehicle parameter extrapolation} \end{array} \right. \\ p_e & \\ a_s + \Delta M_1 (2K_8) &= a_s \\ a_e + \Delta M_2 (2K_8) &= a_e \\ d_y + \Delta M_2 (K_5) &= d_y \\ d_x + \Delta M_1 (K_4) &= d_x\end{aligned}$$

D. Extrapolation of launch vehicle parameters.

The launch vehicle parameters are extrapolated for the next measurement using the following equations:

$$\begin{aligned}p(tn+1) &= [C_1 p(tn) + C_2 v(tn) + C_3 a(tn)]^2 \\ v(tn+1) &= [C_4 p(tn) + C_5 v(tn) + C_6 a(tn)]^2 \\ a(tn+1) &= [C_7 p(tn) + C_8 v(tn) + C_9 a(tn)]^2\end{aligned}$$

Where the coefficients C of the transition matrix are:

$$\begin{aligned}C_1 &= 0.47408845 \\ C_2 &= 0.23125894 \\ C_3 &= 0.14561689 \\ C_4 &= -0.06360691 \\ C_5 &= -0.16806746 \\ C_6 &= 0.15582939 \\ C_7 &= -0.06806784 \\ C_8 &= -0.75079894 \\ C_9 &= -0.24878704\end{aligned}$$



- E. Calculation of the sines and cosines of alignment angles for extrapolation of platform variables.

This simply involves computation of the sine and cosine of the various angles using the interpretive trigonometric routines in the CMC program.

The following functions are evaluated:

$$\begin{aligned} \sin \alpha, & \quad \cos \alpha \\ \sin \beta, & \quad \cos \beta \\ \sin \gamma, & \quad \cos \gamma \end{aligned}$$

- F. Extrapolation of stable member variables.

The Euler angles for aligning the stable member to the reference coordinates are computed as follows:

$$\overline{W}_{SM} = \begin{vmatrix} dx \\ dy \\ dz \end{vmatrix} + \left| Y_{SM} \right| \overline{W}_e \quad (\overline{W}_{SM} \text{ is the angular velocity of the stable member})$$

$$\left| Y_{SM} \right| = \begin{vmatrix} \cos \beta & 0 & -\sin \beta \\ 0 & 1 & 0 \\ \sin \beta & 0 & \cos \beta \end{vmatrix} \begin{vmatrix} \cos \gamma & \sin \gamma & 0 \\ -\sin \gamma & \cos \gamma & 0 \\ 0 & 0 & 1 \end{vmatrix} \begin{vmatrix} 1 & 1 & 0 \\ 0 & \cos \alpha & \sin \alpha \\ 0 & -\sin \alpha & \cos \alpha \end{vmatrix}$$

for vertical drift measurement

$$W_{SM_y} = W_{SM_y} + W_{e_y}$$

$$\begin{vmatrix} \dot{\alpha} \\ \dot{\beta} \\ \dot{\gamma} \end{vmatrix} = \begin{vmatrix} \frac{\cos \beta}{\cos \gamma} & 0 & \frac{\sin \beta}{\cos \gamma} \\ \frac{\sin \gamma \cos \beta}{\cos \gamma} & 1 & \frac{\sin \gamma \cos \beta}{\cos \gamma} \\ -\sin \beta & 0 & \cos \beta \end{vmatrix} \overline{W}_{SM}$$

$$\begin{vmatrix} \alpha \\ \beta \\ \gamma \end{vmatrix} = \begin{vmatrix} \alpha \\ \beta \\ \gamma \end{vmatrix} + \left( \begin{vmatrix} \dot{\alpha} \\ \dot{\beta} \\ \dot{\gamma} \end{vmatrix} \Delta T \right) \frac{.59737013}{4096} \text{ (radians)}$$

- G. Computation of estimates of velocity to be measured.

This computation adds to the previous value of south and east velocity the component of velocity expected due to the rotation with respect to gravity.

$$\begin{aligned}\hat{p}o_s &= \hat{p}o_s + \sin\gamma g \\ \hat{p}o_e &= \hat{p}o_e + \sin\beta \cos\gamma g\end{aligned}$$

Revised

SUNDANCE

Added

GSOP #R-557 PCR 262

Rev. 1

Date 12/68

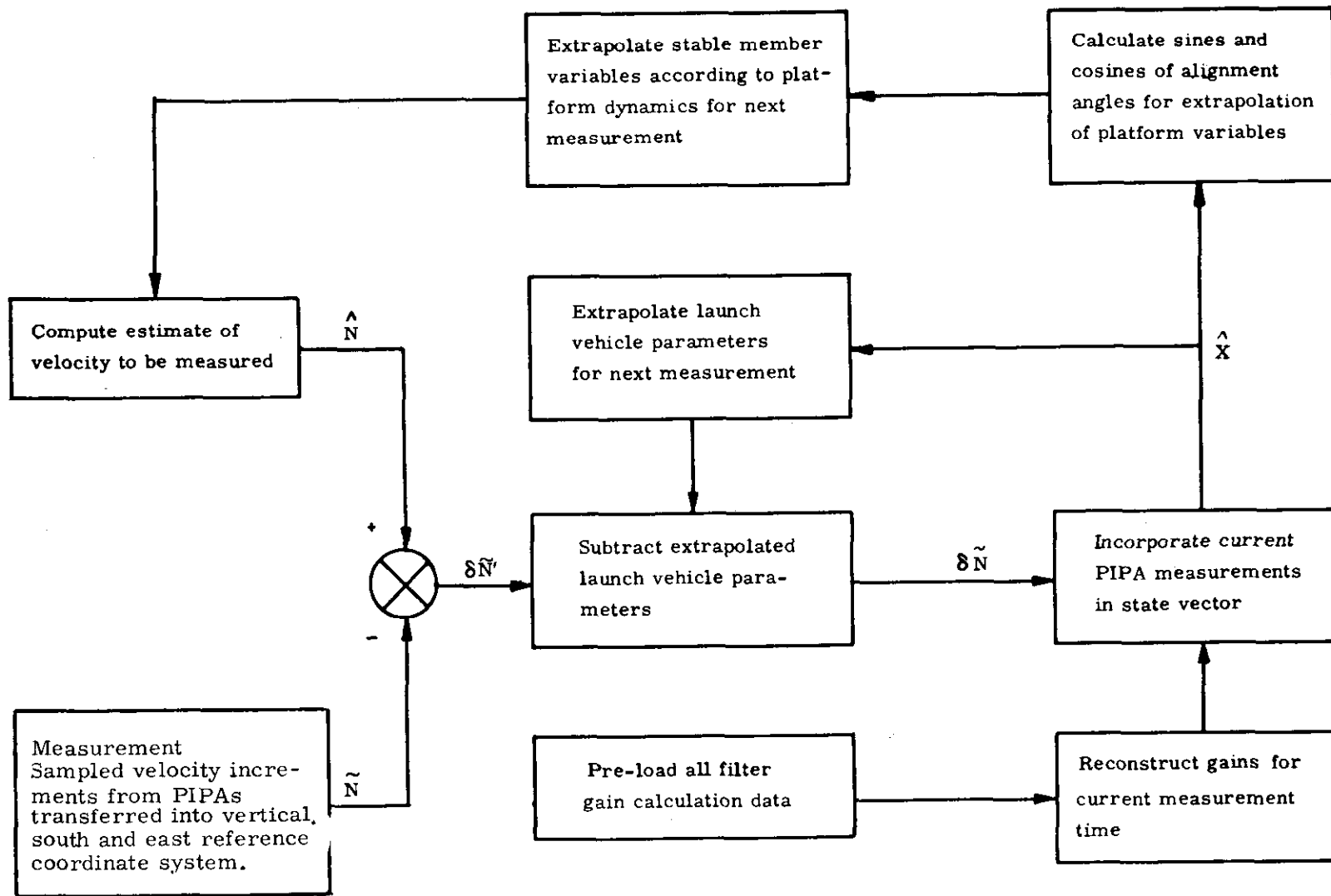

Fig. 1.3.1-1 Operation of the Simplified Optimum Filter

TABLE 1

Prelaunch Calibration State Vector Components

1. Azimuth Alignment Angle ( $\alpha$ )
2. South Axis Leveling Angle ( $\beta$ )
3. East Axis Leveling Angle ( $\gamma$ )
4. South PIPA Velocity Increment ( $po_s$ )
5. East PIPA Velocity Increment ( $po_e$ )
6. Launch Vehicle Velocity; North-South ( $v_s$ )
7. Launch Vehicle Velocity; East-West ( $v_c$ )
8. Launch Vehicle Displacement; North-South ( $p_s$ )
9. Launch Vehicle Displacement; East-West ( $p_e$ )
10. Launch Vehicle Acceleration; North-South ( $a_s$ )
11. Launch Vehicle Acceleration; East-West ( $a_e$ )
12. South Gyro Drift ( $dy$ )
13. Vertical Gyro Drift ( $dx$ )

TIME (seconds)	$a_1$ (Time Constant PIPA Counts)	$a_2$ (Time Constant Leveling Angles)	$a_3$ (Slope Azimuth Angle)	$a_4$ (Slope Vertical Drift)	$a_5$ (Slope North-South Drift)
0-30	0.91230833	0.81193187	-0.00035882	-0.00000029	0.00013262
31-90	0.99122133	0.98940595	-0.00079010	-0.00000265	0.00043154
91-100	0.99971021	0.99852047	0.00042697	-0.00000213	0.00011864
101-200	0.00550063	0.98992124	0.00043452	-0.00000401	-0.00021980
201-450	0.99673264	0.99365467	0.00003767	-0.00002317	-0.00003305
451-790	0.99924362	0.99888274	0.00000064	-0.00004012	-0.00000195
791-1200	0.99963845	0.99913162	0.00000090	-0.00002927	-0.00000026
1201-1700	0.99934865	0.99868793	0.00000055	0.00001183	-0.00000005
1701-2100	0.99947099	0.99894799	0.00000018	0.00000300	-0.00000001
2101-2700	0.99957801	0.99916095	0.00000007	0.00000096	0
2701-3400	0.99966814	0.99933952	0.00000002	0.00000028	0
3401-4000	0.99972716	0.99945654	0.00000001	0.00000010	0

Table 2 Time Constants and Slopes

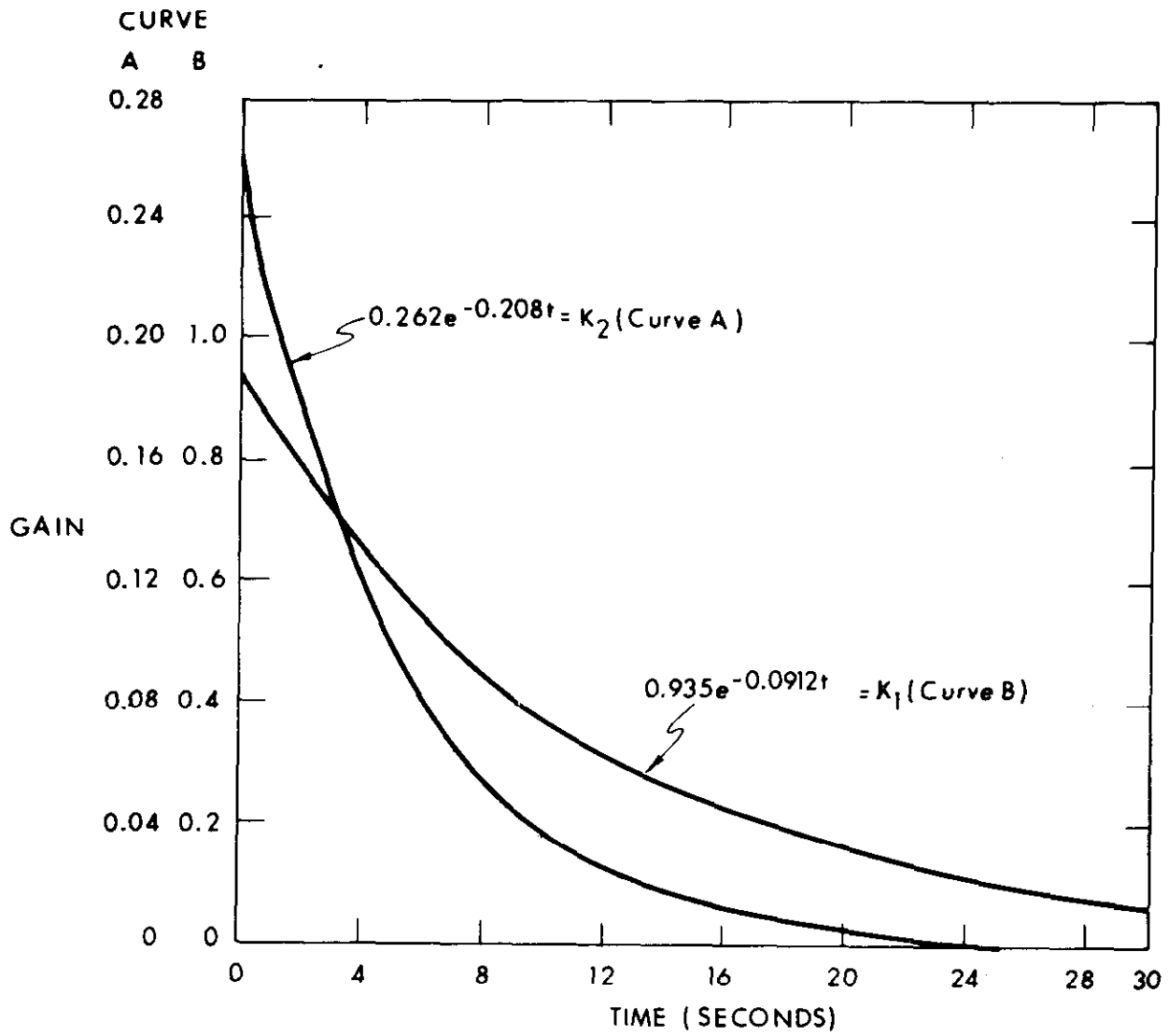

Figure 1.3.1-2 Gain Variation with Time.

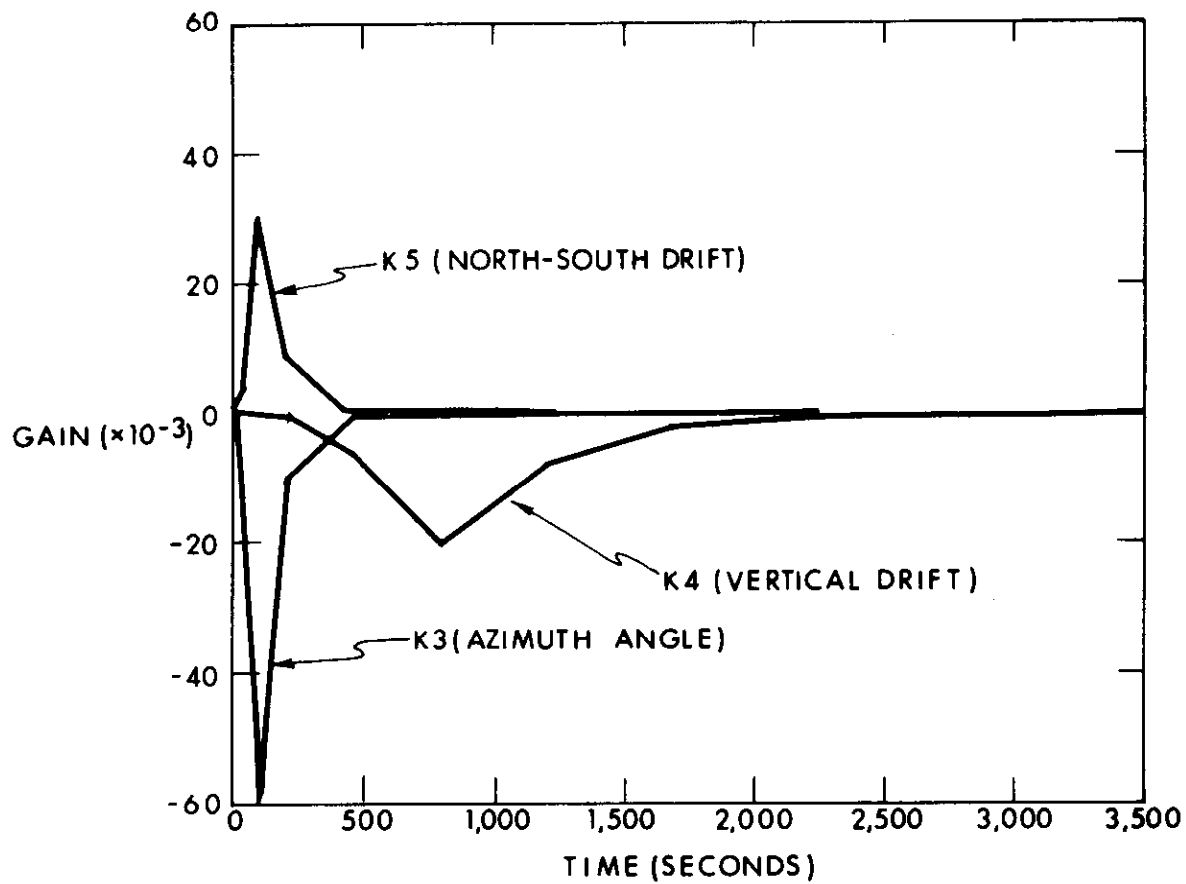

Figure 1.3.1-3 Gain Versus Time

### 1.3.2 Accelerometer Scale Factor Computation

The accelerometer scale factor and bias errors are determined by comparing measured output with local gravity reaction acceleration. The accelerometer is aligned with gravity at the start of the measurement using the estimates of leveling error angles generated by the simplified optimum filter (1.3.1). Pulse rate from the vertical accelerometer is measured. (Figure 1.3.2-1). The pulse rate is converted to  $\text{cm}/\text{sec}^2$  and displayed.

### 1.3.3 Gyro Scale Factor Error Computation

The computation of the gyro scale factor is performed by comparing the number of gyro pulses required to drive a CDU through  $22.5^\circ$  to the number for the ideal scale factor. The result is then scaled for display in units of parts/million (ppm). The effect of CDU quantization (40 arc sec) is eliminated by starting the gyro pulse count at the receipt of a CDU bit and stopping at the receipt of the last bit. A gyro pulse corresponds to only approximately 0.62 arc sec so this quantization is not important. Figure 1.3.3-1 shows the flow of these computations.

A major potential error source is uncertainty in the Navigation Base azimuth arising from uncertainty in the space craft placing and in spacecraft tolerance buildup. The uncertainty in scale factor error is about 136 ppm per degree of Navigation Base azimuth error. Measurement of Navigation Base alignment may be required to reduce this error. To smooth uncertainties due to the CDU pulse rate characteristics, the test should be repeated three times for each gyro in each direction and the results averaged.

### 1.3.4 AGS Alignment Test Computation

A check of the mechanical alignment between the IMU stable member and the ASA is to be made. The check is to be accomplished by a comparison of the IMU CDU angles with angles computed by the AGS from the ASA accelerometer outputs. The IMU platform is to be leveled and the gimbal angles for a level platform transmitted to the AGS. The computations required for leveling the platform and holding an azimuth are depicted in Figures 1.3.4-1 and 1.3.4-2. The majority of the program to accomplish this computation is to be executed by instructions loaded into the LGC erasable memory.



Fig. 1.3.2-1

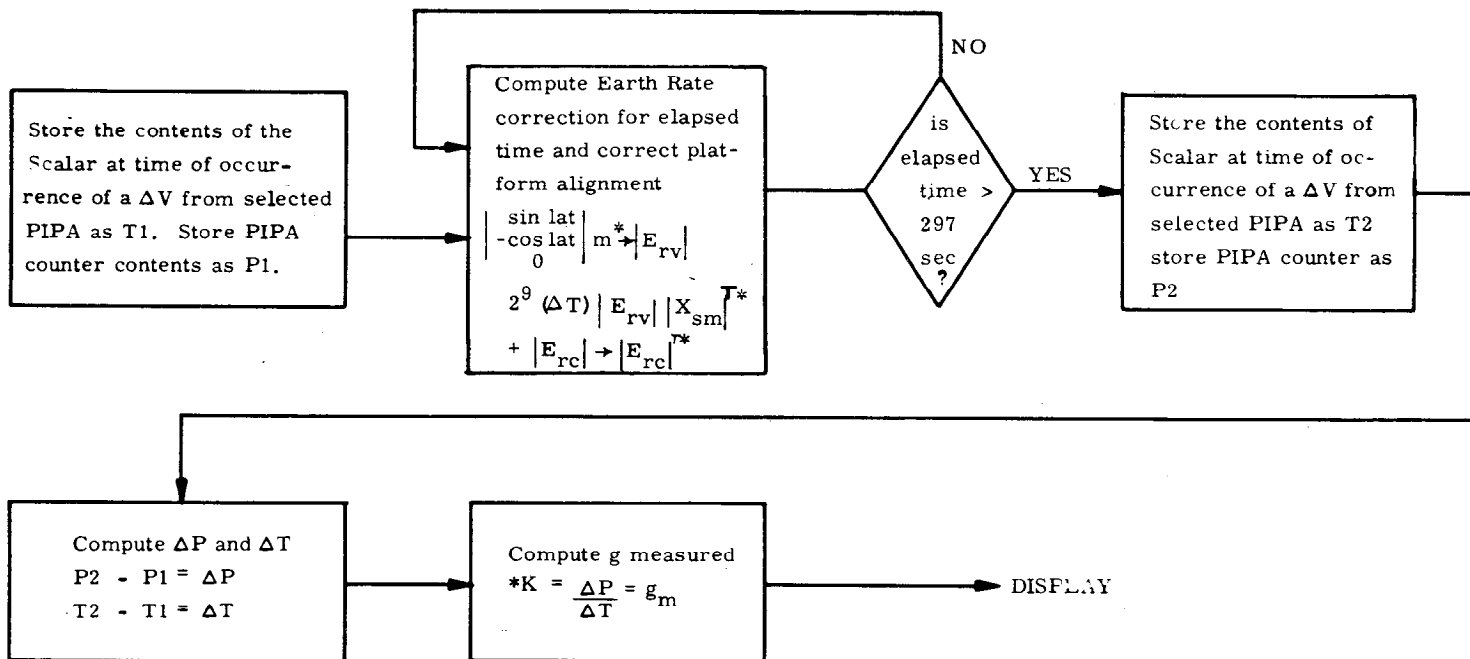

\*K = Ideal Scale Factor x 3200 (Scaling Constant)

\*m = .24339048 gyro pulses/10ms

|E<sub>rc</sub>| = gyro torquing error vector

|X<sub>sm</sub>| = coordinate transformation matrix

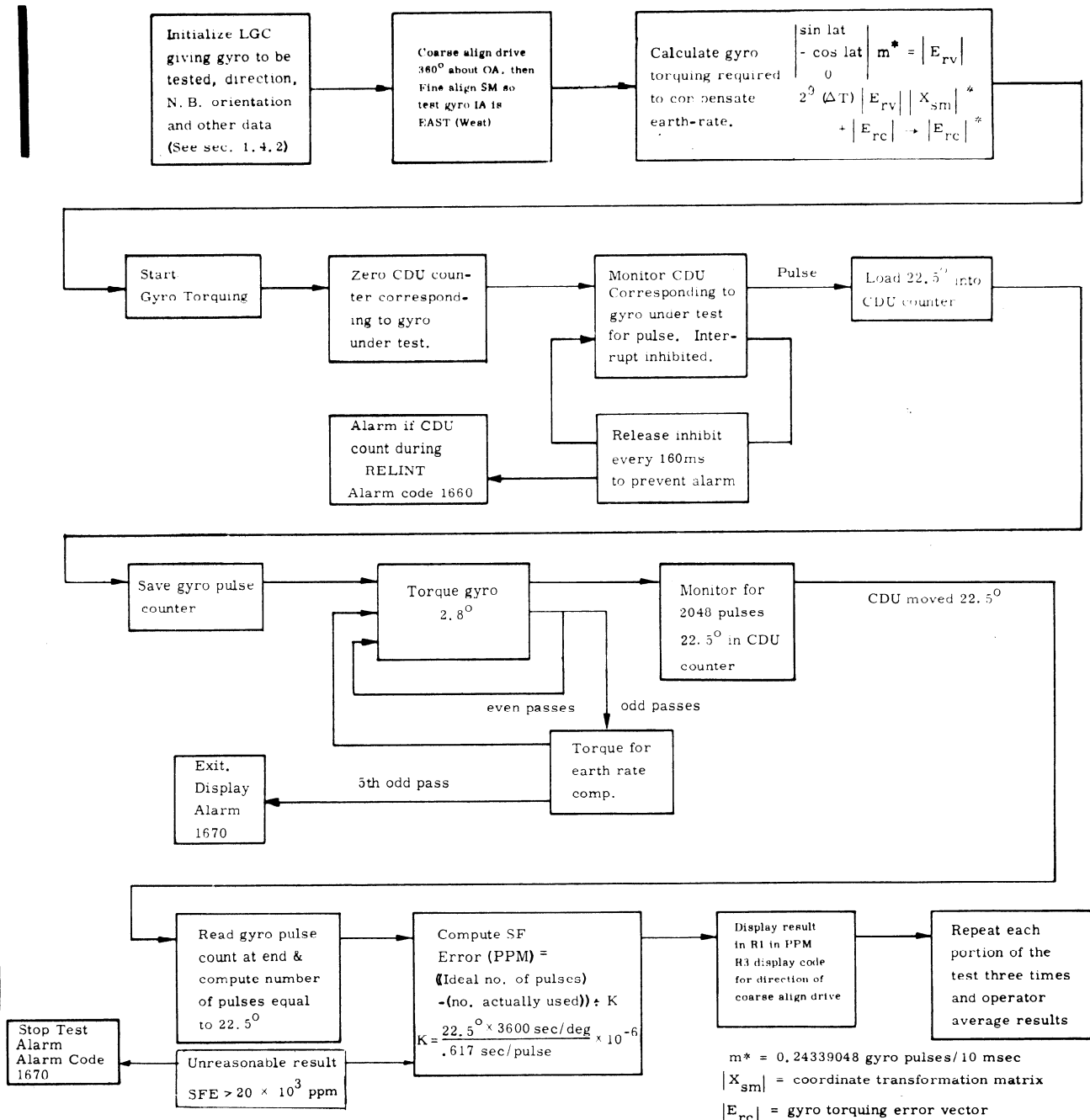

Fig. 1.3.3-1

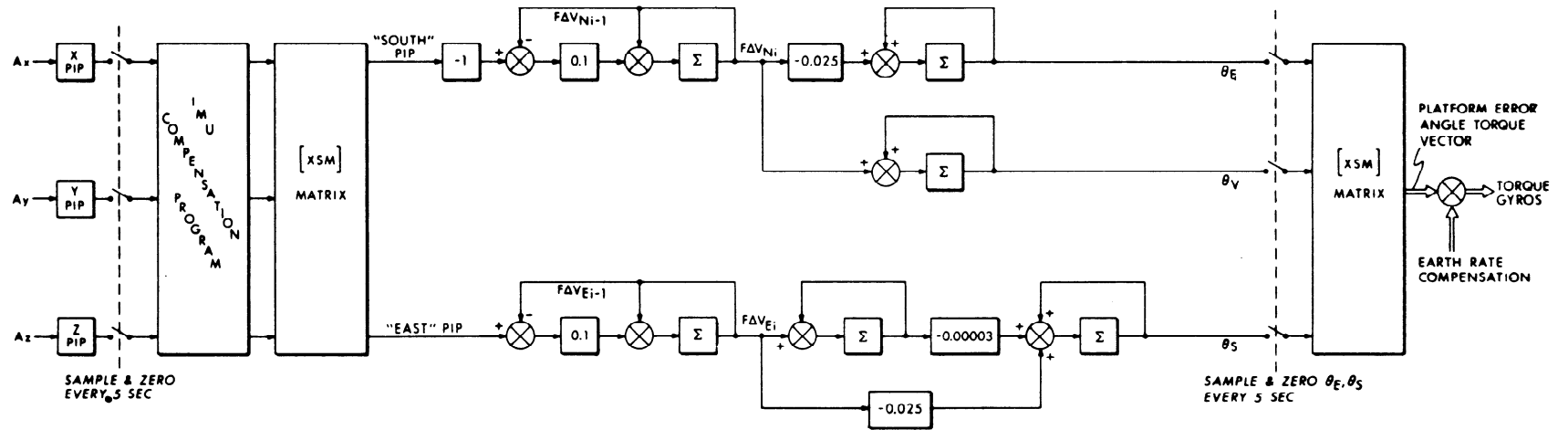

Fig. 1.3.4-1 Azimuth Alignment Loop for AGS Alignment Test Program

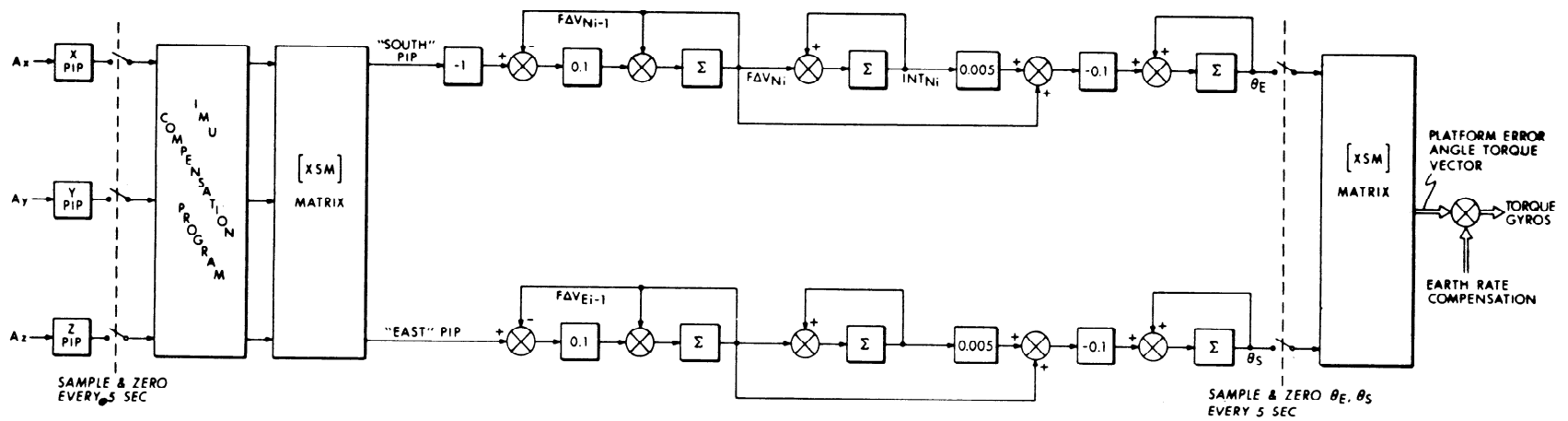

Fig. 1.3.4-2 Vertical Erection Loop for AGS Alignment Test Program

## 1.4 Functional descriptions of system performance tests

### 1.4.1 Gyro and accelerometer calibration program

The gyro and accelerometer calibration program requires initialization of 166 erasable memory addresses prior to starting the test. The complete determination of the performance parameters requires repeat of the test 13 times. Each repeat test will reorient the platform with respect to the following reference coordinate system:

X axis - in the direction of local gravity reaction acceleration  
Y axis - south  
Z axis - east

The initialization data include constants for determination of filter gains (1.3.1), desired stable member orientation, and spacecraft latitude and azimuth.

The initialization data must be pre-loaded for each of the 13 repeat tests. Each test is terminated with a FRESH START (V36) and assumes a FRESH START has been executed prior to its initialization.

The following flow diagram provides a detailed description of the operation. (Fig. 1.4.1-1)

LGC OPERATIONS

OPERATOR OPERATION

COMMENTS

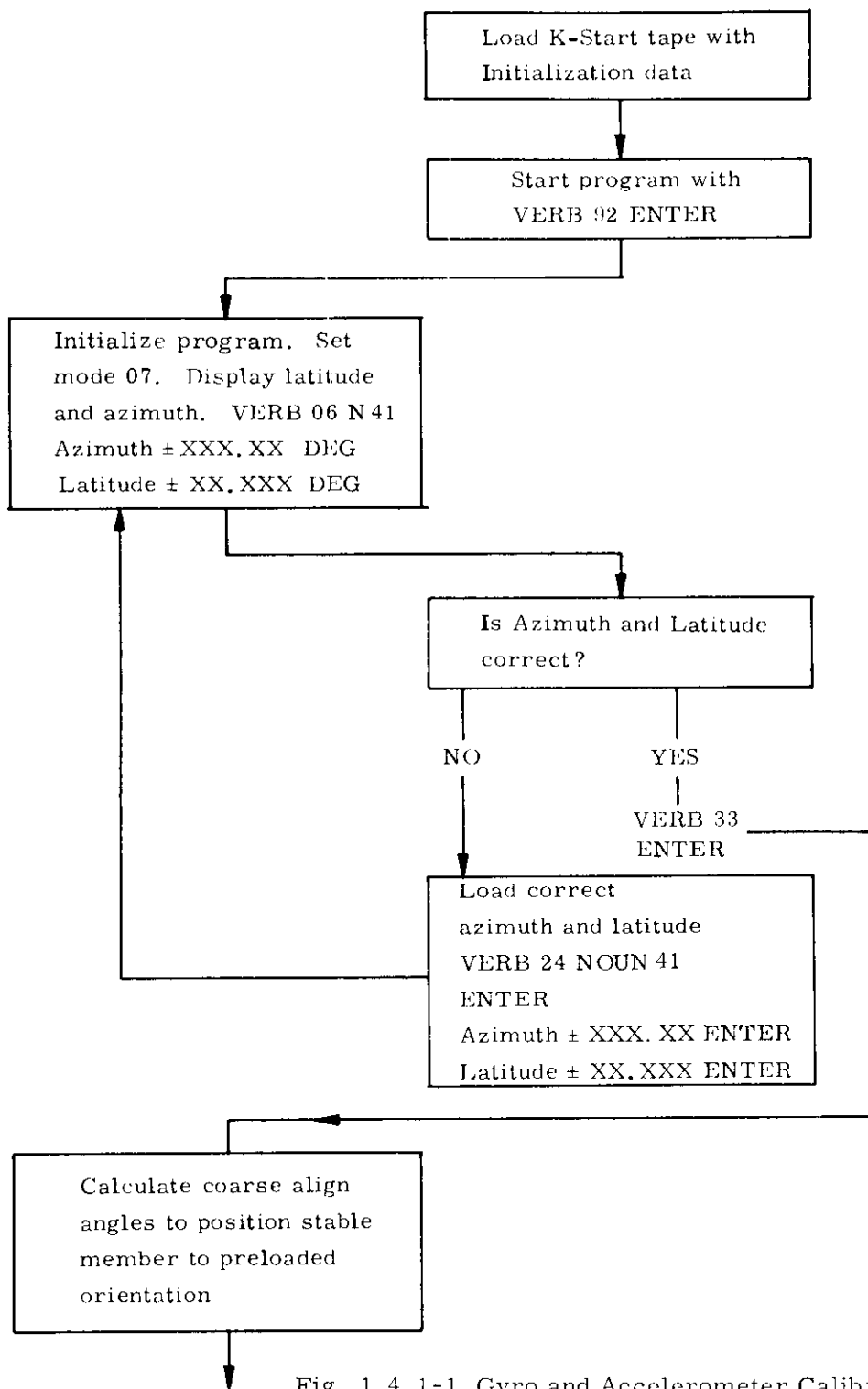

Fig. 1.4.1-1 Gyro and Accelerometer Calibration Program

(continued on next page)

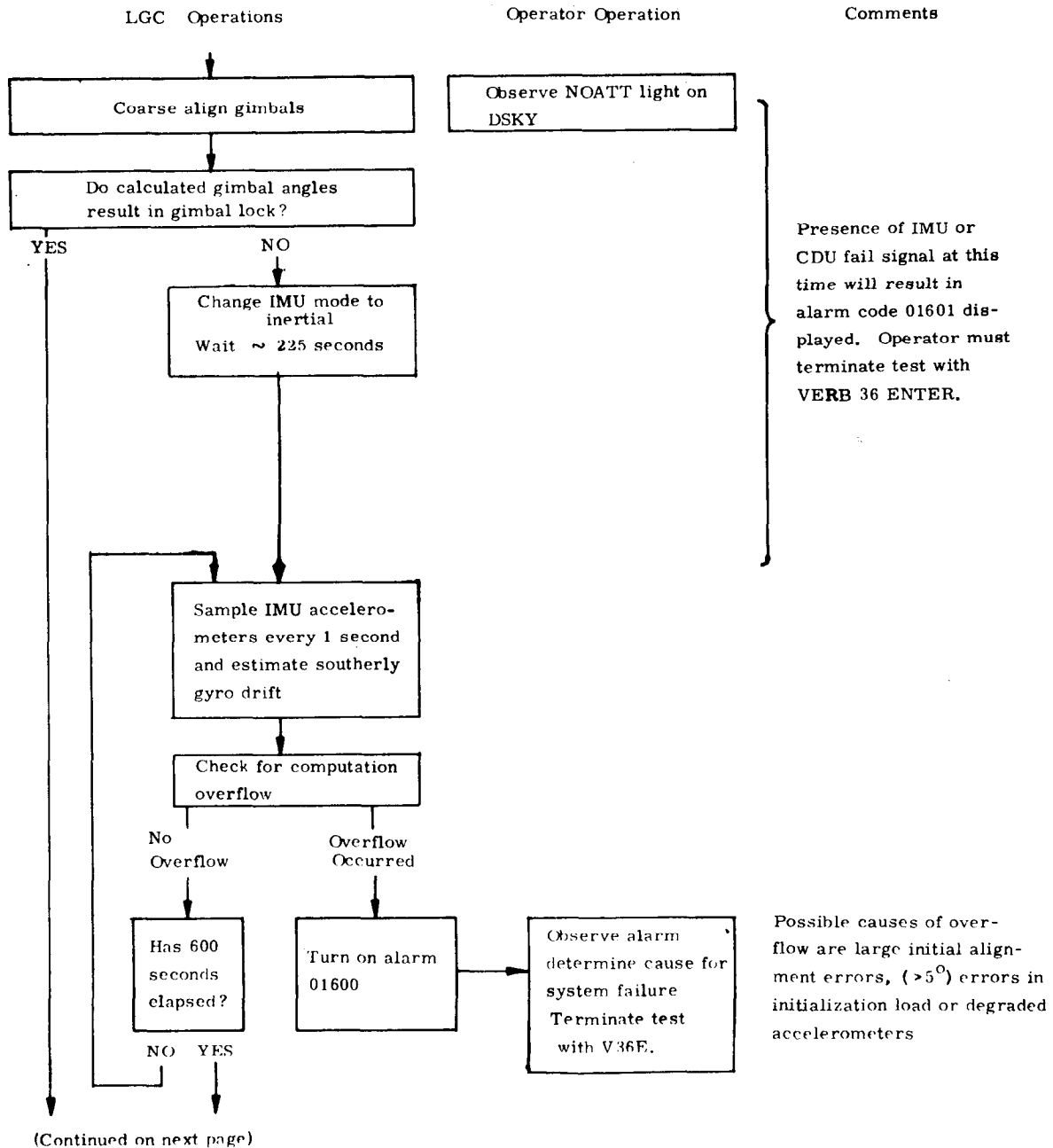
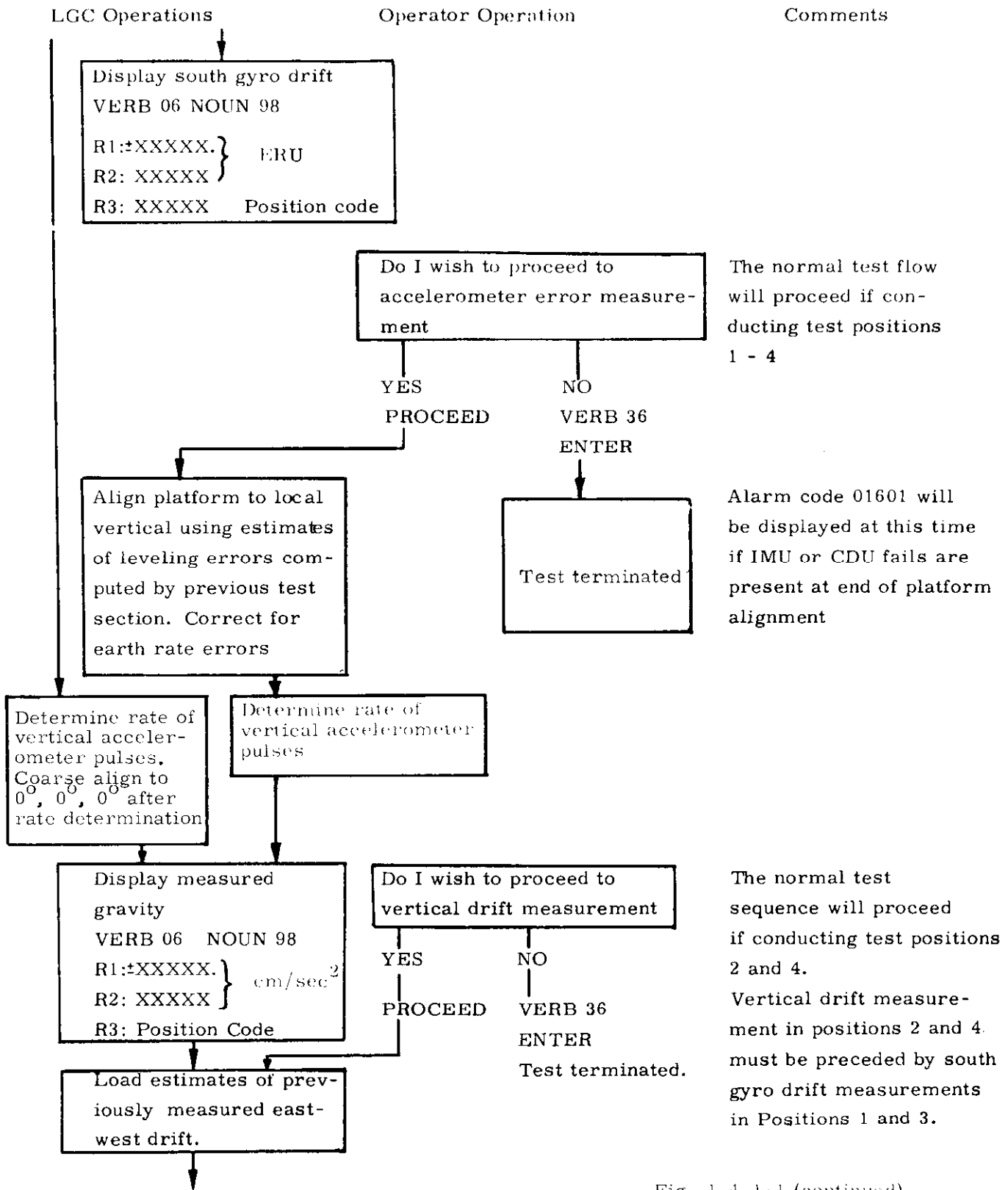

Fig. 1.4.1-1 (Cont'd)



(continued on next page)

Fig. 1.4.1-1 (continued)



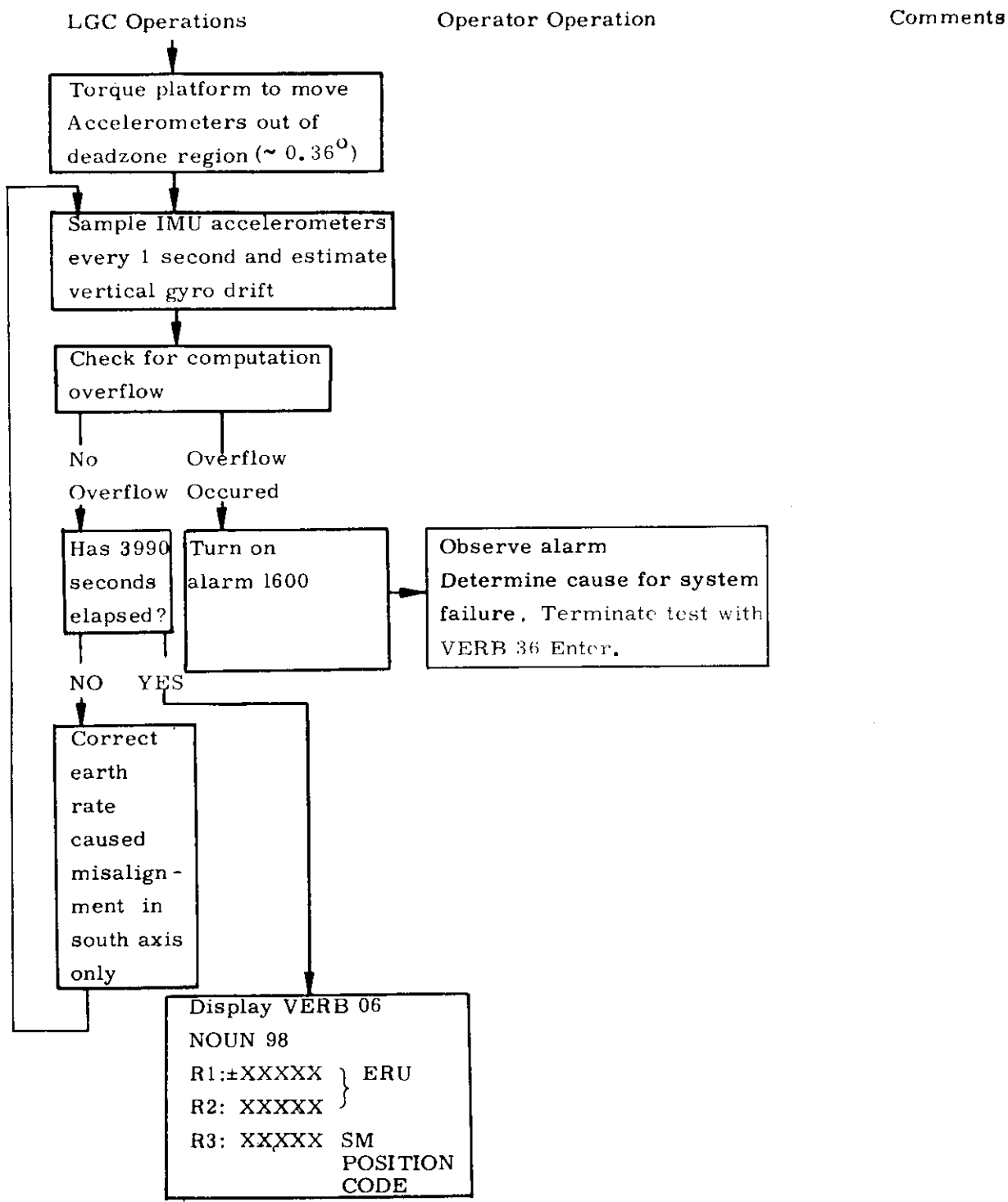

TERMINATE TEST WITH  
VERB 36 ENTER

Fig. 1.4. i-1 (continued)



#### 1.4.2 IRIG SF Functional Description

The stable member is positioned separately for each of six portions of the test. The LGC then positions the platform, torques the gyros, and computes the results without further operator action. The following flow diagram describes the LGC and ground/operator actions required. (Fig. 1.4.2-1)

#### 1.4.3 AGS Alignment Test Functional Description

The AGS alignment test requires that the IMU stable member Y and Z axes be leveled and the Z axis held approximately in the direction of the navigation base Z axis.

The program for leveling the stable member will be loaded into erasable memory. Initialization of program variables will be done by loading the appropriate locations prior to start of the leveling program with a K-Start tape load. The IMU performance parameters must be determined prior to this check and loaded into the appropriate compensation registers.

The following flow diagram describes the details of the program operation. (Fig. 1.4.3-1)

LGC

Ground/ACE

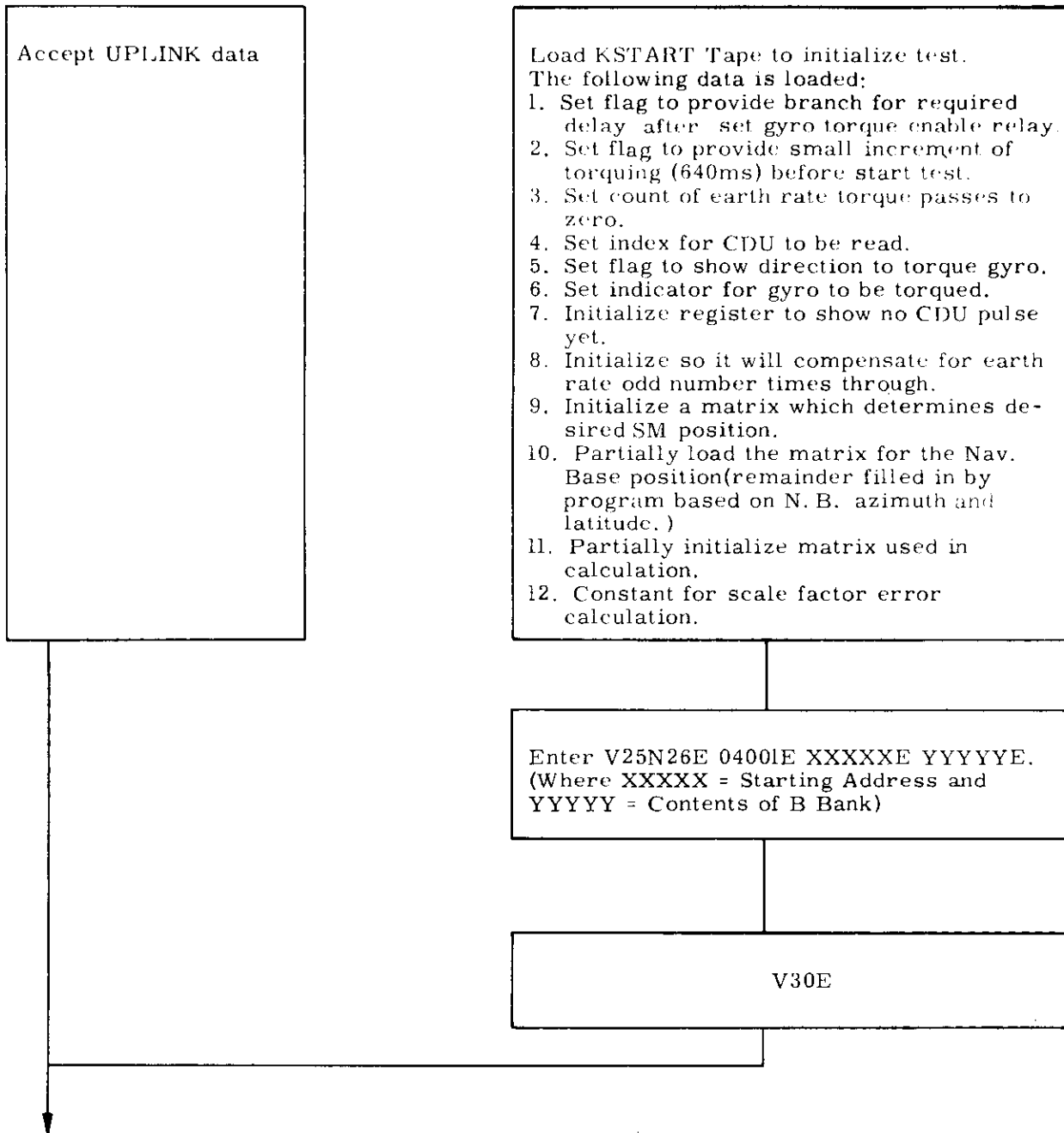

Fig. 1.4.2-1 LGC and Ground/Operator Actions

(continued on the next page)

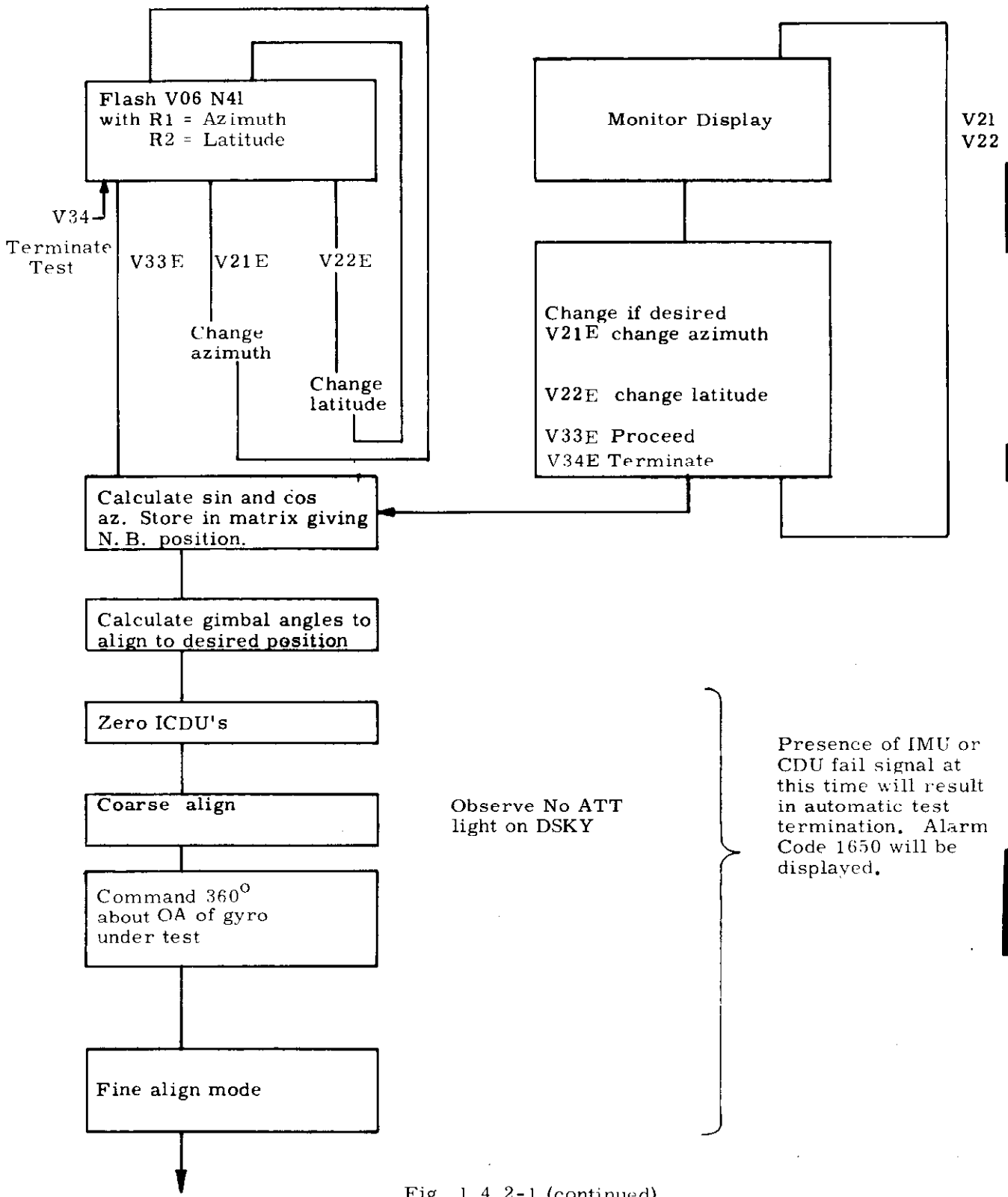
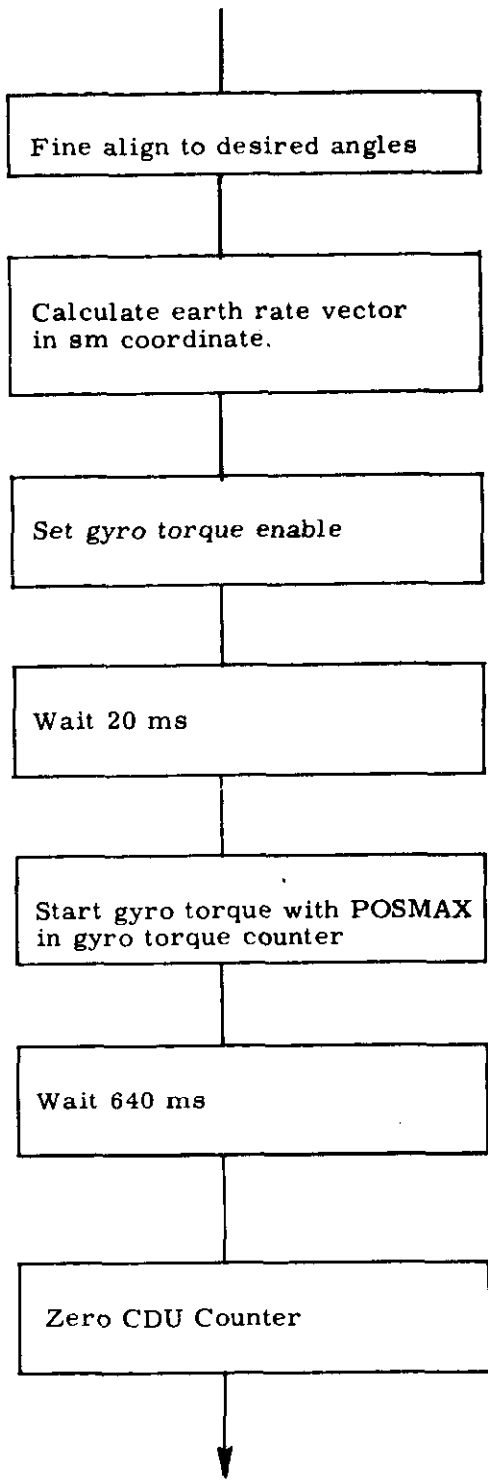

Fig. 1.4.2-1 (continued)



(continued on next page)

Fig. 1.4.2-1 (continued)

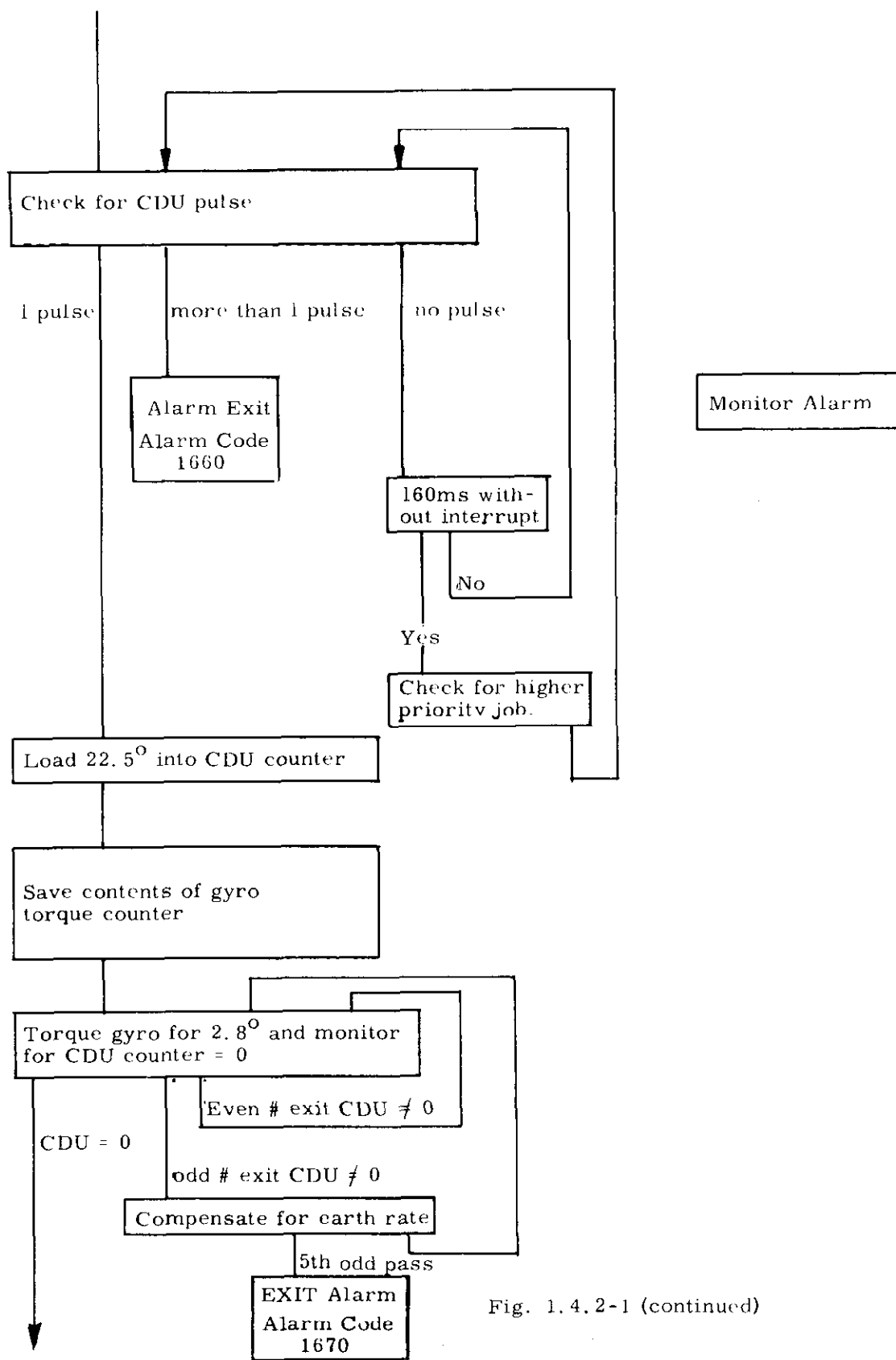

Fig. 1.4.2-1 (continued)

(continued on next page)

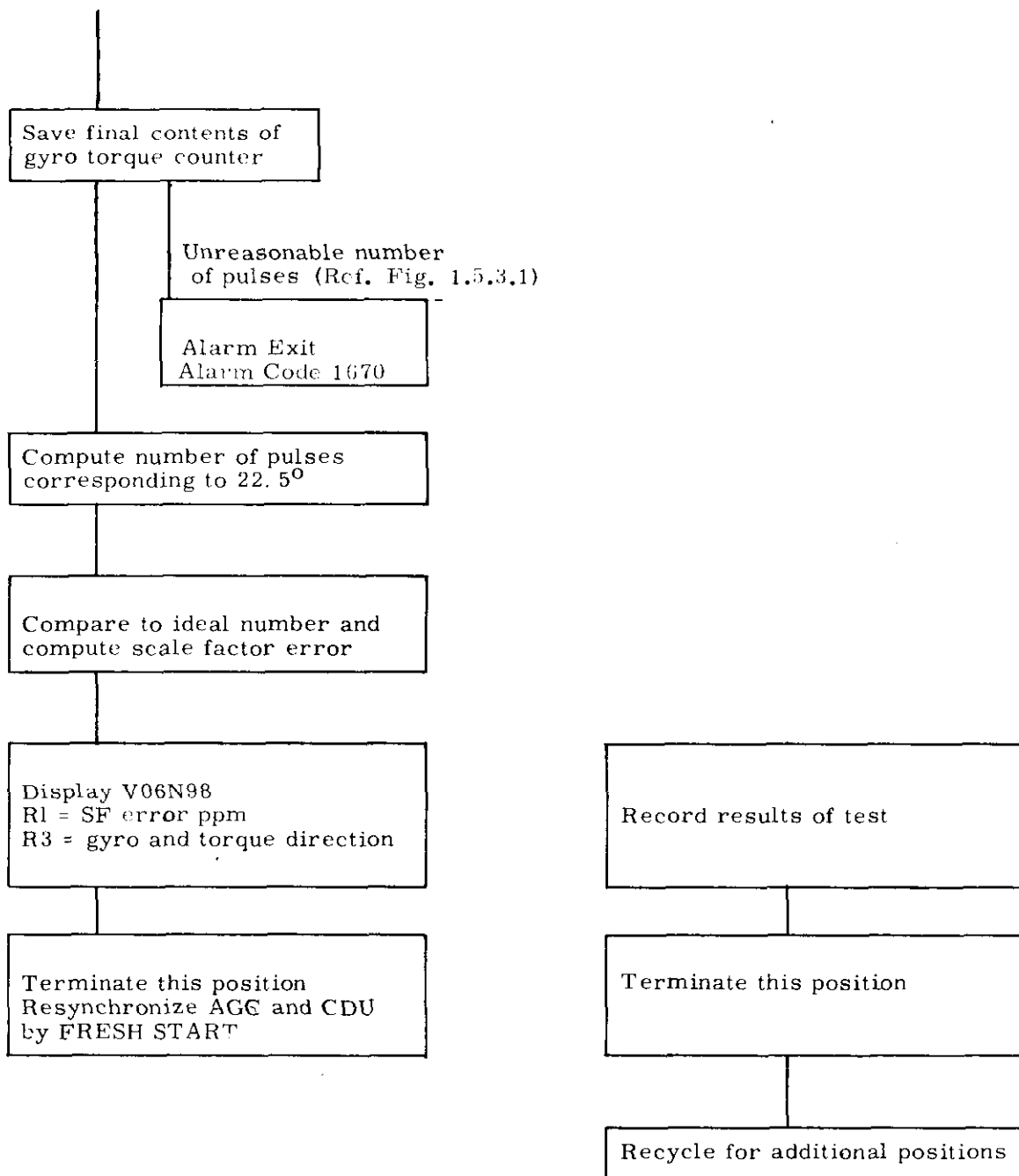
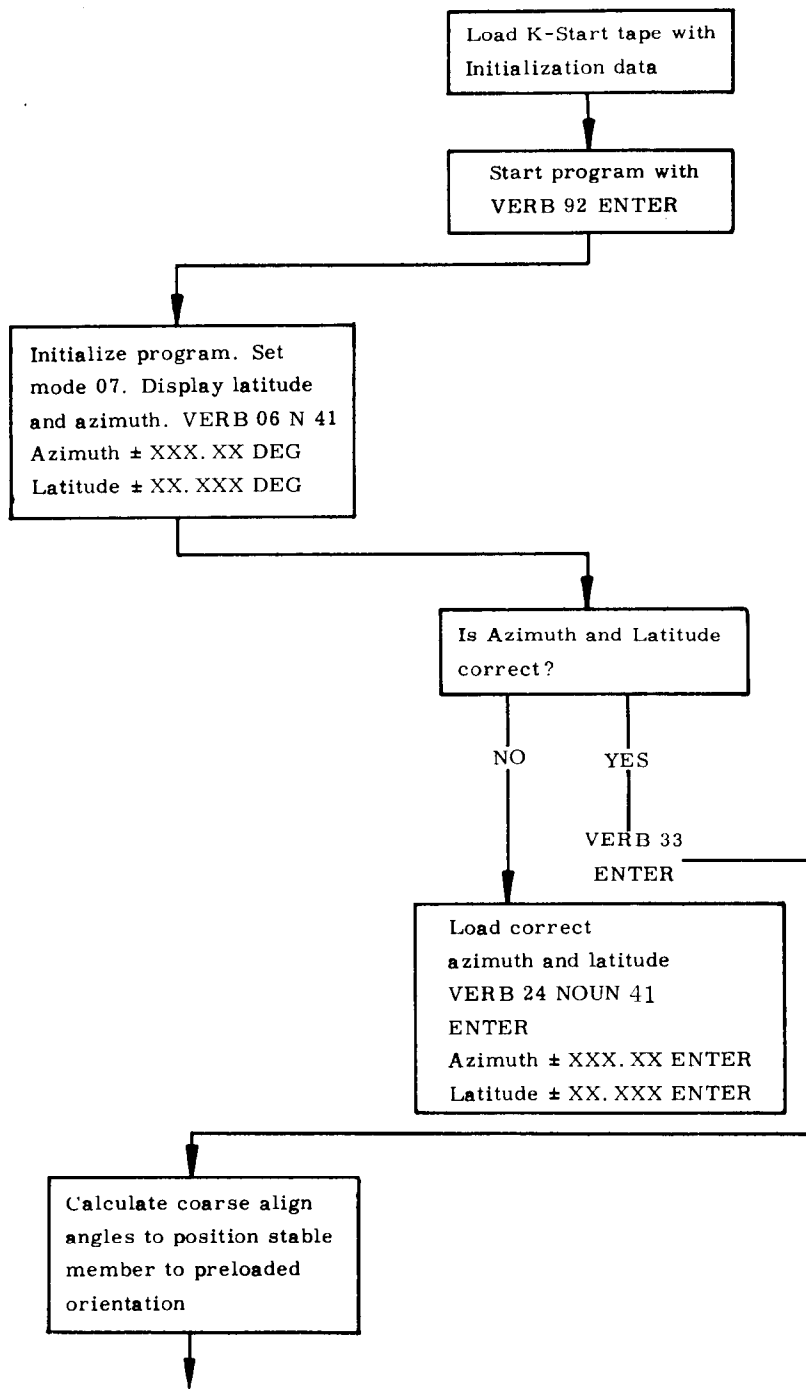

Fig. 1.4.2-1 (continued)





(continued on next page)

Fig. 1.4.3-1 AGS Alignment Test Description

LGC OPERATIONS

OPERATOR OPERATIONS

COMMENTS

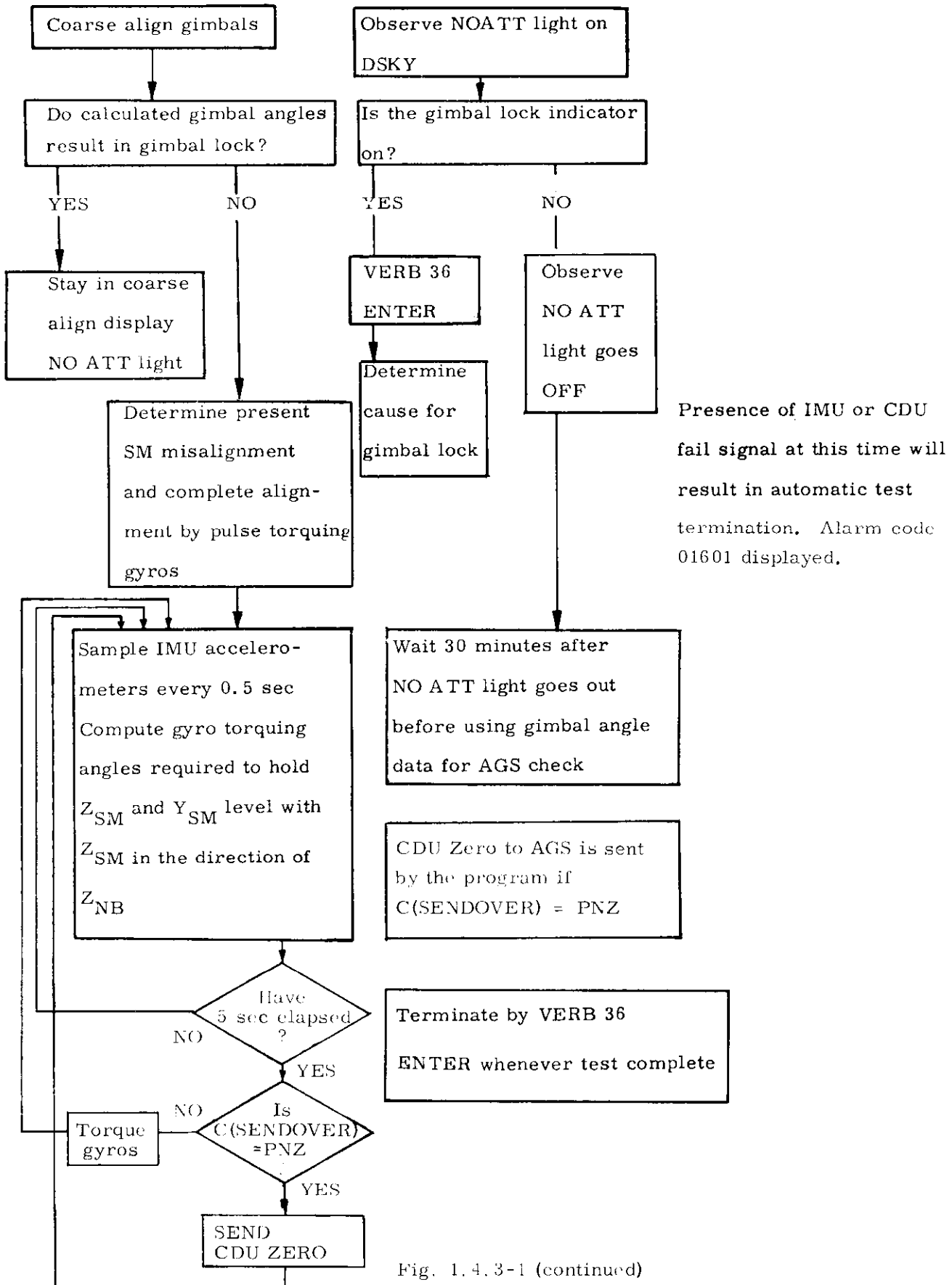

Fig. 1.4.3-1 (continued)

## 1.5 Performance Test Data Analysis

### 1.5.1 IRIG SF Data Analysis

The data for each position are displayed in R1 at the end of the running of each position in units of ppm. The gyro under test and the direction of torquing is displayed in R3 as follows:

- +1 X gyro positive scale factor
- 1 X gyro negative scale factor
- +2 Y gyro positive scale factor
- 2 Y gyro negative scale factor
- +3 Z gyro positive scale factor
- 3 Z gyro negative scale factor

Plus SF error is displayed with a + sign in R1. The scale factor is defined as  $.61798096 \widehat{\text{sec}}/\text{pulse} (1+\text{SFE})$ . The test should be run four times for each gyro in each direction and the results averaged. This is to smooth the effects of occasional 1 pulse irregularities in the CDU pulse rate.

### 1.5.2 Gyro drift data

The model equation used for gyro drift is:

$$W_d = D_B + D_I(\text{SF})_I + D_S(\text{SF})_S + D_O(\text{SF})_O + D_{II}(\text{SF})_I^2 + D_{SS}(\text{SF})_S^2 \\ + D_{OO}(\text{SF})_O^2 + D_{IS}(\text{SF})_I(\text{SF})_S + D_{IO}(\text{SF})_I(\text{SF})_O + D_{OS}(\text{SF})_O(\text{SF})_S$$

where subscripts I, S, and O refer to input, spin and output axes respectively.

- $W_d$  = gyro drift rate, defined as positive by the drift rate vector pointing along gyro input axis.
- $D_B$  = bias or non-acceleration sensitive drift rate  
= NBD in Apollo nomenclature
- $D_I$  = drift rate proportional to specific force along input axis  
= ADIA in Apollo nomenclature
- $D_S$  = drift rate proportional to specific force along spin axis  
= ADSRA in Apollo nomenclature
- $D_O$  = drift rate proportional to specific force along output axis  
= ADOA in Apollo nomenclature
- $D_{II}$  = drift rate proportional to specific force squared along input axis

- $D_{OO}$  = drift rate proportional to specific force squared along output axis  
 $D_{SS}$  = drift rate proportional to specific force squared along spin axis  
 $D_{IS}$  = drift rate proportional to the product of specific force along input and spin axes  
 $D_{IO}$  = drift rate proportional to the product of specific force along input and output axes  
 $D_{OS}$  = drift rate proportional to the product of specific force along output and spin axes

The gyro drift performance test produces data on the NBD, ADSRA, ADIA and ADOA terms in the equation. The other terms are expected to contribute very little. The NBD, ADSRA and ADIA terms are the only ones compensated for by the in-flight gyro drift compensation program.

Position	Stable Member Orientation	Drift Equation (DH = Horizontal Drift; DV = Vertical Drift)
1	$X_{SM}$ DOWN $Y_{SM}$ SOUTH $Z_{SM}$ WEST	$DH_1 = NBDY - ADOAY$
2	$X_{SM}$ DOWN $Y_{SM}$ WEST $Z_{SM}$ NORTH	$DH_2 = NBDZ - ADOAZ$ $DV_2 = - NBDX + ADIAX$
3	$X_{SM}$ SOUTH $Y_{SM}$ WEST $Z_{SM}$ DOWN	$DH_3 = + NBDX - ADOAX$
4	$X_{SM}$ EAST $Y_{SM}$ SOUTH $Z_{SM}$ DOWN	$DH_4 = NBDY + ADSRAY$ $DV_4 = NBDZ + ADIAZ$
5	$X_{SM}$ WEST $Y_{SM}$ UP $Z_{SM}$ NORTH	No drift data for this position

Position	Stable Member Orientation	Drift Equation
6	X <sub>SM</sub> SOUTH Y <sub>SM</sub> DOWN Z <sub>SM</sub> EAST	No drift data for this position
7	X <sub>SM</sub> NORTH Y <sub>SM</sub> UP-WEST Z <sub>SM</sub> UP-EAST	$DH_7 = -NBDX + \frac{1}{\sqrt{2}} ADSRAX - \frac{1}{\sqrt{2}} ADOAX$
8	X <sub>SM</sub> EAST Y <sub>SM</sub> UP-NORTH Z <sub>SM</sub> UP-SOUTH	$DH_8 = \frac{1}{\sqrt{2}} (-NBDZ - NBDY) + 1/2 (ADIAZ - ADIAY) + 1/2 (ADSRAY + ADSRAZ)$
9	X <sub>SM</sub> UP-EAST Y <sub>SM</sub> UP-WEST Z <sub>SM</sub> SOUTH	$DH_9 = \frac{1}{\sqrt{2}} ADSRAZ - NBDZ - \frac{1}{\sqrt{2}} ADOAZ$
10	X <sub>SM</sub> UP-NORTH Y <sub>SM</sub> UP-SOUTH Z <sub>SM</sub> EAST	$DH_{10} = \frac{1}{\sqrt{2}} (NBDY - NBDX) + 1/2 (ADIAY - ADIAX) + 1/2 (ADSRAX) + 1/2 ADOAY$
11	X <sub>SM</sub> NORTH Y <sub>SM</sub> WEST Z <sub>SM</sub> UP	$DH_{11} = -NBDX - ADOAX$
12	X <sub>SM</sub> UP Y <sub>SM</sub> SOUTH Z <sub>SM</sub> EAST	$DH_{12} = NBDY + ADOAY$
13	X <sub>SM</sub> UP Y <sub>SM</sub> EAST Z <sub>SM</sub> NORTH	$DH_{13} = NBDZ + ADOAZ$

The equations for compensable drift terms in terms of the horizontal and vertical drift measurements are:

$$\begin{aligned}
 \text{NBDX} &= 1/2 (\text{DH}_3 - \text{DH}_1) \\
 \text{NBDY} &= 1/2 (\text{DH}_1 + \text{DH}_{12}) \\
 \text{NBDZ} &= 1/2 (\text{DH}_2 + \text{DH}_{13}) \\
 \text{ADSRAX} &= \sqrt{2} \left[ \text{DH}_7 + 1/2 (\text{DH}_3 - \text{DH}_1) \right] - \frac{1}{2} (\text{DH}_{11} + \text{DH}_3) \\
 \text{ADSRAY} &= \text{DH}_4 - 1/2 (\text{DH}_1 + \text{DH}_{12}) \\
 \text{ADSRAZ} &= \sqrt{2} \left[ \text{DH}_9 + 1/2 (\text{DH}_2 + \text{DH}_{13}) \right] + \frac{1}{2} (\text{DH}_{13} - \text{DH}_3) \\
 \text{ADIAX} &= \text{DV}_2 + 1/2 (\text{DH}_3 - \text{DH}_1) \\
 \text{ADIAY} &= 2 \text{DH}_{10} - \frac{1}{\sqrt{2}} \text{DH}_1 - \frac{1}{\sqrt{2}} \text{DH}_{12} \\
 &\quad + \text{DH}_3 + \text{DV}_2 - \sqrt{2} \text{DH}_7 - \frac{1}{2} (\text{DH}_{12} - \text{DH}_1) \\
 \text{ADIAZ} &= \text{DV}_4 - 1/2 (\text{DH}_2 + \text{DH}_{13}) \\
 \text{ADOAX} &= - 1/2 (\text{DH}_{11} + \text{DH}_3) \text{ (Not compensated)} \\
 \text{ADOAY} &= 1/2 (\text{DH}_{12} - \text{DH}_1) \text{ (Not compensated)} \\
 \text{ADOAZ} &= 1/2 (\text{DH}_{13} - \text{DH}_2) \text{ (Not compensated)}
 \end{aligned}$$

### 1.5.3 Accelerometer Test Data Analysis

The complete accelerometer model equation is:

$$\begin{aligned}
 \text{Specific Force Indicated} &= A_B + A_I(\text{SF})_I + A_P(\text{SF})_P + A_O(\text{SF})_O + A_{II}(\text{SF})_I^2 \\
 &\quad + A_{IP}(\text{SF})_I(\text{SF})_P + A_{IO}(\text{SF})_I(\text{SF})_O + A_{PO}(\text{SF})_P(\text{SF})_O
 \end{aligned}$$

where subscripts I, P, and O refer to input, pendulous and output axes respectively.

- $A_B$  = bias coefficient, insensitive to specific forces
- $A_I$  = scale factor of instrument
- $A_P, A_O$  = cross coupling coefficients
- $A_{II}$  = specific force squared coefficient
- $A_{IP}$  = coefficient for the product of specific force along input and pendulous axes

- $A_{IO}$  = coefficient for the product of specific force along input and output axes
- $A_{PO}$  = coefficient for the product of specific force along pendulous and output axes

The accelerometer test data are used to determine only the bias and scale factor coefficients. The other terms are not separately measured or compensated.

The simplified equation for the accelerometer model is:

Specific Force Indicated = Bias + Scale Factor ( Specific Force along input axis )

The specific force used in the test is due to the gravity reaction acceleration. The comparison of the indicated magnitude of the gravity reaction acceleration and the known local gravity provides the calibration of the accelerometer. The scale factor error and bias are separated by reversing the direction of the specific force along the input axis.

For the X and Z accelerometers the orientation of the input axis parallel to the direction of local gravity is easily accomplished by use of the data from the other two accelerometers. For the Y accelerometer the gimbal configuration does not allow accurate positioning, therefore, data from the other two accelerometers is used in the data analysis to correct for input axis alignment errors.

Position	Stable Member Orientation	Accelerometer Error Equation
12	$X_{SM}$ UP	$g_{m1} = b_x + (1 - SFE)g$
	$Y_{SM}$ SOUTH	
	$Z_{SM}$ EAST	
2	$X_{SM}$ DOWN	$g_{m2} = b_x + (1 - SFE)(-g)$
	$Y_{SM}$ WEST	
	$Z_{SM}$ NORTH	
11	$X_{SM}$ NORTH	$g_{m3} = b_z + (1 - SFE)g$
	$Y_{SM}$ WEST	
	$Z_{SM}$ UP	

4	X <sub>SM</sub> EAST Y <sub>SM</sub> SOUTH Z <sub>SM</sub> DOWN	$g_{m4} = b_z + (1 - SFE)(-g)$
5	X <sub>SM</sub> WEST Y <sub>SM</sub> UP Z <sub>SM</sub> NORTH	$g_{m5} = b_y + (1 - SFE)g$
6	X <sub>SM</sub> SOUTH Y <sub>SM</sub> DOWN Z <sub>SM</sub> EAST	$g_{m6} = b_y + (1 - SFE)(-g)$

$g_m$  = measured gravity reaction acceleration (cm/sec<sup>2</sup>) calculated using ideal scale factor of 1 cm/sec/pulse

$g$  = local gravity reaction acceleration (cm/sec<sup>2</sup>)

$b_i$  = bias of  $i$  accelerometer (cm/sec<sup>2</sup>) ( $i = x, y, z$ )

$SF_i$  = scale factor of  $i$  accelerometer in cm/sec/pulse

SFE = scale factor error in parts-per-million defined as positive when  $SF_i >$  ideal scale factor

For positions 5 and 6 the misalignment angle  $\theta_y$  between the Y accelerometer and the vertical shall be determined from pulse rate data from the other two accelerometers.

$$\theta_y = \sqrt{\theta_x^2 + \theta_z^2}$$

$$\theta_z = \frac{(\Delta V_x - \Delta V_x B_x) SF_x}{\Delta T g \text{ local}}$$

$$\theta_x = \frac{(\Delta V_z - \Delta V_z B_z) SF_z}{\Delta T g \text{ local}}$$

where  $\Delta V$  = number of velocity increments accumulated in  $\Delta T$

$$\Delta V_i B_i = \frac{b_i \Delta T}{SF_i}$$



$g_{m5,6}$  will be modified by the misalignment  $\theta_y$  as follows:

$$g_{m5'} = g_{m5} \sec \theta_{y5}$$

$$g_{m6'} = g_{m6} \sec \theta_{y6}$$

$g_{m5'}$  and  $g_{m6'}$  are used to determine Y accelerometer scale factor and bias error coefficients.

The equation for calculating scale factor error for the accelerometer is:

$$SFE_i = 1 - \frac{g_{mj} - g_{m(j+1)}}{2 g_{local}} \times 10^6 \text{ ppm}$$

The equation for determining bias error for the accelerometer is:

$$b_i = \frac{g_{mj} + g_{m(j+1)}}{2} \text{ cm/sec}^2$$

#### 1.5.4 AGS Alignment Check Data Analysis

The PGNCS produces no data for this check. The PGNCS is merely used as a reference for AGS. All analysis of the results will be done by GAEC.



R-557

SUNDANCE  
(LUMINARY)

Section 1 (Rev. 1)

Internal:

P. Adler	<b>K.</b> Kido	<b>K.</b> Riebesell
R. Battin	*J. Kingston	P. Rye
E. Blanchard	A. Kosmala	J. Sapanaro
G. Cherry (3)	W. Kupfer	P. Sarda
E. Copps	A. Laats	C. Schulenberg
S. Copps	L. Larson	N. Sears
W. Day	R. Larson	J. Shillingford
S. Drake	J. Lawrence	W. Stameris
G. Edmonds	D. Lickly	G. Stubbs
P. Felleman	R. Lones	J. Suomala
J. Fleming	F. Martin	J. Sutherland
L. Gediman (30)	W. Marscher	W. Tanner
K. Glick	H. McOuat	R. Tinkham
K. Goodwin	R. McKern	K. Vincent
E. Grace	V. Megna	J. Vittek
K. Greene	D. Millard	F. Walsh
J. Henize	J. E. Miller	R. Weatherbee
P. Heinemann	J. S. Miller	P. Weissman
J. Heybl	P. Mimno	R. Werner
D. Hoag	J. Nevins	R. White
B. Ireland	J. O'Connor	W. Widnall
L. B. Johnson	G. Ogletree	M. Womble
M. Johnson	P. Philliou	Apollo Library (2)
M. Johnston	R. Ragan	MIT/IL Library (6)

\*Letter of transmittal only.

MIT Instrumentation Laboratory c/o North American Rockwell, Inc. Space and Information Division 12214 Lakewood Boulevard Downey, California 90241 Attn: Mr. Thomas A. Hemker	(1)
MIT Instrumentation Laboratory G&N Systems Laboratory c/o Grumman Aircraft Engineering Corp. LM Project - Plant 25 Bethpage, Long Island, New York Attn: Mr. James A. Hand	(1)
MIT Instrumentation Laboratory P. O. Box 21025 Kennedy Space Center, Florida 32815 Attn: Mr. George Silver	(5)
MIT Instrumentation Laboratory Code EG/MIT Building 16 NASA Manned Spacecraft Center Houston, Texas 77058 Attn: Mr. Thomas Lawton	(3)    (10)
NASA MSC HW Building M7-409 Kennedy Space Center, Florida 32815 Attn: Mr. Frank Hughes	
Mr. A. Metzger (NASA/RASPO at MIT/IL)	(1)
AC Electronics Division General Motors Corporation Milwaukee, Wisconsin Attn: Mr. J. Stridde Dept. 32-31 Attn: Mr. Reino Karell	(15)    (13) (2)
Kollsman Instrument Corporation 575 Underhill Boulevard Syosset, Long Island Attn: Mr. F. McCoy	(1)
Raytheon Company Boston Post Road Sudbury, Massachusetts 01776 Attn: Mr. J. Shrmack	(6)
NASA/RASPO/National Aeronautics and Space Administration NAR Resident Apollo Spacecraft Program Office North American Rockwell, Inc. Space and Information Systems Division 12214 Lakewood Boulevard Downey, California	(1)
NASA/KSC National Aeronautics and Space Administration John F. Kennedy Space Center J. F. Kennedy Space Center, Florida 32899 Attn: Technical Document Control Office	(3)

NASA/RASPO GE	NASA Daytona Beach Operation P.O. Box 2500 Daytona Beach, Florida 32015 Attn: Mr. A. S. Lyman	(1)
NASA/HDQ	NASA Headquarters 600 Independence Avenue SW Washington, D.C. 20546 Attn: MAP-2 Attn: Mission Director, Code MA Attn: Robert Aller, Code MAO	(6)  (4) (1) (1)
NASA/LEWIS	National Aeronautics and Space Administration Lewis Research Center Cleveland, Ohio Attn: Library	(2)
NASA/FRC	National Aeronautics and Space Administration Flight Research Center Edwards AFB, California Attn: Research Library	(1)
NASA/LRC	National Aeronautics and Space Administration Langley Research Center Langley AFB, Virginia Attn: Mr. A. T. Mattson	(2)
NASA/GSFC	National Aeronautics and Space Administration Goddard Space Flight Center Greenbelt, Maryland Attn: Mr. Paul Pashby, Code 813	(2)
GAEC	Grumman Aircraft Engineering Corporation Bethpage, Long Island, New York Attn: Mr. J. Marino Mr. C. Tillman Mr. F. Wood Mr. H. Sherman Mr. R. Pratt Mr. B. Sidor Mr. R. Kress	(23 + 1R)  (1R) (13) (1) (3) (4) (1) (1)
NAR	North American Rockwell Inc. Space and Information Systems Division 12214 Lakewood Boulevard Downey, California 90241 Attn: Apollo Data Requirements Dept. 096-340 Building 3, CA 99	(1 + 1R)

NASA/RASPO National Aeronautics and Space Administration (1)  
GAEC Resident Apollo Spacecraft Program Officer  
Grumman Aircraft Engineering Corporation  
Bethpage, Long Island, New York

NASA/RASPO National Aeronautics and Space Administration (1)  
ACED Resident Apollo Spacecraft Program Officer  
AC Electronics Division  
General Motors Corporation  
Milwaukee, Wisconsin 53201  
Attn: Mr. W. Swingle

NASA/WSMR: National Aeronautics and Space Administration (2)  
Post Office Drawer MM  
Las Cruces, New Mexico  
Attn: RH4 Documentation

NASA/MSFC: National Aeronautics and Space Administration (21)  
George C. Marshall Space Flight Center  
Huntsville, Alabama  
Attn: J. Mack R-ASTR-5 (1)  
H. Ledford R-AERO-P (2)  
L. McNair R-AERO-P (1)  
E. Deaton R-AERO-DA (1)  
A. Deaton R-AERO-DG (1)  
L. Stone R-AERO-F (1)  
C. Hagood R-AERO-F (1)  
O. Hardage R-AERO-FM (1)  
F. Moore R-ASTR-N (1)  
S. Seltzer R-ASTR-NG (5)  
H. Hosenthien R-ASTR-F (1)  
A. McNair I-MO-R (1)  
D. Germany I-I/IB-E (1)  
R. Barraza I-V-E (1)  
W. Chubb R-ASTR/NG (1)  
J. McCullough I-VE/T (1)

NASA/MSC National Aeronautics and Space Administration 280 + 2R  
Manned Spacecraft Center  
Apollo Document Control Group (PA 2)  
Houston, Texas 77058  
Attn: A. Alber, FS5 (letter of transmittal only)

BELLCOMM: Bellcomm, Inc. (6)  
1100 17th Street N. W.  
Washington, D. C. 20036  
Attn: Info. Analysis Section

LINK: LINK Group, GPSI SIMCOM (3)  
1740 A NASA Boulevard  
Houston, Texas 77058  
Attn: Mr. D. Klingbell

TRW: Gilbert H. Friedman (5)  
Building 82 Rm 2067  
TRW System Group  
One Space Park  
Redondo Beach, California 90278