

Molecular Visualization and Simulation in VR

John E. Stone

Theoretical and Computational Biophysics Group
Beckman Institute for Advanced Science and Technology
University of Illinois at Urbana-Champaign

<http://www.ks.uiuc.edu/Research/vmd/>

<http://www.ks.uiuc.edu/Research/gpu/>

Indiana University, Wednesday March 6th, 2019

AVL Virtual Reality Workshop Series – Spring 2019

Wednesdays @ 4:00pm – Franklin Hall Reality Lab (052)

Bonus: VR Expeditions select Mondays (FH 052 @4:00pm)

Date	Topic	Presenter
Jan. 16	The Medium of Virtual Reality	Bill Sherman
Jan. 23	A Survey of VR Experiences	Chauncey Frend
Jan. 30	(no talk – cancelled for weather)	
Feb. 6	VR for Simulation and Training	Chauncey Frend
Feb. 11	VR Expedition: Experiential Gaming	Jeff Rogers
Feb. 13	VR for Architectural review	Jeff Rogers
Feb. 18	VR Expedition: Cultural Heritage	Tassie Gniady
Feb. 20	Developing Mobile VR Experiences	Jeff Rogers
Feb. 25	VR Expedition: Creative Tools in VR	Chauncey Frend
Feb. 27	Scientific Visualization with VR	Bill Sherman
Mar. 6	Molecular Visualization and Simulation with VR	John Stone
Mar. 13	(no talk – Spring Break)	N/A
Mar. 20	Virtual Tourism	Tassie Gniady
Mar. 25	VR Expedition: Science Education	Bill Sherman
Mar. 27	(no talk – IEEE VR Conference)	N/A
Apr. 3	Archaeology Training with VR	Laura Shackelford / Cam Merrill / Alan Craig
Apr. 10	VR-Unity Extravaganza	Bill Sherman

Services for Digital Humanities and Creative Activities Workshop Series – Spring 2019

Thursdays @ 4:00pm – Wells Library Scholars' Commons

Date	Topic	Presenter
Jan. 17	Introduction to Text Analysis	Tassie Gniady and David Kloster
Jan. 24	Introduction to Topic Modeling	Tassie Gniady and David Kloster
Jan. 31	Introduction to Sentiment Analysis	David Kloster and Tassie Gniady
Feb. 7	Introduction to Document Similarity	David Kloster and Tassie Gniady
Feb. 14	Hands-on Text Extravaganza	Tassie Gniady and David Kloster
Feb. 21	Rome Reborn: Visiting Rome in A.D. 320	Bernie Frischer
Feb. 28	Virtual Reality in the Art History Classroom	Matthew Brennan
 Mar. 7	Painting Virtual Art: An Artists's History through VR	Margaret Dolinsky
Mar. 13	(no talk – Spring Break)	N/A
Mar. 21	Augmented Reality / Virtual Reality	Chauncey Frend
Mar. 28	3D Digitization	Jeff Rogers and Tassie Gniady
Apr. 4	Advanced Media	Chris Eller
Apr. 11	Create your own VR Tour	Matt Mercer and Tassie Gniady
APr. 18	XR Extravaganza	Jeff Rogers

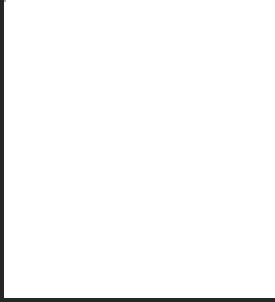

Impact of Virtual Reality Workshop Series

Molecular Visualization and Simulation in VR

Presented by John E. Stone, Senior Research Programmer, U. Illinois

VMD – “Visual Molecular Dynamics”

- Visualization and analysis of:
 - Molecular dynamics simulations
 - Lattice cell simulations
 - Quantum chemistry calculations
 - Cryo-EM densities, volumetric data
 - Sequence information
- User extensible scripting and plugins
- <http://www.ks.uiuc.edu/Research/vmd/>

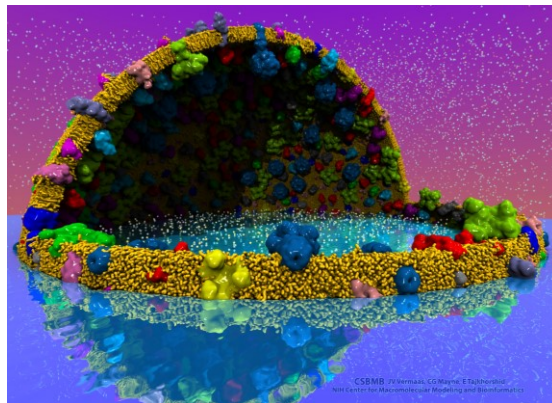

Cell-Scale Modeling

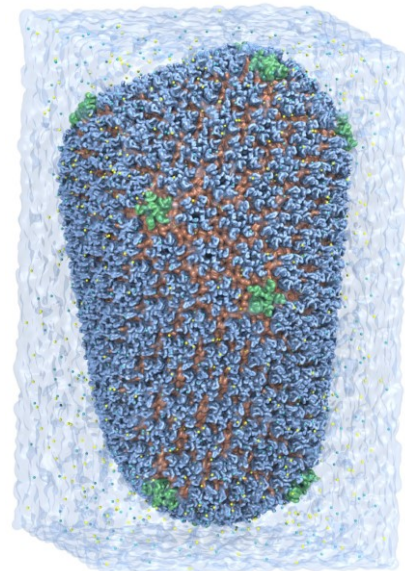

MD Simulation

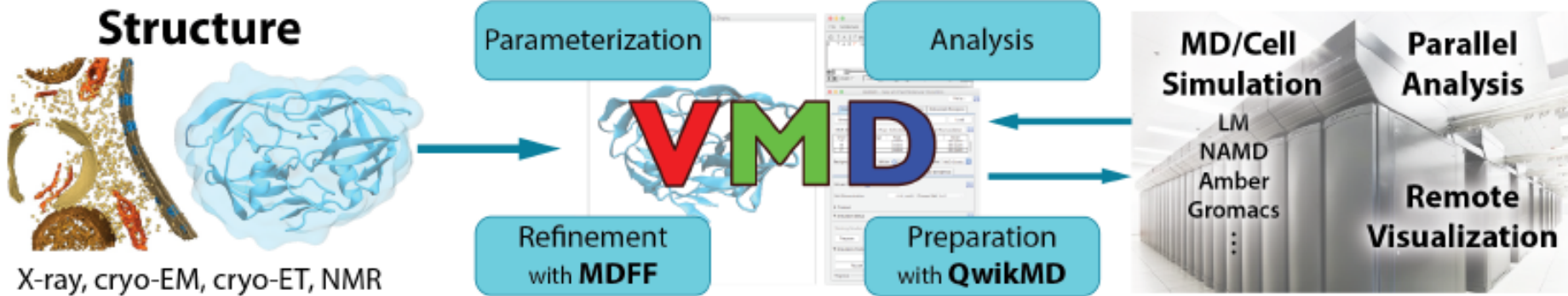

Goal: A Computational Microscope

Study the molecular machines in living cells

Ribosome: target for antibiotics

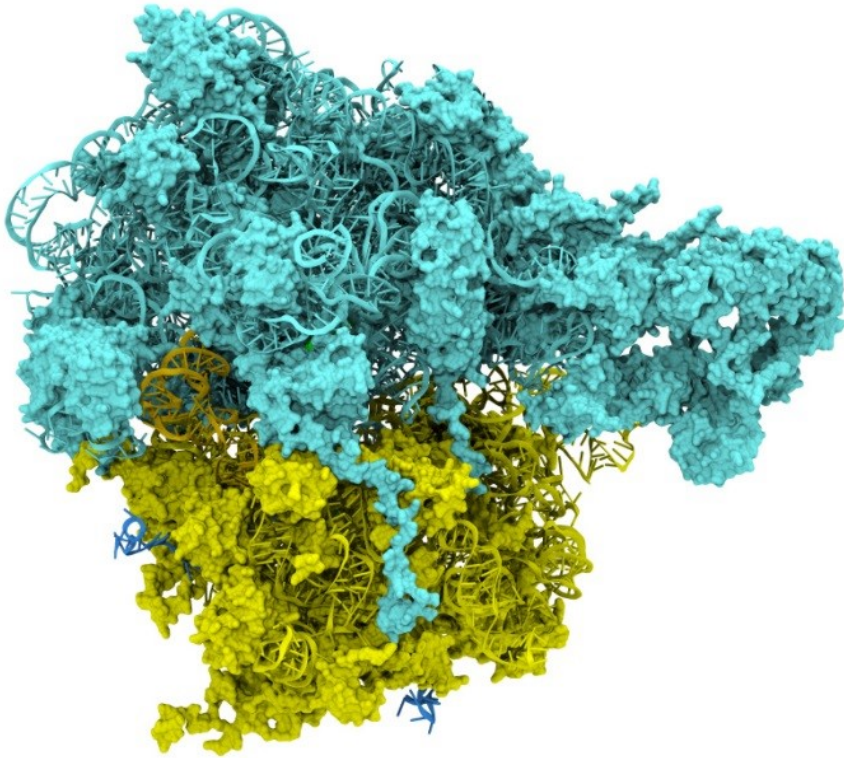

Poliovirus

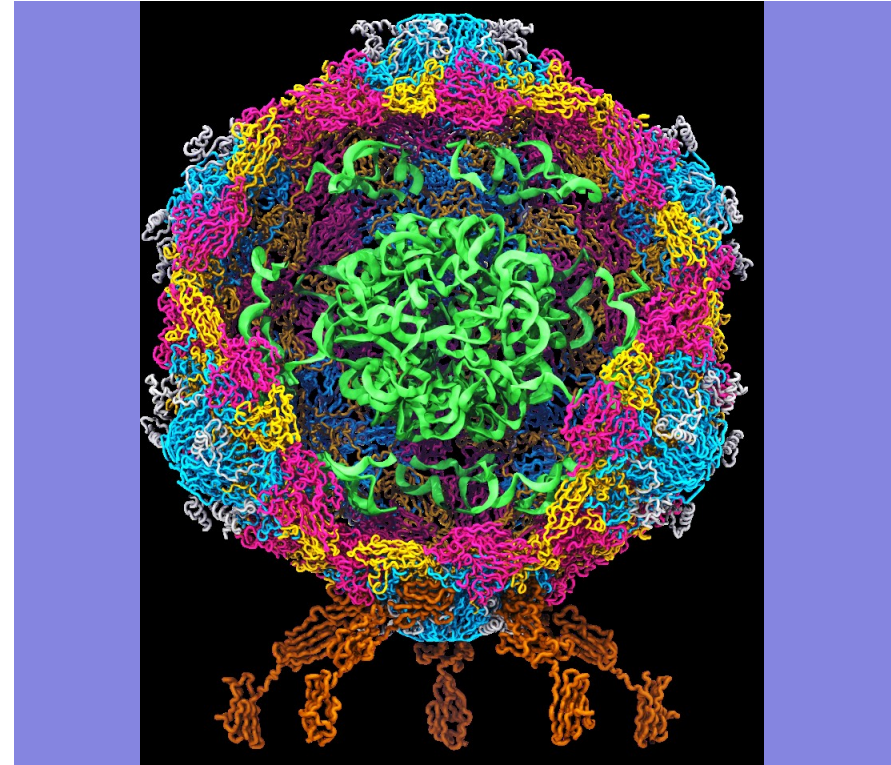

VMD Visualization Concepts

Biomolecular Visualization Challenges

- Geometrically complex scenes
- Spatial relationships important to see clearly: fog, shadows, AO helpful
- Often show a mix of structural and spatial properties
- Time varying!

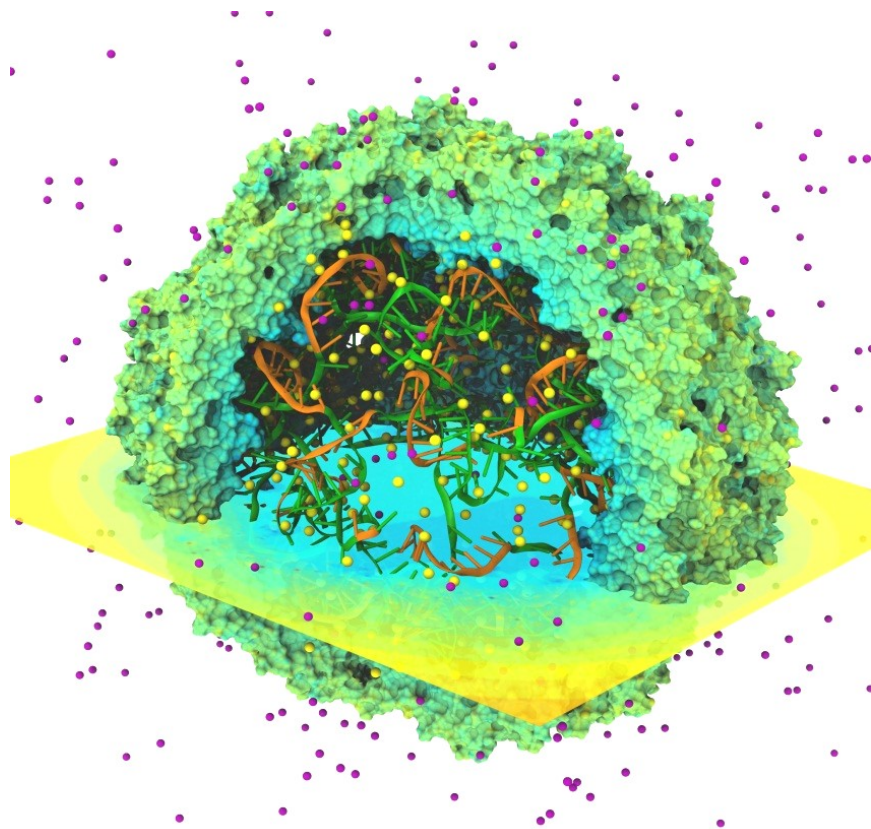

Structure Visualization

Molecular representations provide different levels of abstraction, atomic detail vs. higher level organizational information

- Atoms, VdW spheres, bonds, ball-stick, ...
- Molecular orbitals (quantum chemistry)
- Molecular surfaces
- Coarse-grained “beads”
- Ribbons, secondary structure, “cartoon” reps, RNA/DNA

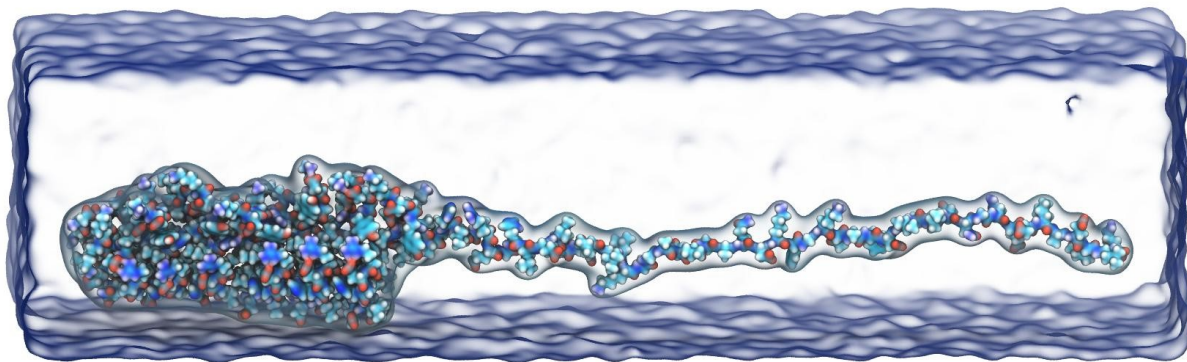

Selection, Filtering

- Most viz tools allow interactive visual picking, menu-driven selections of structure components to display or operate on
- VMD also extensively uses a text-based selection language (think google):
 - “water within 10 of protein and $z > 0$ ”
 - Allows selection on user-defined fields
 - ***Promotes synergy between interactive and scripting interfaces***
 - Works very well when dealing with huge time-varying structures

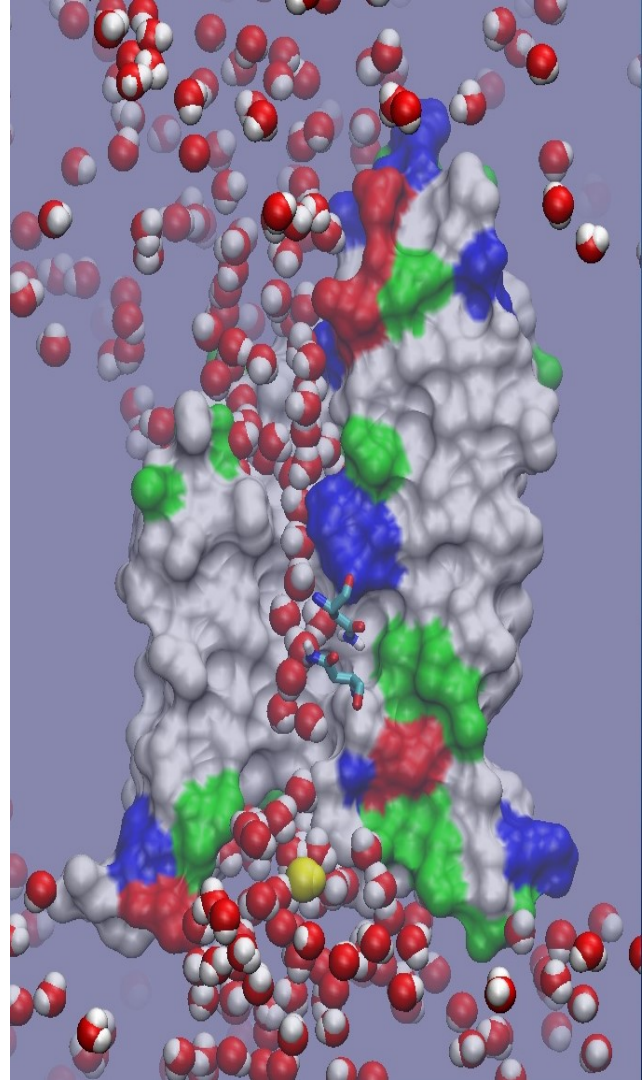

Computed Properties

- Smoothing of thermal noise
- Secondary structure
- Hydrogen bonds, salt bridges
- Forces, energies, stress, strain
- Time averaging of electrostatic fields, occupancy maps
- Quality-of-fit cross correlation with cryo-EM density maps
- Normal modes, principal component analysis, essential dynamics
- Cluster simulation trajectory timesteps by structural similarity

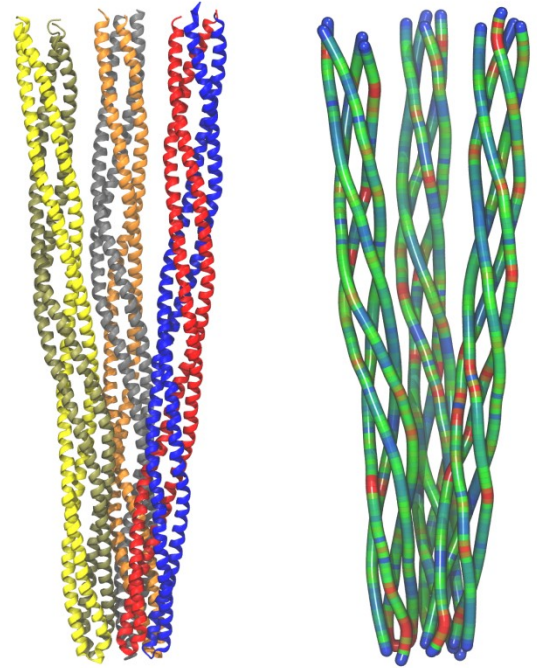

Chemoreceptor trimer-of-dimers analysis with Bendix plugin in VMD

Display of Computed Properties on Structures

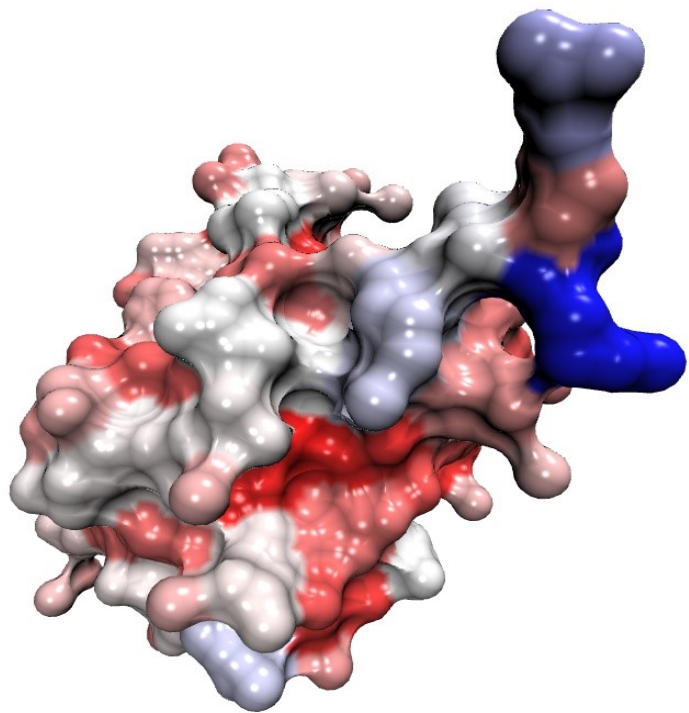

Per-residue solvent-accessible surface area of Ubiquitin

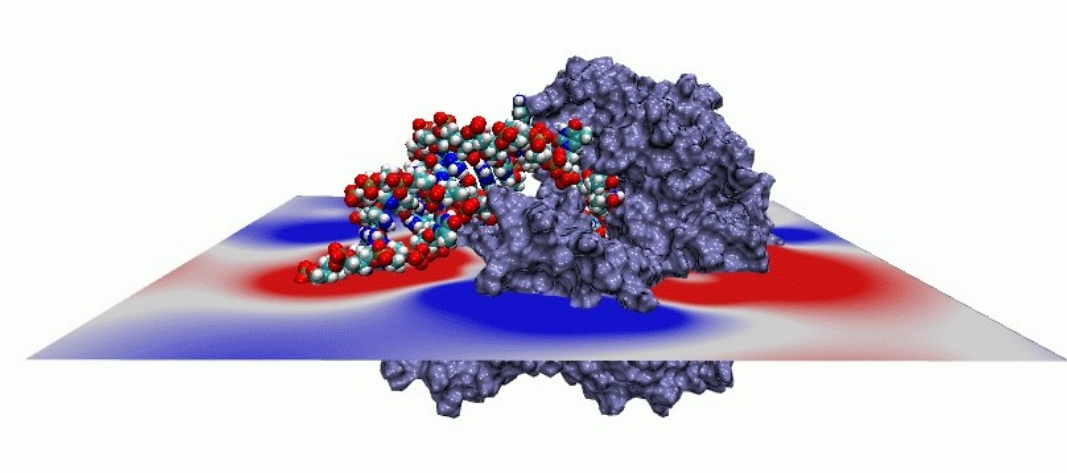

PME electrostatic potential contour for a helicase on a volumetric slice plane

CheA kinase PCA: first principal component porcupine plot

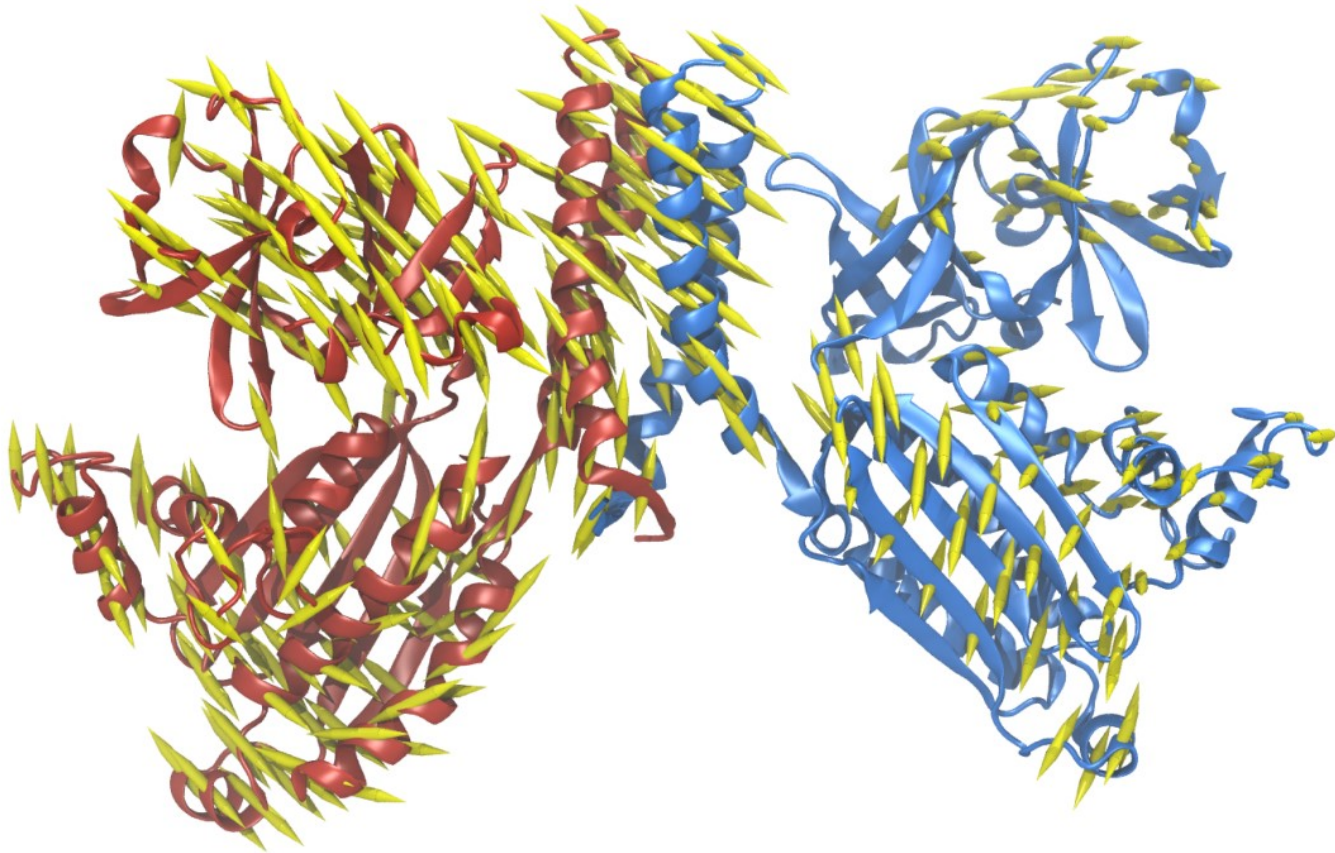

Visualization of Molecular Dynamics

- Molecular dynamics simulations save trajectories of atomic coordinates as simulated time progresses
- Researchers study trajectories by analyzing force profiles, energies, structural changes, etc.
- **Visualization selections, graphics, structure properties recomputed for each trajectory timestep!**

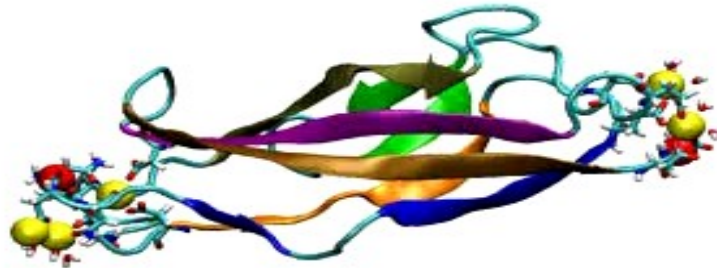

Petascale Computing - A Key Instrument for Life Science

MDFFF Solves Structures from X-ray Crystallography and Cryo-EM

Electron microscopy



FEI microscope

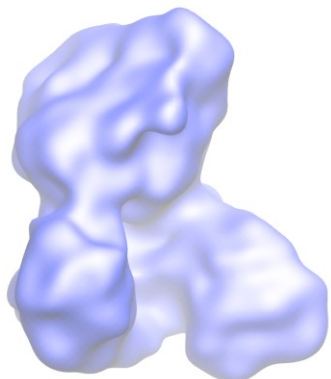

Electron density of protein in action at low resolution

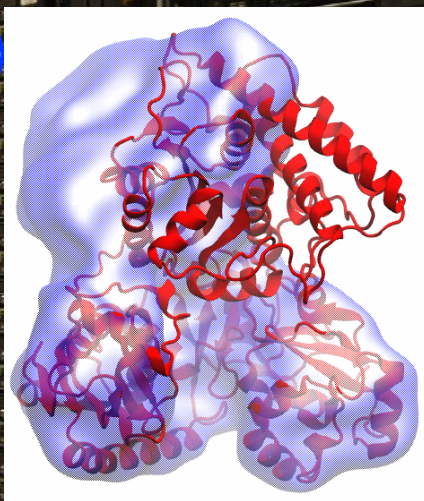
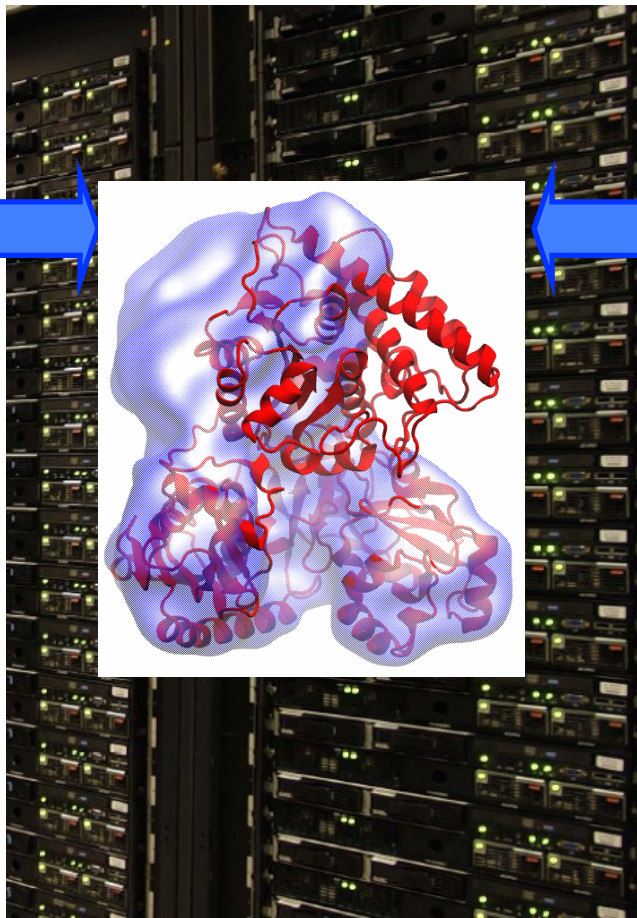

X-ray crystallography



APS at Argonne



Ideal protein structure at high resolution
Acetyl - CoA Synthase

Immersive Visualization and VR for Structural Biology

Immersive Viz. w/ VMD

- VMD began as a CAVE app (1993)
- Use of immersive viz by molecular scientists limited due to cost, complexity, lack of local availability, convenience
- Commoditization of HMDs excellent opportunity to overcome cost/availability
- This leaves many challenges still to solve:
 - Incorporate support for **remote visualization**
 - UIs, **multi-user collaboration**/interaction
 - **Rendering perf for large molecular systems**
 - Accomodate limitations idiosyncracies of commercial HMDs



VMD running in a CAVE w/ VR Juggler

Benefits of VR for Structural Biology

- By far the easiest structure exploration and navigation experience
- Well designed VR “tools” easier to use than conventional windowed visualization interfaces



Goal: Intuitive interactive viz. in crowded molecular complexes

Results from 64 M atom, 1 μ s sim!

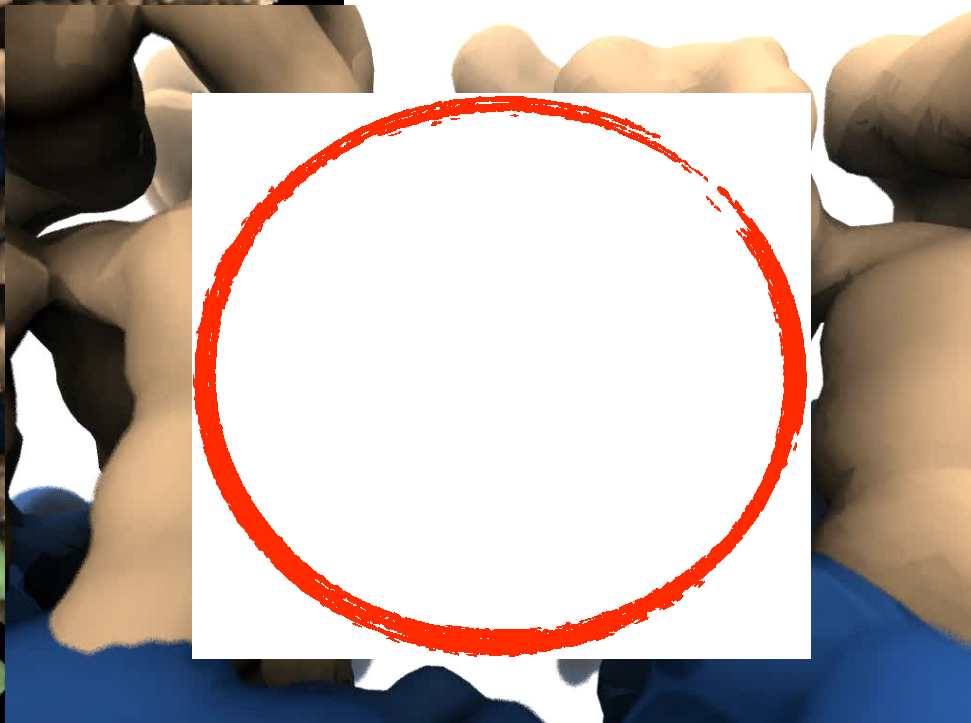
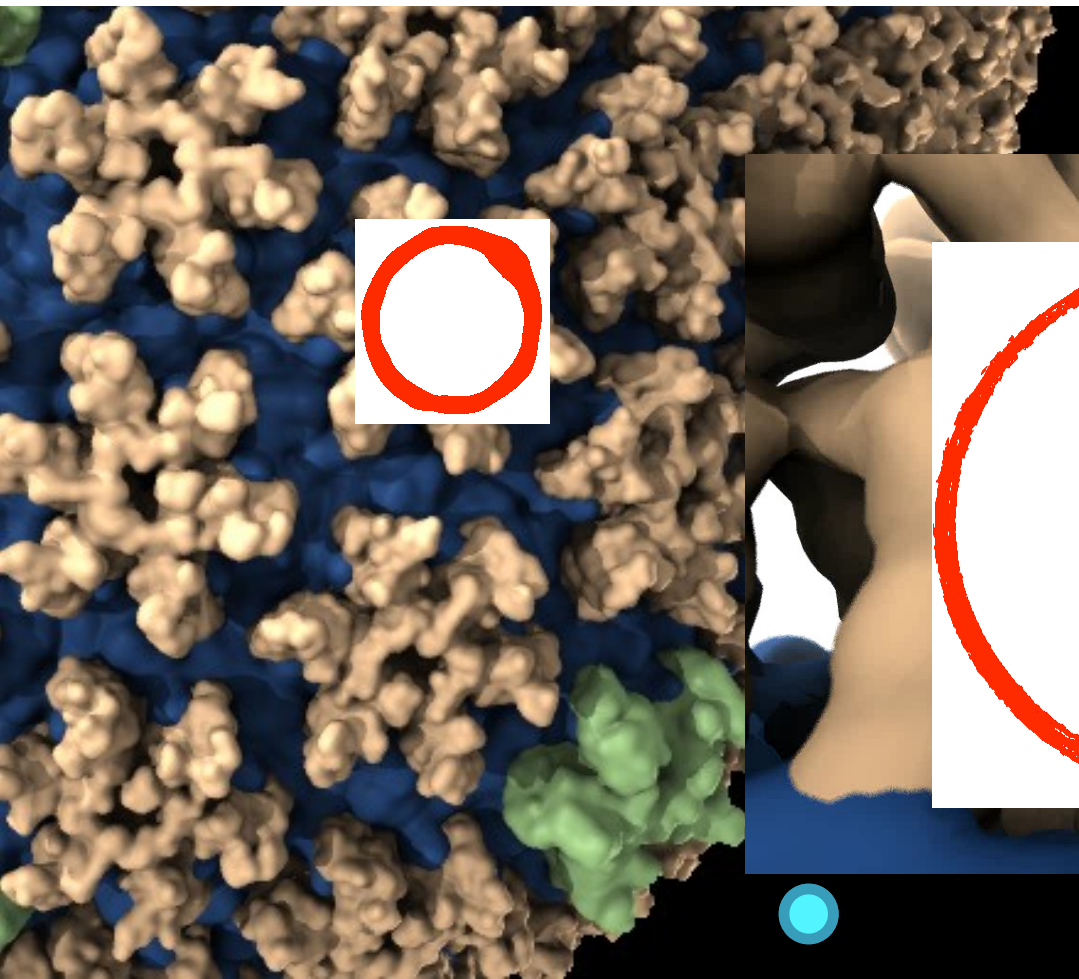

Number of chloride ions permeating
capsid hexameric centers

What Sorts of Tasks Do Researchers Need to Perform in VR

- Heavily skewed toward 3-D atomic structure visualization, analysis, dynamics
- Prime Example: Superposition and direct comparison of multiple modalities of structure information arising from different experimental and computational structure determination methods
 - Conventional windowed visualization interactions can be “clunky” until user uses 6DoF input devices and develops dexterity to use them effectively
 - VR HMDs and hand controllers simple to use and understand
 - Key interactions contextual with the structure/data being interacted with and the visualization or analysis task at hand

What General “VR UI Tools” Are Useful in This Area

- Navigation, teleportation, scaling, view-reset
- Selection
- Grabbing, pulling, orientation
- Hand-held lighting
- Clipping of drawn geometry, to allow peeling away of obscuring layers of atomic structures, density isosurfaces, etc.

Tool Examples: Grabbing, Moving



Tool Examples: Clipping Geometry

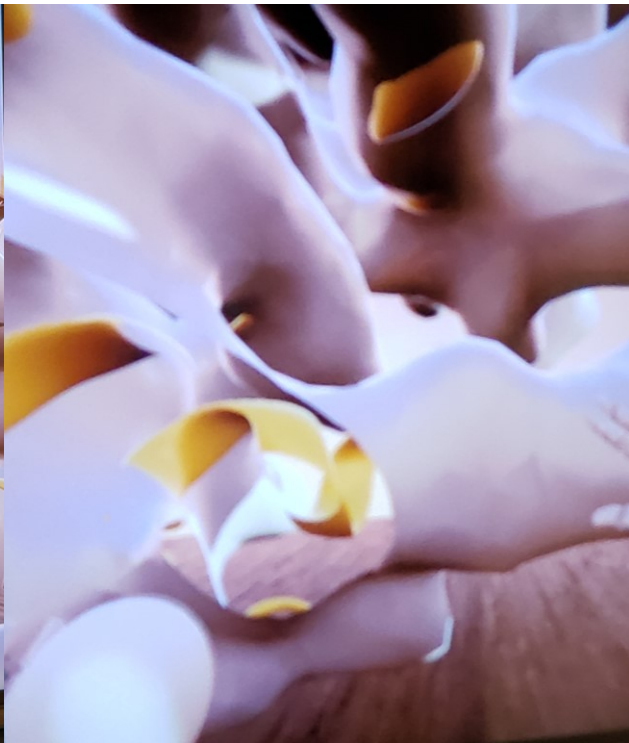

Tool Examples: Hand-Held Lighting



Interactions That are Difficult to Support Within Conventional VR

- Simultaneous interaction between the 3-D atomic structure visualizations and potentially large numbers of other 2-D plots or projections
- Large tabulated displays of quantitative properties, e.g., amino acid residue sequences, gene sequences, other 1-D properties
- Sometimes a “BIG STEREOSCOPIC TV” wins, although they have become difficult to find now...

Data Size Challenges and The Ultimate Limits on What We Can Visualize Interactively

All-Atom Molecular Dynamics Today

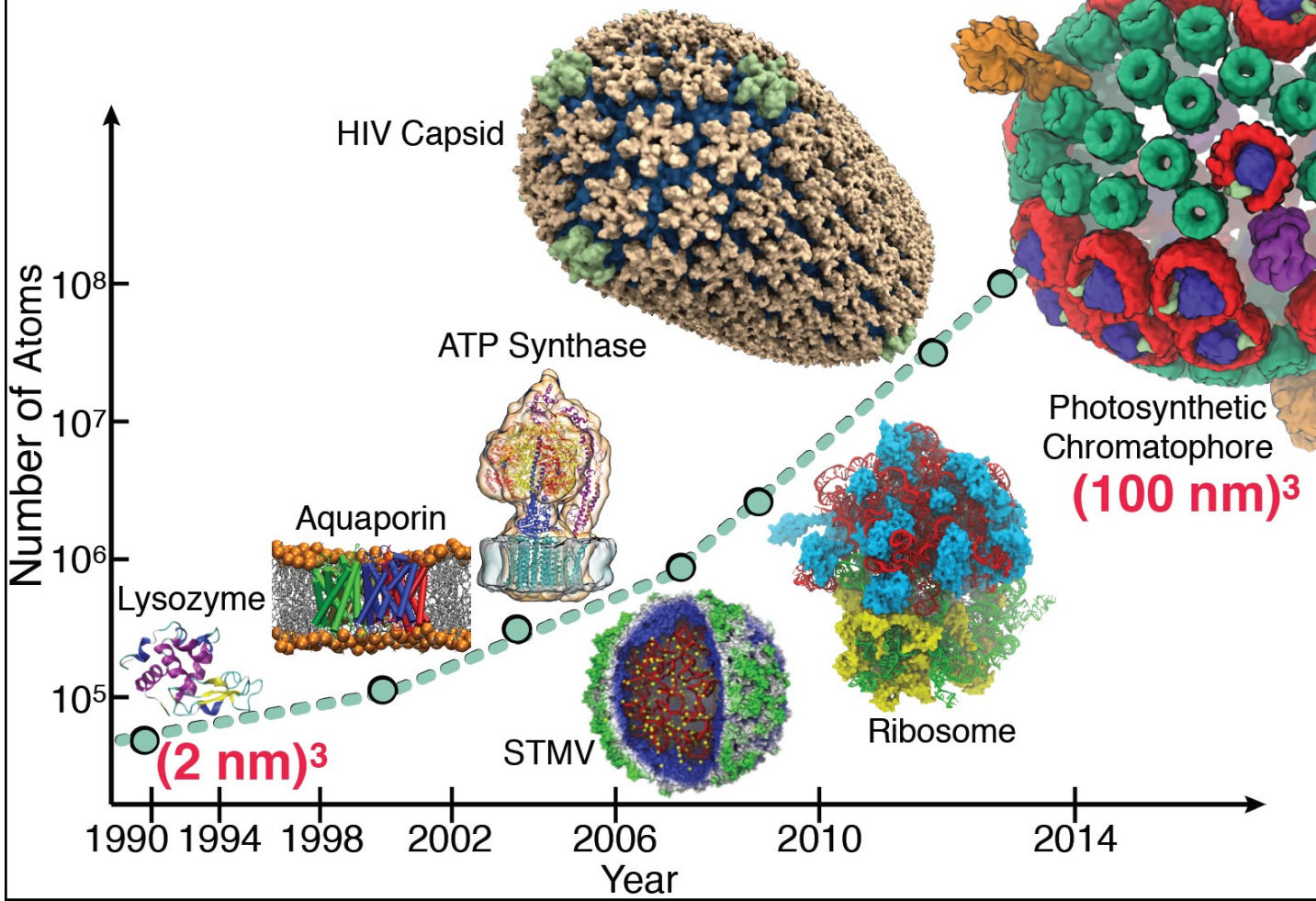

Next Generation: Simulating a Proto-Cell

- Emulate aspects of the *Mycoplasma mycoides* bacterium
- 200nm diameter
- ~1 billion atoms w/ solvent
- ~1400 proteins in membrane

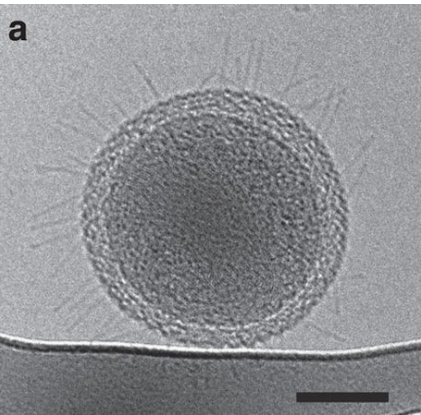
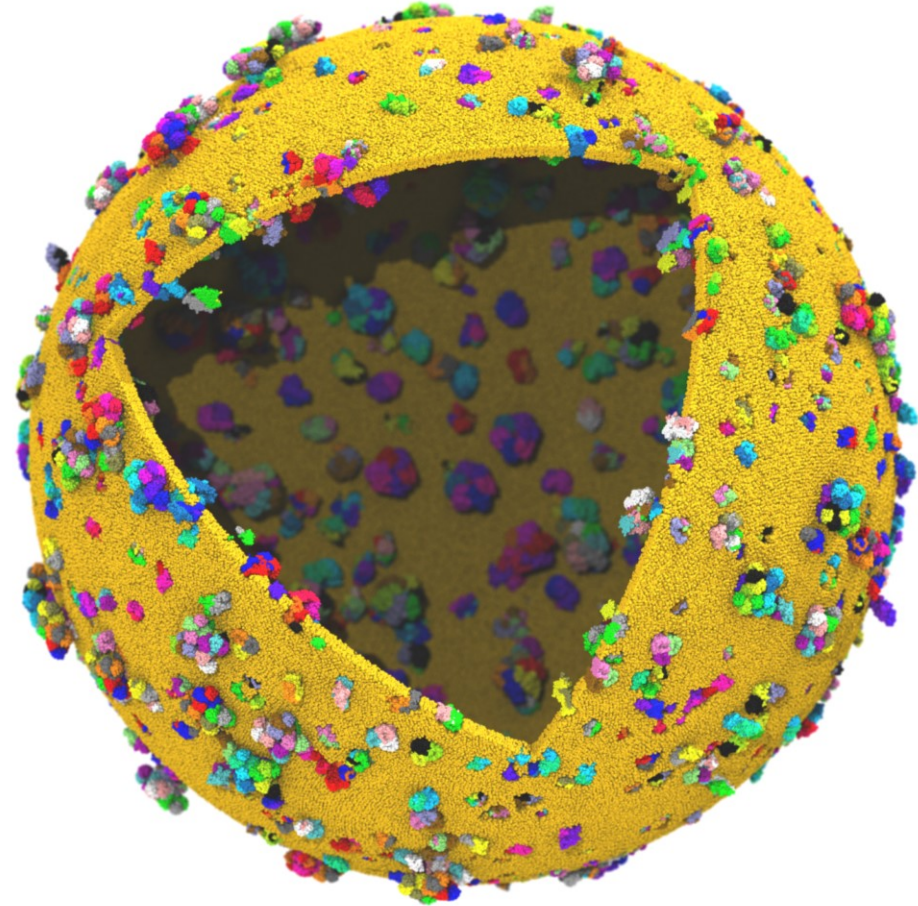

Cryo-ET image of ultra-small bacteria (scale bar 100nm)
Luef et al. Nature Comm., 6:6372, 2015.

Next Generation: Simulating a Proto-Cell

- **ORNL Summit:
NVLink-connected Tesla V100
GPUs enable next-gen
visualizations**
- 200nm diameter
- ~1 billion atoms w/ solvent
- ~1400 proteins in membrane

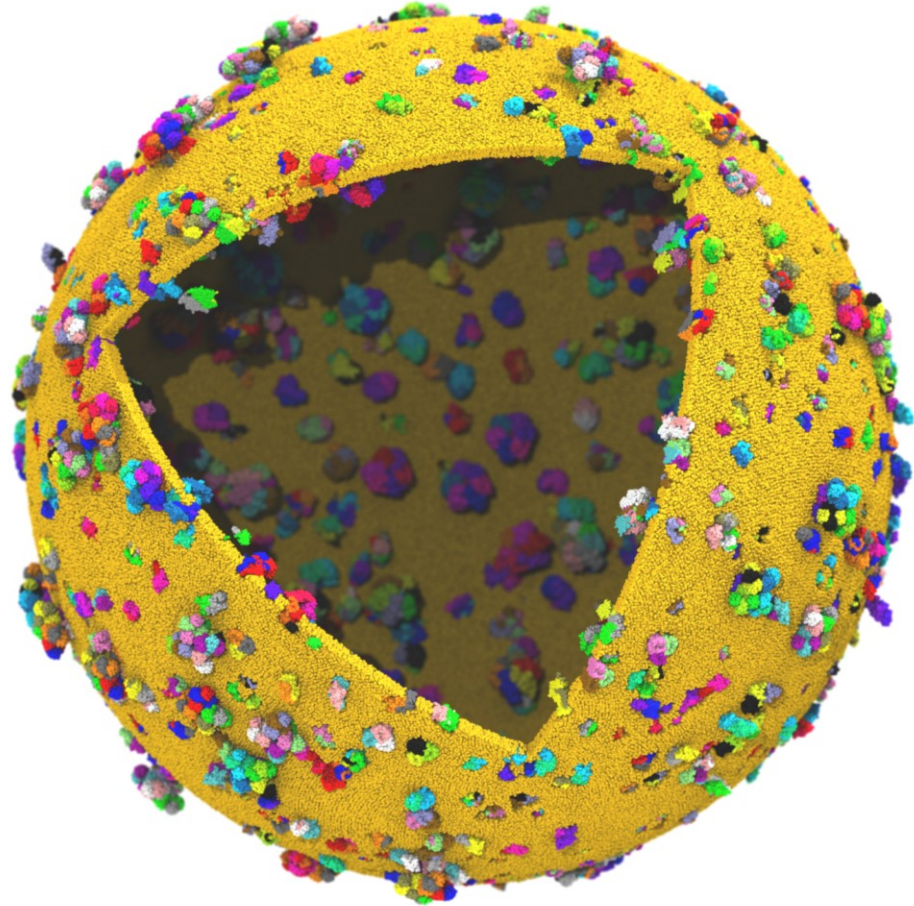

Proto-Cell Data Challenges

- **1B-atom proto-cell requires nodes with more than TB RAM to build complete model...**
- **1B-atom proto-cell binary structure file: 63GB**
- **Trajectory frame atomic coordinates: 12GB, 1.2TB/ns of simulation (1 frame per 10ps)**
- **Routine modeling and visualization tasks are a big challenge at this scale**
 - **Models contain thousands of atomic-detail components** that must work together in harmony
 - **Exploit persistent memory technologies** to enable “instant on” operation on massive cell-scale models – eliminate several minutes of startup during analysis/visualization of known structure
 - **Sparse output of results at multiple timescales** will help ameliorate visualization and analysis I/O
 - **Data quantization, compression, APIs like ZFP**

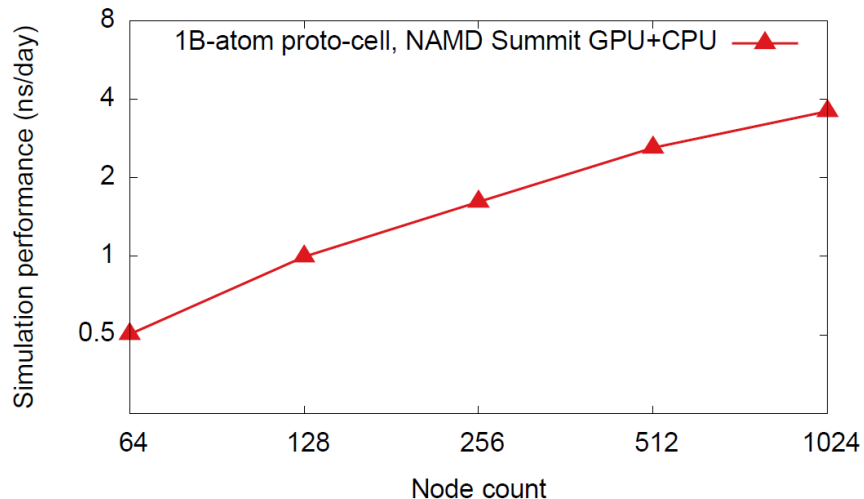
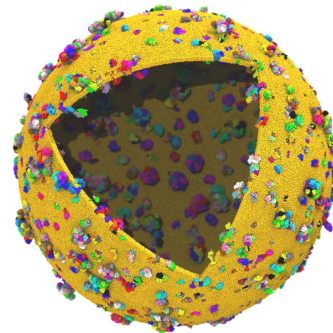

VMD Petascale Visualization and Analysis

- Analyze/visualize large trajectories too large to transfer off-site:
 - User-defined parallel analysis operations, data types
 - Parallel rendering, movie making
- Supports GPU-accelerated Cray XK7 nodes for both visualization and analysis:
 - **GPU accelerated trajectory analysis w/ CUDA**
 - **OpenGL and GPU ray tracing for visualization and movie rendering**
- Parallel I/O rates up to **275 GB/sec** on 8192 Cray XE6 nodes – can read in **231 TB in 15 minutes!**

Parallel VMD currently available on:

**ORNL Titan, NCSA Blue Waters, Indiana Big Red II,
CSCS Piz Daint, and similar systems**



NCSA Blue Waters Hybrid Cray XE6 / XK7
22,640 XE6 dual-Opteron CPU nodes
4,224 XK7 nodes w/ Telsa K20X GPUs

IBM AC922 Summit Node

3 GPUs Per CPU Socket

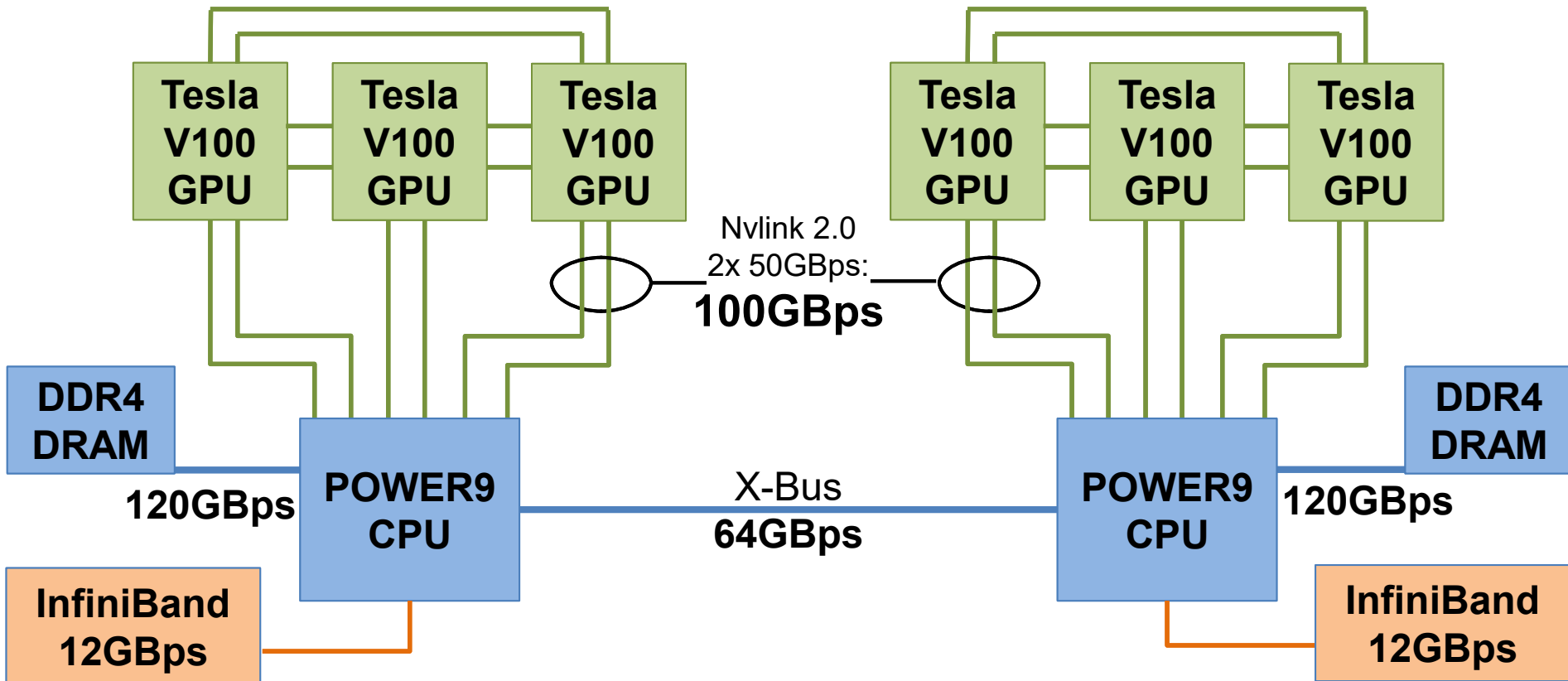

VMD supports EGL for in-situ and parallel rendering on clouds, clusters, and supercomputers

- **No windowing system dependency**
- Easily deploy parallel VMD builds supporting off-screen rendering
- Maintains 100% of VMD OpenGL shaders and rendering features
- Support high-quality vendor-supported commercial OpenGL implementations in HPC systems that were previously limited to Mesa

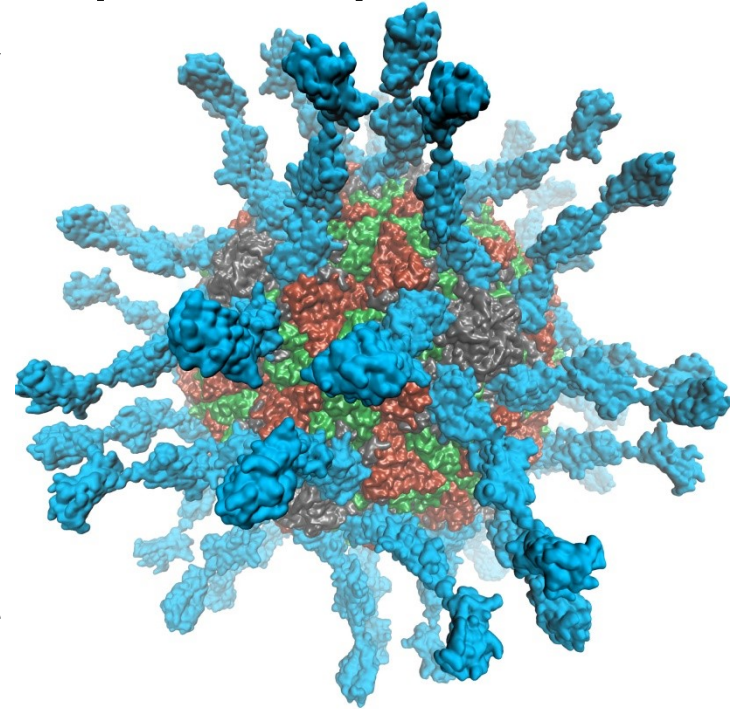

Poliovirus

VMD EGL Rendering: Supports full VMD GLSL shading features, multisample antialiasing, ray cast spheres, 3-D tex mapping, ...

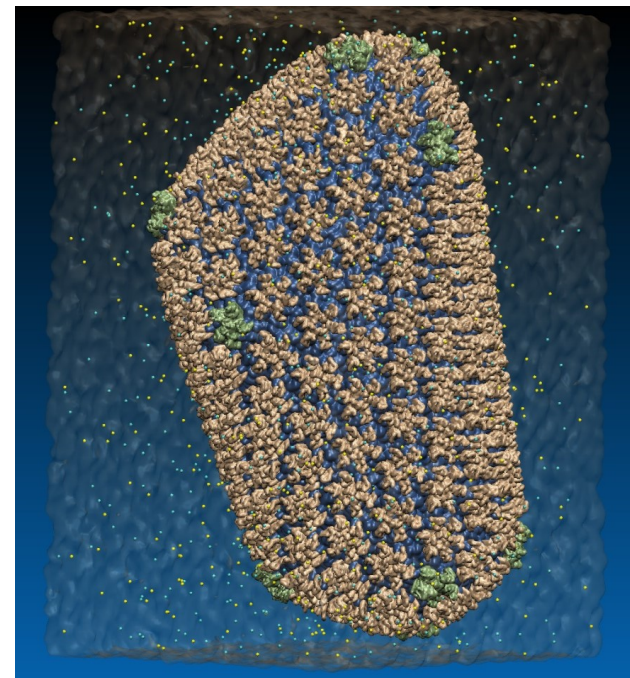
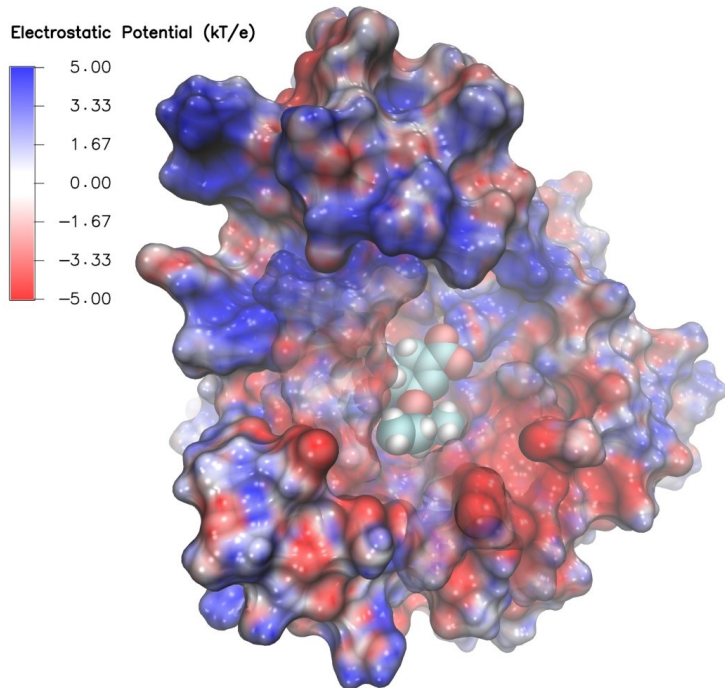

Swine Flu A/H1N1 neuraminidase bound to Tamiflu

64M atom HIV-1 capsid simulation

High Performance Molecular Visualization: In-Situ and Parallel Rendering with EGL.

J. E. Stone, P. Messmer, R. Sisneros, and K. Schulten. High Performance Data Analysis and Visualization Workshop, IEEE IPDPSW, pp. 1014-1023, 2016.

Molecular Structure Data and Global VMD State

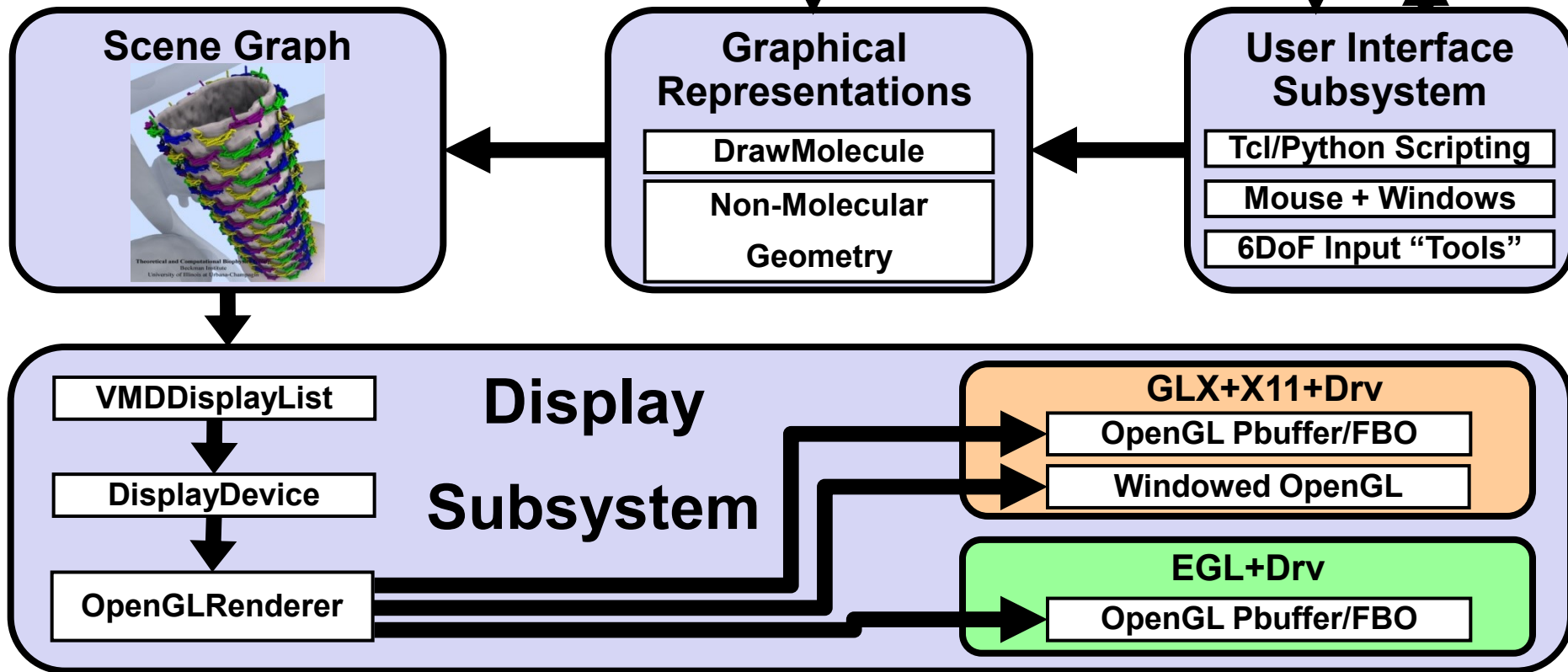

VMD w/ OptiX 5

- Interactive RT on laptops, desktops, and cloud
- Large-scale parallel rendering: in situ or post hoc visualization
- Remote RT on NVIDIA GPU clusters
- Stereoscopic panoramic and full-dome projections
- Omnidirectional VR for YouTube, VR HMDs
- **GPU memory sharing via NVLink on Quadro GP100, Tesla P100**
- **VMD+OptiX 5, NVIDIA NGC container: <https://ngc.nvidia.com/registry/>**
- **In-progress:**
 - **OptiX denoising support: fast turnaround w/ AO, DoF, etc**
 - **Denoising to enable practical use of path tracing in VMD**

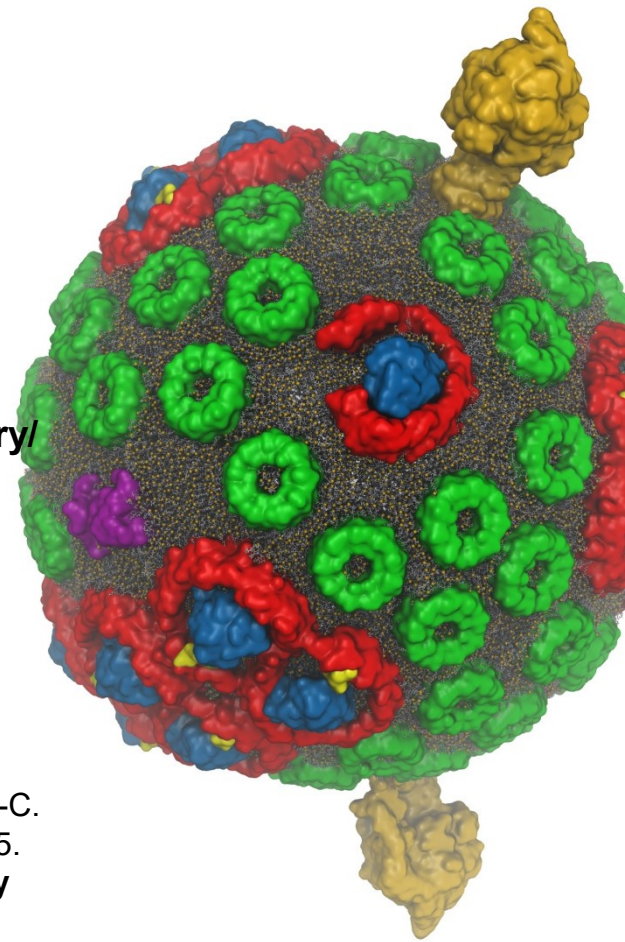

GPU-Accelerated Molecular Visualization on Petascale Supercomputing Platforms.

J. E. Stone, K. L. Vandivort, and K. Schulten. UltraVis'13, pp. 6:1-6:8, 2013.

Visualization of Energy Conversion Processes in a Light Harvesting Organelle at Atomic Detail. M. Sener, et al. SC'14 Visualization and Data Analytics Showcase, 2014.

Chemical Visualization of Human Pathogens: the Retroviral Capsids. J. R. Perilla, B.-C. Goh, J. E. Stone, and K. Schulten. SC'15 Visualization and Data Analytics Showcase, 2015.

Atomic Detail Visualization of Photosynthetic Membranes with GPU-Accelerated Ray Tracing. J. E. Stone et al., J. Parallel Computing, 55:17-27, 2016.

Immersive Molecular Visualization with Omnidirectional Stereoscopic Ray Tracing and Remote Rendering J. E. Stone, W. R. Sherman, and K. HPDAV, IPDPSW, pp. 1048-1057, 2016.

VMD/OptiX GPU Ray Tracing of all-atom Chromatophore w/ lipids.

Lighting Comparison, STMV Capsid

Two lights, no shadows

Two lights, hard shadows, 1 shadow ray per light

Ambient occlusion + two lights, 144 AO rays/hit

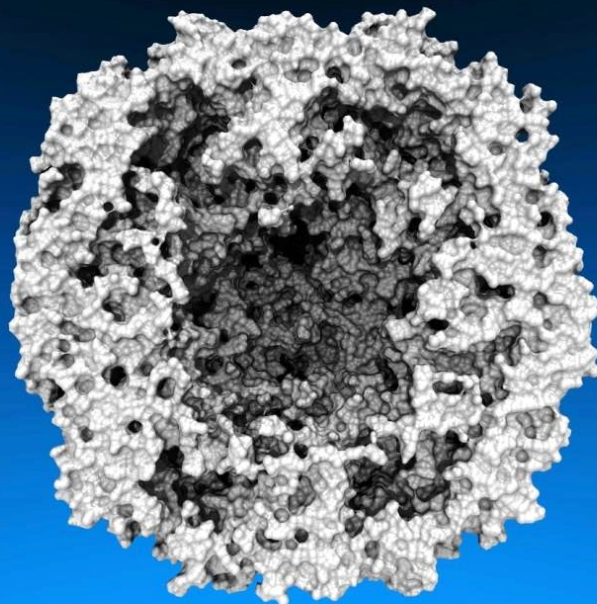
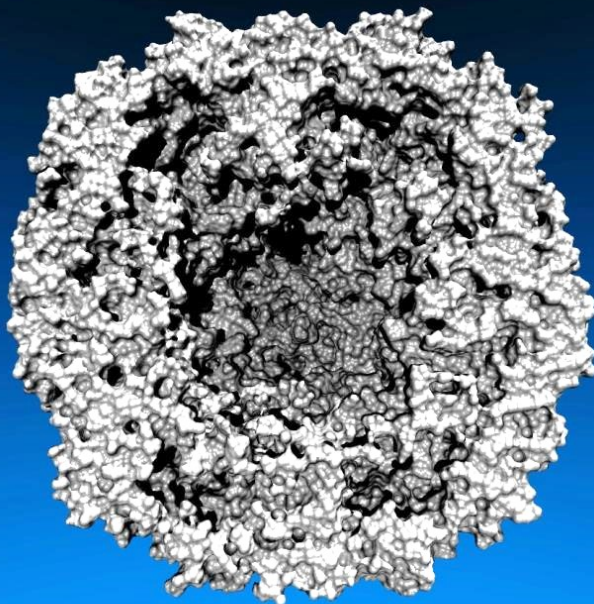
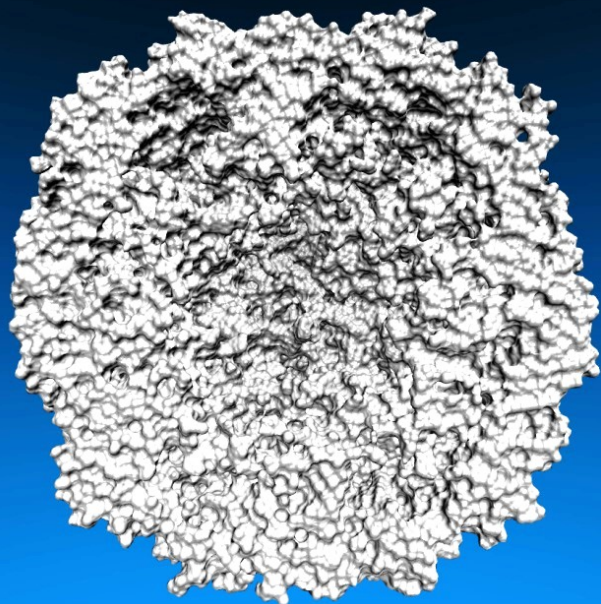

Interactive Remote Visualization and Analysis

- Enabled by hardware H.264/H.265 video encode/decode
- Enable visualization and analyses not possible with conventional workstations
- Access data located anywhere in the world
 - Same VMD session available to any device
- Linux prototype in-development using NVIDIA Video Codec SDK, easy-to-use **NvPipe** wrapper library



Using Omnidirectional Stereoscopic Projections to Permit Remote Ray Tracing for VR HMDs

HMD Ray Tracing Challenges

- HMDs require high frame rates (**90Hz or more**) and minimum latency between IMU sensor reads and presentation on the display
- Multi-GPU workstations fast enough to direct-drive HMDs at required frame rates for simple scenes with direct lighting, hard shadows
- Advanced RT effects such as AO lighting, depth of field require much **larger sample counts**, impractical for direct-driving HMDs
- **Remote viz. required** for many HPC problems due to **large data**
- **Remote viz. latencies too high for direct-drive of HMD**
- **Our two-phase approach: moderate-FPS remote RT combined with local high-FPS view-dependent HMD reprojection w/ OpenGL**

VMD Molecular Structure Data and Global State

Scene Graph

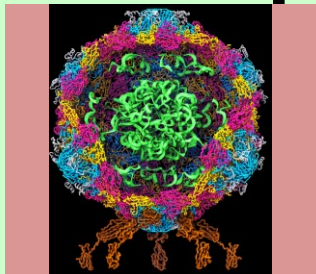

Graphical Representations

DrawMolecule

Non-Molecular
Geometry

User Interface Subsystem

Tcl/Python Scripting

Mouse + Windows

VR Input "Tools"

Display Subsystem

VMDDisplayList

DisplayDevice

OpenGLDisplayDevice

FileRenderer

Windowed OpenGL GPU

OpenGL Pbuffer GPU

Tachyon CPU RT

TachyonL-OptiX GPU RT
Batch + Interactive

VMD TachyonLOptiX: Multi-GPU on NVIDIA VCA Cluster

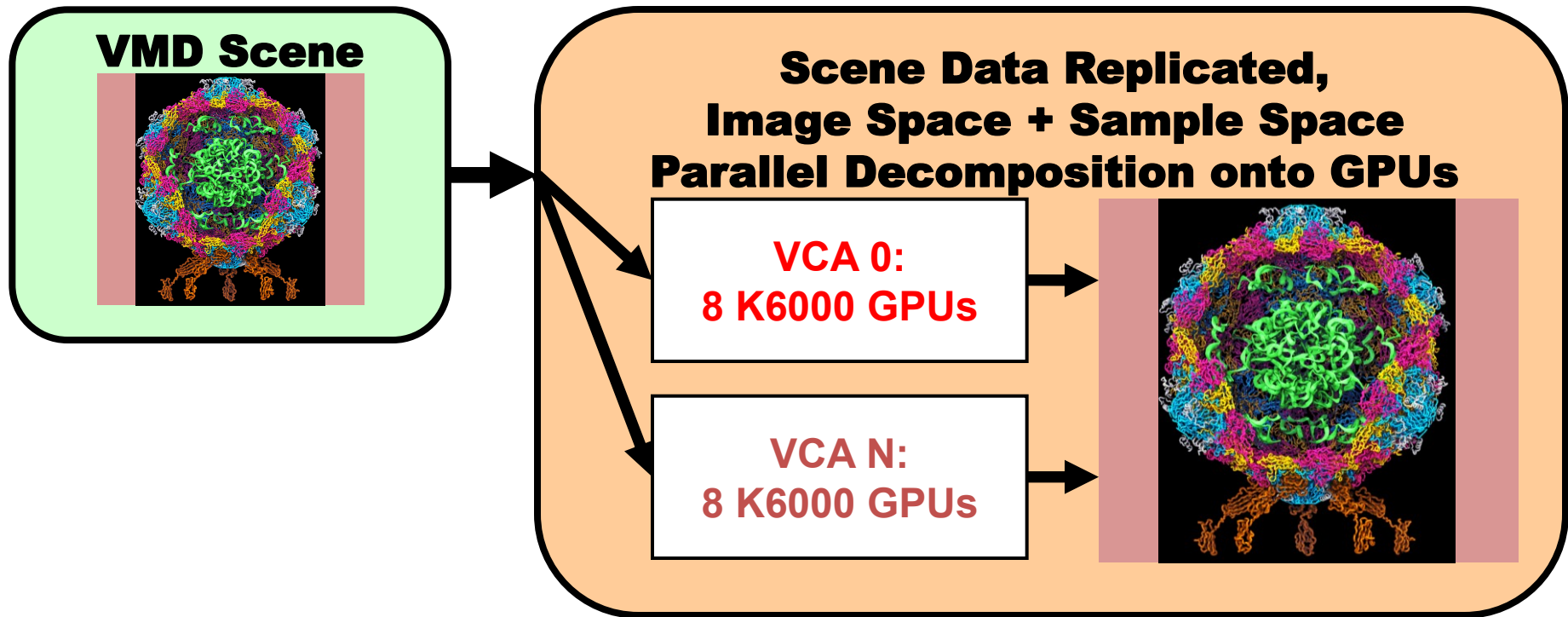

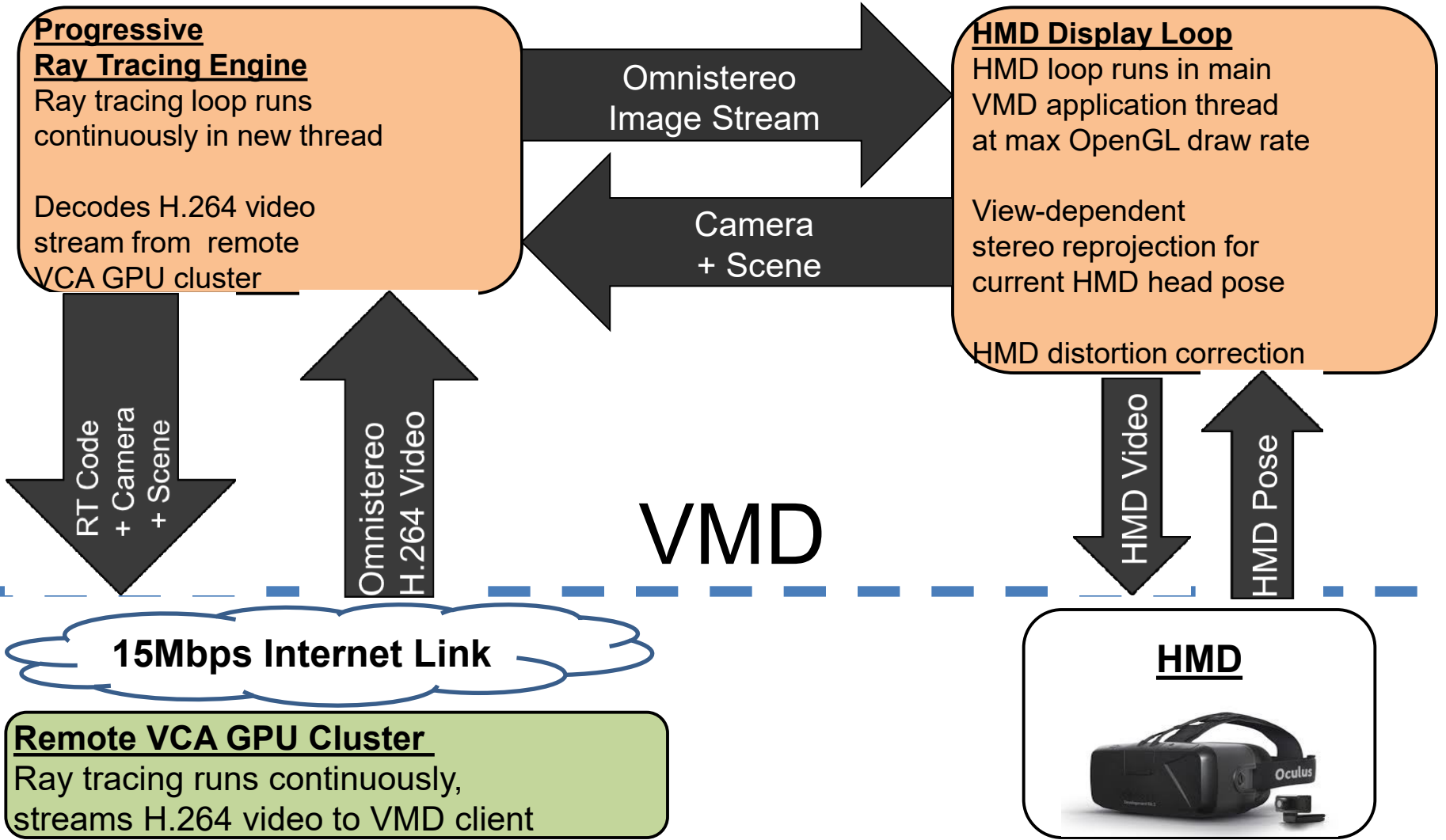

Stereoscopic Panorama Ray Tracing w/ OptiX

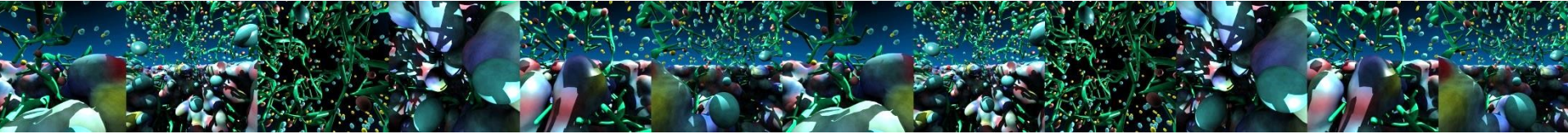

- **Render 360° images and movies for VR headsets such as Oculus Rift, Google Cardboard**
- Ray trace panoramic stereo spheremaps or cubemaps for very high-frame-rate display via OpenGL texturing onto simple geometry
- Stereo requires spherical camera projections **poorly suited to rasterization**
- Benefits from OptiX multi-GPU rendering and load balancing, **remote visualization**

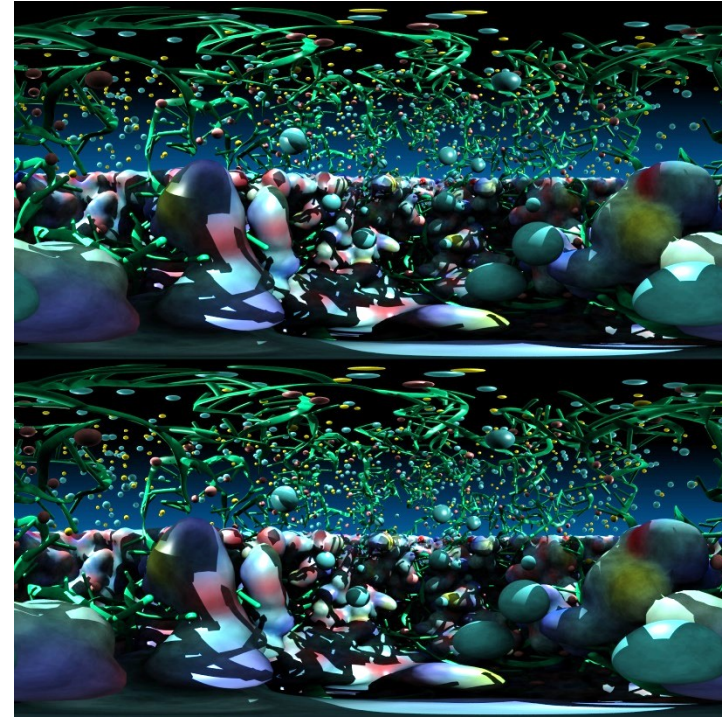

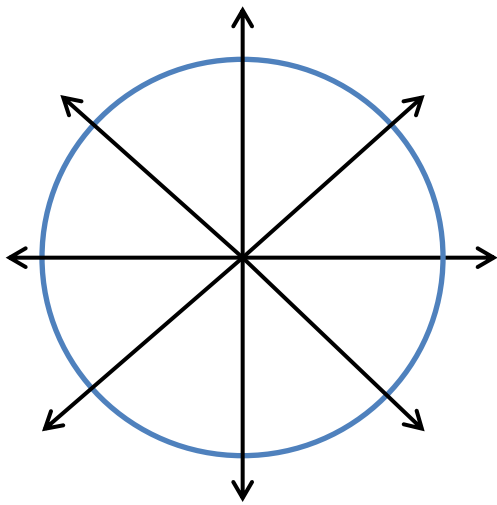

**A) Monoscopic circular projection.
Eye at center of projection (COP).**

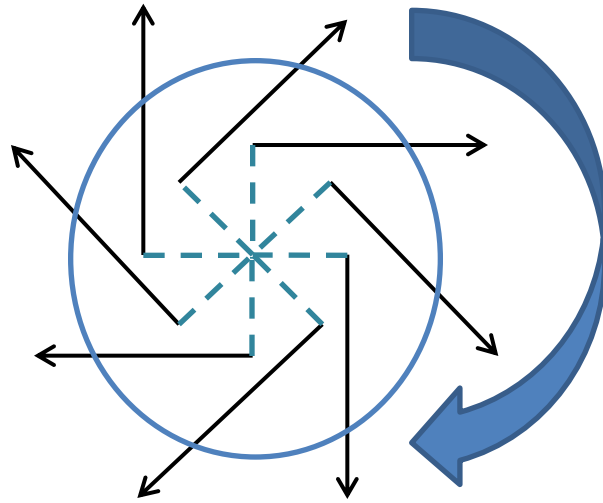

**B) Left eye stereo circular projection.
Eye offset from COP by half of interocular distance.**

C) Stereo eye separation smoothly decreased to zero at zenith and nadir points on the polar axis to prevent incorrect stereo when HMD sees the poles.

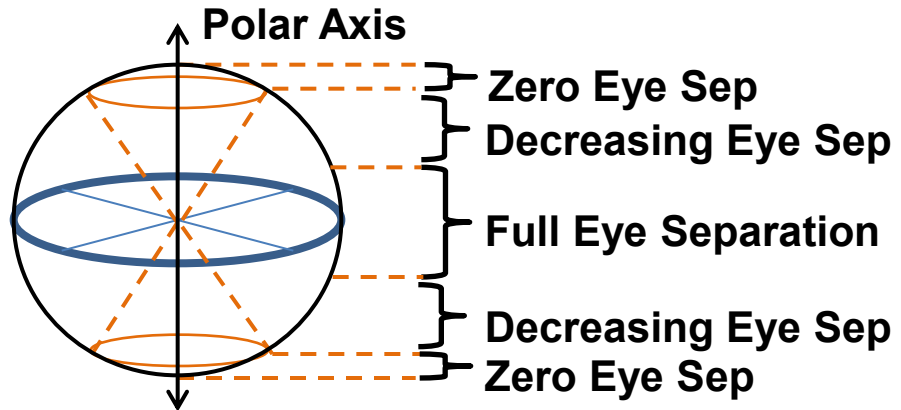

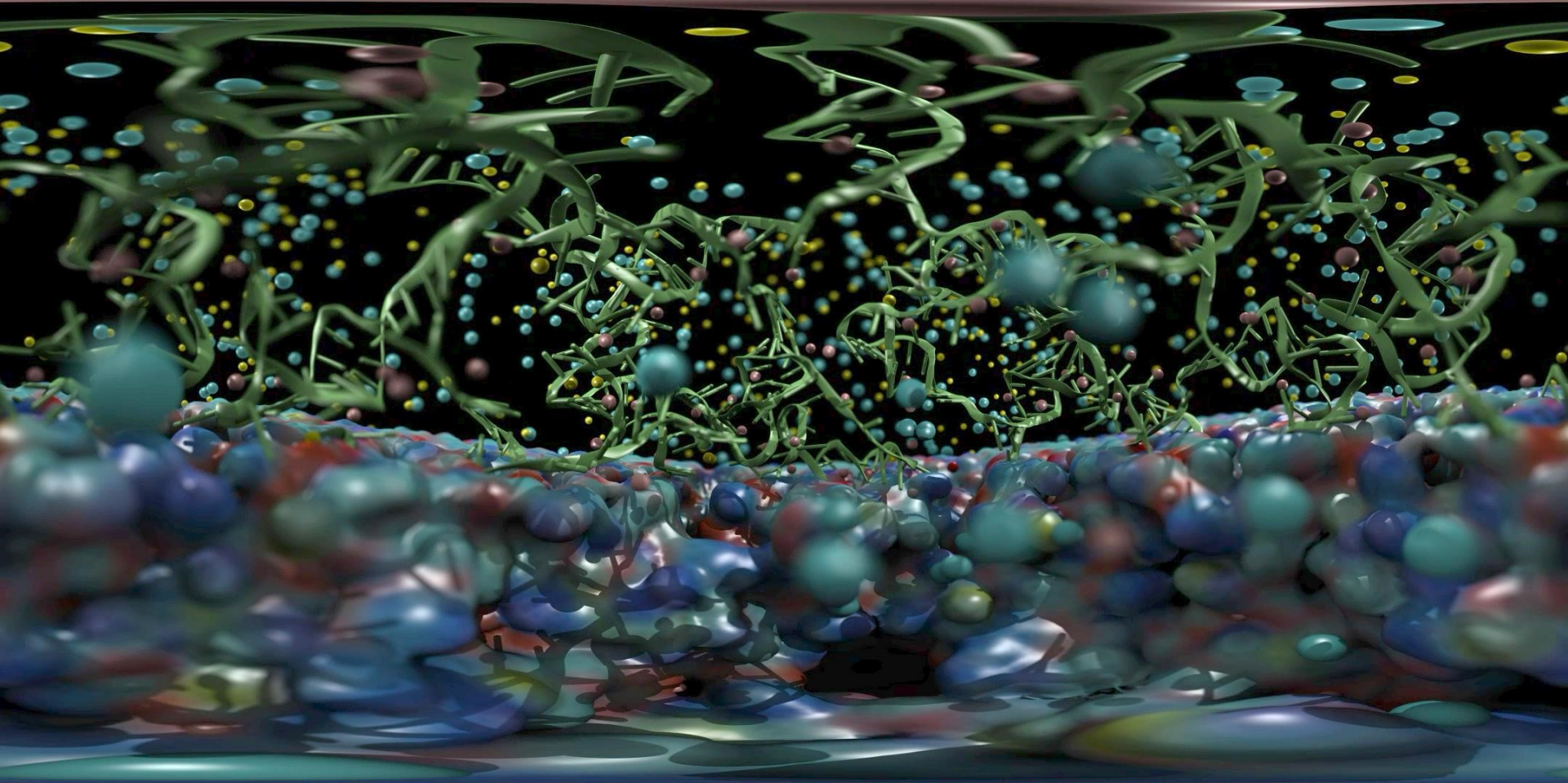

Biomedical Technology Research Center for Macromolecular Modeling and Bioinformatics
Beckman Institute, University of Illinois at Urbana-Champaign - www.ks.uiuc.edu

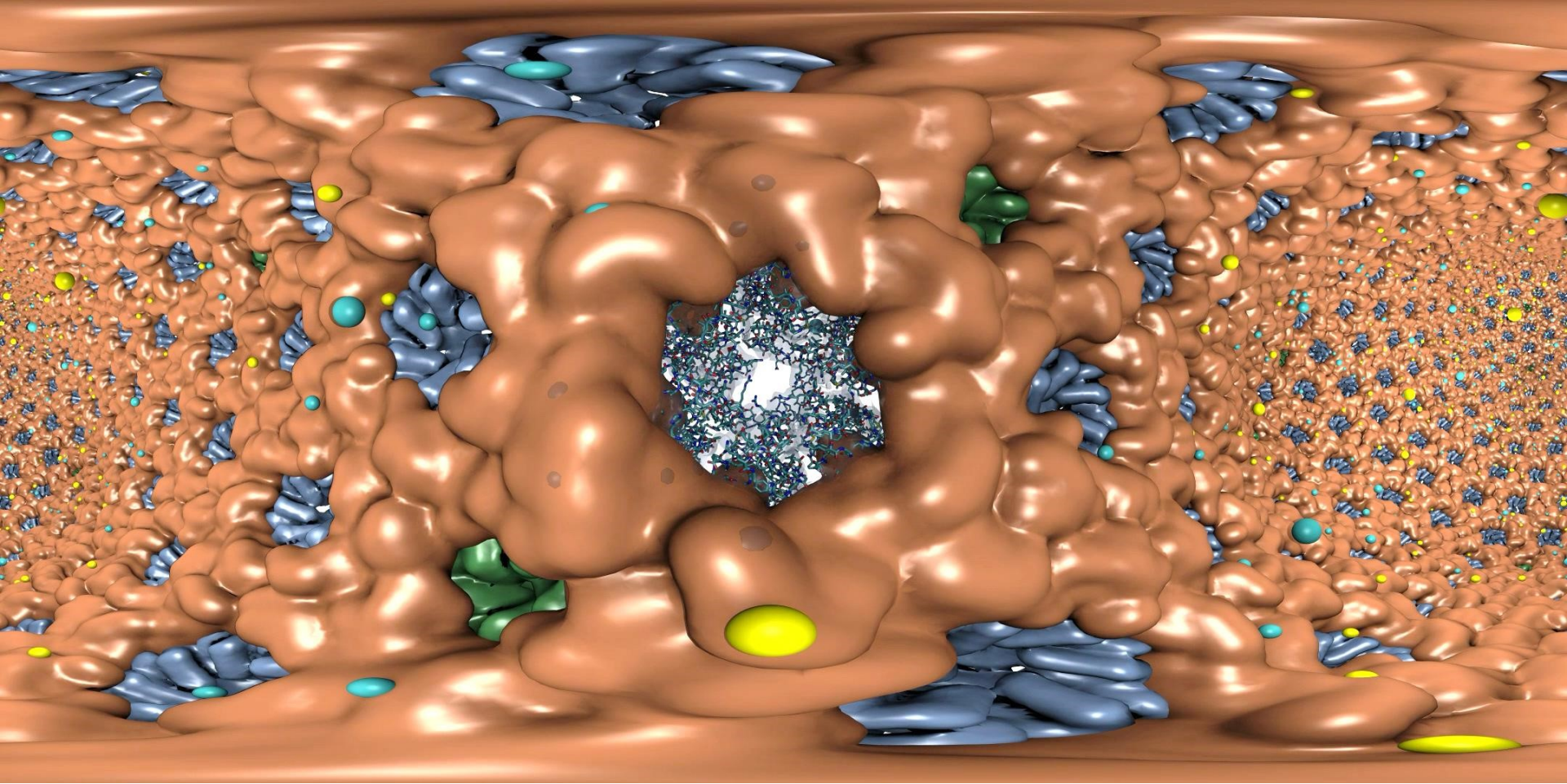

Remote Omnidirectional Stereoscopic RT Performance @ 3072x1536 w/ 2-subframes

Scene	Per-subframe samples AA : AO (AO per-hit)	RT update rate (FPS)
STMV shadows	1:0	22.2
	2:0	18.1
	4:0	10.3
STMV Shadows+AO	1:1	18.2
	1:2	16.1
	1:4	12.4
STMV Shadows+AO+Do F	1:1	16.1
	2:1	11.1
	2:2	8.5
HIV-1 Shadows	1:0	20.1
	2:0	18.1
	4:0	10.2
HIV-1 Shadows+AO	1:1	17.4
	1:2	12.2
	1:4	8.1

HMD View-Dependent Reprojection with OpenGL

- Texture map panoramic image onto reprojection geometry that matches the original RT image formation surface (sphere for equirectangular, cube for cube map)
- HMD sees standard perspective frustum view of the textured surface
- Commodity HMD optics require **software lens distortion and chromatic aberration correction** prior to display, implemented with multi-pass FBO rendering
- **Enables low-latency, high-frame-rate redraw** as HMD head pose changes (**150Hz or more**)



Immersive Molecular Visualization with Omnidirectional Stereoscopic Ray Tracing and Remote Rendering. J. E. Stone, W. R. Sherman, and K. Schulten. High Performance Data Analysis and Visualization Workshop, IEEE International Parallel and Distributed Processing Symposium Workshops (IPDPSW), pp. 1048-1057, 2016.



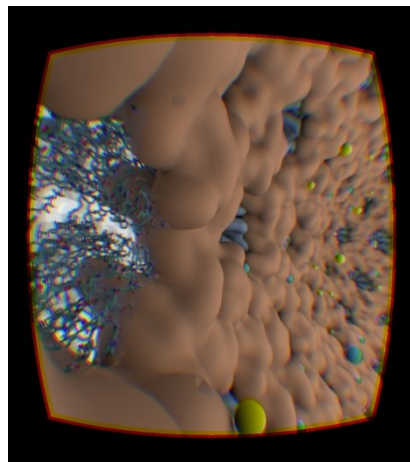
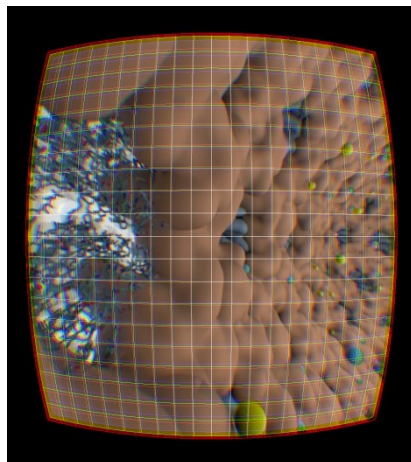
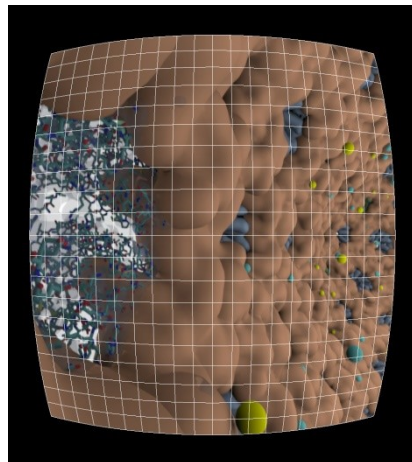
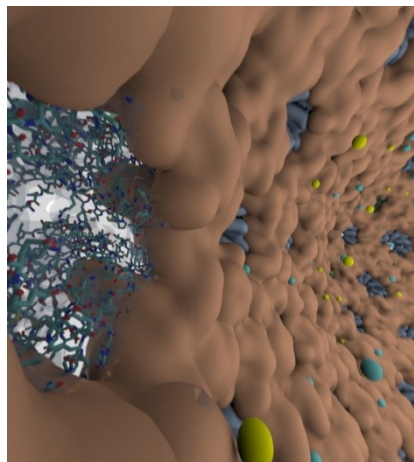
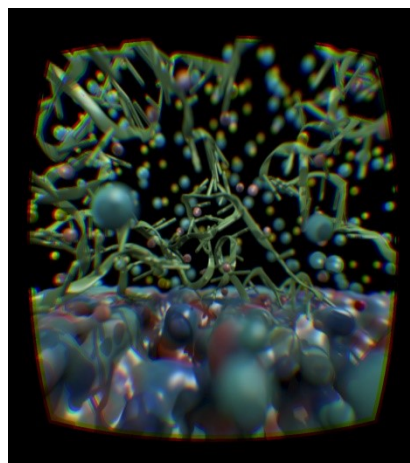
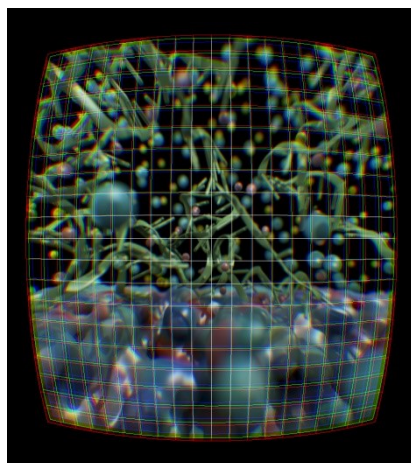
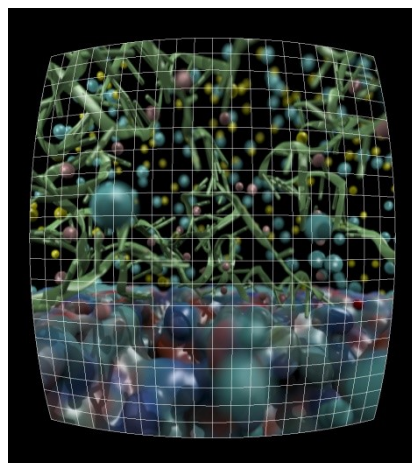
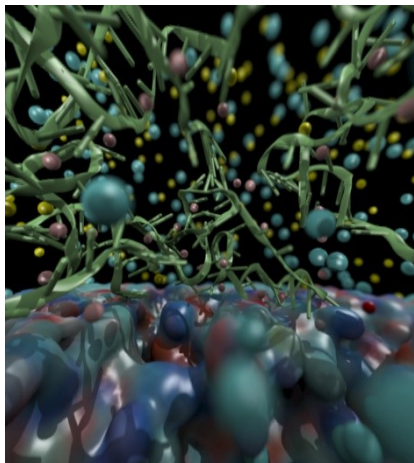

Ongoing VR Work

- OpenXR – cross platform multi-vendor HMD support
- Ray tracing engine **supports NVIDIA RTX Ray Tracing HW Acceleration**
- Future:
 - **AI denoising for better average quality**
 - Interactive RT stochastic sampling strategies to improve interactivity
 - Improved omnidirectional cubemap/spheremap sampling approaches
 - **AI multi-view warping to allow rapid in-between view generation amid multiple HMD head locations**
 - **H.265 for high-res omnidirectional video streaming**
 - **Multi-node parallel RT and remote viz. on general clusters and supercomputers, e.g. NCSA Blue Waters, ORNL Titan**
- Tons of work to do on VR user interfaces, multi-user collaborative visualization, ...

Acknowledgements

- Theoretical and Computational Biophysics Group, University of Illinois at Urbana-Champaign
- NVIDIA CUDA and OptiX teams
- Funding:
 - NIH support: P41GM104601
 - DOE INCITE, ORNL Titan: DE-AC05-00OR22725
 - NSF Blue Waters:
NSF OCI 07-25070, PRAC “The Computational Microscope”,
ACI-1238993, ACI-1440026

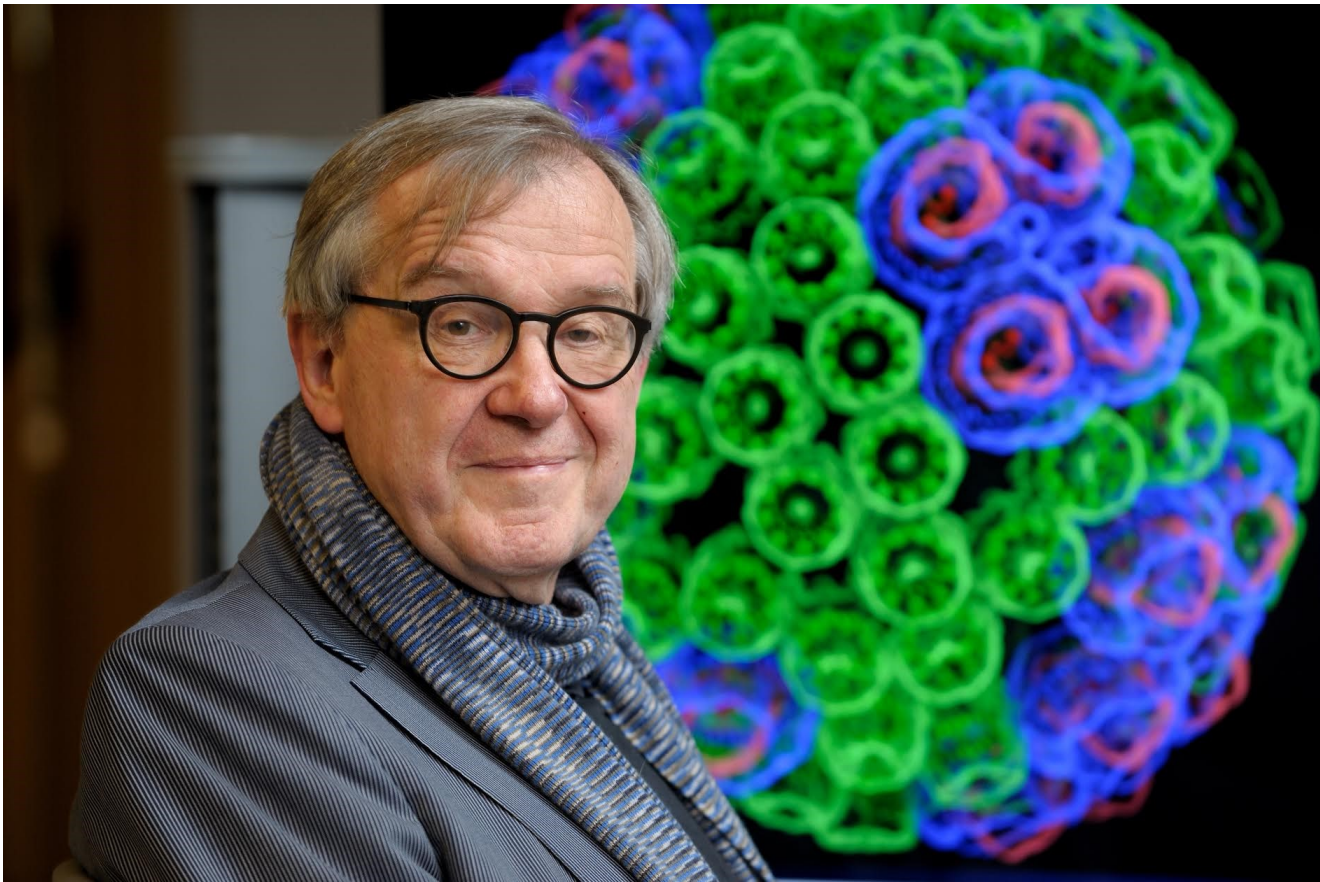

“When I was a young man, my goal was to look with mathematical and computational means at the inside of cells, one atom at a time, to decipher how living systems work. That is what I strived for and I never deflected from this goal.” – Klaus Schulten

Related Publications

<http://www.ks.uiuc.edu/Research/gpu/>

- **NAMD goes quantum: An integrative suite for hybrid simulations.** Melo, M. C. R.; Bernardi, R. C.; Rudack T.; Scheurer, M.; Riplinger, C.; Phillips, J. C.; Maia, J. D. C.; Rocha, G. D.; Ribeiro, J. V.; Stone, J. E.; Neese, F.; Schulten, K.; Luthey-Schulten, Z.; Nature Methods, 2018. (In press)
- **Challenges of Integrating Stochastic Dynamics and Cryo-electron Tomograms in Whole-cell Simulations.** T. M. Earnest, R. Watanabe, J. E. Stone, J. Mahamid, W. Baumeister, E. Villa, and Z. Luthey-Schulten. J. Physical Chemistry B, 121(15): 3871-3881, 2017.
- **Early Experiences Porting the NAMD and VMD Molecular Simulation and Analysis Software to GPU-Accelerated OpenPOWER Platforms.** J. E. Stone, A.-P. Hynninen, J. C. Phillips, and K. Schulten. International Workshop on OpenPOWER for HPC (IWOPH'16), LNCS 9945, pp. 188-206, 2016.
- **Immersive Molecular Visualization with Omnidirectional Stereoscopic Ray Tracing and Remote Rendering.** J. E. Stone, W. R. Sherman, and K. Schulten. High Performance Data Analysis and Visualization Workshop, IEEE International Parallel and Distributed Processing Symposium Workshop (IPDPSW), pp. 1048-1057, 2016.
- **High Performance Molecular Visualization: In-Situ and Parallel Rendering with EGL.** J. E. Stone, P. Messmer, R. Sisneros, and K. Schulten. High Performance Data Analysis and Visualization Workshop, IEEE International Parallel and Distributed Processing Symposium Workshop (IPDPSW), pp. 1014-1023, 2016.
- **Evaluation of Emerging Energy-Efficient Heterogeneous Computing Platforms for Biomolecular and Cellular Simulation Workloads.** J. E. Stone, M. J. Hallock, J. C. Phillips, J. R. Peterson, Z. Luthey-Schulten, and K. Schulten. 25th International Heterogeneity in Computing Workshop, IEEE International Parallel and Distributed Processing Symposium Workshop (IPDPSW), pp. 89-100, 2016.

Related Publications

<http://www.ks.uiuc.edu/Research/gpu/>

- **Atomic Detail Visualization of Photosynthetic Membranes with GPU-Accelerated Ray Tracing.** J. E. Stone, M. Sener, K. L. Vandivort, A. Barragan, A. Singharoy, I. Teo, J. V. Ribeiro, B. Isralewitz, B. Liu, B.-C. Goh, J. C. Phillips, C. MacGregor-Chatwin, M. P. Johnson, L. F. Kourkoutis, C. Neil Hunter, and K. Schulten. *J. Parallel Computing*, 55:17-27, 2016.
- **Chemical Visualization of Human Pathogens: the Retroviral Capsids.** Juan R. Perilla, Boon Chong Goh, John E. Stone, and Klaus Schulten. *SC'15 Visualization and Data Analytics Showcase*, 2015.
- **Visualization of Energy Conversion Processes in a Light Harvesting Organelle at Atomic Detail.** M. Sener, J. E. Stone, A. Barragan, A. Singharoy, I. Teo, K. L. Vandivort, B. Isralewitz, B. Liu, B. Goh, J. C. Phillips, L. F. Kourkoutis, C. N. Hunter, and K. Schulten. *SC'14 Visualization and Data Analytics Showcase*, 2014.
***Winner of the **SC'14 Visualization and Data Analytics Showcase**
- **Runtime and Architecture Support for Efficient Data Exchange in Multi-Accelerator Applications.** J. Cabezas, I. Gelado, J. E. Stone, N. Navarro, D. B. Kirk, and W. Hwu. *IEEE Transactions on Parallel and Distributed Systems*, 26(5):1405-1418, 2015.
- **Unlocking the Full Potential of the Cray XK7 Accelerator.** M. D. Klein and J. E. Stone. Cray Users Group, Lugano Switzerland, May 2014.
- **GPU-Accelerated Analysis and Visualization of Large Structures Solved by Molecular Dynamics Flexible Fitting.** J. E. Stone, R. McGreevy, B. Isralewitz, and K. Schulten. *Faraday Discussions*, 169:265-283, 2014.
- **Simulation of reaction diffusion processes over biologically relevant size and time scales using multi-GPU workstations.** M. J. Hallock, J. E. Stone, E. Roberts, C. Fry, and Z. Luthey-Schulten. *Journal of Parallel Computing*, 40:86-99, 2014.

Related Publications

<http://www.ks.uiuc.edu/Research/gpu/>

- **GPU-Accelerated Molecular Visualization on Petascale Supercomputing Platforms.** J. Stone, K. L. Vandivort, and K. Schulten. *UltraVis'13: Proceedings of the 8th International Workshop on Ultrascale Visualization*, pp. 6:1-6:8, 2013.
- **Early Experiences Scaling VMD Molecular Visualization and Analysis Jobs on Blue Waters.** J. Stone, B. Isralewitz, and K. Schulten. In proceedings, *Extreme Scaling Workshop*, 2013.
- **Lattice Microbes: High-performance stochastic simulation method for the reaction-diffusion master equation.** E. Roberts, J. Stone, and Z. Luthey-Schulten. *J. Computational Chemistry* 34 (3), 245-255, 2013.
- **Fast Visualization of Gaussian Density Surfaces for Molecular Dynamics and Particle System Trajectories.** M. Krone, J. Stone, T. Ertl, and K. Schulten. *EuroVis Short Papers*, pp. 67-71, 2012.
- **Immersive Out-of-Core Visualization of Large-Size and Long-Timescale Molecular Dynamics Trajectories.** J. Stone, K. L. Vandivort, and K. Schulten. G. Bebis et al. (Eds.): *7th International Symposium on Visual Computing (ISVC 2011)*, LNCS 6939, pp. 1-12, 2011.
- **Fast Analysis of Molecular Dynamics Trajectories with Graphics Processing Units – Radial Distribution Functions.** B. Levine, J. Stone, and A. Kohlmeyer. *J. Comp. Physics*, 230(9):3556-3569, 2011.

Related Publications

<http://www.ks.uiuc.edu/Research/gpu/>

- **Quantifying the Impact of GPUs on Performance and Energy Efficiency in HPC Clusters.** J. Enos, C. Steffen, J. Fullop, M. Showerman, G. Shi, K. Esler, V. Kindratenko, J. Stone, J Phillips. *International Conference on Green Computing*, pp. 317-324, 2010.
- **GPU-accelerated molecular modeling coming of age.** J. Stone, D. Hardy, I. Ufimtsev, K. Schulten. *J. Molecular Graphics and Modeling*, 29:116-125, 2010.
- **OpenCL: A Parallel Programming Standard for Heterogeneous Computing.** J. Stone, D. Gohara, G. Shi. *Computing in Science and Engineering*, 12(3):66-73, 2010.
- **An Asymmetric Distributed Shared Memory Model for Heterogeneous Computing Systems.** I. Gelado, J. Stone, J. Cabezas, S. Patel, N. Navarro, W. Hwu. *ASPLOS '10: Proceedings of the 15th International Conference on Architectural Support for Programming Languages and Operating Systems*, pp. 347-358, 2010.

Related Publications

<http://www.ks.uiuc.edu/Research/gpu/>

- **GPU Clusters for High Performance Computing.** V. Kindratenko, J. Enos, G. Shi, M. Showerman, G. Arnold, J. Stone, J. Phillips, W. Hwu. *Workshop on Parallel Programming on Accelerator Clusters (PPAC)*, In Proceedings IEEE Cluster 2009, pp. 1-8, Aug. 2009.
- **Long time-scale simulations of in vivo diffusion using GPU hardware.** E. Roberts, J. Stone, L. Sepulveda, W. Hwu, Z. Luthey-Schulten. In *IPDPS'09: Proceedings of the 2009 IEEE International Symposium on Parallel & Distributed Computing*, pp. 1-8, 2009.
- **High Performance Computation and Interactive Display of Molecular Orbitals on GPUs and Multi-core CPUs.** J. E. Stone, J. Saam, D. Hardy, K. Vandivort, W. Hwu, K. Schulten, *2nd Workshop on General-Purpose Computation on Graphics Processing Units (GPGPU-2)*, *ACM International Conference Proceeding Series*, volume 383, pp. 9-18, 2009.
- **Probing Biomolecular Machines with Graphics Processors.** J. Phillips, J. Stone. *Communications of the ACM*, 52(10):34-41, 2009.
- **Multilevel summation of electrostatic potentials using graphics processing units.** D. Hardy, J. Stone, K. Schulten. *J. Parallel Computing*, 35:164-177, 2009.

Related Publications

<http://www.ks.uiuc.edu/Research/gpu/>

- **Adapting a message-driven parallel application to GPU-accelerated clusters.**
J. Phillips, J. Stone, K. Schulten. *Proceedings of the 2008 ACM/IEEE Conference on Supercomputing*, IEEE Press, 2008.
- **GPU acceleration of cutoff pair potentials for molecular modeling applications.**
C. Rodrigues, D. Hardy, J. Stone, K. Schulten, and W. Hwu. *Proceedings of the 2008 Conference On Computing Frontiers*, pp. 273-282, 2008.
- **GPU computing.** J. Owens, M. Houston, D. Luebke, S. Green, J. Stone, J. Phillips. *Proceedings of the IEEE*, 96:879-899, 2008.
- **Accelerating molecular modeling applications with graphics processors.** J. Stone, J. Phillips, P. Freddolino, D. Hardy, L. Trabuco, K. Schulten. *J. Comp. Chem.*, 28:2618-2640, 2007.
- **Continuous fluorescence microphotolysis and correlation spectroscopy.** A. Arkhipov, J. Hüve, M. Kahms, R. Peters, K. Schulten. *Biophysical Journal*, 93:4006-4017, 2007.

Related Publications

<http://www.ks.uiuc.edu/Research/gpu/>

- **GPU Clusters for High Performance Computing.** V. Kindratenko, J. Enos, G. Shi, M. Showerman, G. Arnold, J. Stone, J. Phillips, W. Hwu. *Workshop on Parallel Programming on Accelerator Clusters (PPAC)*, In Proceedings IEEE Cluster 2009, pp. 1-8, Aug. 2009.
- **Long time-scale simulations of in vivo diffusion using GPU hardware.** E. Roberts, J. Stone, L. Sepulveda, W. Hwu, Z. Luthey-Schulten. In *IPDPS'09: Proceedings of the 2009 IEEE International Symposium on Parallel & Distributed Computing*, pp. 1-8, 2009.
- **High Performance Computation and Interactive Display of Molecular Orbitals on GPUs and Multi-core CPUs.** J. E. Stone, J. Saam, D. Hardy, K. Vandivort, W. Hwu, K. Schulten, *2nd Workshop on General-Purpose Computation on Graphics Processing Units (GPGPU-2)*, *ACM International Conference Proceeding Series*, volume 383, pp. 9-18, 2009.
- **Probing Biomolecular Machines with Graphics Processors.** J. Phillips, J. Stone. *Communications of the ACM*, 52(10):34-41, 2009.
- **Multilevel summation of electrostatic potentials using graphics processing units.** D. Hardy, J. Stone, K. Schulten. *J. Parallel Computing*, 35:164-177, 2009.

Related Publications

<http://www.ks.uiuc.edu/Research/gpu/>

- **Adapting a message-driven parallel application to GPU-accelerated clusters.**
J. Phillips, J. Stone, K. Schulten. *Proceedings of the 2008 ACM/IEEE Conference on Supercomputing*, IEEE Press, 2008.
- **GPU acceleration of cutoff pair potentials for molecular modeling applications.**
C. Rodrigues, D. Hardy, J. Stone, K. Schulten, and W. Hwu. *Proceedings of the 2008 Conference On Computing Frontiers*, pp. 273-282, 2008.
- **GPU computing.** J. Owens, M. Houston, D. Luebke, S. Green, J. Stone, J. Phillips. *Proceedings of the IEEE*, 96:879-899, 2008.
- **Accelerating molecular modeling applications with graphics processors.** J. Stone, J. Phillips, P. Freddolino, D. Hardy, L. Trabuco, K. Schulten. *J. Comp. Chem.*, 28:2618-2640, 2007.
- **Continuous fluorescence microphotolysis and correlation spectroscopy.** A. Arkhipov, J. Hüve, M. Kahms, R. Peters, K. Schulten. *Biophysical Journal*, 93:4006-4017, 2007.