

Measurement of surface alpha-activity of different samples with ion pulse ionization chamber

Yu. M. Gavriljuk,¹ V. N. Gavrin,¹ A. M. Gangapshev,¹ V. V. Kazalov,¹
V. V. Kuzminov,¹ S. I. Panasenکو,² and S. S. Ratkevich²

¹*Baksan Neutrino Observatory INR RAS, Russia*

²*Karazin Kharkiv National University, Ukraine*

(Dated: October 24, 2018)

The construction of an ion pulse ionization chamber aimed at measuring ultra-low levels of surface alpha-activity of different samples is described. The results of measurement carried out with alpha-source and copper samples and light-reflecting film VM2000 are presented.

PACS numbers: 29.40.Cs, 29.40.Gx

I. INTRODUCTION

In construction of up-to-date low background detectors searching for WIMPs and double beta-decay of different isotopes it is necessary to have materials with the lowest possible content of natural radioactive elements ^{238}U , ^{232}Th , their daughter decay products and ^{40}K . Ultra-low background semiconductor detectors are usually used to measure radioactive isotopes in the selected material by registering gamma radiation produced in the beta-decay process. The concentration of the decaying isotopes is calculated by taking into account the efficiency of registration of gamma radiation for the given energy. In the decay chains of ^{238}U , ^{232}Th , it is not all isotopes that undergo beta-decay with gamma quanta emission. Some part of the isotopes decays with alpha-particles emission. Calculation of the latter isotopes content using gamma radiation of their parent nuclei is based on the assumption of secular equilibrium in the chain. However, this condition may not be always satisfied. For example, it is known [1] that in the process of pure metal production from crude ore a significant violation of equilibrium occurs in the rows of ^{238}U , ^{232}Th due to the predominant elimination of isotopes ^{226}Ra ($T_{1/2} = 1600$ yrs) and ^{228}Ra ($T_{1/2} = 5.7$ yrs), respectively. In the finished metal the radium content could be 1000 times less than the equilibrium one [2]. The basic isotopes which emit gamma rays are the products of radium daughters decays. Therefore, in case of using their gamma emission in determination of ^{238}U and ^{232}Th content, under the assumption of equilibrium, the evaluated value would be significantly lower than the real one. Moreover, if the material under consideration has been kept long in the environment with high content of ^{222}Rn , there could be accumulated the superfluous amount of ^{210}Pb atoms ($T_{1/2}=22.3$ yrs) in comparison with the equilibrium content. ^{210}Pb and daughter products decay would give additional background of electrons and alpha-particles. Therefore, it is necessary to measure simultaneously surface alpha-activity and gamma ray background for the material under study. Ion pulse ionization chamber (IPIC) with ion collection could be used for such a purpose.

A gas detector of such a type collects all the charge

generated in the working gas by the ionized particle for any type and mobility of a carrier. This characteristic distinguishes IPIC from other detectors with electronic collection where one needs to use ultra-pure gases having no electronegative admixtures capable of capturing electrons. In case of electron collection detectors, to obtain good energy resolution one needs to insert screen grids separating drift and register gaps. A grid allows one to eliminate dependence of the signal's amplitude, induced by the moving in the electric field ionization electrons, of the distance between the ionizing track and the collector. There is no necessity to insert such grids in case of IPIC and there are no special requirements for the materials used in the fiducial volume of IPIC as to the level and composition of the gases emitted except radon itself.

A possibility to obtain good enough energy resolution for alpha-decays of ^{222}Rn and its daughter products registered in IPIC filled with air is presented in work [3].

II. CHAMBER'S DESIGN AND CONSTRUCTION

The diagram of the cross-section of IPIC and its circuit are presented in fig.1. Chamber consists of two identical cylindrical coaxial sections separated by a high-voltage grid cathode electrode (5). The grid is made of parallel copper wires of 0.08 mm diameter with 2 mm spacing. High voltage of -2 kV is applied to it. The uniform drift field in each section is produced by a set of forming copper circular electrodes (6), connected to the high-voltage resistance divider. Collectors (anodes) of the upper and lower sections are electrically divided to form the inner and outer parts, disk-shaped and circular, respectively. In fig.1 they are denoted as (1), (2), and (4), (3), respectively. Electrode (4) has a cylindrical cavity to accommodate the sample under study. In case when sample is made of non-conductor material it is covered with a copper grid (diameter of the wire 0.08 mm, spacing 88 mm), contacting the skirting of the electrode. Total diameter of the drift spacing is 126 mm, its height is 74 mm; the diameter of the electrode is 91 mm. The diameter and digging depth of the cavity for a sample is

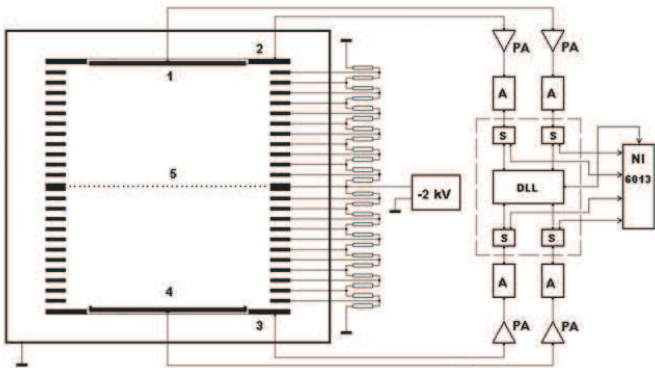

FIG. 1: Schematic cross-sectional view and connection of IPIC to the high-voltage resistance divider 1 - upper central anode; 2 - upper circular anode; 3 - lower circular anode; 4 - lower central anode; 5 - cathode.

84 mm and 3 mm, respectively. Geometrical area of the sample is 55.4 cm^2 . The height for a drift spacing for the given potential on the cathode and gas pressure determines full time charge collection and consequently the amplitude and duration of the current pulse. To improve the signal to noise ratio the height should be as minimal as possible. Its value was chosen so as to satisfy the condition of the complete absorption of alpha-particle with energy of 7.69 MeV leaving the sample's surface in air or nitrogen at normal conditions. In case when a sample under study is used as a collector there would be background components in resulting spectra caused by alpha-particles from the surface of drift volume, and by radon decay and its daughter products in the working gas and on the surface of the electrodes. To obtain starting low level of the alpha-background proper, copper has been chosen as basic construction material due to its low content of radioactive elements. Total suppression of the background from the walls could be achieved by putting the central part of the chamber into anticoincidence mode with the circular part. The background from the high-voltage electrode has been diminished due to its grid structure having far less area than a solid electrode. Moreover, absence of a partition wall between upper and lower sections allows one to eliminate, in the anticoincidence mode, alpha-particles generated in a gas and having crossed the barrier of the high-voltage electrode, from the spectrum. The upper section could be used to perform independent measurement of radon content in the working gas.

Modeling has shown [4] that the additional selection of tracks of the alpha-particles leaving the surface of the sample under study could be performed using pulse shape analysis. An account was taken of the variation of ionization density along track of the alpha-particle, difference in drift velocities of positive and negative ions, values of current pulses from both components, depending on the distance of the track's to the collector. Best predictions have been obtained with nitrogen as a working gas due to its electronic conductivity in contrast to air where neg-

ative charge is transported by molecular ions of oxygen with captured electrons.

Maximum calculated drift times for positive and negative ions in a drift gap for voltage of -2 kV and gas pressure of 620 torr (mean atmospheric pressure at the level of BNO INR RAS) are $1.57 \cdot 10^{-2} \text{ s}$; $1.26 \cdot 10^{-2} \text{ s}$ and $1.73 \cdot 10^{-2} \text{ s}$; $1.7 \cdot 10^{-5} \text{ s}$, for air and nitrogen respectively. To register such long pulses there has been developed a charge-sensitive low-noise preamplifier (CSP) with optical feedback and self-discharge time of about $\sim 100 \text{ ms}$. Signals from the four anodes IPIC are applied, through CSP to the amplifiers with gain of 400. Then the signals are divided into two ones; one signal goes to one of 16 inputs of the analog-to-digital converter (ADC) NI6013 installed in the personal computer (PC) and the other ones goes to one of the inputs of the four-input low level discriminator (LLD). The LLD generates output logic signal for the case where pulse's amplitude at any input exceeds the preset threshold. A pulse from LLD is applied to the input of the external triggering of ADC. Sampling frequency for NI6013 was taken to be 2.5 kHz (total sampling frequency is 10 kHz). Digitized pulses are written down and stored in the PC.

III. RESULTS OF MEASUREMENTS

Fig.2 demonstrates an event of an alpha-particle crossing all four sensitive volumes. Numeration of plots corresponds to that of anodes in fig.1. The chamber was filled with air.

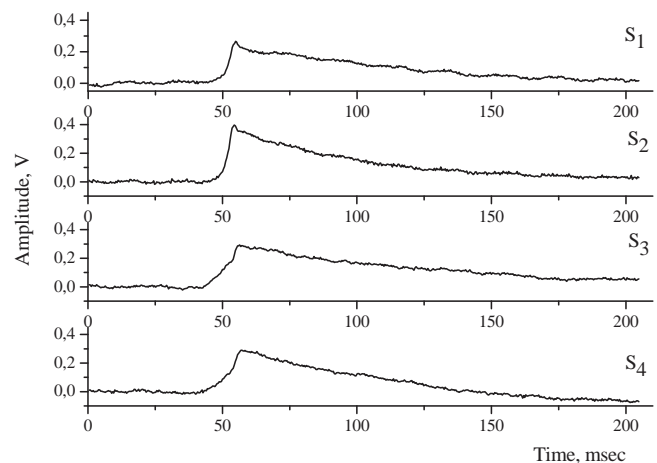

FIG. 2: Example of event where alpha-particle has crossed all four sensitive areas (chamber is filled with air).

Fig.3 illustrates the similar event for a case of IPIC being blown through with liquid nitrogen vapour. Comparing graphs of fig.2 and 3 one can see that the pulse rise time in case of nitrogen is much shorter than for the air. This distinction is related to the given above difference in drift velocities of negative charge carriers. When nitrogen is not properly purified from oxygen, both types of negative charge carriers will take part in pulse

formation, their ratio being dependent on the distance of track's elements from the anode, since the probability for electrically charged molecule of oxygen to capture an electron is proportional to the path it has traveled. To check the operating characteristics of IPIC an ^{239}Pu alpha-source ($E_\alpha \approx 5.157$ MeV) was placed in the center of the cavity for samples. Its surface ($\text{Ø}24$ mm) was covered with nickel foil 0.05 mm thick and a hole of $\text{Ø}1$ mm was made in the center of the foil which provided alpha-particle count rate of ~ 1 s $^{-1}$. The chamber was blown with nitrogen during 3 hours (30 l).

Fig.4a shows a spectrum of pulses obtained during 70 min from the lower central section (S4). The spectrum is plotted for charge pulse amplitudes at their maximum values. Resolution is 7.2%. The value of the amplitude at a pulse maximum could differ for one and the same energy release since this value for the finite CSP discharge decay time constant is a function of current density. The true value of a charge produced by an alpha-particle could be reconstructed by introducing a correction for a CSP discharge through its recalculation to the infinite decay time. With such a correction the amplitude's value is determined by averaging it over a given number of points taken from the time interval following of the pulse current ending. Fig.4b shows a spectrum of recovered pulses. The amplitude has been averaged over ten points. Resolution has been improved up to 4.8%. The alpha-particle background for a sample of copper has been carried out to investigate the IPIC measurement possibilities. The sample was made in the form of a disc with 83.5 mm diameter and 3 mm thickness. Its surface was treated with abrasive materials and it was etched in nitrogen acid.

At first, the chamber was filled with atmospheric air containing ^{222}Rn at a level of ~ 20 Bq/m 3 . Total time to collect statistics made up 97 hours. A triggering threshold was chosen to be 150 mV, which corresponds to the alpha-particle energy of ~ 1 MeV. Total original spectrum of amplitudes of not-reconstructed pulses from central lower section (S4) is given in Fig.5a. Spectrum in fig.5b illustrates the efficiency of active shielding; the spectrum was plotted for pulses selected from the spectrum of fig.?? by excluding events which have pulses with amplitudes higher than 0.5 MeV in the lower circular section (S3). In fig.5c, in addition to this selection, another one has been added, that of exclude events with pulses from the central upper (S1) and circular (S2) sections. Fig.5d shows a spectrum of amplitudes for the same pulses after introducing correction on the CSP's self-discharge and after correction of microphonic noise caused by high-voltage electrode vibrations by summing up noise from S1 with pulse S4. Microphonic noises for these sections are in antiphase.

The majority of pulses is due to alpha-decays of ^{222}Rn ($T_{1/2}=3.82$ days) in the air and its daughter ^{218}Po and ^{214}Po on the high-voltage and collector electrodes S4. Amplitudes of peaks of 6.00 MeV (^{218}Po) and 7.69 MeV (^{214}Po) correspond to alpha-particle energies. When es-

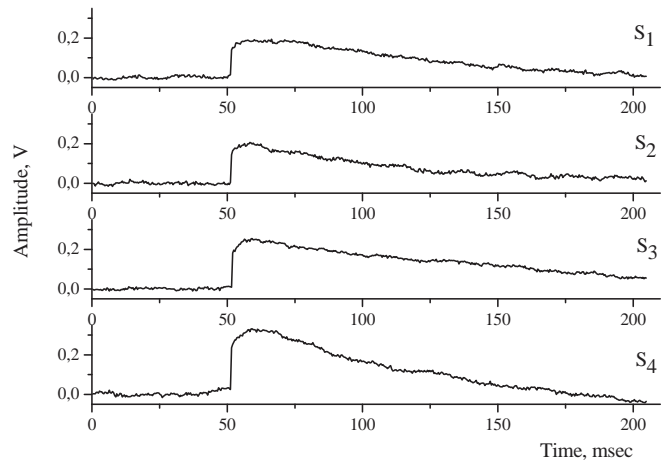

FIG. 3: Example of event where alpha-particle has crossed all four sensitive areas (chamber is filled with nitrogen).

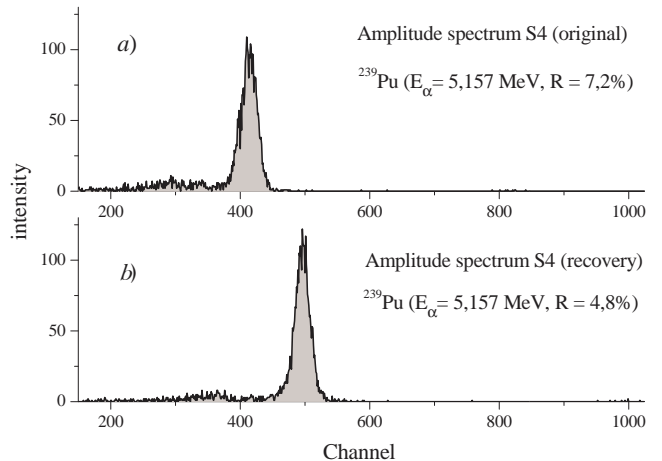

FIG. 4: *a* - original spectrum of pulses taken from the lower central section (S4); *b*-recovered spectrum of pulses from the lower central section (S4).

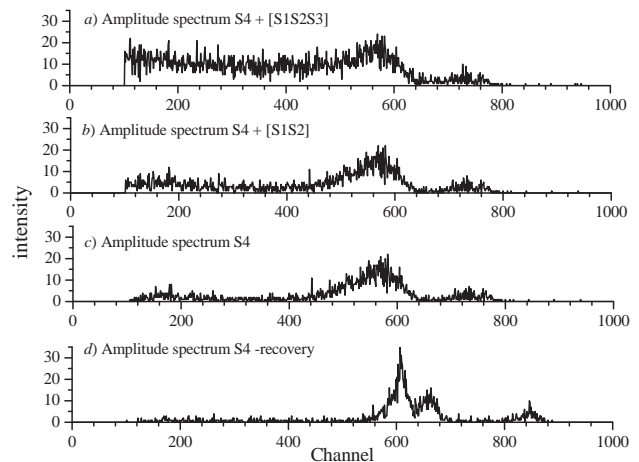

FIG. 5: Background spectrum of the copper sample: *a* - section S4 + sections S1S2S3; *b* - section S4 + sections S1S2; *c* - spectrum of section S4; *d* - recovered spectrum of S4.

timating the position of peak for 5.49 MeV (^{222}Rn), one should take into account the recoil energy (0.10 MeV) which is not entirely transmitted into ionization. In spectrum 5d, the position of peak from ^{222}Rn decay corresponds to 5.54 MeV using in its calculation the position of alpha-particle peaks from ^{218}Po and ^{214}Po . Its resolution is 4.3%. Ratio of peak areas is determined by the efficiency of alpha-particle's absorption in S4 and also by ratio of original line intensities. ^{218}Po and ^{214}Po atoms are produced with charge and they settle on the corresponding electrodes under the electric field, so that half of alpha-particles generated at their decays goes to the wall and is absorbed there. Ideally, ratio of peak areas for ^{222}Rn , ^{218}Po and ^{214}Po should be 2:1:1. In fig.5d it is 2:1.34:0.53.

After measurements with air there were measurements carried out with vapour of liquid nitrogen blowing through the IPIC (~ 10 l/hr). Total time of collecting statistics was 316 hrs. Fig.6 shows spectrum of pulse amplitudes from S4 with correction for microphonic noise.

To analyze the spectrum let's start with peak ^{214}Po (channel 817, R=4,6%). Its energy exceeds all the others and is little subjected to distortions caused by admixture of other lines, if to neglect the contribution of ^{212}Po ($E_\alpha = 8.785$ MeV), the daughter product of decay of ^{220}Rn ($T_{1/2}=55.6$ s) of the series of ^{232}Th , to the alpha-particle background. The ratio of peak areas for ^{222}Rn , ^{218}Po and ^{214}Po should correspond to that obtained from fig.5d, in case when radon atoms decay in the working gas. In such a case it is necessary to take into account the difference in values of alpha-particle path in the air and in nitrogen (the paths of an alpha-particle with energy of 6 MeV and at pressure of 620 torr are 5.135 cm and 5.58 cm, in air and nitrogen, respectively). Though, generally it is not the case. Radon and its daughter products could be present in the copper sample as a part of volume radioactive admixtures. There is some microrelief on the surface of the sample; if the characteristic size of its lugs is much less than the alpha-particle path, then the energy loss due to these lugs turns out to be small. Alpha-particles form the peak. The ratio of areas of related peaks would differ from that obtained above. To clarify the question concerning the type of related peaks from ^{214}Po source (internal or surface) one can use data obtained with air. The events where coinciding pulses are present only in sections S1 and S4 are produced, mainly, by the alpha-particles that were generated in the gas due to radon decay and crossed the border of high-voltage electrode. The ratio of such events to the peak area of ^{214}Po should be constant when activity of radon changes, in case the latter is uniformly distributed in a working gas. These ratios are 1.57 ± 0.15 (for air) and 1.26 ± 0.26 (for nitrogen), which coincide within the bounds of error. Therefore one can conclude that the ^{214}Po source is a surface one.

In fig.6, one can see approximation of ^{222}Rn , ^{218}Po and ^{214}Po peaks with Gaussians. The ratio of their maximum positions corresponds to that in spectrum 5d. It

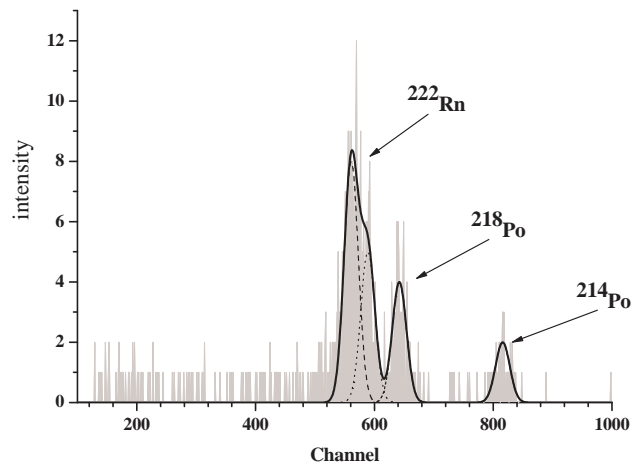

FIG. 6: Spectrum of pulse amplitudes from Cu, collected during 316 hr and corrected for the discharge and microphonic noise (blowing off with liquid nitrogen vapour).

is clear that, in fig.6, in addition to purely 'radon' peaks there is also 5.297 MeV peak corresponding to alpha-particles from ^{210}Po decay ($T_{1/2}=138.4$ days). It is produced in the chain reaction of ^{210}Pb ($T_{1/2}=21.8$ yrs) supposedly accumulated on the cathode during adjustment and alignment while filling the IPIC with ordinary air containing admixture of radon.

To determine surface alpha-activity (SAA) we use the range of energy $1.1 \div 4.7$ MeV and assume that alpha-particle spectrum in this range has a shape of flat step. Alpha-particles of SAA of the sample as well as a portion of peak alpha-particles that has lost part of its energy in the material of the anode and cathode give a contribution to this energy range. The relative part of alpha-particles from radon decay and its daughter products could be determined from fig.5d. As it seems impossible to evaluate the input of surface ^{210}Po at present stage of this experiment, the remaining background is assumed to be due to SAA, which in such a case would be $(3.5 \pm 0.7) \cdot 10^{-3} \text{ cm}^{-2}\text{hr}^{-1}$. The efficiency of registration of alpha-particles with given energies was taken to be a unit (disregarding edge effect). In order to find a limit with 95% C.L., this value of SAA was increased by 2 standard deviations.

When calculating the activity of a given isotope using its measured alpha-activity, all the SAA was assumed to come from this isotope. Recalculation from the energy range under study to the full range of all possible energy release is performed. Upper limit of this range is determined as energy corresponding to that of alpha-particle increased by 3 standard deviations. Standard deviation value is determined by energy resolution. The limit of energy range for ^{238}U and ^{232}Th was determined as 5.16 MeV and 4.30 MeV, respectively. Recalculation has been carried out under the assumption that about 25% of alpha particles that were generated in the layer of the material with width equal to the length of this alpha particle track, go out to the working gas [5].

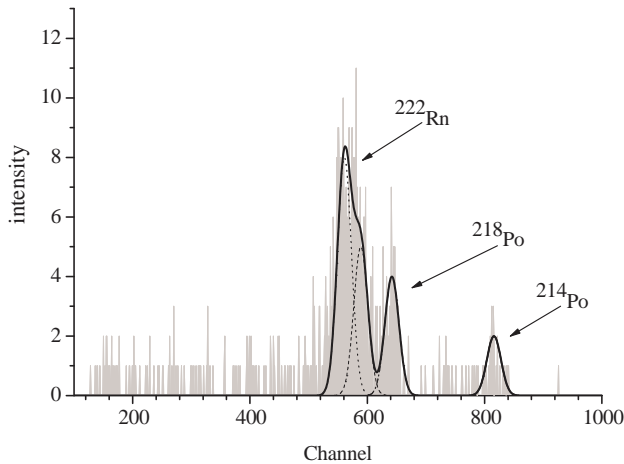

FIG. 7: Spectrum of pulse amplitudes from VM2000, collected during 429 hr and corrected for the discharge and microphonic noise (blowing off with liquid nitrogen vapour).

The obtained results for activity and content of ^{238}U and ^{232}Th in a copper sample calculated in the above described way are given in Table 1.

SAA of light-reflecting film VM2000 which is supposed to be used as a wall reflector in the cryostat with liquid argon in the GERDA installation has been measured with IPIC [6]. Cryostat is used mainly to cool the assemblage of Ge-detectors immersed into liquid. Liquid argon possesses scintillation properties and can also be used as an anticoincidence-detector. Wall reflector is necessary to improve conditions for light collection.

Sample of the film of 83 mm diameter and 70 mcm width was placed at the bottom of the anode cavity in S4. The film being of non-conductor material, it was covered with copper grid. In the course of measurements IPIC was being blown with liquid nitrogen vapors. Spectrum S4, collected during 429 hours is given in fig.7. It is seen it is entirely similar to the spectrum in fig.6. After allowing for input of radon and its daughter products the residual value of count rate in the range of 1.1 ÷ 4.7 MeV is $(3.0 \pm 0.6) \cdot 10^{-3} \text{ cm}^{-2}\text{hr}^{-1}$, which coincide well with the data for the copper sample within bounds of error. This could serve as an indirect confirmation of the supposition that the residual background is mainly due to ^{210}Po presence on the cathode grid. The contribution of proper SAA from the copper cathode grid, alpha-active components being standard for the copper sample, should be about 15 times less. This follows from the ratio of surface areas of the grid and the sample.

The results of calculation for activities and content of ^{238}U and ^{232}Th in the sample VM2000 are presented in Table 1. Values for specific activity of ^{238}U and ^{232}Th in samples of stainless steel and VM2000 obtained from the analysis of gamma spectra are given for comparison. Measurements were carried out in the low background installation 4HPGe with three semiconductor detectors made of ultra-pure germanium [7]. The installation is located in the underground low background laboratory

of the BNO INR RAS at a depth of 660 m w.e. The installation was used earlier in the IGEX experiment to search for neutrinoless double beta-decay of ^{76}Ge .

The direct comparison of the results for VM2000 demonstrates in a clear way that the sensitivity of IPIC achieved at this stage is ~ 150 times worse than that obtained with gamma method. However, taking into account possible distortion of equilibrium in the decay chains by 30 times or more would decrease the difference down to ≤ 5 times.

The suggested above technique enables one to further increase levels of sensitivity. For example, the background created by ^{210}Po in the cathode grid could be decreased by 100 or more times by preliminary purification of the wires' surface and taking measures to prevent its recurring contamination by daughter products of the radon decay in the working gas. For this purpose IPIC should be constantly re-filled with pure nitrogen. The contribution of the SAA proper of the wires could be significantly decreased by lessening the wire's diameter and increasing spacing in the grid. For example, changing diameter from $\text{Ø}80$ mcm to $\text{Ø}20$ mcm and spacing from 2 mm to 4 mm would decrease SAA of the cathode grid by 8 times. Background of radon and its daughter products could be lowered by thousand times, if one would use nitrogen vapours preliminary passed through the cooled charcoal trap to blow the IPIC. The pipes for nitrogen vapour should be impermeable to radon of the air. One should also remove from the fiducial volume of IPIC those materials that have high emission of radon, e.g. elements of the high-voltage divider.

Further enhancement of sensitivity could be achieved by enlarging the area of the sample. At present, there are no reasons preventing the increase of the IPIC's diameter by ~ 3 times. There is also an appealing possibility in section S1 itself. In case the anode of this section is made from guaranteed pure material (e.g., Si or Ge), the spectra of this section could serve as a standard of zero background for the analysis performed for section S4.

Moreover, to select tracks of alpha-particles starting out from the sample's surface one could apply the analysis of the ion component of the current pulse. A form of such a component depends on the orientation of the track and distribution of ionization density along the track. To make quantitative analysis possible one need to improve noise performance of CSP by about 3 times. Thereby energy resolution would be improved as well.

Taking into account all the above mentioned factors the IPIC's sensitivity could be risen by 100 times and even more. E.g., for alpha-particle count rate in the range of 1.1 ÷ 4.7 MeV being equal to 1/500 hr for the copper sample with surface of 400 cm^2 the sensitivity is up to 0.5 mBq/kg for ^{238}U and 0.9 mBq/kg for ^{232}Th . Great advantage of this method consists in the fact that in order to carry out measurements one need not look for low background underground environment, the ordinary room would well accommodate this experiment. To conclude authors thank the chief researcher Donchenko V.A.

Table 1. Concentration of the radio-active isotopes in samples measured IPIC and HPGe-detectors

sample, run-time	activity [mBk/kg] /concentration [g/g]		method
	²³⁸ U	²³² Th	
Cu Ø83 mm, h=3mm 316 h	≤490/≤4.0·10 ⁻⁸ 0	0 ≤860/≤2.1·10 ⁻⁷	surface alpha-activity (IPIC)
VM2000 Ø83 mm, h=0.07mm 429 h	≤1200/≤0.7·10 ⁻⁸ 0	0 ≤2100/≤5.2·10 ⁻⁷	
VM2000 m=372 g 552 h	≤7.9/	≤9.0/	gamma-spectrometer (HPGe-detector)
stainless steel AISI 321 m=4.2 kg 1219.2 h	≤1/	≤1.4/	

for a fruitful interest in this work.

This work was fulfilled under the partial support of INTAS program (grant INTAS-05-1-000008-7996 "The

germanium detector array for the search of neutrinoless double beta decay of ⁷⁶Ge at LNGS").

-
- [1] V.N. Gavrin, S.N. Danshin, A.V. Kopylov, V.I. Cherekhovsky "Lowbackground semi-conductor gamma-spectrometer measuring ultra-low concentration of ²³⁸U, ²²⁶Ra and ²³²Th". Preprint INR RAS P-0494, Moscow, 1986. (in Russian)
- [2] A.V. Kopylov, V.I. Cherekhovsky "Natural radioactivity of construction material" Preprint INR RAS P-0604, Moscow, 1989. (in Russian)
- [3] V.V.Kuzminov. "Ion-pulse Ionization Chamber for Direct Measurement of a Radon Concentration in the Air". Phys. of At. Nucl., V66,N3,2003, pp.462-465.
- [4] V.V. Kazalov (on behalf of the group) "Identification of sources of alpha-particle background in Ion Pulse Ionization Chamber", report presented at the Baksan Youth School of Experimental and Theoretical Physics - 2005, 18-23 April 2005, Elbrus village, Kabardino-Balkaria, Russia. Edited by KBSU, Nalchik, 2006, V.2, pp.101-108. (in Russian)
- [5] A.I. Abramov, Yu.A. Kazansky, Eu. S. Matusevich (Osnovy experimentalnyh metodov jadernoy fiziki) "Basics of the experimental techniques in nuclear physics" Atomizdat, Moscow, 1970, p.471 (in Russian)
- [6] GERDA - The GERmanium Detector Array for the search of neutrinoless $\beta\beta$ decays of ⁷⁶Ge at LNGS. Proposal, INFN LNGS, 2004.
- [7] S.I.Vasiliev (for GERDA collaboration) "Results of radiopurity measurements of the stainless steel samples AISI 321 and VM 2000 WLS at the Baksan Neutrino Observatory (preliminary results)". The talk given on 26-28 June 2006 at Gran Sasso at the GERDA meeting.