

The AARTFAAC All Sky Monitor: System Design and Implementation

Peeyush Prasad[†], Folkert Huizinga[§], Eric Kooistra[‡], Daniel van der Schuur[‡], Andre Gunst[‡], John Romein[‡], Mark Kuiack[§], Gijs Molenaar[§], Antonia Rowlinson[§], John D. Swinbank[¶] and Ralph A.M.J Wijers[§]

[†]*Anton Pannekoek Institute, University of Amsterdam, Postbus 94249 1090 GE, Amsterdam, The Netherlands, p.prasad@uva.nl*

[‡]*ASTRON, Oude Hoogeveensedijk, 7991PD, The Netherlands*

[§]*Anton Pannekoek Institute, University of Amsterdam, Postbus 94249 1090 GE, Amsterdam, The Netherlands*

[¶]*Department of Astrophysical Sciences, Princeton University, Princeton, NJ 08544, USA*

Received (to be inserted by publisher); Revised (to be inserted by publisher); Accepted (to be inserted by publisher);

The Amsterdam-ASTRON Radio Transients Facility And Analysis Center (AARTFAAC) all sky monitor is a sensitive, real time transient detector based on the Low Frequency Array (LOFAR). It generates images of the low frequency radio sky with spatial resolution of 10s of arcmin, MHz bandwidths, and a time cadence of a few seconds, while simultaneously but independently observing with LOFAR. The image timeseries is then monitored for short and bright radio transients. On detection of a transient, a low latency trigger will be generated for LOFAR, which can interrupt its schedule to carry out follow-up observations of the trigger location at high sensitivity and resolutions. In this paper, we describe our heterogeneous, hierarchical design to manage the 240 Gbps raw data rate, and large scale computing to produce real-time images with minimum latency. We discuss the implementation of the instrumentation, its performance, and scalability.

Keywords: Radio Telescopes, Interferometry, Calibration, Imaging, Radio Transients, Correlators

1. Introduction

Transient astronomy deals with the detection and characterization of celestial transients: sources in the sky whose detectable properties can change on short timescales. These explosive events provide insight into a variety of astrophysics, ranging from emission mechanisms of jets to properties of the intervening medium (Fender *et al.*, 2006; Lazio *et al.*, 2009; Cordes *et al.*, 2004).

The serendipitous discovery of a new class of radio transient termed Fast Radio Bursts (FRBs; Spitler, 2015; Thornton *et al.*, 2013) has galvanized interest in the field. The detected FRBs are characterized by large associated dispersion measures, high brightness and short timescales. One (Spitler *et al.*, 2016) discovered source has been found to be non-repeating. Their unknown origins makes it difficult to discover such sources in a targeted observation, with only one possible instance of a multiwavelength association with an FRB (Keane *et al.*, 2016). Thus, discoveries during blind searches along with a rapid follow-up over a large wavelength regime are required to establish their emission phenomena and associated parameters. A recent example of this requirement is the detection by Stewart *et al.* (2016) of a 20Jy transient in 60MHz Low Frequency Array (LOFAR) data, whose characterization has suffered due to inadequate multi-wavelength coverage.

For time-resolved observations, radio instrumentation is generally available in two classes; Firstly, a single dish or phased array beam formed approach characterized by high time and frequency resolution, wide fields of view of a few degrees but poor spatial resolution. This mode is optimized for detection of coherent sources, which are expected to emit on short timescales (milliseconds). Interferometric aperture synthesis observations form the other class, providing high spatial resolutions, but poor time resolution.

[†]Corresponding Author

They typically need several hours of observation time to build up adequate coverage in the UV plane via earth rotation aperture synthesis (however, see (Law *et al.*, 2012; Law & Bower, 2012)). This mode is optimal for detecting incoherent sources, whose timescales of emission are much slower.

Large field of view radio sky monitors are now being developed to continuously survey large parts of the visible sky with shallow sensitivity and at high time resolution, in order to accelerate transient discovery. A trigger can be generated on the reliable detection of a transient in near real-time, allowing other telescopes to carry out follow-up observations.

The Amsterdam-ASTRON Radio Transient Facility and Analysis Center (AARTFAAC) radio transient monitor is such an all-sky radio transient detector. It taps data from a subset of the LOFAR antennas, and processes these data independently of LOFAR. It is a leading effort among a group of new radio telescopes, with other notable examples being the Long Wavelength Array (LWA), (Ellingson *et al.*, 2013), and the Murchison Widefield Array (MWA), (Tingay *et al.*, 2013). Such telescopes are characterized by having moderate resolution and sensitivity as compared to contemporary telescopes, but with extremely wide fields of view (typically all sky), high availability, and autonomous calibration and imaging in near real time.

The AARTFAAC instrument also has secondary uses, besides its primary requirement of generating reliable triggers. Due to the time resolved, wide field and continuous nature of AARTFAAC observations, its secondary data products like all-sky images, calibration solutions and flagging information find use in a variety of science cases, and for LOFAR observatory operations. Application areas include wide field ionospheric monitoring via apparent flux and position variations of calibrator sources, Solar monitoring, RFI surveying, LOFAR beam model validation etc. The search for fast transients across wide fields of view will also be a fundamental capability of phase 1 of the Square Kilometer Array (SKA) telescope (Colegate & Clarke, 2011). The AARTFAAC system is currently the largest aperture array implementation for low frequency transient monitoring. As such, it provides a very realistic test-bench for technological approaches to all aspects of this kind of telescope.

The wide field of views necessary for an instrument like AARTFAAC can be achieved by sampling the sky with wide-field dipoles. This, however comes at the cost of lowered sensitivity per receiving element. A well sampled UV plane is needed to generate an instantaneous Point Spread Function (PSF) with low sidelobes. Both requirements can be met by spatially spreading a large number of dipoles. However, this requires an order of magnitude larger number of elements in the array than contemporary arrays. Bringing the resulting large number of data streams to a central location, as well as their correlation for carrying out aperture synthesis imaging in real time thus poses a significant I/O and compute challenge. Further, the wide fields of view at the sensitivities of operation also result in direction-dependent effects on the incoming signals, mostly due to the ionosphere (Intema *et al.*, 2009; Wijnholds *et al.*, 2010). These pose a challenge to calibration, especially when carried out in an autonomous manner.

In this paper, we describe the AARTFAAC telescope system architecture, its instrumentation, and the commissioning of its various subsystems. Section 2 describes the array and the receiving antenna elements, its relationship with LOFAR, and introduces the full architecture of the instrument. Section 3 describes the hardware implementation in the field which allows creating a data path in parallel to LOFAR. This makes AARTFAAC processing independent of LOFAR to a large extent. In Section 4, we describe the implementation of a real-time, GPU based correlator for AARTFAAC, while Section 5 details the real-time, autonomous calibration and imaging implementation. In Section 6, we elaborate on the actual transient detection mechanism of the system. Section 7 describes our control system for the full instrument, which also interfaces with LOFAR. In Section 8 we present performance metrics of the instrument as a whole.

2. The AARTFAAC Radio Transient Detection System

We begin by summarizing the subsystems of the LOFAR telescope relevant for AARTFAAC processing in Section 2.1, and then elaborate on the scheme for creating a coupled data path for independent processing by AARTFAAC.

2.1. LOFAR Telescope Architecture

The LOFAR telescope (Van Haarlem *et al.*, 2013) is a new generation radio interferometer covering the frequency range from 10-90 MHz using inverted V-dipoles known as the Low-Band Antenna (LBA), and from 110-240 MHz using Bowtie dipoles, also known as the High-Band Antenna (HBA). The antennas are linearly polarized, being made up of orthogonally placed dipoles. The LBA dipole has a sensitivity pattern with a 6dB field of view of about 120° at 60MHz, while the HBA dipoles first undergo an analog phasing within a 4x4 tile, which results in a field of view of about 20° at 140 MHz. Due to this restriction, the AARTFAAC array utilizes only the LBA component of the telescope currently.

The telescope itself consists of a large collection of antennas, spatially organized into several 'stations', each consisting of 96 dual-pol antennas spread over a circle of diameter 60m. Due to limited hardware at stations in the core of the array, only 48 antennas belonging to one of a few layouts (including one termed LBA_OUTER) can be utilized at any point. The stations are laid out in a dense core: 24 stations within a 2km radius, with the long baselines made up using stations up to 1000km away from the core.

In the regular LOFAR station level processing, the sampled bandwidth of each dipole is split into subbands, which are then digitally phased in hardware towards the direction of an astronomical source to form a station beam. The phasing is updated periodically to track the position of the source in the sky. The resulting beam is then transmitted over optical fiber to a central location for further interferometric processing with other stations.

2.2. The AARTFAAC System Architecture

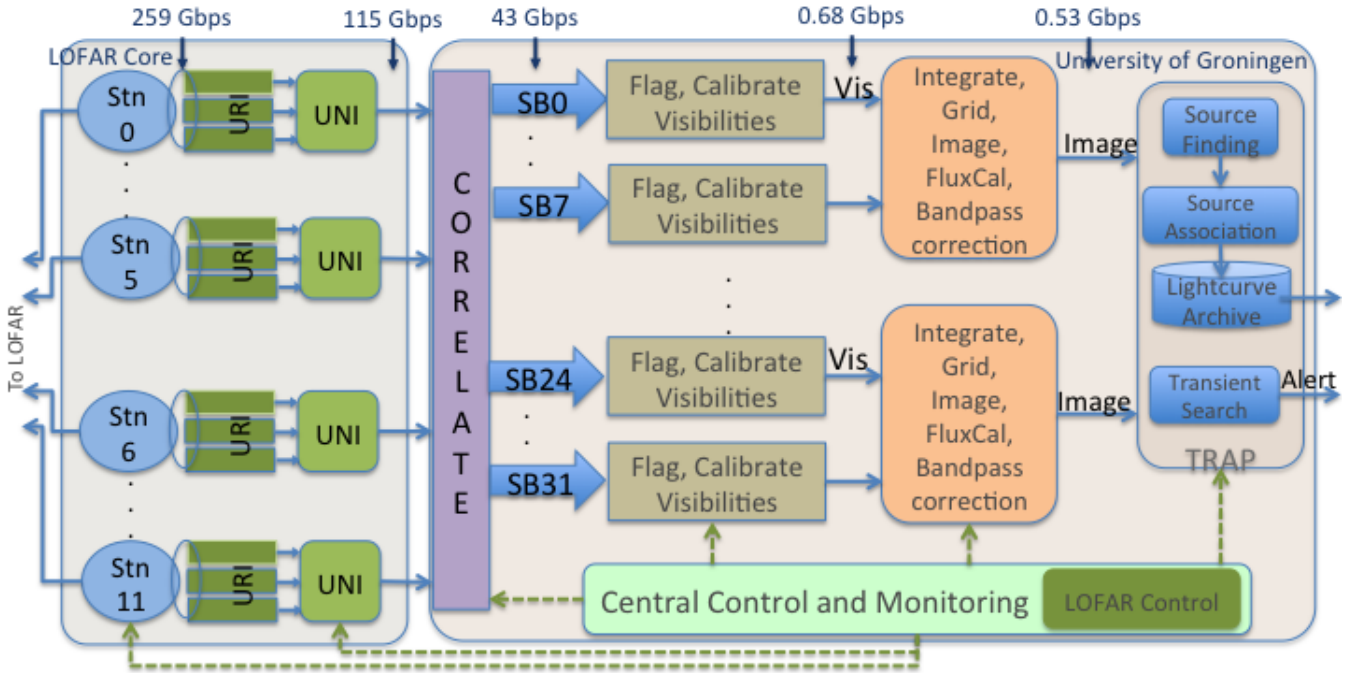

Fig. 1. Overall architecture of the AARTFAAC all-sky monitor depicting each processing sub block, along with the Monitoring and Control (MAC) system. The data rates correspond to the total bandwidth across the specified interface. Stn refers to a single LOFAR station, SB refers to a single subband of 195312.5 Hz. 'Vis' refers to visibilities. The green dashed paths indicate control flow, while the blue solid paths indicate data flow.

The LOFAR station constitutes the first component of the radio sky monitor. This is the only subsystem shared with LOFAR. The AARTFAAC monitor consists of further subsystems which are independent of LOFAR processing. Its overall architecture is shown schematically in Fig. 1, and illustrates the main processing sub-blocks of the instrument, including the data routing and processing blocks, as well as

the control and monitoring flow.

2.2.1. Array Configuration

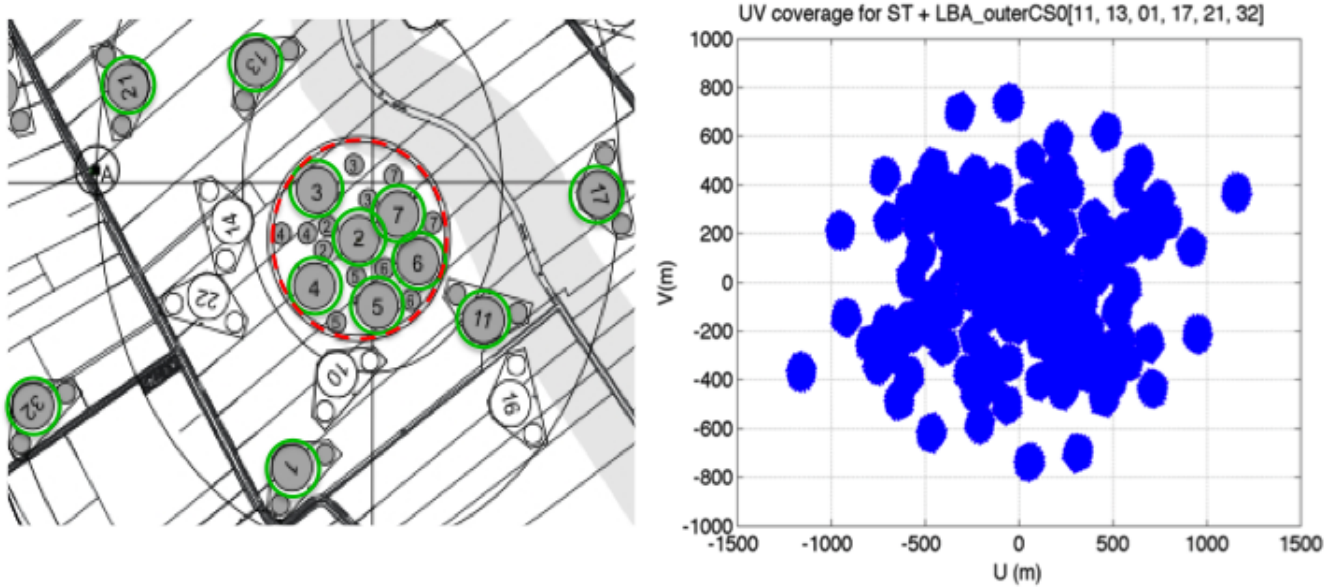

Fig. 2. (Left) The spatial distribution of AARTFAAC-12 stations within the core of LOFAR stations, with LOFAR station number designation specified in the green solid circles. The dashed red circle indicates the stations used for the AARTFAAC-6 subsystem. (Right) The instantaneous zenith pointing UV coverage of the AARTFAAC-12 system.

The choice of the subset of LOFAR stations used in the AARTFAAC system is dictated primarily by imaging quality and sensitivity, as well as due to constraints on the latency of calibration and imaging. Fig. 2 shows the stations in the LOFAR core that are part of the AARTFAAC system, with inter-dipole distances ranging from a few meters, to 1236 meters. The central six stations of the LOFAR telescope is called the Superterp, and is indicated by the dashed red circle in 2. The Superterp forms a densely sampled UV plane, and is ideal for wide field imaging since it is co-planar to high accuracy (centimeter level). The outer six stations (circled in solid green in Fig. 2) provide higher sensitivity and resolution, and have been chosen as a compromise between the UV coverage and the extra processing due to the W-component. The salient features of the LBA_OUTER station configuration for the chosen stations are shown in Table 1.

In contrast to LOFAR, AARTFAAC processes the data of each individual dipole in order to achieve all-sky imaging. Therefore a data spigot for each dipole signal is created prior to the phasing up of dipoles within a LOFAR station. This allows simultaneous observing with LOFAR, leading to high availability. The AARTFAAC system could be built as an off shoot of LOFAR primarily due to the extreme configurability offered by LOFAR system architecture. However, this restricts the layout of the antennas within a station as well as the stations themselves. This results in a sub-optimal configuration from the transients detection perspective, leading to gaps in the instantaneous 12-station UV coverage, and the need for W-projection due to non-coplanarity across the stations. Recognizing this, the co-planar AARTFAAC-6 system remains a viable sub-system for certain science cases. It consists of the 6 innermost stations shown marked with a dashed red circle in Fig. 2.

2.2.2. Hierarchical Data Shuffling and Transpose

The high bandwidth data stream from a large number of spatially distributed dipoles needs to be ingested while sustaining the computationally demanding correlation operation. The data also need arrangement in an optimal manner for the computing architecture, which amounts to a transpose operation.

We achieve both aims by spreading the collation and transpose operation over the hardware on our data transmission network. Intermediate nodes collect data from different input streams and exchange their dimensions, e.g., subbands for dipoles, by physically routing the data out on different paths. Later, the same operation is carried out in the large memories of general purpose CPUs via sequential reads of data written in a strided manner to memory. This delegation of the transpose to various levels in the hierarchy is essential to managing the large data rates, and to optimally use the computing infrastructure, and thus to the functioning of such a telescope.

To summarize the AARTFAAC processing, a user selected subset of subbands from every dipole is transferred as UDP packets over a dedicated 10Gbit fiber connection to the central processing systems. These are received by a streaming, real-time software correlator implementation which aligns the data and estimates the spatial covariance matrix between every pair of dipoles at high spectral and temporal resolutions. The generated visibilities are streamed over TCP/IP to a calibration and imaging pipeline component which carries out autonomous imaging. The images are then analyzed by the LOFAR Transients Pipeline, (TraP; Swinbank *et al.*, 2015), which extracts the light curves of sources within the image, and analyses them for variability using a number of parameters. A (planned) trigger generation subsystem will publish reliable triggers in the form of VOEvents (Williams & Seaman, 2006), which can be claimed by other telescopes to observe candidates with high sensitivity and resolution.

Table 1. Specifications of the AARTFAAC all-sky radio monitor.

Parameter	Specification	Units	Comment
Frequency range	10-90	MHz	Assuming LBA processing
Processed bandwidth	6.25	MHz	Processing 32 subbands
Maximum baseline	1236	m	In LBA.OUTER station array configuration
Resolution	14	arcmin	At 60 MHz
Sensitivity	14 ^a	Jy	1 Subband, 1 sec integration
Frequency resolution	1.56	MHz	For transient detection. Buffered visibilities at 3kHz resolution.
Time resolution	1	sec.	

^a Derived from AARTFAAC-6 measured sensitivity of 25 Jy.

We describe the various subsystems making up the AARTFAAC all-sky monitor in the following sections.

3. AARTFAAC Station Level Processing

In this section the station level instrumentation relevant for the AARTFAAC system is discussed. This involves systems which were already present in LOFAR stations, as well as the additional instrumentation added specifically for the AARTFAAC system.

3.1. Receivers

The antennas in the field are connected to Receiver Units (RCU). On those boards the antenna signals are amplified, band pass limited and converted into the digital domain. The antenna signals are sampled with a 200 MHz clock frequency delivering a bandwidth of 100 MHz to the digital processing system. The A/D converter uses a sample resolution of 12 bits.

3.2. LOFAR Digital Processing

The LOFAR digital processing boards, also referred as Remote Station Processing (RSP) boards are used to channelize the 100 MHz bandwidth into 1024 subbands. The channelization is implemented with a 1024-tap PolyPhase filter bank implementation on each dipole input. The output of this filter bank is used for

both LOFAR and AARTFAAC. The filter bank analyzes the sampled voltage timeseries into a complex voltage spectrum of 512 subbands. Thus, the entire analog band of the LBA between 10-90MHz is available for further processing, of which AARTFAAC utilizes a subset of about 6.25 MHz.

The output, for a set of 1024 real voltage samples, consists of a complex number per subband, with a 2s complement 16-bit representation of the real and imaginary components. A single RSP board can handle the processing of sampled data from 4 dual polarized antennas. Since a LOFAR station is made up of 48 dual polarized dipole antennas, 12 RSP boards are required per station. This is shown in Fig. 3. For LOFAR (and not for AARTFAAC), these subbands are further processed in the RSP boards to form spatially directed station beams by phasing up the information from each antenna for every subband. In order to combine the information of all antenna signals the RSP boards are connected via a ring network. For LOFAR observations, each RSP board is responsible to calculate a partial beamformed sum of the antennas connected to that particular RSP board. It further adds this to the result received from its preceding neighbour, and routes the partial sum onto the ring network to its succeeding neighbour. In this way the last RSP board in the ring calculates the final beamformed sum, resulting in a spatially directed station beam.

The ring network consists of four 2 Gbps links, and is formed by daisy chaining the serial I/O links of one RSP board to the next. These links are also used to carry AARTFAAC data due to availability of left over bandwidth. Therefore, it is now used to carry LOFAR specific data products (partial sums), along with the raw AARTFAAC subbands. Of the total 8Gbps bandwidth of the ring network, about 6 Gbps is occupied by LOFAR specific products, with the remaining bandwidth carrying per dipole subbands used exclusively for AARTFAAC processing.

The RSP firmware on the FPGAs have been modified to enable the transmission of the AARTFAAC data. The AARTFAAC specific firmware selects a subset of the available 512 subbands from all antennas specifically and independent of LOFAR. The available ring network data bandwidth forms the fundamental limitation of the AARTFAAC processed bandwidth. To retrieve more bandwidth, the firmware accommodates a configuration in the number of bits used to represent the complex filtered output per subband. Thus, bandwidth can be traded with bit width, or the dynamic range in the filterbank outputs. The bit mode of AARTFAAC can be set completely independently of LOFAR's choice of bit mode. The choice between the various bit modes depends on the RFI environment of the observation. An 8-bit complex representation of the filterbank subbands are found to be adequate for almost all observing conditions except during severe RFI.

The bandwidth available to AARTFAAC is limited to 36 subbands in 16-bit mode, 72 subbands in 8-bit mode, 108 subbands in 5 bit mode, or 144 subbands in 4-bit mode. This allows AARTFAAC to achieve high sensitivity by placing subbands contiguously, and later integrating them, while at the same time achieving spectral coverage by placing subbands to sample a larger extent of the analog spectrum. In the rest of the document, we refer to 8-bit subbands. Thus, the current system can generate 72 subbands, of which 32 subbands are processed, corresponding to about 6.25 MHz (see 3.3.1).

3.2.1. *Sampling Clock and Timing*

This sub-system is shared with LOFAR. A clock distributor board (SyncOptics) at the center is used to distribute a 10MHz reference to every one of the 24 core LOFAR stations, including the 12 AARTFAAC stations. The 10MHz reference is generated by a GPS disciplined Rubidium frequency standard, and is fed into a Timing and Distribution Board at the station. This board generates the 200MHz sampling clock required by the RCUs, and is also used for the data processing at the RSP boards. It ensures that an identical (hence coherent) clock is used for the sampling of data from the AARTFAAC stations.

The absolute time is communicated to the RSP boards on station reset by the LCU (local control unit) as a 64-bit timestamp counter. The RSP board then embeds this 64-bit timestamp into the data packets that it generates at the start of the next absolute second, indicated by a PPS (pulse per second) signal from the GPS timing system. Once set, the station hardware updates this counter on a derivative of the available 200MHz reference, thus ensuring that the absolute time is embedded in the data with a

resolution of a single subband’s time-sample ($\sim 5\mu\text{sec}$). The absolute timing accuracy depends on the long term stability of the sampling clock that is locked to the 10MHz reference, which in turn is derived from a GPS disciplined Rubidium frequency standard with excellent long term stability. All further aligning and timing of the incoming data in both LOFAR and AARTFAAC systems is carried out based on this embedded timestamp.

3.3. AARTFAAC Piggyback System

The AARTFAAC piggyback system is implemented by URI (UniBoard-RSP Interface) boards. These boards are installed in the ring (as shown in Fig. 3) and basically tap-off the data from each ring interface. The ring data is copied on the URI board. One copy is forwarded to the next RSP board in the ring to carry out regular LOFAR observations, while the other copy is sent to the AARTFAAC data router. Thus, the URI board ensures high availability via simultaneous operation of LOFAR and AARTFAAC.

Each URI board interfaces with the serial I/O links of 4 RSP boards. The URI board further implements the first stage of the overall transpose operation required to bring coincident data of all dipoles for a single subband to consecutive memory locations. It does so by statically routing up to 18 subbands from all dipoles available on the 4 RSP boards to a single output lane. Each incoming link contains 72 subbands from 8 dipoles, while each outgoing link contains 18 subbands from 32 dipoles. This operation can be seen in Fig. 3 in the data-flow layout between the URI and the UNB Data Router (explained next), which shows the collation of data from 18 subbands for 32 dipoles onto a single data link. Altogether, three URI boards are adequate to transfer and transpose 72 subbands at 8 bits into the UniBoard based router for all antennas within a station.

3.3.1. AARTFAAC Data Router

The data router is the interface between the station level instrumentation and the next signal processing unit, the correlator. The data router is implemented with a UniBoard (Gunst *et al.*, 2014). The board consists of 4 upstream Field Programmable Gate Arrays (FPGA) (called back-nodes) connected to the URI boards, and 4 downstream FPGAs (called front-nodes) to connect to the correlator over a long haul fiber link. Each of the back-node FPGAs receives 18 consecutive subbands out of the 72 subbands in the URI board output. However, output bandwidth constraints from the stations to the central signal processing limit the back-nodes to transferring 16 of the 18 subbands onward, making 64 subbands available within this board.

A second level of data rerouting is carried out at this stage such that links from the 3 different URI boards (each containing 18 subbands from 32 dipoles) are connected to the same back-node. This allows the back-node to collect the same subbands from all 96 dipoles making up the station, into a single output link. The data from two back-nodes are transported to a single Front-node FPGA. The latter encapsulates the data into a UDP packet which is transmitted on a long haul 10Gigabit Ethernet interface to the remote correlator.

Due to limitations of central processing, currently only one front-node output is utilized. Thus, only 32 of the 64 subbands available from the UniBoard are transmitted to the central processing machines, located at the University of Groningen about 50 km away. Each station output link carries about 9.7 Gbps of data, consisting of 32 subbands of 8 bits from all dipoles in the station.

3.3.2. Monitoring and Control Interface

Every station is equipped with a Local Control Unit (LCU), which is a computer system running a Linux operating system. These systems are networked to the LOFAR control system, and also act as Network Time Protocol (NTP) clients. Thus, their absolute times are aligned to better than a few milliseconds. The control of the remote station electronics consists of two layers. Firstly, Command and Status Registers have been opened up at the FPGA level, and can be accessed via a dedicated and separate control Gigabit

Ethernet interface to the hardware boards. Secondly, the LCU provides an abstraction layer between the hardware and the global LOFAR control system via a user accessible tool and driver combination. All control and monitoring commands from a global control system are addressed to the LCU, with the hardware driver ultimately communicating the commands over the Gigabit Ethernet control link to the RSP boards of the station.

4. The AARTFAAC Real-Time Correlator

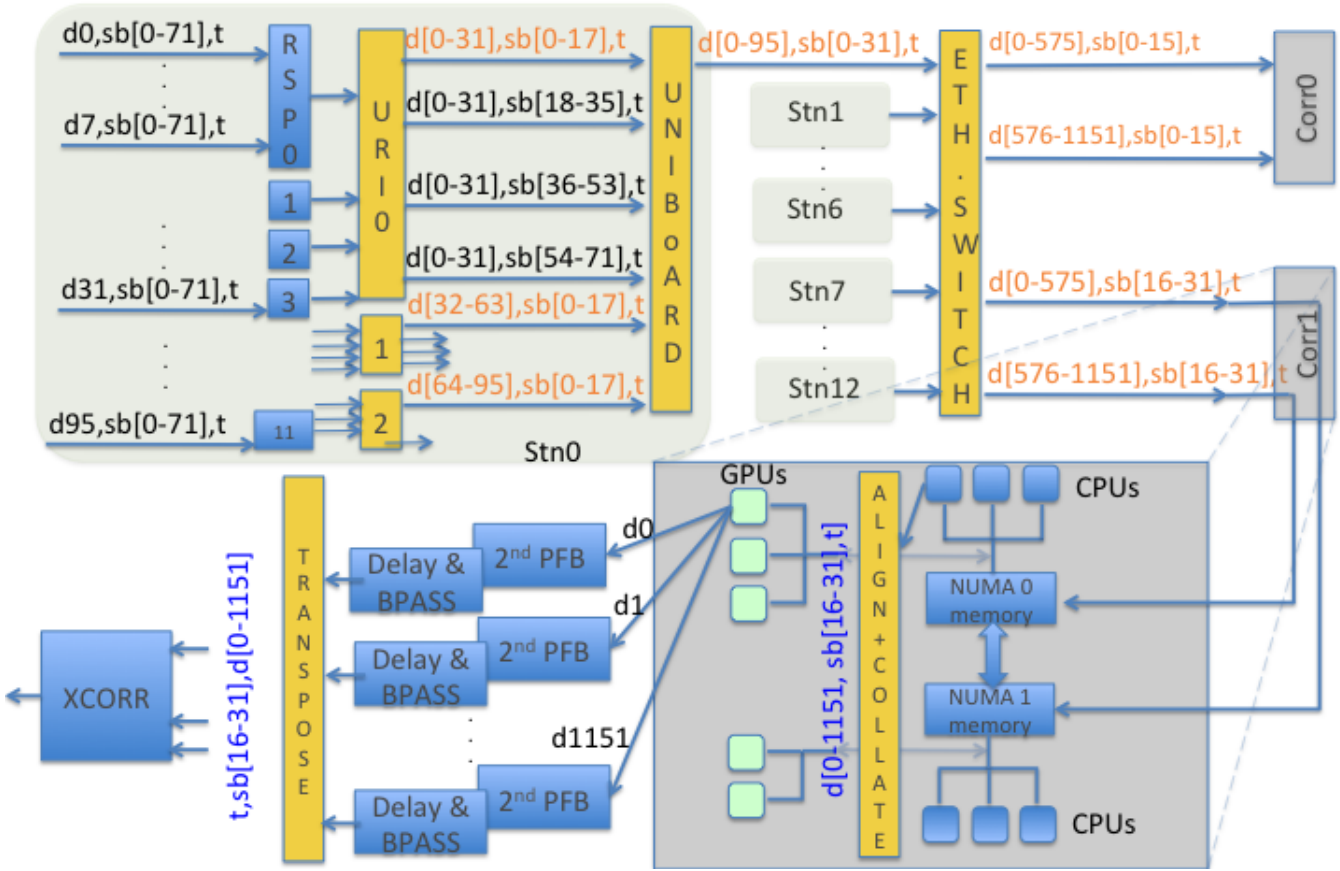

Fig. 3. The hierarchical data processing and routing necessary for optimizing correlator compute performance on GPUs. Here, the flowing data is represented by the triad of $[d[i-j], sb[i-j], t]$, where $d[i-j]$ refer to an individual dipole, $sb[i-j]$ refer to the range of processed subbands, and t refers to a time sample. The yellow blocks correspond to hierarchical elements that shuffle data. $Stni$ refers to the data stream from the i th station. $Corr0$ and $Corr1$ are the two correlator machines.

The correlator subsystem estimates the spatial coherence between all pairs of dipoles in the system per frequency channel, and time integrates the signal down to 1 second. With 12 stations, each containing 48 dual-polarized antennas, the total number of dipoles is 1152, making the correlator one with the highest number of spatially distinct input streams among contemporary instruments. This is the most computationally intensive subsystem of the pipeline, and the entire data routing hierarchy is fashioned to lay out the data such that it can be optimally operated on by our chosen compute architecture.

The correlator's input is formed of the subbanded complex voltage timeseries from each polarization of every antenna. The output consists of a timeseries of dipole array covariance matrices with a chosen time and frequency averaging.

The correlator ingests about 9.7 Gbps per station in real-time, corresponding to 32 subbands of 8 bits for each of the 1152 dipoles. It needs to produce channelized data from the subband inputs due to

the requirements of flagging and calibration. The resulting computation is about 1 Tera Floating Point Operations per second (TFLOPs) per subband for the full array, to be carried out in real-time, with minimum latency. A major requirement was to minimize development effort, which effectively eliminated an FPGA based approach.

Of the available approaches, a heterogeneous architecture consisting of general purpose CPUs in combination with Graphical Processing Units (GPUs) has been found to be the best match between our requirements of ease of development and performance. Compared to contemporary multi-core CPUs and DSP architectures, GPUs have been found to have the best performance and energy efficiency for algorithms relevant to channelizing and correlating radio astronomy data (Romein, 2016). The correlation operation has a high Arithmetic Intensity, implying that the data brought to a device compute unit is operated on many times. For a large number of receivers, the correlation operation is thus compute bound. This implies that the processing engines of the GPU are not data starved due to bandwidth limitations on the PCIe bus between the CPU and the GPU. The latest server class machines come close to meeting our requirements of dense computing and high bandwidth I/O between CPUs and GPUs.

Our correlator implementation shares ancestry with the LOFAR GPU based correlator architecture, which also needs real time processing to reduce the large volumes of data being produced. However, LOFAR deals with far fewer station input streams due to station level beamforming, in turn processing many more subbands. This results in a very different implementation strategy for both.

4.1. *Implementation Hardware Architecture*

The heterogeneous AARTFAAC correlator is made up of server class machines utilizing multiple GPU devices to carry out the computation necessary for the correlation. The host CPU acts as the interface between the station data and the GPU devices. They implement the data reception and collation of data from all stations, and arbitrate the data distribution between different GPUs.

The implementation consists of two identical machine configurations, each capable of processing 16 incoming subbands from 12 stations. Each machine consists of dual Xeon-class processors with 24 cores each. The CPUs are connected to 32 GB of memory each, operating in a Non Uniform Memory Access (NUMA) configuration. The bandwidth between these NUMA domains is limited, and minimizing the amount of memory transfers between these domains complicated the program code significantly. Ten AMD FirePro S10000 dual GPU cards (20 GPUs in total) are available, with 5 cards per machine. These interface with the CPUs over PCIe3.0x16 lanes. To receive the 9.7 Gbps data output from each of the 12 stations, both servers are equipped with two 40Gbps Ethernet interfaces, each interface receiving 16 subbands from 6 stations, and also carrying the output correlations to downstream processors. These machines are depicted in Fig. 3 as Corr0 and Corr1.

4.1.1. *High Bandwidth Switch*

An intermediate high bandwidth Ethernet switch, in combination with the Uniboard data router, is utilized to carry out routing of 12 station data to a single machine. The Back-node FPGAs of the Uniboards encapsulate data such that a subset of 16 subbands from 6 stations have an identical destination IP address of one of the interfaces. Thus, as shown in Fig. 3, half the bandwidth of stations 0-5 goes to interface 0 of Corr0, the same subbands of the stations 6-11 goes to interface 1 of Corr0. The remaining half of the bandwidth goes in a similar fashion to the Corr1 machine.

4.1.2. *NUMA Domains*

Each correlator machine receives up to 16 subbands from all stations and manages the last-stage data exchange, in DRAM, across the NUMA domains. (see Fig. 3). The resources available to a single machine are organized into two NUMA domains on that machine, with each domain handling data from 6 stations.

Each domain includes a 40Gbps Ethernet interface, a set of processing cores, and the 32GB memory associated with them.

However, the split of the 5 GPU cards per machine cannot be made symmetrically between the two domains, leaving one domain with 3 cards, while the other domain as 2 cards. The NUMA domains allow binding of threads handling I/O and processing to preferred CPU cores. This prevents thread migration across cores, which increases data locality in the core’s caches. Thread binding to cores within a NUMA domain allows routing of network interrupts to preferred cores. This is essential for ensuring throughput of the system.

4.2. Implementation of Functional Blocks

In this section, we provide a description of the implementation of individual functional blocks on our target hardware.

4.2.1. CPU Data Collation and Time Alignment

The raw data input packets from individual stations need to be collated for an entire integration period in host memory, before being shipped to the GPUs for correlation. 4 of the 12 available processor cores in a NUMA domain are dedicated for handling the Ethernet I/O interrupts.

The other eight cores are used to run the application threads. By keeping four cores free for interrupt handling, the interrupt handlers do not need to switch contexts upon an interrupt, which would be too time consuming. For each station, the application starts an input thread that receives the station UDP packets and writes the data into a circular buffer. The circular buffer contains the last four seconds of data, and is continuously overwritten by new data. The main purpose of this buffer is to time-align the station data before further processing, and to recover from small hiccups in the remainder of the processing pipeline.

The correlator properly handles lost UDP packets from the stations, generating a weighting matrix along with the integrated visibilities. The aligned and collated subbands are then ready to be transferred to a GPUs global memory for further processing.

4.2.2. GPU Processing

The GPU code is written in OpenCL. Every integration period (one second), when the data from all stations should have arrived, the host CPU starts pushing new work to the GPUs. For each subband, the host dynamically chooses a free GPU. Then, it enqueues the data transfer to the GPU, all compute kernels, and the final transfer of the visibilities back to the host. The GPU performs these operations asynchronously. Different subbands are processed independently, and are spread over the available GPUs. Below, we describe the functional units; more details about the GPU code implementation can be found in (Romein, 2016).

4.2.3. Polyphase Filterbank

The first signal processing block is a 256 channel PolyPhase filterbank. This consists of two kernels: FIR filter and FFT. It is applied onto the single subband stream from every dipole, and constituted of a bank of 256, 16-tap FIR filters, followed by a 1-D, 256 point complex FFT of the filter outputs. The FFT is carried out using an openCL library, while the FIR filter is implemented to maximize the usage of the GPU compute unit registers. The output is stored in the device memory.

4.2.4. Delay, Bandpass Compensation and Transpose Kernel

A delay compensation is applied to the channelized data to account for the fixed cable delays of the dipoles with respect to a reference antenna. These delays are obtained via a separate calibration, which is typically

carried out at a cadence of a few months. The delays are available in calibration tables, and the frequency resolution is high enough to apply them as phase rotations of the visibilities (Zatman, 1998).

The first stage polyphase filterbank implementation in the RSP board results in a deterministic amplitude modulation on the subband bandpass, and leading to unequal powers in each subband channel. This is demodulated via the application of a fixed amplitude correction by applying channel-dependent weights. The resulting data is brought to the user desired frequency resolution by integrating the channels.

Finally, the fine-grained parallelism axis needs to be exchanged from frequency channels to dipoles, which requires a transpose of the data.

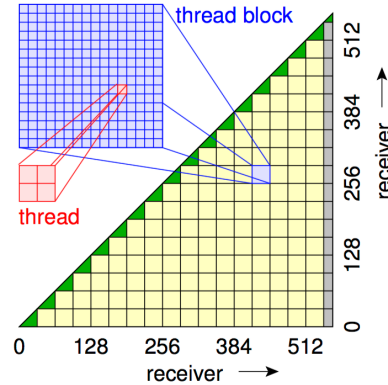

Fig. 4. Depiction of the splitting of the computed covariance matrix into triangles, rectangles and squares of outputs, each unit being computed by a compute unit of a GPU. From (Romein, 2016)

4.2.5. Correlation Kernel

Each dipole’s subbanded and channelized data is then ready for correlation. Fig. 4 shows the output covariance matrix which needs to be computed, given the input per-dipole (mentioned as receiver) channelized data. Only one triangle of the hermitian covariance matrix needs to be computed, as shown.

To distribute the computing of the correlations among the GPU compute units in a given architecture, the covariance matrix per frequency channel is divided into squares and triangles (with a separate kernel to evaluate each), as shown in Fig. 4. The size of the squares depends on the available computing and memory within a GPU compute unit, and for our architecture, squares of size 32×32 receivers is optimum. The computation of the correlation of all receivers within a square is then a *work-group* assigned to a GPU thread-block, with individual threads computing the covariance of a 2×2 receiver tile within the square of 32×32 receivers, as depicted. This arrangement results in optimal performance. The actual correlation operation maps well to the efficient Fused Multiply Add (FMA) instructions of the GPU. In fact, the correlator kernel achieves more than 80% of the GPU’s peak performance. The resulting visibilities are kept in registers while being accumulated in time. The integrated visibilities are written to device global memory by each GPU execution thread. An event is generated on the completion of the task. The timing and weight related meta-data is added to the correlations to form the record which is then streamed out over a TCP connection to downstream processors.

4.2.6. Asynchronous Host to Device Transfers Overlapping with Compute

PCIe bandwidth is a scarce resource which we manage carefully. PCIe transfers to host memory overlap well with computations, to avoid GPU idle times. In addition, we avoid simultaneous transfers between the CPU and GPUs that are connected through the same PCIe bus (through PCIe switches on board the GPU cards), so that the GPUs obtain maximum bandwidth and do not have to share bandwidth with

other GPUs on the same bus. This has been found to have a profound effect on throughput and latency.

5. Real-time Flagging, Calibration and Imaging

The real-time flow of generated visibilities need to be calibrated and imaged autonomously, and with bounded latency. This is a departure from traditional synthesis imaging, where the long observations needed for sensitivity and adequate UV coverage are bracketed within observations of calibrator sources. The over-sampled instantaneous UV coverage, the wide field of view and the relatively poor instantaneous sensitivity of the AARTFAAC array are the reason we use a model sky based multi-source self calibration approach, as described in more detail in (Prasad *et al.*, 2014).

The calibration and imaging is carried out on a cluster of multicore server class machines, where each correlator output subband is connected to a flagging and calibration pipeline, as shown in Fig. 1. We use the Eigen3 (Guennebaud *et al.*, 2010) C++ template library to implement all stages of matrix processing and linear algebra in general within these pipelines.

5.1. Calibration Pipeline

Each channelized subband stream coming out of the correlator is ingested into a multi-threaded calibration pipeline with a ring buffer. This ring buffer stores the raw visibilities for approximately 60 seconds in memory which can be dumped to disk when triggered for further examination by hand. A multi-consumer lock-free queue grabs the raw visibilities for processing through the multiple stages of the calibration pipeline. The processing consists of the following operations.

Weighting: As the correlator receives UDP data per station, packets can get lost. This information is sent to the calibration pipeline and corresponding visibilities are re-weighted to account for the loss of data.

Flagging: The real time flagging scheme consists of sigma clipping the visibilities based on their amplitudes crossing a predefined threshold above the locally computed RMS. The clipping is first applied across visibilities within a spectral channel, eliminating those crossing the threshold. This is followed by clipping channels crossing the threshold, for every visibility.

Calibration: The flagged visibilities are amplitude and phase calibrated at the channel level using a simple point source model of the four brightest sources (Cas A, Cyg A, Vir A, Tau A, termed the A-team) in the visible sky. The instantaneous shift of source position from model locations is estimated using the Weighted Subspace Fitting (Viberg *et al.*, 1991) algorithm. As part of the calibration process, the A-team sources are subtracted out from the calibrated visibilities in order to reduce the contribution of their sidelobes to the generated images. A flux calibration is then applied based on the apparent fluxes of the A-team during the observation. The calibrated per channel visibility stream of every subband is streamed out again over TCP to a machine which implements the actual spectral and temporal integration to the desired level.

5.2. Imaging Pipeline

The various calibrated subbands streaming out of the calibration pipelines are merged into temporally and spectrally integrated images in the imaging pipeline. The processing consists of the following operations.

Visibility Gridding: The calibrated outputs of 8 subbands are ingested into a large buffer and ordered based on their timestamps. The spectral integration is carried out by gridding all visibilities onto a common grid using bi-linear interpolation, while the temporal integration (if requested) is carried out by accumulation of the gridded visibilities. Prior to integration, another round of sigma clipping is carried out in both

the spectral and temporal axis to eliminate outliers.

Imaging: The multi-subband integrated and gridded visibilities are Fourier Transformed to generate the final snapshot image. We generate images of 1024 x 1024 pixels for AARTFAAC-6, and of 2048 x 2048 pixels for AARTFAAC-12 to adequately oversample the PSF.

Beam model: Finally, a beam model determined via simulations of the AARTFAAC antennas is applied in the image plane to correct for the primary beam response of the dipoles in the image. The flux calibration is carried out using measurements of the calibrator sources established by Scaife & Heald (2012). After this stage, the images are sent to TraP (see next section).

6. Transient Search Methodology

The Transients Pipeline (TraP; Swinbank *et al.*, 2015) carries out the automated detection of transients and variable sources in AARTFAAC images, in near real-time. It is a software package¹ optimized for the detection of transients in radio images while specifically dealing with issues related to radio imaging, e.g., noise correlation or PSF related issues. It consists of a collection of python processes carrying out image processing, and a database which is used to store the image processing outputs as well as to carry out operations on the collective. It operates on a timeseries of image cubes (each image cube consisting of two spatial and one spectral axis).

For any given image cube, it constructs a catalog of all point sources (modeled by elliptical Gaussians) in every spectrally resolved image, and compares them against a database of point sources detected in previous timeslices. The result is the detection of *new* or *variable* sources. The former are sources appearing at locations where no sources were seen in previous epochs, and the latter are sources which have been observed for multiple epochs and show significant variability in their light curves (timeseries of detected source intensities). These results are computed on the basis of the multi-frequency light curves for every detected source, which are available in the database.

The TraP is the real-time consumer of the generated multi-frequency AARTFAAC images, and produces two outputs: A trigger to the outside world in near real-time on the reliable detection of a short-duration transient or variable source, and a spectrally resolved database of lightcurves of all sources detected in a timeseries of image cubes, together with time-resolved information about their variability. The latter is available for both real-time and offline data mining, e.g., to implement different transient detection approaches.

Two aspects of TraP are interesting from the AARTFAAC perspective: The effect of AARTFAAC specific characteristics on the image processing, and the overall latency induced by TraP operating in a streaming mode. We discuss these in greater detail below.

6.1. Handling of AARTFAAC Specific Characteristics by TraP

AARTFAAC creates instantaneous, transit mode (non-tracking) all-sky images, and will be continuously monitoring the sky. The very wide field of view results in a varying sensitivity across an instantaneous image, which has to be accounted for before islands of high SNR pixels can be decomposed into sources. TraP approaches this by modeling the background (mean) pixel value and RMS across the image by estimating these values within every cell of a grid laid across the image, and interpolating the values over the full image.

In spite of resolutions of a tens of arcmin, sources in AARTFAAC images can have significant positional jitter due to ionospheric effects. TraP accounts for these during its *source association* step, when it identifies whether a detected source can be associated with an existing source in its database, based on spatial proximity. Due to the non-tracking nature of the instrument, the AARTFAAC sensitivity pattern is fixed

¹Available at <https://github.com/transientskp/tkp>

with respect to local coordinates. Hence, point sources can have very different SNRs when they traverse the sensitivity pattern as they rise and set. They can thus be classified as a new source when their SNR crosses detection thresholds. TraP accommodates such cases by keeping track of the fields-of-view and sensitivities of all images it processes, and comparing a detected source’s flux density against recorded sensitivities of images covering the same area to check if it could have been detected previously.

TraP calculates two variability metrics for every detected source in an instantaneous image, and per frequency bin ν : the flux density coefficient of variation V_ν , and the reduced weighted χ^2 as a significance of flux density variability, denoted by η_ν . Although they are time aggregated values based on the lightcurve of the source, they can be generated iteratively via running statistics, and are available for every timeslice. Thus, the streaming nature of AARTFAAC images can be accommodated in the existing framework.

Since theoretically the AARTFAAC image stream is infinite, the lightcurve database needs to be truncated in time. Based on the data-rates generated and current computing capabilities, a database containing a weeks worth of lightcurves is manageable. After this, a new database will be created for the next weeks’ observation. For requirements of lightcurves with duration longer than a week, wrapper scripts will be used to query the multiple databases and construct required light curve.

Fig. 1 shows TraP as the ultimate sink of AARTFAAC images, which will ingest 4 streams of image timeseries. Each stream corresponds to an 8 subband, 1 second integrated image timeseries.

6.2. Latency

TraP latency is contributed by the source finder, and the database operation. The major operations of the source finder are the RMS and background map estimation, and fitting to detected sources. The former scales quadratically with the number of pixels in an individual image plane, while the latter scales linearly with the number of detected sources. Database operational times have also been shown to scale linearly with the number of sources detected in an image. The total compute times of the source finder and the database population on AARTFAAC data have been measured to be under a second on test hardware (see Table. 2).

7. The AARTFAAC Control System

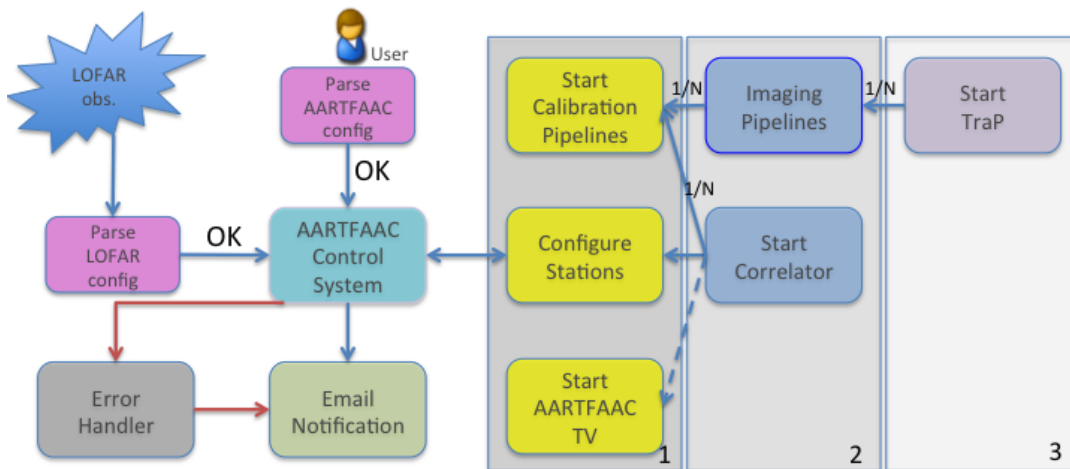

Fig. 5. The control system architecture which interfaces with the LOFAR observation scheduling system and triggers AARTFAAC observations. The components are organized into levels, and the direction of arrows show the call-graph of dependency between the blocks.

The AARTFAAC control subsystem² coordinates the diverse processing and I/O infrastructure of the AARTFAAC system, and acts as a liaison between the LOFAR observatory, AARTFAAC user and system. It is essential to the autonomous functioning of the instrument, and for providing fault tolerance. It has a python based client-server architecture, with the server process existing on the LOFAR manager node and clients waiting for commands on the various AARTFAAC subsystem controllers. Fig. 5 shows the functional blocks of the AARTFAAC control system organized into three levels, indicated by the numbered blocks.

Every scheduled LOFAR observation is monitored for suitability as an AARTFAAC observation, although LOFAR has ultimate control on whether AARTFAAC can piggyback on any given observation. When a LOFAR observation is initiated and AARTFAAC is allowed to piggyback, the control system launches the call-graph using the current active AARTFAAC configuration. This user defined configuration determines many things, such as what subbands to record, and how many images to create. The call-graph initiates everything at level 1 (stations, aartfaac tv, pipelines) by connecting to the appropriate clients and starting the processes. When at least 1 out of N pipelines is started and the stations are functioning properly, it calls everything at level 2 (correlators and imaging pipelines). When at least 1 out of N correlators and 1 out of N imaging pipelines have been spawned, it will initiate TraP at level 3. stage. An email will be sent when an error occurs or when an observation has successfully started.

Monitoring Interface: The control system allows monitoring the various subsystems at fine granularity, making it useful to localize problems within the system by examining the email reports. For monitoring data flow on a hardware level we use Munin³. This tool allows viewing statistics of I/O between nodes, computing on various nodes, and disk usage via a webpage⁴, including history at various time cadences.

AARTFAAC TV is an application to show live uncalibrated images, as an immediate feedback of the status of an observation. The processed outputs at various stages in the pipeline are also presented by AARTFAAC TV onto a webpage⁵ for the end to end, and astronomical monitoring of the system.

8. System Performance and Scalability

Most components of the AARTFAAC-12 system have been commissioned. The correlator has been tested to operate at the full specification and 6.25 MHz bandwidth. The 12-station calibration sub-system is currently being commissioned, Fig. 6 shows an uncalibrated 12-station image on the left.

The AARTFAAC system is currently operating with 6 LOFAR stations, a total bandwidth of 6.25 MHz, with real-time images being created at a 1 second and 1 subband (195.3 kHz) cadence. The remaining results and images in this section are from the 6-station system. Fig. 6 shows the amplitude and phase calibrated all sky image from AARTFAAC-6 on the right, while Fig. 7 shows a mosaic of the whole sky as seen by AARTFAAC. The Galactic plane is indicated by the dashed line. The latter has been created by combining 24 hours of observations taken at 1 second and 1 subband integration. The flux scale on all images is arbitrary.

8.1. System Performance

The overall performance of the real-time system is quantified by the achieved latency. Table 2 presents the measured compute time for various functional blocks of the system. Extrapolations on the values measured from the 6-station system are presented for the calibration block, although the presence of the non-coplanar component would probably make this a lower bound. All reported times have been measured on production systems, except for the TraP.

²Available at <https://github.com/transientskp/aartfaac-control>

³<http://munin-monitoring.org>

⁴<https://proxy.lofar.eu/aartfaac/munin>

⁵<https://proxy.lofar.eu/aartfaac/index.html>

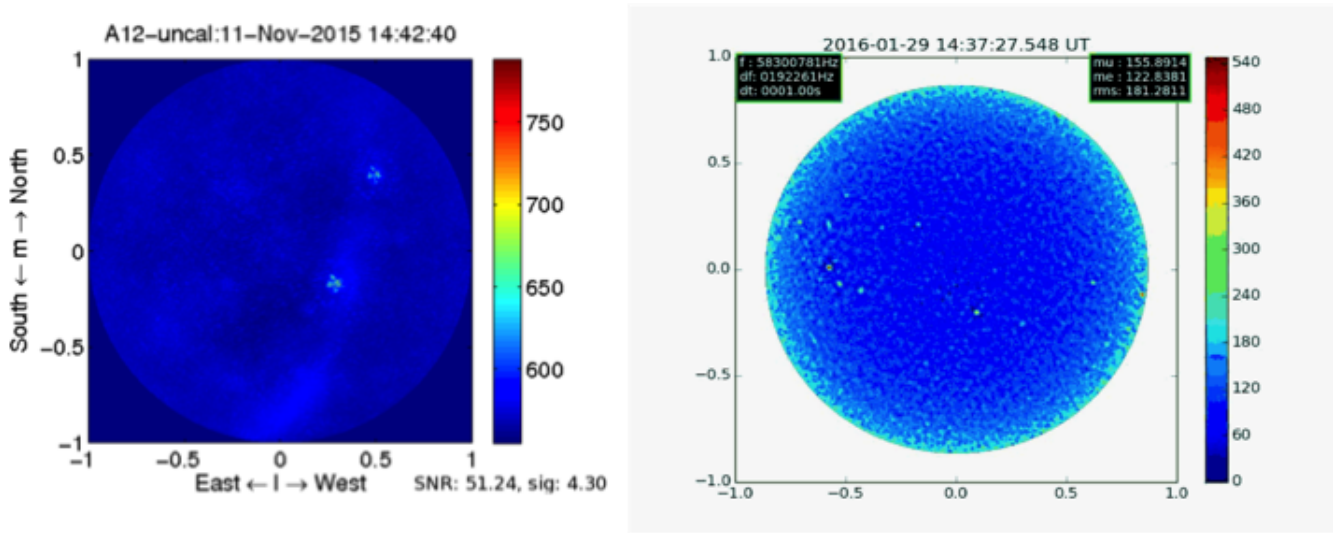

Fig. 6. (Left) An uncalibrated image from the AARTFAAC-12 system demonstrating the hardware data routing and correlator functioning. (Right) A calibrated image from the AARTFAAC-6 system, with a bandwidth of 1.5MHz and 1second integration.

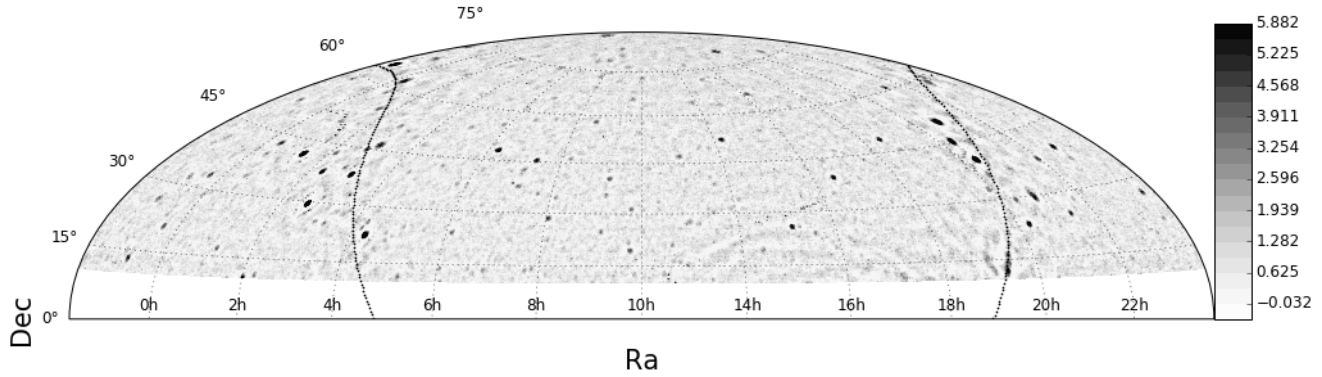

Fig. 7. A calibrated sky-map created from a 24hr observation from AARTFAAC-6.

Here, we see that the most compute intensive functional block is the calibration. Its compute footprint is dominated by the Weighted Subspace Fitting model source position determination sub-block, and scales quadratically with the number of input dipoles. Alternative approaches to this algorithm implementation will be explored to reduce this cost, and thus latency. The current implementation is adequate to maintain a real time throughput. Calibration latency can also vary based on the observing conditions like RFI occupancy and the presence of the flaring Sun. We thus set an upper limit to the calibration iterations, trading off instrumental sensitivity to maintain latency.

The next compute intensive component is the correlator itself. Its latency is independent of missing or poor quality data, since the collated data buffer is processed based on wall-clock time. Thread binding to CPU cores prevents process migration, and the absence of competing processes reduce operating system induced non-deterministic latencies. We see that the FIR, FFT and the delay,bandpass correction and transpose block scale linearly with the number of dipoles, as expected. The correlation scales almost quadratically with input set size. In our measurements, the correlator achieves a 71% operational efficiency of the theoretical maximum.

For the 6-station system, we measure a latency of 1.1 second to calibrated image generation, on production hardware. This value is obtained by comparing the hardware generated timestamp at the end of the correlation integration period, to the wallclock time on completion of calibration. This is about twice

Table 2. Overall latency budget and performance of AARTFAAC subsystems.

Parameter	A-12		A-6		Comment
	Compute time (ms)	Processing TFLOPs	Compute time (ms)	Processing TFLOPs	
GPU FIR	31.1	0.466	13.2	0.547	
GPU FFT	18.6	0.488	9.18	0.493	
GPU Delay, BP, Trans.	83.4	0.0054	25.7	0.0088	
GPU correlation	289	2.98	69	2.12	
Online flagging	199 ^a	X	74.3	X	
Calibration	900 ^b	X	249	X	XX, YY pols, calibrating 63 channels.
Total	1521		440.3		Measured AARTFAAC-6 latency (upto calibration): 1100ms
Imaging	X	X	40		Gridding and FFT, 1 Stokes-I image.
TraP	X	X	696		Measured with 4 input subbands.

^a Based on simulations.

^b Based on extrapolating 6-station measurements.

as expected from timings of the compute blocks. The remaining latency budget includes unmeasured, but significant latencies. These are caused by the wide area network (10s of ms), correlator input buffering, and host to device I/O, among other factors.

We expect the total latency to grow by factors of 2-3 in anticipation of the more complicated calibration and imaging scheme for the 12-station AARTFAAC.

A streaming variant of the TraP is still being commissioned. Current profiling reveals that the source finding step takes 30% of user time, while database operations to update the light curves of detected sources take about 15%. Both these operations scale linearly with the number of detected sources in an image, and thus latencies on the 12-station images are expected to be only slightly more.

8.2. AARTFAAC Scalability

The AARTFAAC all-sky monitor implementation can be scaled up along the spatial (number of dipoles) or spectral (processed subbands) dimensions. A spectral scaling will ultimately be limited by the ring network bandwidth to about 64 subbands ($\sim 12.5\text{MHz}$) of 8 bits, doubling the current bandwidth. A spare 10Gbps link on the uniboards can bring the extra 32 subbands to the center, where they can be processed by an exact duplicate of the current correlator system. The choice of a hierarchical data transpose results in the most efficient final layout for correlation. In the generic case, following the same design, additional subbands could be accommodated by increasing the levels in the network hierarchy to accommodate the transpose. The final correlation would then be possible for the additional subbands by replication of the frequency multiplexed hybrid correlator.

Keeping the current bandwidth while increasing the number of input dipoles is also feasible. The current Ethernet interface bandwidths on the server side can allow another two stations to be added. The compute requirements would be almost 30% higher, due to their quadratic growth with number of input streams. The correlation operation has been tested on the current GPUs for scalability of the input streams, and should be able to cope with the requirements of the extra inputs (Romein, 2016). Accommodating stations in addition to the two mentioned here would require additional correlator machines and the transpose to be performed over a high speed network, instead of memory within a single machine, complicating the implementation of the system significantly.

9. Conclusions

We describe the system architecture and its implementation for the AARTFAAC all sky monitor, an autonomous and real-time image domain transient detection machine piggy-backing on the LOFAR radio telescope. The system consists of a diversity of heterogeneous subsystems ranging from FPGA firmware, to heterogeneous GPU machines, with final processing carried out on commodity computing machines. Its aim is to generate real-time triggers on the detection of reliable transients, to enable their multi-wavelength followup.

Our implementation utilizes a hierarchical routing of high bandwidth data to a central correlator, with co-processing within the hierarchy to spread the computing cost. The most intensive computing of the correlations of 1152 input streams requires ~ 40 TFLOPs, and has been achieved on a system consisting of 10 server grade GPU cards. Our system operates in real-time, with an average measured latency of 1.1 seconds to generate calibrated all-sky images.

Acknowledgments This work is funded by the ERC Advanced Investigator grant no. 247295 awarded to Prof. Ralph Wijers, University of Amsterdam. We thank The Netherlands Foundation for Radio Astronomy (ASTRON) for support provided in carrying out the commissioning observations.

References

- Colegate, T. & Clarke, N. [2011] *Publications of the Astronomical Society of Australia* **28**, 299.
- Cordes, J. M., Lazio, T. J. W. & McLaughlin, M. [2004] *New Astronomy Reviews* **48**, 1459.
- Ellingson, S., Taylor, G. & Craig, J. e. a. [2013] *IEEE Transactions on Antennas and Propagation* **61**, 2540.
- Fender, R. P., Wijers, R., Stappers, B., Braun, R., Wise, M., Coenen, T., Falcke, H., Griessmeier, J.-M., Van Haarlem, M., Jonker, P. *et al.* [2006] “The lofar transients key project,” *VI Microquasar Workshop: Microquasars and Beyond*, p. 104.
- Guennebaud, G., Jacob, B. *et al.* [2010] “Eigen v3,” <http://eigen.tuxfamily.org>.
- Gunst, A., Szomoru, A., Schoonderbeek, G., Kooistra, E., Van der Schuur, D. & Pepping, H.-J. [2014] *Experimental Astronomy* **37**, 55.
- Intema, H. T., van der Tol, S., Cotton, W. D., Cohen, A. S., van Bemmell, I. M. & Röttgering, H. J. A. [2009] *Astronomy and Astrophysics* **501**, 1185, doi:10.1051/0004-6361/200811094.
- Keane, E., Johnston, S., Bhandari, S., Barr, E., Bhat, N., Burgay, M., Caleb, M., Flynn, C., Jameson, A., Kramer, M. *et al.* [2016] *Nature* **530**, 453.
- Law, C. J. & Bower, G. C. [2012] *The Astrophysical Journal* **749**, 143.
- Law, C. J., Bower, G. C., Pokorny, M., Rupen, M. P. & Sowerski, K. [2012] *The Astrophysical Journal* **760**, 124.
- Lazio, J., Bloom, J., Bower, G., Cordes, J., Croft, S., Hyman, S., Law, C. & McLaughlin, M. [2009] *arXiv preprint arXiv:0904.0633* .
- Prasad, P., Wijnholds, S., Huizinga, F. & Wijers, R. [2014] *Astronomy & Astrophysics* **568**, A48.
- Romein, J. W. [2016] “A comparison of accelerator architectures for radio astronomical signal processing algorithms,” *International Conference on Parallel Processing (ICPP’16), Philadelphia, PA, August 2016*, p. 484.
- Scaife, A. M. & Heald, G. H. [2012] *Monthly Notices of the Royal Astronomical Society: Letters* **423**, L30.
- Spitler, L. [2015] *Bulletin of the American Physical Society* **60**.
- Spitler, L., Scholz, P., Hessels, J., Bogdanov, S., Brazier, A., Camilo, F., Chatterjee, S., Cordes, J., Crawford, F., Deneva, J. *et al.* [2016] *Nature* **531**, 202.
- Stewart, A., Fender, R., Broderick, J., Hassall, T., Muñoz-Darias, T., Rowlinson, A., Swinbank, J., Staley, T., Molenaar, G., Scheers, B. *et al.* [2016] *Monthly Notices of the Royal Astronomical Society* **456**, 2321.
- Swinbank, J. D., Staley, T. D., Molenaar, G. J., Rol, E., Rowlinson, A., Scheers, B., Spreeuw, H., Bell, M. E., Broderick, J. W., Carbone, D. *et al.* [2015] *Astronomy and Computing* **11**, 25.
- Thornton, D., Stappers, B., Bailes, M., Barsdell, B., Bates, S., Bhat, N., Burgay, M., Burke-Spolaor, S., Champion, D., Coster, P. *et al.* [2013] *Science* **341**, 53.
- Tingay, S., Goeke, R., Bowman, J., Emrich, D., Ord, S., Mitchell, D., Morales, M., Booler, T., Crosse, B., Wayth, R. *et al.* [2013] *Publications of the Astronomical Society of Australia* **30**, 7.
- Van Haarlem, M., Wise, M., Gunst, A., Heald, G., McKean, J., Hessels, J., De Bruyn, A., Nijboer, R., Swinbank, J., Fallows, R. *et al.* [2013] *Astronomy & Astrophysics* **556**, A2.
- Viberg, M., Ottersten, B. & Kailath, T. [1991] *IEEE Transactions on Signal Processing* **39**, 2436.
- Wijnholds, S., van der Tol, S., Nijboer, R. & van der Veen, A.-J. [2010] *IEEE Signal Processing Magazine* **27**, 30.

- Williams, R. & Seaman, R. [2006] “Voevent: Information infrastructure for real-time astronomy,” *Astronomical Data Analysis Software and Systems XV*, p. 637.
- Zatman, M. [1998] *IEE Proceedings-Radar, Sonar and Navigation* **145**, 85.