

FRIEZE VECTORS AND UNITARY FRIEZES

EMILY GUNAWAN AND RALF SCHIFFLER

ABSTRACT. Let Q be a quiver without loops and 2-cycles, let $\mathcal{A}(Q)$ be the corresponding cluster algebra and let \mathbf{x} be a cluster. We introduce a new class of integer vectors which we call frieze vectors relative to \mathbf{x} . These frieze vectors are defined as solutions of certain Diophantine equations given by the cluster variables in the cluster algebra. We show that every cluster gives rise to a frieze vector and that the frieze vector determines the cluster.

We also study friezes of type Q as homomorphisms from the cluster algebra to an arbitrary integral domain. In particular, we show that every positive integral frieze of affine Dynkin type $\tilde{\mathbb{A}}_{p,q}$ is unitary, which means it is obtained by specializing each cluster variable in one cluster to the constant 1. This completes the answer to the question of unitarity for all positive integral friezes of Dynkin and affine Dynkin types.

CONTENTS

1. Introduction	1
2. Friezes	2
3. Frieze vectors	6
4. Friezes of type $\tilde{\mathbb{A}}$	11
References	14

1. INTRODUCTION

Let Q be a quiver without loops and 2-cycles and let $\mathcal{A}(Q)$ be the corresponding cluster algebra with trivial coefficients. We define a *frieze of type Q* to be a ring homomorphism $\mathcal{F}: \mathcal{A}(Q) \rightarrow R$ from the cluster algebra to an integral domain R . The frieze \mathcal{F} is called *non-zero* if every cluster variable is mapped to a non-zero element of R and \mathcal{F} is said to be *unitary* if there exists a cluster \mathbf{x} such that $\mathcal{F}(x)$ is a unit in R , for all $x \in \mathbf{x}$. Moreover \mathcal{F} is called *integral* if $R = \mathbb{Z}$, and *positive* if $R = \mathbb{Z}$ and every cluster variable is mapped to a positive integer.

Positive integral friezes of Dynkin type \mathbb{A}_n are precisely the classical Conway-Coxeter friezes, where the classical frieze pattern is given by the displaying the values of \mathcal{F} on the cluster variables in the shape of the Auslander-Reiten quiver of the cluster category.

Every non-zero frieze is determined by its values $\mathcal{F}(\mathbf{x}) = (a_1, \dots, a_n)$ on an arbitrary cluster $\mathbf{x} = (x_1, \dots, x_n)$ in $\mathcal{A}(Q)$. It is therefore natural to ask which values (a_1, \dots, a_n) produce positive unitary integral friezes. We call such a vector (a_1, \dots, a_n) a *unitary frieze vector relative to the cluster \mathbf{x}* . Our first main result is the following.

2010 *Mathematics Subject Classification*. Primary 13F60 Secondary 16G20 .

The authors were supported by the NSF-CAREER grant DMS-1254567 and by the University of Connecticut.

Theorem 1. *Let Q be a quiver without loops and 2-cycles and let $\mathbf{x} = (x_1, \dots, x_n)$ be an arbitrary cluster of $\mathcal{A}(Q)$. Then there is a bijection*

$$\begin{aligned} \phi: \{\text{unordered clusters in } \mathcal{A}(Q)\} &\longrightarrow \{\text{positive unitary frieze vectors relative to } \mathbf{x}\} \\ \mathbf{x}' = \{x'_1, \dots, x'_n\} &\longmapsto \phi(\mathbf{x}') = (a_1, \dots, a_n). \end{aligned}$$

Thus every cluster \mathbf{x}' defines a unique unitary frieze vector. One can thus think of the frieze vectors as another parametrization of the clusters in the cluster algebra. The frieze vectors are different from other known vectors associated to clusters like denominator vectors, c -vectors or g -vectors.

Our second main result is about the unitarity of positive integral friezes. Since Conway and Coxeter's work in 1973, it is known that every positive integral frieze of Dynkin type \mathbb{A} is unitary. For Dynkin types \mathbb{D} and \mathbb{E} there exist non-unitary positive integral friezes, see [FP]. We extend these results to the affine Dynkin types as follows.

Theorem 2. *Let Q be a quiver of type $\widetilde{\mathbb{A}}_{p,q}$ and let $\mathcal{F}: \mathcal{A}(Q) \rightarrow \mathbb{Z}$ be a positive integral frieze. Then \mathcal{F} is unitary.*

Our proof is constructive. We give an algorithm that starts from an arbitrary positive integral frieze \mathcal{F} and produces the unique cluster \mathbf{x} such that $\mathcal{F}(\mathbf{x}) = (1, \dots, 1)$. In the other affine types $\widetilde{\mathbb{D}}$ and $\widetilde{\mathbb{E}}$, there are non-unitary positive integral friezes.

It is natural to ask if friezes of types \mathbb{A} and $\widetilde{\mathbb{A}}$ remain unitary if one replaces the ring of integers by other integral domains. However, already over the Gaussian integers we give an example of a non-unitary frieze of Dynkin type \mathbb{A}_2 . The classification of friezes over the Gaussian integers or other integral domains besides \mathbb{Z} is open even in type \mathbb{A} . For type \mathbb{A}_1 there are 12 non-zero friezes over the Gaussian integers, see [F].

The paper is organized as follows. In section 2, we give the formal definition of friezes and show how they are a generalization of Conway-Coxeter friezes. We also give several examples of friezes of type \mathbb{A}_3 over different rings. Section 3 is devoted to the definition of frieze vectors and the proof of Theorem 1, and Theorem 2 is proved in section 4.

2. FRIEZES

Friezes of type \mathbb{A}_n were classified by Conway and Coxeter in [CoCo] in 1973. More than 30 years later, Caldero and Chapoton discovered a relation between friezes and cluster algebras in [CC]. Since then friezes were studied by many authors, see for example [BM, ARS, KS, M1, MOT, FP, BFGST, BRM, BFPT, GMV, LLMSS]. For a survey we refer the reader to [M2].

Usually classical friezes are defined as certain planar arrays of positive integers that satisfy a diamond relation. In this paper however, we take a different point of view and we define a frieze to be a homomorphism from an arbitrary cluster algebra to an arbitrary integral domain R . The usual planar array is obtained from the Auslander-Reiten quiver of the corresponding cluster category by replacing the indecomposable objects (i.e. the vertices of the Auslander-Reiten quiver) by the values of the homomorphism on the corresponding cluster algebra elements. Friezes as homomorphisms to the integers were also considered in [F, FP], and friezes with values in subsets of the complex numbers in [CH].

2.1. Definition. Let Q be a quiver without loops and 2-cycles and let $\mathcal{A}(Q)$ be the corresponding cluster algebra with trivial coefficients, see [FZ]. We could just as well include coefficients in our definition, but since we are not using them in this paper we impose trivial coefficients for simplicity.

Definition 2.1. (1) A *frieze of type Q* is a ring homomorphism

$$\mathcal{F}: \mathcal{A}(Q) \longrightarrow R$$

from the cluster algebra to an integral domain R . The frieze is called *integral* if $R = \mathbb{Z}$.

(2) A frieze $\mathcal{F}: \mathcal{A}(Q) \longrightarrow R$ is said to be *unitary* if there exists a cluster \mathbf{x} in $\mathcal{A}(Q)$ such that every cluster variable $x \in \mathbf{x}$ is mapped by \mathcal{F} to a unit in R .

(3) A frieze is said to be *non-zero* if every cluster variable in $\mathcal{A}(Q)$ is mapped by \mathcal{F} to a non-zero element of R .

(4) An integral frieze is said to be *positive* if every cluster variable in $\mathcal{A}(Q)$ is mapped by \mathcal{F} to a positive integer.

Remark 2.2. Our definition of unitary friezes agrees with that of [M1, FP] for positive integral friezes. Note however that if the integral frieze is not positive, we also allow specialization at -1.

2.2. Cluster category and Auslander-Reiten quiver. Let Q be a quiver without loops and 2-cycles. If the quiver Q is mutation equivalent to an acyclic quiver Q' , we let \mathcal{C}_Q be the cluster category $\mathcal{C}_Q = \mathcal{D}^b(\text{mod } kQ')/\tau^{-1}[1]$ introduced in [BMRRT] and in [CCS] for type \mathbb{A} . More generally, if Q comes with a non-degenerate potential, we let \mathcal{C}_Q be the generalized cluster category introduced in [A]. We denote by $\Gamma(\mathcal{C}_Q)$ the Auslander-Reiten quiver of \mathcal{C}_Q . Its vertices are the isoclasses of indecomposable objects in \mathcal{C}_Q and its arrows are given by irreducible morphisms in \mathcal{C}_Q . If Q is mutation equivalent to an acyclic quiver Q' , then $\Gamma(\mathcal{C}_Q)$ has a special connected component, called the *transjective component*, that contains both the preprojective component and the preinjective component of $\text{mod } kQ'$. In finite type, this transjective component is all of $\Gamma(\mathcal{C}_Q)$.

The cluster category is a triangulated category equipped with a Serre functor given by the Auslander-Reiten translation τ . Moreover \mathcal{C}_Q has Auslander-Reiten triangles and it is 2-Calabi-Yau, meaning that $\text{Ext}_{\mathcal{C}_Q}^1(X, Y) \cong D\text{Ext}_{\mathcal{C}_Q}^1(Y, X)$, where $D = \text{Hom}(-, k)$ denotes the standard duality, see [K, A]. An object $X \in \mathcal{C}_Q$ is called rigid if $\text{Ext}_{\mathcal{C}_Q}^1(X, X) = 0$, and an indecomposable rigid object in \mathcal{C}_Q is called reachable if it can be reached under mutation from kQ' . If Q is mutation equivalent to an acyclic quiver all rigid indecomposable objects are reachable and all indecomposables in the transjective component are rigid.

The cluster character is a map $X_\tau: \mathcal{C}_Q \rightarrow \text{Frac}\mathcal{A}(Q)$ from the cluster category to the field of fractions of the cluster algebra that maps (isoclasses of reachable) indecomposable rigid objects in \mathcal{C}_Q bijectively to cluster variables in $\mathcal{A}(Q)$, see [CC, CK, CK2, P, FK]. The key for the relation to classical friezes lies in the image of Auslander-Reiten triangles under the cluster character, which is expressed in the following proposition.

Proposition 2.3. *Let Q be an acyclic quiver. If $\tau N \rightarrow \bigoplus_{i \in I} M_i \rightarrow N \rightarrow \tau N[1]$ is an Auslander-Reiten triangle in the transjective component of \mathcal{C}_Q with $\tau N, M_i, N$ indecomposable rigid objects then we have the following identity in the cluster algebra.*

$$X_{\tau N} X_N = \prod_{i \in I} X_{M_i} + 1.$$

Proof. Since N is rigid transjective, we have $\dim \text{Ext}^1(N, \tau N) = 1$ and therefore N and τN form an exchange pair [BMRRT, Theorem 7.5]. This implies that there are unique (up to isomorphism) triangles

$$\tau N \rightarrow \bigoplus_{i \in I} M_i \rightarrow N \rightarrow \tau N[1] \quad \text{and} \quad N \rightarrow \bigoplus_{i \in I'} M'_i \rightarrow \tau N \rightarrow N[1]$$

such that $X_{\tau N} X_N = \prod_{i \in I} X_{M_i} + \prod_{i \in I'} X_{M'_i}$. Now, in the cluster category, we have $\tau = [1]$, and thus the second triangle is isomorphic to $N \rightarrow 0 \rightarrow N[1] \xrightarrow{1} N[1]$. This completes the proof. \square

Remark 2.4. (1) This proposition gives the so-called diamond relation in the friezes.

(2) If we were considering cluster algebras with non-trivial coefficients the constant 1 on the right hand side of the equation in Proposition 2.3 would be replaced by a coefficient monomial. Friezes of that type were studied in [BRM].

2.3. Examples. (1) The identity homomorphism $\mathcal{A}(Q) \rightarrow \mathcal{A}(Q)$ is a non-zero frieze of type Q . For example, if Q is the type \mathbb{A}_3 quiver $1 \rightarrow 2 \leftarrow 3$, we can visualize this frieze in the Auslander-Reiten quiver of \mathcal{C}_Q as follows. First let us write down the Auslander-Reiten quiver.

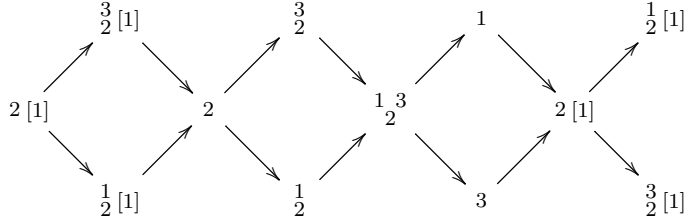

Here we use a standard notation for the representations of the quiver Q , see for example [S], and $[1]$ denotes the shift. Vertices with the same label are identified, so the quiver lies on a Moebius strip. The Auslander-Reiten translation τ is the horizontal translation to the left. For example $\tau 3 = \frac{1}{2}$. The Auslander-Reiten triangles are given by the meshes in the Auslander-Reiten quiver, for example

$$\rightarrow \frac{1}{2}[1] \rightarrow 2 \rightarrow \frac{1}{2} \rightarrow \quad \text{and} \quad \rightarrow 2 \rightarrow \frac{1}{2} \oplus \frac{3}{2} \rightarrow \frac{1}{2} \oplus 3 \rightarrow$$

are Auslander-Reiten triangles.

The identity homomorphism $\mathcal{A}(Q) \rightarrow \mathcal{A}(Q)$ gives the following frieze.

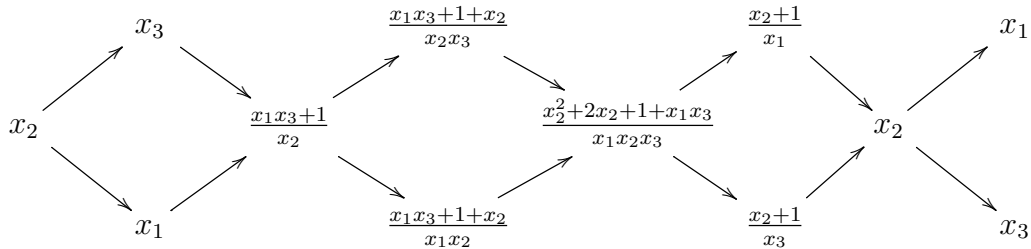

This is an example of a non-zero frieze of type \mathbb{A}_3 . Note that the Auslander-Reiten triangles give the usual diamond rules, for example

$$x_1 \frac{x_1 x_3 + 1 + x_2}{x_1 x_2} = \frac{x_1 x_3 + 1}{x_2} + 1 \quad \text{and}$$

$$\frac{x_1x_3 + 1}{x_2} \frac{x_2^2 + 2x_2 + 1 + x_1x_3}{x_1x_2x_3} = \frac{x_1x_3 + 1 + x_2}{x_1x_2} \frac{x_1x_3 + 1 + x_2}{x_2x_3} + 1$$

(2) Specializations. We compute several specializations of the example above.

(i) Specializing $x_1 = x_2 = x_3 = 1$, we obtain the following unitary positive integral frieze.

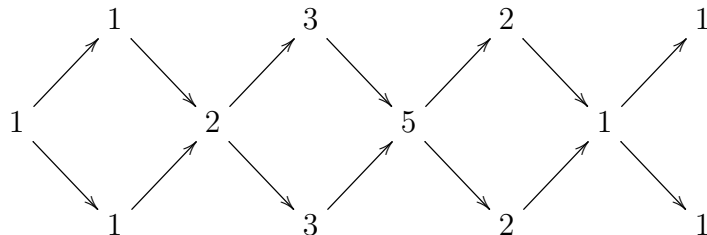

Here the previous examples of the diamond rules become simply

$$1 \cdot 3 = 2 + 1 \quad \text{and} \quad 2 \cdot 5 = 3 \cdot 3 + 1.$$

This is an example of a classical Conway-Coxeter frieze; let us point out that one can extend this frieze pattern by a row of 1's above and below the current pattern, which is how the Conway-Coxeter friezes are usually represented. We will not include these rows of 1's in this article.

(ii) Specializing $x_1 = x_2 = 1$ and $x_3 = -1$, we obtain the following unitary integral frieze which is non-positive, not even non-zero.

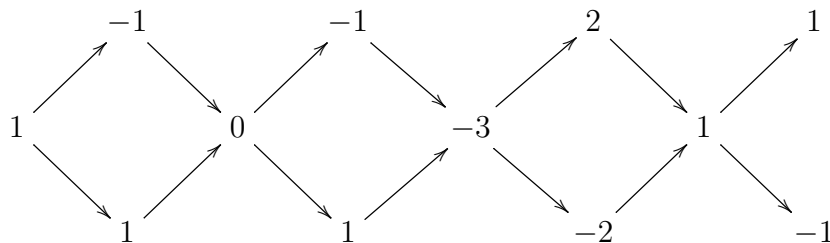

Our example diamond relations become here $1 \cdot 1 = 0 + 1$ and $0 \cdot (-3) = (-1) \cdot 1 + 1$.

(iii) Specializing $x_1 = 1$, $x_2 = i$, and $x_3 = i$, we obtain the following unitary non-zero frieze in the Gaussian integers $\mathbb{Z}[i]$.

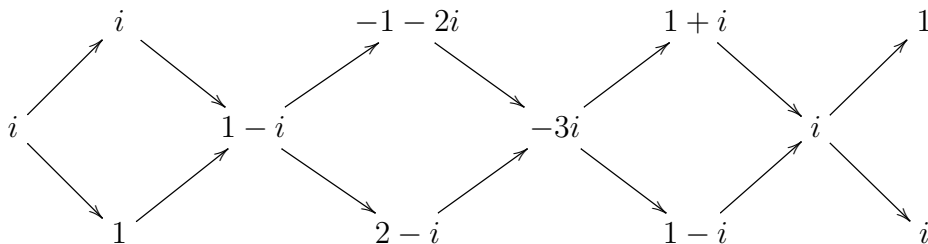

Here our example diamond relations become $1 \cdot (2 - i) = (1 - i) + 1$ and $(1 - i) \cdot (-3i) = (-1 - 2i) \cdot (2 - i) + 1$.

(iv) Specializing $x_1 = 1$, $x_2 = \frac{1+\sqrt{-3}}{2}$, $x_3 = 1$, we obtain the following unitary non-zero frieze in the quadratic integer ring $\mathbb{Z}[\sqrt{-3}]$. Recall that the units in this ring are

$$\{\pm 1, \frac{\pm 1 \pm \sqrt{-3}}{2}\}.$$

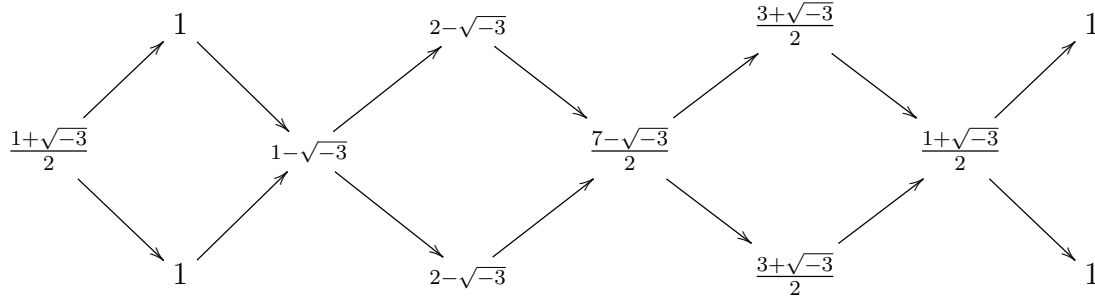

In this case, the examples of the diamond relations become $1 \cdot (2 - \sqrt{-3}) = 1 - \sqrt{-3}$ and $(1 - \sqrt{-3})(\frac{7 - \sqrt{-3}}{2}) = (2 - \sqrt{-3})^2 + 1$.

2.4. Positive unitary integral friezes. In this subsection we show that for a positive unitary integral frieze, the cluster that carries the unitarity property is unique.

Proposition 2.5. *Let $\mathcal{F}: \mathcal{A}(Q) \rightarrow \mathbb{Z}$ be a positive unitary integral frieze and let \mathbf{x} be a cluster such that $\mathcal{F}(\mathbf{x}) = (1, \dots, 1)$. Then for all cluster variables $u \notin \mathbf{x}$ we have $\mathcal{F}(u) > 1$. In particular \mathbf{x} is the unique cluster such that $\mathcal{F}(\mathbf{x}) = (1, \dots, 1)$.*

Proof. Suppose $\mathcal{F}(u) = 1$. Since u is a Laurent polynomial in \mathbf{x} with positive coefficients, this implies that u is a Laurent monomial in \mathbf{x} . Let $M(u)$ be the indecomposable rigid object in the cluster category that is mapped to u under the cluster character. Then the number of terms of the Laurent polynomial of u is equal to the sum $\sum_{\underline{e}} \chi(\text{Gr}_{\underline{e}}(\text{Ext}_{\mathcal{C}_Q}^1(T, M(u))))$, where T is the cluster-tilting object corresponding to \mathbf{x} , $\text{Ext}_{\mathcal{C}_Q}^1(T, M(u))$ is a module over the Jacobian algebra of the quiver with potential of the seed containing \mathbf{x} , $\text{Gr}_{\underline{e}}$ is the quiver Grassmannian of submodules of dimension vector \underline{e} and χ is the Euler characteristic [FK]. Whenever $\text{Ext}_{\mathcal{C}_Q}^1(T, M(u))$ is nonzero, this sum has at least two terms coming from the two trivial submodules 0 and $\text{Ext}_{\mathcal{C}_Q}^1(T, M(u))$. Using the positivity theorem [LS] we see that $\mathcal{F}(u) = 1$ if and only if $\text{Ext}_{\mathcal{C}_Q}^1(T, M(u)) = 0$, which means that $M(u)$ is a summand of T , and thus $u \in \mathbf{x}$, a contradiction. \square

3. FRIEZE VECTORS

In this section, we introduce a class of positive integer vectors and show that they are in bijection with the clusters of the cluster algebra.

3.1. Definition. We start with a general result on non-zero friezes.

Proposition 3.1. *Every non-zero frieze $\mathcal{F}: \mathcal{A}(Q) \rightarrow R$ is completely determined by its values on an arbitrary cluster in $\mathcal{A}(Q)$.*

Proof. Let $\mathbf{x} = (x_1, \dots, x_n)$ be a cluster in $\mathcal{A}(Q)$ and let u be an arbitrary cluster variable in $\mathcal{A}(Q)$ that does not lie in \mathbf{x} . By the Laurent phenomenon [FZ], we can write u as a Laurent polynomial in x_1, \dots, x_n , thus

$$u = \frac{f(x_1, \dots, x_n)}{x_1^{d_1} \cdots x_n^{d_n}} \quad \text{with } f \in \mathbb{Z}[x_1, \dots, x_n], d_i \geq 0.$$

Thus

$$\mathcal{F}(u) = \frac{f(\mathcal{F}(x_1), \dots, \mathcal{F}(x_n))}{\mathcal{F}(x_1)^{d_1} \dots \mathcal{F}(x_n)^{d_n}}$$

in the field of fractions of R . Note that this expression is well-defined since the frieze is non-zero. Therefore $\mathcal{F}(u)$ is determined by the values $\mathcal{F}(x_i)$. Since the cluster algebra is generated by its cluster variables, this completes the proof. \square

Proposition 3.1 implies that given an arbitrary cluster $\mathbf{x} = (x_1, \dots, x_n)$ we can obtain every non-zero frieze by specializing the cluster variables x_i of the cluster to certain ring elements $\mathcal{F}(x_i) = a_i \in R$. It is important to note that by far not every choice of elements $a_i \in R$ will produce a frieze with values in R , because in general the values will be in the field of fractions of R . It is natural to ask which choices $a_i \in R$ do. This leads us to the following definition.

Definition 3.2. Let $\mathbf{x} = (x_1, \dots, x_n)$ be a cluster of $\mathcal{A}(Q)$.

(1) A vector $(a_1, \dots, a_n) \in R^n$ is called a *frieze vector relative to \mathbf{x}* if the frieze \mathcal{F} defined by $\mathcal{F}(x_i) = a_i$ has values in R . If the frieze \mathcal{F} is unitary we say that the frieze vector (a_1, \dots, a_n) is unitary.

(2) A vector $(a_1, \dots, a_n) \in \mathbb{Z}_{>0}^n$ is called a *positive frieze vector relative to \mathbf{x}* if the frieze \mathcal{F} defined by $\mathcal{F}(x_i) = a_i$ is positive integral.

Proposition 3.3. (1) Let $(a_1, \dots, a_n) \in R^n$ such that every a_i is a unit in R . Then (a_1, \dots, a_n) is a (unitary) frieze vector relative to every cluster $\mathbf{x} = (x_1, \dots, x_n)$ in $\mathcal{A}(Q)$.

(2) The vector $(1, \dots, 1) \in \mathbb{Z}_{>0}^n$ is a positive (unitary) frieze vector relative to every cluster $\mathbf{x} = (x_1, \dots, x_n)$ in $\mathcal{A}(Q)$.

Proof. (1) By the Laurent phenomenon, every cluster variable is a Laurent polynomial in \mathbf{x} . Since each x_i is specialized to a unit in R , the denominator of this Laurent polynomial also specializes to a unit in R . Therefore the image of every cluster variable lies in R , and hence $\mathcal{F}(\mathcal{A}(Q)) \subset R$.

(2) The frieze is integral by part (1) and positivity follows from the positivity theorem for cluster variables [LS]. \square

3.2. Acyclic type. In the case where the quiver Q is mutation equivalent to an acyclic quiver, we have the following characterization of frieze vectors.

Proposition 3.4. Let $(\mathbf{x} = (x_1, \dots, x_n), Q)$ be an acyclic seed of the cluster algebra. Then a vector $(a_1, \dots, a_n) \in R^n$ is a frieze vector if and only if a_i is a divisor of $\prod_{i \rightarrow j} a_j + \prod_{i \leftarrow j} a_j$ in R , for all $i = 1, \dots, n$.

Proof. Let x'_i denote the cluster variable obtained from (\mathbf{x}, Q) by mutating in direction i . Then

$$x'_i = \frac{\prod_{i \rightarrow j} x_j + \prod_{i \leftarrow j} x_j}{x_i}.$$

By [BFZ, Corollary 1.21], the cluster algebra is generated by the $2n$ variables $x_1, \dots, x_n, x'_1, \dots, x'_n$. Let \mathcal{F} be the homomorphism defined by $\mathcal{F}(x_i) = a_i$. Then

$$\mathcal{F}(\mathcal{A}(Q)) \subset R \Leftrightarrow \mathcal{F}(x'_i) \in R \text{ for each } i \Leftrightarrow a_i \text{ divides } \prod_{i \rightarrow j} a_j + \prod_{i \leftarrow j} a_j \text{ in } R \text{ for all } i. \quad \square$$

3.3. Main result on frieze vectors. We are now ready to state and prove our first main result.

Theorem 3.5. *Let Q be a quiver without loops and 2-cycles and let $\mathbf{x} = (x_1, \dots, x_n)$ be an arbitrary cluster of $\mathcal{A}(Q)$. Then there is a bijection*

$$\begin{aligned} \phi: \{\text{unordered clusters in } \mathcal{A}(Q)\} &\longrightarrow \{\text{positive unitary frieze vectors relative to } \mathbf{x}\} \\ \mathbf{x}' = \{x'_1, \dots, x'_n\} &\longmapsto \phi(\mathbf{x}') = (a_1, \dots, a_n). \end{aligned}$$

Remark 3.6. (1) The theorem implies that every cluster \mathbf{x}' defines a unique positive unitary frieze vector in $\mathbb{Z}_{>0}^n$. This vector is different from the g -vector and the c -vector of the seed.

(2) We stress that, while the order of the cluster variables x'_1, \dots, x'_n is irrelevant, the order of the entries of the frieze vector $\phi(\mathbf{x}') = (a_1, \dots, a_n)$ is important. In other words, if σ is a permutation then $\phi(\sigma\mathbf{x}') = \phi(\mathbf{x}')$, but $\sigma\phi(\mathbf{x}') \neq \phi(\mathbf{x}')$ in general.

Proof. Each cluster variable x_1, \dots, x_n in the fixed cluster \mathbf{x} can be expressed as a Laurent polynomial in the cluster \mathbf{x}' , say $x_i = \mathcal{L}_i(x'_1, \dots, x'_n)$. We define the map ϕ by $\phi(\mathbf{x}') = (a_1, \dots, a_n)$, with $a_i = \mathcal{L}_i(1, \dots, 1)$. In other words, $\phi(\mathbf{x}')$ is equal to the vector $\mathcal{F}(\mathbf{x}) = (a_1, \dots, a_n)$, where \mathcal{F} is the frieze defined by specializing the cluster variables in \mathbf{x}' to 1. By Proposition 3.3, the frieze \mathcal{F} is unitary, integral and positive. Thus (a_1, \dots, a_n) is a positive unitary frieze vector relative to \mathbf{x} . Furthermore, since every variable in \mathbf{x}' is specialized to 1, we clearly have $\phi(\sigma\mathbf{x}') = \phi(\mathbf{x}')$, for every permutation σ . Thus the map ϕ is well-defined.

To show that ϕ is surjective, let $(a_1, \dots, a_n) \in \mathbb{Z}_{>0}^n$ be any positive unitary frieze vector relative to \mathbf{x} . By definition, the corresponding frieze defined by $\mathcal{F}(x_i) = a_i$ is positive and unitary, which means that there exists a cluster $\mathbf{x}' = (x'_1, \dots, x'_n)$ such that $\mathcal{F}(x'_i) = 1$, for $i = 1, \dots, n$. By construction of ϕ , we have $\phi(\mathbf{x}') = (a_1, \dots, a_n)$, so ϕ is surjective.

To show injectivity, let $\mathbf{x}', \mathbf{x}''$ be two clusters in $\mathcal{A}(Q)$ such that $\phi(\mathbf{x}') = \phi(\mathbf{x}'')$. Let \mathcal{F}' and \mathcal{F}'' be the unitary friezes defined by $\mathcal{F}'(x'_i) = 1$ and $\mathcal{F}''(x''_i) = 1$, respectively. Since $\phi(\mathbf{x}') = \phi(\mathbf{x}'')$, both friezes have the same values on \mathbf{x} , thus $\mathcal{F}'(\mathbf{x}) = \mathcal{F}''(\mathbf{x}) = (a_1, \dots, a_n)$. Now Proposition 3.1 implies that $\mathcal{F}' = \mathcal{F}''$, and Proposition 2.5 yields $\mathbf{x}' = \mathbf{x}''$. \square

Remark 3.7. The inverse of the bijection ϕ is given as follows. Given a positive unitary frieze vector (a_1, \dots, a_n) , we compute the corresponding unitary frieze \mathcal{F} by specializing $(x_1, \dots, x_n) = (a_1, \dots, a_n)$. By Proposition 2.5, this frieze has a unique cluster \mathbf{x}' such that $\mathcal{F}(\mathbf{x}') = (1, \dots, 1)$. Then $\phi^{-1}(a_1, \dots, a_n) = \mathbf{x}'$.

3.4. Example. Thanks to Proposition 3.4, the frieze vectors (a_1, a_2, a_3) relative to the seed $(x_1, x_2, x_3), 1 \rightarrow 2 \leftarrow 3$ are characterized by the condition that the following three expressions are integers

$$\frac{a_2 + 1}{a_1}, \frac{a_1 a_3 + 1}{a_2}, \frac{a_2 + 1}{a_3}.$$

The 14 frieze vectors (a_1, a_2, a_3) are the following.

$$\begin{array}{cccccccc} (1, 1, 1) & (1, 1, 2) & (1, 2, 1) & (1, 2, 3) & (1, 3, 2) & (2, 1, 1) & (2, 1, 2) & (2, 3, 1) & (2, 3, 4) \\ (2, 5, 2) & (3, 2, 1) & (3, 2, 3) & (3, 5, 3) & (4, 3, 2) & & & & \end{array}$$

Equivalently, we can think of the conditions as Diophantine equations in two sets of integers as follows.

$$a_1 b_1 = a_2 + 1, \quad a_2 b_2 = a_1 a_3 + 1, \quad a_3 b_3 = a_2 + 1.$$

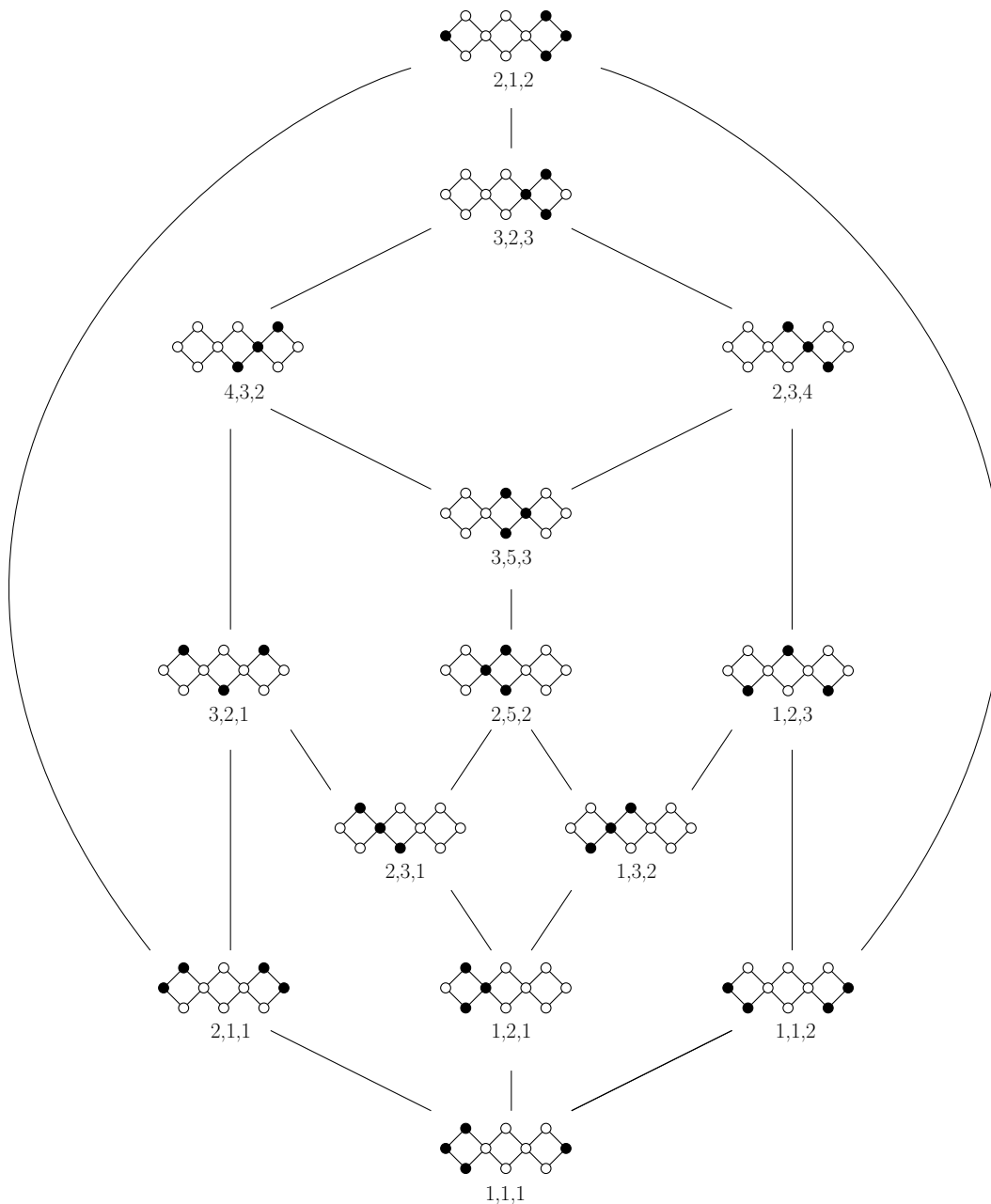

FIGURE 1. Frieze vectors relative to $(x_1, x_2, x_3), 1 \rightarrow 2 \leftarrow 3$ together with their clusters.

The vectors (b_1, b_2, b_3) , in the same order as the frieze-vectors above, are the following.

- | | | | | | | | | |
|-------------|-------------|-------------|-------------|-------------|-------------|-------------|-------------|-------------|
| $(2, 2, 2)$ | $(2, 3, 1)$ | $(3, 1, 3)$ | $(3, 2, 1)$ | $(4, 1, 2)$ | $(1, 3, 2)$ | $(1, 5, 1)$ | $(2, 1, 4)$ | $(2, 3, 1)$ |
| $(3, 1, 3)$ | $(1, 2, 3)$ | $(1, 5, 1)$ | $(2, 2, 2)$ | $(1, 3, 2)$ | | | | |

Figure 1 shows the frieze vectors and their clusters in the exchange graph, where the clusters are illustrated by their position in the Auslander-Reiten quiver of the cluster category.

3.5. Mutation of frieze vectors in type \mathbb{A} . Mutations of positive integral friezes are described in [BFGST], where the authors compute the effect of mutation on the whole frieze.

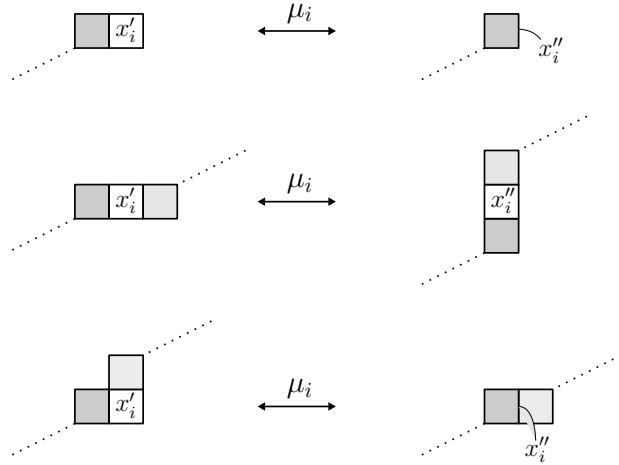
FIGURE 2. Mutation of snake graphs in direction x'_i

Here, we are interested in describing the effect of mutation on the frieze vector relative to a fixed cluster \mathbf{x} . To give this description, we use the combinatorial formula of [MS] to write the cluster variables of \mathbf{x} with respect to the cluster \mathbf{x}' in terms of perfect matchings of snake graphs. Then the values in the frieze vectors are simply given as the number of perfect matchings of the appropriate snake graph.

We will not define snake graphs here but rather refer to the survey [S2]. For our purpose it suffices to say that a snake graph is a planar graph consisting of a sequence of square tiles that are glued together such that two consecutive tiles share exactly one edge which is either the north edge of the first tile and the south edge of the second tile or the east edge of the first tile and the west edge of the second tile. We associate a snake graph to each cluster variable in \mathbf{x} . The tiles of the snake graph are labeled by the cluster variables in the cluster $\mathbf{x}' = (x'_1, \dots, x'_n)$ and its edges are labeled by the cluster variables in \mathbf{x}' or by the constant 1. Since our cluster algebra is of Dynkin type \mathbb{A} , no two tiles have the same label and no two interior edges are labeled by the same cluster variable.

The mutation from \mathbf{x}' to $\mathbf{x}'' = (\mathbf{x}' \setminus \{x'_i\}) \cup \{x''_i\}$ has the following effect on the snake graphs from a cluster algebra of Dynkin type \mathbb{A} .

- (1) If the first or last tile of the snake graph has label x'_i then this tile is removed and the new boundary edge is labeled by the new cluster variable x''_i , see the top row of Figure 2. Conversely, if the snake graph ends with an edge that is labeled x'_i then a new tile with label x''_i is glued to this edge.
- (2) If the snake graph has a tile labeled x'_i that is the middle tile of a 3-tile subgraph then
 - (a) if the 3-tile subgraph is straight then it transforms as shown in the second row of Figure 2;
 - (b) if the 3-tile subgraph is not straight then it transforms as shown in the third row of Figure 2; conversely, if the snake graph contains an interior edge labeled x'_i shared by two tiles with labels x'_h, x'_j then a new tile labeled x''_i is inserted such that the three consecutive tiles labeled x'_h, x''_i, x'_j do not form a straight subgraph.

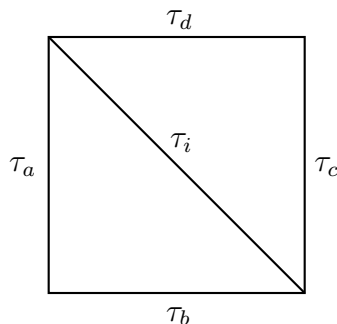
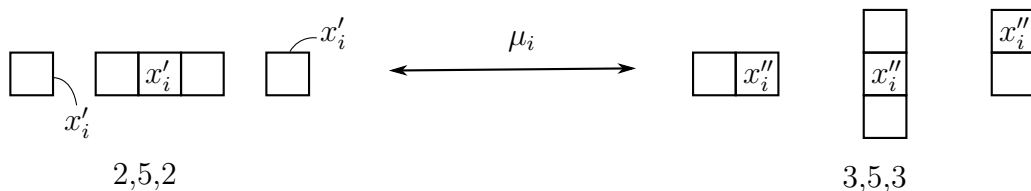

FIGURE 3. Quadrilateral in the triangulation T .

The above description gives the mutations of frieze vectors in the example of Figure 1. For example the mutation $(2, 5, 2) \longleftrightarrow (3, 5, 3)$ is given by the snake graph mutation below.



4. FRIEZES OF TYPE $\tilde{\mathbb{A}}$

In this section, we study the special case of integral friezes of affine Dynkin type \mathbb{A} . We show that every positive integral frieze of this type is unitary.

Let Q be a quiver that is mutation equivalent to a quiver Q' of type $\tilde{\mathbb{A}}_{p,q}$. The cluster algebra $\mathcal{A}(Q)$ is of surface type and the corresponding surface is an annulus with p marked points on one boundary component and q marked points on the other boundary component, see [FST]. The cluster variables x_γ in $\mathcal{A}(Q)$ are in bijection with the arcs γ in the annulus. We call a cluster variable x_γ *transjective* if its arc γ has its two endpoints on two different boundary components (bridging arc) and we call the cluster variable x_γ *regular* if the arc γ has both endpoint on the same boundary component (peripheral arc). The terminology transjective versus regular comes from the cluster category \mathcal{C}_Q .

Lemma 4.1. *Let $\mathcal{F}: \mathcal{A}(Q) \rightarrow \mathbb{Z}$ be a positive integral frieze of type $\tilde{\mathbb{A}}_{p,q}$ and let $\mathbf{x} = (x_1, \dots, x_n)$ be a cluster such that $\mathcal{F}(x) = 1$ for each regular cluster variable $x \in \mathbf{x}$ if any. Let i be such that $\mathcal{F}(x_i) \geq \mathcal{F}(x_j)$ for all j , and suppose that $\mathcal{F}(x_i) > 1$. Let x'_i be the cluster variable obtained from \mathbf{x} by mutation in direction i . Then $\mathcal{F}(x'_i) < \mathcal{F}(x_i)$ and if x'_i is a regular cluster variable then $\mathcal{F}(x'_i) = 1$.*

Proof. Let τ_j be the arc corresponding to the cluster variable x_j , so that $T = (\tau_1, \dots, \tau_n)$ is the triangulation corresponding to the cluster \mathbf{x} . The mutation in direction i is given by flipping the arc τ_i in T , and the exchange relation in the cluster algebra is of the form

$$(4.1) \quad x_i x'_i = x_a x_c + x_b x_d$$

where τ_i is the diagonal in the quadrilateral in T with sides $\tau_a, \tau_b, \tau_c, \tau_d$ as in Figure 3 some of which may be boundary edges.

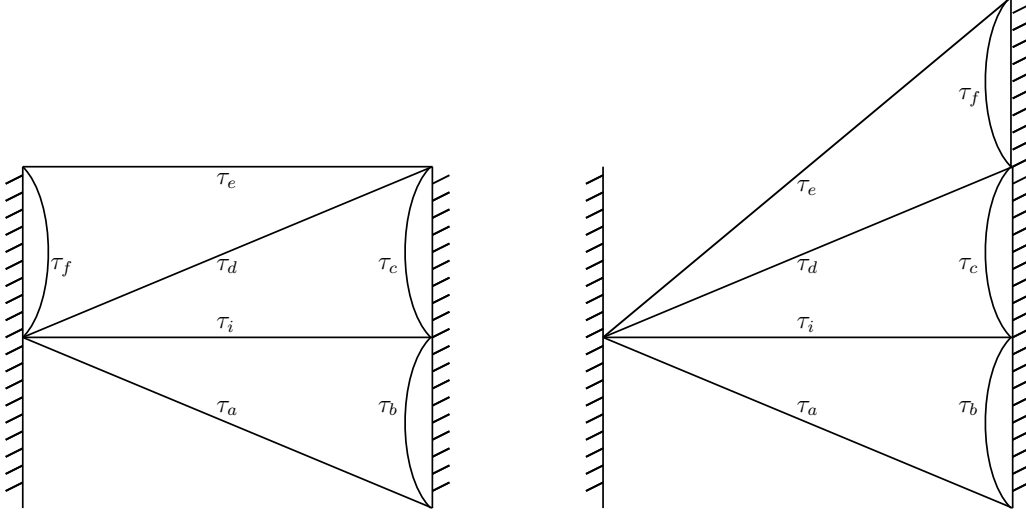

FIGURE 4. Two possible configurations in the triangulation T when τ_c is a peripheral arc or a boundary edge.

Our assumption that $\mathcal{F}(x_i) > 1$ and $\mathcal{F}(x) = 1$ for every regular cluster variable $x \in \mathbf{x}$ imply that x_i is transjective. Hence τ_i is a bridging arc, so its endpoints lie on different boundary components. Therefore one of the arcs τ_a, τ_b is bridging and the other is peripheral (or a boundary edge), and also one of τ_c, τ_d is bridging and the other is peripheral (or a boundary edge). We assume without loss of generality that τ_a is bridging and consider two cases.

Suppose first that τ_c is bridging. Then the relation (4.1) implies

$$(4.2) \quad \mathcal{F}(x'_i) = (\mathcal{F}(x_a)\mathcal{F}(x_c) + 1)/\mathcal{F}(x_i)$$

because the frieze has value 1 on the two regular variables (or boundary edge weights) x_b and x_d . Note that in this case the flipped arc τ'_i is bridging. Recall that $\mathcal{F}(x_a) \leq \mathcal{F}(x_i)$ and $\mathcal{F}(x_c) \leq \mathcal{F}(x_i)$. If $\mathcal{F}(x_a) = \mathcal{F}(x_i)$ then the right hand side of (4.2) would be equal to $\mathcal{F}(x_c) + 1/\mathcal{F}(x_i)$ which is not an integer. Thus $\mathcal{F}(x_a) < \mathcal{F}(x_i)$ and similarly $\mathcal{F}(x_c) < \mathcal{F}(x_i)$. Therefore the right hand side of (4.2) is at most $((\mathcal{F}(x_i) - 1)^2 + 1)/\mathcal{F}(x_i) = \mathcal{F}(x_i) - 2 + (2/\mathcal{F}(x_i))$ which is strictly smaller than $\mathcal{F}(x_i)$, and we are done.

Suppose now that τ_c is a peripheral arc. Then τ_d is bridging and the relation (4.1) implies

$$(4.3) \quad \mathcal{F}(x'_i) = (\mathcal{F}(x_a) + \mathcal{F}(x_d))/\mathcal{F}(x_i)$$

Note that in this case the arc τ'_i is peripheral and forms a triangle with the two peripheral arcs τ_b and τ_c . We will show that $\mathcal{F}(x'_i) = 1$. Since $\mathcal{F}(x_i)$ is the maximal frieze value in \mathbf{x} , equation (4.3) yields $\mathcal{F}(x'_i) \leq 2\mathcal{F}(x_i)/\mathcal{F}(x_i) = 2$. If $\mathcal{F}(x'_i) = 1$ we are done. Assume therefore that $\mathcal{F}(x'_i) = 2$. Then equation (4.3) implies

$$(4.4) \quad \mathcal{F}(x_a) = \mathcal{F}(x_d) = \mathcal{F}(x_i) \geq 2.$$

Consider the quadrilateral in T in which τ_d is the diagonal and denote its sides $\tau_i, \tau_c, \tau_e, \tau_f$ where τ_i, τ_e are bridging arcs and τ_c, τ_f are peripheral, see Figure 4.

Let x'_d be the cluster variable obtained by mutating \mathbf{x} in direction d . Then in the situation of the left picture in Figure 4 we have

$$\mathcal{F}(x'_d) = (\mathcal{F}(x_i)\mathcal{F}(x_e) + 1)/\mathcal{F}(x_d) = \mathcal{F}(x_e) + 1/\mathcal{F}(x_i),$$

where the last equality holds by (4.4). But since $\mathcal{F}(x_i) \geq 2$, this expression is not an integer, so we have a contradiction.

Therefore we must be in the situation of the right picture in Figure 4, and we have

$$\mathcal{F}(x'_d) = (\mathcal{F}(x_i) + \mathcal{F}(x_e))/\mathcal{F}(x_d) = 1 + \mathcal{F}(x_e)/\mathcal{F}(x_i),$$

where the last identity holds by (4.4). Since $\mathcal{F}(x_i) \geq \mathcal{F}(x_e)$ and \mathcal{F} is a positive integral frieze, we must have $\mathcal{F}(x_i) = \mathcal{F}(x_e)$ and $\mathcal{F}(x'_d) = 2$.

We have thus shown that if $\mathcal{F}(x'_i) = 2$ then the triangulation T contains a fan of bridging arcs τ_i, τ_d, τ_e and $\mathcal{F}(x'_d) = 2, \mathcal{F}(x_e) = \mathcal{F}(x_i)$. We can now repeat this argument by considering the cluster variable x'_e obtained by mutating \mathbf{x} in direction e , and recursively with every new bridging arc in the fan and we obtain a fan of bridging arcs in T and each arc in this fan has the same frieze value $\mathcal{F}(x_i) \geq 2$. Since T is a triangulation of the annulus, this fan is finite, and the two arcs bounding it correspond to a sink and a source in the quiver Q_T . Mutating at one of those arcs again gives a contradiction as in the left picture of Figure 4. We have shown that $\mathcal{F}(x'_i)$ cannot be equal to 2, and thus $\mathcal{F}(x'_i) = 1$. \square

We are now ready for the main theorem of this section.

Theorem 4.2. *Let Q be a quiver of type $\tilde{\mathbb{A}}_{p,q}$ and let $\mathcal{F}: \mathcal{A}(Q) \rightarrow \mathbb{Z}$ be a positive integral frieze. Then \mathcal{F} is unitary.*

Proof. We need to show that there exists a cluster \mathbf{x}' such that $\mathcal{F}(\mathbf{x}') = (1, \dots, 1)$. Let \mathbf{x}_0 be a cluster consisting entirely of transjective cluster variables. Its triangulation T_0 consists entirely of bridging arcs. Then $\mathbf{x}_0 = (x_1, \dots, x_n)$ is a cluster that satisfies the condition of Lemma 4.1. If $\mathcal{F}(\mathbf{x}_0) = (1, \dots, 1)$ we are done. Otherwise Lemma 4.1 implies that mutating at a cluster variable x_i with maximal frieze value will produce a cluster $\mathbf{x}_1 = (\mathbf{x}_0 \setminus \{x_i\}) \cup \{x'_i\}$ such that $\mathcal{F}(x'_i) < \mathcal{F}(x_i)$ and if x'_i is regular then $\mathcal{F}(x'_i) = 1$. Therefore, if $\mathcal{F}(\mathbf{x}_1) \neq (1, \dots, 1)$ then the cluster \mathbf{x}_1 also satisfies the hypothesis of Lemma 4.1, and we can repeat this procedure to produce a sequence of clusters $\mathbf{x}_0, \mathbf{x}_1, \dots, \mathbf{x}_s, \dots$ such that $\mathbf{x}_s = (\mathbf{x}_{s-1} \setminus \{x\}) \cup \{x'\}$ with $\mathcal{F}(\mathbf{x}_s) \neq (1, \dots, 1)$ and $\mathcal{F}(x') < \mathcal{F}(x)$. Since the frieze is positive integral this process must stop. Thus there is a cluster \mathbf{x}_t such that $\mathcal{F}(\mathbf{x}_t) = (1, \dots, 1)$. \square

4.1. Friezes of type $\tilde{\mathbb{A}}_{2,1}$. There are precisely two positive integral friezes of type $\tilde{\mathbb{A}}_{2,1}$ up to symmetry, and they are depicted in Figures 5 and 6. By Theorem 4.2 both are unitary. In the first example, the cluster \mathbf{x} with $\mathcal{F}(\mathbf{x}) = (1, 1, 1)$ is transjective and in the second example one of the cluster variables in \mathbf{x} is regular. In the figures, we show the values of the friezes on the transjective component of the Auslander-Reiten quiver.

4.2. Further unitarity questions. It was shown in [CoCo] that every positive integral frieze of Dynkin type \mathbb{A}_n is unitary, and by Theorem 4.2, the same is true for affine type $\tilde{\mathbb{A}}_{p,q}$. It is natural to ask if these results can be extended to friezes with values in other integral domains, for example in quadratic integer rings. However the following example shows that the result already fails over the Gaussian integers.

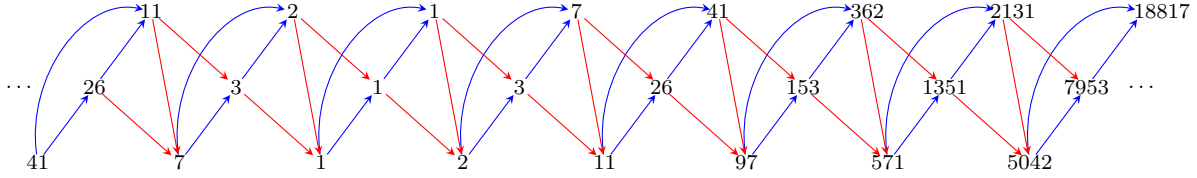

FIGURE 5. An $\tilde{A}_{1,2}$ frieze obtained by specializing the cluster variables of an acyclic seed to 1. The two peripheral arcs have frieze values 2 and 3.

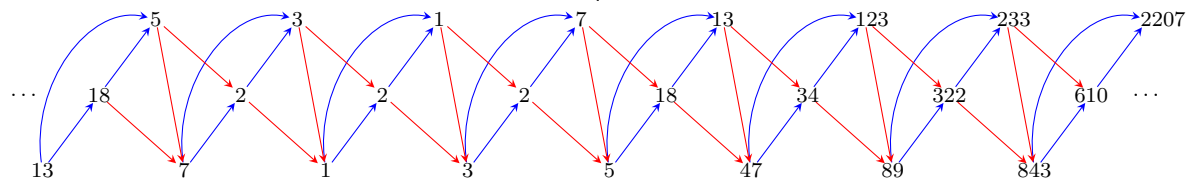
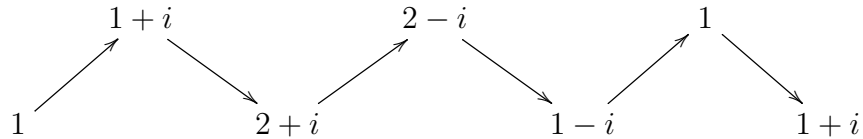

FIGURE 6. An $\tilde{A}_{1,2}$ frieze obtained by specializing the cluster variables of a non-acyclic seed to 1. The two peripheral arcs have frieze values 1 and 5.

Example 4.3. Let Q be the quiver $1 \rightarrow 2$ and define a frieze $\mathcal{F}: \mathcal{A}(Q) \rightarrow \mathbb{Z}[i]$ by $\mathcal{F}(x_1) = 1$ and $\mathcal{F}(x_2) = 1 + i$. We can visualize \mathcal{F} as usual in the Auslander-Reiten quiver as follows



This is a non-unitary frieze of Dynkin type \mathbb{A}_2 .

4.2.1. *Other Dynkin or affine types.* For Dynkin types \mathbb{D} and \mathbb{E} there are non-unitary positive integral friezes, see [FP], and these examples also give rise to non-unitary positive integral friezes in the affine types $\tilde{\mathbb{D}}$ and $\tilde{\mathbb{E}}$.

Acknowledgements. We thank A. García Elsener, G. Musiker and P.-G. Plamondon for helpful discussions.

REFERENCES

- [A] C. Amiot, Cluster categories for algebras of global dimension 2 and quivers with potential, *Ann. Inst. Fourier* **59** no 6, (2009), 2525–2590. [3](#)
- [ARS] I. Assem, C. Reutenauer and D. Smith, Friezes, *Adv. Math.* **225** (2010), no. 6, 3134–3165. [2](#)
- [BFGST] K. Baur, E. Faber, S. Gratz, K. Serhiyenko and G. Todorov, Mutation of friezes. *Bull. Sci. Math.* **142** (2018), 1–48. [2](#), [9](#)
- [BFPT] K. Baur, K. Fellner, M. J. Parsons and M. Tschabold, Growth behaviour of periodic tame friezes, arXiv:1603.02127. [2](#)
- [BM] K. Baur and R. Marsh, Frieze patterns for punctured discs. *J. Algebraic Combin.* **30** (2009), no. 3, 349–379. [2](#)
- [BRM] V. Bazier-Matte, D. Racicot-Desloges and T. S. McMillan, Friezes and continuant polynomials with parameters. *Bol. Soc. Parana. Mat.* (3) **36** (2018), no. 2, 57–81. [2](#), [4](#)
- [BFZ] A. Berenstein, S. Fomin and A. Zelevinsky, Cluster algebras. III. Upper bounds and double Bruhat cells. *Duke Math. J.* **126** (2005), no. 1, 1–52 [7](#)
- [BMRRT] A. Buan, R. Marsh, M. Reineke, I. Reiten and G. Todorov, Tilting theory and cluster combinatorics. *Adv. Math.* 204 (2006), no. 2, 572–618. [3](#), [4](#)

- [CC] P. Caldero and F. Chapoton, Cluster algebras as Hall algebras of quiver representations. *Comment. Math. Helv.* **81** (2006), no. 3, 595–616. [2](#), [3](#)
- [CCS] P. Caldero, F. Chapoton and R. Schiffler, Quivers with relations arising from clusters (A_n case), *Trans. Amer. Math. Soc.* **358** (2006), no. 3, 1347–1364. [3](#)
- [CK] P. Caldero and B. Keller, From triangulated categories to cluster algebras. *Invent. Math.* **172** (2008), no. 1, 169–211. [3](#)
- [CK2] P. Caldero and B. Keller, From triangulated categories to cluster algebras. II. *Ann. Sci. École Norm. Sup. (4)* **39** (2006), no. 6, 983–1009. [3](#)
- [CoCo] J. H. Conway and H. S. M. Coxeter, Triangulated polygons and frieze patterns. *Math. Gaz.* **57** (1973), 87–94, 175–183. [2](#), [13](#)
- [CH] M. Cuntz and T. Holm, Frieze patterns over integers and other subsets of the complex numbers, arXiv:1711.03724. [2](#)
- [FST] S. Fomin, M. Shapiro, and D. Thurston, Cluster algebras and triangulated surfaces. Part I: Cluster complexes, *Acta Math.* **201** (2008), 83–146. [11](#)
- [FZ] S. Fomin and A. Zelevinsky, Cluster algebras I: Foundations, *J. Amer. Math. Soc.* **15** (2002), 497–529. [3](#), [6](#)
- [F] B. Fontaine, Non-zero integral friezes, arXiv:1409.6026. [2](#)
- [FP] B. Fontaine and P.-G. Plamondon, Counting friezes in type D_n . *J. Algebraic Combin.* **44** (2016), no. 2, 433–445. [2](#), [3](#), [14](#)
- [FK] C. Fu and B. Keller, On cluster algebras with coefficients and 2-Calabi-Yau categories. *Trans. Amer. Math. Soc.* **362** (2) (2018), 859–895. [3](#), [6](#)
- [GMV] E. Gunawan, G. Musiker and H. Vogel, Cluster algebraic interpretation of infinite friezes, arXiv:1611.03052. [2](#)
- [K] B. Keller, On triangulated orbit categories, *Documenta Math.* **10** (2005), 551–581. [3](#)
- [KS] B. Keller and S. Scherotzke, Linear recurrence relations for cluster variables of affine quivers, *Adv. Math.* **228** (2011) 1842–1862. [2](#)
- [LLMSS] K. Lee, L. Li, M. Mills, R. Schiffler and A. Seceleanu, Frieze varieties : A characterization of the finite-tame-wild trichotomy for acyclic quivers, arXiv:1803.08459. [2](#)
- [LS] K. Lee and R. Schiffler, Positivity for cluster algebras, *Annals of Math.* **182** (1), (2015) 73–125. [6](#), [7](#)
- [M1] S. Morier-Genoud, Arithmetics of 2-friezes, *J. Algebraic Combin.* **36** (2012), no. 4, 515–539. [2](#), [3](#)
- [M2] S. Morier-Genoud, Coxeter’s frieze patterns at the crossroads of algebra, geometry and combinatorics. *Bull. Lond. Math. Soc.* **47** (2015), no. 6, 895–938. [2](#)
- [MOT] S. Morier-Genoud, V. Ovsienko and S. Tabachnikov, 2-frieze patterns and the cluster structure of the space of polygons. *Ann. Inst. Fourier* **62** (2012), no. 3, 937–987. [2](#)
- [MS] G. Musiker, R. Schiffler, Cluster expansion formulas and perfect matchings, *J. Alg. Comb.* **33**, 2, (2010) 187–209. [10](#)
- [P] Y. Palu, Cluster characters for 2-Calabi-Yau triangulated categories. *Ann. Inst. Fourier* **58** (2008), no. 6, 2221–2248. [3](#)
- [S] R. Schiffler, Quiver representations, CMS Books in Mathematics/Ouvrages de Mathématiques de la SMC, Springer, Cham, 2014. [4](#)
- [S2] R. Schiffler, Cluster algebras arising from surfaces, Homological Methods, Representation Theory, and Cluster Algebras, CRM Short Courses, Springer, 2018. [10](#)

DEPARTMENT OF MATHEMATICS, UNIVERSITY OF CONNECTICUT, STORRS, CT 06269-1009, USA
E-mail address: emily.gunawan@uconn.edu

DEPARTMENT OF MATHEMATICS, UNIVERSITY OF CONNECTICUT, STORRS, CT 06269-1009, USA
E-mail address: schiffler@math.uconn.edu