

Weighted Tree Automata

May it be a little more?

Second Edition

Zoltán Fülöp
University of Szeged
Hungary

Heiko Vogler
Technische Universität Dresden
Germany

June 11, 2024

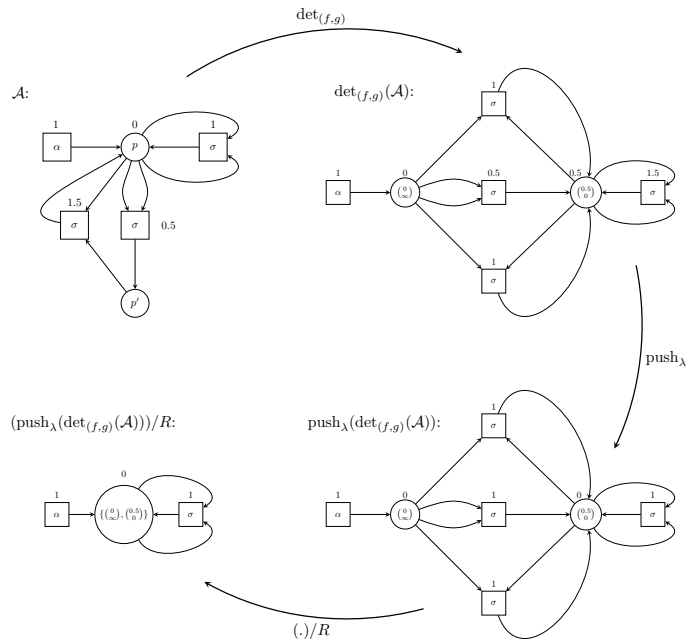

Dedicated to the memory of Magnus Steinby (1941-2021)

Preface to the second edition

In comparison to the first edition [FV22b] of this book, which was published on December 13, 2022, we have we have changed some parts and added further results. A few of the changes and those results are listed below.

- For definitions by induction and proofs by induction, we now employ the concept of terminating reduction system (C, \succ) , instead of well-founded set (C, \prec) . Essentially, they are the same, but we think that the new terminology and notations better fit to the presented theory.
- We have added the definition of universal algebra. Since a universal algebra may contain infinitely many operations, we can consider, e.g., each vector space over the field $\mathbb{B} = (B, \oplus, \otimes, \mathbb{0}, \mathbb{1})$ (with infinitely many scalar multiplications with $b \in B$) as a universal algebra. A Σ -algebra is a particular universal algebra with finitely many operations.
- By definition (new), each ranked alphabet Σ has the property that $\Sigma^{(0)} \neq \emptyset$.
- We have added two items to Observation 2.6.11 (old) which show how left- and right-distributivity influence the relationships between the sets of bi-locally finite strong bimonoids, weakly locally finite strong bimonoids, and locally finite strong bimonoids (see Observation 2.7.11(6) and (7)).
- In Section 2.15 (new) we have recalled the definition of regular tree grammars and reported about a decidability theorem (cf. Theorem 2.15.3).
- We have changed the notion “wta with identity transition weights” (old) into “crisp wta” (new), because the latter notion seems to be well accepted in the community.
- We included a padding lemma (Lemma 4.2.1) which, given a wta over a ranked alphabet with a certain property, can be used to construct another wta over the same alphabet with increased ranks such that the latter wta also has that property.
- Due to [DFTV24], we have strengthened Theorem 3.1.5 (old) by requiring less from the ranked alphabet (cf. Theorem 4.3.1). By using Lemma 4.2.1, we could even generalize this latter to any branching ranked alphabet (cf. Theorem 4.3.2).
- In the (new) Section 4.3 we have collected some results on the finiteness of the images of the run semantics and the initial algebra semantics of wta over restricted strong bimonoids.
- Theorem 7.4.3 (old) was wrong. So we have dropped it and its consequence Corollary 7.4.4 (old).
- We have included new theorems in Chapter 13 (old) “Elementary operations and Médvédjév’s theorem” and Chapter 14 (old) “Weighted MSO-logic and B-E-T’s theorem”. Their proofs are based on the fact that the run semantics of a wta over a bi-locally finite strong bimonoid is a recognizable step mapping, which was proved in Chapter 16 (old) “Crisp-determinization”.

In order to avoid forward references inside the book, we have moved up Chapter 16 (old) together with the related Chapters 17 and 18 (old) (cf. Chapters 12, 13, and 14). The new theorems are Theorems 16.3.1 and 17.4.21, respectively.

- We have added a new chapter (Chapter 18) in which we report about the characterization of recognizability in terms of syntactic congruences assuming that the weight algebra is a field (cf. Theorem 18.4.1).
- We have corrected some typos and small technical mistakes. Also, we have improved the clarity of some of the proofs.

Zoltán Fülöp and Heiko Vogler
Szeged, Hungary and Dresden, Germany

June 11, 2024

Preface to the first edition

Weighted automata form a quantitative extension of the traditional automaton model which is fundamental for Computer Science. They can be viewed as classical nondeterministic finite automata in which the transitions are equipped with weights. These weights could model, for instance, the cost, reward or probability of executing the transition. Already in 1961, Marcel Schützenberger investigated weighted automata and described their behaviors on finite words as rational formal power series. This extended Kleene’s fundamental theorem on the coincidence of the classes of regular and rational formal languages into a quantitative setting. Subsequently, several decidability problems concerning context-free languages could be solved using weighted automata techniques, and up to now no other proof methods are known for this. This developed into a flourishing field, as described in books by Samuel Eilenberg (1974), Arto Salomaa and Matti Soittola (1978), Wolfgang Wechler (1978), Werner Kuich and Arto Salomaa (1986), Jean Berstel and Christophe Reutenauer (1988), Jacques Sakarovitch (2009) and the “Handbook of Weighted Automata” (2009).

Often, the weights employed for weighted automata are taken from a field like the rational numbers, the real numbers or the complex numbers, respectively, with their usual operations. However, we might also consider just the natural numbers which, with their usual operations of addition and multiplication, form the classical example of a semiring. Moreover, in many important applications calculations of the weights combine the operations maximum and addition, or minimum and addition, where the distributivity of the second operation over the first again yields a semiring as weight structure. The weights of the transitions can very conveniently be described as a single matrix (for each letter); the weight at entry (i, j) is the weight of the transition from state i to j . Since in semirings multiplication is distributive over addition, matrix multiplication is associative. This enables us to use techniques from algebra to express and analyse the behavior of weighted automata over semirings, and this was one of the reasons for the success of the weighted automaton model. All classical automata can be recast as weighted automata by taking the Boolean semiring $\{0, 1\}$ as weight structure.

With the turn of the century, further quantitative models began to be investigated as weight structure. For instance, we might be interested in average weights, or in discounting of weights. In semiring-weighted automata, the weight of runs is computed by employing the second operation of the semiring, whereas the weights of the (in case of non-deterministic automata, often several) runs are combined into a single weight by using the semiring’s first operation. The required distributivity of the second operation over the first is quite a strong mathematical assumption. What happens without this assumption? Such ‘semirings without requiring distributivity’ were called strong bimonoids. For instance, in lattices, which arise in multi-valued logic, both operations supremum and infimum are associative but in general not distributive over each other, and large parts of lattice theory in Mathematics concern non-distributive lattices. There are many further possibilities how strong bimonoids may arise. Since for strong bimonoids matrix multiplication is in general not associative, it follows that for weighted automata, techniques from linear algebra can no longer be used. However, fortunately, direct automata constructions can very often still be used to obtain results which previously were derived only for semirings.

In Computer Science, a most important data structure arising, e.g., in programming analysis and from pushdown automata and context-free languages, is given by trees. Therefore, a large part of automata theory concerns automata over trees. Already early on, much research concerned extensions of results

from weighted automata over words to weighted tree automata, which becomes often more intricate. Moreover, weighted tree automata have found very interesting recent applications in natural language processing. In view of the above, much research has recently been devoted to weighted tree automata with strong bimonoids as weight structure.

The present book, written by two leading researchers of this area, is the first book on weighted tree automata. It presents large parts of the theory of weighted tree automata over strong bimonoids and semirings in a systematic way. As indicated above, for weighted automata over strong bimonoids two kinds of defining the behavior arise:

- an automata-theoretic oriented approach using runs of the automaton and calculating their weights, and
- a universal algebra oriented method similar to the algebraic method mentioned above for words, but adjusted to trees.

In contrast to words, trees with tree concatenation do not form a monoid; this is the reason why the algebraic method mentioned above for weighted automata on words now for weighted tree automata has been replaced by a universal algebra approach. Over semirings, the two semantics for weighted tree automata can be shown to coincide, but over strong bimonoids in general they differ. Consequently, general structure results for the possible behaviors of weighted tree automata may have two versions, using the run semantics respectively the initial algebra semantics.

The authors show a number of these structure results. These include, among others, descriptions of the behaviors of weighted tree automata by rational expressions, by weighted context-free or regular grammars, by weighted versions of monadic second order logic, by closure results under various operations, and as abstract families of weighted tree languages, as well as weighted versions of classical pumping lemmas and of determinization results. This shows that many structure results for weighted tree automata can also be derived in the case of strong bimonoids. The authors give full mathematical proofs, which are needed as weighted tree automata often have combinatorial intricacies which are easy to overlook. The reader will appreciate that the authors include numerous examples explaining the various aspects of definitions and differences in the results, often illustrating them with pictures.

The field of weighted automata over strong bimonoids is still developing. This systematic presentation of large parts of recent research is therefore very valuable and right in time. I am sure that this book will stimulate much further research in this exciting area.

Leipzig, December 2022
Manfred Droste

Contents

1	Introduction	1
2	Preliminaries	13
2.1	Numbers and sets	13
2.2	Strings and languages	13
2.3	Binary relations and mappings	14
2.4	Hasse diagram, Venn diagram, and Euler diagram	15
2.5	Reduction systems	16
2.6	Well-founded induction	18
2.7	Algebraic structures	20
2.7.1	Universal algebras, subalgebras, congruences, and homomorphisms	20
2.7.2	Ranked alphabets and Σ -algebras	23
2.7.3	Properties of binary operations	23
2.7.4	Semigroups, monoids, and groups	24
2.7.5	Strong bimonoids, semirings, rings, and fields	27
2.7.6	Lattices and their comparison with strong bimonoids	37
2.7.7	Semimodules and vector spaces	43
2.8	Weighted sets and operations	45
2.9	Matrices and vectors over a strong bimonoid	46
2.10	Trees and tree languages	49
2.11	Term rewrite systems	58
2.12	Weighted tree languages and transformations	61
2.12.1	Weighted tree languages and operations	61
2.12.2	Weighted tree transformations	62
2.13	Finite-state string automata	65
2.14	Context-free grammars	65
2.15	Regular tree grammars	67
2.16	Finite-state tree automata	69
2.17	Recognizable step mappings	70
2.18	Fta-hypergraphs	71

3	The model of weighted tree automata	73
3.1	Basic definitions	74
3.2	Examples	79
3.3	Weighted string automata	100
3.4	Weighted tree automata over the Boolean semiring	104
3.5	Weighted tree automata over the semiring of natural numbers	106
3.6	Weighted tree automata over commutative semirings	108
3.6.1	Multilinear representations	108
3.6.2	Relationship between wta and multilinear representations	111
3.7	Extension of the weight algebra	112
4	Basic properties of wta	115
4.1	Annihilation in wta	115
4.1.1	Annihilation in arbitrary wta	115
4.1.2	Annihilation in bu-deterministic wta	116
4.1.3	Annihilation in crisp-deterministic wta	119
4.2	Padding of wta	123
4.3	Images of the semantics of weighted tree automata	126
4.3.1	Images of initial algebra semantics of wta	126
4.3.2	Image finiteness of the semantics of wta over restricted strong bimonoids	133
5	Comparison of the two semantics	137
5.1	Complexity of calculating the semantics	137
5.2	Negative results for equality of the two semantics	139
5.3	Positive results for equality of the two semantics	143
6	Pumping lemmas	151
6.1	Pumping lemma for runs and wta over strong bimonoids	152
6.2	Pumping lemma for wta over fields	158
6.2.1	The set of contexts viewed as monoid	158
6.2.2	Linear recurrence equation	163
6.2.3	The pumping lemma	164
7	Normal forms of wta	167
7.1	Trimming a wta	167
7.1.1	Basic definitions	167
7.1.2	Trimming for zero-cancellation free strong bimonoids	169
7.1.3	Local-trimming for arbitrary strong bimonoids	171
7.2	Transforming wta into total wta	173
7.3	Normalizing root weights of wta	174
7.4	Normalizing transition weights of wta	178

8	Weighted context-free grammars	181
8.1	The grammar model	181
8.2	Normal forms of wcfg	184
8.3	Yields of recognizable weighted tree languages	196
9	Weighted regular tree grammars	201
9.1	The grammar model	201
9.2	Normal forms of wrtg	204
10	Closure properties	211
10.1	Closure under sum	211
10.2	Closure under scalar multiplications	213
10.3	Characterization of recognizable step mappings	217
10.4	Closure under Hadamard product	219
10.5	Closure under top-concatenations	225
10.6	Closure under tree concatenations	227
10.7	Closure under Kleene stars	231
10.8	Closure under yield-intersection	241
10.9	Closure under strong bimonoid homomorphisms	245
10.10	Closure under tree relabelings	248
10.11	Closure under linear and nondeleting tree homomorphisms	249
10.12	Closure under inverse of linear tree homomorphisms	252
10.13	Closure under weighted projective bismorphisms	256
10.13.1	Weighted projective bismorphisms	257
10.13.2	Split	262
10.13.3	Closure of weighted projective bismorphisms under composition	264
10.13.4	Merge	268
10.13.5	Closure result for wrtg and wta	271
10.13.6	Closure under Hadamard product: an alternative proof	271
10.13.7	Closure under yield-intersection: an alternative proof	272
10.13.8	Closure under tree relabelings: an alternative proof	273
10.14	Summary of some of the closure properties	273
11	Characterizations by weighted local systems	275
11.1	Local tree languages and weighted local systems	275
11.2	Characterization by weighted local systems	278
11.3	Characterization by local systems	281
12	Crisp-determinization	285
12.1	Initial algebra crisp-determinization	285
12.2	Run crisp-determinization	289
12.2.1	Sufficient condition for run crisp-determinizability	289
12.2.2	Equivalence of bi-local finiteness and run crisp-determinizability	296

12.2.3	Run crisp-determinizability for past-finite monotonic strong bimonoids	297
13	Determinization of wta over semirings	303
13.1	Applying the subset method to wta over arbitrary semirings	304
13.2	Negative results for determinization	305
13.3	Positive result for determinization	307
13.3.1	Determinization by factorization	307
13.3.2	Examples and properties of factorizations	311
13.3.3	On the twinning property	314
13.3.4	Proof of Theorem 13.3.2	317
13.3.5	Applying determinization by factorization to bu-deterministic wta	326
14	Support of recognizable weighted tree languages	327
14.1	Negative result for support	327
14.2	Positive results for support	327
14.2.1	Consequences of preimage theorems	328
14.2.2	Both semantics and positive strong bimonoids	328
14.2.3	Both semantics and commutative semirings which are not rings	330
14.2.4	Run semantics and commutative, zero-sum free strong bimonoids	330
14.2.5	Comparison of support theorems	335
15	Rational operations and Kleene's theorem	341
15.1	Rational weighted tree languages	341
15.2	From recognizable to rational	343
15.3	From rational to recognizable	349
15.4	Alternative definition of rational weighted tree languages	349
16	Elementary operations and Médvédjév's theorem	355
16.1	Representable weighted tree languages	355
16.2	The first main result for $\text{RepEx}(\Sigma, \mathbf{B})$	362
16.2.1	From recognizable to restricted representable	363
16.2.2	From restricted representable to recognizable	364
16.3	The second main result for $\text{RepEx}(\Sigma, \mathbf{B})$	366
17	Weighted MSO-logic and B-E-T's theorem	369
17.1	The MSO-logic $\text{MSO}(\Sigma)$	371
17.2	The weighted MSO-logic $\text{MSO}(\Sigma, \mathbf{B})$	380
17.3	The main result for $\text{MSO}(\Sigma, \mathbf{B})$	386
17.3.1	From recognizable to definable	386
17.3.2	From definable to recognizable	390
17.4	Adding weighted conjunction and universal quantification	392
17.4.1	The extended weighted MSO-logic $\text{MSO}^{\text{ext}}(\Sigma, \mathbf{B})$	393
17.4.2	The carefully extended weighted MSO-logic $\text{MSO}^{\text{cext}}(\Sigma, \mathbf{B})$	398

17.4.3	The main result for $\text{MSO}^{\text{cext}}(\Sigma, \mathbf{B})$	400
17.4.4	Weighted first-order universal quantification of recognizable step mappings	407
17.4.5	The main result for $\text{MSO}^{\text{ext}}(\Sigma, \mathbf{B})$	411
17.5	Relationship between decompositions and B-E-T's theorem	414
17.5.1	Alternative proof of "r-recognizable implies definable"	414
17.5.2	Alternative proof of the decomposition Theorem 11.3.1(A) \Rightarrow (B)	416
18	Syntactic congruences and B-A-LB's theorem	419
18.1	Recognizability implies finite dimensionality	419
18.1.1	Vector spaces of left quotients and of right quotients	420
18.1.2	Recognizability implies finite dimensionality	422
18.1.3	Generators for particular bu-deterministically recognizable weighted tree languages	427
18.2	The (Σ, \mathbf{B}) -vector space of polynomials	431
18.3	Syntactic congruences and syntactic (Σ, \mathbf{B}) -vector spaces	434
18.4	The B-A-LB's-theorem and minimality	439
19	Abstract families of weighted tree languages	441
19.1	The basic definitions	441
19.2	Characterization of tree cones	442
19.3	$\text{Reg}(n, \mathbf{B})$ is an AFwtL	445
19.4	The AFwtL $\text{Reg}(n, \mathbf{B})$ is principal	445
20	Corollaries and theorems for wta over bounded lattices	447
20.1	Definition of wta over bounded lattices	447
20.2	Crisp-determinization	448
20.3	Relationship between several sets of recognizable wtl	450
20.4	Support	452
20.5	Closure results	452
20.6	Characterization by rational operations	453
20.7	Characterization by elementary operations	453
20.8	Characterization by weighted MSO-logic	454
20.9	Abstract families of weighted tree languages	454
	Bibliography	455
	Index	475

Chapter 1

Introduction

The purpose of this book is to present the basic definitions and some of the important results for weighted tree automata in a mathematically rigorous and coherent form with full proofs. The concept of weighted tree automata is part of Automata Theory and it touches the area of Universal Algebra. It originated from two sources: weighted string automata and finite-state tree automata.

Historical perspective. Weighted string automata were introduced in [Sch61]; here we recall briefly [Sch61, Def. 1']. Roughly speaking, a weighted string automaton \mathcal{A} is a finite-state automaton in which each transition has a weight, which is an element of the set \mathbb{Z} of integers. Together with summation and multiplication, \mathbb{Z} forms the *weight algebra* of \mathcal{A} . For each input symbol a , the weights of the transitions are represented as a $Q \times Q$ -matrix over \mathbb{Z} where Q is the finite set of states of \mathcal{A} . Due to distributivity of multiplication over summation, the set of $Q \times Q$ -matrices over \mathbb{Z} together with matrix multiplication and the unit matrix forms a monoid. Thus, the representation can be extended to a monoid homomorphism from the free monoid over the set of input symbols to the monoid of $Q \times Q$ -matrices over \mathbb{Z} . Finally, for a given input string w , its matrix representation is multiplied from the left by an initial weight vector and from the right by a final weight vector; the result is the weight of w computed by \mathcal{A} . In this way, \mathcal{A} assigns to each input string a weight in \mathbb{Z} ; this assignment is called the *formal power series recognized by \mathcal{A}* or *weighted language recognized by \mathcal{A}* .¹ We might say that this weighted language is the monoid semantics of \mathcal{A} . Although in [Sch61] mostly the semiring of natural numbers, the ring of integers, or commutative rings were considered, the idea of [Sch61] was general enough to deal with weighted string automata over arbitrary semirings (cf. [Wec78, p. 58]).

Since 1961, weighted string automata and the set of recognizable weighted languages were studied intensively. Different kinds of semantics were investigated (run semantics, free monoid semantics, initial algebra semantics) and various classes of weight algebras were used (e.g., bounded lattices, fields, semirings, pairs of t-conorm and t-norm, valuation monoids, strong bimonoids). We note that, neither in bounded lattices nor in valuation monoids or strong bimonoids or pairs of t-conorm and t-norm, the multiplication has to be distributive over the summation.

The development of weighted string automata is witnessed by the following list of books and survey papers: [Eil74, SS78, Wec78, KS86, BR88, Kui97, MM02, Sak09, DKV09, DK21]. The state-of-the-art of this area was also cultivated and extended by the biennial workshops “Weighted Automata: Theory and Applications” (WATA) since 2002 (cf. [DV03, DV05, DV07b, DV09, DV11a, DV14b, DÉL18, DMV22]).

Finite-state tree automata were invented independently by [Don65, Don70] and [TW68]. A finite-state tree automaton processes a given input tree over some ranked alphabet Σ also by means of transitions. Now a transition on a k -ary input symbol σ has not only one but k starting states (one for the root of each of the k subtrees below σ), and it has one ending state (at the node which is labeled by σ). Viewed as a

¹Since we will not deal with convergence questions, we prefer the latter notion.

bottom-up device², a finite-state tree automaton \mathcal{A} over an input ranked alphabet Σ can be considered as a finite Σ -algebra, as it is known from Universal Algebra. Additionally, \mathcal{A} identifies the set of final states as a subset of the carrier set of that Σ -algebra. Then \mathcal{A} recognizes the set of all Σ -trees which are interpreted in the corresponding Σ -algebra as some final state. We might say that this tree language is the initial algebra semantics of \mathcal{A} .

Also the concept of finite-state tree automata and the set of recognizable tree languages were investigated intensively. Here is a list of books, lecture notes, and survey papers on finite-state tree automata: [Eng75b, Eng80, GS84, GS97, CDG⁺07, LT21]. Some more developments on tree automata and tree transducers were published in the series “International Workshop on Trends in Tree Automata and Tree Transducers” [Man13, Fil15, Mal16].

It is natural to combine the concepts of weighted string automata and finite-state tree automata, resulting in the concept of weighted tree automata (wta). In [IF75] wta were introduced with the weight algebra being the real number interval $[0, 1]$ in which summation is max and multiplication is min; such wta were called fuzzy tree automata. In [BR82], a wta is a finite-dimensional vector space V over some field B equipped with a Σ -algebra. Roughly speaking, each dimension corresponds to a state and each k -ary input symbol is interpreted in the Σ -algebra as a k -ary multilinear operation over V . In the following years, wta over different weight algebras were introduced: wta over semirings [AB87], wta over distributive multioperator monoids [Kui98], wta over multioperator monoids [FMV09, SVF09], wta over pairs of t-conorm and t-norm on the unit interval $[0, 1]$ [BLB10], wta over strong bimonoids [Rad10], and wta over tree valuation monoids [DGMM11].

Here we list some of the seminal papers and survey papers on wta: [IF75, BR82, AB87, Kui98, Kui99b, Boz99, ÉK03, ÉL07, FV09, DGMM11]. We also mention some recent PhD theses: [Bor05, Hög07, Mat09, May10, Tei16, Göt17, Her20b, Pau20, Jon21, Dör22].

Weighted tree automata over strong bimonoids. In this book we will investigate wta over strong bimonoids. In this paragraph we provide an overview on this automaton model. A strong bimonoid is an algebra $B = (B, \oplus, \otimes, 0, \mathbb{1})$ such that

- $(B, \oplus, 0)$ is a commutative monoid (and \oplus is called the summation),
- $(B, \otimes, \mathbb{1})$ is a monoid (and \otimes is called the multiplication), and
- 0 is annihilating with respect to \otimes , i.e., $b \otimes 0 = 0 \otimes b = 0$ for each $b \in B$.

For instance, each semiring (and thus each ring, semifield, and field) is a strong bimonoid; also each bounded lattice (and thus each complete lattice and residuated lattice) is a strong bimonoid; we note that a large part of the field of lattice theory refers to non-distributive lattices [Bir93, Grä03]. The algebra $(\mathbb{N}_\infty, +, \min, 0, \infty)$ is a strong bimonoid, but it is not a semiring, because, e.g., $\min(a, a + a) \neq \min(a, a) + \min(a, a)$ for each $a \in \mathbb{N} \setminus \{0\}$, and hence the multiplication (here: \min) does not distribute over the summation (here: $+$). Further examples of non-distributive strong bimonoids are the finite lattices N_5 and M_3 (cf. Figure 2.4) and the infinite bounded lattice $FL(2 + 2)$ (cf. Figure 2.5).

A wta over Σ and B , for short: (Σ, B) -wta, is a tuple $\mathcal{A} = (Q, \delta, F)$ which is almost like a finite-state tree automaton, i.e., Q is a finite set of states, $\delta = (\delta_k \mid k \in \mathbb{N})$ is a family of transition mappings, and $F : Q \rightarrow B$ is the root weight mapping. However, now each transition and each final state carries a weight, which is taken from B . More precisely, for each $k \in \mathbb{N}$, the mapping δ_k has the type

$$\delta_k : Q^k \times \Sigma^{(k)} \times Q \rightarrow B$$

and it maps each transition $(q_1 \cdots q_k, \sigma, q)$ with starting states q_1, \dots, q_k , a k -ary input symbol σ , and ending state q to a weight, i.e., an element of B . Since Σ is finite, only finitely many δ_k are different from the empty mapping. Finally, the mapping $F : Q \rightarrow B$ maps each state to an element of B ; this is used as root weight (or final weight).

²We draw a tree with its root up and the leaves down, hence bottom-up means: from the leaves towards the root.

We can define two semantics of \mathcal{A} : the run semantics $\llbracket \mathcal{A} \rrbracket^{\text{run}}$ and the initial algebra semantics $\llbracket \mathcal{A} \rrbracket^{\text{init}}$ where each of them is a weighted tree language; more precisely,

$$\llbracket \mathcal{A} \rrbracket^{\text{run}} : T_\Sigma \rightarrow B \quad \text{and} \quad \llbracket \mathcal{A} \rrbracket^{\text{init}} : T_\Sigma \rightarrow B$$

where T_Σ is the set of all Σ -trees.

The run semantics is based on the idea of a run of \mathcal{A} on a given input tree ξ . This is a mapping ρ which maps each position of ξ to a state of Q . Thus ρ determines, for each position w of ξ , a transition $(q_1 \cdots q_k, \sigma, q)$ where q_i (for $i \in \{1, \dots, k\}$) and q are the states assigned by ρ to the i -th successor of w and to w itself, respectively, and σ is the label of ξ at position w . By applying δ_k to $(q_1 \cdots q_k, \sigma, q)$, we obtain the weight of this transition. Then the weight of ρ , denoted by $\text{wt}(\xi, \rho)$, is the \otimes -product of the weights of the transitions for each position of ξ (where the factors are ordered according to the depth-first post-order of the corresponding positions). Finally, we let

$$\llbracket \mathcal{A} \rrbracket^{\text{run}}(\xi) = \bigoplus_{\rho \in R_{\mathcal{A}}(\xi)} \text{wt}(\xi, \rho) \otimes F(\rho(\varepsilon))$$

where $R_{\mathcal{A}}(\xi)$ is the set of all runs of \mathcal{A} on ξ , and $\rho(\varepsilon)$ is the state assigned by ρ to the root of ξ . A weighted tree language $r : T_\Sigma \rightarrow B$ is run recognizable if there exists a (Σ, B) -wta \mathcal{A} such that $r = \llbracket \mathcal{A} \rrbracket^{\text{run}}$. We denote by $\text{Rec}^{\text{run}}(\Sigma, B)$ the set of weighted tree languages which are run recognizable by some (Σ, B) -wta.

The initial algebra semantics of \mathcal{A} is based on the concept of vector algebra of \mathcal{A} , which is the Σ -algebra $(B^Q, \delta_{\mathcal{A}})$ where $\delta_{\mathcal{A}}$ associates with each k -ary input symbol $\sigma \in \Sigma$ a k -ary operation $\delta_{\mathcal{A}}(\sigma) : B^Q \times \cdots \times B^Q \rightarrow B^Q$. For each $q \in Q$, the q -component of a vector $v \in B^Q$ is denoted by v_q . The operation $\delta_{\mathcal{A}}(\sigma)$ is defined, for every $v_1, \dots, v_k \in B^Q$ and $q \in Q$, by

$$\delta_{\mathcal{A}}(\sigma)(v_1, \dots, v_k)_q = \bigoplus_{q_1 \cdots q_k \in Q^k} \left(\bigotimes_{i \in [k]} (v_i)_{q_i} \right) \otimes \delta_k(q_1 \cdots q_k, \sigma, q) .$$

Then, for every $\xi \in T_\Sigma$, we let

$$\llbracket \mathcal{A} \rrbracket^{\text{init}}(\xi) = \bigoplus_{q \in Q} h_{\mathcal{A}}(\xi)_q \otimes F(q)$$

where $h_{\mathcal{A}}$ denotes the unique Σ -algebra homomorphism from the Σ -term algebra to the Σ -algebra $(B^Q, \delta_{\mathcal{A}})$. A weighted tree language $r : T_\Sigma \rightarrow B$ is initial algebra recognizable if there exists a (Σ, B) -wta \mathcal{A} such that $r = \llbracket \mathcal{A} \rrbracket^{\text{init}}$. We denote by $\text{Rec}^{\text{init}}(\Sigma, B)$ the set of weighted tree languages which are initial algebra recognizable by some (Σ, B) -wta.

If B is a semiring, i.e., \otimes distributes over \oplus , then $\llbracket \mathcal{A} \rrbracket^{\text{run}} = \llbracket \mathcal{A} \rrbracket^{\text{init}}$ (as in the case of weighted string automata over semirings, similar to [Eil74, Cor. 6.2]). Hence for wta over semirings we drop the attributes “run” and “initial algebra” and we speak simply about recognizable weighted tree languages. For arbitrary strong bimonoids this equality in general does not hold (cf. [DSV10, Ex. 25] and [CDIV10, Ex. 3.1]). However, the equality does hold for arbitrary strong bimonoids if \mathcal{A} is bottom-up-deterministic.

Since the set of trees does not have a monoid structure (in contrast to the set of strings), there does not exist a semantics of wta which corresponds directly to Schützenberger’s semantics of wsa described above. However, for the case that B is a field, the concept of B - Σ -representation [BA89] can be viewed as kind of monoid-semantics of wta. In that concept it is exploited that the set of contexts over Σ (i.e., trees with a variable at exactly one leaf) is a freely generated monoid; moreover, while switching from contexts to trees, a certain consistency condition has to be satisfied.

Topics of the book. In this book we present a part of the theory of wta over strong bimonoids. Most of the theorems which we present have previously been published in research articles; others are generalizations of the corresponding published theorems. However, some results are published for the first time in [FV22b] or this book as, e.g., Observation 2.7.16; Lemma 4.2.1; Theorem 4.3.2; Theorem 5.1.1;

Theorem 10.3.3; results of Subsections 10.13.6, 10.13.7, and 10.13.8; results of Section 14.2.5, in particular Theorems 14.2.14 and 14.2.15; results of Section 15.4; Theorem 16.3.1; results of Subsections 17.4.2 and 17.4.3, in particular Theorem 17.4.11; and Theorem 17.4.21; results of Section 17.5; Corollaries 20.7.1 and 20.8.1.

In Chapter 2 we collect all the technical ingredients for our development such that the book is self-contained and hence also accessible for, e.g., master students of Mathematics or Computer Science. So this chapter is quite long, and of course, it may be consulted on demand.

In Chapter 3 we define the concept of wta over some ranked alphabet Σ and some strong bimonoid \mathbf{B} , and with each such (Σ, \mathbf{B}) -wta \mathcal{A} , we associate the run semantics $\llbracket \mathcal{A} \rrbracket^{\text{run}}$ and the initial algebra semantics $\llbracket \mathcal{A} \rrbracket^{\text{init}}$. We define the restricted versions bottom-up-deterministic wta and crisp-deterministic wta. We give several examples of a wta and both kinds of semantics. In order to connect the concept of wta with its historical predecessors, we discuss particular cases of wta:

- wta over string ranked alphabets (which are equivalent to weighted string automata),
- wta over the Boolean semiring (which are equivalent to finite-state tree automata),
- wta over the semiring of natural numbers (which reflect multiplicities in finite-state tree automata),
- wta over commutative semirings (which are equivalent to multilinear representations).

In Chapter 4 we prove basic properties of wta and of their bottom-up and crisp-deterministic sub-concepts. The first property is a consequence of the annihilation property of 0 for the multiplication \otimes . The second property is that, by means of a padding, we can extend the rank of input symbols of a wta without changing its semantics (cf. Lemma 4.2.1). Finally, we consider the images of the semantics of wta and prove a universality property (cf. Theorem 4.3.2) and show sufficient conditions under which these images are finite (cf. Lemmas 4.3.4 and 4.3.6). As consequence, we obtain that the initial algebra semantics of wta over weakly locally finite strong bimonoids which are not locally finite, can generate strictly more sets of values than weighted string automata can generate (cf. Corollary 4.3.9).

In Chapter 5 we provide two algorithms (cf. Section 5.1) which compute in a natural way the values $\llbracket \mathcal{A} \rrbracket^{\text{run}}(\xi)$ and $\llbracket \mathcal{A} \rrbracket^{\text{init}}(\xi)$ for any given wta \mathcal{A} and input tree ξ . We analyse the complexity of these algorithms and, as is to be expected, the second algorithm is more efficient than the first one. Moreover, we compare the run semantics and the initial algebra semantics of wta and show some examples of wta for which these semantics are different. We prove that there exist a strong bimonoid \mathbf{B} and a (Σ, \mathbf{B}) -wta \mathcal{A} such that $\llbracket \mathcal{A} \rrbracket^{\text{init}} \notin \text{Rec}^{\text{run}}(\Sigma, \mathbf{B})$ (cf. Theorem 5.2.5). We show conditions under which, for each wta, the two semantics are equal (cf. Theorems 5.3.1 and 5.3.4).

In Chapter 6 we prove three pumping lemmas: one for runs of wta over strong bimonoids (cf. Theorem 6.1.4), another one for supports of weighted tree languages recognizable by wta over positive strong bimonoids (cf. Corollary 6.1.6), and a third one for supports of weighted tree languages recognizable by wta over fields (cf. Theorem 6.2.9). We use these lemmas to show that certain weighted tree languages are not recognizable.

In Chapter 7 we prove under which conditions a wta can be transformed into an equivalent one which is trim, i.e., each state is “useful” (cf. Theorems 7.1.3 and 7.1.4). Moreover, we show how to normalize the root weight mapping F such that there exists a unique state q with $F(q) = \mathbb{1}$ and $F(p) = 0$ for each state p different from q (cf. Theorem 7.3.1). Finally, we prove that each wta can be transformed into a run equivalent crisp wta (i.e., each transition has weight 0 or $\mathbb{1}$) if the multiplication is locally finite 7.4.2.

In Chapter 8 we recall the concept of weighted context-free grammar from [CS63] and prove several normal form lemmas (cf. Section 8.2). We prove the fundamental connection between weighted tree languages that are run recognizable by wta and that are generated by weighted context-free grammars (cf. Theorem 8.3.1). This generalizes the well-known theorem [Bra69, Don70] saying that the yield of a recognizable tree language is a context-free language, and vice versa, each context-free language can be obtained in this way.

In Chapter 9 we introduce weighted regular tree grammars as particular weighted context-free grammars. We show that, under certain conditions, weighted regular tree grammars and the run semantics of

wta are equally expressive (cf. Theorem 9.2.9).

In Chapter 10 we prove a number of closure properties of the set of recognizable weighted tree languages, viz., closure under sum, scalar multiplication, Hadamard product, top-concatenations, tree concatenations, Kleene stars, yield-intersection with weighted regular string languages, strong bimonoid homomorphisms, tree relabelings, linear and nondeleting tree homomorphisms, inverse of linear tree homomorphisms, and weighted projective bimorphisms. A brief summary of these closure results is presented in Table 10.18.

In Chapter 11 we introduce two different kinds of weighted local systems and generalize another fundamental result from the theory of recognizable tree languages: each recognizable tree language is the image of a local tree language under a tree relabeling (cf. Theorem 11.2.6). Moreover, we prove a decomposition of the run semantics of a wta into the inverse of a deterministic tree relabeling, intersection with a local tree language, and a homomorphism into an evaluation algebra (cf. Theorems 11.3.1).

In Chapters 12 and 13 we deal with the questions under which conditions it is possible to construct, for a given wta, an equivalent crisp-deterministic wta and a bottom-up-deterministic wta, respectively. In general, the usual subset construction for unweighted automata leads to an infinite state set and thus cannot be employed.

In Chapter 14 we deal with the question whether the support of a recognizable weighted tree language is a recognizable tree language. We show that, in general, the answer is no, and we give sufficient conditions under which the answer is yes.

In Chapters 15, 16, 17, and 18 we show how well-known results of Kleene, Médvédjév, Büchi-Elgot-Trakhtenbrot, and Myhill-Nerode, respectively, can be generalized from the unweighted string case to the weighted tree case. In particular, we show the proofs of the following characterization theorems:

- for commutative semirings: recognizable weighted tree languages in terms of rational weighted tree languages (cf. Theorem 15.1.2),
- for semirings: recognizable weighted tree languages in terms of \times -restricted representable weighted tree languages (cf. Theorem 16.2.1),
- for bi-locally finite strong bimonoids: run recognizable weighted tree languages in terms of representable weighted tree languages (cf. Theorem 16.3.1),
- for strong bimonoids: run recognizable weighted tree languages in terms of MSO-definable weighted tree languages (cf. Theorem 17.3.1),
- for commutative semirings: recognizable weighted tree languages in terms of carefully extended MSO-definable weighted tree languages (cf. Theorem 17.4.11),
- for commutative and bi-locally finite strong bimonoids: run recognizable weighted tree languages in terms of (fully) extended weighted MSO-logic (cf. Theorem 17.4.21), and
- for fields: recognizable weighted tree languages in terms of syntactic congruences and the corresponding finite-dimensional vector spaces (cf. Theorem 18.4.1).

In Chapter 19 we prove that, for commutative and σ -complete semirings, the set of recognizable weighted tree languages is the smallest principal abstract family of weighted tree languages (cf. Theorem 19.4.5). This generalizes the well-known situation for the set of recognizable string languages [Gin75].

Finally, in Chapter 20 we collect some of the results of the previous chapters for the special case of wta over bounded lattices. In particular, we prove the characterizations of $\text{Rec}^{\text{run}}(\Sigma, L)$ in terms of unrestricted representations (cf. Corollary 20.7.1) and in terms of unrestricted weighted MSO formulas (cf. Corollary 20.8.1). Moreover, we prove the inclusion relationship between several sets of recognizable weighted tree languages (cf. Theorem 20.3.5).

In Figure 1.1 (at the end of this introduction) we show an overview of the models of automata and models of grammars which occur in this book, and we indicate their relationship.

Topics not included in this book. We have covered some of the important theorems for wta over strong bimonoids. However, this book is not meant to present the whole theory of wta over strong

bimonoids, not even that of wta over semirings. The choice of the presented material is biased by our personal research in this area. In particular, we did not address the topics of the following list. For each topic, we have indicated some of the publications where the reader can start investigating the topic.

- wta on infinite trees [Rah07, BP11, LP14]
- wta on unranked trees [HVM09, DV11b, DH15, DHV15, Göt17]
- (weighted) forest automata [Str09, Dör19, Dör21, Dör22]
- wta over M-monoids [Kui98, Kui99b, Mal04, Mal05b, FMV09, SVF09, FSV12, TO15, FV18]
- wta over tree valuation monoids [DGMM11, DM12, TO15, DFG16, Göt17, GFD19]
- \mathbf{B} - Σ -representation of dimension n [BA89, Boz94]
- probabilistic tree automata [MM70, Ell71, Wei15] (but also cf. Theorem 18.4.2)
- decidability and undecidability [Sei89, Sei90, Boz91, Sei94, Bor04, Mal04, Mal05b, SMK18, FKV21, Pau20, DFKV20, DFKV22] (but also cf. Lemma 9.1.2 and Theorem 12.2.16)
- varieties of weighted tree languages [FS11, SJC15]
- cut sets of recognizable weighted tree languages over some ordered structure [BMŠ⁺06, STV08]
- learning of wta [Mal07, DV07a, DHM11, BM15]
- weighted tree transducers [Kui99c, EFV02, FV03, FGV04, Mal04, Mal05b, Mal05a, MV05, Mal06b, Mal06a, Mal06c, FV09, FMV11]
- wta with storage [HV15, VDH16, FHV18, FV19, HVD19, FV22a, Her20b, DFV21]
- applications of wta (and weighted tree transducers) in syntactic processing of natural languages [PRS94, YK02, GHKM04, GK04, KG05, GKM08, KM09, MS09, FMV10, MS10, May10, Mal11a, Mal11b, Buy13, BVN14, Büc14, BDZ15, DGV16, Mal17, Die18, MV19b, MV19a, MV21]; also cf. the workshops [DK10, DK12].

Notes to the reader.

... about prerequisites:

The reader is assumed to be familiar with the fundamental concepts, results, and constructions in the theory of tree automata [Eng75b, GS84, GS97, CDG⁺07] and context-free languages [Har78, HU79, HMU07].

... about the notion “construction”:

In general, a construction is an algorithm which takes some objects as input and produces some objects as output in an effective manner. For instance, [GS84, Thm. 2.4.2] states that, for two finite-state tree automata A_1 and A_2 , a finite-state tree automaton A can be constructed which recognizes the intersection $L(A_1) \cap L(A_2)$ of the tree languages which are recognized by A_1 and A_2 ; then the proof of [GS84, Thm. 2.4.2] (essentially) shows an algorithm which, on input A_1 and A_2 , builds up effectively A such that $L(A) = L(A_1) \cap L(A_2)$.

Also in the present book we show a number of constructions. However, here the situation is more complicated for those constructions which involve some strong bimonoid \mathbf{B} . If the algorithm involves calculations in \mathbf{B} , it may happen that the calculations in \mathbf{B} are not effective. This can arise, e.g., because the arguments of the calculation cannot be given effectively or because the operations \oplus and \otimes are not given algorithmically. In this unpleasant situation, we understand by “construction” just the definition of the output objects, and not an algorithm for their effective building up process. So, in our understanding a construction

- takes some objects as input,
- if the input objects are given effectively and the operations of the strong bimonoid are effective, then the construction gives the output objects effectively,
- otherwise the construction merely defines the output objects (in a mathematical sense).

Let us illustrate this understanding by considering the “weighted version” of [GS84, Thm. 2.4.2]. In Theorem 10.4.1(1) we claim: “Let Σ be a ranked alphabet, \mathbf{B} be a strong bimonoid, and \mathcal{A}_1 and \mathcal{A}_2 be two (Σ, \mathbf{B}) -wta. If \mathbf{B} is a commutative semiring, then we can construct a (Σ, \mathbf{B}) -wta \mathcal{A} such that $\llbracket \mathcal{A} \rrbracket = \llbracket \mathcal{A}_1 \rrbracket \otimes \llbracket \mathcal{A}_2 \rrbracket$.” If \mathbf{B} is, e.g., the Boolean semiring or the semiring of natural numbers, then our

proof shows an algorithm which builds up \mathcal{A} effectively. However, if \mathbf{B} is, e.g., the field of real numbers and some of the coefficients of \mathcal{A}_1 or \mathcal{A}_2 cannot be given effectively, then our proof just shows the definition of \mathcal{A} .

... about general conventions:

In order to avoid many repetitions of the statements “for each ranked alphabet Σ ” and “for each strong bimonoid \mathbf{B} ”, we will use the general conventions that Σ always stands for an arbitrary, i.e., universally quantified ranked alphabet (cf. page 49) and that \mathbf{B} denotes an arbitrary strong bimonoid (cf. page 42). Such a convention is placed inside `\begin{quote}-\end{quote}` in emphasized letter style. In some chapters or sections, we develop results for a particular subset of strong bimonoids, e.g., the set of commutative semirings. Again, in order to avoid repetitions of universal quantifications over this particular subset, we will place a corresponding convention local to these chapters and sections; the scope of each local convention is explicitly indicated. Then, for each result (e.g. observation, lemma, theorem, corollary) within this scope, the general and local conventions and restrictions hold. We hope that this extraction of universal quantifications helps to focus on important argumentation.

... about theorems, lemmas, and corollaries which are in a box:

If a reader just wants to look up some result, then checking for local and global conventions and collecting them is a burden and it is better to see **all** the restrictions, requirements, and universal quantifications inside the corresponding latex-environment. To solve the contradicting wishes: avoiding repetitions of universal quantifications versus fully quantified statements, for some of the main results (lemmas, theorems, and corollaries) we show all the necessary restrictions and requirements inside the latex-environment. In order to ease the search for such main results, we put them into a box.

... about normal forms:

In the book we define several instances of terminating reductions systems and determine the set of their normal forms. We use such reduction systems for definitions and proofs by well-founded induction. For examples of such definitions, see e.g. (3.1) and the definition of f , g , and h on page 54, and for examples of such proofs, see e.g. the proof of Observation 3.1.1 and Lemma 4.3.7. In these cases the normal forms of the reduction system are used to define or prove the base of the induction.

Besides, we prove several normal form lemmas for weighted tree automata, weighted context-free grammars, and weighted regular tree grammars (cf., e.g., Theorem 7.1.3, Lemma 8.2.3, Theorem 8.2.6, and Lemma 9.2.2); here we use the phrase “normal form lemma” as it is known from the theory of classical (unweighted) automata and formal languages. For instance, a normal form lemma for weighted regular tree grammars states that each weighted regular tree grammar can be transformed into an equivalent one which has a particular property.

Now one may wonder, what the concept of “normal form of a reduction system” has in common with the concept of “normal form lemma”, apart from merely sharing the English words “normal form”.

We think that, for each normal form lemma, we can define a specific terminating reduction system such that the grammar or automata which results from the normal form lemma is a normal form of that reduction system. However, several normal forms of weighted tree automata, weighted context-free grammars, and weighted regular tree grammars are obtained as a result of one complex construction and not as a result of the iteration of some elementary reduction steps; for example, see the construction of a local-trim weighted tree automaton (Theorem 7.1.4) or of a chain-free weighted context-free grammar (Theorem 8.2.6). In such cases, the construction of the desired normal form can be described in terms of a terminating reduction system in which the reduction relation is the construction itself, hence the reduction terminates in one step. Therefore, in such cases we will not show the specific terminating reduction system explicitly.

However, for one particular normal form lemma (viz., Lemma 9.2.2: for each weighted regular tree grammar, we can construct an equivalent one which is alphabetic), the use of terminating reduction systems seems to be very well motivated.

... about possible mistakes:

We would like to ask (or: encourage) the readers to share with us their remarks and observations

concerning the contents of the book. In particular, the indication of mistakes or of missing references to published results are very welcome. Please, write an email to `fulop@inf.u-szeged.hu` and `heiko.vogler@tu-dresden.de`.

... about an electronic version:

This book can be found on arXiv by searching for the authors or the title.

Acknowledgements. In 2017 we started to work on this book. But the seed for this work was laid much earlier. In our academic youth, we both had excellent teachers of the theory of tree automata (Ferenc Gécseg and Joost Engelfriet, respectively). After this academic qualification, we met for the first time in the year 1987, when the second author (Heiko) visited the first author (Zoltán) and his colleague Sándor Vágvolgyi in Szeged. And the result of this start was the publication [FHVV93]. Since then we (the authors) jointly investigated the theory of tree automata and tree transducers. In the beginning, we communicated by hand-written letters as it was usual at that time, or we paid regular visits to each other. When in 1999 Werner Kuich visited Ferenc Gécseg, the second author happened to be also in Szeged. Then Werner showed him his fresh paper “Tree transducers and tree series” [Kui99c] and explained its ideas. From that point on, we (Zoltan and Heiko) worked on the theory of weighted tree automata and weighted tree transducers (starting with [EFV02]). During the development of that theory, we benefitted much from the cooperation with Symeon Bozapalidis, Frank Drewes, Manfred Droste, Joost Engelfriet, Andreas Maletti, Mark-Jan Nederhof, George Rahonis, and Magnus Steinby. In the years 2002-2021, the series of workshops “Weighted Automata: Theory and Applications” (WATA), co-organized by Manfred Droste, gave an excellent infrastructure for presenting our results. This book contains many ideas which were produced by these cooperations during the last 20 years; we are very grateful for this.

We would like to thank our colleagues for checking some parts of the book and contributing valuable suggestions: Johanna Björklund, Frank Drewes, Manfred Droste, Zsolt Gazdag, Luisa Herrmann, Eija Jurvanen, Andreas Maletti, George Rahonis, and Sándor Vágvolgyi. In particular, we wish to thank Manfred Droste for several fruitful discussions and suggestions, which had a very positive impact on the book. Of course, each remaining mistake is due to the authors. We are grateful to Felicita Purnama Dewi Gernhardt, Luisa Herrmann, Dávid Kószó, and, in particular, Celina Pohl for preparing the figures. In a number of situations, Celina Pohl and Richard Mörbitz helped us to find the appropriate latex-commands and settings.

“... who prologue-like your humble patience pray, gently to hear, kindly to judge, our play.”

W. Shakespeare, Henry V.

Zoltán Fülöp and Heiko Vogler
Szeged, Hungary and Dresden, Germany

June 11, 2024

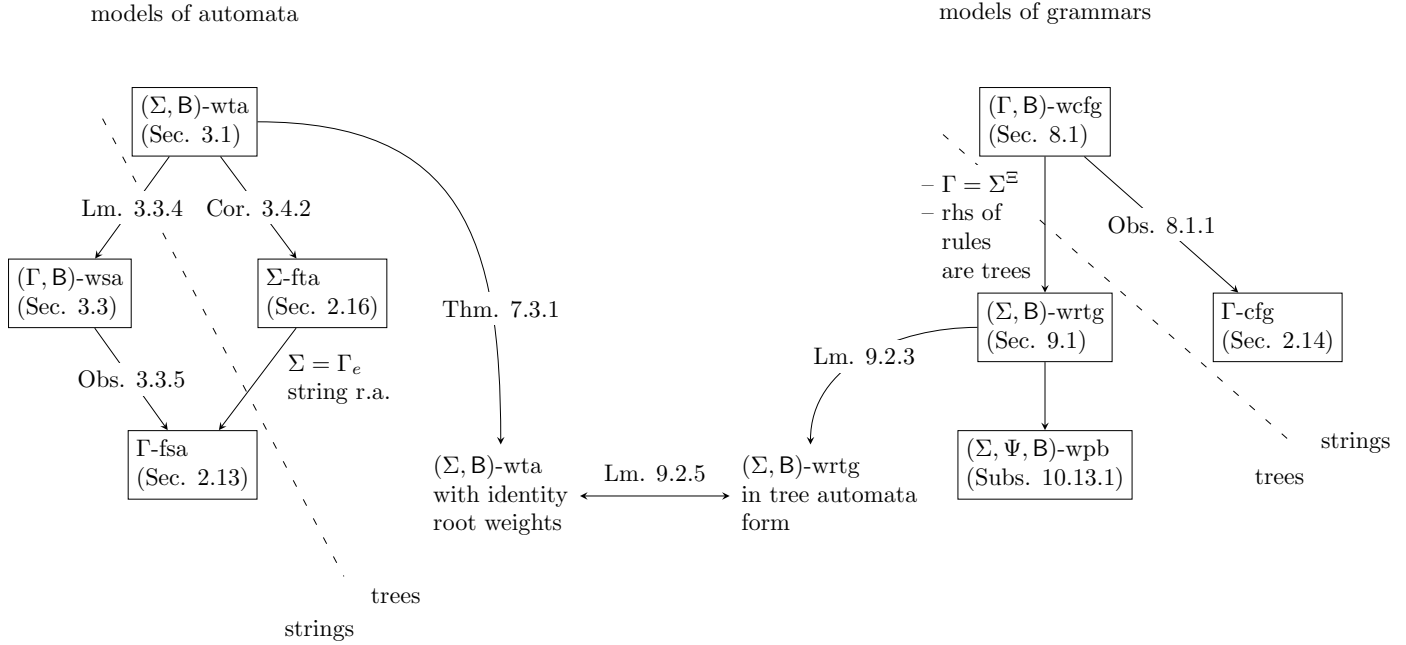

Figure 1.1: Overview of the models of automata and models of grammars which occur in this book. Their relationship is expressed by arrows. For every pair (X, Y) of models, if $X \rightarrow Y$, then Y is a special case of X , and if $X \leftrightarrow Y$, then X and Y are equivalent.

wta: weighted tree automaton
 wsa: weighted string automaton
 fta: finite-state tree automaton
 fsa: finite-state string automaton

wcfg: weighted context-free grammar
 wrtg: weighted regular tree grammar
 cfg: context-free grammar
 wpb: weighted projective bimorphism

Σ, Ψ : ranked alphabets
 Γ : alphabet
 B : strong bimonoid
 rhs: right-hand side

List of all general and local conventions made in this book

- on page 14:
In the rest of this book, Γ will denote an arbitrary alphabet, if not specified otherwise.
- on page 21:
In the rest of this subsection, let $\mathbf{A} = (A, \theta)$ be a universal algebra of type $\tau : I \rightarrow \mathbb{N}$ and with $\theta : I \rightarrow \text{Ops}(A)$.
- on page 42:
In the rest of this book, \mathbf{B} will denote an arbitrary strong bimonoid $(B, \oplus, \otimes, 0, \mathbb{1})$ if not specified otherwise.
- on page 43:
In this section let $\mathbf{B} = (B, \oplus, \otimes, 0, \mathbb{1})$ be a commutative semiring, unless specified otherwise.
- on page 49:
In the rest of this book, Σ and Δ will denote arbitrary ranked alphabets, if not specified otherwise.
- on page 51:
If not specified otherwise, then we denote the unique Σ -algebra homomorphism from the Σ -term algebra $\mathbb{T}_\Sigma = (\mathbb{T}_\Sigma, \theta_\Sigma)$ to some Σ -algebra $\mathbf{A} = (A, \theta)$ by $\mathbf{h}_\mathbf{A}$.
- on page 58:
In the rest of the book, Z and X will denote sets of variables if not specified otherwise. Moreover, we let $Z_n = \{z_1, \dots, z_n\}$ and $X_n = \{x_1, \dots, x_n\}$ for every $n \in \mathbb{N}$.
- on page 108:
In the rest of this section, we let \mathbf{B} denote an arbitrary commutative semiring.
- on page 143:
Due to Theorem 5.3.1, if \mathcal{A} is bu-deterministic, then we write $\llbracket \mathcal{A} \rrbracket$ instead of $\llbracket \mathcal{A} \rrbracket^{\text{run}}$ and $\llbracket \mathcal{A} \rrbracket^{\text{init}}$. Moreover, for a weighted tree language r , we say that r is bu-deterministically recognizable (instead of bu-deterministically i -recognizable and bu-deterministically r -recognizable). Also, we write $\text{bud-Rec}(\Sigma, \mathbf{B})$ for $\text{bud-Rec}^{\text{run}}(\Sigma, \mathbf{B})$ (and hence, for $\text{bud-Rec}^{\text{init}}(\Sigma, \mathbf{B})$). Similarly, we say that r is crisp-deterministically recognizable (instead of crisp-deterministically i -recognizable and crisp-deterministically r -recognizable). Also, we write $\text{cd-Rec}(\Sigma, \mathbf{B})$ for $\text{cd-Rec}^{\text{run}}(\Sigma, \mathbf{B})$ and $\text{cd-Rec}^{\text{init}}(\Sigma, \mathbf{B})$.
- on page 149:
Due to Corollary 5.3.5, if \mathbf{B} is a semiring and \mathcal{A} is a (Σ, \mathbf{B}) -wta, then we write $\llbracket \mathcal{A} \rrbracket$ instead of $\llbracket \mathcal{A} \rrbracket^{\text{run}}$ and $\llbracket \mathcal{A} \rrbracket^{\text{init}}$. Moreover, for an i -recognizable or r -recognizable weighted tree language r , we say that r is recognizable. Also, we denote the set $\text{Rec}^{\text{run}}(\Sigma, \mathbf{B})$ (and hence, $\text{Rec}^{\text{init}}(\Sigma, \mathbf{B})$) by $\text{Rec}(\Sigma, \mathbf{B})$.
- on page 149:
Due to Corollary 5.3.6, if \mathbf{B} is a semiring and \mathcal{A} is a (Γ, \mathbf{B}) -wsa, then we write $\llbracket \mathcal{A} \rrbracket$ instead of $\llbracket \mathcal{A} \rrbracket^{\text{run}}$ and $\llbracket \mathcal{A} \rrbracket^{\text{init}}$.
- on page 152:
In this section, we let $\mathcal{A} = (Q, \delta, F)$ be an arbitrary (Σ, \mathbf{B}) -wta.
- on page 158:
In the rest of this section, we let \mathbf{B} be a field and $(\mathbf{V}, \mu, \gamma)$ be a (Σ, \mathbf{B}) -multilinear representation where \mathbf{V} is a κ -dimensional \mathbf{B} -vector space for some $\kappa \in \mathbb{N}_+$, unless specified otherwise.
- on page 202:
In the rest of this book, for each wrtg \mathcal{G} , we will abbreviate $\llbracket \mathcal{G} \rrbracket^{\text{t}}$ by $\llbracket \mathcal{G} \rrbracket$.

- on page 304:
In this chapter \mathbf{B} is a semiring and $\mathcal{A} = (Q, \delta, F)$ denotes an arbitrary (Σ, \mathbf{B}) -wta unless specified otherwise.
- on page 307:
We recall that $\mathbf{V}(\mathcal{A}) = (B^Q, \delta_{\mathcal{A}})$ is the vector algebra of \mathcal{A} , and that $\mathbb{0}_Q \in B^Q$ is the Q -vector over \mathbf{B} which contains $\mathbb{0}$ in each component (cf. Section 3.1). We assume that there exists $\alpha \in \Sigma^{(0)}$ such that $\delta_{\mathcal{A}}(\alpha)(\cdot) \neq \mathbb{0}_Q$.
- on page 330:
In this subsection we assume that \mathbf{B} is commutative.
- on page 341:
In the rest of this chapter, \mathbf{B} denotes an arbitrary commutative semiring.
- on page 381:
In the sequel we will abbreviate $\mathbf{h}_{\mathbf{M}(\Sigma, \kappa)}$ by \mathbf{h}_{κ} .
- on page 392:
In this section, we assume that \mathbf{B} is commutative.
- on page 419:
In this chapter, we let $\mathbf{B} = (B, \oplus, \otimes, \mathbb{0}, \mathbb{1})$ denote a field unless specified otherwise.
- on page 441:
In the rest of this chapter, \mathbf{B} denotes an arbitrary commutative and σ -complete semiring.
- on page 447:
In this chapter, $\mathbf{L} = (L, \vee, \wedge, \mathbb{0}, \mathbb{1})$ denotes a bounded lattice.

Chapter 2

Preliminaries

2.1 Numbers and sets

We denote the set $\{0, 1, 2, \dots\}$ of natural numbers by \mathbb{N} and the set $\mathbb{N} \setminus \{0\}$ by \mathbb{N}_+ . Let $n, k \in \mathbb{N}$. Then we denote the set $\{i \in \mathbb{N} \mid n \leq i \leq k\}$ by $[n, k]$. We abbreviate $[1, k]$ by $[k]$. Thus $[0] = \emptyset$. We denote the sets of integers, rational numbers, and real numbers by \mathbb{Z} , \mathbb{Q} , and \mathbb{R} , respectively.

For each $a, b \in \mathbb{R}$, we denote by $\max(a, b)$ and $\min(a, b)$ the maximum and the minimum of a and b with respect to \leq , respectively. We extend \max and \min to each nonempty, finite subset of \mathbb{R} in a natural way. Later, when \max (or \min) is an operation of a monoid, we will define $\max \emptyset$ (and $\min \emptyset$, respectively) to be the unit element of that monoid (cf. (2.10)).

Sometimes we use the set $\mathbb{N} \cup \{\infty\}$. We abbreviate it by \mathbb{N}_∞ and extend the operations $+$ and \min to \mathbb{N}_∞ in the obvious way: $a + \infty = \infty$ and $\min(a, \infty) = a$ for each $a \in \mathbb{N}_\infty$. In a similar way we proceed with an extension by $-\infty$ and the operation \max (and also with other sets like \mathbb{Z} and \mathbb{R}).

For the set \mathbb{R} of real numbers, we denote its subset $\{r \in \mathbb{R} \mid r \geq 0\}$ by $\mathbb{R}_{\geq 0}$. For the corresponding subsets of integers and rational numbers we use $\mathbb{Z}_{\geq 0}$ and $\mathbb{Q}_{\geq 0}$, respectively. We denote the set $\mathbb{Q}_{\geq 0} \cup \{\infty\}$ by $\mathbb{Q}_{\geq 0, \infty}$.

Let A be a set. We call A *countable* if its cardinality coincides with that of a subset of the natural numbers. If A is finite and it has n elements a_1, \dots, a_n , then we denote this fact by $A = \{a_1, \dots, a_n\}$. If $n = 1$, then sometimes we identify A with a_1 and simply write a_1 for $\{a_1\}$. Moreover, $|A|$ denotes the cardinality of A . The *power-set of A* , denoted by $\mathcal{P}(A)$, is the set of all subsets of A . We denote by $\mathcal{P}_{\text{fin}}(A)$ the set of all finite subsets of A .

Let $n \in \mathbb{N}$, and A_1, \dots, A_n be sets. The *Cartesian product of A_1, \dots, A_n* is the set $\{(a_1, \dots, a_n) \mid a_i \in A_i \text{ for each } i \in [n]\}$ and it is denoted by $A_1 \times \dots \times A_n$. The *n -fold Cartesian product of a set A* is the set $A \times \dots \times A$, where A appears n times. We abbreviate $A \times \dots \times A$ by A^n . In particular, $A^0 = \{()\}$.

Let A and B be sets. If each element of A is also an element of B , then A is a *subset* of B , denoted by $A \subseteq B$. If $A \subseteq B$ and $A \neq B$, then A is a *strict subset* of B , denoted by $A \subset B$.

2.2 Strings and languages

We recall some notions and notations of strings and (formal) languages from [Har78, HU79, HMU14, Lin12].

Let A be a set. A *string* (or: *word*) *over A* is a finite sequence $a_1 \cdots a_n$ with $n \in \mathbb{N}$ and $a_i \in A$ for each $i \in [n]$. In particular, we denote the sequence $a_1 \cdots a_n$ with $n = 0$ by ε and call it the *empty string*. We say that $a_1 \cdots a_n$ has *length n* . For each $n \in \mathbb{N}$, we denote the *set of strings over A of length n* by

A^n ; thus $A^0 = \{\varepsilon\}$. Moreover, we denote by A^* the *set of all strings over A* , i.e., $A^* = \bigcup_{n \in \mathbb{N}} A^n$ and we let $A^+ = A^* \setminus \{\varepsilon\}$. For each $w \in A^*$, we denote by $|w|$ the length of w .

We note that the notation A^n is overloaded in the sense that it denotes two sets: (a) the n -fold Cartesian product of A and (b) the set of strings over A of length n . Of course, formally these sets are different. But since there exists a bijection between them, we find it acceptable to use the same notation.

The *concatenation* of the strings $a_1 \cdots a_n$ and $b_1 \cdots b_m$ is the string $a_1 \cdots a_n b_1 \cdots b_m$. For every $v, w \in A^*$, we denote the *concatenation of v and w* by $v \cdot w$ or simply by vw .

Let $w \in A^*$. For each $n \in \mathbb{N}$, we define w^n such that $w^0 = \varepsilon$ and $w^n = ww^{n-1}$ for $n \in \mathbb{N}_+$. Moreover, we denote by $\text{postfix}(w)$ the set $\{v \in A^* \mid (\exists u \in A^*) : w = uv\}$ of *postfixes of w* , and by $\text{prefix}(w)$ the set $\{u \in A^* \mid (\exists v \in A^*) : w = uv\}$ of *prefixes of w* . Note that $\{\varepsilon, w\} \subseteq \text{postfix}(w) \cap \text{prefix}(w)$.

An *alphabet* is a finite and nonempty set. Let Γ be an alphabet. Then each subset $L \subseteq \Gamma^*$ is called a *language* (or: *formal language*) *over Γ* . Let $L_1, L_2 \subseteq \Gamma^*$ be two languages. The *concatenation of L_1 and L_2* , denoted by $L_1 \cdot L_2$ or just $L_1 L_2$, is the language $L_1 L_2 = \{w_1 w_2 \mid w_1 \in L_1, w_2 \in L_2\}$.

In the rest of this book, Γ will denote an arbitrary alphabet, if not specified otherwise.

2.3 Binary relations and mappings

Binary relations. Let A and B be sets. A *binary relation (on A and B)* is a subset $R \subseteq A \times B$. As usual, we frequently write aRb for $(a, b) \in R$. For each $A' \subseteq A$, we define $R(A') = \{b \in B \mid (\exists a \in A') : aRb\}$. If $A = B$, then we call R a *binary relation on A* (or: *over A*). We denote by R^{-1} the binary relation $\{(b, a) \mid aRb\}$, and we call it the *inverse of R* .

Let additionally C be a set and $R_1 \subseteq A \times B$ and $R_2 \subseteq B \times C$ be binary relations. The *composition of R_1 and R_2* , denoted by $R_1; R_2$, is the binary relation on A and C defined by $R_1; R_2 = \{(a, c) \in A \times C \mid (\exists b \in B) : (a, b) \in R_1 \text{ and } (b, c) \in R_2\}$.

Let R be a binary relation on A . The relation R is

- *reflexive* if aRa for every $a \in A$,
- *irreflexive* if $(a, a) \notin R$ for every $a \in A$,
- *symmetric* if aRb implies that bRa for every $a, b \in A$,
- *antisymmetric* if aRb and bRa imply that $a = b$ for every $a, b \in A$,
- *transitive* if aRb and bRc imply that aRc for every $a, b, c \in A$, and
- *strict order* if R is irreflexive and transitive.

The *reflexive, transitive closure of R* , denoted by R^* , is the binary relation $R^* = \bigcup_{n \in \mathbb{N}} R^n$ where $R^0 = \{(a, a) \mid a \in A\}$ and $R^{n+1} = R^n; R$ for each $n \in \mathbb{N}$. The *transitive closure of R* , denoted by R^+ , is the binary relation $R^+ = \bigcup_{n \in \mathbb{N}_+} R^n$. Then R^* is reflexive and transitive, and R^+ is transitive.

If R is reflexive, symmetric, and transitive, then we call it an *equivalence relation (on A)*. Then, for every $a \in A$, the *equivalence class with representative a* , denoted by $[a]_R$, is the set $\{b \in A \mid aRb\}$. The *factor set of A modulo R* , denoted by A/R , is the set $\{[a]_R \mid a \in A\}$. The *index of R* is the cardinality of A/R .

Let \leq be a binary relation on A . If \leq is reflexive, antisymmetric, and transitive, then we call it a *partial order (on A)*, and we call the pair (A, \leq) a *partially ordered set*. A partial order \leq on A is a *linear order (on A)* if for every $a, b \in A$ we have $a \leq b$ or $b \leq a$. For $a, b \in A$, we write $a < b$ to denote that $a \leq b$ and $a \neq b$.

Let (A, \leq) be a partially ordered set and let $B \subseteq A$. An element $a \in A$ is an *upper bound of B* if, for each $b \in B$, we have $b \leq a$. Moreover, if a is an upper bound and, for each upper bound a' of B , we have $a \leq a'$, then a is the *least upper bound of B* . If the least upper bound of B exists, then we call it the *supremum of B* and denote it by $\sup_{\leq} B$ (or: $\sup B$). Similarly, we can define *lower bound* and the *greatest lower bound*, i.e., the *infimum of B* . We denote the latter by $\inf_{\leq} B$ (or: $\inf B$).

Mappings. Let $f \subseteq A \times B$ be a binary relation. We say that f is a *mapping from A to B* , denoted by $f : A \rightarrow B$, if for each $a \in A$ there exists a unique $b \in B$ such that $(a, b) \in f$. In this case we write $f(a) = b$ as usual. The set of all mappings from A to B is denoted by B^A . We call A and B the *domain* and *codomain* of f , respectively. The *image* of f is the set $\text{im}(f) = \{f(a) \mid a \in A\}$. A mapping $f : A \rightarrow B$ is *injective* if for every $a_1, a_2 \in A$ with $a_1 \neq a_2$ we have that $f(a_1) \neq f(a_2)$. It is *surjective* if for each $b \in B$ there exists an $a \in A$ such that $f(a) = b$.

In particular, each binary relation $R \subseteq A \times B$ can be considered as a mapping $R : A \rightarrow \mathcal{P}(B)$, where $R(a) = \{b \in B \mid aRb\}$ for each $a \in A$.

Let $f : A \rightarrow B$ be a mapping and A' and B' be sets such that $A' \subseteq A$ and $B' \supseteq B$. Then f is also a mapping from A to B' , i.e., $f : A \rightarrow B'$. The *restriction of f to A'* is the mapping $f|_{A'} : A' \rightarrow B$ and defined by $f|_{A'}(a) = f(a)$ for each $a \in A'$.

Let A , B , and C be sets such that A and B are disjoint. Moreover, let $f : A \rightarrow C$ and $g : B \rightarrow C$. We define the *union of f and g* as the mapping $(f \cup g) : A \cup B \rightarrow C$ such that, for each $x \in (A \cup B)$ we let $(f \cup g)(x) = f(x)$ if $x \in A$, and $(f \cup g)(x) = g(x)$ otherwise. Clearly, $(f \cup g)|_A = f$ and $(f \cup g)|_B = g$.

Let C be a further set. For two mappings $f : A \rightarrow B$ and $g : B \rightarrow C$, the *composition of f and g* is the mapping $(g \circ f) : A \rightarrow C$, where $(g \circ f)(a) = g(f(a))$ for every $a \in A$. If we view f and g as binary relations, then $g \circ f = f; g$.

In the usual way we extend a mapping $f : A \rightarrow B$ to the mapping $f' : \mathcal{P}(A) \rightarrow \mathcal{P}(B)$ by defining $f'(A') = \{b \in B \mid (\exists a \in A') : f(a) = b\}$ for each $A' \subseteq A$. We denote f' also by f .

If we want to emphasize the values of a mapping, then we use the concept of family defined as follows. Let I and B be sets. An *I -indexed family over B* is a mapping $f : I \rightarrow B$. Such a family is also denoted by $(b_i \mid i \in I)$ where $b_i = f(i)$ for each $i \in I$. An I -indexed family over B is *countable (finite, nonempty)* if I is countable (finite, nonempty, respectively). We call I the index set of that family.

Let $f = (B_i \mid i \in I)$ be an I -indexed family over $\mathcal{P}(B)$. We call f a *partitioning of B* (with respect to I) if $\bigcup_{i \in I} B_i = B$, and $B_i \cap B_j = \emptyset$ for every $i, j \in I$ with $i \neq j$.

For each $k \in \mathbb{N}$, a mapping $f : A^k \rightarrow A$ is called *k -ary operation on A* or simply *operation on A* . As usual, we identify a nullary operation f on A with the element $f() \in A$. We denote the set of all k -ary operations on A by $\text{Ops}^k(A)$, and the set of all operations on A by $\text{Ops}(A)$.

We define the *identity mapping on A* as the mapping $\text{id}_A : A \rightarrow A$ such that $\text{id}_A(a) = a$ for each $a \in A$.

Let A and B be sets and $f : A \rightarrow \text{Ops}(B)$. Then, for every $a \in A$ and $b_1, \dots, b_k \in B$ where k is the arity of $f(a)$, we write $f(a)(b_1, \dots, b_k)$ rather than $(f(a))(b_1, \dots, b_k)$.

2.4 Hasse diagram, Venn diagram, and Euler diagram

Let (A, \leq) be a partially ordered set. There are several ways to represent (A, \leq) by means of a diagram in the plane.

Hasse diagram. Each element $a \in A$ is represented in the diagram by a node which is labeled by a . This node is called *a -node*. The nodes are placed into the diagram in such a way that whenever $a < b$ holds for $a, b \in A$, the b -node is drawn above the a -node. Moreover, for every $a, b \in A$, the a -node and the b -node are connected by an edge if $a < b$ and, for every $c \in A$, the condition $a \leq c \leq b$ implies that $a = c$ or $b = c$. From this diagram we can reconstruct \leq by noting that $a \leq b$ holds if and only if $a = b$ or the b -node can be reached from the a -node via a sequence of ascending edges.

Figure 2.1 shows an example of a Hasse diagram for $A = (\mathbb{N} \times \mathbb{N})$ and the partial order \leq defined by $(n_1, n_2) \leq (k_1, k_2)$ if $n_1 \leq k_1$ and $n_2 \leq k_2$. Of course, since A is an infinite set, we can only show a finite part of the Hasse diagram.

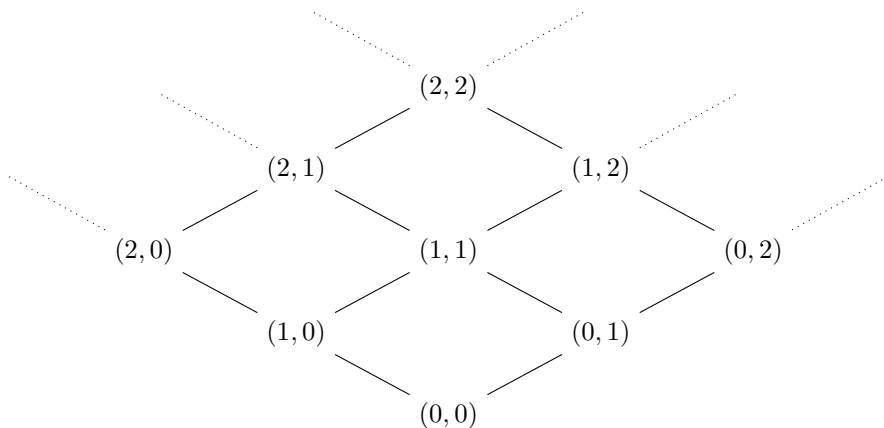

Figure 2.1: A finite part of the Hasse diagram for $A = (\mathbb{N} \times \mathbb{N})$ and $(n_1, n_2) \leq (k_1, k_2)$ if $n_1 \leq k_1$ and $n_2 \leq k_2$.

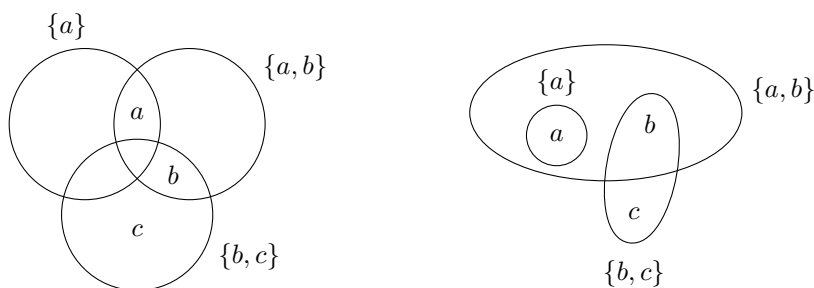

Figure 2.2: The Venn diagram (left) and the Euler diagram (right) for $U = \{a, b, c\}$ and $A = \{\{a\}, \{a, b\}, \{b, c\}\}$.

Venn diagram and Euler diagram. These diagrams can be drawn if there exists a finite set U such that A is a collection of subsets of U , i.e., $A = \{B_1, \dots, B_n\}$ for some $n \in \mathbb{N}_+$ and some subsets B_1, \dots, B_n of U ; moreover, the partial order \leq is the subset relation \subseteq . Then each element $a \in U$ is represented by an individual point in the diagram; this point is labeled by a . Each subset B_i is represented in the diagram by an area which is delimited by an oval or some polygon; this area contains exactly the elements of B_i . We call this area the B_i -area.

In the Venn diagram, the B_i -areas are placed into the diagram in an overlapping manner such that exactly $2^n - 1$ overlap areas are created. It is possible that an overlap area does not contain an element of $\bigcup_{i \in [n]} B_i$.

In the Euler diagram, the B_i -areas are placed into the diagram also in an overlapping manner, but now in such a way that each overlap area contains at least one element of $\bigcup_{i \in [n]} B_i$.

Figure 2.2 shows an example of a Venn diagram and an Euler diagram for $U = \{a, b, c\}$ and $A = \{\{a\}, \{a, b\}, \{b, c\}\}$.

2.5 Reduction systems

We recall the concept of reduction system and some of its main properties [Hue80, BN98].

A *reduction system* is a pair (A, \rightarrow) where A is a set and \rightarrow is a binary relation on A , called *reduction*.

Let (A, \rightarrow) be a reduction system. For every $a, b \in A$, if $a \rightarrow b$, then b is a *direct successor* of a . An element $a \in A$ is called *in normal form* if $\rightarrow(a) = \emptyset$, i.e., there does not exist a $b \in A$ such that $a \rightarrow b$. Let $a, b \in A$. Then b is a *normal form* of a if $a \rightarrow^* b$ and b is in normal form. We denote the set of all normal forms of a by $\text{nf}_{\rightarrow}(a)$. We say that a *has a normal form* if $\text{nf}_{\rightarrow}(a) \neq \emptyset$. If $|\text{nf}_{\rightarrow}(a)| = 1$, then we say that a *has a unique normal form*.

A reduction system (A, \rightarrow) is called *terminating* if there does not exist an \mathbb{N} -indexed family $(a_i \mid i \in \mathbb{N})$ over A such that, for each $i \in \mathbb{N}$, the condition $a_i \rightarrow a_{i+1}$ holds. If a reduction system (A, \rightarrow) is terminating, then we also say that \rightarrow is terminating.

It is easy to see that a terminating binary relation is irreflexive, and that the transitive closure \rightarrow^+ of a terminating relation \rightarrow on A is also terminating. For instance, the relation

$$\succ_{\mathbb{N}} = \{(n+1, n) \mid n \in \mathbb{N}\}$$

on \mathbb{N} is terminating. Since $\succ = (\succ_{\mathbb{N}})^+$ (where \succ is the usual “greater than” relation on \mathbb{N}), the relation \succ is also terminating.

Observation 2.5.1. [BN98, p. 9-10] If the reduction system (A, \rightarrow) is terminating, then each $a \in A$ has a normal form.

Often we will use a particular basic method in order to show that a reduction system is terminating. This method is based on the concept of monotone measure function. Formally, let (A, \rightarrow) and (B, \succ) be reduction systems, and $\varphi : A \rightarrow B$ be a mapping. The mapping φ is *monotone* if, for every $a_1, a_2 \in A$, the reduction $a_1 \rightarrow a_2$ implies $\varphi(a_1) \succ \varphi(a_2)$. If this is the case, then φ is called a *monotone measure function*, or: *monotone embedding of (A, \rightarrow) into (B, \succ)* .

Lemma 2.5.2. [BN98, p. 16] Let (A, \rightarrow) be a reduction system and (B, \succ) be a terminating reduction system. If there exists a monotone embedding of (A, \rightarrow) into (B, \succ) , then (A, \rightarrow) is terminating.

Proof. Let $\varphi : A \rightarrow B$ be a monotone embedding. We prove by contradiction. For this, we assume that (A, \rightarrow) is not terminating. Then there exists an \mathbb{N} -indexed family $(a_i \mid i \in \mathbb{N})$ over A such that, for each $i \in \mathbb{N}$, the condition $a_i \rightarrow a_{i+1}$ holds. Since φ is monotone, for the \mathbb{N} -indexed family $(\varphi(a_i) \mid i \in \mathbb{N})$ over B and for each $i \in \mathbb{N}$, the condition $\varphi(a_i) \succ \varphi(a_{i+1})$ holds. This contradicts to the fact that (B, \succ) is terminating. \square

If in Lemma 2.5.2 we have that (A, \rightarrow) is finitely branching and $(B, \succ) = (\mathbb{N}, >)$, then the implication in the other direction also holds [BN98, Lm. 2.3.3].

The following lemma shows that the property of being terminating is inherited to subsets.

Lemma 2.5.3. Let (B, \succ) be a terminating reduction system, $A \subseteq B$, and $\rightarrow \subseteq \succ \cap (A \times A)$. Then also (A, \rightarrow) is terminating.

Proof. The mapping $(\text{id}_B)|_A : A \rightarrow B$ is a monotone embedding of (A, \rightarrow) into (B, \succ) . Hence, by Lemma 2.5.2, also (A, \rightarrow) is terminating. \square

Moreover, the property of being terminating is propagated to Cartesian products.

Corollary 2.5.4. Let (A_1, \rightarrow_1) and (A_2, \rightarrow_2) be two reduction systems and at least one of them is terminating. Moreover, let \rightarrow be the binary relation over $A_1 \times A_2$ such that, for every $a_1, a_2 \in A_1$ and $b_1, b_2 \in A_2$, we let $(a_1, b_1) \rightarrow (a_2, b_2)$ if $a_1 \rightarrow_1 a_2$ and $b_1 \rightarrow_2 b_2$. Then $(A_1 \times A_2, \rightarrow)$ is terminating.

Proof. Without loss of generality we assume that (A_1, \rightarrow_1) is terminating. We prove by contradiction. Thus we assume that $(A_1 \times A_2, \rightarrow)$ is not terminating. Then there exists an \mathbb{N} -indexed family $((a_i, b_i) \mid i \in \mathbb{N})$ over $A_1 \times A_2$ and for each $i \in \mathbb{N}$, the condition $(a_i, b_i) \rightarrow (a_{i+1}, b_{i+1})$ holds. Thus there exists an \mathbb{N} -indexed family $(a_i \mid i \in \mathbb{N})$ over A_1 and for each $i \in \mathbb{N}$, the condition $a_i \rightarrow_1 a_{i+1}$ holds. This contradicts to the fact that (A_1, \rightarrow_1) is terminating. \square

Corollary 2.5.5. Let (A, \rightarrow) be a reduction system. Moreover, let \succ be the binary relation over $A \times A$ such that, for every $a_1, a_2, b_1, b_2 \in A$, we let $(a_1, b_1) \succ (a_2, b_2)$ if (a) $a_1 \rightarrow a_2$ and $b_1 = b_2$ or (b) $a_1 = a_2$ and $b_1 \rightarrow b_2$. If (A, \rightarrow) is terminating, then $(A \times A, \succ)$ is terminating.

Proof. We prove by contradiction. Assume that $(A \times A, \succ)$ is not terminating, i.e., there exists an \mathbb{N} -indexed family $((a_i, b_i) \mid i \in \mathbb{N})$ over $A \times A$ such that, for each $i \in \mathbb{N}$, the condition $(a_i, b_i) \succ (a_{i+1}, b_{i+1})$ holds. We consider the \mathbb{N} -indexed family $(a_i \mid i \in \mathbb{N})$ over A . Since (A, \rightarrow) is terminating, there exists $j \in \mathbb{N}$ such that $a_j = a_{j'}$ for every $j' \geq j$. For similar reasons, there exists $k \in \mathbb{N}$ such that $b_k = b_{k'}$ for every $k' \geq k$. Let $n = \max(j, k)$. Then, for every $n' \geq n$, we have $(a_n, b_n) = (a_{n'}, b_{n'})$. This is a contradiction, hence $(A \times A, \succ)$ is terminating. \square

In a number of cases, we will use a combination of Lemmas 2.5.2 and 2.5.3. This combination concerns reductions to strict substrings. For this scenario the following corollary holds.

Corollary 2.5.6. Let A be a set and (A^*, \rightarrow) be the reduction system such, for every $w_1, w_2 \in A^*$, we let $w_1 \rightarrow w_2$ if w_2 is a strict substring of w_1 , i.e., if there exist $u, v \in A^*$ with $w_1 = uw_2v$ and $uv \neq \varepsilon$. Moreover, let $B \subseteq A^*$, and $\succ \subseteq \rightarrow \cap (B \times B)$. Then also (B, \succ) is terminating.

Proof. First, we prove that (A^*, \rightarrow) is terminating. For this, we consider the length function $\varphi : A^* \rightarrow \mathbb{N}$, i.e., for each $w \in A^*$, $\varphi(w)$ is the length of w . Obviously, if $w_1 \rightarrow w_2$, then $\varphi(w_1) > \varphi(w_2)$. Hence φ is a monotone embedding of the reduction system (A^*, \rightarrow) into the terminating reduction system $(\mathbb{N}, >)$. Thus, by Lemma 2.5.2, the relation \rightarrow is terminating.

Second, Lemma 2.5.3 implies that (B, \succ) is terminating. \square

In those cases in which Corollary 2.5.6 applies, we will not show the monotone embedding explicitly, but just refer to this corollary.

2.6 Well-founded induction

Let (C, \succ) be a terminating reduction system. Moreover, let $P \subseteq C$ be a subset, called *property*. We will abbreviate the fact that $c \in P$ by $P(c)$ and say that c has the *property* P . Then the following holds:

$$\left((\forall c \in C) : [(\forall c' \in C) : (c \succ c') \Rightarrow P(c')] \Rightarrow P(c) \right) \Rightarrow \left((\forall c \in C) : P(c) \right). \quad (2.1)$$

The formula (2.1) is called the principle of *proof by well-founded induction on (C, \succ)* (for short: *proof by induction on (C, \succ)*). We can use this principle to prove the claim that each $c \in C$ has property P .

Often, the proof of the premise of (2.1), i.e., the formula

$$\left((\forall c \in C) : [(\forall c' \in C) : (c \succ c') \Rightarrow P(c')] \Rightarrow P(c) \right),$$

is split into two parts. Then the first part is the proof of the *induction base* (for short: I.B.)

$$(\forall c \in \text{nf}_{\succ}(C)) : P(c) \quad (2.2)$$

and the second part is the proof of the *induction step* (for short: I.S.)

$$\left((\forall c \in C \setminus \text{nf}_{\succ}(C)) : [(\forall c' \in C) : (c \succ c') \Rightarrow P(c')] \Rightarrow P(c) \right). \quad (2.3)$$

For each $c \in C$, the subformula

$$[(\forall c' \in C) : (c \succ c') \Rightarrow P(c')]$$

is called *induction hypothesis* (for short: I.H.).

There are several instances of terminating reduction systems and well-founded induction which are relevant for us. Two instances are based on the set \mathbb{N} of natural numbers and we present these instances here (later we will present two more instances which are based on the set of trees):

- *proof by induction on $(\mathbb{N}, \succ_{\mathbb{N}})$* (for short: proof by induction on \mathbb{N}): Then $\text{nf}_{\succ_{\mathbb{N}}}(\mathbb{N}) = \{0\}$, and the induction base (2.2) and the induction step (2.3) read

$$P(0) \text{ and } ((\forall n \in \mathbb{N}_+) : P(n-1) \Rightarrow P(n)) , \text{ respectively,}$$

- *proof by induction on $(\mathbb{N}, >)$* : Then $\text{nf}_{>}(\mathbb{N}) = \{0\}$, and the induction base (2.2) and the induction step (2.3) read

$$P(0) \text{ and } ((\forall n \in \mathbb{N}_+) : [(\forall k \in [0, n-1]) : P(k)] \Rightarrow P(n)) , \text{ respectively.}$$

We also use the principle of definition of a mapping by well-founded induction, which is based on the next theorem. Its historical predecessor is [Ded39, 126. *Satz der Definition durch Induktion*] (also cf. [Kla84, Thm. 1.17] and [Win93, Thm. 10.19]) and it is an instance of a more general result in basic set theory, cf. [Jec03, Thm. 6.11]. Our proof follows the lines of the proof of [Ind76, p. 1.8, *Rekursionssatz*]. We recall that $\succ(c)$ denotes the set $\{c' \in C \mid c \succ c'\}$ for each $c \in C$.

Theorem 2.6.1. (cf. [Ded39, 126. Satz]) *Let A be a set, (C, \succ) be a terminating reduction system, and $G : \{(c, g) \mid c \in C, g : \succ(c) \rightarrow A\} \rightarrow A$ a mapping. Then there exists exactly one mapping $f : C \rightarrow A$ such that, for each $c \in C$, we have*

$$f(c) = G(c, f|_{\succ(c)}) . \quad (2.4)$$

Proof. We define the set

$$S = \{T \subseteq C \times A \mid (\forall c \in C)(\forall g : \succ(c) \rightarrow A) : (g \subseteq T) \Rightarrow ((c, G(c, g)) \in T)\} . \quad (2.5)$$

We note that $S \neq \emptyset$ because $(C \times A) \in S$. Moreover, we define

$$\rho = \bigcap (T \mid T \in S) .$$

Next we show the following three statements.

- (1) ρ is a mapping of type $\rho : C \rightarrow A$,
- (2) for each $c \in C$, we have $\rho(c) = G(c, \rho|_{\succ(c)})$, and
- (3) for each mapping $h : C \rightarrow A$ for which $h(c) = G(c, h|_{\succ(c)})$ for each $c \in C$, we have $h = \rho$.

From (1)-(3) it follows that ρ is the desired mapping f , and hence we have proved the theorem.

Proof of (1): We define

$$M = \{c \in C \mid \text{there exists exactly one } a \in A \text{ such that } (c, a) \in \rho\} .$$

By induction on (C, \succ) , we show that $C \subseteq M$. For this, let $c \in C$.

I.B.: Let $c \in \text{nf}_{\succ}(C)$. Since $\succ(c) = \emptyset$, we have $(c, G(c, \emptyset)) \in T$ for each $T \in S$. Hence $(c, G(c, \emptyset)) \in \rho$. We show that $c \in M$ by contradiction.

We assume that there exists an $a \in A$ such that $a \neq G(c, \emptyset)$ and $(c, a) \in \rho$. Let $\rho' = \rho \setminus \{(c, a)\}$; hence $\rho' \subset \rho$. We show that $\rho' \in S$. For this, let $c' \in C$ and let $g : \succ(c') \rightarrow A$ be such that $g \subseteq \rho'$. Then for this c' and g we also have $g \subseteq \rho$. Then by the definition of ρ we have $(c', G(c', g)) \in \rho$. Now if $c' = c$, then $(c', G(c', g)) = (c, G(c, \emptyset)) \neq (c, a)$. Otherwise, again $(c', G(c', g)) \neq (c, a)$. Hence in both cases $(c', G(c', g)) \in \rho'$. Then $\rho' \in S$ and thus $\rho \subseteq \rho'$, which contradicts $\rho' \subset \rho$.

I.S.: Let $c \in C \setminus \text{nf}_{\succ}(C)$. By I.H., for each $c' \in \succ(c)$, we have $c' \in M$. Let $g = \{(c', a) \in \rho \mid c' \in \succ(c)\}$. Then, by the definition of ρ , for each $T \in S$, we have $g \subseteq T$ and hence for each $T \in S$, we also have $(c, G(c, g)) \in T$. Consequently, $(c, G(c, g)) \in \rho$. We show that $c \in M$ by contradiction.

We assume that there is an $a \in A$ such that $a \neq G(c, g)$ and $(c, a) \in \rho$. Let $\rho' = \rho \setminus \{(c, a)\}$; hence $\rho' \subset \rho$. We show that $\rho' \in S$. For this, let $\bar{c} \in C$ and let $g : \succ(\bar{c}) \rightarrow A$ be such that $g \subseteq \rho'$.

Then for this \bar{c} and g we also have $g \subseteq \rho$. Then by the definition of ρ we have $(\bar{c}, G(\bar{c}, g)) \in \rho$. If $\bar{c} = c$, then $(\bar{c}, G(\bar{c}, g)) = (c, G(c, g)) \neq (c, a)$. Otherwise, again $(\bar{c}, G(\bar{c}, g)) \neq (c, a)$. Hence in both cases $(\bar{c}, G(\bar{c}, g)) \in \rho'$. Then $\rho' \in S$ and thus $\rho \subseteq \rho'$, which contradicts $\rho' \subset \rho$.

Proof of (2): It is obvious that, for each $c \in C$, we have $\rho|_{\succ(c)} \subseteq \rho$. Hence, by the definition of ρ , for each $c \in C$, we have $\rho(c) = G(c, \rho|_{\succ(c)})$.

Proof of (3): Let $h : C \rightarrow A$ be a mapping for which $h(c) = G(c, h|_{\succ(c)})$ for each $c \in C$. By induction on (C, \succ) we show that, for each $c \in C$, we have $h(c) = \rho(c)$. Let $c \in C$. By I.H. for each $c' \in \succ(c)$, we have $h(c') = \rho(c')$. Hence, $h|_{\succ(c)} = \rho|_{\succ(c)}$ and thus $h(c) = G(c, h|_{\succ(c)}) = G(c, \rho|_{\succ(c)}) = \rho(c)$. \square

We say that the mapping f of Theorem 2.6.1 is *defined by well-founded induction on (C, \succ)* (for short: *defined by induction on (C, \succ)*).

The mapping $G : \{(c, g) \mid c \in C, g : \succ(c) \rightarrow A\} \rightarrow A$ which determines by Theorem 2.6.1 a unique mapping $f : C \rightarrow A$, might be called a *schema of primitive recursion*. Such schemata have been investigated, e.g., for $C = \mathbb{N}$ in [Pét57], for $C = \Gamma^*$ in [vHIRW75], for C being the set of trees over Σ in [Hup78, EV91, FHV93], and for C being a decomposition algebra in [Kla84].

In many applications of this principle, we will not show the mapping G explicitly, but only implicitly in the definition of f . Moreover, we will split (2.4) into an induction base and an induction step as follows:

I.B.: Let $c \in \text{nf}_{\succ}(C)$. Hence $\succ(c) = \emptyset$ and thus $f|_{\emptyset} : \emptyset \rightarrow A$. Then we define $f(c) = G(c, f|_{\emptyset})$. That means that $f(c)$ does not depend on elements of $\text{im}(f)$.

I.S.: Let $c \in C \setminus \text{nf}_{\succ}(C)$ and we assume that $f(c')$ is defined for each $c' \in \succ(c)$. Then we define $f(c) = G(c, f|_{\succ(c)})$. That means that $f(c)$ may depend on elements of $\{f(c') \mid c' \in \succ(c)\}$.

Next we demonstrate the principle of definition by well-founded induction. More precisely, given a mapping $h : D \rightarrow D$ for some set D , we define the \mathbb{N} -indexed family of iterated applications $(h^n \mid n \in \mathbb{N})$ of h using this principle.

For this we instantiate the objects C, \succ, A , and G which occur in the principle as follows: we let $C = \mathbb{N}$, $\succ = \succ_{\mathbb{N}}$, and $A = D^D$. Then G has the type

$$G : \{(n, g) \mid n \in \mathbb{N}, g : \succ_{\mathbb{N}}(n) \rightarrow D^D\} \rightarrow D^D .$$

We note that $\succ_{\mathbb{N}}(0) = \emptyset$ and, for each $n \in \mathbb{N}_+$, the set $\succ_{\mathbb{N}}(n) = \{n-1\}$. Now, for every $n \in \mathbb{N}$ and $g : \succ_{\mathbb{N}}(n) \rightarrow D^D$, we define

$$G(n, g) = \begin{cases} \text{id}_D & \text{if } n = 0 \\ h \circ g(n-1) & \text{if } n \in \mathbb{N}_+ . \end{cases}$$

By Theorem 2.6.1, there exists a unique mapping $f : \mathbb{N} \rightarrow D^D$ such that $f(n) = G(n, f|_{\succ_{\mathbb{N}}(n)})$. Finally, we define the \mathbb{N} -indexed family of iterated applications of a mapping $h : D \rightarrow D$, denoted by $(h^n \mid n \in \mathbb{N})$, by letting $h^n = f(n)$.

Thus, for $n = 0$, we have $h^0 = f(0) = G(0, f|_{\succ_{\mathbb{N}}(0)}) = \text{id}_D$. Moreover, for each $n \in \mathbb{N}_+$, we have

$$h^n = f(n) = G(n, f|_{\succ_{\mathbb{N}}(n)}) = G(n, f|_{\{n-1\}}) = h \circ f|_{\{n-1\}}(n-1) = h \circ f(n-1) = h \circ h^{n-1} .$$

Hence, the \mathbb{N} -indexed family of iterated applications of a mapping $h : D \rightarrow D$ satisfies the well known equations:

$$h^0 = \text{id}_D \text{ and } h^n = h \circ h^{n-1} \text{ for each } n \in \mathbb{N}_+ . \text{ In particular, } h^1 = h .$$

2.7 Algebraic structures

2.7.1 Universal algebras, subalgebras, congruences, and homomorphisms

We recall some notions from universal algebra [Grä68, GTWW77, BS81, Wec92].

A *universal algebra* is a pair $A = (A, \theta)$ where A is a set and θ is an I -indexed family over $\text{Ops}(A)$ for some set I . We call A the *carrier set* of A and we call each element of $\text{im}(\theta)$ an *operation* of A . If I is finite and $\text{im}(\theta) = \{f_1, \dots, f_n\}$, then we denote (A, θ) also by (A, f_1, \dots, f_n) (where we choose an arbitrary ordering among the operations of A).

Let $A = (A, \theta)$ be a universal algebra with $\theta : I \rightarrow \text{Ops}(A)$. The *type* of A (or: *signature* of A) is the mapping $\tau : I \rightarrow \mathbb{N}$ such that, for each $i \in I$, the number $\tau(i)$ is the arity of the operation $\theta(i)$. Then we also say that A is of type τ . Let $\tau : I \rightarrow \mathbb{N}$ be a mapping, then we denote the *set of all universal algebras of type τ* by $\mathbf{K}(\tau)$.

In the rest of this subsection, let $A = (A, \theta)$ be a universal algebra of type $\tau : I \rightarrow \mathbb{N}$ and with $\theta : I \rightarrow \text{Ops}(A)$.

Let $H \subseteq A$, let $f \in \text{im}(\theta) \cap \text{Ops}^k(A)$ for some $k \in \mathbb{N}$, and let $O \subseteq \text{im}(\theta)$. We say that H is *closed under f* if, for every $a_1, \dots, a_k \in H$, we have that $f(a_1, \dots, a_k) \in H$. We say that H is *closed under O* if, for each $f \in O$, the set H is closed under f . We denote by $\langle H \rangle_O$ the smallest subset B of A such that $H \subseteq B$ and B is closed under O , i.e.¹,

$$\langle H \rangle_O = \bigcap (B \subseteq A \mid H \subseteq B \text{ and } B \text{ is closed under } O) .$$

Let $H \subseteq A$. We denote by $\theta|_H$ the I -indexed family such that, for every $i \in I$, we have $\theta|_H(i) = \theta(i)|_{H^{\tau(i)}}$.

A *subalgebra* of A is a universal algebra $A' = (H, \theta|_H)$, where $H \subseteq A$. In order to avoid complex subscripts, we denote $(H, \theta|_H)$ also by (H, θ) .

Let $H \subseteq A$ such that $\langle H \rangle_{\text{im}(\theta)} \neq \emptyset$. The *subalgebra of A generated by H* is the universal algebra $(\langle H \rangle_{\text{im}(\theta)}, \theta)$. If $\langle H \rangle_{\text{im}(\theta)} = A$, then we say that A is *generated by H* or that H *generates A* . The set H is called *generator set* (of A).

We say that A is

- *finite* if A is finite,
- *locally finite* if, for each finite subset $H \subseteq A$, the set $\langle H \rangle_{\text{im}(\theta)}$ is finite, and
- *finitely generated* if there exists a finite subset $H \subseteq A$ such that $\langle H \rangle_{\text{im}(\theta)} = A$.

Lemma 2.7.1. Let $A = (A, \theta)$ be a universal algebra and $H \subseteq A$. Let $f : \mathcal{P}(A) \rightarrow \mathcal{P}(A)$ be defined for each $U \in \mathcal{P}(A)$ by

$$f(U) = U \cup \{g(u_1, \dots, u_k) \mid k \in \mathbb{N}, g \in \text{im}(\theta) \cap \text{Ops}^k(A), u_1, \dots, u_k \in U\} .$$

Then $\langle H \rangle_{\text{im}(\theta)} = \bigcup (f^n(H) \mid n \in \mathbb{N})$. Moreover, if $\langle H \rangle_{\text{im}(\theta)}$ is finite, then we can construct this set.

Proof. Obviously, for every $U, U' \in \mathcal{P}(A)$,

$$\text{for each } n \in \mathbb{N}, \text{ we have } f^n(U) \subseteq f^{n+1}(U), \text{ and} \tag{2.6}$$

$$\text{if } U \subseteq U' \text{ then } f(U) \subseteq f(U') . \tag{2.7}$$

Let us abbreviate $\bigcup (f^n(H) \mid n \in \mathbb{N})$ by V and show that $V = \langle H \rangle_{\text{im}(\theta)}$.

First we show that $f(V) \subseteq V$ as follows:

$$\begin{aligned} f(V) &= f\left(\bigcup (f^n(H) \mid n \in \mathbb{N})\right) \\ &= \bigcup (f^n(H) \mid n \in \mathbb{N}) \cup \{g(u_1, \dots, u_k) \mid k \in \mathbb{N}, g \in \text{im}(\theta) \cap \text{Ops}^k(A), (\forall i \in [k]) : u_i \in V\} \\ &= \bigcup (f^n(H) \mid n \in \mathbb{N}) \cup \{g(u_1, \dots, u_k) \mid k \in \mathbb{N}, g \in \text{im}(\theta) \cap \text{Ops}^k(A), (\forall i \in [k])(\exists n_i \in \mathbb{N}) : u_i \in f^{n_i}(H)\} \end{aligned}$$

¹Since $(\mathcal{P}(A), \cap, \cup, \emptyset, A)$ is a σ -complete lattice (cf. Example 2.7.15(1)), the right-hand side is well defined.

$$\begin{aligned}
&= \bigcup (f^n(H) \mid n \in \mathbb{N}) \cup \{g(u_1, \dots, u_k) \mid k \in \mathbb{N}, g \in \text{im}(\theta) \cap \text{Ops}^k(A), (\exists n \in \mathbb{N})(\forall i \in [k]) : u_i \in f^n(H)\} \\
&\hspace{25em} \text{(by (2.6))} \\
&= \bigcup (f^n(H) \cup \{g(u_1, \dots, u_k) \mid k \in \mathbb{N}, g \in \text{im}(\theta) \cap \text{Ops}^k(A), (\forall i \in [k]) : u_i \in f^n(H)\} \mid n \in \mathbb{N}) \\
&= \bigcup (f(f^n(H)) \mid n \in \mathbb{N}) = \bigcup (f^n(H) \mid n \in \mathbb{N}_+) \subseteq V .
\end{aligned}$$

Hence V is closed under the operations of $\text{im}(\theta)$. Since $\langle H \rangle_{\text{im}(\theta)}$ is the smallest subset of A with this property, we have $\langle H \rangle_{\text{im}(\theta)} \subseteq V$.

Next we prove the inclusion $V \subseteq \langle H \rangle_{\text{im}(\theta)}$. By induction on \mathbb{N} , we show that $f^n(H) \subseteq \langle H \rangle_{\text{im}(\theta)}$ for each $n \in \mathbb{N}$. The statement is obvious for $n = 0$. Then, for each $n \in \mathbb{N}$, we have

$$f^{n+1}(H) = f(f^n(H)) \subseteq f(\langle H \rangle_{\text{im}(\theta)}) \subseteq \langle H \rangle_{\text{im}(\theta)} ,$$

where the first inclusion follows from the I.H. and (2.7), and the second inclusion follows from the definition of $\langle H \rangle_{\text{im}(\theta)}$. Hence $V \subseteq \langle H \rangle_{\theta(\Sigma)}$.

For each $n \in \mathbb{N}$, if $f^n(H) = f^{n+1}(H)$, then $f^{n+1}(H) = f^{n+2}(H)$ obviously. Now assume that $\langle H \rangle_{\text{im}(\theta)}$ is finite. Then we can find $N \in \mathbb{N}$ such that $f^N(H) = f^{N+1}(H)$ and therefore $\langle H \rangle_{\text{im}(\theta)} = \bigcup (f^n(H) \mid n \in [0, N])$. Hence we can construct the set $\langle H \rangle_{\text{im}(\theta)}$. \square

Let $\sim \subseteq A \times A$ be an equivalence relation on A . We call \sim a *congruence relation on A* if the following holds: for every $k \in \mathbb{N}$, $f \in \text{im}(\theta) \cap \text{Ops}^k(A)$, $a_1, b_1, \dots, a_k, b_k \in A$, if $a_1 \sim b_1, \dots, a_k \sim b_k$, then $f(a_1, \dots, a_k) \sim f(b_1, \dots, b_k)$.

Let \sim a congruence relation on A . The *quotient algebra of A modulo \sim* , denoted by A/\sim , is the universal algebra $A/\sim = (A/\sim, \theta/\sim)$ of type τ , where A/\sim is the factor set of A modulo \sim and $\theta/\sim : I \rightarrow \text{Ops}(A/\sim)$ such that, for each $i \in I$ with $\tau(i) = k$ for some $k \in \mathbb{N}$, and for every $a_1, \dots, a_k \in A$ we have

$$(\theta/\sim)(i)([a_1]_\sim, \dots, [a_k]_\sim) = [\theta(i)(a_1, \dots, a_k)]_\sim .$$

Clearly, this operation is well defined, cf. [Grä68, p.36].

Let $A_1 = (A_1, \theta_1)$ and $A_2 = (A_2, \theta_2)$ be two universal algebras of the same type τ . Moreover, let $h : A_1 \rightarrow A_2$ be a mapping. Then h is an *algebra homomorphism* (from A_1 to A_2) if, for every $i \in I$ with $\tau(i) = k$ for some $k \in \mathbb{N}$, and for every $v_1, \dots, v_k \in A_1$, we have

$$h(\theta_1(i)(v_1, \dots, v_k)) = \theta_2(i)(\sigma)(h(v_1), \dots, h(v_k)) . \quad (2.8)$$

If h is bijective, then h is a *algebra isomorphism*. If there exists such an isomorphism, then we say that A_1 and A_2 are *isomorphic* and we denote this fact by $A_1 \cong A_2$.

Lemma 2.7.2. [Grä68, §7, Lm. 3] Let (A_1, θ_1) and (A_2, θ_2) be two universal algebras of the same type τ , and let $h : A_1 \rightarrow A_2$ be an algebra homomorphism. Then $\text{im}(h)$ is closed under the operations in $\text{im}(\theta_2)$. Hence $(\text{im}(h), \theta_2|_{\text{im}(h)})$ is a subalgebra of (A_2, θ_2) .

Theorem 2.7.3. [Grä68, §7, Lm. 5] Let (A_1, θ_1) , (A_2, θ_2) , and (A_3, θ_3) be three universal algebras. Moreover, let $h : A_1 \rightarrow A_2$ and $g : A_2 \rightarrow A_3$ be two algebra homomorphisms. Then $g \circ h$ is an algebra homomorphism.

Let h be an algebra homomorphism from (A_1, θ_1) to (A_2, θ_2) . The *kernel of h* , denoted by $\ker(h)$, is the equivalence relation on A_1 defined by $\ker(h) = \{(a_1, a_2) \in A_1 \times A_1 \mid h(a_1) = h(a_2)\}$.

Theorem 2.7.4. [Grä68, §7, Lm. 6], [Grä68, §11, Thm. 1] Let h be an algebra homomorphism from $A_1 = (A_1, \theta_1)$ to $A_2 = (A_2, \theta_2)$. Then $\ker(h)$ is a congruence relation on A_1 . Moreover, if h is surjective, then $A_1/\ker(h) \cong A_2$.

Let $\tau : I \rightarrow \mathbb{N}$ be a mapping and let $\mathcal{K} \subseteq \mathbf{K}(\tau)$ be a set of universal algebras of type τ . Moreover, let $A = (A, \theta)$ be a universal algebra and let $H \subseteq A$. The algebra A is called *free in \mathcal{K} with generating set H* if the following conditions hold:

- (a) $A \in \mathcal{K}$,
- (b) A is generated by H , and
- (c) for every universal algebra $A' = (A', \theta')$ in \mathcal{K} and mapping $f: H \rightarrow A'$, there exists a unique extension of f to an algebra homomorphism $h: A \rightarrow A'$ from A to A' .

If A is free in \mathcal{K} with generating set $H = \emptyset$, then, for each $A' = (A', \theta')$ in \mathcal{K} , there exists exactly one algebra homomorphism $h: A \rightarrow A'$ from A to A' . In this case A is called *initial in \mathcal{K}* .

Theorem 2.7.5. [Grä68, §24, Thm. 1] *Let τ be a type and let $\mathcal{K} \subseteq \mathbf{K}(\tau)$ be a set of universal algebras of type τ . Any two algebras which are free in \mathcal{K} with the same generator set are isomorphic.*

2.7.2 Ranked alphabets and Σ -algebras

A *ranked alphabet* is a pair (Σ, rk) , where

- Σ is an alphabet and
- $\text{rk} : \Sigma \rightarrow \mathbb{N}$ is a mapping, called *rank mapping*, such that $\text{rk}^{-1}(0) \neq \emptyset$.

For each $k \in \mathbb{N}$, we denote the set $\text{rk}^{-1}(k)$ by $\Sigma^{(k)}$. Sometimes we write $\sigma^{(k)}$ to indicate that $\sigma \in \Sigma^{(k)}$. We denote $\max\{k \in \mathbb{N} \mid \Sigma^{(k)} \neq \emptyset\}$ by $\text{maxrk}(\Sigma)$. Whenever the rank mapping is clear from the context or it is irrelevant, then we abbreviate the ranked alphabet (Σ, rk) by Σ .

Let Σ be a ranked alphabet. We say that Σ is

- *trivial* if $\Sigma = \Sigma^{(0)}$,
- *monadic* if $\Sigma = \Sigma^{(1)} \cup \Sigma^{(0)}$,
- a *string ranked alphabet* if it is monadic, $\Sigma^{(1)} \neq \emptyset$, and $|\Sigma^{(0)}| = 1$, and
- *branching* if there exists $k \in \mathbb{N}$ such that $k \geq 2$ and $\Sigma^{(k)} \neq \emptyset$.

The following table shows some examples of ranked alphabets.

	$\{\alpha^{(0)}, \beta^{(0)}\}$	$\{\alpha^{(0)}, \gamma^{(1)}, \delta^{(1)}\}$	$\{\alpha^{(0)}, \beta^{(0)}, \gamma^{(1)}, \delta^{(1)}\}$	$\{\alpha^{(0)}, \gamma^{(1)}, \sigma^{(3)}\}$
trivial	yes	no	no	no
string ranked alphabet	no	yes	no	no
monadic	yes	yes	yes	no
branching	no	no	no	yes

Let (Σ, rk) be a ranked alphabet. A Σ -*algebra* is a universal algebra (A, θ) of type $\text{rk} : \Sigma \rightarrow \mathbb{N}$. We denote the set of all Σ -algebras by $\mathbf{K}(\Sigma)$.

Let A_1 and A_2 be Σ -algebras and h an algebra homomorphism (algebra isomorphism) from A_1 to A_2 . Then we call h a Σ -*algebra homomorphism* (Σ -*algebra isomorphism*, respectively).

2.7.3 Properties of binary operations

Let B be a nonempty set. Let \odot be a binary operation on B . The operation \odot is

- *associative* if $(a \odot b) \odot c = a \odot (b \odot c)$ for every $a, b, c \in B$,
- *commutative* if $a \odot b = b \odot a$ for every $a, b \in B$,
- *idempotent* if $a \odot a = a$ for each $a \in B$,
- *extremal* if $a \odot b \in \{a, b\}$ for every $a, b \in B$.

Obviously, extremal implies idempotent. The other direction does not hold, e.g., the set union \cup is idempotent but in general not extremal.

An element $e \in B$ is an *identity element* (of \odot) if $e \odot a = a \odot e = a$ for every $a \in B$. There is at most one identity element. Let $e \in B$ be an identity element and $a \in B$. An element $\bar{a} \in B$ is an *inverse of a*

(with respect to \odot) if $a \odot \bar{a} = \bar{a} \odot a = e$. If an inverse of a exists, then we also say that a has an inverse. If \odot is associative, then each element has at most one inverse.

Let \oplus and \otimes be two binary operations on B . The operation \otimes is

- *right-distributive* (with respect to \oplus), if $(a \oplus b) \otimes c = (a \otimes c) \oplus (b \otimes c)$ for every $a, b, c \in B$,
- *left-distributive* (with respect to \oplus), if $a \otimes (b \oplus c) = (a \otimes b) \oplus (a \otimes c)$ for every $a, b, c \in B$,
- *distributive* (with respect to \oplus) if it is both right-distributive and left-distributive (with respect to \oplus).

Clearly, if \otimes is commutative, then right-distributivity implies left-distributivity and vice versa. Moreover, \oplus and \otimes satisfy the *absorption axiom* if

- $a \otimes (a \oplus b) = a$ and $a \oplus (a \otimes b) = a$ for every $a, b \in B$.

2.7.4 Semigroups, monoids, and groups

In this subsection we recall the definitions of semigroups, monoids, and groups; they are particular universal algebras (cf. Subsection 2.7.1). Moreover, we define extensions of the underlying binary operations to finitely many and countably many arguments.

- A *semigroup* is an algebra (B, \odot) where \odot is an associative binary operation on B .
- A *monoid* is an algebra (B, \odot, e) where (B, \odot) is a semigroup and e is an element of B which is an identity element of \odot . We note that the identity element e can be considered as a nullary operation on B .
- A *group* is a monoid (B, \odot, e) such that each $a \in B$ has an inverse. We note that the inverses of the elements can be defined in terms of a unary operation on B .

The semigroup (B, \odot) is *commutative* if \odot is commutative. Similarly, we define commutative monoids and commutative groups.

Observation 2.7.6. Let (B, \odot) be a semigroup such that \odot is commutative and idempotent. Then (B, \odot) is locally finite.

Proof. Let H be a finite subset of B . We note that $\langle H \rangle_{\{\odot\}} = \{b_1 \odot \dots \odot b_n \mid n \in \mathbb{N}_+, b_1, \dots, b_n \in H\}$. Let us abbreviate this set by $\langle H \rangle$.

By induction on $(\mathbb{N}_+, \succ_{\mathbb{N}_+})$, where $\succ_{\mathbb{N}_+} = \{(n+1, n) \mid n \in \mathbb{N}_+\}$, we prove the following statement.

$$\begin{aligned} &\text{For each } n \in \mathbb{N}_+ \text{ and every } b_1, \dots, b_n \in H, \text{ there exist } m \in \mathbb{N}_+ \\ &\text{and pairwise different } c_1, \dots, c_m \in H \text{ such that } b_1 \odot \dots \odot b_n = c_1 \odot \dots \odot c_m. \end{aligned} \quad (2.9)$$

I.B.: For $n = 1$ the statement is trivially true.

I.S.: Let $b = b_1 \odot \dots \odot b_{n+1}$ with $n \in \mathbb{N}_+$. By I.H. there exist $m \in \mathbb{N}_+$ and pairwise different $c_1, \dots, c_m \in H$ such that $b_1 \odot \dots \odot b_n = c_1 \odot \dots \odot c_m$.

If $b_{n+1} \notin \{c_1, \dots, c_m\}$, then (2.9) holds with $m+1$ by letting $c_{m+1} = b_{n+1}$. Otherwise $b_{n+1} = c_i$ for some $i \in [m]$. Then, by commutativity and idempotency, we have

$$b_1 \odot \dots \odot b_{n+1} = c_1 \odot \dots \odot c_m \odot b_{n+1} = c_1 \odot \dots \odot c_i \odot b_{n+1} \odot \dots \odot c_m = c_1 \odot \dots \odot c_m .$$

Thus (2.9) holds with m . This proves (2.9). Since H is finite, by (2.9) also $\langle H \rangle$ is finite. \square

Next we consider a monoid (B, \odot, e) and formalize two ways of extending \odot to finitely many arguments. Let I be a finite set with $I = \{i_1, \dots, i_k\}$ for some $k \in \mathbb{N}$. If (a) $I \subseteq \mathbb{N}$ and $i_1 < \dots < i_k$, where $<$ is the usual total order “less than” on natural numbers or (b) \odot is commutative, then we define the operation $\odot_I : B^I \rightarrow B$ such that, for each I -indexed family $(b_i \mid i \in I)$ of elements in B , we have

$$\odot_I(b_i \mid i \in I) = \begin{cases} b_{i_1} \odot \dots \odot b_{i_k} & \text{if } I \neq \emptyset \\ e & \text{otherwise .} \end{cases} \quad (2.10)$$

We abbreviate $\bigodot_I(b_i \mid i \in I)$ by $\bigodot(b_i \mid i \in I)$ or $\bigodot_{i \in I} b_i$. Thus, in particular, $\bigodot_{i \in [k]} b_i = b_1 \odot \dots \odot b_k$ for each $k \in \mathbb{N}_+$, and $\bigodot_{i \in \emptyset} b_i = e$.

Observation 2.7.7. Let I be a finite and nonempty index set such that $I \subseteq \mathbb{N}$ or \odot is commutative. If \odot is extremal, then for each I -indexed family $(b_i \mid i \in I)$ over B there exists a $j \in I$ such that $b_j = \bigodot_{i \in I} b_i$. \square

Next let (B, \odot, e) be commutative. We introduce a notation for the case that the index set is the Cartesian product of two sets as follows. Let I and J be finite sets and $(b_{(i,j)} \mid (i,j) \in I \times J)$ be an $(I \times J)$ -indexed family over B . Then it follows from commutativity and associativity that

$$\bigodot_{(i,j) \in I \times J} b_{(i,j)} = \bigodot_{i \in I} \bigodot_{j \in J} b_{(i,j)} .$$

Often we will abbreviate the expression $\bigodot_{i \in I} \bigodot_{j \in J} b_{(i,j)}$ by $\bigodot_{i \in I, j \in J} b_{(i,j)}$. We will use this kind of abbreviation also in the case where the index set is the Cartesian product of finitely many sets.

Finally, we consider a commutative monoid (B, \odot, e) and identify algebraic laws such that \odot can be extended to countably many arguments. We call (B, \odot, e) σ -complete if, for each countable index set I , there exists a mapping $\sum_I^\odot : B^I \rightarrow B$ such that for each I -indexed family $(b_i \mid i \in I)$ over B the equalities (2.11) and (2.12) below are satisfied (cf. [Eil74, p. 124]) using $\sum_{i \in I}^\odot b_i$ as abbreviation for

$$\sum_I^\odot (b_i \mid i \in I):$$

$$\text{If } I = \{j\}, \text{ then } \sum_{i \in I}^\odot b_i = b_j, \quad \text{and if } I = \{j, j'\}, \text{ then } \sum_{i \in I}^\odot b_i = b_j \odot b_{j'} \quad (2.11)$$

$$\sum_{i \in I}^\odot b_i = \sum_{j \in J}^\odot \left(\sum_{i \in I_j}^\odot b_i \right) \text{ for every countable set } J \text{ and partitioning } (I_j \mid j \in J) \text{ of } I. \quad (2.12)$$

Observation 2.7.8. Let (B, \odot, e) be a σ -complete monoid. The following statements hold.

- (1) For each \emptyset -indexed family $(b_i \mid i \in \emptyset)$ over B , we have $\sum_{j \in \emptyset}^\odot b_j = e$.
- (2) For each finite I -indexed family $(b_i \mid i \in I)$ of elements of B , we have $\sum_{i \in I}^\odot b_i = \bigodot_{i \in I} b_i$.
- (3) For each countable index set I , we have $\sum_{j \in I}^\odot e = e$.

Proof. Proof of (1): Let $I = \{1\}$. We consider the I -indexed family $(b_i \mid i \in I)$ over B where b_1 is an arbitrary element of B (recall that $B \neq \emptyset$). Moreover, let $J = \{1, 2\}$, $I_1 = \emptyset$, and $I_2 = I$. Then we have

$$b_1 = \sum_{i \in I}^\odot b_i \quad (\text{by (2.11)})$$

$$= \sum_{j \in J}^\odot \left(\sum_{i \in I_j}^\odot b_i \right) = \left(\sum_{i \in I_1}^\odot b_i \right) \odot \left(\sum_{i \in I_2}^\odot b_i \right) \quad (\text{by (2.12)})$$

$$= \left(\sum_{i \in \emptyset}^\odot b_i \right) \odot b_1 . \quad (\text{by (2.11)})$$

Since \odot is commutative, also $b_1 \odot (\sum_{i \in \emptyset}^{\odot} b_i) = b_1$. Hence $\sum_{i \in \emptyset}^{\odot} b_i$ is an identity element, and hence $\sum_{i \in \emptyset}^{\odot} b_i = e$.

Proof of (2): Let $(b_i \mid i \in I)$ be a finite I -indexed family of elements of B . If $I = \emptyset$, then the statement follows from Statement (1) and (2.10). If $I \neq \emptyset$, then we can prove by induction on \mathbb{N} the following statement:

$$\text{For every } n \in \mathbb{N} \text{ and index set } I \text{ with } |I| = n + 1, \text{ we have } \sum_{i \in I}^{\odot} b_i = \bigodot_{i \in I} b_i \quad (2.13)$$

I.B.: For $n = 0$, this follows from (2.11) and (2.10).

I.S.: Now let $n \in \mathbb{N}_+$ and $|I| = n + 1$. Moreover, let $(b_i \mid i \in I)$ be a finite I -indexed family of elements of B . Let $i' \in I$ be an arbitrary index. Using $J = \{1, 2\}$ and $I_1 = \{i'\}$ and $I_2 = I \setminus \{i'\}$, we have:

$$\begin{aligned} \sum_{i \in I}^{\odot} b_i &= \sum_{j \in J}^{\odot} (\sum_{i \in I_j}^{\odot} b_i) = (\sum_{i \in \{i'\}}^{\odot} b_i) \odot (\sum_{i \in I \setminus \{i'\}}^{\odot} b_i) && \text{(by (2.12))} \\ &= b_{i'} \odot \bigodot_{i \in I \setminus \{i'\}} b_i && \text{(by (2.11) and I.H.)} \\ &= \bigodot_{i \in I} b_i . \end{aligned}$$

Then Statement (2) follows from (2.13).

Proof of (3): Let $I_j = \emptyset$ for every $j \in I$. Then $(I_j \mid j \in I)$ is a partitioning of \emptyset . Hence we have

$$\begin{aligned} \sum_{j \in I}^{\odot} e &= \sum_{j \in I}^{\odot} (\bigodot_{i \in I_j} e) && \text{(by (2.10))} \\ &= \sum_{j \in I}^{\odot} (\sum_{i \in I_j}^{\odot} e) && \text{(by Statement (2))} \\ &= \sum_{j \in \emptyset}^{\odot} e && \text{(because } \bigcup_{j \in I} I_j = \emptyset \text{ and by (2.12))} \\ &= e && \text{(by Statement (1))} \end{aligned}$$

□

Let $(b_i \mid i \in I)$ be an I -indexed family over B . Moreover, let $P \subseteq B$ be a property. Then we denote by $(b_i \mid i \in I, b_i \in P)$ the I' -indexed family $(b_i \mid i \in I')$ over B where $I' = \{i \in I \mid b_i \in P\}$. Also, we abbreviate $\bigodot(b_i \mid i \in I, b_i \in P)$ by $\bigodot_{\substack{i \in I: \\ b_i \in P}} b_i$, and we abbreviate $\sum_I^{\odot}(b_i \mid i \in I, b_i \in P)$ by $\sum_{\substack{i \in I: \\ b_i \in P}}^{\odot} b_i$.

Let (B, \odot, e) be a monoid and $b \in B$. By induction on $(\mathbb{N}, \succ_{\mathbb{N}})$, we define the *family of powers of b* , denoted by $(b^n \mid n \in \mathbb{N})$, to be the \mathbb{N} -indexed family over B defined such that

$$b^0 = e \quad \text{and, for each } n \in \mathbb{N}, \text{ we let } b^{n+1} = b \odot b^n .$$

An element $b \in B$ has *finite order* if $\langle b \rangle_{\{\odot\}}$ is finite. If this is the case, then there exists a least number $i \in \mathbb{N}_+$ such that $b^i = b^{(i+k)}$ for some $k \in \mathbb{N}_+$, and there exists a least number $p \in \mathbb{N}_+$ such that $b^i = b^{(i+p)}$. We call i and p the *index (of b)* and the *period (of b)*, respectively, and denote them by $i(b)$ and $p(b)$, respectively. Moreover, we call $i(b) + p(b) - 1$, i.e., the number of elements of $\langle b \rangle_{\{\odot\}}$, the *order of b* (cf. Figure 2.3). In particular, the order of e is 1 because $i(e) = p(e) = 1$.

Also, if \odot is idempotent, then each $b \in B$ has finite order because $\langle b \rangle_{\{\odot\}} = \{b\}$ is finite. Then, for each $b \in B$, the index of b , the period of b , and the order of b are 1.

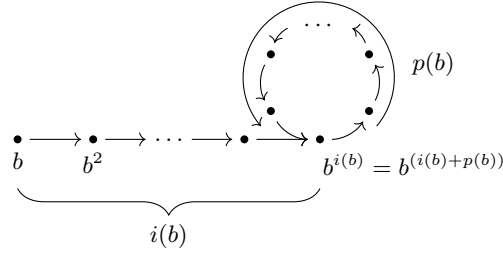

Figure 2.3: Illustration of the index $i(b)$ and the period $p(b)$ of b (cf. [FKV21, Fig. 1]).

2.7.5 Strong bimonoids, semirings, rings, and fields

A *strong bimonoid* [DSV10, Rad10, CDIV10, DV10, DV12] is an algebra $\mathbf{B} = (B, \oplus, \otimes, 0, \mathbb{1})$ where $(B, \oplus, 0)$ is a commutative monoid, $(B, \otimes, \mathbb{1})$ is a monoid, $0 \neq \mathbb{1}$, and 0 is an annihilator for \otimes , i.e., $b \otimes 0 = 0 \otimes b = 0$ holds for every $b \in B$. The operations \oplus and \otimes are called *summation* and *multiplication*, respectively.

Let $\mathbf{B} = (B, \oplus, \otimes, 0, \mathbb{1})$ be a strong bimonoid. It is

- *commutative*, if \otimes is commutative,
- *left-distributive*, if \otimes is left-distributive (with respect to \oplus),
- *right-distributive*, if \otimes is right-distributive (with respect to \oplus),
- *distributive*, if \otimes is left-distributive and right-distributive (with respect to \oplus),
- σ -*complete* if $(B, \oplus, 0)$ is σ -complete, and ,
- *bi-locally finite* if $(B, \oplus, 0)$ and $(B, \otimes, \mathbb{1})$ are locally finite.
- *weakly locally finite* if, for every finite subset $A \subseteq B$, the set $\text{wcl}(A)$, called the *weak closure* of A , is finite, where $\text{wcl}(A)$ is the smallest subset $C \subseteq B$ such that $A \cup \{0, \mathbb{1}\} \subseteq C$, and $(b \oplus b') \in C$ and $(b \otimes a) \in C$ for every $a \in A$ and $b, b' \in C$.

We declare that the precedence order of the two operations in expressions as follows: first \otimes , second \oplus . Using this convention, we can save some parentheses in expressions over \mathbf{B} which use both operations. For instance

$$\bigoplus_{i \in I} (b_i \otimes b) \text{ can be written as } \bigoplus_{i \in I} b_i \otimes b$$

for each finite index set I , I -indexed family $(b_i \mid i \in I)$, and $b \in B$. Similarly, if \mathbf{B} is σ -complete, then

$$\sum_{i \in I}^{\oplus} (b_i \otimes b) \text{ can be written as } \sum_{i \in I}^{\oplus} b_i \otimes b$$

for each countable index set I , I -indexed family $(b_i \mid i \in I)$, and $b \in B$.

A *semiring* [HW93, Gol99] is a strong bimonoid $\mathbf{B} = (B, \oplus, \otimes, 0, \mathbb{1})$ which is distributive. Clearly, if \mathbf{B} is a semiring, then for every finite and nonempty family $(b_i \mid i \in I)$ and $b \in B$ the following equalities hold: $\bigoplus_{i \in I} b \otimes b_i = b \otimes (\bigoplus_{i \in I} b_i)$ and $\bigoplus_{i \in I} b_i \otimes b = (\bigoplus_{i \in I} b_i) \otimes b$.

A semiring $(B, \oplus, \otimes, 0, \mathbb{1})$ is σ -*complete* if $(B, \oplus, 0)$ is σ -complete and the following equalities hold for every countable index set I , I -indexed family $(b_i \mid i \in I)$, and $b \in B$:

$$\sum_{i \in I}^{\oplus} b \otimes b_i = b \otimes \left(\sum_{i \in I}^{\oplus} b_i \right) \text{ and } \sum_{i \in I}^{\oplus} b_i \otimes b = \left(\sum_{i \in I}^{\oplus} b_i \right) \otimes b . \quad (2.14)$$

We note that for semirings σ -completeness is slightly more general than completeness (cf. e.g. [Eil74, p. 125] and [EK03]) because completeness requires the extension of \oplus not only for countable but arbitrary index sets I .

Let $(B, \oplus, \otimes, 0, \mathbb{1})$ be a semiring. It is a

- *ring* if $(B, \oplus, 0)$ is a commutative group (where we usually denote the inverse of $a \in B$ with respect to \oplus by $-a$),
- *semifield* (or: *division semiring*) if $(B \setminus \{0\}, \otimes, 1)$ is a group (where we usually denote the inverse of $a \in B$ with respect to \otimes by a^{-1}), and
- *field* if it is a ring and a commutative semifield.

Next we give a number of examples. We start with examples of semirings because they are more familiar than strong bimonoids.

Example 2.7.9. Here we show examples of semirings, rings, semifields, and fields. If an example shows a σ -complete semiring, i.e., there exists a mapping \sum^{\oplus} which satisfies equalities (2.11), (2.12), and (2.14), then we give such a mapping.

1. The *Boolean semiring* $\mathbf{Boole} = (\mathbb{B}, \vee, \wedge, 0, 1)$, where $\mathbb{B} = \{0, 1\}$ (the truth values) and \vee and \wedge denote disjunction and conjunction, respectively. The Boolean semiring \mathbf{Boole} is σ -complete with the mapping

$$\sum_I^{\vee} : \mathbb{B}^I \rightarrow \mathbb{B} \quad \text{with} \quad (b_i \mid i \in I) \mapsto \begin{cases} 1 & \text{if there exists } i \in I \text{ such that } b_i = 1 \\ 0 & \text{otherwise .} \end{cases}$$

We note that \mathbf{Boole} is a semifield.

2. The semiring $\mathbf{Nat} = (\mathbb{N}, +, \cdot, 0, 1)$ of natural numbers, where $+$ and \cdot are the usual addition and multiplication.
3. The semiring $\mathbf{Nat}_{\infty} = (\mathbb{N}_{\infty}, +, \cdot, 0, 1)$ of natural numbers, where $+$ and \cdot are extended to \mathbb{N}_{∞} in the natural way. The semiring \mathbf{Nat}_{∞} is σ -complete with the mapping

$$\sum_I^{+} : (\mathbb{N}_{\infty})^I \rightarrow \mathbb{N}_{\infty} \quad \text{with} \quad (n_i \mid i \in I) \mapsto \begin{cases} \dagger_{i \in J} n_i & \text{if } \{n_i \mid i \in I\} \subseteq \mathbb{N} \text{ and} \\ & J = \{i \in I \mid n_i \neq 0\} \text{ is finite} \\ \infty & \text{otherwise .} \end{cases}$$

(We recall that \dagger denotes the extension of $+$ to finite sums in the monoid $(\mathbb{N}, +, 0)$.)

4. The ring $\mathbf{Int} = (\mathbb{Z}, +, \cdot, 0, 1)$ of integers.
5. The ring $\mathbf{Intmod4} = (\{0, 1, 2, 3\}, +_4, \cdot_4, 0, 1)$ where $+_4$ and \cdot_4 are the usual addition modulo 4 and the usual multiplication modulo 4, respectively.
6. The field $\mathbf{Rat} = (\mathbb{Q}, +, \cdot, 0, 1)$ of rational numbers and the field $\mathbf{Real} = (\mathbb{R}, +, \cdot, 0, 1)$ of real numbers.
7. There exist only two semirings $(\{0, 1\}, \oplus, \otimes, 0, 1)$ with exactly two elements because, for every $a, b \in \{0, 1\}$ and $\odot \in \{\oplus, \otimes\}$, the value of $a \odot b$ is determined by the strong bimonoid axioms, except the value of $1 \oplus 1$.
 - (a) If we define $1 \oplus 1 = 0$, then $(\{0, 1\}, \oplus, \otimes, 0, 1)$ is a field, denoted by F_2 ; we have $-0 = 0$ and $-1 = 1^{-1} = 1$.
 - (b) If we define $1 \oplus 1 = 1$, then $(\{0, 1\}, \oplus, \otimes, 0, 1)$ is the Boolean semiring \mathbf{Boole} .
8. The *arctic semiring* $\mathbf{Nat}_{\max,+} = (\mathbb{N}_{-\infty}, \max, +, -\infty, 0)$. The arctic semiring is often called max-plus semiring.
9. The semiring $\mathbf{Nat}_{\max,+} = ([0, n]_{-\infty}, \max, \hat{+}_n, -\infty, 0)$ where $n \in \mathbb{N}_+$, $[0, n]_{-\infty} = [0, n] \cup \{-\infty\}$, and $b_1 \hat{+}_n b_2 = \min(b_1 + b_2, n)$ for every $b_1, b_2 \in [0, n]_{-\infty}$ [Gol99, Ex. 1.8]. The semiring $\mathbf{Nat}_{\max,+}$ is σ -complete with the mapping

$$\sum_I^{\max} : ([0, n]_{-\infty})^I \rightarrow [0, n]_{-\infty} \quad \text{with} \quad (n_i \mid i \in I) \mapsto \sup(n_i \mid i \in I) .$$

10. The *tropical semiring* $\mathbf{Nat}_{\min,+} = (\mathbb{N}_\infty, \min, +, \infty, 0)$ over \mathbb{N} . The tropical semiring $\mathbf{Nat}_{\min,+}$ is σ -complete with the mapping

$$\sum_I^{\min} : (\mathbb{N}_\infty)^I \rightarrow \mathbb{N}_\infty \quad \text{with} \quad (n_i \mid i \in I) \mapsto \inf(n_i \mid i \in I) .$$

The tropical semiring is often called the min-plus semiring.

11. The semiring $\mathbf{Nat}_{\max,\min} = (\mathbb{N}_\infty, \max, \min, 0, \infty)$. It is σ -complete with the mapping

$$\sum_I^{\max} : (\mathbb{N}_\infty)^I \rightarrow \mathbb{N}_\infty \quad \text{with} \quad (n_i \mid i \in I) \mapsto \begin{cases} \sup(n_i \mid i \in I) & \text{if } \{n_i \mid i \in I\} \subseteq \mathbb{N} \text{ and} \\ & \text{it is finite} \\ \infty & \text{otherwise .} \end{cases}$$

12. The *semiring of formal languages* $\mathbf{Lang}_\Gamma = (\mathcal{P}(\Gamma^*), \cup, \cdot, \emptyset, \{\varepsilon\})$ where \cdot denotes the concatenation of languages. The semiring \mathbf{Lang}_Γ is σ -complete with the mapping

$$\sum_I^\cup : \mathcal{P}(\Gamma^*)^I \rightarrow \mathcal{P}(\Gamma^*) \quad \text{with} \quad (L_i \mid i \in I) \mapsto \bigcup_{i \in I} L_i .$$

13. The *Viterbi semiring* $\mathbf{Viterbi} = ([0, 1], \max, \cdot, 0, 1)$ where $[0, 1]$ denotes the set $\{r \in \mathbb{R} \mid 0 \leq r \leq 1\}$ of real numbers². The Viterbi semiring is σ -complete with the mapping

$$\sum_I^{\max} : [0, 1]^I \rightarrow [0, 1] \quad \text{with} \quad (r_i \mid i \in I) \mapsto \sup(r_i \mid i \in I) .$$

The Viterbi semiring can be used for calculations with probabilities, and it is isomorphic to $(\mathbb{R}_{\geq 0, \infty}, \min, +, \infty, 0)$ where $\mathbb{R}_{\geq 0, \infty}$ denotes the set $\{r \in \mathbb{R} \mid r \geq 0\} \cup \{\infty\}$. The isomorphism from $[0, 1]$ to $[0, \infty]$ is $x \mapsto -\ln(x)$.

14. The *tropical semifield* $\mathbf{Int}_{\min,+} = (\mathbb{Z}_\infty, \min, +, \infty, 0)$ over \mathbb{Z} , and correspondingly the *tropical semifield* $\mathbf{Rat}_{\min,+} = (\mathbb{Q}_\infty, \min, +, \infty, 0)$ over \mathbb{Q} .

15. The semifields $\mathbf{Rat}_{\geq 0} = (\mathbb{Q}_{\geq 0}, +, \cdot, 0, 1)$ and $\mathbf{Real}_{\geq 0} = (\mathbb{R}_{\geq 0}, +, \cdot, 0, 1)$.

16. The *log semifield* $(\mathbb{R}_{-\infty}, \oplus, +, -\infty, 0)$ with $x \oplus y = \ln(e^x + e^y)$.

17. Let $\mathbf{B} = (B, \otimes, \mathbb{1})$ be a monoid. In the canonical way, we extend the operation \otimes to finite sets of elements of B , i.e., for every $A_1, A_2 \in \mathcal{P}_{\text{fin}}(B)$ we let $A_1 \otimes A_2 = \{a \otimes b \mid a \in A_1, b \in A_2\}$. Then the algebraic structure $(\mathcal{P}_{\text{fin}}(B), \cup, \otimes, \emptyset, \{\mathbb{1}\})$ is a semiring. We denote it by $\mathbf{Sem}(\mathbf{B})$.

18. Let A be a set. Then $\mathbf{PS}_A = (\mathcal{P}(A), \cup, \cap, \emptyset, A)$ is a semiring. It is σ -complete with the mapping

$$\sum_I^\cup : \mathcal{P}(A)^I \rightarrow \mathcal{P}(A) \quad \text{with} \quad (A_i \mid i \in I) \mapsto \bigcup_{i \in I} A_i .$$

Moreover, the monoid $(\mathcal{P}(A), \cap, A)$ is σ -complete with the mapping

$$\sum_I^\cap : \mathcal{P}(A)^I \rightarrow \mathcal{P}(A) \quad \text{with} \quad (A_i \mid i \in I) \mapsto \bigcap_{i \in I} A_i .$$

In the literature (e.g., [Grä68, p. 4]), often the expressions $\sum_I^\cup(A_i \mid i \in I)$ and $\sum_{i \in I}^\cup A_i$ are written as $\bigcup(A_i \mid i \in I)$. Similarly, $\sum_I^\cap(A_i \mid i \in I)$ and $\sum_{i \in I}^\cap A_i$ are written as $\bigcap(A_i \mid i \in I)$. In this book, we will also use these notations from the literature.

²not to be confused with the set $[0, 1] = \{0, 1\}$ of natural numbers.

19. Let $\mathbf{B} = (B, \oplus, \otimes, 0, \mathbb{1})$ be a semiring and $X_k = \{x_1, \dots, x_k\}$ for some $k \in \mathbb{N}$. Then

$$\mathbf{B}[x_1, \dots, x_k] = (B[x_1, \dots, x_k], \oplus, \cdot, p_0, p_1)$$

is a semiring, called *polynomial semiring (over k variables with coefficients in B)*, where $B[x_1, \dots, x_k]$ is the set of all mappings $p : X_k^* \rightarrow B$ such that the set $\{w \in X_k^* \mid p(w) \neq 0\}$ is finite. Each element $p \in B[x_1, \dots, x_k]$ is called *polynomial (over k variables)*. If $|\{w \in X_k^* \mid p(w) \neq 0\}| \leq 1$, then p is called a *monomial*.

Let p and q be polynomials in $B[x_1, \dots, x_k]$. We define the *summation of p and q* , denoted by $p \oplus q$, for each $u \in X_k^*$, by

$$(p \oplus q)(u) = p(u) \oplus q(u) .$$

We define the *Cauchy product of p and q* , denoted by $p \cdot q$, for each $u \in X_k^*$, by

$$(p \cdot q)(u) = \bigoplus_{\substack{v, w \in X_k^* \\ u = vw}} p(v) \otimes q(w) .$$

Finally, the polynomials p_0 and p_1 are defined by

- $p_0(w) = 0$ for each $w \in X_k^*$ and
- $p_1(w) = \mathbb{1}$ if $w = \varepsilon$ and 0 otherwise.

If \mathbf{B} is commutative, then also $\mathbf{B}[x_1, \dots, x_k]$ is commutative, and if \mathbf{B} is a ring, then also $\mathbf{B}[x_1, \dots, x_k]$ is a ring.

(a) By taking $\mathbf{B} = \mathbf{Nat}$, we obtain the polynomial semiring $\mathbf{Nat}[x_1, \dots, x_k]$ over k variables with coefficients in \mathbb{N} . The semiring $\mathbf{Nat}[x_1, \dots, x_k]$ is free in the set of all semirings with generating set X_k (cf. e.g. [Wec92, Ex. 3 on p.166]). Clearly, $\mathbf{Nat}[x_1, \dots, x_k]$ is generated by X_k . Moreover, let $\mathbf{B} = (B, \oplus, \otimes, 0, \mathbb{1})$ be a semiring and $f : X_k \rightarrow B$ a mapping. Then f is extended in a unique way to a semiring homomorphism $\tilde{f} : \mathbf{N}[x_1, \dots, x_k] \rightarrow B$ by letting, for each $p \in \mathbf{N}[x_1, \dots, x_k]$,

$$\tilde{f}(p) = \bigoplus_{\substack{w \in X_k^* \\ p(w) \neq 0}} p(w) \bar{f}(w)$$

where $nb = b \oplus \dots \oplus b$ with n occurrences of b , and \bar{f} is the unique extension of f to a monoid homomorphism from the free monoid $(X_k^*, \circ, \varepsilon)$ to $(B, \otimes, \mathbb{1})$.

(b) For the special case that $k = 1$, we identify X_1^* with \mathbb{N} , and we abbreviate x_1 by x . Then,

$$\mathbf{B}[x] = (B[x], \oplus, \cdot, p_0, p_1)$$

is the polynomial semiring over one variable, and each element of $B[x]$ is a mapping $p : \mathbb{N} \rightarrow B$. We can denote such a polynomial by $a_n \cdot x^n \oplus \dots \oplus a_1 \cdot x^1 \oplus a_0$ where $n = \max\{k \in \mathbb{N} \mid p(k) \neq 0\}$ and $a_i = p(i)$ for each $i \in [0, n]$.

The Cauchy product of two polynomials p and q in $\mathbf{B}[x]$ is defined, for each $i \in \mathbb{N}$, by

$$(p \cdot q)(i) = \bigoplus_{j \in [0, i]} p(j) \otimes q(i - j) .$$

□

In the next example, we show a number of strong bimonoids which are not semirings, except the ones given in Examples 3, 7, and 11. For further examples of strong bimonoids, see Observation 2.7.13, where we show that each bounded lattice is a strong bimonoid, as well as the proof of Theorems 14.2.14 and 14.2.15.

Example 2.7.10. In [DSV10, Ex. 1],[CDIV10, Ex. 2.2], [DV12, Ex. 2.1], and [DFKV22, Ex. 2.2, 2.3] a number of examples of strong bimonoids are given, and in [DV12, Ex. 2.1.4] a general construction principle for strong bimonoids is given, which we recall here. The first two examples are σ -complete strong bimonoids, and we show the mappings \sum_I^\oplus which satisfy equalities (2.11) and (2.12).

1. The algebra $\mathbf{TropBM} = (\mathbb{N}_\infty, +, \min, 0, \infty)$ is a commutative strong bimonoid, called the *tropical bimonoid*. However, it is not bi-locally finite. Moreover, it is not a semiring, because there exist $a, b, c \in \mathbb{N}_\infty$ with $\min(a, b + c) \neq \min(a, b) + \min(a, c)$ (e.g., take $a = b = c \neq 0$). The strong bimonoid \mathbf{TropBM} is σ -complete with the mapping

$$\sum_I^+ : (\mathbb{N}_\infty)^I \rightarrow \mathbb{N}_\infty \quad \text{with} \quad (n_i \mid i \in I) \mapsto \begin{cases} \bigoplus_{i \in J} n_i & \text{if } \{n_i \mid i \in I\} \subseteq \mathbb{N} \text{ and} \\ & J = \{i \in I \mid n_i \neq 0\} \text{ is finite} \\ \infty & \text{otherwise .} \end{cases}$$

2. For each $\lambda \in \mathbb{R}$ with $0 < \lambda < \frac{1}{2}$, let $\mathbf{Trunc}_\lambda = (B, \oplus, \odot, 0, 1)$ be the algebra, where

- $B = \{0\} \cup \{b \in \mathbb{R} \mid \lambda \leq b \leq 1\}$,
- $a \oplus b = \min(a + b, 1)$, and
- $a \odot b = a \cdot b$ if $a \cdot b \geq \lambda$, and 0 otherwise,

and where $+$ and \cdot are the usual addition and multiplication of real numbers, respectively. Then \mathbf{Trunc}_λ is a bi-locally finite and commutative strong bimonoid which can be proved as follows.

First we prove that $(B, \oplus, 0)$ is locally finite. By induction on \mathbb{N} , it is easy to show that for every $n \in \mathbb{N}$ with $n \geq 2$ and $a_1, \dots, a_n \in B$, we have

$$\bigoplus_{i \in [n]} a_i = \min(\bigoplus_{i \in [n]} a_i, 1) . \quad (2.15)$$

Now let $A \subseteq B$ be a finite subset. If $A = \emptyset$ or $A = \{0\}$, then $\langle A \rangle_{\{\oplus, 0\}} = \{0\}$, i.e., a finite set. Otherwise, let $m = \min(A \setminus \{0\})$. Then

$$\text{for every } n > \lfloor \frac{1}{m} \rfloor \text{ and } a_1, \dots, a_n \in A \setminus \{0\}, \text{ we have } \bigoplus_{i \in [n]} a_i = 1. \quad (2.16)$$

This follows from (2.15) using the approximation $\bigoplus_{i \in [n]} a_i \geq \bigoplus_{i \in [n]} m > 1$. Lastly, we obtain that $\langle A \rangle_{\{\oplus, 0\}}$ is finite also in this case, because

$$\begin{aligned} \langle A \rangle_{\{\oplus, 0\}} &= \{0\} \cup A \cup \left\{ \bigoplus_{i \in [n]} a_i \mid 2 \leq n, a_1, \dots, a_n \in A \setminus \{0\} \right\} \\ &= \{0, 1\} \cup A \cup \left\{ \bigoplus_{i \in [n]} a_i \mid 2 \leq n \leq \lfloor \frac{1}{m} \rfloor, a_1, \dots, a_n \in A \setminus \{0\} \right\}. \end{aligned} \quad (\text{by (2.16)})$$

Next we prove that $(B, \odot, 1)$ is locally finite. By induction on \mathbb{N} , it is easy to show that for every $n \in \mathbb{N}$ with $n \geq 2$ and $a_1, \dots, a_n \in B$, we have

$$\bigodot_{i \in [n]} a_i = \prod_{i \in [n]} a_i \text{ if } \prod_{i \in [n]} a_i \geq \lambda \text{ and } 0 \text{ otherwise,} \quad (2.17)$$

where we abbreviate $a_1 \cdot \dots \cdot a_n$ by $\prod_{i \in [n]} a_i$.

Now let $A \subseteq B$ be a finite subset. If $A \subseteq \{0, 1\}$, then $\langle A \rangle_{\{\odot, 1\}} \subseteq \{0, 1\}$, hence it is finite. Otherwise, let $m = \max(A \setminus \{0, 1\})$ and $K = \max(\{k \in \mathbb{N} \mid m^k \geq \lambda\})$. Then

$$\text{for every } n > K \text{ and } a_1, \dots, a_n \in A \setminus \{0, 1\}, \text{ we have } \bigodot_{i \in [n]} a_i = 0. \quad (2.18)$$

This follows from (2.17) using the approximation $\prod_{i \in [n]} a_i \leq \prod_{i \in [n]} m < \lambda$. Lastly, we obtain that $\langle A \rangle_{\{\odot, 1\}}$ is finite also in this case, because

$$\begin{aligned} \langle A \rangle_{\{\odot, 1\}} &= \{1\} \cup A \cup \left\{ \bigodot_{i \in [n]} a_i \mid 2 \leq n, a_1, \dots, a_n \in A \setminus \{0, 1\} \right\} \\ &= \{1\} \cup A \cup \left\{ \bigodot_{i \in [n]} a_i \mid 2 \leq n \leq K, a_1, \dots, a_n \in A \setminus \{0\} \right\}. \end{aligned} \quad (\text{by (2.18)})$$

Trunc_λ is σ -complete with the mapping:

$$\sum_I^\oplus : B^I \rightarrow B \quad \text{with} \quad (n_i \mid i \in I) \mapsto \begin{cases} \min(\bigoplus_{i \in J} n_j, 1) & \text{if } J = \{i \in I \mid n_i \neq 0\} \text{ is finite} \\ 1 & \text{otherwise} \end{cases}.$$

We note that Trunc_λ is not a semiring because \odot is not right-distributive. For instance, for $a = b = 0.9$, and $c = \lambda$, we have $(a \oplus b) \odot c = \lambda$, while $(a \odot c) \oplus (b \odot c) = 0$ because $a \odot c = b \odot c = 0$.

If $\lambda = \frac{1}{4}$, then Trunc_λ is not weakly locally finite, because the set $\text{wcl}(\{\frac{1}{2}\})$ is infinite. We can show this as follows [Dro19]. Let $(b_i \mid i \in \mathbb{N})$ such that

$$b_i = \begin{cases} \frac{1}{2} & \text{if } i = 0 \\ b_{i-1} \cdot \frac{1}{2} & \text{if } i \text{ is odd} \\ b_{i-1} + \frac{1}{2} & \text{if } i \text{ is even and } i \neq 0 \end{cases}$$

Then, e.g., $b_0 = 1/2$, $b_1 = 1/4$, $b_2 = 1/2 + 1/4 = 3/4$, $b_3 = 3/8$, $b_4 = 1/2 + 3/8 = 7/8$, $b_5 = 7/16$, $b_6 = 1/2 + 7/16 = 15/16$, $b_7 = 15/32$, $b_8 = 1/2 + 15/32 = 31/32$, $b_9 = 31/64$, $b_{10} = 1/2 + 31/64 = 63/64$, etc. (In fact, the subsequences $(b_i \mid i \in \mathbb{N}, i \text{ is even})$ and $(b_i \mid i \in \mathbb{N}, i \text{ is odd})$ converge to 1 and $\frac{1}{2}$, respectively.) It is easy to see that $b_i \in \text{wcl}(\{\frac{1}{2}\})$ for each $i \in \mathbb{N}$, and that $b_i \neq b_j$ for every $i, j \in \mathbb{N}$ with $i \neq j$. Hence $\text{wcl}(\{\frac{1}{2}\})$ is an infinite set and thus Trunc_λ is not weakly locally finite (also cf [Tep23]).

3. Let $[0, 1] = \{r \in \mathbb{R} \mid 0 \leq r \leq 1\}$ and let i be a binary operation on $[0, 1]$. We say that i is a t -norm (or: *fuzzy intersection*, cf. [KY95, p. 62]) if i satisfies the following conditions:
 - (a) i is commutative and associative,
 - (b) $i(a, 1) = a$ for each $a \in [0, 1]$ (boundary condition), and
 - (c) $a \leq b$ implies $i(c, a) \leq i(c, b)$ for every $a, b, c \in [0, 1]$ (monotonicity condition).

Moreover, let u be a binary operation on $[0, 1]$. We say that u is a t -conorm (or: *fuzzy union*, cf. [KY95, p. 77]) if u satisfies the the following conditions:

- (a) u is commutative and associative,
- (b) $u(a, 0) = a$ for each $a \in [0, 1]$ (boundary condition), and
- (c) $a \leq b$ implies $u(c, a) \leq u(c, b)$ for every $a, b, c \in [0, 1]$ (monotonicity condition).

Due to the boundary conditions, $([0, 1], u, 0)$ and $([0, 1], i, 1)$ are commutative monoids. Since $i(a, 0) = i(0, a) \leq i(0, 1) = 0$ for each $a \in [0, 1]$ (cf. [KY95, Thm. 3.10]), we have that

$$\text{UnitInt}_{u,i} = ([0, 1], u, i, 0, 1)$$

is a commutative strong bimonoid for each t -conorm u and each t -norm i .

There are combinations of t -conorm u and t -norm i such that the strong bimonoid $\text{UnitInt}_{u,i}$ is not distributive. This is the case, e.g., for the t -conorm bounded sum (cf. Example 2.7.10(4)) and the t -norm *bounded difference* $i(a, b) = \max(0, a + b - 1)$. We also refer to [KY95, Thm. 3.24] for sufficient conditions under which $\text{UnitInt}_{u,i}$ is not distributive.

4. The algebra $([0, 1], \oplus, \cdot, 0, 1)$ with interval $[0, 1] = \{r \in \mathbb{R} \mid 0 \leq r \leq 1\}$ of real numbers and the usual multiplication \cdot of real numbers is a strong bimonoid for each of the following two definitions of \oplus for every $a, b \in [0, 1]$:

- $a \oplus b = a + b - a \cdot b$ (called *algebraic sum*) and
- $a \oplus b = \min(a + b, 1)$ (called *bounded sum*).

Both the algebraic sum and the bounded sum are t-conorm (cf. [KY95, p. 78]), hence they are associative. If \oplus is the algebraic sum, then we denote the algebra by $\mathbf{UnitInt}_{\text{alg}}$; if \oplus is the bounded sum, then we denote the algebra by $\mathbf{UnitInt}_{\text{bs}}$. Neither $\mathbf{UnitInt}_{\text{alg}}$ nor $\mathbf{UnitInt}_{\text{bs}}$ is a semiring.

5. Let $(C, +, 0)$ be a commutative monoid. We consider the set B of all mappings $f : C \rightarrow C$ such that $f(0) = 0$. Moreover, we extend $+$ to B by a pointwise addition on elements of B , i.e., for every $f, g \in B$ and $c \in C$, we define $(f + g)(c) = f(c) + g(c)$. Also, we define the operation \diamond on B such that, for every $f, g \in B$ and $c \in C$, we have $(f \diamond g)(c) = g(f(c))$. Finally, we denote by $\tilde{0}$ the mapping $\tilde{0} : C \rightarrow C$ such that $\tilde{0}(c) = 0$ for each $c \in C$. Then

$$\mathbf{NearSem}_C = (B, +, \diamond, \tilde{0}, \text{id}_C)$$

is a strong bimonoid. Such an algebra is called a *near semiring (over C)* [vHvR67, Kri05]. We note that the condition $f(0) = 0$ is needed to guarantee that $\tilde{0} \diamond f = \tilde{0}$. Except for trivial cases, the operation \diamond is left-distributive over $+$, but not right-distributive.

As example we consider the commutative monoid $(\mathcal{P}(Q), \cup, \emptyset)$ for some set Q . Then we consider the near semiring $(B, \cup, \diamond, \tilde{0}, \text{id}_{\mathcal{P}(Q)})$ as described above, i.e.,

- $B = \{f \mid f : \mathcal{P}(Q) \rightarrow \mathcal{P}(Q), f(\emptyset) = \emptyset\}$,
- $(f \cup g)(U) = f(U) \cup g(U)$ and $(f \diamond g)(U) = g(f(U))$ for every $f, g \in B$ and $U \in \mathcal{P}(Q)$, and
- $\tilde{0}(U) = \emptyset$ and $\text{id}_{\mathcal{P}(Q)}(U) = U$ for each $U \in \mathcal{P}(Q)$.

It is easy to see that the operation \diamond is left-distributive over \cup . However, it is not right-distributive over \cup if $|Q| \geq 2$. To show this, let $p, q \in Q$ with $p \neq q$ and let $f, g, h \in B$ such that for every $U \in \mathcal{P}(Q)$:

$$f(U) = \begin{cases} \{p\} & \text{if } U = \{p\} \\ \emptyset & \text{otherwise} \end{cases}, \quad g(U) = \begin{cases} \{q\} & \text{if } U = \{p\} \\ \emptyset & \text{otherwise} \end{cases}, \quad \text{and } h(U) = \begin{cases} \emptyset & \text{if } |U| = 2 \\ U & \text{otherwise} \end{cases}.$$

Then $((f \cup g) \diamond h)(\{p\}) = h(\{p, q\}) = \emptyset$ and $((f \diamond h) \cup (g \diamond h))(\{p\}) = h(\{p\}) \cup h(\{q\}) = \{p, q\}$.

6. We consider the strong bimonoid $(\Gamma^* \cup \{\infty\}, \wedge, \cdot, \infty, \varepsilon)$ where

- \wedge is the longest common prefix operation,
- \cdot is the usual concatenation of strings, and
- ∞ is a new element such that $s \wedge \infty = \infty \wedge s = s$ and $s \cdot \infty = \infty \cdot s = \infty$ for each $s \in \Gamma^* \cup \{\infty\}$.

This bimonoid occurs in investigations for natural language processing, see [Moh00]. It is clear that $(\Gamma^* \cup \{\infty\}, \wedge, \cdot, \infty, \varepsilon)$ is left-distributive but not right-distributive (consider, e.g., if $\Gamma = \{a, b, c\}$, then $abc = (a \wedge ab) \cdot bc \neq (a \cdot bc) \wedge (ab \cdot bc) = ab$).

7. There exist only two strong bimonoids $(\{0, 1\}, \oplus, \otimes, 0, 1)$ with exactly two elements: the Boolean semiring \mathbf{Boole} and the field \mathbb{F}_2 ; in particular, both are semirings (cf. Example 2.7.9(7)). However, there exist strong bimonoids with three elements which are not semirings, take, e.g., $\mathbf{Three} = (\{0, 1, 2\}, \max, \hat{\cdot}, 0, 1)$ where $a \hat{\cdot} b = (a \cdot b) \bmod 3$ for every $a, b \in \{0, 1, 2\}$; there $\max(2 \hat{\cdot} 2, 2 \hat{\cdot} 1) \neq 2 \hat{\cdot} \max(1, 2)$.
8. We consider the algebra $(\mathbb{N}_0, \oplus, +, 0, 0)$ from [DFKV22, Ex. 2.3], where where $\mathbb{N}_0 = \mathbb{N} \cup \{0\}$ for some new element $0 \notin \mathbb{N}$. The binary operation \oplus , if restricted to \mathbb{N} , and the binary operation $+$, if restricted to \mathbb{N} , are the usual addition on natural numbers (e.g. $3 + 2 = 5$). Moreover,

$0 \oplus x = x \oplus 0 = x$ and $0 + x = x + 0 = 0$ for each $x \in \mathbb{N}_0$. Thus, $(\mathbb{N}_0, \oplus, +, 0, 0)$ is a strong bimonoid. However, it is not a semiring (e.g., $2 + (3 \oplus 4) \neq (2 + 3) \oplus (2 + 4)$). We might call this algebra the *plus-plus strong bimonoid of natural numbers* and denote it by $\text{PP}_{\mathbb{N}}$.

9. We recall the strong bimonoid $\text{Stb} = (\mathbb{N}, \oplus, \odot, 0, 1)$ from [DSV10, Ex. 25]³. Intuitively, both operations are commutative and consider their maximal argument, say, b . Then, depending on the characteristic of b being even or odd, \oplus delivers b or $b + 1$, respectively, and dually, \odot delivers $b + 1$ or b , respectively.

Formally, the two commutative operations \oplus and \odot on \mathbb{N} are defined as follows. First, let $0 \oplus a = a$, $0 \odot a = 0$, and $1 \odot a = a$ for every $a \in \mathbb{N}$. If $a, b \in \mathbb{N} \setminus \{0\}$ with $a \leq b$, we put (with $+$ being the usual addition on \mathbb{N})

$$a \oplus b = \begin{cases} b & \text{if } b \text{ is even} \\ b + 1 & \text{if } b \text{ is odd.} \end{cases}$$

If $a, b \in \mathbb{N} \setminus \{0, 1\}$ with $a \leq b$, let

$$a \odot b = \begin{cases} b + 1 & \text{if } b \text{ is even} \\ b & \text{if } b \text{ is odd.} \end{cases}$$

We prove that \oplus is associative, i.e., that for every $a, b, c \in \mathbb{N}$ we have

$$a \oplus (b \oplus c) = (a \oplus b) \oplus c . \quad (2.19)$$

Since this is obvious if at least one of a, b , or c is 0, we assume that none of them is 0. For each $d \in \{a, b, c\}$, we abbreviate by $d \equiv 0$ that d is an even number and by $d \equiv 1$ that d is odd. Then we can verify that (2.19) holds by making the following case analysis.

if ...	then both sides of (2.19) are equal to ...
$(a \leq b) \wedge (b \leq c) \wedge (b \equiv 0) \wedge (c \equiv 0)$	c
$(a \leq b) \wedge (b \leq c) \wedge (b \equiv 0) \wedge (c \equiv 1)$	$c + 1$
$(a \leq b) \wedge (b + 1 \leq c) \wedge (b \equiv 1) \wedge (c \equiv 0)$	c
$(a \leq b) \wedge (b + 1 \leq c) \wedge (b \equiv 1) \wedge (c \equiv 1)$	$c + 1$
$(a \leq b) \wedge (c < b) \wedge (b \equiv 0)$	b
$(a \leq b) \wedge (c < b) \wedge (b \equiv 1)$	$b + 1$
etc.	

Similarly, we can show that \odot is associative. In that proof we can assume that none of a, b , or c is equal to 0 or 1 because otherwise the statement is trivial.

Then $\text{Stb} = (\mathbb{N}, \oplus, \odot, 0, 1)$ is a strong bimonoid. Clearly, it is not a semiring because, e.g., $2 \odot (2 \oplus 3) = 2 \odot 4 = 5$ and $(2 \odot 2) \oplus (2 \odot 3) = 3 \oplus 3 = 4$. It is easy to see that Stb is bi-locally finite. For this, we show that $(\mathbb{N}, \oplus, 0)$ is locally finite as follows. First, by induction on \mathbb{N} , we show that for every $n \in \mathbb{N}$ with $n \geq 2$ and $a_1, \dots, a_n \in \mathbb{N}_+$ with $a_1 \leq \dots \leq a_n$, we have

$$\bigoplus_{i \in [n]} a_i = \begin{cases} a_n & \text{if } a_n \text{ is even} \\ a_n + 1 & \text{otherwise.} \end{cases} \quad (2.20)$$

I.B.: Let $n = 2$. Then the statement follows by the definition of \oplus .

³Stb refers to one of the authors

I.S.: Next let $n > 2$. By the I.H., we have that $\bigoplus_{i \in [n-1]} a_i = a_{n-1}$ if a_{n-1} is even, and $a_{n-1} + 1$ otherwise. If a_{n-1} is even, then we have $\bigoplus_{i \in [n]} a_i = a_{n-1} \oplus a_n$ and thus the statement follows by the definition of \oplus . If a_{n-1} is odd, then $\bigoplus_{i \in [n]} a_i = (a_{n-1} + 1) \oplus a_n$. If $(a_{n-1} + 1) \leq a_n$, then the statement again follows easily. If $a_n < a_{n-1} + 1$, then by $a_{n-1} \leq a_n$, we have $a_{n-1} = a_n$. Then we obtain $\bigoplus_{i \in [n]} a_i = (a_{n-1} + 1) \oplus a_n = (a_n + 1) \oplus a_n = a_n + 1$, where the last equality follows from the fact that $a_n + 1$ is even.

Now let $N \subseteq \mathbb{N}$ be a finite subset and $K = \max(N)$. It follows from (2.20), that for each $a \in \langle N \rangle_{\{\oplus\}}$, we have $a \leq K + 1$. This proves that $\langle N \rangle_{\{\oplus\}}$ is finite, i.e., $(\mathbb{N}, \oplus, 0)$ is locally finite. The proof of the statement that $(\mathbb{N}, \odot, 1)$ is locally finite is similar.

However, if we apply \oplus and \odot alternatingly, then the result increases arbitrarily. For instance, let $(b_i \mid n \in \mathbb{N})$ be the family defined by $b_0 = 2$ and, for each $n \in \mathbb{N}$, by

$$b_{n+1} = \begin{cases} b_n \oplus 2 & \text{if } n \text{ is odd} \\ b_n \odot 2 & \text{otherwise} \end{cases}.$$

Then, e.g., $b_0 = 2, b_1 = 3, b_2 = 4, b_3 = 5, \dots$. In general we have $\text{wcl}(\{2\}) = \mathbb{N}$, and hence Stb is not weakly locally finite.

10. [Dro24] We consider the algebra $(\mathbb{Q}, +, \odot, 0, 1)$ with the usual addition $+$ on rational numbers, and the binary operation \odot defined, for every $a, b \in \mathbb{Q}$, by

$$a \odot b = \begin{cases} \frac{a}{b} & \text{if } b \neq 0, \\ 0 & \text{otherwise} \end{cases}$$

The operation \odot is associative, and $0 \odot b = b \odot 0 = 0$ for each $b \in \mathbb{Q}$. Clearly, the algebra is a right-distributive strong bimonoid. Moreover, it is not left-distributive because, e.g., $1 \odot (2 + 3) = \frac{1}{2+3} \neq \frac{1}{2} + \frac{1}{3} = (1 \odot 2) + (1 \odot 3)$.

11. Let $(B, +)$ be a commutative semigroup and (B, \cdot) be a semigroup. Combining these two semigroups, we obtain a strong bimonoid structure on B by adding constants 0 and 1 . Formally, let $0, 1 \notin B$ and put $B' = B \cup \{0, 1\}$. Then we define binary operations \oplus and \odot on B' by letting

- $\oplus \mid_{B \times B} = +$ and $0 \oplus b = b \oplus 0 = b$ and $1 \oplus b = b \oplus 1 = b$ if $b \neq 0$, and
- $\odot \mid_{B \times B} = \cdot$ and $0 \odot b = b \odot 0 = 0$, and $1 \odot b = b \odot 1 = b$ for each $b \in B'$.

Then $(B', \oplus, \odot, 0, 1)$ is a strong bimonoid. □

Next we define some more restrictions on strong bimonoids and prove useful relationships.

Let $\mathbf{B} = (B, \oplus, \otimes, 0, 1)$ be a strong bimonoid. It is

- *additively idempotent* if \oplus is idempotent,
- *multiplicatively idempotent* if \otimes is idempotent,
- *zero-sum free* if $a \oplus b = 0$ implies $a = b = 0$ for every $a, b \in B$,
- *zero-divisor free* if $a \otimes b = 0$ implies $a = 0$ or $b = 0$ for every $a, b \in B$,
- *positive* if it is zero-sum free and zero-divisor free,
- *zero-cancellation free* if $a \otimes b \otimes c \neq 0$ implies $a \otimes c \neq 0$ for every $a, b, c \in B$,
- *extremal* if \oplus is extremal.

Observation 2.7.11. Let $\mathbf{B} = (B, \oplus, \otimes, 0, 1)$ be a strong bimonoid. Then the following statements hold.

- (1) If \mathbf{B} is commutative, then it is zero-cancellation free. Moreover, there exists a zero-cancellation free semiring which is not commutative.
- (2) If \mathbf{B} is zero-divisor free, then it is zero-cancellation free. Moreover, there exists a zero-cancellation free semiring which is not zero-divisor free.
- (3) If \mathbf{B} is extremal, then it is additively idempotent.

- (4) If \mathbf{B} is additively idempotent, then it is zero-sum free. Moreover, there exists a zero-sum free semiring which is not additively idempotent.
- (5) If \mathbf{B} is locally finite, then it is weakly locally finite. Moreover, if \mathbf{B} is weakly locally finite, then it is bi-locally finite.
- (6) If \mathbf{B} is right-distributive and bi-locally finite, then it is weakly locally finite (cf. [DSV10, Remark 17]).
- (7) If \mathbf{B} is left-distributive and weakly locally finite, then it is locally finite (cf. [DSV10, Remark 17]).
- (8) If \mathbf{B} is a bi-locally finite semiring, then it is locally finite.
- (9) If \mathbf{B} is σ -complete, then it is zero-sum free [Gol99, Prop. 22.28].
- (10) If \mathbf{B} is σ -complete, then, for every countable index set I and family $(b_i \mid i \in I)$ of elements of B , we have

$$\sum_{i \in I}^{\oplus} b_i \neq 0 \iff (\exists i \in I) : b_i \neq 0 .$$

- (11) If \mathbf{B} is zero-sum free, then for every finite index set I and family $(b_i \mid i \in I)$ of elements of B we have

$$\bigoplus_{i \in I} b_i \neq 0 \iff (\exists i \in I) : b_i \neq 0 .$$

Proof. Proof of (1): For the proof of the first statement, assume that \mathbf{B} is commutative and not zero-cancellation free. By the second condition, there are $a, b, c \in B$ such that $a \otimes b \otimes c \neq 0$ and $a \otimes c = 0$. Using the latter and commutativity, we obtain $a \otimes b \otimes c = a \otimes c \otimes b = 0$ which is a contradiction. For the second, we can consider the semiring $\text{Lang}_\Gamma = (\mathcal{P}(\Gamma^*), \cup, \cdot, \emptyset, \{\varepsilon\})$ of formal languages (cf. Example 2.7.9 (12)), which is zero-cancellation free and not commutative.

Proof of (2): Let us assume that \mathbf{B} is zero-divisor free and not zero-cancellation free. The latter means that there exist $a, b, c \in B$ such that $a \otimes b \otimes c \neq 0$ and $a \otimes c = 0$. Since \mathbf{B} is zero-divisor free, we have $a = 0$ or $c = 0$. Thus $a \otimes b \otimes c = 0$, which contradicts our assumption.

To prove the second statement, we consider the ring $\text{Intmod}4 = (\{0, 1, 2, 3\}, +_4, \cdot_4, 0, 1)$ as defined in Example 2.7.9(5). It is easy to see that $\text{Intmod}4$ is zero-cancellation free and not zero-divisor free.

Proof of (3): It is obvious.

Proof of (4): Let us assume that \mathbf{B} is additively idempotent. Let $a \oplus b = 0$. Then $a = a \oplus 0 = a \oplus (a \oplus b) = (a \oplus a) \oplus b = a \oplus b = 0$. In the same way we can prove that $b = 0$. Hence \mathbf{B} is zero-sum free. The semiring Nat of natural numbers is zero-sum free and not additively idempotent.

Proof of (5): The first statement is obvious because for each finite subset $F \subseteq B$ we have $\text{wcl}(F) \subseteq \langle F \rangle_{\{\oplus, \otimes, 0, \mathbb{1}\}}$. The second statement follows from the fact that $\langle F \rangle_{\{\oplus, 0\}} \cup \langle F \rangle_{\{\otimes, \mathbb{1}\}} \subseteq \text{wcl}(F)$.

Proof of (6): Let $A \subseteq B$ be finite. We show that $\text{wcl}(A) \subseteq \langle \langle A \rangle_{\{\otimes, \mathbb{1}\}} \rangle_{\{\oplus, 0\}}$.

By definition, $\text{wcl}(A)$ is the smallest subset C of B such that (a) $A \cup \{0, \mathbb{1}\} \subseteq C$, (b) C is closed under \oplus , and (c) for every $a \in C$ and $b \in A$, we have $a \otimes b \in C$. Hence, it is sufficient to show that $\langle \langle A \rangle_{\{\mathbb{1}, \otimes\}} \rangle_{\{0, \oplus\}}$ has the properties corresponding to (a), (b), and (c). Obviously, $A \cup \{0, \mathbb{1}\} \subseteq \langle \langle A \rangle_{\{\mathbb{1}, \otimes\}} \rangle_{\{0, \oplus\}}$ and $\langle \langle A \rangle_{\{\mathbb{1}, \otimes\}} \rangle_{\{0, \oplus\}}$ is closed under \oplus . Now let $a \in \langle \langle A \rangle_{\{\mathbb{1}, \otimes\}} \rangle_{\{0, \oplus\}}$ and $b \in A$. There are $n \in \mathbb{N}$, $a_1, \dots, a_n \in \langle A \rangle_{\{\mathbb{1}, \otimes\}}$ such that $a = \bigoplus_{i \in [n]} a_i$. Hence,

$$a \otimes b = \left(\bigoplus_{i \in [n]} a_i \right) \otimes b = \bigoplus_{i \in [n]} a_i \otimes b ,$$

where the second equality follows by right-distributivity. Since $a_i \otimes b \in \langle A \rangle_{\{\mathbb{1}, \otimes\}}$ for each $i \in [n]$, we obtain that $a \otimes b \in \langle \langle A \rangle_{\{\mathbb{1}, \otimes\}} \rangle_{\{0, \oplus\}}$. Hence, $\langle \langle A \rangle_{\{\mathbb{1}, \otimes\}} \rangle_{\{0, \oplus\}}$ has also the property corresponding to (c).

Proof of (7): The proof can be found in Section 2.11.

Proof of (8): It follows from Statements (6) and (7).

Proof of (9): Let $a, b \in B$ such that $a \oplus b = 0$ and let $c = \sum_{i \in \mathbb{N}}^{\oplus} (a \oplus b)$. Then by Observation 2.7.8 we have $c = 0$. Moreover, let $d = \sum_{i \in \mathbb{N}}^{\oplus} a$ and $e = \sum_{i \in \mathbb{N}}^{\oplus} b$. By renaming indices and using axioms (2.11) and (2.12), it is easy to see that

$$\sum_{i \in \mathbb{N}}^{\oplus} (a \oplus b) = \sum_{i \in \mathbb{N}}^{\oplus} a \oplus \sum_{i \in \mathbb{N}}^{\oplus} b ,$$

hence we have $c = d \oplus e$. Similarly, it is easy to see that

$$\sum_{i \in \mathbb{N}}^{\oplus} a = a \oplus \sum_{i \in \mathbb{N}}^{\oplus} a,$$

hence $d = a \oplus d$. Then we obtain $0 = c = d \oplus e = a \oplus d \oplus e = a$ and $0 = a \oplus b = b$.

Proof of (10): Let B be σ -complete. First we prove the implication \Rightarrow in the equivalence. For this we assume that $\sum_{i \in I}^{\oplus} b_i \neq 0$ and $(\forall i \in I) : b_i = 0$. By Observation 2.7.8, the second condition implies that $\sum_{i \in I}^{\oplus} b_i = 0$, which contradicts the first one.

Lastly we prove the implication \Leftarrow . Let $j \in I$ be such that $b_j \neq 0$. Then

$$\sum_{i \in I}^{\oplus} b_i = \sum_{i \in I \setminus \{j\}}^{\oplus} b_i \oplus b_j \neq 0,$$

where at the first equality we applied the laws (2.11) and (2.12), and the second equality follows from the fact that B is zero-sum free.

Proof of (11): The proof is very similar to the proof of (7). However, instead of Observation 2.7.8, we use the fact that, for every finite index set I , we have $\bigoplus_{i \in I} 0 = 0$. \square

In Subsection 2.7.4, we have defined the concept of powers for a monoid (B, \odot, e) . Here we extend this concept to powers in strong bimonoids, and thus we have to distinguish between the additive power and the multiplicative power.

Let $(B, \oplus, \otimes, 0, \mathbb{1})$ be a strong bimonoid and $b \in B$. By induction of $(\mathbb{N}, \succ_{\mathbb{N}})$, we define the \mathbb{N} -indexed family of additive powers of b , denoted by $(nb \mid n \in \mathbb{N})$, and the \mathbb{N} -indexed family of multiplicative powers of b , denoted by $(b^n \mid n \in \mathbb{N})$, to be the \mathbb{N} -indexed families over B defined such that

$$0n = 0, (n+1)b = b \oplus nb \quad \text{and} \quad b^0 = \mathbb{1}, b^{n+1} = b \otimes b^n . \quad (2.21)$$

An element b has *finite additive order* (and *finite multiplicative order*) if $\langle b \rangle_{\oplus}$ is finite (and $\langle b \rangle_{\otimes}$ is finite, respectively).

Of course, now the index $i(b)$ of an element b and its period $p(b)$ refer either to the additive power or to the multiplicative power, and thus, we should notationally distinguish them. However, in each application it will be clear from the context to which sort of power the index and the period refer to. So we will not invent separate notations.

2.7.6 Lattices and their comparison with strong bimonoids

We recall notions from lattice theory [Bir93, Grä03] and [BS81, Ch. 1]. A *lattice* is an algebra (B, \vee, \wedge) in which \vee (the *join*) and \wedge (the *meet*) are binary operations, (B, \vee) and (B, \wedge) are commutative semigroups, the operations \wedge and \vee are idempotent and satisfy the absorption axioms $a \vee (a \wedge b) = a$ and $a \wedge (a \vee b) = a$. The lattice (B, \vee, \wedge) is *bounded* if there exist elements $0, \mathbb{1} \in B$ such that $0 \vee a = a$ and $\mathbb{1} \wedge a = a$ for every $a \in B$. We denote a bounded lattice also by $(B, \vee, \wedge, 0, \mathbb{1})$.

There is an alternative order-theoretic definition of lattice. A partially ordered set (B, \leq) is a *lattice* if for each $a, b \in B$ the elements $\sup_{\leq}\{a, b\}$ and $\inf_{\leq}\{a, b\}$ exist. The lattice (B, \leq) is *bounded* if there exist elements $0, 1 \in B$ such that $\inf_{\leq}(0, a) = 0$ and $\sup_{\leq}(1, a) = 1$ for every $a \in B$; in other words, 0 and 1 are the smallest element and greatest element, respectively, with respect to \leq . We denote a bounded lattice also by $(B, \leq, 0, 1)$.

We recall the well known correspondence between these two definitions.

Theorem 2.7.12. (cf. [BS81, Sect. I.1], [Bir67, Ch. I., Thm 8], [Grä78, Sect. 1.1, Thm 8], [Grä03, p.6]) Let B be a set. The following two statements hold.

- (1) Let the algebra (B, \vee, \wedge) be a lattice. We define the partial order \leq on B such that

$$a \leq b \text{ if } a \wedge b = a \text{ for every } a, b \in B .$$

Then the partially ordered set (B, \leq) is a lattice with $\sup_{\leq}\{a, b\} = a \vee b$ and $\inf_{\leq}\{a, b\} = a \wedge b$ for every $a, b \in B$.

- (2) Let the partially ordered set (B, \leq) be a lattice. We define the binary operations \vee and \wedge on B such that

$$a \vee b = \sup_{\leq}\{a, b\} \text{ and } a \wedge b = \inf_{\leq}\{a, b\} \text{ for every } a, b \in B .$$

Then the algebra (B, \vee, \wedge) is a lattice. □

Clearly, if we apply the transformation in Theorem 2.7.12(1) to the lattice (B, \vee, \wedge) and then apply to the resulting lattice (B, \leq) the transformation in Theorem 2.7.12(2), then we reobtain the lattice (B, \vee, \wedge) . A similar invariant occurs if we apply the transformation of (2) followed by the transformation of (1) to a lattice (B, \leq) .

Another consequence of Theorem 2.7.12 is the following. Let (B, \vee, \wedge) and (B, \leq) be bounded lattices such that the transformations of Theorem 2.7.12 transform the one into the other. Moreover, let 0 and 1 be two elements of B . Then the following equivalence holds: $(B, \vee, \wedge, 0, 1)$ is a bounded lattice iff $(B, \leq, 0, 1)$ is a bounded lattice.

The lattice (B, \vee, \wedge) is *distributive* if \wedge is distributive over \vee and \vee is distributive over \wedge . In fact, the first of the previous two conditions holds if and only if the second one holds [DP12, Lm. 4.3]. Hence it suffices to require one of them.

- Observation 2.7.13.** (1) For each lattice (B, \vee, \wedge) , the semigroups (B, \vee) and (B, \wedge) are locally finite.
 (2) Each bounded lattice $(B, \vee, \wedge, 0, 1)$ is a bi-locally finite and commutative strong bimonoid.
 (3) Each distributive bounded lattice $(B, \vee, \wedge, 0, 1)$ is a locally finite and commutative semiring.

Proof. Proof of (1): Let (B, \vee, \wedge) be a lattice. The statement follows from Observation 2.7.6 because both \vee and \wedge are commutative and idempotent.

Proof of (2): Let $\mathbf{B} = (B, \vee, \wedge, 0, 1)$ be a bounded lattice. Since we have $0 \wedge a = 0 \wedge (0 \vee a) = 0$ for every $a \in B$ (by absorption law), the algebra \mathbf{B} is a strong bimonoid. Obviously, it is commutative. Moreover, it follows from Statement (1) that both $(B, \vee, 0)$ and $(B, \wedge, 1)$ are locally finite.

Proof of (3): This follows from (2) and Observation 2.7.11(8). □

Observation 2.7.14. Let $\mathbf{B} = (B, \oplus, \otimes, 0, 1)$ be an algebra. Then the following two statements hold.

- (1) \mathbf{B} is a bounded lattice if and only if (B, \oplus, \otimes) is a lattice and \mathbf{B} is a strong bimonoid.
 (2) \mathbf{B} is a distributive bounded lattice if and only if (B, \oplus, \otimes) is a lattice and \mathbf{B} is a semiring. □

We recall that a bounded lattice $(B, \vee, \wedge, 0, 1)$ (which is a particular commutative strong bimonoid) is σ -complete if the monoid $(B, \vee, 0)$ is σ -complete (cf. Section 2.7.5). We note that, for bounded lattices, our concept is more general than σ -lattice in [Bir67, Ch. 9] because in a σ -lattice both the join and the meet exist for arbitrary countable index sets. Moreover, σ -lattice is more general than complete lattice [Bir67, Bir93, Grä78, Grä03] because in a complete lattice the join and the meet exist for arbitrary index

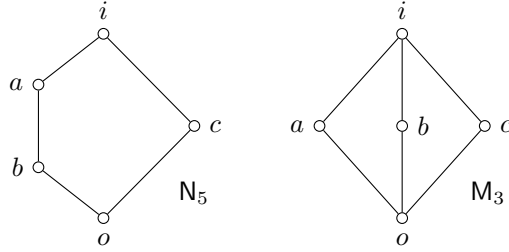

Figure 2.4: The lattices N_5 and M_3 in Figure 2 of [Grä03, p.14].

sets. Lastly, we note that if meet exists for arbitrary index sets, then also join exists for arbitrary index sets and vice versa [Bir67, Ch. V, Thm. 3] [Grä78, Sect. 1.3, Lm. 14].

Example 2.7.15.

1. Let A be a set. The σ -complete semiring $\mathcal{P}S_A = (\mathcal{P}(A), \cup, \cap, \emptyset, A)$ is a σ -complete distributive lattice.
2. The σ -complete semiring $\mathcal{N}at_{\max, \min} = (\mathbb{N}_\infty, \max, \min, 0, \infty)$ is a σ -complete distributive lattice.
3. [Grä03, Fig. 2, p.14], [BS81, Fig. 5] Let $N_5 = \{o, a, b, c, i\}$ be a set with five elements. We consider two binary operations \vee and \wedge such that the following requirements hold:

$$a \wedge b = b, \quad b \vee c = i, \quad \text{and} \quad a \wedge c = o.$$

The definition of the values of \vee and \wedge for other combinations of arguments is given by the unique extension of the above requirements such that $N_5 = (N_5, \vee, \wedge, o, i)$ is a bounded lattice (cf. Figure 2.4). This lattice is not distributive.

4. [Grä03, Fig. 2, p.14], [BS81, Fig. 5] Let $M_3 = \{o, a, b, c, i\}$ be a set with five elements. We consider two binary operations \vee and \wedge such that the following requirements hold:

$$a \wedge b = a \wedge c = b \wedge c = o \quad \text{and} \quad a \vee b = a \vee c = b \vee c = i.$$

Similarly, the definition of the values of \vee and \wedge for other combinations of arguments is given by the unique extension of the above requirements such that $M_3 = (M_3, \vee, \wedge, o, i)$ is a bounded lattice (cf. Figure 2.4). This lattice is not distributive.

It is well known that there exist large sets of lattices that are not distributive [Grä03], e.g., orthomodular lattices. In fact, a lattice is non-distributive if and only if it contains at least one of the two lattices N_5 and M_3 as a sublattice [Grä03, Thm. 1 on p. 80].

5. We consider the algebra (\mathbb{R}, \max, \min) with maximum and minimum based on the usual \leq ordering on the set of real numbers. The algebra (\mathbb{R}, \max, \min) is a lattice. It is not bounded (and hence not σ -complete). Moreover, both \max and \min are extremal.
6. A *residuated lattice* is an algebra $\mathbf{B} = (B, \vee, \wedge, \otimes, \rightarrow, \mathbf{0}, \mathbf{1})$ such that
 - (L1) $(B, \vee, \wedge, \mathbf{0}, \mathbf{1})$ is a bounded lattice,
 - (L2) $(B, \otimes, \mathbf{1})$ is a commutative monoid with the unit $\mathbf{1}$, and
 - (L3) \rightarrow is a binary operation, and \otimes and \rightarrow form an adjoint pair, i.e., they satisfy the adjunction property: for all $a, b, c \in B$, $a \otimes b \leq c$ if and only if $a \leq (b \rightarrow c)$. (Here \leq is the partial order on B defined, as for lattices, by $a \leq b$ iff $a = a \wedge b$ for every $a, b \in B$.)

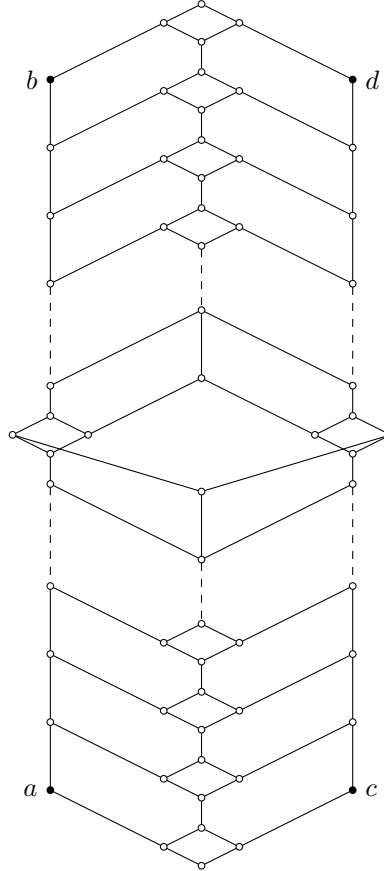

Figure 2.5: The bounded lattice $\text{FL}(2+2)$ is free in the set of all bounded lattices with the two chains $a < b$ and $c < d$ as generators. The upper bound of $\text{FL}(2+2)$ is $b \vee d = \mathbb{1}$, and its lower is $a \wedge c = \mathbb{0}$.

If, additionally, \mathbf{B} is a σ -complete lattice, then \mathbf{B} is called a σ -complete residuated lattice.

The operations \otimes and \rightarrow are called *multiplication* and *residuum*, respectively. The algebra $(B, \vee, \otimes, \mathbb{0}, \mathbb{1})$ is a semiring (cf., e.g., [Gal08, Slide 11]), it is called the *semiring reduct* of \mathbf{B} . Thus, in particular, the semiring reduct of each residuated lattice is a strong bimonoid.

7. The σ -complete Boolean algebras of [Loo47] are σ -complete lattices.
8. A *finite chain* is a finite bounded lattice $(L, \leq, \mathbb{0}, \mathbb{1})$ where \leq is a linear order. Trivially, each finite chain is distributive.
9. The bounded lattice $\text{FL}(2+2) = (\text{FL}(2+2), \vee, \wedge, \mathbb{0}, \mathbb{1})$ (cf. [Rol58], [Grä03, p. 361], [RW09, Fig. 3a]) is free in the set of all bounded lattices with the two finite chains $a < b$ and $c < d$ as generators (cf. Figure 2.5). The upper bound is $\mathbb{1} = b \vee d$ and the lower bound is $\mathbb{0} = a \wedge c$. This lattice is infinite [Rol58, Thm. 2], hence it is not locally finite. Thus, by Observation 2.7.11(8), it is not distributive; this also follows from the fact that $\text{FL}(2+2)$ contains \mathbf{N}_5 as sublattice. \square

We note that semiring-reducts of semi-lattice ordered monoids and of σ -complete residuated lattices, and Brouwerian lattices are commutative semirings.

In Figure 2.6, we have placed five sets of algebras into a diagram. The sets are:

- the set \mathcal{C}_1 of all lattices,
- the set \mathcal{C}_2 of all strong bimonoids,

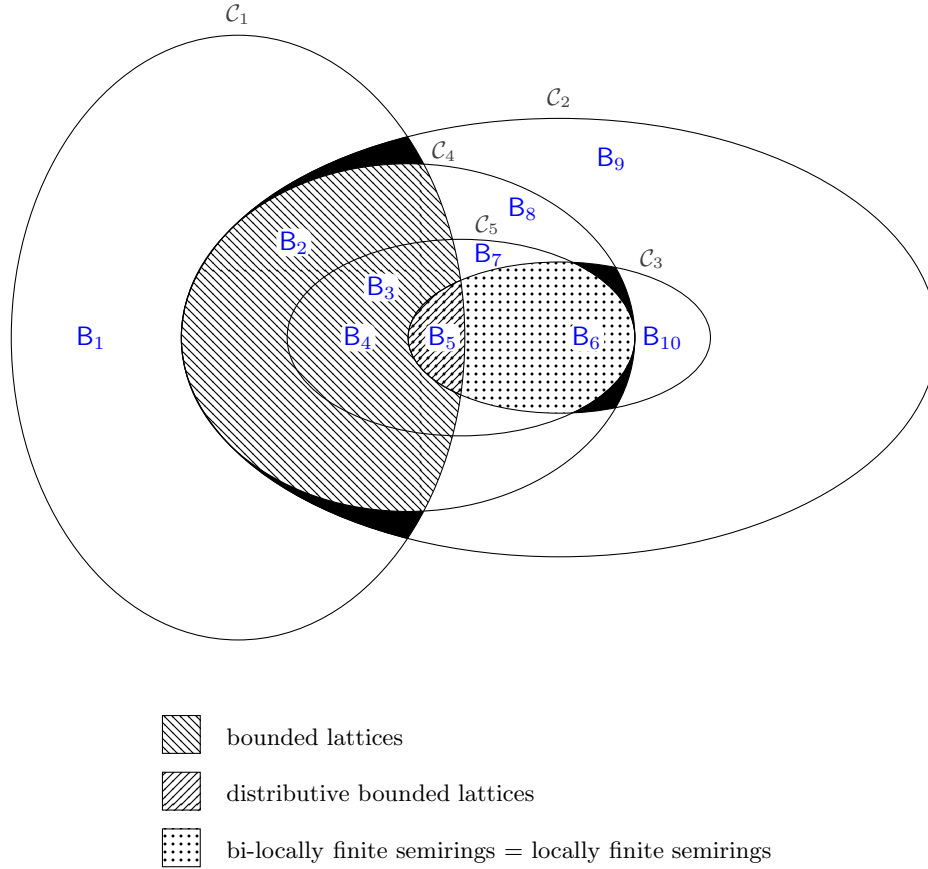

Figure 2.6: The Euler diagram of the sets \mathcal{C}_1 of all lattices, \mathcal{C}_2 of all strong bimonoids, \mathcal{C}_3 of all semirings, \mathcal{C}_4 of all bi-locally finite strong bimonoids, and \mathcal{C}_5 of all locally finite strong bimonoids. Each black area denotes the empty set. The algebras $B_1 - B_{10}$ are shown in the proof of Observation 2.7.16.

- the set \mathcal{C}_3 of all semirings,
- the set \mathcal{C}_4 of all bi-locally finite strong bimonoids, and
- the set \mathcal{C}_5 of all locally finite strong bimonoids.

Observation 2.7.16. Figure 2.6 shows the Euler diagram of the sets \mathcal{C}_1 , \mathcal{C}_2 , \mathcal{C}_3 , \mathcal{C}_4 , and \mathcal{C}_5 .

Proof. By Observation 2.7.11(8), we have $\mathcal{C}_3 \cap \mathcal{C}_4 = \mathcal{C}_3 \cap \mathcal{C}_5$. Moreover, the following subset relationships hold:

- $\mathcal{C}_3 \subseteq \mathcal{C}_2$,
- $\mathcal{C}_5 \subseteq \mathcal{C}_4$,
- $\mathcal{C}_4 \subseteq \mathcal{C}_2$,
- $\mathcal{C}_1 \cap \mathcal{C}_3 \subseteq \mathcal{C}_5$, and
- $\mathcal{C}_1 \cap \mathcal{C}_2 \subseteq \mathcal{C}_4$.

Next, for each nonempty area of the diagram, we show a witness (i.e., an element of that area).

$\mathcal{C}_1 \setminus \mathcal{C}_2 \neq \emptyset$: Let B_1 be the lattice (\mathbb{R}, \max, \min) . Since B_1 is not bounded, it is not a strong bimonoid.

$(\mathcal{C}_1 \cap \mathcal{C}_4) \setminus \mathcal{C}_5 \neq \emptyset$ [Czé19]: We let B_2 be the bounded lattice $FL(2 + 2)$ in Example 2.7.15(9) (cf. Figure 2.5). This lattice is infinite and generated by the two finite chains $a < b$ and $c < d$. Hence it is not locally finite.

$(\mathcal{C}_1 \cap \mathcal{C}_5) \setminus \mathcal{C}_3 \neq \emptyset$: We let $\mathbf{B}_3 = \mathbf{N}_5$ and $\mathbf{B}_4 = \mathbf{M}_3$. These are finite bounded lattices; hence, they are locally finite and commutative strong bimonoids. But neither of them is distributive.

$\mathcal{C}_1 \cap \mathcal{C}_3 \neq \emptyset$: We let \mathbf{B}_5 be the semiring $\mathbf{PS}_A = (\mathcal{P}(A), \cup, \cap, \emptyset, A)$ for some set $A \neq \emptyset$. This is a bounded lattice (cf. Example 2.7.15(1)).

$(\mathcal{C}_3 \cap \mathcal{C}_4) \setminus \mathcal{C}_1 \neq \emptyset$: We let \mathbf{B}_6 be the ring $\mathbf{Intmod}4 = (\{0, 1, 2, 3\}, +_4, \cdot_4, 0, 1)$ defined in Example 2.7.9(5). This is a finite (hence also locally finite) semiring but not a lattice, because e.g. $+_4$ is not idempotent.

$\mathcal{C}_5 \setminus (\mathcal{C}_1 \cup \mathcal{C}_3) \neq \emptyset$: We let \mathbf{B}_7 be the strong bimonoid $(\{0, 1, 2, 3, \infty\}, +_4, \min, 0, \infty)$ where $+_4$ is defined as for \mathbf{B}_6 (extended in the usual way to ∞). Since \mathbf{B}_7 is finite, it is also locally finite. \mathbf{B}_7 is neither a lattice (because $+_4$ is not idempotent) nor a semiring (because, e.g., $\min(1, 1 +_4 1) \neq \min(1, 1) +_4 \min(1, 1)$).

$\mathcal{C}_4 \setminus (\mathcal{C}_1 \cup \mathcal{C}_3 \cup \mathcal{C}_5) \neq \emptyset$ [Dro19]: Let \mathbf{B}_8 be the strong bimonoid $\mathbf{Trunc}_\lambda = (B, \oplus, \odot, 0, 1)$ of Example 2.7.10(2) (also cf. [DV12, Ex. 2.1(2)]). Then \mathbf{B}_8 is a bi-locally finite and commutative strong bimonoid, but not a locally finite strong bimonoid. Moreover, \mathbf{B}_8 is neither a semiring nor a lattice.

$\mathcal{C}_2 \setminus (\mathcal{C}_1 \cup \mathcal{C}_3 \cup \mathcal{C}_4) \neq \emptyset$: We let \mathbf{B}_9 be the tropical bimonoid \mathbf{TropBM} . This is neither a lattice (because $+$ is not idempotent) nor a bi-locally finite strong bimonoid nor a semiring (because, e.g., $\min(1, 1 + 1) \neq \min(1, 1) + \min(1, 1)$).

$\mathcal{C}_3 \setminus (\mathcal{C}_1 \cup \mathcal{C}_4)$: We let \mathbf{B}_{10} be the semiring $\mathbf{Nat} = (\mathbb{N}, +, \cdot, 0, 1)$ of natural numbers. This is neither bi-locally finite nor it is a lattice. \square

We finish this subsection with a characterization theorem. It concerns the smallest set which is closed under certain operations. Such a set can be characterized by using a combination of the fixpoint theorem of Tarski [Tar55, Thm. 1] and the first fixpoint theorem of Kleene [Kle62, p. 348] (cf. [LNS82]). We start with some preparations.

First, we recall some notions and observations from [DP12]. Let A be a set. The pair $(\mathcal{P}(A), \subseteq)$ is a σ -complete lattice in the order-theoretical sense; the corresponding algebraic version is the σ -complete semiring $\mathbf{PS}_A = (\mathcal{P}(A), \cup, \cap, \emptyset, A)$ where $U \cup U'$ and $U \cap U'$ are the supremum of U and infimum of U' , respectively, with respect to \subseteq .

Let $D \subseteq \mathcal{P}(A)$ such that $D \neq \emptyset$. We call D *directed* if, for each $U, U' \in D$, there exists $V \in D$ such that $U \subseteq V$ and $U' \subseteq V$.

Let $f : \mathcal{P}(A) \rightarrow \mathcal{P}(A)$ be a mapping. We say that

- f is *order-preserving* if, for every $U, U' \in \mathcal{P}(A)$, the inclusion $U \subseteq U'$ implies $f(U) \subseteq f(U')$,
- f is *continuous* if, for each directed set $D \subseteq \mathcal{P}(A)$ we have that $f(D)$ is a directed set and $f(\bigcup(U \mid U \in D)) = \bigcup(f(U) \mid U \in D)$,
- $U \in \mathcal{P}(A)$ is a *fixpoint* of f if $f(U) = U$, and
- U is the *least fixpoint* of f if it is a fixpoint and, for each fixpoint U' , the inclusion $U \subseteq U'$ holds.

We note that each continuous mapping $f : \mathcal{P}(A) \rightarrow \mathcal{P}(A)$ is order-preserving [DP12, Lm. 8.7(ii)].

Theorem 2.7.17. (cf. least fixpoint theorems [DP12, Thm. 2.35] and [DP12, Thm. 8.15]) *Let A be a set and $f : \mathcal{P}(A) \rightarrow \mathcal{P}(A)$ be a continuous mapping. Then:*

$$\bigcap (U \in \mathcal{P}(A) \mid f(U) \subseteq U) = \bigcup (f^n(\emptyset) \mid n \in \mathbb{N})$$

(2.22)

and $\bigcup (f^n(\emptyset) \mid n \in \mathbb{N})$ is the least fixpoint of f .

Intuitively, the left-hand side of (2.22) reflects the definition of a set as the smallest set which satisfies a closure property (formalized by f), and the right-hand side offers a kind of slicing (or stratification) of this set; that slicing can be used in a proof by induction on \mathbb{N} .

In the rest of this book, \mathbf{B} will denote an arbitrary strong bimonoid $(B, \oplus, \otimes, 0, 1)$ if not specified otherwise.

2.7.7 Semimodules and vector spaces

In this section, let $\mathbf{B} = (B, \oplus, \otimes, \mathbb{0}, \mathbb{1})$ be a commutative semiring, unless specified otherwise.

Semimodules, linear mappings, linear forms, and multilinear operations. Let $\mathbf{V} = (V, +, 0)$ be a commutative monoid⁴. Moreover, let $\cdot : B \times V \rightarrow V$ be a mapping, called *scalar multiplication*. Then \mathbf{V} is a (*left-*) \mathbf{B} -*semimodule* (via \cdot) if the following laws hold:

$$(b \otimes b') \cdot v = b \cdot (b' \cdot v) \quad (2.23)$$

$$b \cdot (v + v') = (b \cdot v) + (b \cdot v') \quad (2.24)$$

$$(b \oplus b') \cdot v = (b \cdot v) + (b' \cdot v) \quad (2.25)$$

$$\mathbb{1} \cdot v = v \quad (2.26)$$

$$b \cdot \mathbb{0} = \mathbb{0} \cdot v = 0 \quad (2.27)$$

for every $b, b' \in B$ and $v, v' \in V$ (cf. p.149 of [Gol99]). We note that, in Equation (2.27), the element $0 \in V$ occurs twice and the element $\mathbb{0} \in B$ occurs once. In particular, $(B, \oplus, \mathbb{0})$ is a \mathbf{B} -semimodule via scalar multiplication \otimes . Sometimes we drop \cdot and write, e.g., bv instead of $b \cdot v$.

In this book, we will deal with several \mathbf{B} -semimodules. For each of them, we will use \cdot to denote its scalar multiplication. It will always be clear from the context, which type this scalar multiplication has.

We can view a \mathbf{B} -semimodule $\mathbf{V} = (V, +, 0)$ via \cdot as a universal algebra (in the sense of Subsection 2.7.1) as follows. We define the index set $I = \{+, 0\} \cup \{(b \cdot) \mid b \in B\}$ and the mapping $\eta : I \rightarrow \text{Ops}(V)$ such that

- $\eta(+)$ is $+$ and $\eta(0)$ is 0 , and
- for every $b \in B$ and $v \in V$, we let $\eta((b \cdot))(v) = b \cdot v$ for each $b \in B$.

Then \mathbf{V} is the universal algebra (V, η) . Moreover, \mathbf{V} is of type $\tau : I \rightarrow \mathbb{N}$ where $\tau(+)$ is 2, $\tau(0)$ is 0, and $\tau((b \cdot))$ is 1 for each $b \in B$.

Thus, in particular, we can use the concept of “the \mathbf{B} -semimodule \mathbf{V} is generated by some set” as it is defined for universal algebras.

Let $\mathbf{V} = (V, +, 0)$ and $\mathbf{V}' = (V', +', 0')$ be \mathbf{B} -semimodules. A mapping $f : V \rightarrow V'$ is *linear* (from \mathbf{V} to \mathbf{V}') if, for every $b_1, b_2 \in B$ and $u, v \in V$, the equation

$$f(b_1 \cdot u + b_2 \cdot v) = b_1 \cdot f(u) +' b_2 \cdot f(v)$$

holds. The semimodules \mathbf{V} and \mathbf{V}' are *isomorphic* if there exists a bijective linear mapping from \mathbf{V} to \mathbf{V}' .

Let $\mathbf{V} = (V, +, 0)$ be a \mathbf{B} -semimodule. A *linear form* (over \mathbf{V}) is a linear mapping from the \mathbf{B} -semimodule $\mathbf{V} = (V, +, 0)$ to the \mathbf{B} -semimodule $(B, \oplus, \mathbb{0})$. That is, a linear form is a mapping $\gamma : V \rightarrow B$ such that for every $b, b' \in B$ and $v, v' \in V$, we have $\gamma(b \cdot v + b' \cdot v') = b \otimes \gamma(v) \oplus b' \otimes \gamma(v')$. We note that, by viewing semimodules as universal algebras, linear mappings and linear forms are nothing else but algebra homomorphisms.

Let $k \in \mathbb{N}_+$. A k -ary operation $\omega : V^k \rightarrow V$ is called *multilinear* (over \mathbf{V}) if

$$\begin{aligned} \omega(v_1, \dots, v_{i-1}, b \cdot v + b' \cdot v', v_{i+1}, \dots, v_k) = \\ b \cdot \omega(v_1, \dots, v_{i-1}, v, v_{i+1}, \dots, v_k) + b' \cdot \omega(v_1, \dots, v_{i-1}, v', v_{i+1}, \dots, v_k) \end{aligned} \quad (2.28)$$

holds for every $i \in [k]$, $b, b' \in B$, and $v, v', v_1, \dots, v_k \in V$. We denote by $\mathcal{L}(\mathbf{V}^k, \mathbf{V})$ the set of all k -ary multilinear operations over \mathbf{V} .

⁴We note that the $\mathbb{0}$ of the semiring B can be different from the 0 of the monoid V .

We explain why commutativity of \mathbf{B} is assumed in the above. For this we consider the expression $\omega(b_1 \cdot v_1, b_2 \cdot v_2)$ and observe that we can evaluate it in two different ways:

$$\begin{array}{ll}
\omega(b_1 \cdot v_1, b_2 \cdot v_2) & \omega(b_1 \cdot v_1, b_2 \cdot v_2) \\
= b_1 \cdot \omega(v_1, b_2 \cdot v_2) & \text{(by (2.28)(}i=1\text{))} & = b_2 \cdot \omega(b_1 \cdot v_1, v_2) & \text{(by (2.28)(}i=2\text{))} \\
= b_1 \cdot (b_2 \cdot \omega(v_1, v_2)) & \text{(by (2.28)(}i=2\text{))} & = b_2 \cdot (b_1 \cdot \omega(v_1, v_2)) & \text{(by (2.28)(}i=1\text{))} \\
= (b_1 \otimes b_2) \cdot \omega(v_1, v_2) & \text{(by (2.23))} & = (b_2 \otimes b_1) \cdot \omega(v_1, v_2) & \text{(by (2.23))}
\end{array}$$

Then commutativity of \mathbf{B} guarantees the well-definedness of multilinearity.

We note that each linear mapping from \mathbf{V} to \mathbf{V} is a unary multilinear operation over \mathbf{V} . Thus, $\mathcal{L}(\mathbf{V}, \mathbf{V})$ is the set of all linear mappings from \mathbf{V} to \mathbf{V} . Each element of $\mathcal{L}(\mathbf{V}, \mathbf{V})$ is an *endomorphism*. Since endomorphisms are closed under composition, $(\mathcal{L}(\mathbf{V}, \mathbf{V}), \circ, \text{id}_V)$ is a monoid (cf. [MY98, p. 384]).

Semimodules equipped with a Σ -algebra A (Σ, \mathbf{B}) -*semimodule* is a pair (V, θ) where

- $V = (V, +, 0)$ be a \mathbf{B} -semimodule via \cdot ,
- (V, θ) is a Σ -algebra such that, for every $k \in \mathbb{N}$ and $\sigma \in \Sigma^{(k)}$, we have $\theta(\sigma) \in \mathcal{L}(V^k, V)$, i.e., $\theta(\sigma)$ is a k -ary multilinear operation over V .

We denote the pair (V, θ) also in the form $(V, +, 0, \theta)$.

We can view a (Σ, \mathbf{B}) -semimodule $(V, +, 0, \theta)$ as a universal algebra (in the sense of Subsection 2.7.1) as follows. We define the index set $I = \{+, 0\} \cup \{(b \cdot) \mid b \in B\} \cup \Sigma$ and the mapping $\eta : I \rightarrow \text{Ops}(V)$ such that

- $\eta(+)$ is $+$ and $\eta(0)$ is 0 ,
- for every $b \in B$ and $v \in V$, we let $\eta((b \cdot))(v) = b \cdot v$, and
- for each $\sigma \in \Sigma$, we let $\eta(\sigma) = \theta(\sigma)$.

Then $(V, +, 0, \theta)$ is the universal algebra (V, η) . Moreover, $(V, +, 0, \theta)$ is of type $\tau : I \rightarrow \mathbb{N}$ where $\tau(+)$ is 2, $\tau(0)$ is 0, $\tau((b \cdot))$ is 1 for each $b \in B$, and $\tau(\sigma) = \text{rk}(\sigma)$ for each $\sigma \in \Sigma$.

Thus, for (Σ, \mathbf{B}) -semimodules we can use, in particular, the concepts “congruence relation” and “initial” as they are defined for universal algebras. Hence, if \sim is a congruence relation on a (Σ, \mathbf{B}) -semimodule $(V, +, 0, \theta)$, then

- for every $a, b \in B$ and $v_1, v'_1, v_2, v'_2 \in V$, if $v_1 \sim v'_1$ and $v_2 \sim v'_2$, then $(a \cdot v_1 + b \cdot v_2) \sim (a \cdot v'_1 + b \cdot v'_2)$, and
- \sim is a congruence on the Σ -algebra (V, θ) .

Moreover, we call an algebra homomorphism from the (Σ, \mathbf{B}) -semimodule $(V_1, +_1, 0_1, \theta_1)$ to the (Σ, \mathbf{B}) -semimodule $(V_2, +_2, 0_2, \theta_2)$ a (Σ, \mathbf{B}) -*semimodule homomorphism (from $(V_1, +_1, 0_1, \theta_1)$ to $(V_2, +_2, 0_2, \theta_2)$)*. Hence, if h is such a (Σ, \mathbf{B}) -semimodule homomorphism, then

- h is a linear mapping from the \mathbf{B} -semimodule $(V_1, +_1, 0_1)$ to the \mathbf{B} -semimodule $(V_2, +_2, 0_2)$ and
- h is a Σ -algebra homomorphism from the Σ -algebra (V_1, θ_1) to the Σ -algebra (V_2, θ_2) .

Vector spaces. Let $\mathbf{B} = (B, \oplus, \otimes, 0, \mathbb{1})$ be a field. A \mathbf{B} -*vector space* is a \mathbf{B} -semimodule $(V, +, 0)$ where $(V, +, 0)$ is a commutative group. In particular, $(B, \oplus, 0)$ is a \mathbf{B} -vector space via scalar multiplication \otimes .

Let $\mathbf{V} = (V, +, 0)$ be a \mathbf{B} -vector space via \cdot . Moreover, let $U \subseteq V$ be a nonempty subset such that for every $u, v \in U$ and $b \in B$, we have $u + v \in U$ and $b \cdot u \in U$. Then $(U, +', 0)$ is a *subspace of \mathbf{V}* where $+'$ is $+|_{U \times U}$. Often we will drop the prime from $+'$. It is easy to see that any subspace U of \mathbf{V} is a \mathbf{B} -vector space. Two subspaces $(U_1, +, 0)$ and $(U_2, +, 0)$ of \mathbf{V} are *supplementary* if $U_1 \cap U_2 = \{0\}$ and $U_1 + U_2 = V$, where in the latter we denote also by $+$ the natural extension of the binary operation $+$ on V to subsets of V .

The elements of V are called *vectors*. The vectors $v_1, \dots, v_m \in V$ are *linearly independent* if, for every $b_1, \dots, b_m \in B$, the equality $b_1 \cdot v_1 + \dots + b_m \cdot v_m = 0$ implies that $b_1 = \dots = b_m = 0$. Let $Q \subseteq V$. We say that

- Q is *linearly independent* if, for every $m \in \mathbb{N}$ and pairwise different $v_1, \dots, v_m \in Q$, the vectors v_1, \dots, v_m are linearly independent.
- Q *generates* V (or Q is a *generator set of* V) if, for every $v \in V$, there exist $m \in \mathbb{N}_+$, $b_1, \dots, b_m \in B$, and $v_1, \dots, v_m \in Q$ such that $v = b_1 \cdot v_1 + \dots + b_m \cdot v_m$.
- Q is a *basis of* V if Q is linearly independent and Q generates V .

A vector space V that has a finite basis is called *finite-dimensional*. In a finite-dimensional vector space each basis has the same number of elements [MY98, p. 341]. We say that V is κ -*dimensional*, where $\kappa \in \mathbb{N}_+$, if it has a basis consisting of κ elements.

Let $V' = (V', +', 0')$ be a B -vector space and let $f : V \rightarrow V'$ be a linear mapping from V to V' . If $Q = \{v_1, \dots, v_m\}$ is a basis of V , then f is determined by the vectors $f(v_1), \dots, f(v_m)$, because for each $v \in V$ there exist $b_1, \dots, b_m \in B$ such that $v = b_1 \cdot v_1 + \dots + b_m \cdot v_m$ and then

$$f(v) = f(b_1 \cdot v_1 + \dots + b_m \cdot v_m) = b_1 \cdot f(v_1) +' \dots +' b_m \cdot f(v_m) .$$

The *kernel of* f (or: *null-space of* f), denoted by $\ker(f)$, is the set $\{v \in V \mid f(v) = 0'\}$. It is easy to see that $(\ker(f), +, 0)$ and $(\text{im}(f), +', 0')$ are subspaces of V and V' , respectively.

By Sylvester's law of nullity (cf., e.g., [MY98, Thm. 5.12], we have

$$\dim(V) = \dim(\ker(f)) + \dim(\text{im}(f)) . \quad (2.29)$$

An endomorphism $f \in \mathcal{L}(V, V)$ is *pseudo-regular* if $(\ker(f), +, 0)$ and $(\text{im}(f), +, 0)$ are supplementary subspaces of V .

We call a (Σ, B) -semimodule where B is a field a (Σ, B) -*vector space*. In [BA89] such algebras are called B - Σ -algebras. Moreover, if B is a field, then we call a (Σ, B) -semimodule homomorphism a (Σ, B) -*vector space homomorphism*.

2.8 Weighted sets and operations

Let $B = (B, \oplus, \otimes, \mathbb{0}, \mathbb{1})$ be a strong bimonoid, A be a set, and $f : A \rightarrow B$ be a mapping. We call f a B -*weighted set*. We will define several notions for f and characteristics of f . We note that if B_1 and B_2 are different strong bimonoids with the same carrier set B , then a mapping $f : A \rightarrow B$ is both a B_1 -weighted set and a B_2 -weighted set.

Let $f : A \rightarrow B$ be a B -weighted set. The *support of* f , denoted by $\text{supp}_B(f)$, is defined by $\text{supp}_B(f) = \{a \in A \mid f(a) \neq \mathbb{0}\}$. If B is clear from the context, then we abbreviate $\text{supp}_B(f)$ by $\text{supp}(f)$.

We call f

- *polynomial* if $\text{supp}(f)$ is finite.
- *monomial* if $\text{supp}(f) \subseteq \{a\}$ for some $a \in A$; then we denote f also by $f(a).a$.
- *constant* if there exists a $b \in B$ such that for every $a \in A$, we have $f(a) = b$; then we denote f by \tilde{b} .

We note that $\tilde{\mathbb{0}}$ is a monomial and $\tilde{\mathbb{0}} = \mathbb{0}.a$ for each $a \in A$.

Also, we mention that each polynomial $p : X_k^* \rightarrow B$ in $B[x_1, \dots, x_k]$ (cf. Example 2.7.919) is an example of a polynomial B -weighted set.

Let $L \subseteq A$. The *characteristic mapping of* L with respect to B , denoted by $\chi_B(L)$, is the B -weighted set $\chi_B(L) : A \rightarrow B$ defined, for each $a \in A$, by $\chi_B(L)(a) = \mathbb{1}$ if $a \in L$, and $\chi_B(L)(a) = \mathbb{0}$ otherwise. In particular, $\chi_B(\emptyset) = \tilde{\mathbb{0}}$ and $\chi_B(\{a\}) = \mathbb{1}.a$. Certainly, $\text{supp}_B(\chi_B(L)) = L$ and, if $|B| > 2$, then there exists a B -weighted set $f : A \rightarrow B$ such that $\chi_B(\text{supp}_B(f)) \neq f$. However, for each Boole-weighted set $f : A \rightarrow B$, we have $\chi_{\text{Boole}}(\text{supp}_{\text{Boole}}(f)) = f$. If B is clear from the context, then we abbreviate χ_B by χ .

A *weighted language over* Γ and B (for short: (Γ, B) -weighted language) is a B -weighted set $r : \Gamma^* \rightarrow B$.

Next we introduce some operations on B -weighted sets. Let $r : A \rightarrow B$ and $b \in B$. The *scalar multiplication of* r with b from the left (with respect to B), denoted by $b \cdot r$, is the B -weighted set $(b \cdot r) :$

$A \rightarrow B$ defined for each $a \in A$ by $(b \cdot r)(a) = b \otimes r(a)$. In a similar way, we define the *scalar multiplication of r with b from the right* (with respect to \mathbf{B}) and denote it by $r \cdot b$.

Let $r_1 : A \rightarrow B$ and $r_2 : A \rightarrow B$ be two \mathbf{B} -weighted sets. The *sum of r_1 and r_2* (with respect to \mathbf{B}), denoted by $(r_1 \oplus r_2)$, is the \mathbf{B} -weighted set $(r_1 \oplus r_2) : A \rightarrow B$ defined for each $a \in A$ by $(r_1 \oplus r_2)(a) = r_1(a) \oplus r_2(a)$. It is clear that \oplus is associative and commutative. Thus the algebra $(B^A, \oplus, \tilde{0})$ is a commutative monoid. If \mathbf{B} is σ -complete, then also this monoid is σ -complete. If \mathbf{B} is a commutative semiring, then $(B^A, \oplus, \tilde{0})$ is a \mathbf{B} -semimodule (cf. Section 3.6 for the case that A is the set of all Σ -terms).

Moreover, the *Hadamard product of r_1 and r_2* (with respect to \mathbf{B}), denoted by $(r_1 \otimes r_2)$, is the \mathbf{B} -weighted $(r_1 \otimes r_2) : A \rightarrow B$ defined for each $a \in A$ by $(r_1 \otimes r_2)(a) = r_1(a) \otimes r_2(a)$. The Hadamard product \otimes is associative and, in general, it is not commutative. However, for each $L \subseteq A$, the equality $r_1 \otimes \chi(L) = \chi(L) \otimes r_1$ holds.

The algebra $(B^A, \otimes, \tilde{1})$ is a monoid. Since $\tilde{0} \otimes r = r \otimes \tilde{0} = \tilde{0}$ for each $r \in B^A$, the algebra $(B^A, \oplus, \otimes, \tilde{0}, \tilde{1})$ is a strong bimonoid. If \mathbf{B} is a semiring, then so is $(B^A, \oplus, \otimes, \tilde{0}, \tilde{1})$. In particular, the semiring $(B^A, \oplus, \otimes, \tilde{0}, \tilde{1})$ over the Boolean semiring $\text{Boole} = (\mathbb{B}, \vee, \wedge, 0, 1)$ is isomorphic to the semiring $(\mathcal{P}(A), \cup, \cap, \emptyset, A)$.

Let $r : A \rightarrow B$ and $L \subseteq A$ be finite. Then we define $r(L) \in B$ by $r(L) = \bigoplus_{a \in L} r(a)$.

2.9 Matrices and vectors over a strong bimonoid

In this section Q denotes a finite set.

Matrices. A Q -square matrix over B is a \mathbf{B} -weighted set $M : Q \times Q \rightarrow B$, and an entry $M(p, q) \in B$ is denoted by $M_{p,q}$. We recall that the set of all Q -square matrices over B is denoted by $B^{Q \times Q}$. In case that $Q = [\kappa]$ for some $\kappa \in \mathbb{N}$, we write $B^{\kappa \times \kappa}$ instead of $B^{[\kappa] \times [\kappa]}$.

Since each Q -square matrix over B is a particular \mathbf{B} -weighted set, the following operations are already defined for $b \in B$ and Q -square matrices M, M_1, M_2 over B (cf. Section 2.8):

- scalar multiplication from the left: $b \cdot M$,
- scalar multiplication from the right: $M \cdot b$,
- summation: $M_1 \oplus M_2$,
- Hadamard product: $M_1 \otimes M_2$.

From Section 2.8 we also know that $(B^{Q \times Q}, \oplus, \otimes, M_0, N_1)$ is a strong bimonoid, where M_0 and N_1 are the matrices with all entries $\tilde{0}$ and $\tilde{1}$, respectively.

Also we define another type of multiplication on matrices which might be called the Cauchy-product. Formally, the *multiplication of Q -square matrices over B* is the binary operation $\cdot : B^{Q \times Q} \times B^{Q \times Q} \rightarrow B^{Q \times Q}$ by letting for every $M_1, M_2 \in B^{Q \times Q}$ and $p, q \in Q$:

$$(M_1 \cdot M_2)_{p,q} = \bigoplus_{k \in Q} (M_1)_{p,k} \otimes (M_2)_{k,q} \cdot$$

We note that \cdot is overloaded: it is used in $b \cdot M$ where $b \in B$ and M is a Q -square matrix, and in $M_1 \cdot M_2$ where M_1 and M_2 are Q -square matrices. But it will always be clear from the context which operation is meant. In general, \cdot is not associative, because \mathbf{B} may lack distributivity.

The matrix $M_1 \in B^{Q \times Q}$ with

$$(M_1)_{p,q} = \begin{cases} \tilde{1} & \text{if } p = q \\ \tilde{0} & \text{otherwise} \end{cases}$$

for every $p, q \in Q$, is the identity element for \cdot . Moreover, $M_0 \cdot M = M \cdot M_0 = M_0$ for each $M \in B^{Q \times Q}$.

Let $M \in B^{Q \times Q}$ and $n \in \mathbb{N}$. Then we define the n -th power of M , denoted by M^n , as follows: $M^0 = M_{\mathbb{1}}$ and $M^{k+1} = M \cdot M^k$ for each $k \in \mathbb{N}$.

Let $\mathbf{B} = (B, \oplus, \otimes, 0, \mathbb{1})$ be a semiring. Since the operation \otimes of \mathbf{B} is distributive over \oplus , the operation \cdot on $B^{Q \times Q}$ is associative. Thus, $(B^{Q \times Q}, \cdot, M_{\mathbb{1}})$ is a monoid. Also \cdot is distributive with respect to \oplus . Hence $\mathbf{B}^{Q \times Q} = (B^{Q \times Q}, \oplus, \cdot, M_0, M_{\mathbb{1}})$ is a semiring, called the *semiring of Q -square matrices over B* . If \mathbf{B} is σ -complete, then so is $\mathbf{B}^{Q \times Q}$ (cf. [DK09, Sec. 4]).

We mention that the semiring of $\{1, 2\}$ -square matrices over the semiring **Boole** (cf. Section 2.9) is not zero-cancellation free, because

$$\begin{pmatrix} 1 & 0 \\ 0 & 0 \end{pmatrix} \cdot \begin{pmatrix} 1 & 1 \\ 1 & 1 \end{pmatrix} \cdot \begin{pmatrix} 0 & 0 \\ 0 & 1 \end{pmatrix} = \begin{pmatrix} 0 & 1 \\ 0 & 0 \end{pmatrix} \quad \text{and} \quad \begin{pmatrix} 1 & 0 \\ 0 & 0 \end{pmatrix} \cdot \begin{pmatrix} 0 & 0 \\ 0 & 1 \end{pmatrix} = \begin{pmatrix} 0 & 0 \\ 0 & 0 \end{pmatrix}$$

Vectors. A Q -vector v over B is a \mathbf{B} -weighted set $v : Q \rightarrow B$, and an element $v(q) \in B$ of v is denoted by v_q . We recall that the set of all Q -vectors over B is denoted by B^Q . In case that $Q = [\kappa]$ for some $\kappa \in \mathbb{N}$, we write B^κ instead of $B^{[\kappa]}$.

Since each Q -vector over B is a particular \mathbf{B} -weighted set, the following operations are already defined (cf. Section 2.8):

- scalar multiplication from the left: $b \cdot v$,
- scalar multiplication from the right: $v \cdot b$,
- summation: $v_1 \oplus v_2$,
- Hadamard product: $v_1 \otimes v_2$.

We denote by 0_Q the Q -vector over B which contains 0 in each component. Moreover, for each $q \in Q$, we denote by $\mathbb{1}_q$ the q -unit vector in B^Q , i.e., the vector in B^Q defined by $(\mathbb{1}_q)_p = \mathbb{1}$ if $p = q$ and $(\mathbb{1}_q)_p = 0$ otherwise. The algebra $(B^Q, \oplus, 0_Q)$ is a commutative monoid. Moreover, for each $v \in B^Q$, we have $v = \bigoplus_{q \in Q} v_q \cdot \mathbb{1}_q$.

For vectors, we define another type of multiplication. Formally, the *scalar product of Q -vectors* is defined for every $v_1, v_2 \in B^Q$ by:

$$v_1 \cdot v_2 = \bigoplus_{q \in Q} (v_1)_q \otimes (v_2)_q .$$

Products. Here we define products of vectors with matrices. Let $b \in B$, $v_1, v_2 \in B^Q$, and $M \in B^{Q \times Q}$ be a matrix.

We define the *vector-matrix product* $v_1 \cdot M \in B^Q$ and the *matrix-vector product* $M \cdot v_2 \in B^Q$ such that for every $p \in Q$:

$$(v_1 \cdot M)_p = \bigoplus_{q \in Q} (v_1)_q \otimes M_{q,p} \qquad (M \cdot v_2)_p = \bigoplus_{q \in Q} M_{p,q} \otimes (v_2)_q .$$

It is easy to calculate that, if \mathbf{B} is left-distributive, then for every $M_1, M_2 \in B^{Q \times Q}$ and $v \in B^Q$, we have

$$(M_1 \cdot M_2) \cdot v = M_1 \cdot (M_2 \cdot v) . \tag{2.30}$$

Characteristic polynomials. Let $(B, \oplus, \otimes, 0, \mathbb{1})$ be a field. Moreover, let $\kappa \in \mathbb{N}_+$ and $M \in B^{\kappa \times \kappa}$. The *characteristic polynomial of M* , denoted by char_M , is defined by

$$\text{char}_M(x) = \det(M - xM_{\mathbb{1}})$$

where $M_{\mathbb{1}} \in B^{\kappa \times \kappa}$ is the identity for the matrix multiplication and $\det(M')$ is the determinant of the matrix M' (cf. [MY98]). Clearly, the degree of char_M is κ , and the coefficient of x^κ is $(-1)^\kappa$. The following shows an example of $M \in \mathbb{R}^{3 \times 3}$ and $\text{char}_M(x)$:

$$M = \begin{pmatrix} 0 & 0 & 1 \\ 1 & 3 & 2 \\ 2 & 0 & 2 \end{pmatrix}, \quad \det(M - xM_{\mathbb{1}}) = \begin{vmatrix} -x & 0 & 1 \\ 1 & 3-x & 2 \\ 2 & 0 & 2-x \end{vmatrix}, \quad \text{char}_M(x) = -x^3 + 5x^2 - 4x - 6 .$$

The following theorem is due to Cayley and Hamilton. Let $\text{char}_M(x) = a_n \cdot x^n \oplus \dots \oplus a_1 \cdot x^1 \oplus a_0$ be a polynomial over \mathbb{B} and $N \in B^{\kappa \times \kappa}$. The evaluation of $\text{char}_M(x)$ in $(B^{\kappa \times \kappa}, \oplus, \cdot, M_0, M_{\mathbb{1}})$ at $x = N$, denoted by $\text{char}_M(N)$, is the matrix $a_n \cdot N^n \oplus \dots \oplus a_1 \cdot N^1 \oplus a_0 \cdot N^0$ of $B^{\kappa \times \kappa}$.

Theorem 2.9.1. [Lan93, Ch. XIV, Thm. 3.1] *Let $\kappa \in \mathbb{N}_+$ and $M \in B^{\kappa \times \kappa}$. Then $\text{char}_M(M) = M_0$.*

Representing finite-dimensional vector spaces and endomorphisms. Let $\mathbb{B} = (B, \oplus, \otimes, \mathbb{0}, \mathbb{1})$ be a field and $V = (V, +, 0)$ be a \mathbb{B} -vector space via \cdot with the finite basis $Q = \{q_1, \dots, q_\kappa\}$. Let q_1, \dots, q_κ be an arbitrary, but fixed order of the basis vectors. As usual, each vector of V can be represented by a $[\kappa]$ -vector over B , and vice versa (cf. [MY98, Ch. 3]). The key for this representation is the fact that, for each vector $v \in V$, there exist unique $b_1, \dots, b_\kappa \in \mathbb{B}$ such that $v = b_1 \cdot q_1 + \dots + b_\kappa \cdot q_\kappa$. Then, intuitively, we will represent v by (b_1, \dots, b_κ) . Let us formalize this.

Obviously, $(B^\kappa, \oplus, \mathbb{0}_\kappa)$ is a commutative group, where $\mathbb{0}_\kappa$ is the $[\kappa]$ -vector which maps each $i \in [\kappa]$ to $\mathbb{0}$. Moreover, it is easy to check that $(B^\kappa, \oplus, \mathbb{0}_\kappa)$ is a κ -dimensional \mathbb{B} -vector space via the scalar multiplication \cdot . The basis of this vector space is $\{\mathbb{1}_1, \dots, \mathbb{1}_\kappa\}$ where $\mathbb{1}_i$ denotes the i -unit vector in B^κ , i.e., the element in B^κ of which the i -th component is $\mathbb{1}$ and the other components are $\mathbb{0}$.

Then the \mathbb{B} -vector space $(V, +, 0)$ and the \mathbb{B} -vector space $(B^\kappa, \oplus, \mathbb{0}_\kappa)$ are isomorphic via the bijective linear mapping $\psi : V \rightarrow B^\kappa$ defined by

$$\psi(q_i) = \mathbb{1}_i \text{ for each } i \in [\kappa].$$

Hence, we identify $(V, +, 0)$ and $(B^\kappa, \oplus, \mathbb{0}_\kappa)$.

Also as usual, we can represent each endomorphism $f \in \mathcal{L}(V, V)$ by a κ -square matrix over B . For this, we define the mapping $\psi' : \mathcal{L}(V, V) \rightarrow B^{\kappa \times \kappa}$ for each $f : V \rightarrow V$ and $i, j \in [\kappa]$ by:

$$\psi'(f)_{i,j} = \psi(f(q_j))_i ,$$

or, in other words, the j th column of $\psi'(f)$ is the ψ -image of the basis vector q_j . It is easy to see that ψ' is bijective. Moreover, for each $v \in V$, we have $\psi(f(v)) = \psi'(f) \cdot \psi(v)$. To see this, let $v = b_1 \cdot q_1 + \dots + b_\kappa \cdot q_\kappa$. Then $f(v) = b_1 \cdot f(q_1) + \dots + b_\kappa \cdot f(q_\kappa)$ and

$$\begin{aligned} \psi(f(v))_i &= b_1 \cdot \psi(f(q_1))_i + \dots + b_\kappa \cdot \psi(f(q_\kappa))_i \\ &= b_1 \cdot \psi'(f)_{1,i} + \dots + b_\kappa \cdot \psi'(f)_{\kappa,i} = (\psi'(f) \cdot \psi(v))_i . \end{aligned}$$

The mapping ψ' is a monoid homomorphism from the monoid $(\mathcal{L}(V, V), \circ, \text{id}_V)$ to the monoid $(B^{\kappa \times \kappa}, \cdot, M_{\mathbb{1}})$, which can be seen as follows. Clearly, $\psi'(\text{id}_V) = M_{\mathbb{1}}$. Let $f_1, f_2 \in \mathcal{L}(V, V)$. Then, for every $i, j \in [\kappa]$, we have

$$\begin{aligned} \psi'(f_1 \circ f_2)_{i,j} &= \psi((f_1 \circ f_2)(q_j))_i \\ &= \psi(f_1(f_2(q_j)))_i \\ &= \psi(f_1(b_1 \cdot q_1 + \dots + b_\kappa \cdot q_\kappa))_i \\ &\quad \text{(where } b_1, \dots, b_\kappa \in B \text{ are such that } f_2(q_j) = b_1 \cdot q_1 + \dots + b_\kappa \cdot q_\kappa) \\ &= \psi(b_1 \cdot f_1(q_1) + \dots + b_\kappa \cdot f_1(q_\kappa))_i \quad \text{(since } f_1 \text{ is a linear mapping)} \end{aligned}$$

$$\begin{aligned}
&= (b_1 \cdot \psi(f_1(q_1)) \oplus \dots \oplus b_\kappa \cdot \psi(f_1(q_\kappa)))_i && \text{(since } \psi \text{ is a linear mapping)} \\
&= b_1 \otimes \psi(f_1(q_1))_i \oplus \dots \oplus b_\kappa \otimes \psi(f_1(q_\kappa))_i \\
&\quad \text{(by definition of scalar multiplication and vector summation)} \\
&= \psi(f_2(q_j))_1 \otimes \psi(f_1(q_1))_i \oplus \dots \oplus \psi(f_2(q_j))_\kappa \otimes \psi(f_1(q_\kappa))_i && \text{(because } b_k = \psi(f_2(q_j))_k) \\
&= \bigoplus_{k \in [\kappa]} \psi(f_2(q_j))_k \otimes \psi(f_1(q_k))_i \\
&= \bigoplus_{k \in [\kappa]} \psi'(f_2)_{k,j} \otimes \psi'(f_1)_{i,k} \\
&= \bigoplus_{k \in [\kappa]} \psi'(f_1)_{i,k} \otimes \psi'(f_2)_{k,j} && \text{(by commutativity)} \\
&= (\psi'(f_1) \cdot \psi'(f_2))_{i,j} .
\end{aligned}$$

Hence, the two monoids $(\mathcal{L}(V, V), \circ, \text{id}_V)$ and $(B^{\kappa \times \kappa}, \cdot, M_{\mathbb{1}})$ are isomorphic.

A matrix $M \in B^{\kappa \times \kappa}$ is *pseudo-regular* if the endomorphism $(\psi')^{-1}(M)$ is pseudo-regular. Equivalent definitions of pseudo-regularity can be found in [Reu80, Prop. 1].

2.10 Trees and tree languages

We recall some notions from (formal) tree languages [Eng75b, GS84, GS97, CDG⁺07].

In the rest of this book, Σ and Δ will denote arbitrary ranked alphabets, if not specified otherwise.

Trees. Let H be a set and let Ξ denote the set containing the opening and closing parentheses “(” and “)”, respectively, and the comma “,”. We assume that Σ , H , and Ξ are pairwise disjoint. Now we define the Σ -algebra $((\Sigma \cup H \cup \Xi)^*, \theta_\Sigma)$ where, for every $k \in \mathbb{N}$, $\sigma \in \Sigma^{(k)}$, and $w_1, \dots, w_k \in (\Sigma \cup H \cup \Xi)^*$, we let

$$\theta_\Sigma(\sigma)(w_1, \dots, w_k) = \sigma(w_1, \dots, w_k) .$$

Then the *set of Σ -terms over H* , denoted by $T_\Sigma(H)$, is the set $\langle H \rangle_{\theta_\Sigma(\Sigma)}$, i.e., the smallest subset of $(\Sigma \cup H \cup \Xi)^*$ which contains H and is closed under $\theta_\Sigma(\Sigma)$. We denote $T_\Sigma(\emptyset)$ by T_Σ and call it the *set of Σ -terms*. If H is finite, then we can view $T_\Sigma(H)$ as T_Δ , where the ranked alphabet Δ is defined as follows: $\Delta^{(0)} = \Sigma^{(0)} \cup H$ and $\Delta^{(k)} = \Sigma^{(k)}$ for every $k \in \mathbb{N}_+$.

Since terms can be depicted in a very illustrative way as trees, i.e., particular graphs, it has become a custom to call Σ -terms also Σ -trees (or just: *trees*). In this book we follow this custom. Each subset $L \subseteq T_\Sigma$ is called a Σ -tree language (or just: *tree language*).

Obviously, for each $\xi \in T_\Sigma$ there exist unique $k \in \mathbb{N}$, $\sigma \in \Sigma^{(k)}$, and $\xi_1, \dots, \xi_k \in T_\Sigma$ such that $\xi = \sigma(\xi_1, \dots, \xi_k)$. (In case $k = 0$ we identify $\sigma()$ and $\sigma.$) In order to avoid the repetition of all these quantifications, we henceforth only write that we consider a “ $\xi \in T_\Sigma$ of the form $\xi = \sigma(\xi_1, \dots, \xi_k)$ ” or “for every $\xi = \sigma(\xi_1, \dots, \xi_k)$ ”.

As an application of Lemma 2.7.1, we obtain the following characterization of the set T_Σ .

Observation 2.10.1. Let $f_{T_\Sigma} : \mathcal{P}((\Sigma \cup \Xi)^*) \rightarrow \mathcal{P}((\Sigma \cup \Xi)^*)$ be the mapping defined, for each $U \in \mathcal{P}((\Sigma \cup \Xi)^*)$, by $f_{T_\Sigma}(U) = U \cup \{\sigma(\xi_1, \dots, \xi_k) \mid k \in \mathbb{N}, \sigma \in \Sigma^{(k)}, \xi_1, \dots, \xi_k \in U\}$. Then, by Lemma 2.7.1, we have $T_\Sigma = \bigcup_{n \in \mathbb{N}} ((f_{T_\Sigma})^n(\emptyset))$. \square

The Σ -term algebra. Let H be a set disjoint with Σ . The Σ -term algebra over H , denoted by $\mathsf{T}_\Sigma(H)$, is the subalgebra of the Σ -algebra $((\Sigma \cup H \cup \Xi)^*, \theta_\Sigma)$ which is generated by H . Thus, since $\langle H \rangle_{\theta_\Sigma(\Sigma)} = \mathsf{T}_\Sigma(H)$, the Σ -term algebra over H is the Σ -algebra

$$\mathsf{T}_\Sigma(H) = (\mathsf{T}_\Sigma(H), \theta_\Sigma) .$$

The Σ -term algebra, denoted by T_Σ , is the Σ -term algebra over \emptyset , i.e., $\mathsf{T}_\Sigma = \mathsf{T}_\Sigma(\emptyset)$.

Next we prove that $\mathsf{T}_\Sigma(H)$ is free in the set of all Σ -algebras with generator set H , by using Theorem 2.6.1. For this, we use the following auxiliary definitions. We define the binary relation \succ on $\mathsf{T}_\Sigma(H)$ as follows:

$$\text{for every } k \in \mathbb{N}_+, \sigma \in \Sigma^{(k)}, \xi_1, \dots, \xi_k \in \mathsf{T}_\Sigma(H), \text{ and } i \in [k], \text{ we let } \sigma(\xi_1, \dots, \xi_k) \succ \xi_i .$$

By Corollary 2.5.6, the relation \succ is terminating and $\text{nf}_\succ(\mathsf{T}_\Sigma(H)) = \Sigma^{(0)} \cup H$. Let $\mathbf{A} = (A, \theta)$ be a Σ -algebra and $f : H \rightarrow A$. Then we define the mapping

$$G_{\theta, f} : \{(\xi, g) \mid \xi \in \mathsf{T}_\Sigma(H), g : \succ(\xi) \rightarrow A\} \rightarrow A$$

for every $\xi \in \mathsf{T}_\Sigma(H)$ and $g : \succ(\xi) \rightarrow A$ as follows:

$$G_{\theta, f}(\xi, g) = \begin{cases} \theta(\sigma)(g(\xi_1), \dots, g(\xi_k)) & \text{if } (\exists k \in \mathbb{N}, \sigma \in \Sigma^{(k)}, \xi_1, \dots, \xi_k \in \mathsf{T}_\Sigma(H)) : \xi = \sigma(\xi_1, \dots, \xi_k) \\ f(\xi) & \text{otherwise (i.e., } \xi \in H) . \end{cases}$$

Now we prove that the unique mapping defined by $G_{\theta, f}$ (cf. Theorem 2.6.1) is the unique Σ -algebra homomorphism from $\mathsf{T}_\Sigma(H)$ to \mathbf{A} which extends f .

Lemma 2.10.2. Let $\mathbf{A} = (A, \theta)$ be a Σ -algebra and $f : H \rightarrow A$. Moreover, let $\phi : \mathsf{T}_\Sigma(H) \rightarrow A$ be a mapping. Then the following two statements are equivalent.

- (A) For each $\xi \in \mathsf{T}_\Sigma(H)$, the mapping ϕ satisfies $\phi(\xi) = G_{\theta, f}(\xi, \phi|_{\succ(\xi)})$.
- (B) ϕ is a Σ -algebra homomorphism from $\mathsf{T}_\Sigma(H)$ to \mathbf{A} , and ϕ extends f .

Proof. Proof of (A) \Rightarrow (B): Let $\xi = \sigma(\xi_1, \dots, \xi_k)$. Then we can compute as follows:

$$\begin{aligned} \phi(\sigma(\xi_1, \dots, \xi_k)) &= G_{\theta, f}(\xi, \phi|_{\succ(\xi)}) && \text{(by (A))} \\ &= \theta(\sigma)(\phi|_{\succ(\xi)}(\xi_1), \dots, \phi|_{\succ(\xi)}(\xi_k)) && \text{(by definition of } G_{\theta, f}) \\ &= \theta(\sigma)(\phi(\xi_1), \dots, \phi(\xi_k)) . \end{aligned}$$

Hence ϕ is a Σ -algebra homomorphism from $\mathsf{T}_\Sigma(H)$ to \mathbf{A} . By definition of $G_{\theta, f}$, the homomorphism ϕ extends f .

Proof of (B) \Rightarrow (A): We prove by case analysis. Let $\xi \in H$. Then $\phi(\xi) = f(\xi) = G_{\theta, f}(\xi, \phi|_{\succ(\xi)})$. Let $\xi = \sigma(\xi_1, \dots, \xi_k)$. Then we can compute as follows:

$$\begin{aligned} G_{\theta, f}(\xi, \phi|_{\succ(\xi)}) &= \theta(\sigma)(\phi|_{\succ(\xi)}(\xi_1), \dots, \phi|_{\succ(\xi)}(\xi_k)) && \text{(by definition of } G_{\theta, f}) \\ &= \theta(\sigma)(\phi(\xi_1), \dots, \phi(\xi_k)) \\ &= \phi(\xi) . && \text{(by (B))} \end{aligned}$$

□

Theorem 2.10.3. [GTWW77, Prop. 2.3] and [GS84, Thm. 1.3.11] *The Σ -term algebra $\mathsf{T}_\Sigma(H)$ is free in the set of all Σ -algebras generated by H . Moreover, the Σ -term algebra T_Σ is initial in the set of all Σ -algebras.*

Proof. For the proof of the first statement of the theorem, we proceed along the items (a), (b), and (c) of the definition of a free algebra.

(a) As we saw, the Σ -term algebra $T_\Sigma(H)$ over H is a Σ -algebra.

(b) By definition, we have $T_\Sigma(H) = \langle H \rangle_{\theta_\Sigma(\Sigma)}$.

(c) Let $A = (A, \theta)$ be a Σ -algebra and $f : H \rightarrow A$ a mapping. By Theorem 2.6.1, there exists a unique mapping $h : T_\Sigma(H) \rightarrow A$ such that, for each $\xi \in T_\Sigma(H)$, we have $h(\xi) = G_{\theta, f}(\xi, h|_{\succ(\xi)})$. Thus, due to Lemma 2.10.2, we obtain that h is the unique Σ -algebra homomorphism from $T_\Sigma(H)$ to A which extends f .

This proves the first statement of the lemma. The second statement follows from the first one with $H = \emptyset$. \square

If not specified otherwise, then we denote the unique Σ -algebra homomorphism from the Σ -term algebra $T_\Sigma = (T_\Sigma, \theta_\Sigma)$ to some Σ -algebra A by h_A .

Observation 2.10.4. Let $A = (A, \theta)$ be a Σ -algebra and (A', θ) be the smallest subalgebra of A . Then $A' = \text{im}(h_A)$.

Proof. By Lemma 2.7.2, $(\text{im}(h_A), \theta)$ is a subalgebra of A . Moreover, we can show by induction on (T_Σ, \succ) that, for each $\xi \in T_\Sigma$, we have $h_A(\xi) \in A'$. Hence $\text{im}(h_A) \subseteq A'$, and since (A', θ) is the smallest subalgebra of A , we have $\text{im}(h_A) = A'$. \square

String-like terms. We can view strings over an alphabet Γ as trees. For this, we first define an appropriate ranked alphabet.

Let $e \notin \Gamma$ be a symbol. Then Γ and e determine the string ranked alphabet $\Gamma_e = \{a^{(1)} \mid a \in \Gamma\} \cup \{e^{(0)}\}$. Vice versa, each string ranked alphabet Σ can be written in the form Γ_e , where $\Gamma = \Sigma^{(1)}$ and e is the only element of $\Sigma^{(0)}$. In the following, sometimes we denote a string ranked alphabet by Γ_e without mentioning what Γ and e mean.

Now we define the Γ_e -algebra⁵ $(\Gamma^*, \widehat{\Gamma}_e)$ where $\widehat{\Gamma}_e = (\widehat{b} \mid b \in \Gamma_e)$ is the Γ_e -indexed family over $\text{Ops}(\Gamma^*)$ such that

$$\widehat{\varepsilon} = \varepsilon \quad \text{and} \quad \widehat{a}(w) = wa \quad \text{for every } w \in \Gamma^* \text{ and } a \in \Gamma \quad .$$

Then we consider the Γ_e -term algebra $(T_{\Gamma_e}, \theta_{\Gamma_e})$ and show that

$$(\Gamma^*, \widehat{\Gamma}_e) \cong (T_{\Gamma_e}, \theta_{\Gamma_e}) \quad , \quad (2.31)$$

i.e., the two Γ_e -algebras $(\Gamma^*, \widehat{\Gamma}_e)$ and $(T_{\Gamma_e}, \theta_{\Gamma_e})$ are isomorphic. For this, we define the mapping

$$\text{tree}_e : \Gamma^* \rightarrow T_{\Gamma_e}$$

as follows. We consider the reduction system (Γ^*, \succ) where $\succ \subseteq \Gamma^* \times \Gamma^*$ is defined by $\succ = \{(wa, w) \mid w \in \Gamma^*, a \in \Gamma\}$. By Corollary 2.5.6, the relation \succ is terminating and $\text{nf}_\succ(\Gamma^*) = \{\varepsilon\}$. Then we define tree_e by induction on (Γ^*, \succ) by

I.B.: $\text{tree}_e(\varepsilon) = e$ and

I.S.: $\text{tree}_e(wa) = a(\text{tree}_e(w))$ for every $w \in \Gamma^*$ and $a \in \Gamma$.

It is obvious that tree_e is a bijection. Lastly, we show that tree_e is a Γ_e -algebra homomorphism from $(\Gamma^*, \widehat{\Gamma}_e)$ to $(T_{\Gamma_e}, \theta_{\Gamma_e})$:

(i) $\text{tree}_e(\widehat{\varepsilon}) = \text{tree}_e(\varepsilon) = e = \theta_{\Gamma_e}(e)(\cdot)$, and

(ii) for every $w \in \Gamma^*$ and $a \in \Gamma$, we have $\text{tree}_e(\widehat{a}(w)) = \text{tree}_e(wa) = a(\text{tree}_e(w)) = \theta_{\Gamma_e}(a)(\text{tree}_e(w))$.

Hence (2.31) holds.

⁵ $(\Gamma^*, \widehat{\Gamma}_e)$ should not be confused with the free monoid $(\Gamma^*, \cdot, \varepsilon)$.

Proof by induction on $T_\Sigma(H)$ and proof by induction on T_Σ . Let H be a set disjoint with Σ . Many times we will use the following two instances of well-founded induction to prove that each element of $T_\Sigma(H)$ has a property:

- *proof by induction on $(T_\Sigma(H), \succ_{\Sigma, H})$* (for short: *proof by induction on $T_\Sigma(H)$*): we define the binary relation⁶ $\succ_{\Sigma, H}$ on $T_\Sigma(H)$ as follows:

for every $k \in \mathbb{N}_+$, $\sigma \in \Sigma^{(k)}$, $\xi_1, \dots, \xi_k \in T_\Sigma(H)$, and $i \in [k]$, we let $\sigma(\xi_1, \dots, \xi_k) \succ \xi_i$.

By Corollary 2.5.6, the relation $\succ_{\Sigma, H}$ is terminating and $\text{nf}_{\succ_{\Sigma, H}}(T_\Sigma(H)) = \Sigma^{(0)} \cup H$. In this case, the induction base (2.2) and induction step (2.3) read

I.B.: $(\forall \alpha \in \Sigma^{(0)} \cup H) : P(\alpha)$

I.S.: $\left((\forall k \in \mathbb{N}_+, \sigma \in \Sigma^{(k)}, \xi_1, \dots, \xi_k \in T_\Sigma(H)) : [P(\xi_1) \wedge \dots \wedge P(\xi_k)] \Rightarrow P(\sigma(\xi_1, \dots, \xi_k)) \right)$.

- *proof by induction on $(T_\Sigma(H), \succ_{\Sigma, H}^+)$* , where $\succ_{\Sigma, H}^+ = (\succ_{\Sigma, H})^+$, i.e., $\succ_{\Sigma, H}^+$ is the transitive closure of $\succ_{\Sigma, H}$. Again we have $\text{nf}_{\succ_{\Sigma, H}^+}(T_\Sigma(H)) = \Sigma^{(0)} \cup H$. In this case, the induction base (2.2) and the induction step (2.3) read

I.B.: $(\forall \alpha \in \Sigma^{(0)} \cup H) : P(\alpha)$

I.S.: $\left((\forall \xi \in T_\Sigma(H) \setminus (\Sigma^{(0)} \cup H)) : [(\forall \xi' \in T_\Sigma(H) \text{ with } \xi \succ_{\Sigma, H}^+ \xi') : P(\xi')] \Rightarrow P(\xi) \right)$.

Often we will use induction on $T_\Sigma(H)$ for the case that $H = \emptyset$. We will abbreviate $\succ_{\Sigma, \emptyset}$ and $\succ_{\Sigma, \emptyset}^+$ by \succ_Σ and \succ_Σ^+ , respectively; then $\text{nf}_{\succ_\Sigma}(T_\Sigma) = \text{nf}_{\succ_\Sigma^+}(T_\Sigma) = \Sigma^{(0)}$. We will call a proof by induction on $T_\Sigma(\emptyset)$ (i.e., on (T_Σ, \succ_Σ)) a *proof by induction on T_Σ* . As in the general case, we will use the idioms “we prove P by induction on $T_\Sigma(H)$ ” and “we prove P by induction on T_Σ ” with their natural meanings.

In some proofs by induction on T_Σ , we combine the induction base (2.2) and induction step (2.3) by proving

$$(\forall k \in \mathbb{N}, \sigma \in \Sigma^{(k)}, \xi_1, \dots, \xi_k \in T_\Sigma) : [P(\xi_1) \wedge \dots \wedge P(\xi_k)] \Rightarrow P(\sigma(\xi_1, \dots, \xi_k)) .$$

We will define several mappings on $T_\Sigma(H)$ by induction on $(T_\Sigma(H), \succ_{\Sigma, H})$ (cf. (2.4)). Then we will use the idiom “we define a mapping by induction on $T_\Sigma(H)$ ” or, if $H = \emptyset$, “we define a mapping by induction on T_Σ ”.

Mappings on trees. Let H be a set disjoint with Σ . First, we define the three mappings

$$\text{height} : T_\Sigma(H) \rightarrow \mathbb{N}, \quad \text{size} : T_\Sigma(H) \rightarrow \mathbb{N}, \quad \text{and} \quad \text{pos} : T_\Sigma(H) \rightarrow \mathcal{P}(\mathbb{N}_+^*)$$

which, intuitively, for each tree $\xi \in T_\Sigma(H)$ (viewed as graph), deliver the maximal number of edges from the root of ξ to some leaf, the number of nodes of ξ , and the set of Gorn-addresses of ξ , respectively. For instance, let $\Sigma = \{\sigma^{(2)}, \gamma^{(1)}, \alpha^{(0)}, \beta^{(0)}\}$, $H = \{a\}$, and $\xi = \sigma(\gamma(\alpha), \sigma(\gamma(a), \beta))$; then

$$\text{height}(\xi) = 3 \quad , \quad \text{size}(\xi) = 7 \quad , \quad \text{pos}(\xi) = \{\varepsilon, 1, 11, 2, 21, 211, 22\} .$$

Formally, we use Theorem 2.10.3 for the definition of height, size, and pos as follows.

1. Let (\mathbb{N}, θ_1) be the Σ -algebra where θ_1 is defined as follows:

⁶This $\succ_{\Sigma, H}$ is exactly the binary relation \succ which we have used to prove that the Σ -term algebra is free in the set of all Σ -algebras generated by H ; since we will use it often, we give it a specific denotation.

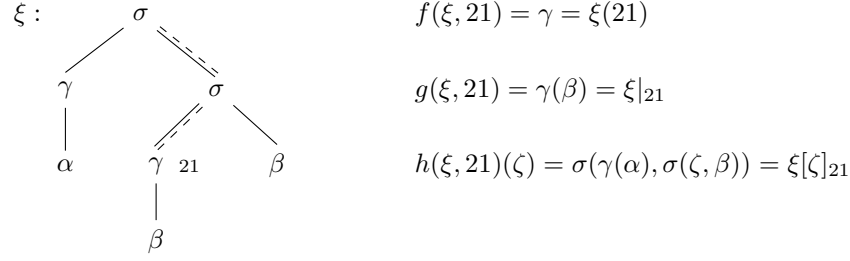

Figure 2.7: For a given tree $\xi = \sigma(\gamma(\alpha), \sigma(\gamma(\beta), \beta))$ and position $w = 21$, the label of ξ at position w , the subtree of ξ at position w , and the replacement of the subtree of ξ at position w by ζ .

- for each $\alpha \in \Sigma^{(0)}$, we let $\theta_1(\alpha)() = 0$, and
- for each $k \in \mathbb{N}_+$, $\sigma \in \Sigma^{(k)}$, and $n_1, \dots, n_k \in \mathbb{N}$, we let $\theta_1(\sigma)(n_1, \dots, n_k) = 1 + \max(n_1, \dots, n_k)$.

Moreover, let $f : H \rightarrow \mathbb{N}$ be defined such that, for each $a \in H$, we let $f(a) = 0$. Then

$$\text{height} : T_\Sigma(H) \rightarrow \mathbb{N}$$

is the unique extension of f to a Σ -algebra homomorphism from the Σ -term algebra $T_\Sigma(H)$ over H to the Σ -algebra (\mathbb{N}, θ_1) .

2. Let (\mathbb{N}, θ_2) be the Σ -algebra where θ_2 is defined as follows: for each $k \in \mathbb{N}$, $\sigma \in \Sigma^{(k)}$, and $n_1, \dots, n_k \in \mathbb{N}$, we let $\theta_2(\sigma)(n_1, \dots, n_k) = 1 + \bigoplus_{i \in [k]} n_i$. Moreover, let $f : H \rightarrow \mathbb{N}$ be defined such that, for each $a \in H$, we let $f(a) = 1$. Then

$$\text{size} : T_\Sigma(H) \rightarrow \mathbb{N}$$

is the unique extension of f to a Σ -algebra homomorphism from the Σ -term algebra $T_\Sigma(H)$ over H to the Σ -algebra (\mathbb{N}, θ_2) .

3. Let $(\mathcal{P}(\mathbb{N}_+^*), \theta_3)$ be the Σ -algebra where θ_3 is defined as follows: for each $k \in \mathbb{N}$, $\sigma \in \Sigma^{(k)}$, and $U_1, \dots, U_k \in \mathcal{P}(\mathbb{N}_+^*)$, we let $\theta_3(\sigma)(U_1, \dots, U_k) = \{\varepsilon\} \cup \{iv \mid i \in [k], v \in U_i\}$. Moreover, let $f : H \rightarrow \mathcal{P}(\mathbb{N}_+^*)$ be defined such that, for each $a \in H$, we let $f(a) = \{\varepsilon\}$. Then

$$\text{pos} : T_\Sigma(H) \rightarrow \mathcal{P}(\mathbb{N}_+^*)$$

is the unique extension of f to a Σ -algebra homomorphism from the Σ -term algebra $T_\Sigma(H)$ over H to the Σ -algebra $(\mathcal{P}(\mathbb{N}_+^*), \theta_3)$.

It is easy to verify that the following equalities hold.

- (i) For each $\alpha \in \Sigma^{(0)} \cup H$, we have $\text{height}(\alpha) = 0$, $\text{size}(\alpha) = 1$, and $\text{pos}(\alpha) = \{\varepsilon\}$.
- (ii) For each $\xi = \sigma(\xi_1, \dots, \xi_k)$ with $k \in \mathbb{N}_+$, we have:
 - $\text{height}(\xi) = 1 + \max(\text{height}(\xi_i) \mid i \in [k])$,
 - $\text{size}(\xi) = 1 + \bigoplus_{i \in [k]} \text{size}(\xi_i)$, and
 - $\text{pos}(\xi) = \{\varepsilon\} \cup \{iv \mid i \in [k], v \in \text{pos}(\xi_i)\}$.

Let $\xi \in T_\Sigma(H)$. Sometimes we refer to the position ε of ξ as the *root of ξ* , and to a position w of ξ with $wi \neq \text{pos}(\xi)$ for each $i \in \mathbb{N}_+$ as a *leaf of ξ* .

Observation 2.10.5. For the mapping $f_{T_\Sigma} : \mathcal{P}((\Sigma \cup \Xi)^*) \rightarrow \mathcal{P}((\Sigma \cup \Xi)^*)$ defined in Observation 2.10.1, there is a connection between the set $f_{T_\Sigma}^{n+1}(\emptyset)$ and the set of Σ -trees of height at most n . Indeed, we can prove by induction on \mathbb{N} that, for each $n \in \mathbb{N}$, we have $f_{T_\Sigma}^{n+1}(\emptyset) = \{\xi \in T_\Sigma \mid \text{height}(\xi) \leq n\}$. \square

Next we define three mappings f , g , and h which show the label at a position of a tree, the subtree at a position of a tree, and the replacement of the subtree at a position of a tree, respectively (cf. Figure 2.7).

We define these mappings by well-founded induction. For this, we define the set $\text{TP} = \{(\xi, w) \mid \xi \in \text{T}_\Sigma(H), w \in \text{pos}(\xi)\}$ and the binary relation \succ on TP as follows:

for every $k \in \mathbb{N}_+$, $\sigma \in \Sigma^{(k)}$, $\xi_1, \dots, \xi_k \in \text{T}_\Sigma(H)$, $i \in [k]$, and $v \in \text{pos}(\xi_i)$, we let $(\sigma(\xi_1, \dots, \xi_k), iv) \succ (\xi_i, v)$.

Since the relation $\succ_{\Sigma, H}$ is terminating, by Corollary 2.5.4, the relation \succ is also terminating. Obviously, $\text{nf}_\succ(\text{TP}) = \{(\xi, \varepsilon) \mid \xi \in \text{T}_\Sigma(H)\}$. By induction on (TP, \succ) , we define the mappings

$$f : \text{TP} \rightarrow \Sigma \cup H, \quad g : \text{TP} \rightarrow \text{T}_\Sigma(H), \quad \text{and} \quad h : \text{TP} \rightarrow \text{T}_\Sigma(H)^{\text{T}_\Sigma(H)}$$

as follows:

I.B.: Let $\xi \in \text{T}_\Sigma(H)$. Moreover, let $\zeta \in \text{T}_\Sigma(H)$. Then we define $f(\xi, \varepsilon)$, $g(\xi, \varepsilon)$, and $h(\xi, \varepsilon)(\zeta)$ as follows.

- If $\xi \in H$, then we define $f(\xi, \varepsilon) = \xi$. If there exist $k \in \mathbb{N}$, $\sigma \in \Sigma^{(k)}$, and $\xi_1, \dots, \xi_k \in \text{T}_\Sigma(H)$ such that $\xi = \sigma(\xi_1, \dots, \xi_k)$, then we define $f(\xi, \varepsilon) = \sigma$,
- $g(\xi, \varepsilon) = \xi$, and
- $h(\xi, \varepsilon)(\zeta) = \zeta$.

I.S.: Let $\xi \in \text{T}_\Sigma(H)$ and $iv \in \text{pos}(\xi)$ with $i \in \mathbb{N}$ and $v \in \mathbb{N}^*$. Thus, there exists $k \in \mathbb{N}_+$ with $k \geq i$ and there exist $\sigma \in \Sigma^{(k)}$ and $\xi_1, \dots, \xi_k \in \text{T}_\Sigma(H)$ such that $\xi = \sigma(\xi_1, \dots, \xi_k)$. Moreover, let $\zeta \in \text{T}_\Sigma(H)$. Then we define $f(\xi, iv)$, $g(\xi, iv)$, and $h(\xi, iv)(\zeta)$ as follows.

- $f(\xi, iv) = f(\xi_i, v)$,
- $g(\xi, iv) = g(\xi_i, v)$, and
- $h(\xi, iv)(\zeta) = \sigma(\xi_1, \dots, \xi_{i-1}, h(\xi_i, v)(\zeta), \xi_{i+1}, \dots, \xi_k)$.

For every $\xi, \zeta \in \text{T}_\Sigma(H)$ and $w \in \text{pos}(\xi)$ we call

- $f(\xi, w)$ the *label of ξ at w* , and we denote it by $\xi(w)$,
- $g(\xi, w)$ the *subtree of ξ at w* , and we denote it by $\xi|_w$, and
- $h(\xi, w)(\zeta)$ the *replacement of the subtree of ξ at w by ζ* , and we denote it by $\xi[\zeta]_w$.

For each subset $Q \subseteq \Sigma \cup H$, we define $\text{pos}_Q : \text{T}_\Sigma(H) \rightarrow \mathcal{P}(\mathbb{N}_+^*)$ by

$$\text{pos}_Q(\xi) = \{w \in \text{pos}(\xi) \mid \xi(w) \in Q\}$$

and, for each $\xi \in \text{T}_\Sigma(H)$, we define the *set of subtrees of ξ* , denoted by $\text{sub}(\xi)$, as the set

$$\text{sub}(\xi) = \{\xi|_w \mid w \in \text{pos}(\xi)\}.$$

In fact, $\text{sub}(\xi) = \{\xi\} \cup \{\xi' \in \text{T}_\Sigma(H) \mid \xi \succ_{\Sigma, H}^+ \xi'\}$.

Let $\Gamma \subseteq \Sigma^{(0)}$. We define the mapping $\text{yield}_\Gamma : \text{T}_\Sigma \rightarrow \Gamma^*$ by induction on T_Σ as follows.

I.B.: Let $\xi \in \Sigma^{(0)}$. If $\xi \in \Gamma$, then let $\text{yield}_\Gamma(\xi) = \xi$, otherwise let $\text{yield}_\Gamma(\xi) = \varepsilon$.

I.S.: Let $\xi = \sigma(\xi_1, \dots, \xi_k)$ with $k \in \mathbb{N}_+$. Then we define $\text{yield}_\Gamma(\xi) = \text{yield}_\Gamma(\xi_1) \cdots \text{yield}_\Gamma(\xi_k)$.

We abbreviate $\text{yield}_{\Sigma^{(0)}}$ by *yield*.

Comparison. Now we wish to compare two methods for defining mappings $h : \text{T}_\Sigma(H) \rightarrow A$, where H and A are two sets.

- (1) We define the mapping h by induction on $\text{T}_\Sigma(H)$, i.e., by using the terminating relation $\succ_{\Sigma, H}$ and Theorem 2.6.1.
- (2) As additional information, we know that A has a Σ -algebra structure (A, θ) . Then we define h to be the unique extension of some mapping $f : H \rightarrow A$ to a Σ -algebra homomorphism, i.e., by using algebraic methods and, in particular, Theorem 2.10.3; this theorem guarantees that h is a Σ -algebra homomorphism from $\text{T}_\Sigma(H)$ to (A, θ) .

Obviously, Method (1) is more general than Method (2) because the first can be used to define not only Σ -algebra homomorphisms. For instance, let $\Sigma = \{\sigma^{(2)}, \alpha^{(0)}, \beta^{(0)}\}$, $H = \emptyset$, and $A = \text{T}_\Sigma$. Moreover, we

define the mapping $G : \{(\xi, g) \mid \xi \in T_\Sigma, g : \succ_\Sigma(\xi) \rightarrow T_\Sigma\} \rightarrow T_\Sigma$ such that for each (ξ, g) we let

$$G(\xi, g) = \begin{cases} \sigma(\alpha, g(\xi')) & \text{if there exists } \xi' \in T_\Sigma \text{ such that } \xi = \sigma(\alpha, \xi') \\ \alpha & \text{otherwise .} \end{cases}$$

According to Theorem 2.6.1, there exists a unique mapping $h : T_\Sigma \rightarrow T_\Sigma$ such that $h(\xi) = G(\xi, h|_{\succ_\Sigma(\xi)})$ for each $\xi \in T_\Sigma$.

We show that h is not a Σ -algebra homomorphism from the Σ -term algebra $T_\Sigma = (T_\Sigma, \theta_\Sigma)$ to itself. (We note that $G \neq G_{\theta_\Sigma, \emptyset}$.) We prove this claim by contradiction. For this, we assume that h is a Σ -algebra homomorphism from T_Σ to itself. Then we can calculate as follows:

$$\begin{aligned} \alpha &= G(\sigma(\beta, \alpha), h|_{\{\alpha, \beta\}}) && \text{(by definition of } G) \\ &= h(\sigma(\beta, \alpha)) && \text{(by definition of } h) \\ &= \theta_\Sigma(\sigma)(h(\beta), h(\alpha)) && \text{(because } h \text{ is a } \Sigma\text{-algebra homomorphism from } T_\Sigma \text{ to } T_\Sigma) \\ &= \sigma(h(\beta), h(\alpha)) && \text{(by definition of } \theta_\Sigma(\sigma)) \\ &= \sigma(\alpha, \alpha) . && \text{(by definition of } h \text{ and by definition of } G) \end{aligned}$$

This is a contradiction. Hence h is not a Σ -algebra homomorphism from T_Σ to T_Σ .

Nevertheless, given that $\mathbf{A} = (A, \theta)$ is some Σ -algebra, Method (1) can also be used to define a Σ -algebra homomorphism from $T_\Sigma(H)$ to \mathbf{A} . However, in this case we have to prove explicitly that h is a homomorphism. By means of an example, we compare the two methods in the case that h is a Σ -algebra homomorphism.

By using Method (1): We define the mapping size_1 by well-founded induction on $(T_\Sigma(H), \succ_{\Sigma, H})$ with the following induction base and induction step:

I.B.: For each $a \in \Sigma^{(0)} \cup H$, we define $\text{size}_1(a) = 1$.

I.S.: For every $k \in \mathbb{N}_+$, $\sigma \in \Sigma^{(k)}$, and $\xi_1, \dots, \xi_k \in T_\Sigma(H)$, we define $\text{size}_1(\sigma(\xi_1, \dots, \xi_k)) = 1 + \bigoplus_{i \in [k]} \text{size}_1(\xi_i)$.

By Theorem 2.6.1, there exists exactly one mapping which satisfies these conditions.

Now we consider the Σ -algebra (\mathbb{N}, θ) with $\theta(\sigma)(n_1, \dots, n_k) = 1 + \sum_{i \in [k]} n_i$ for every $k \in \mathbb{N}$, $\sigma \in \Sigma^{(k)}$, and $n_1, \dots, n_k \in \mathbb{N}$. Then we prove that size_1 is a Σ -algebra homomorphism from $T_\Sigma(H)$ to (\mathbb{N}, θ) . For every $k \in \mathbb{N}$, $\sigma \in \Sigma^{(k)}$, and $\xi_1, \dots, \xi_k \in T_\Sigma(H)$, we have

$$\text{size}_1(\theta_\Sigma(\sigma)(\xi_1, \dots, \xi_k)) = \text{size}_1(\sigma(\xi_1, \dots, \xi_k)) = 1 + \bigoplus_{i \in [k]} \text{size}_1(\xi_i) = \theta(\sigma)(\text{size}_1(\xi_1), \dots, \text{size}_1(\xi_k)) .$$

Hence size_1 is a Σ -algebra homomorphism,

By using Method (2): We consider the Σ -algebra (\mathbb{N}, θ) as above and define the mapping $f : H \rightarrow \mathbb{N}$ by $f(a) = 1$ for each $a \in H$. Then Theorem 2.10.3 guarantees that there exists a unique extension of f , say, size_2 , into a Σ -algebra homomorphism from $T_\Sigma(H)$ to (\mathbb{N}, θ) .

Since size_1 is a Σ -algebra homomorphism and $\text{size}_1(a) = \text{size}_2(a)$ for each $a \in H$, we know that $\text{size}_1 = \text{size}_2$, due to the uniqueness property.

In comparison, for Σ -algebra homomorphisms, Method (1) seems to be slightly less efficient than Method (2), because in the first we have to prove explicitly that the mapping h is a Σ -algebra homomorphism; while in Method (2) this is guaranteed by Theorem 2.10.3.

Representing trees by tree domains. At the beginning of this section, we have defined the set T_Σ of Σ -trees as the smallest set of strings which contains the nullary symbols of Σ and which is closed under top-concatenations. Here we recall an alternative way, which is equivalent.

A *tree domain* is a finite and nonempty set $W \subseteq (\mathbb{N}_+)^*$ such that

- W is prefix-closed, i.e., for each $w \in W$ we have $\text{prefix}(w) \subseteq W$, and
- W is left-closed, i.e., for every $u \in (\mathbb{N}_+)^*$ and $i \in \mathbb{N}_+$, if $ui \in W$ and $i \geq 2$, then $u(i-1) \in W$.

Thus ε is an element of each tree domain. Obviously, for each $\xi \in \mathsf{T}_\Sigma$, the set $\text{pos}(\xi)$ is a tree domain.

A Σ -tree mapping is a mapping $t : W \rightarrow \Sigma$ such that

- W is a tree domain and
- t is rank preserving, i.e., for each $w \in W$, we have $|\{j \in \mathbb{N}_+ \mid wj \in W\}| = \text{rk}_\Sigma(t(w))$.

Let us denote the set of Σ -tree mappings by TF_Σ .

We define the mapping $\varphi : \mathsf{T}_\Sigma \rightarrow \text{TF}_\Sigma$ for each $\xi \in \mathsf{T}_\Sigma$ by $\varphi(\xi) = t$ such that $t : \text{pos}(\xi) \rightarrow \Sigma$ and for each $w \in \text{pos}(\xi)$ we let $t(w) = \xi(w)$. For instance, let ξ be the tree in Figure 2.7. Then $\varphi(\xi) = t$ where $t : W \rightarrow \Sigma$ with tree domain $W = \{\varepsilon, 1, 11, 2, 21, 211, 22\}$ and $t(\varepsilon) = t(2) = \sigma$, $t(1) = t(21) = \gamma$, $t(11) = \alpha$, and $t(211) = t(22) = \beta$.

We show that φ is bijective. To show that φ is injective, let $\xi_1, \xi_2 \in \mathsf{T}_\Sigma$ be such that $\xi_1 \neq \xi_2$ and let $\varphi(\xi_i) = t_i$ for $i \in \{1, 2\}$. Then there exists $w \in \text{pos}(\xi_1) \cap \text{pos}(\xi_2)$ such that $\xi_1(w) \neq \xi_2(w)$. By definition of φ , we have $t_1(w) \neq t_2(w)$, i.e. $t_1 \neq t_2$. Hence φ is injective.

For the proof of surjectivity of φ , we define the reduction system (TD, \succ) where TD is the set of all tree domains and, for every $W, W' \in \text{TD}$, we let $W \succ W'$ if there exists $i \in \mathbb{N}_+$ such that $W' = \{w \in (\mathbb{N}_+)^* \mid iw \in W\}$. Then, the cardinality of tree domains is a monotone embedding of (TD, \succ) into the terminating reduction system $(\mathbb{N}, >)$. Thus, by Lemma 2.5.2, the relation \succ is terminating. Moreover, $\text{nf}_\succ(\text{TD}) = \{\{\varepsilon\}\}$.

By induction on (TD, \succ) , we prove that the following statement holds:

$$\begin{aligned} &\text{For every } W \in \text{TD} \text{ and } \Sigma\text{-tree mapping } t : W \rightarrow \Sigma, \\ &\text{there exists a } \xi \in \mathsf{T}_\Sigma \text{ such that } W = \text{pos}(\xi) \text{ and } \varphi(\xi) = t. \end{aligned} \quad (2.32)$$

For the proof, let $W \in \text{TD}$ and $t : W \rightarrow \Sigma$ be a Σ -tree mapping. Then there exist $k \in \mathbb{N}$ and $\sigma \in \Sigma$ such that $t(\varepsilon) = \sigma$. Moreover, for each $i \in [k]$, we define $W_i = \{w \in (\mathbb{N}_+)^* \mid iw \in W\}$ and the Σ -tree mapping $t_i : W_i \rightarrow \Sigma$ by $t_i(w) = t(iw)$ for each $w \in W_i$. Then $W = \{\varepsilon\} \cup \{iw \mid i \in [k], w \in W_i\}$.

Since $\{W' \in \text{TD} \mid W \succ W'\} = \{W_1, \dots, W_k\}$, the I.H. implies that, for each $i \in [k]$, there exists $\xi_i \in \mathsf{T}_\Sigma$ such that $W_i = \text{pos}(\xi_i)$ and $\varphi(\xi_i) = t_i$.

Then let $\xi = \sigma(\xi_1, \dots, \xi_k)$. We claim that $\varphi(\xi) = t$. First, by definition we have that $\varphi(\xi) : \text{pos}(\xi) \rightarrow \Sigma$. Moreover,

$$\text{pos}(\xi) = \{\varepsilon\} \cup \{iw \mid i \in [k], w \in \text{pos}(\xi_i)\} = \{\varepsilon\} \cup \{iw \mid i \in [k], w \in W_i\} = W ,$$

where the second equality follows from I.H. Second, for the proof of $\varphi(\xi) = t$ we let $w \in W$. If $w = \varepsilon$, then $\xi(w) = \sigma = t(w)$. If $w = iw'$ for some $i \in \mathbb{N}_+$ and $w' \in W_i$, then

$$\xi(iw') = \xi_i(w') = t_i(w') = t(iw') ,$$

where the second equality follows from I.H. Hence $\varphi(\xi) = t$. This proves (2.32), and hence φ is surjective.

Since φ is bijective we can specify a tree $\xi \in \mathsf{T}_\Sigma$ also by means of a Σ -tree mapping (cf., e.g., the proofs of Lemma 8.3.3, of Theorem 10.6.1, and of Theorem 11.3.1).

Orders on positions of trees. The *prefix order* on $\text{pos}(\xi)$, denoted by \leq_{pref} , is the partial order defined for every $w, v \in \text{pos}(\xi)$ by

$$w \leq_{\text{pref}} v \quad \text{iff } w \in \text{prefix}(v) .$$

We let $w <_{\text{pref}} v$ if $(w \leq_{\text{pref}} v) \wedge (w \neq v)$.

The *lexicographic order* on $\text{pos}(\xi)$, denoted by \leq_{lex} , and the *depth-first post-order* on $\text{pos}(\xi)$, denoted by \leq_{dp} , are the linear orders on $\text{pos}(\xi)$ defined for every $w, v \in \text{pos}(\xi)$ by

$$\begin{aligned} w \leq_{\text{lex}} v & \text{ iff } (w \in \text{prefix}(v)) \vee (w <_{\text{left-of}} v) \\ w \leq_{\text{dp}} v & \text{ iff } (v \in \text{prefix}(w)) \vee (w <_{\text{left-of}} v) \text{ , where} \\ (w <_{\text{left-of}} v) & \text{ iff } (\exists u \in \text{prefix}(w) \cap \text{prefix}(v)) (\exists i, j \in \mathbb{N}_+) (ui \in \text{prefix}(w)) \wedge (uj \in \text{prefix}(v)) \wedge (i < j) \text{ .} \end{aligned}$$

The lexicographic order is also called *depth-first pre-order*. We let $w <_{\text{lex}} v$ if $(w \leq_{\text{lex}} v) \wedge (w \neq v)$, and we let $w <_{\text{dp}} v$ if $(w \leq_{\text{dp}} v) \wedge (w \neq v)$.

Tree relabelings. A (Σ, Δ) -tree relabeling (or simply: *tree relabeling*) [Eng75b, Def. 3.1] is an \mathbb{N} -indexed family $\tau = (\tau_k \mid k \in \mathbb{N})$ of mappings $\tau_k : \Sigma^{(k)} \rightarrow \mathcal{P}(\Delta^{(k)})$. We call a tree relabeling τ

- *non-overlapping* if $\tau_k(\sigma) \cap \tau_k(\sigma') = \emptyset$ for every $k \in \mathbb{N}$ and $\sigma, \sigma' \in \Sigma^{(k)}$ with $\sigma \neq \sigma'$.
- *deterministic* if for every $k \in \mathbb{N}$ and $\sigma \in \Sigma^{(k)}$, the set $\tau_k(\sigma)$ contains exactly one element. Then we specify the tree relabeling as an \mathbb{N} -indexed family of mappings $\tau_k : \Sigma^{(k)} \rightarrow \Delta^{(k)}$.

Now let $\tau = (\tau_k \mid k \in \mathbb{N})$ be a (Σ, Δ) -tree relabeling. We extend τ to the mapping

$$\tau' : \mathsf{T}_\Sigma \rightarrow \mathcal{P}_{\text{fin}}(\mathsf{T}_\Delta)$$

by using Theorem 2.10.3 as follows. We define the Σ -algebra $(\mathcal{P}_{\text{fin}}(\mathsf{T}_\Delta), \theta_\tau)$ such that, for every $k \in \mathbb{N}$, $\sigma \in \Sigma^{(k)}$, and $U_1, \dots, U_k \in \mathcal{P}_{\text{fin}}(\mathsf{T}_\Delta)$, we let

$$\theta_\tau(\sigma)(U_1, \dots, U_k) = \{\gamma(\zeta_1, \dots, \zeta_k) \mid \gamma \in \tau_k(\sigma), \zeta_1 \in U_1, \dots, \zeta_k \in U_k\} \text{ .}$$

Then $\tau' : \mathsf{T}_\Sigma \rightarrow \mathcal{P}_{\text{fin}}(\mathsf{T}_\Delta)$ is the unique Σ -homomorphism h from the Σ -term algebra T_Σ to the Σ -algebra $(\mathcal{P}_{\text{fin}}(\mathsf{T}_\Delta), \theta_\tau)$ (cf. Theorem 2.10.3). We also call the mapping $\tau' : \mathsf{T}_\Sigma \rightarrow \mathcal{P}_{\text{fin}}(\mathsf{T}_\Delta)$ a (Σ, Δ) -tree relabeling (or simply: *tree relabeling*) and we abbreviate τ' by τ . The mapping τ can also be considered as a binary relation $\tau \subseteq \mathsf{T}_\Sigma \times \mathsf{T}_\Delta$, and thus, in particular, τ^{-1} is defined.

We note that $\text{pos}(\zeta) = \text{pos}(\xi)$ for each $\zeta \in \tau(\xi)$. Thus, for every $\zeta \in \mathsf{T}_\Delta$, the set $\tau^{-1}(\zeta)$ is finite and, if τ is non-overlapping, then $|\tau^{-1}(\zeta)| \leq 1$. If τ is deterministic, then for every $\xi \in \mathsf{T}_\Sigma$ we have $|\tau(\xi)| = 1$.

Let Ω be a ranked alphabet, $\omega = (\omega_k \mid k \in \mathbb{N})$ be a (Σ, Ω) -tree relabeling, and $\tau = (\tau_k \mid k \in \mathbb{N})$ be a (Ω, Δ) -tree relabeling. The *syntactic composition of ω and τ* , denoted by $\tau \hat{\circ} \omega$, is the (Σ, Δ) -tree relabeling $((\tau \hat{\circ} \omega)_k \mid k \in \mathbb{N})$ such that $(\tau \hat{\circ} \omega)_k = \tau_k \circ \omega_k$, i.e., $(\tau \hat{\circ} \omega)_k(\sigma) = \bigcup_{\delta \in \omega_k(\sigma)} \tau_k(\delta)$ for every $k \in \mathbb{N}$ and $\sigma \in \Sigma^{(k)}$. It follows that if ω and τ are deterministic, then $\tau \hat{\circ} \omega$ is also deterministic.

Theorem 2.10.6. (cf. [Eng75a, Lm. 3.4]) *Let Ω be a ranked alphabet, ω be a (Σ, Ω) -tree relabeling, and τ be a (Ω, Δ) -tree relabeling. Then $\tau \hat{\circ} \omega = \tau \circ \omega$, i.e., the syntactic composition of ω and τ determines the mapping $\tau \circ \omega$.*

Contexts and substitution. Next we define *contexts*. Let $Z = \{z_1, z_2, \dots\}$ be a set of variables, disjoint with Σ , and let $Z_n = \{z_1, \dots, z_n\}$ for every $n \in \mathbb{N}$. Sometimes we write z for z_1 . Moreover, let $\xi \in \mathsf{T}_\Sigma(Z)$ and $V \subseteq Z$. We say that ξ is *linear in V* (ξ is *nondeleting in V*) if for each $z \in V$ we have $|\text{pos}_z(\xi)| \leq 1$ (and $|\text{pos}_z(\xi)| \geq 1$, respectively). We denote by $\mathsf{C}_\Sigma(Z_n)$ the set of all trees $\xi \in \mathsf{T}_\Sigma(Z_n)$ which are both linear and nondeleting in Z_n . Since $Z_0 = \emptyset$, we have $\mathsf{C}_\Sigma(Z_0) = \mathsf{T}_\Sigma$. We call the elements of $\mathsf{C}_\Sigma(Z_n)$ *contexts over Σ and Z_n* (or: *n -contexts* if Σ is clear). We abbreviate $\mathsf{C}_\Sigma(\{z\})$ by C_Σ and call its elements *contexts*.

Now we define *tree substitution* (cf. derived operator in [GTWW77, p. 73]). Let H be a set disjoint with Σ ; moreover, let $n \in \mathbb{N}$, $\xi \in \mathsf{T}_\Sigma(Z_n)$, and $\xi_1, \dots, \xi_n \in \mathsf{T}_\Sigma(H)$. Intuitively, we want to define the tree in $\mathsf{T}_\Sigma(H)$ which is obtained from ξ by replacing, for each $z_i \in Z_n$, each occurrence of z_i by ξ_i . Formally, let $v : Z_n \rightarrow \mathsf{T}_\Sigma(H)$ be the mapping defined by $v(z_i) = \xi_i$ for each $i \in [n]$. Then we denote by \bar{v} the

unique extension of v to a Σ -algebra homomorphism from the Σ -term algebra $(T_\Sigma(Z_n), \theta_\Sigma)$ over Z_n to the Σ -term algebra $(T_\Sigma(H), \theta_\Sigma)$ over H . It is easy to see that $\bar{v}(\xi)$ is the desired tree from our informal discussion. In the sequel, we abbreviate $\bar{v}(\xi)$ by $\xi[\xi_1, \dots, \xi_n]$. For $n = 1$ and $H = \{z\}$, we also denote $\xi[\xi_1]$ by $\xi \circ_z \xi_1$. Hence, \circ_z can be thought of as a binary operation on $T_\Sigma(\{z\})$.

In the rest of the book, Z and X will denote sets of variables if not specified otherwise. Moreover, we let $Z_n = \{z_1, \dots, z_n\}$ and $X_n = \{x_1, \dots, x_n\}$ for every $n \in \mathbb{N}$.

Tree homomorphisms. A (Σ, Δ) -tree homomorphism (or just *tree homomorphism*) [Eng75b, Def. 3.62] is a family $h = (h_k \mid k \in \mathbb{N})$ of mappings $h_k : \Sigma^{(k)} \rightarrow T_\Delta(Z_k)$. We call a tree homomorphism h

- *linear* if, for every $k \in \mathbb{N}$ and $\sigma \in \Sigma^{(k)}$, the tree $h_k(\sigma)$ is linear in Z_k ;
- *nondeleting* if, for every $k \in \mathbb{N}$ and $\sigma \in \Sigma^{(k)}$, the tree $h_k(\sigma)$ is nondeleting in Z_k ;
- *alphabetic* if, for every $k \in \mathbb{N}$ and $\sigma \in \Sigma^{(k)}$, we have $|\text{pos}_\Delta(h_k(\sigma))| \leq 1$;
- *productive* if, for every $k \in \mathbb{N}$ and $\sigma \in \Sigma^{(k)}$, we have $h_k(\sigma) \notin Z_k$ (this notion is borrowed from [FMV10] where it was called output-productive);
- *ordered* if h is linear and nondeleting and, for every $k \in \mathbb{N}$ and $\sigma \in \Sigma^{(k)}$, the sequence of variables occurring in $h_k(\sigma)$ is ordered by increasing indices from left to right, i.e., it is z_1, \dots, z_k ;
- *simple* if h is alphabetic and ordered (and hence also linear and nondeleting).

Now let H be a set disjoint with Σ and Δ . Moreover, let $h = (h_k \mid k \in \mathbb{N})$ be a (Σ, Δ) -tree homomorphism. We extend h to the mapping

$$h : T_\Sigma(H) \rightarrow T_\Delta(H)$$

by using Theorem 2.10.3 as follows. We define the Σ -algebra $(T_\Delta(H), \theta_h)$ such that, for every $k \in \mathbb{N}$, $\sigma \in \Sigma^{(k)}$, and $\xi_1, \dots, \xi_k \in T_\Delta(H)$, we let

$$\theta_h(\sigma)(\xi_1, \dots, \xi_k) = h_k(\sigma)[\xi_1, \dots, \xi_k] .$$

Then $h : T_\Sigma(H) \rightarrow T_\Delta(H)$ is the unique extension of id_H to a Σ -algebra homomorphism from the Σ -term algebra $(T_\Sigma(H), \theta_\Sigma)$ over H to the Σ -algebra $(T_\Delta(H), \theta_h)$ (cf. Theorem 2.10.3).

We also call the mapping $h : T_\Sigma(H) \rightarrow T_\Delta(H)$ a (Σ, Δ) -tree homomorphism (or simply: tree homomorphism).

We note that each deterministic tree relabeling can be thought of as a particular tree homomorphism. Indeed, let $(\tau_k \mid k \in \mathbb{N})$ be a deterministic (Σ, Δ) -tree relabeling. Then τ determines the (Σ, Δ) -tree homomorphism $(\tau'_k \mid k \in \mathbb{N})$ where, for every $k \in \mathbb{N}$ and $\sigma \in \Sigma^{(k)}$, we have $\tau'_k(\sigma) = \tau_k(\sigma)(z_1, \dots, z_k)$. It is obvious that $\tau = \tau'$.

Let Ω be a ranked alphabet, $g = (g_k \mid k \in \mathbb{N})$ be a (Σ, Ω) -tree homomorphism, and $h = (h_k \mid k \in \mathbb{N})$ be an (Ω, Δ) -tree homomorphism. The *syntactic composition of g and h* , denoted by $h \hat{\circ} g$, is the (Σ, Δ) -tree homomorphism $((h \hat{\circ} g)_k \mid k \in \mathbb{N})$ such that $(h \hat{\circ} g)_k(\sigma) = h(g_k(\sigma))$ for every $k \in \mathbb{N}$ and $\sigma \in \Sigma^{(k)}$.

Theorem 2.10.7. (cf. [Eng75a, Lm. 3.4], [GS84, Thm. 4.3.7]) *Let Ω be a ranked alphabet, g be a (Σ, Ω) -tree homomorphism, and h be an (Ω, Δ) -tree homomorphism. Then $h \hat{\circ} g = h \circ g$, i.e., the syntactic composition of g and h determines the mapping $h \circ g$.*

2.11 Term rewrite systems

We recall some notions and results from [Hue80, BN98]. Moreover, as an application, we prove Observation 2.7.11(7).

Let $\xi \in T_\Sigma(X)$. We denote by $\text{Var}(\xi)$ the set of all $x \in X$ which occurs in ξ .

A *term rewrite system* (over Σ) is a finite set R of term rewrite rules of the form $\ell \rightarrow r$ where $\ell, r \in T_\Sigma(X)$ such that $\ell \notin X$ and $\text{Var}(r) \subseteq \text{Var}(\ell)$. We call ℓ and r the *left-hand side* of the rule and the *right-hand side* of the rule, respectively.

A *substitution* is a mapping $\varphi : X \rightarrow T_\Sigma(X)$ such that $\varphi(x) = x$ for almost all $x \in X$. A substitution extends in a unique way to a Σ -algebra homomorphism φ' from $T_\Sigma(X)$ to $T_\Sigma(X)$. In the sequel, we drop the prime from φ' .

The *term rewrite relation induced by R* , denoted by \Rightarrow_R , is the binary relation on $T_\Sigma(X)$ defined as follows. For every $\xi_1, \xi_2 \in T_\Sigma(X)$, we let $\xi_1 \Rightarrow_R \xi_2$ if there exist a position $w \in \text{pos}(\xi_1)$, a rule $\ell \rightarrow r$ in R , a substitution $\varphi : X \rightarrow T_\Sigma(X)$ such that $\xi_1|_w = \varphi(\ell)$ and $\xi_2 = \xi_1[\varphi(r)]_w$.

In fact, $(T_\Sigma(X), \Rightarrow_R)$ is a reduction system. We call a term rewrite system R *terminating*, if \Rightarrow_R is terminating.

Now we turn to the missing proof of Observation 2.7.11(7). We will employ the concept of reduction order [BN98, Def. 5.2.1] and monotone polynomial interpretation [BN98, Def. 5.3.6], which we will recall here.

Let \succ be a strict order on $T_\Sigma(X)$. We say that \succ is a *reduction order* if it is

- terminating,
- *compatible with Σ -operations*, i.e., for every $k \in \mathbb{N}$, $\sigma \in \Sigma^{(k)}$, $i \in [k]$, and $\xi_1, \dots, \xi_k, \zeta, \zeta' \in T_\Sigma(X)$, if $\zeta \succ \zeta'$, then $\sigma(\xi_1, \dots, \xi_{i-1}, \zeta, \xi_{i+1}, \dots, \xi_k) \succ \sigma(\xi_1, \dots, \xi_{i-1}, \zeta', \xi_{i+1}, \dots, \xi_k)$, and
- *closed under substitution*, i.e., for every $\xi_1, \xi_2 \in T_\Sigma(X)$ and substitution $\varphi : X \rightarrow T_\Sigma(X)$, if $\xi_1 \succ \xi_2$, then $\varphi(\xi_1) \succ \varphi(\xi_2)$.

Theorem 2.11.1. [BN98, Thm. 5.2.3] (also cf. [MN70]) *Let R be a term rewrite system over Σ . Then R is terminating iff there exists a reduction order \succ on $T_\Sigma(X)$ such that, for each $\ell \rightarrow r$ in R , we have $\ell \succ r$.*

We obtain particular reduction orders by considering monotone polynomial interpretations. For the definition of the latter, we recall that $\mathbb{N}[x_1, \dots, x_k]$ denotes the set of all polynomials with k variables x_1, \dots, x_k and coefficients in \mathbb{N} (cf. Example 2.7.9(19)).

A *monotone polynomial interpretation* of Σ is a Σ -algebra $\mathcal{A} = (A, \theta)$ such that

- $A \subseteq \mathbb{N} \setminus \{0\}$ and
- for every $k \in \mathbb{N}$ and $\sigma \in \Sigma^{(k)}$, $\theta(\sigma)$ is a polynomial in $\mathbb{N}[x_1, \dots, x_k]$ such that, for each $x_i \in \{x_1, \dots, x_k\}$, the polynomial $\theta(\sigma)$ contains a monomial with non-zero coefficient in which x_i occurs with exponent at least 1.

Let $\mathcal{A} = (A, \theta)$ be a Σ -algebra with $A \neq \emptyset$ and \succ a terminating binary relation on A . We define the binary relation $\succ_{\mathcal{A}}$ on $T_\Sigma(X)$ as follows. For every $\xi_1, \xi_2 \in T_\Sigma(X)$, we let $\xi_1 \succ_{\mathcal{A}} \xi_2$ if for each Σ -algebra homomorphism $\pi : T_\Sigma(X) \rightarrow \mathcal{A}$ we have $\pi(\xi_1) \succ \pi(\xi_2)$. (We recall that each substitution of variables in ξ_1 and ξ_2 determines uniquely such a homomorphism.)

Corollary 2.11.2. Let $\mathcal{A} = (A, \theta)$ be a monotone polynomial interpretation of Σ with $A \neq \emptyset$ and let \succ be a terminating binary relation on A . Then $\succ_{\mathcal{A}}$ is a reduction order on $T_\Sigma(X)$.

Proof. This follows from [BN98, Lm. 5.3.7] and [BN98, Thm. 5.3.3]. □

Now we provide the missing proof of Observation 2.7.11(7).

Proof. Let $A \subseteq B$ be finite and $h : T_{\{\oplus, \otimes, 0, 1\}}(A) \rightarrow B$ be the canonical evaluation homomorphism, i.e., the unique extension of id_A to a homomorphism from $T_{\{\oplus, \otimes, 0, 1\}}(A)$ to B (cf. Theorem 2.10.3). We define the ranked alphabet $\Sigma = \{\oplus^{(2)}, \otimes^{(2)}, 0^{(0)}, 1^{(0)}\} \cup A$ where each element of A has arity 0. Then

$$T_{\{\oplus, \otimes, 0, 1\}}(A) = T_\Sigma .$$

Clearly, $h(\mathbb{T}_\Sigma) = \langle A \rangle_{\{\oplus, \otimes, 0, \mathbb{1}\}}$. Let \mathbb{T}_Σ^r be the set of all $\xi \in \mathbb{T}_\Sigma$ such that, for each $w \in \text{pos}(\xi)$ with $\xi(w) = \otimes$, we have $\xi(w2) \in A \cup \{0, \mathbb{1}\}$. Clearly, $h(\mathbb{T}_\Sigma^r) = \text{wcl}(A)$.

We prove the following statement.

$$\text{For each } \xi \in \mathbb{T}_\Sigma, \text{ we can construct a } \zeta \in \mathbb{T}_\Sigma^r \text{ such that } h(\xi) = h(\zeta). \quad (2.33)$$

For the construction of ζ from the given ξ , we will employ a terminating term rewrite system over Σ ; then ζ will be an arbitrary normal form of ξ with respect to that term rewrite system. (In fact, each ξ has exactly one normal form, but we do not prove this here.) Formally, we consider the set R with the following term rewrite rules:

$$\begin{aligned} (1) : & \quad \otimes(x_1, \otimes(x_2, x_3)) \rightarrow \otimes(\otimes(x_1, x_2), x_3) \\ (2) : & \quad \otimes(x_1, \oplus(x_2, x_3)) \rightarrow \oplus(\otimes(x_1, x_2), \otimes(x_1, x_3)) \quad , \end{aligned}$$

which correspond to one direction of associativity of \otimes and of left-distributivity, respectively. Then, \Rightarrow_R is the term rewrite relation induced by R on $\mathbb{T}_\Sigma(X)$.

It is clear that

$$\text{nf}_{\Rightarrow_R}(\mathbb{T}_\Sigma) = \mathbb{T}_\Sigma^r \quad . \quad (2.34)$$

Due to associativity and left-distributivity in \mathbb{B} , it is clear that the following statement holds:

$$\text{For every } \xi_1, \xi_2 \in \mathbb{T}_\Sigma \text{ with } \xi_1 \Rightarrow_R \xi_2, \text{ we have } h(\xi_1) = h(\xi_2) \quad . \quad (2.35)$$

Next, by using Corollary 2.11.2 and Theorem 2.11.1, we will show that \Rightarrow_R is terminating⁷. For this purpose, we define the Σ -algebra $\mathcal{C} = (C, \theta)$ [Bor24] where

- $C = \mathbb{N} \setminus \{0, 1\}$ and
- $\theta(\oplus)(n_1, n_2) = n_1 + n_2$ for every $n_1, n_2 \in \mathbb{N}$,
- $\theta(\otimes)(n_1, n_2) = n_1 \cdot n_2^2$ for every $n_1, n_2 \in \mathbb{N}$, and
- $\theta(0)() = \theta(\mathbb{1})() = \theta(a)() = 2$ for each $a \in A$.

It is easy to see that \mathcal{C} is a monotone polynomial interpretation of Σ . Hence, by Corollary 2.11.2 (with the usual order $>$ on \mathbb{N} , e.g., $5 > 3$), the relation $>_{\mathcal{C}}$ is a reduction order on $\mathbb{T}_\Sigma(X)$.

In order to apply Theorem 2.11.1, we have to prove that

$$\ell_1 >_{\mathcal{C}} r_1 \quad \text{and} \quad \ell_2 >_{\mathcal{C}} r_2$$

where ℓ_i and r_i abbreviate the left-hand side and the right-hand side of rule (i), respectively, with $i \in \{1, 2\}$.

Let P_{ℓ_1} , P_{ℓ_2} , P_{r_1} , and P_{r_2} be the polynomials in $\mathbb{N}[x_1, x_2, x_3]$ which are obtained from ℓ_1, ℓ_2, r_1, r_2 by replacing each occurrence of \oplus and \otimes by $\theta(\oplus)$ and $\theta(\otimes)$, respectively, and by substituting these polynomials into each other successively. Thus

$$\begin{aligned} P_{\ell_1}(x_1, x_2, x_3) &= x_1 \cdot (x_2 \cdot x_3^2)^2 = x_1 x_2^2 x_3^4 \\ P_{r_1}(x_1, x_2, x_3) &= x_1 x_2^2 x_3^2 \\ P_{\ell_2}(x_1, x_2, x_3) &= x_1 \cdot (x_2 + x_3)^2 = x_1 x_2^2 + 2 \cdot x_1 x_2 x_3 + x_1 x_3^2 \\ P_{r_2}(x_1, x_2, x_3) &= x_1 x_2^2 + x_1 x_3^2 \quad . \end{aligned}$$

Then it is easy to see that, for every $n_1, n_2, n_3 \in \mathbb{N} \setminus \{0, 1\}$, we have

$$P_{\ell_1}(n_1, n_2, n_3) > P_{r_1}(n_1, n_2, n_3) \quad \text{and} \quad P_{\ell_2}(n_1, n_2, n_3) > P_{r_2}(n_1, n_2, n_3) \quad .$$

⁷We are grateful to Stefan Borgwardt for providing us the proof idea and the particular monotone polynomial interpretation.

By definition of $>_{\mathcal{C}}$, this implies that $\ell_1 >_{\mathcal{C}} r_1$ and $\ell_2 >_{\mathcal{C}} r_2$ (also cf. [BN98, Lm. 5.3.8]). Hence, by Theorem 2.11.1, the term rewrite system R is terminating.

Now we turn to the proof of (2.33). For this, let $\xi \in T_{\Sigma}$. Since \Rightarrow_R is terminating, we can apply Observation 2.5.1; hence, $\text{nf}_{\Rightarrow_R}(\xi) \neq \emptyset$. Let $\zeta \in \text{nf}_{\Rightarrow_R}(\xi)$. Then $\zeta \in T_{\Sigma}^r$ by (2.34) and $h(\xi) = h(\zeta)$ by (2.35). This finishes the proof of (2.33).

Finally, we can calculate as follows.

$$\begin{aligned} \langle A \rangle_{\{\oplus, \otimes, \mathbf{0}, \mathbf{1}\}} &= h(T_{\Sigma}) \\ &= h(T_{\Sigma}^r) && \text{(the set inclusion } \subseteq \text{ follows from (2.33))} \\ &= \text{wcl}(A) \end{aligned}$$

Since \mathbf{B} is weakly locally finite, the set $\text{wcl}(A)$ is finite, and hence $\langle A \rangle_{\{\oplus, \otimes, \mathbf{0}, \mathbf{1}\}}$ is finite. Thus \mathbf{B} is locally finite. \square

2.12 Weighted tree languages and transformations

2.12.1 Weighted tree languages and operations

Let H be a set with $\Sigma \cap H = \emptyset$. A *weighted tree language over Σ , H , and \mathbf{B}* is a \mathbf{B} -weighted set $r : T_{\Sigma}(H) \rightarrow B$. If $H = \emptyset$, then we just say *weighted tree language over Σ and \mathbf{B}* or *(Σ, \mathbf{B}) -weighted tree language*. A *\mathbf{B} -weighted tree language* is a (Σ, \mathbf{B}) -weighted tree language for some ranked alphabet Σ . A *weighted Σ -tree language* is a (Σ, \mathbf{B}) -weighted tree language for some strong bimonoid \mathbf{B} . Finally, a *weighted tree language* is a (Σ, \mathbf{B}) -weighted tree language for some ranked alphabet Σ and some strong bimonoid \mathbf{B} .

Since each (Σ, \mathbf{B}) -weighted tree language is a particular \mathbf{B} -weighted set, by Section 2.8 the following notions and operations are already defined for every $b \in B$, $r : T_{\Sigma} \rightarrow B$, $r_1 : T_{\Sigma} \rightarrow B$, $r_2 : T_{\Sigma} \rightarrow B$, and $L \subseteq T_{\Sigma}$:

- polynomial weighted tree language,
- monomial weighted tree language,
- constant weighted tree language,
- support,
- characteristic mapping of $L \subseteq T_{\Sigma}$ with respect to \mathbf{B} ,
- scalar multiplication from the left ($b \cdot r$) and scalar multiplication from the right ($r \cdot b$),
- sum of r_1 and r_2 ($r_1 \oplus r_2$),
- Hadamard product of r_1 and r_2 ($r_1 \otimes r_2$), and
- application of r to L ($r(L)$).

We denote the set of polynomial (Σ, \mathbf{B}) -weighted tree languages by $\text{Pol}(\Sigma, \mathbf{B})$. We call each element of $\text{Pol}(\Sigma, \mathbf{B})$ a *(Σ, \mathbf{B}) -polynomial*.

We note that, for each $r \in \text{Pol}(\Sigma, \mathbf{B})$, there exist $n \in \mathbb{N}_+$, $b_1, \dots, b_n \in B$, and $\xi_1, \dots, \xi_n \in T_{\Sigma}$ such that $r = b_1 \cdot \xi_1 \oplus \dots \oplus b_n \cdot \xi_n$. (We recall that, for each $i \in [n]$, $b_i \cdot \xi_i$ is a monomial such that for each $\xi \in T_{\Sigma}$ we have $(b_i \cdot \xi_i)(\xi) = b_i$ if $\xi = \xi_i$ and $\mathbf{0}$ otherwise). Indeed, if $\text{supp}(r) = \emptyset$, then $r = \mathbf{0} \cdot \alpha$, where α is an arbitrary element of $\Sigma^{(0)}$. Otherwise, $\text{supp}(r) = \{\xi_1, \dots, \xi_n\}$ for some $n \in \mathbb{N}_+$ and, for each $i \in [n]$, there exists $b_i \in B \setminus \{\mathbf{0}\}$ such that $r(\xi_i) = b_i$. Then, by using the definition of monomial and of \oplus , we have $r = b_1 \cdot \xi_1 \oplus \dots \oplus b_n \cdot \xi_n$.

A (Σ, \mathbf{B}) -weighted tree language r has the *preimage property* if, for each $b \in B$, the Σ -tree language $r^{-1}(b)$ is recognizable (in the sense of Section 2.16).

We extend the concept of support to sets of weighted tree languages in the natural way: for each set \mathcal{C} of weighted tree languages, we define $\text{supp}(\mathcal{C}) = \{\text{supp}(r) \mid r \in \mathcal{C}\}$.

Evaluation algebras. We define particular (Σ, \mathbf{B}) -weighted tree languages; they are the unique Σ -algebra homomorphisms from T_Σ to Σ -algebras which are based on the evaluation of Σ -symbols in \mathbf{B} .

Formally, let $\kappa = (\kappa_k \mid k \in \mathbb{N})$ be an \mathbb{N} -indexed family of mappings $\kappa_k : \Sigma^{(k)} \rightarrow B$. The (Σ, κ) -evaluation algebra, denoted by $\mathsf{M}(\Sigma, \kappa)$, is the Σ -algebra $(B, \bar{\kappa})$, where

$$\bar{\kappa}(\sigma)(b_1, \dots, b_k) = b_1 \otimes \cdots \otimes b_k \otimes \kappa_k(\sigma)$$

for every $k \in \mathbb{N}$, $\sigma \in \Sigma^{(k)}$, and $b_1, \dots, b_k \in B$. We recall that $\mathsf{h}_{\mathsf{M}(\Sigma, \kappa)}$ denotes the unique Σ -algebra homomorphism from T_Σ to $\mathsf{M}(\Sigma, \kappa)$. Then, for each $\xi = \sigma(\xi_1, \dots, \xi_k)$ in T_Σ , we have

$$\mathsf{h}_{\mathsf{M}(\Sigma, \kappa)}(\xi) = \bar{\kappa}(\sigma)(\mathsf{h}_{\mathsf{M}(\Sigma, \kappa)}(\xi_1), \dots, \mathsf{h}_{\mathsf{M}(\Sigma, \kappa)}(\xi_k)) = \left(\bigotimes_{i \in [k]} \mathsf{h}_{\mathsf{M}(\Sigma, \kappa)}(\xi_i) \right) \otimes \kappa_k(\sigma) . \quad (2.36)$$

Obviously, we have

$$\mathsf{h}_{\mathsf{M}(\Sigma, \kappa)}(\xi) = \bigotimes_{\substack{w \in \text{pos}(\xi) \\ \text{in } <_{\text{dp}} \text{ order}}} \kappa_{\text{rk}(\xi(w))}(\xi(w)) . \quad (2.37)$$

In particular, $\mathsf{h}_{\mathsf{M}(\Sigma, \kappa)} : \mathsf{T}_\Sigma \rightarrow B$ is a (Σ, \mathbf{B}) -weighted tree language.

2.12.2 Weighted tree transformations

Let A be a set and $\tau : \mathsf{T}_\Sigma \times A \rightarrow B$ a \mathbf{B} -weighted set. We say that

- τ is *supp-i-finite* if, for every $a \in A$, the set $\{\xi \in \mathsf{T}_\Sigma \mid \tau(\xi, a) \neq 0\}$ is finite;
- τ is *supp-o-finite* if, for every $\xi \in \mathsf{T}_\Sigma$, the set $\{a \in A \mid \tau(\xi, a) \neq 0\}$ is finite.

Here *supp-i-finite* and *supp-o-finite* abbreviate “support input finite” and “support output finite”, respectively. If $A = \mathsf{T}_\Delta$, then we call τ a $(\Sigma, \Delta, \mathbf{B})$ -weighted tree transformation or simply *weighted tree transformation*.

Let $r : \mathsf{T}_\Sigma \rightarrow B$ be a weighted tree language and $\tau : \mathsf{T}_\Sigma \times A \rightarrow B$ be a \mathbf{B} -weighted set. We say that r is τ -summable if τ is *supp-i-finite* or r has finite support. If r is τ -summable or \mathbf{B} is σ -complete, then the *application of τ to r* , denoted by $\tau(r)$, is the \mathbf{B} -weighted set $\tau(r) : A \rightarrow B$ defined, for each $a \in A$, by

$$\tau(r)(a) = \sum_{\xi \in \mathsf{T}_\Sigma}^{\oplus} r(\xi) \otimes \tau(\xi, a) . \quad (2.38)$$

Obviously, if r is τ -summable, then

$$\sum_{\xi \in \mathsf{T}_\Sigma}^{\oplus} r(\xi) \otimes \tau(\xi, a) = \bigoplus_{\xi \in \mathsf{T}_\Sigma} r(\xi) \otimes \tau(\xi, a) . \quad (2.39)$$

We will use this application in three different scenarios.

Scenario 1. In this scenario, τ is the characteristic mapping of a binary relation. Formally, let $r : \mathsf{T}_\Sigma \rightarrow B$ and $g \subseteq \mathsf{T}_\Sigma \times A$. If r is $\chi(g)$ -summable or \mathbf{B} is σ -complete, then for each $a \in A$ we have

$$\chi(g)(r)(a) = \sum_{\xi \in \mathsf{T}_\Sigma}^{\oplus} r(\xi) \otimes \chi(g)(\xi, a) = \sum_{\xi \in g^{-1}(a)}^{\oplus} r(\xi) . \quad (2.40)$$

We will use the following five cases of this scenario. In Case (a) we have $A = \Gamma^*$, and in Cases (b)-(e) we have $A = \mathsf{T}_\Delta$. Moreover, τ is the characteristic mapping of

- (a) a yield mapping $g : \mathsf{T}_\Sigma \rightarrow \Gamma^*$, where $\Gamma \subseteq \Sigma^{(0)}$ is an alphabet (Section 8.3),

- (b) a tree relabeling $g \subseteq T_\Sigma \times T_\Delta$ (Section 10.10 and Section 16.1),
- (c) a tree homomorphism $g : T_\Sigma \rightarrow T_\Delta$ (Section 10.11),
- (d) the inverse of a tree homomorphism $g \subseteq T_\Delta \times T_\Sigma$ (Section 10.12), and
- (e) a tree relabeling $g \subseteq T_\Sigma \times T_\Delta$ (Subsection 17.5.1).

As a consequence of (2.40), we obtain the following inclusion and equality:

$$\begin{aligned} & \text{supp}(\chi(g)(r)) \subseteq g(\text{supp}(r)) \quad \text{and,} \\ & \text{if } \mathbf{B} \text{ is zero-sum free, then } \text{supp}(\chi(g)(r)) = g(\text{supp}(r)) \quad . \end{aligned} \tag{2.41}$$

First we prove the inclusion. For this, let $a \in A$. Then we have

$$\begin{aligned} a \in \text{supp}(\chi(g)(r)) & \iff \left(\sum_{\xi \in g^{-1}(a)}^{\oplus} r(\xi) \right) \neq 0 && \text{(by (2.40))} \\ & \implies (\exists \xi \in g^{-1}(a)) : r(\xi) \neq 0 && \text{(by Observation 2.7.8)} \\ & \iff a \in g(\text{supp}(r)) \quad . \end{aligned}$$

If \mathbf{B} is zero-sum free, then the above implication can be turned into an equivalence by Observation 2.7.11(10) or (11), respectively.

The next observation will be useful later.

Observation 2.12.1. Let $g \subseteq T_\Sigma \times T_\Delta$ be a (Σ, Δ) -tree relabeling, $r : T_\Sigma \rightarrow B$, $L \subseteq T_\Sigma$, and $\xi \in T_\Delta$. Then $\chi(g)(\chi(L) \otimes r)(\xi) = r(g^{-1}(\xi) \cap L)$.

Proof.

$$\begin{aligned} r(g^{-1}(\xi) \cap L) &= \bigoplus_{\zeta \in g^{-1}(\xi) \cap L} r(\zeta) && \text{(we note that } g^{-1}(\xi) \cap L \text{ is finite)} \\ &= \bigoplus_{\zeta \in g^{-1}(\xi)} \chi(L)(\zeta) \otimes r(\zeta) = \bigoplus_{\zeta \in g^{-1}(\xi)} (\chi(L) \otimes r)(\zeta) \\ &= \chi(g)(\chi(L) \otimes r)(\xi) \quad . \end{aligned} \tag{by (2.40)}$$

□

Scenario 2. In this scenario, $A = T_\Sigma$ and τ is the diagonalization of a (Σ, \mathbf{B}) -tree language $r' : T_\Sigma \rightarrow B$. We define the *diagonalization of r'* [FMV11, Sect. 2.6] to be the $(\Sigma, \Sigma, \mathbf{B})$ -weighted tree transformation $\overline{r'} : T_\Sigma \times T_\Sigma \rightarrow B$ such that, for every $\xi, \zeta \in T_\Sigma$, we let

$$\overline{r'}(\xi, \zeta) = \begin{cases} r'(\xi) & \text{if } \xi = \zeta \\ \mathbb{0} & \text{otherwise} \quad . \end{cases} \tag{2.42}$$

Obviously, $\overline{r'}$ is supp-i-finite and hence, for each $r : T_\Sigma \rightarrow B$, the application $\overline{r'}(r)$ is defined. Then the application of the diagonalization of r' to r is the Hadamard product of r and r' , i.e., $\overline{r'}(r) = r \otimes r'$, because for each $\zeta \in T_\Sigma$ we have

$$\overline{r'}(r)(\zeta) = \sum_{\xi \in T_\Sigma}^{\oplus} r(\xi) \otimes \overline{r'}(\xi, \zeta) = r(\zeta) \otimes r'(\zeta) = (r \otimes r')(\zeta) \quad . \tag{2.43}$$

In the sequel we will sometimes drop the bar from $\overline{r'}$. Then it will be clear from the context whether r' denotes a (Σ, \mathbf{B}) -weighted tree language or its diagonalization. We will use this type of application, e.g., in the alternative proof of closure of the set of recognizable weighted tree languages under Hadamard product (cf. Subsection 10.13.6).

Scenario 3. Finally, in this scenario, we have $A = T_\Delta$, i.e., τ is a (Σ, Δ, B) -weighted tree transformation. Let $r : T_\Sigma \rightarrow B$ and $\tau : T_\Sigma \times T_\Delta \rightarrow B$. If r is τ -summable or B is σ -complete, then for each $\zeta \in T_\Delta$ we have

$$\tau(r)(\zeta) = \sum_{\xi \in T_\Sigma}^{\oplus} r(\xi) \otimes \tau(\xi, \zeta) . \quad (2.44)$$

We will use this type of application, e.g., in Section 10.13 and in Chapter 19.

Next we define the composition of weighted tree transformations. Let Ω be a ranked alphabet and $\tau : T_\Sigma \times T_\Delta \rightarrow B$ and $\tau' : T_\Delta \times T_\Omega \rightarrow B$ be weighted tree transformations. If τ is supp-o-finite, τ' is supp-i-finite, or B is σ -complete, then we define the *composition* of τ and τ' to be the weighted tree transformation $(\tau; \tau') : T_\Sigma \times T_\Omega \rightarrow B$ defined by

$$(\tau; \tau')(\xi, \zeta) = \sum_{\eta \in T_\Delta}^{\oplus} \tau(\xi, \eta) \otimes \tau'(\eta, \zeta) \quad (2.45)$$

for every $\xi \in T_\Sigma$ and $\zeta \in T_\Omega$. Clearly, if τ is supp-o-finite or τ' is supp-i-finite, then

$$\sum_{\eta \in T_\Delta}^{\oplus} \tau(\xi, \eta) \otimes \tau'(\eta, \zeta) = \bigoplus_{\eta \in T_\Delta} \tau(\xi, \eta) \otimes \tau'(\eta, \zeta) .$$

We show that, roughly speaking, if B is a semiring, then the composition of weighted tree transformations is associative. Intuitively, the conditions P_1 and P_2 of the next observation guarantee that the expressions $(\tau_1; \tau_2); \tau_3$ and $\tau_1; (\tau_2; \tau_3)$, respectively, are well defined.

Observation 2.12.2. Let B be a semiring. Moreover, let Ω and Ψ be ranked alphabets and $\tau_1 : T_\Sigma \times T_\Delta \rightarrow B$, $\tau_2 : T_\Delta \times T_\Omega \rightarrow B$, and $\tau_3 : T_\Omega \times T_\Psi \rightarrow B$ be weighted tree transformations such that the condition $P_1 \wedge P_2$ holds or B is σ -complete, where

- P_1 : [τ_1 is supp-o-finite or τ_2 is supp-i-finite] and [$\tau_1; \tau_2$ is supp-o-finite or τ_3 is supp-i-finite] and
- P_2 : [τ_2 is supp-o-finite or τ_3 is supp-i-finite] and [τ_1 is supp-o-finite or $\tau_2; \tau_3$ is supp-i-finite].

Then $(\tau_1; \tau_2); \tau_3 = \tau_1; (\tau_2; \tau_3)$.

Proof. Due to the first conjunct (and the second conjunct) of P_1 the compositions $\tau_1; \tau_2$ (and $(\tau_1; \tau_2); \tau_3$, respectively) are defined. Moreover, due to the first conjunct (and the second conjunct) of P_2 the compositions $\tau_2; \tau_3$ (and $\tau_1; (\tau_2; \tau_3)$, respectively) are defined.

Let $\xi \in T_\Sigma$ and $\zeta \in T_\Psi$. Then

$$\begin{aligned} ((\tau_1; \tau_2); \tau_3)(\xi, \zeta) &= \sum_{\eta \in T_\Omega}^{\oplus} (\tau_1; \tau_2)(\xi, \eta) \otimes \tau_3(\eta, \zeta) = \sum_{\eta \in T_\Omega}^{\oplus} \left(\sum_{\theta \in T_\Delta}^{\oplus} \tau_1(\xi, \theta) \otimes \tau_2(\theta, \eta) \right) \otimes \tau_3(\eta, \zeta) \\ &= \sum_{\eta \in T_\Omega}^{\oplus} \left(\sum_{\theta \in T_\Delta}^{\oplus} \tau_1(\xi, \theta) \otimes \tau_2(\theta, \eta) \otimes \tau_3(\eta, \zeta) \right) && \text{(by right-distributivity)} \\ &= \sum_{\theta \in T_\Delta}^{\oplus} \tau_1(\xi, \theta) \otimes \left(\sum_{\eta \in T_\Omega}^{\oplus} \tau_2(\theta, \eta) \otimes \tau_3(\eta, \zeta) \right) && \text{(by left-distributivity)} \\ &= \sum_{\theta \in T_\Delta}^{\oplus} \tau_1(\xi, \theta) \otimes (\tau_2; \tau_3)(\theta, \zeta) = (\tau_1; (\tau_2; \tau_3))(\xi, \zeta). \quad \square \end{aligned}$$

Next we show that, roughly speaking, if B is a semiring, then the application of the composition of weighted tree transformations τ_1 and τ_2 to a weighted tree language r can be expressed as the consecutive applications of τ_1 and τ_2 to r . Intuitively, the conditions P_1 and P_2 of the next observation guarantee that the expressions $(\tau; \tau')(r)$ and $\tau'(\tau(r))$, respectively, are well defined.

Observation 2.12.3. Let \mathbf{B} be a semiring. Moreover, let Ω be a ranked alphabet, $\tau : \mathsf{T}_\Sigma \times \mathsf{T}_\Delta \rightarrow B$ and $\tau' : \mathsf{T}_\Delta \times \mathsf{T}_\Omega \rightarrow B$ be weighted tree transformations, and let $r : \mathsf{T}_\Sigma \rightarrow B$ be a weighted tree language such that the condition $P_1 \wedge P_2$ holds or \mathbf{B} is σ -complete, where

- P_1 : [τ is supp-o-finite or τ' is supp-i-finite] and [$\tau; \tau'$ is supp-i-finite or r has finite support] and
- P_2 : [τ is supp-i-finite or r has finite support] and [τ' is supp-i-finite or $\tau(r)$ has finite support].

Then we have $(\tau; \tau')(r) = \tau'(\tau(r))$.

Proof. Due to the first conjunct (and the second conjunct) of P_1 the composition $\tau; \tau'$ (and the application $(\tau; \tau')(r)$, respectively) are defined. Moreover, due to the first conjunct (and the second conjunct) of P_2 the applications $\tau(r)$ (and $\tau'(\tau(r))$, respectively) are defined.

Let $\theta \in \mathsf{T}_\Omega$. Then

$$\begin{aligned}
(\tau; \tau')(r)(\theta) &= \sum_{\xi \in \mathsf{T}_\Sigma}^{\oplus} r(\xi) \otimes (\tau; \tau')(\xi, \theta) = \sum_{\xi \in \mathsf{T}_\Sigma}^{\oplus} r(\xi) \otimes \sum_{\zeta \in \mathsf{T}_\Delta}^{\oplus} \tau(\xi, \zeta) \otimes \tau'(\zeta, \theta) \\
&= \sum_{\xi \in \mathsf{T}_\Sigma}^{\oplus} \sum_{\zeta \in \mathsf{T}_\Delta}^{\oplus} r(\xi) \otimes \tau(\xi, \zeta) \otimes \tau'(\zeta, \theta) && \text{(by left-distributivity)} \\
&= \sum_{\zeta \in \mathsf{T}_\Delta}^{\oplus} \sum_{\xi \in \mathsf{T}_\Sigma}^{\oplus} r(\xi) \otimes \tau(\xi, \zeta) \otimes \tau'(\zeta, \theta) \\
&= \sum_{\zeta \in \mathsf{T}_\Delta}^{\oplus} \left(\sum_{\xi \in \mathsf{T}_\Sigma}^{\oplus} r(\xi) \otimes \tau(\xi, \zeta) \right) \otimes \tau'(\zeta, \theta) && \text{(by right-distributivity)} \\
&= \sum_{\zeta \in \mathsf{T}_\Delta}^{\oplus} \tau(r)(\zeta) \otimes \tau'(\zeta, \theta) = \tau'(\tau(r))(\theta) . && \square
\end{aligned}$$

2.13 Finite-state string automata

We recall the definition of Γ -automaton from [Eil74, p. 12]. A *finite-state string automaton over Γ* (for short: Γ -fsa) is a quadruple $A = (Q, I, \delta, F)$ where Q is a finite nonempty set of states such that $Q \cap \Gamma = \emptyset$, $I \subseteq Q$ (initial states), $\delta \subseteq Q \times \Gamma \times Q$ (transitions), and $F \subseteq Q$ (final states).

Let $w = a_1 \cdots a_n$ be a string in Γ^* with $n \in \mathbb{N}$ and $a_1, \dots, a_n \in \Gamma$. A *run of A on w* is a string $\rho = q_0 \cdots q_n$ in Q^{n+1} such that, for each $i \in [0, n-1]$ we have $(q_i, a_{i+1}, q_{i+1}) \in \delta$. We denote q_0 and q_n by $\text{first}(\rho)$ and $\text{last}(\rho)$, respectively. The *language recognized by A* , denoted by $L(A)$, is the set

$$L(A) = \{w \in \Gamma^* \mid \text{there exists a run } \rho \text{ of } A \text{ on } w \text{ such that } \text{first}(\rho) \in I \text{ and } \text{last}(\rho) \in F\} .$$

Let $L \subseteq \Gamma^*$. We call L *recognizable* if there exists an fsa A such that $L(A) = L$.

2.14 Context-free grammars

The theory of context-free grammars is well established; for more details, we refer the reader to, e.g., [Har78, HU79, HMU07]. Here we only recall the most basic definitions.

A *context-free grammar over Γ* (for short: Γ -cfg) is a triple $G = (N, S, R)$ where N is a finite set (nonterminals) with $N \cap \Gamma = \emptyset$, $S \subseteq N$ with $S \neq \emptyset$ (initial nonterminals), and R is a finite set (rules); each rule has the form $A \rightarrow \alpha$ where $A \in N$ and $\alpha \in (N \cup \Gamma)^*$.

Let $r = (A \rightarrow \alpha)$ be a rule. We call r a *chain rule* (an ε -rule, a *terminal rule*) if $\alpha \in N$ (and if $\alpha = \varepsilon$, and if $\alpha \in \Gamma^*$, respectively). The left-hand side of r is the nonterminal A , denoted by $\text{lhs}(r)$. Moreover, the i -th occurrence of a nonterminal in α (counted from left to right) is denoted by $\text{rhs}_{N,i}(r)$.

We sometimes want to show the occurrences of elements of N in the right-hand side of rule r more explicitly. Then we will also write r in the form

$$A \rightarrow u_0 A_1 u_1 \cdots A_k u_k ,$$

where $k \in \mathbb{N}$, $u_0, u_1, \dots, u_k \in \Gamma^*$, and $A_1, \dots, A_k \in N$. If S contains only one element, say S_0 , then we denote G by (N, S_0, R) .

The *derivation relation* (of G) is the binary relation \Rightarrow_G on $(N \cup \Gamma)^*$ defined as follows. For every $\gamma, \delta \in (N \cup \Gamma)^*$ and rule $A \rightarrow \alpha$ in R , we have $\gamma A \delta \Rightarrow_G \gamma \alpha \delta$. If G is clear from the context, then we denote \Rightarrow_G by \Rightarrow . We recall that the reflexive and transitive closure of \Rightarrow is denoted by \Rightarrow^* .

A *derivation* (of G) is a sequence $d = (\gamma_1, \dots, \gamma_n)$ with $n \in \mathbb{N}_+$, $\gamma_i \in (N \cup \Gamma)^*$, and $\gamma_i \Rightarrow \gamma_{i+1}$ for each $i \in [n-1]$. We denote d also by $\gamma_1 \Rightarrow_G^* \gamma_n$. Let $L_1, L_2 \subseteq (N \cup \Gamma)^*$. We denote by $D_G(L_1, L_2)$ the set of all derivations $\gamma_1 \Rightarrow_G^* \gamma_n$ such that $\gamma_1 \in L_1$ and $\gamma_n \in L_2$.

The *language generated by G* is the set $L(G) = \{w \in \Gamma^* \mid (\exists S_0 \in S) : S_0 \Rightarrow_G^* w\}$. or, equivalently, $L(G) = \{w \in \Gamma^* \mid D_G(S, w) \neq \emptyset\}$. Let $L \subseteq \Gamma^*$. We call L a *context-free language* if there exists a Γ -cfg G such that $L(G) = L$.

The *leftmost derivation relation* $\Rightarrow_{G,1}$ is defined such that, for every $u \in \Gamma^*$, $\gamma \in (N \cup \Gamma)^*$, and rule $A \rightarrow \alpha$ in R , we have $uA\gamma \Rightarrow_{G,1} u\alpha\gamma$. If G is clear from the context, then we denote $\Rightarrow_{G,1}$ by \Rightarrow_1 . The concept of *leftmost derivation* is defined analogously to the concept of derivation. For every $L_1, L_2 \subseteq (N \cup \Gamma)^*$, we denote by $D_{G,1}(L_1, L_2)$ the set of all leftmost derivations $\gamma_1 \Rightarrow_{G,1}^* \gamma_n$ such that $\gamma_1 \in L_1$ and $\gamma_n \in L_2$. It is well known that $L(G) = \{w \in \Gamma^* \mid S_0 \in S, S_0 \Rightarrow_{G,1}^* w\}$.

Let $G = (N, S, R)$ be a context-free grammar over Γ and $A \in N$ be a nonterminal. We say that

- A is *generating* if there exists $w \in \Gamma^*$ such that $A \Rightarrow^* w$,
- A is *reachable* if there exist $S_0 \in S$ and $\gamma, \delta \in (N \cup \Gamma)^*$ such that $S_0 \Rightarrow^* \gamma A \delta$, and
- A is *useful* if it is generating and reachable.

We say that G is *reduced* if $R = \emptyset$ or each nonterminal $A \in N$ is useful.

Theorem 2.14.1. [Har78, Thm. 3.2.3] *For each Γ -cfg G with a single initial nonterminal S_0 , we can construct a Γ -cfg G' such that G' has the single initial nonterminal S_0 , $L(G') = L(G)$, and G' is reduced.*

Finally, we give a characterization of the languages generated by context-free grammars which have a terminal rule. The characterization uses the concept of rule trees (cf. [Eng75b, Def. 3.54] and [GS84, Def. 3.2.8]). Intuitively, each leftmost derivation corresponds to exactly one rule tree, and vice versa. Because of our general assumption made at the beginning of Section 2.10, that each ranked alphabet contains a symbol of rank zero, such a characterization is only possible for cfg which have a terminal rule. Clearly, we can transform each cfg into an equivalent one which has a terminal rule.

Formally, let $G = (N, S, R)$ be a Γ -cfg which has a terminal rule. We consider R as ranked alphabet by defining the rank of each rule r to be the number of nonterminals in the right-hand side of r . Hence, each terminal rule has rank 0 and, due to our assumption, $R^{(0)} \neq \emptyset$.

We define the *projection of G* , denoted by π_G , to be the mapping

$$\pi_G : T_R \rightarrow \Gamma^*$$

defined by induction on T_R as follows. For every $k \in \mathbb{N}$, $r \in R^{(k)}$ of the form $r = (A \rightarrow u_0 A_1 u_1 \cdots A_k u_k)$, and $d_1, \dots, d_k \in T_R$, we define

$$\pi_G(r(d_1, \dots, d_k)) = u_0 \pi_G(d_1) u_1 \cdots \pi_G(d_k) u_k .$$

If there is no confusion, then we drop the index G from π_G and just write π .

Now let $d \in T_R$. We say that d is a *rule tree of G* if, for every $w \in \text{pos}_R(d)$ and $i \in [\text{rk}_R(d(w))]$, we have $\text{rhs}_{N,i}(d(w)) = \text{lhs}(d(wi))$. Let $A \in N$, $u \in \Gamma^*$, and $d \in T_R$ be a rule tree of G . We say that d is

$d \in \text{RT}_G(A, abcbc) :$

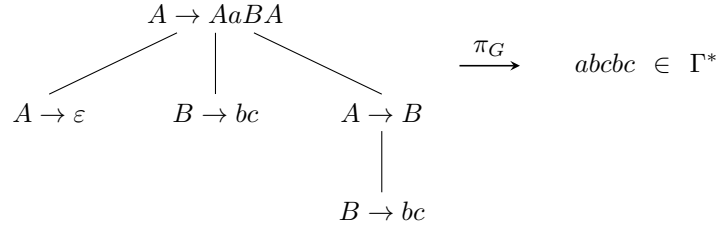

Figure 2.8: The A -rule tree $d \in \text{RT}_G(A, abc bc)$ of G for $abc bc$.

- an A -rule tree of G if $\text{lhs}(d(\varepsilon)) = A$.
- a rule tree of G for u if $\pi_G(d) = u$.

We denote the set of all A -rule trees of G for u by $\text{RT}_G(A, u)$. For every $N' \subseteq N$ and $L \subseteq \Gamma^*$, we define $\text{RT}_G(N', L) = \bigcup_{A \in N', u \in L} \text{RT}_G(A, u)$, and we abbreviate $\text{RT}_G(S, L)$ by $\text{RT}_G(L)$. Obviously, for each $u \in \Gamma^*$, we have $\pi_G^{-1}(u) \cap \text{RT}_G(\Gamma^*) = \text{RT}_G(u)$. Finally, we abbreviate $\text{RT}_G(\Gamma^*)$ by RT_G . Then the following is easy to see.

Observation 2.14.2. For each Γ -cfg G which has a terminal rule we have that $L(G) = \pi_G(\text{RT}_G)$. \square

We note that $L(G) = \emptyset$ for each Γ -cfg G which does not have a terminal rule. Therefore such grammars are not relevant. On the other hand, $L(G) = \emptyset$ does not imply that G does not have a terminal rule.

Example 2.14.3. We consider the alphabet $\Gamma = \{a, b, c\}$ and the Γ -cfg $G = (N, S, R)$ with $N = \{S, A, B\}$ and the rules

$$S \rightarrow aAB, \quad A \rightarrow AaBA, \quad A \rightarrow B, \quad B \rightarrow bc, \quad A \rightarrow \varepsilon .$$

Figure 2.8 shows the A -rule tree $d \in \text{RT}_G(A, abc bc)$ of G for $abc bc$.

2.15 Regular tree grammars

By definition, each tree ξ over Σ is a particular string over the alphabet $\Sigma \cup \Xi$ where Ξ contains the opening and closing parentheses and the comma. For convenience, we abbreviate $\Sigma \cup \Xi$ by Σ^Ξ . Then, by definition, we have $T_\Sigma \subseteq (\Sigma^\Xi)^*$. Of course, $(\Sigma^\Xi)^* \setminus T_\Sigma \neq \emptyset$.

A Σ^Ξ -cfg G is *tree generating* if $L(G) \subseteq T_\Sigma$. Next we give an example of a tree generating Σ^Ξ -cfg.

Example 2.15.1. [Kós22, Ex. 3.9] Let $\Sigma = \{\sigma^{(3)}, \alpha^{(0)}\}$. We consider the Σ^Ξ -cfg $G = (\{S, A, B, C\}, S, R)$ where R contains the following rules:

$$S \rightarrow ASB) \quad S \rightarrow ACB) \quad A \rightarrow \sigma(C, \quad B \rightarrow ,C \quad C \rightarrow \alpha .$$

Note that commas in the above rules must be considered as an element of the alphabet Σ^Ξ .

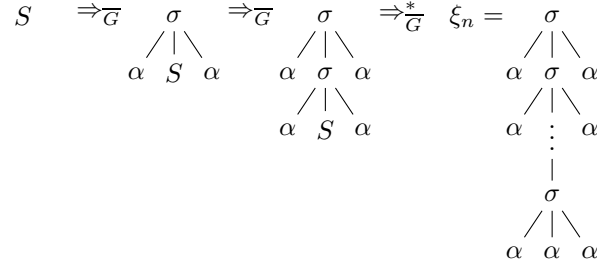

Figure 2.9: [Kós22, Fig. 1] A derivation of the Σ -rtg \overline{G} defined in Example 2.15.2 for $n \in \mathbb{N}_+$ and ξ_n , where ξ_n is the tree in which the symbol σ occurs n times.

Then we have

$$\begin{aligned}
S &\Rightarrow ASB \Rightarrow \sigma(C, SB) \Rightarrow \sigma(\alpha, SB) \\
&\Rightarrow \sigma(\alpha, ACB)B \Rightarrow \sigma(\alpha, \sigma(C, CB)B) \\
&\Rightarrow \sigma(\alpha, \sigma(\alpha, CB)B) \\
&\Rightarrow \sigma(\alpha, \sigma(\alpha, \alpha B)B) \\
&\Rightarrow \sigma(\alpha, \sigma(\alpha, \alpha, C)B) \\
&\Rightarrow \sigma(\alpha, \sigma(\alpha, \alpha, \alpha)B) \\
&\Rightarrow \sigma(\alpha, \sigma(\alpha, \alpha, \alpha), C) \\
&\Rightarrow \sigma(\alpha, \sigma(\alpha, \alpha, \alpha), \alpha) .
\end{aligned}$$

It is easy to see that $L(G) \subseteq T_\Sigma$, and thus, G is tree-generating. \square

Here we recall the concept of regular tree grammar [Bra69] (also cf. [Eng75b, GS84, CDG⁺07]). A *regular tree grammar over Σ* (for short: Σ -rtg) is a Σ^Ξ -cfg $G = (N, S, R)$ where each rule in R has the form $A \rightarrow \xi$ with $\xi \in T_\Sigma(N)$. Obviously, G is ε -free because $\varepsilon \notin T_\Sigma(N)$. Moreover, each regular tree grammar over Σ is a tree generating Σ^Ξ -cfg.

A tree language $L \subseteq T_\Sigma$ is *regular* if there exists a Σ -rtg G such that $L(G) = L$.

Now we give an example of a Σ -rtg.

Example 2.15.2. [Kós22, Ex. 3.10] Let Σ be the ranked alphabet defined in Example 2.15.1. We consider the Σ -rtg $\overline{G} = (\{S\}, S, R)$, where $R = \{S \rightarrow \sigma(\alpha, \alpha, \alpha), S \rightarrow \sigma(\alpha, S, \alpha)\}$. Fig. 2.9 shows, for each $n \in \mathbb{N}_+$, the tree ξ_n and the derivation of \overline{G} for ξ_n . In fact, $L(\overline{G}) = \{\xi_n \mid n \in \mathbb{N}_+\}$.

It is easy to show that, for the tree generating Σ^Ξ -cfg G defined in Example 2.15.1, we have $L(\overline{G}) = L(G)$. \square

The following theorem shows that, in general, for each tree generating Σ^Ξ -cfg we can construct an equivalent Σ -rtg.

Theorem 2.15.3. [Kós22, Thm. V.5 and V.6] *Let G be a Σ^Ξ -cfg. Then the following two statements hold.*

1. *It is decidable whether G is tree generating, i.e., whether $L(G) \subseteq T_\Sigma$.*
2. *If $L(G) \subseteq T_\Sigma$, then we can construct a Σ -rtg G' such that $L(G') = L(G)$.*

2.16 Finite-state tree automata

We recall the notions of finite-state tree automaton and recognizable tree language from [GS84, Eng75b, GS97, CDG⁺07].

A *finite-state tree automaton over Σ* (for short: Σ -fta, or just fta) is a triple $A = (Q, \delta, F)$ where

- Q is a finite nonempty set (states) such that $Q \cap \Sigma = \emptyset$,
- $\delta = (\delta_k \mid k \in \mathbb{N})$ is a family of relations $\delta_k \subseteq Q^k \times \Sigma^{(k)} \times Q^8$ (transition relations) where we consider Q^k as a set of strings over Q of length k , and
- $F \subseteq Q$ (set of root states).

We say that A is *bottom-up-deterministic* (for short: bu-deterministic) if for every $k \in \mathbb{N}$, $w \in Q^k$, and $\sigma \in \Sigma^{(k)}$, there exists at most one $q \in Q$ such that $(w, \sigma, q) \in \delta_k$. And we say that A is *total* if for every $k \in \mathbb{N}$, $w \in Q^k$, and $\sigma \in \Sigma^{(k)}$, there exists at least one $q \in Q$ such that $(w, \sigma, q) \in \delta_k$.

We can associate two semantics with A : the initial algebra semantics and the run semantics. Both lead to the same tree language. Since each of the semantics has its benefits we present them both.

Initial algebra semantics. We define the Σ -algebra associated with A to be the Σ -algebra $(\mathcal{P}(Q), \delta_A)$ where, for every $k \in \mathbb{N}$ and $\sigma \in \Sigma^{(k)}$, the mapping $\delta_A(\sigma) : \mathcal{P}(Q)^k \rightarrow \mathcal{P}(Q)$ is defined by

$$\delta_A(\sigma)(P_1, \dots, P_k) = \{q \in Q \mid (\exists q_1 \in P_1) \dots (\exists q_k \in P_k) : (q_1 \dots q_k, \sigma, q) \in \delta_k\}$$

for every $P_1, \dots, P_k \in \mathcal{P}(Q)$. We denote the unique Σ -algebra homomorphism from the term algebra T_Σ to $(\mathcal{P}(Q), \delta_A)$ by h_A . The *tree language i -recognized by A* , denoted by $L_i(A)$, is defined by

$$L_i(A) = \{\xi \in T_\Sigma \mid h_A(\xi) \cap F \neq \emptyset\} .$$

Run semantics. Let $\xi \in T_\Sigma$. A *run of A on ξ* is a mapping $\rho : \text{pos}(\xi) \rightarrow Q$. Let $q \in Q$. Then ρ is called

- *q -run* if $\rho(\varepsilon) = q$,
- *valid* if for every $w \in \text{pos}(\xi)$ it holds that $(\rho(w_1) \dots \rho(w_k), \xi(w), \rho(w)) \in \delta_k$ where $\xi(w) \in \Sigma^{(k)}$, and
- *accepting* if ρ is valid and $\rho(\varepsilon) \in F$.

The set of all q -runs (all valid q -runs, all accepting q -runs) of A on ξ is denoted by $R_A(q, \xi)$ (respectively, $R_A^v(q, \xi)$ and $R_A^a(q, \xi)$). We let

$$R_A(\xi) = \bigcup_{q \in Q} R_A(q, \xi) \quad \text{and} \quad R_A^v(\xi) = \bigcup_{q \in Q} R_A^v(q, \xi) \quad \text{and} \quad R_A^a(\xi) = \bigcup_{q \in F} R_A^a(q, \xi) .$$

The *tree language r -recognized by A* , denoted by $L_r(A)$, is defined by

$$L_r(A) = \{\xi \in T_\Sigma \mid R_A^a(\xi) \neq \emptyset\} .$$

Lemma 2.16.1. Let $A = (Q, \delta, F)$ be a Σ -fta. Then $L_i(A) = L_r(A)$.

Proof. Let $\xi \in T_\Sigma$. We have

$$\xi \in L_i(A) \text{ iff } h_A(\xi) \cap F \neq \emptyset \text{ iff } (\exists q \in F) : q \in h_A(\xi) \text{ iff}^{(*)} (\exists q \in F) : R_A^v(q, \xi) \neq \emptyset \text{ iff } \xi \in L_r(A).$$

It remains to prove (*). By induction on T_Σ , we prove that the following more general statement holds:

⁸For each $k \in \mathbb{N}$ with $k > \text{maxrk}(\Sigma)$ we have $\delta_k = \emptyset$, because $\Sigma^{(k)} = \emptyset$.

For every $\xi \in T_\Sigma$ and $q \in Q$, we have: $q \in h_A(\xi)$ iff $((\exists \rho \in R_A(q, \xi)) : \rho \text{ is valid})$. (2.46)

Let $\xi = \sigma(\xi_1, \dots, \xi_k)$. Then

$$\begin{aligned} & q \in h_A(\sigma(\xi_1, \dots, \xi_k)) \\ \text{iff } & (\exists q_1 \cdots q_k \in Q^k) : (q_1 \in h_A(\xi_1)) \wedge \dots \wedge (q_k \in h_A(\xi_k)) \wedge ((q_1 \cdots q_k, \sigma, q) \in \delta_k) \\ \text{iff } & (\exists q_1 \cdots q_k \in Q^k) : \\ & ((\exists \rho_1 \in R_A(q_1, \xi_1)) : \rho_1 \text{ is valid}) \wedge \dots \wedge ((\exists \rho_k \in R_A(q_k, \xi_k)) : \rho_k \text{ is valid}) \wedge ((q_1 \cdots q_k, \sigma, q) \in \delta_k) \end{aligned} \quad \text{(I.H.)}$$

$$\begin{aligned} \text{iff } & (\exists q_1 \cdots q_k \in Q^k)(\exists \rho_1 \in R_A(q_1, \xi_1)) \dots (\exists \rho_k \in R_A(q_k, \xi_k)) : \\ & (\rho_1 \text{ is valid}) \wedge \dots \wedge (\rho_k \text{ is valid}) \wedge ((q_1 \cdots q_k, \sigma, q) \in \delta_k) \\ & \quad \text{(by distributivity of } \wedge \text{ over } \exists) \end{aligned}$$

$$\text{iff } (\exists \rho \in R_A(q, \xi)) : \rho \text{ is valid} . \quad \square$$

Since $L_i(A) = L_r(A)$ for each Σ -fta A , we will sometimes drop the indices i and r from $L_i(A)$ and $L_r(A)$, respectively, and we call the language $L(A)$ the *tree language recognized by A* . Two Σ -fta A and A' are *equivalent* if $L(A) = L(A')$. A tree language $L \subseteq T_\Sigma$ is *recognizable* if there exists a Σ -fta A such that $L(A) = L$. The set of all *recognizable Σ -tree languages* is denoted by $\text{Rec}(\Sigma)$.

Theorem 2.16.2. (cf. [GS84, Thm. 2.2.6]⁹ and [Eng75b, Thm. 3.8]¹⁰) *For each Σ -fta A we can construct a total and bu-deterministic Σ -fta B such that $L(A) = L(B)$.*

Theorem 2.16.3. (cf. [Eng75b, Thm. 3.25 and 3.32] and [GS84, Thm. 2.4.2]) *Let A_1, A_2 be two Σ -fta.*

- (1) *We can construct a Σ -fta A such that $L(A) = L(A_1) \cup L(A_2)$.*
- (2) *We can construct a Σ -fta A such that $L(A) = L(A_1) \cap L(A_2)$.*
- (3) *We can construct a Σ -fta A such that $L(A) = L(A_1) \setminus L(A_2)$.*

Thus, the set $\text{Rec}(\Sigma)$ is closed under union, intersection, set subtraction, and complement. Let Σ be a ranked alphabet.

Theorem 2.16.4. (cf. [Eng75b, Thm. 3.25] and [GS84, Thm. 2.3.6]) *Let $L \subseteq T_\Sigma$. Then L is regular iff L is recognizable.*

For the theory of recognizable tree languages we refer to [Eng75b], [GS84, GS97],[CDG⁺07].

2.17 Recognizable step mappings

We recall the concept of recognizable step mapping from [DV06] (also cf. [DG05, DG07, DG09]). Roughly speaking, these are (Σ, B) -weighted tree languages which can be obtained from characteristic mappings of finitely many recognizable Σ -tree languages by multiplying with elements of B and summing up.

Formally, a weighted tree language $r : T_\Sigma \rightarrow B$ is a (Σ, B) -*recognizable step mapping* (or just: *recognizable step mapping*) if there exist $n \in \mathbb{N}_+$, $b_1, \dots, b_n \in B$, and recognizable Σ -tree languages L_1, \dots, L_n such that we have

$$r = \bigoplus_{i \in [n]} b_i \cdot \chi(L_i) , \quad (2.47)$$

(where we have extended the sum of two weighted tree languages to the sum of finitely many weighted tree languages, cf. page 24). In other words, for each $\xi \in T_\Sigma$, we have

$$r(\xi) = \bigoplus_{\substack{i \in [n]: \\ \xi \in L_i}} b_i .$$

⁹When citing results of [GS84] we use the numbers in the arXiv-version of that book.

¹⁰When citing results of [Eng75b] we use the numbers in the arXiv-version of those lecture notes.

In particular, if $\xi \notin L_1 \cup \dots \cup L_n$, then $r(\xi) = \emptyset$. Moreover, if $n = 1$ and $L_1 = \emptyset$, then $r = \tilde{\emptyset}$. The tree languages L_i are called *step languages*. If $n = 1$, then r is called (Σ, \mathbf{B}) -recognizable one-step mapping. We denote by $\text{RecStep}(\Sigma, \mathbf{B})$ the set of (Σ, \mathbf{B}) -recognizable step mappings.

Each polynomial (Σ, \mathbf{B}) -weighted tree language $r = b_1 \cdot \xi_1 \oplus \dots \oplus b_n \cdot \xi_n$ is a recognizable step mapping. This is because also $r = b_1 \cdot \chi(\{\xi_1\}) \oplus \dots \oplus b_n \cdot \chi(\{\xi_n\})$ and because singleton Σ -tree languages are recognizable.

In general, the step languages of a recognizable step mapping need not be disjoint. However, for each recognizable step mapping we can find a characterization in terms of pairwise disjoint step languages.

Observation 2.17.1. [DV06, Lm. 3.1] Let $r : \mathbf{T}_\Sigma \rightarrow B$ be a recognizable step mapping. There exist a finite set F and for each $f \in F$, there exist a recognizable Σ -tree language U_f and an element $a_f \in B$ such that $(U_f \mid f \in F)$ is a partitioning of \mathbf{T}_Σ and $r = \bigoplus_{f \in F} a_f \cdot \chi(U_f)$.

Proof. Let $n \in \mathbb{N}_+$, $b_1, \dots, b_n \in B$, and recognizable Σ -tree languages L_1, \dots, L_n be such that, for each $\xi \in \mathbf{T}_\Sigma$, Equation (2.47) holds.

Let F be the set of all mappings of type $\{1, \dots, n\} \rightarrow \{1, c\}$ (where 1 and c are just viewed as two distinct symbols). For each mapping $f \in F$, we define the Σ -tree language $U_f = \bigcap_{i=1}^n L_i^{f(i)}$ where $L_i^1 = L_i$ and $L_i^c = \mathbf{T}_\Sigma \setminus L_i$. We note that the family $(U_f \mid f \in F)$ forms a partitioning of \mathbf{T}_Σ . Moreover, since the set of recognizable Σ -tree languages is closed under intersection and complementation [GS84], we have that U_f is a recognizable Σ -tree language.

For each $f \in F$, we define the element $a_f = \bigoplus_{i \in f^{-1}(1)} b_i$ in B . Then clearly, for each $\xi \in \mathbf{T}_\Sigma$ we have $r(\xi) = a_f$ if $\xi \in U_f$, where the f is uniquely determined because $(U_f \mid f \in F)$ forms a partitioning of \mathbf{T}_Σ . Thus $r = \bigoplus_{f \in F} a_f \cdot \chi(U_f)$. \square

We mention that recognizable step mappings play an important role in the characterization of recognizable weighted languages by weighted MSO-logic (cf. [DG05, DG07, DG09] for strings, and [DV06, DV11b, FSV12, DHV15] for trees; also cf. Section 17.4). In fact, the semantics of the weighted MSO-formula $\forall x.\varphi$ is a recognizable weighted language if the semantics of φ is a recognizable step mapping ([DG05, Lm. 4.2] and [DG09, Lm. 5.4], also cf. [DV06, Lm. 5.5] and Lemma 17.4.17 for the tree case); moreover, there exists a weighted MSO-formula φ of which the semantics is a recognizable weighted language and the semantics $\forall x.\varphi$ is not recognizable [DG09, Ex. 3.6].

We note that in [GZ12, Def. 3.4], a (Σ, \mathbf{L}) -recognizable step mapping for some σ -complete residuated lattice \mathbf{L} is called an \mathbf{L} -valued regular tree language.

2.18 Fta-hypergraphs

The concept of hypergraph [BC87, HK87, CE12] generalizes that of graphs. In this book we consider particular hypergraphs which we call fta-hypergraphs. Let Q be a finite set. A (Q, Σ) -hypergraph is a pair $g = (Q, E)$, where $E \subseteq \bigcup_{k \in \mathbb{N}} Q^k \times \Sigma^{(k)} \times Q$ (set of hyperedges); the elements of Q are called *nodes*. An *fta-hypergraph* is a (Q, Σ) -hypergraph for some finite set Q and some ranked alphabet Σ .

We can represent a (Q, Σ) -hypergraph as a picture as follows. Each node $q \in Q$ is represented as a circle with q in its center. Each hyperedge $(q_1 \cdots q_k, \sigma, q)$ is represented as a box with σ in its center and with incoming and outgoing arrows. More specifically, this box has exactly one outgoing arrow, which leads to the representation of the node q . Moreover, it has k incoming arrows, which come from the representations of the nodes q_1, \dots, q_k , respectively. The order among q_1, \dots, q_k which is determined by the string $q_1 \cdots q_k$, is represented in the picture as follows: starting from the unique outgoing arrow and moving counter-clockwise around the box, the i -th incoming arrow comes from the representation of the i -th component of the string $q_1 \cdots q_k$.

Figure 2.10 illustrates the (Q, Σ) -hypergraph (Q, E) with $Q = \{h, 0\}$, $\Sigma = \{\sigma^{(2)}, \alpha^{(0)}\}$, and

$$E = \{(\varepsilon, \alpha, h), (h0, \sigma, h), (0h, \sigma, h), (\varepsilon, \alpha, 0), (00, \sigma, 0)\} .$$

For instance, the hyperedge $(0h, \sigma, h)$ is represented by the left-lower box. In the sequel, we will not distinguish between an fta-hypergraph and its representation as picture.

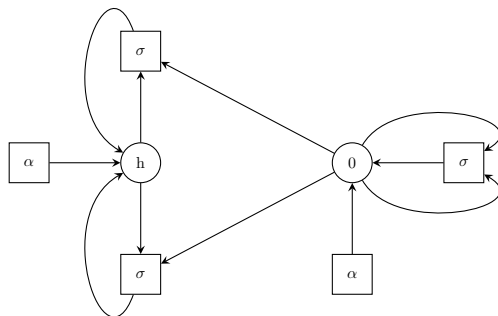

Figure 2.10: A (Q, Σ) -hypergraph.

Chapter 3

The model of weighted tree automata

In this chapter we present the basic model of weighted tree automata. Intuitively, it results from the concept of fta by applying two steps.

In the first step, for a given Σ -fta $\mathcal{A} = (Q, \delta, F)$, we replace each transition relation

$$\delta_k \subseteq Q^k \times \Sigma^{(k)} \times Q \quad \text{by its characteristic mapping} \quad \chi_{\text{Boole}}(\delta_k) : Q^k \times \Sigma^{(k)} \times Q \rightarrow \mathbb{B}$$

with respect to the Boolean semiring $\text{Boole} = (\mathbb{B}, \vee, \wedge, 0, 1)$ (where $\mathbb{B} = \{0, 1\}$), and similarly, we replace

$$F \subseteq Q \quad \text{by its characteristic mapping} \quad \chi_{\text{Boole}}(F) : Q \rightarrow \mathbb{B} .$$

For the sake of simplicity, we denote $\chi_{\text{Boole}}(\delta_k)$ and $\chi_{\text{Boole}}(F)$ also by δ_k and F , respectively.

Since there is a bijection between the set of subsets of $Q^k \times \Sigma^{(k)} \times Q$ and set of mappings of type $Q^k \times \Sigma^{(k)} \times Q \rightarrow \mathbb{B}$ (and the same holds for subsets of Q and mappings of type $Q \rightarrow \mathbb{B}$), this step does not change the concept of an fta; it is simply another way to specify an fta.

In the second step, we replace the Boolean semiring Boole by an arbitrary strong bimonoid $\mathbf{B} = (B, \oplus, \otimes, 0, \mathbb{1})$, i.e., we let

$$\delta_k : Q^k \times \Sigma^{(k)} \times Q \rightarrow B \quad \text{and} \quad F : Q \rightarrow B ,$$

and allow that δ_k and F can map their arguments to any value of B (i.e., not only to 0 and $\mathbb{1}$).

In contrast to the first step, the second one generalizes the concept of fta considerably, because

- (a) a strong bimonoid \mathbf{B} need not be finite and
- (b) a number of algebraic laws which hold for the summation \vee and multiplication \wedge of Boole need not hold anymore in \mathbf{B} , e.g., idempotency, commutativity of \wedge , zero-sum freeness, zero-divisor freeness, absorption axiom, and distributivity.

Hence, in the proofs of lemmas and theorems on weighted tree automata over some arbitrary strong bimonoid \mathbf{B} we have to be careful not to use the latter properties out of habit.

In Section 3.1 we recall the concept of weighted tree automata and define the run semantics, the initial algebra semantics, and the corresponding notions of recognizable weighted tree language. In Section 3.2 we illustrate these definitions by a number of examples. In Sections 3.3, 3.4, 3.5, and 3.6 we connect the concept of weighted tree automata with its historical predecessors in a formal way: weighted string automata, finite-state tree automata, finite-state tree automata with multiplicities, and multilinear representations, respectively. Finally, in Section 3.7 we briefly mention a consequence of extending the weight algebra and we define the concept of Fatou extension.

For the investigation of wta over finite strong bimonoids, we refer the reader to Chapter 12. In fact, there we will deal with wta over even more general “finite-like” weight algebras: the initial algebra semantics of wta over locally finite strong bimonoids (cf. Theorem 12.1.6) and the run semantics of wta over bi-locally finite strong bimonoids (cf. Theorem 12.2.9).

3.1 Basic definitions

A *weighted tree automaton* over Σ and \mathbf{B} (for short: (Σ, \mathbf{B}) -wta, or: wta) is a tuple $\mathcal{A} = (Q, \delta, F)$ where

- Q is a finite nonempty set (*states*) such that $Q \cap \Sigma = \emptyset$,
- $\delta = (\delta_k \mid k \in \mathbb{N})$ is a family of mappings $\delta_k : Q^k \times \Sigma^{(k)} \times Q \rightarrow B$ (*transition mappings*)¹ where we consider Q^k as set of strings over Q of length k , and
- $F : Q \rightarrow B$ is a mapping (*root weight vector*).

For each $k \in \mathbb{N}$, we call each element in $Q^k \times \Sigma^{(k)} \times Q$ a *transition*. For each transition (w, σ, q) , the element $\delta_k(w, \sigma, q)$ of B is its *weight*, and for each $q \in Q$, the element F_q is its *root weight*. (We recall that F_q denotes $F(q)$.) We denote the set of all transition weights and root weights occurring in \mathcal{A} by $\text{wts}(\mathcal{A})$, i.e.,

$$\text{wts}(\mathcal{A}) = \text{im}(\delta) \cup \text{im}(F) \quad \text{where} \quad \text{im}(\delta) = \bigcup_{k \in \mathbb{N}} \text{im}(\delta_k) .$$

Let $\mathcal{A} = (Q, \delta, F)$ be a (Σ, \mathbf{B}) -wta.

- \mathcal{A} is *bottom-up-deterministic* (for short: bu-deterministic) if for every $k \in \mathbb{N}$, $\sigma \in \Sigma^{(k)}$, and $w \in Q^k$ there exists at most one $q \in Q$ such that $\delta_k(w, \sigma, q) \neq 0$.
- \mathcal{A} is *total* if for every $k \in \mathbb{N}$, $\sigma \in \Sigma^{(k)}$, and $w \in Q^k$ there exists at least one state q such that $\delta_k(w, \sigma, q) \neq 0$.
- \mathcal{A} is *crisp* if $\text{im}(\delta) \subseteq \{0, \mathbb{1}\}$.
- \mathcal{A} is *crisp-deterministic* if \mathcal{A} is bu-deterministic, total, and crisp (cf. [CDIV10, Sec. 5]).
- \mathcal{A} has *identity root weights* if $\text{im}(F) \subseteq \{0, \mathbb{1}\}$.
- \mathcal{A} is *root weight normalized* if there exists a state $q \in Q$ such that $\text{supp}(F) = \{q\}$ and $F_q = \mathbb{1}$.

We note that, for each (Σ, \mathbf{B}) -wta $\mathcal{A} = (Q, \delta, F)$, we consider the strong bimonoid \mathbf{B} as integral part of the specification of \mathcal{A} . Thus, if \mathbf{B}' is another strong bimonoid which has the same carrier set as \mathbf{B} (but different operations and/or unit elements), then we consider \mathcal{A} to be different from the (Σ, \mathbf{B}') -wta $\mathcal{A}' = (Q, \delta, F)$. In other words, instead of saying that $\mathcal{A} = (Q, \delta, F)$ is a (Σ, \mathbf{B}) -wta, we could equivalently say that $\mathcal{A} = (Q, \Sigma, \mathbf{B}, \delta, F)$ is a wta. And clearly, $(Q, \Sigma, \mathbf{B}, \delta, F) \neq (Q, \Sigma, \mathbf{B}', \delta, F)$.

Representation of wta by fta-hypergraphs. We can represent each (Σ, \mathbf{B}) -wta $\mathcal{A} = (Q, \delta, F)$ as an fta-hypergraph with extra annotations. For this we first consider the (Q, Σ) -hypergraph

$$g_{\mathcal{A}} = (Q, \bigcup_{k \in \mathbb{N}} \text{supp}(\delta_k)) .$$

Then we add to $g_{\mathcal{A}}$ the root weights of \mathcal{A} and the weights of transitions as follows. For each $q \in Q$ such that $F_q \neq 0$, we add F_q to the node which represents q . If $F_q = 0$, then we do not illustrate F_q in the picture. Moreover, for each transition of \mathcal{A} with non-0-weight, i.e., element in $\bigcup_{k \in \mathbb{N}} \text{supp}(\delta_k)$, we add its weight to its representing hyperedge.

For instance, let us consider the $(\Sigma, \mathbf{Nat}_{\max,+})$ -wta $\mathcal{A} = (Q, \delta, F)$, where

- $\Sigma = \{\sigma^{(2)}, \alpha^{(0)}\}$,
- $\mathbf{Nat}_{\max,+} = (\mathbb{N}_{-\infty}, \max, +, -\infty, 0)$, the arctic semiring,
- $Q = \{h, 0\}$,
- $\delta_0(\varepsilon, \alpha, h) = \delta_0(\varepsilon, \alpha, 0) = 0$ and for every $q_1, q_2, q \in Q$,

$$\delta_2(q_1 q_2, \sigma, q) = \begin{cases} 1 & \text{if } q_1 q_2 q \in \{h0h, 0hh\} , \\ 0 & \text{if } q_1 q_2 q = 000 , \\ -\infty & \text{otherwise} , \end{cases}$$

- $F_h = 0$ and $F_0 = -\infty$.

¹For each $k \in \mathbb{N}$ with $k > \text{maxrk}(\Sigma)$ we have $\delta_k : \emptyset \rightarrow B$, because $\Sigma^{(k)} = \emptyset$.

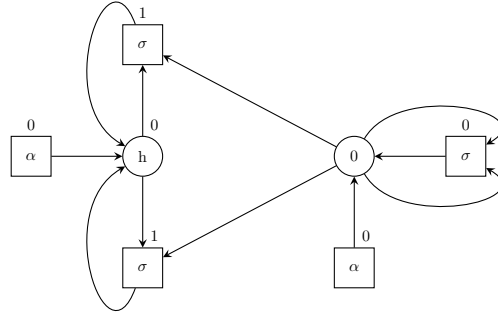

Figure 3.1: The fta-hypergraph for the $(\Sigma, \text{Nat}_{\max,+})$ -wta \mathcal{A} .

In Figure 3.1 we show how \mathcal{A} is represented as fta-hypergraph with extra annotations. We note that, e.g., the transition $(hh, \sigma, 0)$ is not represented in the fta-hypergraph, because $\delta_2(hh, \sigma, 0) = -\infty$ and $-\infty$ is the identity for the summation of the arctic semiring $\text{Nat}_{\max,+}$. Also, the value F_0 is not represented because $F_0 = -\infty$.

Run semantics. The run semantics of a (Σ, \mathbf{B}) -wta can be viewed as a generalization of the algebraic path problem (cf. [Car71], [Zim81, Ch. 8], [Mah81], [Rot90], [CLR90, Sec. 26.4], and [HW93, Ch. IV.6]). Roughly speaking, given a finite, directed graph such that each edge is labeled by an element of some σ -complete strong bimonoid \mathbf{B} , the algebraic path problem asks the following: for each pair q, q' of nodes, how can the value

$$l_{q,q'} = \sum^{\oplus}_{\rho \text{ path from } q \text{ to } q'} \lambda(\rho)$$

in B be computed where, for each path $\rho = (q_0, q_1)(q_1, q_2) \cdots (q_{n-1}, q_n)$ from q_0 to q_n , we let

$$\lambda(\rho) = \bigotimes_{i \in [n]} w(q_{i-1}, q_i)$$

and $w(q_{i-1}, q_i) \in B$ is the label of the edge (q_{i-1}, q_i) . For instance, if \mathbf{B} is the formal language semiring $\text{Lang}_{\Gamma} = (\mathcal{P}(\Gamma^*), \cup, \cdot, \emptyset, \{\varepsilon\})$ and, for every two vertices q, q' , we have $w((q, q')) \subseteq \Gamma$, then the graph can be considered as a Γ -fsa A . Then $l_{q,q'} \in \mathcal{P}(\Gamma^*)$ is the formal language recognized by A starting from q and ending in q' . Another example is that \mathbf{B} is the tropical semiring $\text{Nat}_{\min,+} = (\mathbb{N}_{\infty}, \min, +, \infty, 0)$ and, for every two vertices q, q' , the value $w((q, q'))$ is the distance between q and q' (which may be ∞). Then the value $l_{q,q'} \in \mathbb{N}_{\infty}$ is the length of a shortest path from q to q' .

Since a wta \mathcal{A} corresponds to an fta-hypergraph, the algebraic path problem can be generalized to an “algebraic fta-hyperpath problem” in order to capture the recursive structure of \mathcal{A} (cf. [Knu77] where the fta-hypergraph is called superior context-free grammar, and each hyperedge is labeled by a superior function). Given an fta-hypergraph \mathcal{A} and a node q , a q -hyperpath is an unfolding of the fta-hypergraph, starting in node q and moving in the direction opposite to the direction of the hyperedges; this unfolding results in a Σ -tree ξ (constituted by protocolling the labels of the visited hyperedges) together with a decoration of each position of ξ by some node of the fta-hypergraph \mathcal{A} ; we call this decoration a “ q -run of \mathcal{A} on ξ ”. We note that the first node of a path in a graph (see above) disappears when generalizing to hyperpaths and fta-hypergraphs, because at each leaf of an fta-hyperpath a transition in δ_0 of \mathcal{A} is applied, which does not have source states.

Formally, let $\xi \in \mathbb{T}_{\Sigma}$. A *run of \mathcal{A} on ξ* is a mapping $\rho : \text{pos}(\xi) \rightarrow Q$. If $\rho(\varepsilon) = q$ for some $q \in Q$, then ρ is also called a *q -run*. The *set of all runs of \mathcal{A} on ξ* and the *set of all q -runs of \mathcal{A} on ξ* are denoted by $\mathbf{R}_{\mathcal{A}}(\xi)$ and $\mathbf{R}_{\mathcal{A}}(q, \xi)$, respectively. Each run $\rho \in \mathbf{R}_{\mathcal{A}}(\xi)$ determines, for each $w \in \text{pos}(\xi)$, a unique

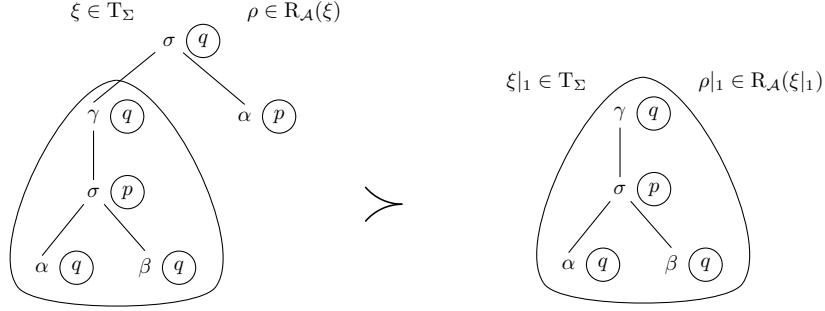

Figure 3.2: An example element $((\xi, \rho), (\xi|_1, \rho|_1))$ of \succ .

transition, viz., if $k = \text{rk}(\xi(w))$ and $\sigma = \xi(w)$, then ρ determines the transition $(\rho(w1) \cdots \rho(wk), \sigma, \rho(w))$. We call this the *transition induced by ρ on ξ at w* . For every $\rho \in R_{\mathcal{A}}(\xi)$ and $w \in \text{pos}(\xi)$, the *run induced by ρ at position w* , denoted by $\rho|_w$, is the run in $R_{\mathcal{A}}(\xi|_w)$ defined for every $w' \in \text{pos}(\xi|_w)$ by $\rho|_w(w') = \rho(ww')$.

Next we define the weight of a run $\rho \in R_{\mathcal{A}}(\xi)$. For this, we will define a mapping $\text{wt}_{\mathcal{A}} : C \rightarrow B$ by well-founded induction on (C, \succ) (using Theorem 2.6.1 and (2.4)). One might be tempted to choose $C = R_{\mathcal{A}}(\xi)$. However, this leads to an underspecification, because one can easily imagine a ranked alphabet Σ and two trees $\xi_1, \xi_2 \in T_{\Sigma}$ such that $\xi_1 \neq \xi_2$ and $\text{pos}(\xi_1) = \text{pos}(\xi_2)$; then $R_{\mathcal{A}}(\xi_1) = R_{\mathcal{A}}(\xi_2)$ and the mapping $\text{wt}_{\mathcal{A}}$ is not able to “see” the Σ -labels at the positions; but, of course, the weight of a run depends on these labels.² Thus, we let C be the set of pairs where each pair consists of a tree $\xi \in T_{\Sigma}$ and a run $\rho \in R_{\mathcal{A}}(\xi)$; due to this origin, we denote C by TR (*tree-run*); and we define an appropriate terminating relation on this set of pairs.

Formally, we let $\text{TR} = \{(\xi, \rho) \mid \xi \in T_{\Sigma}, \rho \in R_{\mathcal{A}}(\xi)\}$ and define the binary relation \succ on TR as follows:

for every $(\xi, \rho) \in \text{TR}$ and $i \in [\text{rk}(\xi(\varepsilon))]$, we let $(\xi, \rho) \succ (\xi|_i, \rho|_i)$.

Since the relation \succ_{Σ} is terminating, by Corollary 2.5.4, the relation \succ is also terminating. Moreover, we have that $\text{nf}_{\succ}(\text{TR}) = \{(\alpha, \rho) \mid \alpha \in \Sigma^{(0)}, \rho : \{\varepsilon\} \rightarrow Q\}$. The terminating relation \succ is illustrated in Figure 3.2.

We define the mapping

$$\text{wt}_{\mathcal{A}} : \text{TR} \rightarrow B$$

by induction on (TR, \succ) for every $\xi \in T_{\Sigma}$ and $\rho \in R_{\mathcal{A}}(\xi)$ by

$$\text{wt}_{\mathcal{A}}(\xi, \rho) = \left(\bigotimes_{i \in [k]} \text{wt}_{\mathcal{A}}(\xi|_i, \rho|_i) \right) \otimes \delta_k(\rho(1) \cdots \rho(k), \sigma, \rho(\varepsilon)) , \quad (3.1)$$

where k and σ abbreviate $\text{rk}(\xi(\varepsilon))$ and $\xi(\varepsilon)$, respectively. We call $\text{wt}_{\mathcal{A}}(\xi, \rho)$ the *weight of ρ by \mathcal{A} on ξ* . If ξ is uniquely determined by the context, then the phrase *weight of ρ by \mathcal{A}* means the value $\text{wt}_{\mathcal{A}}(\xi, \rho)$. If the wta \mathcal{A} is clear from the context, then we drop “by \mathcal{A} ” and the index \mathcal{A} from the phrase “weight of ρ by \mathcal{A} on ξ ” and from the denotation $\text{wt}_{\mathcal{A}}(\xi, \rho)$, respectively.

Intuitively, the run semantics of \mathcal{A} on a tree $\xi \in T_{\Sigma}$ is the finite summation of the weights of each run ρ on ξ , which is additionally multiplied by the root weight $F_{\rho(\varepsilon)}$. Here we use the fact that the binary summation \oplus of B is extended in a unique way to the summation over the finite $R_{\mathcal{A}}(\xi)$ -family $(\text{wt}(\xi, \rho) \otimes F_{\rho(\varepsilon)} \mid \rho \in R_{\mathcal{A}}(\xi))$ over B (cf. page 24). Formally, the *run semantics of \mathcal{A}* , denoted by $\llbracket \mathcal{A} \rrbracket^{\text{run}}$, is the weighted tree language $\llbracket \mathcal{A} \rrbracket^{\text{run}} : T_{\Sigma} \rightarrow B$ such that, for each $\xi \in T_{\Sigma}$, we let

$$\llbracket \mathcal{A} \rrbracket^{\text{run}}(\xi) = \bigoplus_{\rho \in R_{\mathcal{A}}(\xi)} \text{wt}(\xi, \rho) \otimes F_{\rho(\varepsilon)} .$$

²For instance, Equations 11.4 and 11.5 show that the run alone does not determine the value of wt .

Obviously, we have

$$\llbracket \mathcal{A} \rrbracket^{\text{run}}(\xi) = \bigoplus_{q \in Q} \bigoplus_{\rho \in R_{\mathcal{A}}(q, \xi)} \text{wt}(\xi, \rho) \otimes F_q ,$$

because the Q -indexed family $(R_{\mathcal{A}}(q, \xi) \mid q \in Q)$ is a partitioning of $R_{\mathcal{A}}(\xi)$.

Next we prove that the weight $\text{wt}_{\mathcal{A}}(\xi, \rho)$ of a run ρ is the product of the weights of the transitions induced by ρ on ξ .

Observation 3.1.1. For every $\xi \in T_{\Sigma}$ and $\rho \in R_{\mathcal{A}}(\xi)$, we have

$$\text{wt}_{\mathcal{A}}(\xi, \rho) = \bigotimes_{\substack{u \in \text{pos}(\xi) \\ \text{in } <_{\text{dp}} \text{ order}}} \delta_{\text{rk}(\xi(u))}(\rho(u1) \cdots \rho(u \text{rk}(\xi(u))), \xi(u), \rho(u)) .$$

Proof. We prove the statement by induction on T_{Σ} . Let $\xi = \sigma(\xi_1, \dots, \xi_k)$ and $\rho \in R_{\mathcal{A}}(\xi)$. Then we can calculate as follows:

$$\begin{aligned} \text{wt}_{\mathcal{A}}(\xi, \rho) &= \left(\bigotimes_{i \in [k]} \text{wt}_{\mathcal{A}}(\xi_i, \rho|_i) \right) \otimes \delta_k(\rho(1) \cdots \rho(k), \sigma, \rho(\varepsilon)) && \text{(by (3.1))} \\ &= \bigotimes_{\substack{u \in \text{pos}(\xi_1) \\ \text{in } <_{\text{dp}} \text{ order}}} \delta_{\text{rk}(\xi_1(u))}(\rho|_1(u1) \cdots \rho|_1(u \text{rk}(\xi_1(u))), \xi_1(u), \rho|_1(u)) \\ &\quad \otimes \cdots \otimes \bigotimes_{\substack{u \in \text{pos}(\xi_k) \\ \text{in } <_{\text{dp}} \text{ order}}} \delta_{\text{rk}(\xi_k(u))}(\rho|_k(u1) \cdots \rho|_k(u \text{rk}(\xi_k(u))), \xi_k(u), \rho|_k(u)) \\ &\quad \otimes \delta_k(\rho(1) \cdots \rho(k), \sigma, \rho(\varepsilon)) && \text{(by I.H.)} \\ &= \bigotimes_{\substack{u \in \text{pos}(\xi) \\ \text{in } <_{\text{dp}} \text{ order}}} \delta_{\text{rk}(\xi(u))}(\rho(u1) \cdots \rho(u \text{rk}(\xi(u))), \xi(u), \rho(u)) \\ &\hspace{15em} \text{(by associativity of } \otimes \text{ and definition of } <_{\text{dp}}) \end{aligned}$$

□

A weighted tree language $r : T_{\Sigma} \rightarrow B$ is *run recognizable over B* (for short: run recognizable or r-recognizable) if there exists a (Σ, B) -wta \mathcal{A} such that $r = \llbracket \mathcal{A} \rrbracket^{\text{run}}$. The set of all (Σ, B) -weighted tree languages which are run recognizable over B , is denoted by $\text{Rec}^{\text{run}}(\Sigma, B)$. In the obvious way, we can define the notions of *bu-deterministically r-recognizable over B* and *crisp-deterministically r-recognizable over B*. We denote the corresponding sets of all such weighted tree languages by $\text{bud-Rec}^{\text{run}}(\Sigma, B)$ and $\text{cd-Rec}^{\text{run}}(\Sigma, B)$, respectively.

Two (Σ, B) -wta \mathcal{A}_1 and \mathcal{A}_2 are *run equivalent* (r-equivalent) if $\llbracket \mathcal{A}_1 \rrbracket^{\text{run}} = \llbracket \mathcal{A}_2 \rrbracket^{\text{run}}$.

Initial algebra semantics. The heart of the initial algebra semantics [GTWW77] of a (Σ, B) -wta \mathcal{A} is a particular Σ -algebra, called the vector algebra of \mathcal{A} ; it is tailormade for \mathcal{A} . Due to the uniqueness of the Σ -algebra homomorphism from the Σ -term algebra $T_{\Sigma} = (T_{\Sigma}, \theta_{\Sigma})$ to the vector algebra of \mathcal{A} , each Σ -tree ξ can be interpreted (or: evaluated) in a unique way in the vector algebra. Eventually, the interpretation of ξ is modified with root weights. On first glance, the definition of the vector algebra of a wta below might look a bit artificial. However, conceptually, this definition results from the straightforward application of the two steps described at the beginning of this chapter to an fta and its initial algebra semantics.

Formally, the *vector algebra of \mathcal{A}* is the Σ -algebra $V(\mathcal{A}) = (B^Q, \delta_{\mathcal{A}})$ where, for every $k \in \mathbb{N}$, $\sigma \in \Sigma^{(k)}$, the k -ary operation $\delta_{\mathcal{A}}(\sigma) : B^Q \times \cdots \times B^Q \rightarrow B^Q$ is defined by

$$\delta_{\mathcal{A}}(\sigma)(v_1, \dots, v_k)_q = \bigoplus_{q_1 \cdots q_k \in Q^k} \left(\bigotimes_{i \in [k]} (v_i)_{q_i} \right) \otimes \delta_k(q_1 \cdots q_k, \sigma, q) \quad (3.2)$$

for every $v_1, \dots, v_k \in B^Q$ and $q \in Q$.

We abbreviate $h_{V(\mathcal{A})}$ by $h_{\mathcal{A}}$, i.e., we denote the unique Σ -algebra homomorphism from the Σ -term algebra T_Σ to the vector algebra $V(\mathcal{A})$ by $h_{\mathcal{A}}$. Then, for every $\xi = \sigma(\xi_1, \dots, \xi_k)$ in T_Σ and $q \in Q$, we have

$$\begin{aligned} h_{\mathcal{A}}(\sigma(\xi_1, \dots, \xi_k))_q &= h_{\mathcal{A}}(\theta_\Sigma(\sigma)(\xi_1, \dots, \xi_k))_q = \delta_{\mathcal{A}}(\sigma)(h_{\mathcal{A}}(\xi_1), \dots, h_{\mathcal{A}}(\xi_k))_q \\ &= \bigoplus_{q_1 \cdots q_k \in Q^k} \left(\bigotimes_{i \in [k]} h_{\mathcal{A}}(\xi_i)_{q_i} \right) \otimes \delta_k(q_1 \cdots q_k, \sigma, q), \end{aligned}$$

where $\theta_\Sigma(\sigma)$ is the operation of the Σ -term algebra associated to σ ; the second equality holds, because $h_{\mathcal{A}}$ is a Σ -algebra homomorphism. In the subsequent proofs, we will show only the first and the last expressions of the above calculation. For the particular case that $k = 0$, we obtain the following:

$$h_{\mathcal{A}}(\sigma)_q = h_{\mathcal{A}}(\theta_\Sigma(\sigma)(\epsilon))_q = \delta_{\mathcal{A}}(\sigma)(\epsilon)_q = \bigoplus_{\epsilon \in Q^0} \mathbb{1} \otimes \delta_0(\epsilon, \sigma, q) = \delta_0(\epsilon, \sigma, q),$$

and thus we will write $h_{\mathcal{A}}(\sigma)_q = \delta_0(\epsilon, \sigma, q)$ directly.

The *initial algebra semantics* of \mathcal{A} , denoted by $[[\mathcal{A}]]^{\text{init}}$, is the weighted tree language $[[\mathcal{A}]]^{\text{init}} : T_\Sigma \rightarrow B$ defined for every $\xi \in T_\Sigma$ by

$$[[\mathcal{A}]]^{\text{init}}(\xi) = \bigoplus_{q \in Q} h_{\mathcal{A}}(\xi)_q \otimes F_q .$$

The vector algebra $V(\mathcal{A})$ may contain Q -vectors which are not accessible by \mathcal{A} , i.e., in general, we have $B^Q \setminus \text{im}(h_{\mathcal{A}}) \neq \emptyset$. Next we define a Σ -algebra which is a subalgebra of $V(\mathcal{A})$ and has exactly $\text{im}(h_{\mathcal{A}})$ as carrier set. We define the *accessible subalgebra* of $V(\mathcal{A})$, denoted by $\mathfrak{a}V(\mathcal{A})$, to be the Σ -algebra

$$\mathfrak{a}V(\mathcal{A}) = (\text{im}(h_{\mathcal{A}}), \delta_{\mathfrak{a}V(\mathcal{A})}) ,$$

where for each $k \in \mathbb{N}$ and $\sigma \in \Sigma^{(k)}$, the operation $\delta_{\mathfrak{a}V(\mathcal{A})}(\sigma)$ is the restriction of $\delta_{\mathcal{A}}(\sigma)$ to $\text{im}(h_{\mathcal{A}})^k$. By Observation 2.10.4, $\mathfrak{a}V(\mathcal{A})$ is the smallest subalgebra of $V(\mathcal{A})$.

We denote the unique Σ -algebra homomorphism from T_Σ to $\mathfrak{a}V(\mathcal{A})$ by $h_{\mathfrak{a}V(\mathcal{A})}$. Since $\mathfrak{a}V(\mathcal{A})$ is a subalgebra of $V(\mathcal{A})$, the homomorphism $h_{\mathfrak{a}V(\mathcal{A})}$ is a Σ -algebra homomorphism also from T_Σ to $V(\mathcal{A})$, and since T_Σ is initial, we have

$$h_{\mathfrak{a}V(\mathcal{A})}(\xi) = h_{\mathcal{A}}(\xi) \text{ for every } \xi \in T_\Sigma . \quad (3.3)$$

Then we can express the initial algebra semantics $[[\mathcal{A}]]^{\text{init}}$ also in terms of the homomorphism $h_{\mathfrak{a}V(\mathcal{A})}$ as follows:

$$[[\mathcal{A}]]^{\text{init}} = F' \circ h_{\mathfrak{a}V(\mathcal{A})} \quad (3.4)$$

where $F' : \text{im}(h_{\mathcal{A}}) \rightarrow B$ is the mapping defined by $F'(u) = \bigoplus_{q \in Q} u_q \otimes F_q$ for every $u \in \text{im}(h_{\mathcal{A}})$. Indeed, for each $\xi \in T_\Sigma$, we have

$$[[\mathcal{A}]]^{\text{init}}(\xi) = \bigoplus_{q \in Q} h_{\mathcal{A}}(\xi)_q \otimes F_q \stackrel{(3.3)}{=} \bigoplus_{q \in Q} h_{\mathfrak{a}V(\mathcal{A})}(\xi)_q \otimes F_q = (F' \circ h_{\mathfrak{a}V(\mathcal{A})})(\xi) .$$

By Theorem 2.7.4, the kernel $\ker(h_{\mathcal{A}})$ is a congruence relation on the Σ -term algebra $(T_\Sigma, \theta_\Sigma)$.³

Lemma 3.1.2. $\mathfrak{a}V(\mathcal{A}) \cong T_\Sigma / \ker(h_{\mathcal{A}})$, i.e., the accessible subalgebra of $V(\mathcal{A})$ is isomorphic to the quotient algebra of the Σ -term algebra modulo $\ker(h_{\mathcal{A}})$.

³For the case of wsa, in [CDIV10, Prop. 6.2] the relation $\ker(h_{\mathcal{A}})$ was defined and called ‘‘Nerode right congruence’’. We refrain from also calling our relation $\ker(h_{\mathcal{A}})$ ‘‘Nerode congruence relation’’, because the Nerode congruence relation from classical formal language theory means something else: it is based on a language $L \subseteq \Gamma^*$ and defines two strings w_1 and w_2 to be L -equivalent if for each $u \in \Gamma^*$: $w_1 u \in L$ iff $w_2 u \in L$ (also cf. [Koz92] for tree languages). Our $\ker(h_{\mathcal{A}})$ does not depend on a (weighted) language and hence, it is of a different nature.

Proof. Since $h_{\mathbf{aV}(\mathcal{A})}$ is a surjective Σ -algebra homomorphism from the Σ -term algebra to $\mathbf{aV}(\mathcal{A})$, Theorem 2.7.4 implies $\mathbf{aV}(\mathcal{A}) \cong T_\Sigma / \ker(h_{\mathbf{aV}(\mathcal{A})})$. Since (3.3) implies $\ker(h_{\mathcal{A}}) = \ker(h_{\mathbf{aV}(\mathcal{A})})$, we obtain $\mathbf{aV}(\mathcal{A}) \cong T_\Sigma / \ker(h_{\mathcal{A}})$. \square

A weighted tree language $r : T_\Sigma \rightarrow B$ is *initial algebra recognizable over B* (for short: initial algebra recognizable or i-recognizable) if there exists a (Σ, B) -wta \mathcal{A} such that $r = \llbracket \mathcal{A} \rrbracket^{\text{init}}$. The set of all weighted tree languages over Σ and B which are i-recognizable, is denoted by $\text{Rec}^{\text{init}}(\Sigma, B)$. In an obvious way, we can define the notion of *bu-deterministically i-recognizable* weighted tree language and *crisp-deterministically i-recognizable* weighted tree language. We denote the corresponding sets of all such weighted tree languages by $\text{bud-Rec}^{\text{init}}(\Sigma, B)$ and $\text{cd-Rec}^{\text{init}}(\Sigma, B)$, respectively.

Let \mathcal{A}_1 and \mathcal{A}_2 be (Σ, B) -wta. We say that \mathcal{A}_1 and \mathcal{A}_2 are *initial algebra equivalent* (i-equivalent) if $\llbracket \mathcal{A}_1 \rrbracket^{\text{init}} = \llbracket \mathcal{A}_2 \rrbracket^{\text{init}}$. Moreover, \mathcal{A}_1 and \mathcal{A}_2 are *equivalent* if they are both r-equivalent and i-equivalent.

3.2 Examples

Here we list a number of weighted tree languages and show how they can be recognized by wta.

Example 3.2.1. (Number of accepting runs of an fta on a tree.) Let $A = (Q, \delta, F)$ be a Σ -fta. We recall that $R_A(\xi)$, $R_A^v(\xi)$, and $R_A^a(\xi)$ denote the set of runs, valid runs, and accepting runs of A on a tree ξ , respectively. We consider the mapping

$$\#_{R_A^a} : T_\Sigma \rightarrow \mathbb{N} \quad \text{with} \quad \#_{R_A^a}(\xi) = |R_A^a(\xi)| \quad \text{for each } \xi \in T_\Sigma .$$

We call $\#_{R_A^a}$ the *multiplicity mapping of A* (cf. [Eil74, Sect. VI.1]).

As weight algebra we use the semiring $\text{Nat} = (\mathbb{N}, +, \cdot, 0, 1)$ of natural numbers. We construct a (Σ, Nat) -wta $\mathcal{A} = (Q, \delta', F')$ which r-recognizes and also i-recognizes $\#_{R_A^a}$, as follows:

- for each $k \in \mathbb{N}$, we have $(\delta')_k = \chi(\delta_k)$ and
- $F' = \chi(F)$.

Obviously, \mathcal{A} is crisp and has identity root weights.

Next we show that \mathcal{A} r-recognizes $\#_{R_A^a}$, i.e., $\llbracket \mathcal{A} \rrbracket^{\text{run}} = \#_{R_A^a}$. We observe that, for each $\xi \in T_\Sigma$, we have $R_{\mathcal{A}}(\xi) = R_A(\xi)$. By induction on (TR, \succ) (defined on page 76), we prove that, for each $(\xi, \rho) \in \text{TR}$, we have

$$\text{wt}(\xi, \rho) = \begin{cases} 1 & \text{if } \rho \in R_A^v(\xi) \\ 0 & \text{otherwise} . \end{cases} \quad (3.5)$$

I.B.: Let $\xi = \alpha$ for some $\alpha \in \Sigma^{(0)}$, and let $\rho : \{\varepsilon\} \rightarrow Q$. Then $\text{wt}(\xi, \rho) = (\delta')_0(\varepsilon, \alpha, \rho(\varepsilon))$ by definition of wt. We proceed by case analysis.

Case (a): Let $\rho \in R_A^v(\alpha)$. Then $(\varepsilon, \alpha, \rho(\varepsilon)) \in \delta_0$ and by the definition of $(\delta')_0$ we have $(\delta')_0(\varepsilon, \alpha, \rho(\varepsilon)) = 1$. Thus $\text{wt}(\xi, \rho) = 1$.

Case (b): Let $\rho \notin R_A^v(\alpha)$. Then $(\varepsilon, \alpha, \rho(\varepsilon)) \notin \delta_0$ and we have $(\delta')_0(\varepsilon, \alpha, \rho(\varepsilon)) = 0$, i.e., $\text{wt}(\xi, \rho) = 0$.

I.S.: Let $(\xi, \rho) \in \text{TR}$ such that $\xi = \sigma(\xi_1, \dots, \xi_k)$ for some $k \in \mathbb{N}_+$. Then

$$\text{wt}(\xi, \rho) = \left(\text{wt}(\xi_1, \rho|_1) \cdot \dots \cdot \text{wt}(\xi_k, \rho|_k) \right) \cdot (\delta')_k(\rho(1) \cdots \rho(k), \sigma, \rho(\varepsilon))$$

by definition of wt. Again, we proceed by case analysis.

Case (a): Let $\rho \in R_A^v(\xi)$. Then, for each $i \in [k]$, we have $\rho|_i \in R_A^v(\xi_i)$, and $(\rho(1) \cdots \rho(k), \sigma, \rho(\varepsilon)) \in \delta_k$. Hence, by I.H., we have $\text{wt}(\xi_i, \rho|_i) = 1$ for each $i \in [k]$ and, by construction, we have $(\delta')_k(\rho(1) \cdots \rho(k), \sigma, \rho(\varepsilon)) = 1$. Thus $\text{wt}(\xi, \rho) = 1$.

Case (b1): Let $\rho \notin R_A^v(\xi)$ and $(\forall i \in [k]) : \rho|_i \in R_A^v(\xi_i)$. Then $(\rho(1) \cdots \rho(k), \sigma, \rho(\varepsilon)) \notin \delta_k$, i.e., $(\delta')_k(\rho(1) \cdots \rho(k), \sigma, \rho(\varepsilon)) = 0$. Hence $\text{wt}(\xi, \rho) = 0$.

Case (b2): $\rho \notin R_A^v(\xi)$ and $(\exists i \in [k]) : \rho|_i \notin R_A^v(\xi_i)$. Then, by I.H., $\text{wt}(\xi_i, \rho|_i) = 0$ and hence $\text{wt}_{\mathcal{A}}(\xi, \rho) = 0$. This finishes the proof of (3.5).

Hence, for each $\xi \in T_\Sigma$,

$$[[\mathcal{A}]]^{\text{run}}(\xi) = \bigoplus_{\rho \in R_A(\xi)} \text{wt}(\xi, \rho) \cdot F'_{\rho(\varepsilon)} = \bigoplus_{\rho \in R_A^v(\xi)} 1 \cdot F'_{\rho(\varepsilon)} = \bigoplus_{\rho \in R_A^a(\xi)} 1 = |R_A^a(\xi)| = \#R_A^a(\xi) ,$$

i.e., $[[\mathcal{A}]]^{\text{run}}(\xi)$ is the number of accepting runs of A on ξ . Hence $\#R_A^a \in \text{Rec}^{\text{run}}(\Sigma, \text{Nat})$.

Next we show that \mathcal{A} also i-recognizes $\#R_A^a$, i.e., $[[\mathcal{A}]]^{\text{init}} = \#R_A^a$. By induction on T_Σ , we prove that the following statement holds:

$$\text{For every } \xi \in T_\Sigma \text{ and } q \in Q \text{ we have: } h_A(\xi)_q = |R_A^v(q, \xi)|. \quad (3.6)$$

Let $\xi = \sigma(\xi_1, \dots, \xi_k)$. Then we can calculate as follows.

$$\begin{aligned} h_A(\sigma(\xi_1, \dots, \xi_k))_q &= \bigoplus_{q_1, \dots, q_k \in Q} h_A(\xi_1)_{q_1} \cdot \dots \cdot h_A(\xi_k)_{q_k} \cdot (\delta')_k(q_1 \cdots q_k, \sigma, q) \\ &= \bigoplus_{q_1, \dots, q_k \in Q} |R_A^v(q_1, \xi_1)| \cdot \dots \cdot |R_A^v(q_k, \xi_k)| \cdot (\delta')_k(q_1 \cdots q_k, \sigma, q) \quad (\text{by I.H.}) \\ &= |R_A^v(q, \sigma(\xi_1, \dots, \xi_k))| \cdot \quad (\text{by definitions of } (\delta')_k \text{ and of } R_A^v(q, \sigma(\xi_1, \dots, \xi_k))) \end{aligned}$$

Then, for each $\xi \in T_\Sigma$, we have

$$\begin{aligned} [[\mathcal{A}]]^{\text{init}}(\xi) &= \bigoplus_{q \in Q} h_A(\xi)_q \cdot F'_q \\ &= \bigoplus_{q \in Q} |R_A^v(q, \xi)| \cdot F'_q \quad (\text{by (3.6)}) \\ &= \bigoplus_{q \in Q} |R_A^a(q, \xi)| \quad (\text{by definitions of } F', R_A^v(q, \xi), \text{ and } R_A^a(q, \xi)) \\ &= \left| \bigcup_{q \in Q} R_A^a(q, \xi) \right| \quad (\text{because } R_A^a(q_1, \xi) \cap R_A^a(q_2, \xi) = \emptyset \text{ for every } q_1, q_2 \in Q) \\ &= |R_A^a(\xi)| \quad (\text{because } R_A^a(\xi) = \bigcup_{q \in Q} R_A^a(q, \xi)) \\ &= \#R_A^a(\xi) . \end{aligned}$$

Hence $\#R_A^a \in \text{Rec}^{\text{init}}(\Sigma, \text{Nat})$.

There will be a general result which says that, if B is a semiring, then $[[\mathcal{A}]]^{\text{init}} = [[\mathcal{A}]]^{\text{run}}$ for each (Σ, B) -wta \mathcal{A} (cf. Theorem 5.3.4). \square

Example 3.2.2. [Dro21] (**Number of occurrences of transitions of accepting computations of an fta on a tree.**) Let $A = (Q, \delta, F)$ be a Σ -fta. We consider the mapping

$$\#_A : T_\Sigma \rightarrow \mathbb{N} \quad \text{with} \quad \#_A(\xi) = |R_A^a(\xi)| \cdot \text{size}(\xi) \text{ for each } \xi \in T_\Sigma .$$

As weight algebra we use the plus-plus strong bimonoid $\text{PP}_{\mathbb{N}} = (\mathbb{N}_0, \oplus, +, \emptyset, 0)$ (cf. Example 2.7.10(8)).

We construct the $(\Sigma, \text{PP}_{\mathbb{N}})$ -wta $\mathcal{A} = (Q, \delta', F')$ which r-recognizes $\#_A$, as follows. For every $k \in \mathbb{N}$, $q_1, \dots, q_k, q \in Q$, and $\sigma \in \Sigma^{(k)}$, we let:

$$\delta'_k(q_1 \cdots q_k, \sigma, q) = \begin{cases} 1 & \text{if } (q_1 \cdots q_k, \sigma, q) \in \delta_k \\ 0 & \text{otherwise} \end{cases} \quad \text{and} \quad F'_q = \begin{cases} 0 & \text{if } q \in F \\ 0 & \text{otherwise} . \end{cases}$$

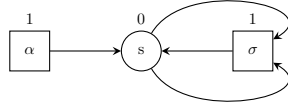

Figure 3.3: The fta-hypergraph for the $(\Sigma, \text{Nat}_{\min,+})$ -wta $\mathcal{A} = (Q, \delta, F)$ which r-recognizes size.

Obviously, for each $\xi \in T_\Sigma$, we have $R_{\mathcal{A}}(\xi) = R_A(\xi)$, and for each $\rho \in R_{\mathcal{A}}(\xi)$, we have

$$\text{wt}(\xi, \rho) = \begin{cases} \text{size}(\xi) & \text{if } \rho \in R_A^v(\xi) \\ 0 & \text{otherwise} . \end{cases} \quad (3.7)$$

Hence, for each $\xi \in T_\Sigma$,

$$\begin{aligned} \llbracket \mathcal{A} \rrbracket^{\text{run}}(\xi) &= \bigoplus_{\rho \in R_{\mathcal{A}}(\xi)} \text{wt}(\xi, \rho) + F'_{\rho(\varepsilon)} \\ &= \bigoplus_{\rho \in R_A^v(\xi)} \text{size}(\xi) + F'_{\rho(\varepsilon)} && \text{(by (3.7))} \\ &= \bigoplus_{\rho \in R_A^a(\xi)} \text{size}(\xi) + 0 && \text{(because } 0 \text{ is the identity element of } \oplus) \\ &= \bigoplus_{\rho \in R_A^a(\xi)} \text{size}(\xi) && \text{(because } \text{size}(\xi) \in \mathbb{N}) \\ &= |R_A^a(\xi)| \cdot \text{size}(\xi) = \#_A(\xi) . \end{aligned}$$

Hence $\#_A \in \text{Rec}^{\text{run}}(\Sigma, \text{PP}_{\mathbb{N}})$. □

Example 3.2.3. (Size of trees.) Let $\Sigma = \{\sigma^{(2)}, \alpha^{(0)}\}$. We consider the mapping

$$\text{size} : T_\Sigma \rightarrow \mathbb{N}$$

defined on page 52. As weight algebra we use the tropical semiring $\text{Nat}_{\min,+} = (\mathbb{N}_\infty, \min, +, \infty, 0)$. Since $\mathbb{N} \subseteq \mathbb{N}_\infty$, by our convention in Section 2.3, size is also a mapping of type $\text{size} : T_\Sigma \rightarrow \mathbb{N}_\infty$, i.e., a $(\Sigma, \text{Nat}_{\min,+})$ -weighted tree language.

We construct the $(\Sigma, \text{Nat}_{\min,+})$ -wta $\mathcal{A} = (Q, \delta, F)$ which r-recognizes size, as follows.

- $Q = \{s\}$, (intuitively, the state s computes the size of the tree),
- $\delta_0(\varepsilon, \alpha, s) = \delta_2(ss, \sigma, s) = 1$, and
- $F_s = 0$.

In Figure 3.3 we represent \mathcal{A} as an fta-hypergraph. Clearly, \mathcal{A} is bu-deterministic, total, and root weight normalized; \mathcal{A} is not crisp-deterministic, because $1 \notin \{\infty, 0\}$.

For each $\xi \in T_\Sigma$, there is exactly one run on ξ . We denote it by ρ^ξ , hence $\rho^\xi(w) = s$ for each $w \in \text{pos}(\xi)$. Obviously, for each $\xi \in T_\Sigma$:

$$\text{wt}(\xi, \rho^\xi) = |\text{pos}(\xi)| .$$

Then, for each $\xi \in T_\Sigma$, we have

$$\llbracket \mathcal{A} \rrbracket^{\text{run}}(\xi) = \min(\text{wt}(\xi, \rho) + F_{\rho(\varepsilon)} \mid \rho \in R_{\mathcal{A}}(\xi)) = \text{wt}(\xi, \rho^\xi) + 0 = |\text{pos}(\xi)| = \text{size}(\xi) .$$

Hence $\llbracket \mathcal{A} \rrbracket^{\text{run}} = \text{size}$ and thus $\text{size} \in \text{bud-Rec}^{\text{run}}(\Sigma, \text{Nat}_{\min,+})$. The construction can easily be generalized to an arbitrary ranked alphabet Σ . □

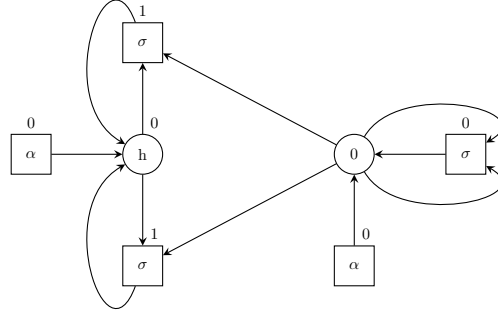

Figure 3.4: The fta-hypergraph for the $(\Sigma, \text{Nat}_{\max,+})$ -wta \mathcal{A} which i-recognizes height.

Example 3.2.4. (Height of trees.) Let $\Sigma = \{\sigma^{(2)}, \alpha^{(0)}\}$. We consider the mapping

$$\text{height} : T_{\Sigma} \rightarrow \mathbb{N}$$

defined on page 52. As weight algebra we use the arctic semiring $\text{Nat}_{\max,+} = (\mathbb{N}_{-\infty}, \max, +, -\infty, 0)$. Thus, the mapping height is a $(\Sigma, \text{Nat}_{\max,+})$ -weighted tree language.

We construct the $(\Sigma, \text{Nat}_{\max,+})$ -wta $\mathcal{A} = (Q, \delta, F)$ which i-recognizes height , as follows.

- $Q = \{h, 0\}$, (intuitively, h and 0 should calculate the height and the natural number 0 , respectively)
- $\delta_0(\varepsilon, \alpha, h) = \delta_0(\varepsilon, \alpha, 0) = 0$ and for every $q_1, q_2, q \in Q$,

$$\delta_2(q_1 q_2, \sigma, q) = \begin{cases} 1 & \text{if } q_1 q_2 q \in \{h0h, 0hh\} , \\ 0 & \text{if } q_1 q_2 q = 000 , \\ -\infty & \text{otherwise .} \end{cases}$$

- $F_h = 0$ and $F_0 = -\infty$.

In Figure 3.4 we represent \mathcal{A} as an fta-hypergraph. Clearly, \mathcal{A} is root weight normalized; \mathcal{A} is not total, because there does not exist a state q such that $\delta_2(hh, \sigma, q) \neq -\infty$; \mathcal{A} is not bu-deterministic, because $\delta_0(\varepsilon, \alpha, h) = \delta_0(\varepsilon, \alpha, 0) = 0 \neq -\infty$.

By induction on T_{Σ} , we prove that the following statement holds:

$$\text{For each } \xi \in T_{\Sigma}, \text{ we have } h_{\mathcal{A}}(\xi)_h = \text{height}(\xi) \text{ and } h_{\mathcal{A}}(\xi)_0 = 0 . \quad (3.8)$$

I.B.: Let $\xi = \alpha$. Then $h_{\mathcal{A}}(\xi)_h = \delta(\varepsilon, \alpha, h) = 0$ (and similarly for $h_{\mathcal{A}}(\xi)_0$).

I.S.: Now let $\xi = \sigma(\xi_1, \xi_2)$ for some trees $\xi_1, \xi_2 \in T_{\Sigma}$. Then

$$\begin{aligned} & h_{\mathcal{A}}(\sigma(\xi_1, \xi_2))_h \\ &= \max(h_{\mathcal{A}}(\xi_1)_{q_1} + h_{\mathcal{A}}(\xi_2)_{q_2} + \delta_2(q_1 q_2, \sigma, h) \mid q_1, q_2 \in Q) \\ &= \max(h_{\mathcal{A}}(\xi_1)_h + h_{\mathcal{A}}(\xi_2)_0 + \delta_2(h0, \sigma, h), h_{\mathcal{A}}(\xi_1)_0 + h_{\mathcal{A}}(\xi_2)_h + \delta_2(0h, \sigma, h)) \\ & \quad \text{(using that } \delta_2(hh, \sigma, h) = \delta_2(00, \sigma, h) = -\infty \text{ and } -\infty \text{ is neutral for max)} \\ &= \max(\text{height}(\xi_1) + 0 + 1, 0 + \text{height}(\xi_2) + 1) \quad \text{(by I.H. and definition of } \delta) \\ &= 1 + \max(\text{height}(\xi_1), \text{height}(\xi_2)) = \text{height}(\xi) . \end{aligned}$$

Moreover, using similar arguments, we can calculate:

$$h_{\mathcal{A}}(\sigma(\xi_1, \xi_2))_0 = h_{\mathcal{A}}(\xi_1)_0 + h_{\mathcal{A}}(\xi_2)_0 + \delta_2(00, \sigma, 0) = 0 + 0 + 0 = 0 .$$

This finishes the proof of Statement (3.8). Then, for each $\xi \in T_{\Sigma}$, we have

$$\llbracket \mathcal{A} \rrbracket^{\text{init}}(\xi) = \max(h_{\mathcal{A}}(\xi)_q + F_q \mid q \in Q) = \max(h_{\mathcal{A}}(\xi)_h + 0, 0 + (-\infty)) = h_{\mathcal{A}}(\xi)_h = \text{height}(\xi) .$$

Hence $\llbracket \mathcal{A} \rrbracket^{\text{init}} = \text{height}$, and thus $\text{height} \in \text{Rec}^{\text{init}}(\Sigma, \mathbf{Nat}_{\max,+})$.

Next we show that the $(\Sigma, \mathbf{Nat}_{\max,+})$ -wta \mathcal{A} also r-recognizes the weighted tree language height. First, we observe that for each $\xi \in T_{\Sigma}$,

$$\text{height}(\xi) = \max(|w| \mid w \in \text{pos}_{\alpha}(\xi)) . \quad (3.9)$$

Let $\xi \in T_{\Sigma}$ be an arbitrary Σ -tree. We define the run $\rho_0 : \text{pos}(\xi) \rightarrow Q$ by $\rho_0(w) = 0$ for each $w \in \text{pos}(\xi)$. It is obvious that $\text{wt}(\xi, \rho_0) = 0$.

Moreover, for every $w \in \text{pos}_{\alpha}(\xi)$, we define the run $\rho_w : \text{pos}(\xi) \rightarrow Q$ such that for each $v \in \text{pos}(\xi)$ we let $\rho_w(v) = h$ if v is a prefix of w , and 0 otherwise. By induction on T_{Σ} , we prove that the following statement holds:

$$\text{For every } \xi \in T_{\Sigma} \text{ and } w \in \text{pos}_{\alpha}(\xi), \text{ we have } \text{wt}(\xi, \rho_w) = |w| . \quad (3.10)$$

I.B.: Let $\xi = \alpha$. Then $w = \varepsilon$ and $\text{wt}(\xi, \rho_{\varepsilon}) = \delta_0(\varepsilon, \alpha, h) = 0$.

I.S.: Now let $\xi = \sigma(\xi_1, \xi_2)$ and assume that $w = 1v$ for some $v \in \text{pos}(\xi_1)$. Then

$$\begin{aligned} \text{wt}(\sigma(\xi_1, \xi_2), \rho_w) &= \text{wt}(\xi_1, \rho_w|_1) + \text{wt}(\xi_2, \rho_w|_2) + \delta_2(\rho_w(1)\rho_w(2), \sigma, \rho_w(\varepsilon)) \\ &= \text{wt}(\xi_1, \rho_v) + \text{wt}(\xi_2, \rho_0) + \delta_2(h0, \sigma, h) \\ &= |v| + 0 + 1 && \text{(by I.H. and definition of } \delta_2) \\ &= |w| . \end{aligned}$$

In a similar way we prove $\text{wt}(\xi, \rho_w) = |w|$ if $w = 2v$ for some v . This proves (3.10). Also it is obvious that

$$\text{for every } \rho \in R_{\mathcal{A}}(\xi) \text{ and } w \in \text{pos}_{\alpha}(\xi), \text{ if } \rho \notin \{\rho_0, \rho_w\}, \text{ then } \text{wt}(\xi, \rho) = -\infty . \quad (3.11)$$

Then we can compute the run semantics of \mathcal{A} on ξ as follows:

$$\begin{aligned} \llbracket \mathcal{A} \rrbracket^{\text{run}}(\xi) &= \max_{\rho \in R_{\mathcal{A}}(\xi)} \text{wt}(\xi, \rho) + F_{\rho(\varepsilon)} = \max(\text{wt}(\xi, \rho) + F_{\rho(\varepsilon)} \mid \rho \in R_{\mathcal{A}}(\xi)) \\ &= \max(\text{wt}(\xi, \rho) + F_h \mid \rho \in R_{\mathcal{A}}(h, \xi)) && \text{(because } F_0 = -\infty) \\ &= \max(\text{wt}(\xi, \rho_w) + 0 \mid w \in \text{pos}_{\alpha}(\xi)) && \text{(by (3.11))} \\ &= \max(|w| \mid w \in \text{pos}_{\alpha}(\xi)) && \text{(by (3.10))} \\ &= \text{height}(\xi) . && \text{(by (3.9))} \end{aligned}$$

Hence $\llbracket \mathcal{A} \rrbracket^{\text{run}} = \text{height}$, and thus $\text{height} \in \text{Rec}^{\text{run}}(\Sigma, \mathbf{Nat}_{\max,+})$. The construction can easily be generalized to an arbitrary ranked alphabet Σ . \square

Example 3.2.5. (Set of positions.) Let $\Sigma = \{\sigma^{(2)}, \gamma^{(1)}, \alpha^{(0)}\}$. We consider the mapping

$$\text{pos} : T_{\Sigma} \rightarrow \mathcal{P}(\mathbb{N}_+^*)$$

defined on page 52.

As weight algebra we use the semiring $\text{Pos} = (\mathcal{P}(\mathbb{N}_+^*), \cup, \circ^R, \emptyset, \{\varepsilon\})$ where $U \circ^R V = VU$ for every $U, V \in \mathcal{P}(\mathbb{N}_+^*)$. Thus, the mapping pos is a (Σ, Pos) -weighted tree language.

We construct the (Σ, Pos) -wta $\mathcal{A} = (Q, \delta, F)$ which r-recognizes pos , as follows.

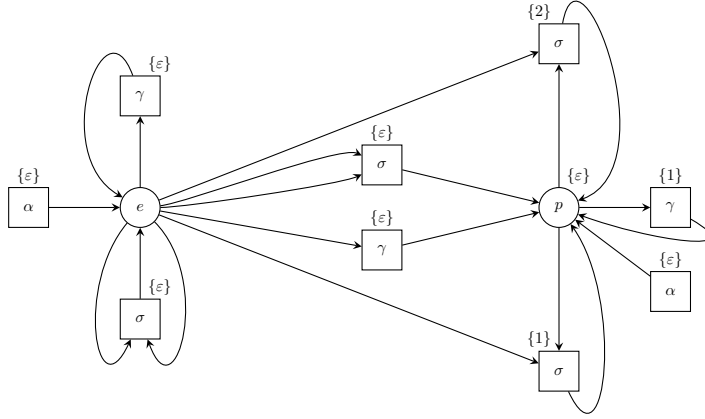

Figure 3.5: The (Σ, Pos) -wta $\mathcal{A} = (Q, \delta, F)$ which r-recognizes pos.

- $Q = \{e, p\}$ (intuitively, e and p calculate $\varepsilon \in \mathbb{N}_+^*$ and a path in \mathbb{N}_+^* , respectively),
- for every $q_1, q_2, q \in Q$ we define $\delta_0(\varepsilon, \alpha, q) = \{\varepsilon\}$ and

$$\delta_1(q_1, \gamma, q) = \begin{cases} \{\varepsilon\} & \text{if } q_1 = e \\ \{1\} & \text{if } q_1 = q = p \\ \emptyset & \text{otherwise} \end{cases} \quad \text{and} \quad \delta_2(q_1 q_2, \sigma, q) = \begin{cases} \{\varepsilon\} & \text{if } q_1 q_2 = ee \\ \{1\} & \text{if } q_1 q_2 = pep \\ \{2\} & \text{if } q_1 q_2 = epp \\ \emptyset & \text{otherwise} \end{cases}$$

- $F_e = \emptyset$ and $F_p = \{\varepsilon\}$.

In Figure 3.5 we represent \mathcal{A} as fta-hypergraph. Clearly, \mathcal{A} is root weight normalized; \mathcal{A} is not bu-deterministic, because e.g. $\delta_1(e, \gamma, e) = \delta_1(e, \gamma, p) = \{\varepsilon\}$, which is different from \emptyset ; \mathcal{A} is not total, because there does not exist a state q such that $\delta_2(pp, \sigma, q) \neq \emptyset$.

Let $\xi \in T_\Sigma$. First we define particular runs on ξ and show their weights. For each $u \in \text{pos}(\xi)$, we define the run $\rho_u^\xi : \text{pos}(\xi) \rightarrow Q$ for each $w \in \text{pos}(\xi)$ by

$$\rho_u^\xi(w) = \begin{cases} p & \text{if } w \text{ is a prefix of } u \\ e & \text{otherwise.} \end{cases}$$

(We recall that ε and u are prefixes of u .) Also, we define the run $\rho_e^\xi : \text{pos}(\xi) \rightarrow Q$ by $\rho_e^\xi(w) = e$ for each $w \in \text{pos}(\xi)$.

Then we claim that the following three statements hold for each $\xi \in T_\Sigma$:

$$\text{wt}(\xi, \rho_e^\xi) = \{\varepsilon\} \quad (3.12)$$

$$\text{for each } \rho \in \mathcal{R}_\mathcal{A}(\xi) \setminus (\{\rho_u^\xi \mid u \in \text{pos}(\xi)\} \cup \{\rho_e^\xi\}), \text{ we have } \text{wt}(\xi, \rho) = \emptyset \quad (3.13)$$

$$\text{for each } u \in \text{pos}(\xi), \text{ we have } \text{wt}(\xi, \rho_u^\xi) = \{u\} . \quad (3.14)$$

By direct inspection of the corresponding definitions we get the proofs of Statements (3.12) and (3.13).

Next we prove Statement (3.14). For this we fix $\xi \in T_\Sigma$ and $u \in \text{pos}(\xi)$. We define the binary relation \succ_d (direct postfix) on $\text{postfix}(u)$ by letting $v_1 \succ_d v_2$ if there exists an $i \in \mathbb{N}_+$ such that $v_1 = iv_2$. By Corollary 2.5.6, the relation \succ_d is terminating. Moreover, we have that $\text{nf}_{\succ_d}(\text{postfix}(u)) = \{\varepsilon\}$. By induction on $(\text{postfix}(u), \succ_d)$, we prove that the following statement holds (where w is determined by $wv = u$.)

$$\text{For each } v \in \text{postfix}(u), \text{ we have } \text{wt}(\xi|_w, \rho_v^{\xi|_w}) = \{v\} . \quad (3.15)$$

I.B.: Let $v = \varepsilon$. Then $w = u$ and $\rho_\varepsilon^{\xi|u} : \text{pos}(\xi|_u) \rightarrow Q$ maps ε to p and each other position to e . Let $\xi(u) = \kappa$ for some $\kappa \in \Sigma^{(k)}$ with $k \in \{0, 1, 2\}$. Then we calculate as follows (abbreviating $\rho_\varepsilon^{\xi|u}$ by ν):

$$\begin{aligned} \text{wt}(\xi|_u, \nu) &= \text{wt}(\xi|_{u_1}, \nu|_1) \circ^R \dots \circ^R \text{wt}(\xi|_{u_k}, \nu|_k) \circ^R \delta_k(\underbrace{e \cdots e}_k, \kappa, p) \\ &= \{\varepsilon\} \circ^R \dots \circ^R \{\varepsilon\} \circ^R \{\varepsilon\} \\ &\text{(by the fact that } \nu|_i = (\rho_\varepsilon^{\xi|u})|_i = \rho_\varepsilon^{\xi|u_i} \text{ for each } i \in [k], \text{ by (3.12), and by definition of } \delta) \\ &= \{\varepsilon\} . \end{aligned}$$

I.S.: Let $v \neq \varepsilon$. Let $\xi(w) = \kappa$ for some $\kappa \in \Sigma^{(k)}$ with $k \in \{1, 2\}$. Then there exists a unique $v' \in \text{postfix}(u)$ with $v \succ_d v'$.

Let $i \in [k]$ be such that $v = iv'$, then $\text{wt}(\xi|_{wi}, \rho_{v'}^{\xi|w_i}) = \{v'\}$ by the I.H. Then we can calculate as follows (abbreviating $\rho_{v'}^{\xi|w}$ by ν):

$$\begin{aligned} \text{wt}(\xi|_w, \nu) &= \text{wt}(\xi_{w_1}, \nu|_1) \circ^R \dots \circ^R \text{wt}(\xi_{w_{(i-1)}}, \nu|_{i-1}) \circ^R \text{wt}(\xi_{wi}, \nu|_i) \\ &\quad \circ^R \text{wt}(\xi_{w_{(i+1)}}, \nu|_{i+1}) \circ^R \dots \circ^R \text{wt}(\xi_{wk}, \nu|_k) \circ^R \delta_k(\underbrace{e \cdots e}_{i-1} p \underbrace{e \cdots e}_{k-i}, \kappa, p) \\ &= \text{wt}(\xi_{wi}, \nu|_i) \circ^R \delta_k(\underbrace{e \cdots e}_{i-1} p \underbrace{e \cdots e}_{k-i}, \kappa, p) \\ &\quad \text{(because } \nu|_j = \rho_e^{\xi|w_j} \text{ for each } j \neq i; \text{ thus } \text{wt}(\xi_{w_j}, \nu|_j) = \{\varepsilon\} \text{ by Statement (3.12))} \\ &= \{v'\} \circ^R \delta_k(\underbrace{e \cdots e}_{i-1} p \underbrace{e \cdots e}_{k-i}, \kappa, p) \quad \text{(because } \nu|_i = \rho_{v'}^{\xi|w_i}; \text{ by I.H. } \text{wt}(\xi_{wi}, \nu|_i) = \{v'\}) \\ &= \{v'\} \circ^R \{i\} = \{iv'\} = \{v\} . \quad \text{(by definition of } \delta_k(\underbrace{e \cdots e}_{i-1} p \underbrace{e \cdots e}_{k-i}, \kappa, p)) \end{aligned}$$

This finishes the proof of Statement (3.15). Choosing $v = u$ in this statement proves Statement (3.14).

Now, for each $\xi \in \text{T}_\Sigma$, we can prove that $\llbracket \mathcal{A} \rrbracket^{\text{run}}(\xi) = \text{pos}(\xi)$ as follows.

$$\begin{aligned} \llbracket \mathcal{A} \rrbracket^{\text{run}}(\xi) &= \bigcup (\text{wt}(\xi, \rho) \circ^R F_{\rho(\varepsilon)} \mid \rho \in \text{R}_{\mathcal{A}}(\xi)) \\ &= \bigcup (\text{wt}(\xi, \rho) \circ^R F_{\rho(\varepsilon)} \mid \rho \in \{\rho_u^\xi \mid u \in \text{pos}(\xi)\} \cup \{\rho_\varepsilon^\xi\}) \quad \text{(by (3.13))} \\ &= \bigcup (\text{wt}(\xi, \rho) \circ^R F_{\rho(\varepsilon)} \mid \rho \in \{\rho_u^\xi \mid u \in \text{pos}(\xi)\}) \quad \text{(because } \rho_\varepsilon^\xi(\varepsilon) = e \text{ and } F_e = \emptyset) \\ &= \bigcup (\text{wt}(\xi, \rho) \mid \rho \in \{\rho_u^\xi \mid u \in \text{pos}(\xi)\}) \quad \text{(because } \rho_u^\xi(\varepsilon) = p \text{ for each } u \in \text{pos}(\xi) \text{ and } F_p = \{\varepsilon\}) \\ &= \bigcup (\text{wt}(\xi, \rho_u^\xi) \mid u \in \text{pos}(\xi)) \\ &= \bigcup (\{u\} \mid u \in \text{pos}(\xi)) \quad \text{(by (3.14))} \\ &= \text{pos}(\xi) . \end{aligned}$$

Hence $\llbracket \mathcal{A} \rrbracket^{\text{run}} = \text{pos}$ and thus $\text{pos} \in \text{Rec}^{\text{run}}(\Sigma, \text{Pos})$. \square

Example 3.2.6. (Yield of trees.) Let $\Sigma = \{\sigma^{(2)}, \alpha^{(0)}, \beta^{(0)}\}$. We consider the mapping

$$\text{yield}^{\mathcal{P}} : \text{T}_\Sigma \rightarrow \mathcal{P}((\Sigma^{(0)})^*)$$

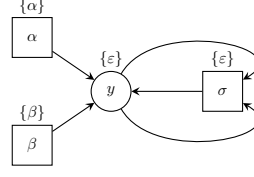

Figure 3.6: The $(\Sigma, \text{Lang}_\Sigma)$ -wta $\mathcal{A} = (Q, \delta, F)$ which i-recognizes $\text{yield}^{\mathcal{P}}$.

defined, for each $\xi \in T_\Sigma$, by $\text{yield}^{\mathcal{P}}(\xi) = \{\text{yield}(\xi)\}$. For the definition of $\text{yield}(\xi)$ we refer to Section 2.10. For instance, $\text{yield}^{\mathcal{P}}(\sigma(\alpha, \sigma(\alpha, \beta))) = \{\alpha\alpha\beta\}$.

As weight algebra we use the formal language semiring $\text{Lang}_\Sigma = (\mathcal{P}(\Sigma^*), \cup, \cdot, \emptyset, \{\varepsilon\})$. Thus, the mapping yield is a $(\Sigma, \text{Lang}_\Sigma)$ -weighted tree language.

We define the $(\Sigma, \text{Lang}_\Sigma)$ -wta $\mathcal{A} = (Q, \delta, F)$ which i-recognizes $\text{yield}^{\mathcal{P}}$, as follows.

- $Q = \{y\}$ (intuitively, y calculates the yield),
- $\delta_0(\varepsilon, \alpha, y) = \{\alpha\}$, $\delta_0(\varepsilon, \beta, y) = \{\beta\}$, and $\delta_2(yy, \sigma, y) = \{\varepsilon\}$,
- $F_y = \{\varepsilon\}$.

In Figure 3.6 we represent \mathcal{A} as fta-hypergraph. Clearly, \mathcal{A} is bu-deterministic, total, and root weight normalized; \mathcal{A} is not crisp-deterministic because, e.g., $\delta_0(\varepsilon, \alpha, y) \notin \{\emptyset, \{\varepsilon\}\}$.

By induction on T_Σ , we prove that the following statement holds:

$$\text{For each } \xi \in T_\Sigma, \text{ we have } h_{\mathcal{A}}(\xi)_y = \{\text{yield}(\xi)\} .$$

I.B.: Let $\xi = \alpha$. Then $h_{\mathcal{A}}(\xi)_y = \delta_0(\varepsilon, \alpha, y) = \{\alpha\} = \{\text{yield}(\alpha)\}$. For $\xi = \beta$ the proof is similar.

I.S.: Now let $\xi = \sigma(\xi_1, \xi_2)$ and assume that $h_{\mathcal{A}}(\xi_i)_y = \{\text{yield}(\xi_i)\}$ for each $i \in \{1, 2\}$. Then

$$h_{\mathcal{A}}(\xi)_y = h_{\mathcal{A}}(\xi_1)_y h_{\mathcal{A}}(\xi_2)_y \delta_2(yy, \sigma, y) = \{\text{yield}(\xi_1)\}\{\text{yield}(\xi_2)\}\{\varepsilon\} = \{\text{yield}(\xi)\} .$$

Then we have $\llbracket \mathcal{A} \rrbracket^{\text{init}}(\xi) = h_{\mathcal{A}}(\xi)_y F_y = \{\text{yield}(\xi)\} = \text{yield}^{\mathcal{P}}(\xi)$. Thus $\text{yield}^{\mathcal{P}} \in \text{bud-Rec}^{\text{init}}(\Sigma, \text{Lang}_\Sigma)$. \square

Example 3.2.7. (Transformation monoid.) We recall from Section 2.13 that a Γ -fsa is a tuple $A = (Q, I, \delta, F)$ where Q is the finite set of states, $I \subseteq Q$ and $F \subseteq Q$ are the sets of initial states and final states, respectively, and $\delta \subseteq Q \times \Gamma \times Q$ is the set of transitions. The language $L(A)$ recognized by A is defined in terms of runs.

Alternatively, we wish to describe $L(A)$ by using the mapping

$$\bar{\delta} : \Gamma^* \rightarrow (\mathcal{P}(Q) \rightarrow \mathcal{P}(Q)) .$$

as follows. Intuitively, for every $w \in \Gamma^*$ and $U \subseteq Q$, the set $\bar{\delta}(w)(U)$ is the set of all states which A can enter when starting in some state of U and reading the string w . Formally, we define $\bar{\delta}$ by induction on (Γ^*, \succ) where, for every $w_1, w_2 \in \Gamma^*$, we let $w_1 \succ w_2$ if there exists an $a \in \Gamma$ such that $w_1 = w_2 a$. By Corollary 2.5.6, the relation \succ is terminating. Moreover, we have that \succ is terminating and $\text{nf}_\succ(\Gamma^*) = \{\varepsilon\}$. For every $a \in \Gamma$, $w \in \Gamma^*$, and $U \subseteq Q$, we define

$$\bar{\delta}(\varepsilon)(U) = U \quad \text{and} \quad \bar{\delta}(wa)(U) = \{p \in Q \mid (\exists r \in \bar{\delta}(w)(U)) : (r, a, p) \in \delta\} .$$

Then it easy to see that $L(A) = \{w \in \Gamma^* \mid \bar{\delta}(w)(I) \cap F \neq \emptyset\}$.

Let $\Sigma = \{\sigma^{(2)}, \alpha^{(0)}, \beta^{(0)}\}$ and let $A = (Q, I, \delta, F)$ be a Γ -fsa with $\Gamma = \{\alpha, \beta\}$. We define the mapping

$$\text{BPS}_A : T_\Sigma \rightarrow (\mathcal{P}(Q) \rightarrow \mathcal{P}(Q)) \quad \text{with} \quad \text{BPS}_A(\xi) = \bar{\delta}(\text{yield}(\xi)) \quad \text{for each } \xi \in T_\Sigma$$

where yield is defined in Section 2.10. Eventually, we will prove that BPS_A is r-recognizable over a suitable strong bimonoid.

The name ‘‘BPS’’ of the mapping refers to Bar-Hillel, Perles, and Shamir [BPS61]; in that paper they have used a technique to fold the computation of a finite-state automaton onto a derivation tree of a context-free grammar. They used this technique for the proof of the fact that the set of context-free languages is closed under intersection with the set of regular languages. We note that the set of context-free languages and the set of yields of recognizable tree languages are equal, cf. [Bra69, Thm. 3.20] and [Don70, Thm. 2.5] (also cf. Corollary 8.3.4 and [GS84, Cor. 3.2.4 and Thm. 3.2.5]). Here we illustrate the BPS-technique for the yield of the particular recognizable tree language T_Σ (also cf. Section 8.3).

We consider the near semiring $\text{NearSem}_{\mathcal{P}(Q)} = (B, \cup, \diamond, \tilde{\emptyset}, \text{id})$ over the commutative semigroup $(\mathcal{P}(Q), \cup, \emptyset)$ as defined in Example 2.7.10(5), where id abbreviates $\text{id}_{\mathcal{P}(Q)}$. We recall that $B = \{f \mid f : \mathcal{P}(Q) \rightarrow \mathcal{P}(Q), f(\emptyset) = \emptyset\}$.

We note that (B, \diamond, id) is a monoid. Moreover, it is easy to verify that $\bar{\delta}$ is monoid homomorphism from $(\Gamma^*, \cdot, \varepsilon)$ to (B, \diamond, id) , i.e., $\bar{\delta}(\varepsilon) = \text{id}$ and,

$$\text{for every } v, w \in \Gamma^*, \text{ we have } \bar{\delta}(vw) = \bar{\delta}(w) \diamond \bar{\delta}(v). \quad (3.16)$$

By induction on (Γ^*, \succ) , we can now easily prove (3.16).

Now we construct the $(\Sigma, \text{NearSem}_{\mathcal{P}(Q)})$ -wta $\mathcal{A} = (\{*\}, \delta', F)$ which r-recognizes BPS_A as follows:

- $(\delta')_0(\varepsilon, \alpha, *) = \bar{\delta}(\alpha)$, $(\delta')_0(\varepsilon, \beta, *) = \bar{\delta}(\beta)$, and $(\delta')_2(**, \sigma, *) = \text{id}$ and
- $F_* = \text{id}$.

In fact, \mathcal{A} is bu-deterministic and root weight normalized, and in general \mathcal{A} is not crisp-deterministic.

Let $\xi \in \text{T}_\Sigma$ and $\rho_\xi : \text{pos}(\xi) \rightarrow Q$ be the run which maps each position of ξ to $*$. By induction on T_Σ , we prove that the following statement holds:

$$\text{For each } \xi \in \text{T}_\Sigma, \text{ we have } \text{wt}_{\mathcal{A}}(\xi, \rho_\xi) = \bar{\delta}(\text{yield}(\xi)) . \quad (3.17)$$

Let $\xi = \alpha$. Then $\text{wt}_{\mathcal{A}}(\xi, \rho_\xi) = (\delta')_0(\varepsilon, \alpha, *) = \bar{\delta}(\alpha) = \bar{\delta}(\text{yield}(\xi))$. In the same way we obtain (3.17) for $\xi = \beta$. Now let $\xi = \sigma(\xi_1, \xi_2)$ and assume that (3.17) holds for ξ_1 and ξ_2 . Then

$$\begin{aligned} \text{wt}_{\mathcal{A}}(\xi, \rho_\xi) &= \text{wt}_{\mathcal{A}}(\xi_1, \rho_{\xi_1}) \diamond \text{wt}_{\mathcal{A}}(\xi_2, \rho_{\xi_2}) \diamond (\delta')_2(**, \sigma, *) \\ &= \bar{\delta}(\text{yield}(\xi_1)) \diamond \bar{\delta}(\text{yield}(\xi_2)) \diamond \text{id} && \text{(by I.H. and construction)} \\ &= \bar{\delta}(\text{yield}(\xi_1)) \diamond \bar{\delta}(\text{yield}(\xi_2)) && \text{(because id is the identity)} \\ &= \bar{\delta}(\text{yield}(\xi_1) \text{ yield}(\xi_2)) && \text{(because } \bar{\delta} \text{ is a monoid homomorphism)} \\ &= \bar{\delta}(\text{yield}(\sigma(\xi_1, \xi_2))) . \end{aligned}$$

Finally, for each $\xi \in \text{T}_\Sigma$ we have

$$[\mathcal{A}]^{\text{run}}(\xi) = \bigcup_{\rho \in \text{R}_{\mathcal{A}}(\xi)} \text{wt}_{\mathcal{A}}(\xi, \rho) = \text{wt}_{\mathcal{A}}(\xi, \rho_\xi) = \bar{\delta}(\text{yield}(\xi)) = \text{BPS}_A(\xi) .$$

Thus $\text{BPS}_A \in \text{bud-Rec}^{\text{run}}(\Sigma, \text{NearSem}_{\mathcal{P}(Q)})$. □

Example 3.2.8. (Exponentiation.) We consider the string ranked alphabet $\Sigma = \{\gamma^{(1)}, \alpha^{(0)}\}$ and the mapping

$$\text{exp} : \text{T}_\Sigma \rightarrow \mathbb{N} \quad \text{with} \quad \text{exp}(\xi) = 2^{n+1} \quad \text{if } \xi = \gamma^n(\alpha) \text{ for some } n \in \mathbb{N} .$$

As weight algebra we consider the tropical bimonoid $\text{TropBM} = (\mathbb{N}_\infty, +, \min, 0, \infty)$ from Example 2.7.10(1). Thus exp is a (Σ, TropBM) -weighted tree language.

We construct the (Σ, TropBM) -wta $\mathcal{A} = (Q, \delta, F)$ which r-recognizes exp , as follows.

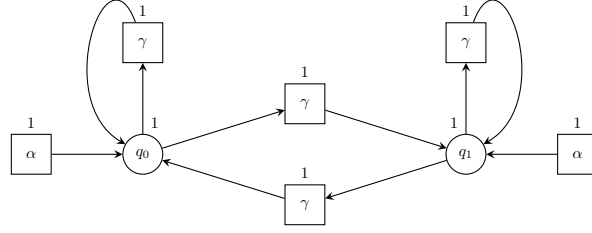

Figure 3.7: The (Σ, TropBM) -wta \mathcal{A} which r-recognizes exp .

- $Q = \{q_0, q_1\}$,
- $\delta_0(\varepsilon, \alpha, p) = \delta_1(p, \gamma, q) = 1$ for every $p, q \in Q$, and
- $F_{q_0} = F_{q_1} = 1$.

In Figure 3.7 we show the wta \mathcal{A} . Obviously, \mathcal{A} is not bu-deterministic.

Now let $n \in \mathbb{N}$. We compute $\llbracket \mathcal{A} \rrbracket^{\text{run}}(\gamma^n(\alpha))$. It is easy to see that $\text{wt}(\gamma^n(\alpha), \rho) = 1$ for each run $\rho \in R_{\mathcal{A}}(\gamma^n(\alpha))$. Then for each $n \in \mathbb{N}$ we have

$$\llbracket \mathcal{A} \rrbracket^{\text{run}}(\gamma^n(\alpha)) = \bigoplus_{\rho \in R_{\mathcal{A}}(\gamma^n(\alpha))} \min(\text{wt}(\gamma^n(\alpha), \rho), F_{\rho(\varepsilon)}) = \bigoplus_{\rho \in R_{\mathcal{A}}(\gamma^n(\alpha))} 1 = |R_{\mathcal{A}}(\gamma^n(\alpha))| = 2^{n+1} = \text{exp}(\gamma^n(\alpha)) ,$$

where the last but one equality is due to the fact that there exists a bijection between the two finite sets $R_{\mathcal{A}}(\gamma^n(\alpha))$ and $\{q_0, q_1\}^{n+1}$. Hence $\llbracket \mathcal{A} \rrbracket^{\text{run}} = \text{exp}$ and thus $\text{exp} \in \text{Rec}^{\text{run}}(\Sigma, \text{TropBM})$. \square

Example 3.2.9. (Exponentiation plus one.) Let $\Sigma = \{\gamma^{(1)}, \alpha^{(0)}\}$ be a string ranked alphabet. We define the mapping

$$(\text{exp} + 1) : T_{\Sigma} \rightarrow \mathbb{N} \quad \text{with} \quad (\text{exp} + 1)(\gamma^n(\alpha)) = 2^n + 1 \quad \text{for each } n \in \mathbb{N} .$$

As weight algebra we consider the semiring $\text{Nat} = (\mathbb{N}, +, \cdot, 0, 1)$. Thus, the mapping exp is a (Σ, \mathbb{N}) -weighted tree language.

We construct the (Σ, Nat) -wta $\mathcal{A} = (Q, \delta, F)$ which i-recognizes $(\text{exp} + 1)$, as follows:

- $Q = \{1, e\}$ (intuitively, 1 and e calculate $1 \in \mathbb{N}$ and 2^n , respectively),
- $\delta_0(\varepsilon, \alpha, 1) = \delta_0(\varepsilon, \alpha, e) = 1$ and for every $q_1, q \in Q$,

$$\delta_1(q_1, \gamma, q) = \begin{cases} 1 & \text{if } q_1 = q = 1 \\ 2 & \text{if } q_1 = q = e \\ 0 & \text{otherwise .} \end{cases}$$

- $F_1 = F_e = 1$.

In Figure 3.8 we represent \mathcal{A} as fta-hypergraph. Clearly, \mathcal{A} is total and has identity root weights; \mathcal{A} is not bu-deterministic and it is not root weight normalized.

We can prove easily that:

$$h_{\mathcal{A}}(\gamma^n(\alpha))_1 = 1 \quad \text{and} \quad h_{\mathcal{A}}(\gamma^n(\alpha))_e = 2^n \quad \text{for each } n \in \mathbb{N} .$$

Then $\llbracket \mathcal{A} \rrbracket^{\text{init}}(\gamma^n(\alpha)) = 2^n + 1 = (\text{exp} + 1)(\gamma^n(\alpha))$ for each $n \in \mathbb{N}$. Thus $(\text{exp} + 1) \in \text{Rec}^{\text{init}}(\Sigma, \text{Nat})$. \square

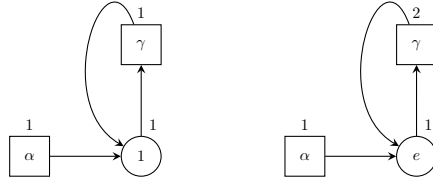

Figure 3.8: The (Σ, Nat) -wta $\mathcal{A} = (Q, \delta, F)$ which i-recognizes $(\text{exp}+1)$.

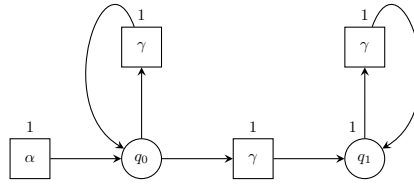

Figure 3.9: The (Σ, \mathbb{F}_2) -wta \mathcal{A} which r-recognizes odd.

Example 3.2.10. (Number of γ 's modulo 2) Let $\Sigma = \{\gamma^{(1)}, \alpha^{(0)}\}$ be a string ranked alphabet. We define the mapping

$$\text{odd} : T_\Sigma \rightarrow \{0, 1\} \quad \text{with} \quad \text{odd}(\gamma^n(\alpha)) = \begin{cases} 1 & \text{if } n \text{ is odd} \\ 0 & \text{otherwise} \end{cases} \quad \text{for each } n \in \mathbb{N}.$$

As weight algebra we consider the field $\mathbb{F}_2 = (\{0, 1\}, \oplus, \otimes, 0, 1)$ (cf. Example 2.7.10(7)). Thus, the mapping odd is a (Σ, \mathbb{F}_2) -weighted tree language.

We construct the (Σ, \mathbb{F}_2) -wta $\mathcal{A} = (Q, \delta, F)$ which r-recognizes odd, as follows.

- $Q = \{q_0, q_1\}$ (intuitively, on each input tree $\gamma^n(\alpha)$, the wta \mathcal{A} starts at the leaf in state q_0 or q_1 and, at any of the occurrences of γ , nondeterministically either stays in q_0 or switches to q_1 and remains there),
- for every $p_1, p_2 \in Q$ we define

$$\delta_0(\varepsilon, \alpha, q_0) = 1 \quad \text{and} \quad \delta_0(\varepsilon, \alpha, q_1) = 0 \quad \text{and} \quad \delta_1(p_1, \gamma, p_2) = \begin{cases} 1 & \text{if } p_1 p_2 \in \{q_0 q_0, q_0 q_1, q_1 q_1\} \\ 0 & \text{otherwise} \end{cases}$$

- $F_{q_0} = 0$ and $F_{q_1} = 1$.

In Figure 3.9 we show the (Σ, \mathbb{F}_2) -wta which r-recognizes odd. Clearly, \mathcal{A} is crisp and root weight normalized; \mathcal{A} is not bu-deterministic.

Let $n \in \mathbb{N}$ and let $\xi = \gamma^n(\alpha)$. Then

$$\llbracket \mathcal{A} \rrbracket^{\text{run}}(\xi) = \bigoplus_{\rho \in R_{\mathcal{A}}(\xi)} \text{wt}(\xi, \rho) \otimes F_{\rho(\varepsilon)} = \bigoplus_{\rho \in R_{\mathcal{A}}(q_1, \xi)} \text{wt}(\xi, \rho) = \bigoplus_{\rho \in [n]} 1 = \text{odd}(\xi) .$$

Here we use the additive monoid $(\{0, 1\}, \oplus, 0)$ of \mathbb{F}_2 to count modulo 2. At the same time, for each strong bimonoid $\mathbb{B} = (B, \oplus, \otimes, 0, 1)$, we can easily design a crisp-deterministic (Σ, \mathbb{B}) -wta with two states

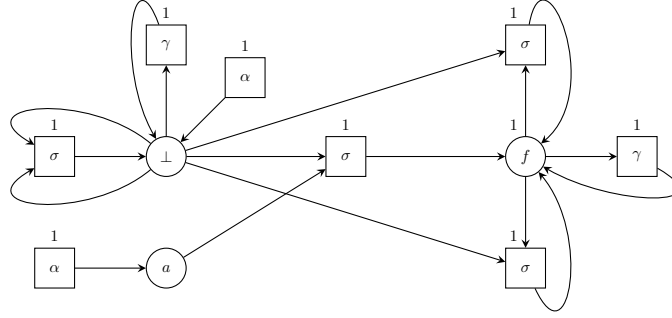

Figure 3.10: The (Σ, Nat) -wta $\mathcal{A} = (Q, \delta, F)$ which r-recognizes $\#_{\sigma(\cdot, \alpha)}$.

and identity root weights such that it simulates counting modulo 2 in its state behaviour. Hence, for each strong bimonoid \mathbf{B} , the corresponding mapping $\text{odd}_{\mathbf{B}} : T_{\Sigma} \rightarrow \{0, 1\}$ is r-recognizable by a crisp-deterministic (Σ, \mathbf{B}) -wta with identity root weights. We note that we use the state behaviour of a wta for “counting” also in Example 3.2.16. \square

Example 3.2.11. (Number of occurrences of a pattern, semiring Nat .)

Let $\Sigma = \{\sigma^{(2)}, \gamma^{(1)}, \alpha^{(0)}\}$. We define the mapping

$$\#_{\sigma(\cdot, \alpha)} : T_{\Sigma} \rightarrow \mathbb{N} \quad \text{with} \quad \#_{\sigma(\cdot, \alpha)}(\xi) = |U(\xi)| \quad \text{for each } \xi \in T_{\Sigma}$$

where $U(\xi) = \{u \in \text{pos}(\xi) \mid \xi(u) = \sigma, \xi(u2) = \alpha\}$. Intuitively, $\#_{\sigma(\cdot, \alpha)}(\xi)$ is the number of occurrences of the pattern $\sigma(\cdot, \alpha)$ in ξ . For instance, $\#_{\sigma(\cdot, \alpha)}(\sigma(\gamma(\sigma(\alpha, \alpha)), \sigma(\alpha, \alpha))) = 2$.

As weight algebra we use the natural number semiring $\text{Nat} = (\mathbb{N}, +, \cdot, 0, 1)$. Thus, the mapping $\#_{\sigma(\cdot, \alpha)}$ is a (Σ, Nat) -weighted tree language.

We construct the (Σ, Nat) -wta $\mathcal{A} = (Q, \delta, F)$ which r-recognizes $\#_{\sigma(\cdot, \alpha)}$, as follows.

- $Q = \{\perp, a, f\}$ (intuitively, \perp ignores occurrences of the pattern, a detects an α -labeled leaf, and f reports “pattern found” up to the root),
- for every $q_1, q_2, q \in Q$ we define

$$\delta_0(\varepsilon, \alpha, q) = \begin{cases} 1 & \text{if } q \in \{\perp, a\} \\ 0 & \text{otherwise} \end{cases} \quad \delta_1(q_1, \gamma, q) = \begin{cases} 1 & \text{if } q_1 q \in \{\perp \perp, f f\} \\ 0 & \text{otherwise} \end{cases}$$

$$\delta_2(q_1 q_2, \sigma, q) = \begin{cases} 1 & \text{if } q_1 q_2 q \in \{\perp \perp \perp, \perp a f, \perp f f, f \perp f\} \\ 0 & \text{otherwise} \end{cases}$$

- $F_{\perp} = F_a = 0$ and $F_f = 1$.

Clearly, \mathcal{A} is root weight normalized; \mathcal{A} is not total, because there does not exist a state q with $\delta_1(a, \gamma, q) \neq 0$; \mathcal{A} is not bu-deterministic. In Figure 3.10 we represent \mathcal{A} as an fta-hypergraph.

Let $\xi \in T_{\Sigma}$. We prove that $\llbracket \mathcal{A} \rrbracket^{\text{run}}(\xi) = \#_{\sigma(\cdot, \alpha)}(\xi)$. For this we define, for each $u \in U(\xi)$, the special run $\rho_u^{\xi} : \text{pos}(\xi) \rightarrow Q$ for each $w \in \text{pos}(\xi)$ by

$$\rho_u^{\xi}(w) = \begin{cases} f & \text{if } w \text{ is a prefix of } u \\ a & \text{if } w = u2 \\ \perp & \text{otherwise} \end{cases}$$

It is obvious that $\text{wt}(\xi, \rho_u^{\xi}) = 1$ and $\rho_u^{\xi}(\varepsilon) = f$. Hence $\text{wt}(\xi, \rho_u^{\xi}) \cdot F_{\rho_u^{\xi}(\varepsilon)} = 1$. Moreover, $\text{wt}(\xi, \rho) \cdot F_{\rho(\varepsilon)} = 0$ for each $\rho \in R_{\mathcal{A}}(\xi) \setminus \{\rho_u^{\xi} \mid u \in U(\xi)\}$.

Then we can calculate as follows.

$$[\mathcal{A}]^{\text{run}}(\xi) = \bigoplus_{\rho \in \mathbf{R}_{\mathcal{A}}(\xi)} \text{wt}(\xi, \rho) \cdot F_{\rho(\varepsilon)} = \bigoplus_{u \in U(\xi)} \text{wt}(\xi, \rho_u^\xi) \cdot F_{\rho_u^\xi(\varepsilon)} = |U(\xi)| = \#_{\sigma(\cdot, \alpha)}(\xi) .$$

Hence $[\mathcal{A}]^{\text{run}} = \#_{\sigma(\cdot, \alpha)}$ and thus $\#_{\sigma(\cdot, \alpha)} \in \text{Rec}^{\text{run}}(\Sigma, \text{Nat})$.

Next we show that \mathcal{A} also i-recognizes $\#_{\sigma(\cdot, \alpha)}$. By induction on \mathbf{T}_Σ , we prove that the following statement holds:

$$\begin{aligned} \text{For each } \xi \in \mathbf{T}_\Sigma, \text{ we have } h_{\mathcal{A}}(\xi)_\perp = 1, h_{\mathcal{A}}(\xi)_a = c(\xi), \text{ and } h_{\mathcal{A}}(\xi)_f = \#_{\sigma(\cdot, \alpha)}(\xi), \\ \text{where } c(\xi) = 1 \text{ if } \xi = \alpha, \text{ and } 0 \text{ otherwise.} \end{aligned} \quad (3.18)$$

I.B.: Let $\xi = \alpha$. Then

$$\begin{aligned} h_{\mathcal{A}}(\alpha)_\perp &= \delta_0(\varepsilon, \alpha, \perp) = 1, \\ h_{\mathcal{A}}(\alpha)_a &= \delta_0(\varepsilon, \alpha, a) = 1 = c(\alpha), \text{ and} \\ h_{\mathcal{A}}(\alpha)_f &= \delta_0(\varepsilon, \alpha, f) = 0 = \#_{\sigma(\cdot, \alpha)}(\alpha) . \end{aligned}$$

I.S.: Let $\xi = \gamma(\xi')$. Then

$$\begin{aligned} h_{\mathcal{A}}(\gamma(\xi'))_\perp &= h_{\mathcal{A}}(\xi')_\perp \cdot \delta_1(\perp, \gamma, \perp) = 1, \\ h_{\mathcal{A}}(\gamma(\xi'))_a &= 0 = c(\gamma(\xi')), \text{ and} \\ h_{\mathcal{A}}(\gamma(\xi'))_f &= h_{\mathcal{A}}(\xi')_f \cdot \delta_1(f, \gamma, f) = \#_{\sigma(\cdot, \alpha)}(\xi') = \#_{\sigma(\cdot, \alpha)}(\gamma(\xi')) . \end{aligned}$$

Let $\xi = \sigma(\xi_1, \xi_2)$. Then

$$\begin{aligned} h_{\mathcal{A}}(\sigma(\xi_1, \xi_2))_\perp &= h_{\mathcal{A}}(\xi_1)_\perp \cdot h_{\mathcal{A}}(\xi_2)_\perp \cdot \delta_2(\perp \perp, \sigma, \perp) = 1, \\ h_{\mathcal{A}}(\sigma(\xi_1, \xi_2))_a &= 0 = c(\sigma(\xi_1, \xi_2)), \text{ and} \\ h_{\mathcal{A}}(\sigma(\xi_1, \xi_2))_f &= h_{\mathcal{A}}(\xi_1)_\perp \cdot h_{\mathcal{A}}(\xi_2)_a \cdot \delta_2(\perp a, \sigma, f) + \\ &\quad h_{\mathcal{A}}(\xi_1)_\perp \cdot h_{\mathcal{A}}(\xi_2)_f \cdot \delta_2(\perp f, \sigma, f) + \\ &\quad h_{\mathcal{A}}(\xi_1)_f \cdot h_{\mathcal{A}}(\xi_2)_\perp \cdot \delta_2(f \perp, \sigma, f) \\ &= c(\xi_2) + \#_{\sigma(\cdot, \alpha)}(\xi_2) + \#_{\sigma(\cdot, \alpha)}(\xi_1) \\ &= \#_{\sigma(\cdot, \alpha)}(\sigma(\xi_1, \xi_2)) . \end{aligned}$$

This proves (3.18). Then for each $\xi \in \mathbf{T}_\Sigma$ we have

$$[\mathcal{A}]^{\text{init}}(\xi) = \bigoplus_{q \in Q} h_{\mathcal{A}}(\xi)_q \cdot F_q = h_{\mathcal{A}}(\xi)_f = \#_{\sigma(\cdot, \alpha)}(\xi) .$$

Hence $\#_{\sigma(\cdot, \alpha)} \in \text{Rec}^{\text{init}}(\Sigma, \text{Nat})$. □

Example 3.2.12. (Number of occurrences of a pattern, semiring $\text{Nat}_{\text{max},+}$.) Again, let $\Sigma = \{\sigma^{(2)}, \gamma^{(1)}, \alpha^{(0)}\}$ and let us consider the mapping $\#_{\sigma(\cdot, \alpha)} : \mathbf{T}_\Sigma \rightarrow \mathbb{N}$ defined in Example 3.2.11.

We construct an $(\Sigma, \text{Nat}_{\text{max},+})$ -wta $\mathcal{A} = (Q, \delta, F)$ which r-recognizes $\#_{\sigma(\cdot, \alpha)}$, where $\text{Nat}_{\text{max},+}$ is the arctic semiring. For this, we let

- $Q = \{\bar{\sigma}, \bar{\gamma}, \bar{\alpha}\}$,
- for every $q_1, q_2, q \in Q$ we define

$$\begin{aligned} \delta_0(\varepsilon, \alpha, q) &= \begin{cases} 0 & \text{if } q = \bar{\alpha} \\ -\infty & \text{otherwise} \end{cases} & \delta_1(q_1, \gamma, q) &= \begin{cases} 0 & \text{if } q = \bar{\gamma} \\ -\infty & \text{otherwise} \end{cases} \\ \delta_2(q_1 q_2, \sigma, q) &= \begin{cases} 1 & \text{if } q_2 = \bar{\alpha} \text{ and } q = \bar{\sigma} \\ 0 & \text{if } q_2 \neq \bar{\alpha} \text{ and } q = \bar{\sigma} \\ -\infty & \text{otherwise} , \end{cases} \end{aligned}$$

- for each $q \in Q$ we define $F_q = 0$.

It is clear that \mathcal{A} is bu-deterministic. Since $\delta_2(q_1\bar{\alpha}, \sigma, \bar{\sigma}) \notin \{-\infty, 0\}$ for each $q_1 \in Q$, the wta \mathcal{A} is not crisp-deterministic.

Now let $\xi \in T_\Sigma$. We define the particular run ρ^ξ on ξ such that $\rho^\xi(w) = \overline{\xi(w)}$ for each $w \in \text{pos}(\xi)$. Then, for each $w \in \text{pos}(\xi)$, the weight of the transition induced by ρ^ξ on ξ at w is 1 if $\xi(w) = \sigma$ and $\xi(w2) = \alpha$ (i.e., the pattern $\sigma(\cdot, \alpha)$ shows up at w) and 0 otherwise. Hence $\text{wt}(\xi, \rho^\xi) = \#_{\sigma(\cdot, \alpha)}(\xi)$. Moreover, for each $\rho \in R_{\mathcal{A}}(\xi) \setminus \{\rho^\xi\}$ we have $\text{wt}(\xi, \rho) = -\infty$.

Thus we can calculate as follows.

$$\llbracket \mathcal{A} \rrbracket^{\text{run}}(\xi) = \max(\text{wt}(\xi, \rho) + F_{\rho(\varepsilon)} \mid \rho \in R_{\mathcal{A}}(\xi)) = \text{wt}(\xi, \rho^\xi) + F_{\rho^\xi(\varepsilon)} = \#_{\sigma(\cdot, \alpha)}(\xi) + 0 = \#_{\sigma(\cdot, \alpha)}(\xi),$$

hence $\llbracket \mathcal{A} \rrbracket^{\text{run}}(\xi) = \#_{\sigma(\cdot, \alpha)}(\xi)$. Thus $\#_{\sigma(\cdot, \alpha)} \in \text{bud-Rec}^{\text{run}}(\Sigma, \text{Nat}_{\max, +})$. \square

Example 3.2.13. (Difference of numbers of occurrences of nullary symbols.) Let $\Sigma = \{\sigma^{(2)}, \alpha^{(0)}, \beta^{(0)}\}$ be a ranked alphabet. We define the weighted tree language

$$\begin{aligned} \text{diff} : T_\Sigma &\rightarrow \mathbb{Z}_\infty \quad \text{such that, for each } \xi \in T_\Sigma, \text{ we let} \\ \text{diff}(\xi) &= \begin{cases} |\text{pos}_\alpha(\xi_1)| - |\text{pos}_\beta(\xi_2)| & \text{if } \xi = \sigma(\xi_1, \xi_2) \text{ for some } \xi_1, \xi_2 \in T_\Sigma \\ \infty & \text{otherwise.} \end{cases} \end{aligned}$$

For instance, $\text{diff}(\sigma(\alpha, \sigma(\beta, \beta))) = -1$. As weight algebra we consider the tropical semiring $\text{Int}_{\min, +} = (\mathbb{Z}_\infty, \min, +, \infty, 0)$ over \mathbb{Z} . Thus, the mapping diff is a $(\Sigma, \text{Int}_{\min, +})$ -weighted tree language.

We construct the $(\Sigma, \text{Int}_{\min, +})$ -wta $\mathcal{A} = (Q, \delta, F)$ which i-recognizes diff , as follows:

- $Q = \{\#_\alpha, \#_\beta, d\}$ (intuitively, $\#_\alpha$ calculates the number of occurrences of α , $\#_\beta$ calculates the negative of the number of occurrences of β , and d calculates the difference),
- for each $q \in Q$ we define

$$\delta_0(\varepsilon, \alpha, q) = \begin{cases} 1 & \text{if } q = \#_\alpha \\ 0 & \text{if } q = \#_\beta \\ \infty & \text{otherwise} \end{cases} \quad \delta_0(\varepsilon, \beta, q) = \begin{cases} 0 & \text{if } q = \#_\alpha \\ -1 & \text{if } q = \#_\beta \\ \infty & \text{otherwise} \end{cases}$$

and for each $q_1, q_2, q \in Q$ we define

$$\delta_2(q_1q_2, \sigma, q) = \begin{cases} 0 & \text{if } q_1q_2q \in \{\#_\alpha\#_\alpha\#_\alpha, \#_\beta\#_\beta\#_\beta, \#_\alpha\#_\beta d\} \\ \infty & \text{otherwise} \end{cases}$$

- $F_{\#_\alpha} = F_{\#_\beta} = \infty$ and $F_d = 0$.

Clearly, \mathcal{A} is root weight normalized; \mathcal{A} is not total, because there does not exist a state q such that $\delta_2(dd, \sigma, q) \neq \infty$; \mathcal{A} is not bu-deterministic, because $\delta_0(\varepsilon, \alpha, \#_\alpha) \neq \infty \neq \delta_0(\varepsilon, \alpha, \#_\beta)$. In Figure 3.11 we represent \mathcal{A} as fta-hypergraph.

First we observe that, for each $\xi \in T_\Sigma$, we have

$$h_{\mathcal{A}}(\xi)_{\#_\alpha} = |\text{pos}_\alpha(\xi)| \quad \text{and} \quad h_{\mathcal{A}}(\xi)_{\#_\beta} = -|\text{pos}_\beta(\xi)|. \quad (3.19)$$

Next we prove that $\llbracket \mathcal{A} \rrbracket^{\text{init}} = \text{diff}$. Let $\xi \in T_\Sigma$. By definition of F , we have:

$$\llbracket \mathcal{A} \rrbracket^{\text{init}}(\xi) = \min(h_{\mathcal{A}}(\xi)_q + F_q \mid q \in Q) = h_{\mathcal{A}}(\xi)_d + F_d = h_{\mathcal{A}}(\xi)_d.$$

Let $\xi \in \{\alpha, \beta\}$. Then $h_{\mathcal{A}}(\xi)_d = \delta_0(\varepsilon, \xi, d) = \infty$. Hence $\llbracket \mathcal{A} \rrbracket^{\text{init}}(\xi) = \infty = \text{diff}(\xi)$.

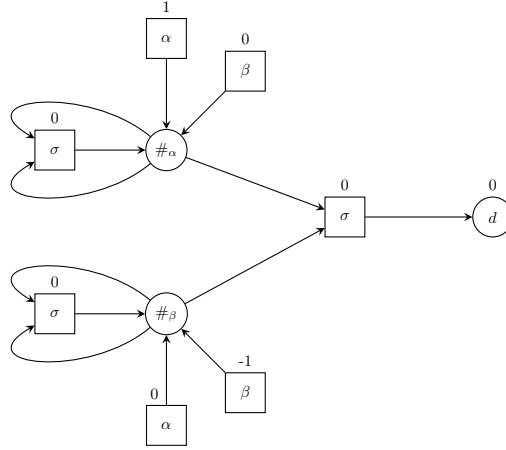

Figure 3.11: The $(\Sigma, \text{Int}_{\min,+})$ -wta $\mathcal{A} = (Q, \delta, F)$ which i-recognizes diff .

Now let $\xi = \sigma(\xi_1, \xi_2)$ for some $\xi_1, \xi_2 \in T_\Sigma$. Then we can calculate as follows:

$$\begin{aligned}
 h_{\mathcal{A}}(\sigma(\xi_1, \xi_2))_d &= \min (h_{\mathcal{A}}(\xi_1)_{q_1} + h_{\mathcal{A}}(\xi_2)_{q_2} + \delta_2(q_1 q_2, \sigma, d) \mid q_1, q_2 \in Q) \\
 &= h_{\mathcal{A}}(\xi_1)_{\#_\alpha} + h_{\mathcal{A}}(\xi_2)_{\#_\beta} + \delta_2(\#_\alpha \#_\beta, \sigma, d) \\
 &= h_{\mathcal{A}}(\xi_1)_{\#_\alpha} + h_{\mathcal{A}}(\xi_2)_{\#_\beta} + 0 \\
 &= |\text{pos}_\alpha(\xi_1)| - |\text{pos}_\beta(\xi_2)| \quad (\text{by (3.19)}) \\
 &= \text{diff}(\sigma(\xi_1, \xi_2)) .
 \end{aligned}$$

Hence $[\mathcal{A}]^{\text{init}} = \text{diff}$ and thus $\text{diff} \in \text{Rec}^{\text{init}}(\Sigma, \text{Int}_{\min,+})$. \square

Example 3.2.14. (Difference of numbers of occurrences of symbols in monadic trees.) Let $\Sigma = \{\gamma^{(1)}, \sigma^{(1)}, \alpha^{(0)}\}$ be a string ranked alphabet. We define the mapping

$$\text{diffm} : T_\Sigma \rightarrow \mathbb{Z} \quad \text{with } \text{diffm}(\xi) = |\text{pos}_\gamma(\xi)| - |\text{pos}_\sigma(\xi)| \quad \text{for each } \xi \in T_\Sigma .$$

As weight algebra we consider the ring $\text{Int} = (\mathbb{Z}, +, \cdot, 0, 1)$ of integers. Thus, the mapping diffm is a (Σ, Int) -weighted tree language.

We construct the (Σ, Int) -wta $\mathcal{A} = (Q, \delta, F)$ which i-recognizes diffm , as follows.

- $Q = \{1, d\}$ (intuitively, the state 1 calculates the integer 1 and, at each non-leaf position u , the state d increases or decreases the difference by 1 depending on the symbol at u),
- $\delta_0(\varepsilon, \alpha, 1) = 1$ and $\delta_0(\varepsilon, \alpha, d) = 0$, and for every $q_1, q_2 \in Q$ and $\nu \in \{\gamma, \sigma\}$ we define

$$\delta_1(q_1, \nu, q_2) = \begin{cases} 1 & \text{if } q_1 q_2 \in \{11, dd\} \\ 1 & \text{if } q_1 q_2 = 1d \text{ and } \nu = \gamma \\ -1 & \text{if } q_1 q_2 = 1d \text{ and } \nu = \sigma \\ 0 & \text{if } q_1 q_2 = d1 \end{cases}$$

- $F_1 = 0$ and $F_d = 1$.

Clearly, \mathcal{A} is root weight normalized; \mathcal{A} is not bu-deterministic, because $\delta_1(1, \gamma, 1) \neq 0 \neq \delta_1(1, \gamma, d)$. In Figure 3.12 we represent \mathcal{A} as fta-hypergraph.

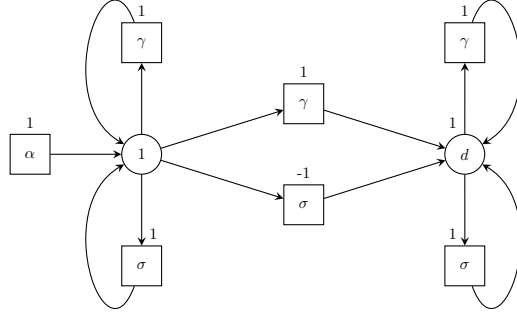

Figure 3.12: The (Σ, Int) -wta $\mathcal{A} = (Q, \delta, F)$ which i-recognizes diffm .

First, by induction on T_Σ , we prove that the following statement holds:

$$\text{For every } \xi \in T_\Sigma, \text{ we have } h_{\mathcal{A}}(\xi)_1 = 1 \text{ and } h_{\mathcal{A}}(\xi)_d = |\text{pos}_\gamma(\xi)| - |\text{pos}_\sigma(\xi)|. \quad (3.20)$$

I.B.: Let $\xi = \alpha$. Then $h_{\mathcal{A}}(\xi)_1 = \delta_0(\varepsilon, \alpha, 1) = 1$ and $h_{\mathcal{A}}(\xi)_d = \delta_0(\varepsilon, \alpha, d) = 0$. Thus (3.20) holds.

I.S.: Let $\xi = \gamma(\xi')$ for some $\xi' \in T_\Sigma$. Then

$$\begin{aligned} h_{\mathcal{A}}(\xi)_1 &= \bigoplus_{q \in Q} h_{\mathcal{A}}(\xi')_q \cdot \delta_1(q, \gamma, 1) \\ &= h_{\mathcal{A}}(\xi')_1 \cdot \delta_1(1, \gamma, 1) && \text{(by definition of } \delta_1 \text{ and by I.H.)} \\ &= 1 \cdot 1 = 1 \end{aligned}$$

and

$$\begin{aligned} h_{\mathcal{A}}(\xi)_d &= \bigoplus_{q \in Q} h_{\mathcal{A}}(\xi')_q \cdot \delta_1(q, \gamma, d) = h_{\mathcal{A}}(\xi')_1 \cdot \delta_1(1, \gamma, d) + h_{\mathcal{A}}(\xi')_d \cdot \delta_1(d, \gamma, d) \\ &= 1 \cdot 1 + (|\text{pos}_\gamma(\xi')| - |\text{pos}_\sigma(\xi')|) \cdot 1 && \text{(by definition of } \delta_1 \text{ and by I.H.)} \\ &= (|\text{pos}_\gamma(\xi')| + 1) - |\text{pos}_\sigma(\xi')| \\ &= |\text{pos}_\gamma(\xi)| - |\text{pos}_\sigma(\xi)|. \end{aligned}$$

In a similar way we can prove that (3.20) holds for $\xi = \sigma(\xi')$.

Using Statement (3.20), we obtain for each $\xi \in T_\Sigma$:

$$\llbracket \mathcal{A} \rrbracket^{\text{init}}(\xi) = \bigoplus_{q \in Q} h_{\mathcal{A}}(\xi)_q \cdot F_q = h_{\mathcal{A}}(\xi)_d = |\text{pos}_\gamma(\xi)| - |\text{pos}_\sigma(\xi)| = \text{diffm}(\xi).$$

Thus $\text{diffm} \in \text{Rec}^{\text{init}}(\Sigma, \text{Int})$. □

Example 3.2.15. (Length of zigzag-path.) Let $\Sigma = \{\sigma^{(2)}, \alpha^{(0)}\}$ be a ranked alphabet. We define the mapping $\text{zigzag} : T_\Sigma \rightarrow \mathbb{N}$ which, intuitively, computes for each tree the length of its zigzag-path (where “zig” means “go to the left child”, and “zag” means “go to the right child”). Formally, we first define the auxiliary mappings $\text{zz}_l : T_\Sigma \rightarrow (\mathbb{N}_+)^*$ and $\text{zz}_r : T_\Sigma \rightarrow (\mathbb{N}_+)^*$ by induction on T_Σ as follows. We let

$$\text{zz}_l(\alpha) = \text{zz}_r(\alpha) = \varepsilon,$$

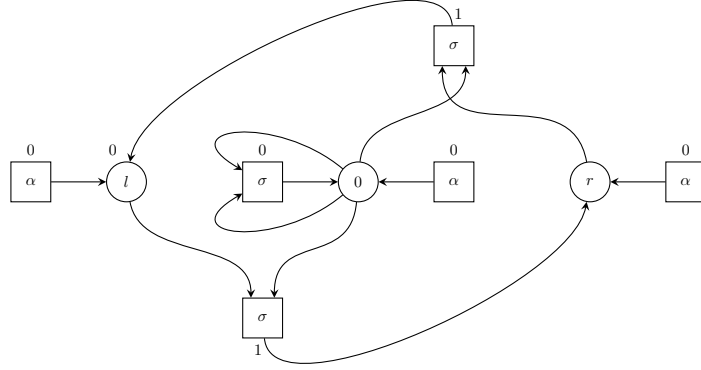

Figure 3.13: The $(\Sigma, \text{Nat}_{\max,+})$ -wta $\mathcal{A} = (Q, \delta, F)$ which i-recognizes zigzag.

and, for each $\xi = \sigma(\xi_1, \xi_2)$, we define

$$\text{zz}_l(\sigma(\xi_1, \xi_2)) = 1 \text{zz}_r(\xi_1) \quad \text{and} \quad \text{zz}_r(\sigma(\xi_1, \xi_2)) = 2 \text{zz}_l(\xi_2) .$$

Then we let

$$\text{zigzag} : T_\Sigma \rightarrow \mathbb{N} \quad \text{with} \quad \text{zigzag}(\xi) = |\text{zz}_l(\xi)| \quad \text{for each} \quad \xi \in T_\Sigma .$$

For instance, for $\xi = \sigma(\sigma(\zeta_1, \alpha), \zeta_2)$ and any $\zeta_1, \zeta_2 \in T_\Sigma$, we have $\text{zigzag}(\xi) = |\text{zz}_l(\xi)| = |12| = 2$.

As weight algebra we use the arctic semiring $\text{Nat}_{\max,+} = (\mathbb{N}_{-\infty}, \max, +, -\infty, 0)$. Thus, the mapping zigzag is a $(\Sigma, \text{Nat}_{\max,+})$ -weighted tree language.

We construct the $(\Sigma, \text{Nat}_{\max,+})$ -wta $\mathcal{A} = (Q, \delta, F)$ which i-recognizes zigzag as follows.

- $Q = \{l, r, 0\}$ (intuitively, l and r stand for “left” and “right”, respectively, and 0 calculates the $0 \in \mathbb{N}$),
- $\delta_0(\varepsilon, \alpha, l) = \delta_0(\varepsilon, \alpha, r) = \delta_0(\varepsilon, \alpha, 0) = 0$ and for every $q_1, q_2, q \in Q$

$$\delta_2(q_1 q_2, \sigma, q) = \begin{cases} 1 & \text{if } q_1 q_2 q \in \{r0l, 0lr\} \\ 0 & \text{if } q_1 q_2 q = 000 \\ -\infty & \text{otherwise} \end{cases}$$

- $F_l = 0, F_r = F_0 = -\infty$.

Clearly, \mathcal{A} is root weight normalized; \mathcal{A} is not bu-deterministic. In Figure 3.13 we represent \mathcal{A} as an fta-hypergraph.

By induction on T_Σ , we can prove that the following statement holds:

$$\text{For each } \xi \in T_\Sigma, \text{ we have } h_{\mathcal{A}}(\xi)_l = |\text{zz}_l(\xi)|, h_{\mathcal{A}}(\xi)_r = |\text{zz}_r(\xi)|, \text{ and } h_{\mathcal{A}}(\xi)_0 = 0 . \quad (3.21)$$

I.B.: Let $\xi = \alpha$. Then, for each $q \in Q$, we have $h_{\mathcal{A}}(\xi)_q = \delta_0(\varepsilon, \alpha, q) = 0 = |\text{zz}_l(\xi)| = |\text{zz}_r(\xi)|$.

I.S.: Now let $\xi = \sigma(\xi_1, \xi_2)$ for some $\xi_1, \xi_2 \in T_\Sigma$. Then

$$\begin{aligned} h_{\mathcal{A}}(\sigma(\xi_1, \xi_2))_l &= \max(h_{\mathcal{A}}(\xi_1)_{q_1} + h_{\mathcal{A}}(\xi_2)_{q_2} + \delta_2(q_1 q_2, \sigma, l) \mid q_1, q_2 \in Q) \\ &= h_{\mathcal{A}}(\xi_1)_r + h_{\mathcal{A}}(\xi_2)_0 + \delta_2(r0, \sigma, l) \\ &= |\text{zz}_r(\xi_1)| + 0 + 1 \\ &= |\text{zz}_l(\sigma(\xi_1, \xi_2))| . \end{aligned} \quad (\text{by I.H.})$$

In a similar way we can prove that $h_{\mathcal{A}}(\sigma(\xi_1, \xi_2))_r = |zz_r(\sigma(\xi_1, \xi_2))|$, and $h_{\mathcal{A}}(\sigma(\xi_1, \xi_2))_0 = 0$. This finishes the proof of Statement (3.21).

Now let $\xi \in T_{\Sigma}$. Then, using (3.21) at the fourth equality below, we obtain

$$\llbracket \mathcal{A} \rrbracket^{\text{init}}(\xi) = \max(h_{\mathcal{A}}(\xi)_q + F_q \mid q \in Q) = h_{\mathcal{A}}(\xi)_l + F_l = h_{\mathcal{A}}(\xi)_l = |zz_l(\xi)| = \text{zigzag}(\xi) .$$

Thus $\llbracket \mathcal{A} \rrbracket^{\text{init}} = \text{zigzag}$ and hence $\text{zigzag} \in \text{Rec}^{\text{init}}(\Sigma, \text{Nat}_{\max,+})$. In [DV06, Ex. 3.2] and [HMM07, Ex. 2], a (Σ, Nat) -wta N (over the semiring of natural numbers) is shown for which $\llbracket N \rrbracket^{\text{init}} = \text{zigzag}$. \square

Example 3.2.16. (Recognizable step mapping twothree.) Let $\Sigma = \{\sigma^{(2)}, \gamma^{(1)}, \alpha^{(0)}\}$ be a ranked alphabet. We define the mapping $\text{twothree} : T_{\Sigma} \rightarrow \mathbb{N}$ for each $\xi \in T_{\Sigma}$ by

$$\text{twothree} : T_{\Sigma} \rightarrow \mathbb{N} \quad \text{with} \quad \text{twothree}(\xi) = \begin{cases} 2 & \text{if } |\text{pos}(\xi)| \text{ is even} \\ 3 & \text{otherwise} \end{cases} \quad \text{for each } \xi \in T_{\Sigma} .$$

As weight algebra we use the natural number semiring $\text{Nat} = (\mathbb{N}, +, \cdot, 0, 1)$. Thus, the mapping twothree is a (Σ, Nat) -weighted tree language. Since the two Σ -tree languages

$$L_e = \{\xi \in T_{\Sigma} \mid |\text{pos}(\xi)| \text{ is even}\} \quad \text{and} \quad L_o = T_{\Sigma} \setminus L_e$$

are recognizable, twothree is even a recognizable step mapping, because

$$\text{twothree} = (2 \cdot \chi_{\text{Nat}}(L_e) + 3 \cdot \chi_{\text{Nat}}(L_o)) .$$

We construct the (Σ, Nat) -wta $\mathcal{A} = (Q, \delta, F)$ which i -recognizes twothree as follows

- $Q = \{e, o\}$ where e and o stand for “even” and “odd”, respectively,
- $\delta_0(\varepsilon, \alpha, e) = 0$ and $\delta_0(\varepsilon, \alpha, o) = 1$ and for every $q_1, q_2, q \in Q$ we let

$$\delta_1(q_1, \gamma, q) = \begin{cases} 1 & \text{if } (q_1 = e \text{ and } q = o) \text{ or } (q_1 = o \text{ and } q = e) \\ 0 & \text{otherwise,} \end{cases}$$

$$\delta_2(q_1 q_2, \sigma, q) = \begin{cases} 1 & \text{if } (q_1 = q_2 \text{ and } q = o) \text{ or } (q_1 \neq q_2 \text{ and } q = e) \\ 0 & \text{otherwise,} \end{cases}$$

and

- $F_e = 2$ and $F_o = 3$.

We note that \mathcal{A} is crisp-deterministic and consequently also bu-deterministic. Figure 3.14 shows the (Σ, Nat) -wta \mathcal{A} .

Let $\xi \in T_{\Sigma}$ and $q \in Q$. It is clear that

$$h_{\mathcal{A}}(\xi)_q = \begin{cases} 1 & \text{if } ((q = e \text{ and } |\text{pos}(\xi)| \text{ is even}) \text{ or } (q = o \text{ and } |\text{pos}(\xi)| \text{ is odd})) \\ 0 & \text{otherwise} \end{cases}$$

Thus

$$\begin{aligned} \llbracket \mathcal{A} \rrbracket^{\text{init}}(\xi) &= \bigoplus_{q \in Q} (h_{\mathcal{A}}(\xi)_q \cdot F_q) \\ &= (h_{\mathcal{A}}(\xi)_e \cdot F_e) + (h_{\mathcal{A}}(\xi)_o \cdot F_o) = (h_{\mathcal{A}}(\xi)_e \cdot 2) + (h_{\mathcal{A}}(\xi)_o \cdot 3) \\ &= \text{twothree}(\xi) . \end{aligned}$$

Hence $\text{twothree} \in \text{bud-Rec}^{\text{init}}(\Sigma, \text{Nat})$. \square

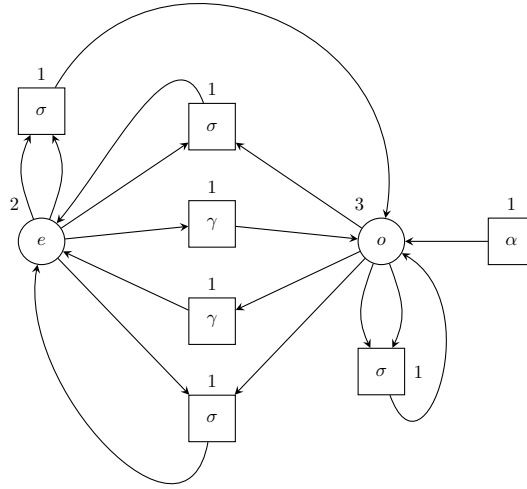

Figure 3.14: The (Σ, Nat) -wta \mathcal{A} which i-recognizes twothree.

Example 3.2.17. (Evaluation algebras.) [FSV12, Lm. 4.3] Let $(\kappa_k \mid k \in \mathbb{N})$ be an \mathbb{N} -indexed family of mappings $\kappa_k : \Sigma^{(k)} \rightarrow B$. We recall that $\mathbf{B} = (B, \oplus, \otimes, \mathbb{0}, \mathbb{1})$ is a strong bimonoid, $\mathbf{M}(\Sigma, \kappa)$ is the (Σ, κ) -evaluation algebra and $\mathbf{h}_{\mathbf{M}(\Sigma, \kappa)} : \mathbf{T}_\Sigma \rightarrow B$ is the unique Σ -algebra homomorphism, as defined in Subsection 2.12.1.

We construct the (Σ, \mathbf{B}) -wta $\mathcal{A} = (Q, \delta, F)$ which i-recognizes $\mathbf{h}_{\mathbf{M}(\Sigma, \kappa)}$ as follows.

- $Q = \{q\}$ and $F_q = \mathbb{1}$ and
- for every $k \in \mathbb{N}$, $\sigma \in \Sigma^{(k)}$, we let $\delta_k(q \cdots q, \sigma, q) = \kappa_k(\sigma)$.

Obviously, \mathcal{A} is bu-deterministic and root weight normalized. Moreover, if there exists a σ such that $\kappa_k(\sigma) \notin \{\mathbb{0}, \mathbb{1}\}$, then \mathcal{A} is not crisp and hence \mathcal{A} is not crisp-deterministic.

It is easy to see that the vector algebra $\mathbf{V}(\mathcal{A}) = (B^Q, \delta_{\mathcal{A}})$ of \mathcal{A} and the (Σ, κ) -evaluation algebra $\mathbf{M}(\Sigma, \kappa) = (B, \bar{\kappa})$ are isomorphic Σ -algebras, by identifying each Q -vector over B with its one and only component in B , and by verifying that, for every $b_1, \dots, b_k \in B$, we have

$$\delta_{\mathcal{A}}(\sigma)((b_1, \dots, (b_k))_q = \left(\bigotimes_{i \in [k]} b_i \right) \otimes \delta_k(q \cdots q, \sigma, q) = \left(\bigotimes_{i \in [k]} b_i \right) \otimes \kappa_k(\sigma) = \bar{\kappa}(\sigma)(b_1, \dots, b_k) .$$

Hence, for each $\xi \in \mathbf{T}_\Sigma$, we have $\mathbf{h}_{\mathcal{A}}(\xi)_q = \mathbf{h}_{\mathbf{M}(\Sigma, \kappa)}(\xi)$. Then, for each $\xi \in \mathbf{T}_\Sigma$, we have

$$[\mathcal{A}]^{\text{init}}(\xi) = \bigoplus_{q \in Q} \mathbf{h}_{\mathcal{A}}(\xi)_q \otimes F_q = \mathbf{h}_{\mathcal{A}}(\xi)_q = \mathbf{h}_{\mathbf{M}(\Sigma, \kappa)}(\xi) .$$

Thus, in particular, $\mathbf{h}_{\mathbf{M}(\Sigma, \kappa)} \in \text{bud-Rec}^{\text{init}}(\Sigma, \mathbf{B})$.

Above we have proved that, for each \mathbb{N} -indexed family $\kappa = (\kappa_k \mid k \in \mathbb{N})$ of mappings $\kappa_k : \Sigma^{(k)} \rightarrow B$, the Σ -algebra homomorphism $\mathbf{h}_{\mathbf{M}(\Sigma, \kappa)}$ is i-recognizable by a bu-deterministic (Σ, \mathbf{B}) -wta. This can be used to show i-recognizability of the mappings size (cf. Example 3.2.3), yield^P (cf. Example 3.2.6), and BPS_A (cf. Example 3.2.7) by instantiating \mathbf{B} and providing \mathbb{N} -indexed families of mappings appropriately.

- We consider the tropical semiring $\text{Nat}_{\min,+} = (\mathbb{N}_\infty, \min, +, \infty, 0)$ and the $(\Sigma, \text{Nat}_{\min,+})$ -weighted tree language

$$\text{size} : \mathbb{T}_\Sigma \rightarrow \mathbb{N}$$

of Example 3.2.3 with $\Sigma = \{\sigma^{(2)}, \alpha^{(0)}\}$. We define the \mathbb{N} -indexed family $\kappa^{\text{size}} = (\kappa_k^{\text{size}} \mid k \in \mathbb{N})$ of mappings by $\kappa_0^{\text{size}}(\alpha) = \kappa_2^{\text{size}}(\sigma) = 1$. Then $\text{size} = \mathbf{h}_{\mathbb{M}(\Sigma, \kappa^{\text{size}})}$.

- We consider the ranked alphabet $\Sigma = \{\sigma^{(2)}, \alpha^{(0)}, \beta^{(0)}\}$ and the formal language semiring $\text{Lang}_\Sigma = (\mathcal{P}(\Sigma^*), \cup, \cdot, \emptyset, \{\varepsilon\})$ (where we forget about the rank of symbols). Moreover, we consider the $(\Sigma, \text{Lang}_\Sigma)$ -weighted tree language

$$\text{yield}^{\mathcal{P}} : \mathbb{T}_\Sigma \rightarrow \mathcal{P}((\Sigma^{(0)})^*)$$

of Example 3.2.6. We define the \mathbb{N} -indexed family $\kappa^{\text{yield}} = (\kappa_k^{\text{yield}} \mid k \in \mathbb{N})$ of mappings by $\kappa_0^{\text{yield}}(\alpha) = \{\alpha\}$, $\kappa_0^{\text{yield}}(\beta) = \{\beta\}$, and $\kappa_2^{\text{yield}}(\sigma) = \{\varepsilon\}$. Then $\text{yield}^{\mathcal{P}} = \mathbf{h}_{\mathbb{M}(\Sigma, \kappa^{\text{yield}})}$.

- Let $A = (Q, I, \delta, F)$ be an $\{\alpha, \beta\}$ -fsa. We consider the near semiring $\text{NearSem}_{\mathcal{P}(Q)} = (B, \cup, \diamond, \emptyset, \text{id}_{\mathcal{P}(Q)})$ with $B = \{f \mid f : \mathcal{P}(Q) \rightarrow \mathcal{P}(Q), f(\emptyset) = \emptyset\}$ and the $(\Sigma, \text{NearSem}_{\mathcal{P}(Q)})$ -weighted tree language

$$\text{BPS}_A : \mathbb{T}_\Sigma \rightarrow \mathcal{P}(Q)^{\mathcal{P}(Q)}$$

of Example 3.2.7 with $\Sigma = \{\sigma^{(2)}, \alpha^{(0)}, \beta^{(0)}\}$. We define the \mathbb{N} -indexed family $\kappa^{\text{BPS}} = (\kappa_k^{\text{BPS}} \mid k \in \mathbb{N})$ of mappings such that, for each $U \in \mathcal{P}(Q)$, we let

$$\begin{aligned} - \kappa_0^{\text{BPS}}(\alpha)(U) &= \{p \in Q \mid (\exists r \in U) : (r, \alpha, p) \in \delta\}, \\ - \kappa_0^{\text{BPS}}(\beta)(U) &= \{p \in Q \mid (\exists r \in U) : (r, \beta, p) \in \delta\}, \text{ and} \\ - \kappa_2^{\text{BPS}}(\sigma)(U) &= U \text{ (i.e., } \kappa_2^{\text{BPS}}(\sigma) = \text{id}_{\mathcal{P}(Q)}\text{)}. \end{aligned}$$

Then $\text{BPS}_A = \mathbf{h}_{\mathbb{M}(\Sigma, \kappa^{\text{BPS}})}$. □

Example 3.2.18. (Σ -algebra homomorphism.) Let Σ be a ranked alphabet and $\mathbf{B} = (B, \oplus, \otimes, 0, \mathbb{1})$ be a strong bimonoid. Moreover, let $\mathcal{B} = (B, \theta)$ be a Σ -algebra such that there exists a family $(b_{\sigma,w} \mid k \in \mathbb{N}, \sigma \in \Sigma^{(k)}, w \in \{0, 1\}^k)$ over B and, for every $k \in \mathbb{N}$, $\sigma \in \Sigma^{(k)}$, and $b_1, \dots, b_k \in B$, the following holds:

$$\theta(\sigma)(b_1, \dots, b_k) = \bigoplus_{w \in \{0,1\}^k} b_1^{w_1} \otimes \dots \otimes b_k^{w_k} \otimes b_{\sigma,w} \quad (3.22)$$

where w_i denotes the i -th symbol of w and $b_i^0 = \mathbb{1}$ and $b_i^1 = b_i$. Thus $\theta(\sigma)$ is a polynomial over k non-commuting variables with degree at most 1. Let us denote by $\mathbf{h}_{\mathcal{B}}$ the unique Σ -algebra homomorphism from \mathbb{T}_Σ to \mathcal{B} .

We construct the (Σ, \mathbf{B}) -wta $\mathcal{A} = (Q, \delta, F)$ such that $\llbracket \mathcal{A} \rrbracket^{\text{init}} = \mathbf{h}_{\mathcal{B}}$, as follows. We let $Q = \{0, 1\}$, $F_0 = \emptyset$, and $F_1 = \mathbb{1}$. Moreover, for every $k \in \mathbb{N}$, $\sigma \in \Sigma^{(k)}$, and $q_1, \dots, q_k, q \in Q$, we let

$$\delta_k(q_1 \cdots q_k, \sigma, q) = \begin{cases} b_{\sigma, q_1 \cdots q_k} & \text{if } q = 1 \\ \mathbb{1} & \text{if } q_1 \cdots q_k q = 0^{k+1} \\ 0 & \text{otherwise} \end{cases}$$

In general, \mathcal{A} is not bu-deterministic, because $\delta_k(0^k, \sigma, 1) = b_{\sigma, q_1 \cdots q_k}$ and $\delta_k(0^k, \sigma, 0) = \mathbb{1}$.

By induction on \mathbb{T}_Σ we prove the following statement:

$$\text{For each } \xi \in \mathbb{T}_\Sigma, \text{ we have: } \mathbf{h}_{\mathcal{A}}(\xi)_1 = \mathbf{h}_{\mathcal{B}}(\xi) \text{ and } \mathbf{h}_{\mathcal{A}}(\xi)_0 = \mathbb{1}. \quad (3.23)$$

Let $\xi = \sigma(\xi_1, \dots, \xi_k)$. Then we can calculate as follows:

$$\mathbf{h}_{\mathcal{A}}(\sigma(\xi_1, \dots, \xi_k))_1 = \bigoplus_{q_1 \cdots q_k \in Q^k} \mathbf{h}_{\mathcal{A}}(\xi_1)_{q_1} \otimes \dots \otimes \mathbf{h}_{\mathcal{A}}(\xi_k)_{q_k} \otimes \delta_k(q_1 \cdots q_k, \sigma, 1)$$

$$\begin{aligned}
&= \bigoplus_{q_1 \cdots q_k \in Q^k} \mathfrak{h}_{\mathcal{A}}(\xi_1)_{q_1} \otimes \cdots \otimes \mathfrak{h}_{\mathcal{A}}(\xi_k)_{q_k} \otimes b_{\sigma, q_1 \cdots q_k} && \text{(by construction)} \\
&= \bigoplus_{q_1 \cdots q_k \in Q^k} \mathfrak{h}_{\mathcal{B}}(\xi_1)^{q_1} \otimes \cdots \otimes \mathfrak{h}_{\mathcal{B}}(\xi_k)^{q_k} \otimes b_{\sigma, q_1 \cdots q_k} && \text{(by I.H.)} \\
&= \theta(\sigma)(\mathfrak{h}_{\mathcal{B}}(\xi_1), \dots, \mathfrak{h}_{\mathcal{B}}(\xi_k)) && \text{(by definition of } \theta) \\
&= \mathfrak{h}_{\mathcal{B}}(\sigma(\xi_1, \dots, \xi_k)) . && \text{(because } \mathfrak{h}_{\mathcal{B}} \text{ is a } \Sigma\text{-algebra homomorphism)}
\end{aligned}$$

Moreover we can calculate:

$$\begin{aligned}
\mathfrak{h}_{\mathcal{A}}(\sigma(\xi_1, \dots, \xi_k))_0 &= \bigoplus_{q_1 \cdots q_k \in Q^k} \mathfrak{h}_{\mathcal{A}}(\xi_1)_{q_1} \otimes \cdots \otimes \mathfrak{h}_{\mathcal{A}}(\xi_k)_{q_k} \otimes \delta_k(q_1 \cdots q_k, \sigma, 0) \\
&= \mathfrak{h}_{\mathcal{A}}(\xi_1)_0 \otimes \cdots \otimes \mathfrak{h}_{\mathcal{A}}(\xi_k)_0 \otimes \mathbb{1} && \text{(by construction)} \\
&= \mathbb{1} \otimes \cdots \otimes \mathbb{1} \otimes \mathbb{1} = \mathbb{1} . && \text{(by I.H.)}
\end{aligned}$$

Then, for each $\xi \in T_{\Sigma}$, we have $[[\mathcal{A}]]^{\text{init}}(\xi) = \bigoplus_{q \in Q} \mathfrak{h}_{\mathcal{A}}(\xi)_q \otimes F_q = \mathfrak{h}_{\mathcal{A}}(\xi)_1 = \mathfrak{h}_{\mathcal{B}}(\xi)$.

We finish this example with three instances of this general scenario. The first two instances result in wta which we have already constructed in an ad hoc manner, viz., in Example 3.2.17 (evaluation algebras) and in Example 3.2.4 (the mapping height : $T_{\Sigma} \rightarrow \mathbb{N}$). The third example is related to Theorem 4.3.1 and Corollary 10.11.3.

1. Let $(\kappa_k \mid k \in \mathbb{N})$ be an \mathbb{N} -indexed family of mappings $\kappa_k : \Sigma^{(k)} \rightarrow B$. We consider the (Σ, κ) -evaluation algebra $\mathfrak{M}(\Sigma, \kappa) = (B, \bar{\kappa})$ and the unique Σ -algebra homomorphism $\mathfrak{h}_{\mathfrak{M}(\Sigma, \kappa)} : T_{\Sigma} \rightarrow B$ (cf. Subsection 2.12.1). We note that $\mathfrak{M}(\Sigma, \kappa)$ is a particular Σ -algebra.

Now we define the family $(b_{\sigma, w} \mid k \in \mathbb{N}, \sigma \in \Sigma^{(k)}, w \in \{0, 1\}^k)$ over B such that $b_{\sigma, w} = \kappa_k(\sigma)$ if $w = 1^k$, and 0 otherwise, and we define the Σ -algebra $\mathcal{B} = (B, \theta)$ as in (3.22). Then, for every $b_1, \dots, b_k \in B$, we have

$$\bar{\kappa}(\sigma)(b_1, \dots, b_k) = b_1 \otimes \cdots \otimes b_k \otimes \kappa_k(\sigma) = \bigoplus_{w \in \{0, 1\}^k} b_1^{w_1} \otimes \cdots \otimes b_k^{w_k} \otimes b_{\sigma, w} = \theta(\sigma)(b_1, \dots, b_k) .$$

Hence $\bar{\kappa} = \theta$ and thus $\mathfrak{h}_{\mathfrak{M}(\Sigma, \kappa)} = \mathfrak{h}_{\mathcal{B}}$. Then, using the general scenario, we can construct a (Σ, \mathcal{B}) -wta \mathcal{A} such that $[[\mathcal{A}]]^{\text{init}} = \mathfrak{h}_{\mathfrak{M}(\Sigma, \kappa)}$. In this sense, the construction of the current example subsumes the one given in Example 3.2.17 (where the state 1 corresponds to state q , and state 0 is superfluous).

2. As strong bimonoid \mathbb{B} we consider the semiring $\mathbf{Nat}_{\max, +} = (\mathbb{N}_{-\infty}, \max, +, -\infty, 0)$. Moreover, we extend the Σ -algebra (\mathbb{N}, θ_1) defined on page 52 to the Σ -algebra $(\mathbb{N}_{-\infty}, \theta'_1)$ canonically as follows:

- for each $\alpha \in \Sigma^{(0)}$, we let $\theta'_1(\alpha)() = 0$, and
- for every $k \in \mathbb{N}_+$, $\sigma \in \Sigma^{(k)}$, and $n_1, \dots, n_k \in \mathbb{N}_{-\infty}$, we let $\theta'_1(\sigma)(n_1, \dots, n_k) = 1 + \max(n_1, \dots, n_k)$.

Then the unique Σ -algebra homomorphism from T_{Σ} to $(\mathbb{N}_{-\infty}, \theta'_1)$ is the mapping height : $T_{\Sigma} \rightarrow \mathbb{N}$.

Now we define the family $(b_{\sigma, w} \mid k \in \mathbb{N}, \sigma \in \Sigma^{(k)}, w \in \{0, 1\}^k)$ over $\mathbb{N}_{-\infty}$ such that $b_{\sigma, w} = 1$ if w contains exactly one occurrence of 1, and $-\infty$ otherwise. Moreover, we define the Σ -algebra $\mathcal{B} = (\mathbb{N}_{-\infty}, \theta)$ as in (3.22). Then we have

$$\begin{aligned}
\theta'_1(\sigma)(n_1, \dots, n_k) &= 1 + \max(n_1, \dots, n_k) = \max(n_1 + 1, \dots, n_k + 1) \\
&= \max_{w \in \{0, 1\}^k} (n_1^{w_1} + \cdots + n_k^{w_k} + b_{\sigma, w}) = \theta(\sigma)(n_1, \dots, n_k) .
\end{aligned}$$

Hence $\theta'_1 = \theta$ and thus height = $\mathfrak{h}_{\mathcal{B}}$. Then, using the general scenario, we can construct a $(\Sigma, \mathbf{Nat}_{\max, +})$ -wta \mathcal{A} such that $[[\mathcal{A}]]^{\text{init}} = \text{height}$. In fact, for $\Sigma = \{\sigma^{(2)}, \alpha^{(0)}\}$, this $(\Sigma, \mathbf{Nat}_{\max, +})$ -wta \mathcal{A} is the same as the one that we have constructed in Example 3.2.4.

3. In the proof of [Rad10, Lm. 6.1](2) \Rightarrow (1), for each finite subset A of the carrier set of the strong bimonoid \mathbf{B} , a ranked alphabet Σ and a (Σ, \mathbf{B}) -wta \mathcal{A} are constructed such that $\langle A \rangle_{\{\oplus, \otimes, 0, 1\}} \subseteq \text{im}(\llbracket \mathcal{A} \rrbracket^{\text{init}})$. Here we use the above general scenario (starting from a particular Σ -algebra that obeys (3.22)) in order to obtain the same \mathcal{A} .⁴

Let $A \subseteq B$ be a finite subset of B . Clearly, $\langle A \rangle_{\{\oplus, \otimes, 0, 1\}} = \langle A \cup \{0, 1\} \rangle_{\{\oplus, \otimes\}}$. Let a_1, \dots, a_n be the elements of $A \cup \{0, 1\}$, i.e., $A \cup \{0, 1\} = \{a_1, \dots, a_n\}$.

We define the ranked alphabet $\Sigma = \{a_1^{(0)}, \dots, a_n^{(0)}\} \cup \{\oplus^{(2)}, \otimes^{(2)}\}$. Moreover, we define the family $(b_{\delta, w} \mid k \in \mathbb{N}, \sigma \in \Sigma^{(k)}, w \in \{0, 1\}^k)$ over B such that, for every $k \in \mathbb{N}$, $\sigma \in \Sigma^{(k)}$, and $w \in \{0, 1\}^k$, we let

$$b_{\delta, w} = \begin{cases} a_i & \text{if } \sigma = a_i \text{ and } w = \varepsilon \\ \mathbb{1} & \text{if } \sigma = \oplus \text{ and } w \in \{10, 01\} \\ \mathbb{1} & \text{if } \sigma = \otimes \text{ and } w = 11 \\ 0 & \text{otherwise .} \end{cases}$$

Finally, we define the Σ -algebra $\mathcal{B} = (B, \theta)$ such that (3.22) holds. Then we can prove the following statement.

$$\begin{aligned} \text{For every } i \in [n] \text{ and } b_1, b_2 \in B, \text{ we have:} \\ \theta(a_i)() = a_i, \theta(\oplus)(b_1, b_2) = b_1 \oplus b_2, \text{ and } \theta(\otimes)(b_1, b_2) = b_1 \otimes b_2. \end{aligned} \quad (3.24)$$

Let $i \in [n]$. Then $\theta(a_i)() = \bigoplus_{w \in \{0, 1\}^0} b_1^{w_1} \otimes \dots \otimes b_k^{w_k} \otimes b_{a_i, w} = b_{a_i, \varepsilon} = a_i$.

Let $b_1, b_2 \in B$. Then:

$$\begin{aligned} \theta(\oplus)(b_1, b_2) &= \bigoplus_{w \in \{0, 1\}^2} b_1^{w_1} \otimes b_2^{w_2} \otimes b_{\oplus, w} \\ &= (b_1^1 \otimes b_2^0 \otimes b_{\oplus, 10}) \oplus (b_1^0 \otimes b_2^1 \otimes b_{\oplus, 01}) \\ &= (b_1 \otimes \mathbb{1} \otimes \mathbb{1}) \oplus (\mathbb{1} \otimes b_2 \otimes \mathbb{1}) = b_1 \oplus b_2 \quad \text{and} \\ \theta(\otimes)(b_1, b_2) &= \bigoplus_{w \in \{0, 1\}^2} b_1^{w_1} \otimes b_2^{w_2} \otimes b_{\otimes, w} \\ &= b_1^1 \otimes b_2^1 \otimes b_{\otimes, 11} = b_1 \otimes b_2. \end{aligned}$$

This proves (3.24). Clearly, (3.24) and Lemma 2.7.1 imply the next statement.

$$\text{For each } a \in \langle A \rangle_{\{\oplus, \otimes, 0, 1\}} \text{ there exists } \xi \in T_\Sigma \text{ such that } h_{\mathcal{B}}(\xi) = a. \quad (3.25)$$

Now, given the Σ -algebra $\mathcal{B} = (B, \theta)$, we use our general scenario to construct the (Σ, \mathbf{B}) -wta \mathcal{A} ; then $\llbracket \mathcal{A} \rrbracket^{\text{init}} = h_{\mathcal{B}}$. Thus, (3.25) implies that $\langle A \rangle_{\{\oplus, \otimes, 0, 1\}} \subseteq \text{im}(\llbracket \mathcal{A} \rrbracket^{\text{init}})$. \square

3.3 Weighted string automata

In this section we recall the concept of weighted string automata [Sch61, Eil74] and show that, essentially, they are equivalent to wta over string ranked alphabets (cf. [FV09, p. 324]). Moreover, we show that they generalize fsa.

A *weighted string automaton* (over Γ and \mathbf{B}) (for short: (Γ, \mathbf{B}) -wsa or wsa) is a tuple $\mathcal{A} = (Q, \lambda, \mu, \gamma)$, where Q is a finite nonempty set of states such that $Q \cap \Gamma = \emptyset$, $\mu : \Gamma \rightarrow B^{Q \times Q}$ is the transition mapping, and $\lambda, \gamma \in B^Q$ are the initial weight mapping and the final weight mapping, respectively. We define the run semantics and the initial algebra semantics for \mathcal{A} as follows.

⁴In fact, the proof of [Rad10, Ex. 6.1](2) \Rightarrow (1) inspired us for this general scenario.

Run semantics. Let $w = a_1 \cdots a_n$ be a string in Γ^* with $n \in \mathbb{N}$. A *run of \mathcal{A} on w* is a string $\rho \in Q^{n+1}$. Let $\rho = q_0 \cdots q_n$ with $q_i \in Q$ for each $i \in [0, n]$. The *weight of ρ for w* , denoted by $\text{wt}_{\mathcal{A}}(w, \rho)$, is the element of B defined by

$$\text{wt}_{\mathcal{A}}(w, \rho) = \lambda_{q_0} \otimes \text{wt}_{\mathcal{A}}^-(w, \rho) \otimes \gamma_{q_n}$$

where

$$\text{wt}_{\mathcal{A}}^-(w, \rho) = \mu(a_1)_{q_0, q_1} \otimes \cdots \otimes \mu(a_n)_{q_{n-1}, q_n} .$$

Thus, in particular, we have that $\text{wt}_{\mathcal{A}}^-(\varepsilon, \rho) = \mathbb{1}$ and $\text{wt}_{\mathcal{A}}(\varepsilon, \rho) = \lambda_{q_0} \otimes \gamma_{q_0}$.

The *run semantics of \mathcal{A}* is the weighted language $\llbracket \mathcal{A} \rrbracket^{\text{run}} : \Gamma^* \rightarrow B$ defined by

$$\llbracket \mathcal{A} \rrbracket^{\text{run}}(w) = \bigoplus_{\rho \in Q^{|w|+1}} \text{wt}_{\mathcal{A}}(w, \rho)$$

for every $w \in \Gamma^*$. In particular, $\llbracket \mathcal{A} \rrbracket^{\text{run}}(\varepsilon) = \bigoplus_{q \in Q} \lambda_q \otimes \gamma_q$.

A weighted language $r : \Gamma^* \rightarrow B$ is *run recognizable (over B)* (for short: r-recognizable) if there exists a (Γ, B) -wsa \mathcal{A} such that $r = \llbracket \mathcal{A} \rrbracket^{\text{run}}$.

We finish this paragraph with a useful restriction of wsa. A (Γ, B) -wsa $\mathcal{A} = (Q, \lambda, \mu, \gamma)$ has *identity initial weights* if $\text{im}(\lambda) \subseteq \{0, \mathbb{1}\}$.

Lemma 3.3.1. [RRLV23] For each (Γ, B) -wsa \mathcal{A} we can construct a (Γ, B) -wsa \mathcal{A}' such that \mathcal{A}' has identity initial weights and $\llbracket \mathcal{A}' \rrbracket^{\text{run}} = \llbracket \mathcal{A} \rrbracket^{\text{run}}$.

Proof. Let $\mathcal{A} = (Q, \lambda, \mu, \gamma)$. We construct $\mathcal{A}' = (Q', \lambda', \mu', \gamma')$ such that

- $Q' = Q \cup \{\bar{q} \mid q \in Q\}$,
- for each $p \in Q'$, we let

$$\lambda'_p = \begin{cases} \mathbb{1} & \text{if } (\exists q \in Q) : p = \bar{q} \\ 0 & \text{otherwise} \end{cases} \quad \text{and} \quad \gamma'_p = \begin{cases} \lambda_q \otimes \gamma_q & \text{if } (\exists q \in Q) : p = \bar{q} \\ \gamma_p & \text{otherwise} \end{cases}$$

- for every $p_1, p_2 \in Q'$ and $a \in \Gamma$, we let

$$\mu'(p_1, a, p_2) = \begin{cases} \lambda_q \otimes \mu(q, a, p_2) & \text{if } (\exists q \in Q) : p_1 = \bar{q} \text{ and } p_2 \in Q \\ \mu(p_1, a, p_2) & \text{if } p_1, p_2 \in Q \\ 0 & \text{otherwise} \end{cases}$$

Obviously, \mathcal{A}' has identity initial weights. Next we prove that $\llbracket \mathcal{A}' \rrbracket^{\text{run}} = \llbracket \mathcal{A} \rrbracket^{\text{run}}$. Let $w \in \Gamma^*$. We proceed by case analysis.

$w = \varepsilon$:

$$\begin{aligned} \llbracket \mathcal{A}' \rrbracket^{\text{run}}(w) &= \bigoplus_{p \in Q'} \lambda'_p \otimes \gamma'_p = \bigoplus_{p \in Q \cup \{\bar{q} \mid q \in Q\}} \lambda'_p \otimes \gamma'_p \\ &= \bigoplus_{p \in \{\bar{q} \mid q \in Q\}} \lambda'_p \otimes \gamma'_p && \text{(because } \lambda'_p = 0 \text{ for each } p \in Q) \\ &= \bigoplus_{q \in Q} \mathbb{1} \otimes (\lambda_q \otimes \gamma_q) && \text{(by construction)} \\ &= \bigoplus_{q \in Q} \lambda_q \otimes \gamma_q = \llbracket \mathcal{A} \rrbracket^{\text{run}}(w) . \end{aligned}$$

$w = a_1 \cdots a_n$ with $n \geq 1$:

$$\llbracket \mathcal{A}' \rrbracket^{\text{run}}(w) = \bigoplus_{\rho \in (Q')^{|w|+1}} \text{wt}_{\mathcal{A}'}(w, \rho)$$

$$\begin{aligned}
&= \bigoplus_{p_0 \cdots p_n \in (Q')^{|w|+1}} \lambda'_{p_0} \otimes \mu'(a_1)_{p_0, p_1} \otimes \mu'(a_2)_{p_1, p_2} \otimes \cdots \otimes \mu'(a_n)_{p_{n-1}, p_n} \otimes \gamma'_{p_n} \\
&= \bigoplus_{q_0 \in Q, p_1 \cdots p_n \in (Q')^{|w|}} \lambda'_{q_0} \otimes \mu'(a_1)_{q_0, p_1} \otimes \mu'(a_2)_{p_1, p_2} \otimes \cdots \otimes \mu'(a_n)_{p_{n-1}, p_n} \otimes \gamma'_{p_n} \\
&\hspace{20em} \text{(because } \lambda'_{p_0} = \mathbb{0} \text{ for each } p_0 \in Q) \\
&= \bigoplus_{q_0 \in Q, p_1 \cdots p_n \in (Q')^{|w|}} \mathbb{1} \otimes \mu'(a_1)_{q_0, p_1} \otimes \mu'(a_2)_{p_1, p_2} \otimes \cdots \otimes \mu'(a_n)_{p_{n-1}, p_n} \otimes \gamma'_{p_n} \\
&\hspace{20em} \text{(by definition of } \lambda') \\
&= \bigoplus_{q_0 \in Q, q_1 \cdots q_n \in Q^{|w|}} \mu'(a_1)_{q_0, q_1} \otimes \mu'(a_2)_{q_1, q_2} \otimes \cdots \otimes \mu'(a_n)_{q_{n-1}, q_n} \otimes \gamma'_{q_n} \\
&\hspace{20em} \text{(because the values of } \mu'(a_i) \text{ on other arguments are equal to } \mathbb{0}) \\
&= \bigoplus_{q_0 \in Q, q_1 \cdots q_n \in Q^{|w|}} (\lambda_{q_0} \otimes \mu(a_1)_{q_0, q_1}) \otimes \mu(a_2)_{q_1, q_2} \otimes \cdots \otimes \mu(a_n)_{q_{n-1}, q_n} \otimes \gamma_{q_n} \text{ (by construction)} \\
&= \llbracket \mathcal{A} \rrbracket^{\text{run}}(w) . \hspace{10em} \square
\end{aligned}$$

Initial algebra semantics. Let $e \notin \Gamma$. For the definition of the initial algebra semantics, we use the string ranked alphabet Γ_e and the Γ_e -algebra $(\Gamma^*, \widehat{\Gamma}_e)$ defined in Paragraph “String-like terms” of Section 2.10.

Also, we define the Γ_e -algebra (B^Q, θ) with

$$\theta(e)() = \lambda \quad \text{and} \quad \theta(a)(v) = v \cdot \mu(a) \quad (\text{vector-matrix product, see Section 2.9})$$

for every $v \in B^Q$ and $a \in \Gamma$. By (2.31), $(\Gamma^*, \widehat{\Gamma}_e)$ is initial, hence there exists a unique Γ_e -algebra homomorphism from $(\Gamma^*, \widehat{\Gamma}_e)$ to (B^Q, θ) . Let us denote this by $h_{\mathcal{A}}$. Then the *initial algebra semantics* of \mathcal{A} is the weighted language $\llbracket \mathcal{A} \rrbracket^{\text{init}} : \Gamma^* \rightarrow B$ defined by

$$\llbracket \mathcal{A} \rrbracket^{\text{init}}(w) = \bigoplus_{q \in Q} h_{\mathcal{A}}(w)_q \otimes \gamma_q$$

for every $w \in \Gamma^*$. We note that, using another nullary symbol e' instead of e , leads to the same weighted language $\llbracket \mathcal{A} \rrbracket^{\text{init}}$.

A weighted language $r : \Gamma^* \rightarrow B$ is *initial algebra recognizable (over B)* (for short: i-recognizable) if there exists a (Γ, B) -wsa \mathcal{A} such that $r = \llbracket \mathcal{A} \rrbracket^{\text{init}}$.

The next lemma shows the connection of the initial algebra semantics of \mathcal{A} to its behaviour semantics as defined in [Eil74, VI.6], if B is a semiring (also cf. [Sch61, Def. 1']). We recall that, under this assumption, the matrix multiplication is associative, and hence $(B^{Q \times Q}, \cdot, M_{\mathbb{1}})$ is a monoid (cf. Section 2.9). Then $\mu : \Gamma^* \rightarrow B^{Q \times Q}$ is a monoid homomorphism from $(\Gamma^*, \cdot, \varepsilon)$ to $(B^{Q \times Q}, \cdot, M_{\mathbb{1}})$.

Lemma 3.3.2. Let B be a semiring and $w \in \Gamma^*$. Then $h_{\mathcal{A}}(w) = \lambda \cdot \mu(w)$. Hence $\llbracket \mathcal{A} \rrbracket^{\text{init}}(w) = \lambda \cdot \mu(w) \cdot \gamma$.

Proof. Let $w \in \Gamma^*$. We consider the terminating reduction system $(\text{prefix}(w), \succ)$ where, for every $w_1, w_2 \in \text{prefix}(w)$, we let $w_1 \succ w_2$ if $w_1 = w_2 a$ for some $a \in \Gamma$. By Corollary 2.5.6, the relation \succ is terminating. Moreover, we have that \succ is terminating and $\text{nf}_{\succ}(\text{prefix}(w)) = \{\varepsilon\}$.

By induction on $(\text{prefix}(w), \succ)$, we prove that the following statement holds:

$$\text{For every } v \in \text{prefix}(w), \text{ we have } h_{\mathcal{A}}(v) = \lambda \cdot \mu(v) . \quad (3.26)$$

Let $v \in \text{prefix}(w)$.

I.B.: Let $v = \varepsilon$. Then we can calculate as follows.

$$h_{\mathcal{A}}(\varepsilon) = h_{\mathcal{A}}(\widehat{e}()) \quad (\text{interpretation of } e \text{ in the } \Gamma_e\text{-algebra } (\Gamma^*, \widehat{\Gamma}_e))$$

$$\begin{aligned}
&= \theta(e)() && (\mathfrak{h}_{\mathcal{A}} \text{ is a } \Gamma_e\text{-algebra homomorphism}) \\
&= \lambda . && (\text{interpretation of } e \text{ in the } \Gamma_e\text{-algebra } (B^Q, \theta))
\end{aligned}$$

I.S.: Let $v = v'a$ for some $a \in \Gamma$. Then we can calculate as follows.

$$\begin{aligned}
\mathfrak{h}_{\mathcal{A}}(v'a) &= \mathfrak{h}_{\mathcal{A}}(\widehat{a}(v')) && (\text{interpretation of } a \text{ in the } \Gamma_e\text{-algebra } (\Gamma^*, \widehat{\Gamma}_e)) \\
&= \theta(a)(\mathfrak{h}_{\mathcal{A}}(v')) && (\mathfrak{h}_{\mathcal{A}} \text{ is a } \Gamma_e\text{-algebra homomorphism}) \\
&= \theta(a)(\lambda \cdot \mu(v')) && (\text{by I.H.}) \\
&= (\lambda \cdot \mu(v')) \cdot \mu(a) && (\text{interpretation of } a \text{ in the } \Gamma_e\text{-algebra } (B^Q, \theta)) \\
&= \lambda \cdot (\mu(v') \cdot \mu(a)) && (\text{because } \mathbf{B} \text{ is a semiring}) \\
&= \lambda \cdot \mu(v'a) . && (\text{because } \mu \text{ is a monoid homomorphism})
\end{aligned}$$

This proves (3.26). Since $w \in \text{prefix}(w)$, Equation (3.26) implies the first statement of the lemma. Finally

$$[[\mathcal{A}]]^{\text{init}}(w) = \bigoplus_{q \in Q} \mathfrak{h}_{\mathcal{A}}(w)_q \otimes \gamma_q = \bigoplus_{q \in Q} (\lambda \cdot \mu(w))_q \otimes \gamma_q = \lambda \cdot \mu(w) \cdot \gamma .$$

□

Embedding of wsa into wta. Now let $\mathcal{A} = (Q, \lambda, \mu, \gamma)$ be a (Γ, \mathbf{B}) -wsa, Σ a string ranked alphabet, and $\mathcal{B} = (Q', \delta, F)$ a (Σ, \mathbf{B}) -wta. We say that \mathcal{A} and \mathcal{B} are *related* if

- $\Sigma = \Gamma_e$ for some $e \notin \Gamma$,
- $Q = Q'$,
- for every $a \in \Sigma^{(1)}$ and $p, q \in Q$, we have $\delta_0(\varepsilon, e, q) = \lambda_q$, and $\delta_1(p, a, q) = \mu(a)_{p,q}$, and
- $F = \gamma$.

For the proof of the next lemma, we recall that tree_e is an isomorphism from the Γ_e -algebra $(\Gamma^*, \widehat{\Gamma}_e)$ to the Γ_e -term algebra $(\mathbf{T}_{\Gamma_e}, \theta_{\Gamma_e})$, cf. Paragraph “String-like terms” in Section 2.10.

Lemma 3.3.3. Let Σ be a string ranked alphabet, $\mathcal{A} = (Q, \lambda, \mu, \gamma)$ a (Γ, \mathbf{B}) -wsa, and $\mathcal{B} = (Q', \delta, F)$ a (Σ, \mathbf{B}) -wta. If \mathcal{A} and \mathcal{B} are related, then $[[\mathcal{A}]]^{\text{run}} = [[\mathcal{B}]]^{\text{run}} \circ \text{tree}_e$ and $[[\mathcal{A}]]^{\text{init}} = [[\mathcal{B}]]^{\text{init}} \circ \text{tree}_e$, where e denotes the unique nullary element of Σ .

Proof. To show that $[[\mathcal{A}]]^{\text{run}} = [[\mathcal{B}]]^{\text{run}} \circ \text{tree}_e$, let $w \in \Gamma^*$ with $w = a_1 \cdots a_n$ for some $n \in \mathbb{N}$. It is obvious that there exists a bijection \mapsto between $Q^{|w|+1}$ and $\mathbf{R}_{\mathcal{B}}(\text{tree}_e(w))$ such that, for $\rho = q_0 \cdots q_n$, we have $\rho \mapsto \rho'$, where $\rho'(1^i) = q_{n-i}$ for every $i \in [0, n]$ (note that $\text{pos}(\text{tree}_e(w)) = \{1^i \mid i \in [0, n]\}$). Moreover, if $\rho \mapsto \rho'$, then due to Observation 3.1.1 we also have

$$\text{wt}_{\mathcal{A}}(w, \rho) = \text{wt}_{\mathcal{B}}(\text{tree}_e(w), \rho') \otimes F_{q_n} ,$$

where $\text{wt}_{\mathcal{B}}(\text{tree}_e(w), \rho')$ denotes the weight of ρ' on $\text{tree}_e(w)$ for \mathcal{B} . Then

$$[[\mathcal{A}]]^{\text{run}}(w) = \bigoplus_{\rho \in Q^{|w|+1}} \text{wt}_{\mathcal{A}}(w, \rho) = \bigoplus_{\rho' \in \mathbf{R}_{\mathcal{B}}(\text{tree}_e(w))} \text{wt}_{\mathcal{B}}(\text{tree}_e(w), \rho') \otimes F_{\rho'(\varepsilon)} = [[\mathcal{B}]]^{\text{run}}(\text{tree}_e(w)),$$

where the second equality follows from the bijection \mapsto described above and the fact that $\rho'(\varepsilon) = q_n$.

Now we show that $[[\mathcal{A}]]^{\text{init}} = [[\mathcal{B}]]^{\text{init}} \circ \text{tree}_e$. Since $\text{tree}_e : \Gamma^* \rightarrow \mathbf{T}_{\Gamma_e}$ and $\mathfrak{h}_{\mathcal{B}} : \mathbf{T}_{\Gamma_e} \rightarrow B^Q$ are Γ_e -algebra homomorphisms, it follows from Theorem 2.7.3 that $(\mathfrak{h}_{\mathcal{B}} \circ \text{tree}_e) : \Gamma^* \rightarrow B^Q$ is a Γ_e -algebra homomorphism. Since $\mathfrak{h}_{\mathcal{A}}$ is the unique Γ_e -algebra homomorphism from $(\Gamma^*, \widehat{\Gamma}_e)$ to (B^Q, θ) , we have $\mathfrak{h}_{\mathcal{A}} = \mathfrak{h}_{\mathcal{B}} \circ \text{tree}_e$.

Then we obtain

$$[[\mathcal{A}]]^{\text{init}}(w) = \bigoplus_{q \in Q} \mathfrak{h}_{\mathcal{A}}(w)_q \otimes \gamma_q = \bigoplus_{q \in Q'} \mathfrak{h}_{\mathcal{B}}(\text{tree}_e(w))_q \otimes F_q = [[\mathcal{B}]]^{\text{init}}(\text{tree}_e(w)) . \quad \square$$

Lemma 3.3.4. Let Γ be an alphabet and \mathbf{B} be a strong bimonoid. Then the following two statements hold.

- (1) For every (Γ, \mathbf{B}) -wsa \mathcal{A} and $e \notin \Gamma$, we can construct a (Γ_e, \mathbf{B}) -wta \mathcal{B} such that $\llbracket \mathcal{A} \rrbracket^{\text{run}} = \llbracket \mathcal{B} \rrbracket^{\text{run}} \circ \text{tree}_e$ and $\llbracket \mathcal{A} \rrbracket^{\text{init}} = \llbracket \mathcal{B} \rrbracket^{\text{init}} \circ \text{tree}_e$.
- (2) For every string ranked alphabet Γ_e and (Γ_e, \mathbf{B}) -wta \mathcal{B} , we can construct a (Γ, \mathbf{B}) -wsa \mathcal{A} such that $\llbracket \mathcal{A} \rrbracket^{\text{run}} = \llbracket \mathcal{B} \rrbracket^{\text{run}} \circ \text{tree}_e$ and $\llbracket \mathcal{A} \rrbracket^{\text{init}} = \llbracket \mathcal{B} \rrbracket^{\text{init}} \circ \text{tree}_e$.

Proof. First we prove Statement (1). For a given (Γ, \mathbf{B}) -wsa \mathcal{A} , it is easy to construct a (Γ_e, \mathbf{B}) -wta \mathcal{B} such that \mathcal{A} and \mathcal{B} are related. Then the statement follows from Lemma 3.3.3. Statement (2) follows analogously. \square

Weighted string automata over the Boolean semiring. Let $\mathcal{A} = (Q, \lambda, \mu, \gamma)$ be a (Γ, Boole) -wsa and $A = (Q, I, \delta, F)$ be a Γ -fsa. We say that \mathcal{A} and A are *related* if $I = \text{supp}(\lambda)$, $F = \text{supp}(\gamma)$, and for every $a \in \Gamma$ and $q, q' \in Q$ we have: $\mu(a)_{q,q'} = 1$ iff $(q, a, q') \in \delta$.

It is easy to see that, if \mathcal{A} and A are related, then $\text{supp}(\llbracket \mathcal{A} \rrbracket^{\text{run}}) = L(A)$. Moreover, for each (Γ, Boole) -wsa, we can construct a Γ -fsa A such that \mathcal{A} and A are related; and vice versa, for each Γ -fsa A , we can construct a (Γ, Boole) -wsa \mathcal{A} such that \mathcal{A} and A are related. Thus we obtain the following equivalence between Γ -fsa and (Γ, Boole) -wsa.

Observation 3.3.5. Let $L \subseteq \Gamma^*$. Then the following two statements are equivalent.

- (A) We can construct a Γ -fsa A such that $L = L(A)$.
- (B) We can construct a (Γ, Boole) -wsa \mathcal{A} such that $L = \text{supp}(\llbracket \mathcal{A} \rrbracket^{\text{run}})$. \square

3.4 Weighted tree automata over the Boolean semiring

Here we prove that every wta over the Boolean semiring $\text{Boole} = (\mathbb{B}, \vee, \wedge, 0, 1)$ is essentially an fta, and vice versa.

Let $\mathcal{A} = (Q, \delta, F)$ be a (Σ, \mathbf{B}) -wta. The *support fta of \mathcal{A}* , denoted by $\text{supp}_{\mathbf{B}}(\mathcal{A})$, is the Σ -fta (Q, δ', F') where for every $k \in \mathbb{N}$ we have $\delta'_k = \text{supp}_{\mathbf{B}}(\delta_k)$ and $F' = \text{supp}_{\mathbf{B}}(F)$. If \mathbf{B} is clear from the context, then we drop \mathbf{B} from $\text{supp}_{\mathbf{B}}$.

Theorem 3.4.1. *Let \mathcal{A} be (Σ, Boole) -wta. Then $\text{supp}(\llbracket \mathcal{A} \rrbracket^{\text{init}}) = \text{supp}(\llbracket \mathcal{A} \rrbracket^{\text{run}}) = L(\text{supp}(\mathcal{A}))$. Thus $\llbracket \mathcal{A} \rrbracket^{\text{init}} = \llbracket \mathcal{A} \rrbracket^{\text{run}}$.*

Proof. Let $\mathcal{A} = (Q, \delta, F)$ and $\text{supp}(\mathcal{A}) = (Q, \delta', F')$. We recall that $L(\text{supp}(\mathcal{A})) = L_i(\text{supp}(\mathcal{A})) = L_r(\text{supp}(\mathcal{A}))$, cf. Lemma 2.16.1.

First we prove $\text{supp}(\llbracket \mathcal{A} \rrbracket^{\text{init}}) = L_i(\text{supp}(\mathcal{A}))$. By induction on T_{Σ} , we prove that the following statement holds:

$$\text{For every } \xi \in T_{\Sigma} \text{ and } q \in Q: h_{\mathcal{A}}(\xi)_q \neq 0 \text{ iff } q \in h_{\text{supp}(\mathcal{A})}(\xi) . \quad (3.27)$$

Let $\xi = \sigma(\xi_1, \dots, \xi_k)$.

$$\begin{aligned} & h_{\mathcal{A}}(\xi)_q \neq 0 \\ \text{iff } & \left(\bigvee_{q_1 \cdots q_k \in Q^k} h_{\mathcal{A}}(\xi_1)_{q_1} \wedge \dots \wedge h_{\mathcal{A}}(\xi_k)_{q_k} \wedge \delta_k(q_1 \cdots q_k, \sigma, q) \right) \neq 0 \\ \text{iff }^{(*)} & (\exists q_1 \cdots q_k \in Q^k) : (h_{\mathcal{A}}(\xi_1)_{q_1} \neq 0) \wedge \dots \wedge (h_{\mathcal{A}}(\xi_k)_{q_k} \neq 0) \wedge (\delta_k(q_1 \cdots q_k, \sigma, q) \neq 0) \\ & \text{iff } (\exists q_1 \cdots q_k \in Q^k) : (q_1 \in h_{\text{supp}(\mathcal{A})}(\xi_1)) \wedge \dots \wedge (q_k \in h_{\text{supp}(\mathcal{A})}(\xi_k)) \wedge ((q_1 \cdots q_k, \sigma, q) \in \delta'_k) \text{ (by I.H.)} \\ & \text{iff } q \in h_{\text{supp}(\mathcal{A})}(\xi) . \end{aligned}$$

At the implication from right to left of equivalence (*), we have used the fact that the Boolean semiring is positive, i.e., zero-divisor free and zero-sum free. This proves (3.27).

Then, for each $\xi \in T_\Sigma$, we can argue as follows:

$$\begin{aligned} \xi \in \text{supp}(\llbracket \mathcal{A} \rrbracket^{\text{init}}) &\text{ iff } \left(\bigvee_{q \in Q} h_{\mathcal{A}}(\xi)_q \wedge F_q \right) \neq 0 \text{ iff } \left(\bigvee_{q \in F'} h_{\mathcal{A}}(\xi)_q \right) \neq 0 \\ &\text{ iff }^{(**)} (\exists q \in F') : h_{\mathcal{A}}(\xi)_q \neq 0 \text{ iff } (\exists q \in F') : q \in h_{\text{supp}(\mathcal{A})}(\xi) \text{ iff } \xi \in L_i(\text{supp}(\mathcal{A})) \end{aligned}$$

where the implication from right to left at equivalence (**) uses the fact that **Boole** is zero-sum free; the last but one equivalence is due to (3.27). This proves $\text{supp}(\llbracket \mathcal{A} \rrbracket^{\text{init}}) = L_i(\text{supp}(\mathcal{A}))$.

Next we prove that $\text{supp}(\llbracket \mathcal{A} \rrbracket^{\text{run}}) = L_r(\text{supp}(\mathcal{A}))$. We note that $R_{\mathcal{A}}(\xi) = R_{\text{supp}(\mathcal{A})}(\xi)$ for every $\xi \in T_\Sigma$. First, by induction on T_Σ , we prove that the following statement holds:

$$\text{For every } \xi \in T_\Sigma \text{ and } \rho \in R_{\mathcal{A}}(\xi): \text{wt}_{\mathcal{A}}(\xi, \rho) \neq 0 \text{ iff } \rho \in R_{\text{supp}(\mathcal{A})}^v(\xi) . \quad (3.28)$$

We let $\xi = \sigma(\xi_1, \dots, \xi_k)$. Then

$$\begin{aligned} \text{wt}_{\mathcal{A}}(\xi, \rho) \neq 0 &\text{ iff } (\text{wt}_{\mathcal{A}}(\xi_1, \rho|_1) \wedge \dots \wedge \text{wt}_{\mathcal{A}}(\xi_k, \rho|_k) \wedge \delta_k(\rho(1) \cdots \rho(k), \sigma, \rho(\varepsilon))) \neq 0 \\ &\text{ iff }^{(***)} (\text{wt}_{\mathcal{A}}(\xi_1, \rho|_1) \neq 0) \wedge \dots \wedge (\text{wt}_{\mathcal{A}}(\xi_k, \rho|_k) \neq 0) \wedge (\delta_k(\rho(1) \cdots \rho(k), \sigma, \rho(\varepsilon)) \neq 0) \\ &\text{ iff } (\rho|_1 \in R_{\text{supp}(\mathcal{A})}^v(\xi_1)) \wedge \dots \wedge (\rho|_k \in R_{\text{supp}(\mathcal{A})}^v(\xi_k)) \wedge ((\rho(1) \cdots \rho(k), \sigma, \rho(\varepsilon)) \in \delta'_k) \quad (\text{by I.H.}) \\ &\text{ iff } \rho \in R_{\text{supp}(\mathcal{A})}^v(\xi) \end{aligned}$$

where at (***) from right to left we have used the fact that **Boole** is zero-divisor free. This proves (3.28).

Now let $\xi \in T_\Sigma$. Then

$$\begin{aligned} \xi \in \text{supp}(\llbracket \mathcal{A} \rrbracket^{\text{run}}) &\text{ iff } \left(\bigvee_{q \in Q} \bigvee_{\rho \in R_{\mathcal{A}}(q, \xi)} \text{wt}_{\mathcal{A}}(\xi, \rho) \wedge F_q \right) \neq 0 \\ &\text{ iff } \left(\bigvee_{q \in F'} \bigvee_{\rho \in R_{\mathcal{A}}(q, \xi)} \text{wt}_{\mathcal{A}}(\xi, \rho) \right) \neq 0 \\ &\text{ iff }^{(v*)} (\exists q \in F') (\exists \rho \in R_{\mathcal{A}}(q, \xi)) : \text{wt}_{\mathcal{A}}(\xi, \rho) \neq 0 \\ &\text{ iff } (\exists q \in F') (\exists \rho \in R_{\text{supp}(\mathcal{A})}(q, \xi)) : \rho \in R_{\text{supp}(\mathcal{A})}^v(\xi) \text{ iff } \xi \in L_r(\text{supp}(\mathcal{A})) \end{aligned}$$

where at (v*) from right to left we have used the fact that **Boole** is zero-sum free; the last but one equivalence is due to (3.28). This proves $\text{supp}(\llbracket \mathcal{A} \rrbracket^{\text{run}}) = L_r(\text{supp}(\mathcal{A}))$.

Finally we have $\llbracket \mathcal{A} \rrbracket^{\text{init}} = \chi(\text{supp}(\llbracket \mathcal{A} \rrbracket^{\text{init}})) = \chi(L(\text{supp}(\mathcal{A}))) = \chi(\text{supp}(\llbracket \mathcal{A} \rrbracket^{\text{run}})) = \llbracket \mathcal{A} \rrbracket^{\text{run}}$, where χ abbreviates χ_{Boole} . \square

In Lemma 14.2.3 we will generalize the first statement of Theorem 3.4.1 from the Boolean semiring **Boole** to arbitrary positive strong bimonoids. In Theorem 5.3.4 we will generalize the second statement of Theorem 3.4.1 from **Boole** to arbitrary semirings.

Theorem 3.4.1 implies that, intuitively, wta over the Boolean semiring and fta are equivalent devices for specifying recognizable tree languages; this is formalized in Corollary 3.4.2. We mention that Corollary 12.1.7 contains the same statement as Corollary 3.4.2, except that the semiring **Boole** is replaced by the field F_2 .

Corollary 3.4.2. Let Σ be a ranked alphabet. Moreover, let $L \subseteq T_\Sigma$. Then the following three statements are equivalent.

- (A) We can construct a Σ -fta A such $L = L(A)$.
 - (B) We can construct a (Σ, Boole) -wta \mathcal{A} such that $L = \text{supp}(\llbracket \mathcal{A} \rrbracket^{\text{run}}) = \text{supp}(\llbracket \mathcal{A} \rrbracket^{\text{init}})$.
 - (C) We can construct a (Σ, Boole) -wta \mathcal{A} such that $\chi(L) = \llbracket \mathcal{A} \rrbracket^{\text{run}} = \llbracket \mathcal{A} \rrbracket^{\text{init}}$.
- Moreover, we have $\text{supp}(\text{Rec}^{\text{init}}(\Sigma, \text{Boole})) = \text{supp}(\text{Rec}^{\text{run}}(\Sigma, \text{Boole})) = \text{Rec}(\Sigma)$.

Proof. Proof of (A) \Rightarrow (B): Let $A = (Q, \delta, F)$ be a Σ -fta such that $L = L(A)$. We construct the (Σ, Boole) -wta $\mathcal{A} = (Q, \delta', F')$ such that $\text{supp}(\delta'_k) = \delta_k$ for each $k \in \mathbb{N}$, and $\text{supp}(F') = F$ (note that this determines δ' and F' because $\mathbb{B} = \{0, 1\}$). Then $A = \text{supp}(\mathcal{A})$ and by Theorem 3.4.1 we obtain $L(A) = L(\text{supp}(\mathcal{A})) = \text{supp}(\llbracket \mathcal{A} \rrbracket^{\text{run}}) = \text{supp}(\llbracket \mathcal{A} \rrbracket^{\text{init}})$.

Proof of (B) \Rightarrow (A): Let (Σ, Boole) -wta \mathcal{A} such that $L = \text{supp}(\llbracket \mathcal{A} \rrbracket^{\text{run}}) = \text{supp}(\llbracket \mathcal{A} \rrbracket^{\text{init}})$. Then, we construct the Σ -fta $\text{supp}(\mathcal{A})$, and by Theorem 3.4.1, we have that $L(\text{supp}(\mathcal{A})) = \text{supp}(\llbracket \mathcal{A} \rrbracket^{\text{run}}) = \text{supp}(\llbracket \mathcal{A} \rrbracket^{\text{init}})$.

Proof of (B) \Leftrightarrow (C): This follows from the equivalence that for every $r : T_\Sigma \rightarrow \mathbb{B}$ and $L \subseteq T_\Sigma$: $r = \chi(L)$ iff $L = \text{supp}(r)$.

Finally, the equality $\text{supp}(\text{Rec}^{\text{init}}(\Sigma, \text{Boole})) = \text{supp}(\text{Rec}^{\text{run}}(\Sigma, \text{Boole}))$ follows from Theorem 3.4.1; and the equality $\text{Rec}(\Sigma) = \text{supp}(\text{Rec}^{\text{run}}(\Sigma, \text{Boole}))$ follows from (A) \Leftrightarrow (B). \square

3.5 Weighted tree automata over the semiring of natural numbers

In this section we will consider the semiring $\text{Nat} = (\mathbb{N}, +, \cdot, 0, 1)$ of natural numbers as weight algebra. In [Eil74, Thm. 9.1] it was proved that, for every alphabet Γ and (Γ, Nat) -wsa \mathcal{A} , there exists an unambiguous (Γ, Nat) -wsa \mathcal{B} such that $\llbracket \mathcal{A} \rrbracket^{\text{run}} = \llbracket \mathcal{B} \rrbracket^{\text{run}}$. There, unambiguous means that each transition weight and each initial and final weight are elements of $\{0, 1\}$. For wta, we call the corresponding property “ \mathcal{B} is crisp and it has identity root weights”. Here we generalize Eilenberg’s result to wta. However, since we will discuss normal forms of wta only later, we have to start with a (Σ, Nat) -wta \mathcal{A} which has identity root weights.

Lemma 3.5.1. (cf. [Eil74, Thm. 9.1]) For each (Σ, Nat) -wta \mathcal{A} which has identity root weights, we can construct a (Σ, Nat) -wta \mathcal{B} such that \mathcal{B} is crisp, it has identity root weights, and $\llbracket \mathcal{A} \rrbracket^{\text{init}} = \llbracket \mathcal{B} \rrbracket^{\text{init}}$.

Proof. Let $\mathcal{A} = (Q, \delta, F)$. Let $m = \max(\text{wts}(\mathcal{A}))$. If $m = 0$, then let $\mathcal{B} = \mathcal{A}$. Otherwise, we construct $\mathcal{B} = (Q', \delta', F')$ according to the following idea. We supply \mathcal{B} with m copies of each state of \mathcal{A} ; a copy is a pair (q, ℓ) with $q \in Q$ and $\ell \in [m]$. If $\tau = (q_1 \cdots q_k, \sigma, q)$ is a transition of \mathcal{A} and $(q_1, \ell_1), \dots, (q_k, \ell_k)$ are copies of q_1, \dots, q_k , then \mathcal{B} simulates the weight $\delta_k(\tau)$ by nondeterministically branching from $(q_1, \ell_1), \dots, (q_k, \ell_k)$ while reading σ into $(q, 1), \dots, (q, \delta_k(\tau))$, and each of these transitions has weight 1. Formally, we let:

- $Q' = Q \times [m]$,
- for each $(q, \ell) \in Q'$, we define $F'_{(q, \ell)} = F_q$,
- for every $k \in \mathbb{N}$, $\sigma \in \Sigma^{(k)}$, $(q_1, \ell_1), \dots, (q_k, \ell_k), (q, \ell) \in Q'$, we define

$$(\delta')_k((q_1, \ell_1) \cdots (q_k, \ell_k), \sigma, (q, \ell)) = \begin{cases} 1 & \text{if } \ell \in [\delta_k(q_1 \cdots q_k, \sigma, q)] \\ 0 & \text{otherwise .} \end{cases}$$

By induction on T_Σ , we prove that the following statement holds:

$$\text{For every } \xi \in T_\Sigma \text{ and } q \in Q, \text{ we have: } h_{\mathcal{A}}(\xi)_q = \bigoplus_{\ell \in [m]} h_{\mathcal{B}}(\xi)_{(q, \ell)} . \quad (3.29)$$

Let $\xi = \sigma(\xi_1, \dots, \xi_k)$. Then we can calculate as follows.

$$\begin{aligned} & h_{\mathcal{A}}(\sigma(\xi_1, \dots, \xi_k))_q \\ &= \bigoplus_{q_1, \dots, q_k \in Q} h_{\mathcal{A}}(\xi_1)_{q_1} \cdots h_{\mathcal{A}}(\xi_k)_{q_k} \cdot \delta_k(q_1 \cdots q_k, \sigma, q) \\ &= \bigoplus_{q_1, \dots, q_k \in Q} \left(\bigoplus_{\ell_1 \in [m]} h_{\mathcal{B}}(\xi_1)_{(q_1, \ell_1)} \right) \cdots \left(\bigoplus_{\ell_k \in [m]} h_{\mathcal{B}}(\xi_k)_{(q_k, \ell_k)} \right) \cdot \delta_k(q_1 \cdots q_k, \sigma, q) \quad (\text{by I.H.}) \end{aligned}$$

$$\begin{aligned}
 &= \bigoplus_{(q_1, \ell_1), \dots, (q_k, \ell_k) \in Q'} h_{\mathcal{B}}(\xi_1)_{(q_1, \ell_1)} \cdots h_{\mathcal{B}}(\xi_k)_{(q_k, \ell_k)} \cdot \left(\bigoplus_{\ell \in [m]} (\delta')_k((q_1, \ell_1) \cdots (q_k, \ell_k), \sigma, (q, \ell)) \right) \\
 &\hspace{15em} \text{(by right-distributivity and construction)} \\
 &= \bigoplus_{\ell \in [m]} \bigoplus_{(q_1, \ell_1), \dots, (q_k, \ell_k) \in Q'} h_{\mathcal{B}}(\xi_1)_{(q_1, \ell_1)} \cdots h_{\mathcal{B}}(\xi_k)_{(q_k, \ell_k)} \cdot (\delta')_k((q_1, \ell_1) \cdots (q_k, \ell_k), \sigma, (q, \ell)) \\
 &\hspace{15em} \text{(by left-distributivity)} \\
 &= \bigoplus_{\ell \in [m]} h_{\mathcal{B}}(\sigma(\xi_1, \dots, \xi_k))_{(q, \ell)}
 \end{aligned}$$

Now let $\xi \in T_{\Sigma}$. Then we can calculate as follows.

$$\begin{aligned}
 \llbracket \mathcal{A} \rrbracket^{\text{init}}(\xi) &= \bigoplus_{q \in Q} h_{\mathcal{A}}(\xi)_q \cdot F_q \\
 &= \bigoplus_{q \in Q} \left(\bigoplus_{\ell \in [m]} h_{\mathcal{B}}(\xi)_{(q, \ell)} \right) \cdot F_q && \text{(by (3.29))} \\
 &= \bigoplus_{q \in Q} \bigoplus_{\ell \in [m]} h_{\mathcal{B}}(\xi)_{(q, \ell)} \cdot F_q && \text{(because } F_q \in \{0, 1\} \text{)} \\
 &= \bigoplus_{(q, \ell) \in Q'} h_{\mathcal{B}}(\xi)_{(q, \ell)} \cdot (F')_{(q, \ell)} && \text{(by construction)} \\
 &= \llbracket \mathcal{B} \rrbracket^{\text{init}}(\xi) . && \square
 \end{aligned}$$

Assuming that Theorems 5.3.4 and 7.3.1 are already available, Lemma 3.5.1 implies the following corollary. We note that the proofs of the Theorems 5.3.4 and 7.3.1 do not depend on Corollary 3.5.2.

Corollary 3.5.2. For each (Σ, Nat) -wta \mathcal{A} , we can construct a (Σ, Nat) -wta \mathcal{B} such that \mathcal{B} is crisp, it has identity root weights, and $\llbracket \mathcal{A} \rrbracket^{\text{init}} = \llbracket \mathcal{B} \rrbracket^{\text{init}}$.

Proof. Let \mathcal{A} be a (Σ, Nat) -wta. By Theorem 5.3.4 we have $\llbracket \mathcal{A} \rrbracket^{\text{init}} = \llbracket \mathcal{A} \rrbracket^{\text{run}}$. By Theorem 7.3.1 we can construct a root weight normalized (Σ, Nat) -wta \mathcal{C} such that $\llbracket \mathcal{A} \rrbracket^{\text{run}} = \llbracket \mathcal{C} \rrbracket^{\text{run}}$. By Theorem 5.3.4 we have $\llbracket \mathcal{C} \rrbracket^{\text{run}} = \llbracket \mathcal{C} \rrbracket^{\text{init}}$. Then, by Lemma 3.5.1 we can construct a (Σ, Nat) -wta \mathcal{B} such that \mathcal{B} is crisp, it has identity root weights, and $\llbracket \mathcal{C} \rrbracket^{\text{init}} = \llbracket \mathcal{B} \rrbracket^{\text{init}}$. \square

Next we define the characteristic wta of a Σ -fta A . For this, let $A = (Q, \delta, F)$ be a Σ -fta. The *characteristic wta of A* , denoted by $\chi_{\text{Nat}}(A)$, is the (Σ, Nat) -wta (Q, δ', F') where for every $k \in \text{Nat}$ we have $\delta'_k = \chi_{\text{Nat}}(\delta_k)$ and $F' = \chi_{\text{Nat}}(F)$. Note that $\chi_{\text{Nat}}(A)$ is crisp and it has identity root weights.

The characteristic wta is the “inverse” of the support fta in the following sense. For each crisp (Σ, Nat) -wta \mathcal{A} with identity root weights, we have $\chi_{\text{Nat}}(\text{supp}(\mathcal{A})) = \mathcal{A}$. Moreover, for each Σ -fta A , we have $\text{supp}(\chi_{\text{Nat}}(A)) = A$.

We recall that, for a Σ -fta A , we denote by $R_A^a(\xi)$ the set of accepting runs of A on a tree ξ . Moreover, we recall that the multiplicity mapping of A is defined as the weighted tree language $\#_{R_A^a} : T_{\Sigma} \rightarrow \mathbb{N}$ such that, for each $\xi \in T_{\Sigma}$, we have $\#_{R_A^a}(\xi) = |R_A^a(\xi)|$ (cf. Example 3.2.1).

In Example 3.2.1 we have proved the following result.

Lemma 3.5.3. For each Σ -fta A , we have $\llbracket \chi_{\text{Nat}}(A) \rrbracket^{\text{init}} = \#_{R_A^a}$.

We also have the following kind of inverse result.

Lemma 3.5.4. Let \mathcal{A} be a crisp (Σ, Nat) -wta which has identity root weights. Then $\llbracket \mathcal{A} \rrbracket^{\text{init}} = \#_{R_{\text{supp}(\mathcal{A})}^a}$.

Proof. This follows from the fact that $\mathcal{A} = \chi_{\text{Nat}}(\text{supp}(\mathcal{A}))$ and from Lemma 3.5.3. \square

For example, the (Σ, \mathbf{Nat}) -wta \mathcal{A} in Example 3.2.11 is crisp and it has identity root weights. Since $\llbracket \mathcal{A} \rrbracket^{\text{init}} = \#_{\sigma(\cdot, \alpha)}$, it follows from Lemma 3.5.4 that $\#_{\sigma(\cdot, \alpha)} = \#_{R_{\text{supp}(\mathcal{A})}^a}$.

We can conclude the following characterization of $\text{Rec}^{\text{init}}(\Sigma, \mathbf{Nat})$, which says that the i -recognizable (Σ, \mathbf{Nat}) -weighted tree languages are exactly the multiplicity mappings of Σ -fta.

Theorem 3.5.5. *Let Σ be a ranked alphabet. Moreover, let $r : T_\Sigma \rightarrow \mathbb{N}$. Then the following three statements are equivalent.*

- (A) *We can construct a (Σ, \mathbf{Nat}) -wta \mathcal{A} such that $r = \llbracket \mathcal{A} \rrbracket^{\text{init}}$.*
- (B) *We can construct a crisp (Σ, \mathbf{Nat}) -wta \mathcal{A} which has identity root weights such that $r = \llbracket \mathcal{A} \rrbracket^{\text{init}}$.*
- (C) *We can construct a Σ -fta A such that $r = \#_{R_A^a}$.*

Proof. (A) \Rightarrow (B) follows from Corollary 3.5.2 and (B) \Rightarrow (A) is obvious. (B) \Rightarrow (C) follows from Lemma 3.5.4 and (C) \Rightarrow (B) follows from Lemma 3.5.3. \square

It will turn out later (cf. Theorem 5.3.4) that $\llbracket \mathcal{A} \rrbracket^{\text{init}} = \llbracket \mathcal{A} \rrbracket^{\text{run}}$ for each (Σ, \mathbf{Nat}) -wta. Hence, Theorem 3.5.5 also shows a characterization of $\text{Rec}^{\text{run}}(\Sigma, \mathbf{Nat})$.

Finally, we show that, for each (Σ, \mathbf{Nat}) -wta \mathcal{A} and $\xi \in T_\Sigma$, the value $\llbracket \mathcal{A} \rrbracket^{\text{run}}(\xi)$ is bounded exponentially by $\text{size}(\xi)$.

Lemma 3.5.6. *Let $\mathcal{A} = (Q, \delta, F)$ be a (Σ, \mathbf{Nat}) -wta. There exists $K \in \mathbb{N}$ such that, for each $\xi \in T_\Sigma$, we have $\llbracket \mathcal{A} \rrbracket^{\text{run}}(\xi) \leq K^{\text{size}(\xi)}$.*

Proof. Let $m = \max(\text{wts}(\mathcal{A}))$ and $K = |Q| \cdot m^2$. Obviously, for each $\xi \in T_\Sigma$, the number of runs on ξ is $|Q|^{\text{size}(\xi)}$. Moreover, for each $\xi \in T_\Sigma$ and $\rho \in R_{\mathcal{A}}(\xi)$, we have $\text{wt}(\xi, \rho) \leq m^{\text{size}(\xi)}$. Then

$$\llbracket \mathcal{A} \rrbracket^{\text{run}}(\xi) = \bigoplus_{\rho \in R_{\mathcal{A}}(\xi)} \text{wt}(\xi, \rho) \cdot F_{\rho(\varepsilon)} \leq \bigoplus_{\rho \in R_{\mathcal{A}}(\xi)} m^{\text{size}(\xi)+1} = |Q|^{\text{size}(\xi)} \cdot m^{\text{size}(\xi)+1} \leq K^{\text{size}(\xi)} .$$

\square

3.6 Weighted tree automata over commutative semirings

In the particular case that \mathbf{B} is a commutative semiring, we can view each (Σ, \mathbf{B}) -wta as a \mathbf{B} -semimodule with multilinear operations and a linear form. The latter combination will be called multilinear representation (cf. [BR82, BA89, Boz91, FS11]). Also, vice versa, each multilinear representation can be viewed as a wta. In the next subsections we will formalize these informal statements. We will use notions from Sections 2.9 and 2.7.7.

In the rest of this section, we let \mathbf{B} denote an arbitrary commutative semiring.

3.6.1 Multilinear representations

Let Q be a finite set. We recall that 0_Q is the Q -vector in B^Q which contains 0 in each component, and that $\mathbb{1}_q$ is the q -unit vector in B^Q for each $q \in Q$. Moreover, \oplus denotes the usual vector addition on B^Q (cf. Section 2.9). We start this subsection with an important observation.

Observation 3.6.1. *For each finite set Q , the triple $(B^Q, \oplus, 0_Q)$ is a \mathbf{B} -semimodule via scalar multiplication.*

Proof. Obviously, $(B^Q, \oplus, 0_Q)$ is a commutative monoid. Also the properties (2.23)-(2.27) are satisfied, where (2.24) and (2.25) require that \mathbf{B} is distributive. Hence $(B^Q, \oplus, 0_Q)$ is a \mathbf{B} -semimodule. \square

A (Σ, \mathbf{B}) -multilinear representation⁵ is a tuple $(\mathbf{V}, \mu, \gamma)$ where

- $\mathbf{V} = (B^Q, \oplus, \mathbb{0}_Q)$ for some finite set Q ,
- (\mathbf{V}, μ) is a (Σ, \mathbf{B}) -semimodule (cf. Section 2.7.7), and
- $\gamma : B^Q \rightarrow B$ is a linear form over \mathbf{V} (cf. Section 2.7.7).

We call (B^Q, μ) the Σ -algebra associated with $(\mathbf{V}, \mu, \gamma)$, and denote the unique Σ -algebra homomorphism from \mathbf{T}_Σ to (B^Q, μ) by $h_{\mathbf{V}}$. The weighted tree language recognized by $(\mathbf{V}, \mu, \gamma)$ is the weighted tree language $r : \mathbf{T}_\Sigma \rightarrow B$ where $r(\xi) = \gamma(h_{\mathbf{V}}(\xi))$ for every $\xi \in \mathbf{T}_\Sigma$.

Before showing an example of a multilinear representation, we prove a useful lemma. For this, we note that the algebra $(B^{\mathbf{T}_\Sigma}, \oplus, \tilde{\mathbb{0}})$ is a \mathbf{B} -semimodule via scalar multiplication from left.

Lemma 3.6.2. (cf. [BR82, Prop. 3.1]) The set of weighted tree languages which are recognizable by (Σ, \mathbf{B}) -multilinear representations is a sub-semimodule of the B -semimodule $(B^{\mathbf{T}_\Sigma}, \oplus, \tilde{\mathbb{0}})$.

Proof. We show that the subset of $B^{\mathbf{T}_\Sigma}$ which consists of all weighted tree languages which are recognizable by (Σ, \mathbf{B}) -multilinear representations is closed under (a) scalar multiplication from left and (b) under sum.

(a) Let $r \in B^{\mathbf{T}_\Sigma}$ and $b \in B$ and assume that r is recognized by the (Σ, \mathbf{B}) -multilinear representation $(\mathbf{V}, \mu, \gamma)$ with $\mathbf{V} = (B^Q, \oplus, \mathbb{0}_Q)$. Then the (Σ, \mathbf{B}) -weighted tree language $b \cdot r$ is recognizable by the (Σ, \mathbf{B}) -multilinear representation $(\mathbf{V}, \mu, \gamma')$, where $\gamma'(v) = b \otimes \gamma(v)$ for each $v \in V$.

(b) Let $r_1, r_2 \in B^{\mathbf{T}_\Sigma}$ and assume that, for each $i \in \{1, 2\}$, the (Σ, \mathbf{B}) -multilinear representation $(\mathbf{V}_i, \mu_i, \gamma_i)$ with $\mathbf{V}_i = (B^{Q_i}, \oplus, \mathbb{0}_{Q_i})$ recognizes r_i . We assume that $Q_1 \cap Q_2 = \emptyset$. We define a (Σ, \mathbf{B}) -multilinear representation $(\mathbf{V}, \mu, \gamma)$ which recognizes $r_1 \oplus r_2$ as follows. Let

- $\mathbf{V} = (B^{Q_1 \cup Q_2}, \oplus, \mathbb{0}_{Q_1 \cup Q_2})$ where \oplus is the usual sum of $(Q_1 \cup Q_2)$ -vectors over B ,
- let μ be the Σ -indexed family over the set of all operations over B such that, for every $k \in \mathbb{N}$, $\sigma \in \Sigma^{(k)}$, and $v_1, \dots, v_k \in B^{Q_1 \cup Q_2}$ and $q \in Q_1 \cup Q_2$, we have (recalling that vectors are mappings)

$$\mu(\sigma)(v_1, \dots, v_k)_q = \begin{cases} \mu_1(\sigma)(v_1|_{Q_1}, \dots, v_k|_{Q_1})_q & \text{if } q \in Q_1 \\ \mu_2(\sigma)(v_1|_{Q_2}, \dots, v_k|_{Q_2})_q & \text{otherwise} \end{cases},$$

- and let $\gamma : B^{Q_1 \cup Q_2} \rightarrow B$ be a mapping such that, for each $u \in B^{Q_1 \cup Q_2}$, we have $\gamma(u) = \gamma_1(u|_{Q_1}) \oplus \gamma_2(u|_{Q_2})$.

It is easy to see that $\mu(\sigma) \in \mathcal{L}(\mathbf{V}^k, \mathbf{V})$ for every $k \in \mathbb{N}$ and $\sigma \in \Sigma^{(k)}$, and that γ is a linear form. Hence $(\mathbf{V}, \mu, \gamma)$ is a (Σ, \mathbf{B}) -multilinear representation.

By induction on \mathbf{T}_Σ , it is also easy to show that $h_{\mathbf{V}}(\xi) = h_{\mathbf{V}_1}(\xi) \cup h_{\mathbf{V}_2}(\xi)$ for each $\xi \in \mathbf{T}_\Sigma$. Then, for each $\xi \in \mathbf{T}_\Sigma$, we have

$$\gamma(h_{\mathbf{V}}(\xi)) = \gamma(h_{\mathbf{V}_1}(\xi) \cup h_{\mathbf{V}_2}(\xi)) = \gamma_1(h_{\mathbf{V}_1}(\xi)) \oplus \gamma_2(h_{\mathbf{V}_2}(\xi)) = r_1(\xi) \oplus r_2(\xi),$$

i.e., $(\mathbf{V}, \mu, \gamma)$ recognizes $r_1 \oplus r_2$. □

Example 3.6.3. [BR82, Ex. 4.1] Here we show an example of a multilinear representation for the field Rat of rational numbers. For this, we consider the weighted tree language $\text{size} : \mathbf{T}_\Sigma \rightarrow \mathbb{Q}$ (cf. Example 3.2.3) over the Rat and we show that size is recognizable by a (Σ, Rat) -multilinear representation.

For each $\delta \in \Sigma$, we define the mapping $\text{size}_\delta : \mathbf{T}_\Sigma \rightarrow \mathbb{Q}$ by $\text{size}_\delta(\xi) = |\text{pos}_\delta(\xi)|$. Then we have $\text{size} = \bigoplus_{\delta \in \Sigma} \text{size}_\delta$. By Lemma 3.6.2, a finite sum of weighted tree languages which are recognizable by (Σ, Rat) -multilinear representation is also recognizable by a (Σ, Rat) -multilinear representation. Hence, it suffices to prove, for an arbitrary but fixed δ that size_δ is recognizable by some (Σ, \mathbb{Q}) -multilinear

⁵called ‘multilinear representation of \mathbf{T}_Σ ’ in [BR82]

representation. From now on let $\delta \in \Sigma$ be arbitrary, but fixed. We assume that δ has rank ℓ for some $\ell \in \mathbb{N}$.

We define the (Σ, Rat) -multilinear representation $(\text{Rat}^2, \mu, \gamma)$ with the $\text{Rat}^2 = (\mathbb{Q}^2, +, (0, 0))$ in the following way. Certainly, it is sufficient to define each multilinear operation $\mu_k(\sigma)$ (for $k \in \mathbb{N}$ and $\sigma \in \Sigma^{(k)}$) and γ on the basis vectors $e_1 = (1, 0)$ and $e_2 = (0, 1)$. For every $e_{i_1}, \dots, e_{i_\ell} \in \{e_1, e_2\}$, we define

$$\mu(\delta)(e_{i_1}, \dots, e_{i_\ell}) = \begin{cases} e_1 + e_2 & \text{if } i_1 = \dots = i_\ell = 1 \\ e_2 & \text{if there exists exactly one } j \in [\ell] \text{ with } i_j = 2 \\ (0, 0) & \text{otherwise,} \end{cases}$$

and, for every $\sigma \in \Sigma^{(k)}$ with $k \in \mathbb{N}$ and $\sigma \neq \delta$ and $e_{i_1}, \dots, e_{i_k} \in \{e_1, e_2\}$, we define

$$\mu(\sigma)(e_{i_1}, \dots, e_{i_k}) = \begin{cases} e_1 & \text{if } i_1 = \dots = i_k = 1 \\ e_2 & \text{if there exists exactly one } j \in [k] \text{ with } i_j = 2 \\ (0, 0) & \text{otherwise.} \end{cases}$$

Thus, in particular, for $\alpha \in \Sigma^{(0)}$, this gives

$$\mu(\alpha)(()) = \begin{cases} e_1 + e_2 & \text{if } \alpha = \delta \\ e_1 & \text{otherwise.} \end{cases} \quad (3.30)$$

Finally, we define $\gamma(e_1) = 0$ and $\gamma(e_2) = 1$.

Next, by induction on T_Σ , we prove that the following statement holds:

$$\text{For every } \xi \in T_\Sigma: \quad \text{h}_{\text{Rat}^2}(\xi) = e_1 + \text{size}_\delta(\xi)e_2. \quad (3.31)$$

I.B.: Let $\xi \in \Sigma^{(0)}$. Then (3.31) follows from (3.30).

I.S.: Now let $\xi = \sigma(\xi_1, \dots, \xi_k)$. Then, using the multilinearity at equations marked by *, we can calculate as follows:

$$\begin{aligned} \text{h}_{\text{Rat}^2}(\xi) &= \mu(\sigma)(\text{h}_{\text{Rat}^2}(\xi_1), \dots, \text{h}_{\text{Rat}^2}(\xi_k)) \\ &= \mu(\sigma)(e_1 + \text{size}_\delta(\xi_1)e_2, \dots, e_1 + \text{size}_\delta(\xi_k)e_2) && \text{(by I.H.)} \\ &=^* \mu(\sigma)(e_1, \dots, e_1) + \bigoplus_{i \in [k]} \mu(\sigma)(e_1, \dots, e_1, \text{size}_\delta(\xi_i)e_2, e_1, \dots, e_1) \\ &\quad + \bigoplus_{1 \leq i < j \leq k} \mu(\sigma)(\dots, \text{size}_\delta(\xi_i)e_2, \dots, \text{size}_\delta(\xi_j)e_2, \dots) \\ &=^* \mu(\sigma)(e_1, \dots, e_1) + \bigoplus_{i \in [k]} \text{size}_\delta(\xi_i) \mu(\sigma)(e_1, \dots, e_1, e_2, e_1, \dots, e_1) \\ &\quad + \bigoplus \dots \text{size}_\delta(\xi_i) \dots \text{size}_\delta(\xi_j) \dots \mu(\sigma)(\dots, e_2, \dots, e_2, \dots) \\ &= \mu(\sigma)(e_1, \dots, e_1) + \bigoplus_{i \in [k]} \text{size}_\delta(\xi_i)e_2 + (0, 0) \\ &= \begin{cases} e_1 + e_2 + \bigoplus_{i \in [k]} \text{size}_\delta(\xi_i)e_2 & \text{if } \sigma = \delta \\ e_1 + \bigoplus_{i \in [k]} \text{size}_\delta(\xi_i)e_2 & \text{otherwise.} \end{cases} \end{aligned}$$

This proves (3.31). Finally, it is easy to see that $\gamma(\text{h}_{\text{Rat}^2}(\xi)) = \text{size}_\delta(\xi)$ for each $\xi \in T_\Sigma$. This means that size_δ is recognizable by the (Σ, Rat) -multilinear representation $(\text{Rat}^2, \mu, \gamma)$. Thus size is recognizable by some (Σ, Rat) -multilinear representation. \square

3.6.2 Relationship between wta and multilinear representations

Let (V, μ, γ) be a (Σ, B) -multilinear representation with $V = (B^Q, \oplus, \mathbb{0}_Q)$. Moreover, let $\mathcal{A} = (Q, \delta, F)$ be a (Σ, B) -wta. We recall that $V(\mathcal{A}) = (B^Q, \delta_{\mathcal{A}})$ is the vector algebra of \mathcal{A} .

We say that (V, μ, γ) and \mathcal{A} are *related* if

- for every $k \in \mathbb{N}$, $\sigma \in \Sigma^{(k)}$, and $q, q_1, \dots, q_k \in Q$, the equation

$$\mu(\sigma)(\mathbb{1}_{q_1}, \dots, \mathbb{1}_{q_k})_q = \delta_k(q_1 \cdots q_k, \sigma, q)$$

holds, and

- for every $q \in Q$, the equation $\gamma(\mathbb{1}_q) = F_q$ holds.

The intention of the first condition in the definition of relatedness is that μ and $\delta_{\mathcal{A}}$ should play the same role. In order to formalize this, we first prove that each $\delta_{\mathcal{A}}(\sigma)$ is a multilinear operation.

Lemma 3.6.4. (cf. [Boz99]) Let $\mathcal{A} = (Q, \delta, F)$ be a (Σ, B) -wta. For every $k \in \mathbb{N}$ and $\sigma \in \Sigma^{(k)}$, the operation $\delta_{\mathcal{A}}(\sigma)$ is multilinear.

Proof. Let $k \in \mathbb{N}$, $\sigma \in \Sigma^{(k)}$, $i \in [k]$, $b, b' \in B$, $v_1, \dots, v_k, v, v' \in B^Q$, and $q \in Q$. Then we can calculate as follows.

$$\begin{aligned} & \delta_{\mathcal{A}}(\sigma)(v_1, \dots, v_{i-1}, b \cdot v \oplus b' \cdot v', v_{i+1}, \dots, v_k)_q \\ &= \bigoplus_{q_1 \cdots q_k \in Q^k} \left(\bigotimes_{j \in [1, i-1]} (v_j)_{q_j} \right) \otimes (b \cdot v \oplus b' \cdot v')_{q_i} \otimes \left(\bigotimes_{j \in [i+1, k]} (v_j)_{q_j} \right) \otimes \delta_k(q_1 \cdots q_k, \sigma, q) \\ &= \bigoplus_{q_1 \cdots q_k \in Q^k} \left(\bigotimes_{j \in [1, i-1]} (v_j)_{q_j} \right) \otimes (b \otimes v_{q_i} \oplus b' \otimes (v')_{q_i}) \otimes \left(\bigotimes_{j \in [i+1, k]} (v_j)_{q_j} \right) \otimes \delta_k(q_1 \cdots q_k, \sigma, q) \\ &= \bigoplus_{q_1 \cdots q_k \in Q^k} \left[\left(\bigotimes_{j \in [1, i-1]} (v_j)_{q_j} \right) \otimes b \otimes v_{q_i} \otimes \left(\bigotimes_{j \in [i+1, k]} (v_j)_{q_j} \right) \otimes \delta_k(q_1 \cdots q_k, \sigma, q) \right. \\ & \quad \left. \oplus \left(\bigotimes_{j \in [1, i-1]} (v_j)_{q_j} \right) \otimes b' \otimes (v')_{q_i} \otimes \left(\bigotimes_{j \in [i+1, k]} (v_j)_{q_j} \right) \otimes \delta_k(q_1 \cdots q_k, \sigma, q) \right] \\ & \hspace{15em} \text{(by distributivity of } B) \\ &= \bigoplus_{q_1 \cdots q_k \in Q^k} \left[\left(\bigotimes_{j \in [1, i-1]} (v_j)_{q_j} \right) \otimes b \otimes v_{q_i} \otimes \left(\bigotimes_{j \in [i+1, k]} (v_j)_{q_j} \right) \otimes \delta_k(q_1 \cdots q_k, \sigma, q) \right] \\ & \quad \oplus \bigoplus_{q_1 \cdots q_k \in Q^k} \left[\left(\bigotimes_{j \in [1, i-1]} (v_j)_{q_j} \right) \otimes b' \otimes (v')_{q_i} \otimes \left(\bigotimes_{j \in [i+1, k]} (v_j)_{q_j} \right) \otimes \delta_k(q_1 \cdots q_k, \sigma, q) \right] \\ &= b \otimes \left[\bigoplus_{q_1 \cdots q_k \in Q^k} \left(\bigotimes_{j \in [1, i-1]} (v_j)_{q_j} \right) \otimes v_{q_i} \otimes \left(\bigotimes_{j \in [i+1, k]} (v_j)_{q_j} \right) \otimes \delta_k(q_1 \cdots q_k, \sigma, q) \right] \\ & \quad \oplus b' \otimes \left[\bigoplus_{q_1 \cdots q_k \in Q^k} \left(\bigotimes_{j \in [1, i-1]} (v_j)_{q_j} \right) \otimes (v')_{q_i} \otimes \left(\bigotimes_{j \in [i+1, k]} (v_j)_{q_j} \right) \otimes \delta_k(q_1 \cdots q_k, \sigma, q) \right] \\ & \hspace{15em} \text{(by commutativity and distributivity)} \\ &= b \otimes \delta_{\mathcal{A}}(\sigma)(v_1, \dots, v_{i-1}, v, v_{i+1}, \dots, v_k)_q \oplus b' \otimes \delta_{\mathcal{A}}(\sigma)(v_1, \dots, v_{i-1}, v', v_{i+1}, \dots, v_k)_q \\ &= (b \cdot \delta_{\mathcal{A}}(\sigma)(v_1, \dots, v_{i-1}, v, v_{i+1}, \dots, v_k) \oplus b' \cdot \delta_{\mathcal{A}}(\sigma)(v_1, \dots, v_{i-1}, v', v_{i+1}, \dots, v_k))_q . \end{aligned}$$

Hence $\delta_{\mathcal{A}}(\sigma)$ is multilinear. \square

Now we can show the semantic implications of the relatedness between a multilinear representation and a wta.

Lemma 3.6.5. Let (V, μ, γ) with $V = (B^Q, \oplus, 0_Q)$ and $\mathcal{A} = (Q, \delta, F)$ be related. Then

- $\mu(\sigma) = \delta_{\mathcal{A}}(\sigma)$ for each $\sigma \in \Sigma$,
- for every $\xi \in T_{\Sigma}$ and $q \in Q$ we have that $\text{h}_V(\xi)_q = \text{h}_{\mathcal{A}}(\xi)_q$, and
- for every $\xi \in T_{\Sigma}$ we obtain: $\gamma(\text{h}_V(\xi)) = \llbracket \mathcal{A} \rrbracket^{\text{init}}(\xi)$.

Proof. Let $k \in \mathbb{N}$, $\sigma \in \Sigma^{(k)}$, and $q, q_1, \dots, q_k \in Q$. Then we have

$$\mu(\sigma)(\mathbb{1}_{q_1}, \dots, \mathbb{1}_{q_k})_q = \delta_k(q_1 \cdots q_k, \sigma, q) = \delta_{\mathcal{A}}(\sigma)(\mathbb{1}_{q_1}, \dots, \mathbb{1}_{q_k})_q,$$

where the first equality holds by relatedness and the second one holds by the definition of $\delta_{\mathcal{A}}(\sigma)$. Since $\mu(\sigma)$ is multilinear (by definition) and $\delta_{\mathcal{A}}(\sigma)$ is multilinear (due to Lemma 3.6.4) and they coincide on unit vectors, we obtain that $\mu(\sigma) = \delta_{\mathcal{A}}(\sigma)$. This proves the first statement.

The second statement follows from the fact that the two Σ -algebras (B^Q, μ) and $(B^Q, \delta_{\mathcal{A}})$ and hence also the two Σ -algebra homomorphisms h_V and $\text{h}_{\mathcal{A}}$ are equal. Now let $\xi \in T_{\Sigma}$. Then

$$\llbracket \mathcal{A} \rrbracket^{\text{init}}(\xi) = \bigoplus_{q \in Q} \text{h}_{\mathcal{A}}(\xi)_q \otimes F_q = \bigoplus_{j \in [\kappa]} \text{h}_{\mathcal{A}}(\xi)_{q_j} \otimes F_{q_j} = \bigoplus_{j \in [\kappa]} \text{h}_V(\xi)_{q_j} \otimes \gamma(\mathbb{1}_{q_j}) = \gamma(\text{h}_V(\xi)). \quad \square$$

The next theorem contains a characterization of recognizability in terms of multilinear representations. For the case that the weight algebra \mathbf{B} is a field, the proof was sketched in [FV09, Thm. 3.52]. Already in [Bor04, p. 518], direct constructions have been indicated. There, the author deals with the concepts of \mathbf{B} -vector space and basis, and thereby gives the impression that \mathbf{B} is a field. On the background of this understanding, it is a bit puzzling that the author mentions twice the condition that “the underlying semiring is commutative”, as if the indicated constructions would also hold for commutative semirings. Anyway, the characterization for the case that \mathbf{B} is a commutative semiring has been (re)discovered in [Dro22].

Theorem 3.6.6. [Dro22] *Let Σ be a ranked alphabet. Moreover, let $\mathbf{B} = (B, \oplus, \otimes, 0, \mathbb{1})$ be a commutative semiring and let $r : T_{\Sigma} \rightarrow B$. Then the following two statements are equivalent.*

- (A) *We can construct a (Σ, \mathbf{B}) -multilinear representation which recognizes r .*
- (B) *We can construct a (Σ, \mathbf{B}) -wta which i -recognizes r .*

Proof. Proof of (A) \Rightarrow (B): Let $r : T_{\Sigma} \rightarrow B$ be recognizable by the (Σ, \mathbf{B}) -multilinear representation (V, μ, γ) with $V = (B^Q, \oplus, 0_Q)$ for some finite set Q . Hence $r(\xi) = \gamma(\text{h}_V(\xi))$ for every $\xi \in T_{\Sigma}$.

It is easy to construct a (Σ, \mathbf{B}) -wta $\mathcal{A} = (Q, \delta, F)$ such that (V, μ, γ) and \mathcal{A} are related. Hence, by Lemma 3.6.5, for every $\xi \in T_{\Sigma}$ we obtain: $\gamma(\text{h}_V(\xi)) = \llbracket \mathcal{A} \rrbracket^{\text{init}}(\xi)$.

Proof of (B) \Rightarrow (A): Let $r : T_{\Sigma} \rightarrow B$ be i -recognizable by some (Σ, \mathbf{B}) -wta $\mathcal{A} = (Q, \delta, F)$ with $Q = \{q_1, \dots, q_{\kappa}\}$. By Observation 3.6.1, $(B^Q, +, 0_Q)$ is a \mathbf{B} -semimodule and for every $k \in \mathbb{N}$ and $\sigma \in \Sigma^{(k)}$, the operation $\delta_{\mathcal{A}}(\sigma)$ is multilinear. We define the linear form $\gamma : B^Q \rightarrow B$ such that, for each $v = b_1 \cdot \mathbb{1}_{q_1} \oplus \dots \oplus b_{\kappa} \cdot \mathbb{1}_{q_{\kappa}}$ in B^Q , we let $\gamma(v) = \bigoplus_{j \in [\kappa]} b_j \otimes F_{q_j}$. In particular, $\gamma(\mathbb{1}_{q_j}) = F_{q_j}$ for each $j \in [\kappa]$. Then $(B^Q, \delta_{\mathcal{A}}, \gamma)$ is a (Σ, \mathbf{B}) -multilinear representation and, moreover, $(B^Q, \delta_{\mathcal{A}}, \gamma)$ and \mathcal{A} are related. Thus it follows from Lemma 3.6.5 that $\gamma(\text{h}_V(\xi)) = \llbracket \mathcal{A} \rrbracket^{\text{init}}(\xi)$ for every $\xi \in T_{\Sigma}$. \square

Finally, we note that Theorem 3.6.6 might be understood as the tree version of the well-known result for wsa that a weighted string language is run recognizable iff it has a linear representation (λ, μ, γ) (cf. [Eil74, Cor. 6.2], [BR88, Ch. I, Sect. 5], and [DK21, Thm. 3.2]).

3.7 Extension of the weight algebra

We finish this chapter with an easy observation on the extension of the weight algebra of a (Σ, \mathbf{B}) -wta \mathcal{A} . If \mathbf{C} is a strong bimonoid such that \mathbf{B} is a subalgebra of \mathbf{C} , then we say that \mathbf{C} is an *extension* of \mathbf{B} .

If this is the case, then we can view each (Σ, \mathbf{B}) -wta \mathcal{A} as a (Σ, \mathbf{C}) -wta. Moreover, the run semantics and the initial algebra semantics of the (Σ, \mathbf{C}) -wta \mathcal{A} are the same as the corresponding semantics of the (Σ, \mathbf{B}) -wta \mathcal{A} . Thus we obtain the following observation.

Observation 3.7.1. Let the strong bimonoid \mathbf{C} be an extension of \mathbf{B} . Then $\text{Rec}^{\text{run}}(\Sigma, \mathbf{B}) \subseteq \text{Rec}^{\text{run}}(\Sigma, \mathbf{C})$ and $\text{Rec}^{\text{init}}(\Sigma, \mathbf{B}) \subseteq \text{Rec}^{\text{init}}(\Sigma, \mathbf{C})$. \square

One might also think of the following inverse problem. Is it true that, for each extension \mathbf{C} of \mathbf{B} , the inclusions

$$\text{Rec}^{\text{run}}(\Sigma, \mathbf{C}) \cap B^{\text{T}\Sigma} \subseteq \text{Rec}^{\text{run}}(\Sigma, \mathbf{B}) \quad \text{and} \quad \text{Rec}^{\text{init}}(\Sigma, \mathbf{C}) \cap B^{\text{T}\Sigma} \subseteq \text{Rec}^{\text{init}}(\Sigma, \mathbf{B}) \quad (3.32)$$

hold?

An extension \mathbf{C} of \mathbf{B} for which (3.32) holds, is called *Fatou extension of \mathbf{B}* (cf. [BR88, Ch. V]). For instance, for string ranked alphabets, the ring of integers is not a Fatou extension of the semiring of natural numbers [KS86, Ex. 8.1] (also cf. Lemma 14.2.5). In contrast, for the case that Σ is a string ranked alphabet, the semiring $\text{Rat}_{\geq 0}$ is a Fatou extension of the semiring Nat of natural numbers [Fli75] (also cf. [BR88, Thm. 3.3]); moreover, for every two fields \mathbf{B} and \mathbf{C} , if \mathbf{C} is an extension of \mathbf{B} , then \mathbf{C} is a Fatou extension of \mathbf{B} [Fli74] (also cf. [BR88, Thm. 3.1]). Recently, the latter result has been extended to wta in [Dro22].

Chapter 4

Basic properties of wta

This chapter concerns basic properties of each wta. In particular, we show that the annihilation property of the strong bimonoids propagates over the computation of the semantics of a wta (cf. Section 4.1). We show how we can extend the arity of input symbols by nullary symbols (padding) without changing the semantics (cf. Section 4.2). Finally, we deal with the images of the semantics of a wta; in particular, we prove a universality property and conditions on the finiteness of the images of the semantics (cf. Section 4.3).

4.1 Annihilation in wta

In this section, we show that the annihilation property (i.e., $0 \otimes b = b \otimes 0 = 0$) propagates over runs of a (Σ, \mathbf{B}) -wta \mathcal{A} on an input tree $\xi \in \Sigma$ and over Q -vectors $h_{\mathcal{A}}(\xi)$ (where Q is the set of states of \mathcal{A} ; cf. Lemma 4.1.1). If \mathcal{A} is bu-deterministic, then for each input tree $\xi \in T_{\Sigma}$, there exists at most one run $\rho \in R_{\mathcal{A}}(\xi)$ with weight different from 0 , and at most one component q of $h_{\mathcal{A}}(\xi)$ is different from 0 ; moreover, such a ρ exists if and only if such a component q exists, and if they exist, then $\text{wt}_{\mathcal{A}}(\xi, \rho) = h_{\mathcal{A}}(\xi)_q$ (cf. Lemma 4.1.2). If \mathcal{A} is crisp-deterministic, then we can replace in the previous sentence “at most one” by “exactly once” and $\text{wt}_{\mathcal{A}}(\xi, \rho) = h_{\mathcal{A}}(\xi)_q = \mathbb{1}$ (cf. Lemma 4.1.5). Moreover, we prove a characterization result which involves the congruence $\ker(h_{\mathcal{A}})$ (cf. Theorem 4.1.9).

4.1.1 Annihilation in arbitrary wta

Let $\mathcal{A} = (Q, \delta, F)$ be a (Σ, \mathbf{B}) -wta. For each $\xi \in T_{\Sigma}$ we define the sets

$$\begin{aligned} Q_{\neq 0}^{\text{h}_{\mathcal{A}}}(\xi) &= \{q \in Q \mid h_{\mathcal{A}}(\xi)_q \neq 0\}, \text{ and} \\ Q_{\neq 0}^{\text{R}_{\mathcal{A}}}(\xi) &= \{q \in Q \mid \exists(\rho \in R_{\mathcal{A}}(q, \xi)) \text{ such that } \text{wt}(\xi, \rho) \neq 0\} . \end{aligned}$$

Since 0 is annihilating with respect to the multiplication of \mathbf{B} , we obtain the following zero-propagation statements (where the second statement can be compared to [Bor04, Cor. 3.6]).

Lemma 4.1.1. Let $\xi \in T_{\Sigma}$ and $w \in \text{pos}(\xi)$. Then the following two statements hold.

- (1) If $Q_{\neq 0}^{\text{h}_{\mathcal{A}}}(\xi|_w) = \emptyset$, then $Q_{\neq 0}^{\text{h}_{\mathcal{A}}}(\xi) = \emptyset$.
- (2) If $Q_{\neq 0}^{\text{R}_{\mathcal{A}}}(\xi|_w) = \emptyset$, then $Q_{\neq 0}^{\text{R}_{\mathcal{A}}}(\xi) = \emptyset$.

Proof. Let $\xi \in T_{\Sigma}$ and $w \in \text{pos}(\xi)$. We define the reduction system $(\text{prefix}(w), \succ)$ where, for every $w_1, w_2 \in \text{prefix}(w)$, we let $w_1 \succ w_2$ if there exists a $j \in \mathbb{N}$ such that $w_2 = w_1 j$. Since $\text{prefix}(w)$ is finite, the relation \succ is terminating. Moreover, we have that \succ is terminating and $\text{nf}_{\succ}(\text{prefix}(w)) = \{w\}$.

Proof of (1): We assume that $Q_{\neq 0}^{\text{h}_A}(\xi|_w) = \emptyset$. By induction on $(\text{prefix}(w), \succ)$, we prove that the following statement holds:

$$\text{For each } w' \in \text{prefix}(w), \text{ we have } Q_{\neq 0}^{\text{h}_A}(\xi|_{w'}) = \emptyset . \quad (4.1)$$

I.B.: Let $w' = w$. Then the statement holds by assumption.

I.S.: Now let $w' \in \text{prefix}(w) \setminus \{w\}$ and $\xi(w') = \sigma$ for some $\sigma \in \Sigma^{(k)}$ and $k \in \mathbb{N}$. Since $w' \in \text{prefix}(w) \setminus \{w\}$, we have that $k \geq 1$ and there exists a $j \in [k]$ such that $w'j \in \text{prefix}(w)$. Moreover, for each $q \in Q$, we have

$$h_A(\xi|_{w'})_q = h_A(\sigma(\xi|_{w'1}, \dots, \xi|_{w'k}))_q = \bigoplus_{q_1 \cdots q_k \in Q^k} \left(\bigotimes_{i \in [k]} h_A(\xi|_{w'i})_{q_i} \right) \otimes \delta(q_1 \cdots q_k, \sigma, q) .$$

Then, by the I.H., $Q_{\neq 0}^{\text{h}_A}(\xi|_{w'j}) = \emptyset$ and thus for each $q_j \in Q$ we have $h_A(\xi|_{w'j})_{q_j} = 0$. Hence each of the summands is a product in which the j -th factor is 0. Consequently, each summand is 0 and thus $h_A(\xi|_{w'})_q = 0$. This proves (4.1).

Finally, $Q_{\neq 0}^{\text{h}_A}(\xi) = \emptyset$ follows from (4.1) with $w' = \varepsilon$. Thus Statement (1) holds.

Proof of (2): We assume that $Q_{\neq 0}^{\text{R}_A}(\xi|_w) = \emptyset$. Then, by induction on $(\text{prefix}(w), \succ)$, we prove that the following statement holds:

$$\text{For each } w' \in \text{prefix}(w), \text{ we have } Q_{\neq 0}^{\text{R}_A}(\xi|_{w'}) = \emptyset . \quad (4.2)$$

I.B.: Let $w' = w$. Then the statement holds by assumption.

I.S.: Now let $w' \in \text{prefix}(w) \setminus \{w\}$. Let $\xi(w') = \sigma$ for some $\sigma \in \Sigma^{(k)}$ and $k \in \mathbb{N}$. Since $w' \in \text{prefix}(w) \setminus \{w\}$, we have that $k \geq 1$ and there exists a $j \in [k]$ such that $w'j \in \text{prefix}(w)$.

Let $q \in Q$ and ρ be an arbitrary run in $R_A(q, \xi|_{w'})$. The weight of ρ , by definition, is

$$\text{wt}(\xi|_{w'}, \rho) = \left(\bigotimes_{i \in [k]} \text{wt}(\xi|_{w'i}, \rho|_i) \right) \otimes \delta(\rho(1) \cdots \rho(k), \sigma, q) .$$

By the I.H. $Q_{\neq 0}^{\text{R}_A}(\xi|_{w'j}) = \emptyset$, hence $\text{wt}(\xi|_{w'j}, \rho|_{w'j}) = 0$. This implies $\text{wt}(\xi|_{w'}, \rho) = 0$ and thus (4.2) holds.

Then $Q_{\neq 0}^{\text{R}_A}(\xi) = \emptyset$ follows from (4.2) for $w' = \varepsilon$. Thus Statement (2) holds. \square

4.1.2 Annihilation in bu-deterministic wta

Next we consider an arbitrary bu-deterministic (Σ, \mathbf{B}) -wta $\mathcal{A} = (Q, \delta, F)$. Thus, for every $k \in \mathbb{N}$, $\sigma \in \Sigma^{(k)}$, and $w \in Q^k$ there exists at most one $q \in Q$ such that $\delta_k(w, \sigma, q) \neq 0$. This fact has the following consequences.

Lemma 4.1.2. [FKV21, Lm. 3.5] Let Σ be a ranked alphabet. Moreover, let $\mathbf{B} = (B, \oplus, \otimes, 0, \mathbb{1})$ be a strong bimonoid, let $\mathcal{A} = (Q, \delta, F)$ be a bu-deterministic (Σ, \mathbf{B}) -wta, and let $\xi \in T_\Sigma$. Then the following three statements hold.

- (1) $|Q_{\neq 0}^{\text{h}_A}(\xi)| \leq 1$ (cf. [BV03, Thm. 3.6]).
- (2) $|Q_{\neq 0}^{\text{R}_A}(\xi)| \leq 1$.
- (3) Either (a) $Q_{\neq 0}^{\text{h}_A}(\xi) = \emptyset = Q_{\neq 0}^{\text{R}_A}(\xi)$ or (b) there exists a $q \in Q$ such that $Q_{\neq 0}^{\text{h}_A}(\xi) = \{q\} = Q_{\neq 0}^{\text{R}_A}(\xi)$, there exists a $\rho \in R_A(q, \xi)$ with $\text{wt}(\xi, \rho) \neq 0$ and $h_A(\xi)_q = \text{wt}(\xi, \rho)$, and for each $\rho' \in R_A(q, \xi) \setminus \{\rho\}$ we have $\text{wt}(\xi, \rho') = 0$.

Proof. Proof of (1): We prove the statement by induction on T_Σ . Let $\xi = \sigma(\xi_1, \dots, \xi_k)$. We assume that $|Q_{\neq 0}^{\text{h}_A}(\xi_i)| \leq 1$ for each $i \in [k]$ (I.H.), and we continue by case analysis.

Case (1a): There exists an $i \in [k]$ such that $|\mathbb{Q}_{\neq 0}^{\mathcal{A}}(\xi_i)| = 0$. Then by Lemma 4.1.1(1) also $|\mathbb{Q}_{\neq 0}^{\mathcal{A}}(\xi)| = 0$.

Case (1b): For each $i \in [k]$, we have $|\mathbb{Q}_{\neq 0}^{\mathcal{A}}(\xi_i)| = 1$. Let $\mathbb{Q}_{\neq 0}^{\mathcal{A}}(\xi_i) = \{q_{\xi_i}\}$. Then for each $q \in Q$:

$$\begin{aligned} \mathfrak{h}_{\mathcal{A}}(\sigma(\xi_1, \dots, \xi_k))_q &= \bigoplus_{q_1 \cdots q_k \in Q^k} \left(\bigotimes_{i \in [k]} \mathfrak{h}_{\mathcal{A}}(\xi_i)_{q_i} \right) \otimes \delta_k(q_1 \cdots q_k, \sigma, q) \\ &= \left(\bigotimes_{i \in [k]} \mathfrak{h}_{\mathcal{A}}(\xi_i)_{q_{\xi_i}} \right) \otimes \delta_k(q_{\xi_1} \cdots q_{\xi_k}, \sigma, q) . \end{aligned}$$

Since \mathcal{A} is bu-deterministic, there exists at most one $q \in Q$ such that $\delta_k(q_{\xi_1} \cdots q_{\xi_k}, \sigma, q) \neq 0$. Thus $|\mathbb{Q}_{\neq 0}^{\mathcal{A}}(\sigma(\xi_1, \dots, \xi_k))| \leq 1$. (We note that, since \mathbb{B} may contain zero-divisors, the cardinality of this set can be 0.)

Proof of (2): Its proof is very similar to that of Statement (1).

Proof of (3): We prove the statement by induction on T_{Σ} . Let $\xi = \sigma(\xi_1, \dots, \xi_k)$. If $\mathbb{Q}_{\neq 0}^{\mathcal{A}}(\xi) = \emptyset = \mathbb{Q}_{\neq 0}^{\mathcal{R}\mathcal{A}}(\xi)$, then we are done. Otherwise, first assume that $\mathbb{Q}_{\neq 0}^{\mathcal{A}}(\xi) \neq \emptyset$. Then, by Statement (1), $\mathbb{Q}_{\neq 0}^{\mathcal{A}}(\xi) = \{q\}$ for some $q \in Q$ and, by Lemma 4.1.1(1), $\mathbb{Q}_{\neq 0}^{\mathcal{A}}(\xi_i) \neq \emptyset$ for every $i \in [k]$. By the I.H, for every $i \in [k]$ there exists a $q_i \in Q$ such that $\mathbb{Q}_{\neq 0}^{\mathcal{A}}(\xi_i) = \{q_i\} = \mathbb{Q}_{\neq 0}^{\mathcal{R}\mathcal{A}}(\xi_i)$ and there exists exactly one $\rho_i \in \mathcal{R}_{\mathcal{A}}(q_i, \xi_i)$ with $\text{wt}(\xi_i, \rho_i) \neq 0$ and $\mathfrak{h}_{\mathcal{A}}(\xi_i)_{q_i} = \text{wt}(\xi_i, \rho_i)$. Now we define the run $\rho \in \mathcal{R}_{\mathcal{A}}(q, \xi)$ by $\rho(\varepsilon) = q$, and $\rho(iw) = \rho_i(w)$ for every $i \in [k]$ and $w \in \text{pos}(\xi_i)$. Then we have

$$\begin{aligned} \text{wt}(\xi, \rho) &= \left(\bigotimes_{i \in [k]} \text{wt}(\xi_i, \rho|_i) \right) \otimes \delta_k(\rho(1) \cdots \rho(k), \sigma, \rho(\varepsilon)) \\ &= \left(\bigotimes_{i \in [k]} \text{wt}(\xi_i, \rho_i) \right) \otimes \delta_k(q_1 \cdots q_k, \sigma, q) \\ &= \left(\bigotimes_{i \in [k]} \mathfrak{h}_{\mathcal{A}}(\xi_i)_{q_i} \right) \otimes \delta_k(q_1 \cdots q_k, \sigma, q) = \mathfrak{h}_{\mathcal{A}}(\xi)_q . \end{aligned}$$

Since $\mathfrak{h}_{\mathcal{A}}(\xi)_q \neq 0$, we have $\text{wt}(\xi, \rho) \neq 0$, i.e., $q \in \mathbb{Q}_{\neq 0}^{\mathcal{R}\mathcal{A}}(\xi)$, and thus, by Statement (2), $\mathbb{Q}_{\neq 0}^{\mathcal{R}\mathcal{A}}(\xi) = \{q\}$. Lastly, let $\rho' \in \mathcal{R}_{\mathcal{A}}(q, \xi)$ with $\rho' \neq \rho$. Using the definition of ρ , the assumption that ρ_i is the only run in $\mathcal{R}_{\mathcal{A}}(q_i, \xi_i)$ with $\text{wt}(\xi_i, \rho_i) \neq 0$ for each $i \in [k]$, and the fact that \mathcal{A} is bu-deterministic, it follows easily that $\text{wt}(\xi, \rho') = 0$.

The case $\mathbb{Q}_{\neq 0}^{\mathcal{R}\mathcal{A}}(\xi) \neq \emptyset$ can be proved similarly. \square

A consequence of Lemma 4.1.2 is that, for each bu-deterministic wta, its run semantics coincides with its initial algebra semantics. We will deal with this topic in Section 5.3. Here we present two easy consequences of Lemma 4.1.2.

Corollary 4.1.3. For each bu-deterministic (Σ, \mathbb{B}) -wta \mathcal{A} , we have that (1) $\text{im}(\llbracket \mathcal{A} \rrbracket^{\text{init}}) \subseteq \langle \text{wts}(\mathcal{A}) \rangle_{\{\otimes\}}$ and (2) $\text{im}(\llbracket \mathcal{A} \rrbracket^{\text{run}}) \subseteq \langle \text{wts}(\mathcal{A}) \rangle_{\{\otimes\}}$.

Proof. Let $\mathcal{A} = (Q, \delta, F)$.

Proof of (1): First we prove by induction on T_{Σ} the following statement.

$$\text{For every } \xi \in T_{\Sigma} \text{ and } q \in Q \text{ we have } \mathfrak{h}_{\mathcal{A}}(\xi)_q \in \langle \text{im}(\delta) \rangle_{\{\otimes\}} . \quad (4.3)$$

For this let $\xi = \sigma(\xi_1, \dots, \xi_k)$. Then

$$\mathfrak{h}_{\mathcal{A}}(\sigma(\xi_1, \dots, \xi_k))_q = \bigoplus_{q_1 \cdots q_k \in Q^k} \left(\bigotimes_{i \in [k]} \mathfrak{h}_{\mathcal{A}}(\xi_i)_{q_i} \right) \otimes \delta_k(q_1 \cdots q_k, \sigma, q) .$$

By Lemma 4.1.2(3), we distinguish two cases.

Case (a): There exists $i \in [k]$ such that $Q_{\neq 0}^{\mathbf{h}_A}(\xi_i) = \emptyset$. Then for each $p \in Q$ we have $\mathbf{h}_A(\xi_i)_p = 0$. Thus, by using the I.H., we have $0 \in \langle \text{im}(\delta) \rangle_{\{\otimes\}}$. Moreover, $\mathbf{h}_A(\xi)_q = 0$ because each summand above is 0. Hence (4.3) holds.

Case (b): For each $i \in [k]$, there exists $p_i \in Q$ such that $Q_{\neq 0}^{\mathbf{h}_A}(\xi) = \{p_i\}$. Then we have

$$\mathbf{h}_A(\sigma(\xi_1, \dots, \xi_k))_q = \left(\bigotimes_{i \in [k]} \mathbf{h}_A(\xi_i)_{p_i} \right) \otimes \delta_k(p_1 \cdots p_k, \sigma, q) .$$

By the I.H., for each $i \in [k]$, we have $\mathbf{h}_A(\xi_i)_{p_i} \in \langle \text{im}(\delta) \rangle_{\{\otimes\}}$ and thus again (4.3) holds.

In order to prove (1), we show the following.

$$\text{For each } \xi \in T_\Sigma, \text{ we have } \llbracket \mathcal{A} \rrbracket^{\text{init}}(\xi) \in \langle \text{wts}(\mathcal{A}) \rangle_{\{\otimes\}} . \quad (4.4)$$

For this, let $\xi \in T_\Sigma$. Then

$$\llbracket \mathcal{A} \rrbracket^{\text{init}}(\xi) = \bigoplus_{q \in Q} \mathbf{h}_A(\xi)_q \otimes F_q .$$

If $Q_{\neq 0}^{\mathbf{h}_A}(\xi) = \emptyset$, then by (4.3) we obtain $0 \in \langle \text{im}(\delta) \rangle_{\{\otimes\}}$ and also $0 \in \langle \text{wts}(\mathcal{A}) \rangle_{\{\otimes\}}$. Moreover, $\llbracket \mathcal{A} \rrbracket^{\text{init}}(\xi) = 0$, hence (4.4) holds.

Otherwise there exists $p \in Q$ such that $Q_{\neq 0}^{\mathbf{h}_A}(\xi) = \{p\}$, i.e., $\llbracket \mathcal{A} \rrbracket^{\text{init}}(\xi) = \mathbf{h}_A(\xi)_p \otimes F_p$. Then by (4.3) we obtain (4.4).

Statement (2) can be show similarly, by using Lemma 4.1.2(3). \square

A further consequence of Lemma 4.1.2(3) is that both, the run semantics and the initial algebra semantics of a bu-deterministic (Σ, \mathbf{B}) -wta \mathcal{A} are determined by the multiplicative monoid of \mathbf{B} ; the additive part does not play any role (apart from its unit element). Hence, if we replace the addition by another operation such that the algebra is still a strong bimonoid, then both the run semantics and the initial algebra semantics of \mathcal{A} remain the same mapping. Below, we prove this statement and show some pairs of strong bimonoids which differ only in the definition of the addition.

Corollary 4.1.4. Let $\mathbf{B}_1 = (B, \oplus, \otimes, 0, \mathbb{1})$ and $\mathbf{B}_2 = (B, +, \otimes, 0, \mathbb{1})$ be strong bimonoids and $\mathcal{A} = (Q, \delta, F)$ be a bu-deterministic (Σ, \mathbf{B}_1) -wta. Then, for the bu-deterministic (Σ, \mathbf{B}_2) -wta $\mathcal{B} = (Q, \delta, F)$, we have (1) $\llbracket \mathcal{B} \rrbracket^{\text{run}} = \llbracket \mathcal{A} \rrbracket^{\text{run}}$ and (2) $\llbracket \mathcal{B} \rrbracket^{\text{init}} = \llbracket \mathcal{A} \rrbracket^{\text{init}}$.

Proof. It is obvious that, for every $\xi \in T_\Sigma$ and $q \in Q$, we have $R_{\mathcal{A}}(q, \xi) = R_{\mathcal{B}}(q, \xi)$. Moreover, for each $\rho \in R_{\mathcal{A}}(q, \xi)$, we have

$$\text{wt}_{\mathcal{A}}(\xi, \rho) = \text{wt}_{\mathcal{B}}(\xi, \rho) . \quad (4.5)$$

Hence it follows that

$$Q_{\neq 0}^{\mathbf{R}_{\mathcal{A}}}(\xi) = Q_{\neq 0}^{\mathbf{R}_{\mathcal{B}}}(\xi) . \quad (4.6)$$

Now let $\xi \in T_\Sigma$. By Lemma 4.1.2(3), we distinguish two cases.

Case (a): $Q_{\neq 0}^{\mathbf{h}_A}(\xi) = \emptyset = Q_{\neq 0}^{\mathbf{R}_{\mathcal{A}}}(\xi)$. Then, by (4.6) and Lemma 4.1.2(3) (applied to \mathcal{B}), we have $Q_{\neq 0}^{\mathbf{h}_B}(\xi) = \emptyset = Q_{\neq 0}^{\mathbf{R}_{\mathcal{B}}}(\xi)$. Hence, for each $\rho \in R_{\mathcal{A}}(\xi)$, we have $\text{wt}_{\mathcal{A}}(\xi, \rho) = 0 = \text{wt}_{\mathcal{B}}(\xi, \rho)$. Then

$$\llbracket \mathcal{A} \rrbracket^{\text{run}}(\xi) = \bigoplus_{\rho \in R_{\mathcal{A}}(\xi)} \text{wt}_{\mathcal{A}}(\xi, \rho) \otimes F_{\rho(\varepsilon)} = \bigoplus_{\rho \in R_{\mathcal{A}}(\xi)} 0 = 0 = \bigoplus_{\rho \in R_{\mathcal{B}}(\xi)} 0 = \bigoplus_{\rho \in R_{\mathcal{B}}(\xi)} \text{wt}_{\mathcal{B}}(\xi, \rho) \otimes F_{\rho(\varepsilon)} = \llbracket \mathcal{B} \rrbracket^{\text{run}}(\xi) .$$

Also, for each $q \in Q$, we have $\mathbf{h}_A(\xi)_q = 0 = \mathbf{h}_B(\xi)_q$. Then, obviously, $\llbracket \mathcal{A} \rrbracket^{\text{init}}(\xi) = 0 = \llbracket \mathcal{B} \rrbracket^{\text{init}}(\xi)$.

Case (b): There exists a $q \in Q$ such that $Q_{\neq 0}^{\mathbf{h}_A}(\xi) = \{q\} = Q_{\neq 0}^{\mathbf{R}_{\mathcal{A}}}(\xi)$, and there exists a $\rho \in R_{\mathcal{A}}(q, \xi)$ with $\text{wt}_{\mathcal{A}}(\xi, \rho) \neq 0$ and $\mathbf{h}_A(\xi)_q = \text{wt}_{\mathcal{A}}(\xi, \rho)$, and for each $\rho' \in R_{\mathcal{A}}(q, \xi) \setminus \{\rho\}$ we have $\text{wt}_{\mathcal{A}}(\xi, \rho') = 0$.

Again, by (4.6) and Lemma 4.1.2(3) (applied to \mathcal{B}), as well as (4.5), we obtain $Q_{\neq 0}^{\mathcal{B}}(\xi) = \{q\} = Q_{\neq 0}^{\mathcal{R}_{\mathcal{B}}}(\xi)$, $\text{wt}_{\mathcal{B}}(\xi, \rho) = \text{wt}_{\mathcal{A}}(\xi, \rho) \neq 0$ and $\text{h}_{\mathcal{B}}(\xi)_q = \text{wt}_{\mathcal{B}}(\xi, \rho)$, and for each $\rho' \in \mathcal{R}_{\mathcal{B}}(q, \xi) \setminus \{\rho\}$ we have $\text{wt}_{\mathcal{B}}(\xi, \rho') = 0$. Then we have

$$\begin{aligned} \llbracket \mathcal{A} \rrbracket^{\text{run}}(\xi) &= \bigoplus_{\rho' \in \mathcal{R}_{\mathcal{A}}(\xi)} \text{wt}_{\mathcal{A}}(\xi, \rho') \otimes F_{\rho'(\varepsilon)} = \text{wt}_{\mathcal{A}}(\xi, \rho) \otimes F_q = \text{wt}_{\mathcal{B}}(\xi, \rho) \otimes F_q \\ &= \bigoplus_{\rho' \in \mathcal{R}_{\mathcal{B}}(\xi)} \text{wt}_{\mathcal{B}}(\xi, \rho') \otimes F_{\rho'(\varepsilon)} = \llbracket \mathcal{B} \rrbracket^{\text{run}}(\xi) . \end{aligned}$$

Since $\text{wt}_{\mathcal{A}}(\xi, \rho) = \text{wt}_{\mathcal{B}}(\xi, \rho)$, we also have $\text{h}_{\mathcal{A}}(\xi)_q = \text{h}_{\mathcal{B}}(\xi)_q$. Moreover, for each $p \in Q \setminus \{q\}$, we have $\text{h}_{\mathcal{A}}(\xi)_p = 0 = \text{h}_{\mathcal{B}}(\xi)_p$. Hence, we obtain

$$\llbracket \mathcal{A} \rrbracket^{\text{init}}(\xi) = \bigoplus_{p \in Q} \text{h}_{\mathcal{A}}(\xi)_p \otimes F_p = \text{h}_{\mathcal{A}}(\xi)_q \otimes F_q = \text{h}_{\mathcal{B}}(\xi)_q \otimes F_q = \bigoplus_{p \in Q} \text{h}_{\mathcal{B}}(\xi)_p \otimes F_p = \llbracket \mathcal{B} \rrbracket^{\text{init}}(\xi) . \quad \square$$

Next we show three examples of pairs of strong bimonoids $\mathbf{B}_1 = (B, \oplus, \otimes, 0, \mathbb{1})$ and $\mathbf{B}_2 = (B, +, \otimes, 0, \mathbb{1})$:

- the strong bimonoids $([0, 1], \oplus, \cdot, 0, 1)$ and $([0, 1], +, \cdot, 0, 1)$ where \oplus and $+$ are t-conorms (cf. Example 2.7.10 (4)) and \cdot is the usual multiplication; examples of a t-conorm $u : [0, 1] \times [0, 1] \rightarrow [0, 1]$ are
 - the standard union $u(a, b) = \max(a, b)$,
 - the algebraic sum $u(a, b) = a + b - a \cdot b$, or
 - the bounded sum $u(a, b) = \min(a + b, 1)$,
- the Boolean semiring Boole and the field \mathbb{F}_2 with two elements (cf. Example 2.7.10 (7)), and
- the plus-plus strong bimonoid of natural numbers $\text{PP}_{\mathbb{N}} = (\mathbb{N}_0, \oplus, +, 0, 0)$ (cf. Example 2.7.10(8)) and the semiring $(\mathbb{N}_0, \max', +, 0, 0)$ where the binary operation \max' , if restricted to \mathbb{N} , is the usual operation \max on natural numbers (e.g. $\max(3, 2) = 3$). Moreover, $\max'(0, x) = \max'(x, 0) = x$ for each $x \in \mathbb{N}_0$.

We mention that Corollary 4.1.4 is meaningless if $\mathbf{B}_1 = (B, \oplus, \otimes, 0, \mathbb{1})$ and $\mathbf{B}_2 = (B, +, \otimes, 0, \mathbb{1})$ are bounded lattices because in this case $\oplus = +$. The latter can be seen as follows [Tep23]. Let \leq be the partial order on B defined by $a \leq b$ if $a \otimes b = a$ for every $a, b \in B$ (cf. Theorem 2.7.12(1)). Then, by Theorem 2.7.12(2) and the remark after that theorem, we have $a \oplus b = \sup_{\leq} \{a, b\} = a + b$ for every $a, b \in B$.

4.1.3 Annihilation in crisp-deterministic wta

Here we consider an arbitrary crisp-deterministic (Σ, \mathbf{B}) -wta $\mathcal{A} = (Q, \delta, F)$. Thus, for every $k \in \mathbb{N}$, $\sigma \in \Sigma^{(k)}$, and $w \in Q^k$ there exists a $q \in Q$ such that $\delta_k(w, \sigma, q) = \mathbb{1}$ and for every $q' \in Q$ with $q' \neq q$ we have $\delta_k(w, \sigma, q') = 0$.

Lemma 4.1.5. Let Σ be a ranked alphabet. Moreover, let $\mathbf{B} = (B, \oplus, \otimes, 0, \mathbb{1})$ be a strong bimonoid and let $\mathcal{A} = (Q, \delta, F)$ be a crisp-deterministic (Σ, \mathbf{B}) -wta. For each $\xi \in T_{\Sigma}$ there exists a $q \in Q$ such that

- (1) $Q_{\neq 0}^{\mathcal{A}}(\xi) = \{q\} = Q_{\neq 0}^{\mathcal{R}_{\mathcal{A}}}(\xi)$ and there exists $\rho \in \mathcal{R}_{\mathcal{A}}(q, \xi)$ with $\text{h}_{\mathcal{A}}(\xi)_q = \text{wt}(\xi, \rho) = \mathbb{1}$ and for each $\rho' \in \mathcal{R}_{\mathcal{A}}(q, \xi) \setminus \{\rho\}$ we have $\text{wt}(\xi, \rho') = 0$, and
- (2) $\llbracket \mathcal{A} \rrbracket^{\text{init}}(\xi) = F_q$.

Thus, in particular, $\text{im}(\llbracket \mathcal{A} \rrbracket^{\text{init}}) \subseteq \text{im}(F)$.

Proof. Proof of (1): First, by induction on T_{Σ} , we prove that the following statement holds:

$$\text{For each } \xi \in T_{\Sigma} \text{ there exists a } q \in Q \text{ such that } Q_{\neq 0}^{\mathcal{A}}(\xi) = \{q\} \text{ and } \text{h}_{\mathcal{A}}(\xi)_q = \mathbb{1} . \quad (4.7)$$

Let $\xi = \sigma(\xi_1, \dots, \xi_k)$. We assume that $Q_{\neq 0}^{\text{h}_A}(\xi_i) = \{q_{\xi_i}\}$ and $\text{h}_A(\xi_i)_{q_{\xi_i}} = \mathbb{1}$ for each $i \in [k]$ (I.H.). Then for every $p \in Q$:

$$\text{h}_A(\sigma(\xi_1, \dots, \xi_k))_p = \bigoplus_{q_1 \cdots q_k \in Q^k} \left(\bigotimes_{i \in [k]} \text{h}_A(\xi_i)_{q_i} \right) \otimes \delta_k(q_1 \cdots q_k, \sigma, p) = \delta_k(q_{\xi_1} \cdots q_{\xi_k}, \sigma, p)$$

where the last equality holds by I.H. Since \mathcal{A} is bu-deterministic and total, there exists a $q \in Q$ such that $\delta_k(q_{\xi_1} \cdots q_{\xi_k}, \sigma, q) \neq 0$ and for each $q' \in Q$ with $q \neq q'$ we have $\delta_k(q_{\xi_1} \cdots q_{\xi_k}, \sigma, q') = 0$. Thus $Q_{\neq 0}^{\text{h}_A}(\xi) = \{q\}$. Since \mathcal{A} is crisp, we have that $\delta_k(q_{\xi_1} \cdots q_{\xi_k}, \sigma, q) = \mathbb{1}$, and hence $\text{h}_A(\xi)_q = \mathbb{1}$. This proves (4.7).

Now let $\xi \in T_\Sigma$. Then Statement (1) follows from Lemma 4.1.2(3).

Proof of (2): Let $\xi \in T_\Sigma$. Then there exists $q \in Q$ such that Statement (1) holds. Thus we have $\llbracket \mathcal{A} \rrbracket^{\text{init}}(\xi) = \text{h}_A(\xi)_q \otimes F_q = F_q$.

Finally, it follows from Statements (2) that $\text{im}(\llbracket \mathcal{A} \rrbracket^{\text{init}}) \subseteq \text{im}(F)$. \square

Essentially, each crisp-deterministic wta \mathcal{A} is a finite Σ -algebra combined with a mapping which reflects the root weights. For the formalization of this statement, let us consider the crisp-deterministic (Σ, \mathbf{B}) -wta $\mathcal{A} = (Q, \delta, F)$. The *state algebra* of \mathcal{A} is the Σ -algebra $\mathbf{S}(\mathcal{A}) = (Q, \theta_{\mathcal{A}})$ such that, for every $k \in \mathbb{N}$, $\sigma \in \Sigma^{(k)}$, $q \in Q$, and $q_1 \cdots q_k \in Q^k$, we define

$$\theta_{\mathcal{A}}(\sigma)(q_1, \dots, q_k) = q, \text{ where } q \text{ is the unique state for which } \delta_k(q_1 \cdots q_k, \sigma, q) = \mathbb{1} .$$

We recall that the unique Σ -algebra homomorphism from the Σ -term algebra to $\mathbf{S}(\mathcal{A})$ is denoted by $\text{h}_{\mathbf{S}(\mathcal{A})}$. Obviously, $\mathbf{S}(\mathcal{A})$ is isomorphic to the subalgebra $(\mathbb{1}_Q, \nu_{\mathcal{A}})$ of the vector algebra $\mathbf{V}(\mathcal{A})$, where

- $\mathbb{1}_Q = \{\mathbb{1}_q \mid q \in Q\}$ is the set of q -unit vectors over Q (cf. Section 2.7.7), and
- $\nu_{\mathcal{A}}(\sigma)(\mathbb{1}_{q_1}, \dots, \mathbb{1}_{q_k})_q = \delta_k(q_1 \cdots q_k, \sigma, q)$ for every $k \in \mathbb{N}$, $\sigma \in \Sigma^{(k)}$, $q \in Q$, and $q_1 \cdots q_k \in Q^k$.

Lemma 4.1.6. Let $\mathcal{A} = (Q, \delta, F)$ be a crisp-deterministic (Σ, \mathbf{B}) -wta and $\mathbf{S}(\mathcal{A}) = (Q, \theta_{\mathcal{A}})$ the state algebra of \mathcal{A} . The following two statements hold.

(1) For each $\xi \in T_\Sigma$ and each $q \in Q$, we have

$$\text{h}_A(\xi)_q = \begin{cases} \mathbb{1} & \text{if } q = \text{h}_{\mathbf{S}(\mathcal{A})}(\xi) \\ 0 & \text{otherwise.} \end{cases}$$

(2) $\llbracket \mathcal{A} \rrbracket^{\text{init}} = F \circ \text{h}_{\mathbf{S}(\mathcal{A})}$.

Proof. Proof of (1): We prove the statement by induction on T_Σ . Let $\xi = \sigma(\xi_1, \dots, \xi_k)$. Then by I.H. and the definition of state algebra we obtain

$$\begin{aligned} \text{h}_A(\sigma(\xi_1, \dots, \xi_k))_q &= \bigoplus_{q_1 \cdots q_k \in Q^k} \left(\bigotimes_{i \in [k]} \text{h}_A(\xi_i)_{q_i} \right) \otimes \delta_k(q_1 \cdots q_k, \sigma, q) = \left(\bigotimes_{i \in [k]} \text{h}_A(\xi_i)_{q_{\xi_i}} \right) \otimes \delta_k(q_{\xi_1} \cdots q_{\xi_k}, \sigma, q) \\ &\quad \text{(where } q_{\xi_i} \text{ is the unique element of } Q_{\neq 0}^{\text{h}_A}(\xi_i) \text{ with } \text{h}_A(\xi_i)_{q_{\xi_i}} = \mathbb{1} \text{ for each } i \in [k], \text{ cf. Lemma 4.1.5(1))} \\ &= \delta_k(\text{h}_{\mathbf{S}(\mathcal{A})}(\xi_1) \cdots \text{h}_{\mathbf{S}(\mathcal{A})}(\xi_k), \sigma, q) && \text{(by I.H.)} \\ &= \begin{cases} \mathbb{1} & \text{if } \theta_{\mathcal{A}}(\sigma)(\text{h}_{\mathbf{S}(\mathcal{A})}(\xi_1), \dots, \text{h}_{\mathbf{S}(\mathcal{A})}(\xi_k)) = q \\ 0 & \text{otherwise .} \end{cases} && \text{(by the definition of } (Q, \theta_{\mathcal{A}})) \end{aligned}$$

Since $\theta_{\mathcal{A}}(\sigma)(\text{h}_{\mathbf{S}(\mathcal{A})}(\xi_1), \dots, \text{h}_{\mathbf{S}(\mathcal{A})}(\xi_k)) = \text{h}_{\mathbf{S}(\mathcal{A})}(\sigma(\xi_1, \dots, \xi_k))$, we have proved Statement (1).

Proof of (2): For each $\xi \in T_\Sigma$, we have

$$\llbracket \mathcal{A} \rrbracket^{\text{init}}(\xi) = \bigoplus_{q \in Q} \text{h}_A(\xi)_q \otimes F_q = F_{\text{h}_{\mathbf{S}(\mathcal{A})}(\xi)} = (F \circ \text{h}_{\mathbf{S}(\mathcal{A})})(\xi) ,$$

where the second equality follows from Statement (1). \square

Now we consider two strong bimonoids B_1 and B_2 which have the same carrier set; note that the unit elements of B_1 and B_2 can be different (examples are given below). Moreover, we let \mathcal{A} be a crisp-deterministic (Σ, B_1) -wta. According to the note on page 74, \mathcal{A} is different from the crisp-deterministic (Σ, B_2) -wta \mathcal{B} which we obtain from \mathcal{A} by replacing the unit elements of B_1 in the transitions of \mathcal{A} by the corresponding unit elements of B_2 . However, due to Lemma 4.1.6(2), the initial algebra semantics of \mathcal{A} and \mathcal{B} viewed as mappings coincide.¹ In [FV24] the next corollary was proved for the special case that B_1 and B_2 are bounded lattices.

Corollary 4.1.7. [FV24] Let B_1 and B_2 be strong bimonoids with the same carrier set. For each crisp-deterministic (Σ, B_1) -wta \mathcal{A} , we can construct a crisp-deterministic (Σ, B_2) -wta \mathcal{B} such that $\llbracket \mathcal{B} \rrbracket^{\text{init}} = \llbracket \mathcal{A} \rrbracket^{\text{init}}$. In particular, $\text{cd-Rec}^{\text{init}}(\Sigma, B_1) = \text{cd-Rec}^{\text{init}}(\Sigma, B_2)$.

Proof. Let $B_1 = (B, \oplus, \otimes, 0, \mathbb{1})$ and $B_2 = (B, +, \times, 0, 1)$ be strong bimonoids. Let $\mathcal{A} = (Q, \delta, F)$ be a crisp-deterministic (Σ, B_1) -wta. We construct the crisp-deterministic (Σ, B_2) -wta $\mathcal{B} = (Q, \delta', F)$ where for every $k \in \mathbb{N}$, $\sigma \in \Sigma^{(k)}$, and $q_1, \dots, q_k, q \in Q$ we let

$$(\delta')_k(q_1 \cdots q_k, \sigma, q) = \begin{cases} 1 & \text{if } \delta_k(q_1 \cdots q_k, \sigma, q) = \mathbb{1} \\ 0 & \text{otherwise.} \end{cases}$$

Clearly, \mathcal{B} is crisp-deterministic. It is obvious that the state algebra $S(\mathcal{A})$ is equal to the state algebra $S(\mathcal{B})$. As a consequence, the Σ -algebra homomorphism from T_Σ to $S(\mathcal{A})$, denoted by $h_{S(\mathcal{A})}$, is the same as the Σ -algebra homomorphism from T_Σ to $S(\mathcal{B})$, denoted by $h_{S(\mathcal{B})}$. Then, by applying Lemma 4.1.6(2) twice, we have $\llbracket \mathcal{A} \rrbracket^{\text{init}} = F \circ h_{S(\mathcal{A})} = F \circ h_{S(\mathcal{B})} = \llbracket \mathcal{B} \rrbracket^{\text{init}}$. \square

Examples for pairs (B_1, B_2) of different strong bimonoids which have the same carrier set (– and the last three also have the same unit elements –) are

- the semiring $(\mathbb{N}_\infty, +, \cdot, 0, 1)$ and the distributive bounded lattice $(\mathbb{N}_\infty, \max, \min, 0, \infty)$,
- the bounded lattices \mathbb{N}_5 and \mathbb{M}_3 from Examples 2.7.15(3) and 2.7.15(4), respectively,
- the tropical semiring $(\mathbb{N}_\infty, \min, +, \infty, 0)$ and the tropical bimonoid $(\mathbb{N}_\infty, +, \min, 0, \infty)$,
- the semiring of formal languages $(\mathcal{P}(\Gamma^*), \cup, \cdot, \emptyset, \{\varepsilon\})$ and the semiring $(\mathcal{P}(\Gamma^*), \cup, \cap, \emptyset, \Gamma^*)$,
- the two different strong bimonoids with the carrier set $[0, 1]$ in Example 2.7.10(4) using algebraic sum and bounded sum, respectively,
- the strong bimonoid $([0, 1], \oplus, \cdot, 0, 1)$ with bounded sum \oplus (cf. Example 2.7.10(4)) and the strong bimonoid $([0, 1], u, i, 0, 1)$ with t-conorm u and t-norm i (cf. Example 2.7.10(3)), and
- the Boolean semiring Boole and the field \mathbb{F}_2 with two elements (cf. Example 2.7.10(7)).

In the next theorem we characterize the set of weighted tree languages which are i-recognizable by crisp-deterministic wta. As preparation we prove the following lemma which is a kind of inverse of Lemma 4.1.6(2).

Lemma 4.1.8. For every finite Σ -algebra $A = (Q, \theta)$ and mapping $F : Q \rightarrow B$, we can construct a crisp-deterministic (Σ, B) -wta \mathcal{A} such that A is the state algebra of \mathcal{A} (as defined on page 120) and $F \circ h_A = \llbracket \mathcal{A} \rrbracket^{\text{init}}$.

Proof. We construct the crisp-deterministic (Σ, B) -wta $\mathcal{A} = (Q, \delta, F)$ where for every $k \in \mathbb{N}$, $\sigma \in \Sigma^{(k)}$, $q \in Q$, and $q_1 \cdots q_k \in Q^k$ we define

$$\delta_k(q_1 \cdots q_k, \sigma, q) = \begin{cases} \mathbb{1} & \text{if } \theta(\sigma)(q_1, \dots, q_k) = q \\ 0 & \text{otherwise.} \end{cases}$$

Clearly, A is the state algebra of \mathcal{A} . Then $h_A = h_{S(\mathcal{A})}$ and thus, by Lemma 4.1.6(2), we obtain $F \circ h_A = \llbracket \mathcal{A} \rrbracket^{\text{init}}$. \square

¹This does not mean that \mathcal{A} and \mathcal{B} are i-equivalent because the latter concept is defined for wta over the same strong bimonoid.

In the next theorem we characterize the weighted tree languages which are recognized by crisp-deterministic wta. Roughly speaking, it shows that each crisp-deterministic (Σ, \mathbf{B}) -wta consists of a finite Σ -algebra with carrier set Q and a mapping $F : Q \rightarrow B$. In [BLB10, Thm. 2], the combination of (a) a finite Σ -algebra with carrier set Q and (b) a mapping $F : Q \rightarrow B$ was called “finite representation”.

Theorem 4.1.9. *Let Σ be a ranked alphabet. Moreover, let $\mathbf{B} = (B, \oplus, \otimes, \mathbf{0}, \mathbf{1})$ be a strong bimonoid and let $r : T_\Sigma \rightarrow B$. Then the following three statements are equivalent.*

- (A) *We can construct a finite Σ -algebra $\mathbf{A} = (Q, \theta)$ and a mapping $F : Q \rightarrow B$ such that $r = F \circ h_{\mathbf{A}}$.*
- (B) *We can construct a crisp-deterministic (Σ, \mathbf{B}) -wta \mathcal{A} such that $r = \llbracket \mathcal{A} \rrbracket^{\text{init}}$.*
- (C) *We can construct a (Σ, \mathbf{B}) -wta \mathcal{A} such that the congruence $\ker(h_{\mathcal{A}})$ has finite index and $r = \llbracket \mathcal{A} \rrbracket^{\text{init}}$.*

Proof. Proof of (A) \Rightarrow (B): This follows directly from Lemma 4.1.8.

Proof of (B) \Rightarrow (C): Let $\mathcal{A} = (Q, \delta, F)$ be a crisp-deterministic (Σ, \mathbf{B}) -wta with $r = \llbracket \mathcal{A} \rrbracket^{\text{init}}$. The image of $h_{\mathcal{A}}$ is a finite set because, by Lemma 4.1.5, $\text{im}(h_{\mathcal{A}}) \subseteq \{\mathbf{0}, \mathbf{1}\}^Q$. Thus $\ker(h_{\mathcal{A}})$ has finite index.

Proof of (C) \Rightarrow (A): Let $\mathcal{A} = (Q, \delta, F_{\mathcal{A}})$ be a (Σ, \mathbf{B}) -wta such that $\ker(h_{\mathcal{A}})$ has finite index and $r = \llbracket \mathcal{A} \rrbracket^{\text{init}}$. We consider the accessible subalgebra $\mathbf{aV}(\mathcal{A}) = (\text{im}(h_{\mathcal{A}}), \delta_{\mathbf{aV}(\mathcal{A})})$ of $\mathbf{V}(\mathcal{A})$ (cf. Section 3.1). Since $\ker(h_{\mathcal{A}})$ has finite index, $\text{im}(h_{\mathcal{A}})$ is finite and hence $\mathbf{aV}(\mathcal{A})$ is a finite Σ -algebra. By Observation 2.10.4, we have $\text{im}(h_{\mathcal{A}}) = \langle \emptyset \rangle_{\delta_{\mathcal{A}}(\Sigma)}$, and by Lemma 2.7.1, we have that $\langle \emptyset \rangle_{\delta_{\mathcal{A}}(\Sigma)}$ can be constructed. Thus $\text{im}(h_{\mathcal{A}})$ can be constructed. Finally we define the mapping $F : \text{im}(h_{\mathcal{A}}) \rightarrow B$ for every $v \in \text{im}(h_{\mathcal{A}})$ by $F(v) = \bigoplus_{q \in Q} v_q \otimes (F_{\mathcal{A}})_q$. Then by (3.4), we have $\llbracket \mathcal{A} \rrbracket^{\text{init}} = F \circ h_{\mathbf{aV}(\mathcal{A})}$. \square

Finally, we prove that the set of weighted tree languages which are recognized by crisp-deterministic (Σ, \mathbf{B}) -wta with identity root weights, is exactly the set of characteristic mappings of recognizable Σ -tree languages. We note that in the following theorem (B) \Rightarrow (A) is in fact Theorem 2.16.2.

Theorem 4.1.10. *Let $L \subseteq T_\Sigma$. Then the following three statements are equivalent.*

- (A) *We can construct a total and bu-deterministic Σ -fta A such that $L(A) = L$.*
- (B) *We can construct a Σ -fta A such that $L(A) = L$.*
- (C) *We can construct a crisp-deterministic (Σ, \mathbf{B}) -wta \mathcal{A} with identity root weights such that $\llbracket \mathcal{A} \rrbracket^{\text{init}} = \chi(L)$.*

Proof. Proof of (A) \Rightarrow (B): This is by definition.

Proof of (B) \Rightarrow (C): Let $A = (Q, \delta, F)$ be a Σ -fta such that $L = L(A)$. We consider the finite Σ -algebra $(\mathcal{P}(Q), \delta_A)$ associated with A (for the definition of this algebra see page 69; we recall that the unique Σ -homomorphism from T_Σ to $(\mathcal{P}(Q), \delta_A)$ is denoted by h_A) and the mapping $F' : \mathcal{P}(Q) \rightarrow B$ defined for each $P \in \mathcal{P}(Q)$ by

$$F'(P) = \begin{cases} \mathbf{1} & \text{if } P \cap F \neq \emptyset \\ \mathbf{0} & \text{otherwise.} \end{cases}$$

Obviously, $\chi(L) = F' \circ h_A$. Then, by Lemma 4.1.8 we can construct a crisp-deterministic (Σ, \mathbf{B}) -wta $\mathcal{A}' = (\mathcal{P}(Q), \delta', F')$ such that $\llbracket \mathcal{A}' \rrbracket^{\text{init}} = F' \circ h_A$. Hence $\llbracket \mathcal{A}' \rrbracket^{\text{init}} = \chi(L)$. Moreover, \mathcal{A}' has identity root weights and thus (C) holds.

Proof of (C) \Rightarrow (A): Let $\mathcal{A} = (Q, \delta, F)$ be a crisp-deterministic (Σ, \mathbf{B}) -wta with identity root weights and $\llbracket \mathcal{A} \rrbracket^{\text{init}} = \chi(L)$. Let $\mathbf{S}(\mathcal{A}) = (Q, \theta_{\mathcal{A}})$ be the state algebra of \mathcal{A} . By Lemma 4.1.6(2), we have $\llbracket \mathcal{A} \rrbracket^{\text{init}} = F \circ h_{\mathbf{S}(\mathcal{A})}$, and by Lemma 4.1.6(1), we have for each $\xi \in T_\Sigma$

$$h_{\mathcal{A}}(\xi)_q = \begin{cases} \mathbf{1} & \text{if } q = h_{\mathbf{S}(\mathcal{A})}(\xi) \\ \mathbf{0} & \text{otherwise.} \end{cases}$$

We construct the total and bu-deterministic Σ -fta $A = (Q, \delta', F')$ such that for every $k \in \mathbb{N}$, $\sigma \in \Sigma^{(k)}$, $q \in Q$, and $q_1 \cdots q_k \in Q^k$ we have $(\delta')_k(q_1 \cdots q_k, \sigma) = q$ iff $\theta_{\mathcal{A}}(\sigma)(q_1, \dots, q_k) = q$, and that $F' = \text{supp}(F)$.

Since $(\delta')_A = \theta_A$, we have $h_A = h_{S(A)}$. Then, for each $\xi \in T_\Sigma$, we have:

$$\begin{aligned} \xi \in L(A) \text{ iff } h_A(\xi) \in F' \text{ iff } F_{h_A(\xi)} = \mathbb{1} \text{ iff } F_{h_{S(A)}(\xi)} = \mathbb{1} \\ \text{iff } \bigoplus_{q \in Q} h_A(\xi)_q \otimes F_q = \mathbb{1} \text{ iff } \llbracket \mathcal{A} \rrbracket^{\text{init}}(\xi) = \mathbb{1} \text{ iff } \xi \in \text{supp}(\llbracket \mathcal{A} \rrbracket^{\text{init}}) \end{aligned}$$

Thus (A) holds. \square

4.2 Padding of wta

Given a (Σ, \mathbf{B}) -wta \mathcal{A} which has a certain property. Then we might wish to increase the rank of the symbols of Σ and to construct a (Σ', \mathbf{B}) -wta \mathcal{B} which also has this property and where Σ' is the same as Σ but with increased ranks. The construction of \mathcal{B} can be achieved by a kind of padding of \mathcal{A} .

Formally, let (Σ, rk) and (Σ, rk_e) be two ranked alphabets over the same set Σ . We say that (Σ, rk_e) is an *extension* of (Σ, rk) if, for every $k \in \mathbb{N}$ and $\sigma \in \Sigma$, the relation $\text{rk}(\sigma) \leq \text{rk}_e(\sigma)$ holds and, moreover, $\text{rk}(\sigma) = 0$ implies $\text{rk}_e(\sigma) = 0$. Then (Σ, rk) is trivial if and only if (Σ, rk_e) is trivial, and if (Σ, rk) is trivial, then $\text{rk} = \text{rk}_e$. We denote the difference $\text{rk}_e(\sigma) - \text{rk}(\sigma)$ by $e(\sigma)$.

Now we can prove the following padding lemma.

Lemma 4.2.1. Let (Σ, rk) and (Σ, rk_e) be two ranked alphabets such that (Σ, rk_e) is an extension of (Σ, rk) . Moreover, let \mathcal{A} be a $((\Sigma, \text{rk}), \mathbf{B})$ -wta. Then we can construct a $((\Sigma, \text{rk}), (\Sigma, \text{rk}_e))$ -tree homomorphism g and a $((\Sigma, \text{rk}_e), \mathbf{B})$ -wta \mathcal{B} such that the following three statements hold.

- (a) If (Σ, rk_e) is trivial, then $\text{wts}(\mathcal{B}) = \text{wts}(\mathcal{A}) \cup \{\mathbb{1}\}$, otherwise $\text{wts}(\mathcal{B}) = \text{wts}(\mathcal{A}) \cup \{0, \mathbb{1}\}$.
- (b) For each $\xi \in T_{(\Sigma, \text{rk})}$ we have $\llbracket \mathcal{B} \rrbracket^{\text{init}}(g(\xi)) = \llbracket \mathcal{A} \rrbracket^{\text{init}}(\xi)$ and $\llbracket \mathcal{B} \rrbracket^{\text{run}}(g(\xi)) = \llbracket \mathcal{A} \rrbracket^{\text{run}}(\xi)$ and for each $\zeta \in T_{(\Sigma, \text{rk}_e)} \setminus g(T_{(\Sigma, \text{rk})})$ we have $\llbracket \mathcal{B} \rrbracket^{\text{init}}(\zeta) = \llbracket \mathcal{B} \rrbracket^{\text{run}}(\zeta) = 0$.
- (c) If $\text{rk} = \text{rk}_e$, then $\text{im}(\llbracket \mathcal{B} \rrbracket^{\text{init}}) = \text{im}(\llbracket \mathcal{A} \rrbracket^{\text{init}})$ and $\text{im}(\llbracket \mathcal{B} \rrbracket^{\text{run}}) = \text{im}(\llbracket \mathcal{A} \rrbracket^{\text{run}})$, otherwise $\text{im}(\llbracket \mathcal{B} \rrbracket^{\text{init}}) = \text{im}(\llbracket \mathcal{A} \rrbracket^{\text{init}}) \cup \{0\}$ and $\text{im}(\llbracket \mathcal{B} \rrbracket^{\text{run}}) = \text{im}(\llbracket \mathcal{A} \rrbracket^{\text{run}}) \cup \{0\}$.

Proof. Let $\mathcal{A} = (Q, \delta, F)$. Let α be an arbitrary element of Σ with $\text{rk}(\alpha) = 0$. Then $\text{rk}_e(\alpha) = 0$.

We define the $((\Sigma, \text{rk}), (\Sigma, \text{rk}_e))$ -tree homomorphism $g = (g_k \mid k \in \mathbb{N})$ as follows. For every $\sigma \in \Sigma$ and $k \in \mathbb{N}$ such that $\text{rk}(\sigma) = k$, we let $g_k(\sigma) = \sigma(z_1, \dots, z_k, \alpha, \dots, \alpha)$ with $e(\sigma)$ occurrences of α . This tree homomorphism might be called a padding. Clearly, for each $\xi \in T_{(\Sigma, \text{rk})}$, we have $\text{pos}(\xi) \subseteq \text{pos}(g(\xi))$, and for each $w \in \text{pos}(g(\xi))$, we have

$$g(\xi)(w) = \begin{cases} \xi(w) & \text{if } w \in \text{pos}(\xi) \\ \alpha & \text{otherwise.} \end{cases} \quad (4.8)$$

We construct the $((\Sigma, \text{rk}_e), \mathbf{B})$ -wta $\mathcal{B} = (Q', \delta', F')$ by letting $Q' = Q \cup \{q_\alpha\}$ where q_α is a new state (i.e., $q_\alpha \notin Q$), $F'_q = F_q$ for each $q \in Q$ and $F'_{q_\alpha} = 0$. Moreover, for every $\sigma \in \Sigma$ and $q'_1, \dots, q'_{\text{rk}_e(\sigma)}, q' \in Q'$, using k as abbreviation for $\text{rk}(\sigma)$, we let

$$(\delta')_{\text{rk}_e(\sigma)}(q'_1 \cdots q'_{\text{rk}_e(\sigma)}, \sigma, q') = \begin{cases} \delta_k(q'_1 \cdots q'_k, \sigma, q') & \text{if } q'_1, \dots, q'_k \in Q, q'_{k+1} \cdots q'_{\text{rk}_e(\sigma)} = q_\alpha^{e(\sigma)}, \text{ and } q' \in Q \\ \mathbb{1} & \text{if } \text{rk}_e = 0, \sigma = \alpha, \text{ and } q' = q_\alpha \\ 0 & \text{otherwise.} \end{cases}$$

If $\text{rk} = \text{rk}_e$, then the only difference between \mathcal{A} and \mathcal{B} is that the later contains the extra state q_α and the transition $(\varepsilon, \alpha, q_\alpha)$ with weight $\mathbb{1}$ (note that $q_\alpha \notin \text{supp}(F)$).

We prove (a). Obviously, $\text{wts}(\mathcal{B}) \subseteq \text{wts}(\mathcal{A}) \cup \{0, \mathbb{1}\}$ and $\text{wts}(\mathcal{A}) \cup \{\mathbb{1}\} \subseteq \text{wts}(\mathcal{B})$.

Assume that (Σ, rk_e) is trivial. Then also (Σ, rk) is trivial and $\text{rk} = \text{rk}_e$. Hence $\text{wts}(\mathcal{B}) = \text{wts}(\mathcal{A}) \cup \{\mathbb{1}\}$. If (Σ, rk_e) is not trivial, then there exists a $\sigma \in \Sigma$ such that $\text{rk}_e(\sigma) \geq 1$. Then, e.g., $(\delta')_{\text{rk}_e(\sigma)}(q_\alpha \cdots q_\alpha, \sigma, q_\alpha) = 0$, and hence $0 \in \text{wts}(\mathcal{B})$. Thus $\text{wts}(\mathcal{B}) = \text{wts}(\mathcal{A}) \cup \{0, \mathbb{1}\}$. This proves (a).

Next we prove (b). First, we prove $[[\mathcal{B}]]^{\text{init}}(g(\xi)) = [[\mathcal{A}]]^{\text{init}}(\xi)$ for each $\xi \in T_{(\Sigma, \text{rk})}$. Obviously the following statement holds:

$$\text{For each } \zeta \in T_{(\Sigma, \text{rk}_e)}, \text{ if } \zeta \neq \alpha, \text{ then } h_{\mathcal{B}}(\zeta)_{q_\alpha} = 0. \quad (4.9)$$

Second, by induction on $T_{(\Sigma, \text{rk})}$, we prove the following statement.

$$\text{For every } \xi \in T_{(\Sigma, \text{rk})} \text{ and } q \in Q, \text{ we have } h_{\mathcal{B}}(g(\xi))_q = h_{\mathcal{A}}(\xi)_q. \quad (4.10)$$

I.B.: Let $\xi = \beta$ with $\beta \in \Sigma$ and $\text{rk}(\beta) = 0$, and let $q \in Q$. Then

$$h_{\mathcal{B}}(g(\beta))_q = h_{\mathcal{B}}(\beta)_q = (\delta')_0(\varepsilon, \beta, q) = \delta_0(\varepsilon, \beta, q) = h_{\mathcal{A}}(\beta)_q.$$

I.S.: Let $\xi = \sigma(\xi_1, \dots, \xi_k)$ with $k \in \mathbb{N}_+$ and $\xi_1, \dots, \xi_k \in T_{(\Sigma, \text{rk})}$, and let $q \in Q$. Then we can calculate as follows

$$\begin{aligned} h_{\mathcal{B}}(g(\sigma(\xi_1, \dots, \xi_k)))_q &= h_{\mathcal{B}}(\sigma(g(\xi_1), \dots, g(\xi_k), \underbrace{\alpha, \dots, \alpha}_{e(\sigma)}))_q && \text{(by definition of } g) \\ &= \bigoplus_{q'_1 \cdots q'_{\text{rk}_e(\sigma)} \in (Q')^{\text{rk}_e(\sigma)}} \left(\bigotimes_{j \in [k]} h_{\mathcal{B}}(g(\xi_j))_{q'_j} \right) \otimes \left(\bigotimes_{j \in [k+1, \text{rk}_e(\sigma)]} h_{\mathcal{B}}(\alpha)_{q'_j} \right) \otimes (\delta')_{\text{rk}_e(\sigma)}(q'_1 \cdots q'_{\text{rk}_e(\sigma)}, \sigma, q) \\ &= \bigoplus_{q_1 \cdots q_k \in Q^k} \left(\bigotimes_{j \in [k]} h_{\mathcal{B}}(g(\xi_j))_{q_j} \right) \otimes \left(\bigotimes_{j \in [k+1, \text{rk}_e(\sigma)]} h_{\mathcal{B}}(\alpha)_{q_\alpha} \right) \otimes (\delta')_{\text{rk}_e(\sigma)}(q_1 \cdots q_k q_\alpha^{e(\sigma)}, \sigma, q) \\ &\quad \text{(because for each } q'_1 \cdots q'_{\text{rk}_e(\sigma)} \in (Q')^{\text{rk}_e(\sigma)} \setminus Q^k \{q_\alpha^{e(\sigma)}\} \text{ we have } (\delta')_{\text{rk}_e(\sigma)}(q'_1 \cdots q'_{\text{rk}_e(\sigma)}, \sigma, q) = 0) \\ &= \bigoplus_{q_1 \cdots q_k \in Q^k} \left(\bigotimes_{j \in [k]} h_{\mathcal{A}}(\xi_j)_{q_j} \right) \otimes \delta_k(q_1 \cdots q_k, \sigma, q) \quad \text{(by I.H. and because } h_{\mathcal{B}}(\alpha)_{q_\alpha} = (\delta')_0(\varepsilon, \alpha, q_\alpha) = \mathbb{1}) \\ &= h_{\mathcal{A}}(\sigma(\xi_1, \dots, \xi_k))_q. \end{aligned}$$

This proves (4.10).

Now let $\xi \in T_{(\Sigma, \text{rk})}$. Then

$$\begin{aligned} [[\mathcal{B}]]^{\text{init}}(g(\xi)) &= \bigoplus_{q' \in Q'} h_{\mathcal{B}}(g(\xi))_{q'} \otimes F'_{q'} \\ &= \bigoplus_{q \in Q} h_{\mathcal{B}}(g(\xi))_q \otimes F'_q && \text{(because } F'_{q_\alpha} = 0) \\ &= \bigoplus_{q \in Q} h_{\mathcal{B}}(g(\xi))_q \otimes F_q && \text{(because } F'_q = F_q \text{ for each } q \in Q) \\ &= \bigoplus_{q \in Q} h_{\mathcal{A}}(\xi)_q \otimes F_q && \text{(by (4.10))} \\ &= [[\mathcal{A}]]^{\text{init}}(\xi). \end{aligned}$$

Next we prove $[[\mathcal{B}]]^{\text{run}}(g(\xi)) = [[\mathcal{A}]]^{\text{run}}(\xi)$ for each $\xi \in T_{(\Sigma, \text{rk})}$. As preparation, for each $\xi \in T_{(\Sigma, \text{rk})}$, we define the mapping $\varphi_\xi : R_{\mathcal{A}}(\xi) \rightarrow R_{\mathcal{B}}(g(\xi))$ such that, for every $\rho \in R_{\mathcal{A}}(\xi)$ and $w \in \text{pos}(g(\xi))$, we let

$$\varphi(\rho)(w) = \begin{cases} \rho(w) & \text{if } w \in \text{pos}(\xi) \\ q_\alpha & \text{otherwise,} \end{cases}$$

cf. (4.8). Obviously, φ_ξ is injective. Moreover,

$$\text{For each } \rho \in \mathbf{R}_B(g(\xi)) \setminus \text{im}(\varphi_\xi) \text{ we have } \text{wt}_B(g(\xi), \rho) = 0. \quad (4.11)$$

By induction on $\mathbf{T}_{(\Sigma, \text{rk})}$ we prove the following statement.

$$\text{For every } \xi \in \mathbf{T}_{(\Sigma, \text{rk})} \text{ and } \rho \in \mathbf{R}_A(\xi) \text{ we have } \text{wt}_A(\xi, \rho) = \text{wt}_B(g(\xi), \varphi_\xi(\rho)). \quad (4.12)$$

Let $\xi = \sigma(\xi_1, \dots, \xi_k)$ and $\rho \in \mathbf{R}_A(\xi)$. Then

$$\begin{aligned} \text{wt}_A(\xi, \rho) &= \left(\bigotimes_{j \in [k]} \text{wt}_A(\xi_j, \rho|_j) \right) \otimes \delta_k(\rho(1) \cdots \rho(k), \sigma, \rho(\varepsilon)) \\ &= \left(\bigotimes_{j \in [k]} \text{wt}_B(g(\xi_j), \varphi_{\xi_j}(\rho|_j)) \right) \otimes \delta_k(\rho(1) \cdots \rho(k), \sigma, \rho(\varepsilon)) && \text{(by I.H.)} \\ &= \left(\bigotimes_{j \in [k]} \text{wt}_B(g(\xi_j), \varphi_{\xi_j}(\rho|_j)) \right) \otimes \left(\bigotimes_{j \in [k+1, \text{rk}_e(\sigma)]} (\delta')_0(\varepsilon, \alpha, q_\alpha) \right) \otimes \delta_k(\rho(1) \cdots \rho(k), \sigma, \rho(\varepsilon)) \\ &&& \text{(because } (\delta')_0(\varepsilon, \alpha, q_\alpha) = \mathbb{1} \text{)} \\ &= \left(\bigotimes_{j \in [\text{rk}_e(\sigma)]} \text{wt}_B(g(\xi_j), \varphi_{\xi_j}(\rho|_j)) \right) \otimes \delta_k(\rho(1) \cdots \rho(k), \sigma, \rho(\varepsilon)) \\ &&& \text{(because } (\delta')_0(\varepsilon, \alpha, q_\alpha) = \text{wt}_B(g(\xi_j), \varphi_{\xi_j}(\rho|_j)) \text{ for each } j \in [k+1, \text{rk}_e(\sigma)] \text{)} \\ &= \left(\bigotimes_{j \in [\text{rk}_e(\sigma)]} \text{wt}_B(g(\xi_j), \varphi_{\xi_j}(\rho|_j)) \right) \otimes (\delta')_{\text{rk}_e(\sigma)}(\rho(1) \cdots \rho(k) q_\alpha^{e(\sigma)}, \sigma, \rho(\varepsilon)) && \text{(by construction)} \\ &= \left(\bigotimes_{j \in [\text{rk}_e(\sigma)]} \text{wt}_B(g(\xi)|_j, \varphi_\xi(\rho)|_j) \right) \otimes (\delta')_{\text{rk}_e(\sigma)}(\rho(1) \cdots \rho(k) q_\alpha^{e(\sigma)}, \sigma, \rho(\varepsilon)) \\ &&& \text{(by definitions of } g, \varphi, \text{ and the restriction } |_j \text{)} \\ &= \text{wt}_B(g(\xi), \varphi_\xi(\rho)) . \end{aligned}$$

This proves (4.12) .

Now let $\xi \in \mathbf{T}_{(\Sigma, \text{rk})}$. Then

$$\begin{aligned} \llbracket B \rrbracket^{\text{run}}(g(\xi)) &= \bigoplus_{\rho \in \mathbf{R}_B(\xi)} \text{wt}_B(g(\xi), \rho) \otimes F'_{\rho(\varepsilon)} \\ &= \bigoplus_{\rho \in \text{im}(\varphi_\xi)} \text{wt}_B(g(\xi), \rho) \otimes F'_{\rho(\varepsilon)} && \text{(by (4.11))} \\ &= \bigoplus_{q \in Q'} \bigoplus_{\rho \in \mathbf{R}_B(q, g(\xi)) \cap \text{im}(\varphi_\xi)} \text{wt}_B(g(\xi), \rho) \otimes F'_q \\ &= \bigoplus_{q \in Q} \bigoplus_{\rho \in \mathbf{R}_B(q, g(\xi)) \cap \text{im}(\varphi_\xi)} \text{wt}_B(g(\xi), \rho) \otimes F_q && \text{(because } F'_{q_\alpha} = 0 \text{ and } F'_q = F_q \text{ for each } q \in Q \text{)} \\ &= \bigoplus_{q \in Q} \bigoplus_{\rho \in \mathbf{R}_A(q, \xi)} \text{wt}_B(g(\xi), \varphi_\xi(\rho)) \otimes F_q && \text{(because } \varphi_\xi \text{ is injective)} \\ &= \bigoplus_{q \in Q} \bigoplus_{\rho \in \mathbf{R}_A(q, \xi)} \text{wt}_A(\xi, \rho) \otimes F_q && \text{(by (4.12))} \\ &= \llbracket A \rrbracket^{\text{run}}(\xi) . \end{aligned}$$

Now let $\zeta \in T_{(\Sigma, \text{rk}_e)} \setminus g(T_{(\Sigma, \text{rk})})$. Then $\text{rk} \neq \text{rk}_e$, thus there exists $w \in \text{pos}(\zeta)$ such that $\text{rk}_e(\sigma) > k \neq 0$ where $\sigma = \zeta(w)$ and $k = \text{rk}(\sigma)$, and there exists $j_0 \in [k+1, \text{rk}_e(\sigma)]$ such that $\zeta(wj_0) \neq \alpha$, cf. (4.8).

First, we prove that $\llbracket \mathcal{B} \rrbracket^{\text{init}}(\zeta) = 0$. Since $\zeta(wj_0) \neq \alpha$, we have $\text{h}_{\mathcal{B}}(\zeta|_{wj_0})_{q_\alpha} = 0$ by (4.9). Next we prove that

$$Q_{\neq \emptyset}^{\text{h}_{\mathcal{B}}}(\zeta|_w) = \emptyset \quad (4.13)$$

where $Q_{\neq \emptyset}^{\text{h}_{\mathcal{B}}}(\zeta|_w)$ is defined in Section 4.1.

Since $\zeta|_w \neq \alpha$, by (4.9), the state $q_\alpha \notin Q_{\neq \emptyset}^{\text{h}_{\mathcal{B}}}(\zeta|_w)$. Let $q \in Q$. Then

$$\begin{aligned} & \text{h}_{\mathcal{B}}(\zeta|_w)_q \\ &= \bigoplus_{q'_1 \cdots q'_{\text{rk}_e(\sigma)} \in (Q')^{\text{rk}_e(\sigma)}} \left(\bigotimes_{j \in [k]} \text{h}_{\mathcal{B}}(\zeta|_{wj})_{q'_j} \right) \otimes \left(\bigotimes_{j \in [k+1, \text{rk}_e(\sigma)]} \text{h}_{\mathcal{B}}(\zeta|_{wj})_{q'_j} \right) \otimes (\delta')_{\text{rk}_e(\sigma)}(q'_1 \cdots q'_{\text{rk}_e(\sigma)}, \sigma, q) \\ &= \bigoplus_{q_1 \cdots q_k \in Q^k} \left(\bigotimes_{j \in [k]} \text{h}_{\mathcal{B}}(\zeta|_{wj})_{q_j} \right) \otimes \left(\bigotimes_{j \in [k+1, \text{rk}_e(\sigma)]} \text{h}_{\mathcal{B}}(\zeta|_{wj})_{q_\alpha} \right) \otimes (\delta')_{\text{rk}_e(\sigma)}(q_1 \cdots q_k q_\alpha^{e(\sigma)}, \sigma, q) \\ & \quad (\text{because for each } q'_1 \cdots q'_{\text{rk}_e(\sigma)} \in (Q')^{\text{rk}_e(\sigma)} \setminus Q^k \{q_\alpha^{e(\sigma)}\} \text{ we have } (\delta')_{\text{rk}_e(\sigma)}(q'_1 \cdots q'_{\text{rk}_e(\sigma)}, \sigma, q) = 0) \\ &= 0. \quad (\text{because } \text{h}_{\mathcal{B}}(\zeta|_{wj_0})_{q_\alpha} = 0 \text{ and } \bigoplus_{q_1 \cdots q_k \in Q^k} 0 = 0) \end{aligned}$$

Hence $q \notin Q_{\neq \emptyset}^{\text{h}_{\mathcal{B}}}(\zeta|_w)$, which means $Q_{\neq \emptyset}^{\text{h}_{\mathcal{B}}}(\zeta|_w) = \emptyset$. This proves (4.13). Then by Lemma 4.1.1, also $Q_{\neq \emptyset}^{\text{h}_{\mathcal{B}}}(\zeta) = \emptyset$, and hence $\llbracket \mathcal{B} \rrbracket^{\text{init}}(\zeta) = 0$.

Second we prove that $\llbracket \mathcal{B} \rrbracket^{\text{run}}(\zeta) = 0$. Obviously the following statement holds:

$$\text{For each } \bar{\zeta} \in T_{(\Sigma, \text{rk}_e)} \text{ with } \bar{\zeta} \neq \alpha \text{ and } \rho \in R_{\mathcal{B}}(q_\alpha, \bar{\zeta}), \text{ we have } \text{wt}_{\mathcal{B}}(\bar{\zeta}, \rho) = 0. \quad (4.14)$$

Since $\zeta(w) \neq \alpha$, by (4.14) it follows that $q_\alpha \notin Q_{\neq \emptyset}^{\text{R}_{\mathcal{B}}}(\zeta|_w)$. Now let $q \in Q$ and $\rho \in R_{\mathcal{B}}(q, \zeta|_w)$. Then

$$\text{wt}_{\mathcal{B}}(\zeta|_w, \rho) = \left(\bigotimes_{j \in [\text{rk}_e(\sigma)]} \text{wt}_{\mathcal{B}}(\zeta|_{wj}, \rho|_j) \right) \otimes (\delta')_{\text{rk}_e(\sigma)}(\rho(1) \cdots \rho(\text{rk}_e(\sigma)), \sigma, q).$$

Now if $\rho(j_0) \neq q_\alpha$, then $(\delta')_{\text{rk}_e(\sigma)}(\rho(1) \cdots \rho(\text{rk}_e(\sigma)), \sigma, q) = 0$, hence $\text{wt}_{\mathcal{B}}(\zeta|_w, \rho) = 0$. If $\rho(j_0) = q_\alpha$, then by $\zeta(wj_0) \neq \alpha$ and 4.14 we obtain $\text{wt}_{\mathcal{B}}(\zeta|_{wj_0}, \rho|_{j_0}) = 0$. Hence again $\text{wt}_{\mathcal{B}}(\zeta|_w, \rho) = 0$. We conclude that $Q_{\neq \emptyset}^{\text{R}_{\mathcal{B}}}(\zeta|_w) = \emptyset$. Then, by Lemma 4.1.1, also $Q_{\neq \emptyset}^{\text{R}_{\mathcal{B}}}(\zeta) = \emptyset$, and hence $\llbracket \mathcal{B} \rrbracket^{\text{run}}(\zeta) = 0$.

Finally we prove (c). If $\text{rk} = \text{rk}_e$, then $T_{(\Sigma, \text{rk}_e)} = g(T_{(\Sigma, \text{rk})})$, hence (c) follows from (b). Otherwise also (c) follows from (b). \square

4.3 Images of the semantics of weighted tree automata

The semantics of a (Σ, \mathcal{B}) -wta \mathcal{A} are mappings $\llbracket \mathcal{A} \rrbracket^{\text{init}} : T_\Sigma \rightarrow B$ and $\llbracket \mathcal{A} \rrbracket^{\text{run}} : T_\Sigma \rightarrow B$. Their images are subsets of B , i.e., $\text{im}(\llbracket \mathcal{A} \rrbracket^{\text{init}}) \subseteq B$ and $\text{im}(\llbracket \mathcal{A} \rrbracket^{\text{run}}) \subseteq B$. In this section, we investigate universality and finiteness of images.

4.3.1 Images of initial algebra semantics of wta

Here we prove an interesting property of the initial algebra semantics (universality property), which will be applied in several proofs. Roughly speaking it says the following: if Σ contains a binary symbol, then for each finite subset A of the strong bimonoid \mathcal{B} , we can construct a (Σ, \mathcal{B}) -wta \mathcal{A} such that the

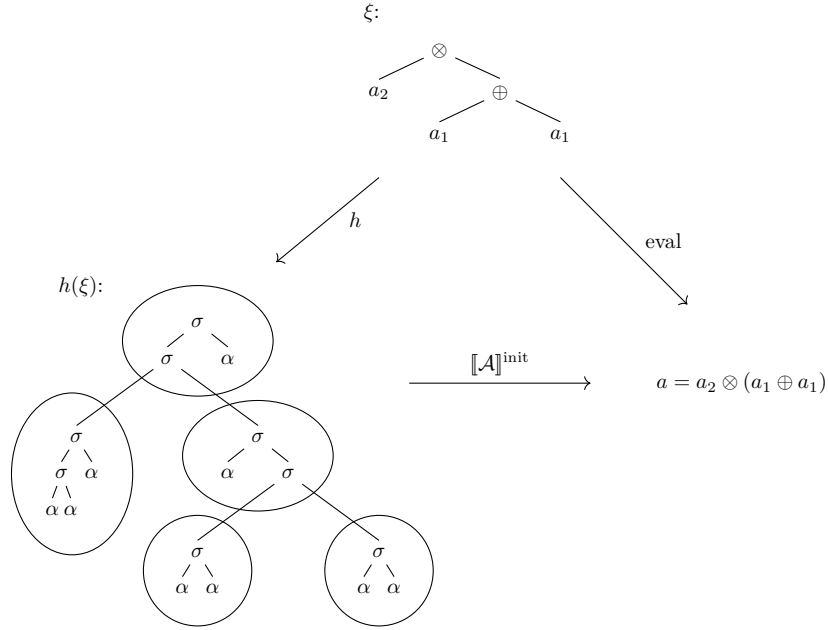

Figure 4.1: The (Σ, \mathbf{B}) -wta \mathcal{A} has the property $[[\mathcal{A}]]^{\text{init}}(h(\xi)) = \text{eval}(\xi)$.

closure of A is a subset of $\text{im}([\mathcal{A}]^{\text{init}})$, see [DFTV24]. This result has two weaker predecessors, which are incomparable:

- In [Rad10, Lm. 6.1], the result was proved under the condition that Σ contains at least $|A \cup \{0, 1\}|$ many nullary symbols and at least two binary symbols (also cf. Example 3.2.18(3)).
- In [FV24, Lm. 12], the result was proved under the condition that Σ contains a binary symbol and \mathbf{B} is a bounded lattice (exploiting idempotency and commutativity).

Also, we refer to Corollary 10.11.3, where a weaker result is proved (viz., \mathbf{B} must be a semiring); its benefit is that its proof is a simple combination of Example 3.2.18 and Corollary 10.11.2.

The idea for the construction is that \mathcal{A} receives as input an encoding $h(\xi)$ of a tree representation ξ of an element $a \in \langle A \rangle_{\{\oplus, \otimes, 0, 1\}}$; the encoding is done by the tree homomorphism h , see Figure 4.1. Then \mathcal{A} should satisfy $[[\mathcal{A}]]^{\text{init}}(h(\xi)) = \text{value}(\xi)$ where eval is the canonical evaluation of ξ .

Next we make some formal preparations for the proof of the mentioned result. We assume that Σ contains a binary symbol and that $A \cup \{0, 1\} = \{a_1, \dots, a_n\}$. Roughly speaking, we represent the values in $\langle A \rangle_{\{\oplus, \otimes, 0, 1\}}$ by trees over the ranked alphabet $\Delta = \{\oplus^{(2)}, \otimes^{(2)}\} \cup \{a_1^{(0)}, \dots, a_n^{(0)}\}$. Formally, we define the mapping $\text{eval} : T_\Delta \rightarrow \langle A \rangle_{\{\oplus, \otimes, 0, 1\}}$ by induction, for each $\xi \in T_\Delta$, as follows:

$$\text{eval}(\xi) = \begin{cases} a_i & \text{if } \xi = a_i \text{ for some } i \in [n] \\ \text{eval}(\xi_1) \oplus \text{eval}(\xi_2) & \text{if } \xi = \oplus(\xi_1, \xi_2) \text{ for some } \xi_1, \xi_2 \in T_\Delta \\ \text{eval}(\xi_1) \otimes \text{eval}(\xi_2) & \text{if } \xi = \otimes(\xi_1, \xi_2) \text{ for some } \xi_1, \xi_2 \in T_\Delta . \end{cases}$$

Clearly, eval is surjective, i.e., $\langle A \rangle_{\{\oplus, \otimes, 0, 1\}} \subseteq \text{eval}(T_\Delta)$.

Since Σ contains a binary symbol, we can fix arbitrary $\alpha \in \Sigma^{(0)}$ and $\sigma \in \Sigma^{(2)}$. For each $i \in [0, n]$ we define the Σ -tree f_i by $f_0 = \alpha$ and $f_{i+1} = \sigma(f_i, \alpha)$ for each $i \in [n-1]$. We define the (Δ, Σ) -tree

homomorphism $h = (h_k \mid k \in \mathbb{N})$ by letting

$$\begin{aligned} h_0(a_i) &= f_i \text{ for each } i \in [n], \\ h_2(\oplus) &= \sigma(\alpha, \sigma(z_1, z_2)), \text{ and} \\ h_2(\otimes) &= \sigma(\sigma(z_1, z_2), \alpha) . \end{aligned}$$

Obviously, h is nondeleting, linear, and productive.

Then we construct the (Σ, \mathbf{B}) -wta \mathcal{A} such that $\llbracket \mathcal{A} \rrbracket^{\text{init}}(h(\xi)) = \text{eval}(\xi)$ for each $\xi \in \mathbf{T}_\Delta$. Since eval is surjective, each element of $\langle A \rangle_{\{\oplus, \otimes, 0, \mathbb{1}\}}$ occurs in the image of $\llbracket \mathcal{A} \rrbracket^{\text{init}}$.

Theorem 4.3.1. [DFTV24, Thm. 5.1] Let Σ be a ranked alphabet such that $\Sigma^{(2)} \neq \emptyset$. Moreover, let $\mathbf{B} = (B, \oplus, \otimes, 0, \mathbb{1})$ be a strong bimonoid and $A \subseteq B$ be a finite subset. Then we can construct a (Σ, \mathbf{B}) -wta \mathcal{A} such that $\text{wts}(\mathcal{A}) = A \cup \{0, \mathbb{1}\}$ and $\text{im}(\llbracket \mathcal{A} \rrbracket^{\text{init}}) = \langle A \rangle_{\{\oplus, \otimes, 0, \mathbb{1}\}}$. In particular, if \mathbf{B} is generated by A , then we obtain $\text{im}(\llbracket \mathcal{A} \rrbracket^{\text{init}}) = B$.

Proof. Clearly, $\langle A \rangle_{\{\oplus, \otimes, 0, \mathbb{1}\}} = \langle A \cup \{0, \mathbb{1}\} \rangle_{\{\oplus, \otimes\}}$. Let a_1, \dots, a_n be the elements of $A \cup \{0, \mathbb{1}\}$, i.e., $A \cup \{0, \mathbb{1}\} = \{a_1, \dots, a_n\}$. Let α and σ be arbitrary elements of $\Sigma^{(0)}$ and $\Sigma^{(2)}$, respectively.

Now we construct the (Σ, \mathbf{B}) -wta $\mathcal{A} = (Q, \delta, F)$ as follows (cf. Figure 4.2).

- $Q = \{v\} \cup \{q_0, \dots, q_{n-1}\} \cup \{q_{\text{one}}, q_\oplus\} \cup \{q_\otimes\}$; the intention of the states is as follows:
 - v is the “main” state with $h_{\mathcal{A}}(h(\xi))_v = \text{eval}(\xi)$ for each $\xi \in \mathbf{T}_\Delta$ (cf. (4.24));
 - the state q_i with $i \in [0, n-1]$ is used to recognize the tree f_i with weight $\mathbb{1}$ (cf. (4.22)), and in combination with v , we will have $h_{\mathcal{A}}(\sigma(f_{i-1}, \alpha))_v = a_i$ (cf. I.B. of (4.24));
 - the states q_\oplus and q_\otimes are intermediate states such that $h_{\mathcal{A}}(\sigma(\xi_1, \xi_2))_{q_\oplus} = \text{eval}(\xi_1) \oplus \text{eval}(\xi_2)$ and $h_{\mathcal{A}}(\sigma(\xi_1, \xi_2))_{q_\otimes} = \text{eval}(\xi_1) \otimes \text{eval}(\xi_2)$, respectively; the state q_{one} supports q_\oplus ;
 - the switch from q_\oplus to v and from q_\otimes to v is triggered by the patterns $\sigma(\alpha, \cdot)$ and $\sigma(\cdot, \alpha)$, respectively,
- $F_v = \mathbb{1}$ and, for each $q \in Q \setminus \{v\}$, we let $F_q = 0$, and
- for each $q \in Q$, we define

$$\delta_0(\varepsilon, \alpha, q) = \begin{cases} \mathbb{1} & \text{if } q \in \{q_0, q_{\text{one}}\} \\ 0 & \text{otherwise} \end{cases}$$

and, for every $p, q, r \in Q$, we define

$$\delta_2(pq, \sigma, r) = \begin{cases} \mathbb{1} & \text{if there exists } i \in [n-1] \text{ such that } pqr = q_{i-1}q_0q_i \\ a_i & \text{if there exists } i \in [n] \text{ such that } pqr = q_{i-1}q_0v \\ \mathbb{1} & \text{if } pqr \in \{vq_{\text{one}}q_\oplus, q_{\text{one}}vq_\oplus, q_0q_\oplus v\} \\ \mathbb{1} & \text{if } pqr \in \{vvq_\otimes, q_\otimes q_0v\} \\ \mathbb{1} & \text{if } pqr = q_{\text{one}}q_{\text{one}}q_{\text{one}} \\ 0 & \text{otherwise} , \end{cases}$$

- for every $k \in \mathbb{N}$, $\eta \in \Sigma^{(k)}$ with $\sigma \neq \eta \neq \alpha$, and $q, q_1, \dots, q_k \in Q$, we define $\delta_k(q_1 \dots q_k, \eta, q) = 0$.
- Clearly, $\text{wts}(\mathcal{A}) = A \cup \{0, \mathbb{1}\}$.

Next we prove that $\text{im}(\llbracket \mathcal{A} \rrbracket^{\text{init}}) = \langle A \rangle_{\{\oplus, \otimes, 0, \mathbb{1}\}}$. Since $\text{wts}(\mathcal{A}) = A \cup \{0, \mathbb{1}\}$, we have $\text{im}(\llbracket \mathcal{A} \rrbracket^{\text{init}}) \subseteq \langle A \rangle_{\{\oplus, \otimes, 0, \mathbb{1}\}}$. Thus it remains to prove $\langle A \rangle_{\{\oplus, \otimes, 0, \mathbb{1}\}} \subseteq \text{im}(\llbracket \mathcal{A} \rrbracket^{\text{init}})$.

For this purpose, we need some auxiliary statements, which are easy to see.

$$\text{For each } q \in \{v, q_\oplus, q_\otimes\} \cup \{q_1, \dots, q_{n-1}\}, \text{ we have } h_{\mathcal{A}}(\alpha)_q = 0 . \quad (4.15)$$

$$\text{For each } i \in [0, n], \text{ we have } h_{\mathcal{A}}(f_i)_{q_\otimes} = 0 . \quad (4.16)$$

$$\text{For every } \zeta_1, \zeta_2 \in \mathbf{T}_\Sigma, \text{ we have } h_{\mathcal{A}}(\sigma(\zeta_1, \zeta_2))_{q_0} = 0 . \quad (4.17)$$

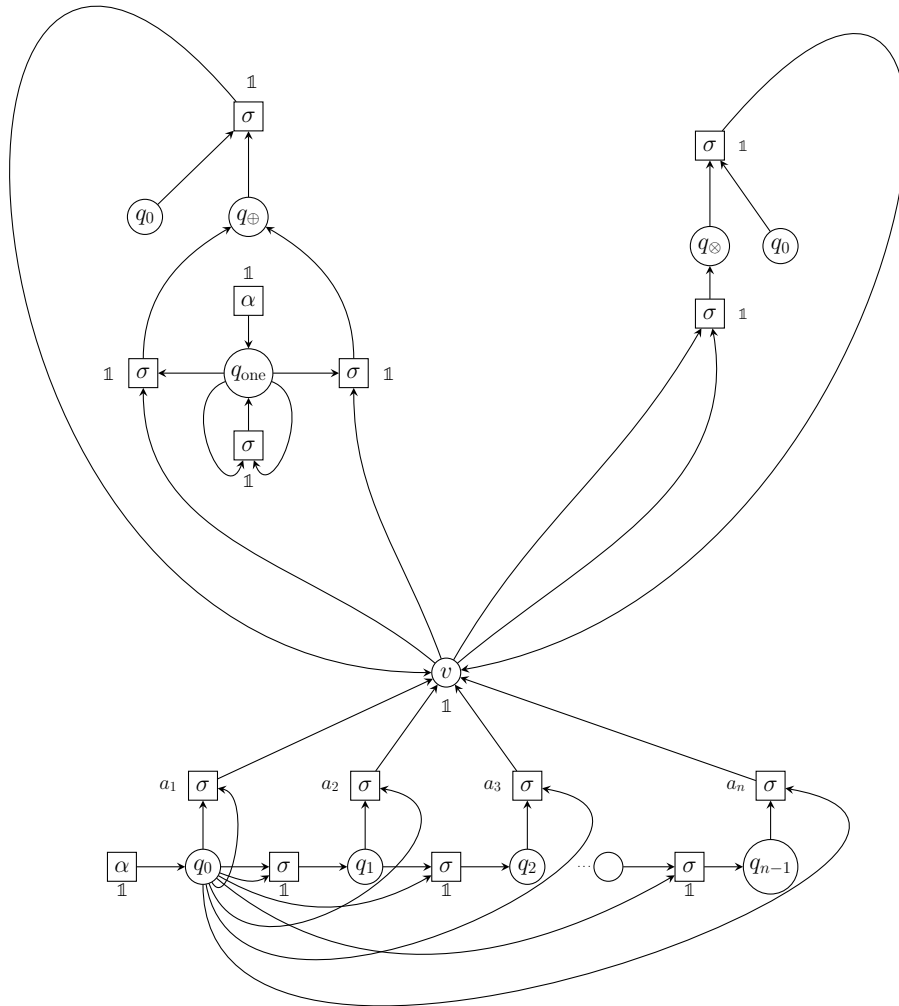

Figure 4.2: The (Σ, \mathbf{B}) -wta \mathcal{A} of the proof of Theorem 4.3.1, where the three occurrences of the state q_0 have to be identified. The wta \mathcal{A} might be called “angle on inline skaters”.

For every $\zeta_1, \zeta_2, \zeta_3 \in T_\Sigma$ and $i \in [0, n-1]$, we have $h_{\mathcal{A}}(\sigma(\zeta_1, \sigma(\zeta_2, \zeta_3)))_{q_i} = 0$. (4.18)

For each $\zeta \in T_\Sigma$, we have $h_{\mathcal{A}}(\zeta)_{q_{\text{one}}} = 1$. (4.19)

As further preparation, we deal with the values of expressions of the form $h_{\mathcal{A}}(f_i)_{q_j}$. First, by bounded induction on i , we prove the following:

For each $i, j \in [0, n-1]$ with $i \leq j$, we have $h_{\mathcal{A}}(f_i)_{q_j} = h_{\mathcal{A}}(f_0)_{q_{j-i}}$. (4.20)

The I.B. with $i = 0$ is trivial. For the I.S., let $i + 1 \leq j$. We can calculate as follows:

$$h_{\mathcal{A}}(f_{i+1})_{q_j} = h_{\mathcal{A}}(\sigma(f_i, \alpha))_{q_j} = h_{\mathcal{A}}(f_i)_{q_{j-1}} \otimes h_{\mathcal{A}}(\alpha)_{q_0} \otimes \delta_2(q_{j-1}q_0, \sigma, q_j) = h_{\mathcal{A}}(f_i)_{q_{j-1}} = h_{\mathcal{A}}(f_0)_{q_{j-(i+1)}} ,$$

where the last equality holds by I.H. This proves (4.20).

Second, by bounded induction on i , we prove the following:

For each $i, j \in [0, n-1]$ with $i \geq j$, we have $h_{\mathcal{A}}(f_i)_{q_j} = h_{\mathcal{A}}(f_{i-j})_{q_0}$. (4.21)

The I.B. with $i = 0$ is trivial. For the I.S., let $i + 1 \geq j$. As above we obtain $h_{\mathcal{A}}(f_{i+1})_{q_j} = h_{\mathcal{A}}(f_i)_{q_{j-1}}$. Then, by I.H., we obtain that $h_{\mathcal{A}}(f_i)_{q_{j-1}} = h_{\mathcal{A}}(f_{(i+1)-j})_{q_0}$. This proves (4.21).

Since,

- for each $i < j$, Equality (4.20) implies that $h_{\mathcal{A}}(f_i)_{q_j} = h_{\mathcal{A}}(f_0)_{q_{j-i}} = h_{\mathcal{A}}(\alpha)_{q_{j-i}} = 0$ (because $q_{j-i} \neq q_0$), and
- for each $i > j$, Equality (4.21) implies that $h_{\mathcal{A}}(f_i)_{q_j} = h_{\mathcal{A}}(f_{i-j})_{q_0} = 0$ (because $f_{i-j} \neq \alpha$), and
- for $i = j$, Equalities (4.20) and (4.21) imply that $h_{\mathcal{A}}(f_i)_{q_j} = h_{\mathcal{A}}(f_0)_{q_{j-i}} = h_{\mathcal{A}}(f_{i-j})_{q_0} = h_{\mathcal{A}}(f_0)_{q_0} = h_{\mathcal{A}}(\alpha)_{q_0} = 1$,

the following two statements hold.

For each $i \in [0, n-1]$, we have $h_{\mathcal{A}}(f_i)_{q_i} = 1$. (4.22)

For each $i, j \in [0, n-1]$ with $j \neq i$, we have $h_{\mathcal{A}}(f_i)_{q_j} = 0$. (4.23)

This finishes the proofs of auxiliary statements.

By induction on T_Σ we prove the following statement:

For each $\xi \in T_\Delta$, we have $h_{\mathcal{A}}(h(\xi))_v = \text{eval}(\xi)$, (4.24)

the ranked alphabet Δ and the mapping $\text{eval} : T_\Delta \rightarrow \langle A \rangle_{\{\oplus, \otimes, 0, 1\}}$ are defined before this theorem.

I.B.: Let $\xi = a_i$ for some $i \in [n]$. Then $h(a_i) = f_i$ and we can calculate as follows.

$$\begin{aligned} h_{\mathcal{A}}(h(a_i))_v &= h_{\mathcal{A}}(f_i)_v = \bigoplus_{p_1 p_2 \in Q^2} h_{\mathcal{A}}(f_{i-1})_{p_1} \otimes h_{\mathcal{A}}(\alpha)_{p_2} \otimes \delta_2(p_1 p_2, \sigma, v) \\ &= \left(\bigoplus_{j \in [0, n-1]} h_{\mathcal{A}}(f_{i-1})_{q_j} \otimes h_{\mathcal{A}}(\alpha)_{q_0} \otimes \delta_2(q_j q_0, \sigma, v) \right) \\ &\quad \oplus \left(h_{\mathcal{A}}(f_{i-1})_{q_0} \otimes h_{\mathcal{A}}(\alpha)_{q_\oplus} \otimes \delta_2(q_0 q_\oplus, \sigma, v) \right) \\ &\quad \oplus \left(h_{\mathcal{A}}(f_{i-1})_{q_\otimes} \otimes h_{\mathcal{A}}(\alpha)_{q_0} \otimes \delta_2(q_\otimes q_0 \sigma, v) \right) \\ &\quad \text{(because for each other combination of } p_1 p_2 \text{ we have } \delta_2(p_1 p_2, \sigma, v) = 0) \\ &= \left(\bigoplus_{j \in [0, n-1]} h_{\mathcal{A}}(f_{i-1})_{q_j} \otimes 1 \otimes \delta_2(q_j q_0, \sigma, v) \right) \\ &\quad \oplus \left(h_{\mathcal{A}}(f_{i-1})_{q_0} \otimes 0 \otimes \delta_2(q_0 q_\oplus, \sigma, v) \right) \end{aligned}$$

$$\begin{aligned}
& \oplus \left(\mathbb{0} \otimes h_{\mathcal{A}}(\alpha)_{q_0} \otimes \delta_2(q_{\otimes} q_0 \sigma, v) \right) && \text{(by (4.22)(for } i = 0), (4.15), \text{ and (4.16))} \\
& = \bigoplus_{j \in [0, n-1]} h_{\mathcal{A}}(f_{i-1})_{q_j} \otimes \delta_2(q_j q_0, \sigma, v) \\
& = h_{\mathcal{A}}(f_{i-1})_{q_{i-1}} \otimes \delta_2(q_{i-1} q_0, \sigma, v) && \text{(by (4.23))} \\
& = \mathbb{1} \otimes a_i && \text{(by (4.22) and because } \delta_2(q_{i-1} q_0, \sigma, v) = a_i) \\
& = \text{eval}(a_i) .
\end{aligned}$$

I.S.: We distinguish two cases. First, let $\xi = \oplus(\xi_1, \xi_2)$ for some $\xi_1, \xi_2 \in T_{\Delta}$. Then:

$$\begin{aligned}
& h_{\mathcal{A}}(h(\oplus(\xi_1, \xi_2)))_v = h_{\mathcal{A}}(\sigma(\alpha, \sigma(h(\xi_1), h(\xi_2))))_v \\
& = \bigoplus_{p_1 p_2 \in Q^2} h_{\mathcal{A}}(\alpha)_{p_1} \otimes h_{\mathcal{A}}(\sigma(h(\xi_1), h(\xi_2)))_{p_2} \otimes \delta_2(p_1 p_2, \sigma, v) \\
& = \left(\bigoplus_{j \in [0, n-1]} h_{\mathcal{A}}(\alpha)_{q_j} \otimes h_{\mathcal{A}}(\sigma(h(\xi_1), h(\xi_2)))_{q_0} \otimes \delta_2(q_j q_0, \sigma, v) \right) \\
& \quad \oplus \left(h_{\mathcal{A}}(\alpha)_{q_0} \otimes h_{\mathcal{A}}(\sigma(h(\xi_1), h(\xi_2)))_{q_{\oplus}} \otimes \delta_2(q_0 q_{\oplus}, \sigma, v) \right) \\
& \quad \oplus \left(h_{\mathcal{A}}(\alpha)_{q_{\otimes}} \otimes h_{\mathcal{A}}(\sigma(h(\xi_1), h(\xi_2)))_{q_0} \otimes \delta_2(q_{\otimes} q_0 \sigma, v) \right) \\
& \hspace{15em} \text{(because for each other combination } p_1 p_2 \text{ we have } \delta_2(p_1 p_2, \sigma, v) = 0) \\
& = \left(\bigoplus_{j \in [0, n-1]} h_{\mathcal{A}}(\alpha)_{q_j} \otimes \mathbb{0} \otimes \delta_2(q_j q_0, \sigma, v) \right) \\
& \quad \oplus \left(h_{\mathcal{A}}(\alpha)_{q_0} \otimes h_{\mathcal{A}}(\sigma(h(\xi_1), h(\xi_2)))_{q_{\oplus}} \otimes \delta_2(q_0 q_{\oplus}, \sigma, v) \right) \\
& \quad \oplus \left(h_{\mathcal{A}}(\alpha)_{q_{\otimes}} \otimes \mathbb{0} \otimes \delta_2(q_{\otimes} q_0 \sigma, v) \right) && \text{(by (4.17))} \\
& = h_{\mathcal{A}}(\alpha)_{q_0} \otimes h_{\mathcal{A}}(\sigma(h(\xi_1), h(\xi_2)))_{q_{\oplus}} \otimes \delta_2(q_0 q_{\oplus}, \sigma, v) \\
& = \mathbb{1} \otimes h_{\mathcal{A}}(\sigma(h(\xi_1), h(\xi_2)))_{q_{\oplus}} \otimes \mathbb{1} && \text{(by (4.22) (for } i = 0) \text{ and definition of } \delta_2) \\
& = h_{\mathcal{A}}(\sigma(h(\xi_1), h(\xi_2)))_{q_{\oplus}} \\
& = \left(h_{\mathcal{A}}(h(\xi_1))_v \otimes h_{\mathcal{A}}(h(\xi_2))_{q_{\text{one}}} \otimes \delta_2(q_v q_{\text{one}}, \sigma, q_{\oplus}) \right) \oplus \left(h_{\mathcal{A}}(h(\xi_1))_{q_{\text{one}}} \otimes h_{\mathcal{A}}(h(\xi_2))_v \otimes \delta_2(q_{\text{one}} q_v, \sigma, q_{\oplus}) \right) \\
& \hspace{15em} \text{(because for each other combination } p_1 p_2 \text{ we have } \delta_2(p_1 p_2, \sigma, q_{\oplus}) = 0) \\
& = (\text{eval}(\xi_1) \otimes \mathbb{1} \otimes \mathbb{1}) \oplus (\mathbb{1} \otimes \text{eval}(\xi_2) \otimes \mathbb{1}) && \text{(by I.H., (4.19), and definition of } \delta_2) \\
& = \text{eval}(\xi_1) \oplus \text{eval}(\xi_2) = \text{eval}(\oplus(\xi_1, \xi_2)) .
\end{aligned}$$

Secondly, let $\xi = \otimes(\xi_1, \xi_2)$ for some $\xi_1, \xi_2 \in T_{\Delta}$. Then:

$$\begin{aligned}
& h_{\mathcal{A}}(\otimes(\xi_1, \xi_2))_v = h_{\mathcal{A}}(\sigma(\sigma(h(\xi_1), h(\xi_2)), \alpha))_v \\
& = \bigoplus_{p_1 p_2 \in Q^2} h_{\mathcal{A}}(\sigma(h(\xi_1), h(\xi_2)))_{p_1} \otimes h_{\mathcal{A}}(\alpha)_{p_2} \otimes \delta_2(p_1 p_2, \sigma, v) \\
& = \left(\bigoplus_{j \in [0, n-1]} h_{\mathcal{A}}(\sigma(h(\xi_1), h(\xi_2)))_{q_j} \otimes h_{\mathcal{A}}(\alpha)_{q_0} \otimes \delta_2(q_j q_0, \sigma, v) \right)
\end{aligned}$$

$$\begin{aligned}
& \oplus \left(\mathfrak{h}_{\mathcal{A}}(\sigma(h(\xi_1), h(\xi_2)))_{q_0} \otimes \mathfrak{h}_{\mathcal{A}}(\alpha)_{q_{\oplus}} \otimes \delta_2(q_0 q_{\oplus}, \sigma, v) \right) \\
& \oplus \left(\mathfrak{h}_{\mathcal{A}}(\sigma(h(\xi_1), h(\xi_2)))_{q_{\otimes}} \otimes \mathfrak{h}_{\mathcal{A}}(\alpha)_{q_0} \otimes \delta_2(q_{\otimes} q_0 \sigma, v) \right) \\
& \quad \text{(because for each other combination } p_1 p_2 \text{ we have } \delta_2(p_1 p_2, \sigma, v) = 0) \\
& = \left(\bigoplus_{j \in [0, n-1]} 0 \otimes \mathfrak{h}_{\mathcal{A}}(\alpha)_{q_0} \otimes \delta_2(q_j q_0, \sigma, v) \right) \\
& \oplus \left(\mathfrak{h}_{\mathcal{A}}(\sigma(h(\xi_1), h(\xi_2)))_{q_0} \otimes 0 \otimes \delta_2(q_0 q_{\oplus}, \sigma, v) \right) \\
& \oplus \left(\mathfrak{h}_{\mathcal{A}}(\sigma(h(\xi_1), h(\xi_2)))_{q_{\otimes}} \otimes 1 \otimes \delta_2(q_{\otimes} q_0 \sigma, v) \right) \\
& \quad \text{(by (4.18) using that } h(\xi_2)(\varepsilon) = \sigma, \text{ (4.15), and (4.22)(for } i = 0)) \\
& = \mathfrak{h}_{\mathcal{A}}(\sigma(h(\xi_1), h(\xi_2)))_{q_{\otimes}} \otimes \delta_2(q_{\otimes} q_0 \sigma, v) \\
& = \mathfrak{h}_{\mathcal{A}}(\sigma(h(\xi_1), h(\xi_2)))_{q_{\otimes}} \quad \text{(by definition of } \delta_2) \\
& = \mathfrak{h}_{\mathcal{A}}(h(\xi_1))_v \otimes \mathfrak{h}_{\mathcal{A}}(h(\xi_2))_v \otimes \delta_2(vv, \sigma, q_{\otimes}) \\
& \quad \text{(because for each other combination } p_1 p_2 \text{ we have } \delta_2(p_1 p_2, \sigma, q_{\otimes}) = 0) \\
& = \text{eval}(\xi_1) \otimes \text{eval}(\xi_2) \quad \text{(by I.H. and definition of } \delta_2) \\
& = \text{eval}(\otimes(\xi_1, \xi_2)) .
\end{aligned}$$

This finishes the proof of (4.24).

Now let $a \in \langle A \rangle_{\{\oplus, \otimes, 0, 1\}}$. Since eval is surjective, there exists $\xi \in T_{\Delta}$ such that $\text{eval}(\xi) = a$. Then

$$\llbracket \mathcal{A} \rrbracket^{\text{init}}(h(\xi)) = \bigoplus_{p \in Q} \mathfrak{h}_{\mathcal{A}}(h(\xi))_p \otimes F_p = \mathfrak{h}_{\mathcal{A}}(h(\xi))_v = \text{eval}(\xi) = a \quad (4.25)$$

where the last but one equality follows from (4.24). Hence $\langle A \rangle_{\{\oplus, \otimes, 0, 1\}} \subseteq \text{im}(\llbracket \mathcal{A} \rrbracket^{\text{init}})$. \square

In fact, Theorem 4.3.1 holds for each ranked alphabet Σ which is branching, i.e., satisfies that $\Sigma^{(k)} \neq \emptyset$ for some $k \geq 2$.

Theorem 4.3.2. *Let Σ be a branching ranked alphabet. Moreover, let $\mathbf{B} = (B, \oplus, \otimes, 0, 1)$ be a strong bimonoid and $A \subseteq B$ be a finite subset. Then we can construct a (Σ, \mathbf{B}) -wta \mathcal{B} such that $\text{im}(\llbracket \mathcal{B} \rrbracket^{\text{init}}) = \langle A \rangle_{\{\oplus, \otimes, 0, 1\}}$. In particular, if \mathbf{B} is generated by A , then we obtain $\text{im}(\llbracket \mathcal{B} \rrbracket^{\text{init}}) = B$.*

Proof. Let (Σ, rk) be a ranked alphabet which is branching. Hence there exist a $k \in \mathbb{N}$ with $k \geq 2$ and a $\sigma \in \Sigma$ such that $\text{rk}(\sigma) = k$.

We define the ranked alphabet (Σ, rk') such that for each $\omega \in \Sigma$ we let

$$\text{rk}'(\omega) = \begin{cases} 2 & \text{if } \omega = \sigma \\ \text{rk}(\sigma) & \text{if otherwise.} \end{cases}$$

Thus, $\text{rk}'(\sigma) = 2$ and (Σ, rk') is an extension of (Σ, rk) .

Now let $A \subseteq B$ be a finite subset.

First, since (Σ, rk') contains a binary symbol (i.e., $(\text{rk}')^{-1}(2) \neq \emptyset$), by Theorem 4.3.1, we can construct an $((\Sigma, \text{rk}'), \mathbf{B})$ -wta \mathcal{A} such that $\text{im}(\llbracket \mathcal{A} \rrbracket^{\text{init}}) = \langle A \rangle_{\{\oplus, \otimes, 0, 1\}}$.

Second, by applying Lemma 4.2.1 to (Σ, rk') , (Σ, rk) , and \mathcal{A} , we obtain the $((\Sigma, \text{rk}), \mathbf{B})$ -wta \mathcal{B} . Since $0 \in \langle A \rangle_{\{\oplus, \otimes, 0, 1\}}$, by Lemma 4.2.1(c) we have $\text{im}(\llbracket \mathcal{B} \rrbracket^{\text{init}}) = \langle A \rangle_{\{\oplus, \otimes, 0, 1\}}$. \square

4.3.2 Image finiteness of the semantics of wta over restricted strong bimonoids

In this subsection, we are interested in sufficient conditions on the strong bimonoid \mathbf{B} such that $\text{im}(\llbracket \mathcal{A} \rrbracket^{\text{run}})$ or $\text{im}(\llbracket \mathcal{A} \rrbracket^{\text{init}})$ are finite. Moreover, we draw some conclusions about the relationship of the classes $\text{Rec}^{\text{run}}(\Sigma, \mathbf{B})$ and $\text{Rec}^{\text{init}}(\Sigma, \mathbf{B})$ under these conditions.

If Σ is trivial, i.e., $\Sigma = \Sigma^{(0)}$, then $T_\Sigma = \Sigma^{(0)}$ and hence T_Σ is a finite set. Thus we can observe the following easy fact.

Observation 4.3.3. Let Σ be a trivial ranked alphabet. Then, for each (Σ, \mathbf{B}) -wta \mathcal{A} , we have that $\text{im}(\llbracket \mathcal{A} \rrbracket^{\text{run}})$ and $\text{im}(\llbracket \mathcal{A} \rrbracket^{\text{init}})$ are finite sets.

The following result is an obvious consequence of the definition of the run semantics.

Lemma 4.3.4. Let \mathbf{B} be bi-locally finite and \mathcal{A} a (Σ, \mathbf{B}) -wta \mathcal{A} . Then $\text{im}(\llbracket \mathcal{A} \rrbracket^{\text{run}})$ is finite.

Proof. Let $\mathcal{A} = (Q, \delta, F)$. For each $\xi \in T_\Sigma$, we have $\text{wt}(\xi, \rho) \otimes F_{\rho(\varepsilon)} \in \langle \text{wts}(\mathcal{A}) \rangle_{\{\otimes\}}$. Thus

$$\llbracket \mathcal{A} \rrbracket^{\text{run}}(\xi) = \bigoplus_{\rho \in R_{\mathcal{A}}(\xi)} \text{wt}(\xi, \rho) \otimes F_{\rho(\varepsilon)} \subseteq \langle \langle \text{wts}(\mathcal{A}) \rangle_{\{\otimes\}} \rangle_{\{\oplus\}}.$$

This latter set is finite because \mathbf{B} is bi-locally finite. Hence $\text{im}(\llbracket \mathcal{A} \rrbracket^{\text{run}})$ is also finite. \square

In Theorem 12.2.9 we will prove the converse result: if for each (Σ, \mathbf{B}) -wta \mathcal{A} the set $\text{im}(\llbracket \mathcal{A} \rrbracket^{\text{run}})$ is finite, then \mathbf{B} is bi-locally finite.

A consequence of Lemma 4.3.4 and Theorem 4.3.2 is the following result.

Corollary 4.3.5. Let $\mathbf{B} = (B, \oplus, \otimes, 0, 1)$ be bi-locally finite and not locally finite. If Σ is branching, then we can construct a (Σ, \mathbf{B}) -wta \mathcal{A} such that $\llbracket \mathcal{A} \rrbracket^{\text{init}} \notin \text{Rec}^{\text{run}}(\Sigma, \mathbf{B})$. Hence, for such a Σ , we have $\text{Rec}^{\text{init}}(\Sigma, \mathbf{B}) \setminus \text{Rec}^{\text{run}}(\Sigma, \mathbf{B}) \neq \emptyset$.

Proof. Let $A \subseteq B$ be a finite subset such that $\langle A \rangle_{\{\oplus, \otimes, 0, 1\}}$ is an infinite set. Let Σ be branching. Then, by Theorem 4.3.2 we can construct a (Σ, \mathbf{B}) -wta \mathcal{A} such that $\text{im}(\llbracket \mathcal{A} \rrbracket^{\text{init}}) = \langle A \rangle_{\{\oplus, \otimes, 0, 1\}}$. Thus $\text{im}(\llbracket \mathcal{A} \rrbracket^{\text{init}})$ is an infinite set. On the other hand, by Lemma 4.3.4, for each $r \in \text{Rec}^{\text{run}}(\Sigma, \mathbf{B})$, the set $\text{im}(r)$ is finite. Hence $\llbracket \mathcal{A} \rrbracket^{\text{init}} \notin \text{Rec}^{\text{run}}(\Sigma, \mathbf{B})$. \square

We show three applications of Corollary 4.3.5. First, we consider the strong bimonoid Trunc_λ from Example 2.7.10(2) which is not a semiring. We recall that $\text{Trunc}_\lambda = (B, \oplus, \odot, 0, 1)$ where $\lambda \in \mathbb{R}$ and $B = \{0\} \cup \{b \in \mathbb{R} \mid \lambda \leq b \leq 1\}$; Trunc_λ is bi-locally finite and not locally finite. In fact, for $\lambda = \frac{1}{4}$, in Example 2.7.10(2) an infinite family $(b_i \mid i \in \mathbb{N})$ of elements of B is given which is generated by $A = \{\frac{1}{2}\}$. Thus, for each branching ranked alphabet Σ , Corollary 4.3.5 implies that $\text{Rec}^{\text{init}}(\Sigma, \text{Trunc}_{\frac{1}{4}}) \setminus \text{Rec}^{\text{run}}(\Sigma, \text{Trunc}_{\frac{1}{4}}) \neq \emptyset$.

Second, we consider the bounded lattice $\text{FL}(2+2)$ in Example 2.7.15(9). This lattice is infinite and generated by the two chains $a < b$ and $c < d$, i.e., by four elements (cf. Figure 2.5). By Observation 2.7.13, the bounded lattice $\text{FL}(2+2)$ is a bi-locally finite strong bimonoid. Thus, for each branching ranked alphabet Σ , Corollary 4.3.5 implies that $\text{Rec}^{\text{init}}(\Sigma, \text{FL}(2+2)) \setminus \text{Rec}^{\text{run}}(\Sigma, \text{FL}(2+2)) \neq \emptyset$.

Third, we consider the strong bimonoid $\text{Stb} = (\mathbb{N}, \oplus, \odot, 0, 1)$ from Example 2.7.10(9). We saw that Stb is bi-locally finite and not locally finite. Moreover, $\langle \{2\} \rangle_{\{\oplus, \odot, 0, 1\}} = \mathbb{N}$. Thus, by Corollary 4.3.5, for each branching ranked alphabet Σ , we have that $\text{Rec}^{\text{init}}(\Sigma, \text{Stb}) \setminus \text{Rec}^{\text{run}}(\Sigma, \text{Stb}) \neq \emptyset$. Later a stronger version of this statement will be shown (cf. Theorem 5.2.5 in which we make a weaker assumption on Σ).

The following result is an obvious consequence of the definition of initial algebra semantics.

Lemma 4.3.6. Let \mathbf{B} be locally finite and \mathcal{A} a (Σ, \mathbf{B}) -wta \mathcal{A} . Then $\text{im}(\llbracket \mathcal{A} \rrbracket^{\text{init}})$ is finite.

Proof. Let $\mathcal{A} = (Q, \delta, F)$. For each $\xi \in T_\Sigma$ and $q \in Q$, we have that $[\mathcal{A}]^{\text{init}}(\xi) \in \langle \text{wts}(\mathcal{A}) \rangle_{\{\oplus, \otimes\}}$. This latter set is finite because \mathbf{B} is locally finite. Hence $\text{im}([\mathcal{A}]^{\text{init}})$ is also finite. \square

In Theorem 12.1.6 we will prove the converse result: if for each (Σ, \mathbf{B}) -wta \mathcal{A} the set $\text{im}([\mathcal{A}]^{\text{init}})$ is finite, then \mathbf{B} is locally finite.

If we restrict in Lemma 4.3.6 the ranked alphabet Σ to be monadic, then we can relax the condition that \mathbf{B} is locally finite and only require that \mathbf{B} is weakly locally finite.

Lemma 4.3.7. Let Σ be a monadic ranked alphabet and \mathcal{A} be a (Σ, \mathbf{B}) -wta \mathcal{A} . Then the following two statements hold.

- (1) $\text{im}([\mathcal{A}]^{\text{init}}) \subseteq \text{wcl}(\text{wts}(\mathcal{A}))$.
- (2) If \mathbf{B} is weakly locally finite, then $\text{im}([\mathcal{A}]^{\text{init}})$ is finite.

Proof. Let $\mathcal{A} = (Q, \delta, F)$.

Proof of (1): First, by induction on T_Σ , we prove that the following statement holds (where $\text{wcl}(\text{im}(\delta))$ is defined in Subsection 2.7.5).

$$\text{For every } \xi \in T_\Sigma \text{ and } q \in Q, \text{ we have that } h_{\mathcal{A}}(\xi)_q \in \text{wcl}(\text{im}(\delta)) . \quad (4.26)$$

The proof for $\xi \in \Sigma^{(0)}$ is trivial. Let $\xi = \sigma(\xi_1)$. Then $(h_{\mathcal{A}}(\xi_1)_p \otimes \delta_1(p, \sigma, q)) \in \text{wcl}(\text{im}(\delta))$ for each $p \in Q$ because $h_{\mathcal{A}}(\xi_1)_p \in \text{wcl}(\text{im}(\delta))$ by I.H. and $\delta_1(p, \sigma, q) \in \text{im}(\delta)$. Moreover, $h_{\mathcal{A}}(\xi)_q = \bigoplus_{p \in Q} h_{\mathcal{A}}(\xi_1)_p \otimes \delta_1(p, \sigma, q)$ is also in $\text{wcl}(\text{im}(\delta))$ because $\text{wcl}(\text{im}(\delta))$ is closed under \oplus . This finishes the proof of (4.26).

Now let $\xi \in T_\Sigma$. By (4.26), for each $q \in Q$, we have $(h_{\mathcal{A}}(\xi)_q \otimes F_q) \in \text{wcl}(\text{wts}(\mathcal{A}))$. Hence also $[\mathcal{A}]^{\text{init}}(\xi) = \bigoplus_{q \in Q} h_{\mathcal{A}}(\xi)_q \otimes F_q$ is in $\text{wcl}(\text{wts}(\mathcal{A}))$. This proves (1).

Then (2) follows from (1) and the fact that, if \mathbf{B} is weakly locally finite, then $\text{wcl}(\text{wts}(\mathcal{A}))$ is finite \square

We note that Lemma 4.3.7 can also be obtained from [DSV10, Lm. 18], where the result was proved for string ranked alphabets, as follows [Dro24]. Let \mathcal{A} be a (Σ, \mathbf{B}) -wta \mathcal{A} , where Σ is monadic, i.e., $\Sigma = \Sigma^{(1)} \cup \Sigma^{(0)}$. If Σ is trivial, then $\text{im}([\mathcal{A}]^{\text{init}})$ is finite by Observation 4.3.3. Now assume that Σ is not trivial. For each $\alpha \in \Sigma^{(0)}$, we let $\Sigma_\alpha = \Sigma^{(1)} \cup \{\alpha\}$. Since Σ is not trivial, Σ_α is a string ranked alphabet and $T_\Sigma = \bigcup_{\alpha \in \Sigma^{(0)}} T_{\Sigma_\alpha}$. Moreover, for each $\alpha \in \Sigma^{(0)}$, we let \mathcal{A}_α be the restriction of \mathcal{A} to Σ_α . Then, for each $\xi \in T_{\Sigma_\alpha}$, we have $[\mathcal{A}]^{\text{init}}(\xi) = [\mathcal{A}_\alpha]^{\text{init}}(\xi)$, and thus $\text{im}([\mathcal{A}]^{\text{init}}) = \bigcup_{\alpha \in \Sigma^{(0)}} \text{im}([\mathcal{A}_\alpha]^{\text{init}})$. By [DSV10, Lm. 18] (using Lemma 3.3.4 as bridge from wsa to wta), for each $\alpha \in \Sigma^{(0)}$, the set $\text{im}([\mathcal{A}_\alpha]^{\text{init}})$ is finite. Hence $\text{im}([\mathcal{A}]^{\text{init}})$ is finite.

A consequence of Lemma 4.3.7 and Theorem 4.3.2 is the fact that, for a particular set of strong bimonoids, the possibility of branching increases the computational power of wta with respect to wta over monadic ranked alphabets.

Corollary 4.3.8. Let \mathbf{B} be a weakly locally finite strong bimonoid which is not locally finite. If Σ is branching, then we can construct a (Σ, \mathbf{B}) -wta \mathcal{A} such that

$$\text{im}([\mathcal{A}]^{\text{init}}) \not\subseteq \{ \text{im}([\mathcal{B}]^{\text{init}}) \mid \Delta \text{ is a monadic ranked alphabet and } \mathcal{B} \text{ is a } (\Delta, \mathbf{B})\text{-wta} \} .$$

Hence

$$\begin{aligned} & \{ \text{im}([\mathcal{B}]^{\text{init}}) \mid \Delta \text{ is a monadic ranked alphabet and } \mathcal{B} \text{ is a } (\Delta, \mathbf{B})\text{-wta} \} \\ & \subset \{ \text{im}([\mathcal{B}]^{\text{init}}) \mid \Delta \text{ is a ranked alphabet and } \mathcal{B} \text{ is a } (\Delta, \mathbf{B})\text{-wta} \} . \end{aligned}$$

Proof. By our assumption, there exists a finite set $A \subseteq B$ such that $\langle A \rangle_{\{\oplus, \otimes, 0, 1\}}$ is an infinite set. By Theorem 4.3.2 we can construct a (Σ, \mathbf{B}) -wta \mathcal{A} such that $\text{im}([\mathcal{A}]^{\text{init}}) = \langle A \rangle_{\{\oplus, \otimes, 0, 1\}}$. Moreover, by Lemma 4.3.7, for every monadic ranked alphabet Δ and (Δ, \mathbf{B}) -wta \mathcal{B} , the set $\text{im}([\mathcal{B}]^{\text{init}})$ is finite.

Then the second statement, i.e., the strict inclusion follows immediately. \square

In [DFTV24], we defined a strong bimonoid $M(X)$ and proved that it is weakly locally finite and not locally finite, cf. [DFTV24, Thm. 3.5].

As a consequence of Lemma 3.3.4 and Corollary 4.3.8 we obtain the following statement on the comparison of the computational power of wta and wsa: If we consider weakly locally finite strong bimonoids which are not locally finite, and the initial algebra semantics, then weighted tree automata can generate strictly more sets of values than weighted string automata can generate.

Corollary 4.3.9. Let B be a weakly locally finite strong bimonoid which is not locally finite. Then

$$\begin{aligned} & \{\text{im}(\llbracket \mathcal{C} \rrbracket^{\text{init}}) \mid \Gamma \text{ is an alphabet and } \mathcal{C} \text{ is a } (\Gamma, B)\text{-wsa}\} \\ & \subset \{\text{im}(\llbracket \mathcal{A} \rrbracket^{\text{init}}) \mid \Sigma \text{ is a ranked alphabet and } \mathcal{A} \text{ is a } (\Sigma, B)\text{-wta}\} . \end{aligned}$$

Proof. The proof is as follows:

$$\begin{aligned} & \{\text{im}(\llbracket \mathcal{C} \rrbracket^{\text{init}}) \mid \Gamma \text{ is an alphabet and } \mathcal{C} \text{ is a } (\Gamma, B)\text{-wsa}\} \\ = & \{\text{im}(\llbracket \mathcal{B} \rrbracket^{\text{init}}) \mid \Gamma_e \text{ is a string ranked alphabet and } \mathcal{B} \text{ is a } (\Gamma_e, B)\text{-wta}\} && \text{(by Lemma 3.3.4)} \\ \subset & \{\text{im}(\llbracket \mathcal{A} \rrbracket^{\text{init}}) \mid \Sigma \text{ is a ranked alphabet and } \mathcal{A} \text{ is a } (\Sigma, B)\text{-wta}\} && \text{(by Corollary 4.3.8)} \end{aligned}$$

□

Chapter 5

Comparison of initial algebra semantics and run semantics

In Section 3.2 we gave a number of examples of a (Σ, \mathbf{B}) -wta \mathcal{A} and we computed its run semantics or initial algebra semantics.

In Section 5.1, we start with an analysis of the complexity of two algorithms; the one calculates $\llbracket \mathcal{A} \rrbracket^{\text{init}}(\xi)$ on input \mathcal{A} and ξ , and the other calculates $\llbracket \mathcal{A} \rrbracket^{\text{run}}(\xi)$ on input \mathcal{A} and ξ (cf. Theorem 5.1.1); both algorithms follow the definition of the respective semantics in a natural way. We refer the reader to [AG20] for investigations on the complexity of the evaluation problem in the general framework of weighted tiling systems.

Second, in Section 5.2, we compare the run semantics and initial algebra semantics of some arbitrary, but fixed wta. In some situations, the semantics are equal. For instance, for the mapping height, in Example 3.2.4 we constructed a $(\Sigma, \mathbf{Nat}_{\max,+})$ -wta \mathcal{A} and proved that $\llbracket \mathcal{A} \rrbracket^{\text{init}} = \llbracket \mathcal{A} \rrbracket^{\text{run}} = \text{height}$. The question arises whether $\llbracket \mathcal{A} \rrbracket^{\text{init}} = \llbracket \mathcal{A} \rrbracket^{\text{run}}$ for each (Σ, \mathbf{B}) -wta \mathcal{A} . In Section 5.2 we will show that the answer is negative, i.e., we show a (Σ, \mathbf{B}) -wta \mathcal{A} such that $\llbracket \mathcal{A} \rrbracket^{\text{init}} \neq \llbracket \mathcal{A} \rrbracket^{\text{run}}$; in fact, we show four such examples. This stimulates the next question: is it possible to construct, for each (Σ, \mathbf{B}) -wta \mathcal{A} , a (Σ, \mathbf{B}) -wta \mathcal{B} such that $\llbracket \mathcal{A} \rrbracket^{\text{init}} = \llbracket \mathcal{B} \rrbracket^{\text{run}}$ (and similarly with run semantics and initial algebra semantics exchanged)? In general, the answer to this question is also negative, i.e., we prove that there exist a strong bimonoid \mathbf{B} and a (Σ, \mathbf{B}) -wta \mathcal{A} such that $\llbracket \mathcal{A} \rrbracket^{\text{init}} \notin \text{Rec}^{\text{run}}(\Sigma, \mathbf{B})$ (cf. Theorem 5.2.5).

On the positive side, in Section 5.3, we will prove that, under certain conditions (on the wta or the strong bimonoid), the two semantics are equal.

5.1 Complexity of calculating run semantics and initial algebra semantics

In this section we analyse the complexity of two natural algorithms: one calculates $\llbracket \mathcal{A} \rrbracket^{\text{run}}(\xi)$ on input \mathcal{A} and ξ (cf. Algorithm 1) and the other calculates $\llbracket \mathcal{A} \rrbracket^{\text{init}}(\xi)$ of input \mathcal{A} and ξ (cf. Algorithm 2). It is obvious that these algorithms are correct.

More specifically, we are interested in the number $\#_{\text{run}}(\mathcal{A}, \xi)$ of occurrences of the strong bimonoid operations \oplus and \otimes that occur in the execution of Algorithm 1 if the inputs are \mathcal{A} and ξ . Similarly, we are interested in the number $\#_{\text{init}}(\mathcal{A}, \xi)$ of occurrences of the strong bimonoid operations \oplus and \otimes that occur in the execution of Algorithm 2 if the inputs are \mathcal{A} and ξ .

Algorithm 1 Computation of the run semantics**Input:** (Σ, \mathbb{B}) -wta $\mathcal{A} = (Q, \delta, F)$ and $\xi \in T_\Sigma$ **Variables:** $b, r : B$; $w : \text{pos}(\xi)$ **Output:** $[\mathcal{A}]^{\text{run}}(\xi)$

```

1:  $b \leftarrow \mathbb{0}$ 
2: for each  $\rho : \text{pos}(\xi) \rightarrow Q$  do
3:    $r \leftarrow \mathbb{1}$ 
4:   for each  $w \in \text{pos}(\xi)$  in depth-first post-order do
5:     let  $k = \text{rk}(\xi(w))$ 
6:      $r \leftarrow r \otimes \delta_k(\rho(w_1) \cdots \rho(w_k), \xi(w), \rho(w))$ 
7:   end for
8:    $b \leftarrow b \oplus (r \otimes F_{\rho(\varepsilon)})$ 
9: end for
10: return  $b$ 

```

Algorithm 2 Computation of the initial algebra semantics**Input:** (Σ, \mathbb{B}) -wta $\mathcal{A} = (Q, \delta, F)$ and $\xi \in T_\Sigma$ **Variables:** $v : \text{pos}(\xi) \rightarrow B^Q$; $w : \text{pos}(\xi)$; $b : B$ **Output:** $[\mathcal{A}]^{\text{init}}(\xi)$

```

1: for each  $w \in \text{pos}(\xi)$  in depth-first post-order do
2:   let  $k = \text{rk}(\xi(w))$ 
3:   for each  $q \in Q$  do
4:      $v(w)_q \leftarrow \mathbb{0}$ 
5:     for each  $q_1 \cdots q_k \in Q^k$  do
6:        $v(w)_q \leftarrow v(w)_q \oplus v(w_1)_{q_1} \otimes \cdots \otimes v(w_k)_{q_k} \otimes \delta_k(q_1 \cdots q_k, \xi(w), q)$ 
7:     end for
8:   end for
9: end for
10:  $b \leftarrow \mathbb{0}$ 
11: for each  $q \in Q$  do
12:    $b \leftarrow b \oplus (v(\varepsilon)_q \otimes F_q)$ 
13: end for
14: return  $b$ 

```

Theorem 5.1.1. *Let Σ be a ranked alphabet. Moreover, let $\mathbb{B} = (B, \oplus, \otimes, \mathbb{0}, \mathbb{1})$ be a strong bimonoid and let $\mathcal{A} = (Q, \delta, F)$ be a (Σ, \mathbb{B}) -wta. For every $\xi \in T_\Sigma$, we have*

- (1) $\#_{\text{run}}(\mathcal{A}, \xi) = (\text{size}(\xi) + 2) \cdot |Q|^{\text{size}(\xi)}$, and
- (2) $\#_{\text{init}}(\mathcal{A}, \xi) \leq \text{size}(\xi) \cdot \max(m + 1, 2) \cdot (|Q|^{m+1} + |Q|)$ where $m = \text{maxrk}(\Sigma)$.

Proof. Proof of (1): The loop in line 2 of Algorithm 1 is executed $|Q|^{\text{size}(\xi)}$ many times. In each execution of the body of this loop, $\text{size}(\xi) + 1$ times \otimes is executed and 1 times \oplus is executed.

Proof of (2): We abbreviate $\text{maxrk}(\Sigma)$ by m . By assuming that each position of w of ξ has m children (apart from the leaves of ξ) we can approximate $\#_{\text{init}}(\mathcal{A}, \xi)$ as follows. The loops in lines 1, 3, and 5 are executed $\text{size}(\xi)$ many times, $|Q|$ many times, and maximally $|Q|^m$ many times, respectively. In line 6 there are maximally $m + 1$ occurrences of \oplus and \otimes . Hence, during execution of the loop in line 1, there are maximally $\text{size}(\xi) \cdot |Q|^{m+1} \cdot (m + 1)$ many occurrences of \oplus and \otimes . During execution of the loop in line 11 there are $2 \cdot |Q|$ many occurrences of \oplus and \otimes . Thus in total we obtain

$$\#_{\text{init}}(\mathcal{A}, \xi) \leq \text{size}(\xi) \cdot |Q|^{m+1} \cdot (m + 1) + 2 \cdot |Q|$$

$$\begin{aligned}
&\leq \text{size}(\xi) \cdot |Q|^{m+1} \cdot \max(m+1, 2) + \max(m+1, 2) \cdot |Q| \cdot \text{size}(\xi) \\
&\leq \text{size}(\xi) \cdot \max(m+1, 2) \cdot (|Q|^{m+1} + |Q|) . \quad \square
\end{aligned}$$

As we can see from Theorem 5.1.1, the effort of calculating $\llbracket \mathcal{A} \rrbracket^{\text{run}}(\xi)$ by Algorithm 1 is exponential in the size of ξ , and the effort of calculating $\llbracket \mathcal{A} \rrbracket^{\text{init}}(\xi)$ by Algorithm 2 is at most linear in the size of ξ .

With respect to the discussion on page 75, both algorithms compute the values of the algebraic fta-hyperpath problem of an fta-hypergraph where the weights come from a strong bimonoid. We note that the value computation algorithm in [MV21, Alg. 6.1] (also cf. [MV19a, Alg. 1]) computes the values of the fta-algebraic hyperpath problem where the weights are calculated in a multioperator monoid.

5.2 Negative results for equality of the two semantics

In general, the run semantics and the initial algebra semantics of a wta over \mathbf{B} are different, which is witnessed by the following four examples for string ranked alphabets.

Example 5.2.1. We consider the string ranked alphabet $\Sigma = \{\gamma^{(1)}, \alpha^{(0)}\}$ and the tropical bimonoid $\text{TropBM} = (\mathbb{N}_\infty, +, \min, 0, \infty)$ from Example 2.7.10(1). Moreover, let $\mathcal{A} = (Q, \delta, F)$ be the (Σ, TropBM) -wta from Example 3.2.8, i.e.,

- $Q = \{q_0, q_1\}$,
- $\delta_0(\varepsilon, \alpha, p) = \delta_1(p, \gamma, q) = 1$ for every $p, q \in Q$, and
- $F_{q_0} = F_{q_1} = 1$.

From Example 3.2.8 we know that $\llbracket \mathcal{A} \rrbracket^{\text{run}}(\gamma^n(\alpha)) = 2^{n+1}$ for every $n \in \mathbb{N}$. Next we compute $\llbracket \mathcal{A} \rrbracket^{\text{init}}(\gamma^n(\alpha))$.

$$\llbracket \mathcal{A} \rrbracket^{\text{init}}(\gamma^n(\alpha)) = \bigoplus_{q \in Q} \min(\text{h}_{\mathcal{A}}(\gamma^n(\alpha))_q, F_q) = \bigoplus_{q \in Q} \min(\text{h}_{\mathcal{A}}(\gamma^n(\alpha))_q, 1) \stackrel{(*)}{=} \bigoplus_{q \in Q} 1 = 2 ,$$

where we have to verify (*). For this, by induction on \mathbb{N} , we prove that the following statement holds:

$$\text{For every } n \in \mathbb{N} \text{ and } q \in Q \text{ we have: } \text{h}_{\mathcal{A}}(\gamma^n(\alpha))_q = \begin{cases} 1 & \text{if } n = 0 \\ 2 & \text{otherwise} . \end{cases}$$

I.B.: Let $n = 0$. Then $\text{h}_{\mathcal{A}}(\gamma^n(\alpha))_q = \text{h}_{\mathcal{A}}(\alpha)_q = \delta_0(\varepsilon, \alpha, q) = 1$ for each $q \in Q$.

I.S.: Let $n \geq 1$. Then for each $q \in Q$:

$$\text{h}_{\mathcal{A}}(\gamma^n(\alpha))_q = \bigoplus_{p \in Q} \min(\text{h}_{\mathcal{A}}(\gamma^{n-1}(\alpha))_p, \delta_1(p, \gamma, q)) = \bigoplus_{p \in Q} 1 = 2 ,$$

where the second equality follows from (a) the I.H. saying that $1 \leq \text{h}_{\mathcal{A}}(\gamma^{n-1}(\alpha))_p \leq 2$ and (b) the fact that $\delta_1(p, \gamma, q) = 1$. Hence $\llbracket \mathcal{A} \rrbracket^{\text{run}} \neq \llbracket \mathcal{A} \rrbracket^{\text{init}}$. \square

Example 5.2.2. (adapted from [CDIV10, Ex. 3.1]) Let $\text{UnitInt}_{\text{bs}} = ([0, 1], \oplus, \cdot, 0, 1)$ be the strong bimonoid given in Example 2.7.10(4), where \oplus is the bounded sum, and let $\Sigma = \{\gamma^{(1)}, \nu^{(1)}, \alpha^{(0)}\}$. We consider the $(\Sigma, \text{UnitInt}_{\text{bs}})$ -wta $\mathcal{A} = (Q, \delta, F)$, where

- $Q = \{p, q\}$,
- the transition mappings are given as follows:
 - $\delta_0(\varepsilon, \alpha, p) = 0.6, \quad \delta_0(\varepsilon, \alpha, q) = 0,$
 - $\delta_1(p, \gamma, p) = 1, \quad \delta_1(p, \gamma, q) = 1, \quad \delta_1(q, \gamma, p) = 0, \quad \delta_1(q, \gamma, q) = 0,$
 - $\delta_1(p, \nu, p) = 1, \quad \delta_1(p, \nu, q) = 0, \quad \delta_1(q, \nu, p) = 1, \quad \delta_1(q, \nu, q) = 0,$

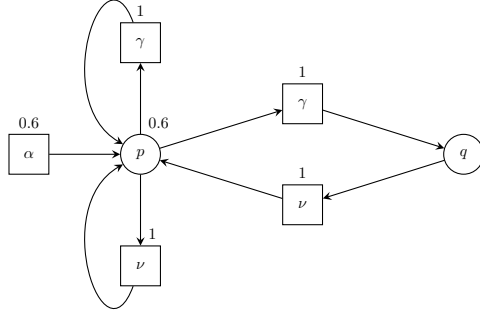

Figure 5.1: The $(\Sigma, \text{UnitInt}_{\text{bs}})$ -wta \mathcal{A} of Example 5.2.2.

- $F_p = 0.6$ and $F_q = 0$.

Figure 5.1 shows the fta-hypergraph of \mathcal{A} .

We consider the tree $\xi = \nu(\gamma(\alpha))$ and the runs ρ_1 and ρ_2 of \mathcal{A} on ξ with $\rho_1(\varepsilon) = \rho_1(1) = \rho_1(11) = p$ and $\rho_2(\varepsilon) = p$, $\rho_1(1) = q$, and $\rho_2(11) = p$. Then $\text{wt}(\xi, \rho_1) = \text{wt}(\xi, \rho_2) = 0.6$. Then we can calculate as follows:

$$\begin{aligned} \llbracket \mathcal{A} \rrbracket^{\text{run}}(\xi) &= \bigoplus_{\rho \in \mathcal{R}_{\mathcal{A}}(\xi)} \text{wt}(\xi, \rho) \cdot F_{\rho(\varepsilon)} = \bigoplus_{\rho \in \mathcal{R}_{\mathcal{A}}(p, \xi)} \text{wt}(\xi, \rho) \cdot 0.6 \\ &= \text{wt}(\xi, \rho_1) \cdot 0.6 \oplus \text{wt}(\xi, \rho_2) \cdot 0.6 = 0.36 \oplus 0.36 = 0.72 . \end{aligned}$$

For the calculation of $\llbracket \mathcal{A} \rrbracket^{\text{init}}(\xi)$ we calculate the following Q -vectors where the upper component corresponds to the state p :

$$\begin{aligned} \mathbf{h}_{\mathcal{A}}(\alpha) &= \begin{pmatrix} 0.6 \\ 0 \end{pmatrix} & \mathbf{h}_{\mathcal{A}}(\gamma(\alpha)) &= \begin{pmatrix} \mathbf{h}_{\mathcal{A}}(\alpha)_p \cdot 1 \\ \mathbf{h}_{\mathcal{A}}(\alpha)_q \cdot 1 \end{pmatrix} = \begin{pmatrix} 0.6 \\ 0.6 \end{pmatrix} \\ \mathbf{h}_{\mathcal{A}}(\nu(\gamma(\alpha))) &= \begin{pmatrix} \mathbf{h}_{\mathcal{A}}(\gamma(\alpha))_p \cdot 1 \oplus \mathbf{h}_{\mathcal{A}}(\gamma(\alpha))_q \cdot 1 \\ \mathbf{h}_{\mathcal{A}}(\gamma(\alpha))_p \cdot 0 \oplus \mathbf{h}_{\mathcal{A}}(\gamma(\alpha))_q \cdot 0 \end{pmatrix} = \begin{pmatrix} 0.6 \oplus 0.6 \\ 0 \end{pmatrix} = \begin{pmatrix} 1 \\ 0 \end{pmatrix} . \end{aligned}$$

Then $\llbracket \mathcal{A} \rrbracket^{\text{init}}(\xi) = \bigoplus_{q' \in Q} \mathbf{h}_{\mathcal{A}}(\xi)_{q'} \cdot F_{q'} = \mathbf{h}_{\mathcal{A}}(\xi)_p \cdot 0.6 = 0.6$. Hence $\llbracket \mathcal{A} \rrbracket^{\text{run}} \neq \llbracket \mathcal{A} \rrbracket^{\text{init}}$. This inequality is due to the lack of right-distributivity in $\text{UnitInt}_{\text{bs}}$:

$$0.72 = 0.36 \oplus 0.36 = (0.6 \cdot 0.6) \oplus (0.6 \cdot 0.6) \neq (0.6 \oplus 0.6) \cdot 0.6 = 1 \cdot 0.6 = 0.6 . \quad \square$$

As the next two examples show, the run semantics and the initial algebra semantics can be different even when the strong bimonoid is finite.

Example 5.2.3. We consider the finite strong bimonoid $\text{Three} = (\{0, 1, 2\}, \max, \hat{\cdot}, 0, 1)$ with

$$a \hat{\cdot} b = (a \cdot b) \bmod 3$$

for every $a, b \in \{0, 1, 2\}$ (cf. Example 2.7.10(7)), and the string ranked alphabet $\Sigma = \{\gamma^{(1)}, \alpha^{(0)}\}$. Now we let $\mathcal{A} = (Q, \delta, F)$ be the (Σ, Three) -wta such that $Q = \{1, 2, q\}$, $F_1 = F_2 = 0$ and $F_q = 2$, and

$$\delta_0(\varepsilon, \alpha, 1) = 1, \quad \delta_0(\varepsilon, \alpha, 2) = 2, \quad \delta_0(\varepsilon, \alpha, q) = 0, \quad \delta_1(1, \gamma, q) = \delta_1(2, \gamma, q) = 1$$

and for every other combination $p_1, p_2 \in Q$ we let $\delta_1(p_1, \gamma, p_2) = 0$. Figure 5.2 shows the fta-hypergraph of \mathcal{A} .

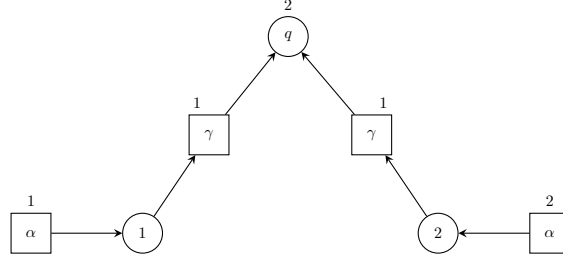

Figure 5.2: The fta-hypergraph of the (Σ, Three) -wta \mathcal{A} of Example 5.2.3.

Now let $\xi = \gamma(\alpha)$. Clearly $\{\rho \in R_{\mathcal{A}}(q, \xi) \mid \text{wt}(\xi, \rho) \neq 0\} = \{\rho_1, \rho_2\}$ with

$$\rho_1(\varepsilon) = \rho_2(\varepsilon) = q, \quad \rho_1(1) = 1, \quad \rho_2(1) = 2, \quad \text{and} \quad \text{wt}(\xi, \rho_1) = 1, \quad \text{wt}(\xi, \rho_2) = 2 .$$

Hence $\llbracket \mathcal{A} \rrbracket^{\text{run}}(\xi) = \max(\text{wt}(\xi, \rho_1) \hat{\cdot} 2, \text{wt}(\xi, \rho_2) \hat{\cdot} 2) = \max(1 \hat{\cdot} 2, 2 \hat{\cdot} 2) = \max(2, 1) = 2$.

For the initial algebra semantics, we have

$$h_{\mathcal{A}}(\alpha)_1 = 1, \quad h_{\mathcal{A}}(\alpha)_2 = 2, \quad h_{\mathcal{A}}(\alpha)_q = 0$$

and

$$h_{\mathcal{A}}(\xi)_q = \max(h_{\mathcal{A}}(\alpha)_1 \hat{\cdot} 1, h_{\mathcal{A}}(\alpha)_2 \hat{\cdot} 1) = \max(1, 2) = 2 .$$

Hence $\llbracket \mathcal{A} \rrbracket^{\text{init}}(\xi) = h_{\mathcal{A}}(\xi)_q \hat{\cdot} 2 = 2 \hat{\cdot} 2 = 1$.

We obtain $\llbracket \mathcal{A} \rrbracket^{\text{run}}(\xi) = 2 \neq 1 = \llbracket \mathcal{A} \rrbracket^{\text{init}}(\xi)$. This inequality is due to the lack of right-distributivity in **Three**: $\max(1 \hat{\cdot} 2, 2 \hat{\cdot} 2) = \max(2, 1) = 2 \neq 1 = 2 \hat{\cdot} 2 = \max(1, 2) \hat{\cdot} 2$. \square

Example 5.2.4. [FV24] We consider the bounded lattice $\mathbf{N}_5 = (N_5, \vee, \wedge, o, i)$ shown in Figure 2.4. Moreover, we consider the string ranked alphabet $\Sigma = \{\gamma^{(1)}, \alpha^{(0)}\}$. Now we let $\mathcal{A} = (Q, \delta, F)$ be the (Σ, \mathbf{N}_5) -wta with $Q = \{q_1, q_2, q\}$, $F_{q_1} = F_{q_2} = o$ and $F_q = a$. Moreover, let

- $\delta_0(\varepsilon, \alpha, q_1) = b$, $\delta_0(\varepsilon, \alpha, q_2) = c$, $\delta_1(q_1, \gamma, q) = \delta_1(q_2, \gamma, q) = i$,
- $\delta_0(\varepsilon, \alpha, q) = o$ and, for each $p_1 p_2 \in (Q \times Q) \setminus \{q_1 q, q_2 q\}$, we let $\delta_1(p_1, \gamma, p_2) = o$.

The fta-hypergraph of \mathcal{A} is obtained from the one in Figure 5.2 by replacing the states 1 and 2 by q_1 and q_2 , respectively, and by adapting the weights appropriately.

Then

$$\begin{aligned} \llbracket \mathcal{A} \rrbracket^{\text{init}}(\gamma(\alpha)) &= \bigvee_{p \in Q} h_{\mathcal{A}}(\gamma(\alpha))_p \wedge F_p = h_{\mathcal{A}}(\gamma(\alpha))_q \wedge a = \left(\bigvee_{p \in Q} h_{\mathcal{A}}(\alpha)_p \wedge \delta_1(p, \gamma, q) \right) \wedge a \\ &= \left((h_{\mathcal{A}}(\alpha)_{q_1} \wedge \delta_1(q_1, \gamma, q)) \vee (h_{\mathcal{A}}(\alpha)_{q_2} \wedge \delta_1(q_2, \gamma, q)) \right) \wedge a \\ &= \left((\delta_0(\varepsilon, \alpha, q_1) \wedge i) \vee (\delta_0(\varepsilon, \alpha, q_2) \wedge i) \right) \wedge a \\ &= (b \vee c) \wedge a = a . \end{aligned}$$

Also we have

$$\begin{aligned} \llbracket \mathcal{A} \rrbracket^{\text{run}}(\gamma(\alpha)) &= \bigvee_{p \in Q} \bigvee_{\rho \in R_{\mathcal{A}}(p, \xi)} \text{wt}(\gamma(\alpha), \rho) \wedge F_p = \bigvee_{\rho \in R_{\mathcal{A}}(q, \xi)} (\text{wt}(\gamma(\alpha), \rho) \wedge a) \\ &= (\delta_0(\varepsilon, \alpha, q_1) \wedge \delta_1(q_1, \gamma, q) \wedge a) \vee (\delta_0(\varepsilon, \alpha, q_2) \wedge \delta_1(q_2, \gamma, q) \wedge a) \\ &= (b \wedge i \wedge a) \vee (c \wedge i \wedge a) \\ &= (b \wedge a) \vee (c \wedge a) = b . \end{aligned}$$

Hence $\llbracket \mathcal{A} \rrbracket^{\text{init}} \neq \llbracket \mathcal{A} \rrbracket^{\text{run}}$. \square

For the particular string ranked alphabet Σ and the (Σ, TropBM) -wta \mathcal{A} of Example 5.2.1, it is easy to construct a (Σ, TropBM) -wta \mathcal{B} such that $\llbracket \mathcal{A} \rrbracket^{\text{init}} = \llbracket \mathcal{B} \rrbracket^{\text{run}}$ (just let \mathcal{B} have one state q , the weight of each transition is 2, and the root weight of q is also 2). The next theorem shows that, in general, this is not possible. Its proof is a slight adaptation of the proof of [DSV10, Ex. 25].

Theorem 5.2.5. [DSV10, Ex. 25] *Let Σ be a ranked alphabet. The following two statements hold.*

- (1) *For each (Σ, Stb) -wta \mathcal{A} , the set $\text{im}(\llbracket \mathcal{A} \rrbracket^{\text{run}})$ is finite.*
- (2) *If Σ is not trivial, then $\text{Rec}^{\text{init}}(\Sigma, \text{Stb}) \setminus \text{Rec}^{\text{run}}(\Sigma, \text{Stb}) \neq \emptyset$.*

Proof. Before proving Statements (1) and (2), we recall the strong bimonoid $\text{Stb} = (\mathbb{N}, \oplus, \odot, 0, 1)$ from Example 2.7.10(9). The two commutative operations \oplus and \odot on \mathbb{N} are defined as follows. First, let $0 \oplus a = a$, $0 \odot a = 0$, and $1 \odot a = a$ for every $a \in \mathbb{N}$. If $a, b \in \mathbb{N} \setminus \{0\}$ with $a \leq b$, we put (with $+$ being the usual addition on \mathbb{N})

$$a \oplus b = \begin{cases} b & \text{if } b \text{ is even} \\ b + 1 & \text{if } b \text{ is odd.} \end{cases}$$

If $a, b \in \mathbb{N} \setminus \{0, 1\}$ with $a \leq b$, let

$$a \odot b = \begin{cases} b + 1 & \text{if } b \text{ is even} \\ b & \text{if } b \text{ is odd.} \end{cases}$$

Proof of (1): It follows from Lemma 4.3.4 because Stb is bi-locally finite (cf. Example 2.7.10(9)).

Proof of (2): Let Σ be not trivial. Now we consider the particular (Σ, Stb) -wta $\mathcal{A} = (Q, \delta, F)$ with $Q = \{q_1, q_2\}$ and $\delta_k(p_1 \cdots p_k, \sigma, p) = F_p = 2$ for every $k \in \mathbb{N}$, $\sigma \in \Sigma^{(k)}$, and $p, p_1, \dots, p_k \in Q$. By induction on T_Σ , we prove that the following statement holds:

$$\text{For every } \xi \in T_\Sigma \text{ and } p \in Q, \text{ we have : } h_{\mathcal{A}}(\xi)_p = 2 \cdot \text{height}(\xi) + 2 . \quad (5.1)$$

I.B.: Let $\xi = \alpha$ be in $\Sigma^{(0)}$. Then $h_{\mathcal{A}}(\xi)_p = \delta_0(\varepsilon, \alpha, p) = 2 = 2 \cdot \text{height}(\xi) + 2$.

I.S.: Let $\xi = \sigma(\xi_1, \dots, \xi_k)$ with $k \geq 1$ and $p \in Q$. Moreover, let $j \in [k]$ be such that $\text{height}(\xi_j) = \max(\text{height}(\xi_i) \mid i \in [k])$. Then,

$$\begin{aligned} h_{\mathcal{A}}(\sigma(\xi_1, \dots, \xi_k))_p &= \bigoplus_{p_1 \cdots p_k \in Q} h_{\mathcal{A}}(\xi_1)_{p_1} \odot \dots \odot h_{\mathcal{A}}(\xi_k)_{p_k} \odot \delta_k(p_1 \cdots p_k, \sigma, p) \\ &= \bigoplus_{p_1 \cdots p_k \in Q} (2 \cdot \text{height}(\xi_1) + 2) \odot \dots \odot (2 \cdot \text{height}(\xi_k) + 2) \odot 2 \\ &\hspace{15em} \text{(by I.H. and definition of } \delta_k) \\ &= \bigoplus_{p_1 \cdots p_k \in Q} (2 \cdot \text{height}(\xi_j) + 3) \\ &\hspace{1em} \text{(by definition of } \odot \text{ and our choice of } j; \text{ note that } 2 \cdot \text{height}(\xi_j) + 2 \text{ is even)} \\ &= 2 \cdot \text{height}(\xi_j) + 4 \\ &\hspace{1em} \text{(by definition of } \oplus \text{ and the fact that there are at least two summands due to } k \geq 1 \text{ and } |Q| = 2) \\ &= 2 \cdot \text{height}(\sigma(\xi_1, \dots, \xi_k)) + 2 . \end{aligned}$$

This finished the proof of (5.1).

Hence, for each $\xi \in T_\Sigma$, we have

$$\llbracket \mathcal{A} \rrbracket^{\text{init}}(\xi) = \bigoplus_{p \in Q} h_{\mathcal{A}}(\xi)_q \odot F_p = \bigoplus_{p \in Q} (2 \cdot \text{height}(\xi) + 2) \odot 2 = \bigoplus_{p \in Q} (2 \cdot \text{height}(\xi) + 3) = 2 \cdot \text{height}(\xi) + 4 .$$

Since Σ is not trivial, this implies that the set $\text{im}(\llbracket \mathcal{A} \rrbracket^{\text{init}})$ is infinite.

By using Statement (1), we obtain that

$$\llbracket \mathcal{A} \rrbracket^{\text{init}} \in \text{Rec}^{\text{init}}(\Sigma, \text{Stb}) \setminus \text{Rec}^{\text{run}}(\Sigma, \text{Stb}) . \quad \square$$

The result which is dual to Theorem 5.2.5 would be that there exists a ranked alphabet Σ and a strong bimonoid \mathbf{B} such that $\text{Rec}^{\text{run}}(\Sigma, \mathbf{B}) \setminus \text{Rec}^{\text{init}}(\Sigma, \mathbf{B}) \neq \emptyset$. The corresponding statement for wsa was shown in [DSV10, Ex. 26]. However, we were not able to reproduce that proof, and thus, we cannot include its version for wta into the book.

5.3 Positive results for equality of the two semantics

In this section we show that the run semantics and the initial algebra semantics of a (Σ, \mathbf{B}) -wta \mathcal{A} are equal if \mathcal{A} is bu-deterministic or \mathbf{B} is distributive.

Theorem 5.3.1. (cf. [FKV21, Thm. 3.6]) *Let Σ be a ranked alphabet. Moreover, let \mathbf{B} be a strong bimonoid. For each bu-deterministic (Σ, \mathbf{B}) -wta \mathcal{A} we have $\llbracket \mathcal{A} \rrbracket^{\text{run}} = \llbracket \mathcal{A} \rrbracket^{\text{init}}$. Thus, in particular, $\text{bud-Rec}^{\text{run}}(\Sigma, \mathbf{B}) = \text{bud-Rec}^{\text{init}}(\Sigma, \mathbf{B})$ and $\text{cd-Rec}^{\text{run}}(\Sigma, \mathbf{B}) = \text{cd-Rec}^{\text{init}}(\Sigma, \mathbf{B})$.*

Proof. Let $\mathcal{A} = (Q, \delta, F)$ and $\xi \in T_\Sigma$. Using $Q_{\neq 0}^{\text{R}, \mathcal{A}}(\xi)$ and $Q_{\neq 0}^{\text{h}, \mathcal{A}}(\xi)$ (cf. Section 4.1), we have

$$\llbracket \mathcal{A} \rrbracket^{\text{run}}(\xi) = \bigoplus_{q \in Q_{\neq 0}^{\text{R}, \mathcal{A}}(\xi)} \bigoplus_{\rho \in R_{\mathcal{A}}(q, \xi)} \text{wt}(\xi, \rho) \otimes F_q \quad \text{and} \quad \llbracket \mathcal{A} \rrbracket^{\text{init}}(\xi) = \bigoplus_{q \in Q_{\neq 0}^{\text{h}, \mathcal{A}}(\xi)} h_{\mathcal{A}}(\xi)_q \otimes F_q .$$

Then we proceed by case analysis. Using Lemma 4.1.2(3) we distinguish the following two cases.

Case (a): Let $Q_{\neq 0}^{\text{R}, \mathcal{A}}(\xi) = \emptyset = Q_{\neq 0}^{\text{h}, \mathcal{A}}(\xi)$. Then

$$\llbracket \mathcal{A} \rrbracket^{\text{run}}(\xi) = \bigoplus_{q \in \emptyset} \bigoplus_{\rho \in R_{\mathcal{A}}(q, \xi)} \text{wt}(\xi, \rho) \otimes F_q = 0 = \bigoplus_{q \in \emptyset} h_{\mathcal{A}}(\xi)_q \otimes F_q = \llbracket \mathcal{A} \rrbracket^{\text{init}}(\xi)$$

Case (b): Let $Q_{\neq 0}^{\text{R}, \mathcal{A}}(\xi) = \{q\} = Q_{\neq 0}^{\text{h}, \mathcal{A}}(\xi)$ for some $q \in Q$ and there exists exactly one $\rho \in R_{\mathcal{A}}(q, \xi)$ with $h_{\mathcal{A}}(\xi)_q = \text{wt}(\xi, \rho)$. Then

$$\llbracket \mathcal{A} \rrbracket^{\text{run}}(\xi) = \text{wt}(\xi, \rho) \otimes F_q = h_{\mathcal{A}}(\xi)_q \otimes F_q = \llbracket \mathcal{A} \rrbracket^{\text{init}}(\xi) . \quad \square$$

Due to Theorem 5.3.1, if \mathcal{A} is bu-deterministic, then we write $\llbracket \mathcal{A} \rrbracket$ instead of $\llbracket \mathcal{A} \rrbracket^{\text{run}}$ and $\llbracket \mathcal{A} \rrbracket^{\text{init}}$. Moreover, for a weighted tree language r , we say that r is bu-deterministically recognizable (instead of bu-deterministically i -recognizable and bu-deterministically r -recognizable). Also, we write $\text{bud-Rec}(\Sigma, \mathbf{B})$ for $\text{bud-Rec}^{\text{run}}(\Sigma, \mathbf{B})$ (and hence, for $\text{bud-Rec}^{\text{init}}(\Sigma, \mathbf{B})$). Similarly, we say that r is crisp-deterministically recognizable (instead of crisp-deterministically i -recognizable and crisp-deterministically r -recognizable). Also, we write $\text{cd-Rec}(\Sigma, \mathbf{B})$ for $\text{cd-Rec}^{\text{run}}(\Sigma, \mathbf{B})$ and $\text{cd-Rec}^{\text{init}}(\Sigma, \mathbf{B})$.

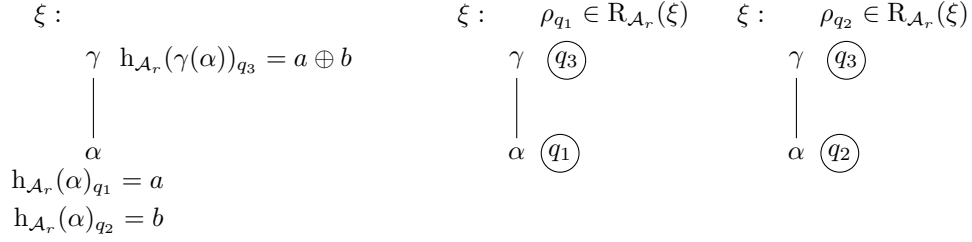

Figure 5.3: (left) Computation of $\text{h}_{\mathcal{A}_r}(\xi)_q$ for some state $q \in Q$ and some subtree ξ of $\gamma(\alpha)$ and (middle and right) runs ρ_{q_1} and ρ_{q_2} of \mathcal{A}_r on $\xi = \gamma(\alpha)$ for the wta \mathcal{A}_r in the proof of Lemma 5.3.2.

Also the two semantics are equal for each (Σ, \mathbf{B}) -wta if \mathbf{B} is a semiring (as, e.g., for the Boolean semiring, cf. Lemma 2.16.1). In Theorem 5.3.4 we will prove that even the “converse” result holds. That theorem was proved in [DSV10, Lm. 4] for the particular case that Σ is a string ranked alphabet; in this case only right-distributivity is needed. It turns out that in the tree case also left-distributivity is needed if Σ is branching. Moreover, in [LP05, Thm. 3.1(i),(iii)], the implication (A) \Rightarrow (B) of the theorem was proved for string ranked alphabets and lattice-ordered monoids in which the unit element of the monoid equals the upper bound of the lattice.

As preparation for the proof of Theorem 5.3.4, for every $a, b, c \in B$, we define two wta \mathcal{A}_r and \mathcal{A}_l where the intention is that,

- $\text{im}(\llbracket \mathcal{A}_r \rrbracket^{\text{init}}) = \{0, (a \oplus b) \otimes c\}$ and $\text{im}(\llbracket \mathcal{A}_r \rrbracket^{\text{run}}) = \{0, a \otimes c \oplus b \otimes c\}$, i.e., apart from 0 the two sides of the axiom for right-distributivity are computed, and
- $\text{im}(\llbracket \mathcal{A}_l \rrbracket^{\text{init}}) = \{0, a \otimes (b \oplus c)\}$ and $\text{im}(\llbracket \mathcal{A}_l \rrbracket^{\text{run}}) = \{0, a \otimes b \oplus a \otimes c\}$, i.e., apart from 0 the two sides of the axiom for left-distributivity are computed.

Lemma 5.3.2. For every $a, b, c \in B$ and ranked alphabet Σ with $\Sigma^{(1)} \neq \emptyset$, we can construct a (Σ, \mathbf{B}) -wta \mathcal{A}_r such that $\text{im}(\llbracket \mathcal{A}_r \rrbracket^{\text{init}}) = \{0, (a \oplus b) \otimes c\}$ and $\text{im}(\llbracket \mathcal{A}_r \rrbracket^{\text{run}}) = \{0, a \otimes c \oplus b \otimes c\}$.

Proof. Let $a, b, c \in B$. Moreover, let $\alpha \in \Sigma^{(0)}$ and $\gamma \in \Sigma^{(1)}$.

We construct the (Σ, \mathbf{B}) -wta $\mathcal{A}_r = (Q, \delta, F)$ as follows: $Q = \{q_1, q_2, q_3\}$, $F_{q_1} = F_{q_2} = 0$, and $F_{q_3} = c$. Moreover,

- $\delta_0(\varepsilon, \alpha, q_1) = a$, $\delta_0(\varepsilon, \alpha, q_2) = b$, and $\delta_0(\varepsilon, \alpha, q_3) = 0$
- $\delta_1(q_1, \gamma, q_3) = \delta_1(q_2, \gamma, q_3) = \mathbb{1}$ and $\delta_1(p, \gamma, q) = 0$ for each $pq \notin \{q_1q_3, q_2q_3\}$, and
- for every $k \in \mathbb{N}$, $\sigma \in \Sigma^{(k)} \setminus \{\alpha, \gamma\}$, and $(w, p) \in Q^k \times Q$, we let $\delta_k(w, \sigma, p) = 0$.

In fact, the state behaviour of \mathcal{A}_r is very similar to the one of the wta in Example 5.2.4.

We consider the particular input tree $\xi = \gamma(\alpha)$ in T_Σ and calculate its initial algebra semantics (cf. Figure 5.3).

$$\begin{aligned}
\llbracket \mathcal{A}_r \rrbracket^{\text{init}}(\xi) &= \bigoplus_{q \in Q} \text{h}_{\mathcal{A}_r}(\xi)_q \otimes F_q = \text{h}_{\mathcal{A}_r}(\xi)_{q_3} \otimes F_{q_3} && \text{(because } F_{q_1} = F_{q_2} = 0) \\
&= \left(\left(\bigoplus_{q \in Q} \text{h}_{\mathcal{A}_r}(\alpha)_q \right) \otimes \delta_1(q, \gamma, q_3) \right) \otimes c && \text{(because } F_{q_3} = c) \\
&= \left(\text{h}_{\mathcal{A}_r}(\alpha)_{q_1} \otimes \delta_1(q_1, \gamma, q_3) \oplus \text{h}_{\mathcal{A}_r}(\alpha)_{q_2} \otimes \delta_1(q_2, \gamma, q_3) \right) \otimes c && \text{(because } \delta_1(q_3, \gamma, q_3) = 0) \\
&= (a \oplus b) \otimes c . && \text{(because } \text{h}_{\mathcal{A}_r}(\alpha)_{q_1} = a, \text{h}_{\mathcal{A}_r}(\alpha)_{q_2} = b, \text{ and } \delta_1(q_1, \gamma, q_3) = \delta_1(q_2, \gamma, q_3) = \mathbb{1})
\end{aligned}$$

Moreover, it is easy to see that, for each $\xi \in \text{T}_\Sigma \setminus \{\gamma(\alpha)\}$, we have $\llbracket \mathcal{A}_r \rrbracket^{\text{init}}(\xi) = 0$. Since $\text{T}_\Sigma \setminus \{\gamma(\alpha)\} \neq \emptyset$, we have $\text{im}(\llbracket \mathcal{A}_r \rrbracket^{\text{init}}) = \{0, (a \oplus b) \otimes c\}$.

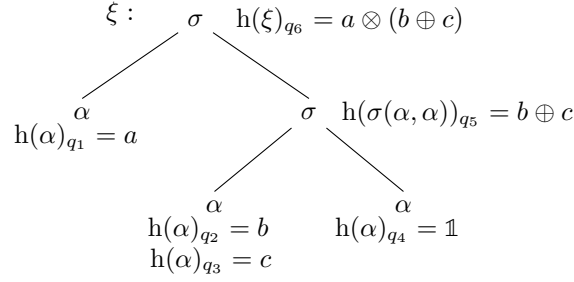

Figure 5.4: Computation of $h_{\mathcal{A}_l}(\xi)_q$ for some state $q \in Q$ and some subtree ξ of $\sigma(\alpha, \sigma(\alpha, \alpha))$ for the wta \mathcal{A}_l in the proof of Lemma 5.3.3.

For the calculation of the run semantics of $\xi = \gamma(\alpha)$ we consider the particular runs ρ_{q_1} and ρ_{q_2} of \mathcal{A}_r on ξ defined by $\rho_{q_1}(\varepsilon) = q_3$, $\rho_{q_1}(1) = q_1$, and $\rho_{q_2}(\varepsilon) = q_3$, $\rho_{q_2}(1) = q_2$ (cf. Figure 5.3). Then we can calculate as follows:

$$\begin{aligned}
\llbracket \mathcal{A}_r \rrbracket^{\text{run}}(\xi) &= \bigoplus_{\rho \in \mathbb{R}_{\mathcal{A}}(\xi)} \text{wt}(\xi, \rho) \otimes F_{\rho(\varepsilon)} \\
&= \bigoplus_{\rho \in \mathbb{R}_{\mathcal{A}}(q_3, \xi)} \text{wt}(\xi, \rho) \otimes c && \text{(because } F_{q_1} = F_{q_2} = \mathbb{0} \text{ and } F_{q_3} = c) \\
&= (\text{wt}(\xi, \rho_{q_1}) \otimes c) \oplus (\text{wt}(\xi, \rho_{q_2}) \otimes c) \\
&= (\text{wt}(\alpha, \rho_{q_1}|_1) \otimes \delta_1(q_1, \gamma, q_3) \otimes c) \oplus (\text{wt}(\alpha, \rho_{q_2}|_1) \otimes \delta_1(q_2, \gamma, q_3) \otimes c) && \text{(by (3.1))} \\
&= (\delta_0(\varepsilon, \alpha, q_1) \otimes \delta_1(q_1, \gamma, q_3) \otimes c) \oplus (\delta_0(\varepsilon, \alpha, q_2) \otimes \delta_1(q_2, \gamma, q_3) \otimes c) \\
&= (a \otimes c) \oplus (b \otimes c) .
\end{aligned}$$

Moreover, it is easy to see that, for each $\xi \in \mathbb{T}_{\Sigma} \setminus \{\gamma(\alpha)\}$, we have $\llbracket \mathcal{A}_r \rrbracket^{\text{run}}(\xi) = \mathbb{0}$. Since $\mathbb{T}_{\Sigma} \setminus \{\gamma(\alpha)\} \neq \emptyset$, we have $\text{im}(\llbracket \mathcal{A}_r \rrbracket^{\text{run}}) = \{\mathbb{0}, a \otimes c \oplus b \otimes c\}$. \square

Lemma 5.3.3. For every $a, b, c \in B$ and ranked alphabet Σ with $\Sigma^{(2)} \neq \emptyset$, we can construct a (Σ, B) -wta \mathcal{A}_l such that $\text{im}(\llbracket \mathcal{A}_l \rrbracket^{\text{init}}) = \{\mathbb{0}, a \otimes (b \oplus c)\}$ and $\text{im}(\llbracket \mathcal{A}_l \rrbracket^{\text{run}}) = \{\mathbb{0}, a \otimes b \oplus a \otimes c\}$.

Proof. Let $a, b, c \in B$. Moreover, let $\alpha \in \Sigma^{(0)}$ and $\sigma \in \Sigma^{(2)}$.

We construct the (Σ, B) -wta $\mathcal{A}_l = (Q, \delta, F)$ as follows: $Q = \{q_1, q_2, q_3, q_4, q_5, q_6\}$, $F_{q_1} = F_{q_2} = F_{q_3} = F_{q_4} = F_{q_5} = \mathbb{0}$, and $F_{q_6} = \mathbb{1}$. Moreover, we define the transition mappings as follows:

- $\delta_0(\varepsilon, \alpha, q_1) = a$, $\delta_0(\varepsilon, \alpha, q_2) = b$, $\delta_0(\varepsilon, \alpha, q_3) = c$, and $\delta_0(\varepsilon, \alpha, q_4) = \mathbb{1}$
- $\delta_1(q_2q_4, \sigma, q_5) = \delta_1(q_3q_4, \sigma, q_5) = \delta_1(q_1q_5, \sigma, q_6) = \mathbb{1}$ and for every $p_1p_2p_3 \notin \{q_2q_4q_5, q_3q_4q_5, q_1q_5q_6\}$ we let $\delta_2(p_1p_2, \sigma, p_3) = \mathbb{0}$, and
- for every $k \in \mathbb{N}$, $\theta \in \Sigma^{(k)} \setminus \{\alpha, \sigma\}$, and $(w, p) \in Q^k \times Q$ we can define $\delta_k(w, \theta, p) = \mathbb{0}$.

We consider the particular input tree $\xi = \sigma(\alpha, \sigma(\alpha, \alpha))$ in \mathbb{T}_{Σ} and calculate its initial algebra semantics (cf. Figure 5.4).

$$\begin{aligned}
\llbracket \mathcal{A}_l \rrbracket^{\text{init}}(\xi) &= \bigoplus_{q \in Q} h_{\mathcal{A}_l}(\xi)_q \otimes F_q = h_{\mathcal{A}_l}(\xi)_{q_6} \otimes F_{q_6} && \text{(because } F_q = \mathbb{0} \text{ for each } q \neq q_6) \\
&= \bigoplus_{p_1p_2 \in Q^2} h_{\mathcal{A}_l}(\alpha)_{p_1} \otimes h_{\mathcal{A}_l}(\sigma(\alpha, \alpha))_{p_2} \otimes \delta_2(p_1p_2, \sigma, q_6) && \text{(because } F_{q_6} = \mathbb{1}) \\
&= h_{\mathcal{A}_l}(\alpha)_{q_1} \otimes h_{\mathcal{A}_l}(\sigma(\alpha, \alpha))_{q_5} \otimes \delta_2(q_1q_5, \sigma, q_6) \\
&\quad \text{(because } \delta_2 \text{ is } \mathbb{0} \text{ for each other argument with } q_6 \text{ in its third component)} \\
&= a \otimes h_{\mathcal{A}_l}(\sigma(\alpha, \alpha))_{q_5} && \text{(because } h_{\mathcal{A}_l}(\alpha)_{q_1} = a \text{ and } \delta_2(q_1q_5, \sigma, q_6) = \mathbb{1})
\end{aligned}$$

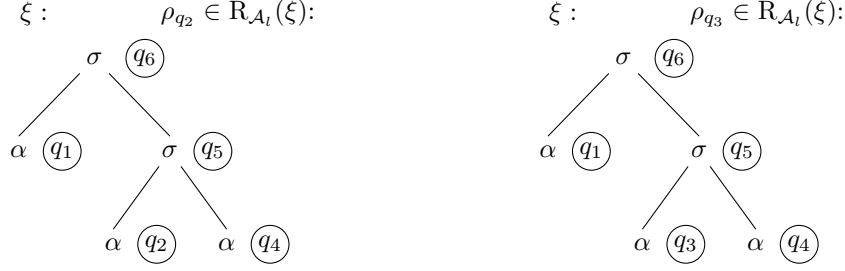

Figure 5.5: Runs ρ_{q_2} and ρ_{q_3} of \mathcal{A}_l on $\xi = \sigma(\alpha, \sigma(\alpha, \alpha))$ for the wta \mathcal{A}_l in the proof of Lemma 5.3.3.

$$\begin{aligned}
&= a \otimes \left(\bigoplus_{p_1 p_2 \in Q^2} h_{\mathcal{A}_l}(\alpha)_{p_1} \otimes h_{\mathcal{A}_l}(\alpha)_{p_2} \otimes \delta_2(p_1 p_2, \sigma, q_5) \right) \\
&= a \otimes \left(h_{\mathcal{A}_l}(\alpha)_{q_2} \otimes h_{\mathcal{A}_l}(\alpha)_{q_4} \otimes \delta_2(q_2 q_4, \sigma, q_5) \oplus h_{\mathcal{A}_l}(\alpha)_{q_3} \otimes h_{\mathcal{A}_l}(\alpha)_{q_4} \otimes \delta_2(q_3 q_4, \sigma, q_5) \right) \\
&\quad \text{(because } \delta_2 \text{ is } 0 \text{ for each other argument with } q_5 \text{ in its third component)} \\
&= a \otimes (b \oplus c) . \\
&\quad \text{(because } h_{\mathcal{A}_l}(\alpha)_{q_2} = b, h_{\mathcal{A}_l}(\alpha)_{q_3} = c, h_{\mathcal{A}_l}(\alpha)_{q_4} = \mathbb{1}, \text{ and } \delta_2(q_2 q_4, \sigma, q_5) = \delta_2(q_3 q_4, \sigma, q_5) = \mathbb{1})
\end{aligned}$$

Moreover, it is easy to see that, for each $\xi \in T_\Sigma \setminus \{\sigma(\alpha, \sigma(\alpha, \alpha))\}$, we have $\llbracket \mathcal{A}_l \rrbracket^{\text{init}}(\xi) = 0$. Since $T_\Sigma \setminus \{\sigma(\alpha, \sigma(\alpha, \alpha))\} \neq \emptyset$, we have $\text{im}(\llbracket \mathcal{A}_l \rrbracket^{\text{init}}) = \{0, a \otimes (b \oplus c)\}$.

For the calculation of the run semantics of $\xi = \sigma(\alpha, \sigma(\alpha, \alpha))$ we consider the particular runs ρ_{q_2} and ρ_{q_3} of \mathcal{A}_l on ξ defined by (cf. Figure 5.5)

- $\rho_{q_2}(\varepsilon) = q_6, \rho_{q_2}(1) = q_1, \rho_{q_2}(2) = q_5, \rho_{q_2}(21) = q_2, \rho_{q_2}(22) = q_4$, and
- ρ_{q_3} is the same as ρ_{q_2} except that $\rho_{q_3}(21) = q_3$.

Then we can calculate as follows:

$$\begin{aligned}
\llbracket \mathcal{A}_l \rrbracket^{\text{run}}(\xi) &= \bigoplus_{\rho \in R_{\mathcal{A}_l}(\xi)} \text{wt}(\xi, \rho) \otimes F_{\rho(\varepsilon)} \\
&= \bigoplus_{\rho \in R_{\mathcal{A}_l}(q_6, \xi)} \text{wt}(\xi, \rho) \quad \text{(because } F_q = 0 \text{ for each } q \neq q_6) \\
&= \bigoplus_{\rho \in R_{\mathcal{A}_l}(q_6, \xi)} \text{wt}(\alpha, \rho|_1) \otimes \text{wt}(\sigma(\alpha, \alpha), \rho|_2) \otimes \delta_2(\rho(1)\rho(2), \sigma, q_6) \quad \text{(by (3.1))} \\
&= \bigoplus_{\rho_1 \in R_{\mathcal{A}_l}(q_1, \alpha)} \bigoplus_{\rho_2 \in R_{\mathcal{A}_l}(q_5, \sigma(\alpha, \alpha))} \text{wt}(\alpha, \rho_1) \otimes \text{wt}(\sigma(\alpha, \alpha), \rho_2) \otimes \delta_2(q_1 q_5, \sigma, q_6) \\
&\quad \text{(because } \delta_2 \text{ is } 0 \text{ for each other argument with } q_6 \text{ in its third component)} \\
&= \bigoplus_{\rho_2 \in R_{\mathcal{A}_l}(q_5, \sigma(\alpha, \alpha))} \delta_0(\varepsilon, \alpha, q_1) \otimes \text{wt}(\sigma(\alpha, \alpha), \rho_2) \\
&\quad \text{(because } R_{\mathcal{A}_l}(q_1, \alpha) = \{\varepsilon \mapsto q_1\} \text{ and } \delta_2(q_1 q_5, \sigma, q_6) = \mathbb{1}) \\
&= \bigoplus_{\rho_2 \in R_{\mathcal{A}_l}(q_5, \sigma(\alpha, \alpha))} a \otimes \text{wt}(\sigma(\alpha, \alpha), \rho_2) \quad \text{(because } \delta_0(\varepsilon, \alpha, q_1) = a) \\
&= \bigoplus_{\rho_2 \in R_{\mathcal{A}_l}(q_5, \sigma(\alpha, \alpha))} a \otimes \text{wt}(\alpha, \rho_2|_1) \otimes \text{wt}(\alpha, \rho_2|_2) \otimes \delta_2(\rho_2(1)\rho_2(2), \sigma, q_5) \quad \text{(by (3.1))}
\end{aligned}$$

$$\begin{aligned}
&= \left(a \otimes \delta_0(\varepsilon, \alpha, q_2) \otimes \delta_0(\varepsilon, \alpha, q_4) \otimes \delta_2(q_2 q_4, \sigma, q_5) \right) \oplus \\
&\quad \left(a \otimes \delta_0(\varepsilon, \alpha, q_3) \otimes \delta_0(\varepsilon, \alpha, q_4) \otimes \delta_2(q_3 q_4, \sigma, q_5) \right) \\
&\quad \text{(because } \delta_2 \text{ is } \mathbb{0} \text{ for each other argument with } q_5 \text{ in its third component)} \\
&= (a \otimes b) \oplus (a \otimes c) \quad \text{(by definition of } \delta)
\end{aligned}$$

It is obvious that, for each $\xi \in T_\Sigma \setminus \{\sigma(\alpha, \sigma(\alpha, \alpha))\}$, we have $\llbracket \mathcal{A}_l \rrbracket^{\text{run}}(\xi) = \mathbb{0}$. Since $T_\Sigma \setminus \{\sigma(\alpha, \sigma(\alpha, \alpha))\} \neq \emptyset$, we have $\text{im}(\llbracket \mathcal{A}_l \rrbracket^{\text{run}}) = \{\mathbb{0}, (a \otimes b) \oplus (a \otimes c)\}$. \square

Now we can prove the characterization of the equality of the two semantics.

Theorem 5.3.4. (cf. [Rad10, Thm. 4.1] and [Bor05, Lm. 4.1.13]) *Let Σ be a ranked alphabet. Moreover, let $\mathbf{B} = (B, \oplus, \otimes, \mathbb{0}, \mathbb{1})$ be a strong bimonoid. The following two statements are equivalent:*

(A) *If Σ is not trivial, then \mathbf{B} is right-distributive, and if Σ is branching, then \mathbf{B} is left-distributive.*

(B) *For each (Σ, \mathbf{B}) -wta \mathcal{A} we have $\llbracket \mathcal{A} \rrbracket^{\text{run}} = \llbracket \mathcal{A} \rrbracket^{\text{init}}$.*

Proof. Proof of (A) \Rightarrow (B): Let $\xi \in T_\Sigma$. Since

$$\llbracket \mathcal{A} \rrbracket^{\text{run}}(\xi) = \bigoplus_{q \in Q} \bigoplus_{\rho \in \mathbf{R}_{\mathcal{A}}(q, \xi)} \text{wt}(\xi, \rho) \otimes F_q \quad \text{and} \quad \llbracket \mathcal{A} \rrbracket^{\text{init}}(\xi) = \bigoplus_{q \in Q} h_{\mathcal{A}}(\xi)_q \otimes F_q,$$

it suffices to show that

$$\text{for each } q \in Q, \text{ we have } h_{\mathcal{A}}(\xi)_q \otimes F_q = \bigoplus_{\rho \in \mathbf{R}_{\mathcal{A}}(q, \xi)} \text{wt}(\xi, \rho) \otimes F_q.$$

If Σ is trivial, then $|\mathbf{R}_{\mathcal{A}}(q, \xi)| = 1$. Otherwise \mathbf{B} is right-distributive. Thus in both cases we have

$$\bigoplus_{\rho \in \mathbf{R}_{\mathcal{A}}(q, \xi)} \text{wt}(\xi, \rho) \otimes F_q = \left(\bigoplus_{\rho \in \mathbf{R}_{\mathcal{A}}(q, \xi)} \text{wt}(\xi, \rho) \right) \otimes F_q.$$

Hence, by induction on T_Σ , we prove that the following statement holds:

$$\text{For every } \xi \in T_\Sigma \text{ and } q \in Q, \text{ we have } h_{\mathcal{A}}(\xi)_q = \bigoplus_{\rho \in \mathbf{R}_{\mathcal{A}}(q, \xi)} \text{wt}(\xi, \rho). \quad (5.2)$$

For this, let $\xi = \sigma(\xi_1, \dots, \xi_k)$ and $q \in Q$. Then

$$\begin{aligned}
&h_{\mathcal{A}}(\xi)_q \\
&= \bigoplus_{q_1 \cdots q_k \in Q^k} \left(\bigotimes_{i \in [k]} h_{\mathcal{A}}(\xi_i)_{q_i} \right) \otimes \delta_k(q_1 \cdots q_k, \sigma, q) \\
&= \bigoplus_{q_1 \cdots q_k \in Q^k} \left(\bigoplus_{\rho_1 \in \mathbf{R}_{\mathcal{A}}(q_1, \xi_1)} \text{wt}(\xi_1, \rho_1) \right) \otimes \dots \otimes \left(\bigoplus_{\rho_k \in \mathbf{R}_{\mathcal{A}}(q_k, \xi_k)} \text{wt}(\xi_k, \rho_k) \right) \otimes \delta_k(q_1 \cdots q_k, \sigma, q) \quad \text{(by I.H.)} \\
&= \bigoplus_{q_1 \cdots q_k \in Q^k} \left(\bigoplus_{\rho_1 \in \mathbf{R}_{\mathcal{A}}(q_1, \xi_1)} \text{wt}(\xi_1, \rho_1) \otimes \left(\dots \otimes \left(\bigoplus_{\rho_k \in \mathbf{R}_{\mathcal{A}}(q_k, \xi_k)} \text{wt}(\xi_k, \rho_k) \otimes \delta_k(\rho_1(\varepsilon) \cdots \rho_k(\varepsilon), \sigma, q) \right) \dots \right) \right) \\
&\quad \text{(by right-distributivity, in case } k \geq 1) \\
&= \bigoplus_{q_1 \cdots q_k \in Q^k} \left(\bigoplus_{\rho_1 \in \mathbf{R}_{\mathcal{A}}(q_1, \xi_1)} \dots \bigoplus_{\rho_k \in \mathbf{R}_{\mathcal{A}}(q_k, \xi_k)} \left(\bigotimes_{i \in [k]} \text{wt}(\xi_i, \rho_i) \right) \otimes \delta_k(\rho_1(\varepsilon) \cdots \rho_k(\varepsilon), \sigma, q) \right) \\
&\quad \text{(by left-distributivity, in case } k \geq 2)
\end{aligned}$$

$$\begin{aligned}
&= \bigoplus_{q_1 \cdots q_k \in Q^k} \left(\bigoplus_{\substack{\rho \in \mathcal{R}_{\mathcal{A}}(q, \xi), \\ \rho(1)=q_1, \dots, \rho(k)=q_k}} \left(\bigotimes_{i \in [k]} \text{wt}(\xi_i, \rho|_i) \right) \otimes \delta_k(\rho(1) \cdots \rho(k), \sigma, \rho(\varepsilon)) \right) \\
&= \bigoplus_{\rho \in \mathcal{R}_{\mathcal{A}}(q, \xi)} \left(\bigotimes_{i \in [k]} \text{wt}(\xi_i, \rho|_i) \right) \otimes \delta_k(\rho(1) \cdots \rho(k), \sigma, \rho(\varepsilon)) = \bigoplus_{\rho \in \mathcal{R}_{\mathcal{A}}(q, \xi)} \text{wt}(\xi, \rho).
\end{aligned}$$

Proof of (B) \Rightarrow (A): We have to show:

- (i) If Σ is not trivial, then $(a \oplus b) \otimes c = a \otimes c \oplus b \otimes c$ for every $a, b, c \in B$, and
- (ii) if Σ is branching, then $a \otimes (b \oplus c) = a \otimes b \oplus a \otimes c$ for every $a, b, c \in B$.

To prove (i), we assume that (Σ, rk) is not trivial. Hence there exists a $k \in \mathbb{N}$ with $k \geq 1$ and a $\gamma \in \Sigma$ such that $\text{rk}(\gamma) = k$. Moreover, let $a, b, c \in B$.

First, we define the ranked alphabet (Σ, rk') such that for each $\sigma \in \Sigma$ we let

$$\text{rk}'(\sigma) = \begin{cases} 1 & \text{if } \sigma = \gamma \\ \text{rk}(\sigma) & \text{if otherwise.} \end{cases}$$

Thus, $\text{rk}'(\gamma) = 1$ and (Σ, rk) is an extension of (Σ, rk') .

Second, since (Σ, rk') contains a unary symbol, i.e., $(\text{rk}')^{-1}(1) \neq \emptyset$, by Lemma 5.3.2, we can construct a $((\Sigma, \text{rk}'), \mathbf{B})$ -wta \mathcal{A}_r such that $\text{im}(\llbracket \mathcal{A}_r \rrbracket^{\text{init}}) = \{0, (a \oplus b) \otimes c\}$ and $\text{im}(\llbracket \mathcal{A}_r \rrbracket^{\text{run}}) = \{0, a \otimes c \oplus b \otimes c\}$.

Third, by applying Lemma 4.2.1(c) to (Σ, rk') , (Σ, rk) , and \mathcal{A}_r , we obtain the $((\Sigma, \text{rk}), \mathbf{B})$ -wta \mathcal{B} such that,

- $\text{im}(\llbracket \mathcal{B} \rrbracket^{\text{init}}) = \text{im}(\llbracket \mathcal{A}_r \rrbracket^{\text{init}})$ and $\text{im}(\llbracket \mathcal{B} \rrbracket^{\text{run}}) = \text{im}(\llbracket \mathcal{A}_r \rrbracket^{\text{run}})$, or
- $\text{im}(\llbracket \mathcal{B} \rrbracket^{\text{init}}) = \text{im}(\llbracket \mathcal{A}_r \rrbracket^{\text{init}}) \cup \{0\}$ and $\text{im}(\llbracket \mathcal{B} \rrbracket^{\text{run}}) = \text{im}(\llbracket \mathcal{A}_r \rrbracket^{\text{run}}) \cup \{0\}$.

Thus $\text{im}(\llbracket \mathcal{B} \rrbracket^{\text{init}}) = \{0, (a \oplus b) \otimes c\}$ and $\text{im}(\llbracket \mathcal{B} \rrbracket^{\text{run}}) = \{0, a \otimes c \oplus b \otimes c\}$. By (B) we obtain that $\{0, (a \oplus b) \otimes c\} = \{0, a \otimes c \oplus b \otimes c\}$, and hence $(a \oplus b) \otimes c = a \otimes c \oplus b \otimes c$. Thus \mathbf{B} is right-distributive.

To prove (ii), we assume that (Σ, rk) is branching. Hence there exists a $k \in \mathbb{N}$ with $k \geq 2$ and a $\gamma \in \Sigma$ such that $\text{rk}(\gamma) = k$. Moreover, let $a, b, c \in B$.

First, we define the ranked alphabet (Σ, rk') such that for each $\sigma \in \Sigma$ we let

$$\text{rk}'(\sigma) = \begin{cases} 2 & \text{if } \sigma = \gamma \\ \text{rk}(\sigma) & \text{if otherwise.} \end{cases}$$

Thus, $\text{rk}'(\gamma) = 2$ and (Σ, rk) is an extension of (Σ, rk') .

Second, since (Σ, rk') contains a binary symbol, i.e., $(\text{rk}')^{-2}(2) \neq \emptyset$, by Lemma 5.3.3, we can construct a $((\Sigma, \text{rk}'), \mathbf{B})$ -wta \mathcal{A}_l such that $\text{im}(\llbracket \mathcal{A}_l \rrbracket^{\text{init}}) = \{0, a \otimes (b \oplus c)\}$ and $\text{im}(\llbracket \mathcal{A}_l \rrbracket^{\text{run}}) = \{0, a \otimes b \oplus a \otimes c\}$.

Third, by applying Lemma 4.2.1(c) to (Σ, rk') , (Σ, rk) , and \mathcal{A}_l , we obtain the $((\Sigma, \text{rk}), \mathbf{B})$ -wta \mathcal{B} such that,

- $\text{im}(\llbracket \mathcal{B} \rrbracket^{\text{init}}) = \text{im}(\llbracket \mathcal{A}_l \rrbracket^{\text{init}})$ and $\text{im}(\llbracket \mathcal{B} \rrbracket^{\text{run}}) = \text{im}(\llbracket \mathcal{A}_l \rrbracket^{\text{run}})$, or
- $\text{im}(\llbracket \mathcal{B} \rrbracket^{\text{init}}) = \text{im}(\llbracket \mathcal{A}_l \rrbracket^{\text{init}}) \cup \{0\}$ and $\text{im}(\llbracket \mathcal{B} \rrbracket^{\text{run}}) = \text{im}(\llbracket \mathcal{A}_l \rrbracket^{\text{run}}) \cup \{0\}$.

Thus $\text{im}(\llbracket \mathcal{B} \rrbracket^{\text{init}}) = \{0, a \otimes (b \oplus c)\}$ and $\text{im}(\llbracket \mathcal{B} \rrbracket^{\text{run}}) = \{0, a \otimes b \oplus a \otimes c\}$. By (B) we obtain $\{0, a \otimes (b \oplus c)\} = \{0, a \otimes b \oplus a \otimes c\}$, and hence $a \otimes (b \oplus c) = a \otimes b \oplus a \otimes c$. Thus \mathbf{B} is left-distributive. \square

In Examples 3.2.4 and 3.2.11 we gave a wta over the semiring $\mathbf{Nat}_{\max,+}$ and a wta over the semiring \mathbf{Nat} , respectively, and we have proved that for both wta the run semantics coincides with the initial algebra semantics. The following corollary of Theorem 5.3.4 shows that this coincidence is valid for each wta over an arbitrary semiring.

Corollary 5.3.5. Let Σ be a ranked alphabet. Moreover, let $\mathbf{B} = (B, \oplus, \otimes, 0, 1)$ be a semiring. For each (Σ, \mathbf{B}) -wta \mathcal{A} , we have

- (1) $h_{\mathcal{A}}(\xi)_q = \bigoplus_{\rho \in R_{\mathcal{A}}(q, \xi)} \text{wt}(\xi, \rho)$ for every $\xi \in T_{\Sigma}$ and state q of \mathcal{A} and
- (2) $\llbracket \mathcal{A} \rrbracket^{\text{run}} = \llbracket \mathcal{A} \rrbracket^{\text{init}}$.

Thus, in particular, $\text{Rec}^{\text{run}}(\Sigma, \mathbf{B}) = \text{Rec}^{\text{init}}(\Sigma, \mathbf{B})$.

Proof. Since \mathbf{B} is a semiring, Equation (5.2) holds, and hence Statement (1) holds. Moreover, Theorem 5.3.4((A) \Rightarrow (B)) implies that $\llbracket \mathcal{A} \rrbracket^{\text{run}} = \llbracket \mathcal{A} \rrbracket^{\text{init}}$ and $\text{Rec}^{\text{run}}(\Sigma, \mathbf{B}) = \text{Rec}^{\text{init}}(\Sigma, \mathbf{B})$. \square

Due to Corollary 5.3.5, if \mathbf{B} is a semiring and \mathcal{A} is a (Σ, \mathbf{B}) -wta, then we write $\llbracket \mathcal{A} \rrbracket$ instead of $\llbracket \mathcal{A} \rrbracket^{\text{run}}$ and $\llbracket \mathcal{A} \rrbracket^{\text{init}}$. Moreover, for an i -recognizable or r -recognizable weighted tree language r , we say that r is recognizable. Also, we denote the set $\text{Rec}^{\text{run}}(\Sigma, \mathbf{B})$ (and hence, $\text{Rec}^{\text{init}}(\Sigma, \mathbf{B})$) by $\text{Rec}(\Sigma, \mathbf{B})$.

With respect to the complexity of calculating the semantics $\llbracket \mathcal{A} \rrbracket$ of some (Σ, \mathbf{B}) -wta \mathcal{A} where \mathbf{B} is a semiring, Theorem 5.1.1 implies the following: in general, it is more efficient to calculate $\llbracket \mathcal{A} \rrbracket$ according to Algorithm 2 (initial algebra semantics) than to calculate it according to Algorithm 1 (run semantics).

In Section 3.3 we have recalled the definition of wsa and the definitions of their run semantics and initial algebra semantics. Moreover, we have shown that wsa can be considered as particular wta (cf. Lemma 3.3.3). An easy consequence of the previous results is that the two semantics of each wsa over right-distributive strong bimonoid are equal.

Corollary 5.3.6. (cf. [DSV10, Lm. 4]) Let Γ be an alphabet and \mathbf{B} be a right-distributive strong bimonoid. For each (Γ, \mathbf{B}) -wsa \mathcal{A} we have $\llbracket \mathcal{A} \rrbracket^{\text{run}} = \llbracket \mathcal{A} \rrbracket^{\text{init}}$.

Proof. Let \mathcal{A} be a (Γ, \mathbf{B}) -wsa. Moreover, let $e \notin \Gamma$. By Lemma 3.3.3, we can construct a (Γ_e, \mathbf{B}) -wta \mathcal{B} such that $\llbracket \mathcal{A} \rrbracket^{\text{run}} = \llbracket \mathcal{B} \rrbracket^{\text{run}} \circ \text{tree}_e$ and $\llbracket \mathcal{A} \rrbracket^{\text{init}} = \llbracket \mathcal{B} \rrbracket^{\text{init}} \circ \text{tree}_e$. We note that $\Gamma \neq \emptyset$ and hence Γ_e is not trivial. Then, by Theorem 5.3.4 and again by Lemma 3.3.3, we obtain that $\llbracket \mathcal{A} \rrbracket^{\text{run}} = \llbracket \mathcal{A} \rrbracket^{\text{init}}$. \square

Due to Corollary 5.3.6, if \mathbf{B} is a semiring and \mathcal{A} is a (Γ, \mathbf{B}) -wsa, then we write $\llbracket \mathcal{A} \rrbracket$ instead of $\llbracket \mathcal{A} \rrbracket^{\text{run}}$ and $\llbracket \mathcal{A} \rrbracket^{\text{init}}$.

Another consequence of Theorem 5.3.4 is the following.

Observation 5.3.7. For every trivial ranked alphabet Σ and (Σ, \mathbf{B}) -wta \mathcal{A} we have $\llbracket \mathcal{A} \rrbracket^{\text{init}} = \llbracket \mathcal{A} \rrbracket^{\text{run}}$.

Proof. Let Σ be a trivial ranked alphabet. Since $\Sigma = \Sigma^{(0)}$, we also have $\Sigma = \Sigma^{(0)} \cup \Sigma^{(1)}$, i.e., Σ is monadic. Hence, Statement (A) of Theorem 5.3.4 holds. Thus Theorem 5.3.4(A) \Rightarrow (B) implies the result. \square

Of course, Observation 5.3.7 can also be proved directly. Let $\alpha \in \Sigma^{(0)}$ and $\mathcal{A} = (Q, \delta, F)$. Then

$$\llbracket \mathcal{A} \rrbracket^{\text{init}}(\alpha) = \bigoplus_{q \in Q} h_{\mathcal{A}}(\alpha)_q \otimes F_q = \bigoplus_{q \in Q} \delta_0(\varepsilon, \alpha, q) \otimes F_q = \bigoplus_{q \in Q} \bigoplus_{\rho \in R_{\mathcal{A}}(q, \alpha)} \text{wt}_{\mathcal{A}}(\alpha, \rho) \otimes F_q = \llbracket \mathcal{A} \rrbracket^{\text{run}}(\alpha) .$$

Chapter 6

Pumping lemmas

In this chapter we show three pumping lemmas, which have different flavors: the pumping lemma for runs [Bor04, Sec. 5] (cf. Theorem 6.1.4) and, as a corollary, a pumping lemma for wta over positive strong bimonoids (cf. Corollary 6.1.6), and the pumping lemma for wta over fields [BR82] (cf. Theorem 6.2.9).

The pumping lemma in Theorem 6.1.4 concerns runs of weighted tree automata over \mathbf{B} . It says that, given a big tree and a run on that tree, both the tree and the run can be decomposed such that both, the tree and the run can be pumped up along its components, and the weight of a pumped run on the corresponding pumped tree can be constructed as the product of the weights of the components of the run. As a corollary of Theorem 6.1.4, we prove a pumping lemma for the support of weighted tree languages recognizable by wta over a positive strong bimonoid \mathbf{B} (cf. Corollary 6.1.6). Essentially this is the classical pumping lemma for recognizable Σ -tree languages [GS84, Lm. 2.10.1].

The pumping lemma in Theorem 6.2.9 concerns the support of weighted tree languages recognizable by wta over a field \mathbf{B} . It says that, given a recognizable weighted tree language r and a big tree in the support of r , the tree can be decomposed such that it can be pumped up along its components and infinitely many of the pumped trees belong to the support of r .

We mention that in [MR18, CMMR21] five pumping lemmas for wsa over particular important semirings are shown. They concern weighted languages (a) which are recognizable by wsa over \mathbf{Nat}_∞ , (b) which have the form $\min(r_1, \dots, r_m)$, where r_1, \dots, r_m are recognizable by wsa over \mathbf{Nat}_∞ , (c) which are recognizable by polynomially-ambiguous wsa over $\mathbf{Nat}_{\min,+}$, (d) which are recognizable by finitely-ambiguous wsa over $\mathbf{Nat}_{\max,+}$, and (e) which are recognizable by polynomially-ambiguous wsa over $\mathbf{Nat}_{\max,+}$, respectively. Each of these pumping lemmas is used to show that certain weighted languages do not belong to the corresponding set of recognizable weighted languages.

We also mention that the pumping lemma in [Reu80] for wsa over fields (which can be considered as a predecessor of the above mentioned pumping lemma in [BR82]) was generalized to wsa over Artinian semirings in [MN23].

We recall that $C_\Sigma \subseteq T_\Sigma(\{z\})$ denotes the set of all Σ -contexts (cf. page 57). For each $c \in C_\Sigma$, we denote by $\text{depth}(c)$ the length of the unique z -labeled position of c , i.e. $\text{depth}(c) = |\text{pos}_z(c)|$. We say that c is *elementary* if $\text{depth}(c) = 1$, i.e., there exist $k \in \mathbb{N}_+$, $\sigma \in \Sigma^{(k)}$, $i \in [k]$, and $\xi_1, \dots, \xi_{i-1}, \xi_{i+1}, \dots, \xi_k \in T_\Sigma$ such that

$$c = \sigma(\xi_1, \dots, \xi_{i-1}, z, \xi_{i+1}, \dots, \xi_k) .$$

We denote the set of all elementary Σ -contexts by eC_Σ . Lastly we define the binary relation \succ_{C_Σ} on C_Σ such that, for every $c_1, c_2 \in C_\Sigma$, we have $c_1 \succ_{C_\Sigma} c_2$ if there exists an elementary context $c \in eC_\Sigma$ such that $c_1 = c[c_2]$. By Corollary 2.5.6, the relation \succ_{C_Σ} is terminating. Moreover, we have that $\text{nf}_{\succ_{C_\Sigma}}(C_\Sigma) = \{z\}$.

6.1 Pumping lemma for runs and wta over strong bimonoids

The pumping lemma of this section is based on the idea in [Bor04, Sec. 5]. The form in which we present it is adapted from [DFKV20, DFKV22].

In this section, we let $\mathcal{A} = (Q, \delta, F)$ be an arbitrary (Σ, \mathbf{B}) -wta.

We extend the concept of run (cf. Section 2.10) to runs on trees in $T_\Sigma(\{z\})$, where z is a variable. For this, let $\xi \in T_\Sigma(\{z\})$ and $q \in Q$. A *run (of \mathcal{A}) on ξ* is a mapping $\rho : \text{pos}(\xi) \rightarrow Q$, and it is a q -run if $\rho(\varepsilon) = q$. Also, we denote the set of all runs on ξ by $R_{\mathcal{A}}(\xi)$ and the set of all q -runs on ξ by $R_{\mathcal{A}}(q, \xi)$. For every $\xi \in T_\Sigma(\{z\})$, $\rho \in R_{\mathcal{A}}(\xi)$, and $w \in \text{pos}(\xi)$, the *run induced by ρ at position w* , denoted by $\rho|_w$, is defined in a similar way as shown on page 76.

Next we define the weight of a run on trees in $T_\Sigma(\{z\})$ in a similar way as shown on page 76. We consider the reduction system (TR_z, \succ) where $\text{TR}_z = \{(\xi, \rho) \mid \xi \in T_\Sigma(\{z\}), \rho \in R_{\mathcal{A}}(\xi)\}$ and \succ is the binary relation on TR_z defined as follows:

$$\text{for every } (\xi, \rho) \in \text{TR}_z \text{ and } i \in [\text{rk}(\xi(\varepsilon))], \text{ we let } (\xi, \rho) \succ (\xi|_i, \rho|_i) \quad .$$

By Corollaries 2.5.6 and 2.5.4, the relation \succ is terminating. Moreover, we have that $\text{nf}_\succ(\text{TR}_z) = \{(\alpha, \rho) \mid \alpha \in \Sigma^{(0)} \cup \{z\}, \rho : \{\varepsilon\} \rightarrow Q\}$. We define the mapping

$$\text{wt}_{\mathcal{A}} : \text{TR}_z \rightarrow B$$

by induction on (TR_z, \succ) for every $\xi \in T_\Sigma(\{z\})$ and $\rho \in R_{\mathcal{A}}(\xi)$ as follows:

I.B.: If $\xi = z$, then $\text{wt}_{\mathcal{A}}(\xi, \rho) = \mathbb{1}$. If $\xi = \alpha$ is in $\Sigma^{(0)}$, then $\text{wt}_{\mathcal{A}}(\xi, \rho) = \delta_0(\varepsilon, \alpha, \rho(\varepsilon))$.

I.S.: Let $\xi = \sigma(\xi_1, \dots, \xi_k)$ with $k \geq 1$. Then we define

$$\text{wt}_{\mathcal{A}}(\xi, \rho) = \left(\bigotimes_{i \in [k]} \text{wt}_{\mathcal{A}}(\xi|_i, \rho|_i) \right) \otimes \delta_k(\rho(1) \cdots \rho(k), \sigma, \rho(\varepsilon)) \quad . \quad (6.1)$$

We call $\text{wt}_{\mathcal{A}}(\xi, \rho)$ the *weight of ρ (by \mathcal{A} on ξ)*.

Now let $c \in C_\Sigma$ be a context with $\text{pos}_z(c) = v$ and let $\rho \in R_{\mathcal{A}}(q, c)$ for some $q \in Q$. If $\rho(v) = p$, then we call ρ a (q, p) -run on c and we denote the set of all such (q, p) -runs by $R_{\mathcal{A}}(q, c, p)$. A (q, q) -run is called a *loop*. If $\rho \in R_{\mathcal{A}}(z)$ with $\rho(\varepsilon) = q$ for some $q \in Q$, then sometimes we write \tilde{q} for ρ .

Let $c \in C_\Sigma$, $\zeta \in T_\Sigma$, $v = \text{pos}_z(c)$, $q', q \in Q$, $\rho \in R_{\mathcal{A}}(q', c, q)$, and $\theta \in R_{\mathcal{A}}(q, \zeta)$. The *combination of ρ and θ* , denoted by $\rho[\theta]$, is the mapping $\rho[\theta] : \text{pos}(c[\zeta]) \rightarrow Q$ defined for every $u \in \text{pos}(c[\zeta])$ as follows: if $u = vw$ for some w , then we define $\rho[\theta](u) = \theta(w)$, otherwise we define $\rho[\theta](u) = \rho(u)$. Clearly, $\rho[\theta] \in R_{\mathcal{A}}(q', c[\zeta])$.

Let $\xi \in T_\Sigma$ and $v \in \text{pos}(\xi)$. We denote by $\xi|_v$ the context $\xi[z]_v$ obtained by replacing the subtree of ξ at v by z (cf. page 54). Moreover, for each $\rho \in R_{\mathcal{A}}(\xi)$, we define the run $\rho|_v$ on the context $\xi|_v$ such that for every $w \in \text{pos}(\xi|_v)$ we set $\rho|_v(w) = \rho(w)$.

Let $c \in C_\Sigma$, $v = \text{pos}_z(c)$, and $\rho \in R_{\mathcal{A}}(c)$. We define two mappings

$$l_{c, \rho} : \text{prefix}(v) \rightarrow B \quad \text{and} \quad r_{c, \rho} : \text{prefix}(v) \rightarrow B$$

(cf. [Bor04, p. 526] for deterministic wta). Intuitively, the product (6.1) which yields the element $\text{wt}(c, \rho) \in B$, can be split into a left subproduct $l_{c, \rho}(\varepsilon)$ and a right subproduct $r_{c, \rho}(\varepsilon)$, where the border is given by the factor $\mathbb{1}$ coming from the weight of z . Figure 6.1 illustrates the mappings $l_{c, \rho}$ and $r_{c, \rho}$.

Formally, we define the reduction system $(\text{prefix}(v), \succ)$ where, for every $w_1, w_2 \in \text{prefix}(v)$, we let $w_1 \succ w_2$ if there exists an $i \in \mathbb{N}$ such that $w_2 = w_1 i$. We define the mapping $d : \text{prefix}(v) \rightarrow \mathbb{N}$ by $d(w) = |v| - |w|$ for each $w \in \text{prefix}(v)$. Clearly, d is a monotone embedding of the reduction system

$(\text{prefix}(v), \succ)$ into the terminating reduction system $(\mathbb{N}, \succ_{\mathbb{N}})$. Hence, by Lemma 2.5.2, the reduction system $(\text{prefix}(v), \succ)$ is terminating.

Then we define $l_{c,\rho}$ and $r_{c,\rho}$ by induction on $(\text{prefix}(v), \succ)$ as follows. Let $w \in \text{prefix}(v)$ and assume that $c(w) = \sigma$ and $\text{rk}_{\Sigma}(\sigma) = k$. Then we define

$$l_{c,\rho}(w) = \begin{cases} \mathbb{1} & \text{if } w = v \\ \bigotimes_{j \in [1, i-1]} \text{wt}(c|_{wj}, \rho|_{wj}) \otimes l_{c,\rho}(wi) & \text{if } wi \in \text{prefix}(v) \text{ for some } i \in \mathbb{N}_+ \end{cases}$$

$$r_{c,\rho}(w) = \begin{cases} \mathbb{1} & \text{if } w = v \\ r_{c,\rho}(wi) \otimes \bigotimes_{j \in [i+1, k]} \text{wt}(c|_{wj}, \rho|_{wj}) \otimes \delta_k(\rho(w1) \cdots \rho(wk), \sigma, \rho(w)) & \text{if } wi \in \text{prefix}(v) \text{ for some } i \in \mathbb{N}_+ \end{cases}.$$

In the sequel, we abbreviate $l_{c,\rho}(\varepsilon)$ and $r_{c,\rho}(\varepsilon)$ by $l_{c,\rho}$ and $r_{c,\rho}$, respectively.

Observation 6.1.1. Let $c \in C_{\Sigma}$ and $\rho \in R_{\mathcal{A}}(c)$. Then $\text{wt}(c, \rho) = l_{c,\rho} \otimes r_{c,\rho}$. \square

Lemma 6.1.2. (cf. [Bor04, Lm. 5.1]) Let $c \in C_{\Sigma}$, $\zeta \in T_{\Sigma}$, $q', q \in Q$, $\rho \in R_{\mathcal{A}}(q', c, q)$, and $\theta \in R_{\mathcal{A}}(q, \zeta)$. Then $\text{wt}(c[\zeta], \rho[\theta]) = l_{c,\rho} \otimes \text{wt}(\zeta, \theta) \otimes r_{c,\rho}$.

Proof. We prove the statement by induction on $(C_{\Sigma}, \succ_{C_{\Sigma}})$.

I.B.: Let $c = z$. Then

$$\begin{aligned} \text{wt}(c[\zeta], \rho[\theta]) &= \text{wt}(\zeta, \theta) && \text{(since } c[\zeta] = \zeta \text{ and } \rho[\theta] = \theta) \\ &= \mathbb{1} \otimes \text{wt}(\zeta, \theta) \otimes \mathbb{1} \\ &= l_{z,\rho} \otimes \text{wt}(\zeta, \theta) \otimes r_{z,\rho} && \text{(since } l_{z,\rho} = \mathbb{1} \text{ and } r_{z,\rho} = \mathbb{1}) \end{aligned}$$

I.S.: Let $c = \sigma(\xi_1, \dots, \xi_{i-1}, c', \xi_{i+1}, \dots, \xi_k)$ with $k \in \mathbb{N}_+$, $i \in [k]$, $\xi_1, \dots, \xi_k \in T_{\Sigma}$, and $c' \in C_{\Sigma}$. Then we have

$$\begin{aligned} \text{wt}(c[\zeta], \rho[\theta]) &= \left(\bigotimes_{j \in [1, i-1]} \text{wt}(\xi_j, \rho|_j) \right) \otimes \text{wt}(c'[\zeta], (\rho|_i)[\theta]) \\ &\quad \otimes \left(\bigotimes_{j \in [i+1, k]} \text{wt}(\xi_j, \rho|_j) \right) \otimes \delta_k(\rho(1) \cdots \rho(k), \sigma, q') \quad \text{(by the definition of } c[\zeta] \text{ and } \rho[\theta]) \\ &= \left(\bigotimes_{j \in [1, i-1]} \text{wt}(\xi_j, \rho|_j) \right) \otimes l_{c', \rho|_i} \otimes \text{wt}(\zeta, \theta) \otimes r_{c', \rho|_i} \\ &\quad \otimes \left(\bigotimes_{j \in [i+1, k]} \text{wt}(\xi_j, \rho|_j) \right) \otimes \delta_k(\rho(1) \cdots \rho(k), \sigma, q') \quad \text{(by I.H.)} \\ &= l_{c,\rho} \otimes \text{wt}(\zeta, \theta) \otimes r_{c,\rho} \quad \text{(by the definition of } l_{c,\rho} \text{ and } r_{c,\rho}) \\ &\quad \text{(note that } l_{c|_i, \rho|_i} = l_{c', \rho|_i} \text{ and } r_{c|_i, \rho|_i} = r_{c', \rho|_i}) \end{aligned}$$

\square

Let $c \in C_{\Sigma}$. For each $n \in \mathbb{N}$, we define the n -th power of c , denoted by c^n , by induction on \mathbb{N} as follows: $c^0 = z$ and $c^{n+1} = c[c^n]$. Moreover, let $q \in Q$ and $\rho \in R_{\mathcal{A}}(q, c, q)$ be a loop. For each $n \in \mathbb{N}$, the n -th power of ρ , denoted by ρ^n , is the run on c^n defined by induction on \mathbb{N} as follows: $\rho^0 = \tilde{q}$ (note that $c^0 = z$) and $\rho^{n+1} = \rho[\rho^n]$. Next we apply the previous results to the weights of powers of loops.

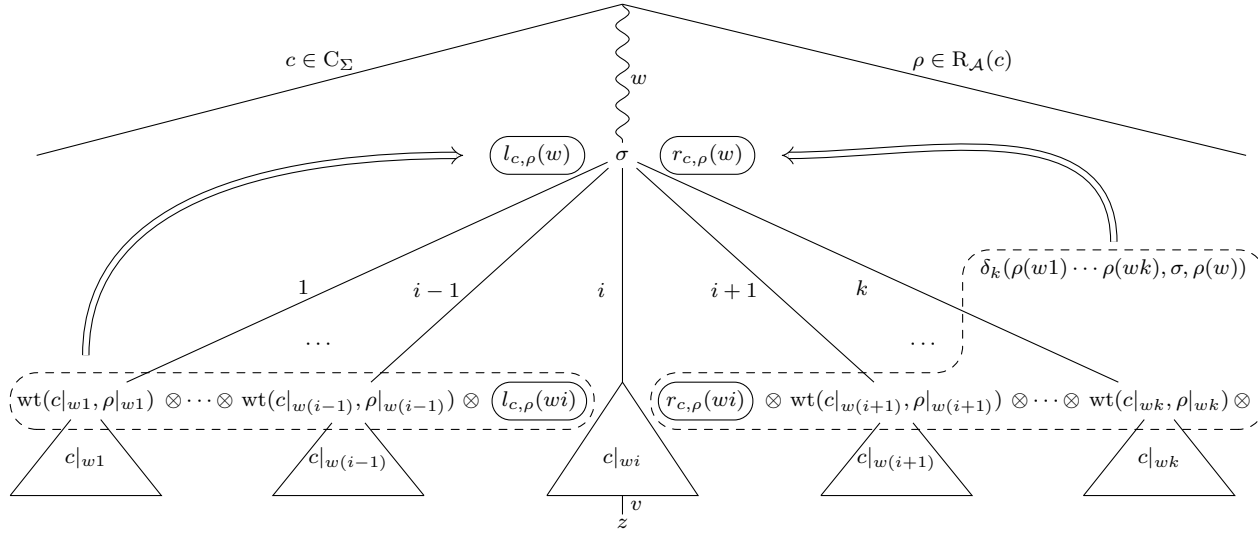

Figure 6.1: Illustration of mappings $l_{c,\rho}$ and $r_{c,\rho}$ (cf. [DFKV20, DFKV22])

Theorem 6.1.3. (cf. [Bor04, Lm. 5.3]) *Let $c', c \in C_\Sigma$ and $\zeta \in T_\Sigma$, $q', q \in Q$, $\rho' \in R_{\mathcal{A}}(q', c', q)$, $\rho \in R_{\mathcal{A}}(q, c, q)$, and $\theta \in R_{\mathcal{A}}(q, \zeta)$. Then, for each $n \in \mathbb{N}$,*

$$\text{wt}(c' [c^n[\zeta]], \rho' [\rho^n[\theta]]) = l_{c', \rho'} \otimes (l_{c, \rho})^n \otimes \text{wt}(\zeta, \theta) \otimes (r_{c, \rho})^n \otimes r_{c', \rho'} . \quad (6.2)$$

Proof. First, by induction on \mathbb{N} , we prove that the following statement holds:

$$\text{For each } n \in \mathbb{N} \text{ we have } \text{wt}(c^n[\zeta], \rho^n[\theta]) = (l_{c, \rho})^n \otimes \text{wt}(\zeta, \theta) \otimes (r_{c, \rho})^n . \quad (6.3)$$

I.B.: Let $n = 0$. Then $c^0 = z$ and we have

$$\begin{aligned} \text{wt}(c^0[\zeta], \rho^0[\theta]) &= \text{wt}(\zeta, \theta) && \text{(since } c^0[\zeta] = \zeta \text{ and } \rho^0[\theta] = \theta) \\ &= \mathbb{1} \otimes \text{wt}(\zeta, \theta) \otimes \mathbb{1} \\ &= (l_{c, \rho})^0 \otimes \text{wt}(\zeta, \theta) \otimes (r_{c, \rho})^0 && \text{(since } (l_{c, \rho})^0 = \mathbb{1} \text{ and } (r_{c, \rho})^0 = \mathbb{1}. \end{aligned}$$

I.S.: We assume that the equality holds for n . Since $c^{n+1} = c[c^n]$ and $\rho^{n+1} = \rho[\rho^n]$, we have

$$\begin{aligned} \text{wt}(c^{n+1}[\zeta], \rho^{n+1}[\theta]) &= l_{c, \rho} \otimes \text{wt}(c^n[\zeta], \rho^n[\theta]) \otimes r_{c, \rho} && \text{(by Lemma 6.1.2)} \\ &= l_{c, \rho} \otimes (l_{c, \rho})^n \otimes \text{wt}(\zeta, \theta) \otimes (r_{c, \rho})^n \otimes r_{c, \rho} && \text{(by I.H.)} \\ &= (l_{c, \rho})^{n+1} \otimes \text{wt}(\zeta, \theta) \otimes (r_{c, \rho})^{n+1}. \end{aligned}$$

This proves (6.3). Now let $n \in \mathbb{N}$. Then we have

$$\begin{aligned} \text{wt}(c' [c^n[\zeta]], \rho' [\rho^n[\theta]]) &= l_{c', \rho'} \otimes \text{wt}(c^n[\zeta], \rho^n[\theta]) \otimes r_{c', \rho'} && \text{(by Lemma 6.1.2)} \\ &= l_{c', \rho'} \otimes (l_{c, \rho})^n \otimes \text{wt}(\zeta, \theta) \otimes (r_{c, \rho})^n \otimes r_{c', \rho'} && \text{(by (6.3))} \end{aligned}$$

□

Next, we prove our pumping lemma for runs of \mathcal{A} on trees in T_Σ which are large enough. We note that \mathbf{B} need not be commutative.

Theorem 6.1.4. (cf. [Bor04, Lm. 5.5]) *Let Σ be a ranked alphabet. Moreover, let $\mathbf{B} = (B, \oplus, \otimes, 0, \mathbb{1})$ be a strong bimonoid and \mathcal{A} be a (Σ, \mathbf{B}) -wta. Let $\xi \in T_\Sigma$, $q' \in Q$, and $\kappa \in R_{\mathcal{A}}(q', \xi)$. If $\text{height}(\xi) \geq |Q|$, then there exist $c', c \in C_\Sigma$, $\zeta \in T_\Sigma$, $q \in Q$, $\rho' \in R_{\mathcal{A}}(q', c', q)$, $\rho \in R_{\mathcal{A}}(q, c, q)$, and $\theta \in R_{\mathcal{A}}(q, \zeta)$ such that $\xi = c' [c[\zeta]]$, $\kappa = \rho' [\rho[\theta]]$, $\text{height}(c) > 0$, $\text{height}(c[\zeta]) < |Q|$, and, for each $n \in \mathbb{N}$,*

$$\text{wt}(c' [c^n[\zeta]], \rho' [\rho^n[\theta]]) = l_{c', \rho'} \otimes (l_{c, \rho})^n \otimes \text{wt}(\zeta, \theta) \otimes (r_{c, \rho})^n \otimes r_{c', \rho'} .$$

Proof. Since $\text{height}(\xi) \geq |Q|$ there exist $u, w \in \mathbb{N}_+^*$ such that $uw \in \text{pos}(\xi)$, $|w| > 0$, $\text{height}(\xi|_u) < |Q|$, and $\kappa(u) = \kappa(uw)$. Then we let $c' = \xi|_u$, $c = (\xi|_u)^w$, $\zeta = \xi|_{uw}$. Clearly, $\xi = c' [c[\zeta]]$, $\text{height}(c) > 0$ because $|w| > 0$, and $\text{height}(c[\zeta]) < |Q|$ because $\text{height}(\xi|_u) < |Q|$. Moreover, we set $q = \kappa(u)$, $\rho' = \kappa|_u$, $\rho = (\kappa|_u)^w$ and $\theta = \kappa|_{uw}$. Then the statement follows from Theorem 6.1.3. □

By Example 3.2.4, for $\Sigma = \{\sigma^{(2)}, \alpha^{(0)}\}$, the weighted tree language $\text{height} : T_\Sigma \rightarrow \mathbb{N}$ is initial algebra recognizable by a $(\Sigma, \mathbf{Nat}_{\max, +})$ -wta. As an application of Theorem 6.1.3, we show that height cannot be recognized by a bu-deterministic $(\Sigma, \mathbf{Nat}_{\max, +})$ -wta. In contrast, if we consider an arbitrary string ranked alphabet Σ , then $\text{height} : T_\Sigma \rightarrow \mathbb{N}$ is in $\text{bud-Rec}(\Sigma, \mathbf{Nat}_{\max, +})$.

Corollary 6.1.5. [Bor04, Ex. 5.9] For the ranked alphabet $\Sigma = \{\sigma^{(2)}, \alpha^{(0)}\}$, we have that $\text{height} \notin \text{bud-Rec}(\Sigma, \mathbf{Nat}_{\max, +})$.

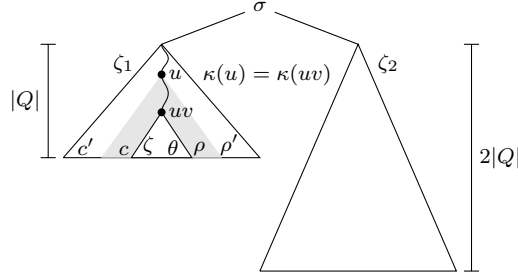

Figure 6.2: Decomposition of the tree ξ and the run κ .

Proof. We prove by contradiction. For this, let us assume that there exists a bu-deterministic $(\Sigma, \text{Nat}_{\max,+})$ -wta $\mathcal{A} = (Q, \delta, F)$ such that $\llbracket \mathcal{A} \rrbracket = \text{height}$.

Let $\xi = \sigma(\zeta_1, \zeta_2)$ be a tree such that $\text{height}(\zeta_1) = |Q|$ and $\text{height}(\zeta_2) = 2|Q|$. By Lemma 4.1.2(3)(b), there exist a $q \in Q$ and a run $\kappa \in R_{\mathcal{A}}(q, \xi)$ such that

$$\llbracket \mathcal{A} \rrbracket(\xi) = \text{wt}(\xi, \kappa) + F_q .$$

Moreover, there exist $u \in (\mathbb{N}_+)^+$ and $v \in (\mathbb{N}_+)^+$ such that $uv \in \text{pos}(\xi)$ and $u = 1u'$ for some $u' \in \text{pos}(\zeta_1)$ (i.e., u is located in ζ_1), and $\kappa(u) = \kappa(uv)$. Let us introduce

- the contexts $c' = \xi|_u$, $c = (\xi|_u)|^v$, the tree $\zeta = \xi|_{uv}$, as well as,
- the runs $\rho' = \kappa|_u$, $\rho = (\kappa|_u)|^v$, and $\theta = \kappa|_{uv}$, see Figure 6.2 and
- let $\xi_n = c'[c^n[\zeta]]$ and $\kappa_n = \rho'[\rho^n[\theta]]$ for each $n \in \mathbb{N}$.

Note that $\xi_1 = \xi$ and $\kappa_1 = \kappa$. By Theorem 6.1.3, we have

$$\text{wt}(\xi_n, \kappa_n) = l_{c', \rho'} + n \cdot l_{c, \rho} + \text{wt}(\zeta, \theta) + n \cdot r_{c, \rho} + r_{c', \rho'}$$

for each $n \in \mathbb{N}$. Since $\text{height}(\xi) = 2|Q| + 1$, we have

$$\llbracket \mathcal{A} \rrbracket(\xi) = l_{c', \rho'} + l_{c, \rho} + \text{wt}(\zeta, \theta) + r_{c, \rho} + r_{c', \rho'} + F_q = 2|Q| + 1.$$

Thus, each of $l_{c', \rho'}$, $l_{c, \rho}$, $\text{wt}(\zeta, \theta)$, $r_{c, \rho}$, $r_{c', \rho'}$, and F_q is in \mathbb{N} . Therefore $\text{wt}(\xi_n, \kappa_n) \neq -\infty$ for each $n \in \mathbb{N}$ and thus, by Lemma 4.1.2(3)(b), we have

$$\llbracket \mathcal{A} \rrbracket(\xi_n) = l_{c', \rho'} + n \cdot l_{c, \rho} + \text{wt}(\zeta, \theta) + n \cdot r_{c, \rho} + r_{c', \rho'} + F_q$$

for each $n \in \mathbb{N}$. It follows that $l_{c, \rho} \neq 0$ or $r_{c, \rho} \neq 0$ because otherwise $\text{height}(\xi_n)$ would be the same number for each $n \in \mathbb{N}$. But then $\llbracket \mathcal{A} \rrbracket(\xi_0) < \llbracket \mathcal{A} \rrbracket(\xi_1)$, which is a contradiction because $\text{height}(\xi_0) = \text{height}(\xi_1)$. \square

Contrary to Corollary 6.1.5, for each string ranked alphabet Σ , the weighted tree language $\text{height} : T_{\Sigma} \rightarrow \mathbb{N}$ is in $\text{bud-Rec}(\Sigma, \text{Nat}_{\max,+})$. To see this, let Σ be a string ranked alphabet and assume that $\Sigma^{(0)} = \{\alpha\}$. Then we consider the bu-deterministic $(\Sigma, \text{Nat}_{\max,+})$ -wta $\mathcal{A} = (\{q\}, \delta, F)$ with $\delta_0(\varepsilon, \alpha, q) = 0$, and $\delta_1(q, \gamma, q) = 1$ for each $\gamma \in \Sigma^{(1)}$; moreover, we let $F_q = 0$. It is easy to see that $\llbracket \mathcal{A} \rrbracket^{\text{run}} = \text{height}$.

As a corollary of Theorem 6.1.4, we prove a pumping lemma for the supports of weighted tree languages recognizable by wta over positive strong bimonoids.

Corollary 6.1.6. Let Σ be a ranked alphabet. Moreover, let \mathbf{B} be a positive strong bimonoid and let $L \subseteq T_{\Sigma}$. If $L \in \text{supp}(\text{Rec}^{\text{run}}(\Sigma, \mathbf{B}))$, then there exists a $p \in \mathbb{N}_+$ such that for each $\xi \in L$ with $\text{height}(\xi) \geq p$, there exist $c', c \in C_{\Sigma}$, $\zeta \in T_{\Sigma}$ such that

- $\xi = c'[c[\zeta]]$,
- $\text{height}(c) > 0$ and $\text{height}(c[\zeta]) < p$, and
- for each $n \in \mathbb{N}$, we have $c'[c^n[\zeta]] \in L$.

Proof. Since $L \in \text{supp}(\text{Rec}^{\text{run}}(\Sigma, \mathbf{B}))$, there exists a (Σ, \mathbf{B}) -wta $\mathcal{A} = (Q, \delta, F)$ such that $L = \text{supp}(\llbracket \mathcal{A} \rrbracket^{\text{run}})$. Let $p = |Q|$.

Let $\xi \in L$ with $\text{height}(\xi) \geq p$. There there exist $q' \in Q$ and $\kappa \in \mathbf{R}_{\mathcal{A}}(q', \xi)$ such that $\text{wt}_{\mathcal{A}}(\xi, \kappa) \otimes F_{q'} \neq 0$. Thus $\text{wt}_{\mathcal{A}}(\xi, \kappa) \neq 0$ and $F_{q'} \neq 0$.

By Theorem 6.1.4, there exist $c', c \in \mathbf{C}_{\Sigma}$, $\zeta \in \mathbf{T}_{\Sigma}$, $q \in Q$, $\rho' \in \mathbf{R}_{\mathcal{A}}(q', c', q)$, $\rho \in \mathbf{R}_{\mathcal{A}}(q, c, q)$, and $\theta \in \mathbf{R}_{\mathcal{A}}(q, \zeta)$ such that $\xi = c'[c[\zeta]]$, $\kappa = \rho'[\rho[\theta]]$, $\text{height}(c) > 0$, $\text{height}(c[\zeta]) < p$, and, for each $n \in \mathbb{N}$, $\text{wt}(c'[c^n[\zeta]], \rho'[\rho^n[\theta]]) = l_{c', \rho'} \otimes (l_{c, \rho})^n \otimes \text{wt}(\zeta, \theta) \otimes (r_{c, \rho})^n \otimes r_{c', \rho'}$. Together with $\text{wt}_{\mathcal{A}}(\xi, \kappa) \neq 0$, this implies (for $n = 1$) that each of the three values $l_{c', \rho'}$, $\text{wt}(\zeta, \theta)$, and $r_{c, \rho}$ is different from 0. Since \mathbf{B} is zero-divisor free, we obtain that

$$l_{c', \rho'} \otimes (l_{c, \rho})^n \otimes \text{wt}(\zeta, \theta) \otimes (r_{c, \rho})^n \otimes r_{c', \rho'} \neq 0$$

for each $n \in \mathbb{N}$, and hence $\text{wt}(c'[c^n[\zeta]], \rho'[\rho^n[\theta]]) \neq 0$ (using Theorem 6.1.4 again). Since $F_{q'} \neq 0$ and \mathbf{B} is zero-divisor free, we obtain that

$$\text{wt}(c'[c^n[\zeta]], \rho'[\rho^n[\theta]]) \otimes F_{q'} \neq 0 .$$

Since \mathbf{B} is zero-sum free, we obtain:

$$\llbracket \mathcal{A} \rrbracket^{\text{run}}(c'[c^n[\zeta]]) = \bigoplus_{\nu \in \mathbf{R}_{\mathcal{A}}(\xi)} \text{wt}(c'[c^n[\zeta]], \nu) \otimes F_{\nu(\varepsilon)} \neq 0 .$$

Thus, for each $n \in \mathbb{N}$, we have that $c'[c^n[\zeta]] \in L$. □

By Corollary 3.4.2, $\text{supp}(\text{Rec}^{\text{run}}(\Sigma, \mathbf{Boole})) = \text{Rec}(\Sigma)$. Thus, for the case that \mathbf{B} is the Boolean semiring, Corollary 6.1.6 shows a slight improvement of the pumping lemma for recognizable tree languages [GS84, Lm. 2.10.1] (because [GS84, Lm. 2.10.1] does not show the condition $\text{height}(c[\zeta]) < p$). Hence in case $\mathbf{B} = \mathbf{Boole}$, by using the contraposition of Corollary 6.1.6, we can give a shorter proof of that a certain tree language is not recognizable, than by using [GS84, Lm. 2.10.1]. The contraposition is the following statement:

Let $L \subseteq \mathbf{T}_{\Sigma}$. If for each $p \in \mathbb{N}_+$, there exists $\xi \in L$ with $\text{height}(\xi) \geq p$ such that for every $c', c \in \mathbf{C}_{\Sigma}$, $\zeta \in \mathbf{T}_{\Sigma}$ with $\xi = c'[c[\zeta]]$, $\text{height}(c) > 0$, and $\text{height}(c[\zeta]) < p$, there exists an $n \in \mathbb{N}$ such that $c'[c^n[\zeta]] \notin L$, then L is not recognizable.

Let us give an example of this application (cf. [HMU14, Ex. 4.2]).

Example 6.1.7. We consider the string ranked alphabet $\Sigma = \{\sigma^{(1)}, \gamma^{(1)}, \alpha^{(0)}\}$ and the Σ -tree language

$$L = \{\xi \in \mathbf{T}_{\Sigma} \mid |\text{pos}_{\gamma}(\xi)| = |\text{pos}_{\sigma}(\xi)|\} .$$

Now we apply the contraposition of Corollary 6.1.6 (for $\mathbf{B} = \mathbf{Boole}$). For this let $p \in \mathbb{N}_+$. We consider the tree $\xi = \sigma^{p+1}\gamma^{p+1}\alpha$. Clearly, $\xi \in L$ and $\text{height}(\xi) \geq p$.

Now we consider an arbitrary decomposition of ξ of the form $\xi = c'[c[\zeta]]$ for some $c', c \in \mathbf{C}_{\Sigma}$, $\zeta \in \mathbf{T}_{\Sigma}$ such that $\text{height}(c) > 0$ and $\text{height}(c[\zeta]) < p$. By our choice of ξ , we have that $c = \gamma^k(z)$ for some $k \geq 1$ (we recall that $\text{height}(z) = 0$).

Now we choose $n = 2$. Obviously, $c'[c^2[\zeta]]$ contains more γ s than σ s, hence $c'[c^2[\zeta]] \notin L$. Hence, by the contraposition of Corollary 6.1.6 (for $\mathbf{B} = \mathbf{Boole}$), the tree language L is not recognizable. □

It will turn out later (when Theorem 14.2.4 is available), that $\text{supp}(\text{Rec}^{\text{run}}(\Sigma, \mathbf{B})) = \text{Rec}(\Sigma)$ for each positive semiring \mathbf{B} , hence Corollary 6.1.6 is the same slight improvement of the classical pumping lemma for recognizable Σ -tree languages [GS84, Lm. 2.10.1] which we described for the case $\mathbf{B} = \mathbf{Boole}$.

6.2 Pumping lemma for wta over fields

Here we deal with weighted tree automata over fields and a pumping lemma which guarantees the existence of infinitely many trees in the support of the semantics of such wta. The pumping lemma is based on [Reu80, BR82].

Let \mathbf{B} be a field and $(\mathbf{V}, \mu, \gamma)$ be a (Σ, \mathbf{B}) -multilinear representation with $\mathbf{V} = (B^Q, \oplus, \tilde{0})$. Then \mathbf{V} is a $|Q|$ -dimensional \mathbf{B} -vector space. Vice versa, let \mathbf{V} be a κ -dimensional \mathbf{B} -vector space with $\kappa \in \mathbb{N}$. According to our convention on representing vector spaces (cf. page 48), we have $\mathbf{V} = (B^\kappa, \oplus, \mathbb{0}_\kappa)$. This justifies to use, as first component of a (Σ, \mathbf{B}) -multilinear representation, also an arbitrary finite-dimensional \mathbf{B} -vector space \mathbf{V} . We will use this point of view in this section.

In the rest of this section, we let \mathbf{B} be a field and $(\mathbf{V}, \mu, \gamma)$ be a (Σ, \mathbf{B}) -multilinear representation where $\mathbf{V} = (V, +, 0)$ is a κ -dimensional \mathbf{B} -vector space for some $\kappa \in \mathbb{N}_+$, unless specified otherwise.

We recall from Section 3.6.1 that (V, μ) is a Σ -algebra and that h_V is the unique Σ -algebra homomorphism from T_Σ to (V, μ) . Moreover, $(\mathbf{V}, \mu, \gamma)$ recognizes the weighted tree language $r : T_\Sigma \rightarrow B$ where $r(\xi) = \gamma(h_V(\xi))$ for every $\xi \in T_\Sigma$. We also recall that $\mathcal{L}(\mathbf{V}, \mathbf{V})$ is the set of all linear mappings $f : V \rightarrow V$ from \mathbf{V} to \mathbf{V} .

6.2.1 The set of contexts viewed as monoid

Each tree ξ can be considered as a sequence c of contexts which are substituted consecutively into each other, and a nullary symbol α for turning the resulting context into ξ . The monoid (C_Σ, \circ_z, z) formalizes the substitution of contexts, where we also denote by \circ_z the restriction of the binary operation \circ_z on $T_\Sigma(\{z\})$ (cf. page 58) to C_Σ . In the next lemma we prove that (C_Σ, \circ_z, z) is free in the set of all monoids with generator set eC_Σ . In the sequel we abbreviate $(eC_\Sigma)^*$ by eC_Σ^* .

Lemma 6.2.1. [BR82, Prop. 9.1] The monoid (C_Σ, \circ_z, z) is free in the set of all monoids with generator set eC_Σ .

Proof. We prove that the monoid (C_Σ, \circ_z, z) is isomorphic to the monoid $(eC_\Sigma^*, \cdot, \varepsilon)$. Since $(eC_\Sigma^*, \cdot, \varepsilon)$ is free in the set of all monoids generated by eC_Σ , this implies the statement of the lemma.

We define the mapping $\psi : eC_\Sigma \rightarrow C_\Sigma$ with $\psi(e) = e$ for each $e \in eC_\Sigma$. Since $(eC_\Sigma^*, \cdot, \varepsilon)$ is free in the set of all monoids generated by eC_Σ , there exists a unique monoid homomorphism $\llbracket \cdot \rrbracket : eC_\Sigma^* \rightarrow C_\Sigma$ which extends ψ . For each $c \in eC_\Sigma^*$, we write $\llbracket c \rrbracket$ instead of $\llbracket \cdot \rrbracket(c)$. Then, for every $n \in \mathbb{N}_+$ and $e_1, \dots, e_n \in eC_\Sigma$ we have

$$\llbracket e_1 \cdots e_n \rrbracket = e_1 \circ_z \cdots \circ_z e_n \quad \text{and} \quad \llbracket \varepsilon \rrbracket = z .$$

We prove that the mapping $\llbracket \cdot \rrbracket$ is surjective. For this, by induction on $(C_\Sigma, \succ_{C_\Sigma})$ (cf. page 151), we prove that the following statement holds:

$$\text{For each } c \in C_\Sigma, \text{ we have } c \in \text{im}(\llbracket \cdot \rrbracket) . \tag{6.4}$$

I.B.: Let $c = z$. Then the statement holds because $\llbracket \varepsilon \rrbracket = z$.

I.S.: Let $c = e[c']$ for some $e \in eC_\Sigma$ and $c' \in C_\Sigma$. By the I.H. we have $c' \in \text{im}(\llbracket \cdot \rrbracket)$ and thus there exists a $d \in eC_\Sigma^*$ such that $\llbracket d \rrbracket = c'$. Since $\llbracket ed \rrbracket = \llbracket e \rrbracket \circ_z \llbracket d \rrbracket = e \circ_z c' = c$, we have that $c \in \text{im}(\llbracket \cdot \rrbracket)$.

Hence (6.4) holds and $\llbracket \cdot \rrbracket$ is surjective.

Finally, we prove that $\llbracket \cdot \rrbracket$ is injective. Let $e_1, \dots, e_n \in eC_\Sigma$ and $e'_1, \dots, e'_m \in eC_\Sigma$ such that $\llbracket e_1 \cdots e_n \rrbracket = \llbracket e'_1 \cdots e'_m \rrbracket$. Since $\text{depth}(\llbracket e_1 \cdots e_n \rrbracket) = n$ and $\text{depth}(\llbracket e'_1 \cdots e'_m \rrbracket) = m$, it follows that $n = m$. Now assume

that there exists $i \in [n]$ such that $e_i \neq e'_i$. Then there exists a $w \in \text{pos}(e_i) \cap \text{pos}(e'_i)$ such that $e_i(w) \neq e'_i(w)$. Using this fact, it is easy to see that $\llbracket e_1 \cdots e_n \rrbracket \neq \llbracket e'_1 \cdots e'_n \rrbracket$. Thus $e_i = e'_i$ for each $i \in [n]$. Hence, $\llbracket \cdot \rrbracket$ is injective.

So we have proved that $\llbracket \cdot \rrbracket$ is an isomorphism from $(\text{eC}_\Sigma^*, \cdot, \varepsilon)$ to $(\text{C}_\Sigma, \circ_z, z)$. \square

Each context $c \in \text{C}_\Sigma$ determines a linear mapping in the following way. We define the mapping $\theta : \text{eC}_\Sigma \rightarrow \mathcal{L}(\mathbb{V}, \mathbb{V})$ for every $e \in \text{eC}_\Sigma$ and $v \in \mathbb{V}$ by

$$(\theta(e))(v) = \mu(\sigma)(\text{h}_\mathbb{V}(\xi_1), \dots, \text{h}_\mathbb{V}(\xi_{i-1}), v, \text{h}_\mathbb{V}(\xi_{i+1}), \dots, \text{h}_\mathbb{V}(\xi_k)) ,$$

if e has the form $\sigma(\xi_1, \dots, \xi_{i-1}, z, \xi_{i+1}, \dots, \xi_k)$. Then $\theta(e)$ is an endomorphism on \mathbb{V} because $\mu(\sigma)$ is multilinear.

By Lemma 6.2.1, the monoid $(\text{C}_\Sigma, \circ_z, z)$ is free in the set of all monoids generated by eC_Σ . Thus there exists a unique monoid homomorphism $\llbracket \cdot \rrbracket$ from the monoid $(\text{C}_\Sigma, \circ_z, z)$ to the monoid $(\mathcal{L}(\mathbb{V}, \mathbb{V}), \circ, \text{id}_\mathbb{V})$ which extends θ . Instead of $\llbracket \cdot \rrbracket(c)$ we write $\llbracket c \rrbracket$ for each $c \in \text{C}_\Sigma$.

In the next example we illustrate the evaluation of $\llbracket c \rrbracket(v)$ for a multilinear representation which is related to a particular (Σ, Rat) -wta. Before that, we would like to discuss a phenomenon: the reversing of the roles of rows and columns when starting from weighted string automata and moving towards multilinear representations.

Let $\mathcal{A} = (Q, \lambda, \mu, \tau)$ be a (Γ, \mathbb{B}) -wsa (where we have used untypically τ as final weight mapping because we use γ as part of the multilinear representation). Then by Lemma 3.3.2 we have $\text{h}_\mathcal{A}(w) = \lambda \cdot \mu(w)$ for each $w \in \Gamma^*$. For instance, let $\Gamma = \{a, b\}$. Since μ is a monoid homomorphism, we have

$$\lambda \cdot \mu(abb) = \lambda \cdot \mu(a) \cdot \mu(b) \cdot \mu(b) .$$

The intuition behind the matrix, say, $\mu(a)$, is that, for each row $q \in Q$ and each column $p \in Q$, the value $\mu(a)_{q,p}$ is the weight of the transition from state q to state p when reading a .

Now we might turn \mathcal{A} into the related (Γ_e, \mathbb{B}) -wta \mathcal{B} (using tree_e and Lemma 3.3.4) and then we can look at the (Γ_e, \mathbb{B}) -multilinear representation which is related to \mathcal{B} (cf. Figure 6.3). When turning \mathcal{A} into \mathcal{B} , the string abb is turned into the tree $b(b(a(e)))$. Obviously, when reading the string $b(b(a(e)))$ from left to right, the order of a and the b 's is reversed with respect to the order of these symbols in the string abb . Hence, the order of the matrices $\mu(a)$ and $\mu(b)$ is also reversed. In order to keep the correct value, the matrices $\mu(a)$ and $\mu(b)$ have to be transposed. (Since we do not distinguish between row- and column-vectors, we do not have to transpose λ .) Thus,

$$\lambda \cdot \mu(a) \cdot \mu(b) \cdot \mu(b) = \mu(b)^\text{T} \cdot \mu(b)^\text{T} \cdot \mu(a)^\text{T} \cdot \lambda = \llbracket b(z) \rrbracket(\llbracket b(z) \rrbracket)(\llbracket a(z) \rrbracket)(\lambda)) ,$$

where the linear mappings $\llbracket a(z) \rrbracket$ and $\llbracket b(z) \rrbracket$ are represented by the matrices $\mu(a)^\text{T}$ and $\mu(b)^\text{T}$, respectively. In particular, an entry $(\mu(b)^\text{T})_{q,p}$ shows the transition weight on the elementary context $b(z)$ when starting at the z -labeled leaf in the q -column of $\mu(b)$ and ending at the b -labeled root in the p -row of $\mu(b)$. In this sense the order of rows and columns is reversed.

Example 6.2.2. Here we consider the mapping $\#_{\sigma(\cdot, \alpha)} : \text{T}_\Sigma \rightarrow \mathbb{N}$ and the (Σ, Nat) -wta \mathcal{A} as defined in Example 3.2.11 with two slight modifications. One modification is that we replace in Σ the unary symbol $\gamma \in \Sigma^{(1)}$ by the unary symbol ω because we use γ as part of the multilinear representation. The other modification is that we view \mathcal{A} as a (Σ, Rat) -wta, which is possible because Rat is an extension of Nat (cf. Section 3.7). Thus, $\Sigma = \{\sigma^{(2)}, \omega^{(1)}, \alpha^{(0)}\}$ and

$$\begin{aligned} \#_{\sigma(\cdot, \alpha)} : \text{T}_\Sigma &\rightarrow \mathbb{Q} \\ \xi &\mapsto |U(\xi)| \quad \text{for every } \xi \in \text{T}_\Sigma \end{aligned}$$

where $U(\xi) = \{u \in \text{pos}(\xi) \mid \xi(u) = \sigma, \xi(u2) = \alpha\}$. We recall that $\mathcal{A} = (Q, \delta, F)$, where

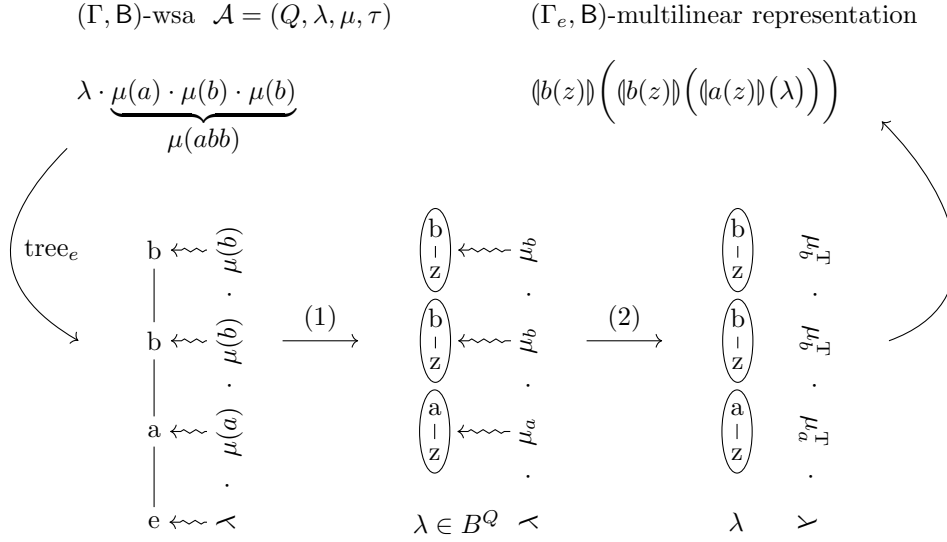

Figure 6.3: The change of roles of rows and columns when starting from wsa and moving towards multilinear representations; (1) from strings to trees and (2) reversing order and transposing the matrices.

- $Q = \{\perp, a, f\}$ (intuitively, \perp ignores occurrences of the pattern, a detects an α -labeled leaf, and f reports “pattern found” up to the root),
- for every $q_1, q_2, q \in Q$ we define

$$\delta_0(\varepsilon, \alpha, q) = \begin{cases} 1 & \text{if } q \in \{\perp, a\} \\ 0 & \text{otherwise} \end{cases} \quad \delta_1(q_1, \omega, q) = \begin{cases} 1 & \text{if } q_1 q \in \{\perp\perp, ff\} \\ 0 & \text{otherwise} \end{cases}$$

$$\delta_2(q_1 q_2, \sigma, q) = \begin{cases} 1 & \text{if } q_1 q_2 q \in \{\perp\perp\perp, \perp a f, \perp f f, f \perp f\} \\ 0 & \text{otherwise} \end{cases}$$

- $F_\perp = F_a = 0$ and $F_f = 1$.

Now we define the (Σ, Rat) -multilinear representation $(\mathbf{V}, \delta_{\mathcal{A}}, \gamma)$ where

- $\mathbf{V} = (\mathbb{Q}^Q, +, 0_3)$ is a Rat -vector space, where the components of each $v \in \mathbb{Q}^Q$ are ordered according to the sequence (\perp, a, f) , and $0_3 = (0, 0, 0)$ and
- $\gamma(v) = v_f$.

Then $(\mathbf{V}, \delta_{\mathcal{A}}, \gamma)$ and \mathcal{A} are related. Hence, by Lemma 3.6.5, for each $\xi \in T_\Sigma$, we have $h_{\mathcal{A}}(\xi) = h_{\mathbf{V}}(\xi)$ and $\llbracket \mathcal{A} \rrbracket^{\text{init}}(\xi) = \gamma(h_{\mathcal{A}}(\xi)) = \#_{\sigma(\cdot, \alpha)}(\xi)$.

For each $\zeta \in C_\Sigma$, we define the $(Q \times Q)$ -matrix :

$$M_\zeta = \begin{pmatrix} 1 & 0 & 0 \\ 0 & a(\zeta) & 0 \\ \#_{\sigma(\cdot, \alpha)}(\zeta) & b(\zeta) & 1 \end{pmatrix}$$

where

- the rows and columns are ordered according to the sequence (\perp, a, f) ,
- we have extended $\#_{\sigma(\cdot, \alpha)}$ in the obvious way such that it is also applicable to contexts, and
- $a(\zeta) = 1$ if $\zeta = z$, and 0 otherwise; and $b(\zeta) = 1$ if there exists a position $w \in \text{pos}(\zeta)$ such that $z = \zeta(w2)$, and 0 otherwise.

Intuitively, for each $q, p \in Q$, the entry $(M_\zeta)_{q,p}$ is the sum of the weights of all (q, p) -runs of \mathcal{A} on ζ . In particular, $M_z = M_1$.

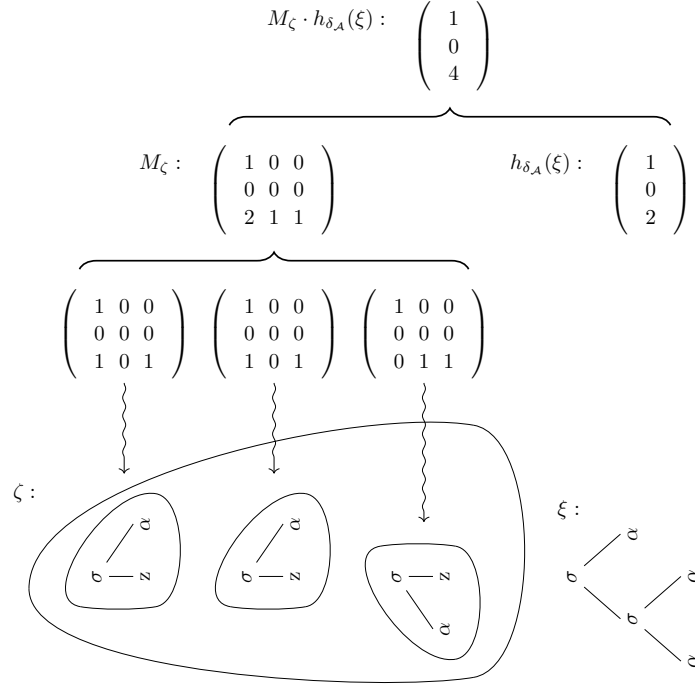

Figure 6.4: An illustration of the evaluation of $\llbracket \zeta \rrbracket(v)$ for $\zeta = \sigma(\sigma(\sigma(\alpha, z), \alpha), \alpha)$ and $v = (1, 0, 2)$.

In Figure 6.4 we illustrate the evaluation of $\llbracket \zeta \rrbracket(v)$ for $\zeta = \sigma(\sigma(\sigma(\alpha, z), \alpha), \alpha)$ and $v = (1, 0, 2)$ (where, e.g., $(1, 0, 2) = h_{\mathcal{A}}(\xi)$ with $\xi = \sigma(\sigma(\alpha, \alpha), \alpha)$).

By induction on $(C_\Sigma, \succ_{C_\Sigma})$, we prove that the following statement holds:

$$\text{For each } \zeta \in C_\Sigma \text{ and } v \in \mathbb{Q}^Q, \text{ we have } \llbracket \zeta \rrbracket(v) = M_\zeta \cdot v . \quad (6.5)$$

I.B.: Let $\zeta = z$ and $v \in \mathbb{Q}^Q$. Then $\llbracket \zeta \rrbracket(v) = \llbracket z \rrbracket(v) = \text{id}_{\mathbb{Q}^Q}(v) = v = M_\zeta \cdot v$.

I.S.: Let $\zeta = e[\zeta']$ for some $e \in eC_\Sigma$ and $\zeta' \in C_\Sigma$. Let $e = \sigma(z, \xi)$ for some $\xi \in T_\Sigma$. Using the I.H., we obtain:

$$\llbracket \zeta \rrbracket(v) = \llbracket e[\zeta'] \rrbracket(v) = \llbracket e \rrbracket(\llbracket \zeta' \rrbracket(v)) = \llbracket e \rrbracket(M_{\zeta'} \cdot v) = \delta_{\mathcal{A}}(\sigma)(M_{\zeta'} \cdot v, h_{\mathcal{A}}(\xi)) .$$

We recall that, by (3.18), for each $\xi \in T_\Sigma$, we have $h_{\mathcal{A}}(\xi)_\perp = 1$, $h_{\mathcal{A}}(\xi)_a = c(\xi)$ and $h_{\mathcal{A}}(\xi)_f = \#\sigma(\cdot, \alpha)(\xi)$, where $c(\xi) = 1$ if $\xi = \alpha$ and $c(\xi) = 0$ otherwise. Then we obtain:

$$\begin{aligned} \llbracket \zeta \rrbracket(v)_\perp &= \delta_{\mathcal{A}}(\sigma)(M_{\zeta'} \cdot v, h_{\mathcal{A}}(\xi))_\perp = (M_{\zeta'} \cdot v)_\perp \cdot h_{\mathcal{A}}(\xi)_\perp \cdot 1 = v_\perp = (M_\zeta \cdot v)_\perp \\ \llbracket \zeta \rrbracket(v)_a &= \delta_{\mathcal{A}}(\sigma)(M_{\zeta'} \cdot v, h_{\mathcal{A}}(\xi))_a = 0 = (M_\zeta \cdot v)_a \quad (\text{the last equality holds because } a(\zeta) = 0) \\ \llbracket \zeta \rrbracket(v)_f &= \delta_{\mathcal{A}}(\sigma)(M_{\zeta'} \cdot v, h_{\mathcal{A}}(\xi))_f \\ &= (M_{\zeta'} \cdot v)_\perp \cdot h_{\mathcal{A}}(\xi)_a + (M_{\zeta'} \cdot v)_\perp \cdot h_{\mathcal{A}}(\xi)_f + (M_{\zeta'} \cdot v)_f \cdot h_{\mathcal{A}}(\xi)_\perp \\ &= (M_{\zeta'} \cdot v)_\perp \cdot (c(\xi) + \#\sigma(\cdot, \alpha)(\xi)) + (M_{\zeta'} \cdot v)_f \\ &= \left(\begin{pmatrix} 1 & 0 & 0 \\ 0 & 0 & 0 \\ c(\xi) + \#\sigma(\cdot, \alpha)(\xi) & 0 & 1 \end{pmatrix} \cdot (M_{\zeta'} \cdot v) \right)_f \\ &= (M_e \cdot (M_{\zeta'} \cdot v))_f \stackrel{(*)}{=} ((M_e \cdot M_{\zeta'}) \cdot v)_f = (M_{e[\zeta']} \cdot v)_f = (M_\zeta \cdot v)_f , \end{aligned}$$

where we have used (2.30) at the equality marked by $(*)$ (note that \mathbb{Q} is distributive).

Now let $e = \sigma(\xi, z)$ for some $\xi \in T_\Sigma$. Using the I.H., we obtain:

$$\llbracket \zeta \rrbracket(v) = \llbracket e[\zeta'] \rrbracket(v) = \llbracket e \rrbracket(\llbracket \zeta' \rrbracket(v)) = \llbracket e \rrbracket(M_{\zeta'} \cdot v) = \delta_{\mathcal{A}}(\sigma)(h_{\mathcal{A}}(\xi), M_{\zeta'} \cdot v) .$$

Then, using (3.18), we obtain:

$$\begin{aligned} \llbracket \zeta \rrbracket(v)_\perp &= \delta_{\mathcal{A}}(\sigma)(h_{\mathcal{A}}(\xi), M_{\zeta'} \cdot v)_\perp = h_{\mathcal{A}}(\xi)_\perp \cdot (M_{\zeta'} \cdot v)_\perp \cdot 1 = v_\perp = (M_\zeta \cdot v)_\perp \\ \llbracket \zeta \rrbracket(v)_a &= \delta_{\mathcal{A}}(\sigma)(h_{\mathcal{A}}(\xi), M_{\zeta'} \cdot v)_a = 0 = (M_\zeta \cdot v)_a && \text{(because } a(\zeta) = 0) \\ \llbracket \zeta \rrbracket(v)_f &= \delta_{\mathcal{A}}(\sigma)(h_{\mathcal{A}}(\xi), M_{\zeta'} \cdot v)_f \\ &= h_{\mathcal{A}}(\xi)_\perp \cdot (M_{\zeta'} \cdot v)_a + h_{\mathcal{A}}(\xi)_\perp \cdot (M_{\zeta'} \cdot v)_f + h_{\mathcal{A}}(\xi)_f \cdot (M_{\zeta'} \cdot v)_\perp \\ &= \left(\begin{pmatrix} 1 & 0 & 0 \\ 0 & 0 & 0 \\ \#_{\sigma(\cdot, \alpha)}(\xi) & 1 & 1 \end{pmatrix} \cdot (M_{\zeta'} \cdot v) \right)_f \\ &= (M_e \cdot (M_{\zeta'} \cdot v))_f \stackrel{(*)}{=} ((M_e \cdot M_{\zeta'}) \cdot v)_f = (M_{e[\zeta']} \cdot v)_f = (M_\zeta \cdot v)_f , \end{aligned}$$

where, again, we have used (2.30) at the equality marked by (*).

Now let $e = \omega(z)$. Using the I.H., we obtain:

$$\llbracket \zeta \rrbracket(v) = \llbracket e[\zeta'] \rrbracket(v) = \llbracket e \rrbracket(\llbracket \zeta' \rrbracket(v)) = \llbracket e \rrbracket(M_{\zeta'} \cdot v) = \delta_{\mathcal{A}}(\omega)(M_{\zeta'} \cdot v) .$$

Then we obtain:

$$\begin{aligned} \llbracket \zeta \rrbracket(v)_\perp &= \delta_{\mathcal{A}}(\omega)(M_{\zeta'} \cdot v)_\perp = (M_{\zeta'} \cdot v)_\perp \cdot 1 = (M_{\zeta'} \cdot v)_\perp \\ &= \left(\begin{pmatrix} 1 & 0 & 0 \\ 0 & 0 & 0 \\ 0 & 0 & 1 \end{pmatrix} \cdot (M_{\zeta'} \cdot v) \right)_\perp \\ &= (M_e \cdot (M_{\zeta'} \cdot v))_\perp \stackrel{(*)}{=} ((M_e \cdot M_{\zeta'}) \cdot v)_\perp = (M_{e[\zeta']} \cdot v)_\perp = (M_\zeta \cdot v)_\perp , \\ \llbracket \zeta \rrbracket(v)_a &= \delta_{\mathcal{A}}(\omega)(M_{\zeta'} \cdot v)_a = 0 = (M_\zeta \cdot v)_a && \text{(because } a(\zeta) = 0) \\ \llbracket \zeta \rrbracket(v)_f &= \delta_{\mathcal{A}}(\omega)(M_{\zeta'} \cdot v)_f = (M_{\zeta'} \cdot v)_f = (M_e \cdot (M_{\zeta'} \cdot v))_f = (M_\zeta \cdot v)_f , \end{aligned}$$

where, again, we have used (2.30) at the equality marked by (*).

This proves (6.5). \square

Lemma 6.2.3. For every $c \in C_\Sigma$ and $\xi \in T_\Sigma$, we have $\llbracket c \rrbracket(h_V(\xi)) = h_V(c[\xi])$.

Proof. We prove this statement by induction on $(C_\Sigma, \succ_{C_\Sigma})$.

I.B.: Let $c = z$. Then the statement is obvious because $\llbracket z \rrbracket$ is the identity mapping on v .

I.S.: Now let $c = e[c']$, where $e = \sigma(\xi_1, \dots, \xi_{i-1}, z, \xi_{i+1}, \dots, \xi_k)$ is an elementary Σ -context and $c' \in C_\Sigma$. Then, for each $\xi \in T_\Sigma$, we have

$$\begin{aligned} \llbracket c \rrbracket(h_V(\xi)) &= \llbracket e \rrbracket(\llbracket c' \rrbracket(h_V(\xi))) && \text{(because } \llbracket \cdot \rrbracket \text{ is a monoid homomorphism)} \\ &= \theta(e)(\llbracket c' \rrbracket(h_V(\xi))) && \text{(because } \llbracket \cdot \rrbracket \text{ extends } \theta) \\ &= \mu(\sigma)(h_V(\xi_1), \dots, h_V(\xi_{i-1}), \llbracket c' \rrbracket(h_V(\xi)), h_V(\xi_{i+1}), \dots, h_V(\xi_k)) \\ &= \mu(\sigma)(h_V(\xi_1), \dots, h_V(\xi_{i-1}), h_V(c'[\xi]), h_V(\xi_{i+1}), \dots, h_V(\xi_k)) && \text{(by I.H)} \\ &= h_V(\sigma(\xi_1, \dots, \xi_{i-1}, c'[\xi], \xi_{i+1}, \dots, \xi_k)) \\ &= h_V(c[\xi]) . && \square \end{aligned}$$

6.2.2 Linear recurrence equation

Weighted tree languages that are recognizable over multilinear operations by a vector space satisfy a particular linear recurrence equation. In the following lemma, for a context $\zeta \in C_\Sigma$, we view $\langle\!\langle\zeta\rangle\!\rangle \in \mathcal{L}(\mathbf{V}, \mathbf{V})$ as an element of $B^{\kappa \times \kappa}$, i.e., as a $[\kappa]$ -square matrix over B (cf. page 48). We recall that the characteristic polynomial of such a $\langle\!\langle\zeta\rangle\!\rangle$ is $\text{char}_{\langle\!\langle\zeta\rangle\!\rangle}(x) = \det(\langle\!\langle\zeta\rangle\!\rangle - xM_{\mathbb{1}})$ (cf. page 47).

Lemma 6.2.4. Let Σ be a ranked alphabet. Moreover, let $\mathbf{B} = (B, \oplus, \otimes, \mathbb{0}, \mathbb{1})$ be a field, \mathbf{V} be a κ -dimensional \mathbf{B} -vector space, and let $r : T_\Sigma \rightarrow B$. Let $(\mathbf{V}, \mu, \gamma)$ be a (Σ, \mathbf{B}) -multilinear representation which recognizes r . Moreover, let $\zeta \in C_\Sigma$ and let $\text{char}_{\langle\!\langle\zeta\rangle\!\rangle}(x) = (-\mathbb{1})^\kappa \cdot x^\kappa \oplus b_{\kappa-1} \cdot x^{\kappa-1} \oplus \dots \oplus b_0$. Then, for every $\theta \in C_\Sigma$, $\alpha \in \Sigma^{(0)}$, and $n \in \mathbb{N}$, we have

$$(-\mathbb{1})^\kappa \otimes r(\theta[\zeta^{n+\kappa}[\alpha]]) \oplus b_{\kappa-1} \otimes r(\theta[\zeta^{n+\kappa-1}[\alpha]]) \oplus \dots \oplus b_0 \otimes r(\theta[\zeta^n[\alpha]]) = \mathbb{0} .$$

Proof. For the sake of brevity we write $\text{char}_{\langle\!\langle\zeta\rangle\!\rangle}(x) = \bigoplus_{i \in [0, \kappa]} b_i \cdot x^i$ where $b_\kappa = (-\mathbb{1})^\kappa$.

By Theorem 2.9.1 (i.e., the theorem of Cayley and Hamilton), we have $\text{char}_{\langle\!\langle\zeta\rangle\!\rangle}(\langle\!\langle\zeta\rangle\!\rangle) = M_{\mathbb{0}}$. Now let $\theta \in C_\Sigma$, $\alpha \in \Sigma^{(0)}$, and $n \in \mathbb{N}$. Then we can calculate as follows (where we abbreviate by v_0 the $[\kappa]$ -vector in B^κ with $\mathbb{0}$ in each of its entries):

$$\begin{aligned} & \text{char}_{\langle\!\langle\zeta\rangle\!\rangle}(\langle\!\langle\zeta\rangle\!\rangle) = M_{\mathbb{0}} \\ \Rightarrow & \bigoplus_{i \in [0, \kappa]} b_i \cdot \langle\!\langle\zeta\rangle\!\rangle^i = M_{\mathbb{0}} && \text{(we use } \oplus \text{ because } b_i \cdot \langle\!\langle\zeta\rangle\!\rangle^i \text{ is a matrix)} \\ \Rightarrow & \left(\bigoplus_{i \in [0, \kappa]} b_i \cdot \langle\!\langle\zeta\rangle\!\rangle^i \right) \cdot h_{\mathbf{V}}(\alpha) = v_0 && \text{(matrix-vector multiplication with } h_{\mathbf{V}}(\alpha)) \\ \Rightarrow & \langle\!\langle\theta[\zeta^n]\!\rangle\!\rangle \cdot \left(\bigoplus_{i \in [0, \kappa]} b_i \cdot \langle\!\langle\zeta\rangle\!\rangle^i \right) \cdot h_{\mathbf{V}}(\alpha) = v_0 && \text{(matrix-vector multiplication with } \langle\!\langle\theta[\zeta^n]\!\rangle\!\rangle) \\ \Rightarrow & \left(\bigoplus_{i \in [0, \kappa]} b_i \cdot \langle\!\langle\theta[\zeta^n]\!\rangle\!\rangle \cdot \langle\!\langle\zeta\rangle\!\rangle^i \right) \cdot h_{\mathbf{V}}(\alpha) = v_0 && \text{(because } \langle\!\langle\theta[\zeta^n]\!\rangle\!\rangle \text{ is a linear mapping)} \\ \Rightarrow & \left(\bigoplus_{i \in [0, \kappa]} b_i \cdot \langle\!\langle\theta[\zeta^{n+i}]\!\rangle\!\rangle \right) \cdot h_{\mathbf{V}}(\alpha) = v_0 && \text{(because } \langle\!\langle\cdot\rangle\!\rangle \text{ is a monoid homomorphism)} \\ \Rightarrow & \left(\bigoplus_{i \in [0, \kappa]} b_i \cdot \langle\!\langle\theta[\zeta^{n+i}]\!\rangle\!\rangle(h_{\mathbf{V}}(\alpha)) \right) = v_0 \\ \Rightarrow & \left(\bigoplus_{i \in [0, \kappa]} b_i \cdot h_{\mathbf{V}}(\theta[\zeta^{n+i}[\alpha]]) \right) = v_0 && \text{(by Lemma 6.2.3)} \\ \Rightarrow & \gamma \left(\bigoplus_{i \in [0, \kappa]} b_i \cdot h_{\mathbf{V}}(\theta[\zeta^{n+i}[\alpha]]) \right) = \mathbb{0} && \text{(by applying the linear form } \gamma \text{ to both sides)} \\ \Rightarrow & \bigoplus_{i \in [0, \kappa]} b_i \otimes \gamma(h_{\mathbf{V}}(\theta[\zeta^{n+i}[\alpha]])) = \mathbb{0} && \text{(because } \gamma \text{ is a linear form)} \\ \Rightarrow & \bigoplus_{i \in [0, \kappa]} b_i \otimes r(\theta[\zeta^{n+i}[\alpha]]) = \mathbb{0} && \text{(because } (\mathbf{V}, \mu, \gamma) \text{ recognizes } r) \end{aligned}$$

□

Example 6.2.5. We continue with Example 6.2.2 and compute the characteristic polynomial of $\langle\!\langle\zeta\rangle\!\rangle$ for each context ζ . This characteristic polynomial has the following form:

- if $\zeta \neq z$, then $a(\zeta) = 0$ and $\text{char}_{\langle\!\langle\zeta\rangle\!\rangle}(x) = -x^3 + 2x^2 - x$ and
- if $\zeta = z$, then $a(\zeta) = 1$ and $\text{char}_{\langle\!\langle\zeta\rangle\!\rangle}(x) = -x^3 + 3x^2 - 3x + 1$.

Then, due to Lemma 6.2.4, we obtain the following linear recurrence equation for $\#_{\sigma(\cdot, \alpha)}$. For every $\theta, \zeta \in C_\Sigma$ with $\zeta \neq z$ and every $n \in \mathbb{N}$ we have

$$\#_{\sigma(\cdot, \alpha)}(\theta[\zeta^{n+3}[\alpha]]) = 2 \cdot \#_{\sigma(\cdot, \alpha)}(\theta[\zeta^{n+2}[\alpha]]) - \#_{\sigma(\cdot, \alpha)}(\theta[\zeta^{n+1}[\alpha]]) . \quad \square$$

In the following corollary, $\text{height} : T_\Sigma \rightarrow \mathbb{N}$ is the weighted tree language defined in Example 3.2.4.

Corollary 6.2.6. [BR82, Ex. 9.2] For the ranked alphabet $\Sigma = \{\sigma^{(2)}, \alpha^{(0)}\}$, we have that $\text{height} \notin \text{Rec}(\Sigma, \text{Real})$.

Proof. We prove by contradiction. For this we assume that there exists a (Σ, Real) -multilinear representation (V, μ, γ) such that $\text{height}(\xi) = \gamma(\text{h}_V(\xi))$ for each $\xi \in T_\Sigma$. Let V be κ -dimensional for some $\kappa \in \mathbb{N}$.

Let $\xi \in T_\Sigma$ be a tree with $\text{height}(\xi) = \kappa$. Due to the definition of Σ such a ξ exists. We consider the two elementary Σ -contexts $\theta = \sigma(z, \xi)$ and $\zeta = \sigma(z, \alpha)$. For each $n \in \mathbb{N}$ we define the tree $\xi_n = \theta[\zeta^n[\alpha]]$ in T_Σ . Then

$$\text{height}(\xi_n) = 1 + \max(n, \kappa) \quad \text{for every } n \in \mathbb{N} .$$

By Lemma 6.2.4, there exist $b_1, \dots, b_\kappa \in \mathbb{R}$ such that

$$(-1)^\kappa \cdot \text{height}(\xi_{n+\kappa}) + b_1 \cdot \text{height}(\xi_{n+\kappa-1}) + \dots + b_\kappa \cdot \text{height}(\xi_n) = 0 \quad \text{for every } n \in \mathbb{N} . \quad (6.6)$$

By using (6.6) for $n = 0$ and $n = 1$, we obtain

$$(-1)^\kappa \cdot (1 + \kappa) + b_1 \cdot (1 + \kappa) + \dots + b_\kappa \cdot (1 + \kappa) = 0 , \quad \text{and} \quad (6.7)$$

$$(-1)^\kappa \cdot (1 + (\kappa + 1)) + b_1 \cdot (1 + \kappa) + \dots + b_\kappa \cdot (1 + \kappa) = 0 , \quad (6.8)$$

respectively. Then Equations (6.7) and (6.8) imply that $\kappa = \kappa + 1$ which is a contradiction. \square

It follows that, for $\Sigma = \{\sigma^{(2)}, \alpha^{(0)}\}$ and any strong bimonoid \mathbf{B} such that Real is an extension of \mathbf{B} , the weighted tree language height is not recognizable by any (Σ, \mathbf{B}) -wta (cf. Observation 3.7.1). In particular, height is not recognizable by any (Σ, Rat) -wta and (Σ, Nat) -wta. Recall that, at the same time, there is a $(\Sigma, \text{Nat}_{\max,+})$ -wta which recognizes height (cf. Example 3.2.4).

6.2.3 The pumping lemma

Lemma 6.2.1 justifies to use the following theorem and lemma from [Reu80] (using $A = eC_\Sigma$). We will use the fact that a matrix $M \in B^{\kappa \times \kappa}$ is pseudo-regular if and only if x^2 does not divide its characteristic polynomial char_M (cf. [Reu80, Prop. 1]). We do not show the proof of this statement.

Theorem 6.2.7. [Reu80, Thm. 3] *Let $\kappa \in \mathbb{N}_+$. There exists $N \in \mathbb{N}$ such that for every set A , monoid homomorphism $\mu : A^* \rightarrow B^{\kappa \times \kappa}$, string $w \in A^*$ of length at least N , the string w has a factor $v \neq \varepsilon$ such that $\mu(v)$ is a pseudo-regular matrix.*

Lemma 6.2.8. [Reu80, Lm. 1] *Let $\kappa \in \mathbb{N}_+$, $M \in B^{\kappa \times \kappa}$, and $\lambda, \gamma \in B^\kappa$. If M is pseudo-regular and $\lambda \cdot M \cdot \gamma \neq 0$, then there exist infinitely many $n \in \mathbb{N}$ such that $\lambda \cdot M^n \cdot \gamma \neq 0$.*

Proof. Let

$$\text{char}_M(x) = (-\mathbb{1})^\kappa \cdot x^\kappa \oplus b_{\kappa-1} \cdot x^{\kappa-1} \oplus \dots \oplus b_1 \cdot x \oplus b_0 .$$

By our assumption $b_1 \neq 0$ or $b_0 \neq 0$. Let us abbreviate $\lambda \cdot M^n \cdot \gamma$ by a_n for each $n \in \mathbb{N}$. We show that, for each $n \in \mathbb{N}$, if $a_n \neq 0$, then there exists $m > n$ such that $a_m \neq 0$. Since $a_1 \neq 0$, this proves the lemma.

Let $n \in \mathbb{N}$ and assume that $a_n \neq 0$. In addition, assume that $b_0 \neq 0$. By Theorem 2.9.1, we have

$$(-\mathbb{1})^\kappa \cdot M^\kappa \oplus b_{\kappa-1} \cdot M^{\kappa-1} \oplus \cdots \oplus b_1 \cdot M \oplus b_0 \cdot M^0 = M_0 .$$

By multiplying both sides first with M^n , second from the left with the vector λ , and third from the right with the vector γ , we obtain

$$(-\mathbb{1})^\kappa \otimes a_{n+\kappa} \oplus b_{\kappa-1} \otimes a_{n+\kappa-1} \oplus \cdots \oplus b_1 \otimes a_{n+1} \oplus b_0 \otimes a_n = 0 .$$

Since $b_0 \neq 0$ and $a_n \neq 0$ and a field is zero-divisor free, we have that $b_0 \otimes a_n \neq 0$. Hence there exists $m \in [n+1, n+\kappa]$ such that $a_m \neq 0$.

Now assume that $b_0 = 0$ and $b_1 \neq 0$. By our assumption $\kappa > 1$ and by Theorem 2.9.1 (as above), we have

$$(-\mathbb{1})^\kappa \otimes a_{n+\kappa-1} \oplus b_{\kappa-1} \otimes a_{n+\kappa-2} \oplus \cdots \oplus b_1 \otimes a_n = 0 .$$

Then again $a_m \neq 0$ for some $m \in [n+1, n+\kappa-1]$. □

Let $\xi \in T_\Sigma$, $c \in C_\Sigma$, and $\alpha \in \Sigma^{(0)}$. The pair (c, α) is a *walk in ξ* if $\xi = c[\alpha]$. The *depth of (c, α)* is $\text{depth}(c)$. Let $c \in C_\Sigma$. We recall that $c^0 = z$, and for every $n \in \mathbb{N}$, we have $c^{n+1} = c[c^n]$.

Theorem 6.2.9. [BR82, Thm. 9.2] *Let Σ be a ranked alphabet. Moreover, let $\mathbf{B} = (B, \oplus, \otimes, 0, \mathbb{1})$ be a field and let $r \in \text{Rec}(\Sigma, \mathbf{B})$. There exists a constant $N \in \mathbb{N}$ such that for every $\xi \in \text{supp}(r)$ and every walk (c, α) in ξ of depth at least N , there exist $c_1, c_2, c_3 \in C_\Sigma$ such that $c_2 \neq z$, $c = c_1 \circ_z c_2 \circ_z c_3$, and the set $\{(c_1 \circ_z c_2^n \circ_z c_3)[\alpha] \mid n \in \mathbb{N}\} \cap \text{supp}(r)$ is infinite.*

Proof. By Theorem 3.6.6 there exists a (Σ, \mathbf{B}) -multilinear representation (V, μ, γ) where $V = (V, +, 0)$ is a κ -dimensional \mathbf{B} -vector space for some $\kappa \in \mathbb{N}$ and

$$r(\xi) = \gamma(\text{h}_V(\xi)) \text{ for each } \xi \in T_\Sigma . \tag{6.9}$$

Since the two monoids $(B^{\kappa \times \kappa}, \cdot, M_{\mathbb{1}})$ and $(\mathcal{L}(V, V), \circ, \text{id})$ are isomorphic (cf Section 2.7.7), we identify them.

Then we can apply Theorem 6.2.7. Let $N \in \mathbb{N}$ be the integer from that theorem. Moreover, let $\xi \in \text{supp}(r)$ and (c, α) be a walk of ξ of depth at least N . By Theorem 6.2.7, there exists $c_1, c_2, c_3 \in C_\Sigma$ such that $c = c_1 \circ_z c_2 \circ_z c_3$ with $c_2 \neq z$ and $\langle c_2 \rangle$ is a pseudo-regular endomorphism. In particular, we have $\xi = c_1[c_2[c_3[\alpha]]]$.

For each $n \in \mathbb{N}$ we define the element $u_n \in B$ by

$$u_n = \gamma(\langle c_1 \rangle(\langle c_2 \rangle^n(\langle c_3 \rangle(\text{h}_V(\alpha)))) .$$

In particular,

$$u_1 = \gamma(\langle c_1 \rangle(\langle c_2 \rangle(\langle c_3 \rangle(\text{h}_V(\alpha)))) = \gamma(\text{h}_V(c_1[c_2[c_3[\alpha]]])) = r(c_1[c_2[c_3[\alpha]]) = r(\xi) \neq 0$$

where the second and third equality are due to Lemma 6.2.3 and (6.9), respectively.

Thus, we can apply Lemma 6.2.8 (using $M = \langle c_2 \rangle$ and $\lambda = \langle c_3 \rangle \cdot \text{h}_V(\alpha)$) and hence, there exist infinitely many n such that $u_n \neq 0$.

Since $u_n = r(c_1[c_2^n[c_3[\alpha]]])$ (by a similar calculation as for u_1), we obtain the statement of the theorem. □

Theorem 6.2.9 can be used to show that certain tree languages cannot be the support of recognizable \mathbf{B} -weighted tree languages.

Corollary 6.2.10. Let $\Sigma = \{\gamma^{(1)}, \sigma^{(1)}, \alpha^{(0)}\}$. For each field \mathbf{B} , the tree language $L = \{\sigma^n \gamma^n(\alpha) \mid n \geq 0\}$ is not in $\text{supp}(\text{Rec}(\Sigma, \mathbf{B}))$.

Proof. Let \mathbf{B} be a field. We continue to prove by contradiction. For this, we assume that there exists an $r \in \text{Rec}(\Sigma, \mathbf{B})$ such that $L = \text{supp}(r)$. Let N be the number for r appearing in Theorem 6.2.9 and consider the tree $\xi = \sigma^N \gamma^N(\alpha)$ and the walk (c, α) in ξ , where $c = \sigma^N \gamma^N(z)$. By Theorem 6.2.9, there exist $c_1, c_2, c_3 \in \mathbf{C}_\Sigma$ such that $c_2 \neq z$, $c = c_1 \circ_z c_2 \circ_z c_3$ and the set $\{(c_1 \circ_z c_2^n \circ_z c_3)[\alpha] \mid n \in \mathbb{N}\} \cap L$ is infinite. On the other hand, for any decomposition $c = c_1 \circ_z c_2 \circ_z c_3$ of c with $c_2 \neq z$ we have $\{(c_1 \circ_z c_2^n \circ_z c_3)[\alpha] \mid n \in \mathbb{N}\} \cap L \subseteq \{(c_1 \circ_z c_3)[\alpha], \xi\}$. This is a contradiction, hence $L \notin \text{supp}(\text{Rec}(\Sigma, \mathbf{B}))$. \square

By similar arguments as in Corollary 6.2.10, we can show that the tree language FB is not in $\text{supp}(\text{Rec}(\Sigma, \mathbf{B}))$. The tree language FB of *fully balanced trees over* $\{\sigma^{(2)}, \alpha^{(0)}\}$ is the smallest Σ -tree language L satisfying (i) $\alpha \in L$, and (ii) $\sigma(\xi, \xi) \in L$ for each $\xi \in L$.

Chapter 7

Normal forms of wta

In this chapter we prove some useful normal forms of wta. More precisely, we define several useful properties which a given wta either has or does not have. Then, for each of these properties, we show that, under some conditions on the weight algebra, any given wta can be transformed into an equivalent wta which has this property. In this sense, the given wta is turned into a normal form. Sometimes normal forms of wta are useful for reducing the complexity of proofs which start from a given wta.

We deal with the following properties: trim, total, root weight normalized, and crisp.

7.1 Trimming a wta

In this section we elaborate two trimming methods for wta. Intuitively, a trimming method takes a wta as input and constructs a run equivalent trim wta as output. A wta is trim if it contains only useful states, i.e., states which occur in a successful run on some input tree.

In the literature trimming methods are known for finite-state automata [Sak09, Prop. 1.9], context-free grammars [Har78, Thm. 3.2.3], regular tree grammars [CDG⁺07, Prop. 2.1.3] and [Dre06, Lm. A.2.6], fta [Sei89, Prop. 1.1], weighted string automata over semirings [Sak09, p. 408], and wta over strong bimonoids [DFKV22, Thm. 4.2]. Except for the last two shown references, each of them deals with the unweighted case.

Our first trimming method is applicable to wta over zero-cancellation free strong bimonoids and it leads to a “strong form” of trim wta. Our second method is applicable to wta over arbitrary strong bimonoids and it leads to a “weak form” of trim wta. We start by defining some useful concepts.

7.1.1 Basic definitions

Let $\mathcal{A} = (Q, \delta, F)$ be a (Σ, \mathbb{B}) -wta. Let $q \in Q$, $\xi \in T_\Sigma$, and $\rho \in R_{\mathcal{A}}(q, \xi)$. We say that

- ρ is *successful* if $\text{wt}(\xi, \rho) \otimes F_q \neq 0$,
- ρ is *local-successful* if (a) for each $v \in \text{pos}(\xi)$ we have $\delta_k(\rho(v1) \cdots \rho(vk), \xi(v), \rho(v)) \neq 0$ where $k = \text{rk}_\Sigma(\xi(v))$ and (b) $F_q \neq 0$.

Let $p \in Q$. We say that

- p is *useful* if there exist $\xi \in T_\Sigma$ and a successful run $\rho \in R_{\mathcal{A}}(\xi)$ such that $p \in \text{im}(\rho)$.
- p is *local-useful* if there exist $\xi \in T_\Sigma$ and a local-successful run $\rho \in R_{\mathcal{A}}(\xi)$ such that $p \in \text{im}(\rho)$.
- p is *accessible* if there exist $\xi \in T_\Sigma$ and $\rho \in R_{\mathcal{A}}(p, \xi)$ such that $\text{wt}(\xi, \rho) \neq 0$.
- p is *local-accessible* if there exist $\xi \in T_\Sigma$ and $\rho \in R_{\mathcal{A}}(p, \xi)$ such that, for each $v \in \text{pos}(\xi)$, we have $\delta_k(\rho(v1) \cdots \rho(vk), \xi(v), \rho(v)) \neq 0$ where $k = \text{rk}_\Sigma(\xi(v))$.

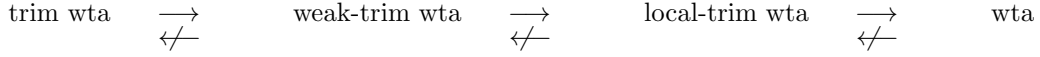

Figure 7.1: An illustration of the relationships between trim wta, weak-trim wta, local-trim wta, and wta where \longrightarrow means “implies” (cf. Observation 7.1.1 (1)-(4)).

- p is *co-accessible* if there exist $q \in Q$, a context $c \in C_\Sigma$, and a run $\rho \in R_{\mathcal{A}}(q, c, p)$ such that $\text{wt}(c, \rho) \otimes F_q \neq 0$.
- p is *weakly useful* if it is accessible and co-accessible.

Clearly, useful implies weakly useful, and weakly useful implies local-useful. Moreover, if \mathbf{B} is zero-divisor free, then the three notions are equivalent; thus, in particular, this holds if \mathbf{B} is the Boolean semiring **Boole**.

A (Σ, \mathbf{B}) -wta \mathcal{A} is called *trim* if each of its states is useful; in a similar way, we define *weak-trim* and *local-trim* by employing weakly useful and local-useful, respectively. We note that the notions of trim in [Sak09] and in [DFKV22] correspond to the notions weak-trim and local-trim, respectively. In the next observation we formally compare the different trim properties (cf. Figure 7.1).

Observation 7.1.1. The following five statements hold.

- (1) Each trim (Σ, \mathbf{B}) -wta is weak-trim, and each weak-trim (Σ, \mathbf{B}) -wta is local-trim.
- (2) There exist a trivial ranked alphabet Σ and a (Σ, \mathbf{B}) -wta \mathcal{A} such that $\llbracket \mathcal{A} \rrbracket^{\text{run}} \neq \tilde{0}$ and \mathcal{A} is not local-trim.
- (3) There exist a string ranked alphabet Σ , a strong bimonoid \mathbf{B} , and a local-trim (Σ, \mathbf{B}) -wta which is not weak-trim.
- (4) There exist a string ranked alphabet Σ , a strong bimonoid \mathbf{B} , and a weak-trim (Σ, \mathbf{B}) -wta which is not trim.
- (5) If \mathbf{B} is zero-divisor free, then for each (Σ, \mathbf{B}) -wta \mathcal{A} we have: \mathcal{A} is trim iff \mathcal{A} is weak-trim iff \mathcal{A} is local-trim.

Proof. Statements (1) and (5) are obvious.

Proof of Statement (2): We consider the ranked alphabet $\Sigma = \{\alpha^{(0)}\}$ and the (Σ, \mathbf{B}) -wta $\mathcal{A} = (Q, \delta, F)$, where $Q = \{q, p\}$, $\delta(\varepsilon, \alpha, q) = \mathbb{1}$, $\delta(\varepsilon, \alpha, p) = 0$, and $F_q = \mathbb{1}$ and $F_p = 0$. Then $\llbracket \mathcal{A} \rrbracket^{\text{run}}(\alpha) = \mathbb{1}$, i.e., $\llbracket \mathcal{A} \rrbracket^{\text{run}} \neq \tilde{0}$. We note that p is not local-useful and hence \mathcal{A} is not local-trim.

Proof of Statement (3): We consider the string ranked alphabet $\Sigma = \{\gamma^{(1)}, \alpha^{(0)}\}$ and the ring $\text{Intmod4} = (\{0, 1, 2, 3\}, +_4, \cdot_4, 0, 1)$ defined in Example 2.7.9(5). This Intmod4 is not zero-divisor free because $2 \cdot_4 2 = 0$.

Then we let $\mathcal{A} = (Q, \delta, F)$ be the $(\Sigma, \text{Intmod4})$ -wta with $Q = \{q, q_1, p, q_2\}$ and for each $f, g \in Q$ we define

$$\delta_0(\varepsilon, \alpha, f) = \begin{cases} 1 & \text{if } f = q \\ 0 & \text{otherwise} \end{cases} \quad \text{and} \quad \delta_1(f, \gamma, g) = \begin{cases} 2 & \text{if } fg \in \{qq_1, q_1p, pq_2, q_2q\} \\ 0 & \text{otherwise} \end{cases}$$

and $F_q = 1$ and $F_{q_1} = F_p = F_{q_2} = 0$. Then each $f \in Q$ is local-useful and hence \mathcal{A} is local-trim. The state q is weakly useful. The state q_1 is accessible; p and q_2 are not accessible; q_2 is co-accessible; p and q_1 are not co-accessible. Hence \mathcal{A} is not weak-trim.

Proof of Statement (4): We consider the ranked alphabet Σ and the semiring Intmod4 as in the proof of Statement (3).

Then we let $\mathcal{A} = (Q, \delta, F)$ be the $(\Sigma, \text{Intmod4})$ -wta with $Q = \{q, p\}$ and for each $f, g \in Q$ we define

$$\delta_0(\varepsilon, \alpha, f) = \begin{cases} 1 & \text{if } f = q \\ 0 & \text{otherwise} \end{cases} \quad \text{and} \quad \delta_1(f, \gamma, g) = \begin{cases} 2 & \text{if } fg \in \{qp, pq\} \\ 0 & \text{otherwise} \end{cases}$$

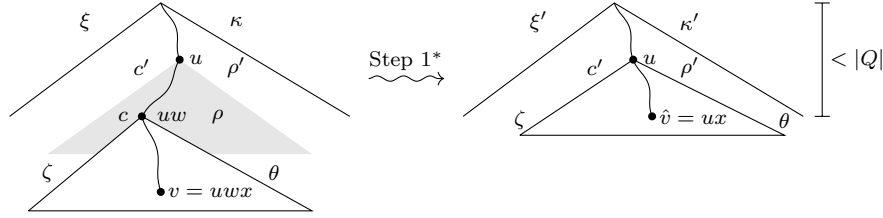

Figure 7.2: Cutting out contexts above v repeatedly.

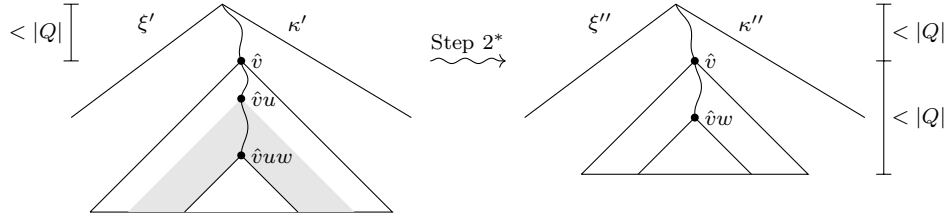

Figure 7.3: Cutting out contexts below \hat{v} repeatedly.

and $F_q = 1$ and $F_p = 0$. Then p and q are accessible and co-accessible, and hence, weakly useful. Thus \mathcal{A} is weak-trim. The state p is not useful and hence \mathcal{A} is not trim. \square

7.1.2 Trimming for zero-cancellation free strong bimonoids

Here we show our first trimming method. It takes a (Σ, \mathbf{B}) -wta over some zero-cancellation free strong bimonoid \mathbf{B} , and constructs a run equivalent trim (Σ, \mathbf{B}) -wta. The method employs the pumping lemma to cut out in a careful way contexts from successful runs; due to zero-cancellation freeness of \mathbf{B} , this results in smaller successful runs. As preparation we characterize useful states.

Lemma 7.1.2. Let \mathbf{B} be zero-cancellation free, $\mathcal{A} = (Q, \delta, F)$ be a (Σ, \mathbf{B}) -wta, and $p \in Q$. Then p is useful if and only if there exist $q \in Q$, $\xi \in T_\Sigma$, and a successful run $\rho \in R_{\mathcal{A}}(q, \xi)$ such that $p \in \text{im}(\rho)$ and $\text{height}(\xi) < 2|Q|$.

Proof. The “if”-direction holds trivially. For the “only-if”-direction we prove the following.

$$\begin{aligned} &\text{For every } q \in Q, \xi \in T_\Sigma, v \in \text{pos}(\xi), \text{ and successful run } \kappa \in R_{\mathcal{A}}(q, \xi), \\ &\text{there exist } \hat{\xi} \in T_\Sigma, \hat{v} \in \text{pos}(\hat{\xi}), \text{ and successful run } \hat{\kappa} \in R_{\mathcal{A}}(q, \hat{\xi}) \\ &\text{such that } \text{height}(\hat{\xi}) < 2|Q|, \text{ and } \hat{\kappa}(\hat{v}) = \kappa(v). \end{aligned} \quad (7.1)$$

Let $q \in Q$, $\xi \in T_\Sigma$, $v \in \text{pos}(\xi)$, and $\kappa \in R_{\mathcal{A}}(q, \xi)$ be a successful run. We prove (7.1) in three steps. Intuitively, in Step 1 we cut out repeatedly contexts above v such that eventually the state $\kappa(v)$ occurs at \hat{v} and $|\hat{v}| < |Q|$. In Step 2 we cut out repeatedly contexts below \hat{v} such that eventually the subtree below \hat{v} has height smaller than $|Q|$. In Step 3 we cut out repeatedly contexts aside of \hat{v} such that eventually we obtain the desired result. Since \mathbf{B} is zero-cancellation free, cutting out a context transforms a successful run into a successful run. We illustrate the three steps in Figures 7.2, 7.3, and 7.4, respectively.

Step 1: We construct a $\xi' \in T_\Sigma$, a $\hat{v} \in \text{pos}(\xi')$, and a successful run $\kappa' \in R_{\mathcal{A}}(q, \xi')$ such that $|\hat{v}| < |Q|$ and $\kappa'(\hat{v}) = \kappa(v)$ as follows.

If $|v| < |Q|$, then we let $\xi' = \xi$, $\hat{v} = v$, and $\kappa' = \kappa$ and we are ready.

Otherwise, there exist $u, x \in \mathbb{N}_+^*$ and $w \in \mathbb{N}_+^+$ such that $v = uwx$ and $\kappa(u) = \kappa(uw)$. Let $c' = \xi|_u$, $c = (\xi|_u)|^w$, and $\zeta = \xi|_{uw}$, and let $\rho' = \kappa|_u$, $\rho = (\kappa|_u)|^w$, and $\theta = \kappa|_{uw}$. Then $\xi = c'[c[\zeta]]$ and $\kappa = \rho'[\rho[\theta]]$,

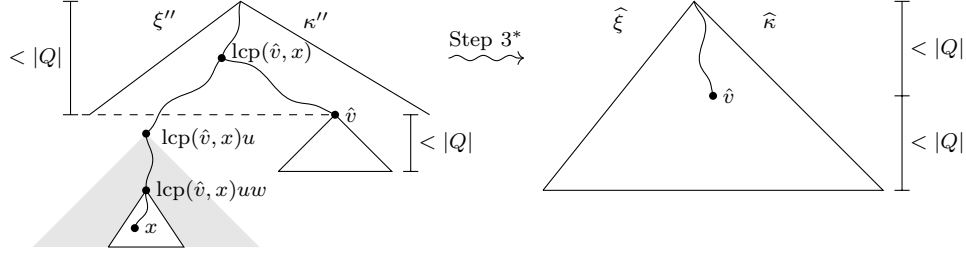

Figure 7.4: Cutting out contexts aside of \widehat{v} repeatedly.

where ρ is a loop due to the condition $\rho(u) = \rho(uw)$. Thus, by Theorem 6.1.3 (equality (6.2) for $n = 1$), we have

$$\text{wt}(\xi, \kappa) \otimes F_q = l_{c', \rho'} \otimes l_{c, \rho} \otimes \text{wt}(\zeta, \theta) \otimes r_{c, \rho} \otimes r_{c', \rho'} \otimes F_q.$$

Now we cut out the context c and the corresponding loop ρ . Formally, let $\xi' = c'[\zeta]$ and $\kappa' = \rho'[\theta]$. By equality (6.2) for $n = 0$, we obtain

$$\text{wt}(\xi', \kappa') \otimes F_q = l_{c', \rho'} \otimes \text{wt}(\zeta, \theta) \otimes r_{c', \rho'} \otimes F_q.$$

Since κ is a successful run, i.e., $\text{wt}(\xi, \kappa) \otimes F_q \neq 0$, and \mathbf{B} is zero-cancellation free, we obtain that κ' is also successful. Moreover, for $\widehat{v} = ux$, we have $\kappa'(\widehat{v}) = \kappa(v)$ by the definition of κ' . If $|\widehat{v}| \geq |Q|$, then we repeat the above procedure with ξ' , \widehat{v} , and κ' . After finitely many steps, we obtain ξ' , \widehat{v} , and κ' such that $|\widehat{v}| < |Q|$.

Step 2: Given $\xi' \in T_\Sigma$, $\widehat{v} \in \text{pos}(\xi')$, and the successful run $\kappa' \in R_{\mathcal{A}}(q, \xi')$ constructed in Step 1, we construct $\xi'' \in T_\Sigma$ and successful run $\kappa'' \in R_{\mathcal{A}}(q, \xi'')$ such that $\widehat{v} \in \text{pos}(\xi'')$, $\kappa''(\widehat{v}) = \kappa'(\widehat{v})$, and $\text{height}(\xi''|_{\widehat{v}}) < |Q|$ as follows.

If $\text{height}(\xi'|_{\widehat{v}}) < |Q|$, then we let $\xi'' = \xi'$ and $\kappa'' = \kappa'$ and we are ready.

Otherwise, there exist $u \in \mathbb{N}_+^*$ and $w \in \mathbb{N}_+^+$ such that $\widehat{v}uw \in \text{pos}(\xi')$ and $\kappa'(\widehat{v}u) = \kappa'(\widehat{v}uw)$. Similarly to the construction in Step 1, by cutting out the context $(\xi'|_{\widehat{v}u})|^w$ and the loop $(\kappa'|_{\widehat{v}u})|^w$ from ξ' and κ' , respectively, we obtain $\xi'' \in T_\Sigma$ and successful run $\kappa'' \in R_{\mathcal{A}}(q, \xi'')$ such that $\widehat{v} \in \text{pos}(\xi'')$, $\kappa''(\widehat{v}) = \kappa'(\widehat{v})$ and $\text{size}(\xi''|_{\widehat{v}}) < \text{size}(\xi'|_{\widehat{v}})$. If $\text{height}(\xi''|_{\widehat{v}}) \geq |Q|$, then we repeat the above procedure with ξ'' and κ'' . After finitely many steps, we obtain ξ'' and κ'' such that $\text{height}(\xi''|_{\widehat{v}}) < |Q|$.

Step 3: Given $\xi'' \in T_\Sigma$, $\widehat{v} \in \text{pos}(\xi'')$, and the successful run $\kappa'' \in R_{\mathcal{A}}(q, \xi'')$ constructed in Step 2, we construct $\widehat{\xi} \in T_\Sigma$ and the successful run $\widehat{\kappa} \in R_{\mathcal{A}}(q, \widehat{\xi})$ such that $\widehat{v} \in \text{pos}(\widehat{\xi})$, $\widehat{\kappa}(\widehat{v}) = \kappa''(\widehat{v})$, and $\text{height}(\widehat{\xi}) < 2|Q|$.

Let $x \in \text{pos}(\xi'')$ be such that $x \notin \text{prefix}(\widehat{v})$. Let us denote by $\text{lcp}(\widehat{v}, x)$ the longest common prefix of \widehat{v} and x . Moreover, let $\text{rest}(\widehat{v}, x)$ be the unique string in \mathbb{N}_+^+ such that $x = \text{lcp}(\widehat{v}, x)\text{rest}(\widehat{v}, x)$. We note that if $\widehat{v} \in \text{prefix}(x)$, i.e., $\text{lcp}(\widehat{v}, x) = \widehat{v}$, then $|\text{rest}(\widehat{v}, x)| < |Q|$ due to the condition $\text{height}(\xi''|_{\widehat{v}}) < |Q|$.

If, for each $x \in \text{pos}(\xi'')$ with $x \notin \text{prefix}(\widehat{v})$ and $\widehat{v} \notin \text{prefix}(x)$, we also have $|\text{rest}(\widehat{v}, x)| < |Q| + 1$, then we are ready because $|\widehat{v}| < |Q|$.

Otherwise, there exist $u \in \mathbb{N}_+^+$ and $w \in \mathbb{N}_+^+$ such that $\text{lcp}(\widehat{v}, x)uw \in \text{prefix}(x)$ and $\kappa''(\text{lcp}(\widehat{v}, x)u) = \kappa''(\text{lcp}(\widehat{v}, x)uw)$. Similarly to the construction in Step 1, by cutting out the context $(\xi''|_{\text{lcp}(\widehat{v}, x)u})|^w$ and the loop $(\kappa''|_{\text{lcp}(\widehat{v}, x)u})|^w$ from ξ'' and κ'' , respectively, we obtain $\widehat{\xi} \in T_\Sigma$ and successful run $\widehat{\kappa} \in R_{\mathcal{A}}(q, \widehat{\xi})$ such that $\widehat{v} \in \text{pos}(\widehat{\xi})$, $\widehat{\kappa}(\widehat{v}) = \kappa''(\widehat{v})$ and $\text{size}(\widehat{\xi}) < \text{size}(\xi'')$. The condition $\widehat{v} \in \text{pos}(\widehat{\xi})$ is ensured by $u \in \mathbb{N}_+^+$. If there still exists an $x \in \text{pos}(\widehat{\xi})$ such that $x \notin \text{prefix}(\widehat{v})$, $\widehat{v} \notin \text{prefix}(x)$, and $|\text{rest}(\widehat{v}, x)| \geq |Q| + 1$, then we repeat the above procedure with $\widehat{\xi}$ and $\widehat{\kappa}$. After finitely many steps, we obtain $\widehat{\xi}$ and $\widehat{\kappa}$ as desired. \square

Now we can prove the trimming result for zero-cancellation free strong bimonoids. By Observation 2.7.11(1) this also covers commutative strong bimonoids.

Theorem 7.1.3. *Let Σ be a ranked alphabet. Moreover, let \mathbf{B} be a zero-cancellation free strong bimonoid and let \mathcal{A} be a (Σ, \mathbf{B}) -wta. If \mathcal{A} contains a useful state, then we can construct a (Σ, \mathbf{B}) -wta \mathcal{A}' such that \mathcal{A}' is trim and $\llbracket \mathcal{A}' \rrbracket^{\text{run}} = \llbracket \mathcal{A} \rrbracket^{\text{run}}$. If \mathcal{A} is bu-deterministic, then so is \mathcal{A}' .*

Proof. Let $\mathcal{A} = (Q, \delta, F)$. We construct the set

$$Q' = \bigcup \{ \text{im}(\rho) \mid \xi \in T_\Sigma, \text{height}(\xi) < 2|Q|, \rho \in R_{\mathcal{A}}(q, \xi), \text{wt}(\xi, \rho) \otimes F_{\rho(\varepsilon)} \neq 0 \}.$$

By Lemma 7.1.2, Q' is the set of all useful states of \mathcal{A} . Due to our assumption on \mathcal{A} , we have $Q' \neq \emptyset$. Then we construct the (Σ, \mathbf{B}) -wta $\mathcal{A}' = (Q', \delta', F')$ such that

- $\delta'_k = \delta_k|_{(Q')^k \times \Sigma^{(k)} \times Q'}$ for each $k \in \mathbb{N}$, and
- $F' = F|_{Q'}$.

If \mathcal{A} is bu-deterministic, then so is \mathcal{A}' because $Q' \subseteq Q$ and each transition mapping δ'_k is a restriction of δ_k . Clearly, \mathcal{A}' is trim.

Let $\xi \in T_\Sigma$. Then

$$\begin{aligned} \llbracket \mathcal{A} \rrbracket^{\text{run}}(\xi) &= \bigoplus_{q \in Q} \bigoplus_{\rho \in R_{\mathcal{A}}(q, \xi)} \text{wt}_{\mathcal{A}}(\xi, \rho) \otimes F_q = \bigoplus_{q \in Q} \bigoplus_{\substack{\rho \in R_{\mathcal{A}}(q, \xi): \\ \rho \text{ is successful}}} \text{wt}_{\mathcal{A}}(\xi, \rho) \otimes F_q \\ &= \bigoplus_{q \in Q'} \bigoplus_{\rho \in R_{\mathcal{A}'}(q, \xi)} \text{wt}_{\mathcal{A}'}(\xi, \rho) \otimes F'_q = \llbracket \mathcal{A}' \rrbracket^{\text{run}}(\xi), \end{aligned}$$

where the third equality follows from the fact that, if ρ is successful, then all states in $\text{im}(\rho)$ are useful and that for every $q \in Q'$ and $\rho \in R_{\mathcal{A}'}(q, \xi)$ we have $\text{wt}_{\mathcal{A}'}(\xi, \rho) = \text{wt}_{\mathcal{A}}(\xi, \rho)$. \square

7.1.3 Local-trimming for arbitrary strong bimonoids

Here we show our second trimming method. It takes a (Σ, \mathbf{B}) -wta over an arbitrary strong bimonoid \mathbf{B} as input and constructs a run equivalent local-trim (Σ, \mathbf{B}) -wta. This trimming method is adapted from [Har78, Thm. 3.2.3] where it is shown how to construct an equivalent reduced context-free grammar from a given context-free grammar.

Theorem 7.1.4. *Let Σ be a ranked alphabet. Moreover, let $\mathbf{B} = (B, \oplus, \otimes, \mathbb{0}, \mathbb{1})$ be a strong bimonoid and \mathcal{A} a (Σ, \mathbf{B}) -wta. If \mathcal{A} contains a local-useful state, then we can construct a (Σ, \mathbf{B}) -wta \mathcal{A}' such that \mathcal{A}' is local-trim and $\llbracket \mathcal{A}' \rrbracket^{\text{run}} = \llbracket \mathcal{A} \rrbracket^{\text{run}}$. If \mathcal{A} is bu-deterministic, then so is \mathcal{A}' .*

Proof. The following proof is based on [Dro22]. Let $\mathcal{A} = (Q, \delta, F)$. First, in a bottom-up process, we construct the set Q_1 of all local-accessible states of \mathcal{A} (by using a mapping f). Second, in a top-down process, we construct the set of all local-useful states (by using a mapping g).

We define the mapping $f : \mathcal{P}(Q) \rightarrow \mathcal{P}(Q)$ for each $U \in \mathcal{P}(Q)$ by

$$f(U) = U \cup \{q \in Q \mid \text{there exist } k \in \mathbb{N}, q_1, \dots, q_k \in U, \text{ and } \sigma \in \Sigma^{(k)} \text{ such that } \delta_k(q_1 \dots q_k, \sigma, q) \neq 0\}.$$

Trivially, f is order-preserving and hence continuous, as Q is finite.

Let Q_1 be the smallest subset of Q which is closed under f . Thus, by Theorem 2.7.17, we have that $Q_1 = \bigcup (f^n(\emptyset) \mid n \in \mathbb{N})$. Since $\bigcup (f^n(\emptyset) \mid n \in \mathbb{N}) = \bigcup (f^n(\emptyset) \mid 0 \leq n \leq |Q|)$, we can construct Q_1 . Moreover, each state in Q_1 is local-accessible in \mathcal{A} . Conversely, working up a run, it follows that each local-accessible state of \mathcal{A} belongs to Q_1 . Hence Q_1 is the set of all local-accessible states of \mathcal{A} .

Next we define $g : \mathcal{P}(Q_1) \rightarrow \mathcal{P}(Q_1)$ for each $U \in \mathcal{P}(Q_1)$ by

$$g(U) = \begin{cases} \{q \in Q_1 \mid F_q \neq \emptyset\} & \text{if } U = \emptyset \\ U \cup \{q_i \in Q_1 \mid \text{there exist } k \in \mathbb{N}_+, q \in U, q_1, \dots, q_k \in Q_1, i \in [k] \text{ and} \\ \sigma \in \Sigma^{(k)} \text{ such that } \delta_k(q_1 \cdots q_k, \sigma, q) \neq \emptyset\} & \text{otherwise.} \end{cases}$$

The mapping g is order-preserving and hence continuous, as Q_1 is finite. Let Q' be the smallest subset of Q_1 which is closed under g . Thus, by Theorem 2.7.17, we have that $Q' = \bigcup \{g^n(\emptyset) \mid n \in \mathbb{N}\}$. Since $\bigcup \{g^n(\emptyset) \mid n \in \mathbb{N}\} = \bigcup \{g^n(\emptyset) \mid 0 \leq n \leq |Q_1|\}$, we can construct Q' .

We claim that

$$Q' \text{ is the set of all local-useful states of } \mathcal{A}. \quad (7.2)$$

(a) First we show that each $q \in Q'$ is local-useful. For this, by induction on \mathbb{N} , we prove the following statement.

$$\text{For each } n \in \mathbb{N}_+, \text{ we have that each state in } g^n(\emptyset) \text{ is local-useful.} \quad (7.3)$$

I.B.: Clearly, each state in $g(\emptyset) = \{q \in Q_1 \mid F_q \neq \emptyset\}$ is local-useful.

I.S.: Let $n \geq 1$ and $p \in g^{n+1}(\emptyset)$. We may assume that $p \in g^{n+1}(\emptyset) \setminus g^n(\emptyset)$ because otherwise the statement follows by the I.H. immediately. Then there exist $k \in \mathbb{N}_+$, $j \in [k]$, $q \in g^n(\emptyset)$, $q_1, \dots, q_k \in Q_1$, and $\sigma \in \Sigma^{(k)}$ such that $\delta_k(q_1 \cdots q_k, \sigma, q) \neq \emptyset$ and $p = q_j$.

Since q_1, \dots, q_k are in Q_1 , i.e., local-accessible, for each $i \in [k]$ there is a tree $\xi_i \in \mathsf{T}_\Sigma$ and run $\rho_i \in \mathsf{R}_\mathcal{A}(q_i, \xi_i)$ such that for every $v \in \text{pos}(\xi_i)$, the weight $\delta_\ell(\rho_i(v1) \cdots \rho_i(v\ell), \xi_i(v), \rho_i(v)) \neq \emptyset$, where $\ell = \text{rk}(\xi(v))$.

By the I.H. q is local-useful, hence there is a $\xi \in \mathsf{T}_\Sigma$, and a local-successful run $\rho \in \mathsf{R}_\mathcal{A}(\xi)$ such that $q \in \text{im}(\rho)$. Let $w \in \text{pos}(\xi)$ with $\rho(w) = q$.

Now consider the tree $\zeta = \sigma(\xi_1, \dots, \xi_k)$ and define the run $\kappa \in \mathsf{R}_\mathcal{A}(\zeta)$ such that $\kappa(\varepsilon) = q$ and for each $i \in [k]$ and $v \in \text{pos}(\xi_i)$ we have $\kappa(iv) = \rho_i(v)$.

Note that $\kappa(j) = p$ and

$$\text{for every } v \in \text{pos}(\zeta), \text{ the weight } \delta_\ell(\kappa(v1) \cdots \kappa(v\ell), \zeta(v), \kappa(v)) \neq \emptyset, \text{ where } \ell = \text{rk}(\xi'(v)). \quad (7.4)$$

Lastly, we consider the tree $\xi' = \xi[\zeta]_w$ and the run $\rho' \in \mathsf{R}_\mathcal{A}(\xi')$ defined, for each $v \in \text{pos}(\xi')$, by

$$\rho'(v) = \begin{cases} \kappa(u) & \text{if } (\exists u \in \mathbb{N}^*) : v = wu \\ \rho(v) & \text{otherwise.} \end{cases}$$

Since ρ is local-successful and κ has property (7.4), the run ρ' is also local-successful. Moreover, $\rho'(wj) = \kappa(j) = p$, hence p is local-useful. This finishes the proof of (7.3).

Since $Q' = \bigcup \{g^n(\emptyset) \mid n \in \mathbb{N}\}$, we obtain that each state of Q' is local-useful in \mathcal{A} .

(b) Next we show that each local-useful state of \mathcal{A} is in Q' . For this, let $\xi \in \mathsf{T}_\Sigma$ and $\rho \in \mathsf{R}_\mathcal{A}(\xi)$ be a local-successful run on ξ . By induction on $(\text{pos}(\xi), <_{\text{pref}}^{-1})$ we show that

$$\text{for each } w \in \text{pos}(\xi), \text{ there exists } n \in \mathbb{N} \text{ such that state } \rho(w) \in g^n(\emptyset). \quad (7.5)$$

We note that, since ρ is local-successful, $\rho(v) \in Q_1$ for each $v \in \text{pos}(\xi)$.

I.B.: Let $w = \varepsilon$. Again, since ρ is local-successful, we have $F_{\rho(\varepsilon)} \neq \emptyset$. Hence $\rho(\varepsilon) \in g(\emptyset)$.

I.S.: Let $w = vi$ for some $v \in \text{pos}(\xi)$ and $i \in \text{maxrk}(\Sigma)$. By I.H., there exists $n \in \mathbb{N}$ such that the state $\rho(v) \in g^n(\emptyset)$. Let $\sigma = \xi(v)$ and $k = \text{rk}(\sigma)$. Since ρ is local-successful, we have $\delta_k(\rho(v1) \cdots \rho(vk), \sigma, \rho(v)) \neq \emptyset$. Then $\rho(v1), \dots, \rho(vk) \in g^{n+1}(\emptyset)$ and thus, in particular, $\rho(w) \in g^{n+1}(\emptyset)$.

With this we proved that (7.2) holds. By our assumption on \mathcal{A} , the set Q' is not empty.

Now we construct the (Σ, \mathbf{B}) -wta $\mathcal{A}' = (Q', \delta', F')$ such that, for each $k \in \mathbb{N}$, $\delta'_k = \delta_k|_{(Q')^k \times \Sigma^{(k)} \times Q'}$, and $F' = F|_{Q'}$. Then \mathcal{A}' is local-trim. If \mathcal{A} is bu-deterministic, then so is \mathcal{A}' because $Q' \subseteq Q$ and each transition mapping δ'_k is a restriction of δ_k .

Finally, we prove that $\llbracket \mathcal{A} \rrbracket^{\text{run}} = \llbracket \mathcal{A}' \rrbracket^{\text{run}}$. Let $\xi \in \mathsf{T}_\Sigma$. Obviously, $\mathsf{R}_{\mathcal{A}'}(\xi) \subseteq \mathsf{R}_{\mathcal{A}}(\xi)$ and for each $\rho \in \mathsf{R}_{\mathcal{A}'}(\xi)$ we have $\text{wt}_{\mathcal{A}'}(\xi, \rho) = \text{wt}_{\mathcal{A}}(\xi, \rho)$. If $\rho \in \mathsf{R}_{\mathcal{A}}(\xi) \setminus \mathsf{R}_{\mathcal{A}'}(\xi)$, then there exists $p \in \text{im}(\rho)$ such that p is not local-useful. Then $\text{wt}_{\mathcal{A}}(\xi, \rho) = 0$ or $F_{\rho(\varepsilon)} = 0$ and hence $\text{wt}_{\mathcal{A}}(\xi, \rho) \otimes F_{\rho(\varepsilon)} = 0$. Thus we can compute

$$\llbracket \mathcal{A} \rrbracket^{\text{run}}(\xi) = \bigoplus_{\rho \in \mathsf{R}_{\mathcal{A}}(\xi)} \text{wt}_{\mathcal{A}}(\xi, \rho) \otimes F_{\rho(\varepsilon)} = \bigoplus_{\rho \in \mathsf{R}_{\mathcal{A}'}(\xi)} \text{wt}_{\mathcal{A}'}(\xi, \rho) \otimes F'_{\rho(\varepsilon)} = \llbracket \mathcal{A}' \rrbracket^{\text{run}}(\xi). \quad \square$$

7.2 Transforming wta into total wta

We recall that a (Σ, \mathbf{B}) -wta $\mathcal{A} = (Q, \delta, F)$ is total if for every $k \in \mathbb{N}$, $\sigma \in \Sigma^{(k)}$, and $w \in Q^k$ there exists at least one state q such that $\delta_k(w, \sigma, q) \neq 0$.

Theorem 7.2.1. *Let Σ be a ranked alphabet. Moreover, let $\mathbf{B} = (B, \oplus, \otimes, 0, \mathbb{1})$ be a strong bimonoid and \mathcal{A} a (Σ, \mathbf{B}) -wta. We can construct a (Σ, \mathbf{B}) -wta \mathcal{A}' such that \mathcal{A}' is total, $\llbracket \mathcal{A} \rrbracket^{\text{init}} = \llbracket \mathcal{A}' \rrbracket^{\text{init}}$, and $\llbracket \mathcal{A} \rrbracket^{\text{run}} = \llbracket \mathcal{A}' \rrbracket^{\text{run}}$. Moreover, if \mathcal{A} is bu-deterministic, then so is \mathcal{A}' .*

Proof. Let $\mathcal{A} = (Q, \delta, F)$. We construct the (Σ, \mathbf{B}) -wta $\mathcal{A}' = (Q', \delta', F')$ as follows.

- $Q' = Q \cup \{q_\perp\}$ where $q_\perp \notin Q$,
- $\delta' = (\delta'_k \mid k \in \mathbb{N})$ such that for every $k \in \mathbb{N}$, $\sigma \in \Sigma^{(k)}$, and $q \in Q'$, and $q_1 \cdots q_k \in (Q')^k$:

$$(\delta')_k(q_1 \cdots q_k, \sigma, q) = \begin{cases} \delta_k(q_1 \cdots q_k, \sigma, q) & \text{if } q_1 \cdots q_k \in Q^k, q \in Q \\ \mathbb{1} & \text{if } q_1 \cdots q_k \in Q^k, q = q_\perp, \text{ and} \\ & (\forall q' \in Q) : \delta_k(q_1 \cdots q_k, \sigma, q') = 0 \\ \mathbb{1} & \text{if } q_\perp \in \{q_1, \dots, q_k\} \text{ and } q = q_\perp \\ 0 & \text{otherwise} \end{cases}$$

- $F'_q = F_q$ for each $q \in Q$ and $F'_{q_\perp} = 0$.

Obviously, if \mathcal{A} is bu-deterministic, then so is \mathcal{A}' . The construction also preserves crisp-determinism.

First we prove that $\llbracket \mathcal{A} \rrbracket^{\text{init}} = \llbracket \mathcal{A}' \rrbracket^{\text{init}}$. By induction on T_Σ , we prove that the following statement holds:

$$\text{For every } \xi \in \mathsf{T}_\Sigma \text{ and } q \in Q: h_{\mathcal{A}}(\xi)_q = h_{\mathcal{A}'}(\xi)_q. \quad (7.6)$$

Let $\xi = \sigma(\xi_1, \dots, \xi_k)$ and assume that (7.6) holds for ξ_1, \dots, ξ_k . Let $q \in Q$. Then we can calculate:

$$\begin{aligned} h_{\mathcal{A}'}(\sigma(\xi_1, \dots, \xi_k))_q &= \bigoplus_{q_1 \cdots q_k \in (Q \cup \{q_\perp\})^k} \left(\bigotimes_{i \in [k]} h_{\mathcal{A}'}(\xi_i)_{q_i} \right) \otimes \delta'_k(q_1 \cdots q_k, \sigma, q) \\ &= \bigoplus_{q_1 \cdots q_k \in Q^k} \left(\bigotimes_{i \in [k]} h_{\mathcal{A}'}(\xi_i)_{q_i} \right) \otimes \delta_k(q_1 \cdots q_k, \sigma, q) \\ &\quad \text{(note that } \delta'_k(q_1 \cdots q_k, \sigma, q) = 0 \text{ if one of the } q_i \text{ is } q_\perp) \\ &= \bigoplus_{q_1 \cdots q_k \in Q^k} \left(\bigotimes_{i \in [k]} h_{\mathcal{A}}(\xi_i)_{q_i} \right) \otimes \delta_k(q_1 \cdots q_k, \sigma, q) \quad \text{(by I.H.)} \\ &= h_{\mathcal{A}}(\sigma(\xi_1, \dots, \xi_k))_q. \end{aligned}$$

Then for each $\xi \in T_\Sigma$.

$$[[\mathcal{A}']]^{\text{init}}(\xi) = \bigoplus_{q \in Q \cup \{q_\perp\}} h_{\mathcal{A}'}(\xi)_q \otimes F'_q = \bigoplus_{q \in Q} h_{\mathcal{A}'}(\xi)_q \otimes F_q = \bigoplus_{q \in Q} h_{\mathcal{A}}(\xi)_q \otimes F_q = [[\mathcal{A}]]^{\text{init}}(\xi) ,$$

where the second equality holds because $F'_{q_\perp} = 0$ and $F'|_Q = F$.

Next we prove that $[[\mathcal{A}]]^{\text{run}} = [[\mathcal{A}']]^{\text{run}}$. First, it is easy to see that

$$\begin{aligned} & \text{for every } \xi \in T_\Sigma \text{ and } q \in Q: R_{\mathcal{A}}(q, \xi) \subseteq R_{\mathcal{A}'}(q, \xi), \text{ and} \\ & \text{for each } \rho \in R_{\mathcal{A}'}(q, \xi) \setminus R_{\mathcal{A}}(q, \xi): \text{wt}_{\mathcal{A}'}(\xi, \rho) = 0. \end{aligned} \quad (7.7)$$

Also it is easy to see that

$$\text{for each } \xi \in T_\Sigma, q \in Q, \text{ and } \rho \in R_{\mathcal{A}}(q, \xi): \text{wt}_{\mathcal{A}'}(\xi, \rho) = \text{wt}_{\mathcal{A}}(\xi, \rho), \quad (7.8)$$

where $\text{wt}_{\mathcal{A}'}$ and $\text{wt}_{\mathcal{A}}$ use δ' and δ , respectively. Now let $\xi \in T_\Sigma$. Then we can calculate as follows.

$$\begin{aligned} [[\mathcal{A}']]^{\text{run}}(\xi) &= \bigoplus_{q \in Q'} \bigoplus_{\rho \in R_{\mathcal{A}'}(q, \xi)} \text{wt}_{\mathcal{A}'}(\xi, \rho) \otimes F'_q \\ &= \bigoplus_{q \in Q} \bigoplus_{\rho \in R_{\mathcal{A}'}(q, \xi)} \text{wt}_{\mathcal{A}'}(\xi, \rho) \otimes F_q && \text{(because } F'_{q_\perp} = 0 \text{ and } F'|_Q = F) \\ &= \bigoplus_{q \in Q} \bigoplus_{\rho \in R_{\mathcal{A}}(q, \xi)} \text{wt}_{\mathcal{A}'}(\xi, \rho) \otimes F_q && \text{(by (7.7))} \\ &= \bigoplus_{q \in Q} \bigoplus_{\rho \in R_{\mathcal{A}}(q, \xi)} \text{wt}_{\mathcal{A}}(\xi, \rho) \otimes F_q && \text{(by (7.8))} \\ &= [[\mathcal{A}]]^{\text{run}}(\xi) . \quad \square \end{aligned}$$

7.3 Normalizing root weights of wta

Next we want to show that each wta can be transformed into a run equivalent root weight normalized wta. In [Bor05, Lm. 6.1.1] the same statement is proved if \mathbf{B} is a semiring. (We also refer to [Boz99, Lm. 22] and [DPV05, Lm. 4.8] for weaker statements.) Here we present a slightly more complicated construction which allows to prove the statement for an arbitrary strong bimonoid.

Theorem 7.3.1. *Let Σ be a ranked alphabet. Moreover, let \mathbf{B} be a strong bimonoid and let \mathcal{A} be a (Σ, \mathbf{B}) -wta. We can construct a (Σ, \mathbf{B}) -wta \mathcal{A}' such that \mathcal{A}' is root weight normalized and $[[\mathcal{A}]]^{\text{run}} = [[\mathcal{A}']]^{\text{run}}$.*

Proof. Let $\mathcal{A} = (Q, \delta, F)$. The idea for the construction of \mathcal{A}' is the following. The wta \mathcal{A}' simulates \mathcal{A} . Additionally, at each leaf of the given input tree ξ , the wta \mathcal{A}' guesses a state p of \mathcal{A} and stores it in its states; at each non-nullary symbol of Σ , the wta \mathcal{A}' checks whether the guesses in the subtrees are consistent and propagates the guessed state; and at the root, the wta \mathcal{A}' multiplies the last transition weight with F_p (if p is the state guessed at each leaf) and moves to the final state q_f . (We note that the idea for maintaining the guessed final states was used in [HVD19, Lm. 9] where initial- and final-state normalization was proved for weighted string automata with storage over unital valuation monoids.)

We construct the (Σ, \mathbf{B}) -wta $\mathcal{A}' = (Q', \delta', F')$ as follows:

- $Q' = (Q \times Q) \cup \{q_f\}$ where $q_f \notin Q$; for each $q' \in Q \times Q$ we let $(q')_i$ denote the i -th component of q' for $i \in \{1, 2\}$;

- $\delta' = (\delta'_k \mid k \in \mathbb{N})$ where for each $k \in \mathbb{N}$, $\sigma \in \Sigma^{(k)}$, $q'_0 \in Q'$ and $q'_1 \cdots q'_k \in (Q')^k$ we define $\delta'_k(q'_1 \cdots q'_k, \sigma, q'_0)$ by case analysis as follows.
Case (a): Let $k = 0$. Then

$$\delta'_0(\varepsilon, \sigma, q'_0) = \begin{cases} \delta_0(\varepsilon, \sigma, (q'_0)_1) & \text{if } q'_0 \in Q \times Q \\ \bigoplus_{p \in Q} \delta_0(\varepsilon, \sigma, p) \otimes F_p & \text{if } q'_0 = q_f . \end{cases}$$

Case (b): Let $k \geq 1$. Then

$$\begin{aligned} & \delta'_k(q'_1 \cdots q'_k, \sigma, q'_0) \\ = & \begin{cases} \delta_k((q'_1)_1 \cdots (q'_k)_1, \sigma, (q'_0)_1) & \text{if } (\exists p \in Q) (\forall i \in [0, k]) (\exists q_i \in Q) : q'_i = (q_i, p) \\ \delta_k((q'_1)_1 \cdots (q'_k)_1, \sigma, (q'_1)_2) \otimes F_{(q'_1)_2} & \text{if } (\exists p \in Q) (\forall i \in [k]) (\exists q_i \in Q) : q'_i = (q_i, p) \text{ and } q'_0 = q_f \\ \mathbb{0} & \text{otherwise,} \end{cases} \end{aligned}$$

where in the second case we have used the assumption that $k \geq 1$,

- $F'_{q_f} = \mathbb{1}$ and $F'_{q'} = \mathbb{0}$ for each $q' \in Q' \setminus \{q_f\}$.

It is clear that, for each position of $\xi \in T_\Sigma$ except at its root, \mathcal{A}' behaves exactly as \mathcal{A} . To make this precise, for each $p \in Q$, we define the family $(\psi_{p,\xi} \mid \xi \in T_\Sigma)$ of mappings

$$\psi_{p,\xi} : R_{\mathcal{A}}(\xi) \rightarrow R_{\mathcal{A}'}(\xi)$$

such that, for every $\rho \in R_{\mathcal{A}}(\xi)$ and $w \in \text{pos}(\xi)$, we let $\psi_{p,\xi}(\rho)(w) = (\rho(w), p)$. Obviously, $\psi_{p,\xi}$ is injective. Also it is obvious that, for every $\xi = \sigma(\xi_1, \dots, \xi_k)$, $i \in [k]$, and $\rho \in R_{\mathcal{A}}(\xi)$, the following holds:

$$\psi_{p,\xi}(\rho)|_i = \psi_{p,\xi_i}(\rho|_i) . \quad (7.9)$$

By induction on T_Σ , we prove that the following statement holds:

$$\text{For every } \xi \in T_\Sigma, \rho \in R_{\mathcal{A}}(\xi), \text{ and } p \in Q, \text{ we have } \text{wt}_{\mathcal{A}}(\xi, \rho) = \text{wt}_{\mathcal{A}'}(\xi, \psi_{p,\xi}(\rho)) . \quad (7.10)$$

Let $\xi = \sigma(\xi_1, \dots, \xi_k)$. Then we can calculate as follows:

$$\begin{aligned} \text{wt}_{\mathcal{A}}(\xi, \rho) &= \left(\bigotimes_{i \in [k]} \text{wt}_{\mathcal{A}}(\xi_i, \rho|_i) \right) \otimes \delta_k(\rho(1) \cdots \rho(k), \sigma, \rho(\varepsilon)) \\ &= \left(\bigotimes_{i \in [k]} \text{wt}_{\mathcal{A}'}(\xi_i, \psi_{p,\xi_i}(\rho|_i)) \right) \otimes \delta'_k((\rho(1), p) \cdots (\rho(k), p), \sigma, (\rho(\varepsilon), p)) \text{ (by I.H. and construction)} \\ &= \left(\bigotimes_{i \in [k]} \text{wt}_{\mathcal{A}'}(\xi_i, \psi_{p,\xi}(\rho)|_i) \right) \otimes \delta'_k((\rho(1), p) \cdots (\rho(k), p), \sigma, (\rho(\varepsilon), p)) \text{ (by (7.9))} \\ &= \text{wt}_{\mathcal{A}'}(\xi, \psi_{p,\xi}(\rho)) . \end{aligned}$$

Next we prove that $\llbracket \mathcal{A} \rrbracket^{\text{run}}(\xi) = \llbracket \mathcal{A}' \rrbracket^{\text{run}}(\xi)$ for each $\xi \in T_\Sigma$ by case analysis.

Case (a): Let $\xi = \alpha$ for some $\alpha \in \Sigma^{(0)}$. Since, for each $p \in Q$, we have $R_{\mathcal{A}}(p, \alpha) = \{\rho\}$ with $\rho(\varepsilon) = p$ and $\text{wt}_{\mathcal{A}}(\alpha, \rho) = \delta_0(\varepsilon, \alpha, p)$, and similarly, $R_{\mathcal{A}'}(q_f, \alpha) = \{\rho'\}$ with $\rho'(\varepsilon) = q_f$ and $\text{wt}_{\mathcal{A}'}(\alpha, \rho') = \delta'_0(\varepsilon, \alpha, q_f)$, we obtain

$$\begin{aligned} \llbracket \mathcal{A} \rrbracket^{\text{run}}(\alpha) &= \bigoplus_{p \in Q} \bigoplus_{\rho \in R_{\mathcal{A}}(p, \alpha)} \text{wt}_{\mathcal{A}}(\alpha, \rho) \otimes F_p = \bigoplus_{p \in Q} \delta_0(\varepsilon, \alpha, p) \otimes F_p = \delta'_0(\varepsilon, \alpha, q_f) \\ &= \delta'_0(\varepsilon, \alpha, q_f) \otimes F'_{q_f} = \bigoplus_{q' \in Q'} \bigoplus_{\rho' \in R_{\mathcal{A}'}(q', \alpha)} \text{wt}_{\mathcal{A}'}(\alpha, \rho') \otimes F'_{q'} = \llbracket \mathcal{A}' \rrbracket^{\text{run}}(\alpha) . \end{aligned}$$

Case (b): Let $\xi \in T_\Sigma \setminus \Sigma^{(0)}$. Let $p \in Q$. First we relate p -runs of \mathcal{A} on ξ with q_f -runs of \mathcal{A}' on ξ which assign states of the form (q, p) to inner nodes of ξ for some $q \in Q$. Formally, we define the mapping

$$\varphi_p : R_{\mathcal{A}}(p, \xi) \rightarrow R_{\mathcal{A}'}^p(q_f, \xi)$$

where $R_{\mathcal{A}'}^p(q_f, \xi) = \{\rho' \in R_{\mathcal{A}'}(q_f, \xi) \mid (\forall w \in \text{pos}(\xi) \setminus \{\varepsilon\}) : \rho'(w) \in Q \times \{p\}\}$, and for every $\rho \in R_{\mathcal{A}}(p, \xi)$ and $w \in \text{pos}(\xi)$ we let $(\varphi_p(\rho))(w) = q_f$ if $w = \varepsilon$, and $(\rho(w), p)$ otherwise. It is obvious that, for every $p \in Q$, the mapping φ_p is bijective (note that $\xi \notin \Sigma^{(0)}$) and

$$\text{for every } \rho' \in R_{\mathcal{A}'}(q_f, \xi) \setminus \bigcup_{p \in Q} R_{\mathcal{A}'}^p(q_f, \xi) \text{ we have } \text{wt}_{\mathcal{A}'}(\xi, \rho') = 0 . \quad (7.11)$$

Moreover, the family $(R_{\mathcal{A}'}^p(q_f, \xi) \mid p \in Q)$ partitions $\bigcup_{p \in Q} R_{\mathcal{A}'}^p(q_f, \xi)$, i.e.,

$$R_{\mathcal{A}'}^p(q_f, \xi) \cap R_{\mathcal{A}'}^{p'}(q_f, \xi) = \emptyset \text{ for every } p, p' \in Q \text{ with } p \neq p' . \quad (7.12)$$

Next we prove a correspondence between the weights of runs of \mathcal{A} and \mathcal{A}' on ξ . We claim:

$$\text{for every } p \in Q, \text{ and } \rho \in R_{\mathcal{A}}(p, \xi), \text{ we have } \text{wt}_{\mathcal{A}}(\xi, \rho) \otimes F_p = \text{wt}_{\mathcal{A}'}(\xi, \varphi_p(\rho)) . \quad (7.13)$$

For the proof let $\xi = \sigma(\xi_1, \dots, \xi_k)$ (note that $k \geq 1$). Let $p \in Q$, and $\rho \in R_{\mathcal{A}}(p, \xi)$ (hence $\rho(\varepsilon) = p$). Then we can calculate as follows:

$$\begin{aligned} \text{wt}_{\mathcal{A}}(\xi, \rho) \otimes F_p &= \left(\left(\bigotimes_{i \in [k]} \text{wt}_{\mathcal{A}}(\xi_i, \rho|_i) \right) \otimes \delta_k(\rho(1) \cdots \rho(k), \sigma, p) \right) \otimes F_p \\ &= \left(\bigotimes_{i \in [k]} \text{wt}_{\mathcal{A}}(\xi_i, \rho|_i) \right) \otimes \left(\delta_k(\rho(1) \cdots \rho(k), \sigma, p) \otimes F_p \right) \\ &= \left(\bigotimes_{i \in [k]} \text{wt}_{\mathcal{A}'}(\xi_i, \psi_{p, \xi_i}(\rho|_i)) \right) \otimes \left(\delta_k(\rho(1) \cdots \rho(k), \sigma, p) \otimes F_p \right) && \text{(by (7.10))} \\ &= \left(\bigotimes_{i \in [k]} \text{wt}_{\mathcal{A}'}(\xi_i, \psi_{p, \xi_i}(\rho|_i)) \right) \otimes \delta'_k((\rho(1), p) \cdots (\rho(k), p), \sigma, q_f) && \text{(by construction)} \\ &= \left(\bigotimes_{i \in [k]} \text{wt}_{\mathcal{A}'}(\xi_i, \varphi_p(\rho)|_i) \right) \otimes \delta'_k(\varphi_p(\rho)(1) \cdots \varphi_p(\rho)(k), \sigma, \varphi_p(\rho)(\varepsilon)) \\ &\quad \text{(because } \psi_{p, \xi_i}(\rho|_i) = \varphi_p(\rho)|_i \text{ for each } i \in [k] \text{ and } \varphi_p(\rho)(\varepsilon) = q_f) \\ &= \text{wt}_{\mathcal{A}'}(\xi, \varphi_p(\rho)) . \end{aligned}$$

Finally, we can prove that $\llbracket \mathcal{A} \rrbracket^{\text{run}}(\xi) = \llbracket \mathcal{A}' \rrbracket^{\text{run}}(\xi)$.

$$\begin{aligned} \llbracket \mathcal{A}' \rrbracket^{\text{run}}(\xi) &= \bigoplus_{q' \in Q'} \bigoplus_{\rho' \in R_{\mathcal{A}'}(q', \xi)} \text{wt}_{\mathcal{A}'}(\xi, \rho') \otimes F'_{q'} \\ &= \bigoplus_{\rho' \in R_{\mathcal{A}'}(q_f, \xi)} \text{wt}_{\mathcal{A}'}(\xi, \rho') && \text{(because } F'_{q_f} = \mathbb{1} \text{ and } F'_{q'} = 0 \text{ for each } q' \in Q' \setminus \{q_f\}) \\ &= \bigoplus_{\rho' \in \bigcup_{p \in Q} R_{\mathcal{A}'}^p(q_f, \xi)} \text{wt}_{\mathcal{A}'}(\xi, \rho') && \text{(by (7.11))} \\ &= \bigoplus_{p \in Q} \bigoplus_{\rho' \in R_{\mathcal{A}'}^p(q_f, \xi)} \text{wt}_{\mathcal{A}'}(\xi, \rho') && \text{(by (7.12))} \\ &= \bigoplus_{p \in Q} \bigoplus_{\rho \in R_{\mathcal{A}}(p, \xi)} \text{wt}_{\mathcal{A}'}(\xi, \varphi_p(\rho)) && \text{(because } \varphi_p \text{ is a bijection)} \\ &= \bigoplus_{p \in Q} \bigoplus_{\rho \in R_{\mathcal{A}}(p, \xi)} \text{wt}_{\mathcal{A}}(\xi, \rho) \otimes F_p && \text{(by (7.13))} \\ &= \llbracket \mathcal{A} \rrbracket^{\text{run}}(\xi) . \quad \square \end{aligned}$$

An analysis of the construction in the proof of Theorem 7.3.1 shows that it does not preserve bu-determinism. If we restrict the set of weight algebras to the set of commutative semifields, then we can transform each wta into an equivalent one with identity root weights and this transformation preserves bu-determinism. The transformation uses the technique of weight pushing [HMQ18, Def. 4.1] (also cf. [Moh97, p. 296] for the case that \mathbf{B} is the tropical semiring on the set of non-negative real numbers), which is of interest of its own.

Formally, let $\mathcal{A} = (Q, \delta, F)$ be a (Σ, \mathbf{B}) -wta over some commutative semifield \mathbf{B} . Moreover, let $\lambda : Q \rightarrow \mathbf{B} \setminus \{0\}$ be a mapping such that $\lambda(q) = F_q$ for each $q \in \text{supp}(F)$. We define the wta $\text{push}_\lambda(\mathcal{A})$ to be the (Σ, \mathbf{B}) -wta (Q, δ', F') as follows. For every $k \in \mathbb{N}$, $\sigma \in \Sigma^{(k)}$, $q \in Q$, and $q_1 \cdots q_k \in Q$:

$$\delta'_k(q_1 \cdots q_k, \sigma, q) = \left(\bigotimes_{i \in [k]} \lambda(q_i)^{-1} \right) \otimes \delta_k(q_1 \cdots q_k, \sigma, q) \otimes \lambda(q)$$

and for each $q \in Q$

$$F'_q = \begin{cases} \mathbb{1} & \text{if } q \in \text{supp}(F) \\ 0 & \text{otherwise} \end{cases} .$$

Lemma 7.3.2. (cf. [HMQ18, Prop. 4.2]) Let \mathcal{A} and λ be defined as above. Then $\llbracket \mathcal{A} \rrbracket = \llbracket \text{push}_\lambda(\mathcal{A}) \rrbracket$.

Proof. We abbreviate $\text{push}_\lambda(\mathcal{A})$ by \mathcal{A}' . By induction on T_Σ , we prove that the following statement holds:

$$\text{For every } \xi \in \mathsf{T}_\Sigma \text{ and } q \in Q, \text{ we have: } h_{\mathcal{A}'}(\xi)_q = \lambda(q) \otimes h_{\mathcal{A}}(\xi)_q . \quad (7.14)$$

Let $\xi = \sigma(\xi_1, \dots, \xi_k)$. Then

$$\begin{aligned} & h_{\mathcal{A}'}(\sigma(\xi_1, \dots, \xi_k))_q \\ &= \bigoplus_{q_1 \cdots q_k \in Q^k} \left(\bigotimes_{i \in [k]} h_{\mathcal{A}'}(\xi_i)_{q_i} \right) \otimes \delta'_k(q_1 \cdots q_k, \sigma, q) \\ &= \bigoplus_{q_1 \cdots q_k \in Q^k} \left(\bigotimes_{i \in [k]} \lambda(q_i) \otimes h_{\mathcal{A}}(\xi_i)_{q_i} \right) \otimes \left(\left(\bigotimes_{i \in [k]} \lambda(q_i)^{-1} \right) \otimes \delta_k(q_1 \cdots q_k, \sigma, q) \otimes \lambda(q) \right) \\ & \hspace{15em} \text{(by I.H. and construction of } \text{push}_\lambda(\mathcal{A}) \text{)} \\ &= \lambda(q) \otimes \bigoplus_{q_1 \cdots q_k \in Q^k} \left(\bigotimes_{i \in [k]} h_{\mathcal{A}}(\xi_i)_{q_i} \right) \otimes \delta_k(q_1 \cdots q_k, \sigma, q) \\ & \hspace{10em} \text{(by commutativity and associativity of } \otimes \text{ and by distributivity)} \\ &= \lambda(q) \otimes h_{\mathcal{A}}(\sigma(\xi_1, \dots, \xi_k))_q . \end{aligned}$$

Then, for each $\xi \in \mathsf{T}_\Sigma$, we have

$$\begin{aligned} & \llbracket \text{push}_\lambda(\mathcal{A}) \rrbracket(\xi) \\ &= \bigoplus_{q \in Q} h_{\mathcal{A}'}(\xi)_q \otimes F'_q = \bigoplus_{q \in Q} h_{\mathcal{A}}(\xi)_q \otimes \lambda(q) \otimes F'_q \quad \text{(by (7.14) and commutativity of } \otimes \text{)} \\ &= \bigoplus_{q \in \text{supp}(F)} h_{\mathcal{A}}(\xi)_q \otimes \lambda(q) \quad \text{(by the definition of } F' \text{)} \\ &= \bigoplus_{q \in \text{supp}(F)} h_{\mathcal{A}}(\xi)_q \otimes F_q \quad \text{(by the definition of } \lambda \text{)} \\ &= \llbracket \mathcal{A} \rrbracket(\xi) . \quad \square \end{aligned}$$

Theorem 7.3.3. *Let Σ be a ranked alphabet. Moreover, let $\mathbf{B} = (B, \oplus, \otimes, 0, \mathbb{1})$ be a commutative semifield and let \mathcal{A} be a (Σ, \mathbf{B}) -wta. We can construct a (Σ, \mathbf{B}) -wta \mathcal{A}' such that \mathcal{A}' has identity root weights and $\llbracket \mathcal{A} \rrbracket = \llbracket \mathcal{A}' \rrbracket$. If \mathcal{A} is bu-deterministic, then so is \mathcal{A}' . Also, if \mathcal{A} is trim, then so is \mathcal{A}' .*

Proof. Let $\mathcal{A} = (Q, \delta, F)$ and let $\lambda : Q \rightarrow B \setminus \{0\}$ be any mapping such that $\lambda(q) = F_q$ for each $q \in \text{supp}(F)$. We note that $\text{push}_\lambda(\mathcal{A})$ has identity root weights. By Lemma 7.3.2 we have $[\mathcal{A}] = [\text{push}_\lambda(\mathcal{A})]$, and hence we can choose $\mathcal{A}' = \text{push}_\lambda(\mathcal{A})$.

Let $\text{push}_\lambda(\mathcal{A}) = (Q, \delta', F')$. Then, for every $k \in \mathbb{N}$, $\sigma \in \Sigma^{(k)}$, $q \in Q$, and $q_1 \cdots q_k \in Q^k$, we have $\delta'_k(q_1 \cdots q_k, \sigma, q) \neq 0$ iff $\delta_k(q_1 \cdots q_k, \sigma, q) \neq 0$; and also $F'_q \neq 0$ iff $F_q \neq 0$ for each $q \in Q$. Thus, if \mathcal{A} is bu-deterministic, then so is $\text{push}_\lambda(\mathcal{A})$. Moreover, if \mathcal{A} is trim, then so is $\text{push}_\lambda(\mathcal{A})$. \square

7.4 Normalizing transition weights of wta

Finally, we want to show that each (Σ, B) -wta \mathcal{A} can be transformed into a run equivalent crisp (Σ, B) -wta provided that the set

$$H(\mathcal{A}) = \{\text{wt}(\xi, \rho) \mid \xi \in T_\Sigma, \rho \in R_{\mathcal{A}}(\xi)\} \quad (7.15)$$

is finite. Due to this requirement on \mathcal{A} , we can code the weights of runs into the states. First we show constructivity of $H(\mathcal{A})$ if this set is finite.

Lemma 7.4.1. [DFKV22, Lm. 6.5] Let $\mathcal{A} = (Q, \delta, F)$ be a (Σ, B) -wta. If $H(\mathcal{A})$ is finite, then we can construct the set $H(\mathcal{A})$.

Proof. Let $H(\mathcal{A})$ be finite. For every $n \in \mathbb{N}$ and $q \in Q$ let

$$H_{n,q} = \{\text{wt}(\xi, \rho) \mid \xi \in T_\Sigma, \text{height}(\xi) \leq n, \rho \in R_{\mathcal{A}}(q, \xi)\} .$$

Clearly, we have $H_{0,q} \subseteq H_{1,q} \subseteq \dots \subseteq H(\mathcal{A})$ for each $q \in Q$. We claim that

$$\text{for each } n \in \mathbb{N}, \text{ if for each } q \in Q: H_{n,q} = H_{n+1,q}, \text{ then for each } q \in Q: H_{n+1,q} = H_{n+2,q}. \quad (7.16)$$

To show this, let $n \in \mathbb{N}$, $q \in Q$, and $b \in H_{n+2,q}$. There exist $\xi \in T_\Sigma$ and $\rho \in R_{\mathcal{A}}(q, \xi)$ such that $\text{height}(\xi) \leq n+2$ and $\text{wt}(\xi, \rho) = b$. We may assume that $\text{height}(\xi) = n+2$. Hence $\xi = \sigma(\xi_1, \dots, \xi_k)$ such that $\text{height}(\xi_i) \leq n+1$ for each $i \in [k]$. Clearly, for each $i \in [k]$, we have $\text{wt}(\xi_i, \rho|_i) \in H_{n+1, \rho(i)}$, so by our assumption there exist $\zeta_i \in T_\Sigma$ with $\text{height}(\zeta_i) \leq n$ and run $\theta_i \in R_{\mathcal{A}}(\rho(i), \zeta_i)$ such that $\text{wt}(\xi_i, \rho|_i) = \text{wt}(\zeta_i, \theta_i)$.

Now let $\zeta = \sigma(\zeta_1, \dots, \zeta_k)$. Obviously, $\text{height}(\zeta) \leq n+1$. Moreover, let $\theta \in R_{\mathcal{A}}(q, \zeta)$ such that $\theta|_i = \theta_i$ for each $i \in [k]$. Clearly, $\text{wt}(\zeta, \theta) \in H_{n+1,q}$, and we calculate

$$\begin{aligned} \text{wt}(\zeta, \theta) &= \left(\bigotimes_{i \in [k]} \text{wt}(\zeta_i, \theta|_i) \right) \otimes \delta_k(\theta(1) \cdots \theta(i), \sigma, q) \\ &= \left(\bigotimes_{i \in [k]} \text{wt}(\xi_i, \rho|_i) \right) \otimes \delta_k(\rho(1) \cdots \rho(i), \sigma, q) = \text{wt}(\xi, \rho) = b . \end{aligned}$$

This shows that $b \in H_{n+1,q}$, proving (7.16).

We recall that $H_{0,q} \subseteq H_{1,q} \subseteq \dots \subseteq H(\mathcal{A})$ for each $q \in Q$. Obviously, we can construct $H_{n,q}$ for every $n \in \mathbb{N}$ and $q \in Q$.

Then, since $H(\mathcal{A})$ is finite, by constructing $H_{0,q}$ for each $q \in Q$, $H_{1,q}$ for each $q \in Q$, and so on, we can find the least number $n_m \in \mathbb{N}$ such that $H_{n_m,q} = H_{n_m+1,q}$ for each $q \in Q$ and thus by (7.16) we have $H_{n_m,q} = H_{j,q}$ for every $q \in Q$ and $j \in \mathbb{N}$ with $j \geq n_m$.

We show that $H(\mathcal{A}) = \bigcup_{q \in Q} H_{n_m,q}$. For this, let $b \in H(\mathcal{A})$, i.e., $b = \text{wt}(\xi, \rho)$ for some $\xi \in T_\Sigma$ with $\text{height}(\xi) = j$, $q \in Q$ and $\rho \in R_{\mathcal{A}}(q, \xi)$. Then $b \in H_{j,q} = H_{n_m,q}$. The other inclusion is obvious. Since we can construct the set $\bigcup_{q \in Q} H_{n_m,q}$, the set $H(\mathcal{A})$ can be constructed. \square

Now we can prove the following normal form theorem.

Theorem 7.4.2. *Let Σ be a ranked alphabet. Moreover, let \mathbf{B} be a strong bimonoid and let \mathcal{A} be a (Σ, \mathbf{B}) -wta \mathcal{A} such that $\mathsf{H}(\mathcal{A})$ is finite. Then we can construct a crisp (Σ, \mathbf{B}) -wta \mathcal{B} such that $\llbracket \mathcal{B} \rrbracket^{\text{run}} = \llbracket \mathcal{A} \rrbracket^{\text{run}}$.*

Proof. Let $\mathbf{B} = (B, \oplus, \otimes, 0, \mathbb{1})$ and $\mathcal{A} = (Q, \delta, F)$. Since $\mathsf{H}(\mathcal{A})$ is finite, by Lemma 7.4.1, we can construct $\mathsf{H}(\mathcal{A})$.

Now we construct the (Σ, \mathbf{B}) -wta $\mathcal{B} = (Q', \delta', F')$ as follows.

- $Q' = Q \times \mathsf{H}(\mathcal{A})$,
- for each $(q, b) \in Q'$, we let $(F')_{(q,b)} = b \otimes F_q$, and
- for every $k \in \mathbb{N}$, $\sigma \in \Sigma^{(k)}$, and $(q_1, b_1), \dots, (q_k, b_k), (q, b) \in Q'$ we define

$$(\delta')_k((q_1, b_1) \cdots (q_k, b_k), \sigma, (q, b)) = \begin{cases} \mathbb{1} & \text{if } b = \left(\bigotimes_{i \in [k]} b_i \right) \otimes \delta_k(q_1 \cdots q_k, \sigma, q) \\ 0 & \text{otherwise .} \end{cases}$$

Obviously, \mathcal{B} is crisp.

As preparation for the proof of $\llbracket \mathcal{A} \rrbracket^{\text{run}} = \llbracket \mathcal{B} \rrbracket^{\text{run}}$, we define a bijection between the set of runs of \mathcal{A} on an input tree and the set of runs of \mathcal{B} on that tree. Indeed, it is easy to see that for every $q \in Q$, $\xi \in \mathsf{T}_\Sigma$, and $b \in \mathsf{H}(\mathcal{A})$, the mapping

$$\varphi : \{\rho \in \mathsf{R}_{\mathcal{A}}(q, \xi) \mid \text{wt}_{\mathcal{A}}(\xi, \rho) = b\} \rightarrow \{\rho' \in \mathsf{R}_{\mathcal{B}}((q, b), \xi) \mid \text{wt}_{\mathcal{B}}(\xi, \rho') = \mathbb{1}\}$$

defined, for each $w \in \text{pos}(\xi)$, by $\varphi(\rho)(w) = (\rho(w), \text{wt}_{\mathcal{A}}(\xi|_w, \rho|_w))$ is a bijection.

Then we can calculate as follows.

$$\begin{aligned} \llbracket \mathcal{A} \rrbracket^{\text{run}}(\xi) &= \bigoplus_{q \in Q} \bigoplus_{\rho \in \mathsf{R}_{\mathcal{A}}(q, \xi)} \text{wt}_{\mathcal{A}}(\xi, \rho) \otimes F_q \\ &= \bigoplus_{q \in Q} \bigoplus_{b \in \mathsf{H}(\mathcal{A})} \bigoplus_{\substack{\rho \in \mathsf{R}_{\mathcal{A}}(q, \xi): \\ \text{wt}_{\mathcal{A}}(\xi, \rho) = b}} \text{wt}_{\mathcal{A}}(\xi, \rho) \otimes F_q \\ &= \bigoplus_{\substack{(q,b) \in Q' \\ \rho \in \mathsf{R}_{\mathcal{A}}(q, \xi): \\ \text{wt}_{\mathcal{A}}(\xi, \rho) = b}} \bigoplus_{\rho} b \otimes F_q && \text{(by the definition of } Q') \\ &= \bigoplus_{\substack{(q,b) \in Q' \\ \rho' \in \mathsf{R}_{\mathcal{B}}((q,b), \xi): \\ \text{wt}_{\mathcal{B}}(\xi, \rho') = \mathbb{1}}} \bigoplus_{\rho'} b \otimes F_q && \text{(because } \varphi \text{ is a bijection)} \\ &= \bigoplus_{\substack{(q,b) \in Q' \\ \rho' \in \mathsf{R}_{\mathcal{B}}((q,b), \xi): \\ \text{wt}_{\mathcal{B}}(\xi, \rho') = \mathbb{1}}} \bigoplus_{\rho'} \text{wt}_{\mathcal{B}}(\xi, \rho') \otimes b \otimes F_q \\ &= \bigoplus_{(q,b) \in Q'} \bigoplus_{\rho' \in \mathsf{R}_{\mathcal{B}}((q,b), \xi)} \text{wt}_{\mathcal{B}}(\xi, \rho') \otimes b \otimes F_q && \text{(because } \text{wt}_{\mathcal{B}}(\xi, \rho') \in \{0, \mathbb{1}\}) \\ &= \bigoplus_{(q,b) \in Q'} \bigoplus_{\rho' \in \mathsf{R}_{\mathcal{B}}((q,b), \xi)} \text{wt}_{\mathcal{B}}(\xi, \rho') \otimes (F')_{(q,b)} && \text{(by definition of } F') \\ &= \llbracket \mathcal{B} \rrbracket^{\text{run}}(\xi) && \square \end{aligned}$$

Chapter 8

Weighted context-free grammars

In the theory of tree languages it is a fundamental theorem that the yield of a recognizable tree language is a context-free language and, vice versa, each context-free language can be obtained in this way [Tha67] (also cf. [Eng75b, Thm. 3.28] and [GS84, Sect. 3.2]). This fundamental theorem has been generalized to the weighted setting in [ÉK03] for continuous and commutative semirings and in [FG18] for arbitrary semirings. Here we generalize it for arbitrary strong bimonoids.

First, we recall the concept of weighted context-free grammars (cf. Section 8.1) and prove a number of normal form lemmas: nonterminal form, start-separated, local-reduced, chain-free, and ε -free (cf. Section 8.2). Then we prove that a weighted language is context-free if and only if it is the yield of an r -recognizable weighted tree language (cf. Theorem 8.3.1).

We note that in [RT19] weighted context-free grammars over bimonoids were investigated; roughly speaking, a bimonoid is a strong bimonoid in which the addition need not be commutative and the annihilation law ($b \otimes 0 = 0 \otimes b = 0$) need not hold. Moreover, we note that we will use the concept of weighted context-free grammar to define the concept of weighted regular tree grammar (cf. Chapter 9) and the concept of weighted projective bimorphism (cf. Section 10.13).

8.1 The grammar model

Weighted context-free grammars were introduced in [CS63] where the weights reflected the degree of ambiguity (also cf [Sha67]). Similar to such grammars, finite systems of algebraic equations were investigated in [SS78, KS86, ÉK03]. We build our definitions along [DV14a].

A *weighted context-free grammar over Γ and B* (for short: (Γ, B) -wcfg, or: wcfg) is a tuple $\mathcal{G} = (N, S, R, wt)$, where

- (N, S, R) is a Γ -cfg which has a terminal rule¹ and
- $wt : R \rightarrow B$ is the *weight mapping*.

The *cfg underlying \mathcal{G}* , denoted by \mathcal{G}^u , is the Γ -cfg (N, S, R) .

Since each (Γ, B) -wcfg \mathcal{G} is an extension of some Γ -cfg (viz. by some weight mapping wt), the concepts and abbreviations which are defined for context-free grammars (cf. Section 2.14) are also available for weighted-context free grammars. This concerns, in particular,

- the abbreviations $\text{lhs}(r)$ and $\text{rhs}_{N,i}(r)$ for some rule r of \mathcal{G} ,
- the explicit form $A \rightarrow u_0 A_1 u_1 \cdots A_k u_k$ of a rule r of \mathcal{G} ,
- the mapping $\pi_{\mathcal{G}^u} : T_R \rightarrow \Gamma^*$, which we will call *projection of \mathcal{G}* and denote by $\pi_{\mathcal{G}}$,
- the concept of rule tree; we will denote the sets $\text{RT}_{\mathcal{G}^u}(A, u)$, $\text{RT}_{\mathcal{G}^u}(N', L)$, $\text{RT}_{\mathcal{G}^u}(L)$, and $\text{RT}_{\mathcal{G}^u}$ by

¹We need this condition because we wish to define the semantics of a wcfg in terms of rule trees (cf. Section 2.14)

$\text{RT}_{\mathcal{G}}(A, u)$, $\text{RT}_{\mathcal{G}}(N', L)$, $\text{RT}_{\mathcal{G}}(L)$, and $\text{RT}_{\mathcal{G}}$, respectively.

Next we define the weight of rule trees by using the concept of evaluation algebra (cf. Section 2.10). For this we consider the mapping wt as \mathbb{N} -indexed family $(wt_k \mid k \in \mathbb{N})$ of mappings $wt_k : R^{(k)} \rightarrow B$ by defining $wt_k = wt|_{R^{(k)}}$. Then, for each $d \in T_R$, the *weight of d* is the value $h_{M(R, wt)}(d)$ in B , where $M(R, wt)$ is the (R, wt) -evaluation algebra. For convenience, we will abbreviate $h_{M(R, wt)}$ by $\text{wt}_{\mathcal{G}}$. We note that, for each $d = r(d_1, \dots, d_k)$ in T_R , we have

$$\text{wt}_{\mathcal{G}}(d) = \text{wt}_{\mathcal{G}}(d_1) \otimes \cdots \otimes \text{wt}_{\mathcal{G}}(d_k) \otimes \text{wt}(r) , \quad (8.1)$$

by (2.36). If there is no confusion, then we drop the index \mathcal{G} from $\text{wt}_{\mathcal{G}}$ and just write $\text{wt}(d)$ for the weight of d .

We define the *weighted rule tree language of \mathcal{G}* , denoted by $\llbracket \mathcal{G} \rrbracket^{\text{wrt}}$, as the weighted tree language $\llbracket \mathcal{G} \rrbracket^{\text{wrt}} : T_R \rightarrow B$ defined by the Hadamard product

$$\llbracket \mathcal{G} \rrbracket^{\text{wrt}} = \text{wt}_{\mathcal{G}} \otimes \chi(\text{RT}_{\mathcal{G}}) .$$

We say that \mathcal{G} is *finite-derivational* if the set $\text{RT}_{\mathcal{G}}(u)$ is finite for every $u \in \Gamma^*$. We note that, if \mathcal{G} is finite-derivational, then $\llbracket \mathcal{G} \rrbracket^{\text{wrt}}$ is $\chi(\pi_{\mathcal{G}})$ -summable (cf. Section 2.12.2) because $\pi_{\mathcal{G}}^{-1}(u) \cap \text{supp}(\llbracket \mathcal{G} \rrbracket^{\text{wrt}}) \subseteq \text{RT}_{\mathcal{G}}(u)$ for each $u \in \Gamma^*$.

If \mathcal{G} is finite-derivational or B is σ -complete, then the *weighted language generated by \mathcal{G}* is the weighted language $\llbracket \mathcal{G} \rrbracket^{\text{s}} : \Gamma^* \rightarrow B$ defined by

$$\llbracket \mathcal{G} \rrbracket^{\text{s}} = \chi(\pi_{\mathcal{G}})(\llbracket \mathcal{G} \rrbracket^{\text{wrt}}) .$$

Thus, for each $u \in \Gamma^*$, we have

$$\begin{aligned} \llbracket \mathcal{G} \rrbracket^{\text{s}}(u) &= \chi(\pi_{\mathcal{G}})(\llbracket \mathcal{G} \rrbracket^{\text{wrt}})(u) = \sum_{d \in \pi_{\mathcal{G}}^{-1}(u)}^{\oplus} \llbracket \mathcal{G} \rrbracket^{\text{wrt}}(d) \\ &= \sum_{d \in \pi_{\mathcal{G}}^{-1}(u)}^{\oplus} (\text{wt}_{\mathcal{G}} \otimes \chi(\text{RT}_{\mathcal{G}}))(d) = \sum_{d \in \text{RT}_{\mathcal{G}}(u)}^{\oplus} \text{wt}_{\mathcal{G}}(d) , \end{aligned} \quad (8.2)$$

where in the second equality we have used (2.40). In the last expression of (8.2), the sum is well defined: if B is σ -complete, then the sum is defined on page 25 and, if in addition \mathcal{G} is finite-derivational, then it is equal to $\bigoplus_{d \in \text{RT}_{\mathcal{G}}(u)} \text{wt}(d)$ by (2.7.8); if B is not σ -complete, then \mathcal{G} is finite-derivational and the sum denotes $\bigoplus_{d \in \text{RT}_{\mathcal{G}}(u)} \text{wt}(d)$ by our convention (cf. page 25). Thus, the sum is well defined for arbitrary B . Figure 8.1 illustrates the definition of $\llbracket \mathcal{G} \rrbracket^{\text{s}}(u)$.

Let \mathcal{G}_1 and \mathcal{G}_2 be two (Γ, B) -wcfg such that both \mathcal{G}_1 and \mathcal{G}_2 are finite-derivational or B is σ -complete. Then \mathcal{G}_1 and \mathcal{G}_2 are *equivalent* if $\llbracket \mathcal{G}_1 \rrbracket^{\text{s}} = \llbracket \mathcal{G}_2 \rrbracket^{\text{s}}$.

A weighted language $s : \Gamma^* \rightarrow B$ is called (Γ, B) -*weighted context-free language* if there exists a (Γ, B) -wcfg \mathcal{G} which is finite-derivational if B is not σ -complete such that $s = \llbracket \mathcal{G} \rrbracket^{\text{s}}$.

Since the Boolean semiring $\text{Boole} = (\mathbb{B}, \vee, \wedge, 0, 1)$ is σ -complete, for each (Γ, Boole) -wcfg \mathcal{G} , the weighted language $\llbracket \mathcal{G} \rrbracket^{\text{s}} : \Gamma^* \rightarrow \mathbb{B}$ is defined, and the support of $\llbracket \mathcal{G} \rrbracket^{\text{s}}$ is a context-free language. Vice versa, each context-free language over Γ is the support of some (Γ, Boole) -weighted context-free language. Indeed, the concept of weighted context-free grammars generalizes the concept of context-free grammars in the following sense.

Observation 8.1.1. Let $L \subseteq \Gamma^*$. Then the following two statements are equivalent.

- (A) We can construct a Γ -cfg G which has a terminal rule such that $L(G) = L$.
- (B) We can construct a (Γ, Boole) -wcfg \mathcal{G} such that $\text{supp}(\llbracket \mathcal{G} \rrbracket^{\text{s}}) = L$.

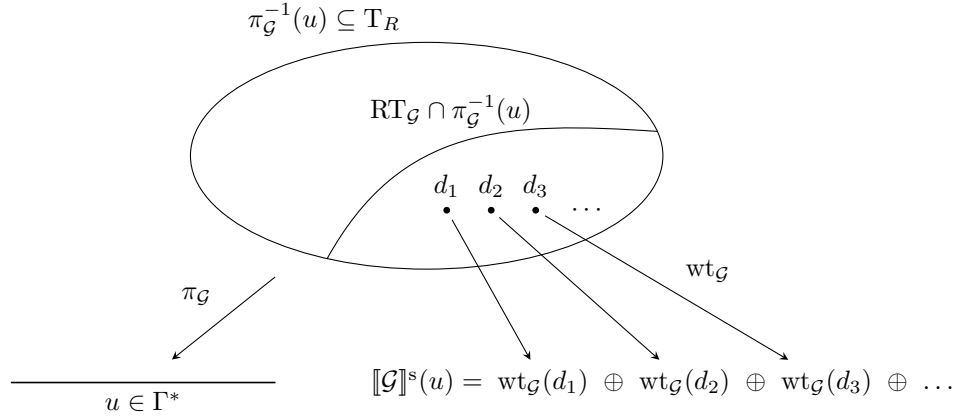

Figure 8.1: An illustration of the definition of $[[\mathcal{G}]]^s(u)$.

Proof. Proof of (A) \Rightarrow (B): Let $G = (N, S, R)$ be a Γ -cfg with a terminal rule. Then we construct the (Γ, Boole) -wcfg $\mathcal{G} = (N, S, R, wt)$ such that for each $r \in R$ we let $wt(r) = 1$. Obviously, $\text{RT}_{\mathcal{G}} = \text{RT}_G$ and, for each $d \in \text{RT}_{\mathcal{G}}$, we have $wt_{\mathcal{G}}(d) = 1$. Then we can prove $L(G) = \text{supp}([[G]]^s)$ as follows.

$$\begin{aligned} \text{supp}([[G]]^s) &= \text{supp}(\chi(\pi_{\mathcal{G}})(wt_{\mathcal{G}} \otimes \chi(\text{RT}_{\mathcal{G}}))) = \text{supp}(\chi(\pi_{\mathcal{G}})(\chi(\text{RT}_{\mathcal{G}}))) \\ &= \pi_{\mathcal{G}}(\text{supp}(\chi(\text{RT}_{\mathcal{G}}))) && \text{(by (2.41))} \\ &= \pi_G(\text{RT}_G) = L(G) . && \text{(because } \pi_{\mathcal{G}} = \pi_G \text{ and } \text{RT}_{\mathcal{G}} = \text{RT}_G \text{)} \end{aligned}$$

Proof of (B) \Rightarrow (A): Let $\mathcal{G} = (N, S, R, wt)$ be a (Γ, Boole) -wcfg. We distinguish two cases.

Case (a): For each terminal rule $r \in R$, we have $wt(r) = 0$. Then $\text{supp}([[G]]^s) = \emptyset$. We construct the Γ -cfg $G = (\{A, S_0\}, \{S_0\}, R')$ where $R' = \{A \rightarrow \varepsilon\}$. Obviously, $L(G) = \emptyset$.

Case (b): There exists a terminal rule $r \in R$ for which $wt(r) = 1$. Then we construct the Γ -cfg $G = (N, S, R')$ where $R' = \text{supp}(wt)$. We can view R' as a ranked alphabet. Hence $\text{RT}_G = \text{RT}_{\mathcal{G}} \cap T_{R'}$. We note that, for each $d \in \text{RT}_{\mathcal{G}}$, we have $wt_{\mathcal{G}}(d) = 1$ if $d \in T_{R'}$, and $wt_{\mathcal{G}}(d) = 0$ otherwise. Then we can prove

$$\text{supp}(wt_{\mathcal{G}} \otimes \chi(\text{RT}_{\mathcal{G}})) = \text{RT}_G . \quad (8.3)$$

For this let $d \in T_R$. Then

$$d \in \text{supp}(wt_{\mathcal{G}} \otimes \chi(\text{RT}_{\mathcal{G}})) \text{ iff } wt_{\mathcal{G}}(d) = 1 \wedge d \in \text{RT}_{\mathcal{G}} \text{ iff } d \in T_{R'} \wedge d \in \text{RT}_{\mathcal{G}} \text{ iff } d \in \text{RT}_G .$$

Then we can prove $L(G) = \text{supp}([[G]]^s)$ as follows.

$$\begin{aligned} \text{supp}([[G]]^s) &= \text{supp}(\chi(\pi_{\mathcal{G}})(wt_{\mathcal{G}} \otimes \chi(\text{RT}_{\mathcal{G}}))) \\ &= \pi_{\mathcal{G}}(\text{supp}(wt_{\mathcal{G}} \otimes \chi(\text{RT}_{\mathcal{G}}))) && \text{(by (2.41))} \\ &= \pi_{\mathcal{G}}(\text{RT}_G) && \text{(by (8.3))} \\ &= \pi_G(\text{RT}_G) = L(G) . && \text{(because } \pi_{\mathcal{G}} = \pi_G \text{)} \end{aligned}$$

□

Example 8.1.2. Let $G = (N, S, R)$ be an arbitrary Γ -cfg which has a terminal rule.

- (cf. [CS63, Sec. 2.3]) We consider the σ -complete semiring $\text{Nat}_{\infty} = (\mathbb{N}_{\infty}, +, \cdot, 0, 1)$ of natural numbers and we define the $(\Gamma, \text{Nat}_{\infty})$ -wcfg $\mathcal{G} = (N, S, R, wt)$ such that $wt(r) = 1$ for each $r \in R$. Then $[[\mathcal{G}]]^{\text{wrt}} = \chi(\text{RT}_{\mathcal{G}})$, i.e., the characteristic mapping of $\text{RT}_{\mathcal{G}}$. Obviously, the sets $D_{G,1}(S, u)$ and

$\text{RT}_{\mathcal{G}}(u)$ are in a one-to-one correspondence for each $u \in \Gamma^*$, and $L(G) = \pi_{\mathcal{G}}(\text{RT}_{\mathcal{G}})$. Moreover, for each $u \in \Gamma^*$, we have

$$\llbracket \mathcal{G} \rrbracket^s(u) = \sum_{d \in \text{RT}_{\mathcal{G}}(u)}^+ \text{wt}_{\mathcal{G}}(d) = |\text{RT}_{\mathcal{G}}(u)| = |D_{G,1}(S, u)| ,$$

where the second equality follows from the fact that $\text{wt}_{\mathcal{G}}(d) = 1$ for each $d \in \text{RT}_{\mathcal{G}}(u)$. Hence $\llbracket \mathcal{G} \rrbracket^s(u)$ is the number of leftmost derivations of u in G .

2. We consider the tropical semiring $\text{Nat}_{\min,+} = (\mathbb{N}_{\infty}, \min, +, \infty, 0)$, which is σ -complete. Moreover, we define the $(\Gamma, \text{Nat}_{\min,+})$ -wcfg $\mathcal{G} = (N, S, R, wt)$ such that $wt(r) = 1$ for each $r \in R$ (as above). Then, for every $u \in \Gamma^*$ and $d \in \text{RT}_{\mathcal{G}}(u)$, we have $\text{wt}_{\mathcal{G}}(d) = \text{size}(d)$ and

$$\llbracket \mathcal{G} \rrbracket^s(u) = \sum_{d \in \text{RT}_{\mathcal{G}}(u)}^{\min} \text{size}(d) .$$

(We recall that \sum^{\min} is the extension of \min to an arbitrary countable index set.) Thus $\llbracket \mathcal{G} \rrbracket^s(u)$ is the minimal size of a rule tree for u . Since $\text{size}(d)$ is equal to the length of the leftmost derivation which corresponds to d , also the number $\llbracket \mathcal{G} \rrbracket^s(u)$ is the minimal length of a leftmost derivation of u in \mathcal{G} . \square

Example 8.1.3. (cf. [FG18, Ex. 1]) Let $\Gamma = \{a, b\}$. It is known that the language $L = \{w \in \Gamma^* \mid |w|_a = |w|_b\}$ is context-free. It can be generated, for instance, by the Γ -cfg $G = (\{S\}, S, R)$, where R is the set of the following rules:

$$r_1 : S \rightarrow SS, \quad r_2 : S \rightarrow aSb, \quad r_3 : S \rightarrow bSa, \quad \text{and} \quad r_4 : S \rightarrow \varepsilon .$$

Now we consider the tropical semiring $\text{Nat}_{\min,+}$ and define the $(\Gamma, \text{Nat}_{\min,+})$ -wcfg $\mathcal{G} = (\{S\}, S, R, wt)$, where $wt(r_1) = wt(r_2) = wt(r_3) = 0$ and $wt(r_4) = 1$.

In Figure 8.2, we show two rule trees d_1 and d_2 of \mathcal{G} , for which the following hold: $\pi_{\mathcal{G}}(d_1) = ab$, $\pi_{\mathcal{G}}(d_2) = abab$, hence $d_1 \in \text{RT}_{\mathcal{G}}(ab)$ and $d_2 \in \text{RT}_{\mathcal{G}}(abab)$. Clearly, $\text{wt}(d_1) = \text{wt}(d_2) = 2$.

Note that \mathcal{G} is not finite-derivational. In fact, for each $u \in L$, the set $\text{RT}_{\mathcal{G}}(u)$ is not finite. However, the semiring $\text{Nat}_{\min,+}$ is σ -complete. Moreover, due to the fact that there exists only one nonterminal, we have $\text{RT}_{\mathcal{G}} = \text{T}_R$ (recall that we view R as a ranked alphabet).

It is clear that, for each $d \in \text{RT}_{\mathcal{G}}$, the weight $\text{wt}(d)$ is the number of the occurrences of r_4 (i.e., the erasing rule) in d . Let us denote this number by $\#_{\text{ers}}(d)$. Hence, for each $d \in \text{T}_R$, we have

$$\llbracket \mathcal{G} \rrbracket^{\text{wrt}}(d) = \#_{\text{ers}}(d) .$$

Moreover, for each $u \in \Gamma^*$ we have $\llbracket \mathcal{G} \rrbracket^s(u) = \sum_{d \in \text{RT}_{\mathcal{G}}(u)}^{\min} \#_{\text{ers}}(d)$. \square

8.2 Normal forms of wcfg

Now we define wcfg which satisfy particular properties. Let $\mathcal{G} = (N, S, R, wt)$ be a (Γ, \mathbb{B}) -wcfg. We say that \mathcal{G} is

- *in nonterminal form* if, for each rule $A \rightarrow \alpha$ in R , either $\alpha \in \Gamma$ or $\alpha \in N^*$,
- *start-separated* if it has exactly one initial nonterminal and this nonterminal does not occur in the right-hand side of a rule,

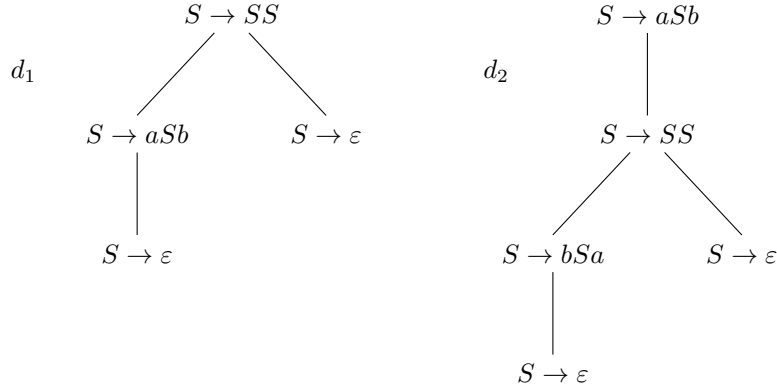

Figure 8.2: Rule trees for ab and $abab$ of Example 8.1.3.

- *chain-free* if \mathcal{G} does not have chain rules, and
- ε -*free* if \mathcal{G} does not have ε -rules.

Moreover,

- a rule tree $d \in \text{RT}_{\mathcal{G}}$ is *local-successful* if $\text{wt}(d(w)) \neq \emptyset$ for each $w \in \text{pos}(d)$,
- a nonterminal $A \in N$ is *local-useful* if there exists a local-successful $d \in \text{RT}_{\mathcal{G}}$ such that A occurs in d , and
- \mathcal{G} is *local-reduced* if $\text{supp}(\text{wt}) = R$ and each nonterminal in N is local-useful.

Finally, we call a nonterminal $A \in N$ *nullable* if $\text{RT}_{\mathcal{G}}(A, \varepsilon) \neq \emptyset$.

We note that \mathcal{G} has a local-useful nonterminal if and only if it has a local-successful rule tree.

Observation 8.2.1. Let $\mathcal{G} = (N, S, R, \text{wt})$ be a finite-derivational and local-reduced (Γ, \mathbb{B}) -wcfg. Then, for every $A \in N$ and $u \in \Gamma^*$, the set $\text{RT}_{\mathcal{G}}(A, u)$ is finite.

Proof. We prove by contradiction. We assume that there exist $A \in N$ and $u \in \Gamma^*$ such that $\text{RT}_{\mathcal{G}}(A, u)$ is not finite. Since \mathcal{G} is local-reduced, there exists an $x \in \Gamma^*$ and a rule tree $d \in \text{RT}_{\mathcal{G}}(x)$ such that A occurs in d , i.e., there exists a $w \in \text{pos}(d)$ with $\text{lhs}(d(w)) = A$. Then there exists a $y \in \Gamma^*$ such that for each $d' \in \text{RT}_{\mathcal{G}}(A, u)$, we have $d[d']_w \in \text{RT}_{\mathcal{G}}(y)$. Hence $\text{RT}_{\mathcal{G}}(y)$ is not finite which contradicts that \mathcal{G} is finite-derivational. \square

Observation 8.2.2. If the (Γ, \mathbb{B}) -wcfg \mathcal{G} is chain-free and ε -free, then it is finite-derivational.

Proof. Let $\mathcal{G} = (N, S, R, \text{wt})$ be chain-free and ε -free. By induction on T_R , we prove that the following statement holds:

$$\text{For each } d \in T_R, \text{ we have } \text{size}(d) \leq 2^{|\pi_{\mathcal{G}}(d)|}. \quad (8.4)$$

For this, let $d = r(d_1, \dots, d_k)$ be in T_R with $r = (A \rightarrow u_0 A_1 u_1 \dots A_k u_k)$. Since \mathcal{G} is chain-free, in case $k = 1$ we have $|u_0 u_1| > 0$. Moreover, since \mathcal{G} is ε -free, we have that $|\pi_{\mathcal{G}}(d_i)| > 0$ for each $i \in [k]$. Then we can calculate as follows:

$$\begin{aligned} \text{size}(r(d_1, \dots, d_k)) &= 1 + \prod_{i \in [k]} \text{size}(d_i) \\ &\leq 1 + \prod_{i \in [k]} 2^{|\pi_{\mathcal{G}}(d_i)|} && \text{(by I.H.)} \\ &\leq 2^{|u_0 u_1 \dots u_k|} \cdot 2^{|\pi_{\mathcal{G}}(d_1)|} \cdot \dots \cdot 2^{|\pi_{\mathcal{G}}(d_k)|} && \text{(since } \mathcal{G} \text{ is chain-free and } \varepsilon\text{-free)} \\ &= 2^{|u_0 u_1 \dots u_k| + \sum_{i \in [k]} |\pi_{\mathcal{G}}(d_i)|} = 2^{|\pi_{\mathcal{G}}(r(d_1, \dots, d_k))|} . \end{aligned}$$

By (8.4), for every $u \in \Gamma^*$ and $d \in \text{RT}_{\mathcal{G}}(u)$, we have that $\text{size}(d) \leq 2^{|u|}$, and hence \mathcal{G} is finite-derivational. \square

Next we consider the following restrictions of a wcfg:

- nonterminal form,
- start-separated,
- local-reduced,
- chain-free, and
- ε -free.

We prove that, under appropriate conditions, each wcfg can be transformed into an equivalent one which satisfies one of the mentioned restrictions. As it is common, we call each of these restrictions a normal form of wcfg.

Lemma 8.2.3. Let \mathcal{G} be a (Γ, \mathbf{B}) -wcfg such that \mathcal{G} is finite-derivational or \mathbf{B} is σ -complete. We can construct a (Γ, \mathbf{B}) -wcfg \mathcal{G}' such that \mathcal{G}' is in nonterminal form and $\llbracket \mathcal{G}' \rrbracket^s = \llbracket \mathcal{G} \rrbracket^s$. Moreover, the construction preserves the properties finite-derivational, start-separated, chain-free, ε -free, and local-reduced.

Proof. Let $\mathcal{G} = (N, S, R, wt)$. We construct the (Γ, \mathbf{B}) -wcfg $\mathcal{G}' = (N', S, R', wt')$ such that $N' = N \cup \{A_a \mid a \in \Gamma\}$ and, for each rule $r = (A \rightarrow \alpha)$ in R ,

- if $\alpha \in \Gamma$, then r is in R' ; we let $wt'(r) = wt(r)$,
- otherwise the rule $r' = (A \rightarrow \alpha')$ is in R' where α' is obtained from α by replacing each symbol $a \in \Gamma$ by A_a ; we let $wt'(r') = wt(r)$.

Moreover, for each $a \in \Gamma$, the rule $A_a \rightarrow a$ is in R' with $wt'(A_a \rightarrow a) = \mathbb{1}$.

Clearly, \mathcal{G}' is in nonterminal form and the construction preserves the mentioned properties. In particular, if \mathcal{G} is finite-derivational, then so is \mathcal{G}' . Hence $\llbracket \mathcal{G}' \rrbracket^s$ is defined. It is clear that, for each $u \in \Gamma^*$, the sets $\text{RT}_{\mathcal{G}}(u)$ and $\text{RT}_{\mathcal{G}'}(u)$ are in a one-to-one correspondence, and $\text{wt}_{\mathcal{G}}(d) = \text{wt}_{\mathcal{G}'}(d')$ if d and d' correspond to each other. Thus $\llbracket \mathcal{G} \rrbracket^s = \llbracket \mathcal{G}' \rrbracket^s$. \square

Lemma 8.2.4. Let \mathcal{G} be a (Γ, \mathbf{B}) -wcfg such that \mathcal{G} is finite-derivational or \mathbf{B} is σ -complete. We can construct a (Γ, \mathbf{B}) -wcfg \mathcal{G}' such that \mathcal{G}' is start-separated and $\llbracket \mathcal{G}' \rrbracket^s = \llbracket \mathcal{G} \rrbracket^s$. Moreover, the construction preserves the properties finite-derivational, nonterminal form, ε -free, and local-reduced. The construction does not preserve the property chain-free.

Proof. Let $\mathcal{G} = (N, S, R, wt)$. We construct the (Γ, \mathbf{B}) -wcfg $\mathcal{G}' = (N', S_0, R', wt')$ as follows. We let $N' = N \cup \{S_0\}$ where $S_0 \notin N \cup \Gamma$. The set R' contains the following rules.

- For each $A \in S$, the rule $r = (S_0 \rightarrow A)$ is in R' with $wt'(r) = \mathbb{1}$.
- Each rule $r \in R$ is in R' with $wt'(r) = wt(r)$.

It is clear that \mathcal{G}' is start-separated and that the construction preserves the mentioned properties. In particular, if \mathcal{G} is finite-derivational, then so is \mathcal{G}' . Hence $\llbracket \mathcal{G}' \rrbracket^s$ is defined. Moreover, it is clear that,

$$\begin{aligned} \text{for every } A \in N \text{ and } u \in \Gamma^*, \text{ we have } \text{RT}_{\mathcal{G}}(A, u) &= \text{RT}_{\mathcal{G}'}(A, u) \\ \text{and } \text{wt}_{\mathcal{G}}(d) &= \text{wt}_{\mathcal{G}'}(d) \text{ for each } d \in \text{RT}_{\mathcal{G}}(A, u). \end{aligned} \tag{8.5}$$

We can prove that $\llbracket \mathcal{G} \rrbracket^s = \llbracket \mathcal{G}' \rrbracket^s$ as follows. Let $u \in \Gamma^*$. Then

$$\begin{aligned} \llbracket \mathcal{G} \rrbracket^s(u) &= \sum_{d \in \text{RT}_{\mathcal{G}}(S, u)}^{\oplus} \text{wt}_{\mathcal{G}}(d) && \text{(by (8.2))} \\ &= \bigoplus_{A \in S} \sum_{d \in \text{RT}_{\mathcal{G}}(A, u)}^{\oplus} \text{wt}_{\mathcal{G}}(d) && \text{(because the family } (\text{RT}_{\mathcal{G}}(A, u) \mid A \in S) \text{ partitions } \text{RT}_{\mathcal{G}}(S, u).) \\ &= \bigoplus_{A \in S} \sum_{d' \in \text{RT}_{\mathcal{G}'}(A, u)}^{\oplus} \text{wt}_{\mathcal{G}'}(d') && \text{(by (8.5))} \end{aligned}$$

$$\begin{aligned}
&= \bigoplus_{A \in S} \sum_{d' \in \text{RT}_{\mathcal{G}'}(A, u)}^{\oplus} \text{wt}_{\mathcal{G}'}(d') \otimes \text{wt}'(S_0 \rightarrow A) \\
&= \sum_{d'' \in \text{RT}_{\mathcal{G}'}(S_0, u)}^{\oplus} \text{wt}_{\mathcal{G}'}(d'') \\
&\quad \text{(because the family } (\{(S_0 \rightarrow A)(d') \mid d' \in \text{RT}_{\mathcal{G}'}(A, u)\} \mid A \in S) \text{ partitions } \text{RT}_{\mathcal{G}'}(S_0, u)) \\
&= \llbracket \mathcal{G}' \rrbracket^s(u). \quad \square
\end{aligned}$$

Next we will prove that for each wcfg we can construct an equivalent local-reduced wcfg. We follow the outline of the proof of constructing an equivalent local-trim wta from a given wta (cf. Theorem 7.1.4). As an auxiliary tool, we associate to each (Γ, \mathbf{B}) -wcfg $\mathcal{G} = (N, S, R, wt)$, the context-free grammar $G(\mathcal{G}) = (N \cup \{S_0\}, S_0, P)$ over Γ , where S_0 is a new symbol and P is the smallest set of rules such that

- for each $A \in S$, the rule $S_0 \rightarrow A$ is in P and
- $\text{supp}(wt) \subseteq P$.

Then it is obvious that a nonterminal $A \in N$ is local-useful in \mathcal{G} if and only if it is useful in $G(\mathcal{G})$. This implies that \mathcal{G} is local-reduced if and only if $G(\mathcal{G})$ is reduced.

Lemma 8.2.5. Let \mathcal{G} be a (Γ, \mathbf{B}) -wcfg such that \mathcal{G} is finite-derivational or \mathbf{B} is σ -complete. If \mathcal{G} has a local-successful rule tree, then we can construct a (Γ, \mathbf{B}) -wcfg \mathcal{G}' such that \mathcal{G}' is local-reduced and $\llbracket \mathcal{G}' \rrbracket^s = \llbracket \mathcal{G} \rrbracket^s$. Moreover, the construction preserves the properties finite-derivational, nonterminal form, start-separated, chain-free, and ε -free.

Proof. Let $\mathcal{G} = (N, S, R, wt)$. We can construct the context-free grammar $G(\mathcal{G}) = (N \cup \{S_0\}, S_0, P)$ associated to \mathcal{G} . Due to our assumption on \mathcal{G} we have $L(G(\mathcal{G})) \neq \emptyset$. Thus, by Theorem 2.14.1, a context-free grammar $G' = (N', S_0, P')$ can be constructed such that G' is reduced and $L(G') = L(G(\mathcal{G}))$. By the proof of that theorem, we know that $N' = N_u \cup \{S_0\}$, where N_u is the set of all useful nonterminals in N . Moreover, $N_u \neq \emptyset$ by our assumption on \mathcal{G} .

Now let $\mathcal{G}' = (N_u, S \cap N_u, R', wt')$ be the (Γ, \mathbf{B}) -wcfg such that

- $R' = \{(A \rightarrow \alpha) \in R \mid A \in N_u, \alpha \in (N_u \cup \Gamma)^*\}$ and
- $wt'(r) = wt(r)$ for each $r \in R'$.

We note that, since \mathcal{G} has a local-successful rule tree, there exists a terminal rule $B \rightarrow u$ in R and B is useful in $G(\mathcal{G})$. This rule is also in R' , hence R' contains a terminal rule. Moreover, it is obvious that \mathcal{G}' is local-reduced and the mentioned properties are preserved. Thus, in particular, $\llbracket \mathcal{G}' \rrbracket$ is defined.

Lastly, we prove that $\llbracket \mathcal{G} \rrbracket^s = \llbracket \mathcal{G}' \rrbracket^s$. Let $u \in \Gamma^*$. Obviously, $\text{RT}_{\mathcal{G}'}(u) \subseteq \text{RT}_{\mathcal{G}}(u)$ and for each $d \in \text{RT}_{\mathcal{G}'}(u)$ we have $\text{wt}_{\mathcal{G}'}(d) = \text{wt}_{\mathcal{G}}(d)$. For each $d \in \text{RT}_{\mathcal{G}}(u) \setminus \text{RT}_{\mathcal{G}'}(u)$, there exists $A' \in N$ such that A' occurs in d and A' is not local-useful. Hence $\text{wt}_{\mathcal{G}}(d) = 0$. Thus we can compute

$$\llbracket \mathcal{G} \rrbracket^s(u) = \bigoplus_{d \in \text{RT}_{\mathcal{G}}(u)} \text{wt}_{\mathcal{G}}(d) = \bigoplus_{d \in \text{RT}_{\mathcal{G}'}(u)} \text{wt}_{\mathcal{G}'}(d) = \llbracket \mathcal{G}' \rrbracket^s(u). \quad \square$$

Next we show how a wcfg can be transformed into an equivalent chain-free wcfg.

Theorem 8.2.6. (cf. [KS86, Thm. 14.2]) Let Γ be an alphabet, \mathbf{B} be a semiring, and \mathcal{G} be a (Γ, \mathbf{B}) -wcfg such that (a) \mathcal{G} is finite-derivational or (b) \mathbf{B} is σ -complete. Then there exists a (Γ, \mathbf{B}) -wcfg \mathcal{G}' such that \mathcal{G}' is chain-free and $\llbracket \mathcal{G}' \rrbracket^s = \llbracket \mathcal{G} \rrbracket^s$. If \mathcal{G} has one of the following properties, then also \mathcal{G}' has it: finite-derivational, nonterminal form, start-separated, ε -free, and local-reduced. Moreover, if \mathcal{G} is finite-derivational, then we can even construct \mathcal{G}' .

Proof. Let $\mathcal{G} = (N, S, R, wt)$. By standard pumping methods, we can decide whether \mathcal{G} has a local-successful rule tree. If the answer is no, then $\llbracket \mathcal{G} \rrbracket^s = \tilde{0}$ and thus the statement of the lemma holds obviously.

Otherwise, by Lemma 8.2.5 we can construct a (Γ, \mathbf{B}) -wcfg which is local-reduced and equivalent to \mathcal{G} . So we may assume that \mathcal{G} is local-reduced.

We will prove the theorem by case analysis according to the Cases (a) and (b). Before doing so, we make some common preparations. Since \mathbf{B} is a semiring, we can consider the semiring $(B^{N \times N}, \oplus, \cdot, M_0, M_{\perp})$ of all N -square matrices over B (where we assume an arbitrary but fixed linear order on N).² We define the N -square matrix M over B such that, for every $A, A' \in N$:

$$M_{A',A} = \begin{cases} wt(r) & \text{if } r = (A \rightarrow A') \text{ is in } R \\ 0 & \text{otherwise.} \end{cases}$$

We recall that, for each $n \in \mathbb{N}$, the N -square matrix M^n over B is defined such that $M^0 = M_{\perp}$ and $M^{k+1} = M^k \cdot M$ for each $k \in \mathbb{N}$. Since \otimes is distributive with respect to \oplus , for each $n \in \mathbb{N}_+$ and $A, A' \in N$, we have

$$(M^n)_{A',A} = \bigoplus_{\substack{C_1, \dots, C_{n+1} \in N: \\ C_1 = A, C_{n+1} = A'}} \bigotimes_{j \in [0, n-1]} M_{C_{n+1-j}, C_{n-j}} . \quad (8.6)$$

Hence, $(M^n)_{A',A}$ is the sum of all products

$$wt(r_n) \otimes \cdots \otimes wt(r_1), \quad (8.7)$$

where, for each $i \in [n]$, r_i is a chain-rule of the form $C_i \rightarrow C_{i+1}$ such that $C_1 = A$ and $C_{n+1} = A'$.

We start the proof with Case (b), i.e., we assume that \mathbf{B} is σ -complete. Then also the semiring $(B^{N \times N}, \oplus, \cdot, M_0, M_{\perp})$ is σ -complete and hence the matrix M^* is well defined where $M^* = \sum_{n \in \mathbb{N}}^{\oplus} M^n$.

Hence, $(M^*)_{A',A}$ is the sum of all products (8.7) for some $n \in \mathbb{N}$.

Then we eliminate the chain rules from \mathcal{G} (cf., e.g., [ÉK03, Thm. 3.2], [FMV11, Lm. 3.2], and [FHV18, Thm. 6.3]). We define the (Γ, \mathbf{B}) -wcfg $\mathcal{G}' = (N, S, R', wt')$ as follows. Let

$$R' = \{A \rightarrow \alpha \mid A \in N, \alpha \notin N, (\exists A' \in N) : A' \rightarrow \alpha \text{ is in } R\}.$$

Moreover, for each rule $A \rightarrow \alpha$ in R' , we define

$$wt'(A \rightarrow \alpha) = \bigoplus_{\substack{A' \in N: \\ (A' \rightarrow \alpha) \in R}} wt(A' \rightarrow \alpha) \otimes (M^*)_{A',A} .$$

Obviously, \mathcal{G}' is chain-free and each mentioned property is preserved. In particular, $\llbracket \mathcal{G}' \rrbracket^s$ is defined.

In fact, the above definition of \mathcal{G}' is the same as the corresponding one in the proof of [FHV18, Thm. 6.3] for the case that (i) the storage type is the trivial one and (ii) the M-monoid K is the M-monoid associated with the σ -complete semiring \mathbf{B} (for the concept of “M-monoid associated with a semiring” cf. [FMV09, Def. 8.5] or [FSV12, p. 261]). By instantiating the correctness proof of [FHV18, Thm. 6.3] to the case specified by (i) and (ii), we obtain a proof of $\llbracket \mathcal{G}' \rrbracket^s = \llbracket \mathcal{G} \rrbracket^s$. For the sake of σ -completeness, we repeat this correctness proof here.

We note that, in virtue of the definition of \mathcal{G}' , we cannot construct \mathcal{G}' . This is due to the fact that the definition of the weights of rules involves the matrix M^* , and, although M^* is well defined, in general, we cannot compute it algorithmically.

For the inductive definition of a mapping that relates rule trees of \mathcal{G} with rule trees of \mathcal{G}' , we employ the reduction system $(RT_{\mathcal{G}}(N, \Gamma^*), \succ)$ where we let

$$\succ = \succ_R \cap (RT_{\mathcal{G}}(N, \Gamma^*) \times RT_{\mathcal{G}}(N, \Gamma^*))$$

²The multiplication \cdot of matrices is associative only if the multiplication \otimes of B distributes over \oplus .

(for the definition of \succ_R we refer to page 52). Since \succ_R is terminating, by Lemma 2.5.3 also \succ is terminating. Moreover, we have that $\text{nf}_{\succ}(\text{RT}_{\mathcal{G}}(N, \Gamma^*))$ is the set of terminal rules of R , which is not empty. We define the mapping $\text{eff} : \text{RT}_{\mathcal{G}}(N, \Gamma^*) \rightarrow \text{RT}_{\mathcal{G}'}(N, \Gamma^*)$ by induction on $(\text{RT}_{\mathcal{G}}(N, \Gamma^*), \succ)$ as follows. Let $d \in \text{RT}_{\mathcal{G}}(N, \Gamma^*)$. Then

- there exist $n \in \mathbb{N}$ and rules $r_1 = (C_1 \rightarrow C_2), \dots, r_n = (C_n \rightarrow C_{n+1})$, and $C_{n+1} \rightarrow \alpha$ with $\alpha = u_0 A_1 u_1 \dots A_k u_k$ in R such that $\alpha \notin N$ and
- for each $i \in [k]$ there exists a rule tree $d_i \in \text{RT}_{\mathcal{G}}(A_i, \Gamma^*)$

such that $d = r_1 \dots r_n (C_{n+1} \rightarrow \alpha)(d_1, \dots, d_k)$. We define

$$\text{eff}(d) = (C_1 \rightarrow \alpha)(\text{eff}(d_1), \dots, \text{eff}(d_k)).$$

Then $\text{lhs}(\text{eff}(d_i)(\varepsilon)) = A_i$ for each $i \in [k]$. Moreover,

$$\begin{aligned} &\text{for every } A \in N, u \in \Gamma^*, \text{ and } d \in \text{RT}_{\mathcal{G}}(N, \Gamma^*) \text{ we have:} \\ &d \in \text{RT}_{\mathcal{G}}(A, u) \text{ if and only if } \text{eff}(d) \in \text{RT}_{\mathcal{G}'}(A, u) . \end{aligned} \quad (8.8)$$

Next we will prove a relationship between the weights of rule trees that are related by eff . For this we use the reduction system $(\text{RT}_{\mathcal{G}'}(N, \Gamma^*), \succ')$ where we let

$$\succ' = \succ_{R'} \cap (\text{RT}_{\mathcal{G}'}(N, \Gamma^*) \times \text{RT}_{\mathcal{G}'}(N, \Gamma^*)) .$$

Since $\succ_{R'}$ is terminating, by Lemma 2.5.3 also \succ' is terminating. Moreover, we have that $\text{nf}_{\succ'}(\text{RT}_{\mathcal{G}'}(N, \Gamma^*))$ is the set of terminal rules of R' , which is not empty. Then, by induction on $(\text{RT}_{\mathcal{G}'}(N, \Gamma^*), \succ')$, we prove that the following statement holds.

$$\text{For every } d' \in \text{RT}_{\mathcal{G}'}(N, \Gamma^*) \text{ we have } \sum_{\substack{d \in \text{RT}_{\mathcal{G}}(N, \Gamma^*) \\ \text{eff}(d) = d'}}^{\oplus} \text{wt}(d) = \text{wt}'(d') . \quad (8.9)$$

Let $d' \in \text{RT}_{\mathcal{G}'}(N, \Gamma^*)$. Hence there exist $A \in N$ and $u \in \Gamma^*$ such that $d' \in \text{RT}_{\mathcal{G}'}(A, u)$. Then

- there exists a rule $r' = (A \rightarrow \alpha)$ in R' with $\alpha = u_0 A_1 u_1 \dots A_k u_k$, $k \in \mathbb{N}_+$, and $\alpha \notin N$ and
- for each $i \in [k]$ there exist $v_i \in \Gamma^*$ and $d'_i \in \text{RT}_{\mathcal{G}'}(A_i, v_i)$

such that $u = u_0 v_1 u_1 \dots v_k u_k$ and $d' = r'(d'_1, \dots, d'_k)$. Then we can calculate as follows:

$$\begin{aligned} &\sum_{\substack{d \in \text{RT}_{\mathcal{G}}(N, \Gamma^*) \\ \text{eff}(d) = d'}}^{\oplus} \text{wt}(d) = \sum_{\substack{d \in \text{RT}_{\mathcal{G}}(A, u) \\ \text{eff}(d) = r'(d'_1, \dots, d'_k)}}^{\oplus} \text{wt}(d) && \text{(by (8.8))} \\ &= \sum_{n \in \mathbb{N}}^{\oplus} \bigoplus_{\substack{C_1, \dots, C_{n+1} \in N \\ C_1 = A}} \sum_{\substack{d_1 \in \text{RT}_{\mathcal{G}}(A_1, v_1), \dots, d_k \in \text{RT}_{\mathcal{G}}(A_k, v_k) \\ (\forall i \in [k]): \text{eff}(d_i) = d'_i}}^{\oplus} \\ &\quad \left(\bigotimes_{i \in [k]} \text{wt}(d_i) \right) \otimes \text{wt}(C_{n+1} \rightarrow u_0 A_1 u_1 \dots A_k u_k) \otimes \bigotimes_{j \in [0, n-1]} M_{C_{n+1-j}, C_{n-j}} \\ &= \sum_{n \in \mathbb{N}}^{\oplus} \bigoplus_{\substack{C_1, \dots, C_{n+1} \in N \\ C_1 = A}} \left(\bigotimes_{i \in [k]} \sum_{\substack{d_i \in \text{RT}_{\mathcal{G}}(A_i, v_i) \\ \text{eff}(d_i) = d'_i}}^{\oplus} \text{wt}(d_i) \right) \\ &\quad \otimes \text{wt}(C_{n+1} \rightarrow u_0 A_1 u_1 \dots A_k u_k) \otimes \bigotimes_{j \in [0, n-1]} M_{C_{n+1-j}, C_{n-j}} && \text{(because } \mathbf{B} \text{ is distributive)} \\ &= \sum_{n \in \mathbb{N}}^{\oplus} \bigoplus_{\substack{C_1, \dots, C_{n+1} \in N \\ C_1 = A}} \left(\bigotimes_{i \in [k]} \text{wt}'(d'_i) \right) \otimes \text{wt}(C_{n+1} \rightarrow u_0 A_1 u_1 \dots A_k u_k) \otimes \bigotimes_{j \in [0, n-1]} M_{C_{n+1-j}, C_{n-j}} && \text{(by I.H.)} \end{aligned}$$

$$\begin{aligned}
&= \bigoplus_{A' \in N} \sum_{n \in \mathbb{N}}^{\oplus} \bigoplus_{\substack{C_1, \dots, C_{n+1} \in N: \\ C_1 = A, C_{n+1} = A'}} \left(\bigotimes_{i \in [k]} \text{wt}'(d'_i) \right) \otimes \text{wt}(A' \rightarrow u_0 A_1 u_1 \dots A_k u_k) \otimes \bigotimes_{j \in [0, n-1]} M_{C_{n+1-j}, C_{n-j}} \\
&\hspace{25em} \text{(by renaming of } C_{n+1} \text{ by } A') \\
&= \left(\bigotimes_{i \in [k]} \text{wt}'(d'_i) \right) \otimes \left(\bigoplus_{A' \in N} \text{wt}(A' \rightarrow u_0 A_1 u_1 \dots A_k u_k) \right) \otimes \sum_{n \in \mathbb{N}}^{\oplus} \bigoplus_{\substack{C_1, \dots, C_{n+1} \in N: \\ C_1 = A, C_{n+1} = A'}} \bigotimes_{j \in [0, n-1]} M_{C_{n+1-j}, C_{n-j}} \\
&\hspace{25em} \text{(by distributivity)} \\
&= \left(\bigotimes_{i \in [k]} \text{wt}'(d'_i) \right) \otimes \left(\bigoplus_{A' \in N} \text{wt}(A' \rightarrow u_0 A_1 u_1 \dots A_k u_k) \right) \otimes \sum_{n \in \mathbb{N}}^{\oplus} (M^n)_{A', A} \hspace{5em} \text{(by (8.6))} \\
&= \left(\bigotimes_{i \in [k]} \text{wt}'(d'_i) \right) \otimes \left(\bigoplus_{A' \in N} \text{wt}(A' \rightarrow u_0 A_1 u_1 \dots A_k u_k) \right) \otimes \left(\sum_{n \in \mathbb{N}}^{\oplus} (M^n) \right)_{A', A} \\
&= \left(\bigotimes_{i \in [k]} \text{wt}'(d'_i) \right) \otimes \left(\bigoplus_{A' \in N} \text{wt}(A' \rightarrow u_0 A_1 u_1 \dots A_k u_k) \otimes (M^*)_{A', A} \right) \\
&= \left(\bigotimes_{i \in [k]} \text{wt}'(d'_i) \right) \otimes \text{wt}'(r') \hspace{15em} \text{(by the definition of } \mathcal{G}') \\
&= \text{wt}'(r'(d'_1, \dots, d'_k)).
\end{aligned}$$

This proves (8.9).

Then we can prove for each $u \in \Gamma^*$:

$$\begin{aligned}
[[\mathcal{G}]]^s(u) &= \sum_{d \in \text{RT}_{\mathcal{G}}(u)}^{\oplus} \text{wt}(d) = \bigoplus_{A \in S} \sum_{d \in \text{RT}_{\mathcal{G}}(A, u)}^{\oplus} \text{wt}(d) = \bigoplus_{A \in S} \sum_{d' \in \text{RT}_{\mathcal{G}'}(A, u)}^{\oplus} \sum_{\substack{d \in \text{RT}_{\mathcal{G}}(A, u): \\ \text{eff}(d) = d'}}^{\oplus} \text{wt}(d) \\
&= \bigoplus_{A \in S} \sum_{d' \in \text{RT}_{\mathcal{G}'}(A, u)}^{\oplus} \text{wt}'(d') \hspace{15em} \text{(by (8.9))} \\
&= \sum_{d' \in \text{RT}_{\mathcal{G}'}(u)}^{\oplus} \text{wt}'(d') = [[\mathcal{G}']]^s(u) .
\end{aligned}$$

Now we continue the proof with Case (a), i.e., we assume that \mathcal{G} is finite-derivational. Since \mathcal{G} is local-reduced and finite-derivational, the length of sequences of chain rules in A -rule trees of \mathcal{G} is bounded by $|N| - 1$ for each $A \in N$. We show this statement by contradiction. For this, let us assume that there exist a string $u \in \Gamma^*$ and a $d \in \text{RT}_{\mathcal{G}}(A, u)$ such that d contains a sequence of chain rules of length at least $|N|$. Then a nonterminal is repeated in that sequence and, by applying the standard pumping argument, we obtain that $\text{RT}_{\mathcal{G}}(A, u)$ is not finite. However, this contradicts Observation 8.2.1.

This boundedness property gives us the possibility to construct \mathcal{G}' , because, in order to eliminate the chain rules from \mathcal{G} , now we can use the matrix $\bigoplus_{n \in [0, |N|-1]} M^n$.

Thus, we construct the (Γ, B) -wcfg $\mathcal{G}' = (N, S, R', \text{wt}')$ as follows. As in Case (b), we let

$$R' = \{A \rightarrow \alpha \mid A \in N, \alpha \notin N, (\exists A' \in N) : A' \rightarrow \alpha \text{ is in } R\}.$$

Moreover, for each rule $A \rightarrow \alpha$ in R' , we define

$$\text{wt}'(A \rightarrow \alpha) = \bigoplus_{\substack{A' \in N: \\ (A' \rightarrow \alpha) \in R}} \text{wt}(A' \rightarrow \alpha) \otimes \left(\bigoplus_{n \in [0, |N|-1]} M^n \right)_{A', A} .$$

Obviously, \mathcal{G}' is chain-free and, again, all the mentioned properties are preserved. Thus, since \mathcal{G} is finite-derivational, also \mathcal{G}' is so, hence $[[\mathcal{G}']]^s$ is defined. By induction on $(\text{RT}_{\mathcal{G}'}(N, \Gamma^*), \succ')$ (where \succ' is

the terminating relation defined in the proof of Case (b) above), we prove that the following statement holds:

$$\text{For every } d' \in \text{RT}_{\mathcal{G}'}(N, \Gamma^*), \text{ we have } \bigoplus_{\substack{d \in \text{RT}_{\mathcal{G}}(N, \Gamma^*) \\ \text{eff}(d)=d'}} \text{wt}(d) = \text{wt}'(d'). \quad (8.10)$$

The proof of (8.10) is the same as the proof of (8.9) except that the four infinite summations

$$\sum_{\substack{d \in \text{RT}_{\mathcal{G}}(A, u) \\ \text{eff}(d)=r'(d'_1, \dots, d'_k)}}^{\oplus} \quad \text{and} \quad \sum_{\substack{d_i \in \text{RT}_{\mathcal{G}}(A_i, v_i) \\ \text{eff}(d_i)=d'_i}}^{\oplus} \quad \text{and} \quad \sum_{n \in \mathbb{N}}^{\oplus} \quad \text{and} \quad \sum_{n \in \mathbb{N}}^{\oplus}$$

are replaced by the finite summations

$$\bigoplus_{\substack{d \in \text{RT}_{\mathcal{G}}(A, u) \\ \text{eff}(d)=r'(d'_1, \dots, d'_k)}} \quad \text{and} \quad \bigoplus_{\substack{d_i \in \text{RT}_{\mathcal{G}}(A_i, v_i) \\ \text{eff}(d_i)=d'_i}} \quad \text{and} \quad \bigoplus_{n \in [0, |N|-1]} \quad \text{and} \quad \bigoplus_{n \in [0, |N|-1]} \quad , \text{ respectively,}$$

as well as,

$$(M^*)_{A', A} \text{ is replaced by } \left(\bigoplus_{n \in [0, |N|-1]} M^n \right)_{A', A} .$$

By a similar modification of the final calculation of (b) we obtain the proof for $[[\mathcal{G}]]^s = [[\mathcal{G}']]^s$. \square

In the next theorem we deal with the transformation of a (Γ, \mathbb{B}) -wcfg into an equivalent ε -free one. More precisely, for a given (Γ, \mathbb{B}) -wcfg $\mathcal{G} = (N, S, R, \text{wt})$ such that (a) \mathbb{B} is a commutative semiring and (b) \mathcal{G} is finite-derivational or \mathbb{B} is σ -complete, we define an ε -free (Γ, \mathbb{B}) -wcfg \mathcal{G}' such that $[[\mathcal{G}']]^s = [[\mathcal{G}]]^s \otimes \chi_{\mathbb{B}}(\Gamma^+)$. We follow the idea of [BPS61, Lm. 4.1] (also cf. [HMU07, Subsec. 7.1.3]) where context-free grammars are transformed into (almost) equivalent ε -free context-free grammars. However, here we have to be careful about the weights and have to cope with two phenomena.

We explain the first phenomenon by means of an example. Let \mathcal{G} contain the initial nonterminal A and the three rules

$$r = (A \rightarrow aCC), \quad r' = (C \rightarrow b), \quad \text{and} \quad r'' = (C \rightarrow \varepsilon).$$

Then $\text{RT}_{\mathcal{G}}(A, ab) = \{d_1, d_2\}$ with $d_1 = r(r', r'')$ and $d_2 = r(r'', r')$. Hence

$$[[\mathcal{G}]]^s(ab) = \text{wt}_{\mathcal{G}}(d_1) \oplus \text{wt}_{\mathcal{G}}(d_2) .$$

According to the construction of [BPS61, Lm. 4.1], the wcfg \mathcal{G}' contains the rules r, r' , and $\bar{r} = (A \rightarrow aC)$, where \bar{r} results from r by erasing either the first occurrence of C or the second one. Thus $\text{RT}_{\mathcal{G}'}(A, ab) = \{\bar{r}(r')\}$ and

$$[[\mathcal{G}']]^s(ab) = \text{wt}_{\mathcal{G}'}(\bar{r}(r')) .$$

We observe that this construction does not take care of the different ways in which a right-hand side (e.g. aC) results from erasing nonterminals from the right-hand side of the \mathcal{G} -rule (e.g. aCC). In this particular example, we could define the weights of the rules of \mathcal{G}' such that the weight balance $[[\mathcal{G}]]^s(ab) = [[\mathcal{G}']]^s(ab)$ is satisfied. But in general, rules of \mathcal{G} call each other recursively, and then this method of defining weights is not successful. Instead, we will code the occurrences of nonterminals which are selected for erasing into the rules of \mathcal{G}' , and thereby we keep the different ways in which a rule for \mathcal{G}' was obtained separately.

The second phenomenon is the fact that the empty string ε can be derived in many different ways, and \mathcal{G}' has to sum up the weights of all the corresponding rule trees. For instance, if there exists a rule $r = (C \rightarrow aAb)$ in R and we have detected that A is nullable, i.e., $\text{RT}_{\mathcal{G}}(A, \varepsilon) \neq \emptyset$, then according to the

construction in [BPS61, Lm. 4.1] the rule $r' = (C \rightarrow ab)$ will be in \mathcal{G}' and the weight of r' in \mathcal{G}' will be $wt(r) \otimes W(A)$, where we define

$$W(A) = \sum_{d \in \text{RT}_{\mathcal{G}}(A, \varepsilon)}^{\oplus} wt_{\mathcal{G}}(d) .$$

By our assumptions on \mathcal{G} and \mathbf{B} , the value $W(A)$ is well defined. We note that, if $\text{RT}_{\mathcal{G}}(A, \varepsilon) = \emptyset$, then $W(A) = \mathbf{0}$. If \mathcal{G} is not finite-derivational (and hence \mathbf{B} is σ -complete), it is in general not clear how to construct $W(A)$. However, if \mathcal{G} is finite-derivational, then $W(A)$ can be computed.

Observation 8.2.7. Let $\mathcal{G} = (N, S, R, wt)$ be a finite-derivational and local-reduced (Γ, \mathbf{B}) -wcfg. Then, for each $A \in N$, we can compute $W(A)$.

Proof. First we show that

$$\text{RT}_{\mathcal{G}}(A, \varepsilon) = \{d \in \text{RT}_{\mathcal{G}}(A, \varepsilon) \mid \text{height}(d) \leq |N| - 1\} . \quad (8.11)$$

We prove (8.11) by contradiction and assume that there exists a $d \in \text{RT}_{\mathcal{G}}(A, \varepsilon)$ such that $\text{height}(d) \geq |N|$. Then there exist $w \in \text{pos}(d)$ and $v \in \mathbb{N}^+$ such that $\text{lhs}(d(w)) = \text{lhs}(d(wv))$. Then, using c as abbreviation for the context $(d|_w)[z]_v$, we obtain that $d[c^n[d|_{wv}]]_w \in \text{RT}_{\mathcal{G}}(A, \varepsilon)$ for each $n \in \mathbb{N}$. Hence $\text{RT}_{\mathcal{G}}(A, \varepsilon)$ is not finite, which contradicts Observation 8.2.1. This proves (8.11).

Then we have

$$\begin{aligned} W(A) &= \sum_{d \in \text{RT}_{\mathcal{G}}(A, \varepsilon)}^{\oplus} wt_{\mathcal{G}}(d) \\ &= \sum_{\substack{d \in \text{RT}_{\mathcal{G}}(A, \varepsilon): \\ \text{height}(d) \leq |N| - 1}}^{\oplus} wt_{\mathcal{G}}(d) && \text{(by (8.11))} \\ &= \bigoplus_{\substack{d \in \text{RT}_{\mathcal{G}}(A, \varepsilon): \\ \text{height}(d) \leq |N| - 1}} wt_{\mathcal{G}}(d) && \text{(by Observation 2.7.8(2))} \end{aligned}$$

Obviously, $\bigoplus_{\substack{d \in \text{RT}_{\mathcal{G}}(A, \varepsilon): \\ \text{height}(d) \leq |N| - 1}} wt_{\mathcal{G}}(d)$ can be computed. □

The next theorem has been achieved in [KS86, Thm. 14.6] for wcfg over a partially ordered, continuous, and commutative semiring \mathbf{B} . We follow the construction given in [KS86, Thm. 14.6].

Theorem 8.2.8. (cf. [KS86, Thm. 14.6]) Let Γ be an alphabet, $\mathbf{B} = (B, \oplus, \otimes, \mathbf{0}, \mathbf{1})$ be a commutative semiring, and \mathcal{G} be a (Γ, \mathbf{B}) -wcfg such that \mathcal{G} is finite-derivational or \mathbf{B} is σ -complete. Then there exists an ε -free (Γ, \mathbf{B}) -wcfg \mathcal{G}' such that $\llbracket \mathcal{G}' \rrbracket^s = \llbracket \mathcal{G} \rrbracket^s \otimes \chi_{\mathbf{B}}(\Gamma^+)$. If \mathcal{G} is finite-derivational, then we can construct \mathcal{G}' .

Proof. Let $\mathcal{G} = (N, S, R, wt)$. By standard pumping methods, we can decide whether \mathcal{G} has a local-successful rule tree. If the answer is no, then $\llbracket \mathcal{G} \rrbracket^s = \tilde{\mathbf{0}}$. Hence, the statement of the theorem holds obviously because we can construct an ε -free (Γ, \mathbf{B}) -wcfg \mathcal{G}' such that $\llbracket \mathcal{G}' \rrbracket^s = \tilde{\mathbf{0}}$.

Otherwise, by Lemma 8.2.3 and Lemma 8.2.5, we can construct a (Γ, \mathbf{B}) -wcfg which is in nonterminal form, local-reduced, and equivalent to \mathcal{G} . Hence we can assume that \mathcal{G} is in nonterminal form and local-reduced. Then we distinguish two cases.

Case (a): Each terminal rule of \mathcal{G} is an ε -rule. Then $\llbracket \mathcal{G} \rrbracket^s \otimes \chi_{\mathbf{B}}(\Gamma^+) = \tilde{\mathbf{0}}$. Again, the statement of the theorem holds obviously.

Case (b): There exists a terminal rule of \mathcal{G} , say $A \rightarrow u$, such that $u \neq \varepsilon$. Since \mathcal{G} is in nonterminal form, we have $u \in \Gamma$. We will use this property when we construct \mathcal{G}' . But before this we need some preparations.

As in the case of context-free grammars, we construct the set of nullable nonterminal symbols (cf. [BPS61, Lm. 4.1]), i.e., the set

$$E = \{A \in N \mid \text{RT}_{\mathcal{G}}(A, \varepsilon) \neq \emptyset\} .$$

In order to prepare for the above mentioned first phenomenon, we introduce the concept of E -selection. Intuitively, an E -selection is a string over $\{0, 1\}$ and it shows, for a given right-hand side $\alpha \in (N \cup \Gamma)^*$ of a rule and each of its nonterminal occurrences, whether that occurrence is selected for erasing (represented by 1) or not (represented by 0). Formally, let $\alpha = u_0 A_1 u_1 \dots A_k u_k$ be in $(N \cup \Gamma)^*$. An E -selection for α is a string $f = f_1 \dots f_k$ with $f_i \in \{0, 1\}$ such that, for every $i \in [k]$, if $f_i = 1$, then $A_i \in E$, i.e., only occurrences of nullable nonterminals can be selected for erasing. In particular, for each $u \in \Gamma^*$, the only E -selection is $f = \varepsilon$.

For instance, if $\alpha = aAbDCC$, $E = \{C, D\}$, then $f = 0110$ is an E -selection. It indicates that the occurrence of D and the leftmost occurrence of C are selected for erasing, and the other two occurrences of nonterminals are not.

Let $\alpha = u_0 A_1 u_1 \dots A_k u_k$ in $(N \cup \Gamma)^*$ and f be an E -selection for α . Then we define the *application of f to α* , denoted by $f(\alpha)$, to be the string $u_0 X_1 u_1 \dots X_k u_k$, where for each $i \in [k]$:

$$X_i = \begin{cases} \varepsilon & \text{if } f_i = 1 \\ A_i & \text{otherwise.} \end{cases}$$

In particular, for each $u \in \Gamma^*$, we have $\varepsilon(u) = u$. For α and f in the above example we have $f(\alpha) = aAbC$.

For each nonterminal which is not selected by f for erasing, we will have to know its target position in $f(\alpha)$. Formally, let $f = f_1 \dots f_k$ be an E -selection for α . We let $\text{pos}_0(f) = \{i \in [k] \mid f_i = 0\}$. Then we define the mapping $g_f : \text{pos}_0(f) \rightarrow [|\text{pos}_0(f)|]$ for each $i \in \text{pos}_0(f)$ by $g_f(i) = j$ if the j th occurrence of 0 in f (counted from left to right) has position i . We note that g_f is bijective. For f in the above example, we have $\text{pos}_0(f) = \{1, 4\}$ and $g_f(1) = 1$ and $g_f(4) = 2$.

Now we define the (Γ, \mathbf{B}) -wcfg $\mathcal{G}' = (N', S, R', wt')$ as follows.

- $N' = N \cup \{[\alpha, f] \mid (\exists (A \rightarrow \alpha) \text{ in } R) : f \text{ is an } E\text{-selection for } \alpha\}$ and
- R' and wt' are defined as follows. For every $r = (A \rightarrow \alpha)$ with $\alpha = u_0 A_1 u_1 \dots A_k u_k$ in R and $\alpha \neq \varepsilon$, and E -selection f for α such that $f(\alpha) \neq \varepsilon$,
 - the rule $r' = (A \rightarrow [\alpha, f])$ is in R' with $wt'(r') = wt(r)$ and
 - the rule $r'' = ([\alpha, f] \rightarrow f(\alpha))$ is in R' with

$$wt'(r'') = \bigotimes_{\substack{i \in [k]: \\ f_i = 1}} W(A_i) .$$

In particular, if $\{i \in [k] \mid f_i = 1\} = \emptyset$, then $wt'(r'') = \mathbb{1}$.

Since R contains a terminal rule $A \rightarrow u$ with $u \in \Gamma$, the set R' contains the rule $[u, \varepsilon] \rightarrow u$, and hence the Γ -cfg (N', S, R') contains a terminal rule. Thus, \mathcal{G}' is a (Γ, \mathbf{B}) -wcfg. Moreover, if \mathcal{G} is finite-derivational, then $wt'(r'')$ can be constructed by Observation 8.2.7, and hence \mathcal{G}' can be constructed.

We note that the construction of \mathcal{G}' is essentially the same as the construction of the algebraic system $(y_i = q_i \mid 1 \leq i \leq n)$ in the proof of Theorem [KS86, Thm. 14.6]. For an explanation, we assume that $N = \{A_1, \dots, A_n\}$ and $A_j \rightarrow \alpha_1, \dots, A_j \rightarrow \alpha_\ell$ are all the rules of \mathcal{G} with left-hand side A_j . Then the corresponding algebraic system has the set $Y = N$ as set of variables and it contains the equation

$$A_j = p_j \quad \text{where} \quad p_j = \alpha_1 + \dots + \alpha_\ell .$$

The set of all right-hand sides $f(\alpha_i)$ where $1 \leq i \leq \ell$ and f is an E -selection for α_i , is in one-to-one correspondence to the set of all monomials in the polynomial q_i (in the proof of Theorem [KS86,

Thm. 14.6]); the latter is obtained by substituting $(\sigma, \varepsilon)\varepsilon + Y$ into p_j . The coefficient (σ, ε) is the N -vector $(W(A_1), \dots, W(A_n))$, which is relevant for all those nonterminals which are selected for erasing, and the part Y reflects the case that a nonterminal is not erased.

Next we prove $[[\mathcal{G}']^s = [[\mathcal{G}]^s \otimes \chi_B(\Gamma^+)$. As preparation, we define the binary relation \succ on $\text{RT}_{\mathcal{G}}(N, \Gamma^+)$ by

$$\succ = \succ_R \cap \text{RT}_{\mathcal{G}}(N, \Gamma^+) \times \text{RT}_{\mathcal{G}}(N, \Gamma^+) .$$

Since \succ_R is terminating, also \succ has this property (using Lemma 2.5.3). Moreover, we have $\text{nf}_{\succ}(\text{RT}_{\mathcal{G}}(N, \Gamma^+)) = \{(A \rightarrow u) \in R \mid u \in \Gamma^+\}$, which is not empty. We define the mapping

$$\varphi : \text{RT}_{\mathcal{G}}(N, \Gamma^+) \rightarrow \text{RT}_{\mathcal{G}'}(N, \Gamma^+)$$

by induction on $(\text{RT}_{\mathcal{G}}(N, \Gamma^+), \succ)$ as follows (cf. Figure 8.3).

Let $d \in \text{RT}_{\mathcal{G}}(N, \Gamma^+)$. Then there exists a rule $(A \rightarrow \alpha)$ in R with $\alpha = u_0 A_1 u_1 \dots A_k u_k$, and for every $i \in [k]$ there exists $d_i \in \text{RT}_{\mathcal{G}}(A_i, \Gamma^*)$ such that

$$d = (A \rightarrow \alpha)(d_1, \dots, d_k) .$$

We can assume that $\varphi(d_i)$ is defined for each $d_i \in \text{RT}_{\mathcal{G}}(N, \Gamma^+)$.

Since $\pi_{\mathcal{G}}(d) \neq \varepsilon$, we have $u_0 u_1 \dots u_k \neq \varepsilon$ or there exists $i \in [k]$ such that $d_i \in \text{RT}_{\mathcal{G}}(A_i, \Gamma^+)$. Let $f = f_1 \dots f_k$ be the E -selection for α defined, for each $i \in [k]$, by

$$f_i = \begin{cases} 1 & \text{if } d_i \in \text{RT}_{\mathcal{G}}(A_i, \varepsilon) \\ 0 & \text{otherwise} . \end{cases}$$

Then the rule $A \rightarrow [\alpha, f]$ is in R' and we define

$$\varphi(d) = (A \rightarrow [\alpha, f])\left(\left([\alpha, f] \rightarrow f(\alpha)\bar{\zeta}\right)\right),$$

where the sequence $\bar{\zeta}$ of rule trees of \mathcal{G}' is obtained from the sequence (d_1, \dots, d_k) by

- (a) dropping each rule tree d_i with $d_i \in \text{RT}_{\mathcal{G}}(A_i, \varepsilon)$ and
- (b) replacing each remaining d_i by $\varphi(d_i)$ (which is defined because $d_i \in \text{RT}_{\mathcal{G}}(N, \Gamma^+)$).

For instance, if $r = (S \rightarrow aAbCDD)$, $d_1 \in \text{RT}_{\mathcal{G}}(A, \Gamma^+)$, $d_2 \in \text{RT}_{\mathcal{G}}(C, \varepsilon)$, $d_3 \in \text{RT}_{\mathcal{G}}(D, \varepsilon)$, and $d_4 \in \text{RT}_{\mathcal{G}}(D, \Gamma^+)$, then $f = 0110$ and $\bar{\zeta} = (\varphi(d_1), \varphi(d_4))$, cf. Figure 8.3.

In the particular case that $d_i \in \text{RT}_{\mathcal{G}}(A_i, \Gamma^+)$ for each $i \in [k]$, we have $f = 0^k$ and

$$\varphi(d) = (A \rightarrow [\alpha, f])\left(\left([\alpha, f] \rightarrow \alpha\right)(\varphi(d_1), \dots, \varphi(d_k))\right) ,$$

and in the particular case that $d_i \in \text{RT}_{\mathcal{G}}(A_i, \varepsilon)$ for each $i \in [k]$, we have $f = 1^k$ and

$$\varphi(d) = (A \rightarrow [\alpha, f])\left(\left([\alpha, f] \rightarrow u_0 u_1 \dots u_k\right)\right) .$$

Next we prove that φ is surjective. More precisely, by induction on $(\text{RT}_{\mathcal{G}'}(N, \Gamma^+), \succ)$, we prove that the following statement holds:

$$\text{For every } d' \in \text{RT}_{\mathcal{G}'}(N, \Gamma^+), \text{ there exists a } d \in \text{RT}_{\mathcal{G}}(N, \Gamma^+) \text{ such that } \varphi(d) = d'. \quad (8.12)$$

Let $d' \in \text{RT}_{\mathcal{G}'}(N, \Gamma^+)$. Then d' has the form

$$(A \rightarrow [\alpha, f])\left(\left([\alpha, f] \rightarrow v_0 C_1 v_1 \dots C_n v_n\right)(d'_1, \dots, d'_n)\right)$$

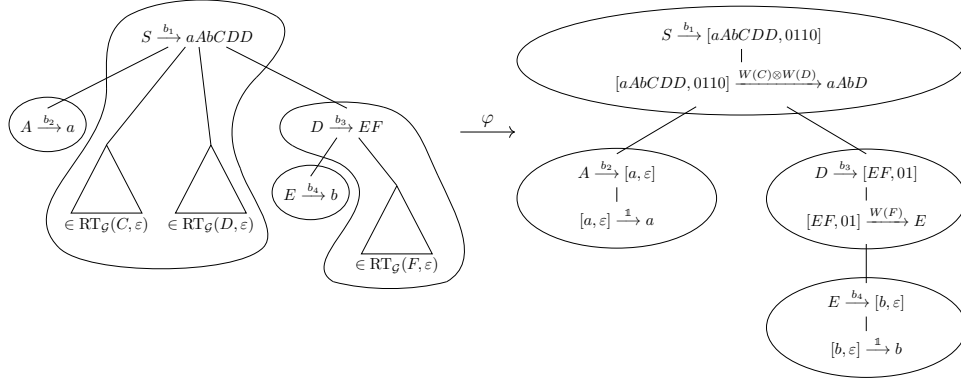

Figure 8.3: An illustration of $\varphi(d) = d'$ in the proof of Theorem 8.2.8.

where $n \in \mathbb{N}$, f is an E -selection for α ; moreover $v_0 C_1 v_1 \dots C_n v_n = f(\alpha)$ and $d'_1 \in \text{RT}_{\mathcal{G}'}(C_j, \Gamma^+)$, \dots , $d'_n \in \text{RT}_{\mathcal{G}'}(C_n, \Gamma^+)$. Let $\alpha = u_0 A_1 u_1 \dots A_k u_k$ and $f = f_1 \dots f_k$. Hence, $C_j = A_{g_f^{-1}(j)}$ for each $j \in [n]$.

By I.H. we can assume that, for every $j \in [n]$, there exists $e_j \in \text{RT}_{\mathcal{G}}(C_j, \Gamma^+)$ such that $\varphi(e_j) = d'_j$. Moreover, for each $i \in [k]$ such that $f_i = 1$, we choose an arbitrary rule tree d''_i from $\text{RT}_{\mathcal{G}}(A_i, \varepsilon)$. We note that $\text{RT}_{\mathcal{G}}(A_i, \varepsilon) \neq \emptyset$ because f is an E -selection for α . Then we construct the rule tree $d = (A \rightarrow \alpha)(d_1, \dots, d_k)$ in $\text{RT}_{\mathcal{G}}(A, \Gamma^+)$ where for each $i \in [k]$ we let

$$d_i = \begin{cases} d''_i & \text{if } f_i = 1 \\ e_{g_f(i)} & \text{otherwise} . \end{cases}$$

Then $\varphi(d) = d'$. This proves that φ is surjective. We mention that, in general, φ is not injective because there may be several rule trees for ε with the same nonterminal on the left-hand side of the rule at their root.

From the construction of \mathcal{G}' , it is obvious that

$$\text{for every } A \in N \text{ and } d \in \text{RT}_{\mathcal{G}}(A, \Gamma^+), \text{ we have } \pi_{\mathcal{G}'}(d) = \pi_{\mathcal{G}'}(\varphi(d)) \quad (8.13)$$

and, by using (8.13), we have that

$$\begin{aligned} &\text{for every } A \in N \text{ and } u \in \Gamma^+, \text{ the sets } \text{RT}_{\mathcal{G}}(A, u) \text{ and} \\ &\{(d', d) \mid d' \in \text{RT}_{\mathcal{G}'}(A, u), d \in \varphi^{-1}(d')\} \text{ are in a one-to-one correspondence.} \end{aligned} \quad (8.14)$$

Finally, by induction on $(\text{RT}_{\mathcal{G}'}(N, \Gamma^+), \succ)$, we prove that the following statement holds:

$$\text{For every } d' \in \text{RT}_{\mathcal{G}'}(N, \Gamma^+) \text{ we have } \text{wt}_{\mathcal{G}'}(d') = \sum_{d \in \varphi^{-1}(d')}^{\oplus} \text{wt}_{\mathcal{G}}(d) . \quad (8.15)$$

Let $d' \in \text{RT}_{\mathcal{G}'}(N, \Gamma^+)$. Then d' has the form

$$d' = (A \rightarrow [\alpha, f]) \left(([\alpha, f] \rightarrow f(\alpha))(d'_1, \dots, d'_n) \right)$$

with $\alpha = u_0 A_1 u_1 \dots A_k u_k$. Hence $f(\alpha)$ contains n occurrences of 0. Moreover, for each $j \in [n]$, we have $d'_j \in \text{RT}_{\mathcal{G}'}(A_{g_f^{-1}(j)}, \Gamma^*)$. Then we can calculate as follows.

$$\text{wt}_{\mathcal{G}'}(d')$$

$$\begin{aligned}
&= \left(\bigotimes_{j \in [n]} \text{wt}_{\mathcal{G}'}(d'_j) \right) \otimes \text{wt}'([\alpha, f] \rightarrow f(\alpha)) \otimes \text{wt}'(A \rightarrow [\alpha, f]) \\
&= \left(\bigotimes_{\substack{i \in [k]: \\ f_i=0}} \text{wt}_{\mathcal{G}'}(d'_{g_f(i)}) \right) \otimes \left(\bigotimes_{\substack{i \in [k]: \\ f_i=1}} W(A_i) \right) \otimes \text{wt}(A \rightarrow \alpha) && \text{(by definition of } f \text{ and construction)} \\
&= \left(\bigotimes_{i \in [k]} c_i \right) \otimes \text{wt}(A \rightarrow \alpha) && \text{(by commutativity)}
\end{aligned}$$

where

$$c_i = \begin{cases} \text{wt}_{\mathcal{G}'}(d'_{g_f(i)}) & \text{if } f_i = 0 \\ W(A_i) & \text{otherwise .} \end{cases}$$

By I.H. and by definition of $W(A_i)$, we have

$$c_i = \begin{cases} \sum_{d_i \in \varphi^{-1}(d'_{g_f(i)})}^{\oplus} \text{wt}_{\mathcal{G}}(d_i) & \text{if } f_i = 0 \\ \sum_{d_i \in \text{RT}_{\mathcal{G}}(A_i, \varepsilon)}^{\oplus} \text{wt}_{\mathcal{G}}(d_i) & \text{otherwise .} \end{cases}$$

Then, by distributivity and by surjectivity of φ (see (8.12)), we obtain

$$\left(\bigotimes_{i \in [k]} c_i \right) \otimes \text{wt}(A \rightarrow \alpha) = \sum_{d \in \varphi^{-1}(d')}^{\oplus} \text{wt}_{\mathcal{G}}(d)$$

which proves (8.15). Then for each $u \in \Gamma^+$

$$\begin{aligned}
\llbracket \mathcal{G}' \rrbracket^s(u) &= \bigoplus_{A \in S} \sum_{d' \in \text{RT}_{\mathcal{G}'}(A, u)}^{\oplus} \text{wt}_{\mathcal{G}'}(d') \\
&= \bigoplus_{A \in S} \sum_{d' \in \text{RT}_{\mathcal{G}'}(A, u)}^{\oplus} \sum_{d \in \varphi^{-1}(d')}^{\oplus} \text{wt}_{\mathcal{G}}(d) && \text{(by (8.15))} \\
&= \bigoplus_{A \in S} \sum_{d \in \text{RT}_{\mathcal{G}}(A, u)}^{\oplus} \text{wt}_{\mathcal{G}}(d) && \text{(by (8.14))} \\
&= \llbracket \mathcal{G} \rrbracket^s(u) .
\end{aligned}$$

Since $\llbracket \mathcal{G}' \rrbracket^s(\varepsilon) = 0$, we obtain $\llbracket \mathcal{G}' \rrbracket^s = \llbracket \mathcal{G} \rrbracket^s \otimes \chi_B(\Gamma^+)$. \square

8.3 Yields of recognizable weighted tree languages

In this section we state the main result of this chapter: the yield of an r-recognizable weighted tree language is a weighted context-free language, and vice versa, each weighted context-free language can be obtained in this way. This result generalizes [Bra69, Thm. 3.20] and [Don70, Thm. 2.5] from the unweighted case to the weighted case (also cf. [GS84, Thm. 3.2.7]), it generalizes [ÉK, Thm. 6.8.6] (also cf. [ÉK03, Thm. 8.6]) from commutative, continuous semirings to strong bimonoids, and it generalizes Theorem [FG18, Thm.1 (1) \Leftrightarrow (5)] from semirings to strong bimonoids. (We also refer to [Boz99, Thm. 30].)

We recall the mapping yield_{Γ} from Section 2.10. Let $\Gamma \subseteq \Sigma^{(0)}$. Then the mapping $\text{yield}_{\Gamma} : \text{T}_{\Sigma} \rightarrow \Gamma^*$ is defined for each $\xi = \sigma(\xi_1, \dots, \xi_k)$ in T_{Σ} by

$$\text{yield}_{\Gamma}(\xi) = \begin{cases} \text{yield}_{\Gamma}(\xi_1) \cdots \text{yield}_{\Gamma}(\xi_k) & \text{if } k \geq 1 \\ \sigma & \text{if } k = 0 \text{ and } \sigma \in \Gamma \\ \varepsilon & \text{otherwise .} \end{cases}$$

Let $r : T_\Sigma \rightarrow B$ be a weighted tree language. Also we recall from (2.40) that, if r is $\chi(\text{yield}_\Gamma)$ -summable or B is σ -complete, then $\chi(\text{yield}_\Gamma)(r) : \Gamma^* \rightarrow B$ is a weighted language such that, for each $u \in \Gamma^*$, we have

$$\chi(\text{yield}_\Gamma)(r)(u) = \sum_{\xi \in \text{yield}_\Gamma^{-1}(u)}^{\oplus} r(\xi) .$$

Theorem 8.3.1. [FG18, Thm. 1] *Let Γ be an alphabet and B be a strong bimonoid. For each weighted language $s : \Gamma^* \rightarrow B$ the following two statements are equivalent.*

- (A) *We can construct a (Γ, B) -wcfg \mathcal{G} such that \mathcal{G} is finite-derivational or B is σ -complete, and $s = \llbracket \mathcal{G} \rrbracket^s$.*
- (B) *We can construct a ranked alphabet Σ with $\Gamma \subseteq \Sigma^{(0)}$ and a (Σ, B) -wta \mathcal{A} such that $\llbracket \mathcal{A} \rrbracket^{\text{run}}$ is $\chi(\text{yield}_\Gamma)$ -summable or B is σ -complete, and $s = \chi(\text{yield}_\Gamma)(\llbracket \mathcal{A} \rrbracket^{\text{run}})$.*

Proof. This follows from Lemmas 8.3.2 and 8.3.3. □

Lemma 8.3.2. Let \mathcal{G} be a (Γ, B) -wcfg such that \mathcal{G} is finite-derivational or B is σ -complete. We can construct a ranked alphabet Σ with $\Gamma \subseteq \Sigma^{(0)}$ and a root weight normalized (Σ, B) -wta $\mathcal{A} = (Q, \delta, F)$ such that (a) $\llbracket \mathcal{A} \rrbracket^{\text{run}}$ is $\chi(\text{yield}_\Gamma)$ -summable if \mathcal{G} is finite-derivational and (b) $\llbracket \mathcal{G} \rrbracket^s = \chi(\text{yield}_\Gamma)(\llbracket \mathcal{A} \rrbracket^{\text{run}})$.

Proof. Let $\mathcal{G} = (N, S, R, wt)$. By Lemmas 8.2.3 and 8.2.4, we can construct a (Γ, B) -wcfg which is in nonterminal form, start-separated, and equivalent to \mathcal{G} . Hence we can assume that \mathcal{G} is in nonterminal form and start-separated.

We define the \mathbb{N} -indexed family $(R_k \mid k \in \mathbb{N})$ such that

$$R_k = \{(A \rightarrow \alpha) \in R \mid |\alpha| = k\} .$$

We note that, if \mathcal{G} is ε -free, then $(R_k \mid k \in \mathbb{N})$ is not a ranked alphabet, because $R_0 = \emptyset$. Moreover, a terminal rule $A \rightarrow a$ with $a \in \Gamma$ is in R_1 (and not in $R^{(0)}$ as defined in Section 8.1).

We construct the ranked alphabet Σ by $\Sigma^{(k)} = R_k$ for each $k \in \mathbb{N}_+$, and $\Sigma^{(0)} = R_0 \cup \Gamma$. We construct the (Σ, B) -wta $\mathcal{A} = (Q, \delta, F)$ as follows.

- $Q = N \cup \bar{\Gamma}$ where $\bar{\Gamma} = \{\bar{a} \mid a \in \Gamma\}$ (note that $Q \cap \Sigma = \emptyset$),
- for every $k \in \mathbb{N}$, $\sigma \in \Sigma^{(k)}$, and $q, q_1, \dots, q_k \in Q$, we let

$$\delta_k(q_1 \cdots q_k, \sigma, q) = \begin{cases} wt(\sigma) & \text{if } q, q_1, \dots, q_k \in N \text{ and } \sigma = (q \rightarrow q_1 \cdots q_k) \text{ is in } R \\ wt(\sigma) & \text{if } k = 1, q \in N, q_1 = \bar{a} \text{ for some } a \in \Gamma \text{ such that } \sigma = (q \rightarrow a) \text{ is in } R \\ \mathbb{1} & \text{if } k = 0, q = \bar{\sigma}, \text{ and } \sigma \in \Gamma \\ 0 & \text{otherwise ,} \end{cases}$$

- for each $q \in Q$, we define $F_q = \mathbb{1}$ if $q = S$, and 0 otherwise.

Obviously, \mathcal{A} is root weight normalized.

For the proof of (a) and (b) we need some preparations. For each $\xi \in T_\Sigma$, we define the run $\rho_\xi : \text{pos}(\xi) \rightarrow Q$ such that, for each $w \in \text{pos}(\xi)$, we let

$$\rho_\xi(w) = \begin{cases} \text{lhs}(\xi(w)) & \text{if } \xi(w) \in R \\ \xi(w) & \text{otherwise .} \end{cases}$$

We define the mapping $\varphi : \text{RT}_\mathcal{G} \rightarrow \{(\xi, \rho) \mid \xi \in T_\Sigma, \rho \in \text{RA}(\xi)\}$ for every $d \in \text{RT}_\mathcal{G}$ by $\varphi(d) = (\xi, \rho_\xi)$ where ξ is obtained from d by replacing each leaf which is labeled by a rule of the form $A \rightarrow a$ with $a \in \Gamma$ by the tree $(A \rightarrow a)(a)$ (cf. Figure 8.4). In particular, for each $(\xi, \rho_\xi) \in \text{im}(\varphi)$, we have that $\rho_\xi \in \text{RA}(S, \xi)$. Obviously, φ is injective.

Next we define $\varphi' : \text{RT}_{\mathcal{G}} \rightarrow \text{im}(\varphi)$ by $\varphi'(d) = \varphi(d)$ for each $d \in \text{RT}_{\mathcal{G}}$. Obviously, φ' is bijective. Moreover,

$$\text{for each } d \in \text{RT}_{\mathcal{G}}, \text{ if } \varphi'(d) = (\xi, \rho_{\xi}), \text{ then } \pi(d) = \text{yield}_{\Gamma}(\xi). \quad (8.16)$$

For the proof of (a), assume that \mathcal{G} is finite-derivational. Then, (8.16) and the fact that φ' is bijective imply that $\text{yield}_{\Gamma}^{-1}(u) \cap \text{supp}(\llbracket \mathcal{A} \rrbracket^{\text{run}})$ is finite for each $u \in \Gamma^*$, i.e., that $\llbracket \mathcal{A} \rrbracket^{\text{run}}$ is $\chi(\text{yield}_{\Gamma})$ -summable.

Finally, we prove (b). It is easy to see that

$$\text{for each } d \in \text{RT}_{\mathcal{G}}, \text{ we have } \text{wt}_{\mathcal{G}}(d) = \text{wt}_{\mathcal{A}}(\varphi'(d)) . \quad (8.17)$$

Moreover,

$$\text{for every } \xi \in \text{T}_{\Sigma} \text{ and } \rho \in \text{R}_{\mathcal{A}}(S, \xi): \text{ if } (\xi, \rho) \notin \text{im}(\varphi), \text{ then } \text{wt}_{\mathcal{A}}(\xi, \rho) = 0 . \quad (8.18)$$

Then, for each $u \in \Gamma^*$, we can calculate as follows.

$$\begin{aligned} \llbracket \mathcal{G} \rrbracket^{\text{s}}(u) &= \sum_{d \in \text{RT}_{\mathcal{G}}(u)}^{\oplus} \text{wt}_{\mathcal{G}}(d) && \text{(by (8.2))} \\ &= \sum_{\substack{d \in \text{RT}_{\mathcal{G}}: \\ \pi(d)=u}}^{\oplus} \text{wt}_{\mathcal{G}}(d) \\ &= \sum_{\substack{(\xi, \rho_{\xi}) \in \text{im}(\varphi): \\ \text{yield}_{\Gamma}(\xi)=u}}^{\oplus} \text{wt}_{\mathcal{G}}((\varphi')^{-1}((\xi, \rho_{\xi}))) && \text{(because } \varphi' \text{ is bijective and by (8.16))} \\ &= \sum_{\substack{(\xi, \rho_{\xi}) \in \text{im}(\varphi): \\ \text{yield}_{\Gamma}(\xi)=u}}^{\oplus} \text{wt}_{\mathcal{A}}(\xi, \rho_{\xi}) && \text{(by (8.17) and because } \varphi((\varphi')^{-1}((\xi, \rho_{\xi}))) = (\xi, \rho_{\xi})) \\ &= \sum_{\xi \in \text{yield}_{\Gamma}^{-1}(u)}^{\oplus} \bigoplus_{\rho \in \text{R}_{\mathcal{A}}(S, \xi)} \text{wt}_{\mathcal{A}}(\xi, \rho) && \text{(by (8.18))} \\ &= \sum_{\xi \in \text{yield}_{\Gamma}^{-1}(u)}^{\oplus} \bigoplus_{q \in Q} \bigoplus_{\rho \in \text{R}_{\mathcal{A}}(q, \xi)} \text{wt}_{\mathcal{A}}(\xi, \rho) \otimes F_q && \text{(because } F_S = \mathbb{1} \text{ and } F_q = \mathbb{0} \text{ for each } q \in Q \setminus \{S\}) \\ &= \sum_{\xi \in \text{yield}_{\Gamma}^{-1}(u)}^{\oplus} \llbracket \mathcal{A} \rrbracket^{\text{run}}(\xi) && \text{(by definition of } \llbracket \mathcal{A} \rrbracket^{\text{run}}) \\ &= \left(\chi(\text{yield}_{\Gamma})(\llbracket \mathcal{A} \rrbracket^{\text{run}}) \right)(u) . && \text{(by (2.40))} \end{aligned}$$

□

Lemma 8.3.3. Let $\Gamma \subseteq \Sigma^{(0)}$. Moreover, let $\mathcal{A} = (Q, \delta, F)$ be a (Σ, \mathbf{B}) -wta such that $\llbracket \mathcal{A} \rrbracket^{\text{run}}$ is $\chi(\text{yield}_{\Gamma})$ -summable or \mathbf{B} is σ -complete. We can construct a (Γ, \mathbf{B}) -wcfg in nonterminal form such that (a) \mathcal{G} is finite-derivational if $\llbracket \mathcal{A} \rrbracket^{\text{run}}$ is $\chi(\text{yield}_{\Gamma})$ -summable and (b) $\llbracket \mathcal{G} \rrbracket^{\text{s}} = \chi(\text{yield}_{\Gamma})(\llbracket \mathcal{A} \rrbracket^{\text{run}})$.

Proof. Let $\mathcal{A} = (Q, \delta, F)$. By Theorem 7.3.1 we can construct a (Σ, \mathbf{B}) -wta which is root weight normalized and r-equivalent to \mathcal{A} . Hence, we can assume that \mathcal{A} is root weight normalized. Thus, $\text{supp}(F) = \{q_f\}$ for some $q_f \in Q$ and $F_{q_f} = \mathbb{1}$.

We construct the (Γ, \mathbf{B}) -wcfg $\mathcal{G} = (N, S, R, wt)$ as follows.

- $N = Q \times \Sigma$ where each element has the form $[q, \sigma]$ for some $q \in Q$ and $\sigma \in \Sigma$,
- $S = \{q_f\} \times \Sigma$,
- R is the smallest set such that the following conditions hold; simultaneously, we define wt .
 - For every $k \in \mathbb{N}_+$, $\sigma \in \Sigma^{(k)}$, $q, q_1, \dots, q_k \in Q$, and $\sigma_1, \dots, \sigma_k \in \Sigma$, the rule $r = ([q, \sigma] \rightarrow [q_1, \sigma_1] \cdots [q_k, \sigma_k])$ is in R and $wt(r) = \delta_k(q_1 \cdots q_k, \sigma, q)$.

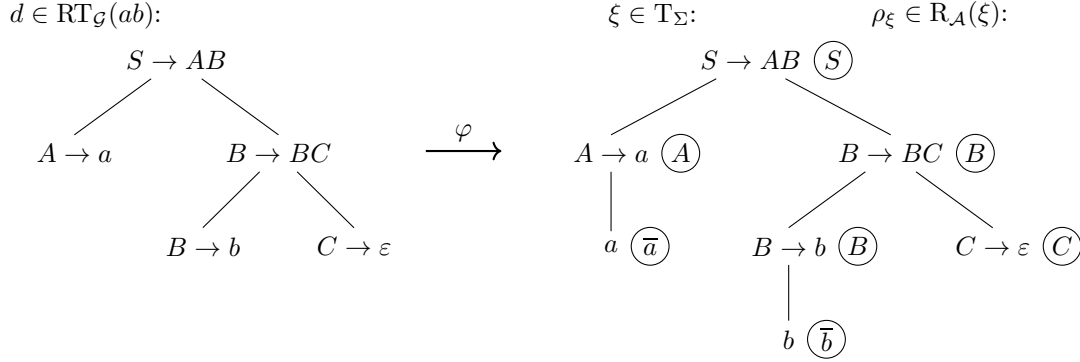

Figure 8.4: A visualization of $\varphi(d) = (\xi, \rho_\xi)$ in the proof of Lemma 8.3.2 with $d \in \mathcal{R}_{\mathcal{A}}(ab)$ for $a, b \in \Gamma$, $\xi \in \mathsf{T}_\Sigma$, and $\rho_\xi \in \mathcal{R}_{\mathcal{A}}(\xi)$. The states of ρ_ξ are circled.

- For every $\sigma \in \Gamma$ and $q \in Q$, the rule $r = ([q, \sigma] \rightarrow \sigma)$ is in R and $\text{wt}(r) = \delta_0(\varepsilon, \sigma, q)$.
- For every $\sigma \in \Sigma^{(0)} \setminus \Gamma$ and $q \in Q$, the rule $r = ([q, \sigma] \rightarrow \varepsilon)$ is in R and $\text{wt}(r) = \delta_0(\varepsilon, \sigma, q)$.

We define the mapping $\varphi : \{(\xi, \rho) \mid \xi \in \mathsf{T}_\Sigma, \rho \in \mathcal{R}_{\mathcal{A}}(q_f, \xi)\} \rightarrow \mathsf{RT}_{\mathcal{G}}$ for every (ξ, ρ) by $\varphi(\xi, \rho) = d$ where d is determined by the tree domain W and the R -tree mapping $d' : W \rightarrow R$ (recall that there is a bijective representation of trees as tree domains and tree mappings, cf. Section 2.10). We define $W = \text{pos}(\xi)$ and for each $w \in W$ (using k as abbreviation for $\text{rk}_\Sigma(\xi(w))$) we let

$$d'(w) = \begin{cases} [\rho(w), \xi(w)] \rightarrow [\rho(w1), \xi(w1)] \cdots [\rho(wk), \xi(wk)] & \text{if } k \geq 1 \\ [\rho(w), \xi(w)] \rightarrow \xi(w) & \text{if } k = 0 \text{ and } \xi(w) \in \Gamma \\ [\rho(w), \xi(w)] \rightarrow \varepsilon & \text{if } k = 0 \text{ and } \xi(w) \in \Sigma^{(0)} \setminus \Gamma \end{cases} .$$

Obviously, φ is injective and surjective, hence bijective (cf. Figure 8.5). Moreover,

$$\begin{aligned} & \text{for every } \xi \in \mathsf{T}_\Sigma \text{ and } \rho \in \mathcal{R}_{\mathcal{A}}(\xi), \\ & \text{if } \varphi(\xi, \rho) = d, \text{ then } \pi(d) = \text{yield}_\Gamma(\xi) \text{ and } \text{wt}_{\mathcal{G}}(d) = \text{wt}_{\mathcal{A}}(\xi, \rho). \end{aligned} \tag{8.19}$$

Thus, since φ is bijective, the assumption that $\llbracket \mathcal{A} \rrbracket^{\text{run}}$ is $\chi(\text{yield}_\Gamma)$ -summable implies that \mathcal{G} is finite-derivational.

Then, for each $u \in \Gamma^*$, we can calculate as follows.

$$\begin{aligned} \llbracket \mathcal{G} \rrbracket^s(u) &= \sum_{d \in \mathsf{RT}_{\mathcal{G}}(u)}^\oplus \text{wt}_{\mathcal{G}}(d) = \sum_{\substack{d \in \mathsf{RT}_{\mathcal{G}}: \\ \pi(d)=u}}^\oplus \text{wt}_{\mathcal{G}}(d) \\ &= \sum_{\substack{\xi \in \mathsf{T}_\Sigma: \\ \text{yield}_\Gamma(\xi)=u}}^\oplus \bigoplus_{\rho \in \mathcal{R}_{\mathcal{A}}(q_f, \xi)} \text{wt}_{\mathcal{A}}(\xi, \rho) && \text{(because } \varphi \text{ is bijective and by (8.19))} \\ &= \sum_{\xi \in \text{yield}_\Gamma^{-1}(u)}^\oplus \bigoplus_{\rho \in \mathcal{R}_{\mathcal{A}}(q_f, \xi)} \text{wt}_{\mathcal{A}}(\xi, \rho) \\ &= \sum_{\xi \in \text{yield}_\Gamma^{-1}(u)}^\oplus \bigoplus_{\rho \in \mathcal{R}_{\mathcal{A}}(\xi)} \text{wt}_{\mathcal{A}}(\xi, \rho) \otimes F_{\rho(\varepsilon)} && \text{(because } \text{supp}(F) = \{q_f\} \text{ and } F_{q_f} = \mathbb{1}) \\ &= \sum_{\xi \in \text{yield}_\Gamma^{-1}(u)}^\oplus \llbracket \mathcal{A} \rrbracket^{\text{run}}(\xi) && \text{(by definition of } \llbracket \mathcal{A} \rrbracket^{\text{run}}) \\ &= \chi(\text{yield}_\Gamma)(\llbracket \mathcal{A} \rrbracket^{\text{run}})(u) . && \text{(by (2.40))} \end{aligned}$$

□

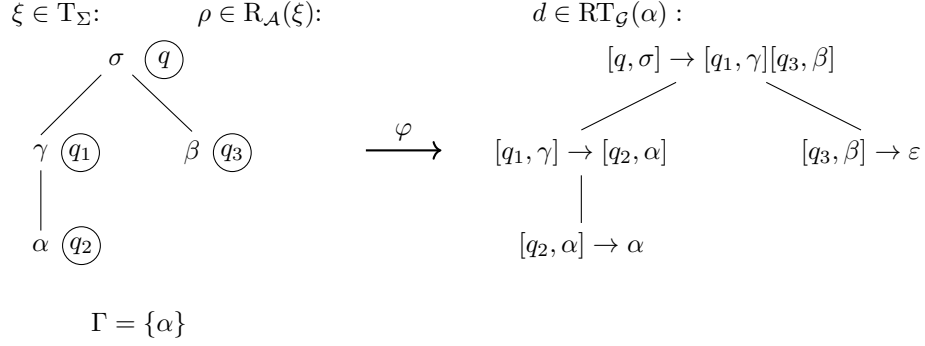

Figure 8.5: A visualization of $\varphi(\xi, \rho) = d$ in the proof of Lemma 8.3.3 with $\xi \in T_\Sigma$, $\rho \in R_{\mathcal{A}}(\xi)$, $\Gamma = \{\alpha\}$, and $d \in RT_{\mathcal{G}}(\alpha)$. The states of ρ are circled.

Finally, we verify that Theorem 8.3.1 generalizes [Bra69, Thm. 3.20] and [Don70, Thm. 2.5]. We achieve this by proving that the latter results are equivalent to Theorem 8.3.1 for the case that \mathbf{B} is the Boolean semiring \mathbf{Boole} .

Corollary 8.3.4. For each language $L \subseteq \Gamma^*$ the following two statements are equivalent.

- (A) We can construct a context-free grammar G such that $L(G) = L$.
- (B) We can construct a ranked alphabet Σ with $\Gamma \subseteq \Sigma^{(0)}$ and a Σ -fta A such that $L = \text{yield}_\Gamma(L(A))$.

Proof. Proof of (A) \Rightarrow (B): Let G be a Γ -cfg such that $L = L(G)$. By Observation 8.1.1(A) \Rightarrow (B), we can construct a (Γ, \mathbf{Boole}) -wcfg \mathcal{G} such that $L = \text{supp}(\llbracket \mathcal{G} \rrbracket^s)$. Since \mathbf{Boole} is σ -complete, Theorem 8.3.1(A) \Rightarrow (B) implies that we can construct a ranked alphabet Σ with $\Gamma \subseteq \Sigma^{(0)}$ and a (Σ, \mathbf{Boole}) -wta \mathcal{A} such that $L = \text{supp}(\chi(\text{yield}_\Gamma)(\llbracket \mathcal{A} \rrbracket))$. By (2.41) (using $r = \llbracket \mathcal{A} \rrbracket$ and $g = \text{yield}_\Gamma$), we obtain $L = \text{yield}_\Gamma(\text{supp}(\llbracket \mathcal{A} \rrbracket))$. By Corollary 3.4.2(B) \Rightarrow (A), we can construct a Σ -fta A such that $\text{supp}(\llbracket \mathcal{A} \rrbracket) = L(A)$. Thus $L = \text{yield}_\Gamma(L(A))$.

Proof of (B) \Rightarrow (A): Let A be a Σ -fta such that $L = \text{yield}_\Gamma(L(A))$. By Corollary 3.4.2(A) \Rightarrow (B), we can construct a (Σ, \mathbf{Boole}) -wta \mathcal{A} such that $L = \text{yield}_\Gamma(\text{supp}(\llbracket \mathcal{A} \rrbracket))$. Then we can apply (2.41) and obtain that $L = \text{supp}(\chi(\text{yield}_\Gamma)(\llbracket \mathcal{A} \rrbracket))$. Since \mathbf{Boole} is σ -complete, Theorem 8.3.1(B) \Rightarrow (A) implies that we can construct a (Γ, \mathbf{Boole}) -wcfg \mathcal{G} such that $L = \text{supp}(\llbracket \mathcal{G} \rrbracket^s)$. Finally, Observation 8.1.1(B) \Rightarrow (A), we can construct a Γ -cfg G such that $L = L(G)$. \square

Chapter 9

Weighted regular tree grammars

Weighted regular tree grammars were introduced and investigated in [IF75] (for $\mathbf{B} = ([0, 1], \max, \min, 0, 1)$) and in [AB87] (for \mathbf{B} being an arbitrary semiring).

Here we define weighted regular tree grammars as particular wcfg. This possibility is based on the simple fact that each tree is a particular string. We indicate that some of the normal forms for wcfg are also normal forms for weighted regular tree grammars. We define two more restricted forms of weighted regular tree grammars: alphabetic and tree automata form, and prove that they are normal forms (cf. Lemmas 9.2.2 and 9.2.3, respectively). In particular, we prove that weighted regular tree grammars in tree automata form are essentially wta (cf. Theorem 9.2.9).

9.1 The grammar model

By definition, each tree ξ over Σ is a particular string over the alphabet $\Sigma \cup \Xi$ where Ξ contains the opening and closing parentheses and the comma. For convenience, we abbreviate $\Sigma \cup \Xi$ by Σ^Ξ . Then, by definition, we have $T_\Sigma \subseteq (\Sigma^\Xi)^*$. Of course, $(\Sigma^\Xi)^* \setminus T_\Sigma \neq \emptyset$.

This aspect of the definition of trees (being particular strings) allows one to define particular wcfg, viz. those which generate weighted tree languages. We call them weighted regular tree grammars.

Formally, a *weighted regular tree grammar over Σ and \mathbf{B}* (for short: (Σ, \mathbf{B}) -wrtg, or: wrtg) is a (Σ^Ξ, \mathbf{B}) -wcfg $\mathcal{G} = (N, S, R, wt)$ where each rule in R has the form $A \rightarrow \xi$ with $\xi \in T_\Sigma(N)$. Obviously, \mathcal{G} is ε -free because $\varepsilon \notin T_\Sigma(N)$. Also here we sometimes want to show the occurrences of elements of N in the right-hand side of a rule more explicitly. Then we will write a rule in the form

$$A \rightarrow \xi[A_1, \dots, A_k] ,$$

where $k \in \mathbb{N}$, $\xi \in C_\Sigma(Z_k)$, and $A_1, \dots, A_k \in N$ and $\xi[A_1, \dots, A_k]$ denotes the tree obtained from ξ by replacing each occurrence of z_i by ξ_i (cf. “Contexts and substitution” on page 57).

Let $\mathcal{G} = (N, S, R, wt)$ be a (Σ, \mathbf{B}) -wrtg. We recall that we considered R as ranked alphabet (where the rank of a rule is the number of nonterminal occurrences in its right-hand side) and that the projection of \mathcal{G} has the type $\pi_{\mathcal{G}} : T_R \rightarrow (\Sigma^\Xi)^*$. Due to the special form of the rules, we have $\text{im}(\pi_{\mathcal{G}}) \subseteq T_\Sigma$, and thus we can view $\pi_{\mathcal{G}}$ as mapping of type

$$\pi_{\mathcal{G}} : T_R \rightarrow T_\Sigma ,$$

and hence $\text{RT}_{\mathcal{G}} = \text{RT}_{\mathcal{G}}(T_\Sigma)$. Moreover, it is easy to see that $\pi_{\mathcal{G}}$ is determined by the (R, Σ) -tree homomorphism $\pi_{\mathcal{G}} = ((\pi_{\mathcal{G}})_k \mid k \in \mathbb{N})$ defined, for every $k \in \mathbb{N}$ and $r \in R^{(k)}$ of the form $r = (A \rightarrow \xi[A_1, \dots, A_k])$, by $(\pi_{\mathcal{G}})_k(r) = \xi$.

By Observation 8.2.2 and since \mathcal{G} is ε -free, if \mathcal{G} is chain-free, then it is finite-derivational.

If \mathcal{G} is finite-derivational or \mathbf{B} is σ -complete, then the *weighted tree language generated by \mathcal{G}* , denoted by $[[\mathcal{G}]^t]$, is the mapping $[[\mathcal{G}]^t] : T_\Sigma \rightarrow B$ defined for each $\xi \in T_\Sigma$ by

$$[[\mathcal{G}]^t](\xi) = [[\mathcal{G}]^s](\xi) .$$

Hence $[[\mathcal{G}]^t] = [[\mathcal{G}]^s]|_{T_\Sigma}$ and for each $\xi \in T_\Sigma$, using (8.2), we have

$$[[\mathcal{G}]^t](\xi) = \sum_{d \in \text{RT}_{\mathcal{G}}(\xi)}^{\oplus} \text{wt}_{\mathcal{G}}(d) .$$

Let r be a (Σ, \mathbf{B}) -weighted tree language. It is called *regular* if there exists a (Σ, \mathbf{B}) -wrtg \mathcal{G} which is finite-derivational if \mathbf{B} is not σ -complete and for which $r = [[\mathcal{G}]^t]$.

Since in this book we will use $[[\mathcal{G}]^t]$ many times, we make the following convention.

In the rest of this book, for each wrtg \mathcal{G} , we will abbreviate $[[\mathcal{G}]^t]$ by $[[\mathcal{G}]]$.

We denote by (i) $\text{Reg}_{\text{nc}}(\Sigma, \mathbf{B})$, (ii) $\text{Reg}_{\text{fd}}(\Sigma, \mathbf{B})$, and (iii) $\text{Reg}(\Sigma, \mathbf{B})$ the sets of (Σ, \mathbf{B}) -weighted tree languages which can be generated by

- (i) chain-free (Σ, \mathbf{B}) -wrtg
- (ii) finite-derivational (Σ, \mathbf{B}) -wrtg, and
- (iii) (Σ, \mathbf{B}) -wrtg which are finite-derivational if \mathbf{B} is not σ -complete, respectively.

Then $\text{Reg}_{\text{nc}}(\Sigma, \mathbf{B}) \subseteq \text{Reg}_{\text{fd}}(\Sigma, \mathbf{B}) \subseteq \text{Reg}(\Sigma, \mathbf{B})$; moreover, $\text{Reg}_{\text{fd}}(\Sigma, \mathbf{B}) = \text{Reg}(\Sigma, \mathbf{B})$ if \mathbf{B} is not σ -complete.

Example 9.1.1. We consider the ranked alphabet $\Sigma = \{\sigma^{(2)}, \gamma^{(1)}, \alpha^{(0)}\}$ and the set of trees $U \subset T_\Sigma$ such that each tree $\xi \in U$ has an upper part, which only contains σ -labeled positions, and a number of lower parts, which only contain γ - and α -labeled positions. Formally,

$$U = \{\zeta[\zeta_1, \dots, \zeta_n] \mid n \in \mathbb{N}, \zeta \in C_\Sigma(Z_n), \text{pos}_{\{\gamma, \alpha\}}(\zeta) = \emptyset, \text{ and } \zeta_1, \dots, \zeta_n \in T_{\{\gamma, \alpha\}}\} .$$

Let $\xi \in U$. There are unique n , ζ , and ζ_1, \dots, ζ_n such that $\xi = \zeta[\zeta_1, \dots, \zeta_n]$. Then ζ is the upper part of ξ and ζ_1, \dots, ζ_n are the lower parts of ξ . We denote by $\text{bor}(\xi)$ the set of positions of ξ which are at the border between the upper part and the lower parts, i.e., $\text{bor}(\xi) = \text{pos}_Z(\zeta)$.

Now we wish to determine, for each $\xi \in U$, the minimal height of a lower part of ξ . For this we consider the tropical semiring $\text{Nat}_{\text{min},+} = (\mathbb{N}_\infty, \min, +, \infty, 0)$ and the mapping $f : T_\Sigma \rightarrow \mathbb{N}_\infty$ defined for each $\xi \in T_\Sigma$ by

$$f(\xi) = \begin{cases} \min(\text{height}(\xi|_w) \mid w \in \text{bor}(\xi)) & \text{if } \xi \in U \\ \infty & \text{otherwise} . \end{cases}$$

We will show that f is a regular $(\Sigma, \text{Nat}_{\text{min},+})$ -weighted tree language. For this we construct the following $(\Sigma, \text{Nat}_{\text{min},+})$ -wrtg $\mathcal{G} = (N, \{S\}, R, \text{wt})$ with $N = \{S, A, B, C, D\}$ and the following rules and weights:

$$\begin{aligned} S &\rightarrow \sigma(A, S) : 0, & S &\rightarrow \sigma(S, A) : 0, & S &\rightarrow B : 0, \\ A &\rightarrow \sigma(A, A) : 0, & A &\rightarrow C : 0, \\ B &\rightarrow \gamma(B) : 1, & B &\rightarrow \alpha : 0, \\ C &\rightarrow \gamma(C) : 0, & C &\rightarrow \alpha : 0. \end{aligned}$$

We note that \mathcal{G} contains two chain-rules. However \mathcal{G} is finite-derivational because of the following. For each $\xi \in U$, there exists a bijection between the sets $\text{RT}_{\mathcal{G}}(\xi)$ and $\text{bor}(\xi)$ (in particular, based on Σ , we can reconstruct from the set $\text{bor}(\xi)$ of positions the tree ξ). Thus $|\text{RT}_{\mathcal{G}}(\xi)| = |\text{bor}(\xi)|$ for each $\xi \in U$, and $|\text{RT}_{\mathcal{G}}(\xi)| = \emptyset$ for each $\xi \in T_\Sigma \setminus U$. Hence \mathcal{G} is finite-derivational. Moreover, it is easy to see that $\text{supp}([[\mathcal{G}]]) = U$.

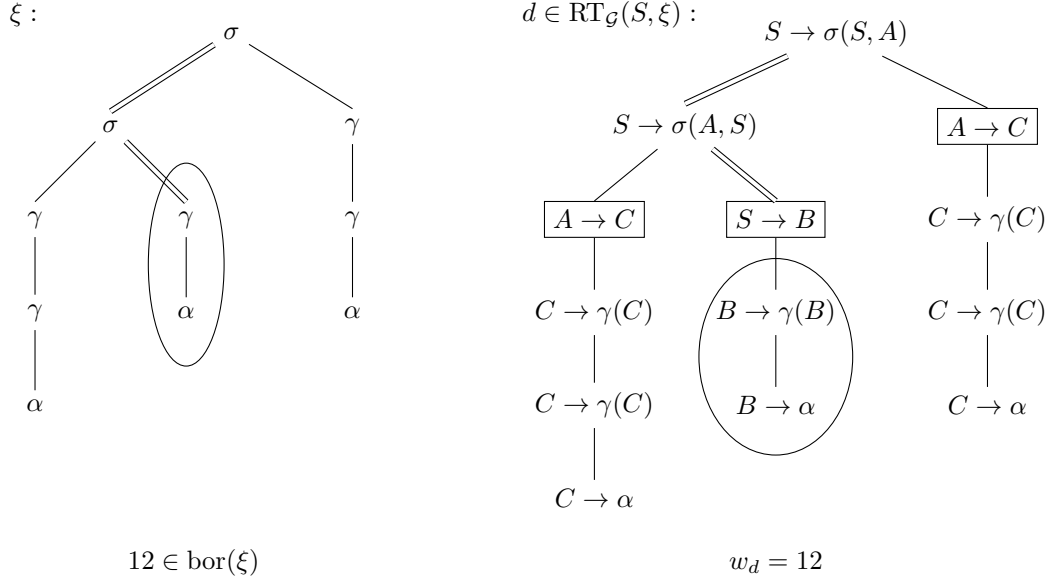

Figure 9.1: An illustration of a rule tree $d \in \text{RT}_{\mathcal{G}}(\xi)$ for some $\xi \in U$.

Now let $\xi \in U$. Then, for every $d \in \text{RT}_{\mathcal{G}}(\xi)$, there exists a unique position $w \in \text{pos}(d)$ such that $d(w) = (S \rightarrow B)$ and $w \in \text{bor}(\xi)$ (i.e., $\xi|_w$ is a lower part of ξ); this is due to the form of the S -rules. Let us denote this unique position by w_d . Vice versa, for each $w \in \text{bor}(\xi)$, there exists a $d \in \text{RT}_{\mathcal{G}}(\xi)$ such that $d(w) = (S \rightarrow B)$. Let us denote this d by d_w . Clearly, $w_{d_w} = w$. We refer to Figure 9.1 for an illustration.

It is clear that, for each $d \in \text{RT}_{\mathcal{G}}(B, T_{\{\gamma, \alpha\}})$ we have $\text{wt}_{\mathcal{G}}(d) = \text{height}(\pi_{\mathcal{G}}(d))$. Moreover, for each $d \in \text{RT}_{\mathcal{G}}(C, T_{\{\gamma, \alpha\}})$ we have $\text{wt}_{\mathcal{G}}(d) = 0$. Since each of the rules

$$\begin{array}{l} S \rightarrow \sigma(A, S) \quad S \rightarrow \sigma(S, A) \quad S \rightarrow B \\ A \rightarrow \sigma(A, A) \quad A \rightarrow C \end{array}$$

has weight 0, we obtain the following:

$$\text{for each } d \in \text{RT}_{\mathcal{G}}(\xi) \text{ we have } \text{wt}_{\mathcal{G}}(d) = \text{height}(\xi|_{w_d}) . \tag{9.1}$$

Then we have

$$\begin{aligned} \llbracket \mathcal{G} \rrbracket(\xi) &= \sum_{d \in \text{RT}_{\mathcal{G}}(S, \xi)}^{\min} \text{wt}_{\mathcal{G}}(d) = \min(\text{wt}_{\mathcal{G}}(d) \mid d \in \text{RT}_{\mathcal{G}}(\xi)) \\ &= \min(\text{wt}_{\mathcal{G}}(d_w) \mid w \in \text{bor}(\xi)) \\ &= \min(\text{height}(\xi|_w) \mid w \in \text{bor}(\xi)) && \text{(by (9.1))} \\ &= f(\xi) . && \square \end{aligned}$$

Lemma 9.1.2. For every (Σ, B) -wrtg \mathcal{G} it is decidable whether \mathcal{G} is finite-derivational.

Proof. Let $\mathcal{G} = (N, S, R, wt)$ be a (Σ, B) -wrtg. By standard methods, we can decide whether there exists a $\xi \in T_{\Sigma}$ such that $\text{RT}_{\mathcal{G}}(\xi) \neq \emptyset$. If for every $\xi \in T_{\Sigma}$ we have $\text{RT}_{\mathcal{G}}(\xi) = \emptyset$, then \mathcal{G} is finite-derivational.

Now let us assume that there exists a $\xi \in T_{\Sigma}$ with $\text{RT}_{\mathcal{G}}(\xi) \neq \emptyset$. The idea is to transform \mathcal{G} into a context-free grammar and to apply the construction in the proof of Theorem 2.14.1 for reducing that context-free grammar. In fact, we view each tree $\xi \in T_{\Sigma}(N)$ as a string over the alphabet $\Sigma^{\equiv} \cup N$.

Formally, we construct the Σ^{Ξ} -cfg $G = (N \cup \{S_0\}, S_0, P)$, where S_0 is a new nonterminal and $P = R \cup \{S_0 \rightarrow A \mid A \in S\}$. (We note that G is not the context-free grammar associated to \mathcal{G} in the sense of Chapter 8.) Then $L(G) \subseteq T_{\Sigma}$ and, due to our assumption on \mathcal{G} , we have $L(G) \neq \emptyset$.

Then we apply the construction (cf. Theorem 2.14.1) to obtain a reduced Σ^{Ξ} -cfg $G' = (N', S_0, P')$ such that G' and G are equivalent. Since G' is reduced, each nonterminal in N' occurs in some rule tree $d \in RT_{G'}(S_0, \Delta^*)$.

Due to the construction, we have that $N' \subseteq N$ and $P' \subseteq P$. Then we construct the (Σ, \mathbf{B}) -wrtg $\mathcal{G}' = (N', S', R', wt')$, where $S' = S \cap N'$, $R' = P' \setminus \{S_0 \rightarrow A \mid A \in S'\}$ (hence $R' \subseteq R$), and $wt' = wt|_{R'}$. Since G' is reduced, the following property holds for \mathcal{G}' :

$$\text{for each } A \in N' \text{ there exist } \xi \in T_{\Sigma} \text{ and } d \in RT_{\mathcal{G}'}(\xi) \text{ such that } A \text{ occurs in } d. \quad (9.2)$$

Moreover, $RT_{\mathcal{G}'}(\xi) = RT_{\mathcal{G}}(\xi)$ for each $\xi \in T_{\Sigma}$. Thus \mathcal{G}' is equivalent to \mathcal{G} , and \mathcal{G}' is finite-derivational iff \mathcal{G} is finite-derivational.

Since \mathcal{G}' satisfies (9.2) and it is ε -free, it is finite-derivational iff there do not exist $n \in \mathbb{N}_+$ and a sequence $A_1 \rightarrow A_2, \dots, A_{n-1} \rightarrow A_n$ of chain rules of \mathcal{G}' such that $A_1 = A_n$. This latter property of \mathcal{G}' is decidable by a standard algorithm on finite graphs [War62]. \square

9.2 Normal forms of wrtg

Since each (Σ, \mathbf{B}) -wrtg \mathcal{G} is a particular $(\Sigma^{\Xi}, \mathbf{B})$ -wcfg, we can apply the normal form lemmas proved in Chapter 8 also to \mathcal{G} . Then it is a question whether the wcfg \mathcal{G}' constructed in the proof of such a lemma is a wrtg or not. Next we tailor those lemmas for wrtg for which the answer to the question is positive.

Lemma 9.2.1. Let \mathcal{G} be a (Σ, \mathbf{B}) -wrtg such that \mathcal{G} is finite-derivational or \mathbf{B} is σ -complete. Then the following three statements hold.

- (1) We can construct a start-separated (Σ, \mathbf{B}) -wrtg \mathcal{G}' such that $\llbracket \mathcal{G} \rrbracket = \llbracket \mathcal{G}' \rrbracket$. The construction preserves the properties finite-derivational and local-reduced. The construction does not preserve the property chain-free.
- (2) We can construct a local-reduced (Σ, \mathbf{B}) -wrtg \mathcal{G}' such that $\llbracket \mathcal{G} \rrbracket = \llbracket \mathcal{G}' \rrbracket$. The construction preserves the properties finite-derivational, start-separated, and chain-free.
- (3) If \mathbf{B} is a semiring, then there exists a chain-free (Σ, \mathbf{B}) -wrtg \mathcal{G}' such that $\llbracket \mathcal{G} \rrbracket = \llbracket \mathcal{G}' \rrbracket$. If \mathcal{G} has one of the properties: start-separated and local-reduced, then also \mathcal{G}' has it. Moreover, if \mathcal{G} is finite-derivational, then we can construct \mathcal{G}' .

Proof. Statement (1) is a corollary of Lemma 8.2.4 because if \mathcal{G} is a wrtg, then the construction in the proof of the lemma yields a wrtg \mathcal{G}' with the properties stated in (1). Similarly, Statements (2) and (3) are corollaries of Lemma 8.2.5 and Theorem 8.2.6, respectively. \square

We continue with the definition of two more restricted forms of wrtg. Let $\mathcal{G} = (N, S, R, wt)$ be a (Σ, \mathbf{B}) -wrtg. We say that \mathcal{G} is

- *alphabetic* if each rule contains at most one occurrence of a symbol in Σ .
- *in tree automata form* if $R = \{A \rightarrow \sigma(A_1, \dots, A_k) \mid k \in \mathbb{N}, \sigma \in \Sigma^{(k)}, A, A_1, \dots, A_k \in N\}$. Thus, there exists a bijection from R to the set $\bigcup_{k \in \mathbb{N}} N \times \Sigma^{(k)} \times N^k$.

Obviously, if \mathcal{G} is in tree automata form, then it is alphabetic and chain-free.

Lemma 9.2.2. (cf. [MW67, Lm. 3.1], [IF75, Thm. 1], and [AB87, Prop. 1.2]) Let \mathcal{G} be a (Σ, \mathbf{B}) -wrtg such that \mathcal{G} is finite-derivational or \mathbf{B} is σ -complete. We can construct a (Σ, \mathbf{B}) -wrtg \mathcal{G}' such that \mathcal{G}' is alphabetic and $\llbracket \mathcal{G}' \rrbracket = \llbracket \mathcal{G} \rrbracket$. The construction preserves the properties finite-derivational, start-separated, chain-free, and local-reduced.

Proof. As preparation, we define a measurement for the degree of “how much” a (Σ, \mathbf{B}) -wrtg does not match the condition of being alphabetic. Formally, let $\mathcal{G} = (N, S, R, wt)$ be a (Σ, \mathbf{B}) -wrtg. We define, for each rule $r = (A \rightarrow \xi)$, the *degree* $\deg(r)$ of r by

$$\deg(r) = \begin{cases} 0 & \text{if } r \text{ is a chain-rule} \\ |\text{pos}_\Sigma(\xi)| - 1 & \text{otherwise,} \end{cases}$$

and we define the *degree* $\deg(\mathcal{G})$ of \mathcal{G} by $\deg(\mathcal{G}) = \sum_{r \in R} \deg(r)$. Then the following equivalence holds: $\deg(\mathcal{G}) = 0$ iff each rule of \mathcal{G} contains at most one occurrence of a symbol in Σ (i.e., \mathcal{G} is alphabetic).

Next we consider a reduction system where its reduction transforms a given wrtg into an equivalent one with a lower degree. Formally, we consider the reduction system $(\text{WRTG}(\Sigma, \mathbf{B}), \succ)$ where $\text{WRTG}(\Sigma, \mathbf{B})$ denotes the set of all (Σ, \mathbf{B}) -wrtg and, for every $\mathcal{G}_1 = (N_1, S_1, R_1, wt_1)$ and $\mathcal{G}_2 = (N_2, S_2, R_2, wt_2)$ in $\text{WRTG}(\Sigma, \mathbf{B})$, we let $\mathcal{G}_1 \succ \mathcal{G}_2$ if

- there exists a rule $r = (A \rightarrow \sigma(\xi_1, \dots, \xi_{i-1}, \xi_i, \xi_{i+1}, \dots, \xi_k))$ in R_1 and
- there exists $i \in [k]$ such that $\xi_i \notin N_1$

such that $N_2 = N_1 \cup \{[\xi_i]\}$, $S_2 = S_1$, $R_2 = (R_1 \setminus \{r\}) \cup \{r_1, r_2\}$ where

$$r_1 = (A \rightarrow \sigma(\xi_1, \dots, \xi_{i-1}, [\xi_i], \xi_{i+1}, \dots, \xi_k)) \quad \text{and} \quad r_2 = ([\xi_i] \rightarrow \xi_i) ,$$

and, for each $r' \in R_2$, we let

$$wt_2(r') = \begin{cases} wt_1(r') & \text{if } r' \in R_1 \setminus \{r\} \\ wt_1(r') & \text{if } r' = r_1 \\ \mathbb{1} & \text{if } r' = r_2 . \end{cases}$$

(This generalizes the construction in [GS84, Lm. 2.3.4] and [Eng75b, Thm. 3.22].) Obviously, if $\deg(\mathcal{G}_1) > 0$, then we can construct a \mathcal{G}_2 such that $\mathcal{G}_1 \succ \mathcal{G}_2$. In this case $\llbracket \mathcal{G}_1 \rrbracket = \llbracket \mathcal{G}_2 \rrbracket$ and if \mathcal{G}_1 is finite-derivational, start-separated, chain-free, or local-reduced, then so is \mathcal{G}_2 .

Next we show that \succ is terminating. For this, we observe that if $\mathcal{G}_1 \succ \mathcal{G}_2$, then $\deg(\mathcal{G}_1) \succ_{\mathbb{N}} \deg(\mathcal{G}_2)$, because $\deg(\mathcal{G}_2) = \deg(\mathcal{G}_1) - 1$. Hence, \deg is a monotone embedding of $(\text{WRTG}(\Sigma, \mathbf{B}), \succ)$ into the terminating reduction system $(\mathbb{N}, \succ_{\mathbb{N}})$ (cf. Section 2.5). Thus, by Lemma 2.5.2, the relation \succ is terminating. Moreover, we have

$$\text{nf}_\succ(\text{WRTG}(\Sigma, \mathbf{B})) = \{\mathcal{G} \in \text{WRTG}(\Sigma, \mathbf{B}) \mid \mathcal{G} \text{ is alphabetic}\} .$$

Now let \mathcal{G} be an arbitrary (Σ, \mathbf{B}) -wrtg. We construct an arbitrary element \mathcal{G}' of $\text{nf}_\succ(\mathcal{G})$. Then $\llbracket \mathcal{G}' \rrbracket = \llbracket \mathcal{G} \rrbracket$ and \mathcal{G}' is alphabetic. \square

Next we relate wrtg with wta.

Lemma 9.2.3. Let Σ be a ranked alphabet. Moreover, let \mathbf{B} be a strong bimonoid and let \mathcal{G} be a (Σ, \mathbf{B}) -wrtg. If (a) \mathcal{G} is chain-free or (b) \mathbf{B} is a semiring and \mathcal{G} is finite-derivational or (c) \mathbf{B} is a σ -complete semiring, then there exists a (Σ, \mathbf{B}) -wrtg \mathcal{G}' such that \mathcal{G}' is in tree automata form and $\llbracket \mathcal{G}' \rrbracket = \llbracket \mathcal{G} \rrbracket$. In Cases (a) and (b) we can even construct \mathcal{G}' .

Proof. Let $\mathcal{G} = (N, S, R, wt)$. In Case (a), by Lemma 9.2.2 we can construct an alphabetic and chain-free (Σ, \mathbf{B}) -wrtg which is equivalent to \mathcal{G} ; thus we can assume that \mathcal{G} is alphabetic and chain-free.

In Cases (b) and (c), by Lemma 9.2.1(3), there exists a chain-free (Σ, \mathbf{B}) -wrtg which is equivalent to \mathcal{G} . Then, by Lemma 9.2.2, there exists an alphabetic and chain-free (Σ, \mathbf{B}) -wrtg which is equivalent to \mathcal{G} . Moreover, in Case (b) we can even assume that \mathcal{G} is alphabetic and chain-free, because then Lemma 9.2.1(3) is constructive.

Next we complete the set R of rules by adding rules with weight 0 . Formally, we construct the (Σ, \mathbf{B}) -wrtg $\mathcal{G}' = (N, S, R', wt')$ such that R' is the set of all rules $r = (A \rightarrow \sigma(A_1, \dots, A_k))$ with $k \in \mathbb{N}$, $\sigma \in \Sigma^{(k)}$, and $A, A_1, \dots, A_k \in N$. Moreover, for each $r \in R'$ we let $wt'(r) = wt(r)$ if $r \in R$, and $wt'(r) = 0$ otherwise. Clearly, \mathcal{G}' is in tree automata form and $\llbracket \mathcal{G}' \rrbracket = \llbracket \mathcal{G} \rrbracket$. \square

Let $\mathcal{A} = (Q, \delta, F)$ be a (Σ, \mathbf{B}) -wta with identity root weights and $\mathcal{G} = (N, S, R, wt)$ be a (Σ, \mathbf{B}) -wrtg in tree automata form. We call \mathcal{A} and \mathcal{G} *related* if $Q = N$, for each $q \in Q$ we have $F_q = \mathbb{1}$ if and only if $q \in S$, and

$$\delta_k(q_1 \cdots q_k, \sigma, q) = wt(q \rightarrow \sigma(q_1, \dots, q_k))$$

for every $k \in \mathbb{N}$, $\sigma \in \Sigma^{(k)}$, $q \in Q$, and $q_1 \cdots q_k \in Q^k$. We note that, if $q \notin S$, then $F_q = 0$ because \mathcal{A} has identity root weights. Moreover, if \mathcal{A} and \mathcal{G} are related, then \mathcal{A} is local-trim iff \mathcal{G} is reduced.

Example 9.2.4. We give an example of a wta and a wrtg which are related. As wta, we choose the root weight normalized (Σ, \mathbf{Nat}) -wta $\mathcal{A} = (Q, \delta, F)$ of Example 3.2.11, which we recall here:

- $\Sigma = \{\sigma^{(2)}, \gamma^{(1)}, \alpha^{(0)}\}$,
- $Q = \{\perp, a, f\}$ and $F_\perp = F_a = 0$ and $F_f = 1$,
- for every $q_1, q_2, q \in Q$ we define

$$\delta_0(\varepsilon, \alpha, q) = \begin{cases} 1 & \text{if } q \in \{\perp, a\} \\ 0 & \text{otherwise} \end{cases} \quad \delta_1(q_1, \gamma, q) = \begin{cases} 1 & \text{if } q_1 q \in \{\perp\perp, ff\} \\ 0 & \text{otherwise} \end{cases}$$

$$\delta_2(q_1 q_2, \sigma, q) = \begin{cases} 1 & \text{if } q_1 q_2 q \in \{\perp\perp\perp, \perp af, \perp ff, f\perp f\} \\ 0 & \text{otherwise} \end{cases} .$$

The (Σ, \mathbf{Nat}) -wrtg $\mathcal{G} = (Q, f, R, wt)$ in tree automata form which is related to \mathcal{A} is defined by:

- $R = \{q \rightarrow \theta(q_1, \dots, q_k) \mid k \in \mathbb{N}, \theta \in \Sigma^{(k)}, q, q_1, \dots, q_k \in Q\}$ and
- for every $q_1, q_2, q \in Q$

$$wt(q \rightarrow \alpha) = \begin{cases} 1 & \text{if } q \in \{\perp, a\} \\ 0 & \text{otherwise} \end{cases} \quad wt(q \rightarrow \gamma(q_1)) = \begin{cases} 1 & \text{if } q_1 q \in \{\perp\perp, ff\} \\ 0 & \text{otherwise} \end{cases}$$

$$wt(q \rightarrow \sigma(q_1, q_2)) = \begin{cases} 1 & \text{if } q_1 q_2 q \in \{\perp\perp\perp, \perp af, \perp ff, f\perp f\} \\ 0 & \text{otherwise} \end{cases} .$$

\square

Lemma 9.2.5. Let Σ be a ranked alphabet. Moreover, let \mathbf{B} be a strong bimonoid, let \mathcal{A} be a (Σ, \mathbf{B}) -wta with identity root weights, and let \mathcal{G} be a (Σ, \mathbf{B}) -wrtg in tree automata form. If \mathcal{A} and \mathcal{G} are related, then $\llbracket \mathcal{A} \rrbracket^{\text{run}} = \llbracket \mathcal{G} \rrbracket$.

Proof. Let $\mathcal{A} = (Q, \delta, F)$ and $\mathcal{G} = (N, S, R, wt)$. Since \mathcal{G} is in tree automata form, we have $\text{pos}(d) = \text{pos}(\xi)$ for every $\xi \in \mathbf{T}_\Sigma$ and $d \in \text{RT}_{\mathcal{G}}(\xi)$. Moreover, since \mathcal{A} and \mathcal{G} are related, there exists a one-to-one correspondence between (a) the rules tree of \mathcal{G} and (b) pairs of Σ -trees and runs on them.

For the formalization we recall the set TR defined in Section 3.1 on p. 75. We have $\text{TR} = \{(\xi, \rho) \mid \xi \in \mathbf{T}_\Sigma, \rho \in \mathbf{R}_{\mathcal{A}}(\xi)\}$. Then we define the mapping $\varphi : \text{RT}_{\mathcal{G}}(N, \mathbf{T}_\Sigma) \rightarrow \text{TR}$ such that, for every $A \in N$, $\xi \in \mathbf{T}_\Sigma$, and $d \in \text{RT}_{\mathcal{G}}(A, \xi)$, we let

$$\varphi(d) = (\xi, \rho)$$

where, for each $w \in \text{pos}(\xi)$, we let $\rho(w) = \text{lhs}(d(w))$ (cf. Figure 9.2). Hence, $\rho \in \mathbf{R}_{\mathcal{A}}(A, \xi)$. Since \mathcal{A} and \mathcal{G} are related, φ is bijective.

Next we will prove a relationship between the weights of rule trees of \mathcal{G} and weights of runs of \mathcal{A} that are related by φ . For this we use the reduction system $(\text{RT}_{\mathcal{G}}(N, \mathbf{T}_\Sigma), \succ)$, where we let

$$\succ = \succ_R \cap (\text{RT}_{\mathcal{G}}(N, \mathbf{T}_\Sigma) \times \text{RT}_{\mathcal{G}}(N, \mathbf{T}_\Sigma)) .$$

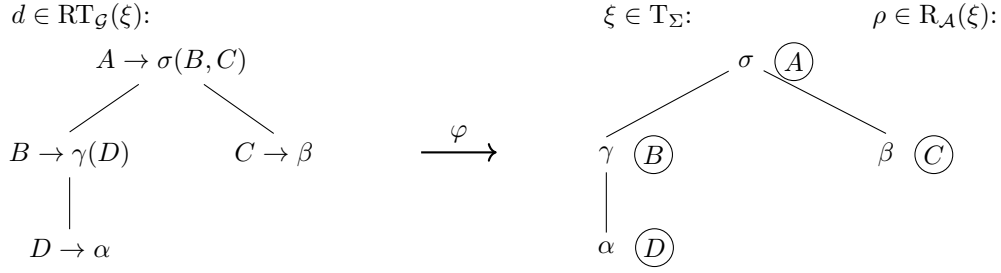

Figure 9.2: A visualization of $\varphi(d) = (\xi, \rho)$ in the proof of Lemma 9.2.5 with $\xi = \sigma(\gamma(\alpha), \beta)$, $d \in \text{RT}_{\mathcal{G}}(\xi)$, and $\rho \in \text{R}_{\mathcal{A}}(A, \xi)$. The states of ρ are circled.

Since \succ_R is terminating, by Lemma 2.5.3 also \succ is terminating and $\text{nf}_{\succ}(\text{RT}_{\mathcal{G}}(N, \text{T}_{\Sigma}))$ is the set of terminal rules of R , which is not empty. Then, by induction on $(\text{RT}_{\mathcal{G}}(N, \text{T}_{\Sigma}), \succ)$, we prove that the following statement holds:

$$\text{For each } d \in \text{RT}_{\mathcal{G}}(N, \text{T}_{\Sigma}), \text{ we have: } \text{wt}_{\mathcal{G}}(d) = \text{wt}_{\mathcal{A}}(\varphi(d)) . \quad (9.3)$$

Let $d \in \text{RT}_{\mathcal{G}}(N, \text{T}_{\Sigma})$, i.e., $d \in \text{RT}_{\mathcal{G}}(A, \xi)$ for some $A \in N$ and $\xi = \sigma(\xi_1, \dots, \xi_k)$. Since $\text{pos}(\xi) = \text{pos}(d)$, there exists a rule $r = (A \rightarrow \sigma(B_1 \dots, B_k))$ in R and for each $i \in [k]$ there exists a rule tree $d_i \in \text{RT}_{\mathcal{G}}(B_i, \xi_i)$ such that $d = r(d_1, \dots, d_k)$. Then

$$\begin{aligned} \text{wt}_{\mathcal{G}}(d) &= \bigotimes_{i \in [k]} \text{wt}_{\mathcal{G}}(d_i) \otimes \text{wt}(A \rightarrow \sigma(B_1 \dots, B_k)) && \text{(by (8.1))} \\ &= \bigotimes_{i \in [k]} \text{wt}_{\mathcal{A}}(\varphi(d_i)) \otimes \delta_k(B_1 \cdots B_k, \sigma, A) && \text{(by I.H. and definition of related)} \\ &= \text{wt}_{\mathcal{A}}(\varphi(d)) . && \text{(by definition of } \varphi \text{ and (3.1))} \end{aligned}$$

This proves (9.3).

Let $\xi \in \text{T}_{\Sigma}$. Then

$$\begin{aligned} \llbracket \mathcal{A} \rrbracket^{\text{run}}(\xi) &= \bigoplus_{\rho \in \text{R}_{\mathcal{A}}(\xi)} \text{wt}_{\mathcal{A}}(\xi, \rho) \otimes F_{\rho(\varepsilon)} \\ &= \bigoplus_{A \in S} \bigoplus_{\rho \in \text{R}_{\mathcal{A}}(A, \xi)} \text{wt}_{\mathcal{A}}(\xi, \rho) \quad \text{(because } \mathcal{A} \text{ has identity root weights and } F_A = \mathbb{1} \text{ iff } A \in S) \\ &= \bigoplus_{A \in S} \bigoplus_{d \in \text{RT}_{\mathcal{G}}(A, \xi)} \text{wt}_{\mathcal{A}}(\xi, \varphi(d)) \\ &\quad \text{(because } \varphi \text{ is a bijection and } \varphi(\text{RT}_{\mathcal{G}}(A, \xi)) = \text{R}_{\mathcal{A}}(A, \xi) \text{ for each } A \in S) \\ &= \bigoplus_{A \in S} \bigoplus_{d \in \text{RT}_{\mathcal{G}}(A, \xi)} \text{wt}_{\mathcal{G}}(d) \quad \text{(by Equation (9.3))} \\ &= \llbracket \mathcal{G} \rrbracket(\xi) . \quad \square \end{aligned}$$

Lemma 9.2.6. For each (Σ, \mathcal{B}) -wta \mathcal{A} , we can construct a (Σ, \mathcal{B}) -wrtg \mathcal{G} such that \mathcal{G} is in tree automata form and $\llbracket \mathcal{A} \rrbracket^{\text{run}} = \llbracket \mathcal{G} \rrbracket$.

Proof. By Theorem 7.3.1, we can construct a root weight normalized (Σ, \mathcal{B}) -wta \mathcal{A}' such that $\llbracket \mathcal{A} \rrbracket^{\text{run}} = \llbracket \mathcal{A}' \rrbracket^{\text{run}}$. Thus, in particular, \mathcal{A}' has identity root weights. It is obvious how to construct the (Σ, \mathcal{B}) -wrtg \mathcal{G} in tree automata form such that \mathcal{A}' and \mathcal{G} are related. By Lemma 9.2.5, we have $\llbracket \mathcal{A}' \rrbracket^{\text{run}} = \llbracket \mathcal{G} \rrbracket$. \square

Corollary 9.2.7. Each r-recognizable (Σ, \mathcal{B}) -weighted tree language is a $(\Sigma^{\exists}, \mathcal{B})$ -weighted context-free language.

Proof. By Lemma 9.2.6, for each (Σ, \mathbf{B}) -wta \mathcal{A} we can construct a (Σ, \mathbf{B}) -wrtg \mathcal{G} such that \mathcal{G} is in tree automata form and $\llbracket \mathcal{A} \rrbracket^{\text{run}} = \llbracket \mathcal{G} \rrbracket$. Since \mathcal{G} is a particular $(\Sigma^{\Xi}, \mathbf{B})$ -wcfg, we obtain the result. \square

Lemma 9.2.8. Let \mathcal{G} be a (Σ, \mathbf{B}) -wrtg. If (a) \mathcal{G} is chain-free or (b) \mathbf{B} is a semiring and \mathcal{G} is finite-derivational or (c) \mathbf{B} is a σ -complete semiring, then there exists a (Σ, \mathbf{B}) -wta \mathcal{A} such that $\llbracket \mathcal{G} \rrbracket = \llbracket \mathcal{A} \rrbracket^{\text{run}}$. In Cases (a) and (b) we can even construct \mathcal{A} .

Proof. By Lemma 9.2.3, in each of the Cases (a), (b), and (c) there exists a (Σ, \mathbf{B}) -wrtg \mathcal{G}' in tree automata form such that $\llbracket \mathcal{G}' \rrbracket = \llbracket \mathcal{G} \rrbracket$. In Cases (a) and (b) we can even construct \mathcal{G}' . Then, it is obvious how to construct a (Σ, \mathbf{B}) -wta \mathcal{A} with identity root weights such that \mathcal{A} and \mathcal{G}' are related. Finally, by Lemma 9.2.5, we have $\llbracket \mathcal{G}' \rrbracket = \llbracket \mathcal{A} \rrbracket^{\text{run}}$. \square

Now we can prove the equivalence of (Σ, \mathbf{B}) -wta and chain-free (Σ, \mathbf{B}) -wrtg. For the case that \mathbf{B} is the Boolean semiring, this is [GS84, Thm. 2.3.6] and [Eng75b, Thm. 3.25].

Theorem 9.2.9. Let Σ be a ranked alphabet. Moreover, let \mathbf{B} be a strong bimonoid. Then the following two statements hold.

- (1) $\text{Reg}_{\text{nc}}(\Sigma, \mathbf{B}) = \text{Rec}^{\text{run}}(\Sigma, \mathbf{B})$.
- (2) If \mathbf{B} is a semiring, then $\text{Reg}(\Sigma, \mathbf{B}) = \text{Rec}(\Sigma, \mathbf{B})$.

Proof. First we prove the inclusions from left to right. In Statement (1), the inclusion follows from Lemma 9.2.8(a). In Statement (2), if \mathbf{B} is not σ -complete, then $\text{Reg}(\Sigma, \mathbf{B}) = \text{Reg}_{\text{fd}}(\Sigma, \mathbf{B})$, hence the inclusion follows from Lemma 9.2.8(b). In Statement (2), if \mathbf{B} is σ -complete, then it follows from Lemma 9.2.8(c). The inclusions from right to left follow from Lemma 9.2.6 and the fact that, if a wrtg is in tree automata form, then it is both chain-free and finite-derivational. \square

Finally, we mention that, for every (Σ, \mathbf{B}) -wta \mathcal{A} with identity root weights and (Σ, \mathbf{B}) -wrtg \mathcal{G} in tree automata form, if \mathcal{A} and \mathcal{G} are related, then the following equivalence holds:

$$\mathcal{A} \text{ is local-trim} \quad \text{iff} \quad \mathcal{G} \text{ is local-reduced.}$$

The following result generalizes [IF75, Thm. 2] (also cf. [Eng75b, Thm. 3.57] and [GS84, Thm. 3.2.2] for the unweighted case). It says that the weighted rule tree language of each wcfg is a regular weighted tree language. In Lemma 11.2.2 we will prove that each such weighted rule tree language can be determined by some weighted local system.

Theorem 9.2.10. Let Γ be an alphabet and \mathbf{B} a strong bimonoid. Let Γ be an alphabet and \mathbf{B} a strong bimonoid. For each (Γ, \mathbf{B}) -wcfg \mathcal{G} with rule set R , we can construct an (R, \mathbf{B}) -wrtg \mathcal{G}' such that $\llbracket \mathcal{G}' \rrbracket = \llbracket \mathcal{G} \rrbracket^{\text{wrt}}$.

Proof. Let $\mathcal{G} = (N, S, R, \text{wt})$. We consider R as ranked alphabet such that, for each $r \in R$, the rank of r is the number of nonterminals in the right-hand side of r .

We construct the (R, \mathbf{B}) -wrtg $\mathcal{G}' = (N, S, R', \text{wt}')$ as follows. If $r = (A \rightarrow u_0 A_1 u_1 \cdots A_k u_k)$ is in R , then $r' = (A \rightarrow r(A_1, \dots, A_k))$ is in R' , and we let $\text{wt}'(r') = \text{wt}(r)$. In the usual way, we also consider R' as ranked alphabet.

Let $\xi \in \text{RT}_{\mathcal{G}}$. We define $d_{\xi} \in \text{RT}_{\mathcal{G}'}$ such that $\text{pos}(d_{\xi}) = \text{pos}(\xi)$ and, for each $w \in \text{pos}(d_{\xi})$, if $\xi(w) = r$ and $r = (A \rightarrow u_0 A_1 u_1 \cdots A_k u_k)$, then we let $d_{\xi}(w) = (A \rightarrow r(A_1, \dots, A_k))$. Obviously, $\text{RT}_{\mathcal{G}'}(\xi) = \{d_{\xi}\}$ and $\text{wt}_{\mathcal{G}'}(d_{\xi}) = \text{wt}_{\mathcal{G}}(\xi)$.

Now let $\xi \in \mathbb{T}_R$. If $\xi \notin \text{RT}_{\mathcal{G}}$, then $\text{RT}_{\mathcal{G}'}(\xi) = \emptyset$ and

$$\llbracket \mathcal{G}' \rrbracket(\xi) = \sum_{d \in \text{RT}_{\mathcal{G}'}(\xi)}^{\oplus} \text{wt}_{\mathcal{G}'}(d) = 0 = (\text{wt}_{\mathcal{G}} \otimes \chi(\text{RT}_{\mathcal{G}}))(\xi) = \llbracket \mathcal{G} \rrbracket^{\text{wrt}}(\xi) .$$

If $\xi \in \text{RT}_{\mathcal{G}}$, then

$$\llbracket \mathcal{G}' \rrbracket(\xi) = \sum_{d \in \text{RT}_{\mathcal{G}'}(\xi)}^{\oplus} \text{wt}_{\mathcal{G}'}(d) = \text{wt}_{\mathcal{G}'}(d_{\xi}) = \text{wt}_{\mathcal{G}}(\xi) = (\text{wt}_{\mathcal{G}} \otimes \chi(\text{RT}_{\mathcal{G}}))(\xi) = \llbracket \mathcal{G} \rrbracket^{\text{wrt}}(\xi) .$$

□

Chapter 10

Closure properties

In this chapter we prove that the set of recognizable weighted tree languages is closed under several operations. For some of the closure results it is technically easier first to prove them in the setting of wrtg and second to instantiate them to wta by using results on the connection between wrtg and wta (cf. Lemmas 9.2.6 and 9.2.8).

Since some of the operations change the ranked alphabet or the strong bimonoid, we define corresponding sets of recognizable weighted tree languages in which these parameters are left open (using the underscore). Formally, we abbreviate by $\text{Rec}^{\text{run}}(_, \mathbf{B})$ the set of all r-recognizable (Σ, \mathbf{B}) -weighted tree languages for some ranked alphabet Σ . Similarly we define the abbreviations $\text{Rec}^{\text{init}}(_, \mathbf{B})$ and $\text{Rec}(_, \mathbf{B})$. Moreover, we abbreviate by $\text{Rec}^{\text{run}}(\Sigma, _)$ the set of all r-recognizable (Σ, \mathbf{B}) -weighted tree language for some strong bimonoid \mathbf{B} . Similarly we define the abbreviations $\text{Rec}^{\text{init}}(\Sigma, _)$ and $\text{Rec}(\Sigma, _)$.

10.1 Closure under sum

In this section we will prove that the sets $\text{Rec}^{\text{run}}(\Sigma, \mathbf{B})$ and $\text{Rec}^{\text{init}}(\Sigma, \mathbf{B})$ are closed under sum. A set \mathcal{L} of \mathbf{B} -weighted tree languages is *closed under sum* if the following holds: for every (Σ, \mathbf{B}) -weighted tree languages r_1 and r_2 , if $r_1, r_2 \in \mathcal{L}$, then $(r_1 \oplus r_2) \in \mathcal{L}$.

Theorem 10.1.1. *Let Σ be a ranked alphabet. Moreover, let $\mathbf{B} = (B, \oplus, \otimes, \mathbb{0}, \mathbb{1})$ be a strong bimonoid and let \mathcal{A}_1 and \mathcal{A}_2 be two (Σ, \mathbf{B}) -wta. Then the following two statements hold.*

- (1) (cf. [Rad10, Lm. 5.1(1)]) *We can construct a (Σ, \mathbf{B}) -wta \mathcal{B} such that $\llbracket \mathcal{B} \rrbracket^{\text{run}} = \llbracket \mathcal{A}_1 \rrbracket^{\text{run}} \oplus \llbracket \mathcal{A}_2 \rrbracket^{\text{run}}$ and $\llbracket \mathcal{B} \rrbracket^{\text{init}} = \llbracket \mathcal{A}_1 \rrbracket^{\text{init}} \oplus \llbracket \mathcal{A}_2 \rrbracket^{\text{init}}$.*
- (2) *If \mathcal{A}_1 and \mathcal{A}_2 are crisp-deterministic, then we can construct a crisp-deterministic (Σ, \mathbf{B}) -wta \mathcal{B} such that $\llbracket \mathcal{B} \rrbracket = \llbracket \mathcal{A}_1 \rrbracket \oplus \llbracket \mathcal{A}_2 \rrbracket$.*

Thus, in particular, the sets $\text{Rec}^{\text{run}}(\Sigma, \mathbf{B})$ and $\text{Rec}^{\text{init}}(\Sigma, \mathbf{B})$ are closed under sum.

Proof. Let $\mathcal{A}_1 = (Q_1, \delta_1, F_1)$ and $\mathcal{A}_2 = (Q_2, \delta_2, F_2)$ such that $Q_1 \cap Q_2 = \emptyset$.

Proof of (1): We construct the (Σ, \mathbf{B}) -wta $\mathcal{B} = (Q, \delta, F)$ as follows:

- $Q = Q_1 \cup Q_2$,
- for every $k \in \mathbb{N}$, $\sigma \in \Sigma^{(k)}$, $q \in Q$, and $q_1 \cdots q_k \in Q^k$ we define

$$\delta_k(q_1 \cdots q_k, \sigma, q) = \begin{cases} (\delta_1)_k(q_1 \cdots q_k, \sigma, q) & \text{if } q_1, \dots, q_k, q \in Q_1 \\ (\delta_2)_k(q_1 \cdots q_k, \sigma, q) & \text{if } q_1, \dots, q_k, q \in Q_2 \\ 0 & \text{otherwise,} \end{cases}$$

- for each $q \in Q$ we define $F_q = (F_1)_q$ if $q \in Q_1$, and $F_q = (F_2)_q$ if $q \in Q_2$.

We prove that $[\mathcal{B}]^{\text{run}} = [\mathcal{A}_1]^{\text{run}} \oplus [\mathcal{A}_2]^{\text{run}}$. Let $\xi \in T_\Sigma$ and $\rho \in R_{\mathcal{B}}(\xi)$. Obviously, $R_{\mathcal{A}_1}(\xi) \cap R_{\mathcal{A}_2}(\xi) = \emptyset$ and $R_{\mathcal{A}_1}(\xi) \cup R_{\mathcal{A}_2}(\xi) \subseteq R_{\mathcal{B}}(\xi)$. Moreover, $\text{wt}_{\mathcal{B}}(\xi, \rho) = \text{wt}_{\mathcal{A}_i}(\xi, \rho)$ if $\rho \in R_{\mathcal{A}_i}(\xi)$ for each $i \in \{1, 2\}$, and $\text{wt}_{\mathcal{B}}(\xi, \rho) = 0$ if $\rho \in R_{\mathcal{B}}(\xi) \setminus (R_{\mathcal{A}_1}(\xi) \cup R_{\mathcal{A}_2}(\xi))$. Thus

$$\begin{aligned} [\mathcal{B}]^{\text{run}}(\xi) &= \bigoplus_{\rho \in R_{\mathcal{B}}(\xi)} \text{wt}_{\mathcal{B}}(\xi, \rho) \otimes F_{\rho(\varepsilon)} \\ &= \bigoplus_{\rho \in R_{\mathcal{A}_1}(\xi)} \text{wt}_{\mathcal{A}_1}(\xi, \rho) \otimes (F_1)_{\rho(\varepsilon)} \oplus \bigoplus_{\rho \in R_{\mathcal{A}_2}(\xi)} \text{wt}_{\mathcal{A}_2}(\xi, \rho) \otimes (F_2)_{\rho(\varepsilon)} \\ &= [\mathcal{A}_1]^{\text{run}}(\xi) \oplus [\mathcal{A}_2]^{\text{run}}(\xi) . \end{aligned}$$

Next we prove $[\mathcal{B}]^{\text{init}} = [\mathcal{A}_1]^{\text{init}} \oplus [\mathcal{A}_2]^{\text{init}}$. Let $\xi \in T_\Sigma$. Obviously, for every $q \in Q$,

$$h_{\mathcal{B}}(\xi)_q = \begin{cases} h_{\mathcal{A}_1}(\xi)_q & \text{if } q \in Q_1 \\ h_{\mathcal{A}_2}(\xi)_q & \text{if } q \in Q_2 . \end{cases}$$

Thus,

$$\begin{aligned} [\mathcal{B}]^{\text{init}}(\xi) &= \bigoplus_{q \in Q} h_{\mathcal{B}}(\xi)_q \otimes F_q = \bigoplus_{q \in Q_1} h_{\mathcal{A}_1}(\xi)_q \otimes (F_1)_q \oplus \bigoplus_{q \in Q_2} h_{\mathcal{A}_2}(\xi)_q \otimes (F_2)_q \\ &= [\mathcal{A}_1]^{\text{init}}(\xi) \oplus [\mathcal{A}_2]^{\text{init}}(\xi) . \end{aligned}$$

Proof of (2): Let \mathcal{A}_1 and \mathcal{A}_2 be crisp-deterministic. We construct the (Σ, \mathbf{B}) wta $\mathcal{B} = (Q, \delta, F)$ as follows:

- $Q = Q_1 \times Q_2$; for each $q \in Q$ we denote its first and second component by q^1 and q^2 , respectively,
- for every $k \in \mathbb{N}$, $\sigma \in \Sigma^{(k)}$, $q \in Q$ and $q_1 \cdots q_k \in Q^k$ we define

$$\delta_k(q_1 \cdots q_k, \sigma, q) = (\delta_1)_k(q_1^1 \cdots q_k^1, \sigma, q^1) \otimes (\delta_2)_k(q_1^2 \cdots q_k^2, \sigma, q^2)$$

- for each $q \in Q$ we define $F_q = (F_1)_{q^1} \oplus (F_2)_{q^2}$.

Obviously, \mathcal{B} is crisp-deterministic.

Let $\xi \in T_\Sigma$ and $i \in \{1, 2\}$. Since \mathcal{A}_i is crisp-deterministic, by Lemma 4.1.5 there exists a state q_ξ^i such that $Q_{\neq 0}^{\mathcal{A}_i}(\xi) = \{q_\xi^i\}$ and $h_{\mathcal{A}_i}(\xi)_{q_\xi^i} = \mathbb{1}$. Then, obviously, $Q_{\neq 0}^{\mathcal{B}}(\xi) = \{(q_\xi^1, q_\xi^2)\}$ and $h_{\mathcal{B}}(\xi)_{(q_\xi^1, q_\xi^2)} = \mathbb{1}$. Then we can calculate as follows:

$$[\mathcal{B}](\xi) = h_{\mathcal{B}}(\xi)_{(q_\xi^1, q_\xi^2)} \otimes F_{(q_\xi^1, q_\xi^2)} = F_{(q_\xi^1, q_\xi^2)} = (F_1)_{q_\xi^1} \oplus (F_2)_{q_\xi^2} = [\mathcal{A}_1](\xi) \oplus [\mathcal{A}_2](\xi) . \quad \square$$

We note that, in the proof of Theorem 10.1.1(1), we cannot use the product construction of the proof of Theorem 10.1.1(2), because that would require the strong bimonoid \mathbf{B} to be commutative. Also, vice versa, in the proof of Theorem 10.1.1(2), we cannot use the union construction of the proof of Theorem 10.1.1(1), because in general that does not preserve bu-determinism: on a nullary symbol the constructed (Σ, \mathbf{B}) -wta \mathcal{B} can start with some $q \in Q_1$ or with some $q' \in Q_2$.

Further, we note that in [Gho22, Thm. 4.1] closure of $\text{Rec}^{\text{init}}(\Sigma, \mathbf{B})$ under sum was proved for the particular case that \mathbf{B} is a σ -complete orthomodular lattice. Since each σ -complete orthomodular lattice is a particular strong bimonoid, [Gho22, Thm. 4.1] follows from Theorem 10.1.1 and from [Rad10, Lm. 5.1(1)].

For the case of bu-deterministic wta we get the following negative result. (Hence [Rad10, Lm. 5.1(2)] is wrong, because the construction of that lemma does not preserve bu-determinism.)

Theorem 10.1.2. *There exists a string ranked alphabet Σ such that $\text{bud-Rec}(\Sigma, \text{Rat})$ is not closed under sum.*

Proof. We let $\Sigma = \{\gamma^{(1)}, \alpha^{(0)}\}$. It is easy to define the bu-deterministic (Σ, Rat) -wta \mathcal{A}_1 and \mathcal{A}_2 over Σ and \mathbb{Q} such that $\llbracket \mathcal{A}_1 \rrbracket(\gamma^n \alpha) = 2^n$ and $\llbracket \mathcal{A}_2 \rrbracket(\gamma^n \alpha) = 1$ for each $n \in \mathbb{N}$. Clearly, $\llbracket \mathcal{A}_1 \rrbracket + \llbracket \mathcal{A}_2 \rrbracket = (\text{exp}+1)$ where the weighted tree language $(\text{exp}+1)$ is defined in Example 3.2.9. However, as Theorem 13.2.2 shows, $(\text{exp}+1)$ is not in $\text{bud-Rec}(\Sigma, \text{Rat})$. \square

10.2 Closure under scalar multiplications

In this section we will prove that the sets $\text{Rec}^{\text{init}}(\Sigma, \mathbf{B})$ and $\text{Rec}^{\text{run}}(\Sigma, \mathbf{B})$ are closed under scalar multiplications from the left and from the right. A set \mathcal{L} of \mathbf{B} -weighted tree languages is *closed under scalar multiplications from the left* if for every $b \in B$ and $r \in \mathcal{L}$, the \mathbf{B} -weighted tree language $b \cdot r$ is in \mathcal{L} . Similarly we define the concept *closed under scalar multiplications from the right*. A set \mathcal{L} is *closed under scalar multiplications* if it is closed under scalar multiplications from the left and closed under scalar multiplications from the right.

Theorem 10.2.1. (cf. [Rad10, Thm. 5.4]) *Let Σ be a ranked alphabet. Moreover, let $\mathbf{B} = (B, \oplus, \otimes, 0, 1)$ be a strong bimonoid, let \mathcal{A} be a (Σ, \mathbf{B}) -wta, and let $b \in B$. Then the following four statements hold.*

- (1) *If (a) \mathbf{B} is left-distributive or (b) \mathcal{A} is bu-deterministic, then we can construct a (Σ, \mathbf{B}) -wta \mathcal{B} such that $\llbracket \mathcal{B} \rrbracket^{\text{init}} = b \cdot \llbracket \mathcal{A} \rrbracket^{\text{init}}$ and $\llbracket \mathcal{B} \rrbracket^{\text{run}} = b \cdot \llbracket \mathcal{A} \rrbracket^{\text{run}}$.*
- (2) *If \mathbf{B} is right-distributive, then we can construct a (Σ, \mathbf{B}) -wta \mathcal{B} such that $\llbracket \mathcal{B} \rrbracket^{\text{init}} = \llbracket \mathcal{A} \rrbracket^{\text{init}} \cdot b$ and $\llbracket \mathcal{B} \rrbracket^{\text{run}} = \llbracket \mathcal{A} \rrbracket^{\text{run}} \cdot b$.*
- (3) *If \mathcal{A} is bu-deterministic, then we can construct a bu-deterministic (Σ, \mathbf{B}) -wta \mathcal{B} such that $\llbracket \mathcal{B} \rrbracket = \llbracket \mathcal{A} \rrbracket \cdot b$. Moreover, if \mathcal{A} is crisp-deterministic, then so is \mathcal{B} .*
- (4) *If \mathcal{A} is crisp-deterministic, then we can construct a crisp-deterministic (Σ, \mathbf{B}) -wta \mathcal{B} such that $\llbracket \mathcal{B} \rrbracket = b \cdot \llbracket \mathcal{A} \rrbracket$.*

Thus, in particular, if \mathbf{B} is a semiring, then the set $\text{Rec}(\Sigma, \mathbf{B})$ is closed under scalar multiplications.

Proof. Proof of (1): Let $\mathcal{A} = (Q, \delta, F)$. We construct the (Σ, \mathbf{B}) -wta $\mathcal{B} = (Q', \delta', F')$ such that, if (a) or (b) holds, then $\llbracket \mathcal{B} \rrbracket^{\text{init}} = b \cdot \llbracket \mathcal{A} \rrbracket^{\text{init}}$ and $\llbracket \mathcal{B} \rrbracket^{\text{run}} = b \cdot \llbracket \mathcal{A} \rrbracket^{\text{run}}$, using the following idea. The wta \mathcal{B} simulates \mathcal{A} but, at the leftmost leaf of each input tree, it multiplies the weight of the applied transition with b from the left. The information about this multiplication is propagated up by using states of the form q^ℓ for each $q \in Q$. Formally, we let

- $Q' = Q^0 \cup Q^\ell$ where $Q^0 = \{q^0 \mid q \in Q\}$ and $Q^\ell = \{q^\ell \mid q \in Q\}$,
- for every $q \in Q$ and $\alpha \in \Sigma^{(0)}$, we let $\delta'_0(\varepsilon, \alpha, q^0) = \delta_0(\varepsilon, \alpha, q)$ and $\delta'_0(\varepsilon, \alpha, q^\ell) = b \otimes \delta_0(\varepsilon, \alpha, q)$,
for every $k \in \mathbb{N}_+$, $\sigma \in \Sigma^{(k)}$, and $q_1^{s_1}, \dots, q_k^{s_k}, q^s \in Q'$, we let

$$\delta'_k(q_1^{s_1} \cdots q_k^{s_k}, \sigma, q^s) = \begin{cases} \delta_k(q_1 \dots q_k, \sigma, q) & \text{if } (s_1 = s = \ell \wedge (\forall i \in [2, k]) : s_i = 0) \\ & \vee (s = 0 \wedge (\forall i \in [k]) : s_i = 0) \\ 0 & \text{otherwise} \end{cases}$$

- for every $q \in Q$ we let $(F')_{q^\ell} = F_q$ and $(F')_{q^0} = 0$.

We note that this construction does not preserve bu-determinism.

Now we assume that \mathbf{B} is left-distributive or \mathcal{A} is bu-deterministic. First, we prove that $\llbracket \mathcal{B} \rrbracket^{\text{init}} = b \cdot \llbracket \mathcal{A} \rrbracket^{\text{init}}$. For this, by induction on T_Σ , we can prove that the following statement holds:

$$\text{For every } \xi \in T_\Sigma \text{ and } q \in Q, \text{ we have } h_{\mathbf{B}}(\xi)_{q^0} = h_{\mathcal{A}}(\xi)_q. \quad (10.1)$$

Since this proof is straightforward, we do not show it. Next, by induction on T_Σ , we prove that the following statement holds:

$$\text{For every } \xi \in T_\Sigma \text{ and } q \in Q, \text{ we have } h_{\mathbf{B}}(\xi)_{q^\ell} = b \otimes h_{\mathcal{A}}(\xi)_q. \quad (10.2)$$

Let $\xi = \sigma(\xi_1, \dots, \xi_k)$. Then

$$\begin{aligned}
h_{\mathcal{B}}(\xi)_{q^\ell} &= \bigoplus_{\substack{q_1 \cdots q_k \in Q^k, \\ s_1, \dots, s_k \in \{0, \ell\}}} h_{\mathcal{B}}(\xi_1)_{q_1^{s_1}} \otimes \dots \otimes h_{\mathcal{B}}(\xi_k)_{q_k^{s_k}} \otimes \delta'_k(q_1^{s_1} \cdots q_k^{s_k}, \sigma, q^\ell) \\
&= \bigoplus_{q_1 \cdots q_k \in Q^k} h_{\mathcal{B}}(\xi_1)_{q_1^\ell} \otimes h_{\mathcal{B}}(\xi_2)_{q_2^0} \otimes \dots \otimes h_{\mathcal{B}}(\xi_k)_{q_k^0} \otimes \delta'_k(q_1^\ell q_2^0 \cdots q_k^0, \sigma, q^\ell) \\
&= \bigoplus_{q_1 \cdots q_k \in Q^k} b \otimes h_{\mathcal{A}}(\xi_1)_{q_1} \otimes h_{\mathcal{A}}(\xi_2)_{q_2} \otimes \dots \otimes h_{\mathcal{A}}(\xi_k)_{q_k} \otimes \delta_k(q_1 \cdots q_k, \sigma, q) \\
&\hspace{15em} \text{(by I.H., (10.1), and construction)}
\end{aligned}$$

We continue with case analysis.

Case (a): Let \mathcal{B} be left-distributive. Then we can continue as follows:

$$\begin{aligned}
&\bigoplus_{q_1 \cdots q_k \in Q^k} b \otimes h_{\mathcal{A}}(\xi_1)_{q_1} \otimes \dots \otimes h_{\mathcal{A}}(\xi_k)_{q_k} \otimes \delta_k(q_1 \cdots q_k, \sigma, q) \\
&= b \otimes \bigoplus_{q_1 \cdots q_k \in Q^k} h_{\mathcal{A}}(\xi_1)_{q_1} \otimes \dots \otimes h_{\mathcal{A}}(\xi_k)_{q_k} \otimes \delta_k(q_1 \cdots q_k, \sigma, q) \\
&= b \otimes h_{\mathcal{A}}(\xi)_q .
\end{aligned}$$

Case (b): Let \mathcal{A} be bu-deterministic. By Lemma 4.1.2(3), there are two subcases.

Case (b1): There exists $i \in [k]$ such that for each $q \in Q$ we have $h_{\mathcal{A}}(\xi_i)_q = 0$. Then we can continue as follows:

$$\begin{aligned}
&\bigoplus_{q_1 \cdots q_k \in Q^k} b \otimes h_{\mathcal{A}}(\xi_1)_{q_1} \otimes \dots \otimes h_{\mathcal{A}}(\xi_i)_{q_i} \otimes \dots \otimes h_{\mathcal{A}}(\xi_k)_{q_k} \otimes \delta_k(q_1 \cdots q_k, \sigma, q) \\
&= \bigoplus_{q_1 \cdots q_k \in Q^k} b \otimes h_{\mathcal{A}}(\xi_1)_{q_1} \otimes \dots \otimes 0 \otimes \dots \otimes h_{\mathcal{A}}(\xi_k)_{q_k} \otimes \delta_k(q_1 \cdots q_k, \sigma, q) \\
&= 0 \\
&= b \otimes \bigoplus_{q_1 \cdots q_k \in Q^k} h_{\mathcal{A}}(\xi_1)_{q_1} \otimes \dots \otimes 0 \otimes \dots \otimes h_{\mathcal{A}}(\xi_k)_{q_k} \otimes \delta_k(q_1 \cdots q_k, \sigma, q) \\
&= b \otimes h_{\mathcal{A}}(\xi)_q .
\end{aligned}$$

Case (b2): For each $i \in [k]$ there exists exactly one $\bar{q}_i \in Q$ such that $h_{\mathcal{A}}(\xi_i)_{\bar{q}_i} \neq 0$. Then we can continue as follows:

$$\begin{aligned}
&\bigoplus_{q_1 \cdots q_k \in Q^k} b \otimes h_{\mathcal{A}}(\xi_1)_{q_1} \otimes \dots \otimes h_{\mathcal{A}}(\xi_k)_{q_k} \otimes \delta_k(q_1 \cdots q_k, \sigma, q) \\
&= b \otimes h_{\mathcal{A}}(\xi_1)_{\bar{q}_1} \otimes \dots \otimes h_{\mathcal{A}}(\xi_k)_{\bar{q}_k} \otimes \delta_k(\bar{q}_1 \cdots \bar{q}_k, \sigma, q) \\
&\quad b \otimes \bigoplus_{q_1 \cdots q_k \in Q^k} h_{\mathcal{A}}(\xi_1)_{q_1} \otimes \dots \otimes h_{\mathcal{A}}(\xi_k)_{q_k} \otimes \delta_k(q_1 \cdots q_k, \sigma, q) \\
&= b \otimes h_{\mathcal{A}}(\xi)_q .
\end{aligned}$$

This finishes the proof of (10.2). Now we prove that $[\mathcal{B}]^{\text{init}} = b \cdot [\mathcal{A}]^{\text{init}}$. For each $\xi \in T_\Sigma$ we have:

$$[\mathcal{B}]^{\text{init}}(\xi) = \bigoplus_{\substack{s \in \{0, \ell\} \\ q^s \in Q'}} h_{\mathcal{B}}(\xi)_{q^s} \otimes (F')_{q^s} = \bigoplus_{q^\ell \in Q^\ell} h_{\mathcal{B}}(\xi)_{q^\ell} \otimes F_{q^\ell} = \bigoplus_{q \in Q} b \otimes h_{\mathcal{A}}(\xi)_q \otimes F_q ,$$

where the last equality follows from (10.2) and the definition of \mathcal{B} .

We proceed by case analysis as above.

Case (a): Let \mathcal{B} be left-distributive. Then we can continue as follows:

$$\bigoplus_{q \in Q} b \otimes h_{\mathcal{A}}(\xi)_q \otimes F_q = b \otimes \bigoplus_{q \in Q} h_{\mathcal{A}}(\xi)_q \otimes F_q = b \otimes \llbracket \mathcal{A} \rrbracket^{\text{init}}(\xi) = (b \cdot \llbracket \mathcal{A} \rrbracket^{\text{init}})(\xi) .$$

Case (b): Let \mathcal{A} be bu-deterministic. Again, by Lemma 4.1.2(3), there are two cases.

Case (b1): For each $q \in Q$ we have $h_{\mathcal{A}}(\xi)_q = 0$. Then we can continue as follows:

$$\bigoplus_{q \in Q} b \otimes h_{\mathcal{A}}(\xi)_q \otimes F_q = 0 = b \otimes \bigoplus_{q \in Q} h_{\mathcal{A}}(\xi)_q \otimes F_q = b \otimes \llbracket \mathcal{A} \rrbracket^{\text{init}}(\xi) = (b \cdot \llbracket \mathcal{A} \rrbracket^{\text{init}})(\xi) .$$

Case (b2): There exists exactly one $\bar{q} \in Q$ such that $h_{\mathcal{A}}(\xi)_{\bar{q}} \neq 0$. Then we can continue as follows:

$$\bigoplus_{q \in Q} b \otimes h_{\mathcal{A}}(\xi)_q \otimes F_q = b \otimes h_{\mathcal{A}}(\xi)_{\bar{q}} \otimes F_{\bar{q}} = b \otimes \bigoplus_{q \in Q} h_{\mathcal{A}}(\xi)_q \otimes F_q = b \otimes \llbracket \mathcal{A} \rrbracket^{\text{init}}(\xi) = (b \cdot \llbracket \mathcal{A} \rrbracket^{\text{init}})(\xi) .$$

This finishes the proof of $\llbracket \mathcal{B} \rrbracket^{\text{init}} = b \cdot \llbracket \mathcal{A} \rrbracket^{\text{init}}$.

Second, we prove that $\llbracket \mathcal{B} \rrbracket^{\text{run}} = b \cdot \llbracket \mathcal{A} \rrbracket^{\text{run}}$. For each $\xi \in T_{\Sigma}$ we define the sets

$$\begin{aligned} \text{pos}_{\text{left}}(\xi) &= \{w \in \text{pos}(\xi) \mid w = 1^n \text{ for some } n \in \mathbb{N}\}, \\ \mathbf{R}_{\mathcal{B}}^0(\xi) &= \{\rho \in \mathbf{R}_{\mathcal{B}}(\xi) \mid \text{im}(\rho) \subseteq Q^0\}, \text{ and} \\ \mathbf{R}_{\mathcal{B}}^{\ell}(\xi) &= \{\rho \in \mathbf{R}_{\mathcal{B}}(\xi) \mid (\forall w \in \text{pos}_{\text{left}}(\xi)) : \rho(w) \in Q^{\ell} \text{ and } (\forall w \in \text{pos}(\xi) \setminus \text{pos}_{\text{left}}(\xi)) : \rho(w) \in Q^0\} . \end{aligned}$$

Moreover, for each $\xi \in T_{\Sigma}$, we define the mapping $\overline{(\cdot)} : \mathbf{R}_{\mathcal{B}}(\xi) \rightarrow \mathbf{R}_{\mathcal{A}}(\xi)$ such that, for every $\rho \in \mathbf{R}_{\mathcal{B}}(\xi)$, we abbreviate $\overline{(\cdot)}(\rho)$ by $\bar{\rho}$ and the run $\bar{\rho}$ of \mathcal{A} is obtained from ρ by dropping the upper index (in $\{0, \ell\}$) from each state.

By the construction of \mathcal{B} , the following observations are easy to see.

$$\text{For every } \xi \in T_{\Sigma} \text{ and } \rho \in \mathbf{R}_{\mathcal{B}}(\xi) \setminus (\mathbf{R}_{\mathcal{B}}^0(\xi) \cup \mathbf{R}_{\mathcal{B}}^{\ell}(\xi)) \text{ we have } \text{wt}_{\mathcal{B}}(\xi, \rho) = 0. \quad (10.3)$$

$$\text{For every } \xi \in T_{\Sigma} \text{ and } \rho \in \mathbf{R}_{\mathcal{B}}^0(\xi) \text{ we have } \text{wt}_{\mathcal{B}}(\xi, \rho) = \text{wt}_{\mathcal{A}}(\xi, \bar{\rho}). \quad (10.4)$$

$$\text{For every } \xi \in T_{\Sigma} \text{ and } \rho \in \mathbf{R}_{\mathcal{B}}^{\ell}(\xi) \text{ we have } \text{wt}_{\mathcal{B}}(\xi, \rho) = b \otimes \text{wt}_{\mathcal{A}}(\xi, \bar{\rho}). \quad (10.5)$$

For the proof of (10.5) we need (10.3), and (10.4). Then for each $\xi \in T_{\Sigma}$ we can compute as follows.

$$\begin{aligned} \llbracket \mathcal{B} \rrbracket^{\text{run}}(\xi) &= \bigoplus_{\rho \in \mathbf{R}_{\mathcal{B}}(\xi)} \text{wt}_{\mathcal{B}}(\xi, \rho) \otimes (F')_{\rho(\varepsilon)} \\ &= \bigoplus_{\substack{\rho \in \mathbf{R}_{\mathcal{B}}(\xi): \\ \rho(\varepsilon) \in Q^{\ell}}} \text{wt}_{\mathcal{B}}(\xi, \rho) \otimes (F')_{\rho(\varepsilon)} && \text{(because } (F')_{q^s} = 0 \text{ for each } q^s \in Q^0) \\ &= \bigoplus_{\substack{\rho \in \mathbf{R}_{\mathcal{B}}(\xi): \\ \rho(\varepsilon) \in Q^{\ell}}} \text{wt}_{\mathcal{B}}(\xi, \rho) \otimes F_{\bar{\rho}(\varepsilon)} && \text{(by definition of } F') \\ &= \bigoplus_{\rho \in \mathbf{R}_{\mathcal{B}}^{\ell}(\xi)} \text{wt}_{\mathcal{B}}(\xi, \rho) \otimes F_{\bar{\rho}(\varepsilon)} && \text{(by (10.3))} \\ &= \bigoplus_{\rho \in \mathbf{R}_{\mathcal{B}}^{\ell}(\xi)} b \otimes \text{wt}_{\mathcal{A}}(\xi, \bar{\rho}) \otimes F_{\bar{\rho}(\varepsilon)} && \text{(by (10.5))} \end{aligned}$$

$$= \bigoplus_{\rho \in R_{\mathcal{A}}(\xi)} b \otimes \text{wt}_{\mathcal{A}}(\xi, \rho) \otimes F_{\rho(\varepsilon)} \quad (\text{because the restriction of } \overline{(\cdot)} \text{ to } R_{\mathcal{B}}^{\ell}(\xi) \text{ is a bijection})$$

We proceed by case analysis.

Case (a): Let \mathcal{B} be left-distributive. Then we can continue as follows:

$$\bigoplus_{\rho \in R_{\mathcal{A}}(\xi)} b \otimes \text{wt}_{\mathcal{A}}(\xi, \rho) \otimes F_{\rho(\varepsilon)} = b \otimes \bigoplus_{\rho \in R_{\mathcal{A}}(\xi)} \text{wt}_{\mathcal{A}}(\xi, \rho) \otimes F_{\rho(\varepsilon)} = b \otimes \llbracket \mathcal{A} \rrbracket^{\text{run}}(\xi) = (b \cdot \llbracket \mathcal{A} \rrbracket^{\text{run}})(\xi) ,$$

where we use left-distributivity at the first equality.

Case (b): Let \mathcal{A} be bu-deterministic. By Lemma 4.1.2(3), there are two cases.

Case (b1): For each $\rho \in R_{\mathcal{A}}(\xi)$ we have $\text{wt}_{\mathcal{A}}(\xi, \rho) = 0$. Then we can continue as follows:

$$\begin{aligned} \bigoplus_{\rho \in R_{\mathcal{A}}(\xi)} b \otimes \text{wt}_{\mathcal{A}}(\xi, \rho) \otimes F_{\rho(\varepsilon)} &= \bigoplus_{\rho \in R_{\mathcal{A}}(\xi)} b \otimes 0 \otimes F_{\rho(\varepsilon)} = b \otimes \bigoplus_{\rho \in R_{\mathcal{A}}(\xi)} 0 \otimes F_{\rho(\varepsilon)} \\ &= b \otimes \bigoplus_{\rho \in R_{\mathcal{A}}(\xi)} \text{wt}_{\mathcal{A}}(\xi, \rho) \otimes F_{\rho(\varepsilon)} \\ &= b \otimes \llbracket \mathcal{A} \rrbracket^{\text{run}}(\xi) = (b \cdot \llbracket \mathcal{A} \rrbracket^{\text{run}})(\xi) . \end{aligned}$$

Case (b2): There exist exactly one $\bar{q} \in Q$ and one $\bar{\rho} \in R_{\mathcal{A}}(\bar{q}, \xi)$ such that $\text{wt}_{\mathcal{A}}(\xi, \bar{\rho}) \neq 0$; then $\text{wt}_{\mathcal{A}}(\xi, \bar{\rho}) = h_{\mathcal{A}}(\xi)_{\bar{q}}$. (Note that $\bar{\rho}(\varepsilon) = \bar{q}$.) Then we continue as follows:

$$\begin{aligned} \bigoplus_{\rho \in R_{\mathcal{A}}(\xi)} b \otimes \text{wt}_{\mathcal{A}}(\xi, \rho) \otimes F_{\rho(\varepsilon)} &= b \otimes \text{wt}_{\mathcal{A}}(\xi, \bar{\rho}) \otimes F_{\bar{q}} = b \otimes \bigoplus_{\rho \in R_{\mathcal{A}}(\xi)} \text{wt}_{\mathcal{A}}(\xi, \rho) \otimes F_{\rho(\varepsilon)} \\ &= b \otimes \llbracket \mathcal{A} \rrbracket^{\text{run}}(\xi) = (b \cdot \llbracket \mathcal{A} \rrbracket^{\text{run}})(\xi) . \end{aligned}$$

This finishes the proof of $\llbracket \mathcal{B} \rrbracket^{\text{run}} = b \cdot \llbracket \mathcal{A} \rrbracket^{\text{run}}$.

Proof of (2): Let $\mathcal{A} = (Q, \delta, F)$. We construct $\mathcal{B} = (Q, \delta, F')$ by letting $(F')_q = F_q \otimes b$ for each $q \in Q$. First, we prove that $\llbracket \mathcal{B} \rrbracket^{\text{init}} = \llbracket \mathcal{A} \rrbracket^{\text{init}} \cdot b$. Obviously,

$$\text{for each } q \in Q \text{ we have } h_{\mathcal{B}}(\xi)_q = h_{\mathcal{A}}(\xi)_q . \quad (10.6)$$

(We note that the proof of (10.6) does not need the assumption that \mathcal{B} is right-distributive.) Now we assume that \mathcal{B} is right-distributive.

Then, for each $\xi \in T_{\Sigma}$, we can calculate as follows.

$$\begin{aligned} \llbracket \mathcal{B} \rrbracket^{\text{init}}(\xi) &= \bigoplus_{q \in Q} h_{\mathcal{B}}(\xi)_q \otimes (F')_q \\ &= \bigoplus_{q \in Q} h_{\mathcal{A}}(\xi)_q \otimes F_q \otimes b && \text{(by (10.6) and the definition of } \mathcal{B}) \\ &= \left(\bigoplus_{q \in Q} h_{\mathcal{A}}(\xi)_q \otimes F_q \right) \otimes b && \text{(by right-distributivity)} \\ &= \llbracket \mathcal{A} \rrbracket^{\text{init}}(\xi) \otimes b = (\llbracket \mathcal{A} \rrbracket^{\text{init}} \cdot b)(\xi) . \end{aligned}$$

Second, we prove that $\llbracket \mathcal{B} \rrbracket^{\text{run}} = \llbracket \mathcal{A} \rrbracket^{\text{run}} \cdot b$. Obviously,

$$\begin{aligned} \text{for each } \xi \in T_{\Sigma} \text{ we have } R_{\mathcal{A}}(\xi) &= R_{\mathcal{B}}(\xi) \text{ and} \\ \text{for each } \rho \in R_{\mathcal{A}}(\xi) \text{ we have } \text{wt}_{\mathcal{A}}(\xi, \rho) &= \text{wt}_{\mathcal{B}}(\xi, \rho) . \end{aligned} \quad (10.7)$$

Then, for each $\xi \in T_\Sigma$, we can calculate as follows.

$$\begin{aligned}
\llbracket \mathcal{B} \rrbracket^{\text{run}}(\xi) &= \bigoplus_{\rho \in R_{\mathcal{B}}(\xi)} \text{wt}_{\mathcal{B}}(\xi, \rho) \otimes (F')_{\rho(\varepsilon)} \\
&= \bigoplus_{\rho \in R_{\mathcal{A}}(\xi)} \text{wt}_{\mathcal{A}}(\xi, \rho) \otimes F_{\rho(\varepsilon)} \otimes b && \text{(by (10.7))} \\
&= \left(\bigoplus_{\rho \in R_{\mathcal{A}}(\xi)} \text{wt}_{\mathcal{A}}(\xi, \rho) \otimes F_{\rho(\varepsilon)} \right) \otimes b && \text{(by right-distributivity)} \\
&= \llbracket \mathcal{A} \rrbracket^{\text{run}}(\xi) \otimes b = (\llbracket \mathcal{A} \rrbracket^{\text{run}} \cdot b)(\xi) .
\end{aligned}$$

Proof of (3): Let $\mathcal{A} = (Q, \delta, F)$ be bu-deterministic. We construct $\mathcal{B} = (Q, \delta, F')$ in the same way as in the proof of Statement (2). It is obvious that this construction preserves bu-determinism and crisp-determinism. Let $\xi \in T_\Sigma$. By Lemma 4.1.2, there are two cases.

Case (a): For each $q \in Q$ we have $h_{\mathcal{A}}(\xi)_q = 0$. Then by (10.6) we obtain:

$$\llbracket \mathcal{B} \rrbracket(\xi) = \bigoplus_{q \in Q} h_{\mathcal{B}}(\xi)_q \otimes (F')_q = 0 = \left(\bigoplus_{q \in Q} h_{\mathcal{A}}(\xi)_q \otimes F_q \right) \otimes b = \llbracket \mathcal{A} \rrbracket(\xi) \otimes b = (\llbracket \mathcal{A} \rrbracket \cdot b)(\xi) .$$

Case (b): There exists exactly one $\bar{q} \in Q$ such that $h_{\mathcal{A}}(\xi)_{\bar{q}} \neq 0$. Then, using (10.6) again, we can continue as follows:

$$\begin{aligned}
\llbracket \mathcal{B} \rrbracket(\xi) &= \bigoplus_{q \in Q} h_{\mathcal{B}}(\xi)_q \otimes (F')_q = h_{\mathcal{B}}(\xi)_{\bar{q}} \otimes F'_{\bar{q}} = h_{\mathcal{A}}(\xi)_{\bar{q}} \otimes F_{\bar{q}} \otimes b = \left(\bigoplus_{q \in Q} h_{\mathcal{A}}(\xi)_q \otimes F_q \right) \otimes b \\
&= \llbracket \mathcal{A} \rrbracket(\xi) \otimes b = (\llbracket \mathcal{A} \rrbracket \cdot b)(\xi) .
\end{aligned}$$

Proof of (4). Let $\mathcal{A} = (Q, \delta, F)$ be crisp-deterministic. We construct $\mathcal{B} = (Q, \delta, F')$ where $F'_q = b \otimes F_q$ for each $q \in Q$. Obviously, \mathcal{B} is crisp-deterministic and (10.6) also holds for this \mathcal{B} . Due to Lemma 4.1.5, there exists a state q_ξ such that $Q_{\neq 0}^{h_{\mathcal{A}}}(\xi) = \{q_\xi\}$ and $h_{\mathcal{A}}(\xi)_{q_\xi} = \mathbb{1}$, and hence $\llbracket \mathcal{A} \rrbracket(\xi) = F_{q_\xi}$. Then:

$$\llbracket \mathcal{B} \rrbracket(\xi) = h_{\mathcal{B}}(\xi)_{q_\xi} \otimes (F')_{q_\xi} = h_{\mathcal{A}}(\xi)_{q_\xi} \otimes b \otimes F_{q_\xi} = b \otimes F_{q_\xi} = b \otimes \llbracket \mathcal{A} \rrbracket(\xi) = (b \cdot \llbracket \mathcal{A} \rrbracket)(\xi) . \quad \square$$

10.3 Characterization of recognizable step mappings

As a kind of application of closure under sum and under scalar multiplications, we show that recognizable step mappings and crisp-deterministic wta are closely related (cf. Theorem 10.3.1). Moreover, we prove a characterization of the set of all recognizable step mappings in terms of characteristic mappings of recognizable tree languages and closure under sum and scalar multiplication (cf. Theorem 10.3.3).

We recall that a weighted tree language $r : T_\Sigma \rightarrow B$ is a recognizable step mapping (cf. Section 2.17) if there exist $n \in \mathbb{N}_+$, $b_1, \dots, b_n \in B$, and recognizable Σ -tree languages L_1, \dots, L_n such that

$$r = \bigoplus_{i \in [n]} b_i \cdot \chi(L_i) .$$

In the next theorem, the equivalences (A) \Leftrightarrow (B) \Leftrightarrow (C) were proved in [DSV10, Lm. 8 and Prop. 9], respectively, for the string case. The implication (B) \Rightarrow (D) of Theorem 10.3.1 was proved in [DV06, Lm. 3.1] for the case that B is a semiring. A similar result was proved in [Li08a, Thm. 2.1] for wsa over a pair of t-conorm and t-norm. We recall that a weighted tree language $r : T_\Sigma \rightarrow B$ has the preimage property, if $r^{-1}(b)$ is a recognizable Σ -tree language for each $b \in B$.

Theorem 10.3.1. *Let Σ be a ranked alphabet. Moreover, let $\mathbf{B} = (B, \oplus, \otimes, \mathbf{0}, \mathbf{1})$ be a strong bimonoid and let $r: \mathsf{T}_\Sigma \rightarrow B$. Then the following four statements are equivalent.*

- (A) *We can construct a crisp-deterministic (Σ, \mathbf{B}) -wta \mathcal{A} such that $r = \llbracket \mathcal{A} \rrbracket$.*
- (B) *r is a recognizable step mapping and we can construct $n \in \mathbb{N}_+$, $b_1, \dots, b_n \in B$, and Σ -fta A_1, \dots, A_n such that $r = \bigoplus_{i \in [n]} b_i \cdot \chi(\mathsf{L}(A_i))$.*
- (C) *$\text{im}(r)$ is finite, r has the preimage property, and we can construct $n \in \mathbb{N}_+$ and elements $b_1, \dots, b_n \in B$ such that $\text{im}(r) = \{b_1, \dots, b_n\}$ and, moreover, for each $b \in B$ we can construct a Σ -fta which recognizes $r^{-1}(b)$.*
- (D) *r is a recognizable step mapping with pairwise disjoint step languages and we can construct $n \in \mathbb{N}_+$, $b_1, \dots, b_n \in B$, and Σ -fta A_1, \dots, A_n such that $r = \bigoplus_{i \in [n]} b_i \cdot \chi(\mathsf{L}(A_i))$.*

Thus, in particular, $\text{cd-Rec}(\Sigma, \mathbf{B}) = \text{RecStep}(\Sigma, \mathbf{B})$.

Proof. Proof of (A) \Rightarrow (D): Let \mathcal{A} be a crisp-deterministic (Σ, \mathbf{B}) -wta such that $r = \llbracket \mathcal{A} \rrbracket$. By Theorem 4.1.9, we can construct a finite Σ -algebra (Q, θ) and a mapping $F: Q \rightarrow B$ such that $\llbracket \mathcal{A} \rrbracket = F \circ \mathsf{h}_Q$.

Let $n = |Q|$ and let p_1, \dots, p_n be a list of the elements of Q . For each $i \in [n]$ we construct the bu-deterministic and total Σ -fta $A_i = (Q, \delta, \{p_i\})$, where for every $k \in \mathbb{N}$, $\sigma \in \Sigma^{(k)}$, and $q \in Q$ and $q_1 \cdots q_k \in Q^k$, we have

$$\delta_k(q_1 \cdots q_k, \sigma) = q \text{ iff } \theta(\sigma)(q_1, \dots, q_k) = q .$$

Since each fta A_i is bu-deterministic, it is obvious that, for every $i, i' \in [n]$ with $i \neq i'$, the sets $\mathsf{L}(A_i)$ and $\mathsf{L}(A_{i'})$ are disjoint, i.e., $\mathsf{L}(A_i) \cap \mathsf{L}(A_{i'}) = \emptyset$.

Let us abbreviate F_{p_i} by b_i for every $i \in [n]$. Next we prove that $r = \bigoplus_{i \in [n]} b_i \cdot \chi(\mathsf{L}(A_i))$. Obviously, for every $i \in [n]$, we have $\mathsf{h}_Q = \mathsf{h}_{A_i}$, where h_{A_i} is the unique homomorphism from T_Σ to the Σ -algebra $(\mathcal{P}(Q), \delta_{A_i})$ defined in Section 2.16.

Now let $\xi \in \mathsf{T}_\Sigma$ and let $\mathsf{h}_Q(\xi) = p_j$. Then, in particular, $\mathsf{h}_Q = \mathsf{h}_{A_j}$. By definition of A_j it follows that $\xi \in \mathsf{L}(A_j)$, and thus $\chi(\mathsf{L}(A_j))(\xi) = \mathbf{1}$. Moreover, for each $p_i \in Q$ with $p_i \neq \mathsf{h}_Q(\xi)$, we have $\xi \notin \mathsf{L}(A_i)$ and thus $\chi(\mathsf{L}(A_i))(\xi) = \mathbf{0}$. Thus we have

$$r(\xi) = (F \circ \mathsf{h}_Q)(\xi) = F_{p_j} = b_j \otimes \chi(\mathsf{L}(A_j))(\xi) = \bigoplus_{i \in [n]} b_i \otimes \chi(\mathsf{L}(A_i))(\xi) = \left(\bigoplus_{i \in [n]} b_i \cdot \chi(\mathsf{L}(A_i)) \right)(\xi) .$$

Hence r is a recognizable step mapping with pairwise disjoint step languages.

Proof of (D) \Rightarrow (C): For each $i \in [n]$, let us abbreviate $\mathsf{L}(A_i)$ by L_i . Hence $r = \bigoplus_{i \in [n]} b_i \cdot \chi(L_i)$, where the step languages L_1, \dots, L_n are pairwise disjoint. Then $\text{im}(r) = \{b_1, \dots, b_n\}$ if $\mathsf{T}_\Sigma = \bigcup_{i \in [n]} L_i$ and $\text{im}(r) = \{b_1, \dots, b_n, \mathbf{0}\}$ if $\mathsf{T}_\Sigma \setminus \bigcup_{i \in [n]} L_i \neq \emptyset$; in both cases $\text{im}(r)$ is finite.

Now let $b \in B$. Then

$$r^{-1}(b) = \begin{cases} \bigcup_{i \in [n]: b_i = b} L_i & \text{if } b \neq \mathbf{0} \\ \mathsf{T}_\Sigma \setminus \bigcup_{i \in [n]: b_i \neq \mathbf{0}} L_i & \text{otherwise.} \end{cases}$$

Since the set of recognizable Σ -tree languages is effectively closed under union and complement [GS84, Thm. 2.4.2], in each case we can construct a Σ -fta which recognizes $r^{-1}(b)$. Thus r has the preimage property.

Proof of (C) \Rightarrow (B): Let $\text{im}(r) = \{b_1, \dots, b_n\}$ for some $n \in \mathbb{N}_+$ and $b_1, \dots, b_n \in B$. By our assumption, for each $i \in [n]$, we can construct a Σ -fta A_i with $\mathsf{L}(A_i) = r^{-1}(b_i)$. Then $r = \bigoplus_{i \in [n]} b_i \cdot \chi(\mathsf{L}(A_i))$. Hence r is a recognizable step mapping.

Proof of (B) \Rightarrow (A): Let $n \in \mathbb{N}_+$ and $r = \bigoplus_{i \in [n]} b_i \cdot \chi(\mathsf{L}(A_i))$ for some Σ -fta A_1, \dots, A_n and coefficients $b_1, \dots, b_n \in B$.

Let $i \in [n]$. By Theorem 4.1.10, we can construct a crisp-deterministic (Σ, \mathbf{B}) -wta \mathcal{A}_i with identity root weights such that $\llbracket \mathcal{A}_i \rrbracket = \chi(\mathsf{L}(A_i))$. By Theorem 10.2.1(4), we can construct a crisp-deterministic

(Σ, \mathbf{B}) -wta \mathcal{A}'_i such that $\llbracket \mathcal{A}'_i \rrbracket = b_i \cdot \chi(L(A_i))$. By Theorem 10.1.1(2), we can construct a crisp-deterministic (Σ, \mathbf{B}) -wta \mathcal{A} such that $\llbracket \mathcal{A} \rrbracket = \bigoplus_{i \in [n]} b_i \cdot \chi(L(A_i))$. \square

We note that Theorem 10.3.1((B) \Rightarrow (D)) also follows from Observation 2.17.1.

Corollary 10.3.2. $\text{RecStep}(\Sigma, \mathbf{B})$ is closed under sum and scalar multiplications.

Proof. By Theorem 10.3.1(A) \Leftrightarrow (B), $\text{RecStep}(\Sigma, \mathbf{B})$ is equal to the set of (Σ, \mathbf{B}) -weighted tree languages recognizable by crisp-deterministic wta. By Theorem 10.1.1(2) the latter is closed under sum. Moreover, by Theorem 10.2.1(3) and (4) it is closed under scalar multiplications from the right and the left, respectively. \square

We finish this section with a characterization of $\text{RecStep}(\Sigma, \mathbf{B})$ which results from several closure properties.

Theorem 10.3.3. *Let Σ be a ranked alphabet. Moreover, let \mathbf{B} be a strong bimonoid. The set $\text{RecStep}(\Sigma, \mathbf{B})$ of (Σ, \mathbf{B}) -recognizable step mappings is the smallest set of (Σ, \mathbf{B}) -weighted tree languages which contains, for each recognizable Σ -tree language L , the characteristic mapping $\chi(L)$ and is closed under sum and scalar multiplication from the left.*

Proof. For the sake of convenience, we denote by \mathcal{C} the smallest set of (Σ, \mathbf{B}) -weighted tree languages which contains, for each recognizable Σ -tree language L , the characteristic mapping $\chi(L)$ and is closed under sum and scalar multiplications from the left.

First we prove that $\text{RecStep}(\Sigma, \mathbf{B}) \subseteq \mathcal{C}$. Let $r \in \text{RecStep}(\Sigma, \mathbf{B})$ with $r = \bigoplus_{i \in [n]} b_i \cdot \chi(L_i)$ for some $n \in \mathbb{N}_+$, $b_1, \dots, b_n \in B$, and L_1, \dots, L_n recognizable Σ -tree languages. Then, for each $i \in [n]$, we have $\chi(L_i) \in \mathcal{C}$ and $b_i \cdot \chi(L_i) \in \mathcal{C}$. Since \mathcal{C} is closed under sum, we have $r \in \mathcal{C}$.

Second we prove that $\mathcal{C} \subseteq \text{RecStep}(\Sigma, \mathbf{B})$. Obviously, for each recognizable Σ -tree language L , the characteristic mapping $\chi(L)$ is in $\text{RecStep}(\Sigma, \mathbf{B})$. Moreover, by Corollary 10.3.2, $\text{RecStep}(\Sigma, \mathbf{B})$ is closed under sum and scalar multiplications from the left. Since \mathcal{C} is the smallest set with these properties, we obtain that $\mathcal{C} \subseteq \text{RecStep}(\Sigma, \mathbf{B})$. \square

10.4 Closure under Hadamard product

In this section we will prove that the set $\text{Rec}(\Sigma, \mathbf{B})$ is closed under Hadamard product if \mathbf{B} is a commutative semiring. A set \mathcal{L} of \mathbf{B} -weighted tree languages is *closed under Hadamard product* if the following holds: for every (Σ, \mathbf{B}) -weighted tree languages r_1 and r_2 , if $r_1, r_2 \in \mathcal{L}$, then $(r_1 \otimes r_2) \in \mathcal{L}$.

Theorem 10.4.1. *Let Σ be a ranked alphabet. Moreover, let $\mathbf{B} = (B, \oplus, \otimes, 0, 1)$ be a strong bimonoid and let \mathcal{A}_1 and \mathcal{A}_2 be two (Σ, \mathbf{B}) -wta. Then the following three statements hold.*

- (1) (cf. [Bor04, Cor. 3.9]) *If \mathbf{B} is a commutative semiring, then we can construct a (Σ, \mathbf{B}) -wta \mathcal{A} such that $\llbracket \mathcal{A} \rrbracket = \llbracket \mathcal{A}_1 \rrbracket \otimes \llbracket \mathcal{A}_2 \rrbracket$.*
- (2) (cf. [Rad10, Lm. 5.3]) *If \mathbf{B} is commutative and \mathcal{A}_1 and \mathcal{A}_2 are bu-deterministic, then we can construct a bu-deterministic (Σ, \mathbf{B}) -wta \mathcal{A} such that $\llbracket \mathcal{A} \rrbracket = \llbracket \mathcal{A}_1 \rrbracket \otimes \llbracket \mathcal{A}_2 \rrbracket$.*
- (3) *If \mathcal{A}_1 and \mathcal{A}_2 are crisp-deterministic, then we can construct a crisp-deterministic (Σ, \mathbf{B}) -wta \mathcal{A} such that $\llbracket \mathcal{A} \rrbracket = \llbracket \mathcal{A}_1 \rrbracket \otimes \llbracket \mathcal{A}_2 \rrbracket$.*

Thus, in particular, the set $\text{RecStep}(\Sigma, \mathbf{B})$ is closed under Hadamard product. Moreover, if \mathbf{B} is a commutative semiring, then the set $\text{Rec}(\Sigma, \mathbf{B})$ is closed under Hadamard product.

Proof. Let $\mathcal{A}_1 = (Q_1, \delta_1, F_1)$ and $\mathcal{A}_2 = (Q_2, \delta_2, F_2)$. We construct the (Σ, \mathbf{B}) -wta $\mathcal{A} = (Q, \delta, F)$ which we will use in the proof of each of the Statements (1), (2), and (3). We define:

- $Q = Q_1 \times Q_2$; for each $q \in Q$ we denote its first and second component by q^1 and q^2 , respectively,
- for every $k \in \mathbb{N}$, $\sigma \in \Sigma^{(k)}$, $q \in Q$, and $q_1 \cdots q_k \in Q^k$ we define

$$\delta_k(q_1 \cdots q_k, \sigma, q) = (\delta_1)_k(q_1^1 \cdots q_k^1, \sigma, q^1) \otimes (\delta_2)_k(q_1^2 \cdots q_k^2, \sigma, q^2)$$

- for each $q \in Q$ we define $F_q = (F_1)_{q^1} \otimes (F_2)_{q^2}$.

Obviously, if \mathcal{A}_1 and \mathcal{A}_2 are bu-deterministic (or crisp-deterministic), then so is \mathcal{A} .

Proof of (1): We assume that \mathbf{B} is a commutative semiring. First, by induction on T_Σ , we prove that the following statement holds.

$$\text{For every } \xi \in T_\Sigma \text{ and } q = (q^1, q^2) \in Q, \text{ we have: } h_{\mathcal{A}}(\xi)_q = h_{\mathcal{A}_1}(\xi)_{q^1} \otimes h_{\mathcal{A}_2}(\xi)_{q^2} \quad . \quad (10.8)$$

Let $\xi = \sigma(\xi_1, \dots, \xi_k)$ and $q = (q^1, q^2) \in Q$. Then:

$$\begin{aligned} & h_{\mathcal{A}}(\xi)_q \\ &= \bigoplus_{q_1 \cdots q_k \in Q^k} \left(\bigotimes_{i \in [k]} h_{\mathcal{A}}(\xi_i)_{q_i} \right) \otimes \delta_k(q_1 \cdots q_k, \sigma, q) \\ &= \bigoplus_{q_1 \cdots q_k \in Q^k} \left(\bigotimes_{i \in [k]} (h_{\mathcal{A}_1}(\xi_i)_{q_i^1} \otimes h_{\mathcal{A}_2}(\xi_i)_{q_i^2}) \right) \otimes \left(\bigotimes_{j \in [2]} (\delta_j)_k(q_1^j \cdots q_k^j, \sigma, q^j) \right) \\ & \hspace{20em} \text{(by I.H. and construction)} \\ &= \bigoplus_{q_1^1 \cdots q_k^1 \in (Q_1)^k} \bigoplus_{q_1^2 \cdots q_k^2 \in (Q_2)^k} \left(\bigotimes_{i \in [k]} (h_{\mathcal{A}_1}(\xi_i)_{q_i^1} \otimes h_{\mathcal{A}_2}(\xi_i)_{q_i^2}) \right) \otimes \left(\bigotimes_{j \in [2]} (\delta_j)_k(q_1^j \cdots q_k^j, \sigma, q^j) \right) \\ &= \bigoplus_{q_1^1 \cdots q_k^1 \in (Q_1)^k} \bigoplus_{q_1^2 \cdots q_k^2 \in (Q_2)^k} \left(\bigotimes_{i \in [k]} h_{\mathcal{A}_1}(\xi_i)_{q_i^1} \right) \otimes (\delta_1)_k(q_1^1 \cdots q_k^1, \sigma, q^1) \otimes \left(\bigotimes_{i \in [k]} h_{\mathcal{A}_2}(\xi_i)_{q_i^2} \right) \otimes (\delta_2)_k(q_1^2 \cdots q_k^2, \sigma, q^2) \\ & \hspace{20em} \text{(by commutativity)} \\ &= \bigoplus_{q_1^1 \cdots q_k^1 \in (Q_1)^k} \left[\left(\bigotimes_{i \in [k]} h_{\mathcal{A}_1}(\xi_i)_{q_i^1} \right) \otimes (\delta_1)_k(q_1^1 \cdots q_k^1, \sigma, q^1) \right] \otimes \\ & \quad \left(\bigoplus_{q_1^2 \cdots q_k^2 \in (Q_2)^k} \left(\bigotimes_{i \in [k]} h_{\mathcal{A}_2}(\xi_i)_{q_i^2} \right) \otimes (\delta_2)_k(q_1^2 \cdots q_k^2, \sigma, q^2) \right) \quad \text{(by left-distributivity)} \\ &= \left(\bigoplus_{q_1^1 \cdots q_k^1 \in (Q_1)^k} \left(\bigotimes_{i \in [k]} h_{\mathcal{A}_1}(\xi_i)_{q_i^1} \right) \otimes (\delta_1)_k(q_1^1 \cdots q_k^1, \sigma, q^1) \right) \otimes \\ & \quad \left(\bigoplus_{q_1^2 \cdots q_k^2 \in (Q_2)^k} \left(\bigotimes_{i \in [k]} h_{\mathcal{A}_2}(\xi_i)_{q_i^2} \right) \otimes (\delta_2)_k(q_1^2 \cdots q_k^2, \sigma, q^2) \right) \quad \text{(by right-distributivity)} \\ &= h_{\mathcal{A}_1}(\xi)_{q^1} \otimes h_{\mathcal{A}_2}(\xi)_{q^2} \quad . \end{aligned}$$

This proves (10.8). Then for each $\xi \in T_\Sigma$:

$$\begin{aligned} \llbracket \mathcal{A} \rrbracket(\xi) &= \bigoplus_{q \in Q} h_{\mathcal{A}}(\xi)_q \otimes F_q = \bigoplus_{q \in Q} \left(h_{\mathcal{A}_1}(\xi)_{q^1} \otimes h_{\mathcal{A}_2}(\xi)_{q^2} \right) \otimes \left((F_1)_{q^1} \otimes (F_2)_{q^2} \right) \\ & \hspace{10em} \text{(by Equation (10.8) and construction of } F) \end{aligned}$$

$$\begin{aligned}
&= \left(\bigoplus_{q \in Q_1} h_{\mathcal{A}_1}(\xi)_q \otimes (F_1)_q \right) \otimes \left(\bigoplus_{q \in Q_2} h_{\mathcal{A}_2}(\xi)_q \otimes (F_2)_q \right) \\
&\quad \text{(by commutativity and distributivity of } \mathbf{B} \text{)} \\
&= \llbracket \mathcal{A}_1 \rrbracket(\xi) \otimes \llbracket \mathcal{A}_2 \rrbracket(\xi) .
\end{aligned}$$

Proof of (2): Let \mathbf{B} be commutative and \mathcal{A}_1 and \mathcal{A}_2 be bu-deterministic. Then \mathcal{A} is bu-deterministic. Here we prove (10.8) as follows. Let $\xi = \sigma(\xi_1, \dots, \xi_k)$ and $q = (q^1, q^2) \in Q$. As above we obtain

$$\begin{aligned}
h_{\mathcal{A}}(\xi)_q &= \bigoplus_{q_1^1 \cdots q_k^1 \in (Q_1)^k} \bigoplus_{q_1^2 \cdots q_k^2 \in (Q_2)^k} \\
&\quad \left(\bigotimes_{i \in [k]} h_{\mathcal{A}_1}(\xi_i)_{q_i^1} \right) \otimes (\delta_1)_k(q_1^1 \cdots q_k^1, \sigma, q^1) \otimes \left(\bigotimes_{i \in [k]} h_{\mathcal{A}_2}(\xi_i)_{q_i^2} \right) \otimes (\delta_2)_k(q_1^2 \cdots q_k^2, \sigma, q^2) .
\end{aligned} \tag{10.9}$$

We note that this part uses commutativity and it does not use distributivity. By Lemma 4.1.2(1) (applied to \mathcal{A}_1 and \mathcal{A}_2), there are four cases. We can combine the four cases into the following two cases.

Case (a): (i) There exists an $i \in [k]$ such that, for every $q_1 \in Q_1$, we have $h_{\mathcal{A}_1}(\xi_i)_{q_1} = 0$ or (ii) there exists a $j \in [k]$ such that, for every $q_2 \in Q_2$, we have $h_{\mathcal{A}_2}(\xi_j)_{q_2} = 0$.

Due to (10.9) we have $h_{\mathcal{A}}(\xi)_q = 0$. In Case (i), $h_{\mathcal{A}_1}(\xi)_{q^1} = 0$ by Lemma 4.1.1(1). Similarly, in Case (ii), $h_{\mathcal{A}_2}(\xi)_{q^2} = 0$. In both cases we have $h_{\mathcal{A}_1}(\xi)_{q^1} \otimes h_{\mathcal{A}_2}(\xi)_{q^2} = 0$.

Case (b): For every $i \in [k]$ there exist exactly one $p_1^i \in Q_1$ and exactly one $p_2^i \in Q_2$ such that $h_{\mathcal{A}_1}(\xi_i)_{p_1^i} \neq 0$ and $h_{\mathcal{A}_2}(\xi_i)_{p_2^i} \neq 0$. (The states p_j^i are unique by Lemma 4.1.2(1).) Then, together with (10.9), we have

$$\begin{aligned}
h_{\mathcal{A}}(\xi)_q &= \left(\bigotimes_{i \in [k]} h_{\mathcal{A}_1}(\xi_i)_{p_1^i} \right) \otimes (\delta_1)_k(p_1^1 \cdots p_k^1, \sigma, q^1) \otimes \left(\bigotimes_{i \in [k]} h_{\mathcal{A}_2}(\xi_i)_{p_2^i} \right) \otimes (\delta_2)_k(p_1^2 \cdots p_k^2, \sigma, q^2) \\
&= h_{\mathcal{A}_1}(\xi)_{q^1} \otimes h_{\mathcal{A}_2}(\xi)_{q^2} .
\end{aligned}$$

This proves (10.8).

Now let $\xi \in T_{\Sigma}$. We can prove $\llbracket \mathcal{A} \rrbracket(\xi) = \llbracket \mathcal{A}_1 \rrbracket(\xi) \otimes \llbracket \mathcal{A}_2 \rrbracket(\xi)$ by case analysis.

Case (a): Let (i) $h_{\mathcal{A}_1}(\xi)_{q_1} = 0$ for every $q_1 \in Q_1$ or (ii) $h_{\mathcal{A}_2}(\xi)_{q_2} = 0$ for every $q_2 \in Q_2$. Then $\llbracket \mathcal{A}_1 \rrbracket(\xi) = \llbracket \mathcal{A}_2 \rrbracket(\xi) = 0$. By (10.8) we have that $h_{\mathcal{A}}(\xi)_{(q_1, q_2)} = h_{\mathcal{A}_1}(\xi)_{q_1} \otimes h_{\mathcal{A}_2}(\xi)_{q_2} = 0$ for every $(q_1, q_2) \in Q$, and hence $\llbracket \mathcal{A} \rrbracket(\xi) = 0$.

Case (b): There exist exactly one $p_1 \in Q_1$ and exactly one $p_2 \in Q_2$ such that $h_{\mathcal{A}_1}(\xi)_{p_1} \neq 0$ and $h_{\mathcal{A}_2}(\xi)_{p_2} \neq 0$. Then, by (10.8), we have that $h_{\mathcal{A}}(\xi)_{(q_1, q_2)} = 0$ for each $(q_1, q_2) \in Q \setminus \{(p_1, p_2)\}$. Then

$$\begin{aligned}
\llbracket \mathcal{A} \rrbracket(\xi) &= h_{\mathcal{A}}(\xi)_{(p_1, p_2)} \otimes F_{(p_1, p_2)} \\
&= (h_{\mathcal{A}_1}(\xi)_{p_1} \otimes h_{\mathcal{A}_2}(\xi)_{p_2}) \otimes ((F_1)_{p_1} \otimes (F_2)_{p_2}) \quad \text{(by Equation (10.8) and construction of } F \text{)} \\
&= (h_{\mathcal{A}_1}(\xi)_{p_1} \otimes (F_1)_{p_1}) \otimes (h_{\mathcal{A}_1}(\xi)_{p_1} \otimes (F_2)_{p_2}) \quad \text{(by commutativity of } \mathbf{B} \text{)} \\
&= \llbracket \mathcal{A}_1 \rrbracket(\xi) \otimes \llbracket \mathcal{A}_2 \rrbracket(\xi) .
\end{aligned}$$

Proof of (3): Now let \mathcal{A}_1 and \mathcal{A}_2 be crisp-deterministic. Then also \mathcal{A} is crisp-deterministic. Let $\xi \in T_{\Sigma}$. By Lemma 4.1.5 there exist states $p_1 \in Q_1$ and $p_2 \in Q_2$ such that $h_{\mathcal{A}_1}(\xi)_{p_1} = \mathbb{1} = h_{\mathcal{A}_2}(\xi)_{p_2}$ and for every $(q_1, q_2) \in Q \setminus \{(p_1, p_2)\}$ we have $h_{\mathcal{A}_1}(\xi)_{q_1} = 0 = h_{\mathcal{A}_2}(\xi)_{q_2}$. Then we can prove (10.8) and $\llbracket \mathcal{A} \rrbracket(\xi) = \llbracket \mathcal{A}_1 \rrbracket(\xi) \otimes \llbracket \mathcal{A}_2 \rrbracket(\xi_2)$ as in the proof of Statement (2) but without the use of commutativity.

Finally, by Theorem 10.3.1 (A) \Leftrightarrow (B), $\text{RecStep}(\Sigma, \mathbf{B})$ is equal to the set of (Σ, \mathbf{B}) -weighted tree languages recognizable by crisp-deterministic wta. By (3) the latter is closed under Hadamard product. \square

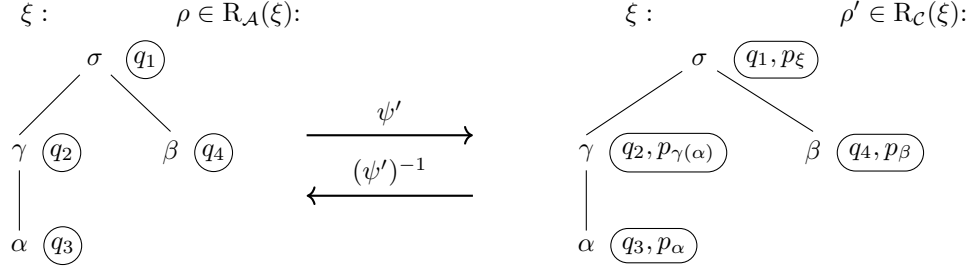

Figure 10.1: An illustration of the mapping ψ' .

We note that in [Gho22, Thm. 4.2(2)] closure of $\text{Rec}^{\text{init}}(\Sigma, \mathbf{B})$ under Hadamard product was proved for the particular case that \mathbf{B} is a σ -complete distributive orthomodular lattice. Since each σ -complete distributive orthomodular lattice is a particular commutative semiring, [Gho22, Thm. 4.2(2)] follows from Theorem 10.4.1 and from [Bor04, Cor. 3.9].

The next theorem can be compared to [DGMM11, Thm. 5.12.1(b)].

Theorem 10.4.2. *Let Σ be a ranked alphabet. Moreover, let $\mathbf{B} = (B, \oplus, \otimes, \mathbf{0}, \mathbf{1})$ be a strong bimonoid, let \mathcal{A} be a (Σ, \mathbf{B}) -wta, and let \mathcal{B} be a crisp-deterministic (Σ, \mathbf{B}) -wta. Moreover, let D be a Σ -fta. Then the following three statements hold.*

- (1) *If \mathbf{B} is right-distributive, then we can construct a (Σ, \mathbf{B}) -wta \mathcal{C} such that $\llbracket \mathcal{C} \rrbracket^{\text{run}} = \llbracket \mathcal{A} \rrbracket^{\text{run}} \otimes \llbracket \mathcal{B} \rrbracket$.*
 - (2) *We can construct a (Σ, \mathbf{B}) -wta \mathcal{C} such that $\llbracket \mathcal{C} \rrbracket^{\text{run}} = \llbracket \mathcal{A} \rrbracket^{\text{run}} \otimes \chi(\text{L}(D))$.*
 - (3) *We can construct a (Σ, \mathbf{B}) -wta \mathcal{C} such that $\llbracket \mathcal{C} \rrbracket^{\text{run}} = \chi(\text{L}(D)) \otimes \llbracket \mathcal{A} \rrbracket^{\text{run}}$.*
 - (4) [Dro22] *If \mathbf{B} is left-distributive, then we can construct a (Σ, \mathbf{B}) -wta \mathcal{C} such that $\llbracket \mathcal{C} \rrbracket^{\text{run}} = \llbracket \mathcal{B} \rrbracket \otimes \llbracket \mathcal{A} \rrbracket^{\text{run}}$.*
- In Statements (1), (2), and (3), if \mathcal{A} is bu-deterministic (or crisp-deterministic), then so is \mathcal{C} .*

Proof. Proof of (1): Let \mathbf{B} be right-distributive. Moreover, let $\mathcal{A} = (Q_1, \delta_1, F_1)$ and $\mathcal{B} = (Q_2, \delta_2, F_2)$. We construct the (Σ, \mathbf{B}) -wta $\mathcal{C} = (Q, \delta, F)$ in the same way as in the proof of Theorem 10.4.1:

- $Q = Q_1 \times Q_2$; for each $q \in Q$ we denote its first and second component by q^1 and q^2 , respectively,
- for every $k \in \mathbb{N}$, $\sigma \in \Sigma^{(k)}$, $q \in Q$, and $q_1 \cdots q_k \in Q^k$ we define

$$\delta_k(q_1 \cdots q_k, \sigma, q) = (\delta_1)_k(q_1^1 \cdots q_k^1, \sigma, q^1) \otimes (\delta_2)_k(q_1^2 \cdots q_k^2, \sigma, q^2)$$

- for each $q \in Q$ we define $F_q = (F_1)_{q^1} \otimes (F_2)_{q^2}$.

Obviously, if \mathcal{A} is bu-deterministic (or crisp-deterministic), then so is \mathcal{C} .

Let $\xi \in \text{T}_\Sigma$. By Lemma 4.1.5 there exists $p \in Q_2$ and a $\rho \in \text{R}_\mathcal{B}(p, \xi)$ such that (a) $\text{wt}_\mathcal{B}(\xi, \rho) = \mathbf{1}$ and (b) for each $\kappa \in \text{R}_\mathcal{B}(\xi) \setminus \{\rho\}$ we have $\text{wt}_\mathcal{B}(\xi, \kappa) = \mathbf{0}$. Since (a) and (b) determine p and ρ uniquely, we will denote them by p_ξ and ρ_ξ , respectively. Then $p_\xi = \rho_\xi(\varepsilon)$, hence we obtain

$$\llbracket \mathcal{B} \rrbracket(\xi) = \left(\bigoplus_{\kappa \in \text{R}_\mathcal{B}(\xi)} \text{wt}_\mathcal{B}(\xi, \kappa) \otimes (F_2)_{\kappa(\varepsilon)} \right) = \text{wt}_\mathcal{B}(\xi, \rho_\xi) \otimes (F_2)_{\rho_\xi(\varepsilon)} = (F_2)_{p_\xi} . \quad (10.10)$$

Then we define the mapping $\psi : \text{R}_\mathcal{A}(\xi) \rightarrow \text{R}_\mathcal{C}(\xi)$ for every $\rho \in \text{R}_\mathcal{A}(\xi)$ and $w \in \text{pos}(\xi)$ by

$$\psi(\rho)(w) = (\rho(w), p_{\xi|_w})$$

(cf. Figure 10.1). Obviously, ψ is injective. Moreover, we define the mapping $\psi' : \text{R}_\mathcal{A}(\xi) \rightarrow \text{im}(\psi)$ such that $\psi'(\rho) = \psi(\rho)$ for each $\rho \in \text{R}_\mathcal{A}(\xi)$. It follows that ψ' is bijective.

The following statement is easy to see.

$$\text{For every } \xi \in \text{T}_\Sigma \text{ and } \rho \in \text{R}_\mathcal{C}(\xi): \quad \text{wt}_\mathcal{C}(\xi, \rho) = \begin{cases} \text{wt}_\mathcal{A}(\xi, (\psi')^{-1}(\rho)) & \text{if } \rho \in \text{im}(\psi') \\ \mathbf{0} & \text{otherwise} \end{cases} \quad (10.11)$$

Then, for each $\xi \in T_\Sigma$, we can compute as follows.

$$\begin{aligned}
[[\mathcal{C}]]^{\text{run}}(\xi) &= \bigoplus_{\rho \in R_{\mathcal{C}}(\xi)} \text{wt}_{\mathcal{C}}(\xi, \rho) \otimes F_{\rho(\varepsilon)} \\
&= \bigoplus_{\rho \in \text{im}(\psi')} \text{wt}_{\mathcal{A}}(\xi, (\psi')^{-1}(\rho)) \otimes F_{\rho(\varepsilon)} && \text{(by (10.11))} \\
&= \bigoplus_{\rho \in \text{im}(\psi')} \text{wt}_{\mathcal{A}}(\xi, (\psi')^{-1}(\rho)) \otimes (F_1)_{\rho(\varepsilon)^1} \otimes (F_2)_{\rho(\varepsilon)^2} && \text{(by the construction of } F) \\
&= \bigoplus_{\rho \in \text{im}(\psi')} \text{wt}_{\mathcal{A}}(\xi, (\psi')^{-1}(\rho)) \otimes (F_1)_{\rho(\varepsilon)^1} \otimes (F_2)_{p_\xi} \quad \text{(because } \rho(\varepsilon)^2 = p_\xi \text{ by the definition of } \psi) \\
&= \bigoplus_{\rho' \in R_{\mathcal{A}}(\xi)} \text{wt}_{\mathcal{A}}(\xi, (\psi')^{-1}(\psi'(\rho'))) \otimes (F_1)_{\psi'(\rho')(\varepsilon)^1} \otimes (F_2)_{p_\xi} && \text{(because } \psi' \text{ is bijective)} \\
&= \bigoplus_{\rho' \in R_{\mathcal{A}}(\xi)} \text{wt}_{\mathcal{A}}(\xi, \rho') \otimes (F_1)_{\rho'(\varepsilon)} \otimes (F_2)_{p_\xi} && \text{(because } \psi'(\rho')(\varepsilon)^1 = \rho'(\varepsilon)) \\
&=^{(*)} \left(\bigoplus_{\rho' \in R_{\mathcal{A}}(\xi)} \text{wt}_{\mathcal{A}}(\xi, \rho') \otimes (F_1)_{\rho'(\varepsilon)} \right) \otimes (F_2)_{p_\xi} && \text{(by right-distributivity)} \\
&= [[\mathcal{A}]]^{\text{run}}(\xi) \otimes [[\mathcal{B}]](\xi) . && \text{(by (10.10))}
\end{aligned}$$

The (*) at the last but one equality will be used and explained in the proof of (2).

Proof of (2): By Theorem 4.1.10 we can construct a crisp-deterministic (Σ, \mathbf{B}) -wta $\mathcal{B} = (Q_2, \delta_2, F_2)$ with identity root weights (i.e., $\text{im}(F_2) \subseteq \{0, \mathbb{1}\}$) such that $[[\mathcal{B}]] = \chi(L(D))$. We construct the (Σ, \mathbf{B}) -wta \mathcal{C} and define the mappings ψ and ψ' as in the proof of Statement (1). Obviously, (10.11) also holds. Then we can prove that $[[\mathcal{C}]]^{\text{run}} = [[\mathcal{A}]]^{\text{run}} \otimes \chi(L(D))$ in the same way as we have proved $[[\mathcal{C}]]^{\text{run}} = [[\mathcal{A}]]^{\text{run}} \otimes [[\mathcal{B}]]$ in Statement (1) except that the equality (*) is justified because $(F_2)_{p_\xi} \in \{0, \mathbb{1}\}$. Thus no right-distributivity of \mathbf{B} is used.

Proof of (3): As in the proof of (2), by Theorem 4.1.10 we can construct a crisp-deterministic (Σ, \mathbf{B}) -wta $\mathcal{B} = (Q_2, \delta_2, F_2)$ with identity root weights (i.e., $\text{im}(F_2) \subseteq \{0, \mathbb{1}\}$) such that $[[\mathcal{B}]] = \chi(L(D))$. Then, in the same way as in the proof of Statement (1), we construct the (Σ, \mathbf{B}) -wta \mathcal{C} . We mention that we do not have to reverse the order of $(\delta_1)_k$ and $(\delta_2)_k$ in the right-hand side of the definition of δ_k , because $\text{im}((\delta_2)_k) \in \{0, \mathbb{1}\}$ and thus

$$(\delta_2)_k(q_1^2 \cdots q_k^2, \sigma, q^2) \otimes (\delta_1)_k(q_1^1 \cdots q_k^1, \sigma, q^1) = (\delta_1)_k(q_1^1 \cdots q_k^1, \sigma, q^1) \otimes (\delta_2)_k(q_1^2 \cdots q_k^2, \sigma, q^2) .$$

Next we define the mappings φ and ψ in the same way as in the proof of (1), and of course, Equality (10.11) holds also in this case. Due to the first six steps in the final calculation of the proof of (1), we obtain:

$$[[\mathcal{C}]]^{\text{run}}(\xi) = \bigoplus_{\rho' \in R_{\mathcal{A}}(\xi)} \text{wt}_{\mathcal{A}}(\xi, \rho') \otimes (F_1)_{\rho'(\varepsilon)} \otimes (F_2)_{p_\xi} .$$

Then we finish the proof as follows:

$$\begin{aligned}
&\bigoplus_{\rho' \in R_{\mathcal{A}}(\xi)} \text{wt}_{\mathcal{A}}(\xi, \rho') \otimes (F_1)_{\rho'(\varepsilon)} \otimes (F_2)_{p_\xi} \\
&= \bigoplus_{\rho' \in R_{\mathcal{A}}(\xi)} (F_2)_{p_\xi} \otimes \text{wt}_{\mathcal{A}}(\xi, \rho') \otimes (F_1)_{\rho'(\varepsilon)} && \text{(because } (F_2)_{p_\xi} \in \{0, \mathbb{1}\}) \\
&= (F_2)_{p_\xi} \otimes \bigoplus_{\rho' \in R_{\mathcal{A}}(\xi)} \text{wt}_{\mathcal{A}}(\xi, \rho') \otimes (F_1)_{\rho'(\varepsilon)} && \text{(because } (F_2)_{p_\xi} \in \{0, \mathbb{1}\})
\end{aligned}$$

$$= \llbracket \mathcal{B} \rrbracket(\xi) \otimes \llbracket \mathcal{A} \rrbracket^{\text{run}}(\xi) . \quad (\text{by (10.10)})$$

Thus no commutativity and no left-distributivity of \mathbf{B} is used.

Proof of (4): Let \mathbf{B} be left-distributive. By Theorem 10.3.1(A) \Rightarrow (D), we can construct $n \in \mathbb{N}_+$, $b_1, \dots, b_n \in B$, and Σ -fta A_1, \dots, A_n such that $\llbracket \mathcal{B} \rrbracket = \bigoplus_{i \in [n]} b_i \cdot \chi(\mathbf{L}(A_i))$ and the step languages $\mathbf{L}(A_i)$ are pairwise disjoint. Due to the disjointness of the step languages and by associativity of \otimes , we have

$$\left(\bigoplus_{i \in [n]} b_i \cdot \chi(\mathbf{L}(A_i)) \right) \otimes \llbracket \mathcal{A} \rrbracket^{\text{run}} = \bigoplus_{i \in [n]} b_i \cdot (\chi(\mathbf{L}(A_i)) \otimes \llbracket \mathcal{A} \rrbracket^{\text{run}}) .$$

By Theorem 10.4.2(3), we can construct a (Σ, \mathbf{B}) -wta \mathcal{B}_i such that $\llbracket \mathcal{B}_i \rrbracket^{\text{run}} = \chi(\mathbf{L}(A_i)) \otimes \llbracket \mathcal{A} \rrbracket^{\text{run}}$. Hence

$$\bigoplus_{i \in [n]} b_i \cdot (\chi(\mathbf{L}(A_i)) \otimes \llbracket \mathcal{A} \rrbracket^{\text{run}}) = \bigoplus_{i \in [n]} b_i \cdot \llbracket \mathcal{B}_i \rrbracket^{\text{run}} .$$

Since \mathbf{B} is left-distributive, by Theorem 10.2.1(1) we can construct, for each $i \in [n]$, a (Σ, \mathbf{B}) -wta \mathcal{C}_i such that $\llbracket \mathcal{C}_i \rrbracket^{\text{run}} = b_i \cdot \llbracket \mathcal{B}_i \rrbracket^{\text{run}}$. Hence

$$\bigoplus_{i \in [n]} b_i \cdot \llbracket \mathcal{B}_i \rrbracket^{\text{run}} = \bigoplus_{i \in [n]} \llbracket \mathcal{C}_i \rrbracket^{\text{run}} .$$

By Theorem 10.1.1 we can construct a (Σ, \mathbf{B}) -wta \mathcal{C} such that $\llbracket \mathcal{C} \rrbracket^{\text{run}} = \bigoplus_{i \in [n]} \llbracket \mathcal{C}_i \rrbracket^{\text{run}}$. \square

The next corollary shows that recognizable step mappings are closed under Hadamard product if the weight structure is a semiring. This result is a special instance of Theorem 10.4.2 (the proof of which uses Theorem 10.3.1). Nevertheless, here we show a proof of the weaker result without referring to Theorem 10.3.1; its proof exploits the special structure of recognizable step mappings. The reader may view this proof as an exercise.

Corollary 10.4.3. (cf. [DGMM11, Thm. 5.12] and [Her20a, Lm. 1.4.22]) Let Σ be a ranked alphabet and $\mathbf{B} = (B, \oplus, \otimes, 0, \mathbb{1})$ be a semiring. Moreover, let $r : \mathbf{T}_\Sigma \rightarrow B$ and $r' : \mathbf{T}_\Sigma \rightarrow B$ be recognizable (Σ, \mathbf{B}) -weighted tree languages. If r or r' is a recognizable step mapping, then $r \otimes r'$ is (Σ, \mathbf{B}) -recognizable.

Proof. First we assume that r is a recognizable step mapping. Hence, there exist $n \in \mathbb{N}_+$, $b_1, \dots, b_n \in B$, and recognizable Σ -tree languages L_1, \dots, L_n such that $r = \bigoplus_{i \in [n]} b_i \cdot \chi(L_i)$. Then, for each $\xi \in \mathbf{T}_\Sigma$, we can calculate as follows.

$$\begin{aligned} (r \otimes r')(\xi) &= \left(\bigoplus_{i \in [n]} b_i \otimes \chi(L_i)(\xi) \right) \otimes r'(\xi) \\ &= \bigoplus_{i \in [n]} b_i \otimes \chi(L_i)(\xi) \otimes r'(\xi) && (\text{by right-distributivity}) \\ &= \left(\bigoplus_{i \in [n]} b_i \cdot (\chi(L_i) \otimes r') \right)(\xi) . \end{aligned}$$

By Theorem 10.4.2(3), the weighted tree language $\chi(L_i) \otimes r'$ is recognizable. Since \mathbf{B} is left-distributive, we can apply Theorem 10.2.1(1a) and obtain that the weighted tree language $b_i \cdot (\chi(L_i) \otimes r')$ is recognizable. Finally, by Theorem 10.1.1, the weighted tree language $\bigoplus_{i \in [n]} b_i \cdot (\chi(L_i) \otimes r')$ is recognizable. Hence $r \otimes r'$ is recognizable.

Now we assume that r' is a recognizable step mapping. Hence, there are $n \in \mathbb{N}_+$, $b_1, \dots, b_n \in B$, and recognizable Σ -tree languages L_1, \dots, L_n such that $r' = \bigoplus_{i \in [n]} b_i \cdot \chi(L_i)$. Then, for each $\xi \in \mathbf{T}_\Sigma$, we can calculate as follows.

$$(r \otimes r')(\xi) = r(\xi) \otimes \bigoplus_{i \in [n]} b_i \otimes \chi(L_i)(\xi)$$

$$\begin{aligned}
&= \bigoplus_{i \in [n]} r(\xi) \otimes b_i \otimes \chi(L_i)(\xi) && \text{(by left-distributivity)} \\
&= \left(\bigoplus_{i \in [n]} (r \cdot b_i) \otimes \chi(L_i) \right) (\xi) .
\end{aligned}$$

Since \mathbf{B} is right-distributive, we can apply Theorem 10.2.1(2) and obtain that the weighted tree language $r \cdot b_i$ is recognizable. By Theorem 10.4.2(2), the weighted tree language $(r \cdot b_i) \otimes \chi(L_i)$ is recognizable. Finally, by Theorem 10.1.1, the weighted tree language $\bigoplus_{i \in [n]} (r \cdot b_i) \otimes \chi(L_i)$ is recognizable. Hence $r \otimes r'$ is recognizable. \square

Finally, we show an overview of the closure results for the Hadamard product, cf. Figure 10.2.

Theorem	restriction on (Σ, \mathbf{B})-wta \mathcal{A}_1	restriction on (Σ, \mathbf{B})-wta \mathcal{A}_2	subset of strong bimonoids	$[[\mathcal{A}_1]]^{\text{run}} \otimes [[\mathcal{A}_2]]^{\text{run}}$ included in
10.4.1(1)	-	-	commutative semirings	$\text{Rec}(\Sigma, \mathbf{B})$
10.4.1(2)	bu-deterministic	bu-deterministic	commutative	$\text{bud-Rec}(\Sigma, \mathbf{B})$
10.4.1(3)	crisp-deterministic	crisp-deterministic	all strong bimonoids	$\text{cd-Rec}(\Sigma, \mathbf{B})$
10.4.2(1)	-	crisp-deterministic	right-distributive	$\text{Rec}^{\text{run}}(\Sigma, \mathbf{B})$
10.4.2(2)	-	$[[\mathcal{A}_2]]^{\text{run}} = \chi(L)$ for some $L \in \text{Rec}(\Sigma)$	all strong bimonoids	$\text{Rec}^{\text{run}}(\Sigma, \mathbf{B})$
10.4.2(3)	$[[\mathcal{A}_1]]^{\text{run}} = \chi(L)$ for some $L \in \text{Rec}(\Sigma)$	-	all strong bimonoids	$\text{Rec}^{\text{run}}(\Sigma, \mathbf{B})$
10.4.2(4)	crisp-deterministic	-	left-distributive	$\text{Rec}^{\text{run}}(\Sigma, \mathbf{B})$

Figure 10.2: An overview of the closure results for the Hadamard product of $[[\mathcal{A}_1]]^{\text{run}}$ and $[[\mathcal{A}_2]]^{\text{run}}$ for two (Σ, \mathbf{B}) -wta \mathcal{A}_1 and \mathcal{A}_2 .

10.5 Closure under top-concatenations

Let $k \in \mathbb{N}$, $\sigma \in \Sigma^{(k)}$, and r_1, \dots, r_k be (Σ, \mathbf{B}) -weighted tree languages. The *top-concatenation* of r_1, \dots, r_k with σ is the (Σ, \mathbf{B}) -weighted tree language $\text{top}_\sigma(r_1, \dots, r_k) : \mathbb{T}_\Sigma \rightarrow \mathbf{B}$ defined, for each $\xi \in \mathbb{T}_\Sigma$, as follows:

$$\text{top}_\sigma(r_1, \dots, r_k)(\xi) = \begin{cases} r_1(\xi_1) \otimes \dots \otimes r_k(\xi_k) & \text{if } \xi = \sigma(\xi_1, \dots, \xi_k) \\ \mathbb{0} & \text{otherwise} \end{cases}$$

If $\alpha \in \Sigma^{(0)}$, then we call $\text{top}_\alpha()$ the *top-concatenation with α* . For each $\xi \in \mathbb{T}_\Sigma$, we have

$$\text{top}_\alpha()(\xi) = \begin{cases} \mathbb{1} & \text{if } \xi = \alpha \\ \mathbb{0} & \text{otherwise} \end{cases} ,$$

i.e., $\text{top}_\alpha() = \mathbb{1} \cdot \alpha$. It follows that $\text{top}_\sigma(r_1, \dots, r_k)(\xi) = \mathbb{0}$ for each $\xi \in \mathbb{T}_\Sigma$ with $\xi(\varepsilon) \neq \sigma$.

A set \mathcal{L} of \mathbf{B} -weighted tree languages is *closed under top-concatenations* if for every $k \in \mathbb{N}$, $\sigma \in \Sigma^{(k)}$, and (Σ, \mathbf{B}) -weighted tree languages r_1, \dots, r_k in \mathcal{L} , the (Σ, \mathbf{B}) -weighted tree language $\text{top}_\sigma(r_1, \dots, r_k)$ is in \mathcal{L} . Thus, in particular, a set \mathcal{L} of (Σ, \mathbf{B}) -weighted tree languages which is closed under top-concatenations contains the (Σ, \mathbf{B}) -weighted tree language $\text{top}_\alpha()$ for each $\alpha \in \Sigma^{(0)}$.

Theorem 10.5.1. *Let \mathbf{B} be a semiring. Moreover, let $k \in \mathbb{N}$ and $\sigma \in \Sigma^{(k)}$. Also, for each $i \in [k]$, let \mathcal{G}_i be a (Σ, \mathbf{B}) -wrtg such that (a) for each $i \in [k]$ the wrtg \mathcal{G}_i is finite-derivational or (b) \mathbf{B} is σ -complete. We can construct a (Σ, \mathbf{B}) -wrtg \mathcal{G} such that $[[\mathcal{G}]] = \text{top}_\sigma([[\mathcal{G}_1]], \dots, [\mathcal{G}_k]]$.*

Thus, in particular, if \mathbf{B} is a semiring, then the set $\text{Reg}(\Sigma, \mathbf{B})$ is closed under top-concatenations.

Proof. For each $i \in [k]$, let $\mathcal{G}_i = (N_i, S_i, R_i, \text{wt}_i)$ be a (Σ, \mathbf{B}) -wrtg such that $N_i \cap N_j = \emptyset$ for each $i, j \in [k]$ with $i \neq j$. By Lemma 9.2.1(1), for each $i \in [k]$, we can construct a wrtg which is start-separated and equivalent to \mathcal{G}_i . The construction preserves the property finite-derivational. So we can assume that each \mathcal{G}_i is start-separated, i.e., S_i is a singleton (and then we assume that S_i denotes the only initial nonterminal).

We let S be a new nonterminal, i.e., $S \notin \bigcup_{i \in [k]} N_i$, and construct the (Σ, \mathbf{B}) -wrtg $\mathcal{G} = (N, S, R, \text{wt})$ as follows.

- $N = \{S\} \cup \bigcup_{i \in [k]} N_i$ and
- R is the smallest set R' of rules which satisfies the following conditions:
 - $r = (S \rightarrow \sigma(S_1, \dots, S_k))$ is in R' and $\text{wt}(r) = \mathbb{1}$ and
 - for every $i \in [k]$ and $r \in R_i$, we let $r \in R'$ and $\text{wt}(r) = \text{wt}_i(r)$.

In case $k = 0$ we have $N = \{S\}$ and $R = \{r\}$ with $r = (S \rightarrow \sigma)$ and $\text{wt}(r) = \mathbb{1}$.

It is obvious that, if for each $i \in [k]$ the wrtg \mathcal{G}_i is finite-derivational, then \mathcal{G} is finite-derivational. Hence $\llbracket \mathcal{G} \rrbracket$ is defined.

Next we prove that

$$\llbracket \mathcal{G} \rrbracket(\xi) = \text{top}_\sigma(\llbracket \mathcal{G}_1 \rrbracket, \dots, \llbracket \mathcal{G}_k \rrbracket)(\xi) \text{ for each } \xi \in \mathbf{T}_\Sigma . \quad (10.12)$$

For this, we mention some properties which are easy to see.

$$\text{For every } \xi \in \mathbf{T}_\Sigma \text{ with } \xi(\varepsilon) \neq \sigma \text{ we have } \text{RT}_{\mathcal{G}}(S, \xi) = \emptyset. \quad (10.13)$$

$$\begin{aligned} &\text{For every } \xi = \sigma(\xi_1, \dots, \xi_k) \text{ in } \mathbf{T}_\Sigma \text{ and } d \in \text{RT}_{\mathcal{G}}(S, \xi), \\ &\text{we have } \text{lhs}(d(i)) = S_i \text{ for each } i \in [k]. \end{aligned} \quad (10.14)$$

$$\text{For every } \xi \in \mathbf{T}_\Sigma \text{ and } i \in [k], \text{ we have } \text{RT}_{\mathcal{G}}(S_i, \xi) = \text{RT}_{\mathcal{G}_i}(S_i, \xi). \quad (10.15)$$

$$\text{For every } \xi \in \mathbf{T}_\Sigma, i \in [k], \text{ and } d \in \text{RT}_{\mathcal{G}_i}(S_i, \xi), \text{ we have } \text{wt}_{\mathcal{G}}(d) = \text{wt}_{\mathcal{G}_i}(d). \quad (10.16)$$

Now we prove (10.12). Let $\xi \in \mathbf{T}_\Sigma$. Then we have:

$$\llbracket \mathcal{G} \rrbracket(\xi) = \bigoplus_{d \in \text{RT}_{\mathcal{G}}(\xi)} \text{wt}_{\mathcal{G}}(d) = \bigoplus_{d \in \text{RT}_{\mathcal{G}}(S, \xi)} \text{wt}_{\mathcal{G}}(\xi) .$$

If $\xi(\varepsilon) \neq \sigma$, then $\llbracket \mathcal{G} \rrbracket(\xi) = 0$ by (10.13). Since $\text{top}_\sigma(\llbracket \mathcal{G}_1 \rrbracket, \dots, \llbracket \mathcal{G}_k \rrbracket)(\xi) = 0$, the equality 10.12 is proved for that case.

Now we assume that $\xi = \sigma(\xi_1, \dots, \xi_k)$. Then we continue with

$$\begin{aligned} &\bigoplus_{d \in \text{RT}_{\mathcal{G}}(S, \xi)} \text{wt}_{\mathcal{G}}(d) \\ &= \bigoplus_{\substack{d \in \text{RT}_{\mathcal{G}}(S, \xi): \\ (\forall i \in [k]): \text{lhs}(d(i)) = S_i}} \text{wt}_{\mathcal{G}}(d) && \text{(by (10.14))} \\ &= \bigoplus_{\substack{d \in \text{RT}_{\mathcal{G}}(S, \xi): \\ (\forall i \in [k]): \text{lhs}(d(i)) = S_i}} \text{wt}_{\mathcal{G}}(d|_1) \otimes \dots \otimes \text{wt}_{\mathcal{G}}(d|_k) \otimes \text{wt}(S \rightarrow \sigma(S_1, \dots, S_k)) \\ &= \bigoplus_{\substack{d \in \text{RT}_{\mathcal{G}}(S, \xi): \\ (\forall i \in [k]): \text{lhs}(d(i)) = S_i}} \text{wt}_{\mathcal{G}}(d|_1) \otimes \dots \otimes \text{wt}_{\mathcal{G}}(d|_k) && \text{(since } \text{wt}(S \rightarrow \sigma(S_1, \dots, S_k)) = \mathbb{1}) \end{aligned}$$

$$\begin{aligned}
&= \bigoplus_{d_1 \in \text{RT}_{\mathcal{G}}(S_1, \xi_1)} \dots \bigoplus_{d_k \in \text{RT}_{\mathcal{G}}(S_k, \xi_k)} \text{wt}_{\mathcal{G}}(d_1) \otimes \dots \otimes \text{wt}_{\mathcal{G}}(d_k) \\
&= \bigoplus_{d_1 \in \text{RT}_{\mathcal{G}_1}(S_1, \xi_1)} \dots \bigoplus_{d_k \in \text{RT}_{\mathcal{G}_k}(S_k, \xi_k)} \text{wt}_{\mathcal{G}}(d_1) \otimes \dots \otimes \text{wt}_{\mathcal{G}}(d_k) && \text{(by (10.15))} \\
&= \bigoplus_{d_1 \in \text{RT}_{\mathcal{G}_1}(S_1, \xi_1)} \dots \bigoplus_{d_k \in \text{RT}_{\mathcal{G}_k}(S_k, \xi_k)} \text{wt}_{\mathcal{G}_1}(d_1) \otimes \dots \otimes \text{wt}_{\mathcal{G}_k}(d_k) && \text{(by (10.16))} \\
&= \left(\bigoplus_{d_1 \in \text{RT}_{\mathcal{G}_1}(S_1, \xi_1)} \text{wt}_{\mathcal{G}_1}(d_1) \right) \otimes \dots \otimes \left(\bigoplus_{d_k \in \text{RT}_{\mathcal{G}_k}(S_k, \xi_k)} \text{wt}_{\mathcal{G}_k}(d_k) \right) && \text{(by distributivity)} \\
&= \llbracket \mathcal{G}_1 \rrbracket(\xi_1) \otimes \dots \otimes \llbracket \mathcal{G}_k \rrbracket(\xi_k) \\
&= \text{top}_{\sigma}(\llbracket \mathcal{G}_1 \rrbracket, \dots, \llbracket \mathcal{G}_k \rrbracket)(\xi) && \text{(because } \xi = \sigma(\xi_1, \dots, \xi_k))
\end{aligned}$$

This proves (10.12) also in the case that $\xi = \sigma(\xi_1, \dots, \xi_k)$. \square

Corollary 10.5.2. (cf. [DPV05, Lm. 6.2]) Let Σ be a ranked alphabet. Moreover, let \mathbf{B} be a semiring, let $k \in \mathbb{N}$, and let $\sigma \in \Sigma^{(k)}$. Also, for each $i \in [k]$, let \mathcal{A}_i be a (Σ, \mathbf{B}) -wta. Then we can construct a (Σ, \mathbf{B}) -wta \mathcal{A} such that $\llbracket \mathcal{A} \rrbracket = \text{top}_{\sigma}(\llbracket \mathcal{A}_1 \rrbracket, \dots, \llbracket \mathcal{A}_k \rrbracket)$. Thus, in particular, if \mathbf{B} is a semiring, then the set $\text{Rec}(\Sigma, \mathbf{B})$ is closed under top-concatenations.

Proof. By Lemma 9.2.6, for each $i \in [k]$, we can construct (Σ, \mathbf{B}) -wrtg \mathcal{G}_i such that \mathcal{G}_i is in tree automata form and $\llbracket \mathcal{A}_i \rrbracket = \llbracket \mathcal{G}_i \rrbracket$. Then, in particular, \mathcal{G}_i is finite-derivational. By Theorem 10.5.1 we can construct a finite-derivational (Σ, \mathbf{B}) -wrtg \mathcal{G} such that $\llbracket \mathcal{G} \rrbracket = \text{top}_{\sigma}(\llbracket \mathcal{G}_1 \rrbracket, \dots, \llbracket \mathcal{G}_k \rrbracket)$. Then, by Lemma 9.2.8, we can construct a (Σ, \mathbf{B}) -wta \mathcal{A} such that $\llbracket \mathcal{G} \rrbracket = \llbracket \mathcal{A} \rrbracket$. \square

10.6 Closure under tree concatenations

In this section we recall the definition of tree concatenation and show that $\text{Rec}(\Sigma, \mathbf{B})$ is closed under tree concatenation. The definition of tree concatenation involves a technical problem which is due to a difference between the concatenation of strings and tree concatenation [TW68, p. 59]. The concatenation of two strings ξ and ζ is simply the string $\xi\zeta$. This also applies if ξ and ζ are particular strings, viz. trees. However, $\xi\zeta$ is not a tree. In order to define tree concatenation as operation on trees, in [TW68] a nullary symbol α is used and each occurrence of α in ξ is replaced by ζ . Hence, tree concatenation consumes the occurrences of α in ξ ; in contrast, string concatenation does not consume symbols.

Let r_1 and r_2 be (Σ, \mathbf{B}) -weighted tree languages and $\alpha \in \Sigma^{(0)}$. We will recall the definition of the α -concatenation of r_1 and r_2 , denoted by $r_1 \circ_{\alpha} r_2$. This is a (Σ, \mathbf{B}) -weighted tree language and hence, for each $\xi \in \mathbf{T}_{\Sigma}$, the value $(r_1 \circ_{\alpha} r_2)(\xi)$ has to be defined. Thus, intuitively, ξ has to be decomposed and the resulting parts of ξ have to be evaluated appropriately in r_1 or r_2 . As preparation for this, we define the concept of α -cut which helps to identify the mentioned parts of ξ .

Let $\alpha \in \Sigma^{(0)}$ and $\xi \in \mathbf{T}_{\Sigma}$. Intuitively, an α -cut through ξ is a sequence (w_1, \dots, w_n) of pairwise different positions of ξ such that neither w_i is a prefix of w_j nor vice versa (for each index pair i, j with $i \neq j$); moreover, each α -labeled position is covered by some w_i (see Figure 10.3). Formally, we define the set of α -cuts through ξ , denoted by $\text{cut}_{\alpha}(\xi)$, to be the set

$$\begin{aligned}
\text{cut}_{\alpha}(\xi) = \{ & (w_1, \dots, w_n) \mid n \in \mathbb{N}, w_1, \dots, w_n \in \text{pos}(\xi), \text{ such that} \\
& w_1 <_{\text{lex}} \dots <_{\text{lex}} w_n \text{ and} \\
& (\forall i, j \in [n]): \text{ if } i \neq j, \text{ then } w_i \notin \text{prefix}(w_j) \text{ and} \\
& (\forall w \in \text{pos}_{\alpha}(\xi)) (\exists i \in [n]) : w_i \text{ is a prefix of } w \} .
\end{aligned}$$

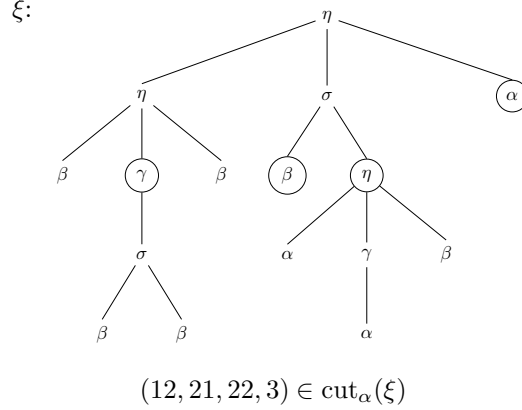

Figure 10.3: An illustration of an α -cut through ξ . Position 22 covers the α at positions 221 and 2221. Moreover, position 3 covers α at position 3.

Let $\tilde{w} = (w_1, \dots, w_n)$ be an element of $\text{cut}_\alpha(\xi)$. Then we will abbreviate $\xi[\alpha]_{w_1} \dots [\alpha]_{w_n}$ by $\xi[\alpha]_{\tilde{w}}$. We point out some properties of $\text{cut}_\alpha(\xi)$.

- The set $\text{cut}_\alpha(\xi)$ is finite and nonempty; in particular, $(\varepsilon) \in \text{cut}_\alpha(\xi)$ and $\xi[\alpha]_{(\varepsilon)} = \xi[\alpha]_\varepsilon = \alpha$.
- For each $\tilde{w} = (w_1, \dots, w_n)$ in $\text{cut}_\alpha(\xi)$, we have $\text{pos}_\alpha(\xi[\alpha]_{\tilde{w}}) = \{w_1, \dots, w_n\}$.
- The following equivalence holds: $\text{pos}_\alpha(\xi) = \emptyset$ if, and only if $(\) \in \text{cut}_\alpha(\xi)$; moreover, $\xi[\alpha]_{(\)} = \xi$.
- $\text{cut}_\alpha(\alpha) = \{(\varepsilon)\}$ and, for each $\beta \in \Sigma^{(0)} \setminus \{\alpha\}$, we have $\text{cut}_\alpha(\beta) = \{(\), (\varepsilon)\}$.

Let $r_1 : \mathbb{T}_\Sigma \rightarrow B$ and $r_2 : \mathbb{T}_\Sigma \rightarrow B$ be weighted tree languages. Moreover, let $\alpha \in \Sigma^{(0)}$. The α -concatenation of r_1 and r_2 [DPV05] is the weighted tree language $(r_1 \circ_\alpha r_2) : \mathbb{T}_\Sigma \rightarrow B$ defined for every $\xi \in \mathbb{T}_\Sigma$ by

$$(r_1 \circ_\alpha r_2)(\xi) = \bigoplus_{(w_1, \dots, w_n) \in \text{cut}_\alpha(\xi)} r_1(\xi[\alpha]_{(w_1, \dots, w_n)}) \otimes r_2(\xi|_{w_1}) \otimes \dots \otimes r_2(\xi|_{w_n})$$

Since, for each $\xi \in \mathbb{T}_\Sigma$, the index set $\text{cut}_\alpha(\xi)$ is finite, we do not need the condition that B is σ -complete for the summation. Moreover, we have $(r_1 \circ_\alpha r_2)(\alpha) = r_1(\alpha) \otimes r_2(\alpha)$ and, for each $\beta \in \Sigma^{(0)} \setminus \{\alpha\}$, we have $(r_1 \circ_\alpha r_2)(\beta) = r_1(\beta) \oplus r_1(\alpha) \otimes r_2(\beta)$. The *tree concatenation* of r_1 and r_2 is the α -concatenation of r_1 and r_2 for some $\alpha \in \Sigma^{(0)}$.

A set \mathcal{L} of B -weighted tree languages is *closed under tree concatenations* if the following holds: for every (Σ, B) -weighted tree languages r_1 and r_2 and for each $\alpha \in \Sigma^{(0)}$, if $r_1, r_2 \in \mathcal{L}$, then $(r_1 \circ_\alpha r_2) \in \mathcal{L}$.

Theorem 10.6.1. (cf. [Eng75b, Thm. 3.35], [GS84, Thm. 2.4.6], and [FV22a, Lm. 6.6]) *Let B be a commutative semiring and let $\alpha \in \Sigma^{(0)}$. Let \mathcal{G}_1 and \mathcal{G}_2 be two (Σ, B) -wrtg such that \mathcal{G}_1 and \mathcal{G}_2 are finite-derivational or B is σ -complete. Then the following two statements hold.*

- (1) *There exists a (Σ, B) -wrtg \mathcal{G} such that $\llbracket \mathcal{G} \rrbracket = \llbracket \mathcal{G}_1 \rrbracket \circ_\alpha \llbracket \mathcal{G}_2 \rrbracket$.*
- (2) *If \mathcal{G}_1 and \mathcal{G}_2 are finite-derivational, then we can construct a finite-derivational (Σ, B) -wrtg \mathcal{G} such that $\llbracket \mathcal{G} \rrbracket = \llbracket \mathcal{G}_1 \rrbracket \circ_\alpha \llbracket \mathcal{G}_2 \rrbracket$.*

Proof. Proof of (1): Let $\mathcal{G}_1 = (N_1, S_1, R_1, wt_1)$ and $\mathcal{G}_2 = (N_2, S_2, R_2, wt_2)$ be two (Σ, B) -wrtg with $N_1 \cap N_2 = \emptyset$. By Lemmas 9.2.1(1) and 9.2.2, we can assume that \mathcal{G}_1 and \mathcal{G}_2 are start-separated and alphabetic. By Lemma 9.2.1(3) we can furthermore assume that \mathcal{G}_1 and \mathcal{G}_2 are chain-free. We call a rule $A \rightarrow \alpha$ of R_1 an α -rule.

We define the (Σ, B) -wrtg $\mathcal{G} = (N, S_1, R, wt)$ such that $\llbracket \mathcal{G} \rrbracket = \llbracket \mathcal{G}_1 \rrbracket \circ_\alpha \llbracket \mathcal{G}_2 \rrbracket$ as follows. We let $N = N_1 \cup N_2$. Moreover, we let $R = \overline{R_1} \cup R_2$ where $\overline{R_1}$ is obtained from R_1 by replacing each α -rule $r = (A \rightarrow \alpha)$ by the rule $r' = (A \rightarrow S_2)$, and we define $wt(r') = wt_1(r)$. Each rule $r \in R$ which is not of the form

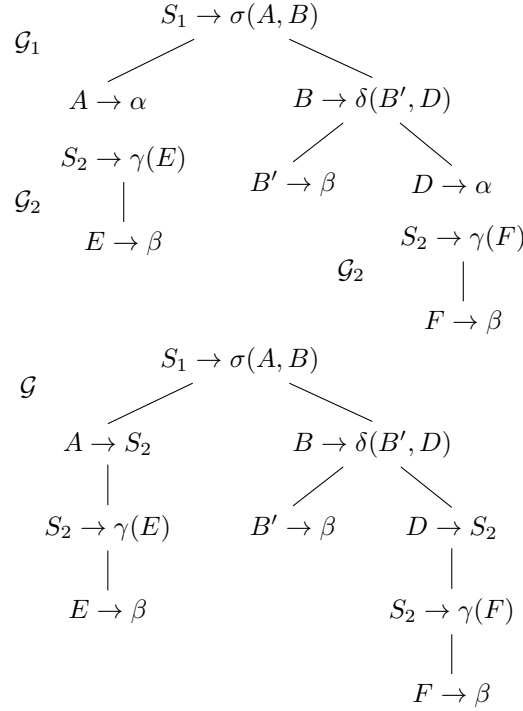

Figure 10.4: Illustration for the proof of $[[\mathcal{G}]] = [[\mathcal{G}_1]] \circ_\alpha [[\mathcal{G}_2]]$.

$A \rightarrow S_2$ keeps the weight from its original grammar. We call each rule of the form $A \rightarrow S_2$ a S_2 -rule. It is obvious that, if \mathcal{G}_1 and \mathcal{G}_2 are finite-derivational, then also \mathcal{G} is finite-derivational. Hence $[[\mathcal{G}]]$ is defined.

Now we prove that $[[\mathcal{G}]] = [[\mathcal{G}_1]] \circ_\alpha [[\mathcal{G}_2]]$ (see Figure 10.4). For this, let $\xi \in \mathbb{T}_\Sigma$ and $\tilde{w} = (w_1, \dots, w_n) \in \text{cut}_\alpha(\xi)$. We define

$$\text{RT}_{\mathcal{G}}^{\tilde{w}}(\xi) = \{d \in \text{RT}_{\mathcal{G}}(\xi) \mid \{w_1, \dots, w_n\} = \{u \in \text{pos}(d) \mid d(u) \text{ is a } S_2\text{-rule}\}\},$$

Obviously, if $() \in \text{cut}_\alpha(\xi)$, i.e., $\text{pos}_\alpha(\xi) = \emptyset$, then $\text{RT}_{\mathcal{G}}^{\tilde{w}}(\xi) = \text{RT}_{\mathcal{G}_1}(\xi)$. The tree in the lower part of Figure 10.4 illustrates an element of $\text{RT}_{\mathcal{G}}^{(1,22)}(\xi)$, where $\xi = \sigma(\gamma(\beta), \delta(\beta, \gamma(\beta)))$. The following is obvious:

$$(\text{RT}_{\mathcal{G}}^{\tilde{w}}(\xi) \mid \tilde{w} \in \text{cut}_\alpha(\xi)) \text{ is a partitioning of } \text{RT}_{\mathcal{G}}(\xi) . \quad (10.17)$$

We will show that there exists a bijection

$$\Phi : \text{RT}_{\mathcal{G}_1}(\xi[\alpha]_{\tilde{w}}) \times \text{RT}_{\mathcal{G}_2}(\xi|_{w_1}) \times \dots \times \text{RT}_{\mathcal{G}_2}(\xi|_{w_n}) \rightarrow \text{RT}_{\mathcal{G}}^{\tilde{w}}(\xi).$$

For this, let $d \in \text{RT}_{\mathcal{G}_1}(\xi[\alpha]_{\tilde{w}})$, $d_1 \in \text{RT}_{\mathcal{G}_2}(\xi|_{w_1})$, \dots , $d_n \in \text{RT}_{\mathcal{G}_2}(\xi|_{w_n})$. Since \mathcal{G}_1 is alphabetic and chain-free, we have $\text{pos}(d) = \text{pos}(\xi[\alpha]_{\tilde{w}})$ and, moreover,

$$\{w_1, \dots, w_n\} = \{u \in \text{pos}(d) \mid d(u) \text{ is an } \alpha\text{-rule}\} .$$

First we define a tree $d' \in \mathbb{T}_R$ by specifying a tree domain and an R -tree mapping and then using the bijective representation of trees as tree domains (cf. Section 2.10). We define the tree domain

$$W = \text{pos}(d) \cup \bigcup_{i \in [n]} \{w_i 1v \mid v \in \text{pos}(d_i)\} \quad (10.18)$$

and we define the mapping $d' : W \rightarrow \Sigma$ for each $v \in W$ by

$$d'(v) = \begin{cases} d(v) & \text{if } (\forall i \in [n]) : \neg(w_i \leq_{\text{pref}} v) \\ d_i(u) & \text{if } (\exists i \in [n])(\exists u \in \mathbb{N}^+) : v = w_i 1u \\ t_i & \text{if } (\exists i \in [n]) : v = w_i, \end{cases} \quad (10.19)$$

where t_i is defined as follows: if $d(w_i) = (A \rightarrow \alpha)$, then $t_i = (A \rightarrow S_2)$.

Since W is a tree domain and d' is an R -tree mapping, we can view d' as a tree over R , i.e., $d' \in \mathsf{T}_R$. It is obvious that $d' \in \mathsf{RT}_{\tilde{\mathcal{G}}}(\xi)$. Then we define Φ by letting

$$\Phi(d, d_1, \dots, d_k) = d'. \quad (10.20)$$

It is easy to see that Φ is bijective. To show that it is injective, we assume that (10.20) holds and that also $\Phi(\hat{d}, \hat{d}_1, \dots, \hat{d}_k) = d'$ for some $\hat{d} \in \mathsf{RT}_{\mathcal{G}_1}(\xi[\alpha]_{\tilde{w}})$, $\hat{d}_1 \in \mathsf{RT}_{\mathcal{G}_2}(\xi|_{w_1})$, \dots , $\hat{d}_n \in \mathsf{RT}_{\mathcal{G}_2}(\xi|_{w_n})$. We prove that $d = \hat{d}$ by contradiction. If $d \neq \hat{d}$, then there exists an $u \in \text{pos}(d) \cap \text{pos}(\hat{d})$ such that $d(u) \neq \hat{d}(u)$. We note that $d(u), \hat{d}(u) \in R_1$ and that, by (10.18), also $u \in \text{pos}(d')$. The following four cases are possible:

- Neither $d(u)$ nor $\hat{d}(u)$ is an α -rule. Then, by (10.19), $d'(u) = d(u)$ and $d'(u) = \hat{d}(u)$, which is a contradiction.
- $d(u) = (A \rightarrow \alpha)$ and $\hat{d}(u)$ is not an α -rule. Then, by (10.19), $d'(u) = (A \rightarrow S_2)$. On the other hand, $d'(u) = \hat{d}(u)$ is a rule in R_1 , a contradiction.
- $d(u)$ is not an α -rule and $\hat{d}(u)$ is an α -rule. By symmetry, this also leads to a contradiction.
- $d(u) = (A \rightarrow \alpha)$ and $\hat{d}(u) = (B \rightarrow \alpha)$, where $A \neq B$. Then by (10.19), $d'(u) = (A \rightarrow S_2)$ and also $d'(u) = (B \rightarrow S_2)$, which is a contradiction.

So we have $d = \hat{d}$. Then, by (10.18) and (10.19), $d_i = \hat{d}_i$ which proves that Φ is injective. Also, it is surjective, because for each $d' \in \mathsf{RT}_{\tilde{\mathcal{G}}}(\xi)$, the positions w_1, \dots, w_n determine $d \in \mathsf{RT}_{\mathcal{G}_1}(\xi[\alpha]_{\tilde{w}})$, $d_1 \in \mathsf{RT}_{\mathcal{G}_2}(\xi|_{w_1})$, \dots , $d_n \in \mathsf{RT}_{\mathcal{G}_2}(\xi|_{w_n})$ such that $\Phi(d, d_1, \dots, d_k) = d'$. Thus Φ is bijective.

Moreover, if (10.20) holds, then

$$\text{wt}_{\mathcal{G}}(d') = \text{wt}_{\mathcal{G}_1}(d) \otimes \bigotimes_{i \in [n]} \text{wt}_{\mathcal{G}_2}(d_i) \quad (10.21)$$

because B is commutative.

Then we can compute as follows (keeping in mind that \mathcal{G}_1 , \mathcal{G}_2 , and \mathcal{G} are finite-derivational if B is not σ -complete):

$$\begin{aligned} & ([\mathcal{G}_1] \circ_{\alpha} [\mathcal{G}_2])(\xi) \\ = & \bigoplus_{\tilde{w}=(w_1, \dots, w_n) \in \text{cut}_{\alpha}(\xi)} [\mathcal{G}_1](\xi[\alpha]_{\tilde{w}}) \otimes [\mathcal{G}_2](\xi|_{w_1}) \otimes \dots \otimes [\mathcal{G}_2](\xi|_{w_n}) \\ = & \bigoplus_{\tilde{w}=(w_1, \dots, w_n) \in \text{cut}_{\alpha}(\xi)} \left(\sum_{d \in \mathsf{RT}_{\mathcal{G}_1}(\xi[\alpha]_{\tilde{w}})}^{\oplus} \text{wt}_{\mathcal{G}_1}(d) \right) \otimes \bigotimes_{i \in [n]} \left(\sum_{d_i \in \mathsf{RT}_{\mathcal{G}_2}(\xi|_{w_i})}^{\oplus} \text{wt}_{\mathcal{G}_2}(d_i) \right) \\ = & \bigoplus_{\tilde{w}=(w_1, \dots, w_n) \in \text{cut}_{\alpha}(\xi)} \sum_{\substack{d \in \mathsf{RT}_{\mathcal{G}_1}(\xi[\alpha]_{\tilde{w}}), \\ (\forall i \in [n]): d_i \in \mathsf{RT}_{\mathcal{G}_2}(\xi|_{w_i})}}^{\oplus} \left(\text{wt}_{\mathcal{G}_1}(d) \otimes \bigotimes_{i \in [n]} \text{wt}_{\mathcal{G}_2}(d_i) \right) \quad (\text{by distributivity}) \\ = & \bigoplus_{\tilde{w} \in \text{cut}_{\alpha}(\xi)} \sum_{d' \in \mathsf{RT}_{\tilde{\mathcal{G}}}(\xi)}^{\oplus} \text{wt}_{\mathcal{G}}(d') \quad (\text{because } \Phi \text{ is a bijection and by (10.21)}) \\ = & \sum_{d' \in \mathsf{RT}_{\mathcal{G}}(\xi)}^{\oplus} \text{wt}_{\mathcal{G}}(d') \quad (\text{by (10.17)}) \\ = & [\mathcal{G}](\xi) . \end{aligned}$$

Thus $\llbracket \mathcal{G} \rrbracket = \llbracket \mathcal{G}_1 \rrbracket \circ_\alpha \llbracket \mathcal{G}_2 \rrbracket$.

Proof of (2): Now let \mathcal{G}_1 and \mathcal{G}_2 finite-derivational. Then, by Lemma 9.2.1(3), we can even construct equivalent chain-free wrtg. Consequently, the definition of \mathcal{G} , as it is given in the proof of (1), is constructive. Finally, as pointed out in the proof of (1), the wrtg \mathcal{G} is finite-derivational. \square

Corollary 10.6.2. (cf. [DPV05, Lm. 6.5]) Let Σ be a ranked alphabet. Moreover, let \mathbf{B} be a commutative semiring, and let \mathcal{A}_1 and \mathcal{A}_2 be two (Σ, \mathbf{B}) -wta. Moreover, let $\alpha \in \Sigma^{(0)}$. Then we can construct a (Σ, \mathbf{B}) -wta \mathcal{A} such that $\llbracket \mathcal{A} \rrbracket = \llbracket \mathcal{A}_1 \rrbracket \circ_\alpha \llbracket \mathcal{A}_2 \rrbracket$. Thus, in particular, if \mathbf{B} is a commutative semiring, then the set $\text{Rec}(\Sigma, \mathbf{B})$ is closed under tree concatenations.

Proof. By Lemma 9.2.6 we can construct (Σ, \mathbf{B}) -wrtg \mathcal{G}_1 and \mathcal{G}_2 such that \mathcal{G}_1 and \mathcal{G}_2 are in tree automata form and $\llbracket \mathcal{A}_1 \rrbracket = \llbracket \mathcal{G}_1 \rrbracket$ and $\llbracket \mathcal{A}_2 \rrbracket = \llbracket \mathcal{G}_2 \rrbracket$. Then, in particular, \mathcal{G}_1 and \mathcal{G}_2 are finite-derivational. By Theorem 10.6.1 we can construct a finite-derivational (Σ, \mathbf{B}) -wrtg \mathcal{G} such that $\llbracket \mathcal{G} \rrbracket = \llbracket \mathcal{G}_1 \rrbracket \circ_\alpha \llbracket \mathcal{G}_2 \rrbracket$. Then, by Lemma 9.2.8, we can construct a (Σ, \mathbf{B}) -wta \mathcal{A} such that $\llbracket \mathcal{G} \rrbracket = \llbracket \mathcal{A} \rrbracket$. \square

10.7 Closure under Kleene stars

In this section we recall the definition of Kleene star and show that $\text{Rec}(\Sigma, \mathbf{B})$ is closed under Kleene stars. We follow the approach developed in [BR82, Eng03, DPV05].

Let $r : T_\Sigma \rightarrow B$ and $\alpha \in \Sigma^{(0)}$. We define the family $(r_\alpha^\ell \mid \ell \in \mathbb{N})$ of weighted tree languages $r_\alpha^\ell : T_\Sigma \rightarrow B$ (called the ℓ -th iteration of r at α) by induction on \mathbb{N} as follows:

I.B.: $r_\alpha^0 = \widetilde{\emptyset}$ and

I.S.: $r_\alpha^{\ell+1} = (r \circ_\alpha r_\alpha^\ell) \oplus \mathbb{1} \cdot \alpha$ for each $\ell \in \mathbb{N}$.

We mention that iteration can also be defined in different ways. For instance, if one generalizes the iteration of tree languages as presented in [Eng75b, p. 38] to the weighted case, then this would read (cf. [DPV05, Def. 3.7]):

I.B.: $r_\alpha^{E,0} = \mathbb{1} \cdot \alpha$ and

I.S.: $r_\alpha^{E,\ell+1} = r_\alpha^{E,\ell} \circ_\alpha (r \oplus \mathbb{1} \cdot \alpha)$ for each $\ell \in \mathbb{N}$.

Another possibility is to generalize the iteration of tree languages as presented in [TW68, p. 66] to the weighted case; this reads as follows (cf. [DPV05, Def. 3.7]):

I.B.: $r_\alpha^{TW,0} = \mathbb{1} \cdot \alpha$ and

I.S.: $r_\alpha^{TW,\ell+1} = (r \oplus \mathbb{1} \cdot \alpha) \circ_\alpha r_\alpha^{TW,\ell}$ for each $\ell \in \mathbb{N}$.

For the Boolean semiring, all three definitions are equivalent. This is due to the facts that disjunction is idempotent and that tree concatenation is associative. If \mathbf{B} is a commutative semiring, then $r_\alpha^{E,\ell} = r_\alpha^{TW,\ell}$ for each $\ell \in \mathbb{N}$ (cf. [DPV05, Lm. 3.8]). If \mathbf{B} is a commutative and idempotent semiring, then $r_\alpha^\ell \leq r_\alpha^{TW,\ell} \leq r_\alpha^{\ell+1}$ for each $\ell \in \mathbb{N}$, where \leq is defined componentwise: for every $a, b \in B$, we let $a \leq b$ if $a \oplus b = b$. For a more detailed comparison we refer the reader to [DPV05, Sec. 3].

We call $r : T_\Sigma \rightarrow B$ α -proper if $r(\alpha) = 0$. For each α -proper weighted tree language r , the application of the iteration of r to a tree ξ becomes stable after $\text{height}(\xi) + 1$ steps.

Lemma 10.7.1. (cf. [DPV05, Lm. 3.10]) Let $r : T_\Sigma \rightarrow B$ be α -proper. For every $\xi \in T_\Sigma$ and $\ell \in \mathbb{N}$, if $\ell \geq \text{height}(\xi) + 1$, then $r_\alpha^{\ell+1}(\xi) = r_\alpha^\ell(\xi)$. In particular, for every $\ell \in \mathbb{N}_+$ and $\beta \in \Sigma^{(0)} \setminus \{\alpha\}$, we have $r_\alpha^\ell(\alpha) = \mathbb{1}$ and $r_\alpha^\ell(\beta) = r(\beta)$.

Proof. We prove the first statement of the lemma by induction on $(T_\Sigma, \succ_\Sigma^+)$; the second statement of the lemma is proved in the induction base.

I.B.: Let $\xi \in \Sigma^{(0)}$. We distinguish two cases.

Case (a): Let $\xi = \alpha$. First we prove that $r_\alpha^\ell(\alpha) = \mathbb{1}$ for each $\ell \in \mathbb{N}_+$.

$$\begin{aligned} r_\alpha^\ell(\alpha) &= \left((r \circ_\alpha r_\alpha^{\ell-1}) \oplus \mathbb{1} \cdot \alpha \right) (\alpha) = (r \circ_\alpha r_\alpha^{\ell-1})(\alpha) \oplus (\mathbb{1} \cdot \alpha)(\alpha) \\ &= r(\alpha) \otimes r_\alpha^{\ell-1}(\alpha) \oplus \mathbb{1} = 0 \otimes r_\alpha^{\ell-1}(\alpha) \oplus \mathbb{1} = \mathbb{1} \ , \end{aligned}$$

where the third equality is due to the facts that $\text{cut}_\alpha(\xi) = \{(\varepsilon)\}$ and $(\mathbb{1} \cdot \alpha)(\alpha) = \mathbb{1}$. Since $\text{height}(\xi) + 1 = 1$, this implies that, for each $\ell \geq \text{height}(\xi) + 1$, we have $r_\alpha^{\ell+1}(\alpha) = r_\alpha^\ell(\alpha)$.

Case (b): Let $\xi \neq \alpha$. First we prove that $r_\alpha^\ell(\xi) = r(\xi)$ for each $\ell \in \mathbb{N}_+$.

$$\begin{aligned} r_\alpha^\ell(\xi) &= \left((r \circ_\alpha r_\alpha^{\ell-1}) \oplus \mathbb{1} \cdot \alpha \right) (\xi) = (r \circ_\alpha r_\alpha^{\ell-1})(\xi) \oplus (\mathbb{1} \cdot \alpha)(\xi) = (r \circ_\alpha r_\alpha^{\ell-1})(\xi) \\ &= r(\xi) \oplus r(\alpha) \otimes r_\alpha^{\ell-1}(\xi) = r(\xi) \oplus 0 \otimes r_\alpha^{\ell-1}(\xi) = r(\xi) \ , \end{aligned}$$

where the fourth equality is due to the fact that $\text{cut}_\alpha(\xi) = \{(), (\varepsilon)\}$. Since $\text{height}(\xi) + 1 = 1$, this implies that, for each $\ell \geq \text{height}(\xi) + 1$, we have $r_\alpha^{\ell+1}(\xi) = r_\alpha^\ell(\xi)$.

I.S.: Now let $\xi = \sigma(\xi_1, \dots, \xi_k)$ with $k \in \mathbb{N}_+$. Let $\ell \in \mathbb{N}$ with $\ell \geq \text{height}(\xi) + 1$.

$$\begin{aligned} r_\alpha^{\ell+1}(\xi) &= (r \circ r_\alpha^\ell)(\xi) \oplus (\mathbb{1} \cdot \alpha)(\xi) = (r \circ r_\alpha^\ell)(\xi) && \text{(because } \xi \neq \alpha) \\ &= \bigoplus_{(w_1, \dots, w_n) \in \text{cut}_\alpha(\xi)} r(\xi[\alpha]_{(w_1, \dots, w_n)}) \otimes r_\alpha^\ell(\xi|_{w_1}) \otimes \dots \otimes r_\alpha^\ell(\xi|_{w_n}) \\ &= r(\xi[\alpha]_{(\varepsilon)}) \otimes r_\alpha^\ell(\xi|_\varepsilon) \oplus \\ &\quad \bigoplus_{(w_1, \dots, w_n) \in \text{cut}_\alpha(\xi) \setminus \{(\varepsilon)\}} r(\xi[\alpha]_{(w_1, \dots, w_n)}) \otimes r_\alpha^\ell(\xi|_{w_1}) \otimes \dots \otimes r_\alpha^\ell(\xi|_{w_n}) \\ &= r(\alpha) \otimes r_\alpha^\ell(\xi|_\varepsilon) \oplus \\ &\quad \bigoplus_{(w_1, \dots, w_n) \in \text{cut}_\alpha(\xi) \setminus \{(\varepsilon)\}} r(\xi[\alpha]_{(w_1, \dots, w_n)}) \otimes r_\alpha^\ell(\xi|_{w_1}) \otimes \dots \otimes r_\alpha^\ell(\xi|_{w_n}) \\ &= \bigoplus_{(w_1, \dots, w_n) \in \text{cut}_\alpha(\xi) \setminus \{(\varepsilon)\}} r(\xi[\alpha]_{(w_1, \dots, w_n)}) \otimes r_\alpha^\ell(\xi|_{w_1}) \otimes \dots \otimes r_\alpha^\ell(\xi|_{w_n}) && \text{(because } r(\alpha) = 0) \\ &= \bigoplus_{(w_1, \dots, w_n) \in \text{cut}_\alpha(\xi) \setminus \{(\varepsilon)\}} r(\xi[\alpha]_{(w_1, \dots, w_n)}) \otimes r_\alpha^{\ell-1}(\xi|_{w_1}) \otimes \dots \otimes r_\alpha^{\ell-1}(\xi|_{w_n}) \\ &\text{(because, for each } i \in [k], \text{ we have } |w_i| \geq 1 \text{ and hence } \ell - 1 \geq \text{height}(\xi|_{w_i}) + 1, \text{ and then by I.H.)} \\ &= \bigoplus_{(w_1, \dots, w_n) \in \text{cut}_\alpha(\xi)} r(\xi[\alpha]_{(w_1, \dots, w_n)}) \otimes r_\alpha^{\ell-1}(\xi|_{w_1}) \otimes \dots \otimes r_\alpha^{\ell-1}(\xi|_{w_n}) \\ &\quad \text{(because } r(\xi[\alpha]_{(\varepsilon)}) \otimes r_\alpha^{\ell-1}(\xi|_\varepsilon) = r(\alpha) \otimes r_\alpha^{\ell-1}(\xi|_\varepsilon) = 0 \text{ as above)} \\ &= (r \circ_\alpha r_\alpha^{\ell-1})(\xi) = (r \circ r_\alpha^{\ell-1})(\xi) \oplus (\mathbb{1} \cdot \alpha)(\xi) = r_\alpha^\ell(\xi) \ . \quad \square \end{aligned}$$

Lemma 10.7.1 justifies to define the operation Kleene star as follows. Let $r : T_\Sigma \rightarrow B$ be α -proper. The α -Kleene star of r , denoted by r_α^* , is the weighted tree language $r_\alpha^* : T_\Sigma \rightarrow B$ defined, for every $\xi \in T_\Sigma$, by $r_\alpha^*(\xi) = r_\alpha^{\text{height}(\xi)+1}(\xi)$ [Eng03] (cf. [DPV05, Def. 3.11]). Thus, in particular, by Lemma 10.7.1, we have

$$r_\alpha^*(\alpha) = r_\alpha^1(\alpha) = \mathbb{1}. \quad (10.22)$$

Moreover, for each $\beta \in \Sigma^{(0)}$ with $\beta \neq \alpha$, by Lemma 10.7.1, we have

$$r_\alpha^*(\beta) = r_\alpha^1(\beta) = r(\beta). \quad (10.23)$$

Example 10.7.2. Let $\Sigma = \{\sigma^{(2)}, \alpha^{(0)}\}$. We consider the (Σ, \mathbf{Nat}) -weighted tree language $r = 1.\sigma(\alpha, \alpha)$, which is a monomial, and compute $r_\alpha^*(\sigma(\alpha, \alpha))$:

$$\begin{aligned} r_\alpha^*(\sigma(\alpha, \alpha)) &= r_\alpha^2(\sigma(\alpha, \alpha)) = (r \circ_\alpha r_\alpha^1)(\sigma(\alpha, \alpha)) + (1.\alpha)(\sigma(\alpha, \alpha)) \\ &= (r \circ_\alpha r_\alpha^1)(\sigma(\alpha, \alpha)) \\ &= r(\alpha) \cdot r_\alpha^1(\sigma(\alpha, \alpha)) + r(\sigma(\alpha, \alpha)) \cdot r_\alpha^1(\alpha) \cdot r_\alpha^1(\alpha) && \text{(because } \text{cut}_\alpha(\sigma(\alpha, \alpha)) = \{(\varepsilon), (1, 2)\}) \\ &= r(\sigma(\alpha, \alpha)) \cdot r_\alpha^1(\alpha) \cdot r_\alpha^1(\alpha) && \text{(because } r(\alpha) = 0) \\ &= 1 \cdot r_\alpha^1(\alpha) \cdot r_\alpha^1(\alpha) \\ &= 1. \end{aligned} \quad \text{(by Lemma 10.7.1)}$$

We might wish to compare the calculation of $r_\alpha^2(\sigma(\alpha, \alpha))$ with that of $r_\alpha^3(\sigma(\alpha, \alpha))$:

$$\begin{aligned} r_\alpha^3(\sigma(\alpha, \alpha)) &= (r \circ_\alpha r_\alpha^2)(\sigma(\alpha, \alpha)) + (1.\alpha)(\sigma(\alpha, \alpha)) \\ &= (r \circ_\alpha r_\alpha^2)(\sigma(\alpha, \alpha)) \\ &= r(\alpha) \cdot r_\alpha^2(\sigma(\alpha, \alpha)) + r(\sigma(\alpha, \alpha)) \cdot r_\alpha^2(\alpha) \cdot r_\alpha^2(\alpha) && \text{(because } \text{cut}_\alpha(\sigma(\alpha, \alpha)) = \{(\varepsilon), (1, 2)\}) \\ &= r(\sigma(\alpha, \alpha)) \cdot r_\alpha^2(\alpha) \cdot r_\alpha^2(\alpha) && \text{(because } r(\alpha) = 0) \\ &= 1 \cdot r_\alpha^2(\alpha) \cdot r_\alpha^2(\alpha) \\ &= 1. \end{aligned} \quad \text{(by Lemma 10.7.1)}$$

Next we compute $r_\alpha^*(\sigma(\alpha, \sigma(\alpha, \alpha)))$:

$$\begin{aligned} r_\alpha^*(\sigma(\alpha, \sigma(\alpha, \alpha))) &= r_\alpha^3(\sigma(\alpha, \sigma(\alpha, \alpha))) \\ &= (r \circ_\alpha r_\alpha^2)(\sigma(\alpha, \sigma(\alpha, \alpha))) + (1.\alpha)(\sigma(\alpha, \sigma(\alpha, \alpha))) \\ &= (r \circ_\alpha r_\alpha^2)(\sigma(\alpha, \sigma(\alpha, \alpha))) \\ &= r(\alpha) \cdot r_\alpha^2(\sigma(\alpha, \sigma(\alpha, \alpha))) \\ &\quad + r(\sigma(\alpha, \alpha)) \cdot r_\alpha^2(\alpha) \cdot r_\alpha^2(\sigma(\alpha, \alpha)) \\ &\quad + r(\sigma(\alpha, \sigma(\alpha, \alpha))) \cdot r_\alpha^2(\alpha) \cdot r_\alpha^2(\alpha) \cdot r_\alpha^2(\alpha) && \text{(because } \text{cut}_\alpha(\sigma(\alpha, \sigma(\alpha, \alpha))) = \{(\varepsilon), (1, 2), (1, 21, 22)\}) \\ &= r(\sigma(\alpha, \alpha)) \cdot r_\alpha^2(\alpha) \cdot r_\alpha^2(\sigma(\alpha, \alpha)) && \text{(because } r(\alpha) = r(\sigma(\alpha, \sigma(\alpha, \alpha))) = 0) \\ &= r_\alpha^2(\alpha) \cdot r_\alpha^2(\sigma(\alpha, \alpha)) && \text{(because } r(\sigma(\alpha, \alpha)) = 1) \\ &= r_\alpha^2(\sigma(\alpha, \alpha)) \cdot r_\alpha^2(\alpha) && \text{(because } r_\alpha^2(\alpha) = 1) \\ &= 1 \end{aligned} \quad \text{(as above)}$$

□

Example 10.7.3. We consider the alphabet $\Gamma = \{a, b\}$ and the string ranked alphabet $\Gamma_e = \{a^{(1)}, b^{(1)}, e^{(0)}\}$. Moreover, we consider the arctic semiring $\mathbf{Nat}_{\max,+} = (\mathbb{N}_{-\infty}, \max, +, -\infty, 0)$ and the monomial $1.a(b(e))$.

We would like to prove that, for each $\xi \in T_{\Gamma_e}$, we have

$$(1.a(b(e)))_e^*(\xi) = \begin{cases} |\text{pos}_a(\xi)| & \text{if there exists } n \in \mathbb{N} \text{ such that } \xi = \text{tree}_e((ab)^n) \\ -\infty & \text{otherwise,} \end{cases} \quad (10.24)$$

where $\text{tree}_e : \Gamma^* \rightarrow T_{\Gamma_e}$ is the bijection defined on page 51. We note that $1.a(b(e))$ is e -proper because $(1.a(b(e)))(e) = -\infty$. In the rest of this example we abbreviate $1.a(b(e))$ by r .

We note that

$$\text{for each } \xi \in T_{\Gamma_e} \text{ we have } \text{cut}_e((a(b(\xi)))) = \{(\varepsilon), (1)\} \cup \{(11w) \mid (w) \in \text{cut}_e(\xi)\} . \quad (10.25)$$

Moreover, it is easy to see that

$$\text{for every } \xi \in T_{\Gamma_e} \text{ and } (w) \in \text{cut}_e(\xi) \setminus \{(11)\}, \text{ we have } r(\xi[e]_{(w)}) = -\infty. \quad (10.26)$$

In the following, for every $n \in \mathbb{N}$ and $\xi \in T_{\Gamma_e}$, we abbreviate the tree $\text{tree}_e((ab)^n)[\xi]_{1^{2n}}$ by $(ab)^n\xi$.

First, by induction on \mathbb{N} , we prove that

$$\text{for every } n \in \mathbb{N} \text{ and } \xi \in T_{\Gamma_e}, \text{ we have } r_e^*((ab)^n\xi) = n + r_e^*(\xi) . \quad (10.27)$$

Let $\xi \in T_{\Gamma_e}$.

I.B.: $r_e^*((ab)^0\xi) = r_e^*(e[\xi]_\varepsilon) = r_e^*(\xi) = 0 + r_e^*(\xi)$.

I.S.: Let $n \in \mathbb{N}$. We abbreviate $\text{height}(\xi)$ by ℓ .

Then we can calculate as follows.

$$\begin{aligned} r_e^*((ab)^{n+1}\xi) &= r_e^{2(n+1)+\ell+1}((ab)^{n+1}\xi) && \text{(by definition of } r_e^*((ab)^{n+1}\xi)) \\ &= \max\left((r \circ_e r_e^{2(n+1)+\ell}((ab)^{n+1}\xi), (0.e)((ab)^{n+1}\xi)\right) && \text{(by definition of } r_e^{2(n+1)+\ell+1}) \\ &= \max_{(w) \in \text{cut}_e((ab)^{n+1}\xi)} r(((ab)^{n+1}\xi)[e]_{(w)}) + r_e^{2(n+1)+\ell}(((ab)^{n+1}\xi)|_w) \\ &\quad \text{(because } (0.e)((ab)^{n+1}\xi) = -\infty \text{ and by definition of } \circ_e) \\ &= r(((ab)^{n+1}\xi)[e]_{(11)}) + r_e^{2(n+1)+\ell}(((ab)^{n+1}\xi)|_{11}) && \text{(by (10.26))} \\ &= r(a(b(e))) + r_e^{2(n+1)+\ell}((ab)^n\xi) \\ &= 1 + r_e^{2n+\ell+1}((ab)^n\xi) && \text{(by definition of } r \text{ and by Lemma 10.7.1)} \\ &= 1 + r_e^*((ab)^n\xi) && \text{(by definition of } r_e^*((ab)^n\xi)) \\ &= (n+1) + r_e^*(\xi) . && \text{(by I.H.)} \end{aligned}$$

This proves (10.27).

Second, we prove that

$$\text{for each } n \in \mathbb{N}, \text{ we have } r_e^*(\text{tree}_e((ab)^n)) = n . \quad (10.28)$$

Let $n \in \mathbb{N}$. Then we can calculate as follows.

$$r_e^*(\text{tree}_e((ab)^n)) = r_e^*((ab)^ne) = n + r_e^*(e)$$

where the second equality is due to (10.27) with $\xi = e$. Now we evaluate $r_e^*(e)$:

$$\begin{aligned} r_e^*(e) &= r_e^1(e) && \text{(by definition of } r_e^*(e)) \\ &= \max\left([r \circ_e r_e^0](e), (0.e)(e)\right) && \text{(by definition of } r_e^1) \\ &= \max\left([r \circ_e r_e^0](e), 0\right) \\ &= \max\left(r(e[e]_{(\varepsilon)}) + r_e^0(e|_\varepsilon), 0\right) && \text{(by definition of } \circ_e \text{ and the fact that } \text{cut}_e(e) = \{(\varepsilon)\}) \\ &= \max\left(r(e) + r_e^0(e), 0\right) \\ &= \max\left(-\infty + -\infty, 0\right) && \text{(because } r_e^0 = \widetilde{-\infty}) \end{aligned}$$

$$= 0 .$$

This proves (10.28).

Third, we prove that,

$$\text{for each } \xi \in T_{\Gamma_e} \setminus \{\text{tree}_e((ab)^n) \mid n \in \mathbb{N}\}, \text{ we have } r_e^*(\xi) = -\infty. \quad (10.29)$$

Let $\xi \in T_{\Gamma_e} \setminus \{\text{tree}_e((ab)^n) \mid n \in \mathbb{N}\}$. Then there exists an $n \in \mathbb{N}$ and a $\zeta \in T_{\Gamma_e}$ such that

$$\xi = (ab)^n \zeta \text{ and } \zeta \in \{a(a(\zeta')) \mid \zeta' \in T_{\Gamma_e}\} \cup \{a(e)\} \cup \{b(\zeta') \mid \zeta' \in T_{\Gamma_e}\} .$$

Thus, by (10.27) and the definitions of $r_e^*(\zeta)$ and \circ_e , we have

$$r_e^*(\xi) = n + r_e^*(\zeta) = n + r_e^{\text{height}(\zeta)+1}(\zeta) = n + \max((r \circ_e r_e^{\text{height}(\zeta)})(\zeta), (0.e)(\zeta)) . \quad (10.30)$$

We proceed by case analysis.

$\zeta = a(a(\zeta'))$ for some $\zeta' \in T_{\Gamma_e}$: Then

$$\begin{aligned} & \max((r \circ_e r_e^{\text{height}(\zeta)})(\zeta), (0.e)(\zeta)) \\ &= \max(r(\zeta[e]_{(11)}) + r_e^{\text{height}(\zeta)}(\zeta|_{11}), (0.e)(\zeta)) \quad (\text{by (10.26) and the fact that } (11) \in \text{cut}_e(\zeta)) \\ &= \max(r(a(a(e))) + r_e^{\text{height}(\zeta)}(\zeta'), (0.e)(a(a(\zeta')))) \\ &= \max(-\infty + r_e^{\text{height}(\zeta)}(\zeta'), -\infty) = -\infty . \end{aligned}$$

$\zeta = a(e)$: Thus $\text{height}(\zeta) = 1$. Then

$$\begin{aligned} & \max((r \circ_e r_e^1)(a(e)), (0.e)(a(e))) \\ &= \max((r \circ_e r_e^1)(a(e)), -\infty) \\ &= (r \circ_e r_e^1)(a(e)) \\ &= \max(r(a(e)[e]_{(\varepsilon)}) + r_e^1(a(e)|_{\varepsilon}), r(a(e)[e]_{(1)}) + r_e^1(a(e)|_1)) \quad (\text{because } \text{cut}_e(a(e)) = \{(\varepsilon), (1)\}) \\ &= \max(r(e) + r_e^1(a(e)), r(a(e)) + r_e^1(e)) \\ &= \max(-\infty + r_e^1(a(e)), -\infty + r_e^1(e)) = -\infty . \end{aligned}$$

$\zeta = b(\zeta')$ for some $\zeta' \in T_{\Gamma_e}$: Then we can proceed as follows.

If $\zeta' = e$, then we have

$$\begin{aligned} & \max((r \circ_e r_e^{\text{height}(\zeta)})(b(e)), (0.e)(b(e))) \\ &= \max(-\infty, -\infty) \quad (\text{because } (11) \notin \text{cut}_e(b(e)) = \{(\varepsilon), (1)\} \text{ and by (10.26)}) \\ &= -\infty . \end{aligned}$$

If $\zeta' \neq e$, then there exist $c \in \{a, b\}$ and $\zeta'' \in T_{\Gamma_e}$ such that $\zeta = b(c(\zeta''))$. Then we have

$$\begin{aligned} & \max((r \circ_e r_e^{\text{height}(\zeta)})(b(c(\zeta''))), (0.e)(b(c(\zeta'')))) \\ &= \max(r(b(c(\zeta''))[e]_{(11)}) + r_e^{\text{height}(\zeta)}(b(c(\zeta''))|_{11}), (0.e)(b(c(\zeta'')))) \quad (\text{by (10.26)}) \\ &= \max(r(b(c(e))) + r_e^{\text{height}(\zeta)}(\zeta''), -\infty) \\ &= \max(-\infty + r_e^{\text{height}(\zeta)}(\zeta''), -\infty) = -\infty . \end{aligned}$$

Hence, for each possible choice of ζ , we have $\max((r \circ_e r_e^{\text{height}(\zeta)})(\zeta), (0.e)(\zeta)) = -\infty$. This fact, and (10.30) prove (10.29). Then (10.28) and (10.29) imply (10.24). \square

A set \mathcal{L} of \mathbf{B} -weighted tree languages is *closed under Kleene stars* if the following holds: for each (Σ, \mathbf{B}) -weighted tree language r and for each $\alpha \in \Sigma^{(0)}$ such that r is α -proper, if $r \in \mathcal{L}$, then $r_\alpha^* \in \mathcal{L}$.

Lemma 10.7.4. [DPV05, Lm. 3.13] Let $r : T_\Sigma \rightarrow B$ be α -proper. Then $r_\alpha^* = (r \circ_\alpha r_\alpha^*) \oplus \mathbb{1}.\alpha$.

Proof. Let $\xi \in T_\Sigma$ and let $\ell = \text{height}(\xi) + 1$. Then we can calculate as follows.

$$r_\alpha^*(\xi) = r_\alpha^\ell(\xi) = r_\alpha^{\ell+1}(\xi) = (r \circ_\alpha r_\alpha^\ell)(\xi) \oplus (\mathbb{1}.\alpha)(\xi) ,$$

where the second equality holds by Lemma 10.7.1. Now we proceed with the subexpression $(r \circ_\alpha r_\alpha^\ell)(\xi)$ as follows.

$$\begin{aligned} & (r \circ_\alpha r_\alpha^\ell)(\xi) \\ &= \bigoplus_{(w_1, \dots, w_n) \in \text{cut}_\alpha(\xi)} r(\xi[\alpha]_{(w_1, \dots, w_n)}) \otimes r_\alpha^\ell(\xi|_{w_1}) \otimes \dots \otimes r_\alpha^\ell(\xi|_{w_n}) \\ &= \bigoplus_{(w_1, \dots, w_n) \in \text{cut}_\alpha(\xi) \setminus \{(\varepsilon)\}} r(\xi[\alpha]_{(w_1, \dots, w_n)}) \otimes r_\alpha^\ell(\xi|_{w_1}) \otimes \dots \otimes r_\alpha^\ell(\xi|_{w_n}) \\ & \hspace{15em} (\text{because } r(\xi[\alpha]_{(\varepsilon)}) \otimes r_\alpha^\ell(\xi|_\varepsilon) = r(\alpha) \otimes r_\alpha^\ell(\xi|_\varepsilon) = 0) \\ &= \bigoplus_{(w_1, \dots, w_n) \in \text{cut}_\alpha(\xi) \setminus \{(\varepsilon)\}} r(\xi[\alpha]_{(w_1, \dots, w_n)}) \otimes r_\alpha^{\text{height}(\xi|_{w_1})+1}(\xi|_{w_1}) \otimes \dots \otimes r_\alpha^{\text{height}(\xi|_{w_n})+1}(\xi|_{w_n}) \\ & \hspace{15em} (\text{because, for each } i \in [n], \text{ we have } |w_i| \geq 1 \text{ and hence } \ell \geq \text{height}(\xi|_{w_i}) + 1, \\ & \hspace{18em} (\text{and then by Lemma 10.7.1.})) \\ &= \bigoplus_{(w_1, \dots, w_n) \in \text{cut}_\alpha(\xi) \setminus \{(\varepsilon)\}} r(\xi[\alpha]_{(w_1, \dots, w_n)}) \otimes r_\alpha^*(\xi|_{w_1}) \otimes \dots \otimes r_\alpha^*(\xi|_{w_n}) \quad (\text{by definition of } \alpha\text{-Kleene star}) \\ &= \bigoplus_{(w_1, \dots, w_n) \in \text{cut}_\alpha(\xi)} r(\xi[\alpha]_{(w_1, \dots, w_n)}) \otimes r_\alpha^*(\xi|_{w_1}) \otimes \dots \otimes r_\alpha^*(\xi|_{w_n}) \quad (\text{as above}) \\ &= (r \circ_\alpha r_\alpha^*)(\xi) . \end{aligned}$$

Hence $r_\alpha^*(\xi) = (r \circ_\alpha r_\alpha^\ell)(\xi) \oplus (\mathbb{1}.\alpha)(\xi) = (r \circ_\alpha r_\alpha^*)(\xi) \oplus (\mathbb{1}.\alpha)(\xi)$, which proves the lemma. \square

In the next theorem we prove that, under certain conditions, the α -Kleene star of a regular (Σ, \mathbf{B}) -weighted tree language is regular. For the Boolean semiring this was proved in [TW68, Lm. 12] (also cf. [Eng75b, Thm. 3.41] and [GS84, Thm. 2.4.8]) and for wta this was proved in [DPV05, Lm. 6.7]. We follow the construction in [FV22a, Lm. 6.7] (for the trivial storage type) and close a gap in the given correctness proof.

Theorem 10.7.5. Let \mathbf{B} be a commutative semiring and let $\alpha \in \Sigma^{(0)}$. Let \mathcal{G} be a (Σ, \mathbf{B}) -wrtg such that (a) $\llbracket \mathcal{G} \rrbracket$ is α -proper and (b) \mathcal{G} is finite-derivational or \mathbf{B} is σ -complete. Then the following two statements hold.

- (1) There exists a (Σ, \mathbf{B}) -wrtg \mathcal{G}' such that $\llbracket \mathcal{G}' \rrbracket = \llbracket \mathcal{G} \rrbracket_\alpha^*$.
- (2) If \mathcal{G} is finite-derivational, then we can construct a finite-derivational (Σ, \mathbf{B}) -wrtg \mathcal{G}' such that $\llbracket \mathcal{G}' \rrbracket = \llbracket \mathcal{G} \rrbracket_\alpha^*$.

Proof. Proof of (1): Let $\mathcal{G} = (N, S, R, wt)$ be a (Σ, \mathbf{B}) -wrtg and $\alpha \in \Sigma^{(0)}$ such that $\llbracket \mathcal{G} \rrbracket$ is α -proper. By Lemmas 9.2.1(1) and 9.2.2, we can assume that \mathcal{G} is start-separated and alphabetic. By Lemma 9.2.1(3) we can furthermore assume that \mathcal{G} is chain-free. Clearly, each mentioned construction preserves α -properness. We call a rule of the form $A \rightarrow \alpha$ in R an α -rule.

Since \mathcal{G} is chain-free, for each $\beta \in \Sigma^{(0)}$, we have $\text{RT}_{\mathcal{G}}(\beta) \subseteq \{S \rightarrow \beta\}$, i.e., if $\text{RT}_{\mathcal{G}}(\beta) \neq \emptyset$, then $d = (S \rightarrow \beta)$ is the only rule tree such that $\pi(d) = \beta$. Hence, if $(S \rightarrow \alpha)$ is in R , then

$$\text{wt}(S \rightarrow \alpha) = \text{wt}_{\mathcal{G}}(S \rightarrow \alpha) = \sum_{d \in \text{RT}_{\mathcal{G}}(\alpha)}^{\oplus} \text{wt}_{\mathcal{G}}(d) = \llbracket \mathcal{G} \rrbracket(\alpha) = \mathbb{0} ,$$

where the last equality holds because \mathcal{G} is α -proper. Thus, $\llbracket \mathcal{G} \rrbracket = \llbracket \tilde{\mathcal{G}} \rrbracket$ where $\tilde{\mathcal{G}}$ is the (Σ, \mathbf{B}) -wrtg $(N, S, \tilde{R}, \tilde{wt})$ with $\tilde{R} = R \setminus \{S \rightarrow \alpha\}$ and $\tilde{wt} = \text{wt}|_{\tilde{R}}$. Hence we can assume that \mathcal{G} does not contain the rule $S \rightarrow \alpha$. Due to our assumptions on \mathcal{G} , for every $\xi \in \text{T}_{\Sigma}$ and $d \in \text{RT}_{\mathcal{G}}(\xi)$, we have $\text{pos}(d) = \text{pos}(\xi)$.

We define the (Σ, \mathbf{B}) -wrtg $\mathcal{G}' = (N', \{S, S_0\}, R', \text{wt}')$, where $S_0 \notin N$ is a new nonterminal, $N' = N \cup \{S_0\}$, and $R' = R \cup R_{\alpha} \cup R_{\text{init}}$, where

- For each rule $r \in R$ we let $\text{wt}'(r) = \text{wt}(r)$.
- R_{α} : If $r = (A \rightarrow \alpha)$ is in R , then $r' = (A \rightarrow S)$ is in R_{α} with $\text{wt}'(r') = \text{wt}(r)$.
- R_{init} : This set contains the rule $S_0 \rightarrow \alpha$ with $\text{wt}'(S_0 \rightarrow \alpha) = \mathbb{1}$.

We call each rule of the form $A \rightarrow S$ an S -rule.

For each $\xi \in \text{T}_{\Sigma}$, we have

$$\text{RT}_{\mathcal{G}'}(\xi) = \begin{cases} \{S_0 \rightarrow \alpha\} & \text{if } \xi = \alpha \\ \text{RT}_{\mathcal{G}'}(S, \xi) & \text{otherwise.} \end{cases} \quad (10.31)$$

Moreover, since \mathcal{G} does not contain chain rules and the rule $S \rightarrow \alpha$, it is easy to see that $\text{RT}_{\mathcal{G}'}(S, \beta) = \text{RT}_{\mathcal{G}}(\beta)$.

Let $\xi \in \text{T}_{\Sigma}$ and $\tilde{w} = (w_1, \dots, w_n) \in \text{cut}_{\alpha}(\xi)$. We define

$$\begin{aligned} \text{RT}_{\mathcal{G}'}^{\tilde{w}}(S, \xi) = \{d' \in \text{RT}_{\mathcal{G}'}(S, \xi) \mid & (\forall i \in [n]) : w_i \in \text{pos}(d') \wedge (d'(w_i) \text{ is an } \alpha\text{-rule or an } S\text{-rule}) \\ & \wedge ((\forall v \in \text{prefix}(w_i) \setminus \{w_i\}) : d'(v) \text{ is not an } S\text{-rule}) \} . \end{aligned}$$

We have that

$$(\text{RT}_{\mathcal{G}'}^{\tilde{w}}(S, \xi) \mid \tilde{w} \in \text{cut}_{\alpha}(\xi)) \text{ is a partitioning of } \text{RT}_{\mathcal{G}'}(S, \xi) . \quad (10.32)$$

In particular, we have $\text{RT}_{\mathcal{G}'}(S, \alpha) = \text{RT}_{\mathcal{G}'}^{\varepsilon}(S, \alpha) = \emptyset$.

Let $\{j_1, \dots, j_{\ell}\}$ be the set of all $i \in [n]$ such that $\xi(w_i) \neq \alpha$. We denote the set $\{j_1, \dots, j_{\ell}\}$ by $\text{iter}(\tilde{w})$.

We define the mapping

$$\Phi_{\tilde{w}} : \text{RT}_{\mathcal{G}}(\xi[\alpha]_{\tilde{w}}) \times \text{RT}_{\mathcal{G}'}(S, \xi|_{w_{j_1}}) \times \dots \times \text{RT}_{\mathcal{G}'}(S, \xi|_{w_{j_{\ell}}}) \rightarrow \text{RT}_{\mathcal{G}'}^{\tilde{w}}(S, \xi)$$

as follows. Let $d \in \text{RT}_{\mathcal{G}}(\xi[\alpha]_{\tilde{w}})$ and $d_1 \in \text{RT}_{\mathcal{G}'}(S, \xi|_{w_{j_1}}), \dots, d_{\ell} \in \text{RT}_{\mathcal{G}'}(S, \xi|_{w_{j_{\ell}}})$. We define the tree

$$d' = d[(B_1 \rightarrow S)(d_1)]_{w_{j_1}} \cdots [(B_{\ell} \rightarrow S)(d_{\ell})]_{w_{j_{\ell}}} ,$$

where, for each $i \in [\ell]$, B_i is the nonterminal on the left-hand side of the α -rule $d(w_{j_i})$. (Since $\text{pos}(\xi[\alpha]_{\tilde{w}}) = \text{pos}(d)$ and $\xi[\alpha]_{\tilde{w}}(w_{j_i}) = \alpha$, the rule $d(w_{j_i})$ is an α -rule.) It is obvious that $yd' \in \text{RT}_{\mathcal{G}'}^{\tilde{w}}(S, \xi)$. Now we define $\Phi_{\tilde{w}}(d, d_1, \dots, d_{\ell}) = d'$.

Also it is easy to see that $\Phi_{\tilde{w}}$ is a bijection. Moreover,

$$\text{wt}_{\mathcal{G}'}(\Phi_{\tilde{w}}(d, d_1, \dots, d_{\ell})) = \text{wt}_{\mathcal{G}}(d) \otimes \bigotimes_{i \in [\ell]} \text{wt}_{\mathcal{G}'}(d_i) \quad (10.33)$$

by the definitions of R' and $\text{wt}_{\mathcal{G}'}$ and by the fact that \mathbf{B} is commutative.

By induction on $(\text{T}_{\Sigma}, \succ_{\Sigma}^+)$, we prove that the following statement holds:

$$\text{For every } \xi \in \text{T}_{\Sigma}, \text{ we have: } \llbracket \mathcal{G}' \rrbracket(\xi) = \llbracket \mathcal{G} \rrbracket_{\alpha}^*(\xi) . \quad (10.34)$$

(We recall that \mathcal{G} is finite-derivational or \mathbf{B} is σ -complete).

I.B.: Let $\xi \in \Sigma^{(0)}$. If $\xi \neq \alpha$, then

$$[[\mathcal{G}']](\xi) = \sum_{d' \in \text{RT}_{\mathcal{G}'}(\xi)}^{\oplus} \text{wt}_{\mathcal{G}'}(d') = \sum_{d' \in \text{RT}_{\mathcal{G}'}(S, \xi)}^{\oplus} \text{wt}_{\mathcal{G}'}(d') = \sum_{d \in \text{RT}_{\mathcal{G}}(\xi)}^{\oplus} \text{wt}_{\mathcal{G}}(d) = [[\mathcal{G}]](\xi) = [[\mathcal{G}]]_{\alpha}^*(\xi) ,$$

where the last equality holds by (10.23).

Now let $\xi = \alpha$. Then we can calculate as follows:

$$[[\mathcal{G}']](\alpha) = \text{wt}_{\mathcal{G}'}((S_0 \rightarrow \alpha)) = \mathbf{1} = [[\mathcal{G}]]_{\alpha}^*(\alpha) ,$$

where the first equality holds by (10.31) and the last equality holds by (10.22).

I.S.: Let $\xi \in (\text{T}_{\Sigma} \setminus \Sigma^{(0)})$. We can calculate as follows.

$$\begin{aligned} [[\mathcal{G}']](\xi) &= \sum_{d' \in \text{RT}_{\mathcal{G}'}(\xi)}^{\oplus} \text{wt}_{\mathcal{G}'}(d') \\ &= \sum_{d' \in \text{RT}_{\mathcal{G}'}(S, \xi)}^{\oplus} \text{wt}_{\mathcal{G}'}(d') && \text{(by (10.31) because } \xi \neq \alpha) \\ &= \bigoplus_{\tilde{w} \in \text{cut}_{\alpha}(\xi)} \sum_{d' \in \text{RT}_{\mathcal{G}'}^{\tilde{w}}(S, \xi)}^{\oplus} \text{wt}_{\mathcal{G}'}(d') && \text{(by (10.32))} \\ &= \bigoplus_{\tilde{w}=(w_1, \dots, w_n) \in \text{cut}_{\alpha}(\xi)} \sum_{\substack{d \in \text{RT}_{\mathcal{G}}(\xi[\alpha]_{\tilde{w}}), \\ (\forall i \in [\ell]): d_i \in \text{RT}_{\mathcal{G}'}(S, \xi|_{w_{j_i}})}}^{\oplus} \left(\text{wt}_{\mathcal{G}}(d) \otimes \bigotimes_{i \in [\ell]} \text{wt}_{\mathcal{G}'}(d_i) \right) \\ &\quad \text{(because } \Phi_{\tilde{w}} \text{ is bijective and by (10.33), where } \text{iter}(\tilde{w}) = \{j_1, \dots, j_{\ell}\}) \\ &= \bigoplus_{\tilde{w}=(w_1, \dots, w_n) \in \text{cut}_{\alpha}(\xi)} \left(\sum_{d \in \text{RT}_{\mathcal{G}}(\xi[\alpha]_{\tilde{w}})}^{\oplus} \text{wt}_{\mathcal{G}}(d) \right) \otimes \bigotimes_{i \in [\ell]} \left(\sum_{d_i \in \text{RT}_{\mathcal{G}'}(S, \xi|_{w_{j_i}})}^{\oplus} \text{wt}_{\mathcal{G}'}(d_i) \right) && \text{(by distributivity)} \\ &= \bigoplus_{\tilde{w}=(w_1, \dots, w_n) \in \text{cut}_{\alpha}(\xi)} [[\mathcal{G}]](\xi[\alpha]_{\tilde{w}}) \otimes \bigotimes_{i \in [\ell]} \left(\sum_{d_i \in \text{RT}_{\mathcal{G}'}(S, \xi|_{w_{j_i}})}^{\oplus} \text{wt}_{\mathcal{G}'}(d_i) \right) \\ &= \bigoplus_{\tilde{w}=(w_1, \dots, w_n) \in \text{cut}_{\alpha}(\xi)} [[\mathcal{G}]](\xi[\alpha]_{\tilde{w}}) \otimes \bigotimes_{i \in [\ell]} \left(\sum_{d_i \in \text{RT}_{\mathcal{G}'}(\xi|_{w_{j_i}})}^{\oplus} \text{wt}_{\mathcal{G}'}(d_i) \right) && \text{(by (10.31) because } \xi|_{w_{j_i}} \neq \alpha) \\ &= \bigoplus_{\tilde{w}=(w_1, \dots, w_n) \in \text{cut}_{\alpha}(\xi)} [[\mathcal{G}]](\xi[\alpha]_{\tilde{w}}) \otimes \bigotimes_{i \in [\ell]} [[\mathcal{G}']](\xi|_{w_{j_i}}) \\ &= \bigoplus_{\tilde{w}=(w_1, \dots, w_n) \in \text{cut}_{\alpha}(\xi)} [[\mathcal{G}]](\xi[\alpha]_{\tilde{w}}) \otimes [[\mathcal{G}']](\xi|_{w_1}) \otimes \dots \otimes [[\mathcal{G}']](\xi|_{w_n}) \\ &\quad \text{(because for each } i \in [n] \setminus \text{iter}(\tilde{w}) \text{ we have } \xi|_{w_i} = \alpha \text{ and } [[\mathcal{G}']](\alpha) = \mathbf{1}) \\ &= \bigoplus_{\substack{\tilde{w}=(w_1, \dots, w_n) \in \text{cut}_{\alpha}(\xi): \\ \tilde{w} \neq (\varepsilon)}} [[\mathcal{G}]](\xi[\alpha]_{\tilde{w}}) \otimes [[\mathcal{G}']](\xi|_{w_1}) \otimes \dots \otimes [[\mathcal{G}']](\xi|_{w_n}) && \text{(because } [[\mathcal{G}]](\xi[\alpha]_{(\varepsilon)}) = [[\mathcal{G}]](\alpha) = \mathbf{0}) \\ &= \bigoplus_{\substack{\tilde{w}=(w_1, \dots, w_n) \in \text{cut}_{\alpha}(\xi): \\ \tilde{w} \neq (\varepsilon)}} [[\mathcal{G}]](\xi[\alpha]_{\tilde{w}}) \otimes [[\mathcal{G}]]_{\alpha}^*(\xi|_{w_1}) \otimes \dots \otimes [[\mathcal{G}]]_{\alpha}^*(\xi|_{w_n}) \\ &\quad \text{(by I.H.: since } \tilde{w} \neq (\varepsilon), \text{ we have } \xi \succ_{\Sigma}^+ \xi|_{w_i} \text{ for every } i \in [n]) \end{aligned}$$

$$\begin{aligned}
&= \bigoplus_{\tilde{w}=(w_1, \dots, w_n) \in \text{cut}_\alpha(\xi)} \llbracket \mathcal{G} \rrbracket(\xi[\alpha]_{\tilde{w}}) \otimes \llbracket \mathcal{G} \rrbracket_\alpha^*(\xi|_{w_1}) \otimes \dots \otimes \llbracket \mathcal{G} \rrbracket_\alpha^*(\xi|_{w_n}) && \text{(because } \llbracket \mathcal{G} \rrbracket(\alpha) = 0) \\
&= (\llbracket \mathcal{G} \rrbracket \circ_\alpha \llbracket \mathcal{G} \rrbracket_\alpha^*)(\xi) \\
&= (\llbracket \mathcal{G} \rrbracket \circ_\alpha \llbracket \mathcal{G} \rrbracket_\alpha^* \oplus \mathbf{1} \cdot \alpha)(\xi) && \text{(because } \xi \neq \alpha) \\
&= \llbracket \mathcal{G} \rrbracket_\alpha^*(\xi) . && \text{(by Lemma 10.7.4)}
\end{aligned}$$

This finishes the proof of (10.34). Thus $\llbracket \mathcal{G}' \rrbracket = \llbracket \mathcal{G} \rrbracket_\alpha^*$.

Proof of (2): Let \mathcal{G} be finite-derivational. Then, by Lemma 9.2.1(3), we can even construct an equivalent chain-free wrtg. Consequently, the definition of \mathcal{G}' , as given in the proof of (1), is constructive. Finally, by analysing the construction of \mathcal{G}' , we obtain that \mathcal{G}' is finite-derivational. \square

Next we give an example of the concepts which appear in the proof of Theorem 10.7.5.

Example 10.7.6. Let $\Sigma = \{\sigma^{(2)}, \alpha^{(0)}\}$ and \mathcal{G} be the (Σ, Nat) -wrtg which has the rules

$$\begin{aligned}
S &\rightarrow \sigma(S, A) : 2 \\
S &\rightarrow \beta : 2 \\
A &\rightarrow \alpha : 2 ,
\end{aligned}$$

and the weight of each rule is 2 (indicated by “: 2” after the rule). If we apply the construction in the proof of Theorem 10.7.5, then we obtain the (Σ, Nat) -wrtg \mathcal{G}' with the rules and weights

$$\begin{aligned}
S &\rightarrow \sigma(S, A) : 2 && S_0 &\rightarrow \alpha : 1 \\
S &\rightarrow \beta : 2 && A &\rightarrow S : 2 \\
A &\rightarrow \alpha : 2 .
\end{aligned}$$

Now let us consider the tree $\xi \in \mathbb{T}_\Sigma$, the cut $\tilde{w} = (12, 2)$ in $\text{cut}_\alpha(\xi)$, and tree $\xi[\alpha]_{\tilde{w}}$ in Figure 10.5. By definition, we have $\text{iter}(\tilde{w}) = \{12\}$. In the upper part of Figure 10.6, there is an example of a tree $d' \in \text{RT}_{\mathcal{G}'}^{\tilde{w}}(S, \xi)$. Moreover, for the trees $d \in \text{RT}_{\mathcal{G}}(\xi[\alpha]_{\tilde{w}})$ and $d_1 \in \text{RT}_{\mathcal{G}'}(S, \xi|_{12})$ in the lower part of Figure 10.6, we have

$$d' = \Phi_{\tilde{w}}(d, d_1) \quad \text{and} \quad \text{wt}_{\mathcal{G}'}(d') = \text{wt}_{\mathcal{G}}(d) \cdot \text{wt}_{\mathcal{G}'}(d_1) ,$$

where $\text{wt}_{\mathcal{G}'}(d') = 2^8$, $\text{wt}_{\mathcal{G}}(d) = 2^5$, and $\text{wt}_{\mathcal{G}'}(d_1) = 2^3$. \square

Finally, as a consequence of Theorem 10.7.5, we show that $\text{Rec}(\Sigma, \mathbb{B})$ is closed under Kleene stars.

Corollary 10.7.7. (cf. [DPV05, Lm. 6.7]) Let Σ be a ranked alphabet. Moreover, let $\alpha \in \Sigma^{(0)}$ and let \mathbb{B} be a commutative semiring. Let \mathcal{A} be a (Σ, \mathbb{B}) -wta such that $\llbracket \mathcal{A} \rrbracket$ is α -proper. Then we can construct a (Σ, \mathbb{B}) -wta \mathcal{A}' such that $\llbracket \mathcal{A}' \rrbracket = \llbracket \mathcal{A} \rrbracket_\alpha^*$. Thus, in particular, if \mathbb{B} is a commutative semiring, then the set $\text{Rec}(\Sigma, \mathbb{B})$ is closed under Kleene stars.

Proof. By Lemma 9.2.6 we can construct (Σ, \mathbb{B}) -wrtg \mathcal{G} such that \mathcal{G} is in tree automata form and $\llbracket \mathcal{A} \rrbracket = \llbracket \mathcal{G} \rrbracket$. Then, in particular, \mathcal{G} is finite-derivational. By Theorem 10.7.5 we can construct a finite-derivational (Σ, \mathbb{B}) -wrtg \mathcal{G}' such that $\llbracket \mathcal{G}' \rrbracket = \llbracket \mathcal{G} \rrbracket_\alpha^*$. Then, by Lemma 9.2.8, we can construct a (Σ, \mathbb{B}) -wta \mathcal{A}' such that $\llbracket \mathcal{G}' \rrbracket = \llbracket \mathcal{A}' \rrbracket$. \square

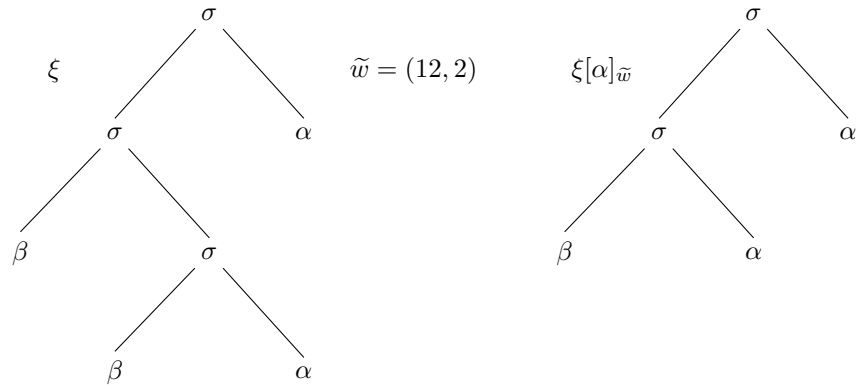

Figure 10.5: Example of a tree $\xi \in T_\Sigma$, a cut $\tilde{w} \in \text{cut}_\alpha(\xi)$, and a tree $\xi[\alpha]_{\tilde{w}}$, cf. Example 10.7.6.

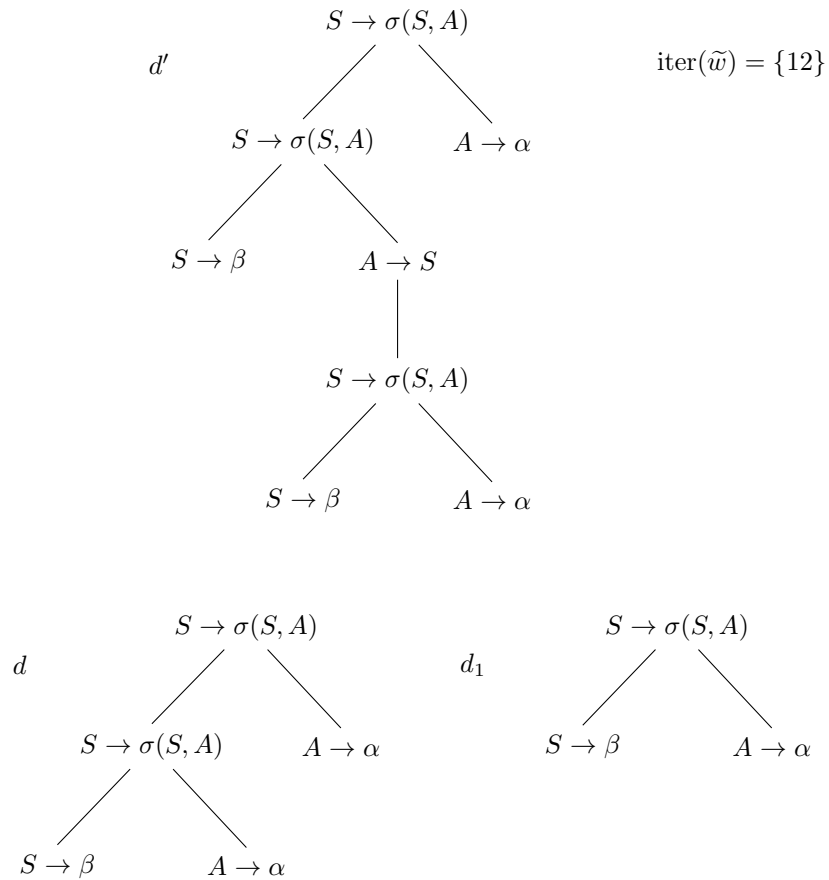

Figure 10.6: Example of trees $d' \in \text{RT}_{\mathcal{G}'}^{\tilde{w}}(S, \xi)$, $d \in \text{RT}_{\mathcal{G}}(\xi[\alpha]_{\tilde{w}})$, and $d_1 \in \text{RT}_{\mathcal{G}'}(S, \xi|_{12})$, cf. Figure 10.5 and Example 10.7.6.

10.8 Closure under yield-intersection with weighted recognizable languages

Bar-Hillel, Perles, and Shamir [BPS61, Thm. 8.1] proved that the intersection of any context-free language and any recognizable language is again a context-free language. This theorem is very valuable, in particular, in natural language processing, where one wishes to have a finite description of the set of all derivations of a string given a context-free grammar [MS09, MS10]. Here we extend this result by replacing (a) the context-free language by a recognizable weighted tree language r , (b) the recognizable language by an r -recognizable weighted language L , and (c) the intersection by the Hadamard product. Roughly speaking, we prove that the Hadamard product of r and $L \circ \text{yield}$ is a recognizable weighted tree language if r and L take their weights in a commutative semiring (cf. Theorem 10.8.2). We refer to [MS09, MS10] for even more extended results.

A set \mathcal{L} of \mathbf{B} -weighted tree languages is *closed under yield-intersection with weighted recognizable languages* if for every (Σ, \mathbf{B}) -weighted tree language r in \mathcal{L} , $\Gamma \subseteq \Sigma^{(0)}$, and r -recognizable (Γ, \mathbf{B}) -weighted language $L : \Gamma^* \rightarrow \mathbf{B}$, the (Σ, \mathbf{B}) -weighted tree language $r \otimes (L \circ \text{yield}_\Gamma)$ is in \mathcal{L} .

Since we have already proved that the set $\text{Rec}^{\text{run}}(\Sigma, \mathbf{B})$ is closed under Hadamard product if \mathbf{B} is a commutative semiring, it remains to prove that $L \circ \text{yield}_\Gamma$ is a recognizable weighted tree language. Indeed, this even holds for commutative strong bimonoids. Our construction is based on the key idea of the proof of [BPS61, Thm. 8.1], cf. also [MS09, Thm. 2]. (We also refer to Example 3.2.7.)

Lemma 10.8.1. Let $\Gamma \subseteq \Sigma^{(0)}$ and \mathcal{B} be a (Γ, \mathbf{B}) -wsa. Then we can construct a (Σ, \mathbf{B}) -wta \mathcal{A} such that $\llbracket \mathcal{A} \rrbracket^{\text{run}} = \llbracket \mathcal{B} \rrbracket^{\text{run}} \circ \text{yield}_\Gamma$.

Proof. Let $\mathcal{B} = (P, \lambda, \mu, \gamma)$. By Lemma 3.3.1, we can assume that \mathcal{B} has identity initial weights, i.e., $\text{im}(\lambda) \subseteq \{0, \mathbb{1}\}$. Intuitively, we construct \mathcal{A} such that it guesses, at each Γ -labeled leaf of a given input Σ -tree ξ , a transition of \mathcal{B} and, at each $(\Sigma^{(0)} \setminus \Gamma)$ -labeled leaf of ξ , a pair (p, p') for some $p \in P$. Then, while moving up towards the root of ξ , the wta \mathcal{A} checks whether subruns of \mathcal{B} can be composed to larger runs of \mathcal{B} . The first state and the last state of such a subrun are coded as a pair and forms a state of \mathcal{A} .

Formally, we construct the (Σ, \mathbf{B}) -wta $\mathcal{A} = (Q, \delta, F)$ as follows.

- $Q = P \times P$,
- we let $F_{(p, p')} = \lambda(p) \otimes \gamma(p')$ for every $(p, p') \in Q$,
- for every $\alpha \in \Gamma$ and $(p, p') \in Q$ we let

$$\delta_0(\varepsilon, \alpha, (p, p')) = \mu(p, \alpha, p')$$

and for every $\alpha \in \Sigma^{(0)} \setminus \Gamma$ and $(p, p') \in Q$ we let

$$\delta_0(\varepsilon, \alpha, (p, p')) = \begin{cases} \mathbb{1} & \text{if } p = p' \\ 0 & \text{otherwise} \end{cases}$$

and for every $k \in \mathbb{N}_+$, $\sigma \in \Sigma^{(k)}$, and $(p_1, p'_1), (p_2, p'_2), \dots, (p_k, p'_k), (p, p') \in Q$ we let

$$\begin{aligned} \delta_k((p_1, p'_1) \cdots (p_k, p'_k), \sigma, (p, p')) = \\ \begin{cases} \mathbb{1} & \text{if } p = p_1, p'_i = p_{i+1} \text{ for each } i \in [k-1], \text{ and } p'_k = p' \\ 0 & \text{otherwise.} \end{cases} \end{aligned}$$

This finishes the construction of \mathcal{A} .

Next we prove that $\llbracket \mathcal{A} \rrbracket^{\text{run}} = \llbracket \mathcal{B} \rrbracket^{\text{run}} \circ \text{yield}_\Gamma$, for which we need some auxiliary tools and statements. Let $\xi \in \mathsf{T}_\Sigma$ and $\rho \in P^{|\text{yield}_\Gamma(\xi)|+1}$. Then there exist $n \in \mathbb{N}$ and $p_1, \dots, p_n \in P$ such that $\rho = p_0 \cdots p_n$. Let

$$u_0, w_1, u_1, \dots, u_{n-1}, w_n, u_n$$

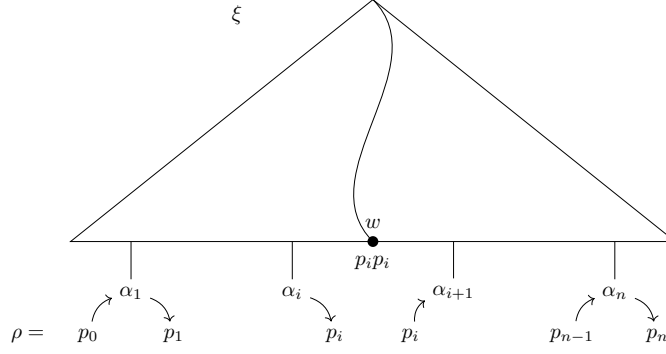

Figure 10.7: Value of $\varphi_{\xi,\rho}(w)$ if $w \in u_i$ for some $i \in [0, n]$.

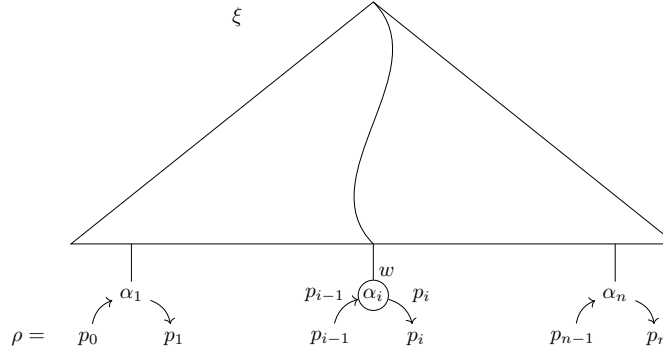

Figure 10.8: Value of $\varphi_{\xi,\rho}(w)$ if $w = w_i$ for some $i \in [n]$.

be the list of elements of $\text{pos}_{\Sigma^{(0)}}(\xi)$ ordered by the lexicographic order $<_{\text{lex}}$ on $\text{pos}(\xi)$, where $\text{pos}_{\Gamma}(\xi) = \{w_1, \dots, w_n\}$ and, for each $i \in [0, n]$, the u_i is the corresponding list of elements in $\text{pos}_{(\Sigma^{(0)} \setminus \Gamma)}(\xi)$.

We define the binary relation \succ on $\text{pos}(\xi)$ by letting $w_2 \succ w_1$ if there is an $i \in \mathbb{N}$ such that $w_1 = w_2 i$. For the proof of termination, we define the mapping $d : \text{pos}(\xi) \rightarrow \mathbb{N}$ by $d(w) = m - |w|$ for each $w \in \text{pos}(\xi)$, where $m = \max(|w| \mid w \in \text{pos}(\xi))$. Then d is a monotone embedding of $(\text{pos}(\xi), \succ)$ into $(\mathbb{N}, >)$. Then, by Lemma 2.5.2, the relation \succ is terminating. Moreover, we have that $\text{nf}_{\succ}(\text{pos}(\xi)) = \text{pos}_{\Sigma^{(0)}}(\xi)$, i.e., it is the set of leaves of ξ .

Then we define the mapping

$$\varphi_{\xi,\rho} : \text{pos}(\xi) \rightarrow Q$$

by induction on $(\text{pos}(\xi), \succ)$ for each $w \in \text{pos}(\xi)$ as follows.

$$\varphi_{\xi,\rho}(w) = \begin{cases} (p_i, p_i) & \text{if } w \in u_i \text{ for some } i \in [0, n] \\ (p_{i-1}, p_i) & \text{if } w = w_i \text{ for some } i \in [n] \\ (\varphi_{\xi,\rho}(w1)_1, \varphi_{\xi,\rho}(wk)_2) & \text{otherwise,} \end{cases}$$

where $w \in u_i$ abbreviates that w is an element in the list u_i and $k = \text{rk}_{\xi}(w)$. Moreover, $\varphi_{\xi,\rho}(w1)_1$ denotes the first component of $\varphi_{\xi,\rho}(w1)$, and $\varphi_{\xi,\rho}(wk)_2$ denotes the second component of $\varphi_{\xi,\rho}(wk)$. In the particular case that $n = 0$, we have $\varphi_{\xi,\rho}(w) = (p_0, p_0)$ for each $w \in \text{pos}(\xi)$. Moreover, $\varphi_{\xi,\rho}(\varepsilon) = (p_0, p_n)$.

We demonstrate the definition of ρ in Figures 10.7, 10.8, and 10.9 where $\alpha_i = \xi(w_i)$ for each $i \in [n]$ and hence $\text{yield}_{\Gamma}(\xi) = \alpha_1 \cdots \alpha_n$.

In fact, $\varphi_{\xi,\rho}$ is a run of \mathcal{A} on ξ , i.e., $\varphi_{\xi,\rho} \in R_{\mathcal{A}}(\xi)$. Thus, if $\xi = \sigma(\xi_1, \dots, \xi_k)$, then for each $l \in [k]$, the

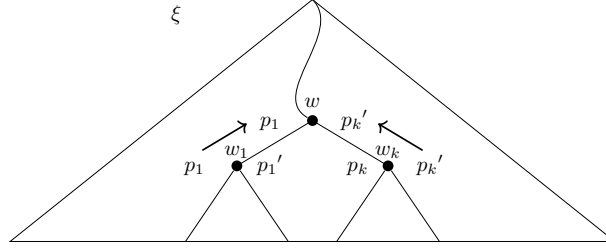

Figure 10.9: Value of $\varphi_{\xi, \rho}(w)$ if w is not a leaf of ξ .

subrun $(\varphi_{\xi, \rho})|_l$ is defined and we have

$$(\varphi_{\xi, \rho})|_l = \varphi_{\xi_l, \rho|(i_l, j_l)} \quad , \quad (10.35)$$

where $\rho|(i_l, j_l)$ is the subsequence $p_{i_l} \cdots p_{j_l}$ of ρ determined by the indices

$$i_l = \max(m \in [n] \mid w_m \in \bigcup_{\kappa=1}^{l-1} \text{pos}_{\Gamma}(\xi_{\kappa})) \text{ and } j_l = \max(m \in [n] \mid w_m \in \bigcup_{\kappa=1}^l \text{pos}_{\Gamma}(\xi_{\kappa}))$$

and the definition $\max(\emptyset) = 0$. Thus $i_1 = 0$, $j_l = i_{l+1}$ for each $l \in [k-1]$, $j_k = n$, and if $\text{pos}_{\Gamma}(\xi_l) = \emptyset$, then $i_l = j_l$. (For instance, let $\xi = \sigma(\xi_1, \xi_2, \xi_3)$, $\text{pos}_{\Gamma}(\xi_1) = \{w_1, w_2\}$ with $w_1 <_{\text{lex}} w_2$, $\text{pos}_{\Gamma}(\xi_2) = \emptyset$, and $\text{pos}_{\Gamma}(\xi_3) = \{w_3\}$, and let $\rho = p_0 p_1 p_2 p_3$. Then $(i_1, j_1) = (0, 2)$, $(i_2, j_2) = (2, 2)$, and $(i_3, j_3) = (2, 3)$ and thus the corresponding subsequences are $p_0 p_1 p_2$, p_2 , and $p_2 p_3$.)

This finishes the preparations.

Now, by induction on T_{Σ} , we prove that the following statement holds:

$$\text{For every } \xi \in T_{\Sigma} \text{ and } \rho \in P^{|\text{yield}_{\Gamma}(\xi)|+1} \text{ we have } \text{wt}_{\mathcal{B}}^-(\text{yield}_{\Gamma}(\xi), \rho) = \text{wt}_{\mathcal{A}}(\xi, \varphi_{\xi, \rho}). \quad (10.36)$$

I.B.: Let $\xi \in \Sigma^{(0)}$. We distinguish two cases.

Case (a): Let $\xi \in \Sigma^{(0)} \setminus \Gamma$. Now let $\rho \in P^{|\text{yield}_{\Gamma}(\xi)|+1}$. Since $|\text{yield}_{\Gamma}(\xi)| + 1 = 1$, there exists a $p \in P$ such that $\rho = p$. Then $\varphi_{\xi, \rho}(\varepsilon) = (p, p)$. Moreover, due to the construction of δ , we have

$$\text{wt}_{\mathcal{A}}(\xi, \varphi_{\xi, \rho}) = \delta_0(\varepsilon, \alpha, (p, p)) = \mathbb{1} \quad .$$

Since $\text{wt}_{\mathcal{B}}^-(\varepsilon, p) = \mathbb{1}$ by definition, we obtain (10.36).

Case (b): Let $\xi \in \Gamma$. Now let $\rho \in P^{|\text{yield}_{\Gamma}(\xi)|+1}$. Since $|\text{yield}_{\Gamma}(\xi)| + 1 = 2$, there exist $p, p' \in P$ such that $\rho = pp'$. Then $\varphi_{\xi, \rho}(\varepsilon) = (p, p')$. Moreover, due to the construction of δ , we have

$$\text{wt}_{\mathcal{A}}(\xi, \varphi_{\xi, \rho}) = \delta_0(\varepsilon, \alpha, (p, p')) = \mu(p, \alpha, p') \quad .$$

Since $\text{wt}_{\mathcal{B}}^-(\varepsilon, p) = \mu(p, \alpha, p')$ by definition, we obtain (10.36).

I.S.: Let $\xi = \sigma(\xi_1, \dots, \xi_k)$ with $k \in \mathbb{N}_+$. Then we can calculate as follows:

$$\begin{aligned} \text{wt}_{\mathcal{B}}^-(\text{yield}_{\Gamma}(\xi), \rho) &= \bigotimes_{l \in [k]} \text{wt}_{\mathcal{B}}^-(\text{yield}_{\Gamma}(\xi_l), \rho|(i_l, j_l)) \\ &= \bigotimes_{l \in [k]} \text{wt}_{\mathcal{A}}(\xi_l, \rho_{\xi_l, \rho|(i_l, j_l)}) && \text{(by I.H.)} \\ &= \left(\bigotimes_{l \in [k]} \text{wt}_{\mathcal{A}}(\xi_l, (\varphi_{\xi, \rho})|_l) \right) \otimes \delta_k(\varphi_{\xi, \rho}(1) \cdots \varphi_{\xi, \rho}(k), \sigma, \varphi_{\xi, \rho}(\varepsilon)) && \text{(by (10.35) and definition of } \delta) \\ &= \text{wt}_{\mathcal{A}}(\xi, \varphi_{\xi, \rho}) \quad . \end{aligned}$$

This finishes the proof of (10.36).

Let $\xi \in T_\Sigma$ and assume that $\text{yield}_\Gamma(\xi)$ has length n . For each $\rho_{\mathcal{A}} \in R_{\mathcal{A}}(\xi) \setminus \{\varphi_{\xi, \rho} \mid \rho \in P^{n+1}\}$ there exists a $w \in \text{pos}(\xi)$ such that, assuming that $\text{rk}_\Sigma(\xi(w)) = k$, we have

- $\rho_{\mathcal{A}}(w)_1 \neq \rho_{\mathcal{A}}(w1)_1$ or $\rho_{\mathcal{A}}(w)_2 \neq \rho_{\mathcal{A}}(wk)_2$ or
- there exists an $i \in [k-1]$ such that $\rho_{\mathcal{A}}(wi)_2 \neq \rho_{\mathcal{A}}(w(i+1))_1$ or
- $k = 0$, $\xi(w) \notin \Gamma$, and $\rho_{\mathcal{A}}(w)_1 \neq \rho_{\mathcal{A}}(w)_2$.

In this case, by definition of δ_k , we have $\delta_k(\rho_{\mathcal{A}}(w1) \cdots \rho_{\mathcal{A}}(wk), \xi(w), \rho_{\mathcal{A}}(w)) = 0$ and thus $\text{wt}_{\mathcal{A}}(\xi, \rho_{\mathcal{A}}) = 0$. Thus we have

$$\text{wt}_{\mathcal{A}}(\xi, \rho_{\mathcal{A}}) = 0 \text{ for each } \rho_{\mathcal{A}} \in R_{\mathcal{A}}(\xi) \setminus \{\varphi_{\xi, \rho} \mid \rho \in P^{n+1}\}. \quad (10.37)$$

For each $\rho \in P^{n+1}$ we denote the first state of ρ and the last state of ρ by $\text{fst}(\rho)$ and $\text{lst}(\rho)$, respectively. Then:

$$\begin{aligned} \llbracket \mathcal{A} \rrbracket^{\text{run}}(\xi) &= \bigoplus_{\rho_{\mathcal{A}} \in R_{\mathcal{A}}(\xi)} \text{wt}_{\mathcal{A}}(\xi, \rho_{\mathcal{A}}) \otimes F_{\rho_{\mathcal{A}}(\varepsilon)} \\ &= \bigoplus_{\rho \in P^{n+1}} \text{wt}_{\mathcal{A}}(\xi, \varphi_{\xi, \rho}) \otimes F_{(\text{fst}(\rho), \text{lst}(\rho))} \quad (\text{by 10.37 and the fact that } \varphi_{\xi, \rho}(\varepsilon) = (\text{fst}(\rho), \text{lst}(\rho))) \\ &= \bigoplus_{\rho \in P^{n+1}} \text{wt}_{\mathcal{B}}^-(\text{yield}_\Gamma(\xi), \rho) \otimes F_{(\text{fst}(\rho), \text{lst}(\rho))} \quad (\text{by (10.36)}) \\ &= \bigoplus_{(p, p') \in Q'} \bigoplus_{\substack{\rho \in P^{n+1}: \\ \text{fst}(\rho)=p, \text{lst}(\rho)=p'}} \text{wt}_{\mathcal{B}}^-(\text{yield}_\Gamma(\xi), \rho) \otimes F_{(p, p')} \\ &= \bigoplus_{(p, p') \in Q'} \bigoplus_{\substack{\rho \in P^{n+1}: \\ \text{fst}(\rho)=p, \text{lst}(\rho)=p'}} \text{wt}_{\mathcal{B}}^-(\text{yield}_\Gamma(\xi), \rho) \otimes \lambda(p) \otimes \gamma(p') \quad (\text{by construction}) \\ &= \bigoplus_{(p, p') \in Q'} \bigoplus_{\substack{\rho \in P^{n+1}: \\ \text{fst}(\rho)=p, \text{lst}(\rho)=p'}} \lambda(p) \otimes \text{wt}_{\mathcal{B}}^-(\text{yield}_\Gamma(\xi), \rho) \otimes \gamma(p') \quad (\text{because } \text{im}(\lambda) \subseteq \{0, \mathbb{1}\}) \\ &= \bigoplus_{(p, p') \in Q'} \bigoplus_{\substack{\rho \in P^{n+1}: \\ \text{fst}(\rho)=p, \text{lst}(\rho)=p'}} \text{wt}_{\mathcal{B}}(\text{yield}_\Gamma(\xi), \rho) \quad (\text{by definition}) \\ &= \llbracket \mathcal{B} \rrbracket^{\text{run}}(\text{yield}_\Gamma(\xi)) \quad \square \end{aligned}$$

The next theorem was proved in [MS09, Thm. 2] via a direct construction. We show a modular proof by exploiting Lemma 10.8.1 and closure under Hadamard product (where the latter requires that \mathcal{B} is a commutative semiring).

Theorem 10.8.2. [MS09, Thm. 2] *Let Σ be a ranked alphabet and Γ be an alphabet such that $\Gamma \subseteq \Sigma^{(0)}$. Moreover, let $\mathcal{B} = (B, \oplus, \otimes, 0, \mathbb{1})$ be a commutative semiring. For every (Σ, \mathcal{B}) -wta \mathcal{A} and every (Γ, \mathcal{B}) -wsa \mathcal{B} , we can construct a (Σ, \mathcal{B}) -wta \mathcal{A}' such that*

$$\llbracket \mathcal{A}' \rrbracket = \llbracket \mathcal{A} \rrbracket \otimes (\llbracket \mathcal{B} \rrbracket \circ \text{yield}_\Gamma) \text{ .}$$

Thus, in particular, the set $\text{Rec}(\Sigma, \mathcal{B})$ is closed under yield-intersection.

Proof. By Corollary 5.3.5 and by convention on page 149 we have $\llbracket \mathcal{A} \rrbracket = \llbracket \mathcal{A} \rrbracket^{\text{run}}$ and $\llbracket \mathcal{A}' \rrbracket = \llbracket \mathcal{A}' \rrbracket^{\text{run}}$. Moreover, by Corollary 5.3.6 and by convention on page 149 we have $\llbracket \mathcal{B} \rrbracket = \llbracket \mathcal{B} \rrbracket^{\text{run}}$. By Lemma 10.8.1, we

can construct a (Σ, \mathbf{B}) -wta \mathcal{C} such that $\llbracket \mathcal{C} \rrbracket = \llbracket \mathcal{B} \rrbracket \circ \text{yield}_\Gamma$. Then, by Theorem 10.4.1(1), we can construct a (Σ, \mathbf{B}) -wta \mathcal{A}' such that $\llbracket \mathcal{A}' \rrbracket = \llbracket \mathcal{A} \rrbracket \otimes \llbracket \mathcal{C} \rrbracket$. \square

Finally, we verify that Theorem 10.8.2 generalizes the classical result of Bar-Hillel, Perles, and Shamir [BPS61, Thm. 8.1]. We achieve this by proving that the latter is equivalent to Theorem 10.8.2 for the case that \mathbf{B} is the Boolean semiring.

Corollary 10.8.3. Let G be a Γ -cfg and A be a Γ -fsa. Then we can construct a Γ -cfg G' such that $L(G') = L(G) \cap L(A)$.

Proof. By Corollary 8.3.4, we can construct a ranked alphabet Σ with $\Gamma \subseteq \Sigma^{(0)}$ and a Σ -fta A' such that $L(G) = \text{yield}_\Gamma(L(A'))$. By Corollary 3.4.2, we can construct a (Σ, \mathbf{Boole}) -wta \mathcal{A}' such that $L(G) = \text{yield}_\Gamma(\text{supp}(\llbracket \mathcal{A}' \rrbracket))$. Moreover, by Observation 3.3.5, we can construct a (Γ, \mathbf{Boole}) -wsa \mathcal{A} such that $L(A) = \text{supp}(\llbracket \mathcal{A} \rrbracket^{\text{run}})$. Then we can calculate as follows.

$$\begin{aligned} L(G) \cap L(A) &= \text{yield}_\Gamma(\text{supp}(\llbracket \mathcal{A}' \rrbracket)) \cap \text{supp}(\llbracket \mathcal{A} \rrbracket^{\text{run}}) \\ &= \text{supp}(\chi(\text{yield}_\Gamma)(\llbracket \mathcal{A}' \rrbracket)) \cap \text{supp}(\llbracket \mathcal{A} \rrbracket^{\text{run}}) && \text{(by (2.41))} \\ &= \text{supp}(\chi(\text{yield}_\Gamma)(\llbracket \mathcal{A}' \rrbracket) \wedge \llbracket \mathcal{A} \rrbracket^{\text{run}}) \\ &=^{(*)} \text{supp}(\chi(\text{yield}_\Gamma)(\llbracket \mathcal{A}' \rrbracket \wedge (\llbracket \mathcal{A} \rrbracket^{\text{run}} \circ \text{yield}_\Gamma))) , \end{aligned}$$

where at $(*)$ we have used the following subcalculation for each $w \in \Gamma^*$:

$$\begin{aligned} (\chi(\text{yield}_\Gamma)(\llbracket \mathcal{A}' \rrbracket) \wedge \llbracket \mathcal{A} \rrbracket^{\text{run}})(w) &= \chi(\text{yield}_\Gamma)(\llbracket \mathcal{A}' \rrbracket)(w) \wedge \llbracket \mathcal{A} \rrbracket^{\text{run}}(w) \\ &= \left(\sum_{\xi \in \text{yield}_\Gamma^{-1}(w)} \llbracket \mathcal{A}' \rrbracket(\xi) \right) \wedge \llbracket \mathcal{A} \rrbracket^{\text{run}}(w) \\ &= \sum_{\xi \in \text{yield}_\Gamma^{-1}(w)} (\llbracket \mathcal{A}' \rrbracket(\xi) \wedge \llbracket \mathcal{A} \rrbracket^{\text{run}}(w)) && \text{(by distributivity)} \\ &= \sum_{\xi \in \text{yield}_\Gamma^{-1}(w)} (\llbracket \mathcal{A}' \rrbracket(\xi) \wedge \llbracket \mathcal{A} \rrbracket^{\text{run}}(\text{yield}_\Gamma(\xi))) \\ &= \sum_{\xi \in \text{yield}_\Gamma^{-1}(w)} (\llbracket \mathcal{A}' \rrbracket \wedge \llbracket \mathcal{A} \rrbracket^{\text{run}} \circ \text{yield}_\Gamma)(\xi) \\ &= \chi(\text{yield}_\Gamma)(\llbracket \mathcal{A}' \rrbracket \wedge \llbracket \mathcal{A} \rrbracket^{\text{run}} \circ \text{yield}_\Gamma)(w) . \end{aligned}$$

By Theorem 10.8.2, we can construct a (Σ, \mathbf{Boole}) -wta \mathcal{B} such that $\llbracket \mathcal{B} \rrbracket^{\text{run}} = \llbracket \mathcal{A}' \rrbracket \wedge (\llbracket \mathcal{A} \rrbracket^{\text{run}} \circ \text{yield}_\Gamma)$. Hence we can continue with:

$$\begin{aligned} \text{supp}(\chi(\text{yield}_\Gamma)(\llbracket \mathcal{A}' \rrbracket \wedge (\llbracket \mathcal{A} \rrbracket^{\text{run}} \circ \text{yield}_\Gamma))) &= \text{supp}(\chi(\text{yield}_\Gamma)(\llbracket \mathcal{B} \rrbracket^{\text{run}})) \\ &= \text{yield}_\Gamma(\text{supp}(\llbracket \mathcal{B} \rrbracket^{\text{run}})) . && \text{(by (2.41))} \end{aligned}$$

By Corollary 3.4.2, we can construct a Σ -fta C such that $\text{supp}(\llbracket \mathcal{B} \rrbracket^{\text{run}}) = L(C)$. Moreover, by Corollary 8.3.4, we can construct a Γ -cfg G' such that $\text{yield}_\Gamma(L(C)) = L(G')$. \square

10.9 Closure under strong bimonoid homomorphisms

A set \mathcal{L} of weighted tree languages is *closed under strong bimonoid homomorphisms* if for every (Σ, \mathbf{B}) -weighted tree language $r \in \mathcal{L}$, strong bimonoid $\mathbf{C} = (C, +, \times, 0, 1)$, and strong bimonoid homomorphism $f : \mathbf{B} \rightarrow \mathbf{C}$, the (Σ, \mathbf{C}) -weighted tree language $f \circ r$ is in \mathcal{L} .

Let $\mathcal{A} = (Q, \delta, F)$ be a (Σ, \mathbf{B}) -wta, C be a strong bimonoid, and $f : B \rightarrow C$ be a strong bimonoid homomorphism. Then we define the f -image of \mathcal{A} , denoted by $f(\mathcal{A})$, to be the (Σ, C) -wta (Q, δ', F') by defining $(\delta')_k = f \circ \delta_k$ for each $k \in \mathbb{N}$, and $F' = f \circ F$.

Note that, if \mathcal{A} is bu-deterministic (or crisp-deterministic), then so is $f(\mathcal{A})$. Moreover, if \mathcal{A} is total and $f^{-1}(0) = \{0\}$, then $f(\mathcal{A})$ is total. The condition $f^{-1}(0) = \{0\}$ cannot be dropped, which can be seen as follows. Let $\mathcal{A} = (Q, \delta, F)$ be a total (Σ, \mathbf{Nat}) -wta (where \mathbf{Nat} is the semiring of natural numbers) such that there exist $k \in \mathbb{N}$, $\sigma \in \Sigma^{(k)}$, $w \in Q^k$, and $q \in Q$ with $\delta_k(w, \sigma, q) = 4$ and for each $p \in Q \setminus \{q\}$ we have $\delta_k(w, \sigma, p) = 0$. We consider the ring $\text{Intmod}4 = (\{0, 1, 2, 3\}, +_4, \cdot_4, 0, 1)$ of natural numbers modulo 4. Finally, we consider the canonical semiring homomorphism $f : \mathbb{N} \rightarrow \{0, 1, 2, 3\}$. Since $f(0) = f(4) = 0$, in $f(\mathcal{A})$ we have $(\delta')_k(w, \sigma, p) = 0$ for every $p \in Q$. Hence $f(\mathcal{A})$ is not total.

Now we can prove the main result of this section.

Lemma 10.9.1. Let $\mathcal{A} = (Q, \delta, F)$ be a (Σ, \mathbf{B}) -wta, $(C, +, \times, 0, 1)$ be a strong bimonoid, and $f : B \rightarrow C$ be a strong bimonoid homomorphism. Then $f \circ \llbracket \mathcal{A} \rrbracket^{\text{init}} = \llbracket f(\mathcal{A}) \rrbracket^{\text{init}}$ and $f \circ \llbracket \mathcal{A} \rrbracket^{\text{run}} = \llbracket f(\mathcal{A}) \rrbracket^{\text{run}}$.

Proof. First we show that $f \circ \llbracket \mathcal{A} \rrbracket^{\text{init}} = \llbracket f(\mathcal{A}) \rrbracket^{\text{init}}$. For this, we define the mapping $\tilde{f} : B^Q \rightarrow C^Q$ for every $v \in B^Q$ and $q \in Q$ by $\tilde{f}(v)_q = f(v_q)$. We prove that \tilde{f} is a Σ -algebra homomorphism from the vector algebra $\mathbf{V}(\mathcal{A}) = (B^Q, \delta_{\mathcal{A}})$ to the vector algebra $\mathbf{V}(f(\mathcal{A})) = (C^Q, \delta'_{f(\mathcal{A})})$. For this, let $k \in \mathbb{N}$, $\sigma \in \Sigma^{(k)}$, and $v_1, \dots, v_k \in B^Q$. Then we can calculate as follows.

$$\begin{aligned} \tilde{f}(\delta_{\mathcal{A}}(\sigma)(v_1, \dots, v_k))_q &= f(\delta_{\mathcal{A}}(\sigma)(v_1, \dots, v_k)_q) \\ &= f\left(\bigoplus_{q_1 \cdots q_k \in Q^k} \left(\bigotimes_{i \in [k]} (v_i)_{q_i}\right) \otimes \delta_k(q_1 \cdots q_k, \sigma, q)\right) \\ &= \bigoplus_{q_1 \cdots q_k \in Q^k} \left(\bigotimes_{i \in [k]} f((v_i)_{q_i})\right) \times f(\delta_k(q_1 \cdots q_k, \sigma, q)) \\ &\quad \text{(because } f \text{ is a strong bimonoid homomorphism)} \\ &= \bigoplus_{q_1 \cdots q_k \in Q^k} \left(\bigotimes_{i \in [k]} \tilde{f}(v_i)_{q_i}\right) \times (\delta')_k(q_1 \cdots q_k, \sigma, q) \quad \text{(be definition of } \tilde{f} \text{ and } \delta') \\ &= \delta'_{f(\mathcal{A})}(\sigma)(\tilde{f}(v_1), \dots, \tilde{f}(v_k))_q . \end{aligned}$$

Hence \tilde{f} is a Σ -algebra homomorphism. By Theorem 2.7.3, $\tilde{f} \circ h_{\mathcal{A}}$ is a Σ -algebra homomorphism from the Σ -term algebra $(T_{\Sigma}, \theta_{\Sigma})$ to the vector algebra $\mathbf{V}(f(\mathcal{A})) = (C^Q, \delta'_{f(\mathcal{A})})$. Since $h_{f(\mathcal{A})}$ is also a Σ -algebra homomorphism of the same type, it follows from Theorem 2.7.5 that $h_{f(\mathcal{A})} = \tilde{f} \circ h_{\mathcal{A}}$. Hence, for every $\xi \in T_{\Sigma}$ and $q \in Q$, we have $h_{f(\mathcal{A})}(\xi)_q = f(h_{\mathcal{A}}(\xi)_q)$.

Then for each $\xi \in T_{\Sigma}$:

$$\begin{aligned} (f \circ \llbracket \mathcal{A} \rrbracket^{\text{init}})(\xi) &= f(\llbracket \mathcal{A} \rrbracket^{\text{init}}(\xi)) = f\left(\bigoplus_{q \in Q} h_{\mathcal{A}}(\xi)_q \otimes F_q\right) \\ &= \bigoplus_{q \in Q} f(h_{\mathcal{A}}(\xi)_q) \times f(F_q) = \bigoplus_{q \in Q} h_{f(\mathcal{A})}(\xi)_q \times F'_q = \llbracket f(\mathcal{A}) \rrbracket^{\text{init}}(\xi) . \end{aligned}$$

Now we show that $f \circ \llbracket \mathcal{A} \rrbracket^{\text{run}} = \llbracket f(\mathcal{A}) \rrbracket^{\text{run}}$. For this, by induction on T_{Σ} , we prove that the following statement holds:

$$\text{For every } \xi \in T_{\Sigma} \text{ and } \rho \in R_{\mathcal{A}}(\xi), \text{ we have: } \text{wt}_{f(\mathcal{A})}(\xi, \rho) = f(\text{wt}_{\mathcal{A}}(\xi, \rho)) . \quad (10.38)$$

Let $\xi = \sigma(\xi_1, \dots, \xi_k)$. Then

$$\text{wt}_{f(\mathcal{A})}(\xi, \rho) = \left(\bigotimes_{i \in [k]} \text{wt}_{f(\mathcal{A})}(\xi_i, \rho|_i)\right) \times \delta'_k(\rho(1) \cdots \rho(k), \sigma, \rho(\varepsilon))$$

$$\begin{aligned}
&= \left(\prod_{i \in [k]} f(\text{wt}_{\mathcal{A}}(\xi_i, \rho|_i)) \right) \times f(\delta_k(\rho(1) \cdots \rho(k), \sigma, \rho(\varepsilon))) \\
&\quad \text{(by I.H. and construction, recall that } \rho|_i \in R_{\mathcal{A}}(\xi_i) \text{ for } 1 \leq i \leq k) \\
&= f \left(\left(\bigotimes_{i \in [k]} \text{wt}_{\mathcal{A}}(\xi_i, \rho|_i) \right) \otimes \delta_k(\rho(1) \cdots \rho(k), \sigma, \rho(\varepsilon)) \right) \\
&\quad \text{(by the fact that } f \text{ is a strong bimonoid homomorphisms)} \\
&= f(\text{wt}_{\mathcal{A}}(\xi, \rho)).
\end{aligned}$$

This proves (10.38). Then for each $\xi \in T_{\Sigma}$:

$$\begin{aligned}
(f \circ \llbracket \mathcal{A} \rrbracket^{\text{run}})(\xi) &= f(\llbracket \mathcal{A} \rrbracket^{\text{run}}(\xi)) = f \left(\bigoplus_{\rho \in R_{\mathcal{A}}(\xi)} \text{wt}_{\mathcal{A}}(\xi, \rho) \otimes F_{\rho(\varepsilon)} \right) \\
&= \bigoplus_{\rho \in R_{\mathcal{A}}(\xi)} f(\text{wt}_{\mathcal{A}}(\xi, \rho)) \times f(F_{\rho(\varepsilon)}) = \bigoplus_{\rho \in R_{f(\mathcal{A})}(\xi)} \text{wt}_{f(\mathcal{A})}(\xi, \rho) \times F'_{\rho(\varepsilon)} = \llbracket f(\mathcal{A}) \rrbracket^{\text{run}}(\xi),
\end{aligned}$$

where the third equation uses again that h is a strong bimonoid homomorphism and the fourth one uses the fact that $R_{\mathcal{A}}(\xi) = R_{f(\mathcal{A})}(\xi)$. \square

The next theorem generalizes [BMS⁺06, Lm. 3] and [FV09, Thm. 3.9] from semirings to strong bimonoids. It uses the following abbreviation. Let \mathcal{C} be a set of (Σ, \mathbf{B}) -weighted tree languages, $\mathbf{C} = (\mathcal{C}, +, \times, 0, 1)$ be a strong bimonoid and $f : B \rightarrow C$ be a strong bimonoid homomorphism. We define $f \circ \mathcal{C} = \{f \circ r \mid r \in \mathcal{C}\}$. Obviously, $f \circ \mathcal{C}$ is a set of (Σ, \mathbf{C}) -weighted tree languages.

Theorem 10.9.2. *Let Σ be a ranked alphabet. Moreover, let $\mathbf{B} = (B, \oplus, \otimes, 0, \mathbb{1})$ and $\mathbf{C} = (C, +, \times, 0, 1)$ be strong bimonoids, and let $f : B \rightarrow C$ be a strong bimonoid homomorphism. Then the following three statements hold.*

- (1) $f \circ \text{Rec}^{\text{init}}(\Sigma, \mathbf{B}) \subseteq \text{Rec}^{\text{init}}(\Sigma, \mathbf{C})$ and $f \circ \text{Rec}^{\text{run}}(\Sigma, \mathbf{B}) \subseteq \text{Rec}^{\text{run}}(\Sigma, \mathbf{C})$.
- (2) If f is surjective, then $f \circ \text{Rec}^{\text{init}}(\Sigma, \mathbf{B}) = \text{Rec}^{\text{init}}(\Sigma, \mathbf{C})$ and $f \circ \text{Rec}^{\text{run}}(\Sigma, \mathbf{B}) = \text{Rec}^{\text{run}}(\Sigma, \mathbf{C})$.
- (3) Statements (1) and (2) also hold for the subsets of $\text{Rec}^{\text{init}}(\Sigma, \mathbf{B})$, $\text{Rec}^{\text{init}}(\Sigma, \mathbf{C})$, $\text{Rec}^{\text{run}}(\Sigma, \mathbf{B})$, and $\text{Rec}^{\text{run}}(\Sigma, \mathbf{C})$ which are recognizable by bu-deterministic wta. The same holds if we replace bu-deterministic by crisp-deterministic.

Thus, in particular, the sets $\text{Rec}^{\text{init}}(\Sigma, -)$, $\text{Rec}^{\text{run}}(\Sigma, -)$ and $\text{Rec}(\Sigma, -)$ are closed under strong bimonoid homomorphisms.

Proof. Proof of (1): Let \mathcal{A} be a (Σ, \mathbf{B}) -wta such that $r = \llbracket \mathcal{A} \rrbracket^{\text{init}}$. By Lemma 10.9.1 we have that $f \circ \llbracket \mathcal{A} \rrbracket^{\text{init}} = \llbracket f(\mathcal{A}) \rrbracket^{\text{init}}$. Hence $f \circ r \in \text{Rec}^{\text{init}}(\Sigma, \mathbf{C})$. By a similar argument we can prove that $r \in \text{Rec}^{\text{run}}(\Sigma, \mathbf{B})$ implies $f \circ r \in \text{Rec}^{\text{run}}(\Sigma, \mathbf{C})$.

Proof of (2): By (1) we have $f \circ \text{Rec}^{\text{init}}(\Sigma, \mathbf{B}) \subseteq \text{Rec}^{\text{init}}(\Sigma, \mathbf{C})$ and $f \circ \text{Rec}^{\text{run}}(\Sigma, \mathbf{B}) \subseteq \text{Rec}^{\text{run}}(\Sigma, \mathbf{C})$.

Next we assume that f is surjective. Then we show that also the other inclusions hold. For this, let $\mathcal{A}' = (Q, \delta', F')$ be an arbitrary (Σ, \mathbf{C}) -wta. We construct the (Σ, \mathbf{B}) -wta $\mathcal{A} = (Q, \delta, F)$ such that

- for every $k \in \mathbb{N}$, $\sigma \in \Sigma^{(k)}$, $w \in Q^k$, and $q \in Q$ we let $\delta_k(w, \sigma, q) = b$ where b is determined as follows: if $\delta'_k(w, \sigma, q) = 0$, then we let $b = 0$, if $\delta'_k(w, \sigma, q) = 1$, then we let $b = \mathbb{1}$, and if $\delta'_k(w, \sigma, q) \notin \{0, 1\}$, then we let b be an arbitrary element in $f^{-1}(\delta'_k(w, \sigma, q))$, and
- for each $q \in Q$, we let $F_q = b$, for some $b \in f^{-1}(F'_q)$.

In both items such values b exist because f is surjective. We have $\mathcal{A}' = f(\mathcal{A})$ and by Lemma 10.9.1 we conclude $f \circ \llbracket \mathcal{A} \rrbracket^{\text{init}} = \llbracket \mathcal{A}' \rrbracket^{\text{init}}$ and $f \circ \llbracket \mathcal{A} \rrbracket^{\text{run}} = \llbracket \mathcal{A}' \rrbracket^{\text{run}}$. Hence the other inclusions also hold.

Proof of (3): This statement holds by (1) and (2) and by the fact that the constructions of the f -image $f(\mathcal{A})$ and of \mathcal{A}' (in the proof of (2)) preserve bu-determinism and crisp-determinism. \square

10.10 Closure under tree relabelings

In this section we will prove that $\text{Rec}^{\text{run}}(-, \mathbf{B})$ is closed under tree relabelings. We recall that a (Σ, Δ) -tree relabeling is a family $\tau = (\tau_k \mid k \in \mathbb{N})$ such that $\tau_k(\sigma) \subseteq \Delta^{(k)}$ for each $\sigma \in \Sigma^{(k)}$. A tree relabeling τ is non-overlapping if $\tau_k(\sigma) \cap \tau_k(\sigma') = \emptyset$ for every $k \in \mathbb{N}$ and $\sigma, \sigma' \in \Sigma^{(k)}$ with $\sigma \neq \sigma'$. Its extension is the mapping $\tau : \mathsf{T}_\Sigma \rightarrow \mathcal{P}_{\text{fin}}(\mathsf{T}_\Delta)$, which can be also considered as binary relation $\tau \subseteq \mathsf{T}_\Sigma \times \mathsf{T}_\Delta$. Then its characteristic mapping $\chi(\tau) : \mathsf{T}_\Sigma \times \mathsf{T}_\Delta \rightarrow B$ is supp-i-finite.

Since $\chi(\tau)$ is supp-i-finite, for each $r : \mathsf{T}_\Sigma \rightarrow B$, the application $\chi(\tau)(r)$ is defined by (2.38) and by (2.39) and (2.40), for each $\zeta \in \mathsf{T}_\Delta$, we have

$$\chi(\tau)(r)(\zeta) = \bigoplus_{\xi \in \tau^{-1}(\zeta)} r(\xi) .$$

A set \mathcal{L} of \mathbf{B} -weighted tree languages is *closed under tree relabelings* if for every (Σ, \mathbf{B}) -weighted tree language $r \in \mathcal{L}$ and every (Σ, Δ) -tree relabeling τ , the (Δ, \mathbf{B}) -weighted tree language $\chi(\tau)(r)$ is in \mathcal{L} .

Theorem 10.10.1. (cf. [SVF09, Lm. 6]) *Let Σ and Δ be ranked alphabets. Moreover, let $\mathbf{B} = (B, \oplus, \otimes, \mathbf{0}, \mathbf{1})$ be a strong bimonoid and let \mathcal{A} be a (Σ, \mathbf{B}) -wta. Also, let τ be a (Σ, Δ) -tree relabeling. Then we can construct a (Δ, \mathbf{B}) -wta \mathcal{B} such that $\llbracket \mathcal{B} \rrbracket^{\text{run}} = \chi(\tau)(\llbracket \mathcal{A} \rrbracket^{\text{run}})$. If, moreover, \mathcal{A} is bu-deterministic (or: crisp-deterministic) and τ is non-overlapping, then \mathcal{B} is bu-deterministic (and crisp-deterministic, respectively). Thus, in particular, the set $\text{Rec}^{\text{run}}(-, \mathbf{B})$ is closed under tree relabelings.*

Proof. Let $\mathcal{A} = (Q, \delta, F)$ be a (Σ, \mathbf{B}) -wta and $\tau = (\tau_k \mid k \in \mathbb{N})$ be a (Σ, Δ) -tree relabeling.

We construct the (Δ, \mathbf{B}) -wta $\mathcal{B} = (Q', \delta', F')$ where

- $Q' = Q \times \Sigma$
- for every $k \in \mathbb{N}$, $\gamma \in \Delta^{(k)}$, $(q, \sigma), (q_1, \sigma_1), \dots, (q_k, \sigma_k) \in Q \times \Sigma$,

$$(\delta')_k((q_1, \sigma_1) \cdots (q_k, \sigma_k), \gamma, (q, \sigma)) = \begin{cases} \delta_k(q_1 \cdots q_k, \sigma, q) & \text{if } \gamma \in \tau_k(\sigma) \\ \mathbf{0} & \text{otherwise,} \end{cases}$$

- $(F')_{(q, \gamma)} = F_q$ for each $(q, \gamma) \in Q'$.

In general, the above construction does not preserve bu-determinism. For instance, let $a, b \in B$ with $a \neq \mathbf{0} \neq b$, and let \mathcal{A} be a bu-deterministic (Σ, \mathbf{B}) -wta with transition mapping δ_1 such that $\delta_1(q, \sigma_1, p) = a$ and $\delta_1(q, \sigma_2, p') = b$. Moreover, let $\tau_1(\sigma_1) = \tau_1(\sigma_2) = \{\gamma\}$ and $\kappa \in \Sigma$. Then $(\delta'_1)((q, \kappa), \gamma, (p, \sigma_1)) = a$ and $(\delta'_1)((q, \kappa), \gamma, (p', \sigma_2)) = b$ and hence \mathcal{B} is not bu-deterministic.

However, if τ is non-overlapping, then this phenomenon cannot occur. Thus, if \mathcal{A} is bu-deterministic and τ is non-overlapping, then \mathcal{B} is bu-deterministic. Moreover, if \mathcal{A} is crisp-deterministic and τ is non-overlapping, then \mathcal{B} is crisp-deterministic.

Next we prove that $\llbracket \mathcal{B} \rrbracket^{\text{run}} = \chi(\tau)(\llbracket \mathcal{A} \rrbracket^{\text{run}})$. Let $\xi \in \mathsf{T}_\Sigma$ and $\zeta \in \tau(\xi)$. We define the mapping $\varphi_{\xi, \zeta} : \mathsf{R}_{\mathcal{A}}(\xi) \rightarrow \mathsf{R}_{\mathcal{B}}(\zeta)$ for every $\rho \in \mathsf{R}_{\mathcal{A}}(\xi)$ and $w \in \text{pos}(\xi)$ by $\varphi_{\xi, \zeta}(\rho)(w) = (\rho(w), \xi(w))$. Obviously, $\varphi_{\xi, \zeta}$ is injective. Moreover, we define the mapping $\varphi'_{\xi, \zeta} : \mathsf{R}_{\mathcal{A}}(\xi) \rightarrow \text{im}(\varphi_{\xi, \zeta})$ by $\varphi'_{\xi, \zeta}(\rho) = \varphi_{\xi, \zeta}(\rho)$ for each $\rho \in \mathsf{R}_{\mathcal{A}}(\xi)$. Clearly, $\varphi'_{\xi, \zeta}$ is bijective.

The following statements are easy to see.

$$\text{For every } \zeta \in \mathsf{T}_\Delta, \xi \in \tau^{-1}(\zeta), \text{ and } \rho \in \mathsf{R}_{\mathcal{A}}(\xi): \text{ wt}_{\mathcal{A}}(\xi, \rho) = \text{wt}_{\mathcal{B}}(\zeta, \varphi'_{\xi, \zeta}(\rho)). \quad (10.39)$$

$$\text{For every } \zeta \in \mathsf{T}_\Delta \text{ and } \rho' \in \mathsf{R}_{\mathcal{B}}(\zeta) \setminus \bigcup_{\xi \in \tau^{-1}(\zeta)} \text{im}(\varphi'_{\xi, \zeta}): \text{wt}_{\mathcal{B}}(\zeta, \rho') = 0. \quad (10.40)$$

$$\text{For every } \zeta \in \mathsf{T}_\Delta \text{ and } \xi_1, \xi_2 \in \tau^{-1}(\zeta): \text{ if } \xi_1 \neq \xi_2, \text{ then } \text{im}(\varphi'_{\xi_1, \zeta}) \cap \text{im}(\varphi'_{\xi_2, \zeta}) = \emptyset. \quad (10.41)$$

Let $\zeta \in T_\Delta$. We can calculate as follows.

$$\begin{aligned}
\llbracket \mathcal{B} \rrbracket^{\text{run}}(\zeta) &= \bigoplus_{\rho' \in R_{\mathcal{B}}(\zeta)} \text{wt}_{\mathcal{B}}(\zeta, \rho') \otimes (F')_{\rho'(\varepsilon)} \\
&= \bigoplus_{\rho' \in \bigcup_{\xi \in \tau^{-1}(\zeta)} \text{im}(\varphi'_{\xi, \zeta})} \text{wt}_{\mathcal{B}}(\zeta, \rho') \otimes (F')_{\rho'(\varepsilon)} && \text{(by (10.40))} \\
&= \bigoplus_{\xi \in \tau^{-1}(\zeta)} \bigoplus_{\rho' \in \text{im}(\varphi'_{\xi, \zeta})} \text{wt}_{\mathcal{B}}(\zeta, \rho') \otimes (F')_{\rho'(\varepsilon)} && \text{(by (10.41))} \\
&= \bigoplus_{\xi \in \tau^{-1}(\zeta)} \bigoplus_{\rho \in R_{\mathcal{A}}(\xi)} \text{wt}_{\mathcal{B}}(\zeta, \varphi'_{\xi, \zeta}(\rho)) \otimes F_{\rho(\varepsilon)} && \text{(because } \varphi'_{\xi, \zeta} \text{ is bijective)} \\
&= \bigoplus_{\xi \in \tau^{-1}(\zeta)} \bigoplus_{\rho \in R_{\mathcal{A}}(\xi)} \text{wt}_{\mathcal{A}}(\xi, \rho) \otimes F_{\rho(\varepsilon)} && \text{(by (10.39))} \\
&= \bigoplus_{\xi \in \tau^{-1}(\zeta)} \llbracket \mathcal{A} \rrbracket^{\text{run}}(\xi) = \chi(\tau)(\llbracket \mathcal{A} \rrbracket^{\text{run}})(\zeta) . && \square
\end{aligned}$$

As a consequence of Theorem 10.10.1 we reobtain the well-known closure of recognizable tree languages under tree relabelings.

Corollary 10.10.2. (cf. [Eng75b, Thm. 3.48]) Let A be a Σ -fta and τ a (Σ, Δ) -tree relabeling. Then we can construct a Δ -fta B such that $L(B) = \tau(L(A))$.

Proof. By Corollary 3.4.2(A) \Rightarrow (B), we can construct a (Σ, Boole) -wta \mathcal{A} such that $L(A) = \text{supp}(\llbracket \mathcal{A} \rrbracket)$. Then we have

$$\tau(L(A)) = \tau(\text{supp}(\llbracket \mathcal{A} \rrbracket)) = \text{supp}(\chi(\tau)(\llbracket \mathcal{A} \rrbracket))$$

where the last equality is due to (2.41). By Theorem 10.10.1 we can construct a (Δ, Boole) -wta \mathcal{B} such that $\llbracket \mathcal{B} \rrbracket = \chi(\tau)(\llbracket \mathcal{A} \rrbracket)$. Finally, by Corollary 3.4.2(B) \Rightarrow (A), we can construct a Δ -fta B such that $L(B) = \text{supp}(\llbracket \mathcal{B} \rrbracket)$. Hence $L(B) = \tau(L(A))$. \square

10.11 Closure under linear and nondeleting tree homomorphisms

In this section we will prove that $\text{Rec}^{\text{run}}(_, \mathbf{B})$ is closed under linear, nondeleting, and productive tree homomorphism. We will even prove a more general closure of regular weighted tree languages under such tree homomorphisms.

Let $h = (h_k \mid k \in \mathbb{N})$ be a (Σ, Δ) -tree homomorphism. We can view its extension $h : T_\Sigma \rightarrow T_\Delta$ as binary relation $h \subseteq T_\Sigma \times T_\Delta$; then its characteristic mapping has type $\chi(h) : T_\Sigma \times T_\Delta \rightarrow B$. We say that h is *supp-i-finite* if $\chi(h) : T_\Sigma \times T_\Delta \rightarrow B$ is supp-i-finite, i.e., for each $\zeta \in T_\Delta$, the set $h^{-1}(\zeta)$ is finite.

In general, a tree homomorphism h is not supp-i-finite. For instance, if $\Sigma = \{\gamma^{(1)}, \alpha^{(0)}\}$, $\Delta = \{\beta^{(0)}\}$, and $h(\gamma) = x_1$ and $h(\alpha) = \beta$, then $h^{-1}(\beta) = \{\gamma^n(\alpha) \mid n \in \mathbb{N}\}$ is infinite. However, if h is productive and nondeleting, then h is supp-i-finite.

Now let h be a (Σ, Δ) -tree homomorphism and $r : T_\Sigma \rightarrow B$ such that h is supp-i-finite or \mathbf{B} is σ -complete. Then the application of $\chi(h) : T_\Sigma \times T_\Delta \rightarrow B$ to r is defined by (2.38), and by (2.40), for each $\zeta \in T_\Delta$, we have

$$\chi(h)(r)(\zeta) = \sum_{\xi \in h^{-1}(\zeta)}^{\oplus} r(\xi).$$

Let us denote by $\text{Hom}(\Sigma, \Delta)$ the set of all tree homomorphisms from Σ to Δ and let \mathcal{C} be a subset of $\text{Hom}(\Sigma, \Delta)$ such that each $h \in \mathcal{C}$ is supp-i-finite. A set \mathcal{L} of \mathbf{B} -weighted tree languages is *closed*

under tree homomorphisms in \mathcal{C} if for every (Σ, \mathbf{B}) -weighted tree language $r \in \mathcal{L}$ and every (Σ, Δ) -tree homomorphism h in \mathcal{C} , the (Δ, \mathbf{B}) -weighted tree language $\chi(h)(r)$ is in \mathcal{C} .

The next theorem can be compared to [FMV11, Thm. 5.3] where the closure of the set of recognizable \mathbf{B} -weighted tree languages under linear and nondeleting weighted extended tree transformations was proved if \mathbf{B} is a σ -complete and commutative semiring. We recall that linear and nondeleting tree homomorphisms are particular linear and nondeleting weighted extended tree transducers. (We also refer to [Boz99, Prop. 25].) This result is weaker than what one might expect when looking at [Eng75b, Thm. 3.65] for the unweighted case. There, it was proved that the set of recognizable tree languages is closed under linear tree homomorphisms (which need not be nondeleting). The underlying construction can be reformulated easily to \mathbf{Boole} -weighted tree languages. But we do not know whether it is possible to generalize the latter to \mathbf{B} -weighted tree languages because it is not clear how to handle the weights of deleted subtrees.

Theorem 10.11.1. *Let \mathcal{G} be a (Σ, \mathbf{B}) -wrtg such that \mathcal{G} is finite-derivational or \mathbf{B} is σ -complete. Moreover, let h be a linear and nondeleting tree homomorphism from Σ to Δ such that h is productive or \mathbf{B} is σ -complete. Then we can construct a (Δ, \mathbf{B}) -wrtg \mathcal{G}' such that (a) if \mathcal{G} is finite-derivational (chain-free) and h is productive, then \mathcal{G}' is finite-derivational (chain-free) and (b) $\llbracket \mathcal{G}' \rrbracket = \chi(h)(\llbracket \mathcal{G} \rrbracket)$.*

Proof. Let $\mathcal{G} = (N, S, R, wt)$ and $h = (h_k \mid k \in \mathbb{N})$. By Lemma 9.2.2 we can assume that \mathcal{G} is alphabetic. We construct the (Δ, \mathbf{B}) -wrtg $\mathcal{G}' = (N', S', R', wt')$, where

- $N' = N \times \Sigma$,
- $S' = S \times \Sigma$, and
- R' is the smallest set of rules satisfying the following conditions:
 - for each rule $r = (A \rightarrow \sigma(A_1, \dots, A_k))$ in R and for every $\sigma_1, \dots, \sigma_k \in \Sigma$, the rule $r' = ((A, \sigma) \rightarrow h_k(\sigma)[(A_1, \sigma_1), \dots, (A_k, \sigma_k)])$ is in R' and $wt'(r') = wt(r)$, and
 - for each rule $r = (A \rightarrow B)$ in R and each $\sigma \in \Sigma$, the rule $r' = ((A, \sigma) \rightarrow (B, \sigma))$ in R' and $wt'(r') = wt(r)$.

Since h is linear and nondeleting, the tree $h_k(\sigma)$ is a context for each $\sigma \in \Sigma^{(k)}$ and $k \in \mathbb{N}$. Hence, for each rule of \mathcal{G}' of the form $(A, \sigma) \rightarrow h_k(\sigma)[(A_1, \sigma_1), \dots, (A_k, \sigma_k)]$, each nonterminal (A_i, σ_i) occurs exactly once in the right-hand side of that rule. Moreover, if \mathcal{G} is chain-free and h is productive, then \mathcal{G}' is chain-free.

We define the mapping

$$\varphi : \text{RT}_{\mathcal{G}}(N, T_{\Sigma}) \rightarrow \text{RT}_{\mathcal{G}'}(N', T_{\Delta})$$

by induction on the terminating reduction system $(\text{RT}_{\mathcal{G}}(N, T_{\Sigma}), \succ)$ where $\succ = \succ_R \cap (\text{RT}_{\mathcal{G}}(N, T_{\Sigma}) \times \text{RT}_{\mathcal{G}}(N, T_{\Sigma}))$. Then $\text{nf}_{\succ}(\text{RT}_{\mathcal{G}}(N, T_{\Sigma}))$ is the set of all rules of R with right-hand side in $\Sigma^{(0)}$.

Let $d \in \text{RT}_{\mathcal{G}}(N, T_{\Sigma})$. We can distinguish the following two cases

Case (a): Let $d = r(d_1, \dots, d_k)$ for some rule $r = (A \rightarrow \sigma(A_1, \dots, A_k))$ and $d_i \in \text{RT}_{\mathcal{G}}(N, T_{\Sigma})$ for each $i \in [k]$. Then we let $\varphi(d) = r'(d'_1, \dots, d'_k)$, where $r' = ((A, \sigma) \rightarrow h_k(\sigma)[(A_1, \sigma_1), \dots, (A_k, \sigma_k)])$ with $\sigma_i = \pi(d_i)(\varepsilon)$ and $d'_i = \varphi(d_i)$ for each $i \in [k]$.

Case (b): Let $d = r(d_1)$ for some rule $r = (A \rightarrow B)$ in R and $d_1 \in \text{RT}_{\mathcal{G}}(N, T_{\Sigma})$. Then we let $\varphi(d) = r'(d'_1)$, where $r' = ((A, \sigma) \rightarrow (B, \sigma))$ and $d'_1 = \varphi(d_1)$.

Due to the construction of \mathcal{G}' ,

$$\text{for every } A \in N \text{ and } \xi \in T_{\Sigma}, \text{ we have } \varphi(\text{RT}_{\mathcal{G}}(A, \xi)) = \text{RT}_{\mathcal{G}'}((A, \xi(\varepsilon)), h(\xi)) ,$$

and

$$\text{for every } (A, \sigma) \in N' \text{ and } \zeta \in T_{\Delta}, \text{ we have } \text{RT}_{\mathcal{G}'}((A, \sigma), \zeta) = \bigcup_{\substack{\xi \in h^{-1}(\zeta): \\ \xi(\varepsilon) = \sigma}} \varphi(\text{RT}_{\mathcal{G}}(A, \xi)) . \quad (10.42)$$

It follows that, if h is productive (and thus it is supp-i-finite) and \mathcal{G} is finite-derivational, then \mathcal{G}' is finite-derivational. It is easy to see that

$$\varphi \text{ is a bijection and } \text{wt}_{\mathcal{G}}(d) = \text{wt}_{\mathcal{G}'}(\varphi(d)) \text{ for each } d \in \text{RT}_{\mathcal{G}}(N, T_{\Sigma}) . \quad (10.43)$$

Moreover,

$$\text{the family } (\varphi(\text{RT}_{\mathcal{G}}(A, \xi)) \mid \xi \in h^{-1}(\zeta), \xi(\varepsilon) = \sigma) \text{ is a partitioning of } \text{RT}_{\mathcal{G}'}((A, \sigma), \zeta) , \quad (10.44)$$

because each $d \in \varphi(\text{RT}_{\mathcal{G}}(A, \xi))$ encodes ξ , thus $\xi \neq \xi'$ implies $\varphi(\text{RT}_{\mathcal{G}}(A, \xi)) \cap \varphi(\text{RT}_{\mathcal{G}}(A, \xi')) = \emptyset$. Hence the union on right-hand side of (10.42) is a disjoint union.

Now let $\zeta \in T_{\Delta}$. Then we can compute as follows

$$\begin{aligned} \llbracket \mathcal{G}' \rrbracket(\zeta) &= \sum_{d' \in \text{RT}_{\mathcal{G}'}(\zeta)}^{\oplus} \text{wt}_{\mathcal{G}'}(d') = \bigoplus_{(A, \sigma) \in S'} \sum_{d' \in \text{RT}_{\mathcal{G}'}((A, \sigma), \zeta)}^{\oplus} \text{wt}_{\mathcal{G}'}(d') \\ &\stackrel{(*)}{=} \bigoplus_{(A, \sigma) \in S'} \sum_{\substack{\xi \in h^{-1}(\zeta), \xi(\varepsilon) = \sigma \\ d \in \text{RT}_{\mathcal{G}}(A, \xi)}}^{\oplus} \text{wt}_{\mathcal{G}}(d) = \bigoplus_{\xi \in h^{-1}(\zeta)} \sum_{\substack{A \in S \\ d \in \text{RT}_{\mathcal{G}}(A, \xi)}}^{\oplus} \text{wt}_{\mathcal{G}}(d) \\ &= \bigoplus_{\xi \in h^{-1}(\zeta)} \llbracket \mathcal{G} \rrbracket(\xi) = \chi(h)(\llbracket \mathcal{G} \rrbracket)(\zeta) , \end{aligned}$$

where (*) follows from (10.43) and (10.44). \square

Corollary 10.11.2. Let Σ and Δ be ranked alphabets. Moreover, let \mathbf{B} be a strong bimonoid and let \mathcal{A} be a (Σ, \mathbf{B}) -wta. Moreover, let h be a linear, nondeleting, and productive tree homomorphism from Σ to Δ . Then we can construct a (Δ, \mathbf{B}) -wta \mathcal{A}' such that $\llbracket \mathcal{A}' \rrbracket^{\text{run}} = \chi(h)(\llbracket \mathcal{A} \rrbracket^{\text{run}})$. Thus, in particular, the set $\text{Rec}^{\text{run}}(-, \mathbf{B})$ is closed under linear, nondeleting, and productive tree homomorphisms.

Proof. By Lemma 9.2.6 we can construct (Σ, \mathbf{B}) -wrtg \mathcal{G} such that \mathcal{G} is in tree automata form and $\llbracket \mathcal{A} \rrbracket^{\text{run}} = \llbracket \mathcal{G} \rrbracket$. In particular, \mathcal{G} is chain-free. By Theorem 10.11.1 we can construct a chain-free (Σ, \mathbf{B}) -wrtg \mathcal{G}' such that $\llbracket \mathcal{G}' \rrbracket = \chi(h)(\llbracket \mathcal{G} \rrbracket)$. Finally, by Lemma 9.2.8(a), we can construct a (Σ, \mathbf{B}) -wta \mathcal{A}' such that $\llbracket \mathcal{G}' \rrbracket = \llbracket \mathcal{A}' \rrbracket^{\text{run}}$. \square

In the rest of this section, we show that we can use Corollary 10.11.2 (in combination with Example 3.2.18(3)) in order to prove Theorem 4.3.1, provided that the underlying strong bimonoid is a semiring. The latter condition is needed in order to get rid of the difference between run semantics (used in Corollary 10.11.2) and initial algebra semantics (used in Example 3.2.18).

Corollary 10.11.3. (cf. Theorem 4.3.1 for a stronger version) Let Σ be a ranked alphabet such that $\Sigma^{(2)} \neq \emptyset$. Moreover, let $\mathbf{B} = (B, \oplus, \otimes, 0, \mathbb{1})$ be a semiring and $A \subseteq B$ be a finite subset. Then we can construct a (Σ, \mathbf{B}) -wta \mathcal{A} such that $\text{im}(\llbracket \mathcal{A} \rrbracket) = \langle A \rangle_{\{\oplus, \otimes, 0, \mathbb{1}\}}$.

Proof. Clearly, $\langle A \rangle_{\{\oplus, \otimes, 0, \mathbb{1}\}} = \langle A \cup \{0, \mathbb{1}\} \rangle_{\{\oplus, \otimes\}}$. Let a_1, \dots, a_n be the elements of $A \cup \{0, \mathbb{1}\}$, i.e., $A \cup \{0, \mathbb{1}\} = \{a_1, \dots, a_n\}$.

The idea for the construction of \mathcal{A} with $\text{im}(\llbracket \mathcal{A} \rrbracket) = \langle A \rangle_{\{\oplus, \otimes, 0, \mathbb{1}\}}$ is similar to that of the proof of Theorem 4.3.1. However, we specify the mapping $\text{eval} : T_{\Delta} \rightarrow \langle A \rangle_{\{\oplus, \otimes, 0, \mathbb{1}\}}$ in the proof (cf. page 127) by a (Δ, \mathbf{B}) -wta \mathcal{A}_1 here; this is done by using Example 3.2.18(3). Then we can apply Corollary 10.11.2 to \mathcal{A}_1 and the tree homomorphism $h : T_{\Delta} \rightarrow T_{\Sigma}$ defined in the proof of Theorem 4.3.1.

For the sake of convenience, we recall here the definitions of Δ and h . The ranked alphabet Δ is $\Delta = \{a_1^{(0)}, \dots, a_n^{(0)}\} \cup \{\oplus^{(2)}, \otimes^{(2)}\}$. We define the (Δ, Σ) -tree homomorphism $h = (h_k \mid k \in \mathbb{N})$ as follows. We fix arbitrary $\alpha \in \Sigma^{(0)}$ and $\sigma \in \Sigma^{(2)}$. Then we let

$$\begin{aligned} h_0(a_i) &= \underbrace{\sigma(\dots \sigma(\alpha, \alpha) \dots)}_{i \text{ times}} \underbrace{\sigma(\dots \sigma(\alpha, \alpha) \dots)}_{i \text{ times}} \alpha \quad \text{for each } i \in [n], \\ h_2(\oplus) &= \sigma(\alpha, \sigma(z_1, z_2)), \text{ and} \\ h_2(\otimes) &= \sigma(\sigma(z_1, z_2), \alpha) . \end{aligned}$$

The tree homomorphism $h : T_\Delta \rightarrow T_\Sigma$ is linear, nondeleting, and productive. Moreover, h is injective.

The latter can be seen as follows. First we show that, (a) for every $\xi_1, \xi_2 \in T_\Delta$, if $\xi_1(\varepsilon) \neq \xi_2(\varepsilon)$, then $h(\xi_1) \neq h(\xi_2)$. Then let $\xi_1, \xi_2 \in T_\Delta$ such that $\xi_1 \neq \xi_2$. The latter means that there exists $w \in \text{pos}(\xi_1) \cap \text{pos}(\xi_2)$ such that $(\xi_1|_w)(\varepsilon) \neq (\xi_2|_w)(\varepsilon)$ and $\xi_1(v) = \xi_2(v)$ for each $v \in \text{prefix}(w) \setminus \{w\}$. Using this fact, statement (a), and that h is nondeleting, we can show that $h(\xi_1) \neq h(\xi_2)$.

Now we construct the (Δ, \mathbf{B}) -wta \mathcal{A}_1 such that $\llbracket \mathcal{A}_1 \rrbracket = \text{eval}$. For this, we define the Δ -algebra $\mathcal{B} = (B, \theta)$ exactly as in Example 3.2.18(3). By (3.25), we have:

$$\text{For each } a \in \langle A \rangle_{\{\oplus, \otimes, 0, 1\}} \text{ there exists } \xi \in T_\Delta \text{ such that } h_{\mathcal{B}}(\xi) = a. \quad (10.45)$$

Clearly, $h_{\mathcal{B}} = \text{eval}$.

Given the Δ -algebra $\mathcal{B} = (B, \theta)$, we construct the (Δ, \mathbf{B}) -wta \mathcal{A}_1 as in Example 3.2.18(3). Then $\llbracket \mathcal{A}_1 \rrbracket^{\text{init}} = h_{\mathcal{B}} = \text{eval}$ and, by (10.45), $\langle A \rangle_{\{\oplus, \otimes, 0, 1\}} \subseteq \text{im}(\llbracket \mathcal{A}_1 \rrbracket^{\text{init}})$. Since \mathbf{B} is a semiring, by Theorem 5.3.4 we have $\llbracket \mathcal{A}_1 \rrbracket^{\text{init}} = \llbracket \mathcal{A}_1 \rrbracket^{\text{run}}$, which by convention we denote by $\llbracket \mathcal{A}_1 \rrbracket$.

By Corollary 10.11.2, we can construct a (Σ, \mathbf{B}) -wta \mathcal{A} such that $\llbracket \mathcal{A} \rrbracket = \chi(h)(\llbracket \mathcal{A}_1 \rrbracket)$. Then we prove that the following statement holds.

$$\text{For each } a \in \langle A \rangle_{\{\oplus, \otimes, 0, 1\}} \text{ there exists } \zeta \in T_\Sigma \text{ such that } \llbracket \mathcal{A} \rrbracket(\zeta) = a . \quad (10.46)$$

Let $a \in \langle A \rangle_{\{\oplus, \otimes, 0, 1\}}$. Since $\langle A \rangle_{\{\oplus, \otimes, 0, 1\}} \subseteq \text{im}(\llbracket \mathcal{A}_1 \rrbracket)$, there exists a $\xi \in T_\Delta$ such that $a = \llbracket \mathcal{A}_1 \rrbracket(\xi)$. Let us choose an arbitrary such ξ and denote it by ξ_a . Then we calculate as follows:

$$\llbracket \mathcal{A} \rrbracket(h(\xi_a)) = \chi(h)(\llbracket \mathcal{A}_1 \rrbracket)(h(\xi_a)) = \sum_{\xi \in h^{-1}(h(\xi_a))}^{\oplus} \llbracket \mathcal{A}_1 \rrbracket(\xi) = \sum_{\xi \in \{\xi_a\}}^{\oplus} \llbracket \mathcal{A}_1 \rrbracket(\xi) = \llbracket \mathcal{A}_1 \rrbracket(\xi_a) = a$$

where the third equality holds because h is injective. This finishes the proof of (10.46). Since $\text{im}(\llbracket \mathcal{A} \rrbracket) \subseteq \langle A \rangle_{\{\oplus, \otimes, 0, 1\}}$ holds obviously, together with (10.46) we have $\text{im}(\llbracket \mathcal{A} \rrbracket) = \langle A \rangle_{\{\oplus, \otimes, 0, 1\}}$. \square

10.12 Closure under inverse of linear tree homomorphisms

Let h be a (Σ, Δ) -tree homomorphism and $r : T_\Delta \rightarrow B$. Since the extension $h : T_\Sigma \rightarrow T_\Delta$ is a particular binary relation $h \subseteq T_\Sigma \times T_\Delta$, its inverse $h^{-1} \subseteq T_\Delta \times T_\Sigma$ is well defined. Moreover, $\chi(h^{-1}) : T_\Delta \times T_\Sigma \rightarrow B$ is supp-i-finite, and hence r is $\chi(h^{-1})$ -summable. Thus, the application of $\chi(h^{-1})$ to r is defined by (2.38), and by (2.40) we obtain, for each $\xi \in T_\Sigma$:

$$\chi(h^{-1})(r)(\xi) = \sum_{\zeta \in h(\xi)}^{\oplus} r(\zeta) = r(h(\xi)) .$$

Again let us denote by $\text{Hom}(\Sigma, \Delta)$ the set of all tree homomorphisms from Σ to Δ . Let \mathcal{C} be a subset of the set $\text{Hom}(\Sigma, \Delta)$. A set \mathcal{L} of \mathbf{B} -weighted tree languages is *closed under inverse of tree homomorphisms* in \mathcal{C} if for every (Δ, \mathbf{B}) -weighted tree language $r \in \mathcal{L}$ and every (Σ, Δ) -tree homomorphism h in \mathcal{C} , the (Σ, \mathbf{B}) -weighted tree language $\chi(h^{-1})(r) = r \circ h$ is in \mathcal{L} .

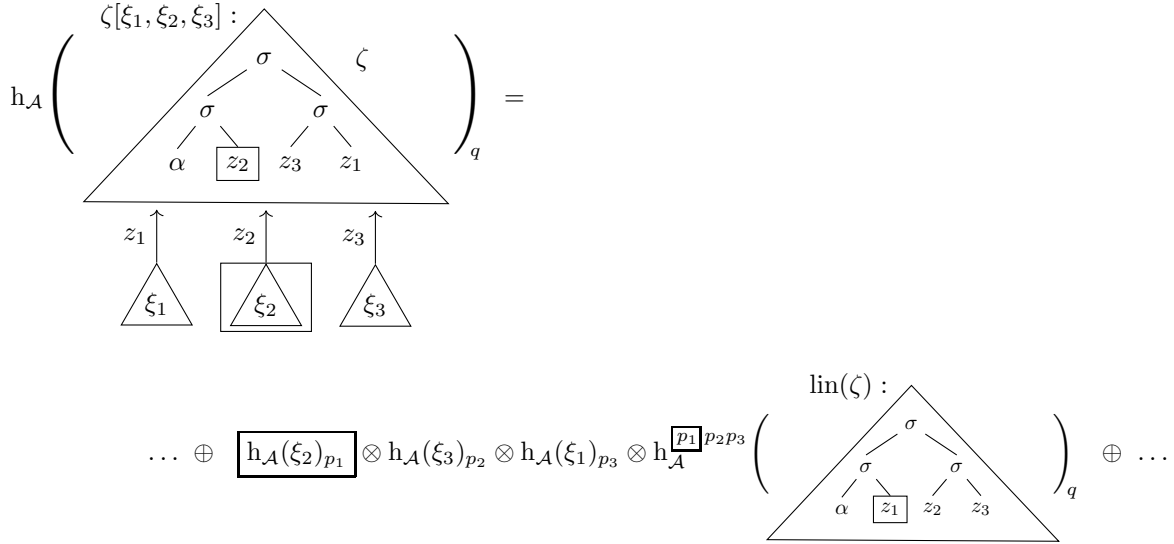

Figure 10.10: The value of $h_{\mathcal{A}}(\sigma(\sigma(\alpha, z_2), \sigma(z_3, z_1))[\xi_1, \xi_2, \xi_3])$ where on the right-hand side of the equality only one summand (for $q_1 q_2 q_3 = p_1 p_2 p_3$ in Q^3) is shown.

In this section we show that, if B is a commutative semiring, then $\text{Rec}(-, B)$ is closed under the inverse of linear tree homomorphisms.

Let $\mathcal{A} = (Q, \delta, F)$ be a (Σ, B) -wta. We wish to extend the Σ -algebra homomorphism $h_{\mathcal{A}} : T_{\Sigma} \rightarrow B^Q$ to a mapping which can also process trees with variables in Z_n (cf. [FV15, p. 85]). Formally, let $n \in \mathbb{N}$ and $q_1, \dots, q_n \in Q$. We define the mapping $f : Z_n \rightarrow B^Q$ such that, for each $z_i \in Z_n$ and $q \in Q$, we let $f(z_i)_q = \mathbb{1}$ if $q = q_i$, and 0 otherwise. Since the Σ -term algebra $(T_{\Sigma}(Z_n), \theta_{\Sigma})$ over Z_n is free in the set of all Σ -algebras generated by Z_n (cf. Theorem 2.10.3), there exists a unique extension of f to a Σ -algebra homomorphism from $(T_{\Sigma}(Z_n), \theta_{\Sigma})$ to the vector algebra $V(\mathcal{A}) = (B^Q, \delta_{\mathcal{A}})$. We denote this Σ -algebra homomorphism by $h_{\mathcal{A}}^{q_1 \dots q_n}$. Thus, in particular, for every $\sigma \in \Sigma^{(k)}$ with $k \in \mathbb{N}$ and $\xi_1, \dots, \xi_k \in T_{\Sigma}(Z_n)$, we have

$$h_{\mathcal{A}}^{q_1 \dots q_n}(\sigma(\xi_1, \dots, \xi_k))_q = \bigoplus_{p_1 \dots p_k \in Q^k} \left(\bigotimes_{i \in [k]} h_{\mathcal{A}}^{q_1 \dots q_n}(\xi_i)_{p_i} \right) \otimes \delta_k(p_1 \dots p_k, \sigma, q) .$$

Obviously, $h_{\mathcal{A}}^{\varepsilon} = h_{\mathcal{A}}$.

In the next lemma, for every $\zeta \in T_{\Sigma}(Z_n)$ which is linear in Z_n and trees $\xi_1, \dots, \xi_n \in T_{\Sigma}$, we wish to express the value $h_{\mathcal{A}}(\zeta[\xi_1, \dots, \xi_n])_q \in B$ by means of $h_{\mathcal{A}}(\xi_1), \dots, h_{\mathcal{A}}(\xi_n)$ (cf. Figure 10.10). For this we need some technical tools to identify variables in subterms of ζ .

Let (m_1, \dots, m_l) be the sequence of indices of variables occurring in ζ in a left-to-right order; we denote this sequence by $\text{seq}(\zeta)$. Obviously, $l \leq n$ and $m_j \leq n$ for each $j \in [l]$. For instance, if $\zeta = \sigma(\sigma(\alpha, z_2), \sigma(z_3, z_1))$, then $\text{seq}(\zeta) = (2, 3, 1)$. We note that, if $\zeta = \sigma(\zeta_1, \dots, \zeta_k)$, then $\text{seq}(\zeta) = \text{seq}(\zeta_1) \dots \text{seq}(\zeta_k)$ (by dropping intermediate occurrences of “(“).

Moreover, we denote by $\text{lin}(\zeta)$ the tree obtained from ζ by replacing its variables by z_1, \dots, z_l in a left-to-right order. Hence $\text{seq}(\text{lin}(\zeta)) = (1, \dots, l)$. For instance, $\text{lin}(\sigma(\sigma(\alpha, z_2), \sigma(z_3, z_1))) = \sigma(\sigma(\alpha, z_1), \sigma(z_2, z_3))$.

Lemma 10.12.1. (cf. [FV15, Lm. 5.4]) Let B be a semiring and $\mathcal{A} = (Q, \delta, F)$ a (Σ, B) -wta. Moreover, let $n \in \mathbb{N}$. Then, for every $\zeta \in T_{\Sigma}(Z_n)$ which ζ is linear in Z_n , $\xi_1, \dots, \xi_n \in T_{\Sigma}$, and $q \in Q$, we have

$$h_{\mathcal{A}}(\zeta[\xi_1, \dots, \xi_n])_q = \bigoplus_{q_1 \dots q_l \in Q^l} \left(\bigotimes_{j \in [l]} h_{\mathcal{A}}(\xi_{m_j})_{q_j} \right) \otimes h_{\mathcal{A}}^{q_1 \dots q_l}(\text{lin}(\zeta))_q ,$$

where $\text{seq}(\zeta) = (m_1, \dots, m_l)$.

Proof. We prove the statement by induction on $T_\Sigma(Z_n)$. For this, let $\zeta \in T_\Sigma(Z_n)$ such that ζ is linear in Z_n .

I.B.: Let $\zeta = z_j$ for some $j \in [n]$. Then $\text{seq}(\zeta) = (j)$ and

$$h_{\mathcal{A}}(z_j[\xi_1, \dots, \xi_n])_q = h_{\mathcal{A}}(\xi_j)_q = \bigoplus_{q_1 \in Q} h_{\mathcal{A}}(\xi_j)_{q_1} \otimes h_{\mathcal{A}}^{q_1}(z_j)_q .$$

Let $\zeta = \sigma$ for some $\sigma \in \Sigma^{(0)}$. The proof of this case is the proof of case $k = 0$ of the I.S.

I.S.: Let $\zeta \in T_\Sigma(Z_n) \setminus Z_n$. Then $\zeta = \sigma(\zeta_1, \dots, \zeta_k)$ for some $k \in \mathbb{N}$, $\sigma \in \Sigma^{(k)}$, and $\zeta_1, \dots, \zeta_k \in T_\Sigma(Z_n)$. For each $j \in [k]$, we have that $\zeta_j \in T_\Sigma(Z_n)$ and ζ_j is linear in Z_n . Moreover, let $\text{seq}(\zeta) = (m_1, \dots, m_l)$ and let $\text{seq}(\zeta_i) = (n_1^i, \dots, n_{\kappa_i}^i)$ for each $i \in [k]$. Hence

$$l = \sum_{j=1}^k \kappa_j \quad \text{and} \quad (m_1, \dots, m_l) = (n_1^1, \dots, n_{\kappa_1}^1, \dots, n_1^l, \dots, n_{\kappa_l}^l) . \quad (10.47)$$

Then

$$\begin{aligned} & h_{\mathcal{A}}(\zeta[\xi_1, \dots, \xi_n])_q \\ &= \bigoplus_{p_1 \cdots p_k \in Q^k} \left[\bigotimes_{i \in [k]} h_{\mathcal{A}}(\zeta_i[\xi_1, \dots, \xi_n])_{p_i} \right] \otimes \delta_k(p_1 \cdots p_k, \sigma, q) \\ &= \bigoplus_{p_1 \cdots p_k \in Q^k} \left[\bigotimes_{i \in [k]} \left(\bigoplus_{q_1^i \cdots q_{\kappa_i}^i \in Q^{\kappa_i}} \left(\bigotimes_{j \in [\kappa_i]} h_{\mathcal{A}}(\xi_{n_j^i})_{q_j^i} \right) \otimes h_{\mathcal{A}}^{q_1^i \cdots q_{\kappa_i}^i}(\text{lin}(\zeta_i))_{p_i} \right) \right] \otimes \delta_k(p_1 \cdots p_k, \sigma, q) \quad (\text{by I.H.}) \\ &= \bigoplus_{p_1 \cdots p_k \in Q^k} \bigoplus_{q_1^1 \cdots q_{\kappa_1}^1 \in Q^{\kappa_1}} \cdots \bigoplus_{q_1^k \cdots q_{\kappa_k}^k \in Q^{\kappa_k}} \\ & \quad \bigotimes_{i \in [k]} \left(\bigotimes_{j \in [\kappa_i]} h_{\mathcal{A}}(\xi_{n_j^i})_{q_j^i} \right) \otimes h_{\mathcal{A}}^{q_1^i \cdots q_{\kappa_i}^i}(\text{lin}(\zeta_i))_{p_i} \otimes \delta_k(p_1 \cdots p_k, \sigma, q) \quad (\text{by right-distributivity}) \\ &= \bigoplus_{q_1^1 \cdots q_{\kappa_1}^1 \in Q^{\kappa_1}} \cdots \bigoplus_{q_1^k \cdots q_{\kappa_k}^k \in Q^{\kappa_k}} \left(\bigotimes_{i \in [k]} \bigotimes_{j \in [\kappa_i]} h_{\mathcal{A}}(\xi_{n_j^i})_{q_j^i} \right) \otimes \\ & \quad \bigoplus_{p_1 \cdots p_k \in Q^k} \left(\bigotimes_{i \in [k]} h_{\mathcal{A}}^{q_1^i \cdots q_{\kappa_i}^i}(\text{lin}(\zeta_i))_{p_i} \right) \otimes \delta_k(p_1 \cdots p_k, \sigma, q) \quad (\text{by left-distributivity}) \\ &= \bigoplus_{q_1 \cdots q_l \in Q^l} \left(\bigotimes_{j \in [l]} h_{\mathcal{A}}(\xi_{m_j})_{q_j} \right) \otimes h_{\mathcal{A}}^{q_1 \cdots q_l}(\text{lin}(\zeta))_q \end{aligned}$$

where the last equality uses (10.47) and the fact that

$$\bigoplus_{p_1 \cdots p_k \in Q^k} \left(\bigotimes_{i \in [k]} h_{\mathcal{A}}^{q_1^i \cdots q_{\kappa_i}^i}(\text{lin}(\zeta_i))_{p_i} \right) \otimes \delta_k(p_1 \cdots p_k, \sigma, q) = h_{\mathcal{A}}^{q_1 \cdots q_l}(\text{lin}(\zeta))_q,$$

where $q^j = q_1^j \cdots q_{\kappa_j}^j$. □

In the next theorem we apply Lemma 10.12.1 to the case where $\zeta = h_k(\sigma)$ for some linear tree homomorphism $h = (h_k \mid k \in \mathbb{N})$. It is helpful to view $\text{seq}(h_k(\sigma))$ as a set of indices; then we can write something like $i \notin \text{seq}(h_k(\sigma))$ with the obvious meaning.

The next theorem can be compared to [FMV11, Thm. 5.1] where the closure of the set of recognizable B-weighted tree languages under inverse of linear weighted extended tree transformations was proved if

\mathbb{B} is a σ -complete and commutative semiring. We recall that linear tree homomorphisms are particular linear weighted extended tree transducers.

Theorem 10.12.2. *Let Σ and Δ be ranked alphabets. Moreover, let \mathbb{B} be a commutative semiring and let \mathcal{A} be a (Δ, \mathbb{B}) -wta. Moreover, let h be a linear (Σ, Δ) -tree homomorphism. Then we can construct a (Σ, \mathbb{B}) -wta \mathcal{B} such that $[[\mathcal{B}]] = \chi(h^{-1})([[\mathcal{A}]])$. Thus, in particular, the set $\text{Rec}(_, \mathbb{B})$ is closed under the inverse of linear tree homomorphisms.*

Proof. Let $\mathcal{A} = (Q, \delta, F)$ and $h = (h_k \mid k \in \mathbb{N})$. For the construction of \mathcal{B} we use a technique from [Eng75a, Thm. 2.8]: it adds a new state e which takes care of those subtrees which are deleted by the tree homomorphism h (the latter corresponding to the given linear top-down tree transducer in [Eng75a, Thm. 2.8]).

Formally, we construct $\mathcal{B} = (Q', \delta', F')$ such that $Q' = Q \cup \{e\}$ and for every $k \in \mathbb{N}$, $\sigma \in \Sigma^{(k)}$, $q_1, \dots, q_k, q \in Q'$ we let

$$(\delta')_k(q_1 \cdots q_k, \sigma, q) = \begin{cases} h_{\mathcal{A}}^w(\text{lin}(h_k(\sigma)))_q & \text{if } q \in Q \text{ and } (\forall i \in [k]): q_i = e \text{ iff } i \notin \text{seq}(h_k(\sigma)) \\ \mathbb{1} & \text{if } q = q_1 = \dots = q_k = e \\ 0 & \text{otherwise} \end{cases}$$

where $w = q_{m_1} \cdots q_{m_l}$ if $\text{seq}(h_k(\sigma)) = (m_1, \dots, m_l)$. Moreover, we let $(F')_q = F_q$ for each $q \in Q$, and $(F')_e = 0$.

The following property is easy to see.

$$\text{For every } \xi \in T_{\Sigma} \text{ we have: } h_{\mathcal{B}}(\xi)_e = \mathbb{1}. \quad (10.48)$$

By induction on T_{Σ} , we prove that the following statement holds:

$$\text{For every } \xi \in T_{\Sigma} \text{ and } q \in Q \text{ we have: } h_{\mathcal{B}}(\xi)_q = h_{\mathcal{A}}(h(\xi))_q. \quad (10.49)$$

Let $\xi = \sigma(\xi_1, \dots, \xi_k)$. We assume that $\text{seq}(h_k(\sigma)) = (m_1, \dots, m_l)$. Then we can compute as follows.

$$\begin{aligned} h_{\mathcal{B}}(\sigma(\xi_1, \dots, \xi_k))_q &= \bigoplus_{q_1 \cdots q_k \in (Q')^k} \left(\bigotimes_{i \in [k]} h_{\mathcal{B}}(\xi_i)_{q_i} \right) \otimes (\delta')_k(q_1 \cdots q_k, \sigma, q) \\ &= \bigoplus_{q_1 \cdots q_k \in (Q')^k} \left(\bigotimes_{i \in [k]} \begin{cases} h_{\mathcal{A}}(h(\xi_i))_{q_i} & \text{if } q_i \in Q \\ \mathbb{1} & \text{otherwise} \end{cases} \right) \otimes (\delta')_k(q_1 \cdots q_k, \sigma, q) \\ &\quad \text{(by I.H. and (10.48))} \\ &= \bigoplus_{\substack{q_1 \cdots q_k \in (Q')^k: \\ q_i = e \iff i \notin \text{seq}(h_k(\sigma))}} \left(\bigotimes_{i \in [k]} \begin{cases} h_{\mathcal{A}}(h(\xi_i))_{q_i} & \text{if } q_i \in Q \\ \mathbb{1} & \text{otherwise} \end{cases} \right) \otimes h_{\mathcal{A}}^w(\text{lin}(h_k(\sigma)))_q \\ &\quad \text{(by construction where } w = q_{m_1} \cdots q_{m_l}) \\ &= \bigoplus_{q_1 \cdots q_l \in Q^l} \left(\bigotimes_{j \in [l]} h_{\mathcal{A}}(h(\xi_{m_j}))_{q_j} \right) \otimes h_{\mathcal{A}}^{q_1 \cdots q_l}(\text{lin}(h_k(\sigma)))_q \quad \text{(by the commutativity of } \mathbb{B}) \\ &= h_{\mathcal{A}}(h_k(\sigma)[h(\xi_1), \dots, h(\xi_k)])_q \quad \text{(by Lemma 10.12.1)} \\ &= h_{\mathcal{A}}(h(\sigma(\xi_1, \dots, \xi_k)))_q. \end{aligned}$$

Then, for each $\xi \in T_{\Sigma}$ we can compute as follows.

$$[[\mathcal{B}]](\xi) = \bigoplus_{q \in Q'} h_{\mathcal{B}}(\xi)_q \otimes (F')_q = \bigoplus_{q \in Q} h_{\mathcal{B}}(\xi)_q \otimes F_q$$

$$\begin{aligned}
&= \bigoplus_{q \in Q} h_{\mathcal{A}}(h(\xi))_q \otimes F_q && \text{(by (10.49))} \\
&= \llbracket \mathcal{A} \rrbracket(h(\xi)) = \chi(h^{-1})(\llbracket \mathcal{A} \rrbracket)(\xi) . && \square
\end{aligned}$$

We note that in [GS84, Thm. 2.4.18] (also cf. [Eng75b, Cor. 4.60]) it was proved that the set of recognizable tree languages is closed under inverse of arbitrary tree homomorphisms. The same is true for crisp-deterministically recognizable weighted tree languages over $\mathbf{UnitInt}_{u,i}$ [BLB10, Prop. 6] (taking Theorem 4.1.9(A) \Leftrightarrow (B) into account). However, in the arbitrary weighted case, the restriction to linear tree homomorphisms is important. In fact, we can give a (nonlinear) tree homomorphism h and a bu-deterministic wta \mathcal{A} over the semiring \mathbf{Nat} such that $\chi(h^{-1})(\llbracket \mathcal{A} \rrbracket)$ is not recognizable.

Example 10.12.3. [FMV11, Ex. 5.1] Let $\Sigma = \{\gamma^{(1)}, \alpha^{(0)}\}$ and $\Delta = \{\sigma^{(2)}, \alpha^{(0)}\}$. For each $n \in \mathbb{N}$, let ζ_n be the fully balanced tree of height n over Δ , which is defined by $\zeta_0 = \alpha$ and $\zeta_n = \sigma(\zeta_{n-1}, \zeta_{n-1})$ for every $n \geq 1$. We consider the (Σ, Δ) -tree homomorphism with $h_1(\gamma) = \sigma(z_1, z_1)$ and $h_0(\alpha) = \alpha$. It is clear that $h(\gamma^n(\alpha)) = \zeta_n$ for each $n \in \mathbb{N}$ where $\gamma^n(\alpha)$ abbreviates the tree $\gamma(\gamma(\cdots \gamma(\alpha) \cdots))$ containing n times the symbol γ .

Moreover, we consider the bu-deterministic (Δ, \mathbf{Nat}) -wta $\mathcal{A} = (\{q\}, \delta, F)$, where $\delta_2(qq, \sigma, q) = 1$, $\delta_0(\varepsilon, \alpha, q) = 2$, and $F_q = 1$. For each $\zeta \in \mathbb{T}_{\Delta}$, we have $\llbracket \mathcal{A} \rrbracket(\zeta) = 2^n$, where n is the number of occurrences of α in ζ . Consequently, we obtain that

$$\chi(h^{-1})(\llbracket \mathcal{A} \rrbracket)(\gamma^n(\alpha)) = \llbracket \mathcal{A} \rrbracket(h(\gamma^n(\alpha))) = \llbracket \mathcal{A} \rrbracket(\zeta_n) = 2^{2^n}$$

for each $n \in \mathbb{N}$.

Now we can easily show by contradiction that the weighted tree language $\chi(h^{-1})(\llbracket \mathcal{A} \rrbracket)$ is not recognizable. For this, we assume there exists a (Δ, \mathbf{Nat}) -wta $\mathcal{B} = (Q, \delta', F')$ such that $\llbracket \mathcal{B} \rrbracket = \chi(h^{-1})(\llbracket \mathcal{A} \rrbracket)$.

By Lemma 3.5.6, there exists a $K \in \mathbb{N}$ such that, for each $n \in \mathbb{N}$, we have $\llbracket \mathcal{B} \rrbracket(\gamma^n(\alpha)) \leq K^{n+1}$. Then, for each $n \in \mathbb{N}$, we have $2^{2^n} = \chi(h^{-1})(\llbracket \mathcal{A} \rrbracket)(\gamma^n(\alpha)) = \llbracket \mathcal{B} \rrbracket(\gamma^n(\alpha)) \leq K^{n+1}$. But this is not true. Hence, there does not exist a (Δ, \mathbf{Nat}) -wta $\mathcal{B} = (Q, \delta', F')$ such that $\llbracket \mathcal{B} \rrbracket = \chi(h^{-1})(\llbracket \mathcal{A} \rrbracket)$. \square

10.13 Closure under weighted projective bimorphisms

In this section, we let Ψ be a ranked alphabet. We define the concept of $(\Sigma, \Psi, \mathbf{B})$ -weighted projective bimorphism as special weighted regular tree grammar; each such grammar \mathcal{H} computes a $(\Sigma, \Psi, \mathbf{B})$ -weighted tree transformation, denoted by $\llbracket \mathcal{H} \rrbracket^{\text{tt}}$; we also call $\llbracket \mathcal{H} \rrbracket^{\text{tt}}$ a $(\Sigma, \Psi, \mathbf{B})$ -weighted projective bimorphism. Intuitively, a weighted projective bimorphism is a tree relabeling in which, additionally, unary input symbols can be deleted without producing output and unary output symbols can be produced without consuming an input symbol.

Then we prove that, roughly speaking, the sets $\text{Reg}(-, \mathbf{B})$ and $\text{Rec}(-, \mathbf{B})$ are closed under weighted projective bimorphisms if \mathbf{B} is a commutative semiring. Given an alphabetic (Σ, \mathbf{B}) -wrtg \mathcal{G} and a $(\Sigma, \Psi, \mathbf{B})$ -weighted projective bimorphism \mathcal{H} , we will proceed in four steps as follows:

1. we split the semantics of \mathcal{G} into an $([R], \Sigma, \mathbf{B})$ -weighted projective bimorphism $\mathcal{H}_{\mathcal{G}}$ and a characteristic mapping $\chi(\mathbb{T}_{[R]})$ such that $\llbracket \mathcal{G} \rrbracket = \llbracket \mathcal{H}_{\mathcal{G}} \rrbracket^{\text{tt}}(\chi(\mathbb{T}_{[R]}))$, where R is the set of rules of \mathcal{G} viewed as ranked alphabet and $[R]$ is the skeleton alphabet of R (cf. Lemma 10.13.6),
2. we prove that weighted projective bimorphisms are closed under composition (cf. Theorem 10.13.7); thus, in particular, we can construct an $([R], \Psi, \mathbf{B})$ -weighted projective bimorphism \mathcal{H}' such that $\llbracket \mathcal{H}' \rrbracket^{\text{tt}} = \llbracket \mathcal{H}_{\mathcal{G}} \rrbracket^{\text{tt}}; \llbracket \mathcal{H} \rrbracket^{\text{tt}}$,
3. we merge \mathcal{H}' and the characteristic mapping $\chi(\mathbb{T}_{[R]})$ into a (Ψ, \mathbf{B}) -wrtg \mathcal{G}' such that $\llbracket \mathcal{G}' \rrbracket = \llbracket \mathcal{H}' \rrbracket^{\text{tt}}(\chi(\mathbb{T}_{[R]}))$ (cf. Lemma 10.13.8), and
4. finally, we deduce the mentioned closure results for $\text{Reg}(-, \mathbf{B})$ and $\text{Rec}(-, \mathbf{B})$ (cf. Theorem 10.13.9 and Corollary 10.13.10).

On first glance, this split-compose-merge procedure looks too complicated for the purpose of just showing the closure of recognizable weighted tree languages under weighted projective bimorphisms. However, in Chapter 19 we will need the result of the second step (i.e., closure of weighted projective bimorphisms under composition), and we want to benefit from this result already here in our current setting.

10.13.1 Weighted projective bimorphisms

We define the ranked alphabet $[\Sigma\Psi]$ such that, for each $k \in \mathbb{N}$, we let $[\Sigma\Psi]^{(k)} = \Sigma^{(k)} \times \Psi^{(k)}$ if $k \neq 1$, and we let $[\Sigma\Psi]^{(1)} = ((\Sigma^{(1)} \cup \{\varepsilon\}) \times (\Psi^{(1)} \cup \{\varepsilon\})) \setminus \{(\varepsilon, \varepsilon)\}$.

Moreover, we define the tree homomorphism $\pi_1 : T_{[\Sigma\Psi]} \rightarrow T_\Sigma$ and the tree homomorphism $\pi_2 : T_{[\Sigma\Psi]} \rightarrow T_\Psi$ which, intuitively, project to the first component of a symbol $[\sigma, \psi]$ and to the second component, respectively. Formally, the tree homomorphism π_1 is induced by the family $((\pi_1)_k \mid k \in \mathbb{N})$ of mappings $(\pi_1)_k : [\Sigma\Psi]^{(k)} \rightarrow T_\Sigma(X_k)$ such that, for every $k \in \mathbb{N}$ and $[\sigma, \psi] \in [\Sigma\Psi]^{(k)}$, we let

$$(\pi_1)_k([\sigma, \psi]) = \begin{cases} \sigma(x_1, \dots, x_k) & \text{if } \sigma \neq \varepsilon \\ x_1 & \text{otherwise.} \end{cases}$$

We recall that $\sigma = \varepsilon$ is possible only in case $k = 1$. Analogously, we define the family $((\pi_2)_k \mid k \in \mathbb{N})$ of mappings $(\pi_2)_k : [\Sigma\Psi]^{(k)} \rightarrow T_\Psi(X_k)$ which induces the tree homomorphism π_2 . Obviously, π_1 and π_2 are linear and nondeleting; moreover, for each $[\sigma, \psi] \in [\Sigma\Psi]^{(k)}$, we have $\text{height}(\pi_1([\sigma, \psi])) \leq 1$ and $\text{height}(\pi_2([\sigma, \psi])) \leq 1$.

A *B-weighted projective bimorphism over Σ and Ψ* (for short: $(\Sigma, \Psi, \mathbf{B})$ -wpb, or just: wpb) is an alphabetic $([\Sigma\Psi], \mathbf{B})$ -wrtg $\mathcal{H} = (N, S, R, wt)$. The alphabets Σ and Ψ are called *input alphabet* and *output alphabet* of \mathcal{H} , respectively; correspondingly, trees in T_Σ and T_Ψ are called *input trees* and *output trees* of \mathcal{H} , respectively.

Obviously, a $(\Sigma, \Psi, \mathbf{B})$ -wpb \mathcal{H} can contain two types of rules:

1. $A \rightarrow [\sigma, \psi](A_1, \dots, A_k)$ with $k \in \mathbb{N}$ and $[\sigma, \psi] \in [\Sigma, \Psi]^{(k)}$, and
2. $A \rightarrow B$ (chain rule).

Let us consider the first type of rules. We call σ the *input of r* and ψ the *output of r* , and we denote them by $\text{inp}(r)$ and $\text{out}(r)$, respectively. Moreover, we give the names shown in the second column of the following table to such rules depending on whether they read a symbol from the input or not and whether they write a symbol to the output or not; in the last column we show the denotation for the set of all rules of a particular type.

$A \rightarrow [\sigma, \psi](A_1, \dots, A_k)$ in R	type of the rule r=read, w=write	denotation for the set of all rules of that type
$\sigma \neq \varepsilon$ and $\psi \neq \varepsilon$	rw-rule	R^{rw}
$\sigma = \varepsilon$ and $\psi \neq \varepsilon$	εw -rule	$R^{\varepsilon w}$
$\sigma \neq \varepsilon$ and $\psi = \varepsilon$	$r\varepsilon$ -rule	$R^{r\varepsilon}$

Moreover, we let $R^{-w} = R^{rw} \cup R^{\varepsilon w}$ and $R^{r-} = R^{rw} \cup R^{r\varepsilon}$. By viewing R as a ranked alphabet, both εw -rules and $r\varepsilon$ -rules have rank 1, i.e., $R^{\varepsilon w} \cup R^{r\varepsilon} \subseteq R^{(1)}$, and each chain rule is in $R^{(1)}$. Finally, we note that, since each wpb is a particular wrtg (and in its turn, each wrtg is a particular wcfg; and in its turn, each wcfg is a cfg equipped with a weight mapping, cf. Figure 1.1), we have the concept of rule tree of \mathcal{H} available, as well as the abbreviation $\text{RT}_{\mathcal{H}}(N', \eta)$ for each $N' \subseteq N$ and $\eta \in T_{[\Sigma\Psi]}$, cf. page 67.

Now we define the weighted tree transformation computed by a $(\Sigma, \Psi, \mathbf{B})$ -wpb $\mathcal{H} = (N, S, R, wt)$. For this, let $N' \subseteq N$, $\xi \in T_\Sigma$, and $\zeta \in T_\Psi$. We define

$$\text{RT}_{\mathcal{H}}(N', \xi, \zeta) = \bigcup_{\substack{\eta \in T_{[\Sigma\Psi]}: \\ \pi_1(\eta) = \xi, \pi_2(\eta) = \zeta}} \text{RT}_{\mathcal{H}}(N', \eta) \quad (10.50)$$

and we define $\text{RT}_{\mathcal{H}}(\xi, \zeta) = \text{RT}_{\mathcal{H}}(S, \xi, \zeta)$. Then the family

$$(\text{RT}_{\mathcal{H}}(N', \eta) \mid \eta \in \mathbb{T}_{[\Sigma\Psi]} : \pi_1(\eta) = \xi, \pi_2(\eta) = \zeta) \quad (10.51)$$

is a partitioning of the set $\text{RT}_{\mathcal{H}}(N', \xi, \zeta)$ because (10.50) holds and $\eta \neq \eta'$ implies that $\text{RT}_{\mathcal{H}}(N', \eta) \cap \text{RT}_{\mathcal{H}}(N', \eta') = \emptyset$. Moreover, the set $\{\eta \in \mathbb{T}_{[\Sigma\Psi]} \mid \pi_1(\eta) = \xi, \pi_2(\eta) = \zeta\}$ is finite, hence (10.51) is a partitioning into finitely many subsets. Due to this fact, \mathcal{H} is finite-derivational if and only if, for every $\xi \in \mathbb{T}_{\Sigma}$ and $\zeta \in \mathbb{T}_{\Psi}$, the set $\text{RT}_{\mathcal{H}}(\xi, \zeta)$ is finite.

We call \mathcal{H}

- *finite-input* if for every $\zeta \in \mathbb{T}_{\Psi}$, the set $\{\xi \in \mathbb{T}_{\Sigma} \mid \text{RT}_{\mathcal{H}}(\xi, \zeta) \neq \emptyset\}$ is finite;
- *finite-output* if for every $\xi \in \mathbb{T}_{\Sigma}$, the set $\{\zeta \in \mathbb{T}_{\Psi} \mid \text{RT}_{\mathcal{H}}(\xi, \zeta) \neq \emptyset\}$ is finite.

If $R = R^{\text{w}}$, then \mathcal{H} is finite-input, and if $R = R^{\text{r}}$, then \mathcal{H} is finite-output.

If \mathcal{H} is finite-derivational or \mathbf{B} is σ -complete, then we define the *weighted projective bimorphism computed by \mathcal{H}* to be the weighted tree transformation $\llbracket \mathcal{H} \rrbracket^{\text{tt}} : \mathbb{T}_{\Sigma} \times \mathbb{T}_{\Psi} \rightarrow B$ such that, for every $\xi \in \mathbb{T}_{\Sigma}$ and $\zeta \in \mathbb{T}_{\Psi}$, we have

$$\llbracket \mathcal{H} \rrbracket^{\text{tt}}(\xi, \zeta) = \sum_{d \in \text{RT}_{\mathcal{H}}(\xi, \zeta)}^{\oplus} \text{wt}_{\mathcal{H}}(d) ,$$

where $\text{wt}_{\mathcal{H}} : \mathbb{T}_R \rightarrow B$ is the weight mapping defined in (8.1) (viewing \mathcal{H} as wcfg).

It is easy to see that, if \mathcal{H} is finite-input, then $\llbracket \mathcal{H} \rrbracket^{\text{tt}}$ is supp-i-finite, and if \mathcal{H} is finite-output, then $\llbracket \mathcal{H} \rrbracket^{\text{tt}}$ is supp-o-finite.

Let $\tau : \mathbb{T}_{\Sigma} \times \mathbb{T}_{\Psi} \rightarrow B$ be a weighted tree transformation. We say that τ is a $(\Sigma, \Psi, \mathbf{B})$ -*weighted projective bimorphism* (or just: *weighted projective bimorphism*) if there exists a $(\Sigma, \Psi, \mathbf{B})$ -wpb \mathcal{H} such that \mathcal{H} is finite-derivational if \mathbf{B} is not σ -complete, and $\llbracket \mathcal{H} \rrbracket^{\text{tt}} = \tau$.

A set \mathcal{L} of \mathbf{B} -weighted tree languages is *closed under weighted projective bimorphisms* if for every (Σ, \mathbf{B}) -weighted tree language $r \in \mathcal{L}$ and every $(\Sigma, \Psi, \mathbf{B})$ -bimorphism \mathcal{H} , the (Ψ, \mathbf{B}) -weighted tree language $\llbracket \mathcal{H} \rrbracket^{\text{tt}}(r)$ is in \mathcal{L} .

In Figure 10.11 we illustrate the relationships between the mappings $\pi_{\mathcal{H}}$, π_1 , and π_2 .

Up to syntactic modifications, the concept of $(\Sigma, \Psi, \mathbf{B})$ -wpb is the same as the concept of \mathbf{B} -weighted generalized relabeling tree transducers over Σ and Ψ (for short: $(\Sigma, \Psi, \mathbf{B})$ -transducer) as it was defined in [FV22a]. The syntactic modifications are shown in the following table where we assume that $\sigma \in \Sigma^{(k)}$ and $\psi \in \Psi^{(k)}$:

$k \in \mathbb{N}$	rule of a $(\Sigma, \Psi, \mathbf{B})$ -wpb	rule of a $(\Sigma, \Psi, \mathbf{B})$ -transducer
$k \geq 0$	$A \rightarrow [\sigma, \psi](A_1, \dots, A_k)$	$(A, \sigma(x_1, \dots, x_k), A_1 \cdots A_k, \psi(x_1, \dots, x_k))$
$k = 1$	$A \rightarrow [\sigma, \varepsilon](A_1)$	$(A, \sigma(x_1), A_1, x_1)$
$k = 1$	$A \rightarrow [\varepsilon, \psi](A_1)$	$(A, x_1, A_1, \psi(x_1))$
$k = 1$	$A \rightarrow A_1$	(A, x_1, A_1, x_1)

In [FV22a] we have assumed that \mathbf{B} is a commutative and σ -complete semiring. Here we are more liberal and do not require per se that \mathbf{B} is σ -complete (and commutative). As a consequence, we have to be more careful with the definedness of the semantics $\llbracket \mathcal{H} \rrbracket^{\text{tt}}$ of a weighted projective bimorphism \mathcal{H} .

Also, we refer the reader to Theorem 19.2.1 where the weighted tree transformation $\llbracket \mathcal{H} \rrbracket^{\text{tt}}$ is decomposed into the inverse of a simple tree homomorphism, followed by the Hadamard product with the recognizable weighted tree language $\llbracket \mathcal{H} \rrbracket^{\text{wrt}}$, followed by a simple tree homomorphism; this decomposition connects our definition of wpb with the classical definition of bimorphisms in [AD76, AD82]. For details we refer to Section 19.2.

Finally, we note that weighted projective bimorphisms are particular linear and nondeleting weighted extended tree transducers [FMV11] in which each rule processes at most one input symbol and generates at most one output symbol. For a comparison to linear nondeleting recognizable tree transducers [Kui99c] we refer to [FMV11].

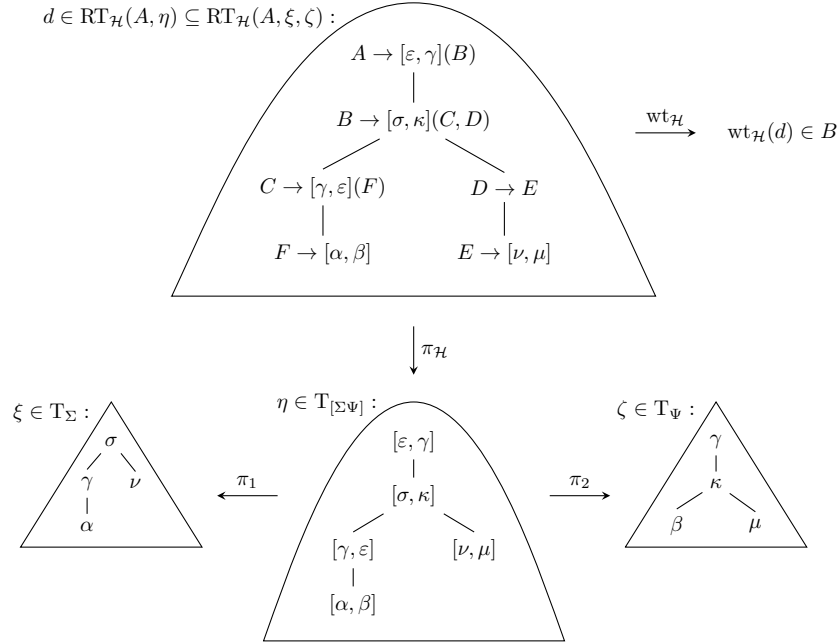

Figure 10.11: An illustration of the relationships between the mappings $\pi_{\mathcal{H}}$, π_1 , and π_2 .

Example 10.13.1. We consider the ranked alphabets $\Sigma = \{\sigma^{(2)}, \gamma^{(1)}, \alpha^{(0)}\}$ and $\Psi = \{\sigma^{(2)}, \gamma'^{(1)}, \alpha^{(0)}\}$. As weight algebra we consider the semiring $\text{Nat} = (\mathbb{N}, +, \cdot, 0, 1)$ of natural numbers.

We wish to define a $(\Sigma, \Psi, \text{Nat})$ -wpb \mathcal{H} such that, for each $(\xi, \zeta) \in \text{supp}(\llbracket \mathcal{H} \rrbracket^{\text{tt}})$, there exists a tree $\kappa \in \mathbb{T}_{\{\sigma^{(2)}, \alpha^{(0)}\}}$ (called kernel of (ξ, ζ)) and (a) ξ is obtained from κ by inserting above an arbitrary position an arbitrary number of γ -labeled positions and (b) ζ is obtained from κ by inserting above an arbitrary position an arbitrary number of γ' -labeled positions; moreover, the insertions of γ into ξ and of γ' into ζ can happen interleaved and in an arbitrary ordering. Then, we define \mathcal{H} such that $\llbracket \mathcal{H} \rrbracket^{\text{tt}}(\xi, \zeta)$ is the number of all possible orderings of insertions to obtain the pair (ξ, ζ) from κ by this insertion method.

For this we let $\mathcal{H} = (N, S, R, wt)$ with $N = S = \{A\}$ and we let R contain the following rules:

$$\begin{array}{ll} A \rightarrow [\sigma, \sigma](A, A) & A \rightarrow [\alpha, \alpha] \quad (\text{for the generation of } \kappa) \\ A \rightarrow [\gamma, \varepsilon](A) & A \rightarrow [\varepsilon, \gamma'](A) \quad (\text{for inserting } \gamma \text{ and } \gamma') \end{array} .$$

We let $wt(r) = 1$ for each $r \in R$. Obviously, $\llbracket \mathcal{H} \rrbracket^{\text{tt}}(\xi, \zeta) = |\text{RT}_{\mathcal{H}}(\xi, \zeta)|$ for every $\xi \in \mathbb{T}_{\Sigma}$ and $\zeta \in \mathbb{T}_{\Psi}$.

For instance, let $\xi = \sigma(\gamma(\alpha), \gamma\gamma(\alpha))$ and $\zeta = \gamma'(\sigma(\gamma'(\alpha), \gamma'(\alpha)))$. The kernel of (ξ, ζ) is the tree $\kappa = \sigma(\alpha, \alpha)$. Then (a) above position ε of κ , \mathcal{H} inserts no γ (for ξ) and one γ' (for ζ) and there exists one (trivial) ordering of this insertion, (b) above position 1 of κ , \mathcal{H} inserts one γ (for ξ) and one γ' (for ζ) and there are two orderings of these insertions, and (c) above position 2 of κ , \mathcal{H} inserts two γ s (for ξ) and one γ' (for ζ) and there are three orderings of these insertions. Multiplying up the number of all such orderings yields $\llbracket \mathcal{H} \rrbracket^{\text{tt}}(\xi, \zeta) = 2 \cdot 3 = 6$. Figure 10.12 illustrates two derivations $d_1, d_2 \in \text{RT}_{\mathcal{H}}(\xi, \zeta)$, the $[\Sigma\Psi]$ -trees $\eta_1 = \pi(d_1)$ and $\eta_2 = \pi(d_2)$, and the trees ξ, ζ and κ . The brackets indicate the regions where reordering is possible without changing ξ and ζ . \square

Example 10.13.2. We have noted that, if \mathcal{H} is finite-input, then $\llbracket \mathcal{H} \rrbracket^{\text{tt}}$ is supp-i-finite. In this example we show that the reverse direction does not hold, even if \mathcal{H} is chain-free. That means, there exists a chain-free wpb \mathcal{H} such that $\llbracket \mathcal{H} \rrbracket^{\text{tt}}$ is supp-i-finite and \mathcal{H} is not finite-input. We let $\Sigma = \{\gamma^{(1)}, \alpha^{(0)}\}$ and $\Psi = \{\beta^{(0)}\}$. We consider the ring $\text{Intmod}4 = (\{0, 1, 2, 3\}, +_4, \cdot_4, 0, 1)$ as defined in Example 2.7.9(5) and the chain-free $(\Sigma, \Psi, \text{Intmod}4)$ -wpb \mathcal{H} with set $\{A, B\}$ of nonterminals, A as only initial nonterminal, and

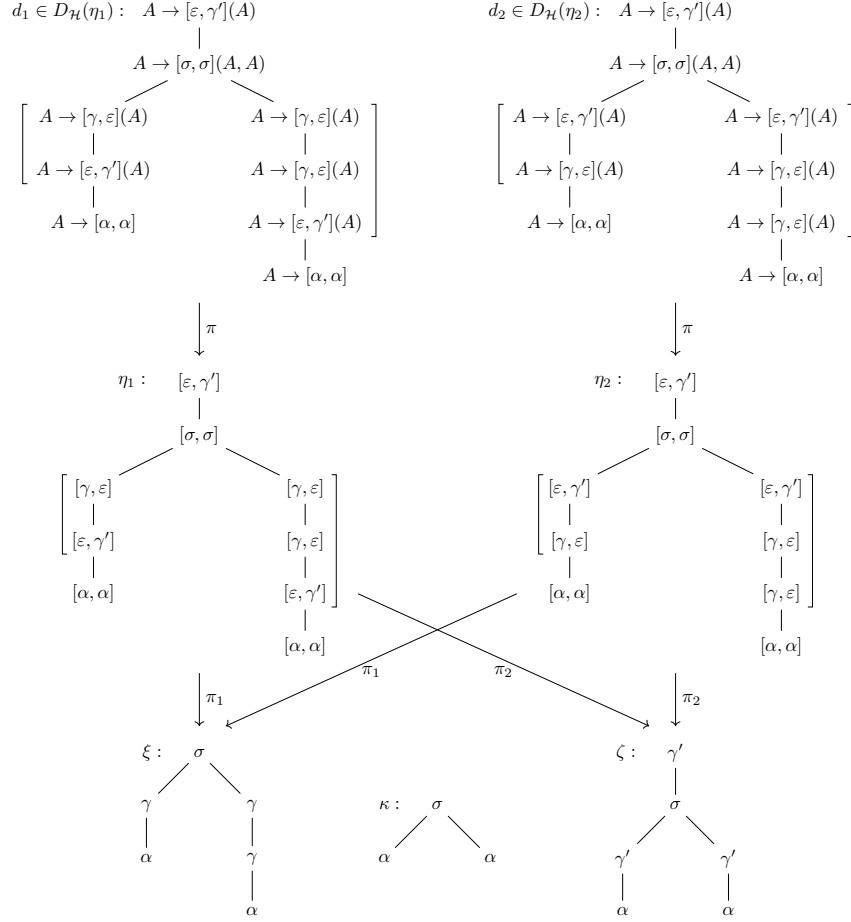

Figure 10.12: Illustration of two rule trees $d_1, d_2 \in \text{RT}_{\mathcal{H}}(\xi, \zeta)$, the $[\Sigma\Psi]$ -trees $\eta_1 = \pi(d_1)$ and $\eta_2 = \pi(d_2)$, and the trees $\xi = \sigma(\gamma(\alpha), \gamma\gamma(\alpha))$, $\zeta = \gamma'(\sigma(\gamma'(\alpha), \gamma'(\alpha)))$, and $\kappa = \sigma(\alpha, \alpha)$ (cf. Example 10.13.1).

the rules:

$$r_1 = (A \rightarrow [\gamma, \varepsilon](B)) \quad r_2 = (B \rightarrow [\gamma, \varepsilon](A)) \quad r_3 = (A \rightarrow [\alpha, \beta])$$

and $wt(r_1) = wt(r_2) = 2$ and $wt(r_3) = 1$. Obviously, $\text{T}_{\Psi} = \{\beta\}$ and the set $\{\xi \in \text{T}_{\Sigma} \mid \llbracket \mathcal{H} \rrbracket^{\text{tt}}(\xi, \beta) \neq 0\} = \{\alpha\}$ is finite. Hence $\llbracket \mathcal{H} \rrbracket^{\text{tt}}$ is supp-i-finite. Moreover, \mathcal{H} is not finite-input, because $\{\xi \in \text{T}_{\Sigma} \mid \text{RT}_{\mathcal{H}}(\xi, \beta) \neq \emptyset\} = \{\gamma^n \alpha \mid n \in \mathbb{N}\}$ is infinite. \square

By definition, each wpb \mathcal{H} is a particular wrtg. Thus \mathcal{H} has two semantics: the weighted tree language $\llbracket \mathcal{H} \rrbracket$ and the weighted tree transformation $\llbracket \mathcal{H} \rrbracket^{\text{tt}}$. The next lemma shows that, under some additional conditions, the equality of the weighted tree languages of two wpb implies the equality of their weighted tree transformations.

Lemma 10.13.3. Let \mathcal{H} and \mathcal{H}' be $(\Sigma, \Psi, \mathbf{B})$ -wpb such that both \mathcal{H} and \mathcal{H}' are finite-derivational or \mathbf{B} is σ -complete. If $\llbracket \mathcal{H} \rrbracket = \llbracket \mathcal{H}' \rrbracket$, then $\llbracket \mathcal{H} \rrbracket^{\text{tt}} = \llbracket \mathcal{H}' \rrbracket^{\text{tt}}$.

Proof. Let us assume that $\llbracket \mathcal{H} \rrbracket = \llbracket \mathcal{H}' \rrbracket$ and let $\xi \in \text{T}_{\Sigma}$ and $\zeta \in \text{T}_{\Psi}$. Then

$$\llbracket \mathcal{H} \rrbracket^{\text{tt}}(\xi, \zeta) = \sum_{d \in \text{RT}_{\mathcal{H}}(\xi, \zeta)}^{\oplus} wt_{\mathcal{H}}(d) = \bigoplus_{\substack{\eta \in \text{T}_{[\Sigma\Psi]}: \\ \pi_1(\eta) = \xi, \pi_2(\eta) = \zeta}} \sum_{d \in \text{RT}_{\mathcal{H}}(\eta)}^{\oplus} wt_{\mathcal{H}}(d) = \bigoplus_{\substack{\eta \in \text{T}_{[\Sigma\Psi]}: \\ \pi_1(\eta) = \xi, \pi_2(\eta) = \zeta}} \llbracket \mathcal{H} \rrbracket(\eta) =$$

$$\bigoplus_{\substack{\eta \in T_{[\Sigma\Psi]}: \\ \pi_1(\eta)=\xi, \pi_2(\eta)=\zeta}} \llbracket \mathcal{H}' \rrbracket(\eta) = \bigoplus_{\substack{\eta \in T_{[\Sigma\Psi]}: \\ \pi_1(\eta)=\xi, \pi_2(\eta)=\zeta}} \sum_{d \in \text{RT}_{\mathcal{H}'}(\eta)}^{\oplus} \text{wt}_{\mathcal{H}'}(d) = \sum_{d \in \text{RT}_{\mathcal{H}}(\xi, \zeta)}^{\oplus} \text{wt}_{\mathcal{H}'}(d) = \llbracket \mathcal{H}' \rrbracket^{\text{tt}}(\xi, \zeta),$$

where the second and the sixth equality hold because (10.51) is a partitioning (of $\text{RT}_{\mathcal{H}}(\xi, \zeta)$ and $\text{RT}_{\mathcal{H}'}(\xi, \zeta)$, respectively), the fourth one holds by our assumption, and all other ones hold by definition. \square

The next example shows that the reverse of Lemma 10.13.3 does not hold.

Example 10.13.4. We consider the ranked alphabets $\Sigma = \{\gamma^{(1)}, \alpha^{(0)}\}$ and $\Psi = \{\gamma'^{(1)}, \alpha^{(0)}\}$. As weight algebra we consider the semiring $\text{Boole} = (\mathbb{B}, \vee, \wedge, 0, 1)$.

We consider the two $(\Sigma, \Psi, \text{Boole})$ -wpb $\mathcal{H} = (N, S, R, \text{wt})$ and $\mathcal{H}' = (N, S, R', \text{wt}')$ with $N = \{A, B, C\}$, $S = \{A\}$, and the rules shown in the following table.

rules of \mathcal{H} :	rules of \mathcal{H}' :
$A \rightarrow [\gamma, \varepsilon](B)$	$A \rightarrow [\varepsilon, \gamma'](B)$
$B \rightarrow [\varepsilon, \gamma'](C)$	$B \rightarrow [\gamma, \varepsilon](C)$
$C \rightarrow [\alpha, \alpha]$	$C \rightarrow [\alpha, \alpha]$

and each rule has weight 1. Thus, \mathcal{H} and \mathcal{H}' differ in the order in which they read the input symbol γ and write the output symbol γ' . For every $\xi \in T_{\Sigma}$ and $\zeta \in T_{\Psi}$ we have

$$\llbracket \mathcal{H} \rrbracket^{\text{tt}}(\xi, \zeta) = 1 \quad \text{iff} \quad \xi = \gamma(\alpha) \text{ and } \zeta = \gamma'(\alpha) \quad \text{iff} \quad \llbracket \mathcal{H}' \rrbracket^{\text{tt}}(\xi, \zeta) = 1 .$$

Thus $\llbracket \mathcal{H} \rrbracket^{\text{tt}} = \llbracket \mathcal{H}' \rrbracket^{\text{tt}}$. However,

$$\text{supp}(\llbracket \mathcal{H} \rrbracket) = \{[\gamma, \varepsilon][\varepsilon, \gamma']([\alpha, \alpha])\} \quad \text{and} \quad \text{supp}(\llbracket \mathcal{H}' \rrbracket) = \{[\varepsilon, \gamma'][\gamma, \varepsilon]([\alpha, \alpha])\}$$

and thus $\llbracket \mathcal{H} \rrbracket \neq \llbracket \mathcal{H}' \rrbracket$. \square

The next lemma shows that, under certain conditions, we can transform a wpb into an equivalent chain-free wpb (with respect to the computed weighted tree transformations). This lemma is based on the corresponding lemma for wrtg (cf. Lemma 9.2.1) which, in its turn, is based on the corresponding lemma for wcfg (cf. Theorem 8.2.6).

Lemma 10.13.5. (cf. [FV22a, Lm. 4.1]) Let \mathbf{B} be a semiring and \mathcal{H} be a $(\Sigma, \Psi, \mathbf{B})$ -wpb such that \mathcal{H} is finite-derivational or \mathbf{B} is σ -complete. Then the following three statements hold.

- (1) There exists a chain-free $(\Sigma, \Psi, \mathbf{B})$ -wpb \mathcal{H}' such that $\llbracket \mathcal{H} \rrbracket^{\text{tt}} = \llbracket \mathcal{H}' \rrbracket^{\text{tt}}$.
- (2) If \mathcal{H} is finite-derivational, then we can construct a chain-free $(\Sigma, \Psi, \mathbf{B})$ -wpb \mathcal{H}' such that $\llbracket \mathcal{H} \rrbracket^{\text{tt}} = \llbracket \mathcal{H}' \rrbracket^{\text{tt}}$.
- (3) In both statements (1) and (2) the following holds: if \mathcal{H} is finite-input (resp. finite-output), then \mathcal{H}' is finite-input (resp. finite-output).

Proof. Proof of (1): By Lemma 9.2.1(3), there exists an alphabetic and chain-free $([\Sigma\Psi], \mathbf{B})$ -wrtg \mathcal{H}' such that $\llbracket \mathcal{H} \rrbracket = \llbracket \mathcal{H}' \rrbracket$. Then, by definition of wpb, \mathcal{H}' is a chain-free $(\Sigma, \Psi, \mathbf{B})$ -wpb, and by Lemma 10.13.3 we have $\llbracket \mathcal{H} \rrbracket^{\text{tt}} = \llbracket \mathcal{H}' \rrbracket^{\text{tt}}$.

Proof of (2): Now let \mathcal{H} be finite-derivational. Then, Lemma 9.2.1(3) is constructive and hence we can construct a chain-free $(\Sigma, \Psi, \mathbf{B})$ -wpb \mathcal{H}' such that $\llbracket \mathcal{H} \rrbracket^{\text{tt}} = \llbracket \mathcal{H}' \rrbracket^{\text{tt}}$.

Proof of (3): By analysing the proof of Theorem 8.2.6 (on which the proof of Lemma 9.2.1(3) is based), it is easy to see that, if \mathcal{H} is finite-input (resp. finite-output), then \mathcal{H}' is finite-input (resp. finite-output). \square

10.13.2 Split

Next we characterize the weighted tree language $\llbracket \mathcal{G} \rrbracket$ of a wrtg \mathcal{G} in terms of the image of a characteristic mapping under a weighted projective bimorphism. For this we introduce the concept of skeleton alphabet as follows. We define the *skeleton alphabet* of Σ , denoted by $[\Sigma]$, to be the ranked alphabet with

$$[\Sigma]^{(k)} = \begin{cases} \{[k]\} & \text{if } \Sigma^{(k)} \neq \emptyset \\ \emptyset & \text{otherwise} \end{cases}$$

for each $k \in \mathbb{N}$ (i.e., $[\Sigma]^{(k)}$ is a singleton or empty and $[\Sigma]^{(0)} = \{[0]\}$).

Let $\mathcal{G} = (N, S, R, wt)$ be an arbitrary (Σ, \mathbf{B}) -wrtg. We define a deterministic tree relabeling β which, intuitively, maps each occurrence of rule r of \mathcal{G} in a tree $d \in \mathbf{T}_R$ to the symbol of the skeleton alphabet which corresponds to the rank of r . Formally, we define $\beta = (\beta_k \mid k \in \mathbb{N})$ with $\beta_k : R^{(k)} \rightarrow [R]^{(k)}$ by

$$\beta_k(r) = [k] \quad \text{for each } r \in R^{(k)} \quad .$$

For each $d \in \mathbf{T}_R$ we call $\beta(d)$ the *skeleton* of d . We note that, for every $\xi \in \mathbf{T}_\Sigma$, the $\mathbf{T}_{[R]}$ -indexed family $(\beta^{-1}(b) \cap \mathbf{RT}_{\mathcal{G}}(\xi) \mid b \in \mathbf{T}_{[R]})$ is a partitioning of $\mathbf{RT}_{\mathcal{G}}(\xi)$. Moreover, for every $\xi \in \mathbf{T}_\Sigma$ and $b \in \mathbf{T}_{[R]}$, the set $\beta^{-1}(b) \cap \mathbf{RT}_{\mathcal{G}}(\xi)$ is finite.

Lemma 10.13.6. (cf. [FV22a, Lm. 4.3] for the trivial storage type) Let $\mathcal{G} = (N, S, R, wt)$ be an alphabetic (Σ, \mathbf{B}) -wrtg such that \mathcal{G} is finite-derivational or \mathbf{B} is σ -complete. Then we can construct a chain-free $([R], \Sigma, \mathbf{B})$ -wpb \mathcal{H} such that (a) \mathcal{H} is finite-output, (b) \mathcal{H} is finite-input if \mathcal{G} is finite-derivational, and (c) $\llbracket \mathcal{G} \rrbracket = \llbracket \mathcal{H} \rrbracket^{\text{tt}}(\chi(\mathbf{T}_{[R]}))$.

Proof. We construct the chain-free $([R], \Sigma, \mathbf{B})$ -wpb $\mathcal{H} = (N, S, R', wt')$ as follows.

- For every $r = (A \rightarrow \sigma(A_1, \dots, A_k))$ in R , the rule $r' = (A \rightarrow [[k], \sigma](A_1, \dots, A_k))$ is in R' and $wt'(r') = wt(r)$.
- For every $r = (A \rightarrow B)$ in R , the rule $r' = (A \rightarrow [[1], \varepsilon](B))$ is in R' and $wt'(r') = wt(r)$.

We continue with introducing some useful mappings. We define the deterministic (R', R) -tree relabeling $\varphi = (\varphi_k \mid k \in \mathbb{N})$ for every $k \in \mathbb{N}$ and $r' \in R'^{(k)}$ by

$$\varphi_k(r') = \begin{cases} A \rightarrow \sigma(A_1, \dots, A_k) & \text{if } r' = (A \rightarrow [[k], \sigma](A_1, \dots, A_k)) \\ A \rightarrow B & \text{if } r' = (A \rightarrow [[1], \varepsilon](B)) \end{cases}$$

where in the second case $k = 1$. Clearly, the deterministic tree relabeling $\varphi : \mathbf{T}_{R'} \rightarrow \mathbf{T}_R$ is bijective. Moreover,

$$\text{for each } d \in \mathbf{RT}_{\mathcal{H}}(N, \mathbf{T}_{[[R]\Sigma})), \text{ we have: } wt_{\mathcal{H}}(d) = wt_{\mathcal{G}}(\varphi(d)) \quad (10.52)$$

This can be proved easily by induction on $(\mathbf{RT}_{\mathcal{H}}(N, \mathbf{T}_{[[R]\Sigma})), \succ$ where

$$\succ = \succ_{R'} \cap (\mathbf{RT}_{\mathcal{H}}(N, \mathbf{T}_{[[R]\Sigma})) \times \mathbf{RT}_{\mathcal{H}}(N, \mathbf{T}_{[[R]\Sigma})) \quad .$$

Since $\succ_{R'}$ is terminating, by Lemma 2.5.3 also \succ is terminating. Moreover, we have that $\text{nf}_{\succ}(\mathbf{RT}_{\mathcal{H}}(N, \mathbf{T}_{[[R]\Sigma})) = (R')^{(0)}$.

Also, for every $b \in \mathbf{T}_{[R]}$ and $\xi \in \mathbf{T}_\Sigma$, we have $\varphi(\mathbf{RT}_{\mathcal{H}}(b, \xi)) = \beta^{-1}(b) \cap \mathbf{RT}_{\mathcal{G}}(\xi)$. Thus, for every $b \in \mathbf{T}_{[R]}$ and $\xi \in \mathbf{T}_\Sigma$, the mapping $\varphi_{b, \xi} : \mathbf{RT}_{\mathcal{H}}(b, \xi) \rightarrow \beta^{-1}(b) \cap \mathbf{RT}_{\mathcal{G}}(\xi)$ defined by $\varphi_{b, \xi} = \varphi|_{\mathbf{RT}_{\mathcal{H}}(b, \xi)}$ is bijective. Figure 10.13 illustrates the connection between the mappings β and φ .

Now we prove (a), (b), and (c). Property (a) holds, because $R' = (R')^f$ - and thus \mathcal{H} is finite-output (and hence, $\llbracket \mathcal{H} \rrbracket^{\text{tt}}$ is supp-o-finite).

To see Property (b), we assume that \mathcal{G} is finite-derivational and let $\xi \in \mathbf{T}_\Sigma$. Then the set $\mathbf{RT}_{\mathcal{G}}(\xi)$ is finite. Since the family $(\beta^{-1}(b) \cap \mathbf{RT}_{\mathcal{G}}(\xi) \mid b \in \mathbf{T}_{[R]})$ is a partitioning of the finite set $\mathbf{RT}_{\mathcal{G}}(\xi)$, the set $\{b \in$

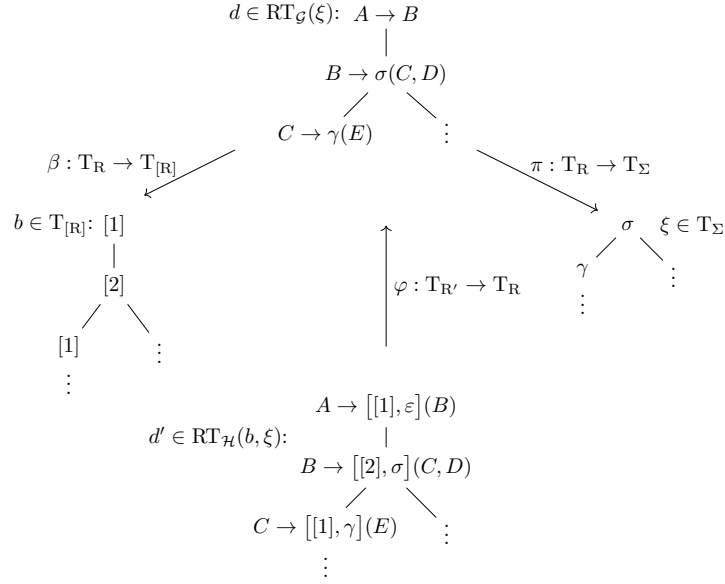

Figure 10.13: An illustration of the mappings β , π , and φ .

$\mathbb{T}_{[R]} \mid \beta^{-1}(b) \cap \text{RT}_{\mathcal{G}}(\xi) \neq \emptyset$ is also finite. Since $\varphi_{b,\xi}$ is bijective, also the set $\{b \in \mathbb{T}_{[R]} \mid \text{RT}_{\mathcal{H}}(b, \xi) \neq \emptyset\}$ is finite. It means that \mathcal{H} is finite-input, which proves Property (b).

Now we turn to the proof of Property (c). Obviously, \mathcal{H} is chain-free and hence finite-derivational; thus, $\llbracket \mathcal{H} \rrbracket^{\text{tt}}$ is well defined. Moreover, if \mathcal{G} is finite-derivational, then \mathcal{H} is finite-input (due to Property (b)), and thus $\llbracket \mathcal{H} \rrbracket^{\text{tt}}$ is supp-i-finite. Hence $\llbracket \mathcal{H} \rrbracket^{\text{tt}}(\chi(\mathbb{T}_{[R]}))$ is well defined.

Now we prove that $\llbracket \mathcal{G} \rrbracket = \llbracket \mathcal{H} \rrbracket^{\text{tt}}(\chi(\mathbb{T}_{[R]}))$. For this, let $\xi \in \mathbb{T}_{\Sigma}$. Then

$$\begin{aligned}
 (\llbracket \mathcal{H} \rrbracket^{\text{tt}}(\chi(\mathbb{T}_{[R]})))(\xi) &= \sum_{b \in \mathbb{T}_{[R]}}^{\oplus} \chi(\mathbb{T}_{[R]})(b) \otimes \llbracket \mathcal{H} \rrbracket^{\text{tt}}(b, \xi) \\
 &\quad \text{(because } \llbracket \mathcal{H} \rrbracket^{\text{tt}} \text{ is supp-i-finite if } \mathbb{B} \text{ is not } \sigma\text{-complete)} \\
 &= \sum_{b \in \mathbb{T}_{[R]}}^{\oplus} \llbracket \mathcal{H} \rrbracket^{\text{tt}}(b, \xi) \\
 &= \sum_{b \in \mathbb{T}_{[R]}}^{\oplus} \bigoplus_{d' \in \text{RT}_{\mathcal{H}}(b, \xi)} \text{wt}_{\mathcal{H}}(d') \quad \text{(because } \mathcal{H} \text{ is finite-derivational)} \\
 &= \sum_{b \in \mathbb{T}_{[R]}}^{\oplus} \bigoplus_{d' \in \text{RT}_{\mathcal{H}}(b, \xi)} \text{wt}_{\mathcal{G}}(\varphi_{b, \xi}(d')) \quad \text{(by (10.52) and definition of } \varphi_{b, \xi}\text{)} \\
 &= \sum_{b \in \mathbb{T}_{[R]}}^{\oplus} \bigoplus_{d \in \beta^{-1}(b) \cap \text{RT}_{\mathcal{G}}(\xi)} \text{wt}_{\mathcal{G}}(d) \quad \text{(since } \varphi_{b, \xi} \text{ is bijective)} \\
 &= \sum_{d \in \text{RT}_{\mathcal{G}}(\xi)}^{\oplus} \text{wt}_{\mathcal{G}}(d) \quad \text{(because } (\beta^{-1}(b) \cap \text{RT}_{\mathcal{G}}(\xi) \mid b \in \mathbb{T}_{[R]}) \text{ is a partitioning of } \text{RT}_{\mathcal{G}}(\xi)\text{)} \\
 &= \llbracket \mathcal{G} \rrbracket(\xi). \quad \text{(because } \mathcal{G} \text{ is finite-derivational or } \mathbb{B} \text{ is } \sigma\text{-complete)}
 \end{aligned}$$

□

10.13.3 Closure of weighted projective bimorphisms under composition

In this subsection we prove that weighted projective bimorphisms are closed under composition. For the proof, we introduce a notation. For every $(\Sigma, \Psi, \mathbf{B})$ -bimorphism $\mathcal{H} = (N, S, R, \text{wt})$ and $N' \subseteq N$, we let

$$\text{RT}_{\mathcal{H}}(N') = \bigcup_{\eta \in \mathbb{T}_{[\Sigma \Psi]}} \text{RT}_{\mathcal{H}}(N', \eta).$$

Theorem 10.13.7. [FV22a, Thm. 4.2] *Let Σ , Ψ , and Δ be ranked alphabets. Moreover, let \mathbf{B} be a commutative semiring. Let \mathcal{H}_1 be a $(\Sigma, \Psi, \mathbf{B})$ -wpb and \mathcal{H}_2 be a $(\Psi, \Delta, \mathbf{B})$ -wpb such that both \mathcal{H}_1 and \mathcal{H}_2 are finite-derivational or \mathbf{B} is σ -complete. Moreover, let $\llbracket \mathcal{H}_1 \rrbracket^{\text{tt}}$ be supp-o-finite or $\llbracket \mathcal{H}_2 \rrbracket^{\text{tt}}$ be supp-i-finite or \mathbf{B} is σ -complete. Then the following three statements hold.*

- (1) *There exists a $(\Sigma, \Delta, \mathbf{B})$ -wpb \mathcal{H} such that $\llbracket \mathcal{H} \rrbracket^{\text{tt}} = \llbracket \mathcal{H}_1 \rrbracket^{\text{tt}}; \llbracket \mathcal{H}_2 \rrbracket^{\text{tt}}$.*
- (2) *If \mathcal{H}_1 and \mathcal{H}_2 are finite-derivational, then we can construct a finite-derivational $(\Sigma, \Delta, \mathbf{B})$ -wpb \mathcal{H} such that $\llbracket \mathcal{H} \rrbracket^{\text{tt}} = \llbracket \mathcal{H}_1 \rrbracket^{\text{tt}}; \llbracket \mathcal{H}_2 \rrbracket^{\text{tt}}$.*
- (3) *In both statements (1) and (2) the following holds. If \mathcal{H}_1 and \mathcal{H}_2 are finite-input, then \mathcal{H} is finite-input.*

Proof. Proof of (1). Let $\mathcal{H}_1 = (N_1, S_1, R_1, \text{wt}_1)$ and $\mathcal{H}_2 = (N_2, S_2, R_2, \text{wt}_2)$. Since \mathcal{H}_1 and \mathcal{H}_2 are finite-derivational or \mathbf{B} is σ -complete, the weighted tree transformations $\llbracket \mathcal{H}_1 \rrbracket^{\text{tt}}$ and $\llbracket \mathcal{H}_2 \rrbracket^{\text{tt}}$ are well defined. Moreover, since $\llbracket \mathcal{H}_1 \rrbracket^{\text{tt}}$ is supp-o-finite or $\llbracket \mathcal{H}_2 \rrbracket^{\text{tt}}$ is supp-i-finite or \mathbf{B} is σ -complete, the weighted tree transformation $\llbracket \mathcal{H}_1 \rrbracket^{\text{tt}}; \llbracket \mathcal{H}_2 \rrbracket^{\text{tt}}$ is well defined. By Lemma 10.13.5(1) we can assume that \mathcal{H}_1 and \mathcal{H}_2 are chain-free.

We define the $(\Sigma, \Delta, \mathbf{B})$ -wpb $\mathcal{H} = (N, S, R, \text{wt})$ by using a modification of the usual product construction for tree transducers [Eng75b, Bak79] and for weighted tree transducers in [EFV02]. We have to use a modification for the following reason. Before producing an output symbol $\psi \in \Psi$, the wpb \mathcal{H}_1 can execute a sequence s_1 of ε -rules on some input tree $\xi \in \mathbb{T}_{\Sigma}$. Also, before reading ψ , the wpb \mathcal{H}_2 can execute a sequence s_2 of ε w-rules, thereby producing a part of some output tree $\zeta \in \mathbb{T}_{\Delta}$. If we combine each rule in the sequence s_1 with each rule in the sequence s_2 into one rule for \mathcal{H} , then we introduce a number of artificial orderings for the applications of the rules in s_1 and s_2 . As a consequence, for one single summand in $(\llbracket \mathcal{H}_1 \rrbracket^{\text{tt}}; \llbracket \mathcal{H}_2 \rrbracket^{\text{tt}})(\xi, \zeta)$, there will be multiple corresponding summands in $\llbracket \mathcal{H} \rrbracket^{\text{tt}}(\xi, \zeta)$. Thus, in order to establish a weight balance between $\llbracket \mathcal{H} \rrbracket^{\text{tt}}(\xi, \zeta)$ and $(\llbracket \mathcal{H}_1 \rrbracket^{\text{tt}}; \llbracket \mathcal{H}_2 \rrbracket^{\text{tt}})(\xi, \zeta)$, we have to forbid artificial orderings in the rule trees of \mathcal{H} .

For this purpose, we introduce auxiliary control nonterminals as follows. Before \mathcal{H} simulates the combination of a rule $r_1 = (A_1 \rightarrow [\sigma, \psi](A_{11}, \dots, A_{1k}))$ in R_1^{w} and of a rule $r_2 = (A_2 \rightarrow [\psi, \delta](A_{21}, \dots, A_{2k}))$ in R_2^{ε} , it first simulates rules in R_1^{ε} (using states of the form $\langle r_1, r_2 \rangle$), and second it simulates rules in $R_2^{\varepsilon \text{w}}$ (using states of the form $\langle r_1, r_2 \rangle$).

Formally, we define \mathcal{H} as follows. We let

$$\begin{aligned} N &= \{ \langle r_1, r_2 \rangle \mid r_1 \in R_1, r_2 \in R_2 \} \cup \{ \langle r_1, r_2 \rangle \mid r_1 \in R_1^{\text{w}}, r_2 \in R_2 \} \\ &\quad \cup \{ \langle r_1, r_2 \rangle \mid (r_1, r_2) \in R_1^{\text{w}} \times R_2^{\varepsilon}, \text{out}(r_1) = \text{inp}(r_2) \} \text{ and} \\ S &= \{ \langle r_1, r_2 \rangle \in Q \mid \text{lhs}(r_1) \in S_1, \text{lhs}(r_2) \in S_2 \} . \end{aligned}$$

The set R and the weight mapping wt are defined by the following five cases.

1. For every $r_1 = (A_1 \rightarrow [\sigma, \varepsilon](A'_1))$ in R_1^{ε} , $r'_1 \in R_1$ with $\text{lhs}(r'_1) = A'_1$, and $r_2 \in R_2$, the rule

$$r = (\langle r_1, r_2 \rangle \rightarrow [\sigma, \varepsilon](\langle r'_1, r_2 \rangle))$$

is in R and $\text{wt}(r) = \text{wt}_1(r_1)$.

2. For every $r_1 \in R_1^w$ and $r_2 \in R_2$, the rule

$$r = (\langle r_1, r_2 \rangle \rightarrow \langle r_1, r_2 \rangle)$$

is in R and $wt(r) = \mathbb{1}$.

3. For every $r_1 \in R_1^w$, $r_2 = (A_2 \rightarrow [\varepsilon, \psi](A'_2))$ in $R_2^{\varepsilon w}$, and $r'_2 \in R_2$ with $\text{lhs}(r'_2) = A'_2$, the rule

$$r = (\langle r_1, r_2 \rangle \rightarrow [\varepsilon, \psi](\langle r_1, r'_2 \rangle))$$

is in R and $wt(r) = wt_2(r_2)$.

4. For every $r_1 \in R_1^w$ and $r_2 \in R_2^*$, the rule

$$r = (\langle r_1, r_2 \rangle \rightarrow (r_1, r_2))$$

is in R and $wt(r) = \mathbb{1}$.

5. For every $r_1 = (A_1 \rightarrow [\sigma, \psi](A_{11}, \dots, A_{1k}))$ in R_1^w ,
 $r_2 = (A_2 \rightarrow [\psi, \delta](A_{21}, \dots, A_{2k}))$ in R_2^* ,
 $r_{11}, \dots, r_{1k} \in R_1$ with $\text{lhs}(r_{1j}) = A_{1j}$ ($j \in [k]$), and
 $r_{21}, \dots, r_{2k} \in R_2$ with $\text{lhs}(r_{2j}) = A_{2j}$ ($j \in [k]$), the rule

$$r = ((r_1, r_2) \rightarrow [\sigma, \delta](\langle r_{11}, r_{21} \rangle, \dots, \langle r_{1k}, r_{2k} \rangle))$$

is in R and $wt(r) = wt_1(r_1) \otimes wt_2(r_2)$.

Clearly, each rule r produced in Cases 1-4 has rank 1. Next, we mention that, for each $d \in \text{RT}_{\mathcal{H}}(\langle r_1, r_2 \rangle, \mathbb{T}_{[\Sigma\Psi]})$ with $r_i \in R_i$ for $i = \{1, 2\}$ and each leaf $w \in \text{pos}(d)$ with $w = i_1 \dots i_m$ for some $m \geq 1$, the sequence of cases which has produced $d(i_1) \dots d(i_m) \in R^*$, is contained in $(1^\ell 23^u 45)^+$ for some $\ell, u \in \mathbb{N}$ (see Figure 10.14).

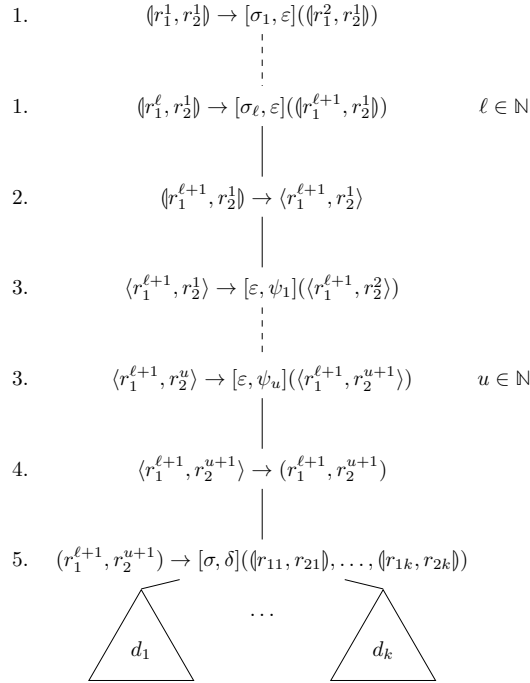

Figure 10.14: A rule tree d of \mathcal{H} .

We also note that \mathcal{H} is not chain-free due to rules of type 2 and 4. However, it is easy to see that, if \mathcal{H}_1 and \mathcal{H}_2 are finite-derivational, then \mathcal{H} is finite-derivational, because rules of type 2 and 4 cannot occur arbitrarily often in rule trees. Hence $\llbracket \mathcal{H} \rrbracket^{\text{tt}}$ is well defined.

For the rest of the proof we need some preparation. We define a mapping h which retrieves from a rule tree in $\text{RT}_{\mathcal{H}}(N, \mathbb{T}_{[\Sigma\Delta]})$ the intermediate tree in \mathbb{T}_{Ψ} . Formally, we define the mapping $h : \text{RT}_{\mathcal{H}}(N, \mathbb{T}_{[\Sigma\Delta]}) \rightarrow \mathbb{T}_{\Psi}$ by induction on $(\text{RT}_{\mathcal{H}}(N, \mathbb{T}_{[\Sigma\Delta]}), \succ)$ where

$$\succ = \succ_R \cap (\text{RT}_{\mathcal{H}}(N, \mathbb{T}_{[\Sigma\Delta]}) \times \text{RT}_{\mathcal{H}}(N, \mathbb{T}_{[\Sigma\Delta]})) .$$

Since \succ_R is terminating, by Lemma 2.5.3 also Obviously, \succ is terminating. Moreover, we have that $\text{nf}_{\succ}(\text{RT}_{\mathcal{H}}(N, \mathbb{T}_{[\Sigma\Delta]})) = R^{(0)}$.

Let $d = r(d_1, \dots, d_k)$ be in $\text{RT}_{\mathcal{H}}(N, \mathbb{T}_{[\Sigma\Delta]})$ with $r \in R$ and $d_1, \dots, d_k \in \text{RT}_{\mathcal{H}}(N, \mathbb{T}_{[\Sigma\Delta]})$. Then we let

$$h(r(d_1, \dots, d_k)) = \begin{cases} h(d_1) & \text{if } r \text{ is obtained by Cases 1, 2, 3, or 4} \\ \psi(h(d_1), \dots, h(d_k)) & \text{if } r \text{ is obtained by Case 5,} \\ & \text{lhs}(r) = (r_1, r_2) \text{ for some } r_1 \text{ and } r_2, \\ & \text{and } \psi = \text{out}(r_1) . \end{cases}$$

We define the set $N_{(\cdot, \cdot)} = \{(r_1, r_2) \mid r_1 \in R_1, r_2 \in R_2\}$. Moreover, we define the mapping

$$\varphi : \text{RT}_{\mathcal{H}}(N_{(\cdot, \cdot)}, \mathbb{T}_{[\Sigma\Delta]}) \rightarrow \text{RT}_{\mathcal{H}_1}(N_1, \mathbb{T}_{\Sigma}) \times \text{RT}_{\mathcal{H}_2}(N_2, \mathbb{T}_{\Psi})$$

by induction on $(\text{RT}_{\mathcal{H}}(N_{(\cdot, \cdot)}, \mathbb{T}_{[\Sigma\Delta]}), \succ)$ where

$$\succ = \succ_R^+ \cap (\text{RT}_{\mathcal{H}}(N_{(\cdot, \cdot)}, \mathbb{T}_{[\Sigma\Delta]}) \times \text{RT}_{\mathcal{H}}(N_{(\cdot, \cdot)}, \mathbb{T}_{[\Sigma\Delta]}))$$

as follows. Since \succ_R is terminating, also \succ_R^+ is terminating, hence by Lemma 2.5.3 also \succ is terminating. Moreover, we have that $\text{nf}_{\succ}(\text{RT}_{\mathcal{H}}(N_{(\cdot, \cdot)}, \mathbb{T}_{[\Sigma\Delta]})) = \{(A \rightarrow \xi) \in R \mid A \in N_{(\cdot, \cdot)}, \xi \in [\Sigma\Delta]^{(0)}\}$.

Let $d \in \text{RT}_{\mathcal{H}}(N_{(\cdot, \cdot)}, \mathbb{T}_{[\Sigma\Delta]})$. Then there exist $r_1 \in R_1$, $r_2 \in R_2$, $\xi \in \mathbb{T}_{\Sigma}$, and $\zeta \in \mathbb{T}_{\Delta}$ such that $d \in \text{RT}_{\mathcal{H}}(\langle r_1, r_2 \rangle, \xi, \zeta)$.

Due to the definition of rules of \mathcal{H} , the rule tree d has the form shown in Figure 10.14 for some $\ell, u \in \mathbb{N}$, rules r_i^j , symbols σ_j and ψ_j (each of appropriate type which can be read off easily from the definition of R), as well as rule $(r_1^{\ell+1}, r_2^{u+1}) \rightarrow [\sigma, \delta](\langle r_{11}, r_{21} \rangle, \dots, \langle r_{1k}, r_{2k} \rangle)$ in R , and $d_1, \dots, d_k \in \text{RT}_{\mathcal{H}}(N_{(\cdot, \cdot)}, \mathbb{T}_{[\Sigma\Delta]})$; moreover, $r_1 = r_1^1$ and $r_2 = r_2^1$.

Then

- there exists a $\psi \in \Psi^{(k)}$ such that $h(d) = \psi(h(d_1), \dots, h(d_k))$,
- $\xi = \sigma(\pi_1(d_1), \dots, \pi_1(d_k))$,
- $\zeta = \delta(\pi_2(d_1), \dots, \pi_2(d_k))$, and
- $d_i \in \text{RT}_{\mathcal{H}}(\langle r_{1i}, r_{2i} \rangle, \pi_1(d_i), \pi_2(d_i))$ for each $i \in [k]$.

We define $\varphi(d) = (t_1, t_2)$, where t_1 and t_2 are shown in Figure 10.15 and where for each $i \in [k]$ we let $(t_{1i}, t_{2i}) = \varphi(d_i)$.

Next we introduce a kind of typing for elements of $\text{RT}_{\mathcal{H}}(N_{(\cdot, \cdot)}, \mathbb{T}_{[\Sigma\Delta]})$ and for elements of $\text{RT}_{\mathcal{H}_1}(N_1, \mathbb{T}_{\Sigma}) \times \text{RT}_{\mathcal{H}_2}(N_2, \mathbb{T}_{\Psi})$. Formally, let $r_1 \in R_1$, $r_2 \in R_2$, $\xi \in \mathbb{T}_{\Sigma}$, $\theta \in \mathbb{T}_{\Psi}$, and $\zeta \in \mathbb{T}_{\Delta}$. We define the following two sets:

$$\begin{aligned} \text{RT}_{\mathcal{H}}(\langle r_1, r_2 \rangle, \xi, \theta, \zeta) &= \{d \in \text{RT}_{\mathcal{H}}(\langle r_1, r_2 \rangle, \xi, \zeta) \mid h(d) = \theta\} \\ \text{RT}_{\mathcal{H}_1 \times \mathcal{H}_2}(r_1, r_2, \xi, \theta, \zeta) &= \{(t_1, t_2) \in \text{RT}_{\mathcal{H}_1}(N_1, \xi, \theta) \times \text{RT}_{\mathcal{H}_2}(N_2, \theta, \zeta) \mid t_1(\varepsilon) = r_1, t_2(\varepsilon) = r_2\}. \end{aligned}$$

Then the families

$$\begin{aligned} &(\text{RT}_{\mathcal{H}}(\langle r_1, r_2 \rangle, \xi, \theta, \zeta) \mid r_1, r_2, \xi, \theta, \zeta \text{ as above}) \\ &(\text{RT}_{\mathcal{H}_1 \times \mathcal{H}_2}(r_1, r_2, \xi, \theta, \zeta) \mid r_1, r_2, \xi, \theta, \zeta \text{ as above}) \end{aligned}$$

are partitionings of $\text{RT}_{\mathcal{H}}(N_{(\cdot, \cdot)}, \mathbb{T}_{[\Sigma\Delta]})$ and of $\text{RT}_{\mathcal{H}_1}(N_1, \mathbb{T}_{\Sigma}) \times \text{RT}_{\mathcal{H}_2}(N_2, \mathbb{T}_{\Psi})$, respectively. One might say that an element $d \in \text{RT}_{\mathcal{H}}(\langle r_1, r_2 \rangle, \xi, \theta, \zeta)$ and an element $(t_1, t_2) \in \text{RT}_{\mathcal{H}_1 \times \mathcal{H}_2}(r_1, r_2, \xi, \theta, \zeta)$ have type $(r_1, r_2, \xi, \theta, \zeta)$.

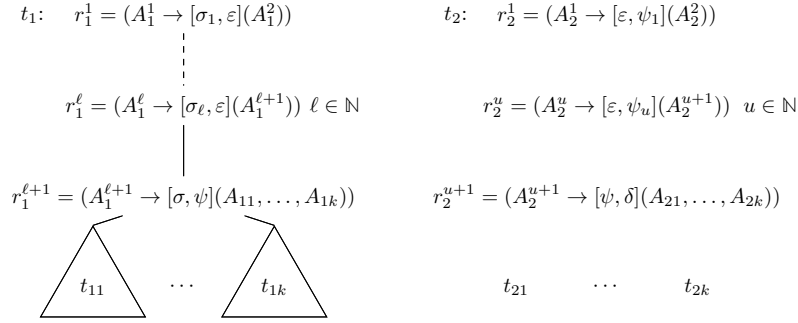

Figure 10.15: A pair (t_1, t_2) of rule trees of \mathcal{H}_1 and \mathcal{H}_2 , respectively, where $\text{lhs}(t_{1j}(\varepsilon)) = A_{1j}$ and $\text{lhs}(t_{2j}(\varepsilon)) = A_{2j}$ for $j \in [k]$.

It is easy to see that $\varphi(\text{RT}_{\mathcal{H}}(\langle r_1, r_2 \rangle, \xi, \theta, \zeta)) \subseteq \text{RT}_{\mathcal{H}_1 \times \mathcal{H}_2}(r_1, r_2, \xi, \theta, \zeta)$. Thus, intuitively, φ is type preserving. Based on this property, we define the mapping

$$\varphi_{r_1, r_2, \xi, \theta, \zeta} : \text{RT}_{\mathcal{H}}(\langle r_1, r_2 \rangle, \xi, \theta, \zeta) \rightarrow \text{RT}_{\mathcal{H}_1 \times \mathcal{H}_2}(r_1, r_2, \xi, \theta, \zeta)$$

for each $d \in \text{RT}_{\mathcal{H}}(\langle r_1, r_2 \rangle, \xi, \theta, \zeta)$ by $\varphi_{r_1, r_2, \xi, \theta, \zeta}(d) = \varphi(d)$.

We show that each mapping $\varphi_{r_1, r_2, \xi, \theta, \zeta}$ is injective. For this, let d and d' be different trees with $\varphi_{r_1, r_2, \xi, \theta, \zeta}(d) = (t_1, t_2)$ and $\varphi_{r_1, r_2, \xi, \theta, \zeta}(d') = (t'_1, t'_2)$. Then there exists a position $w \in \text{pos}(d) \cap \text{pos}(d')$ with $d(w) \neq d'(w)$. Since the nonterminals of \mathcal{H} encode rules of \mathcal{H}_1 and \mathcal{H}_2 , this yields that the rules in t_1 and t'_1 or the rules in t_2 and t'_2 corresponding to $d(w)$ and $d'(w)$, respectively, are different. Hence $(t_1, t_2) \neq (t'_1, t'_2)$, i.e., $\varphi_{r_1, r_2, \xi, \theta, \zeta}$ is injective.

Now let $(t_1, t_2) \in \text{RT}_{\mathcal{H}_1 \times \mathcal{H}_2}(r_1, r_2, \xi, \theta, \zeta)$. Since each $t_1 \in \text{RT}_{\mathcal{H}_1}(N_1)$ and each $t_2 \in \text{RT}_{\mathcal{H}_2}(N_2)$ have the form as shown in Figure 10.15, we can combine t_1 and t_2 into a $d \in \text{RT}_{\mathcal{H}}(\langle r_1, r_2 \rangle, \xi, \theta, \zeta)$ shown in Figure 10.14. For this d we have $\varphi_{r_1, r_2, \xi, \theta, \zeta}(d) = (t_1, t_2)$, hence each mapping $\varphi_{r_1, r_2, \xi, \theta, \zeta}$ is also surjective.

Moreover, by analysing the weights of the rules shown in Figure 10.14 with those shown in Figure 10.15 and taking the commutativity of \mathbf{B} into account, we easily obtain that

$$\text{wt}_{\mathcal{H}}(d) = \text{wt}_{\mathcal{H}_1}(t_1) \otimes \text{wt}_{\mathcal{H}_2}(t_2)$$

for each $d \in \text{RT}_{\mathcal{H}}(\langle r_1, r_2 \rangle, \xi, \theta, \zeta)$, where $\varphi_{r_1, r_2, \xi, \theta, \zeta}(d) = (t_1, t_2)$. Thus, each $\varphi_{r_1, r_2, \xi, \theta, \zeta}$ is a weight preserving bijection.

Now we can finish the proof of (a) as follows. For every $\xi \in \mathbf{T}_{\Sigma}$ and $\zeta \in \mathbf{T}_{\Delta}$, we have

$$\begin{aligned} ([\mathcal{H}_1]^{\text{tt}}; [\mathcal{H}_2]^{\text{tt}})(\xi, \zeta) &= \sum_{\theta \in \mathbf{T}_{\Psi}}^{\oplus} [\mathcal{H}_1]^{\text{tt}}(\xi, \theta) \otimes [\mathcal{H}_2]^{\text{tt}}(\theta, \zeta) && \text{(by (2.45))} \\ &= \sum_{\theta \in \mathbf{T}_{\Psi}}^{\oplus} \sum_{t_1 \in \text{RT}_{\mathcal{H}_1}(\xi, \theta)}^{\oplus} \sum_{t_2 \in \text{RT}_{\mathcal{H}_2}(\theta, \zeta)}^{\oplus} \text{wt}_{\mathcal{H}_1}(t_1) \otimes \text{wt}_{\mathcal{H}_2}(t_2) && \text{(by distributivity)} \\ &= \sum_{\theta \in \mathbf{T}_{\Psi}}^{\oplus} \bigoplus_{\substack{r_1 \in R_1: \\ \text{lhs}(r_1) \in S_1}} \bigoplus_{\substack{r_2 \in R_2: \\ \text{lhs}(r_2) \in S_2}} \sum_{\substack{t_1 \in \text{RT}_{\mathcal{H}_1}(N_1, \xi, \theta): \\ t_1(\varepsilon) = r_1}}^{\oplus} \sum_{\substack{t_2 \in \text{RT}_{\mathcal{H}_2}(N_2, \theta, \zeta): \\ t_2(\varepsilon) = r_2}}^{\oplus} \text{wt}_{\mathcal{H}_1}(t_1) \otimes \text{wt}_{\mathcal{H}_2}(t_2) \\ &= \sum_{\theta \in \mathbf{T}_{\Psi}}^{\oplus} \bigoplus_{\substack{r_1 \in R_1: \\ \text{lhs}(r_1) \in S_1}} \bigoplus_{\substack{r_2 \in R_2: \\ \text{lhs}(r_2) \in S_2}} \sum_{(t_1, t_2) \in \text{RT}_{\mathcal{H}_1 \times \mathcal{H}_2}(r_1, r_2, \xi, \theta, \zeta)}^{\oplus} \text{wt}_{\mathcal{H}_1}(t_1) \otimes \text{wt}_{\mathcal{H}_2}(t_2) \\ &= \sum_{\theta \in \mathbf{T}_{\Psi}}^{\oplus} \bigoplus_{\substack{r_1 \in R_1: \\ \text{lhs}(r_1) \in S_1}} \bigoplus_{\substack{r_2 \in R_2: \\ \text{lhs}(r_2) \in S_2}} \sum_{d \in \text{RT}_{\mathcal{H}}(\langle r_1, r_2 \rangle, \xi, \theta, \zeta)}^{\oplus} \text{wt}_{\mathcal{H}}(d) \\ & && \text{(because } \varphi_{r_1, r_2, \xi, \theta, \zeta} \text{ is a weight preserving bijection)} \end{aligned}$$

$$\begin{aligned}
& \text{(from } \text{RT}_{\mathcal{H}}(\langle r_1, r_2 \rangle, \xi, \theta, \zeta) \text{ to } \text{RT}_{\mathcal{H}_1 \times \mathcal{H}_2}(r_1, r_2, \xi, \theta, \zeta) \text{)} \\
&= \sum_{\theta \in \text{T}_{\Psi}}^{\oplus} \bigoplus_{\substack{r_1 \in R_1: \\ \text{lhs}(r_1) \in S_1}} \bigoplus_{\substack{r_2 \in R_2: \\ \text{lhs}(r_2) \in S_2}} \sum_{\substack{d \in \text{RT}_{\mathcal{H}}(N, \xi, \zeta): \\ h(d) = \theta \\ \text{lhs}(d(\varepsilon)) = \langle r_1, r_2 \rangle}}^{\oplus} \text{wt}_{\mathcal{H}}(d) \\
&= \sum_{\theta \in \text{T}_{\Psi}}^{\oplus} \sum_{\substack{d \in \text{RT}_{\mathcal{H}}(\xi, \zeta): \\ h(d) = \theta}}^{\oplus} \text{wt}_{\mathcal{H}}(d) = \sum_{d \in \text{RT}_{\mathcal{H}}(\xi, \zeta)}^{\oplus} \text{wt}_{\mathcal{H}}(d) = \llbracket \mathcal{H} \rrbracket^{\text{tt}}(\xi, \zeta) .
\end{aligned}$$

Proof of (2): Now let \mathcal{H}_1 and \mathcal{H}_2 be finite-derivational. Then, by Lemma 10.13.5(2), we can even construct equivalent chain-free wpb. Consequently, the definition of \mathcal{H} , as it is given in the proof of (1), is constructive and \mathcal{H} is finite-derivational. Moreover, by the proof of (1), we have $\llbracket \mathcal{H} \rrbracket^{\text{tt}} = \llbracket \mathcal{H}_1 \rrbracket^{\text{tt}}; \llbracket \mathcal{H}_2 \rrbracket^{\text{tt}}$.

Proof of (3). For this we assume that \mathcal{H}_1 and \mathcal{H}_2 are finite-input. Let $\zeta \in \text{T}_{\Delta}$. Since \mathcal{H}_1 and \mathcal{H}_2 are finite-input, the set $A = \{\theta \in \text{T}_{\Psi} \mid \text{RT}_{\mathcal{H}_2}(\theta, \zeta) \neq \emptyset\}$ is finite, and for every $\theta \in A$ the set $B = \{\xi \in \text{T}_{\Sigma} \mid \text{RT}_{\mathcal{H}_1}(\xi, \theta) \neq \emptyset\}$ is finite. Hence the set $C = \{\xi \in \text{T}_{\Sigma} \mid (\exists \theta \in \text{T}_{\Psi}) : \text{RT}_{\mathcal{H}_1}(\xi, \theta) \neq \emptyset \wedge \text{RT}_{\mathcal{H}_2}(\theta, \zeta) \neq \emptyset\}$ is finite.

Next we show that $\{\xi \in \text{T}_{\Sigma} \mid \text{RT}_{\mathcal{H}}(\xi, \zeta) \neq \emptyset\} \subseteq C$. For this, let $\xi \in \text{T}_{\Sigma}$ and $d \in \text{RT}_{\mathcal{H}}(\xi, \zeta)$. Then there exists $\langle r_1, r_2 \rangle \in S$ such that $d \in \text{RT}_{\mathcal{H}}(\langle r_1, r_2 \rangle, \xi, h(d), \zeta)$. Since $\varphi_{r_1, r_2, \xi, h(d), \zeta}$ is bijective, there exist $t_1 \in \text{RT}_{\mathcal{H}_1}(N_1, \xi, h(d))$ and $t_2 \in \text{RT}_{\mathcal{H}_2}(N_2, h(d), \zeta)$. Since $\text{lhs}(r_i) \in S_i$ for $i \in \{1, 2\}$, we have $t_1 \in \text{RT}_{\mathcal{H}_1}(\xi, h(d))$ and $t_2 \in \text{RT}_{\mathcal{H}_2}(h(d), \zeta)$. Hence for $h(d) \in \text{T}_{\Psi}$ we have $\text{RT}_{\mathcal{H}_1}(\xi, h(d)) \neq \emptyset$ and $\text{RT}_{\mathcal{H}_2}(h(d), \zeta) \neq \emptyset$, which means that $\xi \in C$.

Since $\{\xi \in \text{T}_{\Sigma} \mid \text{RT}_{\mathcal{H}}(\xi, \zeta) \neq \emptyset\} \subseteq C$ and C is finite, also $\{\xi \in \text{T}_{\Sigma} \mid \text{RT}_{\mathcal{H}}(\xi, \zeta) \neq \emptyset\}$ is finite. Hence \mathcal{H} is finite-input. \square

10.13.4 Merge

Here we express the application of a weighted projective bimorphism to a characteristic mapping in terms of a weighted regular tree grammar. Since this process is a kind of inverse to the split in Subsection 10.13.2, we call it merge. We recall that $[\Delta]$ denote the skeleton alphabet of Δ , defined on page 262.

Lemma 10.13.8. (cf. [FV19, Lm. 4.4]) Let \mathcal{H} be a chain-free $([\Delta], \Psi, \mathbf{B})$ -wpb such that \mathcal{H} is finite-input or \mathbf{B} is σ -complete. Then we can construct an alphabetic (Ψ, \mathbf{B}) -wrtg \mathcal{G} such that (a) \mathcal{G} is finite-derivational if \mathcal{H} is finite-input and (b) $\llbracket \mathcal{H} \rrbracket^{\text{tt}}(\chi(\text{T}_{[\Delta]})) = \llbracket \mathcal{G} \rrbracket$.

Proof. Let $\mathcal{H} = (N, S, R, wt)$. We recall that \mathcal{H} is a chain-free and alphabetic $([\Delta], \Psi, \mathbf{B})$ -wrtg. We construct the (Ψ, \mathbf{B}) -wrtg $\mathcal{G} = (N', S', R', wt')$ as follows. We let $N' = R$ and $S' = \{r \in R \mid \text{lhs}(r) \in S\}$. The set R' of rules and the weight mapping wt' are defined as follows.

1. For every $r = (A \rightarrow [[k], \psi](A_1, \dots, A_k))$ in R and every $r_1, \dots, r_k \in R$ with $\text{lhs}(r_i) = A_i$ for each $i \in [k]$, the rule $r' = (r \rightarrow \psi(r_1, \dots, r_k))$ is in R' and $wt'(r') = wt(r)$.
2. For every $r = (A \rightarrow [[1], \varepsilon](A_1))$ in R and every $r_1 \in R$ with $\text{lhs}(r_1) = A_1$, the rule $r' = (r \rightarrow r_1)$ is in R' and $wt'(r') = wt(r)$.
3. For every $r = (A \rightarrow [\varepsilon, \psi](A_1))$ in R and every $r_1 \in R$ with $\text{lhs}(r_1) = A_1$, the rule $r' = (r \rightarrow \psi(r_1))$ is in R' and $wt'(r') = wt(r)$.

Obviously, \mathcal{G} is alphabetic.

Before we prove Properties (a) and (b) we need some preparations. We define the mapping $\beta' : \text{T}_{R'} \rightarrow \text{T}_{[\Delta]}$ by induction on $\text{T}_{R'}$ for each $r'(d'_1, \dots, d'_k) \in \text{T}_{R'}$ as follows:

$$\beta'(r'(d'_1, \dots, d'_k)) = \begin{cases} [k](\beta'(d'_1), \dots, \beta'(d'_k)) & \text{if } r' \text{ is defined by 1.} \\ [1](\beta'(d'_1)) & \text{if } r' \text{ is defined by 2.} \\ \beta'(d'_1) & \text{if } r' \text{ is defined by 3.} \end{cases}$$

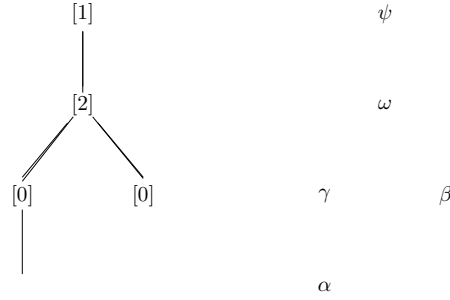

Figure 10.16: Example trees $b \in T_{[\Delta]}$ (left) and $\xi \in T_{\Psi}$ (right).

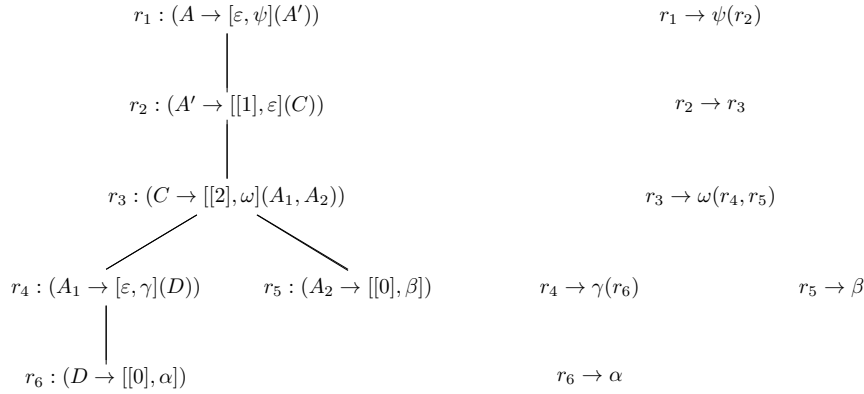

Figure 10.17: Example trees $d \in RT_{\mathcal{H}}(N, b, \xi)$ (left) with $b \in T_{[\Delta]}$ and $\xi \in T_{\Psi}$ from Fig. 10.16, and $\varphi_{b, \xi}(d) \in RT_{\mathcal{G}}(N', \xi)$ (right). Moreover, $\beta'(\varphi_{b, \xi}(d)) = b$ and $\pi(\varphi_{b, \xi}(d)) = \xi$.

In other words, if the terminal symbol in the right-hand side of $\text{lhs}(r')$ has the form $[[k], \psi]$ or $[[1], \varepsilon]$, then β' outputs the terminal symbol $[k]$ and $[1]$, respectively; if the terminal symbol in the right-hand side of $\text{lhs}(r')$ has the form $[\varepsilon, \psi]$, then β' does not output any terminal symbol.

(This β' is a modification of the mapping β defined on page 262.) For instance, if β' is applied to the right tree in Figure 10.17, then the left tree in Figure 10.16 is obtained.

Lastly, we define the relation

$$\succ = \succ_R \cap (RT_{\mathcal{H}}(N, T_{[[\Delta]\Psi]}) \times RT_{\mathcal{H}}(N, T_{[[\Delta]\Psi]})) .$$

Since \succ_R is terminating, by Lemma 2.5.3 also it is easy to see that \succ is terminating. Moreover, we have that $\text{nf}_{\succ}(RT_{\mathcal{H}}(N, T_{[[\Delta]\Psi]}))$ is the set of terminal rules of \mathcal{H} .

Then, by induction on $(RT_{\mathcal{H}}(N, T_{[[\Delta]\Psi]}), \succ)$, we define the mapping

$$\varphi : RT_{\mathcal{H}}(N, T_{[[\Delta]\Psi]}) \rightarrow RT_{\mathcal{G}}(N', T_{\Psi}),$$

as follows.

Let $d \in RT_{\mathcal{H}}(N, T_{[[\Delta]\Psi]})$. Then there exists $r = (A \rightarrow [\kappa, \lambda](A_1, \dots, A_k))$ in R and $d_1, \dots, d_k \in RT_{\mathcal{H}}(N, T_{[[\Delta]\Psi]})$ such that $d = r(d_1, \dots, d_k)$.

- If $\kappa = [k]$ for some $k \neq 1$ and $\lambda \in \Psi$, then we define

$$\varphi(r(d_1, \dots, d_k)) = (r \rightarrow \lambda(d_1(\varepsilon), \dots, d_k(\varepsilon))) (\varphi(d_1), \dots, \varphi(d_k)) .$$

- If $\kappa = [1]$ and $\lambda = \varepsilon$, then $k = 1$ and we define

$$\varphi(r(d_1)) = (r \rightarrow d_1(\varepsilon)) (\varphi(d_1)) .$$

- If $\kappa = \varepsilon$ and $\lambda \in \Psi$, then $k = 1$ and we define

$$\varphi(r(d_1)) = (r \rightarrow \psi(d_1(\varepsilon)))\left(\varphi(d_1)\right) .$$

The following is easy to see:

$$\text{for every } b \in T_{[\Delta]} \text{ and } \xi \in T_{\Psi}, \text{ we have } \varphi(\text{RT}_{\mathcal{H}}(N, b, \xi)) \subseteq \text{RT}_{\mathcal{G}}(N', \xi) \cap (\beta')^{-1}(b) .$$

Thus, for every $b \in T_{[\Delta]}$ and $\xi \in T_{\Psi}$, we can define the mapping

$$\varphi_{b,\xi} : \text{RT}_{\mathcal{H}}(N, b, \xi) \rightarrow \text{RT}_{\mathcal{G}}(N', \xi) \cap (\beta')^{-1}(b)$$

by letting $\varphi_{b,\xi}(d) = \varphi(d)$ for each $d \in \text{RT}_{\mathcal{H}}(N, b, \xi)$.

Next we prove that $\varphi_{b,\xi}$ is bijective for every $b \in T_{[\Delta]}$ and $\xi \in T_{\Psi}$. For this proof let us abbreviate $\varphi_{b,\xi}$, $\text{RT}_{\mathcal{H}}(N, b, \xi)$, and $\text{RT}_{\mathcal{G}}(N', \xi) \cap (\beta')^{-1}(b)$ by φ , $\text{RT}_{\mathcal{H}}$, and $\text{RT}_{\mathcal{G}}$, respectively. To illustrate our arguments we show examples of $b \in T_{[\Delta]}$ and $\xi \in T_{\Psi}$ in Figure 10.16, and examples of $d \in \text{RT}_{\mathcal{H}}$ and $\varphi(d) \in \text{RT}_{\mathcal{G}}$ in Figure 10.17. First we observe that φ is shape preserving, i.e., for every $d \in \text{RT}_{\mathcal{H}}$, we have $\text{pos}(\varphi(d)) = \text{pos}(d)$ (see Figure 10.17). Now let $d_1, d_2 \in \text{RT}_{\mathcal{H}}$ such that $d_1 \neq d_2$. If $\text{pos}(d_1) \neq \text{pos}(d_2)$, then $\varphi(d_1) \neq \varphi(d_2)$ because φ is shape preserving. If $\text{pos}(d_1) = \text{pos}(d_2)$, then there exists a $w \in \text{pos}(d_1)$ such that $d_1(w) \neq d_2(w)$. But then $\varphi(d_1)(w) \neq \varphi(d_2)(w)$ because the left-hand side nonterminals in $\varphi(d_1)(w)$ and $\varphi(d_2)(w)$ are $d_1(w)$ and $d_2(w)$, respectively (see Figure 10.17). This means that φ is injective. Moreover, φ is surjective because, given a $d \in \text{RT}_{\mathcal{G}}$, we can easily reobtain a $d \in \text{RT}_{\mathcal{H}}$ such that $\varphi(d) = d$. In fact, d can be constructed by replacing, at each position u of d , the rule $d(u)$ of \mathcal{G} by the rule $\text{lhs}(d(u))$ of \mathcal{H} (see again Figure 10.17).

Obviously, it also holds that $\varphi_{b,\xi}$ is weight preserving, i.e., $\text{wt}_{\mathcal{H}}(d) = \text{wt}_{\mathcal{G}}(\varphi_{b,\xi}(d))$ for every $d \in \text{RT}_{\mathcal{H}}(N, b, \xi)$. Then, for every $b \in T_{[\Delta]}$ and $\xi \in T_{\Psi}$, there exists a weight preserving bijection $\overline{\varphi}_{b,\xi} : \text{RT}_{\mathcal{H}}(b, \xi) \rightarrow \text{RT}_{\mathcal{G}}(\xi) \cap (\beta')^{-1}(b)$.

Now we prove property (a). Assume that \mathcal{H} is finite-input and let $\xi \in T_{\Psi}$. Then the set $\{b \in T_{[\Delta]} \mid \text{RT}_{\mathcal{H}}(b, \xi) \neq \emptyset\}$ is finite. Since \mathcal{H} is chain-free, it is also finite-derivational, i.e., the set $\text{RT}_{\mathcal{H}}(b, \xi)$ is finite for every $b \in T_{[\Delta]}$. Since $\varphi_{b,\xi}$ is bijective, we obtain that the set $\text{RT}_{\mathcal{G}}(\xi) \cap (\beta')^{-1}(b)$ is finite for each $b \in T_{[\Delta]}$ and thus the set $\{b \in T_{[\Delta]} \mid \text{RT}_{\mathcal{G}}(\xi) \cap (\beta')^{-1}(b) \neq \emptyset\}$ is also finite. Moreover, the family $(\text{RT}_{\mathcal{G}}(\xi) \cap (\beta')^{-1}(b) \mid b \in T_{[\Delta]})$ is a partitioning of $\text{RT}_{\mathcal{G}}(\xi)$. Thus, $\text{RT}_{\mathcal{G}}(\xi)$ is finite and hence \mathcal{G} is finite-derivational. This proves (a).

Finally we prove Property (b): $\llbracket \mathcal{H} \rrbracket^{\text{tt}}(\chi(T_{[\Delta]})) = \llbracket \mathcal{G} \rrbracket$. For this, let $\xi \in T_{\Psi}$. Then

$$\begin{aligned} (\llbracket \mathcal{H} \rrbracket^{\text{tt}}(\chi(T_{[\Delta]})))(\xi) &= \sum_{b \in T_{[\Delta]}}^{\oplus} \chi(T_{[\Delta]})(b) \otimes \llbracket \mathcal{H} \rrbracket^{\text{tt}}(b, \xi) \\ &\quad \text{(by (2.44) because } \llbracket \mathcal{H} \rrbracket \text{ is finite-input or } \mathbf{B} \text{ is } \sigma\text{-complete)} \\ &= \sum_{b \in T_{[\Delta]}}^{\oplus} \llbracket \mathcal{H} \rrbracket^{\text{tt}}(b, \xi) \\ &= \sum_{b \in T_{[\Delta]}}^{\oplus} \bigoplus_{d \in \text{RT}_{\mathcal{H}}(b, \xi)} \text{wt}_{\mathcal{H}}(d) \quad \text{(because } \mathcal{H} \text{ is chain-free and hence finite-derivational)} \\ &= \sum_{b \in T_{[\Delta]}}^{\oplus} \bigoplus_{d \in \text{RT}_{\mathcal{G}}(\xi) \cap (\beta')^{-1}(b)} \text{wt}_{\mathcal{G}}(d) \quad \text{(because } \overline{\varphi}_{b,\xi} \text{ is bijective and weight preserving)} \\ &= \sum_{d \in \text{RT}_{\mathcal{G}}(\xi)}^{\oplus} \text{wt}_{\mathcal{G}}(d) = \llbracket \mathcal{G} \rrbracket(\xi) . \quad \text{(because } \mathcal{G} \text{ is finite-derivational if } \llbracket \mathcal{H} \rrbracket \text{ is finite-input)} \end{aligned}$$

□

10.13.5 Closure result for wrtg and wta

Finally we can prove the closure results for the sets $\text{Reg}(_, \mathbf{B})$ and $\text{Rec}(_, \mathbf{B})$.

Theorem 10.13.9. (cf. [FV22a, Thm. 6.3]) *Let \mathbf{B} be a commutative semiring. Let \mathcal{G} be a (Σ, \mathbf{B}) -wrtg and \mathcal{H} be a $(\Sigma, \Psi, \mathbf{B})$ -wpb such that (both \mathcal{G} and \mathcal{H} are finite-derivational and \mathcal{H} is finite-input) or \mathbf{B} is σ -complete. Then the following two statements hold.*

- (1) *Then there exists a (Ψ, \mathbf{B}) -wrtg \mathcal{G}' such that (a) \mathcal{G}' is finite-derivational if \mathcal{G} is finite-derivational and \mathcal{H} is finite-input and (b) $\llbracket \mathcal{H} \rrbracket^{\text{tt}}(\llbracket \mathcal{G} \rrbracket) = \llbracket \mathcal{G}' \rrbracket$.*
- (2) *If \mathcal{H} is finite-derivational, then we can construct a (Ψ, \mathbf{B}) -wrtg \mathcal{G}' such that (a) \mathcal{G}' is finite-derivational if \mathcal{G} is finite-derivational and \mathcal{H} is finite-input and (b) $\llbracket \mathcal{H} \rrbracket^{\text{tt}}(\llbracket \mathcal{G} \rrbracket) = \llbracket \mathcal{G}' \rrbracket$.*

Proof. Proof of (1): Let $\mathcal{G} = (N, S, R, \text{wt})$. By Lemma 9.2.2, we may assume that \mathcal{G} is alphabetic. Then, by Lemma 10.13.6, we can construct a chain-free $([R], \Sigma, \mathbf{B})$ -wpb $\mathcal{H}_{\mathcal{G}}$ such that $\mathcal{H}_{\mathcal{G}}$ is finite-output, $\mathcal{H}_{\mathcal{G}}$ is finite-input if \mathcal{G} is finite-derivational, and $\llbracket \mathcal{G} \rrbracket = \llbracket \mathcal{H}_{\mathcal{G}} \rrbracket^{\text{tt}}(\chi(\mathbb{T}_{[R]}))$. In particular, since $\mathcal{H}_{\mathcal{G}}$ is chain-free, it is also finite-derivational. Then

$$\llbracket \mathcal{H} \rrbracket^{\text{tt}}(\llbracket \mathcal{G} \rrbracket) = \llbracket \mathcal{H} \rrbracket^{\text{tt}}(\llbracket \mathcal{H}_{\mathcal{G}} \rrbracket^{\text{tt}}(\chi(\mathbb{T}_{[R]}))) = (\llbracket \mathcal{H}_{\mathcal{G}} \rrbracket^{\text{tt}}; \llbracket \mathcal{H} \rrbracket^{\text{tt}})(\chi(\mathbb{T}_{[R]})) ,$$

where the last equality is due to Observation 2.12.3 (recall that \mathbf{B} is a semiring). Any of the two conditions that (i) $\llbracket \mathcal{H}_{\mathcal{G}} \rrbracket^{\text{tt}}$ is supp-o-finite and (ii) $\llbracket \mathcal{H} \rrbracket^{\text{tt}}$ is supp-i-finite or \mathbf{B} is σ -complete, assures that by Theorem 10.13.7(1) there exists an $([R], \Psi, \mathbf{B})$ -wpb \mathcal{H}' such that $\llbracket \mathcal{H}' \rrbracket^{\text{tt}} = \llbracket \mathcal{H}_{\mathcal{G}} \rrbracket^{\text{tt}}; \llbracket \mathcal{H} \rrbracket^{\text{tt}}$. If \mathcal{H} and $\mathcal{H}_{\mathcal{G}}$ are finite-input, then by Theorem 10.13.7(3), also \mathcal{H}' is finite-input. By Lemma 10.13.5(1) we can assume that \mathcal{H}' is chain-free and finite-input.

Finally, by Lemma 10.13.8, if \mathcal{H}' is given, then we can construct a (Ψ, \mathbf{B}) -wrtg \mathcal{G}' such that \mathcal{G}' is finite-derivational \mathcal{H}' is finite-input and $\llbracket \mathcal{H}' \rrbracket^{\text{tt}}(\chi(\mathbb{T}_{[R]})) = \llbracket \mathcal{G}' \rrbracket$.

Proof of (2): Now assume that \mathcal{H} is finite-derivational. Then we follow the proof of (1) and, instead of Theorem 10.13.7(1) and Lemma 10.13.5(1), we apply Theorem 10.13.7(2) and Lemma 10.13.5(2), respectively. Hence, we can even construct \mathcal{H}' . Thus we can also construct \mathcal{G}' with the mentioned properties. \square

Corollary 10.13.10. Let Σ and Ψ be ranked alphabets such that $\Sigma^{(0)} \neq \emptyset \neq \Psi^{(0)}$, let \mathbf{B} be a commutative semiring, and let \mathcal{A} be a (Σ, \mathbf{B}) -wta. Moreover, let \mathcal{H} be a $(\Sigma, \Psi, \mathbf{B})$ -wpb such that (a) \mathcal{H} is finite-derivational and finite-input or (b) \mathbf{B} is σ -complete. Then we can construct a (Ψ, \mathbf{B}) -wta \mathcal{A}' such that $\llbracket \mathcal{H} \rrbracket^{\text{tt}}(\llbracket \mathcal{A} \rrbracket) = \llbracket \mathcal{A}' \rrbracket$. Thus, in particular, if \mathbf{B} is a commutative semiring, then $\text{Rec}(_, \mathbf{B})$ is closed under weighted projective bimorphisms.

Proof. By Lemma 9.2.6 we can construct a (Σ, \mathbf{B}) -wrtg \mathcal{G} such that \mathcal{G} is in tree automata form and $\llbracket \mathcal{A} \rrbracket = \llbracket \mathcal{G} \rrbracket$. Then, in particular, \mathcal{G} is finite-derivational. By Theorem 10.13.9 we can construct a finite-derivational (Ψ, \mathbf{B}) -wrtg \mathcal{G}' such that $\llbracket \mathcal{H} \rrbracket^{\text{tt}}(\llbracket \mathcal{G} \rrbracket) = \llbracket \mathcal{G}' \rrbracket$. Finally, by Lemma 9.2.8, we can construct a (Σ, \mathbf{B}) -wta \mathcal{A}' such that $\llbracket \mathcal{G}' \rrbracket = \llbracket \mathcal{A}' \rrbracket$. \square

10.13.6 Closure under Hadamard product: an alternative proof

We have proved that the set of recognizable (Σ, \mathbf{B}) -weighted tree languages is closed under Hadamard product if \mathbf{B} is a commutative semiring (cf. Theorem 10.4.1). This closure also follows from the closure of this set under weighted projective bimorphisms.

Corollary 10.13.11. (cf. Theorem 10.4.1) Let \mathbf{B} be a commutative semiring. Moreover, let \mathcal{A}_1 and \mathcal{A}_2 be two (Σ, \mathbf{B}) -wta. Then we can construct a (Σ, \mathbf{B}) -wta \mathcal{B} such that $\llbracket \mathcal{B} \rrbracket = \llbracket \mathcal{A}_1 \rrbracket \otimes \llbracket \mathcal{A}_2 \rrbracket$.

Proof. Let $\mathcal{A}_2 = (Q, \delta, F)$. By Theorem 7.3.1 we can assume that \mathcal{A}_2 is root weight normalized and $\text{supp}(F) = \{q_f\}$. We construct the $(\Sigma, \Sigma, \mathbf{B})$ -wpb $\mathcal{H} = (N, S, R, wt)$ as follows.

- $N = Q$ and $S = \{q_f\}$,
- For every $k \in \mathbb{N}$, $\sigma \in \Sigma^{(k)}$, $q \in Q$, and $q_1 \cdots q_k \in Q^k$, the rule $r = (q \rightarrow [\sigma, \sigma](q_1, \dots, q_k))$ is in R and $wt(r) = \delta_k(q_1 \cdots q_k, \sigma, q)$.

We note that \mathcal{H} is in tree automata form and finite-input. Then it is easy to see that $\llbracket \mathcal{H} \rrbracket^{\text{tt}} = \overline{\llbracket \mathcal{A}_2 \rrbracket}$, i.e., $\llbracket \mathcal{H} \rrbracket^{\text{tt}}$ is the diagonalization of $\llbracket \mathcal{A}_2 \rrbracket$ (cf. (2.42)). Then by Equation (2.43) we have $\llbracket \mathcal{H} \rrbracket^{\text{tt}}(\llbracket \mathcal{A}_1 \rrbracket) = \llbracket \mathcal{A}_1 \rrbracket \otimes \llbracket \mathcal{A}_2 \rrbracket$ and thus by Corollary 10.13.10 we can construct a (Σ, \mathbf{B}) -wta \mathcal{B} such that $\llbracket \mathcal{B} \rrbracket = \llbracket \mathcal{H} \rrbracket^{\text{tt}}(\llbracket \mathcal{A}_1 \rrbracket)$. \square

10.13.7 Closure under yield-intersection with weighted recognizable languages: an alternative proof

For every (Σ, \mathbf{B}) -wta \mathcal{A} , $\Gamma \subseteq \Sigma^{(0)}$, and (Γ, \mathbf{B}) -wsa \mathcal{B} , we have constructed a (Σ, \mathbf{B}) -wta \mathcal{A}' such that $\llbracket \mathcal{A}' \rrbracket = \llbracket \mathcal{A} \rrbracket \otimes (\llbracket \mathcal{B} \rrbracket \circ \text{yield}_\Gamma)$, if \mathbf{B} is a commutative semiring (cf. Theorem 10.8.2). Here we give an alternative proof which uses the fact that the set of recognizable (Σ, \mathbf{B}) -weighted tree languages is closed under weighted projective bimorphisms.

Corollary 10.13.12. (cf. Theorem 10.8.2) Let \mathbf{B} be a commutative semiring and $\Gamma \subseteq \Sigma^{(0)}$. For every (Σ, \mathbf{B}) -wta \mathcal{A} and every wsa \mathcal{B} over Γ and \mathbf{B} , we can construct a (Σ, \mathbf{B}) -wta \mathcal{A}' such that $\llbracket \mathcal{A}' \rrbracket = \llbracket \mathcal{A} \rrbracket \otimes (\llbracket \mathcal{B} \rrbracket \circ \text{yield}_\Gamma)$. Thus, in particular, the set $\text{Rec}^{\text{rwm}}(\Sigma, \mathbf{B})$ is closed under yield-intersection.

Proof. Let $\mathcal{B} = (P, \lambda, \mu, \gamma)$ be a $(\Sigma^{(0)}, \mathbf{B})$ -wsa.

The idea is to construct a $(\Sigma, \Sigma, \mathbf{B})$ -wpb \mathcal{H} such that, for every $\xi, \zeta \in T_\Sigma$ we have

$$\llbracket \mathcal{H} \rrbracket^{\text{tt}}(\xi, \zeta) = \begin{cases} \llbracket \mathcal{B} \rrbracket(\text{yield}_\Gamma(\zeta)) & \text{if } \xi = \zeta \\ 0 & \text{otherwise .} \end{cases} \quad (10.53)$$

We construct $\mathcal{H} = (N, S, R, wt)$ as follows.

- $N = (P \times P) \cup \{S\}$ where S is a new symbol, and
- R and wt are defined as follows:
 - for each $(p, p') \in N$, the rule $r = (S \rightarrow (p, p'))$ is in R and we let $wt(r) = \lambda(p) \otimes \gamma(p')$,
 - for each $\alpha \in \Gamma$ and $(p, p') \in P \times P$ we let $r = ((p, p') \rightarrow [\alpha, \alpha])$ be a rule in R with $wt(r) = \mu(p, \alpha, p')$,
 - for each $\alpha \in \Sigma^{(0)} \setminus \Gamma$ and $p \in P$ we let $r = ((p, p) \rightarrow [\alpha, \alpha])$ be a rule in R with $wt(r) = \mathbb{1}$, and
 - for every $k \in \mathbb{N}_+$, $\sigma \in \Sigma^{(k)}$, and $(p_1, p'_1), (p_2, p'_2), \dots, (p_k, p'_k), (p, p') \in N$ we let the rule $r = ((p, p') \rightarrow [\sigma, \sigma]((p_1, p'_1), \dots, (p_k, p'_k)))$ be in R with

$$wt(r) = \begin{cases} \mathbb{1} & \text{if } p = p_1, p'_i = p_{i+1} \text{ for each } i \in [k-1], \text{ and } p'_k = p' \\ 0 & \text{otherwise.} \end{cases}$$

Then \mathcal{H} is finite-derivational and finite-input, and hence $\llbracket \mathcal{H} \rrbracket^{\text{tt}}$ is supp-i-finite. Moreover, apart from the chain rules of the form $S \rightarrow (p, p')$, the wpb \mathcal{H} closely corresponds to the wta \mathcal{A} constructed in the proof of Lemma 10.8.1. Indeed, there exists a bijection between $\text{RT}_{\mathcal{H}}(\xi, \xi)$ and $\text{R}_{\mathcal{A}}(\xi)$, which is defined in a similar way as the bijection in the proof of Lemma 9.2.5.

It is quite obvious that (10.53) holds. Since $\llbracket \mathcal{H} \rrbracket^{\text{tt}}$ is supp-i-finite, $\llbracket \mathcal{A} \rrbracket$ is $\llbracket \mathcal{H} \rrbracket^{\text{tt}}$ -summable. Hence $\llbracket \mathcal{H} \rrbracket^{\text{tt}}(\llbracket \mathcal{A} \rrbracket)$ is defined. Then, for each $\zeta \in T_\Sigma$, we have

$$\begin{aligned} \llbracket \mathcal{H} \rrbracket^{\text{tt}}(\llbracket \mathcal{A} \rrbracket)(\zeta) &= \sum_{\xi \in T_\Sigma}^{\oplus} \llbracket \mathcal{A} \rrbracket(\xi) \otimes \llbracket \mathcal{H} \rrbracket^{\text{tt}}(\xi, \zeta) \\ &= \llbracket \mathcal{A} \rrbracket(\zeta) \otimes \llbracket \mathcal{H} \rrbracket^{\text{tt}}(\zeta, \zeta) && \text{(by the second case of (10.53))} \\ &= (\llbracket \mathcal{A} \rrbracket \otimes (\llbracket \mathcal{B} \rrbracket \circ \text{yield}_\Gamma))(\zeta) && \text{(by the first case of (10.53))} \end{aligned}$$

By Corollary 10.13.10 we can construct a (Σ, \mathbf{B}) -wta \mathcal{A}' such that $\llbracket \mathcal{A}' \rrbracket = \llbracket \mathcal{H} \rrbracket^{\text{tt}}(\llbracket \mathcal{A} \rrbracket)$. \square

10.13.8 Closure under tree relabelings: an alternative proof

Finally, we show that each tree relabeling can be computed by a particular weighted projective bimorphism. Then, for the case that \mathbf{B} is a commutative semiring, the closure of $\text{Rec}(-, \mathbf{B})$ under tree relabelings (cf. Theorem 10.10.1) can be reobtained as corollary of Corollary 10.13.10. However, we recall that Theorem 10.10.1 holds for arbitrary strong bimonoids and not only for commutative semirings.

Observation 10.13.13. Let τ be a (Σ, Δ) -tree relabeling and $r : T_\Sigma \rightarrow B$. Then we can construct a chain-free, finite-input, and finite-output $(\Sigma, \Delta, \mathbf{B})$ -wpb \mathcal{H} such that $\tau(r) = \llbracket \mathcal{H} \rrbracket^{\text{tt}}(r)$.

Proof. Let $\tau = (\tau_k \mid k \in \mathbb{N})$. We construct the $(\Sigma, \Delta, \mathbf{B})$ -wpb $\mathcal{H} = (\{S_0\}, S_0, R, \text{wt})$ as follows. For every $k \in \mathbb{N}$, $\sigma \in \Sigma^{(k)}$, and $\gamma \in \tau_k(\sigma)$, the set R contains the rule $r = (S_0 \rightarrow [\sigma, \gamma](S_0, \dots, S_0))$ with k occurrences of S_0 and $\text{wt}(r) = \mathbb{1}$. Clearly, \mathcal{H} has the desired properties. In particular, $\llbracket \mathcal{H} \rrbracket^{\text{tt}}$ is supp-i-finite.

Then for every $\xi \in T_\Sigma$ and $\zeta \in T_\Delta$: $\llbracket \mathcal{H} \rrbracket^{\text{tt}}(\xi, \zeta) \in \{0, \mathbb{1}\}$, and $\llbracket \mathcal{H} \rrbracket^{\text{tt}}(\xi, \zeta) = \mathbb{1}$ if and only if $\zeta \in \tau(\xi)$. Now let $\zeta \in T_\Delta$. Then we can calculate as follows:

$$\tau(r)(\zeta) = \bigoplus_{\xi \in \tau^{-1}(\zeta)} r(\xi) = \bigoplus_{\xi \in T_\Sigma} r(\xi) \otimes \llbracket \mathcal{H} \rrbracket^{\text{tt}}(\xi, \zeta) = (\llbracket \mathcal{H} \rrbracket^{\text{tt}}(r))(\zeta)$$

Hence $\tau(r) = \llbracket \mathcal{H} \rrbracket^{\text{tt}}(r)$. □

The following corollary follows from Corollary 10.13.10 and Observation 10.13.13.

Corollary 10.13.14. Let \mathbf{B} be a commutative semiring and \mathcal{A} be a (Σ, \mathbf{B}) -wta. Moreover, let τ be a (Σ, Δ) -tree relabeling. Then we can construct a (Δ, \mathbf{B}) -wta \mathcal{A}' such that $\tau(\llbracket \mathcal{A} \rrbracket) = \llbracket \mathcal{A}' \rrbracket$ (cf. Theorem 10.10.1). Thus, in particular, if \mathbf{B} is a commutative semiring, then the set $\text{Rec}(-, \mathbf{B})$ is closed under tree relabelings.

10.14 Summary of some of the closure properties

In the three tables of Figure 10.18 we summarize some of the closure properties of the set of weighted tree languages recognized by wta. Each entry refers to the theorem or corollary where the precise formulation of the closure property can be found; in the figure we only have indicated the additionally required properties of the strong bimonoid. For some of the operations in the first table and the third table, we could only prove the corresponding closure property for the case that \mathbf{B} is a semiring; for a few other operations we did not need distributivity from both sides. In the summary, we did not consider the case of bu-deterministic and crisp-deterministic wta.

	$\text{Rec}^{\text{run}}(\Sigma, \mathbf{B})$	$\text{Rec}^{\text{init}}(\Sigma, \mathbf{B})$	$\text{Rec}(\Sigma, \mathbf{B})$
sum	Thm. 10.1.1	Thm. 10.1.1	Thm. 10.1.1
scalar multiplications ... from left	Thm. 10.2.1(1) (left-distr.)	Thm. 10.2.1(1) (left-distr.)	Thm. 10.2.1(1)
... from right	Thm. 10.2.1(2) (right-distr.)	Thm. 10.2.1(2) (right-distr.)	Thm. 10.2.1(2)
Hadamard product			Thm. 10.4.1, also Cor. 10.13.11 (commutative)
top-concatenations			Cor. 10.5.2
tree concatenations			Cor. 10.6.2 (commutative)
Kleene stars			Cor. 10.7.7 (commutative)
yield-intersection			Thm. 10.8.2, also Cor. 10.13.12 (commutative)

	$\text{Rec}^{\text{run}}(\Sigma, _)$	$\text{Rec}^{\text{init}}(\Sigma, _)$	$\text{Rec}(\Sigma, _)$
strong bimonoid hom.	Thm. 10.9.2	Thm. 10.9.2	Thm. 10.9.2

	$\text{Rec}^{\text{run}}(_, \mathbf{B})$	$\text{Rec}^{\text{init}}(_, \mathbf{B})$	$\text{Rec}(_, \mathbf{B})$
tree relabeling	Thm. 10.10.1		Thm. 10.10.1, also Cor. 10.13.14
linear, nondeleting, and productive tree hom.	Cor. 10.11.2		Cor. 10.11.2
inverse of linear tree hom.			Thm. 10.12.2 (commutative)
weighted projective bimorphisms (finite-derivational, finite-input or \mathbf{B} σ -complete)			Cor. 10.13.10 (commutative)

Figure 10.18: A summary of some closure properties of some sets of weighted tree languages recognized by wta, where “distr.” and “hom.” abbreviate distributive and homomorphisms, respectively, and in the third column \mathbf{B} is a semiring.

Chapter 11

Characterizations by weighted local systems

In this chapter we show two characterization theorems for wta. The first one is Theorem 11.2.6; it is based on a decomposition theorem of wta which is due to [Fül15]. The latter result generalizes the fact that each recognizable tree language is the image of a local tree language under a deterministic tree relabeling [Tha67, Prop. 2] (cf. [GS84, Thm. 2.9.5] and [Eng75b, Cor. 3.59(i)⇒(ii)]).

The second characterization theorem is Theorem 11.3.1, which follows the idea of decomposing a bottom-up tree transducer. In [Eng75a, Thm. 3.5] it was proved that each bottom-up tree transducer can be decomposed into a relabeling, followed by the intersection with a local tree language, followed by a tree homomorphism. Also the reverse composition result holds [Eng75a, p.220]. In Theorem 11.3.1(A) ⇒ (B) we decompose the run semantics $[\mathcal{A}]^{\text{run}}$ of a (Σ, \mathcal{B}) -wta \mathcal{A} into an inverse deterministic tree relabeling (corresponding to the above relabeling), followed by the intersection with a local tree language, followed by a homomorphism which interprets trees in some evaluation algebra with carrier set B (corresponding to the above tree homomorphism). Similar decompositions were proved for weighted tree automata over multioperator monoids [SVF09, Thm. 1].

Before proving the decomposition theorems we recall the definitions of local systems, local tree languages, and weighted local system.

11.1 Local tree languages and weighted local systems

We consider the ranked alphabet $\text{Fork}(\Sigma)$ where $\text{Fork}(\Sigma)^{(k)} = \Sigma^k \times \Sigma^{(k)}$ for each $k \in \mathbb{N}$. Each element of $\text{Fork}(\Sigma)^{(k)}$ has the form $(\sigma_1 \cdots \sigma_k, \sigma)$ with $\sigma_1, \dots, \sigma_k \in \Sigma$ and $\sigma \in \Sigma^{(k)}$, and it is called *k-fork* or just *fork*.

A Σ -local system [GS84, Sec. 2.9] is a pair (K, H) where $K \subseteq \text{Fork}(\Sigma)$ is a set of forks and $H \subseteq \Sigma$. The *tree language generated by* (K, H) , denoted by $L(K, H)$, is defined as follows. First, we let

$$L(K) = \{\xi \in T_\Sigma \mid (\xi(w_1) \cdots \xi(w_k), \xi(w)) \in K \text{ for each } w \in \text{pos}(\xi), \text{ where } k = \text{rk}(\xi(w))\} .$$

Second, we define

$$L(K, H) = \{\xi \in L(K) \mid \xi(\varepsilon) \in H\}.$$

For the particular Σ -local system $(\text{Fork}(\Sigma), \Sigma)$, we have $L(\text{Fork}(\Sigma)) = L(\text{Fork}(\Sigma), \Sigma) = T_\Sigma$. Let $L \subseteq T_\Sigma$. We call L a *local tree language* if there exists a Σ -local system (K, H) such that $L = L(K, H)$.

A (Σ, \mathcal{B}) -weighted local system (for short: (Σ, \mathcal{B}) -wls) [Fül15] is a tuple $\mathcal{S} = (g, F)$ such that $g = (g_k \mid k \in \mathbb{N})$ is an \mathbb{N} -indexed family of mappings $g_k : \text{Fork}(\Sigma)^{(k)} \rightarrow B$ and $F : \Sigma \rightarrow B$. We say that \mathcal{S} has *identity root weights* if $\text{im}(F) \subseteq \{0, 1\}$.

We define the mapping $g' : T_\Sigma \rightarrow B$ by induction on T_Σ . For every $\xi = \sigma(\xi_1, \dots, \xi_k)$, we let

$$g'(\xi) = g'(\xi_1) \otimes \cdots \otimes g'(\xi_k) \otimes g_k(\xi_1(\varepsilon) \cdots \xi_k(\varepsilon), \sigma) .$$

In the following we drop the prime from g' and simply write g for g' . The (Σ, B) -weighted tree language determined by \mathcal{S} , denoted by $\llbracket \mathcal{S} \rrbracket$, is the mapping $\llbracket \mathcal{S} \rrbracket : T_\Sigma \rightarrow B$ defined for each $\xi \in T_\Sigma$ by

$$\llbracket \mathcal{S} \rrbracket(\xi) = g(\xi) \otimes F(\xi(\varepsilon)) .$$

Since the value $g(\sigma(\xi_1, \dots, \xi_k)) \in B$ depends on the root labels of ξ_1, \dots, ξ_k , in general there does not exist a Σ -algebra (B, λ) such that g is the unique Σ -algebra homomorphism from $(T_\Sigma, \theta_\Sigma)$ to (B, λ) .

Example 11.1.1. We consider the ranked alphabet $\Sigma = \{\sigma^{(2)}, \gamma^{(1)}, \alpha^{(0)}\}$ and the weighted tree language $\#_{\sigma^{(\cdot, \alpha)}} : T_\Sigma \rightarrow \mathbb{N}$ defined in Example 3.2.11, where $\#_{\sigma^{(\cdot, \alpha)}}(\xi)$ is the number of occurrences of the pattern $\sigma^{(\cdot, \alpha)}$ in ξ for each $\xi \in T_\Sigma$.

We define the $(\Sigma, \text{Nat}_{\max, +})$ -wls $\mathcal{S} = (g, F)$ such that

- for every $\theta_1, \theta_2 \in \Sigma$ we let $g_2(\theta_1\theta_2, \sigma) = 1$ if $\theta_1\theta_2 \in \{\sigma\alpha, \gamma\alpha, \alpha\alpha\}$ and 0 otherwise; and we let $g_1(\theta_1, \gamma) = 0$ and $g_0(\varepsilon, \alpha) = 0$, and
- $F(\sigma) = F(\gamma) = F(\alpha) = 0$.

It should be clear that $\llbracket \mathcal{S} \rrbracket(\xi) = \#_{\sigma^{(\cdot, \alpha)}}(\xi)$ for each $\xi \in T_\Sigma$. □

Let (K, H) be a Σ -local system and $\kappa = (\kappa_k \mid k \in \mathbb{N})$ an \mathbb{N} -indexed family of mappings $\kappa_k : \Sigma^{(k)} \rightarrow B$. We interpret the trees in $L(K, H)$ by the unique Σ -algebra homomorphism $h_{M(\Sigma, \kappa)} : T_\Sigma \rightarrow B$, where $M(\Sigma, \kappa)$ is the (Σ, κ) -evaluation algebra defined in Section 2.10. Then we obtain the following (Σ, B) -weighted tree language:

$$\begin{aligned} (\chi(L(K, H)) \otimes h_{M(\Sigma, \kappa)}) : T_\Sigma &\rightarrow B \\ \xi &\mapsto \begin{cases} h_{M(\Sigma, \kappa)}(\xi) & \text{if } \xi \in L(K, H) \\ 0 & \text{otherwise} . \end{cases} \end{aligned}$$

In the next lemma we prove that the weighted tree language $\chi(L(K, H)) \otimes h_{M(\Sigma, \kappa)}$ can be computed by a (Σ, B) -wls.

Lemma 11.1.2. Let (K, H) be a Σ -local system and $\kappa = (\kappa_k \mid k \in \mathbb{N})$ a family of mappings $\kappa_k : \Sigma^{(k)} \rightarrow B$. We can construct a (Σ, B) -wls \mathcal{S} which has identity root weights such that $\llbracket \mathcal{S} \rrbracket = \chi(L(K, H)) \otimes h_{M(\Sigma, \kappa)}$.

Proof. We define the (Σ, B) -wls $\mathcal{S} = (g, F)$ as follows. For every $k \in \mathbb{N}$ and $\sigma_1, \dots, \sigma_k \in \Sigma$, and $\sigma \in \Sigma^{(k)}$, we have

$$g_k(\sigma_1 \cdots \sigma_k, \sigma) = \begin{cases} \kappa_k(\sigma) & \text{if } (\sigma_1 \cdots \sigma_k, \sigma) \in K \\ 0 & \text{otherwise} \end{cases} \quad \text{and} \quad F(\sigma) = \begin{cases} 1 & \text{if } \sigma \in H \\ 0 & \text{otherwise.} \end{cases}$$

By induction on T_Σ , we prove that the following statement holds:

$$\text{For each } \xi \in T_\Sigma, \text{ we have } g(\xi) = \begin{cases} h_{M(\Sigma, \kappa)}(\xi) & \text{if } \xi \in L(K) \\ 0 & \text{otherwise.} \end{cases} \quad (11.1)$$

Let $\xi = \sigma(\xi_1, \dots, \xi_k)$. Then

$$g(\xi) = \left(\bigotimes_{i \in [k]} g(\xi_i) \right) \otimes g_k(\xi_1(\varepsilon) \cdots \xi_k(\varepsilon), \sigma)$$

$$\begin{aligned}
&= \begin{cases} \left(\bigotimes_{i \in [k]} h_{M(\Sigma, \kappa)}(\xi_i) \right) \otimes g_k(\xi_1(\varepsilon) \cdots \xi_k(\varepsilon), \sigma) & \text{if } (\forall i \in [k]) : \xi_i \in L(K) \\ 0 & \text{otherwise} \end{cases} \quad (\text{by I.H.}) \\
&= \begin{cases} \left(\bigotimes_{i \in [k]} h_{M(\Sigma, \kappa)}(\xi_i) \right) \otimes \kappa_k(\sigma) & \text{if } (\forall i \in [k]) : \xi_i \in L(K) \\ & \text{and } (\xi_1(\varepsilon) \cdots \xi_k(\varepsilon), \sigma) \in K \\ 0 & \text{otherwise} \end{cases} \quad (\text{by the definition of } g_k) \\
&= \begin{cases} h_{M(\Sigma, \kappa)}(\xi) & \text{if } \xi \in L(K) \\ 0 & \text{otherwise.} \end{cases}
\end{aligned}$$

This proves (11.1). Now let $\xi \in T_\Sigma$. Then

$$\llbracket \mathcal{S} \rrbracket(\xi) = g(\xi) \otimes F(\xi(\varepsilon)) = \begin{cases} g(\xi) & \text{if } \xi \in L(K) \\ & \text{and } \xi(\varepsilon) \in H \\ 0 & \text{otherwise} \end{cases} = \begin{cases} h_{M(\Sigma, \kappa)}(\xi) & \text{if } \xi \in L(K, H) \\ 0 & \text{otherwise} \end{cases}$$

where the last equality is due to (11.1). \square

It seems that the inverse of Lemma 11.1.2 does not hold, because mappings of the form $g_k : \text{Fork}(\Sigma)^{(k)} \rightarrow B$ cannot be coded by mappings of the form $\kappa_k : \Sigma^{(k)} \rightarrow B$.

In the next lemma, we prove that, for each (Σ, Boole) -wls $\mathcal{S} = (g, F)$, the support of $\llbracket \mathcal{S} \rrbracket$ is a local tree language. As preparation, we define the *support local system* of \mathcal{S} , denoted by $\text{supp}(\mathcal{S})$, to be the Σ -local system (K, H) , where $K = \bigcup_{k \in \mathbb{N}} \text{supp}(g_k)$ and $H = \text{supp}(F)$.

Lemma 11.1.3. Let $\mathcal{S} = (g, F)$ be a (Σ, Boole) -wls. Then $\text{supp}(\llbracket \mathcal{S} \rrbracket) = L(\text{supp}(\mathcal{S}))$.

Proof. Let $\text{supp}(\mathcal{S}) = (K, H)$. By induction on T_Σ , we prove that the following statement holds:

$$\text{For each } \xi \in T_\Sigma, \text{ we have } \xi \in \text{supp}(g) \text{ if and only if } \xi \in L(K). \quad (11.2)$$

For this, let $\xi = \sigma(\xi_1, \dots, \xi_k)$. Then

$$\begin{aligned}
\xi \in \text{supp}(g) &\iff g(\xi_1) \wedge \cdots \wedge g(\xi_k) \wedge g_k(\xi_1(\varepsilon) \cdots \xi_k(\varepsilon), \sigma) = 1 \\
&\iff (\forall i \in [k]) : \xi_i \in \text{supp}(g_i) \text{ and } g_k(\xi_1(\varepsilon) \cdots \xi_k(\varepsilon), \sigma) = 1 \\
&\iff (\forall i \in [k]) : \xi_i \in L(K) \text{ and } (\xi_1(\varepsilon) \cdots \xi_k(\varepsilon), \sigma) \in K \\
&\hspace{15em} (\text{by I.H. and the definition of } K) \\
&\iff \xi \in L(K).
\end{aligned}$$

This proves (11.2). Then for each $\xi \in T_\Sigma$ we have

$$\xi \in \text{supp}(\llbracket \mathcal{S} \rrbracket) \iff g(\xi) = 1 \text{ and } F(\xi(\varepsilon)) = 1 \iff \xi \in L(K) \text{ and } \xi(\varepsilon) \in H \iff \xi \in L(K, H). \quad \square$$

The next theorem states that, intuitively, Σ -local systems and (Σ, Boole) -wls are essentially the same.

Theorem 11.1.4. Let $L \subseteq T_\Sigma$ be a tree language. The following two statements are equivalent.

- (A) We can construct a Σ -local system (K, H) such that $L = L(K, H)$.
- (B) We can construct a (Σ, Boole) -wls \mathcal{S} such that $L = \text{supp}(\llbracket \mathcal{S} \rrbracket)$.

Proof. Proof of (A) \Rightarrow (B): Let $\kappa = (\kappa_k \mid k \in \mathbb{N})$ be a family of mappings $\kappa_k : \Sigma^{(k)} \rightarrow \mathbb{B}$ such that $\kappa_k(\sigma) = 1$ for every $k \in \mathbb{N}$ and $\sigma \in \Sigma^{(k)}$. Then

$$L = L(K, H) = \text{supp}(\chi(L(K, H))) = \text{supp}(\chi(L(K, H)) \otimes h_{M(\Sigma, \kappa)}) .$$

By Lemma 11.1.2, we can construct a (Σ, Boole) -wls \mathcal{S} such that $\chi(L(K, H)) \otimes h_{M(\Sigma, \kappa)} = \llbracket \mathcal{S} \rrbracket$. Thus $L = \text{supp}(\llbracket \mathcal{S} \rrbracket)$.

Proof of (B) \Rightarrow (A): This follows from Lemma 11.1.3. \square

11.2 Characterization by weighted local system and deterministic relabeling

In this section we prove the first characterization theorem for recognizable weighted tree languages. Roughly speaking, it says that each recognizable (Σ, \mathbf{B}) -weighted tree language can be represented as the application of some deterministic tree relabeling to the weighted rule tree language of some wrtg in tree automata form (cf. Theorem 11.2.6).

As preparation, we recall the well known fact that the rule tree language of a context-free grammar is a local tree language (cf. [Tha67, Prop. 1], also cf. [Eng75b, Thm. 3.57] and [GS84, Thm. 3.2.9]).

Lemma 11.2.1. Let G be a Γ -cfg with rule set R . We can construct an R -local system (K, H) such that $L(K, H) = \text{RT}_G$.

Proof. Let $G = (N, S, R)$. We construct the R -local system (K, H) as follows.

We construct the set $K \subseteq \text{Fork}(R)$ such that, for every $r = (A \rightarrow u_0 A_1 u_1 \cdots A_k u_k)$ in R and every $r_1 = (A_1 \rightarrow \alpha_1), \dots, r_k = (A_k \rightarrow \alpha_k)$ in R , the tuple $(r_1 \cdots r_k, r)$ is in K .

Moreover, we let $H = \{r \mid \text{lhs}(r) \in S\}$. It is obvious that $L(K, H) = \text{RT}_G$. \square

We note that, due to [Eng75b, Thm. 3.57], the inverse of Lemma 11.2.1 does not hold. Next we generalize Lemma 11.2.1 to the weighted case.

Lemma 11.2.2. Let \mathcal{G} be a (Γ, \mathbf{B}) -wcfg with rule set R . The following two statements hold.

- (1) We can construct an R -local system (K, H) such that $\llbracket \mathcal{G} \rrbracket^{\text{wrt}} = \chi(L(K, H)) \otimes \text{wt}_{\mathcal{G}}$.
- (2) We can construct an (R, \mathbf{B}) -wls \mathcal{S} with identity root weights such that $\llbracket \mathcal{G} \rrbracket^{\text{wrt}} = \llbracket \mathcal{S} \rrbracket$.

Proof. Let $\mathcal{G} = (N, S, R, \text{wt})$ and G be the Γ -cfg underlying \mathcal{G} . We construct the R -local system (K, H) as in Lemma 11.2.1 and then, for (K, H) and wt , the (R, \mathbf{B}) -wls \mathcal{S} as in Lemma 11.1.2. Then we obtain

$$\begin{aligned}
\llbracket \mathcal{G} \rrbracket^{\text{wrt}} &= \chi(\text{RT}_{\mathcal{G}}) \otimes \text{wt}_{\mathcal{G}} && \text{(by definition and because } \text{wt}_{\mathcal{G}} \otimes \chi(\text{RT}_{\mathcal{G}}) = \chi(\text{RT}_{\mathcal{G}}) \otimes \text{wt}_{\mathcal{G}}) \\
&= \chi(\text{RT}_G) \otimes \text{wt}_{\mathcal{G}} \\
&= \chi(L(K, H)) \otimes \text{wt}_{\mathcal{G}} && \text{(by Lemma 11.2.1)} \\
&= \chi(L(K, H)) \otimes \text{h}_{M(R, \text{wt})} && \text{(we recall that } \text{h}_{M(R, \text{wt})} = \text{wt}_{\mathcal{G}} \text{ holds by our convention)} \\
&= \llbracket \mathcal{S} \rrbracket . && \text{(by Lemma 11.1.2)}
\end{aligned}$$

\square

It is known that each local tree language is recognizable [GS84, Thm. 2.9.4]. The following result generalizes this to the weighted case (where [Fül15, Lm. 1] requires that \mathbf{B} is a semiring).

Lemma 11.2.3. [Fül15, Lm. 1] For each (Σ, \mathbf{B}) -wls \mathcal{S} , we can construct a bu-deterministic (Σ, \mathbf{B}) -wta such that $\llbracket \mathcal{A} \rrbracket = \llbracket \mathcal{S} \rrbracket$.

Proof. Let $\mathcal{S} = (g, F)$. We construct the (Σ, \mathbf{B}) -wta $\mathcal{A} = (Q, \delta, F_{\mathcal{A}})$ as follows:

- $Q = \{\bar{\sigma} \mid \sigma \in \Sigma\}$,
- for every $k \in \mathbb{N}$, $\sigma_1 \dots \sigma_k \in \Sigma^k$, $\sigma \in \Sigma^{(k)}$, and $\omega \in \Sigma$,

$$\delta_k(\bar{\sigma}_1 \dots \bar{\sigma}_k, \sigma, \bar{\omega}) = \begin{cases} g_k(\sigma_1 \dots \sigma_k, \sigma) & \text{if } \omega = \sigma \\ 0 & \text{otherwise,} \end{cases}$$

- $F_{\mathcal{A}}(\bar{\sigma}) = F(\sigma)$ for every $\sigma \in \Sigma$.

It is clear that \mathcal{A} is bu-deterministic. Next, by induction on T_Σ , we prove that the following statement holds:

$$\text{For every } \xi \in T_\Sigma \text{ and } \omega \in \Sigma, \text{ we have } h_{\mathcal{A}}(\xi)_{\overline{\omega}} = \begin{cases} g(\xi) & \text{if } \omega = \xi(\varepsilon) \\ 0 & \text{otherwise.} \end{cases} \quad (11.3)$$

Let $\xi = \sigma(\xi_1, \dots, \xi_k)$. Then

$$\begin{aligned} & h_{\mathcal{A}}(\sigma(\xi_1, \dots, \xi_k))_{\overline{\omega}} \\ &= \bigoplus_{\overline{\sigma_1} \cdots \overline{\sigma_k} \in Q^k} h_{\mathcal{A}}(\xi_1)_{\overline{\sigma_1}} \otimes \dots \otimes h_{\mathcal{A}}(\xi_k)_{\overline{\sigma_k}} \otimes \delta_k(\overline{\sigma_1} \cdots \overline{\sigma_k}, \sigma, \overline{\omega}) \\ &= h_{\mathcal{A}}(\xi_1)_{\overline{\xi_1(\varepsilon)}} \otimes \dots \otimes h_{\mathcal{A}}(\xi_k)_{\overline{\xi_k(\varepsilon)}} \otimes \delta_k(\overline{\xi_1(\varepsilon)} \cdots \overline{\xi_k(\varepsilon)}, \sigma, \overline{\omega}) \\ & \quad \text{(because for each } \overline{\sigma_1} \cdots \overline{\sigma_k} \in Q^k \text{ with } \overline{\sigma_1} \cdots \overline{\sigma_k} \neq \overline{\xi_1(\varepsilon)} \cdots \overline{\xi_k(\varepsilon)} \\ & \quad \text{there exists an } i \in [k] \text{ such that } h_{\mathcal{A}}(\xi_i)_{\overline{\sigma_i}} = 0 \text{ by I.H.)} \\ &= g(\xi_1) \otimes \dots \otimes g(\xi_k) \otimes \delta_k(\overline{\xi_1(\varepsilon)} \cdots \overline{\xi_k(\varepsilon)}, \sigma, \overline{\omega}) \quad \text{(by I.H.)} \\ &= \begin{cases} g(\xi_1) \otimes \dots \otimes g(\xi_k) \otimes g_k(\xi_1(\varepsilon) \dots \xi_k(\varepsilon), \sigma) & \text{if } \omega = \sigma \\ 0 & \text{otherwise} \end{cases} \\ &= \begin{cases} g(\sigma(\xi_1, \dots, \xi_k)) & \text{if } \omega = \sigma \\ 0 & \text{otherwise.} \end{cases} \end{aligned}$$

This proves (11.3).

Finally, let $\xi \in T_\Sigma$. Then we get

$$\llbracket \mathcal{A} \rrbracket(\xi) = \bigoplus_{\overline{\omega} \in Q} h_{\mathcal{A}}(\xi)_{\overline{\omega}} \otimes F_{\mathcal{A}}(\overline{\omega}) = g(\xi) \otimes F_{\mathcal{A}}(\overline{\xi(\varepsilon)}) = g(\xi) \otimes F(\xi(\varepsilon)) = \llbracket \mathcal{S} \rrbracket(\xi),$$

where the second equality follows from (11.3) and the other ones from the corresponding definitions. \square

For example, if we apply the construction in Lemma 11.2.3 to the $(\Sigma, \mathbf{Nat}_{\max,+})$ -wls \mathcal{S} of Example 11.1.1, then we obtain the bu-deterministic $(\Sigma, \mathbf{Nat}_{\max,+})$ -wta \mathcal{A} of Example 3.2.12.

Next we verify that Lemma 11.2.3 is a generalization of [GS84, Thm. 2.9.4]. We achieve this by proving that the latter result is equivalent to Lemma 11.2.3 for the case that \mathbf{B} is the semiring \mathbf{Boole} .

Corollary 11.2.4. For each Σ -local system (K, H) , we can construct a bu-deterministic Σ -fta A such that $L(K, H) = L(A)$. Thus, in particular, each local tree language is recognizable.

Proof. Let (K, H) be a Σ -local system. We construct the (Σ, \mathbf{Boole}) -wls $\mathcal{S} = (g, F)$ by letting $g_k = \chi(K \cap \text{Fork}(\Sigma)^{(k)})$ for each $k \in \mathbb{N}$, and $F = \chi(H)$. Then $(K, H) = \text{supp}(\mathcal{S})$ and, by Lemma 11.1.3, we have $L(K, H) = \text{supp}(\llbracket \mathcal{S} \rrbracket)$. By Lemma 11.2.3, we can construct a bu-deterministic (Σ, \mathbf{Boole}) -wta \mathcal{A} such that $L(K, H) = \text{supp}(\llbracket \mathcal{A} \rrbracket)$. By Corollary 3.4.2, we can construct a Σ -fta A such that $L(K, H) = L(A)$. \square

We can easily demonstrate that bu-deterministic wta are more powerful than weighted local systems. For instance, let $\Sigma = \{\gamma^{(1)}, \alpha^{(0)}\}$ and consider the (Σ, \mathbf{Boole}) -weighted tree language r defined by $r(\gamma(\gamma(\alpha))) = 1$ and $r(\xi) = 0$ for every other $\xi \in T_\Sigma$. It is easy to show that $r \in \text{bud-Rec}(\Sigma, \mathbf{Boole})$ and there does not exist a (Σ, \mathbf{Boole}) -wls \mathcal{S} such that $\llbracket \mathcal{S} \rrbracket = r$. To see the latter, we assume that there exists a (Σ, \mathbf{Boole}) -wls $\mathcal{S} = (g, F)$ such that $\llbracket \mathcal{S} \rrbracket = r$. Thus, using ξ as abbreviation for $\gamma(\gamma(\alpha))$, we have $\llbracket \mathcal{S} \rrbracket(\xi) = g(\xi) \wedge F(\gamma) = 1$. Hence $g(\xi) = F(\gamma) = 1$, and thus, in particular, $g_1(\gamma, \gamma) = g_1(\alpha, \gamma) = g_0(\varepsilon, \alpha) = 1$. But this means that, for each $n \in \mathbb{N}_+$, we have $g(\gamma^n(\alpha)) = 1$ and hence $\llbracket \mathcal{S} \rrbracket(\gamma^n(\alpha)) = 1$. This is a contradiction to $\llbracket \mathcal{S} \rrbracket = r$.

It is also known that each recognizable tree language is the image of a rule tree language of some context-free grammar under a deterministic tree relabeling (cf. [Tha67, Prop. 2], [Eng75b, Thm. 3.58]). The next lemma generalizes this to the weighted case.

Lemma 11.2.5. Let \mathcal{A} be a (Σ, \mathbf{B}) -wta. We can construct a (Σ, \mathbf{B}) -wrtg \mathcal{G} in tree automata form with rule set R and a deterministic (R, Σ) -tree relabeling τ such that $\llbracket \mathcal{A} \rrbracket^{\text{run}} = \chi(\tau)(\llbracket \mathcal{G} \rrbracket^{\text{wrt}})$.

Proof. By Lemma 9.2.6 we can construct a (Σ, \mathbf{B}) -wrtg \mathcal{G} in tree automata form such that $\llbracket \mathcal{A} \rrbracket^{\text{run}} = \llbracket \mathcal{G} \rrbracket$. Let R be the set of rules of \mathcal{G} . As argued in Section 9.1, the projection $\pi_{\mathcal{G}} : \mathbb{T}_R \rightarrow \mathbb{T}_{\Sigma}$ is determined by the (R, Σ) -tree homomorphism $\pi_{\mathcal{G}} = ((\pi_{\mathcal{G}})_k \mid k \in \mathbb{N})$ defined, for every $k \in \mathbb{N}$ and $r \in R^{(k)}$ of the form $r = (A \rightarrow \sigma(A_1, \dots, A_k))$, by $(\pi_{\mathcal{G}})_k(r) = \sigma(z_1, \dots, z_k)$ (note that \mathcal{G} is in tree automata form). We construct the deterministic (R, Σ) -tree relabeling $\tau = (\tau_k \mid k \in \mathbb{N})$ such that, for each rule $A \rightarrow \sigma(A_1, \dots, A_k)$, we let

$$\tau_k(A \rightarrow \sigma(A_1, \dots, A_k)) = \sigma .$$

Obviously, the mappings $\pi_{\mathcal{G}} : \mathbb{T}_R \rightarrow \mathbb{T}_{\Sigma}$ and $\tau : \mathbb{T}_R \rightarrow \mathbb{T}_{\Sigma}$ are equal. Then, by definition, we obtain $\llbracket \mathcal{G} \rrbracket = \chi(\pi_{\mathcal{G}})(\llbracket \mathcal{G} \rrbracket^{\text{wrt}}) = \chi(\tau)(\llbracket \mathcal{G} \rrbracket^{\text{wrt}})$. \square

Now we can prove the first characterization theorem.

Theorem 11.2.6. Let Σ be a ranked alphabet such that $\Sigma^{(0)} \neq \emptyset$. Moreover, let \mathbf{B} be a strong bimonoid and let $r : \mathbb{T}_{\Sigma} \rightarrow \mathbf{B}$. Then the following three statements are equivalent.

(A) We can construct a (Σ, \mathbf{B}) -wta \mathcal{A} such that $r = \llbracket \mathcal{A} \rrbracket^{\text{run}}$.

(B) We can construct

- a ranked alphabet R ,
 - a deterministic (R, Σ) -tree relabeling τ , and
 - a (Σ, \mathbf{B}) -wrtg \mathcal{G} in tree automata form with rule set R
- such that $r = \chi(\tau)(\llbracket \mathcal{G} \rrbracket^{\text{wrt}})$.

(C) We can construct

- a ranked alphabet R ,
 - a deterministic (R, Σ) -tree relabeling τ , and
 - an (R, \mathbf{B}) -wls \mathcal{S} with identity root weights
- such that $r = \chi(\tau)(\llbracket \mathcal{S} \rrbracket)$.

Proof. Proof of (A) \Rightarrow (B): It follows from Lemma 11.2.5.

Proof of (B) \Rightarrow (C): It follows from the fact that each (Σ, \mathbf{B}) -wrtg is a $(\Sigma^{\Xi}, \mathbf{B})$ -wcfg and by Lemma 11.2.2(2).

Proof of (C) \Rightarrow (A): It follows from Lemma 11.2.3 and Theorem 10.10.1 (closure of $\text{Rec}^{\text{run}}(-, \mathbf{B})$ under tree relabelings). \square

Next we verify that Theorem 11.2.6 (A) \Rightarrow (C) generalizes [GS84, Thm. 2.9.5]. We achieve this by proving that the latter result is equivalent to Theorem 11.2.6 (A) \Rightarrow (C) for the case that \mathbf{B} is the semiring Boole .

Corollary 11.2.7. Let $L \subseteq \mathbb{T}_{\Sigma}$ be recognizable. We can construct a ranked alphabet R , a deterministic (R, Σ) -tree relabeling τ , and an R -local system (K, H) such that $L = \tau(L(K, H))$.

Proof. Let A be a Σ -fta such that $L = L(A)$. By Corollary 3.4.2 (A) \Rightarrow (B), we can construct a (Σ, Boole) -wta \mathcal{A} such that $L = \text{supp}(\llbracket \mathcal{A} \rrbracket)$. By Theorem 11.2.6 (A) \Rightarrow (C), we can construct a ranked alphabet R , a deterministic (R, Σ) -tree relabeling τ , and an (R, Boole) -wls \mathcal{S} (which has identity root weights by definition) such that $L = \text{supp}(\chi(\tau)(\llbracket \mathcal{S} \rrbracket))$. By (2.41), we obtain that $L = \tau(\text{supp}(\llbracket \mathcal{S} \rrbracket))$. By Theorem 11.1.4(B) \Rightarrow (A), we can construct a Σ -local system (K, H) such that $L = \tau(L(K, H))$. \square

If one traces back the constructions involved in the proof of Theorem 11.2.6(A) \Rightarrow (C) and composes them together, then one can eventually find out how a given wta is decomposed into a wls and a deterministic tree relabeling. Here we compose these constructions and show the resulting direct construction (where we start from a wta with identity root weights).

Construction 11.2.8. Let $\mathcal{A} = (Q, \delta, F)$ be a (Σ, \mathbf{B}) -wta with identity root weights. Then we can construct a ranked alphabet R , a deterministic (R, Σ) -tree relabeling τ , and an (R, \mathbf{B}) -wls \mathcal{S} such that $\llbracket \mathcal{A} \rrbracket^{\text{run}} = \chi(\tau)(\llbracket \mathcal{S} \rrbracket)$ as follows.

- For each $k \in \mathbb{N}$, we let $R^{(k)} = \{q \rightarrow \sigma(q_1, \dots, q_k) \mid \sigma \in \Sigma^{(k)}, q, q_1, \dots, q_k \in Q\}$,
- $\tau = (\tau_k \mid k \in \mathbb{N})$ such that, for every $k \in \mathbb{N}$ and $q \rightarrow \sigma(q_1, \dots, q_k)$ in $R^{(k)}$, we let $\tau_k(q \rightarrow \sigma(q_1, \dots, q_k)) = \sigma$, and
- $\mathcal{S} = (g, F')$ such that $g = (g_k \mid k \in \mathbb{N})$ and for every $k \in \mathbb{N}$, r_1, \dots, r_k in R , and $r \in R^{(k)}$, we let

$$g_k(r_1 \cdots r_k, r) = \begin{cases} \delta_k(q_1 \cdots q_k, \sigma, q) & \text{if } r = (q \rightarrow \sigma(q_1, \dots, q_k)) \text{ and} \\ & \text{for each } i \in [k] \text{ we have } \text{lhs}(r_i) = q_i \\ \emptyset & \text{otherwise} \end{cases}$$

and, for each r in R , we let $F'(r) = F(\text{lhs}(r))$.

In fact, we could even give an arbitrary (Σ, \mathbf{B}) -wta as input to Construction 11.2.8 (i.e., which does not necessarily have identity root weights) and still we would obtain that $\llbracket \mathcal{A} \rrbracket^{\text{run}} = \chi(\tau)(\llbracket \mathcal{S} \rrbracket)$.

11.3 Characterization by local systems and evaluation algebras

In the next theorem we prove the second characterization result for recognizable weighted tree languages. In particular, (B) and (C) only differ in the way in which the Θ -tree language is defined: in (B) it is generated by a Θ -local system and in (C) it is recognized by a bu-deterministic Θ -fta.

Theorem 11.3.1. *Let Σ be a ranked alphabet such that $\Sigma^{(0)} \neq \emptyset$. Moreover, let \mathbf{B} be a strong bimonoid and let $r : \mathbb{T}_\Sigma \rightarrow B$. Then the following three statements are equivalent.*

(A) *We can construct a (Σ, \mathbf{B}) -wta \mathcal{A} such that $r = \llbracket \mathcal{A} \rrbracket^{\text{run}}$.*

(B) *We can construct*

- a ranked alphabet Θ ,
- a deterministic (Θ, Σ) -tree relabeling τ ,
- a Θ -local system (K, H) , and
- a family $\kappa = (\kappa_k \mid k \in \mathbb{N})$ of mappings $\kappa_k : \Theta^{(k)} \rightarrow B$

such that, for each $\xi \in \mathbb{T}_\Sigma$, the following holds: $r(\xi) = \mathbf{h}_{\mathbf{M}(\Theta, \kappa)}(\tau^{-1}(\xi) \cap \mathbf{L}(K, H))$.

(C) *We can construct*

- a ranked alphabet Θ ,
- a deterministic (Θ, Σ) -tree relabeling τ ,
- a bu-deterministic Θ -fta A , and
- a family $\kappa = (\kappa_k \mid k \in \mathbb{N})$ of mappings $\kappa_k : \Theta^{(k)} \rightarrow B$

such that, for each $\xi \in \mathbb{T}_\Sigma$, the following holds: $r(\xi) = \mathbf{h}_{\mathbf{M}(\Theta, \kappa)}(\tau^{-1}(\xi) \cap \mathbf{L}(A))$.

Proof. Proof of (A) \Rightarrow (B): Let \mathcal{A} be a (Σ, \mathbf{B}) -wta. By Theorem 11.2.6 (A) \Rightarrow (B), we construct a ranked alphabet R , a deterministic (R, Σ) -tree relabeling τ , and a (Σ, \mathbf{B}) -wrtg \mathcal{G} in tree automata form with rule set R such that $\llbracket \mathcal{A} \rrbracket^{\text{run}} = \chi(\tau)(\llbracket \mathcal{G} \rrbracket^{\text{wrt}})$. Let wt be the weight assignment of \mathcal{G} .

Then, as in Lemma 11.2.2(1), we can construct an R -local system (K, H) such that

$$\llbracket \mathcal{A} \rrbracket^{\text{run}} = \chi(\tau)(\llbracket \mathcal{G} \rrbracket^{\text{wrt}}) = \chi(\tau)(\chi(\mathbf{L}(K, H)) \otimes \mathbf{h}_{\mathbf{M}(R, wt)}) .$$

Let $\xi \in T_\Sigma$. By applying Observation 2.12.1 (choosing Σ , Δ , L , and r to be R , Σ , $L(K, H)$, and $h_{M(\Sigma, wt)}$, respectively), we obtain that

$$\llbracket \mathcal{A} \rrbracket^{\text{run}}(\xi) = h_{M(R, wt)}(\tau^{-1}(\xi) \cap L(K, H)) .$$

By choosing Θ and κ to be R and $(wt|_{R^{(k)} \mid k \in \mathbb{N}})$, respectively, we have proved (B).

Proof of (B) \Rightarrow (C): This follows from Corollary 11.2.4, which states that, for each Θ -local system (K, H) , a bu-deterministic Θ -fta A can be constructed such that $L(A) = L(K, H)$.

Proof of (C) \Rightarrow (A): Let Θ be a ranked alphabet, $\tau = (\tau_k \mid k \in \mathbb{N})$ be a deterministic (Θ, Σ) -tree relabeling, $A = (Q, \delta, F)$ be a bu-deterministic Θ -fta, and a family $\kappa = (\kappa_k \mid k \in \mathbb{N})$ of mappings $\kappa_k : \Theta^{(k)} \rightarrow B$. By Theorem 4.1.10, we can assume that A is total and bu-deterministic. Then, for each $\zeta \in L(A)$, we denote by ρ_ζ the unique valid run of A on ζ . We will abbreviate $h_{M(\Theta, \kappa)}$ by h .

We construct the (Σ, B) -wta \mathcal{A} by coding the preimage of τ into the states of \mathcal{A} . We let $\mathcal{A} = (Q', \delta', F')$ with $Q' = Q \times \Theta$ and, for each $(q, \theta) \in Q'$ we let $F'_{(q, \theta)} = \mathbb{1}$ if $q \in F$, and $F'_{(q, \theta)} = \mathbb{0}$ otherwise. Moreover, for every $k \in \mathbb{N}$, $\sigma \in \Sigma^{(k)}$, and $(q_1, \theta_1), \dots, (q_k, \theta_k), (q, \theta) \in Q'$ we define

$$(\delta')_k((q_1, \theta_1) \cdots (q_k, \theta_k), \sigma, (q, \theta)) = \begin{cases} \kappa_k(\theta) & \text{if } (q_1 \cdots q_k, \theta, q) \in \delta_k \text{ and } \tau_k(\theta) = \sigma \\ 0 & \text{otherwise.} \end{cases}$$

We let $R_{\mathcal{A}} = \bigcup_{\xi \in T_\Sigma} R_{\mathcal{A}}(\xi)$, and we define the mapping $\bar{\tau} : R_{\mathcal{A}} \rightarrow T_\Sigma$ such that, for every $\xi \in T_\Sigma$ and $\rho \in R_{\mathcal{A}}(\xi)$, we let $\bar{\tau}(\rho)$ be the Σ -tree mapping

$$t : \text{pos}(\xi) \rightarrow \Sigma \text{ with } t(w) = \tau_k(\rho(w)_2) \text{ for each } w \in \text{pos}(\xi) \text{ where } k = \text{rk}_\Theta(\rho(w)_2) .$$

We note that t uniquely determines an element in T_Σ (cf. Section 2.10). Moreover, there may exist $\xi \in T_\Sigma$ and $\rho \in R_{\mathcal{A}}(\xi)$ such that $\bar{\tau}(\rho) \neq \xi$; however, the weight of such a run ρ is 0. Formally,

$$\text{for each } \rho \in R_{\mathcal{A}}(\xi): \text{ if } \bar{\tau}(\rho) \neq \xi, \text{ then } \text{wt}(\xi, \rho) = 0 . \quad (11.4)$$

For each $\xi \in T_\Sigma$, we abbreviate by $R_{\mathcal{A}}(F \times \Theta, \xi)$ the set $\bigcup_{q \in F, \theta \in \Theta} R_{\mathcal{A}}((q, \theta), \xi)$ and by $R_{\mathcal{A}}(F \times \Theta)$ the set $\bigcup_{\xi \in T_\Sigma} R_{\mathcal{A}}(F \times \Theta, \xi)$. Then we define the mapping

$$\varphi : L(A) \rightarrow R_{\mathcal{A}}(F \times \Theta)$$

for each $\zeta \in L(A)$ and $w \in \text{pos}(\xi)$ by $\varphi(\zeta)(w) = (\rho_\zeta(w), \zeta(w))$. (We recall that ρ_ζ is the unique valid run of A on $\zeta \in L(A)$.) It is easy to see that φ is a bijection. Moreover, $\varphi(\zeta) \in R_{\mathcal{A}}(F \times \Theta, \tau(\zeta))$.

By induction on T_Θ , we prove that the following statement holds:

$$\text{For every } \zeta \in L(A), \text{ we have } h(\zeta) = \text{wt}(\tau(\zeta), \varphi(\zeta)) , \quad (11.5)$$

cf. Figure 11.1, where $R_A^V(q, \zeta)$ denotes the set of valid q -runs on ζ .

Let $\zeta = \theta(\zeta_1, \dots, \zeta_k)$. Then

$$\begin{aligned} h(\theta(\zeta_1, \dots, \zeta_k)) &= h(\zeta_1) \otimes \dots \otimes h(\zeta_k) \otimes \kappa_k(\theta) \\ &= \left(\bigotimes_{i \in [k]} \text{wt}(\tau(\zeta_i), \varphi(\zeta_i)) \right) \otimes \kappa_k(\theta) && \text{(by I.H.)} \\ &= \left(\bigotimes_{i \in [k]} \text{wt}(\tau(\zeta_i), \varphi(\zeta_i)) \right) \otimes (\delta')_k((\rho_{\zeta_1}(\varepsilon), \zeta_1(\varepsilon)) \cdots (\rho_{\zeta_k}(\varepsilon), \zeta_k(\varepsilon)), \tau_k(\theta), (\rho_\zeta(\varepsilon), \zeta(\varepsilon))) \\ & && \text{(by definition of } \delta') \\ &= \left(\bigotimes_{i \in [k]} \text{wt}(\tau(\zeta_i), \varphi(\zeta)|_i) \right) \otimes (\delta')_k(\varphi(\zeta_1)(\varepsilon) \cdots \varphi(\zeta_k)(\varepsilon), \tau_k(\theta), \varphi(\zeta)(\varepsilon)) \\ & && \text{(by definition of } \varphi) \end{aligned}$$

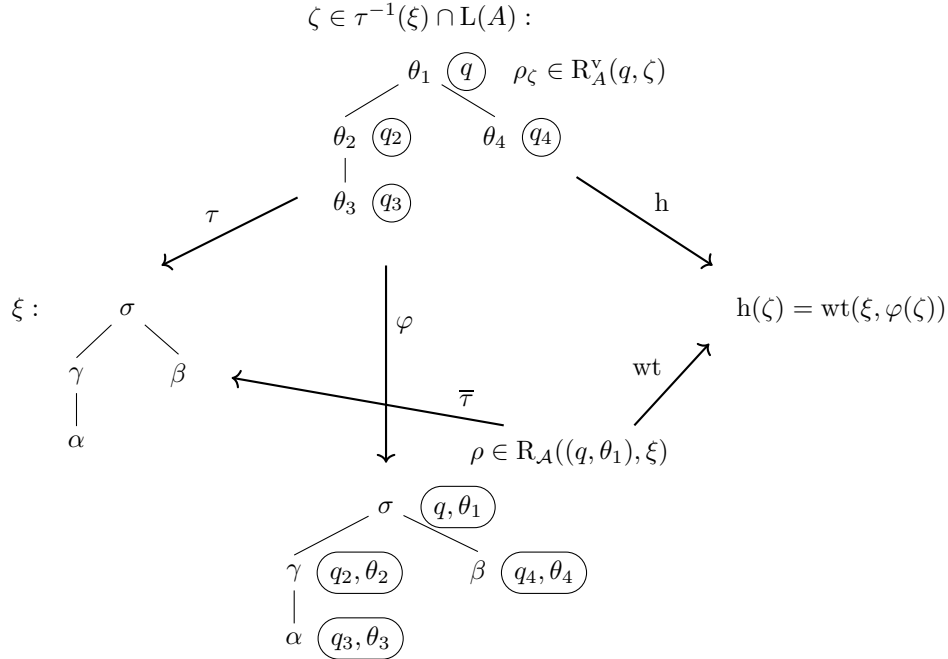

Figure 11.1: An illustration of (11.5): $h(\zeta) = \text{wt}(\tau(\zeta), \varphi(\zeta))$, where $\tau(\zeta) = \xi$.

$$\begin{aligned}
 &= \left(\bigotimes_{i \in [k]} \text{wt}(\tau(\zeta_i), \varphi(\zeta)|_i) \right) \otimes (\delta'_k)_k(\varphi(\zeta)(1) \cdots \varphi(\zeta)(k), \tau_k(\theta), \varphi(\zeta)(\varepsilon)) \\
 &= \text{wt}(\tau_k(\theta)(\tau(\zeta_1), \dots, \tau(\zeta_k)), \varphi(\zeta)) \quad (\text{by definition of wt}) \\
 &= \text{wt}(\tau(\theta(\zeta_1, \dots, \zeta_k)), \varphi(\zeta)) .
 \end{aligned}$$

This proves (11.5). Next we prove that $[\mathcal{A}]^{\text{run}}(\xi) = h(\tau^{-1}(\xi) \cap L(A))$ for each $\xi \in T_\Sigma$.

$$\begin{aligned}
 h(\tau^{-1}(\xi) \cap L(A)) &= \bigoplus_{\zeta \in \tau^{-1}(\xi) \cap L(A)} h(\zeta) && (\text{by definition}) \\
 &= \bigoplus_{\zeta \in \tau^{-1}(\xi) \cap L(A)} \text{wt}(\xi, \varphi(\zeta)) && (\text{by (11.5)}) \\
 &= \bigoplus_{q \in F, \theta \in \Theta} \bigoplus_{\substack{\rho \in R_{\mathcal{A}}((q, \theta), \xi): \\ \bar{\tau}(\rho) = \xi}} \text{wt}(\xi, \rho) && (\text{because } \varphi \text{ is bijective}) \\
 &= \bigoplus_{q \in F, \theta \in \Theta} \bigoplus_{\rho \in R_{\mathcal{A}}((q, \theta), \xi)} \text{wt}(\xi, \rho) && (\text{by (11.4)}) \\
 &= \bigoplus_{\rho \in R_{\mathcal{A}}(\xi)} \text{wt}(\xi, \rho) \otimes F'_{\rho(\varepsilon)} = [\mathcal{A}]^{\text{run}}(\xi) \quad \square
 \end{aligned}$$

As we have seen, the proof of Theorem 11.3.1(A) \Rightarrow (B) is based on Theorem 11.2.6 (A) \Rightarrow (B). Since Observation 2.12.1 is symmetric, one might wonder whether the proof of Theorem 11.2.6 (A) \Rightarrow (B) could be based on Theorem 11.3.1(A) \Rightarrow (B). However, this is not possible because there exist local tree languages which are not rule tree languages, see our remark after Lemma 11.2.1.

Chapter 12

Crisp-determinization

We recall that, in a crisp-deterministic (Σ, \mathbf{B}) -wta \mathcal{B} , the weight of each transition is one of the unit weights 0 and 1 of the strong bimonoid \mathbf{B} ; weights different from these units may only occur as root weights. Also, since crisp-determinism implies bu-determinism, the two semantics of \mathcal{B} coincide, i.e., $\llbracket \mathcal{B} \rrbracket^{\text{init}} = \llbracket \mathcal{B} \rrbracket^{\text{run}}$ (cf. Theorem 5.3.1). We denoted the semantics of \mathcal{B} by $\llbracket \mathcal{B} \rrbracket$.

In this chapter we will investigate the question under which conditions a given wta can be transformed into an equivalent crisp-deterministic wta. More precisely, a (Σ, \mathbf{B}) -wta \mathcal{A} is *initial algebra crisp-determinizable* if there exists an i-equivalent crisp-deterministic (Σ, \mathbf{B}) -wta, i.e., there exists a crisp-deterministic (Σ, \mathbf{B}) -wta \mathcal{B} such that $\llbracket \mathcal{A} \rrbracket^{\text{init}} = \llbracket \mathcal{B} \rrbracket$. It is *run crisp-determinizable* if there exists an r-equivalent crisp-deterministic (Σ, \mathbf{B}) -wta, i.e., there exists a crisp-deterministic (Σ, \mathbf{B}) -wta \mathcal{B} such that $\llbracket \mathcal{A} \rrbracket^{\text{run}} = \llbracket \mathcal{B} \rrbracket$. It follows from the previous definitions that, if \mathbf{B} is semiring, then \mathcal{A} is initial algebra crisp-determinizable if and only if it is run crisp-determinizable (because by Corollary 5.3.5 $\llbracket \mathcal{A} \rrbracket^{\text{init}} = \llbracket \mathcal{A} \rrbracket^{\text{run}}$).

In the sequel we will identify conditions under which a given (Σ, \mathbf{B}) -wta \mathcal{A} is initial algebra crisp-determinizable and under which conditions it is run crisp-determinizable. We approach the answers by recalling that each crisp-deterministic (Σ, \mathbf{B}) -wta \mathcal{B} recognizes a (Σ, \mathbf{B}) -recognizable step mapping, and vice versa, each (Σ, \mathbf{B}) -recognizable step mapping can be obtained in this way (cf. Theorem 10.3.1). Hence, \mathcal{A} is initial algebra crisp-determinizable if and only if $\llbracket \mathcal{A} \rrbracket^{\text{init}}$ is a recognizable step mapping, i.e., $\text{im}(\llbracket \mathcal{A} \rrbracket^{\text{init}})$ is finite and $\llbracket \mathcal{A} \rrbracket^{\text{init}}$ has the preimage property (and similarly for run crisp-determinizable).

Thus, Theorem 10.3.1 provides a blue-print for the answers to the crisp-determinization problems. On the negative side, if we consider a (Σ, \mathbf{B}) -wta \mathcal{A} for which $\llbracket \mathcal{A} \rrbracket^{\text{init}}$ is not a recognizable step mapping, then \mathcal{A} is not initial algebra crisp-determinizable, and similarly for $\llbracket \mathcal{A} \rrbracket^{\text{run}}$ and run crisp-determinizability. For instance, let \mathcal{A} be the $(\Sigma, \text{Nat}_{\max,+})$ -wta from Example 3.2.4 for which $\llbracket \mathcal{A} \rrbracket^{\text{init}} = \text{height}$. Since $\text{im}(\text{height})$ is not finite, $\llbracket \mathcal{A} \rrbracket^{\text{init}}$ is not a recognizable step mapping (by definition). Hence, by Theorem 10.3.1 and the fact that $\text{Nat}_{\max,+}$ is a semiring, \mathcal{A} is neither initial algebra crisp-determinizable nor run crisp-determinizable. On the positive side, each (Σ, \mathbf{B}) -wta \mathcal{A} for which $\llbracket \mathcal{A} \rrbracket^{\text{init}}$ is a recognizable step mapping, is initial algebra crisp-determinizable, and similarly for the run semantics and run crisp-determinizability.

In Section 12.1 we will deal with initial algebra crisp-determinization and in Section 12.2 with run crisp-determinization. This chapter is based on results and constructions in [FKV21], [DFKV20], and [DFKV22].

12.1 Initial algebra crisp-determinization

In this section we will show an equivalence between local finiteness and initial algebra crisp-determinizability (cf. Theorem 12.1.6).

If we recall the way in which a (Σ, \mathbf{B}) -wta \mathcal{A} computes $h_{\mathcal{A}}(\xi)$ for some input tree $\xi \in T_{\Sigma}$, then we see

that the summation and multiplication of \mathbf{B} are used in an alternating way. One possibility to guarantee that these computations only produce finitely many values in B , is to assume that \mathbf{B} is locally finite. Indeed, for each locally finite strong bimonoid \mathbf{B} , the set $\text{Rec}^{\text{init}}(\Sigma, \mathbf{B})$ contains only recognizable step mappings (cf. [BMS⁺06, Thm. 9], [DV06, Lm. 6.1], [FV09, Cor. 3.16], [CDIV10, p. 9], [DSV10, Lm. 18], and [FKV21, Cor. 6.10]). Since each distributive bounded lattice is a particular locally finite semiring (cf. Subsection 2.7.6), the next lemma can also be compared to [Rah09, Thm. 3.8].

Lemma 12.1.1. Let (a) \mathbf{B} be locally finite or (b) let \mathbf{B} be weakly locally finite and Σ is monadic. Moreover, let \mathcal{A} be a (Σ, \mathbf{B}) -wta. Then $\text{im}(h_{\mathcal{A}})$ is finite and \mathcal{A} is initial algebra crisp-determinizable.

Proof. Let $\mathcal{A} = (Q, \delta, F)$. We recall that $\text{im}(\delta) = \bigcup_{k \in \mathbb{N}} \text{im}(\delta_k)$.

First we show that the set $H = \{h_{\mathcal{A}}(\xi)_q \mid \xi \in T_{\Sigma}, q \in Q\}$ is finite.

Case (a): Let \mathbf{B} be locally finite. Since $H \subseteq \langle \text{im}(\delta) \rangle_{\{\oplus, \otimes\}}$ and $\langle \text{im}(\delta) \rangle_{\{\oplus, \otimes\}}$ is finite, the set H is finite.

Case (b): Let \mathbf{B} be weakly locally finite and Σ be monadic. Since Σ is monadic, for every $\xi \in T_{\Sigma}$ and $q \in Q$, we have $h_{\mathcal{A}}(\xi)_q \in \text{wcl}(\text{im}(\delta))$, by (4.26) in the proof of Lemma 4.3.7. This means that $H \subseteq \text{wcl}(\text{im}(\delta))$, and since \mathbf{B} is weakly locally finite, we obtain that H is finite.

Hence, in both Cases (a) and (b), the set H is finite. Then the set $\text{im}(h_{\mathcal{A}})$ is also finite because $h_{\mathcal{A}}(\xi) \in H^Q$ for every $\xi \in T_{\Sigma}$. Hence the congruence $\ker(h_{\mathcal{A}})$ of \mathcal{A} has finite index. Thus, by Theorem 4.1.9(C) \Rightarrow (B), the (Σ, \mathbf{B}) -wta \mathcal{A} is initial algebra crisp-determinizable. \square

Lemma 12.1.1 states that each (Σ, \mathbf{B}) -wta is initial algebra crisp-determinizable if one of its conditions (a) and (b) holds. In fact, if one traces back the proofs of Lemma 12.1.1, Theorem 4.1.9, and Lemma 4.1.8, then one can construct the corresponding crisp-deterministic wta. Since its construction is rather hidden, we want to show this explicitly here (cf. Definition 12.1.2).

In fact, the construction of the corresponding crisp-deterministic wta generalizes the well-known subset method which transforms an fta into an equivalent bu-deterministic fta (cf. [TW68, Thm. 1], [Eng75b, Thm. 3.8], and [GS84, Thm. 2.2.6]). The set of states of the bu-deterministic fta is the set of all subsets of the state set of the given fta. Here, for a given wta $\mathcal{A} = (Q, \delta, F)$, we represent the states of the equivalent bu-deterministic wta by vectors in B^Q . However, we do not use all vectors in B^Q , but only those which are images of trees under $h_{\mathcal{A}}$. This corresponds to using the reachable subsets in the subset method. We generalize the subset method for any wta and strong bimonoid \mathbf{B} , and we keep the name “subset method” also for the generalized version.

A special case of this subset method was given in the proof of [Bél02, Thm. 2.1] for the case of string ranked alphabets (i.e., weighted automata) and complete distributive lattices. (We note that distributivity is not assumed in [Bél02], but it is needed because the many-fold composition of matrices in the definition of the acceptance degree, i.e., run semantics, assumes associativity of matrix multiplication, and in its turn, this assumes distributivity [Bél08]). In fact, the notion of deterministic fuzzy automata in [Bél02] corresponds to our notion of crisp-deterministic wta over some string ranked alphabet and some complete distributive lattice due to Lemma 3.3.4 and Theorem 4.1.9(A) \Leftrightarrow (B). In [BLB10, Thm. 5 and 8] the subset method was presented for wta over $\text{UnitInt}_{u,i}$ where (u, i) are particular pairs of t-conorm u and t-norm i . Another special case of the subset method is given in [MZA11, Thm. 3.5] for wta over $([0, 1], \nabla, \Delta, 0, 1)$ where ∇ and Δ are some t-conorm and t-norm, respectively, such that (∇, Δ) are finite range. The latter property implies that $([0, 1], \nabla, \Delta, 0, 1)$ is locally finite (but not vice versa).

Definition 12.1.2. Let Σ be a ranked alphabet. Moreover, let $\mathbf{B} = (B, \oplus, \otimes, 0, \mathbb{1})$ be a strong bimonoid and let \mathcal{A} be a (Σ, \mathbf{B}) -wta. The *subset method* transforms \mathcal{A} into the triple $\text{sub}(\mathcal{A}) = (Q', \delta', F')$, where

- $Q' = \text{im}(\mathbf{h}_{\mathcal{A}})$,
- $\delta' = (\delta'_k \mid k \in \mathbb{N})$ is the family of mappings $\delta'_k : (Q')^k \times \Sigma^{(k)} \times Q' \rightarrow B$ defined by

$$\delta'_k(u_1 \dots u_k, \sigma, u) = \begin{cases} \mathbb{1} & \text{if } \delta_{\mathcal{A}}(\sigma)(u_1, \dots, u_k) = u \\ 0 & \text{otherwise} \end{cases}$$

for every $k \in \mathbb{N}$, $\sigma \in \Sigma^{(k)}$, $u_1, \dots, u_k \in Q'$, and $u \in Q'$,

- $F' : Q' \rightarrow B$ is a mapping defined by $(F')_u = \bigoplus_{q \in Q} u_q \otimes F_q$ for every $u \in Q'$.

Thus, $\text{sub}(\mathcal{A})$ is merely a triple and, in general, not a wta. In particular, Q' can be an infinite set. However, $\text{sub}(\mathcal{A})$ is a crisp-deterministic wta if and only if Q' is finite. But assuming one of the conditions of Lemma 12.1.1, we can prove that $\text{sub}(\mathcal{A})$ is a crisp-deterministic wta which is i-equivalent to \mathcal{A} .

Theorem 12.1.3. *Let Σ be a ranked alphabet. Moreover, let $\mathbf{B} = (B, \oplus, \otimes, 0, \mathbb{1})$ be a strong bimonoid such that (a) \mathbf{B} is locally finite or (b) \mathbf{B} is weakly locally finite and Σ is monadic. Then the following two statements hold.*

- (1) *For each (Σ, \mathbf{B}) -wta \mathcal{A} , the triple $\text{sub}(\mathcal{A})$ can be constructed; moreover, $\text{sub}(\mathcal{A})$ is a crisp-deterministic (Σ, B) -wta and $\llbracket \mathcal{A} \rrbracket^{\text{init}} = \llbracket \text{sub}(\mathcal{A}) \rrbracket$.*
- (2) *$\text{Rec}^{\text{init}}(\Sigma, \mathbf{B}) \subseteq \text{Rec}^{\text{run}}(\Sigma, \mathbf{B})$.*

Proof. Proof of (1): By Observation 2.10.4, we have $\text{im}(\mathbf{h}_{\mathcal{A}}) = \langle \emptyset \rangle_{\delta_{\mathcal{A}}(\Sigma)}$ and by Lemma 12.1.1, the set $\text{im}(\mathbf{h}_{\mathcal{A}})$ is finite. Hence $\langle \emptyset \rangle_{\delta_{\mathcal{A}}(\Sigma)}$ is finite and by Lemma 2.7.1, it can be constructed. Thus $\text{im}(\mathbf{h}_{\mathcal{A}})$ can be constructed. It is easy to see that $\text{sub}(\mathcal{A})$ is a crisp-deterministic (Σ, B) -wta.

Moreover, the subset method is the composition of the constructions in the proofs of Theorem 4.1.9(C) \Rightarrow (A) and Lemma 4.1.8. Indeed, in Theorem 4.1.9(C) \Rightarrow (A) we construct the finite algebra $(\text{im}(\mathbf{h}_{\mathcal{A}}), \delta_{\text{av}(\mathcal{A})})$ and the mapping F' . Then, using this as input, Lemma 4.1.8 constructs the crisp-deterministic (Σ, \mathbf{B}) -wta $(\text{im}(\mathbf{h}_{\mathcal{A}}), \delta', F')$, which is nothing else but $\text{sub}(\mathcal{A})$. Hence it follows that $\llbracket \mathcal{A} \rrbracket^{\text{init}} = \llbracket \text{sub}(\mathcal{A}) \rrbracket$.

Proof of (2): Let \mathcal{A} be a (Σ, \mathbf{B}) -wta. By (1) we have $\llbracket \mathcal{A} \rrbracket^{\text{init}} = \llbracket \text{sub}(\mathcal{A}) \rrbracket$, where $\llbracket \text{sub}(\mathcal{A}) \rrbracket$ is a crisp-deterministic (Σ, \mathbf{B}) -wta. Since, by Theorem 5.3.1, $\llbracket \text{sub}(\mathcal{A}) \rrbracket = \llbracket \text{sub}(\mathcal{A}) \rrbracket^{\text{run}}$, we have $\text{Rec}^{\text{init}}(\Sigma, \mathbf{B}) \subseteq \text{Rec}^{\text{run}}(\Sigma, \mathbf{B})$. \square

As a consequence of Theorem 12.1.3, we show a preimage theorem. In general, a *preimage theorem* states, for some modifier $x \in \{\text{run}, \text{init}\}$, under which conditions on \mathbf{B} , for each (Σ, \mathbf{B}) -wta \mathcal{A} , the weighted tree language $\llbracket \mathcal{A} \rrbracket^x$ has the preimage property (i.e., for each $b \in B$ we have that $(\llbracket \mathcal{A} \rrbracket^x)^{-1}(b)$ is a recognizable tree language, cf. Section 2.12.1). Clearly, if \mathbf{B} is a semiring, then we can disregard the modifier x (cf. Corollary 5.3.5). The next preimage theorem concerns the initial algebra semantics (i.e., $x = \text{init}$).

Corollary 12.1.4. Let (a) \mathbf{B} be locally finite or (b) let \mathbf{B} be weakly locally finite and Σ monadic. Moreover, let \mathcal{A} be a (Σ, \mathbf{B}) -wta. Then $\llbracket \mathcal{A} \rrbracket^{\text{init}}$ has the preimage property. Moreover, for each $b \in B$, we can construct a Σ -fta A such that $L(A) = (\llbracket \mathcal{A} \rrbracket^{\text{init}})^{-1}(b)$.

Proof. By Theorem 12.1.3 we can construct the crisp-deterministic (Σ, \mathbf{B}) -wta $\text{sub}(\mathcal{A})$ such that $\llbracket \mathcal{A} \rrbracket^{\text{init}} = \llbracket \text{sub}(\mathcal{A}) \rrbracket$. Then our statements follow from Theorem 10.3.1(A) \Rightarrow (C). \square

A special case of Corollary 12.1.4(a) was proved in [DV06, Lm. 6.1] for locally finite commutative semirings (taking into account that for wta over semirings the run semantics and the initial algebra

semantics coincide cf. Corollary 5.3.5(2)).

Also a kind of reverse of Lemma 12.1.1 holds.

Corollary 12.1.5. If for each ranked alphabet Σ , each (Σ, \mathbf{B}) -wta \mathcal{A} is initial algebra crisp-determinizable, then \mathbf{B} is locally finite.

Proof. Let $A \subseteq B$ be a finite set. Let Σ be a ranked alphabet such that $\Sigma^{(2)} \neq \emptyset$. By Theorem 4.3.1, we can construct a (Σ, \mathbf{B}) -wta \mathcal{A} such that $\text{im}(\llbracket \mathcal{A} \rrbracket^{\text{init}}) = \langle A \rangle_{\{\oplus, \otimes, 0, 1\}}$. Since, by assumption, \mathcal{A} is initial algebra crisp-determinizable, we have that $\llbracket \mathcal{A} \rrbracket^{\text{init}}$ is a recognizable step mapping (by Theorem 10.3.1). Thus the set $\text{im}(\llbracket \mathcal{A} \rrbracket^{\text{init}})$ is finite (by definition). Hence $\langle A \rangle_{\{\oplus, \otimes, 0, 1\}}$ is finite, which means that \mathbf{B} is locally finite. \square

Hence we obtain the following equivalence between local finiteness, initial algebra crisp-determinizability, and finiteness of initial algebra semantics (where the equivalence with Statement (C) is due to [Dro22]).

Theorem 12.1.6. Let \mathbf{B} be a strong bimonoid. Then the following four statements are equivalent.

- (A) \mathbf{B} is locally finite.
- (B) For each ranked alphabet Σ and for each (Σ, \mathbf{B}) -wta \mathcal{A} , we can construct a crisp-deterministic (Σ, \mathbf{B}) -wta \mathcal{B} such that $\llbracket \mathcal{A} \rrbracket^{\text{init}} = \llbracket \mathcal{B} \rrbracket$.
- (C) For each ranked alphabet Σ and for each (Σ, \mathbf{B}) -wta \mathcal{A} , the set $\text{im}(\llbracket \mathcal{A} \rrbracket^{\text{init}})$ is finite.
- (D) For each branching ranked alphabet Σ and for each (Σ, \mathbf{B}) -wta \mathcal{A} , the set $\text{im}(\llbracket \mathcal{A} \rrbracket^{\text{init}})$ is finite.

Proof. Proof of (A) \Rightarrow (B): This follows from Theorem 12.1.3(1).

Proof of (B) \Rightarrow (C): This follows from Theorem 10.3.1(A) \Rightarrow (C).

Proof of (C) \Rightarrow (D): This holds trivially.

Proof of (D) \Rightarrow (A): Let $A \subseteq B$ be a finite set. Let Σ be any ranked alphabet which is branching. By Theorem 4.3.2 we can construct a (Σ, \mathbf{B}) -wta \mathcal{B} such that $\text{im}(\llbracket \mathcal{B} \rrbracket^{\text{init}}) = \langle A \rangle_{\{\oplus, \otimes, 0, 1\}}$. Hence, by assumption (D), the set $\langle A \rangle_{\{\oplus, \otimes, 0, 1\}}$ is finite. Thus \mathbf{B} is locally finite. \square

A special case of Theorem 12.1.6 was proved in [Bél02, Thm. 2.1] for the case of string ranked alphabets (i.e., weighted automata) and complete distributive lattices (cf. the remark on p.286). Moreover, it is easy to see that the Viterbi semiring $([0, 1], \max, \cdot, 0, 1)$ is not locally finite. Hence, by Theorem 12.1.6, there exists a ranked alphabet Σ and a $(\Sigma, \text{Viterbi})$ -wta \mathcal{A} such that $\text{im}(\llbracket \mathcal{A} \rrbracket)$ is infinite. The wsa in [LP05, Ex. 3.1] can be thought of as such a wta. Also we note that [LP05, Thm. 3.4] is a special case of Theorem 12.1.6(A) \Leftrightarrow (B) for lattice-ordered monoids.

In Theorem 3.4.1 and Corollary 3.4.2 we proved that $\text{Rec}(\Sigma, \text{Boole})$ and $\text{Rec}(\Sigma)$ are essentially the same. One might wonder, how the set $\text{Rec}(\Sigma, \mathbb{F}_2)$ of weighted tree languages can be characterized, where $\mathbb{F}_2 = (\{0, 1\}, \oplus, \otimes, 0, 1)$ is the field from Example 2.7.9(7), i.e., the other strong bimonoid with two elements. The answer is given in the following corollary, which corresponds to Corollary 3.4.2.

Corollary 12.1.7. Let Σ be a ranked alphabet. Moreover, let $L \subseteq T_\Sigma$. Then the following three statements are equivalent.

- (A) We can construct a Σ -fta A such $L = L(A)$.
 - (B) We can construct a (Σ, \mathbb{F}_2) -wta \mathcal{A} such that $L = \text{supp}(\llbracket \mathcal{A} \rrbracket)$.
 - (C) We can construct a (Σ, \mathbb{F}_2) -wta \mathcal{A} such that $\chi(L) = \llbracket \mathcal{A} \rrbracket$.
- Moreover, we have $\text{supp}(\text{Rec}(\Sigma, \mathbb{F}_2)) = \text{Rec}(\Sigma)$.

Proof. Proof of (A) \Rightarrow (C): It follows from Theorem 4.1.10 (B) \Rightarrow (C).

Proof of (C) \Leftrightarrow (B): This follows from the equivalence that for every $r : T_\Sigma \rightarrow \{0,1\}$ and $L \subseteq T_\Sigma$: $r = \chi(L)$ iff $L = \text{supp}(r)$.

Proof of (C) \Rightarrow (A): Let \mathcal{A} be a (Σ, F_2) -wta with $\llbracket \mathcal{A} \rrbracket = \chi(L)$. By Theorem 12.1.6, we can construct a crisp-deterministic (Σ, F_2) -wta \mathcal{B} such that $\llbracket \mathcal{A} \rrbracket = \llbracket \mathcal{B} \rrbracket$. Since the carrier set of F_2 is the set $\{0,1\}$, \mathcal{B} has identity root weights. Then, by Theorem 4.1.10 (C) \Rightarrow (B), we can construct a Σ -fta A such that $L(A) = L$.

Finally, the equality $\text{supp}(\text{Rec}(\Sigma, F_2)) = \text{Rec}(\Sigma)$ follows from (A) \Leftrightarrow (B). \square

Corollary 12.1.8. Let Σ be a ranked alphabet. Then $\text{Rec}(\Sigma, \text{Boole}) = \text{Rec}(\Sigma, F_2)$.

Proof. Let $r \in \text{Rec}(\Sigma, \text{Boole})$. Since Boole is locally finite, by Theorem 12.1.6, we can construct a crisp-deterministic (Σ, F_2) -wta \mathcal{B} such that $r = \llbracket \mathcal{B} \rrbracket$. Hence $r \in \text{cd-Rec}(\Sigma, \text{Boole})$. Since the semirings Boole and F_2 have the same carrier set, by Corollary 4.1.7, we have that $r \in \text{cd-Rec}(\Sigma, F_2)$. Hence $r \in \text{Rec}(\Sigma, F_2)$. The proof of the other inclusion is very similar. \square

12.2 Run crisp-determinization

In this section we will prove a sufficient condition under which a (Σ, B) -wta \mathcal{A} is run crisp-determinizable (cf. Theorem 12.2.6). We will continue with two characterizations of this property (cf. Theorems 12.2.9 and 12.2.15), where the first one deals with arbitrary strong bimonoids and the second one with past-finite monotonic strong bimonoids.

12.2.1 Sufficient condition for run crisp-determinizability

Let $\mathcal{A} = (Q, \delta, F)$ be a (Σ, B) -wta. We recall that, for each $\xi \in T_\Sigma$, we have

$$\llbracket \mathcal{A} \rrbracket^{\text{run}}(\xi) = \bigoplus_{\rho \in R_{\mathcal{A}}(\xi)} \text{wt}(\xi, \rho) \otimes F_{\rho(\varepsilon)} .$$

In contrast to the initial algebra semantics, multiplication and summation are not used alternatingly but first multiplication is used (for the computation of $\text{wt}(\xi, \rho) \otimes F_{\rho(\varepsilon)}$) and second summation is used. In the following we will formulate a sufficient condition for run crisp-determinizability of \mathcal{A} which is based on the values which occur in the computation of $\llbracket \mathcal{A} \rrbracket^{\text{run}}$ and on structural properties of \mathcal{A} .

For the following discussion we recall the definition $H(\mathcal{A}) = \{\text{wt}(\xi, \rho) \mid \xi \in T_\Sigma, \rho \in R_{\mathcal{A}}(\xi)\}$ (cf. (7.15) of Section 7.4) and define the set

$$C(\mathcal{A}) = \{\text{wt}(\xi, \rho) \otimes F_{\rho(\varepsilon)} \mid \xi \in T_\Sigma, \rho \in R_{\mathcal{A}}(\xi)\} . \quad (12.1)$$

Clearly, if the set $H(\mathcal{A})$ is finite, then $C(\mathcal{A})$ is also finite, because $C(\mathcal{A}) \subseteq H(\mathcal{A}) \otimes \text{im}(F)$.

Lemma 12.2.1. [DFKV22, Lm. 6.5] Let $\mathcal{A} = (Q, \delta, F)$ be a (Σ, B) -wta. If $H(\mathcal{A})$ is finite, then we can construct the set $C(\mathcal{A})$.

Proof. Let $H(\mathcal{A})$ be finite. By Lemma 7.4.1, we construct the set $H(\mathcal{A})$. We recall that in the proof of that lemma, for every $n \in \mathbb{N}$ and $q \in Q$, we construct the set

$$H_{n,q} = \{\text{wt}(\xi, \rho) \mid \xi \in T_\Sigma, \text{height}(\xi) \leq n, \rho \in R_{\mathcal{A}}(q, \xi)\} ,$$

and denote by $n_m \in \mathbb{N}$ the least number such that $H_{n_m,q} = H_{n_m+1,q}$ for each $q \in Q$.

Now we prove that the set $C(\mathcal{A})$ can be constructed. Let n_m be the number as before and

$$C = \{\text{wt}(\xi, \rho) \otimes F_{\rho(\varepsilon)} \mid \xi \in T_\Sigma, \text{height}(\xi) \leq n_m, \rho \in R_{\mathcal{A}}(\xi)\} .$$

It suffices to show that $C = C(\mathcal{A})$ because we can construct the set C . It is obvious that $C \subseteq C(\mathcal{A})$. For the proof of the other inclusion, let $b \in C(\mathcal{A})$, i.e., $b = \text{wt}(\xi, \rho) \otimes F_q$ for some $\xi \in T_\Sigma$, $q \in Q$, and $\rho \in R_{\mathcal{A}}(q, \xi)$. Since $\text{wt}(\xi, \rho) \in H(\mathcal{A})$, by the proof of constructing the set $H(\mathcal{A})$ (cf. Lemma 7.4.1), we have $\text{wt}(\xi, \rho) \in H_{n_m, q}$, i.e., there exist $\xi' \in T_\Sigma$ with $\text{height}(\xi') \leq n_m$, and $\rho' \in R_{\mathcal{A}}(q, \xi')$ such that $\text{wt}(\xi, \rho) = \text{wt}(\xi', \rho')$. Hence $b \in C$. \square

We continue with an analysis of $\text{im}(\llbracket \mathcal{A} \rrbracket^{\text{run}})$. We can achieve that $\text{im}(\llbracket \mathcal{A} \rrbracket^{\text{run}})$ is finite if we guarantee that (a) the set $C(\mathcal{A})$ is finite and (b) there exists an upper bound K such that each $b \in C(\mathcal{A})$ is summed up at most K times. To express this more precisely, for each $b \in C(\mathcal{A})$, we define the mapping $f_{\mathcal{A}, b} : T_\Sigma \rightarrow \mathbb{N}$, called *complete run number mapping of b* , such that for each $\xi \in T_\Sigma$ we let

$$f_{\mathcal{A}, b}(\xi) = |\{\rho \in R_{\mathcal{A}}(\xi) \mid \text{wt}(\xi, \rho) \otimes F_{\rho(\varepsilon)} = b\}| .$$

We recall from (2.21) that, for each $n \in \mathbb{N}$, the value nb is the sum $b \oplus \dots \oplus b$ with n summands. Finally, we define the (Σ, B) -weighted tree language

$$r_{\mathcal{A}, b} : T_\Sigma \rightarrow B \quad \text{with} \quad r_{\mathcal{A}, b}(\xi) = (f_{\mathcal{A}, b}(\xi))b \quad \text{for each } \xi \in T_\Sigma .$$

Thus, if $C(\mathcal{A})$ is finite, then for each $\xi \in T_\Sigma$, we have

$$\llbracket \mathcal{A} \rrbracket^{\text{run}}(\xi) = \bigoplus_{b \in C(\mathcal{A})} (f_{\mathcal{A}, b}(\xi))b = \bigoplus_{b \in C(\mathcal{A})} r_{\mathcal{A}, b}(\xi) . \quad (12.2)$$

Overall, if $C(\mathcal{A})$ is finite and $r_{\mathcal{A}, b}$ is a recognizable step mapping for each $b \in C(\mathcal{A})$, then $\llbracket \mathcal{A} \rrbracket^{\text{run}}$ is a recognizable step mapping (because recognizable step mappings are closed under sum, cf. Corollary 10.3.2).

In order to find out under which conditions $r_{\mathcal{A}, b}$ is a recognizable step mapping (cf. Lemma 12.2.5), we first prove that $f_{\mathcal{A}, b}$ is an r -recognizable (Σ, \mathbb{N}) -weighted tree language. For this we use the set $H(\mathcal{A})$. The next lemma generalizes [DSV10, Thm. 11] and [DGMM11, Thm. 6.2(a)] from the string case to the tree case.

Lemma 12.2.2. [DFKV22, Thm. 6.6] Let \mathcal{A} be a (Σ, B) -wta. If $H(\mathcal{A})$ is finite, then for each $b \in C(\mathcal{A})$ we can construct a (Σ, Nat) -wta \mathcal{A}'_b such that $\llbracket \mathcal{A}'_b \rrbracket = f_{\mathcal{A}, b}$.

Proof. Let $H(\mathcal{A})$ be finite. By Lemma 7.4.1, we construct $H(\mathcal{A})$. Let $b \in C(\mathcal{A})$. We define the (Σ, Nat) -wta $\mathcal{A}'_b = (Q', \delta', F'_b)$ as follows: $Q' = Q \times H(\mathcal{A})$ and for every $k \in \mathbb{N}$, $\sigma \in \Sigma^{(k)}$ and $(q_1, y_1), \dots, (q_k, y_k), (q, y) \in Q'$, let

$$\delta'_k((q_1, y_1) \cdots (q_k, y_k), \sigma, (q, y)) = \begin{cases} 1 & \text{if } (\bigotimes_{i \in [k]} y_i) \otimes \delta_k(q_1 \cdots q_k, \sigma, q) = y \\ 0 & \text{otherwise,} \end{cases}$$

and let

$$(F'_b)_{(q, y)} = \begin{cases} 1 & \text{if } y \otimes F_q = b \\ 0 & \text{otherwise.} \end{cases}$$

Let $\xi \in T_\Sigma$ and $b \in C(\mathcal{A})$. It is obvious that,

$$\text{for each } \rho \in R_{\mathcal{A}'_b}(\xi), \text{ we have } \text{wt}_{\mathcal{A}'_b}(\xi, \rho) \cdot (F'_b)_{\rho'(\varepsilon)} \in \{0, 1\} . \quad (12.3)$$

Next we observe that there exists a bijection between the two sets

$$\{\rho \in R_{\mathcal{A}}(\xi) \mid \text{wt}_{\mathcal{A}}(\xi, \rho) \otimes F_{\rho(\varepsilon)} = b\} \quad \text{and} \quad \{\rho' \in R_{\mathcal{A}'_b}(\xi) \mid \text{wt}_{\mathcal{A}'_b}(\xi, \rho') \cdot (F'_b)_{\rho'(\varepsilon)} = 1\} .$$

Then it follows that

$$\begin{aligned}
f_{\mathcal{A},b}(\xi) &= |\{\rho \in R_{\mathcal{A}}(\xi) \mid \text{wt}_{\mathcal{A}}(\xi, \rho) \otimes F_{\rho(\varepsilon)} = b\}| \\
&= |\{\rho' \in R_{\mathcal{A}'_b}(\xi) \mid \text{wt}_{\mathcal{A}'_b}(\xi, \rho') \cdot (F'_b)_{\rho'(\varepsilon)} = 1\}| \\
&= \bigoplus_{\substack{\rho' \in R_{\mathcal{A}'_b}(\xi): \\ \text{wt}_{\mathcal{A}'_b}(\xi, \rho') \cdot (F'_b)_{\rho'(\varepsilon)} = 1}} 1 \\
&= \bigoplus_{\rho' \in R_{\mathcal{A}'_b}(\xi)} \text{wt}_{\mathcal{A}'_b}(\xi, \rho') \cdot (F'_b)_{\rho'(\varepsilon)} \quad (\text{by (12.3)}) \\
&= \llbracket \mathcal{A}'_b \rrbracket(\xi) \quad \square
\end{aligned}$$

Next we analyse the preimage of $f_{\mathcal{A},b} = \llbracket \mathcal{A}'_b \rrbracket$, where \mathcal{A}'_b is the (Σ, Nat) -wta of Lemma 12.2.2. For this we prove two preimage theorems for an arbitrary (Σ, Nat) -wta instead of the specific \mathcal{A}'_b (cf. Lemmas 12.2.3 and 12.2.4), where the first one is a generalization of [BR88, Cor. III.2.5]).

Lemma 12.2.3. (cf. [DV06, Lm. 6.3(2)] and [DFKV22, Lm. 6.3]) Let \mathcal{A} be a (Σ, Nat) -wta. Then $\llbracket \mathcal{A} \rrbracket$ has the preimage property and, for each $n \in \mathbb{N}$, we can construct a Σ -fta A such that $L(A) = \llbracket \mathcal{A} \rrbracket^{-1}(n)$.

Proof. Let $n \in \mathbb{N}$ and $M = \{k \in \mathbb{N} \mid k > n\}$. Moreover, we let \sim be the equivalence relation on the set \mathbb{N} defined such that its $n+2$ classes are the singleton sets $\{k\}$ for each $k \in [0, n]$ and the set M .

As is well known, \sim is a congruence relation on the semiring of natural numbers, which can be seen as follows. Let $n_1, n_2, n'_1, n'_2 \in \mathbb{N}$ such that $n_1 \sim n'_1$ and $n_2 \sim n'_2$. Since, for each $k \in \mathbb{N}$ with $k \leq n$, the equivalence class $\{k\}$ is a singleton and Nat is commutative, the only interesting case arises if $n_1, n'_1 \in M$. So we assume that $n_1, n'_1 \in M$. For the summation, we obviously have $n_1 \leq n_1 + n_2$ and $n'_1 \leq n'_1 + n'_2$, and hence $n_1 + n_2 \in M$ and $n'_1 + n'_2 \in M$. For the multiplication, if $n_2 \neq 0 \neq n'_2$, then similarly we obtain that $n_1 \cdot n_2 \in M$ and $n'_1 \cdot n'_2 \in M$. If $n_2 = 0 = n'_2$, then $n_1 \cdot n_2 \in \{0\}$ and $n'_1 \cdot n'_2 \in \{0\}$. Hence \sim is a congruence relation on Nat .

Since \sim has finite index, the quotient semiring Nat/\sim is finite. Let $h : \mathbb{N} \rightarrow \text{Nat}/\sim$ be the canonical semiring homomorphism, i.e., $h(n) = [n]_{\sim}$ for each $n \in \mathbb{N}$. Then, by Theorem 10.9.2, the $(\Sigma, \text{Nat}/\sim)$ -weighted tree language $h \circ \llbracket \mathcal{A} \rrbracket$ is recognizable, and by Corollary 12.1.4 we have that $(h \circ \llbracket \mathcal{A} \rrbracket)^{-1}(\{n\})$ is a Σ -recognizable tree language for each $n \in \mathbb{N}$. Since $(h \circ \llbracket \mathcal{A} \rrbracket)^{-1}(\{n\}) = \llbracket \mathcal{A} \rrbracket^{-1}(n)$ for each $n \in \mathbb{N}$, we obtain that $\llbracket \mathcal{A} \rrbracket$ has the preimage property.

Clearly, we can give effectively the congruence classes of \sim , i.e., the elements of Nat/\sim , by choosing only one representative for each congruence class. By Lemma 10.9.1 and the obvious fact that $h(\mathcal{A})$ is constructable, we can construct the $(\Sigma, \text{Nat}/\sim)$ -wta $h(\mathcal{A})$ such that $\llbracket h(\mathcal{A}) \rrbracket = h \circ \llbracket \mathcal{A} \rrbracket$. Since Nat/\sim is finite, by Corollary 12.1.4, we can construct a finite-state Σ -tree automaton A which recognizes $\llbracket h(\mathcal{A}) \rrbracket^{-1}(\{n\}) = \llbracket \mathcal{A} \rrbracket^{-1}(n)$. \square

In the next lemma we deal with the preimage of a set under a recognizable weighted tree language over the semiring of natural numbers. For the sake of simplicity, we call this theorem also preimage theorem. It is a generalization of [BR88, Cor. III.2.4]. For every $m \in \mathbb{N}$ and $n \in \mathbb{N}_+$, we define

$$m + n \cdot \mathbb{N} = \{m + n \cdot j \mid j \in \mathbb{N}\} .$$

Moreover, for each $m \in \mathbb{N}$, we let $\overline{m} = m + n\mathbb{N}$, the equivalence class of m modulo n . The semiring of natural numbers modulo n is the semiring $\text{Nat}/n\text{Nat} = (\{\overline{0}, \dots, \overline{n-1}\}, +_n, \cdot_n, \overline{0}, \overline{1})$, where for every $k, \ell \in [0, n-1]$ we define $\overline{k} +_n \overline{\ell} = \overline{k + \ell \bmod n}$ and $\overline{k} \cdot_n \overline{\ell} = \overline{k \cdot \ell \bmod n}$.

Lemma 12.2.4. (cf. [DV06, Lm. 6.3(2)] and [DFKV22, Lm. 6.4]) Let \mathcal{A} be a (Σ, Nat) -wta. Moreover, let $m \in \mathbb{N}$ and $n \in \mathbb{N}_+$. Then (a) the Σ -tree language $\llbracket \mathcal{A} \rrbracket^{-1}(m + n \cdot \mathbb{N})$ is recognizable and (b) we can construct a Σ -fta A such that $L(A) = \llbracket \mathcal{A} \rrbracket^{-1}(m + n \cdot \mathbb{N})$.

Proof. Proof of (a): Let $m \in \mathbb{N}$ and $n \in \mathbb{N}_+$. If $m < n$, then, by Theorem 10.9.2, $(h \circ \llbracket \mathcal{A} \rrbracket) \in \text{Rec}(\Sigma, \text{Nat}/n\text{Nat})$, where $h : \mathbb{N} \rightarrow \mathbb{N}/n\mathbb{N}$ is the canonical semiring homomorphism. Moreover, $\llbracket \mathcal{A} \rrbracket^{-1}(m + n \cdot \mathbb{N}) = \llbracket \mathcal{A} \rrbracket^{-1}(h^{-1}(\overline{m})) = (h \circ \llbracket \mathcal{A} \rrbracket)^{-1}(\overline{m})$. Since $\text{Nat}/n\text{Nat}$ is a finite semiring, by Corollary 12.1.4, the Σ -tree language $(h \circ \llbracket \mathcal{A} \rrbracket)^{-1}(\overline{m})$ is recognizable. Now assume that $m \geq n$. Then there exist $m' \in [0, n-1]$ and $k \in \mathbb{N}_+$ such that $m = m' + n \cdot k$. Then

$$\llbracket \mathcal{A} \rrbracket^{-1}(m + n \cdot \mathbb{N}) = \llbracket \mathcal{A} \rrbracket^{-1}(m' + n \cdot \mathbb{N}) \setminus \bigcup_{j=0}^{k-1} \llbracket \mathcal{A} \rrbracket^{-1}(m' + n \cdot j). \quad (12.4)$$

As we saw, the Σ -tree language $\llbracket \mathcal{A} \rrbracket^{-1}(m' + n \cdot \mathbb{N})$ is recognizable because $m' < n$. Moreover, by Lemma 12.2.3, for each $j \in [0, k-1]$, the Σ -tree language $\llbracket \mathcal{A} \rrbracket^{-1}(m' + n \cdot j)$ is also recognizable. Finally, Σ -tree languages are closed under union and subtraction (cf. Theorem 2.16.3). Thus, also in this case, the Σ -tree language $\llbracket \mathcal{A} \rrbracket^{-1}(m + n \cdot \mathbb{N})$ is recognizable.

Proof of (b): We follow the proof of (a). Let $m \in \mathbb{N}$. Assume that $m < n$. Obviously, we can give effectively the equivalence classes modulo n , i.e., the elements of $\mathbb{N}/n\mathbb{N}$, by choosing only one representative for each equivalence class. Then we can construct the $(\Sigma, \text{Nat}/n\text{Nat})$ -wta $h(\mathcal{A})$ (cf. page 245). By Lemma 10.9.1 we have $\llbracket h(\mathcal{A}) \rrbracket = h \circ \llbracket \mathcal{A} \rrbracket$.

Since $\text{Nat}/n\text{Nat}$ is a finite semiring, by Corollary 12.1.4, we can construct a Σ -fta which recognizes $(h \circ \llbracket \mathcal{A} \rrbracket)^{-1}(\overline{m}) = \llbracket \mathcal{A} \rrbracket^{-1}(m + n \cdot \mathbb{N})$.

Now assume that $m \geq n$. Since $m' < n$, by the above, we can construct a Σ -fta which recognizes $\llbracket \mathcal{A} \rrbracket^{-1}(m' + n \cdot \mathbb{N})$. Moreover, by Lemma 12.2.3, for each $j \in [0, k-1]$, we can also construct a Σ -fta which recognizes $\llbracket \mathcal{A} \rrbracket^{-1}(m' + n \cdot j)$. Thus, for each tree language which occurs on the right-hand side of (12.4) a Σ -fta can be constructed. Hence, by Theorem 2.16.3, we can construct a Σ -fta which recognizes $\llbracket \mathcal{A} \rrbracket^{-1}(m + n \cdot \mathbb{N})$. \square

Now we have collected the necessary preimage theorems to show that, for each (Σ, \mathbb{B}) -wta \mathcal{A} and $b \in C(\mathcal{A})$, the mapping $r_{\mathcal{A}, b}$ is a recognizable step mapping if $f_{\mathcal{A}, b}$ is bounded or b has finite additive order (cf. Lemma 12.2.5).

We call the mapping $f_{\mathcal{A}, b}$ *bounded* if there exists $K \in \mathbb{N}$ such that $f_{\mathcal{A}, b}(\xi) \leq K$ for each $\xi \in T_\Sigma$.

Lemma 12.2.5. [DFKV22, Thm. 6.6] Let \mathcal{A} be a (Σ, \mathbb{B}) -wta such that $H(\mathcal{A})$ is finite and let $b \in C(\mathcal{A})$. If the mapping $f_{\mathcal{A}, b}$ is bounded or b has finite additive order, then we can construct a crisp-deterministic (Σ, \mathbb{B}) -wta \mathcal{B}_b such that $\llbracket \mathcal{B}_b \rrbracket = r_{\mathcal{A}, b}$.

Proof. By performing Algorithm 3, a crisp-deterministic (Σ, \mathbb{B}) -wta \mathcal{B}_b is constructed.

We prove that $\llbracket \mathcal{B}_b \rrbracket = r_{\mathcal{A}, b}$. If, before execution of line 3, the variable i has the value ℓ , then the family $(A_{b,j} \mid j \in [0, \ell-1])$ of Σ -fta has already been constructed by using Lemma 12.2.3; in particular, if $\ell = 0$, then this family is empty. Thus, after execution of line 3, the family $(A_{b,j} \mid j \in [0, \ell])$ of Σ -fta has been constructed (where $A_{b,\ell}$ is also constructed by Lemma 12.2.3).

Then, line 4 asks whether the mapping $f_{\mathcal{A}, b}$ is bounded by ℓ (i.e., $T_\Sigma \subseteq \bigcup_{j \in [0, \ell]} L(A_{b,j})$); due to [GS84, Thm. 2.10.3] this is decidable). If so, then the for-loop is exited with $K = \ell$.

If not, then line 6 asks whether b has finite additive order ℓ (i.e., $\ell b = j b$ for some $j < \ell$). If so, then $\ell = \min(\ell' \mid \exists j < \ell' : \ell' b = j b)$ and the index $i(b)$ of b and the period $p(b)$ of b (cf. Fig. 2.3) are constructed and, due to lines 8-10, the upper part $(A_{b,j} \mid j \in [i(b), i(b) + p(b) - 1])$ of the family of Σ -fta (generated in line 3) is reconstructed by using Lemma 12.2.4. Thereafter the for-loop is exited with $K = \ell$. (We note that $K = i(b) + p(b) - 1$, i.e., K is the finite additive order of b .)

Since, by our assumption, the mapping $f_{\mathcal{A}, b}$ is bounded or b has finite additive order, the for-loop in lines 2-13, will eventually terminate.

If the for-loop in lines 2-13 was terminated due to the exit in line 4, then the family $(A_{b,j} \mid j \in [0, K])$ of Σ -fta was constructed such that $L(A_{b,j}) = \llbracket \mathcal{A}'_b \rrbracket^{-1}(j)$ for each $j \in [0, K]$. Thus, due to line 1, for each

Algorithm 3 Construction of the cd (Σ, \mathbf{B}) -wta \mathcal{B}_b such that $\llbracket \mathcal{B}_b \rrbracket = r_{\mathcal{A},b}$ (cd=crisp-deterministic)

Input: (a) (Σ, \mathbf{B}) -wta \mathcal{A} such that $H(\mathcal{A})$ is finite and (b) $b \in C(\mathcal{A})$ such that $f_{\mathcal{A},b}$ is bounded or b has finite additive order

Output: cd (Σ, \mathbf{B}) -wta \mathcal{B}_b

- 1: by applying Lemma 12.2.2 to \mathcal{A} , we construct the (Σ, \mathbf{Nat}) -wta \mathcal{A}'_b s.t. $\llbracket \mathcal{A}'_b \rrbracket = f_{\mathcal{A},b}$;
- 2: **for each** $i = 0, 1, 2, \dots$ **do**
- 3: by applying Lemma 12.2.3 to \mathcal{A}'_b , we construct the Σ -fta $A_{b,i}$ s.t. $L(A_{b,i}) = \llbracket \mathcal{A}'_b \rrbracket^{-1}(i)$;
- 4: **if** $T_\Sigma \subseteq \bigcup_{j \in [0, i]} L(A_{b,j})$ **then** let $K \leftarrow i$ and exit the for-loop; ▷ $f_{b,\mathcal{A}}$ is bounded by K
- 5: **end if**
- 6: **if** $ib = jb$ for some $j < i$ **then**
- 7: $i(b) \leftarrow \min\{j \in \mathbb{N}_+ \mid j < i \text{ and } jb = ib\}$ and $p(b) \leftarrow i - i(b)$; ▷ construct the index and period of b
- 8: **for each** $j \in [i(b), i(b) + p(b) - 1]$ **do**
- 9: by applying Lemma 12.2.4 to \mathcal{A}'_b , we construct the Σ -fta $A_{b,j}$ s.t. $L(A_{b,j}) = \llbracket \mathcal{A}'_b \rrbracket^{-1}(j + p(b) \cdot \mathbb{N})$
- 10: **end for**
- 11: let $K \leftarrow i(b) + p(b) - 1$ and exit the for-loop ▷ b has additive order K
- 12: **end if**
- 13: **end for**
- 14: **for each** $j \in [0, K]$ **do**
- 15: by applying Theorem 4.1.10(B) \Rightarrow (C) to $A_{b,j}$, we construct the cd (Σ, \mathbf{B}) -wta $\mathcal{C}_{b,j}$ s.t.

$$\llbracket \mathcal{C}_{b,j} \rrbracket = \chi(L(A_{b,j})) ;$$

- 16: by applying Theorem 10.2.1(4) to jb and $\mathcal{C}_{b,j}$, we construct the cd (Σ, \mathbf{B}) -wta $\mathcal{D}_{b,j}$ s.t.

$$\llbracket \mathcal{D}_{b,j} \rrbracket = (jb) \cdot \llbracket \mathcal{C}_{b,j} \rrbracket ;$$

17: **end for**

- 18: by applying iteratively Theorem 10.1.1(2) to the members of the finite family $(\mathcal{D}_{b,j} \mid j \in [0, K])$, we construct the cd (Σ, \mathbf{B}) -wta \mathcal{B}_b s.t.

$$\llbracket \mathcal{B}_b \rrbracket = \bigoplus_{j \in [0, K]} \llbracket \mathcal{D}_{b,j} \rrbracket .$$

19: **return** \mathcal{B}_b

$j \in [0, K]$ and $\xi \in T_\Sigma$, we have: $\xi \in L(A_{b,j})$ iff $f_{\mathcal{A},b}(\xi) = j$. Hence $L(A_{b,j}) \cap L(A_{b,j'}) = \emptyset$ for every $j, j' \in [0, K]$ with $j \neq j'$, and for each $\xi \in T_\Sigma$ there exists $j \in [0, K]$ such that $\xi \in L(A_{b,j})$; that means that the family $(L(A_{b,j}) \mid j \in [0, K])$ is a partitioning of T_Σ . Since $r_{\mathcal{A},b}(\xi) = (f_{\mathcal{A},b}(\xi))b$ for each $\xi \in T_\Sigma$, we finally obtain

$$r_{\mathcal{A},b} = \bigoplus_{j \in [0, K]} (jb) \cdot \chi(L(A_{b,j})) .$$

If the for-loop in lines 2-13 was terminated due to the exit in line 11, then the family $(A_{b,j} \mid j \in [0, K])$ of Σ -fta was constructed such that

- $L(A_{b,j}) = \llbracket \mathcal{A}'_b \rrbracket^{-1}(j)$ for each $j \in [0, i(b) - 1]$ and
- $L(A_{b,j}) = \llbracket \mathcal{A}'_b \rrbracket^{-1}(j + p(b) \cdot \mathbb{N})$ for each $j \in [i(b), K]$.

Thus, due to line 1,

- for each $j \in [0, i(b) - 1]$ and $\xi \in T_\Sigma$, we have: $\xi \in L(A_{b,j})$ iff $f_{\mathcal{A},b}(\xi) = j$.
- for each $j \in [i(b), K]$ and $\xi \in T_\Sigma$, we have: $\xi \in L(A_{b,j})$ iff $f_{\mathcal{A},b}(\xi) \in (j + p(b) \cdot \mathbb{N})$.

Hence also in this case the family $(L(A_{b,j}) \mid j \in [0, K])$ is a partitioning of T_Σ and as above we obtain

$$r_{\mathcal{A},b} = \bigoplus_{j \in [0, K]} (jb) \cdot \chi(L(A_{b,j})) .$$

In lines 14-17, the family $(\mathcal{D}_{b,j} \mid j \in [0, K])$ of crisp-deterministic (Σ, \mathbf{B}) -wta is constructed such that

$$\llbracket \mathcal{D}_{b,j} \rrbracket = (jb) \cdot \chi(L(A_{b,j})) .$$

Finally, in line 18, the crisp-deterministic (Σ, \mathbf{B}) -wta \mathcal{B}_b is constructed such that $\llbracket \mathcal{B}_b \rrbracket = \bigoplus_{j \in [0, K]} \llbracket \mathcal{D}_{b,j} \rrbracket$. Hence

$$\llbracket \mathcal{B}_b \rrbracket = \bigoplus_{j \in [0, K]} (jb) \cdot \chi(L(A_{b,j})) = r_{\mathcal{A},b} .$$

□

Next we can show the main theorem of this section. It originated from [DSV10, Thm. 11].

Theorem 12.2.6. [DFKV22, Thm. 6.6] *Let Σ be a ranked alphabet. Moreover, let \mathbf{B} be a strong bimonoid and let \mathcal{A} be a (Σ, \mathbf{B}) -wta such that $H(\mathcal{A})$ is finite. If, for each $b \in C(\mathcal{A})$, the mapping $f_{\mathcal{A},b}$ is bounded or b has finite additive order, then we can construct a crisp-deterministic (Σ, \mathbf{B}) -wta \mathcal{B} such that $\llbracket \mathcal{A} \rrbracket^{\text{run}} = \llbracket \mathcal{B} \rrbracket$.*

Proof. Since $H(\mathcal{A})$ is finite, also $C(\mathcal{A})$ is finite. By Lemma 12.2.1, we construct $C(\mathcal{A})$. Then, by Lemma 12.2.5, for each $b \in C(\mathcal{A})$, we construct a crisp-deterministic (Σ, \mathbf{B}) -wta \mathcal{B}_b such that $\llbracket \mathcal{B}_b \rrbracket = r_{\mathcal{A},b}$. Then by (12.2), we have $\llbracket \mathcal{A} \rrbracket^{\text{run}} = \bigoplus_{b \in C(\mathcal{A})} \llbracket \mathcal{B}_b \rrbracket$. Hence, by Theorem 10.1.1(2), we can construct a crisp-deterministic (Σ, \mathbf{B}) -wta \mathcal{B} such that $\llbracket \mathcal{A} \rrbracket^{\text{run}} = \llbracket \mathcal{B} \rrbracket$. □

There is a slight alternative to the construction in the proof of Theorem 12.2.6 if \mathbf{B} is bi-locally finite. Instead of computing the sets $H(\mathcal{A})$ and $C(\mathcal{A})$ (by Lemmas 7.4.1 and 12.2.1), we can construct the set $\langle \text{wts}(\mathcal{A}) \rangle_{\{\otimes\}}$ (by Lemma 2.7.1). Then we could replace, in Lemmas 12.2.2 and 12.2.5, the sets $H(\mathcal{A})$ and $C(\mathcal{A})$ by the set $\langle \text{wts}(\mathcal{A}) \rangle_{\{\otimes\}}$, and we are also able to construct a crisp-deterministic wta which is run-equivalent to \mathcal{A} . However, this modified construction has the disadvantage that, in the construction of \mathcal{A}'_b in Lemma 12.2.2, its state space contains, in general, too many useless states, because many of the elements of $\langle \text{wts}(\mathcal{A}) \rangle_{\{\otimes\}}$ cannot be generated by \mathcal{A} . Note, however, that bi-local finiteness is a very strong restriction. In contrast, Theorem 12.2.6 holds for *all* strong bimonoids and gives a structural condition for the wta \mathcal{A} which ensures its crisp-determinizability.

Clearly, Theorem 12.2.6 also applies to strong bimonoids which are additively idempotent and multiplicatively locally finite. However, in that case we can show a considerably easier construction because we can use the constructions in the proof of Theorem 7.4.2 and Lemma 12.2.7.

Lemma 12.2.7. Let \mathbf{B} be additively idempotent. Let \mathcal{A} be a crisp (Σ, \mathbf{B}) -wta. Then we can construct a crisp-deterministic (Σ, \mathbf{B}) -wta \mathcal{B} such that $\llbracket \mathcal{A} \rrbracket^{\text{run}} = \llbracket \mathcal{B} \rrbracket$.

Proof. Let $\mathcal{A} = (Q, \delta, F)$. We construct $\mathcal{B} = (Q', \delta', F')$ such that

- $Q' = \mathcal{P}(Q)$,
- for every $k \in \mathbb{N}$, $\sigma \in \Sigma^{(k)}$, and $U_1, \dots, U_k, U \in Q'$ we let

$$(\delta')_k(U_1 \cdots U_k, \sigma, U) = \begin{cases} \mathbb{1} & \text{if } U = \{q \in Q \mid (\exists (q_1, \dots, q_k) \in U_1 \times \dots \times U_k) : \delta_k(q_1 \cdots q_k, \sigma, q) = \mathbb{1}\} \\ 0 & \text{otherwise} , \end{cases}$$

- and for each $U \in Q'$, we let $(F')_U = \bigoplus_{q \in U} F_q$.

Obviously, \mathcal{B} is crisp-deterministic.

By Lemma 4.1.5(1), for each $\xi \in \mathsf{T}_\Sigma$ there exists $\rho \in \mathsf{R}_\mathcal{B}(\xi)$ such that $\text{wt}_\mathcal{B}(\xi, \rho) = \mathbb{1}$ and for each $\rho' \in \mathsf{R}_\mathcal{B}(\xi) \setminus \{\rho\}$ we have $\text{wt}_\mathcal{B}(\xi, \rho') = 0$. We denote this unique run by ρ_ξ . Moreover, we let $Q_\xi = \{q \in Q \mid (\exists \rho \in \mathsf{R}_\mathcal{A}(q, \xi)) : \text{wt}_\mathcal{A}(\xi, \rho) = \mathbb{1}\}$.

By induction on T_Σ , we prove the following auxiliary statement.

$$\text{For each } \xi \in \mathsf{T}_\Sigma, \text{ we have } \rho_\xi(\varepsilon) = Q_\xi. \quad (12.5)$$

For this, let $\xi = \sigma(\xi_1, \dots, \xi_k)$. Then we obtain

$$\begin{aligned} \rho_\xi(\varepsilon) &= \{q \in Q \mid (\forall i \in [k]) (\exists q_i \in \rho_{\xi_i}(\varepsilon)) : \delta_k(q_1 \cdots q_k, \sigma, q) = \mathbb{1}\} \\ &= \{q \in Q \mid (\forall i \in [k]) (\exists q_i \in Q_{\xi_i}) : \delta_k(q_1 \cdots q_k, \sigma, q) = \mathbb{1}\} && \text{(by I.H.)} \\ &= Q_\xi . \end{aligned}$$

This finishes the proof of (12.5).

Now let $\xi \in \mathsf{T}_\Sigma$. Then we can calculate as follows.

$$\begin{aligned} \llbracket \mathcal{A} \rrbracket^{\text{run}}(\xi) &= \bigoplus_{q \in Q} \bigoplus_{\rho \in \mathsf{R}_\mathcal{A}(q, \xi)} \text{wt}_\mathcal{A}(\xi, \rho) \otimes F_q \\ &= \bigoplus_{q \in Q} \bigoplus_{\substack{\rho \in \mathsf{R}_\mathcal{A}(q, \xi) \\ \text{wt}_\mathcal{A}(\xi, \rho) = \mathbb{1}}} F_q && \text{(because } \text{wt}_\mathcal{A}(\xi, \rho) \in \{0, \mathbb{1}\}) \\ &= \bigoplus_{q \in Q} |\{\rho \in \mathsf{R}_\mathcal{A}(q, \xi) \mid \text{wt}_\mathcal{A}(\xi, \rho) = \mathbb{1}\}| F_q && \text{(because } F_q \text{ does not depend on } \rho) \\ &= \bigoplus_{q \in Q_\xi} |\{\rho \in \mathsf{R}_\mathcal{A}(q, \xi) \mid \text{wt}_\mathcal{A}(\xi, \rho) = \mathbb{1}\}| F_q && \text{(by the definition of } Q_\xi) \\ &= \bigoplus_{q \in Q_\xi} F_q && \text{(by idempotency)} \\ &= \bigoplus_{q \in \rho_\xi(\varepsilon)} F_q && \text{(by (12.5))} \\ &= (F')_{\rho_\xi(\varepsilon)} && \text{(by construction)} \\ &= \llbracket \mathcal{B} \rrbracket(\xi) . && \text{(by Lemma 4.1.5(2))} \end{aligned}$$

□

Then the next corollary follows from Theorem 7.4.2 and Lemma 12.2.7.

Corollary 12.2.8. Let Σ be a ranked alphabet. Let B be an additively idempotent and multiplicatively locally finite strong bimonoid. Moreover, let \mathcal{A} be a (Σ, B) -wta. We can construct a crisp-deterministic (Σ, B) -wta \mathcal{B} such that $\llbracket \mathcal{A} \rrbracket^{\text{run}} = \llbracket \mathcal{B} \rrbracket$.

Next we show some examples of additively idempotent and multiplicatively locally finite strong bimonoid:

- each bounded lattice.
- the semiring $\mathsf{Nat}_{\max, +, n} = ([0, n]_{-\infty}, \max, \hat{+}_n, -\infty, 0)$ from Example 2.7.9(9).
- the semiring $\mathsf{Nat}_{\max, \min} = (\mathbb{N}_\infty, \max, \min, 0, \infty)$ from Example 2.7.9(11).
- the strong bimonoid $(B, \max, \odot, 0, 1)$ where
 - $B = \{0\} \cup \{b \in \mathbb{R} \mid \lambda \leq b \leq 1\}$ for some $\lambda \in \mathbb{R}$ with $0 < \lambda < \frac{1}{2}$ and
 - $a \odot b = a \cdot b$ if $a \cdot b \geq \lambda$, and 0 otherwise,

and \cdot is the usual multiplication of real numbers (thus, \odot is the same as the multiplication of Trunc_λ of Example 2.7.10(2)).

12.2.2 Equivalence of bi-local finiteness and run crisp-determinizability

First we recall, for a (Σ, \mathbf{B}) -wta $\mathcal{A} = (Q, \delta, F)$, the definitions of $H(\mathcal{A})$ and of $C(\mathcal{A})$:

$$H(\mathcal{A}) = \{\text{wt}(\xi, \rho) \mid \xi \in T_\Sigma, \rho \in R_{\mathcal{A}}(\xi)\} \quad \text{and} \quad C(\mathcal{A}) = \{\text{wt}(\xi, \rho) \otimes F_{\rho(\varepsilon)} \mid \xi \in T_\Sigma, \rho \in R_{\mathcal{A}}(\xi)\} .$$

Then we can prove the following characterization of bi-locally finiteness in terms of crisp-determinization, where the equivalence with Statement (C) is due to [Dro22]. It can be compared directly to Theorem 12.1.6. For the comparison we recall that each locally finite strong bimonoid is bi-locally finite, but not vice versa (cf. the Euler diagram in Figure 2.6). We note that in Lemma 4.3.4 we have already proved that (A) \Rightarrow (C).

Theorem 12.2.9. (cf. [FKV21, Cor. 7.7]) *Let $\mathbf{B} = (B, \oplus, \otimes, 0, \mathbb{1})$ be a strong bimonoid. Then the following four statements are equivalent.*

- (A) \mathbf{B} is bi-locally finite.
 - (B) For each ranked alphabet Σ and for each (Σ, \mathbf{B}) -wta \mathcal{A} , we can construct a crisp-deterministic (Σ, \mathbf{B}) -wta \mathcal{B} such that $\llbracket \mathcal{A} \rrbracket^{\text{run}} = \llbracket \mathcal{B} \rrbracket$.
 - (C) For each ranked alphabet Σ and for each (Σ, \mathbf{B}) -wta \mathcal{A} , the set $\text{im}(\llbracket \mathcal{A} \rrbracket^{\text{run}})$ is finite.
 - (D) For each string ranked alphabet Σ and for each (Σ, \mathbf{B}) -wta \mathcal{A} , the set $\text{im}(\llbracket \mathcal{A} \rrbracket^{\text{run}})$ is finite.
- Thus, for each ranked alphabet Σ , if \mathbf{B} is bi-locally finite, then $\text{Rec}^{\text{run}}(\Sigma, \mathbf{B}) \subseteq \text{Rec}^{\text{init}}(\Sigma, \mathbf{B})$, and if \mathbf{B} is locally finite, then $\text{Rec}^{\text{run}}(\Sigma, \mathbf{B}) = \text{Rec}^{\text{init}}(\Sigma, \mathbf{B})$.

Proof. Proof of (A) \Rightarrow (B): Since \mathbf{B} is bi-locally finite, the set $H(\mathcal{A})$ is finite and each $b \in C(\mathcal{A})$ has finite additive order. Hence the statement follows from Theorem 12.2.6.

Proof of (B) \Rightarrow (C): It follows from Theorem 10.3.1(A) \Rightarrow (C).

Proof of (C) \Rightarrow (D): It is obvious.

Proof of (D) \Rightarrow (A): This can be obtained by an easy adaptation of [DSV10, Lm. 12] from weighted string automata to wta over string ranked alphabet as follows.

First we show that the additive monoid $(B, \oplus, 0)$ is locally finite. Since \oplus is commutative and associative, it suffices to show that, for each $b \in B$, the monoid $\langle b \rangle_{\{\oplus\}}$ is finite. Thus, let $b \in B$ and $\Sigma = \{\gamma^{(1)}, \alpha^{(0)}\}$. We construct the (Σ, \mathbf{B}) -wta $\mathcal{A} = (Q, \delta, F)$, where $Q = \{p, q\}$, $F_p = 0$, $F_q = \mathbb{1}$, and δ is defined as follows (cf. Figure 12.1):

- $\delta_0(\varepsilon, \alpha, p) = \delta_1(p, \gamma, p) = \delta_1(q, \gamma, q) = \mathbb{1}$,
- $\delta_1(p, \gamma, q) = b$, and
- $\delta_0(\varepsilon, \alpha, q) = \delta_1(q, \gamma, p) = 0$.

Then, for each $n \in \mathbb{N}$, we have $\llbracket \mathcal{A} \rrbracket^{\text{run}}(\gamma^n(\alpha)) = nb$ (cf. (2.21)). Hence, $\langle b \rangle_{\{\oplus\}} \subseteq \text{im}(\llbracket \mathcal{A} \rrbracket^{\text{run}})$. By (C), the set $\text{im}(\llbracket \mathcal{A} \rrbracket^{\text{run}})$ is finite. Hence $\langle b \rangle_{\{\oplus\}}$ is also finite.

Next we prove that the multiplicative monoid $(B, \otimes, \mathbb{1})$ is locally finite. Let $n \in \mathbb{N}$ and $b_1, \dots, b_n \in B$. We show that the set

$$B' = \{b_{l_1} \otimes \dots \otimes b_{l_m} \mid m \in \mathbb{N}, l_1, \dots, l_m \in [n]\}$$

is finite. Let $\Sigma = \{\gamma_1^{(1)}, \gamma_2^{(1)}, \beta^{(0)}\}$. We construct the (Σ, \mathbf{B}) -wta $\mathcal{A}' = (Q', \delta', F')$ with $Q' = \{q_0, \dots, q_n\}$, $F'_{q_0} = \mathbb{1}$ and $F'_q = 0$ for every $q \in Q' \setminus \{q_0\}$, and δ' is defined as follows (cf. Figure 12.2):

- $\delta'_0(\varepsilon, \beta, q_0) = \mathbb{1}$,
- $\delta'_1(q_{i-1}, \gamma_1, q_i) = \mathbb{1}$ for each $i \in [n]$,
- $\delta'_1(q_i, \gamma_2, q_0) = b_i$ for each $i \in [n]$, and

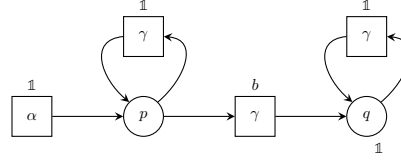

Figure 12.1: The (Σ, \mathbf{B}) -wta \mathcal{A} with $\llbracket \mathcal{A} \rrbracket^{\text{run}}(\gamma^n(\alpha)) = nb$.

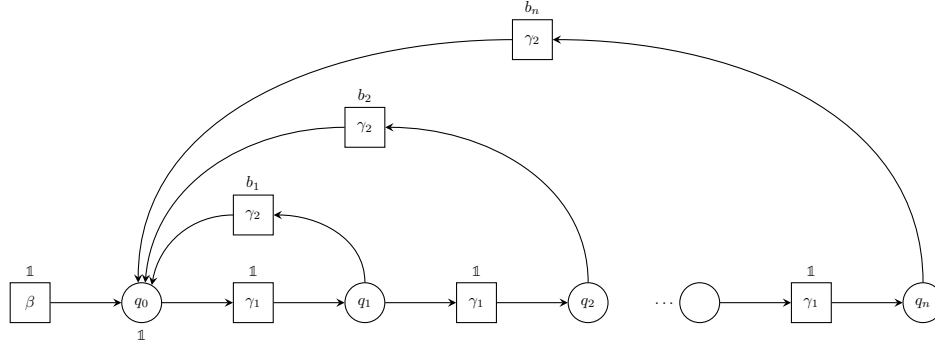

Figure 12.2: The (Σ, \mathbf{B}) -wta \mathcal{A}' with $\llbracket \mathcal{A}' \rrbracket^{\text{run}}(\gamma_2 \gamma_1^{l_m} \gamma_2 \gamma_1^{l_{m-1}} \gamma_2 \dots \gamma_1^{l_1} \beta) = b_{l_1} \otimes \dots \otimes b_{l_m}$.

• $\delta'_k(q'_1 \dots q'_k, \sigma, q') = 0$ for each other combination of $k \in \mathbb{N}$, $\sigma \in \Sigma^{(k)}$ and $q'_1 \dots q'_k \in Q^k$ and $q' \in Q'$. Hence, $\llbracket \mathcal{A}' \rrbracket^{\text{run}}(\gamma_2 \gamma_1^{l_m} \gamma_2 \gamma_1^{l_{m-1}} \gamma_2 \dots \gamma_1^{l_1} \beta) = b_{l_1} \otimes \dots \otimes b_{l_m}$ for every $m \in \mathbb{N}$ and $l_1, \dots, l_m \in [n]$. Thus $B' \subseteq \text{im}(\llbracket \mathcal{A}' \rrbracket^{\text{run}})$. By (C), the set $\text{im}(\llbracket \mathcal{A}' \rrbracket^{\text{run}})$ is finite, and therefore B' is finite. Hence (C) \Rightarrow (A).

For the proof of the next statement, let \mathcal{A} be a (Σ, \mathbf{B}) -wta. If \mathbf{B} is bi-locally finite, then by (A) \Rightarrow (B) we can construct a crisp-deterministic (Σ, \mathbf{B}) -wta \mathcal{B} such that $\llbracket \mathcal{A} \rrbracket^{\text{run}} = \llbracket \mathcal{B} \rrbracket$. Since, in particular, $\llbracket \mathcal{B} \rrbracket = \llbracket \mathcal{B} \rrbracket^{\text{init}}$, we have $\text{Rec}^{\text{run}}(\Sigma, \mathbf{B}) \subseteq \text{Rec}^{\text{init}}(\Sigma, \mathbf{B})$.

If \mathbf{B} is locally finite, then this inclusion together with Theorem 12.1.3(2) imply that $\text{Rec}^{\text{run}}(\Sigma, \mathbf{B}) = \text{Rec}^{\text{init}}(\Sigma, \mathbf{B})$. □

As a consequence of Theorem 12.2.9(A) \Rightarrow (B) and Theorem 10.3.1 (A) \Rightarrow (C), we show one more preimage theorem.

Corollary 12.2.10. [DFKV22, Cor. 6.9] Let \mathbf{B} be bi-locally finite and \mathcal{A} a (Σ, \mathbf{B}) -wta. Then, for each $b \in B$, we can construct a Σ -fta A such that $L(A) = (\llbracket \mathcal{A} \rrbracket^{\text{run}})^{-1}(b)$.

12.2.3 Characterization of run crisp-determinizability for past-finite monotonic strong bimonoids

In this subsection we show a characterization of run crisp-determinizability for wta over past-finite monotonic strong bimonoids (cf. Theorem 12.2.15). Each past-finite monotonic strong bimonoid shares many properties with the semiring of natural numbers, like (a) having a partial order on its carrier set (which is not necessarily total), (b) being zero-sum free and zero-divisor free, (c) monotonicity of its operations with respect to that partial order, and (d) a strong kind of well-foundedness (called past-finiteness). However, in general, distributivity is not required and also does not follow from the axioms. The idea of past-finite strong bimonoids and the characterization stems from [DFKV22].

First we define these strong bimonoids. Let (B, \preceq) be a partially ordered set. We say that \preceq is *past-finite* if for each $b \in B$ the set $\text{past}(b) = \{a \in B \mid a \preceq b\}$ is finite. In the sequel, we write $a \prec b$ if $a \preceq b$ and $a \neq b$.

Thus, for each past-finite partial order \preceq , the relation \prec is well-founded. However, there exists a well-founded relation \prec such that the relation \preceq (defined by $a \preceq b$ if $a \prec b$ or $a = b$) is a partial order and it is not past-finite. For instance, let $B = \{b, a_1, a_2, \dots\}$ and $\prec = \{(a_1, b), (a_2, b), \dots\}$.

Let us consider a strong bimonoid \mathbf{B} and let \preceq be a partial order on B . We say that \mathbf{B} is *monotonic with respect to \preceq* (cf. [BFGM05, Def. 5] and [DFKV22]) if

$$\text{for every } a, b \in B, \text{ we have } a \preceq a \oplus b \text{ and} \quad (12.6)$$

$$\text{for every } a, b, c \in B \setminus \{0\} \text{ with } b \neq \mathbb{1} \text{ we have: } a \otimes c \prec a \otimes b \otimes c . \quad (12.7)$$

From (12.7) we easily obtain that

$$\text{for every } a, b \in B \setminus \{0\} \text{ with } b \neq \mathbb{1} \text{ we have: } a \prec a \otimes b \text{ and } a \prec b \otimes a . \quad (12.8)$$

If \mathbf{B} is monotonic with respect to \preceq , then we also write that $(\mathbf{B}, \preceq) = (B, \oplus, \otimes, 0, \mathbb{1}, \preceq)$ is a *monotonic strong bimonoid*. A monotonic strong bimonoid (\mathbf{B}, \preceq) has several properties [BFGM05, Lm. 14].

Lemma 12.2.11. If (\mathbf{B}, \preceq) is a monotonic strong bimonoid, then

- (1) $0 \preceq b$ for each $b \in B$, and $\mathbb{1} \preceq b$ for each $b \in B \setminus \{0\}$,
- (2) \mathbf{B} is positive, i.e., zero-sum free and zero-divisor free,
- (3) \mathbf{B} is *one-summand free*, i.e., for every $a, b \in B$ if $a \oplus b = \mathbb{1}$, then $a, b \in \{0, \mathbb{1}\}$, and
- (4) \mathbf{B} is *one-product free*, i.e., for every $a, b \in B$ if $a \otimes b = \mathbb{1}$, then $a = b = \mathbb{1}$.

Proof. Let $a, b \in B$.

Proof of (1): By (12.6), we obtain $0 \preceq 0 \oplus b = b$. If $b \neq 0$, then by (12.8), $\mathbb{1} \preceq \mathbb{1} \otimes b = b$.

Proof of (2): First we prove zero-sum freeness. Let $b \in B \setminus \{0\}$. Then, by Item (1) and (12.6), we have $0 \prec b \preceq a \oplus b$. Hence \mathbf{B} is zero-sum free.

Next we show zero-divisor freeness. Let $a, b \in B \setminus \{0\}$. Then, by Item (1) and (12.8), $0 \prec a \preceq a \otimes b$. Thus \mathbf{B} is zero-divisor free.

Proof of (3): Assume that $a \notin \{0, \mathbb{1}\}$. Then, by (1) and (12.6), we obtain $\mathbb{1} \prec a \preceq a \oplus b$. Hence \mathbf{B} is one-summand free.

Proof of (4): We show by contradiction that $a \otimes b = \mathbb{1}$ implies $a = \mathbb{1}$ and $b = \mathbb{1}$. Assume that $a \neq \mathbb{1}$ or $b \neq \mathbb{1}$ and $a \otimes b = \mathbb{1}$. Apparently, $a, b \in B \setminus \{0\}$. Hence by (1) and (12.8) we obtain $\mathbb{1} \preceq b \prec a \otimes b$ or $\mathbb{1} \preceq a \prec a \otimes b$. This contradicts to $a \otimes b = \mathbb{1}$. Consequently, \mathbf{B} is one-product free. \square

Lemma 12.2.11(1) and (12.8) imply that, for each $b \in B \setminus \{0, \mathbb{1}\}$ and $n \in \mathbb{N}$, we have $0 \prec \mathbb{1} \prec b^n \prec b^{n+1}$, i.e.,

$$0 \prec \mathbb{1} \prec b \prec b \otimes b \prec b \otimes b \otimes b \dots .$$

Hence, if (\mathbf{B}, \preceq) is a finite monotonic strong bimonoid, then B has only two elements 0 and $\mathbb{1}$, we have $0 \prec \mathbb{1}$ and $\mathbb{1} \oplus \mathbb{1} = \mathbb{1}$. Thus \mathbf{B} is isomorphic to the Boolean semiring \mathbf{Boole} .

We call a monotonic strong bimonoid $(B, \oplus, \otimes, 0, \mathbb{1}, \preceq)$ *past-finite* if (B, \preceq) is past-finite. In [DFKV22, Ex. 2.2-2.4] a number of past-finite monotonic strong bimonoids are shown. Here we only mention the following examples:

- (a) the semiring (\mathbf{Boole}, \leq) , where $0 \leq 1$,
- (b) the semiring (\mathbf{Nat}, \leq) of natural numbers, where \leq is the common relation “less than or equal to” on \mathbb{N} ,
- (c) the semiring $(\mathbf{Nat}_{\max, +}, \leq)$, where \leq is the natural extension of \leq to $\mathbb{N}_{-\infty}$,
- (d) the semiring $(\mathcal{P}_f(\Gamma^*), \cup, \cdot, \emptyset, \{\varepsilon\}, \preceq)$ where $\mathcal{P}_f(\Gamma^*)$ is the set of finite subsets of Γ^* and $L_1 \preceq L_2$ if there exists an injective mapping $f : L_1 \rightarrow L_2$ such that w is a substring of $f(w)$ for each $w \in L_1$,
- (e) the semiring $(\mathcal{P}_f(\mathbb{N}), \cup, +, \emptyset, \{0\}, \preceq)$ where $\mathcal{P}_f(\mathbb{N})$ is the set of finite subsets of \mathbb{N} , the operation $+$ is extended in the usual way to sets, and $N_1 \preceq N_2$ if there exists an injective mapping $f : N_1 \rightarrow N_2$ such that $n \leq f(n)$ for each $n \in N_1$, and

- (f) the plus-plus strong bimonoid $(\mathbb{P}\mathbb{N}, \leq) = (\mathbb{N}_0, \oplus, +, 0, 0, \leq)$ of natural numbers (cf. Example 2.7.10(8)), where \leq is the usual order on \mathbb{N} together with $0 \leq x$ for each $x \in \mathbb{N}$. Then $(\mathbb{P}\mathbb{N}, \leq)$ is a past-finite monotonic strong bimonoid which is not a semiring.

The set of past-finite monotonic strong bimonoids shares another property with the semiring of natural numbers (cf. Lemma 12.2.3).

Theorem 12.2.12. [DFKV22, Thm. 6.10] *Let (\mathbf{B}, \preceq) be past-finite monotonic strong bimonoid and \mathcal{A} a (Σ, \mathbf{B}) -wta and $b \in B$.*

- (1) *The tree language $(\llbracket \mathcal{A} \rrbracket^{\text{run}})^{-1}(b)$ is recognizable. Hence $\llbracket \mathcal{A} \rrbracket^{\text{run}}$ has the preimage property.*
- (2) *If the set $\text{past}(b)$ can be constructed, then we can construct a finite-state Σ -tree automaton which recognizes $\llbracket \mathcal{A} \rrbracket^{-1}(b)$.*

Proof. Let $b \in B$.

Proof of (1): We define the set $C = B \setminus \text{past}(b) = \{a \in B \mid a \not\leq b\}$. Moreover, we define the equivalence relation \sim on the set B such that its classes are the singleton sets $\{a\}$ for each $a \in \text{past}(b)$ and the set C .

We claim that \sim is a congruence. To show this let $c, c' \in C$ and $d \in B$. Since (\mathbf{B}, \preceq) is monotonic, we have $c \preceq c \oplus d$ and $c' \preceq c' \oplus d$. Hence $c \oplus d \in C$ and $c' \oplus d \in C$. By commutativity of \oplus we also have $d \oplus c \in C$ and $d \oplus c' \in C$. Thus \oplus obeys the structure of the equivalence classes. Now let $d \neq 0$. Then we obtain $c \preceq c \otimes d$ and $c \preceq d \otimes c$, showing that $c \otimes d \in C$ and $d \otimes c \in C$, and similarly $c' \otimes d \in C$ and $d \otimes c' \in C$. Hence \sim is a congruence on the strong bimonoid \mathbf{B} .

By definition, the quotient strong bimonoid of \mathbf{B} modulo \sim is finite. Let $h : B \rightarrow B/\sim$ be the canonical strong bimonoid homomorphism, i.e., for each $c \in B$ we let $h(c) = [c]_{\sim}$. By Lemma 10.9.2, we obtain $(h \circ \llbracket \mathcal{A} \rrbracket^{\text{run}}) \in \text{Rec}^{\text{run}}(\Sigma, B/\sim)$. Moreover $(\llbracket \mathcal{A} \rrbracket^{\text{run}})^{-1}(b) = (h \circ \llbracket \mathcal{A} \rrbracket^{\text{run}})^{-1}(\{b\})$. Since B/\sim is finite, by Corollary 12.2.10, the Σ -tree language $(h \circ \llbracket \mathcal{A} \rrbracket^{\text{run}})^{-1}(\{b\})$ is recognizable. Thus $\llbracket \mathcal{A} \rrbracket^{\text{run}}$ has the preimage property.

Proof of (2): Assume that $\text{past}(b)$ is constructed. Then we can construct the congruence \sim as defined in the proof of Statement 1 and the canonical strong bimonoid homomorphism $h : B \rightarrow B/\sim$. We can construct the $(\Sigma, \mathbf{B}/\sim)$ -wta $h(\mathcal{A})$, and by Lemma 10.9.1, we have $\llbracket h(\mathcal{A}) \rrbracket^{\text{run}} = h \circ \llbracket \mathcal{A} \rrbracket^{\text{run}}$. Since \mathbf{B}/\sim is finite, by Corollary 12.2.10, we can construct a finite-state Σ -tree automaton which recognizes $(\llbracket h(\mathcal{A}) \rrbracket^{\text{run}})^{-1}(\{b\})$. \square

By Theorems 10.3.1 and 12.2.12(1), \mathcal{A} is run crisp-determinizable if and only if $\text{im}(\llbracket \mathcal{A} \rrbracket^{\text{run}})$ is finite. As first step towards our characterization theorem we analyse the impact of this finiteness property on the structure of a (Σ, \mathbf{B}) -wta \mathcal{A} where (\mathbf{B}, \preceq) is a past-finite monotonic strong bimonoid. In particular, we consider local-non-zero runs and small loops of \mathcal{A} . (We recall that the definition of a run on a context and the weight of such a run can be found in Section 6.1.)

For each $\xi \in \text{T}_{\Sigma}(\{z\})$, we call a run $\rho \in \mathbf{R}_{\mathcal{A}}(\xi)$ *local-non-zero* if for each $w \in \text{pos}_{\Sigma}(\xi)$ we have $\delta_k(\rho(w1) \cdots \rho(wk), \sigma, \rho(w)) \neq 0$ where $k = \text{rk}(\xi(w))$ and $\sigma = \xi(w)$. We note that, for every $\xi \in \text{T}_{\Sigma}$ and $\rho \in \mathbf{R}_{\mathcal{A}}(\xi)$, the run ρ is local-successful (cf. Subsection 7.1.1) if it is local-non-zero and $F_{\rho(\varepsilon)} \neq 0$.

We say that *small loops of \mathcal{A} have weight 1* if, for every $q \in Q$, $c \in C_{\Sigma}$, and local-non-zero $\rho \in \mathbf{R}_{\mathcal{A}}(q, c, q)$, if $\text{height}(c) < |Q|$, then $\text{wt}(c, \rho) = 1$.

Theorem 12.2.13. [DFKV22, Thm. 7.1] *Let (\mathbf{B}, \preceq) be a past-finite monotonic strong bimonoid and \mathcal{A} be a local-trim (Σ, \mathbf{B}) -wta. If $\text{im}(\llbracket \mathcal{A} \rrbracket^{\text{run}})$ is finite, then small loops of \mathcal{A} have weight 1.*

Proof. We prove by contraposition. Suppose there exist $q \in Q$, $c \in C_{\Sigma}$, and local-non-zero $\rho \in \mathbf{R}_{\mathcal{A}}(q, c, q)$ such that $\text{height}(c) < |Q|$ and $\text{wt}(c, \rho) \neq 1$. Since ρ is local-non-zero and (\mathbf{B}, \preceq) is monotonic, we have that $1 \prec \text{wt}(c, \rho)$. Since \mathcal{A} is local-trim, the state q is local-useful and thus there exist $\xi \in \text{T}_{\Sigma}$, $\theta \in \mathbf{R}_{\mathcal{A}}(q, \xi)$, $c' \in C_{\Sigma}$, $q' \in Q$ with $F_{q'} \neq 0$, and $\rho' \in \mathbf{R}_{\mathcal{A}}(q', c', q)$, and θ and ρ' are local-non-zero. By Theorem 6.1.3, for each $n \in \mathbb{N}$, we have

$$\text{wt}(c' [c^n[\xi]], \rho' [\rho^n[\theta]]) = l_{c', \rho'} \otimes (l_{c, \rho})^n \otimes \text{wt}(\xi, \theta) \otimes (r_{c, \rho})^n \otimes r_{c', \rho'} .$$

Since $\mathbb{1} \prec \text{wt}(c, \rho) = l_{c, \rho} \otimes r_{c, \rho}$, we have $\mathbb{1} \prec l_{c, \rho}$ or $\mathbb{1} \prec r_{c, \rho}$, because \mathbf{B} is one-product free. Thus, by monotonicity of (\mathbf{B}, \preceq) , we obtain

$$\text{wt}(c' [c^0[\xi]], \rho' [\rho^0[\theta]]) \prec \text{wt}(c' [c^1[\xi]], \rho' [\rho^1[\theta]]) \prec \dots \quad (12.9)$$

Next we define a sequence $\xi_1, \xi_2, \xi_3, \dots$ of trees in \mathbf{T}_Σ such that the elements $\llbracket \mathcal{A} \rrbracket^{\text{run}}(\xi_1), \llbracket \mathcal{A} \rrbracket^{\text{run}}(\xi_2), \llbracket \mathcal{A} \rrbracket^{\text{run}}(\xi_3), \dots$ are pairwise different as follows. We let $\xi_1 = c' [c[\xi]]$. Since (\mathbf{B}, \preceq) is past-finite, the set $P_1 = \text{past}(\llbracket \mathcal{A} \rrbracket^{\text{run}}(\xi_1))$ is finite. By (12.9) we choose n_2 such that $\text{wt}(c' [c^{n_2}[\xi]], \rho' [\rho^{n_2}[\theta]]) \notin P_1$ and let $\xi_2 = c' [c^{n_2}[\xi]]$. Since $\rho' [\rho^{n_2}[\theta]] \in \mathbf{R}_{\mathcal{A}}(q', \xi_2)$ and (\mathbf{B}, \preceq) is monotonic, we have

$$\text{wt}(\xi_2, \rho' [\rho^{n_2}[\theta]]) \preceq \text{wt}(\xi_2, \rho' [\rho^{n_2}[\theta]]) \otimes F_{q'} \preceq \bigoplus_{\kappa \in \mathbf{R}_{\mathcal{A}}(\xi_2)} \text{wt}(\xi_2, \kappa) \otimes F_{\kappa(\varepsilon)} = \llbracket \mathcal{A} \rrbracket^{\text{run}}(\xi_2).$$

(Note that $F_{q'}$ may be $\mathbb{1}$.) Hence $\llbracket \mathcal{A} \rrbracket^{\text{run}}(\xi_2) \notin P_1$. Put $P_2 = \text{past}(\llbracket \mathcal{A} \rrbracket^{\text{run}}(\xi_2))$. Then we choose $n_3 \in \mathbb{N}$ such that $\text{wt}(c' [c^{n_3}[\xi]], \rho' [\rho^{n_3}[\theta]]) \notin P_1 \cup P_2$ and let $\xi_3 = c' [c^{n_3}[\xi]]$. As before, we have $\llbracket \mathcal{A} \rrbracket^{\text{run}}(\xi_3) \notin P_1 \cup P_2$. Continuing this process, we obtain the desired sequence of trees. It means that $\text{im}(\llbracket \mathcal{A} \rrbracket^{\text{run}})$ is infinite. \square

We recall, for a (Σ, \mathbf{B}) -wta $\mathcal{A} = (Q, \delta, F)$, the definitions

$$\mathbf{H}(\mathcal{A}) = \{\text{wt}(\xi, \rho) \mid \xi \in \mathbf{T}_\Sigma, \rho \in \mathbf{R}_{\mathcal{A}}(\xi)\} \text{ and } \mathbf{C}(\mathcal{A}) = \{\text{wt}(\xi, \rho) \otimes F_{\rho(\varepsilon)} \mid \xi \in \mathbf{T}_\Sigma, \rho \in \mathbf{R}_{\mathcal{A}}(\xi)\} .$$

Also a kind of inverse of Theorem 12.2.13 holds.

Lemma 12.2.14. [DFKV22, Lm. 5.5, 6.7] Let \mathbf{B} be a one-product free strong bimonoid and \mathcal{A} be a (Σ, \mathbf{B}) -wta. If small loops of \mathcal{A} have weight $\mathbb{1}$, then

- (1) for every $\xi \in \mathbf{T}_\Sigma$, $q' \in Q$, and local-non-zero $\kappa \in \mathbf{R}_{\mathcal{A}}(q', \xi)$, there exist $\xi' \in \mathbf{T}_\Sigma$ and $\kappa' \in \mathbf{R}_{\mathcal{A}}(q', \xi')$ such that $\text{height}(\xi') < |Q|$ and $\text{wt}(\xi, \kappa) = \text{wt}(\xi', \kappa')$ and
- (2) the set $\mathbf{H}(\mathcal{A})$ is finite.

Proof. Proof of (1): The idea is to cut out iteratively local-non-zero, small loops with weight $\mathbb{1}$. Formally, let $\xi \in \mathbf{T}_\Sigma$, $q' \in Q$, and $\kappa \in \mathbf{R}_{\mathcal{A}}(q', \xi)$ be a local-non-zero run. We may assume that $\text{height}(\xi) \geq |Q|$. Applying Theorem 6.1.4 (for $n = 1$ and $n = 0$), there exist $c, c' \in \mathbf{C}_\Sigma$, $\zeta \in \mathbf{T}_\Sigma$, $q \in Q$, $\rho' \in \mathbf{R}_{\mathcal{A}}(q', c', q)$, $\rho \in \mathbf{R}_{\mathcal{A}}(q, c, q)$, and $\theta \in \mathbf{R}_{\mathcal{A}}(q, \zeta)$ such that $\xi = c' [c[\zeta]]$, $\kappa = \rho' [\rho[\theta]]$, $\text{height}(c) > 0$, $\text{height}(c[\zeta]) < |Q|$, and

$$\begin{aligned} \text{wt}(\xi, \kappa) &= \text{wt}(c' [c[\zeta]], \rho' [\rho[\theta]]) = l_{c', \rho'} \otimes l_{c, \rho} \otimes \text{wt}(\zeta, \theta) \otimes r_{c, \rho} \otimes r_{c', \rho'} \quad (\text{for } n = 1) , \\ \text{wt}(c' [\zeta], \rho' [\theta]) &= l_{c', \rho'} \otimes \text{wt}(\zeta, \theta) \otimes r_{c', \rho'} \quad (\text{for } n = 0) . \end{aligned}$$

Since κ is local-non-zero, also the runs ρ' , ρ , and θ are local-non-zero. Thus $\text{wt}(c, \rho) = \mathbb{1}$ by our assumption.

Moreover, by Observation 6.1.1, we have $\text{wt}(c, \rho) = l_{c, \rho} \otimes r_{c, \rho}$. Since \mathbf{B} is one-product free, we have $l_{c, \rho} = r_{c, \rho} = \mathbb{1}$. Hence we have $\text{wt}(\xi, \kappa) = \text{wt}(c' [\zeta], \rho' [\theta])$.

Obviously, $\rho' [\theta] \in \mathbf{R}_{\mathcal{A}}(q', c' [\zeta])$ and $\text{size}(c' [\zeta]) < \text{size}(\xi)$. If $\text{height}(c' [\zeta]) < |Q|$, then we are ready. Otherwise we continue with $c' [\zeta]$, q' , and $\rho' [\theta]$ as before. After finitely many steps, we obtain $\xi' \in \mathbf{T}_\Sigma$ and $\kappa' \in \mathbf{R}_{\mathcal{A}}(q', \xi')$ with $\text{height}(\xi') < |Q|$ as required.

Proof of (2): If small loops of \mathcal{A} have weight $\mathbb{1}$, then by Statement 1 of this lemma we have

$$\mathbf{H}(\mathcal{A}) = \{\text{wt}(\xi, \rho) \mid \xi \in \mathbf{T}_\Sigma, \text{height}(\xi) < |Q|, \text{ and } \rho \in \mathbf{R}_{\mathcal{A}}(\xi)\} .$$

Hence $\mathbf{H}(\mathcal{A})$ is finite. \square

Now we can prove the main result of this subsection.

Theorem 12.2.15. [DFKV22, Thm. 6.10, 7.1] *Let Σ be a ranked alphabet. Moreover, let $(\mathbf{B}, \preceq) = (B, \oplus, \otimes, \mathbb{0}, \mathbb{1}, \preceq)$ be a past-finite monotonic strong bimonoid and let \mathcal{A} be a local-trim (Σ, \mathbf{B}) -wta. Then the following two statements are equivalent.*

- (A) \mathcal{A} is run crisp-determinizable.
- (B) Small loops of \mathcal{A} have weight $\mathbb{1}$ and, for each $b \in C(\mathcal{A})$, the mapping $f_{\mathcal{A},b}$ is bounded or b has finite additive order.

Proof. Proof of (A) \Rightarrow (B): Since \mathcal{A} is run crisp-determinizable, the set $\text{im}(\llbracket \mathcal{A} \rrbracket^{\text{run}})$ is finite by Theorem 10.3.1. Thus, by Theorem 12.2.13, small loops of \mathcal{A} have weight $\mathbb{1}$.

Now let $b \in C(\mathcal{A})$. If the mapping $f_{\mathcal{A},b}$ is not bounded, then there exists an infinite sequence ξ_1, ξ_2, \dots of trees in T_Σ such that $f_{\mathcal{A},b}(\xi_1) < f_{\mathcal{A},b}(\xi_2) < \dots$. By Equality (12.2), we have $(f_{\mathcal{A},b}(\xi_i))b \preceq \llbracket \mathcal{A} \rrbracket^{\text{run}}(\xi_i)$ for each $i \in \mathbb{N}$. Thus $(f_{\mathcal{A},b}(\xi_i))b \in P$, where $P = \bigcup_{a \in \text{im}(\llbracket \mathcal{A} \rrbracket^{\text{run}})} \text{past}(a)$. Since $\text{im}(\llbracket \mathcal{A} \rrbracket^{\text{run}})$ is finite and (\mathbf{B}, \preceq) is past-finite, the set P is also finite. Hence $(f_{\mathcal{A},b}(\xi_i))b = (f_{\mathcal{A},b}(\xi_j))b$ for some $i, j \in \mathbb{N}$ with $i < j$, which implies that b has finite additive order.

Proof of (B) \Rightarrow (A): This implication follows from Lemma 12.2.14 (we recall that each monotonic strong bimonoid is one-product free) and Theorem 12.2.6. \square

Finally we show an application of Theorem 12.2.15.

Theorem 12.2.16. [DFKV20, Thm. 10] *Let (\mathbf{B}, \preceq) be an additively locally finite and past-finite monotonic strong bimonoid. Moreover, let \mathcal{A} be a (Σ, \mathbf{B}) -wta which contains at least one local-useful state. It is decidable whether \mathcal{A} is run crisp-determinizable.*

Proof. Let $\mathcal{A} = (Q, \Sigma, \delta)$. By Theorem 7.1.4, we can construct a (Σ, \mathbf{B}) -wta \mathcal{A}' such that \mathcal{A}' is local-trim and $\llbracket \mathcal{A}' \rrbracket^{\text{run}} = \llbracket \mathcal{A} \rrbracket^{\text{run}}$. Hence we may assume that \mathcal{A} is local-trim. Since \mathbf{B} is additively locally finite, each $b \in C(\mathcal{A})$ has finite additive order. Thus, by Theorem 12.2.15, \mathcal{A} is run crisp-determinizable if and only if small loops of \mathcal{A} have weight $\mathbb{1}$. The latter property is decidable because (a) there exist only finitely many $c \in C_\Sigma$ such that $\text{height}(c) < |Q|$, and (b) since (\mathbf{B}, \preceq) is monotonic, for every $c \in C_\Sigma$, $q \in Q$, and $\rho \in R_{\mathcal{A}}(q, c, q)$ we have $\text{wt}(c, \rho) = \mathbb{1}$ if and only if for each $v \in \text{pos}(c)$ we have $\delta_k(\rho(v1) \cdots \rho(vk), \sigma, \rho(v)) = \mathbb{1}$ where $\sigma = c(v)$ and $k = \text{rk}(\sigma)$, and (c) this is decidable because \mathbf{B} has an effective test for $\mathbb{1}$. \square

The decidability problem addressed in Theorem 12.2.16 is meaningful, because there exists an additively locally finite and past-finite monotonic semiring and a wta over that semiring which is not run crisp-determinizable. Such a semiring and wta is the arctic semiring $\text{Nat}_{\max,+}$ and the $(\Sigma, \text{Nat}_{\max,+})$ -wta \mathcal{A} in Example 3.2.4, respectively. We recall that $\llbracket \mathcal{A} \rrbracket^{\text{init}} = \llbracket \mathcal{A} \rrbracket^{\text{run}} = \text{height}$ (cf. Theorem 5.3.1). As we mentioned \mathcal{A} is not run crisp-determinizable because $\text{im}(\text{height})$ is not finite.

We refer the reader to [DFKV20, DFKV22] for further decidability and undecidability results for wta and wsa over past-finite monotonic strong bimonoids.

Chapter 13

Determinization of wta over semirings

In this chapter, we consider as weight algebras only semirings. A (Σ, \mathbf{B}) -wta \mathcal{A} over some semiring \mathbf{B} is *bu-determinizable* (or just: determinizable) if there exists an equivalent bu-deterministic (Σ, \mathbf{B}) -wta \mathcal{B} , i.e., $\llbracket \mathcal{A} \rrbracket = \llbracket \mathcal{B} \rrbracket$.¹

If \mathbf{B} is locally finite (e.g., finite), then we can apply the subset method of Definition 12.1.2 to \mathcal{A} and obtain an i-equivalent crisp-deterministic (Σ, \mathbf{B}) -wta \mathcal{B} . In Section 13.1, it will turn out that, in general, the subset method will not yield a bu-deterministic wta, i.e., it is not able to determinize each wta. One might think that there exist other, successful approaches. However, there are recognizable weighted tree languages which are not bu-deterministically recognizable (as already in the string case, cf. [KLMP04, pp.354]). Hence, if r is such a weighted tree language, then each wta \mathcal{A} with $\llbracket \mathcal{A} \rrbracket = r$ is not bu-determinizable. For example, the mapping $\text{height} : \mathsf{T}_\Sigma \rightarrow \mathbb{N}$ is recognizable by a $(\Sigma, \mathbf{Nat}_{\max,+})$ -wta (cf. Example 3.2.4) but it is not bu-deterministically recognizable (cf. Corollary 6.1.5). In Section 13.2 we show two further recognizable weighted tree languages which are not bu-deterministically recognizable.

In Section 13.3 we show an advanced version of the subset method which is based on factorization and it is called determinization by factorization (cf. Definition 13.3.1). We elaborate sufficient conditions under which determinization by factorization transforms a given wta into a bu-deterministic wta which is equivalent to the given wta. More precisely, if \mathbf{B} is an extremal and commutative semiring for which there exists a maximal factorization, and the given (Σ, \mathbf{B}) -wta \mathcal{A} has the twinning property, then \mathcal{A} is bu-determinizable (cf. Theorem 13.3.2) and a bu-deterministic wta equivalent to \mathcal{A} can be obtained by applying determinization by factorization to \mathcal{A} . The approach of bu-determinization of wta by factorization was published in [BVM10] (also cf. [Büc14, Sec. 5]), and it is based on the determinization by factorization of wsa [KM05]. In its turn, the latter is a generalization of determinization of wsa over the tropical semiring [Moh97].

We mention that in [Pau20, Sect. 4.5] the decidability of the determinization of $(\Sigma, \mathbf{Real}_{\max,+})$ -wta was considered, where $\mathbf{Real}_{\max,+}$ is the semifield $(\mathbb{R}_{-\infty}, \max, +, -\infty, 0)$. One of the main results is [Pau20, Thm. 4.33] which states the following. For a finitely ambiguous $(\Sigma, \mathbf{Real}_{\max,+})$ -wta \mathcal{A} it is decidable whether there exists a deterministic $(\Sigma, \mathbf{Real}_{\max,+})$ -wta \mathcal{A}' such that $\llbracket \mathcal{A} \rrbracket = \llbracket \mathcal{A}' \rrbracket$. If such an automaton $\llbracket \mathcal{A}' \rrbracket$ exists, then it can be constructed. Here finitely ambiguous means that there exists an integer $M \geq 1$ such that, for each tree $\xi \in \mathsf{T}_\Sigma$, there are at most M accepting runs of \mathcal{A} on ξ . We also mention that the base of the construction of \mathcal{A}' is not the factorization as in this chapter.

Also, we mention that in [DSF21] wta over particular semirings were considered which are based on groups. Let $\mathbf{G} = (G, \otimes, \mathbb{1})$ be a group. Then $\mathbf{Sem}(\mathbf{G}) = (\mathcal{P}_{\text{fin}}(G), \cup, \otimes, \emptyset, \{\mathbb{1}\})$ is a semiring where \otimes is

¹We recall that $\llbracket \mathcal{A} \rrbracket = \llbracket \mathcal{A} \rrbracket^{\text{init}} = \llbracket \mathcal{A} \rrbracket^{\text{run}}$ because \mathbf{B} is a semiring.

lifted to finite subsets of G in the straightforward way (cf. Example 2.7.9(17)). A *group-weighted tree automaton over Σ and G* (for short: (Σ, G) -gwta) is a $(\Sigma, \text{Sem}(G))$ -wta. In [DSF21, Thm. 1] it is proved that each (Σ, G) -gwta is sequentializable if it has the twinning property. A (Σ, G) -gwta is sequential if it is bu-deterministic and for each transition $(q_1 \cdots q_k, \sigma, q)$ we have that $|\delta_k(q_1 \cdots q_k, \sigma, q)| \leq 1$. It is easy to see that each crisp-deterministic (Σ, G) -gwta is sequential, and each sequential (Σ, G) -gwta is bu-deterministic. Moreover, both inclusions are strict.

Finally, we mention that in [Dör22] a general framework for the determinization was established, which is based on a theory of factorizations in (multiplicative) monoids [Dör22, Sec. 3.3]. Roughly speaking, the main determinization result [Dör22, Thm. 3.78] says the following. Let $\mathbf{B} = (B, \oplus, \otimes, \mathbf{0}, \mathbf{1})$ be a semiring; moreover, let $\mathbf{M} = (M, \otimes, \mathbf{1})$ be a finitely generated submonoid of $(B, \otimes, \mathbf{1})$ which satisfies a certain monotonicity property and admits centering factorizations; then $\mathbf{B}' = ((M)_{\oplus}, \oplus, \otimes, \mathbf{0}, \mathbf{1})$ is a semiring. Moreover, let \mathcal{A} be a (Σ, \mathbf{B}') -wta which satisfies a certain twinning property. Then [Dör22, Thm. 3.78] says that, if \mathcal{A} is finitely M -ambiguous or \mathbf{B}' is additively idempotent, then \mathcal{A} is \mathbf{M} -sequentializable, which means sequential and the transition weights are in M . As illustrated in [Dör22, Ex. 3.95], the twinning properties of [BVM10] and of [Dör22, Thm. 3.78] are incomparable.

In this chapter \mathbf{B} is a semiring and $\mathcal{A} = (Q, \delta, F)$ denotes an arbitrary (Σ, \mathbf{B}) -wta unless specified otherwise.

13.1 Applying the subset method to wta over arbitrary semirings

One can be tempted to apply the subset method (cf. Definition 12.1.2) to a (Σ, \mathbf{B}) -wta \mathcal{A} where \mathbf{B} is an arbitrary semiring. Then one obtains the triple $\text{sub}(\mathcal{A}) = (Q', \delta', F')$. We note that Q' is finite if and only if $\text{sub}(\mathcal{A})$ is a crisp-deterministic wta.

Lemma 13.1.1. If $\text{sub}(\mathcal{A})$ is a crisp-deterministic (Σ, \mathbf{B}) -wta, then $\llbracket \mathcal{A} \rrbracket$ is a recognizable step mapping.

Proof. Let $\text{sub}(\mathcal{A})$ be a crisp-deterministic (Σ, \mathbf{B}) -wta. Then by Theorem 12.1.3(1) we have $\llbracket \text{sub}(\mathcal{A}) \rrbracket = \llbracket \mathcal{A} \rrbracket$. Hence the statement follows from Theorem 10.3.1. \square

This lemma shows the limitation of the subset method: if $\llbracket \mathcal{A} \rrbracket$ is not a recognizable step mapping, then $\text{sub}(\mathcal{A})$ is not a crisp-deterministic wta, i.e., the subset method does not yield a wta. In the following we give an example of a (not bu-deterministic) (Σ, \mathbf{B}) -wta \mathcal{A} which cannot be determinized by the subset method because $\llbracket \mathcal{A} \rrbracket$ is not a recognizable step mapping (also cf. [BVM10, Ex. 4.1]).

Example 13.1.2. We consider the tropical semifield $\text{Rat}_{\min,+} = (\mathbb{Q}_{\infty}, \min, +, \infty, 0)$ and the ranked alphabet $\Sigma = \{\sigma^{(2)}, \alpha^{(0)}\}$. Moreover, we let $\mathcal{A} = (Q, \delta, F)$ be the $(\Sigma, \text{Rat}_{\min,+})$ -wta given by

- $Q = \{p, p'\}$ and $F_p = 0$ and $F_{p'} = \infty$ and
- $\delta_0(\varepsilon, \alpha, p) = 1$, $\delta_2(pp, \sigma, p) = 1$, $\delta_2(pp, \sigma, p') = 0.5$, and $\delta_2(p'p, \sigma, p) = 1.5$, and all other values of δ_0 and δ_2 are ∞ .

Figure 13.1 shows the fta-hypergraph of \mathcal{A} . Obviously, \mathcal{A} is not bu-deterministic. Moreover, for each $\xi \in T_{\Sigma}$, we have

$$h_{\mathcal{A}}(\xi)_{p'} = \begin{cases} \infty & \text{if } \xi = \alpha \\ \text{size}(\xi) - 0.5 & \text{otherwise} \end{cases} \quad \text{and} \quad h_{\mathcal{A}}(\xi)_p = \text{size}(\xi) .$$

Thus, for each $\xi \in T_{\Sigma}$, we have $\llbracket \mathcal{A} \rrbracket(\xi) = \llbracket \mathcal{A} \rrbracket(\xi) = \text{size}(\xi)$.² Obviously, size is not a recognizable step mapping, because $\text{im}(\text{size})$ is an infinite set. Thus, by the contraposition of Lemma 13.1.1 $\text{sub}(\mathcal{A}) =$

²Indeed, we obtained \mathcal{A} by starting from the bu-deterministic wta shown in Example 3.2.3 and by “unfolding” the transition on σ .

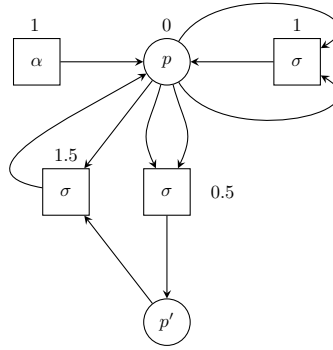

Figure 13.1: The $(\Sigma, \text{Rat}_{\min,+})$ -wta \mathcal{A} .

(Q', δ', F') is not a crisp-deterministic wta. In particular, the set Q' is not finite. We obtain that, in general, the subset method is not appropriate to determinize wta. \square

Finally, we note that the reverse of Lemma 13.1.1 does not hold. For instance, consider the $(\Sigma, \text{Nat}_{\max,+})$ -wta \mathcal{A} of Example 3.2.4 which recognizes the weighted tree language height : $T_\Sigma \rightarrow \mathbb{N}$. In the definition of \mathcal{A} , let us change the mapping F by defining $F_h = -\infty$, and let us denote the obtained wta by \mathcal{A}' . Obviously, $\llbracket \mathcal{A}' \rrbracket = \widetilde{-\infty}$, i.e., a recognizable step mapping. On the other hand, $Q' = \{ \binom{n}{0} \mid n \in \mathbb{N} \}$, i.e., an infinite set. Hence $\text{sub}(\mathcal{A})$ is not a crisp-deterministic $(\Sigma, \text{Nat}_{\max,+})$ -wta.

13.2 Negative results for determinization

We have seen that the subset method does not yield the desired determinization. Actually, there is no determinization which works for each (Σ, \mathbf{B}) -wta because there exist recognizable weighted tree languages which are not bu-deterministically recognizable. For instance, the weighted tree language height is not bu-deterministically recognizable (cf. Corollary 6.1.5). In this section we show two further examples of such weighted tree languages.

Theorem 13.2.1. ([Den17], also cf. [Mal08, Ex. 7]) *The weighted tree language zigzag : $T_\Sigma \rightarrow \mathbb{N}$ defined in Example 3.2.15 is in $\text{Rec}(\Sigma, \text{Nat}_{\max,+})$, but not in $\text{bud-Rec}(\Sigma, \text{Nat}_{\max,+})$. Hence, each $(\Sigma, \text{Nat}_{\max,+})$ -wta which recognizes zigzag is not bu-determinizable.*

Proof. We recall that $\Sigma = \{ \sigma^{(2)}, \alpha^{(0)} \}$ and $\text{Nat}_{\max,+} = (\mathbb{N}_{-\infty}, \max, +, -\infty, 0)$. We prove the claim by contradiction. For this we assume that there exists a bu-deterministic $(\Sigma, \text{Nat}_{\max,+})$ -wta $\mathcal{A} = (Q, \delta, F)$ such that $\llbracket \mathcal{A} \rrbracket = \text{zigzag}$.

By Lemma 4.1.2(1), for every $\xi \in T_\Sigma$ we have $|\mathbb{Q}_{\neq -\infty}^{\text{h}_\mathcal{A}}(\xi)| \leq 1$. If there exists a tree $\xi \in T_\Sigma$ such that $|\mathbb{Q}_{\neq -\infty}^{\text{h}_\mathcal{A}}(\xi)| = 0$, then $\llbracket \mathcal{A} \rrbracket(\xi) = -\infty \neq \text{zigzag}(\xi)$. Thus for every $\xi \in T_\Sigma$ we have $|\mathbb{Q}_{\neq -\infty}^{\text{h}_\mathcal{A}}(\xi)| = 1$. Let us denote, for each $\xi \in T_\Sigma$, the unique element in $\mathbb{Q}_{\neq -\infty}^{\text{h}_\mathcal{A}}(\xi)$ by q_ξ .

If there exists a $\xi \in T_\Sigma$ such that $F_{q_\xi} = -\infty$, then $\llbracket \mathcal{A} \rrbracket(\xi) = -\infty \neq \text{zigzag}(\xi)$. Thus $F_{q_\xi} \neq -\infty$ for every $\xi \in T_\Sigma$. In conclusion we know:

$$(\forall \xi \in T_\Sigma) : (\llbracket \mathcal{A} \rrbracket(\xi) = \text{h}_\mathcal{A}(\xi)_{q_\xi} + F_{q_\xi} = \text{zigzag}(\xi)) \wedge ((\forall q \in Q) : \text{if } q \neq q_\xi, \text{ then } \text{h}_\mathcal{A}(\xi)_q = -\infty). \quad (13.1)$$

Since Q is finite and $\text{zigzag}(T_\Sigma)$ is not, there exist trees $\xi_1, \xi_2 \in T_\Sigma$ such that $q_{\xi_1} = q_{\xi_2}$ and $\text{zigzag}(\xi_1) \neq \text{zigzag}(\xi_2)$. Since \mathcal{A} is bu-deterministic, we have $q_{\sigma(\alpha, \xi_1)} = q_{\sigma(\alpha, \xi_2)}$. Let us abbreviate

q_{ξ_1} by q and $q_{\sigma(\alpha, \xi_1)}$ by q' , respectively. Due to the definition of zigzag we have that $\text{zigzag}(\sigma(\alpha, \xi_1)) = \text{zigzag}(\sigma(\alpha, \xi_2)) = 1$.

Then we can derive the following sequence of implications:

$$\begin{aligned}
& \text{zigzag}(\sigma(\alpha, \xi_1)) &= & \text{zigzag}(\sigma(\alpha, \xi_2)) \\
\Rightarrow & \text{h}_{\mathcal{A}}(\sigma(\alpha, \xi_1))_{q'} + F_{q'} &= & \text{h}_{\mathcal{A}}(\sigma(\alpha, \xi_2))_{q'} + F_{q'} \\
& & & \text{(by (13.1) and because } q_{\sigma(\alpha, \xi_1)} = q_{\sigma(\alpha, \xi_2)}) \\
\Rightarrow & \text{h}_{\mathcal{A}}(\sigma(\alpha, \xi_1))_{q'} &= & \text{h}_{\mathcal{A}}(\sigma(\alpha, \xi_2))_{q'} \quad \text{(because } F_{q'} \neq -\infty) \\
\Rightarrow & \text{h}_{\mathcal{A}}(\alpha)_{q_\alpha} + \text{h}_{\mathcal{A}}(\xi_1)_q + \delta_2(q_\alpha q, \sigma, q') &= & \text{h}_{\mathcal{A}}(\alpha)_{q_\alpha} + \text{h}_{\mathcal{A}}(\xi_2)_q + \delta_2(q_\alpha q, \sigma, q') \\
& & & \text{(by definition of } \text{h}_{\mathcal{A}} \text{ and because } q = q_{\xi_1} = q_{\xi_2}) \\
\Rightarrow & \text{h}_{\mathcal{A}}(\xi_1)_q &= & \text{h}_{\mathcal{A}}(\xi_2)_q \\
& & & \text{(because } \text{h}_{\mathcal{A}}(\alpha)_{q_\alpha} \neq -\infty \neq \delta_2(q_\alpha q, \sigma, q')) \\
\Rightarrow & \text{h}_{\mathcal{A}}(\xi_1)_q + F_q &= & \text{h}_{\mathcal{A}}(\xi_2)_q + F_q \quad \text{(because } F_q \neq -\infty) \\
\Rightarrow & \text{zigzag}(\xi_1) &= & \text{zigzag}(\xi_2) \quad \text{(by (13.1))}
\end{aligned}$$

This is a contradiction. Thus $\text{zigzag} \notin \text{bud-Rec}(\Sigma, \text{Nat}_{\max,+})$. As a consequence, each $(\Sigma, \text{Nat}_{\max,+})$ -wta which recognizes zigzag (including the one in Example 3.2.15) is not bu-determinizable. \square

Theorem 13.2.2. (cf. [BV03, Thm. 6.3]) *The weighted tree language $(\text{exp} + 1) : \text{T}_\Sigma \rightarrow \mathbb{N}$ defined in Example 3.2.9 is in $\text{Rec}(\Sigma, \text{Rat})$, but not in $\text{bud-Rec}(\Sigma, \text{Rat})$, where $\text{Rat} = (\mathbb{Q}, +, \cdot, 0, 1)$ is the field over the rational numbers. Hence, each (Σ, Rat) -wta which recognizes $(\text{exp} + 1)$ is not bu-determinizable.*

Proof. We recall that $\Sigma = \{\gamma^{(1)}, \alpha^{(0)}\}$. In Example 3.2.9, we gave a (Σ, Nat) -wta over the semiring $\text{Nat} = (\mathbb{N}, +, \cdot, 0, 1)$ of natural numbers which recognizes $(\text{exp} + 1)$. We can view this wta as a (Σ, Rat) -wta (cf. Section 3.7), which we denote by $\mathcal{A}_\mathbb{Q}$ in this proof. Hence $(\text{exp} + 1) \in \text{Rec}(\Sigma, \text{Rat})$.

Next we prove that $(\text{exp} + 1) \notin \text{bud-Rec}(\Sigma, \text{Rat})$, and we prove this by contradiction. We assume that $(\text{exp} + 1) \in \text{bud-Rec}(\Sigma, \text{Rat})$. Then, by Theorem 7.3.3 there exists a bu-deterministic (Σ, Rat) -wta $\mathcal{A} = (Q, \delta, F)$ with identity root weights such that $\llbracket \mathcal{A} \rrbracket = (\text{exp} + 1)$.

By Lemma 4.1.2(1), for every $n \in \mathbb{N}$ we have $|\text{Q}_{\neq 0}^{\text{h}_{\mathcal{A}}}(\gamma^n(\alpha))| \leq 1$. If $|\text{Q}_{\neq 0}^{\text{h}_{\mathcal{A}}}(\gamma^n(\alpha))| = 0$ or $|\text{Q}_{\neq 0}^{\text{h}_{\mathcal{A}}}(\gamma^n(\alpha))| = 1$ and $\text{supp}(F) = \emptyset$, then $\llbracket \mathcal{A} \rrbracket(\gamma^n(\alpha)) = 0$ which is a contradiction. Thus $|\text{Q}_{\neq 0}^{\text{h}_{\mathcal{A}}}(\gamma^n(\alpha))| = 1$. We denote the state in the set $|\text{Q}_{\neq 0}^{\text{h}_{\mathcal{A}}}(\gamma^n(\alpha))| \cap \text{supp}(F)$ by q_n . Thus

$$\llbracket \mathcal{A} \rrbracket(\gamma^n(\alpha)) = \text{h}_{\mathcal{A}}(\gamma^n(\alpha))_{q_n} = 2^n + 1. \quad (13.2)$$

It is an easy exercise to show that, for every $q \in Q$ and $n \geq 1$:

$$\delta_0(\varepsilon, \alpha, q) = \begin{cases} 2 & \text{if } q = q_0 \\ 0 & \text{otherwise} \end{cases}$$

and

$$\delta_1(q_{n-1}, \gamma, q) = \begin{cases} (2^{n-1} + 1)^{-1} \cdot (2^n + 1) & \text{if } q = q_n \\ 0 & \text{otherwise} \end{cases}.$$

Since Q is finite, there exist $n, i \in \mathbb{N}$ such that $0 \leq i < n$ and $q_i = q_n$. Then we can calculate as follows:

$$\begin{aligned}
\llbracket \mathcal{A} \rrbracket(\gamma^{n+1}(\alpha)) &= \text{h}_{\mathcal{A}}(\gamma^{n+1}(\alpha))_{q_n} \cdot \delta_1(q_n, \gamma, q_{n+1}) = (2^n + 1) \cdot \delta_1(q_n, \gamma, q_{n+1}) \\
&= (2^n + 1) \cdot \delta_1(q_i, \gamma, q_{i+1}) = (2^n + 1) \cdot (2^i + 1)^{-1} \cdot (2^{i+1} + 1) \neq 2^{n+1} + 1.
\end{aligned}$$

where the inequality follows from a straightforward calculation. However, $\llbracket \mathcal{A} \rrbracket(\gamma^{n+1}(\alpha)) \neq 2^{n+1} + 1$ which contradicts Equation (13.2). Hence $(\text{exp} + 1) \notin \text{bud-Rec}(\Sigma, \text{Rat})$. As a consequence, each (Σ, Rat) -wta which recognizes $(\text{exp} + 1)$ (including $\mathcal{A}_\mathbb{Q}$ from the beginning of the proof) is not bu-determinizable. \square

13.3 Positive result for determinization

In this section we recall the approach of [BVM10] (based on [KM05]) and adapt it to our notations.

We recall that $\mathbf{V}(\mathcal{A}) = (B^Q, \delta_{\mathcal{A}})$ is the vector algebra of \mathcal{A} , and that $\mathbb{0}_Q \in B^Q$ is the Q -vector over \mathbf{B} which contains $\mathbb{0}$ in each component (cf. Section 2.9). We assume that there exists $\alpha \in \Sigma^{(0)}$ such that $\delta_{\mathcal{A}}(\alpha)(\cdot) \neq \mathbb{0}_Q$.

In this section we use the addition of B^Q -vectors and the multiplication of a Q -vector with a scalar both from the left and the right (cf. Section 2.9). Also we recall that, for every $\xi \in T_{\Sigma}$ and $q \in Q$ we have $\mathbf{h}_{\mathcal{A}}(\xi)_q = \bigoplus_{\rho \in R_{\mathcal{A}}(q, \xi)} \text{wt}(\xi, \rho)$ (cf. (5.2)).

In Subsection 13.3.1, we start by defining the concepts of factorization and twinning property, we show the construction of the triple $\det_{(f,g)}(\mathcal{A})^3$ for some wta \mathcal{A} and some factorization (f, g) , and we show the main determinization theorem of this section (cf. Theorem 13.3.2) and an application to a particular wta. In Subsections 13.3.2 and 13.3.3, we elaborate properties and examples of factorizations and of the twinning property, respectively. Finally, in Subsection 13.3.4, we show the proof of Theorem 13.3.2.

13.3.1 Determinization by factorization

The idea of factorization is to represent each Q -vector $u \in B^Q$ as a scalar product $b \cdot u'$ where $b \in B$ and $u' \in B^Q$; moreover, the way in which Q -vectors are split into elements of B and remaining Q -vectors in B^Q should be uniform. Formally, a *factorization over B^Q* (or: *factorization*) is a pair (f, g) of mappings, where

$$f : B^Q \setminus \{\mathbb{0}_Q\} \rightarrow B^Q \text{ and } g : B^Q \setminus \{\mathbb{0}_Q\} \rightarrow B$$

such that $u = g(u) \cdot f(u)$ for every $u \in B^Q \setminus \{\mathbb{0}_Q\}$. Thus $\mathbb{0}_Q \notin \text{im}(f)$ and $\mathbb{0} \notin \text{im}(g)$. We call $g(u)$ the *common factor of u* and $f(u)$ the *remainder of u* . The factorization (f, g) is called

- *maximal* if, for every $u \in B^Q \setminus \{\mathbb{0}_Q\}$ and $b \in B$ with $b \cdot u \neq \mathbb{0}_Q$, we have $f(u) = f(b \cdot u)$, and
- *trivial* if $f(u) = u$ and $g(u) = \mathbb{1}$ for every $u \in B^Q \setminus \{\mathbb{0}_Q\}$.

We recall from Section 6.1 that, for every $c \in C_{\Sigma}$ and $p, q \in Q$, we denote the set of all runs of \mathcal{A} on c and the set of all (q, p) -runs of \mathcal{A} on c by $R_{\mathcal{A}}(c)$ and $R_{\mathcal{A}}(q, c, p)$, respectively. Also the weight of a run on a context is defined in Section 6.1. Moreover, for every $\xi \in T_{\Sigma}$, $\rho \in R_{\mathcal{A}}(\xi)$, and $w \in \text{pos}(\xi)$, we defined the run $\rho|_w$ on the context $\xi|_w$.

Additionally, for each $\xi \in T_{\Sigma} \cup C_{\Sigma}$ and $R \subseteq R_{\mathcal{A}}(\xi)$, we define

$$\text{wt}(R) = \bigoplus_{\rho \in R} \text{wt}(\xi, \rho) .$$

By Observation 2.7.7, if \mathbf{B} is extremal, then there exists $\rho \in R$ such that $\text{wt}(\xi, \rho) = \text{wt}(R)$. We call such a run *victorious in R* .

The wta \mathcal{A} has the *twinning property* if, for every $p, q \in Q$, $\xi \in T_{\Sigma}$, and $c \in C_{\Sigma}$, the following holds:

$$\begin{aligned} &\text{If } \text{wt}(R_{\mathcal{A}}(p, c, p)) \neq \mathbb{0} \text{ and } \text{wt}(R_{\mathcal{A}}(p, \xi)) \neq \mathbb{0} \text{ and} \\ &\quad \text{wt}(R_{\mathcal{A}}(q, c, q)) \neq \mathbb{0} \text{ and } \text{wt}(R_{\mathcal{A}}(q, \xi)) \neq \mathbb{0} , \\ &\text{then } \text{wt}(R_{\mathcal{A}}(p, c, p)) = \text{wt}(R_{\mathcal{A}}(q, c, q)) . \end{aligned}$$

The following determinization by factorization is based on [KM05, Sect. 3.3] and [BVM10, p. 11]. Roughly speaking, it differs from the subset method as follows. In the subset method, for every $u_1, \dots, u_k \in B^Q$ and $\sigma \in \Sigma^{(k)}$, the transition

$$(u_1 \cdots u_k, \sigma, \delta_{\mathcal{A}}(\sigma)(u_1, \dots, u_k)) \text{ with weight } \mathbb{1}$$

³The notation $\det_{(f,g)}(\mathcal{A})$ should not be confused with the determinant of a matrix.

is constructed. In the determinization by factorization, the Q -vector $\delta_{\mathcal{A}}(\sigma)(u_1, \dots, u_k)$ is factorized as

$$\delta_{\mathcal{A}}(\sigma)(u_1, \dots, u_k) = \underbrace{g(\delta_{\mathcal{A}}(\sigma)(u_1, \dots, u_k))}_{\text{common factor in } B} \cdot \underbrace{f(\delta_{\mathcal{A}}(\sigma)(u_1, \dots, u_k))}_{\text{remainder in } B^Q}$$

and the transition

$$(u_1 \cdots u_k, \sigma, f(\delta_{\mathcal{A}}(\sigma)(u_1, \dots, u_k))) \text{ with weight } g(\delta_{\mathcal{A}}(\sigma)(u_1, \dots, u_k))$$

is constructed. Thus, the remainder $f(\delta_{\mathcal{A}}(\sigma)(u_1, \dots, u_k))$ is the target state of the transition and the common factor $g(\delta_{\mathcal{A}}(\sigma)(u_1, \dots, u_k))$ is its weight. We do this because, as we will see, in certain cases the set of remainders will be a finite set, while the set of vectors produced by the subset method is infinite.

In the following we give the definition of determinization by factorization. Like the subset method, it is not a construction in the sense described in the Introduction, because the set Q' might be infinite and in this case the triple (Q', δ', F') is not a bu-deterministic wta. We will need further conditions to assure that (Q', δ', F') is a bu-deterministic wta (cf. Theorem 13.3.2).

Definition 13.3.1. [BVM10, p. 11] Let Σ be a ranked alphabet. Moreover, let $\mathbf{B} = (B, \oplus, \otimes, 0, \mathbb{1})$ be a semiring, let $\mathcal{A} = (Q, \delta, F)$ be a (Σ, \mathbf{B}) -wta, and let (f, g) be a factorization over B^Q . The *determinization by factorization* transforms \mathcal{A} and (f, g) into the triple $\det_{(f,g)}(\mathcal{A}) = (Q', \delta', F')$ where

- Q' is the smallest set $P \subseteq B^Q$ such that, for every $k \in \mathbb{N}$, $\sigma \in \Sigma^{(k)}$, $u_1, \dots, u_k \in P$: if $\delta_{\mathcal{A}}(\sigma)(u_1, \dots, u_k) \neq 0_Q$, then $f(\delta_{\mathcal{A}}(\sigma)(u_1, \dots, u_k)) \in P$,
- $\delta' = (\delta'_k \mid k \in \mathbb{N})$ is the family of mappings $\delta'_k : (Q')^k \times \Sigma^{(k)} \times Q' \rightarrow B$ defined for every $k \in \mathbb{N}$, $\sigma \in \Sigma^{(k)}$, $u_1, \dots, u_k \in Q'$, and $u \in Q'$ by

$$\delta'_k(u_1 \dots u_k, \sigma, u) = \begin{cases} g(\delta_{\mathcal{A}}(\sigma)(u_1, \dots, u_k)) & \text{if } \delta_{\mathcal{A}}(\sigma)(u_1, \dots, u_k) \neq 0_Q \text{ and} \\ & u = f(\delta_{\mathcal{A}}(\sigma)(u_1, \dots, u_k)), \\ 0 & \text{otherwise,} \end{cases}$$

- $F'_u = \bigoplus_{q \in Q} u_q \otimes F_q$ for every $u \in Q'$.

We call the triple $\det_{(f,g)}(\mathcal{A})$ the *determinization of \mathcal{A} by (f, g)* .

In the following, we list some properties of determinization by factorization.

- (1) Since $0_Q \notin \text{im}(f)$, we have $0_Q \notin Q'$.
- (2) If Q' is finite, then $\det_{(f,g)}(\mathcal{A})$ is a bu-deterministic (Σ, \mathbf{B}) -wta. However, even in this case $\det_{(f,g)}(\mathcal{A})$ is not necessarily crisp-deterministic.
- (3) If (f, g) is the trivial factorization, then the determinization by factorization is the same as the subset method except that the latter may generate the state 0_Q .
- (4) If (f, g) is the trivial factorization and \mathbf{B} is locally finite, then the determinization by factorization is the same as the subset method except that the latter may generate the state 0_Q ; in particular, the state set Q' is finite. Hence $\det_{(f,g)}(\mathcal{A})$ is a bu-deterministic (Σ, \mathbf{B}) -wta. Moreover, $\text{sub}(\mathcal{A})$ and $\det_{(f,g)}(\mathcal{A})$ are equivalent, because the state 0_Q is useless for $\text{sub}(\mathcal{A})$. More precisely, (a) the operation $\delta_{\mathcal{A}}(\sigma)$ yields 0_Q if there exists an argument which is 0_Q (cf. (3.2)) and (b) $F'(0_Q) = 0$. Thus, if $0_Q \in \text{im}(h_{\mathcal{A}})$, then we can also drop 0_Q from the state set without changing the semantics of $\text{sub}(\mathcal{A})$. Then, by applying the construction of Theorem 7.2.1 to $\det_{(f,g)}(\mathcal{A})$ (which transforms a given wta into an equivalent total one such that bu-determinism is preserved), we obtain a crisp-deterministic wta which is equivalent to $\det_{(f,g)}(\mathcal{A})$. This construction can be compared to the construction of the Nerode wsa in [CDIV10, Sec. 6].
- (5) If \mathbf{B} is the semiring Boole, then there exists exactly one factorization (f, g) , viz. the trivial and maximal factorization defined by $g(u) = 1$ and $f(u) = u$. Since \mathbf{B} is finite, determinization by factorization is a particular case of the one described in (4).

The main result of this chapter will be the following theorem.

Theorem 13.3.2. [BVM10, Thm. 5.2] *Let Σ be a ranked alphabet. Moreover, let \mathbf{B} be an extremal and commutative semiring, let \mathcal{A} be a (Σ, \mathbf{B}) -wta with the twinning property, and let (f, g) be a maximal factorization over B^Q . Then*

- (1) $\det_{(f,g)}(\mathcal{A})$ is a bu-deterministic (Σ, \mathbf{B}) -wta (finiteness),
- (2) $\llbracket \det_{(f,g)}(\mathcal{A}) \rrbracket = \llbracket \mathcal{A} \rrbracket$ (correctness), and
- (3) $\det_{(f,g)}(\mathcal{A})$ is minimal with respect to the number of states among all bu-deterministic (Σ, \mathbf{B}) -wta which are obtained from \mathcal{A} by determinization by factorization (minimality).

Proof. It follows from Theorems 13.3.17, 13.3.18, and 13.3.19, which are proved in the next subsections. \square

We show six examples of extremal and commutative semirings:

- the semiring $\mathbf{Boole} = (\mathbb{B}, \vee, \wedge, 0, 1)$,
- the arctic semiring $\mathbf{Nat}_{\max,+} = (\mathbb{N}_{-\infty}, \max, +, -\infty, 0)$,
- the semiring $\mathbf{Nat}_{\max,+,\hat{n}} = ([0, n]_{-\infty}, \max, \hat{+}_n, -\infty, 0)$ where $[0, n]_{-\infty}$ is an abbreviation of $[0, n] \cup \{-\infty\}$ (defined in Example 2.7.9(9)),
- the tropical semifield $\mathbf{Rat}_{\min,+} = (\mathbb{Q}_{\infty}, \min, +, \infty, 0)$,
- the semifield $(\mathbb{R}_{\geq 0}, \max, \cdot, 0, 1)$, and
- the semiring $\mathbf{Viterbi} = ([0, 1], \max, \cdot, 0, 1)$.

We note that, due to Lemma 13.3.6 (below), Theorem 13.3.2 cannot be used to determinize a (Σ, \mathbf{B}) -wta (Q, δ, F) with at least two states if \mathbf{B} is not zero-divisor free, because in this case there does not exist a maximal factorization of B^Q .

Example 13.3.3. Again, we consider the $(\Sigma, \mathbf{Rat}_{\min,+})$ -wta $\mathcal{A} = (Q, \delta, F)$ given in Example 13.1.2. For convenience, we recall that

- $Q = \{p, p'\}$ and $F_p = 0$ and $F_{p'} = \infty$ and
- $\delta_0(\varepsilon, \alpha, p) = 1$, $\delta_2(pp, \sigma, p) = 1$, $\delta_2(pp, \sigma, p') = 0.5$, and $\delta_2(p'p, \sigma, p) = 1.5$, and all other values of δ_0 and δ_2 are ∞ .

As it turned out in Example 13.1.2, the subset method is not applicable to determinize \mathcal{A} . Now we determinize \mathcal{A} by factorization according to Definition 13.3.1.

For this, we define the mappings $f : (\mathbb{Q}_{\infty})^Q \setminus \{\infty_Q\} \rightarrow (\mathbb{Q}_{\infty})^Q$ and $g : (\mathbb{Q}_{\infty})^Q \setminus \{\infty_Q\} \rightarrow \mathbb{Q}_{\infty}$ defined for each $u = \begin{pmatrix} u_p \\ u_{p'} \end{pmatrix}$ in $(\mathbb{Q}_{\infty})^Q \setminus \{\infty_Q\}$ by

$$f(u)_q = u_q - g(u) \quad \text{for each } q \in Q \quad \text{and} \quad g(u) = \min(u_p, u_{p'}) .$$

Then (f, g) is a maximal factorization.

Then $\det_{(f,g)}(\mathcal{A}) = (Q', \delta', F')$, which we will abbreviate by \mathcal{A}' in the sequel, is defined by (cf. Figure 13.2)

- $Q' = \left\{ \begin{pmatrix} 0 \\ \infty \end{pmatrix}, \begin{pmatrix} 0.5 \\ 0 \end{pmatrix} \right\}$ and $F'(\begin{pmatrix} 0 \\ \infty \end{pmatrix}) = 0$ and $F'(\begin{pmatrix} 0.5 \\ 0 \end{pmatrix}) = 0.5$
- $\delta'_0(\varepsilon, \alpha, \begin{pmatrix} 0 \\ \infty \end{pmatrix}) = 1$ and

$$\begin{aligned} \delta'_2\left(\begin{pmatrix} 0 \\ \infty \end{pmatrix}\begin{pmatrix} 0 \\ \infty \end{pmatrix}, \sigma, \begin{pmatrix} 0.5 \\ 0 \end{pmatrix}\right) &= 0.5, & \delta'_2\left(\begin{pmatrix} 0 \\ \infty \end{pmatrix}\begin{pmatrix} 0.5 \\ 0 \end{pmatrix}, \sigma, \begin{pmatrix} 0.5 \\ 0 \end{pmatrix}\right) &= 1, \\ \delta'_2\left(\begin{pmatrix} 0.5 \\ 0 \end{pmatrix}\begin{pmatrix} 0 \\ \infty \end{pmatrix}, \sigma, \begin{pmatrix} 0.5 \\ 0 \end{pmatrix}\right) &= 1, & \delta'_2\left(\begin{pmatrix} 0.5 \\ 0 \end{pmatrix}\begin{pmatrix} 0.5 \\ 0 \end{pmatrix}, \sigma, \begin{pmatrix} 0.5 \\ 0 \end{pmatrix}\right) &= 1.5 , \end{aligned}$$

and $\delta'_0(\varepsilon, \alpha, p) = \delta'_2(pq, \sigma, r) = \infty$ for every other combination of $p, q, r \in Q'$.

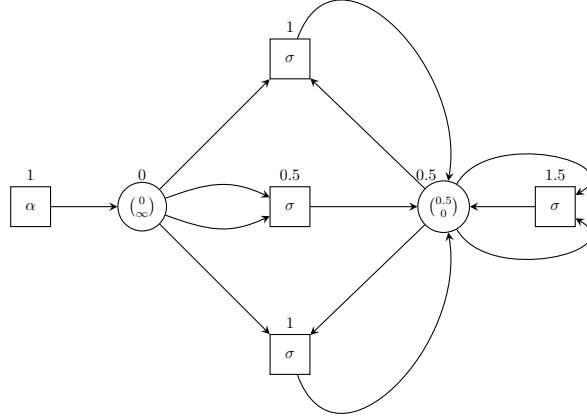

Figure 13.2: The $(\Sigma, \text{Rat}_{\min,+})$ -wta $\det_{(f,g)}(\mathcal{A}) = (Q', \delta', F')$.

Since Q' is finite, $\det_{(f,g)}(\mathcal{A})$ is a bu-deterministic $(\Sigma, \text{Rat}_{\min,+})$ -wta. For two transitions of $\det_{(f,g)}(\mathcal{A})$, we illustrate the way in which they are constructed. We abbreviate vectors of the form $\begin{pmatrix} a-c \\ b-c \end{pmatrix}$ by $\begin{pmatrix} a \\ b \end{pmatrix} - c$ for every $a, b, c \in \mathbb{Q}_{\geq 0}$.

$\delta'_0(\varepsilon, \alpha, \begin{pmatrix} 0 \\ \infty \end{pmatrix})$: We have $\delta_{\mathcal{A}}(\alpha)() = \begin{pmatrix} 1 \\ \infty \end{pmatrix} \neq \begin{pmatrix} \infty \\ \infty \end{pmatrix}$ and $g(\begin{pmatrix} 1 \\ \infty \end{pmatrix}) = 1$. Thus

$$f(\delta_{\mathcal{A}}(\alpha)()) = f(\begin{pmatrix} 1 \\ \infty \end{pmatrix}) = \begin{pmatrix} 1 \\ \infty \end{pmatrix} - g(\begin{pmatrix} 1 \\ \infty \end{pmatrix}) = \begin{pmatrix} 1 \\ \infty \end{pmatrix} - 1 = \begin{pmatrix} 0 \\ \infty \end{pmatrix} .$$

Thus

$$\delta'_0(\varepsilon, \alpha, \begin{pmatrix} 0 \\ \infty \end{pmatrix}) = g(\delta_{\mathcal{A}}(\alpha)()) = g(\begin{pmatrix} 1 \\ \infty \end{pmatrix}) = 1 .$$

$\delta'_2(\begin{pmatrix} 0 \\ \infty \end{pmatrix} \begin{pmatrix} 0.5 \\ 0 \end{pmatrix}, \sigma, \begin{pmatrix} 0.5 \\ 0 \end{pmatrix})$: We have

$$\delta_{\mathcal{A}}(\sigma)(\begin{pmatrix} 0 \\ \infty \end{pmatrix} \begin{pmatrix} 0.5 \\ 0 \end{pmatrix}) = \begin{pmatrix} \min(0+0.5+1, \infty+0.5+1.5) \\ 0+0.5+0.5 \end{pmatrix} = \begin{pmatrix} 1.5 \\ 1 \end{pmatrix} .$$

Since $g(\begin{pmatrix} 1.5 \\ 1 \end{pmatrix}) = 1$, we have

$$f(\delta_{\mathcal{A}}(\sigma)(\begin{pmatrix} 0 \\ \infty \end{pmatrix}, \begin{pmatrix} 0.5 \\ 0 \end{pmatrix})) = f(\begin{pmatrix} 1.5 \\ 1 \end{pmatrix}) = \begin{pmatrix} 1.5 \\ 1 \end{pmatrix} - g(\begin{pmatrix} 1.5 \\ 1 \end{pmatrix}) = \begin{pmatrix} 1.5 \\ 1 \end{pmatrix} - 1 = \begin{pmatrix} 0.5 \\ 0 \end{pmatrix} .$$

Thus we obtain

$$\delta'_2(\begin{pmatrix} 0 \\ \infty \end{pmatrix} \begin{pmatrix} 0.5 \\ 0 \end{pmatrix}, \sigma, \begin{pmatrix} 0.5 \\ 0 \end{pmatrix}) = g(\delta_{\mathcal{A}}(\sigma)(\begin{pmatrix} 0 \\ \infty \end{pmatrix} \begin{pmatrix} 0.5 \\ 0 \end{pmatrix})) = g(\begin{pmatrix} 1.5 \\ 1 \end{pmatrix}) = 1 .$$

Finally we show how the value of $F'(\begin{pmatrix} 0.5 \\ 0 \end{pmatrix})$ is obtained.

$$F'(\begin{pmatrix} 0.5 \\ 0 \end{pmatrix}) = \begin{pmatrix} 0.5 & 0 \end{pmatrix} \cdot \begin{pmatrix} 0 \\ \infty \end{pmatrix} = \min(0.5 + 0, 0 + \infty) = 0.5 .$$

Indeed, $[\det_{(f,g)}(\mathcal{A})](\xi) = \text{size}(\xi)$ for each $\xi \in T_{\Sigma}$ which can be seen as follows. Let us abbreviate $h_{\det_{(f,g)}(\mathcal{A})}$ by h , and the states $\begin{pmatrix} 0 \\ \infty \end{pmatrix}$ and $\begin{pmatrix} 0.5 \\ 0 \end{pmatrix}$ by q_1 and q_2 , respectively. Then for each $\xi \in T_{\Sigma}$ we have

$$h(\xi)_{q_1} = \begin{cases} 1 & \text{if } \xi = \alpha \\ \infty & \text{otherwise} \end{cases} \quad \text{and} \quad h(\xi)_{q_2} = \begin{cases} \infty & \text{if } \xi = \alpha \\ \text{size}(\xi) - 0.5 & \text{otherwise} . \end{cases}$$

This can be proved easily by induction on T_Σ . Then

$$\llbracket \det_{(f,g)}(\mathcal{A}) \rrbracket(\xi) = \min(\mathsf{h}(\xi)_{q_1} + F'(q_1), \mathsf{h}(\xi)_{q_2} + F'(q_2)) = \mathsf{size}(\xi)$$

where the last equality follows from case analysis $\xi = \alpha$ or $\xi \neq \alpha$. \square

In [BVM10, Ex. 3.1] another example of a wta \mathcal{A} is shown for which $\mathsf{sub}(\mathcal{A})$ is not finite, but $\det_{(f,g)}(\mathcal{A})$ is a bu-deterministic wta which is equivalent to \mathcal{A} .

13.3.2 Examples and properties of factorizations

We start with some examples of factorizations for extremal and commutative semirings.

Example 13.3.4. In the following list we show pairs where each pair consists of an extremal and commutative semiring \mathbb{B} and a maximal factorization (f, g) over B^Q . We assume that $u \in B^Q \setminus \{0_Q\}$.

1. the semiring $\mathsf{Boole} = (\mathbb{B}, \vee, \wedge, 0, 1)$ and the trivial factorization
2. $\mathsf{Nat}_{\max,+} = (\mathbb{N}_{-\infty}, \max, +, -\infty, 0)$ and $g(u) = \min(u_q \mid q \in Q, u_q \neq -\infty)$ and $f(u)_q = u_q - g(u)$ for each $q \in Q$
3. $\mathsf{Nat}_{\max,+}^n = ([0, n]_{-\infty}, \max, \hat{+}_n, -\infty, 0)$ where $n \in \mathbb{N}_+$ and $g(u) = \min(u_q \mid q \in Q, u_q \neq -\infty)$ and $f(u)_q = u_q - g(u)$ for every $q \in Q$
4. $\mathsf{Rat}_{\min,+} = (\mathbb{Q}_\infty, \min, +, \infty, 0)$ and $g(u) = \min(u_q \mid q \in Q)$ and $f(u)_q = u_q - g(u)$ for each $q \in Q$
5. $(\mathbb{R}_{\geq 0}, \max, \cdot, 0, 1)$ and $g(u) = \max(u_q \mid q \in Q)$ and $f(u) = \frac{1}{g(u)} \cdot u$
6. the semiring $\mathsf{Viterbi} = ([0, 1], \max, \cdot, 0, 1)$ and $g(u) = \max(u_q \mid q \in Q)$ and $f(u) = \frac{1}{g(u)} \cdot u$ \square

Next we will show some properties of factorizations.

The last two examples in Example 13.3.4 show particular semifields with maximal factorizations. In fact, for each zero-sum free semifield, we can show a general construction of a maximal factorization.

Lemma 13.3.5. [BVM10, Lm. 4.2] Let \mathbb{B} be a zero-sum free semifield. Then (f, g) is a maximal factorization where $g(u) = \bigoplus_{q \in Q} u_q$ and $f(u) = g(u)^{-1} \cdot u$ for each $u \in B^Q \setminus \{0_Q\}$.

Proof. First we show that (f, g) is a factorization. Let $u \in B^Q \setminus \{0_Q\}$. Since \mathbb{B} is zero-sum free, $g(u) \neq 0$ and hence $g(u) \cdot f(u) = g(u) \cdot (g(u)^{-1} \cdot u) = (g(u) \otimes g(u)^{-1}) \cdot u = u$.

Second we show that (f, g) is maximal. Let $b \in B$ such that $b \cdot u \neq 0_Q$. Moreover let $q \in Q$. Then

$$\begin{aligned} (f(b \cdot u))_q &= (g(b \cdot u)^{-1} \cdot (b \cdot u))_q = \left(\bigoplus_{q' \in Q} b \otimes u_{q'} \right)^{-1} \otimes b \otimes u_q \\ &= (b \otimes \bigoplus_{q' \in Q} u_{q'})^{-1} \otimes b \otimes u_q = \left(\bigoplus_{q' \in Q} u_{q'} \right)^{-1} \otimes b^{-1} \otimes b \otimes u_q \\ &= g(u)^{-1} \otimes u_q = (f(u))_q. \end{aligned} \quad \square$$

The next lemma shows that, for a commutative semiring with zero-divisors and $|Q| \geq 2$, there does not exist a maximal factorization (also cf. [GdM20, Lm. 1] where, however, Q is an infinite countable set).

Lemma 13.3.6. [BVM10, Lm. 4.4] If \mathbb{B} is commutative and (f, g) is a maximal factorization, then $|Q| = 1$ or \mathbb{B} is zero-divisor free.

Proof. If $|Q| = 1$, then the statement holds. So assume that $|Q| \geq 2$ and let $a_1 \in B \setminus \{0\}$ and $a_2 \in B$ be such that $a_1 \otimes a_2 = 0$. We choose a pair $q_1, q_2 \in Q$ such that $q_1 \neq q_2$. For each $i \in \{1, 2\}$, we define the Q -vector $u_i \in B^Q$ as the Q -vector whose q_i -component is $\mathbb{1}$ while the other components are 0 . Since (f, g) is maximal and $a_1 \otimes a_2 = 0$, we have that

$$\begin{aligned} f(u_1) &= f(a_1 \cdot u_1) = f(a_1 \cdot u_1 \oplus (a_1 \otimes a_2) \cdot u_2) = f(a_1 \cdot (u_1 \oplus a_2 \cdot u_2)) \\ &= f(u_1 \oplus a_2 \cdot u_2) . \end{aligned}$$

Let $u = u_1 \oplus a_2 \cdot u_2$. Since $f(u_1) = f(u)$ and (f, g) is a factorization, we obtain the equalities

$$g(u_1) \otimes f(u_1)_{q_1} = (u_1)_{q_1} = \mathbb{1} \tag{I}$$

$$g(u_1) \otimes f(u_1)_{q_2} = (u_1)_{q_2} = 0 \tag{II}$$

$$g(u) \otimes f(u_1)_{q_1} = u_{q_1} = \mathbb{1} \tag{III}$$

$$g(u) \otimes f(u_1)_{q_2} = u_{q_2} = a_2 . \tag{IV}$$

By (I) and (III), and using commutativity, we derive

$$g(u_1) = g(u_1) \otimes (g(u) \otimes f(u_1)_{q_1}) = (g(u_1) \otimes f(u_1)_{q_1}) \otimes g(u) = g(u) .$$

Then by (II) and (IV) we obtain that $a_2 = 0$. Hence B is zero-divisor free. \square

If $|Q| = 1$, then \mathcal{A} is already bu-deterministic and there is no need to determinize it. Thus, as a consequence of Lemma 13.3.6, if we want to determinize by means of maximal factorization a (Σ, B) -wta which is not bu-deterministic, then B has to be zero-divisor free.

The next lemma shows that, e.g., in the representation

$$f(\delta_{\mathcal{A}}(\sigma)(f(\delta_{\mathcal{A}}(\alpha)), f(\delta_{\mathcal{A}}(\alpha))))$$

of a state of Q' , the inner two occurrences of f can be dropped without changing the value of the expression, i.e.,

$$f(\delta_{\mathcal{A}}(\sigma)(f(\delta_{\mathcal{A}}(\alpha)), f(\delta_{\mathcal{A}}(\alpha)))) = f(\delta_{\mathcal{A}}(\sigma)(\delta_{\mathcal{A}}(\alpha), \delta_{\mathcal{A}}(\alpha))) = f(h_{\mathcal{A}}(\sigma(\alpha, \alpha))) .$$

The next lemma also says that dropping the f from $\delta_{\mathcal{A}}(\sigma)(\dots, f(u_i), \dots) \neq 0_Q$ preserves the non-zero property if B is zero-divisor free.

Lemma 13.3.7. [BVM10, Lm. 5.5] Let B be commutative and (f, g) be a maximal factorization. Furthermore, let $k \in \mathbb{N}$, $\sigma \in \Sigma^{(k)}$, and $u_1, \dots, u_k \in B^Q \setminus \{0_Q\}$. Then the following two statements hold.

(1) If $\delta_{\mathcal{A}}(\sigma)(u_1, \dots, u_k) \neq 0_Q$, then $\delta_{\mathcal{A}}(\sigma)(f(u_1), \dots, f(u_k)) \neq 0_Q$ and

$$f(\delta_{\mathcal{A}}(\sigma)(u_1, \dots, u_k)) = f(\delta_{\mathcal{A}}(\sigma)(f(u_1), \dots, f(u_k))) .$$

(2) If B is zero-divisor free and $\delta_{\mathcal{A}}(\sigma)(f(u_1), \dots, f(u_k)) \neq 0_Q$, then $\delta_{\mathcal{A}}(\sigma)(u_1, \dots, u_k) \neq 0_Q$.

Proof. Clearly we have (\star)

$$\begin{aligned} \delta_{\mathcal{A}}(\sigma)(u_1, \dots, u_k) &= \delta_{\mathcal{A}}(\sigma)(g(u_1) \cdot f(u_1), \dots, g(u_k) \cdot f(u_k)) && ((f, g) \text{ factorization}) \\ &= (g(u_1) \otimes \dots \otimes g(u_k)) \cdot \delta_{\mathcal{A}}(\sigma)(f(u_1), \dots, f(u_k)) . && (\text{Lemma 3.6.4}) \end{aligned}$$

Proof of (1). Let $\delta_{\mathcal{A}}(\sigma)(u_1, \dots, u_k) \neq 0_Q$. By (\star) also $\delta_{\mathcal{A}}(\sigma)(f(u_1), \dots, f(u_k)) \neq 0_Q$. Applying f to (\star) and using that (f, g) is maximal, we obtain that $f(\delta_{\mathcal{A}}(\sigma)(u_1, \dots, u_k)) = f(\delta_{\mathcal{A}}(\sigma)(f(u_1), \dots, f(u_k)))$.

Proof of (2). We assume that $\delta_{\mathcal{A}}(\sigma)(f(u_1), \dots, f(u_k)) \neq 0_Q$. Since $g(u_i) \neq 0$ for every $i \in [k]$, and since B is zero-divisor free, (\star) yields that $\delta_{\mathcal{A}}(\sigma)(u_1, \dots, u_k) \neq 0_Q$. \square

Let B be commutative and (f, g) a maximal factorization. Then the set Q' of states of $\det_{(f, g)}(\mathcal{A})$ can be enumerated by enumerating T_{Σ} in the sense that $Q' \subseteq f(h_{\mathcal{A}}(T_{\Sigma}) \setminus \{0_Q\})$ (cf. Lemma 13.3.9). As preparation we have the following easy observation.

Lemma 13.3.8. [BVM10, Obs. 4.5] Let $\det_{(f,g)}(\mathcal{A}) = (Q', \delta', F')$. Moreover, let $(Q'_n \mid n \in \mathbb{N})$ be the family defined by $Q'_0 = \emptyset$, and for every $n \in \mathbb{N}$ we let

$$Q'_{n+1} = Q'_n \cup \{f(\delta_{\mathcal{A}}(\sigma)(u_1, \dots, u_k)) \mid k \in \mathbb{N}, \sigma \in \Sigma^{(k)}, u_1, \dots, u_k \in Q'_n, \delta_{\mathcal{A}}(\sigma)(u_1, \dots, u_k) \neq 0_Q\} .$$

Then $Q' = \bigcup (Q'_n \mid n \in \mathbb{N})$. Moreover, Q' is finite iff there exists an $N \in \mathbb{N}$ with $Q'_{N+1} = Q'_N$. \square

Proof. We define the mapping $h : \mathcal{P}(B^Q) \rightarrow \mathcal{P}(B^Q)$ for each $U \in \mathcal{P}(B^Q)$ by

$$h(U) = U \cup \{f(\delta_{\mathcal{A}}(\sigma)(u_1, \dots, u_k)) \mid k \in \mathbb{N}, \sigma \in \Sigma^{(k)}, u_1, \dots, u_k \in U, \delta_{\mathcal{A}}(\sigma)(u_1, \dots, u_k) \neq 0_Q\} .$$

It is easy to see that h is continuous. Moreover, we have

$$\begin{aligned} Q' &= \bigcap (U \mid U \in \mathcal{P}(B^Q), h(U) \subseteq U) && \text{(by definition of } Q' \text{ and } h) \\ &= \bigcup (h^n(\emptyset) \mid n \in \mathbb{N}) && \text{(by Theorem 2.7.17)} \\ &= \bigcup (Q'_n \mid n \in \mathbb{N}) . && \text{(by definition of } Q'_n \text{ and } h) \end{aligned}$$

The second statement of the lemma is obvious. \square

Then we can show the following enumeration lemma (which is based on [KM05, Lm. 2]). Intuitively, it is obtained by iterating Lemma 13.3.7, thereby pulling out f from Q'_1 , then from Q'_2 , then from Q'_3 , and so on.

Lemma 13.3.9. [BVM10, Lm. 5.8] Let \mathbf{B} be commutative, (f, g) a maximal factorization, and $\det_{(f,g)}(\mathcal{A}) = (Q', \delta', F')$. Then $Q' \subseteq f(\mathbf{h}_{\mathcal{A}}(\mathbf{T}_{\Sigma}) \setminus \{0_Q\})$.

Proof. Again, we prove by case analysis on the cardinality of Q .

Case (a): Let $|Q| = 1$. We can identify B^Q with B . Then,

$$\text{for each } u \in B \setminus \{0\}, \text{ we have } f(u) = f(\mathbf{1}). \quad (13.3)$$

To see this we compute:

$$\begin{aligned} f(u) &= f(u \cdot \mathbf{1}) && \text{(where on the left-hand side } u \in B^Q \text{ and on the right-hand side } u \in B) \\ &= f(\mathbf{1}) . && \text{(because } (f, g) \text{ is maximal)} \end{aligned}$$

By our assumption on \mathcal{A} , there exists an $\alpha \in \Sigma^{(0)}$ such that $\delta_{\mathcal{A}}(\alpha)() \neq 0$. Hence

$$\mathbf{h}_{\mathcal{A}}(\alpha) = \delta_{\mathcal{A}}(\alpha)() \neq 0$$

and thus, by (13.3), we have $f(\mathbf{h}_{\mathcal{A}}(\alpha)) = f(\mathbf{1})$ and $f(\mathbf{h}_{\mathcal{A}}(\mathbf{T}_{\Sigma}) \setminus \{0\}) = \{f(\mathbf{1})\}$.

Next, by induction on \mathbb{N}_+ , we show that $Q'_n = \{f(\mathbf{1})\}$ for each $n \in \mathbb{N}_+$. The I.B. follows from $f(\delta_{\mathcal{A}}(\alpha)()) = f(\mathbf{1})$ and (13.3); then the I.S. can be proved by using (13.3).

Thus $Q' = \{f(\mathbf{1})\}$ and we obtain $Q' = f(\mathbf{h}_{\mathcal{A}}(\mathbf{T}_{\Sigma}) \setminus \{0\})$.

Case (b): Let $|Q| > 1$. By Lemma 13.3.6, \mathbf{B} is zero-divisor free. Using Lemma 13.3.8, it suffices to prove the following statement by induction on \mathbb{N} :

$$\text{for each } n \in \mathbb{N}, \text{ we have } Q'_n \subseteq f(\mathbf{h}_{\mathcal{A}}(\mathbf{T}_{\Sigma}) \setminus \{0_Q\}). \quad (13.4)$$

I.B.: Let $n = 0$. Then (13.4) is trivially true.

I.S.: Let $n = n' + 1$ for some $n' \in \mathbb{N}$. We assume that (13.4) holds for n' . Let $u \in Q'_n$. If $u \in Q'_{n'}$, then we are done. Otherwise, there exist $k \in \mathbb{N}$, $\sigma \in \Sigma^{(k)}$, and $u_1, \dots, u_k \in Q'_{n'}$ such that

$\delta_{\mathcal{A}}(\sigma)(u_1, \dots, u_k) \neq \mathbb{0}_Q$ and $u = f(\delta_{\mathcal{A}}(\sigma)(u_1, \dots, u_k))$. By I.H., for each $i \in [k]$ there exists $\xi_i \in T_{\Sigma}$ such that $u_i = f(h_{\mathcal{A}}(\xi_i))$. Hence

$$u = f(\delta_{\mathcal{A}}(\sigma)(u_1, \dots, u_k)) = f(\delta_{\mathcal{A}}(\sigma)(f(h_{\mathcal{A}}(\xi_1)), \dots, f(h_{\mathcal{A}}(\xi_k)))) .$$

By assumption $\delta_{\mathcal{A}}(\sigma)(u_1, \dots, u_k) \neq \mathbb{0}_Q$, i.e., $\delta_{\mathcal{A}}(\sigma)(f(h_{\mathcal{A}}(\xi_1)), \dots, f(h_{\mathcal{A}}(\xi_k))) \neq \mathbb{0}_Q$. By Lemma 13.3.7(2) (using zero-divisor freeness), $\delta_{\mathcal{A}}(\sigma)(h_{\mathcal{A}}(\xi_1), \dots, h_{\mathcal{A}}(\xi_k)) \neq \mathbb{0}_Q$. Thus, we can continue with:

$$\begin{aligned} f(\delta_{\mathcal{A}}(\sigma)(f(h_{\mathcal{A}}(\xi_1)), \dots, f(h_{\mathcal{A}}(\xi_k)))) &= f(\delta_{\mathcal{A}}(\sigma)(h_{\mathcal{A}}(\xi_1), \dots, h_{\mathcal{A}}(\xi_k))) && \text{(Lemma 13.3.7(1))} \\ &= f(h_{\mathcal{A}}(\sigma(\xi_1, \dots, \xi_k))) \in f(h_{\mathcal{A}}(T_{\Sigma}) \setminus \{\mathbb{0}_Q\}) . && \square \end{aligned}$$

13.3.3 On the twinning property

Obviously, there exist (Σ, \mathbb{B}) -wta which do not have the twinning property. For example, consider the $(\Sigma, \text{Nat}_{\max,+})$ -wta $\mathcal{A} = (Q, \delta, F)$ with $\Sigma = \{\gamma^{(1)}, \alpha^{(0)}\}$, $Q = \{p, q\}$, and

$$\begin{aligned} \delta_0(\varepsilon, \alpha, p) &= 2 & \delta_1(p, \gamma, p) &= 5 \\ \delta_0(\varepsilon, \alpha, q) &= 3 & \delta_1(q, \gamma, q) &= 7 \end{aligned}$$

and the weight of each other transition is $-\infty$. Then, for $\xi = \alpha$ and context $c = \gamma(z)$, we have

$$\begin{aligned} \text{wt}(\mathcal{R}_{\mathcal{A}}(p, \xi)) &= 2 \neq -\infty & \text{wt}(\mathcal{R}_{\mathcal{A}}(p, c, p)) &= 5 \neq -\infty \\ \text{wt}(\mathcal{R}_{\mathcal{A}}(q, \xi)) &= 3 \neq -\infty & \text{wt}(\mathcal{R}_{\mathcal{A}}(q, c, q)) &= 7 \neq -\infty \end{aligned}$$

and $\text{wt}(\mathcal{R}_{\mathcal{A}}(p, c, p)) \neq \text{wt}(\mathcal{R}_{\mathcal{A}}(q, c, q))$.

But, in particular, each bu-deterministic wta has the twinning property.

Observation 13.3.10. The conditions $\text{wt}(\mathcal{R}_{\mathcal{A}}(p, \xi)) \neq 0$ and $\text{wt}(\mathcal{R}_{\mathcal{A}}(q, \xi)) \neq 0$ imply that $p, q \in \mathbb{Q}_{\neq 0}^{\mathcal{R}_{\mathcal{A}}}(\xi)$ (cf. Section 4.1). If \mathcal{A} is bu-deterministic, then by Lemma 4.1.2(2) it follows that $p = q$. Hence, each bu-deterministic wta has the twinning property. \square

In the next example we illustrate that proving the twinning property can be a tedious task even for a small wta.

Example 13.3.11. We prove that the wta \mathcal{A} given in Example 13.1.2 has the twinning property. For the sake of convenience, we repeat the definition of that $(\Sigma, \text{Rat}_{\min,+})$ -wta.

We recall that $\text{Rat}_{\min,+} = (\mathbb{Q}_{\infty}, \min, +, \infty, 0)$ is the tropical semifield. We consider the ranked alphabet $\Sigma = \{\sigma^{(2)}, \alpha^{(0)}\}$ and the $(\Sigma, \text{Rat}_{\min,+})$ -wta $\mathcal{A} = (Q, \delta, F)$ given by

- $Q = \{p, p'\}$ and $F_p = 0$ and $F_{p'} = \infty$ and
- $\delta_0(\varepsilon, \alpha, p) = 1$, $\delta_2(pp, \sigma, p) = 1$, $\delta_2(pp, \sigma, p') = 0.5$, and $\delta_2(p'p, \sigma, p) = 1.5$, and all other values of δ_0 and δ_2 are ∞ .

Next we show that \mathcal{A} has the twinning property. First, by induction on T_{Σ} , we prove that the following statement holds:

$$\begin{aligned} &\text{For every } \xi \in T_{\Sigma}, \rho \in \mathcal{R}_{\mathcal{A}}(p, \xi), \text{ and } \rho' \in \mathcal{R}_{\mathcal{A}}(p', \xi) \text{ we have} \\ (1) \quad &\text{wt}(\xi, \rho) = \infty \text{ or } \text{wt}(\xi, \rho) = \text{size}(\xi) \text{ and} && (13.5) \\ (2) \quad &\text{wt}(\xi, \rho') = \infty \text{ or } \text{wt}(\xi, \rho') = \text{size}(\xi) - 0.5. \end{aligned}$$

I.B.: Let $\xi = \alpha$. Then (1) holds because $\mathcal{R}_{\mathcal{A}}(p, \xi) = \{p\}$, where $\rho(\varepsilon) = p$. Hence $\text{wt}(\xi, \rho) = \delta_0(\varepsilon, \alpha, p) = 1 = \text{size}(\xi)$. Also, (2) holds because $\mathcal{R}_{\mathcal{A}}(p', \xi) = \{p'\}$, where $\rho(\varepsilon) = p'$. Hence $\text{wt}(\xi, \rho) = \delta_0(\varepsilon, \alpha, p') = \infty$.

I.S.: Let $\xi = \sigma(\xi_1, \xi_2)$. For the proof, let $\rho \in \mathcal{R}_{\mathcal{A}}(p, \xi)$. Then

$$\text{wt}(\xi, \rho) = \text{wt}(\xi_1, \rho|_1) + \text{wt}(\xi_2, \rho|_2) + \delta_2(\rho(1)\rho(2), \sigma, p), \quad (13.6)$$

where $\rho|_i$ is the run induced by ρ at position i for each $i \in [2]$; in particular, $\rho|_i \in \mathcal{R}_{\mathcal{A}}(\rho(i), \xi_i)$.

For the proof of (13.5)(1), we distinguish three cases as follows.

Case (a): Let $\rho(1)\rho(2) = pp$. By I.H., part (1), $\text{wt}(\xi_i, \rho|_i) = \infty$ or $\text{wt}(\xi_i, \rho|_i) = \text{size}(\xi_i)$ for each $i \in [2]$. If $\text{wt}(\xi_i, \rho|_i) = \infty$ for some $i \in [2]$, then by (13.6) we have $\text{wt}(\xi, \rho) = \infty$. Otherwise, again by (13.6), we have $\text{wt}(\xi, \rho) = \text{size}(\xi_1) + \text{size}(\xi_2) + \delta_2(pp, \sigma, p) = \text{size}(\xi_1) + \text{size}(\xi_2) + 1 = \text{size}(\xi)$.

Case (b): Let $\rho(1)\rho(2) = p'p$. By I.H., part (2), $\text{wt}(\xi_1, \rho|_1) = \infty$ or $\text{wt}(\xi_1, \rho|_1) = \text{size}(\xi_1) - 0.5$, and by I.H., part (1), $\text{wt}(\xi_2, \rho|_2) = \infty$ or $\text{wt}(\xi_2, \rho|_2) = \text{size}(\xi_2)$. If $\text{wt}(\xi_i, \rho|_i) = \infty$ for some $i \in [2]$, then by (13.6) we have $\text{wt}(\xi, \rho) = \infty$. Otherwise, also by (13.6), we have $\text{wt}(\xi, \rho) = \text{size}(\xi_1) - 0.5 + \text{size}(\xi_2) + \delta_2(p'p, \sigma, p) = \text{size}(\xi_1) - 0.5 + \text{size}(\xi_2) + 1.5 = \text{size}(\xi)$.

Case (c): Let $\rho(1)\rho(2) \notin \{pp, p'p\}$. Then $\delta_2(\rho(1)\rho(2), \sigma, p) = \infty$ and thus by (13.6) we have $\text{wt}(\xi, \rho) = \infty$.

For the proof of (13.5)(2), we distinguish two cases.

Case (a): Let $\rho(1)\rho(2) = pp$. By I.H., part (1), $\text{wt}(\xi_i, \rho|_i) = \infty$ or $\text{wt}(\xi_i, \rho|_i) = \text{size}(\xi_i)$ for each $i \in [2]$. If $\text{wt}(\xi_i, \rho|_i) = \infty$ for some $i \in [2]$, then by (13.6) we have $\text{wt}(\xi, \rho) = \infty$. Otherwise, by (13.6), we have $\text{wt}(\xi, \rho) = \text{size}(\xi_1) + \text{size}(\xi_2) + \delta_2(pp, \sigma, p') = \text{size}(\xi_1) + \text{size}(\xi_2) + 0.5 = \text{size}(\xi) - 0.5$.

Case (b): Let $\rho(1)\rho(2) \neq pp$. Then $\delta_2(\rho(1)\rho(2), \sigma, p') = \infty$ and thus by (13.6) we have $\text{wt}(\xi, \rho) = \infty$.

This finishes the proof of (13.5).

Next we prove the following statement for contexts. For every $c \in \mathcal{C}_{\Sigma} \setminus \{z\}$:

- (1) for every $\rho \in \mathcal{R}_{\mathcal{A}}(p, c, p)$: $\text{wt}(c, \rho) = \infty$ or $\text{wt}(c, \rho) = \text{size}(c) - 1$ and
 - (2) for every $\rho \in \mathcal{R}_{\mathcal{A}}(p, c, p')$: $\text{wt}(c, \rho) = \infty$ or $\text{wt}(c, \rho) = \text{size}(c) - 0.5$ and
 - (3) for every $\rho \in \mathcal{R}_{\mathcal{A}}(p', c, p)$: $\text{wt}(c, \rho) = \infty$ or $\text{wt}(c, \rho) = \text{size}(c) - 1.5$, and
 - (4) for every $\rho \in \mathcal{R}_{\mathcal{A}}(p', c, p')$: $\text{wt}(c, \rho) = \infty$ or $\text{wt}(c, \rho) = \text{size}(c) - 1$.
- (13.7)

For the proof, we recall the relation $\succ_{\mathcal{C}_{\Sigma}}$ on \mathcal{C}_{Σ} defined in Chapter 6: for every $c_1, c_2 \in \mathcal{C}_{\Sigma}$ we have $c_1 \succ_{\mathcal{C}_{\Sigma}} c_2$ if there exists an elementary context $c \in \text{e}\mathcal{C}_{\Sigma}$ such that $c_1 = c[c_2]$. We denote the restriction of $\succ_{\mathcal{C}_{\Sigma}}$ to $\mathcal{C}_{\Sigma} \setminus \{z\}$ also by $\succ_{\mathcal{C}_{\Sigma}}$ and we note that $\succ_{\mathcal{C}_{\Sigma}}$ is terminating and $\text{nf}_{\succ_{\mathcal{C}_{\Sigma}}}(\mathcal{C}_{\Sigma} \setminus \{z\}) = \text{e}\mathcal{C}_{\Sigma}$, i.e., the set of elementary contexts.

We prove (13.7) by induction on $(\mathcal{C}_{\Sigma} \setminus \{z\}, \succ_{\mathcal{C}_{\Sigma}})$

I.B.: We distinguish the two cases that (a) $c = \sigma(z, \xi)$ and (b) $c = \sigma(\xi, z)$ for some $\xi \in \mathcal{T}_{\Sigma}$. Then we proceed as follows.

(1) Let $\rho \in \mathcal{R}_{\mathcal{A}}(p, c, p)$. If $\text{wt}(c, \rho) \neq \infty$, then the following two cases are possible:

- c has the form (a), $\rho(1) = \rho(2) = p$, and $\rho|_2 \in \mathcal{R}_{\mathcal{A}}(p, \xi)$. By (13.5)(1), we have $\text{wt}(\xi, \rho|_2) = \text{size}(\xi)$. Hence $\text{wt}(c, \rho) = 0 + \text{wt}(\rho|_2) + \delta_2(pp, \sigma, p) = \text{size}(\xi) + 1 = \text{size}(c) - 1$.
- c has the form (b), $(\rho(1) = \rho(2) = p$ and $\rho|_1 \in \mathcal{R}_{\mathcal{A}}(p, \xi)$) or $(\rho(1) = p', \rho(2) = p$, and $\rho|_1 \in \mathcal{R}_{\mathcal{A}}(p', \xi))$. In the first case, by symmetry, we get as before $\text{wt}(c, \rho) = \text{size}(c) - 1$. In the second case, by (13.5)(2), we have $\text{wt}(\xi, \rho|_1) = \text{size}(\xi) - 0.5$. Hence $\text{wt}(c, \rho) = \text{wt}(\rho|_1) + 0 + \delta_2(p'p, \sigma, p) = \text{size}(\xi) - 0.5 + 1.5 = \text{size}(\xi) + 1 = \text{size}(c) - 1$.

(2) Let $\rho \in \mathcal{R}_{\mathcal{A}}(p, c, p')$. If $\text{wt}(c, \rho) \neq \infty$, then

- c has the form (a), $\rho(1) = p', \rho(2) = p$ and $\rho|_2 \in \mathcal{R}_{\mathcal{A}}(p, \xi)$. By (13.5)(1), we have $\text{wt}(\xi, \rho|_2) = \text{size}(\xi)$. Hence $\text{wt}(c, \rho) = 0 + \text{wt}(\rho|_2) + \delta_2(p'p, \sigma, p) = \text{size}(\xi) + 1.5 = \text{size}(c) - 0.5$.

- (3) Let $\rho \in R_{\mathcal{A}}(p', c, p)$. If $\text{wt}(c, \rho) \neq \infty$, then the following two cases are possible:
- c has the form (a), $\rho(1) = \rho(2) = p$, and $\rho|_2 \in R_{\mathcal{A}}(p, \xi)$. By (13.5)(1), we have $\text{wt}(\xi, \rho|_2) = \text{size}(\xi)$. Hence $\text{wt}(c, \rho) = 0 + \text{wt}(\rho|_2) + \delta_2(pp, \sigma, p') = \text{size}(\xi) + 0.5 = \text{size}(c) - 1.5$.
 - c has the form (b), $\rho(1) = \rho(2) = p$, and $\rho|_1 \in R_{\mathcal{A}}(p, \xi)$. By symmetry with the previous case, we obtain $\text{wt}(c, \rho) = \text{size}(c) - 1.5$.
- (4) Let $\rho \in R_{\mathcal{A}}(p', c, p')$. We have $\text{wt}(c, \rho) = \infty$ because $\delta_2(p'q, \sigma, p) = \delta_2(qp', \sigma, p) = \infty$ for each $q \in Q$.

I.S.: We distinguish the two cases that (a) $c = \sigma(c', \xi)$ and (b) $c = \sigma(\xi, c')$ for some $c' \in C_{\Sigma}$ and $\xi \in T_{\Sigma}$. Then we proceed as follows.

- (1) Let $\rho \in R_{\mathcal{A}}(p, c, p)$. If $\text{wt}(c, \rho) \neq \infty$, then the following two cases are possible:
- c has the form (a), $\rho(1) = \rho(2) = p$, $\rho|_1 \in R_{\mathcal{A}}(p, c', p)$, and $\rho|_2 \in R_{\mathcal{A}}(p, \xi)$. By I.H., part (1), we have $\text{wt}(c', \rho|_1) = \text{size}(c') - 1$ and by (13.5)(1), we have $\text{wt}(\xi, \rho|_2) = \text{size}(\xi)$. Hence $\text{wt}(c, \rho) = \text{wt}(c', \rho|_1) + \text{wt}(\xi, \rho|_2) + \delta_2(pp, \sigma, p) = \text{size}(c') - 1 + \text{size}(\xi) + 1 = \text{size}(c) - 1$.
 - c has the form (a), $\rho(1) = p'$, $\rho(2) = p$, $\rho|_1 \in R_{\mathcal{A}}(p', c', p)$, and $\rho|_2 \in R_{\mathcal{A}}(p, \xi)$. By I.H., part (3) we have $\text{wt}(c', \rho|_1) = \text{size}(c') - 1.5$ and by (13.5)(1), we have $\text{wt}(\xi, \rho|_2) = \text{size}(\xi)$. Hence $\text{wt}(c, \rho) = \text{wt}(c', \rho|_1) + \text{wt}(\xi, \rho|_2) + \delta_2(p'p, \sigma, p) = \text{size}(c') - 1.5 + \text{size}(\xi) + 1.5 = \text{size}(c) - 1$.
 - c has the form (b), $\rho(1) = \rho(2) = p$, $\rho|_1 \in R_{\mathcal{A}}(p, \xi)$, and $\rho|_2 \in R_{\mathcal{A}}(p, c', p)$. By symmetry with the previous case, we obtain $\text{wt}(c, \rho) = \text{size}(c) - 1$.
 - c has the form (b), $\rho(1) = p'$, $\rho(2) = p$, $\rho|_1 \in R_{\mathcal{A}}(p', \xi)$ and $\rho|_2 \in R_{\mathcal{A}}(p, c', p)$. By (13.5)(2), we have $\text{wt}(\xi, \rho|_1) = \text{size}(\xi) - 0.5$ and by I.H., part (1), we have $\text{wt}(c', \rho|_2) = \text{size}(c') - 1$. Hence $\text{wt}(c, \rho) = \text{wt}(\xi, \rho|_1) + \text{wt}(c', \rho|_2) + \delta_2(p'p, \sigma, p) = \text{size}(\xi) - 0.5 + \text{size}(c') - 1 + 1.5 = \text{size}(c) - 1$.
- (2) Let $\rho \in R_{\mathcal{A}}(p, c, p')$. If $\text{wt}(c, \rho) \neq \infty$, then we have the following cases.
- c has the form (a), $\rho(1) = p'$, $\rho(2) = p$, $\rho|_1 \in R_{\mathcal{A}}(p', c', p')$, and $\rho|_2 \in R_{\mathcal{A}}(p, \xi)$. By I.H., part (4) and by (13.5)(1), we have $\text{wt}(c', \rho|_1) = \text{size}(c') - 1$ and $\text{wt}(\xi, \rho|_2) = \text{size}(\xi)$, respectively. Hence $\text{wt}(c, \rho) = \text{wt}(c', \rho|_1) + \text{wt}(\xi, \rho|_2) + \delta_2(p'p, \sigma, p) = \text{size}(c') - 1 + \text{size}(\xi) + 1.5 = \text{size}(c) - 0.5$.
 - c has the form (a), $\rho(1) = \rho(2) = p$, $\rho|_1 \in R_{\mathcal{A}}(p, c', p')$, and $\rho|_2 \in R_{\mathcal{A}}(p, \xi)$. By I.H., part (2) and by (13.5)(1), we have $\text{wt}(c', \rho|_1) = \text{size}(c') - 0.5$ and $\text{wt}(\xi, \rho|_2) = \text{size}(\xi)$, respectively. Hence $\text{wt}(c, \rho) = \text{wt}(c', \rho|_1) + \text{wt}(\xi, \rho|_2) + \delta_2(pp, \sigma, p) = \text{size}(c') - 0.5 + \text{size}(\xi) + 1 = \text{size}(c) - 0.5$.
 - c has the form (b), $\rho(1) = p'$, $\rho(2) = p$, $\rho|_1 \in R_{\mathcal{A}}(p', \xi)$, and $\rho|_2 \in R_{\mathcal{A}}(p, c', p')$. By (13.5)(2) and by I.H., part (2) $\text{wt}(\xi, \rho|_1) = \text{size}(\xi) - 0.5$ and $\text{wt}(c', \rho|_2) = \text{size}(c') - 0.5$, respectively. Hence $\text{wt}(c, \rho) = \text{wt}(\xi, \rho|_1) + \text{wt}(c', \rho|_2) + \delta_2(p'p, \sigma, p) = \text{size}(\xi) - 0.5 + \text{size}(c') - 0.5 + 1.5 = \text{size}(c) - 0.5$.
 - c has the form (b), $\rho(1) = \rho(2) = p$, $\rho|_1 \in R_{\mathcal{A}}(p, \xi)$, and $\rho|_2 \in R_{\mathcal{A}}(p, c', p')$. By symmetry, we have $\text{wt}(c, \rho) = \text{size}(c) - 0.5$.
- (3) Let $\rho \in R_{\mathcal{A}}(p', c, p)$. If $\text{wt}(c, \rho) \neq \infty$, then the following two cases are possible:
- c has the form (a), $\rho(1) = \rho(2) = p$, $\rho|_1 \in R_{\mathcal{A}}(p, c', p)$, and $\rho|_2 \in R_{\mathcal{A}}(p, \xi)$. By I.H., part (1) and by (13.5)(1), we have $\text{wt}(c', \rho|_1) = \text{size}(c') - 1$ and $\text{wt}(\xi, \rho|_2) = \text{size}(\xi)$, respectively. Hence $\text{wt}(c, \rho) = \text{wt}(c', \rho|_1) + \text{wt}(\xi, \rho|_2) + \delta_2(pp, \sigma, p') = \text{size}(c') - 1 + \text{size}(\xi) + 0.5 = \text{size}(c) - 1.5$.
 - c has the form (b), $\rho(1) = \rho(2) = p$, $\rho|_1 \in R_{\mathcal{A}}(p, \xi)$, and $\rho|_2 \in R_{\mathcal{A}}(p, c', p)$. By symmetry with the previous case, we obtain $\text{wt}(c, \rho) = \text{size}(c) - 1.5$.
- (4) Let $\rho \in R_{\mathcal{A}}(p', c, p')$. If $\text{wt}(c, \rho) \neq \infty$, then the following two cases are possible:
- c has the form (a), $\rho(1) = \rho(2) = p$, $\rho|_1 \in R_{\mathcal{A}}(p, c', p')$, and $\rho|_2 \in R_{\mathcal{A}}(p, \xi)$. By I.H., part (2) and by (13.5)(1), we have $\text{wt}(c', \rho|_1) = \text{size}(c') - 0.5$ and $\text{wt}(\xi, \rho|_2) = \text{size}(\xi)$, respectively. Hence $\text{wt}(c, \rho) = \text{wt}(c', \rho|_1) + \text{wt}(\xi, \rho|_2) + \delta_2(pp, \sigma, p') = \text{size}(c') - 0.5 + \text{size}(\xi) + 0.5 = \text{size}(c) - 1$.

- c has the form (b), $\rho(1) = \rho(2) = p$, $\rho|_1 \in R_{\mathcal{A}}(p, \xi)$, and $\rho|_2 \in R_{\mathcal{A}}(p, c', p')$. By symmetry with the previous case, we obtain $\text{wt}(c, \rho) = \text{size}(c) - 1$.

This finishes the proof of the statement 13.7.

Now we prove that \mathcal{A} has the twinning property. In fact, we show that even the following stronger property holds: for every context $c \in C_{\Sigma}$, if $\text{wt}(R_{\mathcal{A}}(p, c, p)) \neq \infty$ and $\text{wt}(R_{\mathcal{A}}(p', c, p')) \neq \infty$, then $\text{wt}(R_{\mathcal{A}}(p, c, p)) = \text{wt}(R_{\mathcal{A}}(p', c, p'))$. The proof is as follows. If $c = z$, then $R_{\mathcal{A}}(p, c, p) = \{\rho\}$ with $\rho(\varepsilon) = p$ and $R_{\mathcal{A}}(p', c, p') = \{\rho'\}$ with $\rho'(\varepsilon) = p'$. Hence $\text{wt}(R_{\mathcal{A}}(p, c, p)) = 0 = \text{wt}(R_{\mathcal{A}}(p', c, p'))$. If $c \neq z$, then the condition $\text{wt}(R_{\mathcal{A}}(p, c, p)) \neq \infty$ implies that there exists a run $\rho \in R_{\mathcal{A}}(p, c, p)$ with $\text{wt}(c, \rho) \neq \infty$. By (13.7)(1) we know that $\text{wt}(c, \rho) = \text{size}(c) - 1$ for every such ρ , hence by the fact that summation of $\text{Rat}_{\min,+}$ is min, we obtain that $\text{wt}(R_{\mathcal{A}}(p, c, p)) = \text{size}(c) - 1$. Similarly, the conditions $\text{wt}(R_{\mathcal{A}}(p', c, p')) \neq \infty$ and (13.7)(4) imply that $\text{wt}(R_{\mathcal{A}}(p', c, p')) = \text{size}(c) - 1$.

This ends the proof of the fact that \mathcal{A} has the twinning property. \square

Thus, the $(\Sigma, \text{Rat}_{\min,+})$ -wta \mathcal{A} given in Example 13.1.2 has the twinning property. Also the other requirements of Theorem 13.3.2 are satisfied, because $\text{Rat}_{\min,+} = (\mathbb{Q}_{\infty}, \min, +, \infty, 0)$ is an extremal semiring and the pair (f, g) is a maximal factorization with $f : (\mathbb{Q}_{\infty})^Q \setminus \{\infty_Q\} \rightarrow (\mathbb{Q}_{\infty})^Q$ and $g : (\mathbb{Q}_{\infty})^Q \setminus \{\infty_Q\} \rightarrow \mathbb{Q}_{\infty}$ defined for each $u = \begin{pmatrix} u_p \\ u_{p'} \end{pmatrix}$ in $\mathbb{Q}_{\infty}^Q \setminus \{\infty_Q\}$ by

$$f(u)_q = u_q - g(u) \quad \text{for each } q \in Q \quad \text{and} \quad g(u) = \min(u_p, u_{p'}) .$$

Hence, for the bu-deterministic $(\Sigma, \text{Rat}_{\min,+})$ -wta $\det_{(f,g)}(\mathcal{A})$ (cf. Figure 13.2), Theorem 13.3.2 guarantees that

- $\llbracket \det_{(f,g)}(\mathcal{A}) \rrbracket = \llbracket \mathcal{A} \rrbracket = \text{size}$ and
- $\det_{(f,g)}(\mathcal{A})$ is minimal with respect to the number of states among all bu-deterministic $(\Sigma, \text{Rat}_{\min,+})$ -wta which are equivalent to \mathcal{A} and obtained by determinization by factorization.

We note that the bu-deterministic $(\Sigma, \text{Nat}_{\min,+})$ -wta of Example 3.2.3, which also recognizes size, has only one state, and hence it is smaller than $\det_{(f,g)}(\mathcal{A})$ (where, in this comparison, we disregard the difference between $\text{Nat}_{\min,+}$ and $\text{Rat}_{\min,+}$). However, by means of two transformations, viz. weight pushing and forward bisimulation, we can transform $\det_{(f,g)}(\mathcal{A})$ into the $(\Sigma, \text{Rat}_{\min,+})$ -wta of Example 3.2.3 (cf. Figure 13.3). Let us briefly explain these transformations.

Since $\text{Rat}_{\min,+}$ is a commutative semifield, we can apply weight pushing to $\det_{(f,g)}(\mathcal{A})$ (cf. Section 7.3). More precisely, we define the mapping $\lambda(\begin{pmatrix} 0 \\ \infty \end{pmatrix}) = 0$ and $\lambda(\begin{pmatrix} 0.5 \\ 0 \end{pmatrix}) = 0.5$. Then Figure 13.3 shows the $(\Sigma, \text{Rat}_{\min,+})$ -wta $\text{push}_{\lambda}(\det_{(f,g)}(\mathcal{A}))$. By Lemma 7.3.2 we have that $\llbracket \det_{(f,g)}(\mathcal{A}) \rrbracket = \llbracket \text{push}_{\lambda}(\det_{(f,g)}(\mathcal{A})) \rrbracket$.

For the second transformation (viz., forward bisimulation, cf. [HMM07]), we define the equivalence relation $R = Q \times Q$. Thus, the factor set Q/R contains one equivalence class, namely Q . One can easily check that R is a forward bisimulation on $\text{push}_{\lambda}(\det_{(f,g)}(\mathcal{A}))$ in the sense of [HMM07, Def. 1]. Thus we can construct the forward aggregate $(\Sigma, \text{Rat}_{\min,+})$ -wta $(\text{push}_{\lambda}(\det_{(f,g)}(\mathcal{A}))/R$ (cf. [HMM07, Def. 3]). By [HMM07, Thm. 6] we have $\llbracket \text{push}_{\lambda}(\det_{(f,g)}(\mathcal{A})) \rrbracket = \llbracket (\text{push}_{\lambda}(\det_{(f,g)}(\mathcal{A}))/R) \rrbracket$. (We note that the relation R is not a forward bisimulation on $\det_{(f,g)}(\mathcal{A})$ because $F(\begin{pmatrix} 0 \\ \infty \end{pmatrix}) = 0 \neq 0.5 = F(\begin{pmatrix} 0.5 \\ 0 \end{pmatrix})$.) It is obvious that the forward aggregate $(\Sigma, \text{Rat}_{\min,+})$ -wta $(\text{push}_{\lambda}(\det_{(f,g)}(\mathcal{A}))/R$ is exactly the $(\Sigma, \text{Rat}_{\min,+})$ -wta \mathcal{A} of Example 3.2.3 (modulo state renaming and the change of the weight algebra from $\text{Nat}_{\min,+}$ to $\text{Rat}_{\min,+}$).

Finally, we mention that in [BVM10, Sect. 5.5], [BF12], and [Büc14, Sect. 5.4] the question of deciding the twinning property is investigated.

13.3.4 Proof of Theorem 13.3.2

We organize the proof of Theorem 13.3.2 as follows:

- (1) finiteness of $\det_{(f,g)}(\mathcal{A})$ (cf. Theorem 13.3.17),
- (2) correctness of $\det_{(f,g)}(\mathcal{A})$ (cf. Theorem 13.3.18), and
- (3) minimality of $\det_{(f,g)}(\mathcal{A})$ (cf. Theorem 13.3.19).

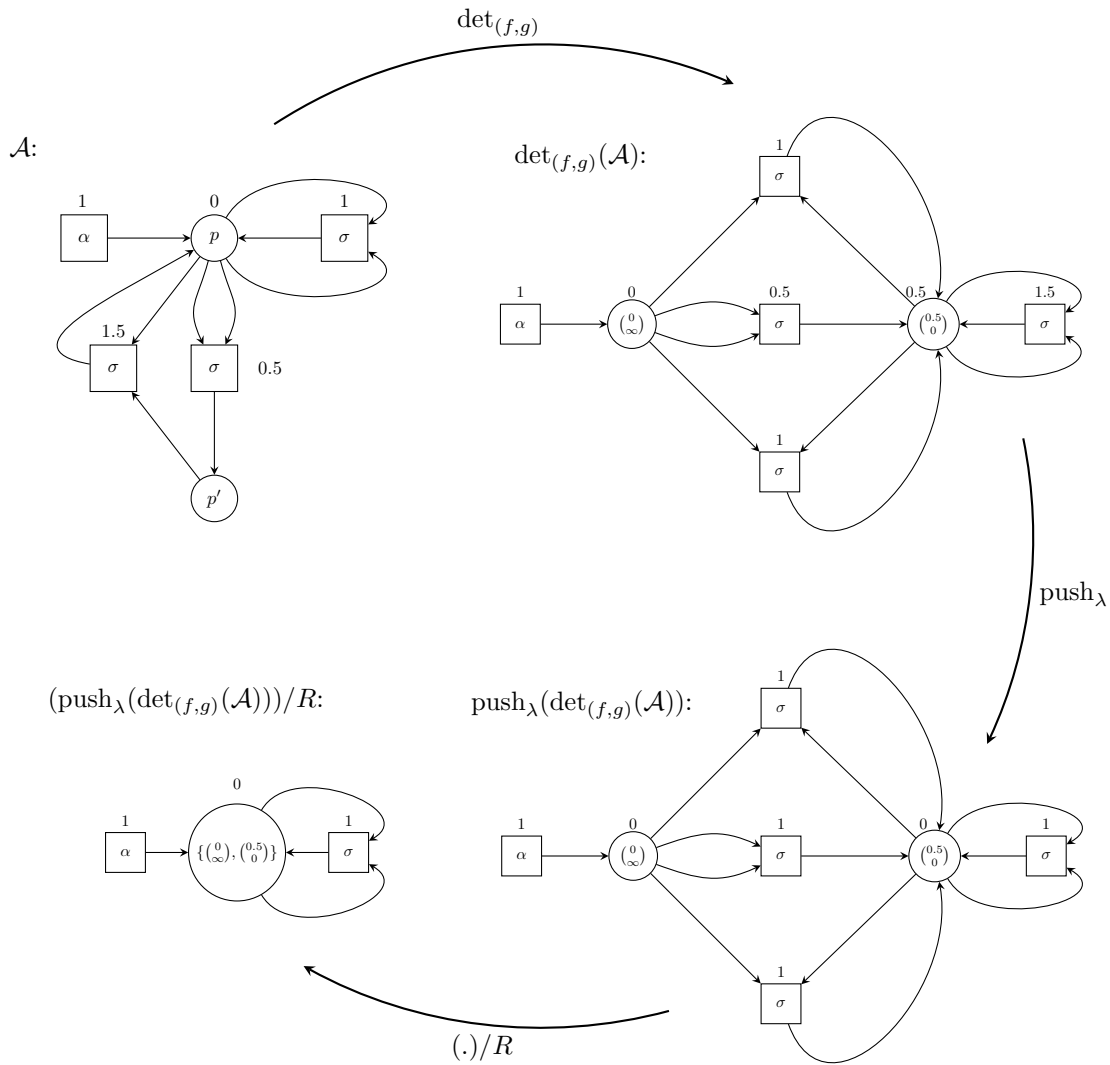

Figure 13.3: The following $(\Sigma, \text{Rat}_{\min,+})$ -wta are shown clockwise, starting up-left: (a) \mathcal{A} of Figure 13.1, (b) $\det_{(f,g)}(\mathcal{A})$, (c) $\text{push}_\lambda(\det_{(f,g)}(\mathcal{A}))$, and (d) $(\text{push}_\lambda(\det_{(f,g)}(\mathcal{A}))) / R$. The wta in (b), (c), and (d) are bu-deterministic.

Finiteness of $\det_{(f,g)}(\mathcal{A})$ (proof of Theorem 13.3.2(1))

Here we show sufficient conditions under which $\det_{(f,g)}(\mathcal{A})$ is a (Σ, \mathbf{B}) -wta (cf. Theorem 13.3.17).

Let $\xi \in T_\Sigma$, $w \in \text{pos}(\xi)$, and $\rho \in R_{\mathcal{A}}(\xi)$ such that $\rho(w) = \rho(\varepsilon)$ and assume that \mathbf{B} is extremal and commutative. Then the following kind of Bellman optimality property holds (where “optimality” has to be replaced by “victory”): If ρ is victorious in $R_{\mathcal{A}}(\rho(\varepsilon), \xi)$, then $\rho|_w$ is victorious for $R_{\mathcal{A}}(\rho(\varepsilon), \xi|_w, \rho(w))$ (modulo right multiplication with $\text{wt}(\xi|_w, \rho|_w)$). The property is based on the following trivial fact.

Let \mathbf{B} be extremal, $b \in B$, and $B_1, B_2 \subseteq B$ be finite subsets.

$$\text{If } b \in B_1, B_1 \subseteq B_2, \text{ and } b = \bigoplus_{b' \in B_2} b', \text{ then } b = \bigoplus_{b' \in B_1} b'. \quad (13.8)$$

Observation 13.3.12. [BVM10, Obs. 5.12] Let \mathbf{B} be extremal and commutative. Moreover, let $\xi \in T_\Sigma$, $w \in \text{pos}(\xi)$, and $\rho \in R_{\mathcal{A}}(\xi)$ such that $\rho(w) = \rho(\varepsilon)$ and $\text{wt}(\xi, \rho) = \text{wt}(R_{\mathcal{A}}(\rho(\varepsilon), \xi))$. Then

$$\text{wt}(\xi, \rho) = \text{wt}(\xi|_w, \rho|_w) \otimes \text{wt}(\xi|_w, \rho|_w) = \text{wt}(R_{\mathcal{A}}(\rho(\varepsilon), \xi|_w, \rho(\varepsilon))) \otimes \text{wt}(\xi|_w, \rho|_w) .$$

Proof. We have

$$\begin{aligned} & \text{wt}(R_{\mathcal{A}}(\rho(\varepsilon), \xi|_w, \rho(\varepsilon))) \otimes \text{wt}(\xi|_w, \rho|_w) \\ &= \left(\bigoplus_{\nu \in R_{\mathcal{A}}(\rho(\varepsilon), \xi|_w, \rho(\varepsilon))} \text{wt}(\xi|_w, \nu) \right) \otimes \text{wt}(\xi|_w, \rho|_w) \\ &= \bigoplus_{\nu \in R_{\mathcal{A}}(\rho(\varepsilon), \xi|_w, \rho(\varepsilon))} \text{wt}(\xi|_w, \nu) \otimes \text{wt}(\xi|_w, \rho|_w) && \text{(by distributivity)} \\ &= \text{wt}(\xi, \rho) && (\star) \\ &= \text{wt}(\xi|_w, \rho|_w) \otimes \text{wt}(\xi|_w, \rho|_w) . && \text{(by commutativity)} \end{aligned}$$

At (\star) we have used (13.8) with

- $b = \text{wt}(\xi, \rho)$,
- $B_1 = \{\text{wt}(\xi|_w, \nu) \otimes \text{wt}(\xi|_w, \rho|_w) \mid \nu \in R_{\mathcal{A}}(\rho(\varepsilon), \xi|_w, \rho(\varepsilon))\}$, and
- $B_2 = \{\text{wt}(\xi, \rho) \mid \nu \in R_{\mathcal{A}}(\rho(\varepsilon), \xi)\}$.

Obviously, (a) $b \in B_1$, (b) by commutativity we have $B_1 \subseteq B_2$, and (c) by assumption (viz. $\text{wt}(\xi, \rho) = \text{wt}(R_{\mathcal{A}}(\rho(\varepsilon), \xi))$) we have $b = \bigoplus_{b' \in B_2} b'$. \square

The next definitions are taken from [BVM10, Def. 5.13]. Let $S \subseteq Q$. Then we define

$$\mathcal{C}'(S) = \{(\xi, \kappa) \mid \xi \in T_\Sigma, \kappa : S \rightarrow R_{\mathcal{A}}(\xi), (\forall q \in S) : \kappa_q \in R_{\mathcal{A}}(q, \xi), \text{wt}(\xi, \kappa_q) \neq \emptyset\} .$$

We set $\mathcal{C}' = \bigcup_{S \subseteq Q} \mathcal{C}'(S)$.

In the following, we define (a) the mapping $\overline{\text{wt}} : \mathcal{C}' \rightarrow B^Q$ and (b) for each $S \subseteq Q$, the family $(U(\xi, \kappa) \mid (\xi, \kappa) \in \mathcal{C}'(S))$ and (c) the sets $\mathcal{C}(S) \subseteq \mathcal{C}'(S)$ and \mathcal{C} . To this end, let $S \subseteq Q$ and $(\xi, \kappa) \in \mathcal{C}'(S)$. Then

- for each $q \in Q$ we set $\overline{\text{wt}}(\xi, \kappa)_q = \text{wt}(\xi, \kappa_q)$ if $q \in S$, otherwise we set $\overline{\text{wt}}(\xi, \kappa)_q = \emptyset$,
- we define $U(\xi, \kappa)$ to be the set of all pairs $(w_1, w_2) \in \text{pos}(\xi) \times \text{pos}(\xi)$ such that $w_1 <_{\text{pref}} w_2$ and for every $q \in S$ we have $\kappa_q(w_1) = \kappa_q(w_2)$, and
- we have $(\xi, \kappa) \in \mathcal{C}(S)$ iff for every $(w_1, w_2) \in U(\xi, \kappa)$ and $q \in S$ we have

$$\text{wt}(\xi|_{w_1}, \kappa_q|_{w_1}) = \text{wt}(R_{\mathcal{A}}(\kappa_q(w_1), \xi|_{w_1}))$$

i.e., $\kappa_q|_{w_1}$ is victorious in $R_{\mathcal{A}}(\kappa_q(w_1), \xi|_{w_1})$. We set $\mathcal{C} = \bigcup_{S \subseteq Q} \mathcal{C}(S)$.

Lemma 13.3.13. [BVM10, Lm. 5.14] Let \mathbf{B} be commutative and extremal. For each $\xi \in \mathsf{T}_\Sigma$ there exists $(\xi, \kappa) \in \mathcal{C}$ such that, for each $q \in Q$, we have $\overline{\text{wt}}(\xi, \kappa)_q = \text{wt}(\mathbf{R}_{\mathcal{A}}(q, \xi))$.

Proof. We begin by showing the following statement:

$$\begin{aligned} &\text{for each } \xi \in \mathsf{T}_\Sigma \text{ there exists a } \kappa : Q \rightarrow \mathbf{R}_{\mathcal{A}}(\xi) \text{ such that} \\ &\text{for each } q \in Q \text{ we have } \kappa_q \in \mathbf{R}_{\mathcal{A}}(q, \xi) \text{ and } P(\xi, \kappa, q) \text{ holds,} \end{aligned} \quad (13.9)$$

where $P(\xi, \kappa, q)$ is the abbreviation of the statement

$$\text{for every } w \in \text{pos}(\xi) : \text{wt}(\xi|_w, \kappa_q|_w) = \text{wt}(\mathbf{R}_{\mathcal{A}}(\kappa_q(w), \xi|_w)).$$

We prove (13.9) by induction on T_Σ . Let $\xi = \sigma(\xi_1, \dots, \xi_k)$. By I.H., for each $i \in [k]$, there exists a $\kappa_i : Q \rightarrow \mathbf{R}_{\mathcal{A}}(\xi_i)$ such that, for each $q \in Q$, we have $(\kappa_i)_q \in \mathbf{R}_{\mathcal{A}}(q, \xi_i)$ and the statement $P(\xi_i, \kappa_i, q)$ holds. We define κ as follows: for every $q \in Q$, we let $\kappa_q \in \mathbf{R}_{\mathcal{A}}(\xi)$ be such that

- $\kappa_q(\varepsilon) = q$,
- for every $i \in [k]$ and $w \in \text{pos}(\xi_i)$, we let $\kappa_q(iw) = (\kappa_i)_{p_i}(w)$, where the states p_1, \dots, p_k are defined such that

$$\left(\bigotimes_{i \in [k]} \text{wt}(\xi_i, (\kappa_i)_{p_i}) \right) \otimes \delta_k(p_1 \cdots p_k, \sigma, q) = \bigoplus_{q_1, \dots, q_k \in Q} \left(\bigotimes_{i \in [k]} \text{wt}(\xi_i, (\kappa_i)_{q_i}) \right) \otimes \delta_k(q_1 \cdots q_k, \sigma, q), \quad (13.10)$$

where, for each $i \in [k]$, the state p_i is defined such that

$$\bigoplus_{q_i \in Q} \text{wt}(\xi_i, (\kappa_i)_{q_i}) = \text{wt}(\xi_i, (\kappa_i)_{p_i}). \quad (13.11)$$

We recall that such a choice of p_i exists by Observation 2.7.7.

Let $q \in Q$. We show that $P(\xi, \kappa, q)$ holds. For this, let $w \in \text{pos}(\xi)$. We proceed by case analysis.

Case (a): Let $w = \varepsilon$. Then

$$\begin{aligned} \text{wt}(\xi, \kappa_q) &= \left(\bigotimes_{i \in [k]} \text{wt}(\xi|_i, \kappa_q|_i) \right) \otimes \delta_k(\kappa_q(1) \cdots \kappa_q(k), \sigma, \kappa_q(\varepsilon)) \\ &= \left(\bigotimes_{i \in [k]} \text{wt}(\xi_i, (\kappa_i)_{p_i}) \right) \otimes \delta_k(p_1 \cdots p_k, \sigma, q) && \text{(by definition of } \kappa) \\ &= \left(\bigotimes_{i \in [k]} \bigoplus_{q_i \in Q} \text{wt}(\xi_i, (\kappa_i)_{q_i}) \right) \otimes \delta_k(p_1 \cdots p_k, \sigma, q) && \text{(by (13.11))} \\ &= \bigoplus_{q_1, \dots, q_k \in Q} \left(\bigotimes_{i \in [k]} \text{wt}(\xi_i, (\kappa_i)_{q_i}) \right) \otimes \delta_k(q_1 \cdots q_k, \sigma, q) && \text{(by distributivity)} \\ &= \bigoplus_{q_1, \dots, q_k \in Q} \left(\bigotimes_{i \in [k]} \text{wt}(\mathbf{R}_{\mathcal{A}}(q_i, \xi_i)) \right) \otimes \delta_k(q_1 \cdots q_k, \sigma, q) && \text{(by } P(\xi_i, \kappa_i, q_i) \text{ for } w = \varepsilon) \\ &= \bigoplus_{q_1, \dots, q_k \in Q} \bigoplus_{\rho_1 \in \mathbf{R}_{\mathcal{A}}(q_1, \xi_1)} \cdots \bigoplus_{\rho_k \in \mathbf{R}_{\mathcal{A}}(q_k, \xi_k)} \left(\bigotimes_{i \in [k]} \text{wt}(\xi_i, \rho_i) \right) \otimes \delta_k(q_1 \cdots q_k, \sigma, q) && \text{(by distributivity)} \\ &= \bigoplus_{\rho \in \mathbf{R}_{\mathcal{A}}(q, \xi)} \text{wt}(\xi, \rho) = \text{wt}(\mathbf{R}_{\mathcal{A}}(q, \xi)) = \text{wt}(\mathbf{R}_{\mathcal{A}}(\kappa_q(\varepsilon), \xi)). \end{aligned}$$

Case (b): Let $w = iv$. Then $\text{wt}(\xi|_{iv}, \kappa_q|_{iv}) = \text{wt}(\xi_i|_v, (\kappa_i)_{p_i}|_v) = \text{wt}(\mathbf{R}_{\mathcal{A}}((\kappa_i)_{p_i}(v), \xi_i|_v)) = \text{wt}(\mathbf{R}_{\mathcal{A}}(\kappa_q(iv), \xi|_{iv}))$, where the second equality holds by $P(\xi_i, \kappa_i, p_i)$ for v .

This finishes the proof of (13.9).

Now we prove the statement of our lemma. Let $\xi \in \mathsf{T}_\Sigma$. By (13.9) there exists a $\kappa : Q \rightarrow \mathbf{R}_{\mathcal{A}}(\xi)$ such that for every $q \in Q$ we have $\kappa_q \in \mathbf{R}_{\mathcal{A}}(q, \xi)$ and $P(\xi, \kappa, q)$. Let $S = \{q \in Q \mid \text{wt}(\mathbf{R}_{\mathcal{A}}(q, \xi)) \neq 0\}$ and $\kappa' = \kappa|_S$. We note that $(\xi, \kappa') \in \mathcal{C}(S)$ (and hence, $(\xi, \kappa') \in \mathcal{C}$), because

- for every $q \in S$: $\kappa'_q \in \mathcal{R}_{\mathcal{A}}(q, \xi)$ and $\text{wt}(\xi, \kappa'_q) = \text{wt}(\mathcal{R}_{\mathcal{A}}(q, \xi)) \neq 0$ (hence $(\xi, \kappa') \in \mathcal{C}'(S)$) and
- for every $w \in \text{pos}(\xi)$: $\text{wt}(\xi|_w, \kappa'_q|_w) = \text{wt}(\mathcal{R}_{\mathcal{A}}(\kappa'_q(w), \xi|_w))$ by (13.9) (hence $(\xi, \kappa') \in \mathcal{C}(S)$).

Then, for each $q \in S$, we have $\kappa'_q \in \mathcal{R}_{\mathcal{A}}(q, \xi)$ and $P(\xi, \kappa', q)$. Moreover, for each $q \in S$:

$$\overline{\text{wt}}(\xi, \kappa')_q = \text{wt}(\xi, \kappa'_q) = \text{wt}(\mathcal{R}_{\mathcal{A}}(q, \xi)).$$

If $q \in Q \setminus S$, then also $\overline{\text{wt}}(\xi, \kappa')_q = 0 = \text{wt}(\mathcal{R}_{\mathcal{A}}(q, \xi))$ by definitions of $\overline{\text{wt}}$ and of S . \square

The next lemma shows how one slice can be cut out.

Lemma 13.3.14. [BVM10, Lm. 5.15] Let \mathbf{B} be extremal and commutative and \mathcal{A} have the twinning property. Moreover, let $S \subseteq Q$ and $(\xi, \kappa) \in \mathcal{C}(S)$ such that $U(\xi, \kappa) \neq \emptyset$. Then there exist $(\xi', \kappa') \in \mathcal{C}(S)$ and $b \in B$ such that $\overline{\text{wt}}(\xi, \kappa) = b \cdot \overline{\text{wt}}(\xi', \kappa')$ and $|U(\xi, \kappa)| > |U(\xi', \kappa')|$.

Proof. Since $U(\xi, \kappa) \neq \emptyset$, there exists a pair $(w_1, w_2) \in U(\xi, \kappa)$ such that for every $(w'_1, w'_2) \in U(\xi, \kappa)$, if $w'_1 \leq_{\text{pref}} w_1$, then $w'_1 = w_1$. (Thus, intuitively, there does not exist a repetition of states above w_1 .) We construct $\xi' = \xi[\xi|_{w_2}]_{w_1}$ and, for every $q \in S$ and $w \in \text{pos}(\xi')$, we set $\kappa'_q(w) = \kappa_q(w_2 v)$ if $w = w_1 v$ and $\kappa'_q(w) = \kappa_q(w)$ otherwise. Before defining $b \in B$, we show that κ has the following property:

$$(\forall q', \bar{q} \in S) : \text{wt}(\mathcal{R}_{\mathcal{A}}(\kappa_{q'}(w_1), (\xi|^{w_2})|_{w_1}, \kappa_{q'}(w_2))) = \text{wt}(\mathcal{R}_{\mathcal{A}}(\kappa_{\bar{q}}(w_1), (\xi|^{w_2})|_{w_1}, \kappa_{\bar{q}}(w_2))). \quad (13.12)$$

We prove (13.12) by using the twinning property of \mathcal{A} . Roughly speaking, the twinning property is an implication where the premise has two conditions, viz., (i) certain states repeat and (ii) certain weights are not 0. For (i) we remark that $(w_1, w_2) \in U(\xi, \kappa)$ and thus $\kappa_{q'}(w_1) = \kappa_{q'}(w_2)$ and $\kappa_{\bar{q}}(w_1) = \kappa_{\bar{q}}(w_2)$. For (ii), by definition, we have $\text{wt}(\xi, \kappa_{q'}) \neq 0$ and $\text{wt}(\xi, \kappa_{\bar{q}}) \neq 0$. Thus, using commutativity,

- $0 \neq \text{wt}(\xi, \kappa_{q'}) = \text{wt}(\xi_{w_1}, \kappa_{q'}|_{w_1}) \otimes \text{wt}((\xi|^{w_2})|_{w_1}, (\kappa_{q'}|^{w_2})|_{w_1}) \otimes \text{wt}(\xi|_{w_2}, \kappa_{q'}|_{w_2})$ and
- $0 \neq \text{wt}(\xi, \kappa_{\bar{q}}) = \text{wt}(\xi_{w_1}, \kappa_{\bar{q}}|_{w_1}) \otimes \text{wt}((\xi|^{w_2})|_{w_1}, (\kappa_{\bar{q}}|^{w_2})|_{w_1}) \otimes \text{wt}(\xi|_{w_2}, \kappa_{\bar{q}}|_{w_2})$

and hence

- $\text{wt}((\xi|^{w_2})|_{w_1}, (\kappa_{q'}|^{w_2})|_{w_1}) \otimes \text{wt}(\xi|_{w_2}, \kappa_{q'}|_{w_2}) \neq 0$ and
- $\text{wt}((\xi|^{w_2})|_{w_1}, (\kappa_{\bar{q}}|^{w_2})|_{w_1}) \otimes \text{wt}(\xi|_{w_2}, \kappa_{\bar{q}}|_{w_2}) \neq 0$.

Since 0 is annihilating, each of the four values

$$\text{wt}((\xi|^{w_2})|_{w_1}, (\kappa_{q'}|^{w_2})|_{w_1}), \quad \text{wt}(\xi|_{w_2}, \kappa_{q'}|_{w_2}), \quad \text{wt}((\xi|^{w_2})|_{w_1}, (\kappa_{\bar{q}}|^{w_2})|_{w_1}), \quad \text{and} \quad \text{wt}(\xi|_{w_2}, \kappa_{\bar{q}}|_{w_2})$$

is different from 0. Since \mathbf{B} is extremal, and hence by Observation 2.7.11(3,4) it is zero-sum free, we obtain that

- $\text{wt}(\mathcal{R}_{\mathcal{A}}(\kappa_{q'}(w_1), (\xi|^{w_2})|_{w_1}, \kappa_{q'}(w_2))) \neq 0$ and $\text{wt}(\mathcal{R}_{\mathcal{A}}(\kappa_{q'}(w_2), \xi|_{w_2})) \neq 0$ and
- $\text{wt}(\mathcal{R}_{\mathcal{A}}(\kappa_{\bar{q}}(w_1), (\xi|^{w_2})|_{w_1}, \kappa_{\bar{q}}(w_2))) \neq 0$ and $\text{wt}(\mathcal{R}_{\mathcal{A}}(\kappa_{\bar{q}}(w_2), \xi|_{w_2})) \neq 0$.

Hence (13.12) follows by the twinning property of \mathcal{A} .

Next we define b by case analysis as follows:

$$b = \begin{cases} 0 & \text{if } S = \emptyset \\ \text{wt}(\mathcal{R}_{\mathcal{A}}(\kappa_q(w_1), (\xi|^{w_2})|_{w_1}, \kappa_q(w_2))) & \text{for some } q \in S \quad \text{otherwise.} \end{cases}$$

We note that, by (13.12), b does not depend on the choice of q . Now we show that the following three statements hold:

- (1) $(\xi', \kappa') \in \mathcal{C}(S)$,
- (2) $\overline{\text{wt}}(\xi, \kappa) = b \cdot \overline{\text{wt}}(\xi', \kappa')$, and
- (3) $|U(\xi, \kappa)| > |U(\xi', \kappa')|$.

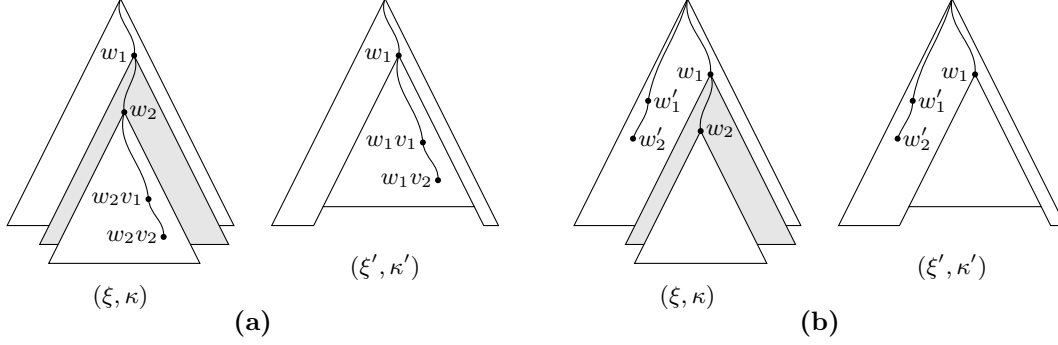

Figure 13.4: The Cases (a) and (b) for $(w'_1, w'_2) \in U(\kappa')$ (cf. [BVM10, Fig. 7]).

We begin with the proof of Statement (1). It is easy to see that $(\xi', \kappa') \in \mathcal{C}'(S)$. Now let $(w'_1, w'_2) \in U(\xi', \kappa')$ and $q \in S$. We show that $\text{wt}(\xi'|_{w'_1}, \kappa'_q|_{w'_1}) = \text{wt}(\mathcal{R}_{\mathcal{A}}(\kappa'_q(w'_1), \xi'|_{w'_1}))$. Note that $w'_1 \not\prec_{\text{pref}} w_1$. We distinguish two cases.

Case (a): There exist $v_1, v_2 \in \mathbb{N}^*$ such that $w'_1 = w_1v_1$ and $w'_2 = w_1v_2$ (cf. Fig. 13.4(a)). Since $\kappa'_q|_{w_1} = \kappa_q|_{w_2}$ for every $q \in S$, we obtain that $(w_2v_1, w_2v_2) \in U(\xi, \kappa)$. Hence

$$\text{wt}(\xi'|_{w'_1}, \kappa'_q|_{w'_1}) = \text{wt}(\xi|_{w_2v_1}, \kappa_q|_{w_2v_1}) = \text{wt}(\mathcal{R}_{\mathcal{A}}(\kappa_q(w_2v_1), \xi|_{w_2v_1})) = \text{wt}(\mathcal{R}_{\mathcal{A}}(\kappa'_q(w'_1), \xi'|_{w'_1})) .$$

Case (b): Otherwise, $\kappa'_q|_{w'_1} = \kappa_q|_{w'_1}$ (cf. Fig. 13.4(b)). Thus $(w'_1, w'_2) \in U(\xi, \kappa)$ and

$$\text{wt}(\xi'|_{w'_1}, \kappa'_q|_{w'_1}) = \text{wt}(\xi|_{w'_1}, \kappa_q|_{w'_1}) = \text{wt}(\mathcal{R}_{\mathcal{A}}(\kappa_q(w'_1), \xi|_{w'_1})) = \text{wt}(\mathcal{R}_{\mathcal{A}}(\kappa'_q(w'_1), \xi'|_{w'_1})) .$$

Now we prove Statement (2) for the non-trivial case of b , i.e., $S \neq \emptyset$. Let $q \in S$. Then

$$\begin{aligned} & \text{wt}(\xi, \kappa_q) \\ &= \text{wt}(\xi|^{w_1}, \kappa_q|^{w_1}) \otimes \text{wt}((\xi|^{w_2})|_{w_1}, (\kappa_q|^{w_2})|_{w_1}) \otimes \text{wt}(\xi|_{w_2}, \kappa_q|_{w_2}) && \text{(because B is commutative)} \\ &= \text{wt}(\xi|^{w_1}, \kappa_q|^{w_1}) \otimes \text{wt}(\mathcal{R}_{\mathcal{A}}(\kappa_q(w_1), (\xi|^{w_2})|_{w_1}, \kappa_q(w_2))) \otimes \text{wt}(\xi|_{w_2}, \kappa_q|_{w_2}) && \text{(Observation 13.3.12)} \\ &= b \otimes \text{wt}(\xi|^{w_1}, \kappa_q|^{w_1}) \otimes \text{wt}(\xi|_{w_2}, \kappa_q|_{w_2}) && \text{(because B is commutative)} \\ &= b \otimes \text{wt}(\xi', \kappa'_q) . \end{aligned}$$

Finally, for the proof of Statement (3), we remark that κ' is obtained from κ by removing the cycle (w_1, w_2) , and that this process does not introduce new cycles. Hence $|U(\xi, \kappa)| > |U(\xi', \kappa')|$. \square

The following lemma is used for the proof that our cutting process can only end in a finite set of trees. For this we define the finite set

$$\mathcal{F} = \{(\xi, \kappa) \in \mathcal{C}' \mid \text{height}(\xi) < |Q|^{|Q|}\} .$$

Next we will use $U^{-1}(\emptyset)$ as shorthand for the set $\{(\xi, \kappa) \mid U(\xi, \kappa) = \emptyset\}$.

Lemma 13.3.15. [BVM10, Lm. 5.16] $U^{-1}(\emptyset) \subseteq \mathcal{F}$.

Proof. Let $(\xi, \kappa) \in \mathcal{C}' \setminus \mathcal{F}$. We show that $U(\xi, \kappa) \neq \emptyset$ follows. First of all, there exists an $S \subseteq Q$ such that $(\xi, \kappa) \in \mathcal{C}'(S)$. Since $(\xi, \kappa) \notin \mathcal{F}$, there exists a $w \in \text{pos}(\xi)$ such that $|w| \geq |Q|^{|S|}$. Hence, there exist $k \in \mathbb{N}$, $w_1, \dots, w_k \in \mathbb{N}^*$, and $u_1, \dots, u_k \in Q^S$ such that $k > |Q|^{|S|}$, $w_i \in \text{pos}(\xi)$ for every $i \in [k]$, $w_1 \prec_{\text{pref}} w_2 \prec_{\text{pref}} \dots \prec_{\text{pref}} w_k$, and $\kappa_q|_{w_i} \in \mathcal{R}_{\mathcal{A}}((u_i)_q, \xi)$ for every $i \in [k]$ and $q \in S$. By the pigeon-hole principle, there exist $i, j \in [k]$ such that $i < j$ and $u_i = u_j$. Hence $\kappa_q(w_i) = (u_i)_q = (u_j)_q = \kappa_q(w_j)$ for every $q \in S$, which means that $(w_i, w_j) \in U(\xi, \kappa)$. \square

We recall that $\det_{(f,g)}(\mathcal{A}) = (Q', \delta', F')$, and by Lemma 13.3.9 we have that $Q' \subseteq f(\mathfrak{h}_{\mathcal{A}}(\mathbb{T}_{\Sigma}) \setminus \{0_Q\})$ if \mathbf{B} is commutative and (f, g) is a maximal factorization. If we could show that $\mathfrak{h}_{\mathcal{A}}(\mathbb{T}_{\Sigma})$ is finite, then we have shown that Q' is finite. In the next lemma we prove that $\mathfrak{h}_{\mathcal{A}}(\mathbb{T}_{\Sigma})$ is finite under the conditions that \mathbf{B} is commutative and extremal and \mathcal{A} has the twinning property. The idea of the proof is the following. Let us consider a large tree $\xi \in \mathbb{T}_{\Sigma}$ for which we want to compute $\mathfrak{h}_{\mathcal{A}}(\xi)$, which is nothing else but the Q -vector $(\text{wt}(\mathbb{R}_{\mathcal{A}}(q, \xi)) \mid q \in Q)$. Then, by Lemma 13.3.13, there exists $\kappa : Q \rightarrow \mathbb{R}_{\mathcal{A}}(\xi)$ such that, for each $q \in Q$, we have $\text{wt}(\mathbb{R}_{\mathcal{A}}(q, \xi)) = \text{wt}(\xi, \kappa_q) = \overline{\text{wt}}(\xi, \kappa)_q$ (which needs extremality), i.e., κ_q is victorious for $\mathbb{R}_{\mathcal{A}}(q, \xi)$. If ξ is large enough, then there exists a pair $(w_1, w_2) \in \text{pos}(\xi) \times \text{pos}(\xi)$ such that $\kappa_q(w_1) = \kappa_q(w_2)$. Now we can cut out the slice of ξ which is determined by w_1 and w_2 . By Lemma 13.3.14, we obtain a pair (ξ', κ') such that $\overline{\text{wt}}(\xi, \kappa) = b \cdot \overline{\text{wt}}(\xi', \kappa')$ where b is the weight of the victorious run on the slice which we cut out, and ξ' contains one less pair of positions with repeating states. After repeating this cutting process, we end up in a pair (ξ'', κ'') such that ξ'' does not contain a pair of positions with repeating states, i.e., $(\xi'', \kappa'') \in U^{-1}(\emptyset)$. By Lemma 13.3.15, the set $U^{-1}(\emptyset)$ is finite.

The following lemma is based on [KM05, Thm. 5].

Lemma 13.3.16. [BVM10, Lm. 5.9] If \mathbf{B} is commutative and extremal and \mathcal{A} has the twinning property, then there exists a finite set $P \subseteq B^Q$ with $\mathfrak{h}_{\mathcal{A}}(\mathbb{T}_{\Sigma}) \subseteq \{b \cdot u \mid b \in B, u \in P\}$.

Proof. Let $\xi \in \mathbb{T}_{\Sigma}$. We set $P = \{\overline{\text{wt}}(\xi, \kappa) \mid (\xi, \kappa) \in \mathcal{F}\}$.

Let $n \in \mathbb{N}$ be maximal such that there exist $(\xi_1, \kappa_1), \dots, (\xi_n, \kappa_n) \in \mathcal{C}$ and $b_1, \dots, b_n \in B$ such that

- $\xi = \xi_1$,
- $\mathfrak{h}_{\mathcal{A}}(\xi) = \overline{\text{wt}}(\xi_1, \kappa_1)$ and $\overline{\text{wt}}(\xi_1, \kappa_1) = b_i \cdot \overline{\text{wt}}(\xi_i, \kappa_i)$ for every $i \in [n]$, and
- $|U(\xi_{i+1}, \kappa_{i+1})| < |U(\xi_i, \kappa_i)|$ for every $i \in [n-1]$.

We claim that

$$n > 0 \tag{13.13}$$

and

$$(\xi_n, \kappa_n) \in \mathcal{F}, \tag{13.14}$$

which allows us to derive

$$\mathfrak{h}_{\mathcal{A}}(\xi) = \overline{\text{wt}}(\xi_1, \kappa_1) = b_n \cdot \overline{\text{wt}}(\xi_n, \kappa_n) \in \{b \cdot u \mid b \in B, u \in P\}.$$

Claim (13.13) follows from Lemma 13.3.13 if we set $b_1 = 1$. Finally, we prove (13.14). Assume that $U(\xi_n, \kappa_n) \neq \emptyset$. By Lemma 13.3.14, there exist (ξ', κ') and b' such that $\overline{\text{wt}}(\xi_n, \kappa_n) = b' \cdot \overline{\text{wt}}(\xi', \kappa')$ and $|U(\xi', \kappa')| < |U(\xi_n, \kappa_n)|$. Using $\kappa_{n+1} = \kappa'$ and $b_{n+1} = b' \cdot b_n$, we see that n was not maximal. Hence, $U(\xi_n, \kappa_n) = \emptyset$, and by Lemma 13.3.15, $(\xi_n, \kappa_n) \in \mathcal{F}$. \square

Theorem 13.3.17. [BVM10, Thm. 5.10] Let \mathbf{B} be commutative and extremal and let (f, g) be a maximal factorization of B^Q . Moreover, let \mathcal{A} have the twinning property. Then $\det_{(f,g)}(\mathcal{A})$ is a (Σ, \mathbf{B}) -wta.

Proof. Let $\det_{(f,g)}(\mathcal{A}) = (Q', \delta', F')$. By Lemma 13.3.9, we have $Q' \subseteq f(\mathfrak{h}_{\mathcal{A}}(\mathbb{T}_{\Sigma}) \setminus \{0_Q\})$. We show that Q' is finite. Lemma 13.3.16 yields that there exists a finite set $P \subseteq B^Q$ such that $\mathfrak{h}_{\mathcal{A}}(\mathbb{T}_{\Sigma}) \subseteq \{b \cdot u \mid b \in B, u \in P\}$. We calculate

$$Q' \subseteq f(\mathfrak{h}_{\mathcal{A}}(\mathbb{T}_{\Sigma}) \setminus \{0_Q\}) \subseteq f(\{b \cdot u \mid b \in B, u \in P\} \setminus \{0_Q\}) \subseteq f(P \setminus \{0_Q\})$$

because (f, g) is maximal. Hence, Q' is finite. \square

Correctness of $\det_{(f,g)}(\mathcal{A})$ (proof of Theorem 13.3.2(2))

Theorem 13.3.18. [BVM10, Thm. 5.4] *Let (f, g) be a factorization and \mathbf{B} be commutative. If $\det_{(f,g)}(\mathcal{A})$ is a wta, then $\llbracket \mathcal{A} \rrbracket = \llbracket \det_{(f,g)}(\mathcal{A}) \rrbracket$.*

Proof. Let $\det_{(f,g)}(\mathcal{A}) = (Q', \delta', F')$ be a wta, i.e., Q' be finite. We abbreviate $\det_{(f,g)}(\mathcal{A})$ by \mathcal{A}' . By induction on T_Σ , we prove that the following statement holds:

$$\text{For every } \xi \in \mathsf{T}_\Sigma, \text{ we have: } h_{\mathcal{A}}(\xi) = \bigoplus_{u \in Q'} h_{\mathcal{A}'}(\xi)_u \cdot u . \quad (13.15)$$

Let $\xi = \sigma(\xi_1, \dots, \xi_k)$. Since \mathcal{A}' is bu-deterministic, by Lemma 4.1.2(1) there are $u'_1, \dots, u'_k \in Q'$ such that, for every $i \in [k]$ and $u \in Q' \setminus \{u'_i\}$, we have $h_{\mathcal{A}'}(\xi_i)_u = 0$. We derive (\star) :

$$\begin{aligned} h_{\mathcal{A}}(\xi) &= \delta_{\mathcal{A}}(\sigma)(h_{\mathcal{A}}(\xi_1), \dots, h_{\mathcal{A}}(\xi_k)) \\ &= \delta_{\mathcal{A}}(\sigma)\left(\bigoplus_{u_1 \in Q'} h_{\mathcal{A}'}(\xi_1)_{u_1} \cdot u_1, \dots, \bigoplus_{u_k \in Q'} h_{\mathcal{A}'}(\xi_k)_{u_k} \cdot u_k\right) && \text{(by I.H.)} \\ &= \delta_{\mathcal{A}}(\sigma)(h_{\mathcal{A}'}(\xi_1)_{u'_1} \cdot u'_1, \dots, h_{\mathcal{A}'}(\xi_k)_{u'_k} \cdot u'_k) \\ &= (h_{\mathcal{A}'}(\xi_1)_{u'_1} \otimes \dots \otimes h_{\mathcal{A}'}(\xi_k)_{u'_k}) \cdot \delta_{\mathcal{A}}(\sigma)(u'_1, \dots, u'_k), && \text{(Lemma 3.6.4)} \end{aligned}$$

where Lemma 3.6.4 uses the assumption that \mathbf{B} is commutative.

Moreover, we derive (\dagger) : for every $u \in Q'$

$$\begin{aligned} h_{\mathcal{A}'}(\xi)_u &= \delta_{\mathcal{A}'}(\sigma)(h_{\mathcal{A}'}(\xi_1), \dots, h_{\mathcal{A}'}(\xi_k))_u \\ &= \bigoplus_{u_1, \dots, u_k \in Q'} h_{\mathcal{A}'}(\xi_1)_{u_1} \otimes \dots \otimes h_{\mathcal{A}'}(\xi_k)_{u_k} \otimes \delta'_k(u_1 \dots u_k, \sigma, u) \\ &= h_{\mathcal{A}'}(\xi_1)_{u'_1} \otimes \dots \otimes h_{\mathcal{A}'}(\xi_k)_{u'_k} \otimes \delta'_k(u'_1 \dots u'_k, \sigma, u) . \end{aligned}$$

Now we distinguish two cases.

Case (a): Let $\delta_{\mathcal{A}}(\sigma)(u'_1, \dots, u'_k) = 0_Q$. Then (\star) implies $h_{\mathcal{A}}(\xi) = 0_Q$. By definition of δ' , we have $\delta'_k(u'_1 \dots u'_k, \sigma, u) = 0$ for every $u \in Q'$. Hence, (\dagger) implies $h_{\mathcal{A}'}(\xi) = 0_Q$.

Case (b): Let $\delta_{\mathcal{A}}(\sigma)(u'_1, \dots, u'_k) \neq 0_Q$. Then we set $u' = f(\delta_{\mathcal{A}}(\sigma)(u'_1, \dots, u'_k))$ and derive

$$\begin{aligned} h_{\mathcal{A}}(\xi) &= (h_{\mathcal{A}'}(\xi_1)_{u'_1} \otimes \dots \otimes h_{\mathcal{A}'}(\xi_k)_{u'_k}) \cdot \delta_{\mathcal{A}}(\sigma)(u'_1, \dots, u'_k) && \text{(by } (\star) \text{)} \\ &= (h_{\mathcal{A}'}(\xi_1)_{u'_1} \otimes \dots \otimes h_{\mathcal{A}'}(\xi_k)_{u'_k} \otimes g(\delta_{\mathcal{A}}(\sigma)(u'_1, \dots, u'_k))) \cdot u' && \text{((} f, g \text{) is a factorization)} \\ &= h_{\mathcal{A}'}(\xi)_{u'} \cdot u' && \text{(by definition of } \delta'_k(u'_1 \dots u'_k, \sigma, u') \text{ and by } (\dagger) \text{)} \\ &= \bigoplus_{u \in Q'} h_{\mathcal{A}'}(\xi)_u \cdot u . && \text{(Lemma 4.1.2(1))} \end{aligned}$$

Now we show that $\llbracket \mathcal{A} \rrbracket(\xi) = \llbracket \mathcal{A}' \rrbracket(\xi)$ for every $\xi \in \mathsf{T}_\Sigma$.

$$\begin{aligned} \llbracket \mathcal{A}' \rrbracket(\xi) &= \bigoplus_{u \in Q'} h_{\mathcal{A}'}(\xi)_u \otimes F'_u \\ &= \bigoplus_{u \in Q'} h_{\mathcal{A}'}(\xi)_u \otimes \left(\bigoplus_{q \in Q} u_q \otimes F_q \right) && \text{(by construction of } \det_{(f,g)}(\mathcal{A}) \text{)} \\ &= \bigoplus_{u \in Q'} \bigoplus_{q \in Q} (h_{\mathcal{A}'}(\xi)_u \otimes u_q \otimes F_q) && \text{(by left-distributivity)} \\ &= \bigoplus_{q \in Q} \bigoplus_{u \in Q'} (h_{\mathcal{A}'}(\xi)_u \otimes u_q \otimes F_q) && \text{(by commutativity of } \oplus \text{)} \end{aligned}$$

$$\begin{aligned}
&= \bigoplus_{q \in Q} \left[\left(\bigoplus_{u \in Q'} h_{\mathcal{A}'}(\xi)_u \otimes u_q \right) \otimes F_q \right] && \text{(by right-distributivity)} \\
&= \bigoplus_{q \in Q} \left[\left(\bigoplus_{u \in Q'} h_{\mathcal{A}'}(\xi)_u \cdot u \right)_q \otimes F_q \right] \\
&= \bigoplus_{q \in Q} h_{\mathcal{A}}(\xi)_q \otimes F_q && \text{(by (13.15))} \\
&= \llbracket \mathcal{A} \rrbracket(\xi) . && \square
\end{aligned}$$

Minimality of $\det_{(f,g)}(\mathcal{A})$ (proof of Theorem 13.3.2(3))

The following theorem corresponds to [KM05, Thm. 3].

Theorem 13.3.19. [BVM10, Thm. 5.6] *Let \mathbf{B} be commutative and let (f, g) and (\tilde{f}, \tilde{g}) be factorizations such that (f, g) is maximal. Moreover, let $\det_{(f,g)}(\mathcal{A}) = (Q', \delta', F')$ and $\det_{(\tilde{f}, \tilde{g})}(\mathcal{A}) = (\tilde{Q}, \tilde{\delta}, \tilde{F})$. Then $Q' = f(\tilde{Q})$; hence $|Q'| \leq |\tilde{Q}|$, and if $\det_{(\tilde{f}, \tilde{g})}(\mathcal{A})$ is a wta, then so is $\det_{(f,g)}(\mathcal{A})$.*

Proof. We prove by case analysis on the cardinality of Q .

Case (a): Let $|Q| = 1$. Then we can identify B^Q with B . Since (f, g) is maximal, we have that $f(B \setminus \{0\}) = \{f(\mathbb{1})\}$. Since $Q' \neq \emptyset$, $\tilde{Q} \neq \emptyset$, and $\tilde{Q} \subseteq B \setminus \{0\}$, we obtain that $Q' = \{f(\mathbb{1})\} = f(\tilde{Q})$.

Case (b): Let $|Q| > 1$. By Lemma 13.3.6, \mathbf{B} is zero-divisor free. Note that (\star) for every $u \in B^Q \setminus \{0_Q\}$, we have $\tilde{g}(u) \cdot \tilde{f}(u) = u = g(u) \cdot f(u)$, and by applying f we obtain $f(\tilde{f}(u)) = f(u) = f(f(u))$ because (f, g) is maximal.

We begin with the proof of $f(\tilde{Q}) \subseteq Q'$. Using Lemma 13.3.8, it suffices to prove the following statement by induction on \mathbb{N} :

$$\text{for every } n \in \mathbb{N}, \text{ we have } f(\tilde{Q}_n) \subseteq Q'.$$

I.B.: Since $\tilde{Q}_0 = \emptyset$, the statement holds trivially.

I.S.: Let $n \in \mathbb{N}$ and $\tilde{u} \in f(\tilde{Q}_{n+1})$. If $\tilde{u} \in f(\tilde{Q}_n)$, then we are ready. Otherwise, there exist $k \in \mathbb{N}$, $\sigma \in \Sigma^{(k)}$, and $\tilde{u}_1, \dots, \tilde{u}_k \in \tilde{Q}_n$ such that $\tilde{u} = f(\tilde{f}(\delta_{\mathcal{A}}(\sigma)(\tilde{u}_1, \dots, \tilde{u}_k)))$. Hence

$$\begin{aligned}
\tilde{u} &= f(\tilde{f}(\delta_{\mathcal{A}}(\sigma)(\tilde{u}_1, \dots, \tilde{u}_k))) \\
&= f(\delta_{\mathcal{A}}(\sigma)(\tilde{u}_1, \dots, \tilde{u}_k)) && (\star) \\
&= f(\delta_{\mathcal{A}}(\sigma)(f(\tilde{u}_1), \dots, f(\tilde{u}_k))) && \text{(Lemma 13.3.7(2) and Lemma 13.3.7(1))} \\
&\in Q' . && \text{(I.H. and def. of } Q')
\end{aligned}$$

Now we prove $Q' \subseteq f(\tilde{Q})$. Using Lemma 13.3.8 again, it suffices to prove the following statement by induction on \mathbb{N} :

$$\text{for every } n \in \mathbb{N}, \text{ we have } Q'_n \subseteq f(\tilde{Q}).$$

I.B.: Since $Q'_0 = \emptyset$, the statement holds trivially.

I.S.: Let $n \in \mathbb{N}$ and $u' \in Q'_{n+1}$. Then there are $k \in \mathbb{N}$, $\sigma \in \Sigma^{(k)}$, and $u'_1, \dots, u'_k \in Q'_n$ such that $u' = f(\delta_{\mathcal{A}}(\sigma)(u'_1, \dots, u'_k))$. By I.H., there exist $\tilde{u}_1, \dots, \tilde{u}_k \in \tilde{Q}$ such that $u'_i = f(\tilde{u}_i)$ for every $i \in [k]$. Hence

$$\begin{aligned}
u' &= f(\delta_{\mathcal{A}}(\sigma)(f(\tilde{u}_1), \dots, f(\tilde{u}_k))) \\
&= f(\delta_{\mathcal{A}}(\sigma)(\tilde{u}_1, \dots, \tilde{u}_k)) && \text{(Lemma 13.3.7(2) and Lemma 13.3.7(1))} \\
&= f(\tilde{f}(\delta_{\mathcal{A}}(\sigma)(\tilde{u}_1, \dots, \tilde{u}_k))) && (\star) \\
&\in f(\tilde{Q}) . && \square
\end{aligned}$$

13.3.5 Applying determinization by factorization to bu-deterministic wta

In this subsection let $\mathcal{A} = (Q, \delta, F)$ be a bu-deterministic (Σ, \mathbf{B}) -wta. Then of course there is no need to determinize \mathcal{A} . However, in order to show the robustness of determinization by factorization, we apply it to \mathcal{A} and a maximal factorization (f, g) . We prove that the resulting triple $\det_{(f,g)}(\mathcal{A}) = (Q', \delta', F')$ is indeed a bu-deterministic wta (i.e., Q' is finite) by showing that $|Q'| \leq |Q|$. This is due to the fact that $h_{\mathcal{A}}(\mathbb{T}_{\Sigma})$ consists of single-valued elements of B^Q and that f takes single-valued Q -vectors to q -unit vectors. We note that we do not require that \mathbf{B} is extremal (which we do in Theorem 13.3.17).

Formally, for every $b \in B$ and $q \in Q$, we let b_q be the element of B^Q such that $(b_q)_q = b$ and $(b_q)_p = 0$ for each $p \in Q \setminus \{q\}$. Then we define the set of *single-valued Q -vectors over B* , denoted by B_{sv}^Q , as the set

$$B_{sv}^Q = \{b_q \in B^Q \mid q \in Q, b \in B\} .$$

By Lemma 4.1.2(1), the following is obvious.

Observation 13.3.20. $h_{\mathcal{A}}(\mathbb{T}_{\Sigma}) \subseteq B_{sv}^Q$. □

Then we can prove the following result.

Corollary 13.3.21. [Büc14, Lm. 5.3.11] Let \mathbf{B} be commutative and $\mathcal{A} = (Q, \delta, F)$ be a bu-deterministic (Σ, \mathbf{B}) -wta. Moreover, let (f, g) be a maximal factorization and $\det_{(f,g)}(\mathcal{A}) = (Q', \delta', F')$. Then we have $|Q'| \leq |Q|$.

Proof. By Lemma 13.3.9 and Observation 13.3.20, we have

$$Q' \subseteq f(h_{\mathcal{A}}(\mathbb{T}_{\Sigma}) \setminus \{0_Q\}) \subseteq f(B_{sv}^Q \setminus \{0_Q\}) .$$

Since (f, g) is maximal, for each $q \in Q$ and $b_q \in B_{sv}^Q$, we have $f(b_q) = f(b \cdot \mathbb{1}_q) = f(\mathbb{1}_q)$. Hence $|f(B_{sv}^Q \setminus \{0_Q\})| \leq |f(\{\mathbb{1}_q \mid q \in Q\})| \leq |Q|$, which proves our lemma. □

Chapter 14

Support of recognizable weighted tree languages

In this chapter we will consider the question whether the support of a recognizable (Σ, \mathbf{B}) -weighted tree language is a recognizable Σ -tree language. We will start with a negative result by showing a string ranked alphabet and a (Σ, Int) -wta \mathcal{A} (where Int is the ring of integers) such that $\text{supp}(\llbracket \mathcal{A} \rrbracket)$ is not recognizable. We will continue with positive results and show *support theorems*; a support theorem states conditions under which the support of a recognizable weighted tree language is a recognizable tree language. The support theorems concern the run semantics or the initial algebra semantics; moreover, they are based on additional requirements on the wta or on the strong bimonoid.

14.1 Negative result for support

Lemma 14.1.1. [BR88, Ex. III. 3.1] For the (Σ, Int) -wta \mathcal{A} in Example 3.2.14, we have $\text{supp}(\llbracket \mathcal{A} \rrbracket) \notin \text{Rec}(\Sigma)$.

Proof. We recall that $\Sigma = \{\sigma^{(1)}, \gamma^{(1)}, \alpha^{(0)}\}$ and that $\llbracket \mathcal{A} \rrbracket(\xi) = |\text{pos}_\gamma(\xi)| - |\text{pos}_\sigma(\xi)|$ for each $\xi \in \mathbf{T}_\Sigma$. Hence

$$\text{supp}(\llbracket \mathcal{A} \rrbracket) = \{\xi \in \mathbf{T}_\Sigma \mid |\text{pos}_\gamma(\xi)| \neq |\text{pos}_\sigma(\xi)|\}.$$

By contradiction, we can easily prove that $\text{supp}(\llbracket \mathcal{A} \rrbracket)$ is not recognizable. For this, we assume that $\text{supp}(\llbracket \mathcal{A} \rrbracket) \in \text{Rec}(\Sigma)$. The complement of $\text{supp}(\llbracket \mathcal{A} \rrbracket)$ is the tree language

$$L = \{\xi \in \mathbf{T}_\Sigma \mid |\text{pos}_\gamma(\xi)| = |\text{pos}_\sigma(\xi)|\} .$$

Since, by Theorem 2.16.3, recognizable Σ -tree languages are closed under complement, L is also recognizable. However, this contradicts to Example 6.1.7 in which we proved that L is not a recognizable Σ -tree language. Hence $\text{supp}(\llbracket \mathcal{A} \rrbracket)$ is not recognizable. \square

The following result immediately follows from Lemma 14.1.1.

Theorem 14.1.2. *There exists a string ranked alphabet Σ such that $\text{supp}(\text{Rec}(\Sigma, \text{Int})) \setminus \text{Rec}(\Sigma) \neq \emptyset$.*

14.2 Positive results for support

In this section we elaborate some support theorems. By a support theorem we mean a result which, for a certain set of recognizable weighted tree languages, guarantees that the support of each element of

that set is a recognizable tree language. We start with a support theorem which can be derived from the preimage theorems. Then we consider (arbitrary) wta and classify the support theorem according to two criteria: the type of semantics of the wta (initial algebra semantics or run semantics) and the set of strong bimonoids. Finally, we compare some of the sets of strong bimonoids for which we have a support theorem.

14.2.1 Consequences of preimage theorems

In Chapter 12 we have proved some preimage theorems. Roughly speaking, each of them states conditions such that the following implication holds: if a recognizable weighted tree language $r : T_\Sigma \rightarrow B$ satisfies the conditions, then for each $b \in B$, the Σ -tree language $r^{-1}(b)$ is recognizable. In a straightforward way, each of these preimage theorems implies a support theorem. In the next corollary we merely collect these support theorems (without dealing with their relationship).

Corollary 14.2.1. Let Σ be a ranked alphabet. Moreover, let $\mathbf{B} = (B, \oplus, \otimes, 0, 1)$ be a strong bimonoid and let $r : T_\Sigma \rightarrow B$. If one of the following conditions is satisfied:

- (1) r is a recognizable step mapping,
 - (2) $r \in \text{Rec}^{\text{init}}(\Sigma, B)$ and (a) \mathbf{B} is locally finite or (b) \mathbf{B} is weakly locally finite and Σ is monadic,
 - (3) $r \in \text{Rec}^{\text{run}}(\Sigma, B)$ and \mathbf{B} is bi-locally finite,
 - (4) $r \in \text{Rec}^{\text{run}}(\Sigma, B)$ and (\mathbf{B}, \preceq) is a past-finite monotonic strong bimonoid,
- then $\text{supp}(r) \in \text{Rec}(\Sigma)$. Moreover, if r is given effectively, then in each case we can construct a Σ -fta A such that $\text{supp}(r) = L(A)$.

Proof. Since $\text{supp}(r) = T_\Sigma \setminus r^{-1}(0)$ and the set of Σ -recognizable tree languages is closed under complement (cf. Theorem 2.16.3), the following equivalence holds:

$$r^{-1}(0) \text{ is recognizable if and only if } \text{supp}(r) \text{ is recognizable.} \quad (14.1)$$

Then, each of the four implications is justified by equivalence (14.1) and the corresponding preimage theorem: (1) Theorem 10.3.1($B \Rightarrow C$), (2) Corollary 12.1.4, (3) Corollary 12.2.10, and (4) Theorem 12.2.12(1).

Now let r be given effectively. Then, in each of the Cases (1)-(3), by the corresponding preimage theorem and Theorem 2.16.3 we can construct a Σ -fta A such that $\text{supp}(r) = L(A)$. In Case(4) we use Theorem 12.2.12(2) and Theorem 2.16.3 to construct the Σ -fta A ; note that $\text{past}(0) = \{0\}$. \square

14.2.2 Both semantics and positive strong bimonoids

Corollary 3.4.2 is a support theorem for the Boolean semiring. If we analyse the proof of the underlying Theorem 3.4.1, then we realize that we have used the fact that the semiring Boole is positive, i.e., zero-sum free and zero-divisor free. In this subsection we generalize Corollary 3.4.2 from Boole to an arbitrary positive strong bimonoid.

We define the particular mapping $\text{sgn} : B \rightarrow \mathbb{B}$ for each $b \in B$ by

$$\text{sgn}(b) = \begin{cases} 1 & \text{if } b \neq 0 \\ 0 & \text{otherwise} \end{cases}$$

Lemma 14.2.2. Let \mathbf{B} be positive. Then $\text{sgn} : B \rightarrow \mathbb{B}$ is a strong bimonoid homomorphism from \mathbf{B} to Boole .

Proof. Let $b_1, b_2 \in B$. Then

$$\begin{aligned} \text{sgn}(b_1 \oplus b_2) = 1 \text{ iff } b_1 \oplus b_2 \neq 0 \text{ iff}^* b_1 \neq 0 \vee b_2 \neq 0 \\ \text{iff } (\text{sgn}(b_1) = 1) \vee (\text{sgn}(b_2) = 1) \text{ iff } (\text{sgn}(b_1) \vee \text{sgn}(b_2)) = 1 \end{aligned}$$

where at equivalence iff^* from right to left we have used the fact that B is zero-sum free. Thus $\text{sgn}(b_1 \oplus b_2) = \text{sgn}(b_1) \vee \text{sgn}(b_2)$. Also

$$\begin{aligned} \text{sgn}(b_1 \otimes b_2) = 1 \text{ iff } b_1 \otimes b_2 \neq 0 \text{ iff}^* b_1 \neq 0 \wedge b_2 \neq 0 \\ \text{iff } (\text{sgn}(b_1) = 1) \wedge (\text{sgn}(b_2) = 1) \text{ iff } (\text{sgn}(b_1) \wedge \text{sgn}(b_2)) = 1 \end{aligned}$$

where at equivalence iff^* from right to left we have used the fact that B is zero-divisor free. Hence $\text{sgn}(b_1 \otimes b_2) = \text{sgn}(b_1) \wedge \text{sgn}(b_2)$. Moreover, $\text{sgn}(0) = 0$ and $\text{sgn}(1) = 1$. Thus sgn is a strong bimonoid homomorphism. \square

Our next support theorem can be compared to [FV09, Thm. 3.12]. In Lemma 14.2.3 we prove that the support of the run semantics of a wta \mathcal{A} is the same as the support of its initial algebra semantics if the strong bimonoid is positive (cf. [GV22, Thm. 4.1] for a direct proof). Moreover, the fta $\text{supp}(\text{sgn}(\mathcal{A}))$ recognizes the support. Since each monotonic strong bimonoid is positive (cf. Subsection 12.2.3), it contains Corollary 14.2.1(4).

Lemma 14.2.3. Let B be positive and \mathcal{A} be a (Σ, B) -wta. Then $L(\text{supp}(\text{sgn}(\mathcal{A}))) = \text{supp}(\llbracket \mathcal{A} \rrbracket^{\text{init}}) = \text{supp}(\llbracket \mathcal{A} \rrbracket^{\text{run}})$. Hence, both $\text{supp}(\llbracket \mathcal{A} \rrbracket^{\text{run}})$ and $\text{supp}(\llbracket \mathcal{A} \rrbracket^{\text{init}})$ are recognizable Σ -tree languages.

Proof. First we prove that $L(\text{supp}(\text{sgn}(\mathcal{A}))) = \text{supp}(\llbracket \mathcal{A} \rrbracket^{\text{run}})$. For this, we consider the mapping $\text{sgn} : B \rightarrow \mathbb{B}$. Since B is positive, sgn is a strong bimonoid homomorphism by Lemma 14.2.2. We note that $\text{sgn}(\mathcal{A})$ is a (Σ, Boole) -wta. Then we have

$$\begin{aligned} L(\text{supp}(\text{sgn}(\mathcal{A}))) &= \text{supp}(\llbracket \text{sgn}(\mathcal{A}) \rrbracket^{\text{run}}) && \text{(by Theorem 3.4.1)} \\ &= \text{supp}(\text{sgn} \circ \llbracket \mathcal{A} \rrbracket^{\text{run}}) && \text{(by Lemma 14.2.2 and Lemma 10.9.1)} \\ &= \text{supp}(\llbracket \mathcal{A} \rrbracket^{\text{run}}) . && \text{(by definition of supp and sgn)} \end{aligned}$$

Using the same results as in the above calculation, we can also prove that $L(\text{supp}(\text{sgn}(\mathcal{A}))) = \text{supp}(\llbracket \mathcal{A} \rrbracket^{\text{init}})$. Since $\text{supp}(\text{sgn}(\mathcal{A}))$ is a Σ -fta, both $\text{supp}(\llbracket \mathcal{A} \rrbracket^{\text{run}})$ and $\text{supp}(\llbracket \mathcal{A} \rrbracket^{\text{init}})$ are recognizable Σ -tree languages. \square

It is clear that Lemma 14.2.3 generalizes also Theorem 3.4.1, because Boole is positive. However, we have used Theorem 3.4.1 for the proof of Lemma 14.2.3.

We note that, in spite of Lemma 14.2.3, there exist a positive strong bimonoid B and a (Σ, B) -wta \mathcal{A} such that $\llbracket \mathcal{A} \rrbracket^{\text{init}} \neq \llbracket \mathcal{A} \rrbracket^{\text{run}}$; witnesses of this fact are shown in Examples 5.2.1 and 5.2.2, as well as in the proof of Theorem 5.2.5.

The following theorem is a generalization of [FV09, Thm. 3.12] from positive semirings to positive strong bimonoids.

Theorem 14.2.4. *Let Σ be a ranked alphabet. Moreover, let B be a positive strong bimonoid. Then*

$$\text{Rec}(\Sigma) = \text{supp}(\text{Rec}^{\text{init}}(\Sigma, B)) = \text{supp}(\text{Rec}^{\text{run}}(\Sigma, B)) .$$

Proof. The inclusion $\text{Rec}(\Sigma) \subseteq \text{supp}(\text{Rec}^{\text{init}}(\Sigma, B))$ follows from $(B) \Rightarrow (C)$ of Theorem 4.1.10 (without using that B is positive). The inclusion $\text{supp}(\text{Rec}^{\text{init}}(\Sigma, B)) \subseteq \text{Rec}(\Sigma)$ and the equality $\text{supp}(\text{Rec}^{\text{init}}(\Sigma, B)) = \text{supp}(\text{Rec}^{\text{run}}(\Sigma, B))$ follow from Lemma 14.2.3. \square

At this point we can prove that Int is not a Fatou extension of Nat (cf. Section 3.7).

Lemma 14.2.5. [KS86, Ex. 8.1 on p. 129] The ring Int is not a Fatou extension of the semiring Nat .

Proof. Let $r = \llbracket \mathcal{A} \rrbracket$, where \mathcal{A} is the (Σ, Int) -wta in Example 3.2.14. By Theorem 10.4.1, $r' = r \otimes r$ is also recognizable by a (Σ, Int) -wta. Moreover, $\text{im}(r') \subseteq \mathbb{N}$, hence $r' \in \text{Rec}(\Sigma, \text{Int}) \cap \mathbb{N}^{\mathbb{T}^\Sigma}$. Next we observe that $\text{supp}(r') = \text{supp}(r)$ and hence, by Lemma 14.1.1, the Σ -tree language $\text{supp}(r')$ is not recognizable. Since the semiring Nat is positive, by Theorem 14.2.4, we obtain that $r' \notin \text{Rec}(\Sigma, \text{Nat})$. \square

14.2.3 Both semantics and commutative semirings which are not rings

Here we show a support theorem which deals with commutative semirings which are not rings. It is based on the following result.

Theorem 14.2.6. [Wan97, Thm. 2.1] (also cf. [DK21, Lm. 9.3]) *Let \mathbb{B} be a commutative semiring which is not a ring. Then there exists a semiring homomorphism from \mathbb{B} onto the Boolean semiring.*

Theorem 14.2.7. *Let Σ be a ranked alphabet. Moreover, let $\mathbb{B} = (B, \oplus, \otimes, 0, \mathbb{1})$ be a commutative semiring which is not a ring, and let $L \subseteq \mathbb{T}_\Sigma$ be a tree language. If $\chi_{\mathbb{B}}(L) \in \text{Rec}(\Sigma, \mathbb{B})$, then L is in $\text{Rec}(\Sigma)$.*

Proof. Let $\chi_{\mathbb{B}}(L) \in \text{Rec}(\Sigma, \mathbb{B})$. By Theorem 14.2.6, there exists a semiring homomorphism $h : \mathbb{B} \rightarrow \mathbb{B}$. Clearly, $h(\chi_{\mathbb{B}}(L)) = \chi_{\text{Boole}}(L)$. Then, by Theorem 10.9.2, we have $\chi_{\text{Boole}}(L) \in \text{Rec}(\Sigma, \text{Boole})$. Thus, since $L = \text{supp}(\chi_{\text{Boole}}(L))$, we have $L \in \text{supp}(\text{Rec}(\Sigma, \text{Boole}))$. By Corollary 3.4.2 we obtain that $L \in \text{Rec}(\Sigma)$. \square

14.2.4 Run semantics and commutative, zero-sum free strong bimonoids

In [Kir11, Thm. 3.1] (also cf. [Kir09, Thm. 1]) it was proved that the support of every recognizable (Γ, \mathbb{B}) -weighted string language is a recognizable string language provided that the weight algebra \mathbb{B} is a commutative zero-sum free semiring. This generalizes [Wan98, Cor. 5.2] where this result was proved for commutative quasi-positive semirings, because each commutative quasi-positive semiring is a commutative zero-sum free semiring by definition. Here we show how [Kir11, Thm. 3.1] can be generalized to the tree case by adapting the proof technique from [Kir11] (cf. [DH15], [Göt17, Thm. 4.6], and [FHV18, Thm. 4.3(1)]). Distributivity is not needed.

In this subsection we assume that \mathbb{B} is commutative.

Let us consider a (Σ, \mathbb{B}) -wta \mathcal{A} , a tree $\xi \in \mathbb{T}_\Sigma$, and a run $\rho \in R_{\mathcal{A}}(\xi)$. By definition, $\text{wt}_{\mathcal{A}}(\xi, \rho)$ is the product of some occurrences of elements of $\text{im}(\delta)$ (cf. Observation 3.1.1). Since $\text{im}(\delta)$ is finite, we can sort its elements in a vector of n components, where $n = |\text{im}(\delta)|$. Then, since \otimes is commutative, we can represent $\text{wt}_{\mathcal{A}}(\xi, \rho)$ as a vector $\vec{z} \in \mathbb{N}^n$ of the multiplicities of these occurrences. Next we will formalize this representation.

Let $\vec{b} = (b_1, \dots, b_n)$ be an arbitrary, but fixed enumeration of $\text{im}(\delta)$. Then $b_i \neq b_j$ for $i \neq j$. Let $(z_1, \dots, z_n), (z'_1, \dots, z'_n) \in \mathbb{N}^n$. Then we define

$$(z_1, \dots, z_n) + (z'_1, \dots, z'_n) = (z_1 + z'_1, \dots, z_n + z'_n) .$$

It is clear that the binary operation $+$ is associative. By identifying each $b_j \in \text{im}(\delta)$ with $(\underbrace{0, \dots, 0}_{j-1}, 1, \underbrace{0, \dots, 0}_{n-j})$, we have

$$(z_1, \dots, z_n) + b_j = (z_1, \dots, z_{j-1}, z_j + 1, z_{j+1}, \dots, z_n) .$$

For the inductive definition of the representation, we use the terminating reduction system (TR, \succ) defined in Section 3.1 on p. 76. For the sake of convenience we recall that $\text{TR} = \{(\xi, \rho) \mid \xi \in \text{T}_\Sigma, \rho \in \text{R}_\mathcal{A}(\xi)\}$ and that the terminating relation \succ on TR is the binary relation defined as follows:

$$\text{for every } (\xi, \rho) \in \text{TR} \text{ and } i \in [\text{rk}(\xi(\varepsilon))], \text{ we let } (\xi, \rho) \succ (\xi|_i, \rho|_i) .$$

Clearly $\text{nf}_\succ(\text{TR}) = \{(\alpha, \rho) \mid \alpha \in \Sigma^{(0)}, \rho : \{\varepsilon\} \rightarrow Q\}$. Then we define the mapping $\overline{(\cdot)} : \text{TR} \rightarrow \mathbb{N}^n$ by induction on (TR, \succ) for every $\xi \in \text{T}_\Sigma$ and $\rho \in \text{R}_\mathcal{A}(\xi)$ by

$$\overline{(\xi, \rho)} = (0, \dots, 0) + \overline{(\xi|_1, \rho|_1)} + \dots + \overline{(\xi|_k, \rho|_k)} + \delta_k(\rho(1) \cdots \rho(k), \xi(\varepsilon), \rho(\varepsilon))$$

where $k = \text{rk}(\xi(\varepsilon))$. We have added the vector $(0, \dots, 0)$ in order to have $\overline{(\xi, \rho)}$ well defined for the case $k = 0$.

Moreover, each vector $\vec{z} = (z_1, \dots, z_n) \in \mathbb{N}^n$ represents an element of B . Formally, we define the mapping $\llbracket \cdot \rrbracket : \mathbb{N}^n \rightarrow B$ for each $\vec{z} = (z_1, \dots, z_n) \in \mathbb{N}^n$ by

$$\llbracket \vec{z} \rrbracket = b_1^{z_1} \otimes \dots \otimes b_n^{z_n} .$$

Since B is commutative,

$$\text{for every } \xi \in \text{T}_\Sigma \text{ and } \rho \in \text{R}_\mathcal{A}(\xi), \text{ we have } \text{wt}_\mathcal{A}(\xi, \rho) = \llbracket \overline{(\xi, \rho)} \rrbracket . \quad (14.2)$$

In other words, $\text{wt}_\mathcal{A} = \llbracket \cdot \rrbracket \circ \overline{(\cdot)}$. In this sense, the vector $\overline{(\xi, \rho)}$ represents $\text{wt}_\mathcal{A}(\xi, \rho)$.

Next we will analyse the set $\llbracket \cdot \rrbracket^{-1}(0)$ of vectors $\vec{z} \in \mathbb{N}^n$ which are mapped to 0 . (We note that $(0, \dots, 0) \notin \llbracket \cdot \rrbracket^{-1}(0)$, because $b_1^0 \otimes \dots \otimes b_n^0 = 1$.)

For this, we consider the partially ordered set (\mathbb{N}^n, \leq) , where the binary relation \leq is defined as follows: for all vectors $\vec{z} = (z_1, \dots, z_n) \in \mathbb{N}^n$ and $\vec{y} = (y_1, \dots, y_n) \in \mathbb{N}^n$, we define $\vec{z} \leq \vec{y}$ if $z_i \leq y_i$ for each $i \in [n]$. We note that, for every $\vec{z}, \vec{y} \in \mathbb{N}^n$, if $\llbracket \vec{z} \rrbracket = 0$ and $\vec{z} \leq \vec{y}$, then $\llbracket \vec{y} \rrbracket = 0$ (because 0 is annihilating). Let $M \subseteq \mathbb{N}^n$. An element $\vec{z} \in M$ is *minimal in M* if, for each $\vec{y} \in M$, the assumption $\vec{y} \leq \vec{z}$ implies $\vec{y} = \vec{z}$. We denote by $\min(M)$ the set of all minimal elements in M . Thus, in particular, $\min(\emptyset) = \emptyset$. The following result is called Dickson's Lemma.

Lemma 14.2.8. [Dic13] (cf. also [Kir11, Lm. 2.1] and [KR08]) For each $M \subseteq \mathbb{N}^n$, the set $\min(M)$ is finite.

By Lemma 14.2.8, the set $\min(\llbracket \cdot \rrbracket^{-1}(0))$ is finite. Hence there exists a smallest number $m \in \mathbb{N}$ satisfying $\min(\llbracket \cdot \rrbracket^{-1}(0)) \subseteq \{0, \dots, m\}^n$, and we call this number m the *degree of \vec{b}* and denote it by $\text{dg}(\vec{b})$. (We note that if B is zero-divisor free and $0 \notin \text{im}(\delta)$, then $\llbracket \cdot \rrbracket^{-1}(0) = \emptyset$, hence $\text{dg}(\vec{b}) = 0$. We also note that, for any other enumeration \vec{b}' of $\text{im}(\delta)$, we have $\text{dg}(\vec{b}) = \text{dg}(\vec{b}')$.)

The next lemma states that, if $\llbracket \vec{z} \rrbracket = 0$ for some \vec{z} , then also the evaluation of \vec{z}' results in 0 where \vec{z}' is obtained from \vec{z} by restricting the components to $\text{dg}(\vec{b})$. Formally, for every $\vec{z} \in \mathbb{N}^n$, we define the *cut of \vec{z}* , denoted by $\llbracket \vec{z} \rrbracket_{\text{dg}(\vec{b})}$, to be the vector $\llbracket \vec{z} \rrbracket_{\text{dg}(\vec{b})} \in \mathbb{N}^n$ with

$$(\llbracket \vec{z} \rrbracket_{\text{dg}(\vec{b})})_i = \min\{z_i, \text{dg}(\vec{b})\}$$

as i -th component for each $i \in [n]$.

Lemma 14.2.9. ([Kir11, Lm. 4.1]) For every $\vec{z} \in \mathbb{N}^n$, we have $\llbracket \vec{z} \rrbracket = 0$ iff $\llbracket \llbracket \vec{z} \rrbracket_{\text{dg}(\vec{b})} \rrbracket = 0$.

Proof. Let $\llbracket \llbracket \vec{z} \rrbracket_{\text{dg}(\vec{b})} \rrbracket = 0$. Since $\llbracket \vec{z} \rrbracket_{\text{dg}(\vec{b})} \leq \vec{z}$ and 0 is an annihilator for \otimes , we have $\llbracket \vec{z} \rrbracket = 0$.

Now let $\llbracket \vec{z} \rrbracket = 0$. Then there exists a $\vec{y} \in \min(\llbracket \cdot \rrbracket^{-1}(0))$ such that $\vec{y} \leq \vec{z}$. We prove that $\vec{y} \leq \llbracket \vec{z} \rrbracket_{\text{dg}(\vec{b})}$. For this let $\vec{y} = (y_1, \dots, y_n)$, $\vec{z} = (z_1, \dots, z_n)$, and $i \in [n]$. If $z_i \leq \text{dg}(\vec{b})$, then $y_i \leq z_i = (\llbracket \vec{z} \rrbracket_{\text{dg}(\vec{b})})_i$. If $z_i > \text{dg}(\vec{b})$, then $y_i \leq \text{dg}(\vec{b}) = (\llbracket \vec{z} \rrbracket_{\text{dg}(\vec{b})})_i$. Hence $\vec{y} \leq \llbracket \vec{z} \rrbracket_{\text{dg}(\vec{b})}$ and thus $\llbracket \llbracket \vec{z} \rrbracket_{\text{dg}(\vec{b})} \rrbracket = 0$. \square

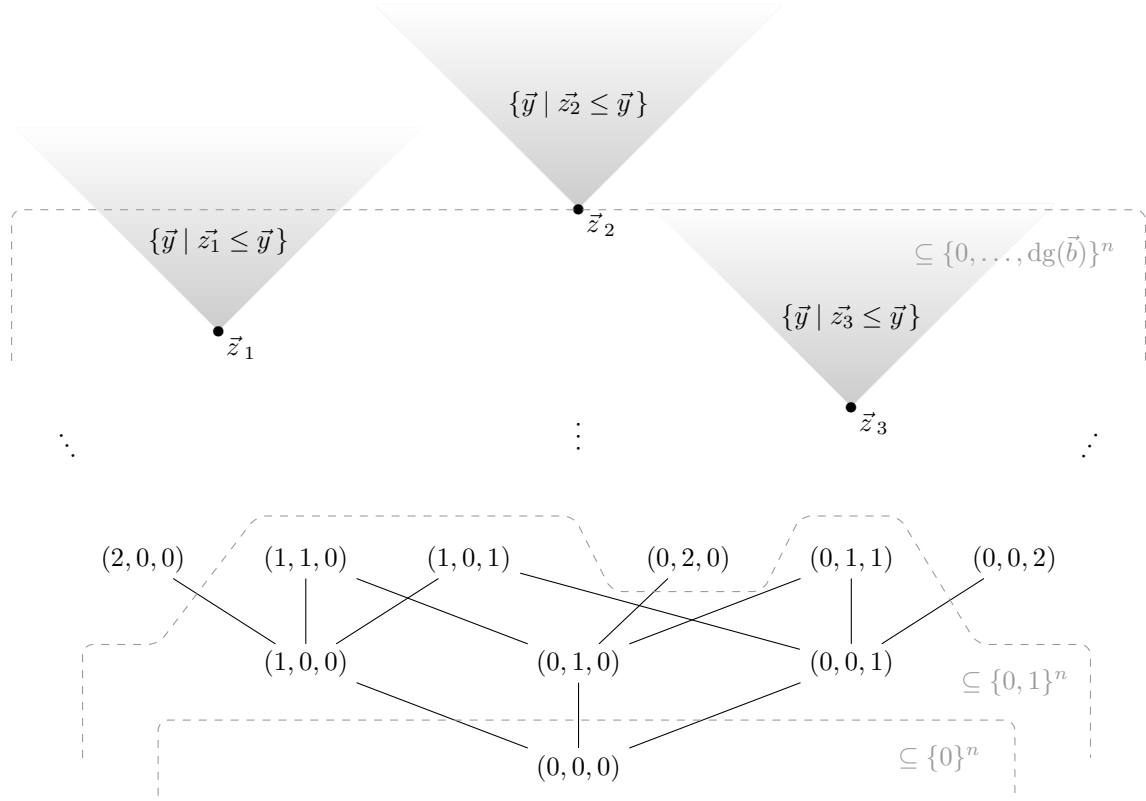

Figure 14.1: The Hasse diagram of tuples \mathbb{N}^3 with $\min([\cdot]^{-1}(0)) = \{z_1, z_2, z_3\}$.

In Figure 14.1 we indicate the partial order on \mathbb{N}^3 . We assume that $\min([\cdot]^{-1}(0)) = \{z_1, z_2, z_3\}$. For each $i \in \{1, 2, 3\}$ we indicate the set $\{\vec{y} \mid z_i \leq \vec{y}\}$ by a shaded filter. Clearly, for each \vec{y} in one of these filters we have $[\vec{y}] = 0$. We also indicate the set $\{0, \dots, j\}^n$ for $j = 0, j = 1$, and $j = \text{dg}(\vec{b})$.

Now we can prove the main support theorem of this subsection. We follow the proof of the corresponding result [Kir11, Thm. 3.1] for weighted string automata over semirings. This result has been generalized to (a) weighted unranked tree automaton over zero-sum free, commutative strong bimonoids [DH15] and (b) weighted unranked tree automata over zero-sum free, commutative, zero-preserving tv-monoids [Göt17, Thm. 4.7]. We also refer to [FHV18, Thm. 4.4] where the support theorem was proved for weighted tree automata over σ -complete and commutative strong bimonoids¹.

Theorem 14.2.10. *Let Σ be a ranked alphabet. Moreover, let $\mathbf{B} = (B, \oplus, \otimes, 0, \mathbb{1})$ be a commutative strong bimonoid and let \mathcal{A} be a (Σ, \mathbf{B}) -wta. If (a) \mathbf{B} is zero-sum free or (b) \mathcal{A} is bu-deterministic and root weight normalized, then $\text{supp}([\mathcal{A}]^{\text{run}}) \in \text{Rec}(\Sigma)$.*

Proof. Let $\mathcal{A} = (Q, \delta, F)$ be a (Σ, \mathbf{B}) -wta. If \mathcal{A} is not root weight normalized, then by Theorem 7.3.1 we can construct a run equivalent and root weight normalized (Σ, \mathbf{B}) -wta. Hence, in both cases (a) and (b) we may assume that \mathcal{A} is root weight normalized. Thus, there exists $q_f \in Q$ such that $F_{q_f} = \mathbb{1}$ and $F_q = 0$ for each $q \in Q \setminus \{q_f\}$. Let $\vec{b} = (b_1, \dots, b_n) \in B^n$ be an arbitrary but fixed enumeration of $\text{im}(\delta)$.

Then we define the Σ -fta $A = (Q', \delta', F')$ which counts, up to the threshold $\text{dg}(\vec{b})$, the number of

¹(We note that, by Observation 2.7.11(9), σ -completeness implies zero-sum freeness.)

occurrences of the b_j 's in the runs of \mathcal{A} . Formally, we let $T = \{0, \dots, \text{dg}(\vec{b})\}$ and we define

- $Q' = Q \times T^n$,
- $F' = \{(q_f, \vec{z}) \in Q' \mid \llbracket \vec{z} \rrbracket \neq 0\}$,
- we define for each $k \in \mathbb{N}$

$$\delta'_k = \{((q_1, \vec{z}_1) \cdots (q_k, \vec{z}_k), \sigma, (q, \vec{z})) \mid \sigma \in \Sigma^{(k)}, ((q_1, \vec{z}_1) \cdots (q_k, \vec{z}_k)) \in (Q')^k, (q, \vec{z}) \in Q', \\ \vec{z} = \lfloor (0, \dots, 0) + \vec{z}_1 + \dots + \vec{z}_k + \delta_k(q_1 \dots q_k, \sigma, q) \rfloor_{\text{dg}(\vec{b})}\} .$$

Now we prove that $\text{supp}(\llbracket \mathcal{A} \rrbracket^{\text{run}}) = L(A)$. First, for each $\xi \in T_\Sigma$, we define the mapping

$$\varphi : R_{\mathcal{A}}(\xi) \rightarrow R_A^v(\xi)$$

as follows. For every $\rho \in R_{\mathcal{A}}(\xi)$, we define the family $(\varphi(\rho)(w) \mid w \in \text{pos}(\xi))$ of states $\varphi(\rho)(w) \in Q'$.

For this definition, we recall the binary relation \succ on $\text{pos}(\xi)$ defined by $w_1 \succ w_2$ if there exists $i \in \mathbb{N}$ such that $w_2 = w_1 i$, for every $w_1, w_2 \in \text{pos}(\xi)$ (cf. the proof of Lemma 10.8.1). Then \succ is terminating and $\text{nf}_\succ(\text{pos}(\xi)) = \text{pos}_{\Sigma^{(0)}}(\xi)$, i.e., it is the set of leaves of ξ .

Now we define $\varphi(\rho)$ by induction on $(\text{pos}(\xi), \succ)$ as follows. Let $w \in \text{pos}(\xi)$ with $\xi(w) = \sigma$ for some $\sigma \in \Sigma^{(k)}$ with $k \in \mathbb{N}$. We assume that $\varphi(\rho)(wi) = (q_i, \vec{z}_i)$ for each $i \in [k]$. Then we define

$$\varphi(\rho)(w) = (\rho(w), \lfloor (0, \dots, 0) + \vec{z}_1 + \dots + \vec{z}_k + \delta_k(q_1 \dots q_k, \sigma, \rho(w)) \rfloor_{\text{dg}(\vec{b})}) .$$

It is clear that the run $\varphi(\rho)$ of the Σ -fta A is valid and that φ is bijective. Moreover, by induction on T_Σ , we can prove the following:

$$\text{for every } \xi \in T_\Sigma, (q, \vec{z}) \in Q', \text{ and } \rho' \in R_A^v((q, \vec{z}), \xi): \vec{z} = \lfloor \overline{(\xi, \varphi^{-1}(\rho'))} \rfloor_{\text{dg}(\vec{b})} \quad (14.3)$$

Let $\xi = \sigma(\xi_1, \dots, \xi_k)$, $(q, \vec{z}) \in Q'$, and $\rho' \in R_A^v((q, \vec{z}), \xi)$. Then, for each $i \in [k]$, there exist $(q_i, \vec{z}_i) \in Q'$ such that $\rho'|_i \in R_A^v((q_i, \vec{z}_i), \xi_i)$ and

$$\vec{z} = \lfloor (0, \dots, 0) + \vec{z}_1 + \dots + \vec{z}_k + \delta_k(q_1 \dots q_k, \sigma, q) \rfloor_{\text{dg}(\vec{b})} . \quad (14.4)$$

Then we can calculate as follows (where we abbreviate $\lfloor \cdot \rfloor_{\text{dg}(\vec{b})}$ by $\lfloor \cdot \rfloor$):

$$\begin{aligned} & \lfloor \overline{(\sigma(\xi_1, \dots, \xi_k), \varphi^{-1}(\rho'))} \rfloor \\ &= \lfloor (0, \dots, 0) + \overline{(\xi_1, \varphi^{-1}(\rho'|_1))} + \dots + \overline{(\xi_k, \varphi^{-1}(\rho'|_k))} + \delta_k(q_1 \dots q_k, \sigma, q) \rfloor \quad (\text{by definition of } \overline{(\cdot)}) \\ &= \lfloor (0, \dots, 0) + \lfloor \overline{(\xi_1, \varphi^{-1}(\rho'|_1))} \rfloor + \dots + \lfloor \overline{(\xi_k, \varphi^{-1}(\rho'|_k))} \rfloor + \delta_k(q_1 \dots q_k, \sigma, q) \rfloor \\ & \quad (\text{because } \lfloor \vec{y}_1 + \vec{y}_2 \rfloor = \lfloor \vec{y}_1 \rfloor + \lfloor \vec{y}_2 \rfloor = \lfloor \lfloor \vec{y}_1 \rfloor + \lfloor \vec{y}_2 \rfloor \rfloor \text{ for every } \vec{y}_1, \vec{y}_2 \in T^n) \\ &= \lfloor (0, \dots, 0) + \vec{z}_1 + \dots + \vec{z}_k + \delta_k(q_1 \dots q_k, \sigma, q) \rfloor \quad (\text{by I.H.}) \\ &= \vec{z} . \quad (\text{by (14.4)}) \end{aligned}$$

This proves (14.3).

Now let $\xi \in T_\Sigma$. We note that, if \mathbf{B} is not zero-sum free, then \mathcal{A} is bu-deterministic. Then

$$\begin{aligned} & \xi \in \text{supp}(\llbracket \mathcal{A} \rrbracket^{\text{run}}) \text{ iff } \llbracket \mathcal{A} \rrbracket^{\text{run}}(\xi) \neq 0 \\ & \text{iff } \bigoplus_{\rho \in R_{\mathcal{A}}(q_f, \xi)} \text{wt}_{\mathcal{A}}(\xi, \rho) \neq 0 \quad (\text{because } \text{supp}(F) = \{q_f\} \text{ and } F_{q_f} = \mathbb{1}) \\ & \text{iff } (\exists \rho \in R_{\mathcal{A}}(q_f, \xi)): \text{wt}_{\mathcal{A}}(\xi, \rho) \neq 0 \quad (\text{because } \mathbf{B} \text{ is zero-sum free or } \mathcal{A} \text{ is bu-deterministic}) \\ & \text{iff } (\exists \vec{z} \in T^n)(\exists \rho' \in R_A^v((q_f, \vec{z}), \xi)): \text{wt}_{\mathcal{A}}(\xi, \varphi^{-1}(\rho')) \neq 0 \quad (\text{because } \varphi \text{ is bijective}) \\ & \text{iff } (\exists \vec{z} \in T^n)(\exists \rho' \in R_A^v((q_f, \vec{z}), \xi)): \lfloor \overline{(\xi, \varphi^{-1}(\rho'))} \rfloor \neq 0 \quad (\text{by 14.2}) \end{aligned}$$

$$\begin{aligned}
& \text{iff } (\exists \vec{z} \in T^n)(\exists \rho' \in R_A^v((q_f, \vec{z}), \xi)): \llbracket \overline{[(\xi, \varphi^{-1}(\rho'))]}_{\text{dg}(\vec{b})} \rrbracket \neq 0 && \text{(Lemma 14.2.9)} \\
& \text{iff } (\exists \vec{z} \in T^n)(\exists \rho' \in R_A^v((q_f, \vec{z}), \xi)): \llbracket \vec{z} \rrbracket \neq 0 && \text{(by 14.3)} \\
& \text{iff } (\exists q' \in F'): R_A^v(q', \xi) \neq \emptyset && \text{(by construction of } F') \\
& \text{iff } \xi \in L(A) . && \square
\end{aligned}$$

As a direct consequence of Theorem 14.2.10 we obtain a support theorem for wta over each strong bimonoid in which the summation is a t-conorm (cf. Example 2.7.10(3) and thus, in particular, for wta over $\text{UnitInt}_{u,i}$ where u is a t-conorm and i is a t-norm. The latter consequence generalizes the case $\lambda = 0$ of [San68, Thm. 7] from $\text{UnitInt}_{\max, \min}$ to $\text{UnitInt}_{u,i}$ for each tuple (u, i) of t-conorm u and t-norm i .

Corollary 14.2.11. Let $B = ([0, 1], u, \otimes, 0, 1)$ be a commutative strong bimonoid such that u is a t-conorm. Moreover, let \mathcal{A} be a (Σ, B) -wta. Then $\text{supp}(\llbracket \mathcal{A} \rrbracket^{\text{run}}) \in \text{Rec}(\Sigma)$.

Proof. We show that $B = ([0, 1], u, \otimes, 0, 1)$ is zero-sum free. Then the statement follows from Theorem 14.2.10.

Let $a, b \in [0, 1]$ and $u(a, b) = 0$. Using the boundary condition and monotonicity condition of u (cf. Example 2.7.10(3)), we have

$$\begin{aligned}
a &= u(a, 0) && \text{(by the boundary condition for } u) \\
&\leq u(a, b) && \text{(by monotonicity condition for } u) \\
&= 0 . && \text{(by assumption)}
\end{aligned}$$

This implies that $a = 0$. In a similar way we can derive that $b = 0$. Hence $B = ([0, 1], u, \otimes, 0, 1)$ is zero-sum free. \square

In Theorem 14.2.10(a), the strong bimonoid B is assumed to be commutative and zero-sum free. The theorem is not constructive because, in order to construct an fta which accepts the support of a run recognizable weighted tree language, we should construct $\text{dg}(\vec{b})$. However, it is not clear how to construct $\text{dg}(\vec{b})$. We mention that in [Kir11] the zero generation problem (ZGP) is considered, and the decidability of the ZGP implies that $\text{dg}(\vec{b})$ can be constructed and hence the fta in the support theorem can be constructed.

In the following theorem, we require additionally that B is multiplicatively idempotent. Then we do not need to compute $\text{dg}(\vec{b})$ and we can construct the desired fta. We note that our assumption on B implies that the ZGP is decidable. However, we do not wish to include the ZGP in our proof. For more details on ZGP we refer to, e.g., [Kir11, DH15, Göt17, FHV18].

Theorem 14.2.12. Let Σ be a ranked alphabet. Moreover, let $B = (B, \oplus, \otimes, 0, 1)$ be a zero-sum free, commutative, and multiplicatively idempotent strong bimonoid. Then, for each (Σ, B) -wta \mathcal{A} , we can construct a Σ -fta A such that $L(A) = \text{supp}(\llbracket \mathcal{A} \rrbracket^{\text{run}})$.

Proof. Let $\mathcal{A} = (Q, \delta, F)$ be a (Σ, B) -wta. By Theorem 7.3.1 we can assume that \mathcal{A} is root weight normalized and $F_{q_f} = \mathbb{1}$ and $F_q = \mathbb{0}$ for each $q \in Q \setminus \{q_f\}$. Let $\vec{b} = (b_1, \dots, b_n) \in B^n$ be an arbitrary but fixed enumeration of $\text{im}(\delta)$.

Since B is commutative and multiplicatively idempotent, it is clear that $\min(\llbracket \cdot \rrbracket^{-1}(0)) \subseteq \{0, 1\}^n$. Hence, instead of $\text{dg}(\vec{b})$, we can use 1 as threshold for the frequency with which an element of $\text{im}(\delta)$ can occur in the weight of a run. More precisely, we construct the Σ -fta A in the same way as in the proof of Theorem 14.2.10 except that we define the set Q' of states of A by $Q' = Q \times \{0, 1\}^n$. We obtain $L(A) = \text{supp}(\llbracket \mathcal{A} \rrbracket^{\text{run}})$. \square

subsets of strong bimonoids	support theorems for	
	run semantics	initial algebra semantics
\mathcal{C} set of all strong bimonoids	Corollary 14.2.1(1) (for crisp-deterministic wta)	Corollary 14.2.1(1) (for crisp-deterministic wta)
\mathcal{C}_1 positive	Theorem 14.2.4	Theorem 14.2.4
\mathcal{C}_2 commutative semirings, not rings	Theorem 14.2.7	Theorem 14.2.7
\mathcal{C}_3 commutative, zero-sum free	Theorem 14.2.10	
\mathcal{C}_4 locally finite		Corollary 14.2.1(2)
\mathcal{C}_5 bi-locally finite	Corollary 14.2.1(3)	

Figure 14.2: Some support theorems proved in this chapter.

Finally we mention that in [Kir14, Thm. 3.5] the following characterization result was shown: for each semiring \mathbb{B} , the supports of all recognizable \mathbb{B} -weighted string languages are recognizable if and only if in every finitely generated subsemiring of \mathbb{B} , there exists a congruence of finite index such that $\{0\}$ is a singleton congruence class. We refer the reader for further support theorems for wsa to [BR88, DK21].

14.2.5 Comparison of support theorems

Finally, we will make two comparisons of the support theorems shown in Figure 14.2. First we compare some support theorems concerning run semantics, then we do the same for initial algebra semantics. Since each such support theorem requires a particular subset of strong bimonoids, we compare these support theorems by comparing the corresponding sets of strong bimonoids with respect to set inclusion. We denote the involved sets of strong bimonoids as follows:

- \mathcal{C} : set of all strong bimonoids,
- \mathcal{C}_1 : set of all positive strong bimonoids,
- \mathcal{C}_2 : set of all commutative semirings which are not rings,
- \mathcal{C}_3 : set of all commutative, zero-sum free strong bimonoids,
- \mathcal{C}_4 : set of all locally finite strong bimonoids,
- \mathcal{C}_5 : set of all bi-locally finite strong bimonoids.

Hence, first we compare the sets \mathcal{C} , \mathcal{C}_1 , \mathcal{C}_2 , \mathcal{C}_3 , and \mathcal{C}_5 (cf. Theorem 14.2.14), and second the sets \mathcal{C} , \mathcal{C}_1 , \mathcal{C}_2 , and \mathcal{C}_4 (cf. Theorem 14.2.15).

The following observation is trivial, but useful.

Observation 14.2.13. $(\mathcal{C}_1 \cap \mathcal{C}_2) \subseteq \mathcal{C}_3$. □

Theorem 14.2.14. [DM20, Dro22] *Figure 14.3 shows the Euler diagram of the sets \mathcal{C}_1 , \mathcal{C}_2 , and \mathcal{C}_3 . Moreover, for each of the shown seven nonempty regions X , we show two strong bimonoids \mathbb{B}_i and \mathbb{B}_j in the form of the fraction $\frac{\mathbb{B}_i}{\mathbb{B}_j}$ such that $\mathbb{B}_i \in X \cap \mathcal{C}_5$ and $\mathbb{B}_j \in X \setminus \mathcal{C}_5$.*

Proof. For the sake of a more complete picture, we also show the set \mathcal{C} of all strong bimonoids in Figure 14.3. In the following, we prove that each of the seven regions X which are shown in the figure is not empty. Together with Observation 14.2.13 this proves that Figure 14.3 is the Euler diagram of \mathcal{C}_1 , \mathcal{C}_2 , and \mathcal{C}_3 . Interleaved, we prove the existence of \mathbb{B}_i and \mathbb{B}_j with the desired properties.

We organize the proof as follows. Since there are four sets involved (viz. $\mathcal{C}_1, \mathcal{C}_2, \mathcal{C}_3$, and \mathcal{C}_5) there exist 16 Boolean combinations of these sets. Each Boolean combination is identified by an expression of the form $D \setminus E$ where D is the intersection of some of the sets in $\{\mathcal{C}_1, \mathcal{C}_2, \mathcal{C}_3, \mathcal{C}_5\}$ and E is the union of those sets in $\{\mathcal{C}_1, \mathcal{C}_2, \mathcal{C}_3, \mathcal{C}_5\}$ which do not occur in D . We order the 16 Boolean combinations by increasing number of sets occurring in E , starting with $E = \emptyset$.

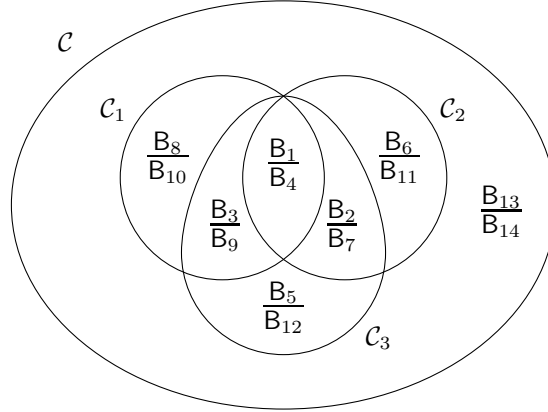

Figure 14.3: The Euler diagram of the sets \mathcal{C}_1 , \mathcal{C}_2 , and \mathcal{C}_3 .

$\mathcal{C}_1 \cap \mathcal{C}_2 \cap \mathcal{C}_3 \cap \mathcal{C}_5 \neq \emptyset$: By Observation 14.2.13, $\mathcal{C}_1 \cap \mathcal{C}_2 \cap \mathcal{C}_3 \cap \mathcal{C}_5 = \mathcal{C}_1 \cap \mathcal{C}_2 \cap \mathcal{C}_5$. The Boolean semiring $B_1 = \text{Boole} = (\mathbb{B}, \vee, \wedge, 0, 1)$ is in $\mathcal{C}_1 \cap \mathcal{C}_2 \cap \mathcal{C}_5$.

$(\mathcal{C}_2 \cap \mathcal{C}_3 \cap \mathcal{C}_5) \setminus \mathcal{C}_1 \neq \emptyset$: Let $A = \{a, b\}$ be a set. The commutative semiring

$$B_2 = \text{PS}_A = (\mathcal{P}(A), \cup, \cap, \emptyset, A)$$

is not zero-divisor free, because, e.g., $\{a\} \cap \{b\} = \emptyset$ and $\{a\} \neq \emptyset$ and $\{b\} \neq \emptyset$. Hence $B_2 \notin \mathcal{C}_1$. Since B_2 is zero-sum free, finite, and not a ring, we have $B_2 \in \mathcal{C}_2 \cap \mathcal{C}_3 \cap \mathcal{C}_5$.

$(\mathcal{C}_1 \cap \mathcal{C}_3 \cap \mathcal{C}_5) \setminus \mathcal{C}_2 \neq \emptyset$: We consider the algebra

$$B_3 = (\{0, 1, 2, 3, 4\}, +', \min, 0, 4)$$

where $a +' b = \min(a + b, 4)$. Obviously B_3 is a commutative strong bimonoid. Since B_3 is also finite and positive, it is in $\mathcal{C}_1 \cap \mathcal{C}_3 \cap \mathcal{C}_5$. B_3 is not distributive, because $\min(2, 2 +' 2) = 2$ and $\min(2, 2) +' \min(2, 2) = 2 +' 2 = 4$. Hence $B_3 \notin \mathcal{C}_2$.

$(\mathcal{C}_1 \cap \mathcal{C}_2 \cap \mathcal{C}_5) \setminus \mathcal{C}_3 \neq \emptyset$: This follows from Observation 14.2.13.

$(\mathcal{C}_1 \cap \mathcal{C}_2 \cap \mathcal{C}_3) \setminus \mathcal{C}_5 \neq \emptyset$: By Observation 14.2.13, $(\mathcal{C}_1 \cap \mathcal{C}_2 \cap \mathcal{C}_3) \setminus \mathcal{C}_5 = (\mathcal{C}_1 \cap \mathcal{C}_2) \setminus \mathcal{C}_5$. The semiring

$$B_4 = \text{Nat} = (\mathbb{N}, +, \cdot, 0, 1)$$

of natural numbers is positive and commutative, it is not a ring and not bi-locally finite.

$(\mathcal{C}_3 \cap \mathcal{C}_5) \setminus (\mathcal{C}_1 \cup \mathcal{C}_2) \neq \emptyset$: We consider the algebra

$$B_5 = (\{0, 1, 2, 3\}, +', \cdot_4, 0, 1)$$

where $a +' b = \min(a + b, 3)$ and \cdot_4 is multiplication modulo 4. Obviously, B_5 is a commutative strong bimonoid. Since B_5 is commutative, finite, and zero-sum free, we have $B_5 \in \mathcal{C}_3 \cap \mathcal{C}_5$. Since $2 \cdot_4 2 = 0$, $B_5 \notin \mathcal{C}_1$. The strong bimonoid B_5 is not distributive, because $2 \cdot_4 (3 +' 1) = 2$ and $2 \cdot_4 3 +' 2 \cdot_4 1 = 3$. Thus $B_5 \notin \mathcal{C}_2$.

$(\mathcal{C}_2 \cap \mathcal{C}_5) \setminus (\mathcal{C}_1 \cup \mathcal{C}_3) \neq \emptyset$: The semiring

$$B_6 = \text{PS}_{\{a,b\}} = (\mathcal{P}(\{a,b\}), \cap, \cup, \{a,b\}, \emptyset)$$

is commutative, not a ring, and finite; hence $B_6 \in \mathcal{C}_2 \cap \mathcal{C}_5$. Moreover, B_6 is not zero-sum free; hence $B_6 \notin \mathcal{C}_1 \cup \mathcal{C}_3$.

$(\mathcal{C}_2 \cap \mathcal{C}_3) \setminus (\mathcal{C}_1 \cup \mathcal{C}_5) \neq \emptyset$: We consider the commutative semiring

$$\mathbf{B}_7 = (\mathbb{N} \times \mathbb{N}, +, \times, (0, 0), (1, 1))$$

with componentwise addition and multiplication. This is not a ring (hence $\mathbf{B}_7 \in \mathcal{C}_2$), and it is zero-sum free (hence $\mathbf{B}_7 \in \mathcal{C}_3$). Moreover, \mathbf{B}_7 is not zero-divisor free because, e.g., $(1, 0) \times (0, 1) = (0, 0)$ (hence $\mathbf{B}_7 \notin \mathcal{C}_1$) and not bi-locally finite (hence $\mathbf{B}_7 \notin \mathcal{C}_5$).

$(\mathcal{C}_1 \cap \mathcal{C}_5) \setminus (\mathcal{C}_2 \cup \mathcal{C}_3) \neq \emptyset$: By Observation 14.2.13, $(\mathcal{C}_1 \cap \mathcal{C}_5) \setminus (\mathcal{C}_2 \cup \mathcal{C}_3) = (\mathcal{C}_1 \cap \mathcal{C}_5) \setminus \mathcal{C}_3$. We consider the algebra

$$\mathbf{B}_8 = (\{0, a, b, 1\}, +, \cdot, 0, 1)$$

where $+$ is defined as supremum with respect to the partial order $0 < a < b < 1$; moreover, the operation \cdot is determined by $x \cdot y = x$ for every $x, y \in \{a, b\}$. Then $(\{0, a, b, 1\}, +, 0)$ and $(\{0, a, b, 1\}, \cdot, 1)$ are commutative monoids and $x \cdot 0 = 0$. Hence \mathbf{B}_8 is a strong bimonoid.

Moreover, \mathbf{B}_8 is zero-sum free and zero-divisor free (hence $\mathbf{B}_8 \in \mathcal{C}_1$) and \mathbf{B}_8 is finite (hence $\mathbf{B}_8 \in \mathcal{C}_5$). Since \cdot is not commutative ($a \cdot b \neq b \cdot a$), we have $\mathbf{B}_8 \notin \mathcal{C}_3$.

$(\mathcal{C}_1 \cap \mathcal{C}_3) \setminus (\mathcal{C}_2 \cup \mathcal{C}_5) \neq \emptyset$: The tropical bimonoid

$$\mathbf{B}_9 = \mathbf{TropBM} = (\mathbb{N}_\infty, +, \min, 0, \infty)$$

is positive and commutative, hence $\mathbf{B}_9 \in \mathcal{C}_1 \cap \mathcal{C}_3$. But \mathbf{B}_9 is neither distributive nor bi-locally finite.

$(\mathcal{C}_1 \cap \mathcal{C}_2) \setminus (\mathcal{C}_3 \cup \mathcal{C}_5) \neq \emptyset$: This follows from Observation 14.2.13.

$\mathcal{C}_1 \setminus (\mathcal{C}_2 \cup \mathcal{C}_3 \cup \mathcal{C}_5) \neq \emptyset$: By Observation 14.2.13, $\mathcal{C}_1 \setminus (\mathcal{C}_2 \cup \mathcal{C}_3 \cup \mathcal{C}_5) = \mathcal{C}_1 \setminus (\mathcal{C}_3 \cup \mathcal{C}_5)$. We consider the formal language semiring

$$\mathbf{B}_{10} = \mathbf{Lang}_\Gamma = (\mathcal{P}(\Gamma^*), \cup, \circ, \emptyset, \{\varepsilon\}) .$$

This is a positive, non-commutative, and not bi-locally finite semiring.

$\mathcal{C}_2 \setminus (\mathcal{C}_1 \cup \mathcal{C}_3 \cup \mathcal{C}_5) \neq \emptyset$: By Observation 14.2.13, $\mathcal{C}_2 \setminus (\mathcal{C}_1 \cup \mathcal{C}_3 \cup \mathcal{C}_5) = \mathcal{C}_2 \setminus (\mathcal{C}_3 \cup \mathcal{C}_5)$. We consider the commutative semiring

$$\mathbf{B}_{11} = (\mathbb{Z} \times \mathbb{N}, +, \cdot, (0, 0), (1, 1))$$

with pointwise addition and pointwise multiplication. \mathbf{B}_{11} is not a ring, not zero-sum free, and not bi-locally finite.

$\mathcal{C}_3 \setminus (\mathcal{C}_1 \cup \mathcal{C}_2 \cup \mathcal{C}_5) \neq \emptyset$: We consider the strong bimonoid

$$\mathbf{B}_{12} = (\mathbb{N}, +, \cdot_4, 0, 1)$$

with $a \cdot_4 b = (a \cdot b) \bmod 4$. Then \mathbf{B}_{12} is commutative and zero-sum free, i.e., $\mathbf{B}_{12} \in \mathcal{C}_3$. Since $2 \cdot_4 2 = 0$, \mathbf{B}_{12} contains zero-divisors, and hence $\mathbf{B}_{12} \notin \mathcal{C}_1$. \mathbf{B}_{12} is not a semiring, because, e.g., $2 \cdot_4 (3 + 1) = 0$ and $2 \cdot_4 3 + 2 \cdot_4 1 = 2 + 2 = 4$. Hence $\mathbf{B}_{12} \notin \mathcal{C}_2$. Also \mathbf{B}_{12} is not bi-locally finite (because $\langle 1 \rangle_+$ is not finite). Thus $\mathbf{B}_{12} \in \mathcal{C}_3 \setminus (\mathcal{C}_1 \cup \mathcal{C}_2 \cup \mathcal{C}_5)$.

$\mathcal{C}_5 \setminus (\mathcal{C}_1 \cup \mathcal{C}_2 \cup \mathcal{C}_3) \neq \emptyset$: We consider the ring

$$\mathbf{B}_{13} = \mathbf{Intmod4} = (\{0, 1, 2, 3\}, +_4, \cdot_4, 0, 1)$$

as defined in Example 2.7.9(5). Since \mathbf{B}_{13} is finite, $\mathbf{B}_{13} \in \mathcal{C}_5$. Since \mathbf{B}_{13} is a ring and is not zero-sum free, $\mathbf{B}_{13} \notin \mathcal{C}_1 \cup \mathcal{C}_2 \cup \mathcal{C}_3$.

$\mathcal{C} \setminus (\mathcal{C}_1 \cup \mathcal{C}_2 \cup \mathcal{C}_3 \cup \mathcal{C}_5)$: The ring

$$\mathbf{B}_{14} = \mathbf{Int} = (\mathbb{Z}, +, \cdot, 0, 1)$$

is neither zero-sum free nor bi-locally finite. □

In particular, it follows from the proof of Theorem 14.2.14 that each of the support theorems Theorem 14.2.4, Theorem 14.2.7, Theorem 14.2.10, and Corollary 14.2.1(3), for \mathcal{C}_1 , \mathcal{C}_2 , \mathcal{C}_3 , and \mathcal{C}_5 respectively, has its own benefit with respect to run semantics. More precisely, let $i \in \{1, 2, 3, 5\}$. Then there exists $B \in \mathcal{C}_i \setminus (\mathcal{C}_j \cup \mathcal{C}_k \cup \mathcal{C}_\ell)$ with pairwise different $j, k, \ell \in \{1, 2, 3, 5\} \setminus \{i\}$ such that the support theorem for \mathcal{C}_i implies the property $\text{supp}(\llbracket \mathcal{A} \rrbracket^{\text{run}}) \in \text{Rec}(\Sigma)$ for each (Σ, B) -wta \mathcal{A} , and this property does not follow from the support theorems for \mathcal{C}_j , \mathcal{C}_k , and \mathcal{C}_ℓ .

Next we compare the sets \mathcal{C}_1 , \mathcal{C}_2 , and \mathcal{C}_4 .

Theorem 14.2.15. [DM20, Dro22] *Figure 14.4 shows the Euler diagram of the sets \mathcal{C}_1 , \mathcal{C}_2 , and \mathcal{C}_4 . Thus, for every $\mathcal{D}_1 \in \{\mathcal{C}_1, \mathcal{C} \setminus \mathcal{C}_1\}$, $\mathcal{D}_2 \in \{\mathcal{C}_2, \mathcal{C} \setminus \mathcal{C}_2\}$, and $\mathcal{D}_4 \in \{\mathcal{C}_4, \mathcal{C} \setminus \mathcal{C}_4\}$, we have $\mathcal{D}_1 \cap \mathcal{D}_2 \cap \mathcal{D}_4 \neq \emptyset$.*

Proof. $\mathcal{C}_1 \cap \mathcal{C}_2 \cap \mathcal{C}_4 \neq \emptyset$: The Boolean semiring

$$B_1 = \text{Boole} = (\mathbb{B}, \vee, \wedge, 0, 1)$$

is in $\mathcal{C}_1 \cap \mathcal{C}_2 \cap \mathcal{C}_4$.

$(\mathcal{C}_1 \cap \mathcal{C}_2) \setminus \mathcal{C}_4 \neq \emptyset$: The commutative semiring

$$B_2 = \text{Nat} = (\mathbb{N}, +, \cdot, 0, 1)$$

is positive and not a ring and not locally finite.

$(\mathcal{C}_1 \cap \mathcal{C}_4) \setminus \mathcal{C}_2 \neq \emptyset$: We consider the strong bimonoid

$$B_3 = (\{0, a, b, 1\}, +, \cdot, 0, 1)$$

which is the same as B_8 on page 337, i.e., $+$ is defined as supremum with respect to the partial order $0 < a < b < 1$; moreover, the operation \cdot is determined by $x \cdot y = x$ for every $x, y \in \{a, b\}$.

This B_3 is zero-sum free and zero-divisor free (hence $B_3 \in \mathcal{C}_1$) and B_3 is finite (hence $B_3 \in \mathcal{C}_4$). Since \cdot is not commutative ($a \cdot b \neq b \cdot a$), we have $B_3 \notin \mathcal{C}_2$.

$(\mathcal{C}_2 \cap \mathcal{C}_4) \setminus \mathcal{C}_1 \neq \emptyset$: We consider the algebra

$$B_4 = (\{-1, 0, 1\} \times \{0, 1\}, +', \cdot, (0, 0), (1, 1))$$

where $(a_1, a_2) +' (b_1, b_2) = (\max(-1, \min(a_1 + b_1, 1)), \min(a_2 + b_2, 1))$ (i.e., $+'$ is defined componentwise by using the usual addition except that the first component is truncated by 1 from above and by -1 from below, and the second component is truncated by 1 from above). The multiplication is defined componentwise. Obviously, B_4 is a finite commutative semiring.

Since there does not exist an element (a_1, a_2) such that $(0, 1) +' (a_1, a_2) = (0, 0)$, B_4 is not a ring. Hence $B_4 \in \mathcal{C}_2$. B_4 is not zero-sum free, because $(-1, 0) +' (1, 0) = (0, 0)$. Hence $B_4 \notin \mathcal{C}_1$.

$\mathcal{C}_1 \setminus (\mathcal{C}_2 \cup \mathcal{C}_4) \neq \emptyset$: We consider the formal language semiring

$$B_5 = \text{Lang}_\Gamma = (\mathcal{P}(\Gamma^*), \cup, \circ, \emptyset, \{\varepsilon\}) .$$

This is a positive, non-commutative, and not locally finite semiring.

$\mathcal{C}_2 \setminus (\mathcal{C}_1 \cup \mathcal{C}_4) \neq \emptyset$: We consider the commutative semiring

$$B_6 = (\mathbb{Z} \times \mathbb{N}, +, \cdot, (0, 0), (1, 1))$$

with pointwise addition and pointwise multiplication. B_6 is not a ring, not zero-sum free, and not locally finite.

$\mathcal{C}_4 \setminus (\mathcal{C}_1 \cup \mathcal{C}_2) \neq \emptyset$: The ring

$$B_7 = \text{Intmod4} = (\{0, 1, 2, 3\}, +_4, \cdot_4, 0, 1)$$

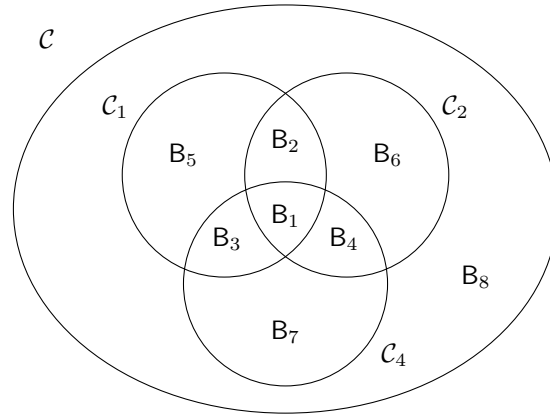

Figure 14.4: The Euler diagram of the sets C_1 , C_2 , and C_4 .

as defined in Example 2.7.9(5), is in $C_4 \setminus (C_1 \cup C_2)$.

$C \setminus (C_1 \cup C_2 \cup C_4)$: The ring

$$B_8 = \text{Int} = (\mathbb{Z}, +, \cdot, 0, 1)$$

is neither zero-sum free nor locally finite. □

In particular, it follows from the proof of Theorem 14.2.15 that each of the support theorems Theorem 14.2.4, Theorem 14.2.7, and Corollary 14.2.1(2), for C_1 , C_2 , and C_4 respectively, has its own benefit with respect to initial algebra semantics. More precisely, let $i \in \{1, 2, 4\}$. Then there exists $B \in C_i \setminus (C_j \cup C_k)$ with different $j, k \in \{1, 2, 4\} \setminus \{i\}$ such that the support theorem for C_i implies the property $\text{supp}(\llbracket \mathcal{A} \rrbracket^{\text{init}}) \in \text{Rec}(\Sigma)$ for each (Σ, B) -wta \mathcal{A} , and this property does not follow from the support theorems for C_j and C_k .

Chapter 15

Rational operations and Kleene's theorem

In Chapter 10 we have proved that, in particular, for every commutative semiring \mathbf{B} , the set $\text{Rec}(\Sigma, \mathbf{B})$ of recognizable (Σ, \mathbf{B}) -weighted tree languages is closed under the rational operations, i.e., sum, tree concatenations, and Kleene stars.

In Theorem 15.2.3, we will show that each recognizable weighted tree language can be expressed by polynomial weighted tree language and rational operations (cf. [DPV05, Thm. 5.2]). This generalizes the analysis part of Kleene's result [Kle56] (recognizable implies rational), and the corresponding result for tree languages [TW68, Thm. 9] (cf. [Eng75b, Thm. 3.43] and [GS84, Thm. 2.5.7]) and weighted string languages (cf. [Sch61]). We recall that, in the tree case, extra symbols for tree concatenation were supplied; we will deal with this issue in detail below.

Taking together the closure results from Chapter 10 and the analysis result from this chapter, we obtain Kleene's result for recognizable weighted tree languages in Theorem 15.1.2 (cf. [AB87, Thm. 2.3] and [DPV05, Thm. 7.1]). It generalizes the corresponding results for the unweighted case (cf. [TW68, Thm. 8], [Eng75b, Thm. 3.43], and [GS84, Thm. 2.5.8]).

Kleene's result has been extended both, to structures different from finite trees and to algebras different from semirings, e.g., formal tree series over additive \mathbf{B} - Σ -algebras for a commutative, σ -complete semiring \mathbf{B} [Boz99, p.28] (also cf. [Kui98, Thm. 6.14]), formal power series in partially commuting variables (traces) and semirings [DG99], infinite strings and max-plus semiring [DK03, DK06], strings and lattice-ordered monoids [LP05], pictures and commutative semirings [BG05, Mäu05, Mäu07], strings and Conway semirings [ÉK, Sect. 1.3], trees over infinite ranked alphabets and continuous and commutative semirings [ÉK03, Thm. 4.3], [ÉK, Thm. 6.4.3], trees and σ -complete distributive lattices [ÉL07], trees and distributive multioperator monoids (which satisfy some closure properties) [FMV09], trees and tree-valuation monoids [GFD19], and weighted tree automata with storage over commutative, σ -complete semirings [FV19, DFV21].

In this chapter we recall from [DPV05] the proof of the equivalence of recognizable weighted tree languages and rational weighted tree languages for commutative semirings.

In the rest of this chapter, $\mathbf{B} = (B, \oplus, \otimes, \mathbb{0}, \mathbb{1})$ denotes an arbitrary commutative semiring.

15.1 Rational weighted tree languages

Here we formally define the concept of rational operations and rational weighted tree languages.

An operation on the set of (Σ, \mathbf{B}) -weighted tree languages is a *rational operation* if it is the sum, a tree

concatenation, or a Kleene star. The *set of rational* (Σ, \mathbf{B}) -*weighted tree languages*, denoted by $\text{Rat}(\Sigma, \mathbf{B})$, is the smallest set of (Σ, \mathbf{B}) -weighted tree languages which contains each polynomial (Σ, \mathbf{B}) -weighted tree language and is closed under the rational operations. We call each weighted tree language in $\text{Rat}(\Sigma, \mathbf{B})$ *rational*.

For our main result, we will have to prove, in particular, that the semantics $\llbracket \mathcal{A} \rrbracket$ of a (Σ, \mathbf{B}) -wta $\mathcal{A} = (Q, \delta, F)$ is rational. We follow the idea of [TW68, Sect. 3] where extra symbols for the tree concatenations are used, and these extra symbols are the states of \mathcal{A} . In order to have such extra nullary symbols available for tree concatenations and not to change the type of $\llbracket \mathcal{A} \rrbracket$ (which is $T_\Sigma \rightarrow B$ and not $T_{\Sigma \cup Q} \rightarrow B$) we use the concept of 0-extension of ranked alphabet and 0-extension of a weighted tree language (cf. [FV19, Def. 1] and [DFV21, Def. 2]).

Formally, a 0-*extension* of Σ is a ranked alphabet Θ such that $\Sigma \subseteq \Theta$, $\text{rk}_\Theta(\sigma) = \text{rk}_\Sigma(\sigma)$ for each $\sigma \in \Sigma$, and $\text{rk}_\Theta(\sigma) = 0$ for each $\sigma \in \Theta \setminus \Sigma$. If Θ is a 0-extension of Σ , then we write $\Theta \geq_0 \Sigma$.

Now let $\Theta \geq_0 \Sigma$ and $r : T_\Sigma \rightarrow B$. The 0-*extension of r to T_Θ* , denoted by $r \upharpoonright^{\Theta, 0}$, is the weighted tree language $r \upharpoonright^{\Theta, 0} : T_\Theta \rightarrow B$ such that

- (a) $(r \upharpoonright^{\Theta, 0})|_{T_\Sigma} = r$ and
- (b) $(r \upharpoonright^{\Theta, 0})(\xi) = 0$ for every $\xi \in T_\Theta \setminus T_\Sigma$.

These concepts have the following transitivity property.

Observation 15.1.1. Let Θ and Δ be ranked alphabets such that $\Delta \geq_0 \Theta$ and $\Theta \geq_0 \Sigma$. Then $\Delta \geq_0 \Sigma$. Moreover, let $r : T_\Sigma \rightarrow B$. Then $(r \upharpoonright^{\Theta, 0}) \upharpoonright^{\Delta, 0} = r \upharpoonright^{\Delta, 0}$. \square

The *set of extended rational* (Σ, \mathbf{B}) -*weighted tree languages*, denoted by $\text{Rat}(\Sigma, \mathbf{B})^{\text{ext}}$, contains each (Σ, \mathbf{B}) -weighted tree language r such that $r \upharpoonright^{\Theta, 0} \in \text{Rat}(\Theta, \mathbf{B})$ for some 0-extension Θ of Σ .

Similarly, the *set of extended recognizable* (Σ, \mathbf{B}) -*weighted tree languages*, denoted by $\text{Rec}(\Sigma, \mathbf{B})^{\text{ext}}$, contains each (Σ, \mathbf{B}) -weighted tree language r such that $r \upharpoonright^{\Theta, 0} \in \text{Rec}(\Theta, \mathbf{B})$ for some 0-extension Θ of Σ .

In the next two sections, we will prove that $\text{Rec}(\Sigma, \mathbf{B}) \subseteq \text{Rat}(\Sigma, \mathbf{B})^{\text{ext}}$ (cf. Theorem 15.2.3) and $\text{Rat}(\Sigma, \mathbf{B}) \subseteq \text{Rec}(\Sigma, \mathbf{B})$ (cf. Theorem 15.3.1). These theorems imply the following main result of this chapter.

Theorem 15.1.2. *Let Σ be a ranked alphabet. Moreover, let \mathbf{B} be a commutative semiring. Then $\text{Rec}(\Sigma, \mathbf{B})^{\text{ext}} = \text{Rat}(\Sigma, \mathbf{B})^{\text{ext}}$.*

Proof. $\text{Rec}(\Sigma, \mathbf{B})^{\text{ext}} \subseteq \text{Rat}(\Sigma, \mathbf{B})^{\text{ext}}$: Let $r \in \text{Rec}(\Sigma, \mathbf{B})^{\text{ext}}$. Then $r \upharpoonright^{\Theta, 0} \in \text{Rec}(\Theta, \mathbf{B})$ for some 0-extension Θ of Σ . By Theorem 15.2.3 (with $\Sigma = \Theta$), we have that $r \upharpoonright^{\Theta, 0} \in \text{Rat}^{\text{ext}}(\Theta, \mathbf{B})$. Hence $(r \upharpoonright^{\Theta, 0}) \upharpoonright^{\Delta, 0} \in \text{Rat}(\Delta, \mathbf{B})$ for some 0-extension Δ of Θ . Since $\Delta \geq_0 \Theta$ and $\Theta \geq_0 \Sigma$, we obtain by Observation 15.1.1 that $(r \upharpoonright^{\Theta, 0}) \upharpoonright^{\Delta, 0} = r \upharpoonright^{\Delta, 0}$. Hence $r \upharpoonright^{\Delta, 0} \in \text{Rat}(\Delta, \mathbf{B})$. Since $\Delta \geq_0 \Sigma$, we obtain $r \in \text{Rat}(\Sigma, \mathbf{B})^{\text{ext}}$.

$\text{Rat}(\Sigma, \mathbf{B})^{\text{ext}} \subseteq \text{Rec}(\Sigma, \mathbf{B})^{\text{ext}}$: Let $r \in \text{Rat}(\Sigma, \mathbf{B})^{\text{ext}}$. Then $r \upharpoonright^{\Theta, 0} \in \text{Rat}(\Theta, \mathbf{B})$ for some 0-extension Θ of Σ . By Theorem 15.3.1 (with $\Sigma = \Theta$), we have that $r \upharpoonright^{\Theta, 0} \in \text{Rec}(\Theta, \mathbf{B})$. Hence we have $r \in \text{Rec}(\Sigma, \mathbf{B})^{\text{ext}}$. \square

We note that Theorem 15.1.2 is similar to [DPV05, Thm. 7.1], but slightly different in the following way. Theorem 7.1 of [DPV05] says that $\mathbf{B}^{\text{rec}} \langle \langle T_\Sigma(Q_\infty) \rangle \rangle = \mathbf{B}^{\text{rat}} \langle \langle T_\Sigma(Q_\infty) \rangle \rangle$, where

$$\begin{aligned} \mathbf{B}^{\text{rec}} \langle \langle T_\Sigma(Q_\infty) \rangle \rangle & \text{ is defined to be } \bigcup \{ \mathbf{B}^{\text{rec}} \langle \langle T_\Theta \rangle \rangle \mid \text{ranked alphabet } \Theta \text{ such that } \Theta \geq_0 \Sigma \} \text{ and} \\ \mathbf{B}^{\text{rat}} \langle \langle T_\Sigma(Q_\infty) \rangle \rangle & \text{ is defined to be } \bigcup \{ \mathbf{B}^{\text{rat}} \langle \langle T_\Theta \rangle \rangle \mid \text{ranked alphabet } \Theta \text{ such that } \Theta \geq_0 \Sigma \} \text{ and} \end{aligned}$$

$\mathbf{B}^{\text{rat}} \langle \langle T_\Theta \rangle \rangle$ is the smallest set of (Θ, \mathbf{B}) -weighted tree languages which is closed under scalar multiplication, top-concatenations, and rational operations. Moreover, $\mathbf{B}^{\text{rec}} \langle \langle T_\Theta \rangle \rangle$ is just another denotation of the set $\text{Rec}(\Theta, \mathbf{B})$.

However, this setting yields the following type conflict when trying to prove that $\mathbf{B}^{\text{rec}}\langle\langle T_\Theta \rangle\rangle \subseteq \mathbf{B}^{\text{rat}}\langle\langle T_\Sigma(Q_\infty) \rangle\rangle$ for some 0-extension Θ of Σ . For each (Θ, \mathbf{B}) -wta $\mathcal{A} = (Q, \delta, F)$, its semantics has the type $\llbracket \mathcal{A} \rrbracket : T_\Theta \rightarrow B$. In [DPV05, Thm. 5.2] it is proved that there exists an $r \in \mathbf{B}^{\text{rat}}\langle\langle T_{\Theta \cup Q} \rangle\rangle$ (where $\Theta \cup Q$ is a 0-extension of Θ) such that, for each $\xi \in T_\Theta$, the equality $r(\xi) = \llbracket \mathcal{A} \rrbracket(\xi)$ holds and, for each $\xi \in T_{\Theta \cup Q} \setminus T_\Theta$, we have $r(\xi) = 0$. Nevertheless, by the definition of $\mathbf{B}^{\text{rat}}\langle\langle T_{\Theta \cup Q} \rangle\rangle$, r has the type $r : T_{\Theta \cup Q} \rightarrow B$ which is different from the type of $\llbracket \mathcal{A} \rrbracket$. Hence $\llbracket \mathcal{A} \rrbracket \neq r$ and, in fact, there does not exist an $r \in \mathbf{B}^{\text{rat}}\langle\langle T_{\Theta \cup Q} \rangle\rangle$ such that $\llbracket \mathcal{A} \rrbracket = r$.

We solve this type conflict by the concepts of 0-extension and $\mathbb{0}$ -extension. Such a type conflict does not occur in the proof of the analysis theorem [TW68, Thm. 9] because (unweighted) tree languages are not mappings.

In [Dro22] the natural question was posed whether $\text{Rec}(\Sigma, \mathbf{B}) \setminus \text{Rat}(\Sigma, \mathbf{B}) \neq \emptyset$, i.e., whether the extra nullary symbols used in $\text{Rat}(\Sigma, \mathbf{B})^{\text{ext}}$ are really necessary (or just comfortable to use). We claim that, for the ranked alphabet $\Sigma = \{\sigma^{(2)}, \sigma'^{(2)}, \alpha^{(0)}\}$, the weighted tree language $\chi_{\text{Boole}}(L(K, H)) \in \text{Rec}(\Sigma, \text{Boole}) \setminus \text{Rat}(\Sigma, \text{Boole})$ where (K, H) is the Σ -local system with $K = \{(\sigma\sigma', \sigma), (\alpha\alpha, \sigma), (\alpha\alpha, \sigma')\}$ and $H = \{\sigma\}$.

Finally, we note that there were investigations to overcome the difference between string concatenation and tree concatenation (cf. the discussion at the beginning of Section 10.6) by employing forests and forest concatenation [Str09, Dör19, Dör21]. However, since we want to deal with trees, we will not report on these investigations.

15.2 From recognizable to rational

In this section we prove Theorem 15.2.3, i.e., for each (Σ, \mathbf{B}) -recognizable weighted tree language r there exists a 0-extension Θ of Σ such that $r|_{\Theta, \mathbb{0}} \in \text{Rat}(\Theta, \mathbf{B})$.

Intuitively, this result shows that the semantics of a wta can be computed in a dynamic programming style. This computation is organized in the same way as the computation of the transitive closure of the edge relation of graphs in [War62], of the all-pairs shortest-path problem in [Flo62], and of the algebraic path problem for idempotent σ -complete semirings [AHU74, Alg. 5.5]. We follow the lines in [DPV05] (which was crucially inspired by [Eng03]).

As preparation, we extend the concept of run for trees which may contain states of a wta. If for a position w of a tree ξ the symbol $\xi(w)$ is a state, then the extended run assigns the state $\xi(w)$ to that position. Formally, let $\mathcal{A} = (Q, \delta, F)$ be a (Σ, \mathbf{B}) -wta and $\xi \in T_\Sigma(Q)$. A *run of \mathcal{A} on ξ* is a mapping $\rho : \text{pos}(\xi) \rightarrow Q$ such that $\rho(w) = \xi(w)$ for each $w \in \text{pos}_Q(\xi)$. In the same way as for runs on trees in T_Σ , we define the restriction $\rho|_i$ for a run of \mathcal{A} on $\xi \in T_\Sigma(Q)$ and $i \in [\text{rk}(\xi(\varepsilon))]$. Moreover, we denote the set of all runs of \mathcal{A} on ξ by $\text{R}_\mathcal{A}(\xi)$.

Then we define, for each $\xi \in T_\Sigma(Q)$, the weight of each run in $\text{R}_\mathcal{A}(\xi)$. For this we extend the definition of $\text{wt}_\mathcal{A} : \text{TR} \rightarrow B$ given in (3.1). Formally, we let $\text{TR}_Q = \{(\xi, \rho) \mid \xi \in T_\Sigma(Q), \rho \in \text{R}_\mathcal{A}(\xi)\}$ and we define the binary relation \succ on TR_Q as follows:

$$\text{for every } (\xi, \rho) \in \text{TR}_Q \text{ and } i \in [\text{rk}(\xi(\varepsilon))], \text{ we let } (\xi, \rho) \succ (\xi|_i, \rho|_i) .$$

By Corollaries 2.5.6 and 2.5.4, the relation \succ is terminating. Moreover, we have

$$\text{nf}_\succ(\text{TR}_Q) = \{(\alpha, \rho) \mid \alpha \in \Sigma^{(0)}, \rho : \{\varepsilon\} \rightarrow Q\} \cup \{(q, \rho) \mid q \in Q, \rho = \{(\varepsilon, q)\}\} .$$

We define the mapping

$$\text{wt}'_\mathcal{A} : \text{TR}_Q \rightarrow B$$

by induction on (TR_Q, \succ) as follows. Let $(\xi, \rho) \in \text{TR}_Q$.

I.B.: If $\xi \in Q$ (and hence $\rho = \{(\varepsilon, \xi)\}$), then we let $\text{wt}'_\mathcal{A}(\xi, \rho) = \mathbb{1}$.

I.S.: If $\xi = \sigma(\xi_1, \dots, \xi_k)$, then we let

$$\text{wt}'_{\mathcal{A}}(\xi, \rho) = \left(\bigotimes_{i \in [k]} \text{wt}'_{\mathcal{A}}(\xi|_i, \rho|_i) \right) \otimes \delta_k(\rho(1) \cdots \rho(k), \sigma, \rho(\varepsilon)) , \quad (15.1)$$

where k and σ abbreviate $\text{rk}(\xi(\varepsilon))$ and $\xi(\varepsilon)$, respectively. We call $\text{wt}'_{\mathcal{A}}(\xi, \rho)$ the *weight of ρ (by \mathcal{A} on ξ)*. If there is no confusion, then we drop the index \mathcal{A} from $\text{wt}'_{\mathcal{A}}$ and write just $\text{wt}'(\xi, \rho)$ for the weight of ρ . Since, for each $\xi \in T_{\Sigma}$, we have $\text{wt}'(\xi, \rho) = \text{wt}(\xi, \rho)$, we drop the prime from wt' and simply write wt .

Next we define restrictions on (generalized) runs in the way that we restrict the set of states which may occur at positions different from the root and different from Q -labeled positions. Formally, let $q \in Q$, $P \subseteq Q$, and $\xi \in T_{\Sigma}(Q)$. A *q -run of \mathcal{A} on ξ using P* is a run $\rho : \text{pos}(\xi) \rightarrow Q$ such that

- $\rho(\varepsilon) = q$,
- $\rho(w) \in P$ for each $w \in \text{pos}(\xi) \setminus (\{\varepsilon\} \cup \text{pos}_Q(\xi))$.

The set of all q -runs of \mathcal{A} on ξ using P is denoted by $R_{\mathcal{A}}^P(q, \xi)$. We denote the set $\bigcup_{q \in Q} R_{\mathcal{A}}^P(q, \xi)$ by $R_{\mathcal{A}}^P(\xi)$.

Next we recall a particular weighted tree language [Eng03, DPV05] with a slight modification. We consider the 0-extension $\Sigma \cup Q$ of Σ , i.e., $(\Sigma \cup Q)^{(0)} = \Sigma^{(0)} \cup Q$. For every $P \subseteq Q$ and $q \in Q$, we define the weighted tree language $S_{\mathcal{A}}(P, q) : T_{\Sigma}(Q) \rightarrow B$ for each $\xi \in T_{\Sigma}(Q)$ by

$$S_{\mathcal{A}}(P, q)(\xi) = \begin{cases} \bigoplus_{\rho \in R_{\mathcal{A}}^P(q, \xi)} \text{wt}(\xi, \rho) & \text{if } \xi \in T_{\Sigma}(Q) \setminus Q \\ 0 & \text{otherwise .} \end{cases}$$

Then, for each $q' \in Q$, the weighted tree language $S_{\mathcal{A}}(P, q)$ is q' -proper. We recall that in [Eng03, DPV05] the language $S_{\mathcal{A}}(Q', P, q)$ was defined where $Q' \subseteq Q$. But since we will only use $S_{\mathcal{A}}(Q, P, q)$, we refrain from the first parameter and keep it fixed with value Q .

Now we prove that each $S_{\mathcal{A}}(P, q)$ is a rational weighted tree language. For this, we will have to decompose runs of \mathcal{A} at particular positions. Formally, let $P \subseteq Q$, $q \in Q$, and $p \in Q \setminus P$. Let $\xi \in T_{\Sigma}(Q) \setminus Q$. We define the mapping

$$\varphi : R_{\mathcal{A}}^{P \cup \{p\}}(q, \xi) \rightarrow U^{P \cup \{p\}}(q, \xi)$$

where

$$U^{P \cup \{p\}}(q, \xi) = \{(\tilde{v}, \rho', \rho_1, \dots, \rho_n) \mid n \in \mathbb{N}, \tilde{v} = (v_1, \dots, v_n) \text{ in } \text{cut}_p(\xi) \setminus \{\{\varepsilon\}\}, \rho' \in R_{\mathcal{A}}^P(q, \xi|_{\tilde{v}}), \\ \text{and } \xi|_{v_i} \notin Q \setminus \{p\} \text{ and } \rho_i \in R_{\mathcal{A}}^{P \cup \{p\}}(p, \xi|_{v_i}) \text{ for each } i \in [n]\}$$

and for every $\rho \in R_{\mathcal{A}}^{P \cup \{p\}}(q, \xi)$ we define

$$\varphi(\rho) = ((v_1, \dots, v_n), \rho', \rho_1, \dots, \rho_n)$$

such that the following conditions hold (cf. Figure 15.1):

1. $\{w \in \rho^{-1}(p) \setminus \{\varepsilon\} \mid (\forall v \in \text{prefix}(w) \setminus \{w\}) : \rho(v) \neq p\} = \{v_1, \dots, v_n\}$,
2. $\rho' : \text{pos}(\xi|_{\tilde{v}}) \rightarrow Q$ is such that $\rho' = \rho|_{\text{pos}(\xi|_{\tilde{v}})}$, and
3. for each $i \in [n]$, we have $\rho_i = \rho|_{v_i}$.

By the first condition we have $\xi|_{v_i} \notin Q \setminus \{p\}$, because otherwise $\rho(v_i) \in Q \setminus \{p\}$, and hence $v_i \notin \rho^{-1}(p)$.

Obviously, φ is bijective and, if $\varphi(\rho) = ((v_1, \dots, v_n), \rho', \rho_1, \dots, \rho_n)$, then

$$\text{wt}(\xi, \rho) = \text{wt}(\xi|_{\tilde{v}}, \rho') \otimes \bigotimes_{i \in [n]} \text{wt}(\xi|_{v_i}, \rho_i) . \quad (15.2)$$

We note that (15.2) uses (15.1), Observation 3.1.1, and the assumption that B is commutative.

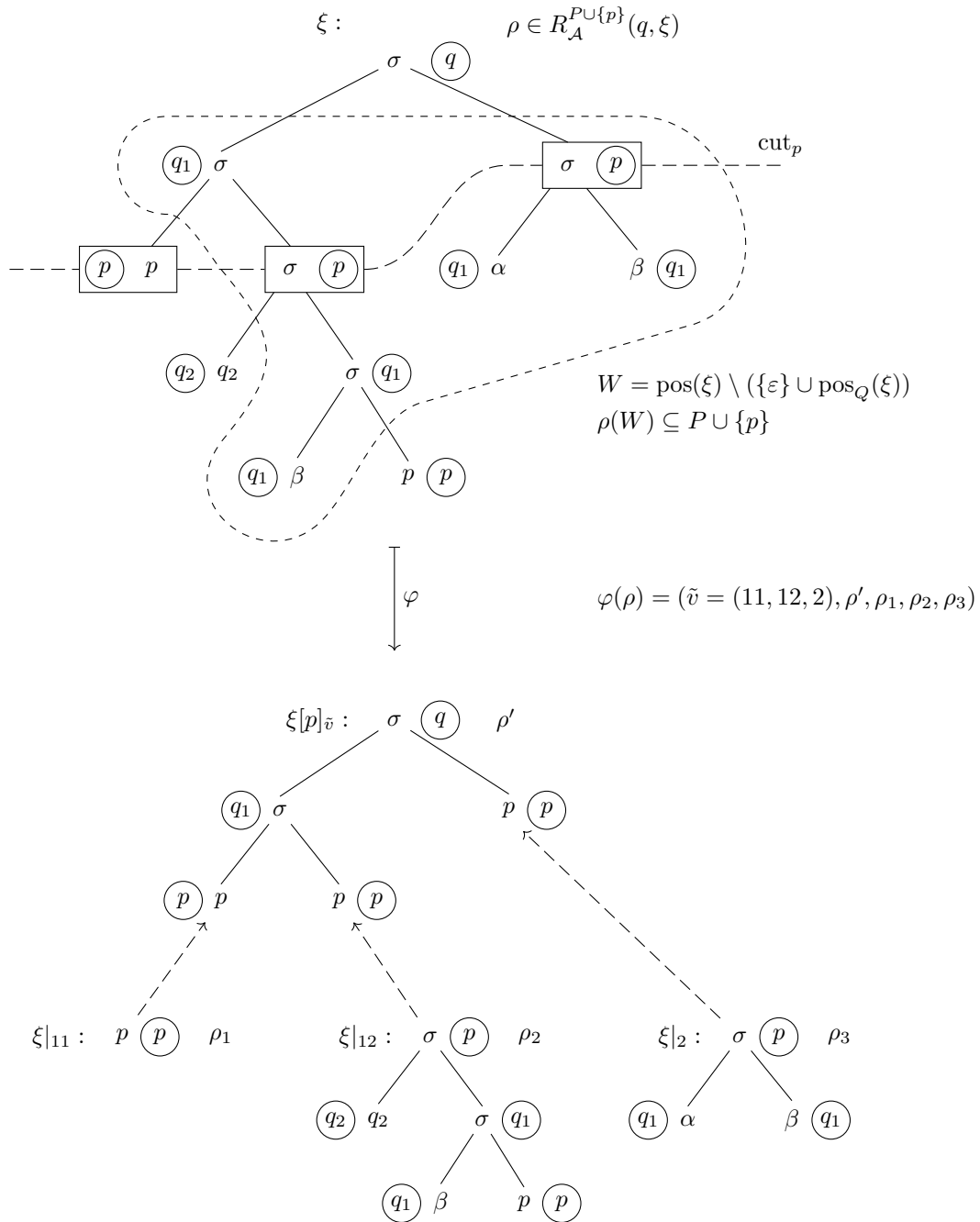

Figure 15.1: An example of $\rho \in R_{\mathcal{A}}^{P \cup \{p\}}(q, \xi)$ and $\varphi(\rho)$ with $Q = \{p, q_1, q_2, q\}$, $P = \{q_1\}$.

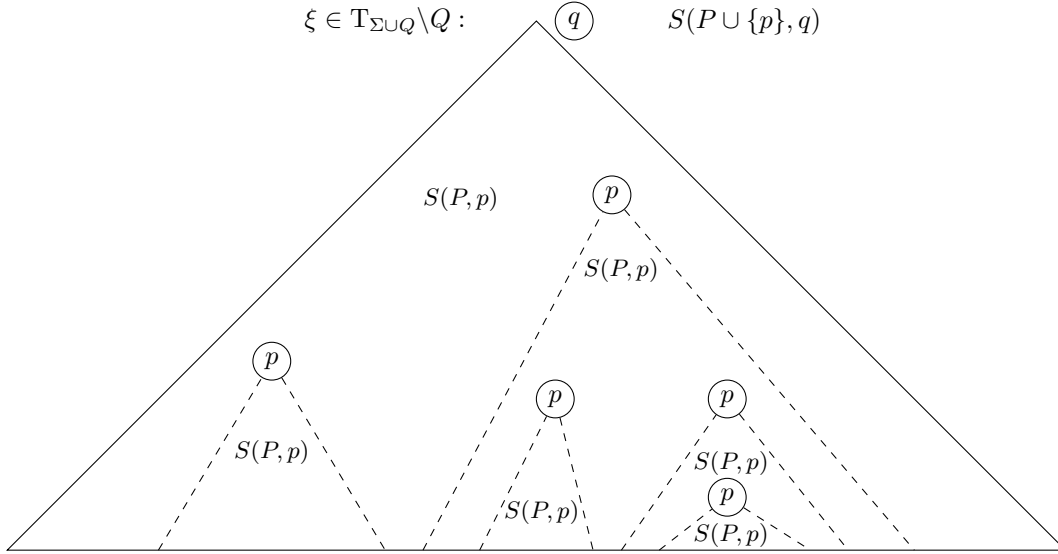

Figure 15.2: An illustration of the equality $S_{\mathcal{A}}(P \cup \{p\}, q) = S_{\mathcal{A}}(P, q) \circ_p S_{\mathcal{A}}(P, p)_p^*$, where $S_{\mathcal{A}}$ is abbreviated by S .

The next lemma shows how the weighted tree languages in the family

$$(S_{\mathcal{A}}(P, q) \mid P \subseteq Q, q \in Q)$$

can be computed in a dynamic programming style (cf. Figure 15.2).

Lemma 15.2.1. (cf. [Eng03, Lm. 12] and [DPV05, Lm. 5.1]) For every $P \subseteq Q$, $p \in Q \setminus P$, and $q \in Q$, we have

$$S_{\mathcal{A}}(P \cup \{p\}, q) = S_{\mathcal{A}}(P, q) \circ_p S_{\mathcal{A}}(P, p)_p^* .$$

Proof. Let $P \subseteq Q$ and $p \in Q \setminus P$. By induction on $T_{\Sigma}(Q)$, we prove that the following statement holds:

$$\text{For every } \xi \in T_{\Sigma}(Q) \text{ and } q \in Q, \text{ we have } S_{\mathcal{A}}(P \cup \{p\}, q)(\xi) = \left(S_{\mathcal{A}}(P, q) \circ_p S_{\mathcal{A}}(P, p)_p^* \right)(\xi) .$$

I.B.: Let $\xi \in Q$. Then $S_{\mathcal{A}}(P \cup \{p\}, q)(\xi) = \emptyset = (S_{\mathcal{A}}(P, q) \circ_p S_{\mathcal{A}}(P, p)_p^*)(\xi)$, because $S_{\mathcal{A}}(P, q)$ is q' -proper for each $q' \in Q$. The case that $\xi \in \Sigma^{(0)}$ is covered in the I.S.

I.S.: Let $\xi = \sigma(\xi_1, \dots, \xi_k)$. For each $\tilde{v} = (v_1, \dots, v_n)$ in $\text{cut}_p(\xi)$, we denote v_i also by \tilde{v}_i .

$$\begin{aligned} & S_{\mathcal{A}}(P \cup \{p\}, q)(\xi) \\ = & \bigoplus_{\rho \in \mathbb{R}_{\mathcal{A}}^{P \cup \{p\}}(q, \xi)} \text{wt}(\xi, \rho) && \text{(by definition and the fact that } \xi \notin Q) \\ = & \bigoplus_{(\tilde{v}, \rho', \rho_1, \dots, \rho_n) \in \mathbb{U}^{P \cup \{p\}}(q, \xi)} \text{wt}(\xi[p]_{\tilde{v}}, \rho') \otimes \bigotimes_{i \in [n]} \text{wt}(\xi|_{\tilde{v}_i}, \rho_i) && \text{(because } \varphi \text{ is a weight preserving bijection)} \\ = & \bigoplus_{\substack{\tilde{v}=(v_1, \dots, v_n) \in \text{cut}_p(\xi) \setminus \{(\varepsilon)\}: \\ \xi[p]_{\tilde{v}} \notin Q \\ (\forall i \in [n]): \xi|_{v_i} \notin Q \setminus \{p\}}} \bigoplus_{\rho' \in \mathbb{R}_{\mathcal{A}}^P(q, \xi[p]_{\tilde{v}})} \bigoplus_{\rho_1 \in \mathbb{R}_{\mathcal{A}}^{P \cup \{p\}}(p, \xi|_{v_1})} \bigoplus_{\rho_n \in \mathbb{R}_{\mathcal{A}}^{P \cup \{p\}}(p, \xi|_{v_n})} \dots \bigoplus_{i \in [n]} \text{wt}(\xi[p]_{\tilde{v}}, \rho') \otimes \bigotimes_{i \in [n]} \text{wt}(\xi|_{v_i}, \rho_i) \\ & && \text{(by definition of } \mathbb{U}^{P \cup \{p\}}(q, \xi)) \end{aligned}$$

$$\begin{aligned}
&= \bigoplus_{\substack{\tilde{v}=(v_1, \dots, v_n) \in \text{cut}_p(\xi) \setminus \{\varepsilon\}: \\ \xi[p]_{\tilde{v}} \notin Q \\ (\forall i \in [n]): \xi|_{v_i} \notin Q \setminus \{p\}}} \left(\bigoplus_{\rho' \in R_{\mathcal{A}}^P(q, \xi[p]_{\tilde{v}})} \text{wt}(\xi[p]_{\tilde{v}}, \rho') \right) \otimes \bigotimes_{i \in [n]} \left(\bigoplus_{\rho_i \in R_{\mathcal{A}}^{P \cup \{p\}}(p, \xi|_{v_i})} \text{wt}(\xi|_{v_i}, \rho_i) \right) \\
&\hspace{25em} \text{(by distributivity)} \\
&= \bigoplus_{\substack{\tilde{v}=(v_1, \dots, v_n) \in \text{cut}_p(\xi) \setminus \{\varepsilon\}: \\ \xi[p]_{\tilde{v}} \notin Q, \\ (\forall i \in [n]): \xi|_{v_i} \notin Q \setminus \{p\}}} S_{\mathcal{A}}(P, q)(\xi[p]_{\tilde{v}}) \otimes \bigotimes_{i \in [n]} ((S_{\mathcal{A}}(P \cup \{p\}, p) \oplus \mathbb{1}.p)(\xi|_{v_i}))
\end{aligned}$$

In the previous equality we have used the following argument (for the second factor up to the $(n+1)$ -st factor). If, for some $i \in [n]$, we have $\xi|_{v_i} = p$, then $R_{\mathcal{A}}^{P \cup \{p\}}(p, \xi|_{v_i})$ contains exactly one run, say ρ , and $\rho(\varepsilon) = p$. Then $\bigoplus_{\rho_i \in R_{\mathcal{A}}^{P \cup \{p\}}(p, \xi|_{v_i})} \text{wt}(\xi|_{v_i}, \rho_i) = \mathbb{1}$. On the other hand, then we have $S_{\mathcal{A}}(P \cup \{p\}, p)(\xi|_{v_i}) = \mathbb{0}$. Thus, we have to add $\mathbb{1}.p$.

Then we can continue as follows:

$$\begin{aligned}
&\bigoplus_{\substack{(v_1, \dots, v_n) \in \text{cut}_p(\xi) \setminus \{\varepsilon\}: \\ \xi[p]_{(v_1, \dots, v_n)} \notin Q, \\ (\forall i \in [n]): \xi|_{v_i} \notin Q \setminus \{p\}}} S_{\mathcal{A}}(P, q)(\xi[p]_{(v_1, \dots, v_n)}) \otimes \bigotimes_{i \in [n]} ((S_{\mathcal{A}}(P \cup \{p\}, p) \oplus \mathbb{1}.p)(\xi|_{v_i})) \\
&= \bigoplus_{\substack{(v_1, \dots, v_n) \in \text{cut}_p(\xi) \setminus \{\varepsilon\}: \\ \xi[p]_{(v_1, \dots, v_n)} \notin Q, \\ (\forall i \in [n]): \xi|_{v_i} \notin Q \setminus \{p\}}} S_{\mathcal{A}}(P, q)(\xi[p]_{(v_1, \dots, v_n)}) \otimes \bigotimes_{i \in [n]} ((S_{\mathcal{A}}(P, p) \circ_p S_{\mathcal{A}}(P, p)_p^*) \oplus \mathbb{1}.p)(\xi|_{v_i})
\end{aligned}$$

The previous equality uses, for each $i \in [n]$, the following facts. If $\xi|_{v_i} \notin Q$, then we have used the I.H. with $q = p$. This is possible because $\xi|_{v_i}$ is a subtree of ξ due to the condition $\xi[p]_{(v_1, \dots, v_n)} \neq p$. If $\xi|_{v_i} = p$, then we have used that

$$((S_{\mathcal{A}}(P \cup \{p\}, p) \oplus \mathbb{1}.p)(\xi|_{v_i}) = \mathbb{1} = ((S_{\mathcal{A}}(P, p) \circ_p S_{\mathcal{A}}(P, p)_p^*) \oplus \mathbb{1}.p)(\xi|_{v_i}) .$$

Then we can continue as follows:

$$\begin{aligned}
&\bigoplus_{\substack{(v_1, \dots, v_n) \in \text{cut}_p(\xi) \setminus \{\varepsilon\}: \\ \xi[p]_{(v_1, \dots, v_n)} \notin Q, \\ (\forall i \in [n]): \xi|_{v_i} \notin Q \setminus \{p\}}} S_{\mathcal{A}}(P, q)(\xi[p]_{(v_1, \dots, v_n)}) \otimes \bigotimes_{i \in [n]} ((S_{\mathcal{A}}(P, p) \circ_p S_{\mathcal{A}}(P, p)_p^*) \oplus \mathbb{1}.p)(\xi|_{v_i}) \\
&= \bigoplus_{\substack{(v_1, \dots, v_n) \in \text{cut}_p(\xi) \setminus \{\varepsilon\}: \\ \xi[p]_{(v_1, \dots, v_n)} \notin Q, \\ (\forall i \in [n]): \xi|_{v_i} \notin Q \setminus \{p\}}} S_{\mathcal{A}}(P, q)(\xi[p]_{(v_1, \dots, v_n)}) \otimes \bigotimes_{i \in [n]} S_{\mathcal{A}}(P, p)_p^*(\xi|_{v_i}) \hspace{2em} \text{(by Lemma 10.7.4)} \\
&= \bigoplus_{(v_1, \dots, v_n) \in \text{cut}_p(\xi)} S_{\mathcal{A}}(P, q)(\xi[p]_{(v_1, \dots, v_n)}) \otimes \bigotimes_{i \in [n]} S_{\mathcal{A}}(P, p)_p^*(\xi|_{v_i}) \\
&\hspace{10em} \text{(by definition of } S_{\mathcal{A}}(P, q) \text{ and because } S_{\mathcal{A}}(P, p)_p^*(q) = \mathbb{0} \text{ for each } q \in Q \setminus \{p\}) \\
&= (S_{\mathcal{A}}(P, q) \circ_p S_{\mathcal{A}}(P, p)_p^*)(\xi) \hspace{10em} \text{(by definition of } \circ_p)
\end{aligned}$$

□

With the help of Lemma 15.2.1 we can show that weighted languages of the form $S_{\mathcal{A}}(P, q)$ are rational.

Lemma 15.2.2. For every $P \subseteq Q$ and $q \in Q$ we have $S_{\mathcal{A}}(P, q) \in \text{Rat}(\Sigma \cup Q, \mathbb{B})$.

Proof. We prove the statement by induction on $(\mathcal{P}(Q), \succ)$, where for every $P, P' \in \mathcal{P}(Q)$ we define $P \succ P'$ if there exists a $p \in Q \setminus P'$ such that $P = P' \cup \{p\}$. Since the cardinality of sets is a monotone embedding from $(\mathcal{P}(Q), \succ)$ into the terminating reduction system $(\mathbb{N}, >)$, Lemma 2.5.2 implies that \succ is terminating. Moreover, we have that $\text{nf}_\succ(\mathcal{P}(Q)) = \{\emptyset\}$.

I.B.: Let $P = \emptyset$. For every $k \in \mathbb{N}$, $\sigma \in \Sigma^{(k)}$, $q, q_1, \dots, q_k \in Q$, we define the run $\rho_{q_1 \dots q_k, q}^\sigma : \text{pos}(\sigma(q_1, \dots, q_k)) \rightarrow Q$ by $\rho_{q_1 \dots q_k, q}^\sigma(\varepsilon) = q$ and $\rho_{q_1 \dots q_k, q}^\sigma(i) = q_i$ for each $i \in [k]$. Then for each $\xi \in \text{T}_\Sigma(Q)$ we have

$$\mathbf{R}_A^\emptyset(q, \xi) = \begin{cases} \{\rho_{q_1 \dots q_k, q}^\sigma\} & \text{if } \xi = \sigma(q_1, \dots, q_k) \\ \emptyset & \text{otherwise} \end{cases} .$$

Let $\Sigma(Q) = \{\sigma(q_1, \dots, q_k) \mid k \in \mathbb{N}, \sigma \in \Sigma^{(k)}, q_1, \dots, q_k \in Q\}$. Then

$$S_A(\emptyset, q) = \bigoplus_{\sigma(q_1, \dots, q_k) \in \Sigma(Q)} \delta_k(q_1 \cdots q_k, \sigma, q) \cdot \sigma(q_1, \dots, q_k) .$$

Since $S_A(\emptyset, q)$ is polynomial, we have that $S_A(\emptyset, q)$ is rational.

I.S.: Let $P = P' \cup \{p\}$ for some $p \in Q \setminus P'$. For the induction step, we assume that $S_A(P', q)$ is rational for each $q \in Q$. By Lemma 15.2.1, we have $S_A(P' \cup \{p\}, q) = S_A(P', q) \circ_p S_A(P', p)_p^*$. Thus, by I.H. and the definition of rational weighted tree languages, we obtain that $S_A(P' \cup \{p\}, q)$ is rational. \square

Theorem 15.2.3. (cf. [DPV05, Thm. 5.2]) $\text{Rec}(\Sigma, \mathbf{B}) \subseteq \text{Rat}(\Sigma, \mathbf{B})^{\text{ext}}$.

Proof. Let $\mathcal{A} = (Q, \delta, F)$ be a (Σ, \mathbf{B}) -wta with $Q = \{q_1, \dots, q_n\}$. By Theorem 7.3.1 we can assume that \mathcal{A} is root weight normalized. Let $q_f \in Q$ such that $\text{supp}(F) = \{q_f\}$ and $F(q_f) = 1$.

We will prove that $\llbracket \mathcal{A} \rrbracket \in \text{Rat}(\Sigma, \mathbf{B})^{\text{ext}}$. For this we want to employ Lemma 15.2.2 (for $P = Q$ and $q = q_f$). We observe that $S_A(Q, q_f)(\xi) = \llbracket \mathcal{A} \rrbracket(\xi)$ for each $\xi \in \text{T}_\Sigma$. Since $\text{supp}(S_A(Q, q_f))$ may contain trees in $\text{T}_\Sigma(Q) \setminus \text{T}_\Sigma$, the weighted tree language $S_A(Q, q_f)$ may not be the 0-extension of $\llbracket \mathcal{A} \rrbracket$ to $\text{T}_{\Sigma \cup Q}$. In order to make it so, we annihilate those trees from $\text{supp}(S_A(Q, q_f))$.

Therefore, we define $r : \text{T}_\Sigma(Q) \rightarrow \mathbf{B}$ for each $\xi \in \text{T}_\Sigma(Q)$ by

$$r(\xi) = (\cdots (S_A(Q, q_f) \circ_{q_1} \tilde{\emptyset}) \cdots \circ_{q_n} \tilde{\emptyset})(\xi) .$$

It is obvious that, for each $\xi \in \text{T}_\Sigma(Q)$, we have

$$r(\xi) = \begin{cases} \llbracket \mathcal{A} \rrbracket(\xi) & \text{if } \xi \in \text{T}_\Sigma \\ \emptyset & \text{otherwise} \end{cases}$$

i.e., $r = \llbracket \mathcal{A} \rrbracket \upharpoonright^{\Sigma \cup Q, 0}$.

It remains to prove that $r \in \text{Rat}(\Sigma \cup Q, \mathbf{B})$. By Lemma 15.2.2 we have that $S_A(Q, q_f) \in \text{Rat}(\Sigma \cup Q, \mathbf{B})$. By definition, $\tilde{\emptyset}$ is a polynomial, hence $\tilde{\emptyset} \in \text{Rat}(\Sigma \cup Q, \mathbf{B})$. Since $\text{Rat}(\Sigma \cup Q, \mathbf{B})$ is closed under q_i -concatenation, we obtain that $r \in \text{Rat}(\Sigma \cup Q, \mathbf{B})$. Hence $\llbracket \mathcal{A} \rrbracket \in \text{Rat}(\Sigma, \mathbf{B})^{\text{ext}}$. \square

We finish this section by an informal comparison. If we analyse the proofs of Theorem 15.2.3 and of Lemmas 15.2.1 and 15.2.2, then we realize that, for each wta \mathcal{A} , we can represent the weighted tree language $\llbracket \mathcal{A} \rrbracket$ in terms of polynomials and the operations tree concatenation and Kleene stars; in particular, the summation \oplus is not needed. This is different from the situation for (unweighted) string languages. In the following we explain the reason of this difference.

In the string case, assuming that the set Q of states of some finite-state string automaton A is $\{1, \dots, n\}$, the dynamic programming equality which we use in the analysis of the behaviour of A is

$$L_{i,j}^{(k+1)} = L_{i,j}^{(k)} \cup L_{i,k+1}^{(k)} (L_{k+1,k+1}^{(k)})^* L_{k+1,j}^{(k)} \quad (15.3)$$

[Har78, p. 58], where i, j , and k are states; and $L_{i,j}^{(k)}$ is the set of strings which lead A from state i to state j and, intermediately, may only visit states in $\{1, \dots, k\}$.

Generalizing this scenario to the (unweighted) tree case means to turn the input string 90° counter-clockwise, i.e., the starting state is at the leaf, and to extend this monadic tree into a “real” tree by allowing arbitrary ranks. This implies that the computation does not only start at one point (leaf) in one state i but at each leaf, and hence i must be replaced by a whole set P of possible starting states. Then (15.3) turns into

$$L_{P,j}^{(k+1)} = L_{P,j}^{(k)} \cup L_{P \cup \{k+1\},j}^{(k)} \circ_{k+1} (L_{P \cup \{k+1\},k+1}^{(k)})_{k+1}^* \circ_{k+1} L_{P,k+1}^{(k)} \quad (15.4)$$

where we assume that $k+1 \notin P$ (and by keeping in mind that the order of arguments of tree concatenation is reversed with respect to that order in string concatenation). This corresponds to (*) on page 78 of [GS84]. Now we can realize that the first part of the union, i.e., the set $L_{P,j}^{(k)}$, is a subset of $L_{P \cup \{k+1\},j}^{(k)}$ and, since the state $k+1$ does not occur in trees in $L_{P,j}^{(k)}$, we obtain that

$$L_{P,j}^{(k)} \subseteq L_{P \cup \{k+1\},j}^{(k)} \circ_{k+1} (L_{P \cup \{k+1\},k+1}^{(k)})_{k+1}^* \circ_{k+1} L_{P,k+1}^{(k)} .$$

Hence (15.4) turns into

$$L_{P,j}^{(k+1)} = L_{P \cup \{k+1\},j}^{(k)} \circ_{k+1} (L_{P \cup \{k+1\},k+1}^{(k)})_{k+1}^* \circ_{k+1} L_{P,k+1}^{(k)} \quad (15.5)$$

and the union disappeared. Then (15.5) corresponds to the equality in [Eng75b, p. 21] where we have to identify the set $\{1, \dots, k\}$ of states with the set Q of nonterminals, the state $k+1$ with the nonterminal B , and the state j with the nonterminal A . Hence, we can represent each recognizable tree language in terms of finite tree languages and the operations tree concatenation and Kleene stars; in particular, the union is not needed. And we generalized this scenario to recognizable weighted tree languages.

15.3 From rational to recognizable

Here we prove Theorem 15.3.1, i.e., $\text{Rat}(\Sigma, \mathbb{B}) \subseteq \text{Rec}(\Sigma, \mathbb{B})$, or in words: each rational (Σ, \mathbb{B}) -weighted tree language is recognizable.

Theorem 15.3.1. $\text{Rat}(\Sigma, \mathbb{B}) \subseteq \text{Rec}(\Sigma, \mathbb{B})$.

Proof. Let r be a polynomial (Σ, \mathbb{B}) -weighted tree language. Then there exist $n \in \mathbb{N}_+$, $b_1, \dots, b_n \in \mathbb{B}$, and $\xi_1, \dots, \xi_n \in \mathbb{T}_\Sigma$ such that $r = b_1 \cdot \xi_1 \oplus \dots \oplus b_n \cdot \xi_n$. Since for each $i \in [n]$ the singleton $\{\xi_i\}$ is a recognizable Σ -tree language, the weighted tree language r is a recognizable step mapping. By Theorem 10.3.1, there exists a crisp-deterministic (Σ, \mathbb{B}) -wta \mathcal{A} such that $\llbracket \mathcal{A} \rrbracket = r$. Hence $r \in \text{Rec}(\Sigma, \mathbb{B})$.

By Theorem 10.1.1 and Corollaries 10.6.2 and 10.7.7, the set $\text{Rec}(\Sigma, \mathbb{B})$ is closed under the rational operations. Since $\text{Rat}(\Sigma, \mathbb{B})$ is the smallest set which contains each polynomial (Σ, \mathbb{B}) -weighted tree language and is closed under the rational operations, the statement follows. \square

15.4 Alternative definition of rational weighted tree languages

In Figure 15.3 we give an overview of the relevant sets of rational weighted tree languages where the sets $\mathbb{B}_{+\text{Pol}}^{\text{rat}} \langle \langle \mathbb{T}_\Sigma \rangle \rangle$ and $\mathbb{B}^{\text{rat}} \langle \langle \mathbb{T}_\Sigma \rangle \rangle^{\text{ext}}$ will be defined below.

In this section we will prove the following: including polynomial weighted tree languages into $\mathbb{B}^{\text{rat}} \langle \langle \mathbb{T}_\Sigma \rangle \rangle$ (yielding the set $\mathbb{B}_{+\text{Pol}}^{\text{rat}} \langle \langle \mathbb{T}_\Sigma \rangle \rangle$) does not enrich the set $\mathbb{B}^{\text{rat}} \langle \langle \mathbb{T}_\Sigma \rangle \rangle$ (cf. Observation 15.4.2 and [DPV05, Obs. 3.19]). Moreover, we prove that the extensions of the sets $\mathbb{B}^{\text{rat}} \langle \langle \mathbb{T}_\Sigma \rangle \rangle$ and $\text{Rat}(\Sigma, \mathbb{B})$ are equal when using our concept of 0-extension (cf. Theorem 15.4.7).

	Pol(Σ, \mathbf{B})	scalar multipl.	top-concat.	rational operations
$\mathbf{B}^{\text{rat}}\langle\langle T_\Sigma \rangle\rangle$ [DPV05]:		closed	closed	closed
$\mathbf{B}_{+\text{Pol}}^{\text{rat}}\langle\langle T_\Sigma \rangle\rangle$ [DPV05]:	includes	closed	closed	closed
$\text{Rat}(\Sigma, \mathbf{B})$:	includes			closed
$\mathbf{B}^{\text{rat}}\langle\langle T_\Sigma(Q_\infty) \rangle\rangle$ [DPV05]	$= \bigcup \{ \mathbf{B}^{\text{rat}}\langle\langle T_\Theta \rangle\rangle \mid \text{ranked alphabet } \Theta \text{ such that } \Theta \geq_0 \Sigma \}$			
$\mathbf{B}^{\text{rat}}\langle\langle T_\Sigma \rangle\rangle^{\text{ext}}$	$= \{ r : T_\Sigma \rightarrow B \mid (\exists \Theta \geq_0 \Sigma) : r _{\Theta, 0} \in \mathbf{B}^{\text{rat}}\langle\langle T_\Theta \rangle\rangle \}$			
$\text{Rat}(\Sigma, \mathbf{B})^{\text{ext}}$	$= \{ r : T_\Sigma \rightarrow B \mid (\exists \Theta \geq_0 \Sigma) : r _{\Theta, 0} \in \text{Rat}(\Theta, \mathbf{B}) \}$			

Figure 15.3: An overview of the definition of several sets of rational weighted tree language. The denotation $\mathbf{B}_{+\text{Pol}}^{\text{rat}}\langle\langle T_\Sigma \rangle\rangle$ does not occur in [DPV05], but we invented this here for the sake of brevity.

As preparation, we characterize the set $\text{Pol}(\Sigma, \mathbf{B})$ of polynomial (Σ, \mathbf{B}) -weighted tree languages in terms of closure properties.

Lemma 15.4.1. The set $\text{Pol}(\Sigma, \mathbf{B})$ is the smallest set of (Σ, \mathbf{B}) -weighted tree languages which is closed under sum, scalar multiplications, and top-concatenations. Hence, in particular, $\text{Pol}(\Sigma, \mathbf{B}) \subseteq \mathbf{B}^{\text{rat}}\langle\langle T_\Sigma \rangle\rangle$.

Proof. For convenience, we denote by \mathcal{C} the smallest set of (Σ, \mathbf{B}) -weighted tree languages which is closed under sum, scalar multiplications, and top-concatenations.

First we prove that each polynomial (Σ, \mathbf{B}) -weighted tree language is in \mathcal{C} . As preparation we prove by induction on T_Σ that the monomial $\mathbb{1}.\xi$ is in \mathcal{C} for each $\xi \in T_\Sigma$. Let $\xi = \sigma(\xi_1, \dots, \xi_k)$ and assume that $\mathbb{1}.\xi_i$ is in $\text{Pol}(\Sigma, \mathbf{B})$ for each $i \in [k]$. Obviously,

$$\mathbb{1}.\xi = \text{top}_\sigma(\mathbb{1}.\xi_1, \dots, \mathbb{1}.\xi_k)$$

and hence $\mathbb{1}.\xi$ is in \mathcal{C} because \mathcal{C} is closed under top-concatenations.

Now let $r : T_\Sigma \rightarrow B$ be polynomial. We distinguish two cases.

Case (a): Let $\text{supp}(r) = \emptyset$. Let $\alpha \in \Sigma^{(0)}$ (recall that $\Sigma^{(0)} \neq \emptyset$ by definition). Then $r = 0 \otimes \mathbb{1}.\alpha$, and since $\mathbb{1}.\alpha$ is in \mathcal{C} and \mathcal{C} is closed under scalar multiplications, we have that r is in \mathcal{C} .

Case (b): Let $\text{supp}(r) = \{\xi_1, \dots, \xi_n\}$ for some $n \in \mathbb{N}_+$. Then $r = \bigoplus_{i \in [n]} r(\xi_i) \otimes (\mathbb{1}.\xi_i)$. By the above, $\mathbb{1}.\xi_i$ is in \mathcal{C} . Since \mathcal{C} is closed under scalar multiplications and sum, we have that r is in \mathcal{C} .

Next we prove that each $r \in \mathcal{C}$ is polynomial, i.e., $\text{supp}(r)$ is finite. This is easy to see, because the application of top-concatenations, scalar multiplications, and sum preserve the property of finite support.

Thus $\text{Pol}(\Sigma, \mathbf{B}) = \mathcal{C}$. The inclusion $\text{Pol}(\Sigma, \mathbf{B}) \subseteq \mathbf{B}^{\text{rat}}\langle\langle T_\Sigma \rangle\rangle$ follows from the definition of $\mathbf{B}^{\text{rat}}\langle\langle T_\Sigma \rangle\rangle$. \square

We denote by $\mathbf{B}_{+\text{Pol}}^{\text{rat}}\langle\langle T_\Sigma \rangle\rangle$ the smallest set of (Σ, \mathbf{B}) -weighted tree languages which contains $\text{Pol}(\Sigma, \mathbf{B})$ and is closed under scalar multiplications, top-concatenations, and the rational operations.

Observation 15.4.2. [DPV05, Obs. 3.19] $\mathbf{B}^{\text{rat}}\langle\langle T_\Sigma \rangle\rangle = \mathbf{B}_{+\text{Pol}}^{\text{rat}}\langle\langle T_\Sigma \rangle\rangle$.

Proof. The inclusion $\mathbf{B}^{\text{rat}}\langle\langle T_\Sigma \rangle\rangle \subseteq \mathbf{B}_{+\text{Pol}}^{\text{rat}}\langle\langle T_\Sigma \rangle\rangle$ is obvious. The inclusion $\mathbf{B}_{+\text{Pol}}^{\text{rat}}\langle\langle T_\Sigma \rangle\rangle \subseteq \mathbf{B}^{\text{rat}}\langle\langle T_\Sigma \rangle\rangle$ holds because $\text{Pol}(\Sigma, \mathbf{B}) \subseteq \mathbf{B}^{\text{rat}}\langle\langle T_\Sigma \rangle\rangle$ (by Lemma 15.4.1), the fact that $\mathbf{B}^{\text{rat}}\langle\langle T_\Sigma \rangle\rangle$ is closed under scalar multiplications, top-concatenations, and the rational operations, and the fact that $\mathbf{B}_{+\text{Pol}}^{\text{rat}}\langle\langle T_\Sigma \rangle\rangle$ is the smallest such set. \square

Next we prove that the extensions of the sets $\mathbf{B}^{\text{rat}}\langle\langle T_\Sigma \rangle\rangle$ and $\text{Rat}(\Sigma, \mathbf{B})$ (using our concepts of 0-extension) are equal.

The set of extended DPV-rational (Σ, \mathbf{B}) -weighted tree languages, denoted by $\mathbf{B}^{\text{rat}}\langle\langle T_\Sigma \rangle\rangle^{\text{ext}}$, contains each (Σ, \mathbf{B}) -weighted tree language r such that $r|_{\Theta, 0} \in \mathbf{B}^{\text{rat}}\langle\langle T_\Theta \rangle\rangle$ for some 0-extension Θ of Σ .

Thus, we wish to show that $\text{Rat}(\Sigma, \mathbf{B})^{\text{ext}} = \mathbf{B}^{\text{rat}}\langle\langle T_\Sigma \rangle\rangle^{\text{ext}}$. Intuitively, this means that, for the extended sets, closure under scalar multiplications and top-concatenations can be traded for polynomials, and vice versa. We prove the two directions in separate lemmas.

Lemma 15.4.3. $\text{Rat}(\Sigma, \mathbf{B})^{\text{ext}} \subseteq \mathbf{B}^{\text{rat}}\langle\langle T_\Sigma \rangle\rangle^{\text{ext}}$.

Proof. Let $r \in \text{Rat}(\Sigma, \mathbf{B})^{\text{ext}}$. Hence $r \upharpoonright^{\Theta, 0} \in \text{Rat}(\Theta, \mathbf{B})$ for some 0-extension Θ of Σ .

As next step we prove that $r \upharpoonright^{\Theta, 0} \in \mathbf{B}^{\text{rat}}\langle\langle T_\Theta \rangle\rangle$. By Lemma 15.4.1, we have that $\text{Pol}(\Theta, \mathbf{B}) \subseteq \mathbf{B}^{\text{rat}}\langle\langle T_\Theta \rangle\rangle$. Hence $\mathbf{B}^{\text{rat}}\langle\langle T_\Theta \rangle\rangle$ is a set of (Θ, \mathbf{B}) -weighted tree languages which contains $\text{Pol}(\Theta, \mathbf{B})$ and is closed under the rational operations. Since $\text{Rat}(\Theta, \mathbf{B})$ is the smallest such set, we obtain $\text{Rat}(\Theta, \mathbf{B}) \subseteq \mathbf{B}^{\text{rat}}\langle\langle T_\Theta \rangle\rangle$. Hence $r \upharpoonright^{\Theta, 0} \in \mathbf{B}^{\text{rat}}\langle\langle T_\Theta \rangle\rangle$. Thus, by definition, we obtain that $r \in \mathbf{B}^{\text{rat}}\langle\langle T_\Sigma \rangle\rangle^{\text{ext}}$. \square

For the other direction, i.e., $\mathbf{B}^{\text{rat}}\langle\langle T_\Sigma \rangle\rangle^{\text{ext}} \subseteq \text{Rat}(\Sigma, \mathbf{B})^{\text{ext}}$, we first prove an auxiliary technical lemma.

Lemma 15.4.4. Let Δ be a 0-extension of Σ and let $r : T_\Sigma \rightarrow B$. If $r \in \text{Rat}(\Sigma, \mathbf{B})$, then $r \upharpoonright^{\Delta, 0} \in \text{Rat}(\Delta, \mathbf{B})$.

Proof. First, we characterize $\text{Rat}(\Sigma, \mathbf{B})$ by means of Theorem 2.7.17 such that we can prove a statement on $\text{Rat}(\Sigma, \mathbf{B})$ by induction on \mathbb{N} . For this, we consider the σ -complete lattice $(\mathcal{P}(B^{T_\Sigma}), \subseteq)$ and the mapping $f : \mathcal{P}(B^{T_\Sigma}) \rightarrow \mathcal{P}(B^{T_\Sigma})$ defined for each $C \in \mathcal{P}(B^{T_\Sigma})$ by

$$f(C) = C \cup \text{Pol}(\Sigma, \mathbf{B}) \cup \{r_1 \oplus r_2 \mid r_1, r_2 \in C\} \cup \{r_1 \circ_\alpha r_2 \mid r_1, r_2 \in C, \alpha \in \Sigma^{(0)}\} \cup \{(r)_\alpha^* \mid r \in C, \alpha \in \Sigma^{(0)}, \text{ and } r \text{ is } \alpha\text{-proper}\} .$$

The mapping f is continuous and, by definition,

$$\text{Rat}(\Sigma, \mathbf{B}) = \bigcap \{C \mid C \in \mathcal{P}(B^{T_\Sigma}) \text{ such that } f(C) \subseteq C\} .$$

Then, by Theorem 2.7.17, we have

$$\text{Rat}(\Sigma, \mathbf{B}) = \bigcup \{f^n(\emptyset) \mid n \in \mathbb{N}\} . \quad (15.6)$$

Now, by induction on \mathbb{N} , we prove that the following statement holds:

$$\text{For every } n \in \mathbb{N} \text{ and } r : T_\Sigma \rightarrow B: \text{ if } r \in f^n(\emptyset), \text{ then } r \upharpoonright^{\Delta, 0} \in \text{Rat}(\Delta, \mathbf{B}). \quad (15.7)$$

I.B.: Let $n = 0$. Since $f^0(\emptyset) = f^0(\emptyset) = \emptyset$, statement (15.7) trivially holds.

I.S.: Let $n = n' + 1$ for some $n' \in \mathbb{N}$. Moreover, let $r \in f^n(\emptyset)$. We assume that (15.7) holds for each $r' \in f^{n'}(\emptyset)$. We proceed by case analysis.

Case (a): Let $r \in f^{n'}(\emptyset)$. Then our statement holds by I.H.

Case (b): Let $r \in \text{Pol}(\Sigma, \mathbf{B})$. Then obviously $r \upharpoonright^{\Delta, 0}$ is a (Δ, \mathbf{B}) -polynomial, hence $r \upharpoonright^{\Delta, 0} \in \text{Rat}(\Delta, \mathbf{B})$.

Case (c): Let $r = r_1 \oplus r_2$ for some (Σ, \mathbf{B}) -weighted tree languages r_1 and r_2 in $f^{n'}(\emptyset)$. By I.H., we have $r_1 \upharpoonright^{\Delta, 0} \in \text{Rat}(\Delta, \mathbf{B})$ and $r_2 \upharpoonright^{\Delta, 0} \in \text{Rat}(\Delta, \mathbf{B})$. Obviously, $r \upharpoonright^{\Delta, 0} = r_1 \upharpoonright^{\Delta, 0} \oplus r_2 \upharpoonright^{\Delta, 0}$. Since $\text{Rat}(\Delta, \mathbf{B})$ is closed under sum, we have that $r \upharpoonright^{\Delta, 0} \in \text{Rat}(\Delta, \mathbf{B})$.

Cases (d) and (e): Let $r = r_1 \circ_\alpha r_2$ and $r = (r_1)_\alpha^*$, respectively, for some r_1 and r_2 in $f^{n'}(\emptyset)$ and $\alpha \in \Sigma$. The proofs of the cases are similar to the proof of Case (c).

This finishes the proof of (15.7). The statement of the lemma follows from (15.7) and (15.6). \square

In the proof of $\mathbf{B}^{\text{rat}}\langle\langle T_\Sigma \rangle\rangle^{\text{ext}} \subseteq \text{Rat}(\Sigma, \mathbf{B})^{\text{ext}}$ we will use the fact that, for each 0-extension Θ of Σ , the set $\text{Rat}(\Theta, \mathbf{B})^{\text{ext}}$ is closed under scalar-multiplications, top-concatenations, and the rational operations. One way to prove this is to use $\text{Rat}(\Theta, \mathbf{B})^{\text{ext}} \subseteq \text{Rec}(\Theta, \mathbf{B})^{\text{ext}}$ (by Theorem 15.1.2), to exploit closure properties of $\text{Rec}(\Theta, \mathbf{B})^{\text{ext}}$, and to use $\text{Rec}(\Theta, \mathbf{B})^{\text{ext}} \subseteq \text{Rat}(\Theta, \mathbf{B})^{\text{ext}}$ (again by Theorem 15.1.2). But here we show an alternative proof, in which we stay inside the area of rational weighted tree languages.

Lemma 15.4.5. Let Θ be a ranked alphabet. Then $\text{Rat}(\Theta, \mathbf{B})^{\text{ext}}$ is closed under (a) scalar-multiplications, (b) top-concatenations, and the (c) rational operations.

Proof. (a) Here we prove that $\text{Rat}(\Theta, \mathbf{B})^{\text{ext}}$ is closed under scalar-multiplications. Let $r \in \text{Rat}(\Theta, \mathbf{B})^{\text{ext}}$ and $b \in B$. We have to prove that $b \otimes r \in \text{Rat}(\Theta, \mathbf{B})^{\text{ext}}$.

By our assumption, $r \uparrow^{\Delta, 0} \in \text{Rat}(\Delta, \mathbf{B})$ for some 0-extension Δ of Θ . Let $\alpha \in \Delta^{(0)}$ be an arbitrary nullary symbol (recall that $\Delta^{(0)} \neq \emptyset$ by definition of ranked alphabets.) We define the (Δ, \mathbf{B}) -weighted tree language s by

$$s = (b.\alpha) \circ_{\alpha} (r \uparrow^{\Delta, 0}) .$$

Since $b.\alpha \in \text{Rat}(\Delta, \mathbf{B})$ and $\text{Rat}(\Delta, \mathbf{B})$ is closed under tree concatenations, we have that $s \in \text{Rat}(\Delta, \mathbf{B})$. Moreover, for each $\xi \in T_{\Delta}$, we have

$$s(\xi) = b \otimes (r \uparrow^{\Delta, 0}(\xi)) .$$

Hence $s = b \otimes r \uparrow^{\Delta, 0}$, and since $b \otimes r \uparrow^{\Delta, 0} = (b \otimes r) \uparrow^{\Delta, 0}$ we obtain that $b \otimes r \in \text{Rat}(\Theta, \mathbf{B})^{\text{ext}}$.

(b) We prove that $\text{Rat}(\Theta, \mathbf{B})^{\text{ext}}$ is closed under top-concatenations. Let $k \in \mathbb{N}$, $\sigma \in \Theta^{(k)}$, and r_1, \dots, r_k be (Θ, \mathbf{B}) -weighted tree languages in $\text{Rat}(\Theta, \mathbf{B})^{\text{ext}}$. We have to prove that $\text{top}_{\sigma}(r_1, \dots, r_k) \in \text{Rat}(\Theta, \mathbf{B})^{\text{ext}}$.

For each $i \in [k]$ let $r_i \uparrow^{\Delta_i, 0} \in \text{Rat}(\Delta_i, \mathbf{B})$ for some 0-extension Δ_i of Θ . Without loss of generality we can assume that $(\Delta_i \setminus \Theta) \cap (\Delta_j \setminus \Theta) = \emptyset$ for every $i, j \in [k]$ with $i \neq j$. We define the ranked alphabet $\Delta = \bigcup_{i \in [k]} \Delta_i$. Obviously, $\Delta \geq_0 \Delta_i$ for each $i \in [k]$. By Observation 15.1.1 we have that $(r_i \uparrow^{\Delta_i, 0}) \uparrow^{\Delta, 0} = r_i \uparrow^{\Delta, 0}$ and hence, by Lemma 15.4.4, we have that $r_i \uparrow^{\Delta, 0} \in \text{Rat}(\Delta, \mathbf{B})$.

Let $P = \{p_1, \dots, p_k\}$ be a set disjoint with Δ . We view $\Delta \cup P$ as 0-extension of Δ . We define the $(\Delta \cup P, \mathbf{B})$ -weighted tree language r by

$$r = (\dots (\mathbb{1}.\sigma(p_1, \dots, p_k) \circ_{p_1} r_1 \uparrow^{\Delta \cup P, 0}) \dots) \circ_{p_k} r_k \uparrow^{\Delta \cup P, 0} .$$

Since $\mathbb{1}.\sigma(p_1, \dots, p_k) \in \text{Rat}(\Delta \cup P, \mathbf{B})$ and $r_i \uparrow^{\Delta \cup P, 0} \in \text{Rat}(\Delta \cup P, \mathbf{B})$ (for each $i \in [k]$ by Lemma 15.4.4) and $\text{Rat}(\Delta \cup P, \mathbf{B})$ is closed under tree concatenations, we have that $r \in \text{Rat}(\Delta \cup P, \mathbf{B})$.

We will show that, for each $\xi \in T_{\Delta \cup P}$, we have

$$r(\xi) = \begin{cases} \text{top}_{\sigma}(r_1, \dots, r_k)(\xi) & \text{if } \xi = \sigma(\xi_1, \dots, \xi_k) \text{ for some } \xi_1, \dots, \xi_k \in T_{\Theta} \\ \emptyset & \text{otherwise .} \end{cases} \quad (15.8)$$

Hence $r = \text{top}_{\sigma}(r_1, \dots, r_k) \uparrow^{\Delta \cup P, 0}$. Since $\Delta \cup P \geq_0 \Theta$, we obtain that $\text{top}_{\sigma}(r_1, \dots, r_k) \in \text{Rat}(\Theta, \mathbf{B})^{\text{ext}}$.

For the proof of (15.8), for each $i \in [0, k]$ we define

$$s_i = (\dots (\mathbb{1}.\sigma(p_1, \dots, p_k) \circ_{p_1} r_1 \uparrow) \dots) \circ_{p_i} r_i \uparrow ,$$

where $r_j \uparrow$ is an abbreviation of $r_j \uparrow^{\Delta \cup P, 0}$ for each $j \in [i]$. (We note that $s_0 = \mathbb{1}.\sigma(p_1, \dots, p_k)$.) Then, by induction on $([0, k], >)$, we prove that the following statement holds:

For each $i \in [0, k]$ and $\xi \in T_{\Delta \cup P}$, we have

$$s_i(\xi) = \begin{cases} \bigotimes_{j \in [i]} r_j(\xi_j) & \text{if } \xi = \sigma(\xi_1, \dots, \xi_i, p_{i+1}, \dots, p_k) \text{ for some } \xi_1, \dots, \xi_i \in T_{\Theta} \\ \emptyset & \text{otherwise .} \end{cases} \quad (15.9)$$

Let $\xi \in T_{\Delta \cup P}$.

I.B.: Let $i = 0$. The statement is obvious because $s_0 = \mathbb{1}.\sigma(p_1, \dots, p_k)$ and the product of an \emptyset -indexed family over B is defined to be $\mathbb{1}$.

I.S.: Let $i = i' + 1$: Then we have

$$s_i(\xi) = (s_{i'} \circ_{p_i} r_i \uparrow)(\xi) = \bigoplus_{(w_1, \dots, w_n) \in \text{cut}_{p_i}(\xi)} s_{i'}(\xi[p_i]_{(w_1, \dots, w_n)}) \otimes r_i \uparrow(\xi|_{w_1}) \otimes \dots \otimes r_i \uparrow(\xi|_{w_n}) . \quad (15.10)$$

By the I.H. we obtain

$$s_{i'}(\xi[p_i]_{(w_1, \dots, w_n)}) = \begin{cases} \left(\bigotimes_{j \in [i']} r_j(\xi_j) \right) & \text{if } \xi[p_i]_{(w_1, \dots, w_n)} = \sigma(\xi_1, \dots, \xi_{i'}, p_i, \dots, p_k) \\ & \text{for some } \xi_1, \dots, \xi_{i'} \in T_\Theta \\ 0 & \text{otherwise .} \end{cases}$$

Now we observe that the condition $\xi[p_i]_{(w_1, \dots, w_n)} = \sigma(\xi_1, \dots, \xi_{i'}, p_i, \dots, p_k)$ for some $\xi_1, \dots, \xi_{i'} \in T_\Theta$ implies that $n = 1$, $w_1 = i$ and there exists $\xi_i \in T_{\Delta \cup P}$ such that $\xi = \sigma(\xi_1, \dots, \xi_{i'}, \xi_i, p_i, \dots, p_k)$.

Hence (15.10) continues as

$$= \begin{cases} \left(\bigotimes_{j \in [i']} r_j(\xi_j) \right) \otimes r_i \upharpoonright (\xi_i) & \text{if } \xi = \sigma(\xi_1, \dots, \xi_{i'}, \xi_i, p_{i+1}, \dots, p_k) \\ & \text{for some } \xi_1, \dots, \xi_{i'} \in T_\Theta \text{ and } \xi_i \in T_{\Delta \cup P} \\ 0 & \text{otherwise .} \end{cases}$$

Since $\xi = \sigma(\xi_1, \dots, \xi_{i'}, \xi_i, p_{i+1}, \dots, p_k)$ implies that $\xi|_i = \xi_i$, and $r_i \upharpoonright$ is the \emptyset -extension of r_i to $T_{\Delta \cup P}$, we obtain

$$= \begin{cases} \bigotimes_{j \in [i]} r_j(\xi_j) & \text{if } \xi = \sigma(\xi_1, \dots, \xi_{i'}, \xi_i, p_{i+1}, \dots, p_k) \\ & \text{for some } \xi_1, \dots, \xi_i \in T_\Theta \\ 0 & \text{otherwise .} \end{cases}$$

This proves (15.9). From this latter, in case $i = k$ and using the definition of $\text{top}_\sigma(r_1, \dots, r_k)$ we obtain (15.8).

(c) We prove that $\text{Rat}(\Theta, \mathbb{B})^{\text{ext}}$ is closed under the rational operations, i.e., sum, tree concatenations, and Kleene stars.

Closure under sum: Let $r_1, r_2 \in \text{Rat}(\Theta, \mathbb{B})^{\text{ext}}$. We show that $r_1 \oplus r_2 \in \text{Rat}(\Theta, \mathbb{B})^{\text{ext}}$.

Let $r_1 \upharpoonright^{\Delta_1, 0} \in \text{Rat}(\Delta_1, \mathbb{B})$ for some 0-extension Δ_1 of Θ . Also let $r_2 \upharpoonright^{\Delta_2, 0} \in \text{Rat}(\Delta_2, \mathbb{B})$ for some 0-extension Δ_2 of Θ . Without loss of generality we can assume that $(\Delta_1 \setminus \Theta) \cap (\Delta_2 \setminus \Theta) = \emptyset$. We define the ranked alphabet $\Delta = \Delta_1 \cup \Delta_2$. Let $i \in [2]$. Obviously, $\Delta \geq_0 \Delta_i$, and hence $\Delta \geq_0 \Theta$. By Observation 15.1.1, we have that $(r_i \upharpoonright^{\Delta_i, 0}) \upharpoonright^{\Delta, 0} = r_i \upharpoonright^{\Delta, 0}$ and hence, by Lemma 15.4.4, we have that $r_i \upharpoonright^{\Delta, 0} \in \text{Rat}(\Delta, \mathbb{B})$.

Since $\text{Rat}(\Delta, \mathbb{B})$ is closed under sum, we obtain that $r_1 \upharpoonright^{\Delta, 0} \oplus r_2 \upharpoonright^{\Delta, 0} \in \text{Rat}(\Delta, \mathbb{B})$. Since $(r_1 \oplus r_2) \upharpoonright^{\Delta, 0}(\xi) = r_1 \upharpoonright^{\Delta, 0}(\xi) \oplus r_2 \upharpoonright^{\Delta, 0}(\xi)$ for each $\xi \in T_\Delta$, we have $(r_1 \oplus r_2) \upharpoonright^{\Delta, 0} \in \text{Rat}(\Delta, \mathbb{B})$. Hence $r_1 \oplus r_2 \in \text{Rat}(\Theta, \mathbb{B})^{\text{ext}}$.

Closure under tree concatenations: Let $r_1, r_2 \in \text{Rat}(\Theta, \mathbb{B})^{\text{ext}}$ and $\alpha \in \Theta^{(0)}$. We show that $r_1 \circ_\alpha r_2 \in \text{Rat}(\Theta, \mathbb{B})^{\text{ext}}$. In the same way as above we have that $r_1 \upharpoonright^{\Delta, 0} \in \text{Rat}(\Delta, \mathbb{B})$ and $r_2 \upharpoonright^{\Delta, 0} \in \text{Rat}(\Delta, \mathbb{B})$ for some 0-extension Δ of Θ .

Since $\text{Rat}(\Delta, \mathbb{B})$ is closed under tree concatenations, we obtain that $r_1 \upharpoonright^{\Delta, 0} \circ_\alpha r_2 \upharpoonright^{\Delta, 0} \in \text{Rat}(\Delta, \mathbb{B})$. Since $(r_1 \circ_\alpha r_2) \upharpoonright^{\Delta, 0}(\xi) = r_1 \upharpoonright^{\Delta, 0}(\xi) \circ_\alpha r_2 \upharpoonright^{\Delta, 0}(\xi)$ for each $\xi \in T_\Delta$, we have $(r_1 \circ_\alpha r_2) \upharpoonright^{\Delta, 0} \in \text{Rat}(\Delta, \mathbb{B})$. Hence $r_1 \circ_\alpha r_2 \in \text{Rat}(\Theta, \mathbb{B})^{\text{ext}}$.

Closure under Kleene stars: Let $\alpha \in \Theta^{(0)}$ and $r \in \text{Rat}(\Theta, \mathbb{B})^{\text{ext}}$ be an α -proper weighted tree language. We show that $r_\alpha^* \in \text{Rat}(\Theta, \mathbb{B})^{\text{ext}}$. By definition, we have that $r \upharpoonright^{\Delta, 0} \in \text{Rat}(\Delta, \mathbb{B})$ for some 0-extension Δ of Θ .

Since $\text{Rat}(\Delta, \mathbb{B})$ is closed under Kleene stars, we obtain that $(r \upharpoonright^{\Delta, 0})_\alpha^* \in \text{Rat}(\Delta, \mathbb{B})$. Since $(r_\alpha^*) \upharpoonright^{\Delta, 0}(\xi) = (r \upharpoonright^{\Delta, 0})_\alpha^*(\xi)$ for each $\xi \in T_\Delta$, we have $(r_\alpha^*) \upharpoonright^{\Delta, 0} \in \text{Rat}(\Delta, \mathbb{B})$. Hence $r_\alpha^* \in \text{Rat}(\Theta, \mathbb{B})^{\text{ext}}$. \square

Lemma 15.4.6. $\mathbb{B}^{\text{rat}} \langle\langle T_\Sigma \rangle\rangle^{\text{ext}} \subseteq \text{Rat}(\Sigma, \mathbb{B})^{\text{ext}}$.

Proof. Let $r \in \mathbb{B}^{\text{rat}} \langle\langle T_\Sigma \rangle\rangle^{\text{ext}}$. Hence $r \upharpoonright^{\Theta, 0} \in \mathbb{B}^{\text{rat}} \langle\langle T_\Theta \rangle\rangle$ for some 0-extension Θ of Σ .

By Lemma 15.4.5, the set $\text{Rat}(\Theta, \mathbb{B})^{\text{ext}}$ is closed under (a) scalar-multiplications, (b) top-concatenations, and the (c) rational operations. Since $\mathbb{B}^{\text{rat}} \langle\langle T_\Theta \rangle\rangle$ is the smallest set which has these

closure properties, we obtain that $\mathbf{B}^{\text{rat}}\langle\langle T_{\Theta} \rangle\rangle \subseteq \text{Rat}(\Theta, \mathbf{B})^{\text{ext}}$, and hence $r \upharpoonright^{\Theta, 0} \in \text{Rat}(\Theta, \mathbf{B})^{\text{ext}}$. Thus $(r \upharpoonright^{\Theta, 0}) \upharpoonright^{\Delta, 0} \in \text{Rat}(\Delta, \mathbf{B})$ for some 0-extension Δ of Θ . Since $\Delta \geq_0 \Theta$ and $\Theta \geq_0 \Sigma$ and $(r \upharpoonright^{\Theta, 0}) \upharpoonright^{\Delta, 0} = r \upharpoonright^{\Delta, 0}$ by Observation 15.1.1, we obtain that $r \upharpoonright^{\Delta, 0} \in \text{Rat}(\Delta, \mathbf{B})$. Thus, by definition, we have $r \in \text{Rat}(\Sigma, \mathbf{B})^{\text{ext}}$. \square

Then the next theorem follows from Lemmas 15.4.3 and 15.4.6.

Theorem 15.4.7. Let Σ be a ranked alphabet. Moreover, let \mathbf{B} be a commutative semiring. Then $\text{Rat}(\Sigma, \mathbf{B})^{\text{ext}} = \mathbf{B}^{\text{rat}}\langle\langle T_{\Sigma} \rangle\rangle^{\text{ext}}$.

Chapter 16

Elementary operations and Médvédjév's theorem

In his paper [Méd56] (cf. also [Bli65]), Médvédjév proved a characterization of the set of regular string languages as the smallest set of string languages which contains some elementary sets and is closed under some elementary operations. He considered this as an alternative to Kleene's characterization in terms of finite languages and the rational operations. This characterization has been generalized to the tree case in [Cos72] (cf. [GS84, Thm. 2.8.6]) and to the weighted case for semirings in [Her17] and [Her20b, Ch. 5].

In this chapter, we will prove two main theorems: one for wta over semirings and restricted representations (cf. Theorem 16.2.1; this closely corresponds to [Her20b, Ch. 5]) and one for wta over bi-locally finite strong bimonoids and arbitrary representations (cf. Theorem 16.3.1 and, for the particular case of bounded lattices cf. Corollary 20.7.1). We recall that the set of semirings and the set of bi-locally finite strong bimonoids are incomparable (cf. Figure 2.6).

16.1 Representable weighted tree languages

In this section we define the generalizations of the mentioned elementary sets and elementary operations to the weighted tree case. First we define the set of \mathbf{B} -representations. It is a family of sets $\text{RepEx}(\Sigma, \mathbf{B})$ of expressions where Σ is an arbitrary ranked alphabet; this provides the type of these expressions.

Formally, the family of \mathbf{B} -representations, denoted by $\text{RepEx}(\mathbf{B})$, is the family

$$\text{RepEx}(\mathbf{B}) = (\text{RepEx}(\Sigma, \mathbf{B}) \mid \Sigma \text{ ranked alphabet})$$

defined as the smallest family $R = (R(\Sigma) \mid \Sigma \text{ ranked alphabet})$ of expressions such that Conditions (1)-(6) hold. (We recall that Δ is an arbitrary ranked alphabet.)

- (1) For every $\sigma \in \Sigma$ and $b \in B$, the expression $\text{RT}_{\Sigma, \sigma, b}$ is in $R(\Sigma)$.
- (2) For every $k \in \mathbb{N}_+$, element $\tilde{\gamma} = \gamma_1 \dots \gamma_k$ of Σ^k , and $b \in B$, the expression $\text{NXT}_{\Sigma, \tilde{\gamma}, b}$ is in $R(\Sigma)$.
- (3) If $e_1, e_2 \in R(\Sigma)$, then $e_1 + e_2 \in R(\Sigma)$.
- (4) If $e_1, e_2 \in R(\Sigma)$, then $e_1 \times e_2 \in R(\Sigma)$.
- (5) If $e \in R(\Delta)$ and τ is a (Δ, Σ) -tree relabeling, then $\tau(e) \in R(\Sigma)$.
- (6) If $e \in R(\Sigma)$, then $\text{REST}(e) \in R(\Sigma)$.

We note that in Case (5) the type of the representation changes from Δ to Σ according to the type of the tree relabeling. Moreover, in [Her17] and [Her20b, Ch. 5], only deterministic tree relabelings are allowed. But since the set of recognizable weighted tree languages is closed under arbitrary tree relabelings (cf. Theorem 10.10.1), we can prove the main theorem also for a larger set of representations.

Informally, we might understand the set $\text{RepEx}(\mathbf{B})$ as the set of expressions generated by the following EBNF; it uses the infinite family $(e_\Sigma \mid \Sigma \text{ ranked alphabet})$ of nonterminals, and for each nonterminal e_Σ it has the following rule:

$$e_\Sigma ::= \text{RT}_{\Sigma, \sigma, b} \mid \text{NXT}_{\Sigma, \tilde{\gamma}, b} \mid e_\Sigma + e_\Sigma \mid e_\Sigma \times e_\Sigma \mid \tau(e_\Delta) \mid \text{REST}(e_\Sigma) \quad (16.1)$$

where $\sigma \in \Sigma$, $\tilde{\gamma} \in \Sigma^k$ for some $k \in \mathbb{N}_+$, $b \in B$, and τ is a (Δ, Σ) -tree relabeling.

In order to perform inductive proofs or to define objects by induction, we will consider the reduction system

$$(\text{RepEx}(\mathbf{B}), \succ)$$

where \succ is the binary relation on $\text{RepEx}(\mathbf{B})$ defined as follows. For every $e_1, e_2 \in \text{RepEx}(\mathbf{B})$ we let $e_1 \succ e_2$ if either of the following three cases hold.

Case (a): There exist $f_1, f_2 \in \text{RepEx}(\Sigma, \mathbf{B})$ such that e_1 has the form $f_1 + f_2$ or $f_1 \times f_2$ and $e_2 \in \{f_1, f_2\}$.

Case (b): There exist $f \in \text{RepEx}(\Delta, \mathbf{B})$ and a (Δ, Σ) -tree relabeling τ such that $e_1 = \tau(f)$ and $e_2 = f$.

Case (c): There exist $f \in \text{RepEx}(\Sigma, \mathbf{B})$ such that $e_1 = \text{REST}(f)$ and $e_2 = f$.

By Corollary 2.5.6, the relation \succ is terminating. Moreover, $\text{nf}_\succ(\text{RepEx}(\mathbf{B}))$ is the set of all representations of the form $\text{RT}_{\Sigma, \sigma, b}$ or $\text{NXT}_{\Sigma, \tilde{\gamma}, b}$. For every $e_1, e_2 \in \text{RepEx}(\mathbf{B})$, we say that e_2 is a *subexpression* of e_1 if $e_1 \succ^* e_2$. We note that the relation “is a subexpression of” is reflexive.

Next we define the semantics of \mathbf{B} -expressions by induction on $(\text{RepEx}(\mathbf{B}), \succ)$. In particular, for each $e \in \text{RepEx}(\Sigma, \mathbf{B})$, the semantics of e is a weighted tree language $\llbracket e \rrbracket : \mathbb{T}_\Sigma \rightarrow B$.

I.B.: We distinguish two cases.

(a) Let $\sigma \in \Sigma$ and $b \in B$. We define $\llbracket \text{RT}_{\Sigma, \sigma, b} \rrbracket : \mathbb{T}_\Sigma \rightarrow B$ by

$$\llbracket \text{RT}_{\Sigma, \sigma, b} \rrbracket = b \cdot \chi(L_{\Sigma, \sigma})$$

where $L_{\Sigma, \sigma} = \{\xi \in \mathbb{T}_\Sigma \mid \xi(\varepsilon) = \sigma\}$. That is, for every $\xi \in \mathbb{T}_\Sigma$, we have

$$\llbracket \text{RT}_{\Sigma, \sigma, b} \rrbracket(\xi) = \begin{cases} b & \text{if } \xi \in L_{\Sigma, \sigma} \\ 0 & \text{otherwise} \end{cases} .$$

A weighted tree language of the form $\llbracket \text{RT}_{\Sigma, \sigma, b} \rrbracket$ is called (Σ, σ, b) -*root mapping* or simply *root mapping*.

(b) Let $k \in \mathbb{N}_+$, $\tilde{\gamma} = \gamma_1 \dots \gamma_k$ be an element of Σ^k , and $b \in B$. We define $\llbracket \text{NXT}_{\Sigma, \tilde{\gamma}, b} \rrbracket : \mathbb{T}_\Sigma \rightarrow B$ by

$$\llbracket \text{NXT}_{\Sigma, \tilde{\gamma}, b} \rrbracket = b \cdot \chi(L_{\Sigma, \tilde{\gamma}}) ,$$

where $L_{\Sigma, \tilde{\gamma}} = \{\xi \in \mathbb{T}_\Sigma \mid \text{rk}(\xi(\varepsilon)) = k \wedge (\forall i \in [k]) : \xi(i) = \gamma_i\}$. That is, for every $\xi \in \mathbb{T}_\Sigma$, we have

$$\llbracket \text{NXT}_{\Sigma, \tilde{\gamma}, b} \rrbracket(\xi) = \begin{cases} b & \text{if } \xi \in L_{\Sigma, \tilde{\gamma}} \\ 0 & \text{otherwise} \end{cases} .$$

In particular, if $\Sigma^{(k)} = \emptyset$, then $L_{\Sigma, \tilde{\gamma}} = \emptyset$ and thus $\llbracket \text{NXT}_{\Sigma, \tilde{\gamma}, b} \rrbracket = \tilde{0}$. A weighted tree language of the form $\llbracket \text{NXT}_{\Sigma, \tilde{\gamma}, b} \rrbracket$ is called $(\Sigma, \tilde{\gamma}, b)$ -*next mapping* or simply *next mapping*.

I.S.: We distinguish four cases.

(a) Let $e_1, e_2 \in \text{RepEx}(\Sigma, \mathbf{B})$. We define $\llbracket e_1 + e_2 \rrbracket : \mathbb{T}_\Sigma \rightarrow B$ by $\llbracket e_1 + e_2 \rrbracket = \llbracket e_1 \rrbracket \oplus \llbracket e_2 \rrbracket$.

(b) Let $e_1, e_2 \in \text{RepEx}(\Sigma, \mathbf{B})$. We define $\llbracket e_1 \times e_2 \rrbracket : \mathbb{T}_\Sigma \rightarrow B$ by $\llbracket e_1 \times e_2 \rrbracket = \llbracket e_1 \rrbracket \otimes \llbracket e_2 \rrbracket$.

(c) Let $e \in \text{RepEx}(\Delta, \mathbf{B})$ and τ is a (Δ, Σ) -tree relabeling. We define $\llbracket \tau(e) \rrbracket : \mathbb{T}_\Sigma \rightarrow B$ by $\llbracket \tau(e) \rrbracket = \chi(\tau)(\llbracket e \rrbracket)$.

(d) Let $e \in \text{RepEx}(\Sigma, \mathbf{B})$. We define $\llbracket \text{REST}(e) \rrbracket : \mathbf{T}_\Sigma \rightarrow \mathbf{B}$ for each $\xi \in \mathbf{T}_\Sigma$ by

$$\llbracket \text{REST}(e) \rrbracket(\xi) = \bigotimes_{\substack{w \in \text{pos}(\xi) \\ \text{in } <_{\text{dp}} \text{ order}}} \llbracket e \rrbracket(\xi|_w) ,$$

i.e., the factors of the product are ordered by depth-first post-order $<_{\text{dp}}$ on $\text{pos}(\xi)$. The weighted tree language $\llbracket \text{REST}(e) \rrbracket$ is called the *restriction of $\llbracket e \rrbracket$* .

We extend the binary operation $+$ on the set of \mathbf{B} -expressions in the natural way to an operation with a finite set I of arguments e_i with $i \in I$, and we denote this expression by $\bigoplus_{i \in I} e_i$. The weighted tree language $\llbracket \bigoplus_{i \in I} e_i \rrbracket$ is well defined, because \oplus is associative and commutative.

Let $r : \mathbf{T}_\Sigma \rightarrow \mathbf{B}$ be a weighted tree language. We say that r is *elementary* if r is a root mapping or a next mapping. Since each of the Σ -tree languages $L_{\Sigma, \sigma}$ and $L_{\Sigma, \tilde{\gamma}}$ is recognizable, each elementary (Σ, \mathbf{B}) -weighted tree language is a (Σ, \mathbf{B}) -recognizable one-step mapping. The operations sum, Hadamard product, tree relabeling, and restriction (cf. (3)-(6), respectively) are called *elementary operations*.

A weighted tree language $r : \mathbf{T}_\Sigma \rightarrow \mathbf{B}$ is *representable* if there exists an $e \in \text{RepEx}(\Sigma, \mathbf{B})$ such that $r = \llbracket e \rrbracket$. The set of all representable (Σ, \mathbf{B}) -weighted tree languages is denoted by $\text{Rep}(\Sigma, \mathbf{B})$. Moreover, $\text{Rep}(_, \mathbf{B})$ denotes the set of all representable (Σ, \mathbf{B}) -weighted tree languages for some ranked alphabet Σ . Hence, $\text{Rep}(_, \mathbf{B})$ is the smallest set of \mathbf{B} -weighted tree languages which contains the elementary weighted tree languages and is closed under the elementary operations.

Next we give two examples of recognizable $(\Sigma, \text{Nat}_{\max, +})$ -weighted tree languages which are representable.

Example 16.1.1. We consider the ranked alphabet $\Sigma = \{\sigma^{(2)}, \gamma^{(1)}, \alpha^{(0)}\}$, the arctic semiring $\text{Nat}_{\max, +} = (\mathbb{N}_{-\infty}, \max, +, -\infty, 0)$, and the weighted tree language $\#_{\sigma^{(2)}, \alpha} : \mathbf{T}_\Sigma \rightarrow \mathbb{N}$ defined in Example 3.2.11. We recall that, for each $\xi \in \mathbf{T}_\Sigma$, the value $\#_{\sigma^{(2)}, \alpha}(\xi)$ is the number of occurrences of the pattern $\sigma^{(2)}, \alpha$ in ξ . In Example 3.2.12 we gave a bu-deterministic $(\Sigma, \text{Nat}_{\max, +})$ -wta \mathcal{A} such that $\llbracket \mathcal{A} \rrbracket(\xi) = \#_{\sigma^{(2)}, \alpha}(\xi)$ for each $\xi \in \mathbf{T}_\Sigma$.

Now we give a $\text{Nat}_{\max, +}$ -representation e such that $\llbracket e \rrbracket = \llbracket \mathcal{A} \rrbracket$. We define

$$e = \text{REST}\left(\left(\bigoplus_{\kappa \in \Sigma} \text{NXT}_{\Sigma, \kappa \alpha, 0}\right) \times \text{RT}_{\Sigma, \sigma, 1} + \bigoplus_{\kappa \in \Sigma} \text{RT}_{\Sigma, \kappa, 0}\right)$$

where we have assumed that \times has higher binding priority than $+$.

First, we observe that, for each $\xi \in \mathbf{T}_\Sigma$, we have $\llbracket \bigoplus_{\kappa \in \Sigma} \text{RT}_{\Sigma, \kappa, 0} \rrbracket(\xi) = 0$. Second, by using the abbreviation

$$e' = \left(\bigoplus_{\kappa \in \Sigma} \text{NXT}_{\Sigma, \kappa \alpha, 0}\right) \times \text{RT}_{\Sigma, \sigma, 1} ,$$

we prove by case analysis that,

$$\text{for each } \xi \in \mathbf{T}_\Sigma, \text{ we have } \llbracket e' \rrbracket(\xi) = \begin{cases} 1 & \text{if } \xi = \sigma(\xi', \alpha) \text{ for some } \xi' \in \mathbf{T}_\Sigma \\ -\infty & \text{otherwise .} \end{cases} \quad (16.2)$$

Case (a): Let $\xi(\varepsilon) = \alpha$. Then

$$\begin{aligned} \llbracket e' \rrbracket(\xi) &= \llbracket \bigoplus_{\kappa \in \Sigma} \text{NXT}_{\Sigma, \kappa \alpha, 0} \rrbracket(\xi) + \llbracket \text{RT}_{\Sigma, \sigma, 1} \rrbracket(\xi) \\ &= \llbracket \bigoplus_{\kappa \in \Sigma} \text{NXT}_{\Sigma, \kappa \alpha, 0} \rrbracket(\xi) + -\infty && \text{(because } \xi(\varepsilon) = \alpha) \\ &= -\infty . \end{aligned}$$

Case (b): Let $\xi(\varepsilon) = \gamma$. In a similar way as in Case (a), we can calculate that $\llbracket e' \rrbracket(\xi) = -\infty$.

Case (c): Let $\xi(\varepsilon) = \sigma$ and $\xi(2) \neq \alpha$. Then

$$\begin{aligned} \llbracket e' \rrbracket(\xi) &= \max(\llbracket \text{NXT}_{\Sigma, \sigma \alpha, 0} \rrbracket(\xi), \llbracket \text{NXT}_{\Sigma, \gamma \alpha, 0} \rrbracket(\xi), \llbracket \text{NXT}_{\Sigma, \alpha \alpha, 0} \rrbracket(\xi)) + \llbracket \text{RT}_{\Sigma, \sigma, 1} \rrbracket(\xi) \\ &= \max(-\infty, -\infty, -\infty) + 1 = -\infty . \end{aligned}$$

Case (d): Let $\xi(\varepsilon) = \sigma$, $\xi(2) = \alpha$, and $\xi(1) = \sigma$. Then

$$\begin{aligned} \llbracket e' \rrbracket(\xi) &= \max(\llbracket \text{NXT}_{\Sigma, \sigma \alpha, 0} \rrbracket(\xi), \llbracket \text{NXT}_{\Sigma, \gamma \alpha, 0} \rrbracket(\xi), \llbracket \text{NXT}_{\Sigma, \alpha \alpha, 0} \rrbracket(\xi)) + \llbracket \text{RT}_{\Sigma, \sigma, 1} \rrbracket(\xi) \\ &= \max(0, -\infty, -\infty) + 1 = 0 + 1 = 1 . \end{aligned}$$

Case (e): Let $\xi(\varepsilon) = \sigma$, $\xi(2) = \alpha$, and $\xi(1) = \gamma$. Then

$$\begin{aligned} \llbracket e' \rrbracket(\xi) &= \max(\llbracket \text{NXT}_{\Sigma, \sigma \alpha, 0} \rrbracket(\xi), \llbracket \text{NXT}_{\Sigma, \gamma \alpha, 0} \rrbracket(\xi), \llbracket \text{NXT}_{\Sigma, \alpha \alpha, 0} \rrbracket(\xi)) + \llbracket \text{RT}_{\Sigma, \sigma, 1} \rrbracket(\xi) \\ &= \max(-\infty, 0, -\infty) + 1 = 0 + 1 = 1 . \end{aligned}$$

Case (f): Let $\xi(\varepsilon) = \sigma$, $\xi(2) = \alpha$, and $\xi(1) = \alpha$. Then

$$\begin{aligned} \llbracket e' \rrbracket(\xi) &= \max(\llbracket \text{NXT}_{\Sigma, \sigma \alpha, 0} \rrbracket(\xi), \llbracket \text{NXT}_{\Sigma, \gamma \alpha, 0} \rrbracket(\xi), \llbracket \text{NXT}_{\Sigma, \alpha \alpha, 0} \rrbracket(\xi)) + \llbracket \text{RT}_{\Sigma, \sigma, 1} \rrbracket(\xi) \\ &= \max(-\infty, -\infty, 0) + 1 = 0 + 1 = 1 . \end{aligned}$$

This proves (16.2).

Hence, for each $\xi \in T_{\Sigma}$, we have

$$\llbracket e' + \bigoplus_{\kappa \in \Sigma} \text{RT}_{\Sigma, \kappa, 0} \rrbracket(\xi) = \begin{cases} 1 & \text{if } \xi = \sigma(\xi', \alpha) \text{ for some } \xi' \in T_{\Sigma} \\ 0 & \text{otherwise .} \end{cases} \quad (16.3)$$

Finally, for each $\xi \in T_{\Sigma}$, we can calculate as follows:

$$\begin{aligned} \llbracket e \rrbracket(\xi) &= \llbracket \text{REST}(e' + \bigoplus_{\kappa \in \Sigma} \text{RT}_{\Sigma, \kappa, 0}) \rrbracket(\xi) = \bigoplus_{w \in \text{pos}(\xi)} \llbracket e' + \bigoplus_{\kappa \in \Sigma} \text{RT}_{\Sigma, \kappa, 0} \rrbracket(\xi|_w) \\ &= \bigoplus_{\substack{w \in \text{pos}(\xi): \\ \xi(w) = \sigma, \xi(w2) = \alpha}} 1 && \text{(by (16.3))} \\ &= \#_{\sigma(\cdot, \alpha)}(\xi) . && \square \end{aligned}$$

Example 16.1.2. We consider the ranked alphabet $\Sigma = \{\sigma^{(2)}, \alpha^{(0)}\}$, the arctic semiring $\text{Nat}_{\max, +} = (\mathbb{N}_{-\infty}, \max, +, -\infty, 0)$, and the weighted tree language height $: T_{\Sigma} \rightarrow \mathbb{N}$. In Example 3.2.4 we gave a $(\Sigma, \text{Nat}_{\max, +})$ -wta \mathcal{A} such that $\llbracket \mathcal{A} \rrbracket^{\text{run}} = \text{height}$. The definition of \mathcal{A} was based on the fact that

$$\text{for each } \xi \in T_{\Sigma}, \text{ we have } \text{height}(\xi) = \max_{w \in \text{pos}_{\alpha}(\xi)} |w|.$$

Then, roughly speaking, the max on the right-hand side matches with the operation max of the semiring, which is used in the definition of the run semantics.

Now we give a $\text{Nat}_{\max, +}$ -representation e such that $\llbracket e \rrbracket = \text{height}$. For this, we will use the fact that

$$\text{for each } \xi \in T_{\Sigma}, \text{ we have } \text{height}(\xi) = \max_{w \in \text{pos}(\xi)} |w|.$$

Here the max is taken over all the positions of ξ (and not only over the α -labeled ones).

Intuitively, for a given position $w \in \text{pos}(\xi)$, we will mark the positions on the path from the root of ξ down to w by an additional symbol $\#$. For this, we define

- the ranked alphabet $\Sigma_{\#}$ for each $k \in \mathbb{N}$ by $(\Sigma_{\#})^{(k)} = \{(\sigma, \#) \mid \sigma \in \Sigma^{(k)}\}$ and
- the ranked alphabet Δ for each $k \in \mathbb{N}$ by $\Delta^{(k)} = \Sigma^{(k)} \cup (\Sigma_{\#})^{(k)}$.

In the set T_{Δ} there are particular trees which are of interest for us: the $\#$ -marked symbols occur exactly on a path from the root to some position. Formally, let $\zeta \in T_{\Delta}$. We say that ζ *shows a path* if, there exists $w \in \text{pos}(\zeta)$ such that, for each $v \in \text{prefix}(w)$, we have $\zeta(v) \in \Sigma_{\#}$ and, for each $v \in \text{pos}(\zeta) \setminus \text{prefix}(w)$, we have $\zeta(v) \in \Sigma$. If ζ shows a path, then the position w which satisfies the above condition is uniquely determined. We denote this position by w_{ζ} .

The marking is done by the inverse of a tree relabeling. We define the (Δ, Σ) -tree relabeling $\tau = (\tau_k \mid k \in \mathbb{N})$ for each $k \in \mathbb{N}$ and $\kappa \in \Delta^{(k)}$ as follows:

$$\tau_k(\kappa) = \begin{cases} \sigma & \text{if } \kappa = (\sigma, \#) \text{ for some } \sigma \in \Sigma^{(k)} \\ \kappa & \text{if } \kappa \in \Sigma^{(k)}. \end{cases}$$

Intuitively, τ drops $\#$. It is easy to see that, for each $\xi \in T_{\Sigma}$,

$$\text{the sets } \text{pos}(\xi) \text{ and } \{\zeta \mid \zeta \in \tau^{-1}(\xi), \zeta \text{ shows a path}\} \text{ are in a one-to-one correspondence.} \quad (16.4)$$

We define the $\text{Nat}_{\max,+}$ -representation

$$e = \tau(\text{REST}(f) + g)$$

where

- $f = f_1 + f_2 + f_3$
- $f_1 = \bigoplus_{k \in \mathbb{N}, \sigma \in \Sigma^{(k)}, \tilde{\gamma} \in \Sigma^k} (\text{RT}_{\Delta, \sigma, 0} \times \text{NXT}_{\Delta, \tilde{\gamma}, 0})$,
- $f_2 = \bigoplus_{k \in \mathbb{N}, \sigma \in \Sigma^{(k)}, i \in [k], \tilde{\gamma} \in \Sigma^k} (\text{RT}_{\Delta, (\sigma, \#), 1} \times \text{NXT}_{\Delta, \tilde{\gamma}, 0})$
- $f_3 = \bigoplus_{k \in \mathbb{N}, \sigma \in \Sigma^{(k)}, i \in [k], \tilde{\gamma} \in \Sigma^{i-1}(\Sigma_{\#})\Sigma^{k-i}} (\text{RT}_{\Delta, (\sigma, \#), 1} \times \text{NXT}_{\Delta, \tilde{\gamma}, 0})$
- $g = \bigoplus_{\kappa \in \Delta} \text{RT}_{\Delta, \kappa, 0}$

Intuitively, the combinations of root mappings and next mappings in f_1 , f_2 , and f_3 guarantee that $\text{supp}(\llbracket \text{REST}(f) \rrbracket) \subseteq \{\zeta \in T_{\Delta} \mid \zeta \text{ shows a path}\}$.

Then the following statements are easy to see.

$$\text{For each } \zeta \in T_{\Delta}, \text{ we have } \llbracket \text{REST}(f) \rrbracket(\zeta) = \begin{cases} |w_{\zeta}| & \text{if } \zeta \text{ shows a path} \\ -\infty & \text{otherwise} \end{cases} \quad (16.5)$$

$$\text{For each } \zeta \in T_{\Delta}, \text{ we have } \llbracket g \rrbracket(\zeta) = 0. \quad (16.6)$$

As combination of (16.5) and (16.6), we obtain:

$$\text{For each } \zeta \in T_{\Delta}, \text{ we have } \llbracket \text{REST}(f) + g \rrbracket(\zeta) = \begin{cases} |w_{\zeta}| & \text{if } \zeta \text{ shows a path} \\ 0 & \text{otherwise} \end{cases} \quad (16.7)$$

Then we can calculate, for each $\xi \in T_{\Sigma}$, as follows:

$$\begin{aligned} \llbracket e \rrbracket(\xi) &= \max_{\zeta \in \tau^{-1}(\xi)} \llbracket \text{REST}(f) + g \rrbracket(\zeta) \\ &= \max_{\substack{\zeta \in \tau^{-1}(\xi): \\ \zeta \text{ shows a path}}} |w_{\zeta}| \quad (\text{by (16.7) and the fact that } \tau^{-1}(\xi) \text{ contains a tree which shows a path}) \\ &= \max_{w \in \text{pos}(\xi)} |w| \quad (\text{by (16.4)}) \\ &= \text{height}(\xi) . \end{aligned}$$

□

It turns out that each recognizable (Σ, \mathbf{B}) -weighted tree language is representable, but not vice versa as the next example shows.

Example 16.1.3. [Her20b, Ex. 5.2.1] We consider the string ranked alphabet $\Sigma = \{\gamma^{(1)}, \alpha^{(0)}\}$ and the semiring $\mathbf{Nat} = (\mathbb{N}, +, \cdot, 0, 1)$ of natural numbers. Moreover, we let $r : T_\Sigma \rightarrow \mathbb{N}$ such that $r(\gamma^n(\alpha)) = 2^{(n+1)^2}$ for each $n \in \mathbb{N}$.

We show that there does not exist a (Σ, \mathbf{Nat}) -wta \mathcal{A} such that $\llbracket \mathcal{A} \rrbracket = r$. For this, we assume that there exists such a (Σ, \mathbb{N}) -wta. Then, by Lemma 3.5.6, there exists $K \in \mathbb{N}$ such that, for each $n \in \mathbb{N}$, we have $\llbracket \mathcal{A} \rrbracket(\gamma^n(\alpha)) = \llbracket e \rrbracket(\gamma^n(\alpha)) = 2^{(n+1)^2} \leq K^{n+1}$. However, this is a contradiction, because if n is big enough, then $2^{(n+1)^2} > K^{n+1}$.

Next we consider the \mathbb{N} -representation

$$e = \text{REST}(\text{RT}_{\Sigma, \gamma, 2} + \text{RT}_{\Sigma, \alpha, 2}) \times \text{REST}(\text{REST}(\text{RT}_{\Sigma, \gamma, 4} + \text{RT}_{\Sigma, \alpha, 1}))$$

Let $n \in \mathbb{N}$. Then we can calculate as follows (where we denote by \prod the extension of the binary operation \cdot to finite numbers of arguments):

$$\begin{aligned} & \llbracket \text{REST}(\text{RT}_{\Sigma, \gamma, 2} + \text{RT}_{\Sigma, \alpha, 2}) \rrbracket(\gamma^n(\alpha)) \\ &= \prod_{w \in \text{pos}(\xi)} \llbracket \text{RT}_{\Sigma, \gamma, 2} + \text{RT}_{\Sigma, \alpha, 2} \rrbracket(\gamma^n(\alpha)|_w) \quad (\text{note that } \cdot \text{ is commutative}) \\ &= \llbracket \text{RT}_{\Sigma, \gamma, 2} + \text{RT}_{\Sigma, \alpha, 2} \rrbracket(\alpha) \cdot \prod_{w \in \text{pos}(\xi) \setminus \{1^n\}} \llbracket \text{RT}_{\Sigma, \gamma, 2} + \text{RT}_{\Sigma, \alpha, 2} \rrbracket(\gamma^n(\alpha)|_w) \\ &= \llbracket \text{RT}_{\Sigma, \alpha, 2} \rrbracket(\alpha) \cdot \prod_{w \in \text{pos}(\xi) \setminus \{1^n\}} \llbracket \text{RT}_{\Sigma, \gamma, 2} \rrbracket(\gamma^n(\alpha)|_w) \\ &= 2 \cdot \prod_{w \in \text{pos}(\xi) \setminus \{1^n\}} 2 = 2^{n+1} . \end{aligned}$$

In a similar way we can calculate that $\llbracket \text{REST}(\text{RT}_{\Sigma, \gamma, 4} + \text{RT}_{\Sigma, \alpha, 1}) \rrbracket(\gamma^n(\alpha)) = 4^n$. Using Gaussian sum, we have

$$\begin{aligned} \text{REST}(\text{REST}(\text{RT}_{\Sigma, \gamma, 4} + \text{RT}_{\Sigma, \alpha, 1}))(\gamma^n(\alpha)) &= \prod_{w \in \text{pos}(\xi)} \text{REST}(\text{RT}_{\Sigma, \gamma, 4} + \text{RT}_{\Sigma, \alpha, 1})(\gamma^n(\alpha)|_w) \\ &= 1 \cdot 4^1 \cdot 4^2 \cdot \dots \cdot 4^n = 4^{\frac{n^2+n}{2}} = 2^{n^2+n} . \end{aligned}$$

Finally, $\llbracket e \rrbracket(\gamma^n(\alpha)) = 2^{n+1} \cdot 2^{n^2+n} = 2^{(n+1)^2}$. \square

Hence, for a characterization of $\text{Rec}(\Sigma, \mathbf{B})$ in terms of representations, we have to restrict the set $\text{Rep}(\Sigma, \mathbf{B})$ (cf. [Her20b, Sec. 5.2]). We define the restriction in a purely syntactic way (in contrast to [Her17, Her20b]). In fact, we define two restrictions: restricted representations and \times -restricted representations. Intuitively,

- in a restricted representation, (a) REST must not occur nested and (b) each tree relabeling occurring in a subexpression of the form REST(e) must be non-overlapping, and
- a \times -restricted representation is a restricted representation such that, in each subexpression of the form $e_1 \times e_2$, there exists at least one $i \in \{1, 2\}$ such that e_i does not contain REST and each tree relabeling in e_i is non-overlapping.

Formally, let $\text{RepEx}^r(\mathbf{B})$ be the subset of $\text{RepEx}(\mathbf{B})$ generated by the following EBNF; it uses the infinite family $(e_\Sigma^r \mid \Sigma \text{ ranked alphabet}) \cup (f_\Sigma^r \mid \Sigma \text{ ranked alphabet})$ of nonterminals, each e_Σ^r is an initial nonterminal, and for every nonterminals e_Σ^r and f_Σ^r it has the following rules:

$$\begin{aligned} e_\Sigma^r &::= \text{RT}_{\Sigma, \sigma, b} \mid \text{NXT}_{\Sigma, \tilde{\gamma}, b} \mid e_\Sigma^r + e_\Sigma^r \mid e_\Sigma^r \times e_\Sigma^r \mid \tau(e_\Delta^r) \mid \text{REST}(f_\Sigma^r) \\ f_\Sigma^r &::= \text{RT}_{\Sigma, \sigma, b} \mid \text{NXT}_{\Sigma, \tilde{\gamma}, b} \mid f_\Sigma^r + f_\Sigma^r \mid f_\Sigma^r \times f_\Sigma^r \mid \tau'(f_\Delta^r) \end{aligned} \quad (16.8)$$

where $\sigma \in \Sigma$, $\tilde{\gamma} \in \Sigma^k$ for some $k \in \mathbb{N}_+$, $b \in B$, τ is a (Δ, Σ) -tree relabeling, and τ' is a non-overlapping (Δ, Σ) -tree relabeling. We call each element of $\text{RepEx}^r(\mathbf{B})$ a *restricted representation*.

Let $\text{RepEx}^{\times r}(\mathbf{B})$ be the subset of $\text{RepEx}^r(\mathbf{B})$ generated by the following EBNF; it uses the infinite family $(e_{\Sigma}^{\times r} \mid \Sigma \text{ ranked alphabet}) \cup (f_{\Sigma}^r \mid \Sigma \text{ ranked alphabet})$ of nonterminals, each $e_{\Sigma}^{\times r}$ is an initial non-terminal, and for every nonterminals $e_{\Sigma}^{\times r}$ and f_{Σ}^r it has the following rules:

$$\begin{aligned} e_{\Sigma}^{\times r} &::= \text{RT}_{\Sigma, \sigma, b} \mid \text{NXT}_{\Sigma, \tilde{\gamma}, b} \mid e_{\Sigma}^{\times r} + e_{\Sigma}^{\times r} \mid e_{\Sigma}^{\times r} \times f_{\Sigma}^r \mid f_{\Sigma}^r \times e_{\Sigma}^{\times r} \mid f_{\Sigma}^r \times f_{\Sigma}^r \mid \tau(e_{\Delta}^{\times r}) \mid \text{REST}(f_{\Sigma}^r) \\ f_{\Sigma}^r &::= \text{RT}_{\Sigma, \sigma, b} \mid \text{NXT}_{\Sigma, \tilde{\gamma}, b} \mid f_{\Sigma}^r + f_{\Sigma}^r \mid f_{\Sigma}^r \times f_{\Sigma}^r \mid \tau'(f_{\Delta}^r) \end{aligned} \quad (16.9)$$

where $\sigma \in \Sigma$, $\tilde{\gamma} \in \Sigma^k$ for some $k \in \mathbb{N}_+$, $b \in B$, τ is a (Δ, Σ) -tree relabeling, and τ' is a non-overlapping (Δ, Σ) -tree relabeling. We call each element of $\text{RepEx}^{\times r}(\mathbf{B})$ a \times -*restricted representation*. We note that the rules for the nonterminals f_{Σ}^r in (16.8) and (16.9) are identical. Clearly, $\text{RepEx}^{\times r}(\mathbf{B}) \subset \text{RepEx}^r(\mathbf{B}) \subset \text{RepEx}(\mathbf{B})$.

A weighted tree language $r : T_{\Sigma} \rightarrow B$ is *restricted representable* (and \times -*restricted representable*) if there exists an $e \in \text{RepEx}^r(\Sigma, \mathbf{B})$ (and an $e \in \text{RepEx}^{\times r}(\Sigma, \mathbf{B})$, respectively) such that $r = \llbracket e \rrbracket$.

We remark that, in [Her17, Her20b], restricted representations are defined in a less strict way as here: a representation e is restricted in the sense of [Her17, Her20b] if, whenever e contains a subexpression of the form $\text{REST}(e')$, then $\llbracket e' \rrbracket$ is a recognizable step mapping (and similarly for \times -restricted representations). Thus, in particular, such a restricted representation may contain nested occurrences of REST (which is not possible in our definition of restricted representation). The expressive power of both forms of restricted representations is equal: they characterize the class of run recognizable weighted tree languages. The variant which we defined above has the advantage that the corresponding characterization result (cf. Theorem 16.2.1) is constructive. The constructivity is guaranteed by the next corollary (and by the constructivity of a number of closure results).

Corollary 16.1.4. Let $e \in \text{RepEx}^r(\Sigma, \mathbf{B})$ be generated by the nonterminal f_{Σ}^r using the rules in (16.8). Then we can construct $n \in \mathbb{N}_+$, $b_1, \dots, b_n \in B$, and Σ -fta A_1, \dots, A_n such that $\llbracket e \rrbracket = \bigoplus_{i \in [n]} b_i \cdot \chi(L(A_i))$. Thus, in particular, $\llbracket e \rrbracket$ is a recognizable step mapping.

Proof. We prove the statement by induction on $(\text{RepEx}(\mathbf{B})', \succ')$, where $\text{RepEx}(\mathbf{B})'$ is the set of all representations which can be generated by nonterminals of the form f_{Σ}^r using the rules in (16.8), and $\succ' = \succ \upharpoonright_{\text{RepEx}(\mathbf{B})' \times \text{RepEx}(\mathbf{B})'}$.

I.B.: For each $e \in \text{RepEx}(\mathbf{B})'$ of the form $e = \text{RT}_{\Sigma, \sigma, b}$ or $e = \text{NXT}_{\Sigma, \tilde{\gamma}, b}$, we can easily construct the Σ -fta $A_{\Sigma, \sigma}$ and $A_{\Sigma, \tilde{\gamma}}$ such that $L(A_{\Sigma, \sigma}) = L_{\Sigma, \sigma}$ and $L(A_{\Sigma, \tilde{\gamma}}) = L_{\Sigma, \tilde{\gamma}}$. Then $\llbracket \text{RT}_{\Sigma, \sigma, b} \rrbracket = b \cdot \chi(L(A_{\Sigma, \sigma}))$ and $\llbracket \text{NXT}_{\Sigma, \tilde{\gamma}, b} \rrbracket = b \cdot \chi(L(A_{\Sigma, \tilde{\gamma}}))$.

I.S.: It follows from I.H., Theorem 10.3.1(B) \Rightarrow (A), and

- Theorem 10.1.1(2) (for the sum),
- Theorem 10.4.1(3) (for the Hadamard product), and
- Theorem 10.10.1 (for the non-overlapping tree relabeling). □

For instance, the $\text{Nat}_{\max, +}$ -representation

$$e = \text{REST}\left(\left(\bigoplus_{\kappa \in \Sigma} \text{NXT}_{\Sigma, \kappa \alpha, 0}\right) \times \text{RT}_{\Sigma, \sigma, 1} + \bigoplus_{\kappa \in \Sigma} \text{RT}_{\Sigma, \kappa, 0}\right)$$

shown in Example 16.1.1 is \times -restricted.

For each semiring \mathbf{B} , we will prove that the class of (Σ, \mathbf{B}) -recognizable weighted tree languages can be characterized by \times -restricted representations (cf. Theorem 16.2.1). On the other hand, for each commutative semiring \mathbf{B} , the class $\text{Rec}(\Sigma, \mathbf{B})$ is characterized by polynomials and rational operations (cf. Theorem 15.1.2). Thus, one might ask how the Kleene stars are expressed in terms of \times -restricted representations. In the next example, we illustrate this possibility in an ad hoc way.

Example 16.1.5. We consider the alphabet $\Gamma = \{a, b\}$ and the string ranked alphabet $\Gamma_e = \{a^{(1)}, b^{(1)}, e^{(0)}\}$. Moreover, we consider the arctic semiring $\mathbf{Nat}_{\max,+} = (\mathbb{N}_{-\infty}, \max, +, -\infty, 0)$. We would like to construct a restricted representation $f \in \text{RepEx}(\Sigma, \mathbf{Nat}_{\max,+})$ such that

$$\llbracket f \rrbracket = (1.a(b(e)))_e^*$$

i.e., $\llbracket f \rrbracket$ is the e -Kleene star of the polynomial $1.a(b(e))$. Recall that, by (10.24), for each $\xi \in \mathbb{T}_{\Gamma_e}$, we have

$$(1.a(b(e)))_e^*(\xi) = \begin{cases} |\text{pos}_a(\xi)| & \text{if there exists } n \in \mathbb{N} \text{ such that } \xi = \text{tree}_e((ab)^n) \\ -\infty & \text{otherwise,} \end{cases}$$

where $\text{tree}_e : \Gamma^* \rightarrow \mathbb{T}_{\Gamma_e}$ is the bijection defined on page 51. In particular, $(1.a(b(e)))_e^*(\text{tree}_e((ab)^n)) = n$ for each $n \in \mathbb{N}$ and, e.g., $(1.a(b(e)))_e^*(a(a(e))) = -\infty$.

For this purpose, we propose the $\mathbf{Nat}_{\max,+}$ -representation

$$f = (\text{RT}_{\Gamma_e,a,0} + \text{RT}_{\Gamma_e,e,0}) \times \text{REST}(h) \quad \text{with}$$

$$h = (\text{RT}_{\Gamma_e,a,1} \times \text{NXT}_{\Gamma_e,b,0}) + (\text{RT}_{\Gamma_e,b,0} \times \text{NXT}_{\Gamma_e,a,0}) + (\text{RT}_{\Gamma_e,b,0} \times \text{NXT}_{\Gamma_e,e,0}) + \text{RT}_{\Gamma_e,e,0} .$$

Clearly, f is \times -restricted. We claim that $\llbracket f \rrbracket = (1.a(b(e)))_e^*$.

Let $\xi \in \mathbb{T}_{\Gamma_e}$.

$$\begin{aligned} \llbracket f \rrbracket(\xi) &= \max(\llbracket \text{RT}_{\Gamma_e,a,0} \rrbracket(\xi), \llbracket \text{RT}_{\Gamma_e,e,0} \rrbracket(\xi)) + \bigoplus_{w \in \text{pos}(\xi)} \llbracket h \rrbracket(\xi|_w) \\ &= \max(\llbracket \text{RT}_{\Gamma_e,a,0} \rrbracket(\xi), \llbracket \text{RT}_{\Gamma_e,e,0} \rrbracket(\xi)) + \bigoplus_{w \in \text{pos}_a(\xi)} \llbracket h \rrbracket(\xi|_w) + \bigoplus_{w \in \text{pos}_b(\xi)} \llbracket h \rrbracket(\xi|_w) + \bigoplus_{w \in \text{pos}_e(\xi)} \llbracket h \rrbracket(\xi|_w) \\ &\hspace{15em} \text{(since } + \text{ is commutative)} \\ &= \begin{cases} 0 & \text{if } \xi(\varepsilon) \in \{a, e\} \\ -\infty & \text{otherwise} \end{cases} \\ &\quad + \begin{cases} |\text{pos}_a(\xi)| & \text{if, for every } w \in \text{pos}_a(\xi): \xi(w1) = b \\ -\infty & \text{otherwise} \end{cases} \\ &\quad + \begin{cases} 0 & \text{if, for every } w \in \text{pos}_b(\xi): \xi(w1) = a \text{ or } \xi(w1) = e \\ -\infty & \text{otherwise} \end{cases} \\ &\quad + 0 \\ &= \begin{cases} |\text{pos}_a(\xi)| & \text{if } \xi(\varepsilon) \in \{a, e\} \text{ and for every } w \in \text{pos}(\xi): \\ & (\xi(w) = a \text{ implies } \xi(w1) = b) \text{ and} \\ & (\xi(w) = b \text{ implies } (\xi(w1) = a \text{ or } \xi(w1) = e)) \\ -\infty & \text{otherwise} \end{cases} \\ &= \begin{cases} |\text{pos}_a(\xi)| & \text{if there exists } n \in \mathbb{N} \text{ such that } \xi = \text{tree}_e((ab)^n) \\ -\infty & \text{otherwise} . \end{cases} \end{aligned}$$

Hence f is the desired $\mathbf{Nat}_{\max,+}$ -representation. \square

16.2 The main result for $\text{RepEx}(\Sigma, \mathbb{B})$ over semirings

Now we can formulate the first main result of this chapter: the Médvédjév characterization of wta over semirings.

Theorem 16.2.1. (cf. [Her17, Thm. 6] and [Her20b, Thm. 5.2.2]) *Let Σ be a ranked alphabet. Moreover, let $\mathbf{B} = (B, \oplus, \otimes, \mathbb{0}, \mathbb{1})$ be a semiring and let $r : T_\Sigma \rightarrow B$. Then the following two statements are equivalent.*

- (A) *We can construct a (Σ, \mathbf{B}) -wta \mathcal{A} such that $\llbracket \mathcal{A} \rrbracket = r$.*
- (B) *We can construct an $e \in \text{RepEx}^{\times r}(\Sigma, \mathbf{B})$ such that $\llbracket e \rrbracket = r$.*

Moreover, if \mathbf{B} is commutative, then (A) and (B) are equivalent to:

- (C) *We can construct an $e \in \text{RepEx}^r(\Sigma, \mathbf{B})$ such that $\llbracket e \rrbracket = r$.*

The proof of this theorem follows from Lemmas 16.2.3 and 16.2.5, which will be shown in the next two sections.

We note that in [Her17] and [Her20a, Sect. 5.3], a comparison between representable weighted tree languages and weighted tree languages defined by the weighted MSO-logic of [DG05, DG07, DG09] has been started.

16.2.1 From recognizable to restricted representable

Since each wta can be decomposed into a deterministic tree relabeling and a weighted local system (cf. Theorem 11.2.6) and the set $\text{Rep}(_, \mathbf{B})$ is closed under tree relabelings (by definition), we first prove that each weighted tree language determined by a weighted local system is \times -restricted representable.

Lemma 16.2.2. Let \mathcal{S} be a (Σ, \mathbf{B}) -wls. Then we can construct an $e \in \text{RepEx}^{\times r}(\Sigma, \mathbf{B})$ such that $\llbracket e \rrbracket = \llbracket \mathcal{S} \rrbracket$.

Proof. Let $\mathcal{S} = (g, F)$ be a (Σ, \mathbf{B}) -wls. The idea for the construction of $e \in \text{RepEx}^{\times r}(\Sigma, \mathbf{B})$ is to simulate the weight $g_k((\sigma_1 \cdots \sigma_k, \sigma))$ of the fork $(\sigma_1 \cdots \sigma_k, \sigma)$ by the representation $\text{NXT}_{\Sigma, \sigma_1 \cdots \sigma_k, \mathbb{1}} \times \text{RT}_{\Sigma, \sigma, g_k(\sigma_1 \cdots \sigma_k, \sigma)}$ if $k \geq 1$, and by the representation $\text{RT}_{\Sigma, \sigma, g_0(\varepsilon, \sigma)}$ if $k = 0$.

Formally, we define the \mathbf{B} -representation $e = \text{REST}(e_1 + e_2) \times e_3$ where

$$e_1 = \bigoplus_{\sigma \in \Sigma^{(0)}} \text{RT}_{\Sigma, \sigma, g_0(\varepsilon, \sigma)} \quad \text{and} \quad e_2 = \bigoplus_{\substack{k \geq 1, \sigma \in \Sigma^{(k)} \\ \sigma_1, \dots, \sigma_k \in \Sigma}} (\text{NXT}_{\Sigma, \sigma_1 \cdots \sigma_k, \mathbb{1}} \times \text{RT}_{\Sigma, \sigma, g_k(\sigma_1 \cdots \sigma_k, \sigma)})$$

$$\text{and} \quad e_3 = \bigoplus_{\sigma \in \Sigma} \text{RT}_{\Sigma, \sigma, F(\sigma)} .$$

It is easy to see that e is \times -restricted. It remains to show that $\llbracket \mathcal{S} \rrbracket = \llbracket e \rrbracket$. Obviously,

$$\text{for every } \xi \in T_\Sigma, \text{ we have } \llbracket e_3 \rrbracket(\xi) = F(\xi(\varepsilon)). \quad (16.10)$$

Moreover,

$$\text{for every } \xi \in T_\Sigma \text{ and } w \in \text{pos}(\xi), \text{ we have} \quad (16.11)$$

$$\llbracket e_1 + e_2 \rrbracket(\xi|_w) = g_{\text{rk}(\xi(w))}(\xi(w_1) \cdots \xi(w_{\text{rk}(\xi(w))}), \xi(w)).$$

Then, for each $\xi \in T_\Sigma$, we can calculate as follows.

$$\begin{aligned} \llbracket \text{REST}(e_1 + e_2) \times e_3 \rrbracket(\xi) &= \left(\bigotimes_{\substack{w \in \text{pos}(\xi), \\ \text{in } <_{\text{dp}} \text{ order}}} \llbracket e_1 + e_2 \rrbracket(\xi|_w) \right) \otimes \llbracket e_3 \rrbracket(\xi) \\ &= \left(\bigotimes_{\substack{w \in \text{pos}(\xi), \\ \text{in } <_{\text{dp}} \text{ order}}} g_{\text{rk}(\xi(w))}(\xi(w_1) \cdots \xi(w_{\text{rk}(\xi(w))}), \xi(w)) \right) \otimes \llbracket e_3 \rrbracket(\xi) \quad (\text{by (16.11)}) \\ &= g(\xi) \otimes F(\xi(\varepsilon)) \quad (\text{by definition of } g \text{ and (16.10)}) \\ &= \llbracket \mathcal{S} \rrbracket(\xi) . \quad \square \end{aligned}$$

Lemma 16.2.3. (cf. [Her17, Lm. 12] and [Her20b, Thm. 5.2.8]) Let \mathcal{A} be a (Σ, \mathbf{B}) -wta. Then we can construct an $e \in \text{RepEx}^{\times r}(\Sigma, \mathbf{B})$ such that $\llbracket \mathcal{A} \rrbracket^{\text{run}} = \llbracket e \rrbracket$.

Proof. By Theorem 11.2.6, we can construct a ranked alphabet Θ , a deterministic (Θ, Σ) -tree relabeling τ , and a (Θ, \mathbf{B}) -weighted local system \mathcal{S} with identity root weights such that $\llbracket \mathcal{A} \rrbracket^{\text{run}} = \chi(\tau)(\llbracket \mathcal{S} \rrbracket)$. By Lemma 16.2.2, we can construct an $e' \in \text{RepEx}^{\times r}(\Theta, \mathbf{B})$ such that $\llbracket e' \rrbracket = \llbracket \mathcal{S} \rrbracket$. Since e' is a \times -restricted representation, also $\tau(e')$ is a \times -restricted representation. Moreover, $\llbracket \mathcal{A} \rrbracket^{\text{run}} = \chi(\tau)(\llbracket \mathcal{S} \rrbracket) = \chi(\tau)(\llbracket e' \rrbracket) = \llbracket \tau(e') \rrbracket$. Thus we can choose $e = \tau(e')$. \square

16.2.2 From restricted representable to recognizable

Here we prove that each \times -restricted representable weighted tree language is recognizable; moreover, if \mathbf{B} is commutative, then each restricted representable weighted tree language is recognizable (cf. Lemma 16.2.5). As to be expected, the proof is by induction on the structure of representations.

We start with a lemma which shows the effect of the restriction of recognizable step mappings. One might compare the construction of this lemma with the one of [DV06, Lm. 5.5] (based in [DG07, Lm. 4.4]) in which the following is proved for a formula φ of weighted monadic second order logic: if $\llbracket \varphi \rrbracket$ is a recognizable step mapping, then $\llbracket \forall x. \varphi \rrbracket$ is recognizable (cf. Lemma 17.4.17).

Lemma 16.2.4. (cf. [Her17, Lm. 10] and [Her20b, Lm. 5.2.5]) Let $e \in \text{RepEx}(\Sigma, \mathbf{B})$ such that there exists a crisp-deterministic (Σ, \mathbf{B}) -wta with $\llbracket \mathcal{A} \rrbracket = \llbracket e \rrbracket$. We can construct a (Σ, \mathbf{B}) -wta \mathcal{B} such that $\llbracket \mathcal{B} \rrbracket^{\text{run}} = \llbracket \text{REST}(e) \rrbracket$.

Proof. By Lemma 4.1.5, for each $\xi \in \text{T}_\Sigma$, there exists $q \in Q$ such that $Q_{\neq 0}^{\text{R}_\mathcal{A}(\xi)} = \{q\}$ and there exists exactly one $\rho \in \text{R}_\mathcal{A}(q, \xi)$ such that $\text{wt}_\mathcal{A}(\xi, \rho) \neq 0$ and for this ρ we have $\text{wt}_\mathcal{A}(\xi, \rho) = 1$. We denote this unique run by ρ_ξ . Thus,

$$\begin{aligned} &\text{for every } \xi \in \text{T}_\Sigma \text{ and } w \in \text{pos}(\xi), \text{ we have} \\ &\delta_{\text{rk}(\xi(w))}(\rho_\xi(w1) \cdots \rho_\xi(w \text{rk}(\xi(w))), \xi(w), \rho_\xi(w)) = 1 \text{ and } \text{wt}_\mathcal{A}(\xi|_w, (\rho_\xi)|_w) = 1. \end{aligned} \quad (16.12)$$

Hence,

$$\text{for every } \xi \in \text{T}_\Sigma \text{ and } w \in \text{pos}(\xi), \text{ we have } \llbracket \mathcal{A} \rrbracket(\xi|_w) = F_{\rho_\xi(w)}. \quad (16.13)$$

We construct the (Σ, \mathbf{B}) -wta \mathcal{B} such that $\llbracket \mathcal{B} \rrbracket^{\text{run}} = \llbracket \text{REST}(e) \rrbracket$ using the following idea. On a given input tree ξ , the wta \mathcal{B} simulates the state behaviour of \mathcal{A} and, at each position w of ξ , the weight of the transition t which \mathcal{A} applies at w , is the product of $\delta_k(t) \in \{0, 1\}$ (where $k = \text{rk}(\xi(w))$) and the root weight of the target state of t . Formally, we let $\mathcal{B} = (Q, \delta', F')$ with $(F')_q = 1$ for each $q \in Q$, and for every $k \in \mathbb{N}$, $\sigma \in \Sigma^{(k)}$, and $q, q_1, \dots, q_k \in Q$ we let

$$(\delta')_k(q_1 \cdots q_k, \sigma, q) = \delta_k(q_1 \cdots q_k, \sigma, q) \otimes F_q.$$

We recall that $\delta_k(q_1 \cdots q_k, \sigma, q) \in \{0, 1\}$. Obviously, \mathcal{B} is bu-deterministic, but it is not crisp-deterministic, and not even total (because \mathbf{B} need not be zero-divisor free). Also, for each $\xi \in \text{T}_\Sigma$, we have $\text{R}_\mathcal{A}(\xi) = \text{R}_\mathcal{B}(\xi)$ and

$$\text{for each } \rho \in \text{R}_\mathcal{B}(\xi): \text{ if } \rho \neq \rho_\xi, \text{ then } \text{wt}_\mathcal{B}(\xi, \rho) = 0. \quad (16.14)$$

Then, for each $\xi \in \text{T}_\Sigma$, we can calculate as follows:

$$\begin{aligned} \llbracket \mathcal{B} \rrbracket^{\text{run}}(\xi) &= \bigoplus_{\rho \in \text{R}_\mathcal{B}(\xi)} \text{wt}_\mathcal{B}(\xi, \rho) \otimes (F')_{\rho(\varepsilon)} \\ &= \text{wt}_\mathcal{B}(\xi, \rho_\xi) && \text{(by (16.14))} \\ &= \bigotimes_{\substack{w \in \text{pos}(\xi) \\ \text{in } <_{\text{dp}} \text{ order}}} (\delta')_{\text{rk}(\xi(w))}(\rho_\xi(w1) \cdots \rho_\xi(w \text{rk}(\xi(w))), \xi(w), \rho_\xi(w)) && \text{(by Observation 3.1.1)} \end{aligned}$$

$$\begin{aligned}
&= \bigotimes_{\substack{w \in \text{pos}(\xi) \\ \text{in } <_{\text{dp}} \text{ order}}} \delta_{\text{rk}(\xi(w))}(\rho_\xi(w1) \cdots \rho_\xi(w \text{rk}(\xi(w))), \xi(w), \rho_\xi(w)) \otimes F_{\rho_\xi(w)} \\
&= \bigotimes_{\substack{w \in \text{pos}(\xi) \\ \text{in } <_{\text{dp}} \text{ order}}} F_{\rho_\xi(w)} && \text{(by (16.12))} \\
&= \bigotimes_{\substack{w \in \text{pos}(\xi) \\ \text{in } <_{\text{dp}} \text{ order}}} \llbracket \mathcal{A} \rrbracket(\xi|_w) && \text{(by (16.13))} \\
&= \bigotimes_{\substack{w \in \text{pos}(\xi) \\ \text{in } <_{\text{dp}} \text{ order}}} \llbracket e \rrbracket(\xi|_w) = \llbracket \text{REST}(e) \rrbracket(\xi) . && \square
\end{aligned}$$

In the next lemma, we will need distributivity, because the Hadamard product is one of the elementary operations, and distributivity is needed in order to guarantee closure of the set of recognizable weighted tree languages under Hadamard product.

Lemma 16.2.5. (cf. [Her17, Lm. 11] and [Her20b, Thm. 5.2.7]) Let \mathbf{B} be a semiring. Then the following two statements hold.

- (1) For every ranked alphabet Σ and $e \in \text{RepEx}^{\times r}(\Sigma, \mathbf{B})$, we can construct a (Σ, \mathbf{B}) -wta \mathcal{A} such that $\llbracket \mathcal{A} \rrbracket = \llbracket e \rrbracket$.
- (2) Let \mathbf{B} be commutative. For every ranked alphabet Σ and $e \in \text{RepEx}^r(\Sigma, \mathbf{B})$, we can construct a (Σ, \mathbf{B}) -wta \mathcal{A} such that $\llbracket \mathcal{A} \rrbracket = \llbracket e \rrbracket$.

Proof. Proof of (1): We prove the statement by induction on the terminating reduction system $(\text{RepEx}^{\times r}(\mathbf{B}), \succ')$ which is defined in an obvious way as restriction of $(\text{RepEx}(\mathbf{B}), \succ)$.

I.B.: Let $e = \text{RT}_{\Sigma, \sigma, b}$ or $e = \text{NXT}_{\Sigma, \tilde{\gamma}, b}$. Then the statement follows from Corollary 16.1.4 and Theorem 10.3.1(B) \Rightarrow (A).

I.S.: We distinguish four cases.

Case (a): Let $e = e_1 + e_2$ for some $e_1, e_2 \in \text{RepEx}^{\times r}(\Sigma, \mathbf{B})$. By I.H. we can construct (Σ, \mathbf{B}) -wta \mathcal{A}_1 and \mathcal{A}_2 such that $\llbracket e_1 \rrbracket = \llbracket \mathcal{A}_1 \rrbracket$ and $\llbracket e_2 \rrbracket = \llbracket \mathcal{A}_2 \rrbracket$. Then by Theorem 10.1.1(1) we can construct a (Σ, \mathbf{B}) -wta \mathcal{A} such that $\llbracket \mathcal{A} \rrbracket = \llbracket \mathcal{A}_1 \rrbracket \oplus \llbracket \mathcal{A}_2 \rrbracket$. Thus $\llbracket \mathcal{A} \rrbracket = \llbracket \mathcal{A}_1 \rrbracket \oplus \llbracket \mathcal{A}_2 \rrbracket = \llbracket e_1 \rrbracket \oplus \llbracket e_2 \rrbracket = \llbracket e_1 + e_2 \rrbracket = \llbracket e \rrbracket$.

Case (b): Let $e = e_1 \times e_2$ for some $e_1, e_2 \in \text{RepEx}^{\times r}(\Sigma, \mathbf{B})$. We distinguish three cases.

Case (b1): Let e_1 be generated by the nonterminal e_Σ^r and let e_2 be generated by the nonterminal f_Σ^r using the rules in (16.8). By I.H. we can construct a (Σ, \mathbf{B}) -wta \mathcal{A}_1 such that $\llbracket \mathcal{A}_1 \rrbracket = \llbracket e_1 \rrbracket$. By Corollary 16.1.4, we can construct $n \in \mathbb{N}_+$, $b_1, \dots, b_n \in B$, and Σ -fta A_1, \dots, A_n such that $\llbracket e_2 \rrbracket = \bigoplus_{i \in [n]} b_i \cdot \chi(\text{L}(A_i))$. By Theorem 10.3.1(B) \Rightarrow (A), we can construct a crisp-deterministic (Σ, \mathbf{B}) -wta \mathcal{A}_2 such that $\llbracket \mathcal{A}_2 \rrbracket = \llbracket e_2 \rrbracket$. Since \mathbf{B} is right-distributive, by Theorem 10.4.2(1), we can construct a (Σ, \mathbf{B}) -wta \mathcal{A} such that $\llbracket \mathcal{A} \rrbracket = \llbracket \mathcal{A}_1 \rrbracket \otimes \llbracket \mathcal{A}_2 \rrbracket$. Then $\llbracket \mathcal{A} \rrbracket = \llbracket \mathcal{A}_1 \rrbracket \otimes \llbracket \mathcal{A}_2 \rrbracket = \llbracket e_1 \rrbracket \otimes \llbracket e_2 \rrbracket = \llbracket e_1 \times e_2 \rrbracket = \llbracket e \rrbracket$.

Case (b2): Let e_1 be generated by the nonterminal f_Σ^r and let e_2 be generated by the nonterminal e_Σ^r using the rules in (16.8). By I.H. we can construct a (Σ, \mathbf{B}) -wta \mathcal{A}_2 such that $\llbracket \mathcal{A}_2 \rrbracket = \llbracket e_2 \rrbracket$. As for e_2 in Case (b1), we can construct a crisp-deterministic (Σ, \mathbf{B}) -wta \mathcal{A}_1 such that $\llbracket \mathcal{A}_1 \rrbracket = \llbracket e_1 \rrbracket$. Then, by using Theorem 10.4.2(4) (which assumes left-distributivity) instead of Theorem 10.4.2(1), we can finish the proof in the same way as in Case (b1).

Case (b3): Let e_1 and e_2 be generated by the nonterminal f_Σ^r using the rules in (16.8). As indicated in the previous cases, we can construct crisp-deterministic (Σ, \mathbf{B}) -wta \mathcal{A}_1 and \mathcal{A}_2 such that $\llbracket e_1 \rrbracket = \llbracket \mathcal{A}_1 \rrbracket$ and $\llbracket e_2 \rrbracket = \llbracket \mathcal{A}_2 \rrbracket$. By Theorem 10.4.1(3), we can construct a crisp-deterministic (Σ, \mathbf{B}) -wta \mathcal{A} such that $\llbracket \mathcal{A} \rrbracket = \llbracket \mathcal{A}_1 \rrbracket \otimes \llbracket \mathcal{A}_2 \rrbracket$, and then we can finish as in Case (b1).

Case (c): Let $e = \tau(e')$ for some $e' \in \text{RepEx}^{\times r}(\Delta, \mathbf{B})$ and (Δ, Σ) -tree relabeling τ . By I.H. we can construct a (Δ, \mathbf{B}) -wta \mathcal{A}' such that $\llbracket \mathcal{A}' \rrbracket = \llbracket e' \rrbracket$. Then by Theorem 10.10.1, we can construct a (Σ, \mathbf{B}) -wta \mathcal{A} such that $\llbracket \mathcal{A} \rrbracket = \chi(\tau)(\llbracket \mathcal{A}' \rrbracket)$. Then $\llbracket \mathcal{A} \rrbracket = \chi(\tau)(\llbracket \mathcal{A}' \rrbracket) = \chi(\tau)(\llbracket e' \rrbracket) = \llbracket \tau(e') \rrbracket = \llbracket e \rrbracket$.

Case (d): Let $e = \text{REST}(e')$ for some $e' \in \text{RepEx}^{\times r}(\Sigma, \mathbf{B})$ which is generated by the nonterminal f_Σ^r using the rules in (16.8). By Corollary 16.1.4 and Theorem 10.3.1(B) \Rightarrow (A), we can construct a crisp-deterministic (Σ, \mathbf{B}) -wta \mathcal{B} such that $\llbracket \mathcal{B} \rrbracket = \llbracket e' \rrbracket$. Then, by Lemma 16.2.4, we can construct a (Σ, \mathbf{B}) -wta \mathcal{A} such that $\llbracket \mathcal{A} \rrbracket = \llbracket \text{REST}(e') \rrbracket$.

Proof of (2): The proof of this statement proceeds in the same way as the proof of (1) except that, in the case that $e = e_1 \times e_2$, we use Theorem 10.4.1(1) (which needs commutativity) instead of Theorems 10.4.2(1) and 10.4.1(3) for closure under Hadamard product. \square

16.3 The main result for $\text{RepEx}(\Sigma, \mathbf{B})$ over bi-locally finite strong bimonoids

Since each run recognizable weighted tree language over a bi-locally finite strong bimonoid is a recognizable step mapping (cf. Theorems 12.2.9 and 10.3.1), we can show that the notions of representable, restricted representable, and \times -restricted representable coincide. This is the second main result of this chapter: the Médvédjév's characterization of wta over bi-locally finite strong bimonoids.

Theorem 16.3.1. *Let Σ be a ranked alphabet. Moreover, let $\mathbf{B} = (B, \oplus, \otimes, 0, \mathbf{1})$ be a bi-locally finite strong bimonoid and let $r : T_\Sigma \rightarrow B$. Then the following four statements are equivalent.*

- (A) *We can construct a (Σ, \mathbf{B}) -wta \mathcal{A} such that $r = \llbracket \mathcal{A} \rrbracket^{\text{run}}$.*
- (B) *We can construct an $e \in \text{RepEx}(\Sigma, \mathbf{B})$ such that $r = \llbracket e \rrbracket$.*
- (C) *We can construct an $e \in \text{RepEx}^r(\Sigma, \mathbf{B})$ such that $r = \llbracket e \rrbracket$.*
- (D) *We can construct an $e \in \text{RepEx}^{\times r}(\Sigma, \mathbf{B})$ such that $r = \llbracket e \rrbracket$.*

Proof. The implication (A) \Rightarrow (D) holds by Lemma 16.2.3. The implications (D) \Rightarrow (C) and (C) \Rightarrow (B) hold by definition.

Proof of (B) \Rightarrow (A): By induction on $(\text{RepEx}(\mathbf{B}), \succ)$ we prove the following statement:

$$\text{For every ranked alphabet } \Sigma \text{ and every } e \in \text{RepEx}(\Sigma, \mathbf{B}), \quad (16.15)$$

we can construct a crisp-deterministic (Σ, \mathbf{B}) -wta \mathcal{A} such that $\llbracket e \rrbracket = \llbracket \mathcal{A} \rrbracket^{\text{run}}$.

I.B.: For the case that $e = \text{RT}_{\Sigma, \sigma, b}$ or $e = \text{NXT}_{\Sigma, \tilde{\gamma}, b}$, the statement follows from Corollary 16.1.4 and Theorem 10.3.1(B) \Rightarrow (A).

I.S.: We distinguish four cases.

Case (a): Let $e = e_1 + e_2$ where $e_1, e_2 \in \text{RepEx}(\Delta, \mathbf{B})$. By I.H. we can construct crisp-deterministic (Σ, \mathbf{B}) -wta \mathcal{A}_1 and \mathcal{A}_2 such that $\llbracket \mathcal{A}_1 \rrbracket = \llbracket e_1 \rrbracket$ and $\llbracket \mathcal{A}_2 \rrbracket = \llbracket e_2 \rrbracket$. By Theorem 10.1.1(2) we can construct a crisp-deterministic (Σ, \mathbf{B}) -wta \mathcal{A} such that $\llbracket \mathcal{A} \rrbracket = \llbracket \mathcal{A}_1 \rrbracket \oplus \llbracket \mathcal{A}_2 \rrbracket$. Thus $\llbracket \mathcal{A} \rrbracket = \llbracket \mathcal{A}_1 \rrbracket \oplus \llbracket \mathcal{A}_2 \rrbracket = \llbracket e_1 \rrbracket \oplus \llbracket e_2 \rrbracket = \llbracket e_1 + e_2 \rrbracket = \llbracket e \rrbracket$.

Case (b): Let $e = e_1 \times e_2$. The proof is the same as the one for Case (a) except that we use Theorem 10.4.1(3) (instead of Theorem 10.1.1(2)).

Case (c): Let $e = \tau(e')$ where τ is a (Δ, Σ) -tree relabeling and $e' \in \text{RepEx}(\Delta, \mathbf{B})$. By I.H. we can construct a crisp-deterministic (Δ, \mathbf{B}) -wta \mathcal{B} such that $\llbracket e' \rrbracket = \llbracket \mathcal{B} \rrbracket$. By Theorem 10.10.1 we can construct (Σ, \mathbf{B}) -wta \mathcal{C} such that $\llbracket \mathcal{C} \rrbracket^{\text{run}} = \chi(\tau)(\llbracket \mathcal{B} \rrbracket)$. By Theorem 12.2.9(A) \Rightarrow (B), we can construct a crisp-deterministic (Σ, \mathbf{B}) -wta \mathcal{A} such that $\llbracket \mathcal{A} \rrbracket = \llbracket \mathcal{C} \rrbracket^{\text{run}}$. Hence $\llbracket \mathcal{A} \rrbracket = \llbracket \mathcal{C} \rrbracket^{\text{run}} = \chi(\tau)(\llbracket \mathcal{B} \rrbracket) = \chi(\tau)(\llbracket e' \rrbracket) = \llbracket \tau(e') \rrbracket = \llbracket e \rrbracket$.

Case (d): Let $e = \text{REST}(e')$ where $e' \in \text{RepEx}(\Sigma, \mathbf{B})$. By I.H. we can construct a crisp-deterministic (Σ, \mathbf{B}) -wta \mathcal{B} such that $\llbracket \mathcal{B} \rrbracket = \llbracket e' \rrbracket$. By Lemma 16.2.4, we can construct a (Σ, \mathbf{B}) -wta \mathcal{C} such that $\llbracket \mathcal{C} \rrbracket^{\text{run}} = \llbracket \text{REST}(e') \rrbracket$. By Theorem 12.2.9(A) \Rightarrow (B), we can construct a crisp-deterministic (Σ, \mathbf{B}) -wta \mathcal{A} such that $\llbracket \mathcal{A} \rrbracket = \llbracket \mathcal{C} \rrbracket^{\text{run}}$. Thus $\llbracket \mathcal{A} \rrbracket = \llbracket \mathcal{C} \rrbracket^{\text{run}} = \llbracket \text{REST}(e') \rrbracket = \llbracket e \rrbracket$.

This proves (16.15). Clearly, (16.15) implies $(B) \Rightarrow (A)$.

□

Chapter 17

Weighted MSO-logic and Büchi-Elgot-Trakhtenbrot's theorem

The Büchi-Elgot-Trakhtenbrot's theorem (B-E-T's theorem¹) [Büc60, Elg61, Tra61], cf. also [Str94], states that regular string languages and string languages definable in monadic second-order logic coincide. In this chapter we prove the corresponding B-E-T's theorem for the set $\text{Rec}^{\text{run}}(\Sigma, \mathbb{B})$ of run recognizable (Σ, \mathbb{B}) -weighted tree languages for an arbitrary strong bimonoid \mathbb{B} (cf. Theorem 17.3.1). The theorem states that, for every (Σ, \mathbb{B}) -weighted tree language r the following equivalence holds: r is r -recognizable if and only if r is definable by a sentence of $\text{MSO}(\Sigma, \mathbb{B})$ -logic.

The first approach for a weighted version of B-E-T's theorem appeared in [DG05, DG07, DG09] where they generalized from the unweighted version (i.e., \mathbb{B} -weighted string languages) to the weighted version (i.e., \mathbb{B} -weighted string languages where \mathbb{B} is an arbitrary semiring). Then the interpretation of a formula φ on a string w does not deliver the Boolean-valued answer to the question whether w is a model of φ , but it delivers an arbitrary element in B as truth value. A first problem in the design of the weighted logic was to give a semantics to the negation of a formula, because in a semiring (or strong bimonoid) it is not clear whether a value has a kind of complement. The solution published in [DG05, DG07, DG09] can be understood as follows: start from the usual MSO-logic with atomic formulas (i.e., tests $P_a(x)$ on labels, next relation $x \leq y$, and membership $x \in X$), negation, disjunction, first-order existential quantification, and second-order existential quantification; turn each formula into a semantically equivalent formula in which the negations are applied to atomic formulas only; this can be achieved by introducing conjunction, first-order universal quantification, and second-order universal quantification as part of the logic and by replacing

- $\neg(\varphi \vee \psi)$ by $\neg\varphi \wedge \neg\psi$,
- $\neg\exists x.\varphi$ by $\forall x.\neg\varphi$, and
- $\neg\exists X.\varphi$ by $\forall X.\neg\varphi$.

As a part of the solution, the truth value of each atomic formula can only be $\mathbb{0}$ or $\mathbb{1}$ (i.e., the unit elements of \mathbb{B}); thus, its truth value can be complemented. Moreover, each $b \in B$ is added as new atomic formula, and this has the semantics b . Disjunction and existential quantification are semantically expressed by the summation of the semiring \mathbb{B} , and conjunction and universal quantification are expressed by the multiplication of \mathbb{B} . Overall, the following EBNF shows the syntax of the weighted MSO-logic (where now φ is a nonterminal and not a formula):

$$\begin{aligned} \varphi ::= & b \mid P_a(x) \mid x \leq y \mid x \in X \mid \neg P_a(x) \mid \neg(x \leq y) \mid \neg(x \in X) \mid \\ & \varphi \vee \varphi \mid \varphi \wedge \varphi \mid \exists x.\varphi \mid \forall x.\varphi \mid \exists X.\varphi \mid \forall X.\varphi . \end{aligned} \tag{17.1}$$

¹where “s” distributes over “-”

In fact, the first-order fragment of (17.1) is a subset of the fuzzy predicate calculus [Wec78, Sec. 1.2.2]. Since Wechler uses fuzzy algebras [Wec78, Def. 1.2] as weight algebras, atomic formulas can have any truth value (not only $\mathbb{0}$ and $\mathbb{1}$) and the negation can be applied to any formula. The interpretation of the propositional connectives and quantifiers as it is defined in [DG05, DG07, DG09] is essentially the same as in the fuzzy predicate calculus [Wec78, Def. 1.8 and 1.10].

It turned out that the weighted MSO-logic generated by (17.1) is too strong for B-E-T's theorem. Hence, in [DG05, DG07, DG09] restrictions are defined which, roughly speaking, amount to (a) having a kind of commutativity of the semiring multiplication (for exchanging values which appear in conjunctions), (b) restricting the application of first-order universal quantification to formulas of which the semantics is a recognizable step mapping, and (c) dropping second-order universal quantification. Indeed, this restricted weighted MSO-logic characterizes recognizable weighted string languages [DG09, Thm. 4.7]. In the proof (at least) two technical difficulties were mastered.

(A) The proof of “recognizable implies definable” follows the well-known idea of expressing runs of an automaton by formulas. However, since the resulting formulas just check structural properties, i.e., have semantic value $\mathbb{0}$ or $\mathbb{1}$, it was important to disambiguate subformulas which involve disjunction or existential quantification, because the underlying semiring is not necessarily additively idempotent.

(B) Since conjunction and first-order universal quantification are part of the weighted logic, preservation of recognizability under these constructs had to be proven. The main problem showed up with first-order universal quantification, because there exists a non recognizable weighted language which is definable by a formula of the form $\forall x.\varphi$ in that weighted logic [DG05, Ex. 3.4]. Thus, appropriate restrictions on the form of the body formula φ had to be found (cf. restriction (b) above), and then a new automaton construction had to be invented. This problem did not arise in classical unweighted MSO logic, because in classical logic universal quantification can be expressed using existential quantification and negations.

This approach to weighted MSO-logic has been generalized to a number of structures (different from strings) and weight algebras (different from semirings), e.g. for Mazurkiewicz traces and semirings [Mei06], ranked and unranked trees and semirings [DV06, DV11b], finite and infinite strings with discounting and semirings [DR07], nested words and semirings [Mat08, Mat10], timed words and semirings [Qua09], pictures and semirings [Fic11], strings and infinite strings and valuation monoids [DM12], ranked and unranked trees and tree-valuation monoids [DGMM11, DHV15]. In [BGMZ14] (see also [BGMZ10]) an approach different to [DG09] was taken: there, not the logic was restricted but the automaton model was extended. Indeed, the set of weighted string languages recognizable by pebble two-way weighted automata is equal to the set of weighted string languages definable by, roughly speaking, a first-order fragment of the unrestricted weighted MSO-logic of [DG09] enriched by a transitive closure operator. In [FV15] semiring-weighted tree automata were characterized by a weighted transitive closure logic. For a survey we refer to [GM18]. The disambiguation reported in (A) above is cumbersome. This has been overcome in [BGMZ10, FSV12, BGMZ14] by allowing explicitly (Boolean-valued) MSO-formulas as guards of weighted formulas. Finally, we mention that, in [Li08b], B-E-T's theorem has been proved for mv-algebra.

In this chapter we follow the approach of [FSV12] in which B-E-T's theorem was proved for recognizable weighted tree languages over absorptive multioperator monoids [FSV12, Thm. 4.1]. In particular, each strong bimonoid (and hence, each semiring) is an absorptive multioperator monoid. In the MSO-logic proposed in that paper, formulas of classical MSO-logic on trees can be used to guard weighted formulas. Moreover, a universal quantification over some recognizable step mapping (as it appears in the restricted MSO-logic of [DG05]) is represented by a guarded atomic formula where the guard simulates the step languages and the atomic formula is interpreted as a unique algebra homomorphism (cf. Lemma 17.4.12). For semirings, each formula of the restricted weighted MSO-logic of [DV06] (which is a straightforward generalization of [DG09]) can be transformed syntactically into an equivalent formula of the logic in [FSV12] (cf. [FSV12, Lm. 5.10]), and vice versa (cf. [FSV12, Lm. 5.12]).

We note that each strong bimonoid is a particular tree-valuation monoid of [DGMM11]. In [DGMM11,

Sec. 6] this is made explicit and from the main result of [DGMM11] a B-E-T's theorem has been derived for wta over strong bimonoids. We also note that the approach of [FSV12] has been generalized in [FHV18] to weighted tree grammars with storage over complete M-monoids, and B-E-T's theorem was proved in [FHV18, Thm. 7.4] (for the string case cf. [VDH16, Thm. 8]).

The goal of this chapter is to report on B-E-T's theorem [FSV12, Thm. 4.1] for the particular case of strong bimonoids (cf. Theorem 17.3.1). Moreover, we prove that extending carefully the logic by weighted conjunction and weighted first-order universal quantification on recognizable step formulas does not increase its expressive power if the underlying weight algebra is a commutative semiring (cf. Theorem 17.4.11). In Subsection 17.4.5, we prove that this also holds for the full extension if the underlying weight algebra is a commutative and bi-locally finite strong bimonoid (cf. Theorem 17.4.21); this is closely related to [DV12, Thm. 5.3]. Finally, in Section 17.5 we show a strong relationship between a decomposition result of wta (proved in Chapter 11) and the fact that, for weighted tree languages, r-recognizable implies definable (cf. Theorems 17.5.2 and 17.5.4).

17.1 The MSO-logic $\text{MSO}(\Sigma)$

We recall the monadic second-order logic on trees (cf. [TW68, Don70, GS97]) and make several formal definitions, constructions, and proofs explicit.

As first-order variables we use small letters from the end of the Latin alphabet, e.g., x, x_1, x_2, \dots, y, z , and as second-order variables we use capital letters, like X, X_1, X_2, \dots, Y, Z . The *set of monadic second-order formulas over Σ* , denoted by $\text{MSO}(\Sigma)$, is the set of all expressions generated by the following EBNF with nonterminal φ :

$$\varphi ::= \text{label}_\sigma(x) \mid \text{edge}_i(x, y) \mid x \in X \mid \neg\varphi \mid (\varphi \vee \varphi) \mid \exists x.\varphi \mid \exists X.\varphi, \quad (17.2)$$

where $\sigma \in \Sigma$ and $i \in [\text{maxrk}(\Sigma)]$.

In order to perform inductive proofs or to define objects for $\text{MSO}(\Sigma)$ by induction, we will consider the reduction system

$$(\text{MSO}(\Sigma), \succ_{\text{MSO}(\Sigma)})$$

where $\succ_{\text{MSO}(\Sigma)}$ is the binary relation on $\text{MSO}(\Sigma)$ defined as follows. For every $\varphi_1, \varphi_2 \in \text{MSO}(\Sigma)$, we let $\varphi_1 \succ_{\text{MSO}(\Sigma)} \varphi_2$ if either of the following two cases holds.

Case (a) : There exists $\psi \in \text{MSO}(\Sigma)$ such that φ_1 has the form $\neg\psi$, $\exists x.\psi$, or $\exists X.\psi$ and $\varphi_2 = \psi$.

Case (b) : There exist $\psi_1, \psi_2 \in \text{MSO}(\Sigma)$ such that $\varphi_1 = (\psi_1 \vee \psi_2)$ and $\varphi_2 \in \{\psi_1, \psi_2\}$.

By Corollary 2.5.6, the relation $\succ_{\text{MSO}(\Sigma)}$ is terminating. Moreover, we have that $\text{nf}_{\succ_{\text{MSO}(\Sigma)}}(\text{MSO}(\Sigma))$ is the set of formulas of the form $\text{label}_\sigma(x)$, $\text{edge}_i(x, y)$, and $x \in X$. For every $\varphi, \psi \in \text{MSO}(\Sigma)$, we say that ψ is a *subformula of φ* if $\varphi \succ_{\text{MSO}(\Sigma)}^* \psi$. We note that the relation “is a subformula of” is reflexive.

Next we prepare the definition of the semantics of $\text{MSO}(\Sigma)$ -formulas. Let \mathcal{V} be a finite set of variables; we abbreviate by $\mathcal{V}^{(1)}$ and $\mathcal{V}^{(2)}$ the set of first-order variables in \mathcal{V} and the set of second-order variables in \mathcal{V} , respectively. Let $\xi \in \text{T}_\Sigma$. A \mathcal{V} -assignment for ξ is a mapping η with domain \mathcal{V} which maps each first-order variable in \mathcal{V} to a position of ξ and each second-order variable to a subset of $\text{pos}(\xi)$. By $\Phi_{\mathcal{V}, \xi}$ we denote the set of all \mathcal{V} -assignments for ξ . Let $\eta \in \Phi_{\mathcal{V}, \xi}$, x be a first-order variable, and $w \in \text{pos}(\xi)$. By $\eta[x \mapsto w]$ we denote the $(\mathcal{V} \cup \{x\})$ -assignment for ξ that agrees with η on $\mathcal{V} \setminus \{x\}$ and that satisfies $\eta[x \mapsto w](x) = w$. Similarly, if X is a second-order variable and $W \subseteq \text{pos}(\xi)$, then $\eta[X \mapsto W]$ denotes the $(\mathcal{V} \cup \{X\})$ -assignment for ξ that agrees with η on $\mathcal{V} \setminus \{X\}$ and that satisfies $\eta[X \mapsto W](X) = W$.

For the definition of the semantics of $\text{MSO}(\Sigma)$ -formulas, we need the notion of free variable; for later purpose, we also define the notion of bound variables. Formally, for each $\varphi \in \text{MSO}(\Sigma)$, we define the set $\text{Free}(\varphi)$ of *free variables of φ* and the set $\text{Bound}(\varphi)$ of *bound variables of φ* by induction on $(\text{MSO}(\Sigma), \succ_{\text{MSO}(\Sigma)})$ as follows:

I.B.: We distinguish three cases.

- $\text{Free}(\text{label}_\sigma(x)) = \{x\}$ and $\text{Bound}(\text{label}_\sigma(x)) = \emptyset$,
- $\text{Free}(\text{edge}_i(x, y)) = \{x, y\}$ and $\text{Bound}(\text{edge}_i(x, y)) = \emptyset$,
- $\text{Free}(x \in X) = \{x, X\}$ and $\text{Bound}(x \in X) = \emptyset$

I.S.: We distinguish four cases.

- $\text{Free}(\neg\varphi) = \text{Free}(\varphi)$ and $\text{Bound}(\neg\varphi) = \text{Bound}(\varphi)$,
- $\text{Free}(\varphi_1 \vee \varphi_2) = \text{Free}(\varphi_1) \cup \text{Free}(\varphi_2)$ and $\text{Bound}(\varphi_1 \vee \varphi_2) = \text{Bound}(\varphi_1) \cup \text{Bound}(\varphi_2)$,
- $\text{Free}(\exists x.\varphi) = \text{Free}(\varphi) \setminus \{x\}$ and $\text{Bound}(\exists x.\varphi) = \text{Bound}(\varphi) \cup \{x\}$, and
- $\text{Free}(\exists X.\varphi) = \text{Free}(\varphi) \setminus \{X\}$ and $\text{Bound}(\exists X.\varphi) = \text{Bound}(\varphi) \cup \{X\}$.

If a formula φ has the free variables, say, x, y , and X and no others, then we also write $\varphi(x, y, X)$. As usual, we abbreviate formulas like $\exists x.\exists y.\exists z.\varphi$ by $\exists x, y, z.\varphi$. A formula $\varphi \in \text{MSO}(\Sigma)$ is called *MSO(Σ)-sentence* (or just: *sentence*) if $\text{Free}(\varphi) = \emptyset$.

Let $\varphi \in \text{MSO}(\Sigma)$ and \mathcal{V} be a finite set such that $\text{Free}(\varphi) \subseteq \mathcal{V}$. For every $\xi \in \text{T}_\Sigma$ and $\eta \in \Phi_{\mathcal{V}, \xi}$, the relation “ (ξ, η) satisfies φ ”, denoted by $(\xi, \eta) \models \varphi$, is defined by induction on $(\text{MSO}(\Sigma), \succ_{\text{MSO}(\Sigma)})$ as follows.

I.B.: We distinguish three cases.

$$\begin{aligned} (\xi, \eta) \models \text{label}_\sigma(x) & \quad \text{iff} \quad \sigma = \xi(\eta(x)) \\ (\xi, \eta) \models \text{edge}_i(x, y) & \quad \text{iff} \quad \eta(y) = \eta(x).i \\ (\xi, \eta) \models (x \in X) & \quad \text{iff} \quad \eta(x) \in \eta(X) \end{aligned}$$

I.S.: We distinguish four cases.

$$\begin{aligned} (\xi, \eta) \models (\varphi_1 \vee \varphi_2) & \quad \text{iff} \quad (\xi, \eta) \models \varphi_1 \text{ or } (\xi, \eta) \models \varphi_2 \\ (\xi, \eta) \models (\neg\varphi) & \quad \text{iff} \quad (\xi, \eta) \models \varphi \text{ is not true} \\ (\xi, \eta) \models (\exists x.\varphi) & \quad \text{iff} \quad \text{there exists a } w \in \text{pos}(\xi) \text{ such that } (\xi, \eta[x \rightarrow w]) \models \varphi \\ (\xi, \eta) \models (\exists X.\varphi) & \quad \text{iff} \quad \text{there exists a set } W \subseteq \text{pos}(\xi) \text{ such that } (\xi, \eta[X \rightarrow W]) \models \varphi. \end{aligned}$$

We denote by $L_{\mathcal{V}}(\varphi)$ the set $\{(\xi, \eta) \mid \xi \in \text{T}_\Sigma, \eta \in \Phi_{\mathcal{V}, \xi}, (\xi, \eta) \models \varphi\}$, and we will simply write $L(\varphi)$ instead of $L_{\text{Free}(\varphi)}(\varphi)$. If φ is a sentence, i.e., $\text{Free}(\varphi) = \emptyset$, then $\Phi_{\text{Free}(\varphi), \xi}$ contains exactly one assignment, which is the \emptyset ; then we can identify (ξ, \emptyset) with ξ , and hence $L(\varphi)$ can be thought of as a subset of T_Σ . A tree language $L \subseteq \text{T}_\Sigma$ is called *MSO definable* if there exists a sentence $\varphi \in \text{MSO}(\Sigma)$ such that $L = L(\varphi)$.

For every formula φ , finite set \mathcal{V} of variables with $\text{Free}(\varphi) \subseteq \mathcal{V}$, and $(\xi, \eta) \in L_{\mathcal{V}}(\varphi)$, the membership of (ξ, η) in $L_{\mathcal{V}}(\varphi)$ is independent from the values assigned to variables outside of $\text{Free}(\varphi)$. This is formally expressed in the following consistency lemma.

Lemma 17.1.1. Let $\varphi \in \text{MSO}(\Sigma)$. For each finite set \mathcal{V} of variables containing $\text{Free}(\varphi)$ and for every $\xi \in \text{T}_\Sigma$ and $\eta \in \Phi_{\mathcal{V}, \xi}$, the following equivalence holds: $(\xi, \eta) \in L_{\mathcal{V}}(\varphi)$ iff $(\xi, \eta|_{\text{Free}(\varphi)}) \in L(\varphi)$.

Proof. We prove the statement by induction on $(\text{MSO}(\Sigma), \succ_{\text{MSO}(\Sigma)})$. Let $\xi \in \text{T}_\Sigma$ and $\eta \in \Phi_{\mathcal{V}, \xi}$.

I.B.: For the induction base we distinguish three cases.

Case (a): Let $\varphi = \text{label}_\sigma(x)$. Then $\text{Free}(\varphi) = \{x\}$ and we have

$$(\xi, \eta) \models \varphi \quad \text{iff} \quad \sigma = \xi(\eta(x)) \quad \text{iff} \quad \sigma = \xi(\eta|_{\{x\}}(x)) \quad \text{iff} \quad (\xi, \eta|_{\{x\}}) \models \varphi \quad \text{iff} \quad (\xi, \eta|_{\text{Free}(\varphi)}) \models \varphi .$$

Case (b): Let $\varphi = \text{edge}_i(x, y)$. Then $\text{Free}(\varphi) = \{x, y\}$ and we have

$$(\xi, \eta) \models \varphi \quad \text{iff} \quad \eta(y) = \eta(x).i \quad \text{iff} \quad \eta|_{\{x, y\}}(y) = \eta|_{\{x, y\}}(x).i \quad \text{iff} \quad (\xi, \eta|_{\{x, y\}}) \models \varphi \quad \text{iff} \quad (\xi, \eta|_{\text{Free}(\varphi)}) \models \varphi .$$

Case (c): Let $\varphi = (x \in X)$. Then $\text{Free}(\varphi) = \{x, X\}$ and the proof of this case is very similar to the proof of Case (b).

I.S.: For the induction step we distinguish four cases.

Case (a): Let $\varphi = \varphi_1 \vee \varphi_2$. Then $\text{Free}(\varphi) = \text{Free}(\varphi_1) \cup \text{Free}(\varphi_2)$ and we have

$$\begin{aligned} (\xi, \eta) \models \varphi & \text{ iff } (\xi, \eta) \models \varphi_1 \text{ or } (\xi, \eta) \models \varphi_2 \\ & \text{ iff } (\xi, \eta|_{\text{Free}(\varphi_1)}) \models \varphi_1 \text{ or } (\xi, \eta|_{\text{Free}(\varphi_2)}) \models \varphi_2 & \text{(by I.H.)} \\ & \text{ iff } (\xi, \eta|_{\text{Free}(\varphi)}) \models \varphi_1 \text{ or } (\xi, \eta|_{\text{Free}(\varphi)}) \models \varphi_2 & \text{(by I.H.)} \\ & \text{ iff } (\xi, \eta|_{\text{Free}(\varphi)}) \models \varphi . \end{aligned}$$

Case (b): Let $\varphi = \neg\varphi'$. This is similar to Case (a).

Case (c): Let $\varphi = (\exists x.\varphi')$. Then $\text{Free}(\varphi) = \text{Free}(\varphi') \setminus \{x\}$ and we have

$$\begin{aligned} (\xi, \eta) \models \varphi & \text{ iff } (\exists w \in \text{pos}(\xi)) : (\xi, \eta[x \rightarrow w]) \models \varphi' \\ & \text{ iff } (\exists w \in \text{pos}(\xi)) : (\xi, (\eta[x \rightarrow w])|_{\text{Free}(\varphi')}) \models \varphi' & \text{(by I.H.)} \\ & \text{ iff } (\exists w \in \text{pos}(\xi)) : (\xi, ((\eta|_{\text{Free}(\varphi')})[x \rightarrow w])|_{\text{Free}(\varphi')}) \models \varphi' \\ & \quad \text{(because } (\eta[x \rightarrow w])|_{\text{Free}(\varphi')} = ((\eta|_{\text{Free}(\varphi')})[x \rightarrow w])|_{\text{Free}(\varphi')} \text{)} \\ & \text{ iff } (\exists w \in \text{pos}(\xi)) : (\xi, (\eta|_{\text{Free}(\varphi')})[x \rightarrow w]) \models \varphi' & \text{(by I.H.)} \\ & \text{ iff } (\exists w \in \text{pos}(\xi)) : (\xi, (\eta|_{\text{Free}(\varphi)})[x \rightarrow w]) \models \varphi' & \text{(by (*))} \\ & \text{ iff } (\xi, \eta|_{\text{Free}(\varphi)}) \models \varphi . \end{aligned}$$

where at (*) we have used that either (i) $x \notin \text{Free}(\varphi')$ and thus $\text{Free}(\varphi') = \text{Free}(\varphi)$ or (ii) $x \in \text{Free}(\varphi')$ and thus $\text{Free}(\varphi') = \text{Free}(\varphi) \cup \{x\}$. In both cases we have $(\eta|_{\text{Free}(\varphi')})[x \rightarrow w] = (\eta|_{\text{Free}(\varphi)})[x \rightarrow w]$.

Case (d): Let $\varphi = (\exists X.\varphi')$. This case is similar to Case (c). \square

We will use the following macros:

$$\begin{aligned} \varphi \wedge \psi & := \neg(\neg\varphi \vee \neg\psi) \\ \varphi \rightarrow \psi & := \neg\varphi \vee \psi \\ \varphi \leftrightarrow \psi & := (\varphi \rightarrow \psi) \wedge (\psi \rightarrow \varphi) \\ \forall x.\varphi & := \neg(\exists x.\neg\varphi) \\ \forall X.\varphi & := \neg(\exists X.\neg\varphi) \\ \bigvee_{i \in I} \varphi_i & := \varphi_{i_1} \vee \dots \vee \varphi_{i_n} \text{ and} \\ \bigwedge_{i \in I} \varphi_i & := \varphi_{i_1} \wedge \dots \wedge \varphi_{i_n} \text{ for each finite family } (\varphi_i \mid i \in I) \text{ with } I = \{i_1, \dots, i_n\} \\ \text{label}_\Delta(x) & := \bigvee_{\sigma \in \Delta} \text{label}_\sigma(x) \text{ for each } \Delta \subseteq \Sigma \\ \text{edge}(x, y) & := \bigvee_{i \in [\text{maxrk}(\Sigma)]} \text{edge}_i(x, y) \\ (x = y) & := \forall X.(x \in X) \leftrightarrow (y \in X) \\ \text{root}(x) & := \neg\exists y.\text{edge}(y, x) \end{aligned}$$

Since disjunction and conjunction are associative, the placement of parentheses in the expressions $\varphi_{i_1} \vee \dots \vee \varphi_{i_n}$ and $\varphi_{i_1} \wedge \dots \wedge \varphi_{i_n}$ is irrelevant and hence not shown.

Example 17.1.2. (cf. e.g. [CE12, Sec. 1.3.1]) We consider the following formulas in $\text{MSO}(\Sigma)$:

$$\begin{aligned} \text{closed}(X) & = \forall z_1.\forall z_2.(\text{edge}(z_1, z_2) \wedge (z_1 \in X)) \rightarrow (z_2 \in X) \\ \text{path}(x, y) & = \forall X.(\text{closed}(X) \wedge (x \in X)) \rightarrow (y \in X) . \end{aligned}$$

We claim that $\text{path}(x, y)$ specifies a descending path from x to y . Formally, we claim that

$$L_{\{x,y\}}(\text{path}(x, y)) = \{(\xi, \{(x, u), (y, v)\}) \mid \xi \in T_\Sigma, u, v \in \text{pos}(\xi) \text{ such that } u \in \text{prefix}(v)\} . \quad (17.3)$$

(a) First we prove the inclusion from left to right. Let $\xi \in T_\Sigma$, $u, v \in \text{pos}(\xi)$, and $\eta = \{(x, u), (y, v)\}$ such that $(\xi, \eta) \in L_{\{x,y\}}(\text{path}(x, y))$. Then $\xi \in T_\Sigma$ and $(\xi, \eta) \models \text{path}(x, y)$.

Moreover, we have:

$$\text{for each set } U \subseteq \text{pos}(\xi): \text{ if } (\xi, \eta \cup \{(X, U)\}) \models \text{closed}(X) \text{ and } u \in U, \text{ then } v \in U. \quad (17.4)$$

Moreover, we have $(\xi, \eta \cup \{(X, \text{pos}(\xi|_u))\}) \models \text{closed}(X)$ and $u \in \text{pos}(\xi|_u)$. Hence, by (17.4) with $U = \text{pos}(\xi|_u)$, we have that $v \in \text{pos}(\xi|_u)$. Thus $u \in \text{prefix}(v)$.

(b) Next we prove the inclusion from right to left. For this, let $\xi \in T_\Sigma$, $u, v \in \text{pos}(\xi)$, and $\eta = \{(x, u), (y, v)\}$ such that $u \in \text{prefix}(v)$. Thus there exist $n \in \mathbb{N}$, $j_1, \dots, j_n \in \mathbb{N}_+$ such that $v = u j_1 \cdots j_n$. Now let $U \subseteq \text{pos}(\xi)$ such that $(\xi, \{(X, U)\}) \models \text{closed}(X)$ and $u \in U$.

First, by induction on $([0, n], >)$, we prove that the following statement holds:

$$\text{For each } \ell \in [0, n], \text{ we have } u j_1 \cdots j_\ell \in U. \quad (17.5)$$

I.B.: Let $\ell = 0$. The statement trivially holds, because $u \in U$.

I.S.: Let $\ell = \ell' + 1$ for some $\ell' \in \mathbb{N}$. We assume that (17.5) holds for $\ell' \in [0, n - 1]$. By I.H., we have $u j_1 \cdots j_{\ell'} \in U$. Since $(\xi, \{(X, U)\}) \models \text{closed}(X)$ and

$$(\xi, \{(X, U), (z_1, u j_1 \cdots j_{\ell'}), (z_2, u j_1 \cdots j_{\ell'} j_{\ell'})\}) \models (\text{edge}(z_1, z_2) \wedge z_1 \in X) ,$$

we have that

$$(\xi, \{(X, U), (z_1, u j_1 \cdots j_{\ell'}), (z_2, u j_1 \cdots j_{\ell'} j_{\ell'})\}) \models (z_2 \in X)$$

and hence $u j_1 \cdots j_{\ell'} j_{\ell'} \in U$. This proves (17.5).

Then (17.5) implies (by choosing $\ell = n$) that $u j_1 \cdots j_n \in U$, and hence $v \in U$. Thus $(\xi, \eta) \models \text{path}(x, y)$ and hence $(\xi, \eta) \in L_{\{x,y\}}(\text{path}(x, y))$. This finishes the proof of (17.3).

We note that the formula $\exists X.((\text{closed}(X) \wedge x \in X) \rightarrow y \in X)$ does not specify a descending path from x to y . To see this, we consider the tree $\xi = \sigma(\gamma(\alpha), \beta)$ and the assignment $\eta(x) = 1$ and $\eta(y) = 2$. Obviously, there does not exist a descending path from 1 to 2. However, with the assignment η' with $\eta'(x) = \eta(x)$, $\eta'(y) = \eta(y)$, and $\eta'(X) = \text{pos}(\xi)$ we have

$$(\xi, \eta') \models (\text{closed}(X) \wedge (x \in X)) \rightarrow (y \in X)$$

and hence

$$(\xi, \eta) \models \exists X.((\text{closed}(X) \wedge (x \in X)) \rightarrow (y \in X)) .$$

□

Finally, we recall B-E-T's theorem for recognizable tree languages. It follows from Lemmas 17.1.4 and 17.1.10.

Theorem 17.1.3. [TW68, Don70] *Let Σ be a ranked alphabet. Moreover, let $L \subseteq T_\Sigma$. Then the following two statements are equivalent.*

- (A) *We can construct an fta A over Σ such that $L(A) = L$.*
- (B) *We can construct a sentence $\varphi \in \text{MSO}(\Sigma)$ such that $L(\varphi) = L$.*

Lemma 17.1.4. *For each Σ -fta A , we can construct a sentence $\varphi \in \text{MSO}(\Sigma)$ such that $L(A) = L(\varphi)$.*

Proof. Let $A = (Q, \delta, F)$ be a Σ -fta. Without loss of generality we can assume that there exists an $n \in \mathbb{N}$ such that $Q = [n]$. We let $\mathcal{U} = \{X_1, \dots, X_n\}$.

Now we construct a sentence $\varphi \in \text{MSO}(\Sigma)$ such that $L(\varphi) = L(A)$. The following relationship will be the key for this construction. Let $\xi \in \text{T}_\Sigma$. We can relate

- (a) mappings from $\text{pos}(\xi)$ into Q (i.e., runs of A on ξ) and
- (b) Q -indexed partitionings over $\mathcal{P}(\text{pos}(\xi))$

in the following way. Let $\rho: \text{pos}(\xi) \rightarrow Q$ and $P = (P_q \mid q \in Q)$ be a Q -indexed partitioning over $\mathcal{P}(\text{pos}(\xi))$. Then ρ and P are related iff $P_q = \rho^{-1}(q)$ for every $q \in Q$. Obviously, this relationship is a one-to-one correspondence.

We define the sentence $\varphi \in \text{MSO}(\Sigma)$ by

$$\varphi = \exists X_1. \dots \exists X_n. \varphi_{\text{part}} \wedge \varphi_{\text{valid}} \wedge \varphi_{\text{final}}$$

where

- $\varphi_{\text{part}} = \forall x. \bigvee_{q \in Q} \left((x \in X_q) \wedge \bigwedge_{\substack{p \in Q: \\ p \neq q}} \neg(x \in X_p) \right)$,
- $\varphi_{\text{valid}} = \varphi_{\text{valid}, \neq 0} \wedge \varphi_{\text{valid}, = 0}$ with

$$\varphi_{\text{valid}, \neq 0} = \forall x. \bigwedge_{k \in \mathbb{N}_+, \sigma \in \Sigma^{(k)}} \text{label}_\sigma(x) \rightarrow$$

$$\forall y_1. \dots \forall y_k. \left(\text{edge}_1(x, y_1) \wedge \dots \wedge \text{edge}_k(x, y_k) \rightarrow \right.$$

$$\left. \bigvee_{\substack{q, q_1, \dots, q_k \in Q: \\ (q_1 \dots q_k, \sigma, q) \in \delta_k}} \left((y_1 \in X_{q_1}) \wedge \dots \wedge (y_k \in X_{q_k}) \wedge (x \in X_q) \right) \right)$$
 and
- $\varphi_{\text{valid}, = 0} = \forall x. \bigwedge_{\alpha \in \Sigma^{(0)}} \text{label}_\alpha(x) \rightarrow \left(\bigvee_{\substack{q \in Q: \\ (\varepsilon, \alpha, q) \in \delta_0}} (x \in X_q) \right)$, and
- $\varphi_{\text{final}} = \forall x. (\text{root}(x) \rightarrow \bigvee_{q \in F} (x \in X_q))$.

For every $\xi \in \text{T}_\Sigma$ and $\eta \in \Phi_{\mathcal{U}, \xi}$, the following statement is obvious.

$(\xi, \eta) \models \varphi_{\text{part}} \wedge \varphi_{\text{valid}} \wedge \varphi_{\text{final}}$ iff the Q -indexed family $\Psi = (\eta(X_q) \mid q \in Q)$ is a partitioning of $\text{pos}(\xi)$ and the run related to Ψ is accepting .

Finally, we can calculate as follows:

$$\begin{aligned} \xi \in L(\varphi) \text{ iff } & \text{there exists a } \eta \in \Phi_{\mathcal{U}, \xi} \text{ such that} \\ & \text{the } Q\text{-indexed family } \Psi = (\eta(X_q) \mid q \in Q) \text{ is a partitioning of } \text{pos}(\xi) \\ & \text{and the run related to } \Psi \text{ is accepting} \\ \text{iff } & R_{\mathcal{A}}^a(\xi) \neq \emptyset \\ \text{iff } & \xi \in L(A) . \end{aligned}$$

□

Next we will prove that definable implies recognizable. For this we need a few preparations.

Since we will prove that definable implies recognizable by induction on $(\text{MSO}(\Sigma), \succ_{\text{MSO}(\Sigma)})$, we will also have to construct an fta also for formulas which contains free variables. However, a Σ -fta recognizes

$$\Sigma = \{\sigma^{(2)}, \alpha^{(0)}\}, \mathcal{V} = \mathcal{V}^{(1)} \cup \mathcal{V}^{(2)}, \mathcal{V}^{(1)} = \{x, y\}, \text{ and } \mathcal{V}^{(2)} = \{X, Y\}$$

$$\Sigma_{\mathcal{V}} : (\sigma, \{x, X\})^{(2)}, (\sigma, \{x, y\})^{(2)}, (\alpha, \{Y\})^{(0)}, (\alpha, \emptyset)^{(0)}, \dots$$

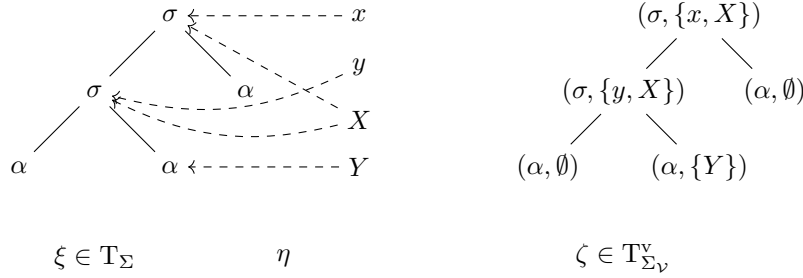

Figure 17.1: The one-to-one correspondence $(\xi, \eta) \mapsto \zeta$.

Σ -trees and not pairs (ξ, η) with $\xi \in T_{\Sigma}$ and $\eta \in \Phi_{\mathcal{V}, \xi}$. Thus, by using an extended ranked alphabet, we code \mathcal{V} -assignment for ξ into the labels of ξ . Formally, we define the ranked alphabet $\Sigma_{\mathcal{V}}$ by letting

$$(\Sigma_{\mathcal{V}})^{(k)} = \Sigma^{(k)} \times \mathcal{P}(\mathcal{V}) \text{ for each } k \in \mathbb{N} .$$

Instead of $(\Sigma_{\mathcal{V}})^{(k)}$ we will write $\Sigma_{\mathcal{V}}^{(k)}$. We identify the sets Σ and Σ_{\emptyset} . A tree $\zeta \in T_{\Sigma_{\mathcal{V}}}$ is called *valid* if for each $x \in \mathcal{V}^{(1)}$ there exists a unique $w \in \text{pos}(\zeta)$ such that x is contained in the second component of $\zeta(w)$. We denote by $T_{\Sigma_{\mathcal{V}}}^{\vee}$ the set of all valid trees in $T_{\Sigma_{\mathcal{V}}}$.

The two sets $\{(\xi, \eta) \mid \xi \in T_{\Sigma}, \eta \in \Phi_{\mathcal{V}, \xi}\}$ and $T_{\Sigma_{\mathcal{V}}}^{\vee}$ are in a one-to-one correspondence via $(\xi, \eta) \mapsto \zeta$, where $\text{pos}(\zeta) = \text{pos}(\xi)$ and

$$\zeta(w) = (\xi(w), \{x \in \mathcal{V}^{(1)} \mid w = \eta(x)\} \cup \{X \in \mathcal{V}^{(2)} \mid w \in \eta(X)\}) .$$

In the sequel, we will not distinguish between the sets $\{(\xi, \eta) \mid \xi \in T_{\Sigma}, \eta \in \Phi_{\mathcal{V}, \xi}\}$ and $T_{\Sigma_{\mathcal{V}}}^{\vee}$. In particular, sometimes we call pairs (ξ, η) in the first set also trees.

Example 17.1.5. Let $\Sigma = \{\sigma^{(2)}, \alpha^{(0)}\}$ and $\mathcal{V} = \mathcal{V}^{(1)} \cup \mathcal{V}^{(2)}$ with $\mathcal{V}^{(1)} = \{x, y\}$ and $\mathcal{V}^{(2)} = \{X, Y\}$.

Let $\xi = \sigma(\alpha, \alpha)$. We define an element $\eta \in \Phi_{\mathcal{V}, \xi}$ by

$$\eta(x) = \varepsilon, \eta(y) = 1, \eta(X) = \{\varepsilon, 1\}, \text{ and } \eta(Y) = \{12\} .$$

Moreover, e.g., $(\sigma, \{x, y, X\}) \in \Sigma_{\mathcal{V}}^{(2)}$ and $(\alpha, \emptyset), (\alpha, \{Y\}) \in \Sigma_{\mathcal{V}}^{(0)}$. According to the one-to-one correspondence defined above, we have

$$(\xi, \eta) \mapsto \zeta = (\sigma, \{x, X\}) \left((\sigma, \{y, X\}) \left((\alpha, \emptyset), (\alpha, \{Y\}) \right), (\alpha, \emptyset) \right) ,$$

see Figure 17.1. Then $\zeta \in T_{\Sigma_{\mathcal{V}}}^{\vee}$. Moreover, for $\zeta' = (\sigma, \{x\}) \left((\sigma, \{x, y, X\}) \left((\alpha, \emptyset), (\alpha, \{Y\}) \right), (\alpha, \emptyset) \right)$, we have $\zeta' \in T_{\Sigma_{\mathcal{V}}} \setminus T_{\Sigma_{\mathcal{V}}}^{\vee}$ because x occurs in the second component of both $\zeta'(\varepsilon) = (\sigma, \{x\})$ and $\zeta'(1) = (\sigma, \{x, y, X\})$. Hence there does not exist $\eta' \in \Phi_{\mathcal{V}, \xi}$ such that $(\xi, \eta') \mapsto \zeta'$. \square

We “lift” the update of a variable assignment to trees in $T_{\Sigma_{\mathcal{V}}}^{\vee}$ as follows. Let $(\xi, \eta) \in T_{\Sigma_{\mathcal{V}}}^{\vee}$, x be a first-order variable, and $w \in \text{pos}(\xi)$. By $(\xi, \eta)[x \mapsto w]$ we denote the valid tree $(\xi, \eta[x \mapsto w])$ over $\Sigma_{\mathcal{V} \cup \{x\}}$. Similarly, if X is a second-order variable and $W \subseteq \text{pos}(\zeta)$, then $(\xi, \eta)[X \mapsto W]$ denotes the valid tree

$(\xi, \eta[X \mapsto W])$ over $\Sigma_{\mathcal{V} \cup \{X\}}$. Moreover, let $\mathcal{U} \subseteq \mathcal{V}$. Then $\eta|_{\mathcal{U}}$ is a \mathcal{U} -assignment and we denote the tree $(\xi, \eta|_{\mathcal{U}})$ also by $(\xi, \eta)|_{\mathcal{U}}$.

As second preparation, we observe that, for each finite set \mathcal{V} of variables, the set $\text{T}_{\Sigma_{\mathcal{V}}}^{\mathcal{V}}$ is a recognizable $\Sigma_{\mathcal{V}}$ -tree language.

Lemma 17.1.6. Let Σ be a ranked alphabet and \mathcal{V} be a finite set of variables. Then we can construct a total and bu-deterministic $\Sigma_{\mathcal{V}}$ -fta A such that $L(A) = \text{T}_{\Sigma_{\mathcal{V}}}^{\mathcal{V}}$.

Proof. Let x_1, \dots, x_m be the first-order variables in \mathcal{V} , i.e., $\mathcal{V}^{(1)} = \{x_1, \dots, x_m\}$. Obviously, $\text{T}_{\Sigma_{\mathcal{V}}}^{\mathcal{V}} = \bigcap_{j \in [m]} L_j$ where

$$L_j = \{\xi \in \text{T}_{\Sigma_{\mathcal{V}}} \mid x_j \text{ occurs exactly once in } \xi\} .$$

First, for each $j \in [m]$, we construct a total and bu-deterministic $\Sigma_{\mathcal{V}}$ -fta $B_j = (Q, \delta, F)$ such that $L_j = L(B_j)$. The idea for this is to count the number of occurrences of x_j up to 2 while traversing the tree from the leaves towards the root. If x_j is encountered twice, then the tree automaton reaches a non-final state which is propagated towards the root.

Formally, we let $Q = \{0, 1, 2\}$ and $F = \{1\}$. For every $k \in \mathbb{N}$, $(\sigma, U) \in \Sigma_{\mathcal{V}}^{(k)}$, and $q_1, \dots, q_k \in Q$ we let

$$\delta_k(q_1 \cdots q_k, (\sigma, U)) = \begin{cases} 2 & \text{if } (\sum_{i \in [k]} q_i \geq 2) \vee ((\sum_{i \in [k]} q_i = 1) \wedge (x_j \in U)) \\ 1 & \text{if } ((\sum_{i \in [k]} q_i = 1) \wedge (x_j \notin U)) \vee ((\sum_{i \in [k]} q_i = 0) \wedge (x_j \in U)) \\ 0 & \text{otherwise ,} \end{cases}$$

where \sum denotes the extension of $+$ to finite sums in the monoid $(\mathbb{N}, +, 0)$. It is clear that $L(A) = L_j$.

Then, by Theorems 2.16.2 and 2.16.3, we can construct a total and bu-deterministic $\Sigma_{\mathcal{V}}$ -fta A such that $L(A) = \bigcap_{j \in [m]} L(B_j)$. Then

$$L(A) = \bigcap_{j \in [m]} L(B_j) = \bigcap_{j \in [m]} L_j = \text{T}_{\Sigma_{\mathcal{V}}}^{\mathcal{V}} .$$

□

As third preparation, we prove that two particular tree languages are recognizable.

Lemma 17.1.7. Let Δ be a ranked alphabet, $\Gamma \subseteq \Delta$, and $L_{\Gamma} = \{\xi \in \text{T}_{\Delta} \mid (\exists w \in \text{pos}(\xi)) : \xi(w) \in \Gamma\}$. Then we can construct a total and bu-deterministic Δ -fta A such that $L(A) = L_{\Gamma}$.

Proof. We construct the Δ -fta $A = (Q, \delta, F)$ with $Q = \{0, 1\}$ (and each state is viewed as natural number), $F = \{1\}$, and for every $k \geq 0$, $\sigma \in \Delta^{(k)}$, $q_1, \dots, q_k \in Q$ we define

$$\delta_k(q_1 \cdots q_k, \sigma) = \begin{cases} 1 & \text{if } (\sum_{i \in [k]} q_i \geq 1) \vee (\sigma \in \Gamma) \\ 0 & \text{otherwise .} \end{cases}$$

It is obvious that A is total and deterministic, and that $L(A) = L_{\Gamma}$. □

Lemma 17.1.8. Let Δ be a ranked alphabet, $\Gamma_1, \Gamma_2 \subseteq \Delta$, $j \in \mathbb{N}$ with $j \geq 1$, and $L_{\Gamma_1, \Gamma_2, j} = \{\xi \in \text{T}_{\Delta} \mid (\exists w_1, w_2 \in \text{pos}(\xi)) : w_2 = w_1 j, \xi(w_1) \in \Gamma_1, \xi(w_2) \in \Gamma_2\}$. Then we can construct a Δ -fta A such that $L(A) = L_{\Gamma_1, \Gamma_2, j}$.

Proof. We construct the Δ -fta $A = (Q, \delta, F)$ with $Q = \{0, 1, 2\}$, $F = \{2\}$, and for every $k \geq 0$, we define δ_k to be the smallest set δ'_k such that $(q_1 \cdots q_k, \sigma, q) \in \delta'_k$ iff (at least) one of the following four conditions is satisfied:

- $q = 0$,
- $\sigma \in \Gamma_2$ and $q = 1$,
- $j \leq k$, $q_j = 1$, $\sigma \in \Gamma_1$, and $q = 2$, or
- $(\exists l \in [k]) : q_l = 2$ and $q = 2$.

It is obvious that $L(\mathcal{A}) = L_{\Gamma_1, \Gamma_2, j}$. □

As final preparation, we prove a consistency lemma for fta.

Lemma 17.1.9. Let $\varphi \in \text{MSO}(\Sigma)$, let \mathcal{V} abbreviate $\text{Free}(\varphi)$, and let A be a $\Sigma_{\mathcal{V}}$ -fta such that $L(A) = L(\varphi)$. Moreover, let V be a finite set of variables. Then we can construct a $\Sigma_{\mathcal{V} \cup V}$ -fta A' such that $L(A') = L_{\mathcal{V} \cup V}(\varphi)$.

Proof. Case (a): Let $V \subseteq \mathcal{V}$. Then we can choose $A' = A$ and we are ready.

Case (b): Let $V \not\subseteq \mathcal{V}$. Moreover, let $A = (Q, \delta, F)$. First we construct the $\Sigma_{\mathcal{V} \cup V}$ -fta $B = (Q, \delta', F)$ such that, for every $k \in \mathbb{N}$, $(\sigma, \mathcal{W}) \in (\Sigma_{\mathcal{V} \cup V})^{(k)}$, and $q_1, \dots, q_k, q \in Q$ we define

$$\delta'_k(q_1 \cdots q_k, (\sigma, \mathcal{W}), q) = \delta_k(q_1 \cdots q_k, (\sigma, \mathcal{W} \cap \mathcal{V}), q) .$$

Obviously, for each $\xi \in T_{\Sigma_{\mathcal{V} \cup V}}$, we have $\text{pos}(\xi) = \text{pos}(\xi|_{\mathcal{V}})$ and $R_B^a(\xi) = R_A^a(\xi|_{\mathcal{V}})$. Hence, we have

$$\xi \in L(B) \quad \text{iff} \quad R_B^a(\xi) \neq \emptyset \quad \text{iff} \quad R_A^a(\xi|_{\mathcal{V}}) \neq \emptyset \quad \text{iff} \quad \xi|_{\mathcal{V}} \in L(A) . \quad (17.6)$$

Next we show that

$$L(B) \cap T_{\Sigma_{\mathcal{V} \cup V}}^v = L_{\mathcal{V} \cup V}(\varphi) . \quad (17.7)$$

For this, let $\xi \in T_{\Sigma_{\mathcal{V} \cup V}}$. Then we have

$$\begin{aligned} \xi \in L(B) \cap T_{\Sigma_{\mathcal{V} \cup V}}^v & \text{ iff } (\xi|_{\mathcal{V}} \in L(A)) \wedge (\xi \in T_{\Sigma_{\mathcal{V} \cup V}}^v) & \text{ (by (17.6))} \\ & \text{ iff } (\xi|_{\mathcal{V}} \in L(\varphi)) \wedge (\xi \in T_{\Sigma_{\mathcal{V} \cup V}}^v) \\ & \text{ iff } \xi \in L_{\mathcal{V} \cup V}(\varphi) & \text{ (by Lemma 17.1.1)} \end{aligned}$$

Now, by Lemma 17.1.6, we can construct a $\Sigma_{\mathcal{V} \cup V}$ -fta C such that $L(C) = T_{\Sigma_{\mathcal{V} \cup V}}^v$. By Theorem 2.16.3, we can construct and $\Sigma_{\mathcal{V} \cup V}$ -fta A' with $L(A') = L(B) \cap L(C)$. Then, by (17.7) we have $L(A') = L_{\mathcal{V} \cup V}(\varphi)$. □

Now we can prove that definable implies recognizable.

Lemma 17.1.10. For every finite set \mathcal{V} of variables and formula $\varphi \in \text{MSO}(\Sigma)$ with $\text{Free}(\varphi) \subseteq \mathcal{V}$, we can construct a $\Sigma_{\mathcal{V}}$ -fta A such that $L(A) = L_{\mathcal{V}}(\varphi)$.

Proof. First, by induction on $(\text{MSO}(\Sigma), \succ_{\text{MSO}(\Sigma)})$, we prove the following.

$$\text{For each } \varphi \in \text{MSO}(\Sigma), \text{ we can construct a } \Sigma_{\text{Free}(\varphi)}\text{-fta } B \text{ such that } L(B) = L(\varphi). \quad (17.8)$$

I.B.: For the induction base we distinguish three cases.

Case (a): Let $\varphi = \text{label}_{\sigma}(x)$. Then $\text{Free}(\varphi) = \{x\}$. Moreover, let $\Gamma = \{(\sigma, \{x\})\}$. Clearly $L(\varphi) = L_{\Gamma} \cap T_{\Sigma_{\{x\}}}^v$. By Lemma 17.1.7 we can construct a $\Sigma_{\{x\}}$ -fta C such that $L(C) = L_{\Gamma}$. By Lemma 17.1.6 we can construct a $\Sigma_{\mathcal{V}}$ -fta D such that $L(D) = T_{\Sigma_{\{x\}}}^v$. By Theorem 2.16.3, we can construct a $\Sigma_{\{x\}}$ -fta B such that $L(B) = L(C) \cap L(D)$.

Case (b): Let $\varphi = \text{edge}_j(x, y)$. Then $\text{Free}(\varphi) = \{x, y\}$. Moreover, let $\Gamma_1 = \{(\sigma, \{x\}) \mid \sigma \in \Sigma\}$ and $\Gamma_2 = \{(\sigma, \{y\}) \mid \sigma \in \Sigma\}$. Clearly $L(\varphi) = L_{\Gamma_1, \Gamma_2, j} \cap T_{\Sigma_{\{x, y\}}}^v$. By Lemma 17.1.8, we can construct a $\Sigma_{\{x, y\}}$ -fta C such that $L(C) = L_{\Gamma_1, \Gamma_2, j}$. Then we proceed as in Case (a).

Case (c): Let $\varphi = (x \in X)$. Then $\text{Free}(\varphi) = \{x, X\}$. Moreover, let $\Gamma = \{(\sigma, \{x, X\}) \mid \sigma \in \Sigma\}$. Clearly $L(\varphi) = L_\Gamma \cap T_{\Sigma_{\{x, X\}}}^\vee$. Then we proceed as in Case (a).

I.S.: For the induction step we distinguish four cases.

Case (a): Let $\varphi = (\neg\psi)$. We note that $L(\varphi) = T_{\Sigma_{\text{Free}(\varphi)}}^\vee \setminus L(\psi)$. By Lemma 17.1.6 we can construct a $\Sigma_{\text{Free}(\varphi)}$ -fta D such that $L(D) = T_{\Sigma_{\text{Free}(\varphi)}}^\vee$. By I.H. we can construct a $\Sigma_{\text{Free}(\varphi)}$ -fta C such that $L(C) = L(\psi)$. By Theorem 2.16.3, we can construct a $\Sigma_{\text{Free}(\varphi)}$ -fta B such that $L(B) = L(D) \setminus L(C)$.

Case (b): Let $\varphi = \psi_1 \vee \psi_2$. We note that $L(\varphi) = L_{\text{Free}(\varphi)}(\psi_1) \cup L_{\text{Free}(\varphi)}(\psi_2)$. By I.H. we can construct $\Sigma_{\text{Free}(\psi_i)}$ -fta C_i such that $L(C_i) = L(\psi_i)$ for $i \in \{1, 2\}$. Then, by Lemma 17.1.9 we can construct $\Sigma_{\text{Free}(\varphi)}$ -fta D_i such that $L(D_i) = L_{\text{Free}(\varphi)}(\psi_i)$ for $i \in \{1, 2\}$. Lastly, by Theorem 2.16.3, we can construct a $\Sigma_{\text{Free}(\varphi)}$ -fta B such that $L(B) = L(D_1) \cup L(D_2)$.

Case (c): Let $\varphi = (\exists x.\psi)$. By I.H. we can construct a $\Sigma_{\text{Free}(\psi)}$ -fta C such that $L(C) = L(\psi)$. Then, by Lemma 17.1.9, we can construct a $\Sigma_{\text{Free}(\psi) \cup \{x\}}$ -fta $D = (Q, \delta, F)$ such that $L(D) = L_{\text{Free}(\psi) \cup \{x\}}(\psi)$.

Lastly, we construct the $\Sigma_{\text{Free}(\varphi)}$ -fta $B = (Q', \delta', F')$ such that $Q' = Q \times \{0, 1\}$ (where 0 and 1 are understood as natural numbers, which can be summed up), $F' = F \times \{1\}$, and for each $k \in \mathbb{N}$, we have

$$\begin{aligned} \delta'_k = & \{((q_1, 0) \cdots (q_k, 0), (\sigma, U), (q, 0)) \mid (\sigma, U) \in \Sigma_{\text{Free}(\varphi)}^{(k)}, (q_1 \cdots q_k, (\sigma, U), q) \in \delta_k\} \\ & \cup \{((q_1, 0) \cdots (q_k, 0), (\sigma, U), (q, 1)) \mid (\sigma, U) \in \Sigma_{\text{Free}(\varphi)}^{(k)}, (q_1 \cdots q_k, (\sigma, U \cup \{x\}), q) \in \delta_k\} \\ & \cup \{((q_1, p_1) \cdots (q_k, p_k), (\sigma, U), (q, 1)) \mid (\sigma, U) \in \Sigma_{\text{Free}(\varphi)}^{(k)}, (q_1 \cdots q_k, (\sigma, U), q) \in \delta_k, \bigoplus_{i \in [k]} p_i = 1\}. \end{aligned}$$

Now we prove that $L(\varphi) = L(B)$. For this, let $\zeta = (\xi, \eta)$ be in $T_{\Sigma_{\text{Free}(\varphi)}}^\vee$. For each $\rho : \text{pos}(\xi) \rightarrow Q'$, we define $\pi_1(\rho) : \text{pos}(\xi) \rightarrow Q$ and $\pi_2(\rho) : \text{pos}(\xi) \rightarrow \{0, 1\}$ such that, for each $w \in \text{pos}(\xi)$, we let $\pi_1(\rho)(w)$ and $\pi_2(\rho)(w)$ be the first component of $\rho(w)$ and the second component of $\rho(w)$, respectively.

$$\begin{aligned} & \zeta \in L(\varphi) \\ \text{iff } & \zeta \models (\exists x.\psi) \\ \text{iff } & (\exists w \in \text{pos}(\xi)) : (\xi, \eta[x \mapsto w]) \models \psi \\ \text{iff } & (\exists w \in \text{pos}(\xi)) : (\xi, \eta[x \mapsto w]) \in L(D) \\ \text{iff } & (\exists w \in \text{pos}(\xi), \rho_1 \in R_D^\vee((\xi, \eta[x \mapsto w]))) : \rho_1(\varepsilon) \in F \\ \text{iff } & (\exists w \in \text{pos}(\xi), \rho \in R_B^\vee(\zeta)) : \pi_1(\rho) \in R_D^\vee((\xi, \eta[x \mapsto w])) \wedge \pi_1(\rho)(\varepsilon) \in F \wedge \\ & (\forall v \in \text{prefix}(w)) : \pi_2(\rho)(v) = 1 \wedge (\forall v \in \text{pos}(\xi) \setminus \text{prefix}(w)) : \pi_2(\rho)(v) = 0 \\ \text{iff } & (\exists \rho \in R_B^\vee(\zeta)) : \rho(\varepsilon) \in F' \\ \text{iff } & \zeta \in L(B) . \end{aligned}$$

We can also give an alternative proof as follows (using closure under tree relabelings). We observe that $L(\varphi) = \tau(L_{\text{Free}(\psi) \cup \{x\}}(\psi))$ where $\tau = (\tau_k \mid k \in \mathbb{N})$ is the deterministic $(\Sigma_{\text{Free}(\psi) \cup \{x\}}, \Sigma_{\text{Free}(\varphi)})$ -tree relabeling defined, for each $k \in \mathbb{N}$ and $(\sigma, U) \in \Sigma_{\text{Free}(\psi) \cup \{x\}}^{(k)}$ by $\tau((\sigma, U)) = (\sigma, U \cap \text{Free}(\varphi))$. This can be seen as follows:

$$\begin{aligned} (\xi, \rho) \in L(\varphi) \text{ iff } & (\xi, \rho) \models \varphi \\ \text{iff } & (\exists w \in \text{pos}(\xi)) : (\xi, \rho[x \rightarrow w]) \models \psi \\ \text{iff } & (\exists \zeta' \in T_{\Sigma_{\text{Free}(\psi) \cup \{x\}}}^\vee) : \tau(\zeta') = (\xi, \rho) \text{ and } \zeta' \models \psi \\ \text{iff } & (\exists \zeta' \in L_{\text{Free}(\psi) \cup \{x\}}(\psi)) : \tau(\zeta') = (\xi, \rho) \\ \text{iff } & (\xi, \rho) \in \tau(L_{\text{Free}(\psi) \cup \{x\}}(\psi)). \end{aligned}$$

By I.H. we can construct a $\Sigma_{\text{Free}(\psi)}$ -fta C such that $L(C) = L(\psi)$. Hence, by Lemma 17.1.9, we can also construct a $\Sigma_{\text{Free}(\psi) \cup \{x\}}$ -fta D such that $L(D) = L_{\text{Free}(\psi) \cup \{x\}}(\psi)$. Then, by the fact that $L(\varphi) = \tau(L_{\text{Free}(\psi) \cup \{x\}}(\psi))$ and by Corollary 10.10.2, we can construct a $\Sigma_{\text{Free}(\varphi)}$ -fta B such that $L(B) = L(\varphi)$.

Case (d): Let $\varphi = (\exists X.\psi)$. By I.H. we can construct a $\Sigma_{\text{Free}(\psi)}$ -fta C such that $L(C) = L(\psi)$. Then, by Lemma 17.1.9, we can construct a $\Sigma_{\text{Free}(\psi) \cup \{X\}}$ -fta $C' = (Q, \delta, F)$ such that $L(C') = L_{\text{Free}(\psi) \cup \{X\}}(\psi)$. Lastly, we construct the $\Sigma_{\text{Free}(\varphi)}$ -fta $B = (Q, \delta', F)$ such that, for every $k \in \mathbb{N}$, we let

$$\delta'_k = \{(q_1 \cdots q_k, (\sigma, U), q) \mid (\sigma, U) \in \Sigma_{\text{Free}(\varphi)}^{(k)} \text{ and} \\ ((q_1 \cdots q_k, (\sigma, U), q) \in \delta_k \text{ or } (q_1 \cdots q_k, (\sigma, U \cup \{X\}), q) \in \delta_k)\}$$

Then it is easy to see that $L(B) = L(\varphi)$.

Also here we can give an alternative proof as follows. Now we observe that $L(\varphi) = \tau(L_{\text{Free}(\psi) \cup \{X\}}(\psi))$ where $\tau = (\tau_k \mid k \in \mathbb{N})$ is the $(\Sigma_{\text{Free}(\psi) \cup \{X\}}, \Sigma_{\text{Free}(\varphi)})$ -tree relabeling defined, for every $k \in \mathbb{N}$ and $(\sigma, U) \in \Sigma_{\text{Free}(\psi) \cup \{X\}}^{(k)}$ by $\tau((\sigma, U)) = (\sigma, U \cap \text{Free}(\varphi))$. Then the proof can be finished similarly as in Case (c).

This finishes the proof of (17.8). Finally, by applying Lemma 17.1.9 to the fta B , we obtain the desired $\Sigma_{\mathcal{V}}$ -fta A with $L(A) = L_{\mathcal{V}}(\varphi)$. \square

17.2 The weighted MSO-logic $\text{MSO}(\Sigma, \mathbf{B})$

Now we add weights to $\text{MSO}(\Sigma)$ in the following way. As atomic formulas of the weighted logic $\text{MSO}(\Sigma, \mathbf{B})$ we use formulas of the form $H(\kappa)$, where κ is an \mathbb{N} -indexed family of mappings $\kappa_k : (\Sigma_{\mathcal{U}})^{(k)} \rightarrow B$. This introduces the weights into the logic. Roughly speaking, the semantics of $H(\kappa)$ is the unique Σ -algebra homomorphism $h_{M(\Sigma, \kappa)}$ from the $\Sigma_{\mathcal{U}}$ -term algebra to the (Σ, κ) -evaluation algebra (cf. Section 2.10 and Equation (2.37)). In the setting of the weighted logics of [DG05], the formula $H(\kappa)$ can be simulated by a weighted first-order universal quantification over a formula of which the semantics is a recognizable step mapping (cf. [FSV12, Lm. 5.12] and Lemma 17.4.9).

We define the set of *MSO formulas over Σ and \mathbf{B}* , denoted by $\text{MSO}(\Sigma, \mathbf{B})$, by the following EBNF with nonterminal e :

$$e ::= H(\kappa) \mid (\varphi \triangleright e) \mid (e + e) \mid \dagger_x e \mid \dagger_X e, \quad (17.9)$$

where

- there exists a finite set \mathcal{U} of variables such that $\kappa = (\kappa_k \mid k \in \mathbb{N})$ is an \mathbb{N} -indexed family of mappings $\kappa_k : (\Sigma_{\mathcal{U}})^{(k)} \rightarrow B$,
- $\varphi \in \text{MSO}(\Sigma)$.

We will drop parentheses whenever no confusion arises. We call formulas of the form $H(\kappa)$ *atomic formulas*, formulas of the form $\varphi \triangleright e$ *guarded formulas*, formulas of the form $(e_1 + e_2)$ *weighted disjunction*, and formulas of the form $\dagger_x e$ and $\dagger_X e$ the *weighted first-order existential quantification (of e)* and *weighted second-order existential quantification (of e)*, respectively.

As for $\text{MSO}(\Sigma)$ -formulas in Section 17.1, in order to perform inductive proofs or to define objects by induction, we will consider the reduction system

$$(\text{MSO}(\Sigma, \mathbf{B}), \succ_{\text{MSO}(\Sigma, \mathbf{B})})$$

where $\succ_{\text{MSO}(\Sigma, \mathbf{B})}$ is the binary relation on $\text{MSO}(\Sigma, \mathbf{B})$ defined as follows. For every $e_1, e_2 \in \text{MSO}(\Sigma, \mathbf{B})$, we let $e_1 \succ_{\text{MSO}(\Sigma, \mathbf{B})} e_2$ if either of the following three cases holds.

- Case (a) There exist $\varphi \in \text{MSO}(\Sigma)$ and $e \in \text{MSO}(\Sigma, \mathbf{B})$ such that $e_1 = (\varphi \triangleright e)$ and $e_2 = e$.
- Case (b) There exist $f_1, f_2 \in \text{MSO}(\Sigma, \mathbf{B})$ such that $e_1 = f_1 + f_2$ and $e_2 \in \{f_1, f_2\}$.
- Case (c) There exists $f \in \text{MSO}(\Sigma, \mathbf{B})$ such that e_1 has the form $\dagger_x f$ or $\dagger_X f$ and $e_2 = f$.

By Corollary 2.5.6, the relation $\succ_{\text{MSO}(\Sigma, \mathbf{B})}$ is terminating. Moreover, we have that $\text{nf}_{\succ_{\text{MSO}(\Sigma, \mathbf{B})}}(\text{MSO}(\Sigma, \mathbf{B}))$ is the set of formulas of the form $H(\kappa)$.

For every $e \in \text{MSO}(\Sigma, \mathbf{B})$ and $w \in \text{MSO}(\Sigma, \mathbf{B}) \cup \text{MSO}(\Sigma)$, we say that w is a subformula of e if w is a substring of e . We note that the relation “is a subformula of” is reflexive.

Next we define the semantics of MSO formulas over Σ and \mathbf{B} . For this purpose, we need the notion of free variable; for later purpose, we also define the notion of bound variables. Formally, for each $e \in \text{MSO}(\Sigma, \mathbf{B})$, we define the set $\text{Free}(e)$ of *free variables of e* and the set $\text{Bound}(e)$ of *bound variables of e* by induction on $(\text{MSO}(\Sigma, \mathbf{B}), \succ_{\text{MSO}(\Sigma, \mathbf{B})})$ as follows:

I.B.: If \mathcal{U} is a finite set of variables and $\kappa = (\kappa_k \mid n \in \mathbb{N})$ with $\kappa_k : (\Sigma_{\mathcal{U}})^{(k)} \rightarrow B$, then $\text{Free}(\mathbf{H}(\kappa)) = \mathcal{U}$ and $\text{Bound}(\mathbf{H}(\kappa)) = \emptyset$.

I.S.: We distinguish four cases.

- $\text{Free}(\varphi \triangleright e) = \text{Free}(\varphi) \cup \text{Free}(e)$ and $\text{Bound}(\varphi \triangleright e) = \text{Bound}(\varphi) \cup \text{Bound}(e)$,
- $\text{Free}(e_1 + e_2) = \text{Free}(e_1) \cup \text{Free}(e_2)$ and $\text{Bound}(e_1 + e_2) = \text{Bound}(e_1) \cup \text{Bound}(e_2)$, and
- $\text{Free}(+_x e) = \text{Free}(e) \setminus \{x\}$ and $\text{Bound}(+_x e) = \text{Bound}(e) \cup \{x\}$, and
- $\text{Free}(+_X e) = \text{Free}(e) \setminus \{X\}$ and $\text{Bound}(+_X e) = \text{Bound}(e) \cup \{X\}$.

If $\text{Free}(e) = \emptyset$, then we call e a *sentence*.

Since the semantics of an atomic formula uses the concept of evaluation algebra, we briefly recall it from Section 2.10. For a given \mathbb{N} -indexed family $\kappa = (\kappa_k \mid k \in \mathbb{N})$ with $\kappa_k : \Sigma^{(k)} \rightarrow B$, the (Σ, κ) -evaluation algebra $(\mathbf{B}, \bar{\kappa})$ with $\bar{\kappa}(\sigma)(b_1, \dots, b_k) = b_1 \otimes \dots \otimes b_k \otimes \kappa_k(\sigma)$, is denoted by $\mathbf{M}(\Sigma, \kappa)$, and the Σ -algebra homomorphism from the Σ -term algebra to $\mathbf{M}(\Sigma, \kappa)$ is denoted by $\mathbf{h}_{\mathbf{M}(\Sigma, \kappa)}$. We will employ this concept for various ranked alphabets when defining the semantics of atomic formulas.

In the sequel we will abbreviate $\mathbf{h}_{\mathbf{M}(\Sigma, \kappa)}$ by \mathbf{h}_{κ} .

Now let \mathcal{U} and \mathcal{V} be finite sets of variables such that $\mathcal{U} \subseteq \mathcal{V}$. Moreover, let $\kappa = (\kappa_k \mid k \in \mathbb{N})$ with $\kappa_k : \Sigma_{\mathcal{U}}^{(k)} \rightarrow B$. We define the \mathbb{N} -indexed family $\kappa[\mathcal{U} \rightsquigarrow \mathcal{V}] = (\kappa[\mathcal{U} \rightsquigarrow \mathcal{V}]_k \mid k \in \mathbb{N})$ with $\kappa[\mathcal{U} \rightsquigarrow \mathcal{V}]_k : \Sigma_{\mathcal{V}}^{(k)} \rightarrow B$ such that, for every $\sigma \in \Sigma^{(k)}$ and $\mathcal{W} \subseteq \mathcal{V}$, we have

$$\kappa[\mathcal{U} \rightsquigarrow \mathcal{V}]_k(\sigma, \mathcal{W}) = \kappa_k(\sigma, \mathcal{U} \cap \mathcal{W}) .$$

Let $e \in \text{MSO}(\Sigma, \mathbf{B})$ and \mathcal{V} be a finite set of variables such that $\mathcal{V} \supseteq \text{Free}(e)$. We define the *semantics of e with respect to \mathcal{V}* , denoted by $\llbracket e \rrbracket_{\mathcal{V}}$, to be a $(\Sigma_{\mathcal{V}}, \mathbf{B})$ -weighted tree language. In other words, for each $e \in \text{MSO}(\Sigma, \mathbf{B})$, we define the family $(\llbracket e \rrbracket_{\mathcal{V}} \mid \mathcal{V} \supseteq \text{Free}(e), \mathcal{V} \text{ finite})$. Since $\llbracket e \rrbracket_{\mathcal{V}}$ depends on the semantics of the subformulas of e (each with respect to its own set of variables), we define the family

$$\left((\llbracket e \rrbracket_{\mathcal{V}} \mid \mathcal{V} \supseteq \text{Free}(e), \mathcal{V} \text{ finite}) \mid e \in \text{MSO}(\Sigma, \mathbf{B}) \right)$$

by induction on $(\text{MSO}(\Sigma, \mathbf{B}), \succ_{\text{MSO}(\Sigma, \mathbf{B})})$ as follows.

I.B.: Let \mathcal{U} be a finite set of variables and $\kappa = (\kappa_k \mid k \in \mathbb{N})$ be an \mathbb{N} -indexed family with $\kappa_k : (\Sigma_{\mathcal{U}})^{(k)} \rightarrow B$. Let $\mathcal{V} \supseteq \text{Free}(\mathbf{H}(\kappa))$ be a finite set of variables. Then, for each $\zeta \in \mathbf{T}_{\Sigma_{\mathcal{V}}}$, we define

$$\llbracket \mathbf{H}(\kappa) \rrbracket_{\mathcal{V}}(\zeta) = \begin{cases} \mathbf{h}_{\kappa[\mathcal{U} \rightsquigarrow \mathcal{V}]}(\zeta) & \text{if } \zeta \in \mathbf{T}_{\Sigma_{\mathcal{V}}}^{\mathcal{V}} \\ \emptyset & \text{otherwise .} \end{cases}$$

I.S.: We distinguish four cases.

- Let $\varphi \in \text{MSO}(\Sigma)$ and $e \in \text{MSO}(\Sigma, \mathbf{B})$. Let $\mathcal{V} \supseteq \text{Free}(\varphi \triangleright e)$ be a finite set of variables. Then, for each $\zeta \in \mathbf{T}_{\Sigma_{\mathcal{V}}}$, we define

$$\llbracket \varphi \triangleright e \rrbracket_{\mathcal{V}}(\zeta) = \begin{cases} \llbracket e \rrbracket_{\mathcal{V}}(\zeta) & \text{if } \zeta \in \mathbf{L}_{\mathcal{V}}(\varphi) \\ \emptyset & \text{otherwise .} \end{cases}$$

- Let $e_1, e_2 \in \text{MSO}(\Sigma, \mathbf{B})$. Let $\mathcal{V} \supseteq \text{Free}(e_1 + e_2)$ be a finite set of variables. Then, for each $\zeta \in \mathbf{T}_{\Sigma_{\mathcal{V}}}$, we define

$$\llbracket e_1 + e_2 \rrbracket_{\mathcal{V}}(\zeta) = \begin{cases} (\llbracket e_1 \rrbracket_{\mathcal{V}}(\zeta) \oplus \llbracket e_2 \rrbracket_{\mathcal{V}}(\zeta)) & \text{if } \zeta \in \mathbf{T}_{\Sigma_{\mathcal{V}}}^{\mathcal{V}} \\ \emptyset & \text{otherwise .} \end{cases}$$

- Let x be a first-order variable and $e \in \text{MSO}(\Sigma, \mathbf{B})$. Let $\mathcal{V} \supseteq \text{Free}(+_x e)$ be a finite set of variables. Then, for each $\zeta \in \mathbf{T}_{\Sigma, \mathcal{V}}$, we define

$$\llbracket +_x e \rrbracket_{\mathcal{V}}(\zeta) = \begin{cases} \bigoplus_{w \in \text{pos}(\zeta)} \llbracket e \rrbracket_{\mathcal{V} \cup \{x\}}(\zeta[x \mapsto w]) & \text{if } \zeta \in \mathbf{T}_{\Sigma, \mathcal{V}}^{\vee} \\ 0 & \text{otherwise .} \end{cases}$$

- Let X be a second-order variable and $e \in \text{MSO}(\Sigma, \mathbf{B})$. Let $\mathcal{V} \supseteq \text{Free}(+_X e)$ be a finite set of variables. Then, for each $\zeta \in \mathbf{T}_{\Sigma, \mathcal{V}}$, we define

$$\llbracket +_X e \rrbracket_{\mathcal{V}}(\zeta) = \begin{cases} \bigoplus_{W \subseteq \text{pos}(\zeta)} \llbracket e \rrbracket_{\mathcal{V} \cup \{X\}}(\zeta[X \mapsto W]) & \text{if } \zeta \in \mathbf{T}_{\Sigma, \mathcal{V}}^{\vee} \\ 0 & \text{otherwise .} \end{cases}$$

By definition, it is clear that the following holds:

$$\begin{aligned} & \text{for every finite set } \mathcal{V} \text{ of variables, } \varphi \in \text{MSO}(\Sigma), \text{ and } e \in \text{MSO}(\Sigma, \mathbf{B}) \\ & \text{such that } \mathcal{V} \supseteq \text{Free}(\varphi \triangleright e), \text{ we have } \llbracket \varphi \triangleright e \rrbracket_{\mathcal{V}} = \chi(\mathbf{L}_{\mathcal{V}}(\varphi)) \otimes \llbracket e \rrbracket_{\mathcal{V}}. \end{aligned} \quad (17.10)$$

We abbreviate $\llbracket e \rrbracket_{\text{Free}(e)}$ by $\llbracket e \rrbracket$. We say that a (Σ, \mathbf{B}) -weighted tree language r is *definable by a formula* in $\text{MSO}(\Sigma, \mathbf{B})$ -logic (or: *definable*) if there exists a sentence $e \in \text{MSO}(\Sigma, \mathbf{B})$ with $\llbracket e \rrbracket = r$.

Next we show a consistency lemma for formulas in $\text{MSO}(\Sigma, \mathbf{B})$.

Lemma 17.2.1. (cf. [FSV12, Lm. 3.8]) Let $e \in \text{MSO}(\Sigma, \mathbf{B})$ and let \mathcal{V} and \mathcal{W} be finite sets of variables with $\text{Free}(e) \subseteq \mathcal{W} \subseteq \mathcal{V}$. Then, for each $(\xi, \eta) \in \mathbf{T}_{\Sigma, \mathcal{V}}^{\vee}$, we have $\llbracket e \rrbracket_{\mathcal{V}}(\xi, \eta) = \llbracket e \rrbracket_{\mathcal{W}}(\xi, \eta|_{\mathcal{W}})$.

Proof. We prove the statement by induction on $(\text{MSO}(\Sigma, \mathbf{B}), \succ_{\text{MSO}(\Sigma, \mathbf{B})})$.

I.B.: Let $e = \mathbf{H}(\kappa)$. Let \mathcal{U} be a finite set of variables and $\kappa = (\kappa_k \mid k \in \mathbb{N})$ an \mathbb{N} -indexed family of mappings $\kappa_k : (\Sigma_{\mathcal{U}})^{(k)} \rightarrow B$. Moreover, let \mathcal{V} and \mathcal{W} be finite sets of variables with $\mathcal{U} \subseteq \mathcal{W} \subseteq \mathcal{V}$ and $(\xi, \eta) \in \mathbf{T}_{\Sigma, \mathcal{V}}^{\vee}$. Then

$$\llbracket \mathbf{H}(\kappa) \rrbracket_{\mathcal{V}}(\xi, \eta) = h_{\kappa[\mathcal{U} \rightsquigarrow \mathcal{V}]}(\xi, \eta) \stackrel{(*)}{=} h_{\kappa[\mathcal{U} \rightsquigarrow \mathcal{W}]}(\xi, \eta|_{\mathcal{W}}) = \llbracket \mathbf{H}(\kappa) \rrbracket_{\mathcal{W}}(\xi, \eta|_{\mathcal{W}}) ,$$

where the equality $(*)$ can be proved as follows. Let $\zeta \in \mathbf{T}_{\Sigma, \mathcal{V}}^{\vee}$ and $\zeta' \in \mathbf{T}_{\Sigma, \mathcal{W}}^{\vee}$ be the trees which correspond to (ξ, η) and $(\xi, \eta|_{\mathcal{W}})$, respectively. We have to show that

$$h_{\kappa[\mathcal{U} \rightsquigarrow \mathcal{V}]}(\zeta) = h_{\kappa[\mathcal{U} \rightsquigarrow \mathcal{W}]}(\zeta') . \quad (17.11)$$

Obviously, ζ' can be obtained from ζ by replacing each symbol (σ, \mathcal{V}') in ζ by $(\sigma, \mathcal{W} \cap \mathcal{V}')$. By 2.37, $h_{\kappa[\mathcal{U} \rightsquigarrow \mathcal{V}]}(\zeta)$ is the product of the weights of the symbols of ζ , where the factors are ordered according to the depth-first post-order of the positions. The product $h_{\kappa[\mathcal{U} \rightsquigarrow \mathcal{W}]}(\zeta')$ is defined analogously. Since $\text{pos}(\zeta) = \text{pos}(\zeta')$, there exists a bijection between the lists of the factors of the two products. Moreover, the factors which correspond to each other are equal, because for every $k \in \mathbb{N}$, $\sigma \in \Sigma^{(k)}$, and $\mathcal{V}' \subseteq \mathcal{V}$, by definition we have

$$\kappa[\mathcal{U} \rightsquigarrow \mathcal{V}]_k(\sigma, \mathcal{V}') = \kappa_k(\sigma, \mathcal{U} \cap \mathcal{V}') = \kappa_k(\sigma, \mathcal{U} \cap (\mathcal{W} \cap \mathcal{V}')) = \kappa[\mathcal{U} \rightsquigarrow \mathcal{W}]_k(\sigma, \mathcal{W} \cap \mathcal{V}') .$$

This proves (17.11) and hence $(*)$.

I.S.: For each form of e , the induction step is straightforward, hence we do not show the details. We note that in case $e = (\varphi \triangleright e')$ we use Lemma 17.1.1. \square

Example 17.2.2. Let $b \in B$ and x be a first-order variable.

1. We define the family $\kappa(b) = (\kappa(b)_k \mid k \in \mathbb{N})$ of mappings $\kappa(b)_k : \Sigma_{\{x\}}^{(k)} \rightarrow B$ such that, for each $(\sigma, U) \in \Sigma_{\{x\}}^{(k)}$, we let

$$\kappa(b)_k((\sigma, U)) = \begin{cases} b & \text{if } U = \{x\} \\ \mathbf{1} & \text{otherwise .} \end{cases}$$

Then,

$$\text{for every } \xi \in T_\Sigma \text{ and } w \in \text{pos}(\xi), \text{ we have } \llbracket \mathbf{H}(\kappa(b)) \rrbracket_{\{x\}}(\xi, [x \mapsto w]) = b . \quad (17.12)$$

This can be seen as follows:

$$\begin{aligned} \llbracket \mathbf{H}(\kappa(b)) \rrbracket_{\{x\}}(\xi, [x \mapsto w]) &= h_{\kappa(b)[\{x\} \rightsquigarrow \{x\}]}(\xi, [x \mapsto w]) = h_{\kappa(b)}(\xi, [x \mapsto w]) \\ &= \bigotimes_{\substack{v \in \text{pos}(\xi) \\ \text{in } <_{\text{dp}} \text{ order}}} \kappa(b)_{\text{rk}(\xi(v))}((\xi, [x \mapsto w])(v)) && \text{(by (2.37))} \\ &= \underbrace{\mathbb{1} \otimes \cdots \otimes \mathbb{1}}_{n-1} \otimes b \otimes \mathbb{1} \otimes \cdots \otimes \mathbb{1} = b , \end{aligned}$$

where we assume that w occurs at the n -th position in the $<_{\text{dp}}$ order of $\text{pos}(\xi)$.

2. Let us consider the $\text{MSO}(\Sigma, \mathbf{B})$ -sentence $\langle b \rangle$ defined by

$$\langle b \rangle = \bigoplus_x (\text{root}(x) \triangleright \mathbf{H}(\kappa(b)))$$

where the family $\kappa(b)$ is defined in the first part of this example. It is clear that $L_{\{x\}}(\text{root}(x)) = \{(\xi, [x \mapsto \varepsilon]) \mid \xi \in T_\Sigma\}$. Then, for each $\xi \in T_\Sigma$, we have

$$\begin{aligned} \llbracket \langle b \rangle \rrbracket(\xi) &= \llbracket \bigoplus_x (\text{root}(x) \triangleright \mathbf{H}(\kappa(b))) \rrbracket(\xi) = \bigoplus_{w \in \text{pos}(\xi)} \llbracket \text{root}(x) \triangleright \mathbf{H}(\kappa(b)) \rrbracket_{\{x\}}(\xi, [x \mapsto w]) \\ &= \bigoplus_{w \in \text{pos}(\xi)} \chi(L_{\{x\}}(\text{root}(x)))(\xi, [x \mapsto w]) \otimes \llbracket \mathbf{H}(\kappa(b)) \rrbracket_{\{x\}}(\xi, [x \mapsto w]) && \text{(by (17.10))} \\ &= \bigoplus_{\substack{w \in \text{pos}(\xi): \\ (\xi, [x \mapsto w]) \in L_{\{x\}}(\text{root}(x))}} \llbracket \mathbf{H}(\kappa(b)) \rrbracket_{\{x\}}(\xi, [x \mapsto w]) = \llbracket \mathbf{H}(\kappa(b)) \rrbracket_{\{x\}}(\xi, [x \mapsto \varepsilon]) \\ &= b . && \text{(by (17.12))} \end{aligned}$$

Hence $\llbracket \langle b \rangle \rrbracket = \tilde{b}$.

3. Now let φ be an $\text{MSO}(\Sigma)$ -formula. We consider the $\text{MSO}(\Sigma, \mathbf{B})$ -formula $\varphi \triangleright \langle b \rangle$. Then, for each finite set \mathcal{V} of variables with $\text{Free}(\varphi) \subseteq \mathcal{V}$ and $\xi \in T_{\Sigma_{\mathcal{V}}}$, we have

$$\begin{aligned} \llbracket \varphi \triangleright \langle b \rangle \rrbracket_{\mathcal{V}}(\xi) &= \chi(L_{\mathcal{V}}(\varphi))(\xi) \otimes \llbracket \langle b \rangle \rrbracket_{\mathcal{V}}(\xi) && \text{(by (17.10))} \\ &= \llbracket \langle b \rangle \rrbracket_{\mathcal{V}}(\xi) \otimes \chi(L_{\mathcal{V}}(\varphi))(\xi) && \text{(because } \chi(L(\varphi))(\xi) \in \{0, \mathbb{1}\}) \\ &= \llbracket \langle b \rangle \rrbracket(\xi) \otimes \chi(L_{\mathcal{V}}(\varphi))(\xi) && \text{(by Lemma 17.2.1)} \\ &= (b \cdot \chi(L_{\mathcal{V}}(\varphi)))(\xi) . && \text{(because } \llbracket \langle b \rangle \rrbracket(\xi) = b) \end{aligned}$$

Hence $\llbracket \varphi \triangleright \langle b \rangle \rrbracket_{\mathcal{V}} = b \cdot \chi(L_{\mathcal{V}}(\varphi))$. \square

Now we will define particular $\text{MSO}(\Sigma, \mathbf{B})$ -formulas called recognizable step formulas. We show that the semantics of recognizable step sentences are recognizable step mappings, and vice versa, each recognizable step mapping is the semantics of such a recognizable step sentence.

A (Σ, \mathbf{B}) -recognizable step formula is a formula in $\text{MSO}(\Sigma, \mathbf{B})$ of the form

$$(\varphi_1 \triangleright \langle b_1 \rangle) + \cdots + (\varphi_n \triangleright \langle b_n \rangle) , \quad (17.13)$$

where φ_i is an $\text{MSO}(\Sigma)$ -formula and $\langle b_i \rangle$ is an $\text{MSO}(\Sigma, \mathbf{B})$ -sentence defined in Example 17.2.2(2) for each $i \in [n]$. If, in addition, $\varphi_1, \dots, \varphi_n$ are sentences, then (17.13) is called a (Σ, \mathbf{B}) -recognizable step sentence.

By Example 17.2.2(3), for each finite set \mathcal{V} of variables such that $\mathcal{V} \supseteq \bigcup_{i \in [n]} \text{Free}(\varphi_i)$, we have

$$\llbracket (\varphi_1 \triangleright \langle b_1 \rangle) + \cdots + (\varphi_n \triangleright \langle b_n \rangle) \rrbracket_{\mathcal{V}} = \bigoplus_{i \in [n]} b_i \cdot \chi(L_{\mathcal{V}}(\varphi_i)) . \quad (17.14)$$

Lemma 17.2.3. Let $r : T_\Sigma \rightarrow B$ be a weighted tree language, $n \in \mathbb{N}_+$, and $b_1, \dots, b_n \in B$. Then the following two statements are equivalent.

- (A) We can construct Σ -fta A_1, \dots, A_n such that $r = \bigoplus_{i \in [n]} b_i \cdot \chi(L(A_i))$.
 (B) We can construct sentences $\varphi_1, \dots, \varphi_n$ in $\text{MSO}(\Sigma)$ such that $r = \llbracket (\varphi_1 \triangleright \langle b_1 \rangle) + \dots + (\varphi_n \triangleright \langle b_n \rangle) \rrbracket$.

Proof. The proof follows from Theorem 17.1.3(A) \Leftrightarrow (B) and (17.14). \square

Example 17.2.4. In this example, the weight algebra is the semiring $\text{Nat} = (\mathbb{N}, +, \cdot, 0, 1)$.

1. We consider the $\text{MSO}(\Sigma, \text{Nat})$ -sentence

$$e = \bigoplus_x \text{H}(\kappa(1)) ,$$

where the \mathbb{N} -indexed family $\kappa(1)$ of mappings is defined in Example 17.2.2.

Then, for each $\xi \in T_\Sigma$, we have

$$\begin{aligned} \llbracket e \rrbracket(\xi) &= \llbracket \bigoplus_x \text{H}(\kappa(1)) \rrbracket(\xi) = \bigoplus_{w \in \text{pos}(\xi)} \llbracket \text{H}(\kappa(1)) \rrbracket_{\{x\}}(\xi, [x \mapsto w]) \\ &= \bigoplus_{w \in \text{pos}(\xi)} 1 && \text{(by (17.12))} \\ &= \text{size}(\xi) . \end{aligned}$$

Hence $\llbracket e \rrbracket = \text{size}$.

2. Now let $\Sigma = \{\sigma^{(2)}, \gamma^{(1)}, \alpha^{(0)}\}$ and consider the $\text{MSO}(\Sigma, \text{Nat})$ -sentence

$$e = \bigoplus_x (\varphi(x) \triangleright \text{H}(\kappa(1))) ,$$

where $\varphi(x) = (\text{label}_\sigma(x) \wedge \forall y. (\text{edge}_2(x, y) \rightarrow \text{label}_\alpha(y)))$. It is easy to see that

$$L_{\{x\}}(\varphi(x)) = \{(\xi, [x \mapsto w]) \mid \xi \in T_\Sigma, w \in \text{pos}(\xi), \xi(w) = \sigma \text{ and } \xi(w2) = \alpha\} .$$

Then for each $\xi \in T_\Sigma$, we have

$$\begin{aligned} \llbracket e \rrbracket(\xi) &= \llbracket \bigoplus_x (\varphi(x) \triangleright \text{H}(\kappa(1))) \rrbracket(\xi) = \bigoplus_{w \in \text{pos}(\xi)} \llbracket \varphi(x) \triangleright \text{H}(\kappa(1)) \rrbracket_{\{x\}}(\xi, [x \mapsto w]) \\ &= \bigoplus_{w \in \text{pos}(\xi)} \chi(L_{\{x\}}(\varphi(x)))(\xi, [x \mapsto w]) \cdot \llbracket \text{H}(\kappa(1)) \rrbracket_{\{x\}}(\xi, [x \mapsto w]) && \text{(by (17.10))} \\ &= \bigoplus_{\substack{w \in \text{pos}(\xi): \\ \xi(w) = \sigma, \xi(w2) = \alpha}} \llbracket \text{H}(\kappa(1)) \rrbracket_{\{x\}}(\xi, [x \mapsto w]) \\ &= \bigoplus_{\substack{w \in \text{pos}(\xi): \\ \xi(w) = \sigma, \xi(w2) = \alpha}} 1 && \text{(by (17.12))} \\ &= \#_{\sigma(\cdot, \alpha)}(\xi) . && \text{(for } \#_{\sigma(\cdot, \alpha)}, \text{ see Example 3.2.11)} \end{aligned}$$

Hence $\llbracket e \rrbracket = \#_{\sigma(\cdot, \alpha)}$. \square

Example 17.2.5. Here we show that the weighted tree language height $: T_\Sigma \rightarrow \mathbb{N}$ is definable over the arctic semiring $\text{Nat}_{\max, +} = (\mathbb{N}_{-\infty}, \max, +, -\infty, 0)$. We let φ be the following $\text{MSO}(\Sigma)$ -formula with $\text{Free}(\varphi) = \{x, X\}$:

$$\begin{aligned} \varphi(x, X) &= \text{leaf}(x) \wedge \text{Path}(X, x), \text{ where} \\ \text{leaf}(x) &= \neg \exists y. \text{edge}(x, y), \\ \text{Path}(X, x) &= \forall y. (y \in X) \leftrightarrow \text{path}(y, x), \end{aligned}$$

and $\text{path}(y, x)$ is the formula defined in Example 17.1.2.

The following is obvious:

$$L_{\{x, X\}}(\varphi) = \{(\xi, [x \mapsto w, X \mapsto \text{prefix}(w)]) \mid \xi \in \mathbf{T}_\Sigma, w \in \text{pos}(\xi), \xi(w) \in \Sigma^{(0)}\} \quad (17.15)$$

Then we consider the $\text{MSO}(\Sigma, \mathbf{Nat}_{\max, +})$ -formula

$$e_{\text{height}} = \bigoplus_x \bigoplus_X (\varphi(x, X) \triangleright \mathbf{H}(\kappa))$$

where $\kappa = (\kappa_k \mid k \in \mathbb{N})$ and $\kappa_k : (\Sigma_{\{x, X\}})^{(k)} \rightarrow B$ defined, for each $(\sigma, U) \in (\Sigma_{\{x, X\}})^{(k)}$, by

$$\kappa_k((\sigma, U)) = \begin{cases} 1 & \text{if } X \in U \text{ and } k \geq 1 \\ 0 & \text{otherwise .} \end{cases}$$

It is clear that, for every $(\xi, [x \mapsto w, X \mapsto \text{prefix}(w)]) \in L_{\{x, X\}}(\varphi)$, we have

$$\llbracket \mathbf{H}(\kappa) \rrbracket_{\{x, X\}}(\xi, [x \mapsto w, X \mapsto \text{prefix}(w)]) = |w| . \quad (17.16)$$

Then, for each $\xi \in \mathbf{T}_\Sigma$, we have

$$\begin{aligned} \llbracket e_{\text{height}} \rrbracket(\xi) &= \llbracket \bigoplus_x \bigoplus_X (\varphi(x, X) \triangleright \mathbf{H}(\kappa)) \rrbracket(\xi) \\ &= \max \left(\max \left(\llbracket \varphi(x, X) \triangleright \mathbf{H}(\kappa) \rrbracket_{\{x, X\}}(\xi[x \mapsto w, X \mapsto W]) \mid W \subseteq \text{pos}(\xi) \mid w \in \text{pos}(\xi) \right) \right) \\ &= \max \left(\llbracket \varphi(x, X) \triangleright \mathbf{H}(\kappa) \rrbracket_{\{x, X\}}(\xi[x \mapsto w, X \mapsto W]) \mid W \subseteq \text{pos}(\xi), w \in \text{pos}(\xi) \right) \\ &= \max \left(\llbracket \mathbf{H}(\kappa) \rrbracket_{\{x, X\}}(\xi[x \mapsto w, X \mapsto \text{prefix}(w)]) \mid w \in \text{pos}(\xi), \xi(w) \in \Sigma^{(0)} \right) \quad (\text{by (17.15)}) \\ &= \max(|w| \mid w \in \text{pos}(\xi), \xi(w) \in \Sigma^{(0)}) \quad (\text{by (17.16)}) \\ &= \text{height}(\xi) . \quad \square \end{aligned}$$

We finish this section with two easy properties. Roughly speaking, they say that weighted existential quantification can be expressed by deterministic tree relabelings, where in the first-order case we have to take care of preserving validity.

Lemma 17.2.6. Let $e \in \text{MSO}(\Sigma, \mathbf{B})$.

- (1) Let $\mathcal{V} = \text{Free}(\bigoplus_x e)$. Then $\llbracket \bigoplus_x e \rrbracket = \chi(\tau)(\llbracket e \rrbracket_{\mathcal{V} \cup \{x\}}) \otimes \chi(\mathbf{T}_{\Sigma_{\mathcal{V}}}^{\mathcal{V}})$, where $\tau = (\tau_k \mid k \in \mathbb{N})$ is the deterministic $(\Sigma_{\mathcal{V} \cup \{x\}}, \Sigma_{\mathcal{V}})$ -tree relabeling such that, for every $k \in \mathbb{N}$, $\sigma \in \Sigma^{(k)}$, and $\mathcal{W} \subseteq \mathcal{V} \cup \{x\}$, we let $\tau_k((\sigma, \mathcal{W})) = \{(\sigma, \mathcal{W} \setminus \{x\})\}$.
- (2) Let $\mathcal{V} = \text{Free}(\bigoplus_X e)$. Then $\llbracket \bigoplus_X e \rrbracket = \chi(\tau)(\llbracket e \rrbracket_{\mathcal{V} \cup \{X\}})$, where $\tau = (\tau_k \mid k \in \mathbb{N})$ is the deterministic $(\Sigma_{\mathcal{V} \cup \{X\}}, \Sigma_{\mathcal{V}})$ -tree relabeling such that, for every $k \in \mathbb{N}$, $\sigma \in \Sigma^{(k)}$, and $\mathcal{W} \subseteq \mathcal{V} \cup \{X\}$, we let $\tau_k((\sigma, \mathcal{W})) = \{(\sigma, \mathcal{W} \setminus \{X\})\}$.

Proof. Proof of (1): Let $\mathcal{V} = \text{Free}(\bigoplus_x e)$ and $\xi \in \mathbf{T}_{\Sigma_{\mathcal{V}}}$. We note that $x \notin \mathcal{V}$. We distinguish the following two cases.

Case (a): Let $\xi \notin \mathbf{T}_{\Sigma_{\mathcal{V}}}^{\mathcal{V}}$. Then $\llbracket \bigoplus_x e \rrbracket(\xi) = 0 = \chi(\tau)(\llbracket e \rrbracket_{\mathcal{V} \cup \{x\}})(\xi) \otimes \chi(\mathbf{T}_{\Sigma_{\mathcal{V}}}^{\mathcal{V}})(\xi)$.

Case (b): Let $\xi \in \mathbf{T}_{\Sigma_{\mathcal{V}}}^{\mathcal{V}}$. Then we can calculate as follows:

$$\begin{aligned} \llbracket \bigoplus_x e \rrbracket(\xi) &= \bigoplus_{w \in \text{pos}(\xi)} \llbracket e \rrbracket_{\mathcal{V} \cup \{x\}}(\xi[x \mapsto w]) \\ &= \bigoplus_{\zeta \in \{\xi[x \mapsto w] \mid w \in \text{pos}(\xi)\}} \llbracket e \rrbracket_{\mathcal{V} \cup \{x\}}(\zeta) \quad (\text{because } \xi[x \mapsto w] \neq \xi[x \mapsto w'] \text{ for } w \neq w') \end{aligned}$$

$$\begin{aligned}
&= \bigoplus_{\zeta \in \tau^{-1}(\xi) \cap T_{\Sigma \cup \{x\}}^v} \llbracket e \rrbracket_{\mathcal{V} \cup \{x\}}(\zeta) && \text{(by definition of } \tau) \\
&= \bigoplus_{\zeta \in \tau^{-1}(\xi)} \llbracket e \rrbracket_{\mathcal{V} \cup \{x\}}(\zeta) && \text{(because } \llbracket e \rrbracket_{\mathcal{V} \cup \{x\}}(\zeta) = 0 \text{ for } \zeta \in \tau^{-1}(\xi) \setminus T_{\Sigma \cup \{x\}}^v) \\
&= \chi(\tau)(\llbracket e \rrbracket_{\mathcal{V} \cup \{x\}})(\xi) && \text{(by (2.40))} \\
&= (\chi(\tau)(\llbracket e \rrbracket_{\mathcal{V} \cup \{x\}}) \otimes \chi(T_{\Sigma \cup \{x\}}^v))(\xi) . && \text{(because } \chi(T_{\Sigma \cup \{x\}}^v)(\xi) = \mathbb{1})
\end{aligned}$$

Proof of (2): Let $\mathcal{V} = \text{Free}(\bigoplus_X e)$ and $\xi \in T_{\Sigma \cup \mathcal{V}}$. We note that $X \notin \mathcal{V}$. Since $\mathcal{U}^{(1)} = \mathcal{V}^{(1)}$ (i.e., the set of first-order variables of \mathcal{U} is the same as the set of first-order variables of \mathcal{V}), we have

$$\text{for every } \xi \in T_{\Sigma \cup \mathcal{V}} \text{ and } \zeta \in \tau^{-1}(\xi): \xi \in T_{\Sigma \cup \mathcal{V}}^v \text{ iff } \zeta \in T_{\Sigma \cup \mathcal{V} \cup \{X\}}^v. \quad (17.17)$$

We distinguish the following two cases.

Case (a): Let $\xi \notin T_{\Sigma \cup \mathcal{V}}^v$. Then $\llbracket \bigoplus_X e \rrbracket(\xi) = 0 = \chi(\tau)(\llbracket e \rrbracket_{\mathcal{V} \cup \{X\}})(\xi)$ where the second equality holds by (17.17).

Case (b): Let $\xi \in T_{\Sigma \cup \mathcal{V}}^v$. Then we can calculate as follows:

$$\begin{aligned}
\llbracket \bigoplus_X e \rrbracket(\xi) &= \bigoplus_{W \subseteq \text{pos}(\xi)} \llbracket e \rrbracket_{\mathcal{V} \cup \{X\}}(\xi[X \mapsto W]) \\
&= \bigoplus_{\zeta \in \{\xi[X \mapsto W] \mid W \subseteq \text{pos}(\xi)\}} \llbracket e \rrbracket_{\mathcal{V} \cup \{X\}}(\zeta) && \text{(because } \xi[X \mapsto W] \neq \xi[X \mapsto W'] \text{ for } W \neq W') \\
&= \bigoplus_{\zeta \in \tau^{-1}(\xi)} \llbracket e \rrbracket_{\mathcal{V} \cup \{X\}}(\zeta) && \text{(by definition of } \tau) \\
&= \chi(\tau)(\llbracket e \rrbracket_{\mathcal{V} \cup \{X\}})(\xi) && \text{(by (2.40))}
\end{aligned}$$

□

17.3 The main result for $\text{MSO}(\Sigma, \mathbf{B})$

The main theorem of this chapter will be the following B-E-T theorem for weighted tree languages over strong bimonoids.

Theorem 17.3.1. *Let Σ be a ranked alphabet. Moreover, let $\mathbf{B} = (B, \oplus, \otimes, 0, \mathbb{1})$ be a strong bimonoid and let $r : T_{\Sigma} \rightarrow B$. Then the following two statements are equivalent.*

- (A) *We can construct a (Σ, \mathbf{B}) -wta \mathcal{A} such that $r = \llbracket \mathcal{A} \rrbracket^{\text{run}}$.*
- (B) *We can construct a sentence $e \in \text{MSO}(\Sigma, \mathbf{B})$ such that $r = \llbracket e \rrbracket$.*

This theorem follows from Theorems 17.3.2 and 17.3.8, which we will prove in the next two subsections.

17.3.1 From recognizable to definable

We prove that, for each (Σ, \mathbf{B}) -wta \mathcal{A} , we can construct a sentence $e \in \text{MSO}(\Sigma, \mathbf{B})$ such that the run semantics $\llbracket \mathcal{A} \rrbracket^{\text{run}}$ is equal to $\llbracket e \rrbracket$. In the usual way, we use second-order quantifications to label positions of the given tree $\xi \in T_{\Sigma}$ by transitions of \mathcal{A} ; by means of a formula of $\text{MSO}(\Sigma)$ -logic we can check whether this labeling corresponds to a run on ξ . Finally, we define a mapping κ which translates each transition into its weight.

Theorem 17.3.2. [FSV12, Lm. 4.2] *For each (Σ, \mathbf{B}) -wta \mathcal{A} , we can construct a sentence $e \in \text{MSO}(\Sigma, \mathbf{B})$ such that $\llbracket e \rrbracket = \llbracket \mathcal{A} \rrbracket^{\text{run}}$.*

Proof. Let $\mathcal{A} = (Q, \delta, F)$ be a (Σ, \mathbf{B}) -wta. By Theorem 7.3.1 we can assume that \mathcal{A} is root weight normalized. Thus $\text{supp}(F)$ contains exactly one element, say, q_f , and $F_{q_f} = \mathbb{1}$.

We define the set

$$\mathcal{U} = \bigcup (Q^k \times Q \mid k \in \mathbb{N} \text{ such that } \text{rk}^{-1}(k) \neq \emptyset) .$$

Let $n \in \mathbb{N}_+$ be the cardinality of \mathcal{U} . Then we choose an arbitrary bijection $\nu : \mathcal{U} \rightarrow \{X_1, \dots, X_n\}$ and fix it for the rest of the proof. In the sequel, we will not distinguish between a state behaviour $(q_1 \cdots q_k, q) \in \mathcal{U}$ and the second-order variable $\nu((q_1 \cdots q_k, q))$. Thus, it is legitimate to consider each $(q_1 \cdots q_k, q) \in \mathcal{U}$ as a second-order variable. Then, in particular, $\mathcal{U} = \mathcal{U}^{(2)}$ and hence $\text{T}_{\Sigma \mathcal{U}} = \text{T}_{\Sigma \mathcal{U}}^{\vee}$.

Moreover, for every $\xi \in \text{T}_{\Sigma}$ and $\rho \in \text{R}_{\mathcal{A}}(\xi)$, we define the \mathcal{U} -assignment $\eta_{\xi, \rho} \in \Phi_{\mathcal{U}, \xi}$ as follows. For each $(q_1 \cdots q_k, q) \in \mathcal{U}$, we let

$$\eta_{\xi, \rho}((q_1 \cdots q_k, q)) = \{w \in \text{pos}(\xi) \mid \rho(w) = q, \text{rk}(\xi(w)) = k, (\forall i \in [k]) : \rho(w_i) = q_i\} .$$

Now we define the formula $\varphi \in \text{MSO}(\Sigma)$ where $\text{Free}(\varphi) = \mathcal{U}$ with the following intention:

$$\begin{aligned} & \text{The mapping } f : \text{R}_{\mathcal{A}}(q_f, \xi) \rightarrow \{\eta \in \Phi_{\mathcal{U}, \xi} \mid (\xi, \eta) \in \text{L}_{\mathcal{U}}(\varphi)\} \text{ which is} \\ & \text{defined for each } \rho \in \text{R}_{\mathcal{A}}(q_f, \xi) \text{ by } f(\rho) = \eta_{\xi, \rho}, \text{ is bijective.} \end{aligned} \quad (17.18)$$

For this, we let

$$\varphi = \varphi_{\text{part}} \wedge \varphi_{\text{run}} \wedge \varphi_{\text{suc}} \quad (17.19)$$

where

- φ_{part} checks whether the family $(\eta(X) \mid X \in \mathcal{U})$ forms a partitioning of $\text{pos}(\xi)$, i.e., whether each position of ξ is assigned to exactly one transition,
- φ_{run} checks whether η codes a run in $\text{R}_{\mathcal{A}}(\xi)$, and
- φ_{suc} checks whether the target state of the transition associated to the root of ξ is q_f .

Formally, we define

$$\begin{aligned} \varphi_{\text{part}} &= \forall x. \left(\bigvee_{X \in \mathcal{U}} (x \in X \wedge \bigwedge_{Y \in \mathcal{U} \setminus \{X\}} \neg(x \in Y)) \right) \\ \varphi_{\text{run}} &= \forall x. \bigwedge_{(q_1 \cdots q_k, q) \in \mathcal{U}} \left[(x \in (q_1 \cdots q_k, q)) \rightarrow \bigwedge_{i \in [k]} \left(\forall y. \text{edge}_i(x, y) \rightarrow \bigvee_{(q'_1 \cdots q'_\ell, q_i) \in \mathcal{U}} y \in (q'_1 \cdots q'_\ell, q_i) \right) \right] \\ \varphi_{\text{suc}} &= \forall x. \text{root}(x) \rightarrow \bigvee_{(q_1 \cdots q_k, q_f) \in \mathcal{U}} x \in (q_1 \cdots q_k, q_f) \end{aligned}$$

It is easy to check that (17.18) holds.

Now we define the \mathbb{N} -indexed family $(\kappa_k \mid k \in \mathbb{N})$ with $\kappa_k : \Sigma_{\mathcal{U}}^{(k)} \rightarrow B$ which supplies the weights. For every $k \in \mathbb{N}$, $\sigma \in \Sigma^{(k)}$, and $\mathcal{W} \subseteq \mathcal{U}$ we let

$$\kappa_k((\sigma, \mathcal{W})) = \begin{cases} \delta_k(q_1 \cdots q_k, \sigma, q) & \text{if } \mathcal{W} = \{(q_1 \cdots q_k, q)\} \\ 0 & \text{otherwise} \end{cases} \quad (17.20)$$

Let $\xi \in \text{T}_{\Sigma}$ and $\rho \in \text{R}_{\mathcal{A}}(\xi)$ be arbitrary but fixed. We consider $(\xi, \eta_{\xi, \rho})$ to be an element of $\text{T}_{\Sigma \mathcal{U}}^{\vee}$ (by the identification which we discussed in Section 17.1).

For the inductive proof of the next statement, we define the reduction system

$$(\text{pos}(\xi), \succ)$$

where the binary relation \succ on $\text{pos}(\xi)$ is defined as follows. For every $w_1, w_2 \in \text{pos}(\xi)$, we let $w_1 \succ w_2$ if there exists $i \in \mathbb{N}$ such that $w_2 = w_1 i$. Since $\text{pos}(\xi)$ is finite, the relation \succ is terminating. Moreover, we have that $\text{nf}_{\succ}(\text{pos}(\xi)) = \text{pos}_{\Sigma^{(0)}}(\xi)$, i.e., it is the set of leaves of ξ (cf. the proof of Lemma 10.8.1). Then we can prove the next statement by induction on $(\text{pos}(\xi), \succ)$.

$$\text{For every } w \in \text{pos}(\xi): \quad \text{h}_{\kappa}((\xi, \eta_{\xi, \rho})|_w) = \text{wt}_{\mathcal{A}}(\xi|_w, \rho|_w) . \quad (17.21)$$

For this, let $w \in \text{pos}(\xi)$ with $\sigma = \xi(w)$, and $k = \text{rk}_{\Sigma}(\sigma)$. Then we have

$$(\xi, \eta_{\xi, \rho})(w) = (\sigma, \{X \in \mathcal{U} \mid w \in \eta_{\xi, \rho}(X)\}) = (\sigma, \{(\rho(w1) \cdots \rho(wk), \rho(w))\}) .$$

We obtain:

$$\begin{aligned} \text{h}_{\kappa}((\xi, \eta_{\xi, \rho})|_w) &= \left(\bigotimes_{i \in [k]} \text{h}_{\kappa}((\xi, \eta_{\xi, \rho})|_{wi}) \right) \otimes \kappa_k((\sigma, \{(\rho(w1) \cdots \rho(wk), \rho(w))\})) && \text{(by (2.36))} \\ &= \left(\bigotimes_{i \in [k]} \text{wt}_{\mathcal{A}}(\xi|_{wi}, \rho|_{wi}) \right) \otimes \delta_k(\rho(w1) \cdots \rho(wk), \sigma, \rho(w)) && \text{(by I.H. and the definition of } \kappa) \\ &= \text{wt}_{\mathcal{A}}(\xi|_w, \rho|_w) . && \text{(by Observation 3.1.1)} \end{aligned}$$

Now we define the sentence $e \in \text{MSO}(\Sigma, \mathbf{B})$ and prove that it simulates \mathcal{A} (we recall that we do not distinguish between elements of \mathcal{U} and elements of $\{X_1, \dots, X_n\}$):

$$e = \bigoplus_{X_1} \cdots \bigoplus_{X_n} (\varphi \triangleright \text{H}(\kappa)) . \quad (17.22)$$

Then, for each $\xi \in \text{T}_{\Sigma}$, we have:

$$\begin{aligned} \llbracket e \rrbracket(\xi) &= \bigoplus_{W_1, \dots, W_n \subseteq \text{pos}(\xi)} \llbracket \varphi \triangleright \text{H}(\kappa) \rrbracket_{\mathcal{U}}(\xi[X_1 \mapsto W_1, \dots, X_n \mapsto W_n]) \\ &= \bigoplus_{\eta \in \Phi_{\mathcal{U}, \xi}} \llbracket \varphi \triangleright \text{H}(\kappa) \rrbracket_{\mathcal{U}}(\xi, \eta) = \bigoplus_{\substack{\eta \in \Phi_{\mathcal{U}, \xi}: \\ (\xi, \eta) \in \text{L}_{\mathcal{U}}(\varphi)}} \llbracket \text{H}(\kappa) \rrbracket_{\mathcal{U}}(\xi, \eta) \\ &= \bigoplus_{\substack{\eta \in \Phi_{\mathcal{U}, \xi}: \\ (\xi, \eta) \in \text{L}_{\mathcal{U}}(\varphi)}} \text{h}_{\kappa}((\xi, \eta)) && \text{(because } \kappa[\mathcal{U} \rightsquigarrow \mathcal{U}] = \kappa) \\ &= \bigoplus_{\rho \in \text{R}_{\mathcal{A}}(q_f, \xi)} \text{h}_{\kappa}((\xi, \eta_{\xi, \rho})) && \text{(by (17.18))} \\ &= \bigoplus_{\rho \in \text{R}_{\mathcal{A}}(q_f, \xi)} \text{wt}_{\mathcal{A}}(\xi, \rho) && \text{(by (17.21) for } w = \varepsilon) \\ &= \llbracket \mathcal{A} \rrbracket^{\text{run}}(\xi) . && \square \end{aligned}$$

Example 17.3.3. We illustrate the definition of the $\text{MSO}(\Sigma, \mathbf{B})$ -formula (17.22) in the proof of Theorem 17.3.2. For this we consider the root weight normalized $(\Sigma, \text{Nat}_{\max, +})$ -wta $\mathcal{A} = (Q, \delta, F)$ from Example 3.2.4, which i-recognizes the $(\Sigma, \text{Nat}_{\max, +})$ -weighted tree language height. We recall that $\Sigma = \{\sigma^{(2)}, \alpha^{(0)}\}$, $\text{Nat}_{\max, +} = (\mathbb{N}_{-\infty}, \max, +, -\infty, 0)$, $Q = \{\text{h}, 0\}$, $\delta_0(\varepsilon, \alpha, \text{h}) = \delta_0(\varepsilon, \alpha, 0) = 0$ and for every $q_1, q_2, q \in Q$,

$$\delta_2(q_1 q_2, \sigma, q) = \begin{cases} 1 & \text{if } q_1 q_2 q \in \{\text{h}0\text{h}, 0\text{h}\text{h}\} , \\ 0 & \text{if } q_1 q_2 q = 000 , \\ -\infty & \text{otherwise} , \end{cases}$$

and $F_{\text{h}} = 0$ and $F_0 = -\infty$.

X	$\eta_1(X)$	$\eta_2(X)$	$\eta_3(X)$
$(\varepsilon, \alpha, \mathbf{h})$	$\{11\}$	$\{12\}$	$\{2\}$
$(\varepsilon, \alpha, 0)$	$\{12, 2\}$	$\{11, 2\}$	$\{11, 12\}$
$(00, \sigma, 0)$	\emptyset	\emptyset	$\{1\}$
$(0\mathbf{h}, \sigma, 0)$	\emptyset	\emptyset	\emptyset
$(\mathbf{h}0, \sigma, 0)$	\emptyset	\emptyset	\emptyset
$(\mathbf{h}\mathbf{h}, \sigma, 0)$	\emptyset	\emptyset	\emptyset
$(00, \sigma, \mathbf{h})$	\emptyset	\emptyset	\emptyset
$(0\mathbf{h}, \sigma, \mathbf{h})$	\emptyset	$\{1\}$	$\{\varepsilon\}$
$(\mathbf{h}0, \sigma, \mathbf{h})$	$\{\varepsilon, 1\}$	$\{\varepsilon\}$	\emptyset
$(\mathbf{h}\mathbf{h}, \sigma, \mathbf{h})$	\emptyset	\emptyset	\emptyset

Figure 17.2: The \mathcal{U} -assignments η_1 , η_2 , and η_3 for ξ .

The set \mathcal{U} of second-order variables is the following:

$$\begin{aligned} \mathcal{U} = \{ & (\varepsilon, \alpha, \mathbf{h}), (\varepsilon, \alpha, 0), \\ & (00, \sigma, 0), (0\mathbf{h}, \sigma, 0), (\mathbf{h}0, \sigma, 0), (\mathbf{h}\mathbf{h}, \sigma, 0), \\ & (00, \sigma, \mathbf{h}), (0\mathbf{h}, \sigma, \mathbf{h}), (\mathbf{h}0, \sigma, \mathbf{h}), (\mathbf{h}\mathbf{h}, \sigma, \mathbf{h}) \} . \end{aligned}$$

Let $\varphi \in \text{MSO}(\Sigma)$ be the instance of the MSO formula (17.19) for the particular $(\Sigma, \mathbf{Nat}_{\max,+})$ -wta \mathcal{A} above. We will not give further details of φ . Instead, in Figure 17.3, we show the tree $(\xi, \eta_2) \in \mathbf{T}_{\Sigma_{\mathcal{U}}}^{\mathbf{V}}$ which satisfies φ , where $\xi = \sigma(\sigma(\alpha, \alpha), \alpha)$ and the assignment η_2 is defined in Figure 17.2.

Next we instantiate the family of (17.20) to the particular $(\Sigma, \mathbf{Nat}_{\max,+})$ -wta \mathcal{A} above. This provides the following \mathbb{N} -indexed family $\kappa = (\kappa_k \mid k \in \mathbb{N})$ with $\kappa_k : (\Sigma_{\mathcal{U}})^{(k)} \rightarrow \mathbb{N}_{-\infty}$:

$$\begin{aligned} \kappa_0((\alpha, \{(\varepsilon, \alpha, \mathbf{h})\})) &= \delta_0(\varepsilon, \alpha, \mathbf{h}) = 0 \\ \kappa_0((\alpha, \{(\varepsilon, \alpha, 0)\})) &= \delta_0(\varepsilon, \alpha, 0) = 0 \\ \kappa_2((\sigma, \{(\mathbf{h}0, \sigma, \mathbf{h})\})) &= \delta_2(\mathbf{h}0, \sigma, \mathbf{h}) = 1 \\ \kappa_2((\sigma, \{(0\mathbf{h}, \sigma, \mathbf{h})\})) &= \delta_2(0\mathbf{h}, \sigma, \mathbf{h}) = 1 \\ \kappa_2((\sigma, \{(00, \sigma, 0)\})) &= \delta_2(00, \sigma, 0) = 0 \end{aligned}$$

and for each other argument, κ_0 and κ_2 yield $-\infty$. Then we instantiate the formula (17.22) to be the $\text{MSO}(\Sigma, \mathbf{Nat}_{\max,+})$ -formula e is defined by

$$e = \bigoplus_{(\varepsilon, \alpha, \mathbf{h})} \bigoplus_{(\varepsilon, \alpha, 0)} \bigoplus_{(00, \sigma, 0)} \cdots \bigoplus_{(\mathbf{h}\mathbf{h}, \sigma, \mathbf{h})} \varphi \triangleright \mathbf{H}(\kappa) .$$

Next we compute $\llbracket e \rrbracket(\xi)$ for the tree $\xi = \sigma(\sigma(\alpha, \alpha), \alpha)$. First, we note that

$$\{(\xi, \eta) \in \mathbf{T}_{\Sigma_{\mathcal{U}}} \mid (\xi, \eta) \models \varphi\} = \{(\xi, \eta_1), (\xi, \eta_2), (\xi, \eta_3)\}$$

where the \mathcal{U} -assignments η_1 , η_2 , and η_3 for ξ are defined in the table shown in Figure 17.2 (where $X \in \mathcal{U}$).

By applying the unique $\Sigma_{\mathcal{U}}$ -algebra homomorphism \mathbf{h}_{κ} to (ξ, η_2) , we obtain

$$\begin{aligned} \mathbf{h}_{\kappa}((\xi, \eta_2)) &= \mathbf{h}_{\kappa}((\xi, \eta_2)|_1) + \mathbf{h}_{\kappa}((\xi, \eta_2)|_2) + \kappa_2((\sigma, \{(\mathbf{h}0, \sigma, \mathbf{h})\})) \\ &= \mathbf{h}_{\kappa}((\xi, \eta_2)|_1) + \mathbf{h}_{\kappa}((\xi, \eta_2)|_2) + 1 \\ &= \left(\mathbf{h}_{\kappa}((\xi, \eta_2)|_{11}) + \mathbf{h}_{\kappa}((\xi, \eta_2)|_{12}) + \kappa_2((\sigma, \{(0\mathbf{h}, \sigma, \mathbf{h})\})) \right) + \mathbf{h}_{\kappa}((\xi, \eta_2)|_2) + 1 \\ &= \left(\mathbf{h}_{\kappa}((\xi, \eta_2)|_{11}) + \mathbf{h}_{\kappa}((\xi, \eta_2)|_{12}) + 1 \right) + \mathbf{h}_{\kappa}((\xi, \eta_2)|_2) + 1 \end{aligned}$$

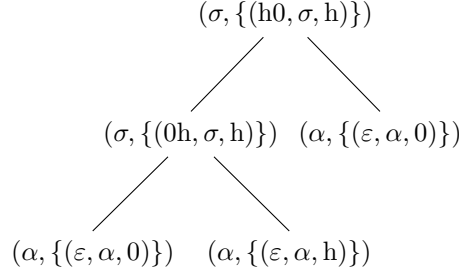

Figure 17.3: The $\Sigma_{\mathcal{U}}$ -tree (ξ, η_2) ; it satisfies φ .

$$\begin{aligned}
&= \left(\kappa_0((\alpha, \{\varepsilon, \alpha, 0\})) + \kappa_0((\alpha, \{\varepsilon, \alpha, \text{h}\})) + 1 \right) + \kappa_0((\alpha, \{\varepsilon, \alpha, 0\})) + 1 \\
&= (0 + 0 + 1) + 0 + 1 = 2 .
\end{aligned}$$

By similar computations we obtain $h_{\kappa}((\xi, \eta_1)) = 2$ and $h_{\kappa}((\xi, \eta_3)) = 1$. Finally,

$$\begin{aligned}
\llbracket e \rrbracket(\xi) &= \max(\llbracket \mathbf{H}(\kappa) \rrbracket_{\mathcal{U}}(\xi, \eta_1), \llbracket \mathbf{H}(\kappa) \rrbracket_{\mathcal{U}}(\xi, \eta_2), \llbracket \mathbf{H}(\kappa) \rrbracket_{\mathcal{U}}(\xi, \eta_3)) \\
&= \max(h_{\kappa}((\xi, \eta_1)), h_{\kappa}((\xi, \eta_2)), h_{\kappa}((\xi, \eta_3))) \\
&= \max(2, 2, 1) = 2 = \text{height}(\xi) .
\end{aligned}$$

□

17.3.2 From definable to recognizable

By induction on $(\text{MSO}(\Sigma, \mathbf{B}), \succ_{\text{MSO}(\Sigma, \mathbf{B})})$, we prove that, for each formula $e \in \text{MSO}(\Sigma, \mathbf{B})$, we can construct a $(\Sigma_{\text{Free}(e)}, \mathbf{B})$ -wta \mathcal{A} such that $\llbracket \mathcal{A} \rrbracket^{\text{run}} = \llbracket e \rrbracket$.

For this we make some preparation. As first preparation, we prove a consistency lemma for wta.

Lemma 17.3.4. Let $e \in \text{MSO}(\Sigma, \mathbf{B})$, let \mathcal{V} abbreviate $\text{Free}(e)$, and let \mathcal{A} be a $(\Sigma_{\mathcal{V}}, \mathbf{B})$ -wta such that $\llbracket \mathcal{A} \rrbracket^{\text{run}} = \llbracket e \rrbracket$. Moreover, let V be a finite set of variables. Then we can construct a $(\Sigma_{\mathcal{V} \cup V}, \mathbf{B})$ -wta \mathcal{A}' such that $\llbracket \mathcal{A}' \rrbracket^{\text{run}} = \llbracket e \rrbracket_{\mathcal{V} \cup V}$.

Proof. Case (a): Let $V \subseteq \mathcal{V}$. Then we can choose $\mathcal{A}' = \mathcal{A}$ and we are ready.

Case (b): Let $V \not\subseteq \mathcal{V}$. Moreover, let $\mathcal{A} = (Q, \delta, F)$. First we construct the $(\Sigma_{\mathcal{V} \cup V}, \mathbf{B})$ -wta $\mathcal{B} = (Q, \delta', F)$ such that, for every $k \in \mathbb{N}$, $(\sigma, \mathcal{W}) \in (\Sigma_{\mathcal{V} \cup V})^{(k)}$, and $q_1, \dots, q_k, q \in Q$ we define

$$\delta'_k(q_1 \cdots q_k, (\sigma, \mathcal{W}), q) = \delta_k(q_1 \cdots q_k, (\sigma, \mathcal{W} \cap \mathcal{V}), q) .$$

Obviously, for each $\xi \in \mathbf{T}_{\Sigma_{\mathcal{V} \cup V}}$, we have $\text{pos}(\xi) = \text{pos}(\xi|_{\mathcal{V}})$ and $\mathbf{R}_{\mathcal{B}}(\xi) = \mathbf{R}_{\mathcal{A}}(\xi|_{\mathcal{V}})$. Moreover, for each $\rho \in \mathbf{R}_{\mathcal{B}}(\xi)$, we have $\text{wt}_{\mathcal{B}}(\xi, \rho) = \text{wt}_{\mathcal{A}}(\xi|_{\mathcal{V}}, \rho)$. Then

$$\llbracket \mathcal{B} \rrbracket^{\text{run}}(\xi) = \bigoplus_{\rho \in \mathbf{R}_{\mathcal{B}}(\xi)} \text{wt}_{\mathcal{B}}(\xi, \rho) \otimes F_{\rho(\varepsilon)} = \bigoplus_{\rho \in \mathbf{R}_{\mathcal{A}}(\xi|_{\mathcal{V}})} \text{wt}_{\mathcal{A}}(\xi|_{\mathcal{V}}, \rho) \otimes F_{\rho(\varepsilon)} = \llbracket \mathcal{A} \rrbracket^{\text{run}}(\xi|_{\mathcal{V}}) .$$

Now we prove the following statement.

$$\text{For each } \xi \in \mathbf{T}_{\Sigma_{\mathcal{V} \cup V}} \text{ we have } \llbracket \mathcal{B} \rrbracket^{\text{run}}(\xi) \otimes \chi(\mathbf{T}_{\Sigma_{\mathcal{V} \cup V}}^{\mathcal{V}})(\xi) = \llbracket e \rrbracket_{\mathcal{V} \cup V}(\xi) . \quad (17.23)$$

For this, let $\xi \in \mathbf{T}_{\Sigma_{\mathcal{V} \cup V}}$.

Case (i): Let ξ not be valid. Then both sides of (17.23) evaluate to \emptyset .

Case (ii): Let ξ be valid. Then we obtain

$$\begin{aligned} \llbracket \mathcal{B} \rrbracket^{\text{run}}(\xi) \otimes \chi(\text{T}_{\Sigma_{\mathcal{V} \cup \mathcal{V}}}^{\mathcal{V}})(\xi) &= \llbracket \mathcal{B} \rrbracket^{\text{run}}(\xi) && \text{(because } \xi \text{ is valid)} \\ &= \llbracket \mathcal{A} \rrbracket^{\text{run}}(\xi|_{\mathcal{V}}) \\ &= \llbracket e \rrbracket(\xi|_{\mathcal{V}}) \\ &= \llbracket e \rrbracket_{\mathcal{V} \cup \mathcal{V}}(\xi) && \text{(by Lemma 17.2.1)} \end{aligned}$$

This finishes the proof of (17.23).

By Lemma 17.1.6, we can construct a $\Sigma_{\mathcal{V} \cup \mathcal{V}}$ -fta A such that $L(A) = \text{T}_{\Sigma_{\mathcal{V} \cup \mathcal{V}}}^{\mathcal{V}}$. Finally, by Theorem 10.4.2, we can construct a $(\Sigma_{\mathcal{V} \cup \mathcal{V}}, \mathbf{B})$ -wta \mathcal{A}' such that $\llbracket \mathcal{A}' \rrbracket^{\text{run}} = \llbracket \mathcal{B} \rrbracket^{\text{run}} \otimes \chi(\text{T}_{\Sigma_{\mathcal{V} \cup \mathcal{V}}}^{\mathcal{V}})$. Hence $\llbracket \mathcal{A}' \rrbracket^{\text{run}} = \llbracket e \rrbracket_{\mathcal{V} \cup \mathcal{V}}$. \square

Now we proceed by transforming atomic formulas, guarded formulas, and weighted existential quantifications into a wta. (For formulas of the form $e_1 + e_2$ we will exploit a closure result.)

Lemma 17.3.5. [FSV12, Lm. 4.5] For every finite sets \mathcal{V} of variables and family $\kappa = (\kappa_k \mid k \in \mathbb{N})$ of mappings $\kappa_k : (\Sigma_{\mathcal{V}})^{(k)} \rightarrow B$, we can construct a bu-deterministic $(\Sigma_{\mathcal{V}}, \mathbf{B})$ -wta \mathcal{B} such that $\llbracket \text{H}(\kappa) \rrbracket = \llbracket \mathcal{B} \rrbracket$.

Proof. We recall that $\text{Free}(\text{H}(\kappa)) = \mathcal{V}$. It is easy to see that $\llbracket \text{H}(\kappa) \rrbracket = \text{h}_{\kappa} \otimes \chi(\text{T}_{\Sigma_{\mathcal{V}}}^{\mathcal{V}})$. In Example 3.2.17 we have constructed a bu-deterministic $(\Sigma_{\mathcal{V}}, \mathbf{B})$ -wta \mathcal{A} such that $\llbracket \mathcal{A} \rrbracket = \text{h}_{\kappa}$. Then, by Lemma 17.1.6 and by Theorem 10.4.2(2), we can construct a bu-deterministic $(\Sigma_{\mathcal{V}}, \mathbf{B})$ -wta \mathcal{B} such that $\llbracket \mathcal{B} \rrbracket = \text{h}_{\kappa} \otimes \chi(\text{T}_{\Sigma_{\mathcal{V}}}^{\mathcal{V}})$. \square

In the next lemma we prove that adding a guard to a formula preserves r-recognizability.

Lemma 17.3.6. (cf. [FSV12, Lm. 4.10]) Let $\varphi \in \text{MSO}(\Sigma)$ and $e \in \text{MSO}(\Sigma, \mathbf{B})$. We let $\mathcal{U} = \text{Free}(\varphi)$ and $\mathcal{V} = \text{Free}(e)$. If there exists a $(\Sigma_{\mathcal{V}}, \mathbf{B})$ -wta \mathcal{A} such that $\llbracket \mathcal{A} \rrbracket^{\text{run}} = \llbracket e \rrbracket$, then we can construct a $(\Sigma_{\mathcal{U} \cup \mathcal{V}}, \mathbf{B})$ -wta \mathcal{B} such that $\llbracket \mathcal{B} \rrbracket^{\text{run}} = \llbracket \varphi \triangleright e \rrbracket$.

Proof. Starting with \mathcal{A} , we can apply Lemma 17.3.4; thereby we can construct a $(\Sigma_{\mathcal{U} \cup \mathcal{V}}, \mathbf{B})$ -wta \mathcal{A}' such that $\llbracket \mathcal{A}' \rrbracket^{\text{run}} = \llbracket e \rrbracket_{\mathcal{U} \cup \mathcal{V}}$. Moreover, by Lemma 17.1.10, we can construct a $\Sigma_{\mathcal{U} \cup \mathcal{V}}$ -fta D which recognizes $L_{\mathcal{U} \cup \mathcal{V}}(\varphi)$, i.e., $L(D) = L_{\mathcal{U} \cup \mathcal{V}}(\varphi)$. Then, by Theorem 10.4.2(2), we can construct a $(\Sigma_{\mathcal{U} \cup \mathcal{V}}, \mathbf{B})$ -wta \mathcal{B} such that $\llbracket \mathcal{B} \rrbracket^{\text{run}} = \chi(L(D)) \otimes \llbracket \mathcal{A}' \rrbracket^{\text{run}}$. Finally, we can calculate as follows.

$$\begin{aligned} \llbracket \varphi \triangleright e \rrbracket &= \chi(L_{\mathcal{U} \cup \mathcal{V}}(\varphi)) \otimes \llbracket e \rrbracket_{\mathcal{U} \cup \mathcal{V}} && \text{(by (17.10))} \\ &= \chi(L(D)) \otimes \llbracket \mathcal{A}' \rrbracket^{\text{run}} = \llbracket \mathcal{B} \rrbracket^{\text{run}} . && \square \end{aligned}$$

The next lemma shows that weighted existential quantification preserves r-recognizability.

Lemma 17.3.7. [FSV12, Lm. 4.9] Let $e \in \text{MSO}(\Sigma, \mathbf{B})$. Then the following two statements hold.

- (1) If $\mathcal{V} = \text{Free}(+_x e)$, $\mathcal{U} = \text{Free}(e)$, and there exists a $(\Sigma_{\mathcal{U}}, \mathbf{B})$ -wta \mathcal{A} with $\llbracket \mathcal{A} \rrbracket^{\text{run}} = \llbracket e \rrbracket$, then we can construct a $(\Sigma_{\mathcal{V}}, \mathbf{B})$ -wta \mathcal{B} such that $\llbracket \mathcal{B} \rrbracket^{\text{run}} = \llbracket +_x e \rrbracket$.
- (2) If $\mathcal{V} = \text{Free}(+_x e)$, $\mathcal{U} = \text{Free}(e)$, and there exists a $(\Sigma_{\mathcal{U}}, \mathbf{B})$ -wta \mathcal{A} with $\llbracket \mathcal{A} \rrbracket^{\text{run}} = \llbracket e \rrbracket$, then we can construct a $(\Sigma_{\mathcal{V}}, \mathbf{B})$ -wta \mathcal{B} such that $\llbracket \mathcal{B} \rrbracket^{\text{run}} = \llbracket +_x e \rrbracket$.

Proof. Proof of (1). Assume that $\mathcal{V} = \text{Free}(+_x e)$, $\mathcal{U} = \text{Free}(e)$, and there exists a $(\Sigma_{\mathcal{U}}, \mathbf{B})$ -wta \mathcal{A} such that $\llbracket \mathcal{A} \rrbracket^{\text{run}} = \llbracket e \rrbracket$. We note that $\mathcal{V} = \mathcal{U} \setminus \{x\}$, thus $x \notin \mathcal{V}$.

We define the deterministic $(\Sigma_{\mathcal{V} \cup \{x\}}, \Sigma_{\mathcal{V}})$ -tree relabeling $\tau = (\tau_k \mid k \in \mathbb{N})$ such that, for every $k \in \mathbb{N}$, $\sigma \in \Sigma^{(k)}$, and $\mathcal{W} \subseteq \mathcal{V} \cup \{x\}$ we let $\tau_k((\sigma, \mathcal{W})) = \{(\sigma, \mathcal{W} \setminus \{x\})\}$.

Then, starting from the $(\Sigma_{\mathcal{U}}, \mathbf{B})$ -wta \mathcal{A} , by Lemma 17.3.4, we can construct a $(\Sigma_{\mathcal{U} \cup \{x\}}, \mathbf{B})$ -wta \mathcal{A}' such that $\llbracket \mathcal{A}' \rrbracket^{\text{run}} = \llbracket e \rrbracket_{\mathcal{U} \cup \{x\}}$. Since $\mathcal{U} \cup \{x\} = (\mathcal{U} \setminus \{x\}) \cup \{x\} = \mathcal{V} \cup \{x\}$, we obtain that $\llbracket \mathcal{A}' \rrbracket^{\text{run}} = \llbracket e \rrbracket_{\mathcal{V} \cup \{x\}}$. By using \mathcal{A}' and Theorem 10.10.1, we can construct a $(\Sigma_{\mathcal{V}}, \mathbf{B})$ -wta which r-recognizes $\chi(\tau)(\llbracket e \rrbracket_{\mathcal{V} \cup \{x\}})$. By Lemma 17.1.6, we can construct a $\Sigma_{\mathcal{V}}$ -fta which recognizes $\text{T}_{\Sigma_{\mathcal{V}}}^{\mathcal{V}}$. By Theorem 10.4.2(2), we can construct

a $(\Sigma_{\mathcal{V}}, \mathbf{B})$ -wta \mathcal{B} such that $\llbracket \mathcal{B} \rrbracket^{\text{run}} = \chi(\tau)(\llbracket e \rrbracket_{\mathcal{V} \cup \{x\}}) \otimes \chi(\mathsf{T}_{\Sigma_{\mathcal{V}}}^{\vee})$. Finally, by Lemma 17.2.6(1), we obtain $\llbracket \mathcal{B} \rrbracket^{\text{run}} = \llbracket +_x e \rrbracket$.

Proof of (2). Assume that $\mathcal{V} = \text{Free}(+_X e)$, $\mathcal{U} = \text{Free}(e)$, and there exists a $(\Sigma_{\mathcal{U}}, \mathbf{B})$ -wta \mathcal{A} such that $\llbracket \mathcal{A} \rrbracket^{\text{run}} = \llbracket e \rrbracket$. We note that $\mathcal{V} = \mathcal{U} \setminus \{X\}$, this $X \notin \mathcal{V}$.

We define the $(\Sigma_{\mathcal{V} \cup \{X\}}, \Sigma_{\mathcal{V}})$ -tree relabeling $\tau = (\tau_k \mid k \in \mathbb{N})$ such that, for every $k \in \mathbb{N}$, $\sigma \in \Sigma^{(k)}$, and $\mathcal{W} \subseteq \mathcal{V} \cup \{X\}$ we let $\tau_k((\sigma, \mathcal{W})) = \{(\sigma, \mathcal{W} \setminus \{X\})\}$.

Similarly as above, starting from the $(\Sigma_{\mathcal{U}}, \mathbf{B})$ -wta \mathcal{A} , by Lemma 17.3.4, we can construct a $(\Sigma_{\mathcal{U} \cup \{X\}}, \mathbf{B})$ -wta \mathcal{A}' such that $\llbracket \mathcal{A}' \rrbracket^{\text{run}} = \llbracket e \rrbracket_{\mathcal{U} \cup \{X\}}$. Since $\mathcal{U} \cup \{X\} = (\mathcal{U} \setminus \{X\}) \cup \{X\} = \mathcal{V} \cup \{X\}$, we obtain that $\llbracket \mathcal{A}' \rrbracket^{\text{run}} = \llbracket e \rrbracket_{\mathcal{V} \cup \{X\}}$. By using \mathcal{A}' and Theorem 10.10.1, we can construct a $(\Sigma_{\mathcal{V}}, \mathbf{B})$ -wta \mathcal{B} such that $\llbracket \mathcal{B} \rrbracket^{\text{run}} = \chi(\tau)(\llbracket e \rrbracket_{\mathcal{V} \cup \{X\}})$. Finally, by Lemma 17.2.6(2), we obtain $\llbracket \mathcal{B} \rrbracket^{\text{run}} = \llbracket +_X e \rrbracket$. \square

Now we can prove that definability implies recognizability.

Theorem 17.3.8. *Let $e \in \text{MSO}(\Sigma, \mathbf{B})$ and let \mathcal{V} abbreviate $\text{Free}(e)$. Then we can construct a $(\Sigma_{\mathcal{V}}, \mathbf{B})$ -wta \mathcal{B} such that $\llbracket \mathcal{B} \rrbracket^{\text{run}} = \llbracket e \rrbracket$.*

Proof. By induction on $(\text{MSO}(\Sigma, \mathbf{B}), \succ_{\text{MSO}(\Sigma, \mathbf{B})})$, we prove the statement of the theorem.

I.B.: Let $e = \mathsf{H}(\kappa)$ where $\kappa : \Sigma_{\mathcal{V}} \rightarrow \mathbf{B}$ for some finite set \mathcal{V} of variables. By Lemma 17.3.5, we can construct a bu-deterministic $(\Sigma_{\mathcal{V}}, \mathbf{B})$ -wta \mathcal{B} such that $\llbracket \mathcal{B} \rrbracket = \llbracket \mathsf{H}(\kappa) \rrbracket$.

I.S.: Case (a): Let $e = (\varphi \triangleright e')$ and $\mathcal{V} = \text{Free}(\varphi \triangleright e')$. By I.H., we can construct a $(\Sigma_{\text{Free}(e')}, \mathbf{B})$ -wta \mathcal{A} such that $\llbracket \mathcal{A} \rrbracket^{\text{run}} = \llbracket e' \rrbracket$. By Lemma 17.3.6, we can construct a $(\Sigma_{\mathcal{V}}, \mathbf{B})$ -wta \mathcal{B} such that $\llbracket \mathcal{B} \rrbracket^{\text{run}} = \llbracket e \rrbracket$.

Case (b): Let $e = e_1 + e_2$ and let $\mathcal{V} = \text{Free}(e_1 + e_2)$. By I.H., we can construct a $(\Sigma_{\text{Free}(e_1)}, \mathbf{B})$ -wta \mathcal{A}_1 and a $(\Sigma_{\text{Free}(e_2)}, \mathbf{B})$ -wta \mathcal{A}_2 such that $\llbracket \mathcal{A}_1 \rrbracket^{\text{run}} = \llbracket e_1 \rrbracket$ and $\llbracket \mathcal{A}_2 \rrbracket^{\text{run}} = \llbracket e_2 \rrbracket$. By Lemma 17.3.4, we can construct $(\Sigma_{\mathcal{V}}, \mathbf{B})$ -wta \mathcal{A}'_1 and \mathcal{A}'_2 such that $\llbracket \mathcal{A}'_1 \rrbracket^{\text{run}} = \llbracket e_1 \rrbracket_{\mathcal{V}}$ and $\llbracket \mathcal{A}'_2 \rrbracket^{\text{run}} = \llbracket e_2 \rrbracket_{\mathcal{V}}$. By Theorem 10.1.1 we can construct a $(\Sigma_{\mathcal{V}}, \mathbf{B})$ -wta \mathcal{B} such that $\llbracket \mathcal{B} \rrbracket^{\text{run}} = \llbracket \mathcal{A}'_1 \rrbracket^{\text{run}} + \llbracket \mathcal{A}'_2 \rrbracket^{\text{run}} = \llbracket e_1 \rrbracket_{\mathcal{V}} + \llbracket e_2 \rrbracket_{\mathcal{V}} = \llbracket e_1 + e_2 \rrbracket_{\mathcal{V}}$.

Case (c): Let $e = +_x e'$ and let $\mathcal{V} = \text{Free}(+_x e')$. By I.H., we can construct a $(\Sigma_{\text{Free}(e')}, \mathbf{B})$ -wta \mathcal{A} such that $\llbracket \mathcal{A} \rrbracket^{\text{run}} = \llbracket e' \rrbracket$. By Lemma 17.3.7(1), we can construct a $(\Sigma_{\mathcal{V}}, \mathbf{B})$ -wta \mathcal{B} such that $\llbracket \mathcal{B} \rrbracket^{\text{run}} = \llbracket e \rrbracket$.

Case (d): Let $e = +_X e'$ and let $\mathcal{V} = \text{Free}(+_X e')$. We can finish the proof as in Case (d), except that we use Lemma 17.3.7(2). \square

17.4 Adding weighted conjunction and weighted universal quantification

In this section we extend $\text{MSO}(\Sigma, \mathbf{B})$ by weighted conjunction, weighted first-order universal quantification, and weighted second-order universal quantification [DG05, DG07, DG09]; the resulting logic is denoted by $\text{MSO}^{\text{ext}}(\Sigma, \mathbf{B})$. Since $\text{MSO}^{\text{ext}}(\Sigma, \mathbf{B})$ is more powerful than run recognizability, we identify a fragment of $\text{MSO}^{\text{ext}}(\Sigma, \mathbf{B})$, called carefully extended weighted MSO-logic and denoted by $\text{MSO}^{\text{cext}}(\Sigma, \mathbf{B})$, which characterizes the set of run recognizable (Σ, \mathbf{B}) -weighted tree languages, if \mathbf{B} is a commutative semiring (cf. Theorem 17.4.11). Roughly speaking, in the fragment $\text{MSO}^{\text{cext}}(\Sigma, \mathbf{B})$, (a) the weighted first-order universal quantification may only be applied to a recognizable step formula, and (b) the weighted second-order universal quantification is forbidden. The latter restriction corresponds to the restriction (c) of the weighted MSO-logic in [DG05, DG07, DG09] which is discussed in the preface of this chapter. Our restriction (a) is more severe than the corresponding restriction (b) there, because it forbids nesting of weighted first-order universal quantification. In Subsection 17.4.5 we will prove that, for each commutative and bi-locally finite strong bimonoid \mathbf{B} , the fully extended weighted logic $\text{MSO}^{\text{ext}}(\Sigma, \mathbf{B})$ characterizes the set of run recognizable (Σ, \mathbf{B}) -weighted tree languages (cf. Theorem 17.4.21).

In this section, we assume that \mathbf{B} is commutative.

17.4.1 The extended weighted MSO-logic $\text{MSO}^{\text{ext}}(\Sigma, \mathbf{B})$

We define the set of *extended MSO formulas over Σ and \mathbf{B}* , denoted by $\text{MSO}^{\text{ext}}(\Sigma, \mathbf{B})$, by the following EBNF with nonterminal e :

$$e ::= \text{H}(\kappa) \mid (\varphi \triangleright e) \mid (e + e) \mid (e \times e) \mid \text{+}_x e \mid \text{+}_X e \mid \text{X}_x e \mid \text{X}_X e, \quad (17.24)$$

where

- there exists a finite set \mathcal{U} of variables such that $\kappa = (\kappa_k \mid k \in \mathbb{N})$ is an \mathbb{N} -indexed family of mappings $\kappa_k : (\Sigma_{\mathcal{U}})^{(k)} \rightarrow B$,
- $\varphi \in \text{MSO}(\Sigma)$.

Formulas of the form $(e_1 \times e_2)$, $\text{X}_x e$, and $\text{X}_X e$ are called *weighted conjunction*, *weighted first-order universal quantification*, and *weighted second-order universal quantification*, respectively. Obviously, $\text{MSO}(\Sigma, \mathbf{B}) \subset \text{MSO}^{\text{ext}}(\Sigma, \mathbf{B})$.

As for $\text{MSO}(\Sigma, \mathbf{B})$ -formulas in Section 17.2, in order to perform inductive proofs or to define objects by induction, we will consider the reduction system

$$(\text{MSO}^{\text{ext}}(\Sigma, \mathbf{B}), \succ_{\text{MSO}^{\text{ext}}(\Sigma, \mathbf{B})})$$

where $\succ_{\text{MSO}^{\text{ext}}(\Sigma, \mathbf{B})}$ is the binary relation on $\text{MSO}^{\text{ext}}(\Sigma, \mathbf{B})$ defined as follows. For every $e_1, e_2 \in \text{MSO}^{\text{ext}}(\Sigma, \mathbf{B})$, we let $e_1 \succ_{\text{MSO}^{\text{ext}}(\Sigma, \mathbf{B})} e_2$ if either of the following three cases holds.

Case (a) There exist $\varphi \in \text{MSO}(\Sigma)$ and $e \in \text{MSO}^{\text{ext}}(\Sigma, \mathbf{B})$ such that $e_1 = (\varphi \triangleright e)$ and $e_2 = e$.

Case (b) There exist $f_1, f_2 \in \text{MSO}^{\text{ext}}(\Sigma, \mathbf{B})$ such that e_1 has the form $f_1 + f_2$ or $f_1 \times f_2$ and $e_2 \in \{f_1, f_2\}$.

Case (c) There exists $f \in \text{MSO}^{\text{ext}}(\Sigma, \mathbf{B})$ such that e_1 has the form $\text{+}_x f$, $\text{+}_X f$, $\text{X}_x f$, or $\text{X}_X f$ and $e_2 = f$.

By Corollary 2.5.6, the relation $\succ_{\text{MSO}^{\text{ext}}(\Sigma, \mathbf{B})}$ is terminating. Moreover, we have that $\text{nf}_{\succ_{\text{MSO}^{\text{ext}}(\Sigma, \mathbf{B})}}(\text{MSO}(\Sigma, \mathbf{B}))$ is the set of formulas of the form $\text{H}(\kappa)$. For every $e \in \text{MSO}^{\text{ext}}(\Sigma, \mathbf{B})$ and $w \in \text{MSO}^{\text{ext}}(\Sigma, \mathbf{B}) \cup \text{MSO}(\Sigma)$, we say that w is a *subformula of e* if w is a substring of e . We note that the relation “is a subformula of” is reflexive.

For each $e \in \text{MSO}^{\text{ext}}(\Sigma, \mathbf{B})$, the set $\text{Free}(e)$ of *free variables of e* and set $\text{Bound}(e)$ of *bound variables of e* are defined in the same way as for $\text{MSO}(\Sigma, \mathbf{B})$ -formulas and additionally we have the following three cases in the I.S.:

- $\text{Free}(e_1 \times e_2) = \text{Free}(e_1) \cup \text{Free}(e_2)$ and $\text{Bound}(e_1 \times e_2) = \text{Bound}(e_1) \cup \text{Bound}(e_2)$,
- $\text{Free}(\text{X}_x e) = \text{Free}(e) \setminus \{x\}$ and $\text{Bound}(\text{X}_x e) = \text{Bound}(e) \cup \{x\}$, and
- $\text{Free}(\text{X}_X e) = \text{Free}(e) \setminus \{X\}$ and $\text{Bound}(\text{X}_X e) = \text{Bound}(e) \cup \{X\}$.

By induction on $(\text{MSO}^{\text{ext}}(\Sigma, \mathbf{B}), \succ_{\text{MSO}^{\text{ext}}})$, we define the $\text{MSO}^{\text{ext}}(\Sigma, \mathbf{B})$ -indexed family

$$\left(\llbracket e \rrbracket_{\mathcal{V}} \mid \mathcal{V} \supseteq \text{Free}(e), \mathcal{V} \text{ finite} \mid e \in \text{MSO}^{\text{ext}}(\Sigma, \mathbf{B}) \right)$$

as follows, where $\llbracket e \rrbracket_{\mathcal{V}}$ is a $(\Sigma_{\mathcal{V}}, \mathbf{B})$ -weighted tree language which is called the *semantics of e with respect to \mathcal{V}* .

I.B.: Let $e = \text{H}(\kappa)$. Let $\mathcal{V} \supseteq \text{Free}(e)$ be a finite set of variables. The definition of $\llbracket e \rrbracket_{\mathcal{V}}$ is the same as in Section 17.2.

I.S.: We distinguish four cases.

- Let $e = (\varphi \triangleright e')$, $e = e_1 + e_2$, $e = \text{+}_x e'$, or $e = \text{+}_X e'$. Let $\mathcal{V} \supseteq \text{Free}(e)$ be a finite set of variables. The definition of $\llbracket e \rrbracket_{\mathcal{V}}$ is the same as in Section 17.2.
- Let $e_1, e_2 \in \text{MSO}^{\text{ext}}(\Sigma, \mathbf{B})$. Let $\mathcal{V} \supseteq \text{Free}(e_1 \times e_2)$ be a finite set of variables. Then, for each $\zeta \in \text{T}_{\Sigma_{\mathcal{V}}}$, we define

$$\llbracket e_1 \times e_2 \rrbracket_{\mathcal{V}}(\zeta) = \begin{cases} \llbracket e_1 \rrbracket_{\mathcal{V}}(\zeta) \otimes \llbracket e_2 \rrbracket_{\mathcal{V}}(\zeta) & \text{if } \zeta \in \text{T}_{\Sigma_{\mathcal{V}}}^{\vee} \\ 0 & \text{otherwise} \end{cases}.$$

- Let x be a first-order variable and $e \in \text{MSO}^{\text{ext}}(\Sigma, \mathbf{B})$. Let $\mathcal{V} \supseteq \text{Free}(\times_x e)$ be a finite set of variables. Then, for each $\zeta \in \mathbf{T}_{\Sigma \mathcal{V}}$, we define

$$\llbracket \times_x e \rrbracket_{\mathcal{V}}(\zeta) = \begin{cases} \bigotimes_{w \in \text{pos}(\zeta)} \llbracket e \rrbracket_{\mathcal{V} \cup \{x\}}(\zeta[x \mapsto w]) & \text{if } \zeta \in \mathbf{T}_{\Sigma \mathcal{V}}^v \\ 0 & \text{otherwise} \end{cases} .$$

- Let X be a second-order variable and $e \in \text{MSO}^{\text{ext}}(\Sigma, \mathbf{B})$. Let $\mathcal{V} \supseteq \text{Free}(\times_X e)$ be a finite set of variables. Then, for each $\zeta \in \mathbf{T}_{\Sigma \mathcal{V}}$, we define

$$\llbracket \times_X e \rrbracket_{\mathcal{V}}(\zeta) = \begin{cases} \bigotimes_{W \subseteq \text{pos}(\zeta)} \llbracket e \rrbracket_{\mathcal{V} \cup \{X\}}(\zeta[X \mapsto W]) & \text{if } \zeta \in \mathbf{T}_{\Sigma \mathcal{V}}^v \\ 0 & \text{otherwise} \end{cases} .$$

We note that the definitions of $\llbracket \times_x e \rrbracket_{\mathcal{V}}$ and $\llbracket \times_X e \rrbracket_{\mathcal{V}}$ use the fact that \otimes is commutative (cf. page 24).

Next we show that the extension of an assignment does not change the semantics of extended MSO formulas.

Lemma 17.4.1. (cf. Lemma 17.2.1) Let $e \in \text{MSO}^{\text{ext}}(\Sigma, \mathbf{B})$ and let \mathcal{V} and \mathcal{W} be finite sets of variables with $\text{Free}(e) \subseteq \mathcal{W} \subseteq \mathcal{V}$. Then for every $(\xi, \eta) \in \mathbf{T}_{\Sigma \mathcal{V}}^v$, we have $\llbracket e \rrbracket_{\mathcal{V}}(\xi, \eta) = \llbracket e \rrbracket_{\mathcal{W}}(\xi, \eta|_{\mathcal{W}})$.

Proof. We prove the statement by induction on $(\text{MSO}^{\text{ext}}(\Sigma, \mathbf{B}), \succ_{\text{MSO}^{\text{ext}}})$. The proof is very similar to that of Lemma 17.2.1 and thus it is dropped. \square

We will prove the main theorem of this section (cf. Theorem 17.4.11) by replacing subformulas of a formula in $\text{MSO}^{\text{ext}}(\Sigma, \mathbf{B})$ by equivalent formulas in $\text{MSO}(\Sigma, \mathbf{B})$. Next we will formalize this replacement.

Let φ be an $\text{MSO}(\Sigma)$ -formula and V and W be two first-order variables or two second-order variables. Intuitively, we let $\varphi[V/W]$ be the $\text{MSO}(\Sigma)$ -formula obtained from φ by replacing each free occurrence of V by W (similar to α -conversion in λ -calculus). Formally, we define the $\text{MSO}(\Sigma)$ -formula $\varphi[V/W]$ by induction on $(\text{MSO}(\Sigma), \succ_{\text{MSO}(\Sigma)})$ (cf. (17.2)) as follows:

I.B.: We distinguish three cases.

$$\text{label}_{\sigma}(x)[V/W] = \begin{cases} \text{label}_{\sigma}(W) & \text{if } x = V \\ \text{label}_{\sigma}(x) & \text{otherwise} \end{cases} \quad \text{edge}_i(x, y)[V/W] = \begin{cases} \text{edge}_i(W, y) & \text{if } x = V, y \neq V \\ \text{edge}_i(x, W) & \text{if } y = V, x \neq V \\ \text{edge}_i(W, W) & \text{if } x = y = V \\ \text{edge}_i(x, y) & \text{otherwise} \end{cases}$$

$$(x \in X)[V/W] = \begin{cases} (W \in X) & \text{if } x = V \\ (x \in W) & \text{if } X = V \\ (x \in X) & \text{otherwise} \end{cases}$$

I.S.: We distinguish four cases:

$$\begin{aligned} (\neg \varphi)[V/W] &= \neg(\varphi[V/W]) & (\varphi_1 \vee \varphi_2)[V/W] &= \varphi_1[V/W] \vee \varphi_2[V/W] \\ (\exists x. \varphi)[V/W] &= \begin{cases} (\exists x. \varphi) & \text{if } x = V \\ \exists x. (\varphi[V/W]) & \text{otherwise} \end{cases} & (\exists X. \varphi)[V/W] &= \begin{cases} (\exists X. \varphi) & \text{if } X = V \\ \exists X. (\varphi[V/W]) & \text{otherwise} \end{cases} \end{aligned}$$

Next by induction on $(\text{MSO}^{\text{ext}}(\Sigma, \mathbf{B}), \succ_{\text{MSO}^{\text{ext}}})$ we define $e[V/W]$ for each $\text{MSO}^{\text{ext}}(\Sigma, \mathbf{B})$ -formula e and first-order or second order variables V and W .

I.B.: Let $e = \mathbf{H}(\kappa)$ and $\kappa = (\kappa_k \mid k \in \mathbb{N})$ with $\kappa_k : \Sigma_{\mathcal{U}}^{(k)} \rightarrow B$. Then

$$\mathbf{H}(\kappa)[V/W] = \begin{cases} \mathbf{H}(\kappa) & \text{if } V \notin \mathcal{U} \\ \mathbf{H}(\kappa') & \text{otherwise,} \end{cases}$$

where, for each $k \in \mathbb{N}$, the mapping $\kappa'_k : \Sigma_{\mathcal{V}}^{(k)} \rightarrow B$ is defined as follows: $\mathcal{V} = (\mathcal{U} \setminus \{V\}) \cup \{W\}$ and for every $(\sigma, \mathcal{W}) \in \Sigma_{\mathcal{V}}^{(k)}$, we have

$$\kappa'_k((\sigma, \mathcal{W})) = \begin{cases} \kappa_k((\sigma, \mathcal{W})) & \text{if } W \notin \mathcal{W} \\ \kappa_k((\sigma, (\mathcal{W} \setminus \{W\}) \cup \{V\})) & \text{otherwise.} \end{cases}$$

I.S.: We distinguish seven cases.

- Let $e = (\varphi \triangleright e')$. Then $e[V/W] = (\varphi[V/W] \triangleright e'[V/W])$.
- The definition of $e[V/W]$ for the other six cases of e is left to the reader.

We observe that renaming a bound variable in a formula does not change the semantics of that formula.

Observation 17.4.2. The following two statements hold.

- (1) Let $\exists V.\varphi$ be an $\text{MSO}(\Sigma)$ -formula, where V is a variable, and \mathcal{V} be a finite set of variables with $\text{Free}(\exists V.\varphi) \subseteq \mathcal{V}$. Moreover, let W be a variable of the same type as V with $W \notin \mathcal{V}$. Then $L_{\mathcal{V}}(\exists V.\varphi) = L_{\mathcal{V}}(\exists W.\varphi[V/W])$.
- (2) Let $Q_V e$ be an $\text{MSO}^{\text{ext}}(\Sigma, B)$ -formula for some $Q \in \{+, \times\}$, where V is a variable, and \mathcal{V} be a finite set of variables with $\text{Free}(Q_V e) \subseteq \mathcal{V}$. Moreover, let W be a variable of the same type as V with $W \notin \mathcal{V}$. Then $\llbracket Q_V e \rrbracket_{\mathcal{V}} = \llbracket Q_W e[V/W] \rrbracket_{\mathcal{V}}$. \square

Moreover, we formalize three variants of the observation that, for each formula, the replacement of a subformula by an equivalent formula does not change the semantics of the original formula.

Observation 17.4.3. Let $\varphi \in \text{MSO}(\Sigma)$ and let \mathcal{V} be a finite set of variables such that $\mathcal{V} \supseteq \text{Free}(\varphi)$. Moreover, let ψ be a subformula of φ . Also let $\psi' \in \text{MSO}(\Sigma)$ such that $\text{Free}(\psi') = \text{Free}(\psi)$ and $L(\psi') = L(\psi)$. Then $L_{\mathcal{V}}(\varphi) = L_{\mathcal{V}}(\varphi[\psi/\psi'])$, where $\varphi[\psi/\psi']$ is the formula in $\text{MSO}(\Sigma)$ obtained from φ by replacing each occurrence of the subformula ψ by ψ' . \square

Observation 17.4.4. Let $e \in \text{MSO}^{\text{ext}}(\Sigma, B)$ and let \mathcal{V} be a finite set of variables such that $\mathcal{V} \supseteq \text{Free}(e)$. Moreover, let ψ be an $\text{MSO}(\Sigma)$ -subformula of e . Also let $\psi' \in \text{MSO}(\Sigma)$ such that $\text{Free}(\psi') = \text{Free}(\psi)$ and $L(\psi') = L(\psi)$. Then $\llbracket e \rrbracket_{\mathcal{V}} = \llbracket e[\psi/\psi'] \rrbracket_{\mathcal{V}}$, where $e[\psi/\psi']$ is the formula in $\text{MSO}^{\text{ext}}(\Sigma, B)$ obtained from e by replacing each occurrence of the subformula ψ by ψ' . \square

Observation 17.4.5. Let $e \in \text{MSO}^{\text{ext}}(\Sigma, B)$ and let \mathcal{V} be a finite set of variables such that $\mathcal{V} \supseteq \text{Free}(e)$. Moreover, let t be an $\text{MSO}^{\text{ext}}(\Sigma, B)$ subformula of e . Also let $t' \in \text{MSO}^{\text{ext}}(\Sigma, B)$ such that $\text{Free}(t') = \text{Free}(t)$ and $\llbracket t' \rrbracket = \llbracket t \rrbracket$. Then $\llbracket e \rrbracket_{\mathcal{V}} = \llbracket e[t/t'] \rrbracket_{\mathcal{V}}$, where $e[t/t']$ is the formula in $\text{MSO}^{\text{ext}}(\Sigma, B)$ obtained from e by replacing each occurrence of the subformula t by t' . \square

Let e be an $\text{MSO}^{\text{ext}}(\Sigma, B)$ -formula. We say that e is *variable separated* if $\text{Free}(e) \cap \text{Bound}(e) = \emptyset$.

Next we show that each $\text{MSO}^{\text{ext}}(\Sigma, B)$ -formula can be transformed into an equivalent one which is variable separated (cf. rectified formula in [Gal87] and [Sch89]).

Lemma 17.4.6. Let e be an $\text{MSO}^{\text{ext}}(\Sigma, B)$ -formula and \mathcal{V} be a finite set of variables with $\text{Free}(e) \subseteq \mathcal{V}$. We can construct an $\text{MSO}^{\text{ext}}(\Sigma, B)$ -formula e' such that e' is variable separated, $\text{Free}(e) = \text{Free}(e')$, and $\llbracket e \rrbracket_{\mathcal{V}} = \llbracket e' \rrbracket_{\mathcal{V}}$.

Proof. Let \mathcal{V} be a finite set of variables and $\text{MSO}^{\text{ext}}(\Sigma, B)_{\mathcal{V}}$ be the set of all those $e \in \text{MSO}^{\text{ext}}(\Sigma, B)$ such that $\text{Free}(e) \subseteq \mathcal{V}$.

Intuitively, we define the reduction relation \succ on $\text{MSO}^{\text{ext}}(\Sigma, \mathbf{B})_{\mathcal{V}}$ such that, in each reduction step, the variable V of an (unweighted or weighted) quantification where V also occurs freely somewhere else in e , is replaced by a fresh variable W . Formally, for every $e_1, e_2 \in \text{MSO}^{\text{ext}}(\Sigma, \mathbf{B})_{\mathcal{V}}$, we let $e_1 \succ e_2$ if either (a) or (b) holds.

Case (a):

- e_1 contains a subformula of the form $\varphi = \exists V.\psi$ such that $V \in \text{Free}(e_1)$ and
- $e_2 = e_1[\varphi/\varphi']$ where $\varphi' = \exists W.\psi[V/W]$ for some variable W of the same type as V with $W \notin \text{Free}(e_1) \cup \text{Bound}(e_1)$.

Case (b):

- e_1 contains a subformula of the form $t = Q_V u$ for some $Q \in \{+, \times\}$ such that $V \in \text{Free}(e_1)$ and
- $e_2 = e_1[t/t']$ where $t' = Q_W u[V/W]$ for some variable W of the same type as V with $W \notin \text{Free}(e_1) \cup \text{Bound}(e_1)$.

Next we prove that \succ is terminating. For each $e \in \text{MSO}^{\text{ext}}(\Sigma, \mathbf{B})_{\mathcal{V}}$, we let $\#(e)$ denote the number of occurrences of subformulas of e of the form $\exists V.\psi$ or of the form $Q_V u$, where $Q \in \{+, \times\}$ and $V \in \text{Free}(e)$. Obviously, for each $e_1 \in \text{MSO}^{\text{ext}}(\Sigma, \mathbf{B})$ with $\#(e_1) > 0$, we can construct an $e_2 \in \text{MSO}^{\text{ext}}(\Sigma, \mathbf{B})$ such that $e_1 \succ e_2$. Moreover, for every $e_1, e_2 \in \text{MSO}^{\text{ext}}(\Sigma, \mathbf{B})_{\mathcal{V}, \succ}$ we have that, if $e_1 \succ e_2$, then $\#(e_1) \succ_{\mathbb{N}} \#(e_2)$. Thus, $\#$ is a monotone embedding of $(\text{MSO}^{\text{ext}}(\Sigma, \mathbf{B})_{\mathcal{V}, \succ})$ into $(\mathbb{N}, \succ_{\mathbb{N}})$, and hence, by Lemma 2.5.2, the reduction system $(\text{MSO}^{\text{ext}}(\Sigma, \mathbf{B})_{\mathcal{V}, \succ})$ is terminating. Obviously, we have

$$\text{nf}_{\succ}(\text{MSO}^{\text{ext}}(\Sigma, \mathbf{B})_{\mathcal{V}}) = \{e \in \text{MSO}^{\text{ext}}(\Sigma, \mathbf{B})_{\mathcal{V}} \mid e \text{ is variable separated}\} . \quad (17.25)$$

Next we prove that, for every $e_1, e_2 \in \text{MSO}^{\text{ext}}(\Sigma, \mathbf{B})_{\mathcal{V}}$ we have the following: if $e_1 \succ e_2$, then $\llbracket e_1 \rrbracket_{\mathcal{V}} = \llbracket e_2 \rrbracket_{\mathcal{V}}$. Let $e_1, e_2 \in \text{MSO}^{\text{ext}}(\Sigma, \mathbf{B})_{\mathcal{V}, \succ}$ with $e_1 \succ e_2$. In case (a), we have $\text{Free}(\varphi') = \text{Free}(\varphi)$ and by Observation 17.4.2(1), we have $L(\varphi') = L(\varphi)$. Hence, by Observation 17.4.4, we have $\llbracket e_1 \rrbracket_{\mathcal{V}} = \llbracket e_1[\varphi/\varphi'] \rrbracket_{\mathcal{V}} = \llbracket e_2 \rrbracket_{\mathcal{V}}$. In case (b), we have $\text{Free}(t') = \text{Free}(t)$ and by Observation 17.4.2(2), we have $\llbracket t' \rrbracket = \llbracket t \rrbracket$. Hence, by Observation 17.4.5, we have $\llbracket e_1 \rrbracket_{\mathcal{V}} = \llbracket e_1[t/t'] \rrbracket_{\mathcal{V}} = \llbracket e_2 \rrbracket_{\mathcal{V}}$.

Finally, we can prove the statement of the lemma as follows. Let e be an $\text{MSO}^{\text{ext}}(\Sigma, \mathbf{B})$ -formula and \mathcal{V} be a finite set of variables with $\text{Free}(e) \subseteq \mathcal{V}$, i.e., $e \in \text{MSO}^{\text{ext}}(\Sigma, \mathbf{B})_{\mathcal{V}}$. Then we construct an $f \in \text{nf}_{\succ}(e)$. By the above, $\llbracket f \rrbracket_{\mathcal{V}} = \llbracket e \rrbracket_{\mathcal{V}}$, and, by (17.25), f is variable separated. \square

The next example shows the usefulness of weighted conjunction and weighted universal first-order quantification as specification tool.

Example 17.4.7. In this example we show that, for each (Σ, \mathbf{B}) -weighted local system \mathcal{S} (cf. Section 11.1) we can construct a sentence $e_{\mathcal{S}} \in \text{MSO}^{\text{ext}}(\Sigma, \mathbf{B})$ such that (a) $\llbracket e_{\mathcal{S}} \rrbracket = \llbracket \mathcal{S} \rrbracket$ and (b) $e_{\mathcal{S}}$ does not contain weighted second-order universal or existential quantification. For the definition of the macro $\langle b \rangle$ (with $b \in B$) we refer to Example 17.2.2. In an obvious way, we extend the syntax of $\text{MSO}^{\text{ext}}(\Sigma, \mathbf{B})$ by allowing that $+$ can combine finitely many formulas (and not just two). Hence, for each finite family $(e_i \mid i \in I)$ of formulas $e_i \in \text{MSO}^{\text{ext}}(\Sigma, \mathbf{B})$ we may write

$$\bigoplus_{i \in I} e_i .$$

This formula has the obvious semantics.

Let $\mathcal{S} = (g, F)$. We construct the sentence $e_{\mathcal{S}} = e_1 \times e_2$ in $\text{MSO}^{\text{ext}}(\Sigma, \mathbf{B})$ where the intuition behind e_1 and e_2 is that they simulate g and F , respectively. Formally, we let

$$e_1 = \times_x \left(\bigoplus_{\substack{k \in \text{maxrk}(\Sigma), \\ f \in \text{Fork}(\Sigma)^{(k)}}} (\varphi_f(x) \triangleright \langle g(f) \rangle) \right)$$

$$e_2 = \bigoplus_x \left(\bigoplus_{\sigma \in \Sigma} (\text{root}(x) \wedge \text{label}_{\sigma}(x) \triangleright \langle F(\sigma) \rangle) \right)$$

and, for each fork $(\sigma_1 \cdots \sigma_k, \sigma) \in \text{Fork}(\Sigma)^{(k)}$, the formula $\varphi_{(\sigma_1 \cdots \sigma_k, \sigma)}(x)$ in $\text{MSO}(\Sigma_{\{x\}})$ is defined by

$$\varphi_{(\sigma_1 \cdots \sigma_k, \sigma)}(x) = \text{label}_\sigma(x) \wedge \forall y. \bigwedge_{i \in [k]} (\text{edge}_i(x, y) \rightarrow \text{label}_{\sigma_i}(y)) .$$

Clearly, the subformulas

$$\bigoplus_{\substack{k \in \text{maxrk}(\Sigma), \\ f \in \text{Fork}(\Sigma)^{(k)}}} (\varphi_f(x) \triangleright \langle g(f) \rangle) \quad \text{and} \quad \bigoplus_{\sigma \in \Sigma} (\text{root}(x) \wedge \text{label}_\sigma(x) \triangleright \langle F(\sigma) \rangle)$$

of e_1 and e_2 , respectively, are recognizable step formulas.

Now we consider the semantics of e_S . The following is easy to see:

$$\begin{aligned} &\text{For every } \xi \in \mathbb{T}_\Sigma \text{ and } w \in \text{pos}(\xi), \text{ we have that} \\ &(\xi, [x \mapsto w]) \models \varphi_{(\sigma_1 \cdots \sigma_k, \sigma)}(x) \quad \text{iff} \\ &(\xi(w) = \sigma \text{ and } \xi(wi) = \sigma_i \text{ for each } i \in [\text{rk}(\xi(w))]). \end{aligned} \tag{17.26}$$

Since for every $\xi \in \mathbb{T}_\Sigma$ and $w \in \text{pos}(\xi)$, there exists exactly one fork f which occurs in ξ at w , we can also see the following easily (using (17.26)).

$$\begin{aligned} &\text{For every } \xi \in \mathbb{T}_\Sigma \text{ and } w \in \text{pos}(\xi), \text{ we have that} \\ &\llbracket \bigoplus_{\substack{k \in \text{maxrk}(\Sigma), \\ f \in \text{Fork}(\Sigma)^{(k)}}} (\varphi_f(x) \triangleright \langle g(f) \rangle) \rrbracket(\xi, [x \mapsto w]) = g((\xi(w1) \cdots \xi(w \text{rk}(\xi(w))), \xi(w))). \end{aligned} \tag{17.27}$$

Now let $\xi \in \mathbb{T}_\Sigma$. Then we can calculate as follows.

$$\begin{aligned} \llbracket e_1 \rrbracket(\xi) &= \llbracket \bigotimes_x \left(\bigoplus_{\substack{k \in \text{maxrk}(\Sigma), \\ f \in \text{Fork}(\Sigma)^{(k)}}} (\varphi_f(x) \triangleright \langle g(f) \rangle) \right) \rrbracket(\xi) \\ &= \bigotimes_{w \in \text{pos}(\xi)} \llbracket \left(\bigoplus_{\substack{k \in \text{maxrk}(\Sigma), \\ f \in \text{Fork}(\Sigma)^{(k)}}} (\varphi_f(x) \triangleright \langle g(f) \rangle) \right) \rrbracket_{\{x\}}(\xi, [x \mapsto w]) \\ &= \bigotimes_{w \in \text{pos}(\xi)} g((\xi(w1) \cdots \xi(w \text{rk}(\xi(w))), \xi(w))) \quad (\text{by (17.27)}) \\ &= g(\xi) . \end{aligned}$$

Moreover, we can calculate as follows.

$$\begin{aligned} \llbracket e_2 \rrbracket(\xi) &= \llbracket \bigoplus_x \left(\bigoplus_{\sigma \in \Sigma} (\text{root}(x) \wedge \text{label}_\sigma(x) \triangleright \langle F(\sigma) \rangle) \right) \rrbracket(\xi) \\ &= \bigoplus_{w \in \text{pos}(\xi)} \llbracket \bigoplus_{\sigma \in \Sigma} (\text{root}(x) \wedge \text{label}_\sigma(x) \triangleright \langle F(\sigma) \rangle) \rrbracket_{\{x\}}(\xi, [x \mapsto w]) \\ &= \llbracket \langle F(\xi(\varepsilon)) \rangle \rrbracket \quad (\text{because } (\xi, [x \mapsto w]) \models (\text{root}(x) \wedge \text{label}_\sigma(x)) \text{ iff } w = \varepsilon \text{ and } \sigma = \xi(w)) \\ &= F(\xi(\varepsilon)) . \end{aligned}$$

Hence $\llbracket e \rrbracket(\xi) = \llbracket e_1 \times e_2 \rrbracket(\xi) = \llbracket e_1 \rrbracket(\xi) \otimes \llbracket e_2 \rrbracket(\xi) = g(\xi) \otimes F(\xi(\varepsilon)) = \llbracket \mathcal{S} \rrbracket(\xi)$. \square

17.4.2 The carefully extended weighted MSO-logic $\text{MSO}^{\text{cext}}(\Sigma, \mathbf{B})$

Similar to the situation of the weighted MSO formulas defined in [DV06] (also cf. [DG05, Ex. 3.4]), there exists an extended MSO formula $e \in \text{MSO}^{\text{ext}}(\Sigma, \mathbf{Nat})$ such that $\llbracket e \rrbracket$ is not recognizable. In fact, we can give an atomic formula such that its weighted first-order universal quantification is not recognizable. The same holds for the weighted second-order universal quantification.

Example 17.4.8. Let $\Sigma = \{\gamma^{(1)}, \alpha^{(0)}\}$. We consider the semiring \mathbf{Nat} of natural numbers and the formula $e \in \text{MSO}^{\text{ext}}(\Sigma, \mathbf{Nat})$, where

$$e = \bigtimes_x \mathbf{H}(\kappa)$$

and $\kappa = (\kappa_k \mid k \in \mathbb{N})$ with $\kappa_k : \Sigma_{\{x\}}^{(k)} \rightarrow \mathbb{N}$ and $\kappa_k((\sigma, \mathcal{U})) = 2$ for each $(\sigma, \mathcal{U}) \in \Sigma_{\{x\}}^{(k)}$.

Then, for each $n \in \mathbb{N}$, we have (using \prod as notation for the generalization of \cdot to a finite number of arguments)

$$\begin{aligned} \llbracket \bigtimes_x \mathbf{H}(\kappa) \rrbracket(\gamma^n(\alpha)) &= \prod_{w \in \text{pos}(\gamma^n(\alpha))} \llbracket \mathbf{H}(\kappa) \rrbracket_{\{x\}}(\gamma^n(\alpha)[x \mapsto w]) \\ &= \prod_{w \in \text{pos}(\gamma^n(\alpha))} h_\kappa(\gamma^n(\alpha)[x \mapsto w]) = \prod_{w \in \text{pos}(\gamma^n(\alpha))} 2^{n+1} = 2^{(n+1)^2}. \end{aligned}$$

In Example 16.1.3 we have shown that there does not exist a (Σ, \mathbf{Nat}) -wta \mathcal{A} such that $\llbracket \mathcal{A} \rrbracket = \llbracket e \rrbracket$.

Also weighted second-order universal quantification grows too fast for being recognizable; it grows even faster than weighted first-order universal quantification. To see this, we consider the formula $f \in \text{MSO}^{\text{ext}}(\Sigma, \mathbf{Nat})$, where

$$f = \bigtimes_X \mathbf{H}(\kappa)$$

and $\kappa = (\kappa_k \mid k \in \mathbb{N})$ with $\kappa_k : \Sigma_{\{X\}}^{(k)} \rightarrow \mathbb{N}$ and $\kappa_k((\sigma, \mathcal{U})) = 2$ for each $(\sigma, \mathcal{U}) \in \Sigma_{\{X\}}^{(k)}$.

Then, for each $n \in \mathbb{N}$, we have

$$\llbracket \bigtimes_X \mathbf{H}(\kappa) \rrbracket(\gamma^n(\alpha)) = \prod_{W \subseteq \text{pos}(\gamma^n(\alpha))} \llbracket \mathbf{H}(\kappa) \rrbracket_{\{X\}}(\gamma^n(\alpha)[X \mapsto W]) = \prod_{W \subseteq \text{pos}(\gamma^n(\alpha))} 2^{n+1} = 2^{(n+1) \cdot 2^{n+1}}.$$

As in Example 16.1.3, we can prove that there does not exist a (Σ, \mathbf{Nat}) -wta \mathcal{A} such that $\llbracket \mathcal{A} \rrbracket = \llbracket f \rrbracket$. \square

In order to decrease the computational power, we define the above mentioned fragment of $\text{MSO}^{\text{ext}}(\Sigma, \mathbf{B})$. Formally, we define the set of *carefully extended MSO formulas over Σ and \mathbf{B}* , denoted by $\text{MSO}^{\text{cext}}(\Sigma, \mathbf{B})$, to be the set of all formulas $e \in \text{MSO}^{\text{ext}}(\Sigma, \mathbf{B})$ such that the following two conditions hold:

- if e contains a subformula of the form $\bigtimes_x e'$, then e' is a recognizable step formula, i.e., a formula in $\text{MSO}(\Sigma, \mathbf{B})$ of the form $(\varphi_1 \triangleright \langle b_1 \rangle) + \dots + (\varphi_n \triangleright \langle b_n \rangle)$ as specified in (17.13) and
- e does not have a subformula of the form $\bigtimes_X e'$.

Thus, in particular, weighted first-order universal quantification cannot be nested. Moreover, obviously, $\text{MSO}(\Sigma, \mathbf{B}) \subset \text{MSO}^{\text{cext}}(\Sigma, \mathbf{B}) \subset \text{MSO}^{\text{ext}}(\Sigma, \mathbf{B})$.

In the extension $\text{MSO}^{\text{cext}}(\Sigma, \mathbf{B})$ of $\text{MSO}(\Sigma, \mathbf{B})$, formulas of the form $\mathbf{H}(\kappa)$ are obsolete; more precisely, they can be expressed by weighted first-order universal quantification over recognizable step formulas; we recall that recognizable step formulas are elements of $\text{MSO}(\Sigma, \mathbf{B})$.

Lemma 17.4.9. (cf. [FSV12, Lm. 5.12]) Let \mathcal{U} be a finite set of variables and $\kappa = (\kappa_k \mid k \in \mathbb{N})$ be an \mathbb{N} -indexed family with $\kappa_k : \Sigma_{\mathcal{U}}^{(k)} \rightarrow \mathbf{B}$. Moreover, let $x \notin \mathcal{U}$. We can construct a recognizable step formula e such that $\text{Free}(e) = \mathcal{U} \cup \{x\}$ and $\llbracket \mathbf{H}(\kappa) \rrbracket = \llbracket \bigtimes_x e \rrbracket$.

Proof. Let $\Sigma_{\mathcal{U}} = \{(\sigma_1, U_1), \dots, (\sigma_n, U_n)\}$. We define the recognizable step formula

$$e = \left(\varphi_{(\sigma_1, U_1)}(\{x\} \cup U_1) \triangleright \langle b_{(\sigma_1, U_1)} \rangle \right) + \dots + \left(\varphi_{(\sigma_n, U_n)}(\{x\} \cup U_n) \triangleright \langle b_{(\sigma_n, U_n)} \rangle \right)$$

where, for each $i \in [n]$, we let

- $b_{(\sigma_i, U_i)} = \kappa_{\text{rk}((\sigma_i, U_i))}((\sigma_i, U_i))$ and
- $\varphi_{(\sigma_i, U_i)}(\{x\} \cup U_i)$ is the MSO(Σ)-formula

$$\text{label}_{\sigma_i}(x) \wedge \left(\bigwedge_{y \in U_i} (x = y) \right) \wedge \left(\bigwedge_{y \in \mathcal{U} \setminus U_i} \neg(x = y) \right) \wedge \left(\bigwedge_{X \in U_i} (x \in X) \right) \wedge \left(\bigwedge_{X \in \mathcal{U} \setminus U_i} \neg(x \in X) \right) .$$

Obviously, for every $\zeta \in \mathbb{T}_{\Sigma_{\mathcal{U}}}^{\vee}$, $w \in \text{pos}(\zeta)$, and $(\sigma_i, U_i) \in \mathcal{U}$, we have

$$\zeta[x \mapsto w] \in \mathbb{L}_{\mathcal{U} \cup \{x\}}(\varphi_{(\sigma_i, U_i)}) \quad \text{iff} \quad \zeta(w) = (\sigma_i, U_i) , \quad (17.28)$$

and hence $(\mathbb{L}_{\mathcal{U} \cup \{x\}}(\varphi_{(\sigma_i, U_i)}) \mid i \in [n])$ is a partitioning of $\mathbb{T}_{\Sigma_{\mathcal{U} \cup \{x\}}}^{\vee}$. Thus we have

$$\llbracket \varphi_{(\sigma_i, U_i)}(\{x\} \cup U_i) \triangleright \langle b_{(\sigma_i, U_i)} \rangle \rrbracket(\zeta[x \mapsto w]) = \begin{cases} b_{(\sigma_i, U_i)} & \text{if } \zeta(w) = (\sigma_i, U_i) \\ 0 & \text{otherwise} . \end{cases} \quad (17.29)$$

Let $\zeta \in \mathbb{T}_{\Sigma_{\mathcal{U}}}$. If ζ is not valid, then $\llbracket \mathbb{H}(\kappa) \rrbracket(\zeta) = 0 = \llbracket \bigotimes_x e \rrbracket(\zeta)$. Now let ζ be valid. Then we have

$$\begin{aligned} \llbracket \bigotimes_x e \rrbracket(\zeta) &= \bigotimes_{w \in \text{pos}(\zeta)} \llbracket e \rrbracket_{\mathcal{U} \cup \{x\}}(\zeta[x \mapsto w]) \\ &= \bigotimes_{w \in \text{pos}(\zeta)} b_{\zeta(w)} && \text{(by (17.29))} \\ &= \bigotimes_{w \in \text{pos}(\zeta)} \kappa_{\text{rk}(\zeta(w))}(\zeta(w)) && \text{(by definition of } b_{\zeta(w)}) \\ &= \llbracket \mathbb{H}(\kappa) \rrbracket(\zeta) && \text{(by (2.37))} \end{aligned}$$

□

In Lemma 17.4.12 we will show how formulas of the form $\bigotimes_x e$, where e is a recognizable step formula, can be simulated by a formula in MSO(Σ, \mathbb{B}) (cf. t in (17.30)). Here we prove that atomic formulas alone are not powerful enough to simulate recognizable step formulas.

Lemma 17.4.10. For the ranked alphabet $\Sigma = \{\alpha^{(2)}, \gamma^{(1)}, \alpha^{(0)}\}$ we can construct a recognizable step sentence e over Σ and \mathbb{N} such that $\llbracket e \rrbracket \neq \llbracket \mathbb{H}(\kappa) \rrbracket$ for any family $\kappa = (\kappa_k \mid k \in \mathbb{N})$ of mappings $\kappa_k : \Sigma^{(k)} \rightarrow \mathbb{N}$.

Proof. By Theorem 10.3.1(A) \Rightarrow (B) and Lemma 17.2.3(A) \Rightarrow (B), it is sufficient to construct a crisp-deterministic (Σ, \mathbb{N}) -wta \mathcal{A} such that $\llbracket \mathcal{A} \rrbracket \neq \llbracket \mathbb{H}(\kappa) \rrbracket$ for any family $\kappa = (\kappa_k \mid k \in \mathbb{N})$ of mappings $\kappa_k : \Sigma^{(k)} \rightarrow \mathbb{N}$.

We consider the crisp-deterministic (Σ, \mathbb{N}) -wta \mathcal{A} constructed in Example 3.2.16. There it was shown that $\llbracket \mathcal{A} \rrbracket = \text{twothree}$, where the weighted tree language $\text{twothree} : \mathbb{T}_{\Sigma} \rightarrow \mathbb{N}$ is defined by

$$\text{twothree}(\xi) = \begin{cases} 2 & \text{if } |\text{pos}(\xi)| \text{ is even} \\ 3 & \text{otherwise} \end{cases}$$

for each $\xi \in \mathbb{T}_{\Sigma}$.

We show by contradiction that \mathcal{A} has the desired property. For this, we assume that there is a family $\kappa = (\kappa_k \mid k \in \mathbb{N})$ of mappings $\kappa_k : \Sigma^{(k)} \rightarrow \mathbb{N}$ with $\llbracket \mathbf{H}(\kappa) \rrbracket = \llbracket \mathcal{A} \rrbracket$. By definition,

$$\llbracket \mathbf{H}(\kappa) \rrbracket(\gamma^n(\alpha)) = \kappa_0(\alpha) \cdot (\kappa_1(\gamma))^n$$

for each $n \in \mathbb{N}$. Since $\text{im}(\llbracket \mathcal{A} \rrbracket) = \{2, 3\}$, i.e., a finite set, it follows that $\kappa_1(\gamma) = 0$ or $\kappa_1(\gamma) = 1$. In the first case $\llbracket \mathbf{H}(\kappa) \rrbracket(\gamma^n(\alpha)) = 0$ for each $n \in \mathbb{N}_+$. In the second case $\llbracket \mathbf{H}(\kappa) \rrbracket(\gamma^n(\alpha)) = \kappa_0(\alpha)$ for each $n \in \mathbb{N}$. Thus, in both cases, we have $\llbracket \mathbf{H}(\kappa) \rrbracket(\gamma^2(\alpha)) = \llbracket \mathbf{H}(\kappa) \rrbracket(\gamma(\alpha))$. This contradicts $\llbracket \mathbf{H}(\kappa) \rrbracket = \llbracket \mathcal{A} \rrbracket$, because $\llbracket \mathcal{A} \rrbracket(\gamma^2(\alpha)) = 2 \neq 3 = \llbracket \mathcal{A} \rrbracket(\gamma(\alpha))$. \square

17.4.3 The main result for $\text{MSO}^{\text{cext}}(\Sigma, \mathbf{B})$ over commutative semirings

In this subsection we prove that the two weighted logics $\text{MSO}(\Sigma, \mathbf{B})$ and $\text{MSO}^{\text{cext}}(\Sigma, \mathbf{B})$ are equivalent (cf. Theorem 17.4.11), if \mathbf{B} is a commutative semiring. This theorem follows directly from Lemmas 17.4.12 and Lemma 17.4.16. For each bounded lattice \mathbf{B} , we will prove that even the two weighted logics $\text{MSO}(\Sigma, \mathbf{B})$ and $\text{MSO}^{\text{cext}}(\Sigma, \mathbf{B})$ are equivalent (cf. Corollary 20.8.1).

Theorem 17.4.11. *Let Σ be a ranked alphabet. Moreover, let \mathbf{B} be a commutative semiring, let $e \in \text{MSO}^{\text{cext}}(\Sigma, \mathbf{B})$, and let \mathcal{V} be a finite set of variables such that $\mathcal{V} \supseteq \text{Free}(e)$. Then we can construct an $\text{MSO}(\Sigma, \mathbf{B})$ -formula f such that $\text{Free}(e) = \text{Free}(f)$ and $\llbracket e \rrbracket_{\mathcal{V}} = \llbracket f \rrbracket_{\mathcal{V}}$.*

In the next lemma we get rid of weighted first-order universal quantification. We follow the proof of [FSV12, Lm. 5.10]; in its turn, the construction in the proof of the latter lemma was inspired by the construction in the proof of [DG09, Lm. 5.4]. In the proof we will use that \mathbf{B} is commutative.

Lemma 17.4.12. (cf. [FSV12, Lm. 5.10]) *Let $e \in \text{MSO}^{\text{cext}}(\Sigma, \mathbf{B})$ and let \mathcal{V} be a finite set of variables such that $\mathcal{V} \supseteq \text{Free}(e)$. Then we can construct an $\text{MSO}^{\text{cext}}(\Sigma, \mathbf{B})$ -formula f such that (a) $\text{Free}(e) = \text{Free}(f)$, (b) $\llbracket e \rrbracket_{\mathcal{V}} = \llbracket f \rrbracket_{\mathcal{V}}$, and (c) f does not contain a subformula of the form $\times_x e'$.*

Proof. Intuitively, we define a reduction system on $\text{MSO}^{\text{cext}}(\Sigma, \mathbf{B})$ such that, in each reduction step, the semantics of the formula is preserved and the number of occurrences of subformulas of the form $\times_x e'$ decreases by one.

Formally, we define the binary relation $\succ \subseteq \text{MSO}^{\text{cext}}(\Sigma, \mathbf{B}) \times \text{MSO}^{\text{cext}}(\Sigma, \mathbf{B})$ such that, for every $e, f \in \text{MSO}^{\text{cext}}(\Sigma, \mathbf{B})$, we let $e \succ f$ if

- e has a subformula of the form $\times_x e'$, where e' is a recognizable step formula, i.e., there exist $n \in \mathbb{N}_+$, $b_1, \dots, b_n \in B$, and $\varphi_1, \dots, \varphi_n \in \text{MSO}(\Sigma)$ such that $e' = (\varphi_1 \triangleright \langle b_1 \rangle) + \dots + (\varphi_n \triangleright \langle b_n \rangle)$, we abbreviate by \mathcal{V}' the set $\text{Free}(\times_x e')$, and
- f is obtained from e by replacing an occurrence of $\times_x e'$ by the $\text{MSO}(\Sigma, \mathbf{B})$ -formula

$$t = \bigoplus_{X_1} \dots \bigoplus_{X_n} \left(\left(\bigwedge_{i \in [n]} \forall x. ((x \in X_i) \leftrightarrow \varphi_i) \right) \triangleright \mathbf{H}(\kappa) \right) \quad (17.30)$$

where

- X_1, \dots, X_n are second-order variables which do not occur in $\text{Free}(e) \cup \text{Bound}(e)$ and
- κ is the \mathbb{N} -indexed family $(\kappa_k \mid k \in \mathbb{N})$ of mappings $\kappa_k : \Sigma_{\mathcal{U}}^{(k)} \rightarrow B$, where $\mathcal{U} = \mathcal{V}' \cup \{X_1, \dots, X_n\}$, such that, for each $(\sigma, \mathcal{W}) \in \Sigma_{\mathcal{U}}^{(k)}$, we define

$$\kappa_k((\sigma, \mathcal{W})) = \bigoplus_{i \in [n]: X_i \in \mathcal{W}} b_i .$$

We make the following observations:

1. Intuitively, the MSO(Σ)-formula $(\bigwedge_{i \in [n]} \forall x. ((x \in X_i) \leftrightarrow \varphi_i))$ (which is a part of t) guarantees that, for each $i \in [n]$, the set of positions assigned to X_i is exactly the set of positions for which φ_i is true (cf. (17.33)).
2. On purpose, we use the variable x , which might occur in φ_i , also as variable for the universal quantification; thereby we “synchronize” the sequence X_1, \dots, X_n with the formulas $\varphi_1, \dots, \varphi_n$. Obviously, $\text{Free}(t) = \mathcal{V}'$ and hence $\text{Free}(\bigtimes_x e') = \text{Free}(t)$ and thus $\text{Free}(e) = \text{Free}(f)$.

Next we prove that \succ is terminating. For each $e \in \text{MSO}^{\text{cext}}(\Sigma, \mathbf{B})$, we let $\#_{\times}(e)$ denote the number of occurrences of a subformula of the form $\bigtimes_x e'$. Obviously, for each $e \in \text{MSO}^{\text{cext}}(\Sigma, \mathbf{B})$ with $\#_{\times}(e) > 0$, we can construct an $f \in \text{MSO}^{\text{cext}}(\Sigma, \mathbf{B})$ such that $e \succ f$. Moreover, the mapping $\#_{\times}$ is a monotone embedding of $(\text{MSO}^{\text{cext}}(\Sigma, \mathbf{B}), \succ)$ into $(\mathbb{N}, \succ_{\mathbb{N}})$ because $e \succ f$ implies that $\#_{\times}(e) = \#_{\times}(f) + 1$. Hence, by Lemma 2.5.2, the reduction system $(\text{MSO}^{\text{cext}}(\Sigma, \mathbf{B}), \succ)$ is terminating and, obviously,

$$\text{nf}_{\succ}(\text{MSO}^{\text{cext}}(\Sigma, \mathbf{B})) = \{e \in \text{MSO}^{\text{cext}}(\Sigma, \mathbf{B}) \mid e \text{ does not have a subformula of the form } \bigtimes_x e'\} . \quad (17.31)$$

Next we prove that, for every $e, f \in \text{MSO}^{\text{cext}}(\Sigma, \mathbf{B})$, if $e \succ f$, then $\llbracket e \rrbracket_{\mathcal{V}} = \llbracket f \rrbracket_{\mathcal{V}}$. For this purpose, we will prove that

$$\llbracket t \rrbracket = \llbracket \bigtimes_x e' \rrbracket , \quad (17.32)$$

where t and e' are specified as in the definition of \succ , and then we will use Observation 17.4.5. We start with the analysis of the semantics of the MSO(Σ)-subformula $(\bigwedge_{i \in [n]} \forall x. ((x \in X_i) \leftrightarrow \varphi_i))$. Let $(\xi, \mu) \in \mathbb{T}_{\Sigma_{\mathcal{V}'}}^{\vee}$ and let $V_1, \dots, V_n \subseteq \text{pos}(\xi)$. Obviously, the following equivalence holds:

$$\begin{aligned} (\xi, \mu[X_1 \mapsto V_1, \dots, X_n \mapsto V_n]) \models (\bigwedge_{i \in [n]} \forall x. ((x \in X_i) \leftrightarrow \varphi_i)) \quad \text{iff} \\ (\forall i \in [n]) : V_i = \{w \in \text{pos}(\xi) \mid (\xi, \mu[x \mapsto w]) \in L_{\mathcal{V}' \cup \{x\}}(\varphi_i)\} . \end{aligned} \quad (17.33)$$

For every $i \in [n]$, we abbreviate the set $\{w \in \text{pos}(\xi) \mid (\xi, \mu[x \mapsto w]) \in L_{\mathcal{V}' \cup \{x\}}(\varphi_i)\}$ by $W(\xi, \mu, i)$.

Now we prove (17.32). For this, let $(\xi, \mu) \in \mathbb{T}_{\Sigma_{\mathcal{V}'}}^{\vee}$. If (ξ, μ) is not valid, then both sides of (17.32) evaluate to 0. Now let $(\xi, \mu) \in \mathbb{T}_{\Sigma_{\mathcal{V}'}}^{\vee}$. Then we obtain

$$\begin{aligned} \llbracket t \rrbracket(\xi, \mu) &= \bigoplus_{V_1, \dots, V_n \subseteq \text{pos}(\xi)} \left((\bigwedge_{i \in [n]} \forall x. ((x \in X_i) \leftrightarrow \varphi_i)) \triangleright \mathbf{H}(\kappa) \right) (\xi, \mu[X_1 \mapsto V_1, \dots, X_n \mapsto V_n]) \\ &= \llbracket \mathbf{H}(\kappa) \rrbracket_{\mathcal{U}}(\xi, \mu[X_1 \mapsto W(\xi, \mu, 1), \dots, X_n \mapsto W(\xi, \mu, n)]) \quad (\text{by (17.33)}) \\ &= h_{\kappa[\mathcal{U} \rightsquigarrow \mathcal{U}]}((\xi, \mu[X_1 \mapsto W(\xi, \mu, 1), \dots, X_n \mapsto W(\xi, \mu, n)])) \\ &= h_{\kappa}((\xi, \mu[X_1 \mapsto W(\xi, \mu, 1), \dots, X_n \mapsto W(\xi, \mu, n)])) \\ &= \bigotimes_{w \in \text{pos}(\xi)} \kappa_k \left((\xi(w), \mathcal{W} \cup \{X_j \mid w \in W(\xi, \mu, j)\}) \right) \\ &\quad (\text{by (2.37) and the fact that } \mathbf{B} \text{ is commutative}) \end{aligned}$$

where $k = \text{rk}(\zeta(w))$ and $\mathcal{W} = \{y \in (\mathcal{V}')^{(1)} \mid w = \mu(y)\} \cup \{Y \in (\mathcal{V}')^{(2)} \mid w \in \mu(Y)\}$ (note that $\mathcal{W} \cap \{X_1, \dots, X_n\} = \emptyset$).

Let $w \in \text{pos}(\xi)$. Clearly,

$$\begin{aligned} \kappa_k((\xi(w), \mathcal{W} \cup \{X_j \mid w \in W(\xi, \mu, j)\})) &= \bigoplus_{\substack{i \in [n]: \\ X_i \in \mathcal{W} \cup \{X_j \mid w \in W(\xi, \mu, j)\}}} b_i \\ &= \bigoplus_{\substack{i \in [n]: \\ w \in W(\xi, \mu, i)}} b_i \quad (\text{because } X_i \notin \mathcal{W}) \\ &= \bigoplus_{\substack{i \in [n]: \\ (\xi, \mu[x \mapsto w]) \in L_{\mathcal{V}' \cup \{x\}}(\varphi_i)}} b_i \end{aligned}$$

$$\begin{aligned}
&= \bigoplus_{i \in [n]} b_i \otimes \chi(\mathbf{L}_{\mathcal{V}' \cup \{x\}}(\varphi_i))((\xi, \mu[x \mapsto w])) \\
&= \llbracket e' \rrbracket_{\mathcal{V}' \cup \{x\}}(\xi, \mu[x \mapsto w]) .
\end{aligned}$$

Hence,

$$\llbracket t \rrbracket(\xi, \mu) = \bigotimes_{w \in \text{pos}(\xi)} \llbracket e' \rrbracket_{\mathcal{V}' \cup \{x\}}(\xi, \mu[x \mapsto w]) = \llbracket \bigtimes_x e' \rrbracket_{\mathcal{V}'}(\xi, \mu) = \llbracket \bigtimes_x e' \rrbracket(\xi, \mu) .$$

This proves (17.32).

Now let $e, f \in \text{MSO}^{\text{cext}}(\Sigma, \mathbf{B})$ such that $e \succ f$ and e' and t are specified as in the definition of \succ . Then, by (17.32) and Observation 17.4.5, we obtain $\llbracket e \rrbracket_{\mathcal{V}} = \llbracket f \rrbracket_{\mathcal{V}}$.

Now let $e \in \text{MSO}^{\text{cext}}(\Sigma, \mathbf{B})$ be an arbitrary formula. Let us construct an $f \in \text{nf}_{\succ}(e)$. Then $\llbracket e \rrbracket_{\mathcal{V}} = \llbracket f \rrbracket_{\mathcal{V}}$ and, by (17.31), f does not contain a subformula of the form $\bigtimes_x e'$. \square

Example 17.4.13. In this example we want to illustrate the construction defined in the proof of Lemma 17.4.12. We consider the string ranked alphabet $\Sigma = \{\gamma^{(1)}, \alpha^{(0)}\}$ and the semiring $\mathbf{Nat} = (\mathbb{N}, +, \cdot, 0, 1)$. Moreover, we let $e = (\bigtimes_x \text{label}_{\alpha}(x) \triangleright \langle 2 \rangle)$. Obviously, $\text{Free}(e) = \emptyset$; we let $\mathcal{V} = \emptyset$.

Then the formula t in $\text{MSO}(\Sigma, \mathbf{Nat})$ (cf. (17.30)) has the following form (with $n = 1$ and $\varphi_1 = \text{label}_{\alpha}(x)$):

$$t = \bigoplus_{X_1} \left((\forall x. ((x \in X_1) \leftrightarrow \text{label}_{\alpha}(x))) \triangleright \mathbf{H}(\kappa) \right) ,$$

where κ is the \mathbb{N} -indexed family of mappings $\kappa_k : \Sigma_{\{X_1\}}^{(k)} \rightarrow \mathbb{N}$ such that

- $\kappa_0((\alpha, \emptyset)) = \kappa_1((\gamma, \emptyset)) = \bigoplus_{X_1 \in \emptyset} 2 = 0$ and
- $\kappa_0((\alpha, \{X_1\})) = \kappa_1((\gamma, \{X_1\})) = \bigoplus_{X_1 \in \{X_1\}} 2 = 2$.

For the tree $\gamma(\alpha) \in \mathbf{T}_{\Sigma, \emptyset}^{\vee}$, we can calculate as follows:

$$\begin{aligned}
&\llbracket (\bigtimes_x \text{label}_{\alpha}(x) \triangleright \langle 2 \rangle) \rrbracket_{\emptyset}(\gamma(\alpha)) \\
&= \llbracket \text{label}_{\alpha}(x) \triangleright \langle 2 \rangle \rrbracket_{\{x\}}(\gamma(\alpha), [x \mapsto 1]) \cdot \llbracket \text{label}_{\alpha}(x) \triangleright \langle 2 \rangle \rrbracket_{\{x\}}(\gamma(\alpha), [x \mapsto \varepsilon]) \\
&= \llbracket \langle 2 \rangle \rrbracket_{\{x\}}(\gamma(\alpha), [x \mapsto 1]) \cdot 0 = 2 \cdot 0 = 0 .
\end{aligned}$$

Using the above mentioned instance of t , we can calculate as follows:

$$\begin{aligned}
&\llbracket \bigoplus_{X_1} \left((\forall x. ((x \in X_1) \leftrightarrow \text{label}_{\alpha}(x))) \triangleright \mathbf{H}(\kappa) \right) \rrbracket_{\emptyset}(\gamma(\alpha)) \\
&= \bigoplus_{W \subseteq \{\varepsilon, 1\}} \underbrace{\llbracket (\forall x. ((x \in X_1) \leftrightarrow \text{label}_{\alpha}(x))) \triangleright \mathbf{H}(\kappa) \rrbracket_{\{X_1\}}(\gamma(\alpha), [X_1 \mapsto W])}_g \\
&= \llbracket g \rrbracket_{\{X_1\}}(\gamma(\alpha), [X_1 \mapsto \{\varepsilon, 1\}]) + \llbracket g \rrbracket_{\{X_1\}}(\gamma(\alpha), [X_1 \mapsto \{1\}]) \\
&\quad + \llbracket g \rrbracket_{\{X_1\}}(\gamma(\alpha), [X_1 \mapsto \{\varepsilon\}]) + \llbracket g \rrbracket_{\{X_1\}}(\gamma(\alpha), [X_1 \mapsto \emptyset]) .
\end{aligned}$$

Due to (17.33), we have

$$\begin{aligned}
&(\gamma(\alpha), [X_1 \mapsto V_1']) \models (\forall x. ((x \in X_1) \leftrightarrow \text{label}_{\alpha}(x))) \text{ iff} \\
&V_1' = \{w \in \text{pos}(\gamma(\alpha)) \mid (\gamma(\alpha), [x \mapsto w]) \in \mathbf{L}_{\{x\}}(\text{label}_{\alpha}(x))\} = \{1\} .
\end{aligned} \tag{17.34}$$

Since $V_1' = \{1\}$, we can continue as follows:

$$\begin{aligned}
&\llbracket g \rrbracket_{\{X_1\}}(\gamma(\alpha), [X_1 \mapsto \{\varepsilon, 1\}]) + \llbracket g \rrbracket_{\{X_1\}}(\gamma(\alpha), [X_1 \mapsto \{1\}]) \\
&\quad + \llbracket g \rrbracket_{\{X_1\}}(\gamma(\alpha), [X_1 \mapsto \{\varepsilon\}]) + \llbracket g \rrbracket_{\{X_1\}}(\gamma(\alpha), [X_1 \mapsto \emptyset]) \\
&= \llbracket \mathbf{H}(\kappa) \rrbracket_{\{X_1\}}(\gamma(\alpha), [X_1 \mapsto \{1\}]) \\
&= \kappa_0((\alpha, \{X_1\})) \cdot \kappa_1((\gamma, \emptyset)) \\
&= 2 \cdot 0 = 0 .
\end{aligned} \quad \square$$

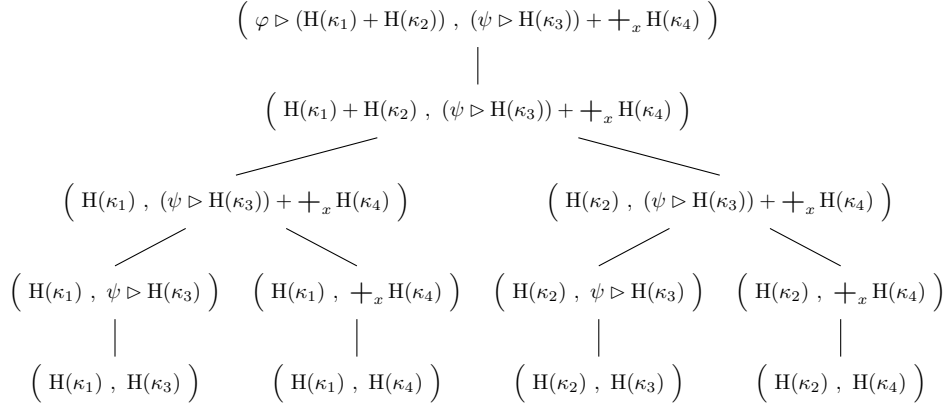

Figure 17.4: Illustration of \succ where moving from a node labeled by A to its direct successor labeled by B means that $A \succ B$.

Next we eliminate weighted conjunction in formulas which do not contain weighted first-order universal quantification. Informally, we define a mapping hp which, on a pair (e_1, e_2) of $\text{MSO}(\Sigma, \mathsf{B})$ -formulas as argument, shows an $\text{MSO}(\Sigma, \mathsf{B})$ -formula as result such that $e_1 \times e_2$ and $\text{hp}(e_1, e_2)$ are equivalent (cf. proof of [FSV12, Lm. 5.7]). For technical purposes, we have to assume that $e_1 \times e_2$ is variable separated. Moreover, we will assure that $\text{Free}(\text{hp}(e_1, e_2)) = \text{Free}(e_1) \cup \text{Free}(e_2)$ and $\text{Bound}(\text{hp}(e_1, e_2)) = \text{Bound}(e_1) \cup \text{Bound}(e_2)$.

Since we will define hp by induction, we first have to introduce a terminating reduction system. Formally, we let $\text{vsMSO}^2(\Sigma, \mathsf{B})$ denote the set

$$\{(e_1, e_2) \in \text{MSO}(\Sigma, \mathsf{B}) \times \text{MSO}(\Sigma, \mathsf{B}) \mid e_1 \times e_2 \text{ is variable separated}\}$$

and we define the reduction system

$$(\text{vsMSO}^2(\Sigma, \mathsf{B}), \succ)$$

such that, for every $(e_1, e_2), (e'_1, e'_2) \in \text{vsMSO}^2(\Sigma, \mathsf{B})$, we let $(e_1, e_2) \succ (e'_1, e'_2)$ if

- $e_1 \succ_{\text{MSO}(\Sigma, \mathsf{B})} e'_1$ (i.e., e'_1 is a direct subformula of e_1 , cf. Section 17.2) and $e_2 = e'_2$ or
- $e_1 = e'_1 = \mathsf{H}(\kappa)$ for some \mathbb{N} -indexed family $\kappa = (\kappa_k \mid k \in \mathbb{N})$ and $e_2 \succ_{\text{MSO}(\Sigma, \mathsf{B})} e'_2$.

By Corollary 2.5.5 and Lemma 2.5.3, the relation \succ is terminating and $\text{nf}_\succ(\text{vsMSO}^2(\Sigma, \mathsf{B}))$ is the set of all pairs of the form $(\mathsf{H}(\kappa_1), \mathsf{H}(\kappa_2))$ where for each $i \in [2]$, $\kappa_i = ((\kappa_i)_k \mid k \in \mathbb{N})$ is an \mathbb{N} -indexed family of mappings $(\kappa_i)_k : \Sigma_{\mathcal{U}_i}^{(k)} \rightarrow \mathsf{B}$ for some finite sets \mathcal{U}_i . In Figure 17.4 we illustrate the well-founded order \succ by means of an example.

By induction on $(\text{vsMSO}^2(\Sigma, \mathsf{B}), \succ)$, we define the family $(\text{hp}(e_1, e_2) \mid e_1, e_2 \in \text{vsMSO}^2(\Sigma, \mathsf{B}))$ as follows. Let $(e_1, e_2) \in \text{vsMSO}^2(\Sigma, \mathsf{B})$.

I.B.: Let $e_1 = \mathsf{H}(\kappa_1)$ and $e_2 = \mathsf{H}(\kappa_2)$ where for each $i \in [2]$, the members of the \mathbb{N} -indexed family $\kappa_i = ((\kappa_i)_k \mid k \in \mathbb{N})$ have the type $(\kappa_i)_k : \Sigma_{\mathcal{U}_i}^{(k)} \rightarrow \mathsf{B}$. Then we define $\text{hp}(e_1, e_2) = \mathsf{H}(\kappa)$, where $\kappa = (\kappa_k \mid k \in \mathbb{N})$ and for every $k \in \mathbb{N}$ we define the mapping $\kappa_k : \Sigma_{\mathcal{U}_1 \cup \mathcal{U}_2}^{(k)} \rightarrow \mathsf{B}$ for each $(\sigma, V) \in \Sigma_{\mathcal{U}_1 \cup \mathcal{U}_2}^{(k)}$ by $\kappa_k((\sigma, V)) = (\kappa_1)_k((\sigma, V \cap \mathcal{U}_1)) \otimes (\kappa_2)_k((\sigma, V \cap \mathcal{U}_2))$.

I.S.: We distinguish eight cases.

- (a) Let $e_1 = g_1 + g_2$. We define $\text{hp}((g_1 + g_2), e_2) = \text{hp}(g_1, e_2) + \text{hp}(g_2, e_2)$.
- (b) Let $e_1 = \dagger_x g$. We define $\text{hp}(\dagger_x g, e_2) = \dagger_x \text{hp}(g, e_2)$.
- (c) Let $e_1 = \dagger_X g$. We define $\text{hp}(\dagger_X g, e_2) = \dagger_X \text{hp}(g, e_2)$.
- (d) Let $e_1 = (\varphi \triangleright g)$. We define $\text{hp}(\varphi \triangleright g, e_2) = (\varphi \triangleright \text{hp}(g, e_2))$.

In each of the following cases, let $e_1 = H(\kappa_1)$ with $\kappa_1 = ((\kappa_1)_k \mid k \in \mathbb{N})$ and $(\kappa_1)_k : \Sigma_{\mathcal{U}_1}^{(k)} \rightarrow B$.

(e) Let $e_2 = g_1 + g_2$. We define $\text{hp}(H(\kappa_1), g_1 + g_2) = \text{hp}(H(\kappa_1), g_1) + \text{hp}(H(\kappa_1), g_2)$.

(f) Let $e_2 = \bigoplus_x g$. We define $\text{hp}(H(\kappa_1), \bigoplus_x g) = \bigoplus_x \text{hp}(H(\kappa_1), g)$.

(g) Let $e_2 = \bigoplus_X g$. We define $\text{hp}(H(\kappa_1), \bigoplus_X g) = \bigoplus_X \text{hp}(H(\kappa_1), g)$.

(h) Let $e_1 = (\varphi \triangleright g)$. We define $\text{hp}(H(\kappa_1), \varphi \triangleright g) = (\varphi \triangleright \text{hp}(H(\kappa_1), g))$.

It is easy to see that in each case $\text{Free}(\text{hp}(e_1, e_2)) = \text{Free}(e_1) \cup \text{Free}(e_2) = \text{Free}(e_1 \times e_2)$ and $\text{Bound}(\text{hp}(e_1, e_2)) = \text{Bound}(e_1) \cup \text{Bound}(e_2) = \text{Bound}(e_1 \times e_2)$.

Example 17.4.14. Here we show how to compute $\text{hp}(e_1, e_2)$ for the pair (e_1, e_2) which is the label of the root of the tree in Figure17.4. We do not specify the families $\kappa_1, \kappa_2, \kappa_3, \kappa_4$, and hence we do not compute $\text{hp}(H(\kappa_1), H(\kappa_3))$, $\text{hp}(H(\kappa_1), H(\kappa_4))$, $\text{hp}(H(\kappa_2), H(\kappa_3))$, and $\text{hp}(H(\kappa_2), H(\kappa_4))$.

$$\begin{aligned}
& \text{hp}\left(\varphi \triangleright (H(\kappa_1) + H(\kappa_2)), (\psi \triangleright H(\kappa_3)) + \bigoplus_x H(\kappa_4)\right) \\
&= \varphi \triangleright \text{hp}\left(H(\kappa_1) + H(\kappa_2), (\psi \triangleright H(\kappa_3)) + \bigoplus_x H(\kappa_4)\right) && \text{(by (d))} \\
&= \varphi \triangleright \left(\text{hp}\left(H(\kappa_1), (\psi \triangleright H(\kappa_3)) + \bigoplus_x H(\kappa_4)\right) + \right. \\
&\quad \left.\text{hp}\left(H(\kappa_2), (\psi \triangleright H(\kappa_3)) + \bigoplus_x H(\kappa_4)\right)\right) && \text{(by (a))} \\
&= \varphi \triangleright \left(\text{hp}\left(H(\kappa_1), \psi \triangleright H(\kappa_3)\right) + \text{hp}\left(H(\kappa_1), \bigoplus_x H(\kappa_4)\right) + \right. \\
&\quad \left.\text{hp}\left(H(\kappa_2), \psi \triangleright H(\kappa_3)\right) + \text{hp}\left(H(\kappa_2), \bigoplus_x H(\kappa_4)\right)\right) && \text{(by (e))} \\
&= \varphi \triangleright \left(\left(\psi \triangleright \text{hp}\left(H(\kappa_1), H(\kappa_3)\right)\right) + \left(\bigoplus_x \text{hp}\left(H(\kappa_1), H(\kappa_4)\right)\right) + \right. \\
&\quad \left.\left(\psi \triangleright \text{hp}\left(H(\kappa_2), H(\kappa_3)\right)\right) + \left(\bigoplus_x \text{hp}\left(H(\kappa_2), H(\kappa_4)\right)\right)\right). && \text{(by (f))}
\end{aligned}$$

□

Next we prove that, roughly speaking, $e_1 \times e_2$ and $\text{hp}(e_1, e_2)$ are equivalent, if \mathbf{B} is distributive.

Lemma 17.4.15. (cf. [FSV12, Lm. 5.7]) Let \mathbf{B} be distributive, let $e_1, e_2 \in \text{MSO}(\Sigma, \mathbf{B})$ such that $e_1 \times e_2$ is variable separated, and let \mathcal{U}_1 and \mathcal{U}_2 abbreviate $\text{Free}(e_1)$ and $\text{Free}(e_2)$, respectively. For each finite set \mathcal{V} of variables which contains $\mathcal{U}_1 \cup \mathcal{U}_2$ we have $\llbracket e_1 \times e_2 \rrbracket_{\mathcal{V}} = \llbracket \text{hp}(e_1, e_2) \rrbracket_{\mathcal{V}}$.

Proof. We prove the statement of the lemma by induction on $(\text{vs}^2\text{MSO}(\Sigma, \mathbf{B}), \succ)$ (see above). In the proof we refer to I.B. and Cases (a)–(h) of I.S. of the definition of $\text{hp}(e_1, e_2)$. Let $\zeta \in \text{T}_{\Sigma, \mathcal{V}}^v$.

I.B.: Let e_1 and e_2 be as in I.B. of the definition of $\text{hp}(e_1, e_2)$. Then we can calculate as follows:

$$\begin{aligned}
\llbracket H(\kappa_1) \times H(\kappa_2) \rrbracket_{\mathcal{V}}(\zeta) &= \llbracket H(\kappa_1) \rrbracket_{\mathcal{V}}(\zeta) \otimes \llbracket H(\kappa_2) \rrbracket_{\mathcal{V}}(\zeta) = \mathfrak{h}_{\kappa_1[\mathcal{U}_1 \rightsquigarrow \mathcal{V}]}(\zeta) \otimes \mathfrak{h}_{\kappa_2[\mathcal{U}_2 \rightsquigarrow \mathcal{V}]}(\zeta) \\
&= \mathfrak{h}_{\kappa[\mathcal{U}_1 \cup \mathcal{U}_2 \rightsquigarrow \mathcal{V}]}(\zeta) = \llbracket H(\kappa) \rrbracket_{\mathcal{V}}(\zeta) = \llbracket \text{hp}(H(\kappa_1), H(\kappa_2)) \rrbracket_{\mathcal{V}}(\zeta),
\end{aligned}$$

where the third equality holds because

$$\begin{aligned}
& \bigotimes_{\substack{w \in \text{pos}(\zeta), \\ \zeta(w) = (\sigma, V)}} \kappa_1((\sigma, \mathcal{U}_1 \cap V)) \otimes \bigotimes_{\substack{w \in \text{pos}(\zeta), \\ \zeta(w) = (\sigma, V)}} \kappa_2((\sigma, \mathcal{U}_2 \cap V)) \\
&= \bigotimes_{\substack{w \in \text{pos}(\zeta), \\ \zeta(w) = (\sigma, V)}} \kappa_1((\sigma, \mathcal{U}_1 \cap V)) \otimes \kappa_2((\sigma, \mathcal{U}_2 \cap V))
\end{aligned}$$

where the latter equality holds because \mathbf{B} is commutative.

I.S.: We distinguish eight cases.

Let e_1 be as in Case (a). Then our statement holds due to right-distributivity of \mathbf{B} .

Let e_1 be as in Case (b). Then

$$\begin{aligned}
\llbracket (\bigoplus_x g) \times e_2 \rrbracket_{\mathcal{V}}(\zeta) &= \llbracket \bigoplus_x g \rrbracket_{\mathcal{V}}(\zeta) \otimes \llbracket e_2 \rrbracket_{\mathcal{V}}(\zeta) \\
&= \left(\bigoplus_{w \in \text{pos}(\zeta)} \llbracket g \rrbracket_{\mathcal{V} \cup \{x\}}(\zeta[x \mapsto w]) \right) \otimes \llbracket e_2 \rrbracket_{\mathcal{V}}(\zeta) \\
&= \bigoplus_{w \in \text{pos}(\zeta)} \left(\llbracket g \rrbracket_{\mathcal{V} \cup \{x\}}(\zeta[x \mapsto w]) \otimes \llbracket e_2 \rrbracket_{\mathcal{V}}(\zeta) \right) && \text{(by right-distributivity)} \\
&= \bigoplus_{w \in \text{pos}(\zeta)} \left(\llbracket g \rrbracket_{\mathcal{V} \cup \{x\}}(\zeta[x \mapsto w]) \otimes \llbracket e_2 \rrbracket_{\mathcal{V} \cup \{x\}}(\zeta[x \mapsto w]) \right) \\
&&& \text{(by Lemma 17.4.1; we note that } e_1 \times e_2 \text{ is variable separated)} \\
&= \bigoplus_{w \in \text{pos}(\zeta)} \left(\llbracket g \rrbracket_{\mathcal{V} \cup \{x\}} \otimes \llbracket e_2 \rrbracket_{\mathcal{V} \cup \{x\}} \right) (\zeta[x \mapsto w]) \\
&= \bigoplus_{w \in \text{pos}(\zeta)} \llbracket \text{hp}(g, e_2) \rrbracket_{\mathcal{V} \cup \{x\}}(\zeta[x \mapsto w]) && \text{(by I.H.)} \\
&= \llbracket \bigoplus_x \text{hp}(g, e_2) \rrbracket_{\mathcal{V}}(\zeta) && \text{(by definition of semantics)} \\
&= \llbracket \text{hp}(\bigoplus_x g, e_2) \rrbracket_{\mathcal{V}}(\zeta) . && \text{(by definition of hp)}
\end{aligned}$$

Let e_1 be as in Case (c). Then the corresponding equation for $\text{hp}(\bigoplus_X g, e_2)$ can be verified in a similar way as for $\text{hp}(\bigoplus_x g, e_2)$.

Let e_1 be as in Case (d). Then

$$\begin{aligned}
\llbracket (\varphi \triangleright g) \times e_2 \rrbracket_{\mathcal{V}}(\zeta) &= \llbracket \varphi \triangleright g \rrbracket_{\mathcal{V}}(\zeta) \otimes \llbracket e_2 \rrbracket_{\mathcal{V}}(\zeta) = \begin{cases} \llbracket g \rrbracket_{\mathcal{V}}(\zeta) \otimes \llbracket e_2 \rrbracket_{\mathcal{V}}(\zeta) & \text{if } \zeta \in L_{\mathcal{V}}(\varphi) \\ 0 & \text{otherwise} \end{cases} \\
&= \begin{cases} \llbracket \text{hp}(g, e_2) \rrbracket_{\mathcal{V}}(\zeta) & \text{if } \zeta \in L_{\mathcal{V}}(\varphi) \\ 0 & \text{otherwise} \end{cases} && \text{(by I.H.)} \\
&= \llbracket \varphi \triangleright \text{hp}(g, e_2) \rrbracket_{\mathcal{V}}(\zeta) = \llbracket \text{hp}(\varphi \triangleright g, e_2) \rrbracket_{\mathcal{V}}(\zeta) .
\end{aligned}$$

Let e_1 and e_2 be as in Case (e). Then our statement holds by left-distributivity.

Let e_1 and e_2 be as in Case (f). Then the proof is analogous to the proof of Case (b) except that we use left-distributivity instead of right-distributivity.

Let e_1 and e_2 be as in Case (g). Then the proof is analogous to the proof of Case (c) except that we use left-distributivity instead of right-distributivity.

Let e_1 and e_2 be as in Case (h). Then the proof is analogous to the proof of Case (d). \square

In Lemma 17.4.15, we assume that $e_1 \times e_2$ is variable separated. We have used this condition in the proof for the case that $e_1 = \bigoplus_x g$ (cf. Case (b) of the definition of $\text{hp}(e_1, e_2)$). More precisely, it is used in the justification of the equality:

$$\bigoplus_{w \in \text{pos}(\zeta)} \left(\llbracket g \rrbracket_{\mathcal{V} \cup \{x\}}(\zeta[x \mapsto w]) \otimes \llbracket e_2 \rrbracket_{\mathcal{V}}(\zeta) \right) = \bigoplus_{w \in \text{pos}(\zeta)} \left(\llbracket g \rrbracket_{\mathcal{V} \cup \{x\}}(\zeta[x \mapsto w]) \otimes \llbracket e_2 \rrbracket_{\mathcal{V} \cup \{x\}}(\zeta[x \mapsto w]) \right) \quad (17.35)$$

Here we show that, in general, Equation (17.35) is wrong if we drop the condition that $(\bigoplus_x g) \times e_2$ is variable separated. For this we let $\Sigma = \{\gamma^{(1)}, \alpha^{(0)}\}$, $\mathcal{V} = \{x\}$, $\xi = \gamma(\alpha)$, $\eta(x) = \varepsilon$, $\zeta = (\xi, \eta)$ in $\mathbf{T}_{\Sigma}^{\mathcal{V}}$ (i.e., $\zeta = (\gamma, \{x\})(\alpha, \emptyset)$), and

- $\kappa = (\kappa_k \mid k \in \mathbb{N})$ with $\kappa_1((\gamma, \{x\})) = \kappa_0((\alpha, \emptyset)) = \mathbb{1}$ and $\kappa_1((\gamma, \emptyset)) = \kappa_0((\alpha, \{x\})) = \mathbb{0}$ and
- $\nu = (\nu_k \mid k \in \mathbb{N})$ with $\nu_1((\gamma, \{x\})) = \nu_0((\alpha, \emptyset)) = \mathbb{0}$ and $\nu_1((\gamma, \emptyset)) = \nu_0((\alpha, \{x\})) = \mathbb{1}$.

We let $g = \mathbf{H}(\nu)$ and $e_2 = \mathbf{H}(\kappa)$. We note that $\text{Bound}(+_x g) \cap \text{Free}(e_2) = \{x\}$, hence $\text{Free}((+_x g) \times e_2) \cap \text{Bound}((+_x g) \times e_2) \neq \emptyset$. We can calculate the left-hand side of (17.35) as follows:

$$\begin{aligned}
& \bigoplus_{w \in \text{pos}(\zeta)} \left(\llbracket g \rrbracket_{\mathcal{V} \cup \{x\}}(\zeta[x \mapsto w]) \otimes \llbracket e_2 \rrbracket_{\mathcal{V}}(\zeta) \right) \\
&= \bigoplus_{w \in \{\varepsilon, 1\}} \left(\llbracket \mathbf{H}(\nu) \rrbracket_{\{x\}}(\zeta[x \mapsto w]) \otimes \llbracket \mathbf{H}(\kappa) \rrbracket_{\{x\}}(\zeta) \right) \\
&= \bigoplus_{w \in \{\varepsilon, 1\}} \left(\llbracket \mathbf{H}(\nu) \rrbracket_{\{x\}}(\zeta[x \mapsto w]) \otimes \mathbb{1} \right) \\
&= \llbracket \mathbf{H}(\nu) \rrbracket_{\{x\}}(\zeta[x \mapsto \varepsilon]) \oplus \llbracket \mathbf{H}(\nu) \rrbracket_{\{x\}}(\zeta[x \mapsto 1]) \\
&= \llbracket \mathbf{H}(\nu) \rrbracket_{\{x\}}((\gamma, \{x\})((\alpha, \emptyset))) \oplus \llbracket \mathbf{H}(\nu) \rrbracket_{\{x\}}((\gamma, \emptyset)((\alpha, \{x\}))) = \mathbb{0} \oplus \mathbb{1} = \mathbb{1} .
\end{aligned}$$

And we can calculate the right-hand side of (17.35) as follows:

$$\begin{aligned}
& \bigoplus_{w \in \text{pos}(\zeta)} \left(\llbracket g \rrbracket_{\mathcal{V} \cup \{x\}}(\zeta[x \mapsto w]) \otimes \llbracket \mathbf{H}(\kappa) \rrbracket_{\mathcal{V} \cup \{x\}}(\zeta[x \mapsto w]) \right) \\
&= \bigoplus_{w \in \{\varepsilon, 1\}} \left(\llbracket \mathbf{H}(\nu) \rrbracket_{\{x\}}(\zeta[x \mapsto w]) \otimes \llbracket \mathbf{H}(\kappa) \rrbracket_{\{x\}}(\zeta[x \mapsto w]) \right) \\
&= \left(\llbracket \mathbf{H}(\nu) \rrbracket_{\{x\}}((\gamma, \{x\})((\alpha, \emptyset))) \otimes \llbracket \mathbf{H}(\kappa) \rrbracket_{\{x\}}((\gamma, \{x\})((\alpha, \emptyset))) \right) \oplus \\
& \quad \left(\llbracket \mathbf{H}(\nu) \rrbracket_{\{x\}}((\gamma, \emptyset)((\alpha, \{x\}))) \otimes \llbracket \mathbf{H}(\kappa) \rrbracket_{\{x\}}((\gamma, \emptyset)((\alpha, \{x\}))) \right) \\
&= (\mathbb{0} \otimes \mathbb{1}) \oplus (\mathbb{1} \otimes \mathbb{0}) = \mathbb{0} .
\end{aligned}$$

Thus, without the mentioned property, Equation (17.35) does not hold in general.

In the next lemma we get rid of weighted conjunction in formulas which do not contain weighted first-order universal quantification. Here we will need commutativity and distributivity of \mathbf{B} . We repeatedly apply Lemma 17.4.15.

Lemma 17.4.16. Let \mathbf{B} be distributive, let $e \in \text{MSO}^{\text{cext}}(\Sigma, \mathbf{B})$, and let \mathcal{V} be a finite set of variables such that $\mathcal{V} \supseteq \text{Free}(e)$. If e does not contain a subformula of the form $\bigtimes_x e'$, then we can construct an $\text{MSO}(\Sigma, \mathbf{B})$ -formula f such that $\text{Free}(e) = \text{Free}(f)$ and $\llbracket e \rrbracket_{\mathcal{V}} = \llbracket f \rrbracket_{\mathcal{V}}$.

Proof. Intuitively, we will define a terminating reduction system on a subset of $\text{MSO}^{\text{cext}}(\Sigma, \mathbf{B})$ -formulas such that each reduction replaces a weighted conjunction $e_1 \times e_2$ by the formula which is denoted by $\text{hp}(e_1, e_2)$.

Formally, we define the set

$$\begin{aligned}
\text{resMSO}^{\text{cext}}(\Sigma, \mathbf{B}) = \{ e \in \text{MSO}^{\text{cext}}(\Sigma, \mathbf{B}) \mid & e \text{ is variable separated and} \\
& e \text{ does not contain a subformula of the form } \bigtimes_x e' \} .
\end{aligned}$$

We define the reduction system $(\text{resMSO}^{\text{cext}}(\Sigma, \mathbf{B}), \succ)$ where, for every $e, f \in \text{resMSO}^{\text{cext}}(\Sigma, \mathbf{B})$, we let

$$\begin{aligned}
e \succ f \text{ if } & e \text{ contains a subformula of the form } e_1 \times e_2 \text{ such that } e_1, e_2 \in \text{MSO}(\Sigma, \mathbf{B}) \text{ and} \\
& f \text{ is obtained from } e \text{ by replacing this subformula by the formula which is} \\
& \text{denoted by } \text{hp}(e_1, e_2) .
\end{aligned}$$

We note that, since $\text{Free}(e_1 \times e_2) = \text{Free}(\text{hp}(e_1, e_2))$ and $\text{Bound}(e_1 \times e_2) = \text{Bound}(\text{hp}(e_1, e_2))$, also the formula f is variable separated, and hence f is indeed an element of the set $\text{resMSO}^{\text{cext}}(\Sigma, \mathbf{B})$.

Next we prove the following statement.

$$\text{Let } e, f \in \text{resMSO}^{\text{cext}}(\Sigma, \mathbf{B}). \text{ If } e \succ f, \text{ then } \llbracket e \rrbracket_{\mathcal{V}} = \llbracket f \rrbracket_{\mathcal{V}} \text{ for each } \mathcal{V} \text{ which contains } \text{Free}(e). \quad (17.36)$$

Since $\text{Free}(e_1 \times e_2) = \text{Free}(\text{hp}(e_1, e_2))$, we have that $\text{Free}(e) = \text{Free}(f)$. Since e is variable separated, also $e_1 \times e_2$ is variable separated. Then, by Lemma 17.4.15, we have $\llbracket e_1 \times e_2 \rrbracket = \llbracket \text{hp}(e_1, e_2) \rrbracket$, and thus, by Observation 17.4.5, we have $\llbracket e \rrbracket_{\mathcal{V}} = \llbracket f \rrbracket_{\mathcal{V}}$ for each \mathcal{V} which contains $\text{Free}(e)$. This finishes the proof of (17.36).

For proving the fact that \succ is terminating, we define the mapping $\#_{\times} : \text{resMSO}^{\text{cext}}(\Sigma, \mathbf{B}) \rightarrow \mathbb{N}$ such that, for each $e \in \text{resMSO}^{\text{cext}}(\Sigma, \mathbf{B})$, we let $\#_{\times}(e)$ be the number of occurrences of \times . It is clear that, if $e \succ f$, then $\#_{\times}(e) = \#_{\times}(f) + 1$. Hence $\#_{\times}$ is a monotone embedding of $(\text{resMSO}^{\text{cext}}(\Sigma, \mathbf{B}), \succ)$ into the terminating reduction system $(\mathbb{N}, >)$. Thus, by Lemma 2.5.2, also $(\text{resMSO}^{\text{cext}}(\Sigma, \mathbf{B}), \succ)$ is terminating. Clearly,

$$\text{nf}_{\succ}(\text{resMSO}^{\text{cext}}(\Sigma, \mathbf{B})) \subseteq \text{MSO}(\Sigma, \mathbf{B}) . \quad (17.37)$$

Now we can prove the statement of the lemma. Let $e \in \text{MSO}^{\text{cext}}(\Sigma, \mathbf{B})$ and $\mathcal{V} \supseteq \text{Free}(e)$ be a finite set of variables. Moreover, e does not contain a subformula of the form $\times_x e'$. By Lemma 17.4.6, we can assume that e is variable separated, i.e., $e \in \text{resMSO}^{\text{cext}}(\Sigma, \mathbf{B})$. Now we compute an arbitrary element f in the set $\text{nf}_{\succ}(e)$. By (17.37), the formula f is an element of $\text{MSO}(\Sigma, \mathbf{B})$. And by (17.36), we obtain that $\llbracket e \rrbracket_{\mathcal{V}} = \llbracket f \rrbracket_{\mathcal{V}}$ for each \mathcal{V} which contains $\text{Free}(e)$. Moreover, we have that $\text{Free}(e) = \text{Free}(f)$. Thus, f is the required formula. \square

17.4.4 Weighted first-order universal quantification of recognizable step mappings

In Example 17.4.8 we gave an atomic formula such that its weighted first-order universal quantification is not recognizable. Here we show that, if the semantics of a weighted MSO^{ext} -formula is a recognizable step mapping, then its weighted first-order universal quantification is run recognizable.

Lemma 17.4.17. (cf. [DG05, Lm. 4.2], [DG07, Lm. 4.4], and [DV06, Lm. 5.5]) Let $e \in \text{MSO}^{\text{ext}}(\Sigma, \mathbf{B})$ and let \mathcal{U} abbreviate $\text{Free}(e)$. Moreover, let $n \in \mathbb{N}_+$, $b_1, \dots, b_n \in \mathbf{B}$, and $\Sigma_{\mathcal{U} \cup \{x\}}$ -fta A_1, \dots, A_n such that $\llbracket e \rrbracket_{\mathcal{U} \cup \{x\}} = \bigoplus_{j \in [n]} b_j \cdot \chi(L(A_j))$. Then we can construct a $(\Sigma_{\mathcal{V}}, \mathbf{B})$ -wta \mathcal{B} , where $\mathcal{V} = \text{Free}(\times_x e)$, such that $\llbracket \mathcal{B} \rrbracket^{\text{run}} = \llbracket \times_x e \rrbracket$.

Proof. Since $\mathcal{V} = \mathcal{U} \setminus \{x\}$, we have $\mathcal{V} \cup \{x\} = \mathcal{U} \cup \{x\}$. By Theorem 10.3.1(B) \Rightarrow (D) we can assume that $(L(A_j) \mid j \in [n])$ is a partitioning of $\text{T}_{\Sigma_{\mathcal{V} \cup \{x\}}}$.

First, for each $\xi \in \text{T}_{\Sigma_{\mathcal{V}}}$, we define the relation $\nu_{\xi} \subseteq \text{pos}(\xi) \times [n]$ by

$$\nu_{\xi} = \{(w, j) \in \text{pos}(\xi) \times [n] \mid \xi[x \mapsto w] \in L(A_j)\} .$$

Since $(L(A_j) \mid j \in [n])$ is a partitioning of $\text{T}_{\Sigma_{\mathcal{V} \cup \{x\}}}$, this relation is a mapping $\nu_{\xi} : \text{pos}(\xi) \rightarrow [n]$.

In order to understand the idea for the construction of \mathcal{B} , let us perform a few steps in the calculation of $\llbracket \times_x e \rrbracket(\xi)$ where $\xi \in \text{T}_{\Sigma_{\mathcal{V}}}$.

$$\llbracket \times_x e \rrbracket(\xi) = \bigotimes_{w \in \text{pos}(\xi)} \llbracket e \rrbracket_{\mathcal{V} \cup \{x\}}(\xi[x \mapsto w]) = \bigotimes_{w \in \text{pos}(\xi)} \left(\bigoplus_{j \in [n]} b_j \cdot \chi(L(A_j)) \right)(\xi[x \mapsto w]) = \bigotimes_{w \in \text{pos}(\xi)} b_{\nu_{\xi}(w)} .$$

Before constructing \mathcal{B} , we wish to construct a bu-deterministic wta \mathcal{C} which computes $\bigotimes_{w \in \text{pos}(\xi)} b_{\nu_{\xi}(w)}$; as input, \mathcal{C} receives the information ξ and ν_{ξ} . Since \mathcal{C} can only read trees (and not pairs of the form

(ξ, ν) , we encode each pair (ξ, ν) where $\xi \in \mathsf{T}_{\Sigma_{\mathcal{V}}}$ and $\nu : \text{pos}(\xi) \rightarrow [n]$ into one tree. For this purpose, we introduce the new ranked alphabet $n\Sigma_{\mathcal{V}}$ by letting

$$(n\Sigma_{\mathcal{V}})^{(k)} = \Sigma_{\mathcal{V}}^{(k)} \times [n] \text{ for each } k \in \mathbb{N} .$$

Instead of $(n\Sigma_{\mathcal{V}})^{(k)}$ we write $n\Sigma_{\mathcal{V}}^{(k)}$. Moreover, for $((\sigma, U), j) \in n\Sigma_{\mathcal{V}}$ we also write (σ, U, j) .

Now it is clear that the two sets $\mathsf{T}_{n\Sigma_{\mathcal{V}}}$ and $\mathsf{T}_{\Sigma_{\mathcal{V}}}^{+\text{steps}}$, where $\mathsf{T}_{\Sigma_{\mathcal{V}}}^{+\text{steps}} = \{(\xi, \nu) \mid \xi \in \mathsf{T}_{\Sigma_{\mathcal{V}}}, \nu : \text{pos}(\xi) \rightarrow [n]\}$, are in a one-to-one correspondence. Indeed,

- each tree $\zeta \in \mathsf{T}_{n\Sigma_{\mathcal{V}}}$ corresponds to the pair (ξ, ν) , where $\text{pos}(\xi) = \text{pos}(\zeta)$ and, for each $w \in \text{pos}(\xi)$, if $\zeta(w) = (\sigma, U, j)$, then $\xi(w) = (\sigma, U)$ and $\nu(w) = j$ and
- each pair $(\xi, \nu) \in \mathsf{T}_{\Sigma_{\mathcal{V}}}^{+\text{steps}}$ corresponds to the tree $\zeta \in \mathsf{T}_{n\Sigma_{\mathcal{V}}}$ where $\text{pos}(\zeta) = \text{pos}(\xi)$ and, for each $w \in \text{pos}(\zeta)$, we let $\zeta(w) = (\xi(w), \nu(w))$.

Due to this one-to-one correspondence, we can assume that elements of $\mathsf{T}_{n\Sigma_{\mathcal{V}}}$ have the form (ξ, ν) and, vice versa, that each pair (ξ, ν) with $\xi \in \mathsf{T}_{\Sigma_{\mathcal{V}}}$ and $\nu : \text{pos}(\xi) \rightarrow [n]$ is an element of $\mathsf{T}_{n\Sigma_{\mathcal{V}}}$.

Now we can turn back to the expression $\bigotimes_{w \in \text{pos}(\xi)} b_{\nu_{\xi}(w)}$ above and can be more precise with respect to the type and the semantics of \mathcal{C} . We will construct a bu-deterministic $(n\Sigma_{\mathcal{V}}, \mathsf{B})$ -wta \mathcal{C} such that, for each $(\xi, \nu) \in \mathsf{T}_{n\Sigma_{\mathcal{V}}}$, we have

$$\llbracket \mathcal{C} \rrbracket((\xi, \nu)) = \begin{cases} \bigotimes_{w \in \text{pos}(\xi)} b_{\nu_{\xi}(w)} & \text{if } \nu = \nu_{\xi} \\ \mathbb{0} & \text{otherwise} . \end{cases} \quad (17.38)$$

For the time being, let us assume that we have constructed such a \mathcal{C} already. Then, by using the deterministic tree relabeling $\tau : n\Sigma_{\mathcal{V}} \rightarrow \Sigma_{\mathcal{V}}$ defined, for each (σ, U, j) by $\tau((\sigma, U, j)) = (\sigma, U)$, we can continue the calculation as follows: for each $\xi \in \mathsf{T}_{\Sigma_{\mathcal{V}}}$, we have

$$\bigotimes_{w \in \text{pos}(\xi)} b_{\nu_{\xi}(w)} = \llbracket \mathcal{C} \rrbracket((\xi, \nu_{\xi})) = \bigoplus_{(\xi, \nu) \in \tau^{-1}(\xi)} \llbracket \mathcal{C} \rrbracket((\xi, \nu)) = \chi(\tau)(\llbracket \mathcal{C} \rrbracket)(\xi)$$

where the first and the second equality hold due to (17.38).

Lastly, by Theorem 10.10.1 (closure of $\text{Rec}^{\text{run}}(_, \mathsf{B})$ under tree relabelings), we can construct the desired $(\Sigma_{\mathcal{V}}, \mathsf{B})$ -wta \mathcal{B} such that $\llbracket \mathcal{B} \rrbracket^{\text{run}} = \chi(\tau)(\llbracket \mathcal{C} \rrbracket)$ and we have proved the lemma. (We note that, since τ is overlapping, in general \mathcal{B} is not bu-deterministic.)

Thus it remains to construct the bu-deterministic $(n\Sigma_{\mathcal{V}}, \mathsf{B})$ -wta \mathcal{C} such that (17.38) holds. For this purpose we first construct an (unweighted) total and bu-deterministic $n\Sigma_{\mathcal{V}}$ -fta C such that $L(C) = L$ where

$$L = \{(\xi, \nu_{\xi}) \mid \xi \in \mathsf{T}_{\Sigma_{\mathcal{V}}}\} .$$

Assume that $C = (\tilde{Q}, \tilde{\delta}, \tilde{F})$ is such an $n\Sigma_{\mathcal{V}}$ -fta. Then we construct the bu-deterministic $(n\Sigma_{\mathcal{V}}, \mathsf{B})$ -wta $\mathcal{C} = (\tilde{Q}, \delta, F)$ such that, for every $k \in \mathbb{N}$, $(\sigma, U, j) \in n\Sigma_{\mathcal{V}}^{(k)}$, and $q_1, \dots, q_k, q \in \tilde{Q}$, we let

$$\delta_k(q_1 \cdots q_k, (\sigma, U, j), q) = \begin{cases} b_j & \text{if } \tilde{\delta}_k(q_1 \cdots q_k, (\sigma, U, j)) = q \\ \mathbb{0} & \text{otherwise} \end{cases}$$

and $F_q = \mathbb{1}$ if $q \in \tilde{F}$ and $\mathbb{0}$ otherwise. It is obvious that (17.38) holds.

Thus it remains to construct a total and bu-deterministic $n\Sigma_{\mathcal{V}}$ -fta C such that $L(C) = L$.

We observe the following:

$$\begin{aligned} L &= \{(\xi, \nu_{\xi}) \mid \xi \in \mathsf{T}_{\Sigma_{\mathcal{V}}}\} \\ &= \{(\xi, \nu) \in \mathsf{T}_{n\Sigma_{\mathcal{V}}} \mid (\forall j \in [n], w \in \text{pos}(\xi)) : \text{if } \nu(w) = j, \text{ then } \xi[x \rightarrow w] \in L(A_j)\} \\ &= \bigcap_{j \in [n]} \{(\xi, \nu) \in \mathsf{T}_{n\Sigma_{\mathcal{V}}} \mid (\forall w \in \text{pos}(\xi)) : \text{if } \nu(w) = j, \text{ then } \xi[x \rightarrow w] \in L(A_j)\} . \end{aligned}$$

Thus, due to Theorems 2.16.3(2) and 2.16.2, it suffices to construct, for each $j \in [n]$, a total and bu-deterministic $n\Sigma_{\mathcal{V}}$ -fta C_j such that $L(C_j) = L_j$ where

$$L_j = \{(\xi, \nu) \in T_{n\Sigma_{\mathcal{V}}} \mid (\forall w \in \text{pos}(\xi)) : \text{if } \nu(w) = j, \text{ then } \xi[x \rightarrow w] \in L(A_j)\} .$$

Let $j \in [n]$. The idea behind the construction of C_j follows the one in the proof of [DG07, Lm. 4.4] and it is roughly described as follows. On an input tree $\zeta = (\xi, \nu)$, the $n\Sigma_{\mathcal{V}}$ -fta C_j simulates the work of A_j on ξ and, whenever a position w of ζ is encountered for which $\nu(w) = j$ holds, then, additionally, C_j splits off a copy of A_j ; this copy behaves as if at w the x would occur (or, in other words: as if A_j would have $\xi[x \mapsto w]$ as input tree). Moreover, since we have to guarantee that the placement of x is done at most once in ξ , we maintain a bit d in every state of C_j which indicates whether the x was placed ($d = 1$) or not ($d = 0$).

In the sequel, we will reuse the standard notations δ , F , \tilde{Q} , $\tilde{\delta}$, and \tilde{F} , which occurred already in the specification of C and \mathcal{C} , for other purposes. This will be harmless because below we will not deal with C and \mathcal{C} anymore.

Formally, let $A_j = (Q, \delta, F)$ be the $\Sigma_{\mathcal{V} \cup \{x\}}$ -fta given in the statement of the lemma. By Theorem 2.16.2, we may assume that A_j is total and bu-deterministic. We construct the total and bu-deterministic $n\Sigma_{\mathcal{V}}$ -fta $C_j = (\tilde{Q}, \tilde{\delta}, \tilde{F})$, where

- $\tilde{Q} = \mathcal{P}(Q \times \{0, 1\})$,
- $\tilde{F} = \{P \subseteq Q \times \{0, 1\} \mid P \cap (Q \times \{1\}) \subseteq F \times \{1\}\}$, and
- $\tilde{\delta}$ is defined such that, for every $k \in \mathbb{N}$, $(\sigma, U, l) \in n\Sigma_{\mathcal{V}}^{(k)}$, and $P_1, \dots, P_k \in \tilde{Q}$, we let

$$\tilde{\delta}_k(P_1 \cdots P_k, (\sigma, U, l)) = P \quad \text{where } P = \begin{cases} P' & \text{if } l \neq j \\ P' \cup P'' & \text{otherwise} \end{cases}$$

and

$$P' = \left\{ \left(\delta_k(p_1 \cdots p_k, (\sigma, U)), \bigoplus_{i \in [k]} d_i \right) \mid (\forall i \in [k]) : (p_i, d_i) \in P_i \text{ and } \bigoplus_{i \in [k]} d_i \leq 1 \right\}$$

and

$$P'' = \left\{ \left(\delta_k(p_1 \cdots p_k, (\sigma, U \cup \{x\})), 1 \right) \mid (\forall i \in [k]) : (p_i, 0) \in P_i \right\} .$$

Since A_j is total and bu-deterministic, the states $\delta_k(p_1 \cdots p_k, (\sigma, U))$ and $\delta_k(p_1 \cdots p_k, (\sigma, U \cup \{x\}))$ are defined. Obviously, P' formalizes the propagation of the bit value 0 if $\bigoplus_{i \in [k]} d_i = 0$, and the propagation of the bit value 1 if $\bigoplus_{i \in [k]} d_i = 1$. If $l = j$, then additionally to this propagation, C_j can change from the bit vector $(0, \dots, 0)$ to the bit value 1, thereby placing the x to this position; the union with P'' can be described as “splitting off a new copy of A_j ”. Also it is clear that C_j is total and bu-deterministic. Now we will show that C_j recognizes L_j .

Since A_j and C_j are total and bu-deterministic, for each $(\xi, \nu) \in T_{n\Sigma_{\mathcal{V}}}$ and $w \in \text{pos}(\xi)$, the sets of valid runs $R_{A_j}^{\vee}(\xi)$, $R_{A_j}^{\vee}(\xi[x \rightarrow w])$, and $R_{C_j}^{\vee}((\xi, \nu))$ are singletons. We denote these runs by letting

$$R_{A_j}^{\vee}(\xi) = \{\rho_{\xi}\}, \quad R_{A_j}^{\vee}(\xi[x \rightarrow w]) = \{\rho_{\xi[x \rightarrow w]}\}, \quad \text{and} \quad R_{C_j}^{\vee}((\xi, \nu)) = \{\rho_{(\xi, \nu)}\} .$$

By induction on $T_{n\Sigma_{\mathcal{V}}}$, we prove the following statement.

$$\text{For each } (\xi, \nu) \in T_{n\Sigma_{\mathcal{V}}}, \text{ we have } \rho_{(\xi, \nu)}(\varepsilon) = \{(\rho_{\xi}(\varepsilon), 0)\} \cup \{(\rho_{\xi[x \rightarrow w]}(\varepsilon), 1) \mid w \in \text{pos}(\xi), \nu(w) = j\} . \quad (17.39)$$

$$\begin{aligned} & \text{iff } \rho_{(\xi, \nu)}(\varepsilon) \in \tilde{F} && \text{(by (17.39))} \\ & \text{iff } (\xi, \nu) \in L(C_j) . \end{aligned}$$

Hence $L(C_j) = L_j$, and this finishes the proof of the lemma. \square

Finally, we point out the close relationship between Lemma 17.4.17 and Lemma 17.4.12: both show how to eliminate weighted first-order universal quantification. The difference is that in Lemma 17.4.17 we end up in a wta, whereas in Lemma 17.4.12 we end up in an $\text{MSO}(\Sigma, \mathbf{B})$ -formula.

17.4.5 The main result for $\text{MSO}^{\text{ext}}(\Sigma, \mathbf{B})$ over commutative and bi-locally finite strong bimonoids

In this subsection we prove the B-E-T-theorem for commutative and bi-locally finite strong bimonoids (cf. Theorem 17.4.21) where the involved weighted MSO-logic is $\text{MSO}^{\text{ext}}(\Sigma, \mathbf{B})$ (i.e., the fully extended $\text{MSO}(\Sigma, \mathbf{B})$ without any restrictions). This theorem can be compared to [DV12, Thm. 5.3] if one drops negation from the latter. We note that we use commutativity in order to handle weighted second-order universal quantification (cf. Lemma 17.4.20); on the contrary, for Médvédjév's theorem for wta over bi-locally finite strong bimonoids (cf. Theorem 16.3.1) commutativity is not necessary.

In this subsection, let \mathbf{B} denote an arbitrary commutative and bi-locally finite strong bimonoid $(B, \oplus, \otimes, 0, \mathbb{1})$.

For the proof of the B-E-T-theorem, in particular, we have to prove that weighted first-order universal quantification and weighted second-order universal quantification preserve run recognizability. However, let us start with a consistency lemma (cf. Lemma 17.3.4).

Lemma 17.4.18. Let $e \in \text{MSO}^{\text{ext}}(\Sigma, \mathbf{B})$, let \mathcal{U} abbreviate $\text{Free}(e)$, and let \mathcal{A} be a $(\Sigma_{\mathcal{U}}, \mathbf{B})$ -wta such that $\llbracket \mathcal{A} \rrbracket^{\text{run}} = \llbracket e \rrbracket$. Moreover, let V be a finite set of variables. Then we can construct a $(\Sigma_{\mathcal{U} \cup V}, \mathbf{B})$ -wta \mathcal{A}' such that $\llbracket \mathcal{A}' \rrbracket^{\text{run}} = \llbracket e \rrbracket_{\mathcal{U} \cup V}$.

Proof. The proof is the same as the one for Lemma 17.3.4 except that in Case (b)(ii) we have to use the consistency lemma for $\text{MSO}^{\text{ext}}(\Sigma, \mathbf{B})$ (i.e., Lemma 17.4.1) instead of Lemma 17.2.1. \square

Next we prove that weighted first-order universal quantification preserves run recognizability.

Lemma 17.4.19. Let $e \in \text{MSO}^{\text{ext}}(\Sigma, \mathbf{B})$ and x any first-order variable. Moreover, let \mathcal{U} and \mathcal{V} abbreviate $\text{Free}(e)$ and $\text{Free}(\times_x e)$, respectively. If there exists a $(\Sigma_{\mathcal{U}}, \mathbf{B})$ -wta \mathcal{A} with $\llbracket \mathcal{A} \rrbracket^{\text{run}} = \llbracket e \rrbracket$, then we can construct a $(\Sigma_{\mathcal{V}}, \mathbf{B})$ -wta \mathcal{B} such that $\llbracket \mathcal{B} \rrbracket^{\text{run}} = \llbracket \times_x e \rrbracket$.

Proof. Let \mathcal{A} be a $(\Sigma_{\mathcal{U}}, \mathbf{B})$ -wta such that $\llbracket \mathcal{A} \rrbracket^{\text{run}} = \llbracket e \rrbracket$. Since $\mathcal{U} \subseteq \mathcal{V} \cup \{x\}$, by Lemma 17.4.18, we can construct a $(\Sigma_{\mathcal{V} \cup \{x\}}, \mathbf{B})$ -wta \mathcal{A}' such that $\llbracket \mathcal{A}' \rrbracket^{\text{run}} = \llbracket e \rrbracket_{\mathcal{V} \cup \{x\}}$.

Since \mathbf{B} is bi-locally finite, by Theorem 12.2.9(A) \Rightarrow (B) and Theorem 10.3.1 $\llbracket \mathcal{A}' \rrbracket^{\text{run}}$ is a recognizable step mapping and we can construct $n \in \mathbb{N}$, $b_1, \dots, b_n \in L$, and $\Sigma_{\mathcal{V} \cup \{x\}}$ -fta A_1, \dots, A_n such that

$$\llbracket \mathcal{A}' \rrbracket^{\text{run}} = \bigoplus_{j \in [n]} b_j \cdot \chi(L(A_j)) .$$

Then by Lemma 17.4.17 we can construct a $(\Sigma_{\mathcal{V}}, \mathbf{B})$ -wta \mathcal{B} such that $\llbracket \mathcal{B} \rrbracket^{\text{run}} = \llbracket \times_x e \rrbracket$. \square

Next we prove that weighted second-order universal quantification preserves run recognizability.

Lemma 17.4.20. (cf. [DV12, Lm. 5.14], [DV06, Prop. 6.4]) Let $e \in \text{MSO}^{\text{ext}}(\Sigma, \mathbf{B})$ and X any second-order variable. Moreover, let $\mathcal{U} = \text{Free}(e)$ and $\mathcal{V} = \text{Free}(\times_X e)$. If there exists a $(\Sigma_{\mathcal{U}}, \mathbf{B})$ -wta \mathcal{A} with $\llbracket \mathcal{A} \rrbracket^{\text{run}} = \llbracket e \rrbracket$, then we can construct a $(\Sigma_{\mathcal{V}}, \mathbf{B})$ -wta \mathcal{B} such that $\llbracket \mathcal{B} \rrbracket^{\text{run}} = \llbracket \times_X e \rrbracket$.

Proof. Let $\zeta \in \mathsf{T}_{\Sigma_{\mathcal{V}}}$. By definition, we have that

$$\llbracket \times_X e \rrbracket(\zeta) = \begin{cases} \bigotimes_{W \subseteq \text{pos}(\zeta)} \llbracket e \rrbracket_{\mathcal{V} \cup \{X\}}(\zeta[X \mapsto W]) & \text{if } \zeta \in \mathsf{T}_{\Sigma_{\mathcal{V}}}^{\mathcal{V}} \\ 0 & \text{otherwise} . \end{cases}$$

which is equivalent to

$$\llbracket \times_X e \rrbracket(\zeta) = \left(\bigotimes_{W \subseteq \text{pos}(\zeta)} \llbracket e \rrbracket_{\mathcal{V} \cup \{X\}}(\zeta[X \mapsto W]) \right) \otimes \chi(\mathsf{T}_{\Sigma_{\mathcal{V}}}^{\mathcal{V}})(\zeta) .$$

As auxiliary tool, we define the deterministic $(\Sigma_{\mathcal{V} \cup \{X\}}, \Sigma_{\mathcal{V}})$ -tree relabeling $\tau = (\tau_k \mid k \in \mathbb{N})$ with $\tau_k((\sigma, \mathcal{W})) = (\sigma, \mathcal{W} \setminus \{X\})$ for each $(\sigma, \mathcal{W}) \in \Sigma_{\mathcal{V} \cup \{X\}}$. Then we have

$$\llbracket \times_X e \rrbracket(\zeta) = \left(\bigotimes_{\xi \in \tau^{-1}(\zeta)} \llbracket e \rrbracket_{\mathcal{V} \cup \{X\}}(\xi) \right) \otimes \chi(\mathsf{T}_{\Sigma_{\mathcal{V}}}^{\mathcal{V}})(\zeta) .$$

Let \mathcal{A} be a $(\Sigma_{\mathcal{U}}, \mathsf{B})$ -wta with $\llbracket \mathcal{A} \rrbracket^{\text{run}} = \llbracket e \rrbracket$. By Lemma 17.4.18, we can construct a $(\Sigma_{\mathcal{U} \cup \{X\}}, \mathsf{B})$ -wta \mathcal{A}' such that $\llbracket \mathcal{A}' \rrbracket^{\text{run}} = \llbracket e \rrbracket_{\mathcal{U} \cup \{X\}}$. Since $\mathcal{U} \cup \{X\} = \mathcal{V} \cup \{X\}$, we have

$$\llbracket \times_X e \rrbracket(\zeta) = \left(\bigotimes_{\xi \in \tau^{-1}(\zeta)} \llbracket \mathcal{A}' \rrbracket^{\text{run}}(\xi) \right) \otimes \chi(\mathsf{T}_{\Sigma_{\mathcal{V}}}^{\mathcal{V}})(\zeta) .$$

Since B is bi-locally finite, $\llbracket \mathcal{A}' \rrbracket^{\text{run}}$ is a recognizable step mapping. More precisely, by Theorem 12.2.9 (A) \Rightarrow (B) and Theorem 10.3.1 (A) \Rightarrow (B), we can construct $n \in \mathbb{N}_+$, $b_1, \dots, b_n \in \mathsf{B}$, and $\Sigma_{\mathcal{V} \cup \{X\}}$ -fta A_1, \dots, A_n such that

$$\llbracket \mathcal{A}' \rrbracket^{\text{run}} = \bigoplus_{j \in [n]} b_j \cdot \chi(\mathsf{L}(A_j)) .$$

Moreover, by Observation 2.17.1, we can assume that the family $(\mathsf{L}(A_j) \mid j \in [n])$ is a partitioning of $\mathsf{T}_{\Sigma_{\mathcal{V} \cup \{X\}}}$. Thus

$$\llbracket \times_X e \rrbracket(\zeta) = \left(\bigotimes_{\xi \in \tau^{-1}(\zeta)} \left(\bigoplus_{j \in [n]} b_j \otimes \chi(\mathsf{L}(A_j))(\xi) \right) \right) \otimes \chi(\mathsf{T}_{\Sigma_{\mathcal{V}}}^{\mathcal{V}})(\zeta) .$$

Since the tree languages $\mathsf{L}(A_1), \dots, \mathsf{L}(A_n)$ are pairwise disjoint and B is commutative, we obtain

$$\llbracket \times_X e \rrbracket(\zeta) = \left(\bigotimes_{j \in [n]} b_j^{m_j(\zeta)} \right) \otimes \chi(\mathsf{T}_{\Sigma_{\mathcal{V}}}^{\mathcal{V}})(\zeta) \tag{17.41}$$

where, for each $j \in [n]$, the weighted tree language $m_j : \mathsf{T}_{\Sigma_{\mathcal{V}}} \rightarrow \mathbb{N}$ is defined, for each $\theta \in \mathsf{T}_{\Sigma_{\mathcal{V}}}$, by $m_j(\theta) = |\tau^{-1}(\theta) \cap \mathsf{L}(A_j)|$.

We show that m_j is $(\Sigma_{\mathcal{V}}, \mathsf{Nat})$ -recognizable as follows. Since $\mathsf{L}(A_j)$ is a recognizable $\Sigma_{\mathcal{V} \cup \{X\}}$ -tree language, by Theorem 4.1.10(B) \Rightarrow (C), the weighted tree language $\chi_{\mathsf{Nat}}(\mathsf{L}(A_j))$ is $(\Sigma_{\mathcal{V} \cup \{X\}}, \mathsf{Nat})$ -recognizable. Thus, by Theorem 10.10.1, the weighted tree language $\tau(\chi_{\mathsf{Nat}}(\mathsf{L}(A_j)))$ is $(\Sigma_{\mathcal{V}}, \mathsf{Nat})$ -recognizable. Moreover, for each $\theta \in \mathsf{T}_{\Sigma_{\mathcal{V}}}$, we have

$$\tau(\chi_{\mathsf{Nat}}(\mathsf{L}(A_j)))(\theta) = \bigoplus_{\xi \in \tau^{-1}(\theta)} \chi_{\mathsf{Nat}}(\mathsf{L}(A_j))(\xi) = |\tau^{-1}(\theta) \cap \mathsf{L}(A_j)| = m_j(\theta) .$$

Next we analyse the product $\bigotimes_{j \in [n]} b_j^{m_j(\zeta)}$. Since B is, in particular, multiplicatively locally finite, each element of B has finite multiplicative order. Thus, for each element there exists an index and a period (cf. Section 2.7.5).

We recall that, for each $j \in [n]$, the index of b_j and the period of b_j are denoted by $i(b_j)$ and $p(b_j)$, respectively. Then, for each $j \in [n]$, there exists a uniquely determined $d_j(\zeta) \in [0, i(b_j) + p(b_j) - 1]$ such that $b_j^{m_j(\zeta)} = b_j^{d_j(\zeta)}$ and $m_j(\zeta) \in d_j(\zeta) + p(j)\mathbb{N}$. Moreover, for every $d \in [0, i(b_j)]$, we have $b_j^{m_j(\zeta)} = b_j^d$ if and only if $m_j(\zeta) = d$, and for every $d \in [i(b_j), i(b_j) + p(b_j) - 1]$, we have $b_j^{m_j(\zeta)} = b_j^d$ if and only if $m_j(\zeta) \in d + p(b_j)\mathbb{N}$. Then

$$\bigotimes_{j \in [n]} b_j^{m_j(\zeta)} = \bigoplus_{\substack{d_1, \dots, d_n: \\ (\forall j \in [n]): 0 \leq d_j < i(j) + p(j)}} b_1^{d_1} \otimes \dots \otimes b_n^{d_n} \otimes \chi(L_{d_1}^1 \cap \dots \cap L_{d_n}^n)(\zeta), \quad (17.42)$$

where, for every $d \in [0, i(b_j) + p(b_j)]$ and $j \in [n]$, we have $L_d^j = \{\theta \in \mathbb{T}_{\Sigma_{\mathcal{V}}} \mid b_j^{m_j(\zeta)} = b_j^d\}$.

Hence

$$\begin{aligned} L_d^j &= \{\theta \in \mathbb{T}_{\Sigma_{\mathcal{V}}} \mid m_j(\zeta) = d\} = m_j^{-1}(d), \text{ if } 0 \leq d < i(b_j), \text{ and} \\ L_d^j &= \{\theta \in \mathbb{T}_{\Sigma_{\mathcal{V}}} \mid m_j(\zeta) \in d + p(b_j)\mathbb{N}\} = m_j^{-1}(d + p(b_j)\mathbb{N}), \text{ if } i(b_j) \leq d < i(b_j) + p(b_j). \end{aligned}$$

Since m_j is $(\Sigma_{\mathcal{V}}, \mathbf{Nat})$ -recognizable, by Lemmas 12.2.3 and 12.2.4, in both cases L_d^j is a recognizable $\Sigma_{\mathcal{V}}$ -language. Hence, the weighted tree language on the right hand side of (17.42) is a recognizable step mapping (because the set $\text{Rec}(\Sigma_{\mathcal{V}})$ is closed under intersection, cf. Theorem 2.16.3(2)). Thus, by Theorem 10.3.1 (B) \Rightarrow (A), we can construct a crisp-deterministic $(\Sigma_{\mathcal{V}}, \mathbf{B})$ -wta \mathcal{A}'' such that $\bigotimes_{j \in [n]} b_j^{m_j(\zeta)} = \llbracket \mathcal{A}'' \rrbracket(\zeta)$. Then, by (17.41), we obtain

$$\llbracket \bigotimes_X e \rrbracket(\zeta) = \llbracket \mathcal{A}'' \rrbracket(\zeta) \otimes \chi(\mathbb{T}_{\Sigma_{\mathcal{V}}}^{\vee})(\zeta)$$

Lastly, by Lemma 17.1.6 and Theorem 10.4.2(2), we can construct a $(\Sigma_{\mathcal{V}}, \mathbf{B})$ -wta \mathcal{B} such that $\llbracket \mathcal{B} \rrbracket^{\text{run}} = \llbracket \bigotimes_X e \rrbracket$. (We note that \mathcal{B} is even crisp-deterministic.) \square

Now we can prove the B-E-T-theorem for wta over commutative and bi-locally finite strong bimonoids. It can be compared to [DGMM11, Cor. 6.5].

Theorem 17.4.21. (cf. [DV12, Thm. 5.3]) *Let Σ be a ranked alphabet. Moreover, let $\mathbf{B} = (B, \oplus, \otimes, 0, \mathbb{1})$ be a commutative and bi-locally finite strong bimonoid and let $r : \mathbb{T}_{\Sigma} \rightarrow B$. Then the following four statements are equivalent.*

- (A) *We can construct a (Σ, \mathbf{B}) -wta \mathcal{B} such that $r = \llbracket \mathcal{B} \rrbracket^{\text{run}}$.*
- (B) *We can construct a (Σ, \mathbf{B}) -recognizable step formula e such that $\text{Free}(e) = \emptyset$ and $r = \llbracket e \rrbracket$.*
- (C) *We can construct a sentence $e \in \text{MSO}(\Sigma, \mathbf{B})$ such that $r = \llbracket e \rrbracket$.*
- (D) *We can construct a sentence $e \in \text{MSO}^{\text{ext}}(\Sigma, \mathbf{B})$ such that $r = \llbracket e \rrbracket$.*

Proof. Proof of (A) \Rightarrow (B): Let \mathcal{B} be a (Σ, \mathbf{B}) -wta such that $r = \llbracket \mathcal{B} \rrbracket^{\text{run}}$. By Theorem 12.2.9(A) \Rightarrow (B), and Theorem 10.3.1, r is a recognizable step mapping and we can construct $n \in \mathbb{N}_+$, $b_1, \dots, b_n \in L$, and Σ -fta A_1, \dots, A_n such that $r = \bigoplus_{i \in [n]} b_i \cdot \chi(L(A_i))$. By Lemma 17.2.3, we can construct sentences $\varphi_1, \dots, \varphi_n$ in $\text{MSO}(\Sigma)$ such that $r = \llbracket (\varphi_1 \triangleright \langle b_1 \rangle) + \dots + (\varphi_n \triangleright \langle b_n \rangle) \rrbracket$. Then we let $e = (\varphi_1 \triangleright \langle b_1 \rangle) + \dots + (\varphi_n \triangleright \langle b_n \rangle)$.

Proof of (B) \Rightarrow (C): Since each (Σ, \mathbf{B}) -recognizable step formula is in $\text{MSO}(\Sigma, \mathbf{B})$, this is trivial.

Proof of (C) \Rightarrow (D): Since $\text{MSO}(\Sigma, \mathbf{B}) \subset \text{MSO}^{\text{ext}}(\Sigma, \mathbf{B})$, this is trivial.

Proof of (D) \Rightarrow (A): We follow the proof of Theorem 17.3.8 and extend it appropriately. Formally, by induction on $(\text{MSO}^{\text{ext}}(\Sigma, \mathbf{B}), \succ_{\text{MSO}^{\text{ext}}(\Sigma, \mathbf{B})})$, we prove the following statement.

$$\begin{aligned} &\text{For every } e \in \text{MSO}^{\text{ext}}(\Sigma, \mathbf{B}) \text{ and } \mathcal{V} = \text{Free}(e), \\ &\text{we can construct a } (\Sigma_{\mathcal{V}}, \mathbf{B})\text{-wta } \mathcal{B} \text{ such that } \llbracket \mathcal{B} \rrbracket^{\text{run}} = \llbracket e \rrbracket. \end{aligned} \quad (17.43)$$

I.B.: The proof for the case that $e = \text{H}(\kappa)$ is the same as in the proof of Theorem 17.3.8.

I.S.: The proofs for the cases that $e = (\varphi \triangleright e')$, $e = e_1 + e_2$, $e = \bigoplus_x e'$, or $e = \bigoplus_X e'$ are the same as in the proof of Theorem 17.3.8 (except that for $e_1 + e_2$ we use Lemma 17.4.18 instead of Lemma 17.3.4).

Let $e = e_1 \times e_2$. Let $\mathcal{V}_1 = \text{Free}(e_1)$ and $\mathcal{V}_2 = \text{Free}(e_2)$. By I.H. we can construct a $(\Sigma_{\mathcal{V}_1}, \mathbf{B})$ -wta \mathcal{A}_1 such that $\llbracket \mathcal{A}_1 \rrbracket^{\text{run}} = \llbracket e_1 \rrbracket$. By Lemma 17.4.18, we can construct a $(\Sigma_{\mathcal{V}}, \mathbf{B})$ -wta \mathcal{A}'_1 such that $\llbracket \mathcal{A}'_1 \rrbracket^{\text{run}} = \llbracket e_1 \rrbracket_{\mathcal{V}}$. By Theorem 12.2.9(A) \Rightarrow (B), we can construct a crisp-deterministic $(\Sigma_{\mathcal{V}}, \mathbf{B})$ -wta \mathcal{A}''_1 such that $\llbracket \mathcal{A}''_1 \rrbracket = \llbracket e_1 \rrbracket_{\mathcal{V}}$. In the same way we can construct a crisp-deterministic $(\Sigma_{\mathcal{V}}, \mathbf{B})$ -wta \mathcal{A}''_2 such that $\llbracket \mathcal{A}''_2 \rrbracket = \llbracket e_2 \rrbracket_{\mathcal{V}}$. By Theorem 10.4.1(3), we can construct a crisp-deterministic $(\Sigma_{\mathcal{V}}, \mathbf{B})$ -wta \mathcal{B} such that $\llbracket \mathcal{B} \rrbracket = \llbracket \mathcal{A}''_1 \rrbracket \otimes \llbracket \mathcal{A}''_2 \rrbracket$. Thus $\llbracket \mathcal{B} \rrbracket = \llbracket e_1 \times e_2 \rrbracket$.

Let $e = \bigtimes_x e'$. By I.H. and Lemma 17.4.19, we can construct a $(\Sigma_{\mathcal{V}}, \mathbf{B})$ -wta \mathcal{B} such that $\llbracket \mathcal{B} \rrbracket^{\text{run}} = \llbracket e \rrbracket$.

Let $e = \bigtimes_X e'$. By I.H. and Lemma 17.4.20, we can construct a $(\Sigma_{\mathcal{V}}, \mathbf{B})$ -wta \mathcal{B} such that $\llbracket \mathcal{B} \rrbracket^{\text{run}} = \llbracket e \rrbracket$. \square

17.5 Relationship between a decomposition theorem of wta and B-E-T's theorem

In this final section we want to show a strong relationship between the following two results which we have proved already:

- (1) the decomposition of a (Σ, \mathbf{B}) -wta \mathcal{A} (cf. Theorem 11.3.1(A) \Rightarrow (B), roughly): we can construct τ , (G, H) , Θ , and κ such that, for each $\xi \in \mathsf{T}_{\Sigma}$: $\llbracket \mathcal{A} \rrbracket^{\text{run}}(\xi) = \text{h}_{\mathbf{M}(\Theta, \kappa)}(\tau^{-1}(\xi) \cap \mathsf{L}(G, H))$,
- (2) the definability of $\llbracket \mathcal{A} \rrbracket^{\text{run}}$ for each (Σ, \mathbf{B}) -wta \mathcal{A} (cf. Theorem 17.3.2): we can construct a sentence $e \in \text{MSO}(\Sigma, \mathbf{B})$ such that $\llbracket e \rrbracket = \llbracket \mathcal{A} \rrbracket^{\text{run}}$.

We will show that (1) can be used to prove (2) (cf. Theorem 17.5.2) and vice versa (cf. Theorem 17.5.4). Thus Theorem 17.5.2 can be seen as an alternative proof of “r-recognizable implies definable” (cf. Subsection 17.5.1); also, Theorem 17.5.4 can be seen as an alternative proof of the decomposition result Theorem 11.3.1(A) \Rightarrow (B) (cf. Subsection 17.5.2).

This section elaborates the ideas of [HVD19, Sec. 7.5] for the particular case of the trivial storage type and strong bimonoids as weight algebras.

17.5.1 Alternative proof of “r-recognizable implies definable”

We start with an auxiliary lemma which states that the set of definable weighted tree languages is closed under tree relabelings. Actually, we have proved this result already: each definable weighted tree language is r-recognizable (by Theorem 17.3.8), r-recognizable weighted tree languages are closed under tree relabelings (cf. Theorem 10.10.1), and each r-recognizable weighted tree language is definable (by Theorem 17.3.2). But we do not want to use Theorem 17.3.2 for this closure result. So we show a proof with a direct construction.

Essentially the next lemma has been proved in [Her17, Lm. 15] and [Her20a, Lm. 5.3.2]. We follow this proof, but we mention that the notion of “definable” in [Her17] and [Her20a] refers to the weighted logic in [DG05, DV06], and this is different from the one in the present chapter.

Lemma 17.5.1. Let Θ be a ranked alphabet, $e \in \text{MSO}(\Theta, \mathbf{B})$ be a sentence, and $\tau = (\tau_k \mid k \in \mathbb{N})$ be a (Θ, Σ) -tree relabeling. Then we can construct a sentence $f \in \text{MSO}(\Sigma, \mathbf{B})$ such that $\llbracket f \rrbracket = \chi(\tau)(\llbracket e \rrbracket)$.

Proof. Let $(\theta_1, \dots, \theta_n)$ be an arbitrary, but fixed enumeration of Θ . For each $i \in [n]$, we let $k_i = \text{rk}_{\Theta}(\theta_i)$. Moreover, we let $\mathcal{V} = \{X_{\theta} \mid \theta \in \Theta\}$ be a set of second-order variables. The idea is

- to code, for each $\zeta \in \mathsf{T}_{\Sigma}$, each preimage $\xi \in \tau^{-1}(\zeta)$ as a tree in $\mathsf{T}_{\Sigma, \mathcal{V}}$ where the second order variable X_{θ} represents the symbol $\theta \in \Theta$, and

- to evaluate e' on ξ where e' is obtained from e by replacing each subformula of the form $\text{label}_\theta(x)$ by $(x \in X_\theta)$.

Formally, we construct the $\text{MSO}(\Sigma, \mathbf{B})$ -formula

$$f = \left(\bigoplus_{X_{\theta_1}} \cdots \bigoplus_{X_{\theta_n}} (\psi_{\text{part}} \wedge \psi_{\text{relabel}}) \triangleright e' \right)$$

where

- $\psi_{\text{part}} = \forall x. \left(\bigvee_{i \in [n]} ((x \in X_{\theta_i}) \wedge \bigwedge_{\substack{j \in [n]: \\ i \neq j}} \neg(x \in X_{\theta_j})) \right)$,
- $\psi_{\text{relabel}} = \forall x. \left(\bigwedge_{i \in [n]} (\neg(x \in X_{\theta_i}) \vee \text{label}_{\tau_{k_i}(\theta_i)}(x)) \right)$, and
- e' is obtained from e by replacing each subformula of the form $\text{label}_\theta(x)$ by $(x \in X_\theta)$.

We note that ψ_{part} and ψ_{relabel} are in $\text{MSO}(\Sigma)$ and e' is in $\text{MSO}(\Sigma, \mathbf{B})$. Moreover, $\text{Free}(\psi_{\text{part}}) = \text{Free}(\psi_{\text{relabel}}) = \mathcal{V}$ and $\text{Free}(e') \subseteq \mathcal{V}$, hence the formula f is a sentence.

First we analyse the semantics of ψ_{part} and ψ_{relabel} . The following two statements are obvious:

$$\begin{aligned} \text{for every } \zeta \in \mathbf{T}_\Sigma \text{ and } \eta \in \Phi_{\zeta, \mathcal{V}} : (\zeta, \eta) \models \psi_{\text{part}} \quad \text{iff} \\ \{\eta(X_{\theta_1}), \dots, \eta(X_{\theta_n})\} \text{ is a partitioning of } \text{pos}(\zeta) \end{aligned} \quad (17.44)$$

and

$$\begin{aligned} \text{for every } \zeta \in \mathbf{T}_\Sigma \text{ and } \eta \in \Phi_{\zeta, \mathcal{V}} : (\zeta, \eta) \models \psi_{\text{relabel}} \quad \text{iff} \\ (\forall w \in \text{pos}(\zeta), i \in [n]) : (w \in \eta(X_{\theta_i})) \rightarrow (\zeta(w) \in \tau_{k_i}(\theta_i)) . \end{aligned} \quad (17.45)$$

In the following, for every $\zeta \in \mathbf{T}_\Sigma$ and $U_1, \dots, U_n \subseteq \text{pos}(\zeta)$, we abbreviate the \mathcal{V} -assignment $[X_{\theta_1} \mapsto U_1, \dots, X_{\theta_n} \mapsto U_n]$ for ζ by $[X_{\theta_i} \mapsto U_i \mid i \in [n]]$. Then, putting (17.44) and (17.45) together, we obtain the statement:

$$\begin{aligned} \text{for every } \zeta \in \mathbf{T}_\Sigma \text{ and } \eta \in \Phi_{\zeta, \mathcal{V}} : (\zeta, \eta) \models (\psi_{\text{part}} \wedge \psi_{\text{relabel}}) \quad \text{iff} \\ (\exists \xi \in \mathbf{T}_\Theta) : (\zeta \in \tau(\xi)) \wedge (\eta = [X_{\theta_i} \mapsto \text{pos}_{\theta_i}(\xi) \mid i \in [n]]) . \end{aligned} \quad (17.46)$$

We note that $\text{pos}(\zeta) = \text{pos}(\xi)$. Moreover, by construction of e' , we have

$$\text{for every } \zeta \in \mathbf{T}_\Sigma \text{ and } \xi \in \tau^{-1}(\zeta) : \llbracket e \rrbracket(\xi) = \llbracket e' \rrbracket(\zeta, [X_{\theta_i} \mapsto \text{pos}_{\theta_i}(\xi) \mid i \in [n]]) . \quad (17.47)$$

Now we prove that $\llbracket f \rrbracket = \chi(\tau)(r)$. Let $\zeta \in \mathbf{T}_\Sigma$. Then

$$\begin{aligned} & \llbracket f \rrbracket(\zeta) \\ &= \llbracket \bigoplus_{X_{\theta_1}} \cdots \bigoplus_{X_{\theta_n}} (\psi_{\text{part}} \wedge \psi_{\text{relabel}}) \triangleright e' \rrbracket(\zeta) \\ &= \bigoplus_{W_1, \dots, W_n \subseteq \text{pos}(\zeta)} \llbracket (\psi_{\text{part}} \wedge \psi_{\text{relabel}}) \triangleright e' \rrbracket(\zeta, [X_{\theta_i} \mapsto W_i \mid i \in [n]]) \\ &= \begin{cases} \bigoplus_{W_1, \dots, W_n \subseteq \text{pos}(\zeta)} \llbracket e' \rrbracket(\zeta, [X_{\theta_i} \mapsto W_i \mid i \in [n]]) & \text{if } (\zeta, [X_{\theta_i} \mapsto W_i \mid i \in [n]]) \models (\psi_{\text{part}} \wedge \psi_{\text{relabel}}) \\ 0 & \text{otherwise} \end{cases} \\ &= \bigoplus_{\xi \in \tau^{-1}(\zeta)} \llbracket e' \rrbracket(\zeta, [X_{\theta_i} \mapsto \text{pos}_{\theta_i}(\xi) \mid i \in [n]]) \quad (\text{by (17.46)}) \\ &= \bigoplus_{\xi \in \tau^{-1}(\zeta)} \llbracket e \rrbracket(\xi) \quad (\text{by (17.47)}) \\ &= \chi(\tau)(\llbracket e \rrbracket)(\zeta) \quad (\text{by (2.40) and the fact that } \tau^{-1}(\zeta) \text{ is finite}) \end{aligned}$$

□

Now we can show the alternative proof of the fact that r-recognizable implies definable.

Theorem 17.5.2. *For each (Σ, \mathbf{B}) -wta \mathcal{A} , we can construct a sentence $f \in \text{MSO}(\Sigma, \mathbf{B})$ such that $\llbracket f \rrbracket = \llbracket \mathcal{A} \rrbracket^{\text{run}}$.*

Proof. By Theorem 11.3.1(A) \Rightarrow (B), we can construct a ranked alphabet Θ , a deterministic (Θ, Σ) -tree relabeling τ , a Θ -local system (K, H) , and a family $\kappa = (\kappa_k \mid k \in \mathbb{N})$ of mappings $\kappa_k : \Theta^{(k)} \rightarrow B$ such that, for each $\xi \in T_\Sigma$, we have $\llbracket \mathcal{A} \rrbracket^{\text{run}}(\xi) = h_{\mathbf{M}(\Theta, \kappa)}(\tau^{-1}(\xi) \cap L(K, H))$. By Observation 2.12.1 we have

$$\llbracket \mathcal{A} \rrbracket^{\text{run}}(\xi) = \chi(\tau)(\chi(L(K, H)) \otimes h_{\mathbf{M}(\Theta, \kappa)}) . \quad (17.48)$$

By Corollary 11.2.4, we can construct a bu-deterministic Σ -fta A such that $L(K, H) = L(A)$. By Lemma 17.1.4, we can construct a sentence $\varphi \in \text{MSO}(\Theta)$ such that $L(A) = L(\varphi)$. Then

$$\begin{aligned} \chi(L(K, H)) \otimes h_{\mathbf{M}(\Theta, \kappa)} &= \chi(L(A)) \otimes h_{\mathbf{M}(\Theta, \kappa)} = \chi(L(\varphi)) \otimes h_{\mathbf{M}(\Theta, \kappa)} \\ &= \chi(L(\varphi)) \otimes \llbracket H(\kappa) \rrbracket && \text{(because } H(\kappa) \text{ is a sentence)} \\ &= \llbracket \varphi \triangleright H(\kappa) \rrbracket . && \text{(by (17.10))} \end{aligned}$$

By Lemma 17.5.1, we can construct a sentence $f \in \text{MSO}(\Sigma, \mathbf{B})$ such that $\llbracket f \rrbracket = \chi(\tau)(\llbracket \varphi \triangleright H(\kappa) \rrbracket)$. Finally, by (17.48), we obtain $\llbracket f \rrbracket = \llbracket \mathcal{A} \rrbracket^{\text{run}}$. \square

17.5.2 Alternative proof of the decomposition Theorem 11.3.1(A) \Rightarrow (B)

The alternative proof uses the fact that, for each (Σ, \mathbf{B}) -wta \mathcal{A} , we can construct a sentence $e \in \text{MSO}(\Sigma, \mathbf{B})$ such that $\llbracket \mathcal{A} \rrbracket^{\text{run}} = \llbracket e \rrbracket$ (cf. Theorem 17.3.2) and two easy technical lemmas. The first lemma claims that the set of models of the MSO(Σ)-formula φ in (17.19) is a local tree language.

Lemma 17.5.3. Let $\mathcal{A} = (Q, \delta, F)$ be a root weight normalized (Σ, \mathbf{B}) -wta with $\text{supp}(F) = \{q_f\}$ and $\mathcal{U} = \bigcup(Q^k \times Q \mid k \in \mathbb{N} \text{ such that } \text{rk}^{-1}(k) \neq \emptyset)$. Moreover, let φ be the MSO(Σ)-formula φ in (17.19). Then we can construct a $\Sigma_{\mathcal{U}}$ -local system (G, H) such that $L(G, H) = L_{\mathcal{U}}(\varphi)$.

Proof. We define the $\Sigma_{\mathcal{U}}$ -local system (G, H) such that G is the set of all forks

$$\left((\sigma_1, \{(w_1, q_1)\}) \cdots (\sigma_k, \{(w_k, q_k)\}), (\sigma, \{(w, q)\}) \right)$$

in $\text{Fork}(\Sigma_{\mathcal{U}})$ such that

- $\sigma \in \Sigma^{(k)}$ and $\sigma_1, \dots, \sigma_k \in \Sigma$ for some $k \in \mathbb{N}$,
- $q, q_1, \dots, q_k \in Q$, and
- $w = q_1 \cdots q_k$ and for each $i \in [k]$ we have $w_i \in Q^{\text{rk}(\sigma_i)}$.

Moreover, $H = \{(\sigma, \{(w, q_f)\}) \mid k \in \mathbb{N}, \sigma \in \Sigma^{(k)}, w \in Q^k\}$. Then it is easy to see that $L(G, H) = L_{\mathcal{U}}(\varphi)$. \square

Now we can give an alternative proof of Theorem 11.3.1(A) \Rightarrow (B).

Theorem 17.5.4. *Let \mathcal{A} be a (Σ, \mathbf{B}) -wta. Then we can construct*

- a ranked alphabet Θ ,
- a deterministic (Θ, Σ) -tree relabeling τ ,
- a Θ -local system (G, H) , and
- a family $\kappa = (\kappa_k \mid k \in \mathbb{N})$ of mappings $\kappa_k : \Theta^{(k)} \rightarrow B$

such that, for each $\xi \in T_\Sigma$, the following holds: $\llbracket \mathcal{A} \rrbracket^{\text{run}}(\xi) = h_{\mathbf{M}(\Theta, \kappa)}(\tau^{-1}(\xi) \cap L(G, H))$.

Proof. Let $\mathcal{A} = (Q, \delta, F)$. By Theorem 7.3.1 we can assume that \mathcal{A} is root weight normalized, i.e., $\text{supp}(F)$ contains exactly one element q_f and $F(q_f) = \mathbb{1}$.

We define $\mathcal{U} = \bigcup(Q^k \times Q \mid k \in \mathbb{N} \text{ such that } \text{rk}^{-1}(k) \neq \emptyset)$ and $\Theta = \Sigma_{\mathcal{U}}$. We recall the MSO(Σ, B)-formula defined in (17.22):

$$e = \bigoplus_{X_1} \cdots \bigoplus_{X_n} (\varphi \triangleright H(\kappa))$$

and $\kappa = (\kappa_k \mid k \in \mathbb{N})$ with $\kappa_k : (\Sigma_{\mathcal{U}})^{(k)} \rightarrow B$. By the proof of Theorem 17.3.2, we have $\llbracket \mathcal{A} \rrbracket^{\text{run}} = \llbracket e \rrbracket$.

For each $i \in [n]$, we consider the subformula

$$e_i = \bigoplus_{X_i} \cdots \bigoplus_{X_n} (\varphi \triangleright H(\kappa)) .$$

Obviously, $\text{Free}(e_i) = \{X_1, \dots, X_{i-1}\}$ and $X_i \notin \{X_1, \dots, X_{i-1}\}$. Thus we can apply Lemma 17.2.6(2) (with $\mathcal{V} = \text{Free}(e_i)$) and thereby construct the deterministic $(\Sigma_{\{X_1, \dots, X_i\}}, \Sigma_{\{X_1, \dots, X_{i-1}\}})$ -tree relabeling τ_i such that

$$\llbracket \bigoplus_{X_i} \cdots \bigoplus_{X_n} (\varphi \triangleright H(\kappa)) \rrbracket_{\{X_1, \dots, X_{i-1}\}} = \chi(\tau_i) \left(\llbracket \bigoplus_{X_{i+1}} \cdots \bigoplus_{X_n} (\varphi \triangleright H(\kappa)) \rrbracket_{\{X_1, \dots, X_i\}} \right) .$$

Hence, by the n -fold application of Lemma 17.2.6(2), we can construct deterministic tree relabelings τ_1, \dots, τ_n such that

$$\llbracket e \rrbracket = \llbracket \bigoplus_{X_1} \cdots \bigoplus_{X_n} (\varphi \triangleright H(\kappa)) \rrbracket = \chi(\tau_1) \left(\dots \chi(\tau_n) (\llbracket \varphi \triangleright H(\kappa) \rrbracket_{\mathcal{U}}) \dots \right) .$$

Then we construct the deterministic tree relabeling τ such that $\tau = \tau_1 \hat{\circ} \dots \hat{\circ} \tau_n$ (cf. Section 2.10) and, by Theorem 2.10.6, we have

$$\chi(\tau_1) \left(\dots \chi(\tau_n) (\llbracket \varphi \triangleright H(\kappa) \rrbracket_{\mathcal{U}}) \dots \right) = \chi(\tau) \left(\llbracket \varphi \triangleright H(\kappa) \rrbracket_{\mathcal{U}} \right) .$$

Now let $\xi \in T_{\Sigma}$. We can calculate as follows (where we abbreviate the Θ -algebra homomorphism $\mathfrak{h}_{M(\Theta, \kappa)}$ by \mathfrak{h}_{κ}).

$$\begin{aligned} \chi(\tau) \left(\llbracket \varphi \triangleright H(\kappa) \rrbracket_{\mathcal{U}} \right) (\xi) &= \chi(\tau) (\chi(L_{\mathcal{U}}(\varphi)) \otimes \llbracket H(\kappa) \rrbracket_{\mathcal{U}}) (\xi) && \text{(by (17.10))} \\ &= \chi(\tau) (\chi(L_{\mathcal{U}}(\varphi)) \otimes \mathfrak{h}_{\kappa[\mathcal{U} \rightsquigarrow \mathcal{U}]} \otimes \chi(T_{\Sigma_{\mathcal{U}}}^{\vee})) (\xi) && \text{(by definition of } \llbracket H(\kappa) \rrbracket_{\mathcal{U}} \text{)} \\ &= \chi(\tau) (\chi(L_{\mathcal{U}}(\varphi)) \otimes \mathfrak{h}_{\kappa} \otimes \chi(T_{\Sigma_{\mathcal{U}}}^{\vee})) (\xi) && \text{(because } \mathfrak{h}_{\kappa[\mathcal{U} \rightsquigarrow \mathcal{U}]} = \mathfrak{h}_{\kappa} \text{)} \\ &= \chi(\tau) (\chi(L_{\mathcal{U}}(\varphi)) \otimes \mathfrak{h}_{\kappa}) (\xi) && \text{(because } L_{\mathcal{U}}(\varphi) \subseteq T_{\Sigma_{\mathcal{U}}}^{\vee} \text{)} \\ &= \mathfrak{h}_{\kappa}(\tau^{-1}(\xi) \cap L_{\mathcal{U}}(\varphi)) . && \text{(by Observation 2.12.1)} \end{aligned}$$

By Lemma 17.5.3, we can construct a $\Sigma_{\mathcal{U}}$ -local system (G, H) such that $L_{\mathcal{U}}(\varphi) = L(G, H)$. Hence we obtain $\llbracket \mathcal{A} \rrbracket^{\text{run}}(\xi) = \mathfrak{h}_{\kappa}(\tau^{-1}(\xi) \cap L(G, H))$. \square

Chapter 18

Syntactic congruences and B-A-LB's theorem

For string languages, the Myhill-Nerode theorem characterizes the recognizable languages in terms of index-finiteness of their syntactic congruences (cf. [HU79]). This theorem has been generalized to recognizable tree languages [MM70, Ste92, Koz92] and [GS97, Thm. 2.7.1].

Although, in the unweighted case, deterministic automata are equally expressive as nondeterministic automata, one might say that the above mentioned Myhill-Nerode theorems are based on deterministic automata: in their proof, (a) the Myhill-Nerode congruence is compared to the kernel of the algebra homomorphism h_A for a total and deterministic automaton A and (b) the automaton constructed from the Myhill-Nerode congruence is total and deterministic. Taking this point of view, Myhill-Nerode's theorem for trees has been generalized to bu-deterministic wta over semifields [Bor03] and even to bu-deterministic wta over multiplicatively cancellative and commutative semirings (under some mild changes of the scenario) [Mal08].

Also for arbitrary wta a characterization in terms of syntactic congruences was proved: for weighted tree languages over fields, the Bozapalidis-Alexandrakis-Louscou-Bozapalidou's theorem (B-A-LB's theorem) characterizes recognizability in terms of finite dimensionality of vector spaces which result from factorizing the vector space of polynomials by syntactic congruences of weighted tree languages [BLB83, BA89].

In this chapter we recall B-A-LB's theorem (cf. Theorem 18.4.1). Its proof uses the fact that the vector space of left quotients of a weighted tree language r is finite-dimensional if r is recognizable. Hence we start with recalling this implication (cf. Theorem 18.1.4). We follow the proof given in [FV09, Thm. 3.31] and elaborate the details.

In this chapter, we let $\mathbf{B} = (B, \oplus, \otimes, \mathbf{0}, \mathbf{1})$ denote a field unless specified otherwise.

18.1 Recognizability implies finite dimensionality of the vector spaces of left quotients and of right quotients

In this section we recall the definitions of left quotient of a weighted tree language r and right quotient of r . Moreover, we define the (Σ, \mathbf{B}) -vector space $\text{VLQ}(r)$ of left quotients of r and the (Σ, \mathbf{B}) -vector space $\text{VRQ}(r)$ of right quotients of r . We prove that $\text{VLQ}(r)$ is finite-dimensional iff $\text{VRQ}(r)$ is finite-dimensional (cf. Theorem 18.1.1). Moreover, we prove that recognizability of r implies finite dimensionality of $\text{VLQ}(r)$ and of $\text{VRQ}(r)$ (cf. Theorem 18.1.4). Finally, for the case of a bu-deterministically recognizable weighted tree language r , we show how to construct a generator set for $\text{VLQ}(r)$.

18.1.1 Vector spaces of left quotients and of right quotients

Let $r : T_\Sigma \rightarrow B$ be a weighted tree language. For each tree $\xi \in T_\Sigma$, we define the *left quotient of r with respect to ξ* , denoted by $\xi^{-1}r$, to be the B -weighted set

$$\xi^{-1}r : C_\Sigma \rightarrow B \quad \text{such that, for each } c \in C_\Sigma, \text{ we let } \xi^{-1}r(c) = r(c[\xi]) .$$

Moreover, for each context $c \in C_\Sigma$, we define the *right quotient of r with respect to c* , denoted by rc^{-1} , to be the weighted tree languages

$$rc^{-1} : T_\Sigma \rightarrow B \quad \text{such that, for each } \xi \in T_\Sigma, \text{ we let } rc^{-1}(\xi) = r(c[\xi]) .$$

Hence, for every $\xi \in T_\Sigma$ and $c \in C_\Sigma$, we have $rc^{-1}(\xi) = \xi^{-1}r(c)$ and, in particular, $rz_1^{-1}(\xi) = r(\xi) = \xi^{-1}r(z_1)$.

We consider the B -weighted sets $r : C_\Sigma \rightarrow B$, $r_1 : C_\Sigma \rightarrow B$, and $r_2 : C_\Sigma \rightarrow B$, and the value $b \in B$. In Section 2.8, we have defined

- the *scalar multiplication of r with b (from the left)*, denoted by $b \cdot r$, and
- the *sum of r_1 and r_2* , denoted by $r_1 \oplus r_2$.

We note that \oplus is overloaded: \oplus denotes an operation on B^{C_Σ} and an operation on B^{T_Σ} . But we think that this notational ambiguity is preferable against a heavy notational discrimination.

Since $B = (B, \oplus, \otimes, \mathbb{0}, \mathbb{1})$ is a field, the algebras $(B^{C_\Sigma}, \oplus, \tilde{\mathbb{0}})$ and $(B^{T_\Sigma}, \oplus, \tilde{\mathbb{0}})$ are commutative groups; moreover, they are B -vector spaces via the scalar multiplication \cdot .

Let $r : T_\Sigma \rightarrow B$. Moreover, let

$$\text{LQ}(r) = \{\xi^{-1}r \in B^{C_\Sigma} \mid \xi \in T_\Sigma\} \quad \text{and} \quad \text{RQ}(r) = \{rc^{-1} \in B^{T_\Sigma} \mid c \in C_\Sigma\} .$$

We denote

- by $\text{VLQ}(r)$ the B -vector subspace $(\langle \text{LQ}(r) \rangle_{\{\oplus, \tilde{\mathbb{0}}\} \cup \{b \cdot | b \in B\}}, \oplus, \tilde{\mathbb{0}})$ of $(B^{C_\Sigma}, \oplus, \tilde{\mathbb{0}})$ generated by $\text{LQ}(r)$ and
- by $\text{VRQ}(r)$ the B -vector subspace $(\langle \text{RQ}(r) \rangle_{\{\oplus, \tilde{\mathbb{0}}\} \cup \{b \cdot | b \in B\}}, \oplus, \tilde{\mathbb{0}})$ of $(B^{T_\Sigma}, \oplus, \tilde{\mathbb{0}})$ generated by $\text{RQ}(r)$.

In the following we abbreviate $\langle \text{LQ}(r) \rangle_{\{\oplus, \tilde{\mathbb{0}}\} \cup \{b \cdot | b \in B\}}$ and $\langle \text{RQ}(r) \rangle_{\{\oplus, \tilde{\mathbb{0}}\} \cup \{b \cdot | b \in B\}}$ by $\langle \text{LQ}(r) \rangle$ and $\langle \text{RQ}(r) \rangle$, respectively.

Theorem 18.1.1. [BLB83, Thm. 3.1] *Let Σ be a ranked alphabet. Let B be a field and $r : T_\Sigma \rightarrow B$. Then the B -vector space $\text{VLQ}(r)$ is finite-dimensional if and only if the B -vector space $\text{VRQ}(r)$ is finite-dimensional. Moreover, if $\text{VLQ}(r)$ and $\text{VRQ}(r)$ are finite-dimensional, then $\dim(\text{VLQ}(r)) = \dim(\text{VRQ}(r))$.*

Proof. Let us assume that $\text{VLQ}(r)$ is n -dimensional for some $n \in \mathbb{N}$ and let $Q_1 = \{\xi_1^{-1}r, \dots, \xi_n^{-1}r\}$ be a basis of $\text{VLQ}(r)$; moreover, let $\xi_1^{-1}r, \dots, \xi_n^{-1}r$ be an arbitrary but fixed order of the base vectors. Then, by the representation of finite-dimensional vector spaces discussed on page 48, the B -vector space $\text{VLQ}(r)$ is isomorphic to the B -vector space $(B^n, \oplus, \mathbb{0}_n)$ using the linear extension of the bijective mapping $\psi : Q_1 \rightarrow B^n$ defined by $\psi(\xi_i^{-1}r) = \mathbb{1}_i$ for each $i \in [n]$ (note that the i th base vector of $\text{VLQ}(r)$ is $\xi_i^{-1}r$, and that $\mathbb{1}_i$ is the i -unit vector of B^n). Thus, we are allowed to identify the two B -vector spaces $\text{VLQ}(r)$ and $(B^n, \oplus, \mathbb{0}_n)$, which we will do in the sequel.

Next we define the mapping $\psi_1 : \text{RQ}(r) \rightarrow B^n$ such that, for every $c \in C_\Sigma$ and $i \in [n]$, we let

$$\psi_1(rc^{-1})_i = r(c[\xi_i]) .$$

Then we consider its linear extension $\psi'_1 : \langle \text{RQ}(r) \rangle \rightarrow B^n$ from the B -vector space $\text{VRQ}(r)$ to the B -vector space $(B^n, +, \mathbb{0}_n)$, and write ψ_1 instead of ψ'_1 .

Now we prove that ψ_1 is injective. For this, let $s_1, s_2 \in \langle \text{RQ}(r) \rangle$. We show that $\psi_1(s_1) = \psi_1(s_2)$ implies that $s_1 = s_2$. Since ψ_1 is linear, this is equivalent to the implication:

$$\text{if } \psi_1(s_1 \oplus s'_2) = 0_n, \text{ then } s_1 \oplus s'_2 = \tilde{0} ,$$

where s'_2 is obtained from s_2 by replacing each coefficient by its inverse in B (with respect to \oplus). We prove this implication by showing that

$$\text{for each } s \in \langle \text{RQ}(r) \rangle: \text{ if } \psi_1(s) = 0_n, \text{ then } s = \tilde{0} . \quad (18.1)$$

Let $s : T_\Sigma \rightarrow B$ be an element of $\langle \text{RQ}(r) \rangle$. Thus there exist $m \in \mathbb{N}$, $b_1, \dots, b_m \in B$, and $c_1, \dots, c_m \in C_\Sigma$ such that

$$s = (b_1 \cdot r c_1^{-1}) \oplus \dots \oplus (b_m \cdot r c_m^{-1}) = \bigoplus_{j \in [m]} b_j \cdot r c_j^{-1} . \quad (18.2)$$

Now let $\xi \in T_\Sigma$. Then we have:

$$s(\xi) = \bigoplus_{j \in [m]} b_j \otimes r c_j^{-1}(\xi) = \bigoplus_{j \in [m]} b_j \otimes \xi^{-1} r(c_j) . \quad (18.3)$$

Since Q_1 is a basis of $\text{VLQ}(r)$, there exist $a_1, \dots, a_n \in B$ such that

$$\xi^{-1} r = a_1 \cdot \xi_1^{-1} r \oplus \dots \oplus a_n \cdot \xi_n^{-1} r . \quad (18.4)$$

Then we can calculate as follows.

$$\begin{aligned} s(\xi) &= \bigoplus_{j \in [m]} b_j \otimes \xi^{-1} r(c_j) && \text{(by (18.3))} \\ &= \bigoplus_{j \in [m]} b_j \otimes (a_1 \cdot \xi_1^{-1} r \oplus \dots \oplus a_n \cdot \xi_n^{-1} r)(c_j) && \text{(by (18.4))} \\ &= \bigoplus_{j \in [m]} \left((b_j \otimes a_1) \otimes \xi_1^{-1} r(c_j) \oplus \dots \oplus (b_j \otimes a_n) \otimes \xi_n^{-1} r(c_j) \right) \\ &= \left(\bigoplus_{j \in [m]} (b_j \otimes a_1) \otimes \xi_1^{-1} r(c_j) \right) \oplus \dots \oplus \left(\bigoplus_{j \in [m]} (b_j \otimes a_n) \otimes \xi_n^{-1} r(c_j) \right) \\ & && \text{(by commutativity and associativity of } \oplus \text{)} \\ &= a_1 \otimes \left(\bigoplus_{j \in [m]} b_j \otimes \xi_1^{-1} r(c_j) \right) \oplus \dots \oplus a_n \otimes \left(\bigoplus_{j \in [m]} b_j \otimes \xi_n^{-1} r(c_j) \right) . \\ & && \text{(by commutativity of } \otimes \text{ and distributivity)} \end{aligned}$$

Since, for each $i \in [n]$, we have $\xi_i^{-1} r(c_j) = \psi_1(r c_j^{-1})_i$, we obtain the following:

$$s(\xi) = a_1 \otimes \left(\bigoplus_{j \in [m]} b_j \otimes \psi_1(r c_j^{-1})_1 \right) \oplus \dots \oplus a_n \otimes \left(\bigoplus_{j \in [m]} b_j \otimes \psi_1(r c_j^{-1})_n \right) . \quad (18.5)$$

Now let $\psi_1(s) = 0_n$. Since ψ_1 is linear, by (18.2), we have

$$\psi_1(s) = \bigoplus_{j \in [m]} b_j \cdot \psi_1(r c_j^{-1}) = 0_n$$

and hence, for each $i \in [n]$, we have

$$0 = (\psi_1(s))_i = \left(\bigoplus_{j \in [m]} b_j \cdot \psi_1(r c_j^{-1}) \right)_i = \bigoplus_{j \in [m]} b_j \otimes \psi_1(r c_j^{-1})_i$$

By (18.5), it follows that $s = \tilde{0}$. This proves (18.1) and hence that ψ_1 is injective.

By Sylvester's law of nullity (cf. (2.29)), we have

$$\dim(\text{VRQ}(r)) = \dim(\ker(\psi_1)) + \dim(\text{im}(\psi_1)) .$$

Since ψ_1 is injective, the kernel of ψ_1 just contains the vector $\tilde{0}$, and hence $\dim(\ker(\psi_1)) = 0$. Thus

$$\dim(\text{VRQ}(r)) = \dim(\text{im}(\psi_1)) .$$

Since $\text{im}(\psi_1)$ is a subspace of $(B^n, +, 0_n)$, we obtain that

$$\dim(\text{VRQ}(r)) = \dim(\text{im}(\psi_1)) \leq \dim((B^n, +, 0_n)) = \dim(\text{VLQ}(r)) .$$

For the other direction we can proceed in a similar way as above. First, we assume that $\text{VRQ}(r)$ is finite-dimensional, say ℓ -dimensional, and with basis $\{rc_1^{-1}, \dots, rc_\ell^{-1}\}$; moreover, let $rc_1^{-1}, \dots, rc_\ell^{-1}$ be an arbitrary but fixed order of the base vectors. We identify $\text{VRQ}(r)$ with the \mathbf{B} -vector space $(B^\ell, \oplus, 0_\ell)$.

Second, we define a linear mapping $\psi_2 : \langle \text{LQ}(r) \rangle \rightarrow B^\ell$ from the \mathbf{B} -vector space $\text{VLQ}(r)$ to the \mathbf{B} -vector space $(B^\ell, \oplus, 0_\ell)$ such that, for every $\xi \in T_\Sigma$ and $i \in [\ell]$, we let

$$\psi_2(\xi^{-1}r)_i = r(c_i[\xi]) .$$

In a similar way as for ψ_1 above, we can prove that ψ_2 is injective. Hence $\dim(\text{VLQ}(r)) \leq \dim(\text{VRQ}(r))$.

Altogether we obtain the statements of the theorem. \square

18.1.2 Recognizability implies finite dimensionality

Here we will prove that, for each recognizable (Σ, \mathbf{B}) -weighted tree language r , the \mathbf{B} -vector space $\text{VLQ}(r)$ is finite-dimensional (cf. Theorem 18.1.4). For this, we consider an arbitrary but fixed (Σ, \mathbf{B}) -wta $\mathcal{A} = (Q, \delta, F)$.

As technical preparation, we define a Σ -algebra homomorphism which extends $h_{\mathcal{A}}$ such that it is also able to process trees in $T_\Sigma(\{z\})$, and hence, in particular, contexts. Formally, for each $v \in B^Q$, we let $\bar{v} : \{z\} \rightarrow B^Q$ be defined by $\bar{v}(z) = v$. Since the Σ -term algebra over $\{z\}$ is free in the set of all Σ -algebras generated by $\{z\}$, there exists a unique extension of \bar{v} to a Σ -algebra homomorphism from $(T_\Sigma(\{z\}), \theta_\Sigma)$ to the vector algebra $\mathbf{V}(\mathcal{A}) = (B^Q, \delta_{\mathcal{A}})$ of \mathcal{A} (cf. Theorem 2.10.3). We denote this Σ -algebra homomorphism by $h_{\mathcal{A}}^v$. Obviously, the following holds:

$$\text{For every } v \in B^Q \text{ and } \xi \in T_\Sigma, \text{ we have } h_{\mathcal{A}}^v(\xi) = h_{\mathcal{A}}(\xi). \quad (18.6)$$

Next we show two properties of the Σ -algebra homomorphism by $h_{\mathcal{A}}^v$. The first one shows the compatibility of $h_{\mathcal{A}}$ and $h_{\mathcal{A}}^v$.

Lemma 18.1.2. Let \mathcal{A} be a (Σ, \mathbf{B}) -wta. For every $\zeta \in T_\Sigma(\{z\})$ and $\xi \in T_\Sigma$, we have $h_{\mathcal{A}}(\zeta[\xi]) = h_{\mathcal{A}}^{\zeta(\xi)}(\zeta)$.

Proof. By induction on $(T_\Sigma(\{z\}), \succ_{\Sigma, \{z\}})$, we prove the statement.

I.B.:

Case (a): Let $\zeta = z$ and $\xi \in T_\Sigma$. Then $h_{\mathcal{A}}(\zeta[\xi]) = h_{\mathcal{A}}(\xi) = h_{\mathcal{A}}^{\zeta(\xi)}(z)$.

Case (b): Let $\zeta = \alpha$ for some $\alpha \in \Sigma^{(0)}$. Then the statement follows by (18.6).

I.S.: Let $\zeta = \sigma(\zeta_1, \dots, \zeta_k)$ with $k \in \mathbb{N}_+$ and $\zeta_1, \dots, \zeta_k \in T_\Sigma(\{z\})$. Then we have

$$\begin{aligned} h_{\mathcal{A}}(\sigma(\zeta_1, \dots, \zeta_k)[\xi]) &= h_{\mathcal{A}}(\sigma(\zeta_1[\xi], \dots, \zeta_k[\xi])) = \delta_{\mathcal{A}}(\sigma)(h_{\mathcal{A}}(\zeta_1[\xi]), \dots, h_{\mathcal{A}}(\zeta_k[\xi])) \\ &= \delta_{\mathcal{A}}(\sigma)(h_{\mathcal{A}}^{\zeta_1(\xi)}(\zeta_1), \dots, h_{\mathcal{A}}^{\zeta_k(\xi)}(\zeta_k)) && \text{(by I.H.)} \\ &= h_{\mathcal{A}}^{\zeta(\xi)}(\sigma(\zeta_1, \dots, \zeta_k)) . && \square \end{aligned}$$

The second property shows a kind of multilinearity of $h_{\mathcal{A}}^v$ in v .

Lemma 18.1.3. Let \mathcal{A} be a (Σ, \mathbf{B}) -wta. For every $c \in C_{\Sigma}$, $b_1, b_2 \in B$, and $v_1, v_2 \in B^Q$, we have

$$h_{\mathcal{A}}^{b_1 \cdot v_1 \oplus b_2 \cdot v_2}(c) = b_1 \cdot h_{\mathcal{A}}^{v_1}(c) \oplus b_2 \cdot h_{\mathcal{A}}^{v_2}(c) .$$

Proof. We prove the statement by induction on $(C_{\Sigma}, \succ_{C_{\Sigma}})$.

I.B.: Let $c = z$. Then

$$h_{\mathcal{A}}^{b_1 \cdot v_1 \oplus b_2 \cdot v_2}(c) = b_1 \cdot v_1 \oplus b_2 \cdot v_2 = b_1 \cdot h_{\mathcal{A}}^{v_1}(c) \oplus b_2 \cdot h_{\mathcal{A}}^{v_2}(c) .$$

I.S.: Let $c = \sigma(\xi_1, \dots, \xi_{i-1}, c', \xi_{i+1}, \dots, \xi_k)$ with $\xi_1, \dots, \xi_{i-1}, \xi_{i+1}, \dots, \xi_k \in T_{\Sigma}$ and $c' \in C_{\Sigma}$. Let us abbreviate $b_1 \cdot v_1 \oplus b_2 \cdot v_2$ by v . Then we can calculate as follows.

$$\begin{aligned} & h_{\mathcal{A}}^v(\sigma(\xi_1, \dots, \xi_{i-1}, c', \xi_{i+1}, \dots, \xi_k)) \\ &= \delta_{\mathcal{A}}(\sigma)(h_{\mathcal{A}}^v(\xi_1), \dots, h_{\mathcal{A}}^v(\xi_{i-1}), h_{\mathcal{A}}^v(c'), h_{\mathcal{A}}^v(\xi_{i+1}), \dots, h_{\mathcal{A}}^v(\xi_k)) \\ &= \delta_{\mathcal{A}}(\sigma)(h_{\mathcal{A}}(\xi_1), \dots, h_{\mathcal{A}}(\xi_{i-1}), h_{\mathcal{A}}^v(c'), h_{\mathcal{A}}(\xi_{i+1}), \dots, h_{\mathcal{A}}(\xi_k)) && \text{(by (18.6))} \\ &= \delta_{\mathcal{A}}(\sigma)(h_{\mathcal{A}}(\xi_1), \dots, h_{\mathcal{A}}(\xi_{i-1}), b_1 \cdot h_{\mathcal{A}}^{v_1}(c') \oplus b_2 \cdot h_{\mathcal{A}}^{v_2}(c'), h_{\mathcal{A}}(\xi_{i+1}), \dots, h_{\mathcal{A}}(\xi_k)) && \text{(by I.H.)} \\ &= b_1 \cdot \delta_{\mathcal{A}}(\sigma)(h_{\mathcal{A}}(\xi_1), \dots, h_{\mathcal{A}}(\xi_{i-1}), h_{\mathcal{A}}^{v_1}(c'), h_{\mathcal{A}}(\xi_{i+1}), \dots, h_{\mathcal{A}}(\xi_k)) \\ &\quad \oplus b_2 \cdot \delta_{\mathcal{A}}(\sigma)(h_{\mathcal{A}}(\xi_1), \dots, h_{\mathcal{A}}(\xi_{i-1}), h_{\mathcal{A}}^{v_2}(c'), h_{\mathcal{A}}(\xi_{i+1}), \dots, h_{\mathcal{A}}(\xi_k)) \\ &\quad \quad \quad \text{(by multilinearity of } \delta_{\mathcal{A}}(\sigma), \text{ cf. Lemma 3.6.4)} \\ &= b_1 \cdot \delta_{\mathcal{A}}(\sigma)(h_{\mathcal{A}}^{v_1}(\xi_1), \dots, h_{\mathcal{A}}^{v_1}(\xi_{i-1}), h_{\mathcal{A}}^{v_1}(c'), h_{\mathcal{A}}^{v_1}(\xi_{i+1}), \dots, h_{\mathcal{A}}^{v_1}(\xi_k)) \\ &\quad \oplus b_2 \cdot \delta_{\mathcal{A}}(\sigma)(h_{\mathcal{A}}^{v_2}(\xi_1), \dots, h_{\mathcal{A}}^{v_2}(\xi_{i-1}), h_{\mathcal{A}}^{v_2}(c'), h_{\mathcal{A}}^{v_2}(\xi_{i+1}), \dots, h_{\mathcal{A}}^{v_2}(\xi_k)) && \text{(by (18.6))} \\ &= b_1 \cdot h_{\mathcal{A}}^{v_1}(\sigma(\xi_1, \dots, \xi_{i-1}, c', \xi_{i+1}, \dots, \xi_k)) \oplus b_2 \cdot h_{\mathcal{A}}^{v_2}(\sigma(\xi_1, \dots, \xi_{i-1}, c', \xi_{i+1}, \dots, \xi_k)) . \quad \square \end{aligned}$$

Now we can prove the finiteness of $\text{VLQ}(r)$ provided that r is recognizable.

Theorem 18.1.4. [BLB83, Thm. 2.1] *Let Σ be a ranked alphabet and let \mathbf{B} be a field. Moreover, let $r : T_{\Sigma} \rightarrow B$ be recognizable. Then $\text{VLQ}(r)$ is finite-dimensional. In particular, if \mathcal{A} is a (Σ, \mathbf{B}) -wta \mathcal{A} with n states and $\llbracket \mathcal{A} \rrbracket = r$, then the dimension of $\text{VLQ}(r)$ is bounded by n .*

Proof. Let $\mathcal{A} = (Q, \delta, F)$ be a (Σ, \mathbf{B}) -wta such that $\llbracket \mathcal{A} \rrbracket = r$. We will show that $\dim(\text{VLQ}(\llbracket \mathcal{A} \rrbracket)) \leq |Q|$.

We define the mapping

$$\varphi : B^Q \rightarrow B^{C_{\Sigma}} \quad \text{by} \quad (\varphi(v))(c) = \bigoplus_{q \in Q} h_{\mathcal{A}}^v(c)_q \otimes F_q \quad \text{for every } v \in B^Q \text{ and } c \in C_{\Sigma} .$$

We prove that the mapping φ is a linear mapping from the \mathbf{B} -vector space $(B^Q, +, \tilde{0})$ to the \mathbf{B} -vector space $(B^{C_{\Sigma}}, \oplus, \tilde{0})$. For this let $b_1, b_2 \in B$, $v_1, v_2 \in B^Q$, and $c \in C_{\Sigma}$. Then we can calculate as follows:

$$\begin{aligned} & \varphi(b_1 \cdot v_1 \oplus b_2 \cdot v_2)(c) \\ &= \bigoplus_{q \in Q} \left(h_{\mathcal{A}}^{b_1 \cdot v_1 \oplus b_2 \cdot v_2}(c)_q \otimes F_q \right) && \text{(by definition of } \varphi) \\ &= \bigoplus_{q \in Q} \left((b_1 \cdot h_{\mathcal{A}}^{v_1}(c) \oplus b_2 \cdot h_{\mathcal{A}}^{v_2}(c))_q \otimes F_q \right) && \text{(by Lemma 18.1.3)} \\ &= \bigoplus_{q \in Q} \left((b_1 \otimes h_{\mathcal{A}}^{v_1}(c)_q \oplus b_2 \otimes h_{\mathcal{A}}^{v_2}(c)_q) \otimes F_q \right) \end{aligned}$$

$$\begin{aligned}
&= \bigoplus_{q \in Q} \left((b_1 \otimes h_{\mathcal{A}}^{v_1}(c)_q \otimes F_q) \oplus (b_2 \otimes h_{\mathcal{A}}^{v_2}(c)_q \otimes F_q) \right) && \text{(by distributivity)} \\
&= \bigoplus_{q \in Q} (b_1 \otimes h_{\mathcal{A}}^{v_1}(c)_q \otimes F_q) \oplus \bigoplus_{q \in Q} (b_2 \otimes h_{\mathcal{A}}^{v_2}(c)_q \otimes F_q) && \text{(by commutativity and associativity of } \oplus \text{)} \\
&= b_1 \otimes \bigoplus_{q \in Q} (h_{\mathcal{A}}^{v_1}(c)_q \otimes F_q) \oplus b_2 \otimes \bigoplus_{q \in Q} (h_{\mathcal{A}}^{v_2}(c)_q \otimes F_q) && \text{(by distributivity)} \\
&= b_1 \otimes \varphi(v_1)(c) \oplus b_2 \otimes \varphi(v_2)(c) && \text{(by definition of } \varphi \text{)} \\
&= (b_1 \cdot \varphi(v_1))(c) \oplus (b_2 \cdot \varphi(v_2))(c) \\
&= (b_1 \cdot \varphi(v_1) \oplus b_2 \cdot \varphi(v_2))(c) .
\end{aligned}$$

Thus φ is a linear mapping and hence $(\text{im}(\varphi), \oplus, \tilde{0})$ is a \mathbf{B} -vector space.

For every $\xi \in T_\Sigma$ and $c \in C_\Sigma$, we have

$$(\varphi(h_{\mathcal{A}}(\xi))(c) = \bigoplus_{q \in Q} h_{\mathcal{A}}^{h_{\mathcal{A}}(\xi)}(c)_q \otimes F_q = \bigoplus_{q \in Q} h_{\mathcal{A}}(c[\xi])_q \otimes F_q = \llbracket \mathcal{A} \rrbracket(c[\xi]) = (\xi^{-1} \llbracket \mathcal{A} \rrbracket)(c)$$

where the second equality follows from Lemma 18.1.2. Thus $\varphi(h_{\mathcal{A}}(\xi)) = \xi^{-1} \llbracket \mathcal{A} \rrbracket$ and, since ξ was chosen arbitrarily, we obtain that $\text{LQ}(\llbracket \mathcal{A} \rrbracket) \subseteq \text{im}(\varphi)$. Consequently, the \mathbf{B} -vector space $\text{VLQ}(\llbracket \mathcal{A} \rrbracket)$ is a subspace of $(\text{im}(\varphi), \oplus, \tilde{0})$, and thus $\dim(\text{VLQ}(\llbracket \mathcal{A} \rrbracket)) \leq \dim((\text{im}(\varphi), \oplus, \tilde{0}))$.

By (2.29) (with $\mathbf{V} = (B^Q, \oplus, \tilde{0})$ and $\mathbf{V}' = (B^{C_\Sigma}, \oplus, \tilde{0})$), we have $\dim((\text{im}(\varphi), \oplus, \tilde{0})) \leq \dim((B^Q, \oplus, \tilde{0}))$. Thus we obtain

$$\dim(\text{VLQ}(\llbracket \mathcal{A} \rrbracket)) \leq \dim((\text{im}(\varphi), \oplus, \tilde{0})) \leq \dim((B^Q, \oplus, \tilde{0})) = |Q| .$$

□

In the next example we discuss an instance of Theorem 18.1.4.

Example 18.1.5. Let $\Sigma = \{\sigma^{(2)}, \gamma^{(1)}, \alpha^{(0)}\}$ and $\#_\gamma : T_\Sigma \rightarrow \mathbb{Q}$ be defined, for each $\xi \in T_\Sigma$, by $\#_\gamma(\xi) = |\text{pos}_\gamma(\xi)|$. We recall that $\text{Rat} = (\mathbb{Q}, +, \cdot, 0, 1)$ denotes the field of rational numbers.

Indeed, the weighted tree language $\#_\gamma$ is (Σ, Rat) -recognizable which can be seen as follows by using the ideas in Example 3.2.18. Let $(b_{\kappa, w} \mid \kappa \in \mathbb{N}, \kappa \in \Sigma^{(k)}, w \in \{0, 1\})$ be the family over \mathbb{Q} defined by

$$\begin{array}{llll}
b_{\alpha, \varepsilon} = 0 & & & \\
b_{\gamma, 0} = 1 & & b_{\gamma, 1} = 1 & \\
b_{\sigma, 00} = 0 & & b_{\sigma, 01} = 1 & \quad b_{\sigma, 10} = 1 \quad \quad b_{\sigma, 11} = 0 .
\end{array}$$

Then (3.22) determines the Σ -algebra $\mathcal{B} = (\mathbb{Q}, \theta)$ where, for each $n, n_1, n_2 \in \mathbb{N}$, we have

$$\theta(\alpha)() = 0, \quad \theta(\gamma)(n) = n + 1, \quad \text{and} \quad \theta(\sigma)(n_1, n_2) = n_1 + n_2 .$$

It is obvious that $h_{\mathcal{B}} = \#_\gamma$ where $h_{\mathcal{B}}$ is the unique Σ -algebra homomorphism from the Σ -term algebra to \mathcal{B} . Thus, according to Example 3.2.18, we can construct a (Σ, Rat) -wta \mathcal{A} such that $\llbracket \mathcal{A} \rrbracket = \#_\gamma$ with two states (cf. Figure 18.1). We note that \mathcal{A} is not bu-deterministic, because $\delta_1(0, \gamma, 0) = \delta_1(0, \gamma, 1) \neq 0$.

In this example we wish to show a basis of $\text{VLQ}(\#_\gamma)$, and we claim that $P = \{\alpha^{-1} \#_\gamma, \gamma(\alpha)^{-1} \#_\gamma\}$ is such a basis. For this, we have to prove two properties: P generates $\text{VLQ}(\#_\gamma)$ and P is linearly independent.

We show that P generates $\text{VLQ}(\#_\gamma)$ by proving the following statement.

$$\begin{aligned}
&\text{For each } b_1 \cdot \xi_1^{-1} \#_\gamma + \dots + b_n \cdot \xi_n^{-1} \#_\gamma \text{ in } \langle \text{LQ}(r) \rangle, \text{ the equality} \\
&b_1 \cdot \xi_1^{-1} \#_\gamma + \dots + b_n \cdot \xi_n^{-1} \#_\gamma = a_1 \cdot \alpha^{-1} \#_\gamma + a_2 \cdot \gamma(\alpha)^{-1} \#_\gamma \text{ holds where} \\
&\quad a_1 = b_1 \cdot (1 - \#_\gamma(\xi_1)) + \dots + b_n \cdot (1 - \#_\gamma(\xi_n)) \quad \text{and} \\
&\quad a_2 = b_1 \cdot \#_\gamma(\xi_1) + \dots + b_n \cdot \#_\gamma(\xi_n).
\end{aligned} \tag{18.7}$$

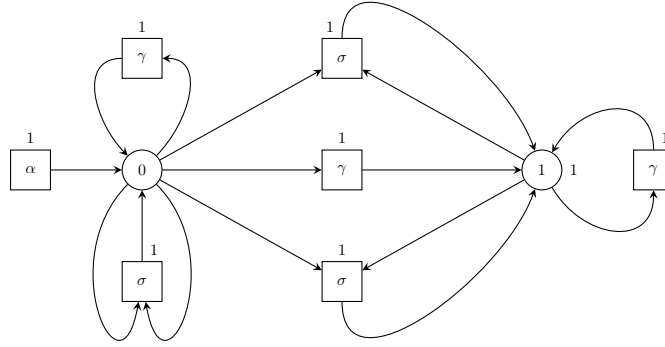

Figure 18.1: The (Σ, Rat) -wta \mathcal{A} with $\llbracket \mathcal{A} \rrbracket = \#_\gamma$.

(We note that both the multiplication in Rat and the scalar multiplication with elements of \mathbb{Q} are denoted by \cdot .)

Let $c \in C_\Sigma$. We can calculate as follows (where we extend $\#_\gamma$ in a natural way to a mapping $\#_\gamma : T_\Sigma \cup C_\Sigma \rightarrow \mathbb{N}$):

$$\begin{aligned}
 (b_1 \cdot \xi_1^{-1} \#_\gamma + \dots + b_n \cdot \xi_n^{-1} \#_\gamma)(c) &= b_1 \cdot \xi_1^{-1} \#_\gamma(c) + \dots + b_n \cdot \xi_n^{-1} \#_\gamma(c) \\
 &= b_1 \cdot \#_\gamma(c[\xi_1]) + \dots + b_n \cdot \#_\gamma(c[\xi_n]) \\
 &= b_1 \cdot (\#_\gamma(c) + \#_\gamma(\xi_1)) + \dots + b_n \cdot (\#_\gamma(c) + \#_\gamma(\xi_n)) \\
 &= (b_1 + \dots + b_n) \cdot \#_\gamma(c) + b_1 \cdot \#_\gamma(\xi_1) + \dots + b_n \cdot \#_\gamma(\xi_n) \\
 &= (b_1 + \dots + b_n) \cdot \#_\gamma(c) + a_2 \\
 &= (a_1 + a_2) \cdot \#_\gamma(c) + a_2 \\
 &= a_1 \cdot \#_\gamma(c) + a_2 \cdot (\#_\gamma(c) + 1) \\
 &= a_1 \cdot \#_\gamma(c[\alpha]) + a_2 \cdot \#_\gamma(c[\gamma(\alpha)]) \\
 &= a_1 \cdot \alpha^{-1} \#_\gamma(c) + a_2 \cdot \gamma(\alpha)^{-1} \#_\gamma(c) \\
 &= (a_1 \cdot \alpha^{-1} \#_\gamma + a_2 \cdot \gamma(\alpha)^{-1} \#_\gamma)(c) .
 \end{aligned}$$

This proves (18.7), i.e., P generates $\text{VLQ}(\#_\gamma)$.

Next we prove that the vectors $\alpha^{-1} \#_\gamma$ and $\gamma(\alpha)^{-1} \#_\gamma$ are linearly independent. For this, let $b_1, b_2 \in \mathbb{Q}$ and assume that

$$b_1 \cdot \alpha^{-1} \#_\gamma + b_2 \cdot \gamma(\alpha)^{-1} \#_\gamma = \tilde{0} .$$

Since both sides of this equality are mappings in \mathbb{Q}^{C_Σ} , we can apply them to a context. By application to the context z , we obtain

$$b_1 \cdot \alpha^{-1} \#_\gamma(z) + b_2 \cdot \gamma(\alpha)^{-1} \#_\gamma(z) = b_1 \cdot \#_\gamma(\alpha) + b_2 \cdot \#_\gamma(\gamma(\alpha)) = b_2 = 0 .$$

By application to the context $\gamma(z)$, we obtain

$$b_1 \cdot \alpha^{-1} \#_\gamma(\gamma(z)) + b_2 \cdot \gamma(\alpha)^{-1} \#_\gamma(\gamma(z)) = b_1 \cdot \#_\gamma(\gamma(\alpha)) = b_1 = 0 ,$$

where in the first equality above we have used the fact that $b_2 = 0$. Thus the vectors $\alpha^{-1} \#_\gamma$ and $\gamma(\alpha)^{-1} \#_\gamma$ are linearly independent. Hence $\{\alpha^{-1} \#_\gamma, \gamma(\alpha)^{-1} \#_\gamma\}$ is a basis of $\text{VLQ}(\#_\gamma)$.

It is also interesting to compute the images of the two base vectors $1_0 = \begin{pmatrix} 1 \\ 0 \end{pmatrix}$ and $1_1 = \begin{pmatrix} 0 \\ 1 \end{pmatrix}$ of the Rat-vector space $(\mathbb{Q}^Q, +, \tilde{0})$ under φ . For this, by induction on (C_Σ, \succ_Σ) , we first prove the following statement.

$$\text{For each } c \in C_\Sigma \text{ we have } h_{\mathcal{A}}^{1_0}(c)_0 = 1 \text{ and } h_{\mathcal{A}}^{1_0}(c)_1 = \#_\gamma(c) . \quad (18.8)$$

$$\underline{c = z}: h_{\mathcal{A}}^{1_0}(z)_0 = 1 \text{ and } h_{\mathcal{A}}^{1_0}(z)_1 = 0.$$

$$\underline{c = \gamma(c') \text{ for some } c' \in C_\Sigma:}$$

$$h_{\mathcal{A}}^{1_0}(\gamma(c'))_0 = \bigoplus_{q \in \{0,1\}} h_{\mathcal{A}}^{1_0}(c')_q \cdot \delta_1(q, \gamma, 0) = h_{\mathcal{A}}^{1_0}(c')_0 \cdot \delta_1(0, \gamma, 0) = 1$$

and

$$\begin{aligned} h_{\mathcal{A}}^{1_0}(\gamma(c'))_1 &= \bigoplus_{q \in \{0,1\}} h_{\mathcal{A}}^{1_0}(c')_q \cdot \delta_1(q, \gamma, 1) = h_{\mathcal{A}}^{1_0}(c')_0 \cdot \delta_1(0, \gamma, 1) + h_{\mathcal{A}}^{1_0}(c')_1 \cdot \delta_1(1, \gamma, 1) \\ &= 1 + \#_\gamma(c') = \#_\gamma(c) . \end{aligned}$$

$$\underline{c = \sigma(c', \xi) \text{ for some } c' \in C_\Sigma \text{ and } \xi \in T_\Sigma:}$$

$$\begin{aligned} h_{\mathcal{A}}^{1_0}(\sigma(c', \xi))_0 &= \bigoplus_{q_1 q_2 \in \{0,1\}^2} h_{\mathcal{A}}^{1_0}(c')_{q_1} \cdot h_{\mathcal{A}}^{1_0}(\xi)_{q_2} \cdot \delta_2(q_1 q_2, \sigma, 0) = h_{\mathcal{A}}^{1_0}(c')_0 \cdot h_{\mathcal{A}}^{1_0}(\xi)_0 \cdot \delta_2(00, \sigma, 0) \\ &= 1 \cdot h_{\mathcal{A}}^{1_0}(\xi)_0 \cdot 1 = 1 \end{aligned}$$

and

$$\begin{aligned} h_{\mathcal{A}}^{1_0}(\sigma(c', \xi))_1 &= \bigoplus_{q_1 q_2 \in \{0,1\}^2} h_{\mathcal{A}}^{1_0}(c')_{q_1} \cdot h_{\mathcal{A}}^{1_0}(\xi)_{q_2} \cdot \delta_2(q_1 q_2, \sigma, 1) \\ &= h_{\mathcal{A}}^{1_0}(c')_0 \cdot h_{\mathcal{A}}^{1_0}(\xi)_1 \cdot \delta_2(01, \sigma, 1) + h_{\mathcal{A}}^{1_0}(c')_1 \cdot h_{\mathcal{A}}^{1_0}(\xi)_0 \cdot \delta_2(10, \sigma, 1) \\ &= \#_\gamma(\xi) + \#_\gamma(c') = \#_\gamma(\sigma(c', \xi)) = \#_\gamma(c) . \end{aligned}$$

$c = \sigma(\xi, c')$ for some $c' \in C_\Sigma$ and $\xi \in T_\Sigma$: This case can be proved in a similar way as the previous one.

This finishes the proof of (18.8).

Then, for each $c \in C_\Sigma$, we have:

$$\begin{aligned} \varphi(1_1)(c) &= \varphi(h_{\mathcal{A}}(\gamma(\alpha)) - 1_0)(c) = \bigoplus_{q \in \{0,1\}} h_{\mathcal{A}}^{h_{\mathcal{A}}(\gamma(\alpha)) - 1_0}(c)_q \cdot F_q = h_{\mathcal{A}}^{h_{\mathcal{A}}(\gamma(\alpha)) - 1_0}(c)_1 \\ &= h_{\mathcal{A}}^{h_{\mathcal{A}}(\gamma(\alpha))}(c)_1 - h_{\mathcal{A}}^{1_0}(c)_1 && \text{(by Lemma 18.1.3)} \\ &= h_{\mathcal{A}}(c[\gamma(\alpha)])_1 - \#_\gamma(c) && \text{(by Lemma 18.1.2 and Equation (18.8))} \\ &= \#_\gamma(c) + 1 - \#_\gamma(c) = 1 \end{aligned}$$

and

$$\varphi(1_0)(c) = \bigoplus_{q \in \{0,1\}} h_{\mathcal{A}}^{1_0}(c)_q \cdot F_q = h_{\mathcal{A}}^{1_0}(c)_0 = \#_\gamma(c) ,$$

where the last equality follows from (18.8).

Finally, we calculate the image of an arbitrary vector $b_1 \cdot 1_0 + b_2 \cdot 1_1$ in \mathbb{Q}^Q under φ . We can prove that the following statement holds:

$$\text{For every } b_1, b_2 \in \mathbb{Q} \text{ we have } \varphi(b_1 \cdot 1_0 + b_2 \cdot 1_1) = (b_1 - b_2) \cdot \alpha^{-1} \#_\gamma + b_2 \cdot \gamma(\alpha)^{-1} \#_\gamma . \quad (18.9)$$

For this let $c \in C_\Sigma$. Then we can calculate as follows.

$$\begin{aligned}
\varphi(b_1 \cdot 1_0 + b_2 \cdot 1_1)(c) &= b_1 \cdot \varphi(1_0)(c) + b_2 \cdot \varphi(1_1)(c) = b_1 \cdot \#_\gamma(c) + b_2 \\
&= b_1 \cdot \#_\gamma(c) - b_2 \cdot \#_\gamma(c) + b_2 \cdot \#_\gamma(c) + b_2 \\
&= b_1 \cdot \#_\gamma(c[\alpha]) - b_2 \cdot \#_\gamma(c[\alpha]) + b_2 \cdot \#_\gamma(c[\gamma(\alpha)]) \\
&= b_1 \cdot \alpha^{-1} \#_\gamma(c) - b_2 \cdot \alpha^{-1} \#_\gamma(c) + b_2 \cdot \gamma(\alpha)^{-1} \#_\gamma(c) \\
&= (b_1 - b_2) \cdot \alpha^{-1} \#_\gamma(c) + b_2 \cdot \gamma(\alpha)^{-1} \#_\gamma(c) \\
&= \left((b_1 - b_2) \cdot \alpha^{-1} \#_\gamma + b_2 \cdot \gamma(\alpha)^{-1} \#_\gamma \right)(c) .
\end{aligned}$$

In particular, for each $\xi \in T_\Sigma$, Equation (18.9) implies the following (where the upper component corresponds to state 0):

$$\varphi(h_{\mathcal{A}}(\xi)) = \varphi\left(\frac{1}{\#_\gamma(\xi)}\right) = \varphi(1 \cdot 1_0 + \#_\gamma(\xi) \cdot 1_1) = (1 - \#_\gamma(\xi)) \cdot \alpha^{-1} \#_\gamma + \#_\gamma(\xi) \cdot \gamma(\alpha)^{-1} \#_\gamma$$

□

We note that in [Boz91] an algorithm is given to construct a basis of $\text{VLQ}(r)$, where r is a recognizable (Σ, \mathbf{B}) -weighted tree language. In Example 18.1.5 we do not use this algorithm but show a basis of $\text{VLQ}(\#_\gamma)$ in an ad hoc way; and also, in (18.7), the coefficients a_1 and a_2 are given in an ad hoc way.

We finish this section with the proof of the fact that the left quotients of a recognizable weighted tree languages are recognizable.

Lemma 18.1.6. Let \mathcal{A} be a (Σ, \mathbf{B}) -wta and $\xi \in T_\Sigma$. Then we can construct a $(\Sigma \cup \{z\}, \mathbf{B})$ -wta \mathcal{B} such that $\llbracket \mathcal{B} \rrbracket_{C_\Sigma} = \xi^{-1} \llbracket \mathcal{A} \rrbracket$. Moreover, if \mathcal{A} is bu-deterministic, then so is \mathcal{B} .

Proof. Let $\mathcal{A} = (Q, \delta, F)$. We construct the $(\Sigma \cup \{z\}, \mathbf{B})$ -wta $\mathcal{B} = (Q, \delta', F)$ such that, for each $k \in \mathbb{N}$ with $k > 0$, we let $\delta'_k = \delta_k$; moreover, for each $\alpha \in \Sigma^{(0)}$ and $q \in Q$ we let $\delta'_0(\varepsilon, \alpha, q) = \delta_0(\varepsilon, \alpha, q)$, and for each $q \in Q$ we let $\delta'_0(\varepsilon, z, q) = h_{\mathcal{A}}(\xi)_q$. Clearly, if \mathcal{A} is bu-deterministic, then by Lemma 4.1.2 also \mathcal{B} is bu-deterministic.

Since $h_{\mathcal{B}}(z) = h_{\mathcal{A}}(\xi)$, we have that $h_{\mathcal{B}} = h_{\mathcal{A}}^{h_{\mathcal{A}}(\xi)}$. By Lemma 18.1.2, it follows that, for each $\zeta \in T_{\Sigma}(\{z\})$ and $q \in Q$, we have $h_{\mathcal{B}}(\zeta)_q = h_{\mathcal{A}}^{h_{\mathcal{A}}(\xi)}(\zeta)_q = h_{\mathcal{A}}(\zeta[\xi])_q$. Thus, for each $\zeta \in T_{\Sigma}(\{z\})$, we have

$$\llbracket \mathcal{B} \rrbracket(\zeta) = \bigoplus_{q \in Q} h_{\mathcal{B}}(\zeta)_q \otimes F_q = \bigoplus_{q \in Q} h_{\mathcal{A}}(\zeta[\xi])_q \otimes F_q = \llbracket \mathcal{A} \rrbracket(\zeta[\xi]) .$$

Now let $\zeta \in C_\Sigma$. Then

$$\llbracket \mathcal{B} \rrbracket(\zeta) = \llbracket \mathcal{A} \rrbracket(\zeta[\xi]) = \xi^{-1} \llbracket \mathcal{A} \rrbracket(\zeta)$$

where the last equality holds because $\zeta \in C_\Sigma$. Hence $\llbracket \mathcal{B} \rrbracket_{C_\Sigma} = \xi^{-1} \llbracket \mathcal{A} \rrbracket$. □

18.1.3 Construction of a generator set for particular bu-deterministically recognizable weighted tree languages

In this section, we deal with bu-deterministically recognizable weighted tree languages. In Theorem 18.1.9, we construct, for each trim and simple (Σ, \mathbf{B}) -wta \mathcal{A} , a generator set of $\text{VLQ}(\llbracket \mathcal{A} \rrbracket)$, where \mathcal{A} is *simple* if it is bu-deterministic, total, and has identity root weights. Moreover, for each element p in $\langle \text{LQ}(\llbracket \mathcal{A} \rrbracket) \rangle_{\{\oplus, \otimes, \bar{0}\}}$, we explicitly give the coefficients for the representation of p as a linear combination over those generators.

In the rest of this section, we let $\mathcal{A} = (Q, \delta, F)$ denote an arbitrary trim and simple (Σ, \mathbf{B}) -wta with $Q = \{q_1, \dots, q_\ell\}$, if not specified otherwise.

First we start with some preparations.

Observation 18.1.7. For every $\xi \in T_\Sigma$, we can construct a state $q \in Q$ such that $h_{\mathcal{A}}(\xi)_q \neq 0$ and for every $p \in Q \setminus \{q\}$ we have $h_{\mathcal{A}}(\xi)_p = 0$.

Proof. We can prove the statement by induction on T_Σ , using the fact that \mathcal{A} is bu-deterministic and total and that \mathbf{B} is zero-divisor free. \square

We define the mapping $\text{state}_{\mathcal{A}} : T_\Sigma \rightarrow Q$ as follows: for each $\xi \in T_\Sigma$, let $\text{state}_{\mathcal{A}}(\xi) = q$, where q is the unique state with $h_{\mathcal{A}}(\xi)_q \neq 0$. If \mathcal{A} is clear from the context, then we drop the index \mathcal{A} from $\text{state}_{\mathcal{A}}$. Moreover, for each $\xi \in T_\Sigma$, we denote by $\overline{\text{state}(\xi)}$ the vector in B^Q defined, for each $p \in Q$, by $\overline{\text{state}(\xi)}_p = \mathbb{1}$ if $p = \text{state}(\xi)$, and 0 otherwise. Then, by definition, we have $h_{\mathcal{A}}(\xi) = h_{\mathcal{A}}(\xi)_{\text{state}(\xi)} \cdot \overline{\text{state}(\xi)}$.

Using the definition of $\text{state}(\xi)$, we can express $\llbracket \mathcal{A} \rrbracket$ in a simple way. Moreover, due to the bu-determinism of \mathcal{A} , we can split up, for every state q of \mathcal{A} , context $c \in C_\Sigma$, and $\xi \in T_\Sigma$, the value $h_{\mathcal{A}}(c[\xi])_q$ into a product of the two factors $h_{\mathcal{A}}(\xi)_{\text{state}(\xi)}$ and $h_{\mathcal{A}}^{\overline{\text{state}(\xi)}}(c)_q$. Lastly, we can prove that the mapping state is surjective.

Lemma 18.1.8. The following two statements hold.

- (1) For each $\xi \in T_\Sigma$, we have $\llbracket \mathcal{A} \rrbracket(\xi) = h_{\mathcal{A}}(\xi)_{\text{state}(\xi)} \otimes F_{\text{state}(\xi)}$.
- (2) For every $\xi \in T_\Sigma$, $c \in C_\Sigma$, and $q \in Q$, we have $h_{\mathcal{A}}(c[\xi])_q = h_{\mathcal{A}}(\xi)_{\text{state}(\xi)} \otimes h_{\mathcal{A}}^{\overline{\text{state}(\xi)}}(c)_q$.
- (3) For each $p \in Q$, there exists a $\xi \in T_\Sigma$ such that $\text{state}(\xi) = p$.

Proof. Proof of (1): It follows immediately from the definition of $\text{state}(\xi)$.

Proof of (2): Let $\xi \in T_\Sigma$, $c \in C_\Sigma$, and $q \in Q$. Then

$$\begin{aligned}
& h_{\mathcal{A}}(c[\xi])_q \\
&= h_{\mathcal{A}}^{\text{state}(\xi)}(c)_q && \text{(by Lemma 18.1.2)} \\
&= h_{\mathcal{A}}^{\text{state}(\xi) \cdot \overline{\text{state}(\xi)}}(c)_q && \text{(because } h_{\mathcal{A}}(\xi) = h_{\mathcal{A}}(\xi)_{\text{state}(\xi)} \cdot \overline{\text{state}(\xi)}\text{)} \\
&= (h_{\mathcal{A}}(\xi)_{\text{state}(\xi)} \cdot h_{\mathcal{A}}^{\overline{\text{state}(\xi)}}(c))_q && \text{(by Lemma 18.1.3)} \\
&= h_{\mathcal{A}}(\xi)_{\text{state}(\xi)} \otimes h_{\mathcal{A}}^{\overline{\text{state}(\xi)}}(c)_q .
\end{aligned}$$

Proof of (3): Let $p \in Q$. Since \mathcal{A} is trim, there exists a state $q \in Q$, a tree $\xi \in T_\Sigma$, and a run $\rho \in R_{\mathcal{A}}(q, \xi)$ such that $\text{wt}(\xi, \rho) \otimes F_q \neq 0$ and $p \in \text{im}(\rho)$. In particular, $\text{wt}(\xi, \rho) \neq 0$ because \mathbf{B} is zero-divisor free.

Let $v \in \text{pos}(\xi)$ be such that $\rho(v) = p$. Then, $\rho|_v \in R_{\mathcal{A}}(p, \xi|_v)$. By Lemma 6.1.2 and the fact that \mathbf{B} is zero-divisor free, we obtain that $\text{wt}(\xi|_v, \xi|_v) \neq 0$. Moreover, by Lemma 4.1.2, we have $\text{wt}(\xi|_v, \xi|_v) = h_{\mathcal{A}}(\xi|_v)_p$. Hence $\text{state}(\xi|_v) = p$. \square

In general, the vector space $\text{VLQ}(\llbracket \mathcal{A} \rrbracket)$ can have several generator sets. We focus on those generator sets which consist of the left quotients of trees which are ‘‘recognized’’ in the states of \mathcal{A} . Formally, a *candidate generator set of* $\text{VLQ}(\llbracket \mathcal{A} \rrbracket)$ is a set

$$\{\zeta_1^{-1} \llbracket \mathcal{A} \rrbracket, \dots, \zeta_\ell^{-1} \llbracket \mathcal{A} \rrbracket\}$$

such that $\zeta_1 \in \text{state}^{-1}(q_1), \dots, \zeta_\ell \in \text{state}^{-1}(q_\ell)$. We note that each candidate generator set of \mathcal{A} has ℓ elements.

Algorithm 4 Computation of a mapping $t : Q \rightarrow T_\Sigma$ such that $t \subseteq \text{state}^{-1}$.

Input: trim and simple (Σ, \mathbf{B}) -wta $\mathcal{A} = (Q, \delta, F)$ **Variables:** $n \in \mathbb{N}$; $t \subseteq Q \times T_\Sigma$ **Output:** $t : Q \rightarrow T_\Sigma$ such that $t \subseteq \text{state}^{-1}$.

```

1:  $t \leftarrow \emptyset$ ;  $n \leftarrow 0$ ;
2: while  $\neg(t$  is a mapping from  $Q$  to  $T_\Sigma)$  do
3:   for each  $\xi \in T_\Sigma$  with  $\text{height}(\xi) = n$  do
4:     if  $t(\text{state}(\xi)) = \emptyset$  then
5:        $t \leftarrow t \cup \{(\text{state}(\xi), \xi)\}$ 
6:     end if
7:   end for
8:    $n \leftarrow n + 1$ 
9: end while
10: return  $t$ 

```

Theorem 18.1.9. Let $\mathbf{B} = (B, \oplus, \otimes, \mathbf{0}, \mathbf{1})$ be a field and Σ be a ranked alphabet. Let \mathcal{A} be a trim and simple (Σ, \mathbf{B}) -wta with state set $Q = \{q_1, \dots, q_\ell\}$. Then the following two statements hold.

- (1) We can construct a candidate generator set of $\text{VLQ}(\llbracket \mathcal{A} \rrbracket)$ with ℓ elements.
- (2) Each candidate generator set of $\text{VLQ}(\llbracket \mathcal{A} \rrbracket)$ generates $\text{VLQ}(\llbracket \mathcal{A} \rrbracket)$. In particular, if $S = \{\zeta_1^{-1} \llbracket \mathcal{A} \rrbracket, \dots, \zeta_\ell^{-1} \llbracket \mathcal{A} \rrbracket\}$ is a candidate generator set of $\text{VLQ}(\llbracket \mathcal{A} \rrbracket)$, then for each element $p \in \text{VLQ}(\llbracket \mathcal{A} \rrbracket)$ of the form

$$p = (b_1 \cdot \xi_1^{-1} \llbracket \mathcal{A} \rrbracket) \oplus \dots \oplus (b_n \cdot \xi_n^{-1} \llbracket \mathcal{A} \rrbracket) ,$$

we have

$$p = \left((b_1 \otimes c_1) \cdot \varphi(\xi_1)^{-1} \llbracket \mathcal{A} \rrbracket \right) \oplus \dots \oplus \left((b_n \otimes c_n) \cdot \varphi(\xi_n)^{-1} \llbracket \mathcal{A} \rrbracket \right)$$

where

- $\varphi : \{\xi_1, \dots, \xi_n\} \rightarrow \{\zeta_1, \dots, \zeta_\ell\}$ is the mapping such that, for each $i \in [n]$, we let $\varphi(\xi_i) = \zeta_j$ if $\text{state}(\xi_i) = \text{state}(\zeta_j)$ and
- for each $i \in [n]$, we let $c_i = \mathbf{h}_{\mathcal{A}}(\xi_i)_{\text{state}(\xi_i)} \otimes \left(\mathbf{h}_{\mathcal{A}}(\varphi(\xi_i))_{\text{state}(\varphi(\xi_i))} \right)^{-1}$.

Proof. Proof of (1): It is easy to see that Algorithm 4 computes a mapping $t : Q \rightarrow T_\Sigma$ such that $t(q) \in \text{state}^{-1}(q)$ for each $q \in Q$. In particular, $\text{state}(\xi)$ in Step 4 can be constructed by Observation 18.1.7. By Lemma 18.1.8(3), the algorithm terminates. By Lemma 18.1.6, we can construct, for each $q \in Q$, the $(\Sigma \cup \{z\}, \mathbf{B})$ -wta \mathcal{B}_q such that $\llbracket \mathcal{B}_q \rrbracket_{C_\Sigma} = t(q)^{-1} \llbracket \mathcal{A} \rrbracket$. Thus, we can construct the set $S = \{t(q)^{-1} \llbracket \mathcal{A} \rrbracket \mid q \in Q\}$. Clearly, S is a candidate generator set of $\text{VLQ}(\llbracket \mathcal{A} \rrbracket)$.

Proof of (2): Let $S = \{\zeta_1^{-1} \llbracket \mathcal{A} \rrbracket, \dots, \zeta_\ell^{-1} \llbracket \mathcal{A} \rrbracket\}$ be a candidate generator set of $\text{VLQ}(\llbracket \mathcal{A} \rrbracket)$ and $p \in \text{VLQ}(\llbracket \mathcal{A} \rrbracket)$ of the form $p = (b_1 \cdot \xi_1^{-1} \llbracket \mathcal{A} \rrbracket) \oplus \dots \oplus (b_n \cdot \xi_n^{-1} \llbracket \mathcal{A} \rrbracket)$. Moreover, let $c \in C_\Sigma$. Then we can calculate as follows.

$$\begin{aligned}
p(c) &= \bigoplus_{i \in [n]} b_i \otimes \llbracket \mathcal{A} \rrbracket(c[\xi_i]) \\
&= \bigoplus_{i \in [n]} b_i \otimes \mathbf{h}_{\mathcal{A}}(c[\xi_i])_{\text{state}(c[\xi_i])} \otimes F_{\text{state}(c[\xi_i])} && \text{(by Lemma 18.1.8(1))} \\
&= \bigoplus_{i \in [n]} b_i \otimes \mathbf{h}_{\mathcal{A}}(\xi_i)_{\text{state}(\xi_i)} \otimes \overline{\mathbf{h}_{\mathcal{A}}^{\text{state}(\xi_i)}}(c)_{\text{state}(c[\xi_i])} \otimes F_{\text{state}(c[\xi_i])} && \text{(by Lemma 18.1.8(2))}
\end{aligned}$$

$$\begin{aligned}
&= \bigoplus_{i \in [n]} b_i \otimes h_{\mathcal{A}}(\xi_i)_{\text{state}(\xi_i)} \otimes \overline{h_{\mathcal{A}}^{\text{state}(\varphi(\xi_i))}}(c)_{\text{state}(c[\varphi(\xi_i)])} \otimes F_{\text{state}(c[\varphi(\xi_i)])} \\
&\quad \text{(because } \text{state}(\xi_i) = \text{state}(\varphi(\xi_i)) \text{ and thus } \text{state}(c[\xi_i]) = \text{state}(c[\varphi(\xi_i)])\text{)} \\
&= \bigoplus_{i \in [n]} b_i \otimes c_i \otimes h_{\mathcal{A}}(\varphi(\xi_i))_{\text{state}(\varphi(\xi_i))} \otimes \overline{h_{\mathcal{A}}^{\text{state}(\varphi(\xi_i))}}(c)_{\text{state}(c[\varphi(\xi_i)])} \otimes F_{\text{state}(c[\varphi(\xi_i)])} \\
&\quad \text{(where } c_i \text{ is defined in the statement of the theorem)} \\
&= \bigoplus_{i \in [n]} b_i \otimes c_i \otimes h_{\mathcal{A}}(c[\varphi(\xi_i)])_{\text{state}(c[\varphi(\xi_i)])} \otimes F_{\text{state}(c[\varphi(\xi_i)])} \quad \text{(by Lemma 18.1.8(2))} \\
&= \bigoplus_{i \in [n]} b_i \otimes c_i \otimes \llbracket \mathcal{A} \rrbracket(c[\varphi(\xi_i)]) \quad \text{(by Lemma 18.1.8(1))} \\
&= \bigoplus_{i \in [n]} b_i \otimes c_i \otimes \varphi(\xi_i)^{-1} \llbracket \mathcal{A} \rrbracket(c) \quad \text{(by definition of left quotient)} \\
&= \bigoplus_{i \in [n]} \left((b_i \otimes c_i) \cdot \varphi(\xi_i)^{-1} \llbracket \mathcal{A} \rrbracket \right)(c) . \quad \square
\end{aligned}$$

Let us apply Theorem 18.1.9 to a particular bu-deterministic wta.

Example 18.1.10. As weight algebra we consider the field $\text{Rat} = (\mathbb{Q}, +, \cdot, 0, 1)$ of rational numbers. As ranked alphabet we consider the string ranked alphabet $\Sigma = \{\sigma^{(2)}, \gamma^{(1)}, \alpha^{(0)}\}$. As (Σ, Rat) -wta \mathcal{A} we consider a slight modification of the (Σ, Nat) -wta of Example 3.2.16). We let $\mathcal{A} = (Q, \delta, F)$ where

- $Q = \{e, o\}$ where e and o stand for “even” and “odd”, respectively,
- $\delta_0(\varepsilon, \alpha, e) = 0$ and $\delta_0(\varepsilon, \alpha, o) = 1$ and for every $q_1, q_2, q \in Q$ we let

$$\delta_1(q_1, \gamma, q) = \begin{cases} 2 & \text{if } (q_1 = e \text{ and } q = o) \text{ or } (q_1 = o \text{ and } q = e) \\ 0 & \text{otherwise,} \end{cases}$$

$$\delta_2(q_1 q_2, \sigma, q) = \begin{cases} 3 & \text{if } (q_1 = q_2 \text{ and } q = o) \text{ or } (q_1 \neq q_2 \text{ and } q = e) \\ 0 & \text{otherwise,} \end{cases}$$

and

- $F_e = 1$ and $F_o = 0$.

We note that \mathcal{A} is simple and trim, but it is not crisp.

Let $\xi \in T_{\Sigma}$ and $q \in Q$. It is clear that

$$h_{\mathcal{A}}(\xi)_q = \begin{cases} 2^{|\text{pos}_{\gamma}(\xi)|} \cdot 3^{|\text{pos}_{\sigma}(\xi)|} & \text{if } ((q = e \text{ and } |\text{pos}(\xi)| \text{ is even}) \text{ or } (q = o \text{ and } |\text{pos}(\xi)| \text{ is odd})) \\ 0 & \text{otherwise} \end{cases}$$

Therefore

$$\text{state}(\xi) = \begin{cases} e & \text{if } |\text{pos}(\xi)| \text{ is even} \\ o & \text{otherwise.} \end{cases}$$

Thus, by Lemma 18.1.8(1), we have

$$\llbracket \mathcal{A} \rrbracket(\xi) = h_{\mathcal{A}}(\xi)_{\text{state}(\xi)} \cdot F_{\text{state}(\xi)} = \begin{cases} 2^{|\text{pos}_{\gamma}(\xi)|} \cdot 3^{|\text{pos}_{\sigma}(\xi)|} & \text{if } |\text{pos}(\xi)| \text{ is even} \\ 0 & \text{otherwise.} \end{cases}$$

We observe that $\text{state}(\alpha) = o$ and $\text{state}(\gamma(\alpha)) = e$. We do not construct the wta \mathcal{A}_o and \mathcal{A}_e , we just conclude that the set $S = \{\alpha^{-1}[\![\mathcal{A}]\!], \gamma(\alpha)^{-1}[\![\mathcal{A}]\!]\}$ is a candidate generator set of $\text{VLQ}([\![\mathcal{A}]\!])$. Due to Theorem 18.1.9(2), S generates $\text{VLQ}([\![\mathcal{A}]\!])$.

Indeed, the set S is even a basis of $\text{VLQ}([\![\mathcal{A}]\!])$. To see this, we have to prove that the vectors $\alpha^{-1}[\![\mathcal{A}]\!]$ and $\gamma(\alpha)^{-1}[\![\mathcal{A}]\!]$ are linearly independent, which can be shown as follows. Let $b_1, b_2 \in \mathbb{Q}$ and

$$b_1 \cdot \alpha^{-1}[\![\mathcal{A}]\!] + b_2 \cdot \gamma(\alpha)^{-1}[\![\mathcal{A}]\!] = \tilde{0} .$$

Since both sides of the equality are mappings in $\mathbb{Q}^{\mathbb{C}^\Sigma}$, we can apply them to a context. By application to the context z , we obtain

$$b_1 \cdot [\![\mathcal{A}]\!](\alpha) + b_2 \cdot [\![\mathcal{A}]\!](\gamma(\alpha)) = b_1 \cdot 0 + b_2 \cdot 2^1 \cdot 3^0 = 2 \cdot b_2 = 0$$

and thus $b_2 = 0$. By application to the context $\gamma(z)$, we obtain

$$b_1 \cdot [\![\mathcal{A}]\!](\gamma(\alpha)) + b_2 \cdot [\![\mathcal{A}]\!](\gamma(\gamma(\alpha))) = b_1 \cdot 2 + 0 \cdot [\![\mathcal{A}]\!](\gamma(\gamma(\alpha))) = 2 \cdot b_1 = 0$$

and thus also $b_1 = 0$. Hence the vectors $\alpha^{-1}[\![\mathcal{A}]\!]$ and $\gamma(\alpha)^{-1}[\![\mathcal{A}]\!]$ are linearly independent, and thus S is a basis of $\text{VLQ}([\![\mathcal{A}]\!])$.

Now let us consider a particular $p \in \text{VLQ}([\![\mathcal{A}]\!])$ and represent it as linear combination of the generators. We let

$$p = \left(b_1 \cdot \sigma(\alpha, \alpha)^{-1}[\![\mathcal{A}]\!] \right) + \left(b_2 \cdot \gamma(\alpha)^{-1}[\![\mathcal{A}]\!] \right) + \left(b_3 \cdot \sigma(\gamma(\alpha), \alpha)^{-1}[\![\mathcal{A}]\!] \right)$$

for some arbitrary $b_1, b_2, b_3 \in \mathbb{Q}$. Then, the mapping φ in Theorem 18.1.9 has the form

$$\begin{aligned} \varphi : \{ \sigma(\alpha, \alpha), \gamma(\alpha), \sigma(\gamma(\alpha), \alpha) \} &\rightarrow \{ \alpha, \gamma(\alpha) \} \quad \text{with} \\ \varphi(\sigma(\alpha, \alpha)) &= \alpha \quad \text{and} \quad \varphi(\gamma(\alpha)) = \varphi(\sigma(\gamma(\alpha), \alpha)) = \gamma(\alpha) , \end{aligned}$$

Thus, due to Theorem 18.1.9 we have that

$$p = \left(b_1 \cdot c_1 \cdot \alpha^{-1}[\![\mathcal{A}]\!] \right) + \left(b_2 \cdot c_2 \cdot \gamma(\alpha)^{-1}[\![\mathcal{A}]\!] \right) + \left(b_3 \cdot c_3 \cdot \gamma(\alpha)^{-1}[\![\mathcal{A}]\!] \right)$$

where

$$\begin{aligned} c_1 &= \mathbf{h}_{\mathcal{A}}(\sigma(\alpha, \alpha))_{\text{state}(\sigma(\alpha, \alpha))} \cdot \left(\mathbf{h}_{\mathcal{A}}(\alpha)_{\text{state}(\alpha)} \right)^{-1} = \mathbf{h}_{\mathcal{A}}(\sigma(\alpha, \alpha))_o \cdot \left(\mathbf{h}_{\mathcal{A}}(\alpha)_o \right)^{-1} = 3 \cdot 1 = 3 \\ c_2 &= \mathbf{h}_{\mathcal{A}}(\gamma(\alpha))_{\text{state}(\gamma(\alpha))} \cdot \left(\mathbf{h}_{\mathcal{A}}(\gamma(\alpha))_{\text{state}(\gamma(\alpha))} \right)^{-1} = 1 \\ c_3 &= \mathbf{h}_{\mathcal{A}}(\sigma(\gamma(\alpha), \alpha))_{\text{state}(\sigma(\gamma(\alpha), \alpha))} \cdot \left(\mathbf{h}_{\mathcal{A}}(\gamma(\alpha))_{\text{state}(\gamma(\alpha))} \right)^{-1} = \mathbf{h}_{\mathcal{A}}(\sigma(\gamma(\alpha), \alpha))_e \cdot \left(\mathbf{h}_{\mathcal{A}}(\gamma(\alpha))_e \right)^{-1} \\ &= 2^1 \cdot 3^1 \cdot (2^1)^{-1} = 2 \cdot 3 \cdot \frac{1}{2} = 3 . \end{aligned}$$

Thus we can write p in the following form:

$$p = \left(3 \cdot b_1 \cdot \alpha^{-1}[\![\mathcal{A}]\!] \right) + \left((b_2 + 3 \cdot b_3) \cdot \gamma(\alpha)^{-1}[\![\mathcal{A}]\!] \right) .$$

□

18.2 The (Σ, \mathbf{B}) -vector space of polynomials

Here we define the (Σ, \mathbf{B}) -vector space of polynomial (Σ, \mathbf{B}) -weighted tree languages, for short: (Σ, \mathbf{B}) -polynomials (cf. Subsection 2.12.1). We will prove that it is initial in the class of all (Σ, \mathbf{B}) -vector spaces.

Formally, we start from the \mathbf{B} -vector space

$$\text{Pol}(\Sigma, \mathbf{B}) = (\text{Pol}(\Sigma, \mathbf{B}), \oplus, \tilde{0})$$

of (Σ, \mathbf{B}) -polynomials via \cdot . The basis of $\text{Pol}(\Sigma, \mathbf{B})$ is the set $\{\mathbf{1}.\xi \mid \xi \in \mathbf{T}_\Sigma\}$.

Then we consider the pair $(\text{Pol}(\Sigma, \mathbf{B}), \text{top})$ where, for each $\sigma \in \Sigma$, the operation $\text{top}(\sigma)$ is the restriction of the top-concatenation top_σ (cf. Section 10.5) to polynomials. Thus, the type of $\text{top}(\sigma)$ is

$$\text{top}(\sigma) : \text{Pol}(\Sigma, \mathbf{B})^k \rightarrow B^{\mathbf{T}_\Sigma} .$$

The combination of $\text{Pol}(\Sigma, \mathbf{B})$ and top is a (Σ, \mathbf{B}) -vector space if the following two requirements are satisfied for each $\sigma \in \Sigma$:

- (a) $\text{im}(\text{top}(\sigma)) \subseteq \text{Pol}(\Sigma, \mathbf{B})$, i.e., $\text{top}(\sigma)$ is an operation on $\text{Pol}(\Sigma, \mathbf{B})$, and
- (b) $\text{top}(\sigma)$ is multilinear.

In the next two lemmas and corollary we prove that these requirements are indeed satisfied.

Lemma 18.2.1. For every $k \in \mathbb{N}$, $\sigma \in \Sigma^{(k)}$, and $s_1, \dots, s_k \in \text{Pol}(\Sigma, \mathbf{B})$ with $s_i = b_{i1}.\xi_{i1} \oplus \dots \oplus b_{in_i}.\xi_{in_i}$ for each $i \in [k]$ and some $n_i \in \mathbb{N}$, $b_{i1}, \dots, b_{in_i} \in B$, and $\xi_{i1}, \dots, \xi_{in_i} \in \mathbf{T}_\Sigma$, we have

$$\text{top}(\sigma)(s_1, \dots, s_k) = \bigoplus_{j_1 \in [n_1], \dots, j_k \in [n_k]} (b_{1j_1} \otimes \dots \otimes b_{kj_k}).\sigma(\xi_{1j_1}, \dots, \xi_{kj_k}) .$$

Thus, in particular, $\text{top}(\sigma)$ is an operation on $\text{Pol}(\Sigma, \mathbf{B})$.

Proof. Let $\xi \in \mathbf{T}_\Sigma$. Then we can calculate as follows.

$$\begin{aligned} & \text{top}(\sigma)(s_1, \dots, s_k)(\xi) \\ &= \begin{cases} s_1(\xi_1) \otimes \dots \otimes s_k(\xi_k) & \text{if } \xi = \sigma(\xi_1, \dots, \xi_k) \\ 0 & \text{otherwise} \end{cases} && \text{(by definition of } \text{top}(\sigma)) \\ &= \begin{cases} b_{1j_1} \otimes \dots \otimes b_{kj_k} & \text{if } (\exists j_1 \in [n_1]) : \xi_1 = \xi_{1j_1}, \dots, \text{ and } (\exists j_k \in [n_k]) : \xi_k = \xi_{kj_k} \\ 0 & \text{otherwise} \end{cases} \\ &= \bigoplus_{j_1 \in [n_1], \dots, j_k \in [n_k]} ((b_{1j_1} \otimes \dots \otimes b_{kj_k}).\sigma(\xi_{1j_1}, \dots, \xi_{kj_k}))(\xi) \\ &= \left(\bigoplus_{j_1 \in [n_1], \dots, j_k \in [n_k]} (b_{1j_1} \otimes \dots \otimes b_{kj_k}).\sigma(\xi_{1j_1}, \dots, \xi_{kj_k}) \right)(\xi) \quad \square \end{aligned}$$

Lemma 18.2.2. For each $\sigma \in \Sigma$, the operation top_σ is multilinear.

Proof. Let $k \in \mathbb{N}$ and $\sigma \in \Sigma^{(k)}$. Moreover, let $s_1, \dots, s_k, s, s' \in B^{\mathbf{T}_\Sigma}$ and $b, b' \in B$. Also let $i \in [k]$ and $\xi \in \mathbf{T}_\Sigma$. Then we can calculate as follows.

$$\begin{aligned} & \text{top}_\sigma(s_1, \dots, s_{i-1}, b \cdot s \oplus b' \cdot s', s_{i+1}, \dots, s_k)(\xi) \\ &= \begin{cases} s_1(\xi_1) \otimes \dots \otimes s_{i-1}(\xi_{i-1}) \otimes (b \cdot s \oplus b' \cdot s')(\xi_i) \otimes s_{i+1}(\xi_{i+1}) \otimes \dots \otimes s_k(\xi_k) & \text{if } \xi = \sigma(\xi_1, \dots, \xi_k) \\ 0 & \text{otherwise} \end{cases} && \text{(by definition of } \text{top}_\sigma) \\ &= \begin{cases} s_1(\xi_1) \otimes \dots \otimes s_{i-1}(\xi_{i-1}) \otimes ((b \cdot s)(\xi_i) \oplus (b' \cdot s')(\xi_i)) \otimes s_{i+1}(\xi_{i+1}) \otimes \dots \otimes s_k(\xi_k) & \text{if } \xi = \sigma(\xi_1, \dots, \xi_k) \\ 0 & \text{otherwise} \end{cases} \\ &= \begin{cases} (s_1(\xi_1) \otimes \dots \otimes s_{i-1}(\xi_{i-1}) \otimes (b \cdot s)(\xi_i) \otimes s_{i+1}(\xi_{i+1}) \otimes \dots \otimes s_k(\xi_k)) \oplus \\ (s_1(\xi_1) \otimes \dots \otimes s_{i-1}(\xi_{i-1}) \otimes (b' \cdot s')(\xi_i) \otimes s_{i+1}(\xi_{i+1}) \otimes \dots \otimes s_k(\xi_k)) & \text{if } \xi = \sigma(\xi_1, \dots, \xi_k) \\ 0 & \text{otherwise} \end{cases} && \text{(by distributivity)} \end{aligned}$$

$$\begin{aligned}
&= \begin{cases} b \otimes (s_1(\xi_1) \otimes \dots \otimes s_{i-1}(\xi_{i-1}) \otimes s(\xi_i) \otimes s_{i+1}(\xi_{i+1}) \otimes \dots \otimes s_k(\xi_k)) \oplus \\ b' \otimes (s_1(\xi_1) \otimes \dots \otimes s_{i-1}(\xi_{i-1}) \otimes s'(\xi_i) \otimes s_{i+1}(\xi_{i+1}) \otimes \dots \otimes s_k(\xi_k)) & \text{if } \xi = \sigma(\xi_1, \dots, \xi_k) \\ 0 & \text{otherwise} \end{cases} \\
&\hspace{15em} \text{(by associativity and commutativity of } \otimes \text{)} \\
&= \begin{cases} b \otimes (s_1(\xi_1) \otimes \dots \otimes s_{i-1}(\xi_{i-1}) \otimes s(\xi_i) \otimes s_{i+1}(\xi_{i+1}) \otimes \dots \otimes s_k(\xi_k)) & \text{if } \xi = \sigma(\xi_1, \dots, \xi_k) \\ 0 & \text{otherwise} \end{cases} \\
&\oplus \begin{cases} b' \otimes (s_1(\xi_1) \otimes \dots \otimes s_{i-1}(\xi_{i-1}) \otimes s'(\xi_i) \otimes s_{i+1}(\xi_{i+1}) \otimes \dots \otimes s_k(\xi_k)) & \text{if } \xi = \sigma(\xi_1, \dots, \xi_k) \\ 0 & \text{otherwise} \end{cases} \\
&= b \otimes \text{top}_\sigma(s_1, \dots, s_{i-1}, s, s_{i+1}, \dots, s_k)(\xi) \oplus b' \otimes \text{top}_\sigma(s_1, \dots, s_{i-1}, s', s_{i+1}, \dots, s_k)(\xi) \\
&= \left(b \cdot \text{top}_\sigma(s_1, \dots, s_{i-1}, s, s_{i+1}, \dots, s_k) \oplus b' \cdot \text{top}_\sigma(s_1, \dots, s_{i-1}, s', s_{i+1}, \dots, s_k) \right)(\xi) . \quad \square
\end{aligned}$$

By Lemmas 18.2.1 and 18.2.2 we immediately obtain the following result.

Corollary 18.2.3. For each $\sigma \in \Sigma$, the operation $\text{top}(\sigma)$ is multilinear.

By Lemma 18.2.1 and Corollary 18.2.3, the pair

$$(\text{Pol}(\Sigma, \mathbf{B}), \text{top}) = (\text{Pol}(\Sigma, \mathbf{B}), \oplus, \tilde{0}, \text{top})$$

is a (Σ, \mathbf{B}) -vector space. We call it the (Σ, \mathbf{B}) -vector space of polynomials. The next lemma shows the significance of this (Σ, \mathbf{B}) -vector space.

Lemma 18.2.4. $(\text{Pol}(\Sigma, \mathbf{B}), \text{top})$ is initial in the class of all (Σ, \mathbf{B}) -vector spaces.

Proof. First we recall from page 44 that $(\text{Pol}(\Sigma, \mathbf{B}), \oplus, \tilde{0}, \text{top})$ is the universal algebra $(\text{Pol}(\Sigma, \mathbf{B}), \eta_{\text{Pol}})$ where

- $I = \{\oplus, \tilde{0}\} \cup \{(b \cdot) \mid b \in B\} \cup \Sigma$,
- $\eta_{\text{Pol}} : I \rightarrow \text{Ops}(\text{Pol}(\Sigma, \mathbf{B}))$ such that
 - $\eta_{\text{Pol}}(\oplus) = \oplus$ and $\eta_{\text{Pol}}(\tilde{0})() = \tilde{0}$,
 - for every $b \in B$ and $r \in \text{Pol}(\Sigma, \mathbf{B})$, we let $\eta_{\text{Pol}}((b \cdot))(r) = b \cdot r$, and
 - for every $k \in \mathbb{N}$ and $\sigma \in \Sigma^{(k)}$, we let $\eta_{\text{Pol}}(\sigma) = \text{top}(\sigma)$.

Now we prove the three properties (a), (b), and (c) of the definition of initial universal algebra on page 23.

(a) Clearly, $(\text{Pol}(\Sigma, \mathbf{B}), \text{top})$ is a member of the class of all (Σ, \mathbf{B}) -vector spaces.

(b) Here we will prove that the universal algebra $(\text{Pol}(\Sigma, \mathbf{B}), \eta_{\text{Pol}})$ is generated by \emptyset , i.e., that $\langle \emptyset \rangle_{\text{im}(\eta_{\text{Pol}})} = \text{Pol}(\Sigma, \mathbf{B})$.

Since $\Sigma^{(0)} \neq \emptyset$, there exists an $\alpha \in \Sigma^{(0)}$. Thus, the weighted tree language

$$\eta_{\text{Pol}}((\emptyset \cdot))(\eta_{\text{Pol}}(\alpha)()) = \eta_{\text{Pol}}((\emptyset \cdot))(\mathbb{1} \cdot \alpha) = \tilde{0}$$

is an element of $\langle \emptyset \rangle_{\text{im}(\eta_{\text{Pol}}) \setminus \{\tilde{0}\}}$. Hence, $\langle \emptyset \rangle_{\text{im}(\eta_{\text{Pol}})} = \langle \emptyset \rangle_{\text{im}(\eta_{\text{Pol}}) \setminus \{\tilde{0}\}}$, i.e., the set $\langle \emptyset \rangle_{\text{im}(\eta_{\text{Pol}})}$ is the smallest set which is closed under $\text{im}(\eta_{\text{Pol}}) \setminus \{\tilde{0}\}$. By Lemma 15.4.1, we have that $\langle \emptyset \rangle_{\text{im}(\eta_{\text{Pol}}) \setminus \{\tilde{0}\}} = \text{Pol}(\Sigma, \mathbf{B})$. Thus we obtain the equality $\langle \emptyset \rangle_{\text{im}(\eta_{\text{Pol}})} = \text{Pol}(\Sigma, \mathbf{B})$.

(c) Let $(V, +, 0, \theta)$ be an arbitrary (Σ, \mathbf{B}) -vector space. We will prove that there is a unique (Σ, \mathbf{B}) -vector space homomorphism from $(\text{Pol}(\Sigma, \mathbf{B}), \text{top})$ to $(V, +, 0, \theta)$.

For this, we define the mapping $h : \text{Pol}(\Sigma, \mathbf{B}) \rightarrow V$ such that, for each $n \in \mathbb{N}$, $b_1, \dots, b_n \in B$, and $\xi_1, \dots, \xi_n \in \mathbb{T}_\Sigma$, we let

$$h(b_1 \cdot \xi_1 \oplus \dots \oplus b_n \cdot \xi_n) = b_1 \cdot h_{(V, \theta)}(\xi_1) + \dots + b_n \cdot h_{(V, \theta)}(\xi_n) , \quad (18.10)$$

where, as usual, $h_{(V,\theta)}$ denotes the unique Σ -algebra homomorphism from $(T_\Sigma, \theta_\Sigma)$ to (V, θ) . Now we prove that h is a (Σ, \mathbf{B}) -vector space homomorphism from $(\text{Pol}(\Sigma, \mathbf{B}), \text{top})$ to $(V, +, 0, \theta)$.

It is obvious that, for every $s, s' \in \text{Pol}(\Sigma)$ and $b \in B$, we have $h(s \oplus s') = h(s) + h(s')$ and that $h(b \cdot s) = b \cdot h(s)$. Thus, h is a linear mapping.

Next we show that h is a Σ -algebra homomorphism from $(\text{Pol}(\Sigma, \mathbf{B}), \text{top})$ to (V, θ) , i.e., for every $k \in \mathbb{N}$, $\sigma \in \Sigma^{(k)}$, and $s_1, \dots, s_k \in \text{Pol}(\Sigma, \mathbf{B})$, we have $h(\text{top}(\sigma)(s_1, \dots, s_k)) = \theta(\sigma)(h(s_1), \dots, h(s_k))$. For this, for each $i \in [k]$, let $s_i = b_{i1} \cdot \xi_{i1} \oplus \dots \oplus b_{in_i} \cdot \xi_{in_i}$ for some $n_i \in \mathbb{N}$, $b_{i1}, \dots, b_{in_i} \in B$ and $\xi_{i1}, \dots, \xi_{in_i} \in T_\Sigma$.

Then we can calculate as follows.

$$\begin{aligned}
& h(\text{top}(\sigma)(s_1, \dots, s_k)) \\
&= h\left(\bigoplus_{j_1 \in [n_1], \dots, j_k \in [n_k]} (b_{1j_1} \otimes \dots \otimes b_{kj_k}) \cdot \sigma(\xi_{1j_1}, \dots, \xi_{kj_k})\right) && \text{(by Lemma 18.2.1)} \\
&= \bigoplus_{j_1 \in [n_1], \dots, j_k \in [n_k]} (b_{1j_1} \otimes \dots \otimes b_{kj_k}) \cdot h_{(V,\theta)}(\sigma(\xi_{1j_1}, \dots, \xi_{kj_k})) \\
&= \bigoplus_{j_1 \in [n_1], \dots, j_k \in [n_k]} (b_{1j_1} \otimes \dots \otimes b_{kj_k}) \cdot \theta(\sigma)(h_{(V,\theta)}(\xi_{1j_1}), \dots, h_{(V,\theta)}(\xi_{kj_k})) \\
&= \theta(\sigma)\left(\bigoplus_{j_1 \in [n_1]} b_{1j_1} \cdot h_{(V,\theta)}(\xi_{1j_1}), \dots, \bigoplus_{j_k \in [n_k]} b_{kj_k} \cdot h_{(V,\theta)}(\xi_{kj_k})\right) && \text{(because } \theta(\sigma) \text{ is multilinear)} \\
&= \theta(\sigma)(h(s_1), \dots, h(s_k)) .
\end{aligned}$$

This proves that h is a Σ -algebra homomorphism. Hence h is a (Σ, \mathbf{B}) -vector space homomorphism.

Next we prove that h is unique. For this, let $g : \text{Pol}(\Sigma, \mathbf{B}) \rightarrow V$ be an arbitrary (Σ, \mathbf{B}) -vector space homomorphism from $(\text{Pol}(\Sigma, \mathbf{B}), \text{top})$ to $(V, +, 0, \theta)$. We will prove that $h = g$. For this let $n \in \mathbb{N}$, $b_1, \dots, b_n \in B$, and $\xi_1, \dots, \xi_n \in T_\Sigma$. Then we can calculate as follows.

$$\begin{aligned}
& h(b_1 \cdot \xi_1 \oplus \dots \oplus b_n \cdot \xi_n) = b_1 \cdot h_{(V,\theta)}(\xi_1) + \dots + b_n \cdot h_{(V,\theta)}(\xi_n) \\
&= b_1 \cdot g(\xi_1) + \dots + b_n \cdot g(\xi_n) \\
& \text{(because (i) } h_{(V,\theta)} \text{ is the unique } \Sigma\text{-algebra homomorphism from } (T_\Sigma, \theta_\Sigma) \text{ to } (V, \theta) \text{ and} \\
& \quad \text{(ii) } g|_{T_\Sigma} \text{ is a } \Sigma\text{-algebra homomorphism of the same type as } h_{(V,\theta)} \\
&= g(b_1 \cdot \xi_1 \oplus \dots \oplus b_n \cdot \xi_n) . && \text{(because } g \text{ is linear)}
\end{aligned}$$

Hence $h = g$. □

18.3 Syntactic congruences and syntactic (Σ, \mathbf{B}) -vector spaces

Here we will factorize the (Σ, \mathbf{B}) -vector space $(\text{Pol}(\Sigma, \mathbf{B}), \text{top})$ of polynomials by particular congruence relations each of which depends on a weighted tree language $r : T_\Sigma \rightarrow B$; more precisely, the congruence is the kernel of the unique (Σ, \mathbf{B}) -vector space homomorphism Φ_r from $(\text{Pol}(\Sigma, \mathbf{B}), \text{top})$ to the (Σ, \mathbf{B}) -vector space $(\text{VLQ}(r), \theta_r)$ (where θ_r is defined below). We will call the mentioned congruence a syntactic congruence and the quotient $(\text{Pol}(\Sigma, \mathbf{B})/\ker(\Phi_r), \text{top}/\ker(\Phi_r))$ a syntactic (Σ, \mathbf{B}) -vector space. In order to formalize this, we need some preparations.

Let $r : T_\Sigma \rightarrow B$. We consider the \mathbf{B} -vector space $\text{VLQ}(r) = (\langle \text{LQ}(r) \rangle, \oplus, \tilde{0})$ (cf. Section 18.1) and extend it into the particular (Σ, \mathbf{B}) -vector space $(\text{VLQ}(r), \theta_r)$ (cf. Section 2.7.7 for the concept of (Σ, \mathbf{B}) -vector space) by using the following observation. Since each \mathbf{B} -vector space has a basis (assuming Zorn's lemma), also $\text{VLQ}(r)$ has a basis, say Q (which need not be finite). Clearly, $Q \subseteq \text{LQ}(r)$. Then, for every

$k \in \mathbb{N}$ and $\sigma \in \Sigma^{(k)}$, we define the mapping $\theta_r(\sigma) : Q^k \rightarrow \text{LQ}(r)$ such that, for every $\eta_1^{-1}r, \dots, \eta_k^{-1}r \in Q$, we let

$$\theta_r(\sigma)(\eta_1^{-1}r, \dots, \eta_k^{-1}r) = \sigma(\eta_1, \dots, \eta_k)^{-1}r .$$

In the canonical way, we extend $\theta_r(\sigma)$ to a k -ary multilinear operation on $\langle \text{LQ}(r) \rangle$, and we denote this extension also by $\theta_r(\sigma)$. Then $(\text{VLQ}(r), \theta_r)$ is a (Σ, \mathbf{B}) -vector space.

By Lemma 18.2.4, the (Σ, \mathbf{B}) -vector space $(\text{Pol}(\Sigma, \mathbf{B}), \text{top})$ is initial in the class of all (Σ, \mathbf{B}) -vector spaces. Hence, there exists a unique (Σ, \mathbf{B}) -vector space from $(\text{Pol}(\Sigma, \mathbf{B}), \text{top})$ to $(\text{VLQ}(r), \theta_r)$. We denote this homomorphism by Φ_r , i.e.,

$$\Phi_r : \text{Pol}(\Sigma, \mathbf{B}) \rightarrow \text{VLQ}(r) \text{ is a } (\Sigma, \mathbf{B})\text{-vector space homomorphism .}$$

In a canonical way, we extend the concept of left quotient of r with respect to ξ to the concept of left quotient of r with respect to a polynomial. Formally, for each (Σ, \mathbf{B}) -polynomial $s = b_1 \cdot \xi_1 \oplus \dots \oplus b_m \cdot \xi_m$ we define the *left quotient of s with respect to r* , denoted by $s^{-1}r$, to be the mapping $s^{-1}r : C_\Sigma \rightarrow B$ defined by

$$s^{-1}r = b_1 \cdot (\xi_1^{-1}r) \oplus \dots \oplus b_m \cdot (\xi_m^{-1}r) .$$

Let $r : T_\Sigma \rightarrow B$ and \sim be a congruence relation on the (Σ, \mathbf{B}) -vector space $(\text{Pol}(\Sigma, \mathbf{B}), \text{top})$. We say that \sim *respects r* if there exists a linear form $\gamma : \text{Pol}(\Sigma, \mathbf{B})/\sim \rightarrow B$ such that $r(\xi) = \gamma([\mathbb{1}, \xi]_\sim)$ for each $\xi \in T_\Sigma$.

The next lemma shows some properties of the (Σ, \mathbf{B}) -vector space homomorphism Φ_r .

Lemma 18.3.1. Let $r : T_\Sigma \rightarrow B$. Then the following three statements hold.

- (1) For each $s \in \text{Pol}(\Sigma, \mathbf{B})$, we have $\Phi_r(s) = s^{-1}r$.
- (2) Φ_r is surjective.
- (3) $\ker(\Phi_r)$ respects r .

Proof. Proof of (1): First, by induction on T_Σ , we prove the following statement.

$$\text{For each } \xi \in T_\Sigma \text{ we have: } h_{(\text{VLQ}(r), \theta_r)}(\xi) = \xi^{-1}r. \quad (18.11)$$

Let $\xi = \sigma(\xi_1, \dots, \xi_k)$. Then we can calculate as follows.

$$\begin{aligned} h_{(\text{VLQ}(r), \theta_r)}(\sigma(\xi_1, \dots, \xi_k)) &= \theta_r(\sigma)(h_{(\text{VLQ}(r), \theta_r)}(\xi_1), \dots, h_{(\text{VLQ}(r), \theta_r)}(\xi_k)) \\ &= \theta_r(\sigma)(\xi_1^{-1}r, \dots, \xi_k^{-1}r) && \text{(by I.H.)} \\ &= (\sigma(\xi_1, \dots, \xi_k))^{-1}r . && \text{(by definition of } \theta_r) \end{aligned}$$

Let $s = b_1 \cdot \xi_1 \oplus \dots \oplus b_n \cdot \xi_n$ be a (Σ, \mathbf{B}) -polynomial. Then we can calculate as follows.

$$\begin{aligned} \Phi_r(s) &= \Phi_r(b_1 \cdot \xi_1 \oplus \dots \oplus b_n \cdot \xi_n) \\ &= b_1 \cdot h_{(\text{VLQ}(r), \theta_r)}(\xi_1) \oplus \dots \oplus b_n \cdot h_{(\text{VLQ}(r), \theta_r)}(\xi_n) && \text{(by (18.10))} \\ &= b_1 \cdot \xi_1^{-1}r \oplus \dots \oplus b_n \cdot \xi_n^{-1}r && \text{(by (18.11))} \\ &= s^{-1}r . \end{aligned}$$

Proof of (2): We let $t = b_1 \cdot \xi_1^{-1}r \oplus \dots \oplus b_n \cdot \xi_n^{-1}r$ be an arbitrary element of $\text{VLQ}(r)$. Then $\Phi_r(b_1 \cdot \xi_1 \oplus \dots \oplus b_n \cdot \xi) = t$. Hence Φ_r is surjective.

Proof of (3): We define the mapping $\gamma : \text{Pol}(\Sigma, \mathbf{B})/\ker(\Phi_r) \rightarrow B$ for each (Σ, \mathbf{B}) -polynomial $s = b_1 \cdot \xi_1 \oplus \dots \oplus b_m \cdot \xi_m$ by $\gamma([s]_{\ker(\Phi_r)}) = b_1 \otimes r(\xi_1) \oplus \dots \oplus b_m \otimes r(\xi_m)$. We show that γ is well defined. For this, let $t = a_1 \cdot \zeta_1 \oplus \dots \oplus a_n \cdot \zeta_n$ be a (Σ, \mathbf{B}) -polynomial such that $\Phi_r(s) = \Phi_r(t)$, i.e., $s^{-1}r = t^{-1}r$. Then, for each $c \in C_\Sigma$, we have $s^{-1}r(c) = t^{-1}r(c)$. This, for $c = z$, yields

$$b_1 \otimes r(\xi_1) \oplus \dots \oplus b_m \otimes r(\xi_m) = a_1 \otimes r(\zeta_1) \oplus \dots \oplus a_n \otimes r(\zeta_n) ,$$

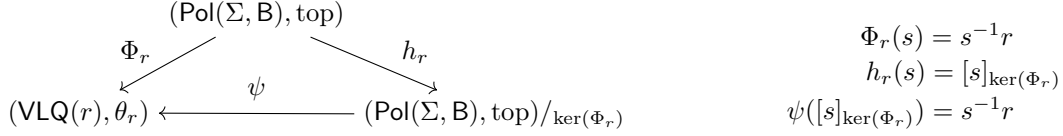

Figure 18.2: Illustration of the relationship between the (Σ, \mathbf{B}) -vector spaces $(\text{Pol}(\Sigma, \mathbf{B}), \text{top})$, $(\text{VLQ}(r), \theta_r)$, and $(\text{Pol}(\Sigma, \mathbf{B}), \text{top}) / \ker(\Phi_r)$.

i.e., $\gamma([s]_{\ker(\Phi_r)}) = \gamma([t]_{\ker(\Phi_r)})$. Obviously, γ is a linear form. Moreover, for each $\xi \in T_\Sigma$, we have $\gamma([\mathbb{1}.\xi]_{\ker(\Phi_r)}) = r(\xi)$. That means that $\ker(\Phi_r)$ respects r . \square

Now let $r : T_\Sigma \rightarrow B$ be a weighted tree language. We recall that Φ_r is the unique (Σ, \mathbf{B}) -vector space homomorphism from $(\text{Pol}(\Sigma, \mathbf{B}), \text{top})$ to $(\text{VLQ}(r), \theta_r)$. Thus, by Theorem 2.7.4, the relation $\ker(\Phi_r)$ is a congruence relation on $(\text{Pol}(\Sigma, \mathbf{B}), \text{top})$. By Lemma 18.3.1(2), the mapping Φ_r is surjective. Hence, by Theorem 2.7.4, the following two structures are isomorphic:

$$(\text{Pol}(\Sigma, \mathbf{B}) / \ker(\Phi_r), \text{top} / \ker(\Phi_r)) \cong (\text{VLQ}(r), \theta_r) . \quad (18.12)$$

In particular, the isomorphism in (18.12) is the mapping

$$\psi : \text{Pol}(\Sigma, \mathbf{B}) / \ker(\Phi_r) \rightarrow \text{VLQ}(r) \quad \text{with} \quad \psi([s]_{\ker(\Phi_r)}) = s^{-1}r . \quad (18.13)$$

Figure 18.2 illustrates the relationship between the involved (Σ, \mathbf{B}) -vector spaces.

We call $\ker(\Phi_r)$ the *syntactic congruence of r* and we call $(\text{Pol}(\Sigma, \mathbf{B}) / \ker(\Phi_r), \text{top} / \ker(\Phi_r))$ the *syntactic (Σ, \mathbf{B}) -vector space of r* . Since $\text{Pol}(\Sigma, \mathbf{B}) = (\text{Pol}(\Sigma, \mathbf{B}), \oplus, \tilde{\mathbb{0}})$, we have

$$(\text{Pol}(\Sigma, \mathbf{B}), \text{top}) / \ker(\Phi_r) = (\text{Pol}(\Sigma, \mathbf{B}) / \ker(\Phi_r), \oplus / \ker(\Phi_r), [\tilde{\mathbb{0}}]_{\ker(\Phi_r)}, \text{top} / \ker(\Phi_r)) .$$

We denote the canonical homomorphism from $\text{Pol}(\Sigma, \mathbf{B})$ to $\text{Pol}(\Sigma, \mathbf{B}) / \ker(\Phi_r)$ by h_r , i.e.,

$$h_r : \text{Pol}(\Sigma, \mathbf{B}) \rightarrow \text{Pol}(\Sigma, \mathbf{B}) / \ker(\Phi_r)$$

defined by $h_r(s) = [s]_{\ker(\Phi_r)}$ for each $s \in \text{Pol}(\Sigma, \mathbf{B})$. Thus, using the isomorphism ψ in (18.13), we have

$$\Phi_r = \psi \circ h_r .$$

In contrast to the unweighted case, the involved congruence relation $\ker(\Phi_r)$ can have an infinite index, although r is (Σ, \mathbf{B}) -recognizable. This case is witnessed by Example 18.3.2.

Example 18.3.2. As in Example 18.1.5, we consider the ranked alphabet $\Sigma = \{\sigma^{(2)}, \gamma^{(1)}, \alpha^{(0)}\}$, the mapping $\#_\gamma : T_\Sigma \rightarrow \mathbb{Q}$ with $\#_\gamma(\xi) = |\text{pos}_\gamma(\xi)|$ for each $\xi \in T_\Sigma$, and the (Σ, Rat) -vector space homomorphism $\Phi_{\#_\gamma}$ from $(\text{Pol}(\Sigma, \text{Rat}), \text{top})$ to $(\text{VLQ}(\#_\gamma), \theta_{\#_\gamma})$. In this example we wish to show the congruence relation $\ker(\Phi_{\#_\gamma})$ explicitly.

As auxiliary tool, we define the mappings $\text{sumc} : \text{Pol}(\Sigma, \text{Rat}) \rightarrow \mathbb{Q}$ and $\text{sum}_\gamma : \text{Pol}(\Sigma, \text{Rat}) \rightarrow \mathbb{Q}$ for each (Σ, Rat) -polynomial

$$s = b_1.\xi_1 + \dots + b_n.\xi_n$$

by

$$\text{sumc}(s) = \bigoplus_{i \in [n]} b_i \quad \text{and} \quad \text{sum}_\gamma(s) = b_1 \cdot \#_\gamma(\xi_1) + \dots + b_n \cdot \#_\gamma(\xi_n) .$$

Then we can prove the following.

$$\ker(\Phi_{\#_\gamma}) = \{(s_1, s_2) \in \text{Pol}(\Sigma, \text{Rat}) \times \text{Pol}(\Sigma, \text{Rat}) \mid \text{sumc}(s_1) = \text{sumc}(s_2) \text{ and } \text{sum}_\gamma(s_1) = \text{sum}_\gamma(s_2)\} \quad (18.14)$$

For this, let

$$\begin{aligned} s_1 &= b_{11} \cdot \xi_{11} + \dots + b_{1n_1} \cdot \xi_{1n_1} \\ s_2 &= b_{21} \cdot \xi_{21} + \dots + b_{2n_2} \cdot \xi_{2n_2} \end{aligned}$$

be two (Σ, Rat) -polynomials. Then we can calculate as follows.

$$\begin{aligned} &\Phi_{\#_\gamma}(s_1) = \Phi_{\#_\gamma}(s_2) \\ \text{iff } &b_{11} \cdot \xi_{11}^{-1} \#_\gamma + \dots + b_{1n_1} \cdot \xi_{1n_1}^{-1} \#_\gamma = b_{21} \cdot \xi_{21}^{-1} \#_\gamma + \dots + b_{2n_2} \cdot \xi_{2n_2}^{-1} \#_\gamma \\ \text{iff } &b_{11} \cdot (1 - \#_\gamma(\xi_{11})) + \dots + b_{1n_1} \cdot (1 - \#_\gamma(\xi_{1n_1})) \\ &= b_{21} \cdot (1 - \#_\gamma(\xi_{21})) + \dots + b_{2n_2} \cdot (1 - \#_\gamma(\xi_{2n_2})) \text{ and} \\ &b_{11} \cdot \#_\gamma(\xi_{11}) + \dots + b_{1n_1} \cdot \#_\gamma(\xi_{1n_1}) = b_{21} \cdot \#_\gamma(\xi_{21}) + \dots + b_{2n_2} \cdot \#_\gamma(\xi_{2n_2}) \\ &\quad \text{(by componentwise comparison of coefficients and by (18.7))} \\ \text{iff } &(b_{11} + \dots + b_{1n_1}) - (b_{11} \cdot \#_\gamma(\xi_{11}) + \dots + b_{1n_1} \cdot \#_\gamma(\xi_{1n_1})) \\ &= (b_{21} + \dots + b_{2n_2}) - (b_{21} \cdot \#_\gamma(\xi_{21}) + \dots + b_{2n_2} \cdot \#_\gamma(\xi_{2n_2})) \text{ and} \\ &b_{11} \cdot \#_\gamma(\xi_{11}) + \dots + b_{1n_1} \cdot \#_\gamma(\xi_{1n_1}) = b_{21} \cdot \#_\gamma(\xi_{21}) + \dots + b_{2n_2} \cdot \#_\gamma(\xi_{2n_2}) \\ \text{iff } &\text{sumc}(s_1) - \text{sum}_\gamma(s_1) = \text{sumc}(s_2) - \text{sum}_\gamma(s_2) \text{ and } \text{sum}_\gamma(s_1) = \text{sum}_\gamma(s_2) \\ \text{iff } &\text{sumc}(s_1) = \text{sumc}(s_2) \text{ and } \text{sum}_\gamma(s_1) = \text{sum}_\gamma(s_2) . \end{aligned}$$

This proves (18.14).

An example of a pair (s_1, s_2) in $\ker(\Phi_{\#_\gamma})$ is

$$\begin{aligned} s_1 &= 4 \cdot \sigma(\gamma(\alpha, \alpha)) + 5 \cdot \alpha \\ s_2 &= 2 \cdot \sigma(\gamma(\alpha), \gamma(\alpha)) + 7 \cdot \alpha , \end{aligned}$$

because $\text{sumc}(s_1) = \text{sumc}(s_2) = 9$ and $\text{sum}_\gamma(s_1) = \text{sum}_\gamma(s_2) = 4$.

In fact, $\ker(\Phi_{\#_\gamma})$ has infinitely many equivalence classes, which can be seen as follows. For each $n \in \mathbb{N}$ there exists a $\xi_n \in T_\Sigma$ with $\text{sum}_\gamma(1 \cdot \xi_n) = n$. Thus, for every $n, m \in \mathbb{N}$ with $n \neq m$, the polynomials $1 \cdot \xi_n$ and $1 \cdot \xi_m$ are in different classes of $\ker(\Phi_{\#_\gamma})$. \square

For each congruence relation \sim on the (Σ, \mathbf{B}) -vector space $(\text{Pol}(\Sigma, \mathbf{B}), \text{top})$ for which the \mathbf{B} -vector space $\text{Pol}(\Sigma, \mathbf{B})/\sim$ is finite-dimensional and which respects a (Σ, \mathbf{B}) -weighted tree language r , there exists a (Σ, \mathbf{B}) -wta such that it recognizes r and the cardinality of its state set is the dimension of $\text{Pol}(\Sigma, \mathbf{B})/\sim$. First we prove that there exists a basis of $\text{Pol}(\Sigma, \mathbf{B})/\sim$ in which the elements have a particular form.

Lemma 18.3.3. Let \sim be a congruence relation on the (Σ, \mathbf{B}) -vector space $(\text{Pol}(\Sigma, \mathbf{B}), \text{top})$ such that the \mathbf{B} -vector space $\text{Pol}(\Sigma, \mathbf{B})/\sim$ is n -dimensional. Then there exists a basis of $\text{Pol}(\Sigma, \mathbf{B})/\sim$ such that each base vector has the form $[1 \cdot \xi]_\sim$ for some $\xi \in T_\Sigma$.

Proof. We abbreviate the equivalence class $[s]_\sim \in \text{Pol}(\Sigma, \mathbf{B})/\sim$ by $[s]$ for each $s \in \text{Pol}(\Sigma, \mathbf{B})$. Let G be a basis. Let G' be the set of vectors obtained by replacing, for each $[s] \in G$ with $[s] = [b_1 \cdot \xi_1 \oplus \dots \oplus b_\ell \cdot \xi_\ell]$, the vector $[s]$ by the vectors $[1 \cdot \xi_1], \dots, [1 \cdot \xi_\ell]$. It is easy to see that G' is a generator set of $\text{Pol}(\Sigma, \mathbf{B})/\sim$. Since $\text{Pol}(\Sigma, \mathbf{B})/\sim$ is n -dimensional, there exist a subset G'' of G' which is linearly independent and has n elements, i.e., G'' is the desired basis. \square

Lemma 18.3.4. Let $r : T_\Sigma \rightarrow B$ and $n \in \mathbb{N}_+$. Moreover, let \sim be a congruence relation on the (Σ, \mathbf{B}) -vector space $(\text{Pol}(\Sigma, \mathbf{B}), \text{top})$ such that (a) the \mathbf{B} -vector space $\text{Pol}(\Sigma, \mathbf{B})/\sim$ is n -dimensional and (b) the congruence relation \sim respects r . Then there exists a (Σ, \mathbf{B}) -wta \mathcal{A}_\sim with n states and with $\llbracket \mathcal{A}_\sim \rrbracket = r$.

Proof. We abbreviate the equivalence class $[\mathbb{1}.\xi]_{\sim}$ by $[\xi]$ for each $\xi \in T_{\Sigma}$. Due to (a), there exists a basis of $\text{Pol}(\Sigma, B)/_{\sim}$ with n elements. By Lemma 18.3.3, we can assume that the basis has the form $Q_{\sim} = \{[\zeta_1], \dots, [\zeta_n]\}$ for some $\zeta_1, \dots, \zeta_n \in T_{\Sigma}$. Let us fix the order $[\zeta_1], \dots, [\zeta_n]$ of the base vectors. Then, for each $\xi \in T_{\Sigma}$ there exist unique $b_1, \dots, b_n \in B$ such that

$$[\xi] = b_1 \cdot [\zeta_1] \oplus_{\sim} \dots \oplus_{\sim} b_n \cdot [\zeta_n] , \quad (18.15)$$

i.e., we express $[\xi]$ as a linear combination of the base vectors $[\zeta_1], \dots, [\zeta_n]$. In this case, for each $i \in [n]$, we denote b_i also by $[\xi]_{[\zeta_i]}$.

Due to (b), there exists a linear form $\gamma : \text{Pol}(\Sigma, B)/_{\sim} \rightarrow B$ such that $\gamma([\xi]) = r(\xi)$ for each $\xi \in T_{\Sigma}$.

We define the (Σ, B) -wta $\mathcal{A}_{\sim} = (Q_{\sim}, \delta_{\sim}, F_{\sim})$ as follows. For every $k \in \mathbb{N}$, $\sigma \in \Sigma^{(k)}$, and $[\zeta_{i_1}], \dots, [\zeta_{i_k}], [\zeta_i] \in Q_{\sim}$, we define

$$(\delta_{\sim})_k([\zeta_{i_1}] \cdots [\zeta_{i_k}], \sigma, [\zeta_i]) = [\sigma(\zeta_{i_1}, \dots, \zeta_{i_k})]_{[\zeta_i]} .$$

Moreover, for each $[\zeta_i] \in Q_{\sim}$, we define $(F_{\sim})_{[\zeta_i]} = \gamma([\zeta_i])$.

The transition mapping $(\delta_{\sim})_k$ is well defined which can be seen as follows. Let $\eta_{i_1}, \dots, \eta_{i_k}, \eta_i \in T_{\Sigma}$ be such that $[\zeta_{i_1}] = [\eta_{i_1}], \dots, [\zeta_{i_k}] = [\eta_{i_k}]$ and $[\zeta_i] = [\eta_i]$. Then $[\sigma(\zeta_{i_1}, \dots, \zeta_{i_k})] = [\sigma(\eta_{i_1}, \dots, \eta_{i_k})]$ because \sim is a congruence relation on the Σ -algebra $(\text{Pol}(\Sigma, B), \text{top})$. Thus

$$\begin{aligned} (\delta_{\sim})_k([\zeta_{i_1}] \cdots [\zeta_{i_k}], \sigma, [\zeta_i]) &= [\sigma(\zeta_{i_1}, \dots, \zeta_{i_k})]_{[\zeta_i]} = [\sigma(\eta_{i_1}, \dots, \eta_{i_k})]_{[\zeta_i]} \\ &= [\sigma(\eta_{i_1}, \dots, \eta_{i_k})]_{[\eta_i]} = (\delta_{\sim})_k([\eta_{i_1}] \cdots [\eta_{i_k}], \sigma, [\eta_i]) , \end{aligned}$$

where the last but one equality follows from $[\zeta_i] = [\eta_i]$.

In general, the wta \mathcal{A}_{\sim} is not bu-deterministic. Indeed, let $k \in \mathbb{N}$, $\sigma \in \Sigma^{(k)}$, and $[\zeta_{i_1}], \dots, [\zeta_{i_k}] \in Q_{\sim}$ be fixed. Moreover, let $b_1, \dots, b_n \in B$ be the coefficients obtained by using (18.15) for $\xi = \sigma(\zeta_{i_1}, \dots, \zeta_{i_k})$. Then, by the definition of $(\delta_{\sim})_k$, for every $i \in [n]$, we have that

$$(\delta_{\sim})_k([\zeta_{i_1}] \cdots [\zeta_{i_k}], \sigma, [\zeta_i]) = b_i .$$

If there exist $i, j \in [k]$ with $b_i \neq 0 \neq b_j$, then we have

$$(\delta_{\sim})_k([\zeta_{i_1}] \cdots [\zeta_{i_k}], \sigma, [\zeta_i]) \neq 0 \quad \text{and} \quad (\delta_{\sim})_k([\zeta_{i_1}] \cdots [\zeta_{i_k}], \sigma, [\zeta_j]) \neq 0 .$$

Hence, in this case, \mathcal{A}_{\sim} is not bu-deterministic.

By induction on T_{Σ} , we can prove the following statement.

$$\text{For each } \xi \in T_{\Sigma}, \text{ we have } h_{\mathcal{A}_{\sim}}(\xi) = [\xi]. \quad (18.16)$$

Let $\xi = \sigma(\xi_1, \dots, \xi_k)$ and $[\zeta_i] \in Q_{\sim}$. Moreover, for each $i \in [k]$, let $b_{i_1}, \dots, b_{i_n} \in B$ such that $[\xi_i] = b_{i_1} \cdot [\zeta_1] \oplus_{\sim} \dots \oplus_{\sim} b_{i_n} \cdot [\zeta_n]$. Then we can calculate as follows.

$$\begin{aligned} & h_{\mathcal{A}_{\sim}}(\sigma(\xi_1, \dots, \xi_k))_{[\zeta_i]} \\ &= \bigoplus_{[\zeta_{i_1}] \cdots [\zeta_{i_k}] \in (Q_{\sim})^k} h_{\mathcal{A}_{\sim}}(\xi_1)_{[\zeta_{i_1}]} \otimes \dots \otimes h_{\mathcal{A}_{\sim}}(\xi_k)_{[\zeta_{i_k}]} \otimes (\delta_{\sim})_k([\zeta_{i_1}] \cdots [\zeta_{i_k}], \sigma, [\zeta_i]) \\ &= \bigoplus_{[\zeta_{i_1}] \cdots [\zeta_{i_k}] \in (Q_{\sim})^k} [\xi_1]_{[\zeta_{i_1}]} \otimes \dots \otimes [\xi_k]_{[\zeta_{i_k}]} \otimes (\delta_{\sim})_k([\zeta_{i_1}] \cdots [\zeta_{i_k}], \sigma, [\zeta_i]) \quad (\text{by I.H.}) \\ &= \bigoplus_{[\zeta_{i_1}] \cdots [\zeta_{i_k}] \in (Q_{\sim})^k} b_{1i_1} \otimes \dots \otimes b_{ki_k} \otimes [\sigma(\zeta_{i_1}, \dots, \zeta_{i_k})]_{[\zeta_i]} \quad (\text{by definition}) \\ &= \left(\bigoplus_{[\zeta_{i_1}] \cdots [\zeta_{i_k}] \in (Q_{\sim})^k} (b_{1i_1} \otimes \dots \otimes b_{ki_k}) \cdot [\sigma(\zeta_{i_1}, \dots, \zeta_{i_k})] \right)_{[\zeta_i]} \end{aligned}$$

$$\begin{aligned}
&= \left(\text{top}/\sim(\sigma)(b_{11} \cdot [\zeta_1] \oplus/\sim \dots \oplus/\sim b_{1n} \cdot [\zeta_n], \dots, b_{k1} \cdot [\zeta_1] \oplus/\sim \dots \oplus/\sim b_{kn} \cdot [\zeta_n]) \right)_{[\zeta_i]} \\
&= \left(\text{top}/\sim(\sigma)([\xi_1], \dots, [\xi_k]) \right)_{[\zeta_i]} \\
&= [\sigma(\xi_1, \dots, \xi_k)]_{[\zeta_i]} .
\end{aligned}$$

This finishes the proof of (18.16).

Now let $\xi \in T_\Sigma$ and let $[\xi] = b_1 \cdot [\zeta_1] \oplus/\sim \dots \oplus/\sim b_n \cdot [\zeta_n]$ be the representation of $[\xi]$ as linear combination of base vectors. Then we can calculate as follows:

$$\begin{aligned}
\llbracket \mathcal{A}_\sim \rrbracket(\xi) &= \bigoplus_{[\zeta_i] \in Q_\sim} h_{\mathcal{A}_\sim}(\xi)_{[\zeta_i]} \otimes (F_\sim)_{[\zeta_i]} \\
&= \bigoplus_{[\zeta_i] \in Q_\sim} b_i \otimes \gamma([\zeta_i]) \\
&\quad \text{(by (18.16), definition of } F_\sim, \text{ and by assumption on the form of } [\xi]) \\
&= \gamma(b_1 \cdot [\zeta_1] \oplus/\sim \dots \oplus/\sim b_n \cdot [\zeta_n]) \quad \text{(because } \gamma \text{ is a linear form)} \\
&= \gamma([\xi]) = r(\xi) . \quad \square
\end{aligned}$$

18.4 The B-A-LB's-theorem and minimality

Now we can prove B-A-LB's-theorem.

Theorem 18.4.1. [BA89, Prop. 2, 3] and [BLB83, Thm. 2.1] *Let Σ be a ranked alphabet. Moreover, let $B = (B, \oplus, \otimes, 0, 1)$ be a field and let $r : T_\Sigma \rightarrow B$. Then the following five statements are equivalent.*

- (A) $r \in \text{Rec}(\Sigma, B)$.
- (B) *There exists a congruence relation \sim on the (Σ, B) -vector space $(\text{Pol}(\Sigma, B), \text{top})$ such that the B -vector space $\text{Pol}(\Sigma, B)/\sim$ is finite-dimensional and \sim respects r .*
- (C) *The B -vector space $\text{Pol}(\Sigma, B)/_{\ker(\Phi_r)}$ is finite-dimensional.*
- (D) *The B -vector space $\text{VRQ}(r)$ is finite-dimensional.*
- (E) *The B -vector space $\text{VLQ}(r)$ is finite-dimensional.*

Proof. Proof of (A) \Rightarrow (E): This follows from Theorem 18.1.4.

Proof of (C) \Leftrightarrow (E): This follows from the fact that the (Σ, B) -vector space homomorphism Φ_r is surjective (cf. Lemma 18.3.1(2)) and Theorem 2.7.4.

Proof of (D) \Leftrightarrow (E): This follows from Theorem 18.1.1.

Proof of (C) \Rightarrow (B): We choose $\sim = \ker(\Phi_r)$. Hence $\text{Pol}(\Sigma, B)/\sim$ is finite-dimensional. By Lemma 18.3.1(3) $\ker(\Phi_r)$ respects r .

Proof of (B) \Rightarrow (A): This follows from Lemma 18.3.4. \square

Let $r : T_\Sigma \rightarrow B$ be a recognizable weighted tree language. By Theorem 18.4.1(A) \Leftrightarrow (C), the B -vector space $\text{Pol}(\Sigma, B)/_{\ker(\Phi_r)}$ is finite-dimensional and by Lemma 18.3.1(3), the congruence relation $\ker(\Phi_r)$ respects r . Hence, by Lemma 18.3.4 (for the congruence relation $\sim = \ker(\Phi_r)$), there exists the (Σ, B) -wta $\mathcal{A}_{\ker(\Phi_r)}$ such that $\llbracket \mathcal{A}_{\ker(\Phi_r)} \rrbracket = r$ and the cardinality of $\mathcal{A}_{\ker(\Phi_r)}$'s state set is the dimension of $\text{Pol}(\Sigma, B)/_{\ker(\Phi_r)}$. The next theorem shows that $\mathcal{A}_{\ker(\Phi_r)}$ is the minimal (Σ, B) -wta which recognizes r .

Theorem 18.4.2. [BA89, Cor. on p.458], [Boz91, Prop. 03] *Let Σ be a ranked alphabet. Moreover, let $B = (B, \oplus, \otimes, 0, 1)$ be a field and let $r : T_\Sigma \rightarrow B$ be (Σ, B) -recognizable. Then the (Σ, B) -wta $\mathcal{A}_{\ker(\Phi_r)}$ is minimal with respect to the number of states among all (Σ, B) -wta which recognize r .*

Proof. Let $\mathcal{A}_{\ker(\Phi_r)} = (Q_{\ker(\Phi_r)}, \delta_{\ker(\Phi_r)}, F_{\ker(\Phi_r)})$. Moreover, let $\mathcal{B} = (Q, \delta, F)$ be an arbitrary (Σ, \mathbf{B}) -wta with $\llbracket \mathcal{B} \rrbracket = r$. Then the following holds:

$$\begin{aligned} |Q_{\ker(\Phi_r)}| &= \dim(\text{Pol}(\Sigma, \mathbf{B}) /_{\ker(\Phi_r)}) && \text{(by the discussion above this lemma)} \\ &= \dim(\text{VLQ}(r)) && \text{(because } (\text{Pol}(\Sigma, \mathbf{B}), \text{top}) /_{\ker(\Phi_r)} \cong (\text{VLQ}(r), \theta_r) \text{ (cf. (18.12)))} \\ &\leq |Q| . && \text{(by Theorem 18.1.4)} \end{aligned}$$

□

Chapter 19

Abstract families of weighted tree languages

In the 60's and 70's of the previous century, Ginsburg, Greibach, and Hopcroft proposed a unifying concept for the study of closure properties of sets of formal languages [GG67, GG69, GGH69, Gin75]. This is the concept of *abstract family of languages* (AFL). Roughly speaking, an AFL is a set of formal languages which is closed under intersection with regular languages, inverse homomorphisms, ε -free homomorphisms, union, concatenation, and Kleene star. An AFL is *full* if it is closed under arbitrary homomorphisms. Of particular interest are principal AFL; an AFL is *principal* if it is generated from one formal language by using the mentioned closure properties. For instance, the sets of regular languages, context-free languages, stack languages, nested-stack languages, and recursively enumerable languages are full principal AFL [GG70, Sec. 2].

The importance of principal AFL shows up in one of the main theorems of AFL-theory [Gin75, Thm. 5.2.1]: a set \mathcal{L} is a full principal AFL if and only if there exists a finitely encoded abstract family of acceptors (AFA) \mathcal{D} such that \mathcal{L} is set of all formal languages accepted by \mathcal{D} . Roughly speaking, an acceptor \mathcal{D} is a one-way nondeterministic finite-state automaton which uses an additional storage (indicated by the type \mathcal{D}) such as, e.g. counter, pushdown, stack, or nested-stack. Thus, in other words, “each family of languages defined by a set of ‘well-behaving’ one-way nondeterministic acceptors of a same ‘type’ is a full principal AFL” (cited from [ESvL80, p. 109]).

In this chapter we define the concept of abstract family of weighted tree languages. It is inspired by the definitions of abstract family of languages [GG67, GG69, GG70, GGH69, Gin75], abstract family of formal power series [KS86], abstract family of fuzzy languages [Asv03] (also cf. [Wec78, Ch. 3]), abstract family of tree series [Kui99a, Thm. 3.5] and [ÉK03, Sect. 7], and sheaf of forests [BR94].

In the rest of this chapter, \mathbf{B} denotes an arbitrary commutative and σ -complete semiring.

Thus, by Theorem 9.2.9, we have that $\text{Rec}(\Sigma, \mathbf{B}) = \text{Reg}(\Sigma, \mathbf{B})$, and, in particular, the closure results developed in Chapter 10 for $\text{Rec}(\Sigma, \mathbf{B})$ also hold for $\text{Reg}(\Sigma, \mathbf{B})$.

In this chapter we follow the notions and definitions in [FV22a]. The main theorem is the following (cf. Theorem 19.4.5): for each $n \in \mathbb{N}$, the set $\text{Reg}(n, \mathbf{B})$ of all (n, \mathbf{B}) -weighted tree languages is the smallest principal abstract family of (n, \mathbf{B}) -weighted tree languages.

19.1 The basic definitions

For each $n \in \mathbb{N}$, an (n, \mathbf{B}) -weighted tree language is a (Σ, \mathbf{B}) -weighted tree language for some ranked alphabet Σ with $\text{maxrk}(\Sigma) \leq n$.

In this chapter we will often consider a set \mathcal{L} of (n, \mathbb{B}) -weighted tree languages and write that “ \mathcal{L} is closed under some operation”, like scalar multiplication, sum, tree concatenations, or weighted projective bimorphisms (wpb). If we consider a binary operation, then we always assume that the two arguments of the operation are based on the same ranked alphabet. For instance, if we write that a set \mathcal{L} of (n, \mathbb{B}) -weighted tree languages is closed under sum, then this means that, for every ranked alphabet Σ with $\text{maxrk}(\Sigma) \leq n$, and $r_1 : T_\Sigma \rightarrow B$ and $r_2 : T_\Sigma \rightarrow B$ in \mathcal{L} , the weighted tree language $r_1 \oplus r_2$ is in \mathcal{L} .

As a consequence of the definition of an (n, \mathbb{B}) -weighted tree language, we have that a regular (n, \mathbb{B}) -weighted tree language is a regular (Σ, \mathbb{B}) -weighted tree language for some ranked alphabet Σ with $\text{maxrk}(\Sigma) \leq n$. We denote the set of all regular (n, \mathbb{B}) -weighted tree languages by $\text{Reg}(n, \mathbb{B})$. That is

$$\text{Reg}(n, \mathbb{B}) = \bigcup (\text{Reg}(\Sigma, \mathbb{B}) \mid \Sigma \text{ is a ranked alphabet such that } \text{maxrk}(\Sigma) \leq n) .$$

Similarly to the unweighted string case, we require that a family of weighted tree languages contains at least one element. Here we let this element be a recognizable step mapping which is unit-valued, one-step, and over a very simple ranked alphabet. Formally, let \mathcal{L} be a set of (n, \mathbb{B}) -weighted tree languages. We call \mathcal{L} a *family of (n, \mathbb{B}) -weighted tree languages* if there exists a ranked alphabet Δ such that

- $\text{maxrk}(\Delta) = n$,
- $|\Delta^{(k)}| = 1$ for each $k \in [0, n]$, and
- $\chi(T_\Delta) \in \mathcal{L}$.

If Δ is such a ranked alphabet, then for each ranked alphabet Σ with $\text{maxrk}(\Sigma) \leq n$ and $\xi \in T_\Sigma$, there exists a unique $\zeta \in T_\Delta$ such that $\text{pos}(\zeta) = \text{pos}(\xi)$. We will exploit this obvious fact later.

Let \mathcal{L} be a family of (n, \mathbb{B}) -weighted tree languages. We call \mathcal{L} an (n, \mathbb{B}) -*tree cone* if it is closed under wpb. (For the definition of wpb, we refer to cf. Section 10.13. For related concepts, we refer to [Ber79, p. 136] for rational cones, to [Kui99a, p. 8] for recognizable tree cones, and to [ÉK03, Sect. 7] for recognizable tree series cones.)

We call \mathcal{L} an *abstract family of (n, \mathbb{B}) -weighted tree languages* (for short: (n, \mathbb{B}) -AFwtL, or just: AFwtL) if \mathcal{L} is an (n, \mathbb{B}) -tree cone which is closed under the rational operations, i.e., under sum, tree concatenations, and Kleene stars.

The above definition of (n, \mathbb{B}) -AFwtL is equivalent to the one in [FV22a] where additionally closure under scalar multiplication was required. However, scalar multiplication of some (Σ, \mathbb{B}) -weighted tree language r with some $b \in B$ can be simulated as the Hadamard product of r and the constant weighted tree language \tilde{b} . In its turn, the Hadamard product of r and \tilde{b} , can be expressed as application $[[\mathcal{H}]]^{\text{tt}}(r)$ for some $(\Sigma, \Sigma, \mathbb{B})$ -wpb \mathcal{H} such that $[[\mathcal{H}]]^{\text{tt}}(\xi, \zeta) = b$ if $\xi = \zeta$, and 0 otherwise (cf. (2.38)). It is obvious how to construct such an \mathcal{H} . Thus, scalar multiplication can be simulated by wpb, and hence closure under scalar multiplication can be neglected in the definition of (n, \mathbb{B}) -AFwtL. We note that the concept of full abstract family of languages [GG67, GG69, GGH69, Gin75] is a particular instance of the concept of AFwtL (cf. [FV22a, Sec. 7]).

Let \mathcal{S} be a set of (n, \mathbb{B}) -weighted tree languages. We denote the smallest (n, \mathbb{B}) -AFwtL which contains \mathcal{S} by $\mathcal{F}(\mathcal{S})$.

Now assume that \mathcal{L} is an (n, \mathbb{B}) -AFwtL. Then it is *principal* if there exists an (n, \mathbb{B}) -weighted tree language $g \in \mathcal{L}$ such that $\mathcal{L} = \mathcal{F}(\{g\})$; and if this is the case, then g is called *generator (of \mathcal{L})*.

19.2 Characterization of tree cones

As defined above, a family of (n, \mathbb{B}) -weighted tree languages is an (n, \mathbb{B}) -tree cone if it is closed under wpb. Here we characterize the property of being an (n, \mathbb{B}) -tree cone by decomposing each wpb into (a) the inverse of a linear and nondeleting tree homomorphism, (b) the Hadamard product with a recognizable weighted tree language, and (c) a linear and nondeleting tree homomorphism. In other words, we make the two homomorphisms and the center language of a wpb explicit (cf. Corollary 19.2.2).

The characterization resembles Nivat's decomposition theorem of gsm [Niv68], Arnold's and Dauchet's bimorphism [AD76, AD82], Ginsburg's decomposition of a-transducers [Gin75, Lm. 3.2.2], and Engelfriet's decomposition of bottom-up tree transducers [Eng75a, Thm. 3.5]. Moreover, it is an instance of [FMV11, Thm. 4.2].

Let $\mathcal{H} = (N, S, R, wt)$ be a (Σ, Ψ, B) -wpb. We recall that \mathcal{H} is a particular $([\Sigma\Psi], B)$ -wrtg and hence, we have defined the $(R, [\Sigma\Psi])$ -tree homomorphism $\pi : T_R \rightarrow T_{[\Sigma\Psi]}$, which extracts from a rule tree the derived $[\Sigma\Psi]$ -tree. Moreover, for the wpb \mathcal{H} , we have defined the $([\Sigma\Psi], \Sigma)$ -tree homomorphism π_1 and the $([\Sigma\Psi], \Psi)$ -tree homomorphism π_2 , which project a $[\Sigma\Psi]$ -tree to its first and second component, respectively. Each of the three tree homomorphisms π , π_1 , and π_2 is linear and nondeleting. Now we compose (a) π and π_1 and (b) π and π_2 , and thereby obtain two linear and nondeleting tree homomorphisms $h_1^{\mathcal{H}}$ and $h_2^{\mathcal{H}}$.

Formally, we define $h_1^{\mathcal{H}} = \pi_1 \hat{\circ} \pi$ and $h_2^{\mathcal{H}} = \pi_2 \hat{\circ} \pi$, where $\hat{\circ}$ is the syntactic composition of tree homomorphisms defined in Section 2.10. For the convenience of the reader, we recall that $h_1^{\mathcal{H}} = ((h_1^{\mathcal{H}})_k \mid k \in \mathbb{N})$ is the (R, Σ) -tree homomorphism and $h_2^{\mathcal{H}} = ((h_2^{\mathcal{H}})_k \mid k \in \mathbb{N})$ is an (R, Ψ) -tree homomorphism such that the following holds.

- For every $k \in \mathbb{N}$ and rule $r = (A \rightarrow [\sigma, \psi](A_1, \dots, A_k))$ with $[\sigma, \psi] \in [\Sigma\Psi]^{(k)}$, we have

$$(h_1^{\mathcal{H}})_k(r) = \begin{cases} \sigma(x_1, \dots, x_k) & \text{if } \sigma \neq \varepsilon \\ x_1 & \text{otherwise} \end{cases} \quad \text{and} \quad (h_2^{\mathcal{H}})_k(r) = \begin{cases} \psi(x_1, \dots, x_k) & \text{if } \psi \neq \varepsilon \\ x_1 & \text{otherwise} \end{cases} .$$

- For each chain-rule $r = (A \rightarrow B)$, we have $(h_1^{\mathcal{H}})_1(r) = x_1$ and $(h_2^{\mathcal{H}})_1(r) = x_1$.

In fact, $h_1^{\mathcal{H}}$ and $h_2^{\mathcal{H}}$ are simple, i.e., linear, nondeleting, alphabetic, and ordered tree homomorphisms. Moreover, by Theorem 2.10.7, we have $h_1^{\mathcal{H}} = \pi_1 \circ \pi$ and $h_2^{\mathcal{H}} = \pi_2 \circ \pi$.

Now we can prove the characterization of wpb reported above. We mention that the composition of weighted tree transformations involved in the following theorem is associative due to Observation 2.12.2. Moreover, we will use the concepts of characteristic mapping and diagonalization as follows (cf. Subsections 2.12.1 and 2.12.2). Since $h_1^{\mathcal{H}}$ and $h_2^{\mathcal{H}}$ are particular binary relations, i.e., $h_1^{\mathcal{H}} \subseteq T_R \times T_\Sigma$ and $h_2^{\mathcal{H}} \subseteq T_R \times T_\Psi$, we can consider the characteristic mappings $\chi((h_1^{\mathcal{H}})^{-1}) : T_\Sigma \times T_R \rightarrow B$ and $\chi(h_2^{\mathcal{H}}) : T_R \times T_\Psi \rightarrow B$. Also we will use the diagonalization $\overline{[\mathcal{H}]}^{\text{wrt}} : T_R \times T_R \rightarrow B$ of $[\mathcal{H}]^{\text{wrt}}$.

Theorem 19.2.1. *Let \mathcal{H} be a (Σ, Ψ, B) -wpb. Then $[\mathcal{H}]^{\text{tt}} = \chi((h_1^{\mathcal{H}})^{-1}); \overline{[\mathcal{H}]}^{\text{wrt}}; \chi(h_2^{\mathcal{H}})$.*

Proof. Let $\xi \in T_\Sigma$ and $\zeta \in T_\Psi$. By the definition of $\text{RT}_{\mathcal{H}}(T_{[\Sigma\Psi]})$ in Section 8.1 (notice the fact that each wpb in a particular weighted context-free grammar) and by (10.50), we have

$$\text{RT}_{\mathcal{H}}(\xi, \zeta) = \{d \in T_R \mid (\xi, \zeta) = (h_1^{\mathcal{H}}(d), h_2^{\mathcal{H}}(d)), d \in \text{RT}_{\mathcal{H}}(T_{[\Sigma\Psi]})\} . \quad (19.1)$$

Then we can calculate as follows.

$$\begin{aligned} [\mathcal{H}]^{\text{tt}}(\xi, \zeta) &= \sum_{d \in \text{RT}_{\mathcal{H}}(\xi, \zeta)}^{\oplus} \text{wt}_{\mathcal{H}}(d) \\ &= \sum_{\substack{d \in T_R: \\ (\xi, \zeta) = (h_1^{\mathcal{H}}(d), h_2^{\mathcal{H}}(d))}}^{\oplus} \text{wt}_{\mathcal{H}}(d) \otimes \chi(\text{RT}_{\mathcal{H}}(T_{[\Sigma\Psi]}))(d) && \text{(by (19.1))} \\ &= \sum_{\substack{d \in T_R: \\ (\xi, \zeta) = (h_1^{\mathcal{H}}(d), h_2^{\mathcal{H}}(d))}}^{\oplus} [\mathcal{H}]^{\text{wrt}}(d) && \text{(by definition of } [\mathcal{H}]^{\text{wrt}}) \\ &= \sum_{d \in T_R}^{\oplus} \chi(h_1^{\mathcal{H}})(d, \xi) \otimes \overline{[\mathcal{H}]}^{\text{wrt}}(d, d) \otimes \chi(h_2^{\mathcal{H}})(d, \zeta) \\ &= \sum_{d, d' \in T_R}^{\oplus} \chi(h_1^{\mathcal{H}})(d, \xi) \otimes \overline{[\mathcal{H}]}^{\text{wrt}}(d, d') \otimes \chi(h_2^{\mathcal{H}})(d', \zeta) && \text{(because } \overline{[\mathcal{H}]}^{\text{wrt}}(d, d') = 0 \text{ if } d \neq d') \end{aligned}$$

$$\begin{aligned}
&= \sum_{d, d' \in T_R}^{\oplus} \chi((h_1^{\mathcal{H}})^{-1})(\xi, d) \otimes \overline{[\mathcal{H}]^{\text{wrt}}}(d, d') \otimes \chi(h_2^{\mathcal{H}})(d', \zeta) \\
&= (\chi((h_1^{\mathcal{H}})^{-1}); \overline{[\mathcal{H}]^{\text{wrt}}}; \chi(h_2^{\mathcal{H}}))(\xi, \zeta) . \quad (\text{by definition of composition, see Subsection 2.12.2})
\end{aligned}$$

□

An n -tree homomorphism is a (Σ, Ψ) -tree homomorphism where Σ and Ψ are ranked alphabets and $\text{maxrk}(\Sigma) \leq n$ and $\text{maxrk}(\Psi) \leq n$. The closure under n -tree homomorphisms and closure under inverse n -tree homomorphisms are defined in a way analogous to the corresponding closure under tree homomorphisms and inverse tree homomorphisms (cf. Sections 10.11 and 10.12).

A set \mathcal{L} of (n, \mathbf{B}) -weighted tree languages is *closed under Hadamard product with recognizable (n, \mathbf{B}) -weighted tree languages* if, for every (Σ, \mathbf{B}) -weighted tree language r in \mathcal{L} and for each recognizable (Σ, \mathbf{B}) -weighted tree language r' , we have $r \otimes r'$ is in \mathcal{L} .

Corollary 19.2.2. Let $\mathbf{B} = (B, \oplus, \otimes, 0, \mathbf{1})$ be a commutative and σ -complete semiring. Let $n \in \mathbb{N}$ and \mathcal{L} be a family of (n, \mathbf{B}) -weighted tree languages. Then the following three statements are equivalent.

- (A) \mathcal{L} is an (n, \mathbf{B}) -tree cone.
- (B) \mathcal{L} is closed under (a) simple n -tree homomorphisms, (b) inverse of simple n -tree homomorphisms, and (c) Hadamard product with recognizable (n, \mathbf{B}) -weighted tree languages.
- (C) \mathcal{L} is closed under (a) simple n -tree homomorphisms, (b) inverse of simple n -tree homomorphisms, and (c) Hadamard product with bu-deterministically recognizable (n, \mathbf{B}) -weighted tree languages.

Proof. Proof of (A) \Rightarrow (B): (a) Let $h = (h_k \mid k \in \mathbb{N})$ be a simple (Σ, Ψ) -tree homomorphism with $\text{maxrk}(\Sigma) \leq n$ and $\text{maxrk}(\Psi) \leq n$. Then we construct the $(\Sigma, \Psi, \mathbf{B})$ -wpb $\mathcal{H} = (N, S, R, wt)$ as follows. We let $N = S = \{A\}$ and, for every $k \in \mathbb{N}$ and $\sigma \in \Sigma^{(k)}$, we have the following.

If $h_k(\sigma) = \psi(x_1, \dots, x_k)$, then $r = (A \rightarrow [\sigma, \psi](A, \dots, A))$ is in R and $wt(r) = \mathbf{1}$.

If $k = 1$ and $h_k(\sigma) = x_1$, then $r = (A \rightarrow [\sigma, \varepsilon](A))$ is in R and $wt(r) = \mathbf{1}$.

It is obvious that $[\mathcal{H}]^{\text{tt}} = \chi(h)$. Since \mathcal{L} is closed under (n, \mathbf{B}) -wpb, we obtain that \mathcal{L} is closed under simple n -tree homomorphisms.

(b) This can be proved in the same way as (a) except that the order of σ and ψ (and σ and ε) in the rules of R are exchanged.

(c) Let $r : T_{\Sigma} \rightarrow B$ be a weighted tree language in \mathcal{L} and \mathcal{A} be a (Σ, \mathbf{B}) -wta. By definition, $\text{maxrk}(\Sigma) \leq n$. By the proof of Corollary 10.13.11, we can construct a $(\Sigma, \Sigma, \mathbf{B})$ -wpb \mathcal{H} such that $[\mathcal{H}]^{\text{tt}} = \overline{[\mathcal{A}]}$, i.e., $[\mathcal{H}]^{\text{tt}}$ is the diagonalization of $[\mathcal{A}]$ (cf. page 63). Then by Equation (2.43) we have $[\mathcal{H}]^{\text{tt}}(r) = r \otimes [\mathcal{A}]$. Since \mathcal{L} is closed under wpb, we can conclude that \mathcal{L} is closed under Hadamard product with recognizable (n, \mathbf{B}) -weighted tree languages.

Proof of (B) \Rightarrow (C): It is obvious.

Proof of (C) \Rightarrow (A): Let $r : T_{\Sigma} \rightarrow B$ be in \mathcal{L} and let \mathcal{H} be a $(\Sigma, \Psi, \mathbf{B})$ -wpb with $\text{maxrk}(\Psi) \leq n$. Let R be the set of rules of \mathcal{H} . By Theorem 19.2.1, we have

$$[\mathcal{H}]^{\text{tt}}(r) = \left(\chi((h_1^{\mathcal{H}})^{-1}); \overline{[\mathcal{H}]^{\text{wrt}}}; \chi(h_2^{\mathcal{H}}) \right)(r)$$

and thus, by Observation 2.12.3, we have

$$[\mathcal{H}]^{\text{tt}}(r) = \chi(h_2^{\mathcal{H}}) \left(\overline{[\mathcal{H}]^{\text{wrt}}} \left(\chi((h_1^{\mathcal{H}})^{-1})(r) \right) \right) .$$

Let us denote the weighted tree language $\chi((h_1^{\mathcal{H}})^{-1})(r)$ by r' . Since \mathcal{L} is closed under inverse of simple n -tree homomorphism, r' is in \mathcal{L} . Then, by Equation (2.43), we have

$$\overline{[\mathcal{H}]^{\text{wrt}}}(r') = r' \otimes [\mathcal{H}]^{\text{wrt}} .$$

By Lemma 11.2.2(2) and Lemma 11.2.3, the weighted tree language $\llbracket \mathcal{H} \rrbracket^{\text{wrt}}$ is bu-deterministically recognizable. Since \mathcal{L} is closed under Hadamard product with bu-deterministically recognizable n -weighted tree languages, we obtain that $\overline{\llbracket \mathcal{H} \rrbracket^{\text{wrt}}}(r')$ is in \mathcal{L} . Let us denote this weighted tree language by r'' . Finally, since \mathcal{L} is closed under simple n -tree homomorphism, the weighted tree language $\chi(h_2^{\mathcal{H}})(r'')$ is in \mathcal{L} . Hence $\llbracket \mathcal{H} \rrbracket^{\text{tt}}(r)$ is in \mathcal{L} . \square

19.3 $\text{Reg}(n, \mathbf{B})$ is an AFwtL

Here we prove that the set of regular (n, \mathbf{B}) -weighted tree languages is an AFwtL. For each $n \in \mathbb{N}$, we define the ranked alphabet Δ_n by

$$\Delta_n = \bigcup_{k \in [0, n]} \Delta_n^{(k)} \quad \text{and} \quad \Delta_n^{(k)} = \{[k]\} \quad \text{for each } k \in [0, n].$$

We note that, for each ranked alphabet Σ with $\text{maxrk}(\Sigma) = n$ for some $n \in \mathbb{N}$, the skeleton alphabet of Σ is a subset of Δ_n , i.e., $[\Sigma] \subseteq \Delta_n$. For the definition of the skeleton alphabet we refer to page 262.

Lemma 19.3.1. [FV22a, Lm. 6.2,6.9] The (Δ_n, \mathbf{B}) -weighted tree language $\chi(\mathbf{T}_{\Delta_n})$ is in $\text{Reg}(n, \mathbf{B})$. Moreover, $\text{Reg}(n, \mathbf{B})$ is a family of (n, \mathbf{B}) -weighted tree languages.

Proof. We construct the (Δ_n, \mathbf{B}) -wrtg $\mathcal{G} = (\{*\}, \{*\}, R, \text{wt})$ such that, for each $k \in [0, n]$, R contains the rule $r = (* \rightarrow [k](*, \dots, *))$ with k occurrences of $*$ in the right-hand side and $\text{wt}(r) = \mathbb{1}$. Since $\llbracket \mathcal{G} \rrbracket = \chi(\mathbf{T}_{\Delta_n})$, we have $\chi(\mathbf{T}_{\Delta_n}) \in \text{Reg}(n, \mathbf{B})$.

Since $\text{maxrk}(\Delta_n) = n$, $|\Delta_n^{(k)}| = 1$ for each $k \in [0, n]$, and $\chi(\mathbf{T}_{\Delta_n}) \in \text{Reg}(n, \mathbf{B})$, we have that $\text{Reg}(n, \mathbf{B})$ is a family of (n, \mathbf{B}) -weighted tree languages. \square

Theorem 19.3.2. [FV22a, Thm. 6.8] $\text{Reg}(n, \mathbf{B})$ is an AFwtL.

Proof. By Lemma 19.3.1, the set $\text{Reg}(n, \mathbf{B})$ is a family of (n, \mathbf{B}) -weighted tree languages.

By Theorem 10.13.9, $\text{Reg}(n, \mathbf{B})$ is closed under wpb, and hence $\text{Reg}(n, \mathbf{B})$ is a tree cone. We note that the image of an (n, \mathbf{B}) -weighted tree language under a wpb is again an (n, \mathbf{B}) -weighted tree language.

Let $r, r_1, r_2, s \in \text{Reg}(\Sigma, \mathbf{B})$ for some ranked alphabet Σ with $\text{maxrk}(\Sigma) \leq n$. Moreover, let $\alpha \in \Sigma^{(0)}$. We require that s is α -proper. By Theorems 10.1.1, 10.6.1, and 10.7.5, the (Σ, \mathbf{B}) -weighted tree languages $r_1 \oplus r_2$, $r_1 \circ_\alpha r_2$, and s_α^* are in $\text{Reg}(\Sigma, \mathbf{B})$, respectively. (We recall that $\text{Rec}(\Sigma, \mathbf{B}) = \text{Reg}(\Sigma, \mathbf{B})$ because we assumed that \mathbf{B} is a σ -complete semiring.) Hence $\text{Reg}(n, \mathbf{B})$ is closed under the rational operations, i.e., under sum, tree concatenations, and Kleene stars. Hence, $\text{Reg}(n, \mathbf{B})$ is an AFwtL. \square

19.4 The AFwtL $\text{Reg}(n, \mathbf{B})$ is principal

We will prove that the (Δ_n, \mathbf{B}) -weighted tree language $\chi(\mathbf{T}_{\Delta_n})$ is the generator of $\text{Reg}(n, \mathbf{B})$.

Lemma 19.4.1. [FV22a, Lm. 6.10] Let \mathcal{G} be a (Σ, \mathbf{B}) -wrtg with $\text{maxrk}(\Sigma) \leq n$. Then there exists a (Δ_n, Σ) -wbp \mathcal{H} such that $\llbracket \mathcal{G} \rrbracket = \llbracket \mathcal{H} \rrbracket^{\text{tt}}(\chi(\mathbf{T}_{\Delta_n}))$.

Proof. Let $\mathcal{G} = (N, S, R, \text{wt})$ with $\text{maxrk}(\Sigma) \leq n$. By Lemma 9.2.3, we can assume that \mathcal{G} is in tree automata form. Thus $[R] = [\Sigma]$ and hence $[R] \subseteq \Delta_n$ (also for $n = 0$).

By Lemma 10.13.6, there exists a chain-free $([R], \Sigma, \mathbf{B})$ -wbp \mathcal{H}' such that $\llbracket \mathcal{G} \rrbracket = \llbracket \mathcal{H}' \rrbracket^{\text{tt}}(\chi(\mathbf{T}_{[R]}))$. Since $[R] \subseteq \Delta_n$, we can view \mathcal{H}' as a $(\Delta_n, \Sigma, \mathbf{B})$ -wbp \mathcal{H} . Obviously, $\llbracket \mathcal{H}' \rrbracket = \llbracket \mathcal{H} \rrbracket|_{\mathbf{T}_{[R]} \times \mathbf{T}_\Sigma}$ and, for each $(b, \xi) \in (\mathbf{T}_{\Delta_n} \times \mathbf{T}_\Sigma) \setminus (\mathbf{T}_{[R]} \times \mathbf{T}_\Sigma)$, we have that $\llbracket \mathcal{H} \rrbracket(b, \xi) = 0$. Thus $\llbracket \mathcal{H}' \rrbracket(\chi(\mathbf{T}_{[R]})) = \llbracket \mathcal{H} \rrbracket(\chi(\mathbf{T}_{\Delta_n}))$. Hence $\llbracket \mathcal{G} \rrbracket = \llbracket \mathcal{H} \rrbracket^{\text{tt}}(\chi(\mathbf{T}_{\Delta_n}))$. \square

Lemma 19.4.2. [FV22a, Lm. 6.11] Let $\text{maxrk}(\Sigma) \leq n$ and $r : T_\Sigma \rightarrow B$. The following statements are equivalent.

- (A) $r \in \text{Reg}(n, B)$.
- (B) There exists a (Δ_n, Σ) -wpb \mathcal{H} such that $r = \llbracket \mathcal{H} \rrbracket^{\text{tt}}(\chi(T_{\Delta_n}))$.
- (C) $r \in \mathcal{F}(\{\chi(T_{\Delta_n})\})$.

Proof. Proof of (A) \Rightarrow (B): This follows from Lemma 19.4.1.

Proof of (B) \Rightarrow (C): This holds by definition of $\mathcal{F}(\{\chi(T_{\Delta_n})\})$.

Proof of (C) \Rightarrow (A): By Theorem 19.3.2, the set $\text{Reg}(n, B)$ is an AFwtL. By Lemma 19.3.1, we have that $\chi(T_{\Delta_n})$ is in $\text{Reg}(n, B)$. Since $\mathcal{F}(\{\chi(T_{\Delta_n})\})$ is the smallest AFwtL containing $\chi(T_{\Delta_n})$, we obtain that $r \in \text{Reg}(n, B)$. \square

The equivalence of (A) and (C) of Lemma 19.4.2 implies the following theorem.

Theorem 19.4.3. [FV22a, Thm. 6.12] *The AFwtL $\text{Reg}(n, B)$ is principal with generator $\chi(T_{\Delta_n})$.*

Next we prove that the set $\text{Reg}(n, B)$ is contained in each (n, B) -tree cone.

Corollary 19.4.4. [FV22a, Cor. 6.13] For each (n, B) -tree cone \mathcal{L} we have $\text{Reg}(n, B) \subseteq \mathcal{L}$.

Proof. Let \mathcal{G} be a (Σ, B) -wrtg with $\text{maxrk}(\Sigma) \leq n$. By Lemma 19.4.1, there exists a (Δ_n, Σ) -wpb \mathcal{H} such that

$$\llbracket \mathcal{G} \rrbracket = \llbracket \mathcal{H} \rrbracket^{\text{tt}}(\chi(T_{\Delta_n})) .$$

Now let \mathcal{L} be an (n, B) -tree cone. Since \mathcal{L} is a family of (n, B) -weighted tree languages, there exists a ranked alphabet Δ such that $\text{maxrk}(\Delta) = n$, $|\Delta^{(k)}| = 1$ for each $k \in [0, n]$, and $\chi(T_\Delta)$ is in \mathcal{L} . The only difference between Δ and Δ_n is the fact that the symbols look different. Let $\langle k \rangle$ denote the unique element in $\Delta^{(k)}$.

We construct the (Δ, Δ_n, B) -wpb $\mathcal{N} = (\{*\}, \{*\}, R, \text{wt})$ such that for each $k \in [0, n]$, the rule

$$* \rightarrow [\langle k \rangle, [k]](*, \dots, *)$$

is in R with k occurrences of $*$. Obviously, $\chi(T_{\Delta_n}) = \llbracket \mathcal{N} \rrbracket^{\text{tt}}(\chi(T_\Delta))$. Hence,

$$\llbracket \mathcal{G} \rrbracket = \llbracket \mathcal{H} \rrbracket^{\text{tt}}(\llbracket \mathcal{N} \rrbracket^{\text{tt}}(\chi(T_\Delta))) .$$

By Theorem 10.13.7, wpb are closed under composition. Hence there exists a (Δ, Σ) -wpb \mathcal{H}' such that

$$\llbracket \mathcal{G} \rrbracket = \llbracket \mathcal{H}' \rrbracket^{\text{tt}}(\chi(T_\Delta)) .$$

Since $\chi(T_\Delta)$ is in \mathcal{L} and \mathcal{L} is an (n, B) -tree cone, we obtain that $\llbracket \mathcal{G} \rrbracket$ is in \mathcal{L} . \square

Theorem 19.4.5. *Let B be a commutative and σ -complete semiring and $n \in \mathbb{N}$. Then $\text{Reg}(n, B)$ is the smallest principal abstract family of (n, B) -weighted tree languages.*

Proof. By Theorem 19.4.3, the set $\text{Reg}(n, B)$ is a principal (n, B) -AFwtL. Now let \mathcal{L} be an arbitrary principal (n, B) -AFwtL. Since, in particular, \mathcal{L} is an (n, B) -tree cone, by Corollary 19.4.4, we have $\text{Reg}(n, B) \subseteq \mathcal{L}$. \square

Other examples of principal abstract families of (n, B) -weighted tree languages are the members of the infinite family $(\text{Reg}(P^\ell, n, B) \mid \ell \in \mathbb{N})$ (cf. [FV22a, Thm. 8.1]). Here $\text{Reg}(P^\ell, n, B)$ is the set of all (n, B) -weighted tree languages which are generated by weighted regular tree grammars with additional storage P^ℓ , the ℓ -iterated pushdown storage [Gre70, Mas76, Eng86]. The particular instance $(\text{Reg}(P^\ell, n, \text{Boole}) \mid \ell \in \mathbb{N})$ is known as the OI-hierarchy [Wan74, Dam82, ES77, ES78, DG82, Eng91], which starts with the set of regular tree languages ($\ell = 0$) and the set of OI context-free tree languages ($\ell = 1$).

Chapter 20

Corollaries and theorems for wta over bounded lattices

In the literature, (Σ, L) -wta have been investigated where L is a bounded lattice (or a bounded lattice with some further restrictions, like distributivity), e.g., [IF75, MM02, ÉL07, BLB10, MZA11, GZ12, GZA12, GZ16, GZ17, Gho18, Gho22] and for the string case [DV10, DV12]; for a survey we refer to [Rah09]. We also refer to [Asv96] for a bibliography on fuzzy automata, grammars, and languages. In this chapter, we will present some part of the theory of wta over bounded lattices which follows from the results of the previous chapters. This attempt is reasonable, due to Observation 2.7.13(2) and (3), i.e.,

- each bounded lattice is a particular bi-locally finite and commutative strong bimonoid, and
- each distributive bounded lattice is a particular locally finite and commutative semiring,

respectively. We will use the above facts without reference in the proofs of the corollaries and theorems in this chapter. For each lattice-oriented result that we present here, we will only refer to the covering strong bimonoid-oriented result of some previous chapter; there the reader can find references to the literature.

In this chapter, $L = (L, \vee, \wedge, 0, 1)$ denotes a bounded lattice.¹

20.1 Definition of wta over bounded lattices

Since a bounded lattice is a particular strong bimonoid, Section 3.1 provides the definition of a (Σ, L) -wta. This definition coincides with the definition of weighted tree automata over bounded lattices as it is given in the literature, e.g. [ÉL07] (apart from notational variations). In the same way, the notions of crisp-deterministic (Σ, L) -wta and bu-deterministic (Σ, L) -wta are defined. The definitions of the run semantics and initial algebra semantics of a (Σ, L) -wta are also given in Section 3.1. For the sake of convenience, we repeat their main parts here.

Let $\mathcal{A} = (Q, \delta, F)$ be a (Σ, L) -wta. We note that, due to (3.1), for each $\xi = \sigma(\xi_1, \dots, \xi_k)$ and $\rho \in R_{\mathcal{A}}(\xi)$, we have

$$\text{wt}_{\mathcal{A}}(\xi, \rho) = \left(\bigwedge_{i \in [k]} \text{wt}_{\mathcal{A}}(\xi_i, \rho|_i) \right) \wedge \delta_k(\rho(1) \cdots \rho(k), \sigma, \rho(\varepsilon)) \quad , \quad (20.1)$$

¹We use the capital letter “L” for the following different meanings: L for some bounded lattice with carrier set L , L_i for some tree language, and $L(A)$ for the tree language recognized by some fta A . It will always be clear from the context which meaning is appropriate.

and the run semantics of \mathcal{A} is defined, for each $\xi \in T_\Sigma$, by

$$\llbracket \mathcal{A} \rrbracket^{\text{run}}(\xi) = \bigvee_{\rho \in \mathcal{R}_{\mathcal{A}}(\xi)} \text{wt}(\xi, \rho) \wedge F_{\rho(\varepsilon)} .$$

Moreover, due to (3.2), the interpretation function $\delta_{\mathcal{A}}$ of the vector algebra $\mathbb{V}(\mathcal{A}) = (L^Q, \delta_{\mathcal{A}})$ is defined, for every $k \in \mathbb{N}$, $\sigma \in \Sigma^{(k)}$, $v_1, \dots, v_k \in L^Q$, and $q \in Q$, by

$$\delta_{\mathcal{A}}(\sigma)(v_1, \dots, v_k)_q = \bigvee_{q_1 \cdots q_k \in Q^k} \left(\bigwedge_{i \in [k]} (v_i)_{q_i} \right) \wedge \delta_k(q_1 \cdots q_k, \sigma, q) . \quad (20.2)$$

We recall that the unique Σ -algebra homomorphism from T_Σ to $\mathbb{V}(\mathcal{A})$ is denoted by $h_{\mathcal{A}}$. Then the initial algebra semantics of \mathcal{A} is defined, for each $\xi \in T_\Sigma$, by

$$\llbracket \mathcal{A} \rrbracket^{\text{init}}(\xi) = \bigvee_{q \in Q} h_{\mathcal{A}}(\xi)_q \wedge F_q .$$

For instance, in [Asv03, ÉL07] and in [Gho22] the initial algebra semantics was used (where L is a σ -complete distributive lattice and a σ -complete orthomodular lattice, respectively). In [Bél02] the run semantics was used (for wsa where L is a complete distributive lattice, cf. the remark on page 286).

As we have seen in Example 5.2.4, there exists a (Σ, N_5) -wta \mathcal{A} such that $\llbracket \mathcal{A} \rrbracket^{\text{run}} \neq \llbracket \mathcal{A} \rrbracket^{\text{init}}$. We recall that \mathcal{A} is not bu-deterministic and that N_5 (cf. Figure 2.4) is not distributive. However, in the following cases run semantics and initial algebra semantics coincide.

Corollary 20.1.1. Let Σ be a ranked alphabet. Moreover, let L be a bounded lattice. For each (Σ, L) -wta \mathcal{A} the following two statements hold.

- (1) If \mathcal{A} is bu-deterministic, then $\llbracket \mathcal{A} \rrbracket^{\text{run}} = \llbracket \mathcal{A} \rrbracket^{\text{init}}$.
- (2) If L is distributive, then $\llbracket \mathcal{A} \rrbracket^{\text{run}} = \llbracket \mathcal{A} \rrbracket^{\text{init}}$.

Proof. Proof of (1) and (2) follows from Theorem 5.3.1 and Corollary 5.3.5(2), respectively. \square

Due to Corollary 20.1.1, for each (Σ, L) -wta \mathcal{A} , if \mathcal{A} is bu-deterministic or L is distributive, then we write $\llbracket \mathcal{A} \rrbracket$ instead of $\llbracket \mathcal{A} \rrbracket^{\text{run}}$ and $\llbracket \mathcal{A} \rrbracket^{\text{init}}$. Moreover, if L is distributive, then for an i -recognizable or r -recognizable weighted tree language r , we say that r is recognizable and we denote the set $\text{Rec}^{\text{run}}(\Sigma, L)$ (and hence, $\text{Rec}^{\text{init}}(\Sigma, L)$) by $\text{Rec}(\Sigma, L)$.

20.2 Crisp-determinization

Corollary 20.2.1. Let Σ be a ranked alphabet. Moreover, let L be a bounded lattice. For each (Σ, L) -wta \mathcal{A} the following statements hold.

- (1) We can construct a crisp-deterministic (Σ, L) -wta \mathcal{B} such that $\llbracket \mathcal{A} \rrbracket^{\text{run}} = \llbracket \mathcal{B} \rrbracket$.
 - (2) If L is locally finite, then we can construct a crisp-deterministic (Σ, L) -wta \mathcal{B} such that $\llbracket \mathcal{A} \rrbracket^{\text{init}} = \llbracket \mathcal{B} \rrbracket$.
- Thus, in particular, $\text{Rec}^{\text{run}}(\Sigma, L) = \text{cd-Rec}(\Sigma, L)$ and, if L is locally finite, then $\text{Rec}^{\text{init}}(\Sigma, L) = \text{cd-Rec}(\Sigma, L)$.

Proof. Proof of (1): Since L is a additively idempotent and multiplicatively locally finite strong bimonoid, we can apply Corollary 12.2.8 and obtain the desired crisp-deterministic (Σ, L) -wta \mathcal{B} with $\llbracket \mathcal{A} \rrbracket^{\text{run}} = \llbracket \mathcal{B} \rrbracket$.

Proof of (2): It follows from Theorem 12.1.3(1).

Finally, the equality of the sets follow from Statements (1) and (2) and the trivial fact that $\text{cd-Rec}(\Sigma, \mathbf{L}) \subseteq \text{Rec}^{\text{run}}(\Sigma, \mathbf{L}) \cap \text{Rec}^{\text{init}}(\Sigma, \mathbf{L})$. \square

Corollary 20.2.1(2) can be applied, e.g., to the locally finite bounded lattice $(\mathbb{N}_\infty, \max, \min, 0, \infty)$. Moreover, it can be applied to each finite lattice and to each distributive bounded lattice.

A direct consequence of Corollary 20.2.1 and Corollary 4.1.7 is the stability of the set of run recognizable weighted tree languages under changing the bounded lattice \mathbf{L}_1 into the bounded lattice \mathbf{L}_2 if \mathbf{L}_1 and \mathbf{L}_2 have the same carrier set (as, e.g., \mathbf{N}_5 and \mathbf{M}_3) and similarly for initial algebra recognizable weighted tree languages over locally finite bounded lattices. Moreover, the expressive power of wta with run semantics over bounded lattices is the same as that of wta with initial algebra semantics over locally finite bounded lattices [Dro22].

Corollary 20.2.2. Let \mathbf{L}_1 and \mathbf{L}_2 be bounded lattices with the same carrier set. Then the following three statements hold.

- (1) $\text{Rec}^{\text{run}}(\Sigma, \mathbf{L}_1) = \text{cd-Rec}(\Sigma, \mathbf{L}_1) = \text{cd-Rec}(\Sigma, \mathbf{L}_2) = \text{Rec}^{\text{run}}(\Sigma, \mathbf{L}_2)$.
- (2) If \mathbf{L}_1 and \mathbf{L}_2 are locally finite, then $\text{Rec}^{\text{init}}(\Sigma, \mathbf{L}_1) = \text{cd-Rec}(\Sigma, \mathbf{L}_1) = \text{cd-Rec}(\Sigma, \mathbf{L}_2) = \text{Rec}^{\text{init}}(\Sigma, \mathbf{L}_2)$.
- (3) If \mathbf{L}_2 is locally finite, then $\text{Rec}^{\text{run}}(\Sigma, \mathbf{L}_1) = \text{Rec}^{\text{init}}(\Sigma, \mathbf{L}_2)$.

Proof. Proof of (1): The equalities $\text{Rec}^{\text{run}}(\Sigma, \mathbf{L}_1) = \text{cd-Rec}(\Sigma, \mathbf{L}_1)$ and $\text{cd-Rec}(\Sigma, \mathbf{L}_2) = \text{Rec}^{\text{run}}(\Sigma, \mathbf{L}_2)$ follow from Corollary 20.2.1. The equality $\text{cd-Rec}(\Sigma, \mathbf{L}_1) = \text{cd-Rec}(\Sigma, \mathbf{L}_2)$ follows from Corollary 4.1.7 (and Theorem 5.3.1, and the convention on page 143).

Proof of (2): This proof is analogous to the proof of (1).

Proof of (3): By (1) we have $\text{Rec}^{\text{run}}(\Sigma, \mathbf{L}_1) = \text{cd-Rec}(\Sigma, \mathbf{L}_2)$. Then, by (2), we obtain $\text{Rec}^{\text{run}}(\Sigma, \mathbf{L}_1) = \text{Rec}^{\text{init}}(\Sigma, \mathbf{L}_2)$. \square

We recall from Section 2.17 that a (Σ, \mathbf{L}) -weighted tree language r is a recognizable step mapping if there exist $n \in \mathbb{N}_+$, $b_1, \dots, b_n \in L$, and recognizable Σ -tree languages L_1, \dots, L_n such that

$$r = \bigvee_{i \in [n]} b_i \cdot \chi(L_i) .$$

The expression $b_i \cdot \chi(L_i)$ denotes the scalar multiplication of b_i and $\chi(L_i)$ (see Section 2.8) and is defined, for each $\xi \in T_\Sigma$, by $(b_i \cdot \chi(L_i))(\xi) = b_i \wedge \chi(L_i)(\xi)$.

Corollary 20.2.3. Let Σ be a ranked alphabet. Moreover, let $\mathbf{L} = (L, \vee, \wedge, 0, \mathbb{1})$ be a bounded lattice. For each (Σ, \mathbf{L}) -wta \mathcal{A} , the following statements hold.

- (1) $\llbracket \mathcal{A} \rrbracket^{\text{run}}$ is a recognizable step mapping.
- (2) If \mathbf{L} is locally finite, then $\llbracket \mathcal{A} \rrbracket^{\text{init}}$ is a recognizable step mapping.

Moreover, in (1) we can construct $n \in \mathbb{N}_+$, $b_1, \dots, b_n \in L$, and Σ -fta A_1, \dots, A_n such that $\llbracket \mathcal{A} \rrbracket^{\text{run}} = \bigvee_{i \in [n]} b_i \cdot \chi(\mathbf{L}(A_i))$. The same holds for $\llbracket \mathcal{A} \rrbracket^{\text{init}}$ in (2).

Proof. The proof follows from Corollary 20.2.1 and Theorem 10.3.1 (A) \Leftrightarrow (B). \square

Corollary 20.2.4. Let Σ be a ranked alphabet. Moreover, let $\mathbf{L} = (L, \vee, \wedge, 0, \mathbb{1})$ be a bounded lattice and let $r : T_\Sigma \rightarrow L$. Then the following four statements are equivalent.

- (A) We can construct a (Σ, \mathbf{L}) -wta \mathcal{A} such that $r = \llbracket \mathcal{A} \rrbracket^{\text{run}}$.
- (B) r is a recognizable step mapping and we can construct $n \in \mathbb{N}_+$, $b_1, \dots, b_n \in L$ and Σ -fta A_1, \dots, A_n such that $r = \bigvee_{i=1}^n b_i \cdot \chi(\mathbf{L}(A_i))$.

Moreover, if \mathbf{L} is distributive, then $\llbracket \mathcal{A} \rrbracket^{\text{run}}$ in condition (A) can be replaced by $\llbracket \mathcal{A} \rrbracket$.

Proof. Proof of (A) \Rightarrow (B): This follows from Corollary 20.2.3(1) and Theorem 10.3.1(A) \Rightarrow (B).

Proof of (B) \Rightarrow (A): By Theorem 10.3.1(B) \Rightarrow (A), we can construct a crisp-deterministic (Σ, L) -wta \mathcal{A} such that $r = \llbracket \mathcal{A} \rrbracket$. By the convention on page 448, $\llbracket \mathcal{A} \rrbracket$ is an abbreviation of $\llbracket \mathcal{A} \rrbracket^{\text{run}}$.

Let L be distributive. Then the statement follows from Corollary 20.1.1(2). \square

20.3 Relationship between several sets of recognizable weighted tree languages

Here we study the relationship between several sets of r -recognizable, i -recognizable, or crisp-deterministically recognizable weighted tree languages where the weight algebra is a bounded lattice, locally finite bounded lattice, distributive bounded lattice, or finite chain. By combining these modes of recognizability and weight algebras, we obtain twelve sets of recognizable weighted tree languages.

It will turn out that eleven of the twelve sets are equal; let us denote this set by C . The exception is the set of i -recognizable weighted tree languages over bounded lattices. Moreover, we show that C is a subset of the latter set and, if the ranked alphabet is large enough, then the inclusion is strict. Thus, roughly speaking, using initial algebra semantics over bounded lattices, one can specify strictly more weighted tree languages than using another combination. The results of this section are taken from [FV24].

More precisely, we consider the set

$$\mathcal{Q} = \{\text{Rec}^y(\Sigma, Z) \mid y \in \{\text{run}, \text{init}\}, Z \in \{\text{BL}, \text{lfBL}, \text{dBL}, \text{FC}\}\} \cup \{\text{cd-Rec}(\Sigma, Z) \mid Z \in \{\text{BL}, \text{lfBL}, \text{dBL}, \text{FC}\}\},$$

where

- $\text{BL}, \text{lfBL}, \text{dBL}, \text{FC}$ denote the sets of bounded lattices, locally finite bounded lattices, distributive bounded lattices, and finite chains,
- $\text{Rec}^y(\Sigma, Z) = \bigcup_{L \in Z} \text{Rec}^y(\Sigma, L)$, i.e., the set of all mappings $r : T_\Sigma \rightarrow L$ where L is the carrier set of some $L \in Z$ and r is a y -recognizable (Σ, L) -weighted tree language, and
- $\text{cd-Rec}(\Sigma, Z) = \bigcup_{L \in Z} \text{cd-Rec}(\Sigma, L)$, i.e., the set of all mappings $r : T_\Sigma \rightarrow L$ where L is the carrier set of some $L \in Z$ and r is a crisp-deterministically recognizable (Σ, L) -weighted tree language.

Our goal is to present the inclusion diagram of \mathcal{Q} (cf. Theorem 20.3.5), i.e., the Hasse diagram of \mathcal{Q} with set inclusion as partial order.

By definition we have $\text{FC} \subset \text{dBL}$ and by Observation 2.7.16, we have $\text{dBL} \subset \text{lfBL} \subset \text{BL}$. Thus

$$\text{for each } y \in \{\text{run}, \text{init}\}, \text{ we have } \text{Rec}^y(\Sigma, \text{FC}) \subseteq \text{Rec}^y(\Sigma, \text{dBL}) \subseteq \text{Rec}^y(\Sigma, \text{lfBL}) \subseteq \text{Rec}^y(\Sigma, \text{BL}) \quad (20.3)$$

and we have

$$\text{cd-Rec}(\Sigma, \text{FC}) \subseteq \text{cd-Rec}(\Sigma, \text{dBL}) \subseteq \text{cd-Rec}(\Sigma, \text{lfBL}) \subseteq \text{cd-Rec}(\Sigma, \text{BL}). \quad (20.4)$$

In Figure 20.1 (ignoring the ovals for the time being) we show all the twelve elements of \mathcal{Q} , organized according to their known subset relationships; these relationships follow from (a) Equations (20.3) and (20.4), (b) the trivial fact that each crisp-deterministic wta is a wta, and (c) Theorem 5.3.1. We note that this is not a Hasse diagram; in particular, the edges do not show strict inclusions but merely inclusions.

From the trivial fact that $\text{cd-Rec}(\Sigma, \text{BL}) \subseteq \text{Rec}^{\text{run}}(\Sigma, \text{BL}) \cap \text{Rec}^{\text{init}}(\Sigma, \text{lfBL})$ and from Corollary 20.2.1, we directly obtain four equalities (corresponding to the four ovals in Figure 20.1)

Corollary 20.3.1. [FV24] The following four statements hold.

- (1) $\text{Rec}^{\text{run}}(\Sigma, \text{BL}) = \text{cd-Rec}(\Sigma, \text{BL})$.
- (2) $\text{Rec}^{\text{run}}(\Sigma, \text{lfBL}) = \text{cd-Rec}(\Sigma, \text{lfBL}) = \text{Rec}^{\text{init}}(\Sigma, \text{lfBL})$.
- (3) $\text{Rec}^{\text{run}}(\Sigma, \text{dBL}) = \text{cd-Rec}(\Sigma, \text{dBL}) = \text{Rec}^{\text{init}}(\Sigma, \text{dBL})$.
- (4) $\text{Rec}^{\text{run}}(\Sigma, \text{FC}) = \text{cd-Rec}(\Sigma, \text{FC}) = \text{Rec}^{\text{init}}(\Sigma, \text{FC})$. \square

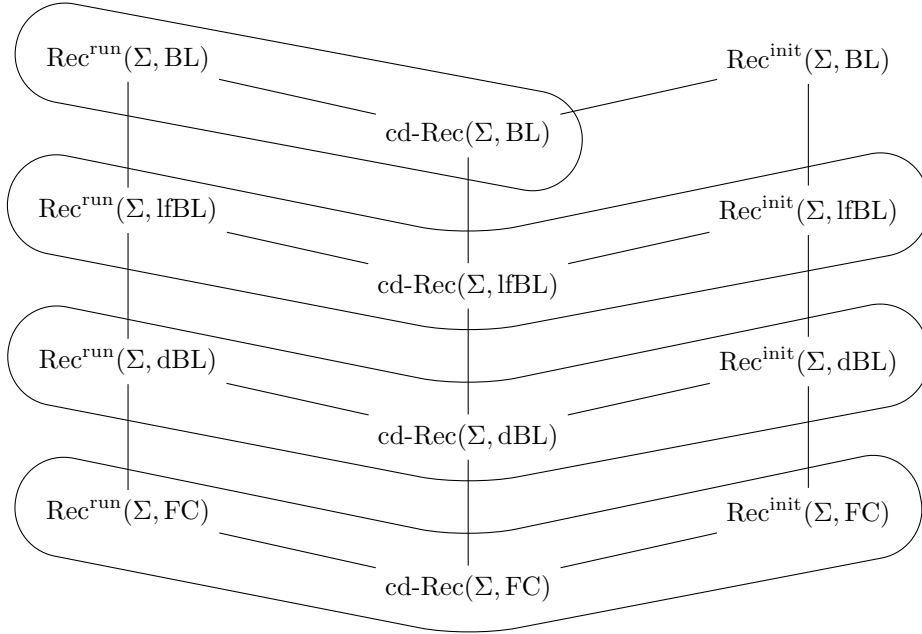

Figure 20.1: Illustration of some of the set inclusions (vertical and diagonal lines) and some of the equalities (ovals) of the elements of \mathcal{Q} .

Next we prove that $\text{cd-Rec}(\Sigma, \text{BL}) \subseteq \text{cd-Rec}(\Sigma, \text{FC})$.

Lemma 20.3.2. [Dro22] [FV24] For every crisp-deterministic (Σ, \mathbb{L}) -wta \mathcal{A} we can construct a finite chain \mathbb{L}' with carrier set $\text{wts}(\mathcal{A}) \cup \{0\}$ and a crisp-deterministic (Σ, \mathbb{L}') -wta \mathcal{B} such that $\llbracket \mathcal{A} \rrbracket = \llbracket \mathcal{B} \rrbracket$. Thus, in particular, $\text{cd-Rec}(\Sigma, \text{BL}) \subseteq \text{cd-Rec}(\Sigma, \text{FC})$.

Proof. Let $\mathcal{A} = (Q, \delta, F)$. We note that $\mathbb{1} \in \text{wts}(\mathcal{A})$ because $\Sigma^{(0)} \neq \emptyset \neq Q$ and \mathcal{A} is crisp-deterministic. We construct the finite chain $\mathbb{L}' = (\text{wts}(\mathcal{A}) \cup \{0\}, \leq, 0, \mathbb{1})$ where \leq is an arbitrary linear order on $\text{wts}(\mathcal{A}) \cup \{0\}$. It is obvious that, for the crisp-deterministic (Σ, \mathbb{L}') -wta $\mathcal{B} = (Q, \delta, F)$, we have $\llbracket \mathcal{A} \rrbracket = \llbracket \mathcal{B} \rrbracket$. This also proves that $\text{cd-Rec}(\Sigma, \text{BL}) \subseteq \text{cd-Rec}(\Sigma, \text{FC})$. \square

From the previous results, we obtain an intermediate answer to our goal.

Corollary 20.3.3. [FV24] Let $\mathcal{Q}' = \mathcal{Q} \setminus \{\text{Rec}^{\text{init}}(\Sigma, \text{BL})\}$, i.e., \mathcal{Q}' is the set with the following eleven elements:

- $\text{Rec}^{\text{run}}(\Sigma, \text{BL}), \text{Rec}^{\text{run}}(\Sigma, \text{lfBL}), \text{Rec}^{\text{run}}(\Sigma, \text{dBL}), \text{Rec}^{\text{run}}(\Sigma, \text{FC}),$
- $\text{Rec}^{\text{init}}(\Sigma, \text{lfBL}), \text{Rec}^{\text{init}}(\Sigma, \text{dBL}), \text{Rec}^{\text{init}}(\Sigma, \text{FC}),$ and
- $\text{cd-Rec}(\Sigma, \text{BL}), \text{cd-Rec}(\Sigma, \text{lfBL}), \text{cd-Rec}(\Sigma, \text{dBL}),$ and $\text{cd-Rec}(\Sigma, \text{FC}).$

Then all elements of \mathcal{Q}' are equal.

Proof. By Lemma 20.3.2, $\text{cd-Rec}(\Sigma, \text{BL}) \subseteq \text{cd-Rec}(\Sigma, \text{FC})$. Hence, by the inclusions shown in Figure 20.1 and Corollary 20.3.1, all elements of \mathcal{Q}' are equal. \square

Next we prove that $\text{Rec}^{\text{init}}(\Sigma, \text{BL}) \setminus \text{Rec}^{\text{init}}(\Sigma, \text{lfBL}) \neq \emptyset$ under some mild conditions on Σ . For this, we consider the bounded lattice $\text{FL}(2+2)$ in Example 2.7.15(9).

Lemma 20.3.4. (cf. [FV24]) If Σ is branching, then we can construct a $(\Sigma, \text{FL}(2+2))$ -wta \mathcal{A} such that $\llbracket \mathcal{A} \rrbracket^{\text{init}} \notin \text{Rec}^{\text{init}}(\Sigma, \text{lfBL})$. In particular, for such a Σ we have $\text{Rec}^{\text{init}}(\Sigma, \text{BL}) \setminus \text{Rec}^{\text{init}}(\Sigma, \text{lfBL}) \neq \emptyset$.

Proof. We consider the finite set $A = \{a, b, c, d\}$ of generators of $\text{FL}(2+2)$ (cf. Figure 2.5). Since $b \vee d = \mathbb{1}$ and $a \wedge c = \mathbb{0}$ and $\text{FL}(2+2)$ is generated by A , we have $\langle A \rangle_{\{\vee, \wedge, \mathbb{0}, \mathbb{1}\}} = \langle A \rangle_{\{\vee, \wedge\}} = \text{FL}(2+2)$, which is an infinite set. By Theorem 4.3.2, we can construct a $(\Sigma, \text{FL}(2+2))$ -wta \mathcal{A} such that $\text{im}(\llbracket \mathcal{A} \rrbracket^{\text{init}}) = \langle A \rangle_{\{\vee, \wedge, \mathbb{0}, \mathbb{1}\}}$, i.e., $\text{im}(\llbracket \mathcal{A} \rrbracket^{\text{init}})$ is an infinite set.

On the other hand, by Corollary 20.2.3, each element $r \in \text{Rec}^{\text{init}}(\Sigma, \text{lfBL})$ is a recognizable step mapping, and hence $\text{im}(r)$ is finite. Thus $\llbracket \mathcal{A} \rrbracket^{\text{init}} \notin \text{Rec}^{\text{init}}(\Sigma, \text{lfBL})$. \square

From Corollary 20.3.3, the fact that $\text{Rec}^{\text{init}}(\Sigma, \text{lfBL}) \subseteq \text{Rec}^{\text{init}}(\Sigma, \text{BL})$, and Lemma 20.3.4 we obtain the final picture of the Hasse diagram for \mathcal{Q} .

Theorem 20.3.5. (cf. [FV24]) *Let Σ be a ranked alphabet. Moreover, let*

$$\mathcal{Q} = \{\text{Rec}^y(\Sigma, Z) \mid y \in \{\text{run}, \text{init}\}, Z \in \{\text{BL}, \text{lfBL}, \text{dBL}, \text{FC}\}\} \cup \{\text{cd-Rec}(\Sigma, Z) \mid Z \in \{\text{BL}, \text{lfBL}, \text{dBL}, \text{FC}\}\}.$$

Then the following three statements hold.

- (1) $\text{Rec}^{\text{run}}(\Sigma, \text{BL}) = \text{Rec}^{\text{run}}(\Sigma, \text{lfBL}) = \text{Rec}^{\text{run}}(\Sigma, \text{dBL}) = \text{Rec}^{\text{run}}(\Sigma, \text{FC}) = \text{Rec}^{\text{init}}(\Sigma, \text{lfBL}) = \text{Rec}^{\text{init}}(\Sigma, \text{dBL}) = \text{Rec}^{\text{init}}(\Sigma, \text{FC}) = \text{cd-Rec}(\Sigma, \text{BL}) = \text{cd-Rec}(\Sigma, \text{lfBL}) = \text{cd-Rec}(\Sigma, \text{dBL}) = \text{cd-Rec}(\Sigma, \text{FC})$. We denote this set by C .
- (2) $C \subseteq \text{Rec}^{\text{init}}(\Sigma, \text{BL})$.
- (3) If Σ is branching, then we have $C \subset \text{Rec}^{\text{init}}(\Sigma, \text{BL})$. In this case, the Hasse diagram for \mathcal{Q} with set inclusion as partial order consists of the two nodes C and $\text{Rec}^{\text{init}}(\Sigma, \text{BL})$.

20.4 Support

Corollary 20.4.1. Let Σ be a ranked alphabet. Moreover, let L be a bounded lattice. For each (Σ, L) -wta \mathcal{A} the following statements hold.

- (1) The Σ -tree language $\text{supp}(\llbracket \mathcal{A} \rrbracket^{\text{run}})$ is recognizable.
- (2) If L is locally finite, then the Σ -tree language $\text{supp}(\llbracket \mathcal{A} \rrbracket^{\text{init}})$ is recognizable.

Moreover, for the tree language $\text{supp}(\llbracket \mathcal{A} \rrbracket^{\text{run}})$ in (1), we can construct a Σ -fta which recognizes that tree language. The same holds for the tree languages $\text{supp}(\llbracket \mathcal{A} \rrbracket^{\text{init}})$ in (2).

Proof. Proof of (1) and (2): They follow from Corollary 14.2.1(3) and (2), respectively. We note that (1) also follows from Theorem 14.2.10(a) because L is zero-sum free.

Now consider the tree language $\text{supp}(\llbracket \mathcal{A} \rrbracket^{\text{run}})$ in (1). By Corollary 20.2.1(1), we can construct a crisp-deterministic (Σ, L) -wta \mathcal{B} such that $\llbracket \mathcal{A} \rrbracket^{\text{run}} = \llbracket \mathcal{B} \rrbracket$. Then $\text{supp}(\llbracket \mathcal{A} \rrbracket^{\text{run}}) = T_\Sigma \setminus \llbracket \mathcal{B} \rrbracket^{-1}(\mathbb{0})$. By Theorem 10.3.1(C), we can construct a Σ -fta which recognizes $\llbracket \mathcal{B} \rrbracket^{-1}(\mathbb{0})$. Finally, it is easy to construct a Σ -fta which recognizes the complement tree language $T_\Sigma \setminus \llbracket \mathcal{B} \rrbracket^{-1}(\mathbb{0})$ (cf. e.g. [GS84, Thm. 2.4.2]).

By using Theorem 14.2.12, we can give an alternative proof for the constructability of a Σ -fta which recognizes $\text{supp}(\llbracket \mathcal{A} \rrbracket^{\text{run}})$ in (1). Moreover, by using Corollary 20.2.1(2) and Theorem 10.3.1(C), we can give an alternative proof for the constructability a Σ -fta which recognizes $\text{supp}(\llbracket \mathcal{A} \rrbracket^{\text{init}})$ in (2). \square

20.5 Closure results

Here we instantiate the closure results of Chapter 10 to the particular case where L is a (distributive) bounded lattice (cf. Figure 10.18 for the more general cases).

Corollary 20.5.1. Let Σ be a ranked alphabet. Moreover, let \mathbf{L} be a bounded lattice. The following statements hold.

- (1) The sets $\text{Rec}^{\text{run}}(\Sigma, \mathbf{L})$ and $\text{Rec}^{\text{init}}(\Sigma, \mathbf{L})$ are closed under sum (cf. Theorem 10.1.1).
- (2) If \mathbf{L} is distributive, then the set $\text{Rec}(\Sigma, \mathbf{L})$ is closed under
 - scalar multiplications (cf. Theorem 10.2.1),
 - Hadamard product (cf. Theorem 10.4.1),
 - top-concatenations (cf. Corollary 10.5.2),
 - tree concatenations (cf. Corollary 10.6.2),
 - Kleene stars (cf. Corollary 10.7.7), and
 - yield-intersection (cf. Theorem 10.8.2).
- (3) The sets $\text{Rec}^{\text{run}}(\Sigma, _)$ and $\text{Rec}^{\text{init}}(\Sigma, _)$ are closed under homomorphisms between two bounded lattices (cf. Theorem 10.9.2).
- (4) The set $\text{Rec}^{\text{run}}(_, \mathbf{L})$ is closed under
 - tree relabelings (cf. Theorem 10.10.1) and
 - linear, nondeleting, and productive tree homomorphisms (cf. Corollary 10.11.2).
- (5) If \mathbf{L} is distributive, then the set $\text{Rec}(_, \mathbf{L})$ is closed under
 - inverse of linear tree homomorphisms (cf. Theorem 10.12.2),
 - weighted projective bimorphisms (cf. Corollary 10.13.10).

20.6 Characterization by rational operations

We recall that an operation on the set of (Σ, \mathbf{L}) -weighted tree languages is a rational operation if it is the sum, a tree concatenation, or a Kleene star. Moreover, the set of rational (Σ, \mathbf{L}) -weighted tree languages, denoted by $\text{Rat}(\Sigma, \mathbf{L})$, is the smallest set of (Σ, \mathbf{L}) -weighted tree languages which contains each polynomial (Σ, \mathbf{L}) -weighted tree language and is closed under the rational operations.

Due to the need for extra symbols at which tree concatenation can take place (cf. [TW68, Sect. 3]), we have introduced in Section 15.1 the concept of 0-extension and defined the sets of extended rational (Σ, \mathbf{L}) -weighted tree languages, denoted by $\text{Rat}(\Sigma, \mathbf{L})^{\text{ext}}$, and the set of extended recognizable (Σ, \mathbf{L}) -weighted tree languages, denoted by $\text{Rec}(\Sigma, \mathbf{L})^{\text{ext}}$, which formalize these extensions.

Then Theorem 15.1.2 implies the following Kleene theorem for distributive bounded lattices.

Corollary 20.6.1. Let Σ be a ranked alphabet. Moreover, let \mathbf{L} be a distributive bounded lattice. Then

$$\text{Rec}(\Sigma, \mathbf{L})^{\text{ext}} = \text{Rat}(\Sigma, \mathbf{L})^{\text{ext}} .$$

20.7 Characterization by elementary operations

Since \mathbf{L} is a bounded lattice, we can show that, the notions of representable, restricted representable, and \times -restricted representable (as defined in Chapter 16 for an arbitrary strong bimonoid) coincide. This results in Médvédév's theorem for wta over bounded lattices (cf. Corollary 20.7.1). Its proof follows from Theorem 16.3.1 and the fact that each bounded lattice is a bi-locally finite strong bimonoid.

Corollary 20.7.1. Let Σ be a ranked alphabet. Moreover, let $\mathbf{L} = (L, \vee, \wedge, \mathbf{0}, \mathbf{1})$ be a bounded lattice and let $r : T_\Sigma \rightarrow L$. Then the following four statements are equivalent.

- (A) We can construct a (Σ, \mathbf{L}) -wta \mathcal{A} such that $r = \llbracket \mathcal{A} \rrbracket^{\text{run}}$.
- (B) We can construct an $e \in \text{RepEx}(\Sigma, \mathbf{L})$ such that $r = \llbracket e \rrbracket$.
- (C) We can construct an $e \in \text{RepEx}^r(\Sigma, \mathbf{L})$ such that $r = \llbracket e \rrbracket$.
- (D) We can construct an $e \in \text{RepEx}^{\times r}(\Sigma, \mathbf{L})$ such that $r = \llbracket e \rrbracket$.

20.8 Characterization by weighted MSO-logic

In this situation where \mathbf{L} is a bounded lattice, we can prove that run recognizability of a (Σ, \mathbf{L}) -weighted tree language is equivalent to its definability in $\text{MSO}^{\text{ext}}(\Sigma, \mathbf{L})$, and the transformations from wta to formula and vice versa are constructive (cf. Corollary 20.8.1). We recall the syntax of the formulas in $\text{MSO}^{\text{ext}}(\Sigma, \mathbf{L})$ from Section 17.4. It was given by the following EBNF with nonterminal e :

$$e ::= H(\kappa) \mid (\varphi \triangleright e) \mid (e + e) \mid (e \times e) \mid \vdash_x e \mid \vdash_X e \mid \times_x e \mid \times_X e . \quad (20.5)$$

In particular, no restriction is needed on the use of weighted conjunction, weighted first-order universal quantification, and weighted second-order universal quantification.

Since each bounded lattice is a commutative and bi-locally finite strong bimonoid, the proof of the next corollary follows from Theorem 17.4.21.

Corollary 20.8.1. Let Σ be a ranked alphabet. Moreover, let $\mathbf{L} = (L, \vee, \wedge, \mathbf{0}, \mathbf{1})$ be a bounded lattice and let $r : T_\Sigma \rightarrow L$. Then the following four statements are equivalent.

- (A) We can construct a (Σ, \mathbf{L}) -wta \mathcal{B} such that $r = \llbracket \mathcal{B} \rrbracket^{\text{run}}$.
- (B) We can construct a (Σ, \mathbf{L}) -recognizable step formula e such that $\text{Free}(e) = \emptyset$ and $r = \llbracket e \rrbracket$.
- (C) We can construct a sentence $e \in \text{MSO}(\Sigma, \mathbf{L})$ such that $r = \llbracket e \rrbracket$.
- (D) We can construct a sentence $e \in \text{MSO}^{\text{ext}}(\Sigma, \mathbf{L})$ such that $r = \llbracket e \rrbracket$.

20.9 Abstract families of weighted tree languages

In Chapter 19 we have defined and investigated abstract families of weighted tree languages over commutative and σ -complete semirings. Since each σ -complete lattice is a commutative and σ -complete semiring, we can immediately apply the main result of that chapter (cf. Theorem 19.4.5) to the case of σ -complete lattices.

For this, we recall that, for each $n \in \mathbb{N}$, an (n, \mathbf{L}) -weighted tree language is a (Σ, \mathbf{L}) -weighted tree language for some ranked alphabet Σ with $\text{maxrk}(\Sigma) \leq n$, and $\text{Reg}(n, \mathbf{L})$ denotes the set of all regular (n, \mathbf{L}) -weighted tree languages. Moreover, a family \mathcal{L} of (n, \mathbf{L}) -weighted tree languages is an abstract family of (n, \mathbf{L}) -weighted tree languages if \mathcal{L} is an (n, \mathbf{L}) -tree cone which is closed under the rational operations, i.e., under sum, tree concatenations, and Kleene stars.

Corollary 20.9.1. Let \mathbf{L} be a σ -complete lattice and $n \in \mathbb{N}$. Then $\text{Reg}(n, \mathbf{L})$ is the smallest principal abstract family of (n, \mathbf{L}) -weighted tree languages.

Bibliography

- [AB87] A. Alexandrakis and S. Bozapalidis. Weighted grammars and Kleene’s theorem. *Inform. Process. Lett.*, 24(1):1–4, 1987.
- [AD76] A. Arnold and M. Dauchet. Bi-transductions de forêts. In S. Michaelson and R. Milner, editors, *3rd Int. Coll. Automata, Languages and Programming (ICALP 1976)*, pages 74–86. Edinburgh University Press, 1976.
- [AD82] A. Arnold and M. Dauchet. Morphismes et bimorphismes d’arbres. *Theoret. Comput. Sci.*, 20(1):33–93, 1982.
- [AG20] C. Aiswarya and P. Gastin. Weighted tiling systems for graphs: Evaluation complexity. In N. Saxena and S. Simon, editors, *40th IARCS Annual Conference on Foundations of Software Technology and Theoretical Computer Science (FSTTCS 2020)*, volume 182 of *Leibniz International Proceedings in Informatics (LIPIcs)*, pages 34:1–34:17, Dagstuhl, Germany, 2020. Schloss Dagstuhl–Leibniz-Zentrum für Informatik.
- [AHU74] A.V. Aho, J.E. Hopcroft, and J.D. Ullman. *The Design and Analysis of Computer Algorithms*. Addison-Wesley, 1974.
- [Asv96] P.R.J. Asveld. A bibliography on fuzzy automata, grammars and languages. *Bulletin of the European Association for Theoretical Computer Science*, 58:187–196, 1996.
- [Asv03] P.R.J. Asveld. Algebraic aspects of families of fuzzy languages. *Theoret. Comput. Sci.*, 293(2):417–445, 2003.
- [BA89] S. Bozapalidis and A. Alexandrakis. Représentation matricielles de séries d’arbre reconnaissables. *Informatique théorique et applications*, 23(4):449–459, 1989.
- [Bak79] B.S. Baker. Composition of top-down and bottom-up tree transductions. *Inf. Control*, 41(2):186–213, 1979.
- [BC87] M. Bauderon and B. Courcelle. Graph expressions and graph rewritings. *Math. Syst. Theory*, 20(1):83–127, 1987.
- [BDZ15] J. Björklund, F. Drewes, and N. Zechner. An efficient best-trees algorithm for weighted tree automata over the tropical semiring. In A.-H. Dediu, E. Formenti, C. Martin-Vide, and B. Truthe, editors, *9th Int. Conf. on Language and Automata Theory and Applications (LATA 2015)*, volume 8977 of *Lecture Notes in Computer Science*, pages 97–108. Springer, 2015.
- [Bě102] R. Bělohlávek. Determinism and fuzzy automata. *Information Sciences*, 143:205–209, 2002.
- [Bě108] R. Bělohlávek. personal communication, 2008.
- [Ber79] J. Berstel. *Transductions and Context-Free Languages*. Teubner Stuttgart, 1979.

- [BF12] M. Büchse and A. Fischer. Deciding the twins property for weighted tree automata over extremal semifields. In *Workshop on Applications of Tree Automata Techniques in Natural Language Processing (ATANLP 2012)*. Association for Computational Linguistics, 2012.
- [BFGM05] B. Borchardt, Z. Fülöp, Z. Gazdag, and A. Maletti. Bounds for tree automata with polynomial costs. *J. Autom. Lang. Comb.*, 10:107–157, 2005.
- [BG05] S. Bozapalidis and A. Grammatikopoulou. Recognizable picture series. *J. Autom. Lang. Comb.*, 10(2–3):159–183, 2005.
- [BGMZ10] B. Bollig, P. Gastin, B. Monmege, and M. Zeitoun. Pebble weighted automata and transitive closure logics. In S. Abramsky, F. Meyer auf der Heide, and P. Spirakis, editors, *37th Int. Colloquium on Automata, Languages and Programming (ICALP 2010) – Part II*, volume 6199 of *Lecture Notes in Computer Science*, pages 587–598. Springer, 2010.
- [BGMZ14] B. Bollig, P. Gastin, B. Monmege, and M. Zeitoun. Pebble weighted automata and weighted logics. *ACM Transactions on Computational Logic*, 15(2), 2014.
- [Bir67] G. Birkhoff. *Lattice Theory*, volume 25 of *Colloquium Publications*. American Mathematical Society, 1967. 3rd edition.
- [Bir93] G. Birkhoff. *Lattice Theory*, volume 25 of *Colloquium Publications*. American Mathematical Society, 1993. 3rd edition.
- [BLB83] S. Bozapalidis and O. Louscou-Bozapalidou. The rank of a formal tree power series. *Theoret. Comput. Sci.*, 27:211–215, 1983.
- [BLB10] S. Bozapalidis and O. Louscou-Bozapalidou. Fuzzy tree language recognizability. *Fuzzy Sets and Systems*, 161:716–734, 2010.
- [Bli65] A.J. Blikle. Ú.T. Médvédév. O klassé sobytij, dopuskaúših prédstavleníé v konéčnom avtomaté (On a class of events representable in a finite automaton). *Avtomaty, Izdatél'stvo Inostrannoj Litératury, Moscow 1956*, pp. 385–401. *J. Symb. Logic*, 30(3):381–382, 1965.
- [BM15] B. Balle and M. Mohri. Learning weighted automata. In A. Maletti, editor, *6th Int. Conf. on Algebraic Informatics (CAI 2015)*, volume 9270 of *Lecture Notes in Computer Science*, pages 1–21. Springer, 2015.
- [BMŠ+06] B. Borchardt, A. Maletti, B. Šešelja, A. Tepavčević, and H. Vogler. Cut sets as recognizable tree languages. *Fuzzy Sets and Systems*, 157(11):1560–1571, 2006.
- [BN98] F. Baader and T. Nipkow. *Term Rewriting and All That*. Cambridge University Press, 1998.
- [Bor03] B. Borchardt. The Myhill-Nerode theorem for recognizable tree series. In *7th Int. Conf. on Developments in Language Theory (DLT)*, volume 2710 of *LNCS*, pages 146–158, 2003.
- [Bor04] B. Borchardt. A pumping lemma and decidability problems for recognizable tree series. *Acta Cybern.*, 16(4):509–544, 2004.
- [Bor05] B. Borchardt. *The Theory of Recognizable Tree Series*. Verlag für Wissenschaft und Forschung, 2005. (PhD thesis, 2004, Technische Universität Dresden, Germany).
- [Bor24] S. Borgwardt. personal communication. Technische Universität Dresden, 2024.
- [Boz91] S. Bozapalidis. Effective construction of the syntactic algebra of a recognizable series on trees. *Acta Inform.*, 28:351–363, 1991.
- [Boz94] S. Bozapalidis. Representable tree series. *Fundamenta Informaticae*, 21:367–389, 1994.

- [Boz99] S. Bozapalidis. Equational elements in additive algebras. *Theory Comput. Syst.*, 32(1):1–33, 1999.
- [BP11] S. Borgwardt and R. Peñaloza. The Inclusion Problem for Weighted Automata on Infinite Trees. In P. Dömösi and I. Szabolcs, editors, *13th Int. Conf. on Automata and Formal Languages (AFL 2011)*, pages 108–122, Debrecen, Hungary, 2011. College of Nyíregyháza.
- [BPS61] Y. Bar–Hillel, M. Perles, and E. Shamir. On Formal Properties of Simple Phrase Structure Grammars. *Z. Phonetik. Sprach. Komm.*, 14:143–172, 1961.
- [BR82] J. Berstel and C. Reutenauer. Recognizable formal power series on trees. *Theoret. Comput. Sci.*, 18(2):115–148, 1982.
- [BR88] J. Berstel and Ch. Reutenauer. *Rational Series and Their Languages*, volume 12 of *EATCS Monographs on Theoretical Computer Science*. Springer-Verlag, 1988.
- [BR94] S. Bozapalidis and G. Rahonis. On two families of forests. *Acta Inform.*, 31(3):235–260, 1994.
- [Bra69] W.S. Brainerd. Tree generating regular systems. *Inf. Control*, 14(2):217–231, 1969.
- [BS81] S. Burris and H.P. Sankappanavar. *A Course in Universal Algebra*, volume 78 of *Graduate Texts in Mathematics*. Springer-Verlag, New York, first edition, 1981. Corrected version available at <http://www.thoralf.uwaterloo.ca/htdocs/ualg.html>.
- [Büc60] J.R. Büchi. Weak second-order arithmetic and finite automata. *Zeitschr. f. math. Logik und Grundlagen der Math.*, 6:66–92, 1960.
- [Büc14] M. Büchse. *Algebraic decoder specification: coupling formal-language theory and statistical machine translation*. PhD thesis, Technische Universität Dresden, Germany, 2014.
- [Buy13] J.M. Buys. Probabilistic tree transducers for grammatical error correction, 2013. Master thesis, Computer Science Division, Department of Mathematical Sciences, University of Stellenbosch, South Africa.
- [BV03] B. Borchardt and H. Vogler. Determinization of finite state weighted tree automata. *J. Autom. Lang. Comb.*, 8(3):417–463, 2003.
- [BVM10] M. Büchse, H. Vogler, and J. May. Determinization of weighted tree automata using factorizations. *J. Autom. Lang. Comb.*, 15(3-4):229–254, 2010.
- [BVN14] M. Büchse, H. Vogler, and M. Nederhof. Tree parsing for tree-adjointing machine translation. *J. Logic and Comput.*, 24(2):351–373, 2014.
- [Car71] B. A. Carré. An algebra for network routing problems. *IMA J. Applied Math.*, 7(3):273–294, 1971.
- [CDG⁺07] H. Comon, M. Dauchet, R. Gilleron, F. Jacquemard, D. Lugiez, S. Tison, and M. Tommasi. Tree automata techniques and applications, 2007.
- [CDIV10] M. Ćirić, M. Droste, J. Ignjatović, and H. Vogler. Determinization of weighted finite automata over strong bimonoids. *Inform. Sci.*, 180(18):3497–3520, 2010.
- [CE12] B. Courcelle and J. Engelfriet. *Graph Structure and Monadic Second-Order Logic: A Language-Theoretic Approach*, volume 138 of *Encyclopedia of Mathematics and its Applications*. Cambridge University Press, 2012.
- [CLR90] T.H. Cormen, C.E. Leiserson, and R.L. Rivest. *Introduction to Algorithms*. The MIT Press, 1990.

- [CMMR21] A. Chattopadhyay, F. Mazowiecki, A. Muscholl, and C. Riveros. Pumping lemmas for weighted automata, 2021. arXiv.2001.06272.
- [Cos72] O.L. Costich. A Medvedev characterization of sets recognized by generalized finite automata. *Mathematical Systems Theory*, 6(1-2):263–267, 1972.
- [CS63] N. Chomsky and M.P. Schützenberger. The algebraic theory of context-free languages. In P. Braffort and D. Hirschberg, editors, *Computer Programming and Formal Systems*, volume 35 of *Studies in Logic and the Foundations of Mathematics*, pages 118–161. North-Holland, Amsterdam, 1963.
- [Cz 19] G. Cz dli. personal communication. 2019.
- [Dam82] W. Damm. The IO- and OI-hierarchies. *Theoret. Comput. Sci.*, 20:95–208, 1982.
- [Ded39] R. Dedekind. *Was sind und was sollen die Zahlen?* Friedr. Vieweg & Sohn, Braunschweig, 1939.
- [D L18] M. Droste, Z.  sik, and K. Larsen, editors. *Special issue on Quantitative Models and Weighted Automata*. Springer, 2018. *Soft Computing*, (22)4, 2018.
- [Den17] T. Denkinger. zigzag is not bottom-up-deterministically recognizable. personal communications, 2017.
- [DFG16] M. Droste, Z. F l p, and D. G tze. A Kleene theorem for weighted tree automata over tree valuation monoids. In A.-H. Dediu, J. Janou sek, C. Martin-Vide, and B. Truthe, editors, *Proceedings of Language Automata Theory and Applications (LATA 2016)*, volume 9618 of *Lecture Notes in Computer Science*, pages 452–463. Springer, Cham, 2016.
- [DFKV20] M. Droste, Z. F l p, D. K sz , and H. Vogler. Crisp-determinization of weighted tree automata over additively locally finite and past-finite monotonic strong bimonoids is decidable. In G. Jir skov  and G. Pighizzini, editors, *Descriptive Complexity of Formal Systems (DCFS 2020)*, volume 12442 of *Lecture Notes in Computer Science*, pages 39–51. Springer Nature Switzerland, 2020.
- [DFKV22] M. Droste, Z. F l p, D. K sz , and H. Vogler. Finite-image property of weighted tree automata over past-finite monotonic strong bimonoids. *Theoret. Comput. Sci.*, 919:118–143, 2022.
- [DFTV24] M. Droste, Z. F l p, A. Tepav evi , and H. Vogler. The generating power of weighted tree automata with initial algebra semantics. submitted for publication, see also: arXiv 2405.20753, 2024.
- [DFV21] F. D rband, Z. F l p, and H. Vogler. Rational weighted tree languages with storage. *Inf. Comput.*, 2021. accepted for publication, special issue for CAI 2019.
- [DG82] W. Damm and A. Goerdt. An automata-theoretical characterization of the OI-hierarchy. In M. Nielsen and E.M. Schmidt, editors, *Automata, Languages and Programming. ICALP 1982*, volume 140 of *Lecture Notes in Computer Science*, pages 141–153. Springer, Berlin, Heidelberg, 1982.
- [DG99] M. Droste and P. Gastin. The Kleene-Sch tzenberger theorem for formal power series in partially commuting variables. *Inf. Comput.*, 153:47–80, 1999. Extended abstract in: 24th ICALP, *Lecture Notes in Computer Science*, vol. 1256, pp. 682–692. Springer (1997).

- [DG05] M. Droste and P. Gastin. Weighted automata and weighted logics. In L. Caires, G. F. Italiano, L. Monteiro, C. Palamidessi, and M. Yung, editors, *32nd Int. Colloquium Automata, Languages and Programming (ICALP 2005)*, volume 3580 of *Lecture Notes in Computer Science*, pages 513–525. Springer, Berlin, Heidelberg, 2005.
- [DG07] M. Droste and P. Gastin. Weighted automata and weighted logics. *Theoret. Comput. Sci.*, 380(1-2):69–86, 2007.
- [DG09] M. Droste and P. Gastin. Weighted automata and weighted logics. In M. Droste, W. Kuich, and H. Vogler, editors, *Handbook of Weighted Automata*, Monographs in Theoretical Computer Science. An EATCS Series, chapter 5. Springer-Verlag, 2009.
- [DGMM11] M. Droste, D. Götze, S. Märcker, and I. Meinecke. Weighted tree automata over valuation monoids and their characterization by weighted logics. In W. Kuich and G. Rahonis, editors, *Algebraic Foundations in Computer Science*, volume 7020 of *Lecture Notes in Computer Science*, pages 30–55. Springer, Berlin, Heidelberg, 2011.
- [DGV16] F. Drewes, K. Gebhardt, and H. Vogler. EM-training for weighted aligned hypergraph bimorphisms. In *Proceedings of the ACL Workshop on Statistical NLP and Weighted automata*, pages 60–69, 2016.
- [DH15] M. Droste and D. Heusel. The supports of weighted unranked tree automata. *Fundam. Inform.*, 136(1-2):37–58, 2015.
- [DHM11] F. Drewes, J. Högberg, and A. Maletti. MAT learners for tree series: an abstract data type and two realizations. *Acta Inform.*, 48(3):165–189, 2011.
- [DHV15] M. Droste, D. Heusel, and H. Vogler. Weighted unranked tree automata over tree valuation monoids and their characterization by weighted logics. In A. Maletti, editor, *6th Int. Conf. on Algebraic Informatics (CAI 2015)*, volume 9270 of *Lecture Notes in Computer Science*, pages 90–102. Springer, Cham, 2015.
- [Dic13] L. E. Dickson. Finiteness of the odd perfect and primitive abundant numbers with n distinct prime factors. *American Journal of Mathematics*, 35(4):413–422, 1913.
- [Die18] T. Dietze. *A Formal View on Training of Weighted Tree Automata by Likelihood-Driven State Splitting and Merging*. PhD thesis, Technische Universität Dresden, 2018.
- [DK03] M. Droste and D. Kuske. Skew and infinitary formal power series. In *13th Int. Colloquium on Automata, Languages and Programming (ICALP 2003)*, volume 2719 of *Lecture Notes in Computer Science*, pages 426–438. Springer, Berlin, Heidelberg, 2003.
- [DK06] M. Droste and D. Kuske. Skew and infinitary formal power series. *Theoret. Comput. Sci.*, 366(3):199–227, 2006.
- [DK09] M. Droste and W. Kuich. Semirings and formal power series. In M. Droste, W. Kuich, and H. Vogler, editors, *Handbook of Weighted Automata*, Monographs in Theoretical Computer Science. An EATCS Series, chapter 1, pages 3–28. Springer-Verlag, 2009.
- [DK10] F. Drewes and M. Kuhlmann, editors. *Proceedings of the Workshop on Applications of Tree Automata Techniques in Natural Language Processing*. Association of Computational Linguistics, 2010.
- [DK12] F. Drewes and M. Kuhlmann, editors. *Proceedings of the Workshop on Applications of Tree Automata Techniques in Natural Language Processing*. Association of Computational Linguistics, 2012.

- [DK21] M. Droste and D. Kuske. Weighted automata. In J.-E. Pin, editor, *Handbook of Automata Theory*, chapter 4, pages 113–150. European Mathematical Society, 2021.
- [DKV09] M. Droste, W. Kuich, and H. Vogler, editors. *Handbook of Weighted Automata*. EATCS Monographs in Theoretical Computer Science. Springer-Verlag, 2009.
- [DM12] M. Droste and I. Meinecke. Weighted automata and weighted MSO logics for average and long-time behaviors. *Inf. Comput.*, 220–221:44–59, 2012.
- [DM20] F. Dörband and R. Mörbitz. Incomparability of classes for support theorems. personal communication, 2020.
- [DMV22] M. Droste, A. Maletti, and H. Vogler, editors. *Special issue on 9th International Workshop Weighted Automata: Theory and Applications (May 22–26, 2018, Leipzig, Germany)*. Information and Computation, 2022.
- [Don65] J.E. Doner. Decidability of the weak second-order theory of two successors. *Notices Amer. Math. Soc.*, 12:819, 1965. Abstract No. 65T 648, 819.
- [Don70] J. Doner. Tree acceptors and some of their applications. *J. Comput. Syst. Sci.*, 4:406–451, 1970.
- [Dör19] F. Dörband. A Kleene theorem for weighted forest automata. Master’s thesis, Technische Universität Dresden, 2019.
- [Dör21] F. Dörband. Kleene and Büchi theorems for weighted forest languages over M-monoids. *Inf. Comput.*, 281, 2021. Article 104765.
- [Dör22] F. Dörband. *Characterisation Theorems for Weighted Tree Automaton Models*. PhD thesis, Technische Universität Dresden, Germany, 2022.
- [DP12] B.A. Davey and H.A. Priestley. *Introduction to Lattices and Order*. Cambridge University Press, 2012.
- [DPV05] M. Droste, Chr. Pech, and H. Vogler. A Kleene theorem for weighted tree automata. *Theory Comput. Syst.*, 38:1–38, 2005.
- [DR07] M. Droste and G. Rahonis. Weighted automata and weighted logics with discounting. In J. Holub and J. Žďárek, editors, *Implementation and Application of Automata (CIAA 2007)*, volume 4783 of *Lecture Notes in Computer Science*, pages 73–84. Springer, Berlin, Heidelberg, 2007.
- [Dre06] F. Drewes. *Grammatical Picture Generation: A Tree-Based Approach*. Texts in Theoretical Computer Science. An EATCS Series. Springer, 2006.
- [Dro19] M. Droste. Personal communication. 2019.
- [Dro21] M. Droste. Weighted automata over monotonic strong bimonoids: Decidability and undecidability of finite image. Talk at the International Colloquium Recent Advances of Quantitative Models in Computer Science, June 22-23, 2021, online, 2021.
- [Dro22] M. Droste. Personal communication. 2022.
- [Dro24] M. Droste. Personal communication. 2024.
- [DSF21] F. Dörband, K. Stier, and T. Feller. Sequentiality of group-weighted tree automata. In A. Leporati, C. Martin-Vide, D. Shapira, and C. Zandron, editors, *Int. Conf. on Language and Automata Theory and Applications (LATA 2021)*, volume 12638 of *Lecture Notes in Computer Science*, pages 267–278, 2021.

- [DSV10] M. Droste, T. Stüber, and H. Vogler. Weighted finite automata over strong bimonoids. *Inform. Sci.*, 180(1):156–166, 2010.
- [DV03] M. Droste and H. Vogler, editors. *Selected Papers of the Workshop “Weighted Automata: Theory and Applications” Dresden University of Technology (Germany), March 4-8, 2002*, volume 8(2). *J. Autom. Lang. Comb.*, 2003.
- [DV05] M. Droste and H. Vogler, editors. *Selected Papers of the Workshop “Weighted Automata: Theory and Applications” Dresden University of Technology (Germany), June 1-5, 2004*, volume 10(2/3). *J. Autom. Lang. Comb.*, 2005.
- [DV06] M. Droste and H. Vogler. Weighted tree automata and weighted logics. *Theoret. Comput. Sci.*, 366(3):228–247, 2006.
- [DV07a] F. Drewes and H. Vogler. Learning deterministically recognizable tree series. *J. Autom. Lang. Comb.*, 12(3):333–354, 2007.
- [DV07b] M. Droste and H. Vogler, editors. *Selected Papers of the Workshop “Weighted Automata: Theory and Applications” University of Leipzig (Germany), March 27-31, 2006*, volume 12(4). *J. Autom. Lang. Comb.*, 2007.
- [DV09] M. Droste and H. Vogler, editors. *Selected Papers of the Workshop “Weighted Automata: Theory and Applications” Technische Universität Dresden (Germany), May 13-16, 2008*, volume 19(2). *Acta Cybernetica*, 2009.
- [DV10] M. Droste and H. Vogler. Kleene and Büchi theorems for weighted automata and multi-valued logics over arbitrary bounded lattices. In Y. Gao, H. Lu, S. Seki, and S. Yu, editors, *Developments in Language Theory (DLT 2020)*, volume 6224 of *Lecture Notes in Computer Science*, pages 160–172. Springer, 2010.
- [DV11a] M. Droste and H. Vogler, editors. *Selected Papers of the Workshop “Weighted Automata: Theory and Applications” University of Leipzig (Germany), May 3 - 7, 2010*, volume 20(2). *Acta Cybernetica*, 2011.
- [DV11b] M. Droste and H. Vogler. Weighted logics for unranked tree automata. *Theory of Computing Systems*, 48(1):23–47, 2011. published online first, 29. June 2009.
- [DV12] M. Droste and H. Vogler. Weighted automata and multi-valued logics over arbitrary bounded lattices. *Theoret. Comput. Sci.*, 418:14–36, 2012.
- [DV14a] M. Droste and H. Vogler. The Chomsky-Schützenberger theorem for quantitative context-free languages. *Int. J. Found. Computer Science*, 25(8):955–969, 2014.
- [DV14b] M. Droste and H. Vogler, editors. *Selected Papers of the Workshop “Weighted Automata: Theory and Applications”, WATA 2012, May 29 - June 2, 2012, Dresden, Germany*, volume 534(1). *Theoret. Comput. Sci.*, 2014.
- [EFV02] J. Engelfriet, Z. Fülöp, and H. Vogler. Bottom-up and top-down tree series transformations. *J. Autom. Lang. Comb.*, 7(1):11–70, 2002.
- [Eil74] S. Eilenberg. *Automata, Languages, and Machines – Volume A*, volume 59 of *Pure and Applied Mathematics*. Academic Press, 1974.
- [ÉK] Z. Ésik and W. Kuich. Modern automata theory.
- [ÉK03] Z. Ésik and W. Kuich. Formal tree series. *J. Autom. Lang. Comb.*, 8(2):219–285, 2003.

- [ÉL07] Z. Ésik and G. Liu. Fuzzy tree automata. *Fuzzy Sets and Systems*, 158(113):1450–1460, 2007.
- [Elg61] C.C. Elgot. Decision problems of finite automata design and related arithmetics. *Trans. Amer. Math. Soc.*, 98(1):21–52, 1961.
- [Ell71] C.A. Ellis. Probabilistic tree automata. *Inform. and Control*, 19(5):401–416, 1971.
- [Eng75a] J. Engelfriet. Bottom-up and top-down tree transformations - a comparison. *Math. Systems Theory*, 9(3):198–231, 1975.
- [Eng75b] J. Engelfriet. Tree automata and tree grammars. Technical Report DAIMI FN-10, Inst. of Mathematics, University of Aarhus, Department of Computer Science, Ny Munkegade, 8000 Aarhus C, Denmark, 1975. arXiv:1510.02036.
- [Eng80] J. Engelfriet. Some open questions and recent results on tree transducers and tree languages. In R.V. Book, editor, *Formal Language Theory*, pages 241–286. Academic Press, 1980.
- [Eng86] J. Engelfriet. Context-free grammars with storage. Technical Report 86-11, University of Leiden, 1986. see also: arXiv:1408.0683 [cs.FL], 2014.
- [Eng91] J. Engelfriet. Iterated stack automata and complexity classes. *Inform. Control*, 95:21–75, 1991.
- [Eng03] J. Engelfriet. Alternative Kleene theorem for weighted automata. personal communication, 2003.
- [ES77] J. Engelfriet and E.M. Schmidt. IO and OI.I. *J. Comput. System Sci.*, 15(3):328–353, 1977.
- [ES78] J. Engelfriet and E.M. Schmidt. IO and OI.II. *J. Comput. System Sci.*, 16(1):67–99, 1978.
- [ESvL80] J. Engelfriet, E. M. Schmidt, and J. van Leeuwen. Stack machines and classes of nonnested macro languages. *J. Assoc. Comput. Machinery*, 27(1):96–117, 1980.
- [EV91] J. Engelfriet and H. Vogler. Modular tree transducers. *Theoret. Comput. Sci.*, 78:267–303, 1991.
- [FG18] Z. Fülöp and Z. Gazdag. Weighted languages recognizable by weighted tree automata. *Acta Cybernetica*, 23(3):867–886, 2018.
- [FGV04] Z. Fülöp, Z. Gazdag, and H. Vogler. Hierarchies of tree series transformations. *Theoret. Comput. Sci.*, 314(3):387–429, 2004.
- [FHV18] Z. Fülöp, L. Herrmann, and H. Vogler. Weighted regular tree grammars with storage. *Discrete Math. Theoret. Comput. Sci.*, 20(1), 2018. #26.
- [FHV93] Z. Fülöp, F. Herrmann, S. Vágvölgyi, and H. Vogler. Tree transducers with external functions. *Theoret. Comput. Sci.*, 108:185–236, 1993.
- [Fic11] I. Fichtner. Weighted picture automata and weighted logics. *Theory Comput. Syst.*, 48:48–78, 2011.
- [Fil15] E. Filot, editor. *3rd Int. Workshop on Trends in Tree Automata and Tree Transducers*, 2015.
- [FKV21] Z. Fülöp, D. Kószó, and H. Vogler. Crisp-determinization of weighted tree automata over strong bimonoids. *Discrete Math. Theoret. Comput. Sci.*, 23(1), 2021. #18, see also arxiv.org:1912.02660v2, 2019.

- [Fli74] M. Fliess. Matrices de Hankel. *J. Math. Pures Appl.*, (9)53:197–222, 1974.
- [Fli75] M. Fliess. Séries rationnelles positives et processus stochastiques. *Ann. Inst. H. Poincaré Set. B (N.S.)*, pages 1–21, 1975.
- [Flo62] R.N. Floyd. Algorithm 97: Shortest path. *Comm. ACM*, 5(6):345, 1962.
- [FMV09] Z. Fülöp, A. Maletti, and H. Vogler. A Kleene Theorem for Weighted Tree Automata over Distributive Multioperator Monoids. *Theory Comput. Syst.*, 44:455–499, 2009.
- [FMV10] Z. Fülöp, A. Maletti, and H. Vogler. Preservation of recognizability for synchronous tree substitution grammars. In *Workshop on Applications of Tree Automata in Natural Language Processing, ACL 2010 (ATANLP 2010)*, pages 1–9. Association for Computational Linguistics, 2010.
- [FMV11] Z. Fülöp, A. Maletti, and H. Vogler. Weighted Extended Tree Transducers. *Fundamenta Informaticae*, 112:1–39, 2011.
- [FS11] Z. Fülöp and M. Steinby. Varieties of recognizable tree series over fields. *Theoret. Comput. Sci.*, 412:736–752, 2011.
- [FSV12] Z. Fülöp, T. Stüber, and H. Vogler. A Büchi-like theorem for weighted tree automata over multioperator monoids. *Theory Comput. Syst.*, 50:241–278, 2012. Submitted on 14 October 2009, published online 28 October 2010.
- [Fül15] Z. Fülöp. Local weighted tree languages. *Acta Cybernetica*, 22(2):393–402, 2015.
- [FV03] Z. Fülöp and H. Vogler. Tree series transformations that respect copying. *Theory Comput. Syst.*, 36:247–293, 2003.
- [FV09] Z. Fülöp and H. Vogler. Weighted tree automata and tree transducers. In M. Droste, W. Kuich, and H. Vogler, editors, *Handbook of Weighted Automata*, Monographs in Theoretical Computer Science. An EATCS Series, chapter 9, pages 313–403. Springer-Verlag, 2009.
- [FV15] Z. Fülöp and H. Vogler. Characterizing weighted MSO for trees by branching transitive closure logics. *Theoret. Comput. Sci.*, 594:82–105, 2015.
- [FV18] Z. Fülöp and H. Vogler. Characterizations of recognizable weighted tree languages by logic and bimorphisms. *Soft Computing*, 22:1035–1046, 2018.
- [FV19] Z. Fülöp and H. Vogler. Rational weighted tree languages with storage and the Kleene-Goldstine theorem. In M. Ćirić, M. Droste, and J.-É. Pin, editors, *Int. Conf. on Algebraic Informatics (CAI 2019)*, volume 11545 of *Lecture Notes in Computer Science*, pages 138–150. Springer International Publishing, 2019.
- [FV22a] Z. Fülöp and H. Vogler. Principal abstract families of weighted tree languages. *Inf. Comput.*, 282, 2022. Available online 16 November 2020, Article 104657.
- [FV22b] Z. Fülöp and H. Vogler. *Weighted Tree Automata – May it be a little more?* arXiv:2212.05529 [cs.FL], 2022.
- [FV24] Z. Fülöp and H. Vogler. A comparison of sets of recognizable weighted tree languages over specific sets of bounded lattices. *International Journal of Foundations of Computer Science*, 35, Nos. 1&2:51–76, 2024. DOI: 10.1142/S0129054123480039.
- [Gal87] J. H. Gallier. *Logic for Computer Science: Foundations of Automatic Theorem Proving*. John Wiley & Sons, 1987.

- [Gal08] N. Galatos. Residuated lattices. Tutorial at "Summer School on General Algebra and Ordered Sets" (SSAOS 2008), 2008.
- [GdM20] S. Gerdjikova and J.R.G. de Mendívil. Conditions for the existence of maximal factorizations. *Fuzzy Sets and Systems*, 397:186–196, 2020.
- [GFD19] D. Götze, Z. Fülöp, and M. Droste. A Kleene theorem for weighted tree automata over tree valuation monoids. *Inf. Comput.*, 269, 2019. Article 104445.
- [GG67] S. Ginsburg and S.A. Greibach. Abstract families of languages. In *8th Annual Symposium on Switching and Automata Theory (SWAT 1967)*, volume 1, pages 128–139, 1967.
- [GG69] S. Ginsburg and S.A. Greibach. Abstract families of languages. In S. Ginsburg, S. Greibach, and J. Hopcroft, editors, *Studies in Abstract Families of Languages*, volume 87, pages 1–32. American Mathematical Society, 1969.
- [GG70] S. Ginsburg and S. Greibach. Principal AFL. *J. Comput. Syst. Sci.*, 4(4):308–338, 1970.
- [GGH69] S. Ginsburg, S. Greibach, and J. Hopcroft. *Studies in Abstract Families of Languages*. Number 87. American Mathematical Society, 1969.
- [GHKM04] M. Galley, M. Hopkins, K. Knight, and D. Marcu. What's in a translation rule? In D. Marcu S. Dumais and S. Roukos, editors, *Proc. HLT-NAACL 2004*, pages 273–280. Association for Computational Linguistics, 2004.
- [Gho18] M. Ghorani. Tree automata on complete residuated lattice-valued logic: reduction algorithms and decision problems. *Iranian Journal of Fuzzy Systems*, 15(7):103–119, 2018.
- [Gho22] M. Ghorani. Characterization of tree automata based on quantum logic. *Int. J. of Theoretical Physics*, 61:13:1–24, 2022.
- [Gin75] S. Ginsburg. *Algebraic and automata-theoretic properties of formal languages*, volume 2 of *Fundamental studies in computer science*. North-Holland, 1975.
- [GK04] J. Graehl and K. Knight. Training tree transducers. In *Proc. Human Language Technologies and North American ACL*, pages 105–112, Boston, Massachusetts, USA, May 2 - 7, 2004. Association for Computational Linguistics.
- [GKM08] J. Graehl, K. Knight, and J. May. Training tree transducers. *Computational Linguistics*, 34(3):391–427, 2008.
- [GM18] P. Gastin and B. Monmege. A unifying survey on weighted logics and weighted automata. *Soft Computing*, 22(4):1047–1065, 2018.
- [Gol99] J.S. Golan. *Semirings and their Applications*. Kluwer Academic Publishers, Dordrecht, 1999.
- [Göt17] D. Götze. *Weighted Unranked Tree Automata over Tree Valuation Monoids*. PhD thesis, University of Leipzig, 2017.
- [Grä68] G. Grätzer. *Universal Algebra*. D. van Nostrand Comp., 1968.
- [Grä78] G. Grätzer. *General Lattice Theory*. Birkhäuser Verlag, 1978.
- [Grä03] G. Grätzer. *General Lattice Theory*. Birkhäuser Verlag, 2nd edition, 2003.
- [Gre70] S. Greibach. Full AFLs and nested iterated substitution. *Inform. Control*, 16:7–35, 1970.
- [GS84] F. Gécseg and M. Steinby. *Tree Automata*. Akadémiai Kiadó, Budapest, 1984. arXiv:1509.06233.

- [GS97] F. Gécseg and M. Steinby. Tree languages. In G. Rozenberg and A. Salomaa, editors, *Handbook of Formal Languages*, volume 3, chapter 1, pages 1–68. Springer-Verlag, 1997.
- [GTWW77] J.A. Goguen, J.W. Thatcher, E.G. Wagner, and J.B. Wright. Initial algebra semantics and continuous algebras. *J. Assoc. Comput. Machinery*, 24(1):68–95, 1977.
- [GV22] M. Ghorani and H. Vogler. A theorem on supports of weighted tree automata over strong bimonoids. *New Mathematics and Natural Computation*, 2022. online ready, <https://doi.org/10.1142/S1793005723500230>.
- [GZ12] M. Ghorani and M.M. Zahedi. Characterizations of complete residuated lattice-valued finite tree automata. *Fuzzy Sets and Systems*, 199:28–46, 2012.
- [GZ16] M. Ghorani and M.M. Zahedi. Alternating regular tree grammars in the framework of lattice-valued logic. *Iranian Journal of Fuzzy Systems*, 13(2):71–94, 2016.
- [GZ17] M. Ghorani and M.M. Zahedi. Coding tree languages based on lattice-valued logic. *Soft Computing*, 21(14):3815–3825, 2017.
- [GZA12] M. Ghorani, M.M. Zahedi, and R. Ameri. Algebraic properties of complete residuated lattice valued tree automata. *Soft Computing*, 16:1723–1732, 2012. DOI 10.1007/s00500-012-0856-y.
- [Har78] M. A. Harrison. *Introduction to Formal Language Theory*. Addison Wesley, 1978.
- [Her17] L. Herrmann. A Medvedev characterization of recognizable tree series. In *21th Int. Conf. on Developments in Language Theory (DLT 2017)*, volume 10396 of *Lecture Notes in Computer Science*, pages 210–221. Springer, 2017.
- [Her20a] L. Herrmann. personal communication. 2020.
- [Her20b] L. Herrmann. *Weighted Tree Automata with Storage*. PhD thesis, Technische Universität Dresden, 2020.
- [HK87] A. Habel and H.-J. Kreowski. Some structural aspects of hypergraph languages generated by hyperedge replacement. In F.J. Brandenburg, G. Vidal-Naquet, and M. Wirsing, editors, *Annual Symposium on Theoretical Aspects of Computer Science (STACS 1987)*, volume 247 of *Lecture Notes in Computer Science*, pages 207–219. Springer Berlin Heidelberg, 1987.
- [HMM07] J. Högberg, A. Maletti, and J. May. Bisimulation minimisation for weighted tree automata. In T. Harju, J. Karhumäki, and A. Lepistö, editors, *11th Int. Conf. Developments in Language Theory (DLT 2007)*, volume 4588 of *Lecture Notes in Computer Science*, pages 229–241. Springer, 2007.
- [HMQ18] T. Hanneforth, A. Maletti, and D. Quernheim. Pushing for weighted tree automata. *Log. Methods Comput. Sci.*, 14(1):1–16, 2018.
- [HMU07] J.E. Hopcroft, R. Motawi, and J.D. Ullman. *Introduction to Automata Theory, Languages, and Computation*. Pearson, Addison-Wesley, 2007.
- [HMU14] J. E. Hopcroft, R. Motwani, and J. D. Ullman. *Introduction to Automata Theory, Languages, and Computation*. Pearson Education Limited, 2014.
- [HMV09] J. Högberg, A. Maletti, and H. Vogler. Bisimulation minimisation of weighted automata on unranked. *Fundam. Inform.*, 92(1-2):103–130, 2009.
- [Hög07] J. Högberg. *Contributions to the Theory and Applications of Tree Languages*. PhD thesis, Umeå University, 2007.

- [HU79] J. E. Hopcroft and J. D. Ullman. *Introduction to automata theory, languages, and computation*. Addison–Wesley, 1979.
- [Hue80] G. Huet. Confluent reductions: Abstract properties and applications to term rewriting systems. *Journal of the ACM*, 27(4):797–821, 1980.
- [Hup78] U. Hupbach. Rekursive Funktionen in mehrsortigen Peano-Algebren. *Elektron. Informationsverarb. Kybern.*, 14:491–506, 1978.
- [HV15] L. Herrmann and H. Vogler. A Chomsky-Schützenberger theorem for weighted automata with storage. In A. Maletti, editor, *6th Int. Conf. on Algebraic Informatics (CAI 2015)*, volume 9270 of *Lecture Notes in Computer Science*, pages 115–127, 2015.
- [HVD19] L. Herrmann, H. Vogler, and M. Droste. Weighted automata with storage. *Inf. Comput.*, 269, 2019. Article 104447.
- [HW93] U. Hebisch and H.J. Weinert. *Semirings - Algebraic Theory and Applications in Computer Science*. World Scientific, 1993.
- [IF75] Y. Inagaki and T. Fukumura. On the description of fuzzy meaning of context-free languages. In L.A. Zadeh, editor, *Fuzzy Sets and Their Applications to Cognitive and Decision Processes*, pages 301–328. Academic Press, New York, 1975.
- [Ind76] K. Indermark. Berechenbarkeit und Algorithmen, 1976. Lecture notes, RWTH Aachen.
- [Jec03] T. Jech. *Set Theory, The Third Millennium Edition, revised and expanded*. Springer Berlin, Heidelberg, 2003.
- [Jon21] A. Jonsson. *Best Trees Extraction and Contextual Grammars for Language Processing*. PhD thesis, Umeå University, Sweden, 2021.
- [KG05] K. Knight and J. Graehl. An overview of probabilistic tree transducers for natural language processing. In A. Gelbukh, editor, *Int. Conf. on Intelligent Text Processing and Computational Linguistics (CICLing 2005)*, volume 3406 of *Lecture Notes in Computer Science*, pages 1–24, Berlin, Heidelberg, 2005. Springer Berlin Heidelberg.
- [Kir09] D. Kirsten. The support of a recognizable series over a zero-sum free, commutative semiring is recognizable. In V. Diekert and D. Nowotka, editors, *9th Int. Conf. on Developments in Language Theory (DLT)*, volume 5583 of *Lecture Notes in Computer Science*, pages 326–333. Springer, 2009.
- [Kir11] D. Kirsten. The support of a recognizable series over a zero-sum free, commutative semiring is recognizable. *Acta Cybern.*, 20(2):211–221, 2011.
- [Kir14] D. Kirsten. An algebraic characterization of semirings for which the support of every recognizable series is recognizable. *Theoret. Comput. Sci.*, 534:43–52, 2014.
- [Kla84] H. Klaeren. A constructive method for abstract algebraic software specification. *Theoret. Comput. Sci.*, 30:139–204, 1984.
- [Kle56] S.E. Kleene. Representation of events in nerve nets and finite automata. In C.E. Shannon and J. McCarthy, editors, *Automata Studies*, volume 34, pages 3–42. Princeton University Press, Princeton, N.J., 1956.
- [Kle62] S.E. Kleene. *Introduction to Meta Mathematics*. Van Nostrand, New York, 1962.
- [KLMP04] I. Klimann, S. Lombardy, J. Mairesse, and C. Prieur. Deciding unambiguity and sequentiality from a finitely ambiguous max-plus automaton. *Theoret. Comput. Sci.*, 327:349–373, 2004.

- [KM05] D. Kirsten and I. Mäurer. On the determinization of weighted automata. *J. Autom. Lang. Comb.*, 10(2–3):287–312, 2005.
- [KM09] K. Knight and J. May. Applications of weighted automata in natural language processing. In M. Droste, W. Kuich, and H. Vogler, editors, *Handbook of Weighted Automata*, Monographs in Theoretical Computer Science. An EATCS Series, chapter 14. Springer-Verlag, 2009.
- [Knu77] D.E. Knuth. A generalization of Dijkstra’s algorithm. *Inform. Process. Lett.*, 6(1):1–5, 1977.
- [Kós22] D. Kósó. Tree generating context-free grammars and regular tree grammars are equivalent. *Annales Mathematicae et Informaticae*, 56:58–70, 2022.
- [Koz92] D. Kozen. On the Myhill-Nerode theorem for trees. *Bull. Eur. Assoc. Theoret. Comput. Sci. EATCS*, 47:170–173, 1992.
- [KR08] M. Kreuzer and L. Robbiano. *Computational Commutative Algebra 1*. Springer Publishing Company, Incorporated, 2008.
- [Kri05] K.V. Krishna. *Near-Semirings: Theory and Applications*. PhD thesis, IIT Delhi, New Delhi, India, 2005.
- [KS86] W. Kuich and A. Salomaa. *Semirings, Automata, Languages*, volume 5 of *EATCS Monographs on Theoretical Computer Science EATCS Ser.* Springer-Verlag, 1986.
- [Kui97] W. Kuich. Semirings and formal power series: Their relevance to formal languages and automata. In G. Rozenberg and A. Salomaa, editors, *Handbook of Formal Languages*, volume 1, chapter 9, pages 609–677. Springer-Verlag, 1997.
- [Kui98] W. Kuich. Formal Power Series over Trees. In S. Bozapalidis, editor, *3rd Int. Conf. Developments in Language Theory (DLT 1997), Thessaloniki, Greece*, pages 61–101. Aristotle University of Thessaloniki, 1998.
- [Kui99a] W. Kuich. Full abstract families of tree series I. In J. Karhumäki, H. Maurer, G. Paun, and G. Rozenberg, editors, *Jewels are forever*, pages 145–156. Springer-Verlag, 1999.
- [Kui99b] W. Kuich. Linear systems of equations and automata on distributive multioperator monoids. In D. Dorninger, G. Eigenthaler, M. Goldstern, H. K. Kaiser, W. More, and W. B Müller, editors, *Contributions to General Algebra 12 - Proceedings of the 58th Workshop on General Algebra “58. Arbeitstagung Allgemeine Algebra”, Vienna University of Technology. June 3-6, 1999*, pages 1–10. Verlag Johannes Heyn, 1999.
- [Kui99c] W. Kuich. Tree transducers and formal tree series. *Acta Cybernet.*, 14(1):135–149, 1999.
- [KY95] G.J. Klir and B. Yuan. *Fuzzy Sets and Fuzzy Logic, Theory and Application*. Prentice-Hall, Englewood Cliffs, NJ, 1995.
- [Lan93] S. Lang. *Algebra*. Addison–Wesley, Reading, 1993. 3rd edition.
- [Li08a] Y. Li. Approximation and robustness of fuzzy finite automata. *International Journal of Approximate Reasoning*, 47:247–257, 2008.
- [Li08b] Y. Li. Fuzzy finite automata and fuzzy monadic second-order logic. In *2008 IEEE International Conference on Fuzzy Systems (IEEE World Congress on Computational Intelligence)*, 2008. DOI: 10.1109/FUZZY.2008.4630353.
- [Lin12] P. Linz. *An Introduction to Formal Languages and Automata*. Jones & Bartlett Publishers, 2012.

- [LNS82] J. Lassez, V. Nguyen, and L. Sonenberg. Fixed point theorems and semantics: a folk tale. *Inf. Proc. Letters*, 14:112–116, 1982.
- [Loo47] L. H. Loomis. On the representation of σ -complete Boolean algebras. *Bull. Amer. Math. Soc.*, 53(8):757–760, 1947.
- [LP05] Y. Li and W. Pedrycz. Fuzzy finite automata and fuzzy regular expressions with membership values in lattice-ordered monoids. *Fuzzy Sets and Systems*, 156:68–92, 2005.
- [LP14] K. Lehmann and R. Peñaloza. The complexity of computing the behaviour of lattice automata on infinite trees. *Theoret. Comput. Sci.*, 534:53–68, 2014.
- [LT21] C. Löding and W. Thomas. Automata on finite trees. In J.-E. Pin, editor, *Handbook of Automata Theory*, chapter 7, pages 113–150. European Mathematical Society, 2021.
- [Mah81] B. Mahr. A birds eye view to path problems. In H. Noltemeier, editor, *Graphtheoretic Concepts in Computer Science. WG 1980*, volume 100 of *Lecture Notes in Computer Science*. Springer, Berlin, Heidelberg, 1981.
- [Mal04] A. Maletti. Relating tree series transducers and weighted tree automata. In C.S. Calude, E. Calude, and M.J. Dinneen, editors, *Int. Conf. Developments in Language Theory (DLT 2004)*, volume 3340 of *Lecture Notes in Computer Science*, pages 321–333. Springer, Berlin, Heidelberg, 2004.
- [Mal05a] A. Maletti. The power of tree series transducers of type i and ii. In C. De Felice and A. Restivo, editors, *Int. Conf. Developments in Language Theory (DLT 2005)*, volume 3572 of *Lecture Notes in Computer Science*, pages 338–349. Springer, Berlin, Heidelberg, 2005.
- [Mal05b] A. Maletti. Relating tree series transducers and weighted tree automata. *Internat. J. Found. Comput. Sci.*, 16(4):723–741, 2005.
- [Mal06a] A. Maletti. Compositions of tree series transformations. *Theoret. Comput. Sci.*, 366(3):248–271, 2006.
- [Mal06b] A. Maletti. Hierarchies of tree series transformations revisited. In O. H. Ibarra and Z. Dang, editors, *10th Int. Conf. Developments in Language Theory (DLT 2006)*, volume 4036 of *Lecture Notes in Computer Science*, pages 215–225. Springer, 2006.
- [Mal06c] A. Maletti. *The Power of Tree Series Transducers*. PhD thesis, Technische Universität Dresden, 2006.
- [Mal07] A. Maletti. Learning deterministically recognizable tree series – revisited. In S. Bozapalidis and G. Rahonis, editors, *2nd Int. Conf. Algebraic Informatics (CAI 2007)*, volume 4728 of *Lecture Notes in Computer Science*, pages 218–235. Springer-Verlag, 2007.
- [Mal08] A. Maletti. Myhill Nerode theorem for recognizable tree series — revisited. In E. Laber, C. Bornstein, L. Nogueira, and L. Faria, editors, *8th Int. Conf. Latin American Theoretical Informatics (LATIN 2008)*, volume 4957 of *Lecture Notes in Computer Science*, pages 106–120. Springer, 2008.
- [Mal11a] A. Maletti. Survey: Weighted extended top-down tree transducers — part I: Basics and expressive power. *Acta Cybernet.*, 20(2):223–250, 2011.
- [Mal11b] A. Maletti. Survey: Weighted Extended Top-Down Tree Transducers — part II: Application in machine translation. *Fundam. Inform.*, 112(2–3):239–261, 2011.
- [Mal16] A. Maletti, editor. *4th Int. Workshop on Trends in Tree Automata and Tree Transducers (TTATT 2016) July 18, 2016 — Seoul, South Korea*, 2016.

- [Mal17] A. Maletti. Survey: Finite-state technology in natural language processing. *Theoret. Comput. Sci.*, 679:2–17, 2017.
- [Man13] S. Maneth, editor. *2nd Int. Workshop on Trends in Tree Automata and Tree Transducers, Hanoi, Vietnam, 19/10/2013*, 2013.
- [Mas76] A. N. Maslov. Multilevel stack automata. *Problems Inform. Transmission*, 12:38–43, 1976.
- [Mat08] C. Mathissen. Weighted logics for nested words and algebraic formal power series. In L. Aceto, I. Damgård, L.A. Goldberg, M.M Halldórsson, A. Ingólfssdóttir, and I. Walukiewicz, editors, *Int. Colloquium on Automata, Languages, and Programming (ICALP 2008)*, volume 5126 of *Lecture Notes in Computer Science*, pages 221–232. Springer, Berlin, Heidelberg, 2008.
- [Mat09] C. Mathissen. *Weighted Automata and Weighted Logics over Tree-like Structures*. PhD thesis, University of Leipzig, 2009.
- [Mat10] C. Mathissen. Weighted logics for nested words and algebraic formal power series. *Logical Methods Comput. Sci.*, 6(1), 2010.
- [Mäu05] I. Mäurer. Rational and recognizable picture series. In *Conf. on Algebraic Informatics (CAI 2005), Thessaloniki*, pages 141–155. Aristotle University of Thessaloniki Press, 2005.
- [Mäu07] I. Mäurer. Characterizations of recognizable picture series. *Theoret. Comput. Sci.*, 374:214–228, 2007.
- [May10] J.D.L. May. *Weighted tree automata and transducers for syntactic natural language processing*. PhD thesis, University of Southern California, 2010.
- [Méd56] Ú. T. Médvédév. O klassé sobytij, dopuskaúših prédstavleníé v konéčnom avtomaté, 1956.
- [Mei06] I. Meinecke. Weighted logics for traces. In D. Grigoriev and J. Harrison E.A. Hirsch, editors, *1st Int. Computer Science Conf. on Theory and Applications (CSR 2006)*, volume 3967 of *Lecture Notes in Computer Science*, pages 235–246. Springer, Berlin, Heidelberg, 2006.
- [MM70] M. Magidor and G. Moran. Probabilistic tree automata and context free languages. *Israel Journal of Mathematics*, 8:340–348, 1970.
- [MM02] J.N. Mordeson and D.S. Malik. *Fuzzy Automata and Languages: Theory and Applications*. Chapman and Hall, 2002.
- [MN70] Z. Manna and S. Ness. On termination of markov algorithms. In *Proc. 3rd Hawaii International Conference on System Sciences*, pages 798–792, 1970.
- [MN23] A. Maletti and N. O. Nuernbergk. Pumping lemmata for recognizable weighted languages over Artinian semirings. In Zs. Gazdag, Sz. Iván, and G. Kovásznai, editors, *16th International Conference on Automata and Formal Languages (AFL 2023)*, volume 386 of *Electronic Proceedings in Theoretical Computer Science*, page 155–169, 2023.
- [Moh97] M. Mohri. Finite-state transducers in language and speech processing. *Computational Linguistics*, 23(2):269–311, 1997.
- [Moh00] M. Mohri. Minimization algorithms for sequential transducers. *Theoret. Comput. Sci.*, 234(1–2):177–201, 2000.
- [MR18] F. Mazowiecki and C. Riveros. Pumping lemmas for weighted automata. In R. Niedermeier and B. Vallée, editors, *35th Symposium on Theoretical Aspects of Computer Science (STACS 2018)*, volume 96 of *Leibniz International Proceedings in Informatics (LIPIcs)*, pages 50:1–50:14. Schloss Dagstuhl–Leibniz-Zentrum fuer Informatik, 2018.

- [MS09] A. Maletti and G. Satta. Parsing algorithms based on tree automata. In *Proceedings of the 11th Int. Conf. on Parsing Technologies (IWPT 2009)*, pages 1–12. Association for Computational Linguistics, 2009.
- [MS10] A. Maletti and G. Satta. Parsing and translation algorithms based on weighted extended tree transducers. In F. Drewes and M. Kuhlmann, editors, *1st Workshop Applications of Tree Automata in Natural Language Processing (ATANLP 2010)*, pages 19–27. Association for Computational Linguistics, 2010.
- [MV05] A. Maletti and H. Vogler. Incomparability results for classes of polynomial tree series transformations. *J. Autom. Lang. Comb.*, 10(4):535–568, 2005.
- [MV19a] R. Mörbitz and H. Vogler. Weighted parsing for grammar-based language models. In H. Vogler and A. Maletti, editors, *Proc. 14th Int. Conf. on Finite-State Methods and Natural Language Processing (FSMNLP 2019)*, pages 46–55. Association for Computational Linguistics, 2019.
- [MV19b] R. Mörbitz and H. Vogler. Weighted parsing for grammar-based language models over multioperator monoids, 2019. arxiv.1911.06585.
- [MV21] R. Mörbitz and H. Vogler. Weighted parsing for grammar-based language models over multioperator monoids. *Inf. Comput.*, 281, 2021. Article 104774.
- [MW67] J. Mezei and J.B. Wright. Algebraic automata and context-free sets. *Inf. Control*, 11(1–2):3–29, 1967.
- [MY98] H.G. Moore and A. Yaqub. *A first course in linear algebra with applications*. Academic Press, 1998.
- [MZA11] S. Moghari, M.M. Zahedi, and R. Ameri. New direction in fuzzy tree automata. *Iranian J. Fuzzy Systems*, 8(5):59–68, 2011.
- [Niv68] M. Nivat. Transduction des langages de Chomsky. *Ann. de l’Inst. Fourier*, 18:339–455, 1968.
- [Pau20] E. Paul. *Expressiveness and Decidability of Weighted Automata and Weighted Logics*. PhD thesis, University of Leipzig, 2020.
- [Pét57] R. Péter. *Rekursive Funktionen*. Akadémiai Kiadó, Budapest, 1957. English translation: Academic Press, New York, 1967.
- [PRS94] F. Pereira, M. Riley, and R. Sproat. Weighted rational transductions and their application to human language processing. In *Human Language Technology: Proceedings of a Workshop held at Plainsboro, New Jersey, March 8-11, 1994*, 1994.
- [Qua09] K. Quaas. Weighted timed MSO logics. In V. Diekert and D. Nowotka, editors, *Int. Conf. on Developments in Language Theory (DLT 2009)*, volume 5583 of *Lecture Notes in Computer Science*, pages 419–430, Berlin, Heidelberg, 2009. Springer, Berlin, Heidelberg.
- [Rad10] D. Radovanović. Weighted tree automata over strong bimonoids. *Novi Sad J. Math.*, 40(3):89–108, 2010.
- [Rah07] G. Rahonis. Weighted Muller tree automata and weighted logics. *J. Autom. Lang. Comb.*, 12(4):455–483, 2007.
- [Rah09] G. Rahonis. Fuzzy languages. In M. Droste, W. Kuich, and H. Vogler, editors, *Handbook of Weighted Automata*, EATCS Monographs in Theoretical Computer Science, chapter 12, pages 481–517. Springer-Verlag, 2009.

- [Reu80] Ch. Reutenauer. An Odgen-like iteration lemma for rational power series. *Acta Inform.*, 13:189–197, 1980.
- [Rol58] H.L. Rolf. The free lattice generated by a set of chains. *Pacific J. Math.*, 8:585–595, 1958.
- [Rot90] G. Rote. Path problems in graphs. In G. Tinhofer, E. Mayr, H. Noltemeier, and M.M. Syslo, editors, *Computational Graph Theory. Computing Supplementum*, volume 7, pages 155–189. Springer, Vienna, 1990.
- [RRLV23] J. Rennert, M. Rossel, Y. Li, and H. Vogler. Discussion during a lecture on weighted tree automata at TU Dresden. 2023.
- [RT19] G. Rahonis and F. Torpari. Weighted context-free grammars over bimonoids. *Scientific Annals of Computer Science*, 29(1):59–80, 2019.
- [RW09] I. Rival and R. Wille. Lattices freely generated by partially ordered sets: which can be ”drawn”. *Journal für die reine und angewandte Mathematik*, 310:56–80, 2009.
- [Sak09] J. Sakarovitch. *Elements of Automata Theory*. Cambridge University Press, 2009.
- [San68] E.S. Santos. Maximin automata. *Information and Control*, 13:363–377, 1968.
- [Sch61] M.P. Schützenberger. On the definition of a family of automata. *Inf. Control*, 4(2–3):245–270, 1961.
- [Sch89] U. Schöning. *Logic for Computer Scientists*. Birkhäuser, 1989.
- [Sei89] H. Seidl. On the finite degree of ambiguity of finite tree automata. *Acta Informatica*, 26(3):527–542, 1989.
- [Sei90] H. Seidl. Deciding equivalence of finite tree automata. *SIAM J. Comput.*, 19(3):424–437, 1990.
- [Sei94] H. Seidl. Finite tree automata with cost functions. *Theoret. Comput. Sci.*, 126(1):113–142, 1994.
- [Sha67] E. Shamir. A representation theorem for algebraic and context-free power series in noncommuting variables. *Information and Control*, 11:239–254, 1967.
- [SJC15] M. Steinby, E. Jurvanen, and A. Cano. Varieties of unranked tree languages, 2015. CoRR, arXiv:1510.07402.
- [SMK18] H. Seidl, S. Maneth, and G. Kemper. Equivalence of deterministic top-down tree-to-string transducers is decidable. *J. Assoc. Comput. Machinery*, 65(4):1–30, 2018.
- [SS78] A. Salomaa and M. Soittola. *Automata-Theoretic Aspects of Formal Power Series*. Texts and Monographs in Computer Science, Springer-Verlag, 1978.
- [Ste92] M. Steinby. A theory of tree language varieties. In M. Nivat and A. Podelski, editors, *Tree Automata and Languages, Studies in Computer Science and Artificial Intelligence*. North-Holland, Amsterdam, 1992.
- [Str94] H. Straubing. *Finite Automata, Formal Logic, and Circuit Complexity*. Birkhäuser, 1994.
- [Str09] L. Strassburger. A Kleene theorem for forest languages. In A.H. Dediu, A.M. Ionescu, and C. Martín-Vide, editors, *3rd Int. Conf. on Language and Automata Theory and Applications (LATA 2009)*, volume 5457 of *Lecture Notes in Computer Science*, pages 715–727. Springer, 2009.

- [STV08] B. Seselja, A. Tepavčević, and H. Vogler. A note on cut-worthyness of recognizable tree series. *Fuzzy Sets and Systems*, 159(22):3087–3090, 2008.
- [SVF09] T. Stüber, H. Vogler, and Z. Fülöp. Decomposition of weighted multioperator tree automata. *Int. J. Foundations of Computer Sci.*, 20(2):221–245, 2009.
- [Tar55] A. Tarski. A lattice-theoretical fixpoint theorem and its applications. *Pacific J. Math.*, 5(2):285–309, 1955.
- [Tei16] M. Teichmann. *Expressing Context-Free Tree Languages by Regular Tree Grammars*. PhD thesis, Technische Universität Dresden, 2016.
- [Tep23] A. Tepavčević. personal communication. 2023.
- [Tha67] J. W. Thatcher. Characterizing derivation trees of context-free grammars through a generalization of finite automata theory. *J. Comput. Syst. Sci.*, 1(4):317–322, 1967.
- [TO15] M. Teichmann and J. Osterholzer. A link between multioperator and tree valuation automata and logics. *Theoret. Comput. Sci.*, 594:106–119, 2015.
- [Tra61] B.A. Trakhtenbrot. Finite automata and logic of monadic predicates. *Doklady Akademii Nauk SSSR*, 149:326–329, 1961. in Russian.
- [TW68] J.W. Thatcher and J.B. Wright. Generalized finite automata theory with an application to a decision problem of second-order logic. *Math. Syst. Theory*, 2(1):57–81, 1968.
- [VDH16] H. Vogler, M. Droste, and L. Herrmann. A weighted MSO logic with storage behaviour and its Büchi-Elgot-Trakhtenbrot theorem. In A.-H. Dediu, J. Janoušek, C. Martín-Vide, and B. Truthe, editors, *Language and Automata Theory and Applications (LATA 2016)*, pages 127–139. Springer, Cham, 2016.
- [vHIRW75] F.W. von Henke, K. Indermark, G. Rose, and K. Weihrauch. On primitive recursive word-functions. *Computing*, 15:217–234, 1975.
- [vHvR67] W.G. van Hoorn and B. van Rootselaar. Fundamental notions in the theory of seminearrings. *Compositio Math.*, 18(1–2):65–78, 1967.
- [Wan74] M. Wand. An algebraic formulation of the chomsky-hierarchy. In *Proc. First International Symp. on Category Theory*, pages 209–213. Mathematics Department and the Department of Computer and Information Science, University of Massachusetts at Amherst, 1974.
- [Wan97] H. Wang. On characters of semirings. *Houston Journal of Mathematics*, 23(3):391–405, 1997.
- [Wan98] H. Wang. On rational series and rational languages. *Theoret. Comput. Sci.*, 205(1–2):329–336, 1998.
- [War62] S. Warshall. A theorem on Boolean matrices. *J. Assoc. Comput. Machinery*, 9(1):11–12, 1962.
- [Wec78] W. Wechler. *The Concept of Fuzziness in Automata and Language Theory*. Studien zur Algebra und ihre Anwendungen. Akademie-Verlag Berlin, 5. edition, 1978.
- [Wec92] W. Wechler. *Universal Algebra for Computer Scientists*, volume 25 of *EATCS Monographs on Theoretical Computer Science*. Springer-Verlag, Heidelberg/Berlin, first edition, 1992.
- [Wei15] T. Weidner. Probabilistic regular expressions and MSO logic on finite trees. In P. Harsha and G. Ramalingam, editors, *35th IARCS Annual Conf. on Foundations of Software Technology and Theoretical Computer Science (FSTTCS 2015)*, volume 45 of *Leibniz International Proceedings in Informatics (LIPIcs)*, pages 503–516, Dagstuhl, Germany, 2015. Schloss Dagstuhl–Leibniz-Zentrum für Informatik.

- [Win93] G. Winskel. *The Formal Semantics of Programming Languages*. Foundations of Computing Series. The MIT Press, 1993.
- [YK02] K. Yamada and K. Knight. A decoder for syntax-based statistical MT. In *Proceedings of the 40th Annual Meeting on Association for Computational Linguistics*, ACL '02, pages 303–310, 2002.
- [Zim81] U. Zimmermann. *Linear and Combinatorial Optimization in Ordered Algebraic Structures*, volume 10 of *Annals of Discrete Mathematics*. 1981.

Index

- $R_1; R_2$, 14
- $[\Sigma\Psi]$, 257
- $[\Sigma]$, 262
- $[n, k]$, 13
- $[n]$, 13
- $\#_{R_A^a}$, 79
- $\#_{\text{init}}(\mathcal{A}, \xi)$, 137
- $\#_{\text{run}}(\mathcal{A}, \xi)$, 137
- $\#_{\sigma(\cdot, \alpha)}$, 90, 91, 159
- $\text{MSO}^{\text{cext}}(\Sigma, \mathbf{B})$, 398
- \cong , 22
- $\text{cut}_\alpha(\xi)$, 227
- $\kappa[\mathcal{U} \rightsquigarrow \mathcal{V}]$, 381
- $\langle H \rangle_O$, 21
- \otimes , 46
- $\overline{r'}$, 63
- $\langle \cdot \rangle$, 159
- $\llbracket e_1 \cdots e_n \rrbracket$, 158
- σ -complete, 25
- \times -restricted representable, 361
- \times -restricted representation, 361
- $g \circ f$, 15
- $r_1 \circ_\alpha r_2$, 228

- absorption axiom, 24
- abstract family of wtls, 442
- accessible, 167
- accessible subalgebra, 78
- additive power, 37
- AFwtL, 442
- algebra homomorphism, 22
- algebra isomorphism, 22
- algebraic sum, 33
- alphabet, 14
- alphabetic, 58, 204
- α -concatenation, 228
- α -cut, 227
- α -Kleene star, 232
- α -proper, 231
- antisymmetric, 14

- application, 62
- arctic semiring, 28
- $\rightarrow_{\mathbb{N}}$, 17
- \mathcal{V} -assignment for ξ , 371
- $\text{aV}(\mathcal{A})$, 78

- B**, 43
- binary relation, 14
- Boolean semiring, 28, 33
- Boole, 28
- bottom-up-deterministic, 69, 74
- bounded, 292
- bounded sum, 33
- branching ranked alphabet, 23
- $\mathbf{B}^{\text{rat}}\langle\langle \mathbf{T}_\Sigma(Q_\infty) \rangle\rangle$, 342
- $\mathbf{B}^{\text{rat}}\langle\langle \mathbf{T}_\Theta \rangle\rangle$, 342
- $\mathbf{B}^{\text{rat}}\langle\langle \mathbf{T}_\Sigma \rangle\rangle^{\text{ext}}$, 350
- $\mathbf{B}^{\text{rat}}_{+\text{Pol}}\langle\langle \mathbf{T}_\Sigma \rangle\rangle$, 349
- $\mathbf{B}^{\text{rec}}\langle\langle \mathbf{T}_\Sigma(Q_\infty) \rangle\rangle$, 342
- bu-deterministic, 69, 74
- bu-deterministically i-recognizable, 79
- bu-deterministically r-recognizable, 77
- bu-deterministically recognizable, 143
- bu-determinizable, 303
- bud-Rec(Σ, \mathbf{B}), 143
- bud-Rec^{init}(Σ, \mathbf{B}), 79
- bud-Rec^{run}(Σ, \mathbf{B}), 77

- char_M , 47
- $C(\mathcal{A})$, 289
- carefully extended MSO formulas, 398
- cd-Rec(Σ, \mathbf{B}), 143
- cd-Rec^{init}(Σ, \mathbf{B}), 79
- cd-Rec^{run}(Σ, \mathbf{B}), 77
- cd-Rec(Σ, BL), 450
- cd-Rec(Σ, FC), 450
- cd-Rec(Σ, dBL), 450
- cd-Rec(Σ, lfBL), 450
- cfg, 65
- cfg underlying, 181

- characteristic mapping, 45
- characteristic polynomial, 47
- characteristic wta, 107
- $\chi_{\mathbb{B}}(L)$, 45
- $\chi_{\text{Nat}}(\mathcal{A})$, 107
- \circ_z , 58
- closed, 21
- co-accessible, 168
- codomain, 15
- combination of runs, 152
- complete, 25
- complete run number mapping, 290
- composition, 14, 15, 64
- concatenation, 14
- congruence relation, 22
- constant, 45
- context, 57
- $C_{\Sigma}(Z_n)$, 57
- context-free grammar, 65
- crisp, 74
- crisp-deterministic, 74
- crisp-deterministically recognizable, 143
- c^n , 153
- cut, 227

- definable, 382
- Δ , 49
- depth-first post-order, 56
- derivation, 66
- derivation relation, 66
- determinization, 308
- diagonalization, 63
- diffin, 93
- diff, 92
- domain, 14

- eC_{Σ} , 151
- elementary, 151, 357
- endomorphism, 44
- equivalence relation, 14
- equivalent, 70, 77, 79, 182
- Euler diagram, 15
- evaluation algebra, 62, 97
- exp, 87
- extremal, 23

- f -image, 245
- $f(\mathcal{A})$, 245
- $f_{\mathcal{A},b}(\xi)$, 290
- factor set, 14
- factorization, 307
- family, 15
- family of (n, \mathbb{B}) -weighted tree languages, 442

- Fatou extension, 113, 329
- field, 27
- finite additive order, 37
- finite multiplicative order, 37
- finite order, 26
- finite-derivational, 182
- finite-input, 258
- finite-output, 258
- finite-state string automaton, 65
- finite-state tree automaton, 69
- finitely generated, 21
- $\text{Fork}(\Sigma)$, 275
- fork, 275
- formal language, 14
- free algebra in the set \mathcal{K} with generating set H ,
23
- $\mathcal{F}(S)$, 442
- fsa, 65
- fta, 69
- fta-hypergraph, 71
- F_2 , 28

- Γ , 14
- (Γ, \mathbb{B}) -wcfg, 181
- Γ_e , 51
- generating, 66
- generator, 442
- group, 24
- $G_{\theta,f}$, 50
- guarded formula, 380

- $H(\mathcal{A})$, 178, 289
- Hadamard product, 46, 47
- Hasse diagram, 15
- $h_{\mathcal{A}}^v$, 422
- $h_{\mathbb{V}}$, 109
- height, 82, 164
- height, 52
- $h_{\mathcal{A}}$, 69
- $h_{\mathbb{A}}$, 51
- $h_{\mathcal{A}}$, 78
- h_{κ} , 381
- $h_{M(\Sigma, \kappa)}$, 62, 381
- $h_{S(\mathcal{A})}$, 120
- hypergraph, 71

- i-equivalent, 79
- i-recognizable, 79, 102
- I.B., 18
- I.H., 18
- I.S., 18
- identity initial weights, 101
- identity mapping, 15

- identity root weight, 74
- image, 15
- f -image, 245
- index, 26
- index in strong bimonoids, 37
- infimum, 14
- initial, 23
- initial algebra crisp-determinizable, 285
- initial algebra preimage theorem, 287
- initial algebra recognizable, 79, 102
- initial algebra semantics, 78
- injective, 15
- Int , 28
- $\text{Int}_{\min,+}$, 29
- Intmod4 , 28
- inverse, 14
- irreflexive, 14
- iteration, 231

- $\kappa(b)$, 382
- kernel, 22, 45
- Kleene star, 232
- Knaster-Tarski theorem, 21
- $K(\tau)$, 21

- label, 54
- Lang_{Γ} , 29
- language, 14
- language generated by \mathcal{G} , 66
- language semiring, 29
- $L(G)$, 66
- $L_i(A)$, 69
- $L(K)$, 275
- $L(K, H)$, 275
- $L_r(A)$, 69
- lattice, 37
 - $\text{FL}(2 + 2)$, 40
 - σ -complete residuated, 40
 - bounded, 37
 - finite chain, 40
 - orthomodular, 39
 - residuated, 39
- $l_{c,\rho}$, 152
- leaf of a tree, 53
- left quotient, 420, 435
- leftmost derivation relation, 66
- \leq_{dp} , 56
- \leq_{pref} , 56
- \leq_{lex} , 56
- lexicographic order, 56
- $\mathcal{L}(V, V)$, 44
- $\mathcal{L}(V^k, V)$, 43

- linear form, 43
- linear mapping, 43
- local system, 275
- local tree language, 275
- local-reduced, 185
- local-successful, 185
- local-trim, 168
- local-useful, 167, 185
- locally finite, 21
- log semifield, 29
- loop, 152
- lower bound, 14
- $\text{LQ}(r)$, 420

- mapping, 14
- matrix, 46
 - semiring of square matrices over B , 47
- max-min semiring, 29
- max-plus semiring, 28
- maximal factorization, 307
- min-plus semiring, 29
- monadic ranked alphabet, 23
- monoid, 24
- monomial, 45
- monotone embedding, 17
- monotone measure function, 17
- monotonic, 298
 - past-finite, 298
- $\text{MSO}(\Sigma)$, 371
- $\text{MSO}(\Sigma, \mathbb{B})$, 380
- $\text{MSO}^{\text{ext}}(\Sigma, \mathbb{B})$, 393
- MSO definable, 372
- M_3 , 39
- multilinear, 43
- multilinear representation, 109
- multiplicative power, 37
- multiplicity mapping, 79, 107

- \mathbb{N} , 13
- Nat , 28
- Nat_{∞} , 28
- $\text{Nat}_{\max,\min}$, 29
- $\text{Nat}_{\max,+}$, 28
- $\text{Nat}_{\max,+,n}$, 28
- $\text{Nat}_{\min,+}$, 29
- (n, \mathbb{B}) -AFwtL, 442
- (n, \mathbb{B}) -tree cone, 442
- near semiring, 33
- NearSem , 33
- $\text{NXT}_{\Sigma, \tilde{\gamma}, b}$, 355
- next mapping, 356
- \mathbb{N}_5 , 39

- \mathbb{N}_∞ , 13
- normal form, 16
- \mathbb{N}_+ , 13
- nullable, 185
- one-product free, 298
- $\mathbb{1}_i$, 48
- $\mathbb{1}_q$, 47
- order, 26, 37
- partial order, 14
- partitioning, 15
- past-finite, 297
- period, 26
- period in strong bimonoids, 37
- Φ_r , 435
- π_1 , 257
- π_2 , 257
- π_G , 66
- $\pi_{\mathcal{G}^u}$, 181
- $\pi_{\mathcal{G}}$, 181, 201
- plus-plus strong bimonoid, 33
- polynomial, 45
- pos, 52, 83
- $\text{pos}_Q(\xi)$, 54
- power, 26
- power of ρ , 153
- power of c , 153
- PS_A , 29
- $\text{PP}_{\mathbb{N}}$, 33
- \prec_{C_Σ} , 315
- prefix order, 56
- preimage property, 61
- preimage theorem, 287
- principal, 442
- projection, 66
- proper, 231
- pseudo-regular, 45, 49
- $\text{push}_\lambda(\mathcal{A})$, 177
- \mathbb{Q} , 13
- $\mathbb{Q}_{\neq 0}^{\text{RA}}(\xi)$, 115
- $\mathbb{Q}_{\neq 0}^{\text{hA}}(\xi)$, 115
- quotient algebra, 22
- $\text{R}_A(q, c, p)$, 152
- \mathbb{R} , 13
- $r \upharpoonright^{\Theta, 0}$, 342
- r-equivalent, 77
- r-recognizable, 77, 101
- $r_{A,b}$, 290
- ranked alphabet, 23
- $\text{R}_A(q, \xi)$, 75
- $\text{Rat}(\Sigma, \mathbb{B})$, 342
- Rat, 28
- $\text{Rat}(\Sigma, \mathbb{B})^{\text{ext}}$, 342
- rational operation, 341
- $\text{Rat}_{\geq 0}$, 29
- $\text{R}_A(\xi)$, 75
- $r_{c,\rho}$, 152
- reachable, 66
- Real, 28
- $\text{Real}_{\geq 0}$, 29
- $\text{Rec}(\Sigma, \mathbb{B})$, 149
- $\text{Rec}^{\text{init}}(\Sigma, \mathbb{B})$, 79
- $\text{Rec}^{\text{init}}(\Sigma, _)$, 211
- $\text{Rec}^{\text{init}}(_, \mathbb{B})$, 211
- $\text{Rec}^{\text{run}}(\Sigma, \mathbb{B})$, 77
- $\text{Rec}^{\text{run}}(\Sigma, _)$, 211
- $\text{Rec}^{\text{run}}(_, \mathbb{B})$, 211
- $\text{Rec}^{\text{init}}(\Sigma, \text{BL})$, 450
- $\text{Rec}^{\text{init}}(\Sigma, \text{FC})$, 450
- $\text{Rec}^{\text{init}}(\Sigma, \text{dBL})$, 450
- $\text{Rec}^{\text{init}}(\Sigma, \text{lfBL})$, 450
- recognizable, 65, 70
- recognizable by a (Σ, B) -multilinear representation, 109
- recognizable step formula, 383
- recognizable step mapping, 70
- $\text{Rec}^{\text{run}}(\Sigma, \text{BL})$, 450
- $\text{Rec}^{\text{run}}(\Sigma, \text{lfBL})$, 450
- $\text{Rec}^{\text{run}}(\Sigma, \text{FC})$, 450
- $\text{Rec}^{\text{run}}(\Sigma, \text{dBL})$, 450
- $\text{RecStep}(\Sigma, \mathbb{B})$, 71
- reduced, 66
- reduction, 16
- reduction system, 16
- reflexive, 14
- $\text{Reg}(\Sigma, \mathbb{B})$, 202
- $\text{Reg}(n, \mathbb{B})$, 442
- $\text{Reg}_{\text{fid}}(\Sigma, \mathbb{B})$, 202
- $\text{Reg}_{\text{nc}}(\Sigma, \mathbb{B})$, 202
- regular, 202
- $\text{RepEx}(\Sigma, \mathbb{B})$, 355
- $\text{RepEx}^r(\mathbb{B})$, 360
- $\text{RepEx}^{\times r}(\mathbb{B})$, 361
- replacement, 54
- representable, 357
- respects, 435
- $\text{REST}(e)$, 355
- restricted representable, 361
- restricted representation, 361
- restriction, 15, 357
- $\rho[\theta]$, 152
- ρ^n , 153

- $\rho^v(w)$, 152
- right quotient, 420
- $\Rightarrow_{G,1}$, 66
- \Rightarrow_G , 66
- ring, 27
- r_α^ℓ , 231
- rk, 23
- root of a tree, 53
- root weight normalized, 74
- root weight vector, 74
- $RQ(r)$, 420
- $RT_{\Sigma,\sigma,b}$, 355
- $RT_G(A, u)$, 67
- $RT_G(N', L)$, 67
- $RT_G(N', L)$, 182
- $RT_{\mathcal{H}}(\xi, \zeta)$, 257
- $RT_{G^u}(N', L)$, 181
- rule tree, 66
- run, 65, 69, 75
 - local-successful, 167
 - successful, 167
- run crisp-determinizable, 285
- run on context, 152
- run preimage theorem, 287
- run recognizable, 77, 101
- run semantics, 76

- $S(\mathcal{A})$, 120
- $S_{\mathcal{A}}(P, q)(\xi)$, 344
- scalar multiplication, 45–47
- scalar product, 47
- schema of primitive recursion, 20
- $\text{Sem}(\mathbf{B})$, 29
 - $[\mathcal{A}]$, 143, 149
 - $[\mathcal{A}]^{\text{init}}$, 78, 102
 - $[\mathcal{A}]^{\text{run}}$, 76, 101
 - $[e]$, 356
 - $[e]_{\nu}$, 393
 - $[\mathcal{G}]$, 202
 - $[\mathcal{G}]^t$, 201
 - $[\mathcal{G}]^s$, 182
 - $[\mathcal{G}]^{\text{wrt}}$, 182
 - $[\mathcal{H}]^{\text{tt}}$, 258
 - $[\mathcal{S}]$, 276
- semifield, 27
- semigroup, 24
- semimodule, 43
- semiring, 27
- Σ , 49
- Σ -algebra associated with fta A , 69
- Σ -algebra, 23
- Σ -algebra homomorphism, 23
- Σ -algebra isomorphism, 23
- (Σ, \mathbf{B}) -weighted tree language, 61
- (Σ, \mathbf{B}) -multilinear representation, 109
- (Σ, \mathbf{B}) -semimodules, 44
- (Σ, \mathbf{B}) -vector space, 45
- (Σ, \mathbf{B}) -vector space of polynomials, 433
- $(\Sigma, \Delta, \mathbf{B})$ -weighted tree transformation, 62
- $(\Sigma, \Psi, \mathbf{B})$ -wpb, 257
- Σ -terms, 49
- Σ -term algebra, 50
- Σ -trees, 49
- Σ^{Ξ} , 67
- signature of a universal algebra, 21
- size, 52, 81
- skeleton alphabet, 262
- \leq_{dp} , 56
- \leq_{pref} , 56
- smallest subalgebra, 21
- state
 - accessible, 167
 - co-accessible, 168
 - local-useful, 167
 - useful, 167
 - weakly useful, 168
- state algebra, 120
- $\text{state}_{\mathcal{A}}$, 428
- Stb , 34, 142
- step languages, 71
- strict, 14
- strict subset, 13
- string bimonoid
 - weakly locally finite, 27
- string ranked alphabet, 23
- strong bimonoid, 27
 - σ -complete, 27
 - additively idempotent, 35
 - bi-locally finite, 27
 - commutative, 27
 - extremal, 35
 - left-distributive, 27
 - multiplicatively idempotent, 35
 - positive, 35
 - right-distributive, 27
 - semiring, 27
 - zero-cancellation free, 35
 - zero-divisor free, 35
 - zero-sum free, 35
- $\text{sub}(\mathcal{A})$, 287
- $\text{sub}(\xi)$, 54
- subalgebra, 21
- subset, 13
- \subset , 13

- \subseteq , 13
- subset method, 287
- substitution, 59
- subtree, 54
- \succ , 51, 53, 76, 86, 115, 152, 188, 194
- \succ' , 189, 190
- \succ , 242, 250, 269, 331, 343, 356, 387
- $\succ_{C\Sigma}$, 151
- $\succ_{\text{MSO}(\Sigma)}$, 371
- $\succ_{\text{MSO}(\Sigma, \mathbf{B})}$, 380
- $\succ_{\text{MSO}^{\text{ext}}(\Sigma, \mathbf{B})}$, 393
- \succ_{Σ} , 52
- $\succ_{\Sigma, H}$, 52
- $\succ_{\Sigma, H}^+$, 52
- \succ_{Σ}^+ , 52
- sum, 46
- summation, 46, 47
- $\text{supp}(\mathcal{A})$, 104
- supp-i-finite, 62
- supp-o-finite, 62
- support, 45
- $\text{supp}(\mathcal{C})$, 61
- $\text{supp}(f)$, 45
- support fta, 104
- support theorem, 327, 329, 330, 332
- $\text{supp}(\mathcal{S})$, 277
- supremum, 14
- surjective, 15
- symmetric, 14
- syntactic (Σ, \mathbf{B}) -vector space, 436
- syntactic congruence, 436
- τ -summable, 62
- TD, 56
- term rewrite system, 58
- term algebra, 50
- terminating, 17
- terms, 49
- TF_{Σ} , 56
- θ_{Σ} , 50
- Three, 33
- top_{σ} , 225
- top-concatenation, 225
- TP, 53
- TR, 76
- transformation monoid, 86
- transition, 74
- transition mapping, 74
- transition relation, 69
- transitive, 14
- tree_e , 51
- tree concatenation, 228
- tree cone, 442
- tree homomorphism, 58
 - productive, 249
- tree relabeling, 57
 - deterministic, 57
 - non-overlapping, 57
- tree substitution, 57
- trees, 49
 - leaf of a tree, 53
 - root of a tree, 53
- trim, 168
- trivial factorization, 307
- trivial ranked alphabet, 23
- TropBM, 31
- tropical bimonoid, 31
- tropical semifield, 29
- tropical semiring, 29
- Trunc_{λ} , 31
- TR_z , 152
- $\text{T}_{\Sigma}(H)$, 49
- $\text{T}_{\Sigma}(H)$, 50
- twinning property, 307
- twothree, 96
- type of a universal algebra, 21
- union of mappings, 15
- unit vector, 48
- $\text{UnitInt}_{\text{alg}}$, 32
- $\text{UnitInt}_{\text{bs}}$, 32
- $\text{UnitInt}_{u,i}$, 32
- universal algebra, 20
- upper bound, 14
- useful, 66, 167
- variables, 57
- $\text{V}(\mathcal{A})$, 77
- vector, 47
- vector algebra, 77
- vector space, 44
- vector space of polynomials, 433
- Venn diagram, 15
- victorious, 307
- Viterbi, 29
- Viterbi semiring, 29
- $\text{VLQ}(r)$, 420
- $\text{VRQ}(r)$, 420
- wcfg, 181
- $\text{wcl}(A)$, 27
- weakly useful, 168
- weighted language generated by \mathcal{G} , 182
- weighted conjunction, 393
- weighted context-free grammar, 181

- chain-free, 184
- finite-derivational, 182
- nonterminal form, 184
- rule tree, 66
- start-separated, 184
- weighted rule tree language, 182
- weighted context-free language, 182
- weighted first-order existential quantification, 380
- weighted first-order universal quantification, 393
- weighted local system, 275
- weighted projective bimorphism, 257
 - finite-input, 258
 - finite-output, 258
- weighted regular tree grammar, 201
 - alphabetic, 204
 - tree automata form, 204
- weighted rule tree language, 182
- weighted second-order existential quantification, 380
- weighted second-order universal quantification, 393
- weighted set, 45
 - constant, 45
 - monomial, 45
 - polynomial, 45
- weighted string automaton, 100
- weighted tree automaton, 74
 - bottom-up-deterministic, 74
 - crisp, 74
 - crisp-deterministic, 74
 - root weight normalized, 74
 - simple, 427
 - total, 74
- weighted tree language, 61
 - (n, \mathbf{B}) -weighted tree language, 441
 - application, 61
 - constant, 61
 - Hadamard product, 61
 - monomial, 61
 - polynomial, 61
 - scalar multiplication, 61
 - sum, 61
 - support, 61
- weighted tree transformation, 62
- well-founded induction, 18
- well-founded set, 18
- wls, 275
- wpb, 257
- wrtg, 201
- wsa, 100
- $\text{wt}_{\mathcal{A}}(\xi, \rho)$, 76, 152, 344
- $\text{wt}_{\mathcal{A}}(w, \rho)$, 100
- $\text{wt}_{\mathcal{A}}^-(w, \rho)$, 100
- $\text{wt}_{\mathcal{G}}$, 182
- wta, 74
- $\text{wts}(\mathcal{A})$, 74
- X , 58
- Ξ , 201
- $\xi[\xi_1, \dots, \xi_n]$, 57
- $\xi \upharpoonright^v$, 152
- $\xi(w)$, 54
- $\text{yield}^{\mathcal{P}}$, 85
- yield_{Γ} , 54, 196
- yield-intersection, 241
- Z , 58
- \mathbb{Z} , 13
- 0-extension of Σ , 342
- 0-extension, 342
- $\mathbb{0}_{\kappa}$, 48
- $\mathbb{0}_Q$, 47
- zigzag, 94