







On the equivalence between squeezing and entanglement potential for two-mode Gaussian states

Bohan Li ^{1,2} Aritra Das ^{1,2} Spyros Tserkis ³ Prineha Narang ³ Ping Koy Lam ^{1,4} and Syed M. Assad ^{1,5,*}

¹*Centre for Quantum Computation and Communication Technology,
Department of Quantum Science and Technology,
Australian National University, Canberra, ACT 2601, Australia*

²*These authors contributed equally*

³*Physical Sciences, College of Letters and Science,
University of California, Los Angeles (UCLA), CA, USA*

⁴*Institute of Materials Research and Engineering, Agency for Science,
Technology and Research (A*STAR), Singapore 138634, Republic of Singapore*

⁵*School of Physical and Mathematical Sciences, Nanyang Technological University, Singapore 639673, Republic of Singapore*

The maximum amount of entanglement achievable under passive transformations by continuous-variable states is called the entanglement potential. Recent work has demonstrated that the entanglement potential is upper-bounded by a simple function of the squeezing of formation, and that certain classes of two-mode Gaussian states can indeed saturate this bound, though saturability in the general case remains an open problem. In this study, we introduce a larger class of states that we prove saturates the bound, and we conjecture that all two-mode Gaussian states can be passively transformed into this class, meaning that for all two-mode Gaussian states, entanglement potential is equivalent to squeezing of formation. We provide an explicit algorithm for the passive transformations and perform extensive numerical testing of our claim, which seeks to unite the resource theories of two characteristic quantum properties of continuous-variable systems.

I. INTRODUCTION

Entanglement is a non-classical property that can be considered as a resource for various quantum technology applications [1]. In continuous-variable (CV) systems [2], e.g., systems consisting of bosonic modes, entanglement is connected with a more fundamental property called squeezing [3]. Squeezing constitutes a necessary condition for entanglement in CV Gaussian systems [4–6] and finds applications in numerous areas of quantum optics and CV quantum information, including metrology [7–9], secure quantum communication [10–13], quantum teleportation [14–16], cluster states [17, 18], heralded gates [19] and quantum computation [20, 21].

Moreover, any multi-mode squeezed state can be transformed into an entangled state under passive operations [22, 23]. Passive operations in CV systems are relatively easier to perform in the laboratory than active operations. There exist multi-mode quantum states that are not entangled, but have the potential to be entangled by simply mixing on a beam splitter [24, 25]. Motivated by this, we study the entanglement potential of Gaussian states. Conceptually, the entanglement potential measures the maximum amount of entanglement obtainable under passive operations [24]. This potential depends on the way that entanglement is measured, e.g., in Ref. [24], logarithmic negativity [26] was selected for this purpose, whereas in Ref. [25], the entanglement of formation [27] was chosen.

Focusing on the entanglement of formation, some of us have previously derived analytic expressions for the

entanglement potential of a few specific classes of two-mode Gaussian states: symmetric states and balanced correlated states [25]. These analytic expressions were shown to be directly connected to the squeezing of formation [28]—a measure that quantifies the amount of squeezing in a quantum state. In Ref. [25], an explicit derivation of the passive operations needed to achieve this potential was provided. Further, it was shown that for general two-mode Gaussian states, a monotonic function, $h_0(\cdot)$, of the squeezing of formation upper-bounds the entanglement potential.

In this work, we extend that analysis in two ways: first, we analytically show that for a larger, six-parameter class of two-mode Gaussian states, the entanglement potential is equal to $h_0(\cdot)$ of the squeezing of formation. Henceforth, we shall refer to all states having entanglement equal to entanglement potential as *potential-saturating* states. Second, we conjecture that any two-mode Gaussian state can be passively transformed into a potential-saturating state from the six-parameter class of states, and present numerical evidence supporting this conjecture. If our conjecture holds true, then the entanglement potential of all two-mode Gaussian states is exactly equal to $h_0(\cdot)$ of the squeezing of formation. In other words, we find that linear passive optics can always maximise the entanglement of a state up to a threshold value decided by the amount of squeezing present in the state. Our result, thus, connects the resource theories of squeezing and entanglement for two-mode Gaussian states and is primarily relevant to quantum information and communication protocols, where squeezed states play a major role.

Our paper is arranged as follows: In Sec. II A, we discuss some preliminaries of Gaussian quantum informa-

* cqtsma@gmail.com, corresponding author

tion. Then, in Sec. II B we introduce a special class of potential-saturating Gaussian states, and propose an algorithm to passively transform arbitrary two-mode Gaussian states into potential-saturating states. We present numerical simulations of our algorithm in Sec. II C to support our conjecture. Finally we conclude in Sec. III with a discussion of our results and remarks on future scope.

II. RESULTS

A. Background

1. Gaussian quantum information

Gaussian quantum states, which are the focus of this work, can be fully described by the second statistical moments of the associated bosonic-field quadrature operators (assuming the first statistical moments, i.e., the mean values, to be zero). The quadrature field operators \hat{x}_j and \hat{p}_j are the real and imaginary parts, respectively, of the bosonic-field annihilation operator for the j^{th} mode. Accordingly, any N -mode Gaussian state admits a finite-dimensional representation via the covariance matrix σ of its quadrature field operators. This covariance matrix is a $2N \times 2N$ real symmetric matrix satisfying the uncertainty relation [29] $\sigma + i\Omega \geq 0$, where Ω is the symplectic form given in Appendix A. Apart from the regular eigenvalues $\{\lambda_j\}$ of σ , it is also useful to also define the symplectic eigenvalues $\{\nu_j\}$ of σ , which are the positive eigenvalues of $i\Omega\sigma$. We denote the symplectic eigenvalues arranged in increasing order by ν_j^\uparrow , so that $\nu_1^\uparrow \leq \nu_2^\uparrow \leq \nu_N^\uparrow$. Then, the uncertainty relation for σ is equivalent to the condition $\nu_1 \geq 1$ [2].

In the symplectic representation, Gaussian transformations, which map Gaussian states to themselves, are given by symplectic matrices $K \in \text{Sp}(2N, \mathbb{R})$, such that $K\Omega K^\top = \Omega$, and K acts on σ as $\sigma \mapsto K\sigma K^\top$. Here $\text{Sp}(2N, \mathbb{R})$ denotes the group of symplectic $2N \times 2N$ matrices over real numbers. Typical Gaussian transformations include beam splitters $K_{\text{bs}}(\tau)$ with transmissivity $\tau \in [0, 1]$ and phase rotations $K_{\text{rot}}(\theta)$ with angle $\theta \in [0, 2\pi)$; these are both passive operations, meaning they do not introduce extra energy into the system and thus, leave the trace of the covariance matrix, $\text{Tr} \sigma$ invariant.

Active Gaussian transformations, on the other hand, include two local single-mode squeezers, denoted $S_1(r_1, r_2)$, with real-valued squeezing parameters r_j for mode $j \in \{1, 2\}$ or two-mode squeezers $S_2(r)$ for r the single real squeezing parameter; these transformations introduce extra energy into the system. We summarise these transformations and their matrix representations in Appendix A. We also list a few standard decompositions in Gaussian quantum optics in Appendix B; these will be used later in Secs. II B and II C.

The covariance matrix π of a pure Gaussian state satisfies $\det \pi = 1$, whereas for a mixed Gaussian state σ , we have $\det \sigma > 1$. Such a mixed state σ can be decomposed into a pure state π and some positive definite matrix, $\phi > 0$, representing noise as $\sigma = \pi + \phi$, but this decomposition is not unique. Owing to this non-uniqueness, one way to extend a resource measure \mathcal{F} defined for pure states to mixed states is by optimising over all possible pure state decompositions as follows

$$\mathcal{F}(\sigma) := \min_{\pi} \{ \mathcal{F}(\pi) \mid \sigma - \pi \geq 0, \det \pi = 1 \}, \quad (1)$$

where the minimisation is over all pure states π . Below we discuss two resource measures defined in this way—the squeezing of formation $\mathcal{S}(\sigma)$ and the entanglement of formation potential $\mathcal{P}(\sigma)$ of a Gaussian state σ .

2. Squeezing of formation

The process of squeezing a Gaussian state's uncertainty below the standard quantum limit [30], along one quadrature, is an active transformation. Operational measures of squeezing have been proposed [28] in order to quantify the amount of squeezing in a state. One such measure called the squeezing of formation (SOF), denoted $\mathcal{S}(\sigma)$, is defined as the minimum amount of local squeezing required to construct σ starting from vacuum [28]. For an N -mode pure Gaussian state π , this quantity is simply a function of the eigenvalues of π ,

$$\mathcal{S}(\pi) := -\frac{1}{2} \sum_{j=1}^N \ln \left(\lambda_j^\uparrow(\pi) \right) = \frac{1}{2} \sum_{j=N+1}^{2N} \ln \left(\lambda_j^\uparrow(\pi) \right), \quad (2)$$

where $\lambda_j^\uparrow(\pi)$ denotes the j^{th} lowest eigenvalue of π . Straightforwardly, the SOF of a two-mode locally-squeezed vacuum with squeezing parameters r_1 and r_2 is simply $r_1 + r_2$. Finally, for mixed states σ , the SOF definition is then extended via

$$\mathcal{S}(\sigma) := \min_{\pi} \{ \mathcal{S}(\pi) \mid \sigma - \pi \geq 0, \det \pi = 1 \}, \quad (3)$$

where the minimisation is over all pure states π .

3. Entanglement of formation potential

A two-mode Gaussian σ is separable if and only if its partial transpose, denoted σ^Γ , is also a valid state, i.e.,

$$\nu_1^\uparrow(\sigma^\Gamma) \geq 1, \quad (4)$$

a result known as the PPT condition [31]. In this case, σ has zero entanglement irrespective of which entanglement measure is employed. However, for mixed entangled states, the various measures of entanglement, including logarithmic negativity [26], entanglement of formation [27], distillable entanglement [27], and relative

entropy of entanglement [32], are all in general inequivalent [33, 34].

We limit our scope to two-mode Gaussian states, which can be treated as a bipartite system, and we choose the entanglement of formation (EOF), denoted $\mathcal{E}(\sigma)$, as our entanglement measure [27]. Conceptually, $\mathcal{E}(\sigma)$ quantifies the minimum amount of entanglement required to produce the state σ , assisted only by local operations and classical communication (LOCC). For pure states π , $\mathcal{E}(\pi)$ is defined to be the entropy of entanglement [33, 35], i.e.,

$$\mathcal{E}(\pi) := \max \left\{ 0, h \left[\nu_1^\uparrow(\pi^\Gamma) \right] \right\}, \quad (5)$$

where $h[\cdot]$ is an auxiliary function defined in Appendix C. Then, for mixed states σ , the definition is extended via Eq. (1) to [36–39]

$$\mathcal{E}(\sigma) := \min_{\pi} \{ \mathcal{E}(\pi) \mid \sigma - \pi \geq 0, \det \pi = 1 \}. \quad (6)$$

Note that Eq. (6) technically defines the Gaussian-EOF [39], which, in general, upper-bounds the EOF for multi-mode states, but coincides with the EOF for two-mode Gaussian states [40].

Next, the EOF potential \mathcal{P} is defined as the maximum EOF a state can attain when transformed only by passive linear optics [25]. Specifically, starting from a two-mode Gaussian state σ , with access to two ancillary vacuum modes, and four-mode passive transformations K , the EOF potential is defined as

$$\mathcal{P}(\sigma) := \sup_K \left\{ \mathcal{E}(\sigma') \mid \sigma' = \text{tr}_2 [K(\sigma \oplus \mathbb{1}_2)K^\top] \right\}, \quad (7)$$

so that $\mathcal{E}(\sigma) \leq \mathcal{P}(\sigma)$ always. In Eq. (7), the $\mathbb{1}_2$ denotes two ancillary vacuum modes and the tr_2 denotes tracing out these modes. Interestingly, $\mathcal{P}(\sigma)$ is upper-bounded by a simple function of $\mathcal{S}(\sigma)$ [25],

$$\mathcal{P}(\sigma) \leq h_0[\mathcal{S}(\sigma)], \quad (8)$$

where $h_0[\cdot]$ is a monotonic auxiliary function defined in Appendix C. However, the saturability of the bound in Eq. (8) for arbitrary σ remains an open problem. In this work, we provide an algorithm that aims to saturate this bound for arbitrary two-mode Gaussian states and then establish this saturability via extensive numerical testing.

B. Saturating the EOF Potential

In this section, we first introduce a special class of potential-saturating two-mode Gaussian states, σ_{sp} (sp for special), which have $\mathcal{E}(\sigma_{\text{sp}}) = \mathcal{P}(\sigma_{\text{sp}}) = h_0[\mathcal{S}(\sigma_{\text{sp}})]$, and thus saturate the bound in Eq. (8). We state this claim as a proposition and then prove it in Sec. IIB 1. Then, in Sec. IIB 2, we conjecture that any arbitrary two-mode Gaussian state can be passively transformed into this special class. In Sec. IIB 3 we provide an explicit algorithm to perform this transformation. If our conjecture holds true, then $\mathcal{P}(\sigma) = h_0[\mathcal{S}(\sigma)]$ for all two-mode Gaussian states.

1. A special class of states

Consider the two-mode Gaussian state

$$\sigma_{\text{sp}} = K_{\text{bs}}(\pi_d(r_1, r_2) + \lambda_1\phi_1 + \lambda_2\phi_2)K_{\text{bs}}^\top, \quad (9)$$

where $\pi_d(r_1, r_2)$ represents a locally-squeezed two-mode pure state in diagonal form with squeezing parameters r_1 and r_2 (matrix representation in Appendix A). Here K_{bs} denotes a balanced beam splitter operation with $\tau = 1/2$, $\lambda_2 \geq \lambda_1 \geq 0$ are two non-negative constants, and $\phi_1 = |\phi_1\rangle\langle\phi_1|$ and $\phi_2 = |\phi_2\rangle\langle\phi_2|$ are two orthogonal, positive semidefinite, rank-one matrices with

$$|\phi_1\rangle = \begin{pmatrix} \alpha \cos \theta \\ \sin \theta \\ \cos \theta \\ \alpha \sin \theta \end{pmatrix} \quad \text{and} \quad |\phi_2\rangle = \begin{pmatrix} \alpha \sin \theta \\ -\cos \theta \\ \sin \theta \\ -\alpha \cos \theta \end{pmatrix}. \quad (10)$$

In Eq. (10), α is a real parameter satisfying $|\alpha| \leq e^{-r_1 - r_2}$ and $\theta \in [0, 2\pi)$ is an angle. The term $\lambda_1\phi_1 + \lambda_2\phi_2$ can be thought of as correlated noise, parameterised by λ_1 , λ_2 , α and θ , added to the pure two-mode squeezed state π_d . The terms λ_1 and λ_2 denote the strength of the noise terms ϕ_1 and ϕ_2 , respectively. The parameter α determines the ratio between the added noise in the first and the second modes in the same quadrature, whereas the angle θ determines the ratio between the added noise in the \hat{x} and \hat{p} quadratures in the same mode. When $\lambda_1 = \lambda_2$, the form of the added noise $\lambda_1\phi_1 + \lambda_2\phi_2$ is special in the sense that the state σ_{sp} becomes passively de-cross-correlatable, i.e., can be passively transformed into a de-cross-correlated state (recall that de-cross-correlated states have no correlations between the \hat{x} and \hat{p} quadratures, i.e., $\langle \hat{x}_i \hat{p}_j + \hat{p}_i \hat{x}_j \rangle = 0$ for $i, j \in \{1, 2\}$, see Appendix A for details). Overall, the state σ_{sp} has 6 free parameters $\{r_1, r_2, \lambda_1, \lambda_2, \alpha, \theta\}$ and thus may be thought of as an element from a six-parameter family of states.

As we shall show in the following proposition, the state σ_{sp} is special in the sense that: σ_{sp} has the same SOF as π_d , the EOF of σ_{sp} saturates its EOF potential and σ_{sp} has the same EOF potential as π_d :

$$\mathcal{S}(\sigma_{\text{sp}}) = \mathcal{S}(\pi_d) \quad \text{and} \quad \mathcal{E}(\sigma_{\text{sp}}) = \mathcal{P}(\sigma_{\text{sp}}) = \mathcal{P}(\pi_d). \quad (11)$$

Moreover, the EOF and SOF properties of a pure state π_d are simply

$$\mathcal{S}(\pi_d) = r_1 + r_2 \quad \text{and} \quad \mathcal{P}(\pi_d) = h_0[\mathcal{S}(\pi_d)]. \quad (12)$$

In other words, the upper bound for EOF in Eq. (8) is saturated for all such σ_{sp} . We now formally state and prove this claim.

Proposition. For any state σ_{sp} of the form in Eq. (9), the EOF upper bound in Eq. (8) is saturated, i.e.,

$$\mathcal{E}(\sigma_{\text{sp}}) = \mathcal{P}(\sigma_{\text{sp}}) = h_0[\mathcal{S}(\sigma_{\text{sp}})]. \quad (13)$$

Proof. The outline of our proof is as follows. By adding classical correlations in the form of noise to σ_{sp} , we get

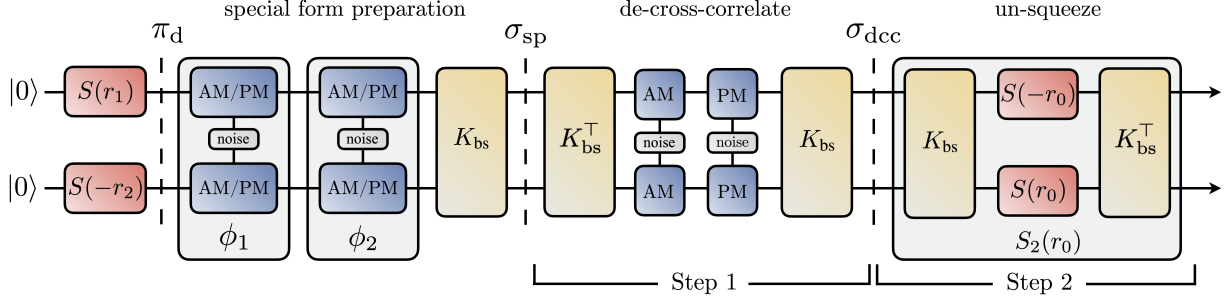

FIG. 1. Schematic of the procedure to compute the EOF potential \mathcal{P} for a state σ_{sp} in the special form given in Eq. (9). Steps 1 and 2 from the proof of our proposition are also indicated. After adding a particular correlated noise to σ_{sp} (step 1), the de-cross-correlated state σ_{dcc} is then two-mode-squeezed to produce a separable state (step 2). The minimum value r_0 of the two-mode squeezing parameter, such that the output state is separable, yields the lower bound $h_0[2r_0]$ to $\mathcal{P}(\sigma_{\text{sp}})$, as in Eq. (17).

a state σ_{dcc} that is de-cross-correlated. We then lower-bound $\mathcal{E}(\sigma_{\text{dcc}})$, which serves as a lower bound for $\mathcal{E}(\sigma_{\text{sp}})$ and thus $\mathcal{P}(\sigma_{\text{sp}})$. Finally, we upper-bound $\mathcal{S}(\sigma_{\text{sp}})$ and show that this upper bound coincides with the lower bound for \mathcal{P} , which along with Eq. (8) implies that $\mathcal{P}(\sigma_{\text{sp}}) = h_0[\mathcal{S}(\sigma_{\text{sp}})]$. The proof presented below is broken up into three steps, and is illustrated in Fig. 1 as a circuit diagram.

Step 1: We first add some noise along $K_{\text{bs}}\phi_1 K_{\text{bs}}^\top$ to σ_{sp} to get a de-cross-correlated state σ_{dcc} ,

$$\begin{aligned} \sigma_{\text{dcc}} &= \sigma_{\text{sp}} + (\lambda_2 - \lambda_1)K_{\text{bs}}\phi_1 K_{\text{bs}}^\top \\ &= K_{\text{bs}}(\pi_d + \lambda_2(\phi_1 + \phi_2))K_{\text{bs}}^\top \\ &= K_{\text{bs}} \left(\pi_d + \lambda_2 \begin{pmatrix} \alpha^2 & 0 & \alpha & 0 \\ 0 & 1 & 0 & \alpha \\ \alpha & 0 & 1 & 0 \\ 0 & \alpha & 0 & \alpha^2 \end{pmatrix} \right) K_{\text{bs}}^\top. \end{aligned}$$

As adding noise cannot increase entanglement, we have

$$\mathcal{E}(\sigma_{\text{dcc}}) \leq \mathcal{E}(\sigma_{\text{sp}}). \quad (14)$$

Step 2: Next, we consider the least amount of two-mode squeezing, r_0 , required to un-squeeze σ_{dcc} into a separable state, i.e.,

$$r_0 := \min_r \left\{ r \mid S_2(r)\sigma_{\text{dcc}}S_2^\top(r) \text{ separable} \right\}. \quad (15)$$

Then $h_0[2r_0]$ is a lower bound to $\mathcal{E}(\sigma_{\text{dcc}})$. By checking the necessary and sufficient conditions for separability (see Sec. II A 3), we find that the state $S_2(r)\sigma_{\text{dcc}}S_2^\top(r)$ is separable when

$$\frac{r_1 + r_2}{2} \leq r \leq \frac{1}{4} \sum_{j=1}^2 \log \left[\frac{\lambda_2 + e^{2r_j}}{1 + \lambda_2 \alpha^2 e^{2r_j}} \right], \quad (16)$$

so that $r_0 = (r_1 + r_2)/2$. Moreover, for the interval in Eq. (16) to be valid, we must have $|\alpha| \leq e^{-r_1 - r_2}$. The lower bound $h_0[2r_0] = h_0[r_1 + r_2] \leq \mathcal{E}(\sigma_{\text{dcc}})$ from Eq. (16), when combined with Eq. (14), results in

$$h_0[r_1 + r_2] \leq \mathcal{E}(\sigma_{\text{dcc}}) \leq \mathcal{E}(\sigma_{\text{sp}}) \leq \mathcal{P}(\sigma_{\text{sp}}). \quad (17)$$

Step 3: Finally, we observe that σ_{sp} can clearly be produced with $r_1 + r_2$ amount of squeezing, so that $\mathcal{S}(\sigma_{\text{sp}}) \leq r_1 + r_2$. The monotonicity of $h_0(\cdot)$ and Eq. (8) then allows us to upper-bound $\mathcal{E}(\sigma_{\text{sp}})$ as

$$\mathcal{E}(\sigma_{\text{sp}}) \leq \mathcal{P}(\sigma_{\text{sp}}) \leq h_0[\mathcal{S}(\sigma_{\text{sp}})] \leq h_0[r_1 + r_2]. \quad (18)$$

Combining Eqs. (17) and (18), we get

$$\mathcal{E}(\sigma_{\text{sp}}) = \mathcal{P}(\sigma_{\text{sp}}) = h_0[r_1 + r_2] \text{ and } \mathcal{S}(\sigma_{\text{sp}}) = r_1 + r_2, \quad (19)$$

thus proving the proposition. \square

The proposition above says that for states in the special form of Eq. (9), the upper bound $h_0[\mathcal{S}(\cdot)]$ (introduced in Ref. [25]) on the EOF potential $\mathcal{P}(\cdot)$ is actually the true value of $\mathcal{P}(\cdot)$. In other words, all states in this six-parameter family saturate the inequality in Eq. (8). Notably, previously, only two three-parameter families of two-mode Gaussian states were known to possess this property: symmetric states and balanced correlated states [25].

2. Extension to all two-mode Gaussians

Let us now denote by G the set of all states in the special form of Eq. (9). Suppose a state σ' is not in this set G , but on applying some passive transformation K' transforms into the special form, i.e.,

$$\sigma' \notin G \text{ but } K'\sigma'K'^\top \in G. \quad (20)$$

As passive transformations by definition do not change the EOF potential of a state [25], we must have

$$\mathcal{P}(\sigma') = \mathcal{P}(K'\sigma'K'^\top) = h_0[\mathcal{S}(K'\sigma'K'^\top)]. \quad (21)$$

Moreover, passive transformations also leave the SOF invariant [28], so $\mathcal{S}(K'\sigma'K'^\top) = \mathcal{S}(\sigma')$. Thus, we have

$$\mathcal{P}(\sigma') = h_0[\mathcal{S}(\sigma')], \quad (22)$$

indicating that σ' too saturates the inequality in Eq. (8) despite not being in the set G . By a similar line of reasoning, it follows that for any state $\sigma' \notin G$, if we can add some noise ϕ' such that its SOF remains unchanged, i.e., $\mathcal{S}(\sigma') = \mathcal{S}(\sigma' + \phi')$, and the resulting state is in the special form, i.e., $\sigma' + \phi' \in G$, then σ' must also satisfy Eq. (22).

It is then evident that any state that can be transformed into G by either passive transformations, or the addition of noise that keeps the SOF constant, or both, must also saturate the upper bound in Eq. (8). We conjecture that all two-mode Gaussian states can be transformed into G in this way.

Conjecture. Any two-mode Gaussian state σ_{in} can be transformed into some element σ_{out} in G , without increasing its SOF, via only passive transformations, the addition of noise and access to ancillary vacuum modes.

From the discussion in Sec. IIB1, we know that our conjecture, if true, would immediately imply that $\mathcal{P}(\sigma_{\text{in}}) = h_0[\mathcal{S}(\sigma_{\text{in}})]$ for all two-mode Gaussian states σ_{in} . In this work, we do not formally prove our conjecture—instead, we provide evidence for the conjecture in the following way. First we present the transformation $\sigma_{\text{in}} \mapsto \sigma_{\text{out}}$ mentioned in the conjecture as an algorithm (Alg. 1 in Sec. IIB3). Algorithm 1 takes σ_{in} as input, and after performing passive operations, adding noise, and adding and then discarding an ancillary vacuum mode, the algorithm outputs the transformed state $\sigma_{\text{out}} \in G$. Next, we numerically ran our algorithm on 10^6 random inputs σ_{in} , and calculate the EOF of the output $\mathcal{E}(\sigma_{\text{out}})$ and compare that to the SOF of the input $\mathcal{S}(\sigma_{\text{in}})$. We verify that $\mathcal{E}(\sigma_{\text{out}}) = h_0[\mathcal{S}(\sigma_{\text{in}})]$ holds true for every input state to within numerical tolerances.

3. Algorithm: Passive operations to maximise EOF

We now propose an algorithm that, starting from any arbitrary two-mode Gaussian σ_{in} , outputs a potential-saturating two-mode Gaussian σ_{out} such that $\mathcal{E}(\sigma_{\text{out}}) = \mathcal{P}(\sigma_{\text{out}}) = h_0[\mathcal{S}(\sigma_{\text{out}})]$ while keeping the SOF constant, i.e., $\mathcal{S}(\sigma_{\text{out}}) = \mathcal{S}(\sigma_{\text{in}})$. In doing so, the algorithm only performs passive operations and adds noise to the input state so that $\mathcal{P}(\sigma_{\text{out}}) \leq \mathcal{P}(\sigma_{\text{in}})$. As a result, our algorithm establishes the fact that $\mathcal{P}(\sigma_{\text{in}}) = h_0[\mathcal{S}(\sigma_{\text{in}})]$ for any arbitrary two-mode Gaussian σ_{in} . The fundamental idea behind the algorithm is to decouple the squeezing between the two modes of σ_{in} , and then mix the two modes on a balanced beam splitter. The resulting de-cross-correlated state, with two identical modes, is known to be potential-saturating and also saturates the EOF bound in Eq. (8) (see Appendix C).

The first step in the algorithm is to find an optimal pure state π_{opt} that has the same SOF as σ_{in} from Eq. (3), i.e., $\mathcal{S}(\sigma_{\text{in}}) = \mathcal{S}(\pi_{\text{opt}})$; in Alg. 1, we denote this

procedure as $\text{OPTSOFSTATE}(\sigma_{\text{in}})$ [28]. Next, $\text{BMDECOMP}(\pi_{\text{opt}})$ leverages the Bloch-Messiah decomposition to find a passive transformation K_{BM} that diagonalises π_{opt} to π_{diag} (see Appendix B for details). Applying K_{BM} to the mixed state $\sigma_{\text{in}} = \pi_{\text{opt}} + \phi$ yields the mixed state $\sigma_{\text{diag}} = \pi_{\text{diag}} + \phi_{\text{diag}}$ (note that σ_{diag} and ϕ_{diag} are not diagonal). In the second step, we calculate the eigenvalues $\{\lambda_j\}$ (arranged in decreasing order) and eigenvectors $\{|\phi_j\rangle\}$ of the matrix ϕ_{diag} via the procedure $\text{SPECTRUM}(\phi_{\text{diag}})$. Then we compute the extra noise term $\phi_{\text{extra}} = (\lambda_1 - \lambda_2)|\phi_2\rangle\langle\phi_2|$, which, when added to σ_{diag} , gives us the state $\sigma' = \sigma_{\text{diag}} + \phi_{\text{extra}}$.

Surprisingly, we find that the state σ' at this point in the algorithm can always be passively de-cross-correlated. This is not true, in general, for mixed Gaussian states. Nevertheless, for all σ_{in} , $K_{\text{BM}}\sigma_{\text{in}}K_{\text{BM}}^\top + \phi_{\text{extra}}$ becomes a passively de-cross-correlatable state—this is crucial because de-cross-correlated states are optimal for the EOF potential (see Appendix C). This passive transformation, which is simply a phase rotation on one mode, is calculated in the procedure $\text{DECROSSCORRELATE}(\cdot)$ by numerically finding the angle $\theta^* \in [0, 2\pi)$ and mode $i^* \in \{1, 2\}$ to be rotated to make σ' de-cross-correlated. The last step in the algorithm comprises mixing one of the modes of the de-cross-correlated state σ_{rot} with a third ancillary vacuum mode on a beam splitter; this is done to remove noise from σ_{rot} . The transmissivity $\tau^* \in [0, 1]$ for this beam splitter operation K_{bs}^{3,j^*} and the mode $j^* \in \{1, 2\}$ to be mixed with vacuum are calculated numerically by maximising the EOF of the resulting state. Details of the numerical procedure for calculating EOF are presented in Sec. IIC. This final state is output as σ_{out} by Alg. 1, which we present below in full.

Algorithm 1 Maximizing EOF

Input:

σ_{in} ▷ Two-mode mixed Gaussian state

Output:

σ_{out} ▷ State which saturates SOF-EOF bound

- 1: **procedure** MAXEOF(σ_{in})
 - 2: $\pi_{\text{opt}} \leftarrow \text{OPTSOFSTATE}(\sigma_{\text{in}})$
 - 3: $\{K_{\text{BM}}, \pi_{\text{diag}}\} \leftarrow \text{BMDECOMP}(\pi_{\text{opt}})$
 - 4: $\sigma_{\text{diag}} \leftarrow K_{\text{BM}}\sigma_{\text{in}}K_{\text{BM}}^\top$
 - 5: $\phi_{\text{diag}} \leftarrow \sigma_{\text{diag}} - \pi_{\text{diag}}$
 - 6: $\{\lambda_j, |\phi_j\rangle\}_{j=1 \text{ to } 4} \leftarrow \text{SPECTRUM}(\phi_{\text{diag}})$ ▷ $\lambda_j \geq \lambda_{j+1}$
 - 7: $\phi_{\text{extra}} \leftarrow (\lambda_1 - \lambda_2)|\phi_2\rangle\langle\phi_2|$
 - 8: $\sigma' \leftarrow \sigma_{\text{diag}} + \phi_{\text{extra}}$ ▷ Add extra noise
 - 9: $\{\theta^*, i^*\} \leftarrow \text{DECROSSCORRELATE}(\sigma')$ ▷ Find $\theta^* \in [0, \pi]$ and mode $i^* \in \{1, 2\}$
 - 10: $\sigma_{\text{rot}} \leftarrow K_{\text{rot}}^{i^*}(\theta^*)\sigma'K_{\text{rot}}^{i^* \top}(\theta^*)$ ▷ De-cross-correlate by rotating mode i^* by θ^*
 - 11: $\sigma_3 \leftarrow \text{ADDMODE3}(\sigma_{\text{rot}})$ ▷ Add third ancillary mode
 - 12: $\{\tau^*, j^*\} \leftarrow \max_{\tau, j} \text{EOF} \left[K_{\text{bs}}^{3,j}(\tau)\sigma_3 \left(K_{\text{bs}}^{3,j}(\tau) \right)^\top \right]$ ▷ Find $\tau^* \in [0, 1]$ to mix mode $j^* \in \{1, 2\}$ with mode 3
 - 13: $\sigma_{\text{out}} \leftarrow \text{REMOVEMODE3} \left(K_{\text{bs}}^{3,j^*}(\tau^*)\sigma_3 \left(K_{\text{bs}}^{3,j^*}(\tau^*) \right)^\top \right)$ ▷ Mix modes and discard ancillary third mode
 - 14: **end procedure**
-

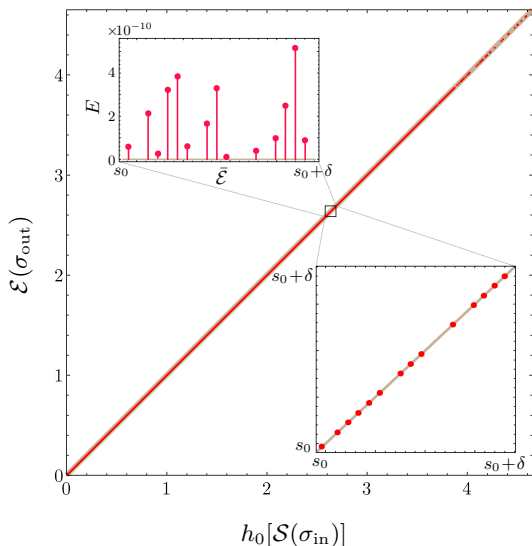

FIG. 2. Numerical results from running Alg. 1 on a million random two-mode Gaussian states. The output state's \mathcal{E} and the input state's $h_0(\mathcal{S})$ values coincide (red dots) and, thus, lie on the $Y = X$ line (thick, gray) to within numerical tolerance. The bottom inset magnifies the section $[s_0, s_0 + \delta]$ (where $s_0 = 2.6430777$ and $\delta = 4.1 \times 10^{-6}$) of the main plot. The top inset rotates this same section, by plotting the error $E = \mathcal{E} - h_0[\mathcal{S}]$ against $\bar{\mathcal{E}} = (\mathcal{E} + h_0[\mathcal{S}])/2$. Over a million runs, the average absolute error $|E|_{\text{avg}}$ is 1.93×10^{-9} .

We note that for states σ_{in} with both modes squeezed, steps 5 through to 13 may be skipped in Alg. 1, and instead a final balanced beam splitter K_{bs} suffices to bring σ_{in} into G . More precisely,

$$\sigma_{\text{out}} = K_{\text{bs}} K_{\text{BM}} \sigma_{\text{in}} K_{\text{BM}}^\top K_{\text{bs}}^\top \in G. \quad (23)$$

Thus $K_{\text{bs}} K_{\text{BM}}$ is the passive transformation that maximizes the EOF of σ_{in} , or, alternatively, transforms σ_{in} into the set G .

C. Numerical Simulations

In order to support our conjecture, we numerically apply Alg. 1 to 10^6 randomly generated two-mode Gaussian states. This random generation leverages Williamson's decomposition (see Appendix B) by applying random active and passive operations on randomly generated two-mode thermal states. For each randomly generated instance, its SOF and the corresponding optimum pure state is computed numerically, based on an algorithm provided in Ref. [28] with a numerical accuracy of 10^{-8} . Then, this state is transformed according to Alg. 1, and the EOF of the output state is calculated. For arbitrary two-mode Gaussian states, there are several equivalent approaches (but no simple analytical expression) to calculate the Gaussian EOF [33, 36, 38, 39, 41]. We used the approach from Ref. [33] to compute Gaussian EOFs in this work.

By testing on 10^6 such randomly generated two-mode Gaussian states, we see that the difference between the EOF $\mathcal{E}(\sigma_{\text{out}})$ and the upper bound $h_0[\mathcal{S}(\sigma_{\text{in}})]$ is always lower than numerical tolerance. The average absolute error $|\mathcal{E} - h_0[\mathcal{S}]|$ over a million runs is 1.93×10^{-9} .

We also explicitly verify that Alg. 1 does not change the SOF of the input state, i.e., $\mathcal{S}(\sigma_{\text{in}}) = \mathcal{S}(\sigma_{\text{out}})$. The results from this test are shown in Fig. 2, where the straight line plot between \mathcal{E} and $h_0[\mathcal{S}]$ provides strong evidence supporting our conjecture.

Based on our proposition, and the numerical results supporting our conjecture shown in Fig. 2, it follows that the EOF potential of all two-mode Gaussian states is a monotonic function of the state's SOF. Qualitatively, this means the maximum EOF, when restricted to linear passive optics, is completely determined by the minimum amount of local squeezing required for state preparation. Conversely, to increase EOF beyond this value, further squeezing operations are necessarily required.

III. DISCUSSION

In this work, we have studied the relation between the squeezing of formation and the maximum entanglement of formation under passive operations for two-mode Gaussian states. We have characterised a special six-parameter family of two-mode states, which are potential-saturating and also saturate the SOF-EOF bound. Moreover, we have conjectured that any arbitrary two-mode Gaussian state can be passively transformed into the aforementioned family. In support of our conjecture, we have proposed an algorithm to passively transform arbitrary two-mode Gaussian states into this special class. Finally, we report numerical results from simulating this algorithm on a million random instances, which supports our conjecture.

In conclusion, we claim that the entanglement potential for all two-mode Gaussian states is completely determined by the minimum amount of squeezing required to construct the state. By connecting an operational measure for squeezing to one for entanglement, our work establishes a satisfying link between the resource theories of squeezing and entanglement. Furthermore, being restricted solely to passive linear optics, the steps in our proposed algorithm are practically feasible in experimental setups. As an example application, our results could be used to quantify and compare the entangling capabilities of different experimental setups.

Our work draws a natural conclusion to the line of research investigating the relationship between entanglement potential and squeezing for two-mode Gaussian states. As both these quantities can be extended to multi-mode states, the validity of the SOF-EOF bound and its saturability remain open problems in the greater-than-two-mode case. Notably, in this case, the Gaussian EOF and the EOF do not coincide so the entanglement potential must be redefined carefully [39, 40].

DATA AVAILABILITY

The data that support the findings of this study are available from the corresponding author upon reasonable request.

CODE AVAILABILITY

The codes that support the findings of this study are available from the corresponding author upon reasonable request.

ACKNOWLEDGEMENTS

The authors are grateful to Prof. Tim Ralph for helpful discussions. This research is supported by the Australian Research Council (ARC) under the Centre of Excellence for Quantum Computation and Communication Technology CE170100012. Authors S.T. and P.N. acknowledge support for this work from the National Science Foundation under grant number NSF CNS 2106887 on ‘‘U.S.-Ireland R&D Partnership: Collaborative Research: CNS Core: Medium: A unified framework for the emulation of classical and quantum physical layer networks’’ and the NSF QuIC-TAQS program ‘‘QuIC-TAQS: Deterministically Placed Nuclear Spin Quantum Memories for Entanglement Distribution’’ under grant number NSF OMA 2137828.

AUTHOR CONTRIBUTIONS STATEMENT

S.T. and S.M.A. conceived the project. B.L., S.T., A.D. and S.M.A. developed the theory and performed the numerical simulation. A.D. wrote the manuscript. All authors contributed to discussions regarding the results of the paper. P.K.L. supervised the project.

ADDITIONAL INFORMATION

The Authors declare no Competing Financial or Non-Financial Interests.

Appendix A: Gaussian transformations and their matrix representations

In this section, we briefly review some common Gaussian transformations. Gaussian transformations are represented by symplectic matrices S , which satisfy $S\Omega S^\top = \Omega$, where

$$\Omega = \bigoplus_{j=1}^N \begin{pmatrix} 0 & 1 \\ -1 & 0 \end{pmatrix} \quad (\text{A1})$$

is the symplectic form. Two-mode beam splitters are represented by

$$K_{\text{bs}}(\tau) = \begin{pmatrix} \sqrt{\tau} \mathbb{1}_2 & \sqrt{1-\tau} \mathbb{1}_2 \\ -\sqrt{1-\tau} \mathbb{1}_2 & \sqrt{\tau} \mathbb{1}_2 \end{pmatrix}, \quad (\text{A2})$$

where $\mathbb{1}_N$ represents the identity operator on N dimensions. For balanced beam splitters, where $\tau = 1/2$, we drop the explicit dependence on τ and simply write K_{bs} . Single-mode phase rotations are represented via the rotation matrices,

$$K_{\text{rot}}(\theta) = \begin{pmatrix} \cos \theta & \sin \theta \\ -\sin \theta & \cos \theta \end{pmatrix}. \quad (\text{A3})$$

Beam splitters and phase rotations constitute the fundamental passive linear transformations, as can be seen, e.g., from the rectangular decomposition for passive Gaussian operations (see Sec. B).

A single-mode squeezer is represented by

$$S(r) = \begin{pmatrix} e^{-r} & 0 \\ 0 & e^r \end{pmatrix}, \quad (\text{A4})$$

whereas a two-mode squeezer can either be local, as in $S_1(r_1, r_2) := S(r_1) \oplus S(-r_2)$, wherein two single-mode squeezers act independently on two modes indexed by $j \in \{1, 2\}$, or non-local, as in

$$\begin{aligned} S_2(r) &:= K_{\text{bs}} S_1(-r, r) K_{\text{bs}}^\top \\ &= K_{\text{bs}} \begin{pmatrix} e^r & 0 & 0 & 0 \\ 0 & e^{-r} & 0 & 0 \\ 0 & 0 & e^{-r} & 0 \\ 0 & 0 & 0 & e^r \end{pmatrix} K_{\text{bs}}^\top. \end{aligned} \quad (\text{A5})$$

The locally-squeezed two-mode diagonal Gaussian state π_d is

$$\begin{aligned} \pi_d(r_1, r_2) &= S_1(r_1, r_2) \mathbb{1}_4 S_1(r_1, r_2)^\top \\ &= \begin{pmatrix} e^{-2r_1} & 0 & 0 & 0 \\ 0 & e^{2r_1} & 0 & 0 \\ 0 & 0 & e^{2r_2} & 0 \\ 0 & 0 & 0 & e^{-2r_2} \end{pmatrix}. \end{aligned} \quad (\text{A6})$$

For convenience, we sometimes drop the r_1, r_2 dependence and write simply π_d . When restricted to two-mode Gaussian states, the Bloch-Messiah decomposition [42, 43] states that phase rotations, beam splitters and single- and two-mode squeezers are sufficient to implement arbitrary Gaussian transformations.

Finally, for a special subset of two-mode Gaussian states called de-cross-correlated states [25, 44] that satisfy $\langle \hat{x}_i \hat{p}_j + \hat{p}_i \hat{x}_j \rangle = 0$ for $i, j \in \{1, 2\}$, the covariance matrix σ takes the form

$$\begin{aligned} \sigma &= \begin{pmatrix} \sigma_{11} & 0 & \sigma_{13} & 0 \\ 0 & \sigma_{22} & 0 & \sigma_{24} \\ \sigma_{13} & 0 & \sigma_{33} & 0 \\ 0 & \sigma_{24} & 0 & \sigma_{44} \end{pmatrix} \\ &= \begin{pmatrix} \sigma_{11} & \sigma_{13} \\ \sigma_{13} & \sigma_{33} \end{pmatrix} \oplus \begin{pmatrix} \sigma_{22} & \sigma_{24} \\ \sigma_{24} & \sigma_{44} \end{pmatrix} =: C_q \oplus C_p, \end{aligned} \quad (\text{A7})$$

where in the second equality we have re-indexed the usual $[\hat{x}_1, \hat{p}_1, \hat{x}_2, \hat{p}_2]$ operators as $[\hat{x}_1, \hat{x}_2, \hat{p}_1, \hat{p}_2]$. Note that the form in Eq. (A7) is also referred to as a standard form [45] and a large class of two-mode Gaussian states can be passively transformed into this form [44]. Moreover, for pure states in this standard form, $C_p = C_q^{-1}$ (the superscript -1 denoting matrix inverse), so that $\pi = C_q \oplus C_q^{-1}$ and consequently, $\mathcal{E}(\pi)$ becomes a monotonically increasing function of the sub-correlation matrix C_q [33, 39].

Appendix B: Standard decompositions in Gaussian optics

In this section, we briefly overview some mathematical decompositions of Gaussian states and operations. The first, known as Williamson's decomposition, provides a way to write arbitrary mixed state σ as a Gaussian (symplectic) transformation S performed on a thermal state represented by diagonal matrix D , i.e.,

$$\sigma = SDS^\top, \quad (\text{B1})$$

where

$$D := \text{Diag}(\nu_1, \nu_1, \dots, \nu_N, \nu_N), \quad (\text{B2})$$

and

$$\{\nu_j\} := |\text{Eigs}(i\Omega\sigma)| \quad (\text{B3})$$

are the symplectic eigenvalues. Here, $\text{Diag}(x)$ denotes a diagonal matrix with diagonal entries given by x and $\text{Eigs}(A)$ denotes the eigenvalues of a matrix A .

The second decomposition, known as the Bloch-Messiah decomposition or Euler decomposition, presents a way to decompose arbitrary Gaussian (symplectic) transformation S into a sequence of a passive (orthogonal) transformation K_1 , followed by single-mode squeezing operations on each mode (represented by diagonal matrix $Z = \bigoplus_{j=1}^N S(r_j)$), and a second passive transformation K_2 , i.e.,

$$S = K_1 Z K_2. \quad (\text{B4})$$

One useful application of the Bloch-Messiah decomposition is in passively diagonalising a pure Gaussian π . Being a pure state, π can be written as $\pi = SS^\top$ for S some symplectic matrix. The Bloch-Messiah decomposition then yields $S = K_1 Z K_2$, which results in

$$\pi = K_1 Z Z^\top K_1^\top = K_1 Z^2 K_1^\top. \quad (\text{B5})$$

Evidently, $K_1^\top \pi K_1 = Z^2$, which is a diagonal matrix, so the passive operation that diagonalises π is K_1^\top .

Third, the rectangular decomposition allows us to decompose arbitrary passive (i.e., real, orthogonal, and symplectic) transformations into as a sequence of $N(N-1)/2$ beam splitters and single-mode phase rotations.

Mathematically, this implies that beam-splitters and single-mode phase rotations generate the set of passive Gaussian transformations.

Lastly, the polar decomposition equates any symplectic matrix S with the product of an orthogonal, symplectic matrix K (representing a passive operation) and a symmetric, positive semidefinite, symplectic matrix P , i.e.,

$$S = KP. \quad (\text{B6})$$

This decomposition is unique and plays a crucial role in Gaussian quantum optics [28].

Appendix C: De-cross-correlated pure states saturating the EOF Potential

In this section, we establish necessary and sufficient conditions for a de-cross-correlated pure state π_{dcc} to be potential-saturating, i.e., $\mathcal{E}(\pi_{\text{dcc}}) = \mathcal{P}(\pi_{\text{dcc}})$. In the process, we also compute the SOF of this state and find that the potential-saturating state also saturates the upper bound

$$\mathcal{P}(\sigma) \leq h_0 [\mathcal{S}(\sigma)], \quad (\text{C1})$$

meaning that

$$\mathcal{E}(\pi_{\text{dcc}}) = \mathcal{P}(\pi_{\text{dcc}}) = h_0 [\mathcal{S}(\pi_{\text{dcc}})] \quad (\text{C2})$$

when π_{dcc} satisfies the necessary and sufficient conditions.

As stated previously, the covariance matrix of a de-cross-correlated pure state π_{dcc} takes the form

$$\pi_{\text{dcc}} = C_q \oplus C_q^{-1} = \begin{pmatrix} q_1 & q_3 \\ q_3 & q_2 \end{pmatrix} \oplus \begin{pmatrix} q_1 & q_3 \\ q_3 & q_2 \end{pmatrix}^{-1}, \quad (\text{C3})$$

and the uncertainty relation for π_{dcc} simplifies to $q_1 q_2 - q_3^2 \geq 0$ and $q_1, q_2 > 0$. As shown in the discussion on the Bloch-Messiah decomposition in Sec. B, any pure state can be passively transformed into a diagonal state, and hence a de-cross-correlated state.

For the de-cross-correlated pure state in Eq. (C3), the two largest eigenvalues λ_3^\dagger and λ_4^\dagger can be computed as

$$\begin{aligned} \lambda_3^\dagger &= \frac{q_1 + q_2 + \sqrt{(q_1 - q_2)^2 + 4q_3^2}}{2}, \\ \text{and } \lambda_4^\dagger &= \frac{q_1 + q_2 + \sqrt{(q_1 - q_2)^2 + 4q_3^2}}{2(q_1 q_2 - q_3^2)}, \end{aligned} \quad (\text{C4})$$

so that the SOF of the state is

$$\begin{aligned} \mathcal{S}(\pi_{\text{dcc}}) &= \frac{1}{2} \ln(\lambda_3^\dagger \lambda_4^\dagger) = \ln \left(\frac{q_+ + \sqrt{q_+^2 - 4\Delta}}{2\sqrt{\Delta}} \right) \\ &= \ln \left(\sqrt{\frac{q_+^2}{4q_1 q_2} \frac{q_1 q_2}{\Delta}} + \sqrt{\frac{q_+^2}{4q_1 q_2} \frac{q_1 q_2}{\Delta} - 1} \right). \end{aligned} \quad (\text{C5})$$

Here we have defined $q_+ := q_1 + q_2$ and $\Delta := \det(C_q)$ in the second equality and rearranged terms in the third. Note that $\mathcal{S}(\pi_{\text{dcc}})$ is a monotonically increasing function of q_+ . Using the AM-GM inequality $q_+ \geq 2\sqrt{q_1 q_2}$ and the monotonicity of logarithms, we get the inequality

$$\mathcal{S}(\pi_{\text{dcc}}) \geq \ln \left(\sqrt{\frac{q_1 q_2}{\Delta}} + \sqrt{\frac{q_1 q_2}{\Delta} - 1} \right), \quad (\text{C6})$$

where the equality can hold if and only if $q_1 = q_2$. Next we define $m(C_q) := q_1 q_2 / \Delta$, so that Eq. (C6) becomes

$$\mathcal{S}(\pi_{\text{dcc}}) \geq \ln \left(\sqrt{m(C_q)} + \sqrt{m(C_q) - 1} \right) =: \mathcal{S}_0(\pi_{\text{dcc}}). \quad (\text{C7})$$

It is now evident that $\mathcal{S}_0(\pi_{\text{dcc}})$ is a monotonically increasing function of $m(C_q)$ and lower-bounds $\mathcal{S}(\pi_{\text{dcc}})$, being equal if and only if $q_1 = q_2$.

Consider, on the other hand, that the EOF $\mathcal{E}(\pi_{\text{dcc}})$ of a pure de-cross-correlated state is also a monotonically increasing function of $m(C_q)$ [33, 39], given by

$$\mathcal{E}(\pi_{\text{dcc}}) = h \left[\sqrt{m(C_q)} - \sqrt{m(C_q) - 1} \right], \quad (\text{C8})$$

where

$$h[x] := \frac{(1+x)^2}{4x} \ln \left(\frac{(1+x)^2}{4x} \right) - \frac{(1-x)^2}{4x} \ln \left(\frac{(1-x)^2}{4x} \right). \quad (\text{C9})$$

and we also define $h_0[x] := h[e^{-x}]$. It then follows from

Eqs. (C7) and (C8) that

$$\begin{aligned} \mathcal{E}(\pi_{\text{dcc}}) &= h \left[e^{\ln(\sqrt{m(C_q)} - \sqrt{m(C_q) - 1})} \right] \\ &= h \left[e^{-\ln(\sqrt{m(C_q)} + \sqrt{m(C_q) - 1})} \right] \\ &= h_0[\mathcal{S}_0(\pi_{\text{dcc}})] \leq h_0[\mathcal{S}(\pi_{\text{dcc}})] \end{aligned} \quad (\text{C10})$$

for all pure de-cross-correlated states, with equality holding if and only if $q_1 = q_2$. The $q_1 = q_2$ condition physically corresponds to the state from a balanced beam splitter mixing two non-correlated modes, which results in a state with two identical modes. Combining $\mathcal{E}(\pi_{\text{dcc}}) = h_0[\mathcal{S}(\pi_{\text{dcc}})] \iff q_1 = q_2$ with $\mathcal{E}(\pi_{\text{dcc}}) \leq \mathcal{P}(\pi_{\text{dcc}}) \leq h_0[\mathcal{S}(\pi_{\text{dcc}})]$, we conclude that a pure de-cross-correlated state can satisfy $\mathcal{E}(\pi_{\text{dcc}}) = \mathcal{P}(\pi_{\text{dcc}})$ if and only if $q_1 = q_2$. We also conclude that this special class of de-cross-correlated states satisfy $\mathcal{P}(\pi_{\text{dcc}}) = h_0[\mathcal{S}(\pi_{\text{dcc}})]$ and thus saturate the upper bound in Eq. (C1).

The above discussion suggests a way to maximise a given state's EOF via passive operations. For mixed states, both the EOF and the SOF are defined via a convex optimisation over all possible pure state decompositions, so a mixed state σ could saturate the upper bound in Eq. (C1) if its potential-saturating pure state π_{opt} is de-cross-correlated (i.e., of the form in Eq. (C3)) and has $q_1 = q_2$. This is the fundamental idea behind our algorithm, which first performs passive operations required to decouple the squeezing between two modes of a given input state, then de-cross-correlates this state passively, and finally, by appropriately mixing with an ancillary vacuum, removes any excess noise in order to maximise the EOF.

-
- [1] R. Horodecki, P. Horodecki, M. Horodecki, and K. Horodecki, Quantum entanglement, *Rev. Mod. Phys.* **81**, 865 (2009).
- [2] C. Weedbrook, S. Pirandola, R. García-Patrón, N. J. Cerf, T. C. Ralph, J. H. Shapiro, and S. Lloyd, Gaussian quantum information, *Rev. Mod. Phys.* **84**, 621 (2012).
- [3] D. F. Walls, Squeezed states of light, *Nature* **306**, 141 (1983).
- [4] S. Scheel and D.-G. Welsch, Entanglement generation and degradation by passive optical devices, *Phys. Rev. A* **64**, 063811 (2001).
- [5] M. S. Kim, W. Son, V. Bužek, and P. L. Knight, Entanglement by a beam splitter: Nonclassicality as a prerequisite for entanglement, *Phys. Rev. A* **65**, 032323 (2002).
- [6] W. Xiang-bin, Theorem for the beam-splitter entangler, *Phys. Rev. A* **66**, 024303 (2002).
- [7] R. Schnabel, N. Mavalvala, D. E. McClelland, and P. K. Lam, Quantum metrology for gravitational wave astronomy, *Nature Communications* **1**, 10.1038/ncomms1122 (2010).
- [8] J. Abadie, T. L. S. Collaboration, *et al.*, A gravitational wave observatory operating beyond the quantum shot-noise limit, *Nature Physics* **7**, 962 (2011).
- [9] J. Aasi, J. Abadie, *et al.*, Enhanced sensitivity of the LIGO gravitational wave detector by using squeezed states of light, *Nature Photonics* **7**, 613 (2013).
- [10] N. J. Cerf, M. Lévy, and G. V. Assche, Quantum distribution of Gaussian keys using squeezed states, *Phys. Rev. A* **63**, 052311 (2001).
- [11] T. C. Ralph, Continuous variable quantum cryptography, *Phys. Rev. A* **61**, 010303 (1999).
- [12] M. Hillery, Quantum cryptography with squeezed states, *Phys. Rev. A* **61**, 022309 (2000).
- [13] M. D. Reid, Quantum cryptography with a predetermined key, using continuous-variable einstein-podolsky-rosen correlations, *Phys. Rev. A* **62**, 062308 (2000).
- [14] S. L. Braunstein and H. J. Kimble, Teleportation of continuous quantum variables, *Phys. Rev. Lett.* **80**, 869 (1998).
- [15] N. Takei, T. Aoki, S. Koike, K.-i. Yoshino, K. Wakui, H. Yonezawa, T. Hiraoka, J. Mizuno, M. Takeoka, M. Ban, and A. Furusawa, Experimental demonstration of quantum teleportation of a squeezed state, *Phys. Rev. A* **72**, 042304 (2005).
- [16] G. J. Milburn and S. L. Braunstein, Quantum teleportation with squeezed vacuum states, *Phys. Rev. A* **60**, 937

- (1999).
- [17] X. Su, A. Tan, X. Jia, J. Zhang, C. Xie, and K. Peng, Experimental preparation of quadripartite cluster and greenberger-horne-zeilinger entangled states for continuous variables, *Phys. Rev. Lett.* **98**, 070502 (2007).
 - [18] X. Su, Y. Zhao, S. Hao, X. Jia, C. Xie, and K. Peng, Experimental preparation of eight-partite cluster state for photonic qumodes, *Opt. Lett.* **37**, 5178 (2012).
 - [19] J. Zhao, K. Liu, H. Jeng, M. Gu, J. Thompson, P. K. Lam, and S. M. Assad, A high-fidelity heralded quantum squeezing gate, *Nature Photonics* **14**, 306 (2020).
 - [20] M. V. Larsen, X. Guo, C. R. Breum, J. S. Neergaard-Nielsen, and U. L. Andersen, Deterministic generation of a two-dimensional cluster state, *Science* **366**, 369 (2019).
 - [21] W. Asavanant, Y. Shiozawa, S. Yokoyama, B. Charoensombutamon, H. Emura, R. N. Alexander, S. Takeda, J. ichi Yoshikawa, N. C. Menicucci, H. Yonezawa, and A. Furusawa, Generation of time-domain-multiplexed two-dimensional cluster state, *Science* **366**, 373 (2019).
 - [22] M. M. Wolf, J. Eisert, and M. B. Plenio, Entangling power of passive optical elements, *Phys. Rev. Lett.* **90**, 047904 (2003).
 - [23] L. Lami, A. Serafini, and G. Adesso, Gaussian entanglement revisited, *New Journal of Physics* **20**, 023030 (2018).
 - [24] J. K. Asbóth, J. Calsamiglia, and H. Ritsch, Computable measure of nonclassicality for light, *Phys. Rev. Lett.* **94**, 173602 (2005).
 - [25] S. Tserkis, J. Thompson, A. P. Lund, T. C. Ralph, P. K. Lam, M. Gu, and S. M. Assad, Maximum entanglement of formation for a two-mode Gaussian state over passive operations, *Phys. Rev. A* **102**, 052418 (2020).
 - [26] G. Vidal and R. F. Werner, Computable measure of entanglement, *Phys. Rev. A* **65**, 032314 (2002).
 - [27] C. H. Bennett, D. P. DiVincenzo, J. A. Smolin, and W. K. Wootters, Mixed-state entanglement and quantum error correction, *Phys. Rev. A* **54**, 3824 (1996).
 - [28] M. Idel, D. Lercher, and M. M. Wolf, An operational measure for squeezing, *Journal of Physics A: Mathematical and Theoretical* **49**, 445304 (2016).
 - [29] R. Simon, N. Mukunda, and B. Dutta, Quantum-noise matrix for multimode systems: $U(n)$ invariance, squeezing, and normal forms, *Phys. Rev. A* **49**, 1567 (1994).
 - [30] L.-A. Wu, H. J. Kimble, J. L. Hall, and H. Wu, Generation of squeezed states by parametric down conversion, *Phys. Rev. Lett.* **57**, 2520 (1986).
 - [31] G. Giedke, B. Kraus, M. Lewenstein, and J. I. Cirac, Entanglement criteria for all bipartite Gaussian states, *Phys. Rev. Lett.* **87**, 167904 (2001).
 - [32] V. Vedral, M. B. Plenio, M. A. Rippin, and P. L. Knight, Quantifying entanglement, *Phys. Rev. Lett.* **78**, 2275 (1997).
 - [33] G. Adesso and F. Illuminati, Gaussian measures of entanglement versus negativities: Ordering of two-mode Gaussian states, *Phys. Rev. A* **72**, 032334 (2005).
 - [34] S. Virmani and M. B. Plenio, Ordering states with entanglement measures, *Physics Letters A* **268**, 31 (2000).
 - [35] A. S. Holevo, M. Sohma, and O. Hirota, Capacity of quantum Gaussian channels, *Phys. Rev. A* **59**, 1820 (1999).
 - [36] P. Marian and T. A. Marian, Entanglement of formation for an arbitrary two-mode Gaussian state, *Phys. Rev. Lett.* **101**, 220403 (2008).
 - [37] S. Tserkis and T. C. Ralph, Quantifying entanglement in two-mode Gaussian states, *Phys. Rev. A* **96**, 062338 (2017).
 - [38] S. Tserkis, S. Onoe, and T. C. Ralph, Quantifying entanglement of formation for two-mode Gaussian states: Analytical expressions for upper and lower bounds and numerical estimation of its exact value, *Phys. Rev. A* **99**, 052337 (2019).
 - [39] M. M. Wolf, G. Giedke, O. Krüger, R. F. Werner, and J. I. Cirac, Gaussian entanglement of formation, *Phys. Rev. A* **69**, 052320 (2004).
 - [40] Y. Akbari-Kourbolagh and H. Alijanzadeh-Boura, On the entanglement of formation of two-mode Gaussian states: a compact form, *Quantum Information Processing* **14**, 4179 (2015).
 - [41] J. S. Ivan and R. Simon, Entanglement of formation for Gaussian states, arXiv <https://arxiv.org/abs/0808.1658> (2008).
 - [42] Arvind, B. Dutta, N. Mukunda, and R. Simon, The real symplectic groups in quantum mechanics and optics, *Pramana* **45**, 471 (1995).
 - [43] S. L. Braunstein, Squeezing as an irreducible resource, *Phys. Rev. A* **71**, 055801 (2005).
 - [44] S. M. Assad, M. Gu, X. Li, and P. K. Lam, Decoupling cross-quadrature correlations using passive operations, *Phys. Rev. A* **102**, 022615 (2020).
 - [45] L.-M. Duan, G. Giedke, J. I. Cirac, and P. Zoller, Inseparability criterion for continuous variable systems, *Phys. Rev. Lett.* **84**, 2722 (2000).