

PREPARED FOR SUBMISSION TO JINST

16TH TOPICAL SEMINAR ON INNOVATIVE PARTICLE AND RADIATION DETECTORS (IPRD23)

25–29 SEPTEMBER 2023

SIENA, ITALY

Silicon Vertex Detector of the Belle II Experiment

S. Mondal,^{a,b,1} K. Adamczyk,^c L. Aggarwal,^d H. Aihara,^e T. Aziz,^f S. Bacher,^c
S. Bahinipati,^g G. Batignani,^{a,b} J. Baudot,^h P. K. Behera,ⁱ S. Bettarini,^{a,b} T. Bilka,^j
A. Bozek,^c F. Buchsteiner,^k G. Casarosa,^{a,b} L. Corona,^b S. B. Das,^l G. Dujany,^h
C. Finck,^h F. Forti,^{a,b} M. Friedl,^k A. Gabrielli,^{m,n} B. Gobbo,ⁿ S. Halder,^f K. Hara,^{o,p}
S. Hazra,^f T. Higuchi,^q C. Imler,^k A. Ishikawa,^{o,p} Y. Jin,ⁿ M. Kaleta,^c A. B. Kaliyar,^k
J. Kandra,^j K. H. Kang,^q P. Kodyš,^j T. Kohriki,^o R. Kumar,^r K. Lalwani,^l K. Lautenbach,^t
R. Leboucher,^t S. C. Lee,^s J. Libby,ⁱ L. Martel,^h L. Massaccesi,^{a,b} G. B. Mohanty,^f
K. R. Nakamura,^{o,p} Z. Natkaniec,^c Y. Onuki,^e F. Otani,^q A. Paladino,^{A, a,b} E. Paoloni,^{a,b}
H. Park,^s L. Polat,^t K. K. Rao,^f I. Ripp-Baudot,^h G. Rizzo,^{a,b} Y. Sato,^o C. Schwanda,^k
J. Serrano,^t T. Shimasaki,^q J. Suzuki,^o S. Tanaka,^{o,p} H. Tanigawa,^e F. Tenchini,^{a,b}
R. Thalmeier,^k R. Tiwary,^f T. Tsuboyama,^o Y. Uematsu,^e L. Vitale,^{m,n} Z. Wang,^e J. Webb,^u
O. Werbycka,ⁿ J. Wiechczynski,^c H. Yin,^k and L. Zani^{B,t}

(Belle-II SVD Collaboration)

^aDipartimento di Fisica, Università di Pisa, I-56127 Pisa, Italy, ^Apresently at INFN Sezione di Bologna, I-40127 Bologna, Italy

^bINFN Sezione di Pisa, I-56127 Pisa, Italy

^cH. Niewodniczanski Institute of Nuclear Physics, Krakow 31-342, Poland

^dPanjab University, Chandigarh 160014, India

^eDepartment of Physics, University of Tokyo, Tokyo 113-0033, Japan

^fTata Institute of Fundamental Research, Mumbai 400005, India

^gIndian Institute of Technology Bhubaneswar, Bhubaneswar 752050, India

^hIPHC, UMR 7178, Université de Strasbourg, CNRS, 67037 Strasbourg, France

ⁱIndian Institute of Technology Madras, Chennai 600036, India

^jFaculty of Mathematics and Physics, Charles University, 121 16 Prague, Czech Republic

^kInstitute of High Energy Physics, Austrian Academy of Sciences, 1050 Vienna, Austria

^lMalaviya National Institute of Technology Jaipur, Jaipur 302017, India

^mDipartimento di Fisica, Università di Trieste, I-34127 Trieste, Italy

ⁿINFN Sezione di Trieste, I-34127 Trieste, Italy

^oHigh Energy Accelerator Research Organization (KEK), Tsukuba 305-0801, Japan

^pThe Graduate University for Advanced Studies (SOKENDAI), Hayama 240-0193, Japan

¹Corresponding author.

^q*Kavli Institute for the Physics and Mathematics of the Universe, University of Tokyo, Kashiwa 277-8583, Japan*

^r*Punjab Agricultural University, Ludhiana 141004, India*

^s*Department of Physics, Kyungpook National University, Daegu 41566, Korea*

^t*Aix Marseille Université, CNRS/IN2P3, CPPM, 13288 Marseille, France,* ^B*presently at INFN Sezione di Roma Tre, I-00185 Roma, Italy*

^u*School of Physics, University of Melbourne, Melbourne, Victoria 3010, Australia*

E-mail: suryamondal@gmail.com

ABSTRACT:

The silicon vertex detector (SVD) is installed at the heart of the Belle II experiment, taking data at the high-luminosity *B*-Factory SuperKEKB since 2019. The SVD is a four-layer double-sided strip detector with tracking and particle-identification capabilities. In this paper, we report on the performance of the reconstruction of SVD hits. The detector has shown a stable and above-99% hit efficiency, with a large signal-to-noise in all sensors since the beginning of data taking. Cluster position and time resolution have been measured with 2020 and 2022 data and show excellent performance and stability. In particular, the cluster-position resolution is between 7 and 12 μm for the small-pitch sensors, in reasonable agreement with the expectations, while the cluster time resolution is measured to be below 3 ns. The effect of radiation damage is visible, but not affecting the performance. As the luminosity increases, higher machine backgrounds are expected and the excellent hit-time information in SVD can be exploited for background rejection. In particular, we have recently developed a novel procedure to select hits by grouping them event-by-event based on their time. This new procedure allows a significant reduction of the fake rate, while preserving the tracking efficiency, and it has therefore replaced the previous cut-based procedure. We have developed a method that uses the SVD hits to estimate the track time (previously unavailable) and the collision time. It has a similar precision to the estimate based on the drift chamber readout but its execution time is three orders of magnitude smaller, allowing a faster online reconstruction that is crucial in a high luminosity regime. The track time is a powerful information that allows, together with the aforementioned grouping selection, to raise the occupancy limit above that expected at nominal luminosity, leaving room for a safety factor. Finally, in June 2022 the data taking of the Belle II experiment was stopped to install a new two-layer DEPFET detector (PXD) and upgrade components of the accelerator. The whole silicon tracker (PXD+SVD) has been extracted from Belle II, the new PXD installed, the detector closed and commissioned. We briefly describe the SVD results of this upgrade.

KEYWORDS: strip detector, tracking, high-luminosity, background rejection

Contents

1	Introduction	1
2	Belle II Silicon Vertex Detector	2
3	SVD Operation and Reconstruction Performance	3
4	Exploiting the Hit Time to Improve Reconstruction	4
5	Activities on SVD During the Long Shutdown	8
6	Conclusion	8
	Acknowledgement	9
	References	9

1 Introduction

The Belle II experiment [1] is a particle physics experiment at the intensity frontier, collecting data at the high-luminosity B -Factory SuperKEKB [2] in Tsukuba, Japan. The main objective of Belle II is the search for physics beyond the Standard Model through high-precision measurements on extensive datasets of mainly B mesons, τ leptons and charm hadrons.

SuperKEKB is an asymmetric electron-positron collider operated at the centre-of-mass energy of the $\Upsilon(4S)$ resonance. Positron and electron beams are accelerated at an energy of 4 GeV and 7 GeV, respectively, leading to a boosted center-of-mass system with $\beta\gamma = 0.28$. SuperKEKB has achieved the world record instantaneous peak luminosity of $4.7 \times 10^{34} \text{ cm}^{-2}\text{s}^{-1}$ in June 2022; its target peak luminosity is $6 \times 10^{35} \text{ cm}^{-1}\text{s}^{-1}$. Belle II has collected 424 fb^{-1} of events in the first years of data taking, while the goal is to collect 50 ab^{-1} of data in the next decade.

The Belle II detector is designed to provide similar or better performance than its predecessor Belle in an environment made much harsher by the significantly increased beam background. Belle II features a superior tracking capability that improves the efficiency of low transverse-momentum tracks and the resolution on the track impact parameters by a factor 2, both thanks to the new Vertex Detector (VXD) shown in Figure 1. The VXD also features particle identifications capabilities, through the measurement of the energy loss. This feature is critical for the low momentum tracks, which do not reach the farther detectors. The VXD consists of two innermost layers of pixel detector (PXD) made of DEPFET sensors [3], and four outer layers of double-sided silicon strip detector (SVD) [4]. The main features of the SVD include standalone tracking for low-momentum tracks, extrapolation of the tracks towards the PXD, precise vertexing of K_S^0 and Λ^0 , and particle identification based on dE/dx measurement.

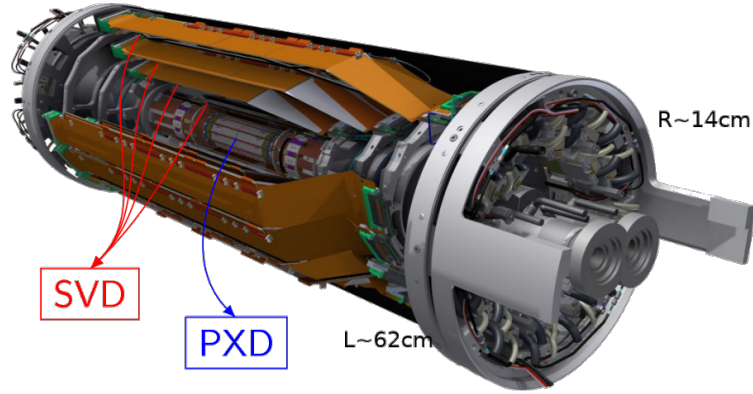

Figure 1: Vertex Detector of Belle II.

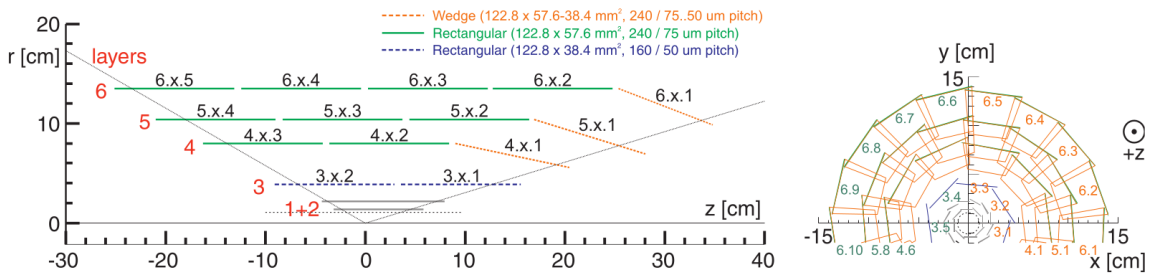

Figure 2: Positions of SVD layers and sensors.

2 Belle II Silicon Vertex Detector

The sensitive detectors of the SVD are double sided silicon strip detectors (DSSD), organised in 4 layers, namely layer 3 (the innermost), 4, 5 and 6 (outermost) and composed respectively of 7, 10, 12 and 16 electrically and mechanically independent ladders with 2, 3, 4 and 5 sensors each. A graphical representation of the placement of the sensors is given in Figure 2. The 172 sensors are covering a sensitive area of 1.2 m^2 with 224×10^3 readout channels. The DSSDs provide two-dimensional spatial position information, as well as the collected charge and time of the hits on the two sensor sides. Each sensor is made of an n-type bulk detector with orthogonal strips on the two sides formed with acceptor (P type) or donor (N type) implants. The readout strips are AC coupled and there is a floating strip between two adjacent readout strips to improve the determination of the hit position. The strips on the acceptor (donor) side, namely u/P (v/N), being parallel (transverse) to the beam axis, measure the $r\phi$ (z) coordinates of the hits.

The layer-3 is equipped with small rectangular sensors with 768 readout strips on both sides and a readout pitch of 50 (160) μm on u/P (v/N) side. The forward sensors in all other layers are slanted and wedge shaped, with 768 (512) readout strips and 50-75 (240) μm readout pitch on u/P (v/N) side. The sensors in the barrel region are rectangular with 768 (512) readout strips and 75 (240) μm readout pitch on the u/P (v/N) side. Sensor thickness is 320 μm for small and large sensors and 300 μm for slanted sensors. The full depletion voltages of the sensors is in the range of 20-60 V, with the operating bias voltage of 100 V.

The APV25 [5] chips, with 128 input channels, are the front-end readout ASICs for the DSSDs.

The chip has a fast pulse shaping time of 50 ns. Being radiation hard up to 100 Mrad these chips meet the requirement of the innermost layer. The APV25 operates in multi-peak mode at a clock frequency of 31.8 MHz which is 1/8 of the SuperKEKB bunch-crossing frequency. Currently, six consecutive samples are read out upon the arrival of the level-1 trigger to reconstruct the height and time of signal pulses. For higher luminosity runs, a 3/6-mixed operation mode, where three or six samples are acquired depending on the level-1 trigger quality, is developed for faster readout and smaller data size.

The SVD adopts the chip-on-sensor ORIGAMI design [4], where all the APV25 chips, reading the two sides of the DSSD, are installed on the same side of the sensor. The signals from the sensor strips on the two sides are connected to the APV25 chips using flex circuits, called pitch adapters. A folded ORIGAMI-like shape is used for the pitch adapters that connect the strip on the other side of the sensor to the side where the APV25 chips are located. This design allows cooling of all the readout chips located on the same sensor side using only one cooling pipe and consequently to reduce the material budget. The averaged material budget per layer of SVD is 0.7% of a radiation length.

3 SVD Operation and Reconstruction Performance

The SVD was installed in Belle II in November 2018 and it has been acquiring data since March 2019. The operation has been smooth and reliable and the performance of SVD has been consistent with expectations. The total fraction of masked strips is less than 1%, and they are mainly due to the initial defects caused in the sensor production or ladder assembly, and the hit efficiency exceeds 99% for all sensors and it is stable with time. The radiation damage to the hardware (in terms of increase in strip noise and sensor leakage current) is observed to be at the expected level and has no impact on the reconstruction performance.

Figure 3 shows the distribution of the cluster charge released in the sensors in layer 3 u/P-side and v/N-side, obtained with 2020 and 2022 data. The release of charge depends on the track incident angle and thus it is normalised with the track length and scaled to the sensor thickness. The fit with the Landau distribution returns a most probable value (MPV) of 21 ke^- . Accounting for 15% uncertainty due to the calibration of the gain, it is in agreement with 24 ke^- expected for a minimum ionising particle (MIP) signal in the $320 \mu\text{m}$ thick sensor.

The cluster signal-to-noise-ratio (SNR) is defined as the total charge collected in the cluster divided by the squared-root of the quadratic-sum of the noises in the strips associated with that cluster. The cluster SNR distributions, measured in 2020 and 2022 data, for the sensors in layer 3 u/P-side and v/N-side, are shown in Figure 4. All the DSSDs perform excellently in terms of cluster SNR with MPV between 13-30 depending on the sensor position, due to the different track incident angle, and sides, with u/P side longer strips that have higher noise. A small reduction in the cluster SNR has been observed in the 2022 data due to increased noise from the radiation damage, at the expected level. The SNR distribution is also slightly wider in 2020 data due to the different physics events used: tracks from hadronic events (used in 2020) span a wider range for the track incident angle with the sensors, and thus have a wider cluster charge distribution, than the tracks from di-muon events used in 2022.

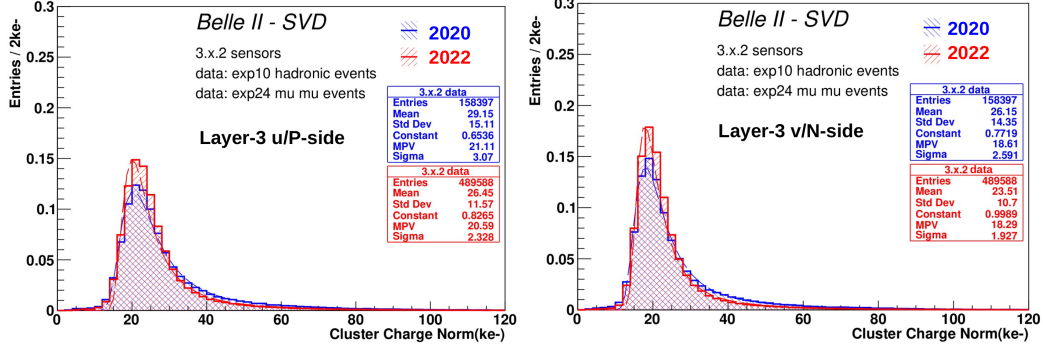

Figure 3: Cluster charge distribution for layer-3 u/P-side (left) v/N-side (right). Data collected in 2020 and 2022 are shown in blue and red respectively.

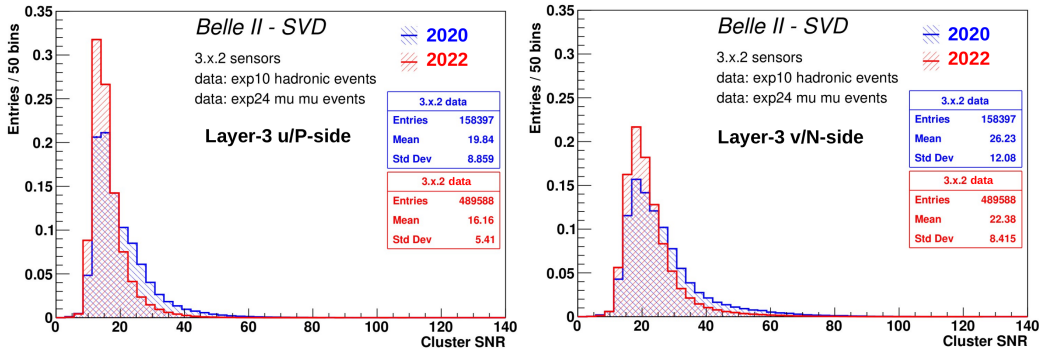

Figure 4: Cluster SNR distribution for layer-3 u/P-side (left) v/N-side (right). Data collected in 2020 and 2022 are shown in blue and red respectively.

The cluster position resolution is estimated from the residual of cluster position against unbiased track extrapolation using $e^-e^+ \rightarrow \mu^-\mu^+$ events. The resolutions are 7-12 μm for u/P strips and 15-25 μm for v/N strips, which are in good agreement with expectations. The cluster position resolutions for layer-3 u/P-side (left) and v/N-side (right) are shown in Figure 5. Both results obtained with 2020 and 2022 data are shown. The SVD is constantly monitored, performance is stable and the cluster position resolution, charge and SNR are consistent over its operation period.

The SVD offers an excellent hit time measurement, explained in detail in [4]. The hit time resolution is measured from the residuals of the hit time with respect to the time of the e^+e^- collision ($EventT0$) calculated by other detectors with very good time resolution (≤ 1 ns). The measured hit time resolution is 2.9 ns (2.4 ns) for the u/P (v/N) side.

4 Exploiting the Hit Time to Improve Reconstruction

One of the main challenges of the high luminosity is handling the large detector occupancy that affects the reconstruction performance. In the last period of data taking, the average hit occupancy in layer 3 was less than 0.5%: however, it is expected to be almost one order of magnitude higher (4.7%) at the nominal luminosity due to the increased beam-induced background. Figure 6 illustrates the expected occupancy at each SVD layer under the nominal extrapolation, 4.7% in

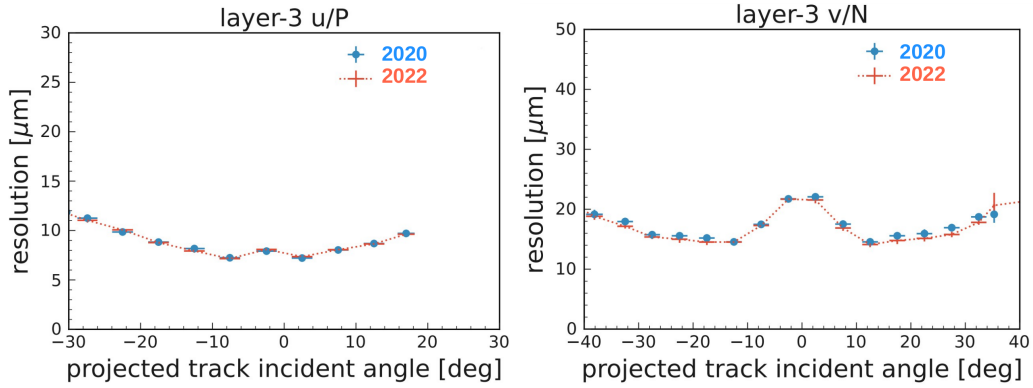

Figure 5: Cluster position resolution as a function of the projected track incident angle for layer-3 u/P-side (left) v/N-side (right). Data collected in 2020 and 2022 are shown in blue and red respectively.

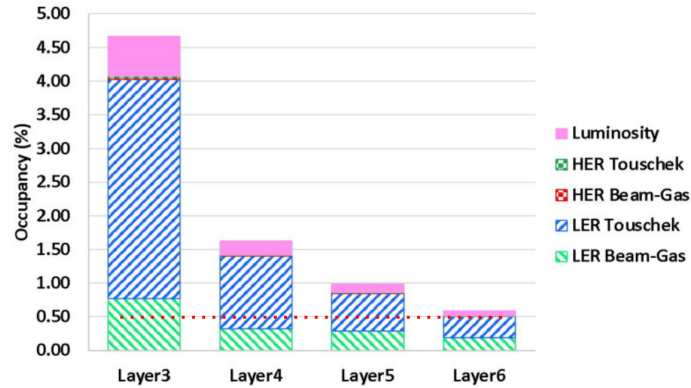

Figure 6: Expected SVD hit-occupancy on layer 3 at nominal luminosity ($6 \times 10^{35} \text{ cm}^{-2}\text{s}^{-1}$).

layer 3. However, background simulations are affected by large uncertainties related to a possible machine evolution as well as a possible redesign of the interaction region. For example, a more conservative extrapolation yields a layer 3 occupancy as high as 8.7%. The SVD hit time is going to play a crucial role in keeping the current excellent tracking performance: the hit-time resolution for signal hits is less than 3 ns, which is much smaller than the time range of beam-induced background hits (around 100 ns) and thus it is very useful for background suppression. The distribution of the time of the hits from a high-background run is shown in Figure 7¹. Signal hits are *on time*, i.e., they accumulate around the trigger time, $t = 0$ ns. Hits from beam-induced background, instead, are uniformly distributed in time since the bunch-crossing frequency is almost one order of magnitude higher than the APV25 readout frequency. The large bump at around $t = -80$ ns and the tail on the right of the integration window reflect the asymmetric shape of the APV25 waveform: the former is due to the accumulation of clusters created by background particles hitting the detector before the start of the acquisition, while the latter is due to missed hits outside the acquisition window.

The hit time is already employed in the SVD-only pattern recognition algorithm [6]. In

¹These data have been taken with wrong collimator settings and are affected by extremely high backgrounds; they are chosen just to show the capability of track reconstruction when the time information is used.

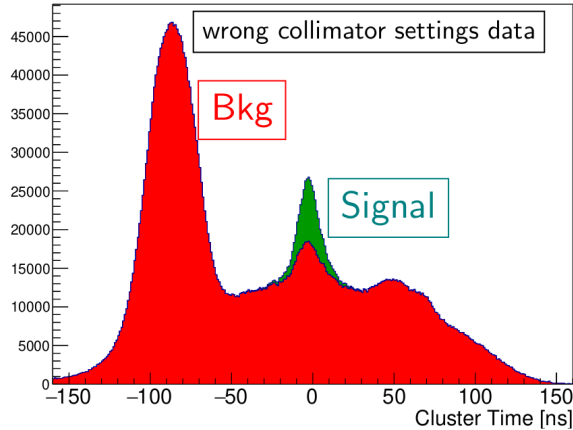

Figure 7: SVD hit time distributions (stacked) in a high background run.

particular, the differences of cluster times are used in filters trained on simulation and applied when creating pairs or triplets of clusters during the track candidate reconstruction. These filters greatly reduce the random combinations of clusters when forming a track, and help avoid using background hits for signal tracks. The filters, though, can't reject *off-time* real track candidates from beam-backgrounds since their clusters have compatible times. Moreover, at high-luminosity, the combinatorics increases significantly because of the higher detector occupancy, and also the number of *off-time* real tracks increases, consequently these filters are not enough to assure the tracking performance needed for physics. To reduce the load on the filters, certain pre-selection criteria have been developed.

The *HitTimeSelection* is applied when pairing clusters from the two sides of the sensors, and it uses two simple time cuts: $|t_{u,v}| < 50$ ns and $|t_u - t_v| < 20$ ns, where $t_{u(v)}$ is the time of u/P (v/N) side cluster. With this selection, it is possible to suppress 50% of background hits, while retaining 99% of hit efficiency. Figure 8a compared to Figure 7 shows the effect of this selection on data, except for the $|t_{u,v}| < 50$ ns cut, indicated by vertical lines on the plot. The *HitTimeSelection* allows setting the layer 3 occupancy limit for good tracking to around 4.5%, which is almost the same as the expected one at the target luminosity with the nominal extrapolation (shown in Figure 6), leaving no safety margin to spare.

An alternative pre-selection, namely the *ClusterGrouping*, has been recently developed and it is under test. This method better exploits the information provided by the cluster times, classifying the clusters in groups on an event-by-event basis. An example is shown in Figure 9 where contributions from at least two bunch-crossings can be seen. In this method, each cluster is represented by a normalised Gaussian centered at the time of the cluster, with a width equal to the cluster-time resolution (stored in the database). The single event is thus represented as the sum of all the Gaussian associated to the clusters in that event, with the result of *smoothing* the original cluster time histogram. Each group of time-correlated clusters forms a peak in the smoothed distribution; each peak j is identified and fitted with a Gaussian with a floating width σ_j . Clusters are tagged in the group j if they are within $7\sigma_j$ from the j^{th} peak. In this procedure, clusters may belong to more than one group. Only the most populated group is finally selected for tracking, after re-weighting the group size with an exponential function of lifetime 30 ns (approximately $3 \times$ the trigger jitter).

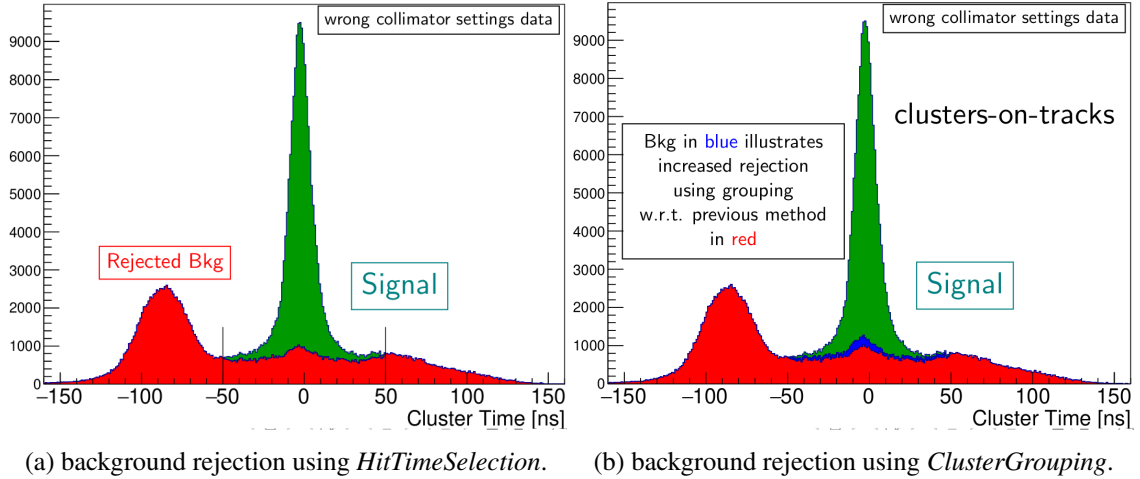

Figure 8: SVD hit time distributions (stacked) in a high background run (the same as Figure 7) after the application of two different pre-selections on clusters before the tracking.

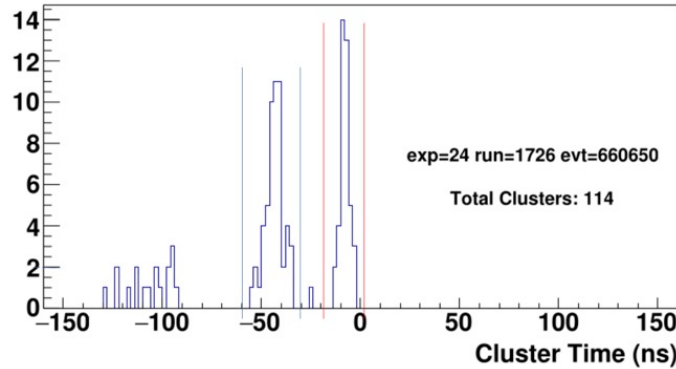

Figure 9: Cluster time distribution in one single event taken in 2022, signal (enclosed by the red vertical lines) and background groups of clusters are clearly visible.

Figure 8b shows the background rejected using this method.

The *ClusterGrouping* selection is significantly better than the *HitTimeSelection* as it allows further reduction of the rate of fake tracks by 16%, while keeping the same tracking efficiency. For this reason it was decided to have it in the default reconstruction in place of the *HitTimeSelection*.

Once the tracks are reconstructed, the SVD hits are used to compute the *track time* as the average time of the clusters belonging to the outgoing arm of the track, relative to the time of the collision, *EventT0*. The *ClusterGrouping*, together with a selection based on the track time ($|t_{\text{track}}| < 20$ ns) that further helps to reduce the fake-track rate, allows setting the layer 3 occupancy limit for good tracking at around 6%, leaving some safety margin for the nominal extrapolation at the target luminosity. Further software improvements and optimizations are planned. Considering the large uncertainty on background extrapolation, and to accommodate a possible new design of the interaction region that is currently under evaluation, a future upgrade of the detector is under study [7].

Date (2023)	Activity	Location
May 10	VXD extraction	Belle II
May 17	SVD detachment	activity
June 1	SVD commissioning	in
June 28	New VXD assembly	clean
July 14	New VXD commissioning	room
July 28	New VXD installation	Belle II
September	Functional tests & commissioning with cosmic-ray	

Table 1: VXD re-commissioning activity during LS1 (in 2023) with the new PXD2.

Finally, the SVD hits are also used to compute the time of the collision, $EventT0$, as the average time of the clusters belonging to high transverse-momentum tracks. The resolution achieved on data is ~ 1 ns. This is similar to the resolution achieved with the central drift chamber (CDC), but it has a great advantage: the computation time of SVD event-time is extremely fast, about 2000 times faster than the computation of the event-time with the CDC. This feature is of particular importance as the full reconstruction chain is run also on the software-based high-level-trigger, where execution time and memory consumption have strict limits to allow processing the events incoming from the L1 trigger. For this reason it was decided to replace the CDC-based event-time computation with the SVD-based one.

5 Activities on SVD During the Long Shutdown

The Belle II experiment paused its operation in July 2022 to allow for maintenance work of the accelerator and improvements of detector, in particular the installation of a brand new pixel detector (PXD2). This period is referred to as long shutdown 1 (LS1). Intense hardware activities involved the SVD crew during the de-installation and re-installation of VXD. A detailed timeline can be seen in Table 1. The VXD was extracted from Belle II in May 2023 and moved to the clean room to separate the half-shells in order to access the PXD. The SVD was then tested to ensure the healthiness of all the sensors. Once the new PXD2 was installed, the VXD half-shells were closed again. A photo of the SVD half-shell and the full PXD2 can be seen in Figure 10. In July 2023, the new VXD was installed in Belle II and a commissioning phase with cosmic rays started in September. The activity on SVD went smoothly and no significant issues were spotted during LS1. The beam operation is expected to be resumed in December 2023.

6 Conclusion

The Belle II SVD is operating smoothly and performing well since March 2019. Excellent SVD performance is observed in data with greater than 99% hit efficiency on all the sensors and less than 1% of strips masked. The cluster position resolution is very good: 7-12 μm for u/P strips and 15-25 μm for v/N strips. Performance in terms of cluster charge and signal-to-noise-ratio is observed to be satisfactory and stable over the operation period. The effect due to radiation on the detector

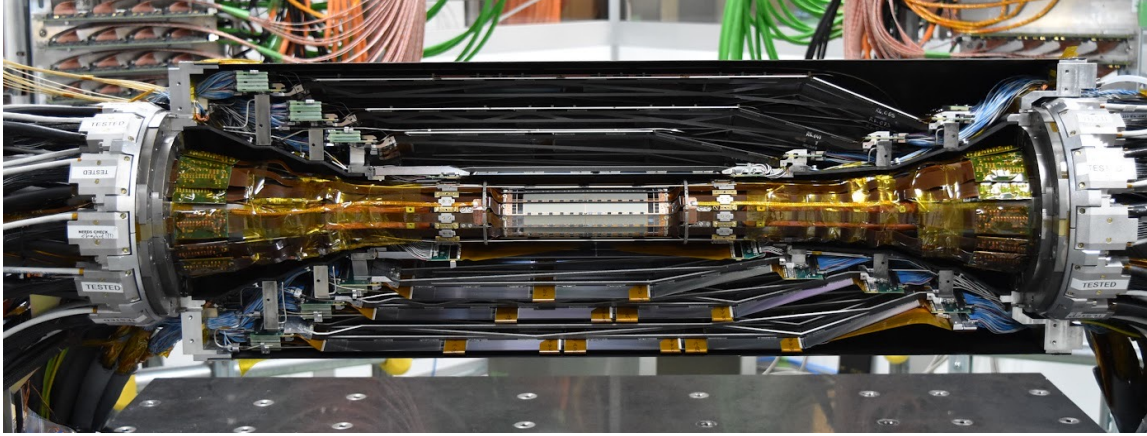

Figure 10: Photograph of the VXD after the installation of the new PXD2.

is observed to be as per expectation and under control. Also the measured hit-time resolutions are very good: 2.9 ns (2.4 ns) for the u/P (v/N) side. Accurate and precise hit-time is crucial for the track reconstruction in high occupancy environment. The recently developed *ClusterGrouping* and *track time* allow setting the layer 3 occupancy limit at 6%, above the occupancy expected at nominal luminosity with nominal background extrapolation 4.7%. The faster SVD-based computation of the *EventT0* reduces the tracking processing time on the high-level-trigger, allowing higher L1-trigger rates.

Extensive activities are performed on the VXD during the long shutdown. A new PXD with a complete second layer is installed within the existing SVD. The commissioning of the detector is performed with cosmic-rays, aiming to resume beam operation in December 2023.

Acknowledgement

This project has received funding from the European Union’s Horizon 2020 research and innovation programme under the Marie Skłodowska-Curie grant agreements No 644294, 822070 and 101026516 and ERC grant agreement No 819127. This work is supported by MEXT, WPI and JSPS (Japan); ARC (Australia); BMBWF (Austria); MSMT (Czechia); CNRS/IN2P3 (France); AIDA-2020 (Germany); DAE and DST (India); INFN (Italy); NRF and RSRI (Korea); and MNiSW (Poland).

References

- [1] T. Abe *et al.*, Belle II technical design report, *arXiv:1011.0352* (2010).
- [2] Y. Ohnishi *et al.*, Accelerator design at SuperKEKB, *Progress of Theoretical and Experimental Physics*, **2013**(3) (2013) 03A011.
- [3] J. Kemmer and G. Lutz, New detector concepts, *Nucl. Instrum. Meth. A*, **253**(3) (1987) 365.
- [4] K. Adamczyk *et al.*, The design, construction, operation and performance of the Belle II silicon vertex detector, *Journal of Instrumentation*, **17**(11) (2022) P11042.

- [5] M. French *et al.*, Design and results from the APV25, a deep sub-micron CMOS front-end chip for the CMS tracker, *Nucl. Instrum. Meth. A*, **466**(2) (2001) 359.
- [6] V. Bertacchi *et al.*, Track Finding at Belle II, *Comput. Phys. Commun.*, **259** (2021) 107610.
- [7] S. Bettarini *et al.*, The DMAPS Upgrade of the Belle II Vertex Detector, *JINST*, **IPRD** (2023).