

LBNF/DUNE

Cryostats and Cryogenics Infrastructure for the DUNE Far Detector

Design Report

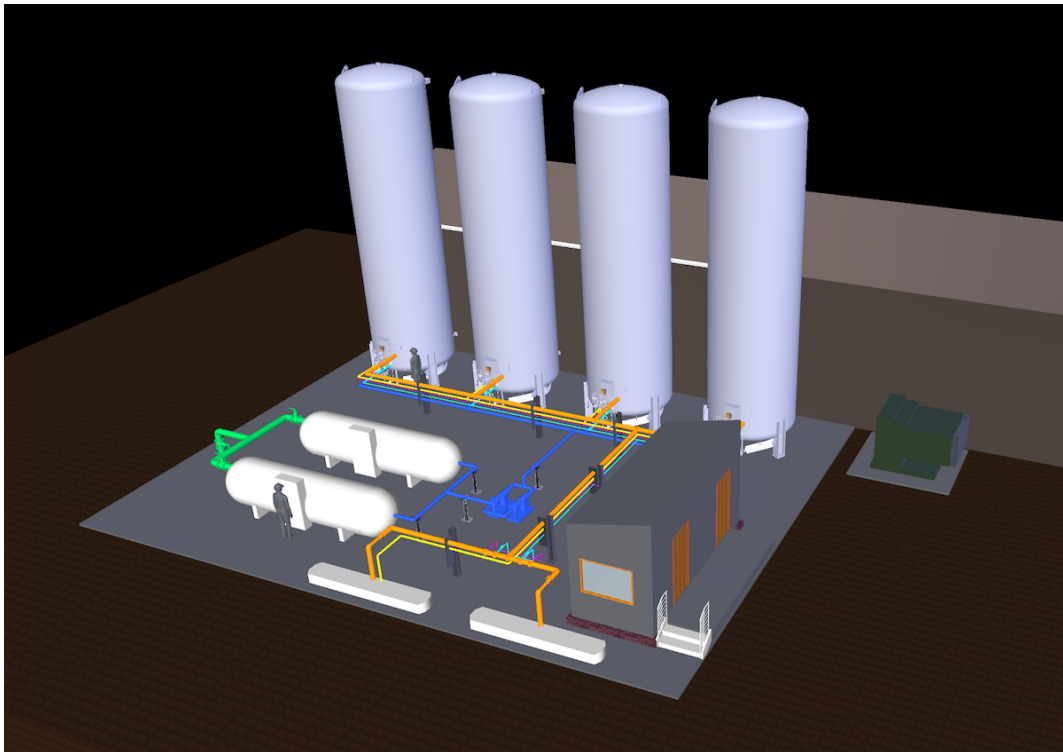

December 15, 2023

The LBNF/DUNE-US Project

This document was prepared by the LBNF/DUNE Project and the DUNE Collaboration using the resources of the Fermi National Accelerator Laboratory (Fermilab), a U.S. Department of Energy, Office of Science, HEP User Facility. Fermilab is managed by Fermi Research Alliance, LLC (FRA), acting under Contract No. DE-AC02-07CH11359.

LBNF/DUNE also acknowledges the international, national, and regional funding agencies supporting the institutions who have contributed to completing this Design Report.

Authors

M. Adamowski, M. Delaney, R. Doubnik, D. Montanari, T. Nichols, and I. Young
*Fermi National Accelerator Laboratory,
Batavia, IL 60510, USA*

J. Bremer, D. Mladenov, A. Parchet, and F. Resnati
*CERN, The European Organization for Nuclear Research,
1211 Meyrin, Switzerland*

on behalf of the Long-Baseline Neutrino Facility and
the Deep Underground Neutrino Experiment (LBNF/DUNE)

Contents

Contents	i
List of Figures	iv
List of Tables	1
1 Introduction	2
1.1 Overview of LBNF/DUNE	2
1.2 The Far Site Cryogenics Infrastructure Overview	3
1.3 Principal Parameters for the Detector’s Cryogenic Environment	4
1.4 Scope and Design Parameters	4
1.4.1 The Cryostats	4
1.4.2 The Cryogenics System	7
1.5 Management and Organization	9
1.6 Participants and Scope Assignment	10
1.7 Acquisition Strategy	11
1.8 Risks	12
2 Cryostat Configuration and Construction	13
2.1 Cryostat Inner Structure	13
2.2 Exterior of Cryostat: Vapor Barrier and Steel Structure	15
2.3 Cryostat Roof	17
2.4 Leak Prevention	18
3 Cryogenics Subsystems	19
3.1 Infrastructure Cryogenics	19
3.1.1 Argon Receiving and Vaporization Facilities at the Surface	19
3.1.2 Systems to Transfer Vaporized Argon (GAr) to the 4850L	21
3.1.3 Nitrogen Refrigeration System	22
3.1.4 Argon and Nitrogen Distribution	24
3.2 Proximity Cryogenics	24
3.2.1 Cryogenics in the CUC	24
3.2.2 Cryogenics in the Detector Caverns	25
3.3 Cryogenics inside the Cryostats	26

4	Cryogenics Procurement	28
4.1	Liquid Argon Procurement and Delivery	28
4.2	Nitrogen Refrigeration System Procurement	30
4.3	Other Procurements	31
5	Cryogenics System Processes	33
5.1	Cryostat Initial Purge and Cool-down	33
5.1.1	Initial Air Piston-Purge	35
5.1.2	Contaminant Removal via GAr Recirculation	35
5.1.3	Cool-down	36
5.2	Cryostat Fill	36
5.3	Recirculation during Detector Operations	37
5.4	Ar Gas Recovery, Reliquefaction, and Pressure Control	37
5.5	Argon Purification	38
5.6	Filter Regeneration	39
5.7	Pressure Control	39
5.7.1	Normal Operations	39
5.7.2	Overpressure Control	40
5.7.3	Vacuum-Relief System	40
5.8	Nitrogen Refrigeration System Cycle	41
5.9	Liquid Argon Removal at the End of Experiment Operations	42
6	Process Controls	43
6.1	System Architecture and Networking	43
6.2	Access to the Process Control System	44
6.3	Supervisory Control and Data Acquisition	47
6.4	Databases for Local and Remote Historians	49
6.5	Programmable Logic Controllers (PLC)	49
6.6	Backup Power	50
6.7	Oxygen Deficiency Hazard System	50
6.7.1	Software	50
6.7.2	Gas Monitors	51
6.7.3	Temperature Monitors	51
6.7.4	Vacuum Monitors	52
6.7.5	Seismic Activity Monitors	52
6.7.6	Safety System Power and Controls	53
6.7.7	Alarms	53
7	Prototyping Program	55
7.1	The Liquid Argon Purity Demonstrator	55
7.2	ProtoDUNE	55
7.2.1	Cryostats	56
7.2.2	Cryogenics Systems	59
8	Environment, Safety, and Health	61
8.1	Argon Gas Piping in the Ross Shaft	61
8.2	Ventilation in CUC and Detector Caverns	63

9	Quality Assurance and Quality Control	64
9.1	Quality Assurance	64
9.1.1	Cryogenics Systems	64
9.1.2	Protego Valves	66
9.1.3	Cryostat	66
9.2	Cryostat QC Prior to Purge	67
9.3	Cryostat QC During Cryostat Fill	67
9.4	Cryostat QC After Cryostat Fill	68
A	Refrigeration Load Scenarios	69
	Glossary	72
	References	78

List of Figures

1.1	Interior of a LNG tanker ship	5
1.2	Cryostat corrugated stainless steel primary barrier	7
1.3	Management Structure	10
1.4	Cryogenics infrastructure risks	12
2.1	GST composite system from GTT	14
2.2	Membrane corner detail	15
2.3	Nozzles in the roof of membrane cryostat	17
3.1	Argon receiving facilities near the Ross Headframe	20
3.2	Cryogenics system components between the surface and the caverns	21
3.3	Ross Shaft frame with GAr pipe	22
3.4	Nitrogen refrigeration plant diagram	23
3.5	Cryogenics system components in CUC	24
3.6	Proximity cryogenics in the detector cavern	26
5.1	Cryogenics process flow diagram	34
5.2	Cryogenics system flow block diagram	36
5.3	Liquid argon recondensers	38
6.1	Far Site process controls system architecture	44
6.2	Control station in the CUC	45
6.3	Control cabinet layout (regular and ODH)	46
6.4	CUC cabinet layout (regular and ODH)	46
6.5	LAr circulation VFD layout	47
6.6	Detector cavern airflow	50
6.7	MSA Ultima gas monitor	51
6.8	Photo of temperature monitor	52
6.9	Photo of convection vacuum gauge	52
6.10	Photo of safety seismic switch	53
7.1	ProtoDUNE cryostats at the CERN Neutrino Platform	56
7.2	Interior view of a ProtoDUNE cryostat showing membrane	57
7.3	Expected deformation of the cryostat	58
7.4	Filling trends	60
8.1	ODH mapping of the underground caverns at 4850L	62

8.2 Homestake mine ventilation paths	62
A.1 Refrigeration Loads	71

List of Tables

1.1	Parameters for the cryogenics system	4
1.2	Parameters for one FD cryostat	6
1.3	Key parameters for cryogenics system	8
1.4	Scope assignments	11
2.1	Cryostat inside and outside dimensions	16
4.1	Phase I LAr delivery rate and schedule	30
4.2	Phase II LAr delivery rate and schedule	30
5.1	Estimated heat loads within the cryostat	38
5.2	Important Pressure Values	40
6.1	Sample HMI process automation hierarchy of displays	48
6.2	HMI user access levels	48
6.3	Alarm levels	48
6.4	Response to alarms	49

Chapter 1

Introduction

1.1 Overview of LBNF/DUNE

The LBNF and DUNE enterprise (LBNF/DUNE) represents an international collaborative effort in neutrino physics. The Deep Underground Neutrino Experiment (DUNE) will be a world-class neutrino observatory and nucleon decay detector designed to answer fundamental questions about elementary particles and their role in the universe. The international DUNE experiment, hosted by the U.S. 's Fermi National Accelerator Laboratory (Fermilab) in Illinois, will consist of a cryogenic far detector (FD) located about 1.5 km underground (this level is referred to as the 4850 foot level underground, or the “4850L”) at the Sanford Underground Research Facility (SURF) in South Dakota, U.S. and a near detector (ND) located at Fermilab. SURF is 1300 km (800 miles) from Fermilab).

The DUNE FD will be a very large, four-module liquid argon time-projection chamber (LArTPC), each detector module in its own cryostat containing approximately 17.5 kt (metric kilotons)¹ of ultra-pure liquid argon (LAr). The LArTPC technology has the unique capability to reconstruct neutrino interactions with image-like precision and unprecedented resolution. DUNE will enable the study of neutrino oscillations from a new beamline originating from Fermilab, as well as from neutrino bursts from any core-collapse supernova that occurs in our galaxy during the experiment's lifetime. DUNE will also enable a search for proton decay.

The LBNF/DUNE Project includes only two of the planned s. They will implement different drift geometries and readout designs, and are designated horizontal drift detector module (FD1-HD) and vertical drift detector module (FD2-VD). A future project that is currently in the early planning stages, referred to informally as DUNE's “Phase II,” will complete the four-module FD, double the beamline power, and add a to the ND [1].

The Long-Baseline Neutrino Facility (LBNF) refers to the facilities and infrastructure that will support this complex system of detectors at the Illinois and South Dakota sites. Also hosted by Fermilab, it is the portion of LBNF/DUNE responsible for developing the neutrino beam,

¹All tonnage listed in this document (with the unit “t” or “kt”) is metric.

excavating and outfitting the underground caverns, and providing the FD cryostats, the far and near site cryogenics systems and cryogens, and the conventional facilities.

The cryostats and cryogenics infrastructure for the far site is part of the Project's Far Detector and Cryogenics () subproject. The Project structure is described in Section 1.5.

1.2 The Far Site Cryogenics Infrastructure Overview

This design report describes the LBNF FD cryogenics infrastructure, which includes cryostats for the first two DUNE far detector modules and the cryogenics infrastructure for them. These facilities are largely in the DOE scope (), but include critical, committed, in-kind contributions from the European Laboratory for Particle Physics (CERN), Brazil (), Switzerland (), and Poland (). This document presents the reference design of the various systems and provides references to the documents in which they are defined.

The cryogenics infrastructure includes systems to receive, transfer, store, purify, and maintain the almost 40,000 t of LAr required for these first two detector modules, and is designed to support expansion to up to four detector modules. Specifically, the scope includes:

- two membrane cryostats,
- space for the remaining membrane cryostats (for a total of four),
- receiving facilities for LAr tanker trucks,
- facilities to vaporize the LAr prior to transfer to the ,
- a transfer system to deliver argon gas from the surface to the underground cavern area,
- a closed-loop refrigeration system for condensing the LAr,
- all required piping for the argon and nitrogen in both gas and liquid phases,
- boil-off gaseous argon (GAr) reliquefaction equipment,
- LAr purification facilities,
- LAr circulation systems,
- regeneration systems,
- equipment to control the pressure inside the cryostat,
- process controls for all equipment, and
- the capability for emptying the cryostats at the end of the experimental run.

A strong, successful prototyping effort to qualify the cryogenics system and the cryostat technologies has been in progress for over ten years. A series of detectors of increasing size, starting with a (metric tons of LAr), outfitted with associated cryostats and cryogenics systems have been built and tested at Fermilab and CERN as part of the and programs, respectively.

1.3 Principal Parameters for the Detector's Cryogenic Environment

LBNF/DUNE has compiled a comprehensive set of requirements on the cryostats and the cryogenics system [2], ensuring that these deliverables satisfy the needs and constraints of both the DUNE far detector and the LBNF/DUNE-US Far Site Conventional Facilities (FSCF), and take into account regulatory and safety codes and standards, as well as logistical concerns. This section presents a subset of the parameters that derive from these requirements, concentrating on those that affect the physical design of these systems most directly.

The overarching requirements are to provide a high-purity, stable LAr environment and mechanical support for the FD LArTPC modules.

Table 1.1: Parameters for the cryogenics system

Parameter	Value	Note
GAr purge flow rate	1123 m ³ /hr	From 1.2 m/hr
LAr filling fill time (Phase I)	243/400 days	1st/2nd cryostats only (w/ three LN ₂ refrigeration units)
LAr filling fill time (Phase II)	362/540 days ²	3rd/4th cryostats only (w/ four LN ₂ refrigeration units)
Cryostat static heat leak	48.7 kW	Each cryostat
Electronics heat leak	23.7 kW	Each cryostat
Total estimated heat leak	87.1/98.1 kW	Each cryostat with two/four pumps in operation
Available cooling power	4 × 100 kW = 400 kW	Three LN ₂ units for cryostats 1 and 2, fourth unit for 3 and 4
Maximum LAr circulation speed (assuming 5 days turnover per cryostat)	1.73 m ³ /min (40 kg/s)	All four LAr pumps in operation
Nominal LAr circulation per cryostat	0.43 m ³ /min (10 kg/s)	Only one LAr pump in operation
LAr Purity (FD1/FD2)	100 parts per trillion (ppt)/50 ppt	Oxygen equivalent contamination (O ₂ , H ₂ O)

1.4 Scope and Design Parameters

1.4.1 The Cryostats

The scope of the Phase I cryostat deliverables for the DUNE far detector (FD) includes the design, procurement, fabrication, testing, delivery and installation of the cryostats for the first two FD modules.

²The cryostat 4 fill time includes supplemental LAr transfer, targeting an 18 month fill time.

The cryostats are free-standing and constructed using membrane cryostat technology, which is widely used for transportation and storage of liquified natural gas (LNG) (Figure 1.1). This technology implements a 1.2 mm thick stainless steel membrane to contain the liquid and transfers the load to the insulation and support structure. The membrane liner is corrugated to provide strain relief resulting from temperature-related expansion and contraction (Figure 1.2). Table 1.2 gives the cryostat dimensions and other parameters. Each cryostat is passively insulated by a 0.8 m thick layer of polyurethane foam on all sides and the roof. The surrounding steel support structure for the cryostats includes a 12 mm thick stainless steel plate serving as a vapor barrier, as well as 1.1 m tall I-beams bearing the weight of the cryostat, the enclosed detector, and the contained liquid and gaseous argon.

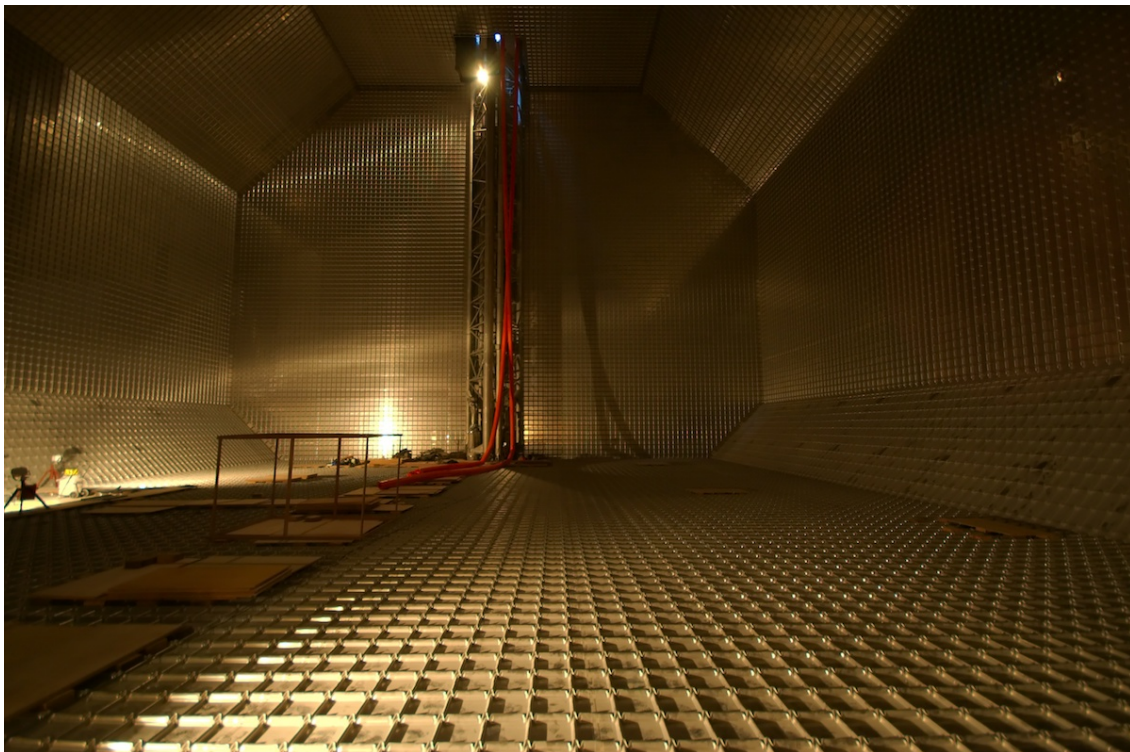

Figure 1.1: Interior of a LNG tanker ship. The tank shown is 24 m high by 35 m wide with interior grid-like corrugations on a 0.34 m pitch. By comparison, a single LBNF cryostat is 14.0 m high by 15.1 m wide.

Two membrane cryostat vendors have been identified that are technically capable of delivering a membrane cryostat that meets the design requirements for LBNF, GTT³ and IHI⁴. LBNF has selected GTT. Chapter 2 describes the GTT cryostat design.

³GTT (Gaztransport & Technigaz) <https://www.gtt.fr/>

⁴IHI (Ishikawajima-Harima Heavy Industries) <https://www.ihi.co.jp/en/>

Table 1.2: Parameters for one FD cryostat

Parameter	Value
Cryostat Internal Volume	13,107 m ³
Total LAr mass contained	17.5 kt
Cryostat inside/outside height	14.0 m / 17.8 m
Cryostat inside/outside width	15.1 m / 18.9 m
Cryostat inside/outside length	62.0 m / 65.8 m
Insulation	Reinforced 80 cm thick polyurethane; two (inner/outer) layers around secondary containment (40 cm per layer)
Primary membrane (GTT Design)	1.2 mm thick type 304L stainless steel with corrugations on 340 mm × 340 mm rectangular pitch
Secondary containment (GTT Design)	≈ 0.07 mm thick aluminum between fiberglass cloth; overall thickness is 0.8 mm located between insulation layers
External vapor barrier thickness (steel plates)	12 mm
External support structure thickness on sides, top, and bottom	1.1 m (steel)
LAr Temperature	88 K ± 1 K
Minimum LAr depth (liquid head)	13.37 m for FD1-HD; 13.51 m for FD2-VD
Ullage contents	Ar gas (3 to 5% of cryostat volume)
Ullage operating pressure	50 mbarg (range:50 mbarg to 150 mbarg)
Cryostat design pressure	350 mbarg
Personnel and equipment access to cavern	Ross Shaft
Base, side walls, and roof	steel structures
Moisture protection (outside cryostat)	combination of convection and continuous exhaust of cold air, replaced with heated fresh air
Vapor barrier	steel plates
LAr containment system	stainless steel primary membrane; secondary barrier

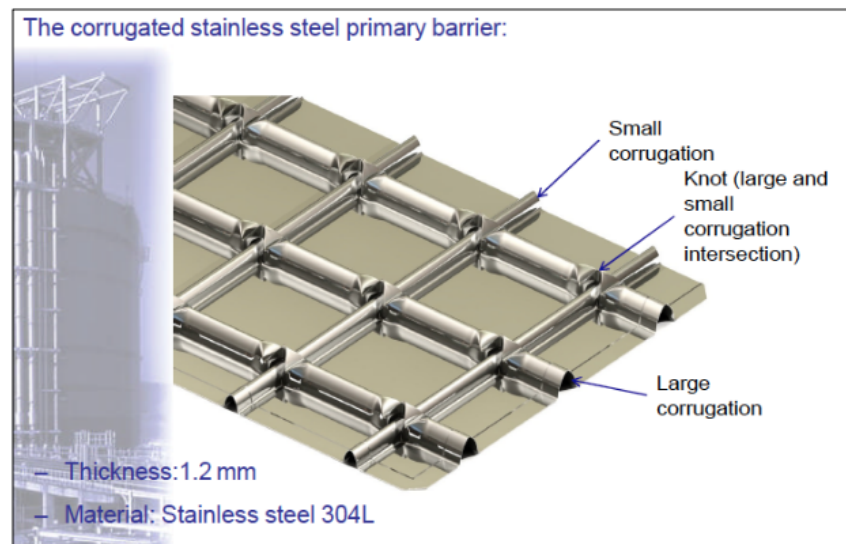

Figure 1.2: Corrugated stainless steel primary barrier of the membrane cryostat (this barrier is referred to as “the membrane”). The corrugations range in height from ~ 70 mm at the intersections (“knuckles”) down to ~ 30 mm to 50 mm in the straight sections.

1.4.2 The Cryogenics System

The scope of the FDC cryogenics system includes the design, procurement, on-site installation and testing of the cryogenics systems to support four DUNE far detector modules. The scope also includes coordination of construction, quality assurance (QA), and quality control (QC) of all the activities related to the cryogenics systems and cryostats, as well as process controls and procurement of the required LAr. This system is funded by both DOE and non-DOE collaborative partners.

The overall cryogenics system is required to enable several modes of operation:

- gaseous argon (GAr) purge,
- cryostat and detector cool-down,
- cryostat fill with LAr,
- steady-state operations with LAr circulation, and
- cryostat emptying.

The cryogenics subsystems are defined as follows:

- The *infrastructure cryogenics* supports the needs of the cryostat and the proximity cryogenics. This subsystem provides the equipment to receive LAr, vaporize the liquid and transfer the gas underground. It is responsible for the designs of the LN₂ refrigeration system and of the nitrogen system (composed of the refrigeration system and the LN₂ buffer tanks, the nitrogen generation, and LN₂/GN₂ distribution). It also provides the argon distribution system. This subsystem, described in Section 3.1, is funded by the DOE.
- The *proximity cryogenics* consists of all the systems that take the LAr from the infrastructure

cryogenics and deliver it to the cryogenics components inside the cryostat at the required temperature, pressure, purity, and mass flow rate. This subsystem circulates and purifies the LAr, condenses the boil-off GAr, and condenses the GAr during the cryostat fill, returning it to the LAr circulation and purification stream. It comprises the GAr purification system, the argon condensers, the LAr filtration and associated regeneration systems, and the LAr pumps and monitoring instrumentation. See Section 3.2. Most of the proximity cryogenics is the responsibility of non-DOE partners.

- The *internal cryogenics* is located within the cryostats themselves and includes the design of all items needed to distribute LAr and GAr throughout the volume, and all features needed for the commissioning, cool-down, fill, and steady-state operations of the cryostats and detectors. See Section 3.3. The internal cryogenics is the responsibility of a non-DOE partner.

The international engineering teams that will design, manufacture, commission, and qualify these subsystems benefit from the experience of the Short-Baseline Neutrino (SBN) and ProtoDUNE programs.

Table 1.3 lists parameters for the overall cryogenics system for one cryostat.

Table 1.3: Key parameters for the cryogenics system for one detector module

	Parameter	Value (per cryostat)
1	Piston purge GAr vertical flow rate	1.2 m/hr
2	Maximum cool-down rate (FD1-HD)	60 K/hr
3	Maximum temperature gradient between any two points in TPC during cool-down	50 K
4	Maximum available cooling power during fill for cryostats 1 and 2	226 and 139 kW, respectively
5	Maximum available cooling power during fill for cryostats 3 and 4	151 and 64 kW, respectively
6	Maximum available cooling power (for all purposes except fill)	100 kW
7	Required LAr purity (oxygen equivalent contamination) for FD1-HD normal operations	< 100 ppt
8	Required LAr purity (oxygen equivalent contamination) for FD2-VD normal operations	< 50 ppt
9	Full volume turnover rate; normal operations	5.5 days

Each of the parameters outlined in Table 1.3 fulfills a specific need during the various operational modes of the cryogenics subsystem, namely:

The linear flow rate (row 1 of Table 1.3) of GAr during the purge (Section 5.1) prevents back-diffusion of oxygen through the purge gas, which would inhibit the process. This flow rate has been experimentally verified in several other LArTPCs, including , the , and most recently, and . At LBNF, this corresponds to a volumetric flow rate of $1123 \text{ m}^3 \text{ h}^{-1}$.

The maximum cool-down rate (row 2) of the time projection chamber (TPC) and the maximum temperature gradient between any two points (row 3) ensure mechanical stability of the TPC during cool-down (Section 5.1.3). They have been selected in order to protect the TPC components from unacceptable stresses arising from thermal gradients between these components and the surrounding structure.

The available cooling power during the fills (rows 4–5) is a function of the total available refrigeration, less the cooling required to offset the various sources of heat ingress into the cryogenics subsystems and the cooling required to maintain the liquid in previously filled cryostats. The cool-down is discussed in Section 5.2.

The maximum cooling power (row 6) is the sum of all estimated heat loads into the subsystem during peak operations with some additional margin.

The LAr purity values (rows 7–8) ensure proper operation of the TPCs by enabling an electron lifetime greater than 3 ms as required by DUNE for FD1-HD, and greater than 6 ms for FD2-VD, which has a longer maximum drift length. These purity levels shall be achieved by recirculating each LAr volume through the purification system (discussed in Section 5.5) at a nominal turnover rate (row 9) of 5.5 days, corresponding to a purification rate of 40 kg/s. Previous experience with ProtoDUNE-SP validates this parameter, as the experiment demonstrated that the smaller detector was able to achieve and sustain an electron lifetime in excess of 30 ms with a comparably slower 10.8 day turnover.

1.5 Management and Organization

Modeled after the project structure of traditional accelerator-based particle physics experiments, such as the and experiments at the , the LBNF/DUNE construction project (the “Project”) includes

- The LBNF/DUNE-US Project (the “U.S. Project”) to design and build the conventional and beamline facilities and the DOE contributions to the detectors; it is organized as a DOE/Fermilab project and incorporates contributions to the facilities from international partners. It also acts as host for the installation and integration of the detectors.
- Projects funded by multiple international partners for the detectors to design, build, and install the detector components; the deliverables from these projects are collectively organized and coordinated by the international DUNE collaboration with oversight provided by Fermilab on behalf of all stakeholders.

LBNF/DUNE-US is divided into five subprojects:

- Far Site Conventional Facilities Excavation (FSCF-EXC),
- Far Site Conventional Facilities Buildings and Site Infrastructure (FSCF-BSI),
- Near Site Conventional Facilities and Beamline (NSCF+B),
- Far Detector modules 1 and 2 and Cryogenics (FDC), and

- Near Detector (ND).

All work required for completion of the Project is included in a single, integrated work breakdown structure (WBS). The DOE-funded portion of the work includes all work that began in FY10 (critical decision (CD)-0) and continues through to project completion at each subproject's CD-4.

The FSCF and FDC subprojects all support the DUNE Far Detector at SURF. The scope of the cryogenics part of FDC is to plan, design, and construct the cryostat and cryogenic systems. The FDC Deputy Project Manager for Cryogenics is responsible for leading the planning, design, and construction of the cryogenics systems and works in conjunction with CERN to deliver the cryostats and other cryogenics systems. The CERN Manager for Cryogenics Infrastructure is responsible for leading the planning, design, and construction of the cryostats and cryogenics infrastructure in conjunction with the rest of the LBNF team. These project managers will be assisted by other staff whom the managers will organize into a project team. This includes engineers, designers, and managers from Fermilab and CERN, as well as contract engineers and designers, to execute the planning and design, oversee the technical aspects of procurements, and oversee the installation. This team will work closely with the two FSCF Project Managers, FDC Project Manager, far site integration and installation (), and SURF staff. The management structure is shown in Figure 1.3.

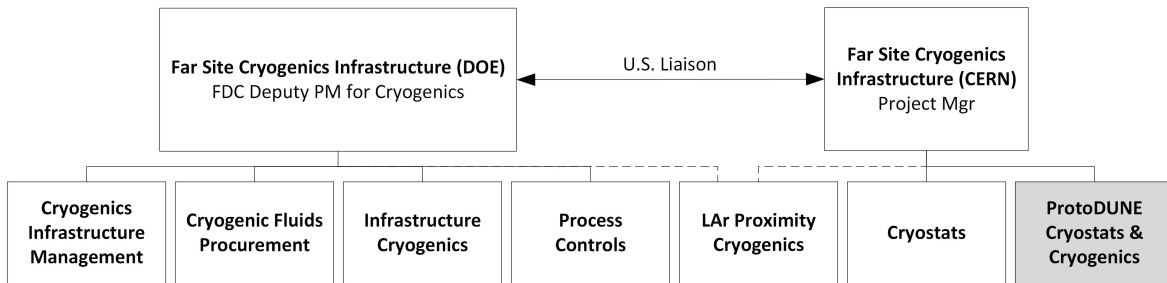

Figure 1.3: Cryogenics Infrastructure Project Management Structure

1.6 Participants and Scope Assignment

The Fermilab Directorate and LBNF/DUNE-US have been working with DOE leadership to identify responsible parties for non-DOE scope. All scope to support the first two far detector modules is committed by either the DOE or partners. Table 1.4 lists the projected scope assignments.

The organization and management is fully described in [3].

Table 1.4: Scope assignments

Item	FD1-HD	FD2-VD
Cryostat (part of Far Site integration)	CERN	CERN
Cryogenics systems integration	DOE	DOE
Nitrogen System (Refrigeration + LN ₂ storage + distribution) – engineering / manufacturing / installation/ commissioning	DOE	DOE
LAr receiving facilities (surface)	DOE + CERN	DOE + CERN
Argon condensers system – engineering / manufacturing	Switzerland	Brazil
Argon distribution	DOE	DOE
Argon purification and regeneration – engineering / manufacturing	Brazil	Brazil
LAr circulation – engineering / manufacturing	Brazil	Brazil
GAr boil-off and pressure control	DOE	DOE
Process controls	DOE	DOE
Internal cryogenics – engineering / manufacturing (part of Far Site Integration)	Poland	Poland
Installation of in-kind contributions (IKC)	DOE	DOE
Collect safety docs and obtain safety approval	DOE	DOE
Purge and cool-down	DOE	DOE
LAr procurement and fill (* LAr only, not labor)	DOE	DOE*

1.7 Acquisition Strategy

The FDC Cryogenics team is using an acquisition strategy known as Engineering/Manufacturing/Installation/Testing and/or Startup in which design documents and specifications are given to a subcontractor or partner to produce/assemble and deliver given systems or equipment. The subcontractor or partner then bears the performance risk for the deliverables.

The team has developed conceptual designs for the cryogenics systems needed to support the DUNE far detector modules. The designs are mature enough to ensure that they meet the requirements and for the team to write performance specifications and interface documents that will be used by subcontractors or partners to produce/assemble and deliver the equipment.

The scope of the FDC cryogenics systems acquisition includes engineering, manufacturing, installation, testing and startup as appropriate (e.g., for the nitrogen system and the argon receiving facilities). The reference design allows partners to familiarize themselves with the systems (that they have to deliver) and write their own procurement documents. Or they can use the performance specifications and interfaces written by the FDC team and customize them for their specific needs. This document presents the reference design of the various systems and references to the actual documents.

1.8 Risks

Figure 1.4 lists the open risks for the Far Site Cryogenics, along with their ranking as high, medium or low, and their probabilities and impacts.

Risk Rank	RI-ID	Title	Probability	Cost Impact	Schedule Impact
3 (High)	RT-131-FDC-CR-129	[CRYO] LAr fluids procurement process is delayed	40.00%	783 -- 1565 -- 2348 k\$	4 -- 8 -- 12 months
3 (High)	RU-131-FDC-CR-148	[CRYO] Price of LAr is uncertain (#1, #2)	100.00%	-2781 -- 0 -- 3204 k\$	0 months
3 (High)	RT-131-FDC-CR-157	[CRYO] Partners require engineering assistance to design and deliver IKC	50.00%	264 -- 1501 -- 2739 k\$	1 -- 2 -- 4 months
3 (High)	RT-131-FDC-CR-175	[CRYO] South Dakota Taxes for In-Kind Contributions to Cryogenics	50.00%	2605 k\$	0 months
2 (Medium)	RT-131-FDC-CR-105	[CRYO] Heat load to cryo plant exceeds estimated load	10.00%	26620 k\$	5 months
2 (Medium)	RT-131-FDC-CR-130	[CRYO] Cryogenic safety review process takes longer than planned for Detectors #1 and #2	40.00%	0 -- 126 -- 376 k\$	0 -- 1 -- 3 months
2 (Medium)	RO-131-FDC-CR-138	[CRYO] Potential partner to fund LAr Piping and LAr valves	1.00%	0 -- -2636 -- -10543 k\$	0 months
2 (Medium)	RO-131-FDC-CR-002	[CRYO] Potential partner to fund FS Receiving Facility	20.00%	0 -- -705 -- -3058 k\$	0 months
2 (Medium)	RT-131-FDC-CR-154	[CRYO] Nitrogen System completion is delayed	40.00%	0 k\$	0 -- 1 -- 4 months
2 (Medium)	RT-131-FDC-CR-158	[CRYO] Difficulties in finding suitable installation subcontractor #1 and #2	10.00%	934 -- 2629 k\$	1 -- 6 months
2 (Medium)	RT-131-FDC-CR-167	[CRYO] CD-3 approval delayed	25.00%	0 -- 2067 -- 4241 k\$	0 -- 3 -- 6 months
2 (Medium)	RT-131-FDC-CR-176	[CRYO] IDIQ IKC installation and Argon distribution review & approval takes longer than planned	40.00%	0 k\$	2 -- 4 -- 6 months
1 (Low)	RT-131-FDC-CR-117	[CRYO] Need to remove LAr during cryostat filling process when it is <25% full	2.00%	7707 k\$	3.5 months
1 (Low)	RT-131-FDC-CR-112	[CRYO] Oxygen deficiency hazard (ODH) incident caused by rock fall from the cavern	1.00%	0 -- 50 -- 100 k\$	0 -- 2 -- 4 months
1 (Low)	RT-131-FDC-CR-126	[CRYO] Significant ODH Event in Detector Cavern or CUC	2.00%	500 -- 1000 k\$	1 -- 2 months
1 (Low)	RT-131-FDC-CR-172	[CRYO] Need alternate LN2 supply for APA integrated cold boxes	20.00%	655 k\$	0 months
0 (Negligible)	RT-131-FDC-CR-171	[CRYO] No chiller redundancy during Far Detector #2 filling	30.00%	0 k\$	0.1 -- 0.25 -- 0.5 months
0 (Negligible)	RT-131-FDC-CR-159	[CRYO] Partner-supplied items do not meet quality standards and are delayed	10.00%	0 k\$	0 -- 0.5 -- 1.5 months

Figure 1.4: Cryogenics infrastructure risks

Chapter 2

Cryostat Configuration and Construction

The cryostats for the Deep Underground Neutrino Experiment (DUNE) far detector (FD) will be constructed using membrane cryostat technology. This technology, employing multiple layers of support and insulation, is commonly used for liquefied natural gas (LNG) storage and transport tanker ships, and has been proven to be an excellent option for liquid argon time-projection chamber (LArTPC) experiments [4, 5].

The cryostats are in-kind contributions from the European Laboratory for Particle Physics (CERN), and thus outside the scope. They are described here for completeness. Cryostat installation is included in the installation activity () schedule.

2.1 Cryostat Inner Structure

In the cryostat design, a 1.2 mm thick, corrugated stainless steel membrane, Figure 1.2, forms a sealed container for the liquid argon (LAr), with surrounding layers of thermal insulation and vapor barriers. Outside these layers, a free-standing steel frame forms the outer (warm) vessel, the bottom and sides of which support the hydrostatic load. The roof of the cryostat supports most of the components and equipment within the cryostat, e.g., the time projection chamber (TPC) and photon detection system (PDS) components, electronics, and sensors. The majority of the cryogenic piping runs along the bottom and is supported by the floor. The cryostat dimensions and other parameters are given in Table 1.2.

Membrane tank vendors, including GTT, have a “cryostat in a kit” design that incorporates the insulation and secondary barriers into packaged units. Figure 2.1 illustrates, from innermost to outermost layers, the composition of the bottom and side walls of the membrane cryostat, which consist of

- a corrugated, stainless steel primary membrane in contact with the LAr,
- inner layer of insulation (polyurethane foam),
- a secondary barrier (a thin triplex secondary membrane that contains the LAr in case of a

- leak in the primary membrane),
- outer layer of insulation,
- a steel barrier to prevent water vapor ingress, and
- the steel frame (the “warm,” i.e., room temperature, outer vessel, not pictured in Figure 2.1).

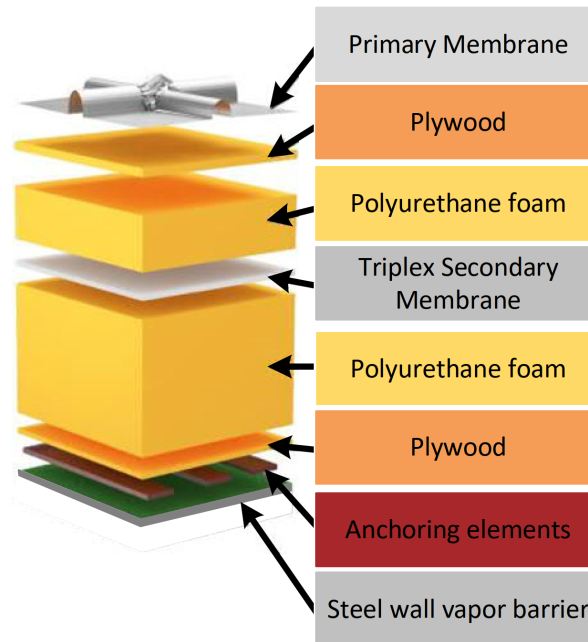

Figure 2.1: GST composite system from GTT.

The cryostat roof design, described in Section 2.3, is somewhat different.

Each cryostat is positioned at one end of a detector cavern with enough air space reserved for a combination of convection and forced air circulation, which maintains the outer steel structure temperatures above freezing.

To minimize the heat ingress and the required refrigeration load, the membrane cryostat requires insulation between the primary stainless steel membrane and the exterior vapor barrier (steel plates). Our choice of insulation thickness of 80 cm, tested in , limits the heat input to a cryostat to an acceptable 48.7 kW, as described in Chapter 7.

The insulation material, a solid polyurethane, is manufactured in $1\text{ m} \times 3\text{ m}$ composite panels. The panels will be laid out in a grid with 3 cm gaps between them (to be filled with loose fiberglass) and fixed onto anchor bolts embedded into the steel outer structure at about $\sim 3\text{ m}$ intervals. The composite panels contain the outer insulation layer, the secondary membrane, and the inner insulation layer. After positioning adjacent composite panels and filling the 3 cm gap, the secondary membrane is spliced together by epoxying. All seams are covered so that the secondary membrane becomes a seamless liner. A corner detail is shown in Figure 2.2.

The secondary membrane is composed of a thin aluminum sheet covered on both sides with fiberglass cloth, a roughly $\sim 1\text{ mm}$ thick composite called triplex that is very durable and flexible. This

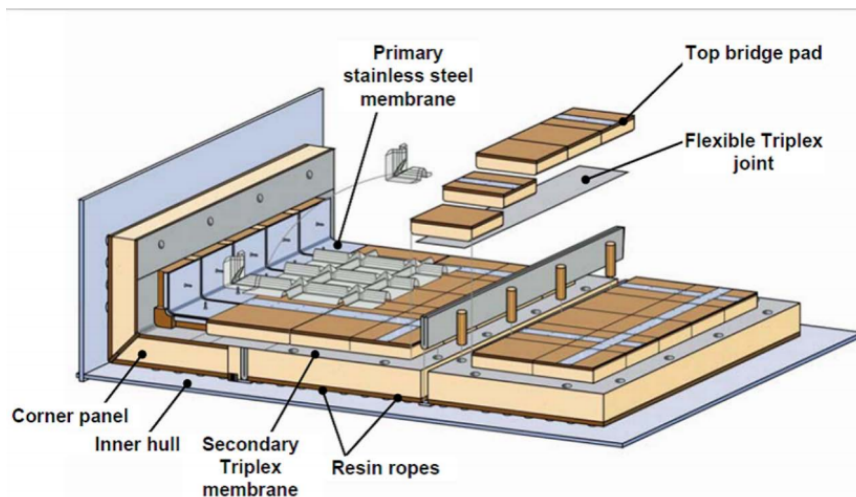

Figure 2.2: Membrane corner detail.

membrane is placed within the insulation space, surrounding the internal tank on the bottom and sides, and separating the insulation space into two distinct, leak-tight, inner and outer volumes. It is connected to embedded metal plates in the vertical steel wall at the upper edge of the tank and separated from the steel frame by the outer insulation layer. In the unlikely event of an internal leak from the cryostat's primary membrane into the inner insulation space, the secondary membrane will contain the liquid cryogen.

2.2 Exterior of Cryostat: Vapor Barrier and Steel Structure

The functions of the steel warm vessel are to (1) contain the membrane vessel and the intermediate layers, (2) provide mechanical support, and (3) provide a vapor barrier from the outside. The vapor barrier, welded to the inside surfaces of the outer steel structure, is required on all six faces of the cryostat to prevent the ingress of water vapor into the insulation space. If water vapor were permitted to migrate into the insulation space, it could freeze and degrade the thermal performance of the insulation. The barrier must also reliably absorb the stresses and strains from all normal loading conditions. The selected vapor barrier material is 12 mm thick steel plate.

Each of the four free-standing cryostats will be positioned on a firm surface with no additional structural connections necessary for either the cavern floor or the cavern walls. It will be positioned with enough air space for convection and forced air circulation, to maintain the steel temperature above the dew point temperature to prevent condensation and freezing. The distance from the outer surface of the structure to the cavern wall will vary from 20 cm to 50 cm. The internal and external dimensions of a cryostat are given in Table 2.1.

The outer vessel consists of outer supporting steel profiles, interconnected through a steel grid and a 12 mm thick steel continuous plate on the inner side that is in contact with the membrane insulation. The material used is S460ML structural carbon steel, with yield strength of 430 MPa and tensile strength of 510 MPa. The main profile used is HL 1100×548 or its ASTM alternative W 44×16×368. Four profiles are bolted together, by four connections, forming a structural "portal." Each bolting connection consists of 16 bolts (M42). The additional grid is made of the IPE300

Table 2.1: Cryostat inner and outer dimensions

Dimension	Value
Cryostat inside/outside height	14.0 m / 17.8 m
Cryostat inside/outside width	15.1 m / 18.9 m
Cryostat inside/outside length	62.0 m / 65.8 m

profile. The total self-weight of the structure is approximately 2000 t (metric).

The main advantage of this design is the fact that such a structure can be fully decoupled from the civil engineering work related to the excavation and finishing of the four caverns. All components can be procured and prepared on the surface, ready to be lowered through the shaft. Underground installation will take 12 months for each of the cryostats and can be done sequentially. The warm vessel will be fully accessible from outside and can be inspected at any time. Stairs and gangways are included in the design.

The design was done mainly using ANSYS code, a commercial finite element analysis (FEA) method. The design adheres to the Eurocode III codes, which were verified using a safety equivalency review process with U.S. codes [6].

Approximately 17.5 kt of LAr acts as load on the floor ($\sim 20 \text{ t/m}^2$). Approximately 8 kt of hydrostatic force acts on each of the long walls, with triangular distribution over the height, and around 2 kt of hydrostatic force acts on each of the short walls. Additionally, a normal ullage operational pressure of 50 mbarg (0.5 t/m^2) acts on every wall. The structure has been verified to accommodate all this plus an accidental overpressure, up to a total of 350 mbarg (3.5 t/m^2), the design pressure of the cryostat. The calculations take into account the weight of the installed detector, as well as any potential seismic action.

The following FEA models and analysis methods have been developed and used¹:

- a model for evaluation of the global behavior of the entire structure;
- analytical models of a single portal, i.e., four main beams connected together (roof, floor, and the two side walls), adjacent portals run the full length of the cryostat;
- an additional shell model of single cell (one portal and eight additional grid beams) to study the main elements of the structure in more detail,
- specific analyses, i.e., linear (eigenvalue) and nonlinear buckling, have been performed on the following parts of the structure to evaluate their stability:
 - a single portal by using beam elements, and
 - a single cell (one portal and two additional grid beams, one on the left and the other on the right) using two different FEA models: (1) beam and shell elements (using ANSYS

¹Solid, shell, and beam models refer to techniques used to model specific geometries. The latter two imply a large computational savings; a shell element is a 2D abstraction of a 3D shape (used when the thickness of the object is much smaller than the length), and a beam element is a 1D abstraction of a 3D shape (typically used for long shapes of constant cross section).

Workbench), and (2) only shell elements (using ANSYS APDL).

- very detailed models on the connections (bolting and/or welding) on a single portal using solid and contact elements.

The maximum stress levels on the main profiles at the location of the maximum moment are on the order of 125 MPa, which allows a safety factor of four with respect to the tensile strength of the chosen material. Additional bracing of the main profiles increases the stability of the structure by a factor of 2.5, as verified by stability analyses.

2.3 Cryostat Roof

The stainless steel primary membrane and all the intermediate layers except the secondary membrane, which is only needed to protect against liquid leaks, continue across the roof of the cryostat, providing a vapor-tight seal. Recall that the cryostat roof must support detector components and equipment inside the cryostat. Except for sidewall penetrations from the external LAr recirculation pumps, all piping and electrical penetrations into the interior of the cryostat are made through the roof to minimize the potential for leaks.

To construct the roof, studs are first welded to the underside of the steel plates of the roof to bolt the insulation panels to the steel plates. Insulation plugs are then inserted into the bolt-access holes. The primary membrane panels are tack-welded to hold them in place, then fully welded to complete the inner cryostat volume.

Feedthrough ports located at regular intervals along the corrugation pattern of the primary membrane along the roof will accommodate TPC hangers, electrical and fiber-optic cables, and piping. See Figure 2.3.

All connections into the cryostat (again, except for the LAr recirculation pumps) will be made via nozzles or penetrations above the maximum liquid level, and located on the roof. See Figure 2.3 for a typical roof-port penetration.



Figure 2.3: Nozzles in the roof of membrane cryostat (Figure courtesy GTT).

2.4 Leak Prevention

To prevent infiltration of water-vapor or oxygen through microscopic membrane leaks (below detection level) the insulation spaces will be continuously purged to provide one volume exchange per day.

The insulation space between the primary and secondary barriers will be maintained at 15 mbarg, slightly above atmospheric pressure. This space will be monitored for changes that might indicate a leak from the primary membrane. The outer insulation space will also be purged with nitrogen at a slightly different pressure. The pressure gradient across the membrane walls will be maintained in the outward direction. Pressure-control devices and relief valves will be installed on both insulation spaces to ensure that the pressures in those spaces do not exceed the operating pressure inside the cryostat.

The purge gas will be provided by a nitrogen generator, separating nitrogen from compressed air. The purge system is not safety-critical, and an outage of the nitrogen generator would have no impact on operations.

All welds will be tested. The primary membrane will be subjected to several leak tests and to weld remediation, as necessary.

Chapter 3

Cryogenics Subsystems

3.1 Infrastructure Cryogenics

The Infrastructure Cryogenics includes (1) the liquid argon (LAr) receiving and vaporizing facilities (above-ground), (2) the systems to transfer the vaporized argon to the , (3) the nitrogen system (below-ground), (4) argon and nitrogen distribution systems (below-ground), and (5) the process controls (above-and below-ground). Piping and Instrumentation Diagrams (P&ID) [7, 8, 9, 10] detail the cryogenics systems and associated process instrumentation.

3.1.1 Argon Receiving and Vaporization Facilities at the Surface

Figure 3.1 illustrates the layout [11, 12] for the planned cryogen receiving station near the Ross Headframe at the Sanford Underground Research Facility (SURF).

To prepare for road tankers to arrive and efficiently offload LAr at the Ross Headframe, SURF must provide vehicle access and hard-surfaced driving areas adjacent to receiving facilities there.

The receiving station will be available for LAr deliveries during the initial filling period, with a set of four interconnected receiving tanks each with a capacity of 50 m³. The total receiving capacity is thus 200 m³.

3.1.1.1 Liquid Argon Testing and Vaporization

To ensure that it meets the purity specification, each LAr road tanker load will be tested using an analyzer rack with instruments to check water, nitrogen, and oxygen content. Only LAr that meets or exceeds the specification will be received into a tank. The tanks serve as a buffer volume enabling receipt of LAr at a pace of about four 20-t-capacity LAr trucks per day during the fill period.

The LAr is transferred from the storage tank to a 300 kW vaporizer that vaporizes it and warms up the resulting gas to room temperature. The warm gaseous argon (GAr) is then transferred down the Ross Shaft (Section 3.1.2). The LAr transfer has been modelled with a process simulator to

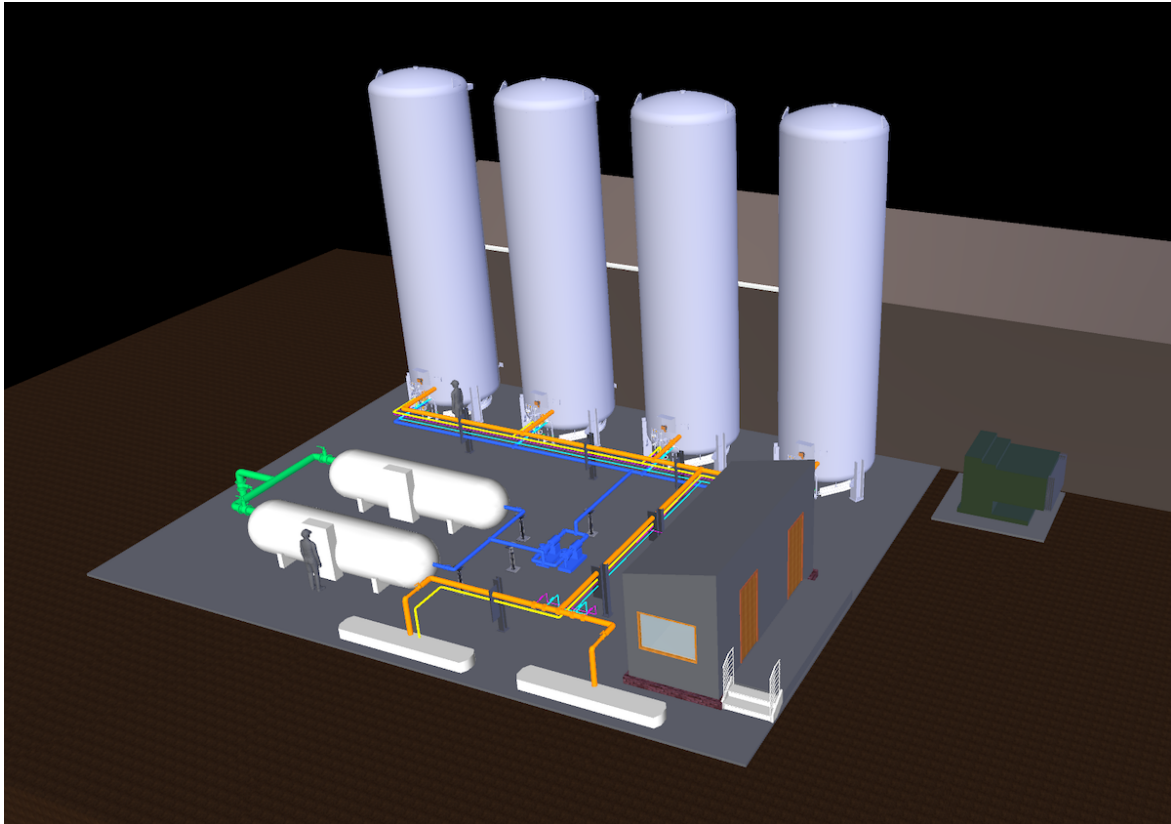

Figure 3.1: View of LAr receiving facilities near the Ross Headframe. The vertical cylinders are LAr dewars providing a total of 200 m^3 storage. The horizontal cylinders are redundant LAr vaporizers; LAr must be vaporized before proceeding down the Ross Shaft. The gray stations serve to receive LAr from delivery trucks; received LAr is tested for purity automatically before deliveries are allowed to proceed.

verify pipe sizing and operating parameters [13]. Pumps may be used to send the LAr through the vaporizers, if needed. They are accounted for in the space and utilities budget. The size of the vaporizer is driven by the size of the condensers available underground to recondense the GAR and fill the cryostats. See Sections 3.1.3 and 3.2.2 for details.

3.1.2 Systems to Transfer Vaporized Argon (GAR) to the 4850L

The GAR is transferred to the 4850L at ambient temperature and a pressure of 0.24 MPa, via a vertical GAR transfer line (one 6-inch SCH 40 stainless steel pipe) that passes down a utility chase in the Ross Shaft, as shown in Figures 3.2 and 3.3. The line is 8-inch SCH 40 above-ground; underground it is reduced to 6 inches inside the shaft to ease installation.

At the 4850L, the piping exits the shaft and runs along a drift to the central utility cavern (CUC) where it deposits the GAR into a gas filtration system.

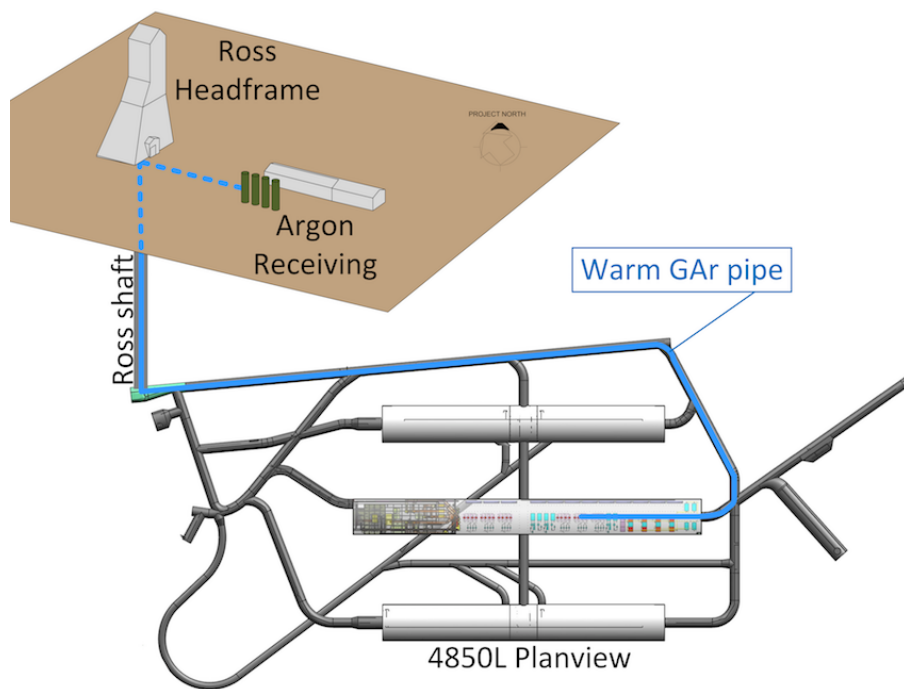

Figure 3.2: Cryogenics system components between the surface and the caverns.

The hydrostatic head for the 1.5 km vertical gas-only piping is on the order of 0.05 MPa. Transferring liquid would increase this number to 20 MPa, which would require about seven pressure-reducing stations evenly spaced along the vertical drop. This would in turn require that the piping be rerouted down the Oro Hondo ventilation shaft, which would first require rehabilitation work. This solution would be much more expensive than the selected design that transfers only gas.

All the GAR piping connections in the Ross Shaft will be welded or sealed with Grayloc™ metal seal fittings. Welded metal bellows will be used to handle thermal expansion and contraction. The

pipework material is stainless steel. The frictional pressure drop for the supply pipe is offset by the pressure gained due to the static head from elevation change.

The effort on pipework between surface and cavern is divided between the cryogenics infrastructure team, who conceptualized the piping, and the team, who designed the support system and will construct the piping system. Section 8.1 discusses the oxygen deficiency hazard (ODH) assessment of the design.

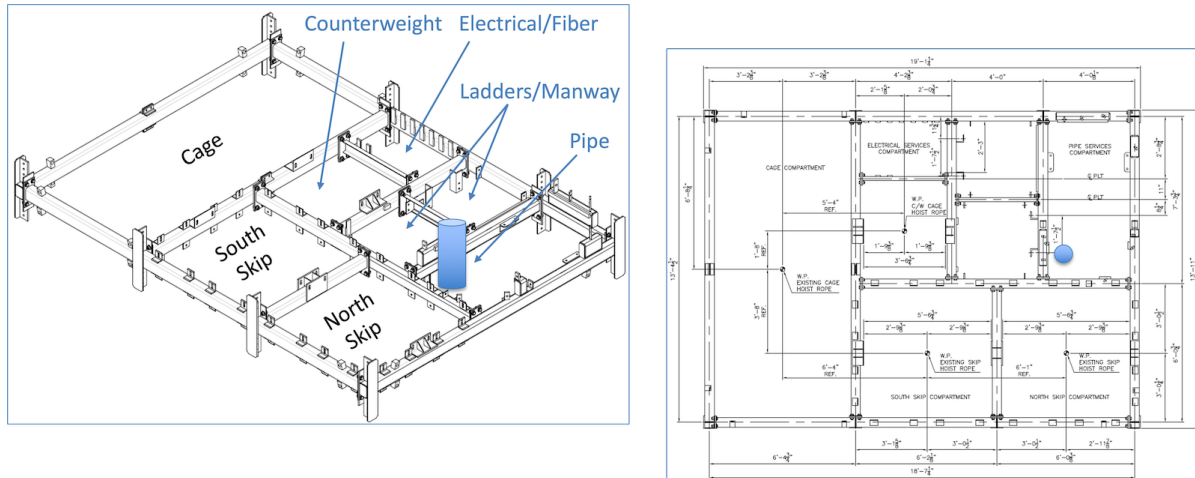

Figure 3.3: Ross Shaft frame with GAr pipe

3.1.3 Nitrogen Refrigeration System

Filling the Deep Underground Neutrino Experiment (DUNE) far detector modules will require a very large volume of argon gas that must be cooled from ~ 300 K to LAr temperature (88.3 ± 1 K). The Long-Baseline Neutrino Facility (LBNF) will procure and install a nitrogen refrigeration system in the CUC at the 4850L that will liquefy nitrogen at a rate sufficient to supply the required liquefaction power to the argon condensers for each cryostat. Filling each cryostat with LAr in a reasonable period of time is the driving consideration in determining the sizes of the nitrogen refrigerator and argon condensers. In addition to providing cooling power to condense the delivered GAr, during operations the refrigerator will cool and recondense the boil-off argon from the cryostats (Section 5.4).

The nitrogen-refrigeration system design consists of four closed-loop refrigeration plants each comprising a cold box, recycle compressor, and expanders. Intermediate storage tanks (dewars) are connected to the refrigeration system and serve as buffer storage to smooth operational variability between production and usage rates. The plants are connected with a common stream so that their use can scale as needed. Three plants will be used for the initial cool-down and filling of each of the first two cryostats (Sections 5.1.3 and 5.2) and the fourth for the final two cryostats.

The refrigeration system operation is expected to be capable of running continuously for at least a year, and then require only minor servicing. The system will be equipped with automatic controls and a remote monitoring system so that human intervention is minimized during normal operation. To ensure optimum efficiency and minimize downtime, the plan is to award a Maintenance & Operations (M&O) subcontract to the vendor supplying the equipment.

The LBNF reference design places the nitrogen compressors underground. A water system with an evaporative-cooling tower removes heat from the compressor. Compression is carried out at close-to-ambient temperature and a compressor after-cooler is provided to reject heat.

The rest of the nitrogen refrigeration system is also underground, comprising cold boxes, expanders and LN₂ storage tanks, as well as the supply of nitrogen to charge the system and replenish losses.

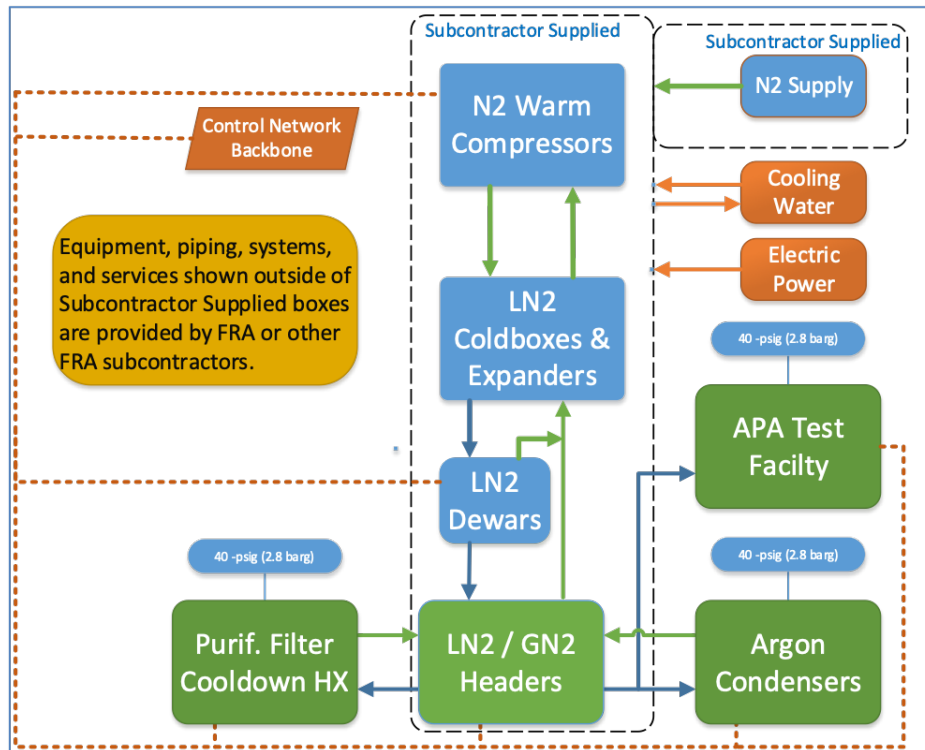

Figure 3.4: Nitrogen refrigeration plant diagram

Three nitrogen refrigeration plants are needed to provide cooling for the fill and operation of the first two s; a fourth unit will be added for the (Phase II) third and fourth modules. All available units are used during the cool-down and fill of each cryostat to minimize the duration of each step. Once all four cryostats are filled and the required LAr purity is achieved, three of the four units will remain in use to recondense boil-off argon, leaving the fourth available as a spare. Vacuum-insulated nitrogen pipes will deliver the LN₂ to the various user systems and collect the vaporized GN₂ back to the refrigeration system to close the cycle. The main user systems are the argon condensers, but the system will also provide cooling power to the cold boxes, which are used to test horizontal drift detector module (FD1-HD) detector components at cryogenic temperature (in gas phase) prior to their installation in the cryostat, and to the regeneration system, where the regenerated filters are cooled before being put back in service or on stand-by.

One of the key aspects of the design is modularity, which will facilitate the transport underground via the Ross Shaft. To minimize installation time at SURF and the risk of any misalignments, the subcontractor will first assemble the full system at one of their facilities, and label the components prior to delivery.

With four units running, the estimated power requirement is 3,840 kW and the estimated cooling

water usage 3,940 kW. During normal operations, 3,000 kW of electrical power and cooling water are available for this system. The full four units are needed only during the fill of cryostats FD3 and FD4 (Phase II), during which extra utilities are available because the detectors in these two cryostats are not operational yet. Once all four detector modules are operational, three units can support them all while keeping the usage within the allowable values. The Statement of Work for this system is available in [14].

3.1.4 Argon and Nitrogen Distribution

The argon and nitrogen distribution piping consists of a series of vacuum and non-vacuum insulated pipes for transporting argon and nitrogen in both the liquid and gas phases between the CUC and the detector caverns. The layout is available in [15].

The nitrogen system acquisition includes both nitrogen generation and distribution [14]. The argon distribution is acquired independently; the reference design is available in [16], and the Statement of Work in [17].

3.2 Proximity Cryogenics

The Proximity Cryogenics includes the LAr and GAr purification and regeneration systems [18, 19], the argon condensers and the LAr circulation pumps [20]. All items are located within either the CUC or the detector caverns.

3.2.1 Cryogenics in the CUC

In addition to the nitrogen refrigeration system (cold boxes, recycle compressors and nitrogen generation) and the LN₂ storage tanks, the CUC at the 4850L houses the argon purification system, which is composed of liquid and gas filtration elements, including particulate filters, and the associated equipment required to regenerate (i.e., clean) these elements (Section 5.6). Figure 3.5 illustrates the layout.

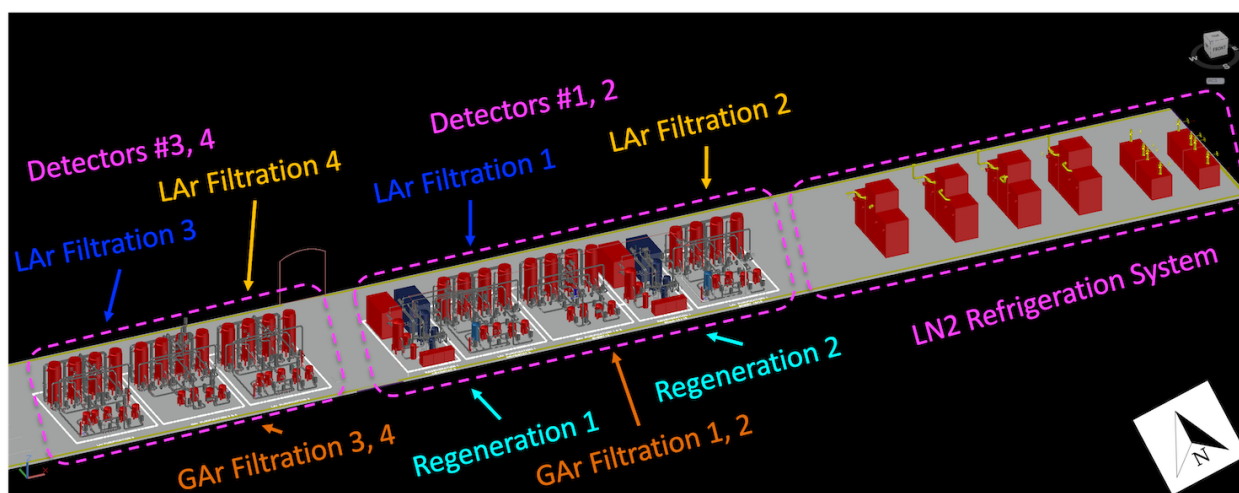

Figure 3.5: Cryogenics system components in the CUC.

The argon purification system also includes interconnecting piping and the necessary valves and instrumentation. The purifiers themselves consist of a molecular sieve and copper pellets that remove water and oxygen, respectively, from the argon. The size of each filter, whether for GAR or LAr, is selected appropriately to purify argon with initial contaminant levels no greater than 5 ppm oxygen and 10 ppm water. The GAR purifiers are used during the argon-purge phase; one set of these will be used for cryostats FD1-HD and FD2-VD, and another set for cryostats FD3 and FD4. In contrast, the LAr filters are actively used throughout the experiment's lifetime to achieve and maintain the contamination level below the required 100 ppt for FD1-HD and 50 ppt for FD2-VD. Each cryostat will have its own set of liquid filters. During operations, the LAr filters will switch between active filtration and regenerative modes (one filter can be regenerated at a time), to keep the argon filtration process uninterrupted.

The reference designs for LAr Purification FD1-HD and FD2-VD are available in [21, 22].

3.2.2 Cryogenics in the Detector Caverns

The bulk of the cryogenics equipment in the detector caverns sits atop the cryostats on a 12 m wide, 60.5 m long mezzanine that is installed about 2.3 m above each cryostat. This cryogenics equipment is planned for installation at the far end of the mezzanine, as shown in Figure 3.6 (left). This equipment includes:

- LAr phase separators, through which LAr is passed and conditioned before returning to the cryostat;
- argon condensers, for initial liquefaction of delivered GAR, and for reliquefaction of boil-off argon before it gets pumped to the LAr purification system;
- nitrogen phase separators;
- a cryostat over-pressure and under-pressure protection system with pressure controls and safety valves;
- programmable logic controller (PLC) racks;
- a nitrogen generator for cryostat insulation purge;
- a xenon injection line, connected to the boiloff GAR manifold, heading to argon condensers;
- a GAR sampling and measuring system; and
- a set of lines (connected to each cryostat feedthrough and piped to a gas manifold) that allows
 - sampling of the GAR locally, and
 - measurement of the concentration of contaminants (oxygen and water) from the cryostat ullage.

The GAR sampling occurs during the purge mode to verify progress, and during steady-state operations to ensure that no contaminants enter the cryostat.

The first two cryostats will have three 100 kW (or six 50 kW) condensers to provide the cooling power needed during initial cool-down and filling operations where warm GAR is cooled and reliquefied to fill the cryostat. The third and fourth cryostats will need only two condensers each.

After filling, only one condenser per cryostat is needed, with the other providing redundancy. This will ensure the high availability of the recondensing system and minimize the need for venting high-purity argon or down-time for maintenance of the recondensers and the refrigeration plants.

Each condenser has a dedicated LAr condenser pump, located in its vicinity, to send the recondensed argon to the liquid filtration in the CUC for purification. This is essential to achieve and maintain the LAr purity inside the cryostat as most of the contaminants are in the ullage space at the top.

Four large pumps recirculate the bulk of the LAr at a rate of 10 kg/s per pump to the CUC for filtration. They are installed on the floor of the cavern at the near (accessible) end of the cryostat. Figure 3.6 (right) shows the planned configuration. The four pumps each withdraw argon from the cryostat through one of the four side penetrations near the bottom of the cryostat, each equipped with an in-line safety valve with its seal inside the cryostat itself. The safety valves normally remain open via actuators, but will close down in case of emergency, loss of actuation, or another triggering event. These safety valves have been successfully used for both μ and ν , and installed at .

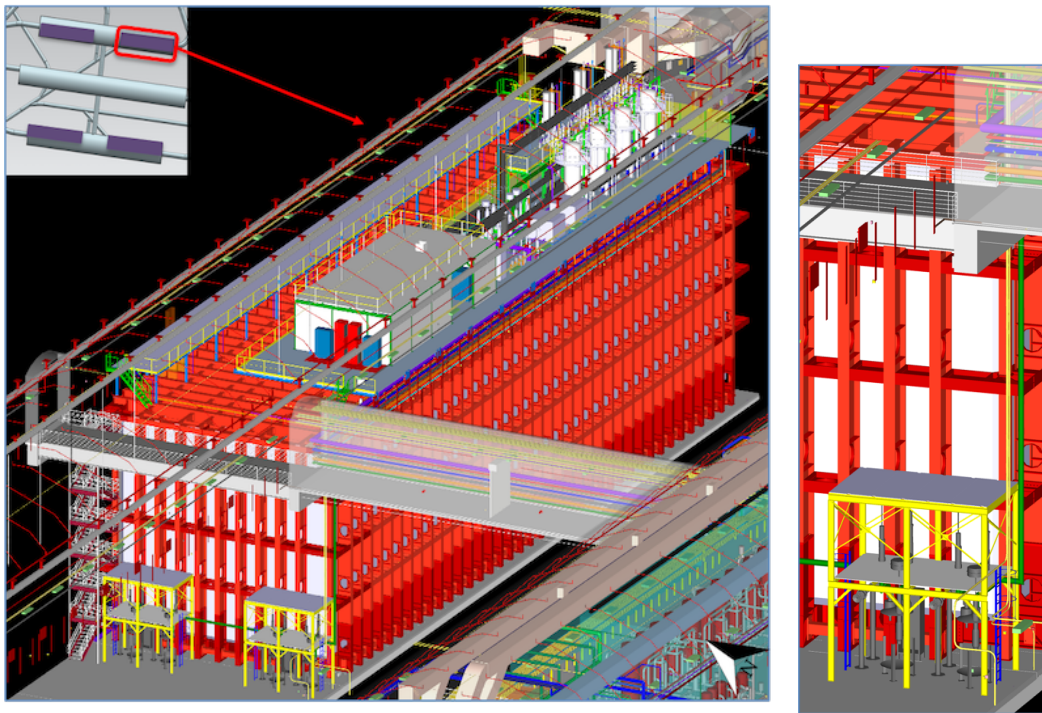

Figure 3.6: Proximity cryogenics in the north detector cavern (mezzanine on the left, LAr pumps on the right)

3.3 Cryogenics inside the Cryostats

The subsystem that distributes LAr and GAr inside each cryostat, the internal cryogenics, is active during all modes of operation. This subsystem consists of manifolds for the GAr purge, the cool-down sprayers (for FD1-HD), and the LAr distribution. The reference design for the internal cryogenics is fully described in [23]. The components are summarized here:

- The purge manifold distributes GAr along both long edges of the cryostat and is supported by the vessel floor. It flows GAr vertically down during the initial purge with a longitudinal opening that allows the GAr to flow everywhere.
- The cool-down sprayers are located at the top of the FD1-HD cryostat, at discrete points staggered along its length. The sprayer distribution has been optimized via computational fluid dynamics (CFD) analysis so that the available cooling power cycles through the cryostat in a controlled way to cool the volume uniformly [24].
- The liquid distribution manifold runs along both long edges of the cryostat and is supported by the vessel floor. It sprays LAr vertically up during the fill and steady-state operations of the cryostat. The pipes have calibrated holes along their lengths for even distribution.

The distribution mechanism, combined with the fact that the LAr is returned to the cryostat slightly warmer (~ 5 K) than the bulk of the liquid (to help the mixing), is very important for obtaining a uniform LAr purity.

The internal cryogenics also includes the GAr boil-off vacuum-insulated pipes that connect the inside of the cryostats to the exterior vacuum-insulated line taking the GAr to the condensers.

Chapter 4

Cryogenics Procurement

4.1 Liquid Argon Procurement and Delivery

Each Deep Underground Neutrino Experiment (DUNE) requires a cryostat that holds 17.5 kt (metric) of high-purity liquid argon (LAr). The standard grade for argon, designated as Grade 4.5 in the gas-supply industry, is specified as having a purity of 99.995% (minimum), allowing a maximum concentration of 5.0 ppm for O₂ and 10.5 ppm for H₂O. Requiring higher-purity product would significantly increase cost. Experience has shown that vendors deliver far better purity than the nominal, allowing us to confidently procure the standard grade.

This design report covers only the roughly 37 kt of LAr required to fill the first two cryostats; this requires procurement of that quantity plus some small amount that will inevitably be lost during transport. Procuring this LAr will require a steady supply over a period of a few years starting in the first quarter of 2028 from vendors with the logistics capabilities to deliver the required amount of LAr.

The Long-Baseline Neutrino Facility (LBNF) has identified three to four qualified LAr vendors, which together represent 98% of the current U.S. LAr production, delivery capacity, and service to the domestic argon market. Other vendors may become available in the coming years.

Planning the supply and logistics of LAr delivery to the Sanford Underground Research Facility (SURF) requires consideration of the following issues:

- total capacity of commercial air-separation plants within trucking distance of the SURF site (the peak delivery potential);
- DUNE detector installation schedule;
- number and frequency of tanker trucks required and their impact on the local community;
- number and frequency of railcars and their availability; and
- availability and cost associated with the delivery of high-purity LAr as opposed to lower-quality commercial-grade argon combined with on-site coarse purification.

The current (2023) total argon delivery capacity (taking boil-off and other losses into account) in the U.S. is approximately 4.9 kt/day and demand is within 2% to 3% of this figure. This demand/supply ratio is quite tight and is likely to remain the same for at least two more years [25]. Argon markets are growing nationally and new LAr capacity is being built, most of it on the Gulf Coast and the Chicago area. The average distance from SURF is about 1,000 miles, therefore LBNF will still look to identify new argon capacity closer to the site. At the same time, the LAr industry has started inter-regional transport of Gulf Coast LAr to distant national markets, including inter-regional rail-tanker intermodal redistribution facilities. A suitable rail depot has been identified in Tiger Transfer, LLC in Upton, WY, less than 100 miles from SURF. This could be very advantageous as more of the long-distance transportation could be done by rail, reducing the overall over-the-road mileage, which is more affected by weather, thereby increasing reliability of deliveries. It would also add intermediate buffer storage, and may lower the cost of LAr delivery.

Given the complexities and expense of the long-distance delivery, the uncertainties in growth and costs of LAr production and transport, the challenges in accessing the SURF site, and the vendors' limitations in committing assets and people this far in advance, LBNF is considering a "group supply" scheme with one vendor or a third party coordinating the effort, as well as awarding multiple subcontracts to multiple vendors directly. Our qualified potential vendors endorse this idea, and believe that the required LAr for LBNF can be delivered with high reliability and at a reasonable cost. They are beginning to plan more creatively about the costs for sourcing and delivering LAr to Lead, SD.

The most efficient mode of argon delivery appears to be a combination of rail plus short-haul and over-the-road long-haul tank truck with a maximum capacity of 20 t. The expected number of such deliveries per cryostat is about 1,000 over a period of eight to 14 months.

Given the large quantity and logistics associated with this acquisition, the acquisition plan has already been submitted to for review and approval [26]. The results from the last RFI and feedback from the consultant are included as well. A requirements subcontract has been selected that will enable procurement of the required amounts within the required timeframe for each phase. The current requirements are as follows (current, pre-baseline schedule).

Phase I of the , which includes the purge, cool-down and fill of cryostats FD1-HD and FD2-VD is scheduled for October 2027–July 2030. The total of 37,350 t of LAr will be delivered over two periods, one per cryostat, as detailed in Table 4.1.

Table 4.1: Phase I LAr delivery rate and schedule

Cryostat	Activity	Rate	Date
FD1-HD	initial purge and system testing	40 t/day, 5 days/week, for 1-2 weeks	Oct 2027
FD1-HD	purge/cool-down	40 t/day, 5 days/week, for 4 mon.	Dec 2027 – Apr 2028
FD1-HD	fill	~70 t/day, 7 days/week	Apr – Dec 2028
FD2-VD	initial purge and system testing	40 t/day, 5 days/week, for 1-2 weeks	Aug 2028
FD2-VD	purge/cool-down	40 t/day, 5 day/week, for 4 mon.	Jan – Apr 2029
FD2-VD	fill	~45 t/day, 7 day/week	May 2029 – Jul 2030

Phase II of the LBNF/DUNE-US, which similarly includes the purge, cool-down and fill of cryostats FD3 and FD4, is scheduled for April 2030 to November 2033. The total of 37,550 t of LAr will be delivered over two periods, one per cryostat, as detailed in Table 4.2.

Table 4.2: Phase II LAr delivery rate and schedule

Cryostat	Activity	Rate	Date
FD3	initial purge and system testing	40 ton/day, 5 day/week, for 1-2 weeks	Apr 2030
FD3	purge/cool-down	40 ton/day, 5 day/week, for 4 mon.	July – November 2030
FD3	fill	~50 ton/day, 7 day/week	Nov 2030 – Nov 2031
FD4	initial purge and system testing	40 ton/day, 5 day/week, for 1-2 weeks	Sep 2031
FD4	purge/cool-down	40 ton/day, 5 day/week, for 4 mon.	Dec 2031 – Apr 2032
FD4	fill	~40 ton/day, 7 day/week	May 2032 – Nov 2033

Deliveries are to vertical tanks located above ground at the Ross Shaft site in limited space near an existing warehouse.

4.2 Nitrogen Refrigeration System Procurement

The nitrogen refrigeration system (Section 3.1.3) will consist of commercially available equipment. To fulfill DUNE performance requirements the equipment will require modifications of a type that is customarily available. The selected vendor will engineer, manufacture, deliver, install and commission the following items, appropriately modified:

- refrigeration units (composed of recycle compressors and liquefiers),
- cryogenic vacuum-jacketed and uninsulated LN₂/GN₂ distribution pipes and valves,
- LN₂ storage tanks,
- nitrogen for the initial charging of the equipment and make-up losses, and
- process controls.

The nitrogen refrigeration system subcontractor will be required to meet interface specifications and requirements for the part of this system that will connect to other parts of the cryogenics system. The nitrogen refrigeration system is procured in two phases. Phase I, Pre- Study, was open competition with down-selection to the top three most technically qualified offerors. Fixed Firm Price (FFP) contracts were awarded to the down-selected offerors. The Phase II subcontract, has been awarded to Air Products and Chemicals, Inc. for the remainder of the engineering work, manufacture, installation (assembly and connection), and commissioning of the equipment. This subcontractor is responsible to deliver a system that meets the required performance specifications. The final engineering is in progress.

4.3 Other Procurements

Other infrastructure cryogenics procurements include:

- surface argon receiving facilities [27, 7, 11],
- argon distribution system [17, 28, 7, 29],
- installation of in-kind contributions [23, 7, 30, 31], and
- miscellaneous items:
 - GAR boil-off and pressure control system [32, 33, 7, 31],
 - GN₂ supply to cryostat insulation [34, 35, 36, 37, 31],
 - xenon injection system [38, 39, 40, 31], and
 - connections to purity monitors.

The surface argon-receiving facilities and the argon distribution system will both be acquired using the approach “engineer, manufacture, install and test, and startup.” Performance specifications have been written and are available in [27] and [17], respectively. In both cases, the selected subcontractor is responsible to deliver a system that meets the required performance specifications.

The in-kind contributions from partners (in Brazil and the European Laboratory for Particle Physics (CERN) in Switzerland) that require installation include, for both FD1-HD and FD2-VD, the:

- argon condenser system,
- LAr purification system,
- gaseous argon (GAR) purification system,
- main LAr circulation, and
- the regeneration system.

To streamline the installation process and reduce the number of subcontractors working underground, it is planned to select a single subcontractor for these activities using delivery order contracts¹ for:

¹This is a type of contract that provides for an indefinite quantity of supplies or services during a fixed period; also known as IDIQ (indefinite delivery/indefinite quantity) or “task order.”

- engineering, manufacturing, installation, and testing of the argon distribution system;
- installation of equipment provided via in-kind contributions; and
- installation of the miscellaneous items listed above.

The contract for the argon distribution system will come first, and the others will follow according to the installation schedule. This allows the partners' engineering and manufacturing work to proceed and allows the LBNF/DUNE-US team to engage with the already selected subcontractor as relevant information for the installation becomes available. The miscellaneous items are mostly catalog items; they can be procured independently and installed as described above, or their procurement can be included in this acquisition.

Chapter 5

Cryogenics System Processes

The Long-Baseline Neutrino Facility (LBNF) cryogenics systems function in a variety of operational modes, appropriate to different phases of the Deep Underground Neutrino Experiment (DUNE) far detector. For each cryostat, the operations include:

- receipt and transfer of cryogenics underground (in gas phase) once all systems for a detector module are fully installed in a cryostat and tested,
- initial purge of the cryostat to replace the air with gaseous argon (GAr),
- GAr circulation inside the cryostat,
- cryostat cool-down to near liquid argon (LAr) temperature,
- cryostat fill with LAr,
- steady-state operations during data-taking, and
- emptying of the cryostat at the end of the experiment's operations.

Receipt of the cryogenics at the Ross Headframe is discussed in Section 3.1.1. Figures 5.1 and 5.2 illustrate the processes.

5.1 Cryostat Initial Purge and Cool-down

Cryostat and detector construction procedures will ensure that the completed cryostat is free of all debris and loose material that could contaminate the LAr. Following installation of all detector components, the cryostat is verified to be clean before it can be purged and cooled with GAr.

Once the LAr arrives at the surface and is vaporized, the GAr is pushed to the Ross Shaft and down, where it picks up additional pressure in the form of static head. At the it is piped to the purification modules and then to the purge manifold within the cryostat. The internal cryogenics (Section 3.3) provides all the piping and manifolds inside each cryostat for the purge, cool-down, and fill processes. The maximum cool-down rate is given in Table 1.3.

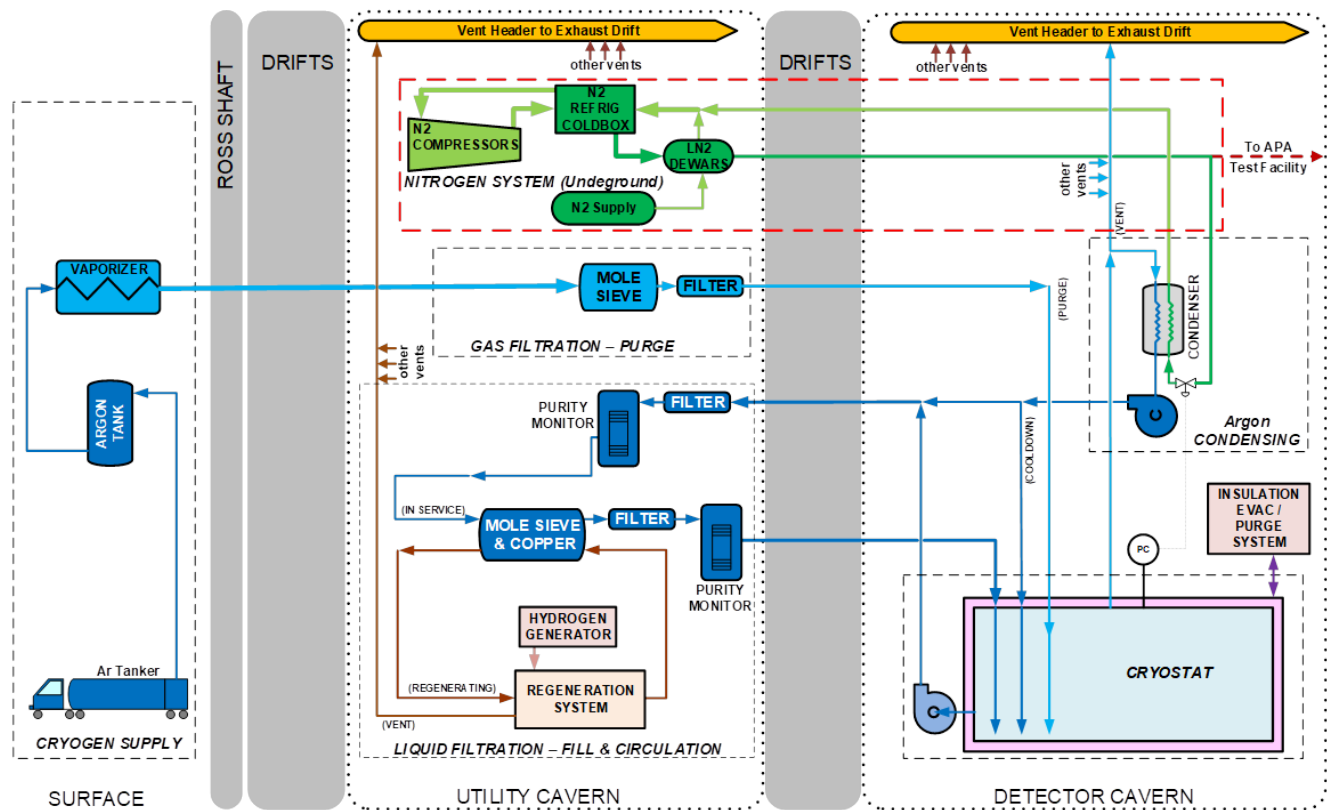

Figure 5.1: Cryogenics process flow diagram

5.1.1 Initial Air Piston-Purge

First, GAr will pass through the argon piping to flush out its atmosphere; this process will be repeated ten times (for eleven volume changes total) to reduce contamination levels in the piping to the ppm level. An argon flow/piston-purge technique will be used to remove air from the membrane cryostat. The heavier argon gas is introduced at the bottom of the cryostat and the exhaust is removed at the top. In horizontal drift detector module (FD1-HD) the bottom (a component of the time projection chamber (TPC) detector) serves an additional role as a flow diffuser during the initial purge. A matrix of small holes in this ground plane, approximately 10 mm in diameter at a 50 mm pitch, will provide a uniform flow.

The design flow velocity of the advancing GAr volume is set to 1.2 vertical meters per hour, high enough to efficiently overcome the molecular diffusion of the air downward into the rising argon so that the pure argon-gas wave front will displace the air rather than just dilute it. A 2D computational fluid dynamics (CFD) simulation of the purge process done for a 5 kt (metric) fiducial-mass cryostat[41] shows that after 20 hours of purge time, and 1.5 volume changes, the air concentration will be reduced to less than 1%. It will take 40 hours of elapsed time and three volume changes to complete the purge process, reducing the residual air to a few ppm. This simulation includes a representation of the perforated field cage at the top and bottom of a FD1-HD-style detector. The cathode planes are modeled as non-porous plates; in both designs they will be constructed of FR-4 sheets laminated on both sides by carbon-impregnated Kapton¹.

The CFD model of the purge process has been verified in multiple arrangements: (1) in an instrumented cylinder of 1 m diameter by 2 m height, (2) Liquid Argon Purity Demonstrator (LAPD), a vertical cylindrical tank of 3 m diameter by 3 m height, taking gas-sampling measurements at varying heights and times during the purge process, (3) within the 35 ton membrane cryostat, a prototype vessel built for LBNE in 2013, of which the results are found at [42], (4) within Micro-BooNE cryostat, a horizontal cylindrical tank of 3.8 m diameter by 12.2 m length, and in the two ProtoDUNEs of dimensions $8.6 \times 8.6 \times 7.9 \text{ m}^3$.

5.1.2 Contaminant Removal via GAr Recirculation

Both s contain over ten tons of FR-4 circuit-board material and a smaller inventory of plastic-jacketed power and signal cables. These somewhat porous materials may contain as much as 0.5% water by weight. Water vapor outgassing from these materials and adsorbed water from the metallic inner surfaces of the cryostat and piping system must be removed.

Following the piston purge, we close the GAr loop. The GAr circulates for several days to sweep remaining contaminants (water vapor and oxygen) from the bottom of the cryostat to the top, then out. The exiting GAr is routed through the recondensers, to the filters, and then reintroduced to the bottom of the cryostat, still as vapor. This cycle continues until the contaminant levels are reduced to parts per million (ppm) levels.

Water deep within porous materials will remain; this is not a problem since the water diffusion rate in FR-4 at room temperature is already quite low ($0.3 \mu^3\text{m/s}$) and decreases as temperature decreases.

¹DuPont™, Kapton® polyimide film, E. I. du Pont de Nemours and Company, <http://www.dupont.com/>.

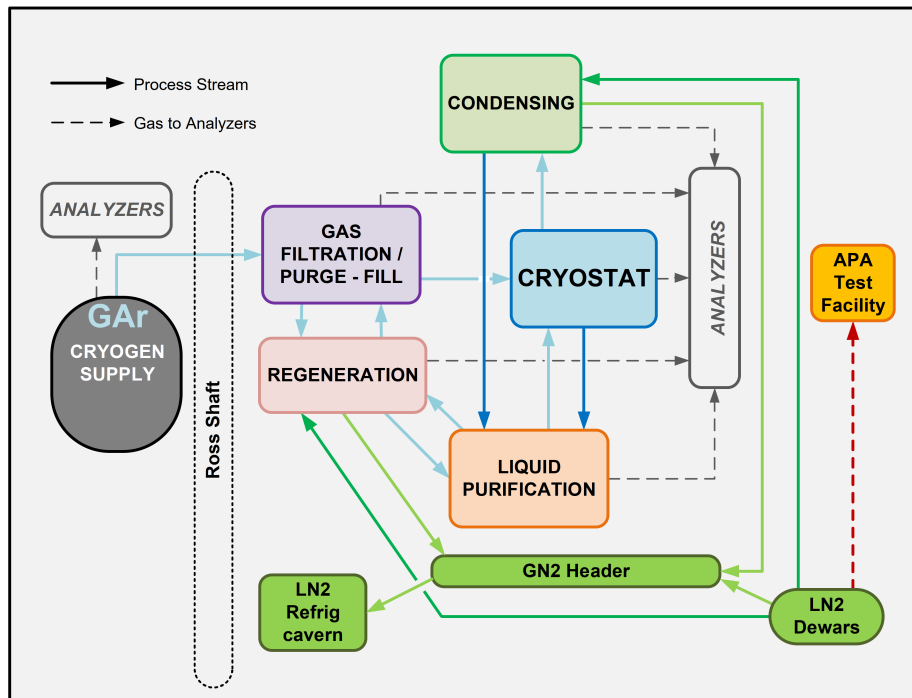

Figure 5.2: Cryogenics system flow block diagram

5.1.3 Cool-down

At this point in FD1-HD the cryostat and detector systems must be cooled in a controlled manner. The vertical drift detector module (FD2-VD) does not have a cool-down requirement (it replaces the delicate wires of FD1-HD with etched s), so this step does not take place. To this end, purified LAr is introduced at the top of the cryostat by means of atomizing sprayers (Section 3.3). The resulting mist distributes itself in the cryostat by means of gravity and convection. The cooling required for this mode is supplied by the LN₂ system to the condensers located on the mezzanine atop the cryostat.

CFD simulation has shown [43] that the liquid cool-down method can be controlled to stay within the available recondenser capacity. The required cooling rate is determined by the maximum stress that detector components can tolerate. For example, in the FD1-HD case, the 152 μm thick wires of the anode plane assemblies (APAs) will cool much more rapidly than the APA frames. A mass flow-control system with a temperature-monitoring system will be used to control the temperature difference across the cryostat. The temperature difference required, 50 K (Table 1.3) is based on input from the cryostat designer and the requirements of the TPC components and structure.

5.2 Cryostat Fill

Once the FD1-HD cryostat and detector are cooled to roughly 90 K, it is time to fill the volume with purified LAr. For FD2-VD, the fill starts right after the purge. The argon, which arrives at

Sanford Underground Research Facility (SURF) in liquid form, is transferred from tanks at the receiving facilities above-ground, vaporized, piped down the Ross Shaft to the 4850L, from there to the GAR purification filters in the central utility cavern (CUC), and then to the mezzanine above the cryostat. Here it is re-liquefied by the nitrogen-fueled condensers, sent to the LAr purification system in the CUC, transferred back to the mezzanine, and injected into the cryostat. The filling of each cryostat will vary in duration, ranging from eight months for the first to about 18 for the fourth, according to the delivery schedule and the power available for argon reliquefaction.

The recirculation pumps can be safely turned on and liquid argon purification (Section 5.5) can begin once the liquid depth in the cryostat reaches about 1.5 m.

Once the fill is complete, the primary operational phase of the experiment can begin.

5.3 Recirculation during Detector Operations

During operations of the detector module, LAr will be recirculated continuously through the purification system by means of external pumps. Initially, four pumps are used to circulate a large flow, up to 40 kg/s, through the purification system; this flow is maintained until the required argon purity level is achieved, at which time the flow (and therefore the number of pumps in operation) is reduced to the level sufficient to maintain the achieved purity.

As each detector module has its own dedicated purification module, each will operate independently of one another.

5.4 Ar Gas Recovery, Reliquefaction, and Pressure Control

The high-purity LAr stored in the cryostat will be evaporating continuously due to the small but unavoidable heat ingress. The argon vapor (boil-off gas) will be recovered, recondensed, and returned to the cryostat in a closed system.

During normal operation the expected heat ingress of approximately 87.1 kW to the argon system will result in an evaporation rate of 1900 kg/hr. In the absence of a pressure-control system an increase in the vapor/liquid ratio within the closed system would raise the internal pressure. To mitigate this problem, the LBNF cryogenics system will remove argon vapor from the top of the cryostat through two cryogenic feedthroughs. As the vapor rises, it cools the cables and feedthroughs, thereby minimizing the outgassing. The exiting GAR will be directed to a heat exchanger (the condensers, illustrated in Figure 5.3) in which it is cooled against a stream of and condensed back to a liquid. As the argon vapor recondenses, its volume reduces, which will draw further gas into the heat exchanger. Pressure-control valves on the boil-off gas lines will control the flow to the recondensers to maintain the pressure within the cryostat at $0.105 \text{ MPa} \pm 0.008 \text{ MPa}$, mitigating the risk of developing a thermal siphon. Pressure control is discussed further in Section 5.7.

The LN₂ stream (serving as the coolant for the condensers) will come from the closed-loop LN₂ refrigeration plant. The commercial refrigeration plant uses compression/expansion and heat re-

jection to continuously liquefy and reuse the returning nitrogen vapor. The estimated heat loads within the cryostat are listed in Table 5.1.

Table 5.1: Estimated heat loads within the cryostat.

Item	Heat Load (kW)
Insulation heat loss	48.7
Electronics power	23.7
Recirculation-pump power (2 pumps in operation)	11.0
Misc. heat leaks (pipes, filters, etc.)	3.7
Total	87.1

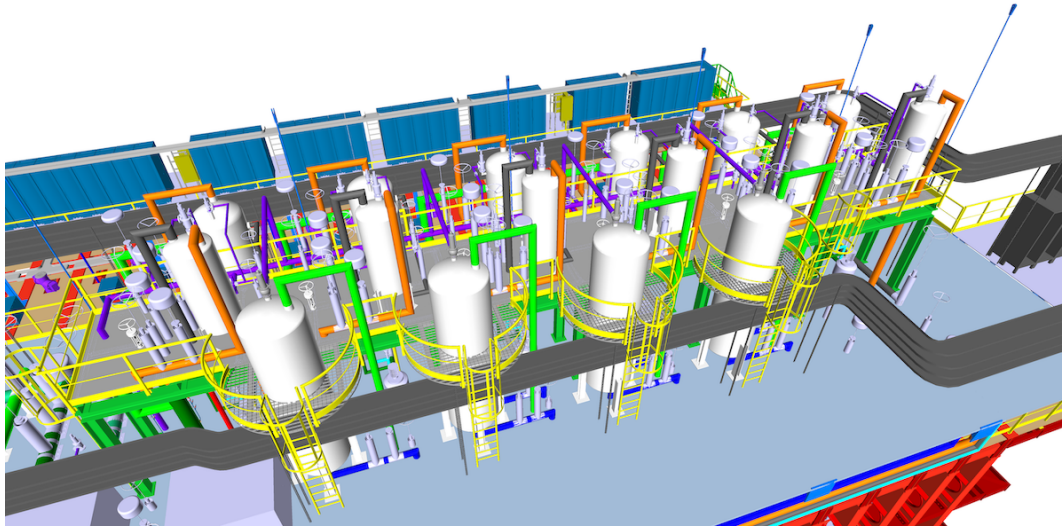

Figure 5.3: Liquid argon recondensers

5.5 Argon Purification

Each cryostat's LAr inventory is circulated through a purification filter in the CUC to achieve and maintain the required purity for the experiment (Section 3.2.1). Four external pumps attached to side penetrations in the cryostat (Section 3.2.2) will continuously circulate the LAr through the filters. Figure 3.6 illustrates the external pumps.

The multiple-pump arrangement will provide a very high level of redundancy that will extend the maintenance-free operating period of the cryostat. Maintenance can be done on off-line pumps, which will eliminate pump-related maintenance interruptions to cryostat operations.

The required flow rate of LAr to be sent for purification is expected to decrease over time as the purity of the LAr inside the cryostat increases. The initial maximum flow rate will be $93\text{ m}^3/\text{h}$ (411 gpm). The LAr volume in one cryostat will turn over every 5.5 days at this rate. Longer term, the rate will decrease to $46\text{ m}^3/\text{h}$ with a turn-over rate of 11 days. As a point of comparison, has a maximum turn-over rate of about 10.8 days. ProtoDUNE-SP has achieved an electron lifetime greater than 30 ms with this turn-over rate.

A purity monitor will monitor the filter effectiveness. When a purification filter becomes saturated it is regenerated to vent the contaminants (Section 5.6). During this time the LAr flow is switched to another purification filter to maintain uninterrupted filtration.

DUNE will also provide purity monitors in the cryostat to ensure that the purity levels remain at or better than their required values.

5.6 Filter Regeneration

The LAr filters, which consist of a molecular sieve and copper pellets that remove contaminants from the argon, are discussed in Section 3.2.1. The molecular sieve traps water and the copper pellets trap oxygen. Both will saturate and require a multi-step regeneration (cleaning) process.

During regeneration, the filter is first warmed with argon gas heated to an elevated temperature (200 °C), driving the water trapped in the molecular sieve into the GAr, and creating water vapor. Hydrogen is then added, creating a mixture of up to 1.5% hydrogen by volume. The hydrogen reacts with the oxygen trapped in the copper pellets, releasing more water vapor. All the vapor is vented from the hot circulating gas in a single stream.

The regenerated but still hot filter requires cooling. A heat exchanger (that uses LN₂ coolant) in contact with the circulating GAr cools the gas to cryogenic temperatures, and the gas in turn cools the filter as it circulates through. This completes the regeneration process, at which point the filter is ready to be switched into service or held cold until needed.

Two spare purification filters are used with separate heating and cooling loops to reduce the usage rate of both electricity and LN₂. Splitting the heating and cooling into separate loops also splits the temperature range seen by the heat exchangers, which decreases mechanical stresses.

5.7 Pressure Control

5.7.1 Normal Operations

The GAr pressure-control valves on the feedthroughs are sized and set to control the internal cryostat pressure to the experimental operating pressure of 50 mbarg (0.105 MPa absolute). Control systems will take actions to prevent excursions over a millibar. These actions may include stopping the LAr circulation pumps (to reduce the heat ingress to the cryostat), increasing the argon flow rate through the condensers, increasing the LN₂ flow through the condenser vessels, and/or powering down heat sources within the cryostat (e.g., detector electronics). Eventually, if the pressure reaches 150 mbarg, automatic venting will open partially to start to release the overpressure; at 200 mbarg the vents will open fully. The vents close after the pressure event is resolved and the pressure in the ullage is back to operating pressure. Table 5.2 gives important pressure values.

The ability of the control system to maintain a set pressure is dependent on the size of pressure deviations (due to changes in flow, heat load, temperature, atmospheric pressure, and so on) and the volume of gas in the system. The reference design specifies a GAr depth at the top of the cryostat (the “ullage”) equivalent to 4.5% of the total argon volume for FD1-HD (3.5% for FD2-

Table 5.2: Important Pressure Values

Operating pressure	50 mbarg
Vessel ullage maximum operating pressure	150 mbarg
Vent fully open	200 mbarg
Relief valve set pressure	250 mbarg
Cryostat Design Pressure	350 mbarg

VD); these are typical vapor fractions used for cryogenic storage vessels. Pressure rise from changes in the heat load is gradual, which provides adequate time for the control systems to respond [44]. Two redundant pressure control valves to the recondensers will maintain the required pressure range, each sized to handle GAR flow during cryostat filling. Two redundant pressure control valves to the vent header will maintain the required pressure range, each sized to handle GAR venting scenarios, including loss of recondensing [45].

5.7.2 Overpressure Control

In addition to the normal-operation pressure-control system, a cryostat overpressure-protection system is planned. This must be a high-integrity, automatic, fail-safe system capable of preventing catastrophic structural failure of the cryostat in the case of excessive internal pressure.

The key active components of the planned system are pressure-relief valves (s) located on the roof of the cryostat that will open rapidly when the differential pressure exceeds a preset value. A pressure-sensing line is used to trigger a pilot valve which in turn opens a PRV. A pressurized reservoir of power fluid is provided to each valve to ensure that the valves will operate under all deviation and/or shutdown scenarios. The PRVs are self-contained devices provided specially for cryostat protection; they are not standard components of the control system. Multiple overpressure scenarios are considered in order to size the PRVs [46].

The installation of the PRVs will ensure that each valve can be isolated periodically and tested for correct operation. The valves must be removable from service for maintenance or replacement without impacting the overall containment envelope of the cryostat or the integrity of the overpressure protection system. This normally requires the inclusion of isolation valves upstream and downstream of the pressure-relief valves, which the design includes, and at least one spare installed relief valve ($2n$ provision) for maintenance.

When the valves open, argon is released, the pressure within the cryostat falls, and argon gas discharges into the argon vent riser. The valves are designed to close when the pressure drops below the preset level.

5.7.3 Vacuum-Relief System

The same PRVs used for overpressure control are used to prevent catastrophic structural failure of the cryostat's primary membrane tank due to low internal pressure. Although activation of this system is a non-routine operation and is not anticipated to occur during the life of the cryostat, the vent header is appropriately sized for this scenario [32].

Potential causes of reduced pressure in the cryostat include operation of discharge pumps while the liquid-return inlet valves are shut, GAr condensing in the recondensers (a thermo-siphon effect), or a failure of the vent system when draining the cryostat.

The PRVs on the roof of the cryostat will monitor the differential pressure between the inside and the outside of the cryostat and open when the differential pressure exceeds a preset value, pulling in air from the spray chamber to restore a safe pressure.

5.8 Nitrogen Refrigeration System Cycle

The nitrogen-refrigeration system, introduced in Section 3.1.3, consists of closed-loop refrigeration plants in the CUC. These plants comprise compressors and cold boxes that are used to liquefy the nitrogen, and storage tanks to store and deliver the liquid nitrogen (LN_2) to the detector caverns as needed. The system serves the argon condensers (Section 5.4), the argon purification filters (Section 5.6) and the integrated cold boxes (for cold APA testing) [47]. Nitrogen is generated underground using membrane technology and supplied to the refrigeration system to initially charge the system, and make up for any losses. LN_2 is delivered from the cold boxes to LN_2 storage tanks with an overall capacity of roughly 30 m^3 . The tanks will allow for greater than six hours of refrigeration time, a time window that is adequate to cover most power outages, refrigerator performance problems, and refrigerator switch-overs.

LN_2 is withdrawn from the storage tanks and supplied via a transfer line to a pressure-reducing valve and phase-separator, both located on the cryostat mezzanine. LN_2 is then withdrawn from the bottom of the phase-separator, at a pressure of 0.62 barg (9 psig) and temperature of 82 K and directed to the argon recondensers, which is at 89 K, i.e., 7 K warmer. After flowing through the recondenser the vaporized nitrogen is returned to the refrigeration plant for re-liquefaction. The overall liquefaction cycle can be summarized as compressing the nitrogen to high pressure, removing heat from that high pressure nitrogen, and then quickly dropping the pressure of the colder nitrogen. This isentropically reduces both the pressure and temperature of the nitrogen stream, eventually leading to liquefaction.

In greater detail, the compression, cooling, and expansion are done in stages, with various portions of the nitrogen stream. Initially the nitrogen is compressed through the recycle compressor, this stream is then passed to two additional compression stages, which are each directly coupled to an expander (commonly called “comanders”). After this high-pressure stream enters the heat exchanger it is split into two primary streams, the refrigeration stream, and the liquefaction stream. The refrigeration stream is cooled incrementally in the heat exchanger and then is expanded through the two expanders. This cold gas stream is then passed through the heat exchanger where it is used to cool the liquefaction stream, and then recycled back to the recycle compressor as a warm gas. The liquefaction stream is cooled to near the boiling point in the heat exchanger, and then the pressure is dropped across a valve, which rapidly cools the gas further and creates LN_2 which is transferred to the storage tanks.

The nitrogen refrigeration system (cold box) is connected to the LN_2 storage tanks by means of an insulated LN_2 supply line. The insulated LN_2 distribution lines handle the distribution of the LN_2 to the three systems they serve. The return gas (still cryogenic) is collected by insulated return

pipings and headers. In the event of loss of nitrogen refrigeration (such as a power outage), the LN₂ storage tanks provide LN₂ to critical argon systems. The gaseous nitrogen is still collected by the return headers, but without an operating nitrogen refrigeration system, the gas is safely vented into an exhaust drift.

5.9 Liquid Argon Removal at the End of Experiment Operations

Although removal of the LAr from the cryostats at the end of life is not in the project scope, it is part of the final disposition of the facility components. LBNF has conceptualized a method to accomplish this. The LAr is assumed to be resold to suppliers at a fraction of the supply cost.

It is expected that storage dewars sized for the task can be carried up and down the skip compartments of the shaft (initially used to haul up waste rock from the mine). Because there are two skip compartments, an empty vessel can simultaneously be lowered to the 4850L in one skip while a full vessel is raised to the surface in the other. The physical dimensions of skip compartment will accommodate a dewar size up to about 3000 L. If the vessel is pressurized to 50 psig, it will contain roughly 3.9 t of LAr (at 95% full). The pumps already present at the cryostats can be used to transfer the LAr from the cryostat to the storage dewar.

Assuming that crews work concurrently at the surface and at the 4850L, one optimized conveyance cycle can be fit in approximately one hour. This will allow for 18 cycles in an 18-hour day, corresponding to a delivery of 75.6 t/day of LAr to the surface. Emptying the FD1-HD cryostat will require about 227 days. Emptying the FD2-VD cryostat will require about 230 days. It is expected that about 88% of the total can be recovered in this process; this takes into account the quantity of liquid below a certain height that cannot be removed using pumps, and a 5% loss in the transfer of remaining liquid to the dewars. That corresponds to 16.9 kt for FD1-HD and 16.1 kt for FD2-VD.

Chapter 6

Process Controls

The cryogenics process control system is programmable logic controller (PLC)-based. It uses a Siemens S7-400 PLC (programmed using the PCS7 software tool) that controls, either directly or indirectly, all aspects of the liquid argon (LAr) and LN₂ systems. It includes an oxygen deficiency hazard (ODH) subsystem dedicated to safety systems for cryogenic hazards. The subcontractor-provided LN₂ system will come with its own PLC-based control system capable of independently automating nitrogen refrigeration and storage operations; it is part of the overall cryogenics process control system. The process controls are designed for fully autonomous operations; i.e., under normal conditions, no human operators are required. Full details of this system can be found in [48].

6.1 System Architecture and Networking

The process controls system will make use of the networking infrastructure put in place by the DUNE data acquisition (DAQ) Consortium. This includes network switches and cavern-to-cavern cabling. All network connections will be by physical cable (copper or fiber). Networking needs are coordinated through the DAQ Consortium, Facilities Working Group, and Online Computing Coordinator. The process controls architecture is illustrated in Figure 6.1.

The regular Fermilab network is extended to the Sanford Underground Research Facility (SURF). The /engineering station computers will make use of this network for clients, connection to historians, and remote control system development.

The process control network is a private VLAN (virtual Local Area Network (LAN)). While it makes use of common network switches and cabling, the physical Ethernet ports are dedicated to the VLAN. Computers used as gateways will make use of this network for communication with the PLCs via the process control network. It can tolerate interruptions, as it is used for monitoring and operator intervention, not continuous control.

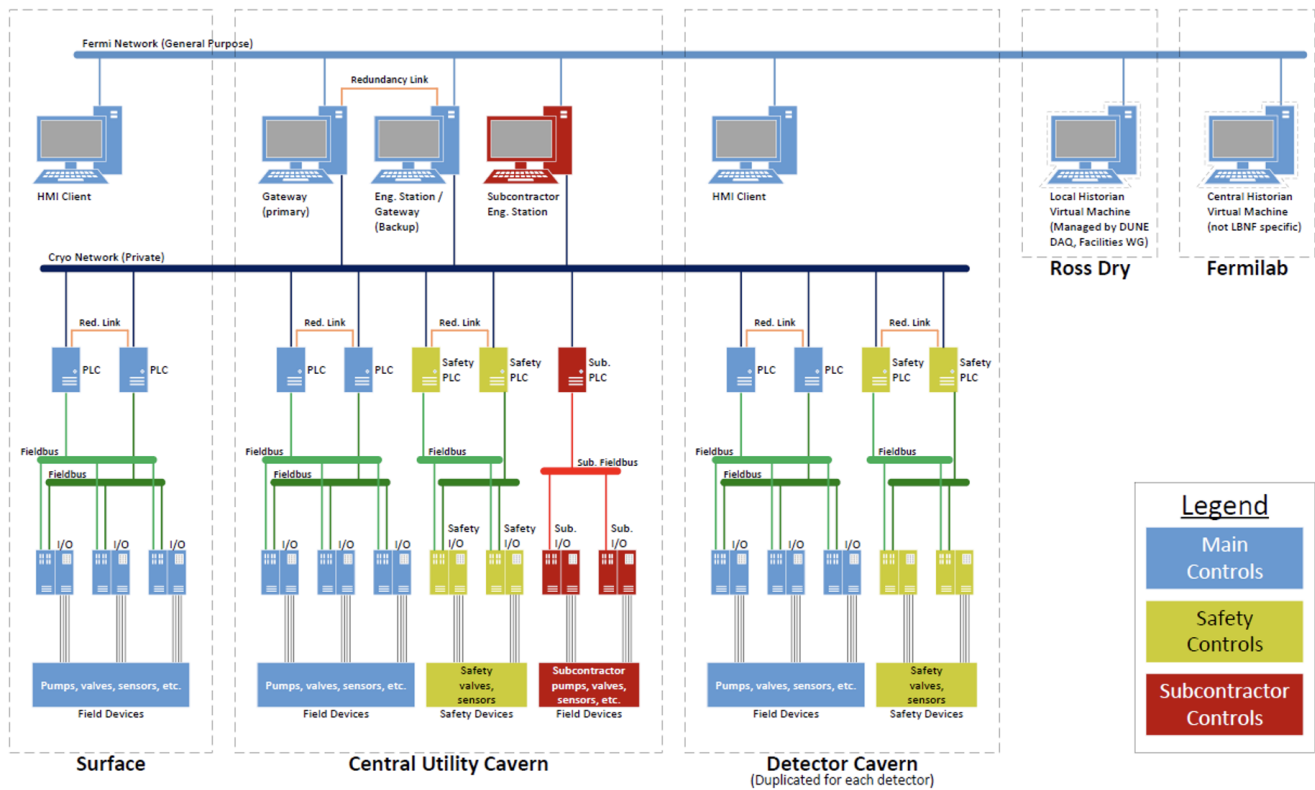

Figure 6.1: Far Site process controls system architecture

6.2 Access to the Process Control System

The process control system will provide multiple means of local and remote access for engineers, technicians, and shifters to monitor and control the cryogenics systems. Full-time operators are not required.

A control room at the west end of the central utility cavern (CUC), the most central location with respect to most of the cryogenics equipment, will house the primary process control station, illustrated in Figure 6.2. This will be a dedicated space with the HMI displayed across multiple monitors, providing local access to monitor and control the system. This control station is also home to the gateway computers (gateways) that communicate with the PLCs; one of these computers will serve also as an engineering station for PLC programming. The layout of the process control system is depicted in Figures 6.3, 6.4, and 6.5.

The process control system will provide additional local access points in the detector cavern workspaces (small offices on the mezzanines) and on the surface (location TBD). These are shared spaces, not dedicated to cryogenics. They are intended to be used primarily for commissioning, not to be occupied under normal operating conditions. Access to the control system in these spaces may be via an HMI client run on a shared computer.

The process control system will provide remote access via personal computers, phones, and tablets. The SCADA computers will be on the Fermilab network and provide unlimited client connections,

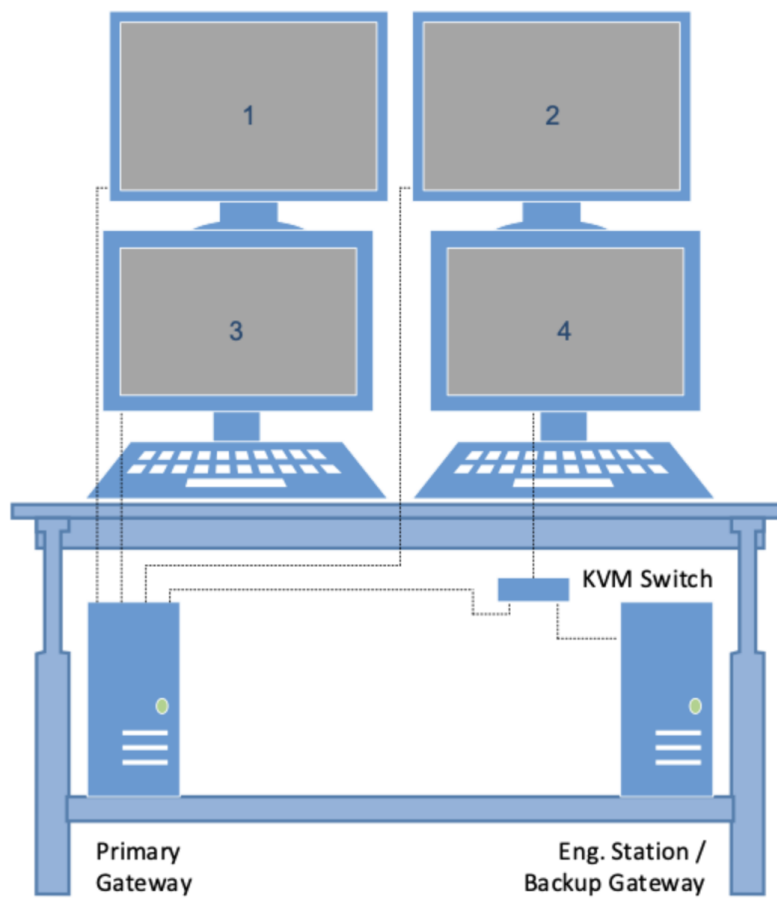

Figure 6.2: Control station in the CUC

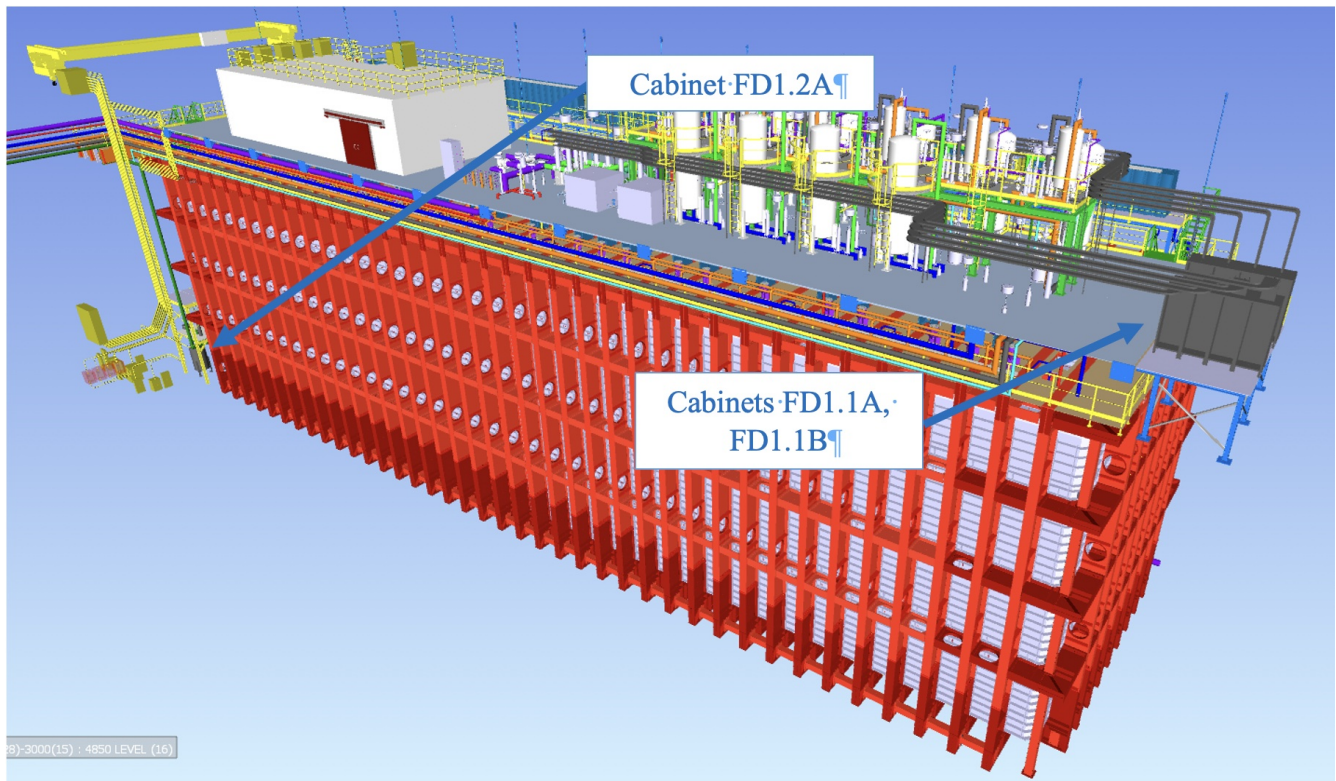

Figure 6.3: FD1-HD control cabinet layout (same respective locations on FD2-VD, locations to be used for both regular and ODH cabinets)

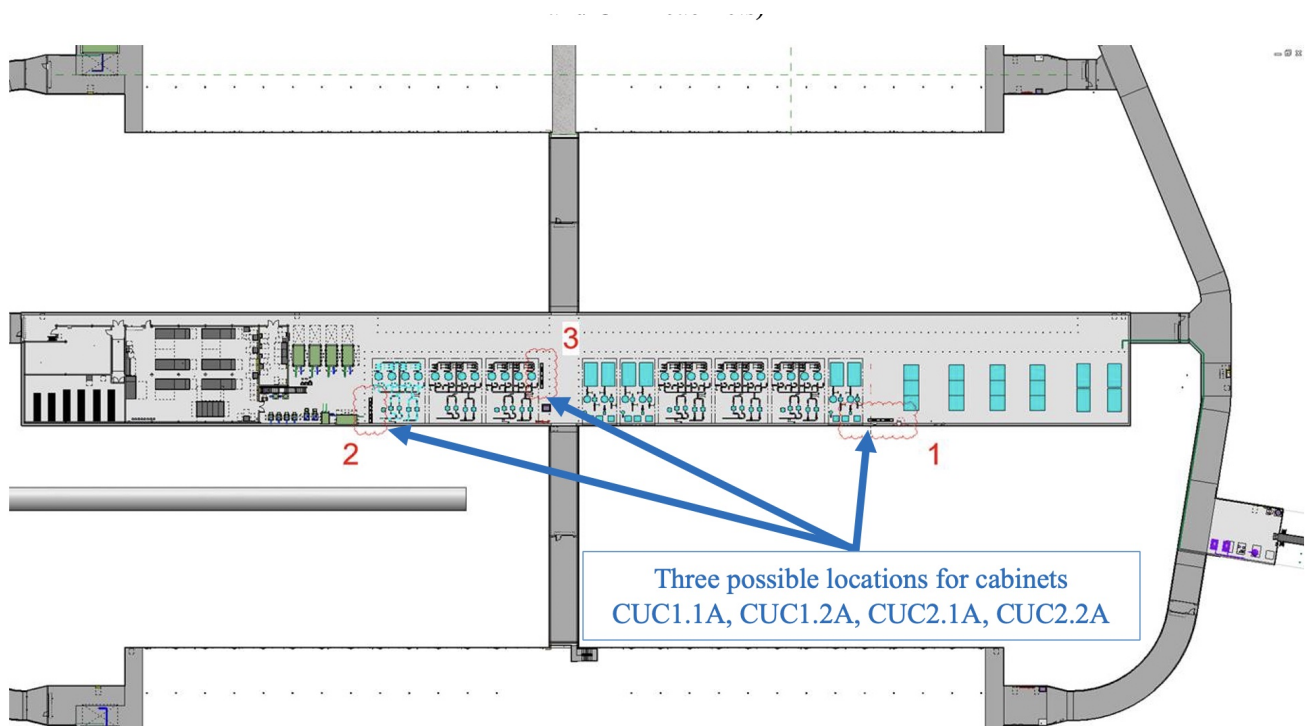

Figure 6.4: CUC Control Cabinet Layout (locations to be used for both regular and ODH cabinets)

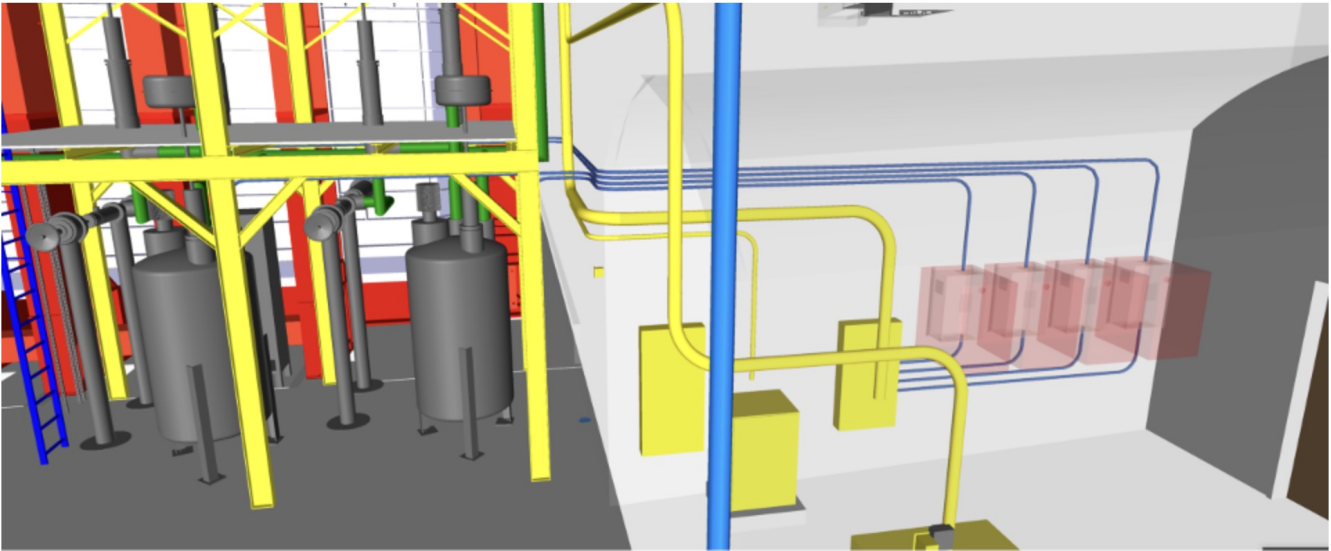

Figure 6.5: LAr circulation VFD layout

subject to the Fermilab computer security protocols.

6.3 Supervisory Control and Data Acquisition

The process control system will implement Ignition by Inductive Automation, a comprehensive SCADA software platform. It provides gateway computers as well as modules that execute HMI, alarm management, and historical data collection functions.

The gateways are the core of the Ignition platform. They will connect to the PLCs, including those provided by subcontractors, and act as the point of data collection and distribution for the entire control system. The gateways also include open platform communications (OPC) United Architecture (UA) servers, allowing data sharing with other systems (e.g., the DUNE Detector Control System) over the Fermilab network.

The process control system will include HMI, using both the Ignition Vision and Perspective modules. Vision is a more traditional HMI, intended for desktops. Perspective is a web-based mobile-responsive HMI.

The HMI will enable monitoring and command of all cryogenics equipment, including that provided by subcontractors. No control hardware or software for cryogenics equipment of any kind will exist fully independently of the HMI. The HMI will not contain any control logic. (PLCs are not dependent on the HMI to operate.)

The design of the HMI will comply with ANSI/ISA-101.01-2015 (or later), Human Machine Interfaces for Process Automation Systems. This includes implementation of a hierarchy of displays. A sample is given in Table 6.1.

Table 6.2 shows the HMI security scheme that permits access to users as appropriate to their role.

Table 6.1: Sample HMI process automation hierarchy of displays

Level	Description
1	Entire Cryogenic System Overview (only very important parameters, shown on gauges)
2	Nitrogen Refrigeration Overview, LAr Filtration Overview (important parameters, shown on gauges and trend charts)
3	LN2 Storage Tanks, LAr Filter Regeneration Hot/Cold Loop (animated P&ID, most parameters)
4	Subsystem Detail

Special security access may be implemented for control of subcontractor-provided equipment.

Table 6.2: HMI user access levels

Role	Description
Guest	Monitoring only
Operator	Basic Control (i.e., open/close valves, set pump speed)
Expert	Advanced Control (i.e., set alarm levels and P&ID tuning parameters)

Alarms (Section 6.7.7) will make use of Ignition’s built-in alarm management functionality, which is consistent with ANSI/ISA-18.2-2016, Management of Alarm Systems for Process Industry. Alarms alert personnel to abnormal conditions, but do not impact system operation in any way. Alarms will implement a consistent level of prioritization. Table 6.3 shows an example.

Table 6.3: Alarm levels

Level	Description
Interlocks	Critical Priority
High-High and Low-Low Alarms	High Priority
High and Low Alarms	Low Priority
Input/Output Errors	Diagnostic Priority

Alarm notification will be handled via the Ignition Alarm Notification Module, which organizes the sequence of events following an alarm into pipelines. Pipelines will be configured by priority to provide alarm notifications via e-mail, text, and or phone call to a limited number of people (i.e., <10 people), namely those engineers and technicians with direct responsibility for far site cryogenic operations. See Table 6.4.

All cryogenics data will be made available to the DUNE Detector Control System so that if DUNE collaborators wish to setup their own alarms and notifications based on cryogenics data, they will have the means to do so.

Historical data collection will be realized by means of the Ignition Tag Historian Module, which filters and stores data in SQL databases. The SQL databases are not part of Ignition and must be

Table 6.4: Response to alarms

Level	Description
Low Priority	Notify primary cryogenic engineer if not acknowledged within 10 minutes; notify alternate cryogenic engineer if not acknowledged within 30 minutes
High Priority	Notify primary cryogenic engineer immediately; notify alternate cryogenic engineer if not acknowledged within 10 minutes

setup separately such that Ignition can point to the desired database. Ignition then creates tables in the database and populates them with historical data. Historical data will be archived to two SQL databases (“historians”) simultaneously, one local and one remote at Fermilab.

6.4 Databases for Local and Remote Historians

The DUNE DAQ Consortium is planning to have a virtual machine cluster at the far site in the computer room at Ross Dry. A virtual machine will be designated for process control with an SQL database to serve as the local historian. At Fermilab, a virtual machine is to be designated for process control with a SQL database to serve as the remote historian. Both SQL databases will be managed by a Fermilab Computing DBA (database administrator).

6.5 Programmable Logic Controllers (PLC)

This section applies to Fermilab-provided, standard (not safety-rated) PLCs. For subcontractor provided PLCs, refer to [14]. The only Fermilab-provided safety PLCs are in the ODH subsystem (Section 6.7).

The process control system will include Siemens S7-400 PLCs. Direct control of all cryogenics equipment will be done exclusively via PLC. PLCs will be installed on the surface, in the CUC, and by each , and will control the cryogenics equipment in their respective areas. Process controls mechanical and electrical drawings for PLC systems can be found in [49]. PLCs will contain all control logic necessary to operate all connected equipment. Under normal conditions, PLCs operate the cryogenics systems autonomously (without input from SCADA).

PLCs will be implemented in redundant pairs. This provides continuous operation in the event of a failure or the need to take one offline (e.g., for updates). Where possible, redundant PLCs will not be co-located, for example, redundant PLCs will be positioned in cabinets on opposite ends of the CUC. This is to prevent a single hazard from neutralizing both PLCs in a redundant pair. For each detector module, one PLC is on the mezzanine while the other is in the pit. At the surface, due to the limited space for controls, the redundant PLCs will be near each other. PLCs will host redundant fieldbus (Profinet) networks for I/O modules.

The engineering station is part of the process control station in the CUC and contains the PLC configuration and programming tools. While the engineering station will contain the PLC programs (control logic) for all PLCs, the programs do not run on the engineering station itself.

6.6 Backup Power

The process control system will make use of the generator provided by Far Site Conventional Facilities (FSCF) and its own UPS (uninterruptable power supply) for short-term backup power to cover the gap between loss of power and the generator coming online.

The detector cavern PLCs and I/O are included, as they are necessary for condenser operation to maintain cryostat pressure and minimize loss of LAr. The CUC and surface PLCs and I/O are currently designed with their own UPS systems, but are not necessary for maintaining cryostat pressure. Their inclusion is consistent with other experiments. The s (for pumps) and heaters are not included.

6.7 Oxygen Deficiency Hazard System

An ODH condition is typically the result of a cryogen (e.g., argon or nitrogen) leak. As cryogenics transform from liquid to gaseous form, they expand and displace oxygen, creating a dangerous environment as oxygen content decreases.

Each cryostat is housed within a warm (room-temperature) vessel in one of the detector caverns. Fresh air flows in from either end of a given detector cavern, across the warm vessels, and into an exhaust duct near the center of the cavern, as shown in Figure 6.6. There are currently no plans for dampers or fans controlled or monitored by the safety PLC system. Air flow and supply is regulated by the FSCF air handling system.

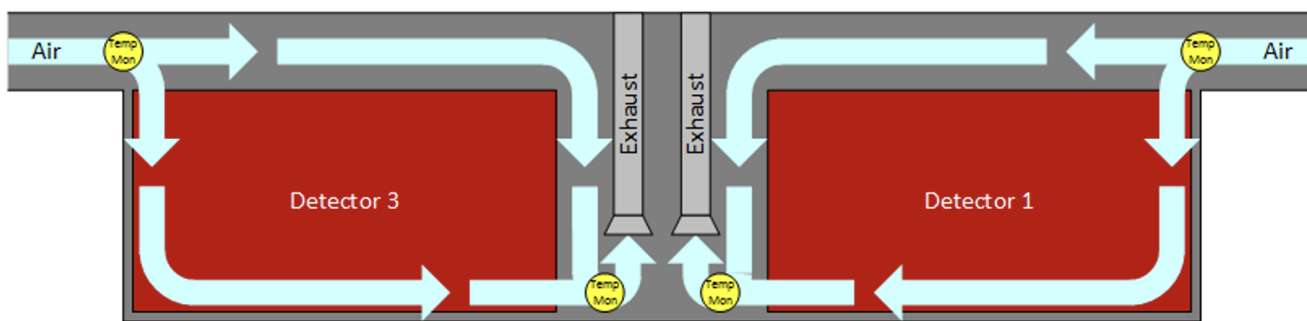

Figure 6.6: Detector cavern airflow

ODH protection is handled by a self-contained subsystem that detects an ODH condition, alerts the occupants of the hazard, and takes action to eliminate the hazard. Details beyond what this section covers are available in [50].

6.7.1 Software

The Siemens PCS7 F-Systems Programming tool combined with the Safety Matrix Tool is used to create the safety subsystem. The programming language is Continuous Function Chart (CFC), a graphical programming language that extends the standard languages of IEC 61131-3. All logic

in the safety program is carried out by certified safety function blocks. The program monitors the conditions covered in the following subsections.

6.7.2 Gas Monitors

Twenty gas monitors (MSA Ultima X5000, Figure 6.7 are installed in strategic positions in each of the three caverns (FD1, CUC, FD2). Each gas monitor provides an independent indication if it detects oxygen content falling below preset limits. Safety PLCs monitor gas monitor function (e.g., can detect a disconnected sensor) and alarms.

Each gas monitor provides analog indication of oxygen content over the range of 0% to 25%. (Standard, i.e., non-safety, PLCs monitor this for information only.) Additionally, the monitors are capable of communication over the analog signal, which may be used to alert the control system when the sensor is reaching its end of life (2-3 months prior to sensor failure).



Figure 6.7: MSA Ultima gas monitor, part number A-X5000-0-F-0-1-0-16-0-0, replacement sensor part number A-5K-SENS-16-0-F-1-0.

6.7.3 Temperature Monitors

Air temperature monitors (Figure 6.8) are located near the two lower corners of each detector nearest the center of the cavern. (This location may change to the intake of the exhaust duct.) An additional monitor is placed above each detector. A drop in air temperature at the center of the detector cavern would indicate a leak.

The temperature monitors alarm if air temperature falls below a preset limit. Safety PLCs monitor the function of the devices (e.g., to detect an internal fault) and alarms. Each temperature monitor also provides analog indication in the range of -40 to 450°F (-40 to 232°C). (The standard PLCs monitor this for information only.)



Figure 6.8: Temperature monitor; United Electric Controls “One Series Safety Transmitter,” part number 2SLP49 TL1-W073

6.7.4 Vacuum Monitors

Cryostat side penetrations are each equipped with an isolation valve, and these valves and associated piping are vacuum jacketed. Loss of vacuum in a jacket would indicate a leak, which could lead to more severe problems, including ODH and equipment damage.

The ODH system therefore includes multiple vacuum monitors, which are in turn monitored by the safety PLC. Each vacuum space on the cryostat side penetrations has two monitors that alarm individually if the pressure exceeds 200 mTorr. Each vacuum monitor also provides analog indication of pressure in the range of 0.1 mTorr to 1000 Torr. (The standard PLCs monitor this for information only.) The vacuum monitors are InstruTech Stinger convection gauge, part number CVM211GGL (Figure 6.9).



Figure 6.9: InstruTech Stinger Convection Vacuum Gauge

6.7.5 Seismic Activity Monitors

Seismic activity can damage equipment and potentially lead to safety hazards, including ODH. The ODH safety system includes one safety seismic switch (Figure 6.10) in the CUC and one per far detector module. Each seismic switch contains three vibration detection devices in different orientations. These seismic switches will alarm if any of their vibration detection devices reads above a preset limit.



Figure 6.10: Sensonics model SA-3 safety seismic switch

6.7.6 Safety System Power and Controls

The ODH safety subsystem is electrically wired to self-contained control circuitry in its own enclosure. The overall process controls UPS system provides power to the ODH subsystem via dedicated 120 VAC circuits that are fed by panels on generator backup. The UPS provides battery power long enough for main power to switch to the generator in the event of an outage.

There is one set of controls in each of the three caverns for the ODH system, each housed in a set of two Rittal 8826.500 cabinets. In each detector cavern, one cabinet is positioned on the cryogenics mezzanine, and the other is positioned in the pit. In the CUC, the cabinets are positioned centrally. The control cabinets each include one CPU410-5H/F-System PLC. The safety program handles all safety-related functions, including detection of hazards, cycling air from outside, alarms, and control of the cryostat safety valve. The standard PLC handles communication with the gateways and monitoring of non-safety-related signals.

6.7.7 Alarms

Each detector ODH safety system includes four pairs of horns and strobes. When enabled, the horns make a warbling noise and the strobes flash, alerting building occupants of a hazard. Two horn/strobe pairs are located at the mezzanine level and positioned such that at least one strobe is visible from anywhere on the cryostat top and mezzanines. Another horn/strobe pair is located on the west side of the detector cavern, positioned to be visible from the grade and platform levels, and another pair is located on the east side of the detector cavern, also for visibility from the grade and platform levels.

These alarms feed into the SURF Fire-Life-Safety system that monitors fire and other emergency

conditions. The ODH system provides to it two distinct signals, one is a warning and another indicates an emergency. The Fire-Life-Safety system would then alert the SURF facilities dispatch center.

The ODH system communicates with the main cryogenics control system via a network connection hosted by the main system OPC server. When necessary, the main system can initiate further mitigation (i.e., stop pumps and close valves).

Chapter 7

Prototyping Program

A prototyping program has been central to the development of the Long-Baseline Neutrino Facility (LBNF) cryostat and cryogenics infrastructure from conceptual to final design. The most significant issue to resolve has been whether a membrane cryostat of the size required by Deep Underground Neutrino Experiment (DUNE) can achieve the required electron drift lifetime.

7.1 The Liquid Argon Purity Demonstrator

The Liquid Argon Purity Demonstrator (LAPD) was an early off-project prototype, built to study the concept of achieving liquid argon (LAr) purity requirements in a non-evacuated vessel. The purge process accomplished in the LAPD was repeated ten years ago on the , developed as an effort, which confirmed that initial evacuation of a membrane cryostat is unnecessary and that a LAr purity level sufficient to enable the electron lifetime required by DUNE can be achieved in a membrane cryostat [42].

7.2 ProtoDUNE

A further prototyping program, aimed at testing and demonstrating the DUNE detector technologies and engineering procedures at the 1 kt (metric) scale, has taken place over the past few years as part of the European Laboratory for Particle Physics (CERN) Neutrino Platform program. Two detectors of this scale, and , were installed in a pair of membrane cryostats, each of inner dimensions $8.6 \times 8.6 \times 7.9 \text{ m}^3$. ProtoDUNE-SP was filled with LAr in July/August 2018 and operated in a test beam and with cosmics, whereas ProtoDUNE-DP was filled in August 2019 and operated only with cosmics.

ProtoDUNE-SP had the same 3.5 m maximum drift length as the full . ProtoDUNE-DP had a 6 m maximum drift length, half of the length that had been planned for an eventual ¹ See the photos in Figures 7.1 and 7.2.

¹The second had been planned to be dual-phase (DP); it is now planned as single-phase (SP) with a vertical drift, with a maximum 6 m drift length.



Figure 7.1: ProtoDUNE-SP (foreground) and ProtoDUNE-DP (right rear, red, at an angle) cryostats in the CERN Neutrino Platform in CERN's North Area.

7.2.1 Cryostats

The performance of the cryostats is fully described in [51]; the text in this section comes largely from this paper.

The cryostat inner and outer structures had to satisfy both U.S. and European regulations and standards, as the ProtoDUNE-SP cryostats were installed and operated in Europe and the far detector (FD) cryostats will operate in the U.S. Rigorous quality assurance (QA) and quality control (QC) procedures were carried out on all materials and techniques used for the construction.

Validation and certification of the cryostat structure had two principal aspects. The first, leak checking, was performed at various stages of the cryostat construction. The second concerned the mechanical behavior of the cryostat in terms of compliance with engineering safety standards and regulations. This validation was also performed multiple times throughout the course of construction, and included test campaigns both during and after filling with LAr.

Leak testing was performed on the external warm structure, the inner membrane, and all the penetrations, generally by spraying helium close to the surface and reading the percentage of helium on the opposite side of the surface using a leak detector in *sniffing mode*. A deviation from the environmental background ($\sim 2 - 3 \times 10^{-6}$ mbar l/s) is considered a possible leak. The checks were performed on the warm structure during the assembly of ProtoDUNE-SP and no leaks were found.

The cryostat inner membrane was tested twice for leaks. The first test, upon completion of the membrane installation, was the official qualification for leak-tightness by the vendor, and was performed on all welding lines. The few small leaks found were swiftly repaired. The second leak test involved pulling vacuum around localized sections of welding lines and testing them one by one. Overall, about 80% of the total length of welding lines on the inner membrane was tested and no leaks were found. This gives confidence that the helium leak-check performed by the vendor can



Figure 7.2: Interior view of one of the ProtoDUNE cryostats, before any detector components were installed, showing the membrane. The gold color is an artifact of the lighting that was set up to protect photo-sensitive detector components during installation.

be fully trusted when it comes time to verify the cryostat inner membranes for the far detector, and that performing the second test will be unnecessary. Retesting single welded lines on a FD-scale cryostat would require months.

The leak-tightness of all feedthrough flanges on the roof was verified. All flanges except one were certified to be leak-tight; the chimney of one temperature profiler was found to be faulty. None of the actions taken fixed the leak entirely, therefore an enclosure was constructed and installed around the leaky flange, defining a buffer volume in which argon gas circulated continuously.

To fully validate the mechanical performance of the cryostat, a careful stress analysis of each structural component was done, together with pressure tests before and after filling with LAr. Two finite element analysis (FEA) models were developed to evaluate the cryostat design against the required codes and regulations. Predictions from the models were compared to the experimental data collected during the commissioning phase and operation.

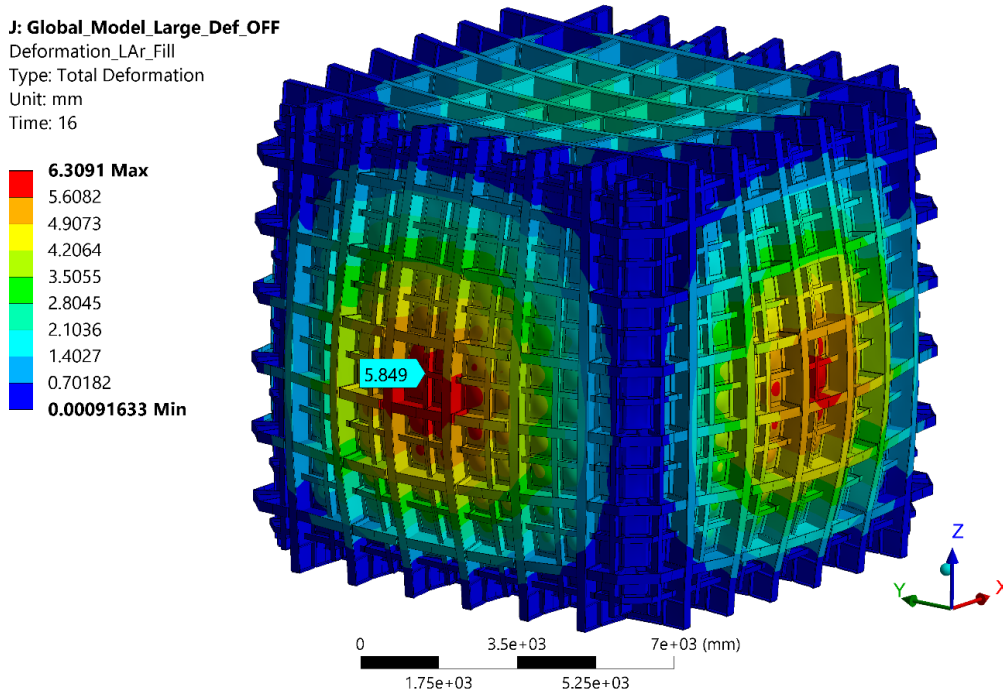

Figure 7.3: Expected deformation (using an exaggerated scale) of the cryostat during standard operations (liquid argon level of 7.4 m and $\Delta P = +57$ mbarg. Predictions are obtained using the *shell* FEA model (see text).

All tests performed during the validation campaign have been successful and the FEA model has reproduced the cryostat behavior in all cases.

The values of the displacement and strain gauges measured during the fill were compared to the FEA predictions and found to fulfill the safety requirements. This comparison also validated the FEA model itself, which was then used to predict the cryostat behavior at the sizing case. The outcome of the simulation was compatible with both EU and U.S. standards, thus providing the final qualification of the inner and outer cryostat mechanical structures.

7.2.2 Cryogenics Systems

The performance of the cryogenics systems is fully described in [51]; the text in this section comes largely from this paper.

The quality assurance (QA) and quality control (QC) steps were performed during the design, construction, installation and commissioning phases, as appropriate. During the construction and installation phases, non-destructive tests (X-rays, He leak tests and pressure tests) were successfully executed. During cold commissioning another series of tests was completed successfully, the main two of which were a check of the I/O signals and a functional test of all valves and equipment. In addition, tests were run on the Ethernet or hardwired signal lines dedicated to the exchange of information between the cryogenics system and the detector system, the safety system, and the CERN Central Control room. Figure 7.4 shows the stability of the level, pressure and outer structure temperature during filling of ProtoDUNE-SP.

A “mirror” station (not connected to the actual field equipment) provided a functional test environment for the process control logic. The tests were subsequently carried out on the real system to verify first alarms, interlocks, and the sequential function charts. Operation modes were tested afterwards, during the system commissioning.

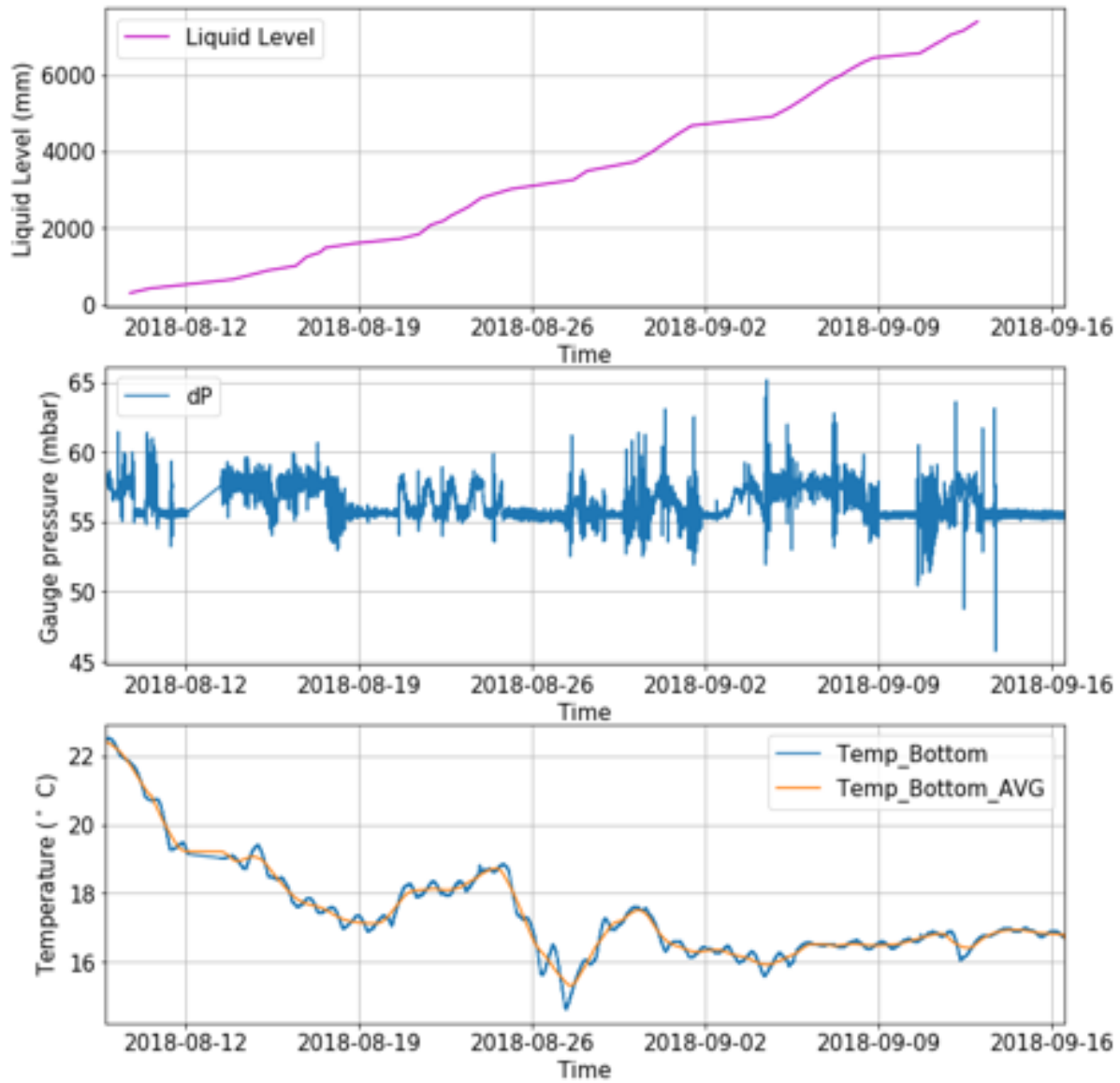

Figure 7.4: LAr level (top), pressure (middle) and cryostat outer structure temperature (bottom) trends during the filling of the ProtoDUNE-SP cryostat.

Chapter 8

Environment, Safety, and Health

Both Fermi National Accelerator Laboratory (Fermilab) and Sanford Underground Research Facility (SURF) environment, safety and health (ES&H) codes and standards have been guiding and will continue to guide the design, prototyping, procurement, and installation phases of the far site cryostat and cryogenics infrastructure for LBNF and DUNE enterprise (LBNF/DUNE). Particular attention is paid to critical sections of Chapter 4240 [52] relating to oxygen deficiency hazard (ODH) and Chapter 5000 [52] standards for piping construction and vessel design. The planned work process will provide for reviews throughout all phases of the project to guarantee stringent adherence to the safety requirements. Requirements on the membrane-cryostat materials and their fabrication are strictly outlined in the specification documents. Close communication between the vendors, Fermilab's and European Laboratory for Particle Physics (CERN)'s cryogenic and process engineers, and Fermilab and SURF ES&H personnel is and will be maintained at all times.

Figure 8.1 shows the ODH classification for underground caverns at the SURF. The detector and central utility cavern (CUC) are Class 1 ODH areas [52], assessed by preliminary ODH analysis taking into account potential risks from undetected defects on materials and equipment, operational causes, etc. During an ODH event, workers must leave the area and head towards the Ross or Yates shaft for evacuation.

8.1 Argon Gas Piping in the Ross Shaft

An ODH assessment for the piping in the Ross Shaft has determined that if any of the pipes for the cryogenics system were to rupture in the shaft, they would only reduce the oxygen content at the to 20.5%, thus not reaching the level of ODH concern. (defines an area as oxygen deficient if the percentage of oxygen is less than 19.5% by volume.) The ODH mapping of underground cavern area is given in Figure 8.1.

The facility is designed to draw the fresh air in through the Ross and Yates Shafts and exhaust the air out of the 4850L through the Oro Hondo shaft (see Figure 8.2). The loss of cavern ventilation for more than a few hours is a safety risk even in the absence of ODH conditions.

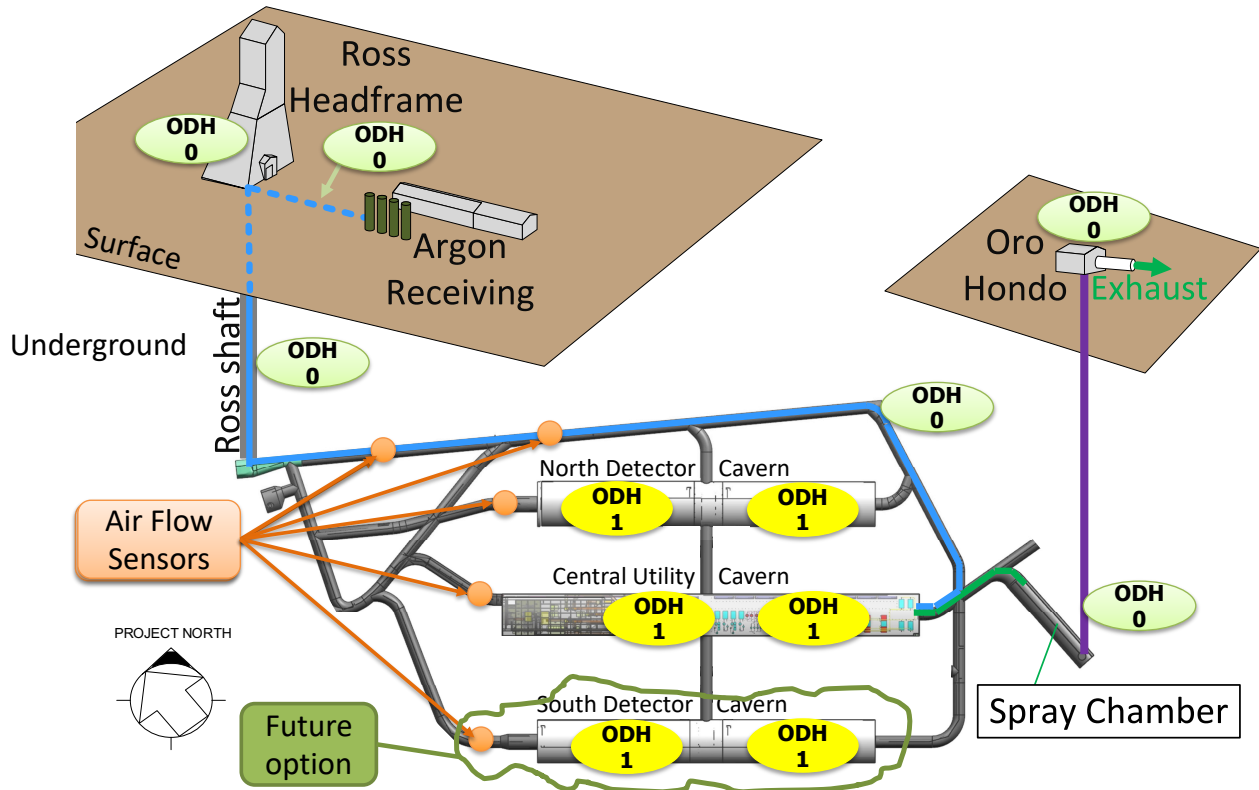

Figure 8.1: ODH mapping of the underground caverns at 4850L

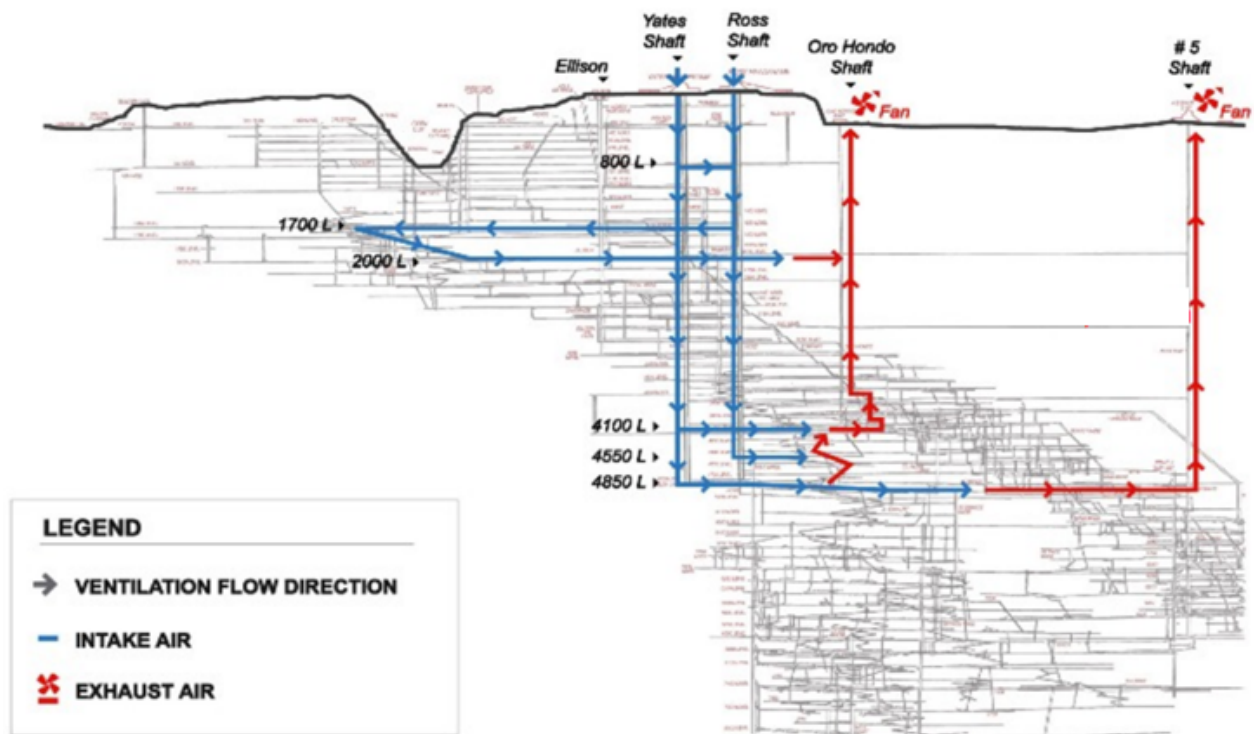

Figure 8.2: Homestake mine ventilation paths

The response for unplanned loss of ventilation is evacuation.

8.2 Ventilation in CUC and Detector Caverns

The Ross and Yates shafts supply fresh ventilation air to the CUC, detector caverns, and 4850L drifts. The fresh air enters the 4850L at which point the flow is split, with some air flowing through the detector caverns, and some flowing through the CUC before being exhausted out via the Oro Hondo exhaust shaft.

Chapter 9

Quality Assurance and Quality Control

9.1 Quality Assurance

The design, fabrication, installation and commissioning of the cryostat and the cryogenics systems will be performed by subcontractors. The Requests for Proposal will provide the quality requirements for the work to be performed. The bidders will be required to provide their quality assurance (QA)/quality control (QC) plans with the bid along with how they will meet the inspection and test requirements. The same quality requirements will apply to the infrastructure, proximity, and internal cryogenics systems.

9.1.1 Cryogenics Systems

During the design phase the supplier will develop mechanical design drawings, mechanical stress, seismic, pressure drop and heat in-leak calculations. Electrical breaks will be identified. A risk analysis will be performed. Materials will be identified during the design. The design will be verified and validated through a preliminary design review and a detailed final design review.

Prior to fabrication, a manufacturing readiness review will be performed. The welding process, welder qualifications, personnel qualifications, process, inspection and test procedures will be reviewed. Material certificates for the welded process pipes, seamless process pipes, welded vacuum pipes, stainless steel fittings, bellows, filler material, and machined parts for the process will be provided for review. The control of traceability of material will be demonstrated and verified. The work processes will be reviewed including cleaning, welding, multilayer insulation, evacuation, and passivation, and packing and marking.

The following inspections and tests will be performed in process at the manufacturing facility:

- visual weld inspection,
- radiographic tests (piping and vessels),
- longitudinal weld test (vessel),
- dye penetrant testing for socket welds that cannot be radiographed,

- helium leak tests for flexibles, uninsulated parts, and all spools,
- pressure test (piping and vessels),
- vacuum retention test,
- instruments test (valves, heaters, T-sensors, P-sensors),
- pressure safety valves (s),
- bellows/flex test, and
- electrical breaks (cold cycle, pressure test, electrical resistance test, He leak test).

A factory acceptance test and final inspection will be performed prior to the equipment being released for shipment. The factory acceptance test will consist of:

- dimensional inspection,
- pressure test, and a
- helium leak test.

Prior to installation and testing, installation review and test review meetings will be held at Sanford Underground Research Facility (SURF). All equipment received at SURF will be receipt-inspected for proper documentation, any shipping damage, transport accelerometer verification, packing list, and leakage.

Installation inspection and testing will consist of:

- visual weld inspection,
- radiographic testing of piping,
- pressure test including interfaces, and
- final inspection of hardware consisting of final position inspection, positioning and layout control, and interfaces control.

The final acceptance test will consist of a warm acceptance test and a cold acceptance test.

The warm acceptance test will consist of the following:

- pressure test, and a
- helium leak test.

The cold acceptance test will consist of the following:

- check of documentation, safety devices, all interfaces installed and ready for test;
- cold tests with LN₂ for two hours verifying there is no condensation on the surface, and a
- helium leak test.

Upon satisfactory completion of the final acceptance test, there will be a final acceptance re-

lease meeting to review test reports and documentation (final), operation manuals, and warranty certificate.

9.1.2 Protego Valves

The manufacturer of the Protego® valves shall perform a visual and dimensional check after production to verify that the valves meet the drawing requirements. All seam welds will be inspected by liquid penetrant examination. The valves will be pressure tested (3.2 mbarg/30 minutes) to verify there is no leakage or deformation. A valve seat tightness test will be performed by the manufacturer to maximum 28.2 cm³/minute at 500 mbar. The completed valve will be helium leak-tested to ensure it does not exceed the maximum leakage rate of the specifications (1.0×10^{-9} mbarL/s). A final inspection will be performed prior to release for shipment consisting of a visual check, a check of marking, and release for shipment.

Upon receipt at SURF, the valves will be inspected for shipping damage and against the Bill of Lading to ensure the shipment is complete. Installation will be performed according to manufacturer's instructions. Installation welds will be inspected by liquid penetrant examination.

9.1.3 Cryostat

All equipment for the warm vessel and the cold vessel received at SURF will be receipt-inspected against the Bill of Lading, and for proper documentation and any shipping damage. All inspections and tests will be performed by qualified personnel using approved procedures.

The warm structure components will be fabricated using qualified personnel for assembly, welding and NDE. Steel components will be dimensionally inspected prior to welding. Welding will be performed by qualified welders and the welds will be inspected using liquid penetrant and ultrasonic examination based on the fabricator's quality plan. Final inspection verifying all parts will be performed prior to shipment to ensure that subassemblies are consistent with the applicable drawings. During installation at SURF, all welds will be inspected by NDE and bolting will be verified as meeting the specification.

The installation of the insulation will be verified through visual inspection of the bonding process. The secondary membrane installation will be inspected and tested through a vacuum box test and liquid penetrant testing of the welds. The primary membrane installation will be verified through vacuum box test, helium leak testing and liquid penetrant testing of welds. A global barrier test (vacuum leak test) will be performed on the primary and secondary membranes.

Prior to, during, and upon completion of the filling of the cryostat the following QC steps are performed to verify the integrity of the structure during the filling process. Throughout the whole process, strain gauges will be used to measure the deformation of the structural elements, particularly after each pressure increase to validate the results of the finite element analysis (FEA) simulations.

9.2 Cryostat QC Prior to Purge

The following lists the steps of the QC test to be performed prior to the start of the gaseous argon (GAR) purge. While this test does not stress the structure to the design conditions, it still provides an additional QC step in the validation process of the warm vessel, including the roof of the cryostat with all the feedthroughs.

- The cryostat PSVs will be locked out for the duration of the test to avoid opening at 250 mbarg.
- The cryostat will be pressurized to 250 mbarg to verify the structure for the first steps: GAR purge, cool-down and liquid argon (LAr) fill.
- The automatic vent valve will be manually reset so that it opens fully when the pressure reaches slightly above 250 mbarg (e.g., 270 mbarg).
- A temporary PSV will be installed in the GAR supply line for the duration of this test.
- Starting from atmospheric, the pressure will be incremented at a rate of about 50 mbar/hour.
- After every pressure increment, the structure and the pressure stability will be observed for one hour without intervention. Should the pressure decrease, the incrementing will stop and investigation will take place. If it is stable, pressure increments will continue.
- Strain gauges and displacement sensors will be used to measure the strains and the deformation of the structural elements throughout the process, particularly after each pressure increment, to validate the results of the FEA simulations. If the readings deviate significantly from the expected values, the incrementing will stop and investigation will take place until the deviation is evaluated.
- During this test, the only source of pressure is the GAR used to pressurize the cryostat. The supply GAR will be regulated as to not exceed the desired pressure at each 50 mbarg increment.
- Once 250 mbarg is reached, the cryostat is qualified for 250 mbarg of maximum gas pressure and will be depressurised (at about 50 mbar/hour) down to 50 mbarg.
- Once the cryostat pressure falls below 150 mbarg, automatic control of the vent valve is re-enabled and reset to 150 mbarg.
- During the commissioning process, the strain gauge and displacement sensor measurements will be analyzed at least once per day. Any abnormal behavior will be evaluated.
- Once the test is completed the cryostat PSVs are unlocked.

9.3 Cryostat QC During Cryostat Fill

Strain gauges will measure the deformation of the structural elements throughout the fill process to validate the results of the FEA simulations as the LAr level rises. Maintaining a stable pressure of about 50 mbarg, the argon flow will be decreased at every meter of fill level long enough to allow reading of the strain gauges. If the readings deviate from the expected values, an investigation will take place and the fill will stop until the deviation is evaluated. The acceptable deviations will be defined prior to the test.

Every 2.0 m of liquid rise (at 2.0 m, 4.0 m, and so on through 12.0 m, and again at the nominal

LAr level), i.e., seven times, the gas pressure will be increased in steps of 50 mbarg up to 200 mbarg, then brought back down to 50 mbarg. The 200 mbarg pressure will be held for one hour in order to check the FEA calculations and examine the most stressed areas of the warm structure. This process will take about seven hours at each level, adding a total of 49 hours (seven hours \times seven levels) to the fill time, assuming nothing unexpected happens during the test and no unexpected values are observed. Due to the settling of the structure, deformations and loads are likely to differ from those of the FEA simulations for levels of LAr up to about 4 m.

9.4 Cryostat QC After Cryostat Fill

Once the cryostat is full and stable at the operating pressure of 50 mbarg, and risk assessment has been completed, the GAR pressure will be increased to test the system close to its maximum design load: full of LAr and at 200 mbarg of GAR pressure. The procedure has following QC steps:

- The automatic vent valve will be manually reset so that it opens fully when the pressure reaches slightly above 200 mbarg (e.g., 230 mbarg).
- The cryostat PSVs will remain operational at the nominal set pressure of 250 mbarg.
- Starting at 50 mbarg, the pressure will be increased at a rate of about 50 mbar/hour.
- Upon reaching 200 mbarg the structure will be observed for one hour without intervention, and the stability of the pressure will be monitored. Should the pressure decrease, the incrementing will stop and investigation will take place. If it is stable, pressure increments will continue.
- Strain gauges and displacement sensors will measure the deformation of the structural elements throughout the process, particularly after each pressure increase, to validate the results of the FEA simulations. If the readings deviate from the expected values, the incrementing will stop and investigation will take place. The acceptable deviations will be defined prior to the test.
- During this step the argon contained inside the cryostat is the only source of pressurization. The condensers will increase and regulate the pressure at the test values (100, 150, 200 mbarg). If the pressure reaches 230 mbarg the vent valve will open automatically and release GAR to the exhaust duct. (This line is sized to release the GAR overpressure generated by the cryostat boil-off in case refrigeration is lost.)
- Once the QC at 200 mbarg has been performed, the cryostat will be depressurized at the rate of about 50 mbar/hour down to the operating pressure of 50 mbarg.
- Once the pressure drops below 200 mbarg, the automatic vent valve will be reset manually to 230 mbarg.
- Once the pressure drops below 150 mbarg, the vent valve will be reset to open automatically at 150 mbarg.

The full test (pressurization, hold, depressurization) is expected to take approximately eight hours. This test provides the final QC step in the validation process of the warm and cold vessels, including the roof of the cryostat with all the feedthroughs.

Appendix A

Refrigeration Load Scenarios

To determine the optimal plant capacity and number of plants required, fourteen scenarios were forecast for the LN₂ refrigeration loads and plant capacity. Those scenarios are described below and a summary is given in Figure A.1.

The conclusion points to the requirement of four 100 kW plants. Each of these plants can achieve a 20% turn up or turn down. Scenarios 1, 4, A and D impose the most severe requirements. In these scenarios, all plants available will be required to run at the maximum duty cycle to cool down and fill a cryostat, while maintaining purity for cryostat(s) filled and purified earlier. These scenarios will also require frequent filter regeneration.

Scenario 1 The initial operation will be the purging, cooling and filling of the first cryostat, condensing gaseous argon in the cavern by heat exchange via the recondensers. The surface and cavern LAr and LN₂ dewars will be operational and the cooling load for the dewars will come directly from the refrigeration plant. The cavern pipework and vessels will be cold, the LAr in the cryostat will be circulating at high flow rate through the purification plant, and the cryostat will be cold. The cryostat cool-down rate is constrained by three variables: 1) The size of the piping from the surface to bottom of Ross shaft, 2) The size of the LN₂ refrigeration units, and 3) the cooling power available via the recondensers. All three variables have been matched for the physical constraints of a 40 kt module at 4850L using the Ross shaft. The refrigerators and condensers have been sized to accommodate the long-term refrigeration load associated with the cryostats. As the LAr is circulated to achieve the operational purity the filtration plant will need to be regularly regenerated. This will mean that the associated refrigeration load will normally be present.

Scenario 2 Once the first cryostat is filled with LAr, the cool-down load will reduce to zero and the cryogenic plant will run for several months purifying the LAr inventory.

Scenario 3 When the LAr in the cryostat reaches the required purity level, the circulation flow rate will be reduced and the detector electronics will be turned on. At this stage the recondenser refrigeration load falls such that only one recondenser is required and the rest of units can operate as spare units.

Scenario 4 The first cryostat continues to operate in normal experimental mode while the second cryostat is being purged, cooled down and filled with LAr. Again a very large burden is placed on the recondensers due to the gas condensation and rate of liquefaction.

Scenario 5 The second cryostat is full and LAr is circulated at high flow rate through the purification plant. The first cryostat continues to operate as normally.

Scenario 6 Both cryostats are operating in normal experimental mode. A spare recondenser is available on each cryostat to facilitate maintenance.

Scenario 7 It is assumed that a total failure of the refrigeration plant has occurred. All noncritical heat sources are isolated and liquid nitrogen from the LN₂ vessels in the central utility cavern is utilized to recondense the inventory of high purity LAr. Nitrogen refrigeration must be reestablished before the liquid nitrogen reservoir is exhausted or the high purity argon will need to be vented. In the locked-down state, the recirculation pumps and the purification plants are shut down.

Scenario A The first and second cryostats continue to operate in normal experimental mode while the third cryostat is being purged, cooled down and filled with LAr. Again a very large burden is placed on the recondensers due to the gas condensation and rate of liquefaction.

Scenario B The third cryostat is full and LAr is circulated at high flow rate through the purification plant. The first and second cryostats continue to operate as normally.

Scenario C Three cryostats are operating in normal experimental mode. A spare recondenser is available on each cryostat to facilitate maintenance.

Scenario D The three cryostats continue to operate in normal experimental mode while the fourth cryostat is being purged, cooled down and filled with LAr. Again a very large burden is placed on the recondensers due to the gas condensation and rate of liquefaction.

Scenario E The fourth cryostat is full and LAr is circulated at high flow rate through the purification plant. The three cryostats previously filled continue to operate as normally.

Scenario F All four cryostats are operating in normal experimental mode. A spare recondenser is available on each cryostat to facilitate maintenance.

Scenario G This is the same condition as Scenario 7, but now all four cryostats are in the LAr inventory protection mode.

GAR Fill	Unit Loads (kW)	Scenarios										Sub-Scenarios							
		1	3	4	6	7	A	C	D	F	G	i	ii	iii	iv	v	vi	vii	viii
Recondenser Load, 1st Cryostat												Recondenser Load, 1st Cryostat							
Cryostat Heat Ingress	48.7	48.7	48.7	48.7	48.7	48.7	48.7	48.7	48.7	48.7	48.7	48.7	48.7	48.7	48.7	48.7	48.7	48.7	48.7
With 2 Recirculation Pump	11.00		11.0	11.0	11.0			11.0	11.0	11.0	11.0			11.0	11.0	11.0	11.0	11.0	11.0
With 4 Recirculation Pumps	22.0	22.0											22.0						
Piping and Purification vessel Heat Ingress	3.7	3.7	3.7	3.7	3.7			3.7	3.7	3.7	3.7			3.7	3.7	3.7	3.7	3.7	3.7
Detector Electronics in cryostat	23.7		23.7	23.7	23.7			23.7	23.7	23.7	23.7			23.7	23.7	23.7	23.7	23.7	23.7
Cryostat Fill - GAR transfer / recondense		226												216					
Number of condensers in operation		3	1	1	1	1	1	1	1	1	1	1	3	1	1	1	1	1	1
Condenser Load		300.0	87.1	87.1	87.1	48.7	87.1	87.1	87.1	87.1	87.1	48.7	290.0	87.1	87.1	87.1	87.1	87.1	87.1
Recondenser Load, 2nd Cryostat												Recondenser Load, 2nd Cryostat							
Cryostat Heat Ingress	48.7			48.7	48.7	48.7	48.7	48.7	48.7	48.7	48.7			48.7	48.7	48.7	48.7	48.7	48.7
With 2 Recirculation Pump	11.00				11.0			11.0	11.0	11.0	11.0				11.0	11.0	11.0	11.0	11.0
With 4 Recirculation Pumps	22.0			22.0									22.0						
Piping and Purification vessel Heat Ingress	3.7			3.7	3.7			3.7	3.7	3.7	3.7			3.7	3.7	3.7	3.7	3.7	3.7
Detector Electronics in cryostat	23.7				23.7			23.7	23.7	23.7	23.7			23.7	23.7	23.7	23.7	23.7	23.7
Cryostat Fill - GAR transfer / recondense				139										129					
Number of condensers in operation				3	1	1	1	1	1	1	1	1		3	1	1	1	1	1
Condenser Load				212.9	87.1	87.1	48.7	87.1	87.1	87.1	87.1	48.7		202.9	87.1	87.1	87.1	87.1	87.1
Recondenser Load, 3rd Cryostat												Recondenser Load, 3rd Cryostat							
Cryostat Heat Ingress	48.7							48.7	48.7	48.7	48.7	48.7			48.7	48.7	48.7	48.7	48.7
With 2 Recirculation Pump	11.00								11.0	11.0	11.0	11.0				11.0	11.0	11.0	11.0
With 4 Recirculation Pumps	22.0							22.0						22.0					
Piping and Purification vessel Heat Ingress	3.7							3.7	3.7	3.7	3.7			3.7	3.7	3.7	3.7	3.7	3.7
Detector Electronics in cryostat	23.7							23.7	23.7	23.7	23.7			23.7	23.7	23.7	23.7	23.7	23.7
Cryostat Fill - GAR transfer / recondense								151						141					
Number of condensers in operation								3	1	1	1	1		3	1	1	1	1	1
Condenser Load								225.8	87.1	87.1	87.1	87.1		215.8	87.1	87.1	87.1	87.1	87.1
Recondenser Load, 4th Cryostat												Recondenser Load, 4th Cryostat							
Cryostat Heat Ingress	48.7								48.7	48.7	48.7							48.7	48.7
With 2 Recirculation Pump	11.00									11.0									11.0
With 4 Recirculation Pumps	22.0									22.0									22.0
Piping and Purification vessel Heat Ingress	3.7									3.7	3.7							3.7	3.7
Detector Electronics in cryostat	23.7									23.7	23.7							23.7	23.7
Cryostat Fill - GAR transfer / recondense										64									41.60
Number of condensers in operation										2	1	1						2	1
Condenser Load										138.7	87.1	48.7						116.0	87.1
Cavern LN2 storage tank & piping heat ingress**	--	--	--	--	--			--	--	--	--			--	--	--	--	--	--
Purification vessel Regen cooling	10												10	10	10	10	10	10	10
Refrigeration Needed		300.0	87.1	300.0	174.2	97.4	400.0	261.3	400.0	348.4	194.8	300.0	97.1	300.0	184.2	400.0	271.3	387.3	358.4
Refrigeration Plants in Operation		3	1	3	2	0	4	3	4	4	0	3	2	3	2	4	3	4	4
Total Refrigeration Capacity Available		300	100	300	200		400	300	400	400		300	200	300	200	400	300	400	400
Required Duty per plant		100	87	100	87		100	87	100	87		100	78	100	92	100	90	97	90
Electric trim heater load		0.0	0.0	0.0	0.0		0.0	0.0	0.0	0.0		0.0	58.9	0.0	0.0	0.0	0.0	0.0	0.0
Total Refrigeration Load		300	87.1	300	174.2	0	400	261.3	400	348.4	0	300	156	300	184.2	400	271.3	387.3	358.4

Figure A.1: Refrigeration Loads. Note that the heat load contribution of the LN₂ storage and LN₂ piping is assumed by the Nitrogen Refrigeration System.

Glossary

35 ton prototype A prototype cryostat and single-phase (SP) detector built at Fermi National Accelerator Laboratory (Fermilab) before the detectors. 3, 55

4850L The depth in feet (1480 m) of the access level for the DUNE underground area at SURF; called the “4850 level”. 3, 19, 21, 22, 24, 33, 37, 42, 61, 63

anode plane assembly (APA) A unit of the horizontal drift detector module (FD1-HD) detector module containing the elements sensitive to ionization in the liquid argon (LAr). Each anode face has three planes of wires (two induction, one collection) to provide a 3D view, and interfaces to the cold electronics and photon detection system. 36

ATLAS One of two general-purpose detectors at the . It investigates a wide range of physics, from the measurements of the Higgs boson properties to searches for extra dimensions and particles that could make up dark matter (DM). 9

critical decision (CD) The U.S. DOE’s Order 413.3B outlines a series of staged project approvals, each of which is referred to as a critical decision (CD). 10

European Laboratory for Particle Physics (CERN) The leading particle physics laboratory in Europe and home to the ProtoDUNEs and other prototypes and demonstrators, including the s. 3, 10, 13, 31, 55, 59, 61

computational fluid dynamics (CFD) High performance computer-assisted modeling of fluid dynamical systems. 27, 35, 36

CMS Compact Muon Solenoid experiment; one of two general-purpose detectors at the LHC.. 9

central utility cavern (CUC) The utility cavern at the 4850L of Sanford Underground Research Facility (SURF) located between the two detector caverns. It contains utilities such as central cryogenics and other systems, and the underground data center and control room. 21, 22, 24, 26, 37, 38, 41, 44, 49, 53, 61, 63

data acquisition (DAQ) The data acquisition system accepts data from the detector front-end

(FE) electronics, buffers the data, performs a , builds events from the selected data and delivers the result to the offline . 43, 49

DOE U.S. Department of Energy. 2, 3, 7–10, 29

dual-phase (DP) Distinguishes a liquid argon time-projection chamber (LArTPC) technology by the fact that it operates using argon in both gas and liquid phases; sometimes called double-phase. 55

DP module dual-phase DUNE far detector (FD) module. 55

Deep Underground Neutrino Experiment (DUNE) A leading-edge, international experiment for neutrino science and proton decay studies; refers to the entire international experiment and collaboration. 2–4, 7, 9, 10, 13, 22, 28, 33, 39, 55

environment, safety and health (ES&H) A discipline and specialty that studies and implements practical aspects of environmental protection and safety at work. 61

far detector module The entire DUNE far detector design calls for segmentation into four modules, each with a total/fiducial mass of approximately 17kt/10kt. 2, 3, 7, 23, 28, 35, 49, 55

far detector (FD) The 70 kt total (40 kt fiducial) mass LArTPC DUNE detector, composed of four 17.5 kt total (10 kt fiducial) mass modules, to be installed at the far site at SURF in Lead, SD, USA. 2–4, 6, 13, 56, 58

horizontal drift detector module (FD1-HD) LArTPC design used in FD1 in which electrons drift horizontally to wire plane anodes (anode plane assemblies (APAs)) that along with the front-end electronics are immersed in LAr. 2, 6, 8, 9, 23, 27, 35–37, 40, 42

vertical drift detector module (FD2-VD) LArTPC design used in FD2 in which electrons drift vertically to PCB-based anodes at the top and bottom of the LAr volume, with a cathode in the middle. 2, 6, 8, 9, 36, 37, 40, 42

FDC Far Detector and Cryogenics Subproject. 3, 7, 10, 13, 23, 43

finite element analysis (FEA) Simulation of a physical phenomenon using the numerical technique called Finite Element Method (FEM), a numerical method for solving problems of engineering and mathematical physics. 16, 58, 66–68

FEED front-end engineering design. 31

Fermi National Accelerator Laboratory (Fermilab) U.S. national laboratory in Batavia, IL. It is the laboratory that hosts Long-Baseline Neutrino Facility (LBNF) and Deep Underground Neutrino Experiment (DUNE), and serves as the experiment’s near site. 2, 3, 9, 10, 61

FRP fiber-reinforced plastic. 35

Far Site Conventional Facilities (FSCF) The conventional facilities (CF) at the DUNE far detector site, SURF, including all detector caverns and support infrastructure. 4, 10, 50

FSCF-BSI subproject for far site conventional facilities, building and site infrastructure. 22

FSII far site integration and installation. 10, 13

gaseous argon (GAR) argon in its gas phase. 3, 8, 19, 21, 22, 24–27, 31, 33, 35, 37, 39–41, 67, 68

ground plane An electrode held electrically neutral relative to Earth ground voltage; it is mounted on the to protect the cryostat wall. 35

HART highway addressable remote transducer. 51

HMI human-machine interface. 43, 44, 47

Local Area Network (LAN) Computing network confined to a relatively small geographic area. 43

Liquid Argon Purity Demonstrator (LAPD) Cryostat at Fermilab for long-term studies requiring a large volume of argon. 55

liquid argon (LAr) Argon in its liquid phase; it is a cryogenic liquid with a boiling point of 87 K and density of 1.4 g/ml. 2–4, 7–9, 13, 16, 17, 19–31, 33, 36–39, 42, 43, 55, 56, 67, 68

liquid argon time-projection chamber (LArTPC) A time projection chamber (TPC) filled with liquid argon; the basis for the DUNE FD modules. 2, 4, 8, 13

LBNE Long Baseline Neutrino Experiment; (1) a terminated U.S. experiment that was reformulated in 2014 under the auspices of the new DUNE collaboration, an internationally coordinated and internationally funded program, with Fermilab as host; and (2) the former incarnation of LBNF/DUNE-US. 55

Long-Baseline Neutrino Facility (LBNF) Long-Baseline Neutrino Facility; refers to the facilities that support the experiment including in-kind contributions under the line-item project. The portion of LBNF/DUNE-US responsible for developing the neutrino beam, the far site cryostats, and far and near site cryogenics systems, and the conventional facilities, including the excavations. 2, 3, 5, 8, 22, 23, 28, 29, 33, 37, 42, 55

LBNF and DUNE enterprise (LBNF/DUNE) Long-Baseline Neutrino Facility/Deep Underground Neutrino Experiment; refers to the overall enterprise or program including LBNF/DUNE-US, participating international projects, and the DUNE experiment and collaboration. 2, 4, 9, 61

- LBNF/DUNE-US** Long-Baseline Neutrino Facility/Deep Underground Neutrino Experiment - United States; project to design and build the conventional and beamline facilities and the contributions to the detectors. It is organized as a DOE/Fermilab project and incorporates contributions to the facilities from international partners. It also acts as host for the installation and integration of the DUNE detectors. 3, 4, 9, 10, 13, 29, 30, 32
- LHC** Large Hadron Collider. 9
- LN₂** liquid nitrogen. 3, 4, 7, 22–24, 37–39
- MicroBooNE** A LArTPC neutrino oscillation experiment at Fermilab. 8
- near detector (ND)** Refers to the collection of DUNE detector components installed close to the neutrino source at Fermilab; also a subproject of LBNF/DUNE-US that includes installation, infrastructure, and the cryogenics systems for this detector. 2
- ND-GAr** component of the near detector with a core gaseous argon TPC surrounded by an electromagnetic calorimeter (ECAL) and a magnet. 2
- NDE** non-destructive evaluation. 64, 66
- oxygen deficiency hazard (ODH)** a hazard that occurs when inert gases such as nitrogen, helium, or argon displace room air and thus reduce the percentage of oxygen below the level required for human life. 22, 43, 49, 50, 52, 53, 61
- open platform communications (OPC)** Open platform communications is a series of standards and specifications for industrial telecommunication. 47, 54
- OSHA** Occupational Safety and Health Administration (USA Department of Labor) formed by the Occupational Safety and Health Act of 1970. 61
- PCB** printed circuit board. 36
- photon detection system (PDS)** The detector subsystem sensitive to light produced in the LAr. 13
- pickling** steel pickling and oiling is a metal surface treatment finishing process used to remove surface impurities such as rust and carbon scale from hot rolled carbon steel. 64
- programmable logic controller (PLC)** An industrial digital computer that has been ruggedized and adapted for the control of manufacturing or other processes that require high reliability, ease of programming, and process fault diagnosis. 25, 43, 47, 49
- parts per million (ppm)** A concentration equal to one part in 10⁶. 35

- parts per trillion (ppt)** A concentration equal to one part in 10^{12} . 4
- ProtoDUNE** Either of the two initial DUNE prototype detectors constructed at European Laboratory for Particle Physics (CERN). One prototype implemented SP technology and the other dual-phase (DP). 3, 8, 14, 56
- ProtoDUNE-DP** The DP ProtoDUNE detector constructed at CERN in . 8, 26, 55
- ProtoDUNE-SP** The FD1-HD ProtoDUNE detector constructed at CERN in . 8, 9, 26, 39, 55, 56, 59, 60
- PRV** pressure-relief valve. 40, 41
- PSV** pressure safety valve. 65, 67, 68
- quality assurance (QA)** The process of ensuring that the quality of each element meets requirements during design and development, and to detect and correct poor results prior to production. 7, 56, 59, 64
- quality control (QC)** The process (e.g., inspection, testing, measurements) of ensuring that each manufactured element meets its quality requirements prior to assembly or installation. 7, 56, 59, 64, 66–68
- Short-Baseline Neutrino (SBN)** A Fermilab program consisting of three collaborations, , , and , to perform sensitive searches for ν_e appearance and ν_μ disappearance in the Booster Neutrino Beam. 8
- SBND** The Short-Baseline Near Detector experiment at Fermilab. 3, 26
- SCADA** supervisory control and data acquisition. 43, 44, 47, 49
- SERI** State Secretariat for Education, Research and Innovation in Switzerland. 3
- single-phase (SP)** Distinguishes a LArTPC technology by the fact that it operates using argon in its liquid phase only; a legacy DUNE term now replaced by and . 55
- SP module** single-phase DUNE FD module. 55
- Sanford Underground Research Facility (SURF)** The laboratory in Lead, SD, USA where the DUNE FD will be installed and operated; also where the LBNF/DUNE-US Far Site Conventional Facilities (FSCF) and the cryostat and cryogenics systems will be constructed. 2, 10, 19, 28, 29, 37, 43, 53, 61, 65, 66
- time projection chamber (TPC)** Depending on context: (1) A type of particle detector that uses an E field together with a sensitive volume of gas or liquid, e.g., LAr, to perform a 3D

reconstruction of a particle trajectory or interaction. The activity is recorded by digitizing the waveforms of current induced on the anode as the distribution of ionization charge passes by or is collected on the electrode. (2) TPC is also used in LBNF/DUNE-US for “total project cost”. 9, 13, 17, 35, 36

UNICAMP University of Campinas, Sao Paulo, Brazil. 3, 31

VFD variable frequency drive. 50

WA105 DP demonstrator The 3m×1m×1m WA105 DP prototype detector at CERN. 8

work breakdown structure (WBS) An organizational project management tool by which the tasks to be performed are partitioned in a hierarchical manner. 10

WUST Wroclaw University of Science and Technology in Poland. 3

References

- [1] DOE, “Letter regarding P5 plan for upgrading beyond Phase I.”
<https://edms.cern.ch/document/2838447>.
- [2] LBNF/DUNE-US Project, “LAr-FD Requirements spreadsheets.”
<https://edms.cern.ch/document/2391830>.
- [3] LBNF/DUNE-US Project, “LBNF/DUNE-US Project Management Plan,” Tech. Rep. 117, 2022. Available upon request.
- [4] D. Adams *et al.*, “Design and performance of a 35-ton liquid argon time projection chamber as a prototype for future very large detectors,” *Journal of Instrumentation* **15** no. 03, (Mar, 2020) P03035–P03035. <https://doi.org/10.1088%2F1748-0221%2F15%2F03%2Fp03035>.
- [5] D. Adams *et al.*, “The ProtoDUNE-SP LArTPC electronics production, commissioning, and performance,” *Journal of Instrumentation* **15** no. 06, (Jun, 2020) P06017–P06017.
<https://doi.org/10.1088%2F1748-0221%2F15%2F06%2Fp06017>.
- [6] LBNF/DUNE, “LBNF Cryostat FNAL Cryo Safety Panel Review April 2020.”
<https://edms.cern.ch/document/2826471>.
- [7] LBNF/DUNE, “Piping and Instrumentation Diagrams (P&ID) .”
<https://edms.cern.ch/document/2211532>.
- [8] LBNF/DUNE, “PIDs for Cryostat 1 Systems.” <https://edms.cern.ch/document/2775007>.
- [9] LBNF/DUNE, “PIDs for Cryostat 2 Systems.” <https://edms.cern.ch/document/2775008>.
- [10] LBNF/DUNE, “PIDs for Cryostat Support Equipment.”
<https://edms.cern.ch/document/2775002>.
- [11] LBNF/DUNE, “Receiving Facilities Model.” <https://edms.cern.ch/document/2211569>.
- [12] LBNF/DUNE, “Receiving Facilities Layout.” <https://edms.cern.ch/document/2447338>.
- [13] LBNF/DUNE, “Receiving Facilities Simulations.”

- <https://edms.cern.ch/document/2211567>.
- [14] LBNF/DUNE, “Nitrogen System Statement of Work.”
<https://edms.cern.ch/document/2705540>.
- [15] LBNF/DUNE, “Layout of Piping for Argon and Nitrogen Distribution Underground.”
<https://edms.cern.ch/document/2810467>.
- [16] LBNF/DUNE, “Argon distribution and vents.”
<https://edms.cern.ch/nav/CERN-0000196907>.
- [17] LBNF/DUNE, “Argon Distribution Statement of Work.”
<https://edms.cern.ch/document/2810641>.
- [18] LBNF/DUNE, “Statement of Work for Regeneration System 1.”
<https://edms.cern.ch/document/2852844>.
- [19] LBNF/DUNE, “Statement of Work Regeneration System 2.”
<https://edms.cern.ch/document/2892643>.
- [20] LBNF/DUNE, “Statement of Work Liquid Argon Circulation Pumps Package for the Cryostat 1.” <https://edms.cern.ch/document/2884649>.
- [21] LBNF/DUNE, “Liquid Argon Purification 1 Statement of Work.”
<https://edms.cern.ch/document/2810432>.
- [22] LBNF/DUNE, “Liquid Argon Purification 2 Statement of Work.”
<https://edms.cern.ch/document/2810433>.
- [23] LBNF/DUNE, “Internal Cryogenics Reference Design.”
<https://edms.cern.ch/document/2211972>.
- [24] E. Voirin, “DUNE Cool Down - CFD Simulation - LAr Sprayers,” tech. rep., Fermilab, 2020.
<https://edms.cern.ch/document/2154410>.
- [25] J. Campbell and Associates, “Report to Fermilab on RFI of May 2021 for LBNF Liquid Argon Supply,” 2023.
- [26] LBNF/DUNE, “LAr Acquisition Plan.” <https://edms.cern.ch/document/2818818>.
- [27] LBNF/DUNE, “Surface Argon Receiving Facilities Performance Specifications.”
<https://edms.cern.ch/document/2211568>.
- [28] LBNF/DUNE, “Distribution Lines with Tie Points and Interfaces.”
<https://edms.cern.ch/document/2778502>.
- [29] LBNF/DUNE, “3D model Cryogenics in CUC, Interconnecting Piping, Circulation pumps in

- DC.” <https://edms.cern.ch/document/2254565>.
- [30] LBNF/DUNE, “LBNF Valve and Instrumentation List .”
<https://edms.cern.ch/document/2248818>.
- [31] LBNF/DUNE, “FD1, FD2, and CUC Cryogenics - Navisworks format only.”
<https://edms.cern.ch/document/2838450>.
- [32] LBNF/DUNE, “LBNF Detector Cavern Relief Header Evaluation.”
<https://edms.cern.ch/document/2154314>.
- [33] LBNF/DUNE, “PSV Calculations.” <https://edms.cern.ch/document/2519457/1>.
- [34] LBNF/DUNE, “GN2 for Cryostat Insulation Scope and Notes.”
<https://edms.cern.ch/document/2771986>.
- [35] LBNF/DUNE, “GN2 Cryostat Insulation Purge sizing.”
<https://edms.cern.ch/document/2771977>.
- [36] LBNF/DUNE, “Cryostat Piping and Instrumentation Diagram.”
https://edms.cern.ch/file/2775007/1/17._F10028334.17_Cryo.pdf.
- [37] LBNF/DUNE, “GN2 supply for cryostat insulation purge.”
<https://edms.cern.ch/document/2227399>.
- [38] LBNF/DUNE, “Xenon injection station scope and notes.”
<https://edms.cern.ch/document/2771736>.
- [39] LBNF/DUNE, “Xenon doping station PFD.” <https://edms.cern.ch/document/2477369/>.
- [40] LBNF/DUNE, “Xenon amount and cost (link requires authorization).”
https://edms.cern.ch/file/2477451/3/Xenon_amount_and_cost.xlsx.
- [41] E. Voirin, “Argon Piston Purge of ProtoDUNE - CFD Simulation,” project doc, 2015.
<https://edms.cern.ch/document/2826472/1>.
- [42] **LBNE** Collaboration, D. Montanari *et al.*, “First Scientific Application of the Membrane Cryostat technology.”
<http://lss.fnal.gov/archive/2013/conf/fermilab-conf-13-076-ppd.pdf>.
- [43] D. Montanari and J. Freitag, “DUNE Cool Down - CFD Simulation.”
<https://edms.cern.ch/document/2154410>.
- [44] LBNF/DUNE, “Avail time for Cryostat pressure recovery from loss of power.”
<https://edms.cern.ch/document/2785497>.
- [45] LBNF/DUNE, “Cost Estimates for pressure control systems in the detector cavern.”

- <https://edms.cern.ch/document/2364392>.
- [46] LBNF/DUNE, “Cryogenics - Cryostat relief valve information.”
<https://edms.cern.ch/document/2153810>.
- [47] **DUNE** Collaboration, B. Abi *et al.*, “Deep Underground Neutrino Experiment (DUNE), Far Detector Technical Design Report, Volume III. DUNE far detector technical coordination,” *JINST* **15** no. 08, (2020) T08009, [arXiv:2002.03008](https://arxiv.org/abs/2002.03008) [physics.ins-det].
- [48] LBNF/DUNE, “Cryogenic Control System.” <https://edms.cern.ch/document/2154307>.
- [49] LBNF/DUNE, “Process Controls Electrical and Mechanical Drawings.”
<https://edms.cern.ch/document/2156486>.
- [50] LBNF/DUNE, “ODH System.” <https://edms.cern.ch/document/2154321>.
- [51] DUNE Collaboration *et al.*, “Design, construction and operation of the ProtoDUNE-SP Liquid Argon TPC,” 2021. <https://arxiv.org/abs/2108.01902>.
- [52] Fermilab, “Fermilab ES&H Manual.”
<https://publicdocs.fnal.gov/cgi-bin/ListBy?topicid=49>.