

---

# AdaWaveNet: Adaptive Wavelet Network for Time Series Analysis

---

Han Yu<sup>1</sup> Peikun Guo<sup>2</sup> Akane Sano<sup>1</sup>

## Abstract

Time series data analysis is a critical component in various domains such as finance, healthcare, and meteorology. Despite the progress in deep learning for time series analysis, there remains a challenge in addressing the non-stationary nature of time series data. Traditional models, which are built on the assumption of constant statistical properties over time, often struggle to capture the temporal dynamics in realistic time series, resulting in bias and error in time series analysis. This paper introduces the Adaptive Wavelet Network (*AdaWaveNet*), a novel approach that employs Adaptive Wavelet Transformation for multi-scale analysis of non-stationary time series data. *AdaWaveNet* designed a lifting scheme-based wavelet decomposition and construction mechanism for adaptive and learnable wavelet transforms, which offers enhanced flexibility and robustness in analysis. We conduct extensive experiments on 10 datasets across 3 different tasks, including forecasting, imputation, and a newly established super-resolution task. The evaluations demonstrate the effectiveness of *AdaWaveNet* over existing methods in all three tasks, which illustrates its potential in various real-world applications.

## 1. Introduction

Time series data, extensively encountered in various domains, including finance, healthcare, and meteorology, require effective analytical methodologies (Esling & Agon, 2012). Therefore, understanding and analyzing time series data has triggered substantial interest in various real-world applications. Recently, the rapid development in deep learning has significantly transformed the landscape of time series analysis. These advancements have facilitated

breakthroughs in various applications, including forecasting (Zhou et al., 2021; 2022b; Wu et al., 2021), imputation (Wu et al., 2022; Xu et al., 2022), and anomaly detection (Blázquez-García et al., 2021; Li & Jung, 2023).

However, even with the promising performances of the aforementioned methods, a notable limitation in this research area is the inadequate focus on the non-stationary nature of time series data. Non-stationarity, with its evolving statistical properties and time-dependent patterns, poses a significant challenge for traditional deep learning models (Hyndman & Athanasopoulos, 2018; Shumway et al., 2017). The dynamic and complex nature of realistic time series data often results in models that are unable to capture these changing patterns effectively, leading to inaccurate predictions and analyses.

To address the non-stationary challenge, recent efforts have aimed to adapt deep learning methods for temporal dynamic analysis (Liu et al., 2022b; 2023b). However, due to the designing basis such as instance-wise normalization and Fourier transform, these methods may lack the adaptability to process multi-scale features and capture the changing temporal dynamics across different signals. Thus, despite the advancements in modeling non-stationary time series data by these methods, there remains a critical need for an approach that combines multi-scale analysis with efficient computational strategies and satisfactory adaptability.

In response to these challenges, this paper introduces a novel approach: the Adaptive Wavelet Network (*AdaWaveNet*). This approach employs Adaptive Wavelet Transformation within an efficient architecture, specifically tailored for multi-scale analysis of non-stationary time series data. Unlike existing wavelet-based methods such as FEDformer (Zhou et al., 2022b), which integrates manually tuned wavelet transformation with a Transformer architecture, *AdaWaveNet* utilizes the lifting scheme (Sweldens, 1998) for adaptive and learnable wavelet transformations, offering a more flexible and robust framework for analyzing time series data.

Our contribution can be summarized as:

- We introduce *AdaWaveNet*, a novel architecture offering an adaptive, multi-scale approach for analyzing non-stationary time series data, enhancing accuracy

---

\*Equal contribution <sup>1</sup>Department of Electrical and Computer Engineering, Rice University, Houston, TX 77005, USA <sup>2</sup>Department of Computer Science, Rice University, Houston, TX 77005, USA. Correspondence to: Han Yu <hy29@rice.edu>, Akane Sano <akane.sano@rice.edu>.

and reliability.

- We establish a new benchmark for super-resolution in the field of time series data. This benchmark aims to enhance the quality of data obtained from under-sampled sequences and improve the overall efficiency and effectiveness of time series data monitoring and analysis.
- Our extensive evaluations demonstrate that *AdaWaveNet* outperforms existing methods in forecasting and super-resolution tasks. These results suggest the capability of the proposed method for diverse real-world applications.

## 2. Related Work

### 2.1. Time Series Analysis with Deep Learning

The evolution of deep learning has significantly impacted temporal modeling and time series analysis. Recurrent neural networks (RNNs), such as those based on Long Short-Term Memory (LSTM) (Hochreiter & Schmidhuber, 1997; Siami-Namini et al., 2019), are designed to capture temporal dependencies through internal states. Multi-Layer Perceptrons (MLPs) (Zeng et al., 2023; Li et al., 2023) have shown effectiveness in temporal modeling by processing point-wise projections of sequences. Convolutional Neural Networks (CNNs) (Lea et al., 2017; Liu et al., 2022a) excel in extracting hierarchical features and detecting complex patterns, leveraging their strength in spatial and temporal data processing. Moreover, the Transformer variants have demonstrated remarkable results in time series applications by capturing long-range dependencies and processing entire sequences efficiently (Zhou et al., 2022b; Liu et al., 2023a; 2022b; Zhang & Yan, 2022). Nevertheless, in real-world applications, these well-proven structures may struggle with non-stationarity in time series data because their learned patterns and dependencies are based on the assumption of consistent statistical properties. On the other hand, most of the realistic temporal data, which is non-stationary with dynamics over time, violates the consistent assumption.

These methods have been developed and applied to various tasks, including forecasting (Zhou et al., 2021; 2022b; Wu et al., 2021), imputation (Wu et al., 2022; Xu et al., 2022), and anomaly detection (Blázquez-García et al., 2021; Li & Jung, 2023). However, the field of super-resolution in time series analysis remains relatively unexplored. This technique, crucial for enhancing signal quality and detail, can significantly benefit sensing applications. For example, in wearable sensors, super-resolution can extend battery life and reduce storage needs by enabling post-processing enhancement of data resolution instead of continuous high-frequency sampling. This approach not only conserves resources but also provides detailed insights for precise

tasks such as health monitoring.

### 2.2. Non-Stationarity-Enhanced Models

Recent developments in time series analysis have started addressing non-stationarity issues (Liu et al., 2022b; Zhou et al., 2022b; Liu et al., 2023b;c). For instance, (Liu et al., 2022b) introduced Non-stationary Transformers with strategies like *Series Stationarization* and *De-stationary Attention* to standardize signal statistics over time. (Zhou et al., 2022b) employed frequency domain-enhanced attentions in Transformers, incorporating Fourier and wavelet transform-based techniques. Additionally, (Liu et al., 2023b) integrated Koopman operator theory for analyzing non-linear dynamical systems by transforming signals into a linear, high-dimensional space. While these methods effectively model stationarity, they exhibit limitations such as the need for manually tuned filters in FEDformer and extensive computations for long-term signals or high-dimensional projections. To overcome these limitations, we propose the Adaptive Wavelet Network (*AdaWaveNet*). This model combines flexibility and efficiency, utilizing adaptive wavelet transforms to naturally address non-stationary challenges in time series data.

## 3. Background

This section reviews the wavelet transform and the lifting scheme (Sweldens, 1998) concepts to provide foundational knowledge essential for understanding the proposed method.

### 3.1. Wavelet Transform

The wavelet transform is a powerful tool for multi-scale signal analysis, capturing both frequency and temporal information. This dual capability is essential for effectively processing non-stationary signals such as audio, images, and various scientific data. Given a signal  $f(x)$ , the wavelet transform decomposes it into the following form:

$$f(x) = \sum_{i,j} \langle f, \psi_{i,j}(x) \rangle \psi(2^i x - j) = \sum_{i,j} c_{i,j} \psi_{i,j}(x) \quad (1)$$

In the equation,  $\psi_{i,j}(x)$  represents the wavelets at different scales  $i$  and translations  $j$ , with  $c = \langle f, \psi(x) \rangle$  denoting the wavelet coefficients. The wavelet transformation provides an extensive capability for analyzing the changing dynamics and non-stationarity inherent in time-series data, surpassing the Fourier transform’s frequency-centric approach. Traditional wavelet bases, such as Haar (Haar, 1909), Daubechies (Daubechies, 1988), and Biorthogonal (Cohen et al., 1992) wavelets, have been widely used in various real-world applications. However, their primary efficacy on periodic signals highlights the ongoing challenge of designing a universally applicable basis for real-world time series data, regardless

of its periodicity.

### 3.2. Lifting Scheme

The lifting scheme, also known as the second-generation wavelet approach, was introduced by (Sweldens, 1998) to enhance the adaptability of wavelet transforms. This method preserves the essential properties of the first-generation wavelets while offering increased flexibility for complex signal processing. It processes an input signal  $x$  to segregate the wavelet transform into the approximation  $c$  and detail  $d$  sub-bands. The scheme comprises three stages: split, update, and predict.

**Split:** The input signal is divided into two non-overlapping components: the even ( $x_e$ ) and odd ( $x_o$ ) components, denoted as  $x_e[n] = x[2n]$  and  $x_o[n] = x[2n + 1]$ .

**Update:** This stage separates the signal in the frequency domain to generate the approximation  $c$ . An update operator  $U(\cdot)$  is applied to a sequence of neighboring odd polyphase samples, yielding  $c[n] = x_e[n] + U(x_o^{L_U}[n])$ .

**Predict:** Given the correlation between  $x_e$  and  $x_o$ , a predictor  $P(\cdot)$  is developed for one partition based on the other. The detail sub-band  $d$ , is computed as the prediction residual  $d[n] = x_o[n] - P(c^{L_P}[n])$ .

The lifting scheme improves the flexibility of wavelet transformations and makes it more suitable for analyzing non-periodic and intricate signals frequently encountered in real-world applications.

## 4. Adaptive Wavelet Network

We propose an Adaptive Wavelet Network (*AdaWaveNet*), which comprises a time series decomposition module, stacked adaptive wavelet (*AdaWave*) blocks based on the lifting scheme (Sweldens, 1998), and a grouped linear module. Figure 1 illustrates the overall framework of our method. We denote the input sequence as  $x_{input} \in \mathbb{R}^{C \times L}$  and the target model output as  $x_{pred} \in \mathbb{R}^{C \times L_p}$ . The target output can represent various terms depending on the task, such as future sequences for the forecasting task or completed signals for the imputation task. The decomposition module processes the time series data into seasonal ( $x_s$ ) and trend ( $x_{trend}$ ) components. The *AdaWave* blocks then transform  $x_s$  into a low-rank approximation  $x_s^l$  and wavelet coefficients  $c_l$  at different levels  $l$ . The channel-wise attention layer models the intermediate  $x_s^l$  across channels to predict the targeted low-rank approximation  $\hat{x}_s^l$ . We reconstruct the predicted seasonal phase  $\hat{x}_s$  from  $c_l$  and  $\hat{x}_s^l$  using inverse adaptive wavelet (*InvAdaWave*) blocks. The trend component  $x_{trend}$  often exhibits alignment issues and discrepancies across variates, and we employ a grouped linear module that applies distinct linear heads to different channel

groups, to enhance the quality of trend phase predictions. The network’s final output is the sum of  $\hat{x}_s$  and  $\hat{x}_{trend}$ .

*AdaWaveNet* offers several advantages, including multi-scale processing to mitigate non-stationary issues and a data-driven approach to learn wavelet coefficients through the lifting scheme adaptively. This adaptability is a key aspect of our proposed method. Additionally, the *AdaWave* and *InvAdaWave* blocks, based on convolutional layers, provide computational efficiency compared to the prior self-attention-based implementation of the wavelet transform (Zhou et al., 2022b). The grouped linear module further improves the modeling of the trend component, taking into account the discrepancies across channels or signal variates.

In the following subsections, we detail the proposed blocks, including the time series decomposition, *AdaWaveNet*, and Grouped Linear Module.

### 4.1. Time Series Decomposition

We use the additive time series decomposition method (Hamilton, 2020) to separate the time series sequences into their seasonal and trend components:

$$x_{input} = x_s + x_{trend} \quad (2)$$

The trend component ( $x_{trend}$ ) represents the long-term progression of the series, capturing directional movements over extended periods, while the seasonal component ( $x_s$ ) reflects systematic patterns observed within a fixed timeframe. We consider this decomposition as the first step in our multi-scale analysis framework.

### 4.2. Adaptive Wavelet Block

Given the seasonal component  $x_s$  of a time series, we apply a Lifting Wavelet Transform (LWT) using Convolutional Neural Networks (CNNs) to refine features at various levels of granularity iteratively. These processes transform the seasonal component at level  $l - 1$  into a more refined level  $l$ , denoted as  $x_s^l$ , and generate the corresponding detail coefficients,  $c^l$ .

**Splitting Step:** The input  $x_s^{l-1}$  (initially  $x_s^0 = x_s$ ) is split into odd and even indexed components:

$$e^l = x_s^{l-1}[2i] \quad \forall i \in \mathbb{N} \quad (3)$$

$$o^l = x_s^{l-1}[2i + 1] \quad \forall i \in \mathbb{N} \quad (4)$$

**Convolutional Kernel-based Prediction and Update Steps:** Inspired by (Huang & Fang, 2021), we employ convolution operations as the wavelet filters in each split subset to extract approximations and coefficients. The learnable 1D convolution kernels are considered the ideal basis of the lifting scheme in our study. This operation can be represented

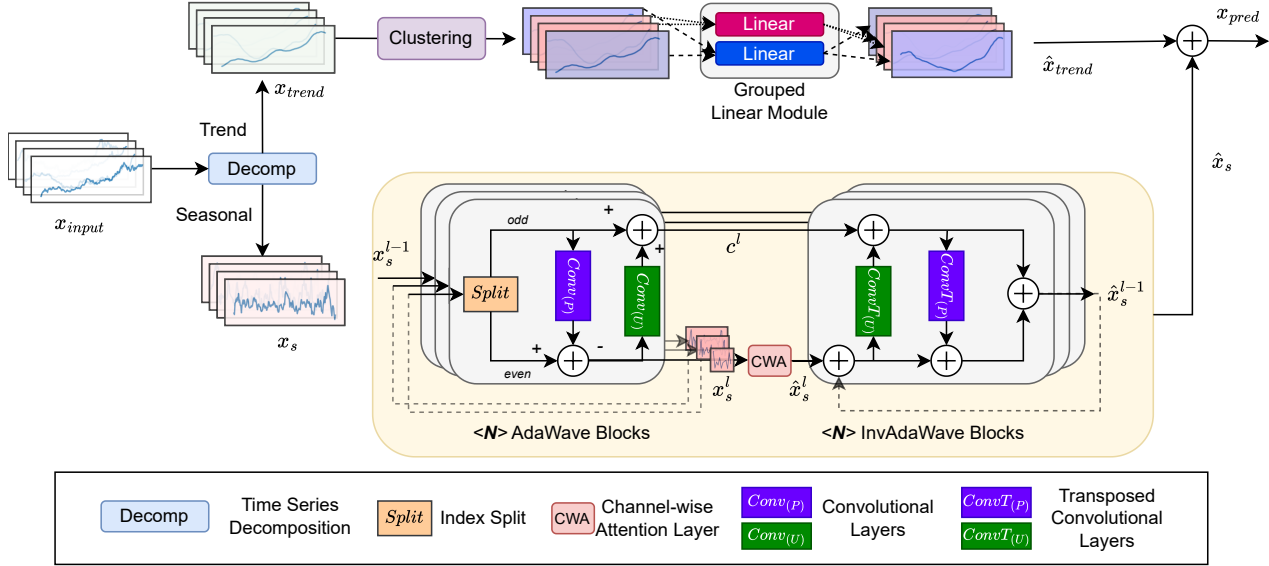

Figure 1. Illustration of the *AdaWaveNet* framework for time series analysis. The input sequence  $x_{input}$  undergoes decomposition into trend ( $x_{trend}$ ) and seasonal ( $x_s$ ) components. The trend component is processed through a clustering algorithm followed by a grouped linear module to produce a refined trend prediction  $\hat{x}_{trend}$ . Concurrently, the seasonal component is processed through stacked *AdaWave* blocks, employing index splitting, convolutional layers, and a channel-wise attention layer to capture multi-scale features and generate a low-rank approximation  $\hat{x}_s^l$ . This is followed by inverse *AdaWave* blocks that reconstruct the seasonal prediction  $\hat{x}_s$ . The final predicted output  $x_{pred}$  is obtained by summing the predicted seasonal and trend components.

as:

$$e^l = \sigma(\mathbf{W}_e^l * e^l + b_e^l) \quad (5)$$

$$o^l = \sigma(\mathbf{W}_o^l * o^l + b_o^l) \quad (6)$$

where  $*$  denotes the convolution operation,  $\mathbf{W}_e^l$  and  $\mathbf{W}_o^l$  are the convolutional filter weights, and  $b_e^l$  and  $b_o^l$  are the biases for the even and odd components at level  $l$ , respectively.

In the prediction step, we use the even indexed components to estimate the odd indexed components. This is because, in many signals, there is a smooth transition between consecutive samples. The prediction step aims to estimate the finer details of the signal (odd indexed components) using a smoothed version (even indexed components), thus capturing the high-frequency variations by computing the detail coefficients  $c^l$ :

$$c^l = o^l - \sigma(\mathbf{W}_p^l * e^l + b_p^l) \quad (7)$$

Then, the update step utilizes these detail coefficients to refine the even indexed components:

$$e^l = e^l + \sigma(\mathbf{W}_u^l * c^l + b_u^l) \quad (8)$$

These steps iteratively improve the signal representation in capturing the overall trend and the intricate details within the data.

Then the approximation of  $x_s$  at level  $l$  can be calculated by summing even indexed components and the detail coefficients, which is also known as the combining step:

$$x_s^l = e^l + c^l \quad (9)$$

### 4.3. Channel-wise Attention for Approximation Projection

To enhance the feature representation of the seasonal component  $x_s^l$  specifically at the final level of the *AdaWave* blocks, a self-attention (SA) mechanism is employed, inspired by (Liu et al., 2023a). The self-attention structure is applied to  $x_s^N$ , where  $N$  denotes the final level of decomposition. This computation after the last layer of decomposition ensures efficient and focused refinement of the feature map of the low rank approximation of the seasonal component, as the length of the sequences after  $N$  blocks of *AdaWave* blocks becomes  $(L/(2^N))$ . The channel-wise attention mechanism operates on the channels of  $x_s^N$  to refine its approximation, to project the processed seasonal component onto the targeted sequences as  $\hat{x}_s^N$ . Importantly, during this process, the detail coefficients ( $c^N$ ) remain unchanged.

Focusing the channel-wise attention mechanism at the final decomposition layer is both computationally efficient and effective in capturing the essential characteristics of the time series. It allows the model to emphasize the global contextual information, which is crucial for the accurate

representation of the seasonal component in complex time series data.

#### 4.4. Inverse Adaptive Wavelet Blocks

To reconstruct the original seasonal component  $\hat{x}_s$  from its refined representation  $\hat{x}_s^l$  obtained after predicted approximation  $\hat{x}_s^N$ , we utilize an inverse process facilitated by Convolutional Transpose Networks. This inverse procedure employs transposed convolutional layers to upscale the feature maps and merge the detail coefficients with the upsampled seasonal components iteratively.

The inverse of the combining step involves an element-wise subtraction of the detail coefficients from the seasonal component at the current level  $l$ :

$$e^l = \hat{x}_s^l - c^l \quad (10)$$

**Inverse Update and Prediction Steps:** The transposed convolution operations are applied to refine the split components and to estimate the original even indexed components:

$$e^l = e^l - \sigma(\mathbf{W}_u^{l,T} * c^l + b_u^{l,T}) \quad (11)$$

The original odd indexed components are reconstructed by adding the predicted detail coefficients:

$$o^l = c^l + \sigma(\mathbf{W}_p^{l,T} * e^l + b_p^{l,T}) \quad (12)$$

where  $\mathbf{W}_u^{l,T}$  and  $\mathbf{W}_p^{l,T}$  denote the transposed convolutional filter weights, and  $b_u^{l,T}$  and  $b_p^{l,T}$  are the corresponding biases for the inverse update and prediction operations, respectively.

Finally, the odd and even indexed components are interleaved to reconstruct the seasonal component at the previous level  $l - 1$ :

$$\hat{x}_s^{l-1}[2i] = e^l \quad (13)$$

$$\hat{x}_s^{l-1}[2i + 1] = o^l \quad \forall i \in \mathbb{N} \quad (14)$$

#### 4.5. Grouped Linear Module

We process the trend component  $x_{trend}$  using a two-step approach: clustering the channels and applying distinct linear projections based on the clustering labels. This method effectively captures and models the long-term progression of the trend component.

Initially, the channels of  $x_{trend}$  are subjected to a clustering algorithm, specifically K-means, to identify patterns and group similar channels together. This step is useful for discerning underlying structures within the trend data that might be indicative of different regimes or states across variates.

Following the clustering, each group of channels undergoes a separate linear transformation. This step ensures that

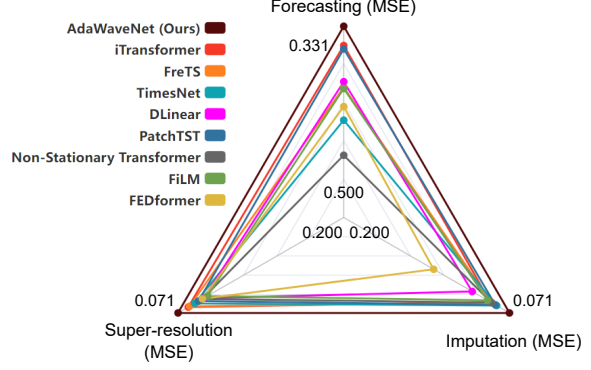

Figure 2. Comparison of model performances in three tasks including forecasting, imputation, and super-resolution.

the model can apply tailored transformations to different segments of the trend data, potentially corresponding to different behaviors or patterns within the time series.

This dual approach of clustering followed by grouped linear transformations is particularly effective in dealing with complex time series data. By initially segmenting the trend component into clusters, the model can recognize and adapt to different underlying patterns. Subsequent application of distinct linear transformations to each cluster further refines the model’s ability to represent and forecast the trend component accurately, catering to its multifaceted nature.

## 5. Experiments

To evaluate the proposed *AdaWaveNet*, we conduct experiments on different time series analysis tasks, including forecasting, imputation, and the newly proposed super-resolution tasks.

*AdaWaveNet* is extensively benchmarked against established models from recent literature. For models related to wavelet and frequency domain enhancements, comparisons include FreTS (Yi et al., 2023), FiLM (Zhou et al., 2022a), TimesNet (Wu et al., 2022), and FEDformer (Zhou et al., 2022b). Additionally, models previously recognized for state-of-the-art (SOTA) performances, such as iTransformer (Liu et al., 2023a), DLinear (Zeng et al., 2023), and PatchTST (Nie et al., 2022), are included as experimental baselines. The Non-stationary Transformer (Stationary) (Liu et al., 2022b), known for addressing non-stationary issues in time series, is also featured for comparison.

Figure 2 presents the aggregated results across forecasting, imputation, and super-resolution tasks. The results indicate that our proposed *AdaWaveNet* method achieves SOTA performance in all three areas of time series analysis.

Table 1. Forecasting task. The prediction lengths for all datasets are established at {96, 192, 336, 720}, with the past sequence length matching the prediction lengths. This table displays the averaged outcomes of predictions across each dataset. Evaluation metrics include Mean Squared Error (MSE) and Mean Absolute Error (MAE). The lowest MSE is indicated in bold red, while the second lowest is underlined in blue. See Table 7 in the Appendix for the full results.

Model (Year)	AdaWaveNet (Ours)		iTransformer (2023a)		FreTS (2023)		TimesNet (2022)		DLinear (2023)		PatchTST (2022)		Stationary (2022b)		FiLM (2022a)		FEDformer (2022b)	
	MSE	MAE	MSE	MAE	MSE	MAE	MSE	MAE	MSE	MAE	MSE	MAE	MSE	MAE	MSE	MAE	MSE	MAE
ECL	<b>0.168</b>	<b>0.267</b>	<u>0.171</u>	<u>0.269</u>	0.195	0.287	0.190	0.294	0.190	0.289	0.181	0.278	0.195	0.298	0.309	0.394	0.217	0.333
Weather	<b>0.233</b>	<b>0.271</b>	0.243	0.276	<u>0.238</u>	0.292	0.264	0.293	0.251	0.303	0.241	<u>0.276</u>	0.294	0.311	0.253	0.283	0.293	0.356
Traffic	<u>0.415</u>	<u>0.288</u>	<b>0.410</b>	<b>0.285</b>	0.528	0.341	0.605	0.329	0.641	0.379	0.562	0.370	0.627	0.354	0.510	0.328	0.596	0.372
Exchange	<u>0.481</u>	<u>0.453</u>	0.513	0.458	0.612	0.527	0.655	0.543	0.508	0.479	<b>0.438</b>	<b>0.435</b>	0.600	0.524	0.498	0.501	0.600	0.540
Solar	<b>0.209</b>	<b>0.262</b>	<u>0.218</u>	0.271	0.234	0.294	0.244	0.286	0.264	0.331	0.217	0.271	0.223	<u>0.263</u>	0.291	0.302	0.248	0.349
ETTh1	0.444	<b>0.441</b>	0.493	0.481	0.496	0.489	0.545	0.514	<b>0.436</b>	0.459	0.444	0.439	0.659	0.566	0.448	<u>0.446</u>	<u>0.437</u>	0.455
ETTm1	<b>0.369</b>	<u>0.390</u>	0.385	0.405	0.392	0.409	0.396	0.414	<u>0.369</u>	<b>0.387</b>	0.374	0.394	0.515	0.472	0.397	0.408	0.424	0.439

## 5.1. Time Series Forecasting

Forecasting is one of the essential in time series applications such as weather, traffic, exchange rate, etc. In this section, we conduct extensive experiments to evaluate the forecasting performance of the proposed *AdaWaveNet* on varying-domain datasets. Following prior studies such as iTransformer (Liu et al., 2023a) and TimesNet (Wu et al., 2022), we adopt a long-term forecasting setting with datasets including traffic, electricity (ECL), exchange rate, weather, solar energy, and electricity transformer temperature (ETT). For each dataset, we set the predicting length  $L_p$  with {96, 192, 336, 720} with the inputting observation length equal to the predicting length.

The performances of evaluations are shown in table 7. The proposed *AdaWaveNet* achieves promising performances in both MSE and MAE across various datasets. In particular, compared to the prior frequency domain-enhanced methods, *AdaWaveNet* outperforms 7.7% in MSE and 6.2% in MAE when compared to the best performances in all these methods. For the SOTA methods such as iTransformer (Liu et al., 2023a) and PatchTST (Nie et al., 2022), the evaluation results also suggest that our proposed method outperforms them in the forecasting task.

## 5.2. Time Series Imputation

Even though the importance of time series data, the robustness of continuous observation and monitoring might not be guaranteed in some cases. For example, factors such as the malfunction of the devices and interference of signals can all trigger data quality issues, e.g., missingness of observation. Therefore, in this study, we also investigate the capability of the proposed method in time series imputation task. Following the evaluation strategy as (Wu et al., 2022), we conduct extensive experiments on the datasets with controlled masking rates under a random missing setting. We further extend the experimental strategy by introducing the extended missingness. In (Wu et al., 2022), the missingness was crafted by randomly masking timestamps with a certain ratio; whereas the extended missingness masks sub-

sequences of the original signals across all channels. Refer to Appendix A.2 for the descriptions of two masking methods. In this experiment, we examine the proposed method and the baselines on the weather and electricity data. Also, considering the common missingness of sensing data of the wearable sensors (Xu et al., 2022), the experiments cover biobehavioral datasets, including 12-lead electrocardiogram (ECG) from the PTB-XL dataset (Wagner et al., 2020), and electroencephalogram (EEG) from the Sleep-EDFE dataset (Kemp et al., 2000).

Table 2 shows the averaged imputation performance for each dataset. The observed results show the two different masking strategies make different levels of challenges upon the imputation tasks. The extended masking task introduces larger errors for all the models. For both imputations, our proposed method shows competitive performances on the PTB-XL and Sleep-EDFE datasets, where the sequence lengths are significantly longer than the ECL and weather datasets. TimesNet (Wu et al., 2022) outperforms all the other models in ECL and Weather random imputation tasks; whereas *AdaWaveNet* shows substantial improvement compared to the other baselines on ECL and Weather data for the random masked imputation task. Visualization of imputed examples can be found in Appendix C.2.

## 5.3. Time Series Super-resolution

This study introduces a benchmark for super-resolution in time series data, which can be crucial for enhancing the detail and quality of data, especially when dealing with under-sampled or low-resolution datasets. We conduct the super-resolution experiments on the dataset of ETT, traffic, ECG (PTB-XL), EEG (Sleep-EDFE), and electrodermal activity (EDA) in the CLAS dataset (Markova et al., 2019). Under this scenario, the objective of the super-resolution task is to reconstruct the original signal from the down-sampled low-resolution version, which involves increasing the sampling granularities in ratios of {2, 5, 10}, e.g. reconstructing 100 Hz ECG signals from {10, 20, 50} Hz.

Table 3 shows the evaluation results for the super-resolution

Table 2. Imputation task. Experiments are conducted on two types of imputation - random and extended. In each case, we mask {12.5%, 25%, 37.5%, 50%} of time points or segments randomly from the original sequences. For the ECL and Weather datasets, sequence lengths are set to 96, while for the PTB-XL and Sleep-EDFE datasets, the lengths are 1000 and 3000, respectively. Evaluation metrics include Mean Squared Error (MSE) and Mean Absolute Error (MAE), with results being averages over 4 different masking ratios. The lowest MSE is marked in bold red, and the second lowest is underlined in blue. Refer to Table 8 in Appendix for the full results.

Model (Year)	AdaWaveNet (Ours)		iTransformer (2023a)		FreTS (2023)		TimesNet (2022)		DLinear (2023)		PatchTST (2022)		Stationary (2022b)		FiLM (2022a)		FEDformer (2022b)		
Metrics	MSE	MAE	MSE	MAE	MSE	MAE	MSE	MAE	MSE	MAE	MSE	MAE	MSE	MAE	MSE	MAE	MSE	MAE	
Random	ECL	0.100	<u>0.215</u>	0.117	0.245	0.121	0.239	<b>0.095</b>	<b>0.212</b>	0.138	0.313	<u>0.099</u>	0.221	0.100	0.218	0.112	0.240	0.130	0.260
	Weather	0.047	0.091	0.050	0.097	0.050	0.098	<b>0.030</b>	<b>0.054</b>	0.053	0.110	0.044	0.087	<u>0.032</u>	<u>0.059</u>	0.050	0.100	0.099	0.203
	PTB-XL	<b>0.029</b>	<b>0.041</b>	0.053	0.063	0.046	0.059	<u>0.033</u>	<u>0.045</u>	0.058	0.069	0.040	0.052	0.039	0.051	0.045	0.057	0.063	0.077
	Sleep-EDFE	<b>0.034</b>	<b>0.045</b>	0.047	0.059	<u>0.043</u>	0.056	0.047	0.065	0.051	0.066	0.045	<u>0.055</u>	0.064	0.079	0.049	0.063	0.062	0.080
Extended	ECL	<b>0.112</b>	<b>0.218</b>	<u>0.127</u>	<u>0.229</u>	0.146	0.240	0.128	0.235	0.172	0.266	0.147	0.247	0.128	0.237	0.140	0.239	0.161	0.270
	Weather	<b>0.089</b>	0.136	0.094	<u>0.132</u>	0.101	0.150	0.129	0.169	0.106	0.160	<b>0.092</b>	<b>0.129</b>	0.106	0.162	0.110	0.157	0.164	0.219
	PTB-XL	<b>0.069</b>	<b>0.088</b>	0.088	0.107	0.078	0.106	<u>0.076</u>	0.100	0.094	0.123	0.086	0.104	0.078	<u>0.099</u>	0.083	0.105	0.097	0.121
	Sleep-EDFE	<b>0.090</b>	<b>0.118</b>	0.114	0.150	<u>0.097</u>	<u>0.127</u>	0.114	0.146	0.128	0.172	0.102	0.128	0.130	0.172	0.112	0.148	0.125	0.172

Table 3. Super-resolution task. Super-resolution upsampling ratios are set at {2, 5, 10}. This table presents averaged values across these ratios for each dataset. Experimentally, sequence lengths are fixed at 200 for ETTm1, ETTh1, and Traffic datasets, and at 1000, 3000, and 960 for PTB-XL, Sleep-EDFE, and CLAS datasets, respectively. Evaluation metrics include Mean Squared Error (MSE) and Mean Absolute Error (MAE), with all results being averages over 4 masking ratios. The lowest MSE is highlighted in bold red, while the second lowest is underlined in blue. Refer to Table 9 in the Appendix for comprehensive results.

Model (Year)	AdaWaveNet (Ours)		iTransformer (2023a)		FreTS (2023)		TimesNet (2022)		DLinear (2023)		PatchTST (2022)		Stationary (2022b)		FiLM (2022a)		FEDformer (2022b)	
Metrics	MSE	MAE	MSE	MAE	MSE	MAE	MSE	MAE	MSE	MAE	MSE	MAE	MSE	MAE	MSE	MAE	MSE	MAE
ETTm1	<b>0.036</b>	<b>0.112</b>	0.041	0.127	0.047	0.132	<u>0.040</u>	<u>0.118</u>	0.067	0.159	0.056	0.146	0.044	0.129	0.056	0.143	0.058	0.152
ETTh1	<b>0.103</b>	<b>0.192</b>	0.118	0.209	0.111	0.201	0.113	0.205	0.131	0.223	<u>0.103</u>	<u>0.197</u>	0.112	0.209	0.115	0.205		
Traffic	<b>0.213</b>	<b>0.191</b>	<u>0.217</u>	<u>0.194</u>	0.235	0.213	0.248	0.223	0.245	0.226	0.227	0.201	0.268	0.250	0.280	0.263	0.258	0.237
PTB-XL	<u>0.019</u>	<u>0.028</u>	0.021	0.031	0.020	0.029	<b>0.017</b>	<b>0.026</b>	0.026	0.040	0.031	0.042	0.026	0.041	0.022	0.032	0.022	0.034
Sleep-EDFE	<b>0.020</b>	<b>0.144</b>	0.031	0.162	<u>0.026</u>	<u>0.154</u>	0.035	0.173	0.035	0.174	0.037	0.177	0.047	0.187	0.037	0.175	0.043	0.186
CLAS	<b>0.034</b>	<b>0.076</b>	0.046	0.087	0.042	<u>0.083</u>	0.048	0.096	<u>0.039</u>	0.085	0.053	0.104	0.052	0.093	0.053	0.106	0.043	0.087

task. The proposed method shows competitive results compared to the baseline methods, especially on datasets such as Traffic, Sleep-EDFE, and CLAS. We credit the observed improvement to the multi-scale analysis inside the model architecture. In this experiment, we find the frequency domain enhanced method including FreTS, TimesNet, and FEDformer generally provides better results in strongly periodic data. For example, the first three places of averaged super-resolution reconstruction performances on ECG signals in PTB-XL dataset are TimesNet, *AdaWaveNet*, and FreTS, respectively. The channel-wise attention also brings advantages to models, such as *AdaWaveNet* and iTransformer, in reconstructing the high-dimensional traffic data.

## 6. Discussion

In this section, we discuss the model ablations and efficiency. Also, we showcase an example of the multi-scale analysis performed by the proposed method. The discussion of the potential limitations of the proposed method can be found in Appendix D.

### 6.1. Ablation Study

An ablation study was conducted to assess the contribution of individual components within the proposed *AdaWaveNet* framework to its overall performance. This involved evaluating the model on forecasting tasks and extended imputation tasks with the omission of specific components: the Grouped Linear Module, reversible instance normalization (RevIn) as described by (Kim et al., 2021), channel-wise Attention inspired by (Liu et al., 2023a), and the *AdaWaveNet* and *InvAdaWaveNet* blocks. The results are presented in Table 4, which indicates that the AWB component significantly enhances performance on the ECL and PTB-XL datasets for imputation tasks. Meanwhile, CWA shows notable efficacy in forecasting tasks. The GL module also demonstrates improved results on the PTB-XL dataset during imputation.

Table 4. The averaged results of model ablation with mean squared error as the evaluation metric. "GL" denotes the Grouped Linear module, "CWA" indicates Channel-wise Attention, and "AWB" signifies the *AdaWave* component. Tasks are marked as (F) for forecasting and (I) for extended imputation. The highest MSE is highlighted in bold red, while the second highest is underlined in blue. Refer to Table 10 in the Appendix for comprehensive results.

w/o	-	GL	RevIN	CWA	AWB
Weather (F)	0.233	0.240	0.246	<b>0.256</b>	<u>0.255</u>
Traffic (F)	0.415	0.425	0.422	<b>0.519</b>	<u>0.473</u>
ECL (I)	0.112	0.115	0.117	<u>0.122</u>	<b>0.131</b>
PTB-XL (I)	0.069	<u>0.080</u>	0.070	0.069	<b>0.082</b>

tation tasks with the omission of specific components: the Grouped Linear Module, reversible instance normalization (RevIn) as described by (Kim et al., 2021), channel-wise Attention inspired by (Liu et al., 2023a), and the *AdaWaveNet* and *InvAdaWaveNet* blocks. The results are presented in Table 4, which indicates that the AWB component significantly enhances performance on the ECL and PTB-XL datasets for imputation tasks. Meanwhile, CWA shows notable efficacy in forecasting tasks. The GL module also demonstrates improved results on the PTB-XL dataset during imputation.

### 6.2. Efficiency Analysis

Efficiency is one of the important concerns in time series analysis. Therefore, we evaluate the efficiency of the pro-

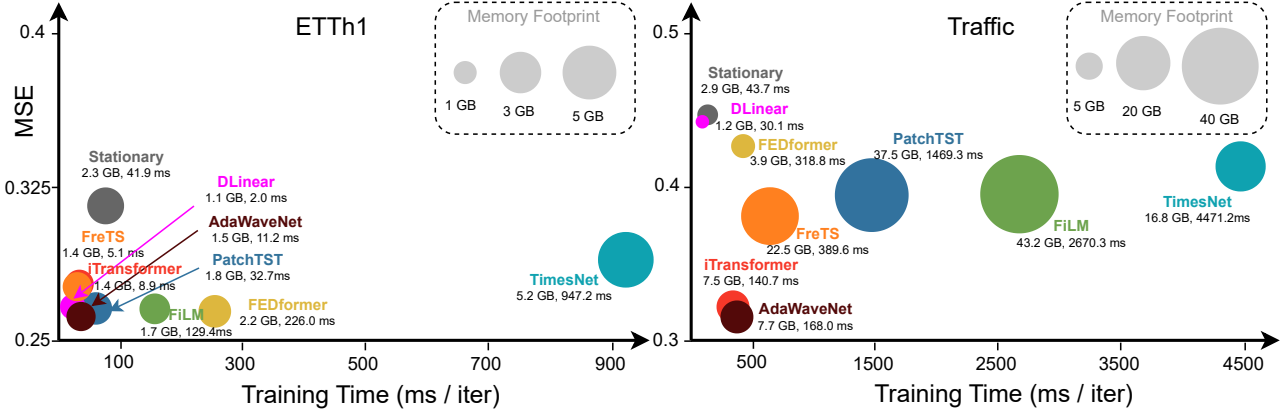

Figure 3. Comparison of model efficiency on the ETTh1 and Traffic datasets. The y-axis represents the averaged mean squared error performances across the forecasting and super-resolution tasks; whereas the x-axis represents the model training time for each iteration. The input length is 192 with a batch size of 16.

posed method and compare the results with all the baseline models we used in the main experiments. Controlling the input length of the sequences as 96 time points, we select the data samples from the ETTh1 and Traffic sets, as they have the least (7) and the most (862) numbers of variates. The environment used in this evaluation is AWS g5 instances with *Nvidia A10* GPUs. The batch size is fixed as 16. Following the previous studies (Wu et al., 2022; Liu et al., 2023a), we evaluate the efficiency of the models in aspects of performances (MSE), training speed, and memory footprints.

The comparison results shown in Figure 3 illustrate that *AdaWaveNet* achieves state-of-the-art performance while maintaining reasonable model efficiency. The *DLinear* model exhibits the smallest memory footprint and fastest training time among the evaluated models. *AdaWaveNet* demonstrates comparable training speed and memory usage to the *iTransformer*; while achieving significant savings in memory and training time compared to established approaches such as *PatchTST*.

### 6.3. Wavelet Decomposition

Figure 4 illustrates the wavelet decomposition process employed by *AdaWaveNet* in a time series forecasting task. The decomposition splits the seasonal component into layers of approximations and detail coefficients. A channel-wise attention mechanism is then applied to forecast future sequence approximations. Each decomposition level incorporates a residual connection that integrates the reconstructed signals from the *InvAdaWave* blocks. This example illustrates the multi-scale analytical capability of the proposed method, which enables the model to extract features across various granularities. Moreover, the adaptability of the model allows the *AdaWave* and *InvAdaWave* blocks to adjust depending on the data.

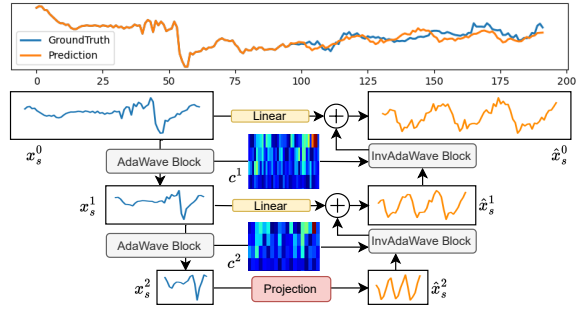

Figure 4. An example of the wavelet decomposition and projection in time series forecasting on ETTh1 data with two layers of *AdaWave* and *InvAdaWave* blocks.  $x_s^l$  and  $\hat{x}_s^l$  represents the the approximation at wavelet level  $l$  of the input and target sequences, respectively.  $c$  is the wavelet coefficients decomposed by the *AdaWave* blocks.

## 7. Conclusion and Future Work

This paper presented *AdaWaveNet*, a novel and efficient architecture for addressing the challenges of non-stationarity in time series data analysis. Through the integration of adaptive wavelet transformations, *AdaWaveNet* demonstrates the advantages of modeling multi-scale data representations in time series data. Our extensive experiments are conducted on 10 datasets for forecasting, imputation, and the newly established super-resolution tasks, and the results indicate the effectiveness of our approach.

Future efforts will focus on exploring and expanding *AdaWaveNet* and its multi-scale analysis framework to a broader range of tasks, such as classification and anomaly detection. Also, we aim to explore the possibility of using multi-scale analysis in large-scale pre-training models.



## Impact Statements

This paper introduces *AdaWaveNet*, a novel approach for analyzing non-stationary time series data, with potential applications across various areas including finance, healthcare, weather, and more. While the primary aim is to advance the field of machine learning, it is important to consider the broader societal implications of this work. The ability of *AdaWaveNet* to accurately forecast, impute, and enhance the resolution of time series data could have significant impacts. In healthcare, for instance, improved prediction models could lead to better patient outcomes through early detection of anomalies in physiological data. In meteorology, more accurate weather forecasting could aid in disaster preparedness, potentially saving lives and resources.

However, the deployment of such machine learning models also raises ethical considerations. The accuracy and reliability of predictions depend heavily on the quality and representativeness of the data, which must be sourced responsibly to avoid biases.

In conclusion, while *AdaWaveNet* presents opportunities for positive societal impact through improved data analysis capabilities, it is crucial to proceed with mindfulness regarding data ethics, privacy, and the potential for unintended consequences.

## Acknowledgement

### References

- Asuncion, A. and Newman, D. Uci machine learning repository, 2007.
- Blázquez-García, A., Conde, A., Mori, U., and Lozano, J. A. A review on outlier/anomaly detection in time series data. *ACM Computing Surveys (CSUR)*, 54(3):1–33, 2021.
- Cohen, A., Daubechies, I., and Feauveau, J.-C. Biorthogonal bases of compactly supported wavelets. *Communications on pure and applied mathematics*, 45(5):485–560, 1992.
- Daubechies, I. Orthonormal bases of compactly supported wavelets. *Communications on pure and applied mathematics*, 41(7):909–996, 1988.
- Esling, P. and Agon, C. Time-series data mining. *ACM Computing Surveys (CSUR)*, 45(1):1–34, 2012.
- Haar, A. *Zur theorie der orthogonalen funktionensysteme*. Georg-August-Universitat, Gottingen., 1909.
- Hamilton, J. D. *Time series analysis*. Princeton university press, 2020.
- Hochreiter, S. and Schmidhuber, J. Long short-term memory. *Neural computation*, 9(8):1735–1780, 1997.
- Huang, H. and Fang, Y. Adaptive wavelet transformer network for 3d shape representation learning. In *International Conference on Learning Representations*, 2021.
- Hyndman, R. J. and Athanasopoulos, G. *Forecasting: principles and practice*. OTexts, 2018.
- Kemp, B., Zwinderman, A. H., Tuk, B., Kamphuisen, H. A., and Obery, J. J. Analysis of a sleep-dependent neuronal feedback loop: the slow-wave microcontinuity of the eeg. *IEEE Transactions on Biomedical Engineering*, 47(9):1185–1194, 2000.
- Kim, T., Kim, J., Tae, Y., Park, C., Choi, J.-H., and Choo, J. Reversible instance normalization for accurate time-series forecasting against distribution shift. In *International Conference on Learning Representations*, 2021.
- Lai, G., Chang, W.-C., Yang, Y., and Liu, H. Modeling long-and short-term temporal patterns with deep neural networks. In *The 41st international ACM SIGIR conference on research & development in information retrieval*, pp. 95–104, 2018.
- Lea, C., Flynn, M. D., Vidal, R., Reiter, A., and Hager, G. D. Temporal convolutional networks for action segmentation and detection. In *proceedings of the IEEE Conference on Computer Vision and Pattern Recognition*, pp. 156–165, 2017.
- Li, G. and Jung, J. J. Deep learning for anomaly detection in multivariate time series: Approaches, applications, and challenges. *Information Fusion*, 91:93–102, 2023.
- Li, Z., Qi, S., Li, Y., and Xu, Z. Revisiting long-term time series forecasting: An investigation on linear mapping. *arXiv preprint arXiv:2305.10721*, 2023.
- Liu, M., Zeng, A., Chen, M., Xu, Z., Lai, Q., Ma, L., and Xu, Q. Scinet: Time series modeling and forecasting with sample convolution and interaction. *Advances in Neural Information Processing Systems*, 35:5816–5828, 2022a.
- Liu, Y., Wu, H., Wang, J., and Long, M. Non-stationary transformers: Exploring the stationarity in time series forecasting. *Advances in Neural Information Processing Systems*, 35:9881–9893, 2022b.
- Liu, Y., Hu, T., Zhang, H., Wu, H., Wang, S., Ma, L., and Long, M. itransformer: Inverted transformers are effective for time series forecasting. *arXiv preprint arXiv:2310.06625*, 2023a.
- Liu, Y., Li, C., Wang, J., and Long, M. Koopa: Learning non-stationary time series dynamics with koopman predictors. *arXiv preprint arXiv:2305.18803*, 2023b.

- Liu, Z., Cheng, M., Li, Z., Huang, Z., Liu, Q., Xie, Y., and Chen, E. Adaptive normalization for non-stationary time series forecasting: A temporal slice perspective. In *Thirty-seventh Conference on Neural Information Processing Systems*, 2023c.
- Markova, V., Ganchev, T., and Kalinkov, K. Clas: A database for cognitive load, affect and stress recognition. In *2019 International Conference on Biomedical Innovations and Applications (BIA)*, pp. 1–4. IEEE, 2019.
- Nie, Y., Nguyen, N. H., Sinthong, P., and Kalagnanam, J. A time series is worth 64 words: Long-term forecasting with transformers. *arXiv preprint arXiv:2211.14730*, 2022.
- Shumway, R. H., Stoffer, D. S., and Stoffer, D. S. *Time series analysis and its applications*, volume 3. Springer, 2017.
- Siami-Namini, S., Tavakoli, N., and Namin, A. S. The performance of lstm and bilstm in forecasting time series. In *2019 IEEE International conference on big data (Big Data)*, pp. 3285–3292. IEEE, 2019.
- Supratak, A. and Guo, Y. Tinsleepnet: An efficient deep learning model for sleep stage scoring based on raw single-channel eeg. In *2020 42nd Annual International Conference of the IEEE Engineering in Medicine & Biology Society (EMBC)*, pp. 641–644. IEEE, 2020.
- Sweldens, W. The lifting scheme: A construction of second generation wavelets. *SIAM journal on mathematical analysis*, 29(2):511–546, 1998.
- Wagner, P., Strodthoff, N., Bousseljot, R.-D., Kreiseler, D., Lunze, F. I., Samek, W., and Schaeffter, T. Ptb-xl, a large publicly available electrocardiography dataset. *Scientific data*, 7(1):154, 2020.
- Wetterstation. Weather, 2020.
- Wu, H., Xu, J., Wang, J., and Long, M. Autoformer: Decomposition transformers with auto-correlation for long-term series forecasting. *Advances in Neural Information Processing Systems*, 34:22419–22430, 2021.
- Wu, H., Hu, T., Liu, Y., Zhou, H., Wang, J., and Long, M. Timesnet: Temporal 2d-variation modeling for general time series analysis. *arXiv preprint arXiv:2210.02186*, 2022.
- Xu, M., Moreno, A., Nagesh, S., Aydemir, V., Wetter, D., Kumar, S., and Rehg, J. M. Pulseimpute: A novel benchmark task for pulsative physiological signal imputation. *Advances in Neural Information Processing Systems*, 35: 26874–26888, 2022.
- Yi, K., Zhang, Q., Fan, W., Wang, S., Wang, P., He, H., Lian, D., An, N., Cao, L., and Niu, Z. Frequency-domain mlps are more effective learners in time series forecasting. *arXiv preprint arXiv:2311.06184*, 2023.
- Zeng, A., Chen, M., Zhang, L., and Xu, Q. Are transformers effective for time series forecasting? In *Proceedings of the AAAI conference on artificial intelligence*, volume 37, pp. 11121–11128, 2023.
- Zhang, Y. and Yan, J. Crossformer: Transformer utilizing cross-dimension dependency for multivariate time series forecasting. In *The Eleventh International Conference on Learning Representations*, 2022.
- Zhou, H., Zhang, S., Peng, J., Zhang, S., Li, J., Xiong, H., and Zhang, W. Informer: Beyond efficient transformer for long sequence time-series forecasting. In *Proceedings of the AAAI conference on artificial intelligence*, volume 35, pp. 11106–11115, 2021.
- Zhou, T., Ma, Z., Wen, Q., Sun, L., Yao, T., Yin, W., Jin, R., et al. Film: Frequency improved legendre memory model for long-term time series forecasting. *Advances in Neural Information Processing Systems*, 35:12677–12690, 2022a.
- Zhou, T., Ma, Z., Wen, Q., Wang, X., Sun, L., and Jin, R. Fedformer: Frequency enhanced decomposed transformer for long-term series forecasting. In *International Conference on Machine Learning*, pp. 27268–27286. PMLR, 2022b.

Table 5. Details of datasets used in the experiments. Data Split means the number of samples split into the train, validation, and test sets.

Dataset	Dimensions	Frequency	Data Split	Forecasting	Imputation	SR
ETTM1	7	15 mins	(34465, 11521, 11521)	✓		✓
ETTh1	7	Hourly	(8545, 2881, 2881)	✓		✓
ECL	321	Hourly	(18317, 2633, 5261)	✓	✓	
Traffic	862	Hourly	(12185, 1757, 3509)	✓		✓
Weather	21	10 mins	(36792, 5291, 10540)	✓	✓	
Exchange	8	Daily	(5120, 665, 1422)	✓		
Solar	137	10 mins	(36601, 5161, 10417)	✓		
PTB-XL	12	500 Hz	(14771, 1493, 1652)		✓	✓
Sleep-EDFE	1	100 Hz	(22212, 9519, 10577)		✓	✓
CLAS	1	100 Hz	(993, 0, 359)			✓

## A. Implementation Details

In this section, we cover the implementation details of the methods and experiments, including datasets, algorithm details, hyperparameters, and baselines.

### A.1. Datasets

There are 9 datasets used in this study, and the overall summary of the datasets information can be seen in Table 5. Also, the descriptions of each set are introduced in this section.

**Traffic (PeMS: Performance Measurement System):** The PeMS dataset, provided by the California Department of Transportation, is a comprehensive collection of traffic flow data. It contains real-time traffic speed and volume information collected from over 39,000 individual sensors across the freeway system of California. These sensors report data every 30 seconds, offering an exceptionally detailed view of traffic patterns. Our study utilizes this dataset to forecast traffic flow and congestion levels. The data spans several years, but for our analysis, we focus on a one-year period, ensuring a mix of workdays and weekends to capture varying traffic behaviors.

**Weather (Global Surface Summary of the Day):** The weather dataset from NOAA’s National Climatic Data Center ([Wetterstation, 2020](#)) offers daily weather summaries from a wide array of weather stations around the world. This dataset includes essential meteorological parameters such as temperature, humidity, precipitation, wind speed, and atmospheric pressure. The data, spanning over several decades, provides a rich source for analyzing and forecasting weather patterns. For our research, we select a subset of the dataset encompassing ten years of data from stations across different climatic zones. The goal is to develop models capable of predicting weather conditions such as temperature and precipitation.

**Exchange Rates:** The Foreign Exchange Rates dataset ([Lai et al., 2018](#)) encompasses daily exchange rates of various currencies against the US dollar from the year 2000 to 2019. It is a comprehensive dataset that includes the exchange rates of over 50 currencies and offers a detailed view of global financial dynamics. Our study aims to forecast the daily exchange rates of major currencies. The dataset’s span allows for the analysis of long-term trends as well as responses to major global events. For preprocessing, we ensure data continuity by addressing any missing values and then normalize the data to account for different scales across currencies.

**Electricity Load Diagrams:** The Electricity Load Diagrams dataset, sourced from the UCI Machine Learning Repository ([Asuncion & Newman, 2007](#)), comprises electricity consumption data recorded at 15-minute intervals from multiple customers. The dataset represents a diverse range of electricity consumers, including both individual households and industrial customers. The data spans from 2011 to 2014, encompassing various consumption patterns and seasonal effects. For our study, we focus on forecasting electricity demand on an hourly basis.

**ETT (Electricity Transformer Temperature):** The ETT dataset ([Zhou et al., 2021](#)) includes detailed records of electricity transformer temperatures and corresponding electricity consumption data. This high-resolution dataset, sampled every 15 minutes, covers two years. It provides insights into the relationship between transformer temperatures and electricity demand, crucial for maintaining efficient and safe operations of power systems. In our research, we utilize the ETT dataset to forecast short-term electricity demand and transformer temperatures.

**Solar Energy Prediction:** The Solar Energy Prediction dataset from the UCI Machine Learning Repository (Asuncion & Newman, 2007) contains solar power generation data alongside various meteorological variables. The dataset, collected over one year, includes measurements such as solar irradiance, temperature, humidity, and wind speed, sampled at 10-minute intervals. This comprehensive dataset enables the development of models for predicting solar energy output, a key factor in managing renewable energy resources. In our analysis, we focus on forecasting daily solar energy data.

**PTB-XL:** The PTB-XL (Wagner et al., 2020) dataset is a large dataset containing 21,837 clinical 12-lead electrocardiogram (ECG) records from 18,885 patients of 10-second length, where 52% are male and 48% are female with ages ranging from 0 to 95 years (median 62 and interquartile range of 22). There are two sampling rates: 100 Hz and 500 Hz, available in the dataset, but in our experiments, only data sampled at 100 Hz are used. The raw ECG data are annotated by two cardiologists into five major categories, including normal ECG (NORM), myocardial infarction (MI), ST/T Change (STTC), Conduction Disturbance (CD), and Hypertrophy (HYP). The dataset contains a comprehensive collection of various co-occurring pathologies and a large proportion of healthy control samples. We experimented with imputation and super-resolution tasks. Further, to ensure a fair comparison of machine learning algorithms trained on the dataset, we follow the recommended splits of training and test sets, which results in a training/testing ratio of 8/1.

**Sleep-EDFE:** The Sleep-EDF (expanded) (Kemp et al., 2000) dataset contains whole-night sleep recordings from 822 subjects with physiological signals and sleep stages that were annotated manually by well-trained technicians. In this dataset, the physiological signals, including Fpz-Cz/Pz-Oz electroencephalogram (EEG), electrooculogram (EOG), and chin electromyogram (EMG), were sampled at 100 Hz. To model the relationship between the sleep patterns and physiological data, we split the whole-night recordings into 30-second Fpz-Cz EEG segments as in (Supratak & Guo, 2020), which resulted in a total of 42308 EEG and sleep pattern pairs. We divided 25% of the samples into a testing set according to the order of the subject IDs.

**CLAS:** The CLAS dataset (Markova et al., 2019) aims to support research on the automated assessment of certain states of mind and emotional conditions using physiological data. The dataset consists of synchronized recordings of ECG, photoplethysmogram (PPG), electrodermal activity (EDA), and acceleration (ACC) signals. Sixty-two healthy subjects participated and were involved in three interactive tasks and two perceptive tasks. The perceptive tasks, which leveraged the images and audio-video stimuli, were purposely selected to evoke emotions in the four quadrants of arousal-valence space. In this study, our goal was to use the EDA signal to detect binary high/low stress states that are annotated in arousal-valence space. We processed the raw EDA data with a lowpass Butterworth filter with a cutoff frequency of 0.2 Hz, then split the sequences into 10-second segments. We divided the train/test set in a subject-independent manner and utilized the data from 17 subjects as the test set according to subject ids ( $> 45$ ).

## A.2. Imputation Settings

In the context of time series imputation, masking refers to the process of artificially removing or concealing parts of the data to simulate missing values, which the model then attempts to impute. Two distinct masking approaches are commonly employed: random masking and extended masking.

**Random Masking:** This method involves randomly selecting points or segments within the time series data and setting them as missing or masked. The randomness of this approach is intended to simulate data missingness that occurs sporadically and without a specific pattern, which is a common scenario in real-world datasets. However, this method may not adequately represent scenarios where data is missing for extended periods, which is also a practical occurrence.

**Extended Masking:** To address the limitations of random masking, we introduce the extended masking approach. This technique creates artificial gaps by masking contiguous segments of the time series. Extended masking is designed to simulate scenarios where data might be missing due to prolonged outages or systematic issues, providing a more challenging and realistic task for the imputation model to tackle.

Both methods are essential for testing the robustness and versatility of imputation models, ensuring they can handle various types of missing data patterns.

## A.3. Implementation Details

In this section, we introduce the experimental environments and the hyperparameter we used for each dataset

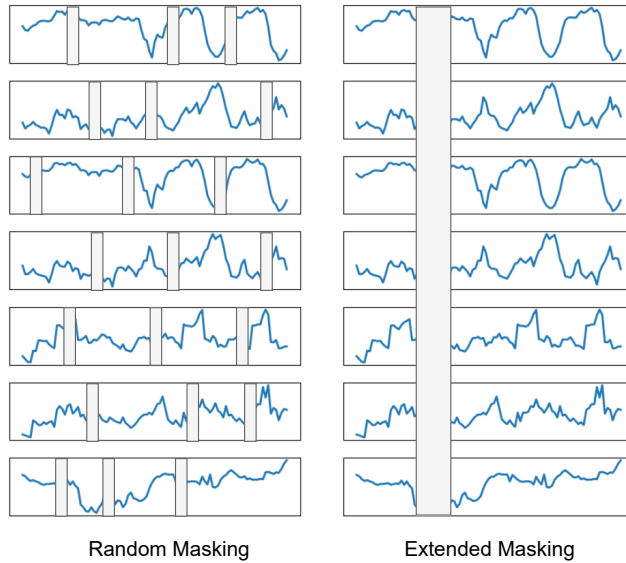

Figure 5. Comparison of masking methods for time series imputation. The left column depicts random masking, where individual data points are randomly concealed throughout the series, simulating sporadic data loss. The right column illustrates extended masking, where contiguous segments are masked to emulate prolonged periods of missing data. Each row represents an independent time series sample subject to the respective masking method.

Table 6. The hyperparameter settings of *AdaWaveNet* for each dataset.

hyperparam.	lifting kernel size	lifting Levels	n_clusters	learning rate
ETT	7	4	4	0.0005
ECL	7	3	4	0.0005
Traffic	5	1	9	0.001
Exchange Rate	7	4	1	0.0001
Weather	7	4	2	0.0005
Solar	7	1	1	0.0005
PTB-XL	16	5	2	0.001
Sleep-EDFE	16	5	1	0.001
CLAS	9	5	1	0.001

### A.3.1. EXPERIMENTAL ENVIRONMENTS

All the modules are implemented in PyTorch 1.11 and a Python version of 3.10. To speed up the experiments, GPU instances are utilized. We use AWS G5 instances, which are equipped with Nvidia A10 24GB GPUs, in training and inferring the models.

### A.3.2. HYPERPARAMETER SETTING

In this section, we list some essential hyperparameters used in this study. For the design of *AdaWave* blocks, we adjust the depth of transformations in a range of 1 to 5; whereas the kernel size of the utilized convolutional kernels is adjusted based on the datasets. The number of clusters used in the grouped linear model varies from 1 to 9 depending on the channels of signals. Also, we adjust the learning rate for each set of experiments to achieve better converge performances. The detailed hyperparameters of each dataset are listed in Table 6.

Table 7. Forecasting task. The prediction lengths for all datasets are established at {96, 192, 336, 720}, with the past sequence length matching the prediction lengths. Evaluation metrics include Mean Squared Error (MSE) and Mean Absolute Error (MAE). The lowest MSE is indicated in bold red, while the second lowest is underlined in blue.

Model (Year)		AdaWaveNet (Ours)		iTransformer (2023a)		FreTS (2023)		TimesNet (2022)		DLinear (2023)		PatchTST (2022)		Stationary (2022b)		FiLM (2022a)		FEDformer (2022b)	
Pred Length		MSE	MAE	MSE	MAE	MSE	MAE	MSE	MAE	MSE	MAE	MSE	MAE	MSE	MAE	MSE	MAE	MSE	MAE
ECL	96	<b>0.146</b>	<b>0.248</b>	<u>0.151</u>	<u>0.243</u>	0.189	0.277	0.165	0.269	0.210	0.302	0.181	0.268	0.167	0.269	0.398	0.452	0.193	0.308
	192	<u>0.158</u>	0.260	<b>0.156</b>	<b>0.258</b>	0.164	0.261	0.185	0.289	0.174	0.275	0.158	<b>0.254</b>	0.193	0.295	0.266	0.361	0.208	0.326
	336	<b>0.171</b>	<b>0.268</b>	0.177	<u>0.274</u>	0.202	0.289	0.196	0.301	0.176	0.278	<u>0.176</u>	0.278	0.207	0.310	0.281	0.377	0.224	0.339
	720	<b>0.196</b>	<b>0.292</b>	<u>0.201</u>	<u>0.299</u>	0.225	0.322	0.215	0.317	0.201	0.300	0.207	0.310	0.214	0.317	0.289	0.385	0.242	0.357
	Avg.	<b>0.168</b>	<b>0.267</b>	<u>0.171</u>	<u>0.269</u>	0.195	0.287	0.190	0.294	0.190	0.289	0.181	0.278	0.195	0.298	0.309	0.394	0.217	0.333
Weather	96	<b>0.169</b>	<b>0.215</b>	0.177	<u>0.217</u>	<u>0.173</u>	0.231	0.172	0.220	0.196	0.254	0.176	0.217	0.197	0.238	0.193	0.234	0.219	0.298
	192	<b>0.203</b>	<b>0.245</b>	0.213	<u>0.253</u>	<u>0.204</u>	0.268	0.222	0.266	0.227	0.286	0.212	0.258	0.264	0.298	0.230	0.266	0.265	0.341
	336	<b>0.248</b>	<b>0.286</b>	0.256	<u>0.289</u>	<u>0.255</u>	0.313	0.286	0.314	0.262	0.313	0.256	0.291	0.316	0.330	0.266	0.295	0.316	0.380
	720	<b>0.313</b>	<b>0.336</b>	0.325	0.343	<u>0.320</u>	0.356	0.375	0.373	0.318	0.359	0.321	<u>0.339</u>	0.400	0.378	0.322	0.338	0.372	0.403
	Avg.	<b>0.233</b>	<b>0.271</b>	0.243	<u>0.276</u>	<u>0.238</u>	0.292	0.264	0.293	0.251	0.303	0.241	<u>0.276</u>	0.294	0.311	0.253	0.283	0.293	0.356
Traffic	96	<u>0.417</u>	<u>0.291</u>	<b>0.396</b>	<b>0.271</b>	0.525	0.333	0.592	0.319	0.652	0.397	0.544	0.359	0.610	0.341	0.647	0.384	0.585	0.363
	192	<u>0.401</u>	<u>0.281</u>	<b>0.400</b>	<b>0.280</b>	0.514	0.329	0.592	0.321	0.622	0.354	0.547	0.361	0.621	0.348	0.462	0.302	0.586	0.366
	336	<b>0.407</b>	<b>0.284</b>	<u>0.415</u>	<u>0.286</u>	0.527	0.341	0.611	0.330	0.624	0.355	0.555	0.368	0.628	0.344	0.447	0.305	0.597	0.369
	720	<u>0.433</u>	<b>0.297</b>	<b>0.428</b>	<u>0.301</u>	0.546	0.359	0.626	0.344	0.664	0.408	0.603	0.393	0.647	0.384	0.485	0.321	0.615	0.390
	Avg.	<u>0.415</u>	<u>0.288</u>	<b>0.410</b>	<b>0.285</b>	0.528	0.341	0.605	0.329	0.641	0.379	0.562	0.370	0.627	0.354	0.510	0.328	0.596	0.372
Exchange	96	<b>0.086</b>	<b>0.204</b>	<u>0.087</u>	<u>0.209</u>	0.088	0.214	0.113	0.243	0.093	0.227	0.093	0.212	0.150	0.265	0.166	0.307	0.147	0.276
	192	<u>0.188</u>	<b>0.310</b>	0.197	<u>0.320</u>	0.211	0.347	0.243	0.361	<b>0.182</b>	0.323	0.188	0.312	0.261	0.375	0.224	0.345	0.260	0.387
	336	<u>0.360</u>	<u>0.437</u>	0.398	0.452	0.572	0.576	0.466	0.522	0.391	0.477	<b>0.328</b>	<b>0.415</b>	0.633	0.581	0.400	0.467	0.502	0.544
	720	1.288	<u>0.862</u>	1.370	0.849	1.576	0.972	1.796	1.044	1.364	0.888	<b>1.144</b>	<b>0.800</b>	1.357	0.875	1.200	0.883	1.491	0.954
	Avg.	<u>0.481</u>	<u>0.453</u>	0.513	0.458	0.612	0.527	0.655	0.543	0.508	0.479	<b>0.438</b>	<b>0.435</b>	0.600	0.524	0.498	0.501	0.600	0.540
Solar	96	<b>0.199</b>	<u>0.254</u>	<u>0.211</u>	0.256	0.227	0.292	0.249	0.290	0.286	0.374	0.223	0.271	0.216	<b>0.251</b>	0.309	0.334	0.243	0.343
	192	<b>0.207</b>	<u>0.262</u>	<u>0.216</u>	0.269	0.216	0.269	0.213	0.279	0.238	0.281	0.261	0.330	0.219	<b>0.252</b>	0.275	0.282	0.244	0.346
	336	<u>0.216</u>	<b>0.269</b>	0.220	0.272	0.242	0.297	0.242	0.285	0.270	0.325	<b>0.214</b>	0.273	0.229	<u>0.272</u>	0.288	0.294	0.251	0.352
	720	<b>0.214</b>	<b>0.263</b>	0.223	0.286	0.255	0.306	0.245	0.287	0.237	0.296	<u>0.221</u>	0.282	0.227	<u>0.275</u>	0.291	0.298	0.252	0.355
	Avg.	<b>0.209</b>	<b>0.262</b>	<u>0.218</u>	<u>0.271</u>	0.234	0.294	0.244	0.286	0.264	0.331	0.217	0.271	0.223	<u>0.263</u>	0.291	0.302	0.248	0.349
ETTh1	96	<u>0.384</u>	<b>0.396</b>	0.420	0.428	0.412	0.430	0.400	0.420	0.385	0.431	0.384	0.402	0.559	0.505	0.387	<u>0.399</u>	<b>0.377</b>	0.418
	192	0.437	0.431	0.463	0.456	0.467	0.461	0.564	0.526	0.430	0.443	<u>0.426</u>	<u>0.428</u>	0.698	0.575	0.437	0.430	<b>0.422</b>	<b>0.451</b>
	336	<u>0.445</u>	<b>0.441</b>	0.489	0.475	0.501	0.493	0.509	0.495	<b>0.437</b>	<u>0.453</u>	0.460	0.456	0.664	0.568	0.459	0.455	0.451	0.453
	720	0.510	<b>0.497</b>	0.600	0.565	0.602	0.573	0.708	0.615	<b>0.492</b>	0.510	0.505	0.470	0.713	0.615	0.509	0.501	<u>0.497</u>	<u>0.499</u>
	Avg.	0.444	<b>0.441</b>	0.493	0.481	0.496	0.489	0.545	0.514	<b>0.436</b>	0.459	0.444	0.439	0.659	0.566	0.448	<u>0.446</u>	<u>0.437</u>	0.455
ETTm1	96	<b>0.326</b>	<b>0.366</b>	0.354	0.381	0.343	0.376	<u>0.330</u>	0.371	0.345	0.371	0.334	<u>0.368</u>	0.422	0.415	0.351	0.370	0.379	0.419
	192	<b>0.335</b>	<u>0.370</u>	0.355	0.384	0.364	0.394	0.396	0.406	<u>0.342</u>	<b>0.368</b>	0.339	0.368	0.466	0.446	0.388	0.404	0.415	0.428
	336	0.375	0.394	0.384	0.406	0.393	0.409	0.403	0.422	<u>0.370</u>	<u>0.386</u>	<b>0.367</b>	<b>0.392</b>	0.555	0.496	0.400	0.420	0.417	0.431
	720	<u>0.439</u>	<u>0.428</u>	0.448	0.449	0.466	0.457	0.456	0.455	<b>0.420</b>	<b>0.422</b>	0.456	0.447	0.615	0.531	0.447	0.439	0.484	0.479
	Avg.	<b>0.369</b>	<u>0.390</u>	0.385	0.405	0.392	0.409	0.396	0.414	<u>0.369</u>	<b>0.387</b>	0.374	0.394	0.515	0.472	0.397	0.408	0.424	0.439
1st Count		18	21	5	3	0	0	0	0	5	3	5	5	0	2	0	0	2	1

## B. Full Results

### B.1. Time Series Forecasting

Comprehensive evaluation results for the forecasting task is list in Table 7. The table presents a comparative analysis of forecasting models across different datasets and prediction lengths. It measures performance using two metrics: Mean Squared Error (MSE) and Mean Absolute Error (MAE). Lower values in these metrics indicate better predictive accuracy. *AdaWaveNet* often achieves the lowest MSE and MAE across various datasets and prediction lengths, with the lowest scores highlighted in bold red. The second-best results are underlined in blue. The table shows that *AdaWaveNet* frequently outperforms other models.

### B.2. Time Series Imputation

See Table 8 for the full results of the time series imputation task. The results are stratified by the percentage of data masked, ranging from 12.5% to 50%. The effectiveness of each model is contingent upon its ability to reconstruct the original data from these incomplete inputs.

In the random mask setting, *AdaWaveNet* often achieves low MSE and MAE, suggesting a strong capacity for dealing with sporadically missing data. Notably, it performs exceptionally well on the Weather dataset at a 25% mask ratio. However, it is outperformed by models like TimesNet and DLinear in certain instances, such as with the ECL dataset at a 37.5% mask ratio for MSE, where DLinear shows superior performance.

The extended mask scenario presents a different challenge. Here, *AdaWaveNet* demonstrates more competitive results compared to the random imputation task. *AdaWaveNet* achieves the best results in both MSE and MAE on 3 datasets out of 4.

Table 8. Imputation task. Experiments are conducted on two types of imputation - random and extended. In each case, we mask {12.5%, 25%, 37.5%, 50%} of time points or segments randomly from the original sequences. For the ECL and Weather datasets, sequence lengths are set to 96, while for the PTB-XL and Sleep-EDFE datasets, the lengths are 1000 and 3000, respectively. Evaluation metrics include Mean Squared Error (MSE) and Mean Absolute Error (MAE). The lowest MSE is marked in bold red, and the second lowest is underlined in blue.

Model (Year)			AdaWaveNet (Ours)		iTransformer (2023a)		FreTS (2023)		TimesNet (2022)		DLinear (2023)		PatchTST (2022)		Stationary (2022b)		FiLM (2022a)		FEDformer (2022b)	
Mask Ratio			MSE	MAE	MSE	MAE	MSE	MAE	MSE	MAE	MSE	MAE	MSE	MAE	MSE	MAE	MSE	MAE	MSE	MAE
Random	ECL	0.125	<u>0.080</u>	<u>0.202</u>	0.089	0.210	0.102	0.218	0.089	0.205	0.123	0.251	<b>0.077</b>	<b>0.194</b>	0.093	0.210	0.095	0.216	0.107	0.237
		0.25	<b>0.091</b>	<b>0.205</b>	0.101	0.229	0.107	0.225	<u>0.092</u>	<u>0.208</u>	0.114	0.242	0.093	0.215	0.097	0.214	0.102	0.246	0.120	0.251
		0.375	0.108	<u>0.219</u>	0.124	0.256	0.128	0.243	<b>0.096</b>	<b>0.213</b>	0.141	0.273	0.110	0.236	<u>0.102</u>	0.220	0.118	0.241	0.136	0.266
		0.5	0.122	0.234	0.152	0.286	0.147	0.271	<b>0.102</b>	<b>0.221</b>	0.173	0.303	0.114	0.240	<u>0.108</u>	<u>0.228</u>	0.135	0.258	0.158	0.284
		Avg.	0.100	<u>0.215</u>	0.117	0.245	0.121	0.239	<b>0.095</b>	<b>0.212</b>	0.138	0.313	<u>0.099</u>	0.221	0.100	0.218	0.112	0.240	0.130	0.260
	Weather	0.125	0.033	<u>0.059</u>	0.029	0.062	<b>0.023</b>	<u>0.049</u>	<u>0.025</u>	<u>0.045</u>	0.039	0.084	0.028	0.065	<u>0.027</u>	0.051	0.031	0.066	0.044	0.110
		0.25	0.041	0.077	0.046	0.083	0.044	0.080	<b>0.029</b>	<b>0.052</b>	0.048	0.103	0.040	0.079	<u>0.029</u>	<u>0.056</u>	0.042	0.086	0.062	0.160
		0.375	0.050	0.099	0.055	0.105	0.059	0.120	<b>0.031</b>	<b>0.057</b>	0.057	0.117	0.051	0.096	<u>0.033</u>	<u>0.062</u>	0.055	0.111	0.107	0.231
		0.5	0.062	0.129	0.068	0.136	0.072	0.142	<b>0.034</b>	<b>0.062</b>	0.066	0.134	0.058	0.107	<u>0.037</u>	<u>0.068</u>	0.073	0.136	0.183	0.311
		Avg.	0.047	0.091	0.050	0.097	0.050	0.098	<b>0.030</b>	<b>0.054</b>	0.053	0.110	0.044	0.087	<u>0.032</u>	<u>0.059</u>	0.050	0.100	0.099	0.203
	PTB-XL	0.125	<b>0.017</b>	<b>0.028</b>	0.032	0.044	0.029	0.040	0.025	<u>0.031</u>	0.042	0.049	0.024	0.035	<u>0.022</u>	0.033	0.028	0.039	0.035	0.051
		0.25	<b>0.024</b>	<b>0.037</b>	0.044	0.055	0.040	0.052	<u>0.030</u>	<u>0.044</u>	0.058	0.071	0.035	0.046	0.033	0.045	0.040	0.052	0.052	0.064
		0.375	<b>0.029</b>	<b>0.039</b>	0.060	0.069	0.052	0.065	<u>0.034</u>	<u>0.047</u>	0.057	0.068	0.044	0.058	0.045	0.059	0.049	0.062	0.074	0.089
		0.5	<u>0.044</u>	<u>0.058</u>	0.077	0.085	0.063	0.077	<b>0.041</b>	<b>0.056</b>	0.073	0.087	0.057	0.069	0.057	0.066	0.063	0.075	0.091	0.103
		Avg.	<b>0.029</b>	<b>0.041</b>	0.053	0.063	0.046	0.059	<u>0.033</u>	<u>0.045</u>	0.058	0.069	0.040	0.052	0.039	0.051	0.045	0.057	0.063	0.077
	Sleep-EDFE	0.125	<b>0.024</b>	<b>0.036</b>	0.033	0.047	<u>0.027</u>	0.039	0.041	0.055	0.036	0.050	0.031	<u>0.038</u>	0.047	0.065	0.036	0.050	0.052	0.068
		0.25	<b>0.031</b>	<b>0.040</b>	0.042	0.058	<u>0.037</u>	0.051	0.046	0.063	0.045	0.058	0.040	<u>0.049</u>	0.059	0.072	0.044	0.057	0.048	0.066
		0.375	<b>0.037</b>	<b>0.048</b>	0.052	0.062	<u>0.048</u>	0.062	0.050	0.067	0.056	0.071	0.051	<u>0.062</u>	0.070	0.084	0.054	0.068	0.067	0.084
		0.5	<b>0.043</b>	<b>0.055</b>	0.061	0.070	0.059	0.073	<u>0.052</u>	0.074	0.068	0.085	0.057	<u>0.069</u>	0.081	0.095	0.063	0.078	0.082	0.102
		Avg.	<b>0.034</b>	<b>0.045</b>	0.047	0.059	<u>0.043</u>	0.056	0.047	0.065	0.051	0.066	0.045	<u>0.055</u>	0.064	0.079	0.049	0.063	0.062	0.080
Extended	ECL	0.125	<b>0.098</b>	<b>0.207</b>	<u>0.109</u>	<u>0.217</u>	0.130	0.217	0.114	0.227	0.168	0.276	0.120	0.229	0.115	0.226	0.126	0.219	0.152	0.254
		0.25	<b>0.104</b>	<b>0.207</b>	<u>0.116</u>	<u>0.218</u>	0.128	0.222	0.117	0.225	0.138	0.230	0.131	0.231	0.124	0.233	0.127	0.228	0.155	0.261
		0.375	<b>0.121</b>	<b>0.228</b>	0.138	<u>0.241</u>	0.160	0.257	0.139	0.243	0.194	0.292	0.163	0.263	0.134	0.243	0.151	0.255	0.161	0.270
		0.5	<b>0.126</b>	<b>0.230</b>	0.143	<u>0.241</u>	0.165	0.262	0.140	0.246	0.186	0.266	0.172	0.263	<u>0.137</u>	0.245	0.156	0.256	0.177	0.293
		Avg.	<b>0.112</b>	<b>0.218</b>	<u>0.127</u>	<u>0.229</u>	0.146	0.240	0.128	0.235	0.172	0.266	0.147	0.247	0.128	0.237	0.140	0.239	0.161	0.270
	Weather	0.125	<b>0.067</b>	<b>0.091</b>	0.074	0.113	0.072	0.112	0.216	0.257	<u>0.072</u>	<u>0.106</u>	0.082	0.108	0.086	0.122	0.101	0.138	0.138	0.197
		0.25	0.084	0.127	<u>0.082</u>	<u>0.118</u>	0.090	0.135	0.086	0.118	0.097	0.149	<b>0.079</b>	<b>0.118</b>	0.101	0.158	0.097	0.143	0.154	0.218
		0.375	<u>0.098</u>	0.154	0.102	<u>0.139</u>	0.115	0.171	0.101	0.142	0.121	0.184	<b>0.096</b>	<b>0.138</b>	0.113	0.176	0.115	0.167	0.177	0.229
		0.5	<b>0.107</b>	0.170	0.119	0.159	0.127	0.182	0.113	<u>0.157</u>	0.135	0.202	<u>0.112</u>	<b>0.153</b>	0.125	0.191	0.128	0.181	0.186	0.231
		Avg.	<b>0.089</b>	0.136	0.094	<u>0.132</u>	0.101	0.150	0.129	0.169	0.106	0.160	<u>0.092</u>	<b>0.129</b>	0.106	0.162	0.110	0.157	0.164	0.219
	PTB-XL	0.125	<u>0.049</u>	<u>0.062</u>	0.069	0.087	0.055	0.071	<b>0.044</b>	<u>0.069</u>	0.075	0.107	0.064	0.083	0.062	0.083	0.061	0.082	0.071	0.096
		0.25	<u>0.063</u>	<b>0.080</b>	0.077	0.098	0.071	0.092	<u>0.065</u>	<u>0.090</u>	0.082	0.118	0.075	0.097	0.071	0.092	0.074	0.097	0.089	0.106
		0.375	<b>0.074</b>	<b>0.089</b>	0.094	0.106	0.085	0.124	0.089	0.108	0.103	0.125	0.096	0.111	<u>0.083</u>	<u>0.106</u>	0.092	0.110	0.109	0.133
		0.5	<b>0.089</b>	<u>0.122</u>	0.112	0.135	0.099	0.136	0.104	0.134	0.114	0.141	0.110	0.126	<u>0.097</u>	<b>0.114</b>	0.105	0.132	0.118	0.147
		Avg.	<b>0.069</b>	<b>0.088</b>	0.088	0.107	0.078	0.106	<u>0.076</u>	0.100	0.094	0.123	0.086	0.104	0.078	<u>0.099</u>	0.083	0.105	0.097	0.121
	Sleep-EDFE	0.125	<b>0.066</b>	<b>0.087</b>	0.092	0.112	<u>0.070</u>	0.098	0.083	0.104	0.102	0.134	0.079	<u>0.096</u>	0.113	0.149	0.089	0.115	0.103	0.140
		0.25	<b>0.082</b>	<b>0.105</b>	0.114	0.146	<u>0.085</u>	<u>0.110</u>	0.106	0.133	0.117	0.158	0.096	0.120	0.125	0.164	0.105	0.136	0.116	0.155
		0.375	<b>0.104</b>	<u>0.137</u>	0.119	0.154	0.110	0.142	0.124	0.155	0.139	0.188	<u>0.104</u>	<b>0.132</b>	0.133	0.177	0.122	0.160	0.142	0.197
		0.5	<b>0.109</b>	<b>0.141</b>	0.131	0.188	<u>0.121</u>	<u>0.157</u>	0.142	0.191	0.155	0.207	<u>0.127</u>	0.163	0.147	0.196	<b>0.134</b>	0.180	0.139	0.195
		Avg.	<b>0.090</b>	<b>0.118</b>	0.114	0.150	<u>0.097</u>	<u>0.127</u>	0.114	0.146	0.128	0.172	0.102	0.128	0.130	0.172	0.112	0.148	0.125	0.172

Table 9. Super-resolution task. Super-resolution upsampling ratios are set at {2, 5, 10}. Experimentally, sequence lengths are fixed at 200 for ETTm1, ETTh1, and Traffic datasets, and at 1000, 3000, and 960 for PTB-XL, Sleep-EDFE, and CLAS datasets, respectively. Evaluation metrics include Mean Squared Error (MSE) and Mean Absolute Error (MAE), with all results being averages over 4 masking ratios. The lowest MSE is highlighted in bold red, while the second lowest is underlined in blue.

Model (Year)		AdaWaveNet (Ours)		iTransformer (2023a)		FreTS (2023)		TimesNet (2022)		DLinear (2023)		PatchTST (2022)		Stationary (2022b)		FiLM (2022a)		FEDformer (2022b)	
SR Ratio		MSE	MAE	MSE	MAE	MSE	MAE	MSE	MAE	MSE	MAE	MSE	MAE	MSE	MAE	MSE	MAE	MSE	MAE
ETTm1	2	<b>0.016</b>	<b>0.085</b>	<u>0.021</u>	0.097	0.024	0.102	0.027	<u>0.096</u>	0.044	0.123	0.035	0.111	0.031	0.104	0.051	0.136	0.037	0.109
	5	<b>0.035</b>	<b>0.101</b>	<u>0.036</u>	<u>0.110</u>	0.040	0.115	0.039	0.112	0.070	0.160	0.057	0.146	0.038	0.117	0.047	0.121	0.055	0.158
	10	<u>0.058</u>	<u>0.151</u>	0.065	0.173	0.077	0.179	<b>0.054</b>	<b>0.147</b>	0.087	0.194	0.077	0.182	0.062	0.166	0.070	0.172	0.081	0.190
	Avg.	<b>0.036</b>	<b>0.112</b>	0.041	0.127	0.047	0.132	<u>0.040</u>	<u>0.118</u>	0.067	0.159	0.056	0.146	0.044	0.129	0.056	0.143	0.058	0.152
ETTh1	2	<u>0.039</u>	<u>0.112</u>	0.046	0.125	0.043	0.115	0.051	0.123	0.063	0.134	0.054	0.128	0.051	0.130	0.048	0.129	<b>0.037</b>	<b>0.109</b>
	5	<u>0.093</u>	<b>0.193</b>	0.107	0.210	0.099	0.200	0.102	0.205	0.128	0.231	0.110	0.217	<b>0.090</b>	<u>0.194</u>	0.100	0.203	0.107	0.208
	10	<u>0.178</u>	<u>0.270</u>	0.202	0.291	0.190	0.287	0.187	0.287	0.202	0.304	0.196	0.292	<b>0.168</b>	<b>0.266</b>	0.189	0.294	0.201	0.297
	Avg.	<u>0.103</u>	<b>0.192</b>	0.118	0.209	0.111	0.201	0.113	0.205	0.131	0.223	0.120	0.212	<b>0.103</b>	<u>0.197</u>	0.112	0.209	0.115	0.205
Traffic	2	<b>0.107</b>	<b>0.096</b>	<u>0.114</u>	<u>0.104</u>	0.127	0.119	0.133	0.125	0.141	0.136	0.124	0.111	0.157	0.155	0.162	0.154	0.155	0.142
	5	<u>0.210</u>	<u>0.197</u>	<b>0.208</b>	<b>0.193</b>	0.226	0.213	0.241	0.221	0.239	0.222	0.219	0.197	0.264	0.250	0.277	0.258	0.256	0.233
	10	<b>0.322</b>	<b>0.281</b>	<u>0.329</u>	<u>0.285</u>	0.351	0.307	0.369	0.322	0.355	0.319	0.337	0.295	0.383	0.346	0.401	0.377	0.363	0.336
	Avg.	<b>0.213</b>	<b>0.191</b>	<u>0.217</u>	<u>0.194</u>	0.235	0.213	0.248	0.223	0.245	0.226	0.227	0.201	0.268	0.250	0.280	0.263	0.258	0.237
PTB-XL	2	0.007	0.016	0.009	0.019	<u>0.007</u>	<u>0.015</u>	<b>0.006</b>	<b>0.015</b>	0.011	0.021	0.014	0.020	0.012	0.025	0.008	0.018	0.010	0.022
	5	<u>0.016</u>	<u>0.023</u>	0.019	0.028	0.017	0.023	<b>0.015</b>	<b>0.021</b>	0.023	0.037	0.026	0.036	0.023	0.037	0.019	0.027	0.020	0.029
	10	<u>0.033</u>	<u>0.045</u>	0.035	0.046	0.036	0.048	<b>0.030</b>	<b>0.042</b>	0.045	0.062	0.052	0.069	0.042	0.061	0.039	0.052	0.037	0.050
	Avg.	<u>0.019</u>	<u>0.028</u>	0.021	0.031	0.020	0.029	<b>0.017</b>	<b>0.026</b>	0.026	0.040	0.031	0.042	0.026	0.041	0.022	0.032	0.022	0.034
Sleep-EDFE	2	<b>0.011</b>	<b>0.133</b>	0.017	0.140	<u>0.015</u>	<u>0.137</u>	0.027	0.160	0.022	0.155	0.025	0.156	0.031	0.166	0.020	0.150	0.027	0.158
	5	<b>0.022</b>	<b>0.141</b>	0.036	0.168	<u>0.028</u>	<u>0.154</u>	0.035	0.179	0.035	0.177	0.038	0.182	0.045	0.184	0.039	0.173	0.042	0.179
	10	<b>0.027</b>	<b>0.159</b>	0.041	0.177	<u>0.036</u>	<u>0.170</u>	0.044	0.181	0.049	0.190	0.048	0.194	0.064	0.212	0.053	0.202	0.061	0.222
	Avg.	<b>0.020</b>	<b>0.144</b>	0.031	0.162	<u>0.026</u>	<u>0.154</u>	0.035	0.173	0.035	0.174	0.037	0.177	0.047	0.187	0.037	0.175	0.043	0.186
CLAS	2	<b>0.018</b>	<b>0.048</b>	0.025	0.057	0.023	0.055	0.037	0.083	<u>0.022</u>	<u>0.054</u>	0.033	0.078	0.044	0.081	0.030	0.071	0.029	0.062
	5	<b>0.034</b>	<b>0.079</b>	0.047	0.084	0.041	0.082	0.046	0.099	<u>0.039</u>	0.088	0.054	0.098	0.046	<u>0.082</u>	0.052	0.103	0.039	0.084
	10	<b>0.051</b>	<b>0.101</b>	0.066	0.120	0.062	0.111	0.060	<u>0.107</u>	<u>0.056</u>	0.114	0.072	0.135	0.066	0.117	0.078	0.144	0.062	0.116
	Avg.	<b>0.034</b>	<b>0.076</b>	0.046	0.087	0.042	<u>0.083</u>	0.048	0.096	<u>0.039</u>	0.085	0.053	0.104	0.052	0.093	0.053	0.106	0.043	0.087

### B.3. Time Series Super-resolution

See Table 9 for the full results of time series super-resolution task. *AdaWaveNet* exhibits commendable performance, frequently achieving the lowest MSE, particularly notable in the ETTm1 and ETTm2 datasets at a super-resolution (SR) ratio of 2. However, other models show their strengths in specific contexts; for instance, TimesNet performs optimally at an SR ratio of 5 for ETTm1 and PTB-XL datasets. Similarly, DLinear and FiLM demonstrate competitive performance in certain datasets and SR ratios, highlighting their efficacy in particular scenarios.

The performance variations across models suggest that while *AdaWaveNet* generally offers strong super-resolution capabilities, there are instances where alternative models may provide better results, potentially due to differences in model architectures, learning mechanisms, and adaptability to the characteristics of each dataset.

### B.4. AdaWaveNet Ablation Study

Table 10 shows the full results of the ablations of the model.

## C. Showcases

In this section, we showcase some of the examples in forecasting, imputation, and super-resolution tasks.

### C.1. Forecasting

Figure 6 presents a comparative example of forecasting future traffic volumes using various models. The figure reveals a notable disparity between past sequences and the predicted sequence for this particular variate. The visual results indicate that *AdaWaveNet* yields the most accurate forecast in this instance. Additionally, the *iTransformer* model also performs commendably, which suggests that its channel-wise attention mechanism is particularly useful at analyzing past traffic patterns for prediction purposes.

### C.2. Imputation

The examples of imputation, including the random imputation and extended imputation are demonstrated in this section.



Table 10. The full results of model ablation with mean squared error as the evaluation metric. The highest MSE is highlighted in bold, while the second highest is underlined. Refer to Table 10 in the Appendix for comprehensive results.

		w/o	/		Grouped Linear		RevIn		Channel Attention		AdaWave Block	
Metrics			MSE	MAE	MSE	MAE	MSE	MAE	MSE	MAE	MSE	MAE
Forecasting	Weather	96	0.169	0.215	0.174	0.226	0.180	0.231	0.185	0.239	0.177	0.231
		192	0.203	0.245	0.209	0.254	0.216	0.260	0.227	0.266	0.222	0.257
		336	0.248	0.286	0.255	0.299	0.262	0.311	0.272	0.328	0.276	0.337
		720	0.313	0.336	0.321	0.348	0.325	0.356	0.341	0.375	0.345	0.382
		Avg.	0.233	0.271	0.240	0.282	0.246	0.290	<b>0.256</b>	<b>0.302</b>	0.255	0.302
	Traffic	96	0.417	0.291	0.429	0.303	0.418	0.293	0.513	0.338	0.472	0.314
		192	0.401	0.281	0.415	0.297	0.409	0.288	0.499	0.331	0.466	0.312
		336	0.407	0.284	0.416	0.297	0.417	0.292	0.520	0.349	0.470	0.306
		720	0.433	0.297	0.439	0.314	0.442	0.314	0.545	0.382	0.483	0.317
		Avg.	0.415	0.288	0.425	0.303	0.422	0.297	<b>0.519</b>	<b>0.350</b>	0.473	0.312
Imputation	ECL	0.125	0.098	0.207	0.099	0.208	0.103	0.212	0.108	0.214	0.112	0.219
		0.25	0.104	0.207	0.106	0.212	0.106	0.214	0.112	0.215	0.121	0.227
		0.375	0.121	0.228	0.124	0.233	0.129	0.240	0.131	0.232	0.140	0.240
		0.5	0.126	0.230	0.131	0.237	0.130	0.235	0.137	0.243	0.149	0.250
		Avg.	0.112	0.218	0.115	0.223	0.117	0.225	0.122	0.226	<b>0.131</b>	<b>0.234</b>
	PTB-XL	0.125	0.049	0.062	0.058	0.071	0.052	0.065	0.053	0.064	0.063	0.084
		0.25	0.063	0.080	0.072	0.089	0.067	0.088	0.062	0.078	0.072	0.091
		0.375	0.074	0.089	0.085	0.114	0.071	0.082	0.077	0.089	0.090	0.110
		0.5	0.089	0.122	0.103	0.136	0.091	0.121	0.085	0.117	0.104	0.127
		Avg.	0.069	0.088	0.080	0.103	0.070	0.089	0.069	0.087	<b>0.082</b>	<b>0.103</b>

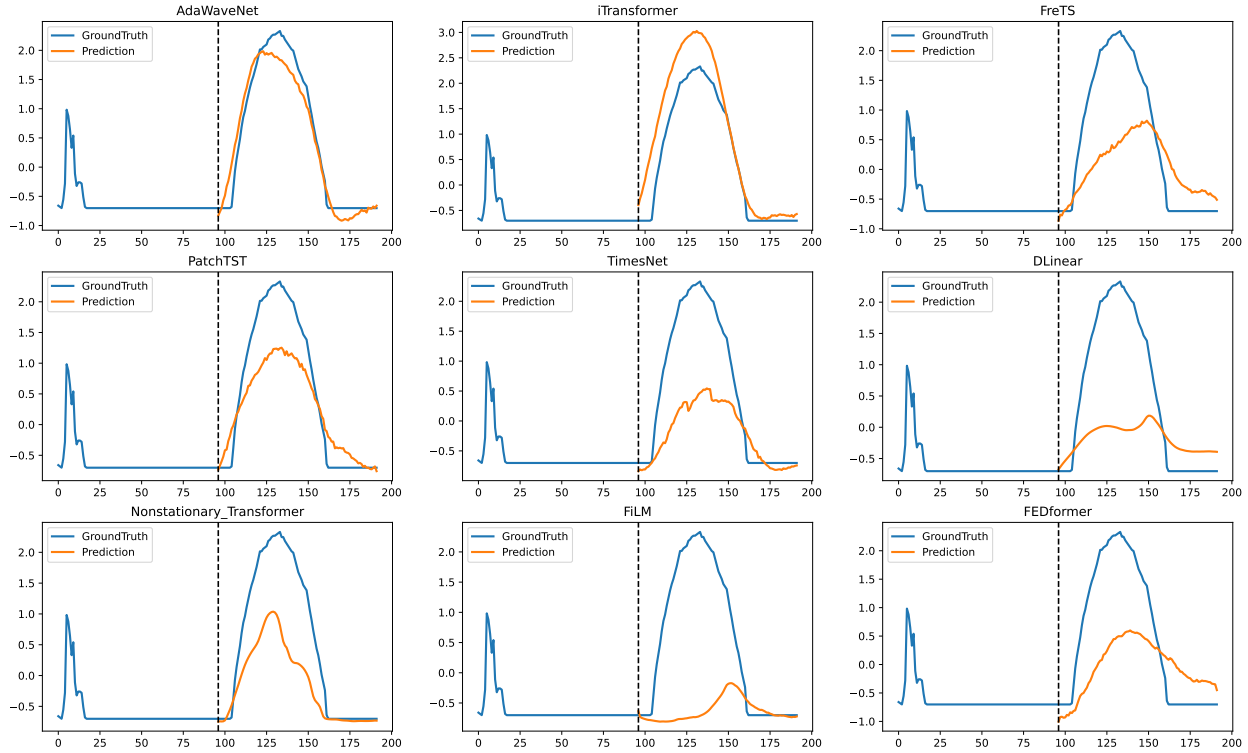

Figure 6. Visualization of a forecasting task on traffic dataset. The length of both input sequence and forecasting sequence are 96.

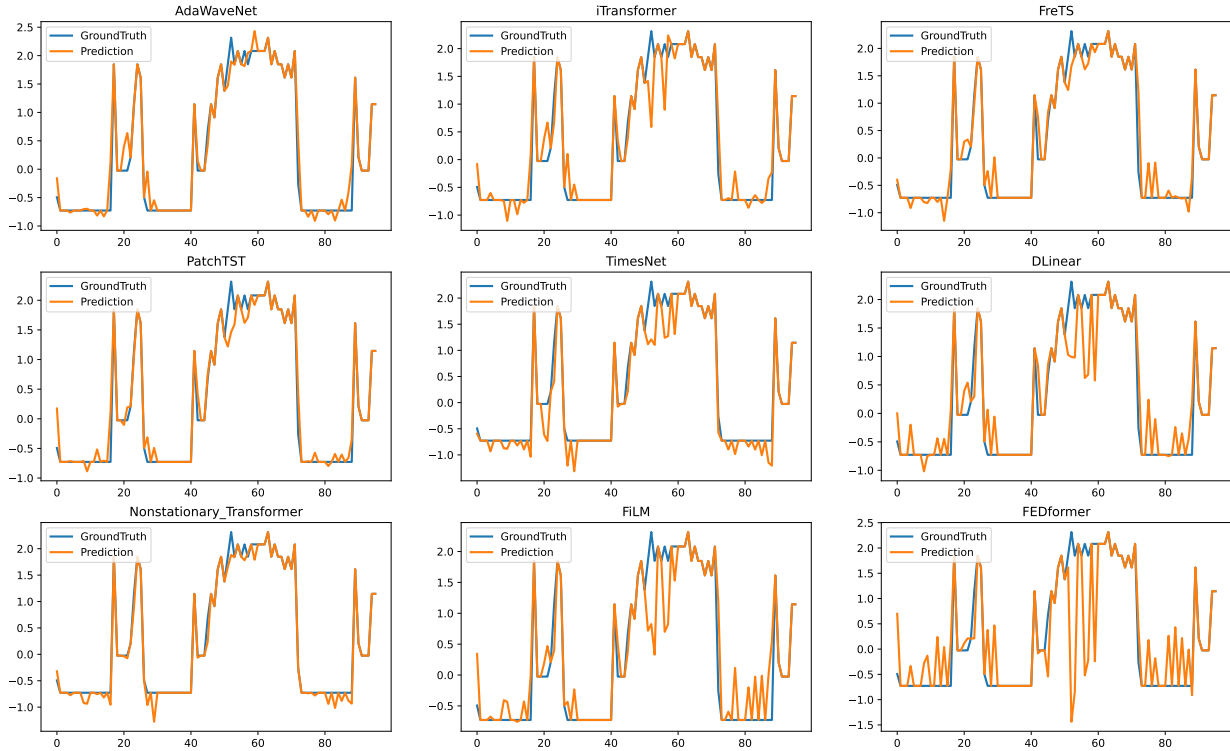

Figure 7. Visualization of a random imputation task on ETTh1 dataset. The sequence length is 96 and the masked ratio is 0.25.

### C.2.1. RANDOM MASKING

We provide an example of imputation with the random masking method. The proposed *AdaWaveNet* and all the other baseline methods. As shown in Figure 7, *AdaWaveNet*, alongside baseline methods such as PatchTST, TimesNet, and Nonstationary-Transformer, is capable at capturing the temporal dynamics. Notably, *AdaWaveNet* shows superior performance in imputing fine-grained details, effectively handling both the seasonality during peak phases and the underlying trends in flatter regions.

### C.2.2. EXTENDED MASKING

We provide an example of imputation with the extended masking method. The proposed *AdaWaveNet* and all the other baseline methods. Shown as in Figure 8, the proposed method exhibits a close approximation to the ground truth, which indicates a higher predictive accuracy within this interval. The consistency across the models outside the masked region implies a shared ability to capture the temporal dynamics in non-masked intervals; while the differences within the masked region highlight the distinct predictive capabilities and potential overfitting issues of the individual models.

### C.3. Super-resolution

The visualization presents the results of a super-resolution task on time series data, specifically forecasting traffic volume. Each subplot represents the performance of a different model: *AdaWaveNet*, *iTransformer*, *FreTS*, *TimesNet*, *DLinear*, *PatchTST*, *Non-stationary Transformer*, *FILM*, and *FEDformer*. In each plot, three lines are denoted as: the Ground Truth (blue line), which is the actual high-resolution data; the Prediction (orange line), which is the model’s predicted high-resolution data; and the Low-resolution Input (gray line), which serves as the model’s input data and represents the downsampled or coarse version of the Ground Truth.

The predictions of *AdaWaveNet* closely follows the Ground Truth across the entire sequence. The fidelity of *AdaWaveNet*’s prediction to the Ground Truth, particularly in capturing the peaks and troughs of the traffic volume, showcases the model’s capability in the super-resolution task. The granularity of details in the prediction suggests that *AdaWaveNet* effectively upsamples the low-resolution input and reconstructs a nuanced and accurate traffic data.

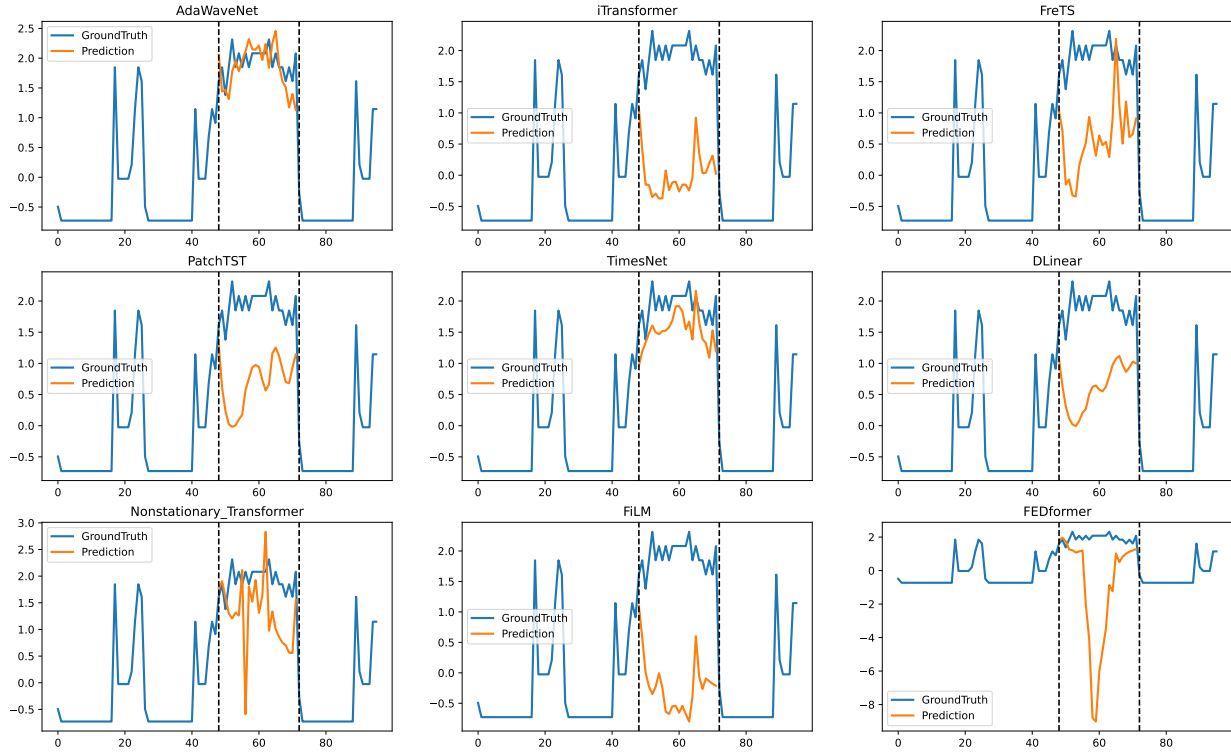

Figure 8. Visualization of an extended imputation task on ETTh1 dataset. The sequence length is 96 and the masked ratio is 0.25.

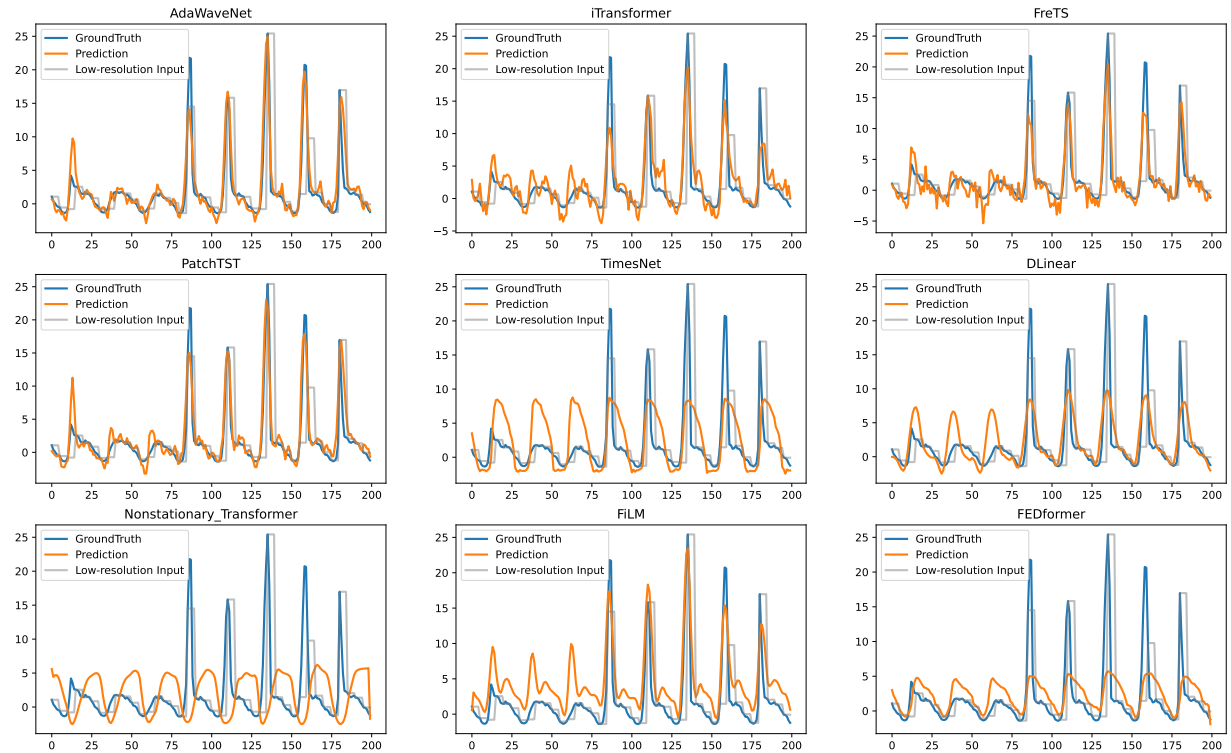

Figure 9. Visualization of a super-resolution task on traffic data with an input length of 200. The super-resolution ratio is 5.

## D. Limitations

This section outlines the limitations in the proposed *AdaWaveNet* framework.

### D.1. Model Complexity

*AdaWaveNet* incorporates effective components, such as the grouped linear module and cross-channel attention mechanisms, to model dependencies across similar variates in the trend phase. It also introduces multi-scale capabilities through the *AdaWave* blocks. Despite its promising performance, *AdaWaveNet* is less efficient compared to simpler MLP-based models such as DLinear (Zeng et al., 2023), which potentially limits its applicability in environments where computational resources are constrained or real-time analysis is required.

### D.2. Generalization to Different Signal Types

*AdaWaveNet* demonstrates robust performance in forecasting tasks with data types such as weather and solar, as well as in extended imputation tasks with electricity and EEG data. However, its capacity to generalize across the full spectrum of time series data and various tasks has the room to be further improved. For example, in tasks involving random imputation of electricity and weather datasets, TimesNet exhibits superior performance. Similarly, iTransformer outperforms *AdaWaveNet* in traffic forecasting tasks.