

THE FIRST DIRICHLET EIGENVALUE AND THE WIDTH

GUOYI XU

ABSTRACT. For a geodesic ball with non-negative Ricci curvature and mean convex boundary, it is known that the first Dirichlet eigenvalue of this geodesic ball has a sharp lower bound in term of its radius. We show a quantitative explicit inequality, which bounds the width of geodesic ball in terms of the spectral gap between the first Dirichlet eigenvalue and the corresponding sharp lower bound.

Mathematics Subject Classification: 53B20, 58C40, 58J05.

CONTENTS

1. Introduction	1
2. Spectral gap bounds the volume difference of level sets.	7
3. Two type estimates by the volume difference	11
3.1. The integral estimates of harmonic functions	11
3.2. The error estimates of extendability	13
4. Stable Gou-Gu Theorem with integral estimates	14
4.1. Distance estimate by line integral of difference.	16
4.2. The existence of ‘good’ pair points	19
4.3. The local stable Gou-Gu theorem	24
5. The width estimate of almost cylinder	29
5.1. The estimate of the outer level sets’ diameter	29
5.2. The width estimate of metric ball	32
6. The width estimate in form of spectral gap	35
Acknowledgments	35
References	36

1. INTRODUCTION

If a complete Riemannian manifold (M^n, g) with $Rc \geq 0$ contains a geodesic line, then from Cheeger-Gromoll splitting theorem, we know that (M^n, g) is isometric to $N^{n-1} \times \mathbb{R}$.

The above splitting theorem has a local stable version established by Cheeger-Colding [CC96]. The local splitting theorem says, if there is a line segment $\gamma \subseteq$

Date: July 16, 2024.

The author was partially supported by NSFC 12141103.

(M^n, g) , then in the mid-point q of γ , there exists a small neighborhood $B_q(R)$ which is Gromov-Hausdorff close to $B(R) \subseteq N^{n-1} \times [-R, R]$; here N^{n-1} is a length space and $B(R)$ is a metric ball in $N^{n-1} \times [-R, R]$ with the product metric. Also see [Xu19] for some quantitative discussion.

The above stable result forms the basis of Cheeger-Colding's theory of Ricci limit spaces. We are interested in the diameter of N^{n-1} . Note the key technical tool to prove those splitting results is linear growth harmonic function. Another key fact is that the 'model' space is a cylinder.

We recall the definition of the width. For Riemannian manifold (M^n, g) where g is the Riemannian metric, the width of M^n is defined as follows:

$$\mathcal{W}(M^n) = \inf_{f \in \text{Lip}(M^n)} \max_{t \in \mathbb{R}} \text{diam}(f^{-1}(t)),$$

where $\text{Lip}(M^n)$ is the set of all Lipschitz functions defined on M^n , and $\text{diam}(f^{-1}(t))$ is defined by

$$\text{diam}(f^{-1}(t)) = \max_{x, y \in f^{-1}(t)} d_g(x, y);$$

and $d_g(x, y)$ the distance between x, y with respect to Riemannian metric g .

In the above context, the width of a geodesic ball depends on two terms. The first term is the Gromov-Hausdorff distance between the geodesic ball and the 'model' cylinder, and the second term is the width of the 'model' cylinder $N^{n-1} \times [-R, R]$. Note the width of the 'model' cylinder $N^{n-1} \times [-R, R]$ is not bigger than the diameter of N^{n-1} , when R has much larger scale comparing the scale of N^{n-1} (see Figure 1).

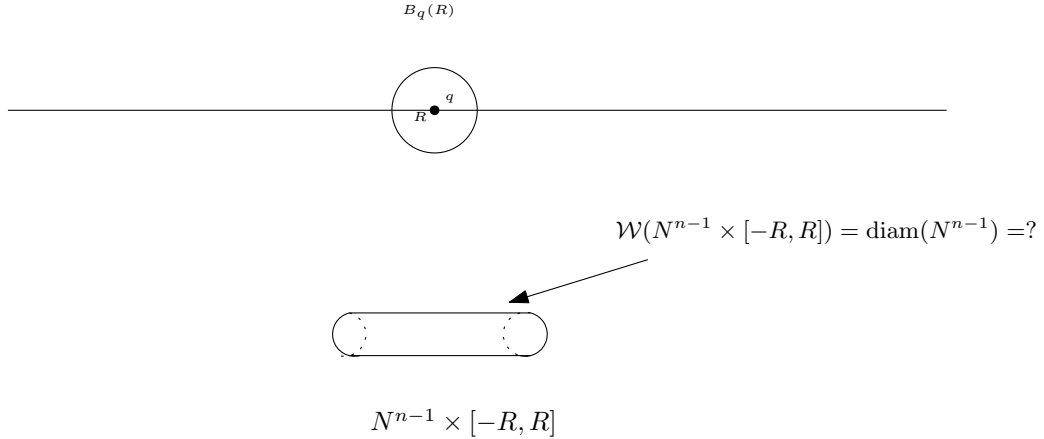

FIGURE 1. Local splitting and 'model' cylinder

We are interested in obtaining an 'analytic' characterization of the different scales in a geodesic ball with $Rc \geq 0$. One conjecture of Hang and Wang [HW07] as follows partially motivates our study along this direction:

Conjecture 1.1. *Assume $\Omega \subseteq \mathbb{R}^2$ is a bounded convex open subset with smooth boundary, then there is a universal constant $c > 0$ such that*

$$(1.1) \quad \mu_1(\Omega)\text{diam}(\Omega)^2 - \pi^2 \geq c \cdot \left(\frac{\mathcal{W}(\Omega)}{\text{diam}(\Omega)}\right)^2,$$

where $\mu_1(\Omega)$ is the first non-zero Neumann eigenvalue of Ω .

Note Payne-Weinberger [PW60] proved that $\mu_1(\Omega) \geq \frac{\pi^2}{\text{diam}(\Omega)^2}$ and Hang-Wang [HW07] showed the equality holds if and only if Ω is isometric to an interval of \mathbb{R} . The above conjecture points out: the spectral gap between the scaling invariant eigenvalue $\mu_1(\Omega)\text{diam}(\Omega)^2$ and the sharp lower bound π^2 , possibly bounds the square of the scaling invariant width $\frac{\mathcal{W}(\Omega)}{\text{diam}(\Omega)}$.

In [CMS23], using localization technique developed [CMM19] (also see [Kla17]), the inequality between the spectral gap and diameter difference is obtained on manifolds with positive Ricci curvature among more general context.

In this paper, we prove an inequality linking the spectral gap (between the first Dirichlet eigenvalue and the corresponding sharp lower bound) with the width, in similar form as (1.1).

Recall the inscribed radius of Riemannian manifold M^n is defined as $\text{IR}(M^n) := \sup_{x \in M^n} d(x, \partial M^n)$. For the convex region $\Omega \subseteq \mathbb{R}^2$, Hersch [Her60] showed $\lambda_1(\Omega) \cdot$

$\text{IR}(\Omega)^2 - \frac{\pi^2}{4} \geq 0$. Later, for convex region $\Omega \subseteq \mathbb{R}^n$, Mendez-Hernandez [MH02] (also see Protter [Pro81]) gave a proof of the inequality

$$(1.2) \quad \lambda_1(\Omega) \cdot \text{IR}(\Omega)^2 - \frac{\pi^2}{4} \geq \frac{(n-1)\pi^2}{4} \cdot \left(\frac{\text{IR}(\Omega)}{\text{diam}(\Omega)}\right)^2.$$

Kasue [Kas84] generalized Hersch's result to manifolds case. More specifically, he proved that for any n -dim bounded region Ω with $Rc \geq 0$ and mean convex boundary, Hersch's inequality also holds. He also showed that the equality case holds if and only if Ω is isometric to $[0, 2 \cdot \text{IR}(\Omega)] \times \tilde{\Omega}$, where $\tilde{\Omega}$ is an $(n-1)$ -dim bounded region with $Rc \geq 0$ and mean convex boundary.

In 1999, among other things, Yang [Yan99] used the gradient estimate method (developed by Li-Yau [LY80] and Zhong-Yang [ZY84]) to present a different proof of Kasue's result. Recently Wang, Zhou and the author [WXZ22] prove that $\lambda_1(B_p(R)) \cdot R^2 - \frac{\pi^2}{16} > 0$ holds for any geodesic ball in non-compact complete Riemannian manifold with $Rc \geq 0$. And the model space in [WXZ22] is a tube, see Figure 2.

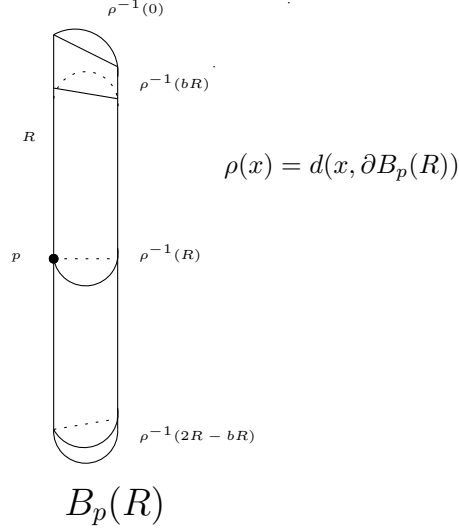

FIGURE 2. Tube type geodesic ball in Theorem 1.2

Motivated by Conjecture 1.1 and the results in [Kas84], [WXZ22], we try to bound the width of geodesic ball, by the gap between the first Dirichlet eigenvalue and the sharp lower bound. Our main result in this paper is the following theorem.

Theorem 1.2. *There is $C(n) > 0$, such that for any n -dim geodesic ball $B_p(R)$ with $Rc \geq 0$ and mean convex boundary (i.e. the mean curvature of $\partial B_p(R)$ with respect to the outforward unit normal vector of $\partial B_p(R)$ is non-negative), we have*

$$\lambda_1(B_p(R)) \cdot R^2 - \frac{\pi^2}{16} \geq C(n) \left\{ \frac{\mathcal{W}(B_p(R))}{R} \right\}^{\frac{4(2n+1)(8n+15)}{n+2}}.$$

Remark 1.3. *Theorem 1.2 partially can be viewed as the stability version of the rigidity result proved in [Kas84]. In this paper we only discuss the case of $\Omega = B_p(R)$. Note the geodesic balls in complete Riemannian manifolds with warped product metric $g = dr^2 + f^2(r) \cdot d\mathbb{S}^{n-1}$ and $Rc(g) \geq 0$, whose center is the origin of the warped product metric (i.e. $r = 0$); have mean convex boundary.*

Recall that by [WXZ22], the inequality $\lambda_1(B_p(R)) \cdot R^2 - \frac{\pi^2}{16} > 0$ always holds for any geodesic ball in non-compact complete Riemannian manifold with $Rc \geq 0$. And we hope to extend our study to any geodesic balls in non-compact complete Riemannian manifolds in the future.

The power $\frac{4(2n+1)(8n+15)}{n+2}$ of $\frac{\mathcal{W}(B_p(R))}{R}$ in Theorem 1.2 is not sharp. Comparing the quantitative isoperimetric inequality (see [FMP08]), Faber-Krahn inequality (see [BDPV15]) and (1.2); whether the sharp power is 2 or not, is an interesting question.

The whole paper devotes to the proof of Theorem 1.2. Now we sketch the proof of Theorem 1.2 and the organization of the paper. In Section 2, we firstly observe the key equality (2.2) linking the spectral gap with the integral of the ratio between

eigenfunction and model distance function. Then we obtain the estimate of the ratio between eigenfunction and model distance function in the form of the spectral gap (see Proposition 2.5). Using the C^0 -estimate of eigenfunction and the integral estimate of model distance function, we obtain the volume comparison for distance function's level sets (see Lemma 2.7).

In Section 3, following Cheeger-Colding [CC96] and volume comparison of level sets, we get the integral estimate of harmonic function's gradient and Hessian, also C^0 estimate of the difference between harmonic function and distance function. One key property about extendability of geodesics in the region is also discussed in quantitative way.

The main result of Section 4 is the Stable Gou-Gu Theorem (see Figure 3 and Theorem 4.10) for any interior two points of geodesic ball, which are close to each other. Although this technical result (Theorem 4.10) is possibly well-known to some experts in this field, we provide a detailed argument in this paper; because we can not find the related explicit discussion in the literature.

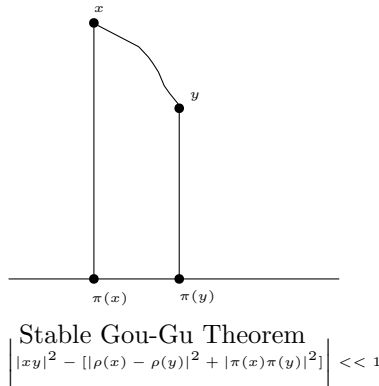
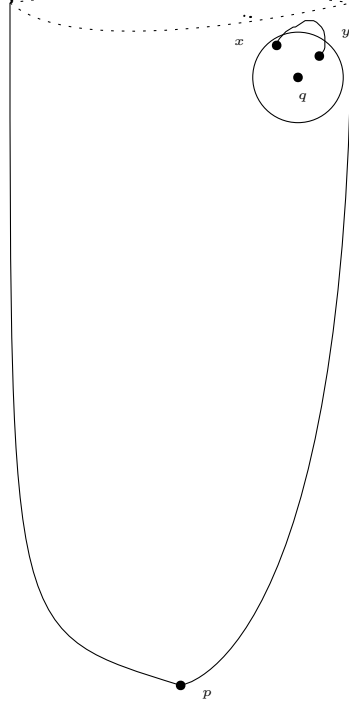

FIGURE 3. Stable-Gou-Gu Theorem



If the segment between x and y is close to the boundary of geodesic ball,
then Stable Gou-Gu theorem does not hold for $B_q(r)$

FIGURE 4. Remark

Remark 1.4. *We require that two points are close to each other, because we need that the segment between them does not touch the boundary of geodesic ball. This is a crucial requirement, because we only have global interior integral estimate. When the points or segments are close to the boundary of geodesic ball, the estimate does not hold anymore. We call the distance estimate for such close pair points as ‘local distance estimate’.*

By modifying the original argument in [CC96] and technical improvement in [CN12], the argument in Section 4 and Section 5 provides quantitative argument to obtain the global distance estimate.

Using Theorem 4.10 and the method of getting the global distance estimate from the local distance estimate in [CC96], in Section 5 we first obtain the estimate for the outer level sets’ diameter. Then we use the geodesic ball property, the crucial distance estimates (5.1) and (5.2), to deduce the width estimate.

Finally we combine the results in Section 2, Section 4 and Section 5, and obtain the width estimate of geodesic ball in term of spectral gap in Section 6.

For reader’s convenience, we provide a diagram as follows, which is the structure of Theorem 6.1(Theorem 1.2)’s proof.

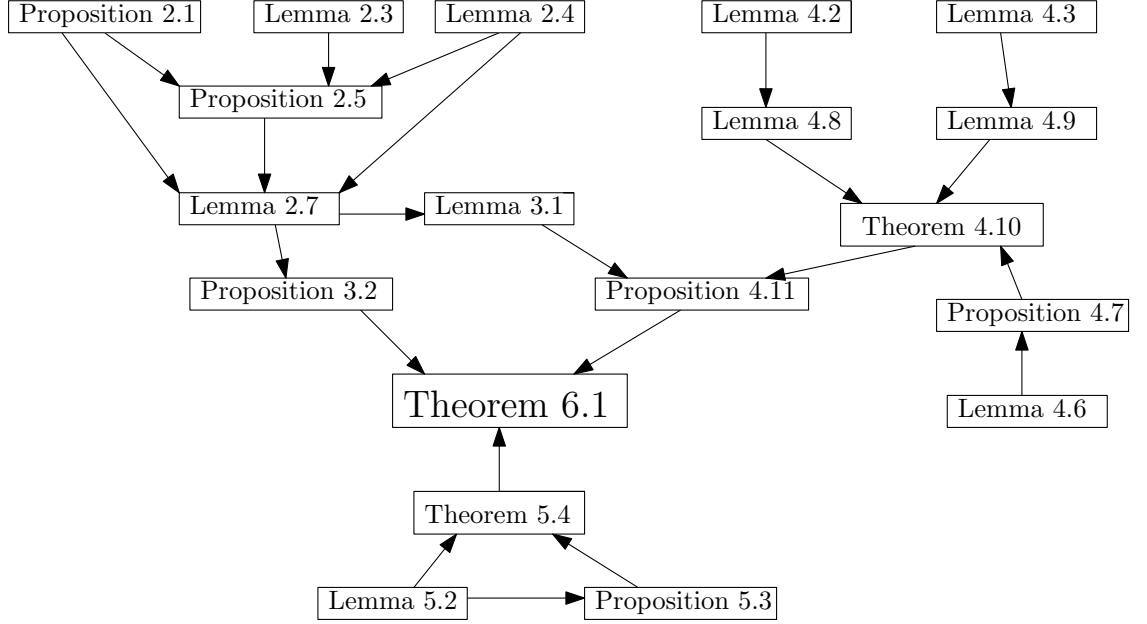

FIGURE 5. The structure of Theorem 6.1's Proof

2. SPECTRAL GAP BOUNDS THE VOLUME DIFFERENCE OF LEVEL SETS

In the rest of the paper, unless otherwise mentioned, we assume $u > 0$ is a normalized eigenfunction with respect to the 1st Dirichlet eigenvalue in $B = B_\rho(R)$ and $\max_{x \in B} |u(x)| = 1$, where B is a geodesic ball with $Rc \geq 0$ and mean convex boundary. Also we define $\psi(x) = \sin(\frac{\pi}{4R}\rho(x))$ where $\rho(x) = d(x, \partial B_\rho(R))$. Furthermore, we always assume

$$\epsilon := \lambda - \frac{\pi^2}{16R^2},$$

where $\lambda = \lambda_1(B_\rho(R))$ and $\epsilon \in (0, R^{-2})$. For convenience, for any $C \cdot \epsilon$, where $C > 0$ is some universal constant; we also use ϵ to denote $C \cdot \epsilon$ in the rest argument.

In the rest of paper, for any $x, y \in B$, we also use $|xy|$ to denote the distance $d_g(x, y)$ and \overline{xy} to denote one geodesic segment between x, y .

Let $v = \frac{\sin^{-1}u}{\sqrt{\lambda}}$, from [Yan99], we know that

$$(2.1) \quad |\nabla v| \leq 1.$$

The following key equality of spectral gap is the starting point of our paper.

Proposition 2.1. *For u, ψ, ϵ defined as above, we have*

$$(2.2) \quad \epsilon = \frac{\int_B |\nabla(\frac{u}{\psi})|^2 \cdot \psi^2}{\int_B u^2} + \frac{\frac{\pi}{4R} \int_B u^2 \cot(\frac{\pi}{4R}\rho) \cdot (-\Delta\rho)}{\int_B u^2}.$$

Remark 2.2. Define $f(x) = d(p, x)$, then $\rho(x) = R - f(x)$. It is well-known that $\Delta f(x) = H(x)$ in the sense of the distribution, where H is the mean curvature of $\partial B_p(f(x))$ (see [Li12, Page 33]). From ∂B is mean convex, we get $\Delta \rho = -\Delta f = -H \leq 0$, where $\Delta \rho$ is again in the sense of the distribution. Therefore, both two terms on the right side of the equality are non-negative. Also the above equation gives another proof of $\lambda_1(\Omega) \cdot \mathbf{IR}(\Omega)^2 - \frac{\pi^2}{4} \geq 0$ if we replace ψ by the function $\sin(\frac{\pi}{2\mathbf{IR}(\Omega)}\tilde{\rho}(x))$, where $\tilde{\rho}(x) = d(x, \partial\Omega)$.

Proof: Define $\eta(x) = \frac{u}{\psi}(x)$, now we have

$$\begin{aligned} \lambda \int_B u^2 &= \int_B |Du|^2 = \int_B |\nabla(\psi \cdot \eta)|^2 = \int_B \eta^2 \cdot |\nabla\psi|^2 + |\nabla\eta|^2 \psi^2 + \nabla(\eta^2) \cdot (\psi \nabla\psi) \\ &= \int_B |\nabla\eta|^2 \psi^2 + \eta^2 \cdot |\nabla\psi|^2 - \eta^2 \nabla(\psi \nabla\psi) = \int_B |\nabla\eta|^2 \psi^2 - \eta^2 \psi \Delta\psi \\ &= \frac{\pi^2}{16R^2} \int_B u^2 + \int_B |\nabla(\frac{u}{\psi})|^2 \cdot \psi^2 + \frac{\pi}{4R} \int_B u^2 \cot(\frac{\pi}{4R}\rho) \cdot (-\Delta\rho). \end{aligned}$$

□

Firstly we get that the ratio between eigenfunction and distance function is close to 1 at the center of the ball.

Lemma 2.3. *We have*

$$|u(p) - \frac{\sqrt{2}}{2}| \leq R^2 \epsilon.$$

Proof: Assume $\bar{p} \in \partial B_p(R)$, from (2.1) we get

$$\sin^{-1} u(p) - \sin^{-1} u(\bar{p}) \leq \sqrt{\lambda} R \leq \frac{\pi}{4} + R^2 \epsilon,$$

which implies $u(p) \leq \frac{\sqrt{2}}{2} + R^2 \epsilon$.

On the other hand, assume $u(q) = 1$. Note $d(p, q) \leq R$ we have

$$\sin^{-1} u(q) - \sin^{-1} u(p) \leq \sqrt{\lambda} d(p, q) \leq \frac{\pi}{4} + R^2 \epsilon;$$

which implies $u(p) \geq \sin(\frac{\pi}{4} - R^2 \epsilon) \geq \frac{\sqrt{2}}{2} - R^2 \epsilon$. □

In the rest of the paper, unless otherwise mentioned, the constant $b \in (0, 1)$ is a very small number to be determined later.

Lemma 2.4. *We have $B_p((1-b)R) = \{bR < \rho < (2-b)R\}$.*

Proof: Firstly note that $B_p((1-b)R) \subseteq \{bR < \rho < (2-b)R\}$.

Secondly note $\partial B_p(R)$ is a compact set; then for any x with $\rho(x) \in (bR, (2-b)R)$, there is a point $\hat{x} \in \partial B_p(R)$ with $\rho(x) = d(x, \hat{x})$.

Note the tangent vector of the geodesic segment $\overline{x, \hat{x}}$ at \hat{x} is perpendicular to the tangent space of $\partial B_p(R)$ at \hat{x} , and one writes $x, \hat{x} \perp \partial B_p(R)$. This implies

$$\overline{p, \hat{x}} \subseteq \overline{x, \hat{x}}, \quad \text{or} \quad \overline{x, \hat{x}} \subseteq \overline{p, \hat{x}};$$

because $\overline{p, \hat{x}} \perp \partial B_p(R)$ at \hat{x} too. The conclusion follows from the above directly. □

Proposition 2.5. *There is $C_1(n) > 0$ such that if*

$$(2.3) \quad \epsilon R^2 \leq C_1(n)b^{n+2},$$

then there is $C_2(n) > 0$ satisfying

$$\sup_{x \in B_p((1-b)R)} \left| \frac{u}{\psi}(x) - 1 \right| \leq C_2(n)(\epsilon R^2)^{\frac{1}{n+2}} b^{-1}.$$

Remark 2.6. *Because of Proposition 2.5, in fact we can analyze the metric structure of cylinder type region, using eigenfunctions instead of harmonic functions. However in the context of $Rc \geq 0$, the harmonic function h (see Definition 3.1) is a canonical approximation to the distance function ρ locally. On the other hand, the eigenfunctions are canonical approximation in the context $Rc \geq (n-1)$ (see [Col96a], [Col96b], [Pet99], [Aub05] and [WZ23]).*

Proof: Step (1). We use the notation $w = \frac{u}{\psi}$ in the rest argument. From Lemma 2.4, we get $\psi|_{B_p((1-b)R)} \geq \sin(\frac{\pi}{4R}b) \geq \frac{1}{2}b$.

Note $|\nabla v| \leq 1 = |\nabla \rho|$, where $|\nabla \rho| = 1$ is in the almost everywhere sense, because ρ is not smooth. We can get

$$u \leq \sin(\sqrt{\lambda}\rho).$$

Then we have

$$\frac{u}{\psi} \leq \frac{\sin(\sqrt{\lambda}\rho)}{\sin(\frac{\pi}{4R}\rho)} \leq 2\sqrt{\lambda}R.$$

Now we know that

$$(2.4) \quad \sup_{B_p((1-b)R)} |\nabla w| \leq \left| \frac{|\nabla u|}{\psi} \right| + \left| \frac{u\nabla\psi}{\psi^2} \right| \leq \frac{2\sqrt{\lambda}}{b} + \frac{4\sqrt{\lambda}}{b} \leq C(n)(bR)^{-1}.$$

Step (2). From Neumann Poincare inequality for geodesic ball (see [Bus82]) and Proposition 2.1, note $|u| \leq 1$; we have

$$(2.5) \quad \begin{aligned} & \int_{B_p((1-\frac{1}{2})b)R} |w(x) - \fint_{B_p((1-\frac{1}{2})b)R} w|^2 dx \leq C(n)R^2 \int_{B_p((1-\frac{1}{2})b)R} |\nabla w|^2 \\ & \leq C(n)R^2 \frac{\int_B |\nabla w|^2 \psi^2}{b^2} \leq C(n)\epsilon R^2 \frac{\int_B u^2}{b^2} \\ & \leq C(n) \frac{\epsilon R^2}{b^2} V(B). \end{aligned}$$

Let $A_\eta = \{x \in B_p((1-\frac{1}{2})b)R : |w(x) - \fint_{B_p((1-\frac{1}{2})b)R} w| \geq \eta\}$, where $\eta = (\epsilon R^2)^{\frac{1}{n+2}} b^{-1}$. Then from (2.5) we obtain

$$(2.6) \quad V(A_\eta) \leq C_3(n)V(B_p(R)) \cdot \frac{\epsilon R^2}{b^2 \eta^2}.$$

For any $x \in B_p((1-b)R)$, from Bishop-Gromov Volume Comparison Theorem there is $C_4(n) > 0$ such that if $r_3 = C_4(n) \cdot (\frac{\epsilon R^2}{\eta^2 b^2})^{\frac{1}{n}}$, then we have

$$\begin{aligned} V(B_x(r_3R)) &\geq \left(\frac{r_3}{2}\right)^n \cdot V(B_x(2R)) \geq \left(\frac{r_3}{2}\right)^n \cdot V(B_p(R)) > \frac{C_3(n)V(B_p(R))}{\eta^2} \cdot \frac{\epsilon R^2}{b^2} \\ &\geq V(A_\eta). \end{aligned}$$

Now we can find $C_1(n) > 0$, such that if $\epsilon R^2 \leq C_1(n)b^{n+2}$, then

$$r_3 = C_4(n) \cdot \left(\frac{\epsilon R^2}{\eta^2 b^2}\right)^{\frac{1}{n}} \leq \frac{1}{40}b.$$

This implies $B_x(r_3R) \subseteq B_p((1-\frac{1}{2}b)R)$ for any $x \in B_p((1-b)R)$. Therefore for any $x \in B_p((1-b)R)$, there is $\check{x} \in (B_x(r_3R) \setminus A_\eta) \subseteq B_p((1-\frac{1}{2}b)R)$. Now using (2.4) we get

$$\begin{aligned} |w(x) - \fint_{B_p((1-\frac{1}{2}b)R)} w| &\leq |w(x) - w(\check{x})| + |w(\check{x}) - \fint_{B_p((1-\frac{1}{2}b)R)} w| \\ &\leq \sup_{B_p((1-\frac{1}{2}b)R)} |\nabla w| \cdot d(x, \check{x}) + \eta \leq \eta + r_3 \cdot \frac{C(n)}{b} \\ (2.7) \quad &\leq \eta + C_4(n) \cdot \left(\frac{\epsilon R^2}{\eta^2 b^2}\right)^{\frac{1}{n}} \cdot \frac{1}{b} \leq C(n)(\epsilon R^2)^{\frac{1}{n+2}} b^{-1}. \end{aligned}$$

By Lemma 2.3 and (2.7), for any $x \in B_p((1-b)R)$ we get

$$\begin{aligned} |w(x) - 1| &\leq |w(x) - \fint_{B_p((1-\frac{1}{2}b)R)} w| + |w(p) - \fint_{B_p((1-\frac{1}{2}b)R)} w| + |1 - w(p)| \\ &\leq C(n)(\epsilon R^2)^{\frac{1}{n+2}} b^{-1} + C(n)R^2 \epsilon \leq C(n)(\epsilon R^2)^{\frac{1}{n+2}} b^{-1}. \end{aligned}$$

□

The following lemma provides reason to use the method of Cheeger-Colding in [CC96].

Lemma 2.7. *There is $C(n) > 0$ such that*

$$\frac{V(\rho^{-1}(bR)) - V(\rho^{-1}((2-b)R))}{V(B_p(R))} \leq C(n) \frac{\epsilon R}{b},$$

where $V(\rho^{-1}(bR))$, $V(\rho^{-1}((2-b)R))$ are the $(n-1)$ -dim Hausdorff measure of corresponding sets and $V(B_p(R))$ is the n -dim Hausdorff measure of $B_p(R)$.

Remark 2.8. *From the above volume comparison between level sets and Cheeger-Colding [CC96, Theorem 4.85], we in fact get $B_p((1-b)R)$ is close to a cylinder $\rho^{-1}(bR) \times [bR, (2-b)R]$ (which has product metric) in Gromov-Hausdorff distance sense; and we call such set as **almost cylinder**. Then we can get the diameter estimate of the level sets in qualitative form. Because we are interested in obtaining the quantitative estimate of the width in form of the spectral gap, we follow the philosophy of Cheeger-Colding to study the metric structure of $B_p((1-b)R)$ in rest sections.*

Proof: By Lemma 2.4, let $A = \rho^{-1}(bR, (2-b)R) = B_\rho((1-b)R)$ in the rest argument. From Proposition 2.5, we get

$$(2.8) \quad \inf_{x \in A} \frac{u}{\psi} \geq \frac{1}{2}.$$

From Proposition 2.1 and (2.8), we have

$$(2.9) \quad \begin{aligned} \epsilon &\geq \frac{\pi \int_B u^2 \cot(\frac{\pi}{4R}\rho)(-\Delta\rho)}{\int_B u^2} \geq \frac{\pi}{8R} \int_B \left(\frac{u}{\psi}\right)^2 \sin(\frac{\pi}{2R}\rho)(-\Delta\rho) \\ &\geq \frac{\pi}{32R} \int_B u^2 \int_A \sin(\frac{\pi}{2R}\rho)(-\Delta\rho). \end{aligned}$$

By mean convex property of $\partial B_\rho(R)$, we know that $\Delta\rho \leq 0$. Now by the Divergence Theorem we get

$$(2.10) \quad \int_A \sin(\frac{\pi}{2R}\rho)(-\Delta\rho) \geq \sin(\frac{b\pi}{2}) \cdot \int_A (-\Delta\rho) \geq b \cdot \{V(\rho^{-1}(bR)) - V(\rho^{-1}((2-b)R))\}.$$

From (2.9) and (2.10), we obtain

$$\frac{V(\rho^{-1}(bR)) - V(\rho^{-1}((2-b)R))}{V(B_\rho(R))} \leq \frac{\int_A (-\Delta\rho)}{\int_B u^2} \leq C(n)\epsilon R b^{-1}.$$

□

3. TWO TYPE ESTIMATES BY THE VOLUME DIFFERENCE

In this section, the function h is defined as follows:

$$(3.1) \quad \begin{cases} \Delta h(x) = 0, & x \in \rho^{-1}(bR, (2-b)R), \\ h(x) = \rho(x), & x \in \rho^{-1}(bR) \cup \rho^{-1}((2-b)R). \end{cases}$$

3.1. The integral estimates of harmonic functions.

Lemma 3.1. *There are $C(n) > 0$ such that*

$$\begin{aligned} \int_{\rho^{-1}(bR, (2-b)R)} |\nabla(h - \rho)|^2 &\leq C(n) \frac{\epsilon R^2}{b}, \\ \int_{\rho^{-1}(2bR, (2-2b)R)} |\nabla^2 h|^2 &\leq \frac{C(n)}{(bR)^2} \cdot \sqrt{\frac{\epsilon R^2}{b}}, \\ \sup_{x \in \rho^{-1}(2bR, (2-2b)R)} |h - \rho|(x) &\leq C(n) (b\epsilon R^2)^{\frac{1}{n+2}} \cdot \frac{R}{b}. \end{aligned}$$

Proof: Step (1). Let $A = \rho^{-1}(bR, (2-b)R)$ and $A_1 = \rho^{-1}(2bR, (2-2b)R)$. Firstly by the Maximum principle, we get $(\rho - h)|_A \geq 0$. Then we have

$$\begin{aligned} \int_A |\nabla(h - \rho)|^2 &= \int_A (\rho - h) \Delta(h - \rho) = \int_A (\rho - h) \cdot (-\Delta\rho) \leq \sup_A (\rho - h) \cdot \int_A (-\Delta\rho) \\ &\leq (2-b)R \cdot [V(\rho^{-1}(bR)) - V(\rho^{-1}((2-b)R))]. \end{aligned}$$

Note $B_\rho((1-b)R) \subseteq A$, from Lemma 2.7 we have

$$(3.2) \quad \begin{aligned} \int_A |\nabla(h-\rho)|^2 &\leq \frac{\int_A |\nabla(h-\rho)|^2}{V(B_\rho(R))} \cdot \left(\frac{R}{(1-b)R}\right)^n \\ &\leq C(n) \frac{(2-b)R \cdot [V(\rho^{-1}(bR)) - V(\rho^{-1}((2-b)R))]}{V(B_\rho(R))} \leq C(n) \frac{\epsilon R^2}{b}. \end{aligned}$$

Step (2). From Bochner formula and $Rc \geq 0$, we get $|\nabla^2 h|^2 \leq \frac{1}{2} \Delta(|\nabla h|^2)$. Therefore choosing cut-off function φ with $\varphi|_{A_1} = 1$ and $\varphi|_{B-A} = 0$, we obtain

$$\begin{aligned} \int_{A_1} |\nabla^2 h|^2 &\leq \int_A |\nabla^2 h|^2 \cdot \varphi \leq \frac{1}{2} \int_A \varphi \cdot \Delta(|\nabla h|^2 - 1) \leq \frac{1}{2} \int_A \Delta \varphi \cdot (|\nabla h|^2 - 1) \\ &\leq \frac{1}{2} \sup_A |\Delta \varphi| \int_A |\nabla(h-\rho)| \cdot (|\nabla h| + 1) \leq \frac{C(n)}{(bR)^2} \int_A |\nabla(h-\rho)| \cdot (|\nabla(h-\rho)| + 2) \\ &\leq \frac{C(n)}{(bR)^2} \left\{ \int_A |\nabla(h-\rho)|^2 + \sqrt{V(A)} \cdot \int_A |\nabla(h-\rho)|^2 \right\}. \end{aligned}$$

By volume comparison Theorem and the above, also using (3.2), we have

$$\int_{A_1} |\nabla^2 h|^2 \leq \frac{C(n)}{(bR)^2} \left\{ \int_A |\nabla(h-\rho)|^2 + \sqrt{\int_A |\nabla(h-\rho)|^2} \right\} \leq \frac{C(n)}{(bR)^2} \cdot \sqrt{\frac{\epsilon R^2}{b}}.$$

Step (3). Note $A \subseteq B_\rho(R)$, from the domain monotonicity of Dirichlet eigenvalues (see [Cha84, Page 17]); we know that

$$\lambda_1(A) \geq \lambda_1(B_\rho(R)) > \frac{\pi^2}{16R^2}.$$

Combining the result from Step (1), we have

$$(3.3) \quad \int_A |h-\rho|^2 \leq \lambda_1(A)^{-1} \int_A |\nabla(h-\rho)|^2 \leq C(n) \frac{\epsilon R^2}{b} R^2.$$

Let $A_2 = \rho^{-1}(\frac{3}{2}bR, (2-\frac{3}{2})bR)$, from Cheng-Yau's gradient estimate for positive harmonic function h , we get

$$(3.4) \quad \sup_{A_2} |\nabla(h-\rho)| \leq \sup_{A_2} (|\nabla h| + 1) \leq \frac{C(n)}{bR} \sup_A h(x) + 1 \leq \frac{C(n)}{b}.$$

For $\eta > 0$ to be determined later, we define

$$W = h - \rho, \quad \Omega_\eta = \{z \in A_2 : |W(z)| \leq \eta\}.$$

Let $r_\eta = C(n)R \cdot \left(\frac{\epsilon R^2}{b} \frac{R^2}{\eta^2}\right)^{\frac{1}{n}}$, for $x \in A_1$ we have $B_x(r_\eta) \subseteq A_2$. From (3.3) we can get

$$\frac{V(B_x(r_\eta))}{V(A)} \geq \left(\frac{r_\eta}{2R}\right)^n > C(n) \frac{\epsilon R^2}{b} R^2 \eta^{-2} \geq \eta^{-2} \int_A |h-\rho|^2 \geq \frac{V(A_2 - \Omega_\eta)}{V(A)}.$$

Therefore $V(B_x(r_\eta)) > V(A_2 - \Omega_\eta)$.

Note $B_x(r_\eta) \subseteq A_2$, then we get that $B_x(r_\eta) \cap \Omega_\eta \neq \emptyset$. Choose $\check{x} \in B_x(r_\eta) \cap \Omega_\eta$, now by (3.4), we get

$$|W(x)| \leq |W(x) - W(\check{x})| + |W(\check{x})| \leq \eta + r_\eta \cdot \sup_{A_2} |\nabla W| \leq \eta + \frac{C(n)R}{b} \cdot \left(\frac{\epsilon R^2}{b} \frac{R^2}{\eta^2}\right)^{\frac{1}{n}}.$$

Now choose $\eta = \frac{C(n)R}{b} \cdot \left(\frac{\epsilon R^2}{b} \frac{R^2}{\eta^2}\right)^{\frac{1}{n}}$, which implies $\eta = C(n) \left(b\epsilon R^2\right)^{\frac{1}{n+2}} \cdot \frac{R}{b}$. The conclusion follows from the above. \square

3.2. The error estimates of extendability. The next proposition says that the gradient curves of distance function are almost extendable.

Proposition 3.2. *For $x \in \rho^{-1}(bR)$ and $t \in [b, 2 - b]$, there is $z \in \rho^{-1}(tR)$ such that*

$$d(x, z) - (t - b)R \leq C(n)R \cdot \left(\frac{\epsilon R^2}{b}\right)^{\frac{1}{n-1}}.$$

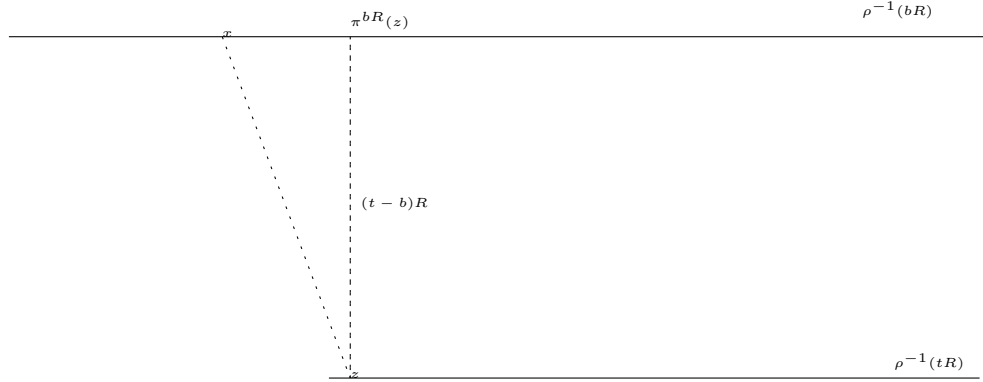

FIGURE 6. gradient curve of ρ is almost extendable

Proof: Step (1). We firstly show the conclusion for $t = 2 - b$: for any $x \in \rho^{-1}(bR)$ there is $y \in \rho^{-1}((2 - b)R)$ such that

$$(3.5) \quad d(x, y) - (2 - 2b)R \leq C(n)R \cdot \left(\frac{\epsilon R^2}{b}\right)^{\frac{1}{n-1}}.$$

Let $\zeta = C(n) \cdot \left(\frac{\epsilon R^2}{b}\right)^{\frac{1}{n-1}}$. By contradiction, assume the conclusion does not hold for $x_0 \in \rho^{-1}(bR)$, which implies

$$d(x_0, y) - (2 - 2b)R > \zeta R, \quad \forall y \in \rho^{-1}((2 - b)R).$$

Then for any $z \in B_{x_0}(\frac{\zeta R}{2})$ and $y \in \rho^{-1}((2 - b)R)$, we have

$$\begin{aligned} d(z, y) - ((2 - b)R - \rho(z)) &\geq d(x_0, y) - (2 - 2b)R - d(z, x) - |bR - \rho(z)| \\ &> \zeta R - \frac{\zeta}{2}R - \frac{\zeta}{2}R = 0. \end{aligned}$$

The above inequality implies that $\rho^{-1}((2-b)R) \subseteq \gamma(\rho^{-1}(rR) - B_{x_0}(\frac{\zeta}{2}R))$ for any $r < 2-b$, where γ is the gradient curve of ρ .

Step (2). Note $B_{x_0}(\frac{\zeta}{2}R) \subseteq \rho^{-1}(bR - \frac{\zeta}{2}R, bR + \frac{\zeta}{2}R)$, by the Co-Area formula we get that there is $r_0 \in [b - \frac{\zeta}{2}, b + \frac{\zeta}{2}]$ such that

$$(3.6) \quad \begin{aligned} V(\rho^{-1}(r_0R) \cap B_{x_0}(\frac{\zeta}{2}R)) &\geq \frac{1}{\zeta R} V(B_{x_0}(\frac{\zeta}{2}R)) \geq \frac{\zeta^{n-1}}{4^n R} V(B_{x_0}(2R)) \\ &\geq \frac{\zeta^{n-1}}{4^n R} V(B_p(R)), \end{aligned}$$

where the last but one inequality above follows from Bishop-Gromov volume comparison Theorem.

By $\Delta\rho \leq 0$, we know the volume element of the slice $\rho^{-1}(t)$ is decreasing along t ; because $\Delta\rho$ is the directional derivative of the volume element of the slice $\rho^{-1}(t)$ along t (see [Li12, Page 4 and Page 33]). Therefore by result in Step (1) and $\frac{b}{2} \leq r_0$, we get

$$\begin{aligned} V(\rho^{-1}((2-b)R)) &\leq V(\gamma(\rho^{-1}(r_0R) - B_{x_0}(\frac{\zeta R}{2}))) \leq V(\rho^{-1}(r_0R) - B_{x_0}(\frac{\zeta R}{2})) \\ &\leq V(\rho^{-1}(r_0R)) - V(\rho^{-1}(r_0R) \cap B_{x_0}(\frac{\zeta R}{2})) \\ &\leq V(\rho^{-1}(\frac{bR}{2})) - C(n)\zeta^{n-1}R^{-1}V(B_p(R)). \end{aligned}$$

Therefore by Lemma 2.7, we obtain

$$\begin{aligned} \zeta^{n-1}R^{-1} &\leq C(n) \frac{V(\rho^{-1}(\frac{b}{2}R)) - V(\rho^{-1}((2-b)R))}{V(B_p(R))} \\ &\leq C(n) \frac{V(\rho^{-1}(\frac{b}{2}R)) - V(\rho^{-1}((2-\frac{b}{2})R))}{V(B_p(R))} \\ &\leq C(n) \cdot \frac{\epsilon R}{2^{-1}b}. \end{aligned}$$

This contradicts the choice of ζ at the beginning of the proof. Hence the conclusion (3.5) holds.

Finally we show the conclusion for $t \in [b, 2-b]$. For x, y as in (3.5), we choose $z \in \overline{x, y} \cap \rho^{-1}(tR)$, then

$$\begin{aligned} |zx| = |xy| - |zy| &\leq (2-2b)R + C(n)R \cdot \left(\frac{\epsilon R^2}{b}\right)^{\frac{1}{n-1}} - |\rho(z) - \rho(y)| \\ &= (t-b)R + C(n)R \cdot \left(\frac{\epsilon R^2}{b}\right)^{\frac{1}{n-1}}. \end{aligned}$$

□

4. STABLE GOU-GU THEOREM WITH INTEGRAL ESTIMATES

In [CC96], there is an original, concise argument explaining how to obtain the local distance estimate. In [CN12], there is a detailed argument around estimating the distance by the integral of suitable terms, which provides effective ways to

get quantitative estimate locally. In [Xu19] and [XZ23], following the strategy of [CC96] and using the technical tools developed in [CN12], we essentially proved the following almost Gou-Gu Theorem:

Theorem 4.1. *There are $C(n) > 0$, such that for any $|xy| \leq r$, we can find \hat{x}, \hat{y} satisfying*

$$\begin{aligned} |x\hat{x}| + |y\hat{y}| &\leq C(n)r \cdot \zeta\left(\sup_{B_x(4r)} \sqrt{\frac{|h-\rho|}{r}}, \int_A H^2, \int_A G^2\right), \\ \left|d(x, y) - \sqrt{|\rho(x) - \rho(y)|^2 + |\pi(\hat{x})\pi(\hat{y})|^2}\right| \\ &\leq C(n)r \cdot \zeta\left(\sup_{B_x(4r)} \sqrt{\frac{|h-\rho|}{r}}, \int_A H^2, \int_A G^2\right), \end{aligned}$$

where ζ is some function satisfying $\lim_{\sum_{i=1}^3 |x_i| \rightarrow 0} \zeta(x_1, x_2, x_3) = 0$.

Basically, the Almost Gou-Gu Theorem says that the distance between two close points x, y can be controlled by their distance to the base level set $\rho^{-1}(t)$, and the distance between the projection of two ‘good’ points \hat{x}, \hat{y} on $\rho^{-1}(t)$, where \hat{x}, \hat{y} are close to x, y and the corresponding integral estimates hold for ‘good’ points (see Figure 7).

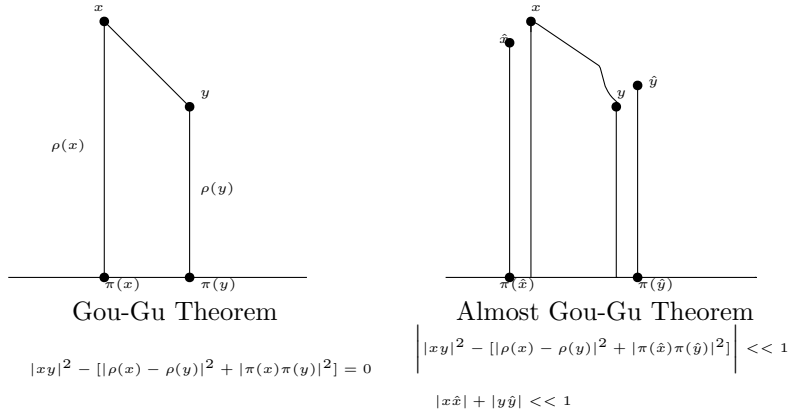

FIGURE 7. Gou-Gu Theorem and Almost Gou-Gu Theorem

For $x \in B$, we firstly define ξ_x as the gradient curve of $-\rho$ starting from x and γ_x is the gradient curve of ρ starting at x . Because $|\nabla\rho| = 1$ almost everywhere, we know ξ_x, γ_x is well-defined and unique for almost every $x \in B$; where the measure is the Hausdorff measure determined by Riemannian metric g on B . In the rest of the paper, unless otherwise mentioned, all inequalities about distance estimates hold for almost every corresponding point on B .

In this section, for $0 < r \ll R$ we assume

$$\begin{aligned} x \in B, \quad \rho(x) = b_2, \quad \frac{1}{2}r \leq b_2 - b_0 \leq \frac{3}{2}r, \quad \pi^{b_0}(x) = \xi_x \cap \rho^{-1}(b_0), \\ |xy| \leq r, \quad \rho(y) - b_0 \geq \frac{1}{2}r; \quad b_0 \geq 20r, \quad b_2 \leq 2R - 20r. \end{aligned}$$

We study the relation between the distance function and the projection map onto $\rho^{-1}(b_0)$. One general philosophy of distance estimate and derivative estimate of distance function on manifolds is, to reduce the estimates to the line integral gradient estimate of error functions between the distance function ρ and harmonic function h and the Hessian estimate of h , where h is defined in (3.1).

In the rest of this section, for simplicity, we use the notation $G = |\nabla(\rho - h)|$, $H = |\nabla^2 h|$ (where G, H means gradient and Hessian respectively) and define

$$\mathcal{G}^{b_0}(x) = (\pi^{b_0}(x), \rho(x)) \in \rho^{-1}(b_0) \times \mathbb{R};$$

where $\rho^{-1}(b_0) \times \mathbb{R}$ is endowed with the product distance.

4.1. Distance estimate by line integral of difference. We firstly estimate the distance $d(x, y)$ in term of line integrals.

Lemma 4.2. *Define $l_t := d(\xi_x(t), \tilde{\xi}_y(t))$ for $t \in [0, 2r]$, where*

$$\tilde{\xi}_y(t) = \xi_y\left(\frac{\rho(y) - b_0}{\rho(x) - b_0}t\right), \quad \tau_t(s) = \overline{\xi_x(t), \tilde{\xi}_y(t)}(s) \text{ for } s \in [0, l_t].$$

Then we have

$$\begin{aligned} & \left| |xy|^2 - |\mathcal{G}^{b_0}(x)\mathcal{G}^{b_0}(y)|^2 \right| \\ & \leq 16r \cdot \left(\int_0^{\rho(y)-b_0} G(\xi_y(t))dt + \int_0^{\rho(x)-b_0} G(\xi_x(t))dt \right) \\ & \quad + 4r \cdot \sup_{B_x(4r)} |h - \rho| + 64r \cdot \int_0^{\rho(x)-b_0} dt \int_0^{l_t} H(\tau_t(s))ds. \end{aligned}$$

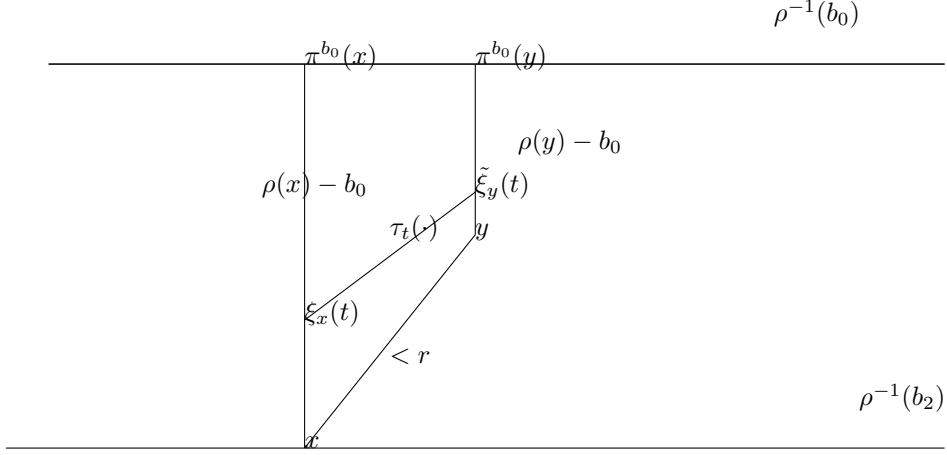
FIGURE 8. Distance estimate of $|xy|$

Proof: In the rest of this proof, for simplicity we use $\pi(x)$ to denote $\pi^{b_0}(x)$.

Assume $\sup_{x \in B_x(4r)} |h - \rho|(x) = \delta$. Define $\beta = \frac{\rho(y) - b_0}{\rho(x) - b_0}$ and note $\beta \in [0, 2]$. Since l_t is almost everywhere differentiable on $[0, 2r]$ with respect to t , from the extension of the first variation formula (see [Liu], and the key is to construct a family of smooth curves as in the proof of Toponogov's comparison theorem, which plays the role of support function of Lipschitz function l_t), we have

$$\begin{aligned} \frac{d}{dt} l_t &= \beta \langle \nabla \rho, \tau'_t \rangle(l_t) - \langle \nabla \rho, \tau'_t \rangle(0) = (I) + (II) + \frac{(\beta - 1)^2}{l_t} t, \\ (I) &= \beta \langle \nabla(\rho - h), \tau'_t \rangle(l_t) - \langle \nabla(\rho - h), \tau'_t \rangle(0), \\ (II) &= \beta [(h \circ \tau_t)'(l_t) - u'_t(l_t)] + [(h \circ \tau_t)'(0) - u'_t(0)], \\ u_t(s) &= \rho(x) - t - \frac{(\beta - 1)t + \rho(x) - \rho(y)}{l_t} s. \end{aligned}$$

The above inequality yields

$$[l_t^2 - (\beta - 1)^2 t^2]' = 2l_t \cdot (I) + 2l_t \cdot (II).$$

Taking integral with respect to t from 0 to $\rho(x) - b_0$ in the above, note $l_t \leq 8r$, we get

$$\begin{aligned} & \left| d(x, y)^2 - [d(\pi(x), \pi(y))^2 + |\rho(x) - \rho(y)|^2] \right| \leq \int_0^{\rho(x)-b_0} \|[l_t^2 - (\beta - 1)^2 t^2]'\} dt \\ & \leq 16r \int_0^{\rho(x)-b_0} |(I)| dt + \int_0^{\rho(x)-b_0} 2l_t \cdot |(II)|. \end{aligned}$$

Direct computation yields

$$\int_0^{\rho(x)-b_0} |(I)| dt \leq \int_0^{\rho(y)-b_0} |\nabla(\rho - h)|(\xi_y(s)) ds + \int_0^{\rho(x)-b_0} |\nabla(\rho - h)|(\xi_x(s)) ds.$$

By the Mean Value Theorem, there is $\zeta \in (0, l_t)$ such that

$$\begin{aligned} & |(h \circ \tau_t)'(\zeta) - \frac{\beta - 1}{l_t} t| = \left| \frac{[(h \circ \tau_t) - u_t](l_t) + [(h \circ \tau_t) - u_t](0)}{l_t} \right| \\ (4.1) \quad & = \left| \frac{(h - \rho)(\xi_y(\beta t)) - (h - \rho)(\xi_x(t))}{l_t} \right| \leq \frac{2\delta}{l_t} \end{aligned}$$

Now note $\beta \in (0, \beta_0]$, we get

$$\begin{aligned} |(II)| & = |(\beta - 1)[(h \circ \tau_t)'(l_t) - \frac{\beta - 1}{l_t} t] + \int_0^{l_t} \frac{d^2}{ds^2}(h \circ \tau_t)(s) ds| \\ & \leq |\beta - 1| \cdot |(h \circ \tau_t)'(\zeta) - \frac{\beta - 1}{l_t} t| + [|\beta - 1| + 1] \cdot \int_0^{l_t} |\nabla^2 h|(\tau_t(s)) ds \\ & \leq \frac{2|\beta - 1|\delta}{l_t} + 4 \int_0^{l_t} |\nabla^2 h|(\tau_t(s)) ds. \end{aligned}$$

Combining all the above, we obtain

$$\begin{aligned} & \left| d(x, y)^2 - [d(\pi(x), \pi(y))^2 + |\rho(x) - \rho(y)|^2] \right| \leq 16r \int_0^{\rho(x)-b_0} |(I)| dt + \int_0^{\rho(x)-b_0} 2l_t \cdot |(II)| \\ & \leq 16r \cdot \left(\int_0^{\rho(y)-b_0} |\nabla(\rho - h)|(\xi_y(t)) dt + \int_0^{\rho(x)-b_0} |\nabla(\rho - h)|(\xi_x(t)) dt \right) \\ & + 4\delta r + 64r \int_0^{\rho(x)-b_0} dt \int_0^{l_t} |\nabla^2 h|(\tau_t(s)) ds. \end{aligned}$$

□

Assume $b_0 - b_1 = 10\delta r$ in the rest of the paper.

Lemma 4.3. For $x_1 \in B_x(\delta r)$, $x_2 \in B_{\pi^{b_0}(x)}(\delta r)$ where $\delta \ll 1$, we have

$$\begin{aligned} & \left| d(x_1, x_2)^2 - d(\mathcal{G}^{b_1}(x_1), \mathcal{G}^{b_1}(x_2))^2 \right| \\ & \leq 16r \cdot \left(\int_0^{\rho(x_2)-b_1} G(\xi_{x_2}(t)) dt + \int_0^{\rho(x_1)-b_1} G(\xi_{x_1}(t)) dt \right) \\ & + 8r \cdot \sup_{B_x(4r)} |h - \rho| + 64r \cdot \int_0^{\rho(x_1)-b_1} dt \int_0^{l_t} H(\tau_t(s)) ds. \end{aligned}$$

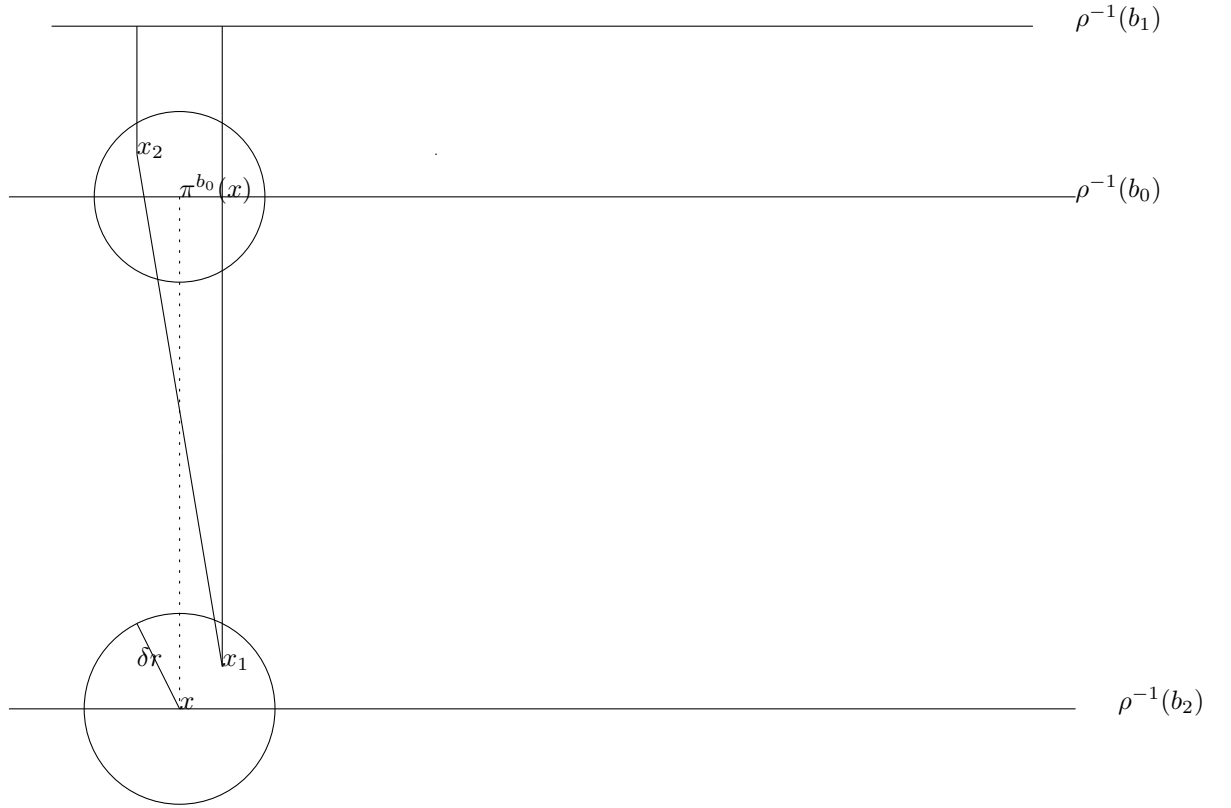
FIGURE 9. Distance estimate of $|x_1 x_2|$

Proof: Similar to the argument of Lemma 4.2. \square

4.2. The existence of ‘good’ pair points. Note in the statement of almost Gou-Gu Theorem (see Theorem 4.1), but we do not know whether

$$(4.2) \quad |\pi^{b_0}(\hat{x})\pi^{b_0}(x)| + |\pi^{b_0}(\hat{y})\pi^{b_0}(y)| \leq C(n)r \cdot \zeta\left(\sup_{B_x(4r)} \sqrt{\frac{|h-\rho|}{r}}, \int_A H^2, \int_A G^2\right).$$

That is why \hat{x}, \hat{y} appear in Theorem 4.1, although we know that the statement is unnatural. This issue can be avoided in local estimate; because we can reduce all discussion to \hat{x}, \hat{y} as in [Xu19] and [XZ23], although the presentation is more complicated.

During the process of gluing the local estimate to obtain the global estimate (we follow the strategy of [CC96, Theorem 3.6], see Section 5), the projection points problem above seems unavoidable; because we need to do projection repeatedly to get the global distance estimate.

Based the above reason, we call Theorem 4.1 as ‘‘Almost Gou-Gu Theorem’’. In the rest of this section, we show that (4.2) in fact holds in our context. Hence we

can remove \hat{x}, \hat{y} in the statement of Theorem 4.1, which is Theorem 4.10. And we call Theorem 4.10 as ‘‘Stable Gou-Gu Theorem’’, which is the main result of this section.

To show (4.2), which is the content of Lemma 4.9; inspired by definition of the set of ‘good’ points satisfying integral estimate in [CN12] (also see [Xu19] and [XZ23]); we introduce the set of ‘good’ pair points (see Definition 4.4 and Figure 10), whose non-emptiness is proved in Proposition 4.7.

For $\delta > 0, x, y \in B$, let $\Omega_\delta(x, y) = B_x(\delta r) \times B_{\pi^{b_0}(x)}(\delta r) \times B_y(\delta r) \times B_{\pi^{b_0}(y)}(\delta r)$ in the rest of this section.

Definition 4.4. For $x_1, x_2, y_1, y_2 \in B$, we define

$$\begin{aligned} \mathcal{G}(x_1, x_2, y_1, y_2) &:= \sum_{i=1}^2 \int_0^{\rho(x_i)-b_1} G(\xi_{x_i}(t)) dt + \int_0^{\rho(y_i)-b_1} G(\xi_{y_i}(t)) dt; \\ \mathcal{H}(x_1, x_2, y_1, y_2) &:= \int_0^{\rho(x_1)-b_1} ds \left(\int_{\xi_{x_1}(s), \check{\xi}_{x_2}(s)} H \right) + \int_0^{\rho(y_1)-b_1} ds \left(\int_{\xi_{y_1}(s), \check{\xi}_{y_2}(s)} H \right) \\ &\quad + \int_0^{\rho(x_1)-b_0} ds \left(\int_{\xi_{x_1}(s), \check{\xi}_{y_1}(s)} H \right). \end{aligned}$$

And for $x, y \in B$ we define

$$I_\delta(x, y) := \{(x_1, x_2, y_1, y_2) \in \Omega_\delta(x, y) : (\mathcal{G} + \mathcal{H})(x_1, x_2, y_1, y_2) \leq \delta r\}.$$

Remark 4.5. The philosophy behind this ‘four points family’ is: we not only need to find ‘good’ points near x, y and their projection $\pi(x), \pi(y)$ with controlled integral, but also put additional restriction on the integral involving those points respectively.

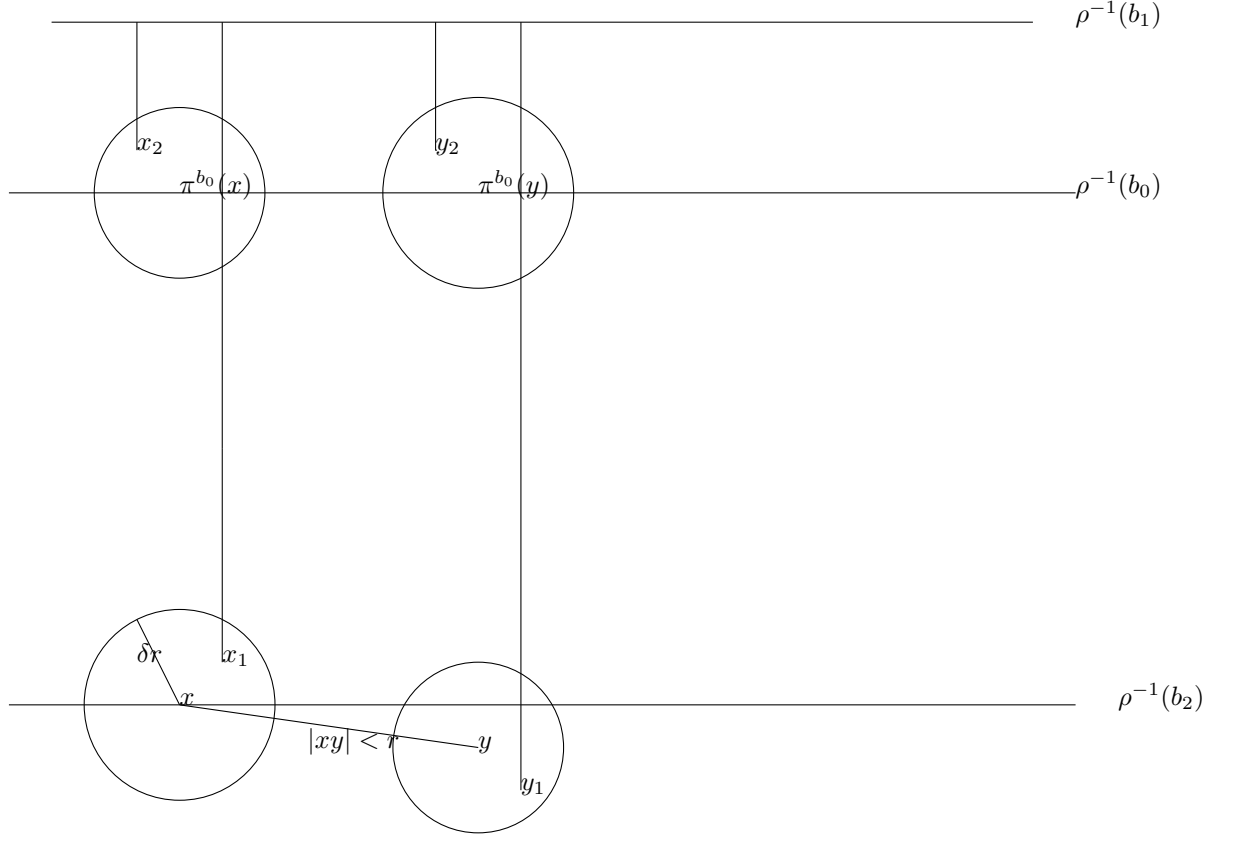
 FIGURE 10. Choice of four points (x_1, x_2, y_1, y_2)

We recall the following segment inequality due to Cheeger and Colding [CC96].

Lemma 4.6 (Segment Inequality). *Assume (M^n, g) is a complete Riemannian manifold with $Rc \geq 0$, then for any nonnegative function Ψ defined on $B_z(2r)$, we have*

$$\int_{B_z(r) \times B_z(r)} \left(\int_0^{d(y_1, y_2)} \Psi(\overline{y_1, y_2}(s)) ds \right) dy_1 dy_2 \leq 2^{n+2} r \cdot V(B_z(r)) \cdot \int_{B_z(2r)} \Psi.$$

□

Proposition 4.7. *There is $C(n) > 0$; such that if $\delta = C(n) \left\{ (r^2 \int_A H^2)^{\frac{1}{2(2n+1)}} + \left(\frac{R}{r}\right) \left(\int_A G^2\right)^{\frac{1}{2n}} \right\}$ where $A = \rho^{-1}(r, 2R-r)$, then for any $|xy| \leq r$, there exists $(\hat{x}, \check{x}, \hat{y}, \check{y}) \in I_\delta(x, y)$.*

Proof: Step (1). Let $\check{I} = B_x(\delta r) \times B_{\pi^{b_0}(x)}(\delta r) \times B_y(\delta r) \times B_{\pi^{b_0}(y)}(\delta r) - I_\delta(x, y)$, we only need to show that

$$V(\check{I}) < V(B_x(\delta r) \times B_{\pi^{b_0}(x)}(\delta r) \times B_y(\delta r) \times B_{\pi^{b_0}(y)}(\delta r)).$$

We know

$$(4.3) \quad \delta r \cdot V(\check{I}) \leq \int_{\Omega} \mathcal{G} + \mathcal{H}.$$

And there is

$$\begin{aligned} & \int_{\Omega} dx_1 dx_2 dy_1 dy_2 \int_0^{\rho(x_1)-b_1} G(\xi_{x_1}(t)) dt \\ & \leq V(B_{\pi^{b_0}(x)}(\delta r) \times B_y(\delta r) \times B_{\pi^{b_0}(y)}(\delta r)) \cdot \int_{B_x(\delta r)} dx_1 \int_0^{\rho(x_1)-b_1} G(\xi_{x_1}(t)) dt. \end{aligned}$$

By the mean convex property, we know that the volume element is increasing along $\xi_x(t)$, which is the gradient curve of $-\rho$. Now we get

$$\begin{aligned} & \int_{B_x(\delta r)} dx_1 \int_0^{\rho(x_1)-b_1} G(\xi_{x_1}(t)) dt \leq \int_{b_2-\delta r}^{b_2+\delta r} ds \int_{\rho^{-1}(s)} dx_1 \int_0^{s-b_1} G(\xi_{x_1}(t)) dt \\ & = \int_{b_2-\delta r}^{b_2+\delta r} ds \int_0^{s-b_1} dt \int_{\rho^{-1}(s)} G(\xi_{x_1}(t)) dx_1 \\ & \leq \int_{b_2-\delta r}^{b_2+\delta r} ds \int_{b_1}^s d\tau \int_{\rho^{-1}(\tau)} G(y) dy \leq 2\delta r \cdot \int_{b_1}^{b_2+2r} d\tau \int_{\rho^{-1}(\tau)} G(y) dy \\ & = C(n)\delta r \cdot \int_{\rho^{-1}(b_1, b_2+\delta r)} G(y) dy. \end{aligned}$$

Combining the above, we get

$$\begin{aligned} & \frac{\int_{\Omega} dx_1 dx_2 dy_1 dy_2 \int_0^{\rho(x_1)-b_1} G(\xi_{x_1}(t)) dt}{V(\Omega)} \leq \frac{C(n)\delta r \cdot \int_{\rho^{-1}(b_1, b_2+\delta r)} G(y) dy}{V(B_x(\delta r))} \\ & \leq \frac{C(n)\delta r \cdot \int_{\rho^{-1}(r, 2R-r)} G(y) dy}{V(A)} \cdot \frac{V(A)}{V(B_x(\delta r))} \\ & \leq \frac{C(n)\delta r \cdot \int_{\rho^{-1}(r, 2R-r)} G(y) dy}{V(A)} \cdot \frac{V(B_p(R))}{V(B_x(\delta r))} \\ (4.4) \quad & \leq C(n)(\delta r) \cdot \left(\frac{R}{\delta r}\right)^n \cdot \left(\int_A G^2\right)^{\frac{1}{2}}. \end{aligned}$$

Similarly we can obtain

$$\begin{aligned}
& \int_{\Omega} dx_1 dx_2 dy_1 dy_2 \int_0^{\rho(x_2)-b_1} G(\xi_{x_2}(t)) dt \\
& \leq V(B_x(\delta r) \times B_y(\delta r) \times B_{\pi^{b_0}(y)}(\delta r)) \cdot C(n) \delta r \int_{\rho^{-1}(b_1, b_0+\delta r)} G; \\
& \int_{\Omega} dx_1 dx_2 dy_1 dy_2 \int_0^{\rho(y_1)-b_1} G(\xi_{y_1}(t)) dt \\
& \leq V(B_x(\delta r) \times B_{\pi^{b_0}(x)}(\delta r) \times B_{\pi^{b_0}(y)}(\delta r)) \cdot C(n) \delta r \int_{\rho^{-1}(b_1, b_2+r+\delta r)} G; \\
& \int_{\Omega} dx_1 dx_2 dy_1 dy_2 \int_0^{\rho(y_2)-b_1} G(\xi_{y_2}(t)) dt \\
& \leq V(B_x(\delta r) \times B_{\pi^{b_0}(x)}(\delta r) \times B_y(\delta r)) \cdot C(n) \delta r \int_{\rho^{-1}(b_1, b_0+\delta r)} G.
\end{aligned}$$

Then we get

$$(4.5) \quad \frac{\int_{\Omega} \mathcal{G} dx_1 dx_2 dy_1 dy_2}{V(\Omega)} \leq C(n)(\delta r) \cdot \left(\frac{R}{\delta r}\right)^n \cdot \left(\int_A G^2\right)^{\frac{1}{2}}.$$

Step (2). Note we have

$$\begin{aligned}
& \int_{\Omega} \int_0^{\rho(x_1)-b_0} dt \int_{\xi_{x_1}(t), \tilde{\xi}_{y_1}(t)} H \\
& \leq V(B_{\pi(x)}(\delta r) \times B_{\pi(y)}(\delta r)) \int_{B_x(\delta r) \times B_y(\delta r)} dx_1 dy_1 \int_0^{\rho(x_1)-b_0} dt \int_{\xi_{x_1}(t), \tilde{\xi}_{y_1}(t)} H.
\end{aligned}$$

From the Co-area formula and volume comparison between level sets of ρ , we have

$$\begin{aligned}
& \int_{B_x(\delta r) \times B_y(\delta r)} dx_1 dy_1 \int_0^{\rho(x_1)-b_0} dt \int_{\xi_{x_1}(t), \tilde{\xi}_{y_1}(t)} H \\
& \leq \int_{b_2-\delta r}^{b_2+\delta r} dt_1 \int_{\rho(y)-\delta r}^{\rho(y)+\delta r} dt_2 \int_{\rho^{-1}(t_1) \times \rho^{-1}(t_2) \cap (B_x(\delta r) \times B_y(\delta r))} dx_1 dy_2 \int_0^{t_1-b_0} dt \left(\int_{\xi_{x_1}(t), \tilde{\xi}_{y_1}(t)} H \right) ds \\
& \leq \int_0^{b_2-b_0+\delta r} dt \int_{B_x(4r) \times B_x(4r)} d\tilde{x} d\tilde{y} \left(\int_{\tilde{x}, \tilde{y}} H \right) \\
& \leq C(n) r^2 V(B_x(4r)) \int_{B_x(8r)} H.
\end{aligned}$$

Now we get

$$\frac{\int_{\Omega} \int_0^{\rho(x_1)-b_0} dt \int_{\xi_{x_1}(t), \tilde{\xi}_{y_1}(t)} H}{V(\Omega)} \leq \frac{C(n) r^2 V(B_x(4r)) \int_{B_x(8r)} H}{V(B_x(\delta r)) \cdot V(B_y(\delta r))} \leq C(n) \delta^{-2n} r^2 \left(\int_A H^2 \right)^{\frac{1}{2}}.$$

Similarly we can obtain

$$\frac{\int_{\Omega} \left(\int_0^{\rho(x_1)-b_1} dt \int_{\xi_{x_1}(t), \check{\xi}_{x_2}(t)} H + \int_0^{\rho(y_1)-b_1} dt \int_{\xi_{y_1}(t), \check{\xi}_{y_2}(t)} H \right)}{V(\Omega)} \leq C(n) \delta^{-2n} r^2 \left(\int_A H^2 \right)^{\frac{1}{2}}.$$

Therefore we have

$$(4.6) \quad \frac{\int_{\Omega} \mathcal{H} dx_1 dx_2 dy_1 dy_2}{V(\Omega)} \leq C(n) \delta^{-2n} r^2 \left(\int_A H^2 \right)^{\frac{1}{2}}.$$

Combining (4.3), (4.5) with (4.6), we get

$$\frac{V(\check{I})}{V(\Omega)} \leq \frac{\int_{\Omega} \mathcal{G} + \mathcal{H}}{\delta r V(\Omega)} \leq C(n) \left\{ \delta^{-2n-1} r \left(\int_A H^2 \right)^{\frac{1}{2}} + \left(\frac{R}{\delta r} \right)^n \left(\int_A G^2 \right)^{\frac{1}{2}} \right\}.$$

Then there is $C(n) > 0$ such that if

$$\delta = C(n) \left\{ \left(r^2 \int_A H^2 \right)^{\frac{1}{2(2n+1)}} + \left(\frac{R}{r} \right) \left(\int_A G^2 \right)^{\frac{1}{2n}} \right\},$$

then $\frac{V(\check{I})}{V(\Omega)} < 1$ and the conclusion follows. \square

4.3. The local stable Gou-Gu theorem. Therefore Theorem 4.10 can be proved by using Lemma 4.9 and Almost Gou-Gu Theorem, and we provide a unified argument to obtain Theorem 4.10 for self-completeness.

In this subsection we assume $\delta = C(n) \left\{ \left(r^2 \int_A H^2 \right)^{\frac{1}{2(2n+1)}} + \left(\frac{R}{r} \right) \left(\int_A G^2 \right)^{\frac{1}{2n}} \right\}$, where $C(n)$ is as in Proposition 4.7.

Lemma 4.8. *For $(\hat{x}, \check{x}, \hat{y}, \check{y}) \in I_{\delta}(x, y)$, we have*

$$\left| |\hat{y}\hat{x}| - |\mathcal{G}^{b_0}(\hat{y})\mathcal{G}^{b_0}(\hat{x})| \right| \leq C(n)r \cdot \left(\delta^{\frac{1}{2}} + \sup_{B_x(8r)} \frac{|h - \rho|}{r} \right).$$

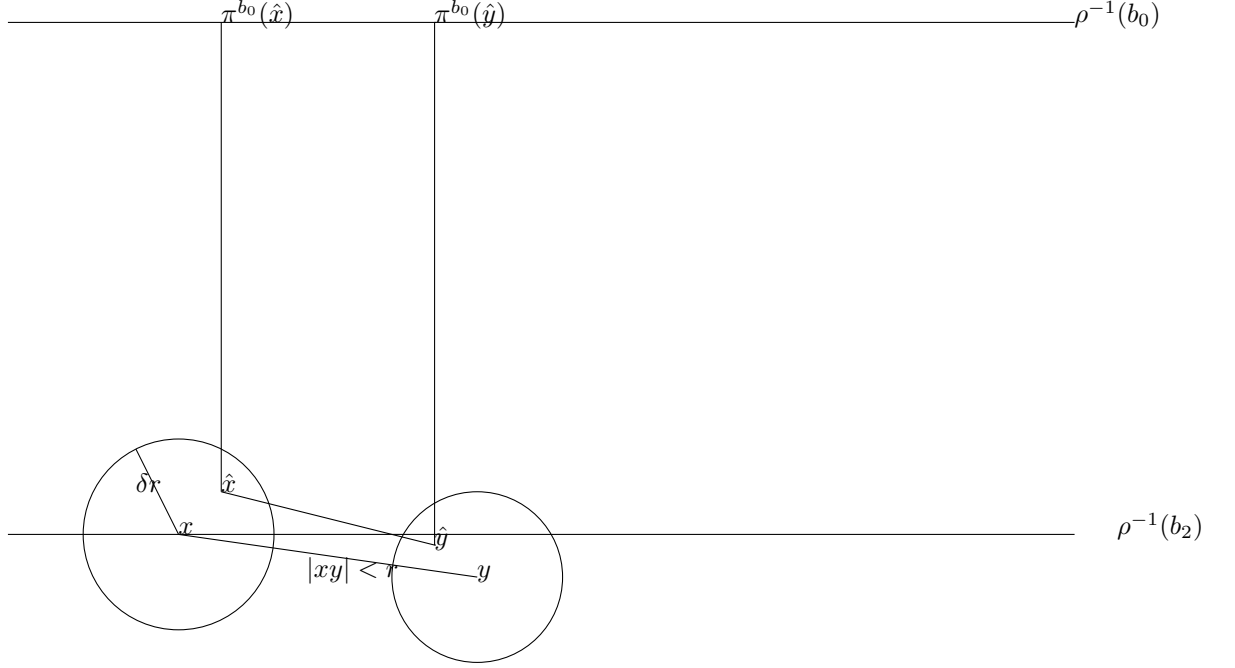
FIGURE 11. Distance estimate of good pair points $|\hat{y}\hat{x}|$

Proof: From Lemma 4.2, we know that

$$\begin{aligned}
& \left| |\hat{y}\hat{x}|^2 - |\mathcal{G}^{b_0}(\hat{y})\mathcal{G}^{b_0}(\hat{x})|^2 \right| \\
& \leq 16r \cdot \left(\int_0^{\rho(\hat{y})-b_0} |\nabla(\rho-h)|(\xi_{\hat{y}}(t))dt + \int_0^{\rho(\hat{x})-b_0} |\nabla(\rho-h)|(\xi_{\hat{x}}(t))dt \right) \\
& \quad + 4|\rho(\hat{x})-\rho(\hat{y})| \cdot \sup_{B_x(4r)} |h-\rho| + 64r \cdot \int_0^{\rho(\hat{x})-b_0} dt \int_0^t |\nabla^2 h|(\tau_t(s))ds \\
(4.7) \quad & \leq C(n) \cdot (\delta r^2 + |\rho(\hat{x})-\rho(\hat{y})| \cdot \sup_{B_x(4r)} |h-\rho|).
\end{aligned}$$

Now we note $|\nabla\rho| = 1$, then from the above we get

$$\begin{aligned}
(I) & := \left| |\hat{y}\hat{x}| - |\mathcal{G}^{b_0}(\hat{y})\mathcal{G}^{b_0}(\hat{x})| \right| = \frac{\left| |\hat{y}\hat{x}|^2 - |\mathcal{G}^{b_0}(\hat{y})\mathcal{G}^{b_0}(\hat{x})|^2 \right|}{|\hat{y}\hat{x}| + |\mathcal{G}^{b_0}(\hat{y})\mathcal{G}^{b_0}(\hat{x})|} \\
(4.8) \quad & \leq C(n) \cdot \left\{ \frac{\delta r^2}{|\hat{y}\hat{x}| + |\mathcal{G}^{b_0}(\hat{y})\mathcal{G}^{b_0}(\hat{x})|} + \sup_{B_x(4r)} |h-\rho| \right\}.
\end{aligned}$$

There are two cases to be dealt with separately as follows:

Case (1) : If $|\hat{y}\hat{x}| \geq \tau r$, where $\tau > 0$ is to be determined later; from (4.8) we have

$$(4.9) \quad (I) \leq C(n) \cdot \left\{ \frac{\delta r}{\tau} + \sup_{B_x(4r)} |h-\rho| \right\}.$$

Case (2) : If $|\hat{x}\hat{y}| \leq \tau r$, from (4.7) we have

$$\begin{aligned} |\mathcal{G}^{b_0}(\hat{y})\mathcal{G}^{b_0}(\hat{x})|^2 &\leq |\hat{x}\hat{y}|^2 + C(n) \cdot (\delta r^2 + |\rho(\hat{x}) - \rho(\hat{y})| \cdot \sup_{B_x(4r)} |h - \rho|) \\ &\leq (\tau r)^2 + C(n) \cdot (\delta r^2 + \tau r \cdot \sup_{B_x(4r)} |h - \rho|), \end{aligned}$$

which implies

$$\begin{aligned} |\mathcal{G}^{b_0}(\hat{y})\mathcal{G}^{b_0}(\hat{x})| &\leq C(n)r \cdot \left\{ \tau + \delta^{\frac{1}{2}} + \sqrt{\tau \cdot \sup_{B_x(4r)} \frac{|h - \rho|}{r}} \right\} \\ &\leq C(n)r \cdot \left\{ \tau + \delta^{\frac{1}{2}} + \sup_{B_x(4r)} \frac{|h - \rho|}{r} \right\}. \end{aligned}$$

Finally we get

$$(I) \leq |\hat{y}\hat{x}| + |\mathcal{G}^{b_0}(\hat{y})\mathcal{G}^{b_0}(\hat{x})| \leq C(n)r \cdot \left\{ \tau + \delta^{\frac{1}{2}} + \sup_{B_x(4r)} \frac{|h - \rho|}{r} \right\}.$$

By Case (1) and (2) above, we always have

$$(I) \leq C(n)r \cdot \left\{ \tau + \frac{\delta}{\tau} + \delta^{\frac{1}{2}} + \sup_{B_x(4r)} \frac{|h - \rho|}{r} \right\}.$$

Let $\tau = \frac{\delta}{\tau}$, then $\tau = \delta^{\frac{1}{2}}$. Plug the value of τ into the above inequality, we obtain

$$(I) \leq C(n)r \cdot \left\{ \delta^{\frac{1}{2}} + \sup_{B_x(4r)} \frac{|h - \rho|}{r} \right\}.$$

□

Lemma 4.9. For $(\hat{x}, \check{x}, \hat{y}, \check{y}) \in I_\delta(x, y)$, we have

$$|\mathcal{G}^{b_0}(x)\mathcal{G}^{b_0}(\hat{x})| + |\mathcal{G}^{b_0}(y)\mathcal{G}^{b_0}(\hat{y})| \leq C(n)r \cdot \left\{ \sup_{B_x(4r)} \sqrt{\frac{|h - \rho|}{r}} + \sqrt{\delta} \right\}.$$

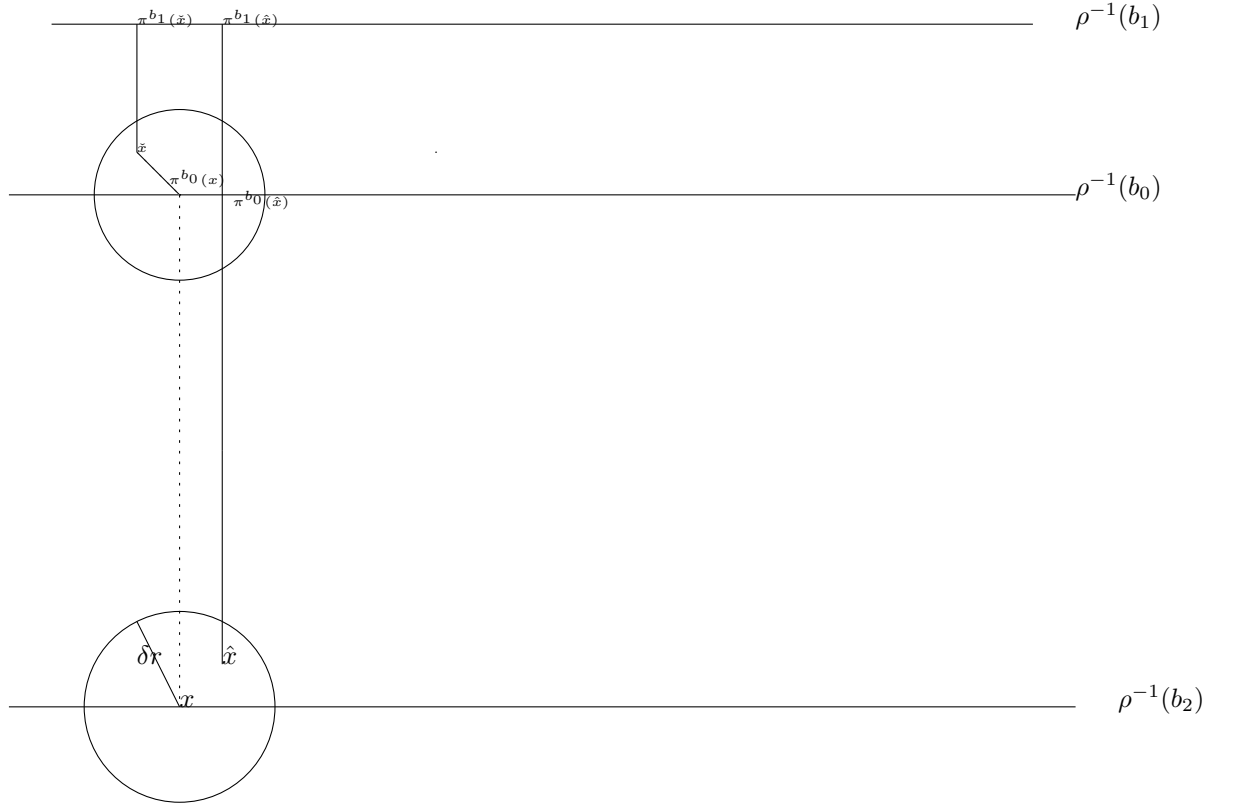
FIGURE 12. Distance estimate of $|\pi^{b_0}(x)\pi^{b_0}(\hat{x})|$

Proof: Step (1). From Lemma 4.3 and the definition 4.4, we have

$$\begin{aligned}
|\pi^{b_1}(\hat{x})\pi^{b_1}(\check{x})|^2 &\leq |\hat{x}\check{x}|^2 - |\rho(\hat{x}) - \rho(\check{x})|^2 + 16r \cdot \left(\int_0^{\rho(\check{x})-b_1} G(\xi_{\check{x}}(t))dt + \int_0^{\rho(\hat{x})-b_1} G(\xi_{\hat{x}}(t))dt \right) \\
&\quad + 4|\rho(\hat{x}) - \rho(\check{x})| \cdot \sup_{B_x(4r)} |h - \rho| + 64r \cdot \int_0^{\rho(\hat{x})-b_1} dt \int_0^{t_i} H(\tau_t(s))ds \\
&\leq (|x\pi^{b_0}(x)| + 2\delta r)^2 - (\rho(x) - 2\delta r - b_0)^2 + C(n)r^2 \cdot \left\{ \sup_{B_x(4r)} \frac{|h - \rho|}{r} + \delta \right\} \\
&\leq C(n)\delta r|\rho(x) - b_0| + C(n)r^2 \cdot \left\{ \sup_{B_x(4r)} \frac{|h - \rho|}{r} + \delta \right\} \\
&\leq C(n)r^2 \cdot \left\{ \sup_{B_x(4r)} \frac{|h - \rho|}{r} + \delta \right\}.
\end{aligned}$$

Therefore we have

$$(4.10) \quad |\pi^{b_1}(\hat{x})\pi^{b_1}(\check{x})| \leq C(n)r \cdot \left\{ \sup_{B_x(4r)} \sqrt{\frac{|h - \rho|}{r}} + \sqrt{\delta} \right\}.$$

Step (2). By metric triangle inequality and (4.10), we get

$$\begin{aligned} |\pi^{b_0}(x)\pi^{b_0}(\hat{x})| &\leq |\pi^{b_0}(x)\check{x}| + |\check{x}\pi^{b_1}(\check{x})| + |\pi^{b_1}(\hat{x})\pi^{b_1}(\check{x})| + |\pi^{b_1}(\hat{x})\pi^{b_0}(\hat{x})| \\ &\leq 2\delta r + 2|b_1 - b_0| + C(n)r \cdot \left\{ \sup_{B_x(4r)} \sqrt{\frac{|h - \rho|}{r}} + \sqrt{\delta} + \sqrt{\delta} \right\} \\ &\leq C(n)r \cdot \left\{ \sup_{B_x(4r)} \sqrt{\frac{|h - \rho|}{r}} + \sqrt{\delta} \right\}. \end{aligned}$$

Then note $|\rho(x) - \rho(\hat{x})| \leq |x\hat{x}| \leq \delta r$, we get

$$|\mathcal{G}^{b_0}(x)\mathcal{G}^{b_0}(\hat{x})| \leq |\pi^{b_0}(x)\pi^{b_0}(\hat{x})| + |\rho(x) - \rho(\hat{x})| \leq C(n)r \cdot \left\{ \sup_{B_x(4r)} \sqrt{\frac{|h - \rho|}{r}} + \sqrt{\delta} \right\}.$$

□

Theorem 4.10. *There is $C(n) > 0$, such that for any $|xy| \leq r$ where $r \ll 1$, we have*

$$\begin{aligned} &\left| d(x, y) - |\mathcal{G}^{b_0}(x)\mathcal{G}^{b_0}(y)| \right| \\ &\leq C(n)r \cdot \left\{ \sup_{B_x(4r)} \sqrt{\frac{|h - \rho|}{r}} + (r^2 \int_A H^2)^{\frac{1}{4(2n+1)}} + \left(\frac{R}{r}\right)^{\frac{1}{2}} \left(\int_A G^2\right)^{\frac{1}{4n}} \right\}. \end{aligned}$$

Proof: From Proposition 4.7 we find $(\hat{x}, \check{x}, \hat{y}, \check{y}) \in I_\delta(x, y)$.

Now from Lemma 4.8 (distance estimate between good pair of points) and Lemma 4.9 ('model' distance estimate between original points and good points), we have

$$\begin{aligned} &\left| |xy| - |\mathcal{G}^{b_0}(x)\mathcal{G}^{b_0}(y)| \right| \\ &\leq \left| |xy| - |\hat{x}\hat{y}| \right| + \left| |\hat{x}\hat{y}| - |\mathcal{G}^{b_0}(\hat{x})\mathcal{G}^{b_0}(\hat{y})| \right| + \left| |\mathcal{G}^{b_0}(\hat{x})\mathcal{G}^{b_0}(\hat{y})| - |\mathcal{G}^{b_0}(x)\mathcal{G}^{b_0}(y)| \right| \\ &\leq |x\hat{x}| + |y\hat{y}| + C(n)r \cdot (\delta^{\frac{1}{2}} + \sup_{B_x(8r)} \frac{|h - \rho|}{r}) + |\mathcal{G}^{b_0}(x)\mathcal{G}^{b_0}(\hat{x})| + |\mathcal{G}^{b_0}(y)\mathcal{G}^{b_0}(\hat{y})| \\ &\leq 2\delta r + C(n)r \cdot (\delta^{\frac{1}{2}} + \sup_{B_x(8r)} \frac{|h - \rho|}{r}) + C(n)r \cdot \left\{ \sup_{B_x(4r)} \sqrt{\frac{|h - \rho|}{r}} + \sqrt{\delta} \right\} \\ &\leq C(n)r \cdot \left\{ \sup_{B_x(4r)} \sqrt{\frac{|h - \rho|}{r}} + \sqrt{\delta} \right\} \\ &\leq C(n)r \cdot \left\{ \sup_{B_x(4r)} \sqrt{\frac{|h - \rho|}{r}} + (r^2 \int_A H^2)^{\frac{1}{4(2n+1)}} + \left(\frac{R}{r}\right)^{\frac{1}{2}} \left(\int_A G^2\right)^{\frac{1}{4n}} \right\}. \end{aligned}$$

□

Proposition 4.11. *There is $C(n) > 0$, such that for any x, y with $|xy| < bR$ where $b \ll 1$, we have*

$$\left| d(x, y) - |\mathcal{G}^{b_0}(x)\mathcal{G}^{b_0}(y)| \right| \leq C(n)(bR) \left\{ b^{-1 + \frac{1}{2n+4}} (\epsilon R^2)^{\frac{1}{8(2n+1)}} \right\}.$$

Proof: It directly follows from Theorem 4.10 and Lemma 3.1. □

5. THE WIDTH ESTIMATE OF ALMOST CYLINDER

In this paper, to get an explicit width estimate of geodesic ball, we need to obtain global distance estimate. Here the global distance estimate means that the segment between x, y possibly touch the boundary of geodesic ball (if the geodesic ball belongs to some complete Riemannian manifold, the segment between x, y possibly run out of the geodesic ball). Anyway, we need to drop the closeness assumption of x, y in the local distance estimate above. The method of getting the global distance estimate from the local distance estimate, is discussed in [CC96] firstly.

In this section, we obtain the global distance estimate, using local stable Gou-Gu theorem and the property that the gradient curves of distance functions are almost extendable. The philosophy of our argument is close to the strategy of [CC96, Theorem 3.6]. Because we focus on the concrete case and are interested in obtaining the quantitative estimate of diameter of the level sets, we give the detailed discussion in our context.

Let $I_k = [kbR, (k+1)bR]$, where $k \in \mathbb{Z}^+$. We define $\pi^{(k)}(x) = \xi_x \cap \rho^{-1}(kbR)$ and

$$\mathcal{G}^{(k)}(x) = (\pi^{(k)}(x), \rho(x)).$$

The main result of this section is the following Theorem.

Theorem 5.1. *Assume there is $\delta_1, \delta_2 > 0$, such that, for any $k \in \mathbb{Z}^+$ and two points x, y satisfying*

$$y \in B(x, bR), \quad \rho(x) - kbR \leq \frac{3}{2}bR, \quad \min\{\rho(x) - kbR, \rho(y) - kbR\} \geq \frac{1}{2}bR,$$

we have

$$(5.1) \quad \left| |xy| - |\mathcal{G}^{(k)}(x)\mathcal{G}^{(k)}(y)| \right| \leq \delta_1 bR.$$

Further assume that for any $x \in \rho^{-1}(bR)$ and $t \in [b, 2-b]$, there is $z \in \rho^{-1}(tR)$ such that

$$(5.2) \quad d(x, z) - (t-b)R \leq \delta_2 R.$$

Then $\mathcal{W}(B_p(R)) \leq 10^7 R \left\{ b + \sqrt{\frac{\delta_1}{b} + \delta_2} \right\}$.

5.1. The estimate of the outer level sets' diameter.

Lemma 5.2. *If $B_p(R)$ is a metric ball satisfying (5.1), then for any $y \in \rho^{-1}(8bR)$, $t \in [8b, 2-b]$, $w \in \rho^{-1}(tR)$ satisfying*

$$d(y, w) - (t-8b)R \leq \delta_2 R;$$

we have

$$\begin{aligned} \{z_i\}_{i=0}^m &\subseteq \rho^{-1}(bR), \quad z_m = \pi^{bR}(w), \quad z_0 = \pi^{bR}(y), \\ \sum_{i=1}^m |z_i z_{i-1}| &\leq 20R(b + \sqrt{\frac{\delta_1}{b} + \delta_2}) \sqrt{t - 7b}; \\ |\pi^{8bR}(w)y| &\leq 20R\{b + \sqrt{\frac{\delta_1}{b} + \delta_2} \sqrt{t - 7b}\}; \end{aligned}$$

where $m = \lfloor \frac{t-8b}{b} \rfloor + 1$ and $\lfloor \frac{t-8b}{b} \rfloor$ is the biggest integer no more than $\frac{t-8b}{b}$.

Proof: Step (1). Let $y_0 = y$, choose $\{y_i\}_{i=1}^m$ from geodesic segment $\overline{w, y_0}$, where

$$y_m = w, \quad |y_i y_0| = \frac{i}{m} |w y_0|.$$

From the assumption, we know that

$$(5.3) \quad (t - 8b)R \leq |w y| \leq (t - 8b + \delta_2)R.$$

Using (5.3) we have

$$\begin{aligned} \rho(y_i) &\geq \rho(w) - |w y_i| \geq tR - (1 - \frac{i}{m})|w y| \geq 8bR + \frac{i}{m}(t - 8b)R - b(1 - \frac{i}{m})R \\ (5.4) \quad &\geq 8bR + \frac{i}{m}|w y| - bR. \end{aligned}$$

Also we have the upper bound

$$(5.5) \quad \rho(y_i) \leq \rho(y_0) + |y_i y_0| \leq 8bR + \frac{i}{m}|w y|.$$

Step (2). For each $1 \leq i \leq m$, we define

$$(5.6) \quad \tau(i) = \max\{j \in \mathbb{Z}^+ : \min\{\rho(y_i) - jbR, \rho(y_{i-1}) - jbR\} \geq \frac{1}{2}bR\}.$$

Note the above choice of $\tau(i)$ also implies

$$(5.7) \quad \min\{\rho(y_i) - \tau(i)bR, \rho(y_{i-1}) - \tau(i)bR\} \leq \frac{3}{2}bR.$$

From (5.1) and the choice of $\tau(i)$, we get

$$(5.8) \quad \left| |y_{i-1} y_i| - |\mathcal{G}^{(\tau(i))}(y_{i-1}) \mathcal{G}^{(\tau(i))}(y_i)| \right| \leq \delta_1 bR,$$

By (5.6) and (5.5), we obtain

$$(\tau(i) + \frac{1}{2})bR \leq 8bR + \frac{i}{m}|w y|.$$

Using the definition of m , the above inequality implies

$$(5.9) \quad \tau(i) \leq i + 9.$$

Similarly, from (5.7) and (5.4) we get

$$(\tau(i) + \frac{3}{2})bR \geq 8bR + \frac{i-1}{m}|w y| - bR.$$

Again using the definition of m , we further obtain

$$(5.10) \quad \tau_i \geq i + 3.$$

We define

$$y_i^{\tau(i),l} := \begin{cases} \pi^{(l)} \circ \pi^{(l+1)} \dots \pi^{(\tau(i))}(y_i), & l \leq \tau(i), \\ \pi^{(l)} \circ \pi^{(l-1)} \dots \pi^{(\tau(i))}(y_i), & l \geq \tau(i). \end{cases}$$

From (5.1) we also have

$$(5.11) \quad \left| |y_{i-1}^{\tau(i),\tau(i)} y_i^{\tau(i),\tau(i)}| - |y_{i-1}^{\tau(i),1} y_i^{\tau(i),1}| \right| \leq (\tau(i) - 1) \cdot \delta_1 bR \leq (i + 8) \delta_1 bR.$$

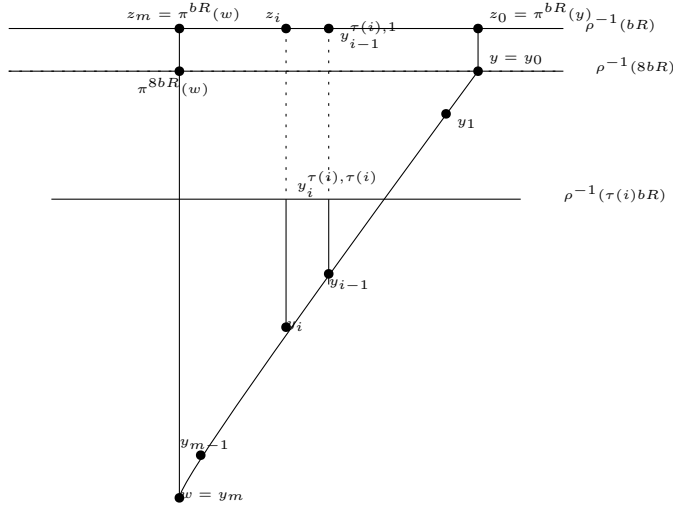

FIGURE 13. Multiple projections of y_i

By (5.8) and (5.11), we obtain

$$\begin{aligned} & \left| |y_{i-1} y_i|^2 - |\rho(y_{i-1}) - \rho(y_i)|^2 - |y_{i-1}^{\tau(i),1} y_i^{\tau(i),1}|^2 \right| \\ & \leq \left| |y_{i-1} y_i|^2 - |\rho(y_{i-1}) - \rho(y_i)|^2 - |y_{i-1}^{\tau(i),\tau(i)} y_i^{\tau(i),\tau(i)}|^2 \right| + \left| |y_{i-1}^{\tau(i),\tau(i)} y_i^{\tau(i),\tau(i)}|^2 - |y_{i-1}^{\tau(i),1} y_i^{\tau(i),1}|^2 \right| \\ & \leq 4(bR)^2 \delta_1 + 4(i + 8) \delta_1 (bR)^2. \end{aligned}$$

Step (3). Take the sum with respect to i , note (5.9) and (5.10), we have

$$\begin{aligned} \sum_{i=1}^m |y_{i-1}^{\tau(i),1} y_i^{\tau(i),1}|^2 &\leq \sum_{i=1}^m |y_{i-1} y_i|^2 - \sum_{i=1}^m |\rho(y_{i-1}) - \rho(y_i)|^2 + 4\delta_1 (bR)^2 \sum_{i=1}^m (i+9) \\ &\leq \frac{|wy_0|^2}{m} - \frac{(\sum_{i=1}^m |\rho(y_{i-1}) - \rho(y_i)|)^2}{m} + 36(bR)^2 \delta_1 m^2 \\ &\leq \frac{1}{m} ((t-8b+\delta_2)R)^2 - \frac{1}{m} |\rho(y_0) - \rho(w)|^2 + 200\delta_1 R^2 \leq 200R^2 (\delta_2 \cdot b + \delta_1). \end{aligned}$$

On the other hand, by Cauchy-Schwarz inequality we have

$$\sum_{i=1}^m |y_{i-1}^{\tau(i),1} y_i^{\tau(i),1}|^2 \geq \frac{1}{m} \left(\sum_{i=1}^m |y_{i-1}^{\tau(i),1} y_i^{\tau(i),1}| \right)^2 \geq \frac{b}{t-7b} |\pi^{bR}(y) w^{m,1}|^2.$$

Note $w^{m,1} = \pi^{bR}(w)$ and $y_0 = y$, combining the above yields

$$|\pi^{bR}(y) \pi^{bR}(w)| \leq 20R \sqrt{\frac{\delta_1}{b} + \delta_2} \sqrt{t-7b}.$$

Therefore

$$\begin{aligned} |\pi^{8bR}(w)y| &\leq |\pi^{bR}(y) \pi^{bR}(w)| + |\pi^{bR}(y)y| + |\pi^{8bR}(w) \pi^{bR}(w)| \\ &\leq 20R \left\{ b + \sqrt{\frac{\delta_1}{b} + \delta_2} \sqrt{t-7b} \right\}. \end{aligned}$$

Let $z_i = \pi^{bR}(y_i)$, the conclusion follows from the above. \square

Proposition 5.3. *If (5.1) holds, then we have*

$$\sup_{x,y \in \rho^{-1}(8bR)} |xy| \leq 80R \left\{ b + \sqrt{\frac{\delta_1}{b} + \delta_2} \right\}.$$

Proof: In Lemma 5.2, let $w = p$ there, then $t = 1$. For any $x_0, y_0 \in \rho^{-1}(8bR)$, we obtain

$$\begin{aligned} |x_0 y_0| &\leq |x_0 \pi^{8bR}(p)| + |y_0 \pi^{8bR}(p)| \leq 40R \left\{ b + \sqrt{\frac{\delta_1}{b} + \delta_2} \right\} \\ &\leq 80R \left\{ b + \sqrt{\frac{\delta_1}{b} + \delta_2} \right\}. \end{aligned}$$

\square

5.2. The width estimate of metric ball. Recall the width of a metric ball is defined as follows:

$$\mathcal{W}(B_p(R)) = \inf_{f \in \text{Lip}(B_p(R))} \max_{t \in \mathbb{R}} \text{diam}(f^{-1}(t)).$$

Theorem 5.4. *If $B_p(R)$ is a metric ball satisfying (5.1) and (5.2), then*

$$\mathcal{W}(B_p(R)) \leq 10^7 R \left\{ b + \sqrt{\frac{\delta_1}{b} + \delta_2} \right\}.$$

Proof: Step (1). We firstly consider any $x, y \in \rho^{-1}(tR)$ where $t \in [8b, 2 - b]$. Applying Lemma 5.2 on $\pi^{8bR}(x), p$ and $\pi^{8bR}(y), p$ respectively, we can find

$$\begin{aligned} \{z_i\}_{i=0}^m \subseteq \rho^{-1}(bR), \quad z_m = \pi^{bR}(p), \quad z_0 = \pi^{bR}(x), \quad \sum_{i=1}^m |z_i z_{i-1}| &\leq 20R(b + \sqrt{\frac{\delta_1}{b} + \delta_2}) \sqrt{1 - 7b}; \\ \{z_i\}_{i=m}^{2m} \subseteq \rho^{-1}(bR), \quad z_m = \pi^{bR}(p), \quad z_{2m} = \pi^{bR}(y), \quad \sum_{i=m}^{2m} |z_i z_{i-1}| &\leq 20R(b + \sqrt{\frac{\delta_1}{b} + \delta_2}) \sqrt{1 - 7b}. \end{aligned}$$

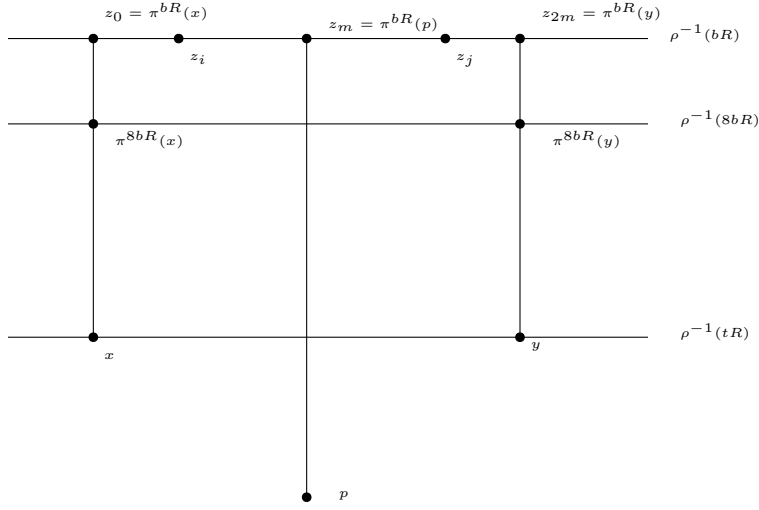

FIGURE 14. The choice of z_i

We define $\check{x} = \pi^{bR}(x), \check{y} = \pi^{bR}(y)$. Therefore we can find $\{v_i\}_{i=0}^{400} \subseteq \{z_i\}_{i=0}^{2m} \subseteq \rho^{-1}(bR)$ such that

$$(5.12) \quad v_0 = \check{x}, \quad v_{400} = \check{y}, \quad \sum_{i=1}^{400} |v_i v_{i-1}| \leq 40R(b + \sqrt{\frac{\delta_1}{b} + \delta_2}) \sqrt{t - 7b};$$

$$|v_i v_{i-1}| \leq 5^{-1}R(b + \sqrt{\frac{\delta_1}{b} + \delta_2}) \sqrt{t - 7b}.$$

For each $v_i \in \rho^{-1}(bR)$, by (5.2) we can find $w_i \in \rho^{-1}(tR)$ such that

$$(5.13) \quad w_0 = x, \quad w_{400} = y, \quad |w_i v_i| - (t - b)R \leq bR.$$

Let $\hat{w}_i = \pi^{bR}(w_i)$, from (5.13), we apply Lemma 5.2 on w_i, v_i (replacing b in Lemma 5.2 by $8^{-1}b$), then

$$(5.14) \quad |\hat{w}_i v_i| \leq 20R \left\{ 8^{-1}b + (b + \sqrt{\frac{\delta_1}{8^{-1}b} + \delta_2}) \sqrt{t - \frac{7}{8}b} \right\}.$$

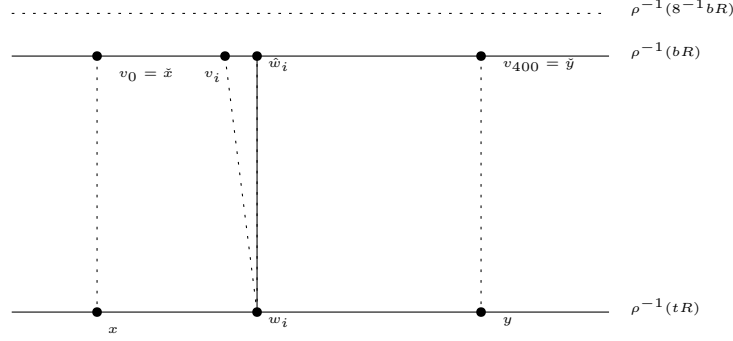
FIGURE 15. The choice of v_i, w_i, \hat{w}_i

Therefore from (5.1) (with respect to $8^{-1}b$ instead of b) and (5.14), we obtain

$$\begin{aligned} |w_i w_{i-1}| &\leq |\hat{w}_i \hat{w}_{i-1}| + \frac{t-b}{8^{-1}b} \cdot \delta_1 b R \\ &\leq |v_i v_{i-1}| + 40R \left\{ 8^{-1}b + \delta_1 + \left(b + \sqrt{\frac{\delta_1}{8^{-1}b} + \delta_2} \right) \sqrt{t - \frac{7}{8}b} \right\}. \end{aligned}$$

Taking the sum with respect to i , using (5.12) we obtain

$$\begin{aligned} |w_0 w_{400}| &\leq 10^6 R \left\{ b + \sqrt{\frac{\delta_1}{b} + \delta_2} \right\} + \sum_{i=1}^{400} |v_i v_{i-1}| \\ &\leq 10^6 R \left\{ b + \sqrt{\frac{\delta_1}{b} + \delta_2} \right\} + 40R \left(b + \sqrt{\frac{\delta_1}{b} + \delta_2} \right) \sqrt{t - 7b} \\ &\leq 10^7 R \left\{ b + \sqrt{\frac{\delta_1}{b} + \delta_2} \right\}. \end{aligned}$$

Step (2). If $x, y \in \rho^{-1}(sR)$ where $s \in [0, 8b]$, then from $\rho(p) = R$ and the continuity of the function ρ , there are

$$\tilde{x} \in \overline{p, \bar{x}} \cap \rho^{-1}(8bR), \quad \tilde{y} \in \overline{p, \bar{y}} \cap \rho^{-1}(8bR).$$

Note

$$|p\tilde{x}| \geq |\rho(p) - \rho(\tilde{x})| = (1 - 8b)R.$$

Then we get

$$|\tilde{x}x| = |px| - |p\tilde{x}| \leq 8bR.$$

Similar argument yields $|\tilde{y}y| \leq 8bR$.

Now from Proposition 5.3 and the above, we have

$$|xy| \leq |x\tilde{x}| + |\tilde{y}y| + |\tilde{x}\tilde{y}| \leq 16bR + 80R \left\{ b + \sqrt{\frac{\delta_1}{b} + \delta_2} \right\} \leq 10^2 R \left\{ b + \sqrt{\frac{\delta_1}{b} + \delta_2} \right\},$$

which yields

$$\sup_{x,y \in \rho^{-1}(sR)} |xy| \leq 10^2 R \left\{ b + \sqrt{\frac{\delta_1}{b} + \delta_2} \right\}.$$

For $s \in [2 - b, 2]$, the similar argument yields the same upper bound as above. Combining all the above, the conclusion follows. \square

6. THE WIDTH ESTIMATE IN FORM OF SPECTRAL GAP

Theorem 6.1. *There is $C(n) > 0$, such that for any n -dim geodesic ball $B_p(R)$ with $Rc \geq 0$ and mean convex boundary, we have*

$$\lambda_1(B_p(R)) \cdot R^2 - \frac{\pi^2}{16} \geq C(n) \left\{ \frac{\mathcal{W}(B_p(R))}{R} \right\}^{\frac{4(2n+1)(8n+15)}{n+2}}.$$

Proof: From Proposition 4.11, we know that (5.1) holds for

$$\delta_1 = C(n) \left\{ b^{-1 + \frac{1}{2n+4}} (\epsilon R^2)^{\frac{1}{8(2n+1)}} \right\}.$$

By Proposition 3.2, we know that (5.2) holds for $\delta_2 = C(n) \left(\frac{\epsilon R^2}{b} \right)^{\frac{1}{n-1}}$.

Now by Theorem 5.4, we get

$$\begin{aligned} \mathcal{W}(B_p(R)) &\leq 10^7 R \left\{ b + \sqrt{\frac{\delta_1}{b} + \delta_2} \right\} \\ &\leq C(n) R \cdot \left(b + b^{-1 + \frac{1}{4n+8}} (\epsilon R^2)^{\frac{1}{16(2n+1)}} + \left(\frac{\epsilon R^2}{b} \right)^{\frac{1}{2(n-1)}} \right) \\ (6.1) \quad &\leq C(n) R \cdot \left(b + b^{-1 + \frac{1}{4n+8}} (\epsilon R^2)^{\frac{1}{16(2n+1)}} \right). \end{aligned}$$

Now we choose b such that $b = b^{-1 + \frac{1}{4n+8}} (\epsilon R^2)^{\frac{1}{16(2n+1)}}$, which implies

$$b = (\epsilon R^2)^{\frac{n+2}{4(2n+1)(8n+15)}}.$$

Plugging the above choice of b into (6.1), we have

$$\mathcal{W}(B_p(R)) \leq C(n) R \cdot (\epsilon R^2)^{\frac{n+2}{4(2n+1)(8n+15)}} = C(n) R \cdot \left(\lambda R^2 - \frac{\pi^2}{16} \right)^{\frac{n+2}{4(2n+1)(8n+15)}}.$$

The conclusion follows. \square

ACKNOWLEDGMENTS

We thank Zuoqin Wang for discussion and helpful suggestion. And we are grateful to an anonymous referee for his detailed suggestion and comments on the earlier version of this paper, which greatly improves this paper.

REFERENCES

- [Aub05] Erwann Aubry, *Pincement sur le spectre et le volume en courbure de Ricci positive*, Ann. Sci. École Norm. Sup. (4) **38** (2005), no. 3, 387–405, DOI 10.1016/j.ansens.2005.01.002.
- [BDPV15] Lorenzo Brasco, Guido De Philippis, and Bozhidar Velichkov, *Faber-Krahn inequalities in sharp quantitative form*, Duke Math. J. **164** (2015), no. 9, 1777–1831, DOI 10.1215/00127094-3120167.
- [Bus82] Peter Buser, *A note on the isoperimetric constant*, Ann. Sci. École Norm. Sup. (4) **15** (1982), no. 2, 213–230.
- [CMM19] F. Cavalletti, F. Maggi, and A. Mondino, *Quantitative isoperimetry à la Levy-Gromov*, Comm. Pure Appl. Math. **72** (2019), no. 8, 1631–1677, DOI 10.1002/cpa.21808.
- [CMS23] Fabio Cavalletti, Andrea Mondino, and Daniele Semola, *Quantitative Obata’s theorem*, Anal. PDE **16** (2023), no. 6, 1389–1431, DOI 10.2140/apde.2023.16.1389.
- [Cha84] Isaac Chavel, *Eigenvalues in Riemannian geometry*, Pure and Applied Mathematics, vol. 115, Academic Press, Inc., Orlando, FL, 1984. Including a chapter by Burton Randol, With an appendix by Jozef Dodziuk.
- [CC96] Jeff Cheeger and Tobias H. Colding, *Lower bounds on Ricci curvature and the almost rigidity of warped products*, Ann. of Math. (2) **144** (1996), no. 1, 189–237, DOI 10.2307/2118589.
- [Col96a] Tobias H. Colding, *Shape of manifolds with positive Ricci curvature*, Invent. Math. **124** (1996), no. 1-3, 175–191, DOI 10.1007/s002220050049.
- [Col96b] ———, *Large manifolds with positive Ricci curvature*, Invent. Math. **124** (1996), no. 1-3, 193–214, DOI 10.1007/s002220050050.
- [CN12] Tobias Holck Colding and Aaron Naber, *Sharp Hölder continuity of tangent cones for spaces with a lower Ricci curvature bound and applications*, Ann. of Math. (2) **176** (2012), no. 2, 1173–1229, DOI 10.4007/annals.2012.176.2.10.
- [FMP08] N. Fusco, F. Maggi, and A. Pratelli, *The sharp quantitative isoperimetric inequality*, Ann. of Math. (2) **168** (2008), no. 3, 941–980, DOI 10.4007/annals.2008.168.941.
- [HW07] Fengbo Hang and Xiaodong Wang, *A remark on Zhong-Yang’s eigenvalue estimate*, Int. Math. Res. Not. IMRN **18** (2007), Art. ID rnm064, 9, DOI 10.1093/imrn/rnm064.
- [Her60] Joseph Hersch, *Sur la fréquence fondamentale d’une membrane vibrante: évaluations par défaut et principe de maximum*, Z. Angew. Math. Phys. **11** (1960), 387–413, DOI 10.1007/BF01604498.
- [Kas84] Atsushi Kasue, *On a lower bound for the first eigenvalue of the Laplace operator on a Riemannian manifold*, Ann. Sci. École Norm. Sup. (4) **17** (1984), no. 1, 31–44.
- [Kla17] Bo’az Klartag, *Needle decompositions in Riemannian geometry*, Mem. Amer. Math. Soc. **249** (2017), no. 1180, v+77, DOI 10.1090/memo/1180.
- [Li12] Peter Li, *Geometric analysis*, Cambridge Studies in Advanced Mathematics, 134. Cambridge University Press, Cambridge, x+406 pp, 2012.
- [LY80] Peter Li and Shing Tung Yau, *Estimates of eigenvalues of a compact Riemannian manifold*, Geometry of the Laplace operator (Proc. Sympos. Pure Math., Univ. Hawaii, Honolulu, Hawaii, 1979), 1980, pp. 205–239.
- [Liu] Zichang Liu, *A generalization of the first variation formula*, Preprint.
- [MH02] Pedro J. Méndez-Hernández, *Brascamp-Lieb-Luttinger inequalities for convex domains of finite inradius*, Duke Math. J. **113** (2002), no. 1, 93–131, DOI 10.1215/S0012-7094-02-11313-1.
- [PW60] L. E. Payne and H. F. Weinberger, *An optimal Poincaré inequality for convex domains*, Arch. Rational Mech. Anal. **5** (1960), 286–292 (1960), DOI 10.1007/BF00252910.
- [Pet99] Peter Petersen, *On eigenvalue pinching in positive Ricci curvature*, Invent. Math. **138** (1999), no. 1, 1–21, DOI 10.1007/s002220050339.
- [Pro81] M. H. Protter, *A lower bound for the fundamental frequency of a convex region*, Proc. Amer. Math. Soc. **81** (1981), no. 1, 65–70, DOI 10.2307/2043987.

- [WXZ22] Haibin Wang, Guoyi Xu, and Jie Zhou, *The sharp lower bound of the first Dirichlet eigenvalue for geodesic balls*, *Math. Z.* **300** (2022), no. 2, 2063–2068, DOI 10.1007/s00209-021-02859-8.
- [Xu19] Guoyi Xu, *Local estimate of fundamental groups*, *Adv. Math.* **352** (2019), 158–230, DOI 10.1016/j.aim.2019.06.006.
- [XZ23] Guoyi Xu and Jie Zhou, *The construction of ϵ -splitting map*, *Calc. Var. Partial Differential Equations* **62** (2023), no. 3, Paper No. 75, DOI 10.1007/s00526-022-02418-x.
- [WZ23] Bing Wang and Xinrui Zhao, *Canonical diffeomorphisms of manifolds near spheres*, *J. Geom. Anal.* **33** (2023), no. 9, Paper No. 304, 31, DOI 10.1007/s12220-023-01375-x.
- [Yan99] DaGang Yang, *Lower bound estimates of the first eigenvalue for compact manifolds with positive Ricci curvature*, *Pacific J. Math.* **190** (1999), no. 2, 383–398, DOI 10.2140/pjm.1999.190.383.
- [ZY84] Jia Qing Zhong and Hong Cang Yang, *On the estimate of the first eigenvalue of a compact Riemannian manifold*, *Sci. Sinica Ser. A* **27** (1984), no. 12, 1265–1273.

GUOYI XU, DEPARTMENT OF MATHEMATICAL SCIENCES, TSINGHUA UNIVERSITY, BEIJING, P. R. CHINA
Email address: guoyixu@tsinghua.edu.cn

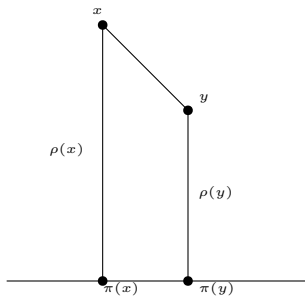

Gou-Gu Theorem

$$|xy|^2 - [|\rho(x) - \rho(y)|^2 + |\pi(x)\pi(y)|^2] = 0$$

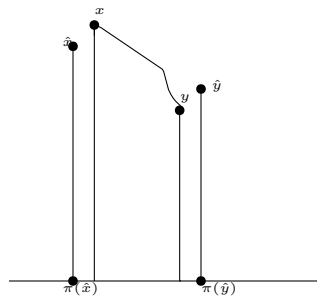

Almost Gou-Gu Theorem

$$\left| |xy|^2 - [|\rho(x) - \rho(y)|^2 + |\pi(\hat{x})\pi(\hat{y})|^2] \right| \ll 1$$

$$|x\hat{x}| + |y\hat{y}| \ll 1$$

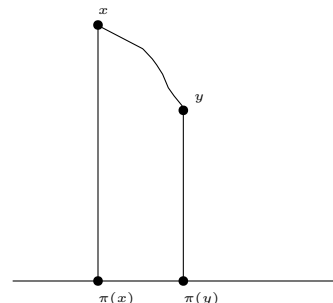

Stable Gou-Gu Theorem

$$\left| |xy|^2 - [|\rho(x) - \rho(y)|^2 + |\pi(x)\pi(y)|^2] \right| \ll 1$$

