

# TWO EXTERIOR ALGEBRAS FOR ORTHOGONAL AND SYMPLECTIC QUANTUM GROUPS

AXEL SCHÜLER

ABSTRACT. Let  $\Gamma$  be one of the  $N^2$ -dimensional bicovariant first order differential calculi on the quantum groups  $O_q(N)$  or  $Sp_q(N)$ , where  $q$  is not a root of unity. We show that the second antisymmetrizer exterior algebra  ${}_s\Gamma^\wedge$  is the quotient of the universal exterior algebra  ${}_u\Gamma^\wedge$  by the principal ideal generated by  $\theta \wedge \theta$ . Here  $\theta$  denotes the unique up to scalars bi-invariant 1-form. Moreover  $\theta \wedge \theta$  is central in  ${}_u\Gamma^\wedge$  and  ${}_u\Gamma^\wedge$  is an inner differential calculus.

AMS subject classification: 58B30, 81R50

## 1. INTRODUCTION

More than a decade ago Woronowicz provided a general framework for covariant differential calculus over arbitrary Hopf algebras, [12]. In the meantime there exists a well developed theory of covariant differential calculus on Hopf algebras, [6, Chapter 14]. In his paper Woronowicz also introduced the concept of higher order forms which is based on a braiding  $\sigma: \Gamma \otimes_A \Gamma \rightarrow \Gamma \otimes_A \Gamma$ . The braiding  $\sigma$  naturally generalizes the classical flip automorphism. It turns out that Woronowicz' external algebra  ${}_w\Gamma^\wedge$  is not simply a bicovariant bimodule but a differential graded Hopf algebra [2], [6, Theorem 14.17]. However there are two other concepts of exterior algebras which are also differential graded Hopf algebras, [1, 7], [6, Theorem 14.18]. The "second antisymmetrizer" exterior algebra  ${}_s\Gamma^\wedge$  is also constructed using the braiding; but it involves only the antisymmetrizer  $I - \sigma$  of second degree while Woronowicz' construction uses antisymmetrizers of all degrees. The universal exterior algebra  ${}_u\Gamma^\wedge$  can be characterized by the following universal property. Each (left-covariant) differential calculus which contains a given first order differential calculus  $\Gamma$  as its first order part is a quotient of  ${}_u\Gamma^\wedge$ . It seems natural to ask for the relation between these three concepts. For the quantum groups  $GL_q(N)$  and  $SL_q(N)$  and their standard bicovariant first order differential calculi (abbreviated FODC) this problem was completely solved in [9]. In this paper we consider the quantum groups  $O_q(N)$  and  $Sp_q(N)$  together with their standard bicovariant FODC. The main result is stated in Theorem 3.1. Suppose that  $q$  is not a root of unity and let  $\theta$  be the unique up to scalars bi-invariant 1-form of  $\Gamma$ . Then  ${}_u\Gamma^\wedge/(\theta^2)$  and  ${}_s\Gamma^\wedge$  are isomorphic differential graded Hopf algebras. Further,  $\theta^2$  is central in  ${}_u\Gamma^\wedge$  and  ${}_u\Gamma^\wedge$  is an inner differential calculus i. e.  $d\rho = \theta \wedge \rho - (-1)^n \rho \wedge \theta$

---

Supported by the Deutsche Forschungsgemeinschaft, e-mail: schueler@mathematik.uni-leipzig.de.

for  $\rho \in {}_u\Gamma^{\wedge n}$ . It is somehow astonishing that the left-invariant parts of  ${}_u\Gamma^{\wedge 2}$  and  ${}_s\Gamma^{\wedge 2}$  differ only by the single element  $\theta^2$ .

This paper is organized as follows. Section 2 contains general notions and facts about bicovariant bimodules and bicovariant differential calculi over Hopf algebras. In Section 3 we recall necessary facts about morphisms of corepresentations for orthogonal and symplectic quantum groups. We give a brief introduction into the graphical calculus with morphisms. The construction of bicovariant FODC on orthogonal and symplectic quantum groups is reviewed. The main result is stated in Theorem 3.1. In Section 4 a very useful criterion for the size of the space of left-invariant 2-forms of  ${}_u\Gamma^{\wedge}$  in terms of the quantum Lie algebra is given. This criterion applies to arbitrary left-covariant differential calculi. We show that  $\Gamma \otimes_{\mathcal{A}} \Gamma$  is the direct sum of 9 bicovariant subbimodules. Every bicovariant subbimodule of  $\Gamma \otimes_{\mathcal{A}} \Gamma$  which contains  $\theta \otimes_{\mathcal{A}} \theta$  already contains the kernel of  $I - \sigma$ . Section 5 exclusively deals with the universal differential calculus. The outcome of the very technical calculations is that  $\theta \wedge \theta$  is non-zero and the unique up to scalars bi-invariant 2-form in  ${}_u\Gamma^{\wedge}$ .

We close the introduction by fixing assumptions and notations that are used in the sequel. All vector spaces, algebras, bialgebras, etc. are meant to be  $\mathbb{C}$ -vector spaces, unital  $\mathbb{C}$ -algebras,  $\mathbb{C}$ -bialgebras etc. The linear span of a set  $\{a_i | i \in K\}$  is denoted by  $\langle a_i | i \in K \rangle$ .  $\mathcal{A}$  always denotes a Hopf algebra. We write  $\mathcal{A}^\circ$  for the dual Hopf algebra. All modules, comodules, and bimodules are assumed to be  $\mathcal{A}$ -modules,  $\mathcal{A}$ -comodules, and  $\mathcal{A}$ -bimodules if nothing else is specified. Denote the comultiplication, the counit, and the antipode by  $\Delta$ ,  $\varepsilon$ , and by  $S$ , respectively. We use the notions “right comodule” and “corepresentation” of  $\mathcal{A}$  as synonyms. By fixing a basis in the underlying vector space we identify corepresentations and the corresponding matrices. Let  $v$  (resp.  $f$ ) be a corepresentation (resp. a representation) of  $\mathcal{A}$ . As usual  $v^c$  (resp.  $f^c$ ) denotes the contragredient corepresentation (resp. contragredient representation) of  $v$  (resp. of  $f$ ). The space of intertwiners of corepresentations  $v$  and  $w$  is  $\text{Mor}(v, w)$ . We write  $\text{Mor}(v)$  for  $\text{Mor}(v, v)$ . By  $\text{End}(V)$  and  $V \otimes W$  we always mean  $\text{End}_{\mathbb{C}}(V)$  and  $V \otimes_{\mathbb{C}} W$ , respectively. If  $A$  is a linear mapping,  $A^\top$  denotes the transpose of  $A$  and  $\text{tr } A$  the trace of  $A$ . Lower indices of  $A$  always refer to the components of a tensor product where  $A$  acts (‘leg numbering’). The unit matrix is denoted by  $I$ . Unless it is explicitly stated otherwise, we use Einstein convention to sum over repeated indices. Set  $\tilde{a} = a - \varepsilon(a)1$  for  $a \in \mathcal{A}$  and  $\tilde{\mathcal{A}} = \{\tilde{a} | a \in \mathcal{A}\}$ . We use Sweedler’s notation for the coproduct  $\Delta(a) = \sum a_{(1)} \otimes a_{(2)}$  and for right comodules  $\Delta_R(\rho) = \sum \rho_{(0)} \otimes \rho_{(1)}$ . The mapping  $\text{Ad}_R: \mathcal{A} \rightarrow \mathcal{A} \otimes \mathcal{A}$  defined by  $\text{Ad}_R a = \sum a_{(2)} \otimes S a_{(1)} a_{(3)}$  is called the *right adjoint coaction* of  $\mathcal{A}$  on itself. The mapping  $b \triangleleft a := S a_{(1)} b a_{(2)}$ ,  $a \in \mathcal{A}$ ,  $b \in \mathcal{B}$ , is called the *right adjoint action* of  $\mathcal{A}$  on  $\mathcal{B}$ , where  $\mathcal{B}$  is an  $\mathcal{A}$ -bimodule.

## 2. PRELIMINARIES

In the next three subsections we shall use the general framework of bicovariant differential calculus developed by Woronowicz [12], see also [6, Chapter 14]. We collect the main notions and facts needed in what follows.

*Bicovariant bimodules.* A *bicovariant bimodule* over  $\mathcal{A}$  is a bimodule  $\Gamma$  together with linear mappings  $\Delta_L: \Gamma \rightarrow \mathcal{A} \otimes \Gamma$  and  $\Delta_R: \Gamma \rightarrow \Gamma \otimes \mathcal{A}$  such that  $(\Gamma, \Delta_L, \Delta_R)$  is a bicomodule and  $\Delta_L(a\omega b) = \Delta(a)\Delta_L(\omega)\Delta(b)$ , and  $\Delta_R(a\omega b) = \Delta(a)\Delta_R(\omega)\Delta(b)$  for  $a, b \in \mathcal{A}$  and  $\omega \in \Gamma$ . Let  $\Gamma$  be a bicovariant bimodule over  $\mathcal{A}$ . We call the elements of the vector space  $\Gamma_L = \{\omega | \Delta_L(\omega) = 1 \otimes \omega\}$  (resp.  $\Gamma_R = \{\omega | \Delta_R(\omega) = \omega \otimes 1\}$ ) *left-invariant* (resp. *right-invariant*). The elements of  $\Gamma_I = \Gamma_L \cap \Gamma_R$  are called *bi-invariant*. The structure of bicovariant bimodules has been completely characterized by Theorems 2.3 and 2.4 in [12]. We recall the corresponding result: Let  $(\Gamma, \Delta_L, \Delta_R)$  be a bicovariant bimodule over  $\mathcal{A}$  and let  $\{\omega_i | i \in K\}$  be a finite linear basis of  $\Gamma_L$ . Then there exist matrices  $v = (v_j^i)$  and  $f = (f_j^i)$  of elements  $v_j^i \in \mathcal{A}$  and of functionals  $f_j^i$  on  $\mathcal{A}$ ,  $i, j \in K$  such that  $v$  is a matrix corepresentation,  $f$  is matrix representation of  $\mathcal{A}$ , and

$$\omega_i \triangleleft a = f_n^i(a)\omega_n, \quad (1)$$

$$\Delta_R(\omega_i) = \omega_n \otimes v_i^n, \quad (2)$$

for  $a \in \mathcal{A}$ ,  $i \in K$ . Conversely, if the corepresentation  $v$  and the representation  $f$  satisfy certain compatibility condition, then there exists a unique bicovariant bimodule  $\Gamma$  with (1) and (2) and  $\{\omega_i | i \in K\}$  is a basis of  $\Gamma_L$ . In this situation we simply write  $\Gamma = (v, f)$ .

*Bicovariant first order differential calculi.* A *first order differential calculus* over  $\mathcal{A}$  (FODC for short) is an  $\mathcal{A}$ -bimodule  $\Gamma$  with a linear mapping  $d: \mathcal{A} \rightarrow \Gamma$  that satisfies the Leibniz rule  $d(ab) = da \cdot b + a \cdot db$  for  $a, b \in \mathcal{A}$ , and  $\Gamma$  is the linear span of elements  $adb$  with  $a, b \in \mathcal{A}$ .

A FODC  $\Gamma$  is called *bicovariant* if there exist linear mappings  $\Delta_L: \Gamma \rightarrow \mathcal{A} \otimes \Gamma$  and  $\Delta_R: \Gamma \rightarrow \Gamma \otimes \mathcal{A}$  such that

$$\Delta_L(adb) = \Delta(a)(\text{id} \otimes d)\Delta(b),$$

$$\Delta_R(adb) = \Delta(a)(d \otimes \text{id})\Delta(b)$$

for all  $a, b \in \mathcal{A}$ . It turns out that  $(\Gamma, \Delta_L, \Delta_R)$  is a bicovariant bimodule. A bicovariant FODC is called *inner* if there exists a bi-invariant 1-form  $\theta \in \Gamma$  such that

$$da = \theta a - a\theta, \quad a \in \mathcal{A}.$$

By the dimension of a bicovariant FODC we mean the dimension of the vector space  $\Gamma_L$  of left-invariant 1-forms. Let  $\Gamma$  be a bicovariant FODC over  $\mathcal{A}$ . Then the set

$$\mathcal{R}_\Gamma = \{a \in \tilde{\mathcal{A}} | \omega(a) = 0\}$$

is an  $\text{Ad}_R$ -invariant right ideal of  $\tilde{\mathcal{A}}$ . Here  $\omega: \mathcal{A} \rightarrow \Gamma_L$  is the mapping

$$\omega(a) = Sa_{(1)}da_{(2)}. \quad (3)$$

Conversely, for any  $\text{Ad}_R$ -invariant right ideal  $\mathcal{R}$  of  $\tilde{\mathcal{A}}$  there exists a bicovariant FODC  $\Gamma$  such that  $\mathcal{R}_\Gamma = \mathcal{R}$ , [6, Proposition 14.7].

The linear space

$$\mathcal{X}_\Gamma = \{X \in \mathcal{A}^\circ | X(1) = 0 \text{ and } X(p) = 0 \text{ for all } p \in \mathcal{R}_\Gamma\}$$

is called the *quantum Lie algebra* of  $\Gamma$ . We recall the main property. The space  $\mathcal{X}_\Gamma$  is an  $\text{ad}_R$ -invariant subspace of the dual Hopf algebra  $\mathcal{A}^\circ$  satisfying  $\Delta(X) - 1 \otimes X \in \mathcal{X}_\Gamma \otimes \mathcal{A}^\circ$  for  $X \in \mathcal{X}_\Gamma$ , [6, Corollary 14.10].

*Higher order differential calculi.* In this subsection we briefly repeat two concepts to construct higher order differential calculi (DC for short) for a given bicovariant FODC  $\Gamma$ . Let  $\Gamma = (v, f)$  be a bicovariant bimodule.

Obviously the tensor product  $\Gamma^{\otimes k} = \Gamma \otimes_{\mathcal{A}} \cdots \otimes_{\mathcal{A}} \Gamma$  ( $k$  factors) is again a bicovariant bimodule. Define the tensor algebra  $\Gamma^\otimes = \bigoplus_{k \geq 0} \Gamma^{\otimes k}$ ,  $\Gamma^{\otimes 0} = \mathcal{A}$ , over  $\mathcal{A}$ . This is also a bicovariant bimodule. Since bicovariant bimodules are free left  $\mathcal{A}$ -modules we always identify  $(\Gamma \otimes_{\mathcal{A}} \cdots \otimes_{\mathcal{A}} \Gamma)_L$  and  $\Gamma_L \otimes \cdots \otimes \Gamma_L$ . This justifies our notation  $\omega_i \otimes \omega_j$  instead of  $\omega_i \otimes_{\mathcal{A}} \omega_j$  for  $\omega_i, \omega_j \in \Gamma_L$ . There exists a unique isomorphism  $\sigma: \Gamma \otimes_{\mathcal{A}} \Gamma \rightarrow \Gamma \otimes_{\mathcal{A}} \Gamma$  of bicovariant bimodules called the *braiding* with  $\sigma(\omega \otimes \rho) = \rho_{(0)} \otimes (\omega \triangleleft \rho_{(1)})$ ,  $\omega, \rho \in \Gamma_L$ . Moreover  $\sigma$  fulfils the braid equation  $(\sigma \otimes \text{id})(\text{id} \otimes \sigma)(\sigma \otimes \text{id}) = (\text{id} \otimes \sigma)(\sigma \otimes \text{id})(\text{id} \otimes \sigma)$  in  $\Gamma \otimes_{\mathcal{A}} \Gamma \otimes_{\mathcal{A}} \Gamma$ . Let  ${}_s J$  denote the two-sided ideal in  $\Gamma^\otimes$  generated by the kernel of  $A_2: \Gamma \otimes_{\mathcal{A}} \Gamma \rightarrow \Gamma \otimes_{\mathcal{A}} \Gamma$ ,  $A_2 = \text{id} - \sigma$ . We call  ${}_s \Gamma^\wedge = \Gamma^\otimes / {}_s J$  the *second antisymmetrizer exterior algebra* over  $\Gamma$ . Since  $\sigma$  is a morphism of bicomodules,  $(\Gamma \otimes_{\mathcal{A}} \Gamma)_L$  is invariant under  $\sigma$ . So there exist complex numbers  $\sigma_{st}^{ij}$  such that  $\sigma(\omega_s \otimes \omega_t) = \sigma_{st}^{ij} \omega_i \otimes \omega_j$ . By [12, (3.15)] we have

$$\sigma_{st}^{ij} = f_j^s(v_t^i). \quad (4)$$

Let  $\mathcal{S}: \mathcal{A} \rightarrow \Gamma_L \otimes \Gamma_L$  be defined by

$$\mathcal{S}(a) = \omega(a_{(1)}) \otimes \omega(a_{(2)}).$$

Let  ${}_u J$  denote the two-sided ideal of  $\Gamma^\otimes$  generated by the vector space  $\mathcal{S}(\mathcal{R}_\Gamma)$ . Then  ${}_u \Gamma^\wedge = \Gamma^\otimes / {}_u J$  is called the *universal exterior algebra* over  $\Gamma$ . Both  ${}_s \Gamma^\wedge$  and  ${}_u \Gamma^\wedge$  are  $\mathbb{N}_0$ -graded algebras, bicovariant bimodules over  $\mathcal{A}$  as well as differential graded Hopf algebras over  $\mathcal{A}$ . They are related by  ${}_u J \subseteq {}_s J$ . Their left-invariant subalgebras  ${}_u \Gamma_L^\wedge$  and  ${}_s \Gamma_L^\wedge$  are both quadratic algebras over the same vector space  $\Gamma_L$ .

### 3. ORTHOGONAL AND SYMPLECTIC QUANTUM GROUPS, THEIR STANDARD FODC, AND THE MAIN RESULT

In this section we recall general facts about orthogonal and symplectic quantum groups. Throughout  $\mathcal{A}$  denotes one of the Hopf algebras  $\mathcal{O}(O_q(N))$  and  $\mathcal{O}(\mathrm{Sp}_q(N))$  as defined in [3, Subsection 1.4]. We give a brief introduction into the graphical calculus with morphisms of corepresentations of  $\mathcal{A}$  and we recall the construction of the standard bicovariant FODC over  $\mathcal{A}$ . At the end we state our main result.

As usual we set  $\epsilon = 1$  in the orthogonal and  $\epsilon = -1$  in the symplectic case. Throughout the deformation parameter  $q$  is *not a root of unity*, and  $N \geq 3$ . We always use the abbreviations  $\hat{q} = q - q^{-1}$ ,  $[2]_q = q + q^{-1}$ ,  $r = \epsilon q^{N-\epsilon}$ , and  $x = 1 + \frac{r-r^{-1}}{q-q^{-1}}$ . Recall that  $R$  denotes the complex invertible  $N^2 \times N^2$ -matrix [3, (1.9)],  $\hat{R}_{st}^{ab} = R_{st}^{ba}$ , and  $C = (C_j^i)$ ,  $C_j^i = \epsilon_i q^{\epsilon_j} \delta_{ij}$ , defines the metric, see [3, (1.10)] for details. The matrix  $K$  is given by  $K_{st}^{ab} = C_b^a B_t^s$ , where  $B = C^{-1} = \epsilon C$ . We need the diagonal matrix  $D = B^\top C$ . Sometimes we use the notation  $C^{ab} = C_b^a$ ,  $C_{ab} = C_b^a$ . Then  $(C^{ab}) \in \mathrm{End}(\mathbb{C}, \mathbb{C}^N \otimes \mathbb{C}^N)$  and  $(C_{ab}) \in \mathrm{End}(\mathbb{C}^N \otimes \mathbb{C}^N, \mathbb{C})$ . The  $N^2$  generators of  $\mathcal{A}$  are denoted by  $u_j^i$ ,  $i, j = 1, \dots, N$ , and we call  $u = (u_j^i)$  the fundamental matrix corepresentation. The element  $U = \sum_{i,j} D_i^j u_j^i$  is called the quantum trace. Note that

$$(C^{ab}) \in \mathrm{Mor}(1, u \otimes u), \quad (C_{ab}) \in \mathrm{Mor}(u \otimes u, 1), \quad C^\top \in \mathrm{Mor}(u^c, u) = \mathrm{Mor}(u, u^c). \quad (5)$$

For  $T = (T_{st}^{ab}) \in \mathrm{End}(\mathbb{C}^N \otimes \mathbb{C}^N)$  define the  $q$ -trace  $\mathrm{tr}_q^1 T \in \mathrm{End}(\mathbb{C}^N)$  by  $(\mathrm{tr}_q^1 T)_t^b = D_a^s T_{st}^{ab}$ . We often use the following well known relations between  $\hat{R}$ ,  $\hat{R}^{-1}$ ,  $K$ , and  $D$ .

$$C_z^y \hat{R}_{st}^{yz} = r^{-1} C_t^s, \quad \hat{R}_{yz}^{ab} C_z^y = r^{-1} C_b^a, \quad (6)$$

$$\hat{R} - \hat{R}^{-1} = \hat{q}(I - K), \quad (7)$$

$$x = \mathrm{tr} D, \quad (8)$$

$$\mathrm{tr}_q^1 \hat{R} = rI, \quad \mathrm{tr}_q^1 I = xI, \quad \mathrm{tr}_q^1 K = I. \quad (9)$$

The mapping  $g_i \mapsto \hat{R}_{i,i+1}$ ,  $e_i \mapsto K_{i,i+1}$  defines a representation of the Birman-Wenzl-Murakami algebra  $\mathbb{C}(q, r)$ , [11]. We shall give a brief introduction into the graphical calculus with morphisms, see also [8, Fig. 1 and Fig. 6]. The calculus is justified in [10]. Using the graphical calculus formulas and proofs become more transparent. In order to distinguish the places for the corepresentation  $u$  and  $u^c$  we use arrows in the graph. A vertex stands for  $u$ , resp.  $u^c$ , if the corresponding edge is downward directed, resp. upward directed. Since for orthogonal and symplectic quantum groups  $u$  and  $u^c$  are isomorphic, it appears that one edge has *two* directions. For instance, the intertwiner  $C^\top \in \mathrm{Mor}(u, u^c)$  is represented by a vertical edge downward directed at the bottom and upward directed at the top. Removing a curl by rotating part of the diagram clockwise (resp. anti-clockwise) acquires a factor  $r$  (resp.  $r^{-1}$ ) (First Reidemeister move). A closed loop gives the factor  $x$ .

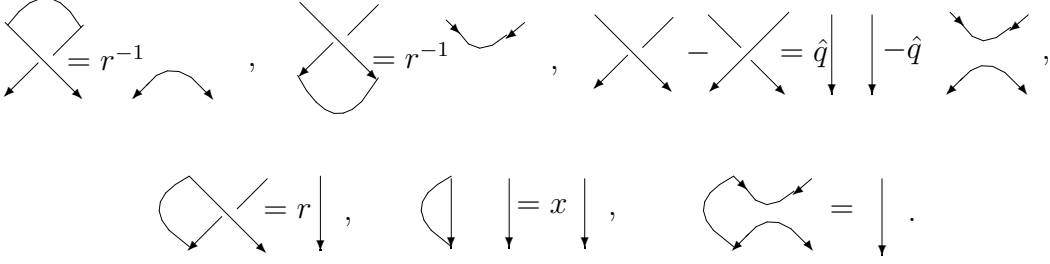

Figure 1: The graphical representation of (6), (7), and (9).

The matrix  $\hat{R}$  has the spectral decomposition

$$\hat{R} = q\hat{P}^+ - q^{-1}\hat{P}^- + r^{-1}\hat{P}^0,$$

where  $\hat{P}^\tau$ ,  $\tau \in \{+, -, 0\}$ , is idempotent.

We recall the method of Jurčo [5] to construct bicovariant FODC over  $\mathcal{A}$ . For the more general construction of bicovariant FODC over coquasitriangular Hopf algebras see [6, Section 14.5]. Let  $\ell^\pm = (\ell_j^{\pm i})$  be the  $N \times N$ -matrix of linear functionals  $\ell_j^{\pm i}$  on  $\mathcal{A}$  as defined in in [3, Section 2]. Recall that  $\ell^\pm$  is uniquely determined by  $\ell_j^{\pm i}(u_n^m) = (\hat{R}^{\pm 1})_{nj}^{im}$  and the property that  $\ell^\pm: \mathcal{A} \rightarrow \text{End}(\mathbb{C}^N)$  is a unital algebra homomorphism. Note that  $\ell_j^{\pm i}(Su_n^m) = (\hat{R}^{\mp 1})_{jn}^{mi}$ . Define the bicovariant bimodules

$$\Gamma_\pm = (u \otimes u^c, \varepsilon_\pm \otimes \ell^{-c} \otimes \ell^+),$$

where  $\varepsilon_+ = \varepsilon$  and  $\varepsilon_-$  is the character on  $\mathcal{A}$  given by  $\varepsilon_-(u_j^i) = -\delta_{ij}$ . The structure of  $\Gamma_\pm$  can easily be described as follows. There exists a basis  $\{\theta_{ij} | i, j = 1, \dots, N\}$  of  $(\Gamma_\pm)_L$  such that the right adjoint action and the right coaction are given by

$$\begin{aligned} \theta_{ij} \triangleleft a &= \varepsilon_\pm(a_{(1)}) S(\ell_i^{-m}) \ell_n^{+j} (a_{(2)}) \theta_{mn}, \quad a \in \mathcal{A}, \\ \Delta_R \theta_{ij} &= \theta_{mn} \otimes u_i^m (u^c)_j^n, \quad i, j = 1, \dots, N. \end{aligned}$$

In particular

$$\begin{aligned} \theta_{ij} \triangleleft u_t^s &= \pm \hat{R}_{iy}^{sm} \hat{R}_{tn}^{jy} \theta_{mn}, \\ \theta \triangleleft u_t^s &= \pm (\hat{R}^2)_{tn}^{sm} \theta_{mn}, \end{aligned} \tag{10}$$

where  $\theta = \sum_i \theta_{ii}$  is the unique up to scalars bi-invariant element. Defining

$$da = \theta a - a \theta \tag{11}$$

for  $a \in \mathcal{A}$ ,  $(\Gamma_\pm, d)$  becomes a bicovariant FODC over  $\mathcal{A}$ . The basis  $\{X_{ij}^\pm\}$  of the quantum Lie algebra  $\mathcal{X}_\pm$  dual to  $\{\theta_{ij}\}$  is given by

$$X_{ij}^\pm := \varepsilon_\pm \ell_j^i - \delta_{ij} := \varepsilon_\pm S(\ell_y^{-i}) \ell_j^{+y} - \delta_{ij}.$$

One easily checks that  $X_0^\pm := D_i^j X_{ij}^\pm = \varepsilon_\pm D_i^j \ell_j^i - x$  is an  $\text{ad}_R$ -invariant element of  $\mathcal{A}^\circ$ . The braiding  $\sigma$  of  $\Gamma_\pm$  can be obtained as follows. Inserting  $v = u \otimes u^c$  and  $f_\pm = \varepsilon_\pm \otimes \ell^{-c} \otimes \ell^+$  into equation (4) the braiding matrices of  $\Gamma_+$  and  $\Gamma_-$  coincide

$$\sigma = \check{R}_{23}^- \hat{R}_{12} \check{R}_{34}^{-1} \hat{R}_{23}, \quad (12)$$

where the matrices  $\hat{R}$ ,  $\check{R}$ , and  $\check{R}^-$  are defined as follows. For a complex  $N^2 \times N^2$ -matrix  $T$  with  $\hat{T} \in \text{Mor}(u \otimes u)$  define the matrices  $\check{T}_{st}^{ab} = \hat{T}_{ba}^{ts}$ ,  $\hat{T}_{st}^{ab} = \hat{T}_{tb}^{sa}$ , and  $\check{T}^- = (\hat{T})^{-1}$ . Note that  $\hat{T} \in \text{Mor}(u^c \otimes u, u \otimes u^c)$  and  $\check{T} \in \text{Mor}(u^c \otimes u^c)$ .

Now we can formulate our main result.

**Theorem 3.1.** *Let  $\mathcal{A}$  be one of the Hopf algebras  $\mathcal{O}(\text{O}_q(N))$  or  $\mathcal{O}(\text{Sp}_q(N))$ ,  $N \geq 3$ , and  $q$  not a root of unity. Let  $\Gamma$  be one of the bicovariant FODC  $\Gamma_\pm$ , and  $2x + (q - q^{-1})(r - r^{-1}) \neq 0$  in case of  $\Gamma_-$ . Denote the unique up to scalars bi-invariant 1-form by  $\theta$ .*

(i) *Then the quotient  ${}_u\Gamma^\wedge/(\theta^2)$  and the second antisymmetrizer algebra  ${}_s\Gamma^\wedge$  are isomorphic bicovariant bimodules.*

(ii) *The bi-invariant 2-form  $\theta^2$  is central in  ${}_u\Gamma^\wedge$ . The calculus  ${}_u\Gamma^\wedge$  is inner, i. e.*

$$d\rho = \theta \wedge \rho - (-1)^n \rho \wedge \theta, \quad \rho \in {}_u\Gamma^{\wedge n}. \quad (13)$$

*Remark 1.* Theorem 1 is true for the quantum group  $\text{SL}_q(2)$  and the  $4D_\pm$  bicovariant FODC as well, [9, Theorem 3.3 (iii)]. In cases  $\text{SL}_q(N)$  and  $\text{GL}_q(N)$ ,  $N \geq 3$ , we have  ${}_u\Gamma^\wedge \cong {}_s\Gamma^\wedge$ , [9, Theorem 3.3 (ii)]. For the quantum super group  $\text{GL}_q(m|n)$  the relation  ${}_u\Gamma^\wedge \cong {}_s\Gamma^\wedge$  was proved in [7, Section 5.3].

*Remark 2.* The isomorphism of bicovariant bimodules  ${}_u\Gamma^\wedge/(\theta^2)$  and  ${}_s\Gamma^\wedge$  implies its isomorphism as differential graded Hopf algebras.

#### 4. PROOF OF THE THEOREM

In the first part of this section we study the duality of  $\Gamma_L \otimes \Gamma_L$  and  $\mathcal{X} \otimes \mathcal{X}$  in more detail. In the second part we examine how  $\Gamma \otimes_{\mathcal{A}} \Gamma$  splits into bicovariant subbimodules. We shall prove that the space of bi-invariant elements of  $\Gamma \otimes_{\mathcal{A}} \Gamma$  generates the whole bimodule  $\ker A_2$ .

*Duality.* There is a useful criterion to describe the dimension of the space of left-invariant 2-forms of  ${}_u\Gamma^\wedge$  in terms of the quantum Lie algebra.

**Lemma 4.1.** *Let  $\mathcal{A}$  be an arbitrary Hopf algebra,  $\Gamma$  a left-covariant FODC over  $\mathcal{A}$  with quantum Lie algebra  $\mathcal{X}$ , and  ${}_u\Gamma^\wedge$  the universal differential calculus over  $\Gamma$ . Then*

$$\dim {}_u\Gamma_L^{\wedge 2} = \dim\{T \in \mathcal{X} \otimes \mathcal{X} \mid \mu(T) \in \mathcal{X}\},$$

where  $\mu: \mathcal{X} \otimes \mathcal{X} \rightarrow \mathcal{A}^\circ$  denotes the multiplication map.

*Proof.* We use the following simple lemma from linear algebra without proof. Let  $B: V \times W \rightarrow \mathbb{C}$  be a non-degenerate linear pairing of finite dimensional vector spaces and  $U$  a subspace of  $V$ . Then the induced pairing  $\overline{B}: V/U \times U^\perp \rightarrow \mathbb{C}$  with  $U^\perp = \{w \in W \mid B(u, w) = 0 \text{ for } u \in U\}$  is also non-degenerate. Applying this lemma to the non-degenerate pairing  $\langle \cdot, \cdot \rangle: \Gamma_L \otimes \Gamma_L \times \mathcal{X} \otimes \mathcal{X} \rightarrow \mathbb{C}$ , [12, p. 164], and  $U = \mathcal{S}(\mathcal{R})$  we have  $T = \alpha^{ij} X_i \otimes X_j \in U^\perp$  if and only if

$$0 = \langle \omega(p_{(1)}) \otimes \omega(p_{(2)}), \alpha^{ij} X_i \otimes X_j \rangle = \alpha^{ij} X_i(p_{(1)}) X_j(p_{(2)}) = \mu(T)(p)$$

for  $p \in \mathcal{R}$ . Hence  $T \in U^\perp$  if and only if  $\mu(T) \in \mathcal{X}$ . Consequently  $U^\perp = \mu^{-1}(\mathcal{X})$ , where  $\mu^{-1}(\mathcal{X})$  denotes the pre-image of  $\mathcal{X}$  under  $\mu$ . Since the induced pairing is also non-degenerate and  ${}_u \Gamma_L^{\wedge 2} = \Gamma_L \otimes \Gamma_L / \mathcal{S}(\mathcal{R})$  by definition, the assertion of the lemma is proved.  $\square$

*Remark 3.* Suppose  $\Gamma$  to be bicovariant. Since for  $f: V \rightarrow V$  linear,  $(\ker f)^\perp = \text{im } f^\top$ , the pairing also factorizes to a non-degenerate pairing of  ${}_s \Gamma_L^{\wedge 2} \times \mathcal{X} \wedge \mathcal{X}$ , where  $\mathcal{X} \wedge \mathcal{X} = A_2^\top(\mathcal{X} \otimes \mathcal{X})$  and  $A_2^\top$  is the dual mapping to  $A_2 \uparrow (\Gamma_L \otimes \Gamma_L)$ .

We proceed with a result for a dual pairing of a comodule and a module.

**Proposition 4.2.** *Let  $V$  be a right  $\mathcal{A}$ -comodule,  $W$  a right  $\mathcal{A}^\circ$ -module, and  $\langle \cdot, \cdot \rangle: V \times W \rightarrow \mathbb{C}$  a non-degenerate dual pairing of vector spaces. Suppose further that*

$$\langle v, w \cdot f \rangle = \langle v_{(0)} f(v_{(1)}), w \rangle,$$

for  $v \in V$ ,  $w \in W$ , and  $f \in \mathcal{A}^\circ$ .

If  $P \in \text{Mor}(V)$  then  $P^\top \in \text{Mor}(W)$ . If in addition  $P^2 = P$ , then the induced pairing  $\text{im } P \times \text{im } P^\top \rightarrow \mathbb{C}$  is also non-degenerate.

*Proof.* Since  $P \in \text{Mor}(V)$ ,  $Pv_{(0)} \otimes v_{(1)} = (Pv)_{(0)} \otimes (Pv)_{(1)}$ . For  $v \in V$ ,  $w \in W$ , and  $f \in \mathcal{A}^\circ$  we thus get

$$\begin{aligned} \langle v, P^\top w \cdot f \rangle &= \langle v_{(0)} f(v_{(1)}), P^\top w \rangle \\ &= \langle Pv_{(0)} f(v_{(1)}), w \rangle \\ &= \langle (Pv)_{(0)} f((Pv)_{(1)}), w \rangle \\ &= \langle Pv, w \cdot f \rangle \\ &= \langle v, P^\top(w \cdot f) \rangle. \end{aligned}$$

Since the pairing is non-degenerate the first assertion follows.

Since  $P$  and  $P^\top$  are morphisms, the corresponding subspaces are invariant. Let  $v_0 \in \text{im } P$ , i. e.  $v_0 = Pv_0$ , and suppose  $0 = \langle v_0, P^\top w \rangle$  for all  $w \in W$ . Then  $0 = \langle Pv_0, P^\top w \rangle = \langle P^2 v_0, w \rangle = \langle v_0, w \rangle$ . Since the pairing is non-degenerate,  $v_0 = 0$ . Similarly one shows that  $\text{im } P$  separates the elements of  $\text{im } P^\top$ .  $\square$



**Corollary 4.3.** *Let  $\mathcal{A}$  be an arbitrary Hopf algebra,  $\Gamma$  a bicovariant FODC over  $\mathcal{A}$  with quantum Lie algebra  $\mathcal{X}$ , and  $P \in \text{Mor}(\Delta_R)$ ,  $P^2 = P$ . We restrict  $\Delta_R$  to  $(\Gamma \otimes_{\mathcal{A}} \Gamma)_L$  or a suitable quotient.*

*Then  $\text{im } P$  is a  $\Delta_R$ -invariant subspace of  $(\Gamma \otimes_{\mathcal{A}} \Gamma)_L$  ( ${}_u\Gamma_L^{\wedge 2}$  resp.  ${}_s\Gamma_L^{\wedge 2}$ ), and  $\text{im } P^\top$  is an  $\text{ad}_R$ -invariant subspace of  $\mathcal{X} \otimes \mathcal{X}$  ( $\mu^{-1}(\mathcal{X})$  resp.  $\mathcal{X} \wedge \mathcal{X}$ ). The induced pairing  $\text{im } P \times \text{im } P^\top \rightarrow \mathbb{C}$  is non-degenerate.*

*Proof.* (i) Since  $\mathcal{S}(\mathcal{R})$  and  $(\ker A_2)_L$  are  $\Delta_R$ -invariant, and since  $\mu^{-1}(\mathcal{X})$  and  $A_2^\top(\mathcal{X} \otimes \mathcal{X})$  are  $\text{ad}_R$ -invariant, the mappings  $\Delta_R$  and  $\text{ad}_R$  are well-defined on both quotients  ${}_u\Gamma_L^{\wedge 2}$  and  ${}_s\Gamma_L^{\wedge 2}$  resp.  $\mu^{-1}(\mathcal{X} \otimes \mathcal{X})$  and  $\mathcal{X} \wedge \mathcal{X}$ .

It follows from [12, (5.17) and (5.21)] that for  $\rho \in (\Gamma \otimes_{\mathcal{A}} \Gamma)_L$ ,  $Y \in \mathcal{X} \otimes \mathcal{X}$ , and  $f \in \mathcal{A}^\circ$

$$\langle \rho_{(0)} f(\rho_{(1)}), Y \rangle = \langle \rho, Y \triangleleft f \rangle.$$

Thus Proposition 4.2 applies to our situation.  $\square$

Our next aim is to compare the bi-invariant components of  $\Gamma \otimes_{\mathcal{A}} \Gamma$ ,  ${}_s\Gamma^{\wedge 2}$ , and  ${}_u\Gamma^{\wedge 2}$  resp. of  $\mathcal{X} \otimes \mathcal{X}$ ,  $\mathcal{X} \wedge \mathcal{X}$ , and  $\mu^{-1}(\mathcal{X})$ . Let  $\mathcal{B}$  be a right  $\mathcal{A}^\circ$ -module with respect to  $\text{ad}_R$ . For the space of invariants we use the notation  $\mathcal{B}_0 = \{b \in \mathcal{B} | b \triangleleft f = \varepsilon(f)b, f \in \mathcal{A}^\circ\}$ .

**Lemma 4.4.** *Let  $\mathcal{A}$  be one of the Hopf algebras  $\mathcal{O}(\text{O}_q(N))$  or  $\mathcal{O}(\text{Sp}_q(N))$ ,  $N \geq 3$ ,  $\Gamma$  one of the  $N^2$ -dimensional bicovariant FODC  $\Gamma_\pm$  over  $\mathcal{A}$  and let  $\mathcal{X}$  be the corresponding quantum Lie algebra. Then we have*

- (i)  $\dim \Gamma_I^{\otimes 2} = 3$ ,  $\dim(\mathcal{X} \otimes \mathcal{X})_0 = 3$ ,
- (ii)  $\dim {}_s\Gamma_I^{\wedge 2} = 0$ ,  $\dim(\mathcal{X} \wedge \mathcal{X})_0 = 0$ ,  $\dim(\ker A_2)_I = 3$ ,
- (iii)  $\dim {}_u\Gamma_I^{\wedge 2} = 1$ ,  $\mu^{-1}(\mathcal{X})_0 = \langle T \rangle$ ,  $\dim(\mathcal{S}(\mathcal{R})_I) = 2$ ,

where

$$T = X_{ij} \otimes X_{mn} B_y^i \hat{R}_{mz}^{jy} C_z^n.$$

*Proof.* (i) It is well known that  $\dim \text{Mor}(u \otimes u) = 3$ , and  $I$ ,  $\hat{R}$ , and  $K$  form a linear basis of  $\text{Mor}(u \otimes u)$ . Using (5) it is easy to see that the mapping  $E \mapsto (B_z^s C_y^r E_{yz}^{ab})$  defines a linear isomorphism  $\text{Mor}(u \otimes u) \rightarrow \text{Mor}(1, u \otimes u^c \otimes u \otimes u^c)$ . Since  $\rho = \alpha^{ijmn} \theta_{ij} \otimes \theta_{mn} \in \Gamma \otimes_{\mathcal{A}} \Gamma$  is bi-invariant if and only if  $(\alpha^{ijmn}) \in \text{Mor}(1, u \otimes u^c \otimes u \otimes u^c)$ , (i) is proved.

(ii) The elements  $\theta \otimes \theta$ ,  $\eta = D_j^k \theta_{ik} \otimes \theta_{ji}$ , and  $\xi = C_z^i \hat{R}_{zn}^{ym} B_j^y \theta_{ij} \otimes \theta_{mn}$  form a basis of  $\Gamma_I^{\otimes 2}$ . Using the graphical calculus it is not difficult to check that  $\sigma$  acts as the identity on  $\Gamma_I^{\otimes 2}$ :

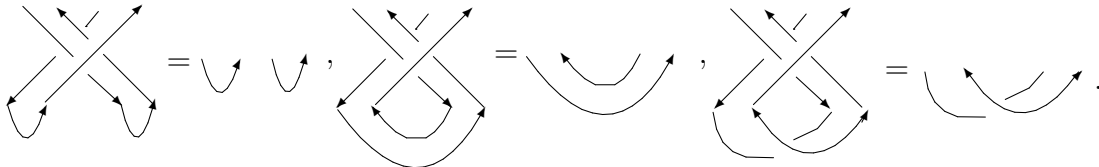

Figure 2:  $\sigma$  acts as the identity on  $\theta \otimes \theta$ ,  $\eta$ , and  $\xi$ .

Consequently,  $\Gamma_1^{\otimes 2} \subseteq \ker A_2$  and  ${}_s\Gamma_1^{\wedge 2} = \{0\}$ . By Corollary 4.3  $(\mathcal{X} \wedge \mathcal{X})_0 = 0$ .

(iii) By [3, (2.3)],  $\hat{R}_{vj}^{wm}(\ell^{-c})_y^m \ell_z^{+j} = \ell_j^{+w}(\ell^{-c})_m^v \hat{R}_{mz}^{jy}$ . Further by [3, Remark 21],  $\ell^\pm C^\top \ell^{\pm\top} = C^\top 1$ . Let

$$T_0 = \ell_j^i \ell_n^m B_y^i \hat{R}_{mz}^{jy} C_z^n = (\ell^{-c})_i^w \ell_j^{+w} (\ell^{-c})_m^v \ell_n^{+v} B_y^i \hat{R}_{mz}^{jy} C_z^n.$$

Using the above identities, (6) twice, and finally (8) one gets

$$\begin{aligned} T_0 &= S \ell_w^{-i} (\ell^{-c})_y^m \ell_z^{+j} \hat{R}_{vj}^{wm} \ell_n^{+v} B_y^i C_z^n \\ &= S \ell_w^{-i} S \ell_m^{-y} \hat{R}_{vj}^{wm} C_j^v B_y^i \\ &= r^{-1} S (\ell_m^{-y} \ell_w^{-i} C_m^w) B_y^i \\ &= r^{-1} C_y^i B_y^i 1 = r^{-1} x. \end{aligned}$$

Using  $X_{ij}^\pm = \varepsilon_\pm \ell_j^i - \delta_j^i$ , the above calculation, and again (6) and (8) it follows that

$$\begin{aligned} \mu(T) &= (\varepsilon_\pm \ell_j^i - \delta_j^i) (\varepsilon_\pm \ell_n^m - \delta_n^m) B_y^i \hat{R}_{mz}^{jy} C_z^n \\ &= r^{-1} x - \varepsilon_\pm B_y^i \hat{R}_{mz}^{iy} C_z^m \ell_n^m - \varepsilon_\pm B_y^i \hat{R}_{mz}^{jy} C_z^m \ell_j^i + B_y^i \hat{R}_{mz}^{iy} C_z^m \\ &= r^{-1} (x - \varepsilon_\pm B_z^m C_z^m \ell_n^m - \varepsilon_\pm B_y^i C_y^j \ell_j^i + x) \\ &= -2r^{-1} X_0^\pm. \end{aligned}$$

Consequently,  $T \in \mu^{-1}(\mathcal{X})$  and  $\dim \mu^{-1}(\mathcal{X})_0 \geq 1$ . By Corollary 4.3 applied to the projection  $P \in \text{Mor}(\Delta_{\mathbb{R}} \upharpoonright_{\mathbb{U}} \Gamma_{\mathbb{L}}^{\wedge 2})$  onto the space  ${}_u\Gamma_1^{\wedge 2}$ , the pairing

$${}_u\Gamma_1^{\wedge 2} \times \mu^{-1}(\mathcal{X})_0 \rightarrow \mathbb{C}$$

is non-degenerate. Since  ${}_u\Gamma_1^{\wedge 2} = \Gamma_1^{\otimes 2} / \mathcal{S}(\mathcal{R})_1$ ,  $\dim \Gamma_1^{\otimes 2} = 3$  by (i), and  $\dim \mathcal{S}(\mathcal{R})_1 \geq 2$  by the result of Section 5 we get  $\dim \mu^{-1}(\mathcal{X})_0 = \dim {}_u\Gamma_1^{\wedge 2} = 1$ . This completes the proof.  $\square$

*Bicovariant subbimodules.* We shall describe a method to construct a class of bicovariant subbimodules of  $\Gamma \otimes_{\mathcal{A}} \Gamma$ . This method is also applicable to higher tensor products  $\Gamma^{\otimes k}$ , cf. [4, p.1356]. In this subsection  $\mathcal{A}$  is one of the Hopf algebras  $\mathcal{O}(\text{O}_q(N))$  or  $\mathcal{O}(\text{Sp}_q(N))$  and  $\Gamma$  always denotes one of the  $N^2$ -dimensional bicovariant bimodules  $\Gamma_{\pm}$  over  $\mathcal{A}$  with left-invariant basis  $\{\theta_{ij} | i, j = 1, \dots, N\}$ . The canonical basis of  $\mathbb{C}^N$  is  $\{e_1, \dots, e_N\}$ .

**Lemma 4.5.** (i) *Let  $\hat{P}$  and  $\check{Q}$  be idempotents in  $\text{Mor}(u \otimes u)$  resp.  $\text{Mor}(u^c \otimes u^c)$ . We identify the underlying spaces of the right coaction on  $\Gamma_{\mathbb{L}} \otimes \Gamma_{\mathbb{L}}$  and the equivalent matrix corepresentation  $u \otimes u^c \otimes u \otimes u^c$  via  $\theta_{ij} \otimes \theta_{kl} \rightarrow e_i \otimes e_j \otimes e_k \otimes e_l$ . Then the subspace*

$$\hat{R}_{23}^- \hat{P}_{12} \check{Q}_{34} \hat{R}_{23} (\Gamma_{\mathbb{L}} \otimes \Gamma_{\mathbb{L}}) \quad (14)$$

*of  $\Gamma_{\mathbb{L}} \otimes \Gamma_{\mathbb{L}}$  is the left-invariant basis of a bicovariant subbimodule of  $\Gamma \otimes_{\mathcal{A}} \Gamma$  of dimension  $\text{rk}(\hat{P}) \text{rk}(\check{Q})$ .*

(ii)  $\Gamma \otimes_A \Gamma$  is the direct sum of 9 bicovariant subbimodules  $\Lambda^{\tau\nu}$ ,  $\tau, \nu \in \{+, -, 0\}$ , generated by the left-invariant elements

$$\hat{R}_{23}^- \hat{P}^\tau \check{P}^\nu \hat{R}_{23} (\Gamma_L \otimes \Gamma_L).$$

Moreover we have the following identity of bicovariant bimodules

$$\ker A_2 = \Lambda^{++} \oplus \Lambda^{--} \oplus \Lambda^{00}.$$

*Proof.* (i) Since all four mappings appearing in (14) are morphisms of corepresentations one easily checks that  $T := \hat{R}_{23}^- \hat{P}_{12} \check{Q}_{34} \hat{R}_{23} \in \text{Mor}(u \otimes u^c \otimes u \otimes u^c)$ . Hence the space is closed under the right coaction.

Now we compute the right adjoint action. Set  $\theta_{mnkl}^{PQ} = T(\theta_{mn} \otimes \theta_{kl})$ . By (10)

$$\begin{aligned} \theta_{mnkl}^{PQ} \triangleleft u_j^i &= T_{mnkl}^{vwcd} \hat{R}_{vy}^{ia} \hat{R}_{eb}^{wy} \hat{R}_{cz}^{es} \hat{R}_{jt}^{dz} \theta_{ab} \otimes \theta_{st} \\ &= (\hat{R}_{12} \hat{R}_{23} \hat{R}_{34} \hat{R}_{45} T_{1234})_{mnklj}^{iabst} \theta_{ab} \otimes \theta_{st} \\ &= (T_{1234} \hat{R}_{12} \hat{R}_{23} \hat{R}_{34} \hat{R}_{45})_{mnklj}^{iabst} \theta_{ab} \otimes \theta_{st} \\ &= \theta_{vwst}^{PQ} (\hat{R}_{12} \hat{R}_{23} \hat{R}_{34} \hat{R}_{45})_{mnklj}^{ivwst}. \end{aligned}$$

The last but one equation becomes evident by taking a look at the graphical presentation of these equations.

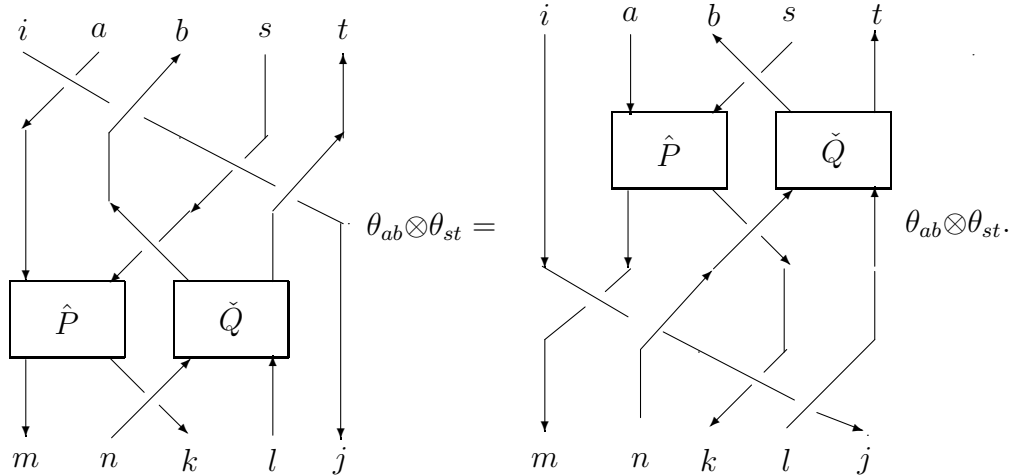

Figure 3:  $\langle \theta^{PQ} \rangle$  is closed under the right adjoint action.

Consequently  $T(\Gamma_L \otimes \Gamma_L)$  is closed under the right adjoint action. Hence  $\mathcal{AT}(\Gamma_L \otimes \Gamma_L)$  is a bicovariant subbimodule.

(ii) The first part follows from (i) and the fact that  $(\hat{P}^+ + \hat{P}^- + \hat{P}^0)_{12} (\check{P}^+ + \check{P}^- + \check{P}^0)_{34}$  is the identity of  $(\mathbb{C}^N)^{\otimes 4}$ . In addition  $\hat{P}^\tau$  and  $\hat{P}^\nu$  as well as  $\check{P}^\tau$  and  $\check{P}^\nu$  are pairwise orthogonal idempotents, respectively. Hence the sum is direct. Let us turn to the second part. Let  $\lambda_\tau$  denote the eigenvalue of  $\hat{R}$  with respect to the idempotent  $\hat{P}^\tau$ ,

$\hat{R}\hat{P}^\tau = \lambda_\tau \hat{P}^\tau$ , namely  $\lambda_+ = q$ ,  $\lambda_- = -q^{-1}$ , and  $\lambda_0 = r^{-1}$ . Note that  $\check{R}\check{P}^\tau = \lambda_\tau \check{P}^\tau$  as well. Put  $\rho = \check{R}_{23}^- \hat{P}^\tau_{12} \check{P}^\nu_{34} \hat{R}_{23}(\theta_{ijkl})$ . Then by (12)

$$\begin{aligned} \sigma(\rho) &= \check{R}_{23}^- \hat{R}_{12} \check{R}_{34}^{-1} \hat{R}_{23} \cdot \check{R}_{23}^- \hat{P}^\tau_{12} \check{P}^\nu_{34} \hat{R}_{23}(\theta_{ijkl}) \\ &= \lambda_\tau \lambda_\nu^{-1} \check{R}_{23}^- \hat{P}^\tau_{12} \check{P}^\nu_{34} \hat{R}_{23}(\theta_{ijkl}) \\ &= \lambda_\tau \lambda_\nu^{-1} \rho. \end{aligned}$$

Since  $q$  is not a root of unity,  $\lambda_\tau \neq \lambda_\nu$  for  $\tau \neq \nu$ . Hence  $\rho \in (\ker A_2)_L$  if and only if  $\tau = \nu$ . We thus get  $(\ker A_2)_L = \Lambda_L^{++} \oplus \Lambda_L^{-} \oplus \Lambda_L^{00}$  as linear spaces. By (i) each space on the right hand side generates a bicovariant subbimodule. This completes the proof.  $\square$

To simplify notations we choose a new basis of  $(\Gamma \otimes_A \Gamma)_L$

$$\bar{\theta}_{vwst} = \check{R}_{ws}^{-yz} \theta_{vy} \otimes \theta_{zt}, \quad \theta_{vwst} = \hat{R}_{ws}^{yz} \bar{\theta}_{vyzt}. \quad (15)$$

The right coaction now reads  $u \otimes u \otimes u^c \otimes u^c$  and the braiding in the new basis is  $\bar{\sigma} = \hat{R}_{12} \check{R}_{34}^{-1}$ . We simply write  $\Lambda^\tau$  instead of  $\Lambda^{\tau\tau}$ ,  $\tau \in \{+, -, 0\}$ . Since the corresponding  $\hat{P}^\tau$  subcorepresentation of  $u \otimes u$  is irreducible, by Schur's lemma  $\Lambda^\tau$  has a *unique* up to scalars bi-invariant element  $\eta^\tau$ .

$$\eta^\tau = (\hat{P}^\tau)_{lk}^{mn} \bar{\theta}_{mnkl} = \begin{array}{c} \begin{array}{cc} m & n \\ \downarrow & \downarrow \\ \boxed{\hat{P}^\tau} & \boxed{\check{P}^\tau} \end{array} \\ \begin{array}{c} \uparrow & \uparrow \\ k & l \end{array} \\ \bar{\theta}_{mnkl} \end{array} = \begin{array}{c} \begin{array}{cc} m & n \\ \downarrow & \downarrow \\ \boxed{\hat{P}^\tau} & \end{array} \\ \begin{array}{c} \uparrow & \uparrow \\ k & l \end{array} \\ \bar{\theta}_{mnkl}. \end{array}$$

Figure 4: The bi-invariant elements  $\eta^+$ ,  $\eta^-$ , and  $\eta^0$ .

The relations with the old basis of  $\Gamma_1^{\otimes 2}$  are  $\eta = r(\eta^0 + \eta^+ + \eta^-)$ ,  $\xi = x\eta^0$ , and

$$\theta \otimes \theta = q\eta^+ - q^{-1}\eta^- + r^{-1}\eta^0. \quad (16)$$

The next lemma is the key step in our proof.

**Lemma 4.6.** *Let  $\Gamma$  be one of the bicovariant FODC  $\Gamma_\pm$  over  $\mathcal{A}$  and  $\Lambda^\tau$ ,  $\tau \in \{+, -, 0\}$  the above defined bicovariant subbimodule of  $\ker A_2$ . Then  $\Lambda^\tau$  is generated by the single element  $\eta^\tau$ . More precisely,*

$$\eta^\tau \triangleleft \mathcal{A} = \Lambda_L^\tau.$$

*Proof.* By Lemma 4.5 the canonical left-invariant basis of  $\Lambda^\tau$  is

$$\theta_{mnkl}^\tau = \check{R}_{23}^- (\hat{P}^\tau)_{12} (\check{P}^\tau)_{34} \hat{R}_{23} (\theta_{mn} \otimes \theta_{kl}) = \check{R}_{yz}^{-ws} (\hat{P}^\tau)_{ma}^{vy} (\check{P}^\tau)_{bl}^{zt} \hat{R}_{nk}^{ab} \theta_{vw} \otimes \theta_{st}.$$

The proof is in two steps. First we compute  $\eta^\tau \triangleleft u_j^i$  and obtain elements

$$\begin{aligned}\eta_{ij}^\tau &= B_z^i (\hat{P}\tau)_{zk}^{mn} (\check{P}\tau)_{ky}^{vw} C_y^j \bar{\theta}_{mnvw}, \\ \xi_{ij}^\tau &= (\hat{P}\tau)_{yk}^{mn} (\check{P}\tau)_{kz}^{vw} \hat{R}_{ij}^{yz} \bar{\theta}_{mnvw}.\end{aligned}$$

The graphical presentation of  $\eta_{ij}^\tau$  and  $\xi_{ij}^\tau$  is as follows.

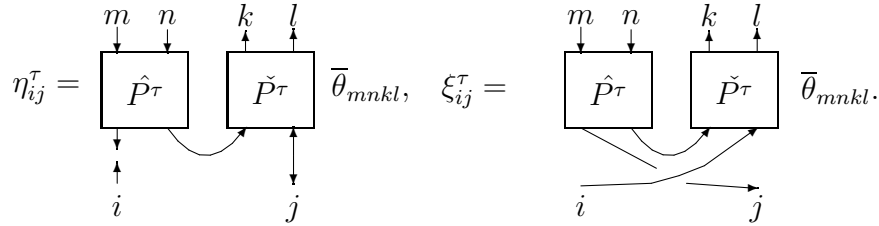

Figure 5: The elements  $\eta_{ij}^\tau$  and  $\xi_{ij}^\tau$ .

First we will show that

$$\eta^\tau \triangleleft \tilde{u}_j^i = \hat{q}(\lambda_\tau^2 + 1)\xi_{ij}^\tau - r^{-1}\hat{q}(1 + \lambda_\tau^{-2})\eta_{ij}^\tau, \quad (17)$$

$$\eta^\tau \triangleleft \tilde{U} = \alpha_\tau \eta^\tau, \quad \alpha_\tau = \hat{q}(\lambda_\tau + \lambda_\tau^{-1})(\lambda_\tau r - \lambda_\tau^{-1}r^{-1}). \quad (18)$$

By (15) and (10) one has

$$\begin{aligned}\bar{\theta}_{mnlk} \triangleleft u_j^i &= \hat{R}_{nk}^{-ab}(\theta_{ma} \triangleleft u_c^i)(\theta_{bl} \triangleleft u_j^c) \\ &= \hat{R}_{nk}^{-ab} \hat{R}_{my}^{iv} \hat{R}_{cd}^{ay} \hat{R}_{bz}^{cp} \hat{R}_{jt}^{lz} \theta_{vd} \otimes \theta_{pt} \\ &= (\hat{R}_{34} \hat{R}_{12} \hat{R}_{23} \hat{R}_{34} \hat{R}_{45} \hat{R}_{23}^-)_{mnlkj}^{ivwst} \bar{\theta}_{vwst}.\end{aligned} \quad (19)$$

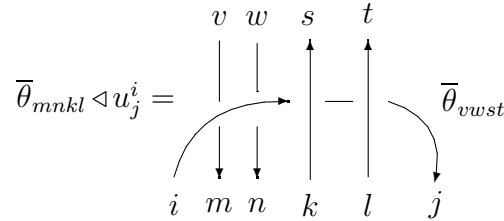

Figure 6: The right adjoint action of  $u_j^i$  on  $\bar{\theta}_{mnlk}$ .

In particular for  $\eta^\tau$  we compute

$$\begin{aligned}
\eta^\tau \triangleleft u_j^i &= (\hat{P}^\tau)_{lk}^{mn} \bar{\theta}_{mnkl} \triangleleft u_j^i = \begin{array}{c} \begin{array}{|c|} \hline \hat{P}^\tau \\ \hline \end{array} \quad \begin{array}{|c|} \hline \check{P}^\tau \\ \hline \end{array} \\ \downarrow \quad \downarrow \quad \uparrow \quad \uparrow \\ i \quad \quad \quad j \end{array} = \\
= \begin{array}{c} \begin{array}{|c|} \hline \hat{P}^\tau \\ \hline \end{array} \quad \begin{array}{|c|} \hline \check{P}^\tau \\ \hline \end{array} \\ \downarrow \quad \downarrow \quad \uparrow \quad \uparrow \\ i \quad \quad \quad j \end{array} + \hat{q} \begin{array}{c} \begin{array}{|c|} \hline \hat{P}^\tau \\ \hline \end{array} \quad \begin{array}{|c|} \hline \check{P}^\tau \\ \hline \end{array} \\ \downarrow \quad \downarrow \quad \uparrow \quad \uparrow \\ i \quad \quad \quad j \end{array} - \hat{q} \begin{array}{c} \begin{array}{|c|} \hline \hat{P}^\tau \\ \hline \end{array} \quad \begin{array}{|c|} \hline \check{P}^\tau \\ \hline \end{array} \\ \downarrow \quad \downarrow \quad \uparrow \quad \uparrow \\ i \quad \quad \quad j \end{array} = \\
= \begin{array}{c} \begin{array}{|c|} \hline \hat{P}^\tau \\ \hline \end{array} \quad \begin{array}{|c|} \hline \check{P}^\tau \\ \hline \end{array} \\ \downarrow \quad \downarrow \quad \uparrow \quad \uparrow \\ i \quad \quad \quad j \end{array} + \hat{q} \begin{array}{c} \begin{array}{|c|} \hline \hat{P}^\tau \\ \hline \end{array} \quad \begin{array}{|c|} \hline \check{P}^\tau \\ \hline \end{array} \\ \downarrow \quad \downarrow \quad \uparrow \quad \uparrow \\ i \quad \quad \quad j \end{array} - \hat{q} r^{-1} \begin{array}{c} \begin{array}{|c|} \hline \hat{P}^\tau \\ \hline \end{array} \quad \begin{array}{|c|} \hline \check{P}^\tau \\ \hline \end{array} \\ \downarrow \quad \downarrow \quad \uparrow \quad \uparrow \\ i \quad \quad \quad j \end{array} + \\
+ \lambda_\tau^2 \hat{q} \begin{array}{c} \begin{array}{|c|} \hline \hat{P}^\tau \\ \hline \end{array} \quad \begin{array}{|c|} \hline \check{P}^\tau \\ \hline \end{array} \\ \downarrow \quad \downarrow \quad \uparrow \quad \uparrow \\ i \quad \quad \quad j \end{array} - \hat{q} r^{-1} \lambda_\tau^{-2} \begin{array}{c} \begin{array}{|c|} \hline \hat{P}^\tau \\ \hline \end{array} \quad \begin{array}{|c|} \hline \check{P}^\tau \\ \hline \end{array} \\ \downarrow \quad \downarrow \quad \uparrow \quad \uparrow \\ i \quad \quad \quad j \end{array} .
\end{aligned}$$

Figure 7: The proof of (17).

In the first step we replaced the crossing in the dash box using (7). In the second step we did the same with the  $\hat{R}$ -matrix in the first dash box. This gives the first three terms in the next line. Moreover the dash box in the second summand is multiplied by  $\check{P}^\tau$  and gives  $\lambda_\tau I$  (no crossing). Similarly, a second crossing in the same term gives another  $\lambda_\tau$ . With the third summand we proceed in the same way; in addition the curl gives the factor  $r^{-1}$ . Since  $\tilde{u}_j^i = u_j^i - \delta_{ij}1$ , (17) follows immediately. Note that for  $\tau = 0$ ,

$$\eta^0 \triangleleft u_j^i = \delta_{ij} \eta^0 \quad (20)$$

is obvious from the first line in Figure 7 since  $\hat{P}^0 = x^{-1}K$  and no crossing appears there. Moreover  $\eta_{ij}^0 = \delta_{ij} \eta^0$  and  $\xi_{ij}^0 = r \delta_{ij} \eta^0$  and (17) and (18) are valid. Since  $\Lambda^0$  is one-dimensional there is nothing to prove. Now we fix  $\tau \in \{+, -\}$ . We shall eliminate  $\eta_{ij}^\tau$  from (17). Multiplying (17) by  $D_i^j$  and using  $D_i^j \eta_{ij}^\tau = \eta^\tau$ ,  $D_i^j \xi_{ij}^\tau = r \eta^\tau$  gives (18). Since  $q$  is not a root of unity,  $T_\tau = \hat{q}(\lambda_\tau^2 + 1)\hat{R}^{-1} - r^{-1}\hat{q}(1 + \lambda_\tau^{-2})$  is invertible with

inverse

$$T_+^{-1} = \frac{1}{\hat{q}[2]_q} \left( \frac{1}{1 - q^{-1}r^{-1}} \hat{P}^+ + \frac{1}{-q^2 - q^{-1}r^{-1}} \hat{P}^- + \frac{1}{rq - r^{-1}q^{-1}} \hat{P}^0 \right),$$

$$T_-^{-1} = \frac{1}{\hat{q}[2]_q} \left( \frac{1}{q^{-2} - qr^{-1}} \hat{P}^+ + \frac{1}{-1 - qr^{-1}} \hat{P}^- + \frac{1}{q^{-1}r - qr^{-1}} \hat{P}^0 \right).$$

Set  $(S_\tau)^{ij}_{st} = B_i^y (T_\tau^{-1})_{zt}^{yj} C_z^s$  and multiply (17) by  $(S_\tau)^{ij}_{st}$ . Then we obtain  $(S_\tau)^{ij}_{st} \eta^\tau \triangleleft \tilde{u}_j^i = \eta_{st}^\tau$ . Consequently,  $\eta_{st}^\tau \in \Lambda^\tau$  for  $s, t = 1, \dots, N$  and  $\tau \in \{+, -\}$ .

In the second step we again compute the right adjoint action of  $u_j^i$  but on elements  $\eta_{st}^\tau$ . We obtain elements

$$\xi_{sijt}^\tau = (\hat{P}^\tau)_{sy}^{mn} (\check{P}^\tau)_{zt}^{vw} \hat{R}_{ij}^{yz} \bar{\theta}_{mnvw},$$

$$\eta_{sijt}^\tau = B_y^s B_z^i (\hat{P}^\tau)_{yz}^{mn} (\check{P}^\tau)_{dc}^{vw} C_d^j C_c^t \bar{\theta}_{mnvw}.$$

Obviously  $\xi_{sijt}^\tau = \eta_{syzt}^\tau \hat{R}_{ij}^{yz}$ . Graphically they are represented by

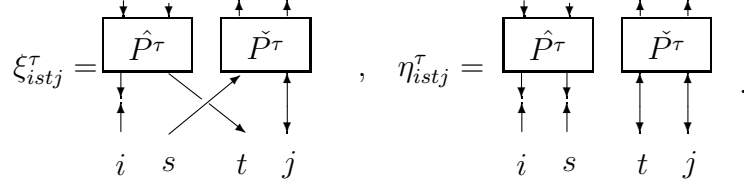

Figure 8: The elements  $\xi_{sijt}^\tau$  and  $\eta_{sijt}^\tau$ .

By (19) one has

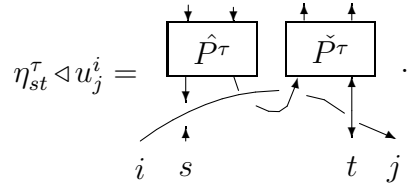

Figure 9: The right adjoint action of  $u_j^i$  on  $\eta_{st}^\tau$ .

Replacing one crossing  $\hat{R}$  by  $\hat{R}^{-1} + \hat{q}I - \hat{q}K$  similarly to the graphical calculations in the first part of the proof one can show that

$$\zeta_{sijt}^\tau := \eta_{uv}^\tau \triangleleft u_b^a \hat{R}_{si}^{au} \hat{R}_{jt}^{vb} - \delta_{ij} \eta_{st}^\tau = \hat{q} \xi_{sijt}^\tau - \hat{q} r^{-1} \eta_{sijt}^\tau.$$

Since  $q$  is not a root of unity,  $T = \hat{q}(\hat{R}^{-1} - r^{-1}I)$  is invertible with inverse  $T^{-1} = \hat{q}^{-1}((q^{-1} - r^{-1})^{-1} \hat{P}^+ - (q + r^{-1})^{-1} \hat{P}^-)$ . Therefore

$$B_i^y (T^{-1})_{zl}^{yj} C_z^k \zeta_{sijt}^\tau = \eta_{sklt}^\tau$$

belongs to  $\Lambda_L^\tau$ . Finally we have  $B_v^m B_y^a C_z^b C_t^l \eta_{vyzt}^\tau \dot{R}_{nk}^{ab} = \theta_{mnkl}^\tau$  which completes the proof.  $\square$

Now we are ready to complete the proof of the theorem. By Lemma 4.4 (iii) both  $\eta^+$  and  $\eta^-$  belong to  $\mathcal{S}(\mathcal{R})$  (see Section 5) and  $\dim_{\mathfrak{u}} \Gamma_1^{\wedge 2} \geq 1$ . Hence  $\eta^0 \notin \mathcal{S}(\mathcal{R})_1$ . Since  $\theta \otimes \theta \equiv r^{-1} \eta^0 \pmod{\mathcal{S}(\mathcal{R})}$  by (16) and  $a \eta^0 = \eta^0 a$ ,  $a \in \mathcal{A}$ , by (20) we get

$$a \theta \wedge \theta = \theta \wedge \theta a, \quad a \in \mathcal{A}. \quad (21)$$

We prove (13) by induction over the degree  $n$  of  $\rho \in {}_{\mathfrak{u}}\Gamma^{\wedge n}$ . For  $n = 0$  it is true by the definition of the FODC. Suppose it is true for  $n - 1$ . Since there exist  $\alpha_i \in {}_{\mathfrak{u}}\Gamma^{\wedge n-1}$  and  $b_i \in \mathcal{A}$  such that  $\rho = \alpha_i db_i$ , we obtain by induction assumption and by (21)

$$\begin{aligned} d\rho &= d\alpha_i db_i = \theta \alpha_i db_i - (-1)^{n-1} \alpha_i \theta (\theta b_i - b_i \theta) \\ &= \theta \rho - (-1)^n (\alpha_i \theta b_i \theta - \alpha_i b_i \theta^2) \\ &= \theta \rho - (-1)^n \alpha_i db_i \theta \\ &= \theta \rho - (-1)^n \rho \theta. \end{aligned}$$

Using  $d^2 \rho = 0$  and (13) twice gives  $\theta^2 \rho = \rho \theta^2$ , and  $\theta^2$  is central in  ${}_{\mathfrak{u}}\Gamma^{\wedge 2}$ . This completes the proof of (ii).

By Lemma 4.4 (iii) and Lemma 4.6

$$\mathcal{S}(\mathcal{R}) \supseteq \mathcal{S}(\mathcal{R})_0 \triangleleft \mathcal{A} = \Lambda_L^+ \oplus \Lambda_L^-.$$

Since  $\mathcal{S}(\mathcal{R}) \subseteq \ker A_2$  by universality of  ${}_{\mathfrak{u}}\Gamma^{\wedge}$  and  $\eta^0 \in \ker A_2$ , we conclude with Lemma 4.5 (ii) that the above inclusion is not strict,  $\mathcal{S}(\mathcal{R}) = \Lambda_L^+ \oplus \Lambda_L^-$  and

$$(\ker A_2)_L = \mathcal{S}(\mathcal{R}) \oplus \Lambda_L^0.$$

Since both  ${}_{\mathfrak{u}}\Gamma_L^{\wedge}$  and  ${}_s\Gamma_L^{\wedge}$  are quadratic algebras,  ${}_{\mathfrak{u}}\Gamma_L^{\wedge}/(\eta^0) \cong \Gamma_L^{\otimes}/(\mathcal{S}(\mathcal{R}) \oplus \langle \eta^0 \rangle) \cong \Gamma_L^{\otimes}/(\ker A_2)_L \cong {}_s\Gamma_L^{\wedge}$ . Since both  ${}_{\mathfrak{u}}\Gamma^{\wedge}/(\eta^0)$  and  ${}_s\Gamma^{\wedge}$  are *free* left  $\mathcal{A}$ -modules it follows  ${}_{\mathfrak{u}}\Gamma^{\wedge}/(\eta^0) \cong {}_s\Gamma^{\wedge}$ . Noting that  $\theta^2 = r^{-1} \eta^0$  in  ${}_{\mathfrak{u}}\Gamma^{\wedge}$  completes the proof of the theorem.

## 5. THE BI-INVARIANT 2-FORM OF THE UNIVERSAL DIFFERENTIAL CALCULUS

In this section we will complete the proof of Lemma 4.4 (iii) and show that both bi-invariant elements  $\eta^+$  and  $\eta^-$  belong to  $\mathcal{S}(\mathcal{R})$ . We give different proofs for the cases  $\Gamma_+$  and  $\Gamma_-$ . The first proof for  $\Gamma_+$  is self-contained and much easier than the second one. In the later one we take results from [8] and make use of a computer algebra program to simplify long terms. For  $q$  *transcendental* however the first proof works for  $\Gamma_-$  as well.

We recall some identities which are easily proved using (3) and the Leibniz rule. Equations (23), [6, formula (14.3)], and (25), [6, Lemma 14.15], are valid for arbitrary *left-covariant* FODC while (22) and (24) in addition require  $da = \theta a - a \theta$ . For  $a, b \in \mathcal{A}$



and  $p \in \mathcal{R}$  we have

$$\omega(a) = \theta \triangleleft a + \varepsilon(a)\theta, \quad \theta \triangleleft p = 0, \quad (22)$$

$$\omega(ab) = \omega(a) \triangleleft b + \varepsilon(a)\omega(b), \quad (23)$$

$$\mathcal{S}(a) = (\theta \otimes \theta) \triangleleft a - \theta \otimes (\theta \triangleleft a) - (\theta \triangleleft a) \otimes \theta + \varepsilon(a)\theta \otimes \theta, \quad (24)$$

$$\mathcal{S}(p) = (\theta \otimes \theta) \triangleleft p,$$

$$\mathcal{S}(\tilde{a}b) = \mathcal{S}(a) \triangleleft b + \omega(a) \triangleleft b_{(1)} \otimes \omega(b_{(2)}) + \omega(b_{(1)}) \otimes (\omega(a) \triangleleft b_{(2)}), \quad (25)$$

$$\mathcal{S}(pb) = \mathcal{S}(p) \triangleleft b.$$

We abbreviate  $\hat{r} = r - r^{-1}$ . In what follows we do *not* sum over signs  $\tau$  and  $\nu$ .

*Part 1.*  $\Gamma = \Gamma_+$ . First we show  $Q := \tilde{U} \cdot \tilde{U} - \hat{q}\hat{r}\tilde{U} \in \mathcal{R}$ . By (10) and (9) we obtain  $\theta \triangleleft U = \text{tr}_q^1(\hat{R}^2)_n^m \theta_{mn} = (\hat{q}\hat{r} + x)\theta$ . Using (22), (23), and  $\varepsilon(U) = x$  we have  $\omega(Q) = (\theta \triangleleft \tilde{U}) \triangleleft \tilde{U} - \hat{q}\hat{r}\theta \triangleleft \tilde{U} = 0$ . In addition  $\varepsilon(Q) = 0$ ; hence  $Q \in \mathcal{R}$ . Next we compute  $\mathcal{S}(Q)$ . Since  $Q \in \mathcal{R}$ , by (24) we have  $\mathcal{S}(Q) = (\theta \otimes \theta) \triangleleft Q$ . Using (16) and (18) we get

$$\begin{aligned} \mathcal{S}(Q) &= (\theta \otimes \theta) \triangleleft Q = (q\eta^+ - q^{-1}\eta^-) \triangleleft (\tilde{U}\tilde{U} - \hat{q}\hat{r}\tilde{U}) \\ &= q\alpha_+^2\eta^+ - q^{-1}\alpha_-^2\eta^- - \hat{q}\hat{r}(q\alpha_+\eta^+ - q^{-1}\alpha_-\eta^-) \\ &= q\alpha_+(\alpha_+ - \hat{q}\hat{r})\eta^+ - q^{-1}\alpha_-(\alpha_- - \hat{q}\hat{r})\eta^-. \end{aligned} \quad (26)$$

Since  $\mathcal{R}$  is a right ideal  $Q\tilde{U} \in \mathcal{R}$ . By (25) and (26)

$$\mathcal{S}(Q\tilde{U}) = q\alpha_+^2(\alpha_+ - \hat{q}\hat{r})\eta^+ - q^{-1}\alpha_-^2(\alpha_- - \hat{q}\hat{r})\eta^-. \quad (27)$$

Solving this linear system (26) and (27) in  $\eta^+$  and  $\eta^-$  we have to consider its coefficient determinant

$$\begin{aligned} \det &= \alpha_+\alpha_-(\alpha_+ - \alpha_-)(\alpha_+ - \hat{q}\hat{r})(\alpha_- - \hat{q}\hat{r}) \\ &= (r + r^{-1})\hat{q}^6 [2]_q^3 (qr - q^{-1}r^{-1})(q^{-1}r - qr^{-1})(q^2r - q^{-2}r^{-1})(q^{-2}r - q^2r^{-1}). \end{aligned}$$

Since  $q$  is not a root of unity,  $\det \neq 0$ . Hence both  $\eta^+$  and  $\eta^-$  belong to  $\mathcal{S}(\mathcal{R})$ .

*Part 2.*  $\Gamma = \Gamma_-$ . We denote the critical value by  $c$ ,  $c = \hat{q}q^2r(2x + \hat{q}\hat{r}) = (q^4 + 1)r^2 + 2q(q^2 - 1)r - (q^4 + 1)$ . We recall some of the defining constants for  $\Gamma_-$  from [8, p. 656]

$$\begin{aligned} \mu^+ &= \frac{\hat{r}(-q^2r + q^{-2}r^{-1} - \hat{q})}{\hat{q}\hat{r} + 2x}, \\ \mu^- &= \frac{\hat{r}(-q^{-2}r + q^2r^{-1} - \hat{q})}{\hat{q}\hat{r} + 2x}. \end{aligned}$$

The idempotents  $\hat{P}^\nu$ ,  $\nu \in \{+, -\}$ , and their  $q$ -traces are as follows

$$\hat{P}^\nu = (\lambda_\nu + \lambda_\nu^{-1})^{-1}(\lambda_\nu^{-1}I + \hat{R} + \hat{q}(1 - r\lambda_\nu)^{-1}K), \quad (28)$$

$$\text{tr}_q^1(\hat{P}^\nu) = \frac{\hat{r}(\lambda_\nu^2r - \lambda_\nu^{-1})}{\hat{q}(\lambda_\nu + \lambda_\nu^{-1})(\lambda_\nu r - 1)}I =: t_\nu I. \quad (29)$$

There are two  $\text{Ad}_R$ -invariant quadratic elements in  $\mathcal{A}$ , namely  $V_\nu = D_a^b D_i^j (\hat{P}^\nu)_{yz}^{ai} u_b^y u_j^z$ . One has  $\varepsilon(V_\nu) = xt_\nu$ . Note that  $\widetilde{W}_\nu \in \mathcal{R}$ , where  $W_\nu = V_\nu - \mu^\nu U$ , [8, p. 656, eq. (3)]. Suppose  $a \in \mathcal{A}$  is  $\text{Ad}_R$ -invariant and  $\rho \in \Lambda_1$ , where  $\Lambda$  is a bicovariant bimodule. Then one has  $\rho \triangleleft a \in \Lambda_1$ . Namely,  $\Delta_R(\rho \triangleleft a) = (Sa_{(2)} \otimes Sa_{(1)})(\rho \otimes 1)(a_{(3)} \otimes a_{(4)}) = \rho \triangleleft a_{(2)} \otimes Sa_{(1)} a_{(3)} = \rho \triangleleft a \otimes 1$ . Applying this fact to  $\Lambda^\tau$  and  $V_\nu$ , and noting that  $\eta^\tau$ ,  $\tau \in \{+, -\}$ , is the only bi-invariant element of  $\Lambda^\tau$  (up to scalars), there exist complex numbers  $c_{\tau\nu}$ ,  $\tau, \nu \in \{+, -\}$ , defined by

$$\eta^\tau \triangleleft \widetilde{V}_\nu = c_{\tau\nu} \eta^\tau.$$

We shall determine these constants. By the definition of  $V_\nu$  and (17)

$$\begin{aligned} \eta^\tau \triangleleft V_\nu &= \eta^\tau \triangleleft u_j^i u_t^s (\hat{P}^\nu)_{ab}^{jt} D_i^a D_s^b \\ &= (\delta_{ij} \eta^\tau + \hat{q}(\lambda_\tau^2 + 1) \xi_{ij}^\tau - r^{-1} \hat{q}(1 + \lambda_\tau^{-2}) \eta_{ij}^\tau) \triangleleft u_t^s (\hat{P}^\nu)_{ab}^{jt} D_i^a D_s^b. \end{aligned}$$

We carry out the calculations for the first term. By (17) and (29) we have

$$\delta_{ij} \eta^\tau \triangleleft (u_t^s (\hat{P}^\nu)_{ab}^{jt} D_i^a D_s^b) = t_\nu \eta^\tau \triangleleft U = t_\nu (x + \alpha_\tau) \eta^\tau.$$

Using graphical calculations we obtain for the other two terms

$$\begin{aligned} \xi_{ij}^\tau \triangleleft (u_t^s (\hat{P}^\nu)_{ab}^{jt} D_i^a D_s^b) &= (\hat{q} \delta_{\tau,\nu} r^2 \lambda_\tau^2 + r \lambda_\nu^2 t_\nu - \hat{q} \lambda_\nu \lambda_\tau^{-1} e_{\tau\nu}) \eta^\tau, \\ \eta_{ij}^\tau \triangleleft (u_t^s (\hat{P}^\nu)_{ab}^{jt} D_i^a D_s^b) &= (\hat{q} r \lambda_\nu^{-1} \lambda_\tau e_{\tau\nu} + \lambda_\nu^{-2} t_\nu - \hat{q} r^{-1} \lambda_\tau^{-2} \delta_{\tau,\nu}) \eta^\tau, \end{aligned}$$

where  $e_{\tau\nu} = (\lambda_\nu + \lambda_\nu^{-1})^{-1} (\lambda_\tau^{-1} + \hat{q}(1 - r \lambda_\nu)^{-1})$  is obtained from (28) and the picture

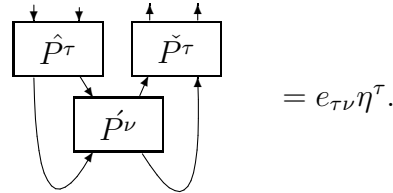

Figure 10: The definition of  $e_{\tau\nu}$ .

Finally we obtain

$$\begin{aligned} c_{++} &= c^{-1}(q^2 + 1)(q^2 r^2 - 1)r^{-2}q^{-6}((q^{12} + q^4)r^4 + (2q^{11} - 2q^9 + 2q^5 - 2)r^3 + \\ &\quad + (-q^{12} + q^8 - 4q^6 + q^4 - 1)r^2 + (-2q^9 + 2q^7 - 2q^3 + 2q)r + q^8 + 1) \\ c_{+-} &= c^{-1}[2]_q(2(q - q^{-1}r^{-2})(r + q^3)(r - q)((q^2 - 1 + q^{-2})r^2 + \hat{q}r - q^2 + 1 - q^{-2}) \\ c_{-+} &= c^{-1}[2]_q(2(q^{-1} - qr^{-2})(qr + 1)(q^3r - 1)((q^2 - 1 + q^{-2})r^2 + \hat{q}r - q^2 + 1 - q^{-2}) \\ c_{--} &= c^{-1}(q^2 + 1)(r^2 - q^2)r^{-2}q^{-6}((q^8 + 1)r^4 + (2q^9 - 2q^7 + 2q^3 - 2q)r^3 + \\ &\quad + (-q^{12} + q^8 - 4q^6 + q^4 - 1)r^2 + (-2q^{11} + 2q^9 - 2q^5 + 2q^3)r + q^{12} + q^4) \end{aligned}$$

Now we are able to compute four bi-invariant elements of  $\mathcal{S}(\mathcal{R})$ . Using (16) and (18) we have

$$\mathcal{S}(W_\nu) = (\theta \otimes \theta) \triangleleft (\widetilde{V}_\nu - \mu^\nu \widetilde{U}) = q(c_{+\nu} - \mu^\nu \alpha_+) \eta^+ - q^{-1}(c_{-\nu} - \mu^\nu \alpha_-) \eta^-. \quad (30)$$

Similarly to Part 1 we get

$$\mathcal{S}(W_\nu \tilde{U}) = q\alpha_+(c_{+\nu} - \mu^\nu \alpha_+) \eta^+ - q^{-1} \alpha_-(c_{-\nu} - \mu^\nu \alpha_-) \eta^-. \quad (31)$$

Consider the  $4 \times 2$ -coefficient matrix  $T = (T_{ij})$  for the linear system of equations (30) and (31),  $\nu \in \{+, -\}$ . The two columns are

$$\begin{aligned} (T_{i1}) &= q(c_{++} - \mu^+ \alpha_+, c_{+-} - \mu^- \alpha_+, \alpha_+(c_{++} - \mu^+ \alpha_+), \alpha_+(c_{+-} - \mu^- \alpha_+))^\top, \\ (T_{i2}) &= -q^{-1}(c_{-+} - \mu^+ \alpha_-, c_{--} - \mu^- \alpha_-, \alpha_-(c_{-+} - \mu^+ \alpha_-), \alpha_-(c_{--} - \mu^- \alpha_-))^\top. \end{aligned}$$

We distinguish three cases:  $(T_{i1}) = 0$ ,  $(T_{i2}) = 0$ , and no column vanishes, respectively.

*Case 1.*  $c_{++} - \mu^+ \alpha_+ = c_{+-} - \mu^- \alpha_+ = 0$ . We obtain the following two equations

$$\begin{aligned} 0 &= (q^2 + 1)(qr - 1)(qr + 1)(q^{12}r^4 + q^4r^4 + 2q^{11}r^3 - 2q^9r^3 + 2q^5r^3 - 2q^3r^3 - \\ &\quad - q^{12}r^2 + q^8r^2 - 4q^6r^2 + q^4r^2 - r^2 - 2q^9r + 2q^7r - 2q^3r + 2qr + q^8 + 1), \\ 0 &= 2(qr - 1)(qr + 1)(r + q^3)(r - q) \times \\ &\quad \times (q^4r^2 - q^2r^2 + r^2 + q^3r - qr - q^4 + q^2 - 1)(q^2 + 1). \end{aligned}$$

Since  $q$  is not a root of unity we have

$$\begin{aligned} d_1 &= q^{12}r^4 + q^4r^4 + 2q^{11}r^3 - 2q^9r^3 + 2q^5r^3 - 2q^3r^3 - \\ &\quad - q^{12}r^2 + q^8r^2 - 4q^6r^2 + q^4r^2 - r^2 - 2q^9r + 2q^7r - 2q^3r + 2qr + q^8 + 1 = 0, \\ d_2 &= q^4r^2 - q^2r^2 + r^2 + q^3r - qr - q^4 + q^2 - 1 = 0. \end{aligned}$$

Using the Euclidean algorithm we eliminate powers of  $r$ . We end up with polynomials

$$\begin{aligned} a &= (q^4 + 1)(q^6 - q^2 + 1)(q^8 + 1)q^4r^3 + \\ &\quad + (q^4 - q^2 + 1)(3q^{14} - 2q^{10} + 2q^8 - q^6 + 2q^2 - 2)q^3r^2 + \\ &\quad + (q^{20} - 2q^{18} + 2q^{14} - 4q^{12} - q^{10} + 5q^8 - 6q^6 + q^4 + q^2 - 1)r + \\ &\quad + (q^4 - q^2 + 1)(q^{16} - 4q^{14} + 2q^{12} + 2q^{10} - 5q^8 + 2q^6 + 2q^4 - 4q^2 + 2)q \end{aligned}$$

and

$$\begin{aligned} b &= (-q^4 - 1)(q^6 - q^2 + 1)(q^4 - q^2 + 1)^4(q - 1)^6(q + 1)^6qr + \\ &\quad + (-2q^{12} + 3q^{10} - 3q^8 + q^6 + q^4 - 2q^2 + 1)(q^4 - q^2 + 1)^3(q - 1)^6(q + 1)^6q^2 \end{aligned}$$

such that  $ad_2 + bd_1 = -(q^6 + q^3 + 1)(q^6 - q^3 + 1)(q - 1)^6(q + 1)^6q$  (there is no  $r$  left). Since  $d_1 = d_2 = 0$ ,  $q$  is a root of unity which contradicts our assumption. Hence Case 1 is impossible.

*Case 2.*  $c_{-+} - \mu^+ \alpha_- = c_{--} - \mu^- \alpha_- = 0$ . Similarly to Case 1 we have

$$\begin{aligned} d_3 &= q^4r^2 - q^2r^2 + r^2 + q^3r - qr - q^4 + q^2 - 1 = 0, \\ d_4 &= q^8r^4 + r^4 + 2q^9r^3 - 2q^7r^3 + 2q^3r^3 - 2qr^3 - \\ &\quad - q^{12}r^2 + q^8r^2 - 4q^6r^2 + q^4r^2 - r^2 - 2q^{11}r + 2q^9r - 2q^5r + 2q^3r + q^{12} + q^4 = 0. \end{aligned}$$

Again there exist polynomials  $a$  and  $b$  in  $q$  and  $r$  such that  $ad_3 + bd_4 = (q^6 + q^3 + 1)(q^6 - q^3 + 1)(q^4 - q^2 + 1)(q - 1)^{12}(q + 1)^{12}q^2$ . This contradicts our assumption that  $q$  is not a root of unity. Hence, the only possibility is

*Case 3.* We will show, that  $T$  has rank 2. Suppose to the contrary that  $T$  has at least rank 1. Then the  $2 \times 2$ -matrices formed by the first and third rows, respectively from the second and fourth rows, both have zero determinant. Since  $\alpha_+ - \alpha_- \neq 0$  this is equivalent to  $(c_{++} - \mu^+ \alpha_+)(c_{-+} - \mu^+ \alpha_-) = 0$  and  $(c_{+-} - \mu^- \alpha_+)(c_{--} - \mu^- \alpha_-) = 0$ . Since moreover the matrix formed by the first two rows has zero determinant, we conclude  $c_{++} - \mu^+ \alpha_+ = c_{+-} - \mu^- \alpha_+ = 0$  or  $c_{-+} - \mu^+ \alpha_- = c_{--} - \mu^- \alpha_- = 0$ . But this is impossible by Case 1 and Case 2. Hence  $T$  has rank 2; both  $\eta^+$  and  $\eta^-$  belong to  $\mathcal{S}(\mathcal{R})$ .

*Acknowledgements.* The author is greatly indebted to I. Heckenberger for many stimulating discussions and helpful comments.

#### REFERENCES

1. T. Brzeziński, *Remark on bicovariant differential calculi and exterior Hopf algebras*, Lett. Math. Phys. **27** (1993), 287–300.
2. B. Drabant, *Hopf bimodules and differential calculus*, Amsterdam Preprint (1995).
3. L. D. Faddeev, N. Yu. Reshetikhin, and L. A. Takhtajan, *Quantization of Lie Groups and Lie Algebras*, Algebra and Analysis **1** (1987), 178–206.
4. I. Heckenberger and A. Schüler, *Exterior Algebras Related to the Quantum Group  $\mathcal{O}(O_q(3))$* , Czech. J. Phys. **48** (1998), 1355–1362.
5. B. Jurčo, *Differential Calculus on Quantized Simple Lie Groups*, Lett. Math. Phys. **22** (1991), 177–186.
6. A. Klimyk and K. Schmüdgen, *Quantum Groups and Their Representations*, Springer-Verlag, Heidelberg, 1997.
7. V. Lyubashenko and A. Sudbery, *Quantum supergroups of  $GL(n|m)$  type: Differential forms, Koszul complexes and Berezinians*, Duke Math. J. **90** (1997), 1–62.
8. K. Schmüdgen and A. Schüler, *Classification of Bicovariant Differential Calculi on Quantum Groups of Type A, B, C and D*, Commun. Math. Phys. **167** (1995), 635–670.
9. A. Schüler, *Differential Hopf Algebras on Quantum Groups of Type A*, J. Algebra **214** (1999), 479–518.
10. V. G. Turaev, *Operator Invariants of Tangles, and R-matrices*, Math. USSR Izvestiya **35** (1990), 411–444.
11. H. Wenzl, *Quantum Groups and Subfactors of Type B, C, and D*, Commun. Math. Phys. **133** (1990), 383–432.
12. S. L. Woronowicz, *Differential Calculus on Quantum Matrix Pseudogroups (Quantum Groups)*, Commun. Math. Phys. **122** (1989), 125–170.

AXEL SCHÜLER, DEPARTMENT OF MATHEMATICS, UNIVERSITY OF LEIPZIG, AUGUSTUSPLATZ 10, 04109 LEIPZIG, GERMANY