

USE OF COHERENT TRANSITION RADIATION TO SET UP THE APS RF THERMIONIC GUN TO PRODUCE HIGH-BRIGHTNESS BEAMS FOR SASE FEL EXPERIMENTS *

N. S. Sereno, M. Borland, A. H. Lumpkin,
Argonne/APS, Argonne, IL, 60439-4800, USA

Abstract

We describe use of the Advanced Photon Source (APS) rf thermionic gun [1], alpha-magnet beamline, and linac [2] to produce a stable high-brightness beam in excess of 100 amperes peak current with normalized emittance of 10π mm-mrad. To obtain peak currents greater than 100 amperes, the rf gun system must be tuned to produce a FWHM bunch length on the order of 350 fs. Bunch lengths this short are measured using coherent transition radiation (CTR) produced when the rf gun beam, accelerated to 40 MeV, strikes a metal foil. The CTR is detected using a Golay detector attached to one arm of a Michelson interferometer. The alpha-magnet current and gun rf phase are adjusted so as to maximize the CTR signal at the Golay detector, which corresponds to the minimum bunch length. The interferometer is used to measure the autocorrelation of the CTR. The minimum phase approximation [3] is used to derive the bunch profile from the autocorrelation. The high-brightness beam is accelerated to 217 MeV and used to produce self-amplified spontaneous emission (SASE) in five APS undulators installed in the Low-Energy Undulator Test Line (LEUTL) experiment hall [4]. Initial optical measurements showed a gain length of 1.3 m at 530 nm.

1 INTRODUCTION

The APS rf thermionic gun serves both as an injector for the APS [2] storage ring as well as a high-brightness source for SASE FEL experiments as part of the APS LEUTL project. Tuning of the gun as a high-brightness source was accomplished using CTR from the rf gun beam accelerated to 40 MeV. The gun, linac, and CTR setup are shown in Figure 1. The beam emerges from the 1.6 cell π mode rf gun and proceeds to the alpha magnet via a beamline containing focusing, steering, a kicker, and an entrance slit. The alpha-magnet vacuum chamber contains a scraper that is used to remove the low energy/high emittance tail from the beam. After the alpha-magnet, the beam traverses some focussing and correction elements, then proceeds through a 3-m SLAC s-band accelerating waveguide to the CTR foil. The CTR foil is mounted on an actuator along with a YAG crystal, which is used to focus the beam to a small beam spot at the foil position. The CTR is collected by a lens and sent to a Michelson interferometer with a Golay detector mounted on one arm. The autocorrelation of the CTR is

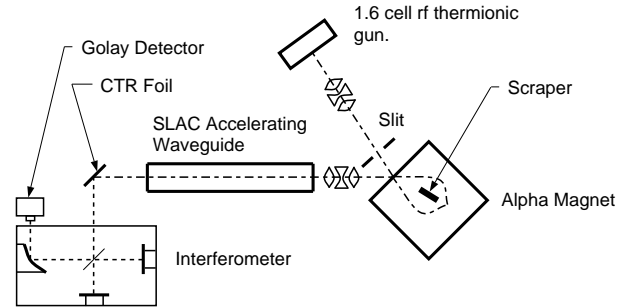

Figure 1: Layout of rf gun, alpha magnet, CTR apparatus, and linac beamline components.

performed by moving one arm of the interferometer while recording the Golay detector output. The Golay detector output can be maximized at the peak of the autocorrelation scan and used to adjust rf gun power and phase, beam current, and alpha-magnet current so as to minimize the bunch length out of the alpha magnet. Once this is done, the CTR signal is a good relative measure of the bunch length.

2 BEAM OPTIMIZATION

To prepare the rf gun to produce a high-brightness beam one must first scan the alpha-magnet current to find the minimum bunch length. Typically the rf gun is powered anywhere from 1.5 to 1.7 MW, and the heater current is adjusted to produce 1 to 2 nC in a train of 23 s-band bunches. The gun power and beam current are kept constant during the scans. Prior to the scan, the beam is focused on the YAG using quads before and after the alpha magnet, with the alpha magnet “close” to the setting required for minimum bunch length. During the scan, the rf gun phase must be adjusted linearly to compensate for path length changes in the alpha magnet. To maximize scan resolution, the interferometer is set to maximize the Golay detector signal. Figure 2 shows a typical alpha-magnet scan showing a peak at 175 amperes. The curve represents the output of the Golay detector from a gated integrator amplifier.

Once the minimum bunch length has been found, an alpha-magnet scraper scan is performed. Simulations show a microbunch profile that has a low-emittance, high-energy core beam and a high-emittance, low-energy tail. The scraper scan is performed to optimize removal of the low-energy tail. Figure 3 shows a typical scraper scan where the CTR signal is plotted vs scraper position. The edge of the core beam is at approximately 9.5 cm. Figure 4 shows

* Work supported by U.S. Department of Energy, Office of Basic Energy Sciences, under Contract No. W-31-109-ENG-38.

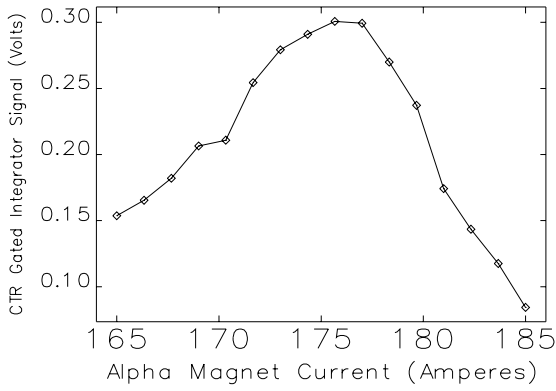

Figure 2: CTR gated integrator signal vs alpha magnet current.

a plot of CTR signal vs beam current, as measured by a beam position monitor (BPM) adjacent to the CTR foil, taken during the scraper scan. Included with the data is a quadratic fit, showing the expected quadratic dependence of the coherent radiation on the number of particles.

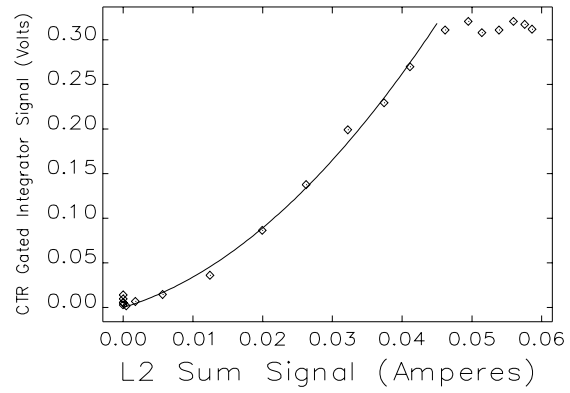

Figure 4: Plot of CTR gated integrator signal vs beam current as measured by a BPM. The plot shows a quadratic fit along with the data indicating a strong quadratic dependence of the CTR.

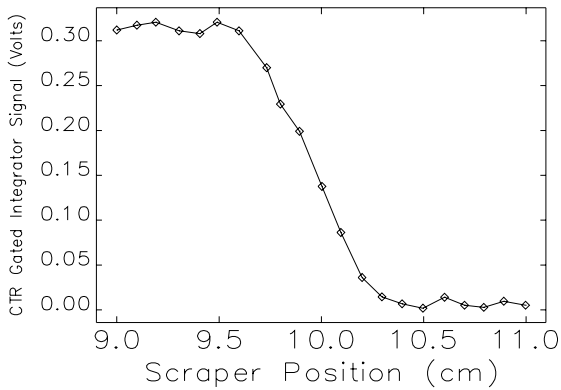

Figure 3: CTR gated integrator signal vs alpha-magnet scraper position.

3 BUNCH PROFILE MEASUREMENT

Once the scraper position is determined, the interferometer is used to measure the autocorrelation of the digitized gated integrator CTR signal. Figure 5 shows the autocorrelation measured for a beam of 1 nC in 23 S-band micropulses. Autocorrelation processing begins with taking the fast Fourier transform (FFT) of the autocorrelation, which gives the square of the bunch spectrum. The method of Lai and Sievers is then used to reconstruct the phase spectrum from the amplitude spectrum by computing a principal value integral. Once the phase spectrum is obtained, an inverse FFT is performed to derive the microbunch profile. Additional processing is performed to

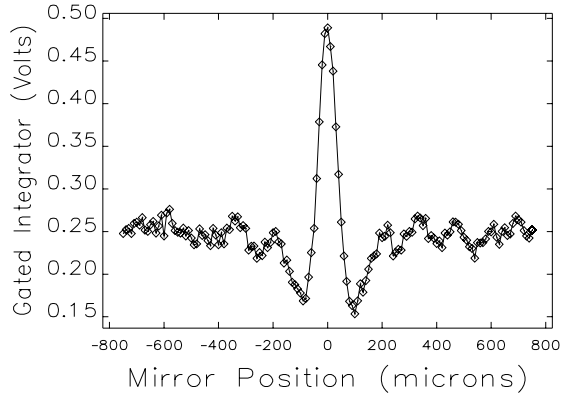

Figure 5: Autocorrelation of the gated integrator CTR signal.

correct for the reduced response of the Golay detector at low frequencies (long wavelengths). Since any bunch spectrum approaches low frequencies quadratically, a quadratic fit is performed for frequencies from the Golay detector 3-dB point to a user-selectable higher frequency, typically including 3 to 5 frequency points [3]. The fit is then used to extrapolate quadratically to DC from the Golay detector 3-dB point. Figure 6 shows the amplitude spectrum derived from the measured autocorrelation and the corrected spectrum for low frequencies. The main effects of this low-frequency correction is to broaden the derived bunch profile and flatten the dips in the autocorrelation adjacent to the peak. These dips are unphysical since the autocorrelation is always positive. Figure 7 shows the derived bunch profile from the the corrected autocorrelation spectrum. The overall profile contains a high-current peak (> 100 amperes), a lower current shoulder, and is overall about 400 fs wide. This beam was used for SASE measurements.

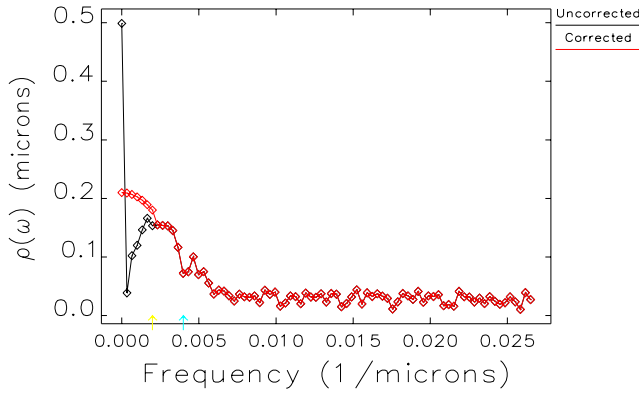

Figure 6: Amplitude spectrum derived from the autocorrelation and corrected spectrum at long wavelengths.

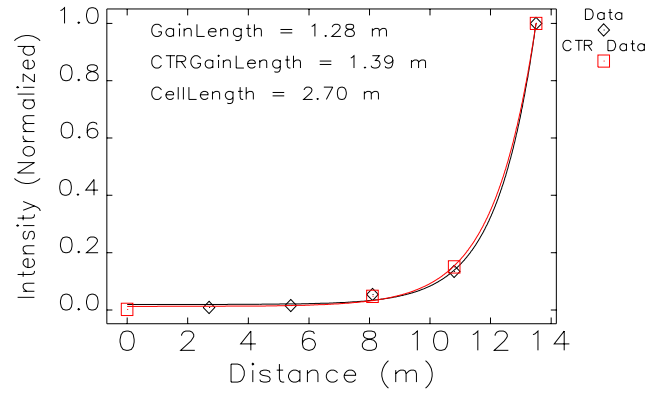

Figure 8: SASE gain measured at undulator diagnostics stations.

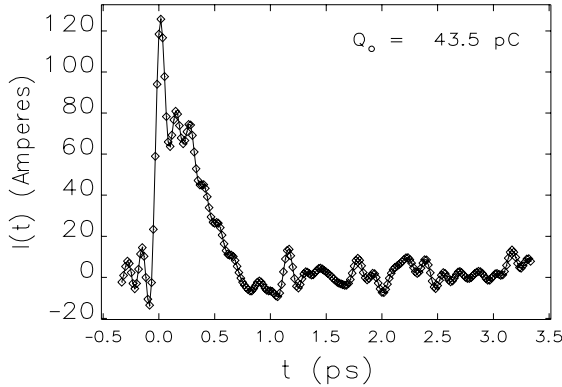

Figure 7: Bunch profile derived from corrected autocorrelation amplitude spectrum.

4 MEASUREMENT OF SASE GAIN

The beam prepared as described above was accelerated to 217 MeV. The emittance was measured in the transport line using the standard three-screen technique, giving a normalized emittance of approximately 10π mm. The energy spread is estimated to be 0.1%. The beam was transported to the undulator hall and passed through five APS undulators with diagnostics stations between them. Figure 8 shows the measured photon intensity (corrected for spontaneous background) at each undulator diagnostic station. The solid line is an exponential fit to the data showing a gain length of 1.3 m for both undulator radiation and coherent transition radiation data [5], in agreement with a calculation using the previously listed peak current, emittance, and energy spread.

The rf thermionic gun beam was quite stable once tuning was completed. One limitation of the beam is that the microbunch length is on the order of the electron slippage length. The final saturated power is therefore expected to be lower for this beam.

5 ACKNOWLEDGEMENTS

The authors thank J. Lewellen, S. Milton, and J. Galayda for useful comments and suggestions.

6 REFERENCES

- [1] M. Borland, "An Improved Thermionic Microwave Gun and Emittance-Preserving Transport Line," Proc. 1993 PAC, May 17-20, 1993, New York, 3015-3017.
- [2] J. Lewellen et al., "Operation of the APS RF Gun," Proceedings of the 1998 Linac Conference, ANL-98/28, 863-865 (1999).
- [3] R. Lai and J. Sievers, "Determination of Bunch Asymmetry from Coherent Radiation in the Frequency Domain," AIP Vol. 367, 312-326 (1996).
- [4] S.V. Milton et al., "Observation of Self-Amplified Spontaneous Emission and Exponential Growth at 530 nm," (submitted to Phys. Rev. Lett.).
- [5] A. H. Lumpkin et al., "First Observation of Z-Dependent Electron Beam Microbunching Using Coherent Transition Radiation," (submitted to Physical Review).