

### General Specifications

Operating Temperature	0° to 60° C (32° to 140° F)	
Storage Temperature	-20° to 85° C (-4° to 185° F)	
Humidity	5 to 95% (non-condensing)	
Environmental Air	No corrosive gases permitted	
Vibration	IEC60068-2-6 (Test Fc)	
Shock	IEC60068-2-27 (Test Ea)	
Enclosure Type	Open Equipment	
Agency Approvals	UL61010-2 - UL File # E185989 Canada and USA CE Compliant EN61131-2*	
Noise Immunity	NEMA ICS3-304	
EU Directive	See the "EU Directive" topic in the Help File	
Weight	BX-12CD3D1	93g (3.3 oz)
	BX-16CD3D1	94g (3.3 oz)
Software Version	Do-more! Designer 2.0 or later	

\*Meets EMC and Safety requirements. See the D.O.C. for details.

### I/O Wiring

#### Sinking Input

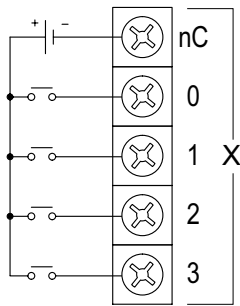

#### Sourcing Input

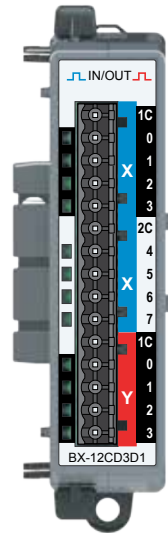
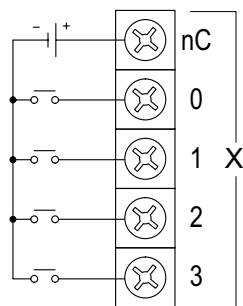

### BX-12CD3D1

**Combination Discrete Module**  
 In – 8-pt, 12–24 VDC, Sink/Source,  
 Out – 4-pt, 12–24 VDC, Sinking

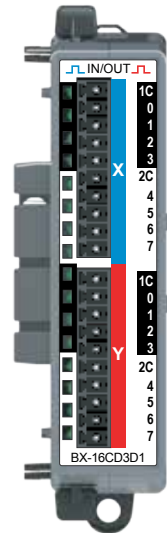

### BX-16CD3D1

**Combination Discrete Module**  
 In – 8-pt, 12–24 VDC, Sink/Source,  
 Out – 8-pt, 12–24 VDC, Sinking

**I/O Terminal Blocks sold separately.**  
 (See Terminal Block Connection Options tables).

### Discrete Input Specifications

Input Type	Sink/Source	
Inputs per Module	8	
Commons	BX-12CD3D1	2 (4 points/common) Isolated
	BX-16CD3D1	2 (4 points/common) Isolated
Nominal Voltage Range	12–24 VDC	
Input Voltage Range	9–30 VDC	
Maximum Voltage	30VDC	
Input Impedance	3kΩ @ 24VDC	
Input Current (typical)	8mA @ 24VDC	
Maximum Input Current	12mA @ 30VDC	
ON Voltage Level	> 9.0 VDC	
OFF Voltage Level	< 2.0 VDC	
Status Indicators	Logic Side, Green	

### Discrete Output Specifications

Outputs Type	Sinking	
Outputs per Module	BX-12CD3D1	4
	BX-16CD3D1	8
Commons	BX-12CD3D1	1 (4 points/common)
	BX-16CD3D1	2 (4 points/common) Isolated
Maximum Current per Common	2A	
Nominal Voltage Range	12–24 VDC	
Operating Voltage Range	5–36 VDC	
Maximum Voltage	36VDC	
Minimum Output Current	0.1 mA @ 24VDC	
Maximum Output Current	0.5 A per output, no derating over temperature range	
Maximum Leakage Current	10μA	
Status Indicators	Logic Side, Green	

**WARNING:** To minimize the risk of potential safety problems, you should follow all applicable local and national codes that regulate the installation and operation of your equipment. These codes vary from area to area and it is your responsibility to determine which codes should be followed, and to verify that the equipment, installation, and operation are in compliance with the latest revision of these codes.

**Equipment damage or serious injury to personnel can result from the failure to follow all applicable codes and standards. We do not guarantee the products described in this publication are suitable for your particular application, nor do we assume any responsibility for your product design, installation, or operation.**

If you have any questions concerning the installation or operation of this equipment, or if you need additional information, please call Technical Support at 770-844-4200.

This publication is based on information that was available at the time it was printed. At AutomationDirect.com® we constantly strive to improve our products and services, so we reserve the right to make changes to the products and/or publications at any time without notice and without any obligation. This publication may also discuss features that may not be available in certain revisions of the product.

Do-more BRX Manual available at  
<http://www.automationdirect.com/pn/doc/manual/BX-USER-M>



### IMPORTANT!



#### Hot-Swapping Information

**Note: This device cannot be Hot Swapped.**

Document Name	Edition/Revision	Date
BX-xxCD3D1	1st Ed. RevE	11/3/2020

Copyright 2021, AutomationDirect.com Incorporated/All Rights Reserved Worldwide.

## Connector Options – 12 point

<b>BX-RTB08</b>	Terminal Block Kit, 90-degree screw type. For use with BRX 5-point, 8-point, and 12-point expansion modules. Kit includes (3) 5-pin 5mm plugs.
<b>BX-RTB08-1</b>	Terminal Block Kit, 180-degree spring clamp type. For use with BRX 5-point, 8-point, and 12-point expansion modules. Kit includes (3) 5-pin 5mm plugs.
<b>BX-RTB08-2</b>	Terminal Block Kit, 180-degree screw type. For use with BRX 5-point, 8-point, and 12-point expansion modules. Kit includes (3) 5-pin 5mm plugs.
<b>ZL-BXEM-CBL15</b>	<b>ZIPLink</b> PLC I/O cable, 15-position terminal block to 24-pin connector, 24AWG, cable length 0.5meter (1.6ft). For use with 5-point and 12-point BRX expansion modules.
<b>ZL-BXEM-CBL15-1</b>	<b>ZIPLink</b> PLC I/O cable, 15-position terminal block to 24-pin connector, 24AWG, cable length 1meter (3.3ft). For use with 5-point and 12-point BRX expansion modules.
<b>ZL-BXEM-CBL15-2</b>	<b>ZIPLink</b> PLC I/O cable, 15-position terminal block to 24-pin connector, 24AWG, cable length 2meter (6.6ft). For use with 5-point and 12-point BRX expansion modules.
<b>ZL-BXEM-CBL15-1P</b>	<b>ZIPLink</b> PLC I/O cable, 15-position terminal block to pigtail connection, 24AWG, cable length 1meter (3.3ft). For use with 5-point and 12-point BRX expansion modules.
<b>ZL-BXEM-CBL15-2P</b>	<b>ZIPLink</b> PLC I/O cable, 15-position terminal block to pigtail connection, 24AWG, cable length 2meter (6.6ft). For use with 5-point and 12-point BRX expansion modules.
<b>ZL-RTB20</b>	<b>ZIPLink</b> Two Level Feedthrough Module, 20-pole, 35mm, DIN mount.
<b>ZL-RTB20-1</b>	<b>ZIPLink</b> Three Level Feedthrough Module, 20-pole, 35mm, DIN mount.

## Module Installation

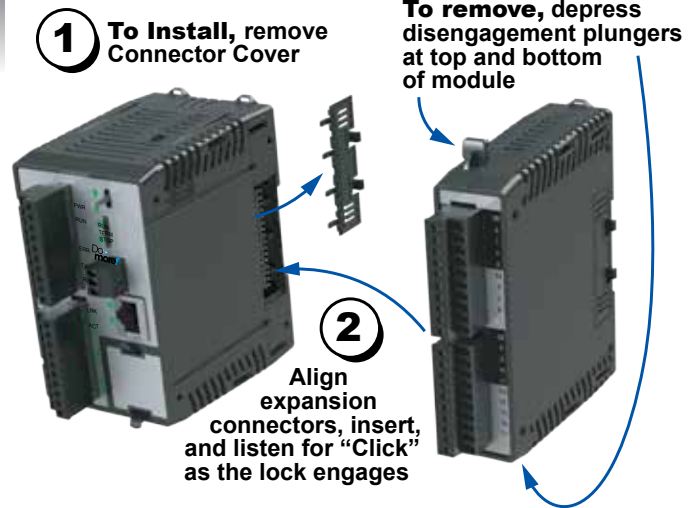

## I/O Wiring

### Sinking Output

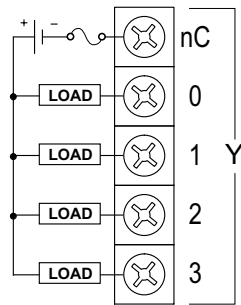

## Dimensional Information

Note: Drawings are for reference only. Shown without terminal blocks.

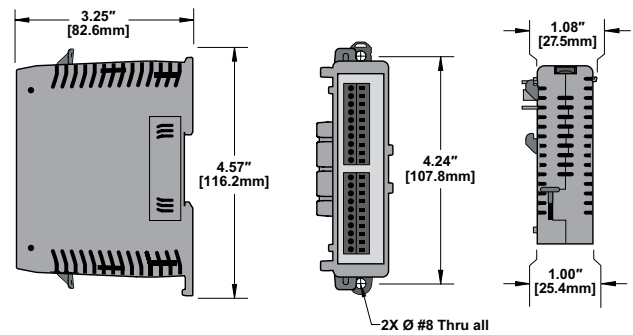

## Connector Options – 16 point

<b>BX-RTB10</b>	Terminal Block Kit, 90-degree screw type. For use with BRX 10-point PLCs and BRX 16-point expansion modules. Kit includes (2) 10-pin 3.8mm plugs.
<b>BX-RTB10-1</b>	Terminal Block Kit, 180-degree spring clamp type. For use with BRX 10-point PLCs and BRX 16-point expansion modules. Kit includes (2) 10-pin 3.8mm plugs.
<b>BX-RTB10-2</b>	Terminal Block Kit, 180-degree screw type. For use with BRX 10-point PLCs and BRX 16-point expansion modules. Kit includes (2) 10-pin 3.8mm plugs.
<b>ZL-BXEM-CBL20</b>	<b>ZIPLink</b> PLC I/O cable, 20-position terminal block to 24-pin connector, 24AWG, cable length 0.5meter (1.6ft). For use with 16-point BRX expansion modules.
<b>ZL-BXEM-CBL20-1</b>	<b>ZIPLink</b> PLC I/O cable, 20-position terminal block to 24-pin connector, 24AWG, cable length 1meter (3.3ft). For use with 16-point BRX expansion modules.
<b>ZL-BXEM-CBL20-2</b>	<b>ZIPLink</b> PLC I/O cable, 20-position terminal block to 24-pin connector, 24AWG, cable length 2meter (6.6ft). For use with 16-point BRX expansion modules.
<b>ZL-BXEM-CBL20-1P</b>	<b>ZIPLink</b> PLC I/O cable, 20-position terminal block to pigtail connection, 24AWG, cable length 1meter (3.3ft). For use with 16-point BRX expansion modules.
<b>ZL-BXEM-CBL20-2P</b>	<b>ZIPLink</b> PLC I/O cable, 20-position terminal block to pigtail connection, 24AWG, cable length 2meter (6.6ft). For use with 16-point BRX expansion modules.
<b>ZL-RTB20</b>	<b>ZIPLink</b> Two Level Feedthrough Module, 20-pole, 35mm, DIN mount.
<b>ZL-RTB20-1</b>	<b>ZIPLink</b> Three Level Feedthrough Module, 20-pole, 35mm, DIN mount.

## 12 point Terminal Block Connector Specifications

Part Number	BX-RTB08	BX-RTB08-1	BX-RTB08-2
Connector Type	Screw Type-90°	Spring Clamp Type-180°	Screw Type-180°
Wire Exit	180°	180°	180°
Pitch	5.0mm	5.0mm	5.0mm
Screw Size	M2.5	N/A	M2.5
Recommended Screw torque	< 3.98 lb-in (0.45 N·m)	N/A	< 3.98 lb-in (0.45 N·m)
Screwdriver Blade Width	3.5mm	3.5mm	3.5mm
Wire Gauge (Single Wire)	28-12 AWG	28-14 AWG	28-12 AWG
Wire Gauge (Two Wires)	28-16 AWG	28-16 AWG (Dual Wire Ferrule Required)	28-16 AWG
Wire Strip Length	0.3in (7.5mm)	0.37in (9.5mm)	0.3in (7.5mm)
Equiv. Dinkle part #	5ESDV-05P-BK	5ESDSR-05P-BK	5ESDF-05P-BK

## 16 point Terminal Block Connector Specifications

Part Number	BX-RTB10	BX-RTB10-1	BX-RTB10-2
Connector Type	Screw Type-90°	Spring Clamp Type-180°	Screw Type-180°
Wire Exit	180°	180°	180°
Pitch	3.81mm	3.81mm	3.81mm
Screw Size	M2	N/A	M2
Recommended Screw torque	<1.77 lb-in (0.2 N·m)	N/A	<1.77 lb-in (0.2 N·m)
Screwdriver Blade Width	2.5mm	2.5mm	2.5mm
Wire Gauge (Single Wire)	28-16 AWG	28-18 AWG	30-16 AWG
Wire Gauge (Two Wires)	28-18 AWG	30-20 AWG (Dual Wire Ferrule Required)	30-18 AWG
Wire Strip Length	0.24in (6mm)	0.35in (9mm)	0.26in (6.5mm)
Equiv. Dinkle part #	EC381V-10P-BK	ESC381V-10-BK	EC381F-10P-BK