

STEP 5

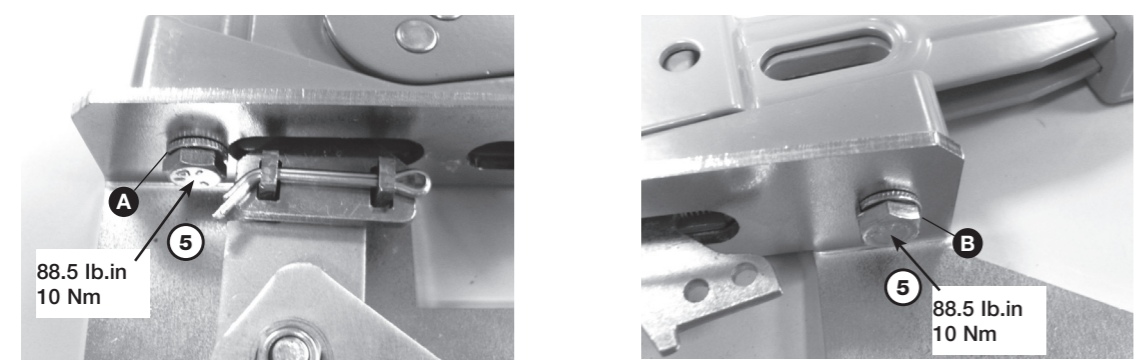

STEP 6

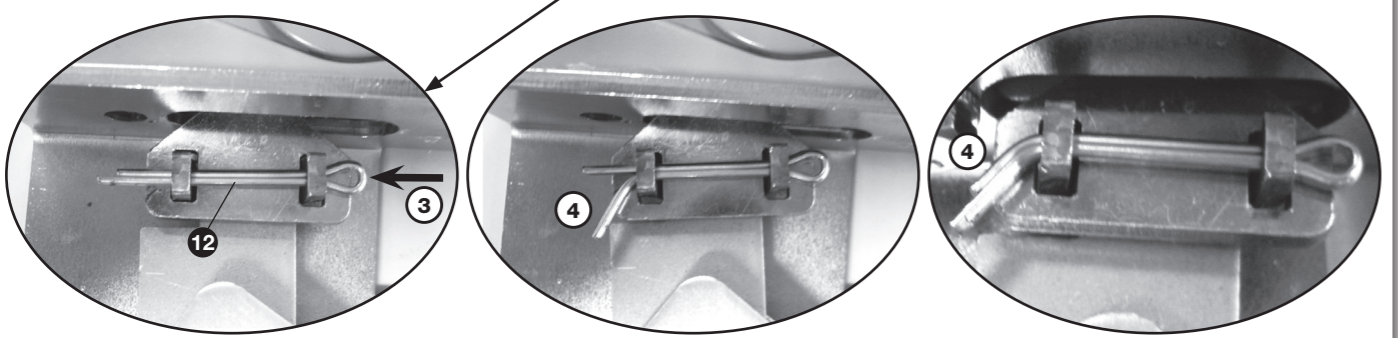
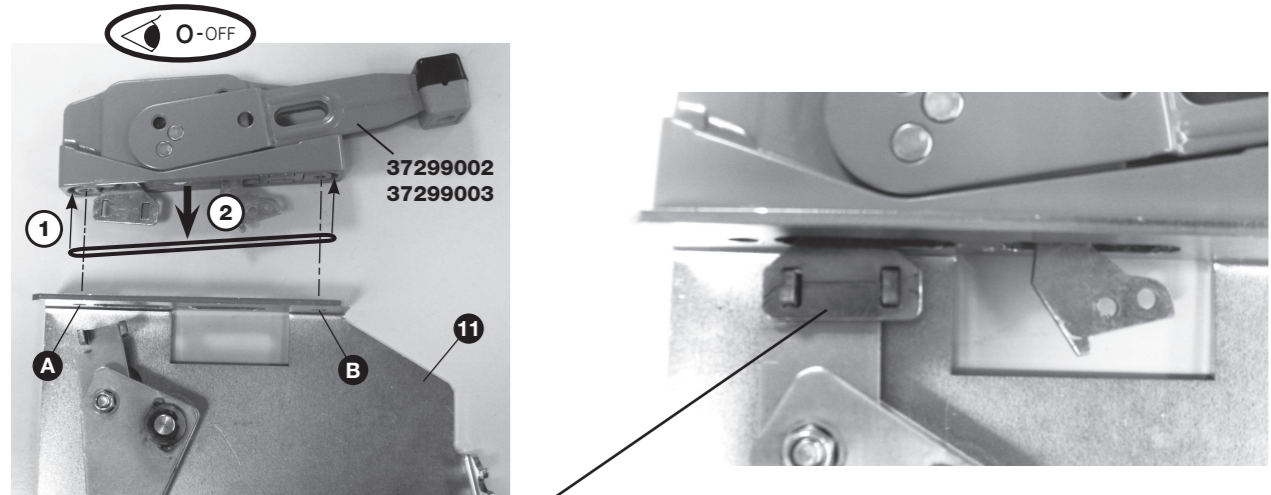
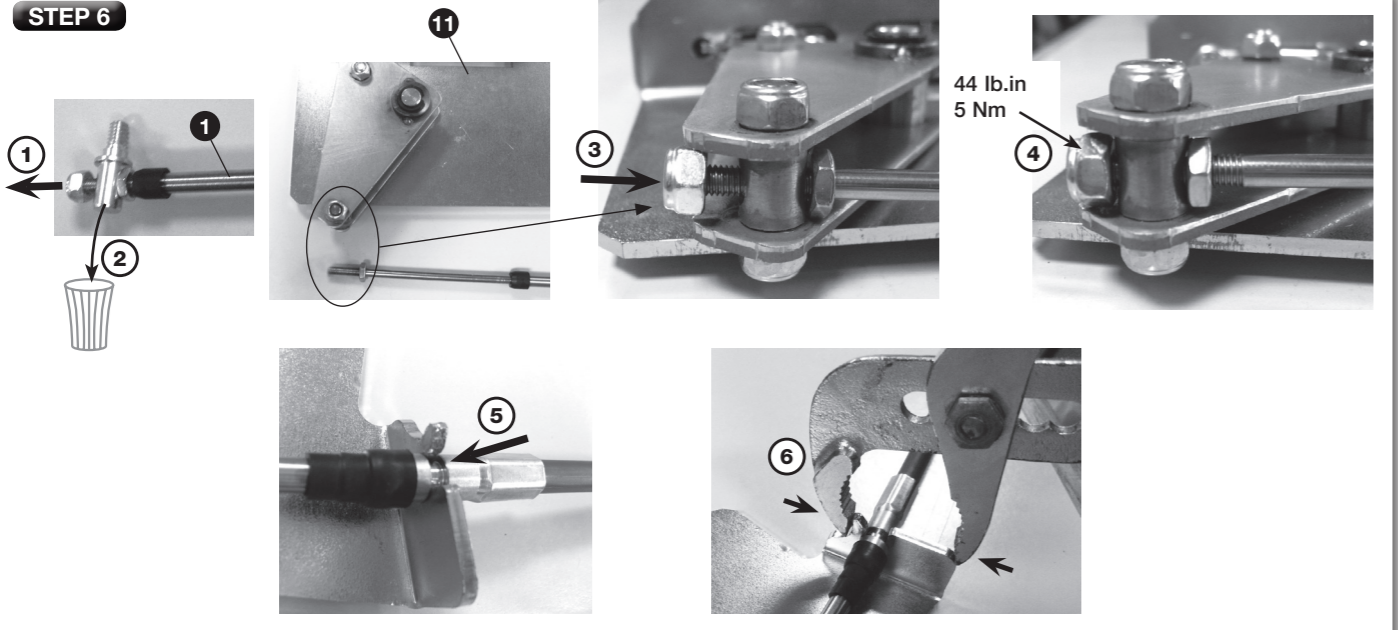

⚠ DANGER / DANGER / PELIGRO

HAZARDOUS VOLTAGE

- This equipment must be installed and serviced only by qualified electrical personnel.
- Turn off all power supplying this equipment before working on or inside equipment.
- Always use a properly rated voltage sensing device to confirm power is off.
- Replace all devices, doors, and covers before turning on power to this equipment.
- Maintain electrical clearances between cable and live parts.

Failure to follow these instructions will result in death or serious injury.

TENSION DANGEREUSE

- L'installation et l'entretien de cet appareil ne doivent être effectués que par du personnel qualifié.
- Coupez l'alimentation de cet appareil avant d'y travailler.
- Utilisez toujours un dispositif de détection de tension à valeur nominale approprié pour confirmer que toute alimentation est coupée.
- Remplacez tous les dispositifs, les portes et les couvercles avant de mettre cet appareil sous tension.
- Maintenez les distances d'isolement électrique entre le câble et les pièces sous tension.

Si ces précautions ne sont pas respectées, cela entraînera la mort ou des blessures graves

TENSION PELIGROSA

- Solamente el personal de mantenimiento eléctrico especializado deberá instalar y prestar servicios de mantenimiento a este equipo.
- Desenergice el equipo antes de realizar cualquier trabajo en él.
- Siempre utilice un dispositivo detector de tensión adecuado para confirmar la desenergización del equipo.
- Vuelva a colocar todos los dispositivos, las puertas y las cubiertas antes de energizar este equipo.
- Mantenga un espacio adecuado para la instalación eléctrica entre el cable y las piezas energizadas.

El incumplimiento de estas precauciones podrá causar la muerte o lesiones serias.

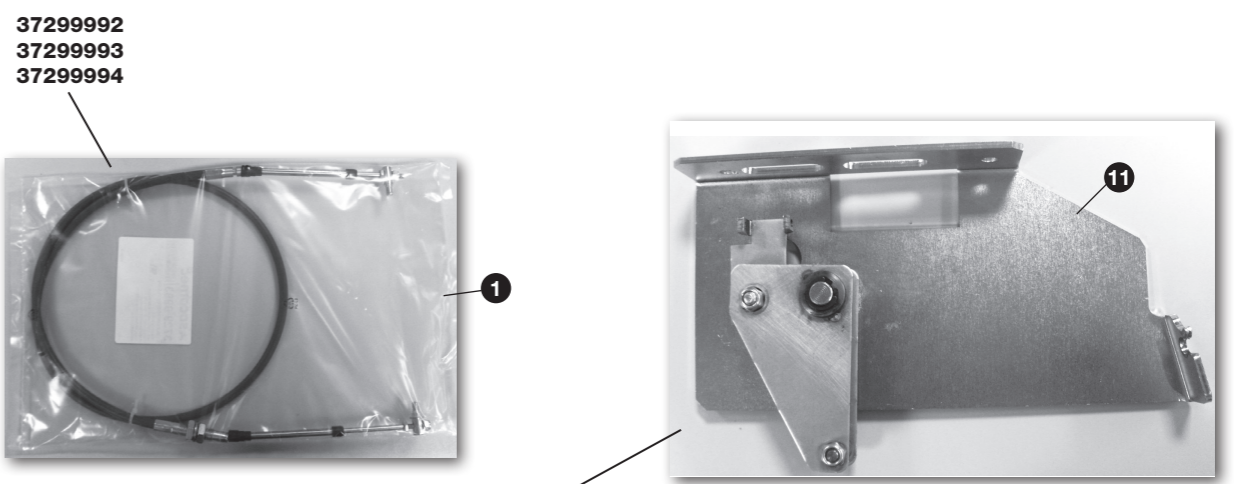

37299903
37299905

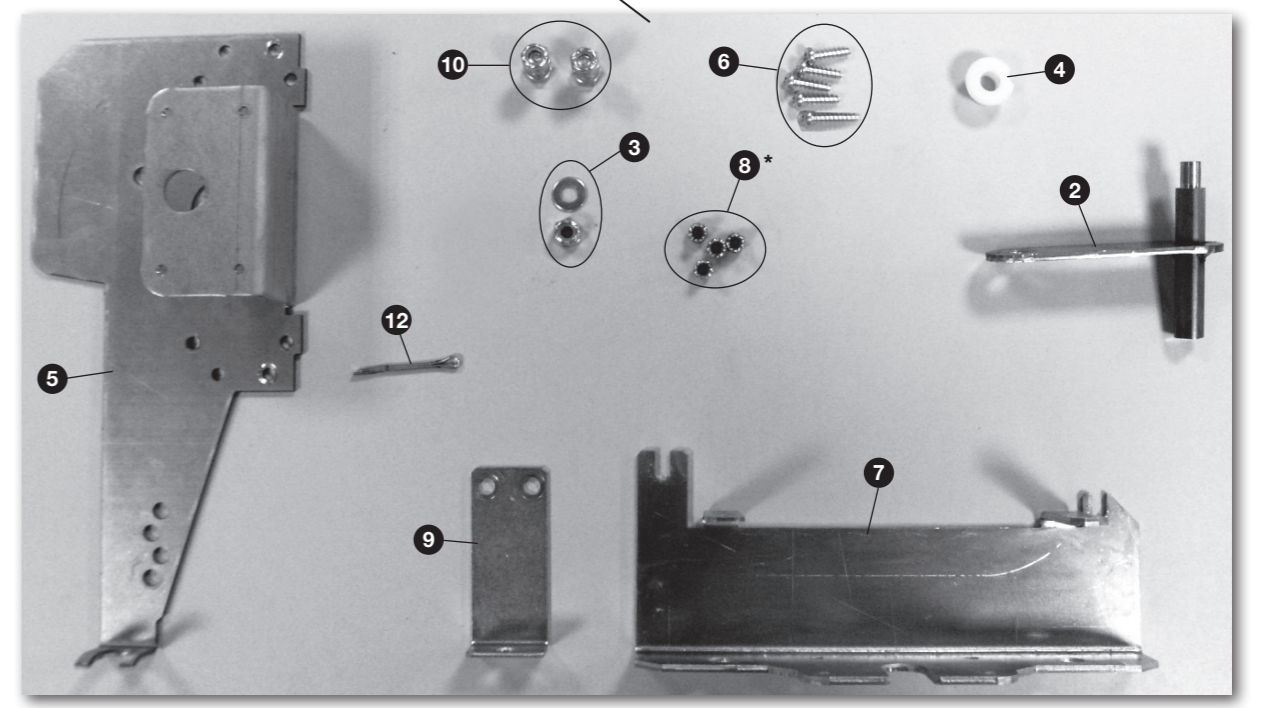

RECTO-VERSO / S blanc offset 100g/m² / I Noire pantone black C / F 297x420 / P 148x210

STEP 1

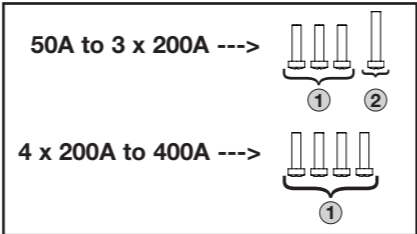
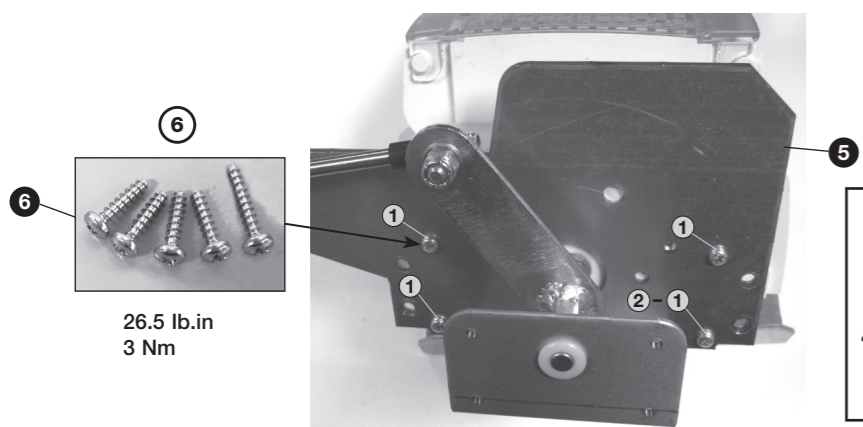
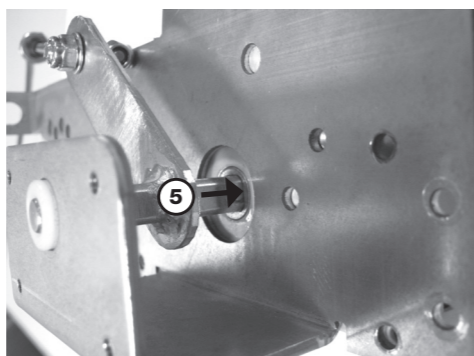
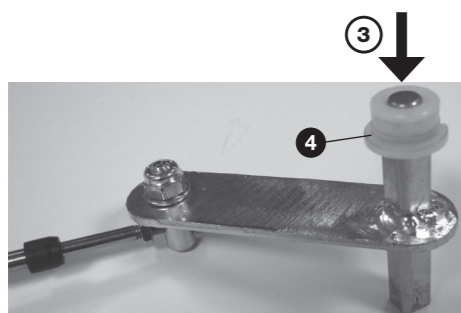
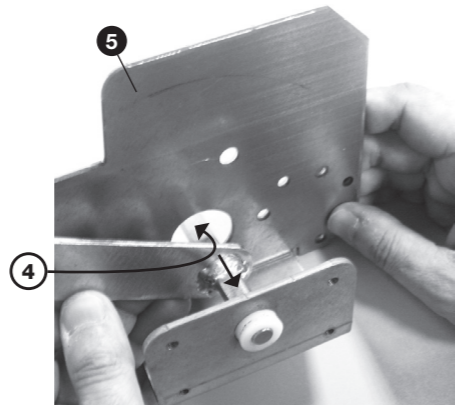
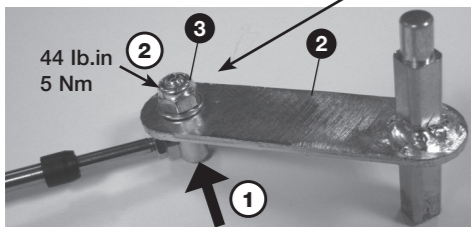
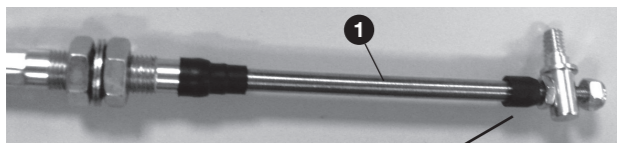

STEP 2

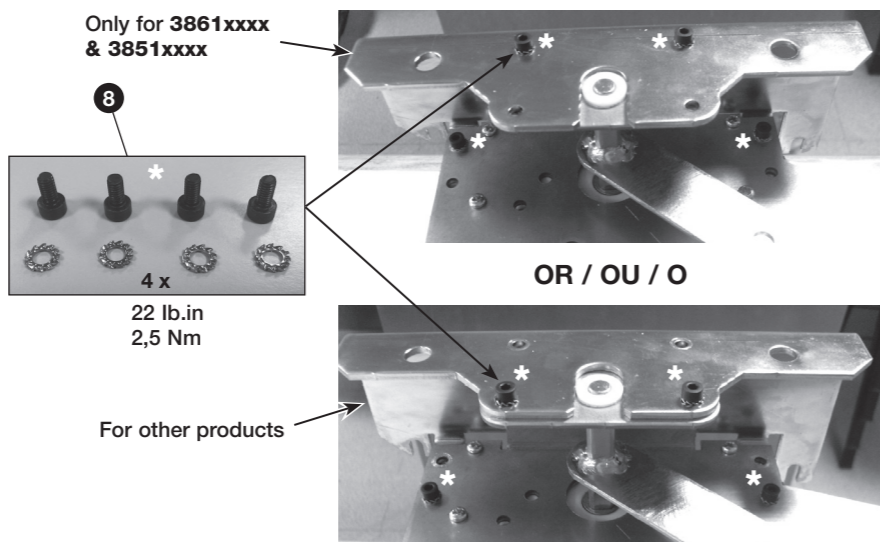
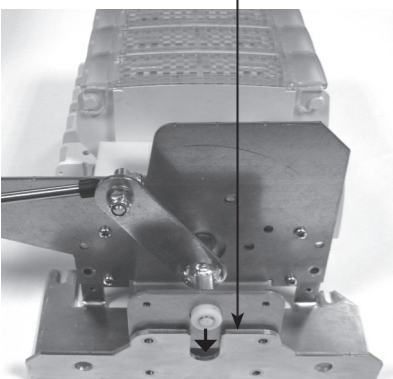
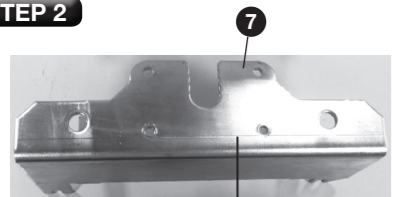

STEP 2

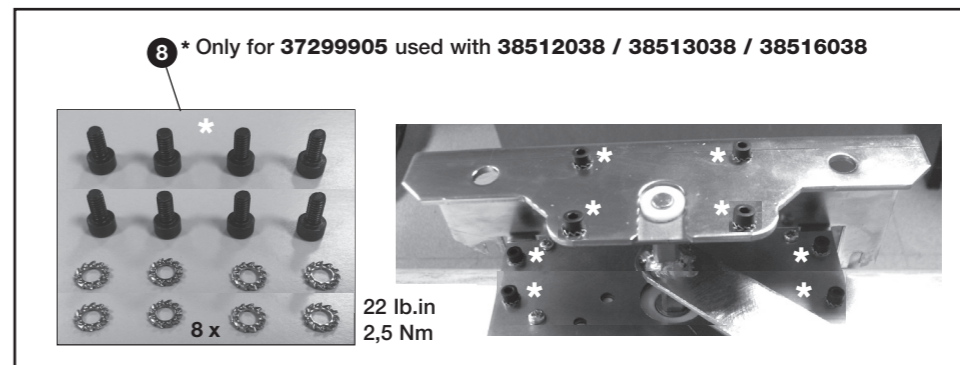

STEP 3

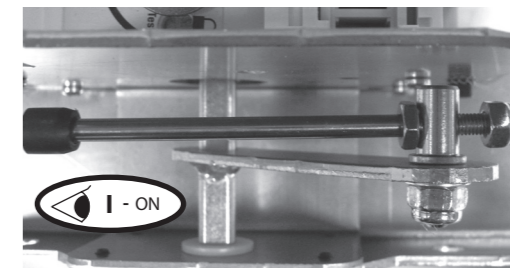
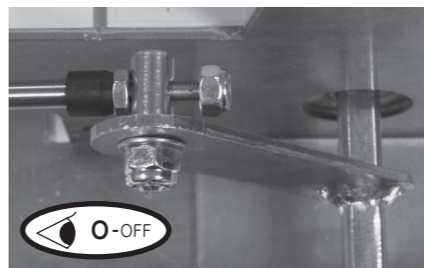
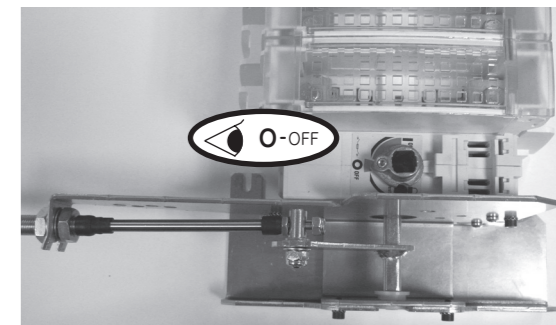
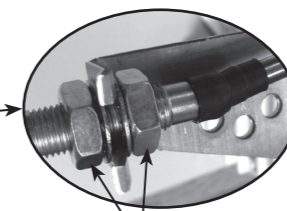
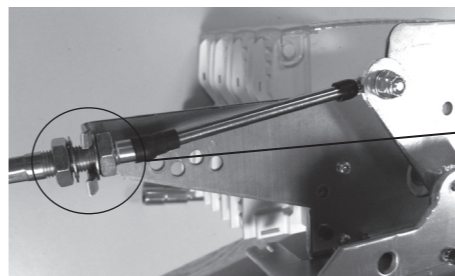

STEP 4

