

**STEP 6**

**Position de l'axe**  
**Position of the shaft**  
**Posición del eje**

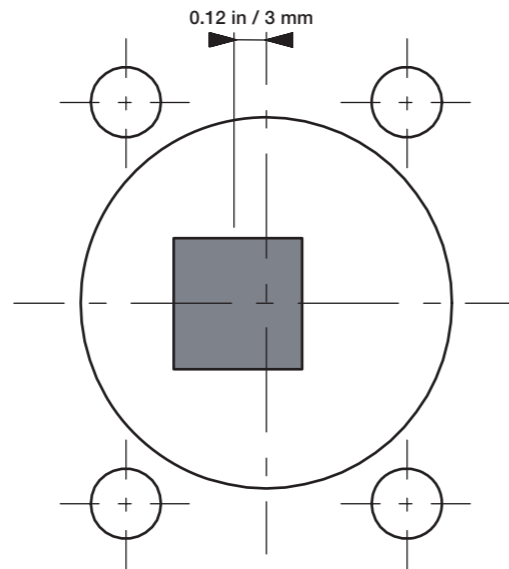
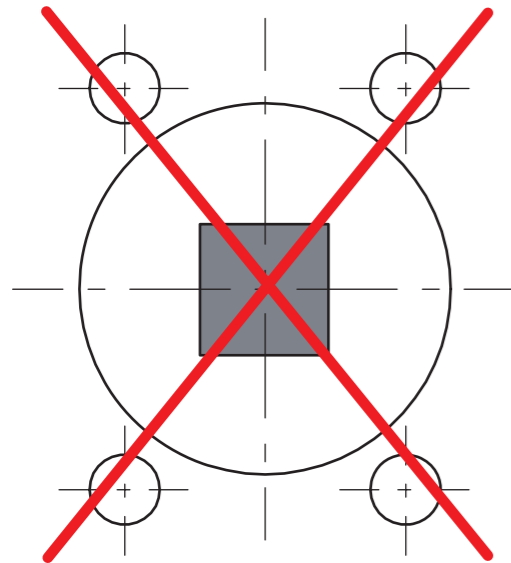
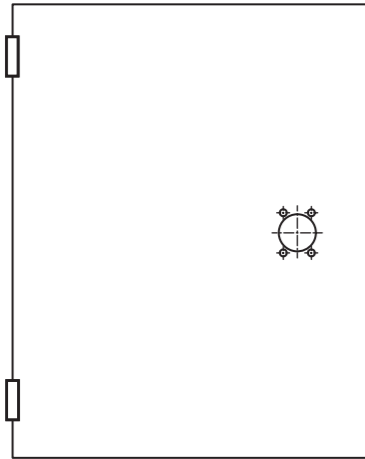

**⚠ DANGER / DANGER / PELIGRO**

**HAZARDOUS VOLTAGE**

- This equipment must be installed and serviced only by qualified electrical personnel.
- Turn off all power supplying this equipment before working on or inside equipment.
- Always use a properly rated voltage sensing device to confirm power is off.
- Replace all devices, doors, and covers before turning on power to this equipment.
- Maintain electrical clearances between cable and live parts.

**Failure to follow these instructions will result in death or serious injury.**

**TENSION DANGEREUSE**

- L'installation et l'entretien de cet appareil ne doivent être effectués que par du personnel qualifié.
- Coupez l'alimentation de cet appareil avant d'y travailler.
- Utilisez toujours un dispositif de détection de tension à valeur nominale approprié pour confirmer que toute alimentation est coupée.
- Remplacez tous les dispositifs, les portes et les couvercles avant de mettre cet appareil sous tension.
- Maintenez les distances d'isolement électrique entre le câble et les pièces sous tension.

**Si ces précautions ne sont pas respectées, cela entraînera la mort ou des blessures graves**

**TENSION PELIGROSA**

- Solamente el personal de mantenimiento eléctrico especializado deberá instalar y prestar servicios de mantenimiento a este equipo.
- Desenergice el equipo antes de realizar cualquier trabajo en él.
- Siempre utilice un dispositivo detector de tensión adecuado para confirmar la desenergización del equipo.
- Vuelva a colocar todos los dispositivos, las puertas y las cubiertas antes de energizar este equipo.
- Mantenga un espacio adecuado para la instalación eléctrica entre el cable y las piezas energizadas.

**El incumplimiento de estas precauciones podrá causar la muerte o lesiones serias.**

**NFPA kit**  
**Kit NFPA**  
**Opción NFPA**

Kit ref : 37297552

USED WITH  
 UTILISER AVEC  
 UTILIZACIÓN CON

38502060 / 38503060 / 38506060  
 38502080 / 38503080 / 38506080

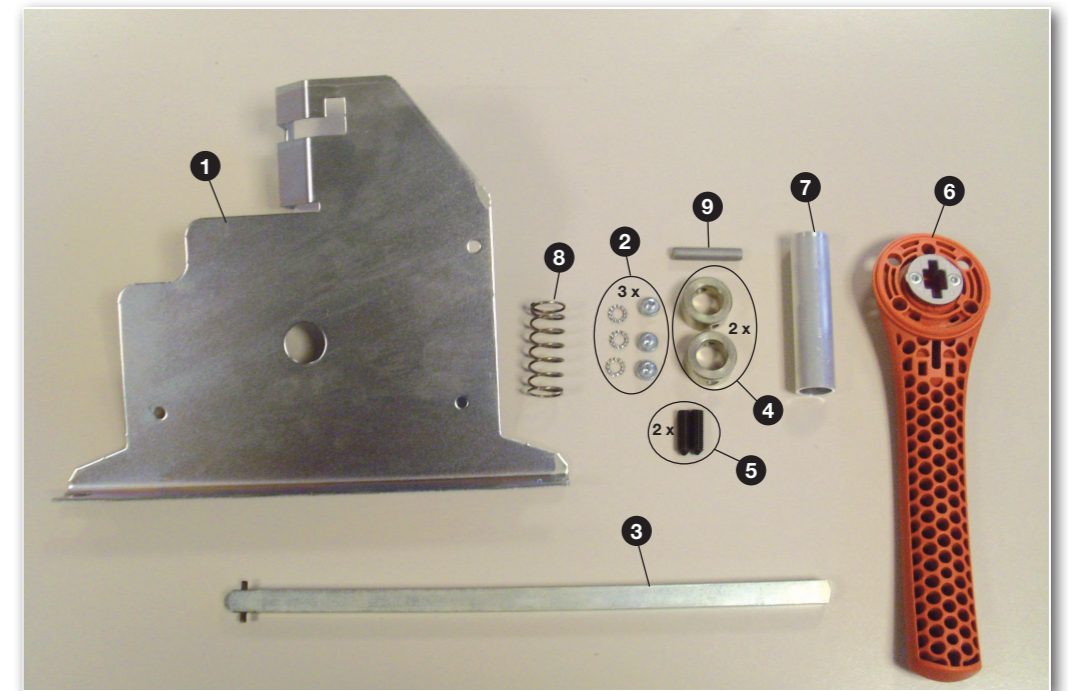

RECTO-VERSO / S blanc offset 100g/m² / I QUADRI / F 297x420 / P 210x297

**STEP 1**

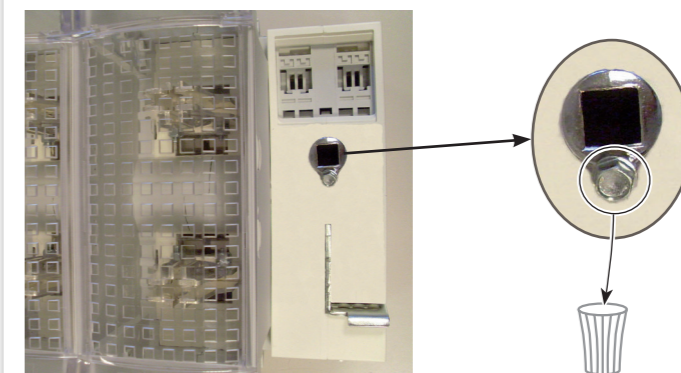

**STEP 2**

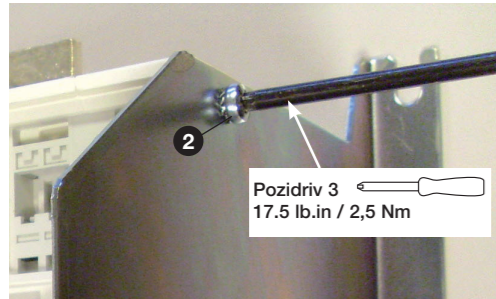
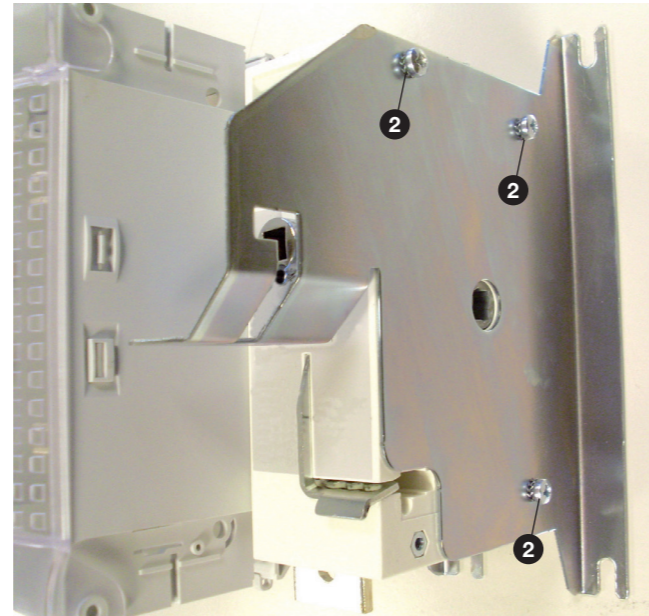
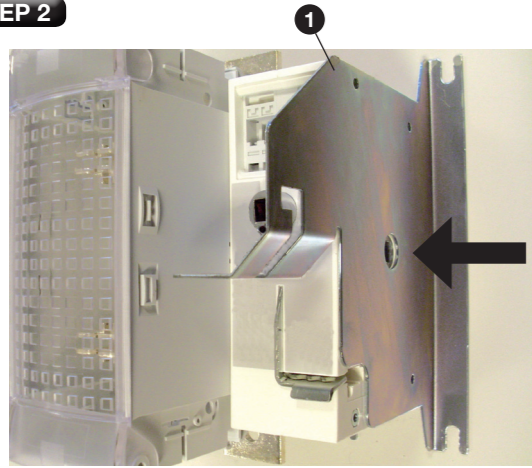

Pozidriv 3  
17.5 lb.in / 2,5 Nm

**STEP 3**

Thigh ten a little  
Pré visser  
Atornillar un poco

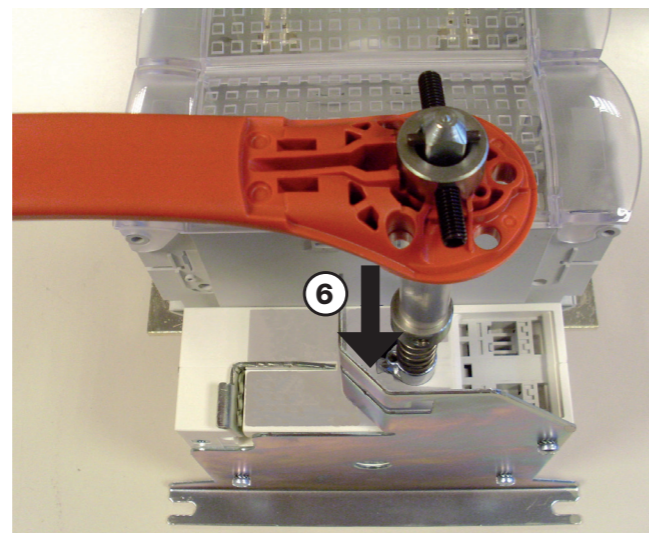
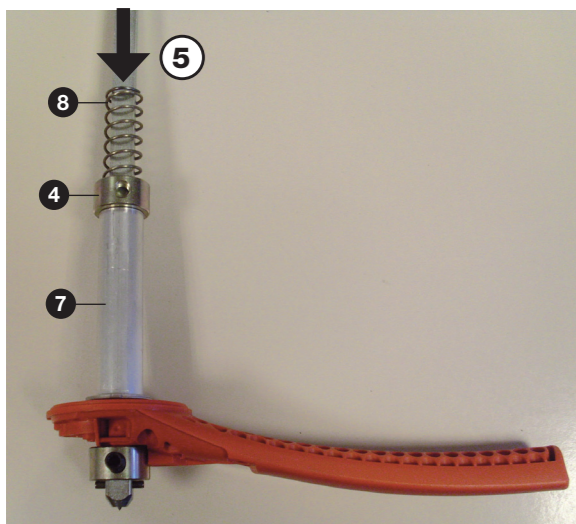
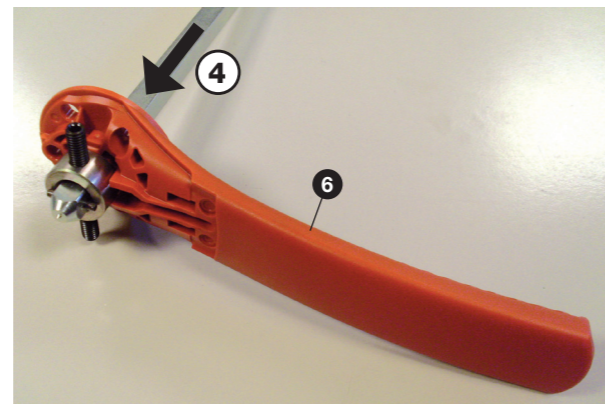
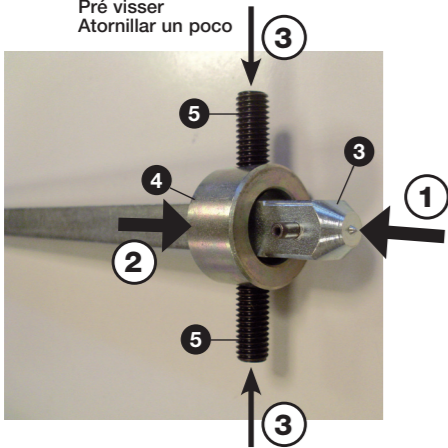

**STEP 4**

Shaft length  
Longueur d'axe  
Longitud del eje

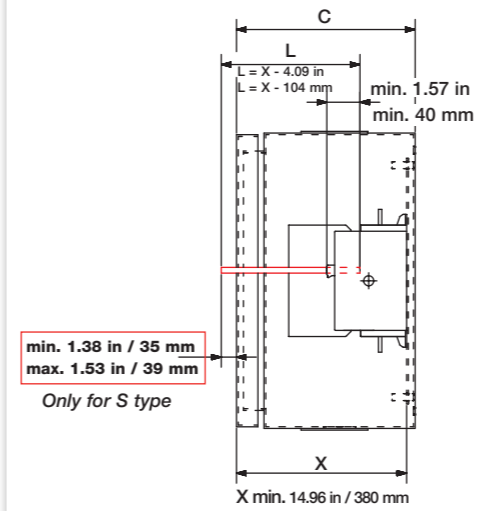

Set the position of the shaft  
Régler la position de l'axe  
Reglar la posición del eje

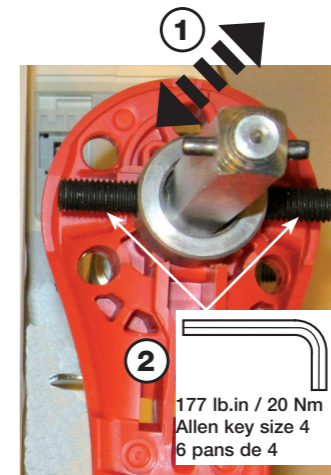

**STEP 5**

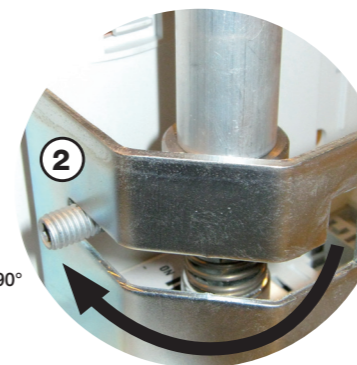
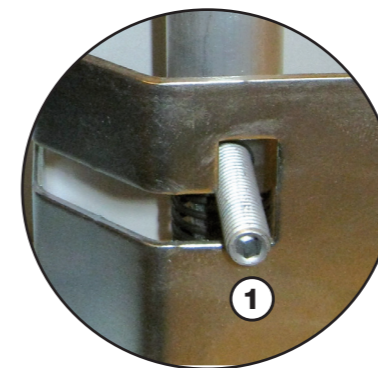

Turn of 90°  
Tourner de 90°  
Girar de 90°

