

AC DRIVE PARAMETERS



CHAPTER

4

CONTENTS OF THIS CHAPTER

<i>GS1 Parameter Summary</i>4-2
<i>GS1 Detailed Parameter Listings</i>4-8
<i>Explanation of Parameter Details Format</i>	4-8
<i>Motor Parameters</i>	4-8
<i>Ramp Parameters</i>	4-9
<i>Volts/Hertz Parameters</i>4-14
<i>Digital Parameters</i>4-16
<i>Analog Parameters</i>4-22
<i>Analog Input Examples</i>4-24
<i>Presets Parameters</i>4-31
<i>Protection Parameters</i>4-32
<i>Display Parameters</i>4-37
<i>Communications Parameters</i>4-38

GS1 PARAMETER SUMMARY

Parameter Summary – Motor Parameters (P0.xx)				
GS1 Parameter	Description	Range	Default Setting	User Setting
P0.00	Motor Nameplate Voltage	200/208/220/230/240	240	
P0.01	Motor Nameplate Amps	Drive Rated Amps x 0.3 to 1.0	Drive Rated Amps x 1.0	
P0.02	Motor Base Frequency	50/60/400	60	
P0.03	Motor Base RPM	375 to 9999 RPM	1750	
P0.04	Motor Maximum RPM	P0.03 to 9999 RPM	P0.03	

Parameter Summary – Ramp Parameters (P1.xx)				
GS1 Parameter	Description	Range	Default Setting	User Setting
P1.00	Stop Methods	0: Ramp to Stop 1: Coast to Stop	0	
◆ P1.01	Acceleration Time 1	0.1 to 600.0 sec	10.0	
◆ P1.02	Deceleration Time 1	0.1 to 600.0 sec	30.0	
P1.03	Accel S-curve	0 to 7	0	
P1.04	Decel S-curve	0 to 7	0	
◆ P1.05	Acceleration Time 2	0.1 to 600.0 sec	10.0	
◆ P1.06	Deceleration Time 2	0.1 to 600.0 sec	30.0	
P1.07	Select method to use 2nd Accel/Decel	0: RMP2 from terminal 1: Transition Frequencies P1.08 & P1.09	0	
P1.08	Accel 1 to Accel 2 frequency transition	0.0 to 400.0 Hz	0.0	
P1.09	Decel 1 to Decel 2 frequency transition	0.0 to 400.0 Hz	0.0	
P1.10	Skip Frequency 1	0.0 to 400.0 Hz	0.0	
P1.11	Skip Frequency 2	0.0 to 400.0 Hz	0.0	
P1.12	Skip Frequency 3	0.0 to 400.0 Hz	0.0	
P1.17	Skip Frequency Band	0.0 to 20.0 Hz	0.0	
P1.19	DC Injection Voltage Level	0 to 30%	0	
P1.20	DC Injection during Start-up	0.0 to 5.0 sec	0.0	
P1.21	DC Injection during Stopping	0.0 to 25.0 sec	0.0	
P1.22	Start-point for DC Injection	0.0 to 60.0 Hz	0.0	

◆ Parameter can be set during RUN Mode.

Parameter Summary – Volts/Hertz Parameters (P2.xx)				
GS1 Parameter	Description	Range	Default Setting	User Setting
P2.00	Volts/Hertz Settings	0: General Purpose 1: High Starting Torque 2: Fans and Pumps 3: Custom	0	
◆ P2.01	Slip Compensation	0.0 to 10.0	0.0	
◆ P2.03	Manual Torque Boost	0 to 10%	1	
P2.04	Mid-point Frequency	1.0 to 400 Hz	1.5	
P2.05	Mid-point Voltage	2.0 to 255V	10.0	
P2.06	Min. Output Frequency	1.0 to 20.0 Hz	1.5	
P2.07	Min. Output Voltage	2.0 to 50V	10.0	
P2.08	PWM Carrier Frequency	03 to 10 kHz	10	

◆ Parameter can be set during RUN Mode.

Parameter Summary – Digital Parameters (P3.xx)				
GS1 Parameter	Description	Range	Default Setting	User Setting
P3.00	Source of Operation Command	0: Operation determined by digital keypad 1: Operation determined by external control terminals, keypad STOP is enabled 2: Operation determined by external control terminals, keypad STOP is disabled 3: Operation determined by RS-485 interface, keypad STOP is enabled 4: Operation determined by RS-485 interface, keypad STOP is disabled	0	
P3.01	Multi-function Inputs 1 & 2 (DI1 & DI2)	0: DI1 - FWD / STOP, DI2 - REV / STOP 1: DI1 - RUN / STOP, DI2- REV / FWD 2: DI1 - RUN momentary (N.O.) DI2 - REV / FWD DI3 - STOP momentary (N.C.)	0	
P3.02	Multi-function Input 3 (DI3)	0: External Fault (N.O.)	0	
P3.03	Multi-function Input 4 (DI4)	1: External Fault (N.C.) 2: External Reset 3: Multi-Speed Bit 1 4: Multi-Speed Bit 2 9: Jog 10: External Base Block (N.O.) 11: External Base Block (N.C.) 12: Second Accel/Decel Time 13: Speed Hold 14: Increase Speed 15: Decrease Speed 16: Reset Speed to Zero 99: Input Disable	3	
P3.11	Multi-Function Output Terminal	0: AC Drive Running 1: AC Drive Fault 2: At Speed 3: Zero Speed 4: Above Desired Frequency (P3.16) 5: Below Desired Frequency (P3.16) 6: At Maximum Speed (P0.04) 7: Over torque detected 8: Above Desired Current (P3.17) 9: Below Desired Current (P3.17)	0	
◆ P3.16	Desired Frequency	0.0 to 400Hz	0.0	
◆ P3.17	Desired Current	0.0 to Drive Rated Amps	0.0	
◆ Parameter can be set during RUN Mode.				

Parameter Summary – Analog Parameters (P4.xx)				
GS1 Parameter	Description	Range	Default Setting	User Setting
P4.00	Source of Frequency Command	0: Frequency determined by keypad potentiometer 1: Frequency determined by digital keypad up/down 2: Frequency determined by 0 to +10V input on AI terminal (switch set to "V") 3: Frequency determined by 4 to 20mA input on AI terminal (switch set to "I") 4: Frequency determined by 0 to 20mA input on AI terminal (switch set to "I") 5: Frequency determined by RS-485 communication interface	0	
P4.01	Analog Input Offset Polarity	0: No Offset 1: Positive Offset 2: Negative Offset	0	
◆ P4.02	Analog Input Offset	0.0 to 100.0%	0.0	
◆ P4.03	Analog Input Gain	0.0 to 300.0%	100.0	
P4.04	Analog Input Reverse Motion Enable	0: Forward Motion Only 1: Reverse Motion Enable	0	
P4.05	Loss of ACI Signal (4–20mA)	0: Decelerate to 0Hz 1: Stop immediately and display error code "EF" 2: Continue operation by the last frequency command	0	
◆ Parameter can be set during RUN Mode.				

Parameter Summary – Presets Parameters (P5.xx)				
GS1 Parameter	Description	Range	Default Setting	User Setting
◆ P5.00	Jog	0.0 to 400Hz	6.0	
◆ P5.01	Multi-Speed 1	0.0 to 400Hz	0.0	
◆ P5.02	Multi-Speed 2	0.0 to 400Hz	0.0	
◆ P5.03	Multi-Speed 3	0.0 to 400Hz	0.0	
◆ Parameter can be set during RUN Mode.				

Parameter Summary – Protection Parameters (P6.xx)				
GS1 Parameter	Description	Range	Default Setting	User Setting
P6.00	Electronic Thermal Overload Relay	0: Constant Torque (inverter/vector duty motors) 1: Variable Torque (fan cooled standard motors) 2: Inactive	0	
P6.01	Auto Restart after Fault	0 to 10	0	
P6.02	Momentary Power Loss	0: Stop operation after momentary power loss 1: Continue operation after momentary power loss, speed search from Speed Reference 2: Continue operation after momentary power loss, speed search from Minimum Speed	0	
P6.03	Reverse Operation Inhibit	0: Enable Reverse Operation 1: Disable Reverse Operation	0	
P6.04	Auto Voltage Regulation	0: AVR enabled 1: AVR disabled 2: AVR disabled during decel 3: AVR disabled during stop	0	
P6.05	Over-Voltage Trip Prevention	0: Enable Over-voltage Trip Prevention 1: Disable Over-voltage Trip Prevention	0	
P6.06	Auto Adjustable Accel/Decel	0: Linear Accel/Decel 1: Auto Accel, Linear Decel 2: Linear Accel, Auto Decel 3: Auto Accel/Decel 4: Auto Accel/Decel Stall Prevention (limited by P1-01, P1-02, P1-05 and P1-06)	0	
P6.07	Over-Torque Detection Mode	0: Disabled 1: Enabled during constant speed operation 2: Enabled during acceleration	0	
P6.08	Over-Torque Detection Level	30 to 200%	150	
P6.09	Over-Torque Detection Time	0.1 to 10.0	0.1	
P6.10	Over-Current Stall Prevention during Acceleration	0 to 200% (0 = disable)	130	
P6.11	Over-Current Stall Prevention during Operation	0 to 200% (0 = disable)	130	
P6.12	Maximum Allowable Power Loss Time	0.3 to 5.0 sec	2.0	
P6.13	Base-Block Time for Speed Search	0.3 to 5.0 sec	0.5	
P6.14	Maximum Speed Search Current Level	30 to 200%	150	
P6.15	Upper Bound of Output Frequency	0.1 to 400.0Hz	400.0	
P6.16	Lower Bound of Output Frequency	0.0 to 400.0Hz	0.0	
P6.30 *	Line Start Lockout	00: Enable Line Start Lockout 01: Disable Line Start Lockout	00	
P6.31	Present Fault Record	0: No Fault occurred	00	
P6.32	Second Most Recent Fault Record	1: Over-current (oc)	00	
P6.33	Third Most Recent Fault Record	2: Over-voltage (ov)	00	
P6.34	Fourth Most Recent Fault Record	3: Overheat (oH)	00	
P6.35	Fifth Most Recent Fault Record	4: Overload (oL)	00	
P6.36	Sixth Most Recent Fault Record	5: Overload 1 (oL1) 6: Overload 2 (oL2) 7: External Fault (EF) 8: CPU failure 1 (CF1) 9: CPU failure 2 (CF2) 10: CPU failure 3 (CF3) 11: Hardware Protection Failure (HPF) 12: Over-current during accel (OCA) 13: Over-current during decel (OCd) 14: Over-current during steady state (OCn) 18: External Base-Block (bb) 19: Auto Adjust accel/decel failure (cFA) 20: Software protection code (codE)	00	

* This parameter is available only with AC drive firmware v1.07 or higher (refer to P9.39).

Parameter Summary – Display Parameters (P8.xx)				
GS1 Parameter	Description	Range	Default Setting	User Setting
◆ P8.00	User Defined Display Function	0: Output Frequency (Hz) 1: Motor Speed (RPM) 2: Output Freq. x P8.01 3: Output Current (A) 4: Motor Output Current (%) 5: Output Voltage (V) 6: DC Bus Voltage (V) 9: Frequency Setpoint	0	
◆ P8.01	Frequency Scale Factor	0.1 to 160.0	1.0	
◆ Parameter can be set during RUN Mode.				

Parameter Summary – Communications Parameters (P9.xx)				
GS1 Parameter	Description	Range	Default Setting	User Setting
P9.00	Communication Address	1 to 254	1	
P9.01	Transmission Speed	0: 4800 baud 1: 9600 baud 2: 19200 baud	1	
P9.02	Communication Protocol	0: MODBUS ASCII mode, 7 data bits, no parity, 2 stop bits 1: MODBUS ASCII mode, 7 data bits, even parity, 1 stop bit 2: MODBUS ASCII mode, 7 data bits, odd parity, 1 stop bit 3: MODBUS RTU mode, 8 data bits, no parity, 2 stop bits 4: MODBUS RTU mode, 8 data bits, even parity, 1 stop bit 5: MODBUS RTU mode, 8 data bits, odd parity, 1 stop bit	0	
P9.03	Transmission Fault Treatment	0: Display fault and continue operating 1: Display fault and RAMP to stop 2: Display fault and COAST to stop 3: No fault displayed and continue operating	0	
P9.04	Time Out Detection	0: Disable 1: Enable	0	
P9.05	Time Out Duration	0.1 to 60.0 seconds	0.5	
◆ P9.07	Parameter Lock	0: All parameters can be set and read 1: All parameters are read-only	0	
P9.08	Restore to Default	99: Restores all parameters to factory defaults	0	
◆ P9.11	Block Transfer Parameter 1	Parameters 0.00 to 8.01, 9.99	9.99	
◆ P9.12	Block Transfer Parameter 2	Parameters 0.00 to 8.01, 9.99	9.99	
◆ P9.13	Block Transfer Parameter 3	Parameters 0.00 to 8.01, 9.99	9.99	
◆ P9.14	Block Transfer Parameter 4	Parameters 0.00 to 8.01, 9.99	9.99	
◆ P9.15	Block Transfer Parameter 5	Parameters 0.00 to 8.01, 9.99	9.99	
◆ P9.16	Block Transfer Parameter 6	Parameters 0.00 to 8.01, 9.99	9.99	
◆ P9.17	Block Transfer Parameter 7	Parameters 0.00 to 8.01, 9.99	9.99	
◆ P9.18	Block Transfer Parameter 8	Parameters 0.00 to 8.01, 9.99	9.99	
◆ P9.19	Block Transfer Parameter 9	Parameters 0.00 to 8.01, 9.99	9.99	
◆ P9.20	Block Transfer Parameter 10	Parameters 0.00 to 8.01, 9.99	9.99	
◆ P9.26	Serial Comm Speed Reference	0.0 to 400.0 Hz	60.0	
◆ P9.27	Serial Comm RUN Command	0: Stop 1: Run	0	
◆ P9.28	Serial Comm Direction Command	0: Forward 1: Reverse	0	
◆ P9.29	Serial Comm External Fault	0: No fault 1: External fault	0	
◆ P9.30	Serial Comm Fault Reset	0: No action 1: Fault Reset	0	
◆ P9.31	Serial Comm JOG Command	0: Stop 1: Jog	0	
P9.39 *	Firmware Version	#.#.#	#.#.#	
P9.41	GS Series Number	1: GS1 2: GS2 3: GS3 4: GS4	##	
P9.42	Manufacturer Model Information	0: GS1-10P2 (120V, 1ph, 0.25HP) 1: GS1-10P5 (120V, 1ph, 0.5HP) 2: GS1-20P2 (230V, 1ph/3ph, 0.25HP) 3: GS1-20P5 (230V, 1ph/3ph, 0.5HP) 4: GS1-21P0 (230V, 1ph/3ph, 1HP) 5: GS1-22P0 (230V, 3ph, 2HP)	##	
* This parameter is available only with AC drive firmware v1.07 or higher.				
◆ Parameter can be set during RUN Mode.				

GS1 DETAILED PARAMETER LISTINGS

EXPLANATION OF PARAMETER DETAILS FORMAT

Px.xx	Parameter Name	Range: xxx	Default: xxx
	This parameter...		
	Where:		
	<ul style="list-style-type: none"> Px.xx = the parameter number Parameter Name = the descriptive name of the parameter 		
	 If the diamond symbol (◆) appears next to the parameter name, the parameter can be edited when the AC drive is in RUN Mode.		
	<ul style="list-style-type: none"> Range = the range or listing of the possible parameter settings Default = the factory default setting of the parameter This parameter... = an explanation of the parameter function 		

MOTOR PARAMETERS

P0.00	Motor Nameplate Voltage	Range: 115/230V series: 200/208/220/230/240	Default Setting: 240
	This parameter determines the Maximum Output Voltage of the AC drive. The Maximum Output Voltage setting must be less than or equal to the rated voltage of the motor as indicated on the motor nameplate. The setting value must be equal to or greater than the Mid-Point Voltage (P2.05).		
P0.01	Motor Nameplate Amps	Range: Drive Rated Amps x 0.3 to Drive Rated Amps x 1.0	Default Setting: Drive Rating (A)
	This parameter sets the output current to the motor. The value is determined by the value found on the motor nameplate.		
P0.02	Motor Base Frequency	Range: 50/60/400	Default Setting: 60
	This value should be set according to the base frequency of the motor as indicated on the motor nameplate. It sets the Maximum Voltage Frequency and determines the volts per hertz ratio.		
P0.03	Motor Base RPM	Range: 375 to 9999 rpm	Default Setting: 1750
	This value should be set according to rated Base RPM of the motor as indicated on the motor nameplate.		
P0.04	Motor Maximum RPM	Range: P0.03 to 9999 rpm	Default Setting: P0.03
	<ul style="list-style-type: none"> This value should be set according to the <u>desired</u> maximum speed of the motor. This value cannot be set lower than Motor Base RPM (P0.03). 		
	 WARNING: THE MOTOR MAXIMUM RPM PARAMETER (P0.04) SHOULD NEVER EXCEED THE MAXIMUM SAFE RPM RATING FOR THE MOTOR YOU ARE USING. IF THIS INFORMATION IS NOT READILY AVAILABLE, CONSULT YOUR MOTOR MANUFACTURER.		

This parameter, along with P 0.02 and P 0.03, determines the *desired* Maximum Output Frequency of the AC Drive. The Maximum Output Frequency can be calculated as follows:

- Max. Out. Freq. = (P0.04 Motor Max. RPM ÷ P0.03 Motor Base RPM) x (P0.02 Motor Base Freq.)

If an output limit based on Maximum Output Frequency is desired, use the following equation to determine the corresponding value for Motor Maximum RPM:

- P0.04 Motor Max. RPM = (Max. Out. Freq. ÷ P0.02 Motor Base Freq.) x (P0.03 Motor Base RPM)

RAMP PARAMETERS

P1.00 Stop Methods

Settings: 0 Ramp to Stop
1 Coast to stop

Default Setting: 0

This parameter determines how the motor is stopped when the AC drive receives a valid stop command.

- **Ramp:** The AC drive decelerates the motor to Minimum Output Frequency (P2.06) according to the deceleration time set in P1.02 or P1.06.
- **Coast:** The AC drive stops output instantly upon command, and the motor free runs until it comes to a complete stop.



The drive application or system requirements will determine which stop method is needed.

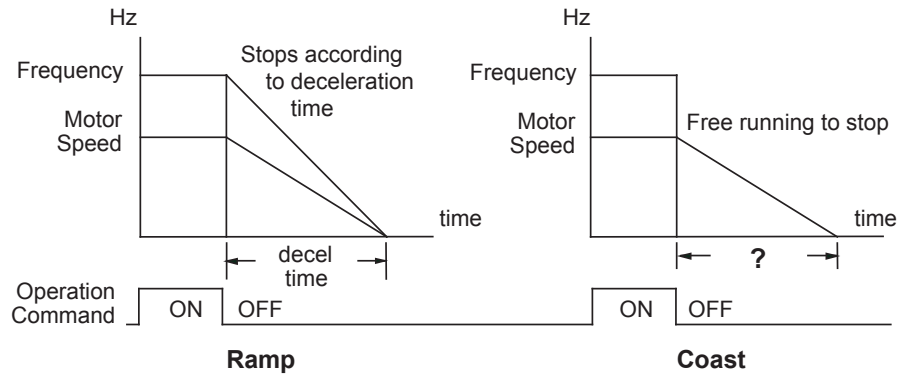

P1.01 Acceleration Time 1

Range: 0.1 to 600.0 sec

Default Setting: 10 sec

This parameter is used to determine the rate of acceleration for the AC drive to reach Maximum Motor RPM (P0.04). The rate is linear unless Accel S-Curve (P1.03) is "Enabled."

P1.02 Deceleration Time 1

Range: 0.1 to 600.0 sec

Default Setting: 30.0 sec

This parameter is used to determine the time required for the AC drive to decelerate from the Maximum Motor RPM (P0.04) down to 0Hz. The rate is linear unless Decel S-Curve (P1.04) is "Enabled."



Bus over-voltage trips may be caused by motor regeneration during rapid deceleration. If this tripping occurs, increase the deceleration time.

P1.03 Accel S-Curve

P1.04 Decel S-Curve

Range: 0 to 7

Default Setting: 0

Parameter P1.03 is used whenever the motor and load need to be accelerated more smoothly. The Accel S-Curve may be set from 0 to 7 to select the desired acceleration S Curve.

Parameter P1.04 is used whenever the motor and load need to be decelerated more smoothly. The Decel S-Curve may be set from 0 to 7 to select the desired deceleration S-Curve.



From the diagrams shown below, the original setting accel/decel time will be for reference when the function of the S-curve is enabled. The actual accel/decel time will be determined based on the S-curve selected (1 to 7).

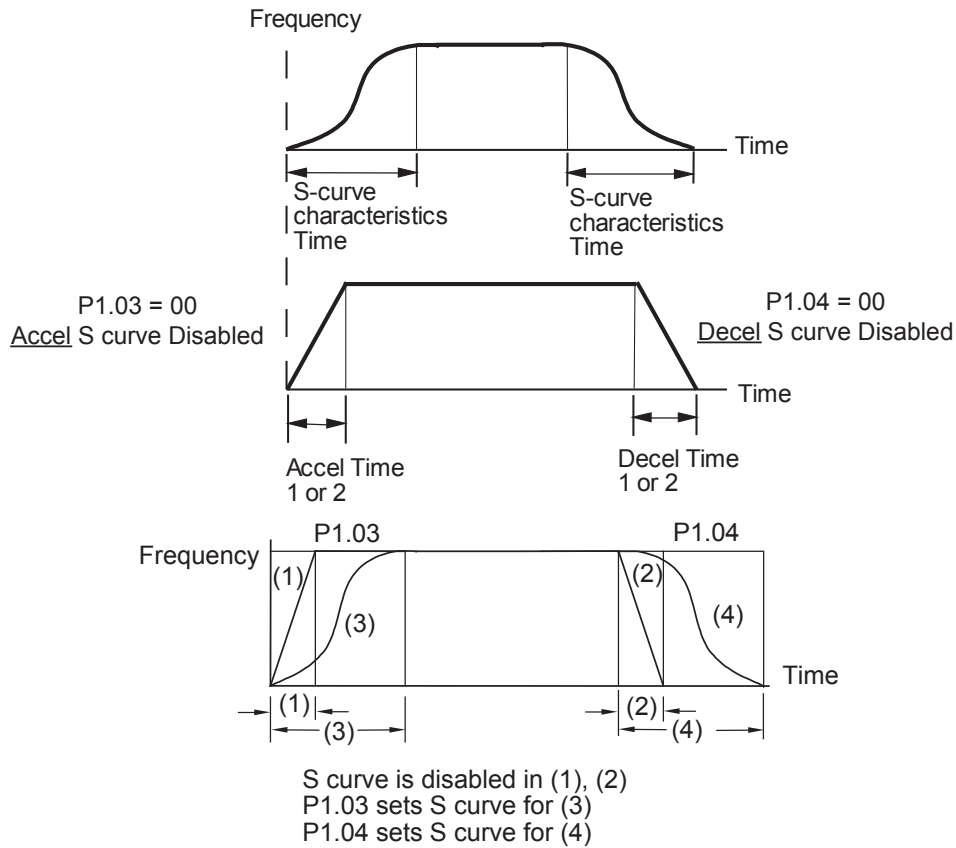

P1.05 Acceleration Time 2

Range: 0.1 to 600.0 sec

Default Setting: 10.0

The Second Acceleration Time determines the time for the AC drive to accelerate from 0 rpm to Maximum Motor RPM (P0.04). Acceleration Time 2 (P1.05) can be selected using a multi-function input terminal or frequency transition (P1.07).

P1.06 Deceleration Time 2

Range: 0.1 to 600.0 sec

Default Setting: 30.0

The Second Deceleration Time determines the time for the AC drive to decelerate from Maximum Motor RPM (P0.04) to 0 rpm. Deceleration Time 2 (P1.06) can be selected using a multi-function input terminal or frequency transition (P1.07).

P1.07 Select method for 2nd Accel/Decel

Range: 0: Second Accel/Decel from terminal
1: Frequency Transition P1.08 & P1.09

Default Setting: 0

The second set of acceleration and deceleration times P1.05 and P1.06 can be selected either with a multi-function input terminal programmed to Second Accel/Decel, or by the values of the transition frequencies P1.08 and P1.09.

Refer to diagrams following P1.08 and P1.09.

P1.08 Accel 1 to Accel 2 Frequency Transition

P1.09 Decel 1 to Decel 2 Frequency Transition

Range: 0.0 to 400.0 Hz

Default Setting: 0.0

Second Accel/Decel Times selected with Multi-Function Input Terminal

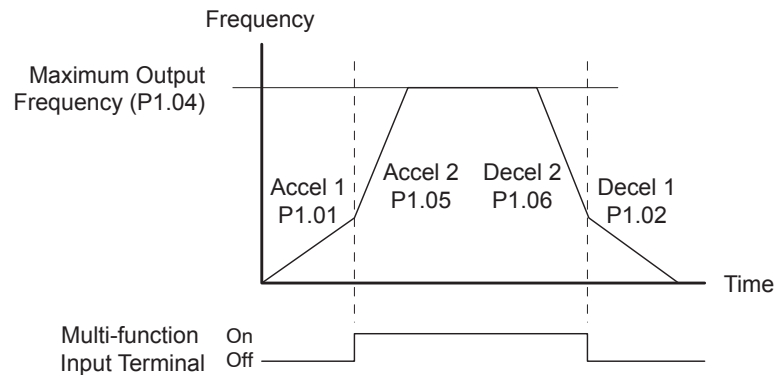

Second Accel/Decel Times selected with Frequency Transition

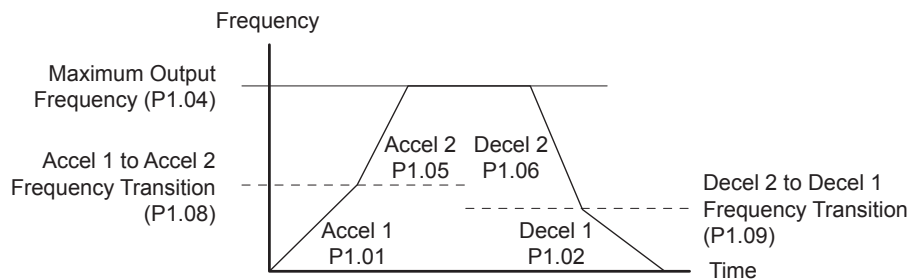

P1.10 Skip Frequency 1

P1.11 Skip Frequency 2

P1.12 Skip Frequency 3

Range: 0.0 to 400.0Hz

Default Setting: 0.0

P1.10, P1.11, and P1.12 determine the location of the frequency bands that will be skipped during AC drive operation.

P1.17 Skip Frequency Band

Range: 0.0 to 20.0 Hz

Default Setting: 0.0

This parameter determines the frequency band for a given Skip Frequency (P1.10, P1.11, or P1.12). Half of the Skip Frequency Band is above the Skip Frequency and the other half is below.

Setting this parameter to 0.0 disables all skip frequencies.

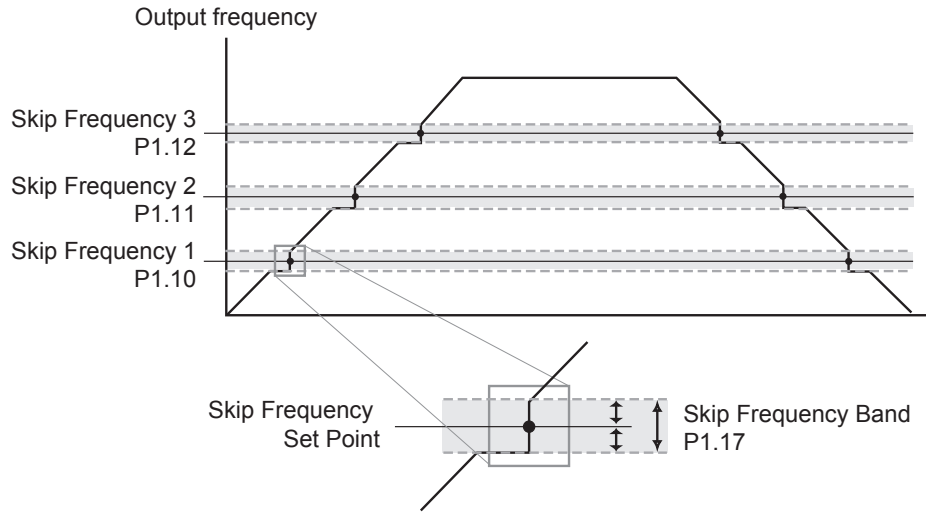

P1.19 DC Injection Voltage Level

Range: 0 to 30%

Default Setting: 0

This parameter determines the amount of DC Braking Voltage applied to the motor during start-up and stopping. When setting DC Braking Voltage, please note that the setting is a percentage of the rated voltage of the drive. It is recommended to start with a low DC Braking Voltage Level and then increase until proper holding torque has been attained.

P1.20 DC Injection during Start-up

Range: 0.0 to 5.0 sec

Default Setting: 0.0

This parameter determines the duration of time that the DC Braking Voltage will be applied to the motor during the AC drive start-up. DC Braking will be applied for the time set in this parameter until the Minimum Frequency is reached during acceleration.

P1.21 DC Injection during Stopping

Range: 0.0 to 25.0 sec

Default Setting: 0.0

This parameter determines the duration of time that the DC braking voltage will be applied to the motor during stopping. If stopping with DC Braking is desired, then P1.00 must be set to Ramp to Stop (00).

P1.22 Start-point for DC Injection

Range: 0.0 to 60.0 Hz

Default Setting: 0.0

This parameter determines the frequency at which DC Braking will begin during deceleration.

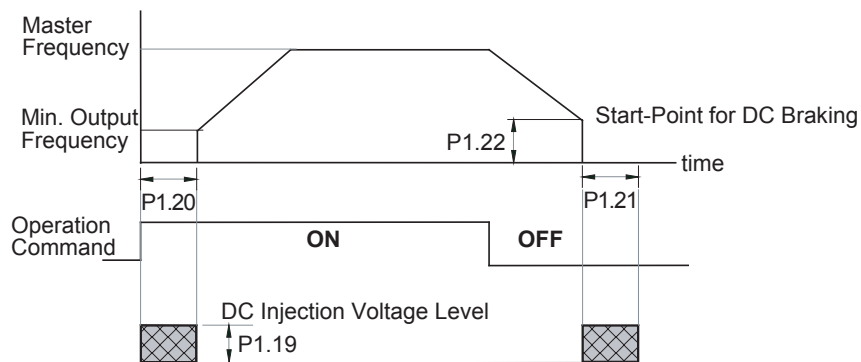

VOLTS/HERTZ PARAMETERS

P2.00 Volts/Hertz Settings

- Settings: 0 - General Purpose (constant torque)
 1 - High Starting Torque
 2 - Fans and Pumps (variable torque)
 3 - Custom

Default Setting: 0



P2.04 through P2.07 are only used when the Volts/Hertz parameter (P2.00) is set to 3.

P2.00 = 0: General Purpose (constant torque)

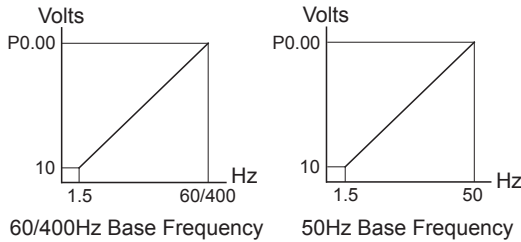

P2.00 = 1: High Starting Torque

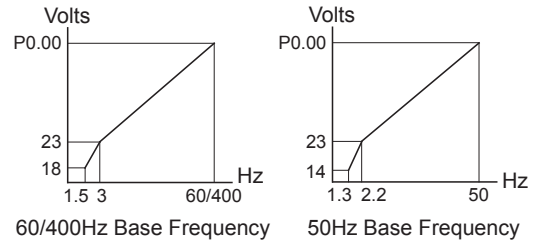

P2.00 = 2: Fans and Pumps (variable torque)

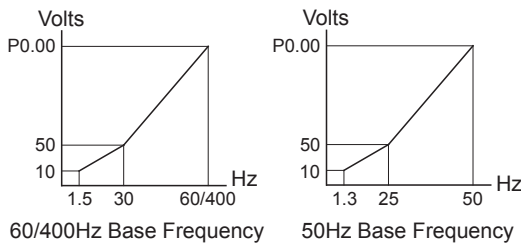

P2.00 = 3: Custom

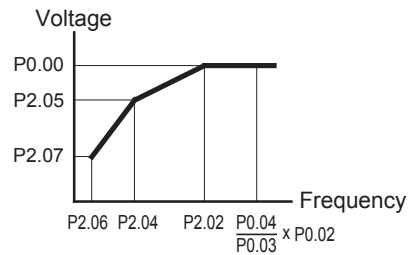

P2.01 ♦ Slip Compensation

Range: 0.0 to 10.0

Default Setting: 0.0

When controlling an asynchronous induction motor, an increase in load on the motor will result in an increase in slip within the motor. This parameter may be used to compensate the nominal slip within a range of 0 to 10. When the output current of the AC drive is greater than 40% of the Motor Nameplate Amps (P0.01), the AC drive will adjust its output frequency according to this parameter.

P2.03 ♦ Manual Torque Boost

Range: 0 to 10%

Default Setting: 1

This parameter provides a gain that increases the output voltage command to enhance output torque.



P2.04 through P2.07 are used only when the Volts/Hertz parameter (P2.00) is set to 3.

P2.04 Mid-point Frequency

Range: 1.0 to 400 Hz

Default Setting: 1.5

This parameter sets the Mid-Point Frequency of V/F curve. With this setting, the V/F ratio between Minimum Frequency and Mid-Point frequency can be determined.

- This parameter must be greater than or equal to the Minimum Output Frequency (P2.06), and less than or equal to the Maximum Voltage Frequency (P0.02).
- This parameter is active only if Volts/Hertz Settings (P2.00) is set to 3.

P2.05 Mid-point Voltage

Range: 2.0 to 255.0V

Default Setting: 10.0

This parameter sets the Mid-Point Voltage of any V/F curve. With this setting, the V/F ratio between Minimum Frequency and Mid-Point Frequency can be determined.

- This parameter must be equal to or greater than the Minimum Output Voltage (P2.07), and equal to or less than the Maximum Output Voltage (P0.00).
- This parameter is active only if Volts/Hertz Settings (P2.00) is set to 3.

P2.06 Minimum Output Frequency

Range: 1.0 to 20.0 Hz

Default Setting: 1.5

This parameter sets the Minimum Output Frequency of the AC drive.

- This parameter must be less than or equal to the Mid-Point Frequency (P2.04).
- This parameter is active only if Volts/Hertz Settings (P2.00) is set to 3.

P2.07 Minimum Output Voltage

Range: 2.0 to 50.0V

Default Setting: 10.0

This parameter sets the Minimum Output Voltage of the AC drive.

- This parameter must be equal to or less than Mid-Point Voltage (P2.05).
- This parameter is active only if Volts/Hertz Settings (P2.00) is set to 3.

P2.08 PWM Carrier Frequency

Range: 3 to 10 kHz

Default Setting: 10

This parameter sets the carrier frequency of PWM (Pulse-Width Modulated) output.

The table below shows that the carrier frequency of PWM output has a significant influence on the electromagnetic noise, leakage current, heat dissipation of the AC drive, and the acoustic noise to the motor.

Carrier Frequency	Acoustic Noise	Electromagnetic Noise, Leakage Current	Heat Dissipation
3kHz	significant	minimal	minimal
10kHz	minimal	moderate	moderate

DIGITAL PARAMETERS

P3.00 Source of Operation Command

Settings:

Default Setting: 0

- 0 – Operation Determined by Digital Keypad.
- 1 – Operation determined by external control terminals. Keypad STOP is enabled.
- 2 – Operation determined by external control terminals. Keypad STOP is disabled.
- 3 – Operation determined by RS-485 interface. Keypad STOP is enabled.
- 4 – Operation determined by RS-485 interface. Keypad STOP is disabled.

This parameter sets the input source for the AC drive operation commands.

- Refer to P3.01 and P3.03 for more details.

P3.01 Multi-function Inputs 1 & 2 (DI1-DI2)

Settings:

Default Setting: 0

- 0 – DI1 = FWD/STOP
DI2 = REV/STOP
- 1 – DI1 = RUN/STOP
DI2 = REV/FWD
- 2 – DI1 = RUN (N.O. latching input)
DI2 = REV/FWD
DI3 = STOP (N.C. latching input)



Multi-function Input Terminals DI1 and DI2 do not have separate parameter designations. DI1 and DI2 must be used in conjunction with each other to operate two and three wire control.

P3.01: Setting 0

DI1	DI2	Result
OFF	OFF	STOP
ON	OFF	FWD
OFF	ON	REV
ON	ON	STOP

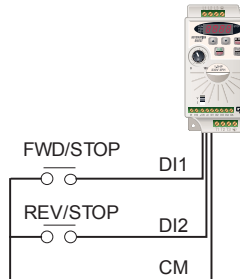

P3.01: Setting 1

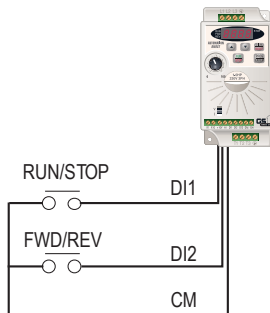

DI1- RUN/STOP select
"Open" : Stop
"Close" : Run
DI2- FWD/REV select
"Open" : FWD
"Close" : REV

P3.01: Setting 2

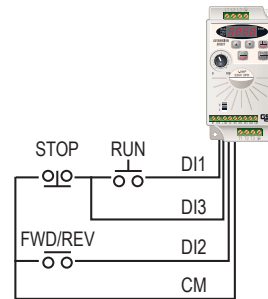

DI1- RUN command
Latching input (N.O.)
Runs when closed
DI2- FWD/REV select
"Open" : FWD
"Close" : REV
DI3- STOP command
Latching input (N.C.)
Stops when open

The external STOP and RUN pushbuttons are momentary.
The circuit latches as does a typical 3-wire control circuit.

P3.02 Multi-Function Input 3 (DI3)

Default Setting: 0

P3.03 Multi-Function Input 4 (DI4)

Default Setting: 3

- Settings:**
- 0 – External Fault (N.O.)
 - 1 – External Fault (N.C.)
 - 2 – External Reset
 - 3 – Multi-Speed Bit 1
 - 4 – Multi-Speed Bit 2
 - 9 – Jog
 - 10 – External Base Block (N.O.)
 - 11 – External Base Block (N.C.)
 - 12 – Second Accel/Decel Time
 - 13 – Speed Hold
 - 14 – Increase Speed (P4.00 must be set to 1)
 - 15 – Decrease Speed (P4.00 must be set to 1)
 - 16 – Reset Speed to Zero (P4.00 must be set to 1)
 - 99 – Input Disable

SETTING EXPLANATIONS FOR PARAMETERS P3.02 AND P3.03

Setting 0: External Fault (N.O.)

When an External Fault input signal is received, the AC drive output will turn off, the drive will display "EF" on the LED Display, and the motor will Coast to Stop. To resume normal operation, the external fault must be cleared, and the drive must be reset.

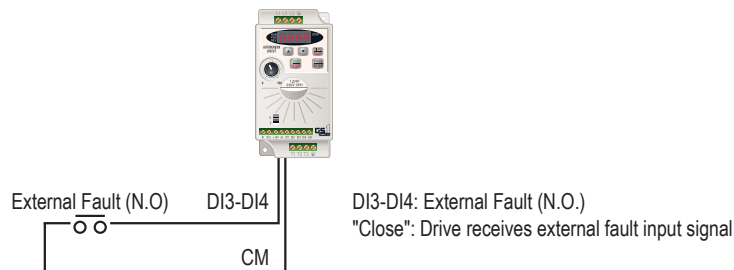

Setting 1: External Fault (N.C.)

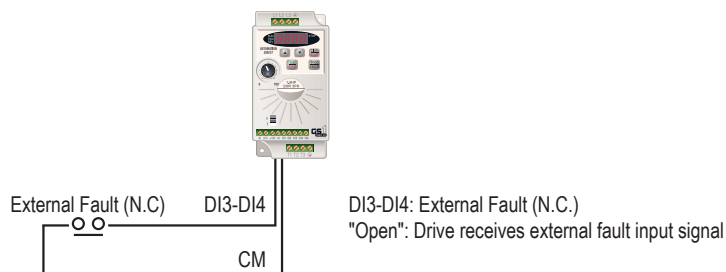

Setting 2: External Reset

An External Reset has the same function as the Reset key on the digital keypad. Use an External Reset to reset the drive after a fault.

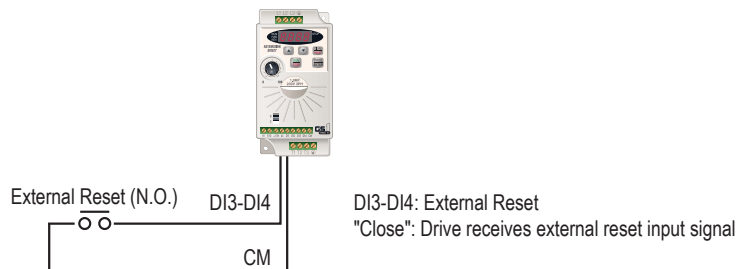

Settings 3 and 4: Multi-Speed Bits 1 and 2

The three Multi-Speed Bits are used to select the multi-speed settings defined by parameters P5.01 to P5.03. (DI3 or DI4 can be assigned as Multi-Speed Bit 1 or as Multi-Speed Bit 2.)

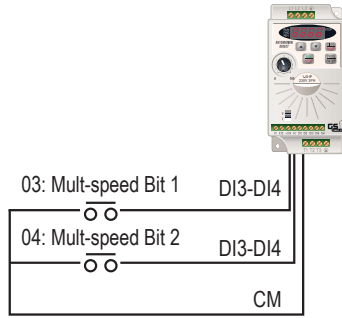

Multi-Speed Bits		Speed Selection
Bit 2	Bit 1	
OFF	OFF	P4.00: Source of Frequency
OFF	ON	P5.01: Multi-Speed 1
ON	OFF	P5.02: Multi-Speed 2
ON	ON	P5.03: Multi-Speed 3



In order to use the Multi-Speed settings, parameters P5.01 to P5.03 must be set.



When all multi-speed inputs are off, the AC drive reverts back to the Command Frequency (P4.00).

Setting 9: Jog Command

This setting configures a Multi-function Input Terminal to give the Jog Command when activated. P5.00 sets the Jog Speed.

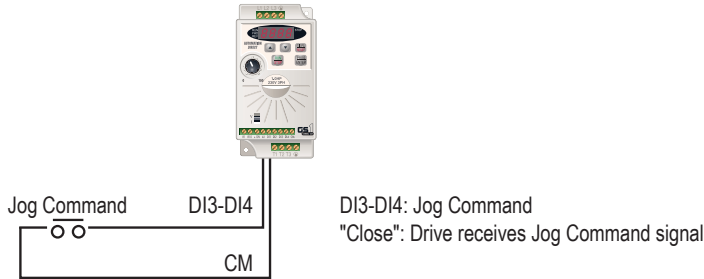

The Jog Command cannot be used when the motor is running. The motor must be stopped to initiate this command.

Setting 10 and 11: External Base Block (N.O.) and External Base Block (N.C.)

Value 10 is for a normally open (N.O) input and value 11 is for a normally closed (N.C.) input.

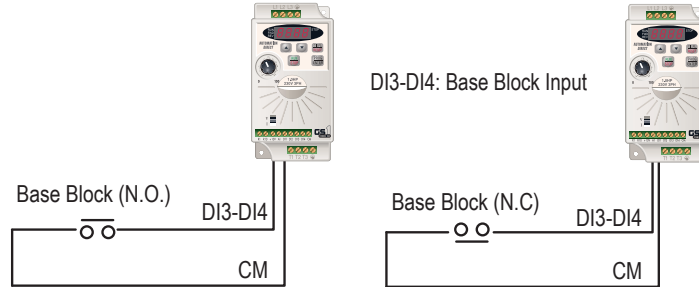

When an External Base Block is activated, the LED display shows "bb", the AC drive stops all output, and the motor will free run.

When the External Base Block is deactivated, the AC drive will start the speed search function and synchronize with the motor speed. The AC drive will then accelerate to the Master Frequency.

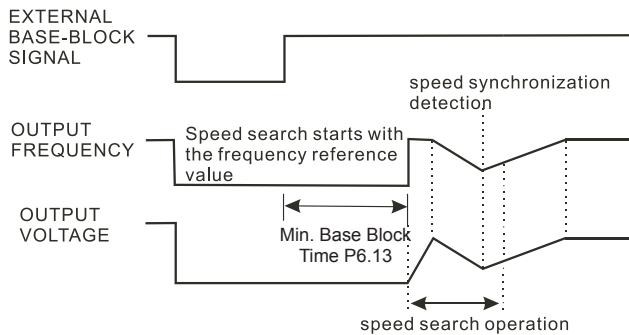

Refer also to P6.13 (Base-Block Time for Speed Search) and P6.14 (Maximum Speed Search Current Level).

Setting 12: Second Accel/Decel Time

Multi-function Input Terminals DI3 and DI4 can be set to select between Accel/Decel times 1 and 2. Parameters 1.01 and 1.02 set times for Accel 1 and Decel 1, and parameters 1.05 and 1.06 set times for Accel 2 and Decel 2.

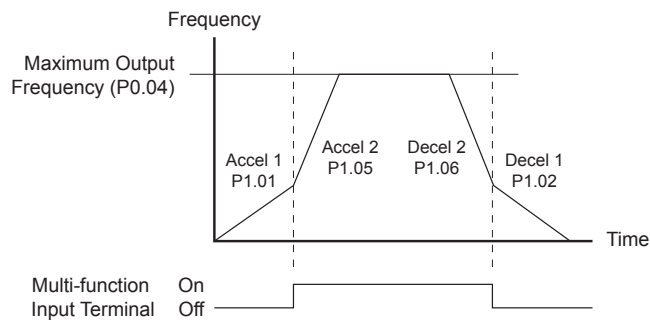
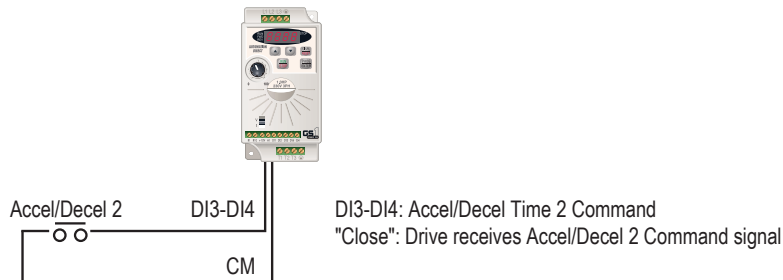

Setting 13: Speed Hold

When the Speed Hold command is received, the drive acceleration or deceleration is stopped and the drive maintains a constant speed.

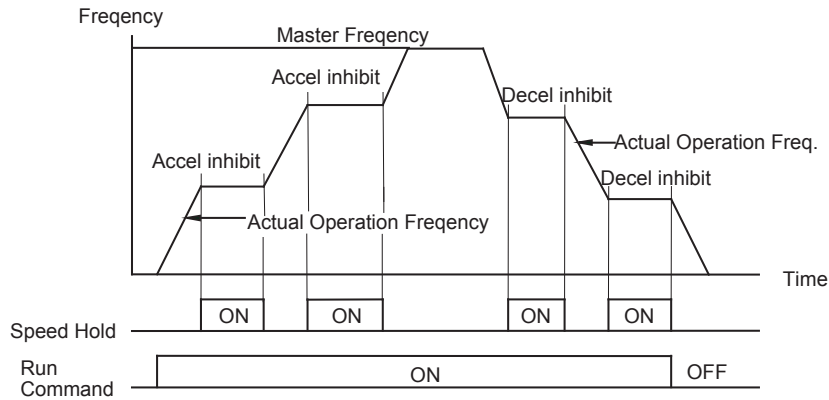

Settings 14 and 15: Increase and Decrease Speed (Electronic Motor Operated Potentiometer)

Settings 14 and 15 allow the Multi-function terminals to be used to increase or decrease speed incrementally. The Master Frequency will increase/decrease by one unit each time an increase/decrease speed input is received.

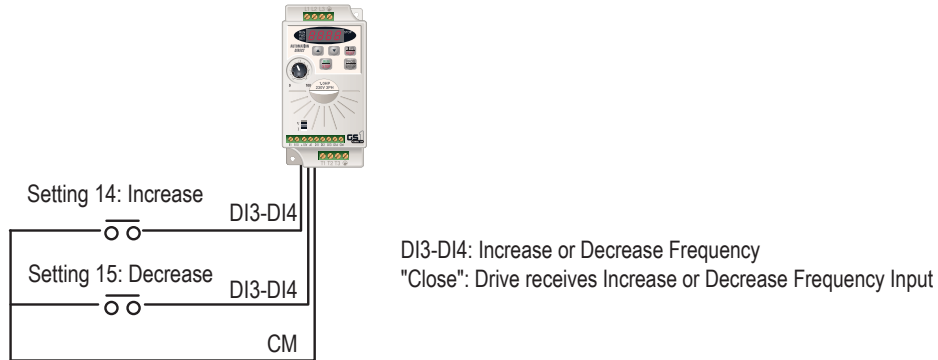

In order to use these settings, P4.00 must be set to 1.

Setting 16: Reset Speed to Zero

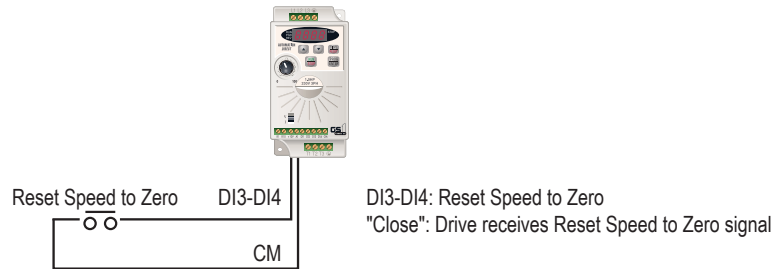

Setting 99: Multi-Function Input Disable

Setting a Multi-Function Input to 99 will disable that input. The purpose of this function is to provide isolation for unused Multi-Function Input Terminals. Any unused terminals should be programmed to 99 to make sure they have no effect on drive operation.



Any unused terminals should be programmed to 99 to make sure that they have no effect on drive operation.

P3.11 Multi-function Output Terminal

Settings:

Default Setting: 0

- 0: AC Drive Running
The terminal will be activated when there is an output from the drive.
- 1: AC Drive Fault
The terminal will be activated when one of the faults listed under parameters P6.31 through P6.36 occurs.
- 2: At Speed
The terminal will be activated when the AC drive attains the Command Frequency (P4.00).
- 3: Zero Speed
The output will be activated when Command Frequency (P4.00) is lower than the Minimum Output Frequency (P2.06).
- 4: Above Desired Frequency
The output will be activated when the AC drive is above the Desired Frequency (P3.16).
- 5: Below Desired Frequency
The output will be activated when the AC drive is below the Desired Frequency (P3.16).
- 6: At Maximum Speed
The output will be activated when the AC drive reaches Motor Maximum RPM (P0.04).
- 7: Over Torque Detected
The output will be activated when the AC drive reaches the Over-torque Detection Level (P6.08) and exceeds this level for a time greater than the Over-torque Detection Time (P6.09).
- 8: Above Desired Current
The output will be activated when the AC drive is above the Desired Current (P3.17).
- 9: Below Desired Current
The output will be activated when the AC drive is below the Desired Current (P3.17).

P3.16 ♦ Desired Frequency

Range: 0.0 to 400.0Hz

Default Setting: 0.0

If the Multi-function output terminal is set to function as Desired Frequency Attained (P3.11 = 04 or 05), then the output will be activated when the programmed frequency is attained.

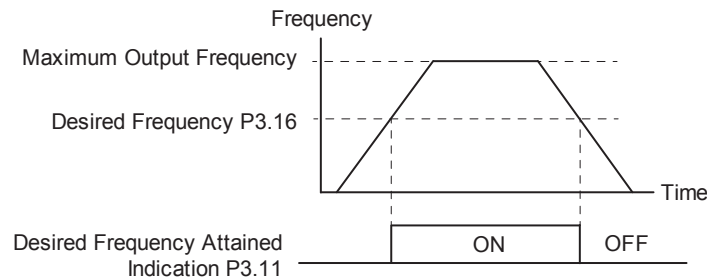

- $Max. Out. Freq. = (P0.04 Motor Max. RPM \div P0.03 Motor Base RPM) \times (P0.02 Motor Base Freq.)$

P3.17 ♦ Desired Current

Range: 0.0 to <Drive Rated Amps>

Default Setting: 0.0

If the Multi-function output terminal is set to function as Desired Current Attained (P3.11 = 08 or 09), then the output will be activated when the programmed current is attained.

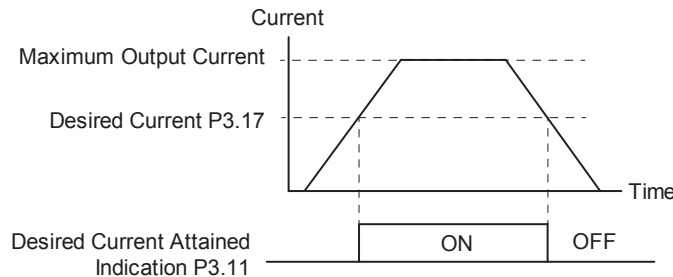

ANALOG PARAMETERS**P4.00 Source of Frequency Command**Settings:Default Setting: 0

- 0 – Frequency determined by keypad potentiometer.
- 1 – Frequency determined by digital keypad up/down.
- 2 – Frequency determined by 0 to +10V input on AI terminal. (*Analog input switch must be set to "V."*)



← **AI switch must be set to "V" in order to use a 0 to +10V input.**

- 3 – Frequency determined by 4 to 20mA input on AI terminal. (*Analog input switch must be set to "I."*)



← **AI switch must be set to "I" in order to use a 4 to 20mA input.**

- 4 – Frequency determined by 0 to 20mA input on AI terminal. (*Analog input switch must be set to "I."*)



← **AI switch must be set to "I" in order to use a 0 to 20mA input.**

- 5 – Frequency determined by RS-485 communication interface.



When configured for "Frequency determined by digital keypad Up/Down, the drive will reset the commanded frequency to zero hertz on a power cycle. This happens only if the drive faults when it powers down (if its running when it loses power). If the drive is stopped when it loses power (and doesn't trigger a Low Voltage Fault), the drive will retain the last set speed when powered back up.



P4.01 to P4.04 are used when the source of frequency command is the analog signal (0 to +10VDC, 4 to 20mA, or 0 to 20mA). Refer to the Analog Input Examples later in this section.

P4.01 Analog Input Offset Polarity

Settings: 0 – Offset disabled
 1 – Positive Offset
 2 – Negative Offset

Default Setting: 0

This parameter sets the potentiometer Bias Frequency to be positive or negative.

- The Analog Input Offset calculation will also define the Offset Polarity. See the note after P4.02.
- P4.01 to P4.04 are used when the source of frequency command is the analog signal (0 to +10VDC, 4 to 20mA, or 0 to 20mA).

P4.02 Analog Input Offset

Range: 0.0 to 100%

Default Setting: 0.0

This parameter provides a frequency offset for an analog input.

Use the equation below to determine the Analog Input Offset. For this equation, you will need to know the necessary Minimum and Maximum Frequency References needed for your application.



The result of the Analog Input Offset calculation will also define the Analog Input Offset Polarity (P4.01). A positive answer means you should have a positive offset. A negative answer means you should have a negative offset.

- $\text{Analog Offset \%} = (\text{Min Frequency Reference} \div \text{Max Frequency Reference}) \times 100$
- P4.01 to P4.04 are used when the source of frequency command is the analog signal (0 to +10VDC, 4 to 20mA, or 0 to 20mA).

P4.03 Analog Input Gain

Range: 0.0 to 300.0%

Default Setting: 100.0

This parameter sets the ratio of analog input vs frequency output.

Use the equation below to calculate the Analog Input Gain. For this equation, you will need to know the minimum and maximum set-point frequencies needed for your application.

- $\text{Analog Gain \%} = ((\text{Max Frequency Ref} - \text{Min Frequency Ref}) \div \text{Max Output Frequency}) \times 100$
- P4.01 to P4.04 are used when the source of frequency command is the analog signal (0 to +10VDC, 4 to 20mA, or 0 to 20mA).

P4.04 Analog Input Reverse Motion Enable

Settings: 0 – Forward Motion Only
 1 – Reverse Motion Enable

Default Setting: 0

- P4.01 to P4.04 are used when the source of frequency command is the analog signal (0 to +10VDC, 4 to 20mA, or 0 to 20mA).

P4.05 Loss of ACI Signal (4–20mA)

Settings: 0 – Decelerate to 0Hz
 1 – Stop immediately and display “EF”
 2 – Continue operation by the last frequency command

Default Setting: 0

This parameter determines the operation of the drive when the ACI frequency command is lost.

ANALOG INPUT EXAMPLES

Use the equations below when calculating the values for the maximum output frequency, Analog Input Offset, Analog Input Gain, and the Mid-point frequency.

A) Max output frequency =
 $(P0.04 \text{ Motor Max RPM} \div P0.03 \text{ Motor Base RPM}) \times (P0.02 \text{ Motor Base Frequency})$



This maximum output frequency calculation is NOT a parameter setting, but is needed in order to calculate the Analog Gain. The default maximum output frequency for the GS1 drive is 60Hz. If parameters P0.02, P0.03, or P0.04 are changed, then the maximum output frequency will change accordingly.

B) $P4.02 \text{ Analog Offset \%} = (\text{min frequency reference} \div \text{max frequency reference}) \times 100$

C) $P4.03 \text{ Analog Gain \%} = ((\text{max frequency reference} - \text{min frequency ref}) \div \text{max output frequency}) \times 100$

D) $\text{Mid-point frequency} = ((\text{max frequency reference} - \text{min frequency ref}) \div 2) + \text{min frequency reference}$



This mid-point frequency calculation is NOT a parameter setting, but it shows the frequency reference of the drive when the potentiometer or other analog device is at its mid-point.

EXAMPLE 1: STANDARD OPERATION

This example illustrates the default operation of the drive. The example is given to further illustrate the use of the analog calculations. The full range of the analog input signal corresponds to the full forward frequency range of the AC drive.

- Minimum frequency reference = 0Hz
- Maximum frequency reference = 60Hz

Calculations

- A) $\text{Max output frequency} = (1750\text{rpm} \div 1750\text{rpm}) \times (60\text{Hz}) = 60\text{Hz}$
- B) $P4.02 \text{ Analog Offset \%} = (0\text{Hz} \div 60\text{Hz}) \times 100 = 0\%$
- C) $P4.03 \text{ Analog Gain \%} = ((60\text{Hz} - 0\text{Hz}) \div 60\text{Hz}) \times 100 = 100\%$
- D) $\text{Mid-point frequency} = ((60\text{Hz} - 0\text{Hz}) \div 2) + 0\text{Hz} = 30\text{Hz}$

Parameter Settings

- P4.01: 00 (default) [Offset disabled]
- P4.02: 00 (default) [0% Analog Input Offset]
- P4.03: 100 (default) [100% Analog Input Gain]
- P4.04: 00 (default) [Forward Motion Only]

Results

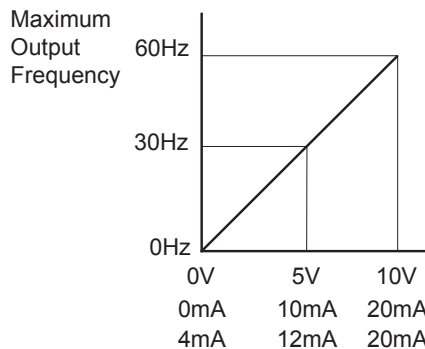

EXAMPLE 2: STANDARD OPERATION WITH INCREASED MAXIMUM OUTPUT FREQUENCY

This example illustrates how to run the motor faster than its base speed. For this purpose, the only required parameter change is P0.04, Motor Maximum RPM. (Motors produce reduced output torque when running above their base speed.)



WARNING: THE MOTOR MAXIMUM RPM PARAMETER (P0.04) SHOULD NEVER EXCEED THE MAXIMUM SPEED RATING FOR THE MOTOR YOU ARE USING. IF THIS INFORMATION IS NOT READILY AVAILABLE, CONSULT YOUR MOTOR MANUFACTURER.

The analog input adjustment parameters P4.01 through P4.04 can remain defaulted, as determined by the analog input calculations shown below. The increased Maximum Output Frequency can be obtained regardless of whether the Source of Frequency Command is an analog input or one of the other sources, such as the keypad, RS-485 communication interface, jog, or multi-speed settings.

- Minimum frequency reference = 0Hz
- Maximum frequency reference = 70Hz
- P0.04 Motor Maximum RPM = 2042rpm

Calculations

- A) Max output frequency = $(2042\text{rpm} \div 1750\text{rpm}) \times (60\text{Hz}) = 70\text{Hz}$
- B) Analog Offset % = $(0\text{Hz} \div 70\text{Hz}) \times 100 = 0\%$
- C) Analog Gain % = $((70\text{Hz} - 0\text{Hz}) \div 70\text{Hz}) \times 100 = 100\%$
- D) Mid-point frequency = $((70\text{Hz} - 0\text{Hz}) \div 2) + 0\text{Hz} = 35\text{Hz}$

Parameter Settings

- P0.04: 2042 [2042rpm Motor Maximum RPM]
- P4.01: 00 (default) [Offset disabled]
- P4.02: 00 (default) [0% Analog Input Offset]
- P4.03: 100 (default) [100% Analog Input Gain]
- P4.04: 00 (default) [Forward Motion Only]

Results

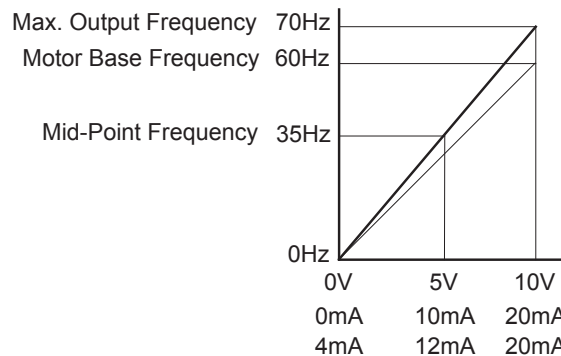

EXAMPLE 3: POSITIVE OFFSET

In this example, the Analog Input will have a positive offset while still using the full scale of the potentiometer or other analog signal device. When the analog signal is at its lowest value (0V, 0mA, or 4mA), the set-point frequency will be at 10Hz. When analog signal is at its maximum value (10V or 20mA), the set-point frequency will be 60Hz.

- Minimum frequency reference = 10Hz
- Maximum frequency reference = 60Hz

Calculations

- A) Max output frequency = (1750rpm ÷ 1750rpm) x (60Hz) = 60Hz
- B) Analog Offset % = (10Hz ÷ 60Hz) x 100 = 16.7%
- C) Analog Gain % = ((60Hz - 10Hz) ÷ 60Hz) x 100 = 83.3%
- D) Mid-point frequency = ((60Hz - 10Hz) ÷ 2) + 10Hz = 35Hz

Parameter Settings

- P4.01: 01 [Positive Input Offset Polarity]
- P4.02: 16.7 [16.7% Analog Input Offset]
- P4.03: 83.3 [83.3% Analog Input Gain]
- P4.04: 00 (default) [Forward Motion Only]

Results

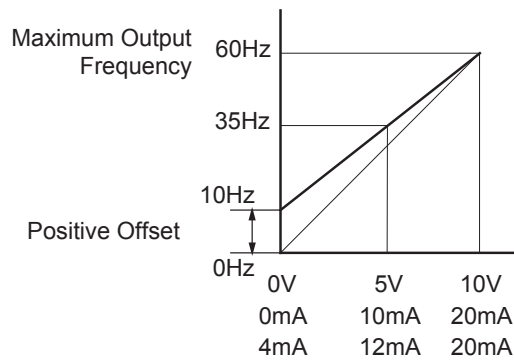

EXAMPLE 4: FORWARD AND REVERSE OPERATION

In this example, the potentiometer (or other analog signal device) is programmed to run a motor full-speed in both forward and reverse directions. The frequency reference will be 0Hz when the potentiometer is positioned at mid-point of its scale. Parameter P4.04 must be set to enable reverse motion.



When calculating the values for the Analog Input using reverse motion, the reverse frequency reference should be shown using a negative (-) number. Pay special attention to signs (+/-) for values representing reverse motion.

- Minimum frequency reference = -60Hz (reverse)
- Maximum frequency reference = 60Hz

Calculations

- A) Max output frequency = (1750rpm ÷ 1750rpm) x (60Hz) = 60Hz
- B) Analog Offset % = (-60Hz ÷ 60Hz) x 100 = -100%



The negative (-) value for the Analog Offset % shows that a negative offset is needed for P4.01.

- C) Analog Gain % = ((60Hz - (-60Hz)) ÷ 60Hz) x 100 = 200%
- D) Mid-point frequency = ((60Hz - (-60Hz)) ÷ 2) + (-60Hz) = 0Hz

Parameter Settings

- P4.01: 02 [Negative Input Offset Polarity]
- P4.02: 100 [100% Analog Input Offset]
- P4.03: 200 [200% Analog Input Gain]
- P4.04: 01 [Reverse Motion Enable]

Results

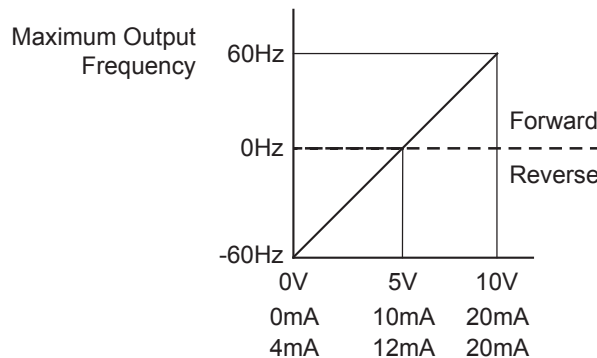

EXAMPLE 5: FORWARD RUN/REVERSE JOG

This example shows an application in which the drive runs full-speed forward and jogs in reverse. The full scale of the potentiometer (or other analog signal device) will be used.



When calculating the values for the Analog Input using reverse motion, the reverse frequency reference should be shown using a negative (-) number. Pay special attention to signs (+/-) for values representing reverse motion.

- Minimum frequency reference = -15Hz (reverse)
- Maximum frequency reference = 60Hz

Calculations

- A) Max output frequency = (1750rpm ÷ 1750rpm) x (60Hz) = 60Hz
- B) Analog Offset % = (-15Hz ÷ 60Hz) x 100 = -25%



The negative (-) value for the Analog Offset % shows that a negative offset is needed for P4.01.

- C) Analog Gain % = ((60Hz - (-15Hz)) ÷ 60Hz) x 100 = 125%
- D) Mid-point frequency = ((60Hz - (-15Hz)) ÷ 2) + (-15Hz) = 22.5Hz

Parameter Settings

- P4.01: 02 [Negative Input Offset Polarity]
- P4.02: 25 [25% Analog Input Offset]
- P4.03: 125 [125% Analog Input Gain]
- P4.04: 01 [Reverse Motion Enable]

Results

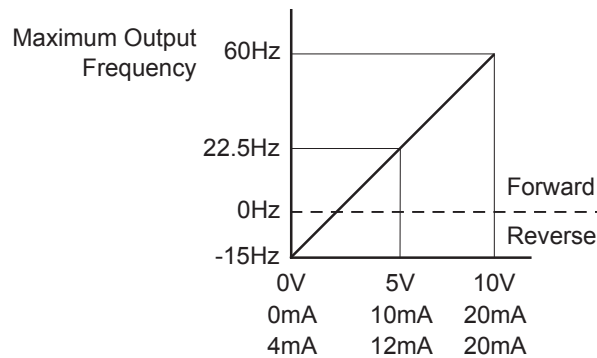

EXAMPLE 6: REDUCED ANALOG GAIN

This example shows how to limit the Maximum Frequency Reference by reducing the Analog Input Gain. When the Analog Input is at its maximum value (10V or 20mA), the set-point frequency will be 50Hz. However, this reduced maximum frequency applies only to an Analog Input Source of Frequency Command. The Maximum Output Frequency can still go to 60Hz if controlled from the Keypad, RS-485 interface, Jog Command, or Multi-Speed settings.

- *Minimum frequency reference = 0Hz*
- *Maximum frequency reference = 50Hz*

Calculations

- A) Max output frequency = (1750rpm ÷ 1750rpm) x (60Hz) = 60Hz
- B) Analog Offset % = (0Hz ÷ 50Hz) x 100 = 0%
- C) Analog Gain % = ((50Hz - 0Hz) ÷ 60Hz) x 100 = 83.3%
- D) Mid-point frequency = ((50Hz - 0Hz) ÷ 2) + (0Hz) = 25Hz

Parameter Settings

- *P4.01: 00 (default) [Negative Input Offset Polarity]*
- *P4.02: 00 (default) [0% Analog Input Offset]*
- *P4.03: 83.3 [83.3% Analog Input Gain]*
- *P4.04: 00 (default) [Forward Motion Only]*

Results

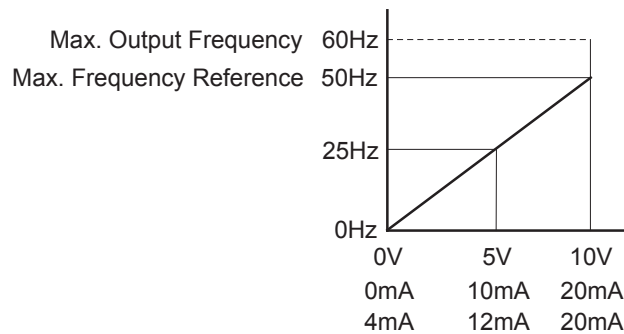

EXAMPLE 7: POSITIVE OFFSET WITH REDUCED ANALOG GAIN

This example illustrates how to provide a positive offset of the Analog Input, while using the full scale of the potentiometer or other analog device. At the same time, the Maximum Frequency Reference is limited by reducing the Analog Input Gain.

When the analog signal is at its lowest value, the set-point frequency will be at 11.5Hz. When the analog signal is at its maximum value, the set-point frequency will be 39.6Hz.

- Minimum frequency reference = 11.5Hz
- Maximum frequency reference = 39.6Hz

Calculations

- A) Max output frequency = (1750rpm ÷ 1750rpm) x (60Hz) = 60Hz
- B) Analog Offset % = (11.5Hz ÷ 60Hz) x 100 = 19.2%
- C) Analog Gain % = ((39.6Hz – 11.5Hz) ÷ 60Hz) x 100 = 46.8%
- D) Mid-point frequency = ((39.6Hz – 11.5Hz) ÷ 2) + (11.5Hz) = 25.6Hz

Parameter Settings

- P4.01: 01 [Positive Input Offset Polarity]
- P4.02: 19.2 [19.2% Analog Input Offset]
- P4.03: 46.8 [46.8% Analog Input Gain]
- P4.04: 00 (default) [Forward Motion Only]

Results

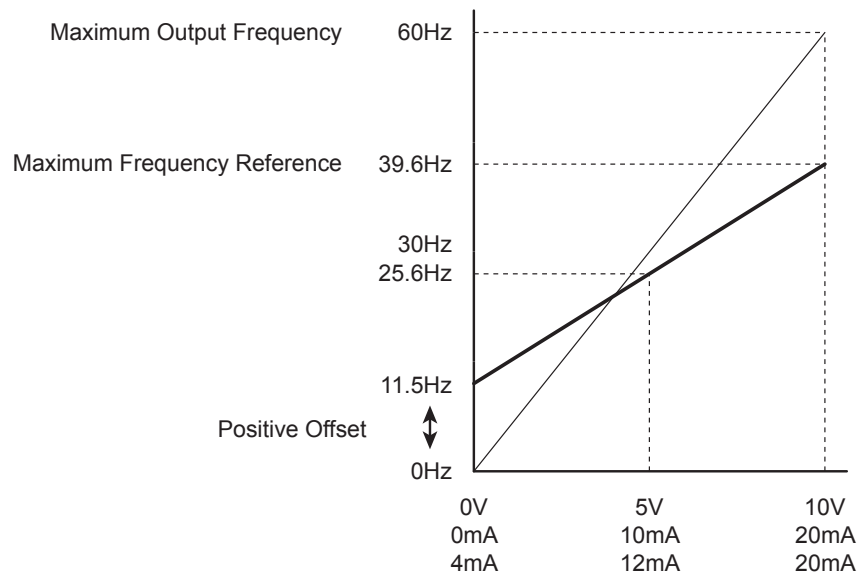

EXAMPLE 8: INVERT THE ANALOG INPUT SIGNAL

This example illustrates how to invert the analog input signal so that the drive is at 0Hz output at full analog signal, and full output at 0 analog signal.

Parameter Settings

- P4.01: 02 [Negative Input Offset Polarity]
- P4.02: 100.0 [100.0% Analog Input Offset]
- P4.03: 100.0 [100.0% Analog Input Gain]
- P4.04: 01 (default) [Forward Motion Only]



This change might require two of the motor leads to be swapped at the T terminals of the drive.

PRESETS PARAMETERS

P5.00 ♦ Jog

Range: 0.0 to 400.0 Hz

Default Setting: 6.0

The Jog Command is selected by a Multi-Function Input Terminal (P3.02 and P3.03) set to the Jog Function (9).

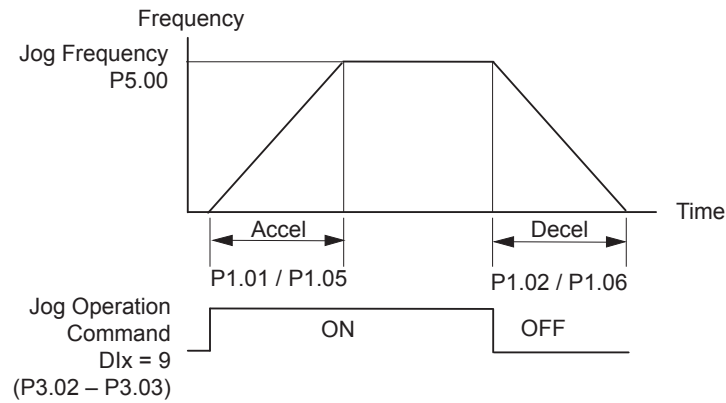

P5.01 ♦ Multi-Speed 1

P5.02 ♦ Multi-Speed 2

P5.03 ♦ Multi-Speed 3

Range: 0.0 to 400.0 Hz

Default Setting: 0.0

The Multi-Function Input Terminals are used to select one of the AC drive Multi-Step speeds. (DI3 or DI4 can be assigned as Multi-Speed Bit 1 or as Multi-Speed Bit 2; refer to P3.02 and P3.03)

The speeds (frequencies) are determined by P5.01 to P5.03.

Multi-Speed Bits		Speed Selection
Bit 2	Bit 1	
OFF	OFF	P4.00: Source of Frequency
OFF	ON	P5.01: Multi-Speed 1
ON	OFF	P5.02: Multi-Speed 2
ON	ON	P5.03: Multi-Speed 3



When all Multi-Speed Inputs are off, the AC drive reverts to the Command Frequency P4.00.

PROTECTION PARAMETERS

P6.00 Electronic Thermal Overload Relay

Settings: 00 – Constant Torque
 01 – Variable Torque
 02 – inactive

Default Setting: 00

This parameter determines the drive’s motor overload protection characteristic. The Variable Torque setting (01) allows less motor current at lower speeds than does the Constant Torque setting (00).

P6.00 = 00: Constant Torque (Recommended for inverter/vector duty motors)

Use this setting when using the drives with motors designed specifically for AC drive outputs and for running at low speeds with high currents. Motor currents will be 100% throughout the speed range, and can be up to 150% for one minute.

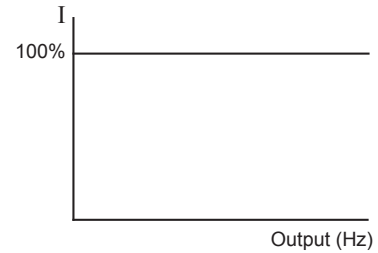

P6.00 = 01: Variable Torque (Recommended for fan-cooled standard motors)

Use this setting when using the drives with motors which are NOT designed specifically for AC drive outputs. Motors with shaft mounted fans offer poor cooling at low speeds; therefore the output can be derated at lower output frequencies. This derated current is for protecting the motor at lower speeds.

The output current is derated as follows:

- $I_{output} (\%) = [f_{output} (\text{Hz}) \times 1.2 (\%/ \text{Hz})] + 40\%$

Example: If the rated motor current is 5A, and the output frequency is 25Hz, the derating will be 70%, and the overload will be 5.25A (150%) for one minute.

- $I_{output} (\%) = [(25\text{Hz}) (1.2 \%/ \text{Hz})] + 40\% = 70\%$
- $5\text{A} \times 70\% = 3.5\text{A}$
- $3.5\text{A} \times 150\% = 5.25\text{A}$

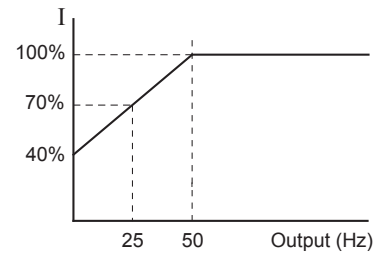

P6.00 = 02: inactive

P6.01 Auto Restart after Fault

Range: 0 to 10

Default Setting: 0

After fault occurs (allowable faults: over-current OC, over-voltage OV), the AC drive can be reset/restarted automatically up to 10 times. Setting this parameter to 0 will disable the reset/restart operation after any fault has occurred. When enabled, the AC drive will restart with speed search, which starts at the previous frequency. To set the fault recovery time after a fault, please see (P6.13) base-block time for speed search.

P6.02 Momentary Power Loss

Settings:

Default Setting: 0

- 0 – Stop operation after momentary power loss.
- 1 – Continue operation after momentary power loss, speed search from Speed Reference.
- 2 – Continue operation after momentary power loss, speed search from Minimum Speed.



This parameter will only work if the Source of Operation (P3.00) is set to something other than 0 (Operation determined by digital keypad).

- Refer also to P6.12 (Maximum Allowable Power Loss Time).

P6.03 Reverse Operation Inhibit

Settings: 0 – Enable Reverse Operation
1 – Disable Reverse Operation

Default Setting: 0

This parameter determines whether or not the AC Motor Drive can operate in the reverse direction.

P6.04 Auto Voltage Regulation

Settings: 0 – AVR enabled
1 – AVR disabled
2 – AVR disabled during Decel
3 – AVR disabled during Stop

Default Setting: 0

AVR function automatically regulates the AC drive output voltage to the Maximum Output Voltage (P0.00). For instance, if P0.00 is set at 200VAC and the input voltage is at 200V to 264 VAC, then the Maximum Output Voltage will automatically be regulated to 200VAC.

Without AVR function, the Maximum Output Voltage may vary between 180V to 264 VAC, due to the input voltage varying between 180V to 264 VAC.

Selecting program value 2 enables the AVR function, but also disables the AVR function during deceleration. AVR improves regulation of the DC bus voltage. With lower DC bus voltage, regeneration and overvoltage faults are reduced, therefore allowing quicker deceleration.

P6.05 Over-Voltage Trip Prevention

Settings: 0 Enable Over-voltage Trip Prevention
1 Disable Over-voltage Trip Prevention

Default Setting: 0

During deceleration, the AC drive DC bus voltage may exceed its Maximum Allowable Value due to motor regeneration. When this function is enabled, the AC drive will stop decelerating, and maintain a constant output frequency. The drive will resume deceleration when the voltage drops below the factory-preset value.

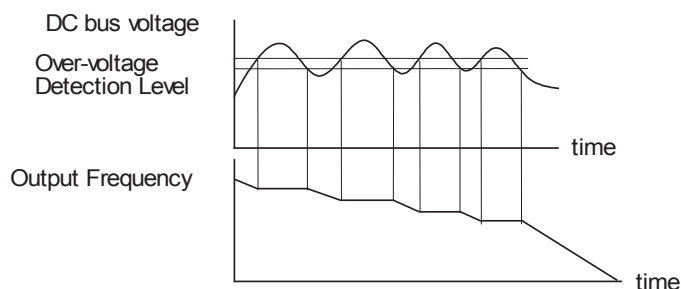

With moderate inertial loads, over-voltage during deceleration will not occur. For applications with high inertia loads, the AC drive will automatically extend the deceleration time.

P6.06 Auto Adjustable Accel/Decel

Settings:

Default Setting: 0

- 0: Linear Accel/Decel – Linear Acceleration and deceleration (Operation by P1.01, P1.02 or P1.05, P1.06 acceleration/deceleration time).
- 1: Auto Accel, Linear Decel – Automatic acceleration, linear deceleration (Operation by automatic acceleration time; P1.02 or P1.06 deceleration time).
- 2: Linear Accel, Auto Decel – Linear acceleration and automatic deceleration (Operation by automatic deceleration time; P1.01 or P1.05 acceleration time).
- 3: Auto Accel/Decel – Automatic acceleration, deceleration (Operation by AC drive auto adjustable control).
- 4: Auto Accel/Decel Stall Prevention – Auto acceleration, deceleration. The auto accel/decel will not be quicker than the settings for acceleration (P1.01 or P1.05) or deceleration (P1.02 or P1.06). The operation is specific to preventing a stall.

If the Auto Accel/Decel is selected, the AC drive will accel/decel in the fastest and smoothest means possible by automatically adjusting the time of accel/decel.

P6.07 Over-Torque Detection Mode

Settings: 0 – Disabled
 1 – Enabled during constant speed operation
 2 – Enabled during acceleration

Default Setting: 0

P6.08 Over-Torque Detection Level

Range: 30 to 200%

Default Setting: 150

This parameter sets the Over-Torque Detection level in 1% increments. (The AC drive rated current is equal to 100%.)

- A setting of 100% is proportional to the Rated Output Current of the drive.

P6.09 Over-Torque Detection Time

Range: 0.1 to 10.0

Default Setting: 0.1

This parameter sets the Over-Torque Detection Time in units of 0.1 seconds.

P6.10 Over-current Stall Prevention during Acceleration

P6.11 Over-current Stall Prevention during Operation

Range: 0 to 200%

Default Setting: 130

- A setting of 0% disables the functionality of this parameter.
- A setting of 100% is equal to the Rated Output Current of the drive.

P6.10: Under certain conditions, the AC drive output current may increase abruptly, and exceed the value specified by P6.10. This is commonly caused by rapid acceleration or excessive load on the motor. When this function is enabled, the AC drive will stop accelerating and maintain a constant output frequency. The AC drive will only resume acceleration when the current drops below the maximum value.

P6.11: During steady-state operation with motor load rapidly increasing, the AC drive output current may exceed the limit specified in P6.11. When this occurs, the output frequency will decrease to maintain a constant motor speed. The drive will accelerate to the steady-state output frequency only when the output current drops below the level specified by P6.11.

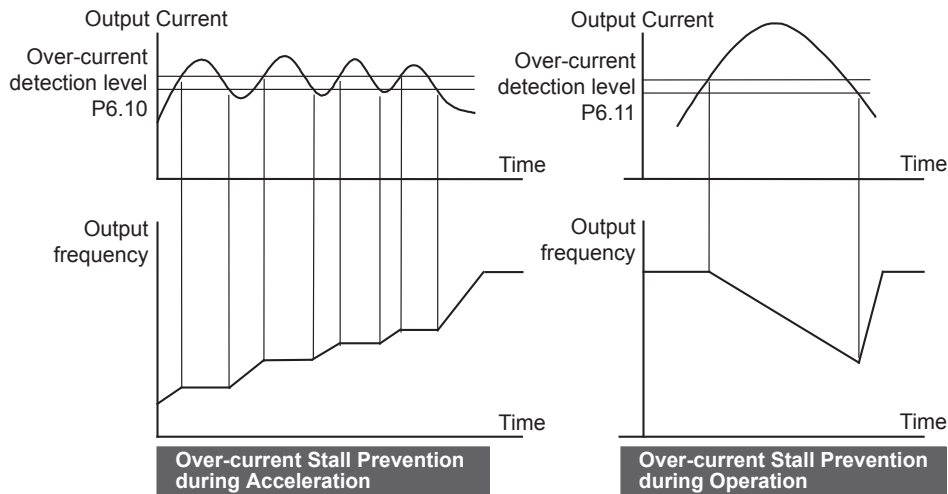

P6.12 Maximum Allowable Power Loss Time

Range: 0.3 to 5.0 sec

Default Setting: 2.0

During a power loss, if the power loss time is less than the time defined by this parameter, the AC drive will resume operation. If the Maximum Allowable Power Loss Time is exceeded, the AC drive output is turned off.

P6.13 Base-Block Time for Speed Search

Range: 0.3 to 5.0 sec

Default Setting: 0.5

When a momentary power loss is detected, the AC drive turns off for a specified time interval determined by P6.13 before resuming operation. This time interval is called Base-Block. This parameter should be set to a value where the residual output voltage due to regeneration is nearly zero, before the drive resumes operation.

- This parameter also determines the searching time when performing external Base-Block and Fault Reset (P6.01).

P6.14 Maximum Speed Search Current Level

Range: 30 to 200%

Default Setting: 150

Following a power failure, the AC drive will start its speed search operation only if the output current is greater than the value determined by P6.14. When the output current is less than that of P6.14, the AC drive output frequency is at a “speed synchronization point.” The drive will start to accelerate or decelerate back to the operating frequency at which it was running prior to the power failure.

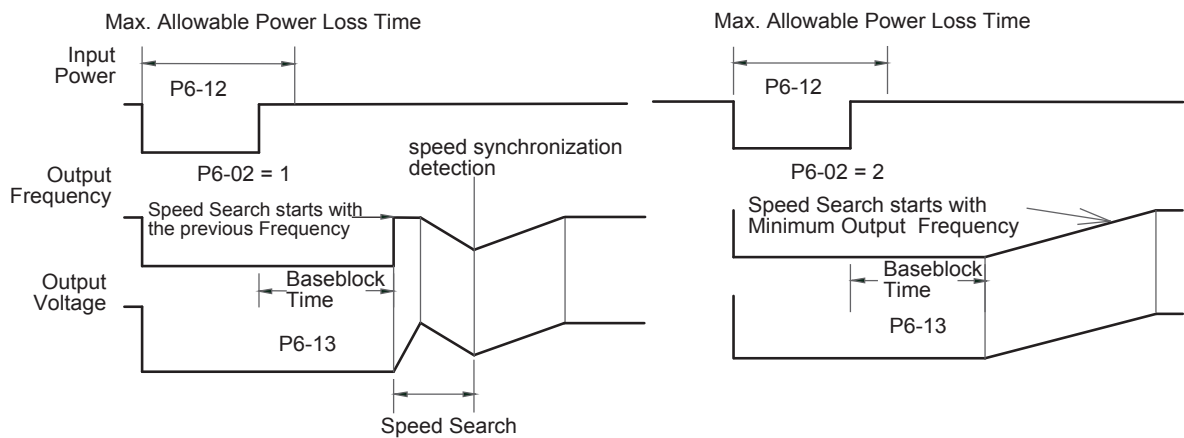

P6.15 Upper Bound of Output Frequency

Range: 0.1 to 400 Hz

Default Setting: 400.0

P6.16 Lower Bound of Output Frequency

Range: 0.0 to 400 Hz

Default Setting: 0.0

The Upper/Lower Bound is to prevent operation error and machine damage.

- The Upper Bound parameter (P6.15) must be greater than or equal to the Lower Bound of Output Frequency (P6.16).
- If the Upper Bound of Output Frequency is 50Hz and the Maximum Output Frequency is 60Hz, then any command frequency above 50 Hz will generate a 50Hz output from the drive.
- The Lower Bound parameter (P6.16) must be less than or equal to the Upper Bound of Output Frequency (P6.15).
- If the Lower Bound of Output Frequency is 10Hz, and the Minimum Output Frequency (P2.06) is set at 1.0Hz, then any Command Frequency between 1–10 Hz will generate a 10Hz output from the drive.
- The Output Frequency is also limited by the Motor Maximum RPM (P0.04).

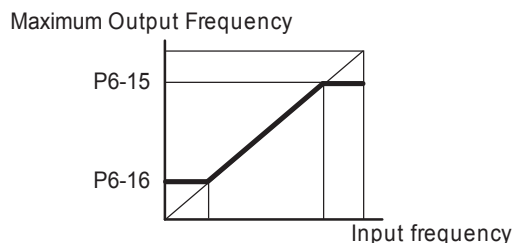

P6.30 Line Start Lockout

Settings: 0 – Enable Line Start Lockout
1 – Disable Line Start Lockout

Default Setting: 0

When this parameter is enabled, the AC Drive will not start the motor when powered up with a RUN command already applied. The drive must see the RUN command change from STOP to RUN before it will start.

When this parameter is disabled, the AC Drive will start the motor when powered up with a RUN command already applied.

- *This parameter is available only with AC drive firmware v1.07 or higher. Refer to P9.39 to determine the drive's firmware version.*

P6.31 Present Fault Record**P6.32 Second Most Recent Fault Record****P6.33 Third Most Recent Fault Record****P6.34 Fourth Most Recent Fault Record****P6.35 Fifth Most Recent Fault Record****P6.36 Sixth Most Recent Fault Record**

Settings: 0 – No Fault occurred

Default Setting: 0

- 1 – Over-current (oc)
- 2 – Over-voltage (ov)
- 3 – Overheat (oH)
- 4 – Overload (oL)
- 5 – Overload 1 (oL1)
- 6 – Overload 2 (oL2)
- 7 – External Fault (EF)
- 8 – CPU failure 1 (CF1)
- 9 – CPU failure 2 (CF2)
- 10 – CPU failure 3 (CF3)
- 11 – Hardware Protection Failure (HPF)
- 12 – Over-current during accel (OCA)
- 13 – Over-current during decel (OCd)
- 14 – Over-current during steady state (OCn)
- 18 – External Base Block (bb)
- 19 – Auto Adjust Accel/decel failure (cFA)
- 20 – Software protection code (co)

DISPLAY PARAMETERS

P8.00 ♦ User Defined Display Function

Settings:

Default Setting: 0

- 0 – Output Frequency (Hz)
- 1 – Motor Speed (RPM)
- 2 – Output Frequency x P8.01
- 3 – Output Current (A)
- 4 – Motor Output Current (%)
- 5 – Output Voltage(V)
- 6 – DC Bus Voltage (V)
- 9 – Frequency Setpoint

P8.01 ♦ Frequency Scale Factor

Range: 0.1 to 160.0

Default Setting: 1.0

The coefficient K determines the multiplying factor for the user-defined unit.

The display value is calculated as follows:

- *Display value = output frequency x K*

The display window is only capable of showing four digits, but P8.01 can be used to create larger numbers.

The display window uses decimal points to signify numbers up to three digits as explained below:

<u>DISPLAY</u>	<u>NUMBER REPRESENTED</u>
9999	The absence of a decimal point indicates a four digit integer.
999.9	A single decimal point between the middle and the right-most numbers is a true decimal point; it separates ones and tenths as in "30.5 (thirty and one-half)."
9999.	A single decimal point after the right-most number is not a true decimal point; instead it indicates that a zero follows the right-most numbers. For example, the number 1230 would be displayed as "123."

COMMUNICATIONS PARAMETERS

P9.00 Communication Address

Range: 1 to 254

Default Setting: 1

If the AC drive is controlled by RS-485 serial communication, the communication address must be set via this parameter.

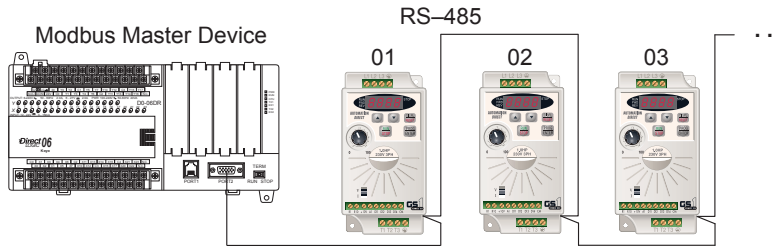

P9.01 Transmission Speed

- Settings:
- 0 – 4800 baud data transmission speed
 - 1 – 9600 baud data transmission speed
 - 2 – 19200 baud data transmission speed

Default Setting: 1

Users can set parameters and control the operation of the AC drive via the RS-485 serial interface of a Modbus master. This parameter is used to set the transmission speed between the master and AC drive.

P9.02 Communication Protocol

- Settings:
- 0 – MODBUS ASCII mode <7 data bits, no parity, 2 stop bits>
 - 1 – MODBUS ASCII mode <7 data bits, even parity, 1 stop bit>
 - 2 – MODBUS ASCII mode <7 data bits, odd parity, 1 stop bit>
 - 3 – MODBUS RTU mode <8 data bits, no parity, 2 stop bits>
 - 4 – MODBUS RTU mode <8 data bits, even parity, 1 stop bit>
 - 5 – MODBUS RTU mode <8 data bits, odd parity, 1 stop bit>

Default Setting: 0

P9.03 Transmission Fault Treatment

- Settings:
- 0 – Display fault and continue operating
 - 1 – Display fault and RAMP to stop
 - 2 – Display fault and COAST to stop
 - 3 – No fault displayed and continue operating

Default Setting: 0

P9.04 Time Out Detection

- Settings:
- 0 – Disable
 - 1 – Enable

Default Setting: 0

When this parameter is set to 01, the communications Time Out Detection is Enabled. If a delay in communications for more than the Time Out Duration (P9.05) is detected, the action selected by the Transmission Fault Treatment (P9.03) will be used. The separation between characters within a message cannot exceed 500ms.

P9.05 Time Out Duration

Range: 0.1 to 60.0 seconds

Default Setting: 0.5

P9.07 ♦ Parameter Lock

- Settings:
- 0 – All parameters can be set and read
 - 1 – All parameters are read-only

Default Setting: 0

P9.08 Restore to Default

Range: 0 to 99

Default Setting: 0

•• Setting 99 restores all parameters to factory defaults. ••

- P9.11** ♦ **Block Transfer Parameter 1**
- P9.12** ♦ **Block Transfer Parameter 2**
- P9.13** ♦ **Block Transfer Parameter 3**
- P9.14** ♦ **Block Transfer Parameter 4**
- P9.15** ♦ **Block Transfer Parameter 5**
- P9.16** ♦ **Block Transfer Parameter 6**
- P9.17** ♦ **Block Transfer Parameter 7**
- P9.18** ♦ **Block Transfer Parameter 8**
- P9.19** ♦ **Block Transfer Parameter 9**
- P9.20** ♦ **Block Transfer Parameter 10**

Range: P0.00 to P8.01, and 9.99

Default Setting: 9.99

Range: Default Setting:

- Setting 9.99 disables this parameter.

The block transfer parameters (P9.11~P9.20) are used to read and write to and from non-consecutive drive addresses via Modbus.

For writing to any of the parameters from P0.00 to P8.01, a group of 10 block transfer parameters (P9.11 to P9.20) is available in the GS1 AC drive. This sequential block of parameters can be used to “group” various miscellaneous non-sequential parameters, so that you can update the parameters in one programming write block instead of having to use multiple write commands.

For example, it would typically take three different write commands to change the three non-sequential parameters Accel Time 1 (P1.01), Accel S-curve (P1.03), and Multi-speed 1 (P5.01).

However, you could make the same three changes using one write command by setting P9.11 to P1.01, P9.12 to P1.03, and P9.13 to P5.01, so that the parameters become sequential.

P9.26 ♦ **Serial Comm Speed Reference**

Range: 0.0 to 400.0 Hz

Default Setting: 60.0

This parameter is used to set the Master Frequency when the AC drive is controlled by communication interface.



In order for this parameter to function, the Source of Frequency Command (P4.00) must be set to 5.

P9.27 ♦ **Serial Comm RUN Command**

Settings: 0 – Stop
1 – Run

Default Setting: 0

- Do not attempt to both Run and Jog (P9.27 & P9.31) in one Modbus write command.

P9.28 ♦ **Serial Comm Direction Command**

Settings: 0 – Forward
1 – Reverse

Default Setting: 0

P9.29 ♦ **Serial Comm External Fault**

Settings: 0 – No fault
1 – External fault

Default Setting: 0

P9.30 ♦ **Serial Comm Fault Reset**

Settings: 0 – No action
1 – Fault Reset

Default Setting: 0

P9.31 ♦ **Serial Comm JOG Command**

Settings: 0 – Stop
1 – Jog

Default Setting: 0

- Do not attempt to both Run and Jog (P9.27 & P9.31) in one Modbus write command.

P9.39 Firmware Version

Settings: Read Only

Default Setting: Factory Set

- This parameter is available only with AC drive firmware v1.07 or higher.

P9.41 GS Series Number

Settings: 1 – GS1
2 – GS2
3 – GS3
4 – GS4

Default Setting: ##

P9.42 Manufacturer Model Information

Settings: 0 – GS1-10P2 (115V, 1ph, 0.25hp)
1 – GS1-10P5 (115V, 1ph, 0.5hp)
2 – GS1-20P2 (230V, 1ph/3ph, 0.25hp)
3 – GS1-20P5 (230V, 1ph/3ph, 0.5hp)
4 – GS1-21P0 (230V, 1ph/3ph, 1hp)
5 – GS1-22P0 (230V, 3ph, 2hp)

Default Setting: ##