

Getting Started



1

In This Chapter....	page
— Introduction	2
— L100 Inverter Specifications	5
— Introduction to Variable-Frequency Drives	17
— Frequently Asked Questions	22

Introduction

Main Features

Congratulations on your purchase of an L100 Series Hitachi inverter! This inverter drive features state-of-the-art circuitry and components to provide high performance. The housing footprint is exceptionally small, given the size of the corresponding motor. The Hitachi L100 product line includes more than a dozen inverter models to cover motor sizes from 1/4 horsepower to 10 horsepower, in either 230 VAC or 460 VAC power input versions. The main features are:

- 200V and 400V Class inverters
- UL or CE version available
- V/f (volts-per-hertz) control algorithm, selectable for either constant or reduced torque loads
- Convenient keypad for parameter settings
- Built-in RS-422 communications interface to allow configuration from a PC and for field bus external modules.
- Sixteen programmable speed levels
- Two-step acceleration and deceleration curves
- PID control adjusts motor speed automatically to maintain a process variable value

The design in Hitachi inverters overcomes many of the traditional trade-offs between speed, torque and efficiency. The performance characteristics are:

- Output frequency range from 0.5 to 360 Hz
- Continuous operation at 100% torque within a 1:10 speed range (6/60 Hz / 5/50 Hz) without motor derating



Model L100-002NFU

A full line of accessories from Hitachi is available to complete your application:

- Digital remote operator keypad
- Dynamic braking unit
- Radio noise filters, CE compliance filters, and EMI filters (shown below)
- DIN rail mounting adapter (35mm rail size)

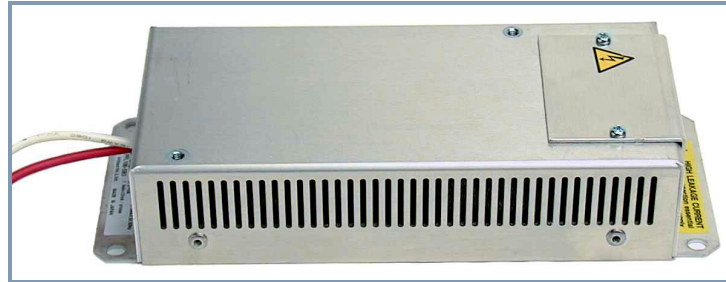

EMI Filter

Operator Interface Options

The optional SRW-0EX digital operator / copy unit is shown to the right. It has the additional capability of reading (uploading) the parameter settings in the inverter into its memory. Then you can connect the copy unit on another inverter and write (download) the parameter settings into that inverter. OEMs will find this unit particularly useful, as one can use a single copy unit to transfer parameter settings from one inverter to many.

Other digital operator interfaces may be available from your Hitachi distributor for particular industries or international markets. Contact your Hitachi distributor for further details.

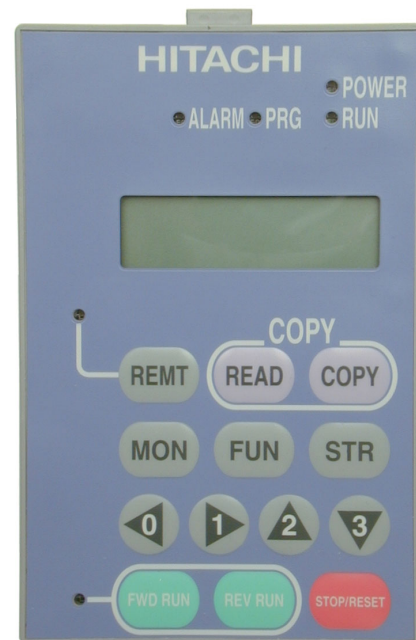

Digital Operator / Copy Unit

Inverter Specifications Label

The Hitachi L100 inverters have product labels located on the right side of the housing, as pictured below. Be sure to verify that the specifications on the labels match your power source, motor, and application safety requirements.

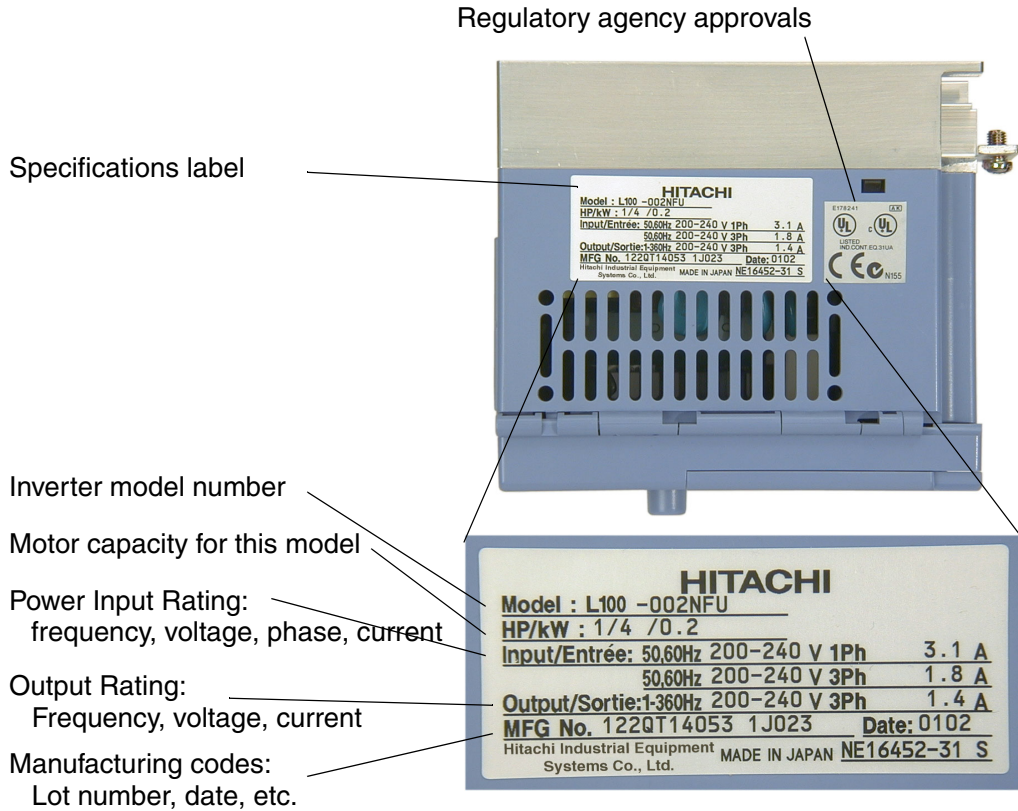

Model Number Convention

The model number for a specific inverter contains useful information about its operating characteristics. Refer to the model number legend below:

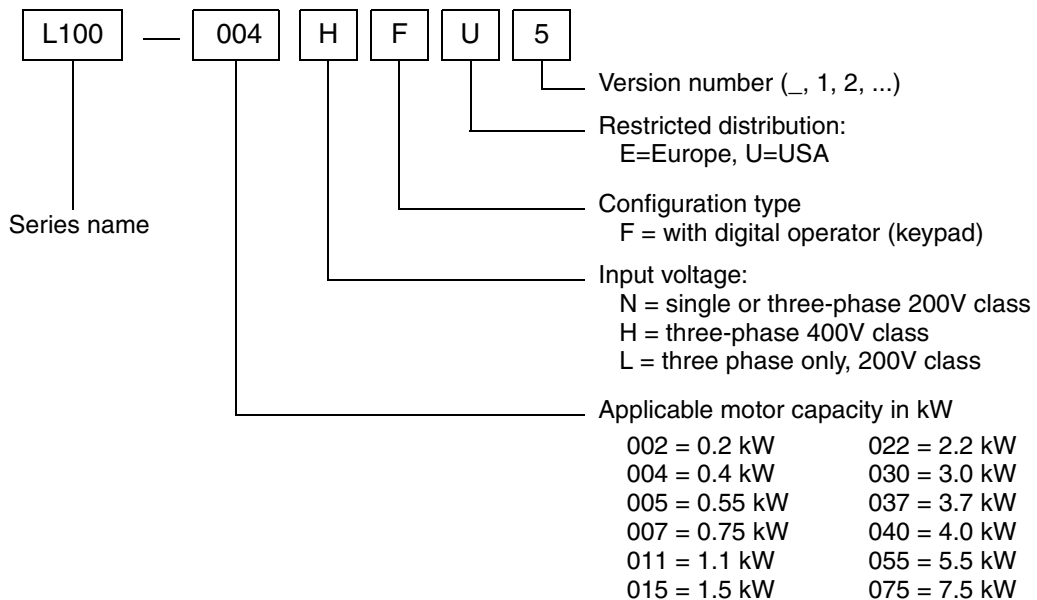

L100 Inverter Specifications

Model-specific tables for 200V and 400V class inverters

The following tables are specific to L100 inverters for the 200V and 400V class model groups. Note that “General Specifications” on page 1–9 apply to both voltage class groups. Footnotes for all specifications tables follow the table below.

Item		200V Class Specifications				
L100 inverters, 200V models	CE version	002NFE	004NFE	005NFE	007NFE	011NFE
	UL version	002NFU	004NFU	—	007NFU	—
Applicable motor size *2	kW	0.2	0.4	0.55	0.75	1.1
	HP	1/4	1/2	3/4	1	1 1/2
Rated capacity (240V) kVA *10		0.5	1.0	1.2	1.6	2.0
Rated input voltage		1-phase: 200 to 240V +5/-10%, 50/60 Hz \pm 5%, 3-phase: 200 to 240V +5/-10%, 50/60 Hz \pm 5%, (037LFU, 055LFU & 075LFU 3-phase only)				
Rated input current (A)	1-phase	3.1	5.8	6.7	9.0	11.2
	3-phase	1.8	3.4	3.9	5.2	6.5
Rated output voltage *3		3-phase: 200 to 240V (corresponding to input voltage)				
Rated output current (A)		1.4	2.6	3.0	4.0	5.0
Efficiency at 100% rated output (%)		91.5	92.8	93.6	94.1	95.4
Watt loss, approximate (W)	at 70% output	13	21	25	31	38
	at 100% output	17	29	32	41	51
Braking	Dynamic braking, approx. % torque, (short time stop from 50 / 60 Hz) *5	100%: \leq 50 Hz, 50%: \leq 60 Hz				
		Capacitive feedback type, dynamic braking unit and braking resistor optional, individually installed				
	DC braking	Variable operating frequency, time, and braking force				
Weight	kg	0.85	0.85	1.3	1.3	2.2
	lb	1.87	1.87	2.87	2.87	4.85

Footnotes for the preceding table and the tables that follow:

- Note 1:** The protection method conforms to JEM 1030.
- Note 2:** The applicable motor refers to Hitachi standard 3-phase motor (4-pole). When using other motors, care must be taken to prevent the rated motor current (50/60 Hz) from exceeding the rated output current of the inverter.
- Note 3:** The output voltage decreases as the main supply voltage decreases (except when using the AVR function). In any case, the output voltage cannot exceed the input power supply voltage.
- Note 4:** To operate the motor beyond 50/60 Hz, consult the motor manufacturer for the maximum allowable rotation speed.
- Note 5:** The braking torque via capacitive feedback is the average deceleration torque at the shortest deceleration (stopping from 50/60 Hz as indicated). It is not continuous regenerative braking torque. The average deceleration torque varies with motor loss. This value decreases when operating beyond 50 Hz. Note that a braking unit is not included in the inverter. If a large regenerative torque is required, the optional regenerative braking unit should be used.
- Note 6:** The frequency command is the maximum frequency at 9.8V for input voltage 0 to 10 VDC, or at 19.6 mA for input current 4 to 20 mA. If this characteristic is not satisfactory for your application, contact your Hitachi sales representative.
- Note 7:** If operating the inverter in an ambient temperature of 40–50° C, reduce the carrier frequency to 2.1 kHz, derate the output current by 80%, and remove the top housing cover. Note that removing the top cover will nullify the NEMA rating for the inverter housing.
- Note 8:** The storage temperature refers to the short-term temperature during transport.
- Note 9:** Conforms to the test method specified in JIS C0911 (1984). For the model types excluded in the standard specifications, contact your Hitachi sales representative.
- Note 10:** The input voltage of xxLFU is 230V.

L100 Inverter Specifications, continued...

Item		200V Class Specifications, continued				
L100 inverters, 200V models	CE version	015NFE	022NFE	—	—	—
	UL version	015NFU	022NFU	037LFU	055LFU	075LFU
Applicable motor size *2	kW	1.5	2.2	3.7	5.5	7.5
	HP	2	3	5	7.5	10
Rated capacity (240V) kVA *10		2.9	4.1	6.3	9.6	12.7
Rated input voltage		1-phase: 200 to 240V +5%/-10%, 50/60 Hz ±5%, 3-phase: 200 to 240V +5%/-10%, 50/60 Hz ±5%, (037LFU, 055LFU & 075LFU 3-phase only)				
Rated input current (A)	1-phase	16.0	22.5	—	—	—
	3-phase	9.3	13.0	20.0	30.0	40.0
Rated output voltage *3		3-phase: 200 to 240V (corresponding to input voltage)				
Rated output current (A)		7.1	10.0	15.9	24	32
Efficiency at 100% rated output (%)		95.3	95.6	95.5	96.1	96.2
Watt loss, approximate (W)	at 70% output	50	71	118	152	204
	at 100% output	70	97	166	216	288
Braking	Dynamic braking, approx. % torque, (short time stop from 50 / 60 Hz) *5	100%: ≤ 50Hz 50%: ≤ 60Hz	40%: ≤ 50Hz 20%: ≤ 60Hz	20%: ≤ 50Hz 20%: ≤ 60Hz		
		Capacitive feedback type, dynamic braking unit and braking resistor optional, individually installed				
	DC braking	Variable operating frequency, time, and braking force				
Weight	kg	2.2	2.8	2.8	5.5	5.7
	lb	4.85	6.17	6.17	12.13	12.57

Item		400V Class Specifications			
L100 inverters, 400V models	CE version	004HFE	007HFE	015HFE	022HFE
	UL version	004HFU	007HFU	015HFU	022HFU
Applicable motor size *2	kW	0.4	0.75	1.5	2.2
	HP	1/2	1	2	3
Rated capacity (460V) kVA *10		1.1	1.9	3.0	4.3
Rated input voltage		3-phase: 380 to 460V ±10%, 50/60 Hz ±5%			
Rated input current (A)		2.0	3.3	5.0	7.0
Rated output voltage *3		3-phase: 380 to 460V (corresponding to input voltage)			
Rated output current (A)		1.5	2.5	3.8	5.5
Efficiency at 100% rated output (%)		92.0	93.7	95.7	95.8
Watt loss, approximate (W)	at 70% output	25	33	48	68
	at 100% output	32	44	65	92
Braking	Dynamic braking, approx. % torque, (short time, stopping from 50 / 60 Hz) *5	100%: ≤ 50Hz 50%: ≤ 60Hz			40%: ≤ 50Hz, 20%: ≤ 60Hz
		Capacitive feedback type, dynamic braking unit and braking resistor optional, individually installed			
	DC braking	Variable operating frequency, time, and braking force			
Weight	kg	1.3	1.7	1.7	2.8
	lb	2.87	3.75	3.75	6.17

Item		400V Class Specifications, continued			
L100 inverters, 400V models	CE version	030HFE	040HFE	055HFE	075HFE
	UL version	—	040HFU	055HFU	075HFU
Applicable motor size *2	kW	3.0	4.0	5.5	7.5
	HP	4	5	7.5	10
Rated capacity (460V) kVA *10		6.2	6.8	10.4	12.7
Rated input voltage		3-phase: 380 to 460V $\pm 10\%$, 50/60 Hz $\pm 5\%$			
Rated input current (A)		10.0	11.0	16.5	20.0
Rated output voltage *3		3-phase: 380 to 460V (corresponding to input voltage)			
Rated output current (A)		7.8	8.6	13	16
Efficiency at 100% rated output (%)		95.4	96.2	96.0	96.5
Watt loss, approximate (W)	at 70% output	100	108	156	186
	at 100% output	138	151	219	261
Braking	Dynamic braking, approx. % torque, (short time stop from 50 / 60 Hz) *5	40%: $\leq 50\text{Hz}$, 20%: $\leq 60\text{Hz}$		20%: $\leq 50\text{Hz}$ 20%: $\leq 60\text{Hz}$	
		Capacitive feedback type, dynamic braking unit and braking resistor optional, individually installed			
	DC braking	Variable operating frequency, time, and braking force			
Weight	kg	2.8	2.8	5.5	5.7
	lb	6.17	6.17	12.13	12.57

General Specifications

The following table applies to all L100 inverters.

Item	General Specifications
Protective housing *1	IP20
Control method	Sine wave pulse-width modulation (PWM) control
Output frequency range *4	0.5 to 360 Hz
Frequency accuracy	Digital command: 0.01% of the maximum frequency Analog command: 0.1% of the maximum frequency (25°C \pm 10°C)
Frequency setting resolution	Digital: 0.1 Hz; Analog: max. frequency/1000
Volt./Freq. characteristic	V/f optionally variable, V/f control (constant torque, reduced torque)
Overload current rating	150%, 60 seconds
Acceleration/deceleration time	0.1 to 3000 sec., (linear accel/decel), second accel/decel setting available

Item		General Specifications	
Input signal	Freq. setting	Operator panel	Up and Down keys / Value settings
		Potentiometer	Analog setting
		External signal *6	0 to 10 VDC (input impedance 10k Ohms), 4 to 20 mA (input impedance 250 Ohms), Potentiometer (1k to 2k Ohms, 2W)
	FWD/REV Run	Operator panel	Run/Stop (Forward/Reverse run change by command)
		External signal	Forward run/stop, Reverse run/stop
Intelligent input terminal		FW (forward run command), RV (reverse run command), CF1~CF4 (multi-stage speed setting), JG (jog command), 2CH (2-stage accel./decel. command), FRS (free run stop command), EXT (external trip), USP (startup function), SFT (soft lock), AT (analog current input select signal), RS (reset), PTC (thermal protection)	
Output signal	Intelligent output terminal	RUN (run status signal), FA1,2 (frequency arrival signal), OL (overload advance notice signal), OD (PID error deviation signal), AL (alarm signal)	
	Frequency monitor	PWM output; Select analog output frequency monitor, analog output current monitor or digital output frequency monitor	
Alarm output contact		ON for inverter alarm (1C contacts, both normally open or closed avail.)	
Other functions		AVR function, curved accel/decel profile, upper and lower limiters, 16-stage speed profile, fine adjustment of start frequency, carrier frequency change (0.5 to 16 kHz) frequency jump, gain and bias setting, process jogging, electronic thermal level adjustment, retry function, trip history monitor	
Protective function		Over-current, over-voltage, under-voltage, overload, extreme high/low temperature, CPU error, memory error, ground fault detection at startup, internal communication error, electronic thermal	
Operating Environment	Temperature	Operating (ambient): -10 to 50°C (*7) / Storage: -25 to 70°C (*8)	
	Humidity	20 to 90% humidity (non-condensing)	
	Vibration *9	5.9 m/s ² (0.6G), 10 to 55 Hz	
	Location	Altitude 1,000 m or less, indoors (no corrosive gasses or dust)	
Coating color		Light purple, cooling fins in base color of aluminum	
Options		Remote operator unit, copy unit, cables for the units, dynamic braking unit, braking resistor, AC reactor, DC reactor, noise filter, DIN rail mounting	

Derating Curves

The maximum available inverter current output is limited by the carrier frequency and ambient temperature. The carrier frequency is the inverter’s internal power switching frequency, settable from 0.5 kHz to 16 kHz. Choosing a higher carrier frequency tends to decrease audible noise, but it also increases the internal heating of the inverter, thus decreasing (derating) the maximum current output capability. Ambient temperature is the temperature just outside the inverter housing—such as inside the control cabinet where the inverter is mounted. A higher ambient temperature decreases (derates) the inverter’s maximum current output capacity.

Use the following derating curves to help determine the optimal carrier frequency setting for your inverter, and to find the output current derating. Be sure to use the proper curve for your particular L100 inverter model number.

- Legend:**
- Standard ratings at 40°C
 - Ratings at 50°C max. with top cover removed
 - · - · - Ratings at 55°C max. with top cover removed

L100-002NFE/NFU

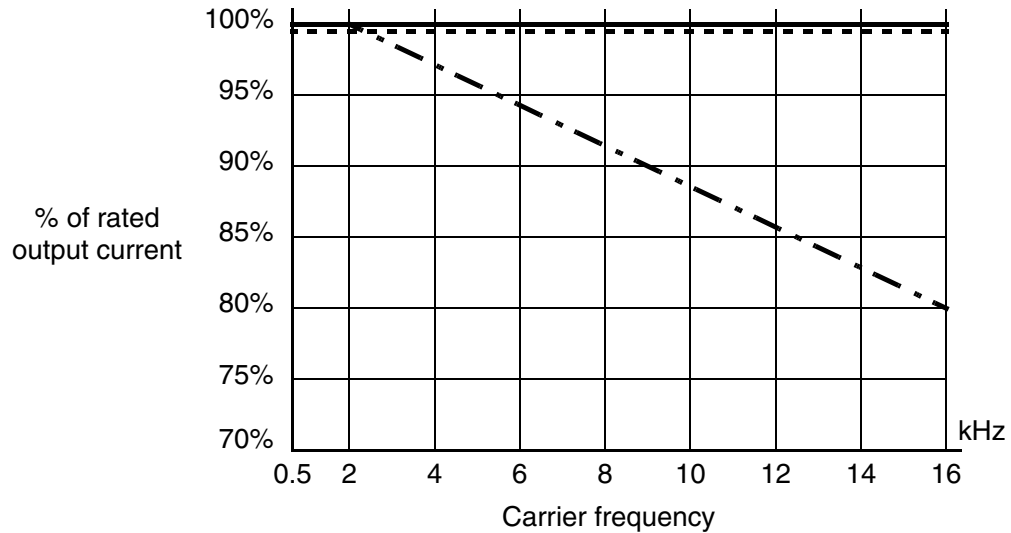

L100-004NFE/NFU

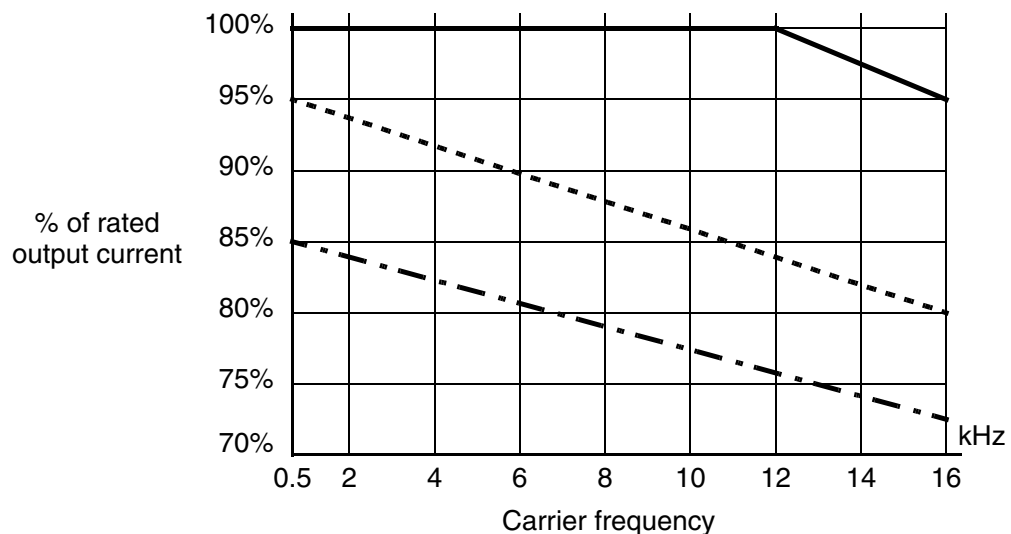

Derating curves, continued...

L100-007NFE/NFU

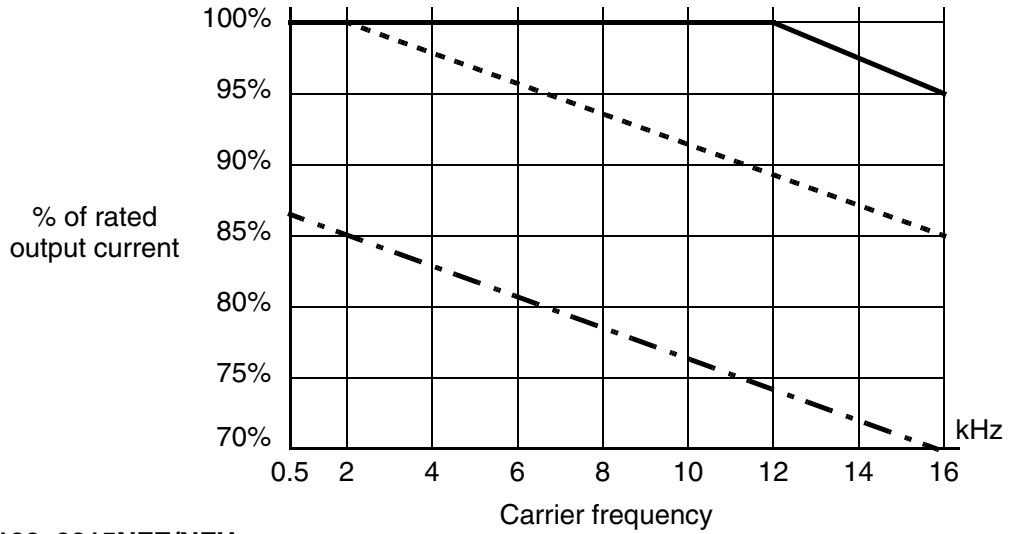

L100-0015NFE/NFU

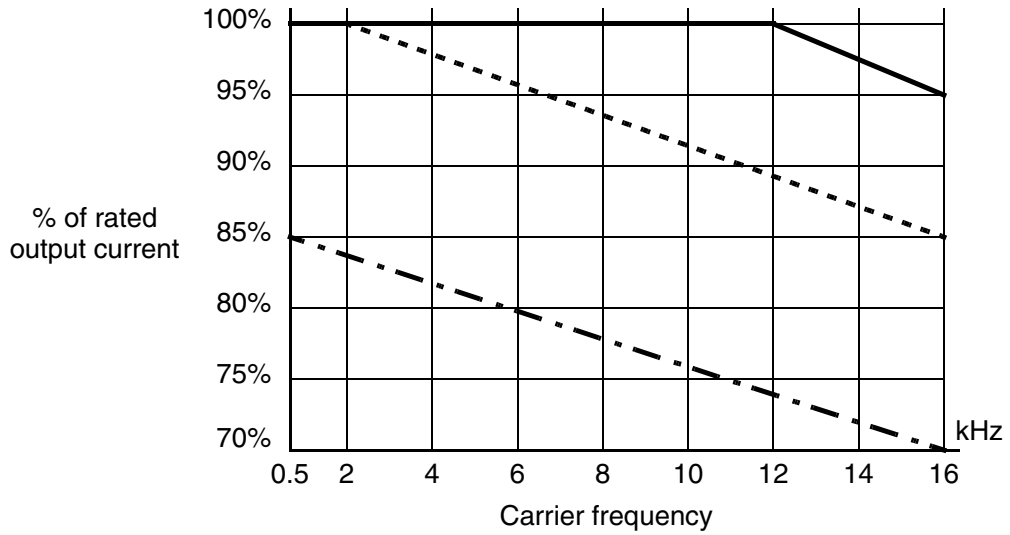

L100-022NFE/NFU

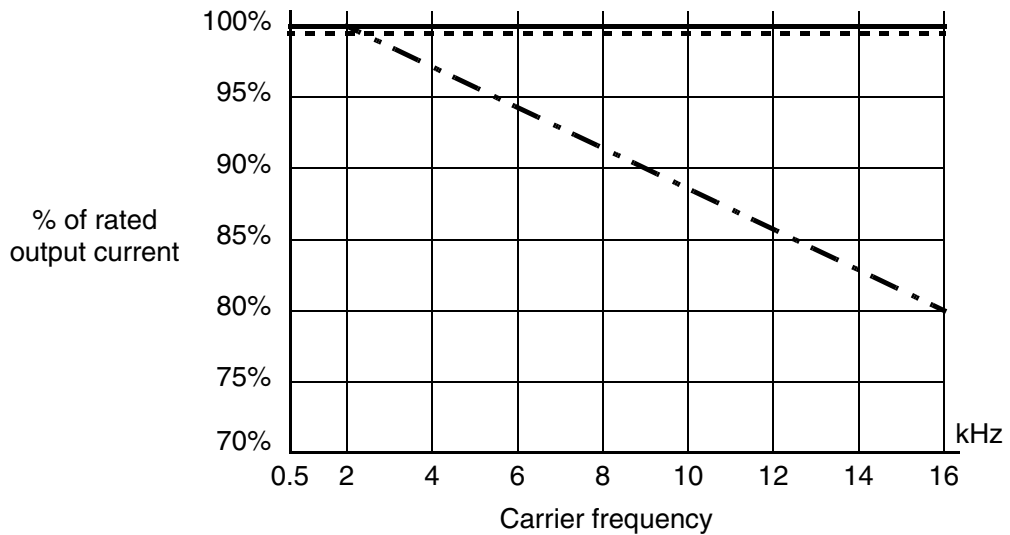

Derating curves, continued...

L100-037LF/LFU

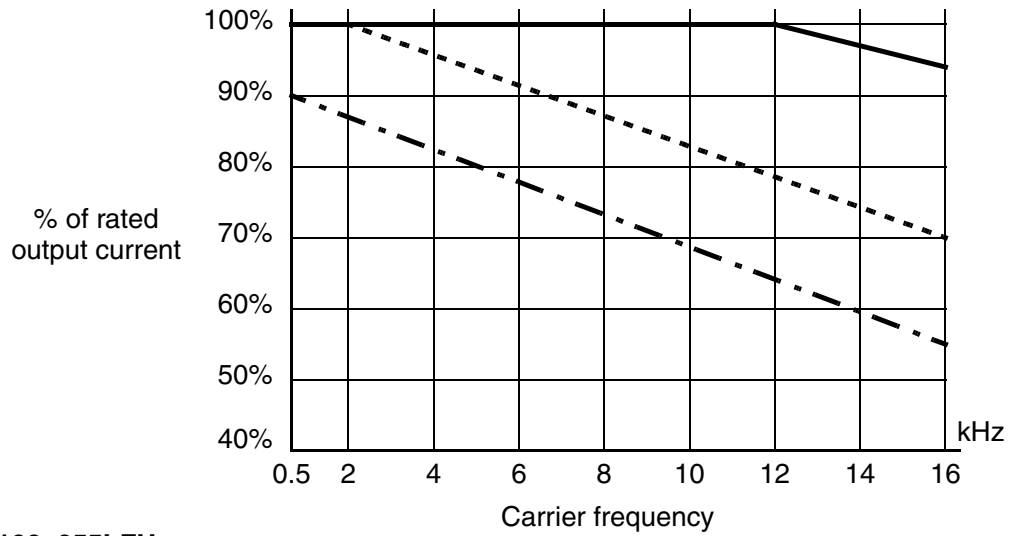

L100-055LFU

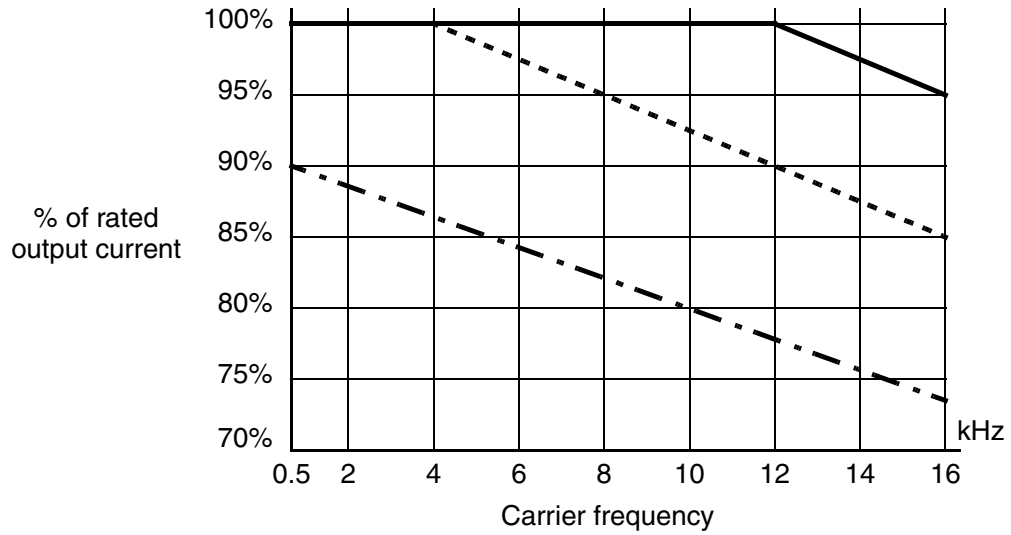

L100-075LFU

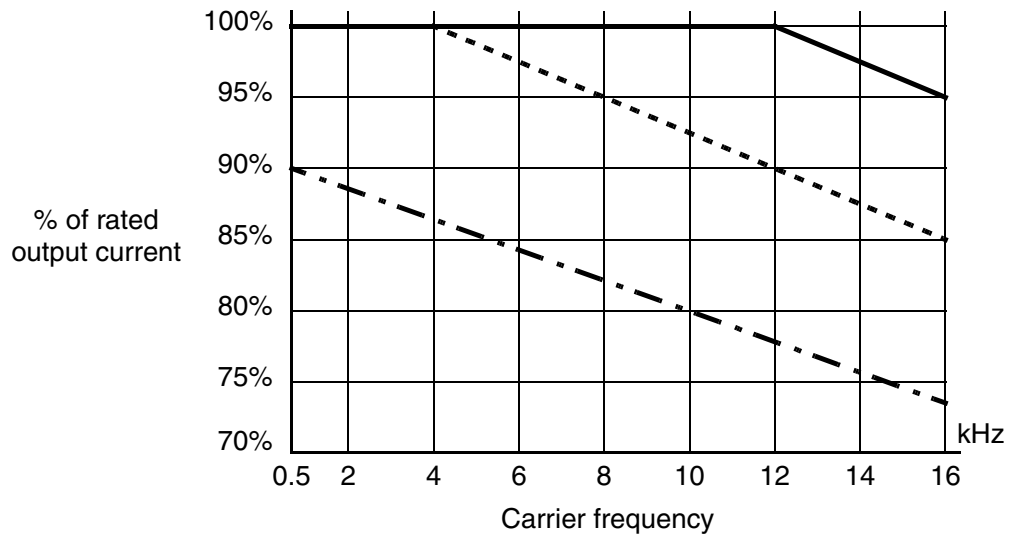

Derating curves, continued...

L100-004HFE/HFU

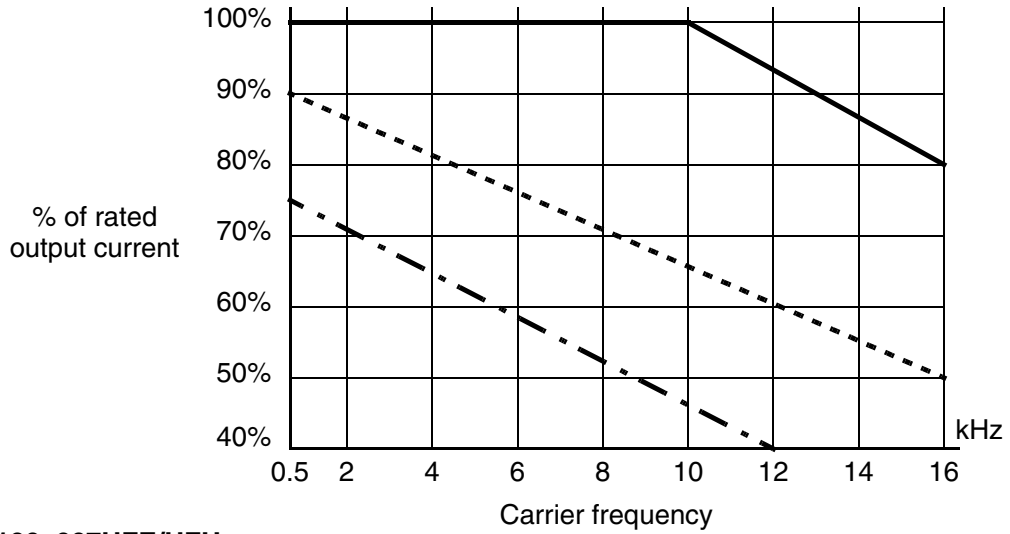

L100-007HFE/HFU

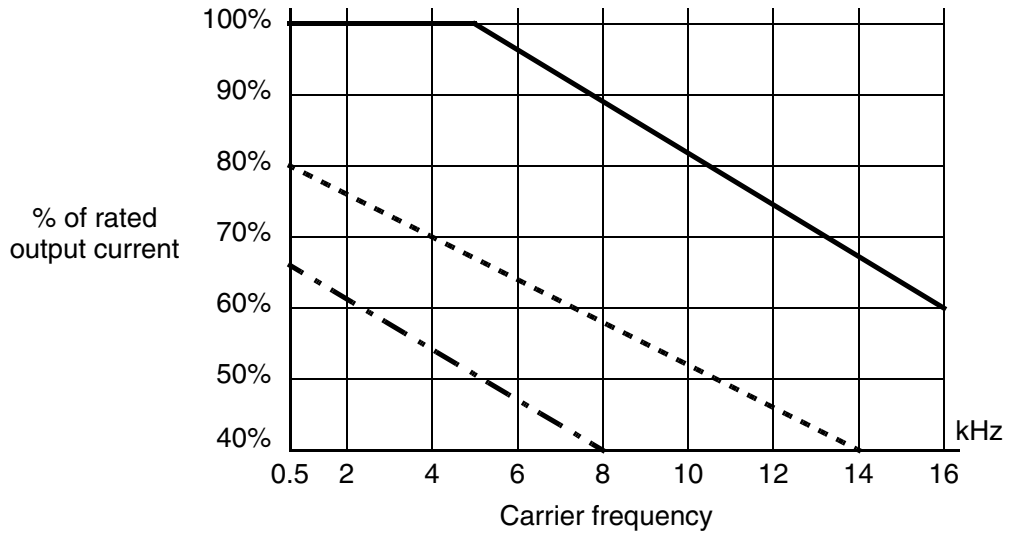

L100-015HFE/HFU

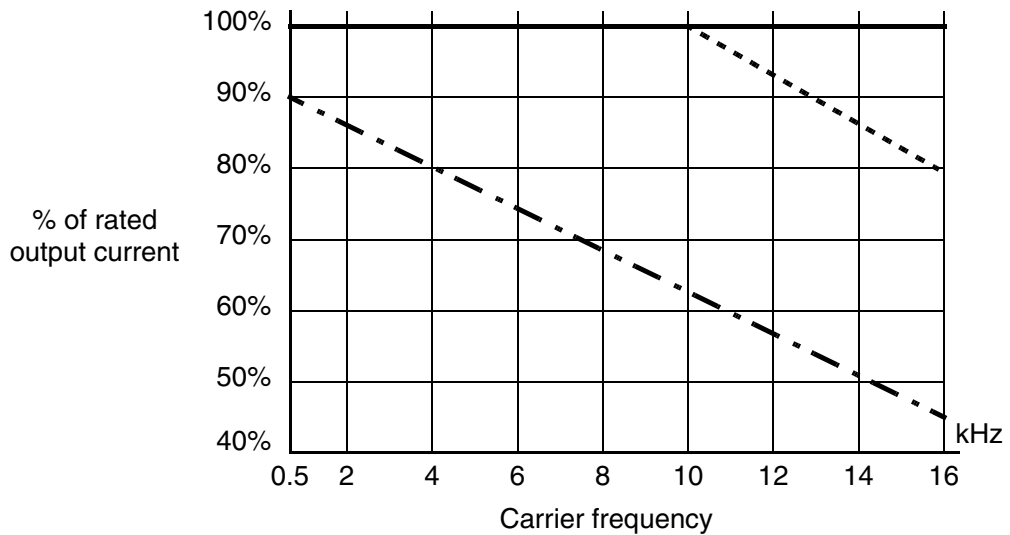

Derating curves, continued...

L100-022HFE/HFU

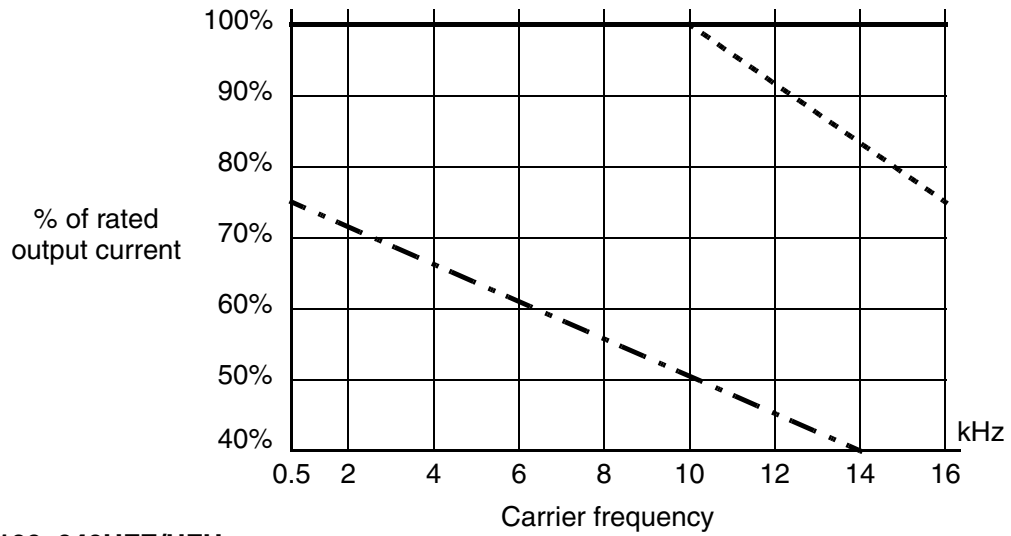

L100-040HFE/HFU

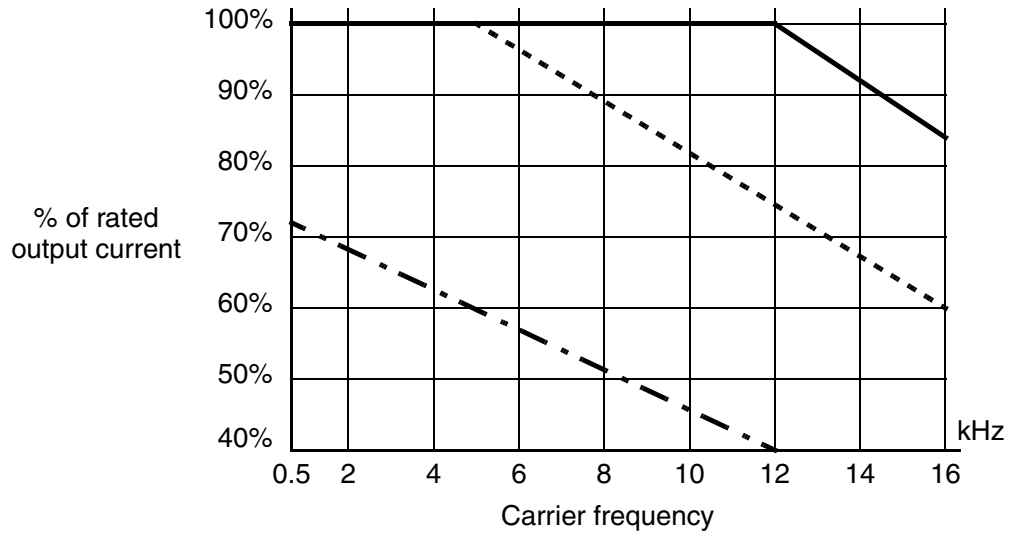

L100-055HFE/HFU

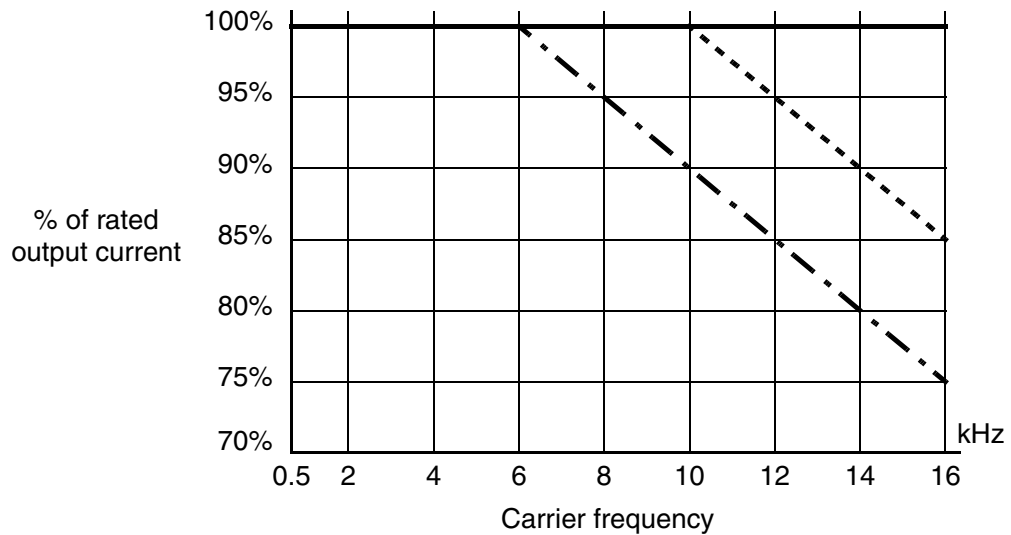

Derating curves, continued...

L100-075HFE/HFU

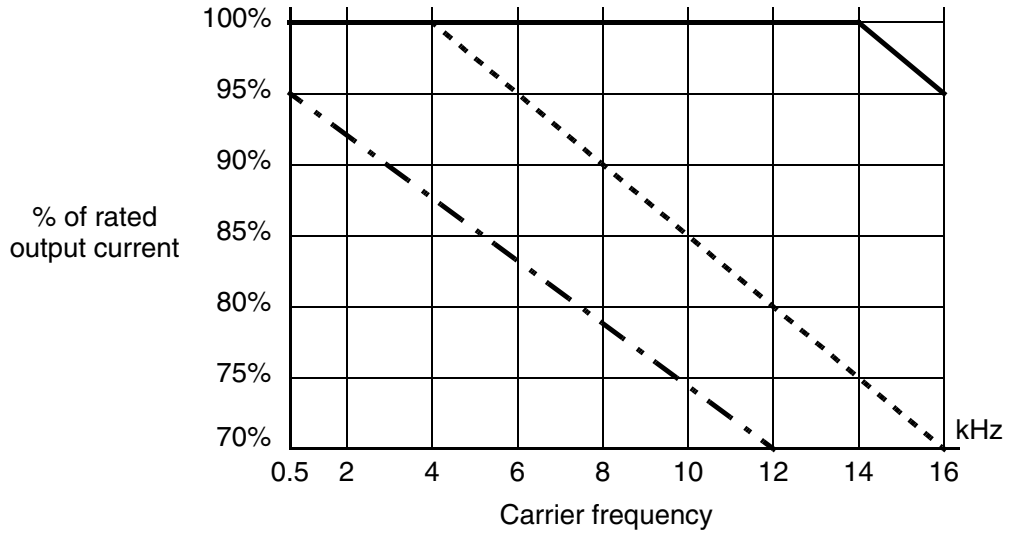

Introduction to Variable-Frequency Drives

The Purpose of Motor Speed Control for Industry

Hitachi inverters provide speed control for 3-phase AC induction motors. You connect AC power to the inverter, and connect the inverter to the motor. Many applications benefit from a motor with variable speed, in several ways:

- Energy savings - HVAC
- Need to coordinate speed with an adjacent process—textiles and printing presses
- Need to control acceleration and deceleration (torque)
- Sensitive loads - elevators, food processing, pharmaceuticals

What is an Inverter?

The term *inverter* and *variable-frequency drive* are related and somewhat interchangeable. An electronic motor drive for an AC motor can control the motor's speed by *varying the frequency* of the power sent to the motor.

An inverter, in general, is a device that converts DC power to AC power. The figure below shows how the variable-frequency drive employs an internal inverter. The drive first converts incoming AC power to DC through a rectifier bridge, creating an internal DC bus voltage. Then the inverter circuit converts the DC back to AC again to power the motor. The special inverter can vary its output frequency and voltage according to the desired motor speed.

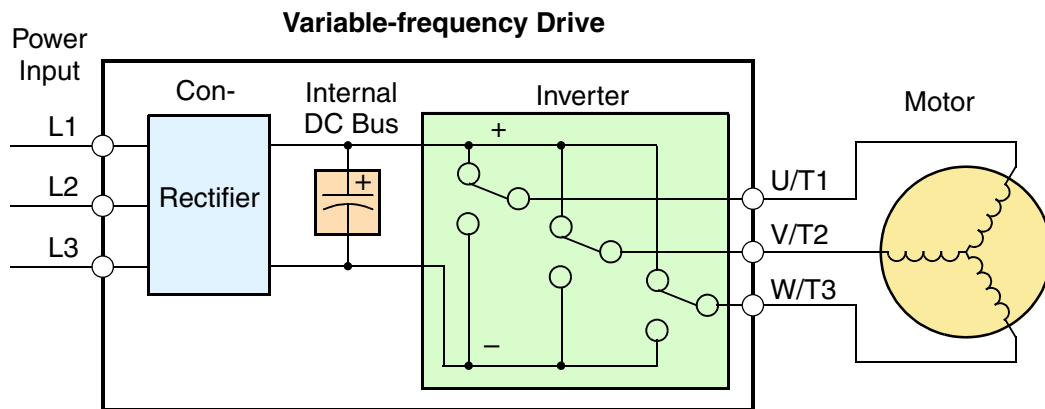

The simplified drawing of the inverter shows three double-throw switches. In Hitachi inverters, the switches are actually IGBTs (isolated gate bipolar transistors). Using a commutation algorithm, the microprocessor in the drive switches the IGBTs on and off at a very high speed to create the desired output waveforms. The inductance of the motor windings helps smooth out the pulses.

Torque and Constant Volts/Hertz Operation

In the past, AC variable speed drives used an open loop (scalar) technique to control speed. The constant-volts-per-hertz operation maintains a constant ratio between the applied voltage and the applied frequency. With these conditions, AC induction motors inherently delivered constant torque across the operating speed range. For some applications, this scalar technique was adequate.

Today, with the advent of sophisticated micro-processors and digital signal processors (DSPs), it is possible to control the speed and torque of AC induction motors with unprecedented accuracy. The L100 utilizes these devices to perform complex mathematical calculations required to achieve superior performance. You can choose various torque curves to fit the needs of your application. *Constant torque* applies the same torque level across the frequency (speed) range. *Variable torque*, also called *reduced torque*, lowers the torque delivered at mid-level frequencies. A torque boost setting will add additional torque in the lower half of the frequency range for the constant and variable torque curves. With the *free-setting torque* curve feature, you can specify a series of data points that will define a custom torque curve to fit your application.

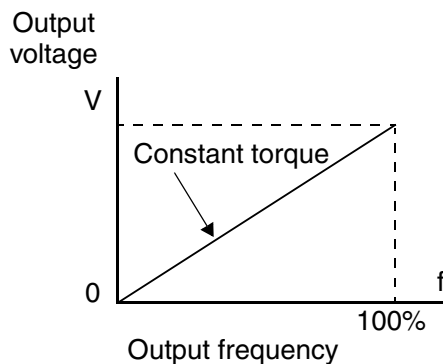

Inverter Input and Three-Phase Power

The Hitachi L100 Series of inverters includes two sub-groups: the 200V class and the 400V class inverters. The drives described in this manual may be used in either the United States or Europe, although the exact voltage level for commercial power may be slightly different from country to country. Accordingly, a 200V class inverter requires (nominal) 200 to 240VAC, and a 400V class inverter requires from 380 to 460VAC. Some 200V class inverters will accept single-phase or three-phase power, but all 400V class inverters require a three-phase power supply.



TIP: If your application only has single phase power available, refer to L100 inverters of 3HP or less; they can accept single phase input power.

The common terminology for single phase power is Line (L) and Neutral (N). Three-phase power connections are usually labeled Line 1 (L1), Line 2 (L2) and Line 3 (L3). In any case, the power source should include an earth ground connection. That ground connection will need to connect to the inverter chassis and to the motor frame (see “Wire the Inverter Output to Motor” on page 2-18).

Inverter Output to the Motor

The AC motor must be connected only to the inverter's output terminals. The output terminals are uniquely labeled (to differentiate them from the input terminals) with the designations U/T1, V/T2, and W/T3. This corresponds to typical motor lead connection designations T1, T2, and T3. It is often not necessary to connect a particular inverter output to a particular motor lead for a new application. The consequence of swapping any two of the three connections is the reversal of the motor direction. In applications where reversed rotation could cause equipment damage or personnel injury, be sure to verify direction of rotation before attempting full-speed operation. For safety to personnel, you must connect the motor chassis ground to the ground connection at the bottom of the inverter housing.

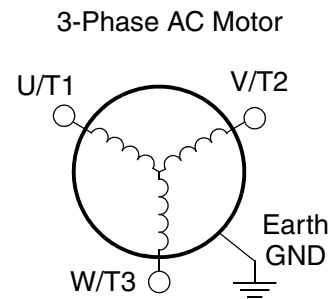

Notice the three connections to the motor do not include one marked “Neutral” or “Return.” The motor represents a balanced “Y” impedance to the inverter, so there is no need for a separate return. In other words, each of the three “Hot” connections serves also as a return for the other connections, because of their phase relationship.

The Hitachi inverter is a rugged and reliable device. The intention is for the inverter to assume the role of controlling power to the motor during all normal operations. Therefore, this manual instructs you not to switch off power to the inverter *while the motor is running* (unless it is an emergency stop). Also, do not install or use disconnect switches in the wiring from the inverter to the motor (except thermal disconnect). Of course, safety-related devices such as fuses must be in the design to break power during a malfunction, as required by NEC and local codes.

Intelligent Functions and Parameters

Much of this manual is devoted to describing how to use inverter functions and how to configure inverter parameters. The inverter is microprocessor-controlled, and has many independent functions. The microprocessor has an on-board EEPROM for parameter storage. The inverter's front panel keypad provides access to all functions and parameters, which you can access through other devices as well. The general name for all these devices is the *digital operator*, or *digital operator panel*. Chapter 2 will show you how to get a motor running, using a minimal set of function commands or configuring parameters.

The optional read/write programmer will let you read and write inverter EEPROM contents from the programmer. This feature is particularly useful for OEMs who need to duplicate a particular inverter's settings in many other inverters in assembly-line fashion.



Braking

In general, braking is a force that attempts to slow or stop motor rotation. So it is associated with motor deceleration, but may also occur even when the load attempts to drive the motor faster than the desired speed (overhauling). If you need the motor and load to decelerate quicker than their natural deceleration during coasting, we recommend installing an optional dynamic braking unit. See “Introduction” on page 5-2 and “Dynamic Braking” on page 5-5 for more information on the BRD-E2 and BRD-EZ2 braking units. The L100 inverter sends excess motor energy into a resistor in the dynamic braking unit to slow the motor and load. For loads that continuously overhaul the motor for extended periods of time, the L100 may not be suitable (contact your Hitachi distributor).

The inverter parameters include acceleration and deceleration, which you can set to match the needs of the application. For a particular inverter, motor, and load, there will be a range of practically achievable accelerations and decelerations.

Velocity Profiles

The L100 inverter is capable of sophisticated speed control. A graphical representation of that capability will help you understand and configure the associated parameters. This manual makes use of the velocity profile graph used in industry (shown at right). In the example, *acceleration* is a ramp to a set speed, and *deceleration* is a decline to a stop.

Acceleration and deceleration settings specify the time required to go from a stop to maximum frequency (or visa versa). The resulting slope (speed change divided by time) is the acceleration or deceleration. An increase in output frequency uses the acceleration slope, while a decrease uses the deceleration slope. The accel or decel time a particular speed change depends on the starting and ending frequencies. However, the slope is constant, corresponding to the full-scale accel or decel time setting. For example, the full-scale acceleration setting (time) may be 10 seconds—the time required to go from 0 to 60 Hz.

The L100 inverter can store up to 16 preset speeds. And, it can apply separate acceleration and deceleration transitions from any preset to any other preset speed. A multi-speed profile (shown at right) uses two or more preset speeds, which you can select via intelligent input terminals. This external control can apply any preset speed at any time. Alternatively, the selected speed is infinitely variable across the speed range. You can use the potentiometer control on the keypad for manual control. The drive accepts analog 0-10V signals and 4-20 mA control signals as well.

The inverter can drive the motor in either direction. Separate FW and RV commands select the direction of rotation. The motion profile example shows a forward motion followed by a reverse motion of shorter duration. The speed presets and analog signals control the magnitude of the speed, while the FWD and REV commands determine the direction before the motion starts.

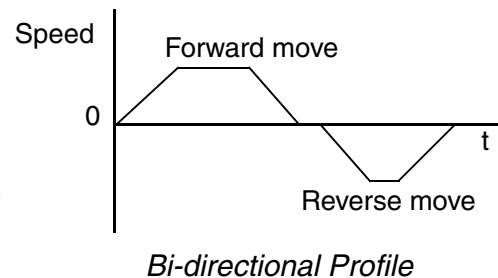
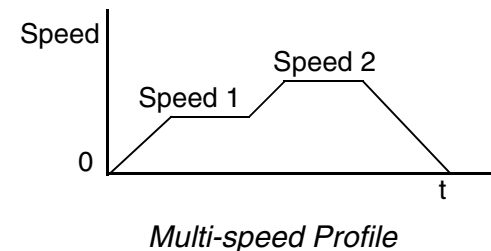
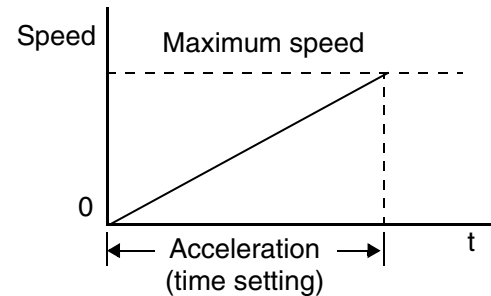
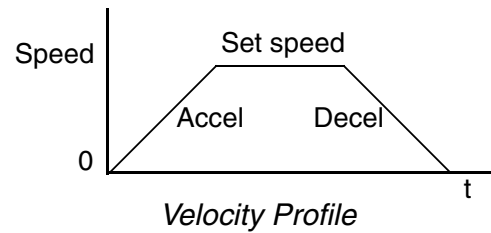

NOTE: The L100 can move loads in both directions. However, it is not designed for use in servo-type applications that use a bipolar velocity signal that determines direction.

Frequently Asked Questions

- Q.** What is the main advantage in using an inverter to drive a motor, compared to alternative solutions?
- A.** An inverter can vary the motor speed with very little loss of efficiency, unlike mechanical or hydraulic speed control solutions. The resulting energy savings usually pays for the inverter in a relatively short time.
- Q.** The term “inverter” is a little confusing, since we also use “drive” and “amplifier” to describe the electronic unit that controls a motor. What does “inverter” mean?
- A.** The terms *inverter*, *drive*, and *amplifier* are used somewhat interchangeably in industry. Nowadays, the terms *drive*, *variable-frequency drive*, *variable-speed drive*, and *inverter* are generally used to describe electronic, microprocessor-based motor speed controllers. In the past, *variable-speed drive* also referred to various mechanical means to vary speed. *Amplifier* is a term almost exclusively used to describe drives for servo or stepper motors.
- Q.** Although the L100 inverter is a variable speed drive, can I use it in a fixed-speed application?
- A.** Yes, sometimes an inverter can be used simply as a “soft-start” device, providing controlled acceleration and deceleration to a fixed speed. Other functions of the L100 may be useful in such applications, as well. However, using a variable speed drive can benefit many types of industrial and commercial motor applications, by providing controlled acceleration and deceleration, high torque at low speeds, and energy savings over alternative solutions.
- Q.** Can I use an inverter and AC induction motor in a positioning application?
- A.** That depends on the required precision, and the slowest speed the motor will must turn and still deliver torque. If you set the torque boost, the L100 can develop starting torque at 100% of its rating. However, DO NOT use an inverter if you need the motor to stop and hold the load position without the aid of a mechanical brake (use a servo or stepper motion control system).
- Q.** Does the optional digital operator interface or the PC software (DOP Professional) provide features beyond what is available from the keypad on the unit?
- A.** Yes. However, note first that the same set of parameters and functions are equally accessible from either the unit’s keypad or from remote devices. The DOP Professional PC software lets you save or load inverter configurations to or from a disk file. And, the hand-held digital operator provides hard-wired terminals, a safety requirement for some installations.

- Q.** Why does the manual or other documentation use terminology such as “200V class” instead of naming the actual voltage, such as “230 VAC?”
- A.** A specific inverter model is set at the factory to work across a voltage range particular to the destination country for that model. The model specifications are on the label on the side of the inverter. A European 200V class inverter (“EU” marking) has different parameter settings than a USA 200V class inverter (“US” marking). The initialization procedure (see “Restoring Factory Default Settings” on page 6–8) can set up the inverter for European or US commercial voltage ranges.
- Q.** Why doesn’t the motor have a neutral connection as a return to the inverter?
- A.** The motor theoretically represents a “balanced Y” load if all three stator windings have the same impedance. The Y connection allows each of the three wires to alternately serve as input or return on alternate half-cycles.
- Q.** Does the motor need a chassis ground connection?
- A.** Yes, for several reasons. Most importantly, this provides protection in the event of a short in the motor that puts a hazardous voltage on its housing. Secondly, motors exhibit leakage currents that increase with aging. Lastly, a grounded chassis generally emits less electrical noise than an ungrounded one.
- Q.** What type of motor is compatible with the Hitachi inverters?
- A.** **Motor type** – It must be a three-phase AC induction motor. Use an inverter-grade motor that has 800V insulation for 200V class inverters, or 1600V insulation for 400V class.
Motor size – In practice, it’s better to find the right size motor for your application; then look for the inverter to match the motor.



NOTE: There may be other factors that will affect motor selection, including heat dissipation, motor operating speed profile, enclosure type, and cooling method.

- Q.** How many poles should the motor have?
- A.** Hitachi inverters can be configured to operate motors with 2, 4, 6, or 8 poles. The greater the number of poles, the slower the top motor speed will be, but it will have higher torque at the base speed.
- Q.** Will I be able to add dynamic (resistive) braking to my Hitachi L100 drive after the initial installation?
- A.** Yes. You can connect a dynamic braking unit to the L100 inverter. The resistor in the braking unit must be sized to meet the braking requirements. More information on dynamic braking is located in Chapter 5.

- Q.** How will I know if my application will require resistive braking?
- A.** For new applications, it may be difficult to tell before you actually test a motor/drive solution. In general, some applications can rely on system losses such as friction to serve as the decelerating force, or otherwise can tolerate a long deceleration time. These applications will not need dynamic braking. However, applications with a combination of a high-inertia load and a required short decel time will need dynamic braking. This is a physics question that may be answered either empirically or through extensive calculations.
- Q.** Several options related to electrical noise suppression are available for the Hitachi inverters. How can I know if my application will require any of these options?
- A.** The purpose of these noise filters is to reduce the inverter electrical noise so the operation of nearby electrical devices is not affected. Some applications are governed by particular regulatory agencies, and noise suppression is mandatory. In those cases, the inverter must have the corresponding noise filter installed. Other applications may not need noise suppression, unless you notice electrical interference with the operation of other devices.
- Q.** The L100 features a PID loop feature. PID loops are usually associated with chemical processes, heating, or process industries in general. How could the PID loop feature be useful in my application?
- A.** You will need to determine the particular main variable in your application the motor affects. That is the process variable (PV) for the motor. Over time, a faster motor speed will cause a faster change in the PV than a slow motor speed will. By using the PID loop feature, the inverter commands the motor to run at the optimal speed required to maintain the PV at the desired value for current conditions. Using the PID loop feature will require an additional sensor and other wiring, and is considered an advanced application.