



XTL™500



User Guide



Copyright

© 2015 Sanford, L.P. All rights reserved. Rev. 10/2/17

No part of this document or the software may be reproduced or transmitted in any form or by any means or translated into another language without the prior written consent of Sanford, L.P.

"Sans" is a DejaVu font. The DejaVu fonts are based on Vera fonts copyright © by Bitstream, Inc. Glyphs in the DejaVu fonts imported from Arev fonts are copyright © by Tavmjong Bah. All Rights Reserved.

Trademarks

DYMO and XTL are trademarks or registered trademarks in the US and other countries. All other trademarks are the property of their respective holders.

Legal Notices

The PDF-417 barcode software program is distributed under the Mozilla Public License v2.1 ("MPL").

The QR code barcode software program and the Qt application framework software program, provided by The Qt Company, are each distributed under the Lesser General Public License v2.1 or greater ("LGPLv2.1").

The label maker software contains components that are distributed under the BSD license.

For copies of each of licenses mentioned above, or information on how to obtain the relevant source code, visit:

<http://mediaserver.newellrubbermaid.com/industrial/License/Licenses.htm>

To request copies of corresponding source or object code licensed by one of the foregoing licenses, send a money order or check for USD \$10 to:

DYMO License Request
Newell Rubbermaid
6655 Peachtree Dunwoody Road
Atlanta, GA 30328
USA

Please indicate the licensed software and the license stated above in your request.

Contents

1	About Your New Label Maker
1	Registering Your Label Maker
1	What's New
2	Getting to Know Your Label Maker
2	Connecting the Power
2	Charging the Battery
3	Removing and Replacing the Battery
4	About Labels
4	Inserting the Label Cartridge
4	Removing the Label Cartridge
5	Selecting a Label Cartridge
5	Removing the Label Backing
6	Using Your Label Maker
6	Keypad
9	Touch Screen Display
10	Status Bar
10	Home Screen
11	Action Bar
11	Label Editor
12	Using the Touch Screen
12	Navigating Labels
14	Using the Label Applications
14	Setting Default Label Properties
15	Quick Label
15	General Label
16	Patch Panel Label
17	Flag Label
17	Laminated Cable Wrap Label
18	Cable Wrap Label
19	Heat-Shrink Tube Label
19	110-Block Label
20	Horizontal Breaker Label
21	Vertical Breaker Label
22	Terminal Block Label
22	Asset Tracking Label
23	Distribution Panel Label
24	Materials Management Label
24	Pipe Marking Label
25	Arc Flash Label
25	Safety Label
26	Changing Label Applications
27	Editing and Formatting Text on Labels
27	Editing Text
27	Changing the Text Size
28	Changing the Text Style
28	Changing the Text Color
28	Rotating the Text

- 29 Aligning the Text
- 29 Inserting Punctuation
- 29 Inserting Symbols
- 29 Inserting International Characters
- 30 Creating a Vertical Label

31 Working with Objects on a Label

- 31 Inserting a Text Box
- 31 Inserting an Image
- 32 Inserting a Barcode
- 33 Inserting a Shape
- 33 Manipulating Objects
- 33 Selecting an Object
- 33 Resizing an Object
- 34 Moving an Object
- 34 Positioning an Object
- 34 Aligning Objects
- 34 Arranging Objects
- 35 Copying an Object
- 35 Deleting an Object

35 Creating a Series of Labels

37 Using the Library

- 37 Saving Labels
- 37 Opening Saved Labels
- 37 Deleting Saved Labels

38 Using Favorites

39 Changing the Settings

- 39 Changing the Language
- 39 Changing the Units of Measure
- 39 Changing the Screen Brightness
- 40 Changing the Auto Shut-off Time
- 40 Changing the Recall Data Setting
- 40 Setting the Print Options
- 41 Print Range
- 41 Number of Copies
- 41 Collate
- 42 Mirror
- 42 Cut Labels
- 42 Feed
- 43 Setting the Default Barcode
- 43 Restoring the Label Application Default Settings
- 43 Restoring Factory Default Settings

44 Connecting the Label Maker to your Computer

- 44 Downloading and Installing DYMO ID™ Software
- 44 Connecting the Label Maker to your Computer
- 45 About DYMO ID Software
- 45 Transferring Files
- 45 Updating the Label Maker Software

47 Caring for the Label Maker

- 47 Cleaning the Label Maker

- 47 Cleaning the Print Head
- 48 Cleaning the Cutter Blade
- 48 Cleaning the Sensors

49 Troubleshooting

51 Images and Symbols

- 51 ISO
- 52 GHS
- 53 WHMIS
- 53 Electrical
- 53 Pro AV
- 54 Arrows
- 54 Symbols

55 Documentation Feedback

55 Environmental Information

56 Safety Precautions for Lithium Polymer Battery

About Your New Label Maker

With the DYMO® XTL™ 500 electronic label maker, you can design and print multiple label types, including barcode labels, panel labels, and heat shrink tubes. The label maker uses DYMO XTL™ label cartridges in label widths of 1/4", 3/8", 1/2", 3/4", 1", 1 1/2", or 2" (6 mm, 9 mm, 12 mm, 19 mm, or 24 mm, 41 mm, or 54 mm). Labels are available in a full range of temperature, chemical, and UV-resistant materials, including continuous tape and pre-sized labels.

Visit www.dymo.com for information on obtaining labels and accessories for your label maker.

Registering Your Label Maker

Visit www.dymo.com/register to register your label maker online. During the registration process you will need the serial number, which is located under the label compartment cover.

Register your label maker to receive these benefits:

- Notification of software upgrades by email
- Special offers and new product announcements

What's New

See **Updating the Label Maker Software** on page 45.

Version 1.1

- Resize a QR code to automatically fit the selected label size.
- Choose the number of times the text is repeated on the label with the improved Cable Wrap label application.

Getting to Know Your Label Maker

Become familiar with the parts of your label maker.



Figure 1

- | | | | |
|---|--------------------------|---|---------------------------------|
| 1 | Power and USB connectors | 5 | Label compartment cover release |
| 2 | On/Off (Cancel printing) | 6 | Label compartment |
| 3 | Touch screen display | 7 | Battery compartment |
| 4 | Label exit slot | | |

Connecting the Power

The label maker is powered by a rechargeable, lithium-polymer (LiPo) battery. The battery installed in your label maker ships partially charged. For best results, fully charge the battery before using the label maker for the first time.

See **Power Status** on page 10 for information about visually determining the battery charging status.

Charging the Battery

Fully charging a discharged battery will take approximately three and a half hours. You can continue to work as long as the power adapter is connected.

 Make sure to read the LiPo Safety Precautions found on page 56.

To charge the battery

- 1 On the left side of the label maker, gently lift and turn the connector cover to expose the power connector. See Figure 2.



Figure 2

- 2 Plug the power cord into the power adapter. See Figure 3.
- 3 Plug the barrel end of the power adapter into the power connector.

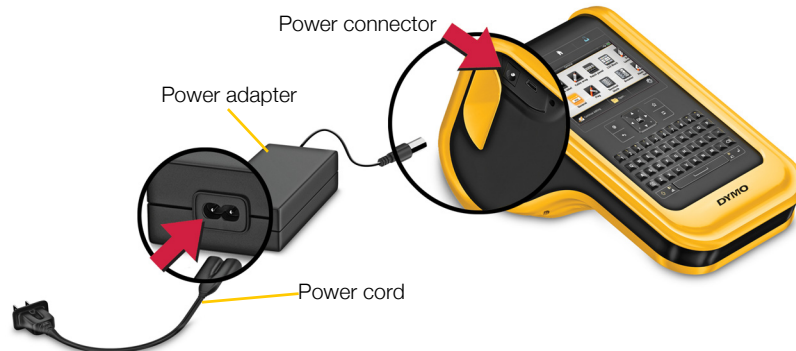



Figure 3

- 4 Plug the power cord into a power outlet.

The power status will show charging  in the upper right corner of the label maker's display.

Removing and Replacing the Battery

The LiPo battery is designed to provide years of service. In the unlikely situation that you need to replace the battery, a replacement battery can be ordered from www.dymo.com.

 Make sure the power adapter and USB cable are disconnected before handling the LiPo battery.

To remove the battery



- 1 Press and hold  for approximately five seconds to turn the power completely off.
- 2 Disconnect the power adapter and USB cable.
- 3 Using a #1 Phillips head screwdriver, loosen the screw holding the battery cover in place. See Figure 4.



Figure 4

 The screw is attached to the battery cover. Do not remove the screw completely from the cover.

- 4 Lift off the cover.
- 5 Pinch the sides of the battery connector to release and gently pull up to disconnect the battery. See Figure 5.
- 6 Remove the battery.
- 7 Insert the new battery and gently press the connector into place.
- 8 Replace the cover over the battery compartment.



Figure 5

9 Tighten the screw only until the battery cover is secure.

 Make sure to read the LiPo Safety Precautions found on page 56.

About Labels

The label maker uses DYMO XTL[®] label cartridges in label widths of 1/4", 3/8", 1/2", 3/4", 1", 1 1/2", or 2" (6 mm, 9 mm, 12 mm, 19 mm, or 24 mm, 41 mm, or 54 mm). Labels are available as continuous tape or pre-sized labels for specific applications.

The label cartridge that is inserted in the label maker determines the type of labels you can create and print. For example, if you have a 1" continuous label cartridge inserted, you will not be able to create a heat-shrink tube or laminated cable wrap label.

See **Using the Label Applications** on page 14 for information about the types of labels you can use with each label application.

Visit www.dymo.com for information on obtaining labels for your label maker.

Inserting the Label Cartridge

A sensitive electronic chip is embedded in the side of each label cartridge. This chip contains information that is read by the label maker and DYMO ID[™] software. This chip must be kept clean to function properly.

 Do not touch the electronic chip in the side of the cartridge; oils from your hand may prevent the chip from working properly. See Figure 6.



Figure 6

To insert the label cartridge

- 1 Press the label compartment release and lift the cover. See Figure 7.
- 2 Make sure the tape and ribbon are taut across the mouth of the label cartridge and that the tape passes between the label guides. See Figure 6.

To tighten the ribbon, turn the ribbon rewind spool in the direction indicated by the arrow on the cartridge.

- 3 Insert the cartridge and press firmly until the cartridge 'clicks' into place.
- 4 Close the label compartment cover.

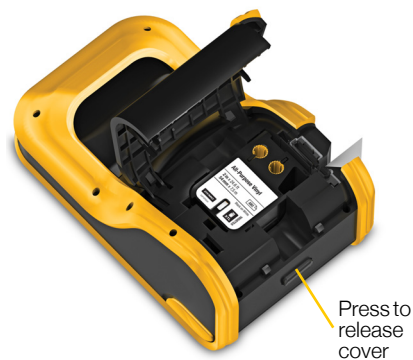

Figure 7

Removing the Label Cartridge

You can design labels without a label cartridge inserted in the label maker. Just remember to insert a compatible label cartridge before attempting to print. See **Using the Label Applications** on page 14.

To remove the label cartridge

- 1 Press the label compartment release and lift the cover. See Figure 7.
- 2 Remove the label cartridge.

You can now create labels using any of the label applications. When you start a new label, you will be asked to select a label cartridge to use.

Selecting a Label Cartridge

You can design any type of label when the label compartment is empty. Each time you select a label application, you are asked to select the properties for your new label.

To select a label cartridge

- 1 Remove the label cartridge from the label maker.
You are warned that the label compartment is empty.
- 2 Select a label application from the Home screen.
You are asked to select a label cartridge.



The labels available for you to choose from are filtered to show only those label cartridges appropriate for the label application you selected.

- 3 Do one of the following:
 - Enter the part number of the label cartridge you wish to use.
 - Scroll through the list of labels and select a specific label.
 - Select **Enter cartridge properties**. You are asked to select the properties for the label you wish to create.

Removing the Label Backing

DYMO XTL™ continuous labels have an easy-to-peel split back for easy removal of the label backing.



Does not apply to heat-shrink tubing or pre-sized labels.

To remove the continuous label backing

- 1 Locate the split on the label backing.
- 2 Gently pinch the label lengthwise, folding toward the printed side of the label. The label backing will separate.
- 3 Carefully peel away the backing from the label.

To remove pre-sized labels from the backing

- ▶ Gently lift the corner of the label and peel the label from the backing.

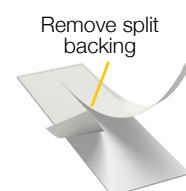

Continuous labels

Figure 8



Pre-sized labels

Figure 9

Using Your Label Maker

Become familiar with the features and function keys on your label maker.



Figure 10

1	On/Off (Cancel printing)	7	Backspace/Delete	13	Caps lock
2	Home	8	Return	14	Navigation
3	Print/Print options	9	Rotate/Align	15	Back
4	Touch screen display	10	Space bar	16	New label/Clear
5	Favorites	11	Text size/Text style	17	OK
6	Save	12	Shift		

Keypad

In addition to the alphanumeric keys, a number of function keys give you quick access to the features of your label maker.

Power

The  key turns the power on and off. Pressing  also cancels printing.

To conserve power, the screen dims after thirty seconds of inactivity and the label maker enters standby mode after three minutes of inactivity. After approximately ten more minutes of inactivity, the label maker automatically shuts off.

You can change the amount of time the label maker remains in standby mode before automatically shutting off. See **Changing the Auto Shut-off Time** on page

40.

To turn power on Press .

To turn on the display when in standby mode Press any key once.

To turn power completely off Press and hold  for five seconds.

When the label maker is turned off, the current label and settings are remembered so you can continue working the next time the label maker is turned on.

If the battery is removed and the power adapter is disconnected, the label and settings you are currently editing will be lost.

Home

The  key returns you to the Home screen at any time. See **Home Screen** on page 10 for more information about the Home screen.

Print

The  key prints the currently displayed label.

To print immediately Press  once.

To set print options Press and hold  for several seconds.

To cancel printing Press  once while label maker is printing.

Shift

The  key when used with another key selects the function or symbol printed above that key.

 + a letter Inserts an uppercase letter. Inserts a lowercase letter if Caps Lock is turned on.

 + a number Inserts the symbol over the selected number.

 +  Opens the Style tool. See **Changing the Text Style** on page 28.

 +  Opens the Align tool. See **Aligning the Text** on page 29.

The  key is also used with the navigation keys to select text in a text box. See **Navigation Keys** on page 9.

Clear

The  key clears a label of all text and formatting or, if in a list screen, removes the selected item.

 on label edit screen Deletes all text and formatting leaving a single blank label.

 in a list screen Deletes a saved label. Also deletes a template or an image added by you. Included images or templates cannot be deleted.

Save

The  key saves the labels you are currently editing. See **Saving Labels** on page 37.



Favorites

The  key opens the list of labels and images that you previously assigned to Favorites.

Selecting a favorite label	Opens that label file in the appropriate label editor.
Selecting a favorite image	Inserts the image into the label being edited at the current cursor position.

Back

The  key cancels an action or exits from a menu without making a selection.

Press  on a label edit screen	Undoes the last edit to the label.
Press  on a wizard screen	Moves back one page of the wizard.
Press  in a list or menu	Moves up one level in the list or menu.

Caps Lock

The  key toggles capitalization on and off.

Caps lock turned on	All letters that you enter are capitalized. The  indicator appears in the status bar.
Caps lock turned off	All letters entered appear in lowercase.

Backspace

The  key deletes the character to the left of the cursor. When an object is selected, deletes the object.

OK

The **OK** key makes a selection, such as choosing a label application, a label file, an image, a list item, or a setting.



Navigation Keys

For most tasks you can use the touch screen to interact with the label maker. However, you can also use the navigation keys as follows:

In a text box	<p>◀ or ▶ moves the cursor one character to the left or right.</p> <p>▲ or ▼ moves the cursor up or down one line.</p> <p>Pressing in any corner of the navigation key will move the cursor to the beginning or end of the current line.</p> <p>⏠ + ◀ or ▶ selects characters beginning at the cursor position to the right or left.</p> <p>⏠ + ▲ or ▼ selects characters beginning at the cursor position to the same position in the line above or below.</p> <p>⏠ + a corner of the navigation key selects characters beginning at the cursor position to the beginning or end of the text box.</p>	
In a multi-cell label such as patch panel	◀ or ▶ moves the cursor one cell to the left or right. At the end of the label, moves the cursor to the next label.	
When a text box, image, barcode, or shape is selected	Resizes or moves the selected object in small increments in the direction of the navigation key.	Pressing ⏠ with a navigation key resizes or moves the object in larger increments.
In menus and lists	Use the navigation keys along with OK to select an item.	

Touch Screen Display

The touch screen display is divided into three areas:

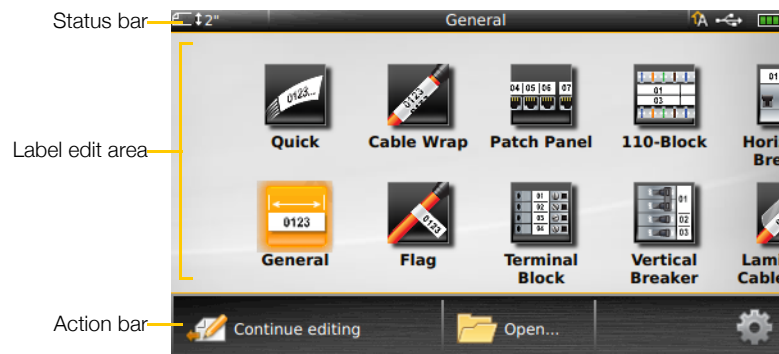



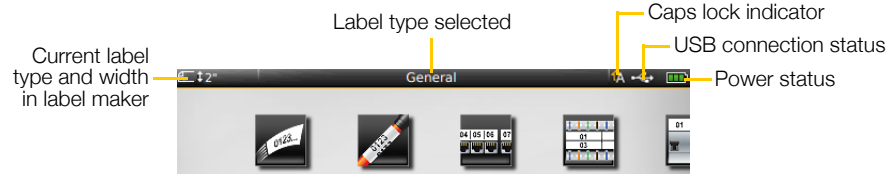

Status Bar

The status bar contains a number of indicators that show label information, label type, Caps lock, USB connection, and power status.



Power Status



The power status is shown at the top right of the display and shows the current battery status.

	Level of battery charge remaining.
	Connected to power adapter and charging. Bars will move from left to right while charging is in progress.
	Very low battery charge remaining; you may not be able to print.
	Battery completely discharged or missing.

Home Screen

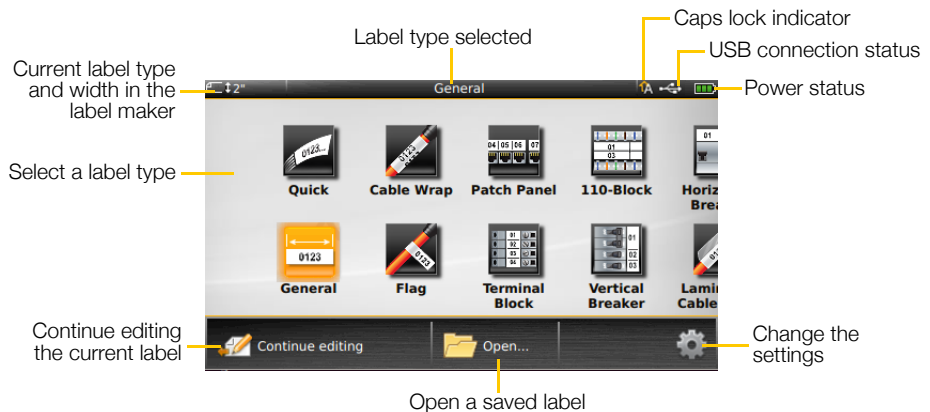
The Home screen contains all the label editor applications. This is where you will start creating labels for your specific application.







When you press the  key while editing a label, the Home screen is displayed; however, your current editing session remains active in the background. To return to editing the label, select  **Continue editing**.

If you select a new label application and the label currently being edited is not yet saved, you are prompted to save the label.

When you press the  key while in a menu or settings screen, any settings or other actions that have not been saved or confirmed are lost.

The Home screen contains the following three actions:

 Continue editing	Return to the label you were editing before pressing  .
 Open a saved label file	Open a previously saved label file.
 Settings	Change the label maker settings.

Action Bar

The Action bar below each screen contains actions that are specific to your current task. For example, the Home screen contains the following actions:

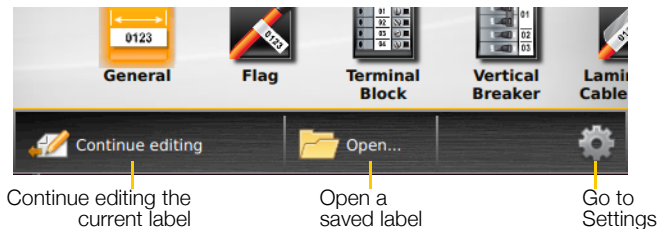



Tap an icon to select that action.

Label Editor

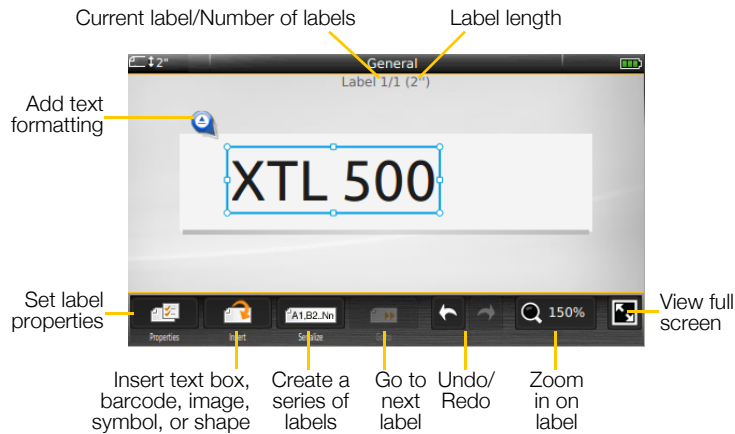



Each label application contains a custom editor for the type of label you are creating. At the bottom of the label editor are feature buttons which are enabled when that feature is available based on your label type and content.



 **Properties** Change the properties for the label. Available for all label types where properties can be customized. See the properties available for each label type in **Using the Label Applications** on page 14.

 **Insert** Add a text box, a barcode, an image, a symbol, or a shape on the label. The objects available depend on the label type selected. See **Working with Objects on a Label** on page 31.

 **Serialize** Automatically fill panel labels, or automatically create a series of single labels. See **Creating a Series of Labels** on page 35.

	View a series of labels, one at a time. Only available when the current file contains more than one label. Also used to locate label errors.
	Undo or redo the previous action.
	Zoom in or out on the label being edited. Select Auto zoom to automatically resize the label to fit the display.
	Show the label in full screen mode.

Using the Touch Screen

For most functions, you interact with the label maker using the touch screen. You can use your fingers or a plastic stylus with a rounded tip to tap, double-tap, pinch, and swipe objects on the touch screen.

 Do not press on the touch screen with a hard, sharp, or pointed object.

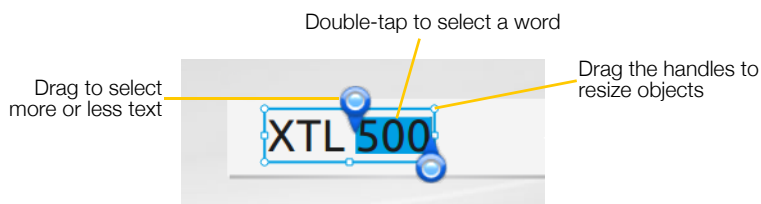

Tap	To select an action or object. To move the cursor within text. To select an object which can then be moved or resized.
Double-tap	To select a word, edit a barcode, change a shape or image object.
Drag	To select more or less text in a text object. To move selected text or an object.
Swipe	To scroll through menus, lists, and wizard steps. To display additional label applications or labels that are off the screen.

Navigating Labels

When a label file contain more than one label, you can view each label. You can also locate and fix labels with errors before printing.

To view labels

- 1 In the label editor, tap  **Go to**.
- 2 Tap **Labels**.
- 3 Tap **+** or **-** to select the label you wish to view. The label appears in the editor.
- 4 Tap **Done** when finished.

To find errors

- 1 In the label editor, tap  **Go to**.
- 2 Tap **Errors**.
- 3 Tap **+** or **-** to select the label with the error you wish to fix. The label appears in the editor.
- 4 Tap **Done** when finished.

Using the Label Applications

The label maker includes a number of label applications that make it easy to create a label for your specific job.

Label applications appropriate for the currently inserted label cartridge appear to the left of those label applications that are not compatible.

A caution symbol  appears when a label application and the current label cartridge are not a match.

The following label applications are available for your specific labeling job and are described in detail in this section:

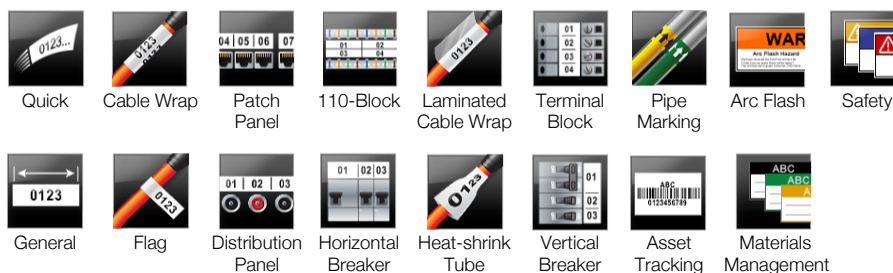
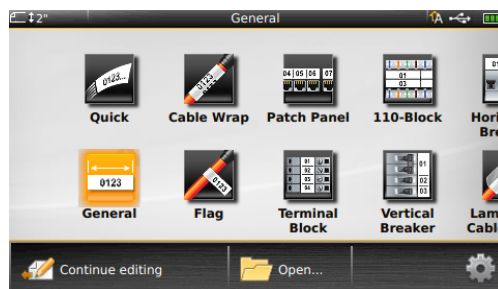

 You can create and save labels for applications that are not compatible with the currently inserted label cartridge by removing the cartridge and leaving the label compartment empty. However, make sure the correct label cartridge is inserted before attempting to print.

This section describes each label application and the label properties you can change to customize your label.

Setting Default Label Properties

Most label editors contain a wizard which steps you through the properties that must be set each time you create a label. For labels you use frequently, you can avoid stepping through the wizard by setting default properties for that label type.

To set default label properties

- 1 While in a label editor, tap .
- 2 Tap a property and change the setting as appropriate.
- 3 Tap **Set as default** on the bottom of the property screen.
- 4 Tap **Set as default** again to confirm.

Next time you select that label application, you will not have to set properties to get started. You can change the properties for an individual label at any time by selecting .

You can always clear any default label properties you set for a label application. See **Restoring the Label Application Default Settings** on page 43.



Quick Label

The Quick Label is a simple, text-only label. No properties need to be set to get started. As you add or delete text, the length of the label will change automatically to fit the text.



One text object is already included on the label by default. Barcodes, images, and shapes cannot be added, and you cannot create multiple labels using serialization.



All text formatting can be applied to this label. Text formatting applies to all text on the label. To apply text formatting to only some of the text, create a general label. Quick labels can be printed on any type of continuous labels.



The label properties you can set are:

Label outline	Yes - Show label outline.
	No - Hide label outline. (Default)
Leader/trailer match	Yes - Blank space is equal at the beginning and end of the label. (Default)
	No - No blank space added at the end of the label.

To create a quick label

- 1 From the Home screen, tap **Quick**.
- 2 Add text and formatting.



General Label

The General Label editor has no special formatting or templates associated with it. To create a custom design, you can add text, images, shapes, or a barcode. See **Working with Objects on a Label** on page 31 for more information.

By default, one text object is available in the center of the label.



This type of label allows text box, barcode, image, and shape objects.



Text size and style apply to the currently selected text. If no text is selected, the size and style apply to all the text in the text box.



Use serialization to automatically create a series of labels. See **Creating a Series of Labels** on page 35.

General labels can be printed on both continuous and pre-sized labels.



The label properties you can set are:

Label orientation	Landscape (Default) abc
	Portrait abc↓
	Changing the label orientation removes any content on the label, creating a new blank label.
Label length	Minimum: 1" (25.4 mm)
	This property is only available for continuous label cartridges. You cannot change the label length when a pre-sized label is selected.
Label outline	Yes - Show label outline.
	No - Hide label outline. (Default)
Leader/trailer match	Yes - Blank space is equal at the beginning and end of the label. (Default)
	No - No blank space is added at the end of the label.
	This property is only available for continuous label cartridges.

To create a general label

- 1 From the Home screen, tap  **General**.
- 2 Follow the steps to configure your label.
- 3 Add text and formatting.



Patch Panel Label

The Patch Panel editor allows you to quickly create a label that can be applied to datacom and electrical panels. Each label can contain up to 99 ports and you can divide the ports into equal groups.

 One text object is already added for each port. Barcodes, images, and shapes cannot be added to a patch panel label.







AB/ Text size and style apply to all ports on the label and to all labels in the file. When **Auto fit text** is selected for font size, the text in each port is automatically resized to fit that port. So you may see differences in text size for each port.

 Use serialization to automatically populate the ports. When all the ports are filled on the current label, a new label is created. See **Creating a Series of Labels** on page 35.

Patch panel labels can be printed on any type of continuous labels.



The label properties you can set are:

Port numbers	Number of ports - maximum of 99 ports In groups of - Number of ports available per group is determined by the number of ports selected so that each group is equal.
Label setup	Continuous - Print groups of ports as one continuous label.  Separate - Print each group of ports as a separate label.  (Default)
Dimensions	Center to center distance - Distance from the center of one port to the center of the next port. Minimum: 5/32" (3.8 mm) Maximum: 20" (508 mm)  Group clearance - Distance between groups of ports when one continuous label is selected. Minimum: 1/64" (0.4 mm) Maximum: 20" (508 mm) 
Separator lines 	Yes - Print a separator line between each port. (Default) No - Don't print a separator line between each port.
Label outline 	Yes - Show label outline. No - Hide label outline. (Default)

You create a patch panel label by using a pre-designed template or by entering the label properties manually. See **Transferring Files** on page 45 for information about transferring the latest templates from your computer.

To use a patch panel template

- 1 From the Home screen, tap  **Patch Panel**.
- 2 Tap **Apply template**.
- 3 Select the template you wish to use.
- 4 Add text and formatting.

To create a patch panel label manually

- 1 From the Home screen, tap  **Patch Panel**.
- 2 Follow the steps to configure your label.
- 3 Add text and formatting.



Flag Label

The flag label is one of several cable management specific labels. The flag label consists of two matching segments that when wrapped around a cable form a flag allowing the user to see the same data from both sides.



One text box is automatically added to the label. You can add additional text box, image, shape, or barcode objects to a flag label.



Text size and style apply to the currently selected text. If no text is selected, the size and style apply to all the text in the text box.





Use serialization to automatically create a series of labels. See **Creating a Series of Labels** on page 35.

Flag labels can be printed on any type of continuous labels. A vertical dashed line will be printed in the center of the wrap part of the label to help you easily center the label on the cable.



The label properties you can set are:

Cable type and diameter 	Cable type: CAT 5/6, COAX, AWG: 4/0 - 2/0, AWG: 0 - 2, AWG: 3 - 5, AWG: 6+, or Custom Diameter: Available when Custom is selected for Cable type. Minimum: 5/32" (4 mm) Maximum: 2" (50.8 mm)
Flag length 	Minimum: 7/16" (11.1 mm) Maximum: 10" (254 mm)
Label outline 	Yes - Show label outline. No - Hide label outline. (Default)

To create a flag label

- 1 From the Home screen, tap  **Flag**.
- 2 Do one of the following:
 - Select the cable type.
 - Tap **Custom** and then select the cable diameter.
- 3 Follow the steps to configure your label.
- 4 Add text and formatting.



Laminated Cable Wrap Label

The laminated cable wrap label is one of several cable management specific labels. This label contains two segments: a segment for the label content and an adhesive-backed, transparent segment that wraps around the cable covering the printed content for durability.



One text box is automatically added to the label. You can add additional text box, image, shape, or barcode objects to a laminated cable wrap label.

AB/I Text size and style apply to the currently selected text. If no text is selected, the size and style apply to all the text in the text box.

Laminated cable wrap labels can only be printed using pre-sized Laminated Wire/Cable Wrap label cartridges.

 Use serialization to automatically create a series of labels. See **Creating a Series of Labels** on page 35.

 Laminated cable wrap label properties are based on the label cartridge selected and cannot be changed.

To create a laminated cable wrap label

- 1 From the Home screen, tap  **Laminated Cable Wrap**.
The editor displays a new blank label based on the label cartridge inserted. If no label cartridge is inserted, you are asked to select a label cartridge.
- 2 Add text and formatting.



Cable Wrap Label

The cable wrap label is one of several cable management specific labels. The content of the cable wrap label is repeated several times vertically so that it can be viewed from any angle when the label is wrapped around the cable.

 One text box is automatically added to the label. Additional text box, barcode, image, and shape objects cannot be added to a cable wrap label.

AB/I Text size and style apply to the text on the label.

 Use serialization to automatically create a series of labels. See **Creating a Series of Labels** on page 35.

Cable wrap labels can be printed on any type of continuous labels.

 The label properties you can set are:

Cable type and diameter	Cable type: CAT 5/6, COAX, AWG: 4/0 - 2/0, AWG: 0 - 2, AWG: 3 - 5, AWG: 6+, or Custom
--------------------------------	--

Diameter - Available when Custom is selected for Cable type. Minimum: 5/32" (4 mm) Maximum: 2" (50.8 mm)

Text repeat	Auto repeat (default) - Number of repeats is determined by label size. Minimum 4 repeats. User selected: Minimum: 1; Maximum: 20
--------------------	---

To create a cable wrap label

- 1 From the Home screen, tap  **Cable Wrap**.
- 2 Do one of the following:
 - Select the cable type.
 - Tap **Custom** and then select the cable diameter.
- 3 Follow the steps to configure your label.
- 4 Add text and formatting.



Heat-Shrink Tube Label

The heat-shrink tube label is one of several cable management specific labels. Heat-shrink tube labels can be printed on any continuous or pre-sized Heat-Shrink Tube labels.



One text object is automatically added to the label. You can add additional text box, barcode, image, or shape objects to heat-shrink tube labels.



Text size and style apply to the currently selected text. If no text is selected, the size and style apply to all the text in the text box.



Use serialization to automatically create a series of labels. See **Creating a Series of Labels** on page 35.

The following table should help in choosing the correct label width for your application.

Heat-shrink tube size	Minimum cable diameter	Maximum cable diameter	Minimum AWG	Maximum AWG
1/4" (6 mm)	0.05" (1.24 mm)	0.14" (3.5 mm)	16	7
1/2" (12 mm)	0.12" (3 mm)	0.28" (7.2 mm)	8	1
1" (24 mm)	0.22" (5.5 mm)	0.57" (14.50 mm)	3	4/0+
2" (54 mm)	0.46" (11.5 mm)	1.27" (32.3 mm)	3	4/0+
2 1/8" (54 mm)	0.46" (11.5 mm)	1.27" (32.3 mm)	3	4/0+



The label properties you can set are:

Label orientation	Landscape (Default) Portrait Changing the label orientation removes any content on the label, creating a new blank label.
Label length	Minimum: 1 1/4" (31.75 mm) Default: 2" (50.8 mm)
Label outline	Yes - Show label outline. No - Hide label outline. (Default)
Leader/trailer match	Yes - Blank space is equal at the beginning and end of the label. (Default) No - No blank space added at the end of the label. This property is only available when using continuous label cartridges.

To create a heat-shrink tube label

- 1 From the Home screen, tap **Heat-Shrink Tube**.
- 2 Follow the steps to configure your label.
- 3 Add text and formatting.



110-Block Label

The 110-block label is one of several datacom specific labels. You enter data into one of three pre-defined block formats depending on the block type you select.





One text object is automatically added for each block. Additional text box, barcode, image, and shape objects cannot be added to 110-block labels.

AB I Text size and style apply to all blocks on the label and all labels in the file. When **Auto fit text** is selected for font size, the text is automatically resized to fit that block. So you may see differences in text size for each block.

 Use serialization to automatically populate the blocks. When all the blocks are filled on the current label, a new label is created. See **Creating a Series of Labels** on page 35.

110-block labels can be printed on any type of continuous labels.

 The label properties you can set are:

Block type	C4-4 pair - Data grade C4-4 pair - Voice grade C5-5 pair - Voice grade
Separator lines	Yes - Print a separator line between each block.  No - Don't print a separator line between each block. (Default)
Label outline	Yes - Show label outline.  No - Hide label outline. (Default)

To create a 110-block label

- 1 From the Home screen, tap  **110-Block**.
- 2 Select a block type.
- 3 Add text for each block.
- 4 Add formatting as desired.



Horizontal Breaker Label

The horizontal breaker label is one of two types of labels for use on a breaker box. See **Vertical Breaker Label** on page 21.

 One text object is automatically added for each breaker. Additional text box, barcode, image, and shape objects cannot be added to horizontal breaker labels.



AB I Text size and style apply to all breakers on the label and all labels in the file. When **Auto fit text** is selected for font size, the text is automatically resized to fit that breaker. So you may see differences in text size for each breaker.

 Use serialization to automatically populate the breakers. When all the breakers are filled on the current label, a new label is created. See **Creating a Series of Labels** on page 35.

Horizontal breaker labels can be printed on any type of continuous labels.



The label properties you can set are:

Breaker dimensions	Number of breakers - Maximum: 99 breakers
	Breaker width - Minimum: 1/4" (6.35 mm); Maximum: 5" (126.9 mm)
Breaker multipliers	Multiplier for each breaker. Maximum: 4 Can be manually entered in 0.5 increments, such as 2.5, 3.5 and so on.
Label outline 	Yes - Show label outline.
	No - Hide label outline. (Default)
Separator lines 	Yes - Print a separator line between each breaker. (Default)
	No - Don't print a separator line between each breaker.
Leader/trailer match 	Yes - Blank space is equal at the beginning and end of the label. (Default)
	No - No blank space is added at the end of the label.

To create a horizontal breaker label

- 1 From the Home screen, tap  **Horizontal Breaker**.
- 2 Follow the steps to configure your label.
- 3 Add text for each breaker.
- 4 Add formatting as desired.



Vertical Breaker Label

The vertical breaker label is one of two types of labels for use on a breaker box. See **Horizontal Breaker Label** on page 20.



One text object is automatically added for each breaker. Additional text box, barcode, image, and shape objects cannot be added to vertical breaker labels.



Text size and style apply to all breakers on the label and all labels in the file. When **Auto fit text** is selected for font size, the text is automatically resized to fit that breaker. So you may see differences in text size for each breaker.





Use serialization to automatically populate the breakers. When all the breakers are filled on the current label, a new label is created. See **Creating a Series of Labels** on page 35.

Vertical breaker labels can be printed on any type of continuous labels.



The label properties you can set are:

Breaker dimensions	Number of breakers - Maximum: 99 breakers
	Breaker height - Minimum: 1/4" (6.35 mm); Maximum: 5" (126.9 mm)
Breaker poles	Number of poles for each breaker. Maximum: 3
Label outline 	Yes - Show label outline.
	No - Hide label outline. (Default)
Separator lines 	Yes - Print a separator line between each breaker. (Default)
	No - Don't print a separator line between each breaker.
Leader/trailer match 	Yes - Blank space is equal at the beginning and end of the label. (Default)
	No - No blank space is added at the end of the label.

To create a vertical breaker label

- 1 From the Home screen, tap  **Vertical Breaker**.

- 2 Follow the steps to configure your label.
- 3 Add text for each breaker.
- 4 Add formatting as desired.



Terminal Block Label

Terminal block labels are created by specifying the orientation (portrait or landscape), the number of blocks, and the block height.



One text object is automatically added for each block. Additional text box, barcode, image, and shape objects cannot be added to terminal block labels.



Text size and style apply to all blocks on the label and all labels in the file. When **Auto fit text** is selected for font size, the text is automatically resized to fit that block. So you may see differences in text size for each block.









Use serialization to automatically populate the blocks. When all the blocks are filled on the current label, a new label is created. See **Creating a Series of Labels** on page 35.

Terminal block labels can be printed on any type of continuous labels.



The label properties you can set are:

Label orientation	Portrait (Default) 
	Landscape 
	 Changing the label orientation removes any content on the label, creating a new blank label.
Terminal block dimensions	Number of blocks. Maximum: 99 blocks Block height. Minimum: 5/32" (3.8 mm); Maximum: 20" (508 mm)
Label outline	Yes - Show label outline.  No - Hide label outline. (Default)
Separator lines	Yes - Print a separator line between each block. (Default)  No - Don't print a separator line between each block.
Leader/trailer match	Yes - Blank space is equal at the beginning and end of the label.  No - No blank space is added at the end of the label. (Default)

To create a terminal block label

- 1 From the Home screen, tap  **Terminal Block**.
- 2 Follow the steps to configure your label.
- 3 Add text for each block.
- 4 Add formatting as desired.



Asset Tracking Label

Asset tracking labels are created using pre-designed templates. The list of available templates is based on the label cartridge you have selected. See **Transferring Files** on page 45 for information about transferring the latest templates from your computer.





You can edit any text, barcode, image, or shape objects on the label, but you cannot edit the templates to add or delete objects.

AB I Text size and style apply to the currently selected text. If no text is selected, the size and style apply to all the text in the text box.

 Use serialization to automatically create a series of labels. See **Creating a Series of Labels** on page 35.

Asset tracking labels can be printed on any type of continuous or pre-sized labels.

 The label properties you can set are:

Label length 	Minimum: 1" (25.4 mm) This property is only available for continuous label cartridges. You cannot change the label length if a pre-sized label is selected.
Label outline 	Yes - Show label outline. No - Hide label outline. (Default)
Leader/trailer match 	Yes - Blank space is equal at the beginning and end of the label. No - No blank space is added at the end of the label. (Default) Available only when a continuous label cartridge is selected.

To create an asset tracking label

- 1 From the Home screen, tap  **Asset Tracking**.
- 2 Select the template you would like to use.
- 3 Add text and formatting.

Distribution Panel Label



Distribution panel labels are created by specifying the number of connectors and the center to center distance between each connector.



 One text object is automatically added for each connector. Additional text box, barcode, image, and shape objects cannot be added to distribution panel labels.

AB I Text size and style apply to all connectors on the label and all labels in the file. When **Auto fit text** is selected for font size, the text is automatically resized to fit that connector. So you may see differences in text size for each connector.

 Use serialization to automatically populate the connectors. When all the connectors are filled on the current label, a new label is created. See **Creating a Series of Labels** on page 35.

Distribution panel labels can be printed on any type of continuous labels.

 The label properties you can set are:

Panel dimensions 	Number of connectors. Maximum: 99 connectors Center to center distance - Distance from the center of one connector to the center of the next connector. Minimum: 5/32" (3.8 mm) Maximum: 20" (508 mm)
Label outline 	Yes - Show label outline. No - Hide label outline. (Default)
Separator lines 	Yes - Print a separator line between each connector. (Default) No - Don't print a separator line between each connector.

To create a distribution panel label

- 1 From the Home screen, tap  **Distribution Panel**.
- 2 Follow the steps to configure your label.

- 3 Add text for each connector.
- 4 Add formatting as desired.

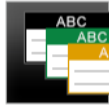

Materials Management Label

Materials management labels are created using pre-designed templates. The list of available templates is based on the label cartridge you have selected. See **Transferring Files** on page 45 for information about transferring the latest templates from your computer.



You can add or edit any text, barcode, image, or shape objects on the label but you cannot edit the template to add or delete objects.



Text size and style apply to the currently selected text. If no text is selected, the size and style apply to all the text in the text box.





Use serialization to automatically create a series of labels. See **Creating a Series of Labels** on page 35.

Materials management labels can only be printed on 3/4" (19 mm) and wider continuous or pre-sized labels.



The label properties you can set are:

Label outline 	Yes - Show label outline. No - Hide label outline. (Default)
Leader/trailer match 	Yes - Blank space is equal at the beginning and end of the label. No - No blank space is added at the end of the label. (Default) Available only when a continuous label cartridge is selected.

To create a materials management label

- 1 From the Home screen, tap .
- 2 Select the template you would like to use.
- 3 Add text and formatting.



Pipe Marking Label

Pipe marking labels are created using pre-defined layouts, and can be printed on any type of continuous labels.



Text size and style apply to the currently selected text. If no text is selected, the size and style apply to all the text in the text box.



One text object is automatically added for each connector. Additional text box, barcode, image, and shape objects cannot be added to pipe marking labels.

Serialization cannot be used with pipe marking labels.



The label properties you can set are:

Label setup	ASME A13.1 01 ASME A13.1 02 ASME A13.1 03 ASME A13.1 04 Other 01 Other 02
Flow direction	Left - Arrow placed to the left of the text. Right - Arrow placed to the right of the text. Both - Arrows placed on both sides of the text.
Pipe diameter 	Minimum: 3/4" (19 mm) (default) Maximum: 10" (254 mm)

To create a pipe marking label

- 1 From the Home screen, tap  **Pipe Marking**.
- 2 Follow the steps to configure your label.
- 3 Add text and formatting.



Arc Flash Label

Arc flash labels are created using pre-designed templates. The list of available templates is based on the label cartridge you have selected. See **Transferring Files** on page 45 for information about transferring the latest templates from your computer.

AB/ Text size and style apply to the currently selected text. If no text is selected, the size and style apply to all the text in the text box.



You can add text box, barcode, image, or shape objects to the label.



Use serialization to automatically create a series of labels. See **Creating a Series of Labels** on page 35.



Because arc flash labels are printed on pre-defined templates, no properties can be set.

To create an arc flash label

- 1 From the Home screen, tap  **Arc Flash**.
- 2 Select the template you would like to use.
- 3 Add text and formatting.



Safety Label

Safety labels are created using pre-designed templates. The list of available templates is based on the label cartridge you have selected. See **Transferring Files** on page 45 for information about transferring the latest templates from your computer.

AB/ Text size and style apply to the currently selected text. If no text is selected, the size and style apply to all the text in the text box.



You can add text box, barcode, image, or shape objects to the label.



Use serialization to automatically create a series of labels. See **Creating a Series of Labels** on page 35.



Because safety labels are printed on pre-defined templates, no properties can be set.

To create an safety label

- 1 From the Home screen, tap  **Safety**.
- 2 Select the template you would like to use.
- 3 Add text and formatting.

Changing Label Applications

After creating labels in one label application, you can change to a different label application. In some cases you will be asked if you want to reuse the data from the previous application.

For some label applications, you may wish to create more than one type of label using the same data. For example, you create a 24 port patch panel label and you also want 24 cable wrap labels to place on the cables. The data recall feature allows you to switch label applications and recall the data to the new application.

See **Changing the Recall Data Setting** on page 40 to change the default setting.



Data recall is not available for label applications.

To change the label application

- 1 Press **Home**.
- 2 Tap the new label application.
If data recall is available for that application, a Recall data dialog box displays.
- 3 Select one of the following:
 - **Recall once** - Recall data from the previous label this one time only. You will continue to be asked each time data recall is available.
 - **Always recall** - Always recall data from the previous label. From now on data will always be recalled to the new label when possible.
 - **Not this time** - Don't recall data this one time. You will continue to be asked each time data recall is available.
 - **Never recall** - You will never be asked to recall data.
- 4 Tap **Continue**.

The new label application is populated with the recalled data.

Editing and Formatting Text on Labels

You can format text in a text box from the touch screen or using the keypad. The instructions in this section give both options when applicable.

This section describes the following:

- Changing text size and style
- Rotating and aligning the text
- Inserting punctuation, symbols, and special characters
- Creating a vertical label

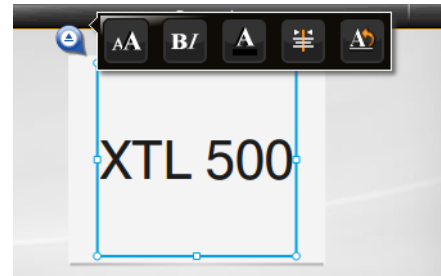

Editing Text

The number of lines of text that you can insert on a label depends on the size of the text and the width of the label. If the text is too large or you add too many lines, you will see a warning icon ⚠ and receive an error message when you try to print.

You can move the cursor position and select one or more characters in a text box using the touch screen or the keypad. See **Navigation Keys** on page 9 for information about moving the cursor and selecting text using the keypad.

To edit text in a text box

- ▶ Tap once in a text box and add text using the keypad.
- ▶ Press ↵ to add a new line.
- ▶ Tap ⚙ to display the Formatting tool bar.



You can also apply text formats from the  **Properties** list.

Changing the Text Size

You can select the font size for the text or you can have the text automatically sized to fit the available space on the label.

See each label type in **Using the Label Applications** on page 14 for how changes to the text size are applied to that type of label.

To change the text size

- 1 Select some text.
To apply the size to all the text, select the text box.
- 2 Tap ⚙ and .
Or, on the keypad, press .
- 3 Select a font size from the list or tap **Auto fit text**.



You can also enter a size directly in the **Font size** box.



B I Changing the Text Style

You can add bold, italic, and underline to your text. You can also add a box around all the text in the selected text box.

See **Using the Label Applications** on page 14 for how changes to the text style are applied to each type of label.

To change the text style.





- 1 Select some text.
To apply the style to all the text, select the text box.
- 2 Tap  and ***B I***.
Or, on the keypad, press  + ***A***.
The Text Style tool appears.
- 3 Tap one or more styles.

A Changing the Text Color

You can change the text color on the label from the foreground color to the background color. This can be useful when layering objects. For example, if you add a rectangular shape object and want to place contrasting text on top of the rectangle.

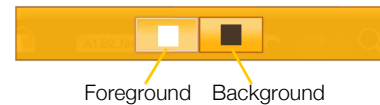
To change the color





- 1 Select a text box.
- 2 Tap  and ***A***.
The Text Color tool appears.
- 3 Tap the color for the selected text.

A ↵ Rotating the Text

The text on your label can appear horizontally or vertically. You can also rotate the text in 90 degree increments.

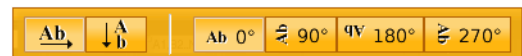
To rotate the text



- 1 Select a text box.
- 2 Tap  and .
Or, on the keypad, press ***A ↵***.
The Text Orientation tool appears.
- 3 Select an orientation and/or a rotation.



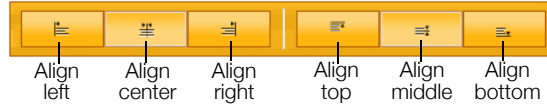

To create a vertical label, see **Creating a Vertical Label** on page 30.

Aligning the Text

The text on your label can be aligned left, center, or right, vertically and horizontally.



To align the text

- 1 Select a text box.
- 2 Tap  and .
- Or, on the keypad, press  + .
- The Text Alignment tool appears.
- 3 Tap an alignment.

Inserting Punctuation

Punctuation characters can be inserted on your label. Once inserted, the character is treated the same as any other text.

Refer to **Symbols** on page 54 for the complete list of punctuation characters available.

To insert a punctuation

- 1 Press  + any numeric key.
The Symbols tool appears.
- 2 Tap a character to insert that character on the label.
The currently selected character is inserted at the cursor position and the Symbols tool disappears after a few seconds.

Inserting Symbols

Fractions and other symbols can be inserted on your label. Once inserted, the symbol becomes a character and is treated the same as text. You can apply bold and underline to most symbols.

Refer to **Symbols** on page 54 for the complete list of symbols available.

To insert a symbol

- 1 From the edit screen, tap .
- 2 Tap **Symbol** and a category.
- 3 Tap the desired symbol to add it to the label at the cursor position.

Symbols can also be inserted from the Symbols tool as described in **Inserting Punctuation** above.

Inserting International Characters

The label maker supports the extended Latin character set. Similar to using a mobile phone, holding down a letter key will display all the variations of that letter.

The order in which the variations appear depends on the language you have selected. For example, if French is selected as the language and you hold down the letter **a**, you will see **à á â ã ä å** and so on through all the variations available.

To insert a character



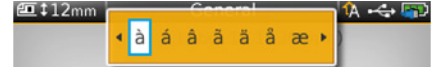

- 1 Press and hold an alphanumeric key.
The Diacritical tool appears and the selected character is added to the label at the cursor position.
- 2 Tap a character to insert that character on the label.
The symbol is inserted and the Diacritical tool disappears after a few seconds.



Creating a Vertical Label

You can create a vertical label with the text in a horizontal or vertical orientation. The instructions in this section are for a general label type.

To create a vertical label

- 1 From the Home screen, tap  **General**.
- 2 Select **Portrait** as the label orientation.
- 3 Select the label length.
- 4 Add your text and formatting.
- 5 Tap  and .
- 6 Tap  to change the text to a vertical orientation.

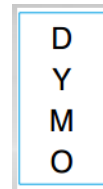

Vertical text on a portrait label



Working with Objects on a Label

Depending on the label type, you can add one or more text box, image, barcode, or shape objects to customize your label.

See **Using the Label Applications** on page 14 for a description of which objects can be used on each label type.

Some label types have pre-designed templates with objects already in place. You only need to add your content. When you start a new label using a pre-designed template, you can add or edit objects on that label, but you cannot change the original template.

Inserting a Text Box

Most labels include at least one text box by default. Depending on the label type, you can add additional text boxes. See the description for each label type in **Using the Label Applications** on page 14 to determine whether you can add additional text boxes to that label.



You cannot add a second text box until you have entered text in the first text box.

To insert a text box

- 1 Tap  **Insert** and select **Text**.
- 2 Move or resize the text box as desired.
- 3 Add text and formatting.



Inserting an Image

You can add one or more images to some types of labels. See the description for each label type in **Using the Label Applications** on page 14 to determine whether you can add images to that label..

A number of standard images are built into your label maker. You can also transfer images from your computer to the label maker for use on your labels.

The image categories are:

Warning	GHS
Mandatory	WHMIS
Prohibit	Electrical
Fire and Exit	ProAV
First aid	Arrows

See **Images and Symbols** on page 51 for the complete list of images included.

A Custom category is added to the category list when you have transferred custom images from your computer to the label maker.

You can mark images you use frequently as Favorites for easy access. See **Using Favorites** on page 38 for more information.

To insert an image

- 1 From the edit screen, tap .
- 2 Select **Image** and then a category.

- 3 Tap the image you want to insert.
- 4 Move or resize the image as desired.

To change the image

- 1 Tap an image and press **OK**.
The image categories list appears.
- 2 Select a new image.



Inserting a Barcode

The label maker can generate the following types of barcodes.

Code 128	Codabar	EAN 8
Code 39	EAN 13	UPC A
Code 39 w/Mod 43	PDF 417	QR



This User Guide assumes that you already understand the differences between barcode types and have a plan in place to incorporate barcodes into your organization. If you need to learn more about barcodes, many excellent how-to books are available at local libraries and book stores.

Code 128 is the default barcode type. You can choose another type as your default barcode. See **Setting the Default Barcode** on page 43.

You can add a barcode to the following label types: general, flag, heat-shrink tube, and laminated cable wrap. If a barcode already exists on a template, the barcode can be edited.

By default the barcode text appears below the barcode. You can choose to show the text above the barcode or hide the text. Showing barcode text is not available for PDF 417 and QR codes.



QR codes can contain the following information:

- Text only
- Phone number
- Email
- SMS text message
- Web page URL

To add a barcode

- 1 From the edit screen, tap  and then tap **Barcode**.
- 2 Select the barcode type.
- 3 Optionally, select the **Show barcode text** check box to show or hide the text.
- 4 Enter the barcode data and tap **Done**.
- 5 Move or resize the barcode as desired.

To change the barcode text position

- 1 Tap to select the barcode and press **OK**.
- 2 Make sure the **Show text** check box is selected.
- 3 Tap one of the following:
 -  Text above barcode
 -  Text below barcode

To edit a barcode

- 1 Tap to select the barcode and press **OK**.
- 2 Select the property you wish to change.
- 3 Change the settings.
- 4 When finished editing the barcode, select **Done**.

Inserting a Shape

You can add shapes to your label. Layering shapes with text or images can produce highly customized designs. See **Arranging Objects** on page 34 for an example.

To add a shape

- 1 From the edit screen, tap  and then tap **Shape**.
- 2 Tap a shape to add to the label.
- 3 Move and resize the shape as desired.

To change a shape

- 1 Tap to select a shape on the label and press **OK**.
- 2 Tap a different shape.



Manipulating Objects

You use the touch screen to select, resize, move, copy, align, arrange, position, and delete objects.

Selecting an Object

A blue border appears around the object when an object is selected. If the label contains more than one object, you can use the Object Selection tool to move the focus to each object on the label.

To select an object

- ▶ Tap once on any object.
The object is selected and the object selection tool appears.
- ▶ If objects are small or layered, tap  or  in the Object Selection tool to select the object you want.
- ▶ To select more than one object, press  and select the additional objects.





Resizing an Object



You can resize an object by dragging or by using the navigation keys. Resizing a text box will only change the text size if you have selected **Auto fit text**. Resizing a barcode object will not change the barcode size.

To resize an object

- 1 Select the object.
- 2 Do one of the following:



- Drag one of the resize handles on the sides of the object.
- Press  to resize the object in the direction of the arrows.
- Press  +  to resize the object in larger increments.



 If the object is too small to resize, tap  to first zoom in on the label.

Moving an Object

You can move an object by dragging the object or using the navigation keys. When you reach the edge of the editable area of the label, red bars appear.

For positioning an object relative to the edge of the label, see **Positioning an Object** on page 34.

To move an object

- 1 Select the object.
- 2 Do one of the following:
 - Drag the object to a new location.
 - Press  to move the object in the direction of the arrows.
 - Press  +  to move the object in larger increments.

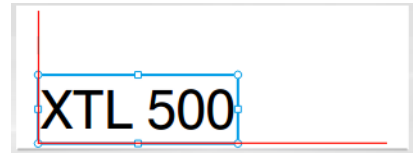

Positioning an Object

You can position an object relative to the edge of the label.

To position an object



- 1 Tap and hold in the center of an object.
The Object manipulation menu appears.
- 2 Tap .
The Position overlay appears.
- 3 Tap a position option.



Aligning Objects

When you have multiple objects selected, you can align the objects on the label vertically and horizontally.

To align objects

- 1 Press  and tap multiple objects.
- 2 Tap and hold in the center of one of the objects.
The Object manipulation menu appears.
- 3 Tap .
The Alignment overlay appears.
- 4 Tap an alignment option.





You can select additional objects while the Alignment tool is displayed.

Arranging Objects

You can place an object in front of or behind other objects.

To arrange objects

- 1 Press  and tap multiple objects.
- 2 Tap and hold in the center of one of the objects.
The Object manipulation menu appears.
- 3 Tap .
The Arrangement overlay appears.
- 4 Tap an arrangement option.





You can select additional objects while the Arrangement tool is displayed.

Copying an Object

You can copy and paste an object on the same label.

To copy an object

- 1 Tap and hold in the center of an object.
The Object manipulation menu appears.
- 2 Tap  to expand the menu.
- 3 Tap .
The object is copied to the clipboard.
- 4 Tap and hold on the location where you want to paste the copy of the object and tap .
A copy of the object is pasted onto the label.



Deleting an Object

 On some label types, you cannot delete all the objects.

To delete an object

- ▶ Select the object and press .



Creating a Series of Labels

You can quickly create a series of labels using the serialization feature.

To create a series, you:

- Select the characters to serialize.
- Set the increment: the value to increase for each increment in the series.
- Set the count: the number of times to increment the series which creates new cells or labels depending on the type of label you are creating.

You can use serialization to:

- Auto-fill multi-cell labels such as patch panel, breaker, distribution panel, 110-block, or terminal block labels. The cells are filled by each increment in the series. If necessary, additional cells are created.
- Create a series of labels by incrementing the data. A new label is created for each increment in the series.

To start serialization, the cursor must be in a text box that can be serialized or a barcode must be selected.

You can select up to five characters for serialization. And, you can choose to create the series sequentially. (A1, A2, A3, B1, B2, B3...)

Serialization creates new labels or, as in the case of a patch panel label, fills the existing cells on the label and, if necessary, creates new labels.

You can view the series as you add and change the values.

To create a series

- 1 From the edit screen, select



The Serialization tool appears.

- 2 Drag the handles or press the ◀ and ▶ to select the character to serialize.

Press  + ◀ and ▶, or while dragging the handles to expand the selection to more than one character.

- 3 Select values for **Increment by** and **Count**.
- 4 To serialize multiple characters at the same time, select **Next character** and repeat steps 2 and 3.
- 5 To serialize sequentially, select the **Serialize sequentially** check box.
- 6 Select **Done** when finished.

When serialization is complete, the cursor is positioned at the end of the new series.

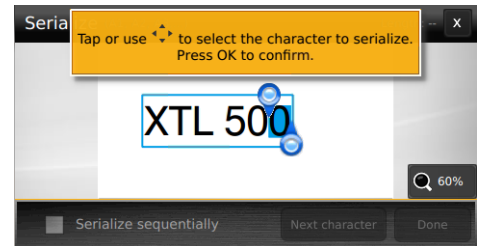

Using the Library

You can save your labels to the label maker's memory so that you can print them later or use them as a template for future labels of the same type. You can also transfer saved labels from the label maker to your computer. See **Transferring Files** on page 45.

Saving Labels

When you save labels, all content and formatting are saved, and you give the label file a unique name. The label cartridge information is also saved with the label.

The following characters cannot be used in file names: > : " / \ | ? *

To save labels

- 1 From the label edit screen, press .
- 2 Enter a name and tap **Save**.

If the memory is full, you are asked to delete some saved labels before you can save a new label.

Opening Saved Labels

Label cartridge information is saved with the label file. If the label cartridge currently in the label maker is not a match for the label information saved with the label, a message appears asking if you want to change the label cartridge selection.



To open a saved label

- 1 From the Home screen, tap .
- 2 Select the label file you want to open.

Deleting Saved Labels

You can free memory space by deleting labels you no longer need.



To delete saved labels

- 1 From the Home screen, tap .
- 2 Select the label you want to delete and press .
- 3 Tap **Delete** to confirm.



Using Favorites

A quick way to access saved labels and images you use frequently is to assign them to Favorites.

To add an image to Favorites

- 1 From the edit screen, tap  and select **Image**.
- 2 Navigate to the desired image and tap  in the upper corner of the image. The  is highlighted.



To add a saved label to Favorites

- 1 From the Home screen, tap .
- 2 Locate the desired label file and tap  next to the file name. The  is highlighted.

To use a Favorite label or image

- 1 While editing a label, press  and select **Labels** or **Images**.
- 2 Tap the item you want to use.

To remove a Favorite

- 1 Press  and select **Labels** or **Images**.
- 2 Locate the item you want to delete.
- 3 Tap **Remove from favorites**. The  next to the item is no longer highlighted.

Changing the Settings

You can change the following settings:

- **Changing the Language**
- **Changing the Units of Measure**
- **Changing the Screen Brightness**
- **Changing the Auto Shut-off Time**
- **Changing the Recall Data Setting**
- **Setting the Print Options**
- **Setting the Default Barcode**

All settings remain in effect until you change them again.

You can also restore certain factory settings:

- **Restoring the Label Application Default Settings**
- **Restoring Factory Default Settings**

Changing the Language

Changing the language setting only affects the text and menus in the display.

To change the language

- 1 From the Home screen, tap  and select **Language**.
- 2 Select a language and tap **Done**.

The language is changed immediately.

Changing the Units of Measure

You can choose to work in millimeters or inches. The default unit of measure is inches.

To change the units of measure

- 1 From the Home screen, tap  and select **Units of measure**.
- 2 Select the **Inches** or **mm** and tap **Done**.

Changing the Screen Brightness

You can change the brightness of the screen to accommodate different lighting situations.

To change the brightness

- 1 From the Home screen, tap  and select **Screen brightness**.
- 2 Drag the slider left or right to select the brightness level you desire and tap **Done**.

Changing the Auto Shut-off Time

To conserve power, the screen will dim after thirty seconds of inactivity and the label maker will enter standby mode after three minutes of inactivity. After ten more minutes of inactivity, the label maker automatically shuts off.

You can change the amount of time the label maker remains in standby mode before automatically shutting off. Although not recommended, you can also set auto shut-off to **Never**.

To change the auto shut-off time

- 1 From the Home screen, tap  and select **Auto shut-off**.
- 2 Select the number of minutes until the power is automatically turned off and tap **Done**.

Changing the Recall Data Setting

When you switch label applications, data from the previous label can sometimes be used on the new label. Recalling data applies to text-only labels.

When data recall is possible and the recall data setting is turned on, you are given several recall options:

- **Recall once** - Recall data from the previous label this one time only. You will continue to be asked each time data recall is available.
- **Always recall** - Always recall data from the previous label. From now on data will always be recalled to the new label when possible.
- **Not this time** - Don't recall data this one time. You will continue to be asked each time data recall is available.
- **Never recall** - You will never be asked to recall data.

When you choose **Always recall** or **Never recall**, you can reverse this setting.

To change data recall

- 1 From the Home screen, select  and tap **Recall data**.
- 2 Select **Yes** or **No**, and then tap **Done**.

Setting the Print Options

Several print options are available for printing your labels. You can change the options each time you print or you can save the options you use most often as default settings.

The options you can set are:

- **Print Range**
- **Number of Copies**
- **Collate**
- **Mirror**
- **Cut Labels**
- **Feed**

You can change these print options in two ways:

- At the time you print labels: the options apply to that one print job.

- As defaults through the Settings menu: the options will apply to all future print jobs. If you set defaults, you will still be able to change the print options individually for a specific label when needed.

To change the default print options

- 1 From the Home screen, tap  and then **Print options**.
- 2 Make your desired changes to the print options.
- 3 Tap **Done** when finished.

These settings will be the default settings every time you print.

To change these settings for an individual print job, press and hold  to display the print options menu.



Print Range

While working with multiple labels, you can choose to print all labels, the current label, or a range of labels.

This setting is not saved with your label file.

To set the print range

- 1 Press and hold  to display the print options menu.
- 2 Select **Print range**.
- 3 Select the range you wish to print.
- 4 Tap **Done** and then press .



Number of Copies

You can print up to 99 copies of the same label at one time.

This setting is not saved with your label file.

To set the number of copies to print

- 1 Press and hold  to display the print options menu.
- 2 Select **Copies**.
- 3 Select the number of copies to print.
- 4 Tap **Done** and then press .

When printing is finished, the number of copies to print returns to the value set as the default.



Collate

When printing multiple copies of a group of labels, by default the labels are printed collated. You can choose not to collate the labels, if desired. If you choose to have the labels print normally, all the copies of the first label are printed before the next label starts printing.

The following example shows three copies of a group of three labels printed with and without collation.

Collated



A101 A102 A103 A101 A102 A103 A101 A102 A103

Not collated

A101 A101 A101 A102 A102 A102 A103 A103 A103

This setting is saved with your label file.

To turn off collation

- 1 Press and hold  to display the print options menu.
- 2 Select **Collate** and then select **No**.
- 3 Tap **Done** and then press .





Mirror

The mirror option allows you to print the contents of your label backwards, from right to left, as you would see the contents of your label in a mirror.

002 JTX

This setting is not saved with your label file.

To print from right to left

- 1 Press and hold  to display the print options menu.
- 2 Select **Mirror** and then select **Mirror content**.
- 3 Tap **Done** and then press .





Cut Labels

When printing multiple copies, the label maker cuts each label as it prints.

You can change this setting so that the label maker prints all labels continuously and automatically cuts once after printing is complete. A label separator cut mark is printed between each label to show where each label should be manually cut.

To choose when to cut multiple labels

- 1 Press and hold  to display the print options menu.
- 2 Select **Cut labels**.
- 3 Select one of the following:
 - **All labels**
 - **Each label** (default)
- 4 Tap **Done** and then press .



Since the XTL™ 500 label maker does not have a manual cutter, the Print options screen contains a **Cut label** button at the bottom of the screen that you can use to cut a label manually at any time. This feature can be useful to cut unwanted label material at the beginning of a new label cartridge.

Feed

You may need to feed additional label material before you cut a label or feed a label that does not advance from the label exit slot properly.

To feed the label

- 1 Press and hold  to display the print options menu.

- 2 Tap **Feed** to advance the label by 1/4" (6 mm).

Setting the Default Barcode

The default barcode type will be inserted automatically each time you insert a barcode on a label. The factory default barcode type is Code 128.

To change the default barcode

- 1 From the Home screen, tap .
- 2 Select **Default settings** and then **Default barcode**.
- 3 Select the barcode type to be used as the default and then tap **Done**.

Restoring the Label Application Default Settings

From within each label editor you can choose to set the current properties as the custom default properties for that label type. When custom default properties are set, you avoid having to step through the label application wizard each time you create that type of label. See **Setting Default Label Properties** on page 14.

You use this setting to remove the custom default label properties you previously set for a label application.

To restore the label application default properties

- 1 From the Home screen, tap  and select **Default settings**.
- 2 Select **Default label properties** and then select the label application you want to reset.
To restore all label application default properties, tap **Reset all label application properties**.
- 3 At the confirmation screen, tap **Reset all** to confirm.

You will now have to set the properties each time you create a label for this label type.

Restoring Factory Default Settings

You can remove any custom settings you made and restore the label maker to the factory default settings. Restoring does not remove your saved labels, favorites, or transferred files.

To change the restore the factory default settings

- 1 From the Home screen, tap  and then select **Restore factory settings**.
- 2 At the confirmation screen, tap **Reset** to confirm.

Connecting the Label Maker to your Computer

The label maker can be used as a standalone label maker or you can print labels directly from your computer using the latest version of DYMO ID™ software.

Using DYMO ID™ software is the recommended method for producing a high-volume of labels.

Downloading and Installing DYMO ID™ Software

Do not connect the label maker to your computer until after the software installation is complete.

To install the software

- 1 Download the latest version of DYMO ID™ software from the DYMO Web site at support.dymo.com.
- 2 Follow the instructions in the installer.

Connecting the Label Maker to your Computer

The label maker connects to your computer using the USB connection located on the left side of the label maker.

 Do not connect the label maker to your computer until after the software installation is complete.

To connect the label maker to your computer

- 1 Lift the connector cover on the left side of the label maker and turn to expose the connectors.
- 2 Plug the USB cable into the USB connector on the label maker and into an available USB port on your computer.



The label maker display will show **Connected to PC** and you will not be able to use the label maker keypad.

Each time you connect the label maker to the computer, DYMO ID™ software will automatically start.

You can now print directly from DYMO ID™ software or transfer labels to the label maker for printing later.

About DYMO ID Software

The following figure shows some of the major features available with DYMO ID™ software.

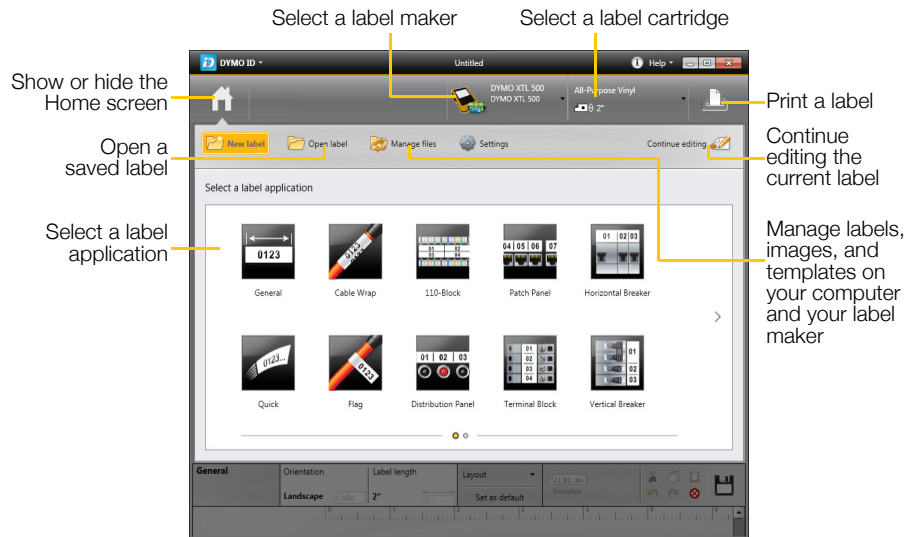

For complete details on using the software, refer to the online Help or the *DYMO ID™ User Guide*.

From the Help menu in DYMO ID software, you can view the following:

- DYMO ID™ Help
- *DYMO ID™ User Guide*

Transferring Files

You can transfer label files and images to and from your label maker through DYMO ID™ software. You can also download and transfer the latest templates to the label maker.

Refer to the DYMO ID™ software online Help or user guide for complete information on transferring files.

Updating the Label Maker Software

Periodically, updates will become available for the label maker or the label templates. When the label maker is connected to your computer, you will be notified from within DYMO ID™ software when an update is available. You complete these updates from within the software.

You will only be automatically notified of a label maker update when the label maker is connected to your computer.

To manually check for label maker updates

- 1 From within DYMO ID software, select **About > Label makers** from the DYMO ID menu.
- 2 Select your connected label maker.

- 3 If an update is available, follow the instructions when prompted by the software.
- 4 When update is complete, turn the power off and then on again.
Press and hold  for at least five seconds to make sure the power is completely off and not just in standby mode.

Refer to the DYMO ID™ software online Help or user guide for information about label maker software or template updates.

Caring for the Label Maker

Your label maker is designed to give you long and trouble-free service, while requiring only occasional maintenance.

Clean your label maker from time to time to keep it working properly.

A cleaning tool is located inside the label compartment cover. The tool has two pads, a felt pad for cleaning the print head and a sponge pad for cleaning the sensors. See Figure 11.



Figure 11

Cleaning the Label Maker

- Clean the keypad, display, and outside of the label maker using a soft damp cloth.
- ⚠ Do not put water or any other liquid directly on the display or keypad.
- Clean the inside of the label compartment using a small, soft brush or cotton swab to wipe away stray particles.

Cleaning the Print Head

To keep printing clear and crisp labels, occasionally clean the print head. Use the cleaning tool that came with your label maker.

- ⚠ The print head is very delicate, so use care when cleaning.

To clean the print head

- 1 Press the label compartment release and lift the cover.
- 2 Remove the label cartridge.
- 3 Remove the cleaning tool from inside the label compartment cover. See Figure 11.
- 4 Gently wipe the felt side of the tool across the print head. See Figure 12.
- 5 Replace the cleaning tool, insert the label cartridge, and close the cover.

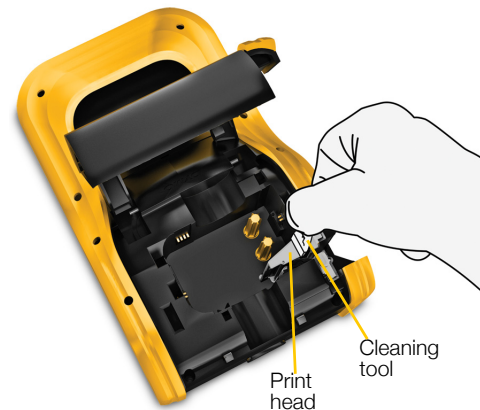

Figure 12

Cleaning the Cutter Blade

Clean the cutter blade each time you replace the label cartridge.

To clean the cutter blade

- 1 Press the label compartment release and lift the cover.
- 2 Remove the label cartridge.
- 3 Pinch the release lever on the outside of the cutter blade and pull the cutter blade straight up to remove. See Figure 13.

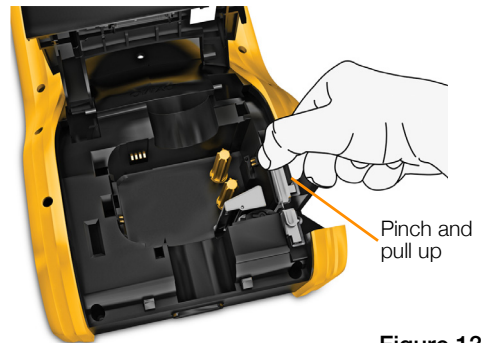



Figure 13

- 4 Place the cutter blade on a flat surface with the blade side facing up. See Figure 14.
 - 5 Use a cotton swab and alcohol to clean both sides of the blade.
-  The cutter blade is extremely sharp. Use caution when cleaning.
- 6 After cleaning the blade, insert the cutter mechanism back into the label maker and press into place.

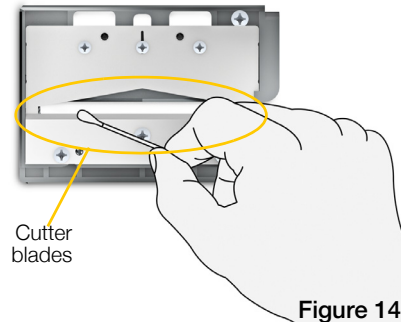

Figure 14

Cleaning the Sensors

Several sensors inside the label compartment need periodic cleaning to remove dust and other particles that may have accumulated.

To clean the sensors

- 1 Press the label compartment release and lift the cover.
- 2 Remove the label cartridge.
- 3 Remove the cleaning tool from inside the label compartment cover.
- 4 Use the sponge end of the cleaning tool to gently wipe the sensors using an up and down motion (not side to side). See Figure 15 for sensor locations.

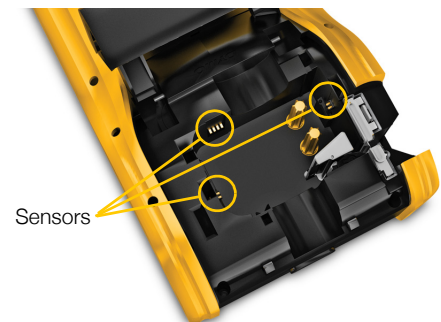



Figure 15

Troubleshooting

Review the following if you encounter a problem with your label maker.

Problem/Error Message	Solution
Poor print quality	<ul style="list-style-type: none">■ Attach the power adapter to the label maker to recharge the battery. See Charging the Battery on page 2.■ Clean the print head. See Cleaning the Print Head on page 47.■ Ensure the label cartridge is inserted properly.■ Replace the label cartridge.
Labels wrapped around roller in label exit slot	<ul style="list-style-type: none">■ Do not attempt to disassemble the label maker. Contact DYMO Customer Care for instructions (http://support.dymo.com).
Labels running low Label cartridge empty	You are about to run out of labels. Replace the label cartridge. Printing will resume from the last complete label printed.
Poor cutter performance	<ul style="list-style-type: none">■ Clean the cutter blade. See Cleaning the Cutter Blade on page 48.
Label maker does not turn on	<ul style="list-style-type: none">■ Press and hold  key for at least five seconds.■ Ensure the power adapter is connected to a working wall outlet.■ Attach the power adapter to the label maker to recharge the battery. See Charging the Battery on page 2.
Cover is open	The label cartridge cover is open. Close the label cartridge cover to continue printing.
Label cartridge is missing	No label cartridge is detected in the label maker. <ul style="list-style-type: none">■ Insert a label cartridge. If label cartridge is inserted, see Label cartridge not recognized .
Label cartridge not recognized	<ul style="list-style-type: none">■ Make sure that the label cartridge is compatible with the label maker and is inserted correctly.■ Make sure the contacts in the label maker and the electronic chip on the label cartridge are free of dirt. See Cleaning the Sensors on page 48.■ If necessary, clean the electronic chip on the side of the label cartridge with a small amount of alcohol on a cotton swab.
Label application - cartridge mismatch	This error can occur for several reasons: <ul style="list-style-type: none">■ The label cartridge in the label maker is not appropriate for the label application you are trying to use.■ The label you are trying to print cannot be printed on this label cartridge.■ The label cartridge in the label maker does not match the label you are trying to print. In this case, you can continue printing but the results may not match the label you see in the label editor.

Problem/Error Message	Solution
No cutter present	The cutter mechanism in the label maker is missing. Make sure the cutter mechanism is inserted properly. See the Cleaning the Cutter Blade on page 48 for instructions on removing and replacing the cutter mechanism.
Cutter jam	The cutter blade is not operating properly. <ul style="list-style-type: none"> ■ Clean the cutter blade. ■ Click Continue in the error message dialog box to clear the error condition. See the Cleaning the Cutter Blade on page 48 for instructions on removing and replacing the cutter mechanism.
Label jam	The labels are not feeding properly in the label maker. <ul style="list-style-type: none"> ■ Feed the label manually. See Feed on page 42. ■ Remove and reinsert the label cartridge.
Label maker overheated	The label maker has overheated. Wait for a few moments until the label maker cools down to resume printing.
Invalid file	A label or image file cannot be read. Delete the file and transfer the file from your computer again. See Transferring Files on page 45 for more information.
Error	An error message with no explanation means a problem with the label maker has been detected but no further information can be supplied. Turn the label maker off and then on again. If this does not solve the problem, contact Customer Support at support.dymo.com .

If you need further assistance, visit the Support section of the DYMO Web site at **support.dymo.com**.



Prohibit



Fire and Exit

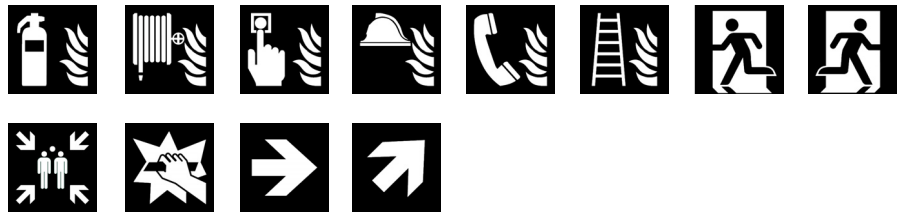

First Aid



GHS

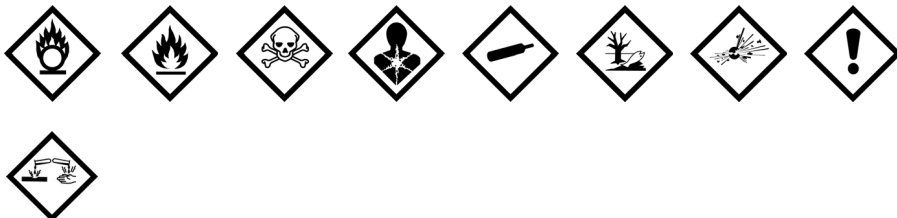

WHMIS

The Hazard Symbols of WHMIS, <http://www.hc-sc.gc.ca/ewh-semt/occup-travail/whmis-simdut/symbols-signaux-eng.php>, Health Canada, 2011.

Reproduced with the permission of the Minister of Public Works and Government Services Canada, 2012.



Electrical

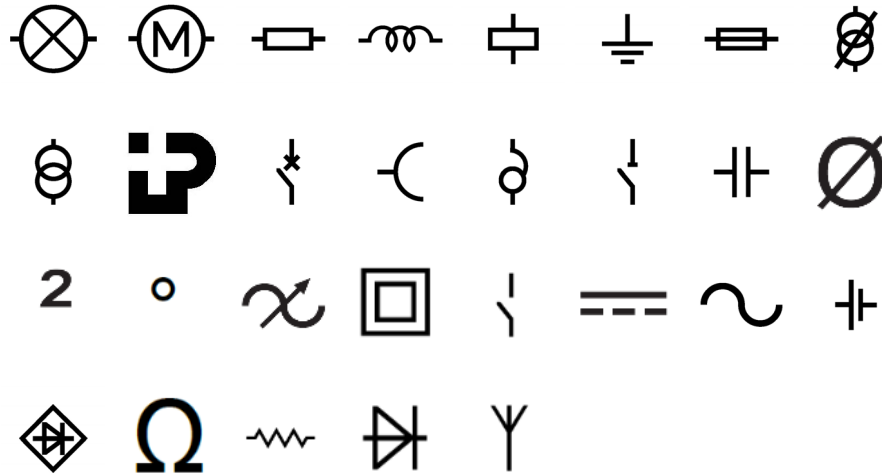

Pro AV



Arrows

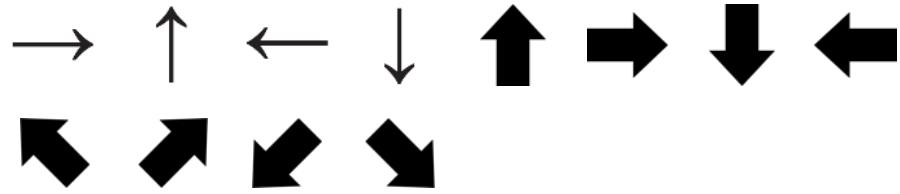

Symbols

$\frac{1}{2}$ $\frac{1}{4}$ $\frac{3}{4}$ $\frac{1}{8}$ $\frac{3}{8}$ $\frac{5}{8}$ $\frac{7}{8}$ $\frac{1}{3}$ $\frac{2}{3}$ %
, ; ' " . : / \ & _
! ¡ ? ¿ () [] { }
+ - * ÷ ± = ≠ ~ @ #
¢ \$ € £ ¥ < ≤ > ≥

Documentation Feedback

We are constantly working to produce the highest quality documentation for our products. We welcome your feedback.

Send us your comments or suggestions about our user guides. Please include the following information with your feedback:

- Product name, model number, and User Guide page number
- Brief description of instructions that are inaccurate or unclear, areas where more detail is needed, and so on

We also welcome your suggestions about additional topics you would like to see covered in the documentation.

Send email messages to: dymo.docfeedback@newellco.com

Please keep in mind that this email address is only for documentation feedback. If you have a technical question, please contact Customer Support.

Environmental Information

The equipment that you have bought requires the extraction and use of natural resources for its production. It may contain substances that are hazardous to health and the environment.

In order to avoid the dissemination of those substances in our environment, and to diminish the pressure on natural resources, we encourage you to use the appropriate take-back systems. These systems will reuse or recycle most of the materials of your end-of-life equipment in an environmentally sound way.

The crossed-bin symbol marked on your device indicates you should use these systems.



If you need more information on the collection, reuse, and recycling of this product, please contact your local or regional waste administration.

You can also contact DYMO for more information on the environmental performance of our products.

Safety Precautions for Lithium Polymer Battery

Battery Type: LiPolymer 14.8V 2000mAh 29.6Wh

Inaccurate handling of a lithium polymer rechargeable battery may cause leakage, heat, smoke, an explosion, or fire. This could cause deterioration of performance or failure. This may also damage the protection device installed in the battery. This could damage equipment or injure users. Thoroughly follow the instructions below.

While Charging the Battery



Danger

To reduce the risks associated with fire and explosion, which if not avoided, could result in serious injury or death:

- Danger of explosion if a battery is incorrectly handled, charged, disposed or replaced. Replace only with the same or equivalent type recommended by DYMO.
- When charging the battery, use dedicated chargers and follow the specified conditions.
- Do not connect directly to an electric outlet or cigarette lighter charger.
- Do not store the battery close to fire or at extremely high temperatures over 60°C (140°F), for example, a vehicle, strong direct sunlight.
- Do not short-circuit the battery under any circumstances.
- Never charge battery near highly flammable objects.



Warning

To reduce the risks associated with fire and explosion, which if not avoided, could result in serious injury or death and/or property damage:

- Stop charging the battery if charging is not completed within the specified time.
- Never leave the battery unattended during charging. Do not attempt to charge a cell that is damaged.
- Immediately remove the battery from the device or battery charger and stop use if the battery gives off an odor, generates heat, becomes discolored or deformed, or in any way appears abnormal during use.



While Charging the Battery



To reduce the risks associated with various hazards, which if not avoided, may result in minor or moderate injury and/or property damage:

- Thoroughly read this document before charging the battery.
 - Lithium cells must be completely discharged before disposal.
 - Always dispose the battery in a manner consistent with local, regional and national regulation.
 - Battery can only be charged within a temperature range of 0°C to 45°C (32°F to 113°F).
-

When Discharging the Battery



To reduce the risks associated with fire and explosion, which if not avoided, could result in serious injury or death and/or property damage:

- Use the battery only in the specified equipment.
 - Do not discharge the battery close to fire or at extremely high temperatures over 60°C (140°F), for example, a vehicle, strong direct sunlight.
-



To reduce the risks associated with various hazards, which if not avoided, may result in minor or moderate injury and/or property damage:

- Battery can only be used within a temperature range of -20°C to 60°C (-4°F to 140°F).
-