

We endeavour to achieve zero claims and complaints rate with respect to product quality assurance.

Although malfunctions are a problem that comes before the warranty and even one should be prevented, malfunctions cannot be prevented through our efforts alone. We would therefore like to request that our customers have an understanding of the functions and specifications of applicable products as indicated in our catalogs, instruction manuals and web site to ensure that they are used properly under specified conditions.

Furthermore, applicable products are designed and manufactured primarily for general industrial use.

Therefore, we would also like to request our customers to cooperate in employing a safe design for preventing accidents, fires and the like through providing of fail-safe measures, preventing operational errors and employing redundant safety designs.

1) Applicable Products

The warranty defined below is applicable to products manufactured and sold by METROL (to be referred to as the "applicable products").

2) Warranty Period

The warranty for applicable products is valid for one year and three months from the original delivery date to the location designated by the customer.

*The initial three months are assumed to be a preparation period until use of the products following purchase.

3) Range of Coverage

a. A replacement product will be provided on an exchange basis or the malfunctioned product will be repaired free of charge within the warranty period. If the product is or becomes defective and that at the sole discretion of METROL, the defects due to faulty materials or workmanship.

However, applicable products will not covered by the warranty in the case of the following malfunctions even within the warranty period.

(I) Malfunctions occurred due to use of a product in a manner that deviates from standards, specifications, environments, usage procedures or usage precautions described in the catalog, instruction manual or specifications.

(II) Malfunctions having occurred for reasons other than those attributable to the delivered product.

(III) Malfunctions having occurred due to modifications or repairs made by someone else other than the Metrol representative.

(IV) Malfunctions or damage that results from external causes outside our control which shall include accident fire disaster, other natural disaster or other force majeure.

b. The range of coverage is limited to warranty of the applicable product only, and any other secondary loss or damage resulting from the malfunction of an applicable product is not covered by the warranty.

c. Please be aware that charges for service (including installation, de-installation on-site confirmation and repairs) are not included in the price of products.

4) Applications

Applicable products are designed and manufactured as general-purpose products used in ordinary industrial environments.

In the case of incorporating an applicable product in an apparatus, machine or system, please confirm the suitability of the application along with any related standards, regulations and restrictions.

With respect to the applications indicated below in particular, customers are requested to conduct necessary tests on an actual product in advance after consulting with the manufacturer regarding usage conditions and other details.

a. Applications for which usage conditions or environment are outside those presumed by the manufacturer or applications unable to be confirmed as being appropriate by the manufacturer when using applicable products.

b. Applications likely to have an effect on human life or property (such as nuclear power equipment, transportation machinery or medical devices), applications used in public utilities (such as electricity, gas or water lines), or applications applying correspondingly thereto.

c. Applications in harsh environments (special environments requiring heat resistance, vacuum and the like)

*Although METROL believes that sound reliability in harsh environments is one of the characteristics of our products, there are still cases in which it is difficult to ascertain actual circumstances.

Since there is the potential for accidents in such cases, customers are requested to have an understanding of protective structures, materials and so forth and provide additional covers and other equipment as necessary.

5) Other Matters

The contents of this catalogue, including specific models and, specifications, and any other contents, are subject to change without notice at METROL's sole discretion.

Help desk

We accept inquiry regarding sensor selection, exclusive specification, and technical matter through website, Fax, and Tel listed below.

www.metrol.co.jp/en

esales@metrol.co.jp

FAX +81-42-528-1442

TEL +81-50-5558-7366

The specifications and descriptions are subjected to change without notice due to improvements in products.

TOKYO JAPAN High-Precision Positioning Switch METROL CO., LTD.

1-100 Takamatsu-cho Tachikawa, Tokyo 190-0011 JAPAN
Tel: +81 50 5558 7366 / Fax: +81 42 528 1442
E-mail: esales@metrol.co.jp

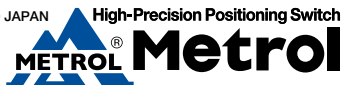

Guide Manual

Ultra-small precision PT-Touch Switch

Standard specification

Repeatability : 1µm type

Repeatability ¹	Protective structure	Product name	Output mode	Pretravel	Contact force	Cable	Size	With LED
0.001mm(range) (Both ON→OFF)	IP40	PT5M1WB	B : NC	0 ²	0.5N	Core-wire cable	M5×0.5	PT5M1WB -L
		φ5					PT5M1WB -L	
		PT5S1WB				M5×0.5	PT5M1CB -L	
	IP67	PT5M1CB	A : NO	About 0.3	0.5N	Cabtyre cable	φ5	PT5S1CB -L
		PT5S1CB					M5×0.5	PTP5M1CB -L
		PTP5M1CB				φ5	PTP5S1CB -L	
IP40	PT5M1WA	A : NO	About 0.3	0.5N	Core-wire cable	M5×0.5	PT5M1WA -L	
	PT5S1WA					φ5	PT5S1WA -L	

Unit : mm

Repeatability : 3µm type

Repeatability ¹	Protective structure	Product name	Output mode	Pretravel	Contact force	Cable	Size	With LED
0.003mm(range) (Both ON→OFF)	IP40	PT5M3WB	B : NC	0 ²	0.5N	Core-wire cable	M5×0.5	PT5M3WB -L
		φ5					PT5S3WB -L	
		PT5S3WB				M5×0.5	PT5M3CB -L	
	IP67	PT5M3CB	A : NO	About 0.3	0.5N	Cabtyre cable	φ5	PT5S3CB -L
		PT5S3CB					M5×0.5	PTP5M3CB -L
		PTP5M3CB				φ5	PTP5S3CB -L	
IP40	PT5M3WA	A : NO	About 0.3	0.5N	Core-wire cable	M5×0.5	PT5M3WA -L	
	PT5S3WA					φ5	PT5S3WA -L	

*1 At operating speed 50-200mm/min (operating speed slower than 10mm/min is not recommended).

*2 Adjust the installed location of the switch by the signal switching point.

-L : LED indicator
(120mm from the switch)

Common specification

Switch structure	Dry contact	Cable	Core-wire cable : 0.5m (x 2)
Movement differential	0		Oil-resistant φ0.6 Tensile strength 15N
Contact life time	3 million (No bungle caused by vibration and use under contacting rating)		Cabtyre cable : 2m Oil-resistant φ2.8/2 cores Tensile strength 30N Minimum bending R7
Stroke	1.5	Operating temperature range	0°C-80°C (ice-free)
Contact material	SUS HRC45	Temperature drift	0 (because of no amplifier)
Case material	SUS303	Oscillation	10-55Hz Total amplitude1.5 for X, Y, Z each direction
		Impact	300m/s ² for X,Y,Z each direction
		Contact rating	DC5V-DC24V Steady current : 10mA or less (rush current : 20mA or less) When using the switch with LED, limit the current below 10mA.
		Standard accessory	Two fixing nuts for threaded type

unit:mm

Tightening torque for case screws and nuts

	Screw / Nut	Tightning torque
PT-Touch Switch	M5×0.5	1N·m

Circuit diagram

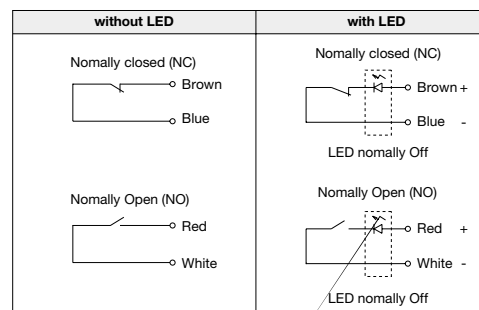

When using the switch with LED, limit the current below 10mA.

How to use

Make contact with detected objects at right angle (within deflection angle ±3°).

If there is a possibility to press the plunger to the stroke end, install a stopper separately to prevent the malfunction.

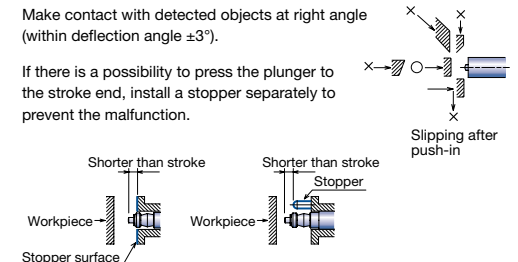

Installation

- Ensure that the threaded part of the switch is not bent during installation.
- When using fixing screws, do not tighten the screws with excessive force. That may distort the switch shape or restrict the movement of the plunger. If the fixing screws are damaged, the switch can be stuck and difficult to be detached.
- When the switch with a protective cover is installed horizontally, an extra cover is needed separately to prevent coolant or cuttings from entering inside and getting piled up on the switch.

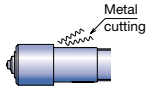

- Do not subject cable or core wire cable to excessive pulling or twisting of 30N or more. The bending radius should be at least R7.
- Do not swing the switch by grabbing the wires or its attaching portion when installing (especially when the wire is perpendicular to the switch).
- When installing it with several cables, hold the switch to avoid the cables from being pulled by weight.

Rubber for protective structure (boot, seal, O-ring)

- Rubbers for some products are intended for water-soluble cutting oil (Alkaline). For oily, chlorine-base, coolants and other chemicals, consult METROL for assistance.
- The rubber material for High-accuracy MT-Touch Switch is for both oily and water-soluble coolants.
- Rubber might be hardened when the ambient temperature is low. When the contact is depressed for a long period of time, it might take longer time for the contact to return the original position.

How to use

- Objects shall be aligned straight ahead for the metal bearing plunger type. (The angle must be within ± 3 degrees when high precision is required such as when using a high precision switch, or when judging existence detection or ON/OFF.)
- For slide, deflection angle, or offset contacts, select bearing or ball contact or lever type.
- When the plunger is pushed straight by the detected object, do not allow the object to abruptly slide away, as it will cause the plunger to snap back. Note that this may cause failure of the bearing and built-in switching part.
- Please also note that forcing the plunger in by your fingers and letting go (snapping it back out) may also cause failure of the internal contact point.
- Because offset distance (misalignment with axis of the plunger) should be shorter than 5mm, the maximum diameter for detecting surface is 10mm for the plunger type with plain bearing.
(Feed speed: 50 mm/min, push-in amount: 1 mm)
- In case the detected surface is angled or ragged, note that the switch may fail to operate properly or cause malfunction.
- If the contacting part is worn away depending on conditions, the signal point becomes different. When designing the detected objects, give consideration to its angle, chamfer and roughness so that the contacting part holds up longer. (Mainly for sliding touch type)

Operating environment

- Use in the environment in where cuttings and dust don't prevent switch movement.
- Choose protective cover option in case cutting may damage the rubber boot.
- An extra cover is recommended to avoid direct hit by high-pressure coolant or heavy cuttings. Periodically remove chips and dust. Apply force to the movable parts only in the direction of measurement. Do not apply force in the other direction.

Contacting part material

- Even though hardened stainless steel is used as the material of the contacting part or stopper surface, they are oxidized and may gather rust under certain conditions.

- Normally-close (NC) type structure might cause chattering depending on the roughness of workpiece surface and environment used (i.e. vibration and contacting speed). In such case, please select Normally-open (NO) type switch.

- Use it with the operating speed of 50 to 200 mm/m when precision is required.

For the switches without stopper

- Do not excessively press the plunger to the stroke end. It may cause malfunction due to impact.

If the switch does not feature a stopper surface, stop it before it reaches the end of the stroke.

- If there is possibility to press the plunger to the stroke end, install a separate stopper to prevent malfunction.

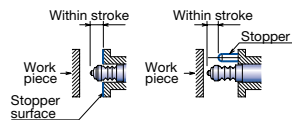

Electrical

- Use under the specified contact rating.
- I/F units with a built-in contact point protection circuit are effective for adverse condition environments where overcurrent may flow. Such environments may involve, regardless of the presence of contact points, inductive loads with coils (such inductive loads mainly mean relay coils, motors, solenoids, many of which require a current of 30mA or more when driven and generate counter-electromotive force when switched OFF).
- Since operating errors may occur due to induction when high-voltage lines or power lines are wired within the same conduit or duct as switch wires, wire them in separate ducts.
- When using the switch with LED, keep the current below 10mA.

Confirmation of switch operation

- Connect the switch in the manner shown in the diagram below.
- Limit the LED forward current to about 10mA by inserting a resistor.
- Resistance value = (power supply voltage - LED forward voltage) \div current = (24-2) \div 0.01 = 2K Ω The LED forward voltage is about 2V.
- The resistor may be installed on the DC 24V or 0V side.
- The LED glows when the circuit is closed. Switch operation is normal.
- In case of using a sequencer, a resistor is not required if the outflow current of the sequencer is about 7mA.
- Operation might not be properly confirmed using a digital test (multi-meter)

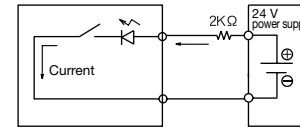

Precautions for Switch Connection

Always make sure to turn off the power before installing or removing switches. This is to prevent damage to the device caused by improper wiring or short-circuits of output lines.

Application of an excessive voltage or application of an alternating current power supply (AC 24 V or higher) to sensors using a direct current power supply has the risk of damaging the switch.

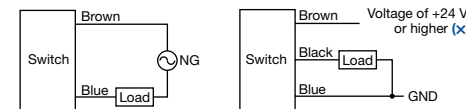

Wiring Precautions

- Do not subject cabtyre cables or core wire cables to excessive pulling or twisting of 30N or more. The bending radius should be at least R7.
- In case of attaching an extension to cables of these switches, since there is greater susceptibility to increased residual voltage, waveform distortion and induction due to the effects of wire resistance and inter-wire capacitance, try to use the shortest length possible. Furthermore, please use a cabtyre cable having a cross-sectional area of 0.3mm² or more.
- Since operating errors may occur due to induction when high-voltage lines or power lines are wired within the same conduit or duct as switch wires, wire them in separate ducts.
- Cabtyre cables having a diameter of 3, 4 or 5mm are compatible for the use as robot cables. Although these cables are not applicable to

- Chattering may occur when opening and closing the circuit with dry contacts regardless of whether the switch has a snap action mechanism. Take the first signal as a judgment signal.

Connecting to a load

- Do not attempt to drive an inductive load directly with these switches. Direct driving can damage the switching parts and semiconductors of the internal circuitry. In case of driving an inductive load, connect a surge absorber in parallel with the load, and connect an external load such as a relay or transistor allowing an adequate flow of current for load driving.

Confirming operation by using resistance

- Set the tester to a resistance range of $\times 10$, and connect the minus lead of the tester to the switch output (brown), and connect the plus lead of the tester to the switch 0V (blue).
- The deflection of the tester needle indicates around 0W when the switch plunger is pushed in and roughly infinity (∞) when switch tip is returned.

Confirming operation by using voltage

- Set the tester to a voltage range of 50V and measure the voltage between the switch output (white) and 0V (blue).
- For NPN output type, when the tip of the switch is pressed, the indicator of the tester changes from 24V down close to 0V.
- For PNP output type, when the tip of the switch is pressed, the indicator of the tester changes from 0V up close to 24V.

Either ground the switch with a switching power supply in close proximity to the switch or ground through a capacitor (approx. 0.1~0.47 μ F) for the purpose of lowering the impedance of the frame in order to increase the resistance to entrance of induction noise by servo drivers or similar devices.

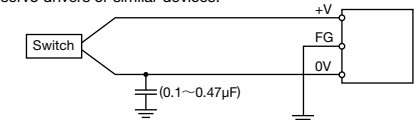

Alternatively, attach a ferrite core to the switch cable.

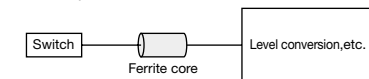

- UL, CSA, EN or other safety standards, there are no problems with safety since the working voltage and current are low.
- Heat-resistant types, anti-sludge types and high flexibility types are available by special order.
- Use a molding when waterproofing is required so that there are no exposed portions of the terminals.
- Please use a wire braid or protective tube in harsh environments where cuttings may be generated.
- Since cables can be produced separately, please consult us when such products are required.
- Switches provided with an optional interface unit use a cable having a diameter of 4mm.