

OP-406
Indicator/Pushbutton
Panel

Manual Number OP-406-M



WARNING

Thank you for purchasing automation equipment from **Automationdirect.com**[™]. We want your new **DirectLOGIC**[™] automation equipment to operate safely. Anyone who installs or uses this equipment should read this publication (and any other relevant publications) before installing or operating the equipment.

To minimize the risk of potential safety problems, you should follow all applicable local and national codes that regulate the installation and operation of your equipment. These codes vary from area to area and usually change with time. It is your responsibility to determine which codes should be followed, and to verify that the equipment, installation, and operation is in compliance with the latest revision of these codes.

At a minimum, you should follow all applicable sections of the National Fire Code, National Electrical Code, and the codes of the National Electrical Manufacturer's Association (NEMA). There may be local regulatory or government offices that can also help determine which codes and standards are necessary for safe installation and operation.

Equipment damage or serious injury to personnel can result from the failure to follow all applicable codes and standards. We do not guarantee the products described in this publication are suitable for your particular application, nor do we assume any responsibility for your product design, installation, or operation.

If you have any questions concerning the installation or operation of this equipment, or if you need additional information, please call us at 770-844-4200.

This publication is based on information that was available at the time it was printed. At **Automationdirect.com**[™] we constantly strive to improve our products and services, so we reserve the right to make changes to the products and/or publications at any time without notice and without any obligation. This publication may also discuss features that may not be available in certain revisions of the product.



Trademarks

This publication may contain references to products produced and/or offered by other companies. The product and company names may be trademarked and are the sole property of their respective owners. **Automationdirect.com**[™] disclaims any proprietary interest in the marks and names of others.

Copyright 1999, Automationdirect.com[™] Incorporated
All Rights Reserved

No part of this manual shall be copied, reproduced, or transmitted in any way without the prior, written consent of **Automationdirect.com**[™] Incorporated. **Automationdirect.com**[™] retains the exclusive rights to all information included in this document.

Manual Revisions



If you contact us in reference to this manual, be sure and include the revision number.

Title: OP-406 Setpoint Panel User Manual

Manual Number: OP-406-M

Issue	Date	Effective Pages	Description of Changes
Original	8/99	All	Original Issue

EU Information

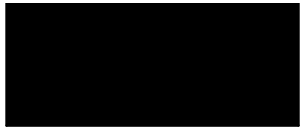

This product is manufactured in compliance with European Union (EU) Directives and carries the CE mark. The following information is provided to comply with EU documentation requirements.



NOTE: Products with CE marks perform their required functions safely and adhere to relevant standards as specified by EU directives provided they are used according to their intended purpose and that the instructions in this manual are adhered to. The protection provided by the equipment may be impaired if this equipment is used in a manner not specified in this manual. Only replacement parts supplied by **Automationdirect.com** or its agents should be used. A listing of international affiliates is available at our Web site: **www.automationdirect.com**.

Technical Support If you need technical assistance, please call the technical support group at **Automationdirect.com** (3505 Hutchinson Rd., Cumming, GA 30040, U.S.A.) at 770-844-4200. They are available Monday through Friday from 9:00 A.M. to 6:00 P.M. Eastern Standard Time. The Web Site address is **www.automationdirect.com**.

SELV Circuits All electrical circuits connected to the communications port receptacle are rated as Safety Extra Low Voltage (SELV).

Environmental Specifications

Operating Temperature 0° to 50° C
Storage Temperature -20° to 70° C
Operating Humidity 95% (non-condensing)
Air Composition No corrosive gases permitted

Preventative Maintenance and Cleaning No preventative maintenance is required. To clean the exterior of the panel disconnect the input power and carefully wipe the panel with a cloth moistened with plain water.

External Fuse Protection for Input Power There are no internal fuses for the input power circuits, so external circuit protection is needed to ensure the safety of service personnel and the safe operation of the equipment itself. To comply with EU specifications, the input power must be fused. Use a fuse rated at **twice** the input current rating of the panel. For example, if the panel has an input current rating of 0.5 amperes, use a fuse rated for 1 ampere.

Table of Contents

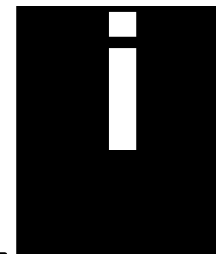

Chapter 1: Getting Started

Introduction	1-2
The Purpose of this Manual	1-2
Supplemental Manuals	1-2
Technical Support	1-2
Chapters	1-3
Conventions Used	1-3
Key Topics for Each Chapter	1-3
OP-406 Overview	1-4
Plan your System	1-4
General Panel Information	1-4
Indicator Lamps and Pushbuttons	1-4
Back-Panel Layout	1-5
Serial Communications Port	1-5
Power Receptacle	1-5
Frequently Asked Questions	1-6

Chapter 2: Installation and Specifications

Labeling the Lamps and Pushbuttons	2-2
Labeling the Lamps and Pushbuttons	2-2
Creating the Labels	2-2
Creating Labels Using OP-WINEDIT	2-2
Templates for Manually Creating Labels	2-4
Dimensions for Mounting	2-5
Panel Specifications	2-6
Physical Specifications	2-6
Environmental Specifications	2-6
Operating Specifications	2-6
Power Supply Connections	2-7
Power Supply Connections	2-8
Connecting the Configuration Cable	2-8
Configuration Cable	2-8
Selecting a Communications Cable	2-9
Communications Cable Details	2-10
OP400 Series Communications Cables	2-10

Chapter 3: Understanding the Features

Learning the Features	3-2
Indicator Lamp and Pushbutton Operations	3-3
Reading Pushbutton Status	3-3
Turning on a Lamp	3-3
Flashing a Lamp	3-3
Turning on the Inset LED	3-3



PLC Registers	3-4
PLC Register Overview	3-4
PLC Register Map	3-4
Force Commands	3-4
DirectLOGIC User Memory Overview	3-6

Chapter 4: Configuring Your Operator Panel

Preparing for Configuration	4-2
OP-WINEDIT Software	4-2
More about OP-WINEDIT	4-2
HELP Screens	4-2
Computer System Requirements	4-3
How to Configure Your Panel	4-3

Chapter 5: Programming Examples

Examples Using PLCDirect PLCs	5-2
Register Usage	5-2
Examples Using DL05, DL105, DL205, D3-350 and DL405	5-3
Turning on a Lamp	5-3
Flashing a Lamp	5-4
Using a Button	5-4
Lighting an Inset LED	5-5
Flashing an Inset LED	5-5
Forcing Button Status	5-6
Force Button Status	5-6
Force Button(s) On	5-6
Force Button(s) Off	5-6
Example Using D3-340	5-7
Register Usage	5-7
Examples Using Allen-Bradley SLC 5/03, 5/04 and Micrologix PLCs	5-8
Interfacing to A-B Memory	5-8
Turning on a Lamp	5-8
Flashing a Lamp	5-9
Using a Button	5-9
Lighting an Inset LED	5-10
Flashing an Inset LED	5-10
Forcing Button Status	5-11
Force Button Status	5-11
Force Button(s) On	5-11
Force Button(s) Off	5-11
Troubleshooting the OP-406 Panel	5-12

Index

Getting Started

1

In This Chapter. . . .

- Introduction
 - Conventions Used
 - OP-406 Overview
 - Frequently Asked Questions
-

Introduction

The Purpose of this Manual

Thank you for purchasing an OP-406 OptiMate panel. This User Manual shows you how to install, configure, and program the OP-406. Also included are application examples. Be sure to keep this manual handy for reference when you run into questions. If you understand PLC systems and operator interface units, this manual will provide all the information that you need to get and keep your panel up and running.

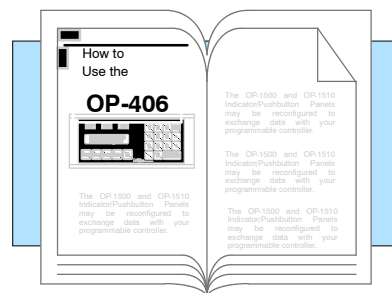

Supplemental Manuals

Reference the appropriate PLC/CPU user manuals for the commands and address references required for your system. If you are using a **Direct**LOGIC PLC product, you will want to keep the **Direct**SOFT User Manual handy while programming your system. For *other* PLC brands you must reference their user manuals to properly program the ladder logic required to operate the OP-panel.

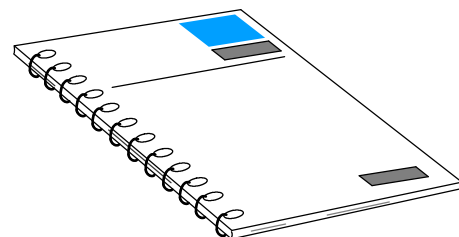

Technical Support

We realize that even though we strive to be the best, we may have arranged our information in such a way that you cannot find what you are looking for. First, check these resources for help in locating the information:

- **Table of Contents** - chapter and section listing of contents, in the front of this manual
- **Quick Guide to Contents** - chapter summary listing on the next page

You can also check our online resources for the latest product support information:

- **Internet** - the address of our Web site is <http://www.automationdirect.com>

If you still need assistance, please call us at 770-844-4200. Our technical support group will be glad to work with you in answering your questions. They are available Monday through Friday from 9:00 A.M. to 6:00 P.M. Eastern Time. If you have a comment or question about any of our products, services, or manuals, please fill out and return the 'Suggestions' card that was shipped with this manual.

Chapters

The main contents of this manual are organized into the following five chapters:

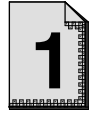
**Getting Started**

Introduces the physical and functional characteristics. Discusses the pushbuttons and the LED indicator lamps. Also provides introduction to planning your system.

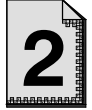
**Installation and Specifications**

Shows how to prepare for system installation, including specifications and mounting instructions. Includes connecting cables part numbers and specifications.

**Understanding the Features**

Explains the features and functions of the OP-406. Teaches concept of how data is exchanged between the panel and the PLC. Also discusses the function of the status register.

**Configuring the Indicator/Pushbutton Panel**

Shows how to use the OP-WINEDIT configuration software to configure your panel. Shows how to load the software on your personal computer, call up the screens you will need and how to download the configuration program to your panel.

**Programming Examples**

Provides example programs for using the standard functions and features. These examples include ladder logic for implementing pushbuttons and messages using *Direct*LOGIC compatibles and Allen-Bradley SLC 5/03, 5/04 and Micrologix CPUs. Also includes troubleshooting information.

Conventions Used

When you see the “notepad” icon in the left-hand margin, the paragraph to its immediate right will be a **special note**.

The word **NOTE:** in boldface will mark the beginning of the text.



When you see the “exclamation mark” icon in the left-hand margin, the paragraph to its immediate right will be a **warning**. This information could prevent injury, loss of property, or even death (in extreme cases).

The word **WARNING:** in boldface will mark the beginning of the text.

Key Topics for Each Chapter

The beginning of each chapter will list the key topics that can be found in that chapter.

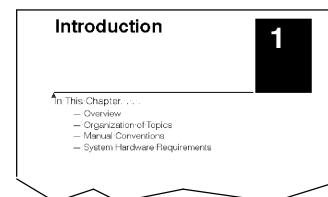

OP-406 Overview

Plan your System Let's look at the OP-406 Indicator/Pushbutton Panel and its individually supported features. As you continue through this manual, try to relate the examples to your Indicator/Pushbutton Panel application.

It is important to read and understand all topics discussed before installing, configuring and programming your application. You should plan your system with all operator interface requirements in mind.

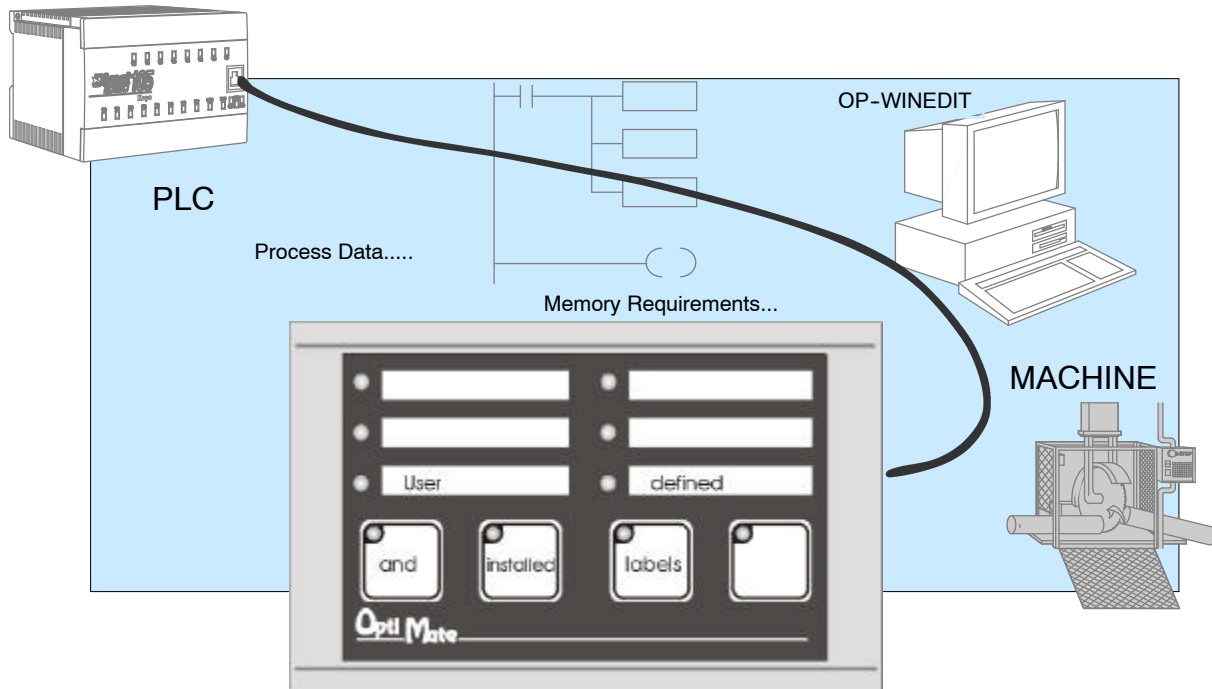

General Panel Information

The OP-406 Indicator/Pushbutton Panel provides a man-machine interface to your PLC automation system. This panel is *not* designed for applications which demand large amounts of operator data entry. The panel communicates with your PLC using RS-232 serial communication. Details on configuration software and programming your Indicator/Pushbutton Panel are covered in later chapters. All OP400 series panels can only be used in a stand alone fashion (one panel can be used with each CPU RS232 port). They cannot be used in multi-panel applications.

Indicator Lamps and Pushbuttons

The OP-406 Indicator/Pushbutton Panel features six LED Indicator Lamps and four pushbuttons. The Lamps can be controlled to be on, off or flashing. The Pushbuttons can be configured to operate as either momentary or alternate action. When a pushbutton is momentary, its LED inset can indicate button status or act independently of button status. The OP-406 connects to a PLC with a single cable. When used with a PLC, operation is transparent to the user. Lamps and buttons appear in the PLC program as coils and contacts. The OP-406 takes care of the rest.

Back-Panel Layout The back side of the OP-406 contains a serial communications port with transmit (TX) and receive (RX) LEDs and a power receptacle.

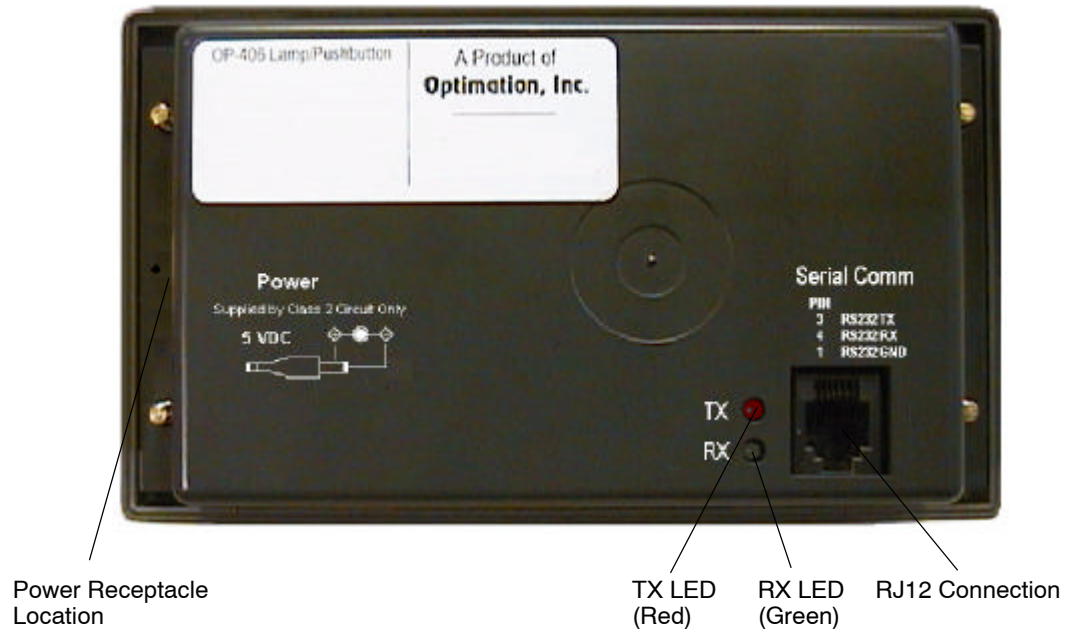

Serial Communications Port

The serial communications port is a 6-pin RJ12 connector, which supports RS-232 interface wiring. This port is used for communications between the OP-panel and PLC, as well as for programming your panel configurations.

The OP-406 can also draw +5VDC input power through this port through the communications cable when using a DL05, DL105, DL205 or DL405 PLC. In this case, the OP-PS400 power supply is only needed for configuration.

Power Receptacle

The center-negative connector is located on the side of the panel, and is used to connect the OP-PS400 power supply. This power supply is used when configuring the panel. It is also used to power the panel when the panel is connected to any CPU that does not supply +5VDC from the communications port.

Frequently Asked Questions

Q. What is required to get started using the OP-406 in my application?

A. You must read this manual and understand the OP-panel requirements and application concepts. You must have programming knowledge for the PLC product you're using, the PLC serial communications capabilities which are available, as well as hook-up and connecting cable data.

Q. How do I configure the OP-406 Indicator/Pushbutton Panel?

A. Using the OP-WINEDIT configuration software available from *PLCDirect*. This software allows you to configure the OP-panels in a Microsoft Windows™ environment. You may configure your programs offline, upload, and/or download them to your OptiMate panel. The OP-WINEDIT software is provided with installation documentation and Help screens.



NOTE: OP-WINEDIT version 2.3 or later is required when using OP400 series panels.

Q. Can the OP-406 be used with other PLC products?

A. Yes. The OP400 units do support Allen-Bradley SLC 5/03, SLC 5/04, and Micrologix.

Q. Can I connect more than one OP-406 panel to one PLC/CPU?

A. Yes, but only if the CPU has more than one communications port. OP400 series panels can only be used in a stand alone fashion; that is, one panel can be used with one CPU port. OP600 and OP1000 series panels can be used in multiple panel applications (even if the CPU has only a single communications port) with an OP-9001 communications panel.

Q. What are the power supply requirements for the OP-406?

A. The OP400 series panels require 5 VDC input power. A 5 VDC external power supply that plugs into a standard 120 VAC receptacle is available (part no. OP-PS400). This power supply (or equivalent, but it **must have** a center negative power jack) is required for configuring your panel. It is also required for operation **unless** you are using a DL05, DL105, DL205 or DL405 PLC; these products supply 5 VDC through the communications cable. All other PLCs, including DL305 CPUs (when used with a D3-05B-1, D3-08B-1 or D3-10B-1 base), require the use of an external 5 VDC power supply.

Q. Will the OP-panels support graphics, animation, or color operator display screens?

A. No, the OP-panels which support display capabilities allow numeric data display, and some panels will also allow text message display.

Installation and Specifications

In This Chapter. . . .

- Labeling the Lamps and Pushbuttons
 - Templates for Manually Creating labels
 - Dimensions for Mounting
 - Panel Specifications
 - Power Supply Connections
 - Connecting the Configuration Cable
 - Selecting a Communications Cable
 - Communications Cable Details
-

Labeling the Lamps and Pushbuttons

Labeling the Lamps and Pushbuttons

Labeling the OP-406 panel is a relatively simple process that involves removing the bezel and sliding a label transparency into a pocket in the panel overlay. The transparent film can be purchased from almost any office supply store in standard 8-1/2" x 11" sheets. It is designed to run through a copy machine or laser printer.

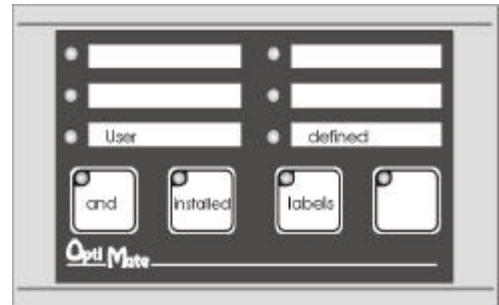

Creating the Labels

The easiest way to create labels is to use the built-in label making function of the OP-WINEDIT configuration software. This is the preferred method and is shown below. The labels can also be created manually using the template shown in the next section to help layout the transparency film. Here are some ways of manually creating labels:

- Use a computer graphics program and a laser printer to create the transparency directly, or print the labels on paper and photocopy them to a transparency sheet.
- Use press-on letters on a transparency sheet.
- Use a typewriter or lettering machine, or use press-on letters to create labels on a paper sheet, then photocopy the paper sheet onto a transparency sheet.

Creating Labels Using OP-WINEDIT

Making labels using the OP-WINEDIT configuration software is easy (see Chapter 4 for information on loading and using OP-WINEDIT). After loading OP-WINEDIT, follow these steps:

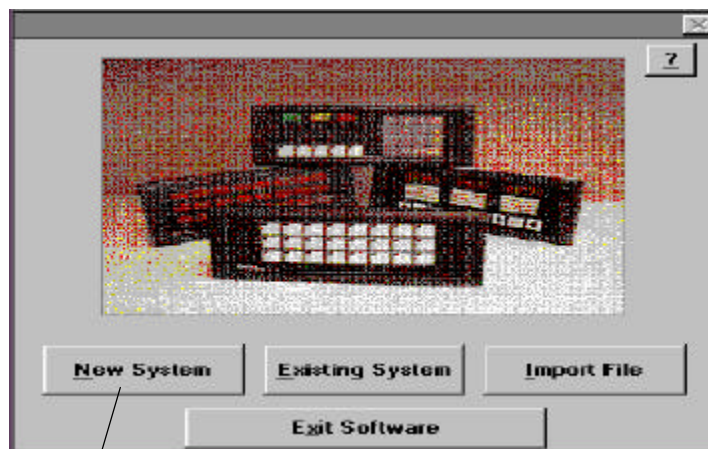

1. Open OP-WINEDIT and select **New System**.

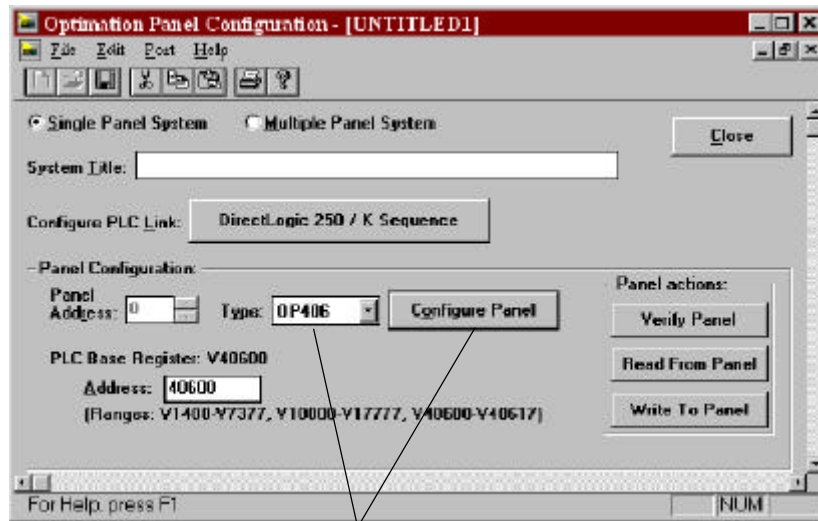

2. Select **OP-406**, and **Configure Panel**.

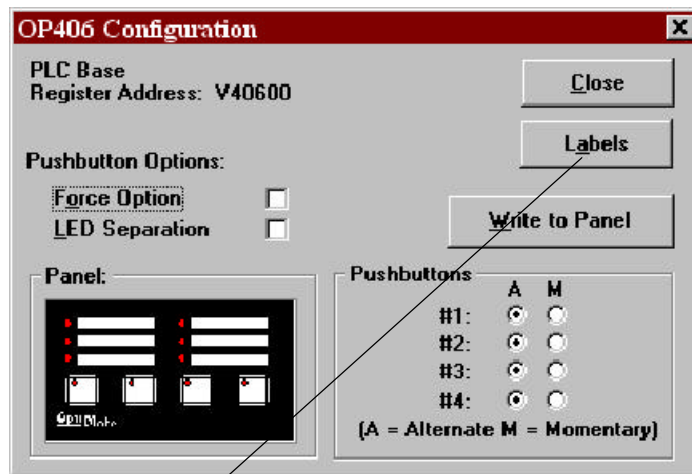

3. Select **Labels**.

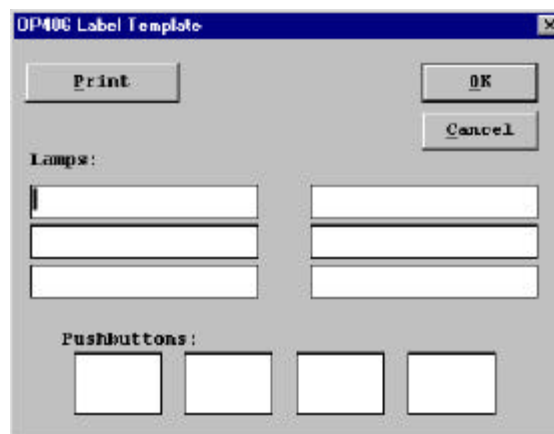

4. The OP-406 Label Template appears. Type in the label text for all indicators and pushbuttons. Press **OK** to save the labels.

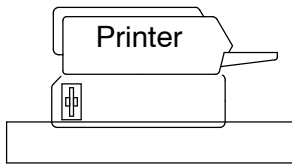

5. **Print** label on transparent film.
6. Cut out the block of labels and insert them in the panel.

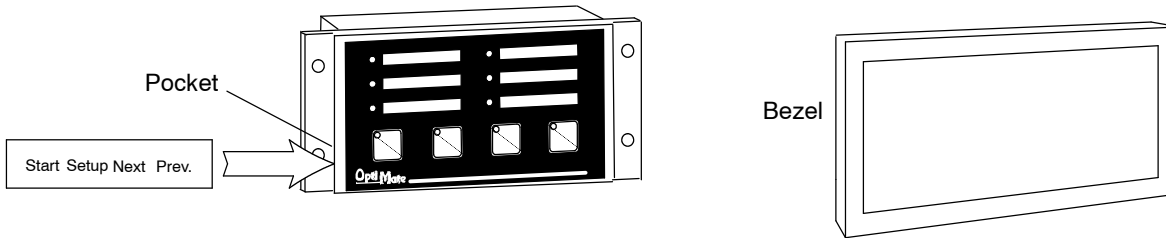
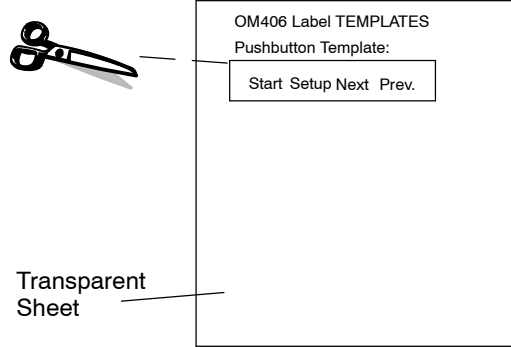

Remove the bezel from the module by unsnapping the four plastic tabs which hold the bezel to the module frame. Locate the pocket, and carefully slide the labels into place. Re-attach the bezel by snapping the bezel onto the case.

Templates for Manually Creating Labels

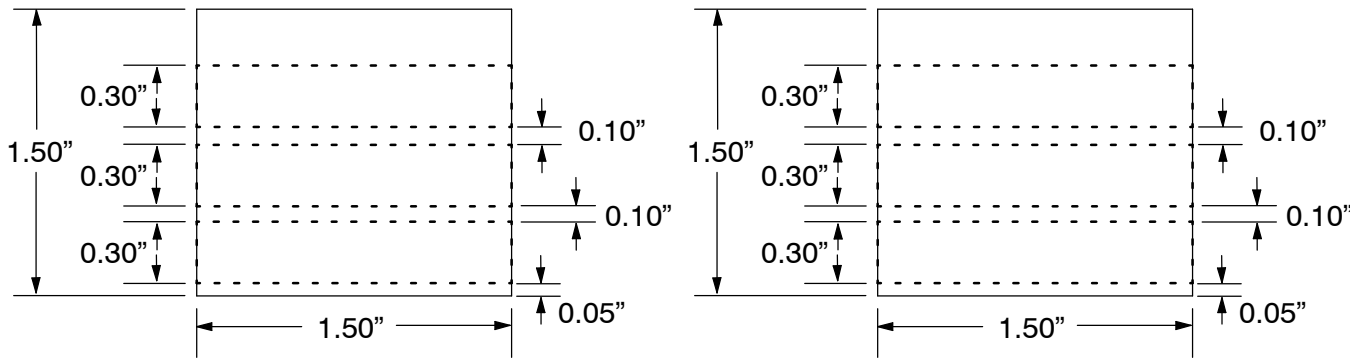

Indicator Lamp Label Inserts

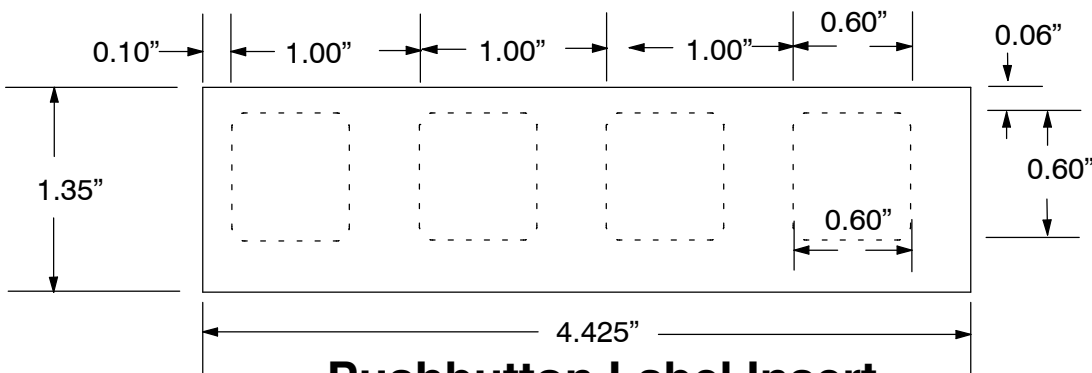

Pushbutton Label Insert

Dimensions for Mounting

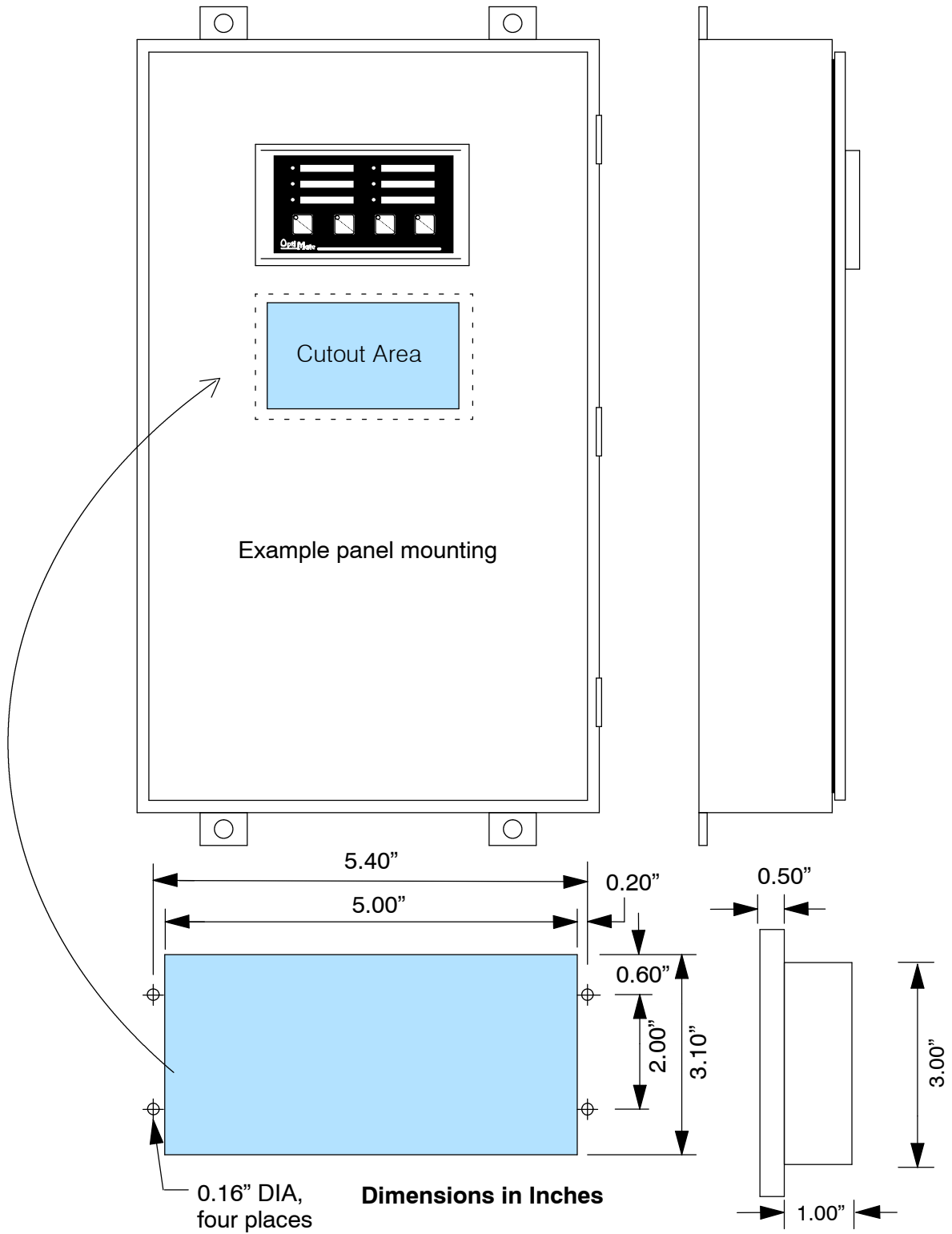

Specifications

Panel Specifications

Physical

Specifications

Weight	8 ounces
Panel Fasteners	Four 6x32 threaded studs
Pushbutton Dimensions	0.65 in. square on 1.0 in. centers
Pushbutton Life	1,000,000 switch cycles
Indicator Lamp Colors	Red
NEMA Rating	NEMA 4 (when properly installed)

Environmental

Specifications

Operating Temperature	0° to 50° C
Storage Temperature	-20° to 70° C
Operating Humidity	95% (non-condensing)
Air Composition	No corrosive gases permitted

Operating

Specifications

Power Consumption	0.25W @ 5 VDC (Power On surge of 0.35A for 1 ms max.)
Power Connector	Three terminal DC power plug, center negative
Power Supply	+5 VDC external power supply required for configuration on all panels; required for operation on all PLCs except DL05, DL105, DL205 and DL405.
Minimum/Maximum Supply Voltage	+5 VDC only
Diagnostics	LED Status
Communication Link	RS-232 4800 to 19200 baud 6-pin RJ12 phone jack type connector

Power Supply Connections

OP400 series panels require +5 VDC input power. An optional 5 VDC external power supply that plugs into a standard 120 VAC receptacle is available (part no. OP-PS400). This power supply (or equivalent) is required for configuring your panel. It is also required for operation **unless** you are using a DL05, DL105, DL205 or DL405 PLC; these products supply 5VDC through the communications cable. All other PLCs, including the DL305s, Allen-Bradley 5/03, 5/04 and Micrologix, require the use of an external 5VDC power supply during operation.

NOTE: Only use a 5 VDC power supply that has a **center negative** DC power jack.



Configuration: 5 VDC Power Supply Required For Configuring All 400 series panels

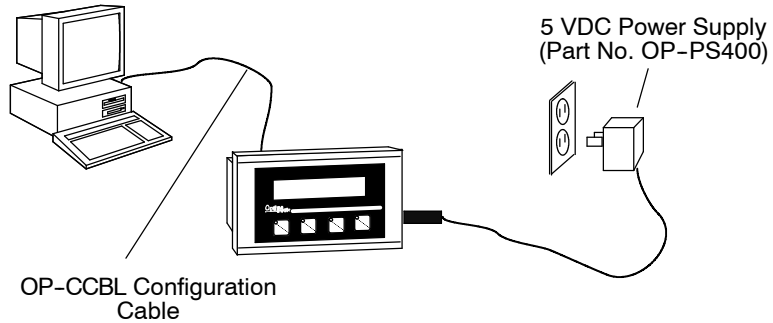

Operation Using a D3-340, D3-350, D3-330 w/DCU, Bottom Port of DL405 or Allen-Bradley CPU: 5 VDC Power Supply Required

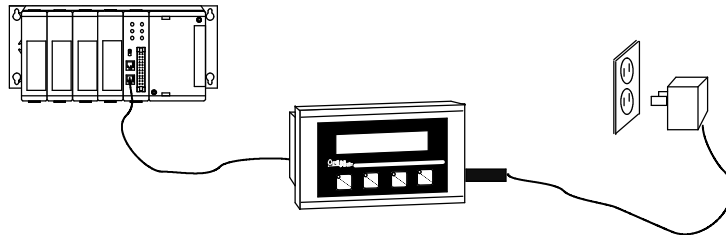

Operation Using a DL05, DL105, DL205, or Top Port of DL405 CPU: 5 VDC Power Supply Not Required

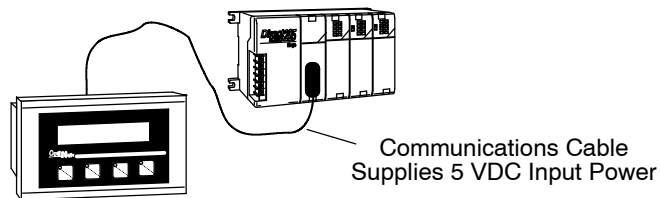

Power Supply Connections



Insert power supply connector into receptacle



Connecting the Configuration Cable

Configuration Cable

You will need two cables to use your OP-panel: A configuration cable (part number OP-CCBL) and a communications cable. Connect the configuration cable between the serial port on the rear of the OP-panel and the serial port of the personal computer. The panel may then be configured using the OP-WINEDIT configuration software. The figure below shows configuration cable connectors and wiring specifications. The wiring diagram refers to the cable connectors, *not* the communication ports. This cable is disconnected after configuration.

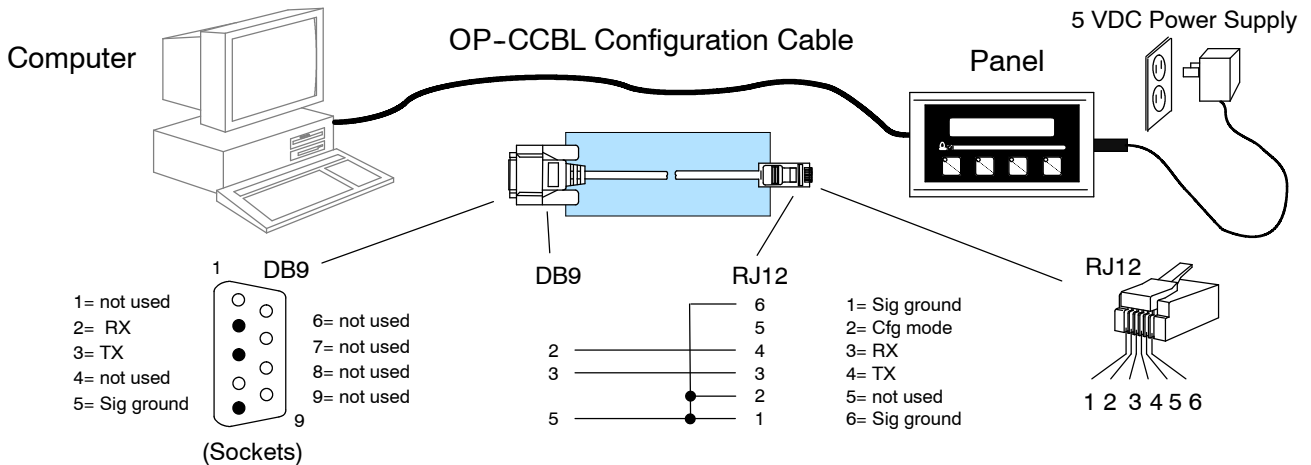

Selecting a Communications Cable

After configuration, connect the communications cable between the OP-panel and the PLC. Use the following table to select the proper communications cable.

Cables for OP400 Series OptiMate Panel-to-PLC Connections			
Family	CPU (or other device)	Port	Cable
<i>Direct</i> LOGIC™ DL05	D0-05xx	Ports 1 and 2	OP-2CBL-2
<i>Direct</i> LOGIC™ DL105	F1-130	Only one	OP-2CBL-2
<i>Direct</i> LOGIC™ DL205	D2-230	Only one	OP-2CBL-2
	D2-240	Top port	OP-2CBL-2
		Bottom port	OP-2CBL-2
	D2-250	Top port	OP-2CBL-2
		Bottom port	* (see note below)
D2-DCM (module)	Only port	* (see note below)	
<i>Direct</i> LOGIC™ DL305	D3-330	Requires DCU	* (see note below)
	D3-330P	Requires DCU	* (see note below)
	D3-340	Top port	OP-3CBL-1
		Bottom port	OP-3CBL-1
	D3-350	Top port	OP-2CBL-2
Bottom port		* (see note below)	
<i>Direct</i> LOGIC™ DL405	D4-430	Top port (15-pin)	OP-4CBL-3
		Bottom port (25-pin)	* (see note below)
	D4-440	Top port	OP-4CBL-3
		Bottom port	* (see note below)
	D4-450	Phone Jack	OP-2CBL-2
		Top port (15-pin)	OP-4CBL-3
		Bottom port (25-pin)	* (see note below)
	D4-DCM (module)	Only port	* (see note below)
	Slice I/O panels	Only one	OP-4CBL-3
TI305™ / SIMATIC® TI305™	325-07, PPX:325-07	Requires DCU	* (see note below)
	330-37, PPX:330-37	Requires DCU	* (see note below)
	325S-07 (or 325 w/ Stage Kt)	Requires DCU	* (see note below)
	330S-37, PPX:330S-37	Requires DCU	* (see note below)
	335-37, PPX:335-37	Phone Jacks	OP-3CBL-1
If DCU is used		* (see note below)	
TI405™ / SIMATIC® TI405™	425-CPU, PPX:425-CPU	Only one	OP-4CBL-3
	PPX:430-CPU	Top port (15-pin)	OP-4CBL-3
		Bottom port (25-pin)	* (see note below)
	435-CPU, PPX:435-CPU	Top port (15-pin)	OP-4CBL-3
		Bottom port (25-pin)	* (see note below)
Smart Slice™ I/O panels	Only one	OP-4CBL-3	
Allen-Bradley™ SLC 500	5/03, 5/04	Bottom port	OP-ACBL-3
Allen-Bradley	MicroLogix	Only one	OP-ACBL-4

* **Note:** Pre-assembled cables for connecting to these ports are not supplied by **Automationdirect.com**; however, you can use the cable pinout diagrams in the following section to make your own cables.

Communications Cable Details

The drawings on this page are for cables which **are** supplied by **Automationdirect.com**. Use this page if you need to make your own cables. We recommend using 22 AWG shielded cable.

OP400 Series Communications Cables



OP-2CBL-2
(DL05, DL105, DL205, D3-350, D4-450)

- 1= Sig ground
- 2= 5 VDC
- 3= RX
- 4= TX
- 5= not used
- 6= Sig ground

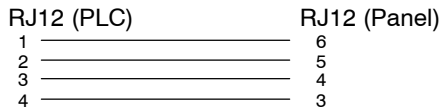
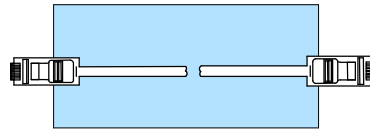
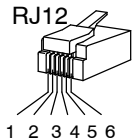

Panel Connection

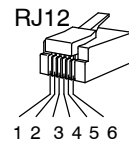

OP-3CBL-1 (D3-340)

- 1= RX
- 2= TX
- 3= not used
- 4= Sig ground

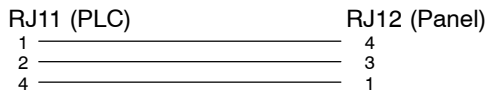
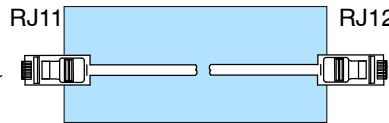
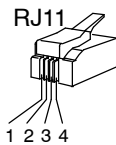

- 1= Sig ground
- 2= not used
- 3= RX
- 4= TX
- 5= 5 VDC
- 6= Sig ground

OP-4CBL-3 (DL405)

- 8= not used
- 7= not used
- 6= not used
- 5= not used
- 4= Sig ground
- 3= RX
- 2= TX
- 1= not used

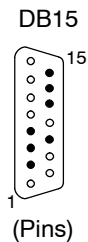

- 15= Sig ground
- 14= Sig ground
- 13= Sig ground
- 12= not used
- 11= 5 VDC
- 10= not used
- 9= not used

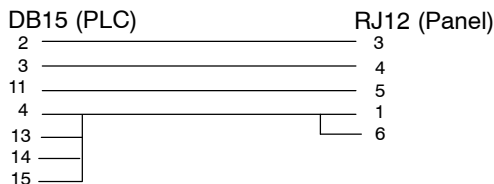
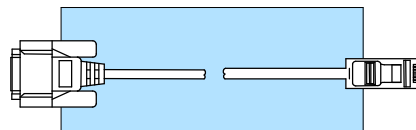

OP-ACBL-3 (Allen-Bradley)

- 1= not used
- 2= RX
- 3= TX
- 4= not used
- 5= Sig ground

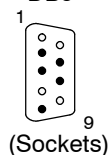

- 6= not used
- 7= RTS
- 8= CTS
- 9= not used

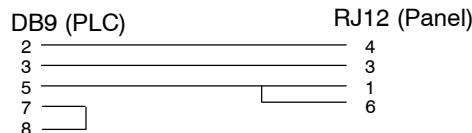
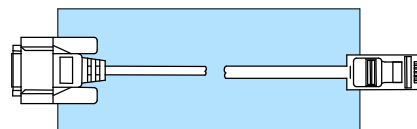

The drawings on this page are for cables which **are not** supplied by **Automationdirect.com**. Use the drawings to make your own cable. We recommend using a 22 AWG or larger shielded cable.

OP400 Series Communications Cables (continued)



Make this cable for use with D2-250 15-pin bottom port.

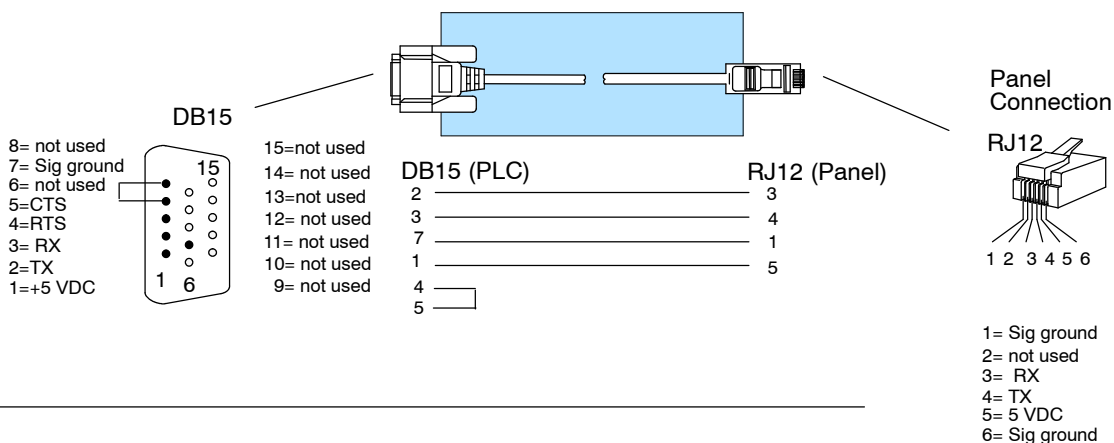

Make this cable for use with D3-330 w/DCU, D3-350, DL405 bottom ports, and all DCM modules (25-pin ports).

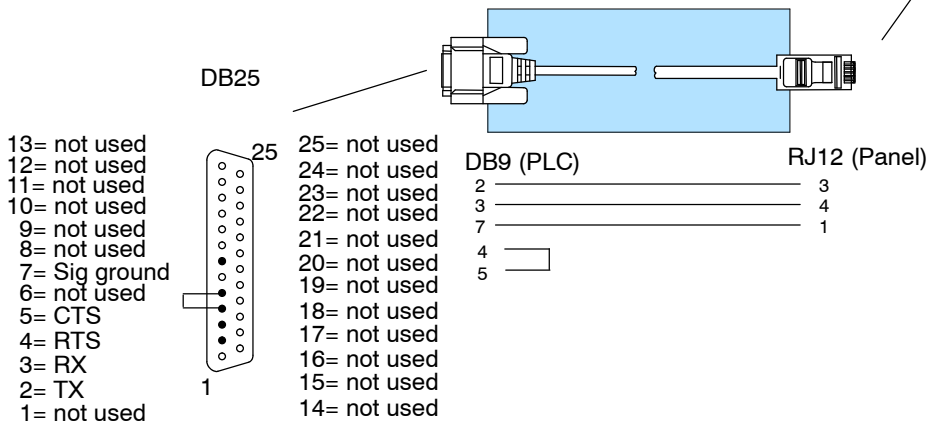

Understanding the Features

In This Chapter. . . .

- Learning the Features
 - Indicator Lamp and Pushbutton Operations
 - PLC Registers
 - *Direct*LOGIC User Memory Overview
-

Learning the Features

In this section, the subject of how to use the OP-406 features is described. We recommend that you study this chapter before attempting to configure and use the OP-panel. As you proceed through this chapter, relate the topics discussed with how your operator panel may be implemented. The concepts discussed in this chapter are applicable to all PLCs.

- Indicator Lamp and Pushbutton Operations
- Turning On a Lamp
- Flashing a Lamp
- PLC Registers
- User Memory Overview

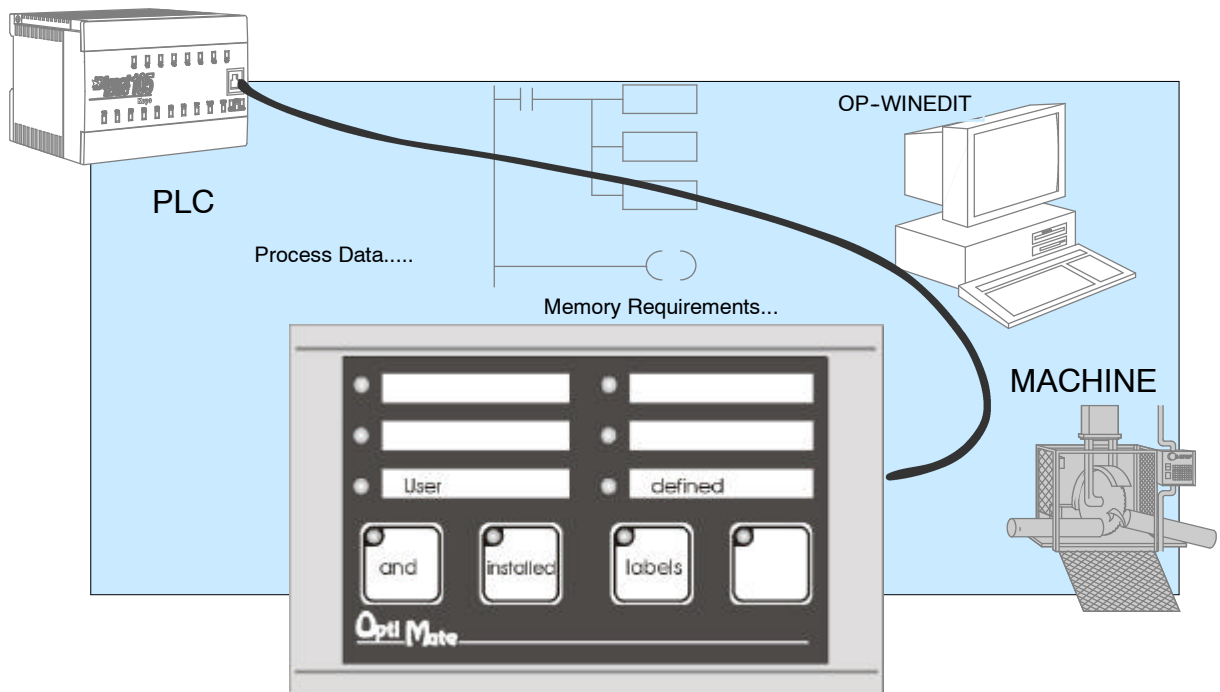

Indicator Lamp and Pushbutton Operations

Reading Pushbutton Status Once the panel is configured and connected to the PLC, reading a pushbutton's status is done by reading the appropriate PLC register bit. The pushbutton normally appears in PLC ladder logic as a contact.

Turning on a Lamp When configured for PLC operation, you must write a 1 to the register bit (L1-L6) to turn on the corresponding lamp. The OP-406 will automatically retrieve the register data and light any lamp whose bit is set.

Flashing a Lamp The X+1 register contains the flash control bits. The lamp will flash only if both the LED bit is set and the flash control bit is set.
The lamp flash is approximately 0.5 seconds on and 0.25 seconds off.



Turning on the Inset LED

Normally the LED inset in each pushbutton indicates the status of the pushbutton. However, if the panel is configured for LED Separation, the LED can be set directly from the PLC, by writing a 1 to its register bit (B1-B4). The OP-406 will automatically retrieve the register data and light any LED whose bit is set.

NOTE: A lamp must be turned on in order for the flash control bits to work.

PLC Registers

PLC Register Overview

The OP400 panels communicate to the PLC through user defined PLC data registers. The starting or “Base” register is assigned during panel configuration and automatically occupies four consecutive 16-bit data registers. In this manual the registers are identified as M+0, M+1, M+2, and M+3. Force control register M+3 is used to force a setpoint to a specified value. The term PLC register is used for the area of memory within the PLC used for data exchange with the OP-406. PLC registers (addresses) are sometimes known as data registers, internal registers or 16-bit (word) addresses.

PLC Register Map

The OP-406 uses a bank of 4 contiguous PLC registers. The register set is shown in the table below.

OP-406 Panel PLC Register Map

PLC Register	Register Function
M+0	Indicator lamps and pushbutton LEDs on/off control
M+1	Indicator lamps and pushbutton LEDs flash control
M+2	Pushbutton on/off status
M+3	Force pushbutton data and commands

Register Bit Association

	MSB								LSB								
	15	14	13	12	11	10	9	8	7	6	5	4	3	2	1	0	
M+0			L6	L5	L4	L3	L2	L1					B4	B3	B2	B1	Indicator Lamp/LED Pushbutton On/Off Control
M+1			L6	L5	L4	L3	L2	L1					B4	B3	B2	B1	Indicator Lamp/LED Pushbutton Flash Control
M+2													B4	B3	B2	B1	Pushbutton On/Off Status
M+3	F1	F2	F3										B4	B3	B2	B1	Force Data and Commands

Force Commands

If the OP406 panel is configured for force capability (using the Force Option), the PLC can directly control button status when desired. This may be useful for initialization purposes.

PLC Register Assignment Examples

Examine the address conventions for **Automationdirect (DirectLOGIC)** and Allen-Bradley. For example, the **DirectLOGIC** address references are **octal**, and the Allen-Bradley's are **decimal**. The **DirectLOGIC** DL05/DL105/DL205/D3-350/DL405 OP-panel address uses V-memory registers which are 16-bit registers. The DL305 family uses reference assignments with 8-bit registers. This means that the DL305 will require eight 8 bit registers for data handling. The Allen-Bradley memory is defined with a reference **(Nx)** which represents the memory area, and **(:n)** which defines the word within the memory area. Please refer to the appropriate CPU User manual for the PLC product you are using.

DirectLOGIC DL05/105/DL205/D3-350/DL405

Example Address		Function
V40600	M+0	Indicator lamps and pushbutton LEDs on/off control
V40601	M+1	Indicator lamps and pushbutton LEDs flash control
V40602	M+2	Pushbutton on/off status
V40603	M+3	Force pushbutton data and commands

DirectLOGIC DL305 (D3-340)

Example Address		Function
R20/R21	M+0	Indicator lamps and pushbutton LEDs on/off control
R22/R23	M+1	Indicator lamps and pushbutton LEDs flash control
R24/R25	M+2	Pushbutton on/off status
R26/R27	M+3	Force pushbutton data and commands

Allen-Bradley SLC 5/03, 5/04, and Micrologix

Example Address		Function
N7:0	M+0	Indicator lamps and pushbutton LEDs on/off control
N7:1	M+1	Indicator lamps and pushbutton LEDs flash control
N7:2	M+2	Pushbutton on/off status
N7:3	M+3	Force pushbutton data and commands

DirectLOGIC User Memory Overview

the Features

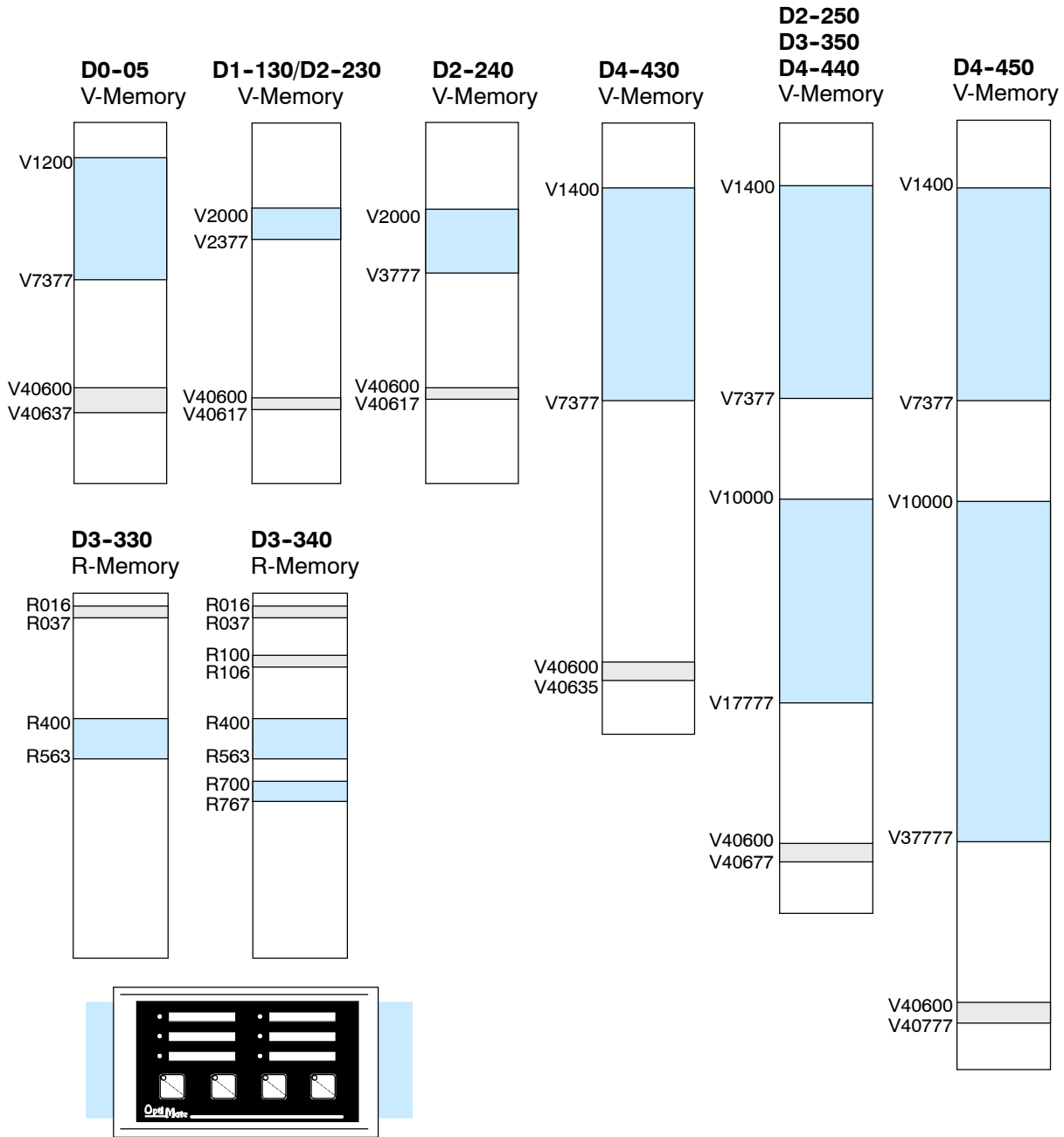

- User Data Space available for OP-panels
- Internal Relay Memory

DirectLOGIC PLCs use octal addressing, as indicated by the shaded areas.

Configuring Your Operator Panel

In This Chapter. . . .

- Preparing for Configuration
- How to Configure Your Panel

Preparing for Configuration

OP-WINEDIT Software

The OP-406 is configured with software running on a personal computer. This software is available through **Automationdirect.com** and is referred to as OP-WINEDIT configuration software.

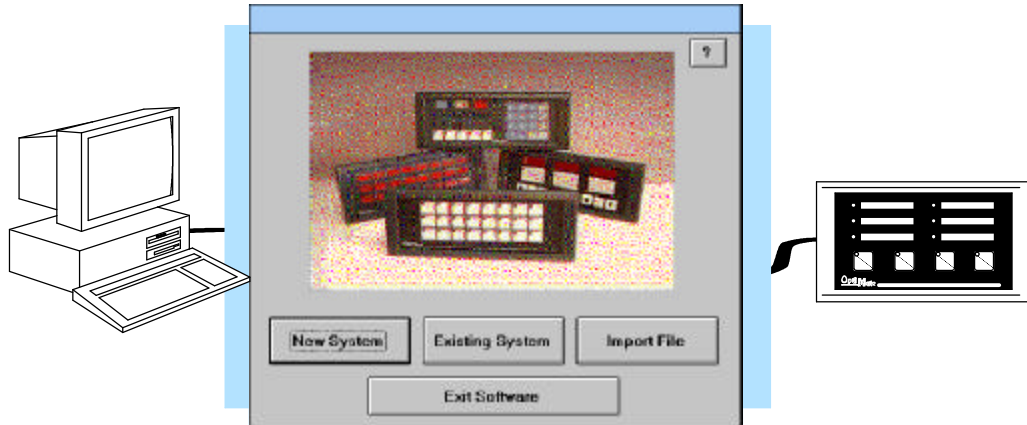

More about OP-WINEDIT

The OP-WINEDIT configuration software allows you to configure OP-panel applications, as well as download (write to panel) and upload (read from panel) the configurations. Use this software to configure your communication link, and select indicator/pushbutton control. Order the software from **Automationdirect.com** using part number OP-WINEDIT. The OP-406 panel requires version 2.3 or later.

HELP Screens

The OP-WINEDIT software provides **Help** windows which supply instructions for performing all necessary configuration tasks. Should you have problems understanding how to program your panel, refer to these built-in Help windows. To access the Help windows, point and click on the Help menu and choose Using help, or click on the [?] icon located near the top of the main configuration window.

HELP Screen
Menu



Computer System Requirements

Your personal computer must meet the following minimum requirements:

- ✓ IBM type 386 or above
- ✓ **Windows 3.1 or later, including Windows 95, 98 or NT**
- ✓ 1 meg of hard drive
- ✓ 1 meg of RAM

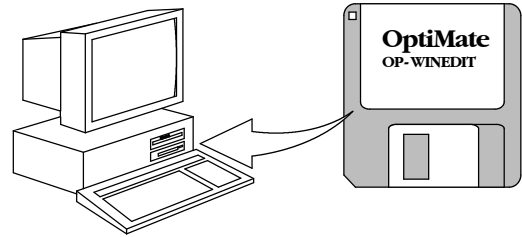

How to Configure Your Panel

Follow these steps to configure your OP-406 operator panel.

- Step 1 Load OP-WINEDIT** - If you are not already using the configuration software or have an older version, you must install version 2.3 or later (if you are using an older version of OP-WINEDIT you can obtain an upgrade at our web site). The software is provided on one 3-1/2 inch high-density diskette and comes with its own manual. Here are brief installation instructions.
- Place the installation disk into your computer's floppy drive (usually either drive A or drive B).
 - Open Microsoft™ Windows (3.1 or above). For Microsoft Windows 95, 98 or NT the **Start/Run** program task bar is located at the bottom left portion of your screen. For Microsoft Windows 3.x versions select **File/Run** from the Program Manager screen.
 - Select **Run**, and a pop-up window appears. Type in the path for the drive in which you have placed the setup disk and designate the file **setup**. Click on **OK** when you are finished.
- Step 2 Connect Panel to PC** - Connect the OP-406 to a COM port on your personal computer using the OP-CCBL configuration cable. Make sure the OP-PS400 5VDC power supply is connected.

- Step 3** Open **OP-WINEDIT** - Select **New System**.
- Step 4** Start **Configuring Your Panel** - Start by filling in these parameters:

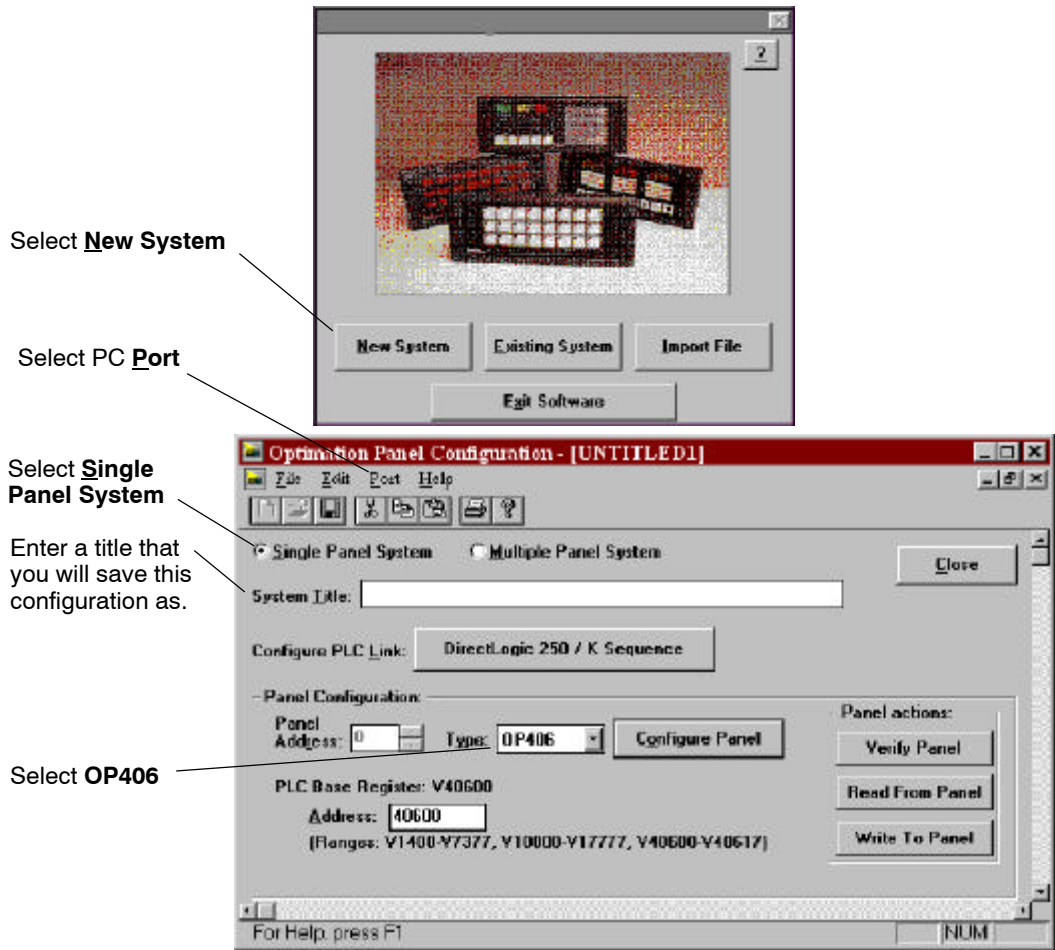

- Step 5** Select **Configure PLC Link** - Here is where you define protocol items such as PLC address, baud rate and parity. Enter the appropriate parameters for your PLC. The following table provides the necessary information for most **DirectLogic** controllers. For other PLC families, reference that product's user manual to determine the port communications capabilities.

During configuration, make sure that your address and communications parameters match the PLC port settings. The PLC **Timeout** works like this: When the panel sends a message to the PLC and does not receive a response or does not understand the response, it will wait the time-out period before resending the message.

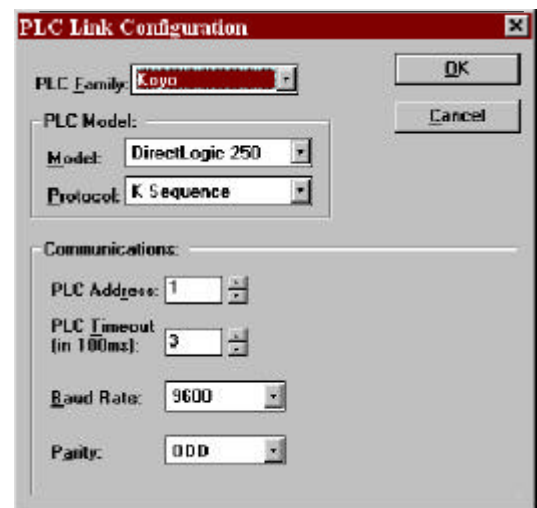

You also have several ports which can be used to connect your communications cable. Some of these ports have fixed PLC address assignments, and some *do not*. The ports which allow configuring the PLC addresses can be set to a unique address, ranging from 1 through 90. **Refer to your User Manual for specific information on the ports of your PLC.**



NOTE: For Allen-Bradley, you will need to connect to Channel 0 (bottom serial port), using DF1 full duplex. Additionally, the Allen-Bradley software allows you to set the bottom port to a unique PLC address. The software default is PLC Address 1. You must select CRC error detection and make sure the address on the configuration screen matches the address you have assigned. This port must also be configured for either 4800 or 9600 baud. No other baud rates are supported for communicating between the OP-panels and an Allen-Bradley PLC. Since the Allen-Bradley software uses a default baud rate of 1200, you must change the settings.

PLC Model	Port/Baud Rates	Parity	Stop Bit
DL05	Port 1	9600	Odd
	Port 2	9600/19.2K	Odd/None
DL105/D2-230/ D2-240	Top	9600	Odd
	Bottom	9600/19.2k (DL240 only)	Odd/None
D2-250	Top	9600	Odd/None
	Bottom	9600/19.2K	Odd/None
D3-330	DCU Only*	4800/9600/19.2k	Odd/None
D3-340	Bottom & Top*	4800/9600/19.2k	Odd/None
D3-350	Top*	9600	Odd/None
	Bottom*	4800/9600/19.2K	Odd
D4-430/440	Top	9600	Odd
	Bottom*	9600/19.2k	Odd/None
D4-450	DB15	9600	Odd
	DB25*	9600/19.2k	Odd/None
	RJ12	9600/19.2k	Odd/None

* These ports do not supply +5VDC. You must use the OP-PS400 external power supply.

Step 6 Select the Base Register Address - This step is very important because it establishes the link in your PLC memory to the panel. Chapter 3, Understanding the Features, describes the mapping process. Once you are familiar with the mapping process and you know which memory block in your PLC to use (refer to the user manual for your PLC), enter your selection.

If you choose Allen-Bradley as your PLC Type, you must enter the PLC File Number in addition to a Base Register Address. You must expand the memory map in the Allen-Bradley PLC to include all registers being used by the OP-panel. The panel will only recognize integer file types N7 and user-defined file types N9 through N255. Enter the number only and not the prefix N. The Base Register Address is any number between 0 and 255.

Step 7 Configure the Panel Features - Select Configure Panel. These features are discussed in detail in Chapter 3, but include:

- **Force Option** - Selecting this option allows the PLC ladder program itself to write to a pushbutton bit. If alternate action is selected for any of the pushbuttons, the Force Option should be selected if you want the capability to force the state of an alternate action pushbutton on or off without touching the panel.
- **LED Separation** - The pushbuttons can be configured as either momentary or alternate action. If momentary is selected for any pushbuttons, select LED Separation if you want the LEDs inset in all of the momentary pushbuttons to act independently of the button status.

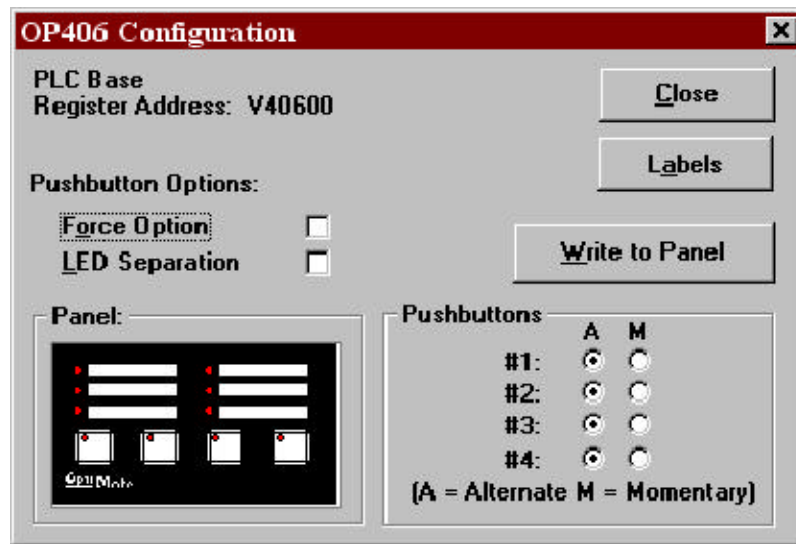

Step 8 Save and Download - Once you have completed your configuration, you can save it to disk and/or write (download) directly to the panel.

NOTE: Be sure to select the correct port on your PC (Com 1, 2, 3, 4) in order to Write to the Panel.



Programming Examples

In This Chapter. . . .

- DL05/105/DL205/D3-350/DL405 Application Examples
 - D3-340 Application Example
 - Allen-Bradley™ Application Examples
 - Troubleshooting
-

Examples Using *Direct*LOGIC PLCs

Register Usage

The OP-WINEDIT configuration software allows you to configure a panel to use a block of registers at a starting value that you define. For a DL05, DL105, DL205, D3-350 or DL405 CPU the recommended memory to use is the control relay registers starting at V40600. For the 305 family (except the D3-350), the recommended memory is the registers beginning at R16. Any block of registers within the data word range can be used.

The following table lists the control relay register addresses for CPUs.

Control Relay Registers for <i>Direct</i> LOGIC™ PLCs		
Family	CPU	Control Relay Registers
<i>Direct</i> LOGIC™ DL05	D0-05	V40600-V40637
<i>Direct</i> LOGIC™ DL105	F1-130	V40600-V40617
<i>Direct</i> LOGIC™ DL205	D2-230	V40600-V40617
	D2-240	V40600-V40617
	D2-250	V40600-V40677
<i>Direct</i> LOGIC™ DL305	D3-330/D3-330P	R16-R37
	D3-340	R016-R037 and R100-R106
	D3-350	V40600-V40677
<i>Direct</i> LOGIC™ DL405	D4-430	V40600-V40635
	D4-440	V40600-V40677
	D4-450	V40600-V40777

Examples Using DL05, DL105, DL205, D3-350 and DL405

The following example programs use a PLC base address of V40600. The table below shows the control relay correlation for an OP-406 panel configured for a PLC base address of V40600.

Device	Lamp/LED On/Off	Lamp/LED Flash	Button Status	Force
B1	C0	C20	C40	C60
B2	C1	C21	C41	C61
B3	C2	C22	C42	C62
B4	C3	C23	C43	C63
L1	C10	C30		
L2	C11	C31		
L3	C12	C32		
L4	C13	C33		
L5	C14	C34		
L6	C15	C35		C75 (F3)
				C76 (F2)
				C77 (F1)

Turning on a Lamp Turning on a lamp requires activating the associated control relay coil. In the figure below, lamp 4 will be turned on as long as input X1 is active (energizing C13).

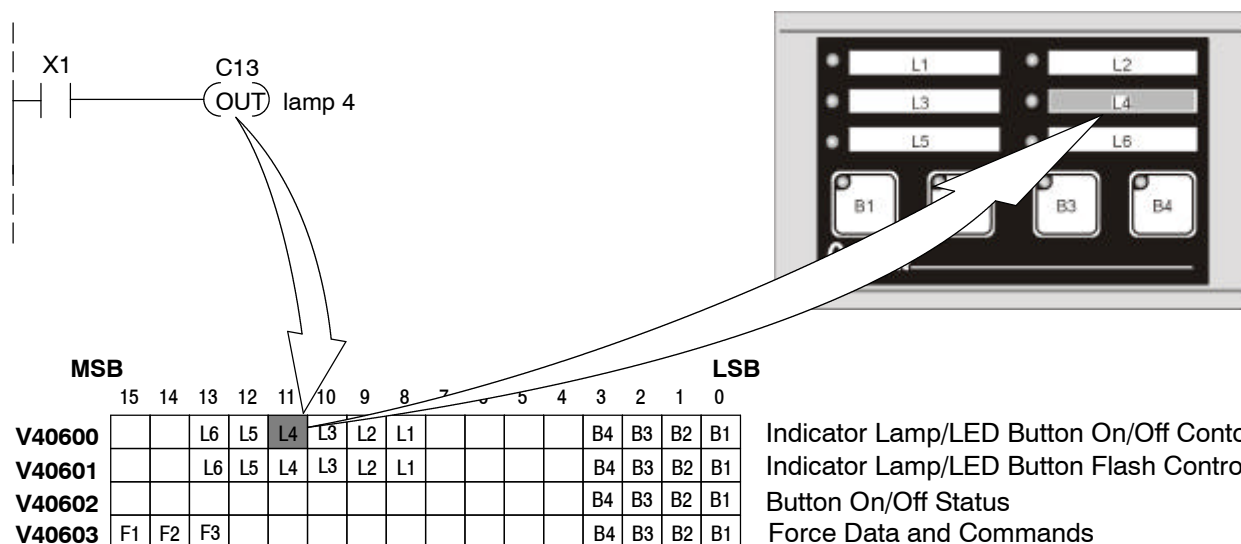

Flashing a Lamp

To cause a lamp to flash, you must turn the lamp on and set the associated flash bit. The example below shows a PLC program used to flash lamp 2 as long as X5 is energized.

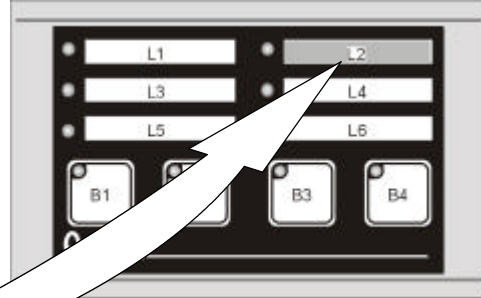
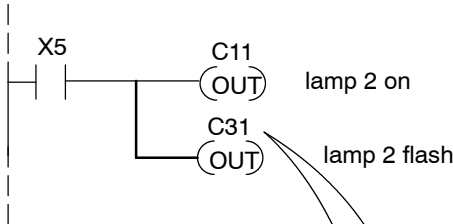

	MSB															LSB					
	15	14	13	12	11	10	9	8	7	6	5	4	3	2	1	0	B4	B3	B2	B1	
V40600			L6	L5	L4	L3	L2	L1									B4	B3	B2	B1	Indicator Lamp/LED Button On/Off Control
V40601			L6	L5	L4	L3	L2	L1									B4	B3	B2	B1	Indicator Lamp/LED Button Flash Control
V40602																	B4	B3	B2	B1	Button On/Off Status
V40603	F1	F2	F3														B4	B3	B2	B1	Force Data and Commands

Using a Button

The following example illustrates the use of an OP-406 button in a program. When button 3 is activated, C42 will become active and energize output Y0.

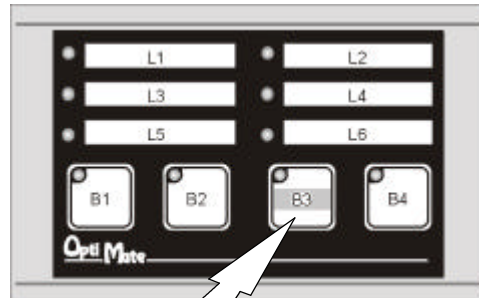
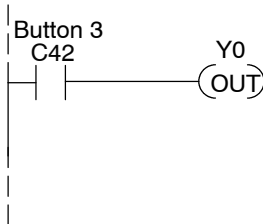

	MSB															LSB					
	15	14	13	12	11	10	9	8	7	6	5	4	3	2	1	0	B4	B3	B2	B1	
V40600			L6	L5	L4	L3	L2	L1									B4	B3	B2	B1	Indicator Lamp/LED Button On/Off Control
V40601			L6	L5	L4	L3	L2	L1									B4	B3	B2	B1	Indicator Lamp/LED Button Flash Control
V40602																	B4	B3	B2	B1	Button On/Off Status
V40603	F1	F2	F3														B4	B3	B2	B1	Force Data and Commands

Lighting an Inset LED

In LED Separation mode, the LEDs in the corner of each momentary pushbutton may be directly controlled by the PLC program. The example on the right shows a segment of a program that lights button 2's inset LED when input X7 is energized. *In order for this example to work, the panel must be configured for LED separation and button 2 must be a momentary pushbutton.*

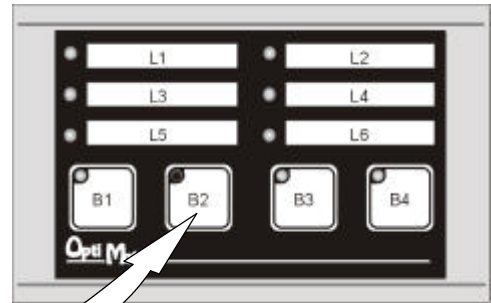
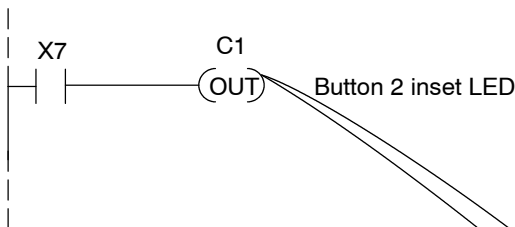

	MSB						LSB										
	15	14	13	12	11	10	9	8	7	6	5	4	3	2	1	0	
V40600			L6	L5	L4	L3	L2	L1					B4	B3	B2	B1	Indicator Lamp/LED Button On/Off Control
V40601			L6	L5	L4	L3	L2	L1					B4	B3	B2	B1	Indicator Lamp/LED Button Flash Control
V40602													B4	B3	B2	B1	Button On/Off Status
V40603	F1	F2	F3										B4	B3	B2	B1	Force Data and Commands

Flashing an Inset LED

To flash an inset LED, you must turn it on and set the associated flash bit. The example below shows a program used to set the LED inset of button 1 to flash whenever X2 is energized. The table below it shows LED operation with button 1 set as alternate action.

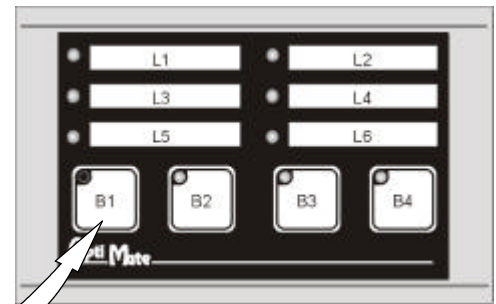
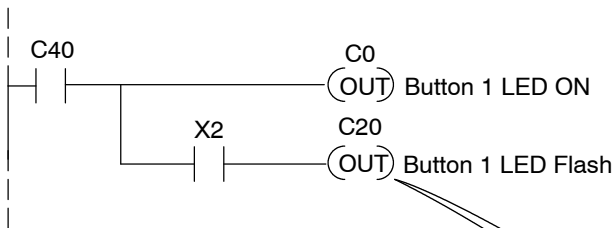

	MSB						LSB										
	15	14	13	12	11	10	9	8	7	6	5	4	3	2	1	0	
V40600			L6	L5	L4	L3	L2	L1					B4	B3	B2	B1	Indicator Lamp/LED Button On/Off Control
V40601			L6	L5	L4	L3	L2	L1					B4	B3	B2	B1	Indicator Lamp/LED Button Flash Control
V40602													B4	B3	B2	B1	Button On/Off Status
V40603	F1	F2	F3										B4	B3	B2	B1	Force Data and Commands

Button State	X2 Status	LED Operation
Inactive	de-energized	Off
Inactive	energized	Off
Active	de-energized	On solid
Active	energized	Flashing

Forcing Button Status

The OP-406 allows you to force the state of a button from the PLC.



NOTE: The Force Option must be selected (in OP-WINEDIT) in order to force setpoints and ONLY applies to Alternate Action Buttons.

Force Button Status

This function is used to set the state (on or off) of every alternate action pushbutton. To use the “Force Button Status” function, set the F1 bit and all buttons that you want to be on, leaving all other bits off. The example below shows buttons 1 and 4 being forced on and buttons 2 and 3 being forced off when C377 is active

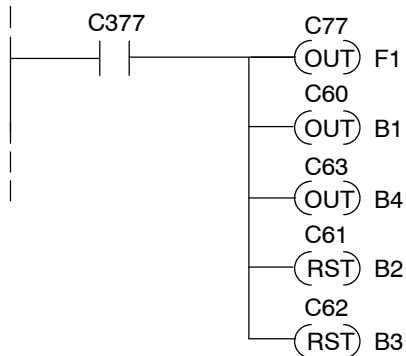

Set the F1 bit and the bits for Buttons 1 and 4. Clear Buttons 2 and 3.

Force Button(s) On This function is used to turn individual buttons on without affecting the state of any other buttons. To use the “Force Buttons On” function, set the F2 and all buttons that you want to turn on. Any buttons associated with bits that are not set will be unaffected. The following example shows buttons 2 and 3 being forced on when C377 is active.

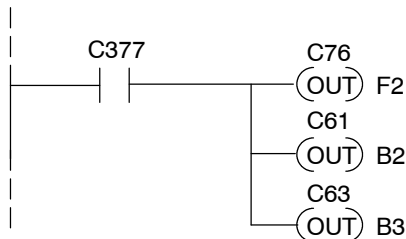

Set the F2 bit and the bits for Buttons 2 and 3. Buttons 1 and 4 are unaffected.

Force Button(s) Off This function is used to turn individual buttons off without affecting the state of any other buttons. To use the “Force Buttons Off” function, set the F3 and all buttons that you want to turn on. Any buttons associated with bits that are not set will be unaffected. The following example shows buttons 2 and 4 being cleared when C377 is active.

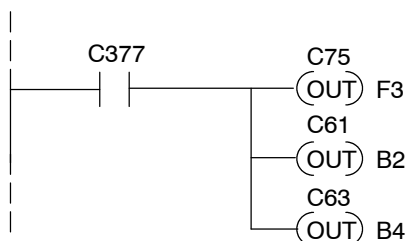

Set the F3 bit and the bits for Buttons 2 and 4. Buttons 1 and 3 are unaffected.

Example Using D3-340

Register Usage

The following example assumes that the OP-406 is configured for a base address of R20.

DirectSOFT

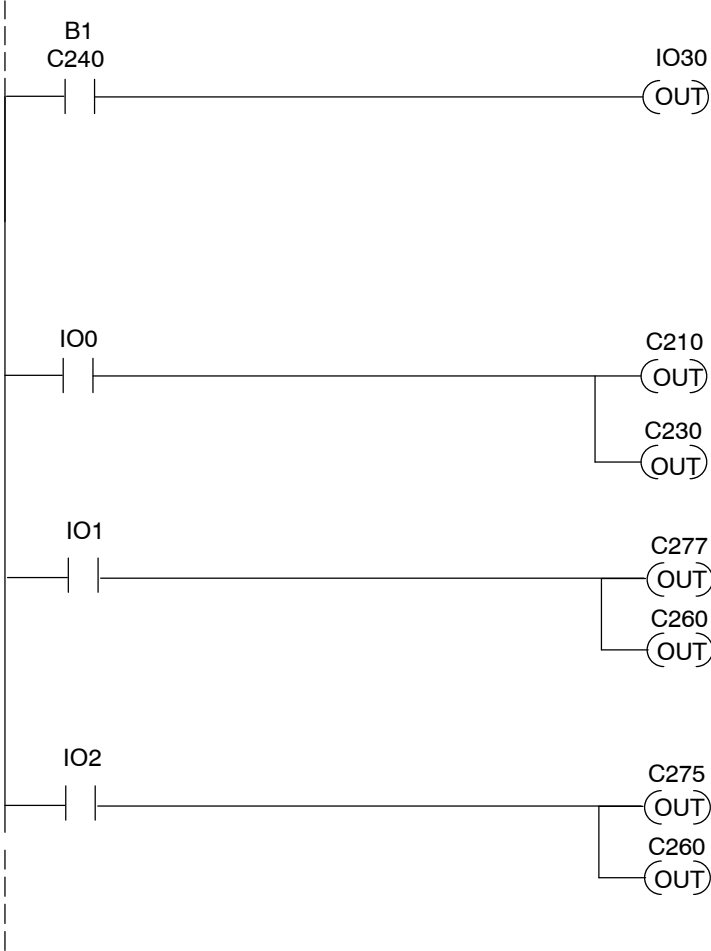

The base address starts at R20 (C200), so B1-B4 is assigned to C240-C243.

L1-L6 are assigned to C210-C215. IO0 turns Lamp 1 on. Turning C230 on makes L1 flash.

This rung uses the Force Function to force Button 1 ON. IO30 energizes when Button 1 is forced ON (see rung 1). R26 is the Force Register.

This rung clears Forced Button 1.

Examples Using Allen-Bradley™ SLC 5/03, 5/04 and Micrologix PLCs

Interfacing to A-B Memory

OptiMate panels interface to Allen-Bradley SLC 5/03, SLC 5/04 and Micrologix PLCs via integer file type N. The 5/03 and 5/04 have file type N7 as standard. Other "N" type files can be created. The Micrologix has a fixed file type N7. Please see A-B documentation for information on setting up and using "N" type files.



NOTE: When using an OP-406 with an Allen-Bradley PLC, always be sure that at least 4 words of memory are allocated to allow proper communications.

Turning on a Lamp

Turning on a lamp requires activating the associated control relay coil. In the figure below, lamp 4 will be turned on as long as input I:0.0/4 is active (energizing N7:0/11).

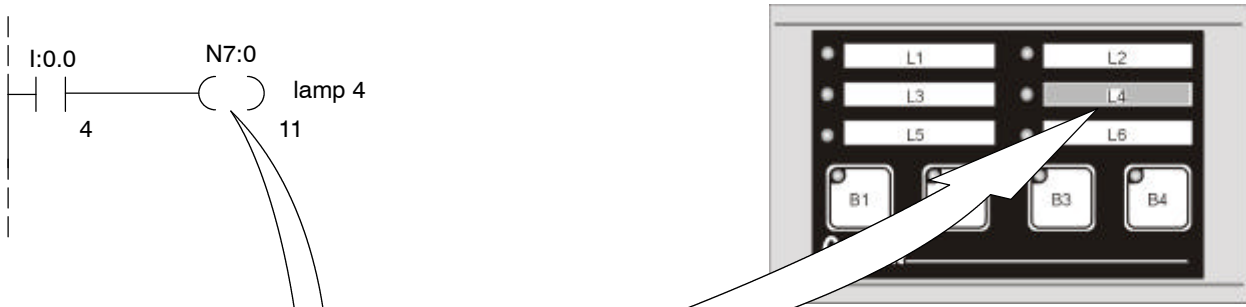

	MSB										LSB						
	15	14	13	12	11	10	9	8	7	6	5	4	3	2	1	0	
N7:0			L6	L5	L4	L3	L2	L1					B4	B3	B2	B1	Indicator Lamp/LED Button On/Off Control
N7:1			L6	L5	L4	L3	L2	L1					B4	B3	B2	B1	Indicator Lamp/LED Button Flash Control
N7:2													B4	B3	B2	B1	Button On/Off Status
N7:3	F1	F2	F3										B4	B3	B2	B1	Force Data and Commands

Flashing a Lamp

To cause a lamp to flash, you must turn the lamp on and set the associated flash bit. The example below shows a PLC program used to flash lamp 2 as long as I:0.0/5 is energized.

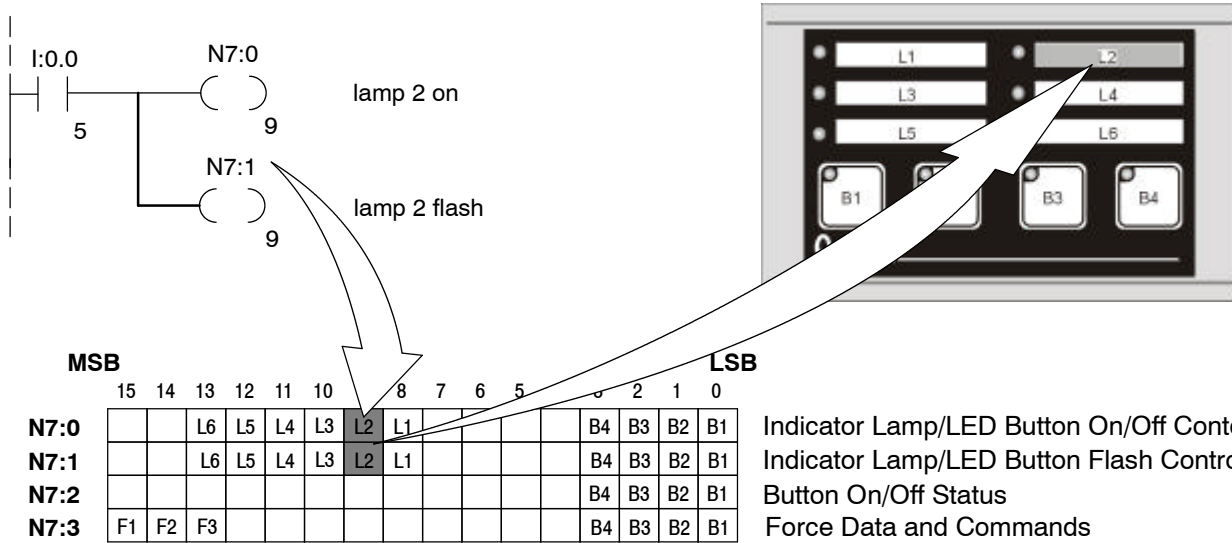

Using a Button

The following example illustrates the use of an OP-406 button in a program. When button 3 is activated, N7:2/2 will become active and energize output O:0.1/5.

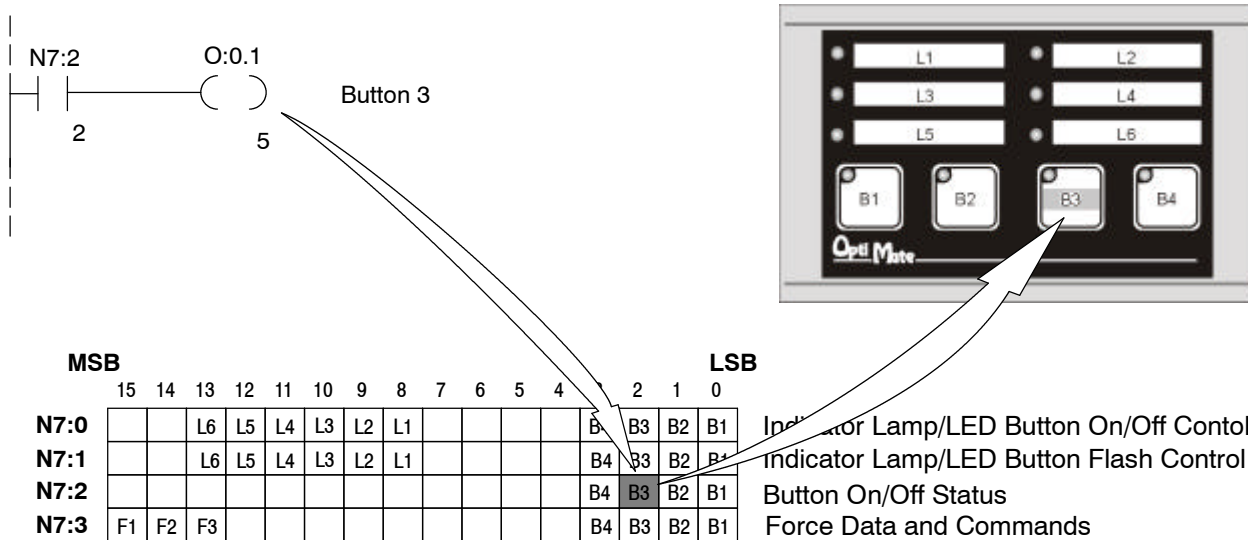

Lighting an Inset LED

In LED Separation mode, the LEDs in the corner of each momentary pushbutton may be directly controlled by the PLC program. The example on the right shows a segment of a program that lights button 4's inset LED when input I:0.2/12 is energized. *In order for this example to work, the panel must be configured for LED separation and button 2 must be a momentary pushbutton.* You can flash the LED by turning on the appropriate flash bit. In the following example, when N7:0/3 is on, turn on N7:1/3 to flash.

MSB 15 14 13 12 11 10 9 8 7 6 5 4 3 2 1 0 LSB

N7:0			L6	L5	L4	L3	L2	L1							B4	B3	B2	B1	Indicator Lamp/LED Button On/Off Control
N7:1			L6	L5	L4	L3	L2	L1							B4	B3	B2	B1	Indicator Lamp/LED Button Flash Control
N7:2															B4	B3	B2	B1	Button On/Off Status
N7:3	F1	F2	F3												B4	B3	B2	B1	Force Data and Commands

Flashing an Inset LED

To flash an inset LED, you must turn it on and set the associated flash bit. The example below shows a program used to set the LED inset of button 1 to flash whenever I:0.3/4 is energized. The table below it shows LED operation with button 1 set as alternate action.

MSB 15 14 13 12 11 10 9 8 7 6 5 4 3 2 1 0 LSB

N7:0			L6	L5	L4	L3	L2	L1							B4	B3	B2	B1	Indicator Lamp/LED Button On/Off Control
N7:1			L6	L5	L4	L3	L2	L1							B4	B3	B2	B1	Indicator Lamp/LED Button Flash Control
N7:2															B4	B3	B2	B1	Button On/Off Status
N7:3	F1	F2	F3												B4	B3	B2	B1	Force Data and Commands

Button State	X2 Status	LED Operation
Inactive	de-energized	Off
Inactive	energized	Off
Active	de-energized	On solid
Active	energized	Flashing

NOTE: When using an OP-406 with an Allen-Bradley PLC, always be sure that at least 4 words of memory are allocated to allow proper communications.



Forcing Button Status



NOTE: The Force Option must be selected (in OP-WINEDIT) in order to force setpoints and ONLY applies to Alternate Action Buttons.

Force Button Status

This function is used to set the state (on or off) of every alternate action pushbutton. To use the "Force Button Status" function, set the F1 bit and all buttons that you want to be on, leaving all other bits off. The example below shows buttons 1 and 3 being forced on and all other buttons forced off when B3:4/2 is active

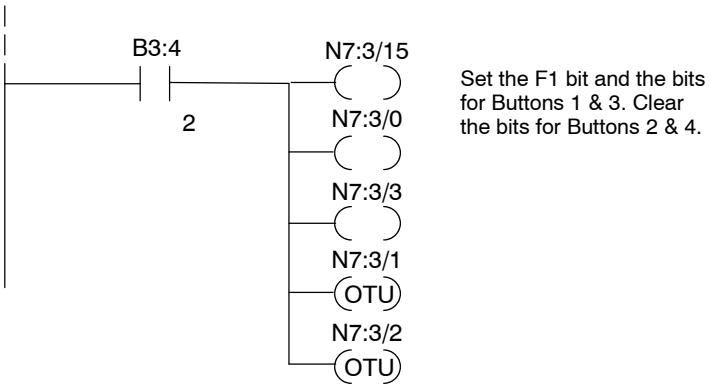

Force Button(s) On

This function is used to turn individual buttons on without affecting the state of any other buttons. To use the "Force Buttons On" function, set the F2 and all buttons that you want to turn on. Any buttons associated with bits that are not set will be unaffected. The following example shows buttons 2 and 4 being forced on when B3:4/2 is active.

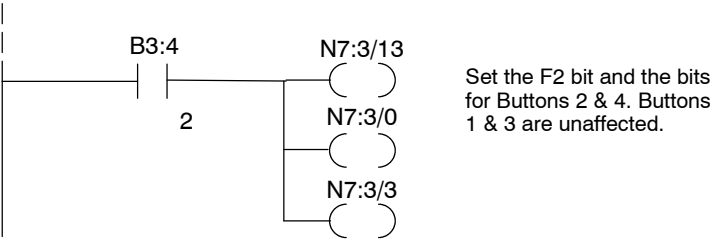

Force Button(s) Off

This function is used to turn individual buttons off without affecting the state of any other buttons. To use the "Force Buttons Off" function, set the F3 and all buttons that you want to turn on. Any buttons associated with bits that are not set will be unaffected. The following example shows buttons 1 and 4 being cleared when B3:4/2 is active.

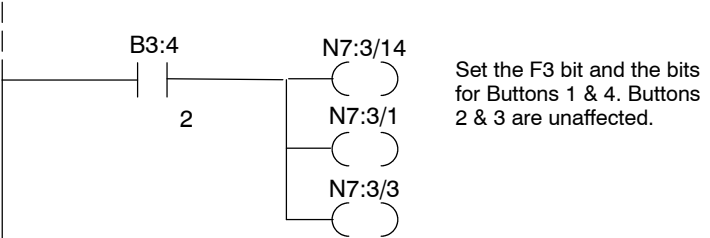

Troubleshooting the OP-406 Panel

- Troubleshooting** In this section, we explain how to isolate potential problems which may occur while using the OP-406. Because these panels have only a power supply connection and a communications connection, (no DIP switches or controls to set, and cannot be used in multiple panel arrangements), troubleshooting is very straightforward.
- Power Supply Problems** If the panel LED display, the Button indicators, and the RX and TX LEDs on the back of the panel do not illuminate, the panel is most likely not receiving input power. Carefully check your connections to make sure they are tight. If this does not help, see Chapter 2 and review the input power requirements.
- Remember, all PLC's require that you use the OP-PS400 5V plug-in power supply (or equivalent) for configuration. Some PLC's also require that you use this power supply for operation. Make sure that the 120 VAC receptacle you plug the power supply into has power. Also, if you are using another 5V power supply, make sure that it has a center negative connector.
- If using a PLC that supplies 5V for operation through the communications cable, check to make sure sure that pin 5 on the lead going into the panel has a 5V signal.
- Configuration Problems** Make sure that you are using the proper configuration cable (OP-CCBL) and that it is securely connected. Check your configuration program and make sure the proper communications port is selected, such as COM1 or COM2. Review your configuration settings to make sure they are correct. Remember, the OP-WINEDIT Help screens provide a lot of valuable information.
- Communication Problems** Observe the RX and TX LEDs on the rear panel. They should be steady flashing or glow (depending on the baud rate). If not, make sure that you are using the proper communications cable and that it is securely connected. Review your configuration settings and make sure that the communications information for your PLC, address number, baud rate, protocol type, etc. is correct. Check the user manual for your PLC for the proper settings.
- Getting Help** See "Technical Support" in Chapter 1 for additional information.

Index

A

Allen-Bradley, programming, 5-8

C

Cables

- connections, 2-8
- selection, 2-9
- wiring details, 2-10

Comm port, 1-5

Communications, connections table, 4-5

Configuration

- address, 2-11
- panel, 4-3
- preparation, 4-2
- software, 4-2

Configuring, communications, 4-5

D

Dimensions

- cutout, 2-5
- mounting, 2-5

DirectLOGIC

- communications table, 4-5
- programming, 5-2

E

Environmental specifications, 2-6

F

Frequently Asked Questions, 1-6

I

Indicator Lamps

- flashing, 3-3
- turning on, 3-3

L

Label

- creating, 2-3
- installation, 2-2
- templates, 2-4

Legends, 2-3

M

Memory

- register assignment, 3-4, 3-5
- register definition, 3-4
- register usage, 5-2

Memory Mapping, overview, 3-6

O

OP-Panel

- overview, 1-4
- pushbuttons, 1-4

OP-panel

- configuration mode, 2-11
- features, 3-2
- labels, 2-2

OPEditor

- configuration cable, 2-11
 - configuration software, 4-2
 - installation, 4-3
 - system requirements, 4-3
 - user steps, 4-3
-

Operating Specifications, 2-6

P

Panel

- configuration, 4-3
- cutout dimensions, 2-5
- features, 3-2
- mounting dimensions, 2-5
- overview, 1-4
- set-up, 4-2

Physical Specifications, 2-6

Power Supply

- connections, 1-5, 2-7
- hook-up, 2-7
- requirements, 2-7

Preparing, labels, 2-2

Programming

- Allen-Bradley, 5-8
- examples, 5-2

Pushbuttons, reading status, 3-3

S

Software, creating labels, 2-2

Specification, storage temperature, 2-6

Specifications, 2-6

- communication link, 2-6
- diagnostics, 2-6
- environmental, 2-6
- NEMA rating, 2-6
- power connector, 2-6

T

Technical Support, 1-2

Troubleshooting, 5-12
