

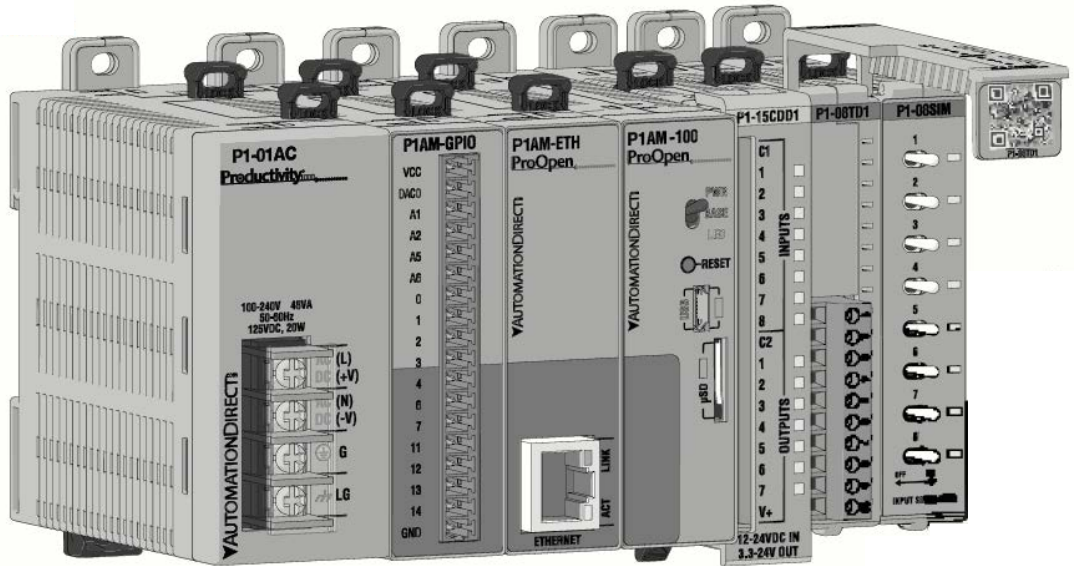

Manual Number: P1AM-USER-M



## ⚡ WARNING ⚡

Thank you for purchasing automation equipment from Automationdirect.com®, doing business as, AutomationDirect. We want your new automation equipment to operate safely. Anyone who installs or uses this equipment should read this publication (and any other relevant publications) before installing or operating the equipment.

To minimize the risk of potential safety problems, you should follow all applicable local and national codes that regulate the installation and operation of your equipment. These codes vary from area to area and usually change with time. It is your responsibility to determine which codes should be followed, and to verify that the equipment, installation, and operation is in compliance with the latest revision of these codes.

At a minimum, you should follow all applicable sections of the National Fire Code, National Electrical Code, and the codes of the National Electrical Manufacturer's Association (NEMA). There may be local regulatory or government offices that can also help determine which codes and standards are necessary for safe installation and operation.

Equipment damage or serious injury to personnel can result from the failure to follow all applicable codes and standards. We do not guarantee the products described in this publication are suitable for your particular application, nor do we assume any responsibility for your product design, installation, or operation.

Our products are not fault-tolerant and are not designed, manufactured or intended for use or resale as on-line control equipment in hazardous environments requiring fail-safe performance, such as in the operation of nuclear facilities, aircraft navigation or communication systems, air traffic control, direct life support machines, or weapons systems, in which the failure of the product could lead directly to death, personal injury, or severe physical or environmental damage ("High Risk Activities"). AutomationDirect specifically disclaims any expressed or implied warranty of fitness for High Risk Activities.

For additional warranty and safety information, see the Terms and Conditions section of our catalog. If you have any questions concerning the installation or operation of this equipment, or if you need additional information, please call us at 770-844-4200.

This publication is based on information that was available at the time it was printed. At AutomationDirect we constantly strive to improve our products and services, so we reserve the right to make changes to the products and/or publications at any time without notice and without any obligation. This publication may also discuss features that may not be available in certain revisions of the product.

## Trademarks

This publication may contain references to products produced and/or offered by other companies. The product and company names may be trademarked and are the sole property of their respective owners. AutomationDirect disclaims any proprietary interest in the marks and names of others.

**Copyright© 2024, Automationdirect.com® Incorporated  
All Rights Reserved**

No part of this manual shall be copied, reproduced, or transmitted in any way without the prior, written consent of Automationdirect.com® Incorporated. AutomationDirect retains the exclusive rights to all information included in this document.

## ⚡ **ADVERTENCIA** ⚡

Gracias por comprar equipo de automatización de Automationdirect.com®. Deseamos que su nuevo equipo de automatización opere de manera segura. Cualquier persona que instale o use este equipo debe leer esta publicación (y cualquier otra publicación pertinente) antes de instalar u operar el equipo.

Para reducir al mínimo el riesgo debido a problemas de seguridad, debe seguir todos los códigos de seguridad locales o nacionales aplicables que regulan la instalación y operación de su equipo. Estos códigos varían de área en área y usualmente cambian con el tiempo. Es su responsabilidad determinar cuales códigos deben ser seguidos y verificar que el equipo, instalación y operación estén en cumplimiento con la revisión mas reciente de estos códigos.

Como mínimo, debe seguir las secciones aplicables del Código Nacional de Incendio, Código Nacional Eléctrico, y los códigos de (NEMA) la Asociación Nacional de Fabricantes Eléctricos de USA. Puede haber oficinas de normas locales o del gobierno que pueden ayudar a determinar cuales códigos y normas son necesarios para una instalación y operación segura.

Si no se siguen todos los códigos y normas aplicables, puede resultar en daños al equipo o lesiones serias a personas. No garantizamos los productos descritos en esta publicación para ser adecuados para su aplicación en particular, ni asumimos ninguna responsabilidad por el diseño de su producto, la instalación u operación.

Nuestros productos no son tolerantes a fallas y no han sido diseñados, fabricados o intencionados para uso o reventa como equipo de control en línea en ambientes peligrosos que requieren una ejecución sin fallas, tales como operación en instalaciones nucleares, sistemas de navegación aérea, o de comunicación, control de tráfico aéreo, máquinas de soporte de vida o sistemas de armamentos en las cuales la falla del producto puede resultar directamente en muerte, heridas personales, o daños físicos o ambientales severos ("Actividades de Alto Riesgo"). Automationdirect.com específicamente rechaza cualquier garantía ya sea expresada o implicada para actividades de alto riesgo.

Para información adicional acerca de garantía e información de seguridad, vea la sección de Términos y Condiciones de nuestro catálogo. Si tiene alguna pregunta sobre instalación u operación de este equipo, o si necesita información adicional, por favor llámenos al número 770-844-4200 en Estados Unidos.

Esta publicación está basada en la información disponible al momento de impresión. En Automationdirect.com nos esforzamos constantemente para mejorar nuestros productos y servicios, así que nos reservamos el derecho de hacer cambios al producto y/o a las publicaciones en cualquier momento sin notificación y sin ninguna obligación. Esta publicación también puede discutir características que no estén disponibles en ciertas revisiones del producto.

## ***Marcas Registradas***

Esta publicación puede contener referencias a productos producidos y/u ofrecidos por otras compañías. Los nombres de las compañías y productos pueden tener marcas registradas y son propiedad única de sus respectivos dueños. Automationdirect.com, renuncia cualquier interés propietario en las marcas y nombres de otros.

**Propiedad Literaria© 2024, Automationdirect.com® Incorporated  
Todos los derechos reservados**

No se permite copiar, reproducir, o transmitir de ninguna forma ninguna parte de este manual sin previo consentimiento por escrito de Automationdirect.com® Incorporated. Automationdirect.com retiene los derechos exclusivos a toda la información incluida en este documento. Los usuarios de este equipo pueden copiar este documento solamente para instalar, configurar y mantener el equipo correspondiente. También las instituciones de enseñanza pueden usar este manual para propósitos educativos.

## ⚡ AVERTISSEMENT ⚡

Nous vous remercions d'avoir acheté l'équipement d'automatisation de AutomationDirect.com®, en faisant des affaires comme, AutomationDirect. Nous tenons à ce que votre nouvel équipement d'automatisation fonctionne en toute sécurité. Toute personne qui installe ou utilise cet équipement doit lire la présente publication (et toutes les autres publications pertinentes) avant de l'installer ou de l'utiliser.

Afin de réduire au minimum le risque d'éventuels problèmes de sécurité, vous devez respecter tous les codes locaux et nationaux applicables régissant l'installation et le fonctionnement de votre équipement. Ces codes diffèrent d'une région à l'autre et, habituellement, évoluent au fil du temps. Il vous incombe de déterminer les codes à respecter et de vous assurer que l'équipement, l'installation et le fonctionnement sont conformes aux exigences de la version la plus récente de ces codes.

Vous devez, à tout le moins, respecter toutes les sections applicables du Code national de prévention des incendies, du Code national de l'électricité et des codes de la National Electrical Manufacturer's Association (NEMA). Des organismes de réglementation ou des services gouvernementaux locaux peuvent également vous aider à déterminer les codes ainsi que les normes à respecter pour assurer une installation et un fonctionnement sûrs.

L'omission de respecter la totalité des codes et des normes applicables peut entraîner des dommages à l'équipement ou causer de graves blessures au personnel. Nous ne garantissons pas que les produits décrits dans cette publication conviennent à votre application particulière et nous n'assumons aucune responsabilité à l'égard de la conception, de l'installation ou du fonctionnement de votre produit.

Nos produits ne sont pas insensibles aux défaillances et ne sont ni conçus ni fabriqués pour l'utilisation ou la revente en tant qu'équipement de commande en ligne dans des environnements dangereux nécessitant une sécurité absolue, par exemple, l'exploitation d'installations nucléaires, les systèmes de navigation aérienne ou de communication, le contrôle de la circulation aérienne, les équipements de survie ou les systèmes d'armes, pour lesquels la défaillance du produit peut provoquer la mort, des blessures corporelles ou de graves dommages matériels ou environnementaux («activités à risque élevé»). La société AutomationDirect nie toute garantie expresse ou implicite d'aptitude à l'emploi en ce qui a trait aux activités à risque élevé.

Pour des renseignements supplémentaires touchant la garantie et la sécurité, veuillez consulter la section Modalités et conditions de notre documentation. Si vous avez des questions au sujet de l'installation ou du fonctionnement de cet équipement, ou encore si vous avez besoin de renseignements supplémentaires, n'hésitez pas à nous téléphoner au 770-844-4200.

Cette publication s'appuie sur l'information qui était disponible au moment de l'impression. À la société AutomationDirect, nous nous efforçons constamment d'améliorer nos produits et services. C'est pourquoi nous nous réservons le droit d'apporter des modifications aux produits ou aux publications en tout temps, sans préavis ni quelque obligation que ce soit. La présente publication peut aussi porter sur des caractéristiques susceptibles de ne pas être offertes dans certaines versions révisées du produit.

## Marques de commerce

La présente publication peut contenir des références à des produits fabriqués ou offerts par d'autres entreprises. Les désignations des produits et des entreprises peuvent être des marques de commerce et appartiennent exclusivement à leurs propriétaires respectifs. AutomationDirect nie tout intérêt dans les autres marques et désignations.

**Copyright © 2024, AutomationDirect.com® Incorporated**  
Tous droits réservés

Nulle partie de ce manuel ne doit être copiée, reproduite ou transmise de quelque façon que ce soit sans le consentement préalable écrit de la société AutomationDirect.com® Incorporated. AutomationDirect conserve les droits exclusifs à l'égard de tous les renseignements contenus dans le présent document.

# ProductivityOpen User Manual

---



**Please include the Manual Number and the Manual Issue, both shown below, when communicating with Technical Support regarding this publication.**

**Manual Number:** P1AM-USER-M  
**Issue:** 1st Edition, Rev. F  
**Issue Date:** 02/2024

Publication History		
Issue	Date	Description of Changes
1st Edition	01/2020	Original
1st Ed. Rev. A	02/2020	Added Appendix A - Networks Security material.
1st Ed. Rev. B	11/2022	Updated manual format.
1st Ed. Rev. C	04/2023	Added P1AM-SERIAL sheild
1st Ed. Rev. D	09/2023	Updated P1AM-100 Reset button attributes
1st Ed. Rev. E	11/2023	Added P1AM-200 module
1st Ed. Rev. F	02/2024	Updated 1AM-200 module "Hardware Limits" - 15 P1000 I/O Modules.

# TABLE OF CONTENTS

---

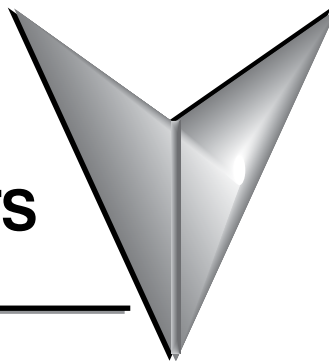

## In This Manual

User Caution .....	ii
Publication History.....	v
<b>Chapter 1 - Getting Started.....</b>	<b>1-1</b>
<b>Introduction .....</b>	<b>1-2</b>
Intended Use of This Product .....	1-2
Purpose of this Manual .....	1-3
Important Online Resources .....	1-3
<b>Conventions Used.....</b>	<b>1-4</b>
Key Topics for Each Chapter.....	1-4
<b>Install Programming Software .....</b>	<b>1-5</b>
<b>Mounting Hardware.....</b>	<b>1-8</b>
<b>Power the System .....</b>	<b>1-9</b>
<b>Chapter 2 - Specifications .....</b>	<b>2-1</b>
<b>Overview .....</b>	<b>2-2</b>
Right Side Expansion - Productivity1000 Input/output Modules.....	2-2
Left Side Expansion - Arduino MKR-compatible Shields .....	2-2
<b>P1AM-100 Arduino Compatible CPU.....</b>	<b>2-3</b>
P1AM-100 Module Faceplate Layout.....	2-4
P1AM-100 MicroB USB Programming Port .....	2-5
microSD Slot.....	2-6
P1AM-100 CPU Headers.....	2-7

## Table of Contents

---

P1AM-200 Arduino Compatible CPU .....	2-8
P1AM-200 Module Faceplate Layout .....	2-9
P1AM-200 MicroB USB Programming Port .....	2-10
microSD Slot.....	2-11
P1AM-200 CPU Headers.....	2-12
Powering Your ProductivityOpen System .....	2-13
<b>AutomationDirect Shields.....</b>	<b>2-14</b>
Ethernet Communications Shield.....	2-14
Serial Communications Shield.....	2-16
Header Pin Breakout Module.....	2-17
<b>Productivity I/O Modules Overview .....</b>	<b>2-19</b>
<b>Chapter 3 - Installation and Wiring .....</b>	<b>3-1</b>
<b>Safety Guidelines .....</b>	<b>3-3</b>
Plan for Safety.....	3-3
Three Levels of Protection .....	3-4
System Power Disconnect.....	3-4
Emergency Stop Circuits.....	3-5
<b>Introduction to the ProductivityOpen Mechanical Design.....</b>	<b>3-6</b>
Typical P1AM-100.....	3-6
<b>Dimensions and Installation .....</b>	<b>3-7</b>
<b>Basic Dimensions .....</b>	<b>3-9</b>
<b>Mounting Guidelines .....</b>	<b>3-12</b>
Enclosures.....	3-12
Mounting P osition.....	3-12
Using Mounting Rails.....	3-12
Mounting Clearances.....	3-13
Temperature Considerations.....	3-13
Power Considerations .....	3-13
Grounding .....	3-14
Agency Approvals .....	3-14
DIN Rail Mounting P1AM-100 System .....	3-15
Surface Mounting P1AM-100 System.....	3-15
Connecting the I/O Modules.....	3-16

- Wiring Guidelines ..... 3-17**
  - Power Supply Wiring.....3-17
  - Grounding .....3-17
  - Fuse Protection.....3-18
- I/O Module Wiring Options ..... 3-19**
  - Hand Wiring System.....3-19
  - ZIPLink** Wiring System.....3-20
  - Terminal Block With Pigtail Cable .....3-20
  - Input and Output Module **ZIPLink** Selections .....3-21
  - Analog Modules **ZIPLink** Selections .....3-22
  - Removable Terminal Blocks (Optional) .....3-23
  - Terminal Block Installation .....3-24
  - Terminal Block Removal .....3-25
  - Planning the I/O Wiring Routes.....3-25
- System Wiring Strategies..... 3-26**
  - CPU Isolation Boundaries.....3-26
  - Sinking/Sourcing Concepts .....3-27
  - I/O "Common Terminal" Concepts .....3-28
  - DC Input Wiring Methods.....3-29
  - DC Output Wiring Methods.....3-29
  - CPU DC Sinking Output to Sinking Load Device.....3-30
  - Relay Outputs - Wiring Methods.....3-31
  - Types of Additional Transient Protection.....3-34
- Appendix A - Security Considerations for Controls Networks.....A-1**
  - Security Considerations for Control Systems Networks..... A-2



# GETTING STARTED

---



# CHAPTER 1

## In This Chapter...

<b>Introduction</b> .....	1-2
Intended Use of This Product .....	1-2
Purpose of this Manual .....	1-3
Important Online Resources .....	1-3
<b>Conventions Used</b> .....	1-4
Key Topics for Each Chapter.....	1-4
<b>Install Programming Software</b> .....	1-5
<b>Mounting Hardware</b> .....	1-8
<b>Power the System</b> .....	1-9

# Introduction

### Intended Use of This Product

The PIAM-100 is a small computer with on-board I/O based on the “Open-Source Arduino platform”. This product can be used to solve various control and automation tasks using customized programs.

The user community website of PIAM-100 (<http://go2adc.com/p1am>) is where you will find various demo programs and libraries that will allow you to jump right into programming and design.

Follow all applicable safety parameters when connecting to external I/O sensors and devices.

Any use other than described in this manual is not permitted, as this may expose the user to possible harm and/or damage to the device or connected equipment.

The P1AM-100 must not be altered or modified. The safety instructions as well as the maximum permissible ambient conditions and operating parameters are given in Chapter 2 “Technical Specifications”.

The instruction manual is meant to be read thoroughly while being mindful of safe and proper operation. It contains important information on mounting, operating and handling the P1AM-100.



**CAUTION:** *THE PIAM CPU BASE CONTROLLER USES PINS A3 AND A4 SO ANY SHIELD THAT USES THESE SAME PINS WILL HAVE A CONFLICT. THE MKR RGB SHIELD IS ONE THAT HAS THIS CONFLICT.*

---

### Purpose of this Manual

Thank you for purchasing the AutomationDirect ProductivityOpen Arduino compatible Controller. This user manual provides information that will help you install, set up, program, troubleshoot, and maintain your ProductivityOpen project.

The manual includes information that is critical to the safety of the personnel who will install and use the controller and to the machinery, processes, and equipment controlled by the P1AM-100.

The manual also includes important information about power and signal wiring, mounting the CPU and modules, and configuring the system.

### Important Online Resources

Access to ADC Community based help for your ProductivityOpen projects is available from our website: <http://go2adc.com/p1am>.



You will need libraries and other files available from our GitHub page at <https://github.com/facts-engineering/P1AM>

The P1AM libraries and Board Support Package and other support files are located on Github.

A variety of other useful information about the Productivity1000 I/O modules, as well as code for example tasks and more is available at <https://facts-engineering.github.io>.

The P1AM-100 may be programmed by Arduino IDE which may be downloaded from <https://www.arduino.cc/en/Main/Software>. A graphical programming tool customized for P1AM-100 based on ArduBlock (ProductivityBlocks®) is accessible from the Tools menu in the Arduino IDE.

In addition, the Productivity1000 series power supplies and I/O modules, which work with the P1AM-100, include an installation insert.

Use a QR symbol reader or click on graphic icon to see an overview video.



# Conventions Used



**NOTE:** When you see the “note pad” icon in the left-hand margin, the paragraph to its immediate right will be a special note. Notes represent information that may make your work quicker or more efficient. The word **NOTE** in boldface will mark the beginning of the text.



**WARNING:** WHEN YOU SEE THE “EXCLAMATION POINT” ICON IN THE LEFT-HAND MARGIN, THE PARAGRAPH TO ITS IMMEDIATE RIGHT WILL BE A WARNING. THIS INFORMATION COULD PREVENT INJURY, LOSS OF PROPERTY, OR EVEN DEATH IN EXTREME CASES. ANY WARNING IN THIS MANUAL SHOULD BE REGARDED AS CRITICAL INFORMATION THAT SHOULD BE READ IN ITS ENTIRETY. THE WORD **WARNING** IN BOLDFACE WILL MARK THE BEGINNING OF THE TEXT.

## Key Topics for Each Chapter

The beginning of each chapter will list the key topics that can be found in that chapter.

<b>GETTING STARTED</b>	
<b>CHAPTER 1</b>	
<b>In This Chapter...</b>	
Introduction.....	1-2
Purpose of this Manual.....	1-2
About Getting Started.....	1-2
Online Help Files and Other Documentation.....	1-2
Technical Support.....	1-2
Conventions Used.....	1-3
Key Topics for Each Chapter.....	1-3
Before you begin.....	1-4
Productivity Suite System Requirements.....	1-5
Productivity Suite Program Requirements.....	1-6

## Install Programming Software



---

**NOTE:** An active Internet connection is required to download the Arduino IDE and access the libraries and board driver.

---

The P1AM-100 CPU may be programmed with the Arduino IDE. ProductivityBlocks® is an optional graphical environment used with the IDE that AutomationDirect has adapted to make Productivity1000 I/O modules conveniently accessible as blocks.

1. Download the latest version of the Arduino IDE software from <https://www.arduino.cc/en/Main/Software>.
2. Library Install:
  - a. In the Arduino IDE go to "Sketch -> Include Library -> Manage Libraries..."
  - b. Leave the Type and Topic filters as "All" and type "P1AM" in the "Filter your search..." box
  - c. Click on the P1AM by FACTS Engineering that appears
  - d. Click the Install button
  - e. Close the Library Manager window
  - f. Confirm the installation by checking for "File -> Examples -> P1AM-100". Several categories of examples should be present.

### 3. Arduino Board Support Package Install:

- a. Go to "File->Preferences" and paste the following link into the "Additional Boards Manager URLs" field.



---

**NOTE:** Make sure you right click on the link and choose "Copy Link".

---

- i. [https://raw.githubusercontent.com/facts-engineering/facts-engineering.github.io/master/package\\_productivity-P1AM-boardmanagermodule\\_index.json](https://raw.githubusercontent.com/facts-engineering/facts-engineering.github.io/master/package_productivity-P1AM-boardmanagermodule_index.json)
- b. Go to "Tools -> Boards -> Board Manager". Type P1AM into the search box at the top. Mouse over the result and click install. The install may take several minutes to complete.
  - c. If you are on a version of Windows before Windows 10 this is mandatory. For Windows 10 users, this may be run if you want the board to appear as P1AM-100 (or P1AM-200) in device manager.
    - i. Download the "driver install" file from this link:  
<https://github.com/facts-engineering/P1AMCore/raw/master/drivers.zip>.
    - ii. Extract the file
    - iii. Run the "P1AM-100\_install.bat" file to complete the driver installation.
  - d. If you are having trouble installing the BSP due to network issues such as firewall restrictions, you can use the "Arduino SAMD Boards" (specifically the MKRZERO) as an alternative. These are present in the board manager automatically.

### 4. Testing installation

- a. Attach the modules and/or shields you wish to use. REMEMBER modules/shields must not be connected or disconnected while power is applied - either 24V or USB.
- b. Plug the micro USB cable into the P1AM CPU and computer
  - i. If using P1000 I/O modules power the system with 24V
- c. Go to "Tools -> Board:" and select the "P1AM-100 or P1AM-200" from the dropdown that appears.
- d. Go to "Tools -> Port" and select the "P1AM CPU" device that you have plugged in.
- e. Go to File -> Examples -> P1AM-100 (or P1AM-200) -> Basic->PrintModules to open the Print Modules example. Note that the PrintModules example is intended for a system with Productivity1000 modules connected and powered.
- f. Click the right facing arrow button under "Edit" to upload the code to the board.
- g. Go to "Tools -> Serial Monitor" and check to see that the name of module(s) you have in the base is printing to the terminal.

### 5. Next Steps

- a. Start with the "Basic" category of the P1AM CPU Library examples to become familiar with the API.
- b. Once you are comfortable with the basic examples you can move on to more complex routines included in the P1AM CPU examples.



### 6. Install ProductivityBlocks®

- a. Run the ProductivityBlocks Installer.
- b. ProductivityBlocks will be installed in the Documents -> ProductivityBlocks folder. The ProductivityBlocks programming environment is accessible from the Tools menu in the Arduino IDE.
- c. Example ProductivityBlocks programs are also included in this folder.

## Mounting Hardware

Install Shields on the left side of the P1AM CPU and P1 I/O Modules on the right side of the P1AM CPU.

The ProductivityOpen Shields and Productivity1000 Input/Output modules are DIN rail mountable and designed to snap together to simplify connection. A system may include communications, inputs and outputs. See Chapter 3 of this manual and Chapters 4 and 5 of the Productivity1000 manual for more detailed hardware installation information.

**WARNING!** Do not add or remove modules with field power applied!

**Step One:** With latch in “locked” position, align connectors on the side of each module and stack by pressing together. An audible click indicates lock is engaged.

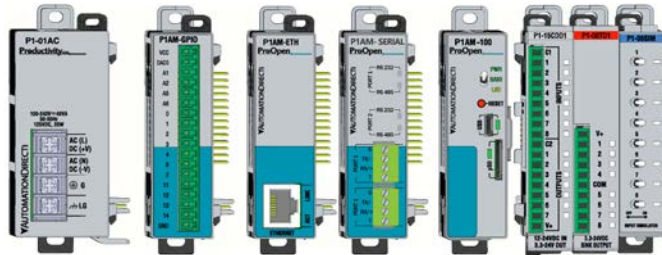

**Step Two:** Attach field wiring using the removable terminal block or ZIPLink wiring system.

**CAUTION!** Ensure all latches are secured after modules are connected.

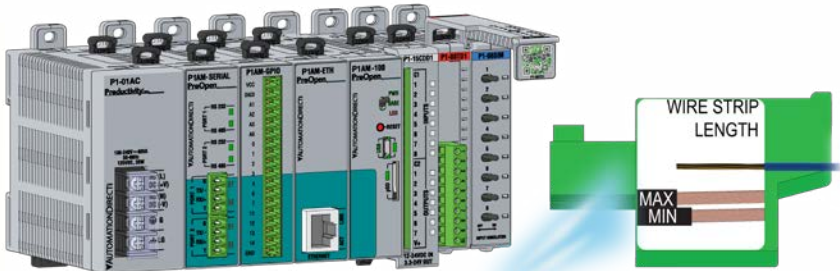

**Step Three:** To unstack modules, pull locking latch up into the unlocked position and then pull modules apart.

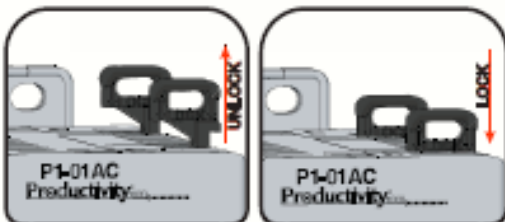



## Power the System



**NOTE:** Ensure all modules are connected to the system before power is applied. Do not assemble or disassemble the system while power is applied.

Productivity1000 Power Supplies:

1. Connect one of the Productivity1000 power supplies to P1AM CPU. Should you choose Arduino MKR compatible shields instead of or in addition to the ProductivityOpen shields, the Productivity1000 power supplies cannot be used. In this case an alternative power supply is required (See below for information on connecting an external power supply).

### P1000 AC input power supplies:

- P1-01AC: AC Input 85–132 / 170–264 VAC, 16W (power for P1AM-100 and up to 8 modules)
- P1-02AC: AC Input 85–132 / 170–264 VAC, 26W (power for P1AM-100 and up to 15 modules)

### P1000 DC input power supplies:

- P1-01DC: DC Input 12–24 VDC, 16W (power for P1AM-100 and up to 8 modules)

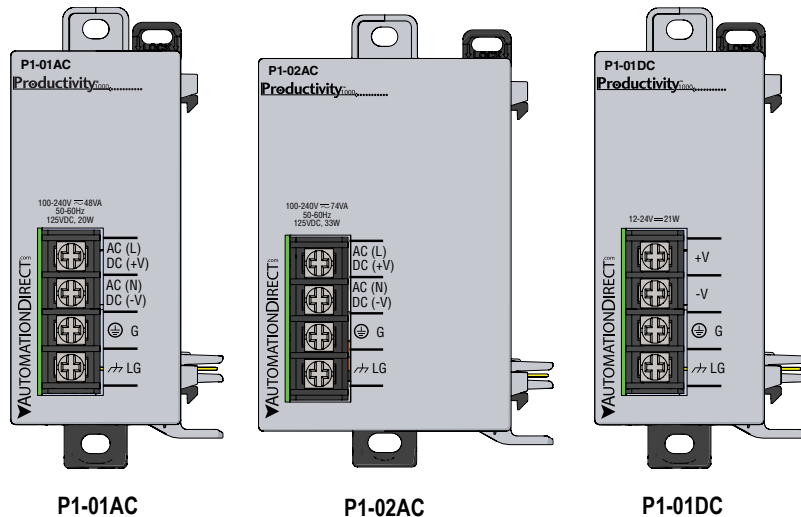

**CAUTION:** ENSURE THAT ONLY ONE POWER SUPPLY SOURCE IS CONNECTED TO THE ARDUINO SYSTEM. WHEN A PRODUCTIVITY1000 POWER SUPPLY IS CONNECTED IMMEDIATELY TO THE LEFT OF THE CPU MODULE, THE BOTTOM POWER CONNECTOR MUST BE REMOVED BEFORE CONNECTING P1-01AC POWER SUPPLY. THIS PRECLUDES CONNECTION OF TWO SEPARATE POWER SUPPLIES. IF AN AUTOMATIONDIRECT SHIELD IS CONNECTED BETWEEN A PRODUCTIVITY1000 POWER SUPPLY AND THE CPU MODULE CARE MUST BE TAKEN TO ENSURE AN EXTERNAL POWER SUPPLY IS NOT CONNECTED TO THE BOTTOM TERMINALS.

2. OR using an alternative 24VDC external power source connect directly to P1AM CPU Optional Power Connector terminals. This option allows for the use of Input/Output modules from the Productivity1000 family as well as all Arduino MKR compatible shields.
  - The LG and minus terminals on the external power supply connection are internally shorted.
  - Use separate 24VDC supplies, one for the P1AM CPU and another for inductive loads to keep the P1AM CPU supply power clean and free of voltage spikes caused by switching inductive loads.

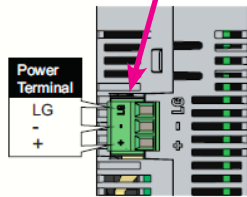
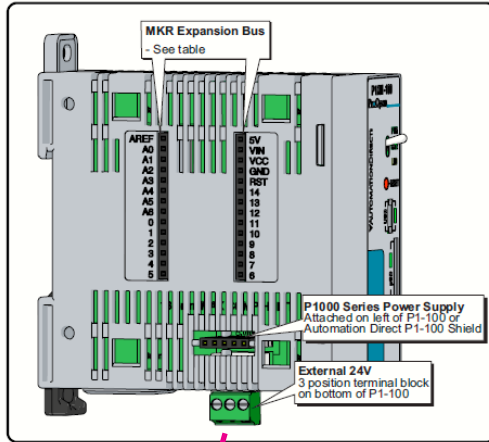

**RHINO Power Supply  
P/N PSV24-50s**



**Example of Alternative  
24VDC Power Supply**

Terminal Block Specifications	
Part Number	PCON-KIT
Number of positions	3 screw terminals
Pitch	3.5 mm
Wire Range	28–16 AWG (0.324 to 3.31 mm <sup>2</sup> ) Solid / Stranded conductor 1/4 in (6–7 mm) Strip Length
Conductors	Use copper conductors, 75°C or equivalent
Screw Driver Width	1/8 in (3.175 mm) Maximum
Screw Size	M2
Screw Torque	1.7 lb·in (0.4 N·m)

*\*Recommended screw driver P/N: TW-SD-MSL-2*

- OR using USB input power, connect to the microB USB port on the face of the P1AM CPU. USB power is intended for programming and will not power Productivity1000 Input /output modules.

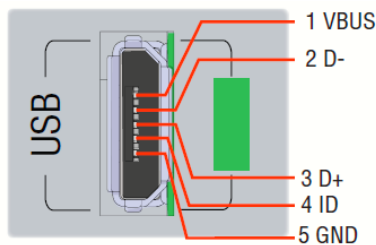
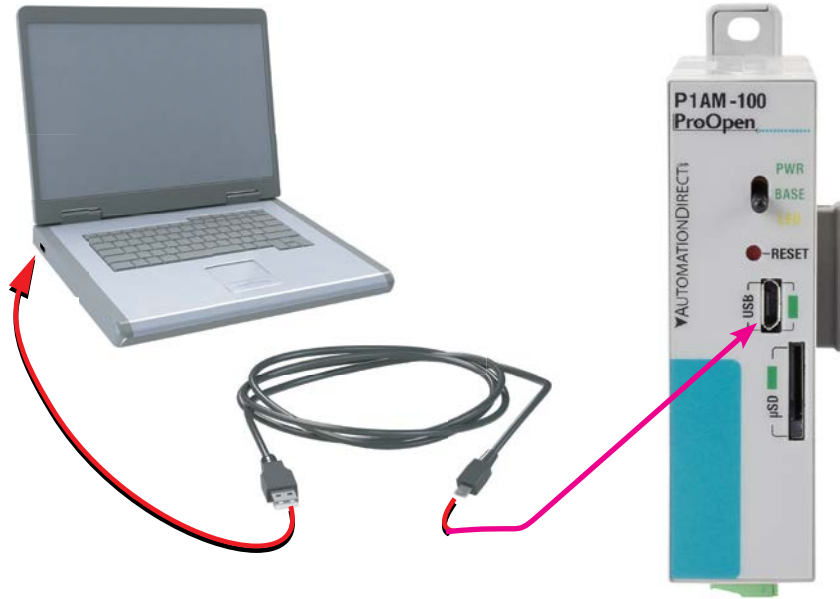

Micro USB Type B Input Specifications	
Port Name	Micro USB
Description	Standard Micro USB input for programming and monitoring
Port Status LED	Green LED is illuminated when a power cable is plugged in.
Cables	USB Type A to Micro USB Type B: 6ft cable part # USB-CBL-AMICB6 15ft cable part # USB-CBL-AMICB15

# SPECIFICATIONS

---



## In This Chapter...

<b>Overview .....</b>	<b>2-2</b>
Right Side Expansion - Productivity1000 Input/output Modules .....	2-2
Left Side Expansion - Arduino MKR-compatible Shields .....	2-2
<b>P1AM-100 Arduino Compatible CPU.....</b>	<b>2-3</b>
P1AM-100 Module Faceplate Layout.....	2-4
P1AM-100 MicroB USB Programming Port .....	2-5
microSD Slot.....	2-6
P1AM-100 CPU Headers.....	2-7
<b>P1AM-200 Arduino Compatible CPU.....</b>	<b>2-8</b>
P1AM-200 Module Faceplate Layout.....	2-9
P1AM-200 MicroB USB Programming Port .....	2-10
microSD Slot.....	2-11
P1AM-200 CPU Headers.....	2-12
Powering Your ProductivityOpen System .....	2-13
<b>AutomationDirect Shields.....</b>	<b>2-14</b>
Ethernet Communications Shield.....	2-14
Serial Communications Shield.....	2-16
Header Pin Breakout Module.....	2-17
<b>Productivity I/O Modules Overview .....</b>	<b>2-19</b>

# Overview

The ProductivityOpen system is intended to provide a robust selection of components for a compact and expandable design with a simple-to-use philosophy.

## Right Side Expansion - Productivity1000 Input/output Modules

The P1AM-100 can be expanded with the addition of easily connected I/O modules and does not require a mounting base. I/O modules are connected via an expansion port on the right side of the P1AM-100 case. A variety of I/O modules are available from the Productivity1000 series for flexible and optimal system configuration. Refer to the Productivity1000 user manual for detailed descriptions (<https://cdn.automationdirect.com/static/manuals/p1userm/p1userm.html>).

## Left Side Expansion - Arduino MKR-compatible Shields

The left side of the case allows expansion with most\* Arduino MKR compatible shields. A selection of shields to support P1AM-100 in housings to conveniently connect to the P1AM-100 specifically are available from AutomationDirect. See detailed descriptions following.



**\* NOTE:** The P1AM CPU Base Controller uses pins A3 and A4 so any shield that uses these same pins will have a conflict. The MKR RGB shield is one that has this conflict.

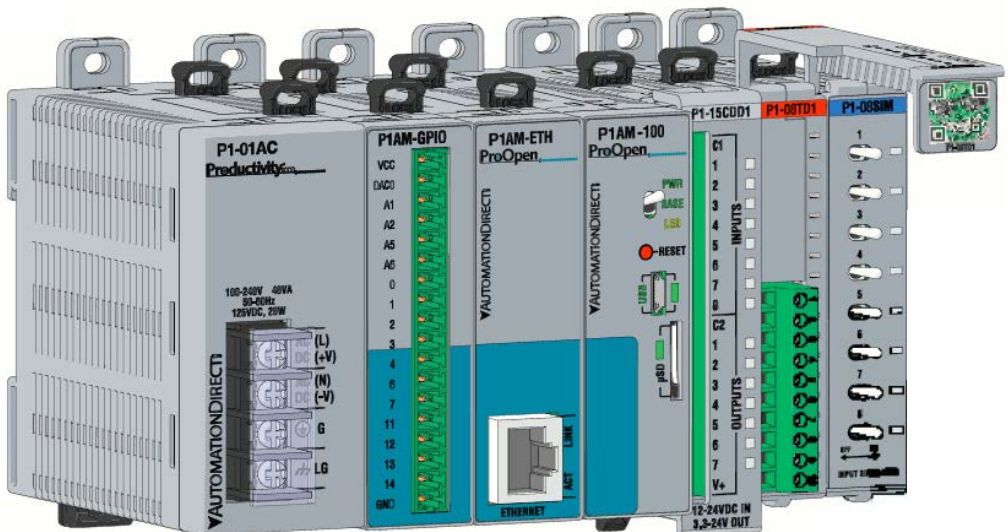

# P1AM-100 Arduino Compatible CPU

The P1AM-100 is an Arduino-compatible CPU. It uses the Atmel SAMD21G18 micro-controller and can be programmed using Arduino IDE or ProductivityBlocks®. It interfaces with all Productivity1000 Series I/O modules connected to the right side of the P1AM-100 and most Arduino MKR form factor shields connected to the left side. The specifications are listed in the tables below.



P1AM-100

## User Specifications

User Memory	256kB Flash with 10kB used for bootloader
Memory Type	Flash: 256kB, SRAM: 32kB
Base Controller and I/O Power Requirement <sup>1</sup>	24VDC $\pm 2\%$ Plan 0.5 W for the SAMD chip and base controller Plan 1.25 W per P1000 I/O module Plan 9W for max. header power draw (which provides max. 4.25 W power to left side connected shields).
Recommended Fuse (External)	Edison S5061-R, Time Delay, 1A Fuse For 9–15 modules: Edison S5062-R, Time Delay, 2A Fuse
Peripherals	MicroB USB, Arduino MKR-compatible, microSD card slot, User controlled LED
Hardware Limits of System <sup>2</sup>	15 Productivity1000 I/O Modules; Arduino MKR shields
Programming	Programmed in C/C++ with the Arduino IDE or ProductivityBlocks® 

<sup>1</sup> If you do not use a Productivity1000 power supply, like the P1-01AC, then use a power supply that has transformer isolation. Use different 24VDC supplies for the CPU and inductive loads to keep the CPU power clean and free of voltage spikes caused by switching solenoids, motors and relay coils.

<sup>2</sup> See MKR Expansion Bus table and notes for shield power budget restrictions.

## General Specifications

Operating Temperature	0° to 60°C (32° to 140°F)
Storage Temperature	-20° to 70°C (-4° to 158°F)
Humidity	5 to 95% (non-condensing)
Altitude	2,000 meters, max.
Pollution Degree	2
Environmental Air	No corrosive gases permitted
Vibration	IEC60068-2-6 (Test Fc)
Shock	IEC60068-2-27 (Test Ea)
Heat Dissipation	4000mW
Overtoltage Category	II
Enclosure Type	Open Equipment
Module Location	Productivity1000 I/O modules connect on the right side of module. Productivity1000 power supply, P1AM Shields and MKR Shields connect on the left side on the module.
Weight	76g (2.8 oz)
Agency Approvals	UL 61010-1 and UL 61010-2-201 File E139594, Canada & USA CE (EN 61131-2 EMC, EN 61010-1 and EN 61010-2-201 Safety)

## P1AM-100 Module Faceplate Layout

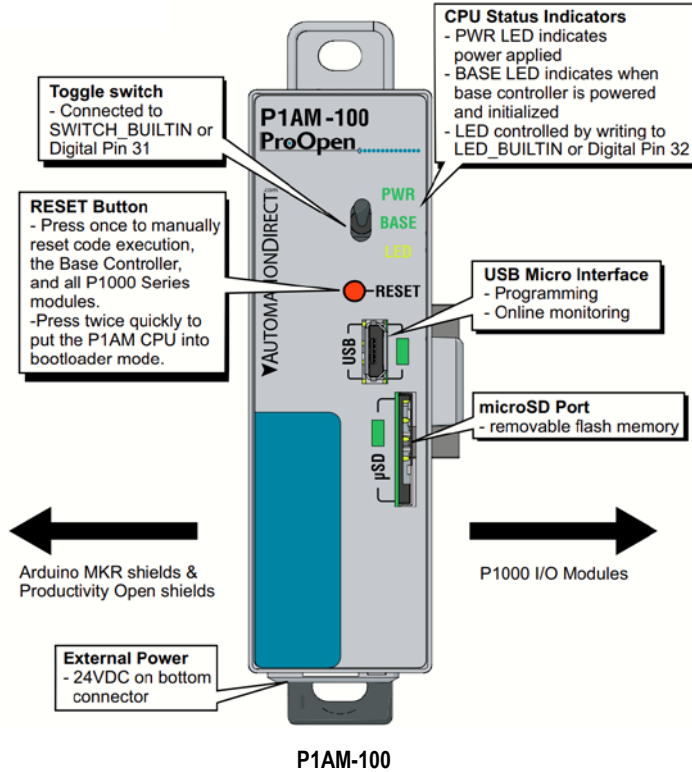

### CPU Status Indicators

PWR	Green LED is illuminated when power is ON
BASE	Green LED is illuminated when P1AM I/O controller is powered and has been initialized
LED	Yellow LED is illuminated when commanded by user program. LED can be referred to as LED_BUILTIN or Pin 32.



### Toggle Switch Specifications

Switch can be read using the "digitalRead" function. Switch can be referred to as "SWITCH\_BUILTIN" or Pin 31.

### Reset Switch Specifications

- Press once to manually reset code execution, the Base Controller, and all P1000 Series modules.
- Press twice quickly to put the P1AM CPU into bootloader mode.

## P1AM-100 MicroB USB Programming Port

The P1AM-100 controller has one built-in communication port; used exclusively for connecting to a PC running the Arduino IDE programming software. Following are the specifications and pin-out diagram.

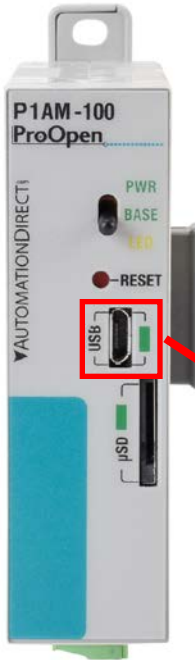

P1AM-100

Micro USB Type B Specifications	
Port Name	MicroB USB
Description	Standard MicroB USB input for programming, monitoring, and a power option
Port Status LED	Green LED is illuminated when a power cable is plugged in.
Cables	USB Type A to Micro USB Type B: 6ft cable part # USB-CBL-AMICB6 15ft cable part # USB-CBL-AMICB15

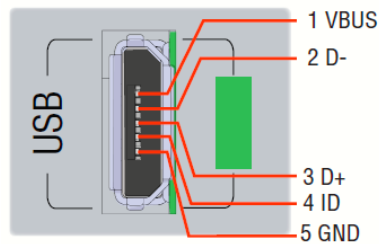



### microSD Slot

Retentive memory for data logging, parameter storage, etc. (Card not included with unit).

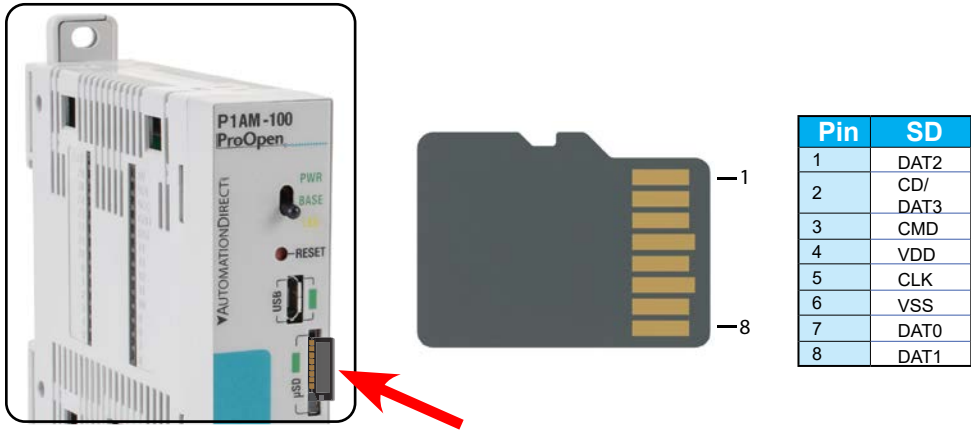

microSD Specifications				
Port Name	microSD			
Description	Standard microSD socket for data logging			
Maximum Card Capacity	32GB			
Transfer Rate (ADATA microSDHC Class 4 memory card)	Mbps	Minimum	Typical	Maximum
	Read	14.3	14.4	14.6
	Write	4.8	4.9	5.1
Port Status LED	Green LED is illuminated when card is inserted and detected			

## P1AM-100 CPU Headers

Following are the specifications and pin-out diagram for the Arduino MKR-compatible expansion bus available for Left Side Expansion Arduino MKR-compatible shields.

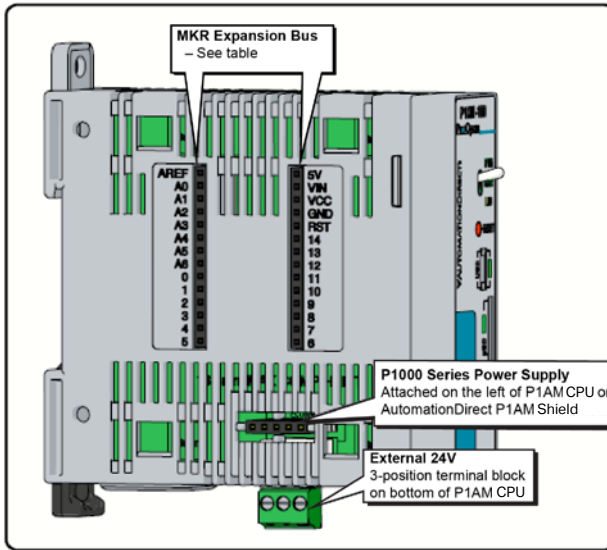

P1AM-100

### MKR Expansion Bus Pins

GPIO	A0–A6, 0–14
Analog Input Pins	A0–A6
Analog Output Pins	A0
PWM Pins	0–8, 10, A3, A4
Interrupt Pins	0, 1, 4–8, A1, A2
5V	5V supply output
Vin	5V regulated supply
VCC	3.3 V supply output
GND	Ground
RST	Reset
AREF	Analog Input Reference

*Critical Notes:*

*Pins A3, A4, and 8–10 are used for the base controller.*

*Do not exceed 46mA combined from pins 0, 1, and 4–10.*

*Do not exceed 3.3 V on any I/O pin.*

*Do not exceed 7mA on any I/O pin.*

*Do not apply power to 5V or VCC*

# P1AM-200 Arduino Compatible CPU

The P1AM-200 is an Arduino-compatible CPU. It uses the Atmel SAMD51P20 micro-controller and can be programmed using Arduino IDE or in CircuitPython using any text editor. It interfaces with all Productivity1000 Series I/O modules connected to the right side of the P1AM-200 and most Arduino MKR form factor shields connected to the left side.



P1AM-200

## User Specifications

User Memory	1MB Internal flash with 16Kb used for bootloader. 16MB External QSPI Flash; 2Kb EEPROM
Memory Type	Flash: 1MB; SRAM: 256Kb; QSPI Flash: 16MB; EEPROM: 2Kb
Base Controller and I/O Power Requirement <sup>1</sup>	24VDC $\pm 2\%$ Plan 0.5 W for the SAMD chip and base controller Plan 1.25 W per P1000 I/O module Plan 9W for max. header power draw (which provides max. 4.25 W power to left side connected shields).
Recommended Fuse (External)	Edison S5061-R, Time Delay, 1A Fuse For 9–15 modules: Edison S5062-R, Time Delay, 2A Fuse
Peripherals	MicroB USB, Arduino MKR-compatible, microSD card slot, User controlled LED
Hardware Limits <sup>2</sup>	15 Productivity1000 I/O Modules; Arduino MKR shields
Programming	Programmed in C/C++ with the Arduino IDE or CircuitPython in any text editor.

<sup>1</sup> If you do not use a Productivity1000 power supply, like the P1-01AC, P1-02AC, or P1-01DC, then use a power supply that has transformer isolation. Use different 24VDC supplies for the CPU and inductive loads to keep the CPU power clean and free of voltage spikes caused by switching solenoids, motors and relay coils.

<sup>2</sup> See Header Power Limitations (page 2-13) in this chapter for additional resources.

## General Specifications

Operating Temperature	0° to 60°C (32° to 140°F)
Storage Temperature	-20° to 70°C (-4° to 158°F)
Humidity	5 to 95% (non-condensing)
Altitude	2,000 meters, max.
Pollution Degree	2
Environmental Air	No corrosive gases permitted
Vibration	IEC60068-2-6 (Test Fc)
Shock	IEC60068-2-27 (Test Ea)
Heat Dissipation	4000mW
Overvoltage Category	II
Enclosure Type	Open Equipment
Module Location	Productivity1000 I/O modules connect on the right side of module. Productivity1000 power supply, P1AM Shields and MKR Shields connect on the left side on the module.
Weight	82g (2.89 oz)
Agency Approvals	UL 61010-1 and UL 61010-2-201 File E139594, Canada & USA CE (EN 61131-2 EMC, EN 61010-1 and EN 61010-2-201 Safety)

## P1AM-200 Module Faceplate Layout

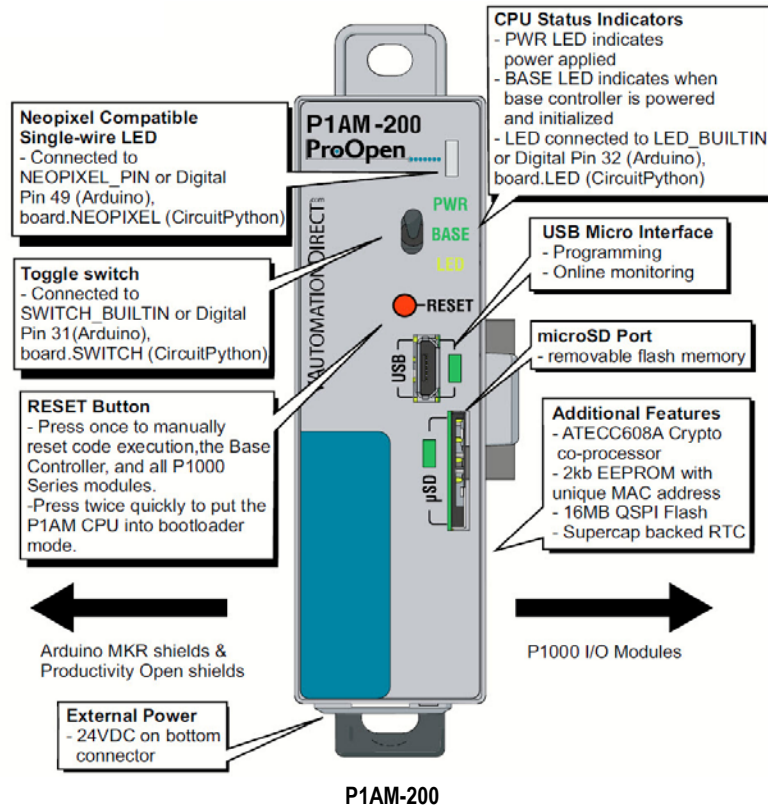

### CPU Status Indicators

PWR	Green LED is illuminated when power is ON
BASE	Green LED is illuminated when P1AM I/O controller is powered and has been initialized
LED	Yellow LED is illuminated when commanded by user program. LED can be referred to as LED_BUILTIN or Pin 32.



### Toggle Switch Specifications

Switch can be read using the "digitalRead" function. Switch can be referred to as "SWITCH\_BUILTIN" or Pin 31.

### Reset Switch Specifications

- Press once to manually reset code execution, the Base Controller, and all P1000 Series modules.
- Press twice quickly to put the P1AM CPU into bootloader mode.

### P1AM-200 MicroB USB Programming Port

The P1AM-200 controller has one built-in communication port, used exclusively for programming. It may be used with the Arduino IDE programming software or as a storage device to load Python files. Following are the specifications and connector pinout diagram.

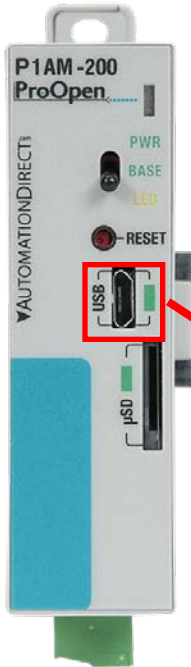

P1AM-200

#### Micro USB Type B Specifications

Port Name	MicroB USB
Description	Standard MicroB USB input for programming, monitoring, and a power option
Port Status LED	Green LED is illuminated when a power cable is plugged in.
Cables	USB Type A to Micro USB Type B: 6ft cable part # USB-CBL-AMICB6 15ft cable part # USB-CBL-AMICB15

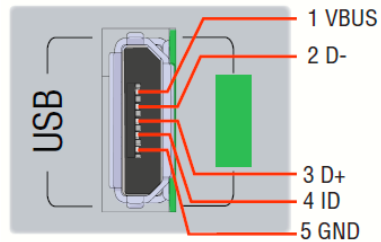

## microSD Slot

Retentive memory for data logging, parameter storage, etc. (Card not included with unit).

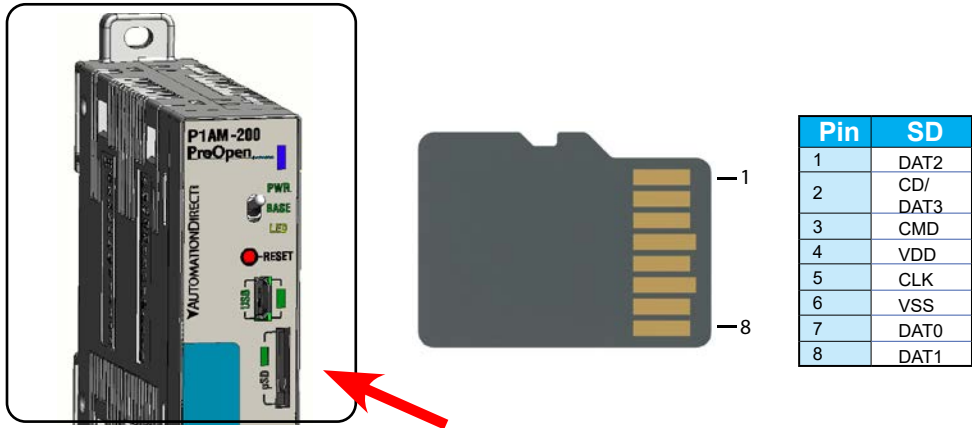

microSD Specifications				
Port Name	microSD			
Description	Standard microSD socket for data logging			
Maximum Card Capacity	32GB			
Transfer Rate (ADATA microSDHC Class 4 memory card)	Mbps	Minimum	Typical	Maximum
	Read	14.3	14.4	14.6
	Write	4.8	4.9	5.1
Port Status LED	Green LED is illuminated when card is inserted and detected			

### P1AM-200 CPU Headers

Following are the specifications and pin-out diagram for the Arduino MKR-compatible expansion bus available for Left Side Expansion Arduino MKR-compatible shields.

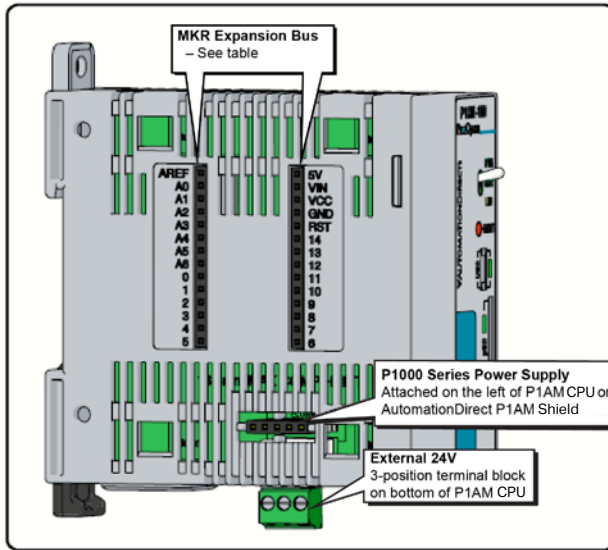

P1AM-200



**WARNING:** Use only a P1000 power supply **OR** an external 24V power supply, not both simultaneously.

### MKR Expansion Bus Pins

GPIO	A0–A6, 0–14
Analog Input Pins	A0–A6
Analog Output Pins	A0
PWM Pins	0–8, 10, A3, A4
Interrupt Pins	0, 1, 4–8, A1, A2
5V	5V supply output
Vin	5V regulated supply
VCC	3.3 V supply output
GND	Ground
RST	Reset
AREF	Analog Input Reference

**Critical Notes:**

*Pins A3, A4, and 8–10 are used for the base controller.*

*Do not exceed 46mA combined from pins 0, 1, and 4–10.*

*Do not exceed 3.3 V on any I/O pin.*

*Do not exceed 7mA on any I/O pin.*

*Do not apply power to 5V or VCC*

## Powering Your ProductivityOpen System

It is important to understand that the Productivity1000 I/O modules on the right side will be powered either by the Productivity1000 power supply\* connected to the left of the CPU OR by an external 24VDC power supply connected to the terminals at the bottom of the CPU module. The ProductivityOpen shields sold by AutomationDirect will also be powered by either of these sources.



**\* NOTE:** Connect only one of these 24VDC sources.

Third party shields on the left side shall be powered in the field according to the manufacturer specs.

The USB programming cable will power the CPU and shields connected on the left side of the CPU.



**CAUTION!** Shields and I/O modules must not be connected or disconnected when power is applied.

Power Supply Options				
	LSX Shields		CPU	RSX
	Open	ADC		ADC I/O
USB Power Cable (5VDC)	Ø	Ø	Ø	
ADC P1-01AC or P1-02AC		Ø	Ø	Ø
AUX 24Vin	Ø	Ø	Ø	Ø

MKR Header Power Limitations			
Power Source	5V	3.3 V	Max. Combined Power
USB	330mA	500mA	1.65 W
VIN (Pin Header)	600mA	1A	3.3 W
P1000 Series Supply OR External 24V	850mA	1.28 A	4.25 W



# AutomationDirect Shields

## Ethernet Communications Shield

The P1AM-ETH is a housed Arduino Compatible Ethernet Shield based on the Wiznet W5500 Ethernet Controller. It interfaces to the left side of the P1AM-100 CPU and most Arduino MKR form factor shields.



### **!WARNING!**

Do not add or remove modules with field power applied!

### Ethernet Features

- Supports Hardwired TCP Protocols: TCP, UDP, ICMP, IPV4, ARP, IGMP, PPPOE
- Supports 8 independent sockets simultaneously
- Supports Power Down Mode
- Supports Wake on LAN over UDP
- Supports High Speed Serial Peripheral Interface (SPI MODE 0, 3)
- Internal 32K bytes of Memory for TX/RX Buffers
- 10BaseT / 100BaseTX Ethernet PHY embedded
- Supports Auto Negotiation (Full and Half Duplex, 10 and 100-based)
- Does Not Support IP Fragmentation
- 3.3 V operation with 5V I/O signal tolerance
- LED outputs (Full / Half duplex, Link, Speed, Active)

General Specifications	
Operating Temperature	0° to 60°C (32° to 140°F)
Storage Temperature	-20° to 70°C (-4° to 158°F)
Humidity	5 to 95% (non-condensing)
Altitude	2,000 meters, max.
Pollution Degree	2
Environmental Air	No corrosive gases permitted
Vibration	IEC60068-2-6 (Test Fc)
Shock	IEC60068-2-27 (Test Ea)
Heat Dissipation	750mW
Overvoltage Category	II
Enclosure Type	Open Equipment
Power Budget	150mA/5V
Recommended Library	Arduino Ethernet
Module Location	Connects to the left side of the P1AM-100 CPU.
Weight	20g (0.8 oz.)
Agency Approvals	UL 61010-1 and UL 61010-2-201 File E139594, Canada & USA CE

# AutomationDirect Shields, cont'd

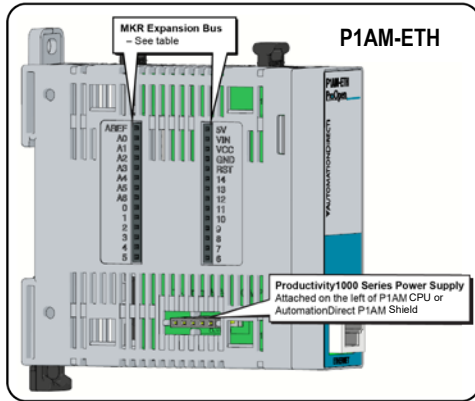

MKR Expansion Bus Pins	
GPIO	A0–A6, 0–14
Analog Input Pins	A0–A6
Analog Output Pins	A0
PWM Pins	0–8, 10, A3, A4
Interrupt Pins	0, 1, 4–8, A1, A2
5V	5V supply output
Vin	5V regulated supply
VCC	3.3 V supply output
GND	Ground
RST	Reset
AREF	Analog Input Reference

Header Pins Used for Ethernet Shield		
Pins Used	Function	Notes
5	ETH SS	
8	MOSI	SPI pins are shared with other devices on SPI bus
9	SCK	
10	MISO	

**Critical Notes:**  
 Pins A3, A4, and 8–10 are used for the base controller.  
 Do not exceed 46mA combined from pins 0, 1, and 4–10.  
 Do not exceed 3.3 V on any I/O pin.  
 Do not exceed 7mA on any I/O pin.  
 Do not apply power to 5V or VCC

### Serial Communications Shield

The P1AM-SERIAL is a housed Arduino MKR Compatible Shield. It interfaces to the left side of the P1AM-100 CPU and most Arduino MKR form factor shields.

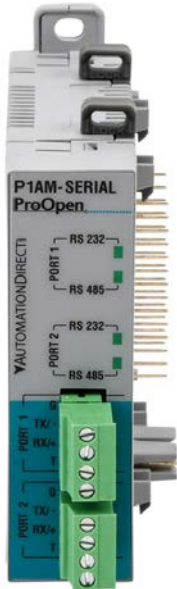

#### **!WARNING!**

Do not add or remove modules with field power applied!

#### Serial Features

- 2 RS-232/RS-485 (4-pin terminal) ports.
- Supports RS-232 and RS-485 connections to serial devices using ASCII or custom communication protocols
- LED outputs (RS-232/RS-485 mode selection, TX and RX activity)

#### General Specifications

Operating Temperature	0° to 60°C (32° to 140°F)
Storage Temperature	-20° to 70°C (-4° to 158°F)
Humidity	5 to 95% (non-condensing)
Altitude	2000 meters max.
Pollution Degree	2
Environmental Air	No corrosive gases permitted
Vibration	IEC60068-2-6 (Test Fc)
Shock	IEC60068-2-27 (Test Ea)
Overvoltage Category	II
Voltage Withstand (dielectric)	Non-Isolated
Insulation Resistance	Non-Isolated
Heat Dissipation	380mW
Enclosure Type	Open Equipment
Power Budget	115mA/3.3 V
Recommended Library	P1AM_Serial
Module Location	Shield connects to the left side of the P1AM CPU. P1-01AC/02AC can connect to the left side of the Shield.
Weight	77g (2.7 oz.)
Agency Approvals	UL 61010-1 and UL 61010-2-201 File E139594, Canada & USA CE

#### Header Pins Used for Serial Shield

Pins Used	Function	Description
3	P1 Mode	Port 1 Mode (Low=RS485 High=RS232)
14	P1 TX -	Port 1 Data -
13	P1 RX +	Port 1 Data +
A6	P1 DE/RE	Port 1 Driver Enable / Receiver Enable
2	P2 Mode	Port 2 Mode (Low=RS485, High=RS232)
0	P2 TX -	Port 2 Data -
1	P2 RX +	Port 2 Data +
6	P2 DE/RE	Port 2 Driver Enable / Receiver Enable

*Note: If a P1AM-GPIO module is installed alongside a P1AM-SERIAL module, the above pins will be unavailable to the P1AM-GPIO.*

## Header Pin Breakout Module

The P1AM-GPIO is a housed Arduino MKR form factor shield that brings a subset of the MKR header pins out to the front 18 position terminal block. These pins include basic overvoltage, undervoltage, and overcurrent protection. It connects to the left side of the P1AM-100 CPU and most Arduino MKR form factor shields.

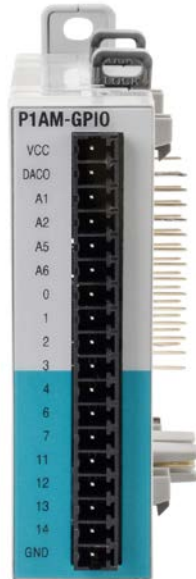

Terminal block connector sold separately. Recommended connector options P2-RTB or P2-RTB-1.

### **!WARNING!**

Do not add or remove modules with field power applied!

### General Specifications

Operating Temperature	0° to 60°C (32° to 140°F)
Storage Temperature	-20° to 70°C (-4° to 158°F)
Humidity	5 to 95% (non-condensing)
Altitude	2,000 meters, max.
Pollution Degree	2
Overvoltage Category	II
Environmental Air	No corrosive gases permitted
Vibration	IEC60068-2-6 (Test Fc)
Shock	IEC60068-2-27 (Test Ea)
Heat Dissipation	475mW
Enclosure Type	Open Equipment
Module Location	Connects to the left side of the P1AM-100 CPU.
Weight	56g (2.0 oz.)
Agency Approvals	UL 61010-1 and UL 61010-2-201 File E139594, Canada & USA CE

# AutomationDirect Shields, cont'd

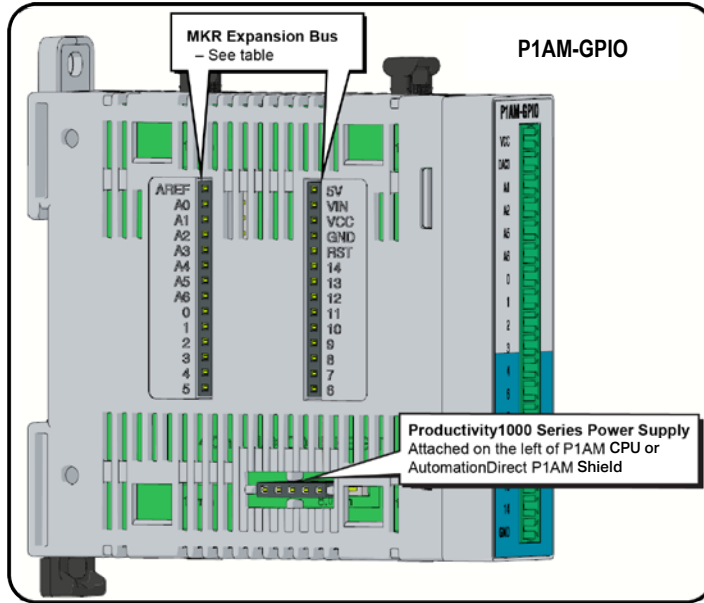

## Terminal Block Pins

Pin	Functions
VCC	3.3 V supply output
DAC0*	GPIO, Analog input, Analog output
A1	GPIO, Analog input, Interrupt
A2	GPIO, Analog input, Interrupt
A5	GPIO, Analog input
A6	GPIO, Analog input
0	GPIO, PWM, Interrupt
1	GPIO, PWM, Interrupt
2	GPIO, PWM
3	GPIO, PWM
4	GPIO, PWM, Interrupt
6	GPIO, PWM, Interrupt
7	GPIO, PWM, Interrupt
11	GPIO, SDA
12	GPIO, SCL
13	GPIO, RX
14	GPIO, TX
GND	Ground

\*There is no ESD, overvoltage, or overcurrent protection on the DAC0 pin.

## MKR Expansion Bus Pins

GPIO	A0–A6, 0–14
Analog Input Pins	A0–A6
Analog Output Pins	A0
PWM Pins	0–8, 10, A3, A4
Interrupt Pins	0, 1, 4–8, A1, A2
5V	5V supply output
Vin	5V regulated supply
VCC	3.3 V supply output
GND	Ground
RST	Reset
AREF	Analog Input Reference

**Critical Notes:**

Pins A3, A4, and 8–10 are used for the base

controller.

Do not exceed 46mA combined from pins 0, 1, and 4–10.

Do not exceed 3.3 V on any I/O pin.

Do not exceed 7mA on any I/O pin.

Do not apply power to 5V or VCC

## Productivity I/O Modules Overview

A variety of discrete and analog I/O modules from our Productivity1000 line are available for use with the P1AM-100 and P1AM-200.

Productivity1000 Modules		
Discrete Input Modules		
Part Number	Inputs	Description
P1-08SIM	8	Input Simulator Module
P1-08ND3	8	Sinking/Sourcing 12–24 VDC Input
P1-08ND-TTL	8	Sinking/Sourcing 3.3–5 VDC Input
P1-16ND3	16	Sinking/Sourcing 12–24 VDC Input
P1-08NE3	8	Sinking/Sourcing 24V AC/DC
P1-16NE3	16	Sinking/Sourcing 24V AC/DC
P1-08NA	8	AC Isolated 100–240 VAC
Discrete Output Modules		
Part Number	Outputs	Description
P1-08TD1	8	Sinking DC Output
P1-08TD2	8	Sourcing DC Output
P1-08TD-TTL	8	Sourcing DC Output
P1-15TD1	15	Sinking DC Output
P1-15TD2	15	Sourcing DC Output
P1-08TA	8	AC Output
P1-08TRS	8	Isolated Relay Output
P1-16TR	16	Relay Output
Discrete Input/Output Modules		
Part Number	Inputs/ Outputs	Description
P1-15CDD1	8   7	Input: Sinking/Sourcing; Output: Sinking
P1-15CDD2	8   7	Input: Sinking/Sourcing; Output: Sourcing
P1-16CDR	8   8	Input: Sinking/Sourcing; Output: Relay

Productivity1000 Modules		
Analog Input Modules		
Part Number	Inputs	Description
P1-04AD	4	Analog Input (Current)
P1-04AD-1	4	Analog Input (Current)
P1-04AD-2	4	Analog Input (Voltage)
P1-04ADL-1	4	Analog Input (Current)
P1-04ADL-2	4	Analog Input (Voltage)
P1-08ADL-1	8	Analog Input (Current)
P1-08ADL-2	8	Analog Input (Voltage)
P1-04RTD	4	RTD Input
P1-04THM	4	Analog Thermocouple Input
P1-04NTC	4	Analog Thermistor Input
Analog Output Modules		
Part Number	Outputs	Description
P1-04DAL-1	4	Analog Output (Current)
P1-04DAL-2	4	Analog Output (Voltage)
P1-08DAL-1	8	Analog Output (Current)
P1-08DAL-2	8	Analog Output (Voltage)
Analog Input/Output Modules		
Part Number	Inputs/ Outputs	Description
P1-4ADL2DAL-1	4   2	Analog Input/Analog Output (Current)
P1-4ADL2DAL-2	4   2	Analog Input/Analog Output (Voltage)

Details on connecting to the Productivity1000 modules can be found at <https://github.com/facts-engineering/P1AM/wiki>.

The Productivity1000 User Manual contains electrical and installation details. It is available for FREE download at: <https://cdn.automationdirect.com/static/manuals/p1userm/p1userm.html>

# INSTALLATION AND WIRING

---



# CHAPTER 3

## In This Chapter...

<b>Safety Guidelines</b> .....	3-3
Plan for Safety.....	3-3
Three Levels of Protection .....	3-4
Orderly System Shutdown .....	3-4
System Power Disconnect.....	3-4
Emergency Stop Circuits.....	3-5
<b>Introduction to the ProductivityOpen Mechanical Design</b> .....	3-6
Typical P1AM-100.....	3-6
<b>Dimensions and Installation</b> .....	3-7
<b>Basic Dimensions</b> .....	3-9
<b>Mounting Guidelines</b> .....	3-12
Enclosures.....	3-12
Mounting Position.....	3-12
Using Mounting Rails.....	3-12
Mounting Clearances.....	3-13
Temperature Considerations.....	3-13
Power Considerations .....	3-13
Grounding .....	3-14
Agency Approvals .....	3-14
DIN Rail Mounting P1AM-100 System .....	3-15
Surface Mounting P1AM-100 System .....	3-15
Installing the I/O Modules.....	3-16
<b>Wiring Guidelines</b> .....	3-17
Power Supply Wiring.....	3-17
Grounding .....	3-17
Fuse Protection.....	3-18

## Table of Contents

---

I/O Module Wiring Options.....	3-19
Hand Wiring System.....	3-19
<b>ZIPLink</b> Wiring System.....	3-20
Terminal Block With Pigtail Cable.....	3-20
Input and Output Modules <b>ZIPLink</b> Selections.....	3-21
Analog Modules <b>ZIPLink</b> Selections.....	3-22
Removable Terminal Blocks (Optional).....	3-23
P1-10RTB and P1-10RTB-1.....	3-23
P2-RTB and P2-RTB-1.....	3-23
Terminal Block Installation.....	3-24
Terminal Block Removal.....	3-25
Planning the I/O Wiring Routes.....	3-25
<b>System Wiring Strategies.....</b>	<b>3-26</b>
CPU Isolation Boundaries.....	3-26
Sinking/Sourcing Concepts.....	3-27
I/O "Common Terminal" Concepts.....	3-28
DC Input Wiring Methods.....	3-29
DC Output Wiring Methods.....	3-29
Relay Outputs - Wiring Methods.....	3-31
Relay Outputs – Transient Suppression for Inductive Loads in a Control System.....	3-32



# Safety Guidelines



**NOTE:** Products with CE marks perform their required functions safely and adhere to relevant standards as specified by CE directives provided they are used according to their intended purpose and that the instructions in this manual are adhered to. The protection provided by the equipment may be impaired if this equipment is used in a manner not specified in this manual. A listing of our international affiliates is available on our Web site at <http://www.automationdirect.com>.



**WARNING:** PROVIDING A SAFE OPERATING ENVIRONMENT FOR PERSONNEL AND EQUIPMENT IS YOUR RESPONSIBILITY AND SHOULD BE YOUR PRIMARY GOAL DURING SYSTEM PLANNING AND INSTALLATION. AUTOMATION SYSTEMS CAN FAIL AND MAY RESULT IN SITUATIONS THAT CAN CAUSE SERIOUS INJURY TO PERSONNEL OR DAMAGE TO EQUIPMENT. DO NOT RELY ON THE AUTOMATION SYSTEM ALONE TO PROVIDE A SAFE OPERATING ENVIRONMENT. YOU SHOULD USE EXTERNAL ELECTROMECHANICAL DEVICES, SUCH AS RELAYS OR LIMIT SWITCHES, THAT ARE INDEPENDENT OF THE PIAM-100 APPLICATION TO PROVIDE PROTECTION FOR ANY PART OF THE SYSTEM THAT MAY CAUSE PERSONAL INJURY OR DAMAGE. EVERY AUTOMATION APPLICATION IS DIFFERENT, SO THERE MAY BE SPECIAL REQUIREMENTS FOR YOUR PARTICULAR APPLICATION. MAKE SURE YOU FOLLOW ALL NATIONAL, STATE, AND LOCAL GOVERNMENT REQUIREMENTS FOR THE PROPER INSTALLATION AND USE OF YOUR EQUIPMENT.

## Plan for Safety

The best way to provide a safe operating environment is to make personnel and equipment safety part of the planning process. You should examine every aspect of the system to determine which areas are critical to operator or machine safety. If you are not familiar with controller type system installation practices, or your company does not have established installation guidelines, you should obtain additional information from the following sources.

- NEMA — The National Electrical Manufacturers Association, located in Washington, D.C., publishes many different documents that discuss standards for industrial control systems. You can order these publications directly from NEMA. Some of these include:
  - ICS 1, General Standards for Industrial Control and Systems
  - ICS 3, Industrial Systems
  - ICS 6, Enclosures for Industrial Control Systems
- NEC — The National Electrical Code provides regulations concerning the installation and use of various types of electrical equipment. Copies of the NEC Handbook can often be obtained from your local electrical equipment distributor or your local library.
- Local and State Agencies — many local governments and state governments have additional requirements above and beyond those described in the NEC Handbook. Check with your local Electrical Inspector or Fire Marshall office for information.

### Three Levels of Protection



**WARNING:** *THE CONTROL PROGRAM MUST NOT BE THE ONLY FORM OF PROTECTION FOR ANY PROBLEMS THAT MAY RESULT IN A RISK OF PERSONAL INJURY OR EQUIPMENT DAMAGE.*

The publications mentioned provide many ideas and requirements for system safety. At a minimum, you should follow these regulations. Also, you should use the following techniques, which provide three levels of system control.

1. Orderly system shutdown sequence in the P1AM-100 control program.
2. Mechanical disconnect for output module power.
3. Emergency stop switch for disconnecting system power.
4. Orderly System Shutdown

The first level of fault detection is ideally the P1AM-100 control program, which can identify machine problems. Certain shutdown sequences should be performed. These types of problems are usually things such as jammed parts, etc., that do not pose a risk of personal injury or equipment damage.

### System Power Disconnect

You should also use electromechanical devices, such as master control relays and/or limit switches, to prevent accidental equipment startup at an unexpected time. These devices should be installed in a manner that will prevent any machine operations from occurring.

For example, if the machine in the illustration has a jammed part, the P1AM-100 control program can turn off the saw blade and retract the arbor. If the operator must open the guard to remove the part, you should also include a bypass switch that disconnects all system power any time the guard is opened.

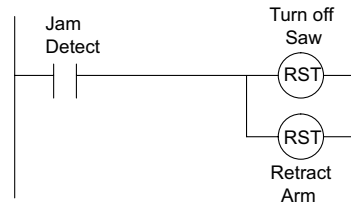
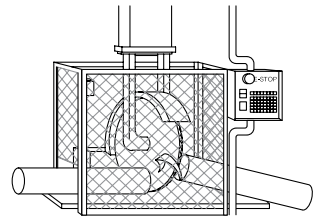

## Emergency Stop Circuits

Emergency stop (E-Stop) circuits are a critical part of automation safety. For each machine controlled by a P1AM-100, provide an emergency stop device that is wired outside the P1AM-100 and easily accessed by the machine operator.

E-Stop devices are commonly wired through a master control relay (MCR) or a safety control relay (SCR) that will remove power from the P1AM-100 I/O system in an emergency.

MCRs and SCRs provide a convenient means for removing power from the I/O system during an emergency situation. By de-energizing an MCR (or SCR) coil, power to the input (optional) and output devices is removed. This event occurs when any emergency stop switch opens. However, the P1AM-100 continues to receive power and operate even though all its inputs and outputs are disabled.

The MCR circuit could be extended by placing a P1AM-100 fault relay (closed during normal P1AM-100 operation) in series with any other emergency stop conditions. This would cause the MCR circuit to drop the P1AM-100 I/O power in case of a P1AM-100 failure (memory error, I/O communications error, etc.).

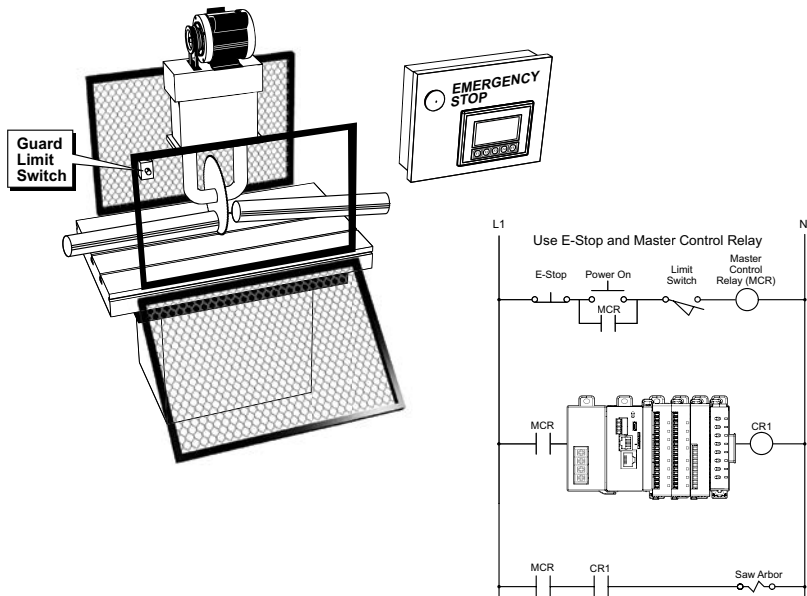

**WARNING:** FOR SOME APPLICATIONS, FIELD DEVICE POWER MAY STILL BE PRESENT ON THE TERMINAL BLOCK EVEN THOUGH THE P1AM-100 IS TURNED OFF. TO MINIMIZE THE RISK OF ELECTRICAL SHOCK, REMOVE ALL FIELD DEVICE POWER BEFORE YOU EXPOSE OR REMOVE P1AM-100 WIRING.

# Introduction to the ProductivityOpen Mechanical Design

The ProductivityOpen is a modular system that can be created by adding Productivity1000 input/output modules and Arduino MKR-compatible shields to a P1AM-100 Arduino-compatible CPU. The I/O modules are connected directly to the right side of the P1AM-100 and to each other in a continuous stack up to 15 modules.

Power budget does need to be considered - 8 or fewer modules can use the P1-01AC; exceeding 8 modules uses P1-02AC. No backplane or base is required. Each module connection extends the integrated communication bus.

Connect Arduino-MKR shields to the left side of the P1AM-100 CPU. The combinations on the left side are limited only by the general purpose I/O pins that must be dedicated to each shield.

Typical P1AM-100

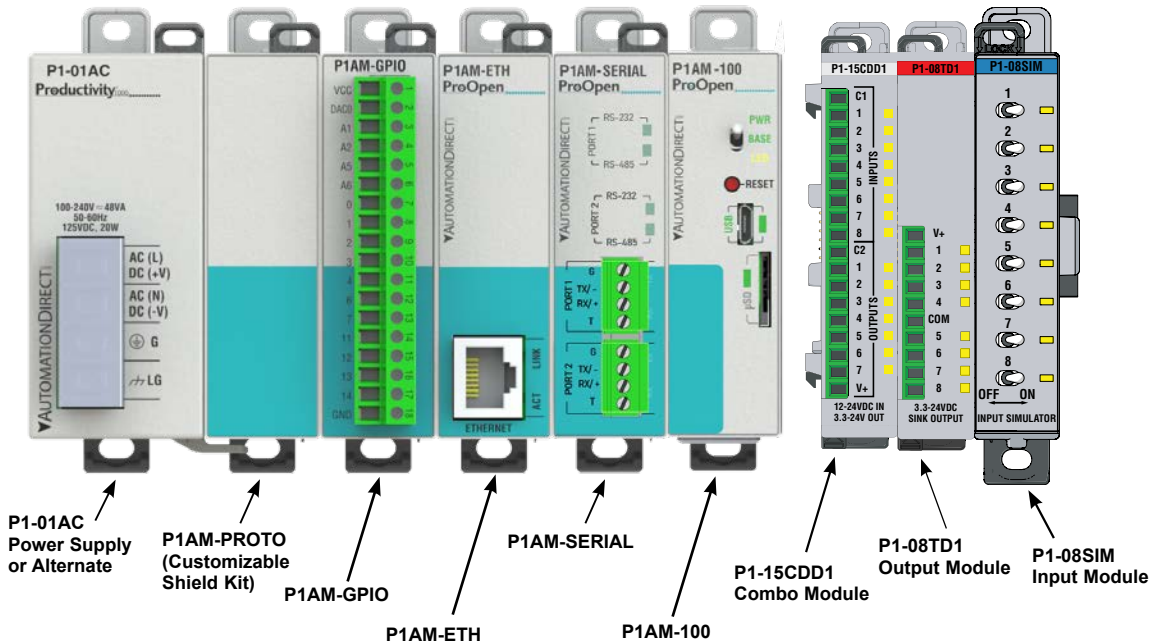

# Dimensions and Installation

Before installing the P1AM-100 you will need to know the dimensions of the components considered. The tables and diagrams on the following pages provide basic dimensions to use in defining your enclosure specifications. Remember to leave room for expansion module insertion and/or replacement and for potential expansion. If you are using other components in your system, refer to the appropriate manual to determine how those units can affect mounting dimensions.

The basic dimensions for the modules are listed in the tables. The width varies depending on the type of module. P1AM-100 is designed to be mounted on standard 35mm DIN rail, or it may be surface mounted. Make sure you have followed the installation guidelines for proper spacing.



**NOTE:** Dimensional drawings for the P1AM-100, power supplies, and all modules are available on the AutomationDirect.com site.

Productivity Open Component Dimensions					
Module	Description	A	B	C	D
		Width mm [in]	Height Faceplate mm [in]	Height w/Tabs mm [in]	Depth mm [in]
P1AM-100	Controller	23.1 [0.91]	77.0 [3.03]	92.8 [3.65]	91.3 [3.59]
P1AM-200	Controller	23.1 [0.91]	77.0 [3.03]	92.8 [3.65]	91.3 [3.59]
Left Side Communication Shields (LSX)					
P1AM-GPIO	General Purpose I/O	23.1 [0.91]	77.0 [3.03]	92.8 [3.65]	86.7 [3.41]
P1AM-ETH	Ethernet Communication	23.1 [0.91]	77.0 [3.03]	92.8 [3.65]	89.7 [3.53]
P1AM-SERIAL	Serial Communication	23.2 [0.91]	77.0 [3.03]	92.8 [3.65]	100.6 [3.96]

Productivity1000 Component Dimensions						
P1-01AC	AC/DC Power Supply	35.0 [1.38]	77.0 [3.03]	92.8 [3.65]	98.3 [3.87]	
P1-02AC	AC/DC Power Supply	52.2 [2.06]				
P1-01DC	DC Power Supply	35.0 [1.38]				
P1-02DC	DC Power Supply	35.0 [1.38]				
Discrete Expansion Modules (Right Side)						
P1-08SIM	Simulator Input	17.2 [0.68]	77.0 [3.03]	93.6 [3.69]	86.6 [3.41]	
P1-08ND-TTL	Sinking/Sourcing 12–24 VDC Input				81.6 [3.21]	
P1-08ND3	Sinking/Sourcing 12–24 VDC Input				86.6 [3.41]	
P1-16ND3	Sinking/Sourcing 12–24 VDC Input					
P1-08NE3	Sinking/Sourcing 12–24 VAC/VDC Input					
P1-16NE3	Sinking/Sourcing 12–24 VAC/VDC Input					
P1-08NA	AC Isolated 100–240 VAC					
P1-08TD1	Sinking Output					
P1-08TD2	Sourcing Output					
P1-08TD-TTL	Sinking/Sourcing Output					81.6 [3.21]
P1-15TD1	Sinking Output					86.6 [3.41]
P1-15TD2	Sourcing Output					

## Dimensions and Installation (continued)

ProductivityOpen Component Dimensions					
Module	Description	A	B	C	D
		Width mm [in]	Height Faceplate mm [in]	Height w/Tabs mm [in]	Depth mm [in]
P1-08TA	AC Output	17.2 [0.68]	77.0 [3.03]	93.6 [3.69]	86.6 [3.41]
P1-08TRS	Isolated Relay Output	17.2 [0.68]			
P1-16TR	Relay Output	26.3 [1.03]			
P1-15CDD1	Input: Sinking/Sourcing; Output: Sinking	17.2 [0.68]			
P1-15CDD2	Input: Sinking/Sourcing; Output: Sourcing				
P1-16CDR	Input: Sinking/Sourcing; Output: Relay	26.3 [1.03]			
Analog Expansion Modules					
P1-04RTD	RTD Input	17.2 [0.68]	77.0 [3.03]	93.6 [3.69]	81.6 [3.21]
P1-04THM	Thermocouple Input				
P1-04NTC	Thermistor Input				
P1-04AD	Analog Input (Current/Voltage)				
P1-04AD-1	Analog Input (Current)				
P1-04AD-2	Analog Input (Voltage)				
P1-04ADL-1	Analog Input (Current)	17.2 [0.68]	77.0 [3.03]	93.6 [3.69]	81.9 [3.22]
P1-04ADL-2	Analog Input (Voltage)				
P1-04DAL-1	Analog Output (Current)				
P1-04DAL-2	Analog Output (Voltage)				
P1-08ADL-1	Analog Input (Current)	17.2 [0.68]	77.0 [3.03]	93.6 [3.69]	81.6 [3.21]
P1-08ADL-2	Analog Input (Voltage)				
P1-08DAL-1	Analog Output (Current)				
P1-08DAL-2	Analog Output (Voltage)				
P1-4ADL2DAL-1	Analog Input/Analog Output (Current)				
P1-4ADL2DAL-2	Analog Input/Analog Output (Voltage)				
Specialty Expansion Modules					
P1-02HSC	High-Speed Input (Current)	17.2 [0.68]	77.0 [3.03]	93.6 [3.69]	81.6 [3.21]
P1-04PWM	Pulse Width Modulation Input (Voltage)				

# Basic Dimensions

P1AM-100

Units: mm [inches]

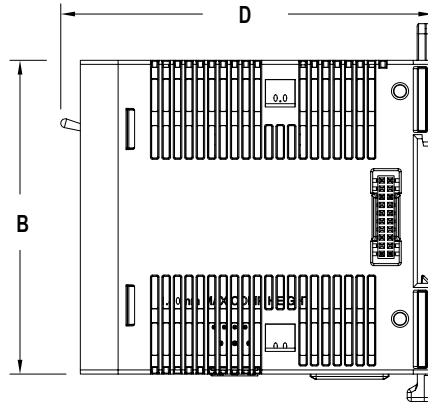
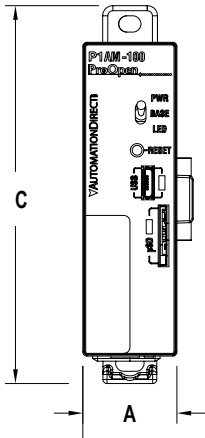

P1-01AC, P1-02AC, and P1-01DC

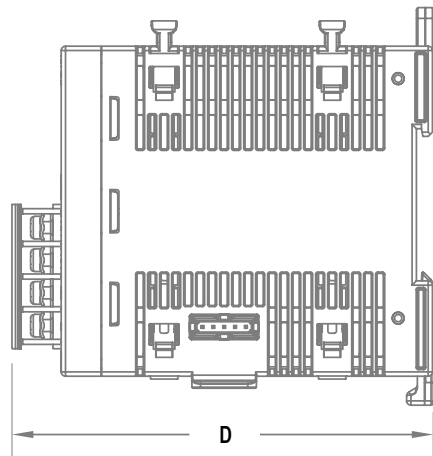
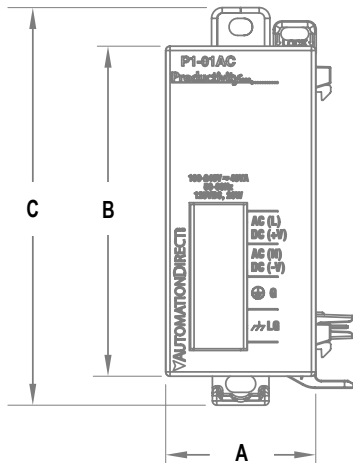

# Basic Dimensions (continued)

## Productivity1000 I/O Modules

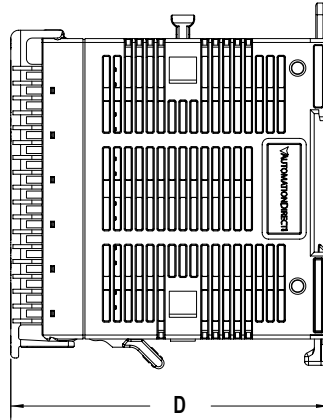
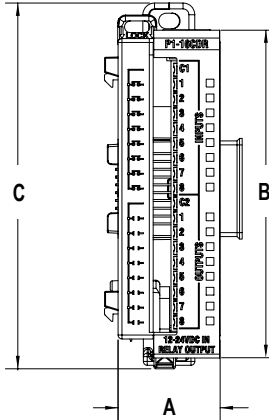

## P1AM-GPIO Module

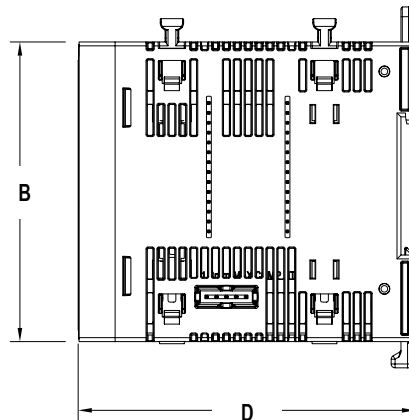
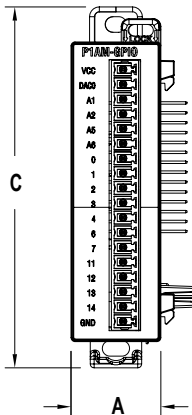

Units: mm [inches]



P1AM-ETH

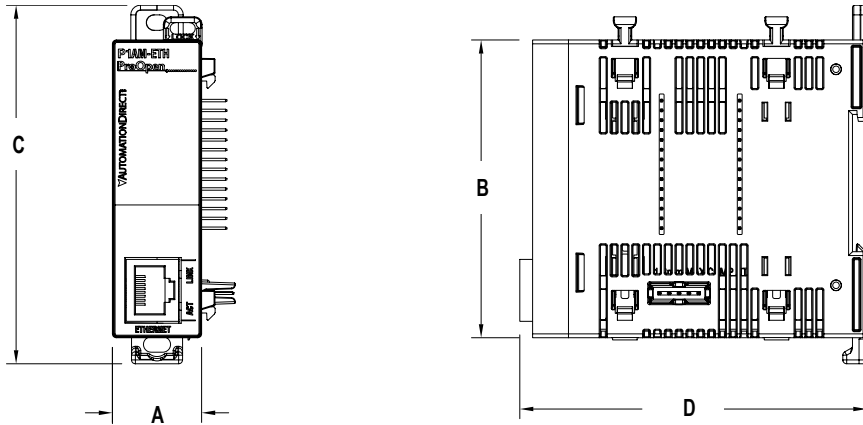

Units: mm [inches]

P1AM-SERIAL

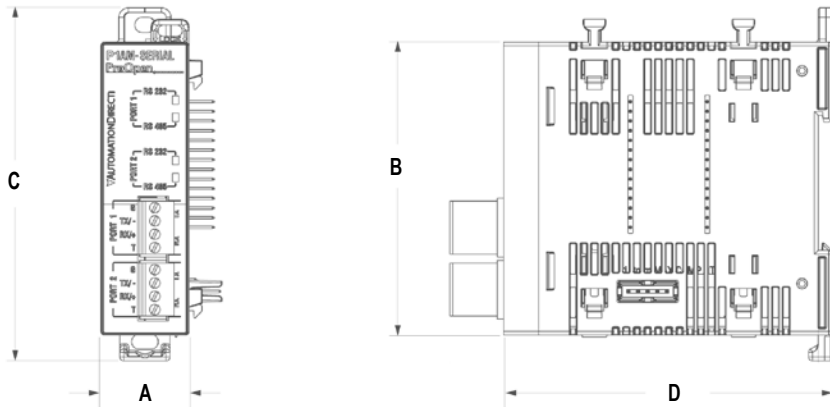

Units: mm [inches]

# Mounting Guidelines

## Enclosures

Your selection of a proper enclosure is important to ensure safe and proper operation of your P1AM-100. Applications for the P1AM-100 vary and may require additional hardware considerations. The minimum considerations for enclosures include:

- Conformance to electrical standards
- Protection from the elements in an industrial environment
- Common ground reference
- Not exceeding the specified maximum ambient temperature
- Access to the equipment
- Security or restricted access
- Sufficient space for proper installation and maintenance of the equipment



**NOTE:** Add 2" to mounting depth when using ZIPLink cable.

## Mounting Position

Mount the P1AM-100 and expansion modules horizontally, as shown in the cabinet illustration on the following page, to provide proper ventilation. Do not mount vertically, upside down, or on a flat horizontal surface.

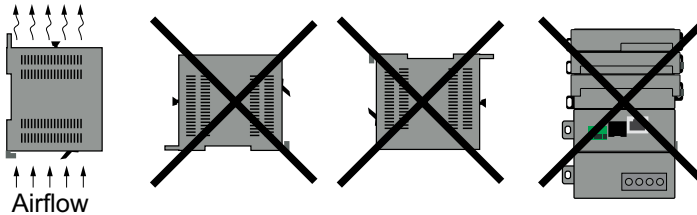

## Using Mounting Rails

The ProductivityOpen modules can be secured within an enclosure or cabinet using mounting rails. Use rails that conform to DIN EN standard 50022. We offer a complete line of DIN rail, DINnectors and DIN rail mounted components. The rails are approximately 35mm high, with a depth of 7.5 mm. When mounting the module(s) on a DIN rail, consider using end brackets on each side of the base. The end brackets keep the module(s) from sliding horizontally along the rail, thus minimizing the possibility of accidentally pulling the wiring loose.

**End Bracket**  
(Part No. DN-EB35)

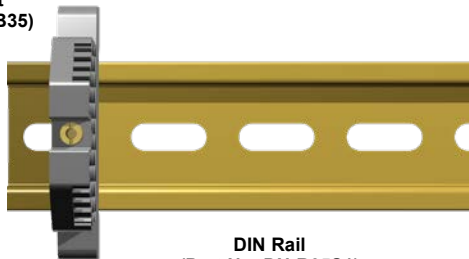

**DIN Rail**  
(Part No. DN-R35S1)

**DIN Rail Dimensions**



### Mounting Clearances

Provide a minimum clearance of 2 inches (50mm) on all sides of the assembled system. Allow extra clearance for door mounted operator panels, push buttons, lights and other items. There should be a minimum of 3 inches (76mm) vertical clearance between the module(s) and any wire duct, and a minimum of 7.2 inches (183mm) vertical distance from chassis to chassis in a multiple unit installation.

The clearances required for P1AM-100 are represented in the graphic below of a similar PLC system when mounted in an enclosure.

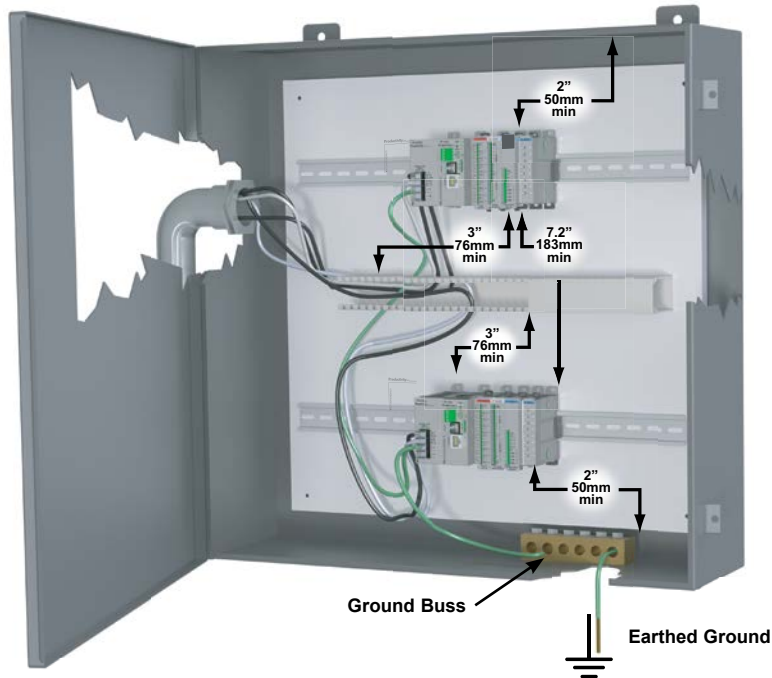

### Temperature Considerations

The P1AM-100 enclosure should be installed in an environment which is within the specified equipment operating temperature. If the environment temperature deviates above or below the specified operating temperature range, measures such as cooling or heating the enclosure should be taken to stay within the range specification.

### Power Considerations

When the P1AM-100 is powered by a Productivity power supply (P1-01AC, P1-02AC or P1-01DC), EMF/RFI line filters are not required to meet the requirements of the CE EMC Directive.

## Chapter 3: Installation and Wiring

In addition to the panel layout guidelines, other specifications can affect the installation of a CPU system. Always consider the following:

- Environmental Specifications
- Power Requirements
- Agency Approvals
- Enclosure Selection and Component Dimensions

### Grounding

A sound common ground reference (earth ground) is essential for proper operation of the P1AM-100. One side of all control circuits and power circuits along with the ground lead, must be properly connected to earth ground (earthing) either by connecting to the incoming power system ground or through a ground rod installed in close proximity to the enclosure. This must be a single-point ground (i.e. copper buss bar) for all devices in the enclosure that require an earth ground.

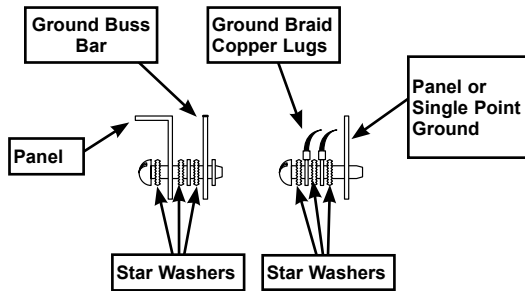

**WARNING: DO NOT DISCONNECT EQUIPMENT UNLESS POWER HAS BEEN SWITCHED OFF.**

### Agency Approvals

Some applications require agency approvals for particular components. The ProductivityOpen agency approvals are listed below:

- UL (Underwriters' Laboratories, Inc.)
- CUL (Canadian Underwriters' Laboratories, Inc.)
- CE (European Economic Union)

### DIN Rail Mounting P1AM-100 System

If you examine the module(s), you'll notice retaining clips. To secure the module(s) to a DIN rail, place the module(s) onto the rail and gently push up on the retaining clips. The spring loaded clips lock the module onto the rail. To remove the module(s), pull down on the retaining clips, rotate upward and lift up the base, drawing it away from the rail.

This installation procedure applies to the P1AM-100, P1AM-SERIAL, P1AM-ETH, and P1AM-GPIO shields, and the Productivity1000 power supplies.

- Step 1: Rotate unit upwards as you engage rear DIN rail slot (image at right). Once engaged, rotate unit downwards, firmly pressing into DIN rail. A noticeable click affirms the unit is secure to DIN rail.
- Step 2: Ensure all retaining clips are pushed up into DIN rail.
- Step 3: Install end brackets on either side of unit to ensure unit will not slide along the DIN rail.



Push up retaining clips

### Surface Mounting P1AM-100 System

The P1AM-100 system may be surface mounted as well. Extend the lower tabs for ease of access. Use mounting holes in upper and lower tabs to secure the unit to panel surface.

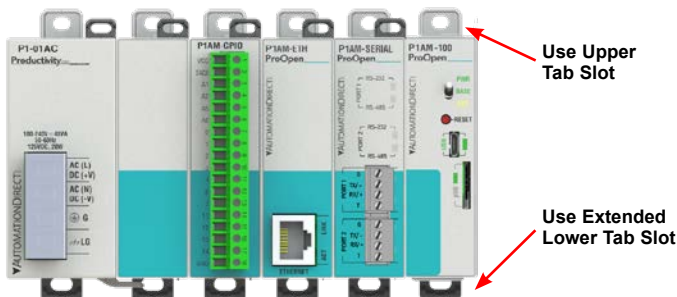

Use Upper Tab Slot

Use Extended Lower Tab Slot

### Connecting the I/O Modules



**Step One:** With latch in “locked” position, align connectors on the side of each module and stack by pressing together. An audible click indicates lock is engaged.

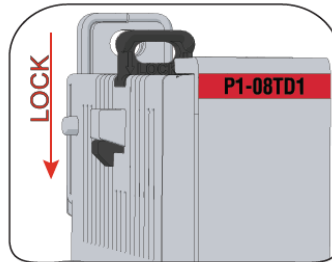

**Step Two:** To unstack modules, pull locking latch up into the unlocked position and then pull modules apart.

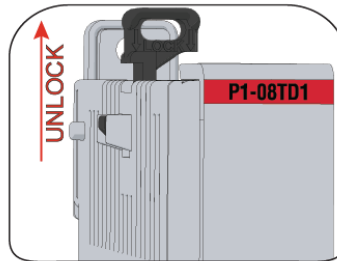

**WARNING:** Do NOT connect, disconnect modules or operate switches while circuit is live. P1AM-100 does NOT support hot swapping!

## Wiring Guidelines

### Power Supply Wiring

Connect the AC power source input wiring to the power supply as shown. The power supply terminals can accept up to 14AWG solid or stranded wire. Do not over tighten the terminal screws; the recommended torque is 7 to 9 inch-pounds (0.882 to 1.02 N-m).

#### P1-01AC and P1-02AC

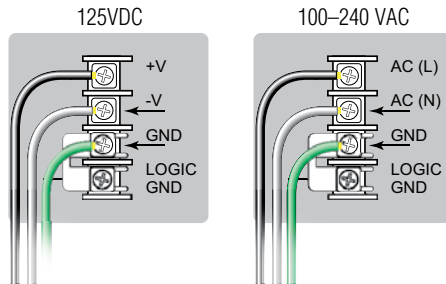

#### P1-01DC

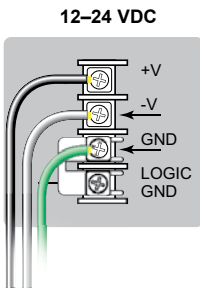

**WARNING:** *ONCE THE POWER WIRING IS CONNECTED, SECURE THE TERMINAL BLOCK COVER IN THE CLOSED POSITION. WHEN THE COVER IS OPEN THERE IS A RISK OF ELECTRICAL SHOCK IF YOU ACCIDENTALLY TOUCH THE CONNECTION TERMINALS OR POWER WIRING.*

### Grounding

A good common ground reference (earth ground) is essential for proper operation of the P1AM-100. One side of all control circuits and power circuits along with the ground lead must be properly connected to earth ground by either installing a ground rod in close proximity to the enclosure or by connecting to the incoming power system ground. There must be a single-point ground (i.e. copper bus bar) for all devices in the enclosure that require an earth ground.

### Fuse Protection

Some of the Input and Output I/O module circuits do not have internal fuses. In order to protect your modules, we suggest you add external fuses to your I/O wiring. A fast-blow fuse with a lower current rating than the I/O bank's common current rating can be wired to each common; or a fuse with a rating of slightly less than the maximum current per output point can be added to each output. Refer to the I/O module specifications in Chapter 2 to find the maximum current per output point or per output common. Adding the external fuse does not guarantee the prevention of CPU damage, but it will provide added protection.

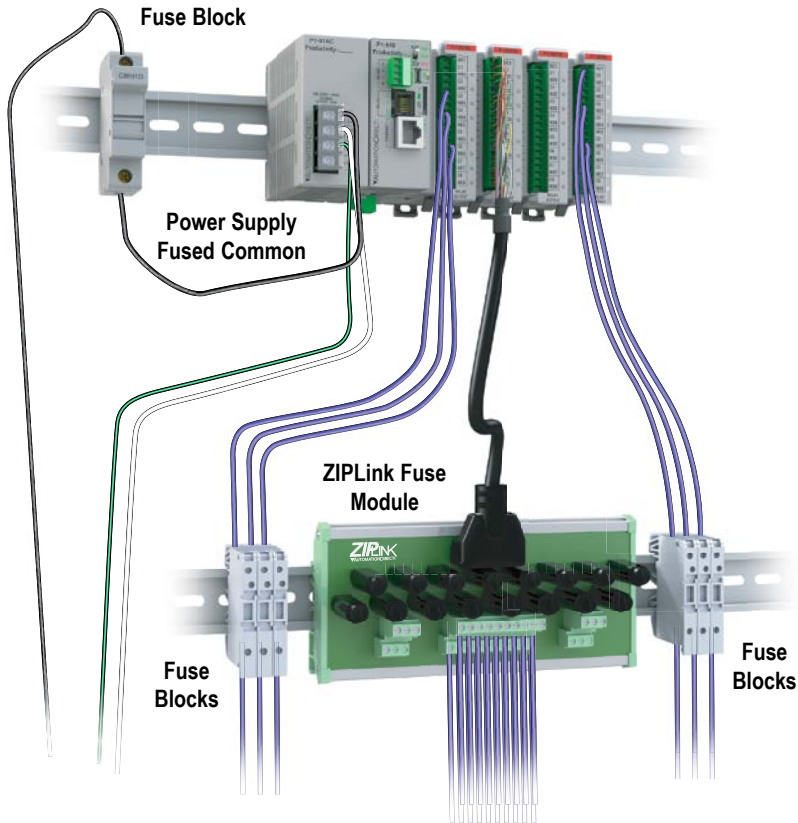



## I/O Module Wiring Options

There are two available methods for wiring most I/O modules: hand wiring to the optional removable I/O module terminal blocks or using the ZIPLink wiring system.



**NOTE:** Thermocouple, Thermistor, RTD, and HSC modules are not compatible with the ZIPLink system and are shipped with fixed terminal blocks included.

### Hand Wiring System

Field wiring may be attached using the removable terminal block connector. Use Wire Strip Length reference on the terminal block as a guide when preparing wire for termination. For easier assembly, wire may be connected to terminal block prior to installing block into expansion module.

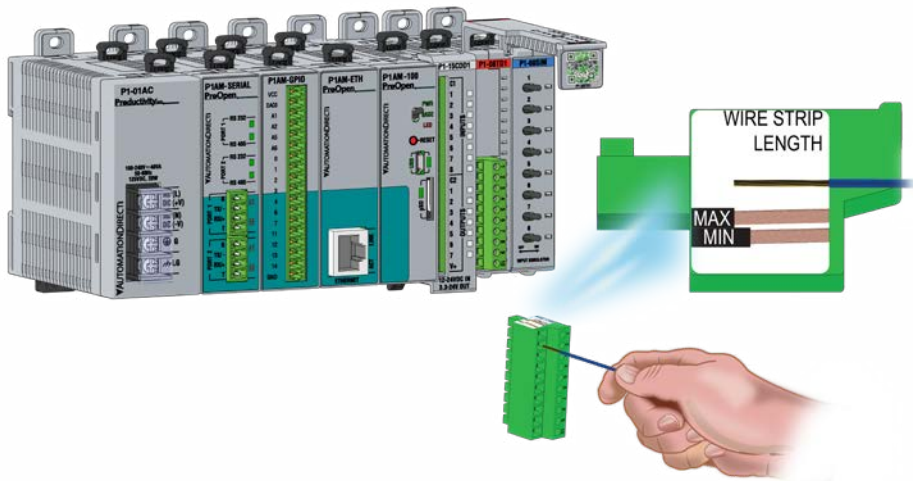

## I/O Module Wiring Options (continued)

### ZIPLink Wiring System

The ZIPLink wiring system is the recommended method, which allows quick and easy connection using cables that are prewired to the I/O module terminals at one end and plug into a ZIPLink connector module terminal block at the other end. Use the tables on the following pages to specify your ZIPLink wiring system.

ZIPLink Wiring System



ZIPLink Pre-Wired Cables



ZIPLink Module

### Terminal Block With Pigtail Cable

For most I/O modules you can also purchase ZIPLink pigtail cables.



ZIPLink Pigtail Cable

Input and Output Module ZIPLink Selections

Productivity1000 Input Module ZIPLink Selector				
I/O Module		ZIPLink		
Input Module	# of Terms	Component	Module Part No.	Cable Part No.
P1-08ND3	10	Feedthrough	ZL-RTB20 or ZL-RTB20-1	ZL-P1-CBL10*
P1-16ND3	18			ZL-P1-CBL18*
P1-08NE3	10			ZL-P1-CBL10*
P1-16NE3	18			ZL-P1-CBL18*
P1-08NA	10			ZL-P1-CBL10*
	10			ZL-P1-CBL10*

Productivity1000 Output Module ZIPLink Selector				
I/O Module		ZIPLink		
Output Module	# of Terms	Component	Module Part No.	Cable Part No.
P1-08TD1	10	Feedthrough	ZL-RTB20 or ZL-RTB20-1	ZL-P1-CBL10*
P1-08TD2				ZL-P1-CBL18*
P1-15TD1	18			ZL-P1-CBL18*
P1-15TD2	18			ZL-P1-CBL18*
P1-08TA	10			ZL-P1-CBL10*
P1-08TRS	10			ZL-P1-CBL10*
P1-16TR	18			ZL-P1-CBL18*
	18			ZL-P1-CBL18*

Productivity1000 Combo Modules ZIPLink Selector				
I/O Module		ZIPLink		
Output Module	# of Terms	Component	Module Part No.	Cable Part No.
P1-15CDD1	18	Feedthrough	ZL-RTB20 or ZL-RTB20-1	ZL-P1-CBL18*
P1-15CDD2				
P1-16CDR				

\* Select the cable length by replacing the \* with: Blank = 0.5 m, -1 = 1.0 m, or -2 = 2.0 m.

## Analog Modules ZIPLink Selections

Productivity1000 Analog Module ZIPLink Selector					
Module		ZIPLink			
Analog Module	# of Terms	Component	Module	Cable	
P1-04AD	18	Feedthrough	ZL-RTB20 or ZL-RTB20-1	ZL-P1-CBL18*	
P1-04AD-1	10	Feedthrough		ZL-RTB20 or ZL-RTB20-1	ZL-P1-CBL10*
P1-04AD-2					
P1-04ADL-1					
P1-04ADL-2					
P1-08ADL-1					
P1-08ADL-2					
P1-04RTD	Matched Only	See Note 1			
P1-04THM	T/C Wire Only	See Note 1			
P1-04NTC	Copper Conductors	See Note 1			
P1-04DAL-1	10	Feedthrough	ZL-RTB20 or ZL-RTB20-1	ZL-P1-CBL10*	
P1-04DAL-2					
P1-08DAL-1					
P1-08DAL-2					

Productivity1000 Analog Combo Module ZIPLink Selector				
Module		ZIPLink		
Analog Module	# of Terms	Component	Module	Cable
P1-4DAL2ADL-1	10	Feedthrough	ZL-RTB20 or ZL-RTB20-1	ZL-P1-CBL10*
P1-4DAL2ADL-2				

Productivity1000 Specialty Modules ZIPLink Selector				
Module		ZIPLink		
Input Module	# of Terms	Component	Module	Cable
P1-08SIM	See Note 1			
P1-02HSC	See Note 1			
P1-04PWM	10	Feedthrough	ZL-RTB20 or ZL-RTB20-1	ZL-P1-CBL10*

\* Select the cable length by replacing the \* with: Blank = 0.5 m, -1 = 1.0 m, or -2 = 2.0 m.  
 1. These modules are not supported by the ZIPLink wiring system.

## Removable Terminal Blocks (Optional)

The hand wiring method consists of purchasing the associated removable I/O module terminal block (table below) and hand wiring from the I/O terminal block to a DIN rail mounted terminal block.

### P1-10RTB and P1-10RTB-1

Removable Terminal Block Specifications		
Part Number	P1-10RTB	P1-10RTB-1
Number of Positions	10 Screw Terminals	10 Spring Clamp Terminals
Wire Range	30–16 AWG (0.051–1.31 mm <sup>2</sup> ) Solid / Stranded Conductor 3/64 in. (1.2 mm) Insulation Max. 1/4 in. (6–7 mm) Strip Length	28–16 AWG (0.081–1.31 mm <sup>2</sup> ) Solid / Stranded Conductor 3/64 in. (1.2 mm) Insulation Max. 19/64 in. (7–8 mm) Strip Length
Conductors	"USE COPPER CONDUCTORS, 75°C" or Equivalent.	
Screw Driver	0.1 inch (2.5 mm) Maximum*	
Screw Size	M2	N/A
Screw Torque	2.5 lb-in (0.28 N-m)	N/A

\* Recommended screw driver: P/N TW-SD-MSL-1.

### P2-RTB and P2-RTB-1

Removable Terminal Block Specifications		
Part Number	P2-RTB	P2-RTB-1
Number of Positions	18 Screw Terminals	18 Spring Clamp Terminals
Wire Range	30–16 AWG (0.051–1.31 mm <sup>2</sup> ) Solid / Stranded Conductor 3/64 in. (1.2 mm) Insulation Max. 1/4 in. (6–7 mm) Strip Length	28–16 AWG (0.081–1.31 mm <sup>2</sup> ) Solid / Stranded Conductor 3/64 in. (1.2 mm) Insulation Max. 19/64 in. (7–8 mm) Strip Length
Conductors	"USE COPPER CONDUCTORS, 75°C" or Equivalent.	
Screw Driver	0.1 inch (2.5 mm) Maximum*	
Screw Size	M2	N/A
Screw Torque	2.5 lb-in (0.28 N-m)	N/A

\* Recommended screw driver: P/N TW-SD-MSL-1.

### Removable Terminal Blocks, continued

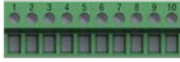

**P1-10RTB (screw terminals)  
Removable Terminal Block**

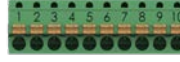

**P1-10RTB-1 (spring-clip terminals)  
Removable Terminal Block**

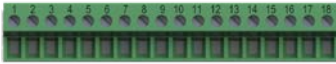

**P2-RTB (screw terminals)  
Removable Terminal Block**

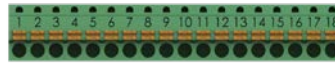

**P2-RTB-1 (spring-clip terminals)  
Removable Terminal Block**

### Terminal Block Installation

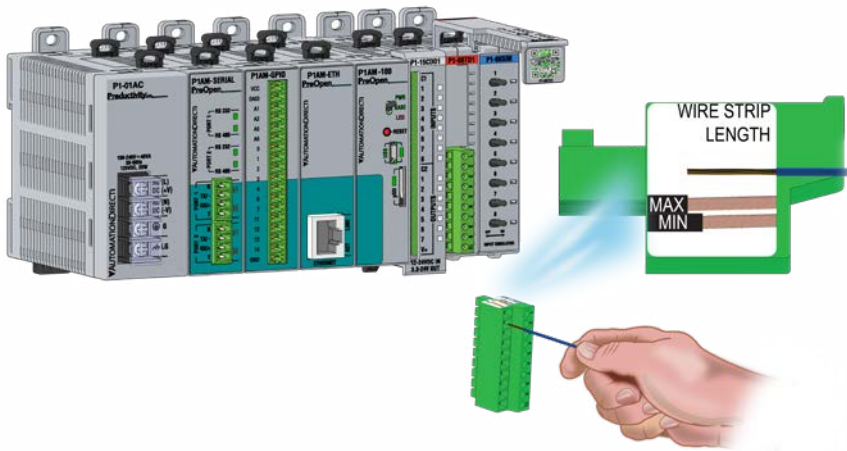

Use the Wire Strip Length gauge printed on the end of the terminal strip as a guide to properly strip wire insulation prior to inserting into terminal block. For ease of assembly, block maybe wired prior to installation, if desired.

Insert terminal block as follows:

- Step 1: Raise finger-safe terminal guard.
- Step 2: Align terminal block with module terminal pins, ensuring correct orientation of block.
- Step 3: Firmly and evenly press terminal block onto terminal pins until seated. Lower finger-safe guard into place.

### Terminal Block Removal



**WARNING:** ENSURE LOCAL AND REMOTE POWER SUPPLIES HAVE BEEN DISCONNECTED PRIOR TO REMOVING TERMINAL BLOCK.

Remove terminal block as follows:

- Step 1: Raise terminal cover.
- Step 2: Pull terminal block release lever forward. This will lift terminal block away from pins.
- Step 3: Grasp block firmly and pull away from module.

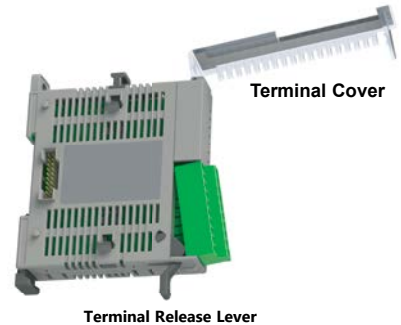

### Planning the I/O Wiring Routes

The following guidelines provide general information on how to wire the I/O connections to Productivity1000 modules. For specific information on wiring a particular I/O module refer to the module specifications in Chapter 2.

1. If using removable terminal blocks, follow the wire size guidelines in the I/O modules specifications in Chapter 2.
2. Always use a continuous length of wire. Do not splice wires to create a needed length.
3. Use the shortest possible wire length.
4. Use wire trays for routing where possible.
5. Avoid running low voltage control wires near high voltage wiring. Use separate conduits for low-voltage DC and AC power/signal wiring runs.
6. Avoid confusion by laying input wiring separate from output wiring where possible.
7. To minimize voltage drops when wires must run a long distance, consider using multiple wires for the return line.
8. Avoid running DC wiring in close proximity to AC wiring where possible.
9. Avoid creating sharp bends in the wires; follow accepted Electrical Code bend allowance standards.

# System Wiring Strategies

The P1AM-100 is very flexible and will work in many different wiring configurations. By studying this section before actual installation, you may find the best wiring strategy for your application. This will help to lower system cost and wiring errors, and avoid safety problems.

## CPU Isolation Boundaries

CPU circuitry is divided into three main regions separated by isolation boundaries, shown in the drawing below. Electrical isolation provides safety, so that a fault in one area does not damage another. The transformer in the power supply provides magnetic isolation between the primary and secondary sides. Optical isolators provide isolation to input and output circuits. This isolates logic circuitry from the field side, where factory machinery connects.

The discrete inputs and discrete outputs are isolated from each other and from the logic side. Isolation boundaries protect the devices which are connected to the communication ports, such as PCs and HMIs, from power input faults or field wiring faults.

When wiring a controller, it is extremely important to avoid making external connections that connect logic side circuits to any other.

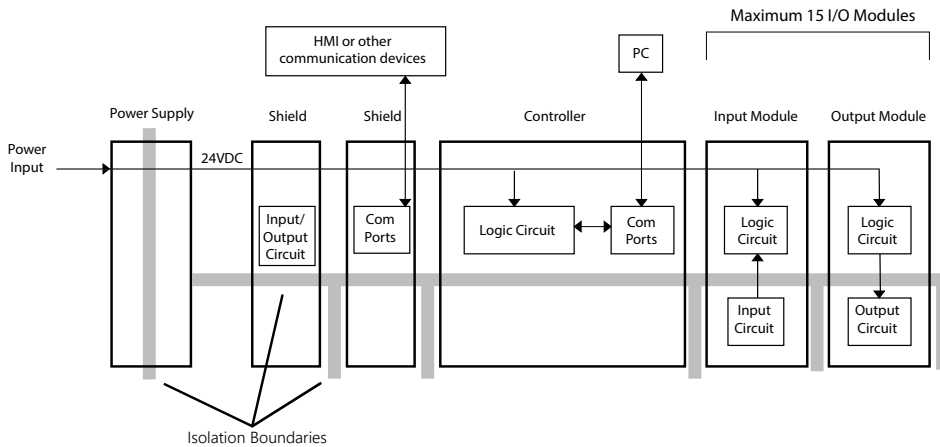



## Sinking/Sourcing Concepts

Before wiring field devices to the CPU I/O, it's necessary to have a basic understanding of "sinking" and "sourcing" concepts. Use of these terms occurs frequently in input or output circuit discussions. These terms only apply to DC circuits, not AC circuits. The purpose of this section is to explain the terms. The short definitions are as follows:

- Sinking = Path to supply ground (-) or switching ground.
- Sourcing = Path to supply source (+) or switching +V.

Input and output points that are either sinking or sourcing can conduct current in only one direction. This means it is possible to wire the external supply and field device to the I/O point with current trying to flow in the wrong direction, in which case the circuit will not operate.

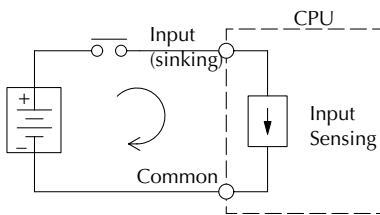

The diagram on the left shows a "sinking" CPU input. To properly connect the external supply, connect it so that the input provides a path to ground (-). Start at the CPU input terminal, follow through the input sensing circuit, exit at the common terminal, and connect the supply (-) to the common terminal.

The switch between the supply (+) and the input completes the circuit. Current flows in the direction of the arrow when the switch is closed. By applying

the circuit principle above to the four possible combinations of input/output sinking/sourcing types, we have the four circuits as shown below.

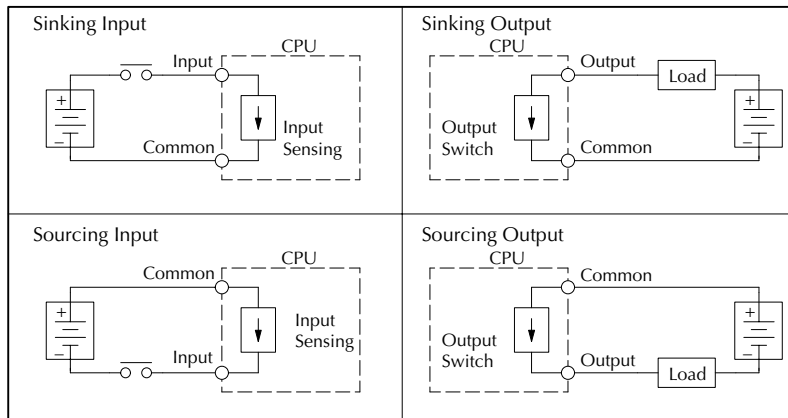

### I/O “Common Terminal” Concepts

In order for a CPU I/O circuit to operate, current must enter at one terminal and exit at another. This means that at least two terminals are associated with every I/O point. In the figure below, the input or output terminal is the main path for the current. One additional terminal must provide the return path to the power supply.

If there was unlimited module space then every I/O point could have two dedicated terminals as the figure above shows. Providing this level of flexibility is not practical or necessary for most applications. Most I/O point groups share the return path (common) among two or more I/O points. The figure below shows a group (or bank) of four input points which share a common return path. In this way, the four inputs require only five terminals instead of eight.

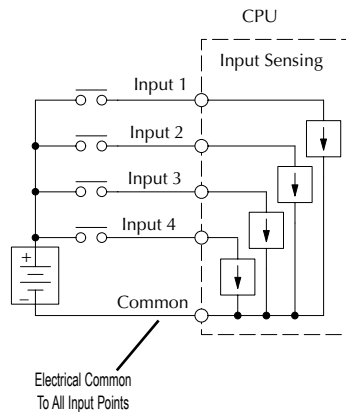
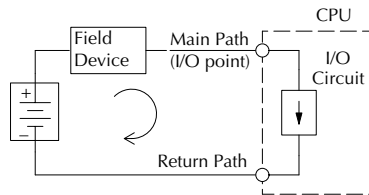

**NOTE:** In the circuit above, the current in the common path is equal to the sum of the energized channels. This is especially important in output circuits, where larger gauge wire is sometimes needed for the commons.

## DC Input Wiring Methods

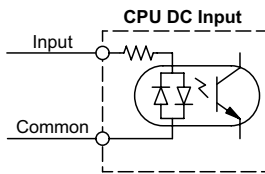

I/O modules with DC inputs can be wired as either sinking or sourcing inputs. The dual diodes (shown in this diagram) allow current to flow in either direction. Inputs grouped by a common point must be either all sinking or all sourcing. DC inputs typically operate in the range of +12–24 VDC.

### Sinking Input Sensor (NPN Type) to CPU Sourcing Input

In the following example, a field device has an open-collector NPN transistor output. When energized, it sinks current to ground from the DC input point. The CPU input current is sourced from the common terminal connected to power supply (+).

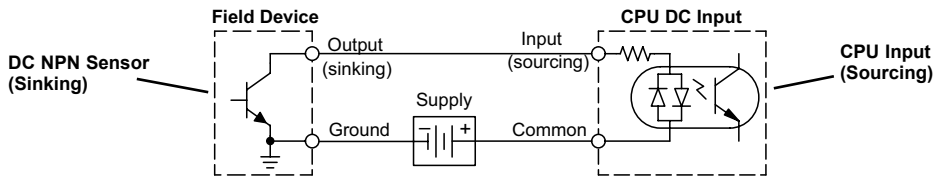

### Sourcing Input Sensor (PNP Type) to CPU Sinking Input

In the following example, a field device has an open-emitter PNP transistor output. When energized, it sources current to the CPU input point, which sinks the current to ground. Since the field device loop is sourcing current, no additional power supply is required for the module.

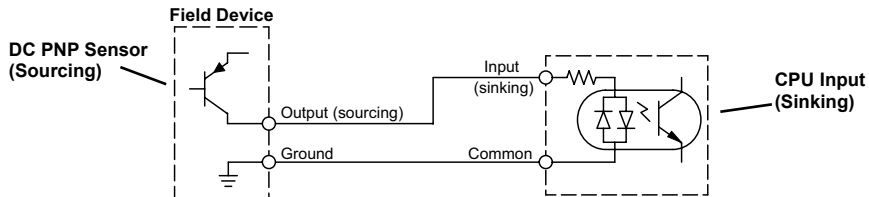

## DC Output Wiring Methods

I/O modules with DC output circuits are wired as all current sinking only or current sourcing only depending on which output module part number is used. DC outputs typically operate in the range of +5 to +24 VDC.

### CPU Sinking Output to Sourcing Load Device

Many applications require connecting a CPU output point to a DC input on a field device load. This type of connection is made to carry a low-level DC signal.

In the following example, the CPU output point sinks current to ground (common) when energized. The output is connected to a field device load with a sourcing input.

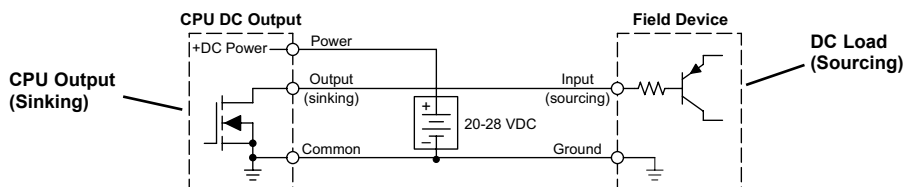

## CPU DC Sinking Output to Sinking Load Device

In the example below, a sinking output point is connected to the sinking input of a field device load. In this case, both the CPU output and field device input are sinking type. Since the circuit must have one sourcing and one sinking device, we add sourcing capability to the CPU output by using a pull-up resistor. In the circuit below, we connect R pull-up from the output to the DC output circuit power input.

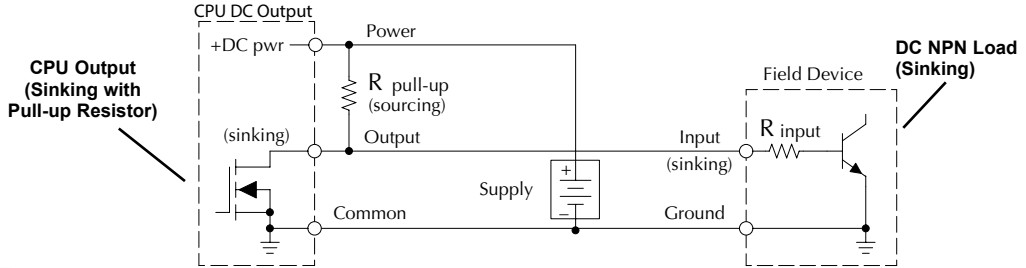

**NOTE:** DO NOT attempt to drive a heavy load (>25mA) with this pull-up method.

**NOTE:** Using the pull-up resistor ( $R_{pull-up}$ ) to implement a sourcing output has the effect of inverting the output point logic. In other words, the field device input is energized when the CPU output is OFF, from a ladder logic point-of-view. Your ladder program must comprehend this and generate an inverted output. Or, you may choose to cancel the effect of the inversion elsewhere, such as in the field device.

It is important to choose the correct value of  $R_{pull-up}$ . In order to do so, we need to know the nominal input current to the field device ( $I_{input}$ ) when the input is energized. If this value is not known, it can be calculated as shown (a typical value is 15mA). Then use  $I_{input}$  and the voltage of the external supply to compute  $R_{pull-up}$ . Then calculate the power  $P_{pull-up}$  (in watts), in order to size  $R_{pull-up}$  properly.

$$I_{input} = \frac{V_{input} \text{ (turn-on)}}{R_{input}}$$

$$R_{pull-up} = \frac{V_{supply} - 0.7}{I_{input}} - R_{input}$$

$$P_{pull-up} = \frac{V_{supply}^2}{R_{pull-up}}$$

### Relay Outputs - Wiring Methods

Relay outputs are available for the ProductivityOpen. Relays are best for the following applications:

- Loads that require higher currents than the solid-state outputs can deliver
- Cost-sensitive applications
- Some output channels need isolation from other outputs (such as when some loads require different voltages than other loads)

Some applications in which NOT to use relays:

- Loads that require currents under 10mA
- Loads which must be switched at high speed or heavy duty cycle.

#### Relay with Form A contacts

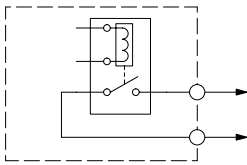

Relay outputs are available in two contact arrangements. Form A type, or SPST (single pole, single throw) type. They are normally open and are the simplest to use. The Form C, or SPDT (single pole, double throw) type has a center contact which moves and a stationary contact on either side. This provides a normally closed contact and a normally open contact.

#### Relay with Form C contacts

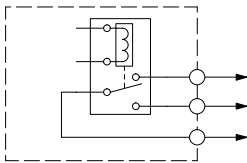

The relays in some relay output modules share common terminals, which connect to the wiper contact in each relay of the bank. Other relay modules have relays which are completely isolated from each other. In all cases, the module drives the relay coil when the corresponding output point is on.

### Relay Outputs – Transient Suppression for Inductive Loads in a Control System

The following pages are intended to give a quick overview of the negative effects of transient voltages on a control system and provide some simple advice on how to effectively minimize them. The need for transient suppression is often not apparent to the newcomers in the automation world. Many mysterious errors that can afflict an installation can be traced back to a lack of transient suppression.

#### What is a Transient Voltage and Why is it Bad?

Inductive loads (devices with a coil) generate transient voltages as they transition from being energized to being de-energized. If not suppressed, the transient can be many times greater than the voltage applied to the coil. These transient voltages can damage CPU outputs or other electronic devices connected to the circuit, and cause unreliable operation of other electronics in the general area. Transients must be managed with suppressors for long component life and reliable operation of the control system.

This example shows a simple circuit with a small 24V/125mA/3W relay. As you can see, when the switch is opened, thereby de-energizing the coil, the transient voltage generated across the switch contacts peaks at 140V.

#### Example: Circuit with no Suppression

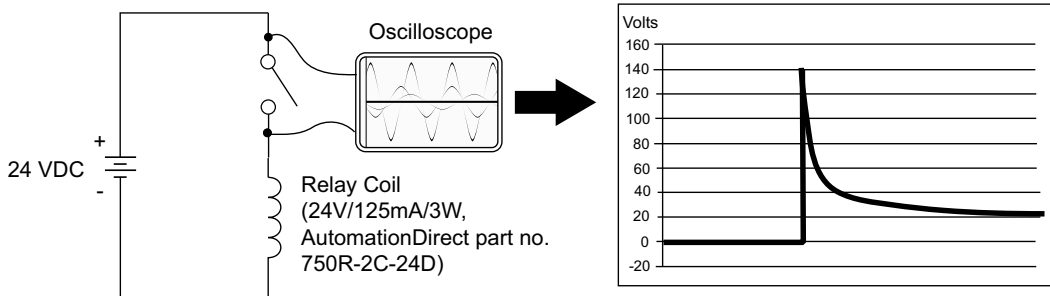

In the same circuit, replacing the relay with a larger 24V/290mA/7W relay will generate a transient voltage exceeding 800V (not shown). Transient voltages like this can cause many problems, including:

- Relay contacts driving the coil may experience arcing, which can pit the contacts and reduce the relay's lifespan.
- Solid state (transistor) outputs driving the coil can be damaged if the transient voltage exceeds the transistor's ratings. In extreme cases, complete failure of the output can occur the very first time a coil is de-energized.
- Input circuits, which might be connected to monitor the coil or the output driver, can also be damaged by the transient voltage.

A very destructive side-effect of the arcing across relay contacts is the electromagnetic interference (EMI) it can cause. This occurs because the arcing causes a current surge, which releases RF energy. The entire length of wire between the relay contacts, the coil, and the power source carries the current surge and becomes an antenna that radiates the RF energy. It will readily couple into parallel wiring and may disrupt the CPU and other electronics in the area. This EMI can make an otherwise stable control system behave unpredictably at times.

## CPU's Integrated Transient Suppressors

Although the CPU outputs typically have integrated suppressors to protect against transients, they are not capable of handling them all. It is usually necessary to have some additional transient suppression for an inductive load.

Here is another example using the same 24V/125mA/3W relay used earlier. This example measures the PNP transistor output of a typical CPU, which incorporates an integrated Zener diode for transient suppression. Instead of the 140V peak in the first example, the transient voltage here is limited to about 40V by the Zener diode. While the CPU will probably tolerate repeated transients in this range for some time, the 40V is still beyond the module's peak output voltage rating of 30V.

### Example: Small Inductive Load with Only Integrated Suppression

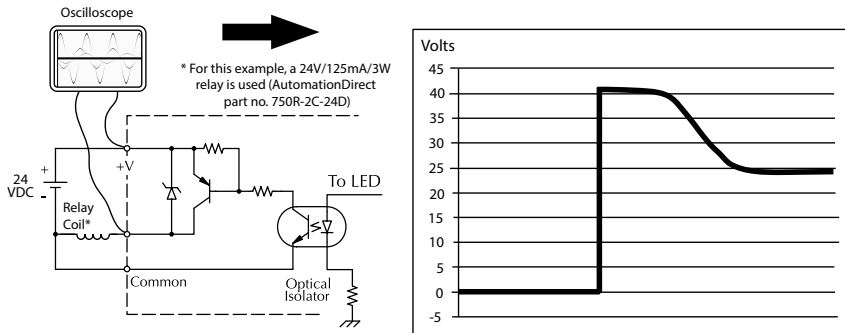

The next example uses the same circuit as above, but with a larger 24V/290mA/7W relay, thereby creating a larger inductive load. As you can see, the transient voltage generated is much worse, peaking at over 50V. Driving an inductive load of this size without additional transient suppression is very likely to permanently damage the CPU output.

### Example: Larger Inductive Load with Only Integrated Suppression

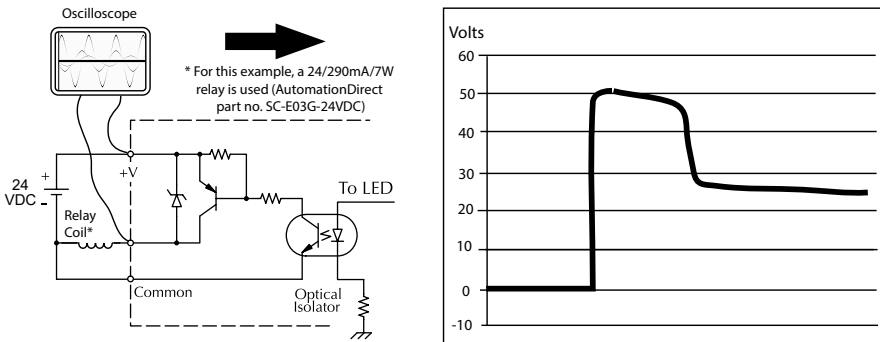

Additional transient suppression should be used in both of these examples. If you are unable to measure the transients generated by the connected loads of your control system, using additional transient suppression on all inductive loads would be the safest practice.

### Types of Additional Transient Protection

#### DC Coils:

The most effective protection against transients from a DC coil is a flyback diode. A flyback diode can reduce the transient to roughly 1V over the supply voltage, as shown in this example.

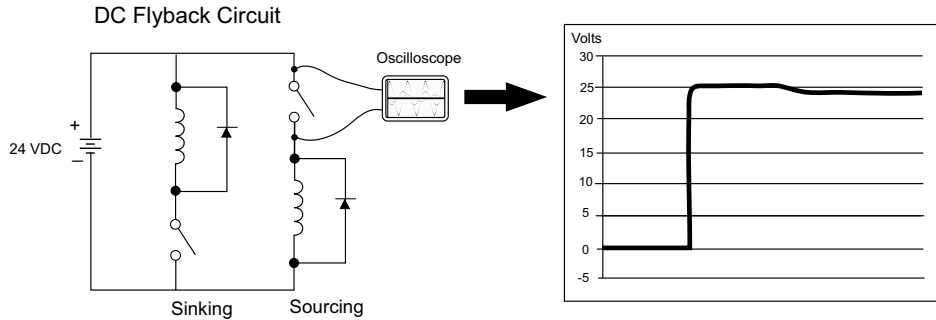

Many AutomationDirect socketed relays and motor starters have add-on flyback diodes that plug or screw into the base, such as the AD-ASMD-250 protection diode module and 784-4C-SKT-1 socket module shown below. If an add-on flyback diode is not available for your inductive load, an easy way to add one is to use AutomationDirect's DN-D10DR-A diode terminal block, a 600VDC power diode mounted in a slim DIN rail housing.

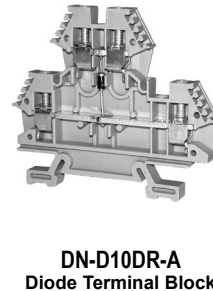



Two more common options for DC coils are Metal Oxide Varistors (MOV) or TVS diodes. These devices should be connected across the driver (CPU output) for best protection as shown below. The optimum voltage rating for the suppressor is the lowest rated voltage available that will NOT conduct at the supply voltage, while allowing a safe margin.

AutomationDirect's ZL-TSD8-24 transorb module is a good choice for 24VDC circuits. It has a bank of 8 uni-directional 30V TVS diodes. Since they are uni-directional, be sure to observe the polarity during installation. MOVs or bi-directional TVS diodes would install at the same location, but have no polarity concerns.



**ZL-TSD8-24**  
Transorb Module

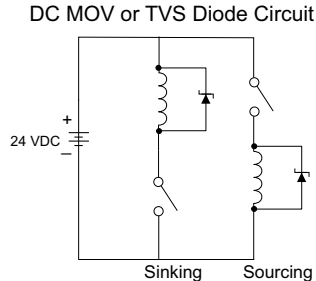

### AC Coils:

Two options for AC coils are MOVs or bi-directional TVS diodes. These devices are most effective at protecting the driver from a transient voltage when connected across the driver (CPU output) but are also commonly connected across the coil. The optimum voltage rating for the suppressor is the lowest rated voltage available that will NOT conduct at the supply voltage, while allowing a safe margin.

AutomationDirect's ZL-TSD8-120 transorb module is a good choice for 120VAC circuits. It is a bank of eight bi-directional 180V TVS diodes.



**ZL-TSD8-120**  
Transorb Module

AC MOV or Bi-Directional Diode Circuit

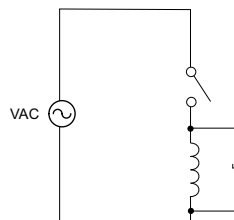

**NOTE:** Manufacturers of devices with coils frequently offer MOV or TVS diode suppressors as an add-on option which mount conveniently across the coil. Before using them, carefully check the suppressor ratings. Just because the suppressor is made specifically for that part does not mean it will reduce the transient voltages to an acceptable level.

For example, a MOV or TVS diode rated for use on 24-48 VDC coils would need to have a high enough voltage rating to NOT conduct at 48V. That suppressor might typically start conducting at roughly 60VDC. If it were mounted across a 24V coil, transients of roughly 84V (if sinking output) or -60V (if sourcing output) could reach the CPU output. Many semiconductor CPU outputs cannot tolerate such levels.

# SECURITY CONSIDERATIONS FOR CONTROL SYSTEMS NETWORKS

---



In This Appendix...

Security Considerations for Controls Networks..... 1-2

# Security Considerations for Control Systems Networks

Manufacturers are realizing that to stay competitive, their Automation and Control Systems need to be more integrated within their plant. The systems often need to be integrated with upstream Enterprise Data Systems, and even further integrated to allow information to be accessible across multiple plants, or even through the Internet. This convergence of the IT world with the Automation World creates challenges in maintaining secure systems and protecting your investments in processes, personnel, data and intellectual property.

While Automation Networks and Systems have built-in password protection schemes, this is only one very small step in securing your systems. Automation Control System Networks need to incorporate data protection and security measures that are at least as robust as a typical business computer system. We recommend that users of PLCs, HMI products and SCADA systems perform your own network security analysis to determine the proper level of security required for your application. However, the Department of Homeland Security's National Cybersecurity and Communications Integration Center (NCCIC) and Industrial Control Systems Cyber Emergency Response Team (ICS-CERT) has provided direction related to network security and safety under an approach described as "Defense in Depth", which is published at [https://ics-cert.uscert.gov/sites/default/files/recommended\\_practices/NCCIC\\_ICSCERT\\_Defense\\_in\\_Depth\\_2016\\_S508C.pdf](https://ics-cert.uscert.gov/sites/default/files/recommended_practices/NCCIC_ICSCERT_Defense_in_Depth_2016_S508C.pdf).

This comprehensive security strategy involves physical protection methods, as well as process and policy methods. This approach creates multiple layers and levels of security for industrial automation systems. Such safeguards include the location of control system networks behind firewalls, their isolation from business networks, the use of intrusion detection systems, and the use of secure methods for remote access such as Virtual Private Networks (VPNs). Further, users should minimize network exposure for all control system devices and such control systems and these systems should not directly face the internet. Following these procedures should significantly reduce your risks both from external sources as well as internal sources, and provide a more secure system.

It is the user's responsibility to protect such systems, just as you would protect your computer and business systems. AutomationDirect recommends using one or more of these resources in putting together a secure system:

- US-CERT's Control Systems Security Program at the following web address: [www.us-cert.gov/control\\_systems/](http://www.us-cert.gov/control_systems/)
- Special Publication 800-82 of the National Institute of Standards and Technology – Guide to Industrial Control Systems (ICS) Security <https://csrc.nist.gov/publications/detail/sp/800-82/rev-2/final>
- ISA99, Industrial Automation and Control Systems Security <http://www.isa.org/MSTemplate.cfm?MicrositeID=988&CommitteeID=6821> (please note this is a summary and these standards have to be purchased from ISA)

The above set of resources provides a comprehensive approach to securing a control system network and reducing risk and exposure from security breaches. Given the nature of any system that accesses the internet, it is incumbent upon each user to assess the needs and requirements of their application, and take steps to mitigate the particular security risks inherent in their control system.