

Installation and Configuration



2

In This Chapter. . . .	page
• Introduction.	2
• Mounting the SC-OPE to an Inverter	5
• Panel Mounting the SC-OPE	8
• DIN Rail Mounting the SC-OPE	12
• Connecting the SC-OPE to an Inverter via a Cable	15
• Powering the SC-OPE via a Dedicated Supply	17
• Connecting the SC-OPE to a PC	18
• SC-OPE Configuration Editing	19

Introduction

Mounting Options

Several mechanical mounting options for the SC-OPE are available. The proper option for your application depends on its requirements as described in the table below. Additional guidelines are on the following page.

Mounting Option	Application Description		
	Inverter Type	Use Network Port, RS-485	Use Network Port, RS-232
Mount to Inverter	SJ300 / L300P only	No	Yes
Panel Mounting	All inverters	Yes	Yes
DIN-rail Mounting	All inverters	Yes	Yes

After the SC-OPE is mounted in the method appropriate for your application, be sure to read the remaining sections in this chapter, starting on page 2-15.

Mount to Inverter

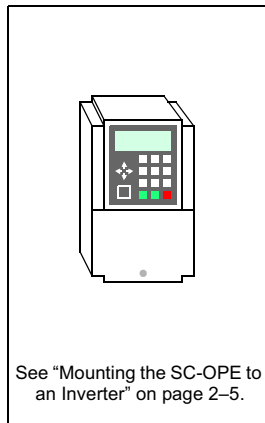

Panel Mounting

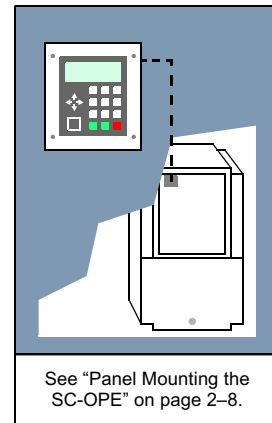

DIN-rail Mounting

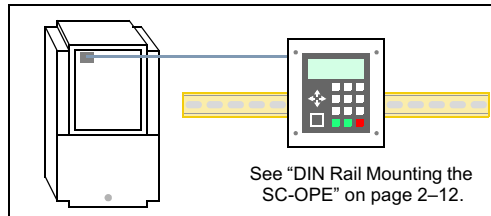

The guidelines for selecting the mounting options are:

- Only the SJ300 and L300P inverter families have the proper keypad bay to accept the SC-OPE for direct mounting. SJ100, L100, and J300 inverters will require remote mounting of the SC-OPE in all applications.
- If you want to use the SC-OPE's RS-485 network port, you must mount the SC-OPE separately from the inverter. This is to accommodate network cabling and a network termination board where applicable. Either the panel mount option or the DIN-rail option will work.
- If you only want to use the SC-OPE's RS-232 network port, any mounting option is permitted.
- If the inverter will be mounted in an enclosure (panel), we generally recommend panel-mounting the SC-OPE. This will provide easy operator access to the keypad, including access to the RS232 port for updating the SC-OPE configuration.
- The Bezel Kit contains the bezel/housing mounting hardware and the network accessories for using the RS-485 port. After performing the basic mechanical SC-OPE mounting you will be ready to make the network connection. See "Setting Up a Network Interface" on page 4-2.



Caution: *Be sure to power OFF the inverter before performing wiring changes to the inverter or SC-OPE 3I, including connecting or disconnecting the SC-OPE from the inverter. Otherwise, erratic operation or damage to either unit may occur.*

Comm Port Introduction

The SC-OPE has two logical serial ports and three physical (connector) ports. Therefore, it is essential to understand the function and location of the SC-OPE serial ports.

- The *inverter port* is located at the top rear edge of the SC-OPE. It must be connected to a single inverter in every application. This serial port is dedicated to communicating with the inverter.
- The *network port* is logically one port, but it is available on two different connectors. The front modular RJ11 connector is an RS-232 network port. The bottom terminal strip connector is an RS-422/485 port. Since these two network ports are logically one port, only one of them may be in use at any time (or you may use neither of them).

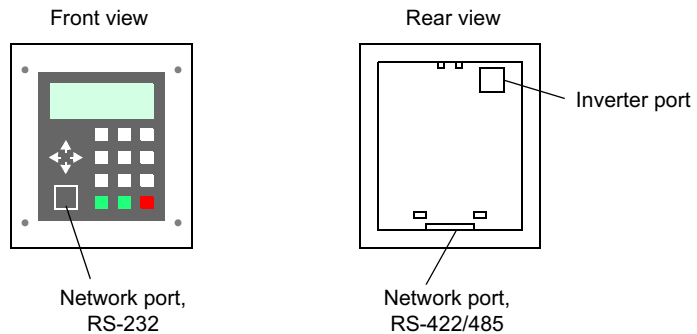

- The SC-OPE automatically detects a connection to a PC (running the Configuration Editor) on the RS-232 network port and communicates with it via a proprietary protocol. This *does not* rely on the current factory network configuration in the SC-OPE. Of course, do not attempt to communicate with the SC-OPE via the Configuration Editor and a factory network protocol at the same time.



Note: The SC-OPE's RS-422/485 port cannot be used for communications to the PC Configuration Editor software. You can only use the RS-232 port.

Mounting the SC-OPE to an Inverter

The SC-OPE 3I can be mounted directly to the inverter housings in the case of SJ300 and L300P families. This is ideal for stand-alone inverter applications (not on a factory network) or laboratory areas in which the inverter is not mounted in a panel enclosure. If the inverter is in a larger enclosure, note that mounting the SC-OPE to the inverter will require panel interior access to use the keypad.

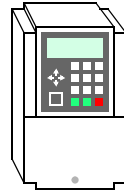

To mount the SC-OPE to an inverter:

1 Remove the standard Hitachi keypad and panel filler plate. The keypad latch is located at its top edge. Press the keypad latch to release. Be sure to put the keypad and filler plate in a safe place in case they may be needed later.



2 Clear the keypad bay of any dust and debris.

3 Remove the SC-OPE from its packing material. Take care not to touch any components on the circuit board to avoid potential static damage.

4 Slide the SC-OPE partially into the keypad bay as shown. As you do this step, keep the SC-OPE front keypad parallel to the inverter front panel. The goal of this step is to ensure the RJ45 interconnect in the inverter's keypad bay aligns with and is partially engaged with the top connector on the back of the SC-OPE. If this is not achieved, the interconnect will bind and make the next two steps impossible to perform.

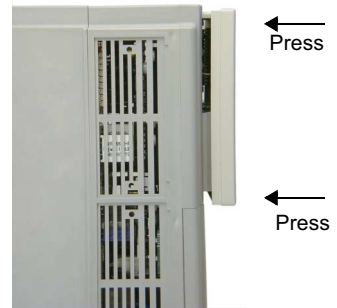

5 Press along the SC-OPE bottom edge to engage the retention latches in the keypad bay. Do not allow the SC-OPE's top edge to slip out of the keypad bay during this step (would cause the RJ45 interconnect to mis-align).

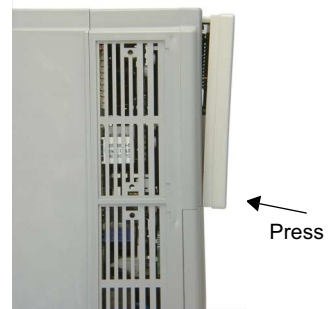

6 Press along the top edge to complete the SC-OPE installation in the inverter.

A proper installation will leave no gaps between the SC-OPE and the inverter front panel as shown below.

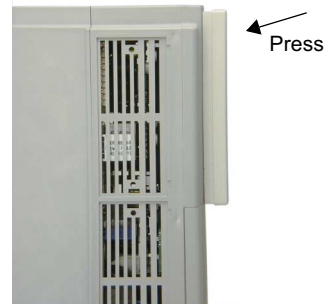

7 To remove the SC-OPE from the inverter, press the retention latch at the top on the SC-OPE housing. One technique is to grasp the SC-OPE at the bottom edge and use the thumb to press the retention latch as shown.



8 Disengage the bottom retention latches and remove the SC-OPE uniformly in order to avoid mechanical binding.

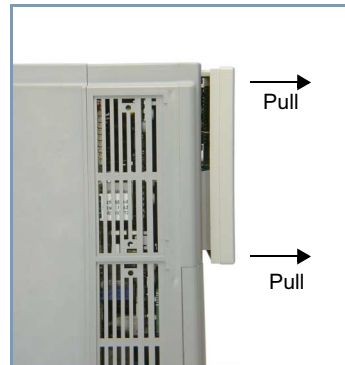

Panel Mounting the SC-OPE

The SC-OPE will be panel mounted in most applications. Panel mounting provides convenient operator access to inverter control while protecting the inverter inside an enclosure / control panel. Also, mounting the SC-OPE remotely from the inverter is required in network application to facilitate network wiring and termination. You will need a Bezel Kit to panel mount each SC-OPE device.



Tip: We recommend initial mounting of the bezel/housing without the SC-OPE keypad. This protects the electrical components from dust, debris, and unnecessary handling until the bezel/housing installation is complete.

To mount the SC-OPE into a control panel or operator panel:

1 Use the dimensions in the diagram below to mark the cutting and drilling locations on the panel. Dimensions are in mm (inches) format.

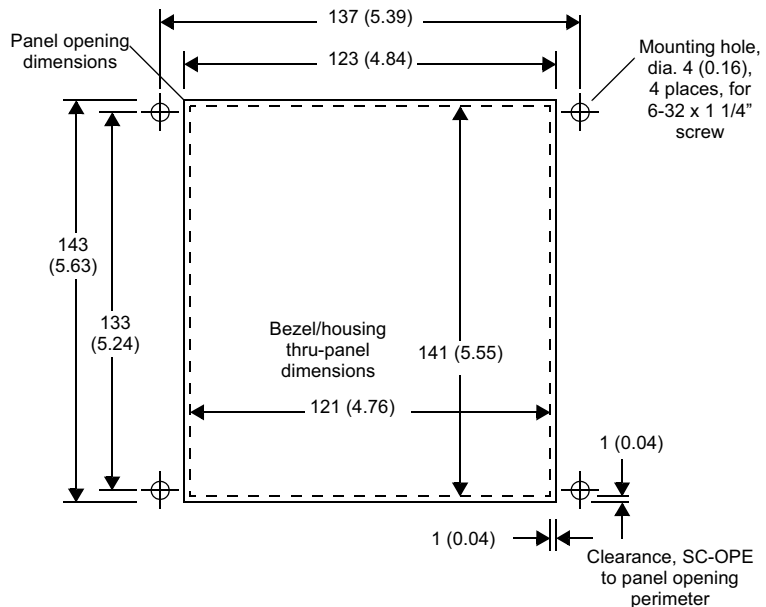

Note: Be sure proper clearance behind the SC-OPE mounting location exists and that the cable from the inverter will be long enough to reach the mounting location.

An example panel cutout is shown to the right. Be sure cutout lines are level and square with the control panel edges. Clean any debris from the edges and holes before proceeding.

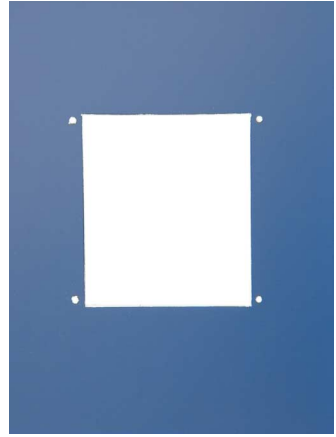

2 Place the gasket (included in the Bezel Kit) around the inside perimeter of the bezel/housing as shown. Align the holes in the gasket with the ones in the corners of the bezel/housing. This gasket provides a seal between the bezel/housing and the panel's front surface.



Tip: We recommend installing only the bezel/housing into the panel at this point. The SC-OPE will be installed into the bezel/housing later in this procedure.



3 From the front side of the bezel/housing, insert the four mounting screws through the housing and the gasket. This will serve to maintain alignment between gasket and housing for the next step.

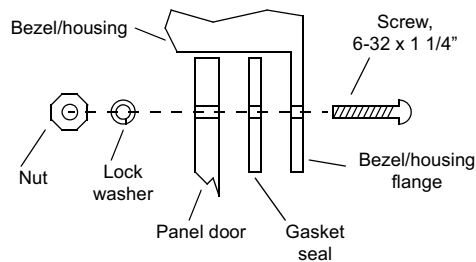

4 Now, take the bezel/housing and gasket assembly and insert it into the panel opening as shown.

5 On the back of the panel, use the lock washers and nuts (provided in the Bezel Kit) to secure the bezel/housing to the panel.

6 Locate the O-ring seal in the Bezel Kit components and orient it as shown (below, left). The seal ensures a tight fit between the SC-OPE and the bezel/housing.

7 Carefully stretch the O-ring around the SC-OPE and situate it in the perimeter stepped channel as shown (below, right).

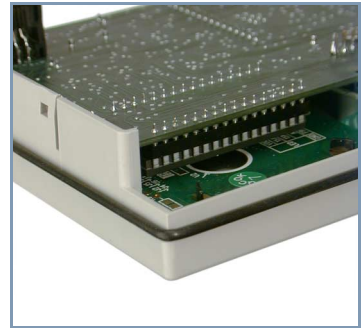
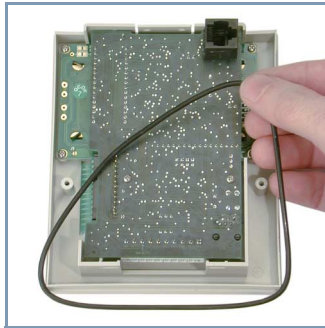

8 Take the SC-OPE and tilt it into the bezel/housing opening in the panel, latching the bottom edge first as shown (below, left). Then push the top of the SC-OPE keypad to engage the upper latch (below, right).



9 Secure the SC-OPE to the bezel/housing with the two 3-38 x 1" screws (included in the Bezel Kit).



To remove the SC-OPE from the bezel/housing (at a later time):

1 Unfasten the two screws on the back of the bezel/housing (below, left).

2 While ensuring the SC-OPE does not fall freely out of the bezel/housing, press gently on the modular connector from the rear of the unit as shown (below, right). This will unfasten the upper latch in the bezel/housing.



DIN Rail Mounting the SC-OPE

The SC-OPE can be mounted to a DIN rail as shown. This option is ideal for mounting in a panel when use of the keypad is primarily for service technicians rather than machine operators. The required bezel/housing and DIN rail clips are included in the Bezel Kit.

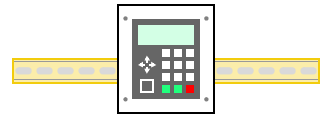

To mount the SC-OPE to a DIN rail:

1 Secure the DIN rail to a solid surface.

- Attach the DIN rail (fasteners not included) at the points shown to keep the DIN rail from twisting when installing/removing the SC-OPE.
- Ensure the space available has adequate clearance for the SC-OPE bezel/housing.
- Ensure keypad access will be suitable for a technician or operator.

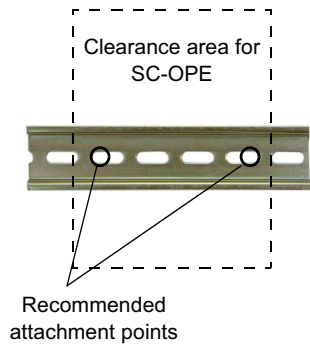

2 Locate the O-ring seal in the Bezel Kit components and orient it as shown (below, left). The seal ensures a tight fit between the SC-OPE and the bezel/housing.

3 Carefully stretch the O-ring around the SC-OPE and situate it in the perimeter stepped channel as shown (below, right).

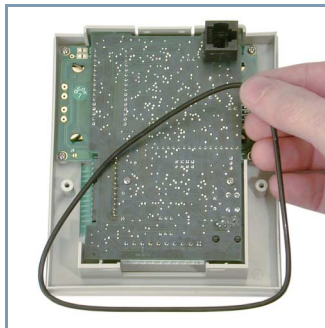

4 Insert the SC-OPE into the bezel/housing. You can use the square modular connector and corresponding opening to verify the orientation of the two parts. Begin with the SC-OPE bottom edge as shown (below, left), engaging the two internal latches at the bottom of the bezel/housing.

5 Tilt the top of the SC-OPE into the bezel/housing and latch (below, right).

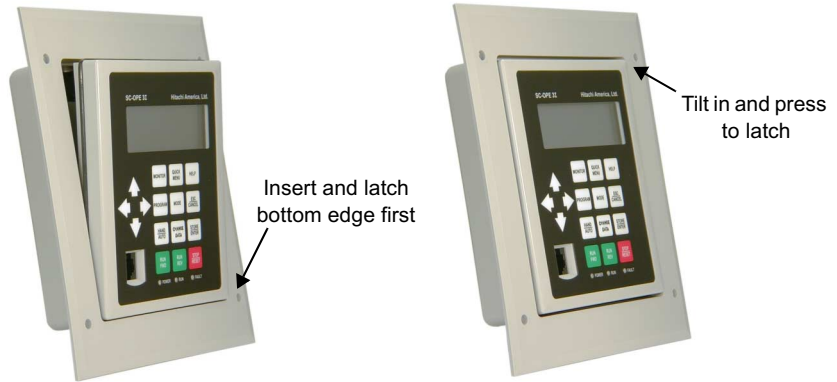

6 Attach the two DIN rail clips using the two 1 1/4" x 4-40 screws included in the Bezel kit. Be sure to orient the clips with the hooked ends pointing upwards as shown (below, left). This will allow you to hang the SC-OPE from the top edge of a DIN rail and press against the rail to latch in the bottom edge as shown (below, right)

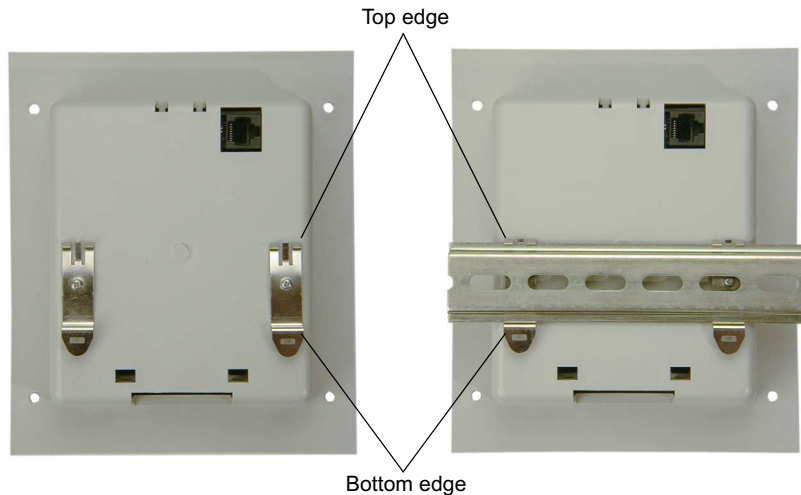

7 Mount the SC-OPE to the DIN rail. First, hang the tops of the DIN rail clips over the top edge of the rail. Then push inward on the lower part of the bezel/housing to latch the SC-OPE to the DIN rail.

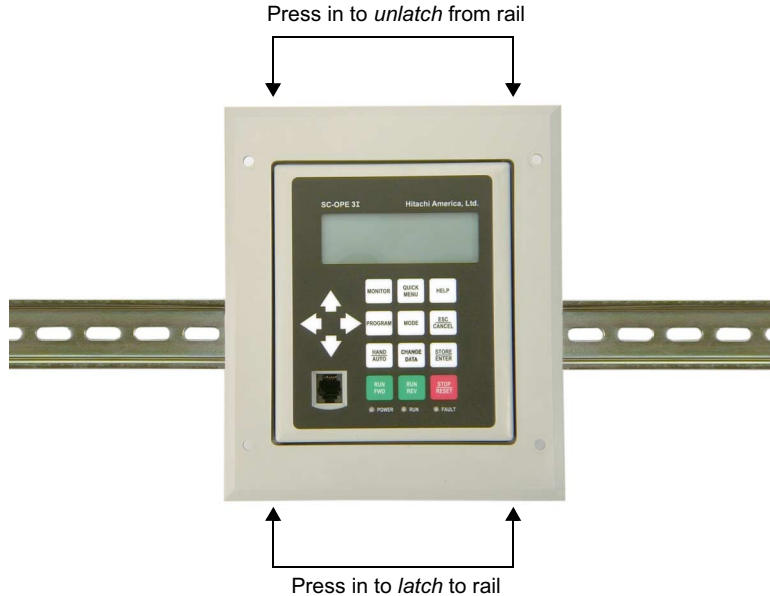

8 Removal of the SC-OPE from the DIN rail is accomplished by pressing on the front top edge of the SC-OPE bezel/housing. This acts as a lever to unlatch the DIN rail clips at the bottom edge of the rail. This capability requires that the DIN rail be mounted securely to a solid surface as described in Step 1.

The next section shows how to connect the SC-OPE to the inverter.

Connecting the SC-OPE to an Inverter via a Cable

The panel mounting and DIN rail mounting options for SC-OPE installation require the use of a cable for SC-OPE-to-inverter communications. A cable is included in the Bezel Kit for this purpose.



Note: DIN-rail mounting the SC-OPE leaves a small clearance for the cable to exit. Standard modular connectors (such as Hitachi cable ICS-3) have an end connector too large to fit between the SC-OPE and the wall behind it when DIN-rail mounted. Be sure to use the cable supplied in the Bezel Kit.

To connect the SC-OPE to an inverter via a cable:

1 Carefully remove the modular interconnect in the inverter's modular as shown. Be sure to grasp the latching prong such that it releases the connector for easy removal.



Caution: DO NOT use excessive force to remove the modular interconnect. Otherwise, damage to inverter circuitry may occur.

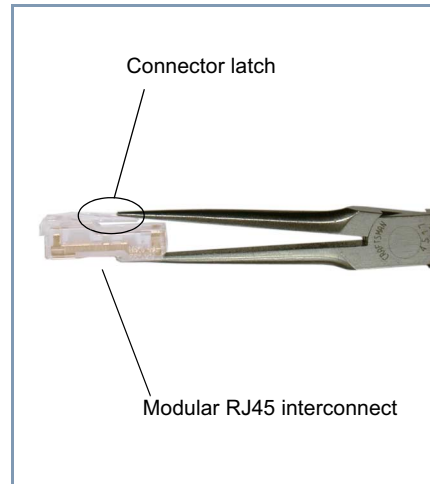

2 Plug the cable (included in the Bezel Kit) into the inverter's communication port (SJ300 shown below, left). The connector location for SJ100/L100 families is under the inverter housing.

3 Connect the other end of the cable to the SC-OPE as shown (below, right). If DIN rail mounted, you'll need to temporarily detach the SC-OPE assembly from the DIN rail for connector access.



Powering the SC-OPE via a Dedicated Supply

If you have already connected the SC-OPE to an inverter (described in the previous section), the SC-OPE will have the communications and power it needs to operate the inverter. In any of the mounting configurations and normal use, the SC-OPE gets its operating power from the inverter. However, it may be desirable in some situations to power the SC-OPE when an inverter is not available. For example, you could connect a PC to the SC-OPE and configure it (described later in this chapter). This section will show you how to power the SC-OPE using an alternate method.



Caution: Do not connect the SC-OPE to an inverter and also connect a power supply to the SC-OPE at the same time. Otherwise, there is the danger of damaging the SC-OPE or the inverter circuitry.

To connect an external supply to the SC-OPE:

- 1 Locate the 10-pin connector plug (supplied in the bezel kit).
- 2 Acquire a fully regulated 5VDC supply, $\pm 5\%$ (4.75V min. to 5.25V max.)
- 3 Connect the power supply to the 10-pin connector as shown below (GND to pin 10, +5V to pin 9).
- 4 Plug the connector into the network port of the SC-OPE.

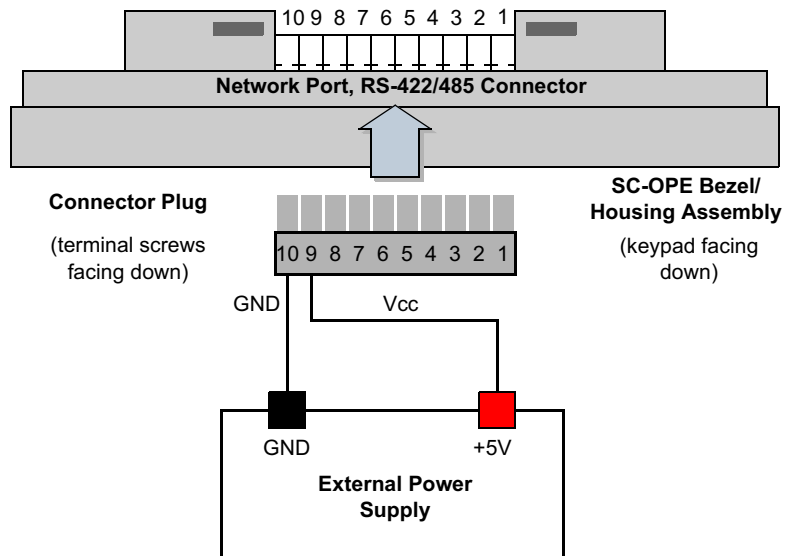

Connecting the SC-OPE to a PC

The Configuration Kit includes a cable for connecting a PC to a SC-OPE. The typical connection will use a standard PC serial port, connecting it to the SC-OPE's front network port (RS-232).

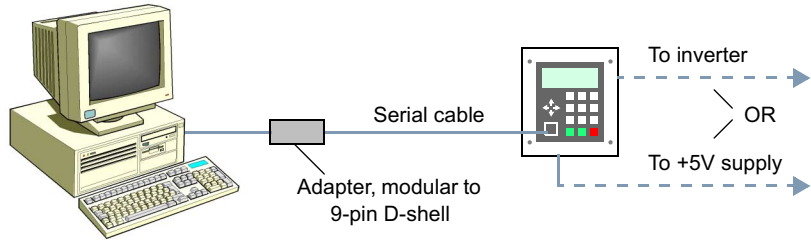

To connect the SC-OPE to a PC:

1 Ensure the SC-OPE has a power source, typically provided by the inverter (see “Connecting the SC-OPE to an Inverter via a Cable” on page 2-15). Or, you may use an external power supply (see “Powering the SC-OPE via a Dedicated Supply” on page 2-17). *Do not* use both power sources at the same time.

2 Plug one RJ11 modular end of the cable into the cable adapter as shown.

3 Plug the other end of the cable into the SC-OPE's RS-232 port as shown.

4 You have two options in connecting the opposite cable end to a PC:

- For shorter distances, connect the adapter end of the cable directly to a 9-pin RS-232 port connector on the PC.
- For longer distances, connect a standard serial cable between the adapter and an RS-232 port connector on the PC.



Note: The SC-OPE will communicate with its Configuration Editor in a PC via the RS-232 port. Do not attempt to use the Configuration Editor over a factory network.



SC-OPE Configuration Editing

Introduction

The SC-OPE 3I firmware enables it to communicate via a particular factory network protocol and with a particular inverter family. Additional settings configure the SC-OPE's Quick Menu, Startup Screen, and Help Screen. You may need to change the SC-OPE configuration from the factory defaults for your application.

The compatible inverter families are:

- SJ300 (factory default)
- L300P
- SJ100
- L100
- J300

The compatible factory networks are:

- DirectNet
- Allen-Bradley DF1
- ModBus RTU (factory default)
- ModBus ASCII
- Metasys N2

A SC-OPE configuration specifies an inverter family and a network protocol (along with associated baud rate, etc.) Even though each configuration contains a network selection, you may operate a SC-OPE and inverter without making any factory network connection.

Basic SC-OPE configuration settings may be edited with the SC-OPE keypad. The Configuration Editor (PC software) provides access to all configuration settings, and it can transfer configurations between the SC-OPE and PC.



Note: A SC-OPE configuration does not contain inverter parameter settings. You can use the SC-OPE as a “copy unit” (upload parameters from one inverter and download them to another inverter). Since inverter parameters are not part of a SC-OPE configuration, a SC-OPE configuration file saved to disk does not store inverter parameters.

Installing the Configuration Editor

The Configuration Kit includes an installation CD-ROM, serial cable, and cable adapter. This is all you will need to connect a PC to the SC-OPE and edit the configuration.

To install the SC-OPE Configuration Editor software:

1 Insert the software installation CD into the CD-ROM drive in your PC. If the drive is configured to auto-run, the installation will automatically begin, and you can skip to step 7.

2 If the CD-ROM does not auto-run... From Windows' desktop, click Start > Run.

3 In the Run dialog, click Browse...

4 In the Browse dialog, navigate to the CD-ROM drive letter (typically D:) and click Open.

5 Click (select) the file "setup" and click Open.

6 In the Run dialog, the filename path "D:\Setup.exe" will appear in the Open field. Click OK.

7 Follow the on-screen instructions in the installation dialog boxes. You will have the choice of the install directory destination and program folder.

8 Click Finish when the installation is complete, and remove the CD-ROM from the drive.

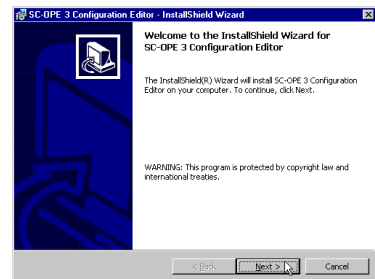
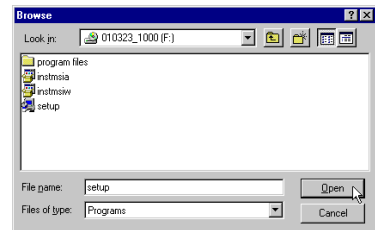

(Optional) To create a desktop shortcut to the Configuration Editor:

- 1 On the desktop, right click and select New > Shortcut from the menu.
- 2 In the Create Shortcut dialog box, click Browse...

3 In the Browse dialog box, navigate to the installation directory. Example:
C:\Program Files\Hitachi\Scope

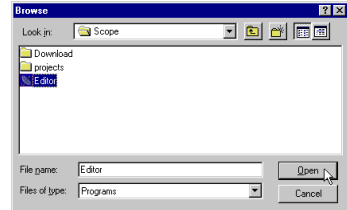

4 Click (select) the Editor file and click Open.

5 In the Create Shortcut dialog box, click Next.

6 In the Select a Title for the Program dialog Box, enter a name such as “Scope 3 Editor.” and click Finish. The new shortcut will be on the desktop.



Uploading a Configuration

Using the Configuration Editor requires that you have performed basic setup tasks (per the procedures given in prior sections in this chapter).

To prepare to edit a SC-OPE configuration:

- 1 Install the configuration software on the PC.
- 2 Connect the SC-OPE to the inverter (either through direct mounting or via the cable supplied in the Bezel Kit).
- 3 Connect the SC-OPE to an open serial port on your PC, using the cable supplied in the Configuration Kit.

PC with Configuration Editor

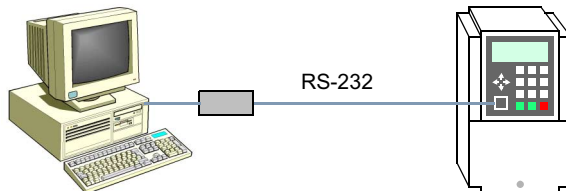

To upload a configuration from the SC-OPE to the PC:

1 From Window's desktop, click Start > Programs > Hitachi > SC-OPE 3 Editor. Then the SC-OPE 3 Configuration Editor window will appear. Initially empty, the window area will eventually contain configuration window(s) when you have uploaded or created new ones.

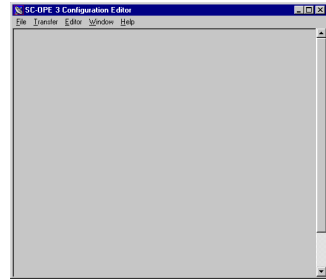

2 Select the COM port the editor will use to communicate with the SC-OPE. From the editor's menu, click Editor > Set COM Port Option > COM1 (or COM2, COM3, or COM4) as needed for your PC.

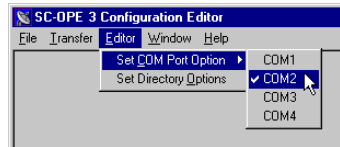

If you select a COM port that is already in use on your PC, an error message will appear. Click OK and repeat this step, selecting an available COM port.

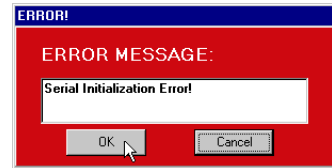

3 Turn on power to the inverter, thus powering the SC-OPE. Ensure the motor (if connected) is not rotating at this time (press the Stop/Reset key if necessary).



Note: The SC-OPE can only communicate with an inverter of the type specified in its configuration. If your SC-OPE is connected to a different type of inverter, the SC-OPE will not power up to normal operation. However, you can still re-configure the SC-OPE for proper operation by following this procedure.

4 Press the Mode key for 4 seconds to place the SC-OPE in Configuration Transfer Mode. This mode permits you to transfer SC-OPE configurations to/from the PC.

MODE
(4 seconds)



Config Transfer Mode
Waiting for PC...
Press MODE key for
Configuration menu.



Note: More information on SC-OPE operating modes is in Chapter 3. This section covers only the essential mode changes for configuration tasks.

5 From the Configuration Editor's menu, click Transfer > Upload Configuration. A dialog box appears, reminding you to do the setup tasks covered in the steps above. Click OK.

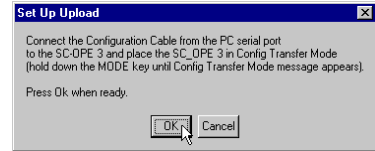

At this point the Editor will attempt to communicate with the SC-OPE and upload its current configuration to the PC. If the upload is successful, you'll see the confirming messages below.

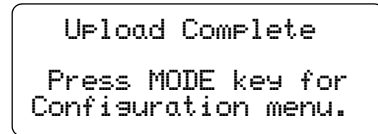
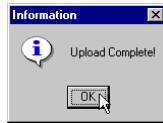

If the upload is *not* successful, correct the problem (such as serial cable connection incorrect, etc.) and repeat the above steps.

6 Click OK in the Information dialog box and the Configuration Editor will display the uploaded configuration in its own window, displaying primary information in the fields as shown. Each settings group can be edited with the corresponding Setup button.

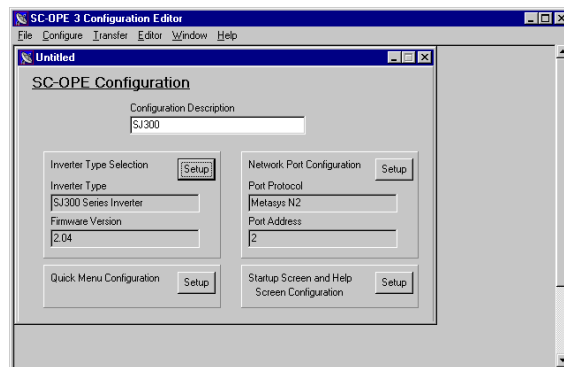

Inverter Type Configuration

The SC-OPE firmware contains the software that enables it to communicate with an inverter. Three unique firmware sets provide SC-OPE communication capability:

1. SJ100 / L100 firmware
2. SJ300 / L300P firmware
3. J300 firmware

When you use the Configuration Editor to configure the inverter type, a Download Configuration operation will automatically load the appropriate firmware to the SC-OPE. In the cases of 1) and 2) above, you can change between the two corresponding inverter types that share the same firmware by using only the SC-OPE keypad (for example, SJ100 and L100). This provides some flexibility without having to use the Configuration Editor in every inverter type change. A change of firmware *always* requires the use of the Configuration Editor, however. When staying within the same firmware type, you can use the SC-OPE keypad for convenience.

This section shows both methods for configuring inverter type.

To change the inverter type selection by using the Configuration Editor:

1 In the Inverter type Selection group, click the Setup button.

2 In the Inverter Type Selection dialog box, use the pull-down menu to select the inverter type you want the SC-OPE to target for communications.

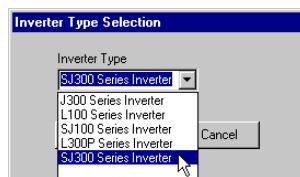

Note: You can configure the SC-OPE for an inverter type belonging to a different firmware set than the type of inverter currently connected to the SC-OPE. However, remember that SC-OPE operation will be restricted to Configuration Mode until its firmware matches the type of inverter that is actually connected. In that case, the SC-OPE will power up and only display the Startup Screen. Press the Mode key for 4 seconds to enter Config Transfer Mode.

To change the inverter type selection by using the SC-OPE keypad:

1 Press the Mode key for 4 seconds to place the SC-OPE in Configuration Transfer Mode.



(4 seconds)

```

Confis Transfer Mode
Waiting for PC...
Press MODE key for
Configuration menu.
    
```

2 Press the Mode key again (briefly) to get the Configuration Menu. The Inverter Port Cfg item at the top of the menu list determines the inverter type selection.



```

Configuration Menu
Inverter Port Cfg
>>
    
```

3 Press the Right Arrow key to view the Inverter Port Cfg sub-menu that consists of one item: Inverter Type.



```

Configuration Menu
Inverter Type
SJ300 Series
    
```

4 Press the Change Data key. The ">" and "<" characters indicate that Change Data is active.



```

Configuration Menu
Inverter Type
>SJ300 Series<
    
```

5 Press the Up Arrow or Down Arrow keys as needed to select the new type. Remember that only the inverter type that shares the current firmware in the SC-OPE can connect (using this method).

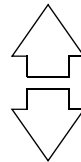

```

Configuration Menu
Inverter Type
>L300 Series<
    
```

6 Press Store/Enter to accept the new inverter type.



```

Configuration Menu
Inverter Type
L300 Series
    
```

7 Press the Left Arrow key to exit the Inverter Type sub-menu.



```

Configuration Menu
Inverter Port Cfg
>>
    
```

8 Press the Down Arrow key twice to access the Store Configuration Menu Item.

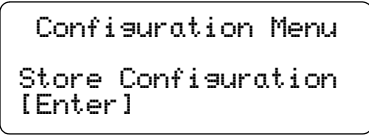
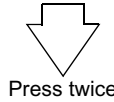

9 Press the Store/Enter key to store the configuration change.

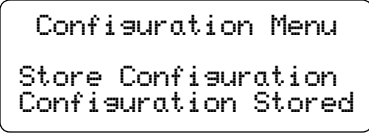

Network Port Configuration

Network port configuration is only necessary when connecting the SC-OPE to a factory network. SC-OPE communications to the Configuration Editor is automatic (does not require network port configuration). This section shows how to configure the network port using the Configuration Editor or using the SC-OPE keypad.

To configure the network port by using the Configuration Editor:

1 In the Network Port Configuration group, click the Setup button. The Network Port dialog box will appear.

2 In the Port Protocol field, click the desired factory network protocol in the list.

3 Please refer to Chapter 4 for a complete discussion on the remainder of the settings and the related wiring diagrams, network termination considerations, etc.

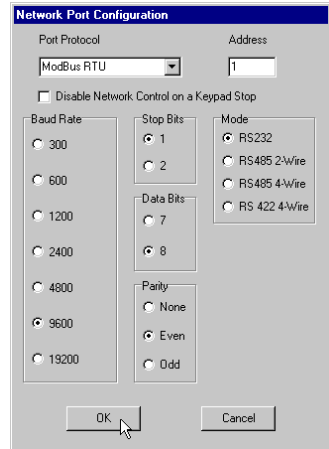

Note: The configuration edits do not affect the SC-OPE until you download the new configuration to the SC-OPE.



To configure the network port by using the SC-OPE keypad:

1 Press the Mode key for 4 seconds to place the SC-OPE in Configuration Transfer Mode.

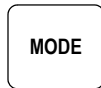

(4 seconds)

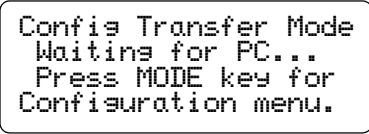

2 Press the Mode key again (briefly) to get the Configuration Menu.



```
Configuration Menu
Inverter Port Cfg
>>
```

3 Press the Down Arrow key once to view the second list item, Network Port Cfg.



```
Configuration Menu
Network Port Cfg
>>
```

4 Press the Right Arrow key to view the Network Port Cfg sub-menu list.



```
Configuration Menu
Network Protocol
Modbus RTU
```

5 Access the desired network port attribute item by using the Up and Down arrow keys.

The list includes:

- Network Protocol (factory network)
- Network Address (node address 1 to 255)
- Network Port Type (RS-232, RS-485 2-wire, RS-485 4-wire, RS-422 4-wire)
- Network Config (baud rate)
- Network Config (data bits)
- Network Config (parity)
- Network Config (Stop bits)
- Network Config (Flow control)
- Network Config (RTS delay)
- Network Port Mode (master/slave)
- Network Max Gap Time
- Stop Key Action (enables or disables keypad Stop key during network control)

6 Press the Change Data key to begin editing a setting.

CHANGE
DATA

```

Confisuration Menu
Network Protocol
>Modbus RTU<
  
```

7 Use the Up and Down Arrow keys to change the setting selection.

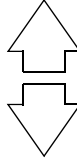

```

Confisuration Menu
Network Protocol
>DirectNet<
  
```

8 Press the Store/Enter key to accept the new setting.

STORE
ENTER

```

Confisuration Menu
Network Protocol
DirectNet
  
```

9 Press the Left Arrow key to exit the Network Port Cfg sub-menu.



```

Confisuration Menu
Network Port Cfg
>>
  
```

10 Press the Down Arrow key once to access the Store Configuration menu item.



```

Confisuration Menu
Store Confisuration
[Enter]
  
```

11 Press the Store/Enter key to store the configuration change.

STORE
ENTER

```

Confisuration Menu
Store Confisuration
Confisuration Stored
  
```

Quick Menu Configuration

The SC-OPE's Quick Menu presents a subset of the inverter parameters for monitoring or editing via the keypad in normal operation. The single key Quick Menu provides fast access to a circular list of up to 32 items. The factory default Quick Menu can be edited with the Configuration Editor to provide a custom menu for specific applications or market segments. For example, a Quick Menu that is optimized for HVAC applications will be different from a menu optimized for a pumping station.

To configure the Quick Menu:

1 In the Quick Menu Configuration group, click the Setup button. The Configure Quick Menu dialog box will appear as shown. The list of parameters is the current Quick Menu in the SC-OPE.

2 Use the buttons at the top of the Configure Quick Menu dialog box to change the list:

- **Add** – Click Add to add a new item to the bottom of the menu list. Select the new parameter from the pop-up menu and click OK.
- **Insert** – Click Insert to insert a new item just above the currently selected item in the menu list. Select the parameter from the pop-up menu and click OK.
- **Delete** – Click Delete to delete the currently selected item in the menu list.
- **Edit** – Click Edit to replace the currently selected item in the menu list. Select the new parameter from the pop-up menu and click OK.
- **Default** – Click Default to restore the factory default list.
- **Cancel** – Click Cancel to discard edit(s) to the Quick Menu Configuration in the Editor.
- **OK** – Click OK to apply the changes (Add, Insert, Delete, Edit, Default) to the configuration.

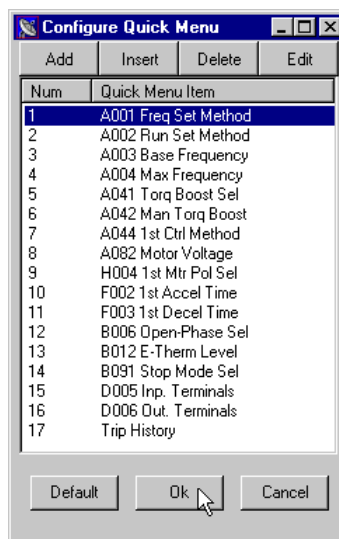

Note: The configuration edits do not affect the SC-OPE until you download the new configuration to the SC-OPE.

Startup Screen and Help Screen Configuration

The SC-OPE features two user-configurable information screens. The *Startup Screen* is displayed momentarily at powerup. The *Help Screen* is displayed (during normal operation) when you press the Help key on the keypad. These configurable screens are suited for editing by OEMs for their specific application areas.

```

-----
HITACHI AMERICA, Ltd
SC-OPE 3I -SJ300
----- Ver 2.09 -----

```

Startup screen (default)

```

For assistance, call
Hitachi America, Ltd
1-914-631-0600

```

Help Screen (default)

To edit the content of the Startup and Help Screens:

1 In the Startup Screen and Help Screen Configuration group, click the Setup button. The Edit Screens dialog box will appear.

2 To edit a line in the screens, click the cursor in the appropriate field and enter (or edit) the existing content.

Note: The bottom two lines of the Startup Screen have fixed content and cannot be edited.

3 Click Default to restore the screens to display the factory default content as shown above.

4 Click OK when you have completed the screen content edits.

Note: The configuration edits do not affect the SC-OPE until you download the new configuration to the SC-OPE.

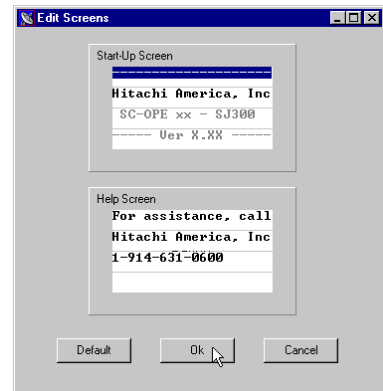

Downloading a Configuration

The previous sections describe how to upload and edit a configuration. To actually update the SC-OPE's firmware, you must download the new configuration from the PC to the SC-OPE.

To download a configuration from the Editor:

1 Ensure the SC-OPE is in Config Transfer Mode (will display screen as shown below). If necessary, press the Mode key for 4 seconds to place the SC-OPE in Configuration Transfer Mode.

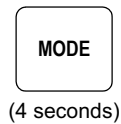

```
Config Transfer Mode
Waiting for PC...
Press MODE key for
Configuration menu.
```

2 From the Configuration Editor, click Transfer > Download Configuration. A dialog box appears, reminding you of transfer setup details. Click OK.

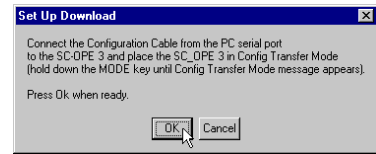

3 The Download SC-OPE Configuration windows shows the transfer progress. When complete, click OK.
(continued, next page...)

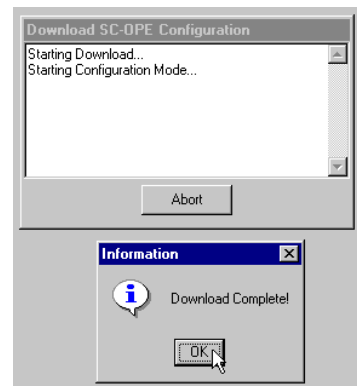

When you have changed the inverter type in a configuration (such as from “L100” to “SJ100”), a configuration download includes inverter-specific firmware for the SC-OPE. The status message “Starting Flash Download Mode” followed by “Buffer 1 of 8” etc. indicates the new inverter-specific firmware is downloading. The SC-OPE shows the buffer (block) number that is currently loading.

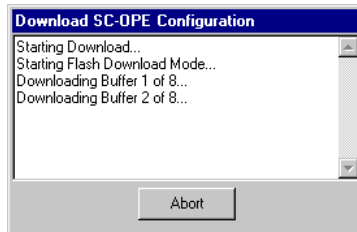

Waiting for
Block 1 of 8

Note: Configuration uploads do not include inverter-specific firmware. The Editor installation already contains all inverter-specific firmware files in its subdirectory named “Download.”

4 After downloading the configuration you may want to return the SC-OPE to normal operation from Configuration Mode. Press the Mode key for 6 seconds as shown.

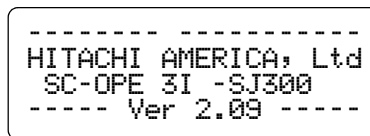
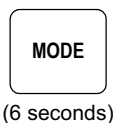

Naming / Saving Configurations

The editor has the capability to save SC-OPE configurations to disk in your PC. Each configuration will have a unique filename. Before saving a configuration, you can enter a text Configuration Description in the field provided as shown.



To save a configuration to disk:

- 1 From the Configuration Editor menu, click File > Save.
- 2 In the Save As dialog box, navigate to the desired directory, enter the filename, and click Save. Each configuration uses the “*.prj” filename format.

Editor Options

The Configuration Editor has options you can set based on your PC hardware and your preferences.

To select the COM port:

- From the Configuration Editor menu, click Editor > Set COM Port Option > COM1 (use available COM port on your PC).

To set the directory options:

1 From the Configuration Editor menu, click Editor > Set Directory Options. The Current Directories dialog box will appear as shown.

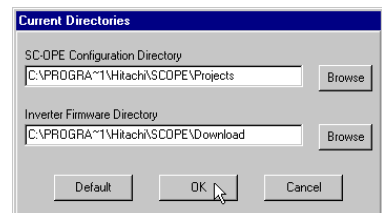

2 The SC-OPE Configuration Directory is the default directory the Editor uses when you click File > Save. Click Browse to navigate to the directory of your choice.

3 The Inverter Firmware Directory is the directory within the Editor installation on your PC that contains SC-OPE firmware versions specific to inverter families. Change this directory ONLY if you have obtained SC-OPE firmware files and located them in a directory different from the default installation directory.

4 Click Default if you want to restore the directory paths to the original ones in the Editor installation.

5 Click OK to save the options for the Editor.

Printing a Configuration

You can print the settings that comprise a configuration. This feature is handy for creating project documentation.

To print a configuration:

- 1 From the Configuration Editor menu, click File > Print.
- 2 In the Print dialog box, change any settings as needed and click OK.

Viewing Multiple Configurations

In applications using multiple SC-OPE devices and configurations, you may have multiple configurations open in the Configuration Editor. Each open configuration file will have its own window.

To manage multiple configuration file windows in the Configuration Editor:

- 1 From the Configuration Editor menu, click Window > Tile, or Window > Cascade, or Window > Arrange icons to display the configuration windows in corresponding fashion.
- 2 You can restore any minimized configuration window to bring it to the front. From the Configuration Editor menu, click Window > <windowname>, where the numbered list contains the configuration window names.