

# Using the Keypad for Inverter Operation

A decorative graphic consisting of a black parallelogram with a white number '3' inside, set against a background of gray and white diagonal stripes.

## 3

---

In This Chapter. . . .	page
• Orientation to Using the SC-OPE. . . . .	2
• Inverter Operation from the SC-OPE Keypad . . . . .	4
• Program Mode . . . . .	12
• SC-OPE and Inverter Memory Resources . . . . .	18
• Quick Menu Operation . . . . .	20
• Copying Parameters Between Inverters. . . . .	26
• Monitor Mode . . . . .	28
• Restoring Factory Default Inverter Settings . . . . .	33

## Orientation to Using the SC-OPE

### Using the Keypad

The SC-OPE 3I keypad provides direct access to inverter control and programming of parameters. The keypad layout arrangement shown below groups the keys into functional groups—keys that perform similar or related functions.

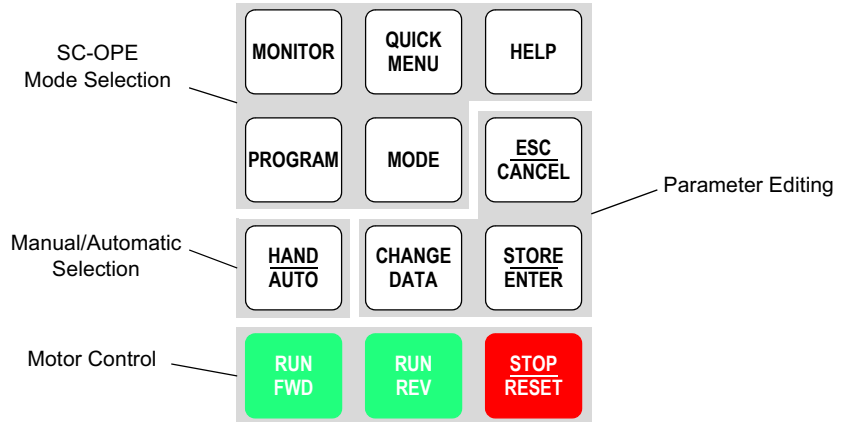

**SC-OPE Mode Selection** The SC-OPE 3I has operational modes that are independent of the attached inverter's modes. These include Monitor Mode, Program Mode, Quick Menu, and Help. The four corresponding keys provide immediate access to the respective mode; you can jump from any of the modes to another with a single key press. Powerup of the SC-OPE always enters Monitor Mode.

The Mode key performs a fundamental role in mode selection by switching the SC-OPE from its four normal modes to Configuration Mode and back to normal operation (to Monitor Mode).

**Manual/Automatic Selection** The Hand/Auto key allows the operator to select the source device for the Run (FWD and REV) Commands and the inverter frequency setting. Successive Hand/Auto key presses sequence through a fixed set of selections. Source devices include the SC-OPE keypad and the inverter input terminals.

**Parameter Editing** The Change Data key, Store/Enter Key, and Esc/Cancel key work together to change inverter settings. When using these keys in Program Mode, you can change inverter parameter values. When used in Monitor Mode, you can change the output frequency (controls motor speed) of the inverter.

**Motor Control** The Run FWD, Run REV, and Stop/Reset keys provide direct control over the inverter's output. These work independently of the SC-OPE's four normal modes. However, you cannot run the motor when in Configuration Mode.

**SC-OPE  
Normal Oper-  
ating Modes**

The SC-OPE 3I normal operational modes feature unique display output fields. Press the corresponding key to view the default or mode entry screen contents.

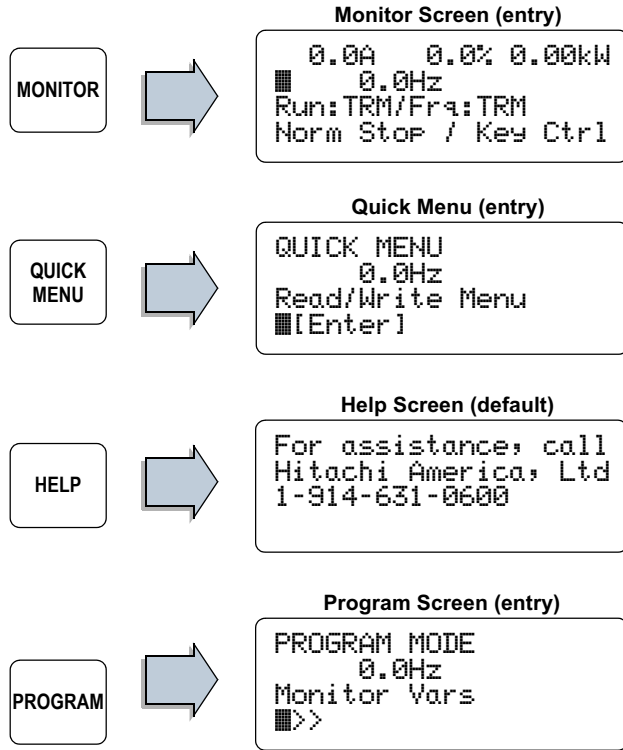

Using the Keypad for Inverter Operation

The diagram below shows the organization of the SC-OPE's operating modes. The line and arrows indicate that you can switch from any mode to any other mode.

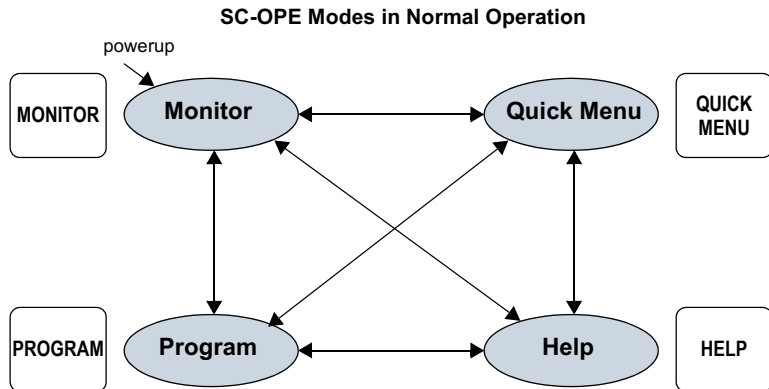

## Inverter Operation from the SC-OPE Keypad

### Selecting Keypad or Network Control

An operator can run and program the inverter from the SC-OPE keypad. To achieve unattended operation, the operator can configure the SC-OPE to send factory network commands it receives on to the inverter. These can also run and program the inverter. During network control, the SC-OPE's keypad will be prevented from editing parameters or running the motor in order to avoid a conflict with network host commands. The diagram below illustrates control via keypad or network.

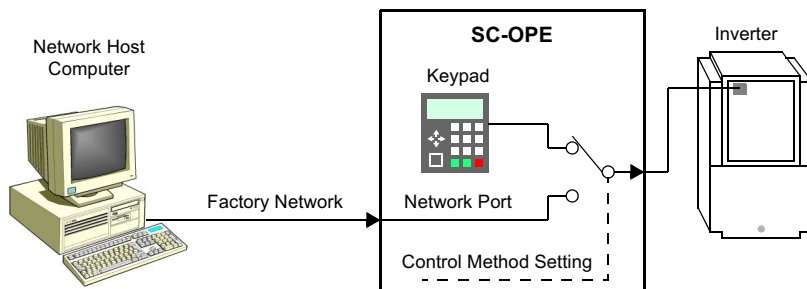

The SC-OPE's control method setting is fundamental and very important to know. Its default setting is "Keypad Control," displayed in Monitor Mode in the corner

MONITOR

```

0.0A  0.0% 0.00kW
0.00  0.00Hz
Run:OPE/Frq:OPE
Norm Stop / Key Ctrl
  
```

Control method setting

of the display. It is not necessary to change this setting unless you have a factory network connection and want the network host to control the inverter.

### To change the Control Method setting:

**1** Press the Program key to enter Program Mode.

PROGRAM

```

PROGRAM MENU
0.0Hz
Monitor Vars
[ ]>>
  
```

**2** Press the Down Arrow key four times to arrive at the Network Control menu item.



4 times

```

PROGRAM MENU
0.0Hz
Network Control
[ ]>>
  
```

3 Press the Right Arrow key to access the first item on the Network Control menu: Control Method.



```
PROGRAM MENU
  0.0Hz
Control Method
■Keypad
```

4 Press the Change Data key. The “>” and “<” characters indicate Change Data is active.



```
PROGRAM MENU
  0.0Hz
Control Method
>Keypad<
```

5 Press the Down Arrow key to select Network, or the Up Arrow key to select Keypad (see note below).



```
PROGRAM MENU
  0.0Hz
Control Method
>Network<
```



**Note:** For the purpose of following the discussion in this chapter, leave the Control Method setting at “Keypad.” If you want a network host to control the inverter, set Control Method to “Network” and refer to Chapter 4 for network control material.

6 Press Store/Enter to accept the new selection, or Esc/Cancel to abort the edit.



```
PROGRAM MENU
  0.0Hz
Control Method
■Keypad
```

7 Press the Monitor Key to return to the default powerup mode of the SC-OPE. The Control Method setting will be displayed in the corner of the display.



```
0.0A  0.0% 0.00kW
■ 0.00  0.00Hz
Run:OPE/Frq:OPE
Norm Stop / Net Ctrl
```

Control method setting

## Limiting the Direction of Rotation



Before you use the SC-OPE the first time in any application, it is very important to consider any motion restrictions the load may place on the motor.

**Caution:** *The SC-OPE 3I keypad has FWD Run and REV Run keys that are equally accessible to an operator. However, some machines are designed for rotation in only one direction—and may be damaged if run in the opposite direction. If you have such an application, you must follow the instructions in this section to protect against accidental reverse rotation.*



When a machine can run in only one direction, it is usually desirable to arbitrarily assign that direction as “forward,” whether the actual rotation is clockwise or counter-clockwise. You can change the direction of rotation associated with a Run FWD command by swapping any two of the three wires going from the inverter to the motor.



**Warning:** *Be sure to power OFF the inverter for five minutes before opening the power terminal access panel. Otherwise, the danger of electric shock exists.*

The procedure in this section shows how to disable either one of the Run keys (typically the Run REV key).



**To restrict the Run key operation to FWD or REV only:**

**1** Press the Program Mode key to enter Program Mode.



```
PROGRAM MENU
  0.0Hz
Monitor Vars
■>>
```

**2** Press the Down Arrow key to reach the Parameters menu item.



```
PROGRAM MENU
  0.0Hz
Parameters
■>>
```

**3** Press the Right Arrow key to enter the Parameters sub-menu list.



```
PROGRAM MENU
  0.0Hz
Initial
■>>
```

**4** Press the Down Arrow key several times until you reach the Protection menu item.

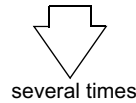

```
PROGRAM MENU
  0.0Hz
Protection
■>>
```

**5** Press the Right Arrow key to enter the Protection sub-menu list.



```
PROGRAM MENU
  0.0Hz
E-Thermal
■>>
```

**6** Press the Down Arrow key several times to access the Other menu item.

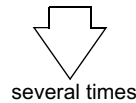

```
PROGRAM MENU
  0.0Hz
Other
■>>
```

**7** Press the Right Arrow key to enter the Other sub-menu. The first item is the Direction Restriction parameter.



```
PROGRAM MENU
  0.0Hz
B035 Dir. Restrict
■FREE
```

**8** Press the Change Data key to enable the Change Data function.



```
PROGRAM MENU
  0.0Hz
B035 Dir. Restrict
>FREE<
```

**9** Use the Up Arrow and Down Arrow keys to scroll through the available settings: Free, REV, FWD. Most applications will be set to "REV" to disable the Run REV key on the keypad.

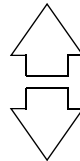

```
PROGRAM MENU
  0.0Hz
B035 Dir. Restrict
>REV <
```

**10** Press the Store/Enter key to accept the entry.



```
PROGRAM MENU
  0.0Hz
B035 Dir. Restrict
■REV
```

**11** Press the Monitor Mode key. The display will prompt you to save the change made in Program Mode to the inverter's EEPROM.



```
Inverter Parameteres
have been changed.
Store to EEPROM?
STORE / CANCEL
```

**12** Press the Store/Enter key to save the parameter change to the inverter's retentive memory (EEPROM).



```
Inverter Parameteres
have been changed.
Store to EEPROM?
** Storing Data **
```

**13** The keypad will now reflect the restriction setting. If set to 'REV' for example, only the Run FWD key will operate.



```
0.0A 0.0% 0.00kW
■ 10.00 0.00Hz
Run:OPE/Frs:OPE
Norm Stop / Key Ctrl
```



**Note:** The parameter F004 Motor Direction determines the particular command (Run FWD or Run REV) the inverter applies when using the standard keypad that has only one Run key. The parameter F004 Motor Direction setting has no effect when used in conjunction with the SC-OPE 3I. Changing the sense of direction will require reversing the two of the three motor wires.



## Motor Control from the SC-OPE

Operating the inverter and motor requires proper parameter setup. If you have a new application, it may be easiest to begin with the default parameters. Refer to the inverter instruction manual and follow the Powerup Test given in the Installation and Wiring Chapter.

### To run the inverter from the SC-OPE keypad:

**1** Press the Monitor Mode key to enter Monitor Mode.

**2** Press the Hand/Auto key successively until the Run and Freq. Source settings are both set to “OPE” as shown to the right. This means the operator interface (SC-OPE) is selected to generate Run FWD and Run REV commands and to generate the basic inverter speed setting (parameter F001). Leave the SC-OPE display in Monitor Mode.

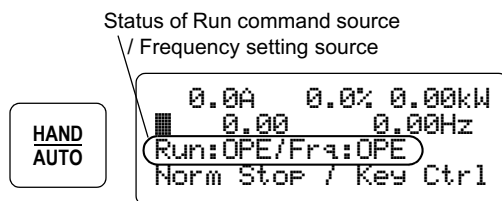

In Monitor mode, the second line displays the desired and actual frequencies. You can edit the desired frequency in Monitor Mode, setting parameter F001 (Frequency Setting) in the inverter.

**3** Press the Change Data key to edit the desired inverter frequency setting. The “>” and “<” characters indicate Change Data is active.

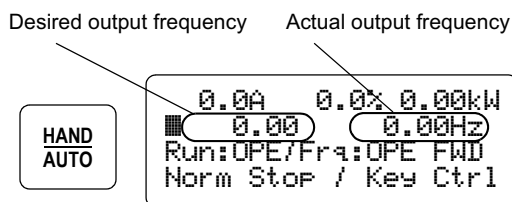

**4** Use Right and Left Arrow keys to move the cursor to the digit you want to change. Then use the Up and Down Arrow keys to increment or decrement the digit. This example uses 10Hz. We recommend using a relatively slow initial speed.

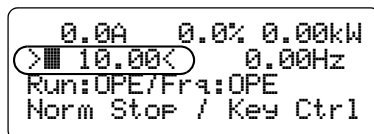
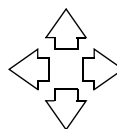
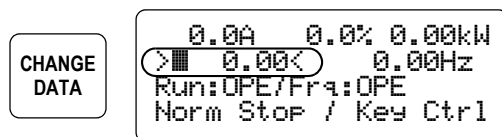

**Caution:** Before running the motor, ensure the mechanical load can move freely from obstructions and personnel. Otherwise, damage to equipment or injury to personnel may occur.

5 Press the Store/Enter key to accept the new desired frequency.

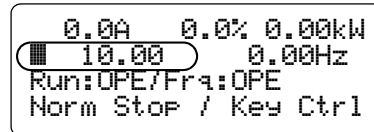

6 Press the Run FWD key. The RUN LED should turn ON to indicate the inverter is in Run Mode. The monitor screen will indicate the actual frequency, motor direction and status such as “Ramp Up,” “Const Spd,” “Ramp Down,” and “Norm Stop.”

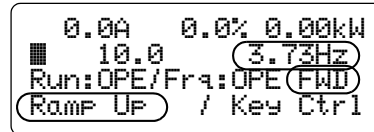

7 Press the Run REV or Stop/Reset key. The example motor profile below shows the keypad command of motor operation. The Up Arrow and Down Arrow keys adjust the motor speed (when the inverter frequency source is configured as the operator keypad—SC-OPE).

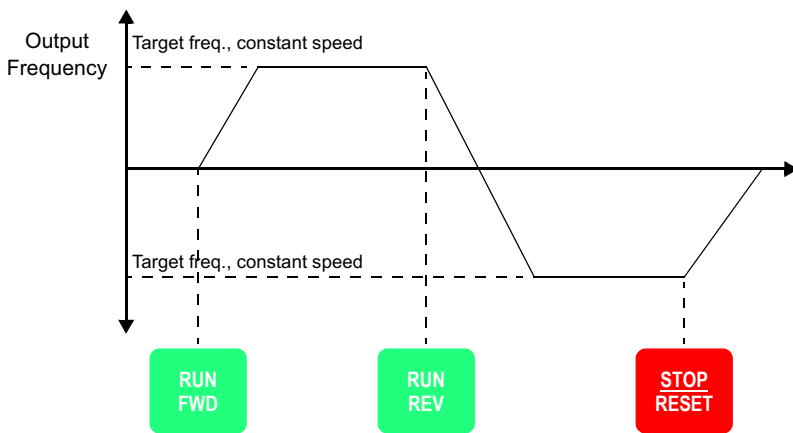

8 While the motor is rotating, press a key for another normal mode such as Program Mode. Note that the second line of the display shows the actual output frequency. This feature permits you to use other modes while still observing the actual output frequency.

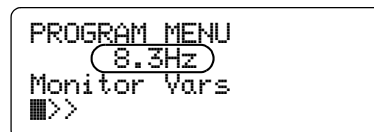

Using the Keypad for Inverter Operation

## Special SC-OPE Modes

The SC-OPE 3I memory contains operating firmware and communications settings. The operating firmware in the SC-OPE makes it specific to a particular inverter family. This data can be transferred to or from a PC disk file called a *configuration*. The SC-OPE has a special Configuration Mode for use during a firmware update. It is globally accessible from any of the four primary SC-OPE modes by pressing and holding the Mode Key. The following diagram shows the relationship of Transfer Mode to the other modes.

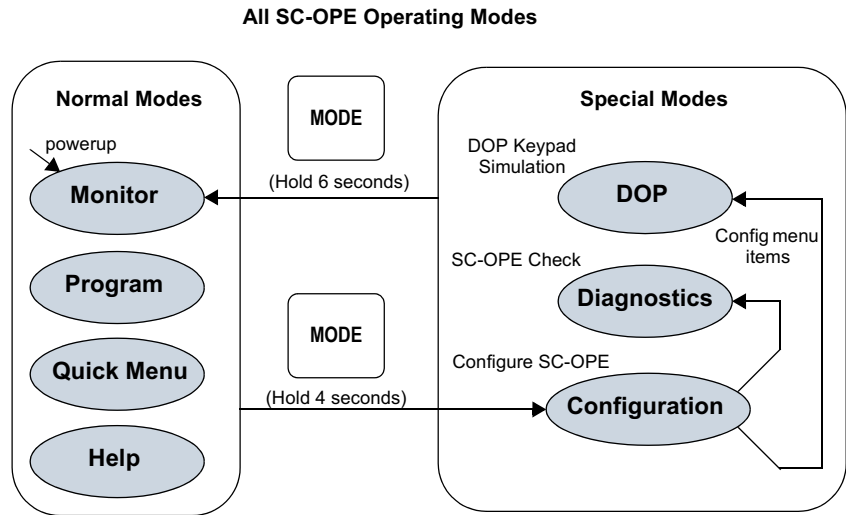

The diagram shows that the Mode key transitions the SC-OPE between Normal Modes and Special Modes, based on the duration of the Mode key press.

- Press the Mode key and *hold for 4 seconds* to enter Configuration Mode. The Config Transfer Mode is the beginning action (or mode) within Configuration Mode. Config Transfer Mode provides PC-to-SC-OPE configuration data transfers. Diagnostics and DOP operations are accessible from menu items from the Configuration Menu. After entering either of these modes, you will need to reset the SC-OPE to exit (see below).
- Press the Mode key and *hold for 6 seconds* to reset the SC-OPE and enter Monitor Mode.

## Program Mode

Programmable settings in the SC-OPE 3I include network port settings, SC-OPE operational modes, and inverter parameter settings. Parameter changes initially affect a *copy* of the inverter's parameters in its RAM to be used for motor control. A separate *Store to EEPROM* step writes any parameter change(s) to the inverter's non-volatile memory, so the changes are in effect upon the next powerup.

The Program Menu provides access to the programming capability outlined above.

### To navigate through the Program Menu selections:

**1** Press the Program key to access the Program Menu. Shown below, the bottom two lines indicate the menu level and item to be programmed. The second line displays inverter output frequency during programming.



**2** Use the arrow keys to move *up* or *down* the list of items at the same level.

**3** Use the *left* or *right* arrow keys to change levels.

**Program Menu Summary** The Program Menu structure has up to four levels. A summary of the Program Menu top level for all inverters is shown in the list below. Within the Parameters submenu, the SC-OPE presents only the inverter parameters that correspond to the inverter that is connected. A Program Menu map corresponding to each inverter family can be found in the appendices in this manual.

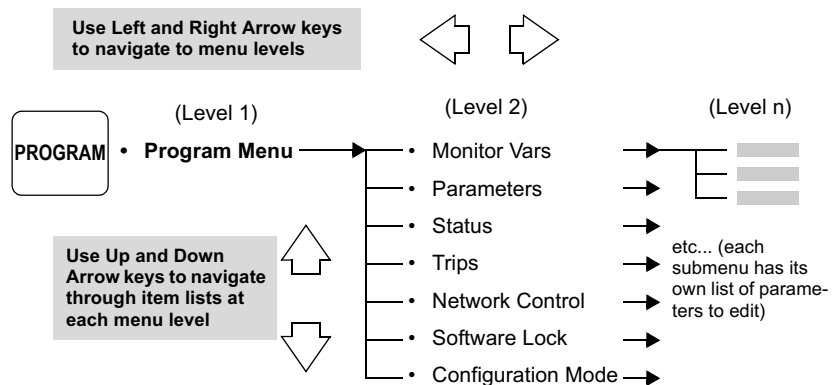

**Program Mode Example**

Within Program Mode you can navigate to various parameters (see previous page) and edit values or settings. The following general procedure shows how to navigate to a parameter, Change Data (edit the value), and either Enter (accept) the new value or Cancel (abort) the edit. The example edits A004 Max. Frequency.

**To edit a parameter or setting in Program Mode:**

1 Press the Program key to enter Program Mode.

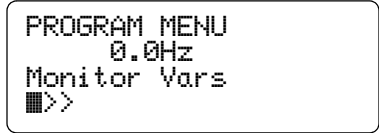

2 Press the Down Arrow key to move down the list by one item to Parameters.

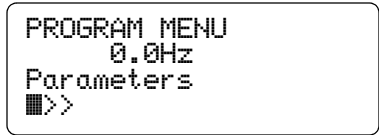

3 Press the Right Arrow key to view the first item under Parameters: Initial.

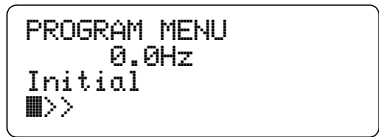

4 Press the Down Arrow key to view the second item under Parameters: Base Setting.



5 Press the Right Arrow key to view the first item under Base Setting.



6 Press the Down Arrow key several times until parameter A004 Max Frequency appears.



Press x times

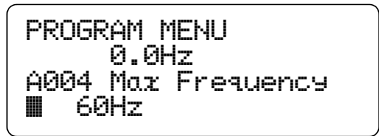

7 Press the Change Data key to permit changing the data from the keypad. The symbols ">" and "<" indicate Change Data is active.

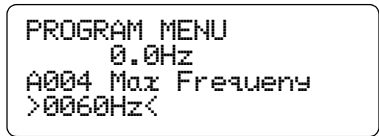

**8** With the Change Data operation pending, use the Left and Right Arrow keys to move the cursor to specific digits. Increment or decrement a digit by using the Up Arrow or Down Arrow key respectively. In this example, make a small (safe) change to the value, or leave it at its current value.

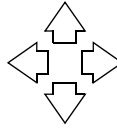

```
PROGRAM MENU
  0.0Hz
A004 Max Frequency
>0055Hz<
```

**9** Press the Store/Enter key to accept the new value for *A004 Max Frequency*. Note that the “>” and “<” characters are now absent; a Change Data is no longer pending.

STORE  
ENTER

```
PROGRAM MENU
  0.0Hz
A004 Max Frequency
■ 55Hz
```

You can change one or more parameters in any Program Mode session. It is very important to remember the following points:

- Program Mode changes to inverter parameters affect only the inverter’s present copy of those parameters in inverter RAM. It will use these parameters for motor control.
- Changes made to parameters in inverter RAM are not retained during inverter power loss.

The next major section, “SC-OPE and Inverter Memory Resources” on page 3-18, describes how to more permanently apply your Change Data updates to the inverter’s EEPROM. The updates are loaded to RAM for use upon each powerup.

## Program Mode Edit Permissions

Hitachi inverters have many user-settable parameters and functions. The inverter monitors various conditions and signals to appropriately allow or prevent editing on a parameter-by-parameter basis. At any point in time, each inverter parameter or functions has an edit permission (allowed or prevented) associated with it. The inverter enforces edit permissions when you use the standard Hitachi keypad that comes with the inverter. When the SC-OPE is connected to the inverter, then the SC-OPE monitors the same conditions and signals as the inverter would do in order to apply the same edit permissions.

Conditions and signals that determine the edit permission for each parameter are:

- Software Lock Mode setting (B031)
- Inverter Run Mode / Stop Mode status
- [SFT] Software Lock intelligent input state (only when an intelligent input is defined as [SFT])
- Run Mode Edit classification of standard parameters (as listed with check “✓” or ex “✗” mark in the parameter tables in the inverter instruction manuals)
- Parameters in special categories, including B031, F001, and the Multi-speed parameters (Ax20, and A021 to A035)

The particular Software Lock Mode (setting B031) in use establishes the general permission levels for all parameters. However, some parameters that directly affect inverter output operation *cannot* be edited when the inverter is in Run Mode, regardless of the particular Software Lock Mode in use. In addition, the optional [SFT] intelligent input state works in combination with the Software Lock Mode in real time to modify the edit permission level. To determine when parameters can/cannot be edited for various conditions, please refer to the inverter instruction manual sections on Software Lock Mode (B031) and the section on [SFT] intelligent input operation.

**Program Mode Behavior** The SC-OPE monitors the conditions and signals listed above during Program Mode use. It evaluates the edit permission (either *allowed* or *prevented*) in real time for each parameter when:

- ...you navigate to a parameter you want to edit and press the Change Data key, or
- ...you have tentatively edited a parameter value and then press the Store/Enter key



**Note:** The SC-OPE re-evaluates the edit permission for each parameter when the Store/Enter key is pressed, because the state of the [SFT] input (if in use) could change just after you press the Change Data key.

**Change Data key** The “> <” edit cursors normally appear after pressing the Change Data key. If the current edit permission result prevents editing, the edit cursors will not appear—indicating editing is prevented.

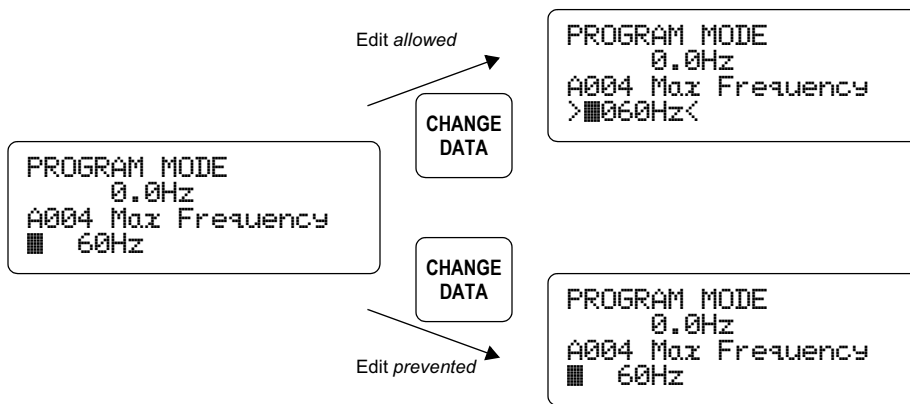

**Store/Enter key** After pressing the Store/Enter key in an allowable edit, the “> <” edit cursors normally disappear, leaving the new parameter value. If the current edit permission result prevents editing, pressing the Store/Enter key will be the same as pressing the Esc/Cancel key—the “> <” edit cursors disappear, and the value displayed returns to the original (actual) parameter value in the inverter.

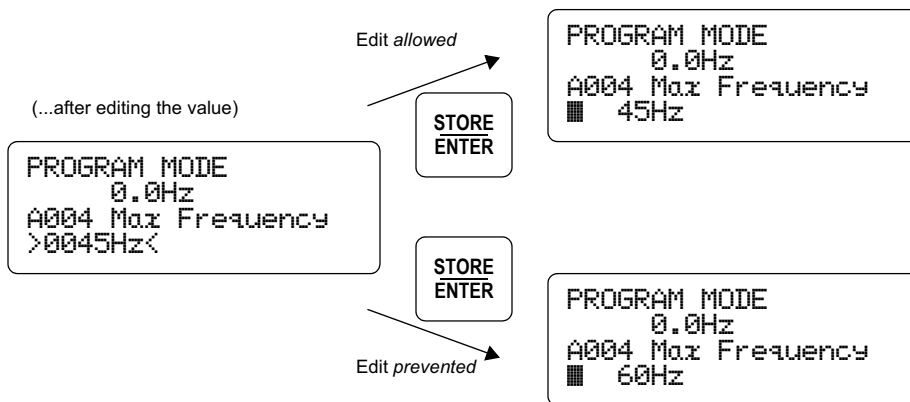



### Stopping the Motor Before Storing Edits (SJ100/L100)

When you edit one or more parameter values and exit Program Mode, the SC-OPE will first prompt you to store the changes to the inverter's EEPROM. If the motor is running at that time, the inverter (SJ100/L100 series only) will need to stop the motor before performing the memory update. Rather than simply applying a free-run stop, the SC-OPE will prompt you to stop the motor (applies controlled deceleration). You can also choose to cancel the storing of parameters, leaving the motor running.

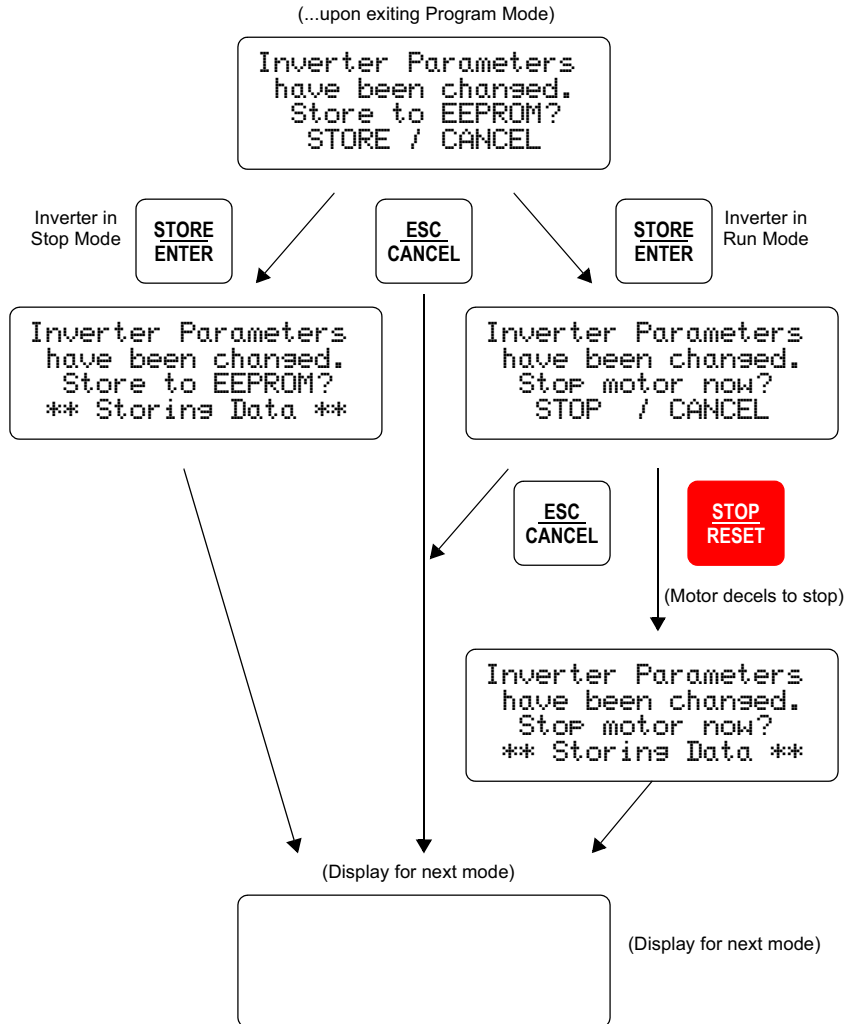

Using the Keypad for Inverter Operation

## SC-OPE and Inverter Memory Resources

### Overview

The block diagram below shows representative memory resources in the SC-OPE and inverter. Events or operations transfer parameter data among these resources.

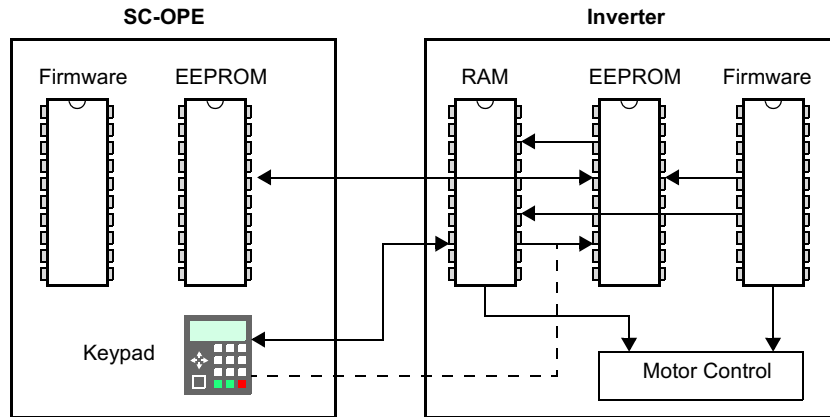

The SC-OPE and inverter memory resources operate according to the following:

- SC-OPE EEPROM** It is the destination or source in Read / Write operations, respectively. The EEPROM data is retained during power loss. This is required when copying one inverter's parameters settings to another inverter.
- SC-OPE Firmware** Stores the SC-OPE's operating system that manages the protocols needed to communicate with specific inverter families. Updating the firmware is necessary when you want to configure the SC-OPE to operate with a different inverter family (requires the use of a PC with the SC-OPE Configuration Editor software).
- Inverter RAM** The inverter's scratchpad (temporary) memory area, containing parameters for real-time motor control. These parameters may be edited during operation. However, the RAM does not retain data during power loss.
- Inverter EEPROM** Stores parameters that are used in real time for motor control in the inverter. Its contents are non-volatile—preserved during power loss.
- Inverter Firmware** Contents include the factory default parameter values. When you perform an initialization of the inverter to restore the factory defaults, these default values are transferred from the firmware to the EEPROM.

**Data Operations** The block diagram below shows data operations or events that transfer parameters from one memory resource to another.

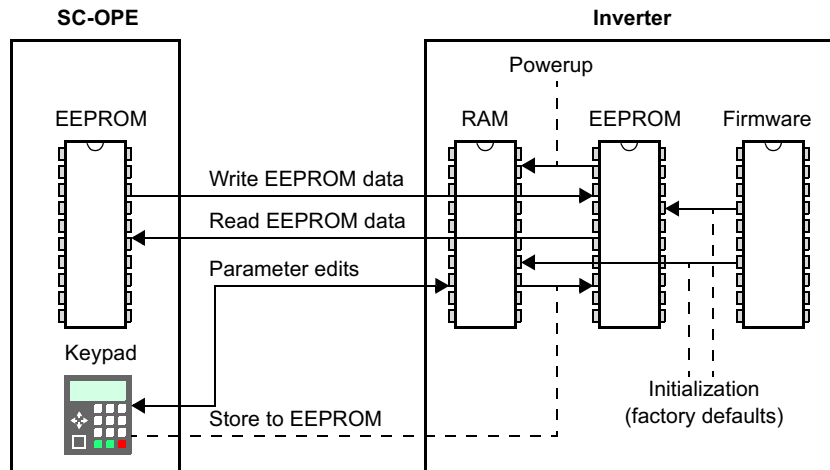

- **Read EEPROM data** Transfers parameter values from the inverter EEPROM to the SC-OPE EEPROM. This operation is available from the Quick Menu, and is a component of the Copy Unit function of the SC-OPE.
- **Write EEPROM data** Transfers parameter values from the SC-OPE EEPROM to the inverter's EEPROM. This operation is available from the Quick Menu, and is a component of the Copy Unit function of the SC-OPE.
- **Parameter edits** Changes the value of (usually one) inverter parameter in RAM. The inverter will operate with this changed value, but it will not be retained during inverter power loss.
- **Store to EEPROM** Copies the inverter's RAM image of all parameters to its EEPROM. This step is necessary for any parameters edits to be retained upon the next powerup of the inverter.
- **Powerup** Automatically copies the inverter's EEPROM parameter image to its RAM, where it is used in motor control and to receive operator parameter edits.
- **Initialization** This operation restores factory default parameter values in the inverter by copying them from its firmware (permanent memory) to its EEPROM (retentive memory) and RAM (working memory). This operation is available in the Program Menu.

## Quick Menu Operation

The Quick Menu in the SC-OPE is a time-saving feature designed to group the most often-used parameters for monitoring or programming for the operator. Accessible with a single key press (Quick Menu key), the menu item list can contain up to 32 programmable items.

The first and last items on the Quick Menu list are fixed and special in that they enable you to apply any data changes to the inverter. You may accumulate data changes (edits) in either Program Mode or when using the Quick Menu. These accumulated changes will be in the inverter's RAM, and are pending transfer to the the inverter's EEPROM. The Read/Write menu item contains the *Read EEPROM data* and *Write EEPROM data* operations, and it is the first item on the Quick Menu list. The *Store to EEPROM* is fixed as the last Quick Menu item.

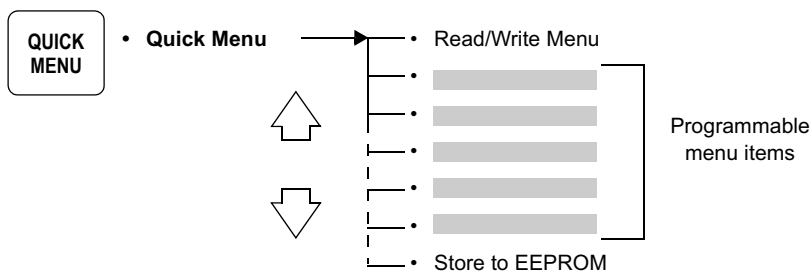

**Read/Write Menu** The Read/Write menu is located at the top of the Quick Menu list. It is necessary to use the Read/Write menu when you want to copy one inverter's parameters to another inverter. See "Copying Parameters Between Inverters" on page 3-26.

Press the Store/Enter key to access the Read/Write menu.

```

QUICK MENU
  0.0Hz
Read/Write Menu
■[ENTER]
  
```

```

STORE
ENTER
  
```

```

READ/WRITE MENU
  0.0Hz
■> Read EEPROM Data
  > Write EEPROM Data
  
```

## Storing to EEPROM

After any change to a parameter(s) value in the inverter's RAM, an additional *Store to EEPROM* operation is required to permanently update the inverter's parameters so they are in effect upon the next inverter powerup. Since the inverter uses the RAM data in real time, only one Store to EEPROM operation is required before powerdown. Note that each of the following operations edit parameter values RAM:

- Program Mode, editing any parameter value
- Monitor Mode, incrementing/decrementing the Output Frequency Setting (F001)
- Monitor Mode, changing the Hand/Auto setting, thus updating the Run Command Source Setting (A002) and/or the Frequency Source Setting (A001)



**Caution:** Any keypad operation in Program Mode or Monitor Mode can only change parameter value(s) in the inverter's RAM. In order for the inverter to resume operation after a power cycle by using your latest parameters, it is essential to perform a Store to EEPROM operation before leaving the SC-OPE and inverter.

### To perform a Store to EEPROM operation:

- 1 Complete any desired parameter edits (will be in inverter's RAM).
- 2 Press the Quick Menu key.



```

QUICK MENU
  0.0Hz
Read/Write Menu
■[ENTER]
  
```

- 3 Press the Down Arrow key as needed to reach the bottom of the Quick Menu list for the Store to EEPROM menu item (or press the Up Arrow key once; the list navigation is also rotary in design).



press as needed

```

QUICK MENU
  0.0Hz
Store to EEPROM
■[ENTER]
  
```

- 4 Press the Store/Enter key to move (store) parameters from the inverter's RAM to its EEPROM. The status "Storing data" displays for a few seconds. When completed, the parameter values will then be in the EEPROM, used in the next powerup of the inverter.



```

QUICK MENU
  0.0Hz
Store to EEPROM
■Storing data
  
```

### Quick Menu Edit Permissions

Some Quick Menu selections write data to the inverter's EEPROM, usually requiring the inverter to be in Stop Mode. These Quick Menu selections are:

- Read/Write Menu, Write EEPROM Data operation (edit permission required for all inverters)
- Store to EEPROM (only SJ100/L100 inverters *must* be in Stop Mode)

Note that these operations do not rely on the Software Lock Mode, [SFT] intelligent input, or related conditions. This is because the inverter's RAM, containing working parameters while running, is not affected in an EEPROM write operation.

#### SJ300/L300P and SJ100/L100 inverters

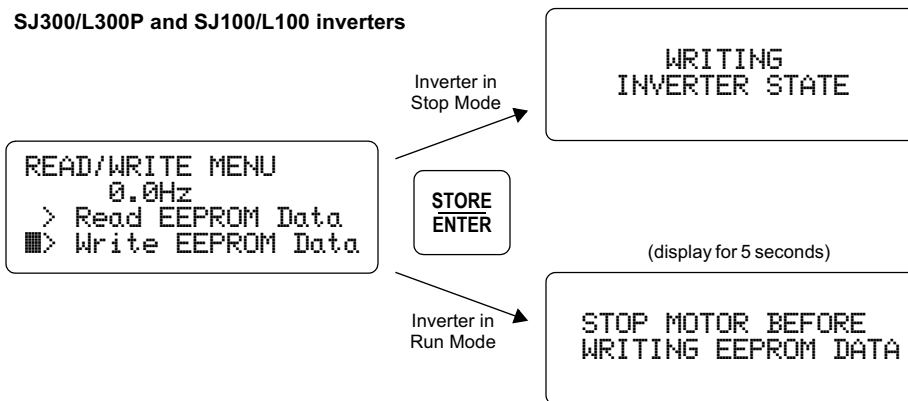

#### SJ100/L100 inverters only

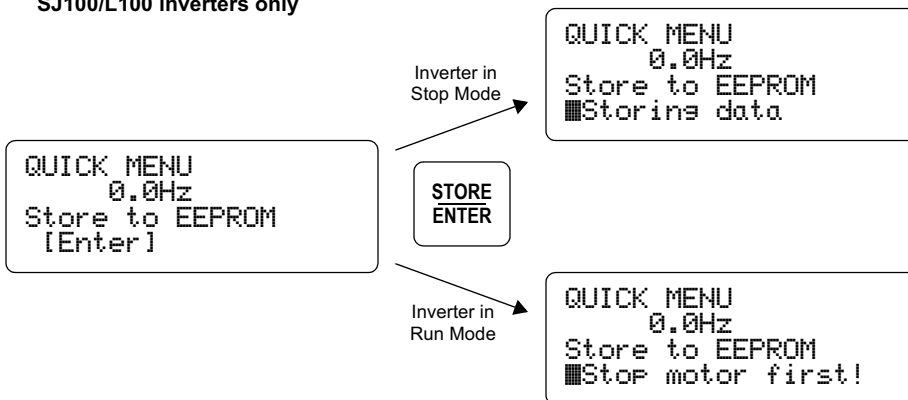

## Quick Menu Standard Items

The remaining Quick Menu items represent a subset of the inverter's parameters. For example, the second (default) item in the Quick Menu is shown in the display. Changing a parameter value in the Quick Menu is easy—the procedure is the same as the one in Program Mode (described previously in this chapter). Just use the Change Data key, Store/Enter key, and Esc/Cancel key as before.

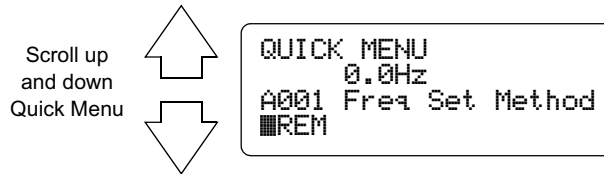

## Configuring the Quick Menu

You can select particular items to be on the Quick Menu list. This feature is useful for particular market segments or applications, or any time you know in advance the parameters that will be edited most often. To configure the Quick Menu in the SC-OPE, you will need the Configuration Kit, SC-OPE-3CK. Install the Configuration Editor as described in Chapter 2.

### To configure the Quick Menu:

- 1 Connect the configuration cable from the SC-OPE's front network (RS-232) port to a Comm port on the PC.
- 2 From the Windows desktop, click Start > Programs > Hitachi > SC-OPE 3 Editor.



**Note:** If necessary, configure the Configuration Editor's COM port settings to match the port used to connect to the SC-OPE. (Click Editor > Set COM Port Option).

- 3 Click Transfer > Upload Configuration.
- 4 Place the SC-OPE in Config Transfer Mode by holding down the Mode key for 4 seconds.

**5** If the SC-OPE is ready, refer back to the PC and in the Set Up Upload dialog box, click OK.

**6** When the Information dialog box indicates Upload Complete, click OK. The untitled SC-OPE Configuration just uploaded will appear in a window in the Configuration Editor.

**7** In the Quick Menu Configuration group, click the Setup button. The Configure Quick Menu dialog box will appear as shown. The list of parameters is the current Quick Menu in the SC-OPE.

**8** You can make edits by using the buttons at the top of the Configure Quick Menu dialog box.

- **Add** – Click Add to add a new item to the bottom of the menu list. Select the parameter from the pop-up menu and click OK.
- **Insert** – Click Insert to insert a new item just above the currently selected item in the menu list. Select the parameter from the pop-up menu and click OK.
- **Delete** – Click Delete to delete the currently selected item in the menu list. Then click OK.
- **Edit** – Click Edit to replace the currently selected item in the menu list. Select the new parameter from the pop-up menu and click OK.
- **Default** – Click Default to restore the factory default list.
- **Cancel** – Click Cancel to discard edit(s) to the Quick Menu Configuration in the Editor.
- **OK** – Click OK to accept the changes to the Quick Menu Configuration.

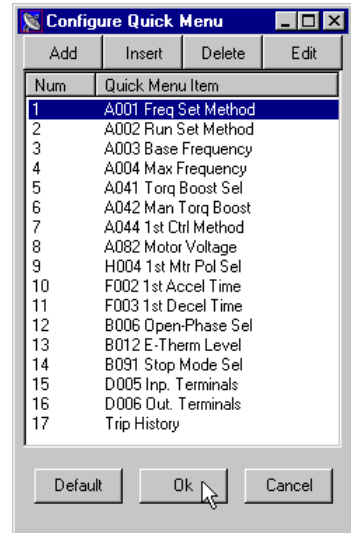



**To download the new Quick Menu to the SC-OPE:**

- 1 From the Configuration Editor's main menu, click Transfer > Download Configuration.
- 2 Confirm the communications cable is connected.
- 3 Confirm the SC-OPE is in Config Transfer Mode, or restore that mode by pressing the Mode key for 4 seconds.
- 4 In the Setup Download dialog box, click OK.
- 5 In the Information dialog box, click OK.

## Copying Parameters Between Inverters

The SC-OPE provides a “copy unit” function—you can copy one inverter’s parameters into another inverter. This capability is often needed in OEM situations. A copy operation consists of two parts:

1. Read one inverter’s parameters into the SC-OPE’s EEPROM.
2. Write the parameters stored in the SC-OPE to the second inverter’s EEPROM.



**Caution:** Be sure to power OFF each inverter before connecting / disconnecting the SC-OPE. Otherwise, damage to the inverter or SC-OPE may occur.



**Note:** The steps in the following example use a cable to connect the SC-OPE to the inverter. You could install the SC-OPE in each inverter’s keypad bay instead.

### To perform a copy operation:

- 1 Connect the SC-OPE to the inverter that contains the parameter settings you want to use as the source.

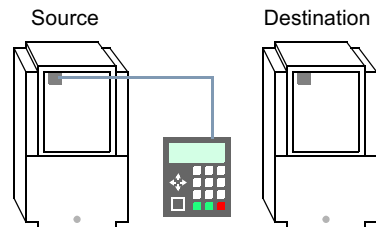

- 2 Press the Quick Menu key to locate the Read/Write menu (scroll with the Up or Down Arrow keys if needed).

QUICK  
MENU

```
QUICK MENU
  0.0Hz
Read/Write Menu
■[ENTER]
```

- 3 Press the Store/Enter key to access the Read/Write Menu as shown.

STORE  
ENTER

```
READ/WRITE MENU
■> Read EEPROM Data
> Write EEPROM Data
```

**Note:** You can use the Up and Down Arrow keys to select either the read or write operation.



4 With the read operation selected, press Store/Enter to perform the Read EEPROM Data. After a few seconds the SC-OPE displays the confirmation message as shown.

STORE  
ENTER

READING  
INVERTER STATE



(automatic)

INVERTER STATE  
STORED IN MEMORY

5 Press the Esc/Cancel key to return to the Quick Menu.

ESC  
CANCEL

QUICK MENU  
0.0Hz  
Read/Write Menu  
[ENTER]

6 Power OFF the inverter and disconnect the SC-OPE.

7 Connect the SC-OPE to the destination inverter of the parameter set.

8 Power ON the inverter.

*Note: Do not run the motor; the inverter cannot update all of its parameters while it is in Run Mode.*

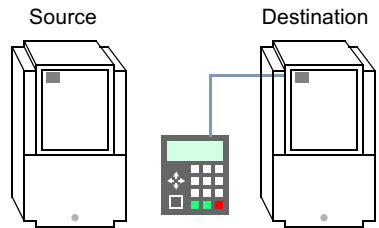

9 Press the Quick Menu key to locate the Read/Write menu (scroll with the Arrow keys if needed).

10 Press Enter to access the Read/Write operations as shown.

READ/WRITE MENU  
> Read EEPROM Data  
[ENTER]> Write EEPROM Data

11 Press the Down Arrow key to select Write EEPROM Data.

12 Press the Store/Enter key. The “Writing Inverter State” message will display for a few seconds.

The *copy operation* is complete! You have copied one inverter’s entire parameter set to another inverter. Those parameters are still in the SC-OPE’s EEPROM, so you can connect the SC-OPE to other (destination) inverters to update their parameters in the same way.

## Monitor Mode

The SC-OPE's Monitor Mode is designed for operators to monitor important inverter data and control status during normal, day-to-day operations. Equipment operators and technicians will typically leave the SC-OPE in monitor mode at all times until the need to change a parameter value arises.

### Orientation

The screen layout in Monitor Mode consists of dedicated text field locations as shown below. The upper two lines display inverter variables. The field locations have reference numbers so you can configure the inverter variable to be displayed in each field. The third line displays the current source of the Run Command and the main Frequency Setting. The fourth line displays the inverter status and the current control source for the SC-OPE (keypad or network connection). The Monitor Mode screen below shows the inverter in a normal stop condition.

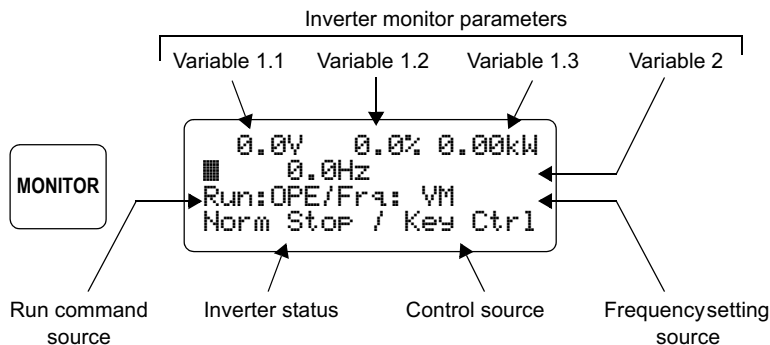

### Inverter Variable Monitoring

In addition to displaying the values, you may occasionally need to refer to the variable *names*. For example, a reading of “0.0%” could refer to torque or current.

Press the Monitor Mode key to view the names of the variables in positions 1.1, 1.2, and 1.3 (display line 1).

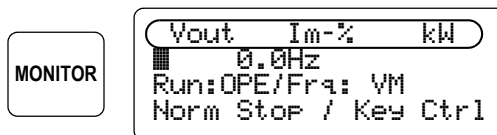

Press the Monitor Mode key again to view the name of the variable in position 2 (display line 2). Press the Monitor Mode key once more to return to the initial display.

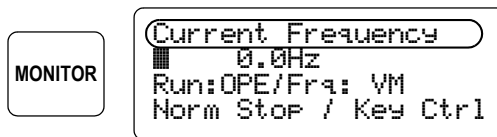

When the source of Frequency Setting is the Operator Keypad (OPE), the second line becomes dedicated to displaying the set frequency and actual frequency (pre-configured variable 2 output is suppressed). This feature is useful to help machine operators avoid severe frequency over-shoot / undershoot when the set acceleration and deceleration rates are relatively low.

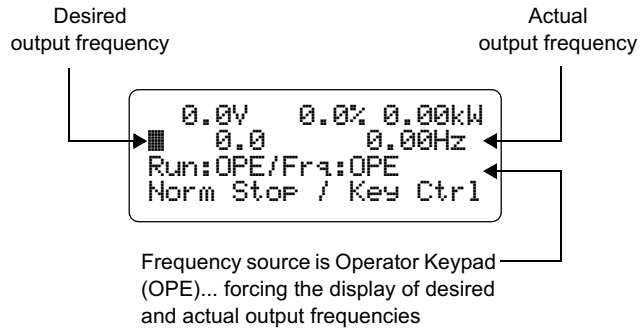

Program Mode provides access to change the four variables you can display on the upper two display lines. The figure below shows the location of the “Monitor Vars” submenu within the menu list in Program Mode.

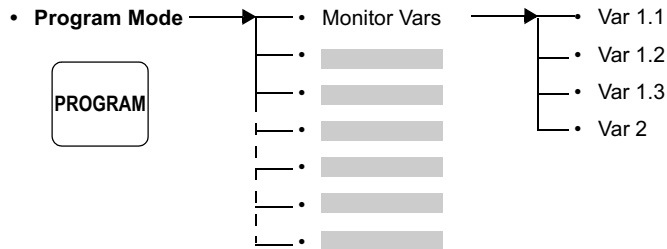

**To configure the Monitor Vars:**

1 Press the Program Mode key. Monitor Vars is at the top of the Program Mode menu list (normally displayed first unless a prior Program Mode session is active.)

2 Press the Up and Down Arrow Keys if necessary to access the Monitor Vars item.

3 Press the Right Arrow key to enter the Monitor Vars sub-menu. The example display to the right shows that the current setting for Var 1.1 is “Output Current (A).”

```
PROGRAM MODE
  0.0Hz
VAR 1.1
■Output Current (A)
```

4 Use the Down Arrow key to scroll to the other Monitor Vars items, if necessary.

5 Press the Change Data key to change a particular Monitor Var. The “>” and “<” characters indicate Change Data is active.

```
PROGRAM MODE
  0.0Hz
VAR 1.1
>Output Voltage (V)<
```

6 Use the Up Arrow and Down Arrow keys to scroll through the list of available variables. Stop at the desired variable such as “Output Voltage (V).”

7 Press Store/Enter to accept the new Monitor Var. To abort the Change Data operation, press the Esc/Cancel key.

8 When you press the Monitor key, the new Monitor Variable will display in the corresponding field.

Output voltage (V)

```
0.0V  0.0%  0.00kW
■    0.0    0.00Hz
Run:OPE/Frs:OPE
Norm Stop / Key Ctrl
```



**Note:** The Monitor Vars configuration is part of a SC-OPE configuration. The SC-OPE Configuration Editor on the PC does not show Monitor Vars status—you must use the Program Mode on the SC-OPE to configure Monitor Vars.

### Hand/Auto Key Operation

Monitor Mode is the central mode for operator-based control of the inverter, and it shows the current status of the user-selectable inverter control sources:

- Run Command Source – set by parameter A002
- Frequency Setting Source – set by parameter A001

The Hand/Auto key serves the purpose of letting the operator scroll through and set applicable combinations of the above source selections. Each press of the Hand/Auto key increments to the next combination of Run Command Source / Freq. Setting Source. The current settings are displayed on the third line of the display as shown. The table below shows the available combinations inverter settings.

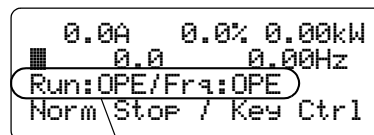

Hand/ Auto Select	Run Command Source		Freq. Command Source	
	Display	A002 Value	Display	A001 Value
1	OPE	02 = Operator keypad (REM)	OPE	02 = Operator keypad (REM)
2			VM	00 = Keypad potentiometer (VR)
3			TRM	01 = Control terminal (TRM)
4	TRM	01 = Control terminals (TRM)	TRM	01 = Control terminal (TRM)
5			VM	00 = Keypad potentiometer (VR)
6			OPE	02 = Operator keypad (REM)

When the SC-OPE is in another normal mode (such as Program Mode or Quick Menu), a press of the Hand/Auto key will automatically switch to Monitor Mode and increment the Hand/Auto setting.



**Note:** Any Hand/Auto setting change immediately changes parameters A001 and A002 in the inverter. However, you must perform a Store to EEPROM operation (available in the Quick Menu) to store the change to retentive memory.



**Note:** Control of the inverter via a network connection to the SC-OPE requires that you use the Hand/Auto setting Run:OPE / Frq:OPE. This will permit the SC-OPE to send network command values to A002 and A001 inverter parameters, respectively.

Using the Keypad for Inverter Operation

**Monitor Mode Edit Permissions**

As discussed in “Program Mode Edit Permissions” on page 3-15, the SC-OPE monitors the inverter’s Software Lock Mode setting, Run/Stop Mode status, [SFT] intelligent input status, etc. This enables the SC-OPE to allow or prevent the editing of inverter parameters, as appropriate for each parameter in real time. Although Program Mode is the obvious method to edit parameter values, Monitor Mode also provides edit capability for specific parameters as shown below. The section “Motor Control from the SC-OPE” on page 3-9 introduced the Monitor Mode display of these parameters and how to edit or change them.

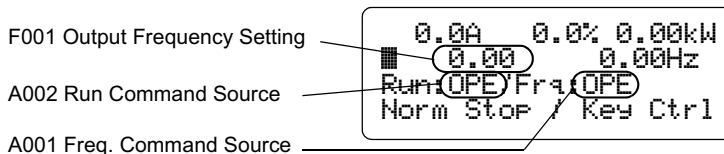

**Output Frequency Editing** The Change Data key provides access to edit the Output Frequency Setting (F001), and the “< >” edit cursors appear. Then the Up/Down Arrow keys will immediately increment/decrement the frequency value with each key press. If the status of the Software Lock Mode or other conditions prevent editing the output frequency at any point, pressing the Change Data key or Up/Down Arrow keys will cause the SC-OPE to display the message shown to the right. Use the checklist to verify that conditions allow parameter editing.

Similarly, pressing the Hand/Auto key immediately updates the Run Command Source (A002) and/or the Frequency Command Source (A001). If the status of the Software Lock Mode or other conditions prevent the editing of these parameters, pressing the Hand/Auto key will cause the SC-OPE to display the message shown to the right. Use the checklist to verify that conditions allow parameter editing.

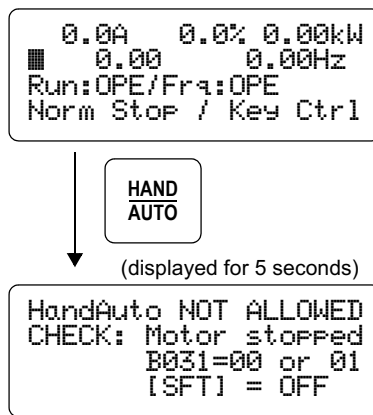
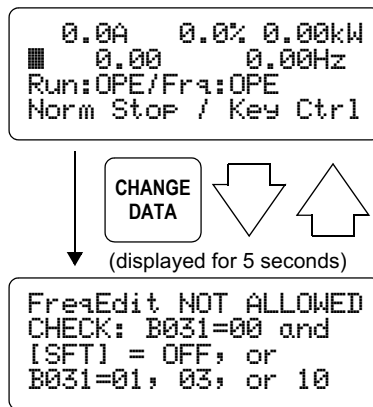



## Restoring Factory Default Inverter Settings

The parameters in a new inverter will already match the default values applicable for your country. However, you may eventually need to initialize an inverter's parameters just to establish a starting point for troubleshooting, etc. The initialization procedure will restore inverter parameters to their factory default values, clear trip history information, or both. Parameter initialization makes use of a "country code" setting (Japan, the U.S., or Europe) for slightly different parameter values.



**Note:** This initialization procedure applies **only to SJ300 and L300P** inverters. Initializing SJ100 / L100 inverters requires disconnecting the SC-OPE and using the inverter's keypad. The J300 inverters require an input signal on terminal STN. Follow the initialization procedure in each inverter's instruction manual.

The initialization functions are accessible in the Program Mode menu. The menu organization of these menu items is shown below.

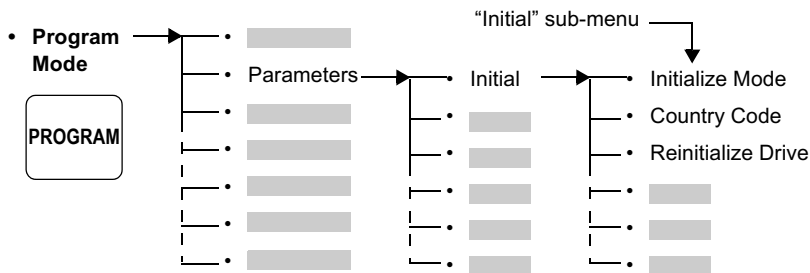

### To initialize inverter parameters:

**1** Press the Program Mode key, and navigate to the "Initial" submenu (see Program Mode menu map above).

**2** Verify the options for Initialize Mode are as you require. If necessary, press the Change Data key, scroll to the desired setting listed below, and press the Store/Enter key.

#### Initialization Options:

- Trip history only
- Both trip history and inverter parameter data
- Inverter parameter only

**3** Press the Down Arrow key to scroll down to the Reinitialize Drive menu item.

**4** Press the Right Arrow key to get the display as shown.

**5** Press Store/Enter to initialize, or Esc/Cancel to abort.

```

PROGRAM MODE
      0.0Hz
ENTER=yes / ESC=no
■[Enter]
  
```

