

Getting Started



In This Chapter....	page
— Introduction	2
— SJ300 Inverter Specifications	6
— Introduction to Variable-Frequency Drives.....	13
— Frequently Asked Questions.....	17

Introduction

Main Features

Congratulations on your purchase of an SJ300 Series Hitachi inverter! This inverter drive features state-of-the-art circuitry and components to provide high performance. The housing footprint is exceptionally small, given the size of the corresponding motor. The Hitachi SJ300 product line includes more than twenty inverter models to cover motor sizes from 1/2 horsepower to 200 horsepower, in either 230 VAC or 480 VAC power input versions. The main features are:

- 200V Class and 400V Class inverters
- UL or CE version available
- Sensorless vector control
- Regenerative braking circuit
- Different operator keypads available for RUN/STOP control and setting parameters
- Built-in RS-422 communications interface to allow configuration from a PC and for field bus external modules
- Sixteen programmable speed levels
- Motor constants are programmable, or may be set via auto-tuning
- PID control adjusts motor speed automatically to maintain a process variable value

The design of Hitachi inverters overcomes many of the traditional trade-offs between speed, torque and efficiency. The performance characteristics are:

- High starting torque of 150% rating or greater
- Continuous operation at 100% rated torque within a 1:10 speed range (6/60 Hz / 5/50 Hz) without motor derating
- Models from 0.4–11kW (1/2 to 15hp) have built-in dynamic braking units
- Cooling fan has ON/OFF selection to provide longer life

A full line of accessories from Hitachi is available to complete your motor control application. These include:

- Digital remote operator keypad
- Expansion card for sensor feedback
- Braking resistors
- Radio noise filters
- CE compliance filters
- Additional factory I/O network interface cards (to be announced)



Model SJ300-037HFU (UL version)



Model SJ300-037HFE (CE Version)

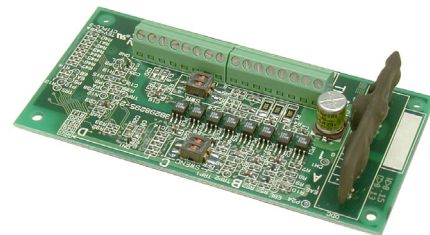

Expansion Card - Encoder Input

Digital Operator Interface Components

The SJ300 Series inverters have a detachable keypad (called a digital operator) on the front panel of the housing. The particular keypad that comes with the inverter depends on the country or continent corresponding to the particular model number. The standard digital operators occupy just part of the keypad recess in the panel. Therefore, the inverter comes with a snap-in panel filler plate that mounts below the keypad as shown.

These detachable keypads can be mounted in a NEMA cabinet panel door cut-out, for example. Threaded metal inserts on the rear of the keypads facilitate this external mounting configuration. A short cable then connects the keypad unit to the connector in the inverter keypad recess. See Chapter 3 for information on how to install and use these keypads and cables.



Digital Operator OPE-SRE standard for -LFU and -HFU models



Digital Operator OPE-S standard for -HFE models

The digital operator / copy unit is optional, and occupies the entire keypad recess when mounted. It has the additional capability of reading (uploading) the parameter settings in the inverter into its memory. Then you can install the copy unit on another inverter and write (download) the parameter settings into that inverter. OEMs will find this unit particularly useful, as one can use a single copy unit to transfer parameter settings from one inverter to many.

Other digital operator interfaces may be available from your Hitachi distributor for particular industries or international markets. Contact your Hitachi distributor for further details.

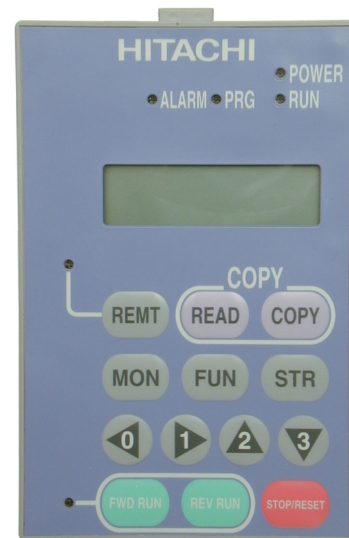

Optional Digital Operator / Copy Unit SRW-0EX

Removable Components

The SJ300 Series inverters are designed for long life and ease of service. Several components are removable as shown below, aiding installation or parts replacement. Details on how and when to remove these parts are in the referenced chapters.

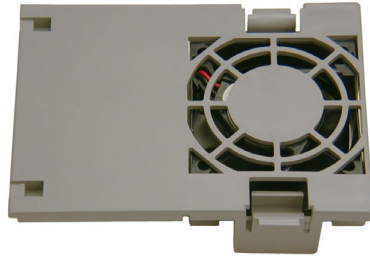

Fan Unit
(See Chapter 6 for servicing)



Digital Operator and Panel Filler Plate
(See Chapter 3 for instructions)



Auxiliary fan (on some models)

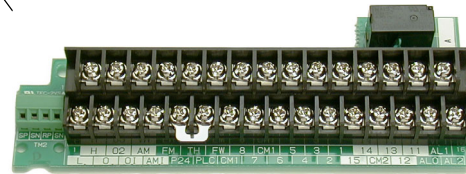

Control Signal Terminal Block
(See Chapter 4 for wiring)



Capacitor Bank for DC Link
(See Chapter 6 for servicing)



Cable entry/exit plate
(See Chapter 2 for instructions)

Specifications Label and Agency Approvals

The Hitachi SJ300 inverters have product specifications labels located on the front and the right side of the housing, as pictured to the right. Be sure to verify that the specifications on the labels match your power source, motor, and application safety requirements.



Product Labels

Regulatory agency approvals (UL, CE, E178241, AK)

Specifications

HITACHI

Model: SJ300 -037LFU

kW/(HP): 3.7 / (5)

Input/Entrée: 50Hz, 60Hz V 1Ph A

50Hz, 60Hz 200-240V 3Ph 18 A

Output/Sortie: 0 - 400Hz 200-240V 3Ph 16.5 A

MFG No. 9JH T18172 90001 Date: 9911

Hitachi Industrial Equipment Systems Co., Ltd. MADE IN JAPAN NE17123 -206

Inverter model number

Motor capacity for this model

Power Input Rating: frequency, voltage, phase, current

Output Rating: frequency, voltage, current

Manufacturing codes: lot number, date, etc.

Model Number Convention

The model number for a specific inverter contains useful information about its operating characteristics. Refer to the model number legend below:

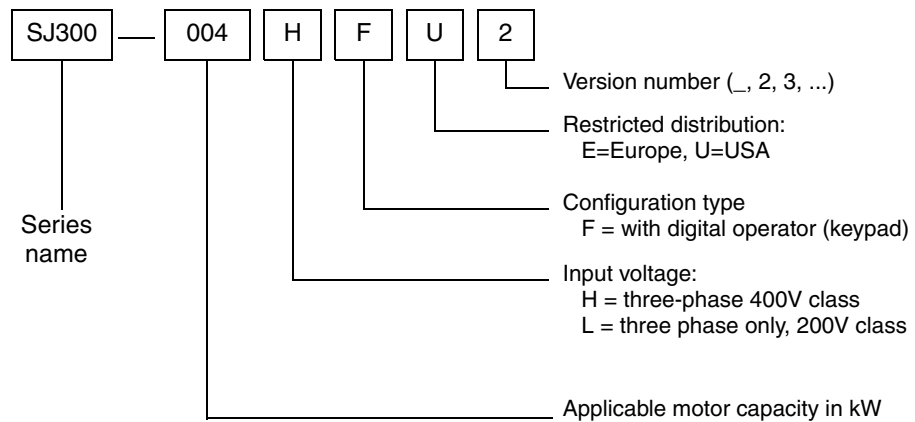

004 = 0.4 kW	075 = 7.5 kW	450 = 45 kW
007 = 0.75 kW	110 = 11 kW	550 = 55 kW
015 = 1.5 kW	150 = 15 kW	750 = 75 kW
022 = 2.2 kW	185 = 18.5 kW	900 = 90 kW
037 = 3.7 kW	220 = 22 kW	1100 = 110 kW
040 = 4.0 kW	300 = 30 kW	1320 = 132 kW
055 = 5.5 kW	370 = 37 kW	1500 = 150 kW

SJ300 Inverter Specifications

Tables for 200V class inverters

Note that “General Specifications” on page 1–9 covers all SJ300 inverters, followed by footnotes for all specifications tables. The 200V models in the upper table below (1/2 to 15 hp) include internal dynamic braking units (see “Dynamic Braking” on page 5–6).

Item		200V Class Specifications							
SJ300 inverters, 200V models, UL version		004LFU	007LFU	015LFU	022LFU	037LFU	055LFU	075LFU	110LFU
Applicable motor size, 4-pole *2	HP	1/2	1	2	3	5	7.5	10	15
	kW	0.4	0.75	1.5	2.2	3.7	5.5	7.5	11
Rated capacity (200/240V) kVA		1.0 / 1.2	1.7 / 2.0	2.5 / 3.1	3.6 / 4.3	5.7 / 6.8	8.3 / 9.9	11 / 13.3	15.9 / 19.1
Rated input voltage		3-phase: 200 to 240V $\pm 10\%$, 50/60 Hz $\pm 5\%$							
Rated input current (A)		3.8	5.5	8.3	12	18	26	35	51
Rated output voltage *3		3-phase (3-wire) 200 to 240V (corresponding to input voltage)							
Rated output current (A)		3.0	5.0	7.5	10.5	16.5	24	32	46
Efficiency at 100% rated output, %		85.1	89.5	92.3	93.2	94.0	94.4	94.6	94.8
Watt loss, approximate (W)	at 70% output	64	76	102	127	179	242	312	435
	at 100% output	70	88	125	160	235	325	425	600
Starting torque *6		200% at 0.5 Hz (SLV), 150% at around 0 Hz (SLV, 0 Hz domain, with motor one frame size down), 100% at 0 Hz (with feedback board)							
Dynamic braking approx. % torque, short time stop *7	internal res. only	50%			20%			10%	
	with external res.	200%			160%	100%	80%	70%	
DC braking		Variable operating frequency, time, and braking force							
Weight	kg / lb	3.5 / 7.7	3.5 / 7.7	3.5 / 7.7	3.5 / 7.7	3.5 / 7.7	3.5 / 7.7	5 / 11	5 / 11

Item		200V Class Specifications, continued							
SJ300 inverters, 200V models, UL version		150LFU	185LFU	220LFU	300LFU	370LFU	450LFU	550LFU	
Applicable motor size *2	HP	20	25	30	40	50	60	75	
	kW	15	18.5	22	30	37	45	55	
Rated capacity (200/240V) kVA		22.1 / 26.6	26.3 / 31.5	32.9 / 39.4	41.9 / 50.2	50.2/60.2	63 / 75.6	76.2/91.4	
Rated input voltage		3-phase: 200 to 240V $\pm 10\%$, 50/60 Hz $\pm 5\%$							
Rated input current (A)		70	84	105	133	160	200	242	
Rated output voltage *3		3-phase (3-wire) 200 to 240V (corresponding to input voltage)							
Rated output current (A)		64	76	95	121	145	182	220	
Efficiency at 100% rated output, %		94.9	95.0	95.0	95.1	95.1	95.1	95.1	
Watt loss, approximate (W)	at 70% output	575	698	820	1100	1345	1625	1975	
	at 100% output	800	975	1150	1550	1900	2300	2800	
Starting torque *6		200% at 0.5 Hz (SLV), 150% at around 0 Hz (SLV, 0 Hz domain, with motor one frame size down), 100% at 0 Hz (with feedback board)							
Dynamic braking approx. % torque, short time stop *7	w/o braking unit	10%							
	with braking unit	30–200%	25–170%	25–150%	55–110%	45–90%	35–75%	30–60%	
DC braking		Variable operating frequency, time, and braking force							
Weight	kg / lb	12 / 26.4	12 / 26.4	12 / 26.4	20 / 44	30 / 66	30 / 66	50 / 110	

Tables for 400V class inverters

Note that “General Specifications” on page 1–9 covers all SJ300 inverters, followed by footnotes for all specifications tables. The 400V models in the upper table below (1 to 15 hp) include internal dynamic braking units (see “Dynamic Braking” on page 5–6).

Item		400V Class Specifications						
SJ300 inverters, 400V models	UL version	007HFU	015HFU	022HFU	040HFU	055HFU	075HFU	110HFU
	CE version	007HFE	015HFE	022HFE	040HFE	055HFE	075HFE	110HFE
Applicable motor size *2	HP	1	2	3	5	7.5	10	15
	kW	0.75	1.5	2.2	4.0	5.5	7.5	11
Rated capacity (400 / 480V) kVA		1.7 / 2.0	2.6 / 3.1	3.6 / 4.4	5.9 / 7.1	8.3 / 9.9	11 / 13.3	15.9/19.1
Rated input voltage		3-phase (3-wire) 380 to 480V ±10%, 50/60 Hz ±5%						
Rated input current (A)		2.8	4.2	5.8	9.5	13	18	25
Rated output voltage *3		3-phase (3-wire): 380 to 480V (corresponding to input voltage)						
Rated output current (A)		2.5	3.8	5.3	8.6	12	16	23
Efficiency at 100% rated output, %		89.5	92.3	93.2	94.0	94.4	94.6	94.8
Watt loss, approximate (W)	at 70% output	76	102	127	179	242	312	435
	at 100% output	88	125	160	235	325	425	600
Starting torque *6		200% at 0.5 Hz (SLV), 150% at around 0 Hz (SLV, 0 Hz domain, with motor one frame size down), 100% at 0 Hz (with feedback board)						
Dynamic braking approx. % torque, short time stop *7	internal res. only	50%			20%			10%
	with external res.	200%			140%	100%		70%
DC braking		Variable operating frequency, time, and braking force						
Weight	kg / lb	3.5 / 7.7	3.5 / 7.7	3.5 / 7.7	3.5 / 7.7	3.5 / 7.7	55 / 121	55 / 121

Item		400V Class Specifications						
SJ300 inverters, 400V models	UL version	150HFU	185HFU	220HFU	300HFU	370HFU	450HFU	550HFU
	CE version	150HFE	185HFE	220HFE	300HFE	370HFE	450HFE	550HFE
Applicable motor size *2	HP	20	25	30	40	50	60	75
	kW	15	18.5	22	30	37	45	55
Rated capacity (400 / 480V) kVA		22.1 / 26.6	26.3 / 31.5	33.2 / 39.9	40.1 / 48.2	51.9 / 62.3	62.3 / 74.8	76.2/91.4
Rated input voltage		3-phase (3-wire) 380 to 480V ±10%, 50/60 Hz ±5%						
Rated input current (A)		35	42	53	64	83	99	121
Rated output voltage *3		3-phase (3-wire): 380 to 480V (corresponding to input voltage)						
Rated output current (A)		32	38	48	58	75	90	110
Efficiency at 100% rated output, %		94.9	95.0	95.0	95.1	95.1	95.1	95.1
Watt loss, approximate (W)	at 70% output	575	698	820	1100	1345	1625	1975
	at 100% output	800	975	1150	1550	1900	2300	2800
Starting torque *6		200% at 0.5 Hz (SLV), 150% at around 0 Hz (SLV, 0 Hz domain, with motor one frame size down), 100% at 0 Hz (with feedback board)						
Dynamic braking approx. % torque, short time stop *7	w/o braking unit	10%						
	with braking unit	40–200%	40–200%	35–200%	110–170%	90–150%	70–120%	60–100%
DC braking		Variable operating frequency, time, and braking force						
Weight	kg / lb	12 / 26.4	12 / 26.4	12 / 26.4	20 / 44	30 / 66	30 / 66	50 / 110

Tables for 400V class inverters, continued...

Item		400V Class Specifications				
SJ300 inverters, 400V models	UL version	750HFU	900HFU	1100HFU	—	1500HFU
	CE version	750HFE	900HFE	1100HFE	1320HFE	—
Applicable motor size *2	HP	100	125	150	175	200
	kW	75	90	110	132	150
Rated capacity (400 / 480V) kVA		103.2 / 123.8	121.9 / 146.3	150.3 / 180.4	180.1 / 216.1	180.1 / 216.1
Rated input voltage		3-phase (3-wire) 380 to 480V $\pm 10\%$, 50/60 Hz $\pm 5\%$				
Rated input current (A)		164	194	239	286	286
Rated output voltage *3		3-phase (3-wire): 380 to 480V (corresponding to input voltage)				
Rated output current (A)		149	176	217	260	260
Efficiency at 100% rated output, %		95.2	95.2	95.2	95.2	95.2
Watt loss, approximate (W)	at 70% output	2675	3375	3900	4670	4670
	at 100% output	3800	4800	5550	6650	6650
Starting torque *6		180% at 0.5 Hz (SLV), 130% at around 0 Hz (SLV, 0 Hz domain, with motor one frame size down), 100% at 0 Hz (with feedback board)				
Dynamic braking approx. % torque, short time stop *7	w/o braking unit	10%				
	with braking unit	45–70%	40–60%	30–50%	25–40%	20–35%
DC braking		Variable operating frequency, time, and braking force				
Weight	kg / lb	60 / 132	60 / 132	80 / 176	80 / 176	80 / 176

Footnotes for the preceding tables and the table that follows:

- Note 1:** The protection method conforms to JEM 1030.
- Note 2:** The applicable motor refers to Hitachi standard 3-phase motor (4-pole). When using other motors, care must be taken to prevent the rated motor current (50/60 Hz) from exceeding the rated output current of the inverter.
- Note 3:** The output voltage decreases as the main supply voltage decreases (except when using the AVR function). In any case, the output voltage cannot exceed the input power supply voltage.
- Note 4:** To operate the motor beyond 50/60 Hz, consult the motor manufacturer for the maximum allowable rotation speed.
- Note 5:** When SLV is selected, please set the carrier frequency higher than 2.1 kHz.
- Note 6:** At the rated voltage when using a Hitachi standard 3-phase, 4-pole motor (when selecting sensorless vector control—SLV).
- Note 7:** The braking torque via capacitive feedback is the average deceleration torque at the shortest deceleration (stopping from 50/60 Hz as indicated). It is not continuous regenerative braking torque. The average decel torque varies with motor loss. This value decreases when operating beyond 50 Hz. If a large regenerative torque is required, the optional regenerative braking resistor should be used.
- Note 8:** The frequency command will equal the maximum frequency at 9.8V for input voltage 0 to 10 VDC, or at 19.6 mA for input current 4 to 20 mA. If this characteristic is not satisfactory for your application, contact your Hitachi sales representative.
- Note 9:** The storage temperature refers to the short-term temperature during transport.
- Note 10:** Conforms to the test method specified in JIS C0911 (1984). For the model types excluded in the standard specifications, contact your Hitachi sales representative.
- Note 11:** NEMA 1 applies up to 22kW. An optional wire-entry conduit box is required for 30kW to 55kW models to meet NEMA 1 rating.

General Specifications

The following table (continued on next page) applies to all SJ300 inverter models.

Item		General Specifications	
Protective enclosure *1, *11		IP20 (NEMA 1)	
Control method		Line-to-line sine wave pulse-width modulation (PWM) control	
Output frequency range *4		0.1 to 400 Hz	
Frequency accuracy		Digital command: $\pm 0.01\%$ of the maximum frequency Analog command: $\pm 0.2\%$ ($25^{\circ}\text{C} \pm 10^{\circ}\text{C}$)	
Frequency setting resolution		Digital: ± 0.01 Hz; Analog: (max. frequency)/4000, [O] terminal: 12-bit 0 to 10V; [OI] terminal: 12-bit, 4-20mA; [O2] terminal: 12-bit -10 to +10V	
Volt./Freq. characteristic *5		V/F optionally variable (30 to 400Hz base frequency), V/F control (constant torque, reduced torque), sensorless vector control	
Speed fluctuation		$\pm 0.5\%$ (sensorless vector control)	
Overload capacity (output current)		150% for 60 seconds, 200% for 0.5 seconds	
Acceleration/deceleration time		0.01 to 3600 sec., (linear curve profiles, accel./decel. selection), two-stage accel./decel.	
Input signal	Freq. setting	Operator keypad	Up and Down keys / Value settings
		Potentiometer	Analog setting via potentiometer on operator keypad
		External signal *8	0 to 10 VDC (input impedance 10k Ohms), 4 to 20 mA (input impedance 100 Ohms), Potentiometer (1k to 2k Ohms, 2W)
		Serial port	RS485 interface
	FW/RV Run	Operator panel	Run key / Stop key (change FW/RV by function command)
		External signal	FW Run/Stop (NO contact), RV set by terminal assignment (NC/NO), 3-wire input available
	Intelligent Input terminals (assign eight functions to terminals)		RV (reverse run/stop), CF1~CF4 (multi-speed select), JG (jogging), DB (external DC braking), SET (set 2nd motor data), 2CH (2-stage accel./decel.), FRS (free-run stop), EXT (external trip), USP (unattended start protection), CS (commercial power source), SFT (software lock), AT (analog input voltage/current select), SET3 (set 3rd motor data), RS (reset inverter), STA (start, 3-wire interface), STP (stop, 3-wire interface), F/R (FW/RV 3-wire interface), PID (PID ON/OFF), PIDC (PID reset), CAS (control gain setting), UP (remote control Up function, motorized speed pot.), DWN (remote control Down function, motorized speed pot.), UDC (remote control data clearing), OPE (Operator control), SF1-SF7 (Multispeed bits 0-7), OLR (Overload limit change), TL (torque limit enable), TRQ1 (torque limit selection bit 1, LSB), TRQ2 (torque limit selection bit 2, MSB), PPI (Proportional / Proportional/Integral mode selection), BOK (Brake confirmation signal), ORT (Orientation – home search), LAC (LAC: LAD cancel), PCLR (Position deviation reset), STAT (pulse train position command input enable), NO (not selected)
Thermistor input		One terminal (PTC characteristics)	
Output signal	Intelligent Output terminals (assign six functions to five open collector outputs and one relay NO-NC contact)	RUN (run signal), FA1 (Frequency arrival type 1 – constant speed), FA2 (Frequency arrival type 2 – over-frequency), OL (overload advance notice signal 1), OD (Output deviation for PID control), AL (alarm signal), FA3 (Frequency arrival type 3 – at-frequency), OTQ (over-torque signal), IP (Instantaneous power failure signal), UV (Under-voltage signal), TRQ (In torque limit), RNT (Run time over), ONT (Power-ON time over), THM (thermal alarm), BRK (Brake release signal), BER (Brake error signal), ZS (Zero speed detect), DSE (speed deviation maximum), POK (Positioning completion), FA4 (Frequency arrival type 4 – over-frequency 2), FA5 (Frequency arrival type 5 – at-frequency 2), OL2 (Overload notice advance signal 2), Terminals 11-13 or 11-14 automatically configured as AC0-AC2 or AC0-AC3 per alarm code output selection)	
	Intelligent monitor output terminals	Analog voltage monitor, analog current monitor (8-bit resolution), and PWM output, on terminals [AM], [AMI], [FM]	
Display monitor		Output frequency, output current, motor torque, scaled value of output frequency, trip history, I/O terminal condition, input power, output voltage	

Item		General Specifications
Other user-settable parameters		V/F free-setting (up to 7 points), frequency upper/lower limit, frequency jump, accel/decel curve selection, manual torque boost value and frequency adjustment, analog meter tuning, start frequency, carrier frequency, electronic thermal protection level, external frequency output zero/span reference, external frequency input bias start/end, analog input selection, retry after trip, restart after instantaneous power failure, various signal outputs, reduced voltage start, overload restriction, default value setting (US, Europe, Japan), deceleration and stop after power failure, AVR function, fuzzy accel/decel, auto-tuning (on-line/off-line), high-torque multi-operation, automatic energy-saving operation
Carrier frequency range		0.5 to 15 kHz
Protective functions		Over-current, overload, braking resistor overload, over voltage, EEPROM error, under-voltage error, CT (current transformer) error, CPU error, external trip, USP error, ground fault, input over voltage, instantaneous power failure, expansion card 1 error, expansion card 2 error, inverter thermal trip, phase failure detection, IGBT error, thermistor error
Environment	Temperature (*9)	Operating (ambient): -10 to 50°C / Storage: -20 to 65°C
	Humidity	20 to 90% humidity (non-condensing)
	Vibration *10	Models SJ300-004xxx to 220xxx: 5.9 m/s ² (0.6G), 10 to 55 Hz Models SJ00-300xx to 1500xxx: 2.94 m/s ² (0.3G), 10 to 55 Hz
	Location	Altitude 1,000 m or less, indoors (no corrosive gasses or dust)
Coating color		Gray
Accessories	Feedback PCB	SJ-FB (vector control loop speed sensor)
	Digital input PCB	SJ-DG (4-digit BCD / 16-bit binary)
	Others	EMI filters, input/output reactors, DC reactors, radio noise filters, braking resistors, braking units, LCR filter, communication cables, factory I/O network interface cards
Operator input devices		OPE-SRE (4-digit LED with potentiometer) / OPE-S (4-digit LED w/o potentiometer), Optional: OPE-SR (4-digit LED with potentiometer, Japanese/English overlay), SRW-0EX Multilingual operator with copy function (English, French, German, Italian, Spanish, and Portuguese)

Derating Curves

The maximum available inverter current output is limited by the carrier frequency and ambient temperature. The carrier frequency is the inverter’s internal power switching frequency, settable from 0.5 kHz to 12 kHz. Choosing a higher carrier frequency tends to decrease audible noise, but it also increases the internal heating of the inverter, thus decreasing (derating) the maximum current output capability. Ambient temperature is the temperature just outside the inverter housing—such as inside the control cabinet where the inverter is mounted. A higher ambient temperature decreases (derates) the inverter’s maximum current output capacity.

Use the following derating curves to help determine the optimal carrier frequency setting for your inverter, and to find the output current derating. Be sure to use the proper curve for your particular SJ300 inverter model number.

SJ300 1.5 to 22 kW at 50 deg. C ambient

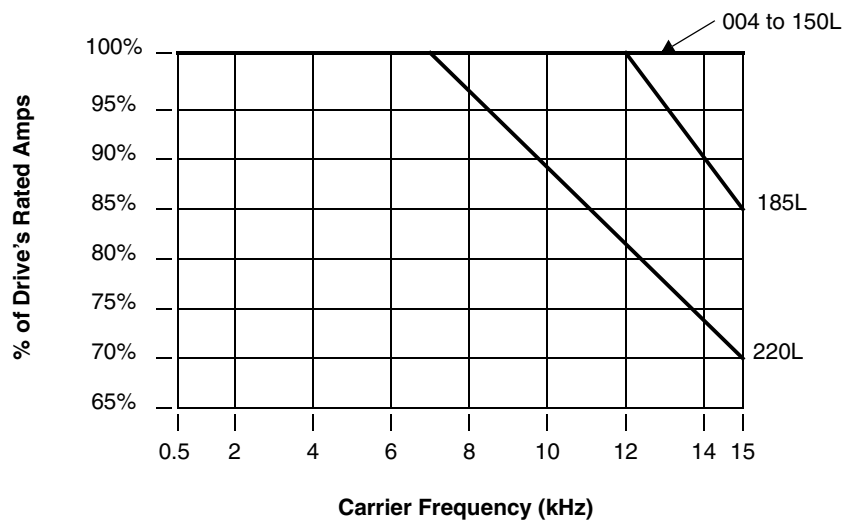

SJ300 30 to 55 kW at 50 deg. C ambient

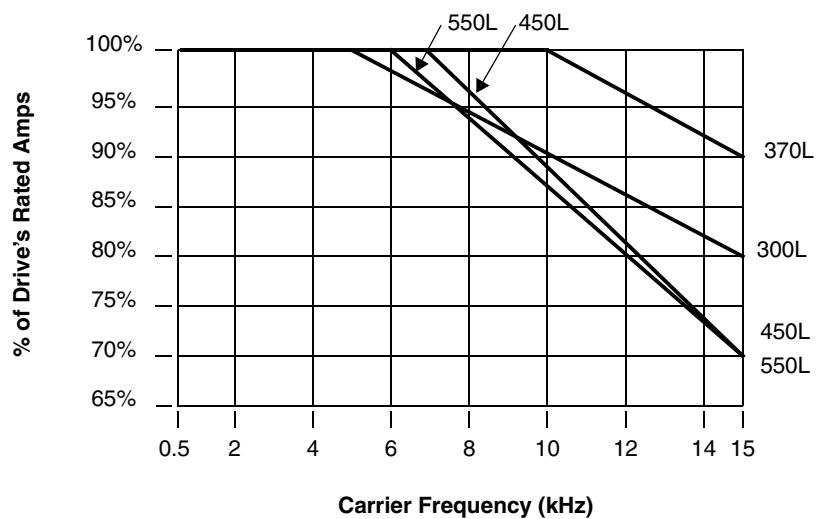

Derating curves, continued...

Getting Started

SJ300 30 to 55 kW at 50 deg. C ambient, continued

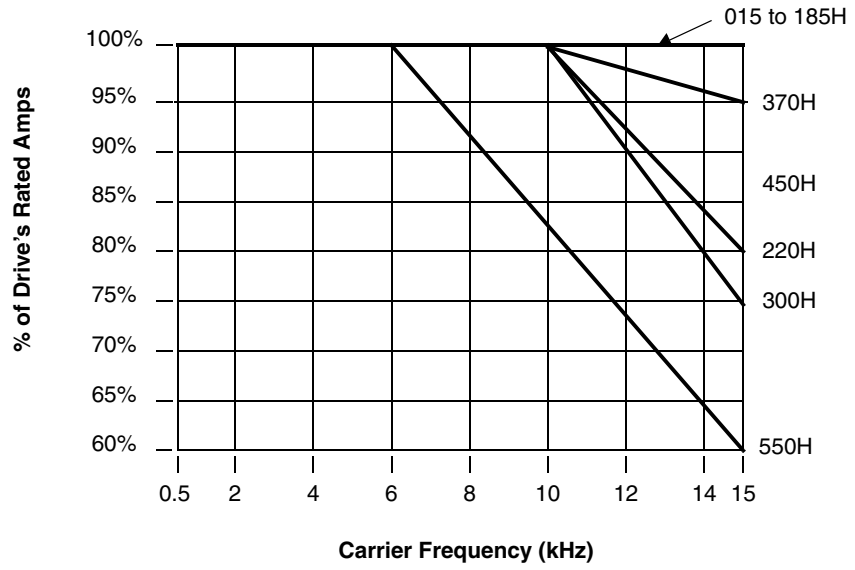

SJ300 75 to 150 kW at 50 deg. C ambient

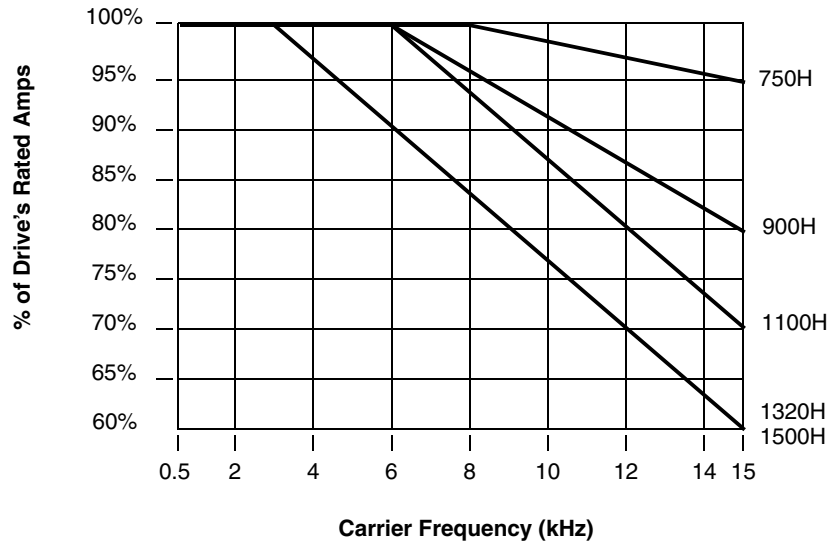

Introduction to Variable-Frequency Drives

The Purpose of Motor Speed Control for Industry

Hitachi inverters provide accurate speed control for 3-phase AC induction motors. You connect AC power to the inverter, and connect the inverter to the motor. Many applications can benefit from the use of variable-speed drives in several ways:

- Energy savings - HVAC
- Need to coordinate speed with an adjacent process - textiles and printing presses
- Need to control acceleration and deceleration (torque)
- Sensitive loads - elevators, food processing, pharmaceuticals

What is an Inverter?

The term *inverter* and *variable-frequency drive* are related and somewhat interchangeable. An electronic drive for an AC motor controls the motor's speed by *varying the frequency* of the power sent to the motor.

An inverter, in general, is a device that converts DC power to AC power. The figure below shows how the variable-frequency drive employs an internal inverter. The drive first converts incoming AC power to DC through a rectifier bridge, creating an internal DC bus voltage. Then the inverter circuit converts the DC back to AC again to power the motor. The special inverter can vary its output frequency and voltage according to the desired motor speed.

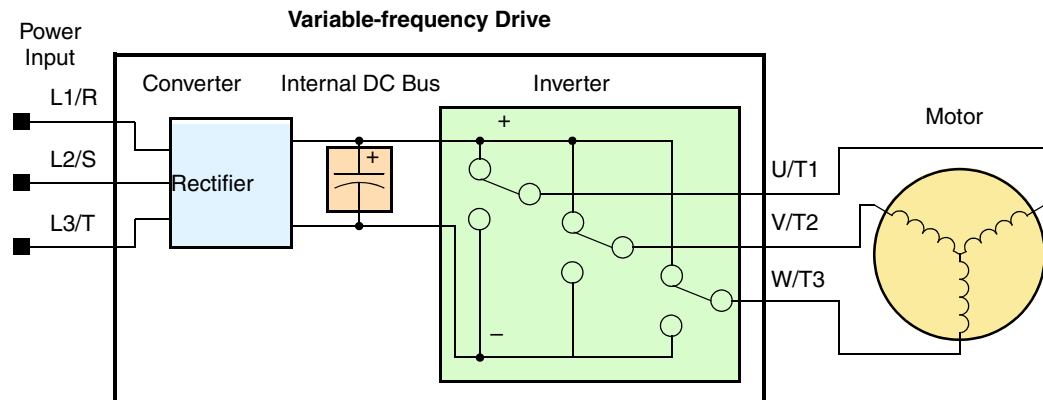

The simplified drawing of the inverter shows three double-throw switches. In Hitachi inverters, the switches are actually IGBTs (isolated gate bipolar transistors). Using a commutation algorithm, the microprocessor in the drive switches the IGBTs ON and OFF at a very high speed to create the desired output waveforms. The inductance of the motor windings helps smooth out the pulses.

Torque and Constant Volts/Hertz Operation

In the past, AC variable speed drives used an open loop (scalar) technique to control speed. The constant-volts-per-hertz operation maintains a constant ratio between the applied voltage and the applied frequency. With these conditions, AC induction motors inherently delivered constant torque across the operating speed range. For some applications, this scalar technique was adequate.

Today, with the advent of sophisticated microprocessors and digital signal processors (DSPs), it is possible to control the speed and torque of AC induction motors with unprecedented accuracy. The SJ300 utilizes these devices to perform complex mathematical calculations required to achieve superior performance. The technique is referred to as *sensorless vector control*. It allows the drive to continuously monitor its output voltage and current, and their relationship to each other. From this it mathematically calculates two vector currents. One

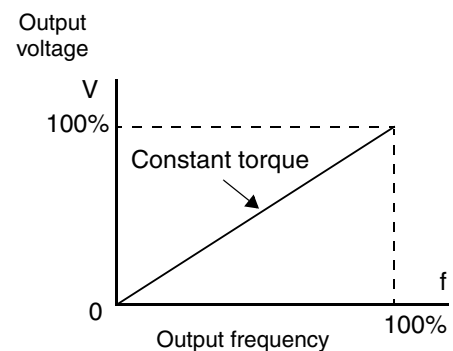

Inverter Input and Three-Phase Power



vector is related to motor flux current, and the other to motor torque current. The ability to separately control these two vectors is what allows the SJ300 to deliver extraordinary low-speed performance and speed control accuracy.

The Hitachi SJ300 Series of inverters includes two sub-groups: the 200V class and the 400V class inverters. The drives described in this manual may be used in either the United States or Europe, although the exact voltage level for commercial power may be slightly different from country to country. Accordingly, a 200V class inverter requires (nominal) 200 to 240VAC, and a 400V class inverter requires from 380 to 480VAC. All SJ300 inverters require three-phase input power, whether 200V or 400V class.

TIP: If your application only has single phase power available, refer to the Hitachi SJ100 Series inverters. SJ100 inverters of 3HP or less can accept single phase input power.

The common terminology for single phase power is Line (L) and Neutral (N). Three-phase power connections are usually labeled Line 1 (L1), Line 2 (L2) and Line 3 (L3). In any case, the power source should include a ground connection. That ground connection will need to connect to the inverter chassis and to the motor frame (see “Wire the Inverter Output to Motor” on page 2-20).

Inverter Output to the Motor

The AC motor must be connected only to the inverter’s output terminals. The output terminals are uniquely labeled (to differentiate them from the input terminals) with the designations U/T1, V/T2, and W/T3. This corresponds to typical motor lead connection designations T1, T2, and T3. It is often not necessary to connect a particular inverter output to a particular motor lead for a new application. The consequence of swapping any two of the three connections is the reversal of the motor direction. In applications where reversed rotation could cause equipment damage or personnel injury, be sure to verify direction of rotation before attempting full-speed operation. For safety to personnel, you must connect the motor chassis ground to the ground connection at the bottom of the inverter housing.

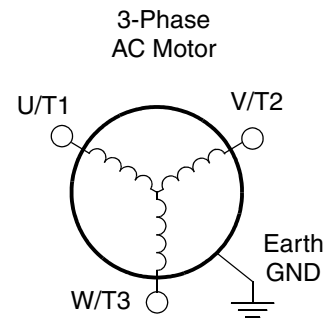

Notice the three connections to the motor do not include one marked “Neutral” or “Return.” The motor represents a balanced “Y” impedance to the inverter, so there is no need for a separate return. In other words, each of the three “Hot” connections serves also as a return for the other connections, because of their phase relationship.

The Hitachi inverter is a rugged and reliable device. The intention is for the inverter to assume the role of controlling power to the motor during all normal operations. Therefore, this manual instructs you not to switch OFF power to the inverter *while the motor is running* (unless it is an emergency stop). Also, do not install or use disconnect switches in the wiring from the inverter to the motor (except thermal disconnect). Of course, safety-related devices such as fuses must be in the design to break power during a malfunction, as required by NEC and local codes.

Intelligent Functions and Parameters

Much of this manual is devoted to describing how to use inverter functions and how to configure inverter parameters. The inverter is microprocessor-controlled, and has many independent functions. The microprocessor has an on-board EEPROM for parameter storage. The inverter's front panel keypad provides access to all functions and parameters, which you can access through other devices as well. The general name for all these devices is the *digital operator*, or *digital operator panel*. Chapter 2 will show you how to get a motor running, using a minimal set of function commands or configuring parameters.

The optional read/write programmer will let you read and write inverter EEPROM contents from the programmer. This feature is particularly useful for OEMs who need to duplicate a particular inverter's settings in many other inverters in assembly-line fashion.



Getting Started

Braking

In general, braking is a force that attempts to slow or stop motor rotation. So it is associated with motor deceleration, but may also occur even when the load attempts to drive the motor faster than the desired speed (overhauling). If you need the motor and load to decelerate quicker than their natural deceleration during coasting, we recommend installing a braking resistor. The dynamic braking unit (built into certain SJ300 models) sends excess motor energy into a resistor to slow the motor and load (see "Introduction" on page 5-2 and "Dynamic Braking" on page 5-6 for more information). For loads that continuously overhaul the motor for extended periods of time, the SJ300 may not be suitable (contact your Hitachi distributor).

The inverter parameters include acceleration and deceleration, which you can set to match the needs of the application. For a particular inverter, motor, and load, there will be a range of practically achievable accelerations and decelerations.

Velocity Profiles

The SJ300 inverter is capable of sophisticated speed control. A graphical representation of that capability will help you understand and configure the associated parameters. This manual makes use of the velocity profile graph used in industry (shown at right). In the example, the acceleration is a ramp to a set speed, and the deceleration is a decline to a stop.

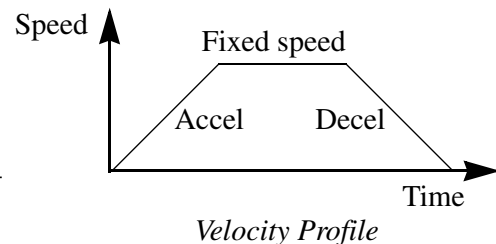

Acceleration and deceleration settings specify the time required to go from a stop to maximum frequency (or visa versa). The resulting slope (speed change divided by time) is the acceleration or deceleration. An increase in output frequency uses the acceleration slope, while a decrease uses the deceleration slope. The accel or decel time a particular speed change depends on the starting and ending frequencies. However, the slope is constant, corresponding to the full-scale accel or decel time setting.

For example, the full-scale acceleration setting (time) may be 10 seconds—the time required to go from 0 to 60 Hz.

The SJ300 inverter can store up to 16 preset speeds. And, it can apply separate acceleration and deceleration transitions from any preset to any other preset speed. A multi-speed profile (shown at right) uses two or more preset speeds, which you can select via intelligent input terminals. This external control can apply any preset speed at any time. Alternatively, the selected speed is infinitely variable across the speed range. You can use the potentiometer control on the keypad for manual control. The drive accepts analog 0-10V signals and 4-20 mA control signals as well.

The inverter can drive the motor in either direction. Separate FW and RV commands select the direction of rotation. The motion profile example shows a forward motion followed by a reverse motion of shorter duration. The speed presets and analog signals control the magnitude of the speed, while the FW and RV commands determine the direction before the motion starts.

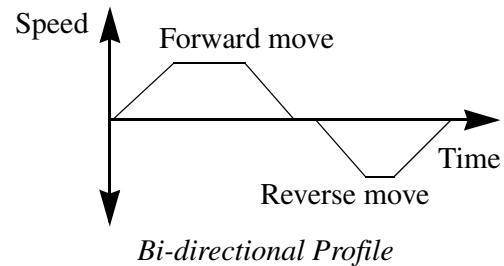
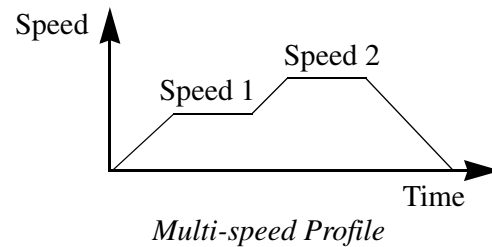
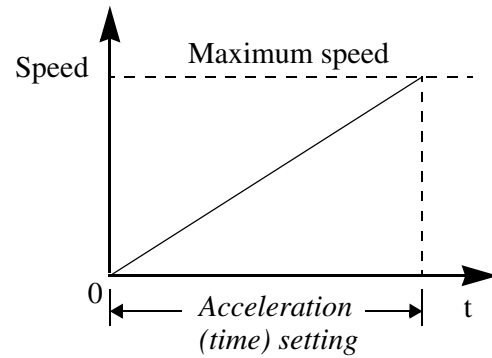

NOTE: The SJ300 can move loads in both directions. However, it is not designed for use in servo-type applications that use a bipolar velocity signal that determines direction.

Frequently Asked Questions

- Q.** What is the main advantage in using an inverter to drive a motor, compared to alternative solutions?
- A.** An inverter can vary the motor speed with very little energy loss, unlike mechanical or hydraulic speed control solutions. The resulting energy savings can often pay for the inverter in a relatively short time.
- Q.** The term “inverter” is a little confusing, since we also use “drive” and “amplifier” to describe the electronic unit that controls a motor. What does “inverter” mean?
- A.** The terms are used somewhat interchangeably in industry. Nowadays, the terms *drive*, *variable-frequency drive*, *variable-speed drive*, and *inverter* are generally used to describe electronic, microprocessor-based motor speed controllers. In the past, *variable speed drive* also referred to various mechanical means to vary speed. *Amplifier* is a term almost exclusively used to describe drives for servo or stepper motors.
- Q.** Although the SJ300 inverter is a variable speed drive, can I use it in a fixed-speed application?
- A.** Yes, sometimes an inverter can be used simply as a “soft-start” device, providing controlled acceleration and deceleration to a fixed speed. Other functions of the SJ300 may be useful in such applications, as well. However, using a variable speed drive can benefit many types of industrial and commercial motor applications, by providing controlled acceleration and deceleration, high torque at low speeds, and energy savings over alternative solutions.
- Q.** Can I use an inverter and AC induction motor in a positioning application?
- A.** That depends on the required precision, and the slowest speed the motor must turn and still deliver torque. The SJ300 inverter will deliver 200% rated torque while turning the motor at only 0.5 Hz. DO NOT use an inverter if you need the motor to stop and hold the load position without the aid of a mechanical brake (use a servo or stepper motion control system).
- Q.** Does the optional digital operator interface or the PC software (DOP Professional) provide features beyond what is available from the keypad on the unit?
- A.** Yes. However, note first that the same set of parameters and functions are equally accessible from either the unit’s keypad or from remote devices. The DOP Professional PC software lets you save or load inverter configurations to or from a disk file. And, the hand-held digital operator provides hard-wired terminals, a safety requirement for some installations.
- Q.** Why does the manual or other documentation use terminology such as “200V class” instead of naming the actual voltage, such as “230 VAC”?
- A.** A specific inverter model is set at the factory to work across a voltage range particular to the destination country for that model. The model specifications are on the label on the side of the inverter. A European 200V class inverter (“EU” marking) has different parameter settings than a USA 200V class inverter (“US” marking). The initialization procedure (see “Restoring Factory Default Settings” on page 6–9) can set up the inverter for European or US commercial voltage ranges.
- Q.** Why doesn’t the motor have a neutral connection as a return to the inverter?
- A.** The motor theoretically represents a “balanced Y” load if all three stator windings have the same impedance. The Y connection allows each of the three wires to alternately serve as input or return on alternate half-cycles.
- Q.** Does the motor need a chassis ground connection?
- A.** Yes, for several reasons. Most importantly, this provides protection in the event of a short in the motor that puts a hazardous voltage on its housing. Secondly, motors exhibit leakage currents that increase with aging. Lastly, a grounded chassis generally emits less electrical noise than an ungrounded one.



- Q.** What type of motor is compatible with the Hitachi inverters?
- A.** **Motor type** – It must be a three phase AC induction motor. Use an inverter-grade motor that has 800V insulation for 200V class inverters, or 1600V insulation for 400V class.
- Motor size** – In practice, it's better to find the right size motor for your application; then look for the inverter to match the motor.

NOTE: There may be other factors that will affect motor selection, including heat dissipation, motor operating speed profile, enclosure type, and cooling method.

- Q.** How many poles should the motor have?
- A.** Hitachi inverters can be configured to operate motors with 2, 4, 6, or 8 poles. The greater the number of poles, the slower the top motor speed will be, but it will have higher torque at the base speed.
- Q.** Will I be able to add dynamic (resistive) braking to my Hitachi SJ300 drive after the initial installation?
- A.** Yes. Models SJ300-004XXX through SJ300-110XXX have built-in dynamic braking units. You can add an external resistor to these models to improve braking performance. Models SJ300-150XXX through SJ300-1500XXX require you to add an external braking unit. The braking resistor connects to the external braking unit for those models. More information on dynamic braking is located in Chapter 5.
- Q.** How will I know if my application will require resistive braking?
- A.** For new applications, it may be difficult to tell before you actually test a motor/drive solution. In general, some applications can rely on system losses such as friction to serve as the decelerating force, or otherwise can tolerate a long decel time. These applications will not need dynamic braking. However, applications with a combination of a high-inertia load and a required short decel time will need dynamic braking. This is a physics question that may be answered either empirically or through extensive calculations.
- Q.** Several options related to electrical noise suppression are available for the Hitachi inverters. How can I know if my application will require any of these options?
- A.** The purpose of these noise filters is to reduce the inverter electrical noise so the operation of nearby electrical devices is not affected. Some applications are governed by particular regulatory agencies, and noise suppression is mandatory. In those cases, the inverter must have the corresponding noise filter installed. Other applications may not need noise suppression, unless you notice electrical interference with the operation of other devices.
- Q.** The SJ300 features a PID loop feature. PID loops are usually associated with chemical processes, heating, or process industries in general. How could the PID loop feature be useful in my application?
- A.** You will need to determine the particular main variable in your application the motor affects. That is the process variable (PV) for the motor. Over time, a faster motor speed will cause a faster change in the PV than a slow motor speed will. By using the PID loop feature, the inverter commands the motor to run at the optimal speed required to maintain the PV at the desired value for current conditions. Using the PID loop feature will require an additional sensor and other wiring, and is considered an advanced application.