

Inverter Mounting and Installation



2

In This Chapter....	page
— Orientation to Inverter Features	2
— Basic System Description	5
— Step-by-Step Basic Installation	6
— Powerup Test	21
— Using the Front Panel Keypad	23

Orientation to Inverter Features

Unpacking and Inspection

Please take a few moments to unpack your new SJ300 inverter and perform these steps:

1. Look for any damage that may have occurred during shipping.
2. Verify the contents of the box include:
 - a. One SJ300 inverter
 - b. One Instruction Manual (supplied by printed book for –FU/–FR models, supplied on CR-ROM for –FE models)
 - c. One SJ300 Quick Reference Guide
 - d. One packet of desiccant—discard (not for human consumption)
3. Inspect the specifications label on the front or side of the inverter. Make sure it matches the product part number you ordered.

Main Physical Features

The SJ300 Series inverters vary in size according to the current output rating and motor size for each model number. All feature the same basic keypad and connector interface for consistent ease of use. The inverter construction has a heat sink at the back of the housing. The fans enhance heat sink performance. Mounting holes are pre-drilled in the heat sink for your convenience. Never touch the heat sink during or just after operation; it can be very hot.

The electronics housing and front panel are built onto the front of the heat sink. The front panel has three levels of physical access designed for convenience and safety:

- **First-level access** – for basic use of inverter and editing parameters during powered operation (power is ON)
- **Second-level access** – for wiring the inverter power supply or motor (power is OFF)
- **Third-level access** – for accessing the expansion bay for adding/removing expansion boards (power is OFF)

1. **First-level Access** - View the unit just as it came from the box as shown. The OPE-SRE or OPE-S digital operator keypad comes installed in the inverter. The four-digit display can show a variety of performance parameters. LEDs indicate whether the display units are Hertz, Volts, Amperes, or kW. Other LEDs indicate Power (external), and Run/Stop Mode and Program/Monitor Mode status. Membrane keys Run and Stop/Reset, and a Min/Max frequency control knob (OPE-SRE only) control motor operation. These controls and indicators are usually the only ones needed after the inverter installation is complete.

The FUNC., Δ , ∇ , and STR keys allow an operator to change the inverter's functions and parameter values, or to select the one monitored on the 4-digit display. Note that some parameters may not be edited if the inverter is in Run mode.



2. **Second-level access** - First, ensure no power source of any kind is connected to the inverter. If power has been connected, wait five minutes after powerdown and verify the Charge Lamp indicator is OFF to proceed. Then locate the recessed retention screw at the bottom of the main front panel. Use a small Phillips screwdriver to remove the screw. Press the two latch release areas near the “SJ300” label as shown, and simultaneously slide the lower front downward to release for removal.

Press here and slide cover downward



Retention screw

Notice the large power terminals at the bottom of the wiring area. The rubber grommets below the power terminals are for wire entry/exit to the power source and motor. Never operate the inverter with the front panel removed.

The control terminals connect logic or analog signals for control and monitoring of the inverter. The nearby alarm relay provides both normally-open and normally-closed logic for interface to an external alarm. The alarm circuit may carry hazardous live voltages even when the main power to the inverter is OFF. So, never directly touch any terminal or circuit component.



Logic Connector

Power terminals

Wire entry/exit plate

Charge lamp indicator



WARNING: Be sure to wait five minutes after powerdown and verify the charge lamp indicator is OFF to proceed. Otherwise there is the risk of electric shock.

3. Third-level access - The SJ300 provides for field installation of interface circuits. These circuits are on expansion cards, to be installed in the expansion bay. To access the expansion bay, you will need to remove the upper front panel. Use the latch to release the digital operator (the panel filler plate may remain). Remove the two retention screws the bottom corners of the upper front panel. Lift up at the bottom, then disengage the two hinge latches at the top.

Latch to release digital operator



Retention screws

The expansion bay has two sites for adding expansion cards. Each card connects via the interface connector, and mounts using three standoff screw locations. Further details on accessories are in Chapter 5. You may also refer to the instruction manual that comes with each type of expansion card.

Expansion bay

Expansion connectors



The following sections will describe the system design and guide you through a step-by-step installation process. After the section on wiring, this chapter will show how to use the front panel keys to access functions and edit parameters.

Basic System Description

A motor control system will obviously include a motor and inverter, as well as a breaker or fuses for safety. If you are connecting a motor to the inverter on a test bench just to get started, that's all you may need for now. But a system can also have a variety of additional components. Some can be for noise suppression, while others may enhance the inverter's braking performance. The figure and table below show a system with all the optional components you may need in your finished application.

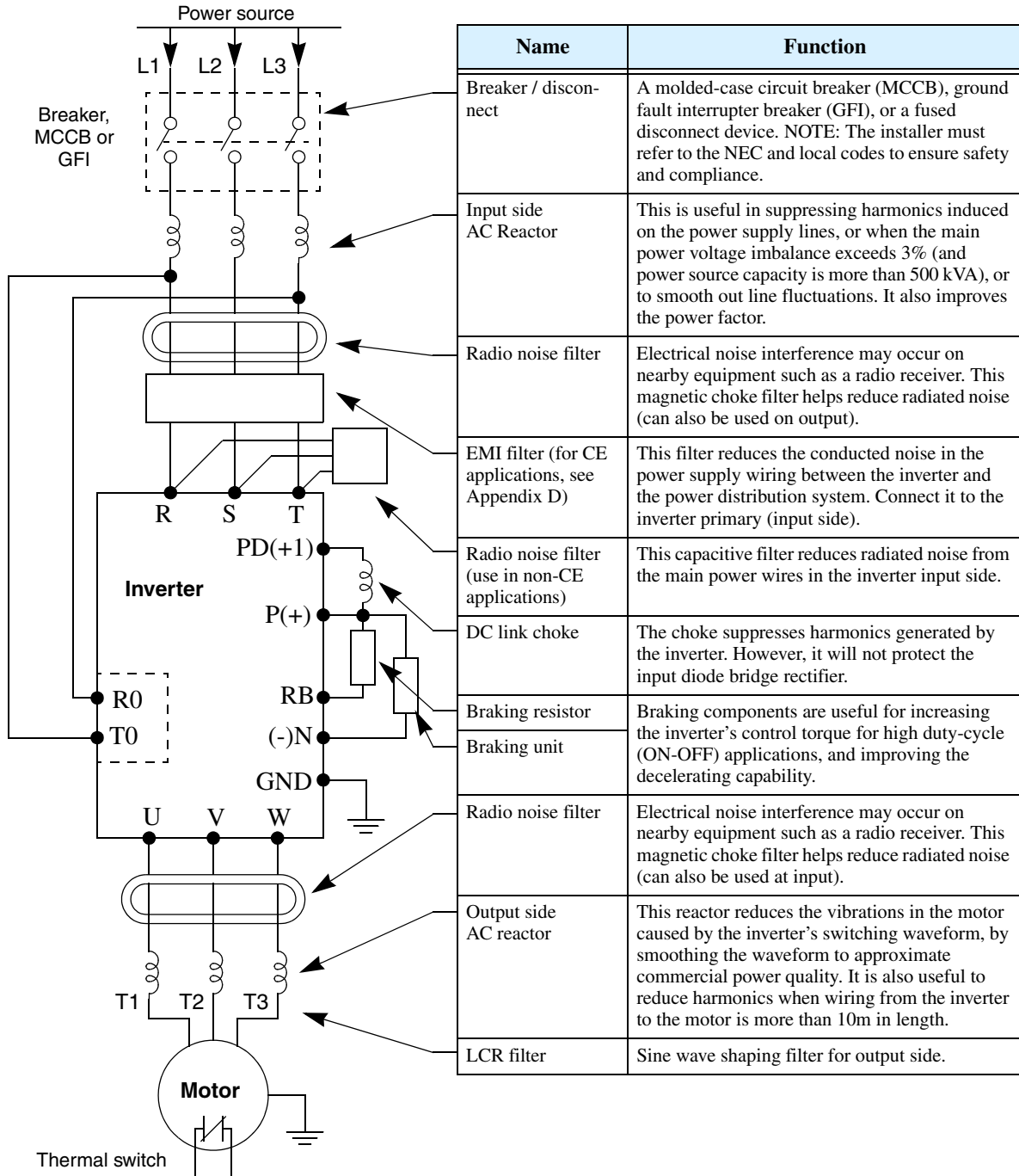

Name	Function
Breaker / disconnect	A molded-case circuit breaker (MCCB), ground fault interrupter breaker (GFI), or a fused disconnect device. NOTE: The installer must refer to the NEC and local codes to ensure safety and compliance.
Input side AC Reactor	This is useful in suppressing harmonics induced on the power supply lines, or when the main power voltage imbalance exceeds 3% (and power source capacity is more than 500 kVA), or to smooth out line fluctuations. It also improves the power factor.
Radio noise filter	Electrical noise interference may occur on nearby equipment such as a radio receiver. This magnetic choke filter helps reduce radiated noise (can also be used on output).
EMI filter (for CE applications, see Appendix D)	This filter reduces the conducted noise in the power supply wiring between the inverter and the power distribution system. Connect it to the inverter primary (input side).
Radio noise filter (use in non-CE applications)	This capacitive filter reduces radiated noise from the main power wires in the inverter input side.
DC link choke	The choke suppresses harmonics generated by the inverter. However, it will not protect the input diode bridge rectifier.
Braking resistor	Braking components are useful for increasing the inverter's control torque for high duty-cycle (ON-OFF) applications, and improving the decelerating capability.
Braking unit	
Radio noise filter	Electrical noise interference may occur on nearby equipment such as a radio receiver. This magnetic choke filter helps reduce radiated noise (can also be used at input).
Output side AC reactor	This reactor reduces the vibrations in the motor caused by the inverter's switching waveform, by smoothing the waveform to approximate commercial power quality. It is also useful to reduce harmonics when wiring from the inverter to the motor is more than 10m in length.
LCR filter	Sine wave shaping filter for output side.

Inverter Mounting and Installation



NOTE: Some components are required for regulatory agency compliance (see Chapter 5 and Appendix D).

Step-by-Step Basic Installation



This section will guide you through the following basic steps of installation:

1. Study the warnings associated with mounting the inverter.
2. Select a suitable mounting location.

NOTE: If the installation is in an EU country, study the EMC installation guidelines in Appendix D.

3. Cover the inverter's top ventilation openings to prevent debris from falling inside.
4. Check the inverter mounting dimensions for footprint and mounting hole locations.
5. Study the caution and warning messages associated with wiring the inverter.
6. Connect wiring for the inverter power input.
7. Connect wiring to the motor.
8. Uncover the inverter's ventilation openings that were covered in Step 3.
9. Perform a powerup test.
10. Make observations and check your installation.

Step 1: Study the following caution messages associated with mounting the inverter. This is the time when mistakes are most likely to occur that will result in expensive rework, equipment damage, or personal injury.



Choosing a Mounting Location



CAUTION: Be sure to install the unit on flame-resistant material such as a steel plate. Otherwise, there is the danger of fire.



CAUTION: Be sure not to place any flammable materials near the inverter. Otherwise, there is the danger of fire.



CAUTION: Be sure not to let the foreign matter enter vent openings in the inverter housing, such as wire clippings, spatter from welding, metal shavings, dust, etc. Otherwise, there is the danger of fire.



CAUTION: Be sure to install the inverter in a place that can bear the weight according to the specifications in the text (Chapter 1, Specifications Tables). Otherwise, it may fall and cause injury to personnel.



CAUTION: Be sure to install the unit on a perpendicular wall that is not subject to vibration. Otherwise, it may fall and cause injury to personnel.



CAUTION: Be sure not to install or operate an inverter that is damaged or has missing parts. Otherwise, it may cause injury to personnel.



CAUTION: Be sure to install the inverter in a well-ventilated room that does not have direct exposure to sunlight, a tendency for high temperature, high humidity or dew condensation, high levels of dust, corrosive gas, explosive gas, inflammable gas, grinding-fluid mist, salt air, etc. Otherwise, there is the danger of fire.

2 Ensure Adequate Ventilation

Step 2: To summarize the caution messages—you will need to find a solid, non-flammable, vertical surface that is in a relatively clean and dry environment. In order to ensure enough room for air circulation around the inverter to aid in cooling, maintain the specified clearance around the inverter specified in the diagram.

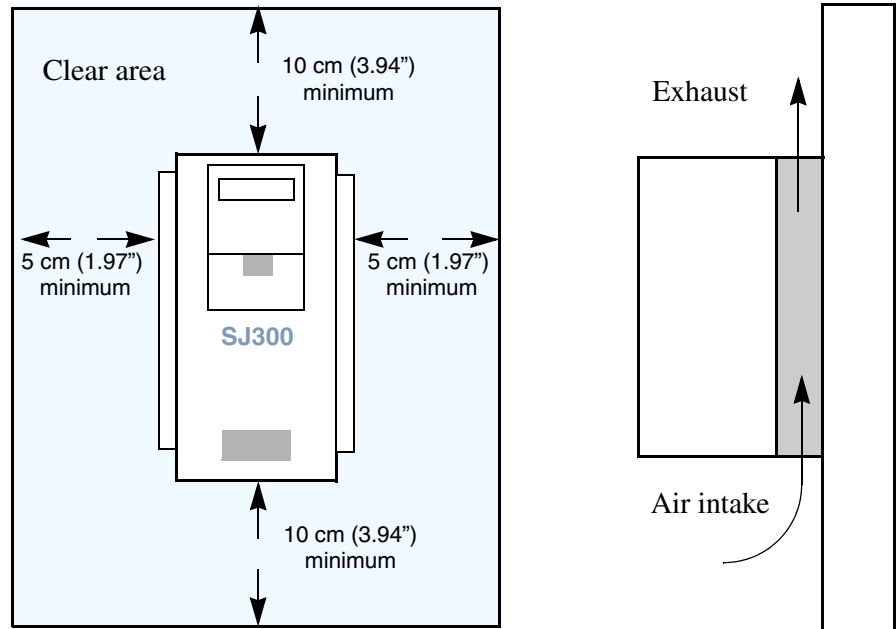

Inverter Mounting
and Installation



CAUTION: Be sure to maintain the specified clearance area around the inverter and to provide adequate ventilation. Otherwise, the inverter may overheat and cause equipment damage or fire.

3 Keep Debris Out of Inverter Vents

Step 3: Before proceeding to the wiring section, it's a good time to *temporarily* cover the inverter's ventilation openings. Paper and masking tape are all that is needed. This will prevent harmful debris such as wire clippings and metal shavings from entering the inverter during installation.

Please observe this checklist while mounting the inverter:

1. The ambient temperature must be in the range of -10 to 40°C. If the range will be up to 50°C (maximum rating), you will need to refer to "Derating Curves" on page 1-11.
2. Keep any other heat-producing equipment as far away from the inverter as possible.
3. When installing the inverter in an enclosure, maintain the clearance around the inverter and verify that its ambient temperature is within specification when the enclosure door is closed.
4. Do not open the main front panel door at any time during operation.

Cover the fan outlet vents

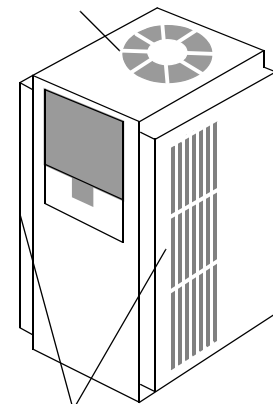

Cover the ventilation slots,
both sides

4

Check Inverter Dimensions

Step 4: Locate the applicable drawing on the following pages for your inverter. Dimensions are given in millimeters (inches) format. Larger models come equipped with NEMA1 adapter for wire entry for U.S. models only as shown (LFU and HFU).

- Model
 SJ300 -004LFU
 -007LFU/HFE, HFU
 -015LFU/HFE, HFU
 -022LFU/HFE, HFU
 -037LFU/HFE, HFU
 -055LFU/HFE, HFU

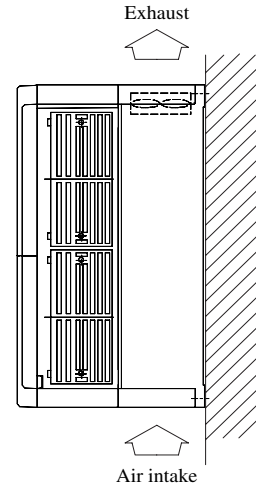
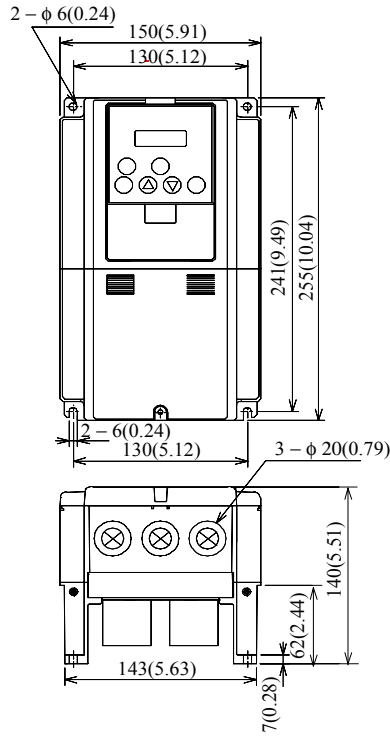

- Model
 SJ300 -075LFU/HFE, HFU
 -110LFU/HFE, HFU

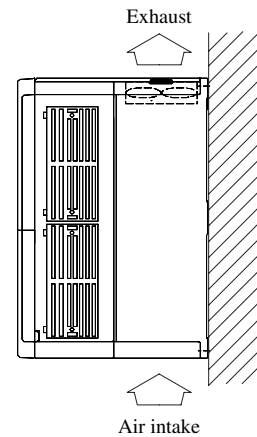
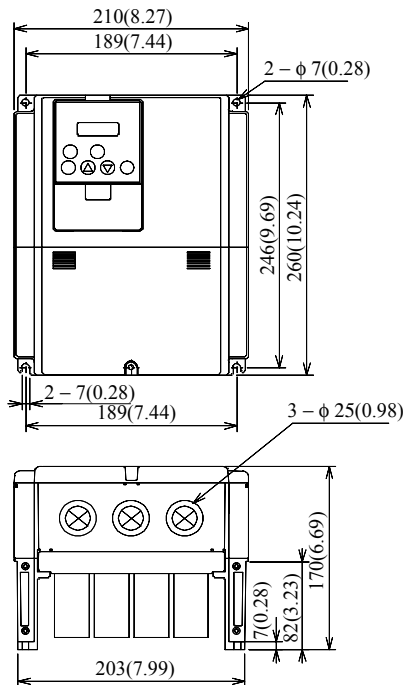

NOTE: Be sure to use lock washers or other means to ensure screws do not loosen due to vibration.

Dimensional drawings, continued...

Model
 SJ300 -150LFU/HFE, HFU
 -185LFU/HFE, HFU
 -220LFU/HFE, HFU

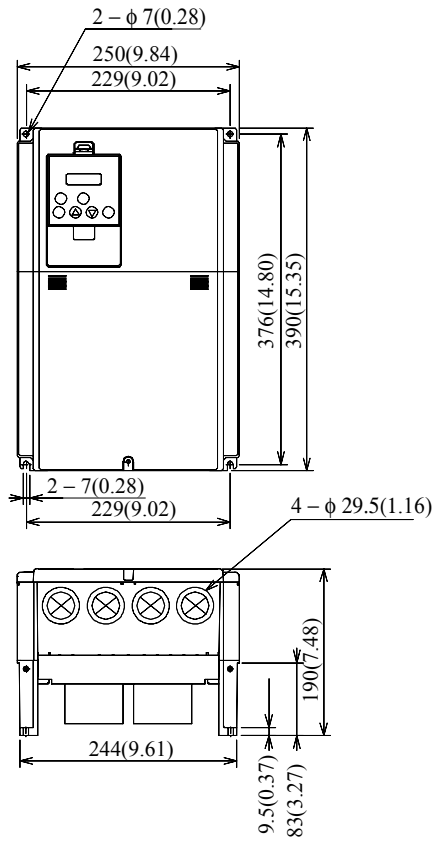

Inverter Mounting and Installation

Model
 SJ300 -300LFU/HFE, HFU

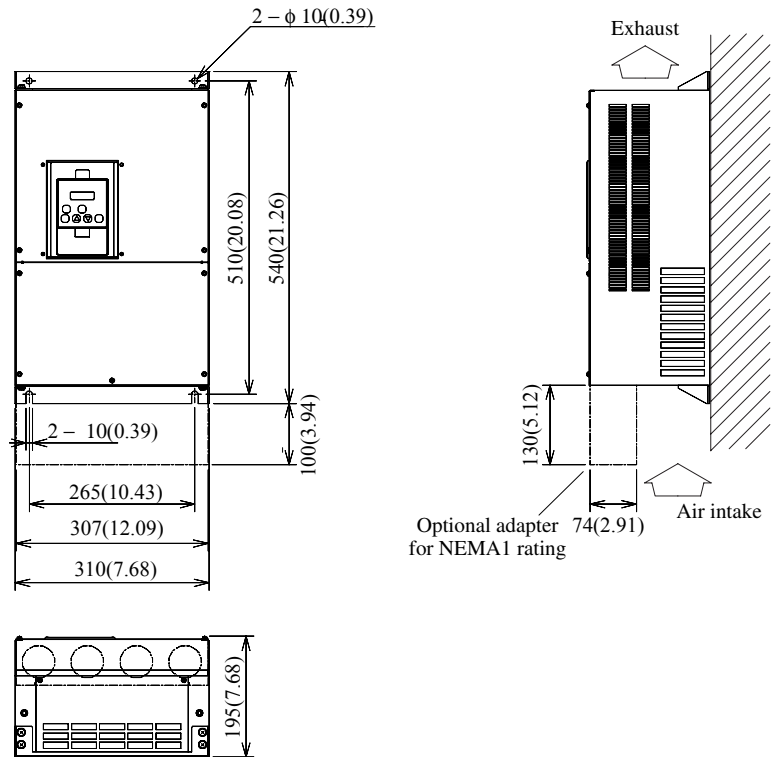

Dimensional drawings, continued...

Inverter Mounting and Installation

Model
 SJ300 -370LFU/HFE, HFU
 -450LFU/HFE, HFU
 -550HFE, HFU

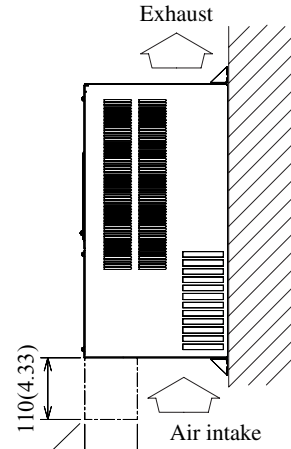
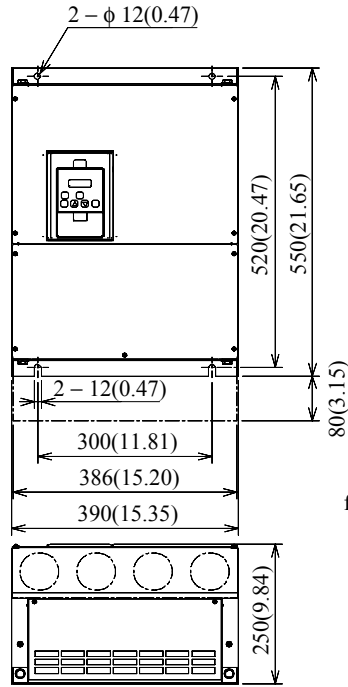

Optional adapter for NEMA1 rating 90(3.54)

Model
 SJ300 -550LFU

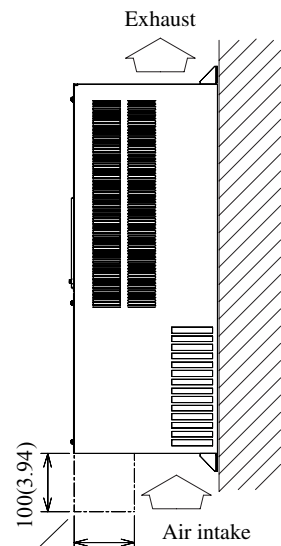
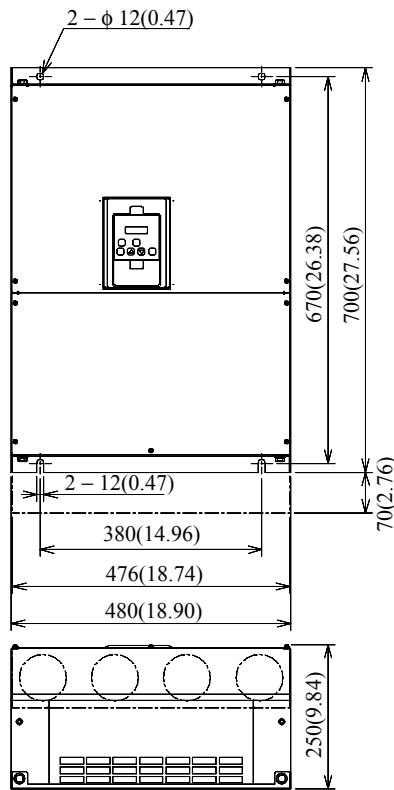

Optional adapter for NEMA1 rating 104(4.09)

Dimensional drawings, continued...

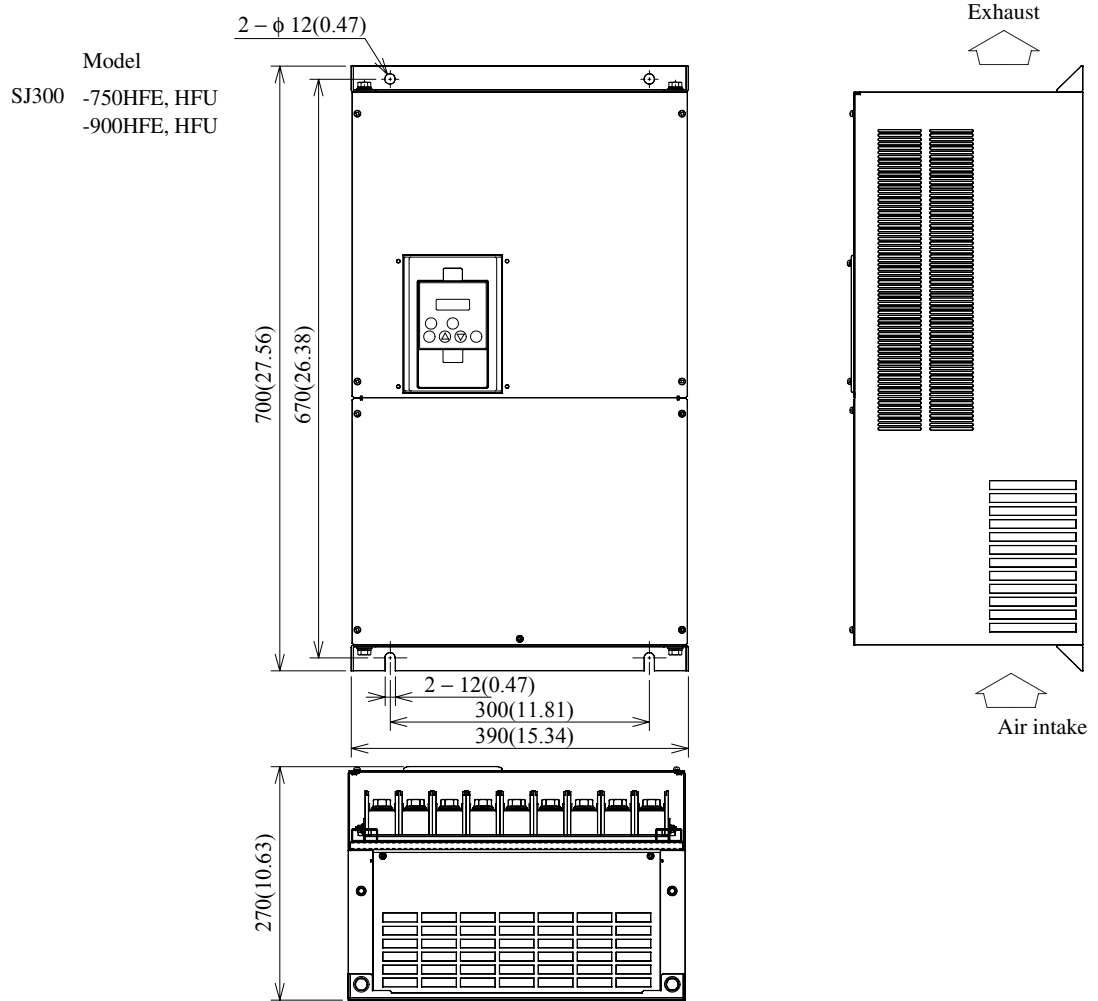

Dimensional drawings, continued...

Model
SJ300 -1100HFE, HFU
-1320HFE
-1500HFU

Inverter Mounting
and Installation

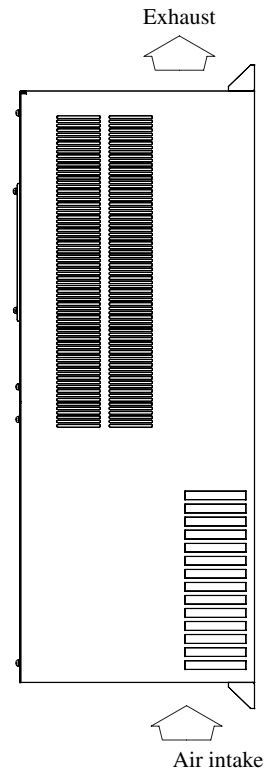
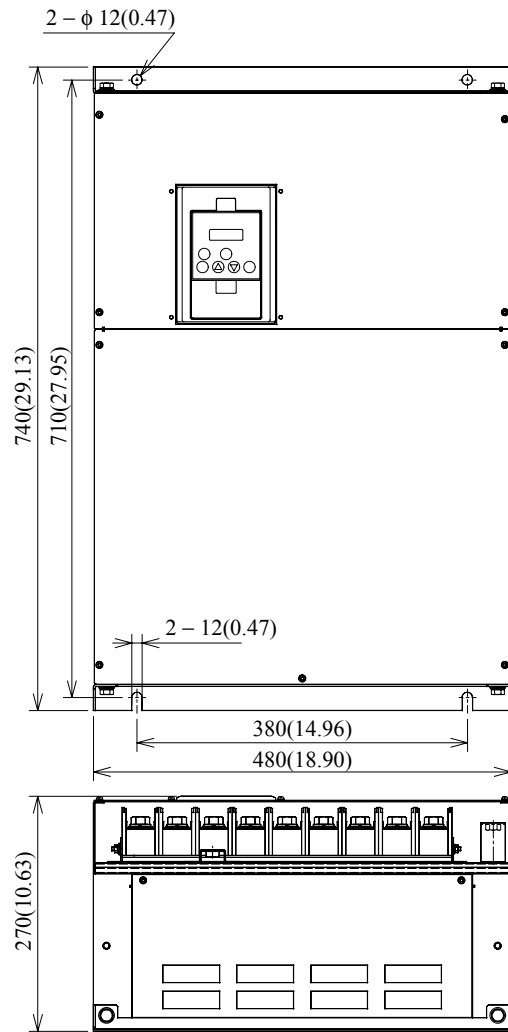

5
Prepare for Wiring



Step 5: The wiring enters the inverter through the entry/exit plate as shown to the right. The rubber grommets have a solid, thin membrane, so that unused ones continue to seal the opening. To create an opening, use a sharp knife and carefully cut an “X” in the center of the grommet as shown. Be especially careful to avoid cutting into the thick outer ring, so that the wiring will have a cushion from contacting the metal plate.

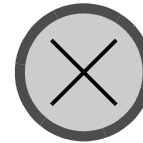
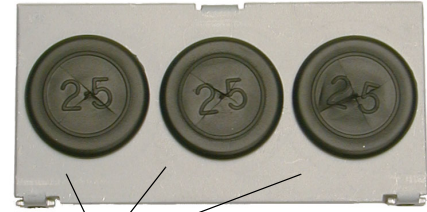

Cut grommet(s) for use as shown

NOTE: Some inverter models will have a wiring box for NEMA rating compliance. Make sure the wire entry to the NEMA box also has protective cushion from chaffing of insulation.

Inverter Mounting and Installation

Before proceeding, please study the caution and warning messages below.



WARNING: “Use 60/75°C Cu wire only” or equivalent.



WARNING: “Open Type Equipment.” For models SJ300-750H to SJ300-1500H.



WARNING: “A Class 2 circuit wired with Class 1 wire” or equivalent.



WARNING: “Suitable for use on a circuit capable of delivering not more than 10,000 rms symmetrical amperes, 240 V maximum.” For models with suffix L.



WARNING: “Suitable for use on a circuit capable of delivering not more than 10,000 rms symmetrical amperes, 480 V maximum.” For models with suffix H.



HIGH VOLTAGE: Be sure to ground the unit. Otherwise, there is a danger of electric shock and/or fire.



HIGH VOLTAGE: Wiring work shall be carried out only by qualified personnel. Otherwise, there is a danger of electric shock and/or fire.



HIGH VOLTAGE: Implement wiring after checking that the power supply is OFF. Otherwise, you may incur electric shock and/or fire.



HIGH VOLTAGE: Do not connect wiring to an inverter or operate an inverter that is not mounted according the instructions given in this manual. Otherwise, there is a danger of electric shock and/or injury to personnel.

Determining Wire and Fuse Sizes

This section includes tables for 200V class and 400V class inverters (on the next page). The following notes will help you read the tables in this section:

- Locate the row corresponding to the motor size and particular inverter in your application. The maximum motor current determines the recommended wire sizes.
- The length column specifies that some inverters can optionally use a smaller wire gauge if the wires are shorter than 10m and the inverter is located in an enclosure.
- Power Lines columns include wires connecting to terminals [R, S, T, U, V, W, P, PD, and N]. Only power input and motor leads will be fused: [R, S, T, U, V, and W]. The breaker ratings (GFI—ground fault interrupter) are slightly higher than fuse ratings to allow for nominal surges without tripping.
- The chassis ground columns list the Hitachi-recommended AWG and the minimal AWG for UL conformity.
- The optional external braking resistor wiring only applies to a few models that have a built-in braking unit. The other models use an optional external braking unit.
- Parallel wires increase effective wire gauge, and are denoted by “||” in the tables.
- Signal Lines, not listed in these tables, connect to the removable logic connector. The recommended wire gauge for all wiring to the logic connector is 28 AWG (0.75 mm²). Be sure to use shielded wire for any analog signals.

Motor Output		200V Inverter Models	Wiring *1								
			Power Lines *3				Chassis Ground			Brake Res.	
HP	kW		AWG	mm ²	Fuse (UL-rated, class J, 600V)	Breaker (GFI type) *2	AWG, rec.	AWG, UL	mm ²	AWG	mm ²
1/2	0.4	SJ300-004LFU	20	1.25	10A	5A	16	14	1.25	20	1.25
1	0.75	SJ300-007LFU	18	1.25	10A	10A	16	14	1.25	18	1.25
2	1.5	SJ300-015LFU	14	2	10A	15A	16	14	1.25	14	2
3	2.2	SJ300-022LFU	14	2	15A	20A	16	14	1.25	14	2
5	3.7	SJ300-037LFU	10	3.5	20A	30A	10	12	3.5	10	3.5
7.5	5.5	SJ300-055LFU	8	5.5	30A	50A	8	10	5.5	8	5.5
10	7.5	SJ300-075LFU	6	8	40A	60A	8	10	8	8	5.5
15	11	SJ300-110LFU	4	14	60A	75A	4	10	14	8	5.5
20	15	SJ300-150LFU	2	22	80A	100A	3	8	22	—	—
25	18.5	SJ300-185LFU	4 4	14 14	100A	100A	3	8	22	—	—
30	22	SJ300-220LFU	4 4	14 14	125A	150A	2	8	30	—	—
40	30	SJ300-300LFU	2 2	22 22	150A	200A	2	6	30	—	—
50	37	SJ300-370LFU	2 2	30 30	175A	225A	1/0	6	38	—	—
60	45	SJ300-450LFU	1 1 (75°C)	38 38	225A	225A	3/0	6	38	—	—
75	55	SJ300-550LFU	2/0 2/0	60 60	250A	350A	3/0	4	60	—	—

* See notes for wiring tables on the following page.

Motor Output		400V Inverter Models	Wiring *1								
			Power Lines *3				Chassis Ground			Brake Res.	
HP	kW		AWG	mm ²	Fuse (UL-rated, class J, 600V)	Breaker (GFI type) *2	AWG, rec.	AWG, UL	mm ²	AWG	mm ²
1	0.75	SJ300-007HFU/E	20	1.25	10A	5A	16	14	1.25	20	1.25
2	1.5	SJ300-015HFU/E	18	2	10A	10A	16	14	1.25	18	2
3	2.2	SJ300-022HFU/E	16	2	10A	10A	16	14	1.25	16	2
5	4.0	SJ300-040HFU/E	14	2	15A	15A	16	14	1.25	14	2
7.5	5.5	SJ300-055HFU/E	12	2	15A	30A	14	14	2	12	2
10	7.5	SJ300-075HFU/E	10	3.5	20A	30A	10	12	3.5	10	3.5
15	11	SJ300-110HFU/E	8	5.5	30A	50A	8	10	5.5	8	5.5
20	15	SJ300-150HFU/E	6	8	40A	60A	8	10	8	—	—
25	18.5	SJ300-185HFU/E	6	14	50A	60A	4	10	14	—	—
30	22	SJ300-220HFU/E	4	14	60A	75A	4	10	14	—	—
40	30	SJ300-300HFU/E	3	22	70A	100A	3	10	22	—	—
50	37	SJ300-370HFU/E	4 4	14 14	90A	100A	3	8	22	—	—
60	45	SJ300-450HFU/E	1 (75°C)	38	125A	150A	1	8	22	—	—
75	55	SJ300-550HFU/E	2 2	22 22	125A	175A	1	6	30	—	—
100	75	SJ300-750HFU/E	1 1 (75°C)	30 30	175A	225A	1/0	6	50	—	—
125	90	SJ300-900HFU/E	1 1 (75°C)	38 38	200A	225A	3/0	6	80	—	—
150	110	SJ300-1100HFU/E	1/0 1/0	50 50	250A	350A	3/0	4	80	—	—
175	132	SJ300-1320HFE	3/0 3/0	80 80	300A	350A	4/0	4	100	—	—
200	150	SJ300-1500HFU	3/0 3/0	80 80	300A	350A	4/0	4	100	—	—

Note 1: Field wiring must be made by a UL-listed and CSA certified ring lug terminal connector sized for the wire gauge involved. The connector must be fixed by using the crimping tool specified by the connector manufacturer.

Note 2: Be sure to consider the capacity of the circuit breaker to be used.

Note 3: Be sure to use a larger wire gauge if power line length exceeds 66 ft (20m).

Terminal Dimensions and Torque Specs



The following tables list the screw size of terminal and recommended torque for tightening for each of the SJ300 inverter models (400V models are on the next page).

CAUTION: Fasten the screws with the specified fastening torque in the table below. Check for any loosening of screws. Otherwise, there is the danger of fire.

Input Voltage	Motor Output		200V Inverter Models	Screw size of terminal	Ring lug connector *1		Torque	
	HP	kW			(AWG-bolt)	(mm ² -bolt)	ft-lbs	(N-m)
200V	1/2	0.4	SJ300-004LFU	M4	20-#10	1.25-4	1.1	1.5
	1	0.75	SJ300-007LFU	M4	20-#10	1.25-4	1.1	1.5
	2	1.5	SJ300-015LFU	M4	14-#10	2-4	1.1	1.5
	3	2.2	SJ300-022LFU	M4	14-#10	2-4	1.1	1.5
	5	3.7	SJ300-037LFU	M4	10-#10	3.5-4	1.1	1.5
	7.5	5.5	SJ300-055LFU	M5	8-#12	5.5-5	1.8	2.5
	10	7.5	SJ300-075LFU	M5	8-#12	8-5	1.8	2.5
	15	11	SJ300-110LFU	M6	4-1/4	14-6	3.6	4.9
	20	15	SJ300-150LFU	M6	2-1/4	22-6	3.6	4.9
	25	18.5	SJ300-185LFU	M6	4-1/4	14-6	3.6	4.9
	30	22	SJ300-220LFU	M8	4-5/16	14-8	6.5	8.8
	40	30	SJ300-300LFU	M8	2-5/16	22-8	6.5	8.8
	50	37	SJ300-370LFU	M8	1-5/16	30-8	6.5	8.8
	60	45	SJ300-450LFU	M10	1/0-1/2	38-10	10.1	13.7
75	55	SJ300-550LFU	M10	2/0-1/2	60-10	10.1	13.7	

Note 1: The recommended ring lug connector listing consists of wire size – screw size format. The wire sizes are in AWG or mm² format. For AWG wire sizes, bolt sizes for the ring lug centers are: #10, #12, 1/4", 5/16", and 1/2". For metric wire sizes, bolt sizes for the ring lug centers are: 6 = 6M, 8 = 8M, 10 = 10M.



TIP: AWG = American Wire Gauge. Smaller numbers represent increasing wire thickness.
 kcmil = 1,000 circular mils, a measure of wire cross-sectional area
 mm² = square millimeters, a measure of wire cross-sectional area

Terminal dimensions and torque specs, continued...

Input Voltage	Motor Output		400V Inverter Models	Screw size of terminal	Ring lug connector *1		Torque	
	HP	kW			(AWG-bolt)	(mm ² -bolt)	ft-lbs	(N-m)
400V	1	0.75	SJ300-007HFU/E	M4	20-#10	1.25-4	1.1	1.5
	2	1.5	SJ300-015HFU/E	M4	14-#10	2-4	1.1	1.5
	3	2.2	SJ300-022HFU/E	M4	14-#10	2-4	1.1	1.5
	5	4.0	SJ300-040HFU/E	M4	14-#10	2-4	1.1	1.5
	7.5	5.5	SJ300-055HFU/E	M5	14-#12	2-5	1.8	2.5
	10	7.5	SJ300-075HFU/E	M5	10-#12	3.5-5	1.8	2.5
	15	11	SJ300-110HFU/E	M6	8-1/4	5.5-6	3.6	4.9
	20	15	SJ300-150HFU/E	M6	6-1/4	8-6	3.6	4.9
	25	18.5	SJ300-185HFU/E	M6	4-1/4	14-6	3.6	4.9
	30	22	SJ300-220HFU/E	M6	4-1/4	14-6	3.6	4.9
	40	30	SJ300-300HFU/E	M6	2-1/4	22-6	3.6	4.9
	50	37	SJ300-370HFU/E	M6	4-1/4	14-6	3.6	4.9
	60	45	SJ300-450HFU/E	M8	1/0-5/16	38-8	6.5	8.8
	75	55	SJ300-550HFU/E	M8	2-5/16	22-8	6.5	8.8
	100	75	SJ300-750HFU/E	M8	1-1/2	30-10	6.5	8.8
	125	90	SJ300-900HFU/E	M10	1/0-1/2	38-10	10.1	13.7
	150	110	SJ300-110HFU/E	M10	1/0-1/2	50-10	10.1	13.7
175	132	SJ300-1320HFE	M10	2/0-1/2	80-10	10.1	13.7	
200	150	SJ300-1500HFU	M10	2/0-1/2	80-10	10.1	13.7	

Note 1: The recommended ring lug connector listing consists of wire size – screw size format. The wire sizes are in AWG or mm² format. For AWG wire sizes, bolt sizes for the ring lug centers are: #10, #12, 1/4", 5/16", and 1/2". For metric wire sizes, bolt sizes for the ring lug centers are: 6 = 6M, 8 = 8M, 10 = 10M.

6

Wire the Inverter Input to a Supply



Step 6: In this step, you will connect wiring to the input of the inverter. All models have the same power connector terminals [R(L1)], [S(L2)], and [T(L3)] for three-phase input. The three phases may be connected in any order, as they are isolated from chassis ground and do not determine motor direction of rotation. **Please refer to the specifications label (on the front or side of the inverter) for the acceptable input voltage ranges!**

NOTE: The wiring example to the right shows an SJ300-037LFU inverter. The terminal locations will vary, depending on the inverter model (see below). Note the use of ring lug connectors for a secure connection.

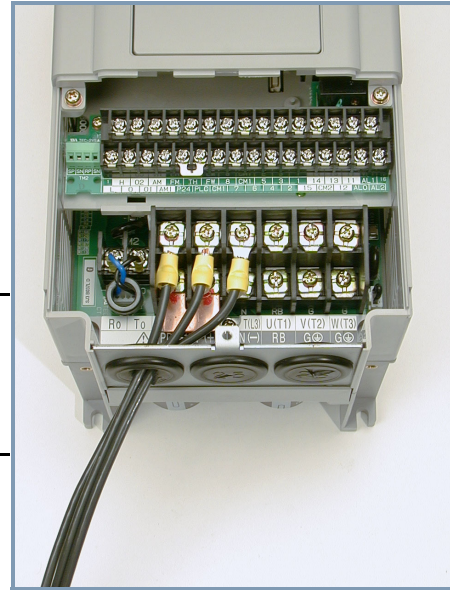

Please use the terminal arrangement below corresponding to your inverter model.

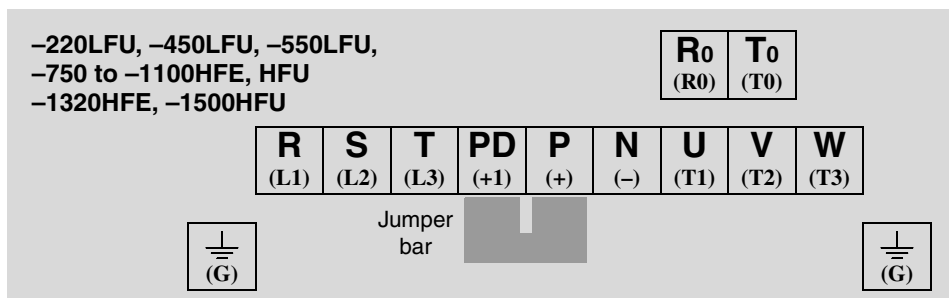
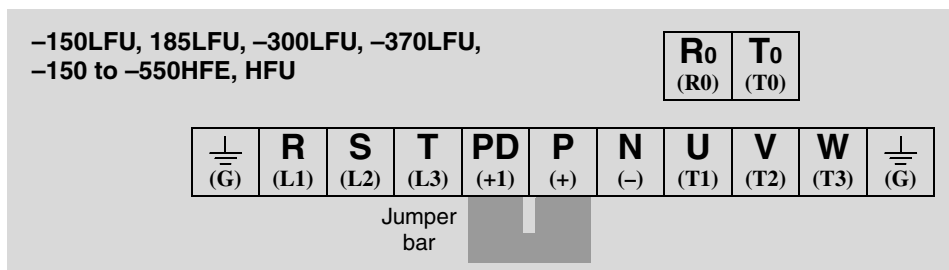
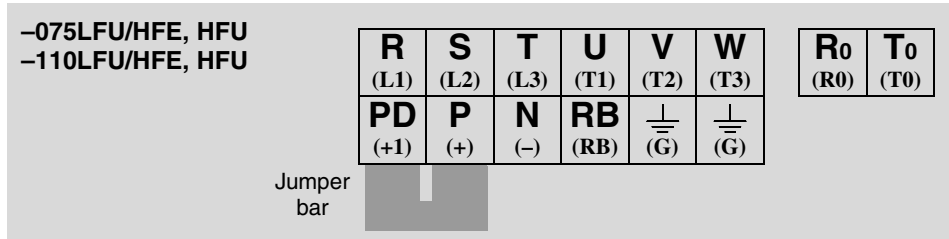
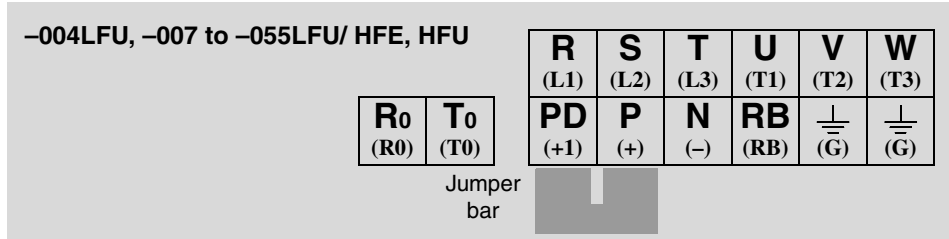



NOTE: An inverter powered by a portable or emergency diesel power generator may result in a distorted power waveform, overheating the generator. In general, the generator capacity should be at least five times that of the inverter (kVA).



CAUTION: Be sure that the input voltage matches the inverter specifications:

- Three phase 200 to 240V 50/60Hz
- Three phase 380 to 480V 50/60Hz



CAUTION: Be sure not to power a three-phase-only inverter with single phase power. Otherwise, there is the possibility of damage to the inverter and the danger of fire.



CAUTION: Be sure not to connect an AC power supply to the output terminals. Otherwise, there is the possibility of damage to the inverter and the danger of injury and/or fire.

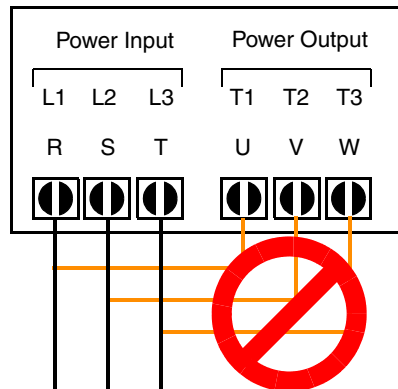

NOTE:

L1, L2, L3:

- Three-phase 200 to 240V 50/60 Hz
- Three-phase 380 to 480V 50/60 Hz



CAUTION: Remarks for using ground fault interrupter breakers in the main power supply: Adjustable frequency inverters with CE-filters (RFI-filter) and shielded (screened) motor cables have a higher leakage current toward Earth GND. Especially at the moment of switching ON this can cause an inadvertent trip of ground fault interrupter breakers. Because of the rectifier on the input side of the inverter there is the possibility to stall the switch-off function through small amounts of DC current. Please observe the following:

- Use only short time-invariant and pulse current-sensitive ground fault interrupter breakers with higher trigger current.
- Other components should be secured with separate ground fault interrupter breakers.
- Ground fault interrupter breakers in the power input wiring of an inverter are not an absolute protection against electric shock.



CAUTION: Be sure to install a fuse in each phase of the main power supply to the inverter. Otherwise, there is the danger of fire.



CAUTION: For motor leads, ground fault interrupter breakers and electromagnetic contactors, be sure to size these components properly (each must have the capacity for rated current and voltage). Otherwise, there is the danger of fire.

7

Wire the Inverter Output to Motor

Step 7: The process of motor selection is beyond the scope of this manual. However, it must be a three-phase AC induction motor. It should also come with a chassis ground lug. If the motor does not have three power input leads, stop the installation and verify the motor type. Other guidelines for wiring the motor include:

- Use an inverter-grade motor for maximum motor life (1600V insulation).
- For standard motors, use an output filter if the wiring between the inverter and motor exceeds 10 meters in length.

Simply connect the motor to the terminals [U/T1], [V/T2], and [W/T3] indicated on the inverter to the right. This is a good time to connect the chassis ground lug on the drive as well. The motor chassis ground must also connect to the same point. Use a star ground (single-point) arrangement, and never daisy-chain the grounds (point-to-point).

Use the same wire gauge on the motor and chassis ground wiring as you used on the power input wiring in the previous step. After completing the wiring:

- Check the mechanical integrity of each wire crimp and terminal connection.
- Replace the front panel and secure the retention screw firmly.

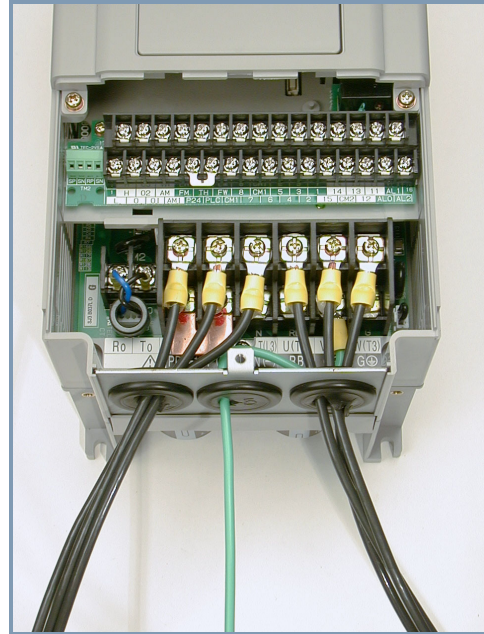

To Power Source

To Chassis Ground

To Motor

Logic Control Wiring

After completing the initial installation and powerup test in this chapter, you may need to wire the logic signal connector for your application. For new inverter users/applications, we highly recommend that you first complete the powerup test in this chapter without adding any logic control wiring. Then you will be ready to set the required parameters for logic control as covered in Chapter 4, Operations and Monitoring.

8

Uncover the Inverter Vents



Step 8: After mounting and wiring the inverter, remove any protective material covering the inverter ventilation openings from Step 3. This includes covers over the side ventilation ports as well as the fan outlet area.

CAUTION: Failure to remove all vent opening covers before electrical operation may result in damage to the inverter.

Uncover the fan outlet vents

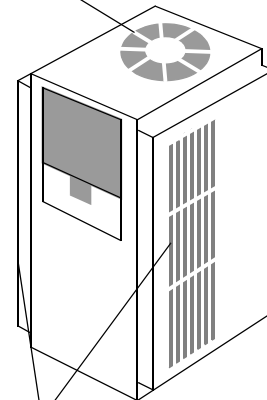

Uncover the ventilation slots, both sides

Powerup Test

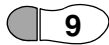

Perform the Powerup Test

Step 9: After wiring the inverter and motor, you're ready to do a powerup test. The procedure that follows is designed for the first-time use of the drive. Please verify the following conditions before conducting the powerup test:

- You have followed all the steps in this chapter up to this step.
- The inverter is new, and is securely mounted to a non-flammable vertical surface
- The inverter is connected to a power source and motor.
- No additional wiring of inverter connectors or terminals has been done.
- The power supply is reliable, and the motor is a known working unit, and the motor nameplate ratings match the inverter ratings.
- The motor is securely mounted, and is not connected to any load.

Goals for the Powerup Test

If there are any exceptions to the above conditions at this step, please take a moment to take any measures necessary to reach this basic starting point. The specific goals of this powerup test are:

1. Verify that the wiring to the power supply and motor is correct.
2. Demonstrate that the inverter and motor are generally compatible.
3. Give a brief introduction to the use of the built-in operator keypad.

The powerup test gives you an important starting point to ensure a safe and successful application of the Hitachi inverter. We highly recommend performing this test before proceeding to the other chapters in this manual.

Pre-test and Operational Precautions

The following instructions apply to the powerup test, or to any time the inverter is powered and operating. Please study the following instructions and messages before proceeding with the powerup test.

1. The power supply must have fusing suitable for the load. Check the fuse size chart presented in Step 5, if necessary.
2. Be sure you have access to a disconnect switch for the drive input power if necessary. However, do not turn OFF power to the inverter during its operation unless it is an emergency.
3. Turn the inverter's front panel potentiometer (if it exists) to the *MIN* position (fully counter-clockwise).



CAUTION: The heat sink fins will have a high temperature. Be careful not to touch them. Otherwise, there is the danger of getting burned.



CAUTION: The operation of the inverter can be easily changed from low speed to high speed. Be sure to check the capability and limitations of the motor and machine before operating the inverter. Otherwise, there is the danger of injury.



CAUTION: If you operate a motor at a frequency higher than the inverter standard default setting (50Hz/60Hz), be sure to check the motor and machine specifications with the respective manufacturer. Only operate the motor at elevated frequencies after getting their approval. Otherwise, there is the danger of equipment damage and/or injury to personnel.



CAUTION: Check the following before and during the powerup test. Otherwise, there is the danger of equipment damage.

- Is the shorting bar between the [P] and [PD] terminals installed? DO NOT power or operate the inverter if the jumper is removed.
 - Is the direction of the motor rotation correct?
 - Did the inverter trip during acceleration or deceleration?
 - Were the rpm and frequency meter readings as expected?
 - Were there any abnormal motor vibrations or noise?
-

Powering the Inverter

If you have followed all the steps, cautions and warnings up to this point, you're ready to apply power. After doing so, the following events should occur:

- The *POWER* LED will illuminate.
- The numeric (7-segment) LEDs will display a test pattern, then stop at *0.0*.
- The *Hz* LED will be ON.

If the motor starts running unexpectedly or any other problem occurs, press the *STOP* key. Only if necessary should you remove power to the inverter as a remedy.



NOTE: If the inverter has been previously powered and programmed, the LEDs (other than the *POWER* LED) may illuminate differently than as indicated above. If necessary, you can initialize all parameters to the factory default settings. See “Restoring Factory Default Settings” on page 6–9.

Using the Front Panel Keypad

Front Panel Introduction

Please take a moment to familiarize yourself with the keypad layout shown in the figure below.

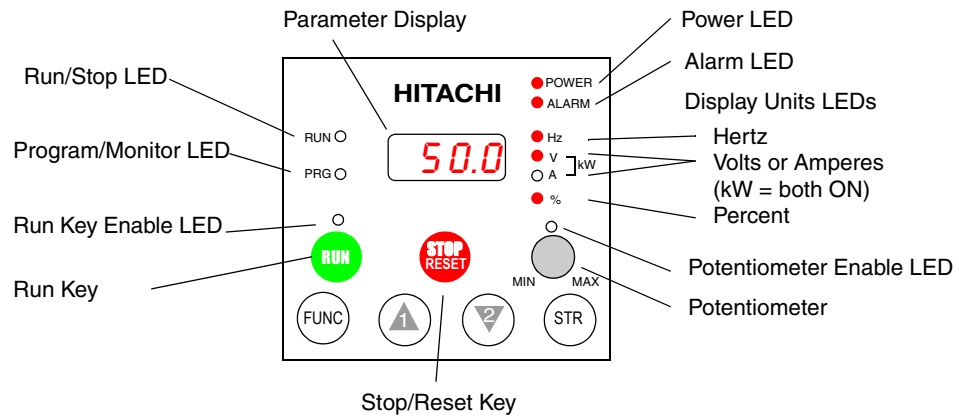

The display is used in programming the inverter's parameters, as well as monitoring specific parameter values during operation. Many functions are applicable only during the initial installation, while others are more useful for maintenance or monitoring.

Parameter Editing and Controls

The front panel controls and indicators are described as follows:

- **Run/Stop LED** – ON when the inverter output is ON and the motor is developing torque, and OFF when the inverter output is OFF (Stop Mode).
- **Program/Monitor LED** – This LED is ON when the inverter is ready for parameter editing (Program Mode). It is normally OFF when the parameter display is monitoring data (Monitor Mode). However, the PRG LED will be ON whenever you are monitoring the value of parameter D001. (When the keypad is enabled as the frequency source via A001=02, you can edit the inverter frequency directly from D001 monitor display by using the Up/Down keys.)
- **Run Key Enable LED** – is ON when the inverter is ready to respond to the Run key, OFF when the Run key is disabled.
- **Run Key** – Press this key to run the motor (the Run Enable LED must be ON first). Parameter F004, Keypad Run Key Routing, determines whether the Run key generates a Run FWD or Run REV command.
- **Stop/Reset Key** – Press this key to stop the motor when it is running (uses the programmed deceleration rate). This key will also reset an alarm that has tripped.
- **Potentiometer** (OPE–SRE only) – allows an operator to directly set the motor speed when the potentiometer is enabled for output frequency control.
- **Potentiometer Enable LED** – ON when the potentiometer is enabled for value entry. (OPE–SRE only).
- **Parameter Display** – a 4-digit, 7-segment display for parameters and function codes.
- **Display Units: Hertz/Volts/Amperes/kW/%** – These LEDs indicate the units associated with the parameter display. When the display is monitoring a parameter, the appropriate LED is ON. In the case of kW units, both Volts and Amperes LEDs will be ON. An easy way to remember this is that $kW = (V \times A)/1000$.
- **Power LED** – This LED is ON when the power input to the inverter is ON.
- **Alarm LED** – This LED is ON when an alarm condition has tripped the inverter. Clearing the alarm will turn this LED OFF again. See Chapter 6 for details on clearing alarms.

- **Function Key** – This key is used to navigate through the lists of parameters and functions for setting and monitoring parameter values.
- **Up/Down (▲, ▼) Keys** – Use these keys alternately to move up or down the lists of parameter and functions shown in the display, and increment/decrement values.
- **Store (STR) Key** – When the unit is in Program Mode and the operator has edited a parameter value, press the Store key to write the new value to the EEPROM. This parameter is then displayed at powerup by default. If you want to change the powerup default, navigate to a new parameter value and press the Store key.

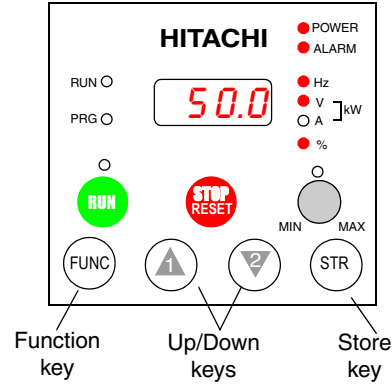

Keys, Modes, and Parameters

Purpose of the keypad is to provide a way to change modes and parameters. The term *function* applies to both monitoring modes and parameters. These are all accessible through *function codes* that are primarily 3 or 4-character codes. The various functions are separated into related groups identifiable by the left-most character, as the table shows.

Function Group	Type (Category) of Function	Mode to Access	PGM LED Indicator
“D”	Monitoring functions	Monitor	○ or ●
“F”	Main profile parameters	Program	●
“A”	Standard functions	Program	●
“B”	Fine tuning functions	Program	●
“C”	Intelligent terminal functions	Program	●
“H”	Motor constant functions	Program	●
“P”	Expansion card functions	Program	●
“U”	User-selectable menu functions	Monitor	○
“E”	Error codes	—	—

For example, function “A004” is the *base frequency setting* for the motor, typically 50 Hz or 60 Hz. To edit the parameter, the inverter must be in Program Mode (PGM LED will be ON). You use the front panel keys to first select the function code “A004.” After displaying the value for “A004,” use the Up/Down (▲ or ▼) keys to edit the value.



NOTE: The inverter 7-segment display shows lower case “b” and “d”, meaning the same as the upper case letters “B” and “D” used in this manual (for uniformity “A to F”).

The inverter automatically switches into Monitor Mode when you access “D” Group functions. It switches into Program Mode when you access any other group, because they all have editable parameters. Error codes use the “E” Group, and appear automatically when a fault event occurs. Refer to “Monitoring Trip Events, History, & Conditions” on page 6-5 for error code details.

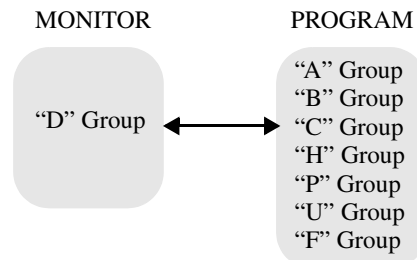

Keypad Navigational Map

The SJ300 Series inverter drives have many programmable functions and parameters. Chapter 3 will cover these in detail, but you need to access just a few items to perform the powerup test. The menu structure makes use of function codes and parameter codes to allow programming and monitoring with only a 4-digit display and a few keys and LEDs. So, it is important to become familiar with the basic navigational map of parameters and functions in the diagram below. You can later use this map as a reference.

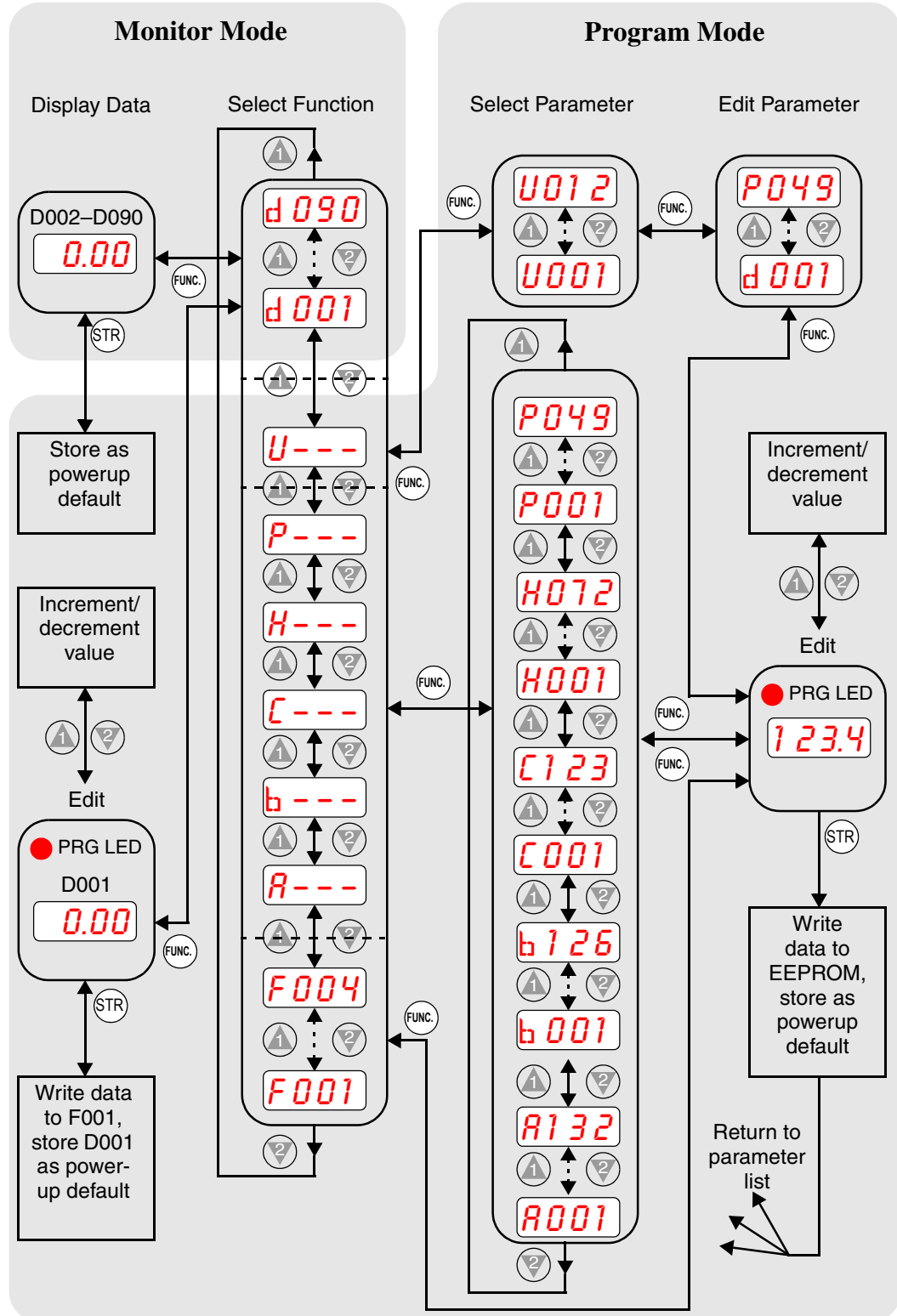

Inverter Mounting and Installation

Selecting Functions and Editing Parameters

In order to run the motor for the powerup test, this section will show how to:

- select the inverter's maximum output frequency to the motor
- select the keypad potentiometer as the source of motor speed command
- select the keypad as the source of the RUN command
- set the number of poles for the motor
- enable the RUN command

The following series of programming tables are designed for successive use. Each table uses the previous table's final state as the starting point. Therefore, start with the first and continue programming until the last one. If you get lost or concerned that some of the other parameters settings may be incorrect, refer to "Restoring Factory Default Settings" on page 6-9.



CAUTION: If you operate a motor at a frequency higher than the inverter standard default setting (50Hz/60Hz), be sure to check the motor and machine specifications with the respective manufacturer. Only operate the motor at elevated frequencies after getting their approval. Otherwise, there is the danger of equipment damage.

Setting the Motor Base Frequency -The motor is designed to operate at a specific AC frequency. Most commercial motors are designed for 50/60 Hz operation. First, check the motor specifications. Then follow the steps in the table below to verify the setting or correct for your motor. **DO NOT** set it for greater than 50/60 Hz unless the motor manufacturer specifically approves operation at the higher frequency.

Action	Display	Func./Parameter
Press the FUNC key.		Monitor functions
Press the or keys until ->		"A" Group selected
Press the FUNC key.		First "A" parameter
Press the key twice.		Base frequency setting
Press the FUNC key.	 or 	Default value for base frequency US = 60 Hz, Europe = 50 Hz
Press the or key as needed.		Set to your motor specs (your display may be different)
Press the STR key.		Stores parameter, returns to "A" Group list











TIP: If you need to scroll through a function or parameter list, press and hold the or key to auto-increment through the list.









Select the Potentiometer for Speed Command - The motor speed may be controlled from the following sources:

- Potentiometer on front panel keypad (if present)
- Control terminals
- Remote panel

Then follow the steps in the table below to select the potentiometer for the speed command (the table resumes action from the end of the previous table).

Action	Display	Func./Parameter
Press the  key twice.		Speed command source setting
Press the  key.		0 = potentiometer 1 = control terminals (default) 2 = keypad
Press the  key.		0 = potentiometer (selected)
Press the  key.		Stores parameter, returns to “A” Group list

Select the Keypad for the RUN Command - The RUN command causes the inverter to accelerate the motor to the selected speed. You can program the inverter to respond to either the control terminal signal or the keypad RUN key. Follow the steps in the table below to select the front panel RUN key as the source for the RUN Command (the table resumes action from the end of the previous table).

Action	Display	Func./Parameter
Press the  key.		Run command source
Press the  key.		1 = control terminals (default) 2 = keypad
Press the  key.		2 = keypad (selected)
Press the  key.		Stores parameter, returns to “A” Group list



NOTE: When you press the STR key in the last step above (and the display = 02), the Run Enable LED above the RUN switch on the keypad will turn ON. This is normal, and does not mean the motor is trying to run. It means that the RUN key is now enabled. **DO NOT** press the RUN key at this time—finish out the programming exercise first.

Configure the Inverter for the Number of Motor Poles- The number of magnetic poles of a motor is determined by the motor's internal winding arrangement. The specifications label on the motor usually indicates its number of poles. For proper operation, verify the parameter setting matches the motor poles. Many industrial motors have four poles, corresponding to the default setting in the inverter.

Follow the steps in the table below to verify the motor poles setting and change it if necessary (the table resumes action from the end of the previous table.)

Action	Display	Func./Parameter
Press the FUNC key.		"A" Group selected
Press the key three times.		"H" Group selected
Press the FUNC key.		First "H" parameter
Press the key five times.		Motor poles parameter
Press the FUNC key.		2 = 2 poles 4 = 4 poles (default) 6 = 6 poles 8 = 8 poles
Press the or key as needed.		Set to match your motor (your display may be different)
Press the STR key.		Stores parameter, returns to "H" Group list

This step concludes the parameter setups for the inverter. You are almost ready to run the motor for the first time!



TIP: If you became lost during any of these steps, first observe the state of the PRG LED. Then study the "Keypad Navigational Map" on page 2-25 to determine the current state of the keypad controls and display. As long as you do not press the STR key, no parameters will be changed by keypad entry errors. Note that power cycling the inverter will not cause it to reset to a particular programming state.

The next section will show you how to monitor a particular parameter from the display. Then you will be ready to run the motor.

Monitoring Parameters with the Display

After using the keypad for parameter editing, it's a good idea to switch the inverter from Program Mode to Monitor Mode. This will turn out the PRG LED, and the Hertz, Volt, Ampere, or % LED indicates the display units.

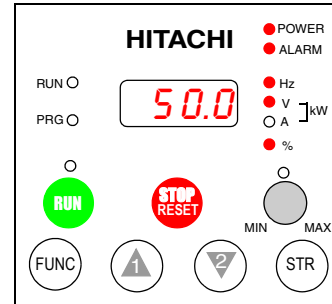

For the powerup test, monitor the motor speed indirectly by viewing the inverter's output frequency. The *output frequency* must not be confused with *base frequency* (50/60 Hz) of the motor, or the *carrier frequency* (switching frequency of the inverter, in the kHz range). The monitoring functions are in the "D" list, located near the top left of the diagram in the "Keypad Navigational Map" on page 2-25.

Output frequency (speed) monitor - Resuming the keypad programming from the previous table, follow the steps in the table below.

Action	Display	Func./Parameter
Press the FUNC key.	H---	"H" Group selected
Press the ▲ key.	d001	Output frequency selected
Press the FUNC key.	0.00	Output frequency displayed

When the **d01** function code appeared, the PRG LED went OFF. This confirms the inverter is no longer in programming mode, even while you are selecting the particular monitoring parameter. After pressing the **FUNC** key, the display shows the current speed (is zero at this point).

Running the Motor

If you have programmed all the parameters up to this point, you're ready to run the motor! First, review this checklist:

1. Verify the Power LED is ON. If not, check the power connections.
2. Verify the Run Key Enable LED is ON. If not, review the programming steps to find the problem.
3. Verify the PRG LED is OFF. If it is ON, review the instructions above.
4. Make sure the motor is disconnected from any mechanical load.
5. Turn the potentiometer to the MIN position (completely counterclockwise).
6. Now, press the RUN key on the keypad. The RUN LED will turn ON.
7. Slowly increase the potentiometer setting in clockwise fashion. The motor should start turning when the indicator is in the 9:00 position and beyond.
8. Press the STOP key to stop the motor rotation.

Inverter Mounting and Installation



Powerup Test Observations and Summary

Step 10: Reading this section will help you make some useful observations when first running the motor.

Error Codes - If the inverter displays an error code (LED format is “*EXX*”), see “Monitoring Trip Events, History, & Conditions” on page 6-5 to interpret and clear the error.

Acceleration and Deceleration - The SJ300 inverter has programmable acceleration and deceleration values. The test procedure left these at the default value, 10 seconds. You can observe this by setting the potentiometer at about half speed before running the motor. Then press RUN, and the motor will take 5 seconds to reach a steady speed. Press the STOP key to see a 5 second deceleration to a stop.

State of Inverter at Stop - If you adjust the motor’s speed to zero, the motor will slow to a near stop, and the inverter turns the outputs OFF. The high-performance SJ300 can rotate at a very slow speed with high torque output, but not zero (must use servo systems with position feedback for that feature). This characteristic means you must use a mechanical brake for some applications.

Interpreting the Display - First, refer to the output frequency display readout. The maximum frequency setting (parameter A004) defaults to 50 Hz or 60 Hz (Europe and United States, respectively) for your application.

Example: Suppose a 4-pole motor is rated for 60 Hz operation, so the inverter is configured to output 60 Hz at full scale. Use the following formula to calculate the RPM.

$$\text{RPM} = \frac{\text{Frequency} \times 60}{\text{Pairs of poles}} = \frac{\text{Frequency} \times 120}{\# \text{ of poles}} = \frac{60 \times 120}{4} = 1800\text{RPM}$$

The theoretical speed for the motor is 1800 RPM (synchronous speed). However, an induction motor cannot generate torque unless its shaft turns at a slightly different speed. This difference is called *slip*. So it’s common to see a rated speed of approximately 1750 RPM on a 60 Hz, 4-pole motor. Using a tachometer to measure shaft speed, you can see the difference between the inverter output frequency and the actual motor speed. The slip increases slightly as the motor’s load increases. This is why the inverter output value is called “frequency,” since it is not exactly equal to motor speed. You can program the inverter to display output frequency in units more directly related to the load speed by entering a constant (discussed more in depth on page 3-41).

Run/Stop Versus Monitor/Program Modes – The Run LED on the inverter is ON in Run Mode, and OFF in Stop Mode. The Program LED is ON when the inverter is in Program Mode, and OFF for Monitor Mode. All four mode combinations are possible. The diagram to the right depicts the modes and the mode transitions via keypad.

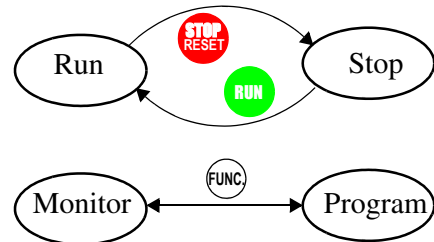

NOTE: Some factory automation devices such as PLCs have alternate Run/Program modes; the device is in either one mode or the other. In the Hitachi inverter, however, Run Mode alternates with Stop Mode, and Program Mode alternates with Monitor Mode. This arrangement lets you program some values while the inverter is operating—providing flexibility for maintenance personnel.