

BX-06RTD Resistance Temperature Detector Input

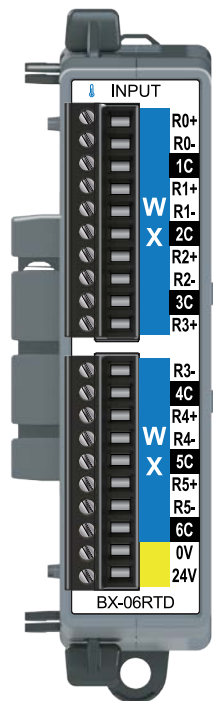

BX-RTB10 Terminal Blocks Included.
 The **BX-RTB10-1** or **BX-RTB10-2** (purchased separately) can also be used.

BX-06RTD \$255.00

Input Module 6-pt,
Resistance Temperature Detector



NOTE: This device does not support **ZIPLink** Wiring Systems

RTD Input Specifications	
Input Channels	6 Differential
Commons	6
Resolution	16-bit, 0.1°C or F (up to 100Hz filter) See Data Range Specifications table
Input Ranges (RTD Types)	Pt100: -200° to 850°C (-328° to 1562°F) (default) Pt1000: -200° to 595°C (-328° to 1103°F) JPt100: -100° to 450°C (-148° to 842°F) 10Ω Cu: -200° to 260°C (-328° to 500°F) ±3°C 25Ω Cu: -200° to 260°C (-328° to 500°F) ±3°C 120Ω Ni: -80° to 260°C (-112° to 500°F)
Resistance Input Ranges	0-10,000 Ω 0-6,250 Ω 0-3,125 Ω 0-1,562.5 Ω 0-781.2 Ω 0-390.6 Ω 0-195.3 Ω
Excitation Current	210µA
RTD Linearization	Automatic
Accuracy vs. Temperature	±10PPM per °C (maximum)
Full Scale Calibration	±1°C
Offset Calibration Error	±1°C, ±3°C for 10Ω/25Ω Cu.
Maximum Inaccuracy	±1°C, ±3°C for 10Ω/25Ω Cu. maximum (excluding RTD error) (including temperature drift)
Warmup Time	2 minutes for ±0.2% repeatability
All Channel Update Rate	210ms + 170ms x (number of active channels) @470Hz 210ms + 750ms x (number of active channels) @16.7 Hz
Filter Characteristics	Digital filter cutoff frequencies: 16.7 Hz, 470Hz
Sample Duration Time	Dependent on digital filter settings: 120ms@16.7 Hz, 4ms@470Hz
Open Circuit Detection Time	Positive full-scale reading within 2s
Maximum Ratings	Fault protected inputs to ±50V
Max. Common Mode Voltage	5VDC
Common Mode Rejection	90dB @ DC and 100dB @ 50/60Hz
Conversion Method	Sigma-Delta
Backplane Power Consumption	0.1 W
External DC Power Required	Class 2 or LPS power supply 24VDC (±20%) 25mA
Heat Dissipation	0.8 W
Weight	96g (3.4 oz)
Software Version Required (Do-more! Designer Programming Software)	2.3 or later

IMPORTANT!



Hot-Swapping Information

Note: This device cannot be Hot Swapped.

BX-06RTD Resistance Temperature Detector Input, continued

Data Range Specifications					
Selection	Description	Raw Counts ¹			
Pt100	Pt100 Platinum RTD	°C:	-2000 to 8500	°F:	-3280 to 15620
Pt1000	Pt1000 Platinum RTD	°C:	-2000 to 5950	°F:	-3280 to 11030
JPt100	JPt100 Platinum RTD	°C:	-1000 to 4500	°F:	-1480 to 8420
10Ω Cu	10Ω Copper RTD	°C:	-2000 to 2600	°F:	-3280 to 5000
25Ω Cu	25Ω Copper RTD	°C:	-2000 to 2600	°F:	-3280 to 5000
120Ω Ni	120Ω Nickel RTD	°C:	-800 to 2600	°F:	-1120 to 5000
0-10,000 Ω					0-10000
0-6,250 Ω					0-6250
0-3,125 Ω					0-3125
0-1,562.5 Ω					0-15625 ²
0-781.2 Ω					0-7812 ²
0-390.6 Ω					0-3906 ²
0-195.3 Ω					0-1953 ²

1. Temperatures have one implied decimal place (e.g., raw count of -1900 is -190.0°).
2. Certain resistance ranges have one implied decimal place (e.g., raw count of 7812 is 781.2 Ω).

Analog RTD/Resistance Input Wiring

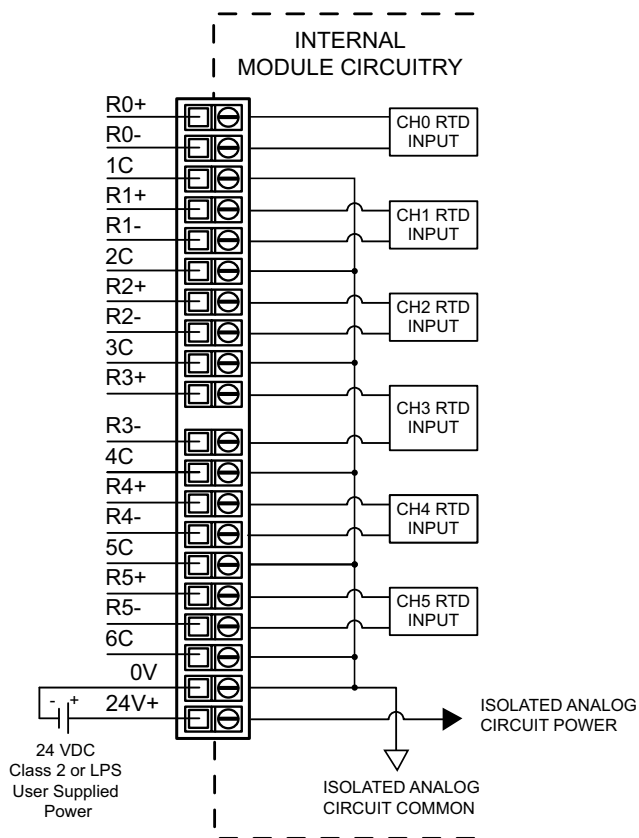

BX-06RTD Resistance Temperature Detector Input, continued

Analog RTD/Resistance Input Circuits

RTD Input Circuits

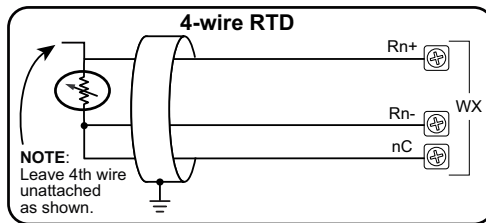
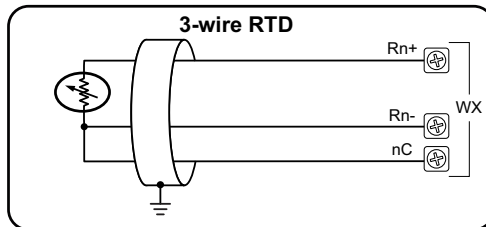
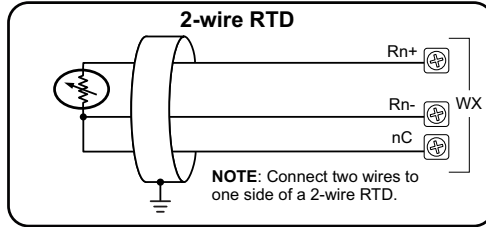

Resistance Input

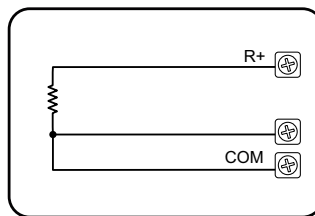

Notes for maximum accuracy:

1. For 2-wire RTD, attach a third wire to module common.
2. R+, R-, and COM wires to an RTD must be equal length and type. Refer to RTD manufacturer's recommendations.
3. Do not use cable shield as sensing wire.
4. When applicable, connect shield to RTD common only, otherwise connect to module common only. Do not connect shield to both ends.
5. Jumper unused inputs to common.

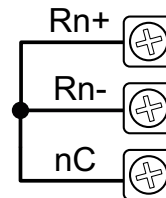

BRX Analog Expansion Modules

Overview

One of the unique features of the BRX platform is its ability to expand its capability to fit your application solution. One of the ways the BRX platform can do this is by using expansion modules that conveniently “snap-on” to the side of any BRX MPU. Once the expansion module has been snapped in place and is added to the project, it instantly adds I/O to the MPU with little to no additional setup required.

The analog expansion modules give you the ability to add analog I/O as needed and are identified as an analog input module, temperature input module, or analog output module. On the front panel of the analog I/O expansion modules, a color scheme and a

symbol are used to denote the module type.

Analog modules are available with current inputs or outputs, unipolar/bipolar voltage inputs or outputs, thermocouple inputs, RTD inputs and thermistor inputs. Input/output combination modules are also available.

With the exception of temperature input modules, the modules ship without wiring terminals. This allows you to select the termination style that best fits your application. Several wiring options are available, including screw terminal connectors, spring clamp terminal connectors and pre-wired **ZIP**Link cable solutions.

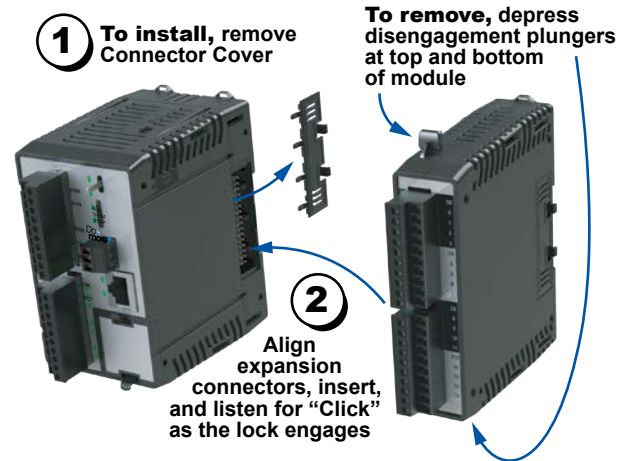

Hot-Swapping Information
 Note: This device cannot be Hot Swapped.

General Specifications

All BRX analog input and output modules and temperature input modules have the same general specifications listed in the table below.

General Specifications	
Storage Temperature	-20° to 70°C (-4° to 158°F)
Humidity	5% to 95% (non-condensing)
Environmental Air	No corrosive gases permitted
Vibration	IEC60068-2-6 (Test Fc)
Shock	IEC60068-2-27 (Test Ea)
Enclosure Type	Open Equipment
Noise Immunity	NEMA ICS3-304
EU Directive	See the “EU Directive” topic in the BRX Help File
Agency Approvals (unless otherwise noted on individual module specifications)	UL 61010-1 and UL 61010-2-201 File E139594, Canada and USA CE (EN 61131-2 EMC, EN 61010-1 and EN 61010-2-201 Safety)

Operating Temperature Range		
Operating Temperature	0° to 45°C (32° to 113°F)	0° to 60°C (32° to 140°F)
Module	Module Revision*	
BX-08AD-1	Rev A (Prior to May 2018)	Rev B (After May 2018)
BX-08AD-2B		
BX-04THM		
BX-08DA-1	Rev B (Prior to May 2018)	Rev C (After May 2018)
BX-08DA-2B		
All other Analog and Temperature Expansion Module part numbers	N/A	Rev A (After May 2018)

* Module Revision can be found in the last letter (last or second-to-last character) of the module serial number.

Dimensions

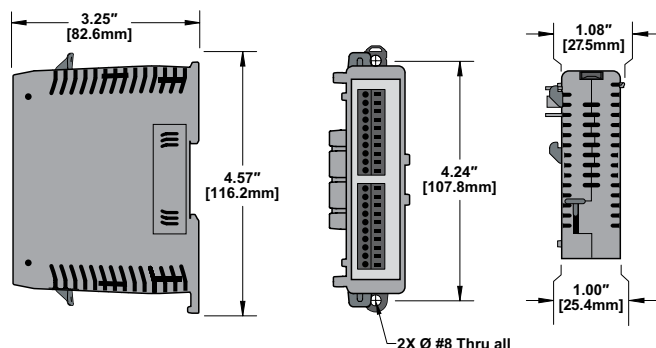

NOTE: When removing an expansion module, make sure there is room for the module to slide away from the system. Failure to do so will result in difficulty removing the module.

BRX Analog Expansion Modules

Analog Input Modules

Nine (9) analog input modules are available, with current or voltage inputs. Analog input module faceplates have a blue terminal bar to distinguish them as inputs, with symbols \swarrow or \blacktriangleleft to signify current or voltage, respectively.

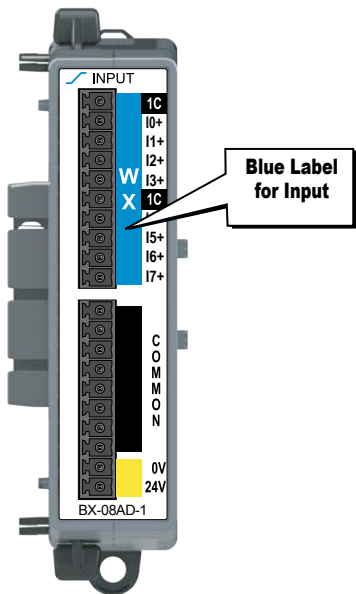

Analog Input Modules				
Part Number	Points	Input Type	Resolution	Price
<u>BX-04ADM-1</u>	4	Current Sink 0–20 mA, 4–20 mA	14-bit	\$182.00
<u>BX-04AD-1</u>	4	Current Sink 0–20 mA, 4–20 mA	16-bit	\$230.00
<u>BX-08AD-1</u>	8			\$255.00
<u>BX-16AD-1</u>	16			\$363.00
<u>BX-04AD-2B</u>	4	Voltage ± 10VDC, ± 5VDC, 0–5 VDC, 0–10 VDC	16-bit	\$230.00
<u>BX-08AD-2B</u>	8			\$255.00
<u>BX-16AD-2B</u>	16			\$363.00
<u>BX-04AD-3</u>	4	Current Sink 0–20mA, 4–20mA	16-bit	\$188.00
<u>BX-08AD-3</u>	8	Voltage ±10VDC, ±5VDC, 0–5VDC, 0–10VDC		\$212.00

Temperature Input Module

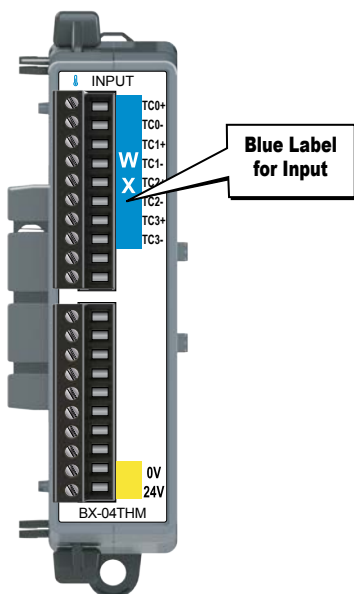

Six (6) temperature input modules are available, with thermocouple, RTD, and/or thermistor inputs. The thermocouple input modules can also be configured for millivolt-level voltage inputs, and the RTD input module can also be configured for resistance input. Temperature module faceplates have a blue terminal bar to distinguish them as inputs, and \updownarrow symbol to signify temperature.



Temperature Input Modules			
Part Number	Points	Input Type	Price
<u>BX-04THM</u>	4	Thermocouple	\$241.00
<u>BX-08THM</u>	8	Thermocouple	\$269.00
<u>BX-06RTD</u>	6	RTD	\$255.00
<u>BX-08NTC</u>	8	Thermistor	\$269.00
<u>BX-04UT</u>	4	Universal Temperature (Thermocouple, RTD, Thermistor supported)	\$211.00
<u>BX-08UT</u>	6	Universal Temperature (Thermocouple, RTD, Thermistor supported)	\$235.00

BRX Analog Expansion Modules

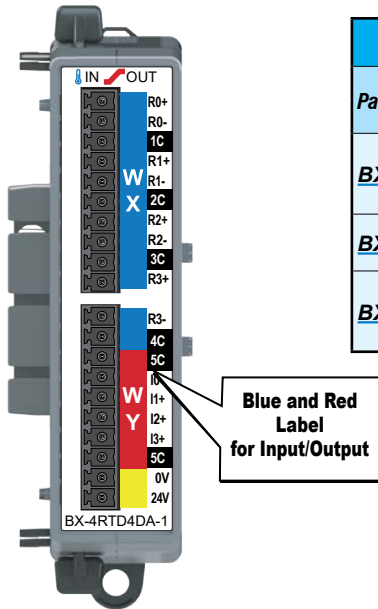

Temperature/Analog Combo Module

Three (3) combination modules are available, with thermocouple, RTD or universal temperature inputs and current sourcing outputs. The thermocouple input modules can also be configured for millivolt-level voltage inputs, and the RTD input module can also be configured for resistance input. The Input/Output faceplate terminal bar is in blue and red, making it easy to distinguish between inputs and outputs, and the  and  symbols signify temperature and current, respectively.



Temperature Input / Analog Output Combo Modules					
Part Number	Points		Input Type	Output Type	Price
	Input	Output			
BX-4RTD4DA-1	4	4	Resistance Temperature Detector (RTD)	Current Source 0–20mA, 4–20mA	\$472.00
BX-4THM4DA-1	4	4	Thermocouple	Current Source 0–20mA, 4–20mA	\$472.00
BX-4UT4DA-3	4	4	Universal Temperature	Current Source: 0–20mA, 4–20mA Voltage: ±10VDC, ±5VDC, 0–5VDC, 0–10VDC	\$412.00

Temperature/Discrete Combo Module

Three (3) combination modules are available with universal temperature inputs and DC sinking, sourcing or relay outputs. The thermocouple inputs can also be configured for millivolt-level voltage inputs, and the RTD inputs can also be configured for resistance input. The Input/Output faceplate terminal bar is in blue and red, making it easy to distinguish between inputs and outputs, and the  and  symbols signify temperature and discrete signals, respectively.

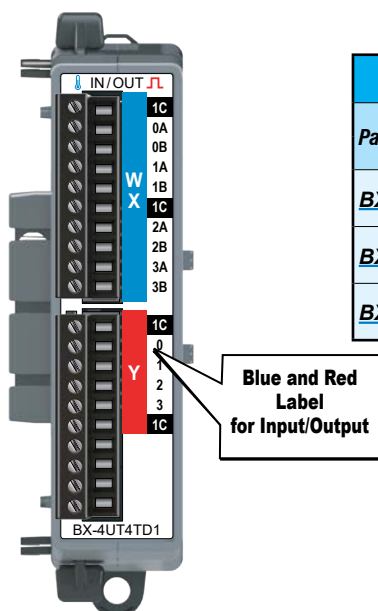

Temperature Input / Discrete Output Combo Modules					
Part Number	Points		Input Type	Output Type	Price
	Input	Output			
BX-4UT4TD1	4	4	Universal Temperature	12–24 VDC Sinking	\$235.00
BX-4UT4TD2	4	4		12–24 VDC Sourcing	\$235.00
BX-4UT4TR	4	4		Relay Form A (SPST)	\$235.00

BRX Wiring Termination Options

Terminal Block Connectors

The terminal block connectors are provided in kits of multiple connectors that are ordered as a single part number. There are 2 different types of kits to choose from; one kit for the five (5), eight (8) and 12-point discrete, and one

kit for the analog modules and 16-point discrete modules. The five (5), eight (8) and 12-point discrete module kits each have (3) 5-pin 5mm connectors. The 8-point modules will use only 2 of the 5-pin connectors.

The five (5) and 12-point modules will use all three connectors. The analog and 16-point digital module kits include (2) 10-pin 3.81 mm connectors.

Terminal Block Connectors, 5, 8 and 12-Point Discrete Modules

Terminal Block Kits for 5-point, 8-point and 12-point Expansion Modules



BX-RTB08 (Kit - 3 pieces)



BX-RTB08-1 (Kit - 3 pieces)



BX-RTB08-2 (Kit - 3 pieces)

Terminal Block Specifications 5-, 8- & 12-Point Type

Part Number Single Block Set of 3 Blocks	<i>BX-RTB05</i> <i>BX-RTB08</i>	<i>BX-RTB05-1</i> <i>BX-RTB08-1</i>	<i>BX-RTB05-2</i> <i>BX-RTB08-2</i>
Price (Single Block)	\$8.50	\$7.00	\$8.00
Price (Kit)	\$15.00	\$14.50	\$15.00
Connector Type	Screw Type - 90-degree	Spring Clamp Type - 180-degree	Screw Type - 180-degree
Wire Exit	180-degree	180-degree	180-degree
Pitch	5.0 mm	5.0 mm	5.0 mm
Screw Size	M2.5	N/A	M2.5
Screw Torque Recommended	< 3.98 lb-in (0.45 N·m)	N/A	< 3.98 lb-in (0.45 N·m)
Screwdriver Blade Width	3.5 mm	3.5 mm	3.5 mm
Wire Gauge (Single Wire)	28-12 AWG	28-14 AWG	28-12 AWG
Wire Gauge (Dual Wire)	28-16 AWG	28-16 AWG (Dual Wire Ferrule Required)	28-16 AWG
Wire Strip Length	0.3 in (7.5 mm)	0.37 in (9.5 mm)	0.3 in (7.5 mm)
Equiv. Dinkle P/N	5ESDV-05P-BK	5ESDSR-05P-BK	5ESDF-05P-BK

Terminal Block Connectors, Analog Modules and 16-Point Discrete Modules

Terminal Block Kits for Analog and 16-point Discrete Expansion Modules



BX-RTB10 (Kit - 2 pieces)

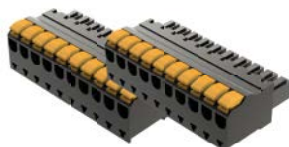

BX-RTB10-1 (Kit - 2 pieces)



BX-RTB10-2 (Kit - 2 pieces)

Terminal Block Specifications 16-Point Type

Part Number	<i>BX-RTB10</i>	<i>BX-RTB10-1</i>	<i>BX-RTB10-2</i>
Price (Kit)	\$21.50	\$24.00	\$22.50
Connector Type	Screw Type 90-degree	Spring Clamp Type 180-degree	Screw Type 180-degree
Wire Exit	180-degree	180-degree	180-degree
Pitch	3.81 mm	3.81 mm	3.81 mm
Screw Size	M2	N/A	M2
Screw Torque Recommended	<1.77 lb-in (0.2 N·m)	N/A	<1.77 lb-in (0.2 N·m)
Screwdriver Blade Width	2.5 mm	2.5 mm	2.5 mm
Wire Gauge (Single Wire)	28-16 AWG	26-18 AWG	30-16 AWG
Wire Gauge (Dual Wire)	28-18 AWG	30-20 AWG (Dual Wire Ferrule Required)	30-18 AWG
Wire Strip Length	0.24 in (6mm)	0.35 in (9mm)	0.26 in (6.5 mm)
Equiv. Dinkle P/N	EC381V-10P-BK	ESC381V-10-BK	EC381F-10P-BK



NOTE: BX-RTB10 terminal blocks are included with Temperature Input modules.