

BX-xADxDA-3 Universal Analog I/O

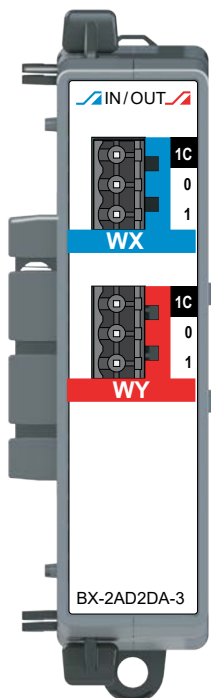

BX-2AD2DA-3
\$269.00

Combination Analog Module
2 Channels In,
2 Channels Out
0–20mA/4–20mA,
Sink/Source
±10 VDC, ±5 VDC,
0–5 VDC, 0–10 VDC

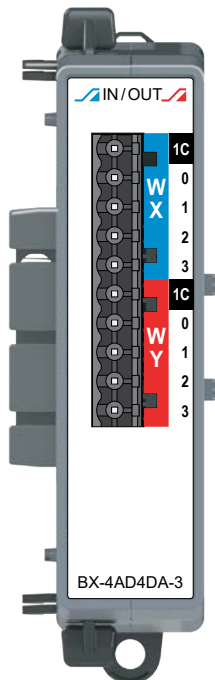

BX-4AD4DA-3
\$330.00

Combination Analog Module
4 Channels In,
4 Channels Out
0–20mA/4–20mA,
Sink/Source
±10 VDC, ±5 VDC,
0–5 VDC, 0–10 VDC

NOTE: BX-2AD2DA-3 does not support ZIP-Link Wiring Systems



Terminal Blocks or ZIP Link Cables Sold Separately

We recommend using prewired ZIP Link cables and connection modules for the BX-4AD4DA-3. A removable terminal block is available for either module. See Wiring Solutions section for all options.

IMPORTANT!



Hot-Swapping Information

Note: This device cannot be Hot Swapped.

Analog Universal Current/Voltage Input Specs		
	BX-2AD2DA-3	BX-4AD4DA-3
Inputs per Module	2	4
Commons	1	
Module Signal Input Range	0–20mA, 4–20mA, ±20mA, ±10 VDC, ±5 VDC, 0–5 VDC (Default), 0–10 VDC	
Signal Resolution	16-bit at ±10V or ±20mA*	
Resolution Value of LSB	See Data Range Specifications table	
Input Impedance	Current Input: 249Ω, Voltage Input: 100kΩ	
All Channel Update Rate	1.2 ms	
Over Current Circuit Detection Time	< 1second	
Maximum Continuous Overload	±40mA current mode, ±20V voltage mode	
Sample Duration Time	1.2 ms	
Hardware Filter Characteristics	Active Low Pass, –3dB @ 1kHz	
Conversion Method	Delta Sigma	
Linearity Error (end to end)	±0.1% of HW full scale (65 counts)	
Input Stability and Repeatability (after 10 min. warmup)	±0.02% of HW full scale (13 counts)	
Full Scale Calibration Error	±0.1% of HW full scale (65 counts)	
Offset Calibration Error	±0.05% of HW full scale (32 counts)	
Accuracy vs. Temperature	±25PPM / °C maximum	
Maximum Inaccuracy	±0.2% of HW full scale (130 counts)	
Maximum Crosstalk	1 count	
Channel to Backplane Isolation	1800VAC applied for one second	
Channel to Channel Isolation	None	
Loop Fusing (External)	Fast-acting 0.032A recommended	

* 16-bit resolution is only available when a bipolar input range is selected.

Analog Universal Current/Voltage Output Specs		
	BX-2AD2DA-3	BX-4AD4DA-3
Outputs per Module	2	4
Commons	1	
Module Signal Output Range	0–20mA, 4–20mA, ±20mA ±10VDC, ±5VDC, 0–5VDC (Default), 0–10VDC	
Signal Resolution	16-bit at ±10V or ±20mA*	
Resolution Value of LSB	See Data Range Specifications table	
Output Type	Current Sink/Source up to 5V Voltage Sink/Source at 10mA (e.g., 10V @ 1kΩ load).	
Output Value in Fault Mode	Current outputs ~0mA Voltage outputs 0V (Unipolar or Bipolar)	
Minimum Load Impedance	1kΩ	
Maximum Current Load Impedance	500Ω	
Allowed Load Type	Grounded	
Maximum Continuous Overload	Indefinitely	
All Channel Update Rate	1.0 ms	
Maximum Inaccuracy	±0.1% of HW full scale (65 counts)	
Maximum Full Scale Calibration Error	±0.1% of HW full scale (65 counts)	
Conversion Method	Amplified Divide-by-2 Resistor String	
Linearity Error (end to end)	±0.1% of HW full scale (65 counts)	
Output Stability and Repeatability	±0.02% of HW full scale (12 cts) after 10 min. warmup	
Output Settling Time	10µs	
Channel to Backplane Isolation	1800VAC applied for one second	
Channel to Channel Isolation	None	
Loop Fusing (External)	Fast-acting 0.032A recommended	

* 16-bit resolution is only available when a bipolar output range is selected.

BX-xADxDA-3 Universal Analog I/O, continued

Analog Universal Current/Voltage General Specs		
	BX-2AD2DA-3	BX-4AD4DA-3
Backplane Power Consumption	2.5 W	3.75 W
Heat Dissipation	2.5 W	4.0 W
Weight	98g [3.5 oz]	
Agency Approvals	UL 61010-2 File E185989, Canada and USA	
Software Version Required (Do-more! Designer Programming Software)	2.7 or later	

Data Range Specifications			
Selection	Description	Raw Counts	Per Count
-20-20mA	bipolar -20 to 20mA	-32768 to 32767	0.61 μ A
4-20mA	unipolar 4-20mA	6553-32767	0.61 μ A
0-10V	unipolar 10VDC	0-32767	305 μ V
0-5V	unipolar 5VDC	0-32767	153 μ V
\pm 10V	bipolar 10VDC	-32768 to 32767	305 μ V
\pm 5V	bipolar 5VDC	-32768 to 32767	153 μ V

Analog Input/Output Wiring

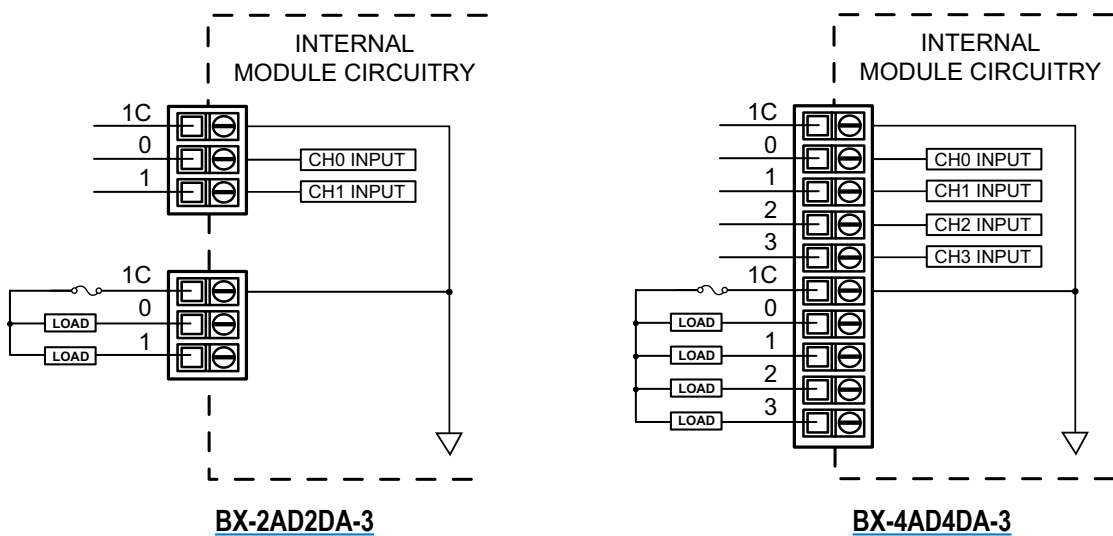

BX-xADxDA-3 Universal Analog I/O, continued

Analog Current Sinking Input Circuits

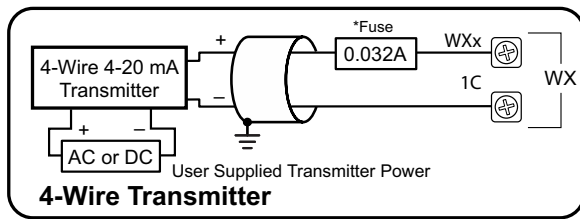
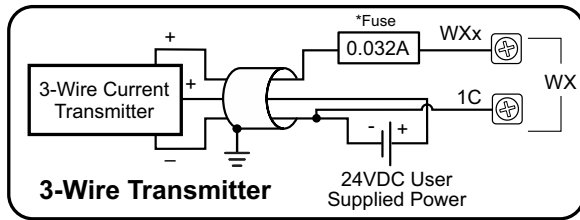
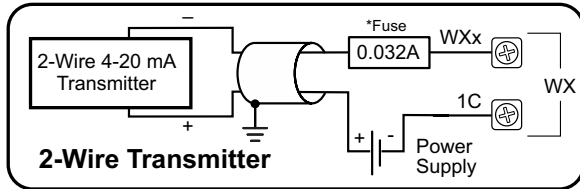

*NOTE: An Edison S500-32-R 0.032A fast-acting fuse is recommended for all analog voltage inputs, analog outputs, and current loops.

Analog Voltage Input Circuits

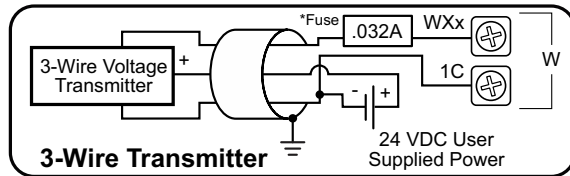
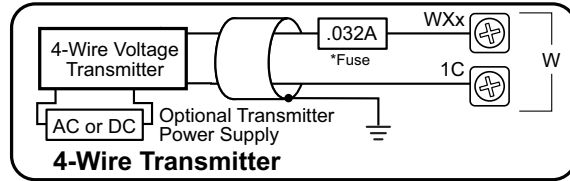

Analog Current Sourcing Output Circuits

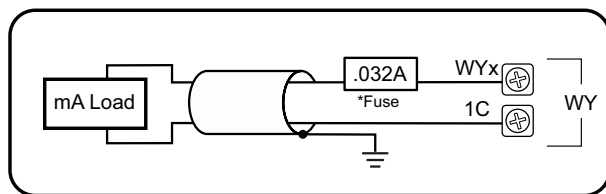

Analog Voltage Output Circuit

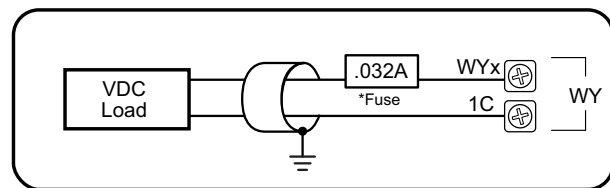

NOTE: Shield should be connected only at one end, to ground at the source device.

*An Edison S500-32-R 0.032A fast-acting fuse is recommended for all analog voltage inputs, analog outputs, and current loops.

BRX Analog Expansion Modules

Overview

One of the unique features of the BRX platform is its ability to expand its capability to fit your application solution. One of the ways the BRX platform can do this is by using expansion modules that conveniently “snap-on” to the side of any BRX MPU. Once the expansion module has been snapped in place and is added to the project, it instantly adds I/O to the MPU with little to no additional setup required.

The analog expansion modules give you the ability to add analog I/O as needed and are identified as an analog input module, temperature input module, or analog output module. On the front panel of the analog I/O expansion modules, a color scheme and a

symbol are used to denote the module type.

Analog modules are available with current inputs or outputs, unipolar/bipolar voltage inputs or outputs, thermocouple inputs, RTD inputs and thermistor inputs. Input/output combination modules are also available.

With the exception of temperature input modules, the modules ship without wiring terminals. This allows you to select the termination style that best fits your application. Several wiring options are available, including screw terminal connectors, spring clamp terminal connectors and pre-wired **ZIP**Link cable solutions.

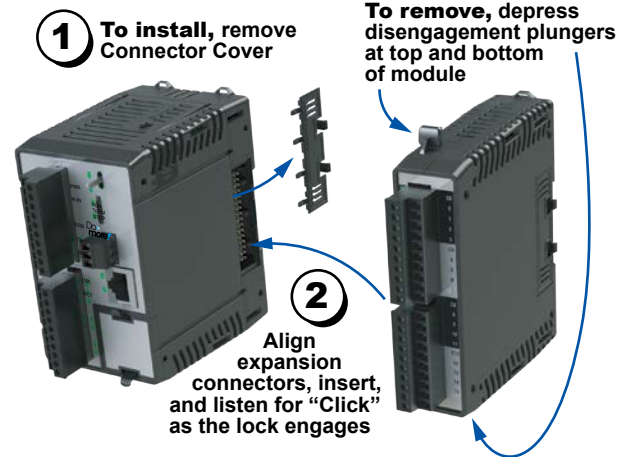

Hot-Swapping Information
 Note: This device cannot be Hot Swapped.

General Specifications

All BRX analog input and output modules and temperature input modules have the same general specifications listed in the table below.

General Specifications	
Storage Temperature	-20° to 70°C (-4° to 158°F)
Humidity	5% to 95% (non-condensing)
Environmental Air	No corrosive gases permitted
Vibration	IEC60068-2-6 (Test Fc)
Shock	IEC60068-2-27 (Test Ea)
Enclosure Type	Open Equipment
Noise Immunity	NEMA ICS3-304
EU Directive	See the “EU Directive” topic in the BRX Help File
Agency Approvals (unless otherwise noted on individual module specifications)	UL 61010-1 and UL 61010-2-201 File E139594, Canada and USA CE (EN 61131-2 EMC, EN 61010-1 and EN 61010-2-201 Safety)

Operating Temperature Range		
Operating Temperature	0° to 45°C (32° to 113°F)	0° to 60°C (32° to 140°F)
Module	Module Revision*	
BX-08AD-1	Rev A (Prior to May 2018)	Rev B (After May 2018)
BX-08AD-2B		
BX-04THM		
BX-08DA-1	Rev B (Prior to May 2018)	Rev C (After May 2018)
BX-08DA-2B		
All other Analog and Temperature Expansion Module part numbers	N/A	Rev A (After May 2018)

* Module Revision can be found in the last letter (last or second-to-last character) of the module serial number.

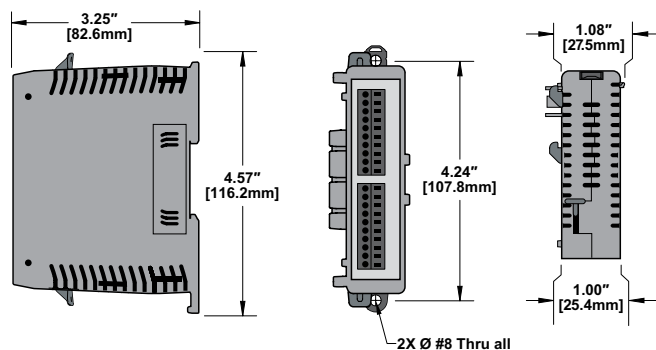

Dimensions



NOTE: When removing an expansion module, make sure there is room for the module to slide away from the system. Failure to do so will result in difficulty removing the module.

BRX Analog Expansion Modules

Analog Input Modules

Nine (9) analog input modules are available, with current or voltage inputs. Analog input module faceplates have a blue terminal bar to distinguish them as inputs, with symbols  or  to signify current or voltage, respectively.

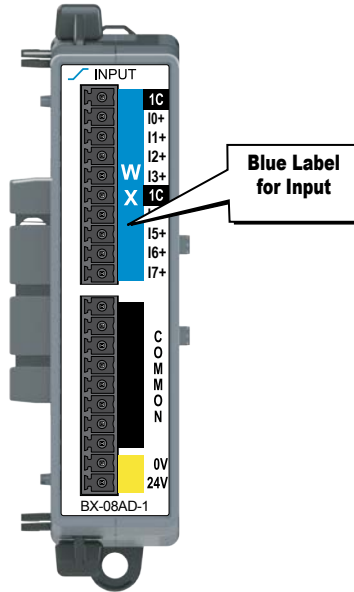

Analog Input Modules				
Part Number	Points	Input Type	Resolution	Price
<u>BX-04ADM-1</u>	4	Current Sink 0–20 mA, 4–20 mA	14-bit	\$182.00
<u>BX-04AD-1</u>	4	Current Sink 0–20 mA, 4–20 mA	16-bit	\$230.00
<u>BX-08AD-1</u>	8			\$255.00
<u>BX-16AD-1</u>	16			\$363.00
<u>BX-04AD-2B</u>	4	Voltage ± 10VDC, ± 5VDC, 0–5 VDC, 0–10 VDC	16-bit	\$230.00
<u>BX-08AD-2B</u>	8			\$255.00
<u>BX-16AD-2B</u>	16			\$363.00
<u>BX-04AD-3</u>	4	Current Sink 0–20mA, 4–20mA	16-bit	\$188.00
<u>BX-08AD-3</u>	8	Voltage ±10VDC, ±5VDC, 0–5VDC, 0–10VDC		\$212.00

Temperature Input Module

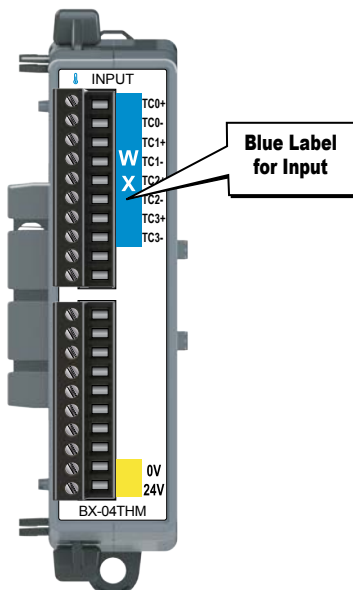

Six (6) temperature input modules are available, with thermocouple, RTD, and/or thermistor inputs. The thermocouple input modules can also be configured for millivolt-level voltage inputs, and the RTD input module can also be configured for resistance input. Temperature module faceplates have a blue terminal bar to distinguish them as inputs, and  symbol to signify temperature.



Temperature Input Modules			
Part Number	Points	Input Type	Price
<u>BX-04THM</u>	4	Thermocouple	\$241.00
<u>BX-08THM</u>	8	Thermocouple	\$269.00
<u>BX-06RTD</u>	6	RTD	\$255.00
<u>BX-08NTC</u>	8	Thermistor	\$269.00
<u>BX-04UT</u>	4	Universal Temperature (Thermocouple, RTD, Thermistor supported)	\$211.00
<u>BX-08UT</u>	6	Universal Temperature (Thermocouple, RTD, Thermistor supported)	\$235.00

BRX Analog Expansion Modules

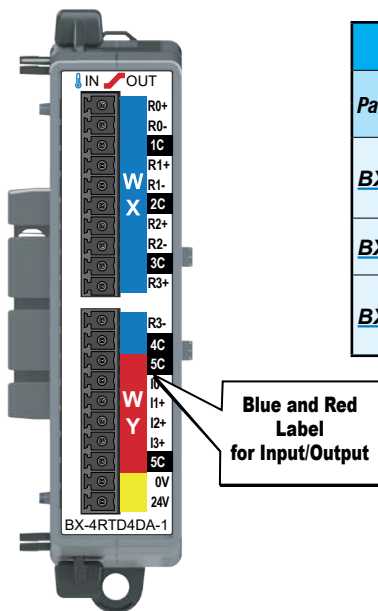

Temperature/Analog Combo Module

Three (3) combination modules are available, with thermocouple, RTD or universal temperature inputs and current sourcing outputs. The thermocouple input modules can also be configured for millivolt-level voltage inputs, and the RTD input module can also be configured for resistance input. The Input/Output faceplate terminal bar is in blue and red, making it easy to distinguish between inputs and outputs, and the  and  symbols signify temperature and current, respectively.



Temperature Input / Analog Output Combo Modules					
Part Number	Points		Input Type	Output Type	Price
	Input	Output			
BX-4RTD4DA-1	4	4	Resistance Temperature Detector (RTD)	Current Source 0–20mA, 4–20mA	\$472.00
BX-4THM4DA-1	4	4	Thermocouple	Current Source 0–20mA, 4–20mA	\$472.00
BX-4UT4DA-3	4	4	Universal Temperature	Current Source: 0–20mA, 4–20mA Voltage: ±10VDC, ±5VDC, 0–5VDC, 0–10VDC	\$412.00

Temperature/Discrete Combo Module

Three (3) combination modules are available with universal temperature inputs and DC sinking, sourcing or relay outputs. The thermocouple inputs can also be configured for millivolt-level voltage inputs, and the RTD inputs can also be configured for resistance input. The Input/Output faceplate terminal bar is in blue and red, making it easy to distinguish between inputs and outputs, and the  and  symbols signify temperature and discrete signals, respectively.

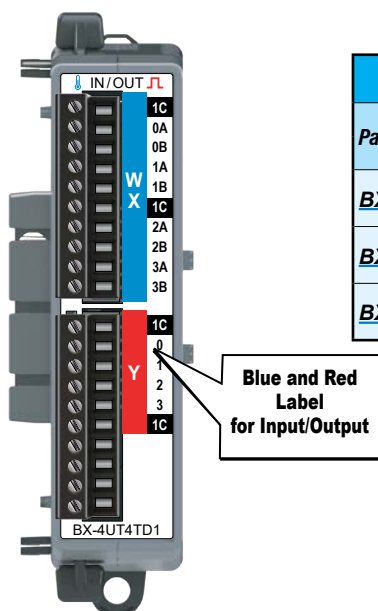

Temperature Input / Discrete Output Combo Modules					
Part Number	Points		Input Type	Output Type	Price
	Input	Output			
BX-4UT4TD1	4	4	Universal Temperature	12–24 VDC Sinking	\$235.00
BX-4UT4TD2	4	4		12–24 VDC Sourcing	\$235.00
BX-4UT4TR	4	4		Relay Form A (SPST)	\$235.00

BRX Analog Expansion Modules

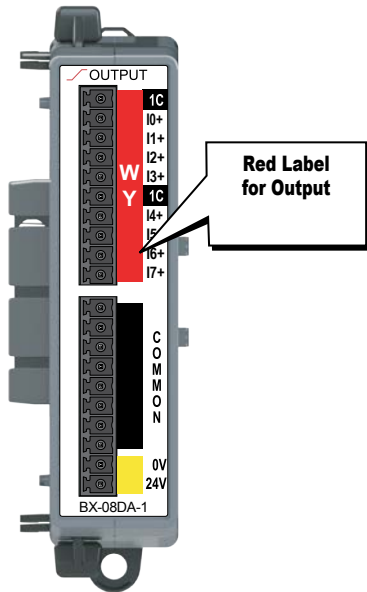

Analog Output Modules

Six (6) analog output modules are available, in current and voltage outputs. Analog output module faceplates have a red terminal bar to distinguish them as outputs, with symbols \swarrow or \blacktriangle to signify current or voltage, respectively.

Analog Output Modules			
Part Number	Points	Output Type	Price
BX-04DA-1	4	Current Source 0-20 mA, 4-20 mA	\$269.00
BX-08DA-1	8		\$350.00
BX-04DA-2B	4	Voltage ± 10 VDC, ± 5 VDC, 0-5 VDC, 0-10 VDC	\$269.00
BX-08DA-2B	8		\$350.00
BX-04DA-3	4	Current Source 0-20mA, 4-20mA Voltage ± 10 VDC, ± 5 VDC, 0-5VDC, 0-10VDC	\$231.00
BX-08DA-3	8		\$294.00

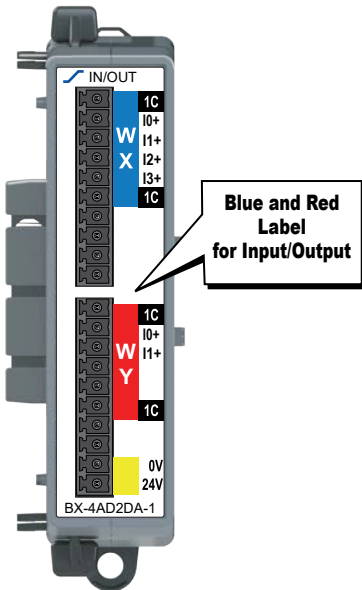

Analog Combo Input / Output Modules

Six (6) analog input/output combo modules are available with current or voltage inputs and outputs. The Input/Output faceplate terminal bar is in blue and red, making it easy to distinguish between inputs and outputs. Symbols \swarrow and \blacktriangle signify current and voltage, respectively.

Analog Combo Input / Output Modules					
Part Number	Points		Input Type	Output Type	Price
	Input	Output			
BX-2AD2DA-1	2	2	Current Sink 0-20mA, 4-20mA	Current Source 0-20mA, 4-20mA	\$309.00
BX-4AD2DA-1	4	2			\$378.00
BX-2AD2DA-2B	2	2	Voltage ± 10 VDC, ± 5 VDC, 0-5VDC, 0-10VDC	Voltage ± 10 VDC, ± 5 VDC, 0-5VDC, 0-10VDC	\$309.00
BX-4AD2DA-2B	4	2			\$378.00
BX-2AD2DA-3	2	2	Current Source 0-20mA, 4-20mA Voltage ± 10 VDC, ± 5 VDC, 0-5VDC, 0-10VDC	Current Source 0-20mA, 4-20mA Voltage ± 10 VDC, ± 5 VDC, 0-5VDC, 0-10VDC	\$269.00
BX-4AD4DA-3	4	4			\$330.00

Expansion Module Support by Controller	
Controller Type	# Expansion Modules
BX-DM1E-M	8
BX-DM1-10	2
BX-DM1E-10	2
BX-DM1-18	4
BX-DM1E-18	8
BX-DM1-36	4
BX-DM1E-36	8
BX-DMIO*	8
BX-EBC100*	8
BX-MBIO*	8

* Remote I/O controllers do not support Motion Control and Communications Modules.

BRX Wiring Termination Options

Terminal Block Connectors

The terminal block connectors are provided in kits of multiple connectors that are ordered as a single part number. There are 2 different types of kits to choose from; one kit for the five (5), eight (8) and 12-point discrete, and one

kit for the analog modules and 16-point discrete modules. The five (5), eight (8) and 12-point discrete module kits each have (3) 5-pin 5mm connectors. The 8-point modules will use only 2 of the 5-pin connectors.

The five (5) and 12-point modules will use all three connectors. The analog and 16-point digital module kits include (2) 10-pin 3.81 mm connectors.

Terminal Block Connectors, 5, 8 and 12-Point Discrete Modules

Terminal Block Kits for 5-point, 8-point and 12-point Expansion Modules



BX-RTB08 (Kit - 3 pieces)



BX-RTB08-1 (Kit - 3 pieces)



BX-RTB08-2 (Kit - 3 pieces)

Terminal Block Specifications 5-, 8- & 12-Point Type

Part Number Single Block Set of 3 Blocks	<i>BX-RTB05</i> <i>BX-RTB08</i>	<i>BX-RTB05-1</i> <i>BX-RTB08-1</i>	<i>BX-RTB05-2</i> <i>BX-RTB08-2</i>
Price (Single Block)	\$8.50	\$7.00	\$8.00
Price (Kit)	\$15.00	\$14.50	\$15.00
Connector Type	Screw Type - 90-degree	Spring Clamp Type - 180-degree	Screw Type - 180-degree
Wire Exit	180-degree	180-degree	180-degree
Pitch	5.0 mm	5.0 mm	5.0 mm
Screw Size	M2.5	N/A	M2.5
Screw Torque Recommended	< 3.98 lb-in (0.45 N·m)	N/A	< 3.98 lb-in (0.45 N·m)
Screwdriver Blade Width	3.5 mm	3.5 mm	3.5 mm
Wire Gauge (Single Wire)	28-12 AWG	28-14 AWG	28-12 AWG
Wire Gauge (Dual Wire)	28-16 AWG	28-16 AWG (Dual Wire Ferrule Required)	28-16 AWG
Wire Strip Length	0.3 in (7.5 mm)	0.37 in (9.5 mm)	0.3 in (7.5 mm)
Equiv. Dinkle P/N	5ESDV-05P-BK	5ESDSR-05P-BK	5ESDF-05P-BK

Terminal Block Connectors, Analog Modules and 16-Point Discrete Modules

Terminal Block Kits for Analog and 16-point Discrete Expansion Modules



BX-RTB10 (Kit - 2 pieces)

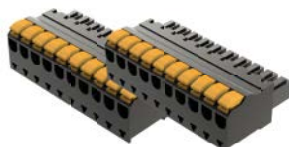

BX-RTB10-1 (Kit - 2 pieces)



BX-RTB10-2 (Kit - 2 pieces)

Terminal Block Specifications 16-Point Type

Part Number	<i>BX-RTB10</i>	<i>BX-RTB10-1</i>	<i>BX-RTB10-2</i>
Price (Kit)	\$21.50	\$24.00	\$22.50
Connector Type	Screw Type 90-degree	Spring Clamp Type 180-degree	Screw Type 180-degree
Wire Exit	180-degree	180-degree	180-degree
Pitch	3.81 mm	3.81 mm	3.81 mm
Screw Size	M2	N/A	M2
Screw Torque Recommended	<1.77 lb-in (0.2 N·m)	N/A	<1.77 lb-in (0.2 N·m)
Screwdriver Blade Width	2.5 mm	2.5 mm	2.5 mm
Wire Gauge (Single Wire)	28-16 AWG	26-18 AWG	30-16 AWG
Wire Gauge (Dual Wire)	28-18 AWG	30-20 AWG (Dual Wire Ferrule Required)	30-18 AWG
Wire Strip Length	0.24 in (6mm)	0.35 in (9mm)	0.26 in (6.5 mm)
Equiv. Dinkle P/N	EC381V-10P-BK	ESC381V-10-BK	EC381F-10P-BK



NOTE: BX-RTB10 terminal blocks are included with Temperature Input modules.

BRX Wiring Termination Options

ZIPLink Wiring System

BRX expansion modules can be quickly connected to convenient **ZIPLink** remote terminal blocks for ease of wiring I/O devices. Your **ZIPLink** selection is dependent on the number of expansion module terminal points. The following tables list the connector options.



8-Point BRX Discrete Expansion Module ZIPLink Selector

Expansion Module Part No.	ZIPLink Module	ZIPLink Module Part No.	Qty Needed	ZIPLink Cable Part No.*	Qty Needed
BX-08ND3	Feedthrough	ZL-RTB20 (Standard) OR ZL-RTB20-1 (Compact)	1	ZL-BXEM-CBL10 ZL-BXEM-CBL10-1 ZL-BXEM-CBL10-2	1
BX-08NF3					
BX-08NA					
BX-08NB					
BX-08TD1					
BX-08TD2					
BX-08TR**					
BX-08TRZ**					
BX-08TA					
BX-08CD3R**					

* Select cable length: Blank = 0.5 m, -1 = 1.0m, -2 = 2.0m.

Available pigtail cables: [ZL-BXEM-CBL10-1P](#) = 1.0 m, [ZL-BXEM-CBL10-2P](#) = 2.0 m.

** The relay outputs are derated not to exceed 2A per common when used with the **ZIPLink** wiring system.

12 & 5-Point BRX Discrete Expansion Module ZIPLink Selector

Expansion Module Part No.	ZIPLink Module	ZIPLink Module Part No.	Qty Needed	ZIPLink Cable Part No.*	Qty Needed
BX-12ND3	Feedthrough	ZL-RTB20 (Standard) OR ZL-RTB20-1 (Compact)	1	ZL-BXEM-CBL15 ZL-BXEM-CBL15-1 ZL-BXEM-CBL15-2	1
BX-12NA					
BX-12NB					
BX-12TD1					
BX-12TD2					
BX-12TR**					
BX-05TRS					
BX-12TA					
BX-12CD3D1					
BX-12CD3D2					

* Select cable length: Blank = 0.5 m, -1 = 1.0m, -2 = 2.0m.

Available pigtail cables: [ZL-BXEM-CBL15-1P](#) = 1.0 m, [ZL-BXEM-CBL15-2P](#) = 2.0 m.

** The relay outputs are derated not to exceed 2A per common when used with the **ZIPLink** wiring system.

BRX Wiring Termination Options

16-Point BRX Discrete Expansion Module ZIPLink Selector							
Expansion Module Part No.	ZIPLink Module	ZIPLink Module Part No.	Qty Needed	ZIPLink Cable Part No. *	Qty Needed		
<u>BX-16ND3</u>	Sensor	<u>ZL-LTB16-24-1</u>	1	<u>ZL-BXEM-CBL20</u> <u>ZL-BXEM-CBL20-1</u> <u>ZL-BXEM-CBL20-2</u>	1		
	Feedthrough	<u>ZL-RTB20</u> (Standard) OR <u>ZL-RTB20-1</u> (Compact)	1				
<u>BX-16NF3</u>	Feedthrough						
<u>BX-16NA</u>							
<u>BX-16NB</u>	Feedthrough						
<u>BX-16TD1</u>							
<u>BX-16TD2</u>	Relay (Sourcing)					<u>ZL-RRL16-24-1</u> , <u>ZL-RRL16W-24-1</u> , <u>ZL-RRL16F-24-1</u> , <u>ZL-RRL16HDF-24-1</u>	1
	Relay (Sinking)					<u>ZL-RRL16-24-2</u> , <u>ZL-RRL16W-24-2</u> , <u>ZL-RRL16F-24-2</u> , <u>ZL-RRL16HDF-24-2</u>	1
<u>BX-16TF2</u>	Feedthrough					<u>ZL-RTB20</u> (Standard) OR <u>ZL-RTB20-1</u> (Compact)	1
<u>BX-16TR**</u>							
<u>BX-16TRZ**</u>							
<u>BX-16CD3D1</u>							
<u>BX-16CD3D2</u>							
<u>BX-16CF3F2</u>							

* Select cable length: Blank = 0.5 m, -1 = 1.0m, -2 = 2.0m.

Available pigtail cables: ZL-BXEM-CBL20-1P = 1.0 m, ZL-BXEM-CBL20-2P = 2.0 m.

** The relay outputs are derated not to exceed 2A per common when used with the ZIPLink wiring system.

32-Point BRX Discrete Expansion Module ZIPLink Selector					
Expansion Module Part No.	ZIPLink Module	ZIPLink Module Part No.	Qty Needed	ZIPLink Cable Part No. *	Qty Needed
<u>BX-32ND3</u>	Sensor	<u>ZL-LTB32-24-1</u>	1	<u>ZL-D24-CBL40</u> <u>ZL-D24-CBL40-1</u> <u>ZL-D24-CBL40-2</u>	1
	Feedthrough	<u>ZL-RTB40</u> (Standard) OR <u>ZL-RTB40-1</u> (Compact)	1		
<u>BX-32TD1</u>					
<u>BX-32TD2</u>					

* Select cable length: Blank = 0.5 m, -1 = 1.0m, -2 = 2.0m.

Available pigtail cables: ZL-D24-CBL40-1P = 1.0 m, ZL-D24-CBL40-2P = 2.0 m.

Suffix -X indicates 45° cable connector angle. Non -X indicates 180° cable connector angle.

16-Point BRX High Speed Expansion Module ZIPLink Selector					
Expansion Module Part No.	ZIPLink Module	ZIPLink Module Part No.	Qty Needed	ZIPLink Cable Part No. *	Qty Needed
<u>BX-HSIO4</u>	Feedthrough	<u>ZL-RTB40</u> (Standard) OR <u>ZL-RTB40-1</u> (Compact)	1	<u>ZL-BX-CBL40-S</u> <u>ZL-BX-CBL40-1S</u>	1

BRX Wiring Termination Options

BRX Analog and Temperature Expansion Module ZIPLink Selector					
Expansion Module Part No.	ZIPLink Module	ZIPLink Module Part No.	Qty Needed	ZIPLink Cable Part No. ¹	Qty Needed
BX-04ADM-1	Feedthrough	ZL-RTB20 (Standard) OR ZL-RTB20-1 (Compact)	1	ZL-BXEM-CBL20 ZL-BXEM-CBL20-1 ZL-BXEM-CBL20-2	1
BX-04AD-1					
BX-08AD-1					
BX-16AD-1					
BX-04AD-2B					
BX-08AD-2B					
BX-16AD-2B					
BX-04DA-1					
BX-08DA-1					
BX-04DA-2B					
BX-08DA-2B					
BX-2AD2DA-1					
BX-4AD2DA-1					
BX-2AD2DA-2B					
BX-4AD2DA-2B					
BX-08AD-3				ZL-BXEM-CBL10 ZL-BXEM-CBL10-1 ZL-BXEM-CBL10-2	1
BX-08DA-3					
BX-2AD2DA-3					
BX-4AD4DA-3					
BX-04THM				Temperature Input modules are not supported by the ZIPLink wiring system.	
BX-08THM					
BX-06RTD					
BX-08NTC					
BX-04UT					
BX-08UT					
BX-4THM4DA-1					
BX-4RTD4DA-1					
BX-4UT4DA-3					
BX-4UT4TD1					
BX-4UT4TD2					
BX-4UT4TR					

1. Select cable length: Blank = 0.5 m, -1 = 1.0m, -2 = 2.0m.
Available pigtail cables: [ZL-BXEM-CBL20-1P](#) = 1.0 m, [ZL-BXEM-CBL20-2P](#) = 2.0 m.