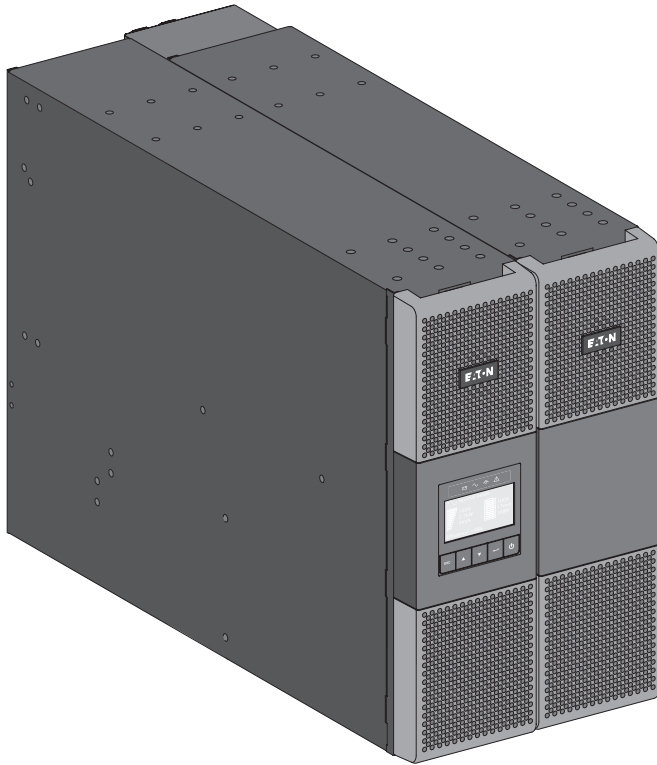

**EATON**

**9PX 8000  
9PX 11000  
9PX EBM 240V**

**Installation  
and user manual**

Copyright © 2013 **EATON**  
All rights reserved.

**Service and support:**  
Call your local service representative

8-11kVA US\_EN



# SAFETY INSTRUCTIONS

**SAVE THESE INSTRUCTIONS.** This manual contains important instructions that should be followed during installation and maintenance of the UPS and batteries.

The 9PX models that are covered in this manual are intended for installation in an environment within 0 to 40°C, free of conductive contaminant.

This equipment has been tested and found to comply with the limits for a Class A digital device, pursuant to Part 15 of the FCC Rules. These limits are designed to provide reasonable protection against harmful interference when the equipment is operated in a commercial environment. This equipment generates, uses, and can radiate radio frequency energy and, if not installed and used in accordance with the instruction manual, may cause harmful interference to radio communications. Operation of this equipment in a residential area is likely to cause harmful interference in which case the user will be required to correct the interference at his own expense.

## Certification standards

- Safety: IEC/EN 62040-1 / Ed.1: 2008.  
UL 1778 4<sup>th</sup> edition
- EMC: IEC/EN 62040-2 / Ed.2: 2006.  
FCC part 15 Class A.
- Performance: IEC/EN 62040-3 / Ed.2.0: 2011.
- IEC 61000-4-2 (ESD): level 3.
- IEC 61000-4-3 (Radiated field): level 3.
- IEC 61000-4-4 (EFT): level 4.
- IEC 61000-4-5 (Fast transients): level 4.
- IEC 61000-4-6 (Electromagnetic field): level 3.
- IEC 61000-4-8 (Conducted magnetic field): level 4.

## Special symbols

The following are examples of symbols used on the UPS or accessories to alert you to important information:



**RISK OF ELECTRIC SHOCK** - Observe the warning associated with the risk of electric shock symbol.



Important instructions that must always be followed.



Do not discard the UPS or the UPS batteries in the trash.  
This product contains sealed lead acid batteries and must be disposed as it's explain in this manual.  
For more information, contact your local recycling/reuse or hazardous waste center.



This symbol indicates that you should not discard waste electrical or electronic equipment (WEEE) in the trash. For proper disposal, contact your local recycling/reuse or hazardous waste center.



Information, advice, help.



Refer to the user manual of UPS accessories.

## Safety of persons

- **RISK OF VOLTAGE BACKFEED.** The system has its own power source (the battery). Isolate the UPS and check for hazardous voltage upstream and downstream during lockout-tagout operation. Terminal blocks may be energized even if the system is disconnected from the AC power source.
- Dangerous voltage levels are present within the system. It should be opened exclusively by qualified service personnel.
- The system must be properly grounded.
- The battery supplied with the system contains small amounts of toxic materials. To avoid accidents, the directives listed below must be observed:
  - Servicing of batteries should be performed or supervised by personnel knowledgeable about batteries and the required precautions.
  - When replacing batteries, replace with the same type and number of batteries or battery packs.
  - Do not dispose of batteries in a fire. The batteries may explode.
  - Batteries constitute a danger (electrical shock, burns). The short-circuit current may be very high.
- Precautions must be taken for all handling:
  - Wear rubber gloves and boots.
  - Do not lay tools or metal parts on top of batteries.
  - Disconnect charging source prior to connecting or disconnecting battery terminals.
  - Determine if battery is inadvertently grounded. If inadvertently grounded, remove source from ground. Contact with any part of a grounded battery can result in electrical shock. The likelihood of such shock can be reduced if such grounds are removed during installation and maintenance (applicable to equipment and remote battery supplies not having a grounded supply circuit).

## Product safety

- The UPS connection instructions and operation described in the manual must be followed in the indicated order.
- **CAUTION** - To reduce the risk of fire, the unit connects only to a circuit provided with branch circuit overcurrent protection for :
  - 50A rating, for 8kVA models,
  - 70A rating, for 11kVA models,
 in accordance with the National Electric Code, ANSI/NFPA 70.  
 The upstream circuit breaker for Normal AC/Bypass AC must be easily accessible. The unit can be disconnected from AC power source by opening this circuit breaker. This circuit breaker is used for backfeed protection and must comply with IEC/EN 62040-1 (the creepage and clearance distances shall meet the basic insulation requirements for pollution degree 2).
- Disconnection and overcurrent protection devices shall be provided by others for permanently connected AC input (Normal AC/Bypass AC) and AC output circuits.
- Check that the indications on the rating plate correspond to your AC powered system and to the actual electrical consumption of all the equipment to be connected to the system.
- For **PLUGGABLE EQUIPMENT**, the socket-outlet shall be installed near the equipment and shall be easily accessible
- Never install the system near liquids or in an excessively damp environment.
- Never let a foreign body penetrate inside the system.
- Never block the ventilation grates of the system.
- Never expose the system to direct sunlight or source of heat.
- If the system must be stored prior to installation, storage must be in a dry place.
- The admissible storage temperature range is -15°C to +50°C.
- The system is not for use in a computer room AS DEFINED IN the standard for the Protection of Information Technology Equipment, ANSI/NFPA 75.  
 Contact Eaton resellers to order a special battery kit, if needed to meet the ANSI/NFPA 75 requirement.

# SAFETY INSTRUCTIONS

## Special precautions

- The unit is heavy: wear safety shoes and use vacuum lifter preferentially for handling operations.
- All handling operations will require at least two people (unpacking, lifting, installation in rack system).
- Straps are provided only for unpacking manually the unit from the carton; don't use the straps to carry the unit around. The unit can slip from the straps during handling (risk of injury and product damage):
  - keep 12in / 30cm minimum distance between the straps
  - lift the unit carefully and keep it at low height
  - keep the unit horizontal during unpacking.
- Before and after the installation, if the UPS remains de-energized for a long period, the UPS must be energized for a period of 24 hours, at least once every 6 months (for a normal storage temperature less than 25°C). This charges the battery, thus avoiding possible irreversible damage.
- During the replacement of the Battery Module, it is imperative to use the same type and number of element as the original Battery Module provided with the UPS to maintain an identical level of performance and safety. In case of doubt, don't hesitate to contact your EATON representative.
- All repairs and service should be performed by AUTHORIZED SERVICE PERSONNEL ONLY. There are NO USER SERVICEABLE PARTS inside the UPS.



|  |           |
|--|-----------|
| <b>1. Introduction.....</b>  | <b>6</b>  |
| 1.1 Environmental protection.....  | 6         |
| <b>2. Presentation .....</b>   | <b>8</b>  |
| 2.1 Standard installations.....  | 8         |
| 2.2 Rear panels.....   | 9         |
| 2.3 Accessories .....  | 10        |
| 2.4 Control panel.....   | 12        |
| 2.5 LCD description .....  | 13        |
| 2.6 Display functions .....  | 14        |
| 2.7 User settings .....  | 14        |
| <b>3. Installation .....</b>   | <b>16</b> |
| 3.1 Inspecting the equipment .....                                       | 16        |
| 3.2 Unpacking the cabinet .....  | 16        |
| 3.3 Checking the accessory kit.....                                      | 17        |
| 3.4 Connecting the EBM(s) .....  | 18        |
| 3.5 Connecting other accessories .....                                   | 18        |
| 3.6 Tower installation .....   | 19        |
| 3.7 Rack installation.....   | 20        |
| 3.8 Installation requirements .....                                      | 22        |
| 3.9 Installation depending on the system earthing arrangement (SEA)..... | 23        |
| <b>4. Power cables connection .....</b>                                  | <b>25</b> |
| 4.1 Access to terminal blocks.....                                       | 25        |
| 4.2 Common input sources connection.....                                 | 25        |
| 4.3 Separate input source connection .....                               | 26        |
| 4.4 Frequency converter connection.....                                  | 26        |
| <b>5. Operation.....</b>   | <b>27</b> |
| 5.1 UPS startup and shutdown .....                                       | 27        |
| 5.2 Operating modes.....   | 28        |
| 5.3 Transferring the UPS between modes.....                              | 28        |
| 5.4 Setting High Efficiency mode .....                                   | 29        |
| 5.5 Configuring Bypass settings.....                                     | 29        |
| 5.6 Configuring battery settings .....                                   | 29        |
| 5.7 Retrieving the Event log.....  | 30        |
| 5.8 Retrieving the Fault log.....  | 30        |
| <b>6. Communication .....</b>  | <b>31</b> |
| 6.1 Communication ports .....  | 31        |
| 6.2 Eaton Intelligent Power Software suite .....                         | 34        |
| <b>7. UPS maintenance.....</b>   | <b>35</b> |
| 7.1 Equipment care.....  | 35        |
| 7.2 Storing the equipment.....   | 35        |
| 7.3 When to replace batteries .....                                      | 35        |
| 7.4 Replacing batteries .....  | 36        |
| 7.5 Replacing the UPS equipped with a HotSwap MBP.....                   | 38        |
| 7.6 Recycling the used equipment .....                                   | 38        |
| <b>8. Troubleshooting .....</b>  | <b>39</b> |
| 8.1 Typical alarms and faults .....                                      | 39        |
| 8.2 Silencing the alarm .....  | 41        |
| 8.3 Service and support.....   | 41        |
| <b>9. Specifications.....</b>  | <b>42</b> |
| 9.1 Model specifications.....  | 42        |
| <b>10. Glossary .....</b>  | <b>46</b> |

# 1. Introduction

Thank you for selecting an EATON product to protect your electrical equipment.

The 9PX range has been designed with the utmost care.

We recommend that you take the time to read this manual to take full advantage of the many features of your UPS (Uninterruptible Power System).

Before installing your 9PX, please read the booklet presenting the safety instructions. Then follow the indications in this manual.

To discover the entire range of EATON products and the options available for the 9PX range, we invite you to visit our web site at [www.eaton.com/powerquality](http://www.eaton.com/powerquality) or contact your EATON representative.

## 1.1 Environmental protection

EATON has implemented an environmental-protection policy. Products are developed according to an eco-design approach.

### Substances

This product does not contain CFCs, HCFCs or asbestos.

### Packing

To improve waste treatment and facilitate recycling, separate the various packing components.

- The cardboard we use comprises over 50% of recycled cardboard.
- Sacks and bags are made of polyethylene.
- Packing materials are recyclable and bear the appropriate identification symbol 

| Materials                 | Abbreviations | Number in the symbols  |
|---------------------------|---------------|---|
| Polyethylene terephthalat | PET           | 01  |
| High-density polyethylene | HDPE          | 02  |
| Polyvinyl chloride        | PVC           | 03  |
| Low-density polyethylene  | LDPE          | 04  |
| Polypropylene             | PP            | 05  |
| Polystyrene               | PS            | 06  |

Follow all local regulations for the disposal of packing materials.

### End of life

EATON will process products at the end of their service life in compliance with local regulations. EATON works with companies in charge of collecting and eliminating our products at the end of their service life.

### Product

The product is made up of recyclable materials.

Dismantling and destruction must take place in compliance with all local regulations concerning waste. At the end of its service life, the product must be transported to a processing center for electrical and electronic waste.

### Battery

The product contains lead-acid batteries that must be processed according to applicable local regulations concerning batteries.

The battery may be removed to comply with regulations and in view of correct disposal.

# 1. Introduction

The Eaton® 9PX uninterruptible power system (UPS) protects your sensitive electronic equipment from the most common power problems, including power failures, power sags, power surges, brownouts, line noise, high voltage spikes, frequency variations, switching transients, and harmonic distortion. Power outages can occur when you least expect it and power quality can be erratic. These power problems have the potential to corrupt critical data, destroy unsaved work sessions, and damage hardware - causing hours of lost productivity and expensive repairs.

With the Eaton 9PX, you can safely eliminate the effects of power disturbances and guard the integrity of your equipment. Providing outstanding performance and reliability, the Eaton 9PX's unique benefits include:

- True online double-conversion technology with high power density, utility frequency independence, and generator compatibility.
- ABM® technology that uses advanced battery management to increase battery service life, optimize recharge time, and provide a warning before the end of useful battery life.
- Selectable High Efficiency mode of operation.
- Standard communication options: one RS-232 communication port, one USB communication port, and relay output contacts.
- Optional connectivity cards with enhanced communication capabilities.
- Extended runtime with up to twelve Extended Battery Modules (EBMs) per UPS.
- Firmware that is easily upgradable without a service call.
- Remote On/Off control through Remote On/Off (ROO) and Remote Power Off (RPO) ports.
- Backed by worldwide agency approvals.

## 2. Presentation

### 2.1 Standard installations

#### Tower installation

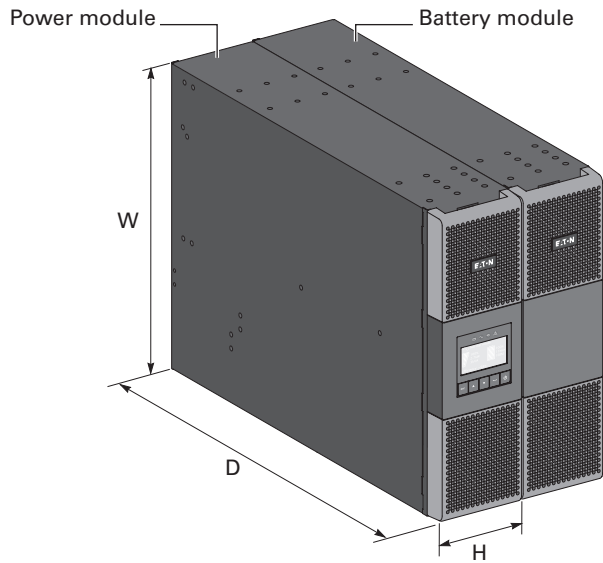

#### Rack installation

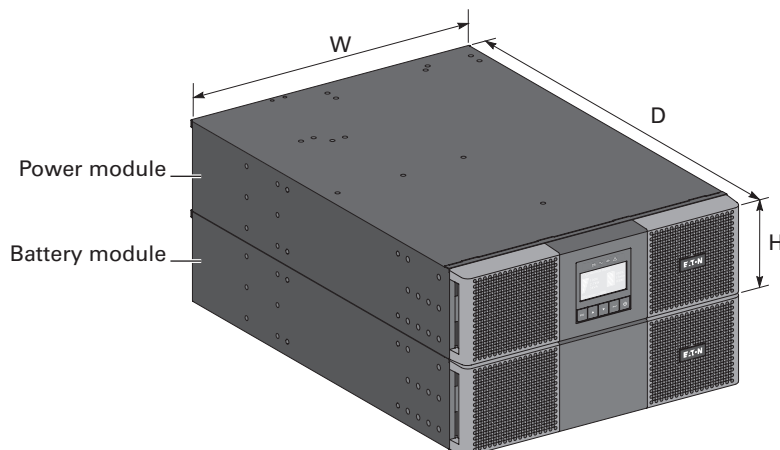

| Description            | Weights (lb/kg) | Dimensions (inch/mm)<br>D x W x H   |
|------------------------|-----------------|-------------------------------------|
| 9PX 8000 Power Module  | 42 / 19         | 27.6 x 17.3 x 5.1 / 700 x 440 x 130 |
| 9PX 11000 Power Module | 46 / 21         | 27.6 x 17.3 x 5.1 / 700 x 440 x 130 |
| 9PX EBM 240V           | 143 / 65        | 26.8 x 17.3 x 5.1 / 680 x 440 x 130 |

## 2. Presentation

### 2.2 Rear panels

#### 9PX 8000 (Power Module)

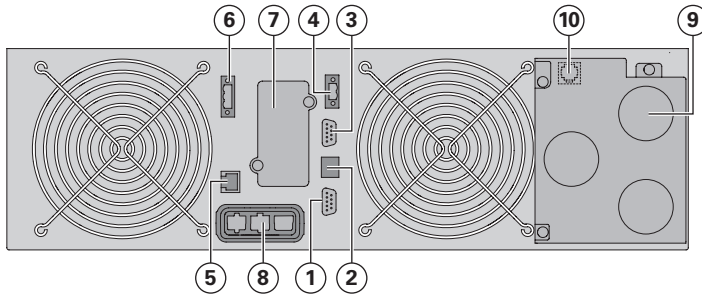

- ① RS232 communication port
- ② USB communication port
- ③ Dry (relay) contacts communication port
- ④ Connector for ROO (Remote On/Off) control
- ⑤ Connectors for automatic recognition of battery module
- ⑥ Connector for RPO (Remote Power Off) control
- ⑦ Slot for optional communication card
- ⑧ Connector for battery module
- ⑨ Input/Output terminal blocks
- ⑩ Connector for HotSwap MBP detection

#### 9PX 11000 (Power Module)

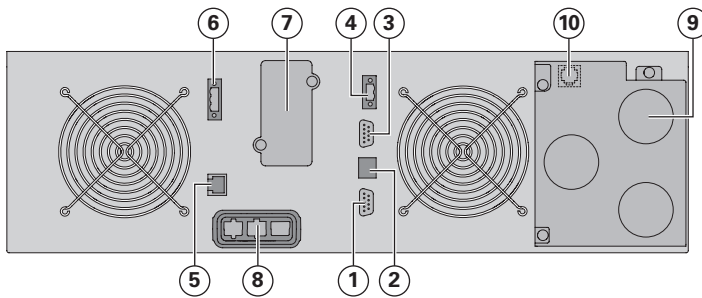

#### 9PX EBM 240V (Extended Battery Module)



- ⑪ Connectors for battery modules (to the UPS or to the other battery modules)
- ⑫ Connectors for automatic recognition of battery modules
- ⑬ Battery circuit breaker

## 2. Presentation

### 2.3 Accessories

| Part number | Description                                      |
|-------------|--|
| 9PXEBM240RT | Extended Battery Module                          |
| 9RK         | Rack kit 9PX                                     |
| RK2PC       | 2-post Rack kit 9PX                              |
| Network-MS  | Network card                                     |
| Modbus-MS   | Modbus and network card                          |
| Relay-MS    | Relay card                                       |
| MBP11K208   | HotSwap MBP 11000 208                            |
| 9PXTFMR5    | 5kVA Transformer                                 |
| 9PXTFMR11   | 11kVA Transformer                                |
| SC240RT     | Supercharger 240VDC (when using more than 6 EBM) |
| BINTSYS     | Battery Integration System                       |
| EBMCBL240   | 1.8m cable 240V EBM                              |

#### MBP11K208

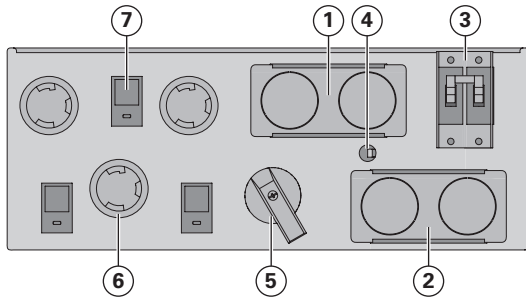

- ① Input/Output terminal blocks
- ② Input/Output terminal blocks for connection to the UPS
- ③ Normal AC source switch
- ④ Connector for HotSwap MBP detection
- ⑤ Manual Bypass switch
- ⑥ (3) 30A outlets
- ⑦ 30A circuit breaker

#### 9PXTFMR5

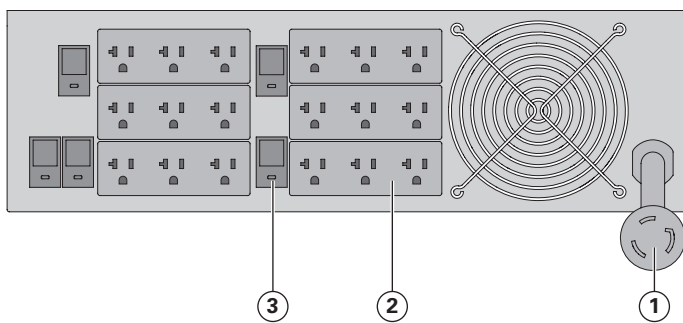

- ① L6-30P input power cable
- ② (18) 5-20R 120V outlets
- ③ 20A circuit breaker

## 2. Presentation

### 9PXTFMR11

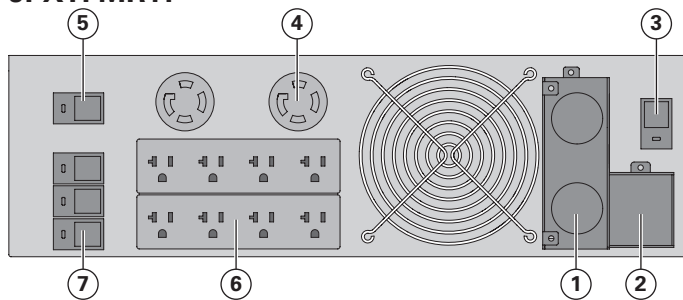

- ① Input/Output terminal blocks
- ② 208V/240V input voltage selection
- ③ 50A output circuit breaker
- ④ (2) L14-30R 120V/240V outlet
- ⑤ 30A circuit breaker
- ⑥ (8) 5-20R 120V outlets
- ⑦ 20A circuit breaker

### SC240RT

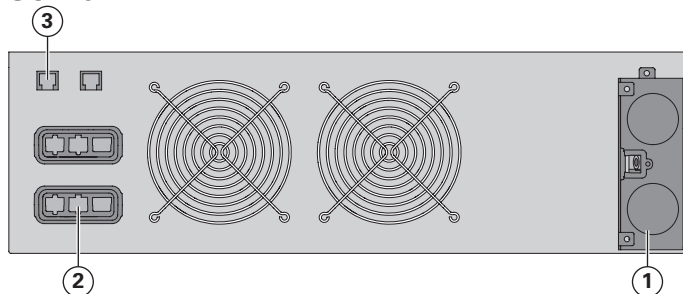

- ① Input AC/Output DC terminal blocks
- ② Connector for battery modules (to the UPS and to the battery modules)
- ③ Connector for automatic recognition of the Supercharger (to the UPS and to the battery modules)



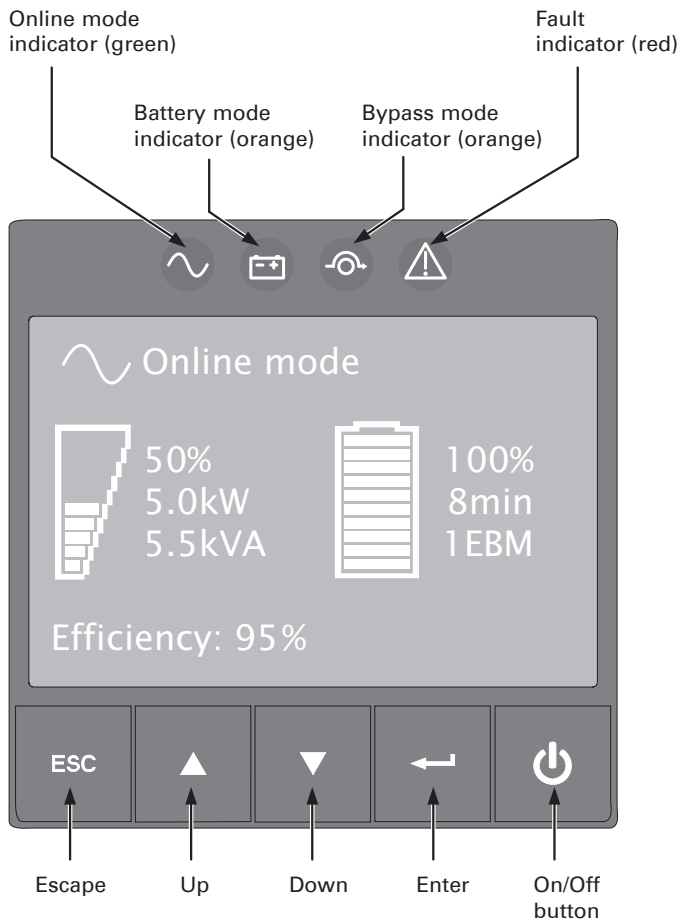

## 2. Presentation

### 2.4 Control panel

The UPS has a five-button graphical LCD. It provides useful information about the UPS itself, load status, events, measurements and settings.



The following table shows the indicator status and description:

| Indicator   | Status | Description  |
|---|--------|--|
| <br>Green  | On     | The UPS is operating normally on Online or on High Efficiency mode.                              |
| <br>Orange | On     | The UPS is on Battery mode.  |
| <br>Orange | On     | The UPS is on Bypass mode.   |
| <br>Red    | On     | The UPS has an active alarm or fault. See troubleshooting on page 39 for additional information. |



## 2.5 LCD description





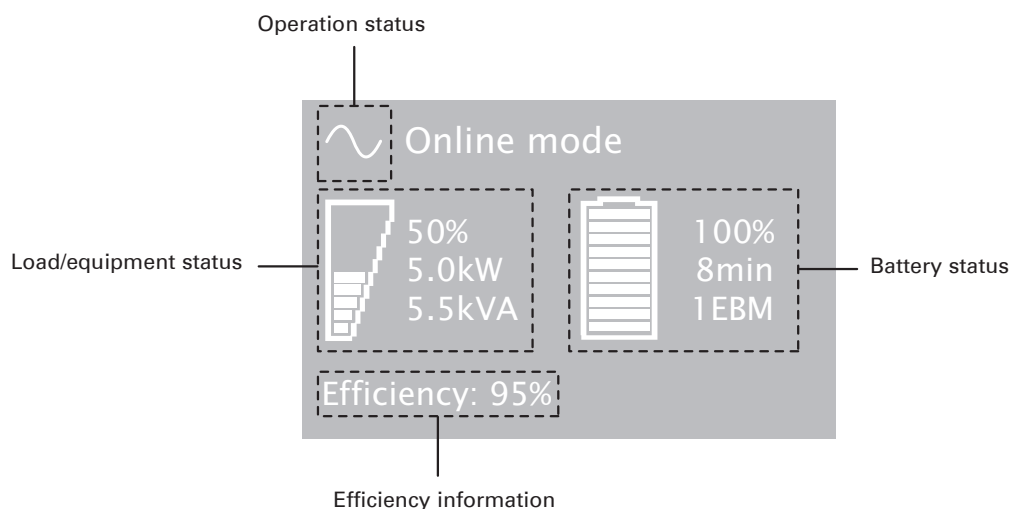

After 5 minutes of inactivity, the LCD displays the screen saver.

The LCD backlight automatically dims after 10 minutes of inactivity. Press any button to restore the screen.



The following table describes the status information provided by the UPS

**Note:** If other indicator appears, see troubleshooting on page 39 for additional information.

| Operation status  | Cause   | Description  |
|---|---|--|
| <br>Standby mode                                 | The UPS is Off.   | Equipment is not powered until  button is pressed.  |
| <br>Online mode                                  | The UPS is operating normally.  | The UPS is powering and protecting the equipment.  |
| <br>Battery mode<br>1 beep every 10 seconds      | A utility failure has occurred and the UPS is on Battery mode.                                      | The UPS is powering the equipment with the battery power. Prepare your equipment for shutdown.   |
| <br>End of backup time<br>1 beep every 3 seconds | The UPS is on Battery mode and the battery is running low.  | This warning is approximate, and the actual time to shutdown may vary significantly. Depending on the UPS load and number of Extended Battery Modules (EBMs), the "Battery Low" warning may occur before the battery reaches 20% capacity. |
| <br>High Efficiency mode                         | The UPS is operating on High Efficiency mode.   | The UPS is powering and protecting the equipment   |
| <br>Bypass mode                                  | An overload or a fault has occurred, or a command has been received, and the UPS is in Bypass mode. | Equipment is powered but not protected by the UPS.   |

## 2. Presentation

### 2.6 Display functions

Press the Enter (↵) button to activate the menu options. Use the two middle buttons (▲ and ▼) to scroll through the menu structure. Press the Enter (↵) button to select an option. Press the ESC button to cancel or return to the previous menu.

| Main menu        | Submenu             | Display information or Menu function   |
|------------------|---------------------|--|
| Measurements     |                     | [Load] W VA A pf / [Input/Bypass] V Hz / [Output/Efficiency] V Hz % / [Battery] % min V n° / [DCbus] V / [Average power usage] Wh / [Cumulat. power usage] Wh since date |
| Control          | Go to Bypass        | Transfers the UPS on Bypass mode   |
|                  | Start battery test  | Starts a manual battery test   |
|                  | Reset fault state   | Clears active fault  |
|                  | Restore factory set | Returns all settings to original values  |
|                  | Reset average power | Clears average power usage measurement   |
|                  | Reset cumul. power  | Clears cumulated power usage measurement   |
|                  | Dry contacts test   | Tests dry contact relay outputs  |
| Settings         | Local settings      | Sets product general parameters  |
|                  | In/Out settings     | Sets Output parameters   |
|                  | On/Off settings     | Sets On/Off conditions   |
|                  | Battery settings    | Sets battery configuration   |
| Event log        | Event filter        | Selects faults, alarms and/or events to display  |
|                  | Event list          | Displays the events stored   |
|                  | Reset event list    | Clears events  |
| Fault log        | Fault list          | Displays the faults stored   |
|                  | Reset fault list    | Clears faults  |
| Identification   |                     | [Product type/model] / [Part/Serial number] / [UPS/NMC firmware] / [Com card IPv4], [Com card IPv6], [Com card MAC] / [Detected accessories]                             |
| Register product |                     | Links to Eaton registration website  |

### 2.7 User settings

The following table displays the options that can be changed by the user.

|                 | Submenu               | Available settings   | Default settings   |
|-----------------|-----------------------|--|--|
| Local settings  | Language              | [English] [Français] [Deutsch] [Español] [Русский] [Português] [Italiano]<br>Menus, status, notices and alarms, UPS fault, Event Log data and settings are in all supported languages. | [English]<br>User selectable when UPS is powered for the first time. |
|                 | Date/ time            | Format:<br>[International] [US]  | [US]   |
|                 | LCD                   | Modify LCD screen brightness and contrast to be adapted to room light conditions.  |  |
|                 | Audible alarm         | [Enabled] [Disabled on battery] [Always disabled]<br>Enable or disable the buzzer if an alarm occurs.  | [Enabled]  |
| In/Out settings | Output voltage        | [200V] [208V] [220V] [230V] [240V] [250V] Can be changed only in Standby mode  | [208V]   |
|                 | Output frequency      | Frequency converter:<br>[Enabled] [Disabled]<br>Frequency settable in frequency converter mode   | Disabled   |
|                 | Output mode           | [Industrial] [Network]<br>Set UPS behavior regarding transfer on Bypass  | [Network]  |
|                 | Input volt hysteresis | Sets input voltage hysteresis from 1 to 10V  | [10V]  |
|                 | High Efficiency mode  | [Enabled] [Disabled]<br>Power the output from Bypass for high efficiency   | [Disabled]   |
|                 | Bypass transfer       | [Transfer if BP AC NOK] [Enabled] [Disabled]<br>Allow transfer on Bypass out of tolerance  | [Disabled]   |

|                         | Submenu              | Available settings   | Default settings  |
|-------------------------|----------------------|--|---|
| In/Out settings         | Interrupt time       | If Bypass transfer is enabled,<br>Interrupt time: [10ms] [20ms]<br>Define break duration when transfer<br>on Bypass  | [10ms]  |
|                         | Overload<br>prealarm | [10%] ... [102%]<br>Load % when overload alarm occurs  | [102%]  |
|                         | Redundancy<br>mode   | [Unitary UPS] [Hot Standby]<br>Force slew rate value to 0.5Hz/s  | Unitary UPS   |
| On/Off settings         | Cold start           | [Enabled] [Disabled]<br>Authorize the product to start on<br>battery power.  | [Enabled]   |
|                         | Forced reboot        | [Enabled] [Disabled]<br>If mains recover during a shutdown<br>sequence:<br>If set to Enabled, shutdown sequence<br>will complete and wait 10 seconds<br>prior to restart,<br>If set to Disabled, shutdown<br>sequence will not complete and<br>restart will occur immediately. | [Enabled]   |
|                         | Auto restart         | [Enabled] [Disabled]<br>Authorize the product to restart<br>automatically when mains recovers<br>after a complete battery discharge.   | [Enabled]   |
|                         | Auto start           | [Enabled] [Disabled]<br>The UPS automatically starts up as<br>soon as mains power is available<br>(no need to press the  button).   | [Disabled]  |
|                         | Energy saving        | [Disabled] [100W] ... [1000W]<br>If Enabled, UPS will shutdown after<br>5 min. of back-up time, if load is less<br>than threshold.   | [Disabled]  |
|                         | Sleep mode           | [Enabled] [Disabled]<br>If Disabled, LCD and communication<br>will turn OFF immediately after UPS<br>is OFF.<br>If Enabled, LCD and communication<br>stays ON 1h30 min after UPS is OFF.   | [Enabled]   |
|                         | Remote command       | [Enabled] [Disabled]<br>If Enabled, shutdown or restart<br>commands from software are<br>authorized.   | [Enabled]   |
|                         | Bypass standby       | [Enabled] [Disabled]<br>Define if output is powered from<br>Bypass in Standby mode.  | [Disabled]  |
|                         | Battery settings     | Automatic battery<br>test  | In constant charge mode:<br>[No test] [Every day] [Every week]<br>[Every month]<br>In ABM cycling mode :<br>[No test] [Every ABM cycle] |
| Low battery<br>warning  |                      | [0%] ... [100%]<br>The alarm triggers when the set<br>percentage of battery capacity is<br>reached during back-up time.  | [20%]   |
| Restart bat. level      |                      | [0%] ... [100%]<br>If set, automatic restart will occur<br>only when percentage of battery<br>charge is reached.   | [0%]  |
| Battery charge<br>mode  |                      | [ABM cycling] [Constant charge]  | [ABM cycling]   |
| External battery        |                      | [Auto detection]<br>[Manual EBM set.]<br>[Manual battery set.]<br>[No battery]   | [Auto detection]<br>Using standard EBM, UPS<br>detects automatically the<br>number of EBM connected                                     |
| Deep Disch.<br>protect. |                      | [Yes] [No]<br>If set to Yes, the UPS automatically<br>prevents battery from deep discharge<br>by adapting end of back-up time<br>voltage threshold.<br>Warranty void if set to No.   | [Yes]   |

## 3. Installation

### 3.1 Inspecting the equipment

If any equipment has been damaged during shipment, keep the shipping cartons and packing materials for the carrier or place of purchase and file a claim for shipping damage. If you discover damage after acceptance, file a claim for concealed damage.

To file a claim for shipping damage or concealed damage:

1. File with the carrier within 15 days of receipt of the equipment;
2. Send a copy of the damage claim within 15 days to your service representative.



Check the battery recharge date on the shipping carton label. If the date has passed and the batteries were never recharged, do not use the UPS. Contact your service representative.

### 3.2 Unpacking the cabinet



- Unpacking the cabinet in a low-temperature environment may cause condensation to occur in and on the cabinet. Do not install the cabinet until the inside and outside of the cabinet are absolutely dry (hazard of electric shock).
- The cabinet is heavy (see page 42). Follow Special precautions provided on page 4 and on the carton.

Unpack the equipment and remove all the packing materials and shipping carton.

**Note:** Do not lift the UPS or EBM from the front panel.

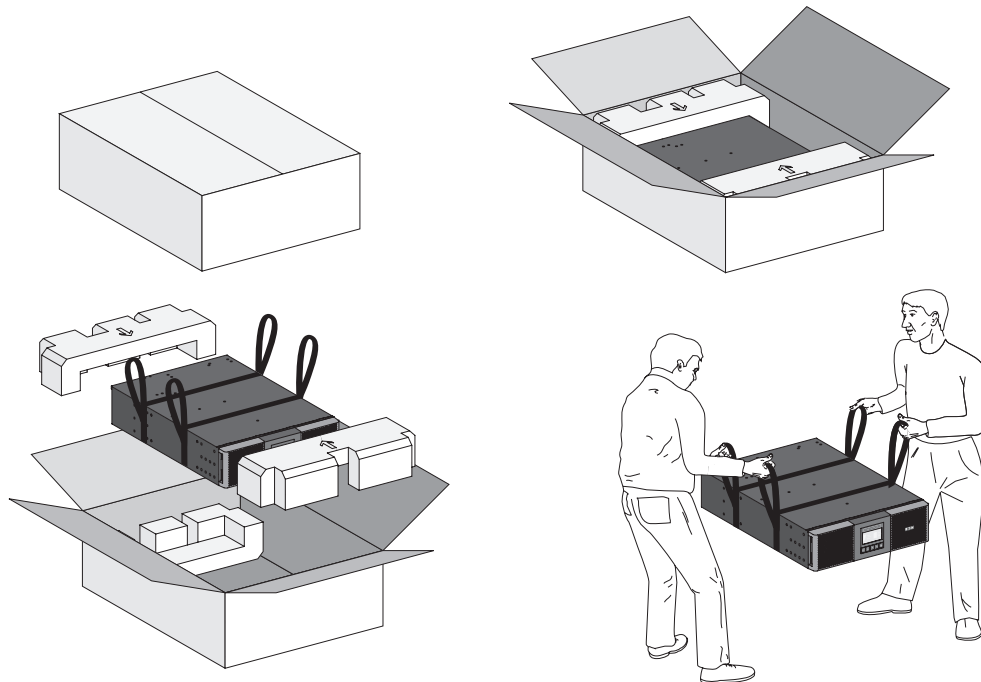

Unpacking UPS and Extended Battery Module.

Discard or recycle the packaging in a responsible manner, or store it for future use.

Place the cabinet in a protected area that has adequate airflow and is free of humidity, flammable gas, and corrosion.



Packing materials must be disposed of in compliance with all local regulations concerning waste. Recycling symbols are printed on the packing materials to facilitate sorting.

## 3.3 Checking the accessory kit

- Verify that the following additional items are included with the UPS:

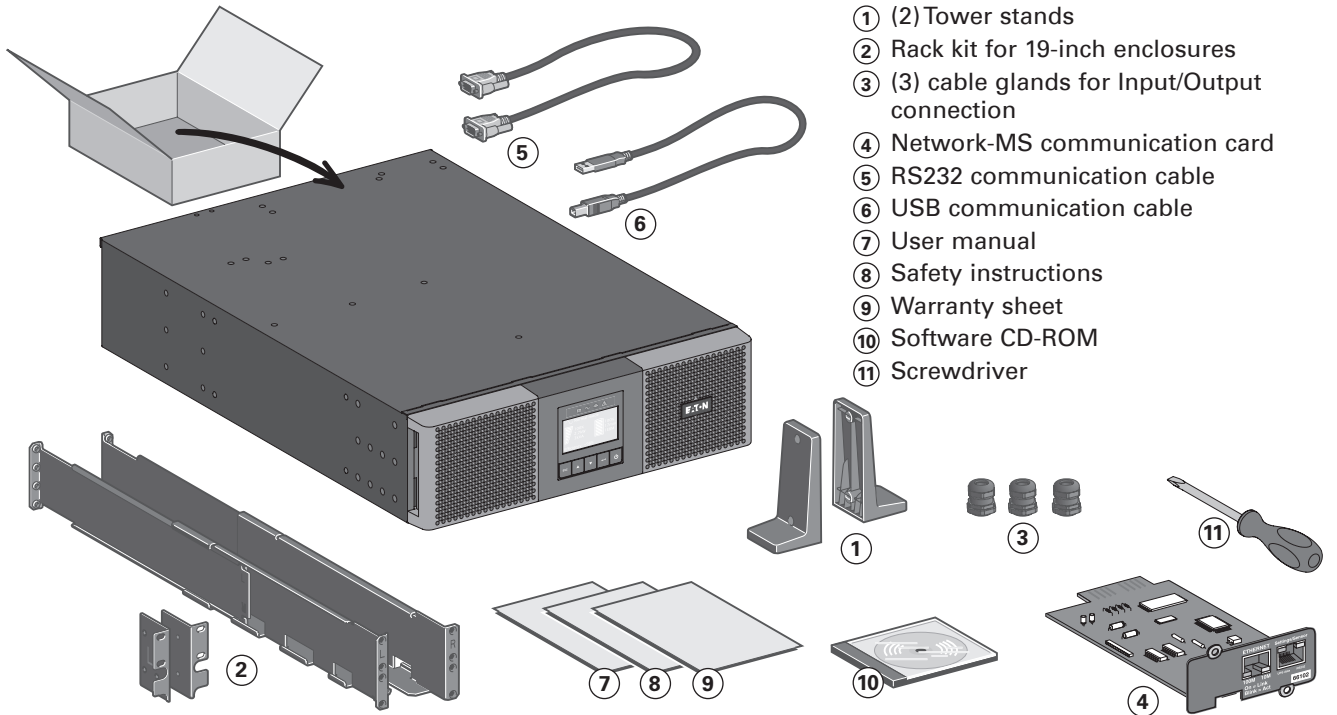

- ① (2) Tower stands
- ② Rack kit for 19-inch enclosures
- ③ (3) cable glands for Input/Output connection
- ④ Network-MS communication card
- ⑤ RS232 communication cable
- ⑥ USB communication cable
- ⑦ User manual
- ⑧ Safety instructions
- ⑨ Warranty sheet
- ⑩ Software CD-ROM
- ⑪ Screwdriver

- If you ordered an optional Extended Battery Module (EBM), verify that the following additional items are included with the EBM:

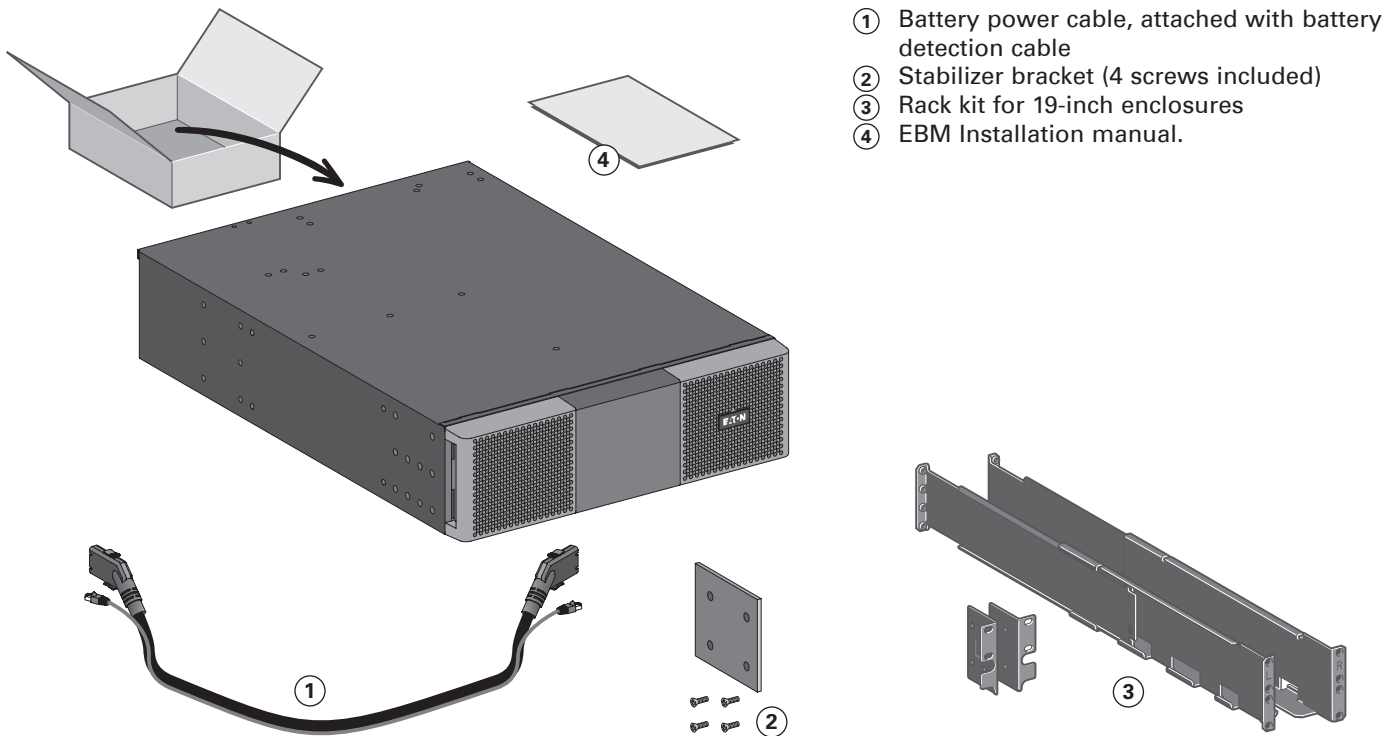

- ① Battery power cable, attached with battery detection cable
- ② Stabilizer bracket (4 screws included)
- ③ Rack kit for 19-inch enclosures
- ④ EBM Installation manual.



Discard the EBM user's guide if you are installing the EBM with a new UPS at the same time. Use the UPS user's guide to install both the UPS and the EBM.



If you ordered other UPS accessories, refer to specific user manuals to check the packing contents.

## 3. Installation

### 3.4 Connecting the EBM(s)



A small amount of arcing may occur when connecting an EBM to the UPS. This is normal and will not harm personnel. Insert the EBM cable into the UPS battery connector quickly and firmly.

1. Plug the EBM power cable(s) into the battery connector(s). Up to 12 EBMs may be connected to the UPS.
2. Verify that the EBM connections are tight and that adequate bend radius and strain relief exist for each cable.
3. Connect the battery detection cable(s) to the connector of the UPS and of the EBM(s).
4. Check that the battery circuit breaker is switched to the "I" position (On)

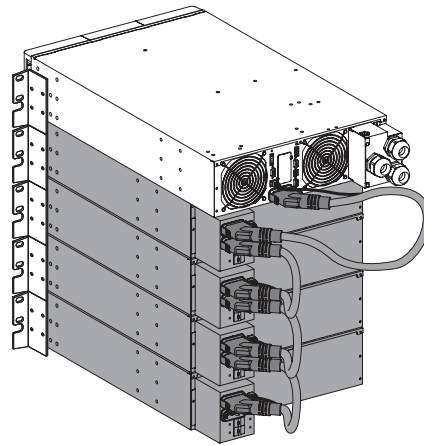
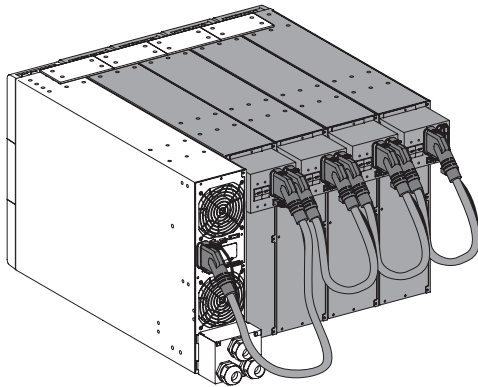

### 3.5 Connecting other accessories



If you ordered other UPS accessories, refer to specific user manuals to check the connection to the UPS.

### 3.6 Tower installation



If you ordered other UPS accessories, refer to specific user manuals to check the tower installation with the UPS.

To install the cabinet:

1. Place the UPS on a flat, stable surface in its final location.
2. Always keep 150 mm of free space behind the UPS rear panel.
3. If installing additional cabinets, place them next to the UPS in their final location.

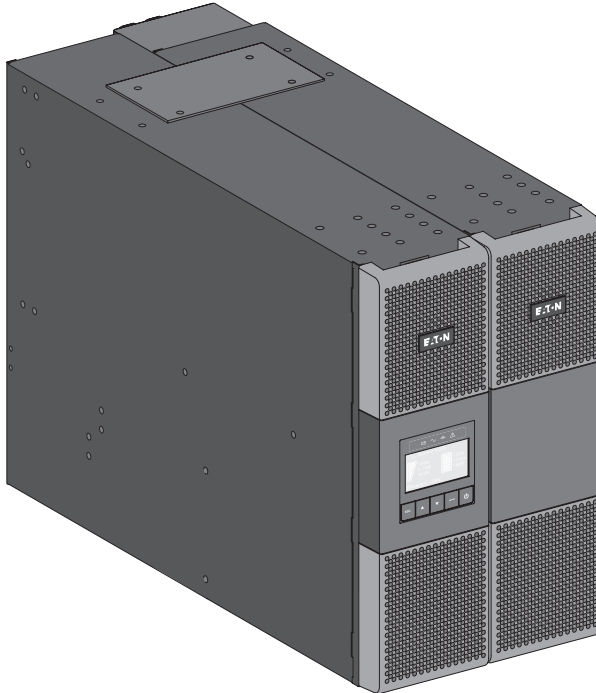

- Adjustment of the orientation of the LCD panel and of the logo.

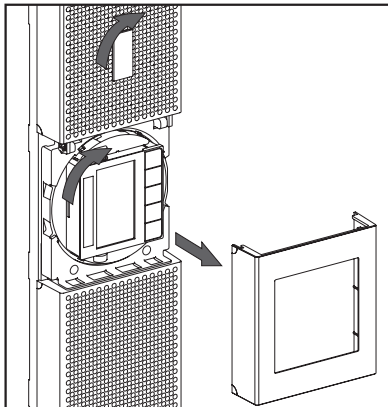

- Adjustment of the angle of vision of the LCD panel.

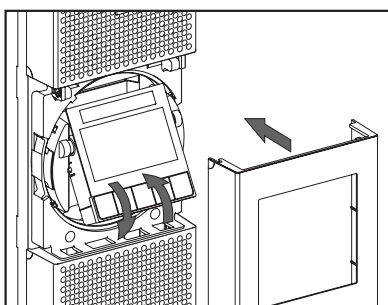

# 3. Installation

## 3.7 Rack installation



If you ordered other UPS accessories, refer to specific user manuals to check the rack installation with the UPS.

- Prepare EBM for rack mounting



This step requires two people.

The Extended Battery Module is very heavy. To ease its rack mounting, you can remove the battery pack from the EBM as explained below.

1. Remove the center cover of the front panel.
2. Remove the four screws to open the front panel.
3. Remove the three screws to pull out the metal protection cover of the battery.

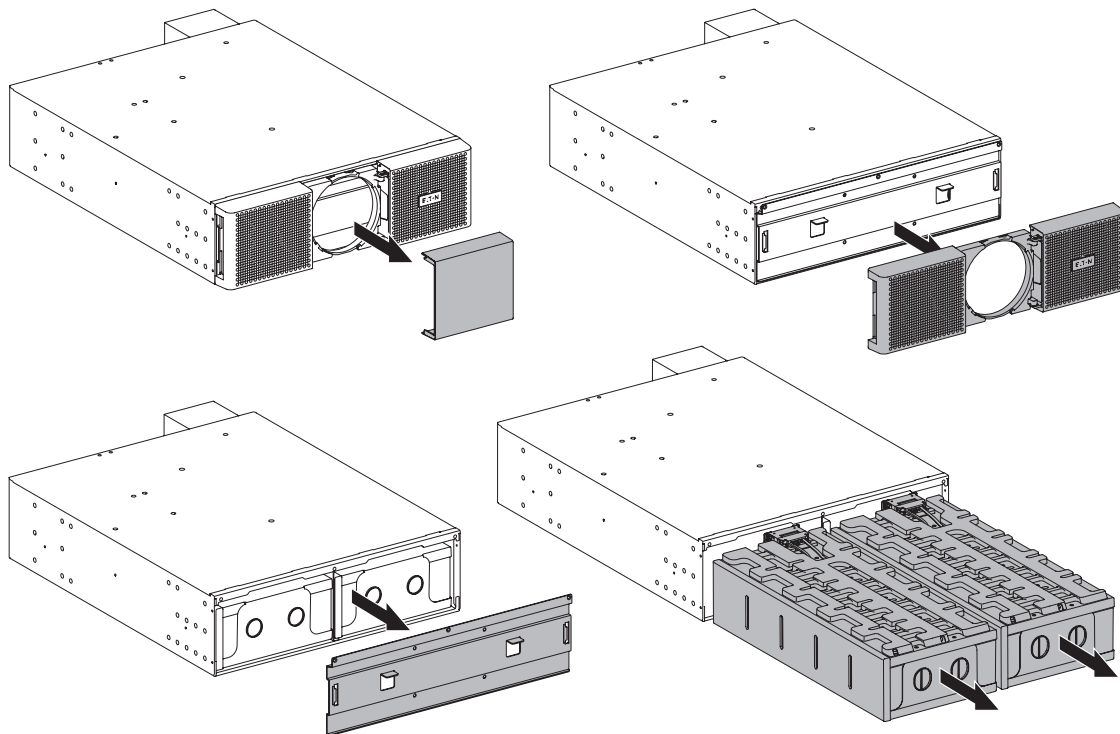

4. Pull out the plastic handle of the left and right battery packs, and slide the packs out slowly on to a flat and stable surface. Use two hands to support the battery packs. Set them aside for reinstalling after that the EBM is rack mounted.
5. Mount the EBM on rack.
6. Put back the battery packs, screw back the metal protection cover and the front panel, then clip the center cover.



- Rack mounting of UPS, EBM, and accessory modules.

Follow steps 1 to 4 for module mounting on the rails.

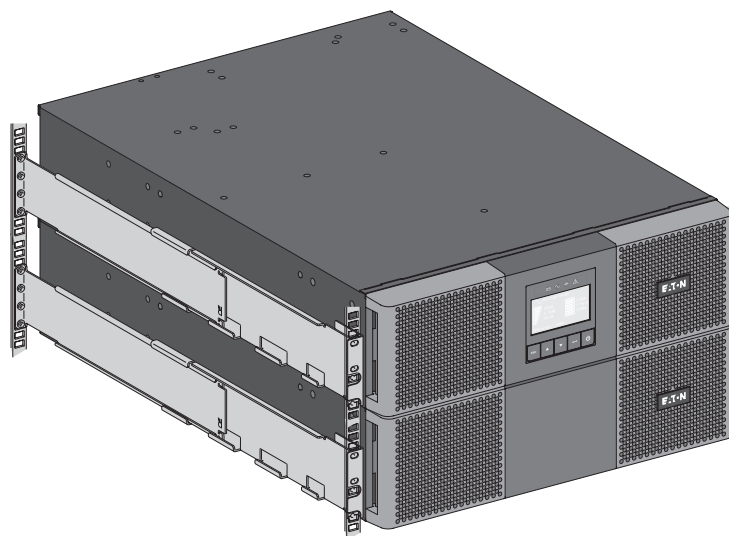
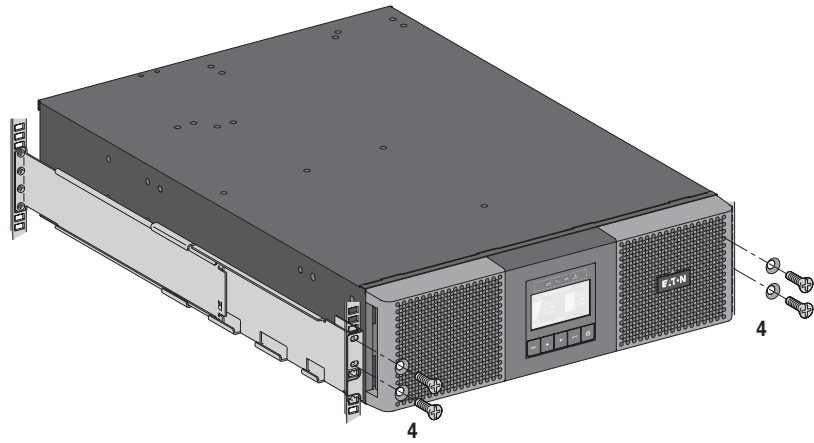
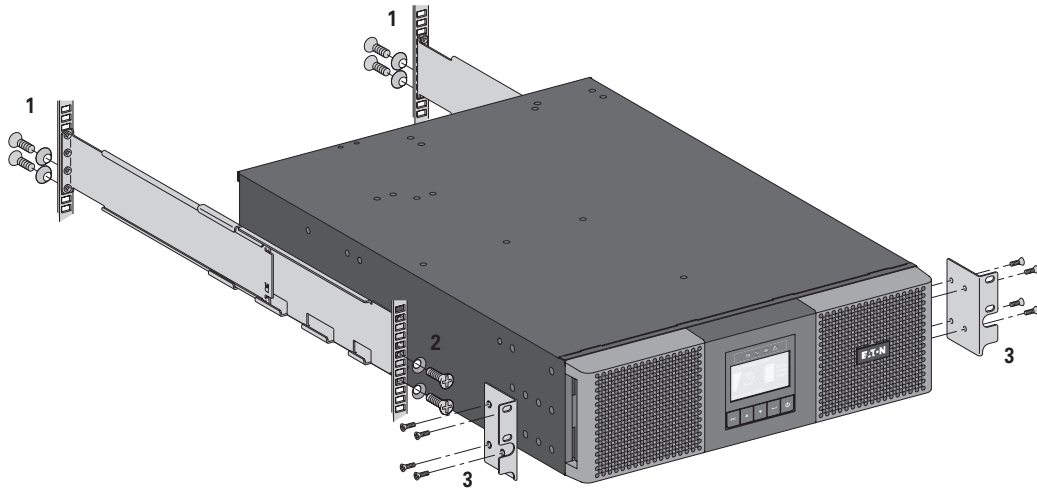

The rails and necessary hardware are supplied by EATON.

# 3. Installation

## 3.8 Installation requirements

### Recommended protective devices and cable cross-sections

#### 1. Recommended upstream protection

| UPS power rating | Upstream circuit breaker |
|------------------|--------------------------|
| 8000VA           | D curve – 50A            |
| 11000VA          | D curve – 70A            |

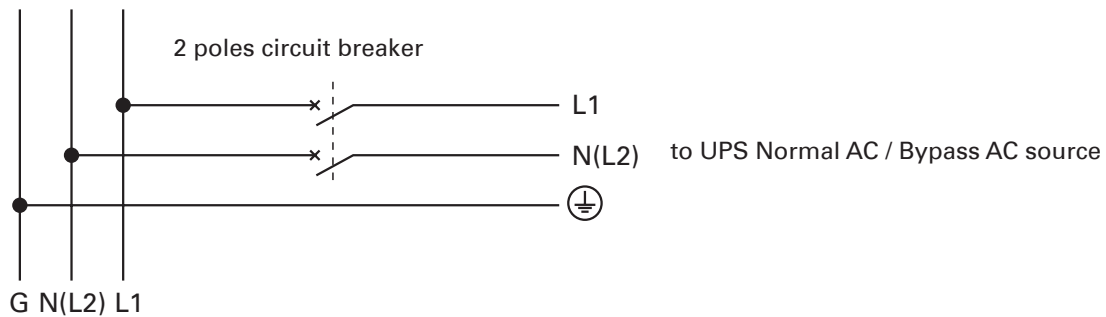

Read the Safety instructions page 3 regarding backfeed protection requirements.

#### 2. Recommended cable cross-sections

| Terminal position | Wire function   | Terminal wire size rating       | Minimum input wire size   | Tightening torque  |
|-------------------|-----------------|---------------------------------|---|--------------------|
| L1                | Phase           | 4-25 mm <sup>2</sup> (12-4 AWG) | 10 mm <sup>2</sup> (8 AWG) 105°C<br>16 mm <sup>2</sup> (6 AWG) 90°C | 18 lb in / 2.03 Nm |
| N(L2)             | Neutral (Phase) |                                 |   |                    |
| ⊕                 | Ground          |                                 |   |                    |

Copper wire, solid or stranded.

### 3.9 Installation depending on the system earthing arrangement (SEA)

• **UPS with common Normal and Bypass AC inputs**

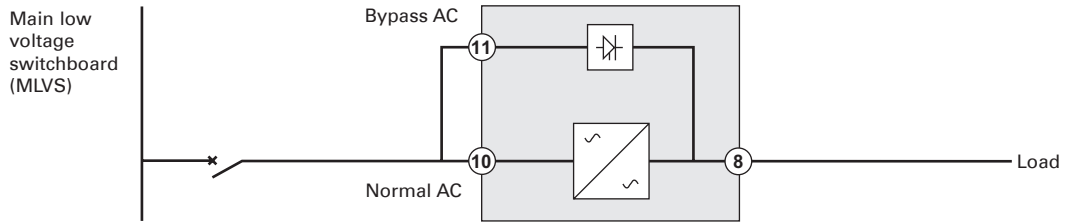

**Change in SEA between upstream and downstream or galvanic isolation required**

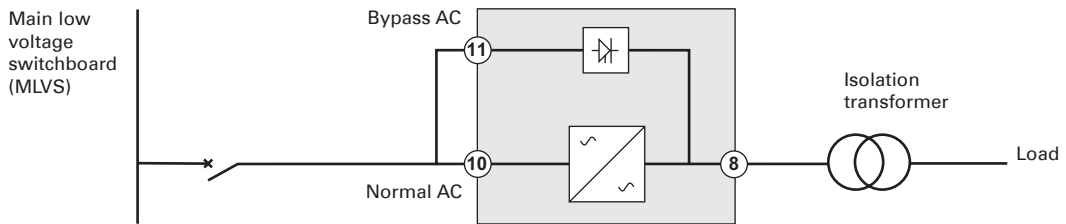

• **UPS with separate Normal and Bypass AC inputs**

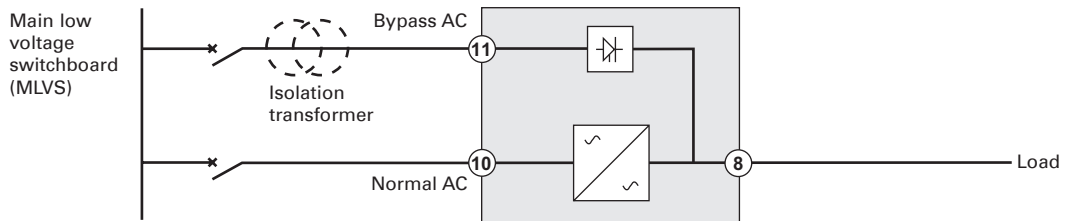

**Change in SEA between upstream and downstream or galvanic isolation required**

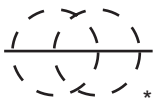
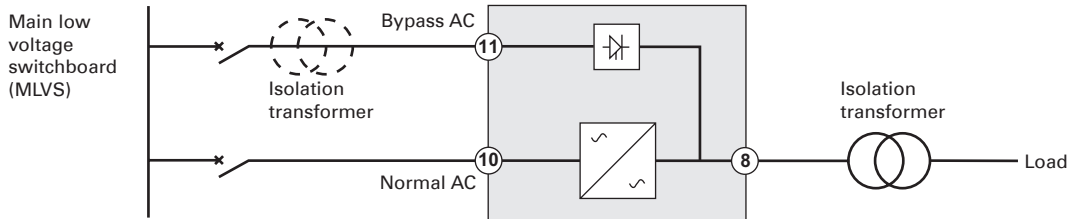

The transformer is not necessary if:

- Normal and Bypass inputs are connected to the same source,
- and wires cross-sections and lengths of Normal and Bypass inputs are identical,
- and upstream protection is provided by only one switch with RCD (Residual Current Device) for Normal and Bypass AC inputs.

# 3. Installation

- **UPS with separate Normal and Bypass AC inputs, supplied by separate sources**

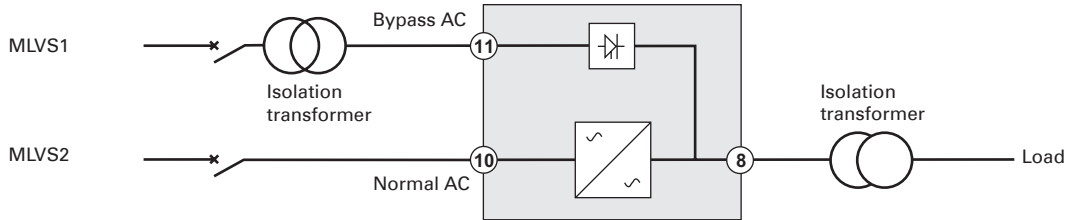
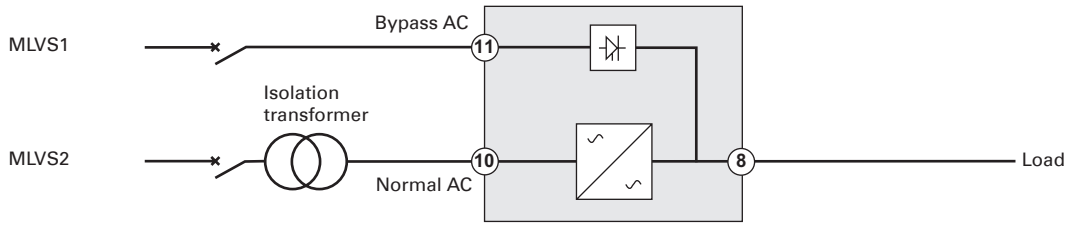

- **Change in SEA between upstream and downstream or galvanic isolation required**

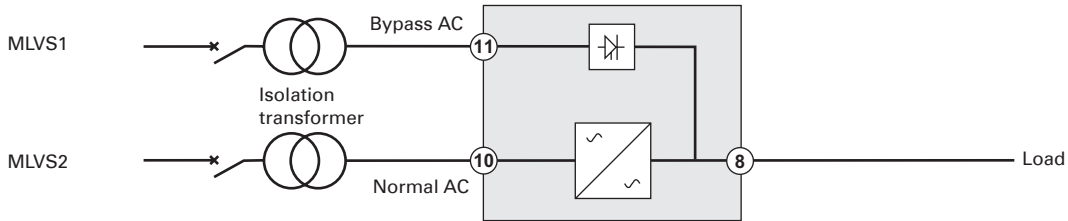

- **Frequency converter (without Bypass AC input)**

Configuration used when the frequency of the application differs from Normal AC (example: marine requirements).

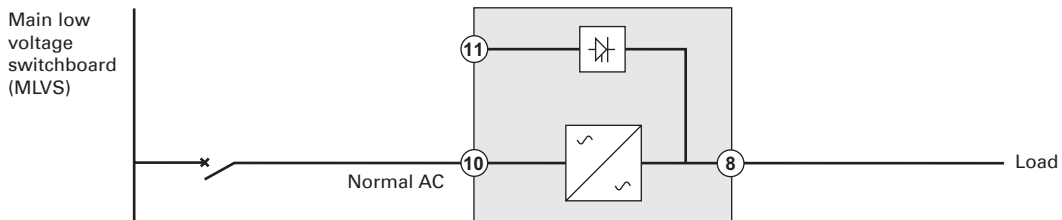

- **Hot standby**

Configuration used to provide N+1 redundancy to critical loads.

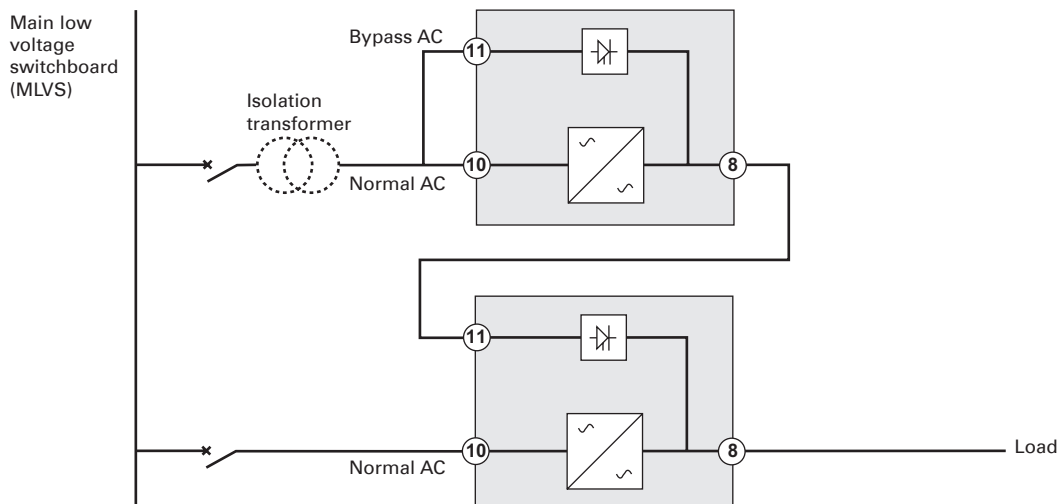

## 4. Power cables connection

### 4.1 Access to terminal blocks

1. Remove the terminal blocks cover (one screw)
2. Punch the knockouts and insert the cables/conduits inside

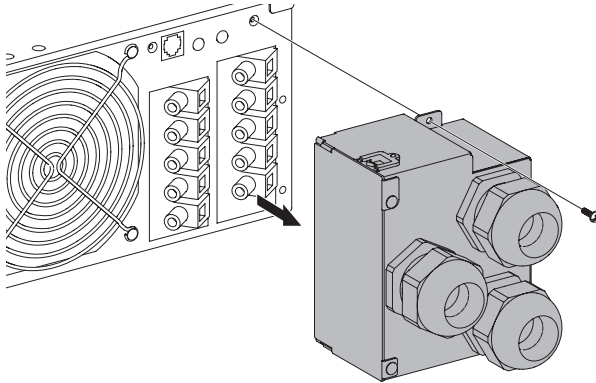

- **High leakage current:**  
Earth connection essential before connecting supply.

### 4.2 Common input sources connection



**This type of connection must be carried out by qualified electrical personnel**

Before carrying out any connection, check that the upstream protection devices (Normal AC source and Bypass AC source) are open "O" (Off).

**Always connect the ground wire first**



If you ordered a HotSwap MBP, refer to the specific user manual to check the terminal blocks connection of the UPS with the MBP.

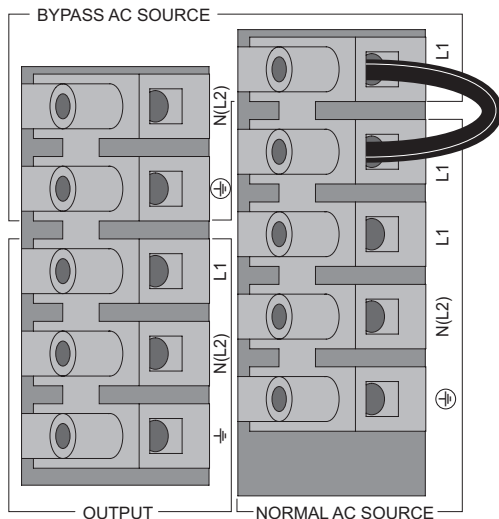

1. Make sure the jumper is connected
2. Insert the Normal AC cable through the cable gland
3. Connect the three cables to the Normal AC source terminal blocks
4. Insert the Output cable through the cable gland
5. Connect the three cables to the Output terminal blocks
6. Put back and secure the terminal blocks cover with the screw
7. -Tighten the cable glands.

## 4. Power cables connection

### 4.3 Separate input source connection



**This type of connection must be carried out by qualified electrical personnel.**

Before carrying out any connection, check that the upstream protection devices (Normal AC source and Bypass AC source) are open "O" (Off).

**Always connect the ground wire first**



If you ordered a HotSwap MBP, refer to the specific user manual to check the terminal blocks connection of the UPS with the MBP.

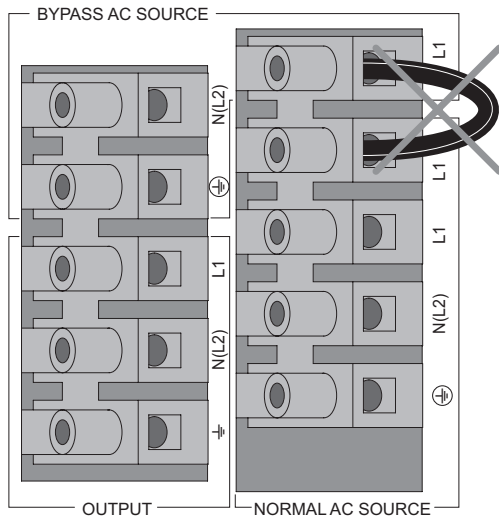

1. Remove the jumper
2. Insert the Normal AC cable through the cable gland
3. Connect the three cables to the Normal AC source terminal blocks
4. Insert the Bypass AC cable through the cable gland
5. Connect the three cables to the Bypass AC source terminal blocks
6. Insert the Output cable through the cable gland
7. Connect the three cables to the Output terminal blocks
8. Put back and secure the terminal blocks cover with the screws
9. Tighten the cable glands.

### 4.4 Frequency converter connection



**This type of connection must be carried out by qualified electrical personnel.**

Before carrying out any connection, check that the upstream protection device (Normal AC source) is open "O" (Off).

**Always connect the ground wire first.**

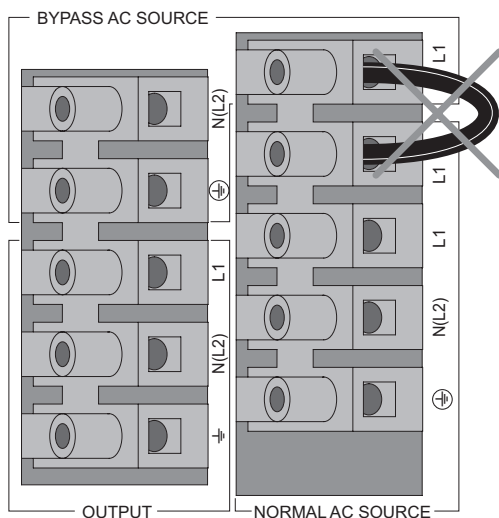

1. Remove the jumper
2. Insert the Normal AC cable through the cable gland
3. Connect the three cables to the Normal AC source terminal blocks
4. Insert the Output cable through the cable gland
5. Connect the three cables to the Output terminal blocks
6. Put back and secure the terminal blocks cover with the screws
7. Tighten the cable glands.



Do not connect anything to the Bypass terminal blocks.

## 5.1 UPS startup and shutdown







If you ordered a HotSwap MBP, refer to the specific user manual to check the startup sequence of the UPS with the MBP.

### Starting the UPS



Verify that the total equipment ratings do not exceed the UPS capacity to prevent an overload alarm.

To start the UPS:

1. Verify that the EBM are connected to the UPS. See "Connecting the EBM(s)" on page 18. Check that the battery circuit breaker is switched to the "I" position (On).
2. Verify that the UPS terminal blocks are connected to AC source.
3. Set the upstream circuit breaker (not provided) to the "I" position (On) to switch on the utility power. The UPS front panel display illuminates and shows EATON logo.
4. Verify that the UPS status screen shows , press  to start.
5. Press the  button on the UPS front panel for at least 3 seconds. The UPS front panel display changes status to "UPS starting...".
6. Check the UPS front panel display for active alarms or notices. Resolve any active alarms before continuing. See "Troubleshooting" on page 39. If the  indicator is on, do not proceed until all alarms are clear. Check the UPS status from the front panel to view the active alarms. Correct the alarms and restart if necessary.
7. Verify that the  indicator illuminates solid, indicating that the UPS is operating normally and powering the output. The UPS should be in Online mode.





The EBM charge to 90% capacity in less than 3 hours. However, Eaton recommends that the batteries charge for 48 hours after installation or long-term storage.

### Starting the UPS on Battery



Before using this feature, the UPS must have been powered by utility power with output enabled at least once. Battery start can be disabled. See Coldstart setting in user settings on page 14.

To start the UPS on battery:

1. Press the  button on the UPS front panel until the UPS front panel display illuminates and shows a status of "UPS starting...". The UPS cycles through Standby mode to Battery mode. The  indicator illuminates solid. The UPS supplies power to your equipment.
2. Check the UPS front panel display for active alarms or notices. Resolve any active alarms before continuing. See "Troubleshooting" on page 39. Check the UPS status from the front panel to view the active alarms. Correct the alarms and restart if necessary.

### UPS shutdown

To shut down the UPS:

1. Press the  button on the UPS front panel. The UPS transfers to Standby mode.
2. Set the upstream circuit breaker (not provided) to the "O" position (Off) to switch off the utility power.

# 5. Operation

## 5.2 Operating modes

The Eaton 9PX front panel indicates the UPS status through the UPS indicators, see page 14.

### Online mode

During Online mode, the  indicator illuminates solid and the UPS is powered from the utility. The UPS monitors and charges the batteries as needed and provides filtered power protection to your equipment. Optional High Efficiency and Energy Saving settings minimize heat contribution to the rack environment. See user settings on page 14.

### Battery mode

When the UPS is operating during a power outage, the alarm beeps once every ten seconds and the  indicator illuminates solid. The necessary energy is provided by the battery.

When the utility power returns, the UPS transfers to Online mode operation while the battery recharges.

If battery capacity becomes low while in Battery mode, the audible alarm beeps once every 3 seconds. This warning is approximate, and the actual time to shutdown may vary significantly.

Shutdown all applications on the connected equipment because automatic UPS shutdown is imminent. When utility power is restored after the UPS shuts down, the UPS automatically restarts.

### Bypass mode

In the event of a UPS overload or internal failure, the UPS transfers your equipment to utility power. Battery mode is not available and your equipment is not protected; however, the utility power continues

to be passively filtered by the UPS. The  indicator illuminates.

Depending on overload conditions, the UPS remains in Bypass mode for at least 5 seconds and will stay in this mode if three transfers to Bypass occur within 20 minutes.

The UPS transfers to Bypass mode when:

- the user activates Bypass mode through the front panel.
- the UPS detects an internal failure.
- the UPS has an overtemperature condition.
- the UPS has an overload condition listed in table 6 on page 43.



The UPS shuts down after a specified delay for overload conditions listed in table 6 on page 43. The UPS remains on to alarm the fault

### Standby mode

When the UPS is turned-off and remains connected to AC source, the UPS is in Standby mode.

Depending if Bypass Standby setting is enabled, the output is powered but not protected.

The battery recharges when necessary and the communication ports are powered.

## 5.3 Transferring the UPS between modes

**From Online (or Battery) to Bypass mode.** Press any button to activate the menu options, then select Control and Go to Bypass.

**From Bypass to Online (or Battery) mode.** Press any button to activate the menu options, then select Control and Go back normal.



## 5.4 Setting High Efficiency mode

In High Efficiency mode, the UPS operates normally on Bypass and transfers to Online (or Battery) mode in less than 10 ms when utility fails. Transfers to High Efficiency mode will be active after 5 minutes of Bypass voltage monitoring: if Bypass quality is not in tolerance, then the UPS will remain in Online mode.



Eaton recommends to use the HE mode only to protect I/T equipment.

To set the High Efficiency mode:

1. Put the UPS on Bypass: press any button to activate the menu options, select Control and Go to Bypass.
2. Then press Escape and select Settings, In/Out settings, and High Efficiency mode.
3. Select Enabled and Enter to confirm.
4. The UPS transfers to High Efficiency mode in 5 minutes.

## 5.5 Configuring Bypass settings

The following settings are available for configuring Bypass operation.

### Bypass transfer out of tolerance

1. Press any button to activate the menu options, then select Settings, Output settings, and Bypass transfer.
2. Select Enabled or Disabled for BP AC NOK, and Enter to confirm.  
If Enabled, the UPS transfers to Bypass even if Bypass AC source is out of tolerance, depending on output mode. If Disabled, the UPS output is shutdown.

### Interrupt time

This setting is displayed to define the break duration during transfer to Bypass, only if transfer out of tolerance is enabled. 10 ms or 20 ms can be selected.

## 5.6 Configuring battery settings

### Automatic battery test

Automatic battery tests are done every week in constant charging mode and at each cycle in ABM mode. The tests frequency can be modified. During the test, the UPS transfers to Battery mode and discharges the batteries for 25 seconds under load.



Battery mode is not displayed and battery low alarm does not activate during a battery test.

The battery test may be cancelled due to bad conditions, or failed.

### Low battery warning

During discharge, the low battery alarm is activated if the battery capacity goes below 20%. This threshold can be modified.

### External battery setting

The number of Extended Battery Module is automatically detected, or can be set manually in number of EBM or in Ah.

### Deep discharge protection

This setting is recommended to avoid damaging the battery. Warranty is void if deep discharge protection is disabled.

## 5. Operation

### 5.7 Retrieving the Event log

To retrieve the Event log through the display:

1. Press any button to activate the menu options, then select Event log.
2. Scroll through the listed events.

### 5.8 Retrieving the Fault log

To retrieve the Fault log through the display:

1. Press any button to activate the menu options, then select Fault log.
2. Scroll through the listed faults.

## 6.1 Communication ports

### • RS232 or USB communication ports

The RS232 and USB communication ports cannot operate simultaneously.

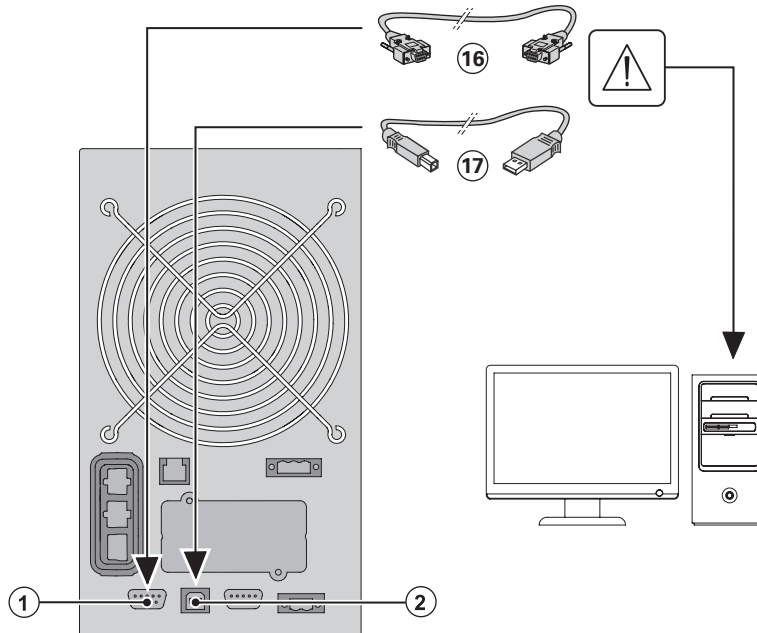

1. Connect the RS232 (16) or USB (17) communication cable to the serial or USB port on the computer.

2. Connect the other end of the communication cable (16) or (17) to the RS232 (1) or USB (2) communication port on the UPS.

The **UPS** can now communicate with EATON power management software.

### • Relay output contacts

The UPS incorporates four relay outputs; each information is available with a close or open contact.

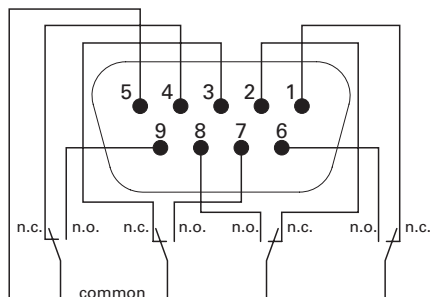

Status active information: (if contact between pin and common is closed)

- Pin 1: not on Bypass
- Pin 2: load not protected
- Pin 3: not low battery
- Pin 4: not on Battery
- Pin 5: user common
- Pin 6: on Bypass
- Pin 7: low battery
- Pin 8: load protected
- Pin 9: on Battery
- n.o.: contact normally open
- n.c.: contact normally closed



The relay output contacts must not be connected to any utility connected circuits. Reinforced insulation to the utility is required. The relay output contacts have a maximum rating of 250 Vac/5A.

## 6. Communication

- **Remote On/Off**

Remote On/Off allows remote action of  button to switch On/Off the UPS.

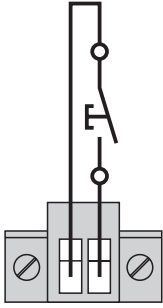

Normally open

When contact changes from open to closed, the UPS is switched-on (or stays On).  
When contact changes from closed to open, the UPS is switched-off (or stays Off).



On/Off control via  button has priority over the remote control.

- **Remote Power Off**

RPO is used to shutdown the UPS remotely. This feature can be used for shutting down the load and the UPS by thermal relay, for instance in the event of room over temperature. When RPO is activated, the UPS shuts down the output and all its power converters immediately. The UPS remains on to alarm the fault.



The RPO circuit is an IEC 60950 safety extra low voltage (SELV) circuit. This circuit must be separated from any hazardous voltage circuits by reinforced insulation.



- The RPO must not be connected to any utility connected circuits. Reinforced insulation to the utility is required. The RPO switch must have a minimum rating of 27 Vdc and 20 mA and be a dedicated latching-type switch not tied into any other circuit. The RPO signal must remain active for at least 250 ms for proper operation.
- To ensure the UPS stops supplying power to the load during any mode of operation, the input power must be disconnected from the UPS when the Remote Power Off function is activated.



Leave the RPO connector installed in the RPO port on the UPS even if the RPO function is not needed.

### RPO connections:

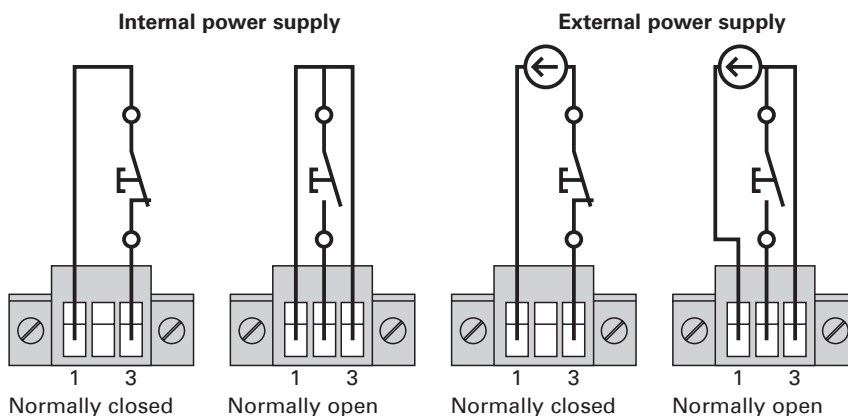

Terminal wire size rating is 0.32-4 mm<sup>2</sup> (22-12 AWG).  
Suggested wire size is 0.82 mm<sup>2</sup> (18 AWG).

**Remote control connection and test**

1. Check the UPS is shut down and the electrical supply network disconnected.
2. Remove RPO connector from the UPS by unfitting the screws.
3. Connect a normally closed volt-free contact between the two pins of connector.

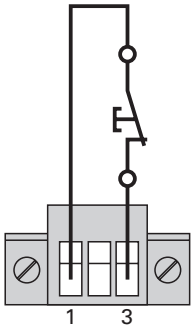

Contact open: shut down of UPS  
 To return to normal operation, deactivate the external remote shut down contact and restart the UPS from the front panel.

4. Plug the RPO connector into the back of the UPS and fix the screws.
5. Connect and restart the UPS according to the previously described procedures.
6. Activate the external remote shut down contact to test the function.



Always test the RPO function before applying your critical load to avoid accidental load loss.

- **Connectivity Cards**

Connectivity cards allow the UPS to communicate in a variety of networking environments and with different types of devices. The 9PX models have one available communication bay for the following connectivity cards:

- **Network-MS card** - has SNMP and HTTP capabilities as well as monitoring through a Web browser interface; connects to Ethernet network. In addition, a Environmental Monitoring Probe can be attached to obtain humidity, temperature, smoke alarm, and security information.
- **Modbus-MS card** - has connection to Modbus protocol in addition to network management.
- **Relay-MS card** - has isolated dry contact (Form-C) relay outputs for UPS status: Utility failure, Battery low, UPS alarm/OK, or on Bypass.

See on page 21 for the location of the communication bay.

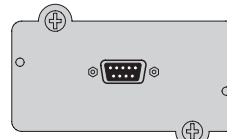
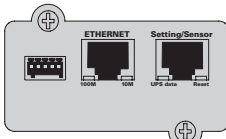
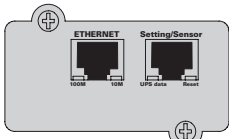

## 6. Communication

### Installation of the communication cards

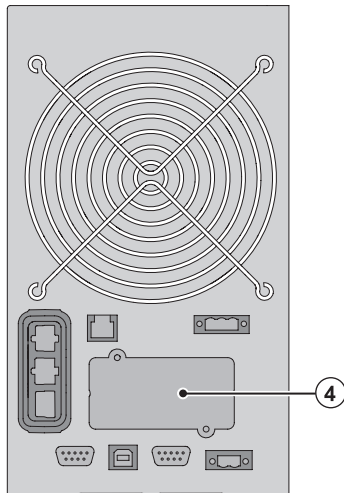

It is not necessary to shutdown the UPS before installing a communication card.

1. Remove the slot cover ④ secured by screws.
2. Insert the communication card in the slot.
3. Secure the card cover with the 2 screws.

### 6.2 Eaton Intelligent Power Software suite

Each 9PX UPS ships with Eaton Intelligent Power Software suite. To begin installing, see the instructions accompanying the Software suite CD.

Eaton Software suite provides up-to-date graphics of UPS power and system data and power flow. It also gives you a complete record of critical power events, and it notifies you of important UPS or power information.

If there is a power outage and the 9PX UPS battery power becomes low, Eaton Software suite can automatically shut down your computer system to protect your data before the UPS shutdown occurs.

## 7.1 Equipment care

For the best preventive maintenance, keep the area around the equipment clean and dust free. If the atmosphere is very dusty, clean the outside of the system with a vacuum cleaner. For full battery life, keep the equipment at an ambient temperature of 25°C (77°F).



If the UPS requires any type of transportation, verify that the UPS is disconnected and turned off. The batteries are rated for a 3-5 year service life. The length of service life varies, depending on the frequency of usage and ambient temperature. Batteries used beyond expected service life will often have severely reduced runtimes. Replace batteries at least every 4 years to keep units running at peak efficiency.

## 7.2 Storing the equipment

If you store the equipment for a long period, recharge the battery every 6 months by connecting the UPS to utility power. The EBM charge to 90% capacity in less than 3 hours. However, Eaton recommends that the batteries charge for 48 hours after long-term storage. Check the battery recharge date on the shipping carton label. If the date has passed and the batteries were never recharged, do not use them. Contact your service representative.

## 7.3 When to replace batteries

When the battery replacement screen is displayed, it is recommended to replace the batteries. Contact your service representative to order new batteries.

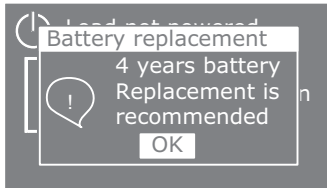

## 7. UPS maintenance

### 7.4 Replacing batteries



DO NOT DISCONNECT the batteries while the UPS is in Battery mode.

Batteries can be replaced easily without turning off the UPS or disconnecting the load. If you prefer to remove input power to change the batteries, see "UPS Shutdown" on page 27.

Consider all warnings, cautions, and notes before replacing batteries.



- Servicing should be performed by qualified service personnel knowledgeable of batteries and required precautions. Keep unauthorized personnel away from batteries.
- Batteries can present a risk of electrical shock or burn from high short circuit current. Observe the following precautions:
  1. Remove watches, rings, or other metal objects,
  2. Use tools with insulated handles,
  3. Do not lay tools or metal parts on top of batteries,
  4. Wear rubber gloves and boots.
- When replacing batteries, replace with the same type and number of batteries or battery packs. Contact your service representative to order new batteries.
- Proper disposal of batteries is required. Refer to your local codes for disposal requirements.
- Never dispose of batteries in a fire. Batteries may explode when exposed to flame.
- Do not open or mutilate the battery or batteries. Released electrolyte is harmful to the skin and eyes and may be extremely toxic.
- Determine if the battery is inadvertently grounded. If inadvertently grounded, remove source from ground. Contact with any part of a grounded battery can result in electrical shock. The likelihood of such shock can be reduced if such grounds are removed during installation and maintenance (applicable to equipment and remote battery supplies not having a grounded supply circuit).
- **ELECTRIC ENERGY HAZARD.** Do not attempt to alter any battery wiring or connectors. Attempting to alter wiring can cause injury.
- Disconnect charging source prior to connecting or disconnecting battery terminals.



- **Replacing the EBM(s)**



The EBM is heavy. Lifting the cabinet into a rack requires a minimum of two people.

To replace the EBM(s):

1. Unplug the EBM power cable and battery detection cable from the UPS.  
If additional EBM(s) are installed, unplug the EBM power cable and battery detection cable from each EBM.
2. Replace the EBM(s). See "Recycling the used equipment" on page 38 for proper disposal.



A small amount of arcing may occur when connecting an EBM to the UPS. This is normal and will not harm personnel. Insert the EBM cable into the UPS battery connector quickly and firmly.

3. Plug the EBM cable(s) into the battery connector(s). Up to twelve EBMs may be connected to the UPS.
4. Verify that the EBM connections are tight and that adequate bend radius and strain relief exist for each cable.
5. Connect the battery detection cable(s) to the connector of the UPS and of the EBM(s).

- **Testing new batteries**

To test new batteries:

1. Charge the batteries for 48 hours.
2. Press any button to activate the menu options.
3. Select Control then Start battery test.

The UPS starts a battery test if the batteries are fully charged, the UPS is in Normal mode with no active alarms, and the bypass voltage is acceptable.

During the battery test, the UPS transfers to Battery mode and discharges the batteries for 25 seconds. The front panel displays "Battery test in progress" and the percentage of the test completed.

## 7. UPS maintenance

### 7.5 Replacing the UPS equipped with a HotSwap MBP

The HotSwap MBP allows to service or replace the UPS without interrupting the connected loads.



Refer to the specific user manual for more information about HotSwap MBP.

To remove the UPS:

1. Press any button to activate the menu options. Select Control then Go to Bypass.
2. Check that the UPS is in Bypass mode (Bypass LED should be On).
3. Turn the HotSwap MBP switch to the Bypass position: the red LED on the HotSwap MBP goes On, indicating that the load is now powered directly from utility power.
4. Set the Normal AC source switch on the HotSwap MBP to the "O" position and wait for 30s.
5. The UPS stops and can now be disconnected.

To reinstall the UPS:

1. Check that the UPS is correctly connected to the HotSwap MBP.
2. Set the Normal AC source switch on the HotSwap MBP to the "I" position.
3. Press the  button to switch On the UPS.
4. Select Control then Go to Bypass (Bypass LED should be On).
5. Turn the HotSwap MBP switch to the Normal position: the red LED on the HotSwap MBP goes Off, indicating that the load is now powered by the UPS.
6. Select Control then Go back normal.
7. Check that the UPS is in Online mode: the load is now protected by the UPS (Online LED should be On).

### 7.6 Recycling the used equipment

Contact your local recycling or hazardous waste center for information on proper disposal of the used equipment.



- Do not dispose of the battery or batteries in a fire. Batteries may explode. Proper disposal of batteries is required. Refer to your local codes for disposal requirements.
- Do not open or mutilate the battery or batteries. Released electrolyte is harmful to the skin and eyes. It may be toxic.



Pb

Do not discard the UPS or the UPS batteries in the trash. This product contains sealed, lead acid batteries and must be disposed of properly. For more information, contact your local recycling/reuse or hazardous waste center.



Do not discard waste electrical or electronic equipment (WEEE) in the trash. For proper disposal, contact your local recycling/reuse or hazardous waste center.

The Eaton 9PX is designed for durable, automatic operation and also alerts you whenever potential operating problems may occur. Usually the alarms shown by the control panel do not mean that the output power is affected. Instead, they are preventive alarms intended to alert the user.

- Events are silent status information that are recorded into the Event log. Example = "AC freq in range".
- Alarms are recorded into the Event log and displayed on the LCD status screen with the logo blinking. Some alarms may be announced by a beep every 3 seconds. Example = "Battery low".
- Faults are announced by a continuous beep and red LED, recorded into the Fault log and displayed on the LCD with a specific message box. Example = Out. short circuit.







Use the following troubleshooting chart to determine the UPS alarm condition.

## 8.1 Typical alarms and faults



To check the Event log or Fault log :

1. Press any button on the front panel display to activate the menu options.
2. Press the ↓ button to select Event log or Fault log.
3. Scroll through the listed events or faults.

The following table describes typical conditions.

| Conditions  | Possible cause  | Action   |
|---|---|--|
| <br>Battery mode<br>LED is On.<br>1 beep every 10 seconds. | A utility failure has occurred and the UPS is in Battery mode.  | The UPS is powering the equipment with battery power. Prepare your equipment for shutdown.   |
| <br>Battery low<br>LED is On.<br>1 beep every 3 seconds. | The UPS is in Battery mode and the battery is running low.  | This warning is approximate, and the actual time to shutdown may vary significantly. Depending on the UPS load and number of Extended Battery Modules (EBMs), the "Battery Low" warning may occur before the batteries reach 20% capacity. |
| <br>No battery<br>LED is On.<br>Beep continuous.         | The batteries are disconnected.   | Verify that all batteries are properly connected. If the condition persists, contact your service representative.  |
| <br>Battery fault<br>LED is On.<br>Beep continuous.      | The battery test is failed due to bad or disconnected batteries, or the battery minimum voltage is reached in ABM cycling mode.           | Verify that all batteries are properly connected. Start a new battery test : if the condition persists, contact your service representative.   |
| The UPS does not provide the expected backup time.  | The batteries need charging or service.   | Apply utility power for 48 hours to charge the batteries. If the condition persists, contact your service representative.  |
| <br>Bypass mode<br>LED is on.                            | An overload or a fault has occurred, or a command has been received and the UPS is in Bypass mode   | Equipment is powered but not protected by the UPS. Check for one of the following alarms: overtemperature, overload or UPS failure.  |
| <br>Power overload<br>LED is On.<br>Beep continuous.     | Power requirements exceed the UPS capacity (greater than 100% of nominal; see in table 6 on page 43 for specific output overload ranges). | Remove some of the equipment from the UPS. The UPS continues to operate, but may switch to Bypass mode or shut down if the load increases. The alarm resets when the condition becomes inactive.   |

## 8. Troubleshooting

|  |   |   |
|--|---|---|
| <p>UPS overtemperature</p>  <p>LED is On.<br/>1 beep every 3 seconds.</p>           | <p>The UPS internal temperature is too high or a fan has failed. At the warning level, the UPS generates the alarm but remains in the current operating state. If the temperature rises another 10°C, the UPS transfers to Bypass mode or shuts down if Bypass is unusable.</p> | <p>If the UPS transferred to Bypass mode, the UPS will return to normal operation when the temperature drops 5°C below the warning level. If the condition persists, shut down the UPS. Clear vents and remove any heat sources. Allow the UPS to cool. Ensure the airflow around the UPS is not restricted. Restart the UPS. If the condition continues to persist, contact your service representative.</p> |
| <p>The UPS does not start.</p>   | <p>The input source is not connected correctly.</p>   | <p>Check the input connections.</p>   |
| <p>Input bad wiring / Output bad wiring</p>  <p>Led is On.<br/>Beep continuous.</p> | <p>Input/Output cables are not connected to the correct terminal blocks.</p>  | <p>Connect correctly the Input/Output cables.</p>   |
| <p>MBP disconnected</p>  | <p>The HotSwap MBP is no more connected to the UPS.</p>   | <p>If the HotSwap MBP is connected to the UPS, check that the detection connector is correctly plugged.</p>   |

## 8.2 Silencing the alarm

Press the ESC (Escape) button on the front panel display to silence the alarm. Check the alarm condition and perform the applicable action to resolve the condition. If the alarm status changes, the alarm beeps again, overriding the previous alarm silencing.

## 8.3 Service and support

If you have any questions or problems with the UPS, call your **Local Distributor** or your local service representative and ask for a UPS technical representative.

Please have the following information ready when you call for service:

- Model number
- Serial number
- Firmware version number
- Date of failure or problem
- Symptoms of failure or problem
- Customer return address and contact information

If repair is required, you will be given a Returned Material Authorization (RMA) number. This number must appear on the outside of the package and on the Bill Of Lading (if applicable). Use the original packaging or request packaging from the Help Desk or distributor. Units damaged in shipment as a result of improper packaging are not covered under warranty. A replacement or repair unit will be shipped, freight prepaid for all warranted units.



For critical applications, immediate replacement may be available. Call the **Help Desk** for the dealer or distributor nearest you.

# 9. Specifications

## 9.1 Model specifications

**Table 1. Power Module model list**

| Model    | Power ratings                              |
|----------|--|
| 9PX8KPM  | 8000VA / 7200W                             |
| 9PX11KPM | 10000VA / 9000W at 200V, 208V, 250V output |
|          | 11000VA / 9900W at 220V output             |
|          | 11000VA / 10000W at 230V, 240V output      |

**Table 2. Extended Battery Module model list**

| Model       | Configuration | Battery voltage | For power ratings |
|-------------|---------------|-----------------|-------------------|
| 9PXEBM240RT | Rack / Tower  | 240Vdc          | 8000-11000VA      |

**Table 3. Weights and dimensions**

| Model (Power Module) | Dimensions D x W x H (mm / inch)    | Weight (lb / kg) |
|----------------------|-------------------------------------|------------------|
| 9PX8KPM              | 700 x 440 x 130 (27.6 x 17.3 x 5.1) | 42 / 19          |
| 9PX11KPM             | 700 x 440 x 130 (27.6 x 17.3 x 5.1) | 46 / 21          |
| Model (EBM)          | Dimensions D x W x H (mm / inch)    | Weight (lb / kg) |
| 9PXEBM240RT          | 680 x 440 x 130 (26.8 x 17.3 x 5.1) | 143 / 65         |

**Table 4. Electrical input**

| <b>Nominal frequency</b>    | 50/60Hz auto-sensing   |                                    |                       |
|-----------------------------|--|------------------------------------|-----------------------|
| <b>Frequency range</b>      | 50Hz : 40-60Hz before transfer to battery<br>60Hz : 50-70Hz before transfer to battery |                                    |                       |
| <b>Bypass voltage range</b> | -20% / +15% of nominal value (default)   |                                    |                       |
| <b>Noise filtering</b>      | MOV for normal and common mode noise   |                                    |                       |
| Model                       | Default input (Voltage/Current)  | Selectable input Voltage range     | Voltages at 100% load |
| 9PX8KPM                     | 208V / 36.6A   | 200V, 208V, 220V, 230V, 240V, 250V | 176-276V              |
| 9PX11KPM                    | 208V / 45.5A   | 200V, 208V, 220V, 230V, 240V, 250V | 176-276V              |

**Table 5. Electrical input connections**

| Model    | Input connection |
|----------|------------------|
| 9PX8KPM  | Hardwired        |
| 9PX11KPM |                  |

**Table 6. Electrical output**

| All models                    | Normal mode  | Battery mode                             |
|-------------------------------|--|--|
| Voltage regulation            | ±1%  | ±1%                                      |
| Efficiency                    | > 98% (High Efficiency mode)<br>> 94.5% for 8kVA models<br>> 95% for 11kVA models  | > 91%                                    |
| Frequency regulation          | Sync with line ±5% of nominal line frequency (outside this range: ±0.5% of auto-selected nominal frequency)  | ±0.5% of auto-selected nominal frequency |
| Nominal output                | 200V*, 208V*, 220V*, 230V, 240V, 250V* (voltage configurable)<br>8000/11000VA* 7200/10000W*  |  |
| Frequency                     | 50 or 60Hz, autosensing or configurable as a frequency converter   |  |
| Output overload               | 100-102% : no alarm<br>102-110% : load transfers to Bypass mode after 2 minutes<br>110-125% : load transfers to Bypass mode after 1 minute<br>125-150% : load transfers to Bypass mode after 10s<br>> 150% : load transfers to Bypass mode after 500ms |  |
| Output overload (Bypass mode) | 100-125% : no alarm<br>125-150% : UPS shuts down after 1 minute<br>> 150% : UPS shuts down after 1s  |  |
| Voltage waveform              | Sinewave   |  |
| Harmonic distortion           | < 2% THDV on linear load<br>< 5% THDV on non-linear load   |  |
| Transfer time                 | Online mode: 0 ms (no break)<br>High Efficiency mode: 10ms maximum (due to loss of utility)  |  |
| Power factor                  | 0.9  |  |
| Load crest ratio              | 3 to 1   |  |

\* 200/208/250V are derated at 10000VA 9000W, 220V is derated at 9900W for 11kVA models.

**Table 7. Electrical output connections**

| Model    | Output connection |
|----------|-------------------|
| 9PX8KPM  | Hardwired         |
| 9PX11KPM |                   |

**Table 8. Environmental and safety**

|                           |  |
|---------------------------|--|
| <b>EMC certifications</b> | IEC/EN 62040-1: 2008<br>IEC/EN 62040-2: 2006 Cat. C2<br>IEC/EN 62040-3: 2011<br>IEC 60950-1<br>UL 1778 4 <sup>th</sup><br>CSA 22.2   |
| <b>EMC (Emissions)*</b>   | CISPR22 Class A<br>AS/NZS 22 Class A<br>IEC 61000-3-2 (-3-12)<br>IEC 61000-3-3 (-3-11)<br>FCC part 15 Class A  |
| <b>EMC (Immunity)</b>     | IEC 61000-2-2<br>IEC 61000-4-2, Level 3<br>IEC 61000-4-3, Level 3<br>IEC 61000-4-4, Level 4 (also on signal ports)<br>IEC 61000-4-5, Level 4, Criteria B<br>IEC 61000-4-6, Level 3<br>IEC 61000-4-8, Level 4<br>IEC 61000-4-11 |

\* for output cable < 10m.

## 9. Specifications

|                              |  |
|------------------------------|--|
| <b>Agency markings</b>       | CE / cULus / NOM   |
| <b>Operating temperature</b> | 0 to 40°C (32 to 104°F) in Online mode, with linear derating for altitude<br><b>Note:</b> thermal protection switches load to Bypass in case of overheating. |
| <b>Storage temperature</b>   | 0 to 40°C (32 to 104°F) with batteries<br>-15 to 60°C (5 to 140°F) without batteries   |
| <b>Transit temperature</b>   | -25 to 55°C (-13 to 130°F)   |
| <b>Relative humidity</b>     | 0 to 95% no condensing   |
| <b>Operating altitude</b>    | Up to 3,000 meters (9,843 ft) above sea level with 10% derating per 1000m  |
| <b>Transit altitude</b>      | Up to 10,000 meters (32,808 ft) above sea level  |
| <b>Audible noise</b>         | < 48 dBA at 1 meter typical for 8kVA models<br>< 50 dBA at 1 meter typical for 11kVA models  |

**Table 9. Battery**

|                                   | <b>EBMs</b>   |
|-----------------------------------|---|
| <b>Rack / Tower configuration</b> | 9PXEBM240RT: 240Vdc   |
| <b>Type</b>                       | Sealed, maintenance-free, valve-regulated, lead-acid, with minimum 3-year float service life at 25°C (77°F). Lifetime is reduced above 30 °C. |
| <b>Monitoring</b>                 | Advanced monitoring for earlier failure detection and warning   |
| <b>Battery port</b>               | External three-pole SBS75G White connector on Power Module for connection to EBM  |
| <b>EBM battery cable length</b>   | 40cm (15.7in)   |

**Table 10. Communication options**

|                                      |  |
|--------------------------------------|--|
| <b>Communication bay</b>             | (1) available independent communication bay for connectivity cards |
| <b>Compatible connectivity cards</b> | Network-MS<br>Modbus-MS<br>Relay-MS                                |
| <b>Communication ports</b>           | RS-232 (DB9): 1200-19200 bps<br>USB: 19200 bps                     |
| <b>Relay output contacts</b>         | (4) relay outputs (normally open or normally closed)               |
| <b>Remote On/Off</b>                 | 2 pins jumper (normally open)                                      |
| <b>Remote Power Off</b>              | 3 pins jumper (normally open or normally closed)                   |



## EATON Customer Care Center

### Technical Support and Product Services



Technical questions? If you encounter a problem while following the instructions in this manual, or have questions about the operation, repair, or servicing of your equipment, please visit our web site [www.eaton.com](http://www.eaton.com) for complete service information.

To insure that your questions are correctly answered, please obtain the part number, assembly number, and serial number of the unit and include them in any discussions or correspondence.

Part Number: \_\_\_\_\_

Assembly Number: \_\_\_\_\_

Serial number: \_\_\_\_\_

### Who To Contact

For Technical Support, Customer Care Center, Customer FAQ please visit our website: [www.eaton.com](http://www.eaton.com)

### Scheduling Field Service Engineer Support

Scheduling of the EATON Field Service Engineers typically should be done 7 to 10 days before they are required on-site. If the startup of the UPS is critical to maintaining your schedule, please contact EATON, to insure a safe installation and start-up that will maintain the EATON warranty and insure smooth performance.

### Return Policy for Single Phase Products (RMA)

Should you require factory service for your equipment, contact EATON Customer Care Center and obtain a Return Materials Authorization (RMA) prior to shipping your unit. Never ship equipment to EATON without first obtaining an RMA number.

For further details please visit our website: [www.eaton.com](http://www.eaton.com)

Date: \_\_\_\_\_

RMA Number: \_\_\_\_\_

Contact Name: \_\_\_\_\_

## 10. Glossary

|  |   |
|--|---|
| <b>Bypass AC source</b>                | Source supplying the bypass line. The equipment can be transferred to the bypass line if an overload occurs on the UPS output, for maintenance or in the event of a malfunction.  |
| <b>Frequency converter</b>             | Operating mode used to convert the AC-power frequency between the UPS input and output (50Hz -> 60Hz or 60Hz -> 50Hz).  |
| <b>Low-battery warning</b>             | This is a battery-voltage level indicating that battery power is low and that the user must take action to prevent the imminent break in the supply of power to the load.   |
| <b>Backup time</b>                     | Time during which the load can be supplied by the UPS operating on battery power.   |
| <b>Load</b>                            | Devices or equipment connected to the UPS output.   |
| <b>HE mode</b>                         | Operating mode by which the load is supplied directly by the AC source if it is within the tolerances defined by the user. This mode reduces the consumption of electrical power  |
| <b>Manual bypass</b>                   | Rotary switch controlled by the user, used to connect the loads directly to the AC source. Transfer of the load to the manual bypass enables UPS maintenance without interrupting the supply of power to the connected loads. |
| <b>Normal (double conversion) mode</b> | The normal UPS operating mode in which the AC source supplies the UPS which in turn supplies the connected loads (after electronic double conversion).  |
| <b>Normal AC source</b>                | Normal source of power for the UPS.   |
| <b>Relay contacts</b>                  | Contacts supplying information to the user in the form of signals.  |
| <b>UPS</b>                             | Uninterruptible Power Supply.   |