



See more • Do more • Be more

## MOUNTING INSTRUCTIONS



13.6kg(30lbs) max.

Amer Mounts  
1-800-262-9703  
Fax: 1-800-314-6805  
Email: sales@amer.com

Technical support  
1-888-998-9189  
Email: support@amer.com

amer mounts.com

## ▶ WARNING STATEMENTS

### Warning

The ceiling structure must be able to take a load of at least equal to the maximum weight, 13.6 kilograms (30lbs). If not, the ceiling must be reinforced. The correct installation procedure, according to installation instructions, should be undertaken only by a qualified service technician.

Failure to do so may result in serious injury or death.

 A secure structure must support the weight or load of the projector mount. When mounting to a wall that contains wooden studs, make sure to mark the center of the wooden stud. This must be confirmed prior to installation of screw fasteners.

 Do not install on a structure that is prone to vibration, movement or chance of impact. Failure to do so could result in damage to the projector and/or damage to the mounting surface.

Choose a location recommended by your projector manufacturer.

 Do not install near a heater, fireplace, direct sunlight, air conditioning or any other source of direct heat energy. Failure to do so may not only reduce the performance of your projector, but may result in damage to the projector and could increase the risk of fire.







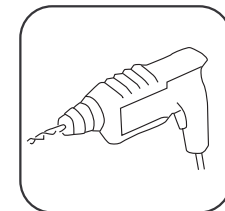
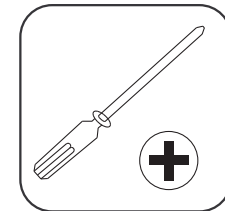
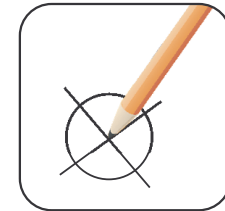



 At least two qualified people should perform the installation procedure. Injury and/or damage can result from dropping or mishandling the projector mount assembly.





 Recommended hard mounting surfaces: wooden studs and solid-flat concrete. If the mount is to be installed on any surface other than wooden studs, use suitable hardware (which is commercially available).

## ▶ TOOLS REQUIRED NOT INCLUDED



## ▶ PARTS INCLUDED

<b>A</b>	 M5x45 Drywall Screw (x2)	<b>F</b>	 M4x40 screw (x4)
<b>B</b>	 Plastic Anchor (x2)	<b>G</b>	 M6x16 screw (x4)
<b>C</b>	 M6.5 Washer (x2)	<b>H</b>	 M6x40 screw (x4)
<b>D</b>	 M3x16 screw (x4)	<b>I</b>	 M5x16 arm screw (x4)
<b>E</b>	 M4x16 screw (x4)	<b>J</b>	 M5 Washer (x4)

<b>K</b>	 S=3mm Allen wrench (x1)
<b>L</b>	 S=6mm Allen wrench (x1)
<b>M</b>	 M5 Washer (x4)
<b>N</b>	 Arm(x4)

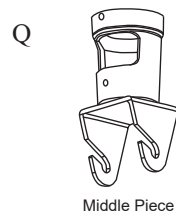
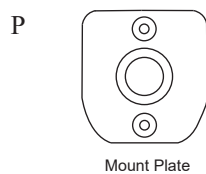
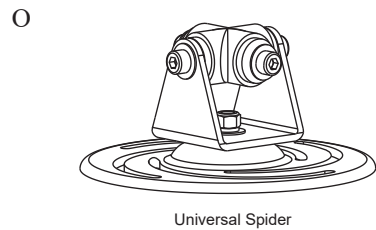

## ▶ INSTALLATION

①

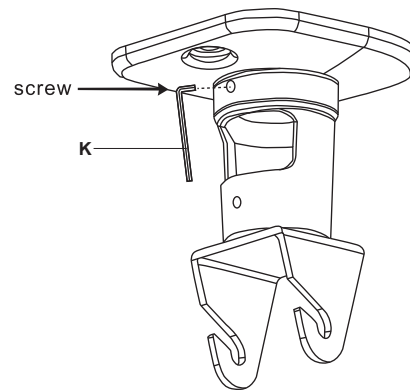

②

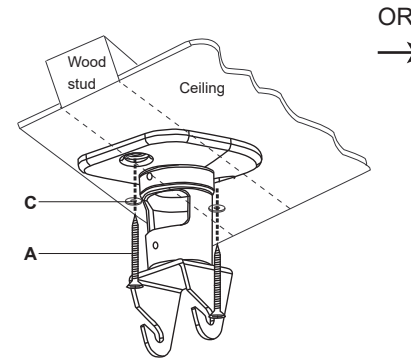

③

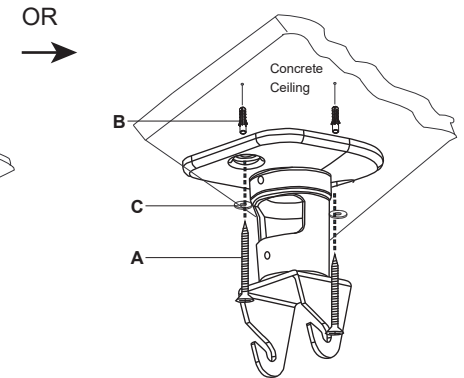

④

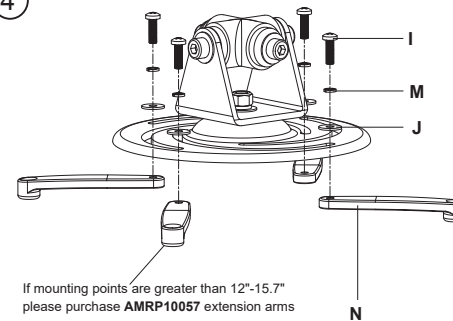

⑥

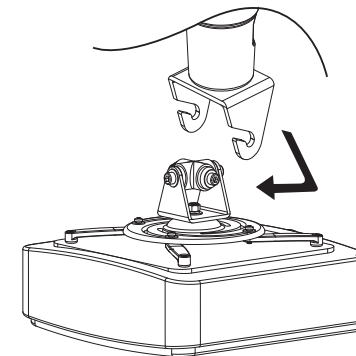

⑧

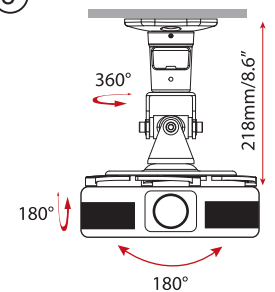

⑤

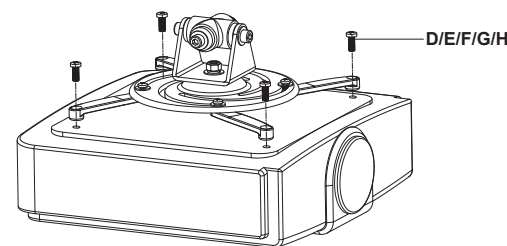

⑦

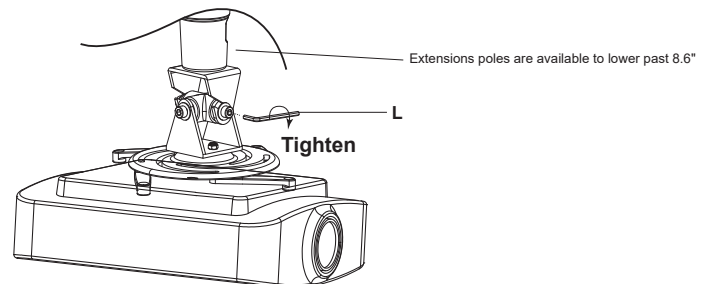

Position mounting points correctly before tightening all screws completely