

## Desk Mount Monitor Arm with Cable Management & Height Adjust

ARMPIVOT



\*actual product may vary from photos

DE: Bedienungsanleitung - [de.startech.com](http://de.startech.com)

FR: Guide de l'utilisateur - [fr.startech.com](http://fr.startech.com)

ES: Guía del usuario - [es.startech.com](http://es.startech.com)

IT: Guida per l'uso - [it.startech.com](http://it.startech.com)

NL: Gebruiksaanwijzing - [nl.startech.com](http://nl.startech.com)

PT: Guia do usuário - [pt.startech.com](http://pt.startech.com)

For the most up-to-date information, please visit: [www.startech.com](http://www.startech.com)

## FCC Compliance Statement

This equipment has been tested and found to comply with the limits for a Class B digital device, pursuant to part 15 of the FCC Rules. These limits are designed to provide reasonable protection against harmful interference in a residential installation. This equipment generates, uses and can radiate radio frequency energy and, if not installed and used in accordance with the instructions, may cause harmful interference to radio communications. However, there is no guarantee that interference will not occur in a particular installation. If this equipment does cause harmful interference to radio or television reception, which can be determined by turning the equipment off and on, the user is encouraged to try to correct the interference by one or more of the following measures:

- Reorient or relocate the receiving antenna.
- Increase the separation between the equipment and receiver.
- Connect the equipment into an outlet on a circuit different from that to which the receiver is connected.
- Consult the dealer or an experienced radio/TV technician for help.

## Use of Trademarks, Registered Trademarks, and other Protected Names and Symbols











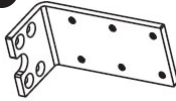

This manual may make reference to trademarks, registered trademarks, and other protected names and/or symbols of third-party companies not related in any way to StarTech.com. Where they occur these references are for illustrative purposes only and do not represent an endorsement of a product or service by StarTech.com, or an endorsement of the product(s) to which this manual applies by the third-party company in question. Regardless of any direct acknowledgement elsewhere in the body of this document, StarTech.com hereby acknowledges that all trademarks, registered trademarks, service marks, and other protected names and/or symbols contained in this manual and related documents are the property of their respective holders.

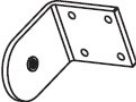
# Table of Contents

<b>Introduction</b> .....	<b>1</b>
Packaging Contents .....	1
<b>Product Diagram</b> .....	<b>2</b>
<b>Installation</b> .....	<b>2</b>
Desk / Grommet Mounting .....	2
Attaching the Display .....	5
Completing the Assembly .....	6
Adjusting Monitor Mount Resistance .....	7
<b>Specifications</b> .....	<b>8</b>
<b>Technical Support</b> .....	<b>9</b>
<b>Warranty Information</b> .....	<b>9</b>

# Introduction

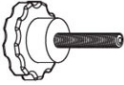
## Packaging Contents

<p>1</p>  <p>Support Post Qty: 1</p>	<p>2</p>  <p>Monitor Mount Qty: 1</p>	<p>3</p>  <p>Large C Clamp Qty: 1</p>
<p>4</p>  <p>EVA Cushion Qty: 1</p>	<p>5</p>  <p>Thumb Screws Qty: 4</p>	<p>6</p>  <p>Small C Clamp Qty: 1</p>
<p>7</p>  <p>Cable Clip / Collar (attached) Qty: 1</p>	<p>8</p>  <p>M6x12mm Phillips Screws Qty: 4</p>	<p>9</p>  <p>M5x14mm Hex Screws Qty: 4</p>
<p>10</p>  <p>M4x15mm Phillips Screw Qty: 1</p>	<p>11</p>  <p>Male Round Washer Qty: 1</p>	<p>12</p>  <p>Female Round Washer Qty: 1</p>
<p>13</p>  <p>Hand Screw (attached) Qty: 1</p>	<p>14</p>  <p>Pressure Plate (attached) Qty: 1</p>	<p>15</p>  <p>M3 (2.5mm) Allen Wrench Qty: 1</p>

# Product Diagram

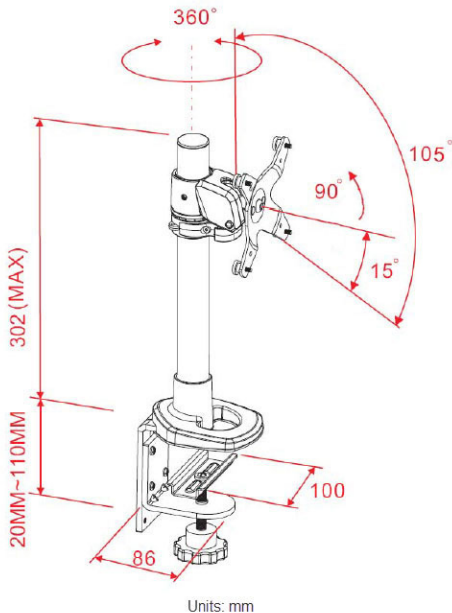

## Installation

**Warning:** It is the installer's responsibility to ensure that the combined weight of all components does not exceed the maximum **14 kg (30.9 lbs)** weight capacity of the mounting arm.

### Desk / Grommet Mounting

The Monitor Arm can be clamped to a desk / table, or mounted through a grommet hole. Instructions for both will be provided in the following sections.

## Grommet Mount

1. Remove the Hand Screw (13) from the base of the Support Post (1).
2. Place the EVA Cushion (4) beneath the Support Post (1) and thread the Hand Screw (13) from below until secure. Ensure that the Pressure Plate (14) is making full contact with the desk surface.

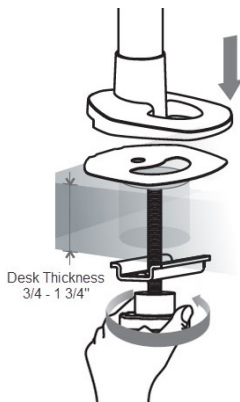

## Desk Mount

1. Attach the Large C Clamp (3) and Small C Clamp (6) pieces using 4 M6x12mm Screws (8) as shown, depending on the thickness of your desk / table.

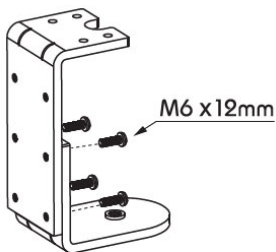

Desk Thickness  
< 50mm / 2in

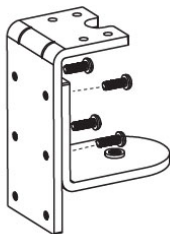

Desk Thickness  
> 50mm / 2"

2. Slide the Hand Screw (13) through the bottom of the clamp and attach the Pressure Plate (14) using the Male Round Washer (11), Female Round Washer (12) and M4x15mm Phillips Screw (10).

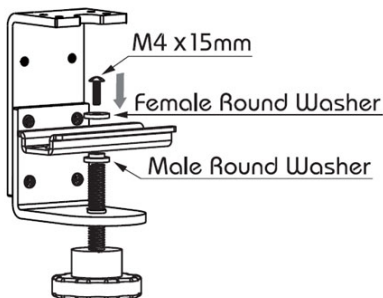

3. Attach the completed Desk Clamp to base of the Support Post (1) using 4 M5x14mm Hex Screws (9).

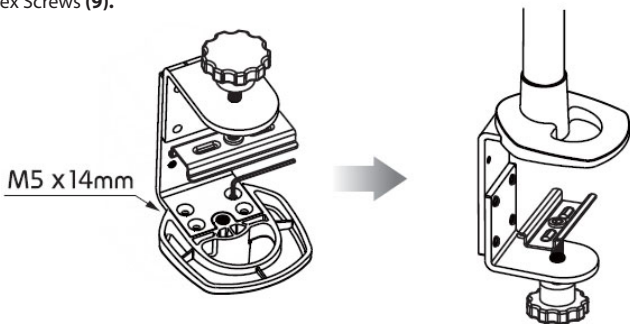

4. Place the EVA Cushion (4) beneath the Support Post (1) and then place the Desk Clamp opening around the edge of your desktop in your desired location. Tighten by hand to secure, ensuring that the clamp is making full contact with the desk surface.

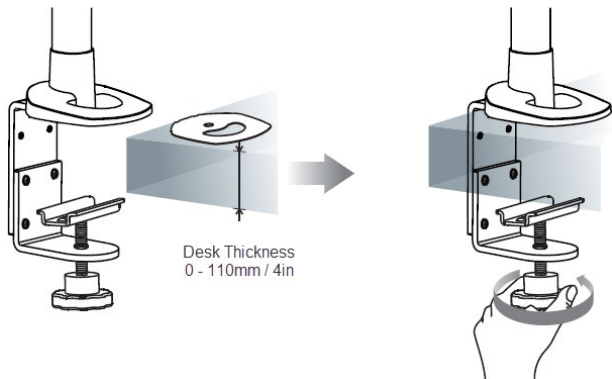

## Attaching the Display

1. Carefully place your display face down on a protective surface to access the mounting points.

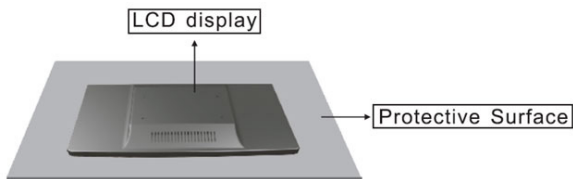

2. Attach the display to the Monitor Mount (2) using the 4 Thumb Screws (5).

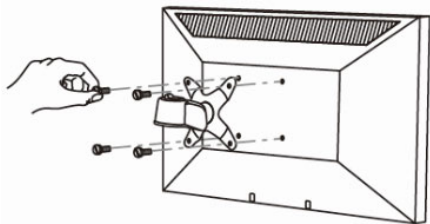



**WARNING!** Do not over-tighten the screws and stop immediately if you encounter resistance to avoid damage to your display. Ensure that all spacers and screws being used are the same length and thread type.

## Completing the Assembly

1. Loosen the Cable Clip / Collar (7) on the Support Post (1) and adjust to the desired height.



2. Slide the Monitor Mount (2) onto the Support Post (1) until it rests on the Collar (7) and tighten the set screw using the M3 Allen Wrench (15).

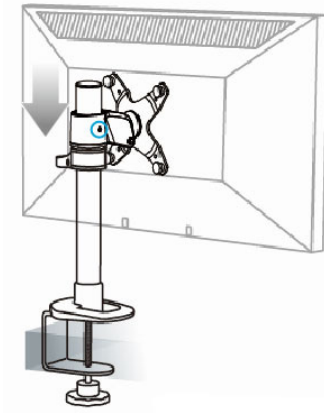

## Adjusting Monitor Mount Resistance

**WARNING!** Forced movement of the Mount Bracket without loosening the screws may damage the product or the mounted displays.

Always support your display from underneath when making any adjustments to the LCD Arms or Mount Brackets to avoid damage to the display.

**Note:** For all adjustments outlined below, turning the screw clockwise will increase the resistance, while turning the screw counter-clockwise will decrease resistance.

To increase / decrease the tilt resistance, adjust the set screw located on the side of the Monitor Mount joint, using the M3 Allen Wrench (15).

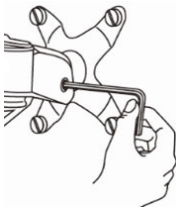

To increase / decrease swivel resistance, adjust the set screw located on the side of the Monitor Mount bracket at the Support Post, using the M3 Allen Wrench (15).



Place the wrench in the collar when not in use.

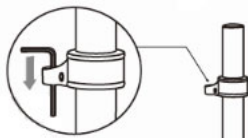

# Specifications

<b>Weight Capacity</b>	30.9 lbs (14 kg)
<b>Max Display Size</b>	30"
<b>VESA Compatibility</b>	75x75 mm and 100x100 mm
<b>Maximum Mounting Surface Thickness</b>	4 in (110 mm)

# Technical Support

StarTech.com's lifetime technical support is an integral part of our commitment to provide industry-leading solutions. If you ever need help with your product, visit [www.startech.com/support](http://www.startech.com/support) and access our comprehensive selection of online tools, documentation, and downloads.

For the latest drivers/software, please visit [www.startech.com/downloads](http://www.startech.com/downloads)

## Warranty Information

This product is backed by a two year warranty.

In addition, StarTech.com warrants its products against defects in materials and workmanship for the periods noted, following the initial date of purchase. During this period, the products may be returned for repair, or replacement with equivalent products at our discretion. The warranty covers parts and labor costs only. StarTech.com does not warrant its products from defects or damages arising from misuse, abuse, alteration, or normal wear and tear.

### Limitation of Liability

In no event shall the liability of StarTech.com Ltd. and StarTech.com USA LLP (or their officers, directors, employees or agents) for any damages (whether direct or indirect, special, punitive, incidental, consequential, or otherwise), loss of profits, loss of business, or any pecuniary loss, arising out of or related to the use of the product exceed the actual price paid for the product. Some states do not allow the exclusion or limitation of incidental or consequential damages. If such laws apply, the limitations or exclusions contained in this statement may not apply to you.

Hard-to-find made easy. At StarTech.com, that isn't a slogan. It's a promise.

StarTech.com is your one-stop source for every connectivity part you need. From the latest technology to legacy products — and all the parts that bridge the old and new — we can help you find the parts that connect your solutions.

We make it easy to locate the parts, and we quickly deliver them wherever they need to go. Just talk to one of our tech advisors or visit our website. You'll be connected to the products you need in no time.

Visit [www.startech.com](http://www.startech.com) for complete information on all StarTech.com products and to access exclusive resources and time-saving tools.

*StarTech.com is an ISO 9001 Registered manufacturer of connectivity and technology parts. StarTech.com was founded in 1985 and has operations in the United States, Canada, the United Kingdom and Taiwan servicing a worldwide market.*