

DS-1630 User's Guide

Contents

DS-1630 User's Guide	7
Scanner Basics.....	8
Scanner Parts Locations	8
Scanner Parts.....	8
Scanner Buttons and Lights.....	10
Epson Scanner Accessories.....	11
Changing the Power Off and Sleep Timer Settings	11
Placing Originals on the Scanner	13
Placing Originals in the Automatic Document Feeder	13
Placing Standard-Size Originals in the ADF	13
Placing Long Originals in the ADF	16
Original Document Specifications for the ADF	19
Placing Originals on the Scanner Glass	20
Using the Network Interface Unit	25
Network Interface Unit Control Panel	25
Connecting the Network Interface Unit.....	26
Setting Up Network Scanning	26
Scanning to Network Computers from the Network Interface Unit - Windows	29
Scanning	30
Starting a Scan.....	30
Starting a Scan from a Scanner Button.....	30
Assigning Start Button Settings or Scan Jobs	31
Starting a Scan Using the Epson Scan 2 Icon	33
Starting a Scan from a Scanning Program.....	35
Scanning with Document Capture Pro and Document Capture.....	37
Scanning in Epson Scan 2	40
Additional Scanning Settings - Main Settings Tab	44
Additional Scanning Settings - Advanced Settings Tab	45
Image Format Options.....	46
Scan Resolution Guidelines	47

Scanning Special Projects.....	47
Scanning Multi-Page Originals as Separate Files - Windows	47
Convert Scanned Documents to Editable Text (OCR).....	49
Scanning Using OCR - Windows	49
Scanning Using OCR - OS X	51
Saving Scanned Documents as a Searchable PDF	53
Scanning to a SharePoint Server or Cloud Service	55
Saving a Scan as an Office Format File - Windows	56
Cleaning and Transporting Your Scanner.....	59
Cleaning Your Scanner	59
Cleaning the ADF	59
Transporting Your Scanner	65
Solving Problems	66
Scanner Light Status	66
Solving Scanning Problems	67
Scanner Does Not Turn On or Turns Off Unexpectedly.....	67
Start Button Does Not Work as Expected.....	67
Scanning Software Does Not Operate Correctly	68
Cannot Start Epson Scan 2	68
Scanning is Slow	69
Solving Original Document Feeding Problems.....	69
Originals Do Not Feed From the Automatic Document Feeder.....	70
Originals Jam in the Automatic Document Feeder.....	70
Solving Scanned Image Quality Problems	74
Image Consists of a Few Dots Only.....	74
Line of Dots Appears in All Scanned Images.....	75
Straight Lines in an Image Appear Crooked	75
Image is Distorted or Blurry	75
Image Colors are Patchy at the Edges	76
Image is Too Dark	76
Back of Original Image Appears in Scanned Image	76
Characters are not Recognized During Conversion to Editable Text (OCR)	77
Binding Margins on a Scanned Booklet are Blurry.....	77

Ripple Patterns Appear in an Image	78
Scanned Image Colors Do Not Match Original Colors	78
Scanned Image Edges are Cropped	79
Resetting the Epson Scan 2 Settings	79
Uninstall Your Scanner Software.....	79
Uninstalling Scanner Software - Windows.....	80
Uninstalling Scanner Software - OS X.....	80
Where to Get Help.....	81
Technical Specifications	83
Windows System Requirements	83
Mac System Requirements	83
General Specifications	84
Dimension Specifications	85
Electrical Specifications	85
Environmental Specifications	86
Safety and Approvals Specifications	86
Notices	88
Important Safety Instructions.....	88
Restrictions on Copying	89
Default Delay Times for Power Management for Epson Products.....	90
Binding Arbitration and Class Waiver	90
Trademarks.....	93
Copyright Notice.....	94
Open Source Software License.....	94
libTIFF Software Acknowledgment.....	96
A Note Concerning Responsible Use of Copyrighted Materials.....	97
Copyright Attribution	97

DS-1630 User's Guide

Welcome to the DS-1630 *User's Guide*.

For a printable PDF copy of this guide, [click here](#).

Scanner Basics

See these sections to learn about the basic features of your scanner.

[Scanner Parts Locations](#)

[Changing the Power Off and Sleep Timer Settings](#)

Scanner Parts Locations

See these sections to identify the parts on your scanner.

[Scanner Parts](#)

[Scanner Buttons and Lights](#)

[Epson Scanner Accessories](#)

Parent topic: [Scanner Basics](#)

Scanner Parts

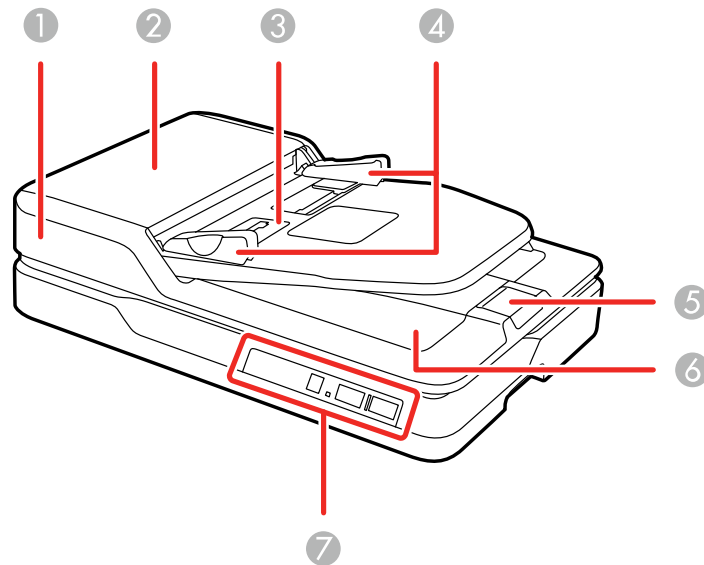

1 ADF (Automatic Document Feeder)

- 2 ADF cover
- 3 Input tray
- 4 Edge guides
- 5 Stopper
- 6 Output tray
- 7 Control panel

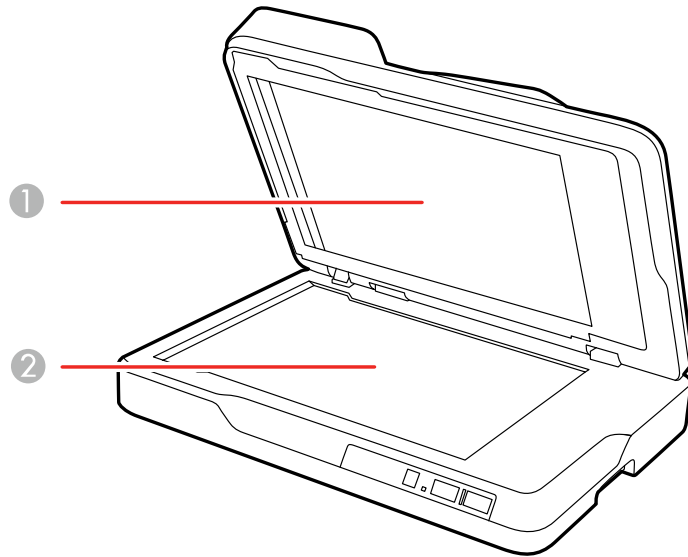

- 1 Document mat
- 2 Scanner glass

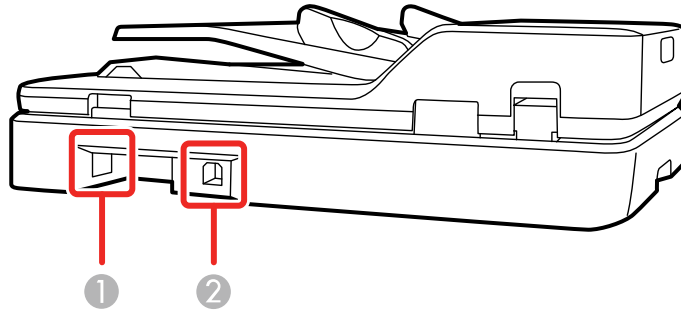



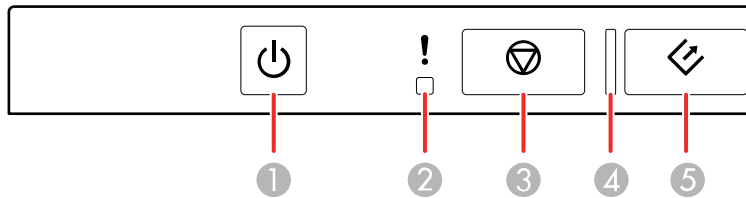

- 1 AC inlet
- 2 USB port

Parent topic: [Scanner Parts Locations](#)

Scanner Buttons and Lights



- 1  power button
- 2  error light
- 3  stop button
- 4  ready light
- 5  start button

Parent topic: [Scanner Parts Locations](#)

Epson Scanner Accessories



You can purchase genuine Epson accessories at epson.com (U.S. sales) or epson.ca (Canadian sales). You can also purchase accessories from an Epson authorized reseller. To find the nearest one, call 800-GO-EPSON (800-463-7766).

Part	Part number
Network interface unit	B12B808441

Parent topic: [Scanner Parts Locations](#)

Changing the Power Off and Sleep Timer Settings

You can use the Epson Scan 2 Utility to change the time period before the scanner enters sleep mode and turns off automatically.

1. Do one of the following to access the Epson Scan Settings utility:
 - **Windows 10:** Click  and select **All Apps > EPSON > Epson Scan 2 Utility**.
 - **Windows 8.x:** Navigate to the **Apps** screen and select **Epson Scan 2 Utility**.
 - **Windows (other versions):** Click  or **Start**, and select **All Programs** or **Programs**. Select **EPSON > Epson Scan 2 > Epson Scan 2 Utility**.
 - **OS X:** Open the **Applications** folder, open the **Epson Software** folder, and select **Epson Scan 2 Utility**.

2. Click the **Power Save** tab.

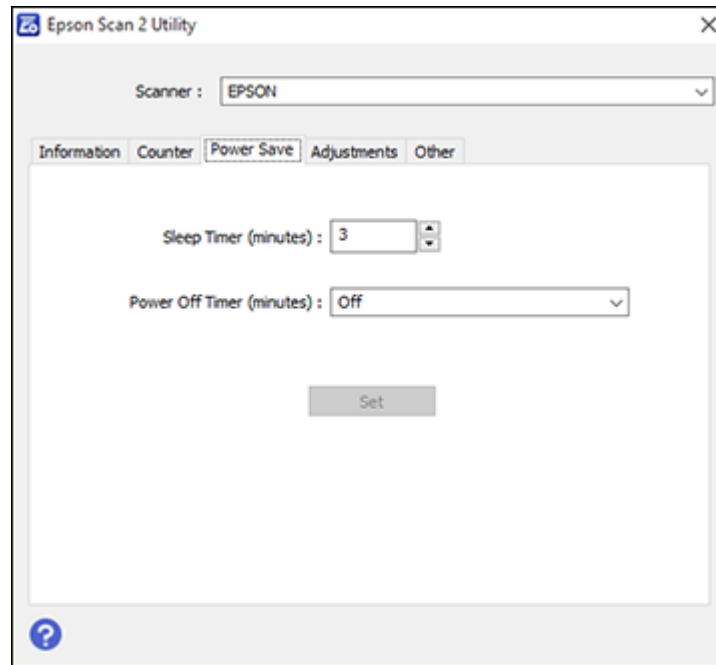

3. Select the length of time after which you want the scanner to go to sleep as the **Sleep Timer** setting.
4. Select the length of time after which you want the scanner to automatically turn off when not in use as the **Power Off Timer** setting.
5. Close the Epson Scan 2 Utility.

Parent topic: [Scanner Basics](#)

Placing Originals on the Scanner

Follow the instructions here to place your originals on the scanner.

Caution: Do not place anything on top of your scanner or use its cover as a writing surface to avoid damaging it.

[Placing Originals in the Automatic Document Feeder](#)

[Placing Originals on the Scanner Glass](#)

Placing Originals in the Automatic Document Feeder

Follow the instructions here to place your originals in the Automatic Document Feeder (ADF).

[Placing Standard-Size Originals in the ADF](#)

[Placing Long Originals in the ADF](#)

[Original Document Specifications for the ADF](#)

Parent topic: [Placing Originals on the Scanner](#)

Related references

[Original Document Specifications for the ADF](#)

Placing Standard-Size Originals in the ADF

You can place multi-page original documents in the Automatic Document Feeder (ADF). You can also use the ADF to scan both sides of a 2-sided document.

Caution: Make sure your originals meet the specifications for the ADF before loading them.

Note: If your originals are 15.5 inches (393.8 mm) or longer, see the link at the end of these steps for instructions on loading long originals in the ADF.

1. Remove any documents from the scanner glass.

Note: Also wipe off any dust or stains from the areas shown here with a soft, dry cloth.

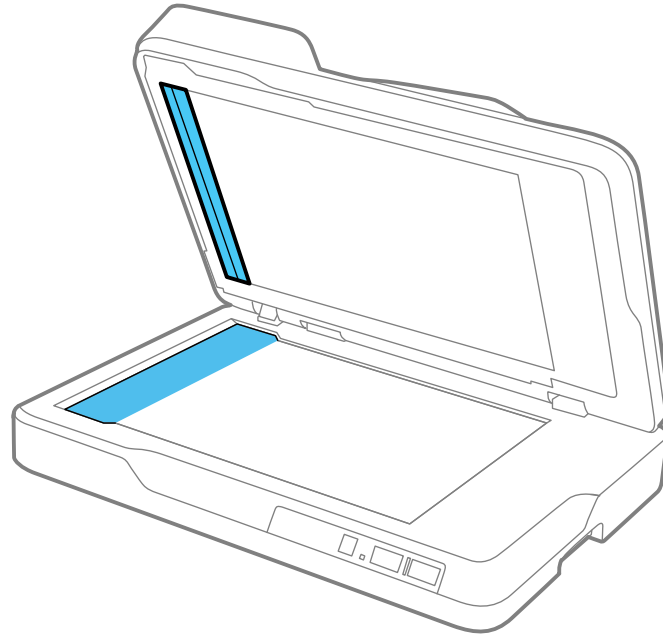

2. Slide the edge guides outward and raise the stopper.

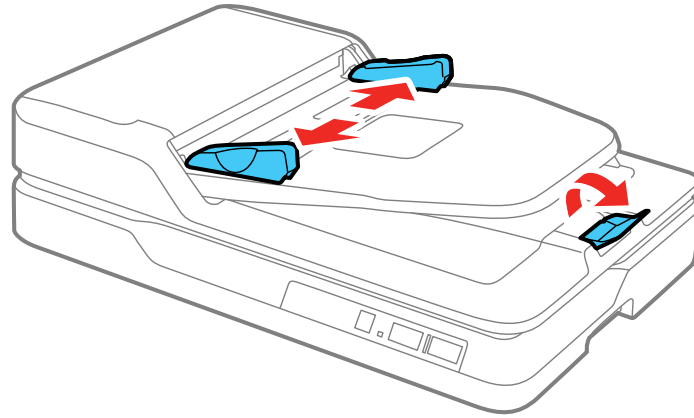

Note: If your originals are legal-size (14 inches [356 mm]) or longer, leave the stopper closed.

3. Fan your stack of originals and tap them gently on a flat surface to even the edges.

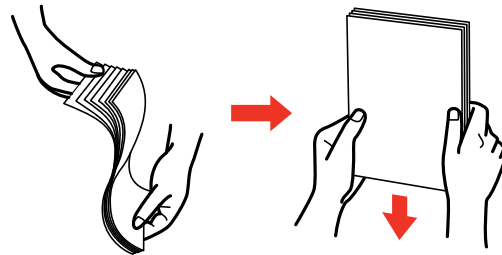

4. Insert the originals into the ADF faceup and top-edge first.

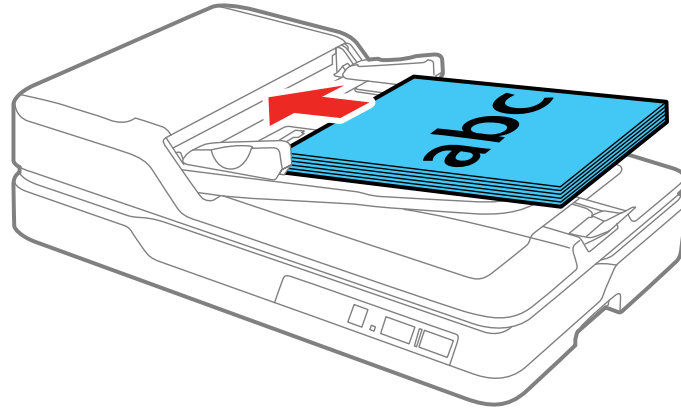

5. Slide the edge guides against the originals, but not too tightly.

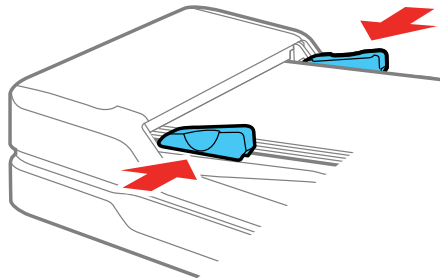

Parent topic: [Placing Originals in the Automatic Document Feeder](#)

Placing Long Originals in the ADF

You can place one original that is 15.5 inches (393.8 mm) or longer in the ADF.

Caution: Make sure your original meets the specifications for the ADF before loading it.

1. Remove any documents from the scanner glass.

Note: Also wipe off any dust or stains from the areas shown here with a soft, dry cloth.



2. Slide the edge guides outward.

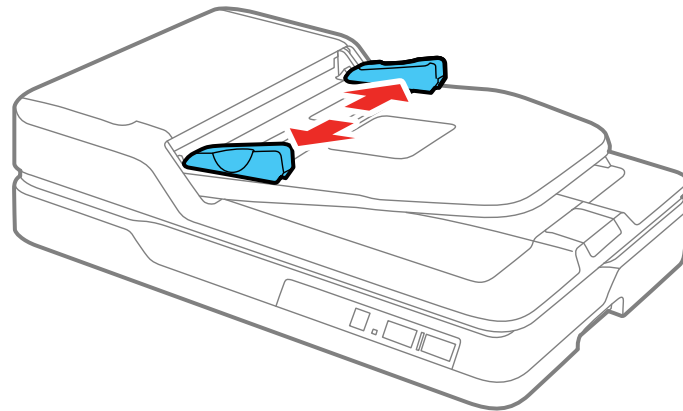

3. Insert your original into the ADF faceup and top-edge first.

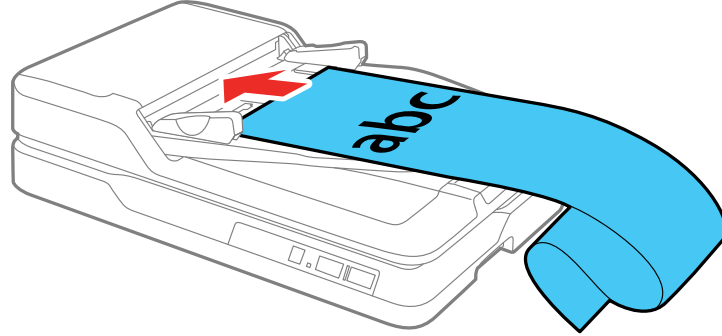

4. Slide the edge guides against the original, but not too tightly.

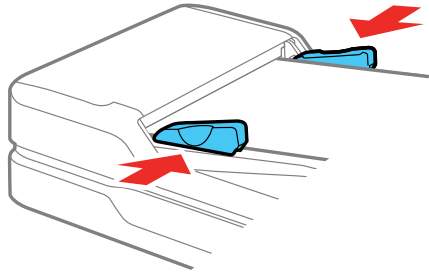

Note: When scanning, support your original as it feeds into and exits the ADF.

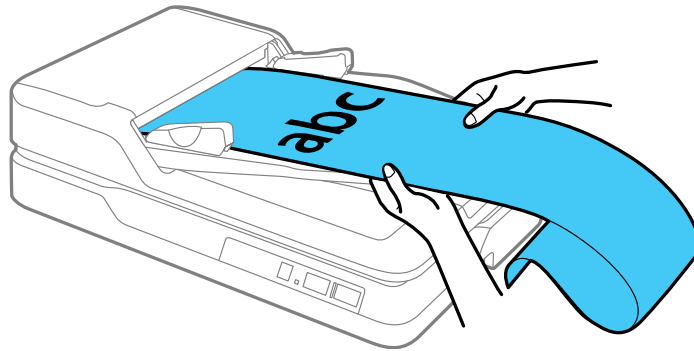

Parent topic: [Placing Originals in the Automatic Document Feeder](#)

Original Document Specifications for the ADF

You can load original documents that meet these specifications in the ADF.

Paper thickness: 13 to 32 lbs (50 to 120 g/m²)

Paper types: Plain paper, fine paper, recycled paper

Paper size	Loading capacity	Double-sided scanning
Letter (8.5 × 11 inches [216 × 279 mm])	Up to the arrow mark on the edge guide or 50 sheets (21 lb [80 g/m ²]); loading capacity varies depending on the paper type	Yes
A4 (8.3 × 11.7 inches [210 × 297 mm])		Yes
Legal (8.5 × 14 inches [216 × 356 mm])		No
A5 (5.8 × 8.2 inches [148 × 210 mm])		Yes
A6 (4.1 × 5.8 inches [105 × 148 mm])		No
B5 (7.2 × 10.1 inches [182 × 257 mm])		Yes
Longer than 15.5 inches (393.8 mm)	1 sheet	No

You can load original documents within the following range of sizes:

- **Maximum:** 8.5 × 120.0 inches (216 × 3048 mm) for single-sided scanning and 8.5 × 11.7 inches (216 × 297 mm) for double-sided scanning
- **Minimum:** 3.5 × 5.0 inches (89 × 127 mm) for single-sided scanning and 3.5 × 6.7 inches (89 × 170 mm) for double-sided scanning

Caution: Load the following types of originals on the scanner glass instead of the ADF, or they may be damaged or may damage the scanner:

- Photos

- Originals with holes, other than standard hole-punched originals
- Booklets
- Non-paper originals, such as fabric or metal foil
- Originals containing staples or paper clips
- Originals with glue on it
- Ripped, curled, or wrinkled originals
- Transparencies
- Originals with carbon paper backing
- Originals with wet ink
- Originals with sticky notes attached
- Originals with labels or tape not firmly attached
- Postcards
- Envelopes
- Business cards
- Plastic cards

Parent topic: [Placing Originals in the Automatic Document Feeder](#)

Placing Originals on the Scanner Glass

You can place originals directly on the scanner glass.

Caution: Do not place heavy objects on the scanner glass and do not press on the glass with too much force, or it may damage the scanner. Do not leave photos on the scanner glass for an extended period, or they may stick to the glass.

1. Open the scanner cover.

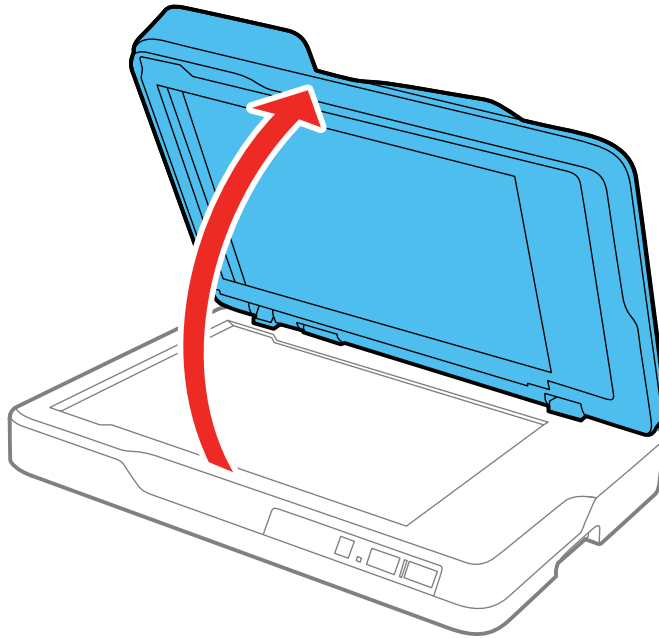

Caution: Be careful not to open the scanner cover more than 70° or you may damage it.

2. Place your original facedown on the scanner glass with the top edge facing as shown. Slide the original to the edges of the indicated corner.

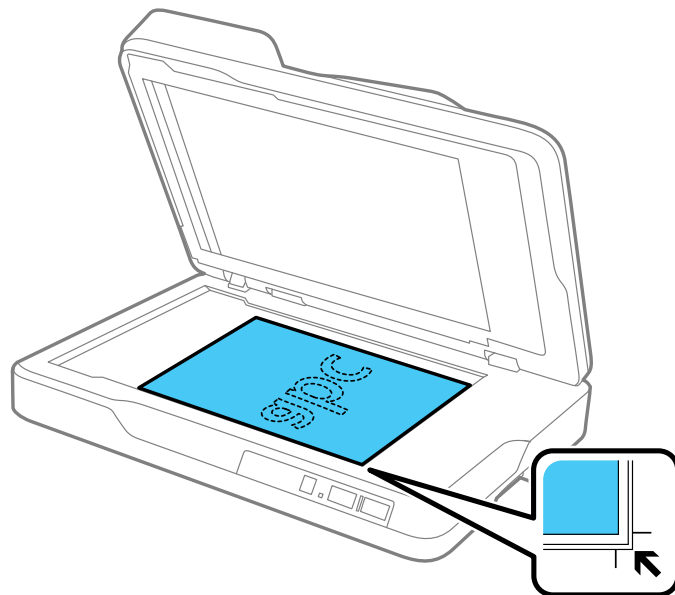

Note: Move your original about 0.1 inch (2.5 mm) away from the edges as shown to avoid cropping.

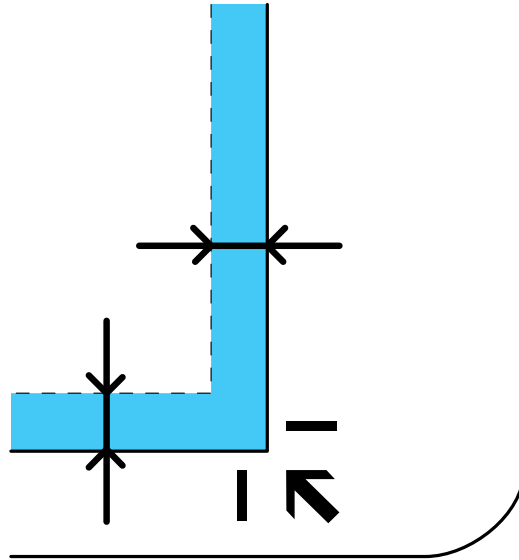

3. Close the scanner cover gently to keep your original in place.

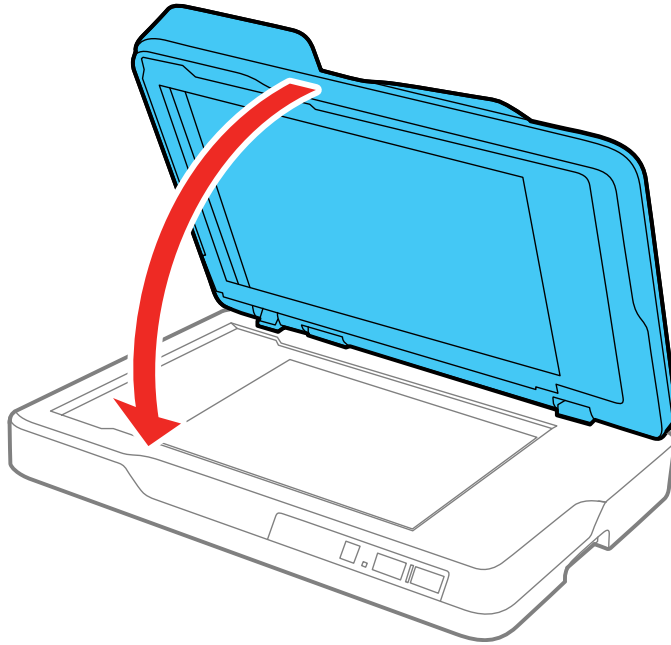

Note: If your original is over 0.4 inch (10 mm) thick, leave the scanner cover open and gently press down on your original instead as you scan.

Parent topic: [Placing Originals on the Scanner](#)

Using the Network Interface Unit

See these sections to use the optional Epson Network Interface Unit to scan over a network.

[Network Interface Unit Control Panel](#)

[Connecting the Network Interface Unit](#)

[Setting Up Network Scanning](#)

[Scanning to Network Computers from the Network Interface Unit - Windows](#)

Network Interface Unit Control Panel

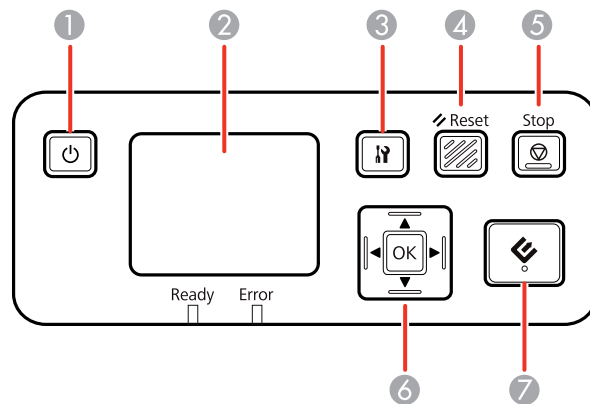

- 1 power button (turns the unit on and off)
- 2 LCD screen (displays status, operations, and error messages)
- 3 settings button (selects product settings, network settings, and maintenance options)
- 4 **Reset** button (returns the LCD to the default screen)
- 5 **Stop** button (cancels scanning)
- 6 **OK** button and arrows (use the arrows to highlight an option and the **OK** button to select it)
- 7 start button (starts scanning when networking is enabled)

Parent topic: [Using the Network Interface Unit](#)

Connecting the Network Interface Unit



See the documentation that came with the optional Epson Network Interface Unit for instructions on connecting it to your scanner.

Parent topic: [Using the Network Interface Unit](#)

Setting Up Network Scanning

You can set up network scanning through the optional Epson Network Interface Unit. First connect the unit to your scanner and verify that both are working properly. Then follow the instructions here to set up computers for network scanning using the Epson Scan 2 Utility.

Note: Make a note of the IP address or host name of the Epson Network Interface Unit so you can enter it in these steps.

1. Do one of the following to start Epson Scan 2 Utility:
 - **Windows 10:** Click  and select **All Apps > EPSON > Epson Scan 2 Utility**.
 - **Windows 8.x:** Navigate to the **Apps** screen and select **Epson Scan 2 Utility**.
 - **Windows (other versions):** Click  or **Start**, and select **All Programs** or **Programs**. Select **EPSON > Epson Scan 2 > Epson Scan 2 Utility**.
 - **OS X:** Open the **Applications** folder, open the **Epson Software** folder, and select **Epson Scan 2 Utility**.
2. Select **Settings** from the Scanner drop-down list.

You see a screen like this:

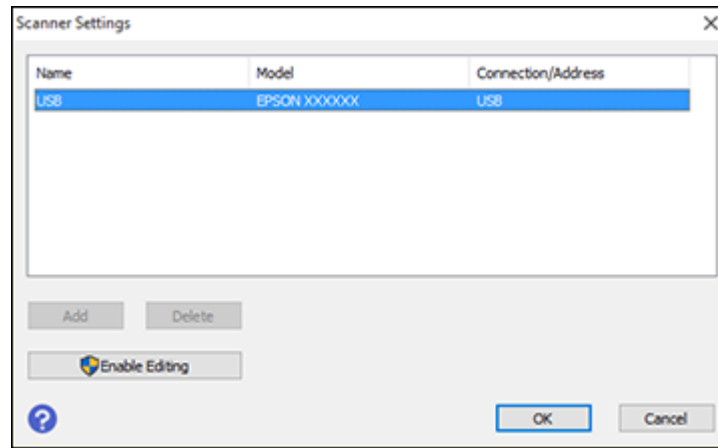

Note: If you see an **Enable Editing** button, click it so that you can modify the scanner settings.

3. Select your scanner and click **Add**.

You see a screen like this:

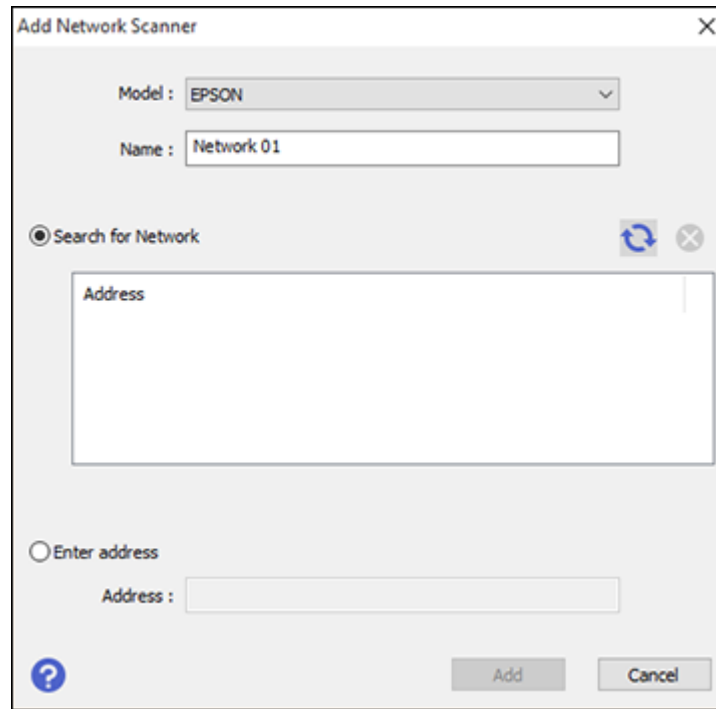

4. Do one of the following:
 - Under **Search for Network**, select the IP address of your Epson Network Interface Unit and click **Add**.
 - Select the **Enter address** setting, type in the IP address or host name of your Epson Network Interface Unit, and click **Add**.
5. Click **OK** to check the connection.
You see a confirmation message.
6. Click **OK** to save your settings and close Epson Scan 2 Utility.

Parent topic: [Using the Network Interface Unit](#)

Scanning to Network Computers from the Network Interface Unit - Windows

You can scan to a network computer directly from the Network Interface Unit (Windows). You first set up a scan job in Document Capture Pro and then select the computer you want to send the scanned file to.

Note: Make sure your scan job settings are set up correctly in Document Capture Pro before scanning with the Network Interface Unit.

1. Press the **OK** button on the Network Interface Unit.
2. On the LCD screen of the Network Interface Unit, select the computer you want to send the scanned file to and press the **OK** button.

Note: If your scanner is part of a network group, make sure to set the computer to the same network group or it will not appear on the LCD screen.

3. If you set up a password in Document Capture Pro, enter the password at the prompt.
4. Select a scan job and press the **OK** button on the Network Interface Unit.
5. Press the  start button on the scanner or Network Interface Unit.

Your original is scanned and the file is sent to the computer you selected.

Parent topic: [Using the Network Interface Unit](#)

Scanning

You can scan original documents or photos and save them as digital files.

[Starting a Scan](#)

[Scanning with Document Capture Pro and Document Capture](#)

[Scanning in Epson Scan 2](#)

[Scan Resolution Guidelines](#)

[Scanning Special Projects](#)

Starting a Scan

After placing your original documents or photos on your product for scanning, start scanning using one of these methods.

[Starting a Scan from a Scanner Button](#)

[Starting a Scan Using the Epson Scan 2 Icon](#)

[Starting a Scan from a Scanning Program](#)

Parent topic: [Scanning](#)

Starting a Scan from a Scanner Button

You can scan using the  start button on your scanner. This automatically starts Document Capture Pro (Windows) or Document Capture (OS X) and the scan job you have assigned to the button.

Note: Make sure Epson Scan 2 and Document Capture Pro (Windows) or Document Capture (OS X) are installed on the computer connected to the scanner.

1. Make sure the scanner is connected to your computer.
2. Load an original in your scanner.
3. Press the  start button.

The scanner starts the job that was assigned to the  start button in Document Capture Pro (Windows) or Document Capture (OS X).

Note: You can view or change the scan settings using Document Capture Pro (Windows) or Document Capture (OS X).

[Assigning Start Button Settings or Scan Jobs](#)

Parent topic: [Starting a Scan](#)

Related tasks

[Assigning Start Button Settings or Scan Jobs](#)

Related topics

[Placing Originals on the Scanner](#)

Assigning Start Button Settings or Scan Jobs

You can view or change the default scan settings when you scan using the  start button on your scanner. You do this by accessing the scan jobs in the Document Capture Pro (Windows) or Document Capture (OS X) program.



1. Start Document Capture Pro or Document Capture on a computer connected to the product.
2. Click the  Manage Job icon from the toolbar at the top of the window.

You see a window showing the current scan job list.

3. If you want to add a scan job, click **Add** or the **+** icon, enter a name for the new job, select settings as necessary, and click **OK**.

You can now use the new scan job when you scan with Document Capture Pro or Document Capture.

Note: See the Help information in Document Capture Pro or Document Capture for details.

4. If you want to assign a scan job to the  start button, do one of the following:
 - **Windows:** Click **Event Settings**.
 - **OS X:** Click the  icon at the bottom of the window, then click **Event Settings**.

5. Do one of the following:
- **Windows:** Select the job that you want to assign to the  start button from the **1** drop-down list.

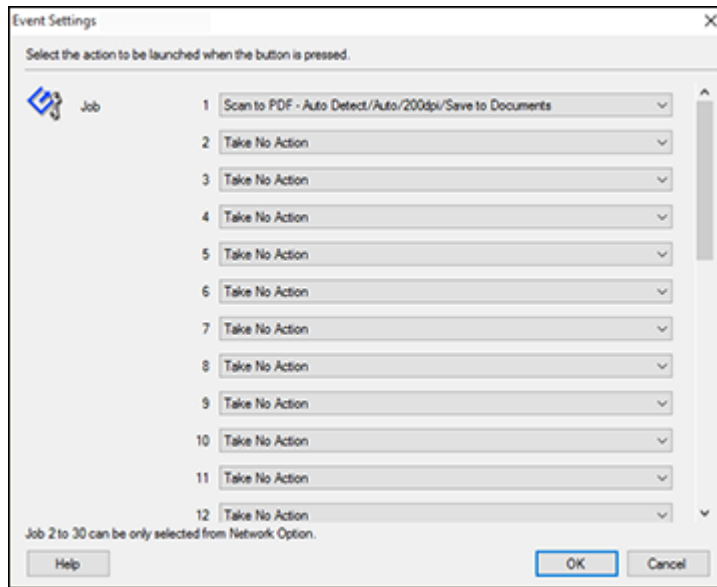

Note: Jobs 2 to 30 can only be selected when using the optional Network Interface Unit.

- **OS X:** Select the job that you want to assign to the  start button.

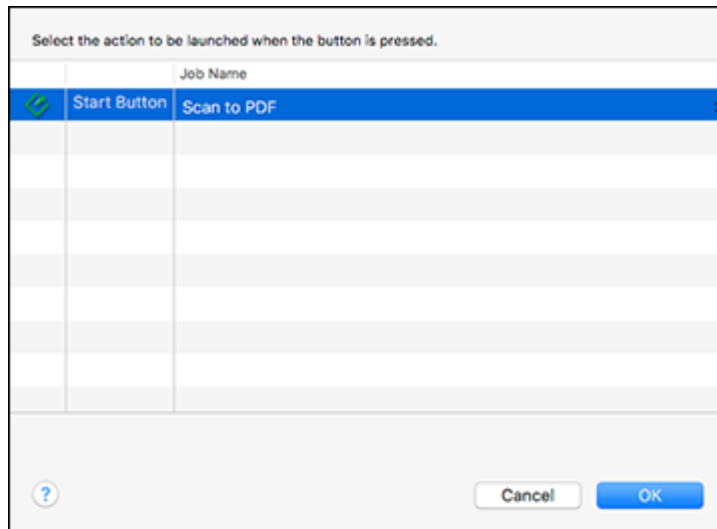



6. Click **OK**.

Parent topic: [Starting a Scan from a Scanner Button](#)

Starting a Scan Using the Epson Scan 2 Icon

You can start the Epson Scan 2 program to select scan settings, scan, and save the scanned image to a file.

- **Windows 10:** Click  and select **All apps > EPSON > Epson Scan 2**.
- **Windows 8.x:** Navigate to the **Apps** screen and select **Epson Scan 2**.
- **Windows (other versions):** Click  or **Start**, and select **All Programs** or **Programs**. Select **EPSON > Epson Scan 2 > Epson Scan 2**.
- **OS X:** Open the **Applications** folder, open the **Epson Software** folder, and select **Epson Scan 2**.

You see an Epson Scan 2 window like this:

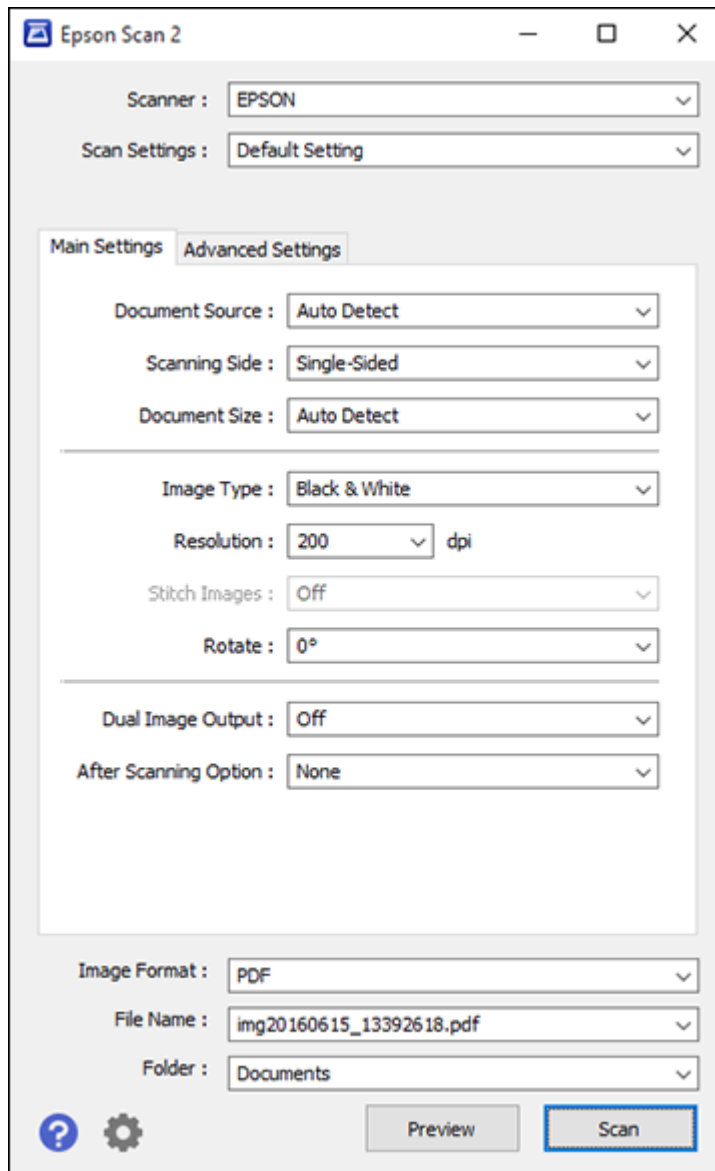

Parent topic: [Starting a Scan](#)

Related tasks

[Scanning in Epson Scan 2](#)

Starting a Scan from a Scanning Program

You can start Epson Scan 2 from a TWAIN-compliant scanning program to select scan settings, scan, and open the scanned image in the program.

1. Open your scanning program and select its scanning option. (See your scanning program help for instructions.)
2. Select your product.

Note: In certain programs, you may need to select your product as the "source" first. If you see a **Select Source** option, choose it and select your product. With Windows, do not select a **WIA** option for your product; it will not work correctly.

You see an Epson Scan 2 window like this:

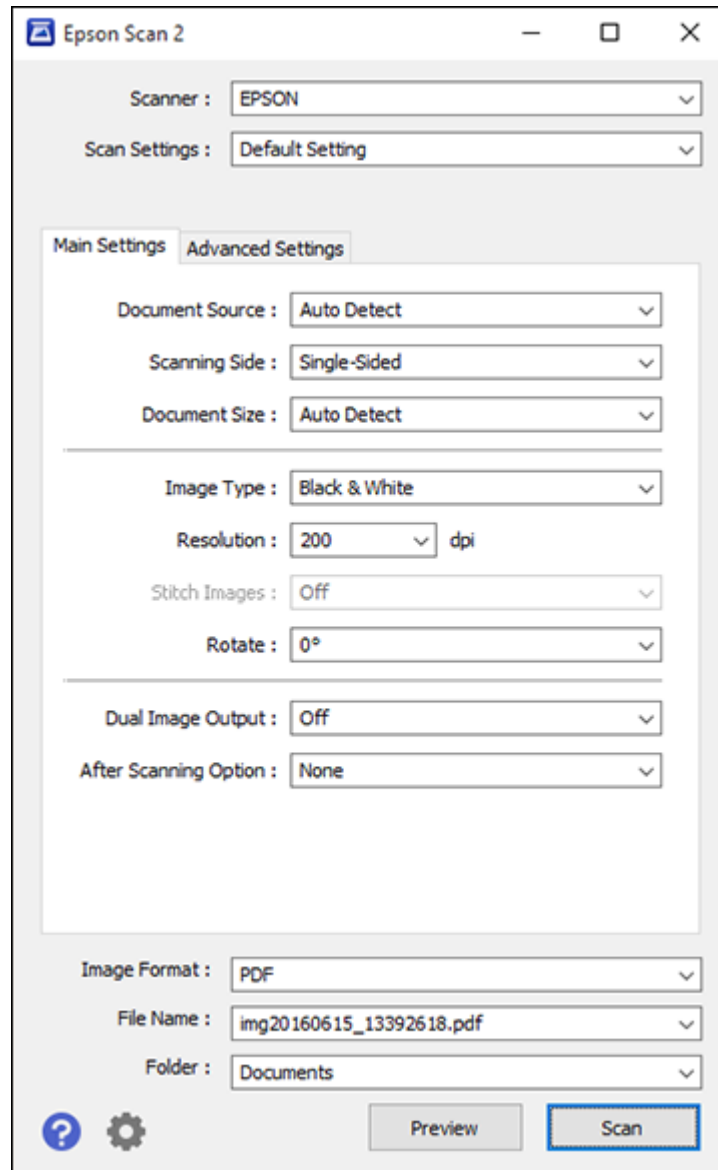

Parent topic: [Starting a Scan](#)



Related tasks

[Scanning in Epson Scan 2](#)

Scanning with Document Capture Pro and Document Capture

When you scan with Document Capture Pro (Windows) or Document Capture (OS X), the program automatically saves your scanned file on your computer in the folder you specify. You can select settings, preview, and change the scanned file settings as necessary.

Note: The settings may vary, depending on the software version you are using. See the Help information in Document Capture or Document Capture Pro for details.

1. Do one of the following to start Document Capture Pro (Windows) or Document Capture (OS X):
 - **Windows 10:** Click  and select **All Apps > Epson Software > Document Capture Pro**.
 - **Windows 8.x:** Navigate to the **Apps** screen and select **Document Capture Pro**.
 - **Windows (other versions):** Click  or **Start**, and select **All Programs** or **Programs**. Select **Epson Software > Document Capture Pro**.
 - **OS X:** Open the **Applications** folder, open the **Epson Software** folder, and select **Document Capture**.

You see a window like this:

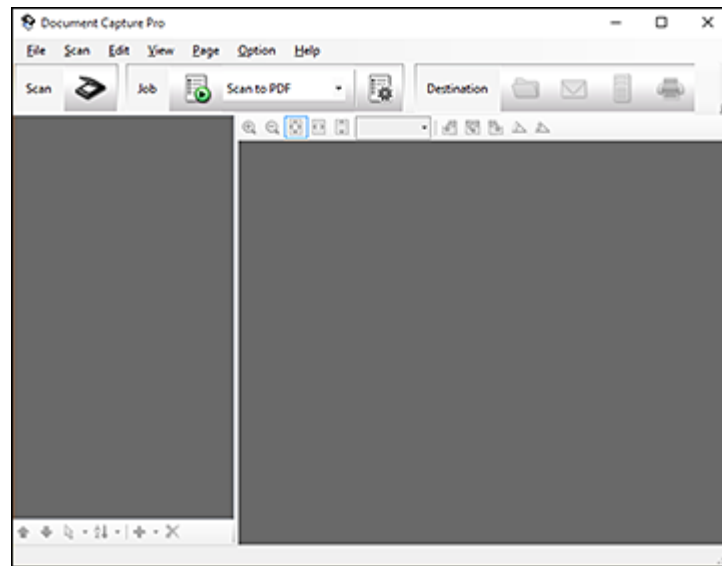

2. Click the  **Scan** icon.

You see a window like this:

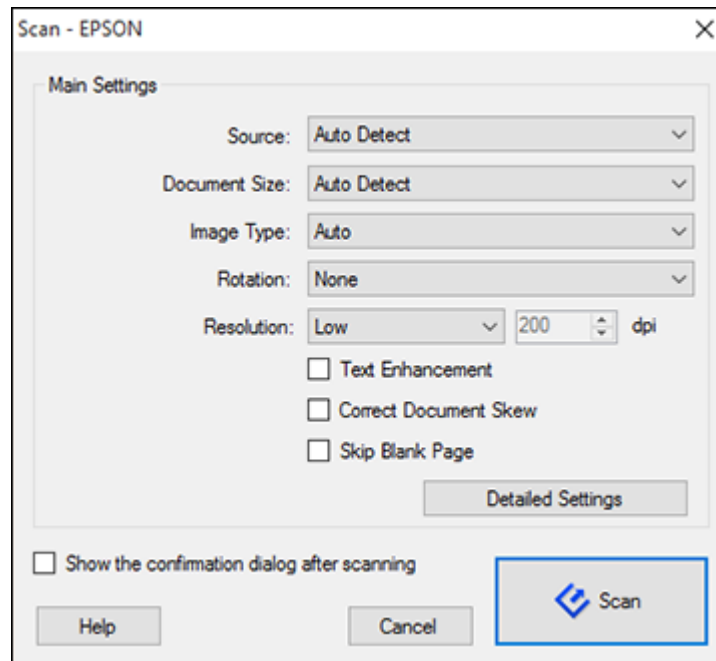

Note: If you want to use a scan job that you created instead, select it from the Job list in the Document Capture Pro or Document Capture window, click the  Start Job button, and skip the rest of these steps.

3. Select any displayed scan settings you want to use.

Note: See the Help information in Document Capture Pro or Document Capture for details.

4. If you want to select detailed scan settings, do one of the following:
 - **Windows:** Click **Detailed Settings**. Select any displayed scan settings you want to use and click **Preview** to see a preview of your scan in the Epson Scan 2 window, then click **Save**.
 - **OS X:** Close the Scan window. Open the **Scan** menu at the top of the screen and select **Displays the EPSON Scan Setup Screen**. Click the  Scan icon and select any displayed scan settings you want to use.

5. Click **Scan**.

You see a preview of your scan in the Document Capture Pro (Windows) or Document Capture (OS X) window.

6. If you would like to scan additional originals and add them to the current captured images, click the  Add Page button, select **Acquire from Scanner**, and repeat the previous steps.
7. Check the scanned images and edit them as necessary.
8. Click one of the Destination icons to choose where to send your scanned files. (If you cannot see all of the icons below, click the arrow next to the icons.)



9. Depending on the destination you chose, click **OK** or **Send** to complete the operation.

Parent topic: [Scanning](#)

Related concepts

[Scan Resolution Guidelines](#)

Scanning in Epson Scan 2

Epson Scan 2 automatically scans your document and saves the scanned file in PDF format in your operating system's Documents or My Documents folder, or opens it in your scanning program. You can select settings, preview, and change the scanned file settings as necessary.

1. Start Epson Scan 2.

You see this window:

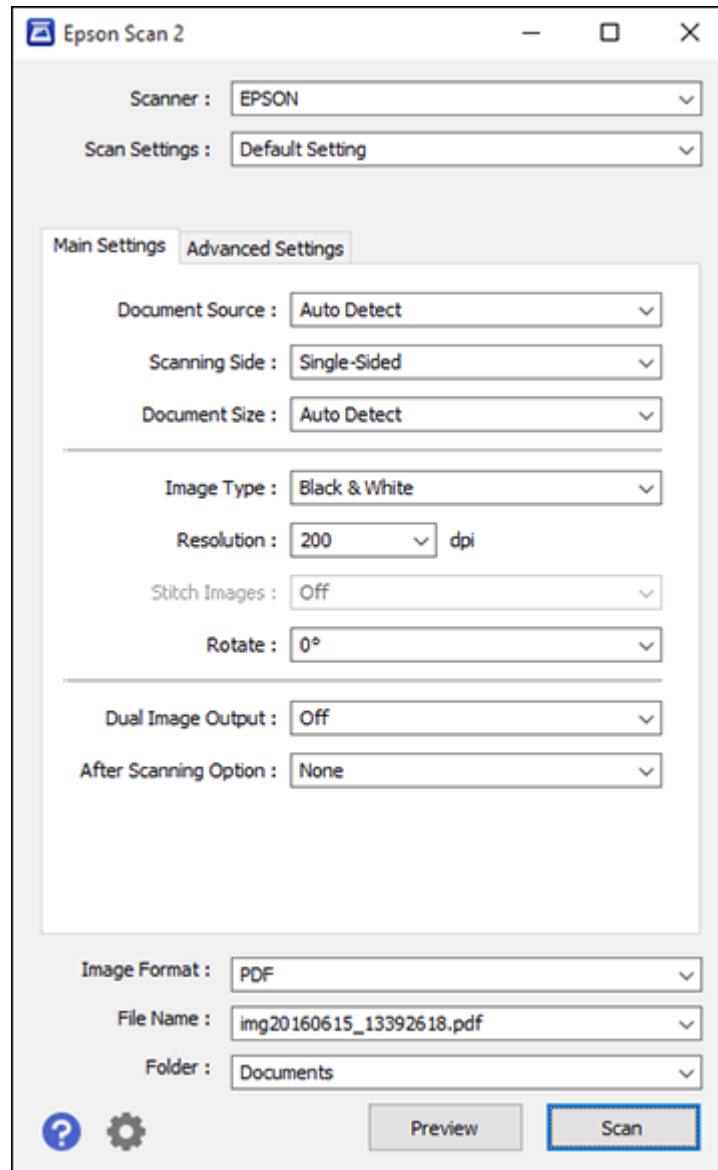

2. Select the **Document Source** setting that matches where you placed your originals, or select **Auto Detect** to have Epson Scan 2 automatically detect the location.
3. Select the **Scanning Side** setting that matches the sides of the original that you want to scan.
4. Select the **Document Size** setting that matches the size of your original, or select **Auto Detect** to have Epson Scan 2 automatically detect the size. You can select **Customize** to enter a custom size, if necessary.
5. Select your original image type and how you want it scanned as the **Image Type** setting.
6. Select the **Resolution** setting you want to use for your scan.
7. Select any of the additional settings that you want to use on the Main Settings tab.
8. Click the **Advanced Settings** tab and select any settings that you want to use.
9. To see a preview of your scan with the settings you selected, click the **Preview** button.

Epson Scan 2 previews your original and displays the results in the Epson Scan 2 window.

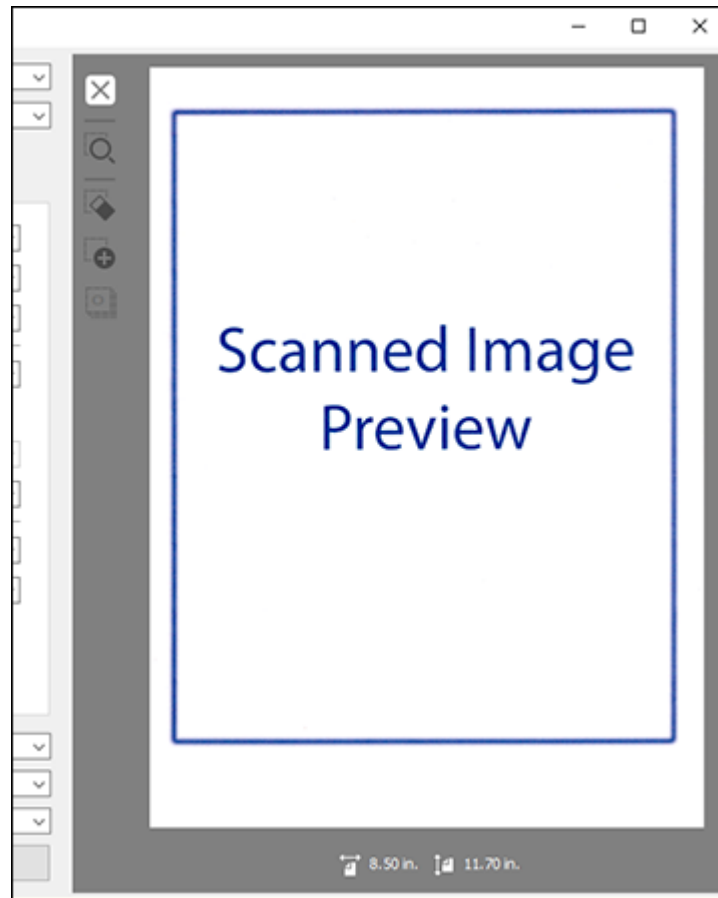

Note: If your originals were scanned from the ADF, reload your originals.

10. Select any additional settings that you want to use on the Main Settings tab.
11. Click the **Advanced Settings** tab and select any settings that you want to use.
12. Select the format in which you want to save your scanned file as the **Image Format** setting. If necessary, select **Options** and select any desired format options.

13. Enter the file name for your scanned file in the **File Name** field. If necessary, select **Settings** to modify the file name settings.
14. Select the location in which you want to save your scanned file as the **Folder** setting. If necessary, select **Select** to create a new folder.
15. Click **Scan**.

The product scans your original and saves the scanned file in the location you specified.

[Additional Scanning Settings - Main Settings Tab](#)

[Additional Scanning Settings - Advanced Settings Tab](#)

[Image Format Options](#)

Parent topic: [Scanning](#)

Related concepts

[Scan Resolution Guidelines](#)

Additional Scanning Settings - Main Settings Tab

You can select these additional scanning settings on the Epson Scan 2 Main Settings tab.

Stitch Images

When scanning double-sided originals, lets you lay out images from both sides of the original one scanned page.

Rotate

Rotates the original image clockwise to the desired angle before scanning it. Select **Auto** to allow your product to automatically rotate the image based on the orientation of the text (may take longer to scan).

Dual Image Output

Scans the original image twice using different output settings.

After Scanning Option

When scanning multi-page originals, lets you add additional pages or add and edit the pages in a job and save all of the scanned pages as one file.

Note: You must select a file format that supports multi-page such as **PDF** or **Multi-TIFF**.

Note: The Dual Image Output setting is available with Windows only.

Parent topic: [Scanning in Epson Scan 2](#)

Additional Scanning Settings - Advanced Settings Tab

You can select these additional scanning settings on the Epson Scan 2 Advanced Settings tab. Not all adjustment settings may be available, depending on other settings you have chosen.

Unsharp Mask

Makes the edges of certain image areas clearer. Turn off this option to leave softer edges.

Descreening

Removes the ripple pattern that might appear in subtly shaded image areas, such as skin tones. This option improves results when scanning magazines or newspapers. (The results of descreening do not appear in the preview image, only in your scanned image.)

Text Enhancement

Sharpens the appearance of letters in text documents.

Auto Area Segmentation

Makes grayscale images clearer and text recognition more accurate by separating the text from the graphics.

Dropout

The scan will not pick up the color you select. This setting is available only if you select **Grayscale** or **Black & White** as the Image Type setting.

Color Enhance

Enhances the red, green, or blue shades in the scanned image.

Brightness

Adjusts the overall lightness and darkness of the scanned image.

Contrast

Adjusts the difference between the light and dark areas of the overall scanned image.

Gamma

Adjusts the midtone density of the scanned image.

Threshold

Adjusts the level at which black areas in text and line art are delineated, improving text recognition in OCR (Optical Character Recognition) programs.

Skip Blank Pages

If the scanner detects marks from the other side of a blank page and adds the marks to the scanned image, adjust this setting to prevent this.

Edge Fill

Corrects shadowing around the edges of the image by filling the shadows with the color you select.

Correct Document Skew

Corrects skewed originals, image contents, or both.

Remove Punch Holes

Removes the shadows caused by holes on the edges of the original.

Parent topic: [Scanning in Epson Scan 2](#)

Image Format Options

You can select different image formats and related options. For details on available options, click the ? icon on the Epson Scan 2 Image Format Options window. Not all image formats have options.

Bitmap (*.bmp)

A standard image file format for most Windows programs.

JPEG (*.jpg)

An image format that lets you highly compress image data. However, the higher the compression, the lower the image quality. (The TIFF format is recommended when you need to modify or retouch your scanned image.)

PNG (*.png)

An image format that does not lose quality during editing.

TIFF (*.tif)

A file format created for exchanging data between many programs, such as graphic and DTP software.

Multi-TIFF (*.tif)

A TIFF file format when multiple pages are saved to the same file, allowing you to edit the images using a compatible program.

PDF (*.pdf)

A document format that is readable by Windows and OS X systems using Adobe Reader, Acrobat, or other programs. You can save multi-page documents in one PDF file.

Searchable PDF (*.pdf)

A document format that is readable by Windows and OS X systems using Adobe Reader, Acrobat, or other programs. You can save multi-page documents in one PDF file. Recognized text in the scanned document can be searched.

Parent topic: [Scanning in Epson Scan 2](#)

Scan Resolution Guidelines

The **Resolution** setting, measured in dpi (dots per inch), controls the amount of detail captured in your scans. Increasing the resolution raises the amount of detailed captured but comes with the following disadvantages:

- Larger file sizes
- It takes longer to scan your originals, send/receive your scans by email or fax, and to print your scans
- The image may become too large to fit on your display or print on paper

Select a Resolution setting based on how you plan to use the scanned image:

- Email, view on a computer screen, or post on the web: 96 to 150 dpi
- Print, fax, convert to editable text (OCR), or create a text searchable PDF: 200 to 300 dpi

Note: If you plan to enlarge a scanned image so you can print it at a larger size, increase the resolution by the same amount you will increase the image size to retain a high image quality. For example, if you normally scan your image in its original size at 300 dpi but plan to double the image size later, change the Resolution setting to 600 dpi.

Parent topic: [Scanning](#)

Scanning Special Projects

Your product's scanning software offers various options to help you quickly complete special scan projects.

[Scanning Multi-Page Originals as Separate Files - Windows](#)

[Convert Scanned Documents to Editable Text \(OCR\)](#)

[Scanning to a SharePoint Server or Cloud Service](#)



[Saving a Scan as an Office Format File - Windows](#)

Parent topic: [Scanning](#)

Scanning Multi-Page Originals as Separate Files - Windows

You can use Document Capture Pro (Windows) to scan multi-page originals as separate scanned files. You indicate where you want the new scanned files to start by inserting a blank page or barcode between the pages of your original.

Note: The settings may vary, depending on the software version you are using. See the Help information in Document Capture Pro for details.

1. Load a multi-page original with blank pages or barcodes inserted where you want to start a new scanned file.
2. Do one of the following to start Document Capture Pro:
 - **Windows 10:** Click  and select **All Apps > Epson Software > Document Capture Pro.**
 - **Windows 8.x:** Navigate to the **Apps** screen and select **Document Capture Pro.**
 - **Windows (other versions):** Click  or **Start**, and select **All Programs** or **Programs**. Select **Epson Software > Document Capture Pro.**

You see this window:

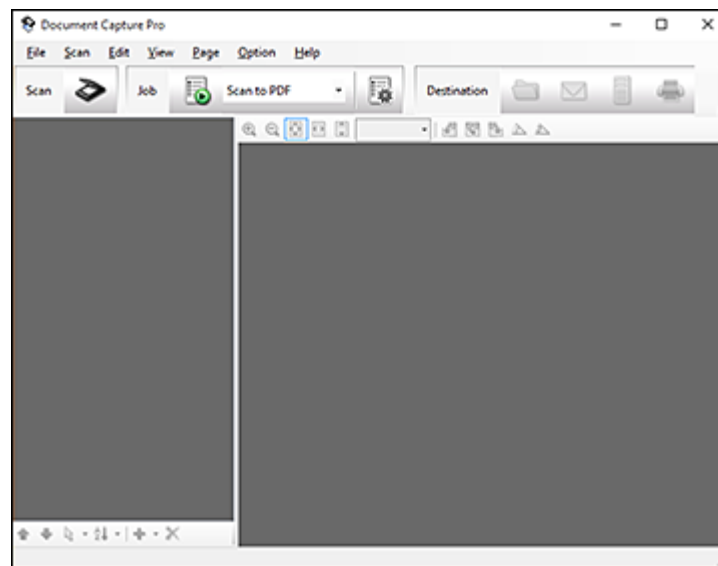

3. Click the  **Scan** icon.
4. Select any displayed scan settings you want to use.
Note: See the Help information in Document Capture Pro for details.
5. Click **Scan**.
You see a preview of your scan in the Document Capture Pro window.

6. Click one of the Destination icons to choose where to send your scanned files. (If you cannot see all of the icons below, click the arrow next to the icons.)



7. Click **File Name & Separation Settings**.
8. Select **Apply job separation** and click **Separation Settings**.
9. Select the method you used to separate the originals, select a folder name specification and click **OK**.
10. Select any additional settings from the File Name Settings dialog and click **OK**.
11. Confirm your settings and click **OK** or **Send**.

Your originals are saved into separate files and folders as specified by your settings.

Parent topic: [Scanning Special Projects](#)

Related topics

[Placing Originals on the Scanner](#)

Convert Scanned Documents to Editable Text (OCR)

You can scan a document and convert the text into data that you can edit with a word processing, spreadsheet, or HTML-editing program. This process is called OCR (Optical Character Recognition).

To scan and use OCR, you need to install an OCR program, such as ABBYY FineReader.

[Scanning Using OCR - Windows](#)

[Scanning Using OCR - OS X](#)

[Saving Scanned Documents as a Searchable PDF](#)

Parent topic: [Scanning Special Projects](#)

Scanning Using OCR - Windows

You can use the ABBYY FineReader OCR program to convert scanned documents to editable text.

1. Load your original in the scanner.
2. Do one of the following to open ABBYY FineReader:
 - **Windows 10:** Click  and select **All Apps > ABBYY FineReader 9.0 Sprint > ABBYY FineReader 9.0 Sprint**.

- **Windows 8.x:** Navigate to the **Apps** screen and select **ABBYY FineReader 9.0 Sprint**.
- **Windows (other versions):** Click  or **Start**, and select **All Programs** or **Programs**. Select **ABBYY FineReader 9.0 Sprint > ABBYY FineReader 9.0 Sprint**.

You see a window like this:



3. Select the language used in the document you are going to scan as the **Document Language** setting.
4. Click the icon that corresponds with the program or format you want to scan to.
5. If you see the Select Scanner window, select your product and click **OK**.

Note: Do not select a **WIA** option for your product; it will not work correctly.

You see the scan settings window.

6. Select your scan settings.
7. Click **Preview** and adjust the area you want to scan, if necessary.

8. Click **Scan**.

Note: To scan a multi-page document, select settings in the Multi-Page Scanning section and click **Scan** for each page.

9. When you are finished scanning, click **Close**.

Your document is scanned and processed into editable text, then you see the Save As window.

10. Select a name and a file format for your document and click **Save**.

The file is saved and then opened in an application associated with the file type you selected, if available on your system.

Parent topic: [Convert Scanned Documents to Editable Text \(OCR\)](#)

Related topics

[Placing Originals on the Scanner](#)

Scanning Using OCR - OS X

You can use the ABBYY FineReader OCR program to convert scanned documents to editable text.

Note: The version of ABBYY FineReader included with your scanner does not support OS X 10.11.

1. Load your original in the scanner.
2. Open the **Applications** folder and click the **ABBYY FineReader Sprint** icon.

You see a window like this:

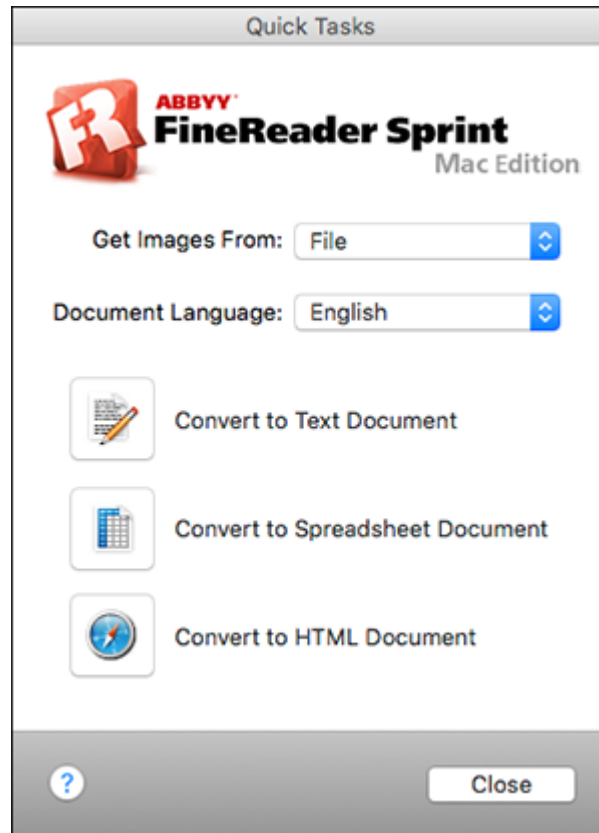

3. Open the **Get Images From** pop-up menu and select your product.
4. Select the language used in the document you are going to scan as the **Document Language** setting.
5. Select the type of document you are going to scan.
6. Select your scan settings and click **Scan**.

Your document is scanned and you see the Epson Scan 2 window while your document is converted to editable text.

7. Click **Close** to close the Epson Scan 2 window and Preview window, if necessary.

You see the Save Converted File As window:

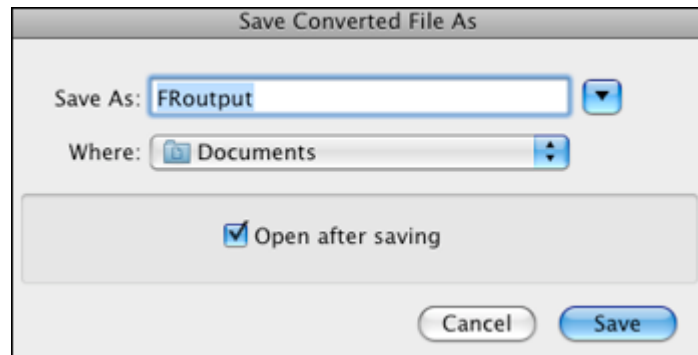

8. Click the **Save** button.

The file is saved and then opened in an application associated with the file type you selected, if available on your system.

Parent topic: [Convert Scanned Documents to Editable Text \(OCR\)](#)

Related topics

[Placing Originals on the Scanner](#)

Saving Scanned Documents as a Searchable PDF

You can scan a document and save the text in a searchable PDF. In a searchable PDF, text is recognized using Optical Character Recognition (OCR) and then embedded in the scanned original.

Note: The required Epson Scan OCR Component (Windows) or Epson Scan 2 OCR Component (OS X) is installed automatically when you install your scanner software as instructed on the Start Here sheet. If you install your scanner software programs individually, be sure to also install the components if you want to perform OCR.

1. Load your original in the scanner.
2. Start Epson Scan 2.
3. Select your scan settings.
4. Click **Preview** and adjust the area you want to scan, if necessary.
5. If you are using the ADF, reload the ejected original in the scanner.

6. Select **Searchable PDF** as the Image Format setting.
7. Select **Options** from the Image Format list.
You see the Image Format Options window.

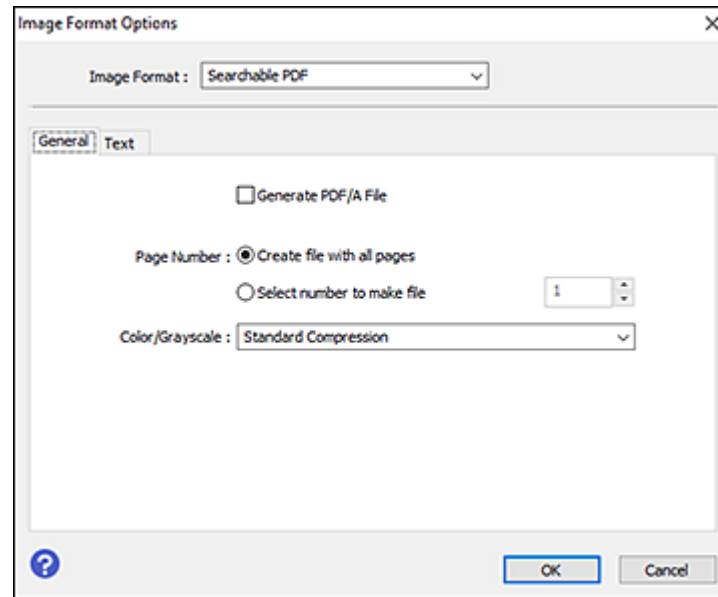

8. Select the **Text** tab.
9. Make sure the language used in the document text is selected as the **Text Language** setting.
10. Click **OK**.
11. Confirm the File Name setting and select a **Folder** setting for your document.
12. Click **Scan**.

The scanned image is saved as a searchable PDF.

Parent topic: [Convert Scanned Documents to Editable Text \(OCR\)](#)

Related tasks



[Scanning in Epson Scan 2](#)

Related topics

[Placing Originals on the Scanner](#)

Scanning to a SharePoint Server or Cloud Service

You can use Document Capture Pro (Windows) or Document Capture (OS X) to upload scanned images to a SharePoint server or a cloud service.

1. Do one of the following to start Document Capture Pro (Windows) or Document Capture (OS X):
 - **Windows 10:** Click  and select **All Apps > EPSON Software > Document Capture Pro**.
 - **Windows 8.x:** Navigate to the **Apps** screen and select **Document Capture Pro**.
 - **Windows (other versions):** Click  or **Start**, and select **All Programs** or **Programs**. Select **EPSON Software > Document Capture Pro**.
 - **OS X:** Open the **Applications** folder, open the **Epson Software** folder, and select **Document Capture**.

You see a window like this:

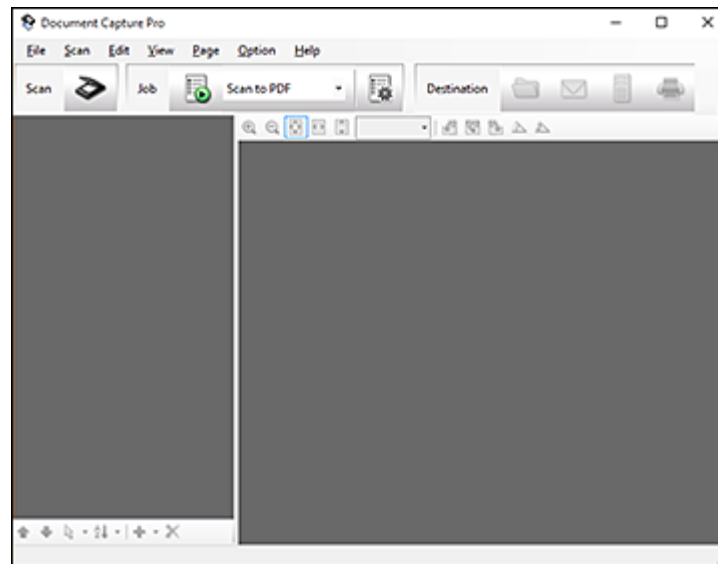





2. Click the  **Scan** icon.
3. Select any displayed scan settings you want to use.

Note: See the Help information in Document Capture Pro or Document Capture for details.

4. Click **Scan**.

You see a preview of your scan in the Document Capture Pro or Document Capture window.

5. Click one of the cloud service Destination icons to choose where to save your scanned file. (If you cannot see all of the icons below, the service software may not be installed, the service may not be available on your platform, or you need to click the arrow next to the icons.)

-  Web Folder (WebDAV)
-  Microsoft SharePoint server (Windows only)
-  Evernote (Windows only)
-  Google Drive
-  SugarSync

You see the Transfer Settings window.



6. Enter any required information to set up the destination. If you have previously created a saved setting for the destination, select it from the drop-down list.
7. Adjust any save settings, then click **OK** or **Send**, depending on the destination.

Your originals are scanned and uploaded to the indicated server.

Parent topic: [Scanning Special Projects](#)

Saving a Scan as an Office Format File - Windows

You can use Document Capture Pro (Windows) to save your scans in one of the following Microsoft Office file formats: Microsoft Word (.docx), Microsoft Excel (.xlsx), or Microsoft PowerPoint (.pptx).

1. Load your original in the scanner.
2. Do one of the following to start Document Capture Pro:
 - **Windows 10:** Click  and select **All Apps > Epson Software > Document Capture Pro**.
 - **Windows 8.x:** Navigate to the **Apps** screen and select **Document Capture Pro**.
 - **Windows (other versions):** Click  or **Start**, and select **All Programs** or **Programs**. Select **EPSON Software > Document Capture Pro**.

You see this window:

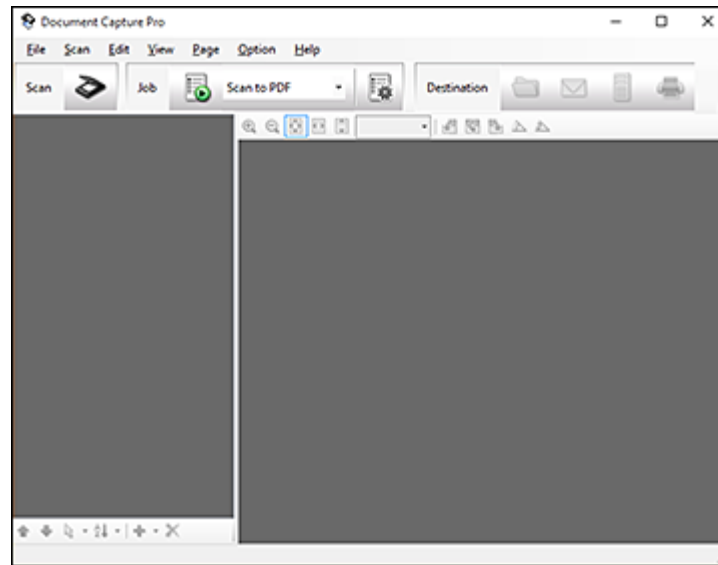

3. Click the  **Scan** icon.
4. Select any displayed scan settings you want to use.

Note: See the Help information in Document Capture Pro for details.

5. Click **Scan**.
You see a preview of your scan in the Document Capture Pro window.
6. Click one of the Destination icons to choose where to send your scanned files. (If you cannot see all of the icons below, click the arrow next to the icons.)



You see the Batch Save or Transfer Settings window.

7. Select the Office format file you want to save your scan as from the **File Type** drop-down list.

8. Click **Options** to display a new window with additional settings.
9. Select any additional settings as necessary, and click **OK**.
10. Confirm your settings and click **OK** or **Send**.

Your originals are saved in the Office file format you selected.

Parent topic: [Scanning Special Projects](#)

Related topics

[Placing Originals on the Scanner](#)

Cleaning and Transporting Your Scanner

See these sections if you need to clean or transport your scanner.

[Cleaning Your Scanner](#)

[Cleaning the ADF](#)

[Transporting Your Scanner](#)

Cleaning Your Scanner

To keep your product working at its best, you should clean it several times a year.

Caution: Do not use a hard brush, alcohol, or paint thinner to clean the product or you may damage it. Do not use oil or other lubricants inside the product or let water get inside it. Do not open the product case. Do not press the surface of the scanner glass with any force and be careful not to scratch or damage the scanner glass. A damaged glass surface can decrease the scan quality.

1. Turn off the scanner using the  power button.
2. Unplug the AC power cord.
3. Disconnect the USB cable.
4. Clean the outer case with a cloth dampened with mild detergent and water.
5. If the scanner glass gets dirty, clean it with a soft, dry cloth. If the glass surface is stained with grease or some other hard-to-remove material, use a small amount of glass cleaner on a soft cloth to remove it. Wipe off all remaining liquid.

Note: Do not spray glass cleaner directly on the scanner glass. Make sure that no dust builds up on the surface of the scanner glass. Dust can cause spots in your scanned images.

Parent topic: [Cleaning and Transporting Your Scanner](#)

Cleaning the ADF

Clean the ADF if you experience paper feed or scanned image quality problems, or you see a message on your computer telling you to clean it.

Caution: Do not use a hard brush, alcohol, or paint thinner to clean the product or you may damage it. Do not use oil or other lubricants inside the product or let water get inside it. Do not open the product

case. Do not press the surface of the scanner glass with any force and be careful not to scratch or damage the scanner glass. A damaged glass surface can decrease the scan quality.

1. Open the ADF cover.

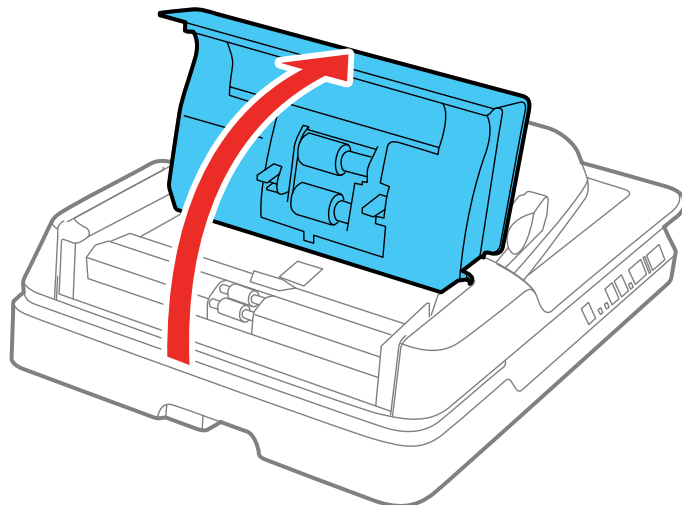

2. Use a soft, dry, lint-free cloth (microfiber is recommended) to clean the rollers.

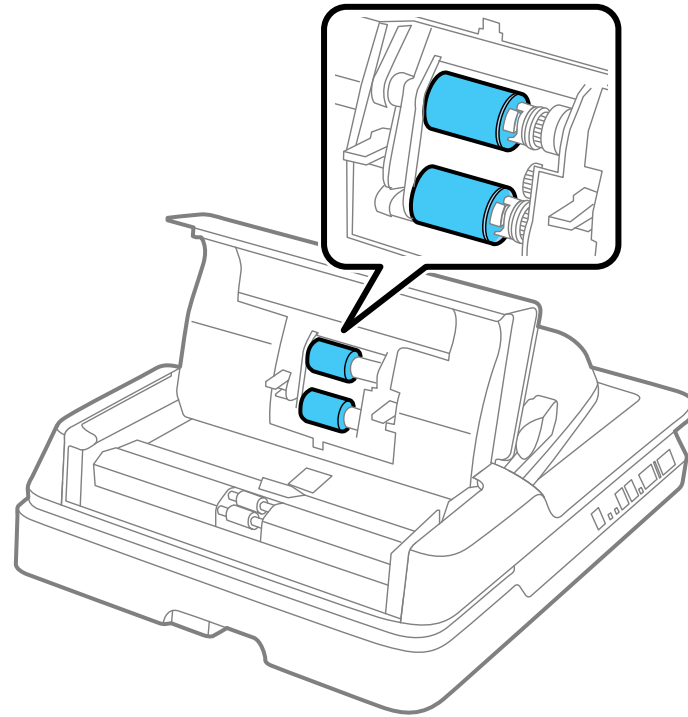

3. Close the ADF cover.

4. Open the ADF.

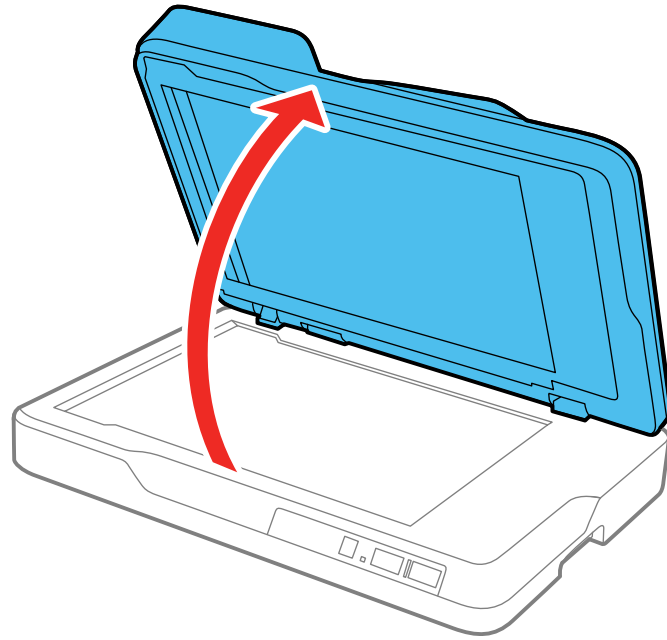

5. Press the tabs on the document mat and remove the mat.

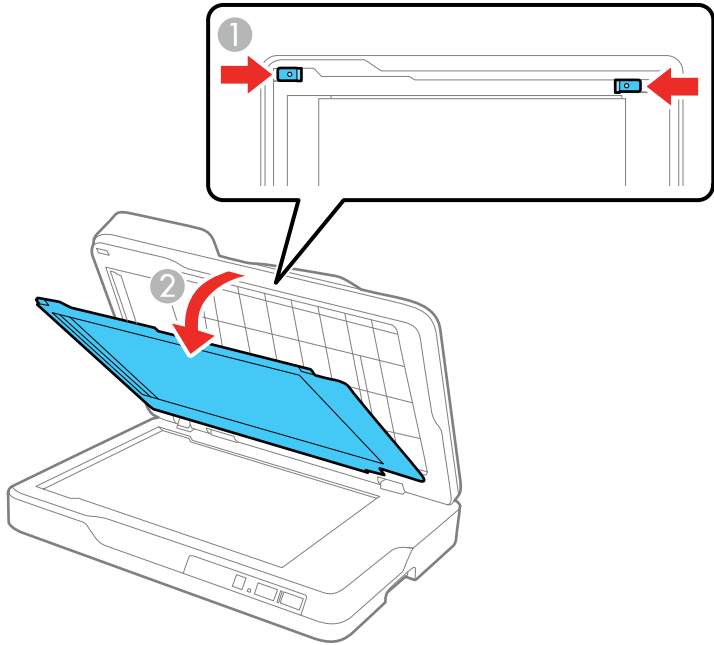

6. Use a soft, dry, lint-free cloth (microfiber is recommended) to clean both sides of the clear portion of the document mat.

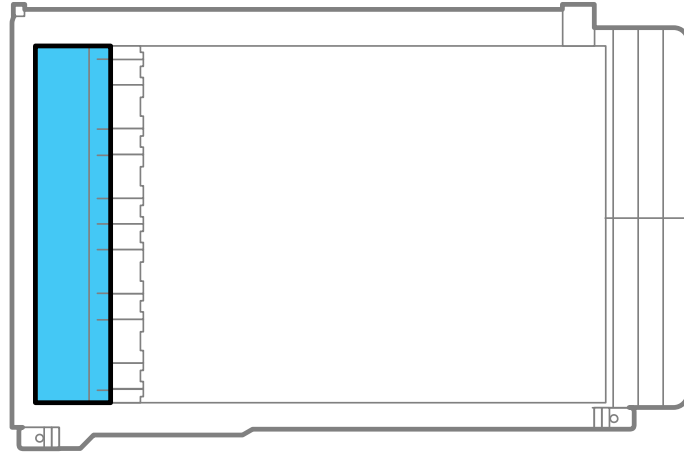

Caution: Do not wipe the clear portion with too much force or you may damage it.

7. Slide the notches on the base of the document mat into the scanner lid and push the top tabs into place until they click.

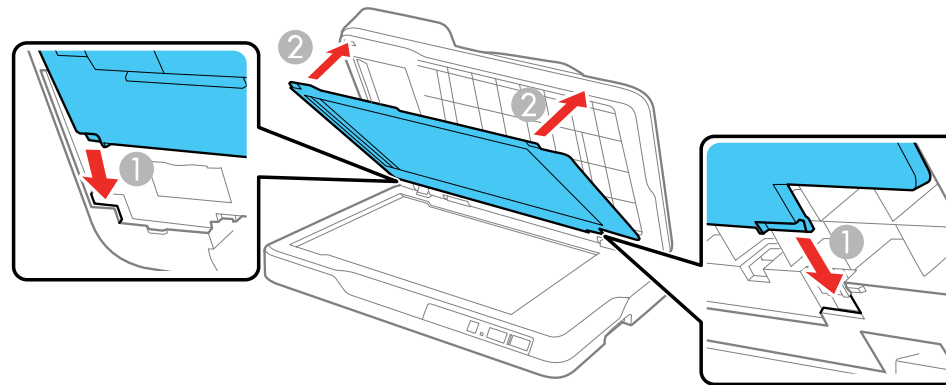

8. Close the ADF.

Parent topic: [Cleaning and Transporting Your Scanner](#)

Transporting Your Scanner

If you need to ship your product, transport it a long distance, or store it for an extended period, prepare it for transportation as described here.

1. Remove any originals from the scanner.
2. Turn off the scanner using the  power button.
3. Unplug the AC power cord.
4. Disconnect the USB cable.
5. Place the scanner in its original packing materials if possible, or use equivalent materials with cushioning around the scanner.

Caution: When carrying the scanner, hold it from the bottom on both sides. Avoid tilting the scanner, or the ADF may open and cause injury.

Parent topic: [Cleaning and Transporting Your Scanner](#)

Solving Problems

Check these sections for solutions to problems you may have using your product.

[Scanner Light Status](#)

[Solving Scanning Problems](#)

[Solving Original Document Feeding Problems](#)

[Solving Scanned Image Quality Problems](#)

[Uninstall Your Scanner Software](#)

[Where to Get Help](#)

Scanner Light Status

You can often diagnose problems with your scanner by checking its lights.

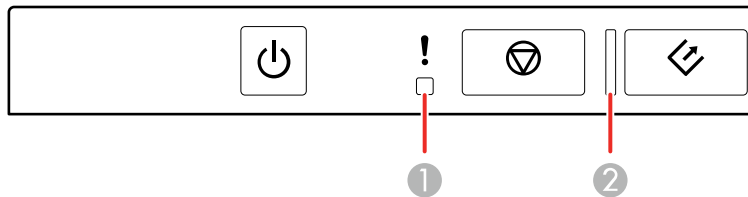

1 ! error light

2 ready light

Light status	Condition/solution
! error light is flashing slowly	A paper jam has occurred. Open the ADF cover and remove any jammed originals. Close the cover to clear the error and load your originals again.
! error and ready lights are flashing fast	A fatal error has occurred. Turn the product off and then back on again. If the error continues, contact Epson for support.
! error light is on ready light is off	The firmware update has failed and the scanner is in recovery mode. Connect your product using a USB cable and try updating the firmware again. If the error continues, contact Epson for support.

Parent topic: [Solving Problems](#)

Related references

[Originals Jam in the Automatic Document Feeder](#)

[Where to Get Help](#)

Solving Scanning Problems

Check these solutions if you have problems scanning with your product.

[Scanner Does Not Turn On or Turns Off Unexpectedly](#)

[Start Button Does Not Work as Expected](#)

[Scanning Software Does Not Operate Correctly](#)

[Cannot Start Epson Scan 2](#)

[Scanning is Slow](#)

Parent topic: [Solving Problems](#)

Scanner Does Not Turn On or Turns Off Unexpectedly

If the scanner does not turn on or if it turns off unexpectedly, try these solutions:

- Make sure the power cord is securely connected to the scanner and to a working electrical outlet.
- If the scanner turns off unexpectedly, you may need to adjust the **Power Off Timer** setting.

Parent topic: [Solving Scanning Problems](#)

Related tasks

[Changing the Power Off and Sleep Timer Settings](#)

Start Button Does Not Work as Expected

If the  start button does not start the correct program or perform the correct action, try these solutions:

- Make sure the scanner is securely connected to your computer.
- Make sure Epson Scan 2 is installed correctly.
- Make sure Document Capture Pro (Windows) or Document Capture (Mac OS X) is installed correctly.
- Make sure the correct settings were assigned to the scanner button in Document Capture Pro (Windows) or Document Capture (Mac OS X).

Parent topic: [Solving Scanning Problems](#)

Related tasks

[Assigning Start Button Settings or Scan Jobs](#)

Scanning Software Does Not Operate Correctly

If your scanning software does not operate correctly, try these solutions:

- Make sure your computer has adequate memory and meets the system requirements for your operating system.
- Make sure your computer is not running in a power-saving mode, such as sleep or standby. If so, wake your system and restart your scanning software.
- Make sure the scanner is turned on.
- Make sure the connection between the scanner and your computer is secure.
- If you upgraded your operating system but did not reinstall your scanning software, try reinstalling it.
- If you connected the scanner using a USB cable, make sure it is connected directly to your computer or through only one USB hub.
- If you are using a TWAIN-compliant program, make sure that the correct product is selected as the **Scanner** or **Source** setting.
- If you are using the scanner with the optional Network Interface Unit, make sure the network cable is securely connected.

Parent topic: [Solving Scanning Problems](#)

Related references

[Windows System Requirements](#)

[Mac System Requirements](#)

Cannot Start Epson Scan 2

If you cannot start Epson Scan 2, try these solutions:

- Make sure your scanner is turned on and any interface cables are securely connected at both ends.
- Make sure Epson Scan 2 is selected in your scanning program.
- Make sure your computer is not running in a power-saving mode, such as sleep or standby. If so, wake your system and restart Epson Scan 2.
- If you connected the scanner using a USB cable, make sure it is connected directly to your computer or through only one USB hub.

- Make sure you do not have multiple versions of Epson Scan 2 installed. If you do, uninstall all versions and install one version.
- If you are using the scanner with the optional Network Interface Unit, make sure the network cable is securely connected.
- If you upgraded your operating system but did not reinstall Epson Scan 2, try reinstalling it.
- If you are using a TWAIN-compliant program, make sure that the correct product is selected as the **Scanner** or **Source** setting.

Parent topic: [Solving Scanning Problems](#)

Related concepts

[Uninstall Your Scanner Software](#)

Scanning is Slow

If scanning becomes slow, try these solutions:

- Scan your original at a lower resolution, if possible.
- Make sure your system meets the requirements for your operating system. If you are scanning a high-resolution image, you may need more than the minimum requirements. If necessary, increase your system's memory.
- If scanning becomes slower after scanning continuously with the ADF for a long time, the scanner may have automatically slowed down to protect the scanner mechanism from overheating or becoming damaged. Let the scanner rest with the power on for 30 minutes, then try scanning again.
- If you are running virus protection or other security software, exclude the TWAIN.log files from monitoring or set the TWAIN.log file as read only. See your virus protection or security software instructions for details. The TWAIN.log file is saved in the following locations:
 - **Windows XP:** C:\Documents and Settings\\Local Settings\Temp
 - **Windows (other versions):** C:\Users\\AppData\Local\Temp

Parent topic: [Solving Scanning Problems](#)

Related references

[Windows System Requirements](#)

[Mac System Requirements](#)

Solving Original Document Feeding Problems

Check these solutions if you have problems feeding originals through your product.

[Originals Do Not Feed From the Automatic Document Feeder](#)

[Originals Jam in the Automatic Document Feeder](#)

Parent topic: [Solving Problems](#)

Originals Do Not Feed From the Automatic Document Feeder

If your originals do not feed when placed in the ADF, try these solutions:

- Make sure the size, weight, and number of your originals are supported by the ADF.
- Make sure the originals are loaded correctly.
- Try cleaning the inside of the ADF.

Parent topic: [Solving Original Document Feeding Problems](#)

Related references

[Original Document Specifications for the ADF](#)

Related tasks

[Cleaning the ADF](#)

Related topics

[Placing Originals on the Scanner](#)

Originals Jam in the Automatic Document Feeder

If your originals jam in the ADF, follow the steps here to clear the jam.

1. Remove your originals from the input tray.
2. Raise the ADF cover and remove any jammed originals.

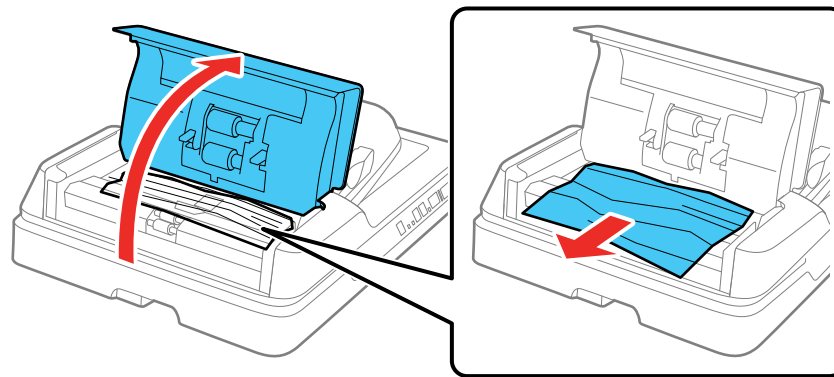

3. If you cannot remove the originals, make sure the ADF cover is open and raise the ADF.

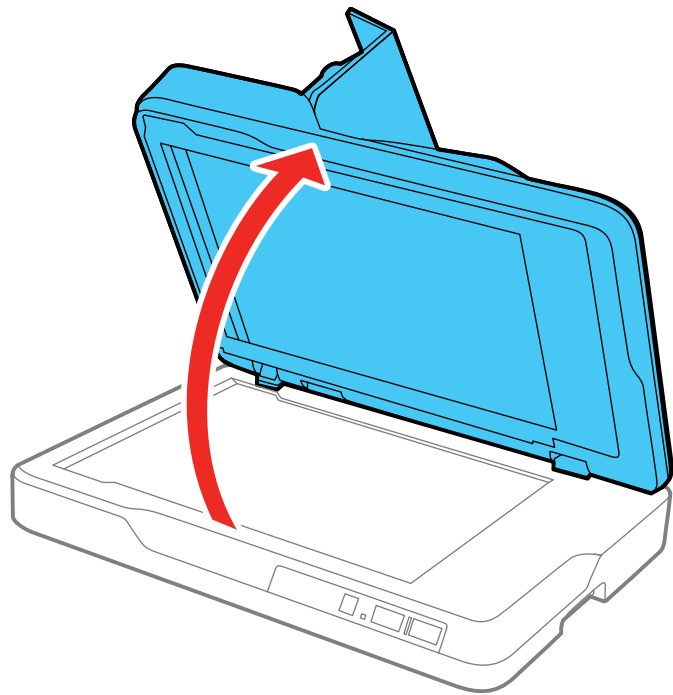

4. Press the tabs on the document mat and remove the mat.

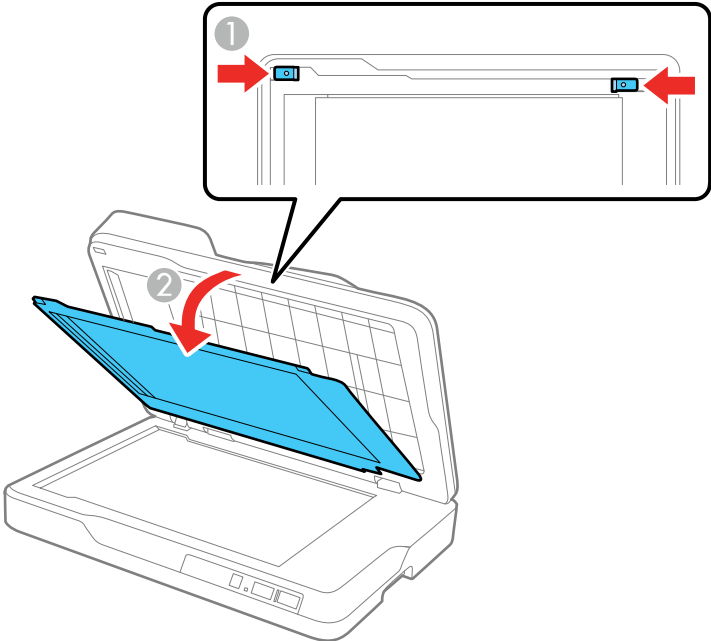

5. Carefully remove any jammed originals.

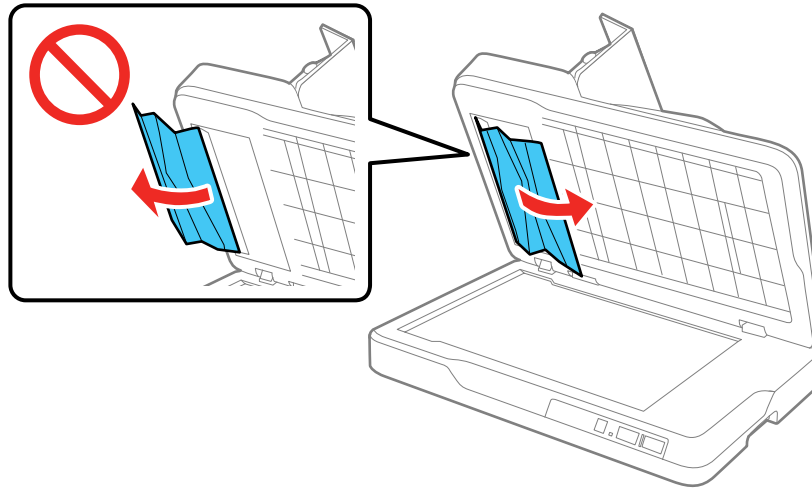

6. Slide the notches on the base of the document mat into the scanner lid and push the top tabs into place until they click.

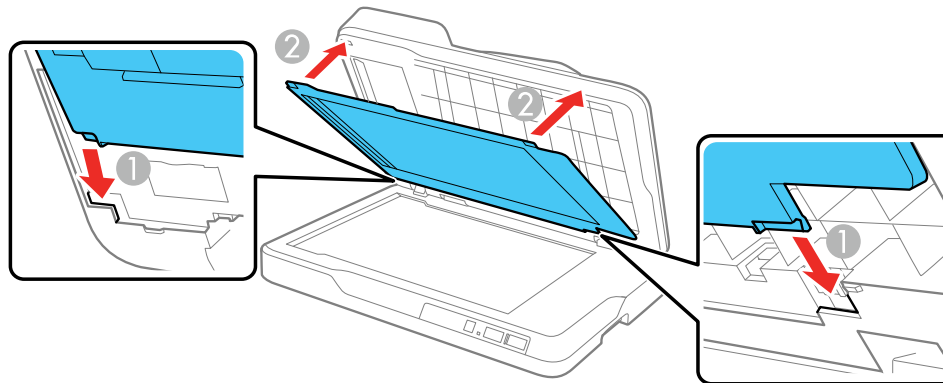

7. Close the ADF, then close the ADF cover.

8. Reload your originals.

Caution: Make sure your originals meets the specifications for the ADF before loading them.

Parent topic: [Solving Original Document Feeding Problems](#)

Related references

[Original Document Specifications for the ADF](#)

Related topics

[Placing Originals on the Scanner](#)

Solving Scanned Image Quality Problems

Check these sections if a scanned image on your computer screen has a quality problem.

[Image Consists of a Few Dots Only](#)

[Line of Dots Appears in All Scanned Images](#)

[Straight Lines in an Image Appear Crooked](#)

[Image is Distorted or Blurry](#)

[Image Colors are Patchy at the Edges](#)

[Image is Too Dark](#)

[Back of Original Image Appears in Scanned Image](#)

[Characters are not Recognized During Conversion to Editable Text \(OCR\)](#)

[Binding Margins on a Scanned Booklet are Blurry](#)

[Ripple Patterns Appear in an Image](#)

[Scanned Image Colors Do Not Match Original Colors](#)

[Scanned Image Edges are Cropped](#)

[Resetting the Epson Scan 2 Settings](#)

Parent topic: [Solving Problems](#)

Image Consists of a Few Dots Only

If your scanned image consists only of a few dots, try these solutions:

- Make sure you placed your original for scanning facing the correct way.
- If you are scanning using the Epson Scan 2 **Black & White** setting, adjust the **Threshold** setting and scan again.

Parent topic: [Solving Scanned Image Quality Problems](#)

Related references

[Additional Scanning Settings - Advanced Settings Tab](#)

Related topics

[Placing Originals on the Scanner](#)

Line of Dots Appears in All Scanned Images

If a line of dots appears in all your scanned images, clean the scanner glass with a soft, dry, lint-free cloth or use a small amount of glass cleaner on the cloth, if necessary. Paper towels are not recommended.

Caution: Do not spray glass cleaner directly on the scanner glass.

Parent topic: [Solving Scanned Image Quality Problems](#)

Related tasks

[Cleaning Your Scanner](#)

Straight Lines in an Image Appear Crooked

If straight lines in an original appear crooked in a scanned image, make sure to place your original straight when you scan it.

If you are scanning from the ADF, try cleaning the ADF and scan again.

Parent topic: [Solving Scanned Image Quality Problems](#)

Related tasks

[Cleaning the ADF](#)

Related topics

[Placing Originals on the Scanner](#)

Image is Distorted or Blurry

If a scanned image appears distorted or blurry, try these solutions:

- Make sure your original is not wrinkled or warped. This may prevent the original from laying flat on the scanner glass.
- Do not move your original or your product during scanning.
- Your product will not operate properly while tilted at an angle. Place your product on a flat, stable surface that extends beyond its base in all directions.

- Adjust these Epson Scan 2 settings (if available) and try scanning again:
 - Increase the **Resolution** setting.
 - If the **Image Type** setting is **Black & White**, adjust the **Threshold** setting.
 - Select the **Unsharp Mask** setting.
 - If the **Image Type** setting is **Black & White**, select **Text Enhancement**. If the **Image Type** setting is **Color** or **Grayscale**, change the **Text Enhancement** setting to **High**.

Parent topic: [Solving Scanned Image Quality Problems](#)

Related references

[Additional Scanning Settings - Advanced Settings Tab](#)

Related tasks

[Scanning in Epson Scan 2](#)

Image Colors are Patchy at the Edges

If you are scanning a thick or warped original, cover its edges with paper to block external light as you scan it.

Parent topic: [Solving Scanned Image Quality Problems](#)

Image is Too Dark

If your scanned image is too dark, try these solutions:

- Select the **Advanced Settings** tab in Epson Scan 2 and adjust the **Brightness** setting.
- Check the brightness and contrast settings of your computer monitor.

Parent topic: [Solving Scanned Image Quality Problems](#)

Related references

[Additional Scanning Settings - Advanced Settings Tab](#)

Back of Original Image Appears in Scanned Image

If an image from the back of a thin original appears in your scanned image, try these solutions:

- Place a piece of black paper on the back of the original and scan it again.
- Adjust these Epson Scan 2 settings (if available) and try scanning again:
 - Select the **Advanced Settings** tab and adjust the **Brightness** setting.
 - Select **Text Enhancement**.

Parent topic: [Solving Scanned Image Quality Problems](#)

Related references

[Additional Scanning Settings - Advanced Settings Tab](#)

Characters are not Recognized During Conversion to Editable Text (OCR)

If characters in your scanned images are not recognized during OCR conversion, try these solutions:

- Make sure your original is placed straight.
- Use an original with clear text.
- Adjust these Epson Scan 2 settings (if available) and try scanning again:
 - Select the correct **Image Type** setting.
 - Select or adjust the **Text Enhancement** setting.
 - Adjust the **Threshold** setting.
 - Select the correct **Text Language** setting.
- Set the scanning resolution between 200 and 600 dpi.
- If you are using OCR software, check the manual for any additional adjustments.

Parent topic: [Solving Scanned Image Quality Problems](#)

Related references

[Additional Scanning Settings - Advanced Settings Tab](#)

Related tasks

[Scanning in Epson Scan 2](#)

Related topics

[Placing Originals on the Scanner](#)

Binding Margins on a Scanned Booklet are Blurry

When scanning a booklet on the scanner glass, characters may appear distorted or blurred on the binding margin. If this occurs, the characters may not be recognized correctly when you save the scanned image as a searchable PDF.

To decrease distortion or blurring, gently press down on the document cover to flatten the booklet while scanning.

Caution: Do not press down on the document cover with too much force, or you may damage the booklet or scanner.

Parent topic: [Solving Scanned Image Quality Problems](#)

Ripple Patterns Appear in an Image

You may see a ripple pattern (called a moiré) in scanned images of printed documents. This is caused by interference from differing pitches in the scanner's screen and your original's halftone screen. To reduce this effect, adjust these Epson Scan 2 settings (if available) and try scanning again:

- Select the **Descreening** setting.
- Select a lower **Resolution** setting.

Parent topic: [Solving Scanned Image Quality Problems](#)

Related references

[Additional Scanning Settings - Advanced Settings Tab](#)

Related tasks

[Scanning in Epson Scan 2](#)

Scanned Image Colors Do Not Match Original Colors

Printed colors can never exactly match the colors on your computer monitor because printers and monitors use different color systems: monitors use RGB (red, green, and blue) and printers typically use CMYK (cyan, magenta, yellow, and black).

Check the color matching and color management capabilities of your computer, display adapter, and the software you are using to see if they are affecting the palette of colors you see on your screen.

To adjust the colors in your scanned image, adjust these Epson Scan 2 settings (if available) and try scanning again:

- If the **Image Type** setting is **Color** or **Grayscale**, adjust the **Contrast** setting.
- If the **Image Type** setting is **Black & White** or **Grayscale**, adjust the **Color Enhance** setting.

Parent topic: [Solving Scanned Image Quality Problems](#)

Related references

[Additional Scanning Settings - Advanced Settings Tab](#)

Scanned Image Edges are Cropped

If the edges of a scanned image are cropped, make sure your original is placed correctly for scanning. If necessary, move your original away from the edges of the scanner glass slightly.



Parent topic: [Solving Scanned Image Quality Problems](#)

Related topics

[Placing Originals on the Scanner](#)

Resetting the Epson Scan 2 Settings

If you continue to experience image quality problems after trying all possible solutions, you may need to reset the Epson Scan 2 Settings using the Epson Scan 2 Utility.

1. Do one of the following to start the Epson Scan 2 Utility:
 - **Windows 10:** Click  and select **All apps > EPSON > Epson Scan 2 Utility**.
 - **Windows 8.x:** Navigate to the **Apps** screen and select **Epson Scan 2 Utility**.
 - **Windows (other versions):** Click  or **Start**, and select **All Programs** or **Programs**. Select **EPSON > Epson Scan 2 > Epson Scan 2 Utility**.
 - **OS X:** Open the **Applications** folder, open the **Epson Software** folder, and select **Epson Scan 2 Utility**.
2. Click the **Other** tab.
3. Click **Reset**.

Note: If resetting the Epson Scan 2 settings does not solve your problem, uninstall Epson Scan 2 and re-install it.

Parent topic: [Solving Scanned Image Quality Problems](#)

Related concepts

[Uninstall Your Scanner Software](#)

Uninstall Your Scanner Software

If you have a problem that requires you to uninstall and re-install your software, follow the instructions for your operating system.

[Uninstalling Scanner Software - Windows](#)

[Uninstalling Scanner Software - OS X](#)

Parent topic: [Solving Problems](#)

Uninstalling Scanner Software - Windows

You can uninstall and then re-install your scanner software to solve certain problems.

1. Turn off the scanner.
2. Disconnect any interface cables.
3. Do the following to uninstall each of your scanning software programs, then follow any on-screen instructions:
 - **Windows 10:** Right-click  and select **Control Panel > Programs > Programs and Features**. Select the scanner software program and click **Uninstall/Change**.
 - **Windows 8.x:** Navigate to the **Apps** screen and select **Control Panel > Programs > Programs and Features**. Select the scanner software program and click **Uninstall/Change**.
 - **Windows 7 or Windows Vista:** Open the Windows **Control Panel** utility. Select **Programs and Features**. (In Classic view, select **Programs** and click **Uninstall a program**.) Select the scanner software program and click **Uninstall/Change**.
 - **Windows XP:** Open the Windows **Control Panel** utility. Double-click **Add or Remove Programs**. Select the scanner software program and click **Change/Remove**.
4. Restart your computer, then see the *Start Here* sheet to re-install your software.

Note: If you find that re-installing your scanner software does not solve a problem, contact Epson.

Parent topic: [Uninstall Your Scanner Software](#)

Uninstalling Scanner Software - OS X

In most cases, you do not need to uninstall your scanner software before re-installing it. However, you can download the Uninstaller utility from the Epson support website to uninstall your scanner software as described here.

1. To download the Uninstaller utility, visit the Epson download site ([U.S. downloads](#) or [Canadian downloads](#)).
2. Follow the instructions on the screen to install the Uninstaller utility.
3. Quit all applications currently running on your Mac.
4. Double-click the **Uninstaller** icon.

5. In the Epson Uninstaller screen, select the checkbox for each software program you want to uninstall.
6. Click **Uninstall**.
7. Follow the on-screen instructions to uninstall the software.
8. To reinstall your scanner software, see the *Start Here* sheet for instructions.

Note: If you find that re-installing your scanner software does not solve a problem, contact Epson.

Parent topic: [Uninstall Your Scanner Software](#)

Where to Get Help

If you need to contact Epson for technical support services, use the following support options.

Internet Support

Visit Epson's support website at epson.com/support (U.S.) or epson.ca/support (Canada) for solutions to common problems. You can download drivers and documentation, get FAQs and troubleshooting advice, or email Epson with your questions.

Speak to a Support Representative

Before you call Epson for support, please have the following information ready:

- Product name
- Product serial number (located on a label on the product)
- Proof of purchase (such as a store receipt) and date of purchase
- Computer configuration
- Description of the problem

Then call:

- U.S.: (562) 276-4382, 6 AM to 8 PM, Pacific Time, Monday through Friday, and 7 AM to 4 PM, Pacific Time, Saturday
- Canada: (905) 709-3839, 6 AM to 8 PM, Pacific Time, Monday through Friday, and 7 AM to 4 PM, Pacific Time, Saturday

Days and hours of support are subject to change without notice. Toll or long distance charges may apply.

Note: For help using any other software on your system, see the documentation for that software for technical support.

Purchase Supplies and Accessories

You can purchase genuine Epson accessories at epson.com (U.S. sales) or epson.ca (Canadian sales). You can also purchase accessories from an Epson authorized reseller. To find the nearest one, call 800-GO-EPSON (800-463-7766).

Parent topic: [Solving Problems](#)

Technical Specifications

These sections list the technical specifications for your scanner.

Note: Epson offers a recycling program for end of life Epson products. Please go to [this site](#) for information on how to return your Epson products for proper disposal.

[Windows System Requirements](#)

[Mac System Requirements](#)

[General Specifications](#)

[Dimension Specifications](#)

[Electrical Specifications](#)

[Environmental Specifications](#)

[Safety and Approvals Specifications](#)

Windows System Requirements

To use your product and its software, your computer should use one of these Microsoft operating systems:

- Windows 10
- Windows 8.x
- Windows 7

Parent topic: [Technical Specifications](#)

Mac System Requirements

To use your product and its software, your Mac should use one of these operating systems:

- OS X 10.11.x
- OS X 10.10.x
- OS X 10.9.x
- OS X 10.8.x
- OS X 10.7.x
- OS X 10.6.8

Note: The UNIX File System (UFS) and Fast User Switching is not supported.

Parent topic: [Technical Specifications](#)

General Specifications

Scanner type	Flatbed color with ADF
Photoelectric device	CIS
Document size	ADF double-sided: Maximum: 8.5 × 11.7 inches (216 × 297 mm) Minimum: 3.5 × 6.7 inches (89 × 170 mm) ADF single-sided: Maximum: 8.5 × 15.5 inches (216 × 394 mm) Minimum: 3.5 × 5.0 inches (89 × 127 mm) ADF single-sided long paper mode (300 dpi): Maximum: 8.5 × 120.0 inches (216 × 3048 mm) Minimum: 3.5 × 15.5 inches (89 × 394 mm) Scanner glass: Maximum: 8.5 × 11.7 inches (216 × 297 mm)
Paper input	Faceup loading
Paper output	Facedown ejection
Paper capacity	50 sheets of paper at 21 lb (80 g/m ²) weight
Scanning resolution	ADF: 600 dpi (main scan), 600 dpi (sub scan) Scanner glass: 1200 dpi (main scan), 2400 dpi (sub scan)
Output resolution	ADF: 50 to 600 dpi for scans between 5.0 to 15.5 inches (127 to 394 mm) long; 50 to 300 dpi for scans between 15.5 inches to 120.0 inches (394 to 3048 mm) long Scanner glass: 50 to 1200 dpi (in 1 dpi increments)

Image data	Color: 30 bits per pixel internal (10 bits per pixel per color internal) 24 bits per pixel external (8 bits per pixel per color external) Grayscale: 10 bits per pixel internal 8 bits per pixel external Black and white: 10 bits per pixel internal 1 bits per pixel external
Interface	One USB 3.0 (SuperSpeed) Type B port
Light source	RGB LED

Parent topic: [Technical Specifications](#)

Dimension Specifications

Height	4.8 inches (121 mm)
Width	17.7 inches (450 mm)
Depth	12.5 inches (318 mm)
Weight	9.0 lb (4.1 kg)

Note: Dimensions do not include projecting parts.

Parent topic: [Technical Specifications](#)

Electrical Specifications

Note: Check the label on the scanner for voltage information. Power consumption varies depending on operating conditions or whether an option is installed.

Power supply rating	100 to 240 V
	220 to 240 V

Rated frequency range	50 to 60 Hz
Rated current	100 to 240 V model: 0.3 to 0.2 A 220 to 240 V model: 0.2 A
Power consumption (100 to 240 V model)	Operating: Approximately 11 W Ready mode: Approximately 5.8 W Sleep mode: Approximately 0.8 W Power off mode: Approximately 0.15 W
Power consumption (220 to 240 V model)	Operating: Approximately 11 W Ready mode: Approximately 6.2 W Sleep mode: Approximately 0.9 W Power off mode: Approximately 0.25 W

Parent topic: [Technical Specifications](#)

Environmental Specifications

Temperature	Operating: 50 to 95 °F (10 to 35 °C) Storage: -4 to 140 °F (-20 to 60 °C)
Humidity (non-condensing)	Operating: 20 to 80% RH Storage: 20 to 80% RH
Operating conditions	Ordinary office or home conditions

Note: Avoid operating the scanner in direct sunlight, near a strong light source, or in extremely dusty conditions.

Parent topic: [Technical Specifications](#)

Safety and Approvals Specifications

United States	Safety: UL60950-1 EMC: FCC part 15 Subpart B class B
----------------------	---

Canada

Safety: CAN/CSA C22.2 No. 60950-1

EMC: CAN/CSA-CEI/IEC CISPR 22 Class B

Parent topic: [Technical Specifications](#)

Notices

Check these sections for important notices about your scanner.

Note: Epson offers a recycling program for end of life Epson products. Please go to [this site](#) for information on how to return your Epson products for proper disposal.

[Important Safety Instructions](#)

[Restrictions on Copying](#)

[Default Delay Times for Power Management for Epson Products](#)

[Binding Arbitration and Class Waiver](#)

[Trademarks](#)

[Copyright Notice](#)

Important Safety Instructions

Follow these safety instructions when setting up and using the scanner:

- Read all these instructions, and follow all warnings and instructions marked on the scanner.
- Place the scanner close enough to the computer for the interface cable to reach it easily.
- Do not use with wet hands.
- When connecting this product to a computer or other device with a cable, ensure the correct orientation of the connectors. Each connector has only one correct orientation. Inserting a connector in the wrong orientation may damage both devices connected by the cable.
- Do not insert objects into any opening as they may touch dangerous voltage points or short out parts. Beware of electrical shock hazards.
- Place the product on a flat, stable surface that extends beyond the base of the product in all directions. If you place the product by the wall, leave at least 3.9 inches (10 cm) between the back of the product and the wall.
- After replacing consumable parts, dispose of them correctly following the rules of your local authority. Do not disassemble them.
- Do not place heavy objects on the scanner glass and do not press down on the glass with too much force.

- Do not place or store the scanner outdoors, in a car, near excessive dirt or dust, water, heat sources, or in locations subject to shocks, vibrations, condensation, high temperature or humidity, direct sunlight, strong light sources, or rapid changes in temperature or humidity.
- Never disassemble, modify, or attempt to repair the scanner or a scanner option by yourself except as specifically explained in this guide.

Power cord

- Place the scanner near an electrical outlet where the power cord can be easily unplugged.
- The power cord should be placed to avoid abrasions, cuts, fraying, crimping, and kinking.
- Do not place objects on top of the power cord and do not allow the cord to be stepped on or run over. Be particularly careful to keep the power cord straight at the end.
- Avoid using outlets on the same circuit as photocopiers or air control systems that regularly switch on and off.
- Unplug the scanner and the power cord, and refer servicing to qualified service personnel under the following conditions: The power cord or plug is damaged; liquid has entered the scanner; the scanner has been dropped or the case has been damaged; the scanner does not operate normally or exhibits a distinct change in performance. (Do not adjust controls that are not covered by the operating instructions.)
- Unplug the scanner before cleaning. Clean with a damp cloth only. Do not use liquid or aerosol cleaners.
- If you are not going to use the scanner for a long period, be sure to unplug the power cord from the electrical outlet.

Parent topic: [Notices](#)

Restrictions on Copying

Observe the following restrictions to ensure responsible and legal use of your scanner.

Copying of the following items is prohibited by law:

- Bank bills, coins, government-issued marketable securities, government bond securities, and municipal securities
- Unused postage stamps, pre-stamped postcards, and other official postal items bearing valid postage
- Government-issued revenue stamps, and securities issued according to legal procedure

Exercise caution when copying the following items:

- Private marketable securities (stock certificates, negotiable notes, checks, etc.), monthly passes, concession tickets, etc.
- Passports, driver's licenses, warrants of fitness, road passes, food stamps, tickets, etc.

Note: Copying these items may also be prohibited by law.

Restriction on disassembling and decompiling

You may not disassemble, decompile or otherwise attempt to derive the source code of any software included with this product.

Parent topic: [Notices](#)

Default Delay Times for Power Management for Epson Products

This product will enter sleep mode after a period of nonuse. This is to ensure that the product meets Energy Star standards of energy efficiency. More energy savings can be achieved by setting the time to sleep to a shorter interval.

Parent topic: [Notices](#)

Binding Arbitration and Class Waiver

1. DISPUTES, BINDING INDIVIDUAL ARBITRATION, AND WAIVER OF CLASS ACTIONS AND CLASS ARBITRATIONS

1.1 Disputes. The terms of this Section 1 shall apply to all Disputes between you and Epson. The term "Dispute" is meant to have the broadest meaning permissible under law and includes any dispute, claim, controversy or action between you and Epson arising out of or relating to this Agreement, Epson branded products (hardware and including any related software), or other transaction involving you and Epson, whether in contract, warranty, misrepresentation, fraud, tort, intentional tort, statute, regulation, ordinance, or any other legal or equitable basis. "DISPUTE" DOES NOT INCLUDE IP CLAIMS, or more specifically, a claim or cause of action for (a) trademark infringement or dilution, (b) patent infringement, (c) copyright infringement or misuse, or (d) trade secret misappropriation (an "IP Claim"). You and Epson also agree, notwithstanding Section 1.6, that a court, not an arbitrator, may decide if a claim or cause of action is for an IP Claim.

1.2 Binding Arbitration. You and Epson agree that all Disputes shall be resolved by binding arbitration according to this Agreement. **ARBITRATION MEANS THAT YOU WAIVE YOUR RIGHT TO A JUDGE OR JURY IN A COURT PROCEEDING AND YOUR GROUNDS FOR APPEAL ARE LIMITED.**

Pursuant to this Agreement, binding arbitration shall be administered by JAMS, a nationally recognized

arbitration authority, pursuant to its code of procedures then in effect for consumer related disputes, but excluding any rules that permit joinder or class actions in arbitration (for more detail on procedure, see Section 1.6 below). You and Epson understand and agree that (a) the Federal Arbitration Act (9 U.S.C. §1, et seq.) governs the interpretation and enforcement of this Section 1, (b) this Agreement memorializes a transaction in interstate commerce, and (c) this Section 1 shall survive termination of this Agreement.

1.3 Pre-Arbitration Steps and Notice. Before submitting a claim for arbitration, you and Epson agree to try, for sixty (60) days, to resolve any Dispute informally. If Epson and you do not reach an agreement to resolve the Dispute within the sixty (60) days, you or Epson may commence an arbitration. Notice to Epson must be addressed to: Epson America, Inc., ATTN: Legal Department, 3840 Kilroy Airport Way, Long Beach, CA 90806 (the "Epson Address"). The Dispute Notice to you will be sent to the most recent address Epson has in its records for you. For this reason, it is important to notify us if your address changes by emailing us at EAlegal@ea.epson.com or writing us at the Epson Address above. Notice of the Dispute shall include the sender's name, address and contact information, the facts giving rise to the Dispute, and the relief requested (the "Dispute Notice"). Following receipt of the Dispute Notice, Epson and you agree to act in good faith to resolve the Dispute before commencing arbitration.

1.4 Small Claims Court. Notwithstanding the foregoing, you may bring an individual action in the small claims court of your state or municipality if the action is within that court's jurisdiction and is pending only in that court.

1.5 WAIVER OF CLASS ACTIONS AND CLASS ARBITRATIONS. YOU AND EPSON AGREE THAT EACH PARTY MAY BRING DISPUTES AGAINST THE OTHER PARTY ONLY IN AN INDIVIDUAL CAPACITY, AND NOT AS A PLAINTIFF OR CLASS MEMBER IN ANY CLASS OR REPRESENTATIVE PROCEEDING, INCLUDING WITHOUT LIMITATION FEDERAL OR STATE CLASS ACTIONS, OR CLASS ARBITRATIONS. CLASS ACTION LAWSUITS, CLASS-WIDE ARBITRATIONS, PRIVATE ATTORNEY-GENERAL ACTIONS, AND ANY OTHER PROCEEDING WHERE SOMEONE ACTS IN A REPRESENTATIVE CAPACITY ARE NOT ALLOWED. ACCORDINGLY, UNDER THE ARBITRATION PROCEDURES OUTLINED IN THIS SECTION, AN ARBITRATOR SHALL NOT COMBINE OR CONSOLIDATE MORE THAN ONE PARTY'S CLAIMS WITHOUT THE WRITTEN CONSENT OF ALL AFFECTED PARTIES TO AN ARBITRATION PROCEEDING.

1.6 Arbitration Procedure. If you or Epson commences arbitration, the arbitration shall be governed by the rules of JAMS that are in effect when the arbitration is filed, excluding any rules that permit arbitration on a class or representative basis (the "JAMS Rules"), available at <http://www.jamsadr.com> or by calling 1-800-352-5267, and under the rules set forth in this Agreement. All Disputes shall be resolved by a single neutral arbitrator, and both parties shall have a reasonable opportunity to participate in the selection of the arbitrator. The arbitrator is bound by the terms of this Agreement. The arbitrator, and not any federal, state or local court or agency, shall have exclusive authority to resolve all disputes arising out of or relating to the interpretation, applicability, enforceability or formation of this Agreement, including any claim that all or any part of this Agreement is void or voidable. Notwithstanding this broad

delegation of authority to the arbitrator, a court may determine the limited question of whether a claim or cause of action is for an IP Claim, which is excluded from the definition of "Disputes" in Section 1.1 above. The arbitrator shall be empowered to grant whatever relief would be available in a court under law or in equity. The arbitrator may award you the same damages as a court could, and may award declaratory or injunctive relief only in favor of the individual party seeking relief and only to the extent necessary to provide relief warranted by that party's individual claim. In some instances, the costs of arbitration can exceed the costs of litigation and the right to discovery may be more limited in arbitration than in court. The arbitrator's award is binding and may be entered as a judgment in any court of competent jurisdiction.

You may choose to engage in arbitration hearings by telephone. Arbitration hearings not conducted by telephone shall take place in a location reasonably accessible from your primary residence, or in Orange County, California, at your option.

a) Initiation of Arbitration Proceeding. If either you or Epson decides to arbitrate a Dispute, both parties agree to the following procedure:

(i) Write a Demand for Arbitration. The demand must include a description of the Dispute and the amount of damages sought to be recovered. You can find a copy of a Demand for Arbitration at <http://www.jamsadr.com> ("Demand for Arbitration").

(ii) Send three copies of the Demand for Arbitration, plus the appropriate filing fee, to: JAMS, 500 North State College Blvd., Suite 600 Orange, CA 92868, U.S.A.

(iii) Send one copy of the Demand for Arbitration to the other party (same address as the Dispute Notice), or as otherwise agreed by the parties.

b) Hearing Format. During the arbitration, the amount of any settlement offer made shall not be disclosed to the arbitrator until after the arbitrator determines the amount, if any, to which you or Epson is entitled. The discovery or exchange of non-privileged information relevant to the Dispute may be allowed during the arbitration.

c) Arbitration Fees. Epson shall pay, or (if applicable) reimburse you for, all JAMS filings and arbitrator fees for any arbitration commenced (by you or Epson) pursuant to provisions of this Agreement.

d) Award in Your Favor. For Disputes in which you or Epson seeks \$75,000 or less in damages exclusive of attorney's fees and costs, if the arbitrator's decision results in an award to you in an amount greater than Epson's last written offer, if any, to settle the Dispute, Epson will: (i) pay you \$1,000 or the amount of the award, whichever is greater; (ii) pay you twice the amount of your reasonable attorney's fees, if any; and (iii) reimburse you for any expenses (including expert witness fees and costs) that your attorney reasonably accrues for investigating, preparing, and pursuing the Dispute in arbitration. Except as agreed upon by you and Epson in writing, the arbitrator shall determine the amount of fees, costs, and expenses to be paid by Epson pursuant to this Section 1.6d).

e) Attorney's Fees. Epson will not seek its attorney's fees and expenses for any arbitration commenced involving a Dispute under this Agreement. Your right to attorney's fees and expenses under Section

1.6d) above does not limit your rights to attorney's fees and expenses under applicable law; notwithstanding the foregoing, the arbitrator may not award duplicative awards of attorney's fees and expenses.

1.7 Opt-out. You may elect to opt-out (exclude yourself) from the final, binding, individual arbitration procedure and waiver of class and representative proceedings specified in this Agreement by sending a written letter to the Epson Address within thirty (30) days of your assent to this Agreement (including without limitation the purchase, download, installation of the Software or other applicable use of Epson Hardware, products and services) that specifies (i) your name, (ii) your mailing address, and (iii) your request to be excluded from the final, binding individual arbitration procedure and waiver of class and representative proceedings specified in this Section 1. In the event that you opt-out consistent with the procedure set forth above, all other terms shall continue to apply, including the requirement to provide notice prior to litigation.

1.8 Amendments to Section 1. Notwithstanding any provision in this Agreement to the contrary, you and Epson agree that if Epson makes any future amendments to the dispute resolution procedure and class action waiver provisions (other than a change to Epson's address) in this Agreement, Epson will obtain your affirmative assent to the applicable amendment. If you do not affirmatively assent to the applicable amendment, you are agreeing that you will arbitrate any Dispute between the parties in accordance with the language of this Section 1 (or resolve disputes as provided for in Section 1.7, if you timely elected to opt-out when you first assented to this Agreement).

1.9 Severability. If any provision in this Section 1 is found to be unenforceable, that provision shall be severed with the remainder of this Agreement remaining in full force and effect. **The foregoing shall not apply to the prohibition against class or representative actions as provided in Section 1.5. This means that if Section 1.5 is found to be unenforceable, the entire Section 1 (but only Section 1) shall be null and void.**

Parent topic: [Notices](#)

Trademarks

EPSON® is a registered trademark, and EPSON Exceed Your Vision is a registered logomark of Seiko Epson Corporation.

Mac and OS X are trademarks of Apple Inc., registered in the U.S. and other countries.

Google® is a registered trademark and Google Drive™ is a trademark of Google Inc.

General Notice: Other product names used herein are for identification purposes only and may be trademarks of their respective owners. Epson disclaims any and all rights in those marks.



Parent topic: [Notices](#)

Copyright Notice

All rights reserved. No part of this publication may be reproduced, stored in a retrieval system, or transmitted in any form or by any means, electronic, mechanical, photocopying, recording, or otherwise, without the prior written permission of Seiko Epson Corporation. The information contained herein is designed only for use with this Epson product. Epson is not responsible for any use of this information as applied to other products.

Neither Seiko Epson Corporation nor its affiliates shall be liable to the purchaser of this product or third parties for damages, losses, costs, or expenses incurred by purchaser or third parties as a result of: accident, misuse, or abuse of this product or unauthorized modifications, repairs, or alterations to this product, or (excluding the U.S.) failure to strictly comply with Seiko Epson Corporation's operating and maintenance instructions.

Seiko Epson Corporation shall not be liable for any damages or problems arising from the use of any options or any consumable products other than those designated as Original Epson Products or Epson Approved Products by Seiko Epson Corporation.

Seiko Epson Corporation shall not be held liable for any damage resulting from electromagnetic interference that occurs from the use of any interface cables other than those designated as Epson approved Products by Seiko Epson Corporation.

This information is subject to change without notice.

[Open Source Software License](#)

[libTIFF Software Acknowledgment](#)

[A Note Concerning Responsible Use of Copyrighted Materials](#)

[Copyright Attribution](#)

Parent topic: [Notices](#)

Open Source Software License

1) This product includes open source software programs according to the license terms of each open source software program.

2) The open source software programs are WITHOUT ANY WARRANTY; without even the implied warranty of MERCHANTABILITY AND FITNESS FOR A PARTICULAR PURPOSE. See the license agreements of each open source software program for more details, which are described below.

SHA1 License

Copyright (C) The Internet Society (2001). All Rights Reserved.

This document and translations of it may be copied and furnished to others, and derivative works that comment on or otherwise explain it or assist in its implementation may be prepared, copied, published and distributed, in whole or in part, without restriction of any kind, provided that the above copyright notice and this paragraph are included on all such copies and derivative works. However, this document itself may not be modified in any way, such as by removing the copyright notice or references to the Internet Society or other Internet organizations, except as needed for the purpose of developing Internet standards in which case the procedures for copyrights defined in the Internet Standards process must be followed, or as required to translate it into languages other than English. The limited permissions granted above are perpetual and will not be revoked by the Internet Society or its successors or assigns.

This document and the information contained herein is provided on an "AS IS" basis and THE INTERNET SOCIETY AND THE INTERNET ENGINEERING TASK FORCE DISCLAIMS ALL WARRANTIES, EXPRESS OR IMPLIED, INCLUDING BUT NOT LIMITED TO ANY WARRANTY THAT THE USE OF THE INFORMATION HEREIN WILL NOT INFRINGE ANY RIGHTS OR ANY IMPLIED WARRANTIES OF MERCHANTABILITY OR FITNESS FOR A PARTICULAR PURPOSE.

Info-ZIP License

This is version 2007-Mar-4 of the Info-ZIP license. The definitive version of this document should be available at <ftp://ftp.info-zip.org/pub/infozip/license.html> indefinitely and a copy at <http://www.info-zip.org/pub/infozip/license.html>.

Copyright (c) 1990-2007 Info-ZIP. All rights reserved.

For the purposes of this copyright and license, "Info-ZIP" is defined as the following set of individuals:

Mark Adler, John Bush, Karl Davis, Harald Denker, Jean-Michel Dubois, Jean-loup Gailly, Hunter Goatley, Ed Gordon, Ian Gorman, Chris Herborth, Dirk Haase, Greg Hartwig, Robert Heath, Jonathan Hudson, Paul Kienitz, David Kirschbaum, Johnny Lee, Onno van der Linden, Igor Mandrichenko, Steve P. Miller, Sergio Monesi, Keith Owens, George Petrov, Greg Roelofs, Kai Uwe Rommel, Steve Salisbury, Dave Smith, Steven M. Schweda, Christian Spieler, Cosmin Truta, Antoine Verheijen, Paul von Behren, Rich Wales, Mike White.

This software is provided "as is," without warranty of any kind, express or implied. In no event shall Info-ZIP or its contributors be held liable for any direct, indirect, incidental, special or consequential damages arising out of the use of or inability to use this software.

Permission is granted to anyone to use this software for any purpose, including commercial applications, and to alter it and redistribute it freely, subject to the above disclaimer and the following restrictions:

1. Redistributions of source code (in whole or in part) must retain the above copyright notice, definition, disclaimer, and this list of conditions.
2. Redistributions in binary form (compiled executables and libraries) must reproduce the above copyright notice, definition, disclaimer, and this list of conditions in documentation and/or other materials provided with the distribution. The sole exception to this condition is redistribution of a standard

UnZipSFX binary (including SFXWiz) as part of a self-extracting archive; that is permitted without inclusion of this license, as long as the normal SFX banner has not been removed from the binary or disabled.

3. Altered versions--including, but not limited to, ports to new operating systems, existing ports with new graphical interfaces, versions with modified or added functionality, and dynamic, shared, or static library versions not from Info-ZIP--must be plainly marked as such and must not be misrepresented as being the original source or, if binaries, compiled from the original source. Such altered versions also must not be misrepresented as being Info-ZIP releases--including, but not limited to, labeling of the altered versions with the names "Info-ZIP" (or any variation thereof, including, but not limited to, different capitalizations), "Pocket UnZip," "WiZ" or "MacZip" without the explicit permission of Info-ZIP. Such altered versions are further prohibited from misrepresentative use of the Zip-Bugs or Info-ZIP e-mail addresses or the Info-ZIP URL(s), such as to imply Info-ZIP will provide support for the altered versions.

4. Info-ZIP retains the right to use the names "Info-ZIP," "Zip," "UnZip," "UnZipSFX," "WiZ," "Pocket UnZip," "Pocket Zip," and "MacZip" for its own source and binary releases.

Parent topic: [Copyright Notice](#)

libTIFF Software Acknowledgment

Copyright © 1988-1997 Sam Leffler

Copyright © 1991-1997 Silicon Graphics, Inc.

Permission to use, copy, modify, distribute, and sell this software and its documentation for any purpose is hereby granted without fee, provided that (i) the above copyright notices and this permission notice appear in all copies of the software and related documentation, and (ii) the names of Sam Leffler and Silicon Graphics may not be used in any advertising or publicity relating to the software without the specific, prior written permission of Sam Leffler and Silicon Graphics.

THE SOFTWARE IS PROVIDED "AS-IS" AND WITHOUT WARRANTY OF ANY KIND, EXPRESS, IMPLIED OR OTHERWISE, INCLUDING WITHOUT LIMITATION, ANY WARRANTY OF MERCHANTABILITY OR FITNESS FOR A PARTICULAR PURPOSE.

IN NO EVENT SHALL SAM LEFFLER OR SILICON GRAPHICS BE LIABLE FOR ANY SPECIAL, INCIDENTAL, INDIRECT OR CONSEQUENTIAL DAMAGES OF ANY KIND, OR ANY DAMAGES WHATSOEVER RESULTING FROM LOSS OF USE, DATA OR PROFITS, WHETHER OR NOT ADVISED OF THE POSSIBILITY OF DAMAGE, AND ON ANY THEORY OF LIABILITY, ARISING OUT OF OR IN CONNECTION WITH THE USE OR PERFORMANCE OF THIS SOFTWARE.

Parent topic: [Copyright Notice](#)

A Note Concerning Responsible Use of Copyrighted Materials

Epson encourages each user to be responsible and respectful of the copyright laws when using any Epson product. While some countries' laws permit limited copying or reuse of copyrighted material in certain circumstances, those circumstances may not be as broad as some people assume. Contact your legal advisor for any questions regarding copyright law.

Parent topic: [Copyright Notice](#)

Copyright Attribution

© 2016 Epson America, Inc.

7/16

CPD-51808

Parent topic: [Copyright Notice](#)