

PowerLite® Presenter



User's Guide



Copyright Notice

All rights reserved. No part of this publication may be reproduced, stored in a retrieval system, or transmitted in any form or by any means, electronic, mechanical, photocopying, recording, or otherwise, without the prior written permission of Seiko Epson Corporation. The information contained herein is designed only for use with this Epson product. Epson is not responsible for any use of this information as applied to other products.

Neither Seiko Epson Corporation nor its affiliates shall be liable to the purchaser of this product or third parties for damages, losses, costs, or expenses incurred by purchaser or third parties as a result of: accident, misuse, or abuse of this product or unauthorized modifications, repairs, or alterations to this product, or (excluding the U.S.) failure to strictly comply with Seiko Epson Corporation's operating and maintenance instructions.

Seiko Epson Corporation shall not be liable for any damages or problems arising from the use of any options or any consumable products other than those designated as Original Epson Products or Epson Approved Products by Seiko Epson Corporation.

Responsible Use

This unit is equipped with Macrovision copy protection. The intellectual property rights to the patent of this copy protection technology are owned by the Macrovision Company of America, and others. When employing this technology, a license is required from the Macrovision Company. The Macrovision Company does not authorize the use of this technology except for a limited range of intended purposes, including home use. Further, remodeling, disassembly, and reverse engineering are prohibited.

Reproduction of a disc for the purposes of broadcast, projection in public, public musical performance, or rental (regardless of compensation, remuneration, or lack thereof) without the permission of the copyright owner, is strictly prohibited. This publication and the features described herein are subject to change without notice.

Trademarks

EPSON and PowerLite are registered trademarks and EPSON Exceed Your Vision is a registered logomark of Seiko Epson Corporation.

PrivateLine and Accolade are registered trademarks, Duet is a trademark, and Extra Care is a service mark of Epson America, Inc.

General Notice: Other product names used herein are for identification purposes only and may be trademarks of their respective owners. Epson disclaims any and all rights in those marks.

This information is subject to change without notice.

Contents

Welcome	6
Registration and Warranty	6
Optional Accessories	7
About This Manual	8
PowerLite Presenter Parts and Controls	9
Important Safety Instructions	12
Unpacking and Setting Up	16
Unpacking	16
Choosing a Location	17
Setting Up PowerLite Presenter	19
Turning the Projector Off	20
Playing DVDs	21
Starting a DVD	21
Adjusting the Picture	22
Adjusting the Sound	23
Controlling Playback	24
Pausing	24
Searching (Fast Forward or Reverse)	25
Playing in Slow Motion	25
Skipping	25
Zooming In or Out	25
Using DVD Menus	26
Temporarily Stopping Audio	26
Adjusting the Color Mode	27
Adjusting the Sound and Audio Modes	27

Listening with Headphones	28
Connecting a Microphone	29
Using PowerLite Presenter with Other Equipment	30
Viewing Video from External Devices	30
Connecting a USB Device	33
Playing Projector Audio Through an External Audio System	34
Connecting a Computer or Laptop	35
Connecting to the USB Port	35
Connecting to the PC Port	37
Doing More with PowerLite Presenter	39
Playing Music and Viewing Photos	39
Playing Music CDs	39
Playing MP3/WMA Music	40
Viewing JPEG Photos	41
Using Advanced Playback Controls	42
Repeating a Chapter, Title, Track, or File	42
Changing the Play Sequence (Program Play)	43
Selecting Language, Subtitles, and Camera Angles	44
Using the Playback Information Screen	44
Customizing PowerLite Presenter	45
Locking DVDs	45
Locking the Power Button on the Control Panel	46
Locking the Projector	47
Saving Power	48
Changing Language Settings	48
Adjusting Picture Quality	49
Using the Others Setup Page	49
Adjusting Dolby Audio Settings	50

Setting Video and Other Options	50
Viewing Status Information and Resetting the Lamp Timer	52
Caring for Your PowerLite Presenter	53
Protecting PowerLite Presenter	53
Cleaning the Lens	53
Cleaning the Case	54
Cleaning and Replacing the Air Filter	54
Replacing the Lamp	56
Resetting the Lamp Timer	58
Storing PowerLite Presenter	59
Transporting PowerLite Presenter	60
Problem Solving	61
What To Do When the Lights Flash	61
Solving PowerLite Presenter Operation Problems	63
Solving Picture and Sound Problems	64
Problems with External Video Equipment	66
Where To Get Help	68
Internet Support	68
Speak to a Support Representative	68
Purchase Supplies and Accessories	68
Specifications	69
Index	75

Welcome

Your PowerLite Presenter is a portable, lightweight projector with a built-in DVD player and powerful speakers. From classrooms to boardrooms, your full-color presentations and videos will be bright and vibrant even in ordinary indoor lighting. You can connect the projector to a wide range of computers and video sources, as well as USB storage devices.

PowerLite Presenter offers these outstanding features:

- Widescreen viewing with native WXGA (1280 × 800) resolution and a 16:10 aspect ratio
- Up to 2500 lumens of White and Color Light Output (brightness), enough for viewing in daylight
- DVD player with Dolby® Digital and DTS®
- Built-in speakers with DTS digital surround sound
- Closed captioning
- Microphone input
- HDMI interface for connecting high-end video equipment.
- Long-life bulb providing up to 5000 hours of use
- USB plug and play connectivity for quick and easy setup
- Automatic digital keystone correction and automatic color mode

Registration and Warranty

Your PowerLite Presenter comes with a warranty that lets you project with confidence. For details, see the warranty brochure included with your projector.

In addition, Epson® offers free Extra CareSM Road Service during your warranty period. In the unlikely event of an equipment failure, you won't have to wait for your unit to be repaired. Instead, Epson will ship you a replacement unit anywhere in the United States or Canada. See the brochure included with your projector for details.

We encourage you to register your PowerLite Presenter. You can register using the CD that came in the box. Or you can register online at <http://www.epson.com/webreg>. Registering also lets you receive special updates on new accessories, products, and service.

Optional Accessories

Epson provides these replacement parts and optional accessories for the PowerLite Presenter:

Product	Part number
Replacement lamp (ELPLP55)	V13H010L55
Replacement air filter (ELPAF26)	V13H134A26
Kensington® security lock	ELPSL01
Accolade® Duet™ Ultra Portable Projection Screen	ELPSC80
ES1000 Ultra Portable Tabletop Projection Screen	V12H002S4Y
ES3000 Ultra Portable Projector Screen	V12H002S3Y
Portable Projection Screen 50"	ELPSC06
DC-11 Document Camera	V12H377020
DC-06 Document Camera	V12H321005
1-Year Extended Exchange Warranty	EPPEXPA1
2-Year Extended Exchange Warranty	EPPEXPA2

You can purchase accessories from an Epson authorized reseller. To find the nearest reseller, call 800-GO-EPSON (800-463-7766). Or you can purchase online at www.epsonstore.com (U.S. sales) or www.epson.ca (Canadian sales).

About This Manual

See the *Quick Setup* sheet to set up your PowerLite Presenter and start using it. This book contains information on using all the features of PowerLite Presenter, troubleshooting tips, and specifications.

Please follow these guidelines as you read through the manual:

Warnings: Must be followed carefully to avoid bodily injury.

Cautions: Must be observed to avoid damage to your equipment.

Notes: Contain important information about your equipment.

Tips: Contain helpful projection tips.

Need additional help? Visit Epson's [U.S. support website](#) or [Canadian support website](#) for solutions to common problems. You can download utilities and documentation, get FAQ's and troubleshooting advice, or e-mail Epson with your questions.

If you need more help, you can use the EPSON PrivateLine® Support service for the duration of your warranty period by calling (800) 637-7661.

PowerLite Presenter Parts and Controls

Front View

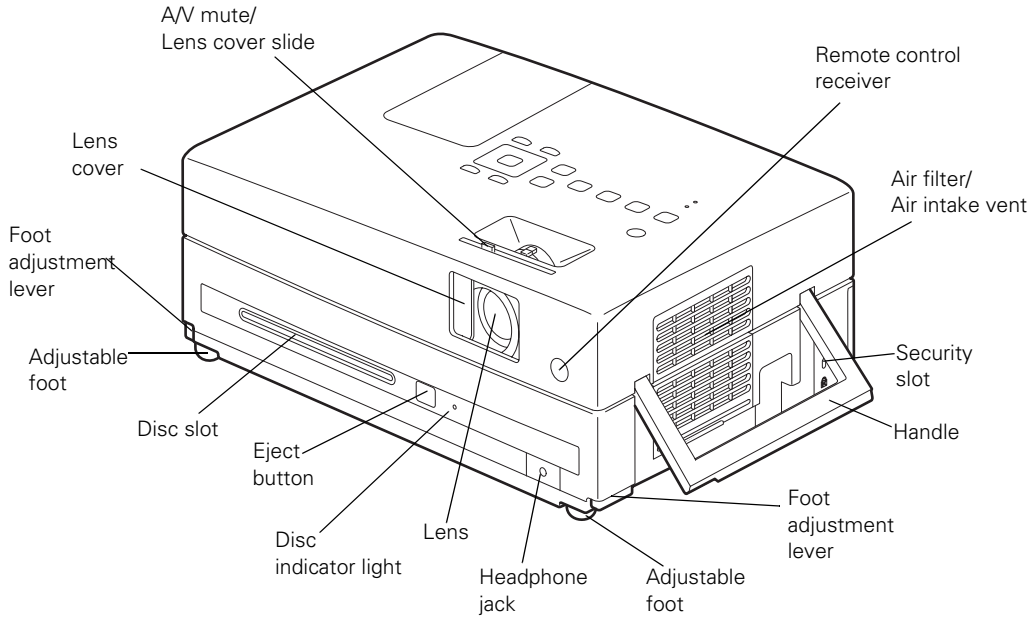

Back View

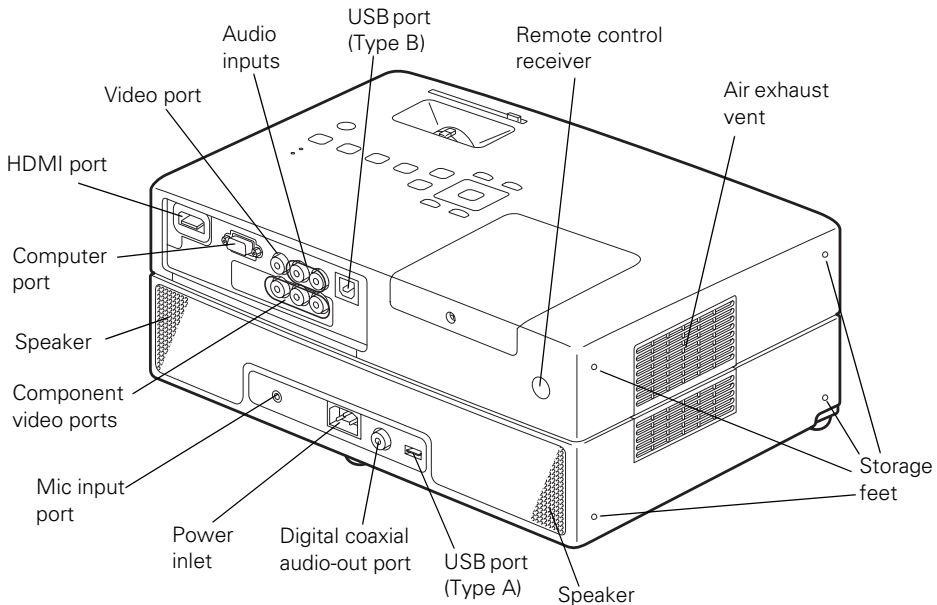

Top View

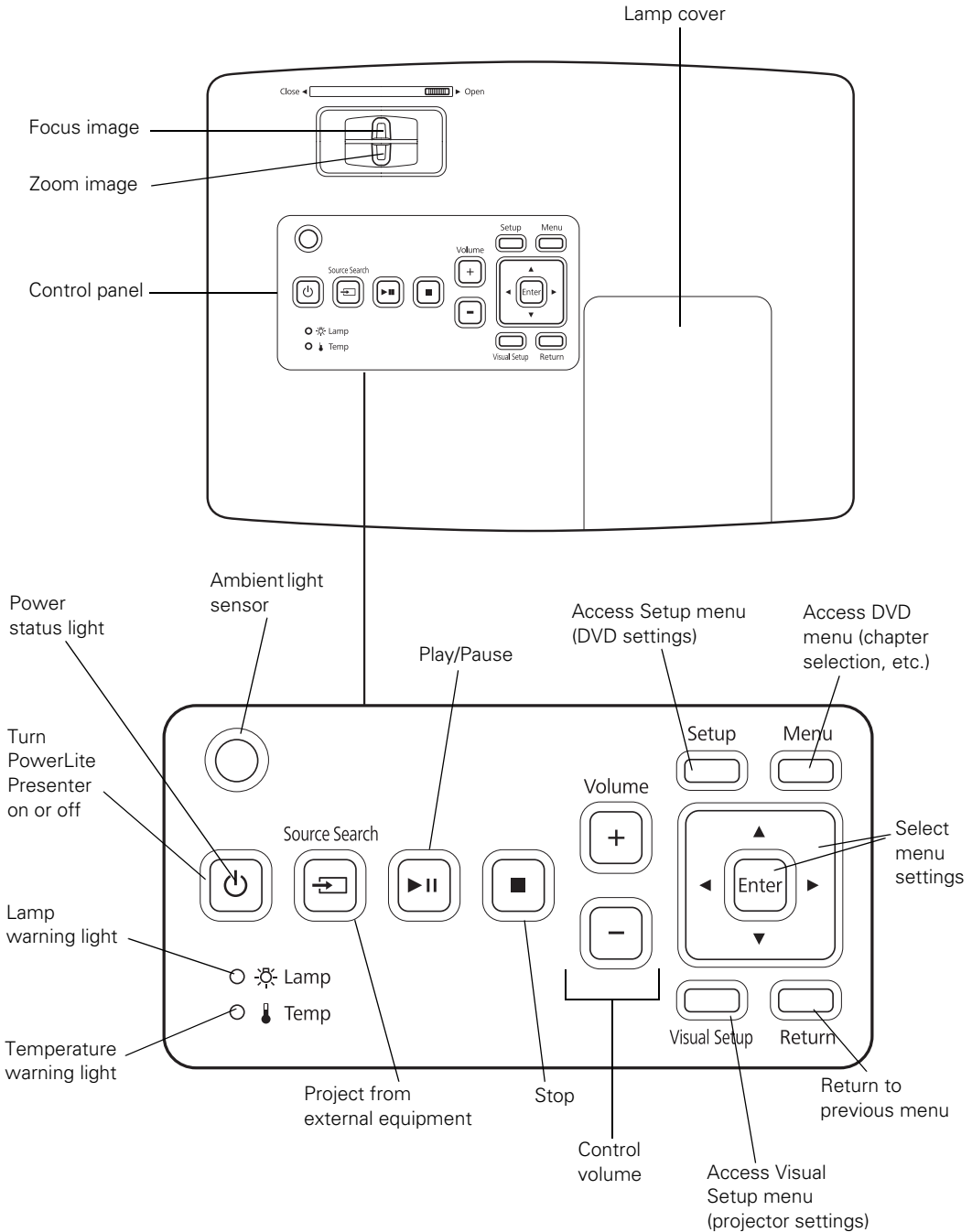

Remote Control

Note: The remote control buttons can glow in the dark. Expose the remote control to light for several minutes before using it in the dark.

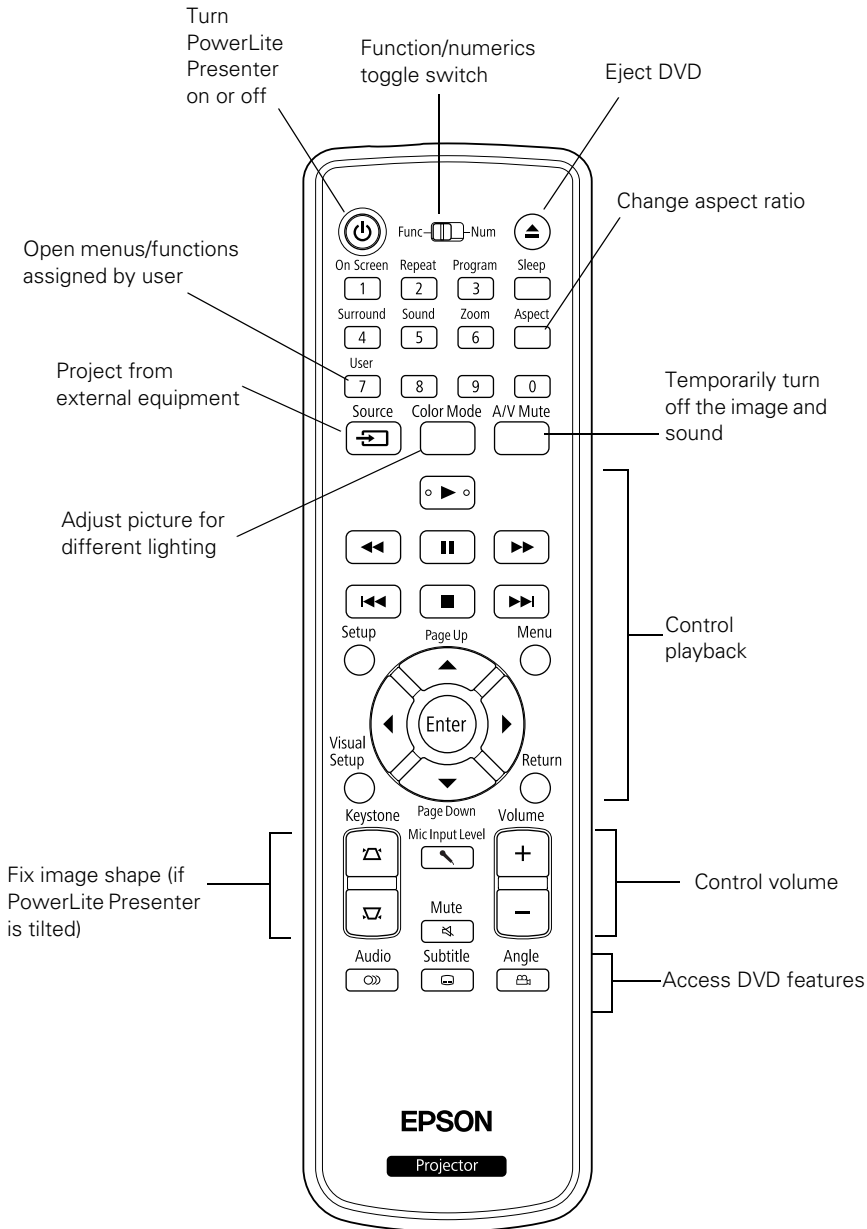

Important Safety Instructions

Follow these safety instructions when setting up and using your PowerLite Presenter:

- Except as specifically explained in this *User's Guide*, do not attempt to service this product yourself. Refer all servicing to qualified service personnel.
- Never open any cover on the projector, except the lamp and filter covers. Dangerous electrical voltages inside the projector can severely injure you.
- The projector's accessories come packaged in plastic bags. Keep plastic bags away from small children to avoid any risk of suffocation.
- Never look into the projector lens when the lamp is turned on; the bright light can damage your eyes. Never let children or pets look into the lens when it is on.
- Don't place the projector on an unstable cart, stand, or table. Also, don't stand on the projector or place heavy objects on it.
- Never push objects through the cabinet slots or spill liquid into the projector.
- Do not use the projector near water, or sources of heat or vibration. Do not expose it to rain or moisture.
- Do not move the unit during playback.
- Do not touch the projection lens with bare hands.
- Use a damp cloth for cleaning. Do not use liquid or aerosol cleaners. Do not use solvents such as alcohol, thinner, or benzine. Unplug the projector from the wall outlet before cleaning.
- Do not use the projector in places where flammable gases or explosive gases may be present in the atmosphere.
- Do not use the projector in places where there is excessive humidity or dust, near cooking or heating appliances, or in places where it may come into contact with smoke or steam. Do not use or store the projector outdoors for an extended length of time.
- Never try to remove the lamp immediately after use. Doing so will result in serious burns. Before removing the lamp, turn off the projector and wait approximately one hour for the lamp to cool completely.
- The lamp is fragile and can easily break. If the lamp breaks, handle the projector with extreme care to avoid injury from broken glass, and contact Epson to replace the lamp.
- Do not use the lamp after the lamp replacement period has elapsed, because the possibility of lamp breakage increases. When the lamp replacement message appears, replace the lamp with a new one as soon as possible.

- (Hg) The lamp(s) in this product contain mercury. Please consult your state and local regulations regarding disposal or recycling. Do not put in the trash.
- The lamp in this projector is under high internal pressure and may make a loud noise if it breaks. If it breaks, ventilate the room to prevent mercury gas inside the lamp from being inhaled or coming into contact with the eyes or mouth.
- Do not bring your face close to the projector while it is in use, to prevent burns from hot air leaving the exhaust vent, and to prevent inhaling or contact with the gases inside the lamp if it breaks.
- Do not place anything that can become warped or damaged by heat near the air exhaust vents.
- Do not place the projector near a flame.
- Before you move the projector, make sure it is turned off, the plug is disconnected from the outlet, and all cables are disconnected.
- If the lamp breaks and gas from the lamp or fragments of broken glass are inhaled or get into the eyes or mouth, or if any other ill effects are noticed, immediately seek medical advice.
- Do not disassemble or damage the lamp or subject it to any impacts.
- Use the type of power source indicated on the projector. If you're not sure of the power available, consult the power company.
- If you use the projector in a country other than where you purchased it, use the correct power cord for that country.
- Place the projector near a wall outlet where the plug can be easily unplugged.
- Don't place the projector where the cord can be walked on. This may result in fraying or damage to the plug.
- Do not bend, twist, or pull the power cable excessively, and do not place heavy objects on top of the power cable.
- Do not modify the power cable.
- Keep the power cable away from hot electrical appliances.
- Do not pull the power cable when disconnecting the plug. Always be sure to hold the plug when disconnecting it.
- Don't insert the plug into an outlet with dust present, and insert the plug firmly into the outlet. Failure to do so could result in sparks or fire.
- Don't handle the plug with wet hands.

- Don't overload wall outlets, extension cords, or integral convenience receptacles. This can cause fire or electric shock.
- Unplug the projector from the wall outlet and refer servicing to qualified service personnel under the following conditions: when the power cord or plug is damaged or frayed; if liquid has been spilled into the projector, or if it has been exposed to rain, water, or excessive humidity; if smoke, unusual smells, or unusual noises come from the projector; if it doesn't operate normally when you follow the operating instructions, or if it exhibits a distinct change in performance, indicating a need for service; if it has been dropped or the housing has been damaged.
- If there is an electrical storm, do not touch the power plug, otherwise you may receive an electric shock.
- Keep the projector unplugged during electrical storms and when the projector is not in use for extended periods.
- Keep the batteries for the remote control out of the reach of children. Batteries are choking hazards and can be very dangerous if swallowed. If they are swallowed, seek medical attention immediately.
- Replace the batteries as soon as they run out.
- Do not expose batteries to heat or flame and do not put them in water.
- Dispose of used batteries according to local regulations.
- Remove the batteries if you won't be using the projector for an extended period.
- Insert batteries so that the polarities are correct, and do not mix new and old batteries.
- Do not use batteries other than those specified in this *User's Guide*.
- Don't block the slots and openings in the projector case. They provide ventilation and prevent the projector from overheating. Don't operate the projector on a sofa, rug, or other soft surface, or in a closed-in cabinet unless proper ventilation is provided.
- Don't leave the projector or remote control on top of heat-producing equipment or in a heated place, such as a car.
- Don't use the projector outside of the required temperature range (41 to 95 °F [5 to 35 °C]). Doing so may cause an unstable display and could lead to projector damage.
- Don't store the projector outside of the required temperature range (14 to 140 °F [-10 to 60 °C]) or in direct sunlight for long periods of time. Doing so may cause damage to the case.
- Make sure there is at least 8 inches of space between the exhaust ventilation slots and the wall or other object.

- Make sure there is at least 4 inches of space between the intake ventilation slots and the wall or other object.
- Avoid projecting a high-contrast still image for more than 15 minutes to prevent burn-in. If this happens, project a bright screen until the burn-in disappears (from 30 to 60 minutes). If you can't eliminate the burn-in, contact Epson as described on page 68.
- Do not turn the volume too high, especially when using headphones. Listening to high volume sounds over an extended period can damage your hearing. Sudden high volume can also damage the speakers.

WARNING: The cords included with this product contain chemicals, including lead, known to the State of California to cause birth defects or other reproductive harm. *Wash hands after handling.* (This notice is provided in accordance with Proposition 65 in Cal. Health & Safety Code § 25249.5 and following.)

Unpacking and Setting Up

Follow these instructions to unpack your projector, choose a location, and set up your projector.

Unpacking

Make sure you have all the parts shown here:

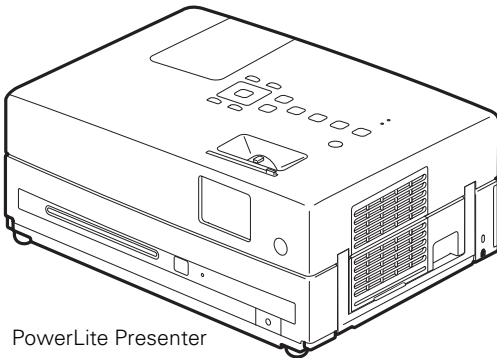

PowerLite Presenter

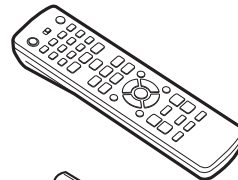

Remote control and
2 AA Batteries

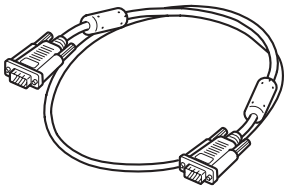

VGA computer cable

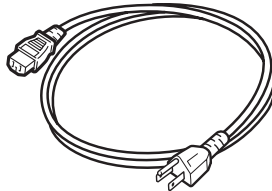

Power cord



Password
Protected
sticker

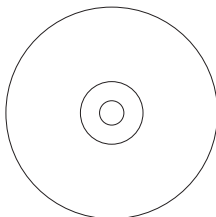

CD with *User's Guide* and
electronic registration

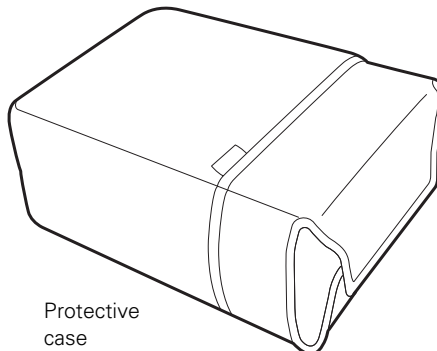

Protective
case

Choosing a Location

You can use your PowerLite Presenter just about anywhere—in the classroom or conference room, on a tabletop, desktop, or cart.

Your projector should be directly in front of the screen, facing straight ahead (at a 90-degree angle to the surface).

If the image is too low, you can raise it by extending the feet and tilting the projector up. This causes the image to lose its rectangular shape, but the projector will correct it automatically. If necessary, you can adjust the shape using the keystone buttons on the remote control or the Visual Setup menu. See page 22 for instructions.

The farther you place the projector from the screen, the larger the image will be.

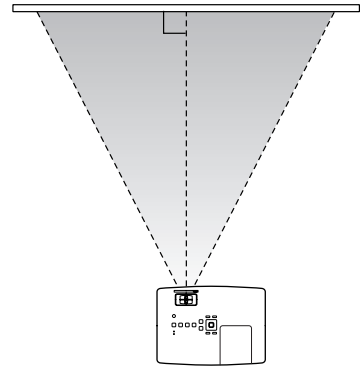

The following tables list the distances required for various image sizes (measured diagonally). Note that the zoom adjustment also affects image size.

Wide screen aspect ratio (16:10)

Image size (diagonal)	Projection distance
33 in.	3.0 to 3.6 ft. (0.91 to 1.1 meters)
40 in.	3.6 to 4.4 ft. (1.1 to 1.3 meters)
50 in.	4.6 to 5.5 ft. (1.4 to 1.7 meters)
60 in.	5.5 to 6.6 ft. (1.7 to 2.0 meters)
80 in.	7.4 to 8.9 ft. (2.3 to 2.7 meters)
100 in.	9.2 to 11.1 ft. (2.8 to 3.4 meters)
150 in.	13.9 to 16.7 ft. (4.2 to 5.1 meters)
200 in.	18.6 to 22.3 ft. (5.7 to 6.8 meters)
320 in.	29.8 to 35.7 ft. (9.1 to 10.9 meters)

Standard aspect ratio (4:3)

Image size (diagonal)	Projection distance
29 in.	3 to 3.6 ft. (0.9 to 1.1 meters)
30 in.	3.1 to 3.7 ft. (0.9 to 1.1 meters)

Standard aspect ratio (4:3)

Image size (diagonal)	Projection distance
40 in.	4.1 to 5 ft. (1.3 to 1.5 meters)
50 in.	5.2 to 6.2 ft. (1.6 to 1.9 meters)
60 in.	6.2 to 7.5 ft. (1.9 to 2.3 meters)
70 in.	7.3 to 8.8 ft. (2.2 to 2.7 meters)
80 in.	8.4 to 10 ft. (2.6 to 3.1 meters)
100 in.	10.5 to 12.6 ft. (3.2 to 3.8 meters)
150 in.	15.7 to 18.9 ft. (4.8 to 5.8 meters)
200 in.	21 to 25.3 ft. (6.4 to 7.7 meters)
280 in.	29.5 to 35.4 ft. (9 to 10.8 meters)

Wide screen aspect ratio (16:9)

Image size (diagonal)	Projection distance
32 in.	3 to 3.6 ft. (0.9 to 1.1 meters)
40 in.	3.7 to 4.5 ft. (1.1 to 1.4 meters)
50 in.	4.7 to 5.7 ft. (1.4 to 1.7 meters)
60 in.	5.7 to 6.8 ft. (1.7 to 2.1 meters)
70 in.	6.6 to 8 ft. (2 to 2.4 meters)
80 in.	7.6 to 9.1 ft. (2.3 to 2.8 meters)
100 in.	9.5 to 11.4 ft. (2.9 to 3.5 meters)
150 in.	14.3 to 17.2 ft. (4.4 to 5.2 meters)
200 in.	19.1 to 22.9 ft. (5.8 to 7 meters)
310 in.	29.6 to 35.6 ft. (9 to 10.8 meters)

When setting up the projector, keep these considerations in mind:

- Make sure you don't block the air vents on the sides.
- Make sure you place the projector within 9 feet (2.7 meters) of an electrical outlet, power strip, or extension cord.
- Do not tilt the projector more than 10 degrees while playing CDs or DVDs.

Setting Up PowerLite Presenter

1. If you have a screen, set it up following the instructions included with the screen. Make sure you read all the instructions to avoid damaging the screen.
2. Put the batteries in the remote control.

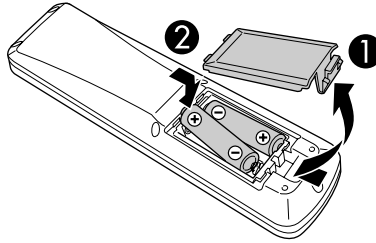

Note: Use only AA-size alkaline or manganese dry batteries.

3. Reattach the battery cover.

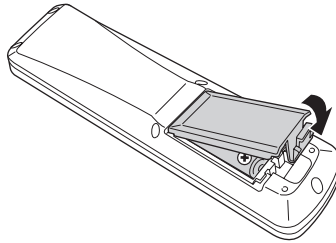

4. Expose the remote control to bright light for several minutes before using it in the dark. The buttons will glow in the dark briefly.

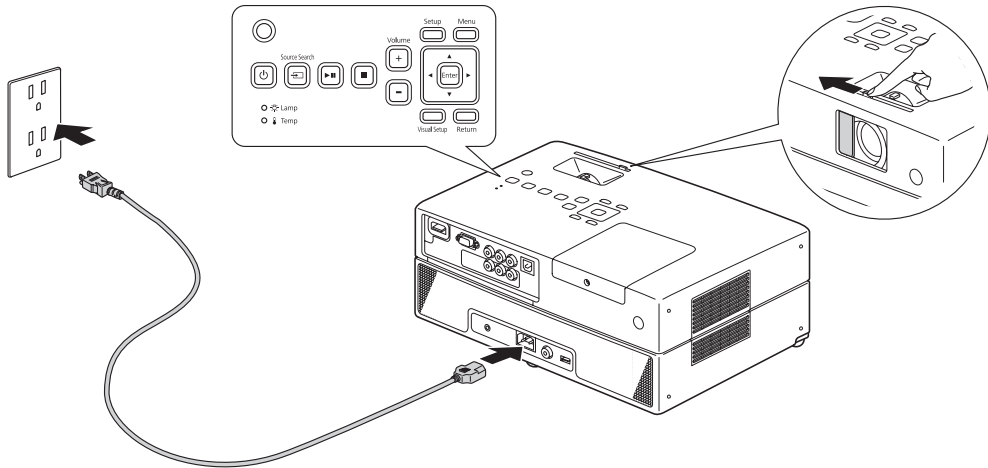

5. Open the lens cover, then connect the power cord and plug in the projector. The  light turns orange.



Once you've finished setting up the projector, do one of the following:

- If you would like to play a DVD, see “Playing DVDs” on page 21.
- If you would like to connect other equipment to the projector, see “Using PowerLite Presenter with Other Equipment” on page 30.

Turning the Projector Off

1. If there is a disc inside the projector, eject it.
2. Press the  button on the projector or the  on the remote control. The projector will beep twice when it is finished powering off.

Warning: Do not disconnect the power cable before the projector beeps, or you may damage the projector.

3. Close the lens cover.

Playing DVDs

Follow the instructions in this section to play a DVD and control playback.

Starting a DVD

Insert your DVD into the slot.

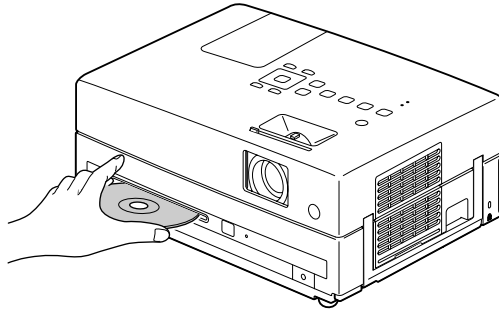

Warning: Close the lens cover before inserting or ejecting a disc. When the picture appears, do not look into the lens, and do not allow children or pets to look into the lens. The bright light may affect your vision.

After about 30 seconds, the projector warms up and the picture comes on.

Adjusting the Picture

After you set up and start the projector, you may need to make certain adjustments.

- If the image is too low, you can extend the feet (by pressing the foot adjustment levers) and tilt the projector up.

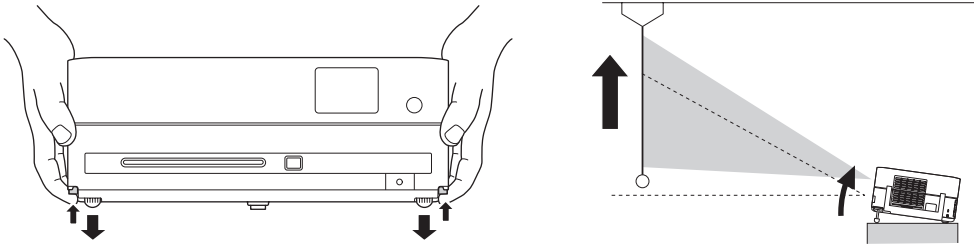

- If the image is horizontally tilted, you can turn the feet to level it.

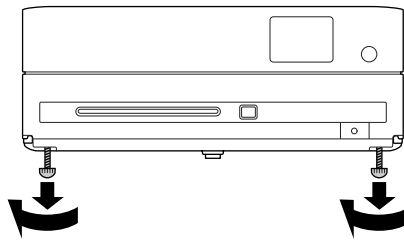

- Your projector automatically detects the vertical tilt and corrects the image shape. If you find that the image is not rectangular, however, use the **Keystone** buttons on the remote control or the Keystone setting in the Signal menu (see page 51) to adjust the image shape.

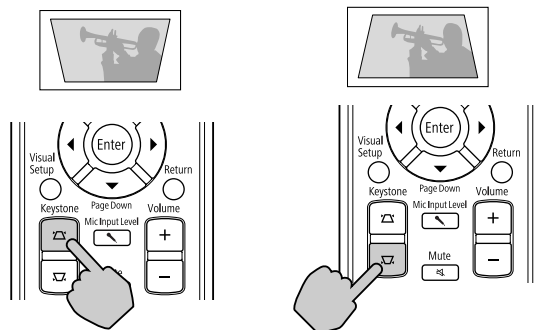

- Use the zoom ring to adjust the image size.

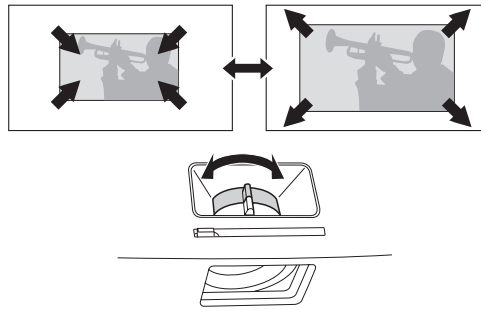

- Rotate the focus ring to sharpen the picture.

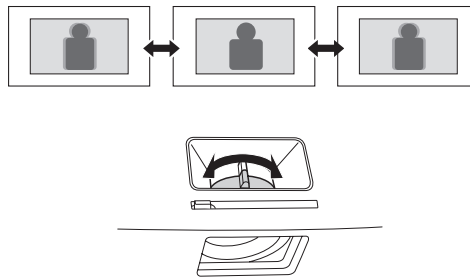

- To enlarge or reduce the aspect ratio of the picture, press the  button on the remote control to select Normal, 16:9, or Zoom (if available for the video source you're using).

Adjusting the Sound

To adjust the volume, use the + or – Volume buttons on the control panel or remote control.

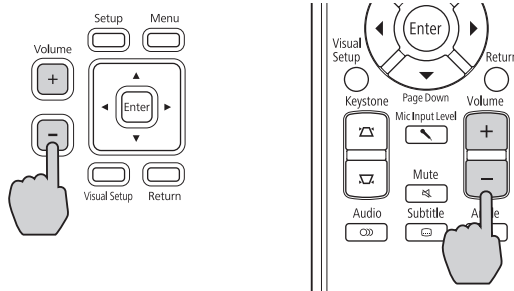

You can also press the  button on the remote control to temporarily turn off the sound.

Controlling Playback

You can use the buttons on the remote control or the control panel to pause, fast-forward, or replay sections of your video or audio. You can also select items on a DVD menu by using the remote control.



Note:



DVD movies are divided into units called titles. Each title may contain any number of chapters. Music CDs and video CDs are divided into tracks.

Some features may not be available depending on your media or file type.



Pausing

There are three ways to pause a DVD or audio track:

- To pause a movie, or a music CD or MP3 player track, press  on the remote control or  on the control panel.

To resume, press  on the remote control or  on the control panel.

- To pause a movie and display the Epson logo, press  on the remote control or control panel.



To resume, press  on the remote control or  on the control panel.

- To temporarily turn off the image and sound, press  on the remote control. Press the button again to resume your DVD or presentation.

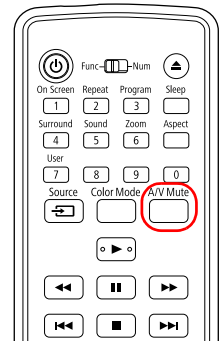
Note: After 5 minutes in A/V Mute mode, the lamp turns off and the screen darkens. After 30 minutes, the power shuts off, and you need to press the  button to turn it on again.



Searching (Fast Forward or Reverse)

- To move forward or backward through a video or music CD, press  or  on the remote control.



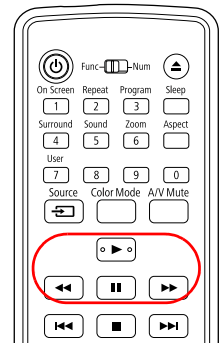

Each time you press the button, the search (or “shuttle”) speed increases.

- To return to normal play, press .





Playing in Slow Motion







You can play a video frame by frame or in slow motion (“jog control”).

1. Press  on the remote control.
2. Press  repeatedly to advance the video frame by frame.
3. Press  or  to move forward or backward in slow motion. Each time you press the button, the speed decreases.
4. Press  to return to normal play.

Skipping







- To skip to the next chapter or track, press  on the remote control.
- To return to the start of the current chapter or track, press  on the remote control.

Zooming In or Out







- Press  to zoom in the image. (Make sure the toggle switch on the remote control is set to the Func- position.)
- Continue pressing  to zoom in or out. Use the , , , and  buttons to pan around the image if necessary.

Using DVD Menus

Many DVDs display a top menu at startup and include submenus that let you select chapters.

- To display a menu, press  (press the button for about 3 seconds to display the top menu).
- To select items in a menu, press , , , or . Then press  if necessary.

You can also select a title or chapter by number.

- If you want to use the numeric buttons, you need to set the toggle switch on the remote control to the -Num position.
- After you set the toggle switch, you can simply press the numeric button for the numbers 1 through 9.
- To enter the number 10, press , then .
- To enter the number 15, press , then .
- To enter the number 20, press , then .
- After entering your number, you may need to press the  button.





Temporarily Stopping Audio

To temporarily stop the soundtrack (from the built-in speakers or headphones), press . The video continues to play.

Press  again to resume.

Adjusting the Color Mode

You can select a color mode to optimize picture quality based on the lighting conditions in the room.

1. Press . The currently selected color mode is displayed on the screen.
2. Press  repeatedly until the desired color mode appears. After a few seconds, the color mode name disappears and the picture quality changes.





You can select from the following color modes:

- **Auto:** Selects the best mode for your surroundings.
- **Dynamic:** Use in rooms with bright light.
- **Presentation:** Use for making color presentations in a bright room.
- **Theatre:** Use in completely darkened rooms.
- **Blackboard:** Use to project accurate colors on a green chalkboard (adjusts the white point).

Note: Fan speed varies depending on the selected color mode. This is normal.

Adjusting the Sound and Audio Modes

You can switch between stereo sound and virtual surround sound and select from several audio modes, depending on the type of movie (or music) you're playing.

1. To display the sound mode, press the  button on the remote control. You see the current setting displayed on the screen.
2. To switch between **Stereo** and **Multi** (virtual surround sound), press  again.
3. To change the audio mode, press . You see the current setting displayed on the screen.
4. Continue pressing  to select the mode you want: **Concert**, **Drama**, **Action**, or **Standard**.

For audio CDs, the modes are: **Classic**, **Jazz**, **Rock**, and **Digital**.

Listening with Headphones

Connect headphones as shown below:

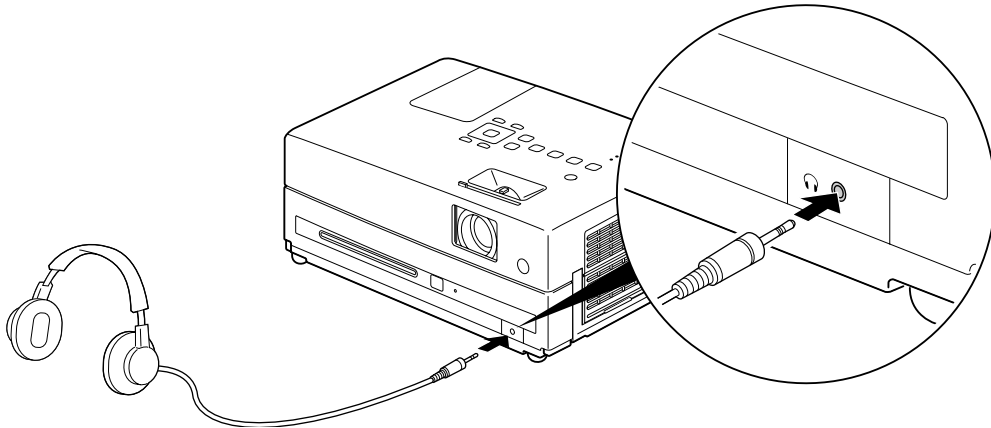

After you connect headphones, you no longer hear any sound from the built-in speakers. However, you can still adjust the volume to the headphones using the projector's volume controls on the control panel or remote control.

Warning:

Make sure the volume is not set too high, especially when you first plug in the headphones. Listening to high volume sounds over an extended period can damage your hearing. Sudden high volume can also damage your hearing or your headphones.

Do not look into the lens, and do not allow children or pets to look into the lens. The bright light may affect your vision.

Connecting a Microphone

Connect a microphone as shown below:

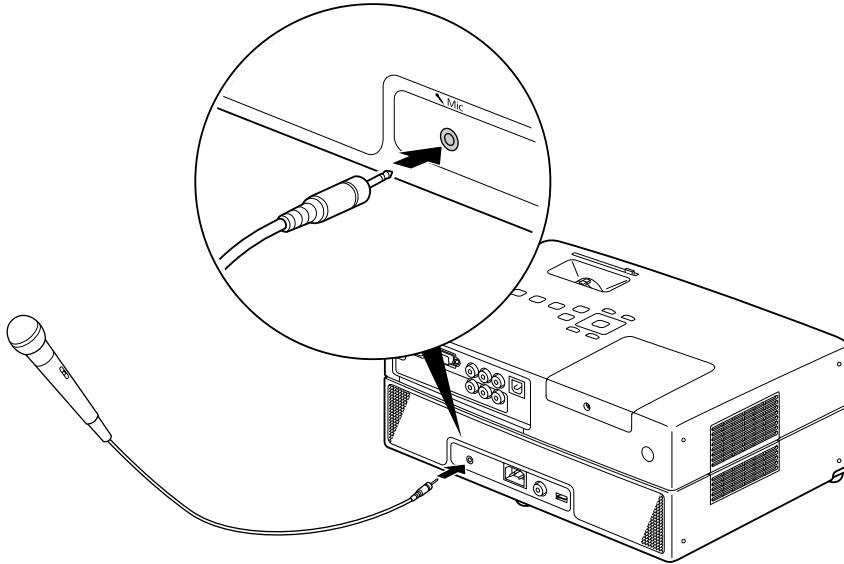

You can adjust the volume using the projector's volume controls on the control panel or remote control. If the microphone level is too low, you can adjust it by pressing the  button on the remote control or through the Option menu (see page 50).

Using PowerLite Presenter with Other Equipment

You can connect a variety of video, audio, and computer equipment to PowerLite Presenter to further enhance your viewing and listening experience.

- Video equipment such as a VCR, DVR, cable or satellite TV receiver, game console, video camera, digital camera, iPod®, or other device that has a video output port
- A USB flash drive containing photos or music files
- Audio input equipment such as an iPod or other MP3 player to play music through the projector (audio cables not included)
- Audio output equipment such as an AV amplifier or a 5.1 Stereo Surround Sound System to play audio from the projector
- Computer or laptop to project anything you can see or hear on your computer through the projector

Warning: Close the lens cover before connecting/disconnecting your device. The bright light may affect your vision. Additionally, you may leave fingerprints on the lens which can affect projection quality. When the picture appears, do not look into the lens, and do not allow children or pets to look into the lens.

Viewing Video from External Devices

You can connect to external video devices that have HDMI, composite video, or component video ports. To play audio from component or composite sources, you also need to connect standard white and red audio jacks to the projector's L and R Audio inputs.

When you view video from an external source, you can use most of the projector's controls, including adjusting color mode, volume, and sound mode.

You will need connection cables, which may be included with your external equipment, or may be purchased from an electronics store.

Caution: Before connecting, make sure all equipment is turned off.

Connect the external equipment as shown on the following pages.

HDMI Connection

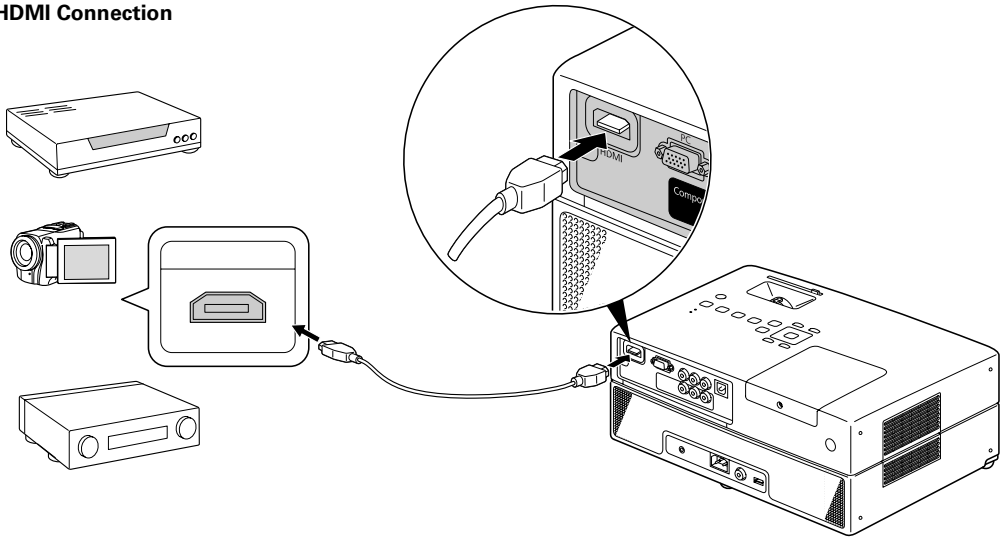

For connecting an HD cable or satellite TV receiver, HD DVR, Blu-ray DVD player, or HD camcorder.

Composite Video Connection

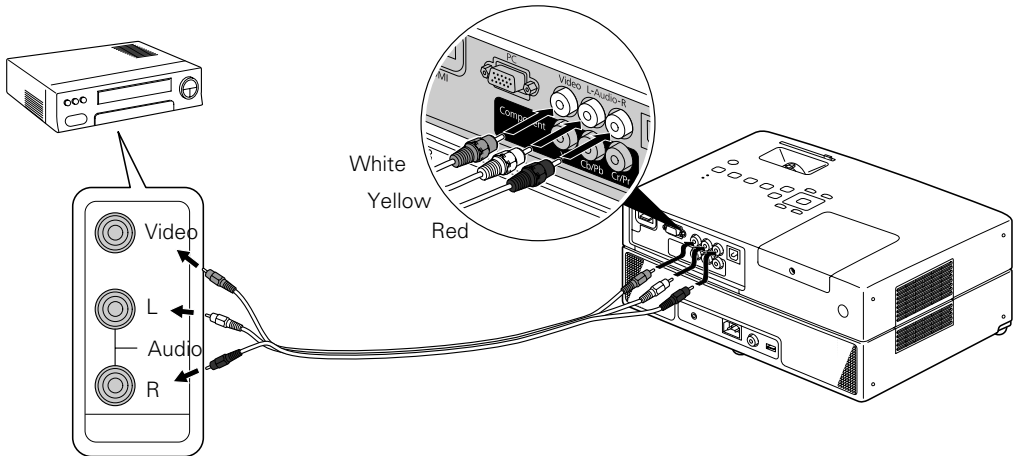





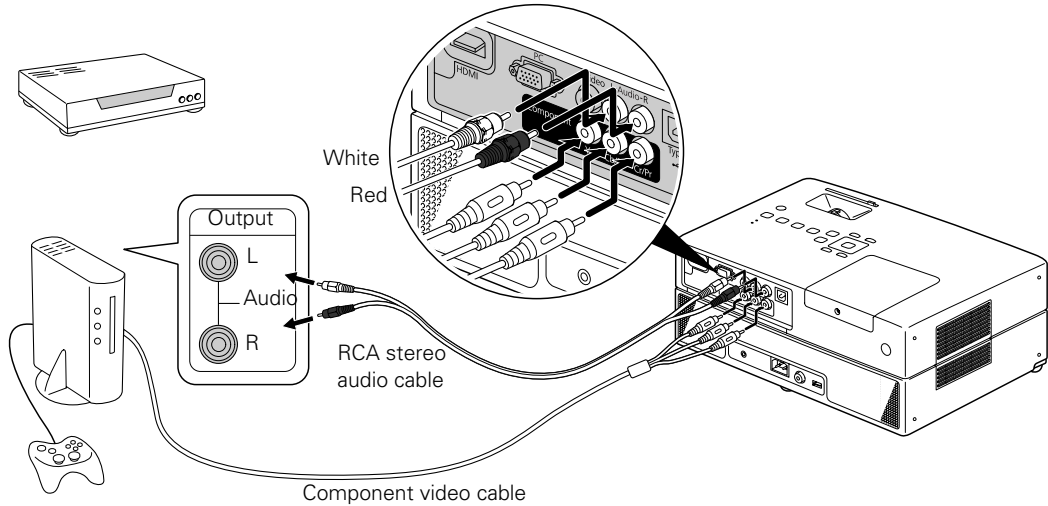

For connecting a VCR, or DVD player, cable or satellite TV receiver or DVR, game console, camcorder, iPod, digital camera, or other device with a video output port.

Component Video Connection



For connecting a cable or satellite TV receiver, DVR, or game console.

After you connect your equipment to the projector, follow these steps to begin:

1. Make sure all of the equipment is plugged into a power source.
2. Open the lens cover and press the  button on the projector or the  on the remote control.
3. Press the  button on the projector or the  button on the remote control.
4. When you see the menu, use the down-arrow or up-arrow button to select the correct source (if necessary), then press the  button on the projector or the  button on the remote control.
 - If you used the HDMI connection, select **HDMI**.
 - If you used the component video connection, select **Component**.
 - Otherwise, select **Video**.
5. Turn on the power to the connected video equipment, then start playing the video or game.
6. Normally, your projector selects the correct aspect ratio automatically. If you need to change the aspect, press the  button on the remote control and select **Normal**, **16:9**, or **Zoom** (if available for the video source you're using).

After you start playing your video or game, you may find that you need to adjust the position or shape of the picture. Or you may need to focus or zoom the image. See “Adjusting the Picture” on page 22.

Connecting a USB Device

You can connect a USB device, such as a flash drive or memory card reader containing a memory card. You can view photos or play music files. The projector supports the following types of files on USB devices:

- MP3
- WMA
- JPEG

Connect the drive or other device to the USB port as shown below. When you're finished, make sure you press before removing the device from the USB slot.

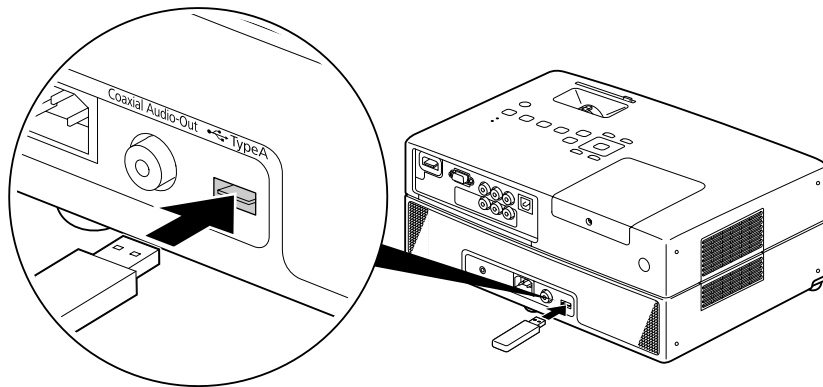

For instructions on playing MP3, WMA, or JPEG files, see page 39.

Playing Projector Audio Through an External Audio System

You can connect the projector to an amplifier, a 5.1 Stereo Surround Sound System, or a digital audio recorder. To output sound from the projector, the external equipment needs to have a digital coaxial (S/PDIF) audio input port.

You will also need a digital coaxial cable, which may be provided with your external equipment, or may be purchased from an electronics store.

1. Make sure the equipment is turned off, then connect the cable as shown:

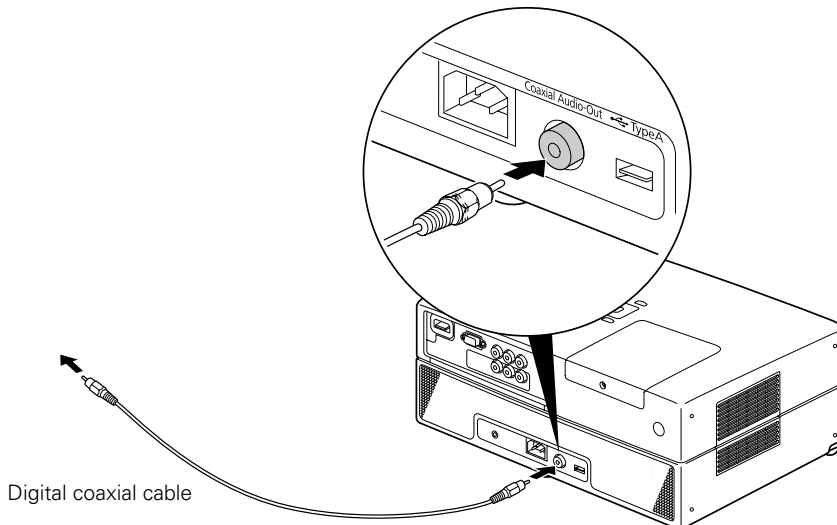

2. Turn on your audio equipment and play your movie, music, or other presentation with sound from your projector.
3. You may need to change the **Digital Output** setting in the Audio Setup Page. Select **Stream** if you are connecting a DTS/Dolby Digital Decoder or **PCM** if you are connecting to equipment that is only compliant with linear PCM. For more information, see page 50.

You can use any of your projector's audio controls, as described on pages 23 and 27.

Connecting a Computer or Laptop

You can connect the projector to a computer or laptop to play videos or games, display presentations or photos, or project anything you can see and hear on your computer.



Connecting to the USB Port

You can connect a Windows® 7, Windows Vista®, Windows XP, or Windows 2000 (SP4) computer to the projector's Type B (square) USB port and project your computer's display.

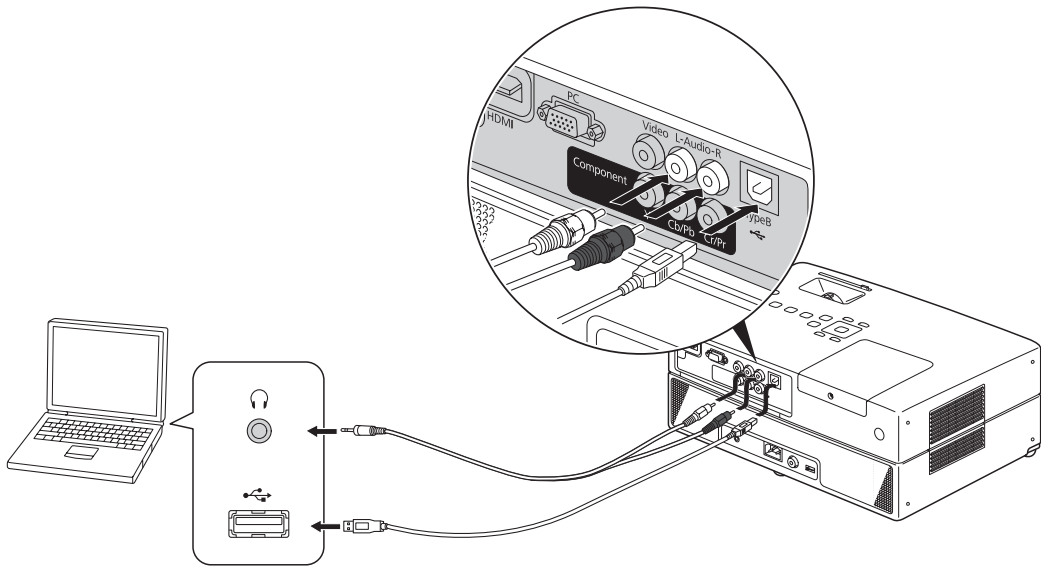
Note: With Windows 7, you may need to visit Epson's [U.S. support website](#) or [Canadian support website](#) to download the latest USB Display driver.





The first time you connect your computer to the projector's USB port, software from the projector installs on your computer.

1. Connect the power cords and plug in all the equipment.
2. Open the lens cover and press the  button on the projector or the  button on the remote control.
3. Turn on your computer.
4. Connect the square end of a USB cable (not included) to the projector's TypeB (square) USB port.

5. Connect the flat end of the cable to any available USB port on your notebook or desktop computer.

Messages appear as the projector is recognized and the software installation begins.

6. Follow the instructions on your computer screen to install the Epson USB Display software. If you see a “Digital Signature Warning,” select Continue. You will only need to install the software the first time you connect.
7. After the software has installed, you see your computer’s desktop displayed by the projector. (It may take a moment.)
8. If you want to play audio from the computer through the projector, you also need to connect a stereo mini-jack cable to the projector’s RCA stereo L and R Audio inputs. Connect the other end of the cable to the audio output connector(s) on your computer.
9. Normally, your projector selects the correct aspect ratio automatically. If you need to change the aspect, press the  button on the remote control and select **Normal**, **16:9**, or **Zoom** (if available for the video source you’re using).

When you are projecting through the USB port, you can use the  Page Up and  Page Down buttons on the projector’s remote control to move through a Microsoft® PowerPoint slide show.

After your image appears, you may find that you need to adjust the position or shape of the picture. Or you may need to focus or zoom the image. See “Adjusting the Picture” on page 22.





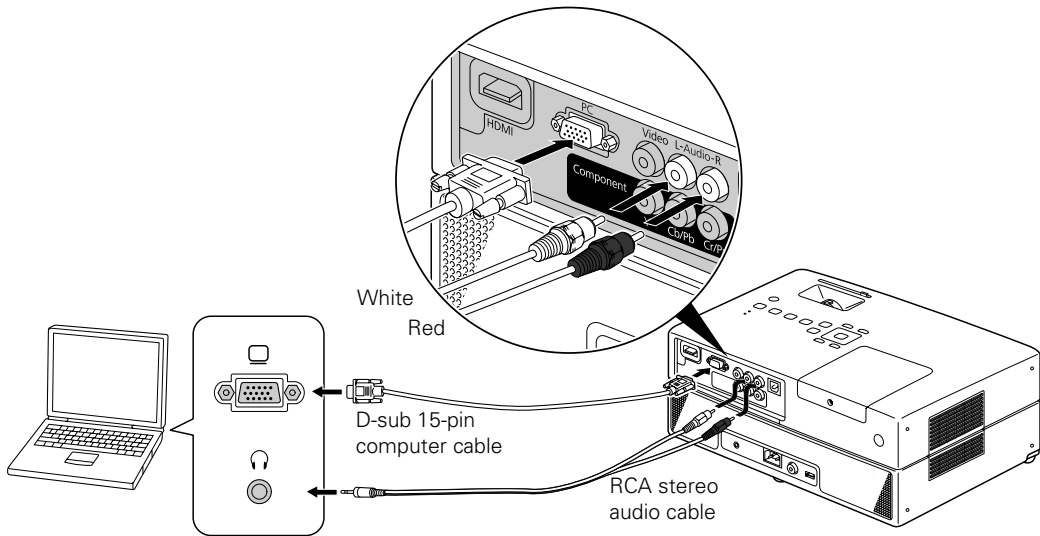

Connecting to the PC Port

You will need a computer cable (D-sub 15-pin to D-sub 15-pin) and an RCA stereo audio cable (2-RCA to stereo mini-pin). You can purchase these cables from an electronics store.

Caution: Before connecting, make sure all equipment is turned off.

1. Connect the computer or laptop as shown.



2. Connect the power cords and plug in all the equipment.
3. Open the lens cover and press the  button on the projector or the  button on the remote control.
4. Press the  button on the projector or the  button on the remote control.
5. When you see the menu, use the down-arrow or up-arrow button to select **PC** (if necessary), then press the  button on the projector or the  button on the remote control.
6. Turn on the power to the connected computer or laptop.

7. Switch the display on the computer or laptop to display on the projector, or on both the projector and the computer screen. Usually you do this by pressing function keys to toggle through display choices; see your computer documentation for instructions.

Note: If your laptop cannot play movies on both the laptop display and an external display, you may need to disable the laptop display to view movies on the projector. See your laptop documentation for instructions.

8. Normally, the projector selects the correct aspect ratio automatically. If you need to change the aspect, press the  button on the remote control and select **Normal**, **16:9**, or **Zoom** (if available).

After your image appears, you may find that you need to adjust the position or shape of the picture. Or you may need to focus or zoom the image. See “Adjusting the Picture” on page 22.

Doing More with PowerLite Presenter

Follow the instructions in this section to play music and view photos on your projector, use advanced playback controls, and adjust various projector features.

Playing Music and Viewing Photos

You can play music CDs and discs with MP3, WMA, MPEG-1, MPEG-2, and JPEG files. You can also play MP3 or WMA music files or view JPEG photos on USB devices.

Playing Music CDs

- To play a music CD, simply insert it in the slot.

You can use most of the playback features, including pause, resume, fast forward, reverse, and skip to the next or previous track. See page 24 for instructions.

- You can also select a specific track by using the numeric buttons, as described on page 26. To use the numeric buttons, you need to set the toggle switch on the remote control to the -Num position.
- To turn off the lamp, close the lens cover.

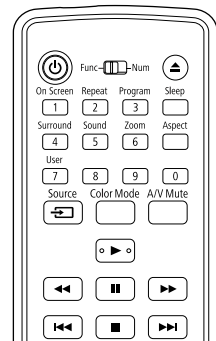





Playing MP3/WMA Music



You can play MP3 or WMA music files on CDs, DVDs, or USB devices. See page 69 for information on the types of discs that are supported.

When you insert a disc or USB device that contains MP3 and/or WMA files, you see a list of files and/or folders:



1. Press  or  to select a folder or file.

To go to the next or previous page, press  or .

2. Press  or  to begin playing the selected track or file.





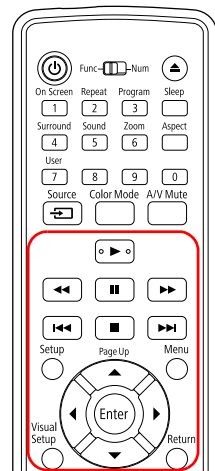

When a file is finished playing, the next file in the sequence will start automatically.

- To turn off the lamp when playing music files, close the lens cover.
- When you play MP3 or WMA files, scrolling through the list of songs will pause the music until you highlight the next file.







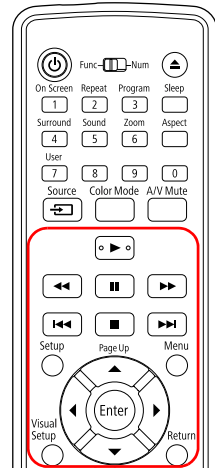

Viewing JPEG Photos

When you insert a disc or USB device that contains JPEG photo files, you see a list of files and/or folders.

- Press  or  to select a folder or file, then press  to begin displaying the photos.
- To rotate an image, press  or .
- To stop the slideshow and display a thumbnail screen, press .





- To display the next or previous page of thumbnails, press  or .
- To display the list of the files and folders, press .
- If your disc or USB device includes both music files and JPEG photos, you can play a slideshow with music.
 1. To display the list of files, press .
 2. Select the music file you want and press  to start playing it.
 3. Select the JPEG file you want and press  to start displaying the slideshow.

Using Advanced Playback Controls

Your projector provides advanced features for looping videos or music tracks and selecting titles, chapters, or tracks. On DVDs that include subtitles, multiple languages, or multiple camera angles, you can use the remote control for easy access to these features.

Repeating a Chapter, Title, Track, or File

You can select a chapter or title on a DVD to repeat continuously (or loop). You can also repeat a track on a music CD or an MP3, WMA, or JPEG file.









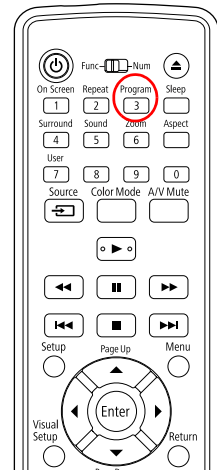
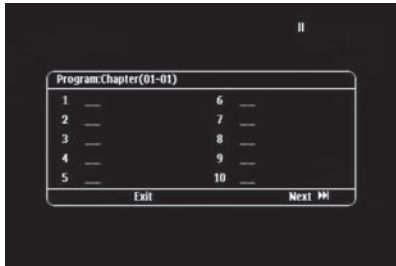

1. To repeat a chapter, title, or track, press  (make sure the toggle switch on the remote control is set to the Func- position). You see an icon on the screen indicating the selected repeat option.
2. Press  again to cycle through the options for repeating.
 - On a video DVD, you can repeat a chapter, title, or all titles and chapters. You can also select random play (Shuffle).
 - On an audio or video CD, you can repeat one track or all tracks or select random play (Shuffle).
 - For MP3, WMA, and JPEG files, you can repeat a file, all files in a folder on a disc, or select random play (Shuffle). You can also select to play the current file one time (Single).
3. To cancel repeat play, press  until Repeat Off is displayed on the screen.

Changing the Play Sequence (Program Play)

You can create your own program for playing tracks on a music CD or chapters and titles on a DVD.



1. Press  (make sure the toggle switch on the remote control is set to the **Func-** position). You see the program screen, which allows you to set a playback sequence:



2. Set the toggle switch on the remote control to the **-Num** position.
3. Use the numeric buttons to set the program order (up to 99 chapters, titles, or tracks).
 - Press , , , or  to move the cursor.
 - If a disc has more than 10 chapters or tracks, press  or  to display the next or previous page. Or, select **Next** or **Prev** on the screen and press .
 - To close the program screen, select **Exit** on the screen and press .
4. To begin playing your programmed sequence, select **Start** on the screen and press .
5. Set the toggle switch on the remote control back to the **Func-** position.
6. To cancel the program, press .
7. To resume normal playback, stop play and press .

Selecting Language, Subtitles, and Camera Angles

Some DVDs allow you to display subtitles or select from several languages or camera angles. If these features are available, you can use the buttons on the remote control to select them.

1. Press the appropriate button on the remote control:
 - To change the language of the video, press .
 - To display subtitles, press .
 - To change camera angles, press .
2. Press the button repeatedly to select the option you want.

Note: For a list of language codes, see page 74.

Using the Playback Information Screen

You can check the current playback status while you are playing a DVD or audio CD.

Press  (make sure the toggle switch on the remote control is set to the Func- position). Each time you press the button, the projector displays information about the time elapsed or the time remaining.

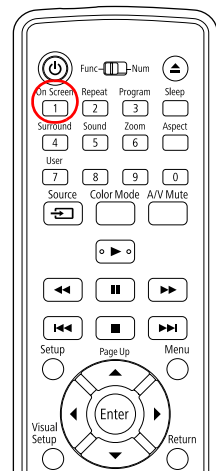









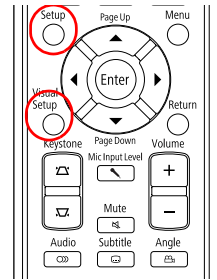



Customizing PowerLite Presenter

You can limit children's access, adjust the sound, and customize other features of the projector. Many of these settings are available by pressing the Setup or Visual Setup buttons on the remote control.

Locking DVDs

You can lock up to 40 DVDs to prevent children from viewing them. When a disc is locked, you need to enter a password before you can play it.





1. Insert the DVD you want to lock. Press  twice to stop the video.
2. Press the  button on the remote control. You see the Language Setup Page.
3. Press  until you see the Others Setup Page.
4. Press  to highlight Disc Lock, then press  to change the setting.
5. Press  to select Lock, then press .
6. Press  to highlight Password, then press  to change it.
7. Press  to select Change.
8. Set the toggle switch on the remote control to the -Num position, then enter 6 digits using the numeric buttons. The first time you set a password, you need to enter 000000 in the Old Password column first, then enter the new password.
9. Enter the same digits again for Confirm PWD using the numeric buttons.
10. Press  to save your password.

Once a password is set, you need to enter it before you can view the locked CD or DVD. If you forget your password, enter 000000 in the Old Password column to reset the password.

11. Press  to exit the menu.





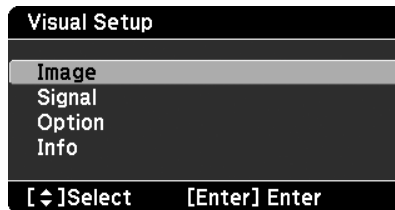

Locking the Power Button on the Control Panel

You can lock the  button on the control panel to prevent young children from accidentally turning on the projector and looking into the lens. (You can still turn on the projector using the remote control, so you may want to place it out of children's reach.) You will also be able to turn on the projector by holding down the  button on the control panel for at least 5 seconds.

Warning: Do not allow young children or pets to look into the projector lens when the projector is turned on. The lens projects bright light that may affect their vision.

1. Press  on the remote control. You see the Visual Setup menu:



2. Press  to highlight Option, then press  to select it.
3. Press  until you see Child Lock.
4. Press  or  to select On, then press .
5. Press  to exit the menu.

You need to restart the projector for the setting to take effect.







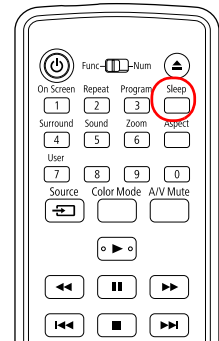
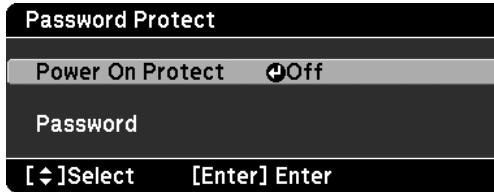

Note: When the Child Lock setting is turned on, the projector will not automatically power up when you insert a disc.

Locking the Projector

You can lock the projector with a password to prevent unauthorized people from using it. When the password lock is active, a password entry screen will display each time you turn the projector on after it has been unplugged.

1. Hold down the  button for at least 5 seconds. You see the Password Protect menu:



2. Press  to select Power On Protect, press  or  to select On, press , then press .
3. Press  to highlight Password, then press  to select it.
4. When you see the message Change the password?, select Yes and press .
5. Set the toggle switch on the remote control to the -Num position, then enter a four digit number using the numeric buttons. When you enter the fourth digit, a confirmation screen is displayed.
6. Enter the password again. A confirmation message is displayed.
7. Press  to exit the menu.

When you turn the projector on and see the password entry screen, set the toggle switch on the remote control to the -Num position and enter the four digit password using the numeric buttons.

Saving Power

The power turns off automatically when a DVD is stopped for more than 30 minutes. You can select a time to turn off the projector while a DVD is playing, in case you fall asleep while watching.

To select a sleep setting, press . Continue pressing the button to select from the following settings:

- **Sleep Off:** The power switches off automatically after 30 minutes of inactivity (default setting).
- **Sleep 10, 20, 30, 60, 90, 120, 150:** The power switches off automatically after the number of minutes specified, whether or not a movie is playing. You can select from 10 to 150 minutes.

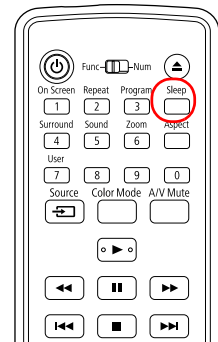



After you set the sleep timer, you can see the time remaining by pressing .



Note: Sleep timer settings are not saved after you turn the projector off.

Changing Language Settings

You can use the Language Setup Page to change the default language for DVDs that allow you to make this selection.

1. Press the  button on the remote control. You see the Language Setup Page.
2. Press  to highlight the setting you want, then press  to display the list of languages available.

OSD Language is the language used for the projector's menus. Other settings may not be available, depending on the DVD you are playing.



3. Press  to select the language you want, then press  to save it. For a list of language codes, see page 74.
4. To exit the menu, press .

Adjusting Picture Quality

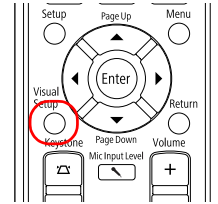

You can use the Image page on the Visual Setup menu to adjust the brightness, contrast, color saturation, tint, sharpness, and other settings that affect image quality.

Note: You cannot change Image page settings when the Color Mode is set to **Auto**.









1. Press  on the remote control. You see the Visual Setup menu.
2. Press  to select **Image**.
3. Press  until you see the option you want to set.



You can adjust the following items for various viewing conditions and individual videos:

- **Brightness**
 - **Contrast**
 - **Color Saturation**
 - **Tint** (only works on NTSC signals)
 - **Sharpness**
 - **Color Temp.** (High makes the image more blue; Low makes it more red.)
 - **Auto Iris** (Adjusts the light intensity based on the brightness of the displayed image.)
4. Press  or  to increase, decrease, or change the setting.
 5. Press  to exit the menu.

Using the Others Setup Page









The Others Setup Page lets you select various settings, including screensaver and password options. You can also return all settings to their defaults.

1. Press  on the remote control. You see the Language Setup page.
2. Press  to display the Others Setup Page.
3. Press  to highlight the setting you want, then press  to view or change the option.
4. Press  to select the option you want, then press  to save it. You can choose from the following:
 - **Screen Saver:** By default, the screen saver starts when a still image is projected for more than 15 minutes. Select **Off** to turn off this setting.

- **Default:** Press  and press  to return all settings to their factory defaults (except for the Disc Lock password and lamp hours).
 - **Password:** See page 45 for instructions on setting a password for locking DVDs.
 - **Disc Lock:** See page 45 for instructions on setting a password for locking DVDs.
5. To exit the Setup menu, press .

Adjusting Dolby Audio Settings

You can adjust settings for external equipment with a DTS/Dolby Digital Decoder or DVDs recorded in Dolby Digital.



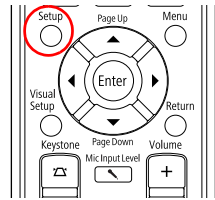

1. Press the  button on the remote control. You see the **Language Setup Page**.
2. Press  to display the **Audio Setup Page**.
3. Press  to highlight **Digital Output** or **Night Mode**, then press  to select it. You can select the following settings:
 - **Digital Output:** Change to **Stream** if you have connected a DTS/Dolby Digital Decoder to the Audio-Out port.
 - **Night Mode:** Turn this setting on if you are watching a Dolby Digital DVD at low volume.
4. Press  or  to select the setting you want to change, then press  to save it.
5. To exit the menu, press .







Setting Video and Other Options

You can use the Visual Setup menus to adjust the signal format for external video equipment and set other options.





Option Menu

1. Press  on the remote control. You see the Visual Setup menu.
2. Press  to highlight **Option**, then press  to select it.
3. Press  until you see the option you want to set.



You can adjust the following items:

- **Mic Input Volume:** Adjust this setting if the microphone level is too low or too high.
 - **Closed Caption:** Turn this setting on to display closed captioning for content that provides it.
 - **User Button:** You can assign one of the following four items to the User button: Closed Caption, Power Consumption, Info, Resolution. By pressing the button, the assigned menu item selection/adjustment screen is displayed, allowing you to make one-touch settings/adjustments.
 - **Child Lock:** Turn this setting on to lock the  button on the control panel. See page 46 for more information.
 - **High Altitude Mode:** Turn this setting on if you use the projector at an altitude above 4900 feet (1500 meters), to ensure that the projector does not overheat.
4. Press  or  to adjust the setting.
 5. Press  to exit the menu.

Signal Menu



1. Press  on the remote control. You see the Visual Setup menu.
2. Press  to highlight **Signal**, then press  to select it.
3. Press  until you see the option you want to set.

You can adjust the following items:



- **Keystone:** Adjust this setting to correct the shape of the image if the projector has been tilted upward.
 - **Auto Keystone:** Select On to have the projector automatically adjust the shape of the image when the projector has been tilted upward or downward.
 - **Power Consumption:** Select ECO if the images being projected are too bright (such as when projecting images in a dark room or onto a small screen). You cannot select a Power Consumption setting when the Color Mode is set to Auto.
 - **Resolution:** Set to Auto to have the projector automatically identify the resolution of the input signal. If necessary (because some of the image is missing, for example), adjust to Wide or Normal.
 - **Video Signal:** Normally, you can leave this set to Auto when using external equipment. If no image appears or you see interference, select the appropriate signal.
4. Press  or  to adjust the setting.
 5. Press  to exit the menu.

Viewing Status Information and Resetting the Lamp Timer

You can use the Info page on the Visual Setup menu to view the number of hours the lamp has been used, and to reset the timer after you install a new lamp. You can also view video signal information and error codes for any problems that occur.

1. Press  on the remote control. You see the Visual Setup menu.
2. Press  to highlight **Info**, then press  to display the lamp usage and other information.

Note: If the lamp has been used less than 10 hours, 0H is displayed.

3. To reset the lamp timer after replacing the lamp, press .
4. Press  to exit.

Caring for Your PowerLite Presenter

The projector needs little maintenance. All you need to do on a regular basis is keep the lens clean. You also may need to clean the air filter to help prevent overheating.

Warning: Before you clean any part of the projector, turn it off and unplug the power cord. Never open any part of the projector, except as described in this *User's Guide*. Dangerous electrical voltages in the projector can injure you severely. Do not try to service this product yourself, except as specifically explained in this *User's Guide*.

The only parts you should replace are the lamp and air filter. If another part needs replacing, contact Epson or a qualified servicer (see page 68).

Follow the instructions in this section to clean the lens and case, clean and replace the air filter, replace the lamp, and store or transport the projector.

Protecting PowerLite Presenter

The projector is designed for use virtually anywhere. However, the projector and its accessories should not be exposed to water, smoke, direct heat or sunlight, or left outside for long periods of time. As with other electronic equipment, please avoid exposure of the projector to moisture, dust, smoke, and other environmental factors which may result in damage to internal electronics over time. See the warranty brochure included with your projector for additional details on the use of the projector.

Cleaning the Lens

Clean the lens whenever you notice dirt or dust on the surface.

To remove dirt or smears, use lens-cleaning paper. If necessary, moisten a soft cloth with lens cleaner and gently wipe the lens surface.

Caution: Never rub the lens with abrasive materials.

Cleaning the Case

Before you clean the case, turn off the projector and unplug the power cord.

- To remove dirt or dust, wipe the case with a soft, dry, lint-free cloth.
- To remove stubborn dirt or stains, moisten a soft cloth with water and a neutral detergent. Wring the cloth as dry as possible, then wipe the case.



Caution: Never use wax, alcohol, benzene, thinner, or other chemical detergents. These can damage the case. Never spray cleaners directly on the projector.

Cleaning and Replacing the Air Filter

Clean the air filter and air intake vent when dust builds up or when you see the following message:

The projector is overheating. Make sure nothing is blocking the air vents, and clean or replace the air filter.

Dust clogs prevent proper ventilation, which can cause overheating and damage the projector.

1. Press the  button on the control panel or the  button on the remote control to turn the projector off. When you hear a short beep, disconnect the power cable.
2. Use a small vacuum cleaner designed for computers and other office equipment to clean the filter, as shown.

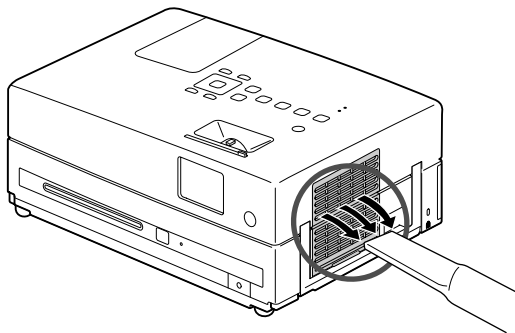

If you cannot clean the removable filter or it is broken, you need to replace it.

You can purchase a new filter (part # V13H134A26) from an Epson authorized reseller. To find the nearest reseller, call 800-GO-EPSON (800-463-7766). Or you can purchase online at www.epsonstore.com (U.S. sales) or www.epson.ca (Canadian sales).

3. If you need to clean or replace the filter, lift up the handle, press up on the tab, and lift off the cover.

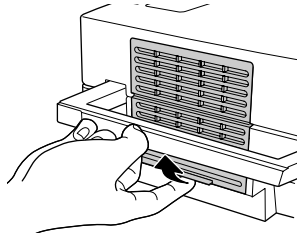

4. Remove the old filter and install the new filter.

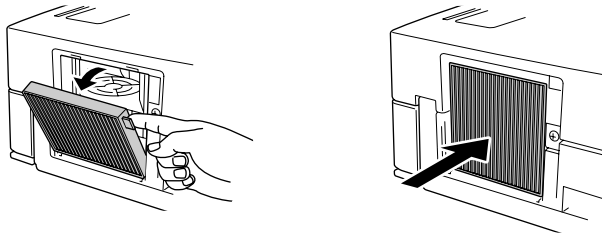

5. Replace the cover.

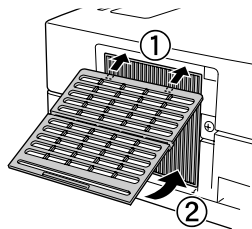

Replacing the Lamp

The life span of the lamp is about 4000 hours if Power Consumption in the Signal menu is set to Normal, and about 5000 hours if Power Consumption is set to ECO.

You can check how long the lamp has been used as described on page 52. If the number shown is close to the limit, make sure you have a spare lamp handy.

Note: Turn off this product when not in use to prolong the life of the projector.

It's time to replace the lamp when:

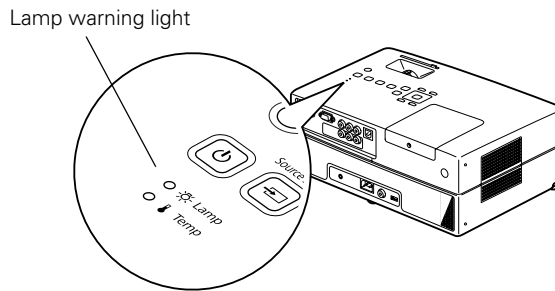



- The projected image gets darker or starts to deteriorate.
- The lamp warning light flashes orange.
- The message **Replace the lamp** appears on the screen when you start projecting.

Caution: If you continue to use the lamp after you see the replacement indicators, the lamp is more likely to break.

You can purchase a new lamp (part # V13H010L55) from an Epson authorized reseller. To find the nearest reseller, call 800-GO-EPSON (800-463-7766). Or you can purchase online at www.epsonstore.com (U.S. sales) or www.epson.ca (Canadian sales).

Be sure to read the safety instructions before replacing the lamp. See page 12.

Follow these steps to replace the lamp:

1. Press the  button on the control panel or the  button on the remote control to turn the projector off. When you hear two short beeps, disconnect the power cable.
2. If the projector has been on, let it cool for at least an hour.

Warning: Let the lamp cool before replacing it. If the lamp breaks, handle the shards carefully to avoid injury.

- Loosen the lamp cover screw using the screwdriver that came with the replacement lamp. (The screw won't come all the way out.) Then slide out the lamp cover and lift up to remove it.

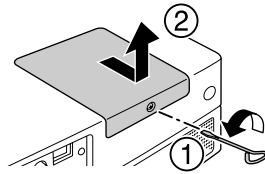

- Loosen the two silver screws holding the lamp in place. (You can't remove these screws.)

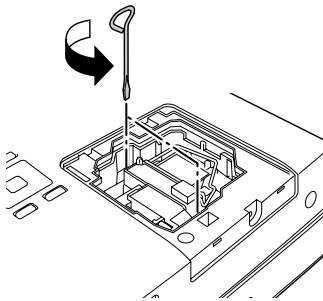

- Grasp the lamp handle as shown and pull the lamp straight out.

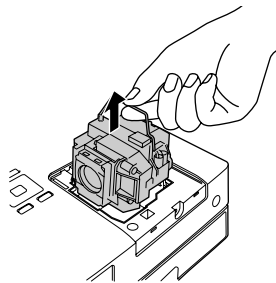

Note: (Hg) The lamp(s) in this product contain mercury. Please consult your state and local regulations regarding disposal or recycling. Do not put in the trash.

6. Gently insert the new lamp and tighten its screws.

Caution: Don't touch the glass portion of the lamp with your bare hands; the invisible residue left by the oil on your hands may shorten the lamp life. Use a cloth or gloves to handle the new lamp assembly.

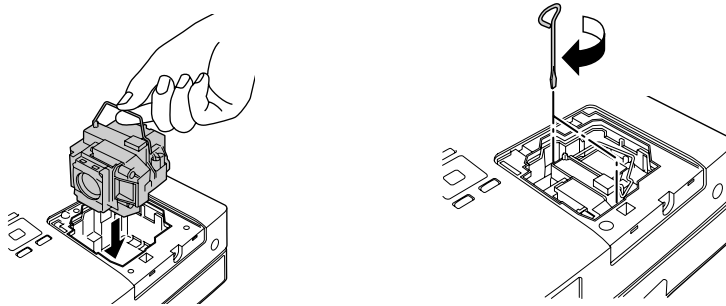



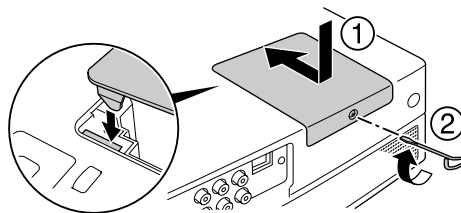





7. To replace the lamp cover, slide it into position, then tighten the screw. (The projector won't work if the lamp cover is loose.)



8. After replacing the lamp, you need to reset the lamp timer, as described in the next section.

Resetting the Lamp Timer

1. Connect the power cable and press the  button on the projector or the  button on the remote control to turn the projector on.
2. Press  on the projector  on the remote control. You see the Visual Setup menu.
3. Press  to highlight Info, then press  on the projector or  on the remote control to select it.

4. Press  again. You see the following on the screen:

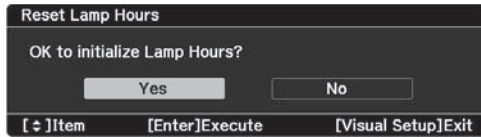

5. Select **Yes** and press  or  to reset the timer.

The lamp usage timer displays 0 H (zero hours) until you've used the lamp for at least 10 hours.

Storing PowerLite Presenter

Follow these guidelines when storing the projector:

- Make sure the temperature and humidity of the storage area are within the recommended range for the projector: 14 to 140 °F (–10 to 60 °C) and 20 to 80% relative humidity without condensation.
- Make sure all discs are ejected.
- Close the lens cover and retract the feet.
- Remove the batteries from the remote control.
- Place the projector in its protective case. You can stand it on end for convenient storage.
- Package the projector in its original packaging or equivalent (as described in the following section).

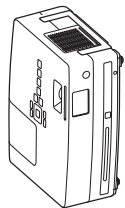

Transporting PowerLite Presenter

Note: Epson shall not be liable for any damages incurred during transportation.

Your projector contains many glass and precision parts. If you need to transport it, follow these guidelines to prevent damage:

- When shipping the projector for repairs, use the original packaging material if possible. If you do not have the original packaging, use equivalent materials, placing plenty of cushioning around the projector. Be sure the carrier is capable of transporting fragile equipment and is aware that the projector is fragile.
- If you move the projector from a cold environment into a warm room, condensation (moisture) may form internally or on the lens surface. To avoid damage that might be caused by condensation, wait approximately an hour before using the projector. If condensation forms, turn off the power, then wait an hour or two before use.
- When you are hand-carrying the projector, make sure all discs are ejected, the lens cover is closed, and the feet are retracted.
- Lift the projector by its handle as shown:

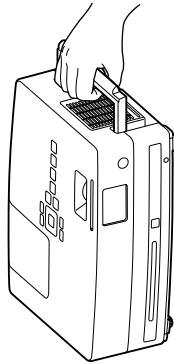

Problem Solving

This section explains how to interpret the projector's status lights, solve problems, and contact technical support.

What To Do When the Lights Flash

The lights on top of the projector indicate its status and let you know when a problem occurs. If all lights are off, make sure the power cable is connected correctly.

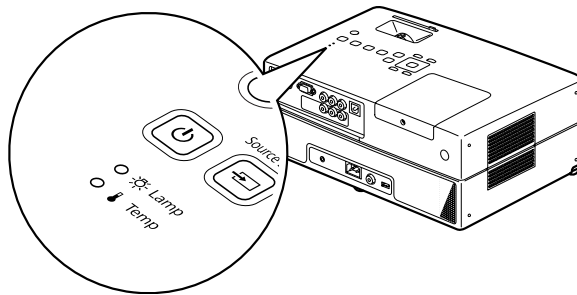

The  light is orange.

The projector is in sleep mode. Press the  button on the projector or the  button on the remote control to turn it on.

The  light is flashing green.

The projector is warming up. Wait for the picture to appear. This can take a few minutes.

The  light is flashing orange.

The projector is cooling down. Wait until the light stops flashing before you unplug the projector.

The  light is green.

The projector is operating correctly. If you don't see a picture, open the lens cover slide.

The 🔊 warning light is flashing orange and the ⏻ light is flashing red.

High-speed cooling is in process. If the projector gets too hot again, projection stops automatically. Make sure the projector is at least 8 inches (20 cm) away from the wall.

Clean or replace the air filters if necessary (see page 54). If you are using the projector at an altitude above 4900 feet (1500 meters), turn on High Altitude Mode (see page 51).

The 🔊 warning light is flashing orange.

The lamp needs to be replaced. See page 56.

The ⏻ light is red and the 🔊 warning light is red.

The projector is too hot and has turned off the lamp. Make sure the projector is at least 8 inches (20 cm) away from the wall.

Clean or replace the air filters if necessary (see page 54). If you are using the projector at an altitude above 4900 feet (1500 meters), turn on High Altitude Mode (see page 51).

Let the projector cool for five minutes. When the ⏻ light turns orange, press the button to turn the lamp back on. If the status doesn't change, wait a few minutes, then unplug the projector and contact Epson. See page 68.

The ⏻ light is red and the 🔊 warning light is flashing red.

The lamp may be incorrectly installed, the lamp cover may be loose, or the lamp may be broken. Turn off the power, wait a few minutes (or wait 1 hour if you've been using the projector), and check the lamp. See page 58. If the lamp is broken, or the lights continue to flash after you turn the power back on, unplug the projector and contact Epson. See page 68.

The ⏻ light is red and the 🔊 warning light is flashing red.

The projector has a problem with its fan or temperature sensor. Wait a few minutes, then unplug the projector and contact Epson. See page 68.

The ⏻ light is red and both 🔊 warning lights are flashing red.





The projector may have an internal error. Press ⏻. Then unplug the power cable, plug it in again, and press ⏻ again. If the lights continue to flash, unplug the projector and contact Epson. See page 68.

The ⏻ light is red and both 🔊 warning lights are red.



The projector may have an auto iris or ballast error. Unplug the projector and contact Epson. See page 68.

Solving PowerLite Presenter Operation Problems



The projector doesn't turn on.

- Make sure the power cord is securely attached at both ends. Try using a different power outlet.
If the power cord has been damaged, turn off the projector, disconnect the power cord, and contact Epson. See page 68.
- Make sure you pressed the  button on the projector or the  button on the remote control.
- If the  light is flashing green, the projector is warming up. Wait for the picture to appear, which can take a few minutes.
- If the  light is flashing orange, the projector is cooling down. Wait for the light to turn orange.
- Make sure the Child Lock is not set. See page 46.

The projector turns itself off after a period of time.

The power turns off automatically when the projector is idle for more than 30 minutes. Press the  button on the projector or the  button on the remote control to turn on the projector. For instructions on changing the Sleep setting, see page 48.

No picture appears on the screen.

- Make sure the projector is turned on (the  light is green and not flashing). If the  light is flashing green, wait for the projector to warm up.
- Make sure the lens cover is open.
- If you're playing a DVD, make sure its region code is 1.
- Check the  warning light. If it is flashing orange, you need to replace the lamp. See page 56.
- The Screensaver feature turns off the picture if a still image is projected for more than 15 minutes. See page 49.
- If you're using external video equipment, check the solutions on page 66.

The DVD skips.

- Make sure the projector is not tilted more than 10 degrees while playing CDs or DVDs. This can cause skipping or disc scratches.
- Make sure there are no fingerprints or scratches on the DVD.

The remote control doesn't work.

- Make sure the toggle switch is in the correct position: set to **-Num** to use the numeric buttons, or to **Func-** to use the other functions of these buttons.
- Make sure you're within 19 feet (6 meters) of the projector, and within range of its front or back sensor (approximately 30° left or right, and 15° above or below).
- You may need to replace the remote control's batteries. Make sure they're inserted with the positive (+) and negative (-) ends positioned as shown in the battery compartment.
- Some discs don't support all of the remote control's functions.
- If you're using a "universal" remote control, it might not work with the projector. Epson does not support any third-party remote controls.

Solving Picture and Sound Problems

The picture is blurry or out of focus.

- Adjust the focus using the focus ring. See page 22 for instructions.
- There may be dirt on the lens. Clean the lens as described on page 53.
- Make sure the lens is not fogged by condensation. If you've just moved the projector from a cold environment, wait approximately an hour before using it. If condensation forms, unplug the projector and wait an hour or two before use.
- Make sure the projector is placed the correct distance from the screen: no closer than 3 feet (0.9 meters) and no farther than 35.7 feet (10.9 meters).
- Adjust the **Sharpness** setting. See page 49.
- If you're using the **Keystone** adjustment, be aware that it lessens image quality. You may want to decrease the projection angle to reduce the amount of keystone correction needed. Try adjusting the projector's position relative to the screen.
- If you're using external video equipment, check the solutions on page 66.



The picture looks too light or too dark.

- Press the  button on the remote control to select the best setting for your viewing environment. See page 27.
- Adjust the **Brightness** and **Contrast** settings. See page 49.
- If the picture looks darker than it used to, you may need to replace the lamp. See page 56.

The colors on the screen don't look right.

- Press the  button on the remote control to select the best setting for your viewing environment.
- Adjust the **Color Saturation** or **Tint** settings. See page 49.
- If you're using external video equipment, check the solutions on page 66.

The picture is wider at the top or bottom.

- You've tilted the projector to raise or lower the image, causing it to become "keystoned." Use the  or  buttons on the remote control or the **Signal** menu (see page 51) to correct the problem.

The picture is taller on the left or right side.

The projector is set at an angle to the screen. Face it squarely toward the screen.

There is no sound, or the sound is not loud enough.

- Try pressing the **+ Volume** button on the projector or on the remote control.
- Press the  button on the remote control to make sure the sound hasn't been turned off temporarily.
- If you're using external video equipment with a component or composite video connection, make sure you connected the red and white audio jacks to the projector's audio ports (see page 30).
- If you're using external equipment, you may need to adjust the **Audio** settings in the setup menu (see page 50).

There is a problem with the sound quality.

- Try pressing the  button on the remote control and adjusting the sound mode. (Make sure the toggle switch on the remote control is set to the **Func-** position.)
- If you're using external equipment, you may need to adjust the Audio settings in the setup menu (see page 50).
- If the sound is distorted or too loud, try pressing the — **Volume** button on the projector or on the remote control.

No sound can be heard from the microphone.

- Make sure the microphone is connected correctly. See page 29.
- Increase the Mic Input Level. See page 29.
- The projector is compatible with dynamic microphones. Make sure you are not using a plug-in power microphone.

Subtitles do not appear.



- The DVD might not include subtitles.
- Make sure the subtitle language is not set to **OFF** (see page 44).

You can't change the language on a DVD.

The DVD might not include multiple languages.



Problems with External Video Equipment

No picture appears on the screen.

- Make sure the equipment is turned on.
- Press the  button on the projector or the  button on the remote control.
- Press the  or **Play** button on the external equipment.

You see the message No Signal.

- Make sure the equipment is turned on.
- Make sure your cable(s) are connected correctly (see page 30).

- Press the  button on the projector or the  button on the remote control to select the external video source. Allow a few seconds for the projector to sync up.
- If you're using a PC notebook, hold down the **Fn** key on the keyboard and press the function key that lets you display on an external monitor. It may have an icon such as , or it may be labelled **CRT/LCD**. Allow a few seconds for the projector to sync up after pressing it. Check your notebook's manual or online help for details.

On most systems, the  key lets you toggle between the LCD screen and the projector, or display on both at the same time.

If you connect the notebook while the projector or computer are already turned on, the function **Fn** key that changes the computer's image signal to external output may not work. Turn the computer and the projector off and then back on again.

You see the message Signal not supported.

Press the  button on the remote control and check the **Video Signal** setting (see page 51).

The picture is cut off (too large) or too small.



Press the  button on the remote control and select the appropriate aspect ratio.

Press the  button on the remote control and select the appropriate zoom setting. (Make sure the toggle switch on the remote control is set to the **Func-** position.)

The picture is distorted.

- If you're using an extension cable, electrical interference may affect the signal.
- Check the solutions on pages 64 and 65.

The colors are not right.

- Press the  button on the remote control and check the **Video Signal** setting (see page 51).
- Press the  button on the remote control to select the best setting for your viewing environment.
- Adjust the **Color Saturation** or **Tint** settings. See page 49.

Where To Get Help

Epson provides these technical support services:

Internet Support

Visit Epson's [U.S. support website](#) or [Canadian support website](#) for solutions to common problems. You can download utilities and documentation, get FAQ's and troubleshooting advice, or e-mail Epson with your questions.

Speak to a Support Representative

To use the Epson PrivateLine Support service, call (800) 637-7661. This is the fastest way of speaking to a live representative, and it's free. This service is available for the duration of your warranty period. You may also speak with a projector support specialist by dialing (562) 276-4394 (U.S.) or (905) 709-3839 (Canada).

Support hours are 6 AM to 8 PM, Pacific Time, Monday through Friday and 7 AM to 4 PM, Pacific Time, Saturday.

Days and hours of support are subject to change without notice. Toll or long distance charges may apply.

Before you call, please have the following information ready:

- Product name (PowerLite Presenter)
- Product serial number (located on the bottom of the projector)
- Proof of purchase (such as a store receipt) and date of purchase
- Computer or video configuration
- Description of the problem

Note: If you need help with optional equipment, see the information included in the box with the equipment.

Purchase Supplies and Accessories

You can purchase screens, carrying cases, or other accessories from an Epson authorized reseller. To find the nearest reseller, call 800-GO-EPSON (800-463-7766). Or you can purchase online at www.epsonstore.com (U.S. sales) or www.epson.ca (Canadian sales).

Specifications

General

Type of display	Poly-silicon TFT active matrix
Size of LCD panels	0.59 inch (15 mm) wide
Lens	F=1.58 to 1.72, f=16.9 to 20.28 mm
Resolution (native format)	1280 × 800 pixels × 3, WXGA
Light Output (brightness)	White Light Output 2500 lumens (ISO 21118 standard) Color Light Output 2500 lumens
Contrast ratio	Up to 300:1 (native), up to 2000:1 (Auto Iris on)
Image size	29 to 320 inches (0.7 to 8.1 meters)
Projection distance	3 to 35.7 feet (0.9 to 10.9 meters)
Speakers	Stereo speakers (10 W × 2)
Zoom ratio	1:1.2
Aspect ratio	Native 16:10 (4:3 resize)
DVD Unit	Audio: Virtual Surround, Dolby Digital, DTS Digital Surround Media: DVD Video, DVD-R/RW, DVD-R DL, DVD+R/RW, DVD+R DL, CD-R/RW, DVD-VR (without CPRM), Video CD, Super Video CD, Audio CD, MP3 (CD/DVD), WMA (CD/DVD), JPEG, Dual Disk, WMV (CD/DVD) See page 73 for detailed file specifications.
Noise level	29 dB (Power Consumption: ECO) 34 dB (Power Consumption: Normal)
Keystone correction	Vertical: -30° to +30°
Tilt angle	Up to 10°

Remote Control

Range	Approx. 19 feet (6 m)
Battery	AA × 2 (Alkaline or Manganese dry cell)
Operating angle	Horizontal: +/- 30° Vertical: +/- 15°

Projection Lamp

Type	200 W UHE (Ultra High Efficiency) E-TORL
Part number	ELPLP55/ V13H010L55
Lamp life	Approx. 4000 hours (Power Consumption: Normal) Approx. 5000 hours (Power Consumption: ECO)

Note: Lamp life results will vary depending upon mode selected, environmental conditions, and usage.

Turn off this product when not in use to prolong the life of the projector.

Dimensions

Height	5 inches (127 mm) excluding feet
Width	13.2 inches (335 mm)
Depth	9.41 inches (239 mm)
Weight	9.5 lb. (4.3 kg)

Electrical

Rated voltage	100 to 240 VAC
Rated frequency	50/60 Hz
Power consumption	Operating: 100 to 120 VAC, 310 W (Power Consumption: Normal) 100 to 120 VAC, 259 W (Power Consumption: ECO) 220 to 240 VAC, 292 W (Power Consumption: Normal) 220 to 240 VAC, 246 W (Power Consumption: ECO) Standby: 100 to 120 VAC, 0.3 W 220 to 240 VAC, 0.4W

Environmental

Temperature	Operating: 41 to 95 °F (5 to 35 °C) without condensation Storage: 14 to 140 °F (–10 to 60 °C) without condensation
Humidity	Operating: 20 to 80% RH, non-condensing
Operating altitude	Up to 7500 feet (2286 m)

Safety and Approvals

United States	FCC Part 15B Class B UL60950-1 2nd Edition (cTUVus Mark)
Canada	ICES-003 Class B CSA C22.2 No.60950-1-07 (cTUVus Mark)

Compatible Video Formats

Composite video

Signal	Resolution	Normal aspect mode	16:9 aspect mode	Zoom aspect mode
TV (NTSC)	720 x 480	1066 x 800 (4:3)	1280 x 720 (16:9)	1280 x 800 (16:10)
TV (PAL, SECAM)	720 x 576	1066 x 800 (4:3)	1280 x 720 (16:9)	1280 x 800 (16:10)

Component video

Signal	Resolution	Normal aspect mode	16:9 aspect mode	Zoom aspect mode
SDTV (480i, 60Hz)	720 x 480	1066 x 800 (4:3)	1280 x 720 (16:9)	1280 x 800 (16:10)
SDTV (576i, 50Hz)	720 x 576	1066 x 800 (4:3)	1280 x 720 (16:9)	1280 x 800 (16:10)
SDTV (480p, 60Hz)	720 x 480	1066 x 800 (4:3)	1280 x 720 (16:9)	1280 x 800 (16:10)
SDTV (576p, 50Hz)	720 x 576	1066 x 800 (4:3)	1280 x 720 (16:9)	1280 x 800 (16:10)
HDTV (720p) 16:9	1280 x 720	1280 x 720 (16:9)	—	1280 x 800 (16:10)
HDTV (1080i) 16:9	1920 x 1080	1280 x 720 (16:9)	—	1280 x 800 (16:10)

HDMI video

Signal	Resolution	Normal aspect mode	16:9 aspect mode	Zoom aspect mode
VGA60	640 x 480	1066 x 800	1280 x 720	1280 x 800
SDTV (480i, 60Hz)	720 x 480	1066 x 800	1280 x 720	1280 x 800
SDTV (576i, 50Hz)	720 x 576	1066 x 800	1280 x 720	1280 x 800
SDTV (480p)	720 x 480	1066 x 800	1280 x 720	1280 x 800
SDTV (576p)	720 x 576	1066 x 800	1280 x 720	1280 x 800
SVGA60	800 x 600	1066 x 800	1280 x 720	1280 x 800
XGA60	1024 x 768	1066 x 800	1280 x 720	1280 x 800
HDTV (720p)	1280 x 720	1280 x 720	—	1280 x 800
WXGA60	1280 x 800	1280 x 800	1280 x 720	1280 x 800
SXGA2_60	1280 x 960	1066 x 800	1280 x 720	1280 x 800
SXGA3_60	1280 x 1024	1000 x 800	1280 x 720	1280 x 800
SXGA+60	1400 x 1050	1066 x 800	1280 x 720	1280 x 800
UXGA60	1600 x 1200	1066 x 800	1280 x 720	1280 x 800
HDTV (1080i)	1920 x 1080	1280 x 720	—	1280 x 800
HDTV (1080p, 50Hz)	1920 x 1080	1280 x 720	—	1280 x 800
HDTV (1080i, 60Hz)	1920 x 1080	1280 x 720	—	1280 x 800

Computer image

Signal	Resolution	Normal aspect mode	16:9 aspect mode	Zoom aspect mode
VGA 60/72/75/85	640 x 480	1066 x 800	1280 x 720	1280 x 800
SVGA56/60/72/75/85	800 x 600	1066 x 800	1280 x 720	1280 x 800
XGA60/70/75/85	1024 x 768	1066 x 800	1280 x 720	1280 x 800
SXGA1_70/75/85	1152 x 864	1066 x 800	1280 x 720	1280 x 800
WXGA60/75/85	1280 x 800	1280 x 800	1280 x 720	1280 x 800
WXGA60-1	1280 x 768	1280 x 768	1280 x 720	1280 x 800
WXGA60-2	1360 x 768	1280 x 722	1280 x 720	1280 x 800
SXGA2_60/75/85	1280 x 960	1066 x 800	1280 x 720	1280 x 800
SXGA3_60/75/85	1280 x 1024	1000 x 800	1280 x 720	1280 x 800
SXGA+60/75/85	1400 x 1050	1066 x 800	1280 x 720	1280 x 800
WXGA+60/75/85	1440 x 900	1280 x 800	1280 x 720	1280 x 800
UXGA60	1600 x 1200	1066 x 800	1280 x 720	1280 x 800

Computer image

Signal	Resolution	Normal aspect mode	16:9 aspect mode	Zoom aspect mode
WSXGA+60	1680 × 1050	1280 × 800	1280 × 720	1280 × 800
MAC13"	640 × 480	1066 × 800	1280 × 720	1280 × 800
MAC16"	832 × 624	1066 × 800	1280 × 720	1280 × 800
MAC19"	1024 × 768	1066 × 800	1280 × 720	1280 × 800
MAC21"	1152 × 870	1059 × 800	1280 × 720	1280 × 800

File Specifications

Your projector supports MP3, WMA, MPEG, and JPG files that conform to the following specifications:

File system	Discs: ISO9660 level 1 or level 2 (Discs that have been recorded in the packet write [UDF] format cannot be read.) USB devices: FAT16 and FAT32
File name	Alphanumeric characters only, with .mp3, .wma, .avi, .vid, .mpe, .mpg, .mpeg, .dat, .vob, or .jpg file extensions.
File size	USB devices: 4GB (FAT32)
Group (folder) count	Up to 300
Track (file) count	Up to 648
Bit rate	MP3: 16 to 320 kbps, WMA: 64 to 192 kbps, MPEG: up to 5.57 mbps for USB devices, up to 5.6 mbps for CDs, up to 19 mbps for DVDs
Sampling frequency	MP3: 11 kHz, 16 kHz, 22.05 kHz, 32 kHz, 44.1 kHz, 48 kHz, WMA: 44.1 kHz, 48 kHz
Total number of pixels	JPG: Up to 3027 × 2048, MPEG-1/MPEG-2 (Advanced Simple Profile): Up to 720 × 576 pixels

Your projector can play multi-session recorded discs. Multiple bit rate files and WAV files are not supported. The projector supports baseline JPEG files created by a digital camera and conforming to the DCF (Design rule for Camera File system) standard. Motion JPEG files are not supported. Certain digital camera functions such as automatic rotation may not be supported.

These specifications are subject to change without notice.

Language Codes

Abkhazian	6566	Gaelic; Scottish Gaelic	7168	Magyar	7285	Sinhalese	8373
Afar	6565	Gallegan	7176	Malayalam	7776	Slovensky	8373
Afrikaans	6570	Georgian	7565	Maltese	7784	Slovenian	8376
Amharic	6577	Gikuyu; Kikuyu	7573	Manx	7186	Somali	8379
Arabic	6582	Guarani	7178	Maori	7773	Sotho; Southern	8384
Armenian	7289	Gujarati	7185	Marathi	7782	South Ndebele	7882
Assamese	6583	Hausa	7265	Marshallese	7772	Sundanese	8385
Avestan	6569	Herero	7290	Moldavian	7779	Suomi	7073
Aymara	6589	Hindi	7273	Mongolian	7778	Swahili	8387
Azerhājani	6590	Hiri Motu	7279	Nauru	7865	Swati	8383
Bahasa Melayu	7783	Hrwatski	6779	Navaho; Navajo	7886	Svenska	8386
Bashkir	6665	Ido	7379	Ndebele, North	7868	Tagalog	8476
Belarusian	6669	Interlingua (International)	7365	Ndebele, South	7882	Tahitian	8489
Bengali	6678	Interlingue	7365	Ndonga	7871	Tajik	8471
Bihari	6672	Inuktitut	7385	Nederlands	7876	Tamil	8465
Bislama	6673	Inupiaq	7375	Nepali	7869	Tatar	8484
Bokmål, Norwegian	7866	Irish	7165	Norsk	7879	Telugu	8469
Bosanski	6683	Islenska	7383	Northern Sami	8369	Thai	8472
Brezhoneg	6682	Italiano	7384	North Ndebele	7868	Tibetan	6679
Bulgarian	6671	Ivrit	7269	Norwegian Nynorsk;	7878	Tigrinya	8473
Burmese	7789	Japanese	7465	Occitan; Provençal	7967	Tonga (Tonga Island)	8479
Castellano, Español	6983	Javanese	7486	Old Bulgarian; Old Slavonic	6785	Tsonga	8483
Catalán	6765	Kalaallisut	7576	Oriya	7982	Tswana	8478
Chamorro	6772	Kannada	7578	Oromo	7977	Türkçe	8482
Chechen	6769	Kashmiri	7583	Ossetian; Ossetic	7983	Türkmen	8475
Chewa; Chichewa; Nyanja	7889	Kazakh	7575	Pali	8073	Twi	8487
中文	9072	Kernewek	7587	Panjabi	8065	Uighur	8571
Chuang; Zhuang	9065	Khmer	7577	Persian	7065	Ukrainian	8575
Church Slavic; Slavonic	6785	Kinyarwanda	8287	Polski	8076	Urdu	8582
Chuvash	6786	Kirghiz	7589	Português	8084	Uzbek	8590
Corsican	6779	Komi	7586	Pushto	8083	Vietnamese	8673
Česky	6783	Korean	7579	Russian	8285	Volapuk	8679
Dansk	6865	Kuanyama; Kwanyama	7574	Quechua	8185	Walloon	8765
Deutsch	6869	Kurdish	7585	Raeto-Romance	8277	Welsh	6789
Dzongkha	6890	Lao	7679	Romanian	8279	Wolof	8779
English	6978	Latina	7665	Rundi	8278	Xhosa	8872
Esperanto	6979	Latvian	7686	Samoan	8377	Yiddish	8973
Estonian	6984	Letzeburgesch;	7666	Sango	8371	Yoruba	8979
Euskara	6985	Limburgan; Limburger	7673	Sanskrit	8365	Zulu	9085
Ελληνικά	6976	Lingala	7678	Sardinian	8367		
Faroese	7079	Lithuanian	7684	Serbian	8382		
Français	7082	Luxembourgish;	7666	Shona	8378		
Frysk	7089	Macedonian	7775	Shqip	8381		
Fijian	7074	Malagasy	7771	Sindhi	8368		

Index

A

- Accessories, 7, 68
- Air filter
 - cleaning and replacing, 54 to 55
 - ordering, 7
- Air vents, 9
- Audio
 - adjusting, 23, 27, 50
 - problems, 65 to 66
- Audio system connection, 34
- Auto Iris, 49
- AV amplifier, connecting, 34

B

- Blurry picture, 64
- Brightness
 - adjusting, 49
 - lamp, 56, 69
- Buttons, 10, 11

C

- Cable box, connecting, 30 to 32
- Camcorder, connecting, 30 to 32
- Camera angle, 44
- CDs, playing, 39
- Child Lock, 46
- Cleaning
 - air filter, 54 to 55
 - lens and projector case, 53 to 54
- Closed captioning, 51
- Color mode, 27
- Color problems, 65, 67
- Component video connection, 30
- Composite video connection, 30
- Computer connection, 35 to 38

- Contrast ratio, 69
- Control panel, projector, 10

D

- Dark image, 65
- Digital audio recorder, connecting, 34
- Digital camera, connecting, 30 to 32
- Distance, projection, 17, 69
- Documentation, 8
- DVDs
 - menus, 26
 - playing, 21 to 28
- DVR, connecting, 30 to 32

E

- Electrical specifications, 70
- Environmental specifications, 71
- EPSON
 - accessories, 7, 68
 - PrivateLine Support, 68
 - Road Service, 6
 - technical support, 8, 68
- Exhaust vent, 9
- External equipment
 - connecting, 30 to 38
 - problems, 66

F

- Fast forward, 25
- File specifications, 73
- Filter, *see* Air filter
- Focus ring, 23
- Formats, video, 71 to 73

G

Game console, connecting, 30 to 32
General specifications, 69

H

HDMI connection, 30
Headphones, 28
Help, 8, 68
High altitude mode, 51, 62

I

Image
 blurry, 64
 distorted, 65
 shape, 65, 69
 size, 17, 69
 too light or dark, 65
 turning off, 24
 wrong colors, 65
Intake vent, 9
iPod, connecting, 30 to 32

J

Jog control, 25
JPEG, 40, 49, 73

K

Kensington lock, 7
Keystone correction, 65, 69

L

Lamp
 brightness, 56, 69
 light, 62
 ordering, 7, 56
 replacing, 56 to 58
 specifications, 70
 usage timer, resetting, 52, 58 to 59
Language, 44, 48, 74
Laptop connection, 35 to 38
Lens, cleaning, 53
Lights, projector, 61 to 62
Location, projector, 17 to 18
Lock, security, 7
Locking
 Power button, 46
 projector, 47
Looping, 42

M

Maintenance, 53 to 59
Menus, 26
Microphone, connecting, 29
Movies
 pausing, 24
 playing, 21 to 28
 searching, 25
MP3, 40, 49, 73
Music, playing, 39 to 41
Muting, 24, 26

N

No Signal message, 66

O

Optional accessories, 7
Overheating, 18, 54, 62

P

- Parental controls, 45
- Parts, identifying, 9 to 10
- Pausing, 24
- Photos, displaying, 39 to 41
- Picture
 - adjusting, 22, 27, 49 to 52
 - problems, 63 to 65
- Positioning projector, 17 to 18
- Power button locking, 46
- Power, saving, 48
- Problems
 - audio, 65 to 66
 - color, 65, 67
 - lights indicating, 61 to 62
 - operation, 63 to 64
 - overheating, 18, 54, 62
 - picture, 63 to 65
 - remote control, 64
- Program play, 43
- Projection distance, 17, 69
- Projector
 - choosing location, 17 to 18
 - cleaning, 54
 - control panel, 10
 - dimensions, 70
 - distance from screen, 17, 69
 - lights, 61 to 62
 - locking, 47
 - maintenance, 53 to 59
 - operation problems, 63 to 64
 - parts, 9
 - positioning, 17 to 18
 - speakers, 69
 - specifications, *see* Specifications
 - storing, 59
 - transporting, 60
 - turning off, 20

R

- Registration, 6
- Remote control
 - buttons, 11
 - problems, 64
 - specifications, 70
- Repeating scenes or tracks, 42
- Replacing lamp, 56 to 58
- Resetting lamp timer, 52, 58 to 59
- Resolution, 69
- Road Service, 6

S

- Safety approvals, 71
- Satellite receiver, connecting, 30 to 32
- Screen distance, 17, 69
- Screen saver setting, 49
- Searching, 25
- Shuttle control, 25
- Signal not supported message, 67
- Size, image, 17, 69
- Skipping chapters or tracks, 25
- Sleep mode, 48, 61, 63
- Slow motion, 25
- Sound
 - adjusting, 23, 27, 50
 - problems, 65 to 66
- Sources, switching, 32, 37, 67
- Speakers, projector, 69
- Specifications
 - compatible video formats, 71 to 73
 - electrical, 70
 - environmental, 71
 - file specifications, 73
 - general, 69
 - lamp, 70
 - language codes, 74
 - remote control, 70
- Storing projector, 59
- Subtitles, 44
- Support, *see* Technical support
- Surround sound system, connecting, 34

T

Technical support, 8, 68
Temperature, projector, 54, 62
Transporting projector, 60
TV video formats, 71 to 73

U

USB cable, projecting with, 35
USB devices, 33

V

VCR, connecting, 30 to 32
Ventilation, 18, 54, 62
Vents, 9
Video camera, connecting, 30 to 32
Video, compatible formats, 71 to 73
Volume, adjusting, 23

W

Warranty, 6
WMA, 40, 49, 73

Z

Zooming, 22, 25