



Eaton 5PX

Advanced User Guide

5PX1500HRTG2
5PX2200HRTG2
5PX3000HRTG2
5PX3000HRTNG2

5PXEBM48RTG2
5PXEBM72RTG2



Copyright © 2021 EATON
All rights reserved.

614-40096-00

Special symbols

The following are examples of symbols used on the UPS or accessories to alert you to important information:











	<p>DANGER: Dangerous voltage levels are present within the UPS. The UPS has its own internal power source (the battery). Consequently, the power outlets may be energized even if the UPS is disconnected from the AC power source.</p>
	<p>Important instructions that must always be followed.</p> <p>CAUTION: Batteries present a risk of energy or electrical shock or burn from high short circuit current. Observe proper precaution. Batteries may contain HIGH VOLTAGE and CORROSIVE, TOXIC and EXPLOSIVE substances.</p>
	<p>Information, advice, help.</p>
	<p>Read the documentation provided.</p>
	<p>Disconnect input plug.</p>
	<p>Before maintenance, first shut down the UPS then disconnect the AC power source, internal and external batteries then discharge capacitors by pressing the ON button and wait 5 minutes.</p>
	<p>This equipment should only be used in a dry indoor environment.</p>
	<p>Operating range of temperature.</p>
	<p>Operating range of humidity.</p>
	<p>The UPS and their batteries must be kept in a ventilated place.</p>

Table of Contents

1	Introduction	5
1.1	Environmental protection	5
1.2	Benefits.....	6
2	Presentation.....	7
2.1	Standard installation	7
2.2	Rear panel.....	8
2.3	Optional accessories.....	9
3	Installation	9
3.1	Inspecting the equipment	9
3.2	Recommended positions.....	11
3.3	Connecting the internal battery	13
3.4	EBM connection	13
3.5	UPS connection.....	15
3.6	Connection with a FlexPDU (Power Distribution Unit) optional module.....	15
3.7	Connection with a HotSwap MBP (Maintenance ByPass) optional module	15
4	Interfaces and communication	17
4.1	Control panel.....	17
4.2	LCD description	18
4.3	Display functions.....	19
4.4	User settings.....	21
4.5	Communication ports.....	24
4.6	UPS remote control functions	26
4.7	Eaton Intelligent Power Software suite	29
4.8	Cybersecurity	29
5	Operation	29
5.1	Start-up and normal operation	29
5.2	Starting the UPS on battery.....	30
5.3	UPS shutdown.....	30
5.4	Operating modes	30
5.5	Return of AC input power	31
5.6	Retrieving the event log.....	31

5.7	Retrieving the fault log	31
6	UPS maintenance.....	31
6.1	Equipment care	31
6.2	Storing the equipment.....	31
6.3	When to replace batteries.....	32
6.4	Replacing batteries	32
6.5	Replacing the UPS equipped with a HotSwap MBP	34
6.6	Recycling the used equipment.....	34
7	Troubleshooting.....	34
7.1	Typical alarms and faults.....	35
7.2	Silencing the alarm	37
7.3	Service and support	37
8	Specification and technical characteristics.....	37
8.1	UPS model list	38
8.2	Extended Battery Module model list.....	38
8.3	Electrical input	38
8.4	Electrical input connections.....	39
8.5	Electrical output.....	39
8.6	Electrical output connection	40
8.7	Battery	40
8.8	Environmental and safety	40
9	Glossary	41

1 Introduction

Thank you for selecting an Eaton 5PX product to protect your electrical equipment.

The Eaton 5PX range has been designed with the utmost care. We recommend that you take the time to read this advanced user guide to take full advantage of the many features of your UPS (Uninterruptible Power System).

Before installing your Eaton 5PX, please read the information and safety instructions provided. Follow the instructions in the quick start guide and if necessary, refer to this advance user guide.

To discover the entire range of Eaton products, we invite you to visit our web site at eaton.com or contact your Eaton local representative.

NOTE: This equipment has been tested and found to comply with the limits for a Class B digital device, pursuant to part 15 of the FCC Rules. These limits are designed to provide reasonable protection against harmful interference in a residential installation. This equipment generates, uses and can radiate radio frequency energy and, if not installed and used in accordance with the instructions, may cause harmful interference to radio communications. However, there is no guarantee that interference will not occur in a particular installation. If this equipment does cause harmful interference to radio or television reception, which can be determined by turning the equipment off and on, the user is encouraged to try to correct the interference by one or more of the following measures:

- Reorient or relocate the receiving antenna.
- Increase the separation between the equipment and receiver.
- Connect the equipment into an outlet on a circuit different from that to which the receiver is connected.
- Consult the dealer or an experienced radio/TV technician for help.

UPS employing batteries with min. V-2 case are intended for use in computer room as defined in the standard for the Protection of Information Technology Equipment, ANSI/NFPA 75.

UPS employing batteries with HB case are intended not for use in a computer room as defined in the standard for the Protection of Information Technology Equipment, ANSI/NFPA 75.

Supplier's Declaration of Conformity of Federal Communications Commission Statement

This device complies with Part 15 of the FCC Rules. Operation is subject to the following two conditions:

- (1) this device may not cause harmful interference, and
- (2) this device must accept any interference received, including interference that may cause undesired operation.

For questions regarding this FCC SDoC declaration, contact Eaton Corporation by telephone or through the Internet.

Eaton Corporation
8609 Six Forks Road,
Raleigh, NC 27615, USA
Telephone: 800-356-5794

This UPS can be used in IT power system. This UPS complies with the IP20 protection type.

1.1 Environmental protection

Eaton has implemented an environmental-protection policy. Products are developed according to an eco-design approach.

Substances

This product does not contain CFC and HCFC. This product does not contain asbestos. This product is compliant with regulations on the restriction of the use of substances in electrical and electronic equipment.

Packaging

To improve waste treatment and facilitate recycling, separate the various packing components.

- The cardboard we use comprises over 50% of recycled cardboard.
- Plastic bags are made of polyethylene.
- Packing materials are recyclable and bear the appropriate identification symbol.



Materials	Abbreviations	Number in the symbols 
Polyethylene terephthalate	PET	01
High-density polyethylene	HDPE	02
Polyvinyl chloride	PVC	03
Low-density polyethylene	LDPE	04
Polypropylene	PP	05
Polystyrene	PS	06

Follow all local regulations for the disposal of packing materials.

End of life

Eaton will process products at the end of their service life in compliance with local regulations. Eaton works with companies in charge of collecting and eliminating our products at the end of their service life.

Product

The product is made up of recyclable materials. Dismantling and destruction must take place in compliance with all local regulations concerning waste. At the end of its service life, the product must be transported to a processing center for electrical and electronic waste. eaton.com/recycling

Battery

The product contains lead-acid batteries that must be processed according to applicable local regulations concerning batteries. The battery may be removed to comply with regulations and in view of correct disposal.

1.2 Benefits

The Eaton 5PX uninterruptible power system (UPS) protects your sensitive electronic equipment from the most common power problems, including power outages, voltage sags, impulsive transients, line noise, and long-term under and over voltage conditions.

Power outages can occur when you least expect it and power quality can be erratic. These power problems have the potential to corrupt critical data, destroy unsaved work sessions, and damage hardware - causing hours of lost productivity and expensive repairs.

With the Eaton 5PX, you can safely eliminate the effects of power disturbances and guard the integrity of your equipment. Providing outstanding performance and reliability, the Eaton 5PX's unique benefits include:

- ABM® technology that uses advanced battery management to increase battery service life, optimize recharge time, and provide a warning before the end of useful battery life
- Standard communication options: one RS-232 communication port, one USB communication port, relay output contacts
- Optional connectivity cards with enhanced communication capabilities
- Extended runtime with up to four Extended Battery Modules (EBMs) per UPS
- Remote On/Off control
- Backed by worldwide agency approvals
- Remote firmware upgrade capability.

2 Presentation

2.1 Standard installation

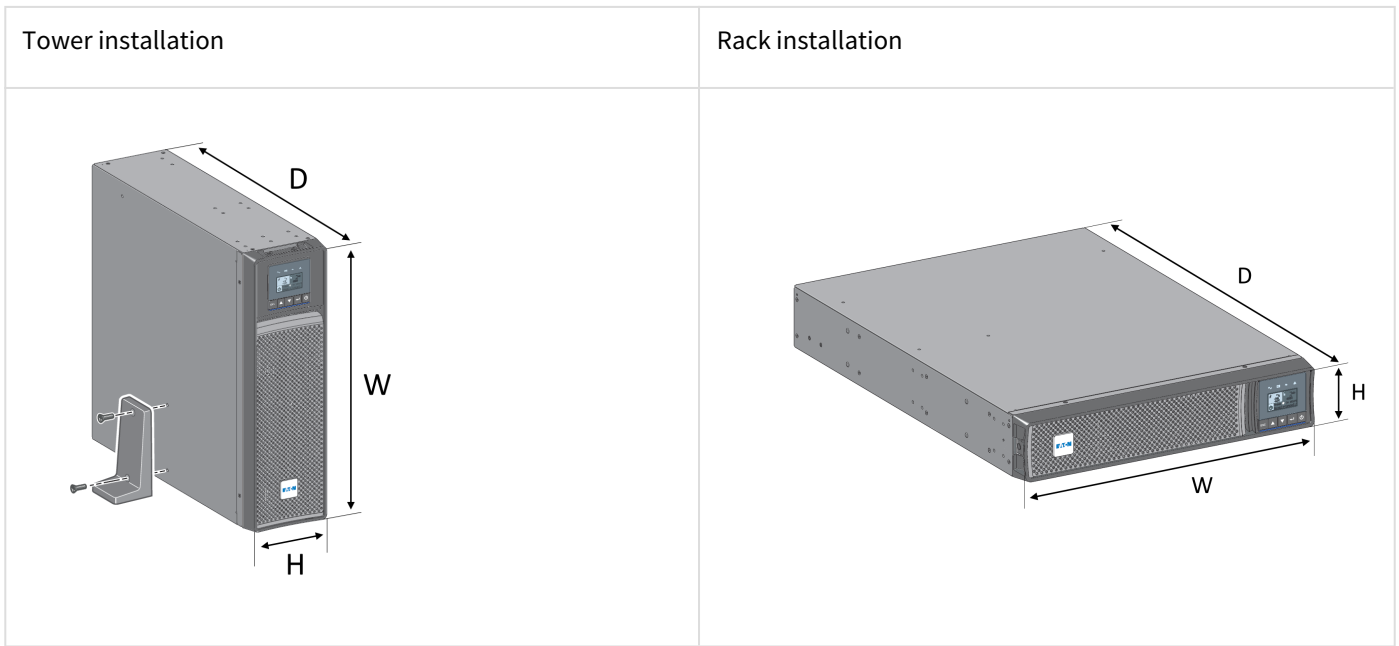

Weights and dimensions

Description (UPS)	Weights (lb / kg)	Dimensions (inch / mm) D x W x H
5PX1500HRTG2	49.4 / 22.4	17.6x17.2x3.4 / 448x438x85.5
5PX2200HRTG2	62.2 / 28.2	23.7x17.2x3.4 / 603x438x85.5
5PX3000HRTG2	69.9 / 31.7	23.7x17.2x3.4 / 603x438x85.5
5PX3000HRTNG2	69.9 / 31.7	23.7x17.2x3.4 / 603x438x85.5
Description (EBM)	Weights (lb / kg)	Dimensions (inch / mm) D x W x H
5PXEBM48RTG2	61.3 / 27.8	17.6x17.2x3.4 / 448x438x85.5
5PXEBM72RTG2	89.1 / 40.4	23.7x17.2x3.4 / 603x438x85.5
5PXEBM72RT3UAG2	87.5 / 39.7	19x17.2x5.1 / 483x438x129

2.2 Rear panel

5PX1500HRTG2

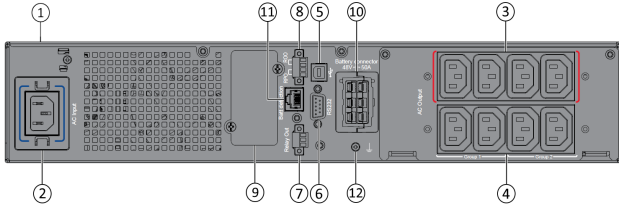

5PX2200HRTG2- 5PX3000HRTG2/5PX3000HRTNG2

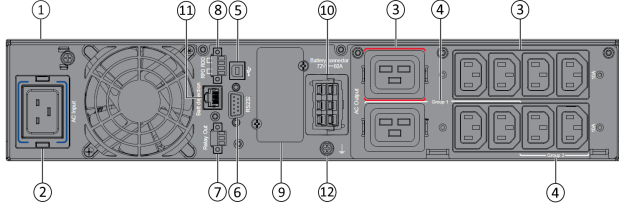

5PXEBM48RT2UG2 - 5PXEBM72RT2UG2

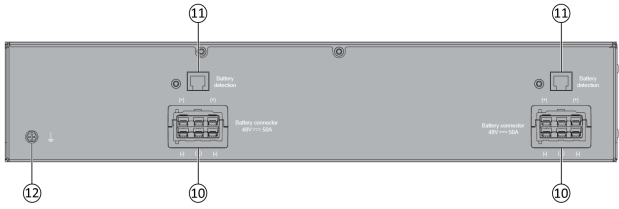

5PXEBM72RT3UG2

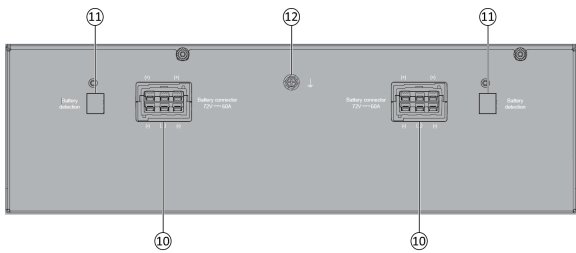

- ① UPS
- ② Input AC power source
- ③ Primary group (critical equipment)
- ④ Outlet group (programmable outlets)
- ⑤ USB communication port
- ⑥ RS232 communication port
- ⑦ Relay output contact
- ⑧ Connector for ROO (Remote On/Off) control and RPO (Remote Power Off)
- ⑨ Slot for optional communication card
- ⑩ Connector for additional External Battery Module
- ⑪ Connector for automatic recognition of an additional battery module
- ⑫ Ground screw

2.3 Optional accessories

Part number	Description
5PXEBM48RTG2 5PXEBM72RTG2 5PXEBM72RT3UAG2	Extended Battery Module
Network-M2	Eaton Gigabit Network Card (SNMP v1/v3 and IP v4/v6 // Ethernet 10/100/1000BaseT)
INDGW-M2	Eaton Industrial Gateway Card (Modbus TCP / RTU)
Relay-MS	Eaton Relay card (1 x RS232 or 5 x Relay output)
INDRELAY-MS	Eaton Industrial relay card (5x relay outputs with dry contacts for remote alarm information)
EMPDT1H1C2	Environmental Monitoring Probe Gen2 Compatible with : Gigabit Network Card (Network-M2) / Industrial Gateway Card (INDGW-M2) / Eaton ePDU G3/G3+
EHBPL1500R-PDU1U EHBPL2000R-PDU1U EHBPL3000R-PDU1U	HotSwap external maintenance bypass (6) 5-15R HotSwap external maintenance bypass (6) 5-20R HotSwap external maintenance bypass (5) 5-20R
EFLXL1500R-PDU1U EFLXL2000R-PDU1U EFLXL2000R-PDU1UL EFLXI3000R-PDU1UIEC	FlexPDU (12) 5-15R FlexPDU (12) 5-20R FlexPDU (5) L5-20R FlexPDU (12) C13, (1) C19

3 Installation

3.1 Inspecting the equipment

If any equipment has been damaged during shipment, keep the shipping cartons and packing materials for the carrier or place of purchase and file a claim for shipping damage. If you discover damage after acceptance, file a claim for concealed damage.

To file a claim for shipping damage or concealed damage:

1. File with the carrier within 15 days of receipt of the equipment;
2. Send a copy of the damage claim within 15 days to your service representative.



Check the battery recharge date on the shipping carton label. If the date has passed and the batteries were never recharged, do not use the UPS. Contact your service representative.

Package content

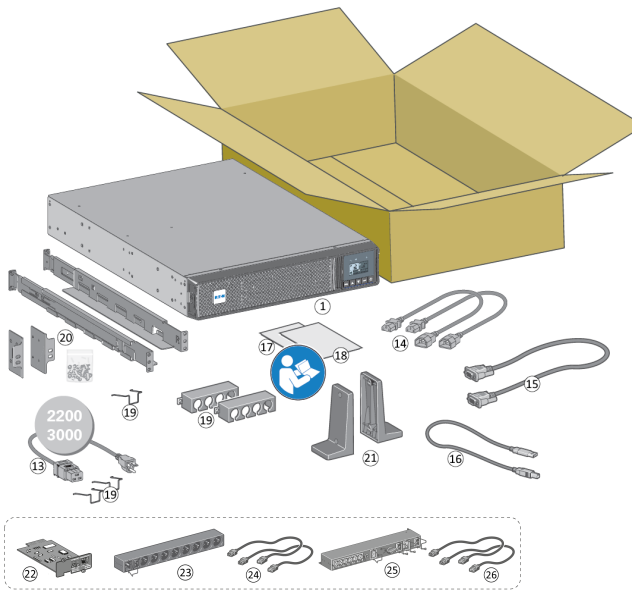

Verify that the following additional items are included with the UPS:

- ① UPS
- ⑬ Connection cable to AC power source (2200VA & 3000VA models only)
- ⑭ Connection cables for the protected equipment
- ⑮ RS232 communication cable
- ⑯ USB communication cable
- ⑰ Safety instructions
- ⑱ Quick start
- ⑲ Cable locking systems
- ⑳ Rack kit for 19-inch 4-post enclosures
- ㉑ Two supports for tower position (tower feet)
- ㉒ Communication card (optional)
- ㉓ FlexPDU module (optional)
- ㉔ Connection cables between FlexPDU module and UPS (optional)
- ㉕ HotSwap MBP module (optional)
- ㉖ Connection cables between HotSwap MBP module and UPS (optional)

3.2 Recommended positions

Installation in tower position



If you ordered other UPS accessories, refer to specific user manuals to check the tower installation with the UPS.

To install the UPS:

Place the UPS on a flat, stable surface in its final location. Always keep 6" or 150 mm of free space behind the UPS rear panel for ventilation.

If installing additional EBM, place them next to the UPS in their final location.

Follow steps 1 to 5 to adjust the orientation of the LCD panel and of the logo.

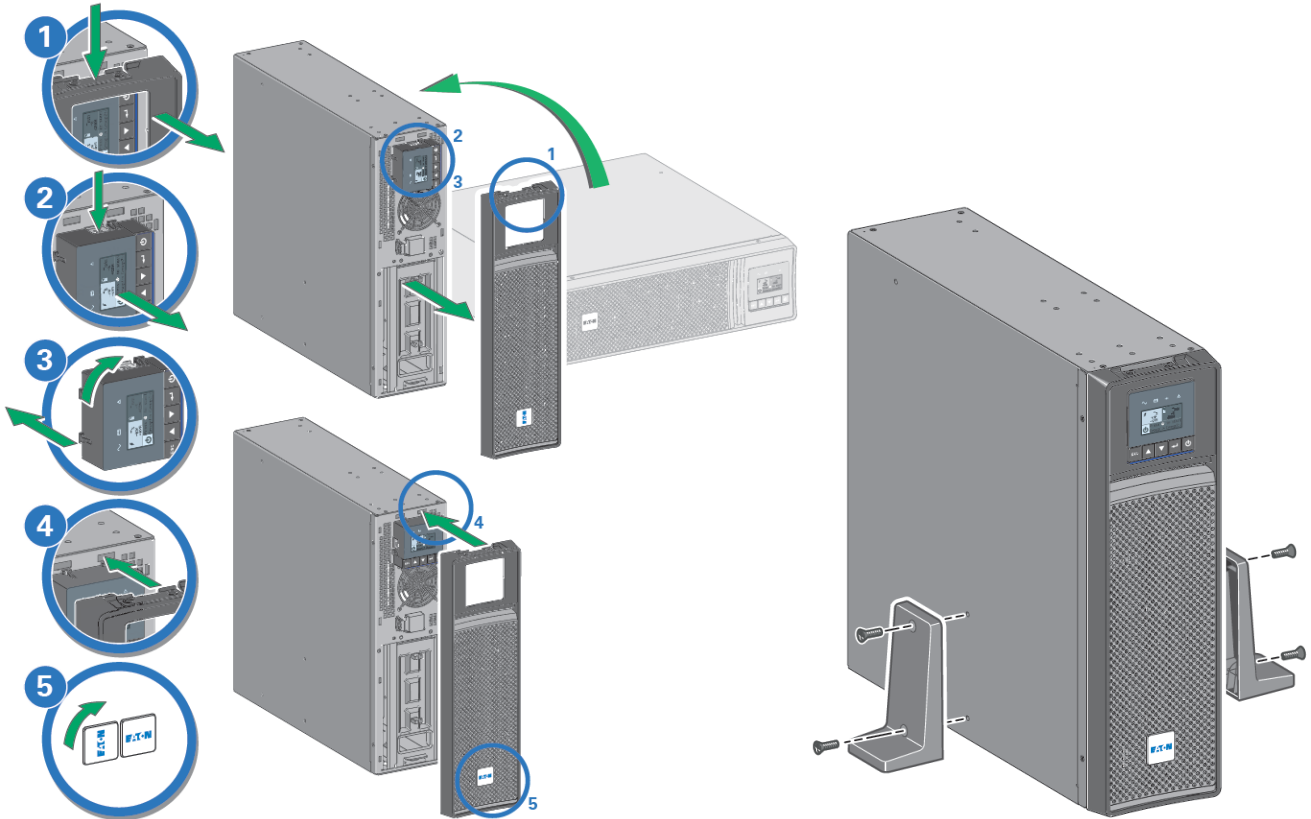

Installation in rack position

Follow steps 1 to 4 for module mounting on the rails.

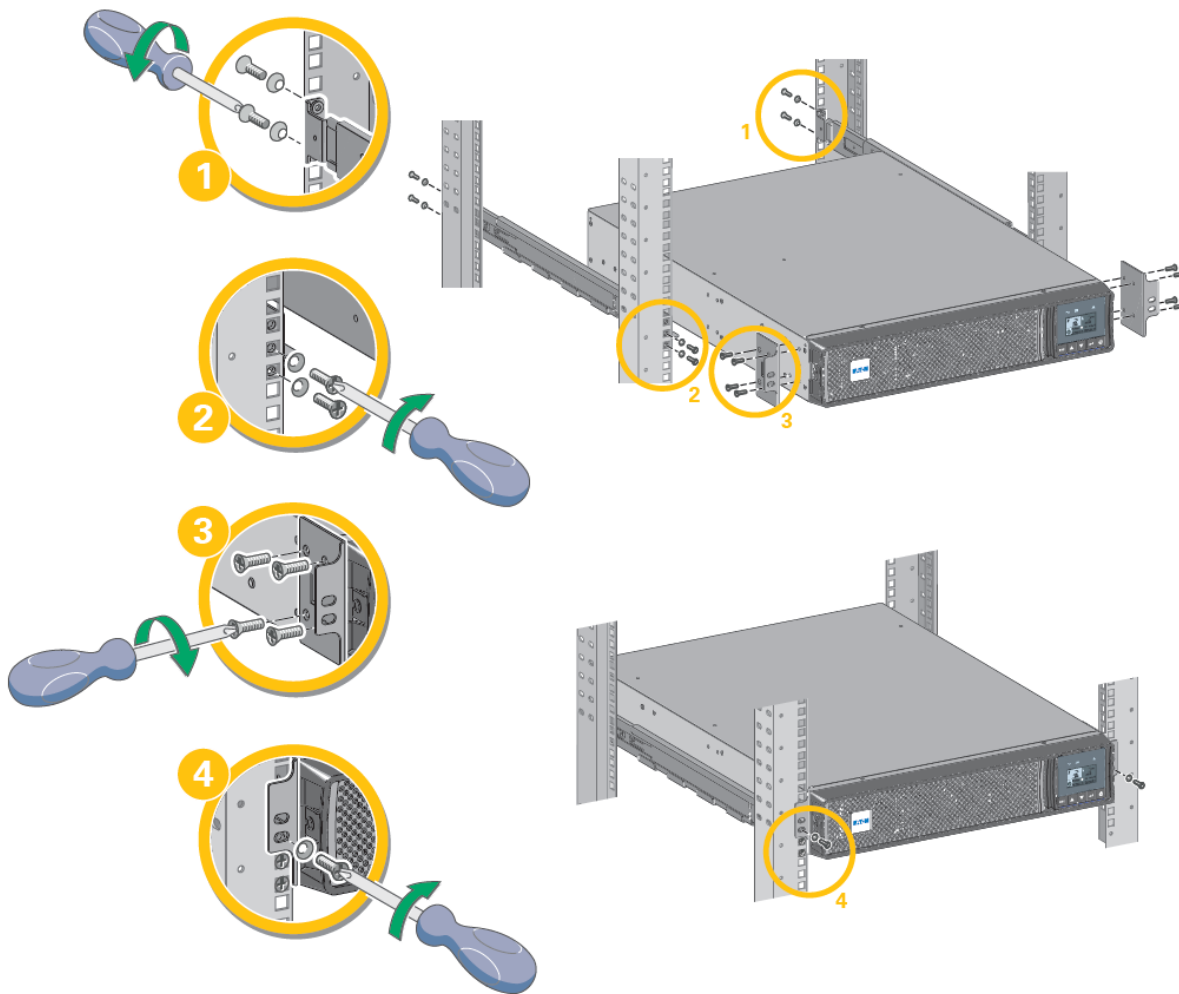

 The rails and necessary hardware are supplied by Eaton.

3.3 Connecting the internal battery

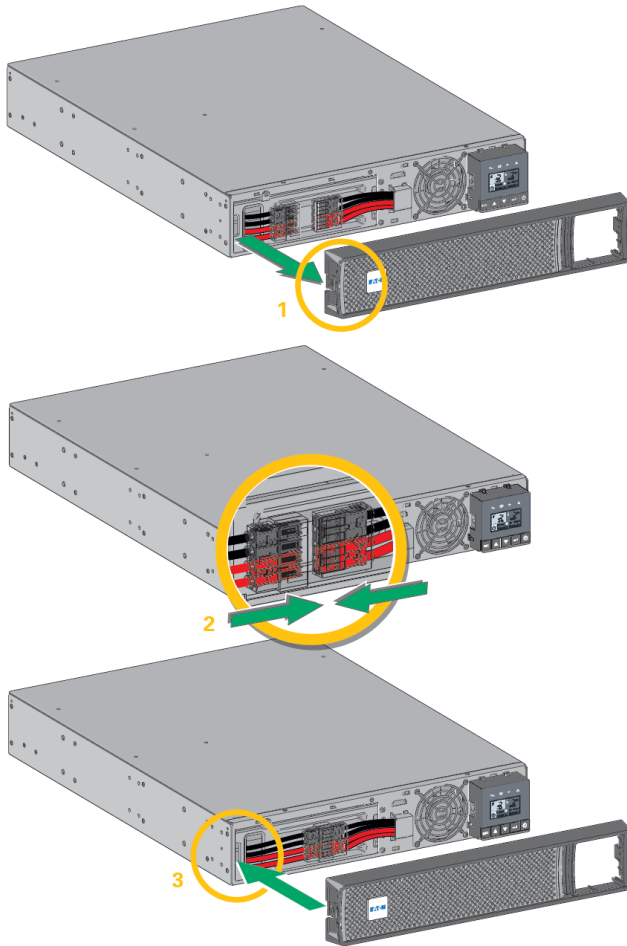



 A small amount of arcing may occur when connecting the internal batteries. This is normal and will not harm personnel. Connect the cables quickly and firmly.

1. Remove the front panel by pressing on both sides of the panel.
2. Connect the two battery connectors together.
3. Replace the front panel.

3.4 EBM connection

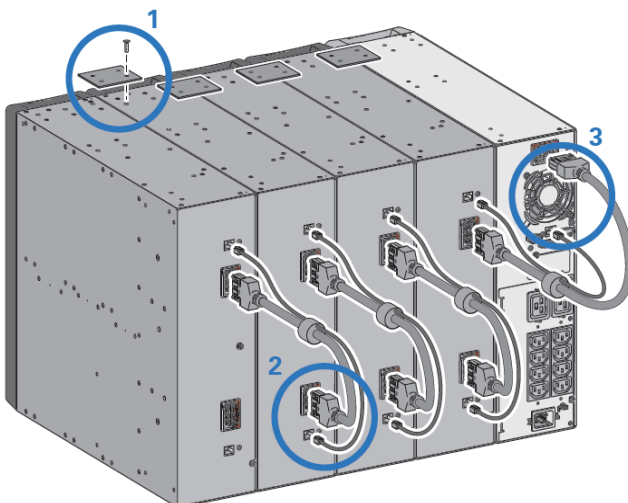
Tour installation





 A small amount of arcing may occur when connecting an EBM to the UPS. This is normal and will not harm personnel. Insert the EBM cable into the UPS battery connector quickly and firmly.

1. Attach the UPS and the EBMs to each other using the supplied mounting plate. Up to 4 EBMs may be connected to the UPS.
2. Connect the EBMs power cable and the attached battery detection cable as shown in the picture.
3. Verify that the EBM connections are tight and that adequate bend radius and strain relief exist for each cable.

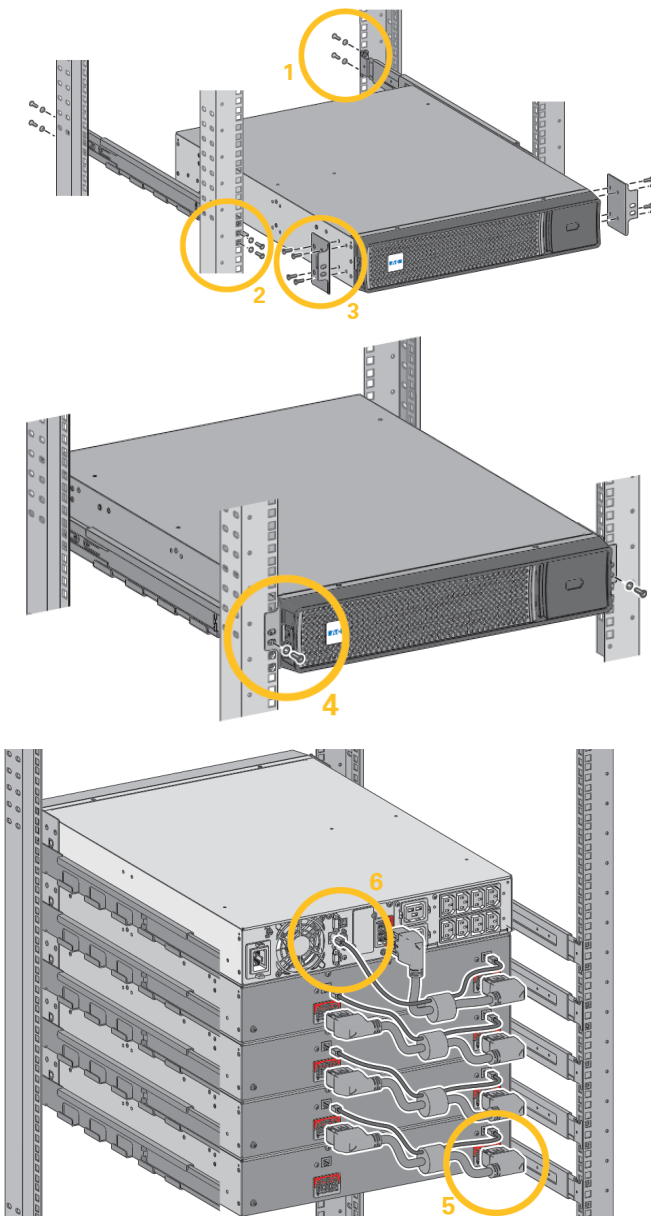
Rack installation



 A small amount of arcing may occur when connecting an EBM to the UPS. This is normal and will not harm personnel. Insert the EBM cable into the UPS battery connector quickly and firmly.

 To increase stability, it is preferable to place the EBM below the UPS.

1. Fix the rail on the back of the rack.
2. Fix the rail on the front of the rack using the two holes at the bottom.
3. Fix the ears plate to the UPS.
4. Place the UPS on the rails and fix the ears plate to the top hole of the rail.
5. Connect the EBM power cable as shown in the picture.
6. Connect the RJ45 battery detection cable of the first EBM between the EBM and the UPS connector "Batt detection" (11). For any additional EBM, connect the battery detection cable to the previous EBM.

Verify that the EBM connections are tight and that adequate bend radius and strain relief exist for each cable.

3.5 UPS connection



Check that the indications on the name plate located on the back of the UPS correspond to the AC-power source and the true electrical consumption of the total load.

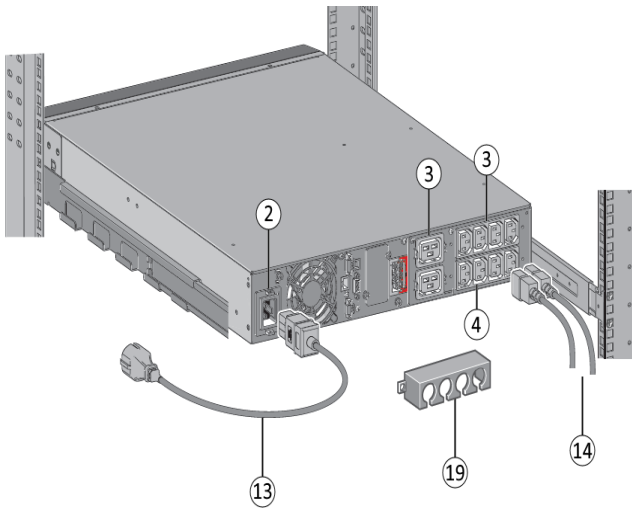

1. For the 5PX 1000 / 1500, connect the UPS input socket (2) to the AC power source using the cable of the protected equipment.

For the 5PX2200 / 3000, connect the UPS input socket (2) to the AC-power source using the cable (13) supplied.

2. Connect the loads to the UPS using the cables (14). It is preferable to connect the priority loads to the outlets marked (3) and the non-priority loads to the outlets Group1, Group2 (4) that can be programmed.

For the 5PX 2200 / 3000 models, connect any high-power devices or matching Power Distribution Unit (PDU) to the 16A outlet.

Fit the connection securing system that prevents the plugs from being pulled out accidentally.

3. To program shutdown and startup of the Group1 and Group2 outlets in order to extend battery runtime and perform scheduled shutdowns, please see the "[In/Out settings](#)" section.

3.6 Connection with a FlexPDU (Power Distribution Unit) optional module

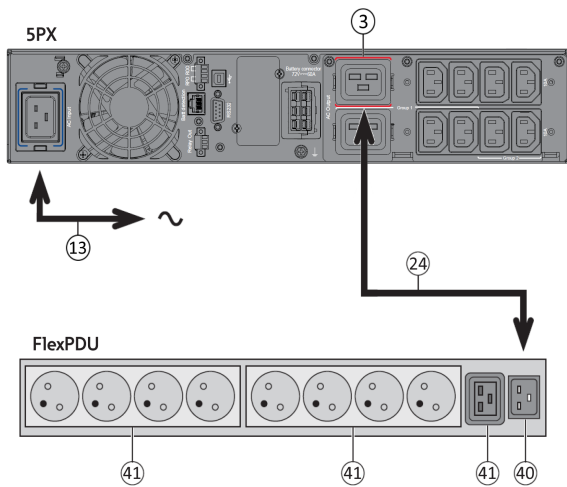

1. 5PX 1000 / 1500 : Use the power cable of the protected equipment.

5PX 2200 / 3000 connect the UPS input socket to the AC power source using the cable (13) supplied.

2. Connect the input socket on the FlexPDU module (40) to the UPS outlet (3) using the cable (24) supplied. The cable and the connectors are marked in red.

3. Connect the equipment to the outlets (41) on the FlexPDU module. These outlets differ, depending on the version of the FlexPDU module.

4. Fit the connection securing system that prevents the plugs from being pulled out accidentally.

3.7 Connection with a HotSwap MBP (Maintenance ByPass) optional module

The HotSwap MBP module makes it possible to service or even replace the UPS without affecting the connected loads (HotSwap function).

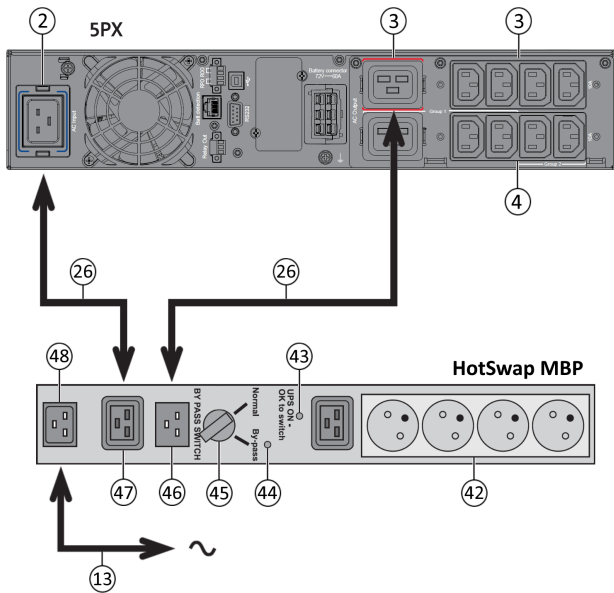

1. Connect the input socket (48) on the HotSwap MBP module to the AC power source using the cable (13) supplied.
2. Connect the UPS input socket (2) to the “UPS Input” (47) on the HotSwap MBP module, using the cable (26) supplied. This cable and the connector are marked blue.
3. Connect the UPS outlet (3) to the “UPS Output” (46) on the HotSwap MBP module, using the cable (26) supplied. This cable and the connector are marked in red.
4. Connect the equipment to the outlets (42) on the HotSwap MBP module.
These outlets differ, depending on the version of the HotSwap MBP module.

Caution : Do not use UPS outlets (4) to supply equipment because use of switch (45) on the HotSwap MBP module would cut supply to the equipment.

HotSwap MBP module operation

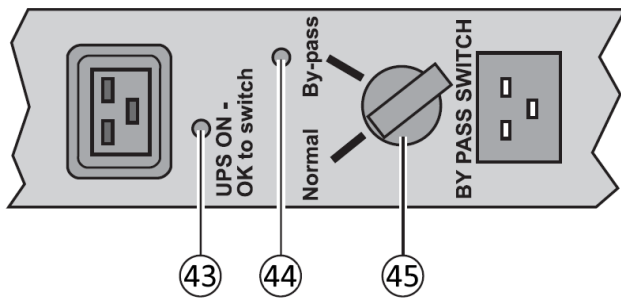

The HotSwap MBP module has a rotary switch (45) with two positions:

Normal : the load is supplied by the UPS, LED (43) is on.
Bypass : the load is supplied directly by the AC power source. LED (44) is on. Load is not protected.

UPS start-up with the HotSwap MBP module

1. Check that the UPS is correctly connected to the HotSwap MBP module.
2. Start the UPS by pressing the  button on the UPS control panel. LED (43) "UPS ON - OK to switch" on the HotSwap MBP module goes ON (otherwise, there is a connection error between the HotSwap MBP module and the UPS).
3. Set switch (45) to Normal position. The red LED on the HotSwap MBP module goes OFF.

HotSwap MBP module test

1. Set switch (45) to Bypass position and check that the load is still supplied.
2. Set switch (45) back to Normal position.

4 Interfaces and communication

4.1 Control panel

The screen provides useful information about the UPS itself, load status, events, measurements and settings.

The LED bar ⑨ has been implemented to provide a quick visual reference of UPS status "at-a-glance".

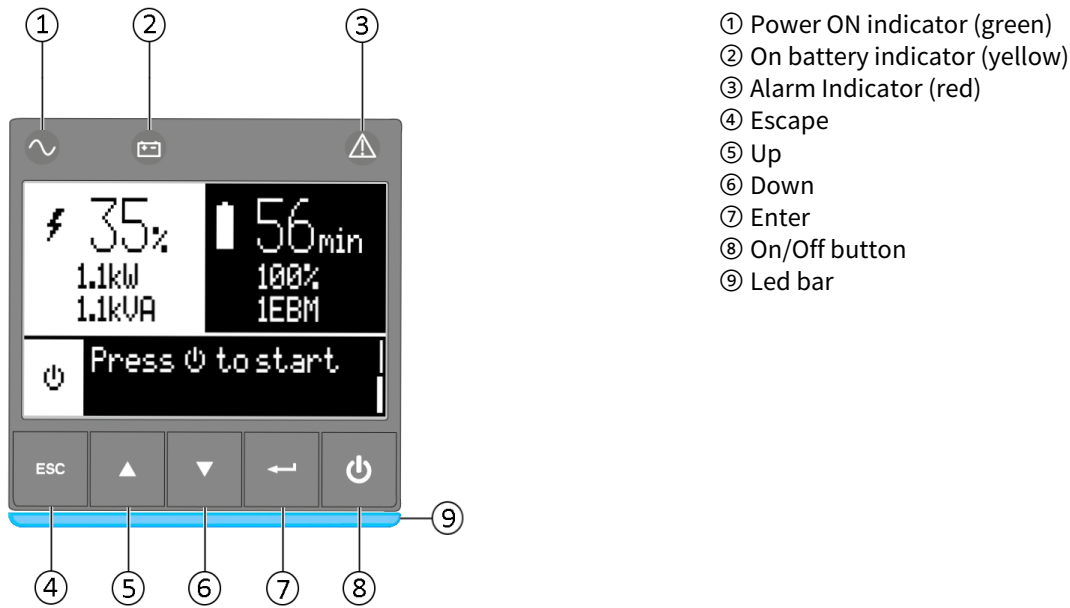

Led indicator

The following table shows the indicator status and description :

Indicator	Status	Description
Green	On	The UPS is "On" and the load is protected.
Yellow	On	The UPS is in battery mode and the load is protected.
	Flashing	The battery voltage is below the warning level.
Red	On	The UPS has an active alarm or fault. See troubleshooting page for additional information.
Led bar	Static blue	The UPS is "On" and the load is protected.
	Flashing blue	The UPS is on battery or the battery service age warning is reached.
	Static red	The UPS has an active alarm or fault.
	Flashing red	The UPS output has stopped due to a fault.

4.2 LCD description









- ① Load status and measurements
- ② Equipment status icon
- ③ Status / Message
- ④ Battery status

As default, or after 5 minutes of inactivity, the LCD displays the screen saver.
The backlight LCD automatically dims after 5 minutes of inactivity. Press any button to restore the screen.

i Note. If other indicator appears, see troubleshooting page for additional information.

The following table describes the status information provided by the UPS :

Operation status	Possible cause	Action
Standby mode 	The UPS is OFF, waiting for start-up command from user	Equipment is not power until button  is pressed during start up and the green "normal mode" LED indicator is illuminated.
Normal mode 	The UPS is operating normally.	The UPS is powering and protecting the equipment.
In AVR mode  No beep	The UPS is operating normally but the utility voltage is outside Normal mode thresholds.	The UPS is powering the equipment through the A utomatic V oltage R egulation device. The equipment is still normally protected.
On Battery  One beep every 10 seconds	A utility failure has occurred and the UPS is in Battery mode.	The UPS is powering the equipment with battery power. Prepare your equipment for shutdown.
End of backup time  1 beep every 3 seconds	The UPS is in Battery mode and the battery is running low.	This warning is approximate, and the actual time to shutdown may vary significantly. Depending on the UPS Load, the "Battery Low" warning may occur before the battery reaches 20% capacity remaining.

4.3 Display functions

Press the Enter (↵) button to activate the menu options. Use the two middle buttons (▲ and ▼) to scroll through the menu structure. Press the Enter (↵) button to select an option. Press the (ESC) button to cancel or return to the previous menu.

Menu map for display functions

Main menu	Submenu	Display information or Menu function
Measurements	-	Load: [Total Load/Load (Primary)/Load (Group 1)/Load (Group 2)] : W, A, VA, pF [Input/Output] : V, f [Efficiency] : % [Battery Info] : %, min, V, number of EBM, Age service, Age Warning [Average power usage] : Total, Primary, Group 1, Group 2 [Cumulative power] : Total, Since Primary, Since Group 1, Since Group 2
Control	Load Segments	Group 1: ON / OFF Group 2: ON / OFF These commands overrule user settings for load segments.
	Start battery test	Starts a manual battery test (possible if load >20% and battery >80%)
	Change battery	Disable charger, Replace battery, Update settings
	Connectivity test	Dry contacts test, Relay card test, Line failure test, Battery low test
Settings	Functions reset	Reset fault state, Reset power usage, Reset battery life, Card reset, Restore factory settings
	Local settings	Sets product general parameters, see User settings
	Input / output settings	Sets input and output parameters
	ON / OFF settings	Sets ON / OFF conditions
	Battery settings	Sets battery configuration
Event log	Communication settings	Sets communication parameters (input/output signals, remote signals, IPV4 address)
	View alarms	Displays the alarms stored
	View events	Displays the events stored
	View all	Displays the faults and events stored
Fault log	Reset all	Clears the faults and events stored
	View fault	Displays the faults stored
	Reset faults	Clears faults

Main menu	Submenu	Display information or Menu function
Identification		Type / Model / Part Number / Serial Number / UPS Firmware / NMC Firmware / IPV4 Address / IPV6 Address / Com card MAC Address
Registration		Links to Eaton registration website

4.4 User settings

The following table displays the options that can be changed by the user.

	Submenu	Available settings	Default settings
Local settings	Language	[English] [Français] [Deutsch] [Español] [Русский] [Português] [Italiano] [Simplified Chinese] [Japanese] Menus, status, notices and alarms, UPS fault, Event Log data and settings are in all supported languages.	English Automatic message for user configuration when UPS is powered for the first time.
	Date / time	Format: [International] [US]	[US]
	LCD	Modify LCD screen brightness and contrast to be adapted to room light conditions.	[0]
	Audible alarm	[Enabled] [Disabled on battery] [Always disabled] Enable or disable the buzzer if an alarm occurs.	[Enabled]
		Level: [0-8]	[6]
Protected access	[Enabled] [Disabled] Allow the user to lock the settings modification. Password is: 0577	[Disabled]	
In/Out settings	Output voltage	[200 V] [208 V] [220 V] [230 V] [240 V]	[208 V]
	Input thresholds	[Normal] [Extended] Extended mode authorises lower input voltage (150V) with out transferring to battery. This can be used if the load can withstand low voltage supply.	[Normal]
	Sensitivity	[High] [Low] Low sensitivity extend the range of input frequency accepted before transferring to battery.	[High]
	Load segments	[Auto start delay]	UPS:[No delay]; Group1:[3s]; Group2:[6s]
		[Auto shutdown delay]	UPS:[Disabled]; Group1:[Disabled]; Group2:[Disabled]
Overload prealarm	[10%] ... [105%] Load % when overload alarm occurs	[105%]	
ON/OFF settings	Start/Restart	[Cold start] [Auto restart] [Auto start]	[Cold start] : ON [Auto restart] : ON [Auto start] : OFF

	Submenu	Available settings	Default settings
	Forced reboot	[Yes] [No] [Timer] [10s] ... [180s] When mains recovers during a shutdown sequence: If set to Enabled, shutdown sequence will complete and wait 10 seconds prior to restart, If set to Disabled, shutdown sequence will not complete, UPS stays on.	[Yes] [10s]
	Energy saving (W,% ,delay)	[Yes] [No] [Time] [1min] ... [15min] [Level] [10W] ... [1000W-3000W] If Enabled, UPS will shut-down after defined duration of back-up time, if load is less than set value.	[No] [5min] [100W]
	Sleep Mode + timer	[Enabled] [Disabled] [Timer] [10min] ... [120min] If Disabled, LCD and communication will turn OFF immediately after UPS is OFF. If Enabled, LCD and communication stays ON for the set time period after UPS is OFF (default 90 min).	[Enabled] [90min]
	Site Wiring Fault	[Enabled] [Disabled] Prevents the UPS from starting if the phase and neutral wires are swapped..	[Enabled]
	Power Off alert	[Yes] [No] If enabled, activates a confirmation screen that requires user confirmation after pressing the power button, before UPS shutdown occurs.	[Yes]
Battery settings	Auto battery test	In ABM® cycling mode: [No test] [Every ABM® cycle] In constant charge mode: [No test] [Daily] [Weekly] [Monthly]	[Every ABM® cycle] [Weekly]
	Battery life warning	[Enabled] [Disabled] [6-120] Battery Age warning If Enabled, the UPS displays a battery replacement reminder through the front LCD and any installed network communication card after the indicated timeframe has elapsed (default 48 months).	[Enable] [48 Month]
	Low battery warning (capacity + remain. time)	[Capacity] [0%] ... [100%] [Runtime] [0min] ... [60min] The alarm triggers when the set percentage of battery capacity or remaining back-up time is reached.	[0%] [3min]

	Submenu	Available settings	Default settings
	Restart batt. level	[0%] ... [100%] Automatic restart will occur only when the set percentage of battery charge is reached, and "Auto Restart" is enabled and set to ON. A setting of 0% allows immediate automatic restart when utility returns after a UPS shutdown due to an extended power outage.	[0%]
	Battery charge mode	[ABM® cycling] [Constant charge]	[ABM® cycling]
	External battery	[Auto detection] [Manual EBM set.] [Manual battery set.]	[Auto detection] Using standard EBM, UPS automatically detects the number of EBM connected
	Deep disch. protect.	[Enabled] [Disabled] If set to Enable, the UPS operates within the normal design range of the battery during discharge. If set to Disable, the UPS allows deeper battery discharge to extend battery runtime at the expense of long-term battery life (warranty is also void if set to disable).	[Enable]
Comm settings	Input signals	[ROO] [RPO] [DB9-4] Sets Input signals parameters (function, delay, operation) through external contact connectors or RS232 port. ROO port: - [Function]: [No] [ROO] [RPO] [Building alarm][Shutdown commands] - [Delay]: [0s] ... [999s] - [Active]: [Open] [Closed] RPO port: - [Function]: [No] [ROO] [RPO] [Building alarm][Shutdown commands] - [Delay]: [0s] ... [999s] - [Active]: [Open] [Closed] DB9-4 port: - [Function]: [No] [ROO] [RPO] [Building alarm][Shutdown Commands] - [Delay]: [0s] ... [999s] - [Active]: [Low] [High]:	[No] [0s] [Closed] [No] [0s] [Open] [No] [0s] [High]
	Outputs signals	[Relay] [DB9-1] [DB9-7] [DB9-8] Sets events or fault that will actuate Output signal parameters through external contact connector or RS232 port [Relay]: [On bat] [Low bat] [Bat fault] [UPS OK] [Load protected] [Load powered] [General alarm] [OVL pre-alarm] [DB9-1]: [On bat] [Low bat] [Bat fault] [UPS OK] [Load protected] [Load powered] [General alarm] [OVL pre-alarm]	[Relay] : [Bat fault] [DB9-1] : [Low bat] [DB9-7] : [UPS OK] [DB9-8] : [On bat]

	Submenu	Available settings	Default settings
		[DB9-7]: [On bat] [Low bat] [Bat fault] [UPS OK] [Load protected] [Load powered] [General alarm] [OVL pre-alarm] [DB9-8]: [On bat] [Low bat] [Bat fault] [UPS OK] [Load protected] [Load powered] [General alarm] [OVL pre-alarm]	
	Remote command	[Yes] [No] If Enabled, shutdown or restart commands from software are authorized.	[Yes]
	Shutdown commands	[Send CMD] [Output OFF] [OFF delay] [restart] Sets events or fault that will actuate Output signal parameters through external contact connector or RS232 port [Send CMD]: [Yes] [No] [Output OFF]: [No] [UPS] [Group 1] [Group 2] [Group 1 + 2] [OFF delay]: [0s] ...[999s] [Restart]: [Yes] [No] For a proper server shutdown please make sure that the Output OFF delay is long enough	Send CMD: [No] Output OFF: [No] OFF delay: [0s] Restart: [Yes]
	On battery notice delay	[0s] ... [99s] Sets delay before providing an on battery notice to software.	[0s]
	General alarm	[On battery] [Battery fault] [Overload pre-alarm] [Internal fault] [Ambient temp.] [Fan lock] [Current limit] [Short circuit] [Inverter overload] [Power overload] [Low battery] [UPS OK] [Load protected] [Load powered] Defines which event or fault will generate a general alarm through Output signal screen.	[Internal fault]
	Set Comm Card IPv4	[DHCP] : [Yes] [No] [IP Adress] [Subnet mask] [Gateway] The UPS does not display the IPv4 settings menu by default, you can activate it by a communication command.	[Yes] XXX.XXX.XXX.XXX

4.5 Communication ports

Connection of RS232/USB communication port

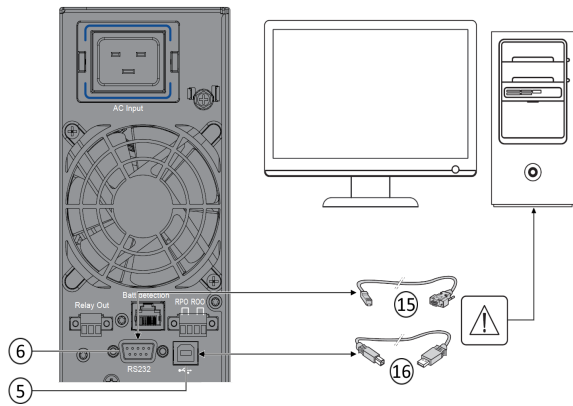

1. Connect the RS232 (15) or USB (16) communication cable to the serial or USB port on the computer equipment.
2. Connect the other end of the communication cable (15) or (16) to the USB (5) or RS232 (6) communication port on the UPS.



The UPS can now communicate with Eaton power management software.

You can improve the remote monitoring and power management of the UPS by adding a [communication card](#) compatible with the 5PX product.

Characteristics of the contact RS232 communication port

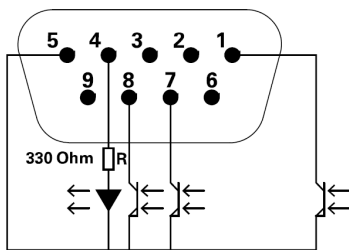

Contact characteristics (optocoupler)

- Voltage: 48 V DC max
- Current: 25 mA max
- Power: 1.2 W

Pin	Signal	Direction	Function
1	Bat low	Output	Low Battery Output
2	TxD	Output	Transmit to external device
3	RxD	Input	Receive from external device
4	I/P SIG	Input	-
5	GNDS	-	Signal Common tied to chassis
6	PNP	Input	Plug and Play
7	UPS OK	Output	UPS OK
8	BAT mode	Output	UPS on battery mode
9	+5V	Output	Power supply for external signal or options

Installation of the communication cards

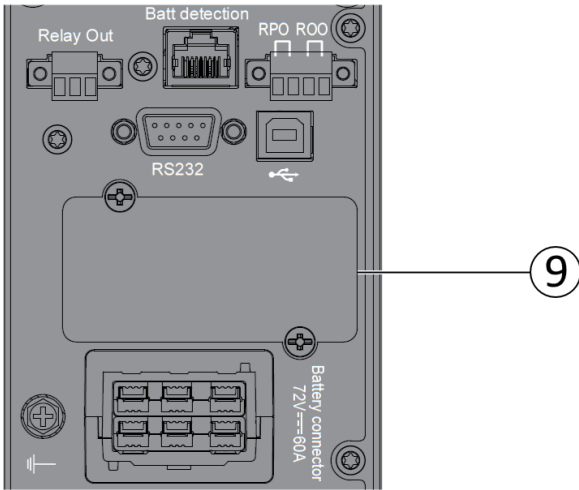

It is not necessary to shutdown the UPS before installing a communication card.

1. Remove the slot cover (9) secured by screws.
2. Insert the communication card in the slot.
3. **Secure the card cover with the two screws to connect the comm card to the ground.**

4.6 UPS remote control functions

Connectivity cards

Connectivity cards allow the UPS to communicate in a variety of networking environments and with different types of devices. The 5PX models have one available communication bay for the following connectivity cards:

- **Gigabit Network card (Network-M2)** : provides a Gigabit Ethernet connection and enables secure UPS monitoring over HTTPS web browser interface, SNMP v1/v3 protocol and email alarms. In addition, up to 3 Environmental Monitoring Probes can be attached to obtain humidity, temperature, smoke alarm, and security information.
- **Industrial Gateway card (INDGW-M2)** : Provides Modbus RTU and Modbus TCP communication support in addition to the same secure UPS monitoring, management and sensor capability as the Gigabit Network card.
- **Relay-MS card** : provides isolated dry contact (Form-C) relay outputs for UPS status: Utility failure, Battery low, UPS alarm/OK, or on Bypass.
- **INDRELAY-MS** : The Industrial relay Card-MS (INDRELAY-MS) provides a simple way to remotely input UPS information to an alarm system, PLC or a computer system via dry contacts. It offers five isolated dry contact outputs and one isolated dry contact input.

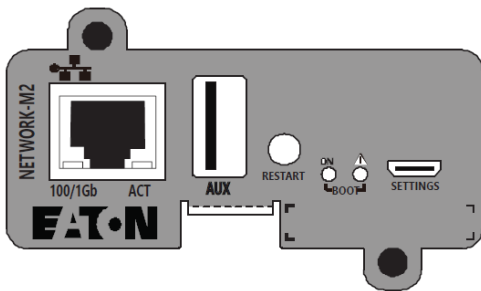

NETWORK-M2 Card

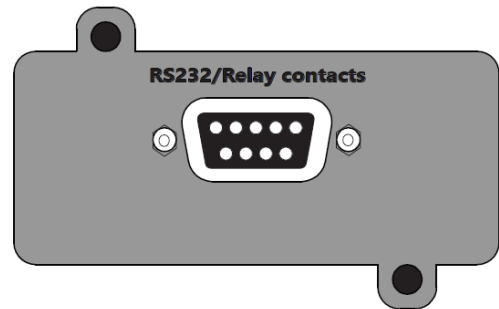

Relay-MS Card

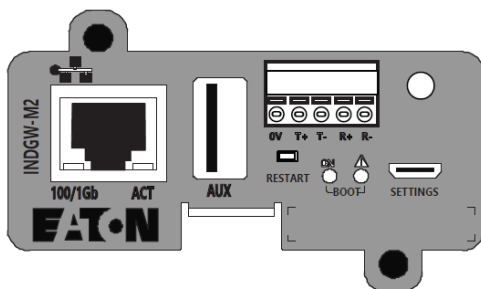

INDGW-M2

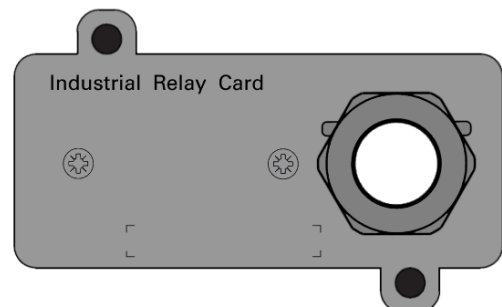

INDRELAY-MS

Programmable signal inputs

The 5PX incorporates several programmable signal inputs: one Remote Power Off (RPO) input terminal, one Remote On/Off (ROO) input terminal, one RS-232 input (pin-4).

Signal inputs can be configured (see Settings > Comm settings > Signal Input) to have one of the following functions:

Function	Description
No	No function. (Please choose a function if you want to use input signal.)
RPO	Remote Power off (RPO) is used to shutdown the UPS remotely.
ROO	Remote On/Off allows remote action of a button or other interface to switch On/Off the UPS. (Cold start is prohibited while using the ROO function.)
Building alarm	Active input generates an alarm "building alarm".
Shutdown commands	Active input turns UPS output (or outlet groups) off after a user defined shutdown delay but keeps on charging batteries according to a selected charging scheme; inactive input does not abort shutdown countdown. Depending on the "Restart" parameter (see Settings > Comm Settings > Shutdown commands) the unit may startup automatically.



Warning: signal inputs have no function by default; please choose a function through the LCD (Settings > Com settings > Input signals).

See below 2 examples of configuration with RPO terminal used as RPO function and ROO terminal use as ROO function:

Remote Power Off (RPO)

RPO is used to shutdown the UPS remotely when the contact is open. This feature can be used for shutting down the load and the UPS by thermal relay, for example, in the event of room over temperature. When RPO is activated, the UPS turns off the output and shuts down all power converters immediately (except for logic power). The UPS remains "ON" to alarm the fault.

The RPO circuit is an IEC 60950 safety extra low voltage (SELV) circuit. This circuit must be separated from any hazardous voltage circuits by reinforced insulation.

- The RPO must not be connected to any utility connected circuits. Reinforced insulation to the utility is required. The RPO switch must be a dedicated latching-type switch not tied into any other circuit. The RPO signal must remain active for at least 250 ms for proper operation.
- To ensure the UPS stops supplying power to the load during any mode of operation, the input power must be disconnected from the UPS when the Remote Power Off function is activated.

RPO connections:

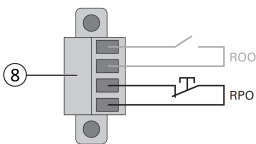

RPO	Comments
Connector type	Terminal, 14 AWG Maximum wires
Terminal rating	60 V DC/30 V AC 20 mA max

Remote On/Off (ROO)

- Remote On/Off allows remote action of button to switch On/Off the UPS.
- When contact changes from open to closed, the UPS is switched-on (or stays On).
- When contact changes from closed to open, the UPS is switched-off (or stays Off).

- On/Off control via button has priority over the remote control.



The ROO function is only active after the first use of the "Remote OFF" function.

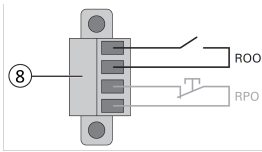

ROO	Comments
Connector type	Terminal, 14 AWG Maximum wires
Terminal rating	60 V DC/30 V AC 20 mA max

Remote control connection and test

1. Check the UPS is shut down and the electrical supply network disconnected.
2. Remove RPO connector from the UPS by removing the screws.
3. Connect a normally closed volt-free contact between the two pins of connector.

<p>Normally closed</p>	<p>Contact open: shut down of UPS. To return to normal operation, deactivate the external remote shut down contact and restart the UPS from the front panel.</p>
------------------------	--

4. Plug the RPO connector into the back of the UPS and fix the screws.
5. Connect and restart the UPS according to the previously described procedures.
6. Activate the external remote shut down contact to test the function.

Always test the RPO function before applying your critical load to avoid accidental load loss.

Programmable signal outputs

The 5PX incorporates several programmable signal outputs: one relay output and two optocoupler outputs (DB9 pins 1 and 8). Signal outputs can be configured (see Settings > Comm settings > Output Signals) to report the following information:

Signal	Default assignment	Description
On battery (On Bat)	DB9-Pin 8	UPS is in battery mode
Low battery (Low Bat)	DB9-Pin 1	UPS is in battery mode and has reached the low battery alarm threshold
Battery fault	(1) Relay output	Battery fault
UPS OK	DB9-Pin 7	Load is powered with no alarm
Load protected	-	UPS is on inverter, with no alarm and ready to go to battery
Load powered	-	Load is powered
General alarm	-	Choose events that will trigger this alarm through the LCD (Settings > Comm settings > General alarm). For more information on possible events please look at User settings

Signal	Default assignment	Description
OVL pre-alarm	-	Overload pre-alarm
Bat disconn	-	Battery is disconnected

(1) Relay output:

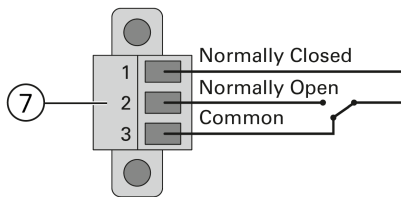

4.7 Eaton Intelligent Power Software suite

Eaton Intelligent Power Software suite is available from eaton.com/downloads.

Eaton Software suite provides up-to-date graphics of UPS power and system data and power flow.

It also gives you a complete record of critical power events, and it notifies you of important UPS or power information.

If there is a power outage and the 5PX UPS battery power becomes low, Eaton Software suite can automatically shut down your computer system to protect your data before the UPS shutdown occurs.

4.8 Cybersecurity

Eaton is committed to minimizing the Cybersecurity risk in its products and employs cybersecurity best practices and the latest cybersecurity technologies in its products and solutions, making them more secure, reliable and competitive for our customers. Eaton also offers Cybersecurity Best Practices whitepapers to its customers, referenced at www.eaton.com/cybersecurity.

5 Operation

5.1 Start-up and normal operation



Check that the indications on the name plate located on the back of the UPS meets to the AC power source and the true electrical consumption of the total load.





Battery charge

The UPS charges the battery as soon as it is connected to the AC outlet, whether the ON/OFF button is pressed or not. It is recommended that the UPS be permanently connected to the AC power supply to ensure the best possible autonomy.



On the first startup of the UPS, you will need to configure the output voltage and time of the UPS.

To start the UPS:

1. Verify that the UPS power cord is plugged in.
2. The UPS front panel display illuminates and shows Eaton logo.
3. Verify that the UPS status screen shows .
4. Press the  button on the UPS front panel for at least two seconds.
5. Check the UPS front panel display for active alarms or notices. Resolve any active alarms before continuing; if the  indicator is on, do not proceed until all alarms are clear (see "[Troubleshooting](#)" section). Check the UPS status from the front panel to view the active alarms. Correct the alarms and restart if necessary.
6. Verify that the  indicator illuminates solid, indicating that the UPS is operating normally and any loads are powered and protected. The UPS should be in Normal mode.

AC-power disturbance



If AC power is disturbed or fails, the UPS continues to operate on battery power. In normal mode, the audio alarm beeps every ten seconds, then every three seconds when the end of battery backup time is near.

If the power outage lasts longer than the battery backup time, the UPS shuts down and automatically restarts when power is restored. Following a complete discharge, at least 48 hours are recommended to recharge the battery back to full backup time.

To extended battery runtime for critical devices, it is possible to program sequenced shutdown (also known as load shedding) of less-critical loads connected to Group 1 or Group 2 outlets during extended power outages.

5.2 Starting the UPS on battery

 Before using this feature, the UPS must have been powered by utility power with output enabled at least once. Battery start can be disabled. See the "Cold start" setting in "ON/OFF Settings".
To start the UPS on battery:

1. When the UPS is disconnected from the AC power source, press the  button on the UPS front panel.
The UPS transfers from Standby mode to Battery mode. The  indicator illuminates solid.
The UPS supplies power to your equipment.
2. Check the UPS front panel display for active alarms or notices besides the "Battery mode" and related notifications that indicates missing utility power. Resolve any active alarms before continuing. See "Troubleshooting".
Check the UPS status from the front panel to view the active alarms. Correct the alarms and restart if necessary.

5.3 UPS shutdown

To shut down the UPS:

Press the  button on the front panel for three seconds.

A confirmation message will appear. When confirmed, the UPS starts to beep and shows a status of "UPS shutting OFF...". The UPS then transfers to Standby mode, and the  indicator turns off.

5.4 Operating modes

The Eaton 5PX front panel indicates the UPS status through the UPS indicators located above the LCD screen.

Normal mode

When the green sinewave symbol is illuminated, the UPS is providing protected AC power output. The UPS monitors and charges the batteries as needed and provides power protection to your equipment.

Battery mode

When the UPS is operating during a power outage, the alarm beeps once every ten seconds and the indicator illuminates solid. The necessary energy is provided by the battery.

When the utility power returns, the UPS transfers to Normal mode operation while the battery recharges.

If battery capacity becomes low while in Battery mode, the audible alarm beeps once every three seconds.

This warning is approximate, and the actual time to shutdown may vary significantly; gracefully shutdown all applications on connected equipment due to imminent UPS shutdown.

When utility power is restored after the UPS shuts down, the UPS automatically restarts.

Low-battery warning

- The  indicator illuminates solid.
- The audio alarm beeps every three seconds.

The remaining battery power is low. Shut down all applications on the connected equipment because automatic UPS shutdown is imminent.

End of battery backup time

- LCD displays "End of backup time".
- All the LEDs go OFF.
- The audible alarm stops.

5.5 Return of AC input power

Following an outage, the UPS restarts automatically when AC input power returns (unless the restart function has been disabled) and the load is supplied again.

5.6 Retrieving the event log

To retrieve the event log through the display:

1. Press any button to activate the menu options, then select event log.
2. Scroll through the listed events.

5.7 Retrieving the fault log

To retrieve the fault log through the display:

1. Press any button to activate the menu options, then select fault log.
2. Scroll through the listed faults.

6 UPS maintenance

6.1 Equipment care

For the best preventive maintenance, keep the area around the equipment clean and dust free. If the atmosphere is very dusty, clean the outside of the system with a vacuum cleaner.

For full battery life, keep the equipment at an ambient temperature of 25 °C (77 °F).

The batteries are rated for a 3-5 year service life. The length of service life varies, depending on the frequency of usage and ambient temperature (life divided by 2 each 10 °C above 25 °C).

If the UPS requires any type of transportation, verify that the UPS is turned off.

Batteries used beyond expected service life will often have severely reduced runtimes. Replace batteries at least every 4 years to keep units running at peak performance.

Batteries runtime will be reduced at low temperature (below 10 °C).

6.2 Storing the equipment

If you store the equipment for a long period, recharge the battery every 6 months by connecting the UPS to utility power. The internal batteries charge to 90% capacity in less than 3 hours. However, Eaton recommends that the batteries charge for 48 hours after long-term storage.

Check the battery recharge date on the shipping carton label. If the date has passed and the batteries were never recharged, do not use them. Contact your service representative.

6.3 When to replace batteries

Eaton UPS batteries have an expected life span of 3-5 years.

After 4 years of operation, the UPS will provide a battery replacement notification reminding you that your batteries are nearing the end of their useful life. You should take proactive steps to ensure you replace your batteries for optimal operation and reliability.

Contact your service representative to order new batteries.

 Battery recommended replacement date and reference can be accessed through the LCD (Measurements > Battery).

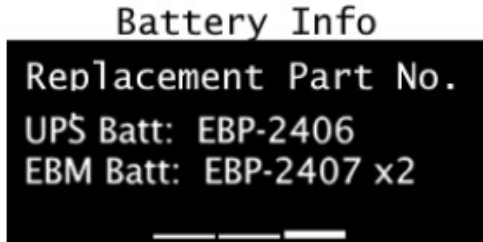

6.4 Replacing batteries



DO NOT DISCONNECT the batteries while the UPS is in Battery mode.

For battery replacement, follow Eaton instructions provided on www.eaton.com/UPSservices.

Batteries can be replaced easily without turning off the UPS or disconnecting the load.

Consider all warnings, cautions, and notes before replacing batteries.

- Servicing should be performed by qualified service personnel knowledgeable of batteries and required precautions. Keep unauthorized personnel away from batteries.
- Batteries can present a risk of electrical shock or burn from high short circuit current. Observe the following precautions:
 - a. Remove watches, rings, or other metal objects,
 - b. Use tools with insulated handles,
 - c. Do not lay tools or metal parts on top of batteries,
 - d. Wear rubber gloves and boots.
- When replacing batteries, replace with the same type and number of batteries or battery packs. Contact your service representative to order new batteries.
- Proper disposal of batteries is required. Refer to your local codes for disposal requirements.
- Never dispose of batteries in a fire. Batteries may explode when exposed to flame.
- Do not open or mutilate the battery or batteries. Released electrolyte is harmful to the skin and eyes and may be extremely toxic.
- Determine if the battery is inadvertently grounded. If inadvertently grounded, remove source from ground. Contact with any part of a grounded battery can result in electrical shock. The likelihood of such shock can be reduced if such grounds are removed during installation and maintenance (applicable to equipment and remote battery supplies not having a grounded supply circuit).
- **ELECTRIC ENERGY HAZARD.** Do not attempt to alter any battery wiring or connectors. Attempting to alter wiring can cause injury.
- Disconnect charging source prior to connecting or disconnecting battery terminals.

Replacing the internal battery :

The internal battery is heavy. Use caution when handling the heavy batteries.

 A Phillips head screwdriver is needed to perform this procedure

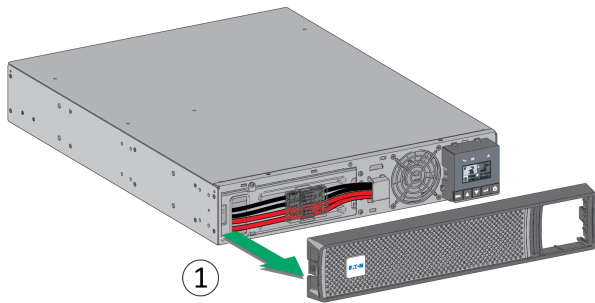

1 - Pull off the front panel by pressing the tabs on both sides.

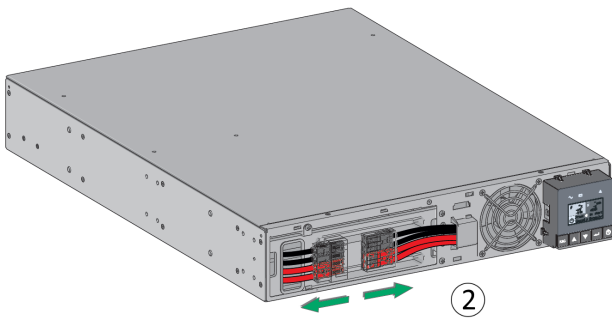

2 - Disconnect the battery pack by separating the connectors (never pull on the wires).

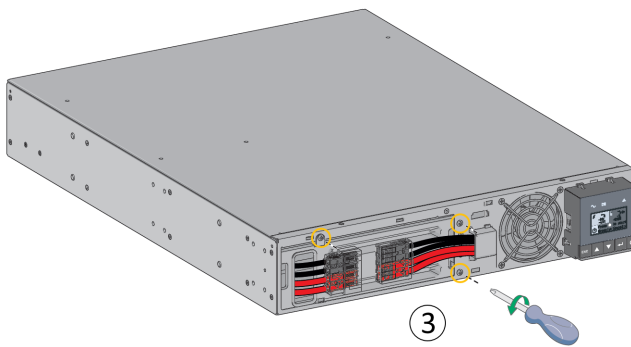

3 - Remove the metal protection cover in front of the battery (three screws or two screws for 3U models).

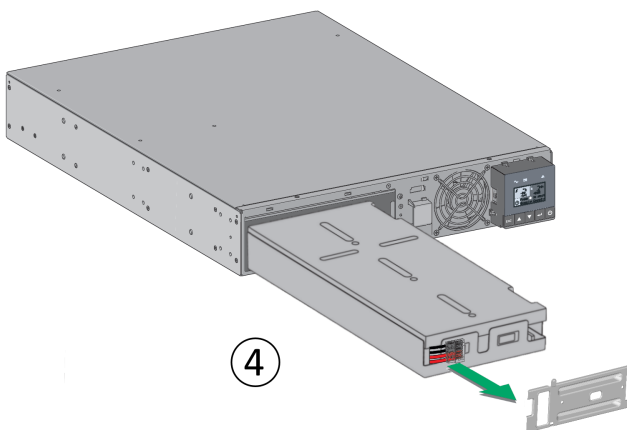

4 - Pull the plastic tab to remove the battery pack and replace it.



Warning: take care not to reverse the polarity + (red) and - (black) when connecting the batteries as this will destroy the device.

6.5 Replacing the UPS equipped with a HotSwap MBP

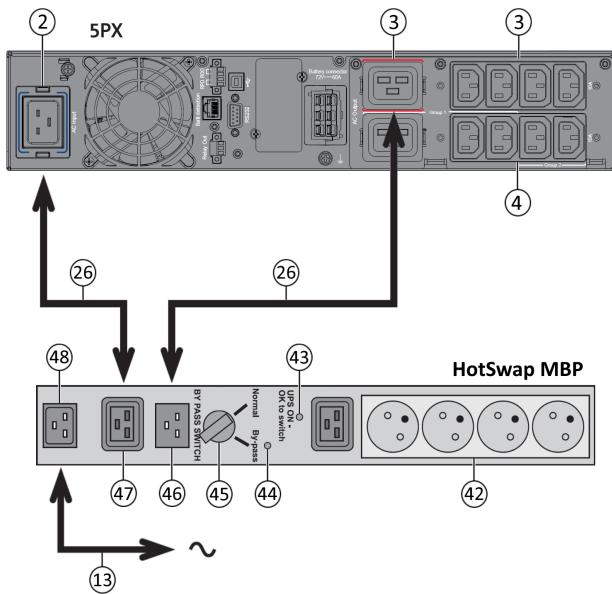

The HotSwap MBP module makes it possible to service or even replace the UPS without affecting the connected loads (HotSwap function).

Maintenance

1. Set switch (45) to Bypass position. The red LED on the HotSwap MBP module goes ON, indicating that the load is supplied directly with AC input source power.
2. Stop the UPS by pressing the  button on the UPS control panel. LED (43) "UPS ON - OK to switch" goes OFF, the UPS can now be disconnected and replaced.

Return to normal operation

1. Check that the UPS is correctly connected to the HotSwap MBP module.
2. Start the UPS by pressing the  button on the UPS control panel. LED (43) "UPS ON - OK to switch" on the HotSwap MBP module goes ON (otherwise, there is a connection error between the HotSwap MBP module and the UPS).
3. Set switch (45) to Normal position. The red LED on the HotSwap MBP module goes OFF.

6.6 Recycling the used equipment

Contact your local recycling or hazardous waste center for information on proper disposal of the used equipment.
eaton.com/recycling



Do not dispose of the battery or batteries in a fire. Batteries may explode. Proper disposal of batteries is required. Refer to your local codes for disposal requirements.
 Do not open or mutilate the battery or batteries. Released electrolyte is harmful to the skin and eyes. It may be toxic.



Do not discard the UPS or the UPS batteries in the trash. This product contains sealed, lead acid batteries and must be disposed of properly. For more information, contact your local recycling/reuse or hazardous waste center.

Pb



Do not discard waste electrical or electronic equipment (WEEE) in the trash. For proper disposal, contact your local recycling/reuse or hazardous waste center.

7 Troubleshooting

The Eaton 5PX is designed for reliable, autonomous operation while providing you with notifications and alerts whenever a potential operational or performance issue occurs.

Usually the alarms shown by the control panel do not mean that the output power is affected. Instead, they are preventive alarms intended to alert the user.

- Events are silent status information that are recorded into the Event log. Example = "AC freq in range".
- Alarms are recorded into the Event log and displayed on the LCD status screen with the logo blinking. Some alarms may be announced by a beep every 3 seconds. Example = "Battery low".
- Faults are announced by a continuous beep and red LED, recorded into the Fault log and displayed on the LCD with a specific message box. Example = Out. short circuit.







Use the following troubleshooting chart to determine the UPS alarm condition.

7.1 Typical alarms and faults

To check the Event log or Fault log:

1. Press any button on the front panel display to activate the menu options.
2. Press the down button to select Event log or Fault log.
3. Scroll through the listed events or faults.

The following table describes typical conditions:

Conditions	Possible cause	Action
Battery mode  LED is On. 1 beep every 10 seconds	A utility failure has occurred and the UPS is in battery mode.	The UPS is powering the equipment with battery power. Prepare your equipment for shutdown.
Battery mode  LED is On. 1 beep every 3 seconds	The UPS is in Battery mode and the battery is running low.	This warning is approximate, and the actual time to shutdown may vary significantly. Depending on the UPS load and number of Extended Battery Modules (EBMs), the "Battery Low" warning may occur before the batteries reach 20% capacity.
No battery  LED is On Beep continuous	The batteries are disconnected.	Verify that all batteries are properly connected. If the condition persists, contact your service representative.
Battery mode  LED is On. Beep continuous	The battery test is failed due to bad or disconnected batteries.	Verify that all batteries are properly connected. If the condition persists, contact your service representative.
The UPS does not provide the expected backup time.	The batteries need charging or service.	Apply utility power for 48 hours to charge the batteries. If the condition persists, contact your service representative.
Power Overload  LED is On	Power requirements exceed the UPS capacity (greater than 100% of nominal; see "User Settings" for specific output overload ranges).	Remove some of the equipment from the UPS. The UPS continues to operate, but may shut down if the load increases. The alarm resets when the condition becomes inactive.
UPS Over temperature  LED is On 1 beep every 3 seconds	The UPS internal temperature is too high or a fan has failed. At the warning level, the UPS generates the alarm but remains in the current operating state. If the temperature rises another 10°C, the UPS shuts down.	Clear vents and remove any heat sources. Allow the UPS to cool. Ensure the airflow around the UPS is not restricted. Restart the UPS. If the condition continues to persist, contact your service representative.
The UPS does not start	The input source is not connected correctly.	Check the input and battery connections.

Conditions	Possible cause	Action
	The Remote Power Off (RPO) switch is active or the RPO connector is missing.	If the UPS Status menu displays the "Remote Power Off" notice, deactivate the RPO input.

7.2 Silencing the alarm

Press the ESC (Escape) button on the front panel display to silence the alarm. Check the alarm condition and perform the applicable action to resolve the condition. If the alarm status changes, the alarm beeps again, overriding the previous alarm silencing.

7.3 Service and support

If you have any question or problem with the UPS, call Eaton or your local service representative in your country / region. Please have the following information ready when you call for service:

- Model number
- Serial number
- Firmware version number
- Date of failure or problem
- Symptoms of failure or problem
- Customer return address and contact information

If repair is required, you will be given a Returned Material Authorization (RMA) number. This number must appear on the outside of the package and on the Bill Of Lading (if applicable). Use the original packaging or request packaging from the Help Desk or distributor. Units damaged in shipment as a result of improper packaging are not covered under warranty. A replacement or repair unit will be shipped freight prepaid for all warranted units.

i For critical applications, immediate replacement may be available. Call the Help Desk for the dealer or distributor nearest you.
For US and Canada you can contact post-sales service support at: 1-(800)-356-5737.

8 Specification and technical characteristics

5PX 1000 / 1500 models :

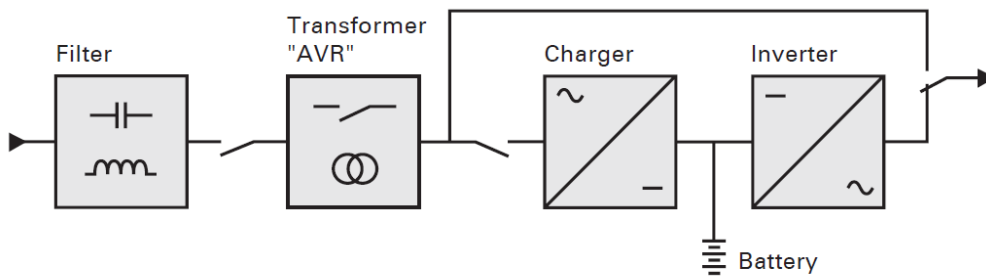

5PX 2200 / 3000 models :

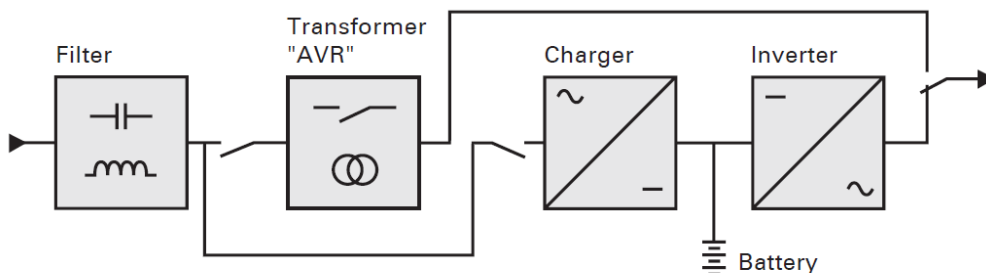

8.1 UPS model list

Description	Catalog Number	Power rating	Configuration
Eaton 5PX 1500H RT2U G2	5PX1500HRTG2	1500W/1500VA	Rack / Tower
Eaton 5PX 2200H RT2U G2	5PX2200HRTG2	2200W/2200VA	Rack / Tower
Eaton 5PX 3000H RT2U G2 Eaton 5PX 3000H RT2U Netpack G2	5PX3000HRTG2 5PX3000HRTNG2	3000W/3000VA	Rack / Tower

8.2 Extended Battery Module model list

Model	Catalog Number	Configuration	Battery voltage	Use with
Eaton 5PX EBM 48V RT2U G2	5PXEBM48RTG2	Rack / Tower	48Vdc	5PX1500HRTG2
Eaton 5PX EBM 72V RT2U G2	5PXEBM72RTG2	Rack / Tower	72Vdc	5PX2200HRTG2, 5PX3000HRTG2, 5PX3000HRTNG2

Weights and dimensions

Description (UPS)	Weights (lb / kg)	Dimensions (inch / mm) D x W x H
5PX1500HRTG2	49.4 / 22.4	17.6x17.2x3.4 / 448x438x85.5
5PX2200HRTG2	62.2 / 28.2	23.7x17.2x3.4 / 603x438x85.5
5PX3000HRTG2	69.9 / 31.7	23.7x17.2x3.4 / 603x438x85.5
5PX3000HRTNG2	69.9 / 31.7	23.7x17.2x3.4 / 603x438x85.5
Description (EBM)	Weights (lb / kg)	Dimensions (inch / mm) D x W x H
5PXEBM48RTG2	61.3 / 27.8	17.6x17.2x3.4 / 448x438x85.5
5PXEBM72RTG2	89.1 / 40.4	23.7x17.2x3.4 / 603x438x85.5
5PXEBM72RT3UAG2	87.5 / 39.7	19x17.2x5.1 / 483x438x129

8.3 Electrical input

Default frequency	60Hz		
Nominal frequency	50/60Hz		
Frequency range	47-70Hz		
Catalog Number	Default input (Voltage/Current)	Input nominal voltages	Input voltage window
5PX1500HRTG2	208V/10A	200-240V	160-294V
5PX2200HRTG2	208V/16A		adjustable to 150~294V

Catalog Number	Default input (Voltage/Current)	Input nominal voltages	Input voltage window
5PX3000HRTG2 5PX3000HRTNG2	208V/16A		

8.4 Electrical input connections

Catalog Number	Input connection	Input cable
5PX1500HRTG2	IEC C14-10A	Not provided
5PX2200HRTG2	IEC C20-16A	C19/16A to NEMA L6-20
5PX3000HRTG2 5PX3000HRTNG2		

8.5 Electrical output

All models	Normal mode	Battery mode										
Voltage regulation	Boost : $V_{in} \times 1.15$ Buck : $V_{in} \times 0.87$	(-10% ,6%)										
Efficiency	>96%	1000-2200 > 82% 3000 > 85%										
Frequency regulation		+/-0.1 Hz										
Nominal output	200/208/220/230/240V											
Frequency	Follows input frequency	50/60Hz										
Output overload	[105%,120%] 30min [120%,150%]5min >150% 10S	[105% ~110%] 10s [110%~150%]1s, >150% 0.15s										
Short circuit current limitation in battery mode		<table border="1"> <thead> <tr> <th>Model</th> <th>Current limitation</th> </tr> </thead> <tbody> <tr> <td>1000</td> <td>31A</td> </tr> <tr> <td>1500</td> <td>38A</td> </tr> <tr> <td>2200</td> <td>38A</td> </tr> <tr> <td>3000</td> <td>64A</td> </tr> </tbody> </table>	Model	Current limitation	1000	31A	1500	38A	2200	38A	3000	64A
Model	Current limitation											
1000	31A											
1500	38A											
2200	38A											
3000	64A											
Transfer time	Utility Outage: 1-4ms for normal mode, >5ms for sensitive mode Utility abnormal: <10ms for normal mode ,<25ms for sensitive mode											

8.6 Electrical output connection

Catalog Number	Output connection	Output cable
5PX1500HRTG2	(4) IEC10A Primary group (2) IEC10A Group 1 (2) IEC10A Group 2	(2) IEC10A
5PX2200HRTG2	(4) IEC10A + (1) IEC16A Primary group (2) IEC10A + (1) IEC16A Group 1 (2) IEC10A Group 2	
5PX3000HRTG2 5PX3000HRTNG2		

8.7 Battery

Internal batteries	Internal batteries	EBM
Specifications	1000VA: 48Vdc - 4 x 12V, 7Ah 1500VA: 48Vdc - 4 x 12V, 9Ah 2000VA: 72Vdc - 6 x 12V, 7Ah 3000VA: 72Vdc - 6 x 12V, 9Ah	5PXEBM48RTG2: 48Vdc - 2 x 4 x 12V, 9Ah 5PXEBM72RTG2: 72Vdc - 2 x 6 x 12V, 9Ah 5PXEBM72RT3UAG2: 72Vdc - 2 x 6 x 12V, 9Ah
Type	Sealed, maintenance-free, valve-regulated, lead-acid, with minimum 3-5 year float service life at 25°C (77°F).	
Monitoring	Advanced monitoring for earlier failure detection and warning	
EBM battery cable length	2U EBM cable length : 350mm/13.78in 3U EBM cable length : 530mm/20.87in	

8.8 Environmental and safety

Standards	IEC/EN 62040-1:2008+A1:2013 EN IEC 62040-2: 2018 IEC 62040-2: 2016 FCC CFR Title 47, Part 15, Subpart B IEC/EN 62040-3 IEC 62040-1:2017 UL1778 5th edition CSA 22.2
EMC (Emissions)	EN IEC 62040-2: 2018 C1 EN 62040-2: 2006 C1 IEC 62040-2: 2016 C1 EN 55011:Class B CISPR11 Class B CISPR32 Class B FCC part 15 Class B

EMC (Immunity)	IEC 61000-4-2, (ESD): 8 kV Contact Discharge / 15 kV Air Discharge IEC 61000-4-3, (Radiated field): 10 V/m IEC 61000-4-4, (EFT): 4 kV IEC 61000-4-5, (Surges): 2 kV Differential Mode / 4 kV Common Mode IEC 61000-4-6, (Electromagnetic field): 10 V IEC 61000-4-8, (Conducted magnetic field): 30 A/m
Agency markings	CE, cTUVus, FCC, Energy star NOM (only on 5PX2200HRTG2)
Operating temperature	0 to 40 °C (32 to 104 °F)
Storage temperature	-15 to 50°C (5 to 122 °F)
Relative humidity	20 to 90 % (without condensation)
Operating altitude	Up to 3,000 meters (9,843 ft) above sea level, no derating for 40°C (104°F) room temperature
Transit altitude	Up to 10,000 meters (32,808 ft) above sea level
Audible noise	Line mode:<40dB Buck/boost mode:<45 dB Batt. Mode: <45dB, 50dB for 3K

9 Glossary

AVR	The A utomatic V oltage R egulation maintains a constant voltage level for electrical equipment loads when the voltage falls outside the voltage tolerance range.
Backup time	Time during which the load can be supplied by the UPS operating on battery power.
EBM	Extended Battery Module
Low-battery warning	This is a battery-voltage level indicating that battery power is low and that the user must take action before the UPS shuts down.
Load	Devices or equipment connected to the UPS output.
Normal mode	The normal UPS operating mode in which the AC source supplies the UPS which, in turn, provides AC power to the connected loads.
Normal AC source	Normal source of power for the UPS.
OVL	Overload. When the load exceeds 100% of the maximum load of the UPS.
Relay contacts	Contacts supplying information to the user in the form of signals.
UPS	Uninterruptible Power System.