

AXIS Camera Station S1264 Rack Recording Server

User Manual

AXIS Camera Station S1264 Rack Recording Server

Table of Contents

About your device	3
Get started	4
Install your device	5
Before installation	5
Configure your device	7
Initial Axis recorder setup	7
Configure AXIS Camera Station	7
License a system online	10
License a system offline	11
Manage Windows® user accounts	13
Create a user account	13
Create an administrator account	13
Create a local user group	13
Delete a user account	13
Change a user account's password	14
Create a password reset disk for a user account	14
Manage AXIS Camera Station user accounts	15
Configure user permissions	15
Add users or groups	15
User or group privileges	16
Manage your device	18
Update Windows®	18
Configure Windows update settings	18
Change the RAID	19
Add a hard drive	19
Configure iDRAC	22
Troubleshooting	24
Check the current BIOS version	24
Upgrade BIOS	24
Run diagnostics	24
Perform a system recovery	24
Export a SupportAssist collection	25
Troubleshoot the power supply unit	25
Troubleshoot memory errors	26
Troubleshoot AXIS Camera Station	26
Product overview	27
Front and rear sides	27
Specifications	27
Need more help?	31
Useful links	31
Contact support	31

AXIS Camera Station S1264 Rack Recording Server

About your device

About your device

AXIS Camera Station S12 Recorder series consist of out-of-the-box ready rack servers and workstations validated for reliable high-definition surveillance up to 4K. For quick and easy installation, the recorder series is preconfigured and preloaded with AXIS Camera Station video management software including licenses plus all necessary system software. The system configuration can easily be imported from AXIS Site Designer, and AXIS Camera Station lets you take full advantage of Axis wide range of video surveillance devices. With enterprise-grade hard disks, operating system stored on solid-state drive, the recorder series provides high-performance and reliability for your system.

AXIS Camera Station S1264 Rack Recording Server

Get started

Get started

The standard workflow to configure an AXIS Camera Station recording server is:

1. *Install your device*
2. Initial Windows® setup: After installing your device, you are guided through a few steps to set up the region, language, keyboard layout, an administrator account and its password.
3. Initial Axis recorder setup: After the initial Windows setup, AXIS Recorder Toolbox is opened and you are guided through a few steps to set up basic and necessary settings, for example, computer name, date and time, and network. See *Initial Axis recorder setup on page 7*.
4. Configure Windows. We recommend to:
 - Update Windows to the latest version. See *Update Windows® on page 18*.
 - Create a standard user account. See *Create a user account on page 13*.
5. Update AXIS Camera Station to the latest version.
 - If your system is online: open the AXIS Recorder Toolbox app and click **Update AXIS Camera Station**.
 - If your system is offline: go to *axis.com* and download the latest version.
6. *Configure AXIS Camera Station*
7. Register your AXIS Camera Station licenses.
 - *License a system online on page 10*
 - *License a system offline on page 11*
8. Connect your system to the AXIS Camera Station mobile viewing app. See *Connect to AXIS Camera Station server*.



To watch this video, go to the web version of this document.

help.axis.com/?&tpid=76450&tsection=about-your-device

AXIS Camera Station S1264 Rack Recording Server

Install your device

Install your device

Before installation

- Prepare additional accessories used for installation: monitor, mouse, keyboard and network cable.
- Note that the power cable to the wall is not included in the box.
- Understand the usage of different user accounts.

The following table lists the user accounts that can be used for installation, configuration and operation of your Axis system.

User account	Description	Note
MyAxis	Used to download the latest software, access the license system, Axis Secure Remote Access, and System Health Monitoring.	Registered from <i>my.axis.com</i> .
Windows®		
Windows administrator	Administrator privileges in Windows. We recommend you do not use it as AXIS Camera Station administrator.	Created during initial Windows setup.
Windows user with AXIS Camera Station administrator privileges	A Windows user granted with administrator privileges in AXIS Camera Station to be used by system integrator or system administrator for configuration or troubleshooting.	Created in Windows settings.
Windows user with AXIS Camera Station operator or viewer privileges	A Windows user granted with operator or viewer privileges in AXIS Camera Station.	Created in Windows settings.
Hardware management		
iDRAC	Used to access the iDRAC (Integrated Dell Remote Access Controller) tool.	Username: root Password: Printed on the back of the information tag.

AXIS Camera Station S1264 Rack Recording Server

Install your device

Device		
Device administrator	Used by the administrator to access the camera from the video management system or device webpage.	Created from the device webpage or when you add the device to AXIS Camera Station.

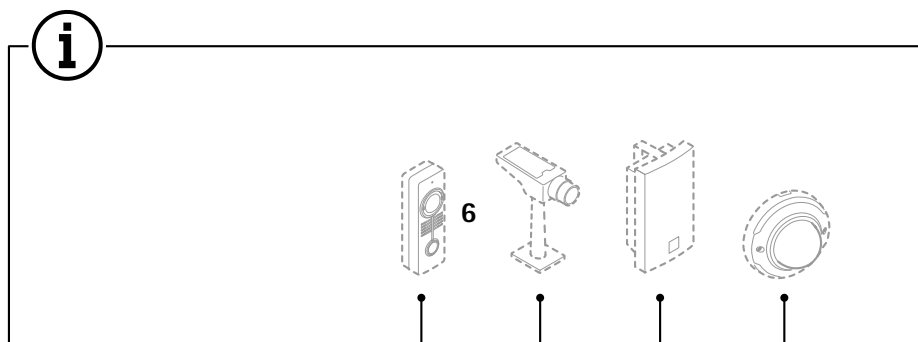
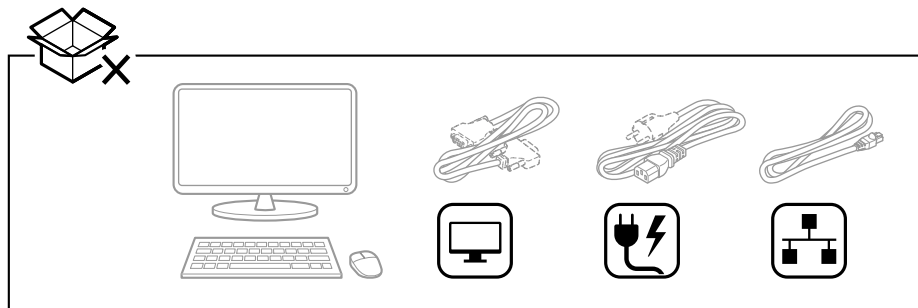
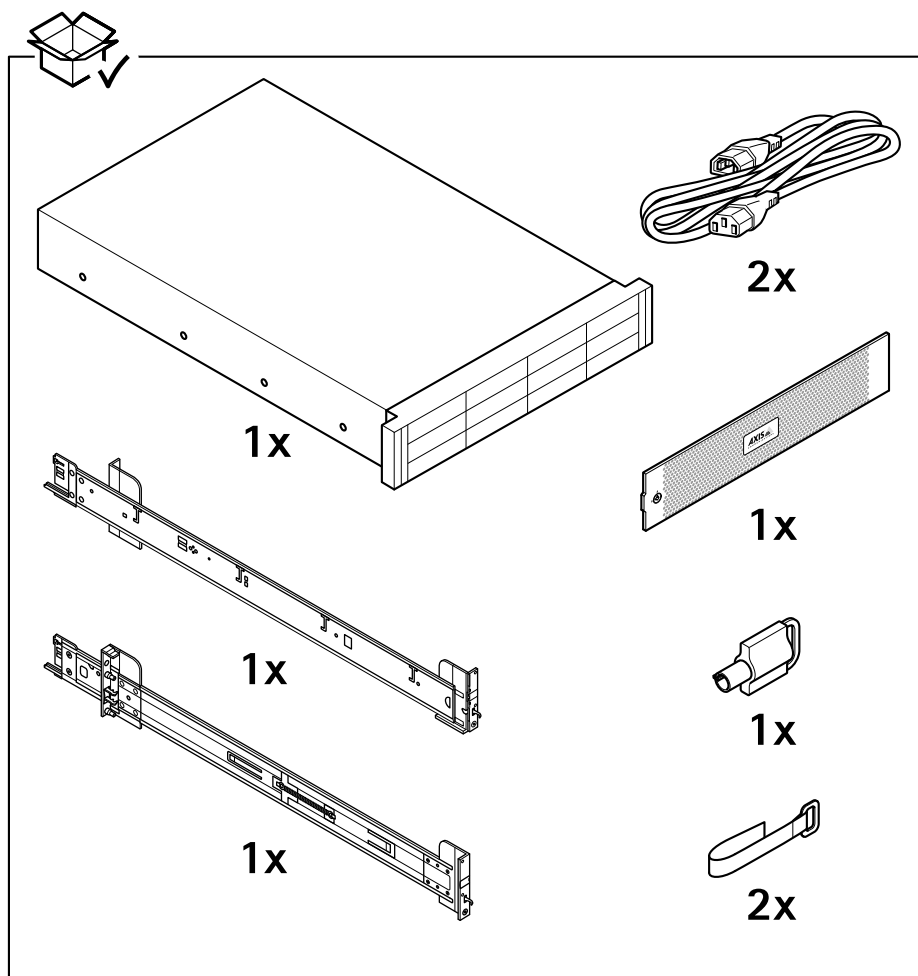

AXIS Camera Station S1264 Rack Recording Server

Configure your device

Configure your device

Initial Axis recorder setup

After you have configured Windows®, AXIS Recorder Toolbox is opened automatically and you are guided through the first-time configuration wizard. In this wizard, you can configure several basic and necessary settings before you manage your device in AXIS Recorder Toolbox.

1. Select **Light** or **Dark** theme and click **Next** (if it's available for your product).
2. Change the computer name if you want and click **Next**.
3. Under **Date and time**, configure the following settings and click **Next**.
 - Select a time zone.
 - To set up an NTP server, select **NTP server** and enter the NTP server address.
 - To set manually, select **Manual** and select a date and time.
4. Under **Network settings**, configure the following settings and click **Next**.
 - **Use automatic IP settings (DHCP)** and **Use automatic DNS settings** are turned on by default.
 - If your device is connected to a network with a DHCP server, the assigned IP address, subnet mask, gateway, and preferred DNS are automatically displayed.
 - If your device is not connected to a network or there is no DHCP server available, enter the IP address, subnet mask, gateway, and preferred DNS manually depending on the network requirements.
5. Click **Finish**. If you have changed the computer name, AXIS Recorder Toolbox will prompt you to restart the device.

Configure AXIS Camera Station

This Get started tutorial will walk you through the basic steps to make your system up and running.

Before you start, you may need to:

- Configure your network depending on your installation. See *Network configuration*.
- Configure your server ports if needed. See *Server port configuration*.
- Consider security issues. See *Security considerations*.

After necessary configurations, you can start to work with AXIS Camera Station:

1. *Start AXIS Camera Station*
2. *Add devices*
3. *Configure recording method on page 8*
4. *Live view cameras on page 8*
5. *Playback recordings on page 8*
6. *Add bookmarks on page 9*
7. *Export recordings on page 9*
8. *Play and verify recordings in AXIS File Player on page 9*

AXIS Camera Station S1264 Rack Recording Server

Configure your device

Start AXIS Camera Station

AXIS Camera Station Service Control automatically starts after the installation is complete.

Double-click the AXIS Camera Station client icon to start the AXIS Camera Station client. When starting the client for the first time, it automatically attempts to log in to the AXIS Camera Station server installed on the same computer as the client.

You can connect to multiple AXIS Camera Station servers in different ways.

Add devices

The first time you start your AXIS Camera Station, you are navigated to the Add devices page. AXIS Camera Station automatically searches the network for connected devices and displays a list of devices found.

1. Select the cameras to add from the list.
If your camera is not listed, click **Manual search**.
2. Click **Add**.
3. Select **Quick configuration** or **Site Designer configuration**. Click **Next**.
4. Use the default settings and ensure the recording method is set to **None**. Click **Install**.

Configure recording method

1. Go to **Configuration > Recording and events > Recording method**.
2. If you want to enable motion detection recording:
 - 2.1 Select a camera.
 - 2.2 Turn on **Motion detection**.
 - 2.3 Click **Apply**.
3. If you want to enable continuous recording:
 - 3.1 Select a camera.
 - 3.2 Turn on **Continuous**.
 - 3.3 Click **Apply**.

Live view cameras

1. Click the Live view tab to navigate to the camera live view.
2. Click a camera to navigate to the live view of that camera.
A blue dot after the camera name shows that continuous recording is in progress. A red dot after the camera name shows that motion detection recording is in progress.
3. Click  to navigate from Live view to Recordings.
A red line in the timeline shows that motion detection recording has been taken for that period. A blue line in the timeline shows that continuous recording is in progress.

Playback recordings

1. Go to the Recording tab.
2. In the timeline of the camera, use the mouse wheel to zoom in and out and drag the timeline to make the marker pointing at your desired position.

AXIS Camera Station S1264 Rack Recording Server



Configure your device

3. To start playing the recording from the desired position, click  .

Add bookmarks

1. Go to the Recording tab.
2. In the timeline of the camera, use the mouse wheel to zoom in and out and drag the timeline to make the marker pointing at your desired position.
3. Click  .
4. Enter the bookmark name and description. Use keywords in the description to make the bookmark easy to find and recognized.
5. Select **Prevent recording deletion** to lock the recording. A locked recording can't be deleted unless actively unlocked.
6. Click **OK**. A bookmark icon is displayed at your desired position in the timeline.

Export recordings

1. Go to the Recording tab.
2. In the timeline of the camera, use the mouse wheel to zoom in and out.
3. Click  to display the selection markers.
4. Drag the markers to include the recordings that you want to export.
5. Click  to open the Export tab.
6. In the Export tab, you can do the following if desired.
 - Click  to add a note for the recording.
 - Click **Browse** to select the location to export the recordings.
 - Select **Include Axis File Player**, **Include notes**, and **Add digital signature**.
7. Click **Export**.
8. Select **Use password** and enter your password for the digital signature. Click **OK**.

Play and verify recordings in AXIS File Player

1. Go to the folder that you have specified for the exported recordings. In this example, the exported files include the recordings in the .asf format, the notes in the .txt format, and AXIS File Player.
2. Double-click AXIS File Player. The exported recordings will be automatically played.
3. Click  to show the notes added to the recordings.
4. To verify the digital signature:
 - 4.1 Go to **Tools > Verify digital signature**.
 - 4.2 Select **Validate with password** and enter your password.
 - 4.3 Click **Verify**. The verification result page is displayed.

AXIS Camera Station S1264 Rack Recording Server

Configure your device

Note

Digital signature is different from Signed video. Signed video allows video to be traced back to the camera it originated from, making it possible to verify that the recording hasn't been tampered with after it left the camera. See *Signed video* and the camera's user manual for more information.

Network configuration

When AXIS Camera Station client, AXIS Camera Station server, and the connected network devices are installed on different networks, you might need to configure proxy or firewall settings before using AXIS Camera Station.

Client proxy settings

When the client and the server are separated by a proxy server, configure the client proxy settings.

1. Double-click the AXIS Camera Station client icon.
2. Click **Change client proxy settings**.
3. Change the client proxy settings.
4. Click **OK**.

Server proxy settings

When network devices and the server are separated by a proxy server, configure the server proxy settings.

1. Double-click the AXIS Service Control icon in Windows notification area.
2. Select **Modify settings**.
3. In the Proxy settings section, use the default **System account internet option** or select **Use manual proxy settings**.
4. Click **Save**.

NAT and Firewall

When the client and the server are separated by a NAT, firewall or similar, configure the NAT or firewall to ensure that the HTTP port, TCP port, and streaming port specified in AXIS Camera Station Service Control are allowed to pass through the firewall and/or NAT. For instructions how to configure the NAT or firewall, contact the network administrator.

Server port configuration

The ports 55752 (HTTP), 55754 (TCP), 55756 (mobile communication), and 55757 (mobile streaming) are used on AXIS Camera Station server for communication between the server and the client. If required, the ports can be changed from AXIS Camera Station Service Control.

Security considerations

To prevent unauthorized access to cameras and recordings, keep the following in mind:

- Use strong passwords for all network devices (cameras, video encoders and auxiliary devices).
- Install AXIS Camera Station server, cameras, video encoders, and auxiliary devices on a secure network separated from the office network. AXIS Camera Station client can be installed on a computer on another network, for example a network with Internet access.
- Ensure all users have strong passwords. Using Windows Active Directory a high level of security can be implemented.

License a system online

Both the AXIS Camera Station client and the server must be connected to the internet.

AXIS Camera Station S1264 Rack Recording Server

Configure your device

1. In the AXIS Camera Station client,
 - 1.1 Go to **Configuration > Licenses > Management**.
 - 1.2 **Manage licenses online** is turned on by default.
 - 1.3 Click **Go to AXIS License Portal**.
2. In the AXIS License Portal www.axis.com/licenses,
 - 2.1 Sign in with your MyAxis account.
 - 2.2 The license key is automatically generated and shown under **License keys**.
 - 2.3 If you have purchased license keys separately, enter your license key under **Add license key** and click **Add**.
3. In the AXIS Camera Station client, check that your license keys are shown under **Configuration > Licenses > Keys**.



To watch this video, go to the web version of this document.

help.axis.com/?&tplid=76450&tsection=license-a-system-with-internet-connection

AXIS Camera Station online license registration

License a system offline

1. In the AXIS Camera Station client, export the system file.
 - 1.1 Go to **Configuration > Licenses > Management**.
 - 1.2 If AXIS Camera Station is online, turn off **Manage licenses online** and click **Export system file**.
 - 1.3 If AXIS Camera Station is offline, click **Export system file**.
 - 1.4 Save your system file on a USB flash drive.
2. In the AXIS License Portal www.axis.com/licenses,
 - 2.1 Sign in with your MyAxis account.
 - 2.2 Click **Upload system file** to upload the system file that you exported to your USB flash drive.
 - 2.3 The license key is automatically generated and shown under **License keys**.
 - 2.4 If you have purchased license keys separately, enter your license key under **Add license key** and click **Add**.
 - 2.5 Under **License keys**, click **Download license file** and save the file to a USB flash drive.
3. In the AXIS Camera Station client, import the license file.
 - 3.1 Go to **Configuration > Licenses > Management**.
 - 3.2 Click **Import license file** and select the license file on your USB flash drive.
 - 3.3 Check that your license keys are shown under **Configuration > Licenses > Keys**.

AXIS Camera Station S1264 Rack Recording Server

Configure your device



To watch this video, go to the web version of this document.

help.axis.com/?&pid=76450&tsection=license-a-system-without-internet-connection

AXIS Camera Station offline license registration

AXIS Camera Station S1264 Rack Recording Server

Manage Windows® user accounts

Manage Windows® user accounts

Create a user account

To help keep your personal data and information more secure, we recommend that you add a password for each local account.

Important

Once you create a password for a local account, don't forget it. There's no way to recover a lost password for local accounts.

1. Go to **Settings > Accounts > Other people > Add someone else to this PC**.
2. Click **I don't have this person's sign-in information**.
3. Click **Add a user without a Microsoft account**.
4. Enter a user name, password and password hint.
5. Click **Next** and follow the instructions.

Create an administrator account

1. Go to **Settings > Accounts > Other people**.
2. Go to the account you want to change and click **Change account type**.
3. Go to **Account type** and select **Administrator**.
4. Click **OK**.
5. Restart your device and sign in with the new administrator account.

Create a local user group

1. Go to **Computer Management**.
2. Go to **Local Users and Groups > Group**.
3. Right-click **Group** and select **New Group**.
4. Enter a group name and a description.
5. Add group members:
 - 5.1 Click **Add**.
 - 5.2 Click **Advanced**.
 - 5.3 Find the user account(s) you want to add to the group and click **OK**.
 - 5.4 Click **OK** again.
6. Click **Create**.

Delete a user account

Important

When you delete an account you remove the user account from the login screen. You also remove all files, settings and program data stored on the user account.

AXIS Camera Station S1264 Rack Recording Server

Manage Windows® user accounts

1. Go to **Settings > Accounts > Other people**.
2. Go to the account you want to remove and click **Remove**.

Change a user account's password

1. Log in with an administrator account.
2. Go to **User Accounts > User Accounts > Manage another account in sequence**.
You'll see a list with all user accounts on the device.
3. Select the user account whose password you would like to change.
4. Click **Change the password**.
5. Enter the new password and click **Change password**.

Create a password reset disk for a user account

We recommend to create a password reset disk using a USB flash drive. Then, if you forget your password, you can reset the password. Without a USB reset disk, you can't reset the password.

If you're using Windows 10, you can add security questions to your local account in case you forget your password, so you don't need to create a password reset disk. To do this, go to **Start** and click **Settings > Sign-in options > Update your security questions**.

1. Sign in to your device with a local user account. You can't create a password reset disk for a connected account.
2. Plug a USB flash drive into your device.
3. If there's any data on the USB flash drive, back it up.
4. From the Windows® search field, go to **Create a password reset disk**.
5. In the Forgotten Password wizard, click **Next**.
6. Select your USB flash drive and click **Next**.
7. Type your current password and click **Next**.
8. Follow the onscreen instructions.
9. Remove the USB flash drive and keep it in a safe place where you'll remember it. You don't have to create a new disk when you change your password even if you change it several times.

AXIS Camera Station S1264 Rack Recording Server

Manage AXIS Camera Station user accounts

Manage AXIS Camera Station user accounts

Configure user permissions

Go to **Configuration > Security > User permissions** to view a list of the users and groups that have been added to AXIS Camera Station.

Note

Administrators of the computer on which the AXIS Camera Station server is installed are automatically given administrator privileges to AXIS Camera Station. You can't change or remove the administrators group's privileges.

Before a user or group can be added, the user or group must be registered on the local computer or have an Windows Active Directory user account. Using Windows Active Directory, a high level of security can be implemented.

When a user is part of a group, the user gets the highest role permission that is assigned to the individual and the group.

When a user is part of a group, the user gets the access granted as an individual and also receives the rights as part of a group. For example, a user is given access to camera X as an individual. The user is also a member of a group. The group is given access to cameras Y and Z. The user then has access to cameras X, Y and Z.

If there are security concerns regarding the access to the computer by a designated AXIS Camera Station user, create a standard user account that you then use for access to Axis Camera Station. You can then elevate the account to administrator in **Configuration > Security > User permissions**.

The list consists of the following information:

Item	Description
Icon	Indicates the entry is a group or a single user.
Name	Username as it appears in the local computer or Active Directory.
Domain	Domain name where the user or group is registered.
Role	The access role given to the user or group. Possible values: Administrator, Operator, and Viewer.
Details	Detailed user information as it appears in the local computer or Active Directory.
Server	Server name where the user or group is registered. Only available when connecting to multiple AXIS Camera Station servers.

To add users or groups, see *Add users or groups*.

To change user access rights for a user or group, click the user or group and make changes. Click **Apply**.

To remove a user or group, select the user or group and click **Remove**. In the pop-up dialog, click **OK** to remove the user or group.

Add users or groups

User accounts in Microsoft Windows and Active Directory users and groups can access AXIS Camera Station. To add a user to AXIS Camera Station, you have to add users or a group to Windows.

To add a user or group in Microsoft Windows: Adding a user in Windows may vary depending on which version of Windows you are running. Follow the instructions on *Microsoft's site*. If you are connected to an Active Directory domain network, consult your network administrator.

Add users or groups

1. Go to **Configuration > Security > User permissions** and click **Add**.

AXIS Camera Station S1264 Rack Recording Server

Manage AXIS Camera Station user accounts

2. When connecting to multiple AXIS Camera Station servers, select a server from the **Selected server** drop-down list.
3. Select **Server** to search for users or groups on the local computer, or select **Domain** to search for Active Directory users or groups. When connecting to multiple AXIS Camera Station servers, you can select which server to search for.
4. Select **Users** or **Groups** to search for only users or groups.
5. The list of users or groups is displayed. Users and groups that have already been added to AXIS Camera Station are not listed.
 - If there are too many users or groups, the search result is not displayed. Use the **Type to search** field to refine the search and find a specific user or group.
 - If the domain user search fails, the **Service logon account** must be changed.
6. Select the users or groups and click **Add**. The users or groups are added to the list and shown in italics.

Configure a user or group

1. Select a user or group in the list.
2. Under **Role**, select **Administrator**, **Operator**, or **Viewer**.
3. If you have selected **Operator** or **Viewer**, you can configure the user or group privileges. See *User or group privileges*.
4. Click **Save**. The user or group in the list is not in italics and ready to be used.

User or group privileges

There are three roles that can be given to a user or group. For how to define access privileges for a user or group, see *Add users or groups*.

- **Administrator:** Full access to the entire system, including access to live and recorded video of all cameras, access to all I/O ports and views. Therefore, you do not need to specify any camera, I/O or view privileges for a user with this role. This role is required in order to configure anything in the system.
- **Operator:** Access to live and recorded video of selected cameras and access to selected I/O ports and views. An operator has full access to all functionality of AXIS Camera Station except system configuration.
- **Viewer:** Access to live video of selected cameras and access to selected I/O ports and views. A viewer does not have access to recorded video or system configuration.

Cameras

The following access privileges are available for users or groups with the Operator or Viewer role.

- **Access:** Allow access to the camera and all camera features.
- **Video:** Allow access to live video from the camera.
- **Audio listen:** Allow access to listen from the camera.
- **Audio speak:** Allow access to speak to the camera.
- **Manual Recording:** Allow to start and stop recordings manually.
- **Mechanical PTZ:** Allow access to mechanical PTZ controls. Only available for cameras with mechanical PTZ.
- **PTZ priority:** Set the PTZ priority. A lower number means a higher priority. 0 means that no priority is assigned. An administrator has the highest priority. When a role with higher priority operates a PTZ camera, others can't operate the same camera for 10 seconds by default. Only available for cameras with mechanical PTZ and **Mechanical PTZ** is selected.

Views

AXIS Camera Station S1264 Rack Recording Server

Manage AXIS Camera Station user accounts

The following access privileges are available for users or groups with the Operator or Viewer role. You can select multiple views and set the access privileges.

- **Access:** Allow access to the views in AXIS Camera Station.
- **Edit:** Allow to edit the views in AXIS Camera Station.

I/O

The following access privileges are available for users or groups with the Operator or Viewer role. The I/O ports are listed by device.

- **Access:** Allow full access to the I/O port.
- **Read:** Allow to view the state of the I/O port. The user is not able to change the port state.
- **Write:** Allow to change the state of the I/O port.

System

The access privileges that can't be configured are greyed out and listed under **Role privileges**. The privileges with check mark means the user or group have this privilege by default.

The following access privileges are available for users or groups with the Operator role.

- **Take snapshots:** Allow taking snapshots in the live view and recordings modes.
- **Export recordings:** Allow exporting recordings.
- **Generate incident report:** Allow generating incident reports.
- **Prevent access to recordings older than:** Prevent accessing recordings older than the specified number of minutes. When using search, the user will not find recordings older than the specified time. Recordings and bookmarks older than the specified time can't be played.
- **Access System Health Monitoring:** Allow accessing System Health Monitoring.

The following access privileges are available for users or groups with the Viewer role.

- **Take snapshots:** Allow taking snapshots in the live view and recordings modes.

AXIS Camera Station S1264 Rack Recording Server

Manage your device

Manage your device

Update Windows®

Windows® 10 periodically checks for updates. When an update is available, your device automatically downloads the update but you've to install it manually.

Note

Recording will be interrupted during a scheduled system restart.

To manually check for updates:

1. Go to **Settings > Update & Security > Windows Update**.
2. Click **Check for updates**.

Configure Windows update settings

Sometimes you might want to change how and when Windows® updates.

Note

All ongoing recordings stop during a scheduled system restart.

1. Open the Run app.
 - Go to **Windows System > Run**, or
 - press WIN and R.
2. Type `gpedit.msc` and click **OK**. The Local Group Policy Editor opens.
3. Go to **Computer Configuration > Administrative Templates > Windows Components > Windows Update**.
4. Configure the settings as required, see example.

Example

To automatically download and install updates without any user interaction and have the device restart if necessary out of office hours use the following configuration:

1. Open **Always automatically restart at the scheduled time** and select:
 - 1.1 **Enabled**
 - 1.2 **The restart timer will give users this much time to save their work (minutes): 15.**
 - 1.3 **Click OK.**
2. Open **Configure Automatic Updates** and select:
 - 2.1 **Enabled**
 - 2.2 **Configure Automatic updates: Auto download and schedule the install**
 - 2.3 **Schedule Install day: Every Sunday**
 - 2.4 **Schedule Install time: 00:00**
 - 2.5 **Click OK.**
3. Open **Allow Automatic Updates immediate installation** and select:

AXIS Camera Station S1264 Rack Recording Server

Manage your device

- 3.1 Enabled
- 3.2 Click OK.

Change the RAID

⚠CAUTION

Changing the RAID deletes all data from your disks.

1. Boot Lifecycle Controller:
 - 1.1 Power on your device.
 - 1.2 When you see the AXIS splash screen, press F10.
2. In the Lifecycle Controller, go to **Hardware Configuration > Configuration Wizards** and select **RAID Configuration**.
3. Select the **RAID Controller** on which you want to have the RAID created. Details of any virtual disk(s) available on the selected controller will be shown in the table displayed on the page below the controller list. *Foreign Configuration* will be displayed if there are any foreign or uninitialized HDD(s) available on the server.

Note

- Clear foreign configuration clears all the foreign HDDs available on the RAID controller selected.
- Ignore foreign Configuration ignores the foreign HDDs available on the RAID controller while creating the RAID.

4. Clear or ignore foreign HDDs and uninitialized HDDs.

If you want, you can initialize the uninitialized disks:

- 4.1 In the list of all non-RAID (uninitialized) HDDs, select the HDDs you want to convert to RAID capable (initialize) and click **Next** to initialize them.
- 4.2 Select the corresponding option on the Configuration Wizards: RAID Configuration page.
5. Select a RAID level.
6. Select the physical disks from the table and click **Next**.

If the you've selected **Ignore foreign configuration**, the foreign HDDs are not displayed in the table.
7. Enter the virtual disk attributes.
8. Click **Next**.
9. Review the settings and click **Finish**.
10. Lifecycle Controller displays a message to indicate that all the current data about the virtual disks available on the controller will be lost. Click **OK** to continue.
11. Click **OK** and **Finish**.
12. Exit the wizard and reboot the system.

Add a hard drive

The demand for storage can differ. Retention time of stored data or for storing high-resolution recordings often leads to the same: the need for installing more storage. This section explains how to expand your AXIS S12 series with more hard drives and how to add them to your RAID 5 configuration.

AXIS Camera Station S1264 Rack Recording Server

Manage your device

Note

The following instructions are to be used when adding additional storage to certain AXIS S12 series. These instructions are as is, and Axis Communications AB takes no responsibility for loss of data and/or misconfiguration during these steps. The standard precautions should be taken to backup data that is business critical. The following procedure of expanding storage will not be supported by Axis Technical Support.

Note

To avoid electrostatic discharge, it is recommended that you always use a static mat and static strap while working on components in the interior of the system.

Warranty

Detailed information about warranty is available at: www.axis.com/support/warranty.

Workflow

1. *Install a hot-swap hard drive on page 20*
 - 1.1 *Remove the bezel on page 20*
 - 1.2 *Remove the hard disk blank on page 20*
 - 1.3 *Install the hard drive on page 20*
2. *Create a new RAID array on page 21*
 - 2.1 *Enter the Dell PERC 11 Configuration Utility on page 21*
 - 2.2 *Create a RAID storage array on page 21*
 - 2.3 *Reconfigure a RAID storage array on page 21*
3. *Configure Microsoft Windows® on page 22*

Install a hot-swap hard drive

Remove the bezel

1. Locate the bezel key.
2. Unlock the bezel by using the key.
3. Slide the release latch up and pull the left end of the bezel.
4. Unhook the right end and remove the bezel.

Remove the hard disk blank

- Press the release button on the front of the blank and slide it out of the hard drive slot.

Install the hard drive

▲CAUTION

- Use only hard drives that have been tested and approved for use with AXIS S12 series.
- When installing a hard drive, ensure that the adjacent drives are fully installed. Inserting a hard drive carrier and attempting to lock its handle next to a partially installed carrier can damage the partially installed carrier's shield spring and make it unusable.
- Combining SAS and SATA hard drives in the same RAID volume is not supported.

AXIS Camera Station S1264 Rack Recording Server

Manage your device

1. If a hard drive blank is installed in the hard drive slot, remove it.
2. Install a hard drive in the hard drive carrier.
3. Press the release button on the front of the hard drive carrier and open the hard drive carrier handle.
4. Insert the hard drive carrier into the hard drive slot until the carrier connects with the backplane.
5. Close the hard drive carrier handle to lock the hard drive in place.

Create a new RAID array

The Human Interface Infrastructure (HII) configuration utility is a storage management application integrated into the System BIOS. It is used to configure and manage the controllers, virtual disks, and physical disks. This utility is independent of the operating system.

Enter the Dell PERC 11 Configuration Utility

1. Turn on the system.
2. While the system startup, press F2 to enter System Setup.
3. Click **Device Settings** to view all the RAID controllers in the system.

Create a RAID storage array

1. *Enter the Dell PERC 11 Configuration Utility on page 21.*
2. Click **Main Menu > Configuration Management > Create Virtual Disk** and define the following virtual disk parameters.
 - **Select RAID Level:** Choose the RAID level.
 - **Select Physical Disks:** Select the physical disks from which the virtual disks are being created. This option is displayed if you select **Unconfigured Capacity** as your physical disk capacity.
 - **Configure Virtual Disk:** Configure the following virtual disk parameters.
 - **Virtual Disk Name:** Enter the name for the virtual disk.
Allowed characters are A-Z, a-z, 0-9, underscore (_), and hyphen (-) only.
 - **Virtual Disk Size:** Set the capacity for the virtual disk.
3. Click **Create Virtual Disk**.

▲CAUTION

There are more parameters available for modification. However, Axis Communications AB does not take responsibility for any misconfigurations that may happen when modifying those parameters. Always exercise caution when modifying parameters.

Reconfigure a RAID storage array

An online virtual disk can be reconfigured in ways that expands its capacity and changes its RAID level.

▲CAUTION

- Spanned virtual disks such as RAID 50 and 60 can't be reconfigured.
 - Reconfiguring virtual disks typically impacts disk performance until the reconfiguration operation is complete. Completion time can vary greatly up to several days. It is highly recommended to do the procedure during a maintenance window.
 - Always create a validated backup of your data before starting any action.
1. *Enter the Dell PERC 11 Configuration Utility on page 21.*
 2. Click **Main Menu > Virtual Disk Management**. All the virtual disks associated with the RAID controller are displayed.

AXIS Camera Station S1264 Rack Recording Server

Manage your device

3. To view the properties, click the virtual disk.
4. In the **Operations** drop-down, select **Reconfigure Virtual Disks** and press **GO**.
5. Select the **RAID Level** and press **Choose the Operation**.
6. Select the disks to be added to the virtual disk and press **Apply Changes**.
7. Confirm the operation and click **YES**.
8. Click **Start Operation**.
9. Click **OK**.

In the Virtual Disk Management page, you can see the status of the reconstruction on the modified Virtual Disk.

After the reconstruction starts, the system can be left in the Dell PERC 11 Configuration Utility until complete or the system can be rebooted into the operating system.

If the system is rebooted into the operating system, the system performance will be affected until the rebuild has completed.

You can also NOT extend the disk in Windows® until the rebuild is complete.

CAUTION

The rebuilding time will vary between systems and can take up to several days.

Configure Microsoft Windows®

To configure a new volume:

1. Right-click the Start menu and select **Disk Management**.
2. Right-click an unallocated region on your hard disk, and select **New Simple Volume**.
3. In the **New Simple Volume Wizard**, click **Next**.
4. Enter the size of the volume you want to create in megabytes (MB) or accept the maximum default size, and click **Next**.
5. Accept the default drive letter or choose a different drive letter to identify the partition, and click **Next**.
6. In the **Format Partition** dialog:
 - If you don't want to format the volume right now, select **Do not format this volume**, and click **Next**.
 - To format the volume with the default settings, click **Next**.
7. Review your choices, and click **Finish**.

Disk Management now shows the new volume. You can now close Disk Management and your system is ready to use the new volume.

To configure an existing volume:

1. Right-click the Start menu and select **Disk Management**.
2. Right-click the volume, and select **Extend Volume**.
3. In the **Extend Volume Wizard**, click **Next**.
4. Select the disk that has unused space and click **Next**. Normally this is selected by default.
5. Review your choices, and click **Finish**.

Disk Management now shows the extended volume. You can now close Disk Management and your system is ready to use the new volume.

AXIS Camera Station S1264 Rack Recording Server

Manage your device

Configure iDRAC

The Integrated Dell Remote Access Controller 9 (iDRAC9) with Lifecycle Controller is designed to make system administrators more productive and improve the overall availability of Dell systems. iDRAC alerts administrators to system issues, help them perform remote system management and reduces the need for physical access to the system. You must configure the initial network settings based on your network infrastructure to enable the communication to and from iDRAC.

1. Press F10 during Power-on Self-test (POST).

Note

The Lifecycle Controller Initial Setup Wizard will be displayed only for the first time. Use the Initial Setup Wizard to select the language and keyboard, configure network settings, iDRAC network settings, credential configuration, and view the summary of the settings. To make configuration changes later, select **Settings** from the Lifecycle Controller home page.

2. Configure the language and keyboard, and click **Next**.
3. Check the product overview and click **Next**.
4. Configure Lifecycle Controller network settings:
 - 4.1 From the **NIC Card** drop-down list, select the NIC port to configure.
 - 4.2 From the **IPV4 Network Settings > IP Address Source** drop-down list, select one of the following options:
 - **DHCP**: indicates that the NIC must be configured by using an IP address from a DHCP server. DHCP is the default option and the DHCP IP address is displayed on the Network Settings page.
 - **Static IP** : indicates that the NIC must be configured by using a static IP. Type the IP address properties including **IP Address**, **Subnet Mask**, **Default Gateway**, and **DNS Address**. If you do not have this information, contact your network administrator.
 - **No Configuration**: indicates that the NIC must not be configured.
 - 4.4 If VLAN is used, click **Enabled** and type the **VLAN ID** and **Priority** under **Lifecycle Controller VLAN Settings** to configure the VLAN settings of a NIC.
 - 4.5 Click **Next**. If Lifecycle Controller settings are not correctly configured, an error message is displayed.
5. Configure iDRAC network and credentials:
 - 5.1 Go to **IPV4 Configuration > IP Address Source** and select one of the following options:
 - **Static**: indicates that the network must be configured by using a static IP. Type the IP address properties including **IP Address**, **Subnet Mask**, **Default Gateway**, **DNS Address Source** and **DNS Address**. If you do not have this information, contact your network administrator.
 - **DHCP**: indicates that the NIC must be configured by using an IP address from a DHCP server. DHCP is the default option and the DHCP IP address is displayed on the Network Settings page.
 - 5.3 Under **Credentials**, enter **Account Username** and **Password** to access iDRAC network.
 - 5.4 Click **Next**.
6. Verify the summary of the Lifecycle Controller and iDRAC network configuration and click **Finish**.

AXIS Camera Station S1264 Rack Recording Server

Troubleshooting

Troubleshooting

Check the current BIOS version

To check the current BIOS:

1. Power on the device.
2. Wait until you see the Axis splash screen. You'll see the version number above the splash screen.

Upgrade BIOS

You should upgrade the BIOS only when you are instructed by Axis technical support.

If you don't have access to Windows®: update package instructions for EFI

1. Go to the support pages on *dell.com* and enter your service tag. Go to **Drivers & Downloads** and download the .efi file.
2. Copy the file to a USB device.
3. Plug in the USB device and press F11 during POST to enter BIOS Boot Manager.
4. Go to **System Utilities menu > BIOS Update File Explorer**.
5. Select the USB device and navigate through the directory contents to find the executable (.efi).
6. Launch the executable and follow the instructions provided by the flash utility.

If you have access to Windows®: update package instructions for Windows® Dup

1. Browse to the location where you downloaded the file and double-click the new file.
2. Read over the release information in the dialog window.
3. Download and install any prerequisites identified in the dialog window before proceeding.
4. Install any necessary Embedded Systems Management firmware prior to this BIOS update.
5. Click **Install**.
6. Follow the onscreen instructions.

Run diagnostics

Running diagnostics help you to identify the cause for a system issue. The diagnostics test your system hardware without requiring additional equipment or risking data loss.

1. While the system is booting, press F10 to enter Lifecycle Controller.
2. Go to **Hardware Diagnostics** and click **Run Hardware Diagnostics**.
3. Note the error code and contact Axis technical support.

Perform a system recovery

If the device has had a complete system failure, you must use a recovery image to recreate the Windows® system. To download the AXIS Recovery Kit, contact Axis technical support and supply the serial number of your device.

1. Download the AXIS Recovery Kit and AXIS ISO to USB Tool.

AXIS Camera Station S1264 Rack Recording Server

Troubleshooting

2. Insert a USB drive into your computer.
 - Use a USB drive with a minimum of 16 GB to 32 GB.
 - The USB drive will be formatted, and all existing data will be erased.
 3. Run the AXIS ISO to USB Tool and follow the onscreen instructions.

Writing data to the USB drive takes approximately 10 to 15 min. Don't remove the USB drive until the process is complete.
 4. After the ISO to USB tool is complete, take the USB drive and plug it into your device.
 5. Start your device.
 6. When you see the AXIS splash screen, press F11.
 7. Click **One-shot UEFI Boot Menu**.
 8. Navigate to your USB drive and press ENTER. The system boots into the AXIS Recovery Kit.
 9. Click **Reinstall Operating System**.
- The recovery takes roughly 10 to 15 min to complete. You find detailed instructions in the download for the recovery kit.

Export a SupportAssist collection

You can export the SupportAssist collection to a USB drive or a network share (CIFS/NFS). The collection includes the following data:

- Hardware
- RAID controller logs

To export the SupportAssist collection:

1. During Power-on-self-test (POST), press F10 to start Lifecycle Controller.
2. Go to **Hardware Diagnostics > Export SupportAssist collection**.
3. Read the terms and conditions and click **Next**.

You must accept the terms and conditions to allow technical support to use the SupportAssist collection data.
4. Select the data options which you want to include in the SupportAssist collection and click **Next**.
5. Enter the required export settings information and click **Next**.
 - To export to a USB drive: select the USB drive option and then select the name of the USB Drive and enter the file path details to where the collection is to export.
 - To export to NFS: select the NFS option and enter the required information.
 - To export to CIFS: select the CIFS option and enter the required information.

Click **Test Network Connection** to verify if the Lifecycle Controller can connect to the IP address that is provided. By default, it pings the Gateway IP, DNS Server IP, host IP and Proxy IP.
6. Verify your selection and click **Finish**.

Lifecycle Controller retrieves the selected collection data and exports to the specified location. This can take a few minutes.

AXIS Camera Station S1264 Rack Recording Server

Troubleshooting

Troubleshoot the power supply unit

Note

After installing a power supply unit, allow several seconds for the system to recognize the power supply unit and determine if it the power supply works properly.

1. Ensure that no loose connections exist. For example, loose power cables.
2. Ensure that the power supply handle LED indicates that the power supply is working properly.
3. Check the status of the power indicator on the power supply unit. See *Specifications on page 27*.
4. If you have a redundant power supply configuration, ensure that both power supply units are of the same type and wattage.
5. Ensure that you use only power supply units with the Extended Power Performance (EPP) label on the back.
6. Reset the power supply unit.
7. If the problem persists, contact Axis technical support.

Troubleshoot memory errors

1. Upgrade the BIOS to the latest version.
2. If the errors persist, contact Axis technical support.

Troubleshoot AXIS Camera Station

For information about how to troubleshoot AXIS Camera Station, go to the *AXIS Camera Station user manual*.

AXIS Camera Station S1264 Rack Recording Server

Product overview

Product overview

Front and rear sides

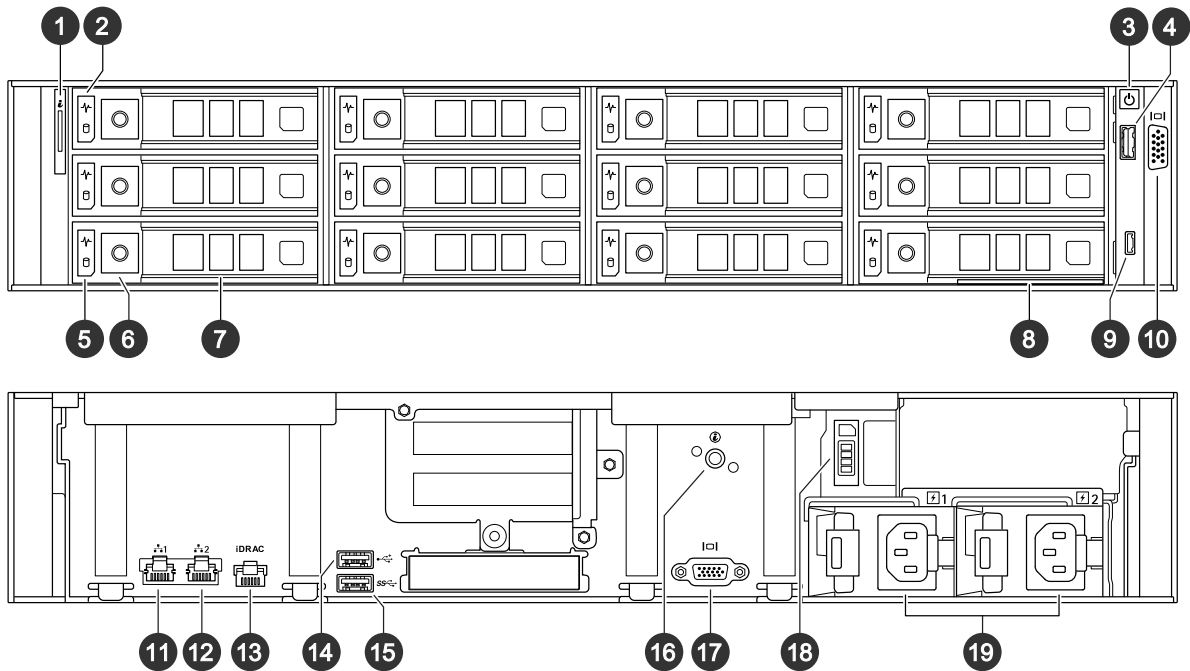

- 1 System identification button and indicator
- 2 Hard drive status LED
- 3 Power button/power LED
- 4 USB 2.0 port
- 5 Hard drive activity LED
- 6 Hard drive tray release button
- 7 Hard drive tray
- 8 Information tag
- 9 iDRAC direct port
- 10 VGA port
- 11 1 GbE Ethernet port 1
- 12 1 GbE Ethernet port 2
- 13 iDRAC dedicated Ethernet port
- 14 USB 2.0 port
- 15 USB 3.0 port
- 16 System identification button and indicator
- 17 VGA port
- 18 Solid state drive tray
- 19 Power supply units

Specifications

Status LED indicators

AXIS Camera Station S1264 Rack Recording Server

Product overview

LED	Description	Action
Drive indicator	The indicator turns solid amber if there is a drive error.	Check the System Event Log to determine if the drive has an error.
Temperature indicator	The indicator turns solid amber if the system experiences a thermal error. For example, the ambient temperature is out of range or there is a fan failure.	Ensure that none of the following conditions exist: <ul style="list-style-type: none"> • A cooling fan has been removed or has failed. • System cover, air shrouds, or back filler bracket has been removed. • Ambient temperature is too high. • External airflow is obstructed.
Electrical indicator	The indicator turns solid amber if the system experiences an electrical error. For example, voltage out of range, or a failed power supply unit (PSU) or voltage regulator.	Check the System Event Log or system messages for the specific issue. If it is due to a problem with the PSU, check the LED on the PSU. Reseat the PSU.
Memory indicator	The indicator turns solid amber if a memory error occurs.	Check the System Event Log or system messages for the location of the failed memory. Reseat the memory module.
PCIe indicator	The indicator turns solid amber if a PCIe card experiences an error.	Restart the system. Update any required drivers for the PCIe card. Reinstall the card.

System health and ID indicators

LED	Description	Action
Solid blue	The system is powered on, is healthy, and system ID mode is not active.	Press the system health and system ID button to switch to system ID mode.
Blinking blue	The system ID mode is active.	Press the system health and system ID button to switch to system health mode.
Solid amber	The system is in fail-safe mode.	
Blinking amber	The system is experiencing a fault.	Check the system event log for the specific error message.

iDRAC direct LED indicators

LED	Description
Solid green for two seconds	The laptop or tablet is connected.
Blinking green (on for two seconds and off for two seconds)	The laptop or tablet connected is recognized.
Off	The laptop or tablet is unplugged.

NIC indicators

LED	Description
Link and activity indicators are off	The NIC is not connected to the network.
Link indicator is green and activity indicator is blinking green	The NIC is connected to a valid network at its maximum port speed and data is being sent or received.

AXIS Camera Station S1264 Rack Recording Server

Product overview

Link indicator is amber and activity indicator is blinking green	The NIC is connected to a valid network at less than its maximum port speed and data is being sent or received.
Link indicator is green and activity indicator is off	The NIC is connected to a valid network at its maximum port speed and data is not being sent or received.
Link indicator is amber and activity indicator is off	The NIC is connected to a valid network at less than its maximum port speed and data is not being sent or received.

Power supply unit (PSU) indicators

LED	Description
Green	A valid power source is connected to the PSU and the PSU is operational.
Blinking amber	There is a problem with the PSU.
Not powered on	Power is not connected to the PSU.
Blinking green	<p>The firmware of the PSU is being updated.</p> <p>CAUTION</p> <p>Do not disconnect the power cord or unplug the PSU when updating firmware. If firmware update is interrupted, the PSUs will not function.</p>
Blinking green and powers off	<p>When hot-plugging a PSU, it blinks green five times at a rate of 4 Hz and powers off. This indicates a PSU mismatch due to efficiency, feature set, health status, or supported voltage.</p> <p>CAUTION</p> <ul style="list-style-type: none"> If two PSUs are installed, both the PSUs must have the same type of label. For example, Extended Power Performance (EPP) label. Mixing PSUs from previous generations of PowerEdge servers is not supported, even if the PSUs have the same power rating. This results in a PSU mismatch condition or failure to power on the system. If two PSUs are used, they must be of the same type and have the same maximum output power. When correcting a PSU mismatch, replace the PSU with the blinking indicator. Swapping the PSU to make a matched pair can result in an error condition and an unexpected system shutdown. To change from a high output configuration to a low output configuration or vice versa, you must power off the system.

Drive indicators

LED	Description
Blinks green twice per second	The drive is being identified or preparing for removal.
Off	<p>The drive is ready for removal.</p> <p>Note</p> <p>The drive status indicator remains off until all drives are initialized after the system is powered on. Drives are not ready for removal during this time.</p>
Blinks green, amber, and then powers off	There is an unexpected drive failure.

AXIS Camera Station S1264 Rack Recording Server

Product overview

Blinks amber four times per second	The drive has failed.
Blinks green slowly	The drive is rebuilding.
Solid green	The drive is online.
Blinks green for three seconds, amber for three seconds, and then powers off after six seconds	The rebuild has stopped.

AXIS Camera Station S1264 Rack Recording Server

Need more help?

Need more help?

Useful links

- *AXIS Camera Station user manual*
- *Configure Axis Secure Remote Access*
- *What to include in an Antivirus allowlist for AXIS Camera Station*

Contact support

Contact support at axis.com/support.

