

# EPSON

## ES-C320W

# User's Guide

---

**Product Features**

---

**Scanner Basics**

---

**Placing Originals**

---

**Scanning**

---

**Maintenance**

---

**Solving Problems**

---

## Contents

---

### **About This Manual**

Introduction to the Manuals. . . . .	6
Marks and Symbols. . . . .	6
Descriptions Used in this Manual. . . . .	6
Operating System References. . . . .	6
Copyright. . . . .	7
Trademarks. . . . .	7

### **Important Instructions**

Safety Instructions. . . . .	10
Restrictions on Copying. . . . .	11
Advisories and Warnings for Connecting to the Internet. . . . .	11
Notes on the Administrator Password. . . . .	12
Initial Administrator Password. . . . .	12
Operations that Require the Administrator Password. . . . .	12
Changing the Administrator Password. . . . .	12
Resetting the Administrator Password. . . . .	12

### **Product Features**

Scanning Passports. . . . .	15
Supports Epson Smart Panel, an App for Smart Devices. . . . .	15
Notification of Dirt on the Glass Surface. . . . .	16
Useful Image Quality Adjustment Features. . . . .	17

### **Scanner Basics**

Part Names and Functions. . . . .	21
Position of Scanner. . . . .	24
Buttons and Lights on the Control Panel. . . . .	25
Buttons. . . . .	25
Lights. . . . .	26
Error Indicators. . . . .	27
Information on Applications. . . . .	29
Application for Scanning from a Computer (Epson ScanSmart). . . . .	29
Application for Scanning from Smart Devices (Epson Smart Panel). . . . .	29
Application for Updating Software and Firmware (EPSON Software Updater). . . . .	29
Application for Configuring Scanner Operations (Web Config). . . . .	30

Application for Setting up the Device on a Network (EpsonNet Config). . . . .	32
Software for Managing Devices on the Network (Epson Device Admin). . . . .	33
Application for Creating Driver Packages (EpsonNet SetupManager). . . . .	33
Application for Scanning Business Cards (Presto! BizCard). . . . .	33
Option Items and Consumables Information. . . . .	34
Carrier Sheet Codes. . . . .	34
Roller Assembly Kit Codes. . . . .	34
Cleaning Kit Codes. . . . .	35

### **Placing Originals**

Specifications for Originals that can be Scanned. . . . .	37
General Specifications for Originals Being Scanned. . . . .	37
Scannable Standard Size Originals. . . . .	37
Scannable Long Paper. . . . .	39
Scannable Receipts. . . . .	40
Scannable Plastic Cards. . . . .	41
Scannable Laminated Cards. . . . .	41
Passports. . . . .	42
Specifications for Originals Using the Carrier Sheet. . . . .	42
Scannable Envelopes. . . . .	44
Types of Originals that Require Attention. . . . .	44
Types of Originals that Must Not be Scanned. . . . .	45
Placing Originals in the Scanner. . . . .	46
Combinations of Originals and Scanner Position. . . . .	46
Placing Standard Size Originals. . . . .	47
Placing Large Size Originals. . . . .	52
Placing Long Paper. . . . .	56
Placing Plastic Cards. . . . .	61
Placing Laminated Cards. . . . .	64
Placing a Passport. . . . .	67
Placing Important Originals or Photos. . . . .	72
Placing an Envelope. . . . .	76
Placing Irregular Shaped Originals. . . . .	79
Loading Batches of Originals with Different Paper Types and Sizes. . . . .	83

### **Scanning**

Scanning Using a Scanner Button. . . . .	89
Scanning from a Computer. . . . .	89

Scanning Using Epson ScanSmart. . . . .	89
Software Image Quality Adjustment Features. . . . .	93
Scanning in Automatic Feeding Mode. . . . .	93
Using AirPrint. . . . .	96
Scanning Using Chromebook. . . . .	96
Scanning from a Smart Device. . . . .	97
Scanning Using Epson Smart Panel. . . . .	97
Scanning Using Mopria Scan. . . . .	97

## **Required Settings for Scanning**

Connecting the Scanner to the Network. . . . .	99
Connecting to the Wireless LAN (Wi-Fi). . . . .	99
Checking the Scanner's IP Address. . . . .	101
Setting Up AirPrint. . . . .	102

## **Useful Features**

Setting the Glass Surface Stain Detection Feature. . . . .	104
Setting the Document Protection Feature. . . . .	105
Setting the Operation when a Double-feed is Detected. . . . .	106

## **Maintenance**

Cleaning Outside the Scanner. . . . .	109
Cleaning Inside the Scanner. . . . .	109
Resetting the Number of Scans After Cleaning Inside the Scanner. . . . .	117
Replacing the Roller Assembly Kit. . . . .	119
Resetting the Number of Scans After Replacing the Rollers. . . . .	126
Energy Saving. . . . .	127
Moving the Scanner. . . . .	128
Transporting the Scanner. . . . .	128
How to Carry the Scanner. . . . .	129
Updating Applications and Firmware. . . . .	130
Updating Firmware Using Web Config. . . . .	131
Updating Firmware without Connecting to the Internet. . . . .	131

## **Solving Problems**

Problems with the Scanner. . . . .	134
Scanner Lights Indicate an Error. . . . .	134
The Scanner Does Not Turn On. . . . .	134
Forgot Your Administrator's Password. . . . .	134
Problems when Preparing Network Scanning. . . . .	135
Hints to Solving Problems. . . . .	135
Problems Starting Scanning. . . . .	137

Cannot Start Scanning from Computer. . . . .	137
Cannot Start Scanning from Smart Device. . . . .	141
Paper Feeding Problems. . . . .	143
Multiple Originals Are Fed (Double Feed). . . . .	143
Removing Jammed Originals from the Scanner. . . . .	145
Paper Jams, Paper Feed Errors, and Document Protection Issues Occur Frequently. . . . .	151
Paper Protection Does not Work Correctly. . . . .	152
The Originals Get Dirty. . . . .	152
Scanning Speed Slows Down when Scanning Continuously. . . . .	152
Scanning Takes a Long Time. . . . .	152
Scanned Image Problems. . . . .	153
Lines (Streaks) Appear when Scanning from ADF. . . . .	153
Alert About Stains Inside the Scanner Still Appears. . . . .	153
Colors Are Uneven in the Scanned Image. . . . .	154
Expanding or Contracting the Scanned Image. . . . .	154
An Image on the Back of Your Original Appears in Your Scanned Image. . . . .	154
Scanned Text or Images are Missing or Blurred. . . . .	155
Moiré Patterns (Web-Like Shadows) Appear. . . . .	155
The Edge of the Original is Not Scanned when Automatically Detecting the Size of the Original. . . . .	156
Character is not Recognized Correctly. . . . .	156
Cannot Solve Problems in the Scanned Image. . . . .	157
Uninstalling and Installing Applications. . . . .	158
Uninstalling Your Applications. . . . .	158
Installing Your Applications. . . . .	159

## **Adding or Replacing the Computer or Devices**

Connecting to a Scanner that has been Connected to the Network. . . . .	161
Using a Network Scanner from a Second Computer. . . . .	161
Using a Network Scanner from a Smart Device. . . . .	162
Connecting a Smart Device and Scanner Directly (Wi-Fi Direct). . . . .	162
About Wi-Fi Direct. . . . .	162
Making AP Mode Settings. . . . .	163
Re-setting the Network Connection. . . . .	163
When Replacing the Wireless Router. . . . .	163
When Changing the Computer. . . . .	164
Changing the Connection Method to the Computer. . . . .	164
Making Wi-Fi Settings from the Control Panel. . . . .	165

Checking the Network Connection Status. . . . .	165
Checking the Network Status Using Network Light. . . . .	165
Checking the Network of the Computer (Windows only). . . . .	165
Disabling the Network Setting from the Control Panel. . . . .	166
Initializing the Network Settings from the Control Panel. . . . .	167

## **Administrator Information**

Connecting the Scanner to the Network. . . . .	169
Before Making Network Connection. . . . .	169
Connecting to the Network Using a Static IP Address. . . . .	171
Setting up the IEEE802.11k/v or IEEE802.11r Features. . . . .	171
Introduction of Product Security Features. . . . .	172
Administrator Settings. . . . .	172
Configuring the Administrator Password. . . . .	172
Locking the Buttons on the Control Panel (Panel Lock). . . . .	173
Logging on to the Scanner from a Computer. . . . .	173
Disabling Network Scanning from your Computer	174
Disabling WSD Scan. . . . .	174
Monitoring a Remote Scanner. . . . .	174
Checking Information for a Remote Scanner. . . . .	174
Receiving Email Notifications When Events Occur. . . . .	175
Backing Up the Settings. . . . .	176
Export the settings. . . . .	176
Import the settings. . . . .	176
Advanced Security Settings. . . . .	177
Security Settings and Prevention of Danger. . . . .	177
Controlling Using Protocols. . . . .	178
Using a Digital Certificate. . . . .	181
SSL/TLS Communication with the Scanner. . . . .	186
Encrypted Communication Using IPsec/IP Filtering. . . . .	187
Connecting the Scanner to an IEEE802.1X Network. . . . .	198
Solving Problems for Advanced Security. . . . .	199

## **Technical Specifications**

General Scanner Specifications. . . . .	208
Network Specifications. . . . .	209
Wi-Fi Specifications. . . . .	209
Network Features and IPv4/IPv6 Support. . . . .	210

Security Protocol. . . . .	210
Supported Third Party Services. . . . .	211
Using Port for the Scanner. . . . .	211
Dimensions and Weight Specifications. . . . .	212
Electrical Specifications. . . . .	213
Scanner Electrical Specifications. . . . .	213
AC Adapter Electrical Specifications. . . . .	213
Environmental Specifications. . . . .	214
System Requirements. . . . .	214

## **Standards and Approvals**

Standards and Approvals for European Models. . . . .	216
Standards and Approvals for Australian Models. . . . .	216
Standards and Approvals for U.S. Models. . . . .	216

## **Where to Get Help**

Technical Support Web Site. . . . .	219
Contacting Epson Support. . . . .	219
Before Contacting Epson. . . . .	219
Help for Users in Europe. . . . .	219
Help for Users in Taiwan. . . . .	219
Help for Users in Australia. . . . .	220
Help for Users in Singapore. . . . .	220
Help for Users in Thailand. . . . .	221
Help for Users in Vietnam. . . . .	221
Help for Users in Indonesia. . . . .	222
Help for Users in Hong Kong. . . . .	222
Help for Users in Malaysia. . . . .	222
Help for Users in India. . . . .	223
Help for Users in the Philippines. . . . .	223

---

# About This Manual

Introduction to the Manuals. . . . .	6
Marks and Symbols. . . . .	6
Descriptions Used in this Manual. . . . .	6
Operating System References. . . . .	6
Copyright. . . . .	7
Trademarks. . . . .	7

---

## Introduction to the Manuals

The latest versions of the following manuals are available from the Epson support website.

<http://www.epson.eu/support> (Europe)

<http://support.epson.net/> (outside Europe)

Start Here (paper manual)

Provides you with information on setting up the product and installing the application.

User's Guide (digital manual)

Provides instructions on using the product, maintenance, and solving problems.

As well as the manuals above, see the help included in the various Epson applications.

---

## Marks and Symbols



**Caution:**

*Instructions that must be followed carefully to avoid bodily injury.*



**Important:**

*Instructions that must be observed to avoid damage to your equipment.*

**Note:**

*Provides complementary and reference information.*

### Related Information

➔ Links to related sections.

---

## Descriptions Used in this Manual

Screenshots for the applications are from Windows 10 or macOS High Sierra. The content displayed on the screens varies depending on the model and situation.

Illustrations used in this manual are for reference only. Although they may differ slightly from the actual product, the operating methods are the same.

---

## Operating System References

### Windows

In this manual, terms such as "Windows 11", "Windows 10", "Windows 8.1", "Windows 8", and "Windows 7" refer to the following operating systems. Additionally, "Windows" is used to refer to all versions.

Microsoft® Windows® 11 operating system

- Microsoft® Windows® 10 operating system
- Microsoft® Windows® 8.1 operating system
- Microsoft® Windows® 8 operating system
- Microsoft® Windows® 7 operating system

### **Mac OS**

In this manual, "macOS 12.x", "macOS 11.x", "macOS 10.15.x", "macOS 10.14.x", "macOS 10.13.x", "macOS 10.12.x", and "OS X 10.11.x" are collectively referred to as "Mac OS".

---

## **Copyright**

No part of this publication may be reproduced, stored in a retrieval system, or transmitted in any form or by any means, electronic, mechanical, photocopying, recording, or otherwise, without the prior written permission of Seiko Epson Corporation. No patent liability is assumed with respect to the use of the information contained herein. Neither is any liability assumed for damages resulting from the use of the information herein. The information contained herein is designed only for use with this Epson product. Epson is not responsible for any use of this information as applied to other products.

Neither Seiko Epson Corporation nor its affiliates shall be liable to the purchaser of this product or third parties for damages, losses, costs, or expenses incurred by the purchaser or third parties as a result of accident, misuse, or abuse of this product or unauthorized modifications, repairs, or alterations to this product, or (excluding the U.S.) failure to strictly comply with Seiko Epson Corporation's operating and maintenance instructions.

Seiko Epson Corporation and its affiliates shall not be liable for any damages or problems arising from the use of any options or any consumable products other than those designated as Original Epson Products or Epson Approved Products by Seiko Epson Corporation.

Seiko Epson Corporation shall not be held liable for any damage resulting from electromagnetic interference that occurs from the use of any interface cables other than those designated as Epson Approved Products by Seiko Epson Corporation.

© 2023 Seiko Epson Corporation

The contents of this manual and the specifications of this product are subject to change without notice.

---

## **Trademarks**

- EPSON, EPSON EXCEED YOUR VISION, EXCEED YOUR VISION and their logos are registered trademarks or trademarks of Seiko Epson.
- Microsoft® and Windows® are registered trademarks of Microsoft Corporation.
- Apple, Mac, macOS, OS X, Bonjour, Safari, and AirPrint are trademarks of Apple Inc., registered in the U.S. and other countries.
- Use of the Works with Apple badge means that an accessory has been designed to work specifically with the technology identified in the badge and has been certified by the developer to meet Apple performance standards.
- Chrome, Chromebook, Google Play and Android are trademarks of Google LLC.
- Mopria® and the Mopria® Logo are registered and/or unregistered trademarks and service marks of Mopria Alliance, Inc. in the United States and other countries. Unauthorized use is strictly prohibited.
- Firefox is a trademark of the Mozilla Foundation in the U.S. and other countries.

- ❑ General Notice: Other product names used herein are for identification purposes only and may be trademarks of their respective owners. Epson disclaims any and all rights in those marks.



---

# Important Instructions

Safety Instructions. . . . .	10
Restrictions on Copying. . . . .	11
Advisories and Warnings for Connecting to the Internet. . . . .	11
Notes on the Administrator Password. . . . .	12

## Safety Instructions

Read and follow these instructions to ensure safe use of this product and options. Make sure you keep this manual for future reference. Also, be sure to follow all warnings and instructions marked on the product and options.

- ❑ Some of the symbols used on your product and options are to ensure safety and proper use of the product. Visit the following Web site to learn the meaning of the symbols.

<http://support.epson.net/symbols>

- ❑ Place the product and options on a flat, stable surface that extends beyond the base of the product and options in all directions. If you place the product and options by the wall, leave more than 10 cm between the back of the product and options and the wall.
- ❑ Place the product and options close enough to the computer for the interface cable to reach it easily. Do not place or store the product and options or the AC adapter outdoors, near excessive dirt or dust, water, heat sources, or in locations subject to shocks, vibrations, high temperature or humidity, direct sunlight, strong light sources, or rapid changes in temperature or humidity.
- ❑ Do not use with wet hands.
- ❑ Place the product and options near an electrical outlet where the adapter can be easily unplugged.
- ❑ The AC adapter cord should be placed to avoid abrasions, cuts, fraying, crimping, and kinking. Do not place objects on top of the cord and do not allow the AC adapter or the cord to be stepped on or run over. Be particularly careful to keep the cord straight at the end.
- ❑ Use only the power cord supplied with the product and do not use the cord with any other equipment. Use of other cords with this product or the use of the supplied power cord with other equipment may result in fire or electric shock.
- ❑ Use only the AC adapter that comes with your product. Using any other adapter could cause fire, electrical shock, or injury.
- ❑ The AC adapter is designed for use with the product with which it was included. Do not attempt to use it with other electronic devices unless specified.
- ❑ Use only the type of power source indicated on the AC adapter's label, and always supply power directly from a standard domestic electrical outlet with the AC adapter that meets the relevant local safety standards.
- ❑ When connecting this product and options to a computer or other device with a cable, ensure the correct orientation of the connectors. Each connector has only one correct orientation. Inserting a connector in the wrong orientation may damage both devices connected by the cable.
- ❑ Avoid using outlets on the same circuit as photocopiers or air control systems that regularly switch on and off.
- ❑ If you use an extension cord with the product, make sure the total ampere rating of the devices plugged into the extension cord does not exceed the cord's ampere rating. Also, make sure the total ampere rating of all devices plugged into the wall outlet does not exceed the wall outlet's ampere rating.
- ❑ Never disassemble, modify, or attempt to repair the AC adapter, product, or product options by yourself except as specifically explained in the product's guides.
- ❑ Do not insert objects into any opening as they may touch dangerous voltage points or short out parts. Beware of electrical shock hazards.
- ❑ If damage occurs to the plug, replace the cord set or consult a qualified electrician. If there are fuses in the plug, make sure you replace them with fuses of the correct size and rating.
- ❑ Unplug the product, options, and the AC adapter, and refer servicing to qualified service personnel under the following conditions: The AC adapter or plug is damaged; liquid has entered the product, options, or the AC adapter; the product or the AC adapter has been dropped or the case has been damaged; the product, options, or the AC adapter does not operate normally or exhibits a distinct change in performance. (Do not adjust controls that are not covered by the operating instructions.)

- Unplug the product and the AC adapter before cleaning. Clean with a damp cloth only. Do not use liquid or aerosol cleaners except as specifically explained in the product's guides.
- If you are not going to use the product for a long period, be sure to unplug the AC adapter from the electrical outlet.
- After replacing consumable parts, dispose of them correctly following the rules of your local authority. Do not disassemble them.
- Keep this product at least 22 cm away from cardiac pacemakers. Radio waves from this product may adversely affect the operation of cardiac pacemakers.
- Do not use this product inside medical facilities or near medical equipment. Radio waves from this product may adversely affect the operation of electrical medical equipment.
- Do not use this product near automatically controlled devices such as automatic doors or fire alarms. Radio waves from this product may adversely affect these devices, and could lead to accidents due to malfunction.

---

## Restrictions on Copying

Observe the following restrictions to ensure the responsible and legal use of your product.

Copying of the following items is prohibited by law:

- Bank bills, coins, government-issued marketable securities, government bond securities, and municipal securities
- Unused postage stamps, pre-stamped postcards, and other official postal items bearing valid postage
- Government-issued revenue stamps, and securities issued according to legal procedure

Exercise caution when copying the following items:

- Private marketable securities (stock certificates, negotiable notes, checks, etc.), monthly passes, concession tickets, etc.
- Passports, driver's licenses, warrants of fitness, road passes, food stamps, tickets, etc.

**Note:**

*Copying these items may also be prohibited by law.*

Responsible use of copyrighted materials:

Products can be misused by improperly copying copyrighted materials. Unless acting on the advice of a knowledgeable attorney, be responsible and respectful by obtaining the permission of the copyright holder before copying published material.

---

## Advisories and Warnings for Connecting to the Internet

Do not connect this product to the Internet directly. Connect it in a network protected by a router or firewall.

## Notes on the Administrator Password

This device allows you to set an administrator password to prevent unauthorized third parties from accessing or changing the device settings or the network settings stored in the device when it is connected to a network.

If you set an administrator password, you need to enter the password when changing settings in configuration software such as Web Config.

The initial administrator password is set on the scanner, but you can change it to any password.

### Initial Administrator Password

The initial administrator password varies depending on the label attached to the product. If there is a "PASSWORD" label attached to the back, enter the 8-digit number shown on the label. If there is no "PASSWORD" label attached, enter the serial number on the label attached to the base of the product for the initial administrator password.

We recommend changing the initial administrator password from the default setting.

**Note:**

*No user name is set as default.*

### Operations that Require the Administrator Password

If you are prompted to enter the administrator password during the following operations, enter the administrator password set on the product.

- When logging on to the advanced settings for Web Config
- When changing the device settings in the application
- When updating the firmware for the device
- When changing or resetting the administrator password

### Changing the Administrator Password

You can change the administrator password in Web Config.

When changing the password, the new password must be 8 to 20 characters long and only contain single-byte alphanumeric characters and symbols.

#### Related Information

➔ [“Configuring the Administrator Password” on page 172](#)

### Resetting the Administrator Password

By resetting the network settings, you can restore the administrator password to its original setting at the time of purchase.

**Note:**

*Resetting the administrator password also resets the user name.*

**Related Information**

➔ [“Initializing the Network Settings from the Control Panel” on page 167](#)

---

# Product Features

Scanning Passports. . . . .	15
Supports Epson Smart Panel, an App for Smart Devices. . . . .	15
Notification of Dirt on the Glass Surface. . . . .	16
Useful Image Quality Adjustment Features. . . . .	17

## Scanning Passports

You can scan passports by changing to the straight path position and using a passport carrier sheet (sold separately).

Scanning software allows you to save only the identification pages of your passport. (for Windows only)

See the scanner driver (Epson Scan 2) help for more details.

**Note:**

*Epson Smart Panel only supports passport scanning.*



### Related Information

- ➔ [“Position of Scanner” on page 24](#)
- ➔ [“Passports” on page 42](#)

---

## Supports Epson Smart Panel, an App for Smart Devices

### Epson Smart Panel, for Intuitive Operations

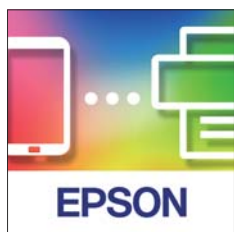

You can perform the following operations.

- You can scan from your smart device and save scanned results to your smart device.
- You can easily upload scanned data to a cloud service.
- You can easily make Wi-Fi settings by following the guidance provided.

- ❑ You can check the causes and solutions to errors from your smart device.

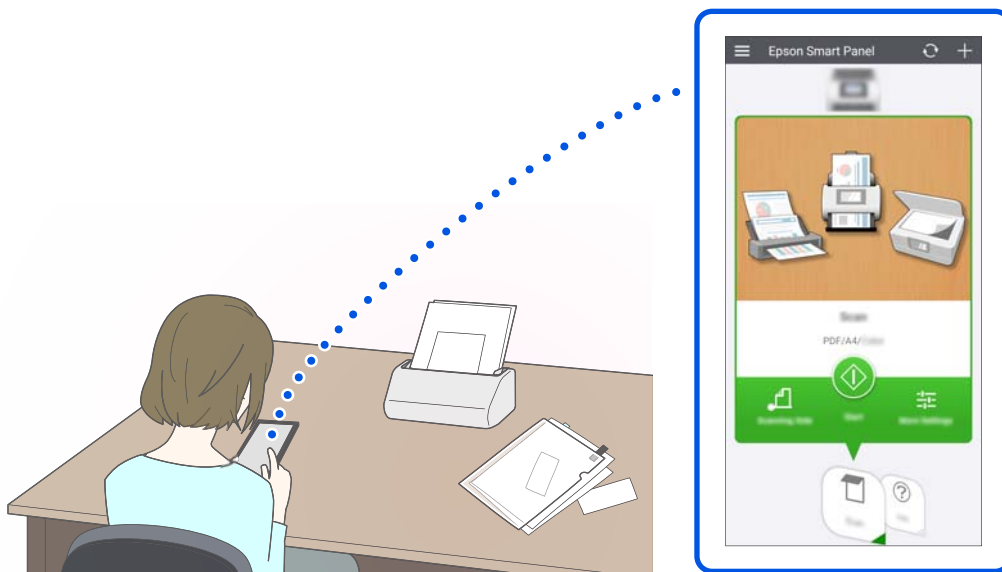

**Related Information**

- ➔ [“Application for Scanning from Smart Devices \(Epson Smart Panel\)” on page 29](#)

---

## Notification of Dirt on the Glass Surface

This scanner can detect dirt on the glass surface, and notify you that you need to clean the glass surface before dirt can cause lines (streaks) in the scanned images.

You can easily keep the glass surface clean, and avoid a decline in image quality.

This feature is off by default.

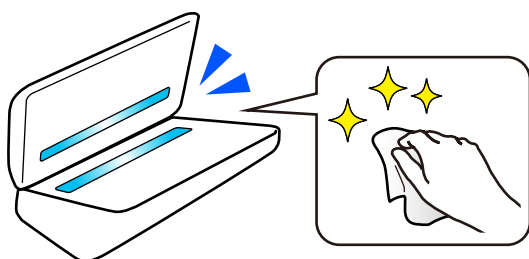

**Related Information**

- ➔ [“Setting the Glass Surface Stain Detection Feature” on page 104](#)
- ➔ [“Cleaning Inside the Scanner” on page 109](#)



# Useful Image Quality Adjustment Features



## Automatically Scan at the Optimum color

You can automatically detect the color of the original and then scan it. Even when color and black-and-white originals are mixed, they can be automatically scanned at the optimum color (Image Type).

Color original: Scan using Color.

Black-and-white originals with gradation (gray areas): Scan using Gray.

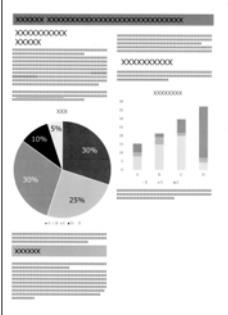
Black-and-white originals without gradation (no gray areas): Scan using B&W.

<p><b>Example of original</b></p>			
<p><b>Image Type to be identified</b></p>	<p>Color</p>	<p>Gray</p>	<p>B&amp;W</p>

Select **Auto** as the **Image Type** in the scanner driver (Epson Scan 2).

**Note:**

When using Epson Smart Panel, setting **Image Type** to **Auto** scans the image in Color or Gray.

## Text Enhancement Feature

You can clearly scan text that is difficult to read due to backgrounds and other factors. You can emphasize text and remove dotted patterns in the background of the original according to the original.

You can set this on the **Advanced Settings** tab > **Text Enhancement** > **Settings** in the scanner driver (Epson Scan 2).

### When scanning in Color or Gray

The following features are available.

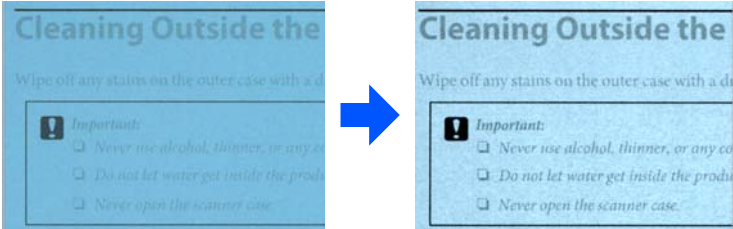
Features	Explanations
<p><b>Emphasize light letters for OCR</b></p>	<p>You can emphasize light letters so that they can be more easily recognized by OCR. You can adjust the level of the effect.</p> <div style="text-align: center;">  </div>

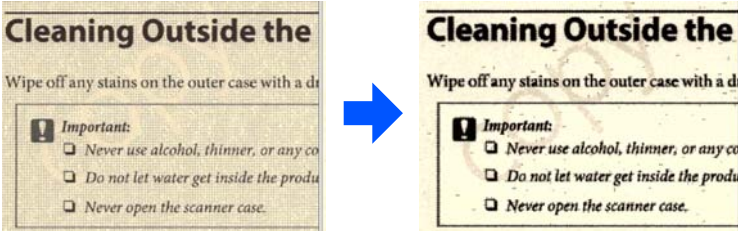
Features	Explanations
<p><b>Remove halftone dots</b></p>	<p>When scanning in Color or Gray, turn this on to remove dotted patterns in the background of the original.</p> 

**When scanning in B&W**

The following features are available.

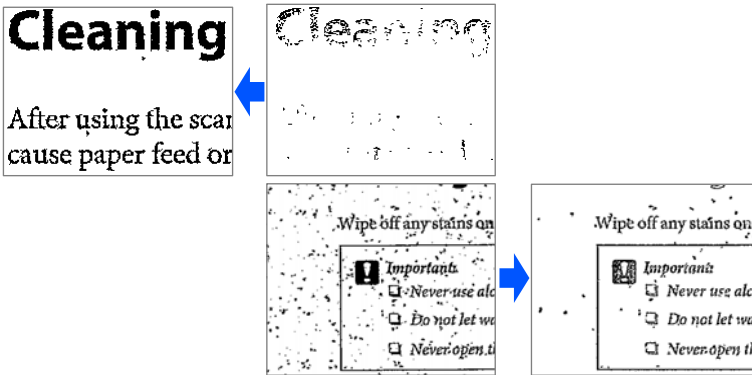
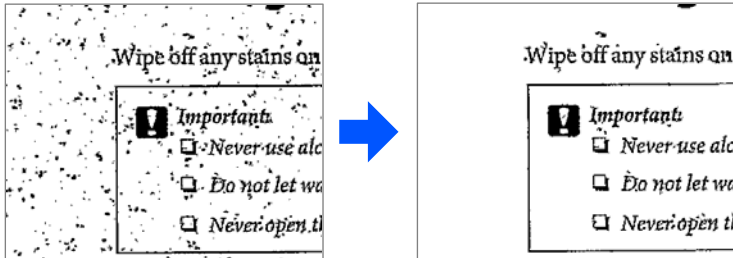
Features	Explanations
<p><b>Emphasize light letters / Remove background</b></p>	<p>You can set the level of text and background correction to enhance light text, remove background colors, patterns, wrinkles, and offset.</p> 
<p><b>Remove spot noise</b></p>	<p>You can remove black dots in the background of the original that cannot be removed by lightening the background. You can adjust the level of the effect.</p> 

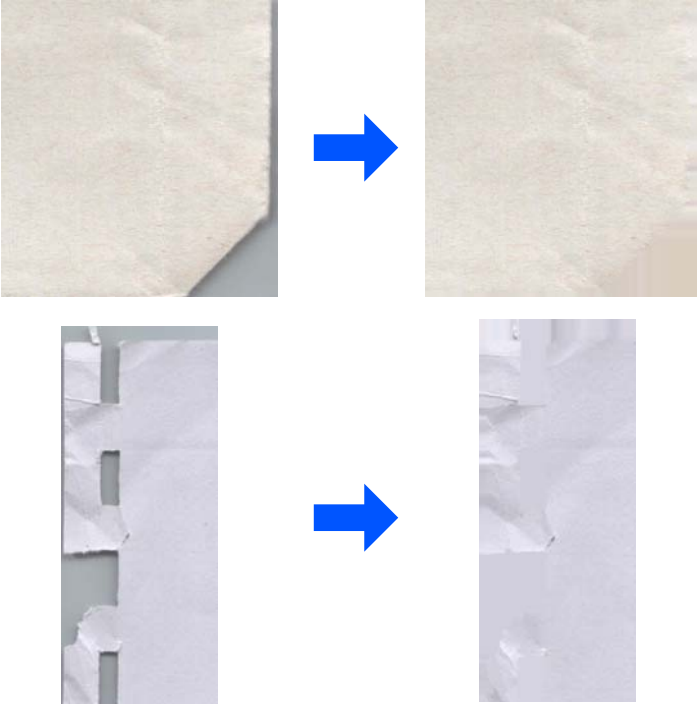
Features	Explanations
<b>Correct folds or tears</b>	<p>You can correct scanned images when the corners or the edges of the original are folded or torn, or when a shadow appears around the scanned image. The missing edges or corners of the scanned image will be filled with the color of the original document.</p> 

**Related Information**

➔ [“Software Image Quality Adjustment Features” on page 93](#)

---

# Scanner Basics

Part Names and Functions. . . . .	21
Position of Scanner. . . . .	24
Buttons and Lights on the Control Panel. . . . .	25
Information on Applications. . . . .	29
Option Items and Consumables Information. . . . .	34

## Part Names and Functions

### Front

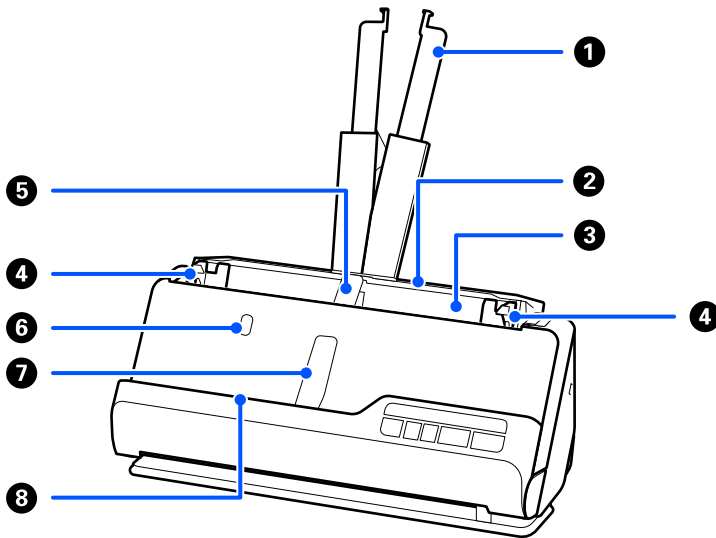

1	Input tray extension	Pull this out if the original extends beyond the edges of the tray. This prevents paper from curling and causing paper jams.
2	Input tray	Loads originals.
3	ADF (Automatic Document Feeder)	Feeds loaded originals automatically.
4	Edge guides	Use guides to supports the original in the input tray to facilitate a smooth feeding operation. Slide to the edges of the originals.
5	Input tray paper support	Supports the ejected original on the input tray side so that it is ejected correctly.
6	Input tray paper support button	Press this button to raise the input tray paper support. Store the paper support manually.
7	Output tray paper support	Supports the ejected original on the output tray side so that it is ejected correctly.
8	Output tray paper support button	Press this button to raise the output tray paper support. Store the paper support manually.

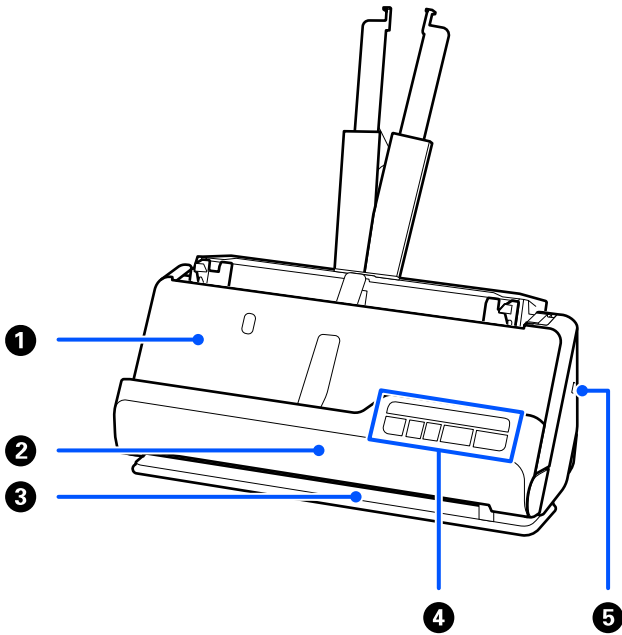

①	Output tray	Originals scanned in the vertical path position are ejected from here.
②	Vertical path cover	Open when cleaning the inside of the scanner, or when an original is jammed while scanning in the vertical path position.
③	Output slot	Originals scanned in the straight path position are ejected from here.
④	Control panel	Displays the scanner's status and performs scanner operations.
⑤	Security slot	Insert a security lock for theft prevention.

**Side / Rear**

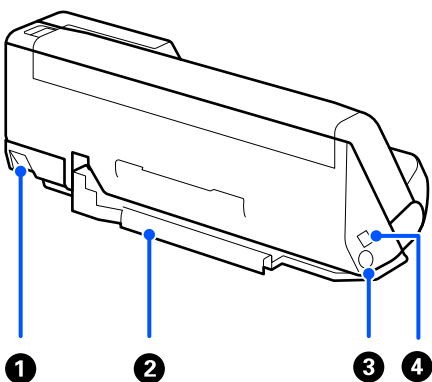

①	Scanner position selector	Used to change the scanner position between vertical path position and straight path position.
---	---------------------------	------------------------------------------------------------------------------------------------

<p>②</p>	<p>Cable holder</p>	<p>Secures the cables neatly to the scanner at the bottom.</p> <p><b>! Important:</b>  <i>Do not secure the AC adapter cord and USB cable to the cable holder in the following situations.</i></p> <ul style="list-style-type: none"> <li><input type="checkbox"/> <i>If the scanner or other objects are placed on top of the cord and cable</i></li> <li><input type="checkbox"/> <i>If the cords and cables are twisted, extremely bent, or otherwise placed under stress</i></li> <li><input type="checkbox"/> <i>If the cords and cables are tangled</i></li> </ul>
<p>③</p>	<p>DC inlet</p>	<p>Connects the AC adapter.</p>
<p>④</p>	<p>USB port</p>	<p>Connects a USB cable.</p>

**Inside**

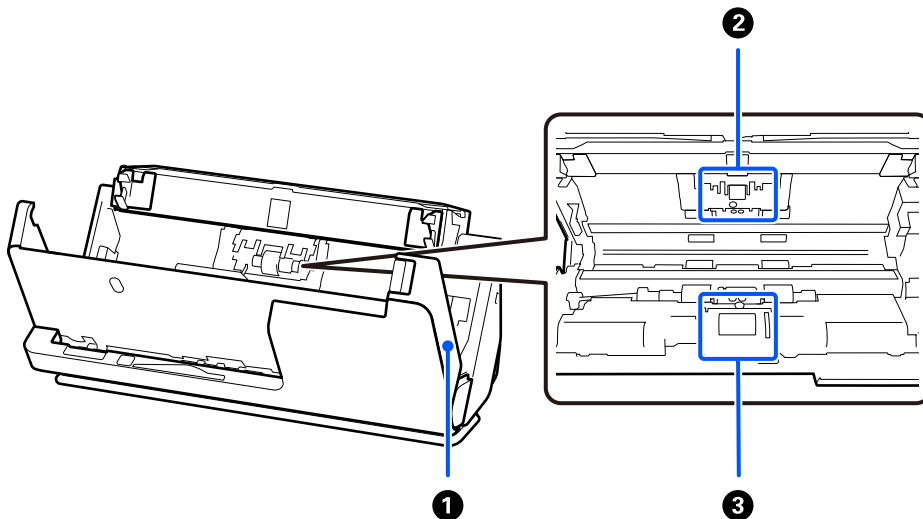

<p>①</p>	<p>Scanner cover</p>	<p>Pull the lever and open the scanner cover when cleaning inside the scanner and removing jammed paper.</p>
<p>②</p>	<p>Separation roller</p>	<p>Feeds originals separately one by one. This needs to be replaced when the number of scans exceeds the service number of papers.</p>
<p>③</p>	<p>Pickup roller</p>	<p>Feeds originals. Roller needs to be replaced when the number of scans exceeds the service number of papers.</p>

**Related Information**

- ➔ [“Cleaning Inside the Scanner” on page 109](#)
- ➔ [“Replacing the Roller Assembly Kit” on page 119](#)

## Position of Scanner

You can change the position of the scanner according to the usage.



**Caution:**

*Be careful not to pinch your fingers or any cables when you change the position of the scanner. Injury or damage may occur.*

See the Related Information page for more information on the combinations of scanner positions and originals.

### Vertical path position

When scanning multiple sheets of standard-size originals, or when scanning thin paper or receipts, pull the scanner position selector to tilt the scanner forward into the vertical path position. When scanning in the vertical path position, originals loaded in the input tray are ejected to the output tray at the top of the scanner.

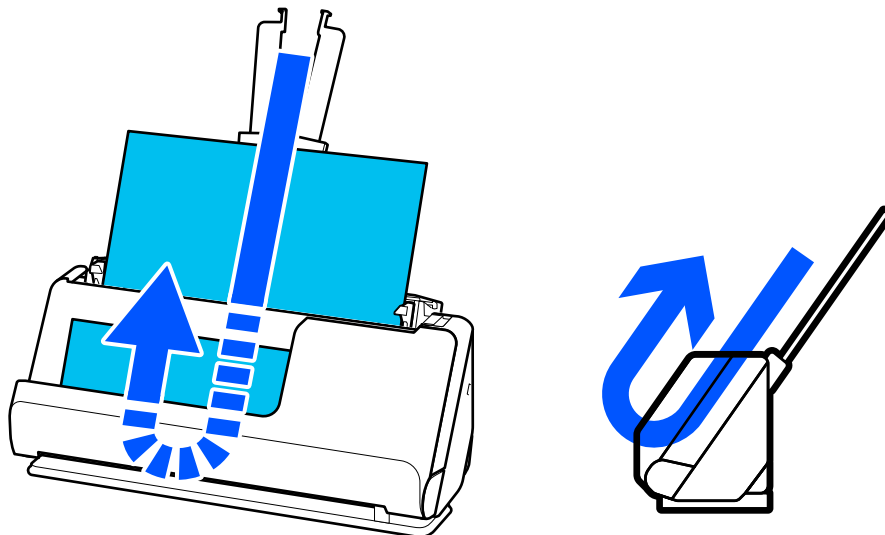



When the vertical path position is changed, the  light on the control panel turns off.

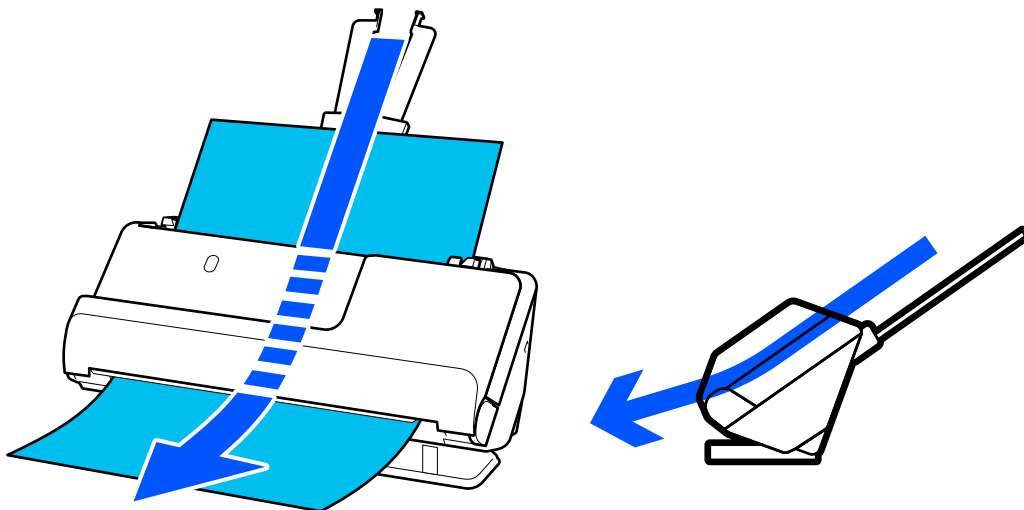

### Straight path position

When scanning thick originals such as passports, pull the scanner position selector to tilt the scanner backward to the straight path position. When scanning in the straight path position, originals loaded in the input tray are ejected to the output slot at the front of the scanner.



When the scanner is changed to the straight path position, the  light on the control panel turns on.

### Related Information





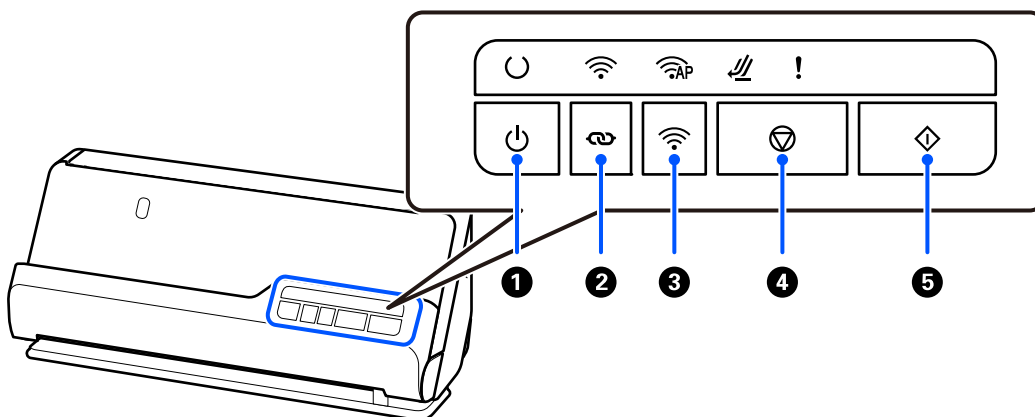

➔ [“Combinations of Originals and Scanner Position” on page 46](#)

## Buttons and Lights on the Control Panel





### Buttons



1		Power button	Turns the scanner on or off.
---	-------------------------------------------------------------------------------------	--------------	------------------------------

2		Wi-Fi connect button	Press the WPS button on the access point, and then press the  button for more than three seconds to connect to a Wi-Fi network. See Related Information below for more details. Press the  button to cancel the settings.
3		Wi-Fi on/off button	Press this button for more than three seconds to turn off the wireless signal. Press again to turn on the signal.
4		Stop button	<input type="checkbox"/> Cancels scanning. <input type="checkbox"/> Finishes Automatic Feeding Mode. <input type="checkbox"/> Cancels Wi-Fi settings by push button setup (WPS). <input type="checkbox"/> Press this to release the error when a network connection error occurs. <input type="checkbox"/> Cancels a firmware update over a network connection.
5		Start button	<input type="checkbox"/> Starts scanning. <input type="checkbox"/> Press this when cleaning the inside of the scanner.

Additional functions are available with different combinations of buttons.

	Hold down the  and  buttons for more than three seconds to start PIN Code Setup (WPS). See Related Information below for more details.
	Turn on the scanner while holding down the  button to restore the default network settings and the administrator password. This also turns off the panel lock function.

**Related Information**

- ➔ [“Adding or Replacing the Computer or Devices” on page 160](#)
- ➔ [“Resetting the Administrator Password” on page 12](#)

**Lights**

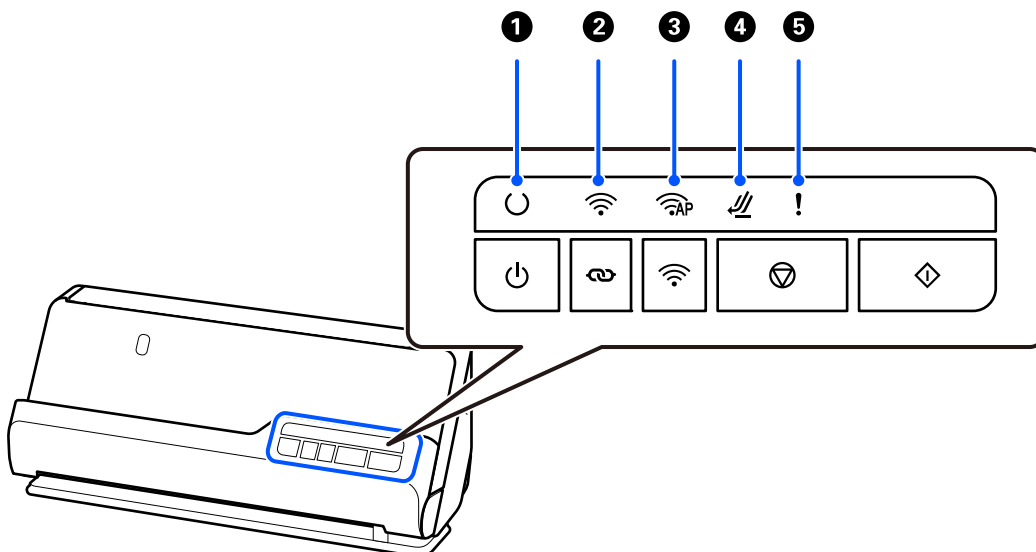

1		Ready light	On: The scanner is ready to be used.
			Flashing: The scanner is scanning, waiting to scan, processing, or sleeping.
			Off: The scanner cannot be used because the power is off or an error has occurred.
2		Wi-Fi light	White indicates that the scanner is connected to a wireless LAN (Wi-Fi). Blue indicates it is searching for an access point.
3		AP mode light	Indicates that the scanner is connected wirelessly in AP mode.
4		Scanner position light	Turns on when the scanner is in the straight path position.
5		Error light	An error has occurred. See "Error Indicators" for more details.











**Related Information**

➔ ["Error Indicators" on page 27](#)









## Error Indicators

**Scanner Errors**

Indicator	Status	Solutions
Flashing	A paper jam or double feed has occurred.	Open the scanner cover, and then remove jammed originals. Close the scanner cover to clear the error. Load the originals again.  This product uses two different positions for scanning, depending on the original being scanned. Check the link to see which position is appropriate for your original.  <a href="#">"Combinations of Originals and Scanner Position" on page 46</a>
On	The scanner cover is opened.	Close the scanner cover.
Flashing On	The scanner position was changed during scanning.	Open the scanner cover, remove the original, and return the scanner to its original position.
Flashing fast	The scanner position has not been set.	Set the scanner in the vertical path position or straight path position.

Indicator	Status	Solutions
 Flashing fast  Flashing fast  Flashing fast  Flashing fast  Flashing fast	A fatal error has occurred.	Turn the power off and on again. If the error continues to occur, contact your dealer.
 Off  On  On  On  On	The scanner has started in recovery mode because the firmware update failed.	The scanner has started in recovery mode because the firmware update failed.  1. Connect the computer and the scanner by USB.  (During recovery mode, you cannot update the firmware over a network connection.)  2. Download the latest firmware from the Epson home page, and then start the update.

### Network Errors

Indicator	Status	Solutions
 Flashing  On	An access point setting error has occurred.	Press the  button to clear the error.
 Flashing  Flashing	An access point settings error has occurred (a security error).	
 Flashing (blue)  Flashing	A network connection error has occurred (the Date and Time has not been set correctly).	Set the correct Date and Time in Web Config.
 Flashing slowly (white)  Flashing	The Wi-Fi connect button and the Wi-Fi on/off button are locked (Panel Lock) and network settings cannot be configured.	Release Panel Lock. See Related Information below for more details.

### Related Information

- ➔ [“Application for Configuring Scanner Operations \(Web Config\)” on page 30](#)
- ➔ [“Connecting the Scanner to the Network” on page 99](#)
- ➔ [“Removing Jammed Originals from the Scanner” on page 145](#)
- ➔ [“Locking the Buttons on the Control Panel \(Panel Lock\)” on page 173](#)

## Information on Applications

This section introduces the application products available for your scanner. The latest application can be installed at the Epson Web site.

### Application for Scanning from a Computer (Epson ScanSmart)

This application allows you to scan documents easily, and then save the scanned images in simple steps.

See the Epson ScanSmart help for details on using the features.

#### Starting on Windows

Windows 11

Click the start button, and then select **All apps > Epson Software > Epson ScanSmart**.

Windows 10

Click the start button, and then select **Epson Software > Epson ScanSmart**.

Windows 8.1/Windows 8

Enter the application name in the search charm, and then select the displayed icon.

Windows 7

Click the start button, and then select **All Programs > Epson Software > Epson ScanSmart**.

#### Starting on Mac OS

Select **Go > Applications > Epson Software > Epson ScanSmart**.

### Application for Scanning from Smart Devices (Epson Smart Panel)

Epson Smart Panel is an application that allows you to scan documents using smart devices such as smart phones and tablet devices. You can save the scanned data in smart devices or cloud services, and send by e-mail.

Even if you do not have a wireless router, you can automatically connect Wi-Fi enabled smart devices to the scanner by using Wi-Fi Direct.

You can download and install Epson Smart Panel from the App Store or Google Play.

### Application for Updating Software and Firmware (EPSON Software Updater)

EPSON Software Updater is an application that installs new software, and updates firmware and manuals over the Internet. If you want to check for update information regularly, you can set the interval for checking for updates in EPSON Software Updater's auto update settings.

#### Starting on Windows

Windows 11

Click the start button, and then select **All apps > Epson Software > EPSON Software Updater**.

❑ Windows 10

Click the start button, and then select **Epson Software > EPSON Software Updater**.

❑ Windows 8.1/Windows 8

Enter the application name in the search charm, and then select the displayed icon.

❑ Windows 7

Click the start button, and then select **All Programs > Epson Software > EPSON Software Updater**.

### Starting on Mac OS

Select **Go > Applications > Epson Software > EPSON Software Updater**.

## Application for Configuring Scanner Operations (Web Config)

Web Config is an application that runs in web browsers, such as Microsoft Edge and Safari, on a computer or a smart device. You can confirm the scanner status or change the network service and scanner settings. To use Web Config, connect the scanner and the computer or device to the same network.

The following browsers are supported. Use the latest version.

Microsoft Edge, Windows Internet Explorer, Firefox, Chrome, Safari

**Note:**

*You may be prompted to enter the administrator password while using this device. See the following for details on the administrator password.*

*[“Notes on the Administrator Password” on page 12](#)*

### Related Information

➔ [“Cannot Access Web Config” on page 135](#)

## How to Run Web Config in a Web Browser

The scanner comes with built-in software called Web Config (a Web page where you can make settings). To access Web Config, simply enter the IP address of a network-connected scanner in your Web browser.

1. Check the scanner's IP address.

Example IP address: 192.168.100.201

2. Launch a Web browser from a computer or a smart device, and then enter the scanner's IP address in the address bar.

Format: `http://scanner's IP address/`

Example: `http://192.168.100.201/`

If a warning screen is displayed in your browser, you can safely ignore the warning and display the Web page (Web Config). Since the scanner uses a self-signed certificate when accessing HTTPS, a warning is displayed on the browser when you start Web Config; this does not indicate a problem and can be safely ignored. Depending on your browser, you may need to click on **Advanced Settings** to view the Web page.

Example: For Microsoft Edge

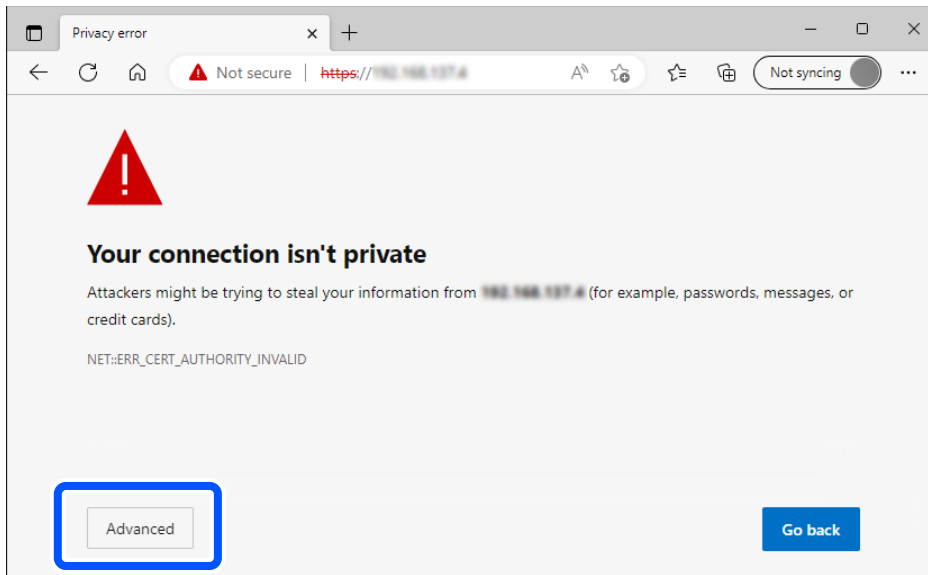

**Note:**

- If a warning screen is not displayed, go to the next step.
- For IPv6 addresses, use the following format.  
Format: `http://[scanner's IP address]/`  
Example: `http://[2001:db8::1000:1]/`

3. To change scanner settings, you need to log in as a Web Config administrator.

Click **Log in** at the top-right of the screen. Enter the **User Name** and **Current password**, and then click **OK**.

The following provides the initial values for the Web Config administrator information.

- User name: none (blank)
- Password: Depends on the label attached to product.

If there is a "PASSWORD" label attached to the back, enter the 8-digit number shown on the label. If there is no "PASSWORD" label attached, enter the serial number on the label attached to the base of the product for the initial administrator password.

**Note:**

If **Log out** is displayed at the top-right of the screen, you are already logged in as an administrator.

**Related Information**

➔ [“Checking the Scanner's IP Address” on page 101](#)

## How to Run Web Config on Windows

When connecting a computer to the scanner using WSD, follow the steps below to run Web Config.

1. Open the scanner list on the computer.

- Windows 11

Click the start button, and then select **Bluetooth & devices > Printers & scanners**.

Windows 10

Click on the start button, and then select **Windows System > Control Panel > View devices and printers** in **Hardware and Sound**.

Windows 8.1/Windows 8

Select **Desktop > Settings > Control Panel > View devices and printers** in **Hardware and Sound** (or **Hardware**).

Windows 7

Click the start button, and select **Control Panel > View devices and printers** in **Hardware and Sound**.

2. Right-click on your scanner and select **Properties**.

3. Select the **Web Service** tab and click the URL.

Since the scanner uses a self-signed certificate when accessing HTTPS, a warning is displayed on the browser when you start Web Config; this does not indicate a problem and can be safely ignored.

**Note:**

The following provides the initial values for the Web Config administrator information.

·User name: none (blank)

·Password: Depends on the label attached to product.

If there is a "PASSWORD" label attached to the back, enter the 8-digit number shown on the label. If there is no "PASSWORD" label attached, enter the serial number on the label attached to the base of the product for the initial administrator password.

If **Log out** is displayed at the top-right of the screen, you have already logged-on as an administrator.

## Application for Setting up the Device on a Network (EpsonNet Config)

EpsonNet Config is an application that allows you to set network interface addresses and protocols. See the operations guide for EpsonNet Config or the application's help for more details.

### Starting on Windows

Windows 11

Click the start button, and then select **All apps > EpsonNet > EpsonNet Config**.

Windows 10

Click the start button, and then select **EpsonNet > EpsonNet Config**.

Windows 8.1/Windows 8

Enter the application name in the search charm, and then select the displayed icon.

Windows 7/Windows Vista

Click the start button, and select **All Programs** or **Programs > EpsonNet > EpsonNet Config SE > EpsonNet Config**.

### Starting on Mac OS

**Go > Applications > Epson Software > EpsonNet > EpsonNet Config SE > EpsonNet Config**.



## Software for Managing Devices on the Network (Epson Device Admin)

Epson Device Admin is a multifunctional application software that manages the device on the network.

The following functions are available.

- Monitor or manage up to 2,000 printers or scanners over the segment
- Make a detailed report, such as for the consumable or product status
- Update the firmware of the product
- Introduce the device to the network
- Apply the unified settings to multiple devices.

You can download Epson Device Admin from Epson support website. For more information, see the documentation or help of Epson Device Admin.

## Application for Creating Driver Packages (EpsonNet SetupManager)

EpsonNet SetupManager is a software to create a package for a simple scanner installation, such as installing the scanner driver and so on. This software allows the administrator to create unique software packages and distribute them among groups.

For more information, visit your regional Epson website.

<http://www.epson.com>

## Application for Scanning Business Cards (Presto! BizCard)

Presto! BizCard by NewSoft provides a full range of contact management functions for adding business cards without having to type. Use the BizCard recognition system to scan business cards, edit, and synchronize the information to the most frequently used personal database management software. You can easily save and manage your contact information.

See the software's help for more information on using the software and its functions.

### Starting on Windows

- Windows 11

Click the start button, and then select **All apps > NewSoft > Presto! BizCard**.

- Windows 10

Click the start button, and then select **NewSoft > Presto! BizCard**.

- Windows 8.1/Windows 8

Enter the application name in the search charm, and then select the displayed icon.

- Windows 7

Click the start button, and then select **All Programs > NewSoft > Presto! BizCard**.

### Starting on Mac OS

Select **Go > Applications > Presto! BizCard**.

## Option Items and Consumables Information

### Carrier Sheet Codes

Using a Carrier Sheet allows you to scan irregular shaped originals or photos that can easily be scratched. You can only load one Carrier Sheet in the straight path position.

When scanning passports, use the Passport Carrier Sheet.

Part Name	Codes* <sup>1</sup>	Number of Times Carrier Sheet Can be Used
Carrier Sheet	B12B819051	3,000* <sup>2</sup>
Passport Carrier Sheet	B12B819651 B12B819661 (for India)	3,000* <sup>2</sup>

\*1 You cannot use any Carrier Sheet or Passport Carrier Sheet except for the codes specified.

\*2 This number is a guide to the replacement cycle. Do not use a Carrier Sheet or Passport Carrier Sheet that is scratched.

#### Related Information

- ➔ [“General Specifications for Originals Being Scanned” on page 37](#)
- ➔ [“Placing Large Size Originals” on page 52](#)
- ➔ [“Placing a Passport” on page 67](#)
- ➔ [“Placing Irregular Shaped Originals” on page 79](#)

### Roller Assembly Kit Codes

Parts (the pickup roller and separation roller) should be replaced when the number of scans exceeds the service number. You can check the latest number of scans in the Epson Scan 2 Utility.

**A**



**B**

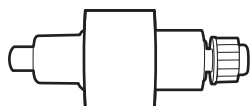

A: Pickup Roller, B: Separation roller

Part Name	Model Number	Life cycle
Roller Assembly Kit	B12B819731 B12B819741 (India only)	50,000*

\* This number was reached by consecutively scanning using Epson test original papers, and is a guide to the replacement cycle. The replacement cycle may vary depending on different paper types, such as paper that generates a lot of paper dust or paper with a rough surface that may shorten the life cycle. The replacement timing also depends on the scanning and cleaning frequency.

**Related Information**

- ➔ [“Replacing the Roller Assembly Kit” on page 119](#)
- ➔ [“Resetting the Number of Scans After Replacing the Rollers” on page 126](#)

## Cleaning Kit Codes

Use this when cleaning inside the scanner. This kit is composed of cleaning liquid and a cleaning cloth.

Part name	Codes
Cleaning Kit	B12B819291

**Related Information**

- ➔ [“Cleaning Inside the Scanner” on page 109](#)

---

# Placing Originals

Specifications for Originals that can be Scanned. . . . .	37
Types of Originals that Require Attention. . . . .	44
Types of Originals that Must Not be Scanned. . . . .	45
Placing Originals in the Scanner. . . . .	46

## Specifications for Originals that can be Scanned

This section explains the specifications and conditions of originals that can be loaded in the ADF.

### General Specifications for Originals Being Scanned

Type of Original	Thickness	Size
Fine paper	When scanning in the vertical path position: 40 to 127 g/m <sup>2</sup>	Max: 215.9×3,048 mm (8.5×120.0 in.) Min: 50.8×50.8 mm (2.0×2.0 in.)
Plain paper		
Recycled paper	When scanning in the straight path position: 40 to 413 g/m <sup>2</sup>	The loadable size varies depending on the type of the originals and the scanning resolution.
Post cards	When scanning A6 size or smaller originals: 40 to 209 g/m <sup>2</sup>	
Business cards		
Envelopes		
Plastic cards complying with ISO7810 ID-1 type (with or without emboss)		
Laminated cards		
Thermal paper		

**Note:**

- ❑ All originals must be flat at the leading edge.
- ❑ Make sure that curls on the leading edge of the originals are kept within the following range.
  - ① must be 5 mm or less.
  - ② must be 3 mm or less.
  - ③ must be greater than or equal to ② if ② is less than 1 mm. When ② is greater than 1 mm, it should be at least 10 times the size of ②.

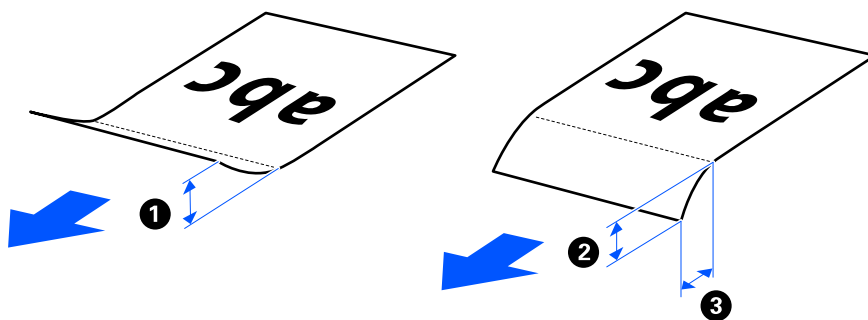

- ❑ Even when the original meets the specifications for originals that can be placed in the ADF, it may not feed from the ADF depending on the paper properties or quality. Additionally, some originals may decrease the scan quality.

### Scannable Standard Size Originals

These are the specifications for standard size originals that you can scan.

Specifications	Size	Thickness	Paper type	Loading Capacity and Thickness
Legal	215.9×355.6 mm (8.5×14 in.)	<input type="checkbox"/> For the vertical path position 40 to 127 g/m <sup>2</sup>  <input type="checkbox"/> For the Straight Path Position 40 to 413 g/m <sup>2</sup>	Plain paper Fine paper Recycled paper	<input type="checkbox"/> For the vertical path position Thickness of the stack of originals: under 2.4 mm (0.09 in.)  40 g/m <sup>2</sup> : 20 sheets* 80 g/m <sup>2</sup> : 20 sheets 90 g/m <sup>2</sup> : 18 sheets 104 g/m <sup>2</sup> : 15 sheets 127 g/m <sup>2</sup> : 12 sheets  <input type="checkbox"/> For the Straight Path Position 1 sheet  The loading capacity varies depending on the paper type.
Letter	215.9×279.4 mm (8.5×11 in.)			
A4	210×297 mm (8.3×11.7 in.)			
B5	182×257 mm (7.2×10.1 in.)			
A5	148×210 mm (5.8×8.3 in.)			
B6	128×182 mm (5.0×7.2 in.)			
A6	105×148 mm (4.1×5.8 in.)			
A8	52×74 mm (2.1×2.9 in.)	<input type="checkbox"/> For the Straight Path Position 40 to 413 g/m <sup>2</sup>		
Business cards	55×89 mm (2.1×3.4 in.)	210 g/m <sup>2</sup>	<input type="checkbox"/> For the vertical path position Thickness of the stack of originals: under 2.4 mm (0.09 in.) 5 sheets  <input type="checkbox"/> For the straight path position 1 sheet	

\* When scanning thin paper originals, we recommend extending the paper output support in both places.

**When Scanning Standard Size Originals (Check the Position of the Scanner)**

When scanning standard size, plain paper originals, scan in the vertical path position.

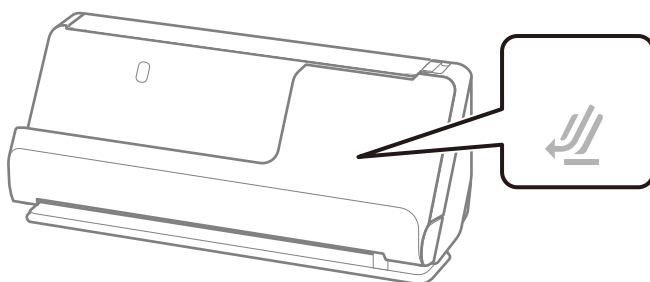

- ❑ When scanning award certificates and other thick originals (originals with a thickness 127 g/m<sup>2</sup> or more), scan in the straight path position and load only one original at a time.

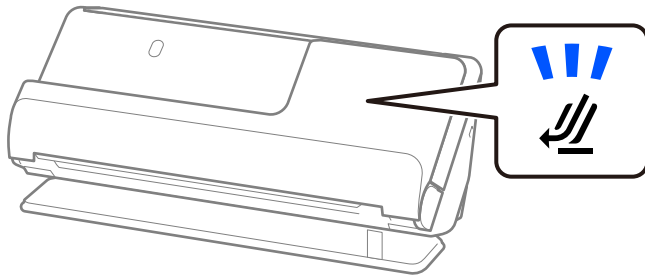

**Related Information**

➔ [“Placing Standard Size Originals” on page 47](#)

## Scannable Long Paper

These are the specifications for long paper that you can scan.

**Note:**

- ❑ *When scanning long paper, scanning speed is reduced.*
- ❑ *Long paper means originals with a length of 393.8 mm (15.5 in.) or more.*
- ❑ *You cannot scan long paper using Epson Smart Panel.*

Size	Thickness	Paper type	Loading Capacity
Maximum width: 215.9 mm (8.5 in.) Maximum length: 3,048 mm (120 in.)*	50 to 130 g/m <sup>2</sup>	Plain paper Fine paper Recycled paper	1 sheet

\* The following shows the maximum lengths according to the scanning resolution.

- ❑ 50 to 300 dpi: 3,048.0 mm (120 in.)
- ❑ 301 to 600 dpi: 762.0 mm (30 in.)

**When Scanning Long Paper (Check the Position of the Scanner)**

When scanning long paper, scan in the straight path position.

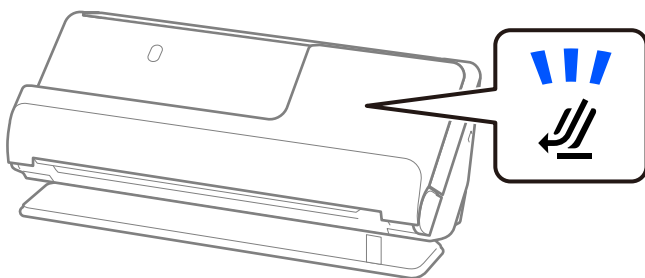

**Related Information**

➔ “Placing Long Paper” on page 56

**Scannable Receipts**

These are the specifications for receipts that you can scan.

Size	Thickness	Loading Capacity and Thickness
Width: 50.8 to 215.9 mm (2.0 to 8.5 in.) Length: 50.8 to 3,048 mm (2.0 to 120.0 in.)* <sup>1</sup>	53 to 77 g/m <sup>2</sup>	<input type="checkbox"/> For the vertical path position Thickness of the stack of originals: under 2.4 mm (0.09 in.) 20 sheets * <sup>2</sup> <input type="checkbox"/> For the straight path position 1 sheet

\*1 Switch the scanner position according to the length of the receipt to be scanned.

\*2 When scanning receipts in the vertical path position, we recommend extending the paper output support in both places.

**When Scanning Receipts (Check the Position of the Scanner)**

When scanning receipts that are shorter than 393.7 mm (15.5 inches), scan in the vertical path position.

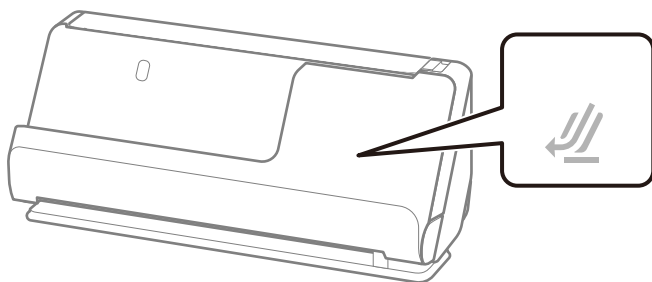

When scanning receipts that are longer than 393.7 mm (15.5 inches), place the scanner in the straight path position and load only one original at a time.

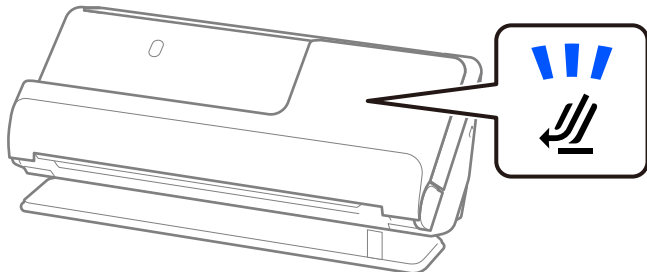

**Related Information**

➔ “Placing Standard Size Originals” on page 47

➔ “Placing Long Paper” on page 56



## Scannable Plastic Cards

These are the specifications for plastic cards that you can scan.

Size	Embossing	Thickness	Loading Capacity	Loading Direction
ISO7810 ID-1 Type 54.0×85.6 mm (2.1×3.3 in.)	With embossing	1.24 mm (0.05 in.) or less	1 card	Horizontal (landscape)
	Without embossing	0.76 mm (0.03 in.) to 1.1 mm (0.04 in)	1 card	
		Less than 0.76 mm (0.03 in.)	1 card	

### When Scanning Plastic Cards (Check the Position of the Scanner)

When scanning plastic cards, scan in the straight path position.

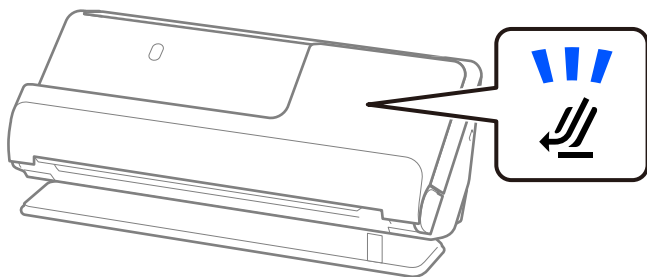

### Related Information

➔ [“Placing Plastic Cards” on page 61](#)

## Scannable Laminated Cards

These are the specifications for laminated cards that you can scan.

Size	Thickness	Loading Capacity
120.0×150.0 mm (4.7×5.9 in.) or less	0.8 mm (0.03 in.) or less	1 sheet

**Note:**

*You cannot scan laminated cards using Epson Smart Panel.*

**When Scanning Laminated Cards (Check the Position of the Scanner)**

When scanning laminated cards, scan in the straight path position.

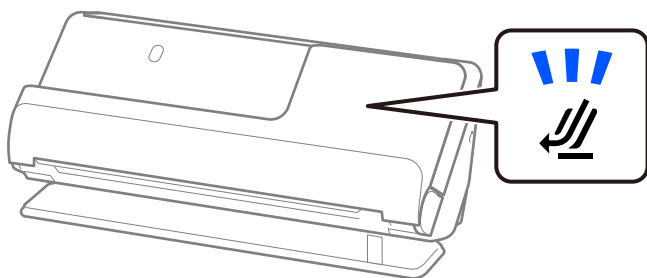

**Passports**

You can scan a passport by using a separately sold passport carrier sheet.

Thickness	Loading Capacity
5 mm (0.20 in.) or less (The total thickness when placed in the Passport Carrier Sheet)	1 passport

**When Scanning Using a Passport Carrier Sheet (Check the Position of the Scanner)**

When scanning using a Passport Carrier Sheet, scan in the straight path position.

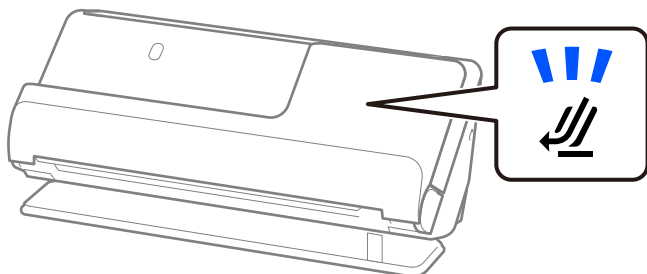

**Related Information**

➔ [“Placing a Passport” on page 67](#)

**Specifications for Originals Using the Carrier Sheet**

The optional Carrier Sheet is a sheet designed to transport originals through the scanner. You can scan originals that are larger than A4/Letter size, important documents or photos which must not be damaged, thin paper, irregular shaped originals, and so on.

The following provides a list of originals that can be scanned using the Carrier Sheet.

Type of Original	Size	Thickness	Loading Capacity of the Carrier Sheet
Originals that cannot be loaded directly into the scanner	A3* <sup>1</sup> A4 B4* <sup>1</sup> Letter Legal* <sup>1</sup> B5 A5 B6 A6 A8 Custom size: <input type="checkbox"/> Width: up to 431.8 mm (17 in.) * <sup>2</sup> <input type="checkbox"/> Length: up to 297 mm (11.7 in.) * <sup>3</sup>	0.3 mm (0.01 in.) or less  (Excluding the thickness of the Carrier Sheet)	1 sheet

\*1 Fold in half to place.

\*2 Originals that are wider than 215.9 mm (8.5 in.) need to be folded in half.

\*3 The leading edge of the original must be placed at the binding part of the Carrier Sheet when scanning an original approximately 297 mm (11.7 in.) long. Otherwise, the length of the scanned image may be longer than intended as the scanner scans to the end of the Carrier Sheet when you select **Auto Detect** as the **Document Size** setting in the application.

### When Scanning Using a Carrier Sheet (Check the Position of the Scanner)

When scanning using a Carrier Sheet, scan in the straight path position.

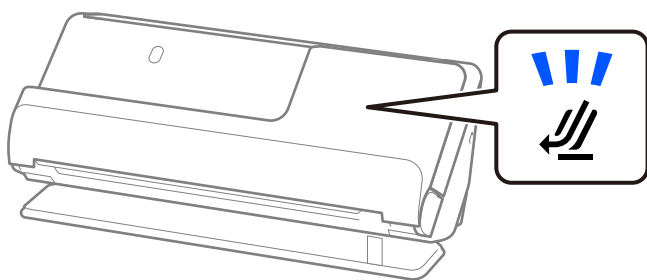

### Related Information

- ➔ [“Carrier Sheet Codes” on page 34](#)
- ➔ [“Placing Large Size Originals” on page 52](#)
- ➔ [“Placing Irregular Shaped Originals” on page 79](#)

## Scannable Envelopes

These are the specifications for envelopes that you can scan.

Specifications	Size	Thickness	Loading Capacity
C6	114×162 mm (4.49×6.38 in.) (standard size)	0.38 mm (0.015 in.) or less	1 envelope
DL	110×220 mm (4.33 x 8.66 in.) (standard size)		

### When Scanning Envelopes (Check the Position of the Scanner)

When scanning envelopes, scan in the straight path position.

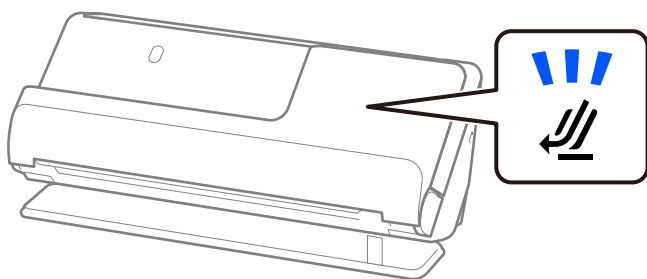

### Related Information

➔ [“Placing an Envelope” on page 76](#)

## Types of Originals that Require Attention

The following types of originals may not be successfully scanned.

- Originals with specially treated surfaces such as glossy paper, thermal paper, or coated paper.
- Originals with a large uneven surface such as letter head paper.
- Originals that have just been printed
- Originals with fold lines
- Perforated originals
- Original with labels or stickers
- Carbon paper and carbon-less paper
- Curled originals
- Originals with wrinkles or tears

 **Important:**

Carbon-less paper contains chemical substances that may damage the rollers inside the scanner. If you scan carbon-less paper, clean the pickup roller and the separation roller regularly. Also, scanning carbon-less paper may shorten the life cycle of the rollers faster than scanning plain paper.

**Note:**

- Wrinkled originals may scan better if you smooth out the wrinkles before scanning.
- To scan delicate originals or originals that are easily wrinkled, use a Carrier Sheet (sold separately).
- To scan originals that are incorrectly detected as double feeds, select **Off** in **Detect Double Feed** on the **Main Settings** tab on the Epson Scan 2 screen before scanning.  
When you are using Epson ScanSmart, you can open the Epson Scan 2 screen by clicking the **Settings** button > **Scanner Settings** tab > **Scan Settings**.
- Labels or stickers must be firmly stuck to the originals with no glue protruding. When scanning an original with labels or stickers that look like they might come off easily, use a carrier sheet and scan the original with the scanner in the straight path position.
- Try to flatten the curled originals before scanning.
- For originals with folds, flatten the original so that the height of the fold is 5 mm (0.2 inches) or less before loading it.  
[“Placing Standard Size Originals” on page 47](#)

**Related Information**

- ➔ [“Scanner Basics” on page 20](#)
- ➔ [“Placing Important Originals or Photos” on page 72](#)
- ➔ [“Placing Irregular Shaped Originals” on page 79](#)
- ➔ [“Maintenance” on page 108](#)

---

## Types of Originals that Must Not be Scanned

The following types of originals must not be scanned.

- Photos
- Booklets
- Passports that are thicker than 5 mm due to visas or supplementary visa pages being stuck inside the passport.
- Bank books
- Non-paper originals (such as clear files, fabric, and metal foil)
- Originals with staples or paper clips
- Originals with glue attached
- Ripped originals
- Heavily wrinkled or curled originals
- Transparent originals such as OHP film
- Originals with carbon paper on the back
- Originals with wet ink
- Originals with sticky notes attached

**Note:**

- ❑ Do not feed valuable photos, artwork, or important documents, which you do not want to damage or deface, into the scanner directly. Misfeeding may wrinkle or damage the original. When scanning such originals, make sure you use a Carrier Sheet (sold separately).
- ❑ Ripped, wrinkled, or curled originals can also be scanned if you use a Carrier Sheet (sold separately).

**Related Information**



- ➔ [“Placing Important Originals or Photos” on page 72](#)
- ➔ [“Placing Irregular Shaped Originals” on page 79](#)



## Placing Originals in the Scanner

### Combinations of Originals and Scanner Position

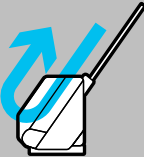
This product uses two different positions for scanning, depending on the original being scanned.

This section explains the combinations of scanner positions and originals. For details on how to change the position, see the Related Information pages or the procedures for placing various types of originals.

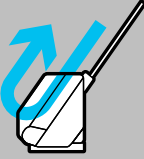
	Vertical path position	Straight path position
		
Explanations	<p>When scanning multiple sheets of standard-size originals, or when scanning thin paper or receipts, place the scanner in the vertical path position.</p> <p>Scanned originals are ejected to the output tray at the top of the scanner.</p>	<p>When scanning thick or long originals, passports, cards, and so on, place the scanner in the straight path position.</p> <p>Scanned originals are ejected to the output slot at the front of the scanner.</p>

	Vertical path position	Straight path position
		
Supported originals	<ul style="list-style-type: none"> <li><input type="checkbox"/> Standard size originals (up to A4)</li> <li><input type="checkbox"/> Thin paper (40 g/m<sup>2</sup>)</li> <li><input type="checkbox"/> Post cards</li> <li><input type="checkbox"/> Receipts less than 393.7 mm (15.5 in.) in length</li> <li><input type="checkbox"/> Business cards  <a href="#">"Placing Standard Size Originals" on page 47</a></li> <li><input type="checkbox"/> Mixture of originals  <a href="#">"Loading Batches of Originals with Different Paper Types and Sizes" on page 83</a></li> </ul>	<ul style="list-style-type: none"> <li><input type="checkbox"/> Large size originals (using a carrier sheet)  <a href="#">"Placing Large Size Originals" on page 52</a></li> <li><input type="checkbox"/> Long paper</li> <li><input type="checkbox"/> Receipts over 393.7 mm (15.5 in.) in length  <a href="#">"Placing Long Paper" on page 56</a></li> <li><input type="checkbox"/> Plastic cards  <a href="#">"Placing Plastic Cards" on page 61</a></li> <li><input type="checkbox"/> Laminated cards  <a href="#">"Placing Laminated Cards" on page 64</a></li> <li><input type="checkbox"/> Passports (using a passport carrier sheet)  <a href="#">"Placing a Passport" on page 67</a></li> <li><input type="checkbox"/> Photos (using a carrier sheet)</li> <li><input type="checkbox"/> Important or essential originals (using a carrier sheet)  <a href="#">"Placing Important Originals or Photos" on page 72</a></li> <li><input type="checkbox"/> Envelopes  <a href="#">"Placing an Envelope" on page 76</a></li> <li><input type="checkbox"/> Irregular size originals (using a carrier sheet)  <a href="#">"Placing Irregular Shaped Originals" on page 79</a></li> </ul>

### Related Information

➔ ["Position of Scanner" on page 24](#)

## Placing Standard Size Originals

1. Make sure the scanner position light () is off.

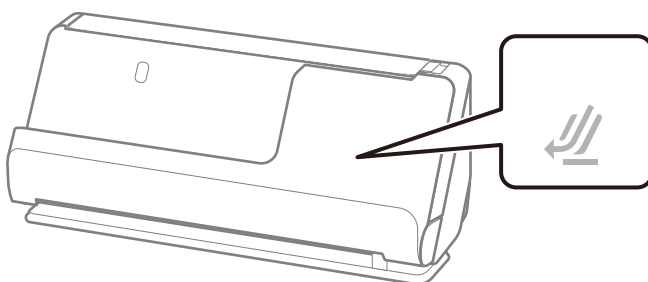

If the scanner position light () is on, pull the scanner position selector to tilt the scanner forward.

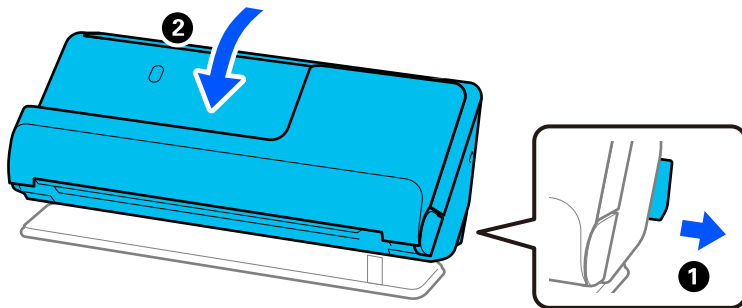

2. Open the input tray.

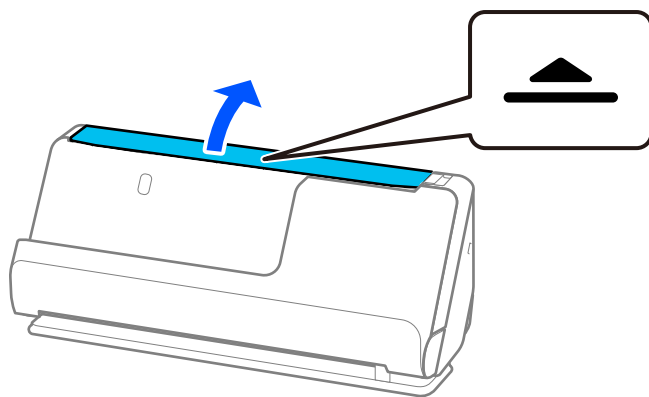

3. Raise the input tray extension.

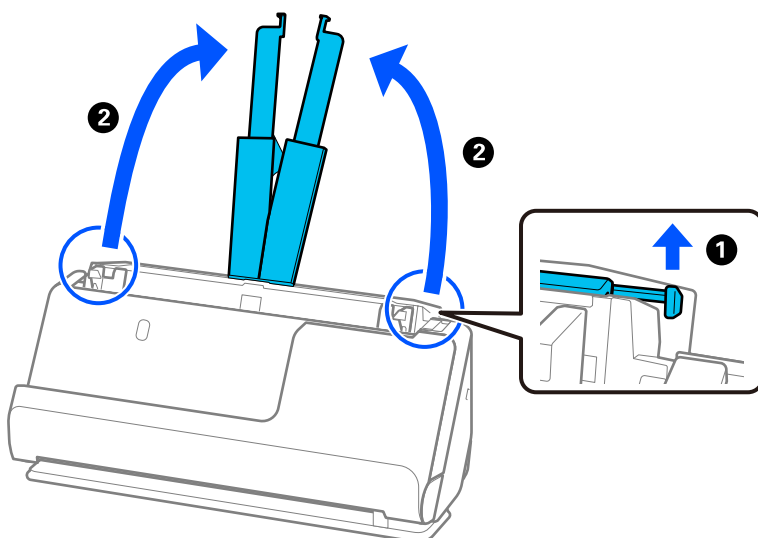



4. Move the edge guides to the edges of the input tray.

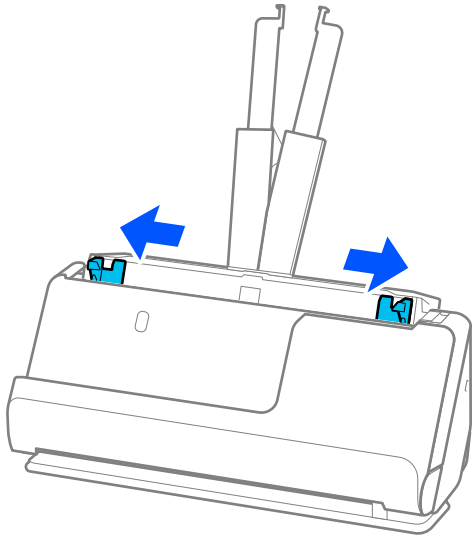

5. Fan the originals.  
Hold both ends of the originals and fan them a few times.

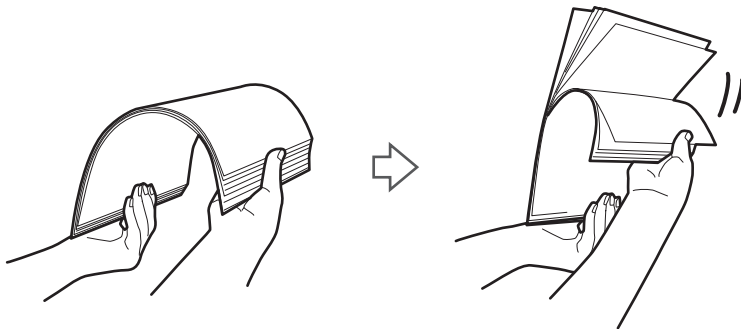

6. Align the edges of the originals, and with the side to be scanned facing up, slide the leading edges into a wedge shape.

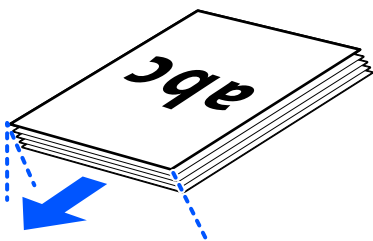

- Place the originals into the ADF input tray facing up and with the top edge facing into the ADF. Insert the paper into the ADF until it meets resistance.

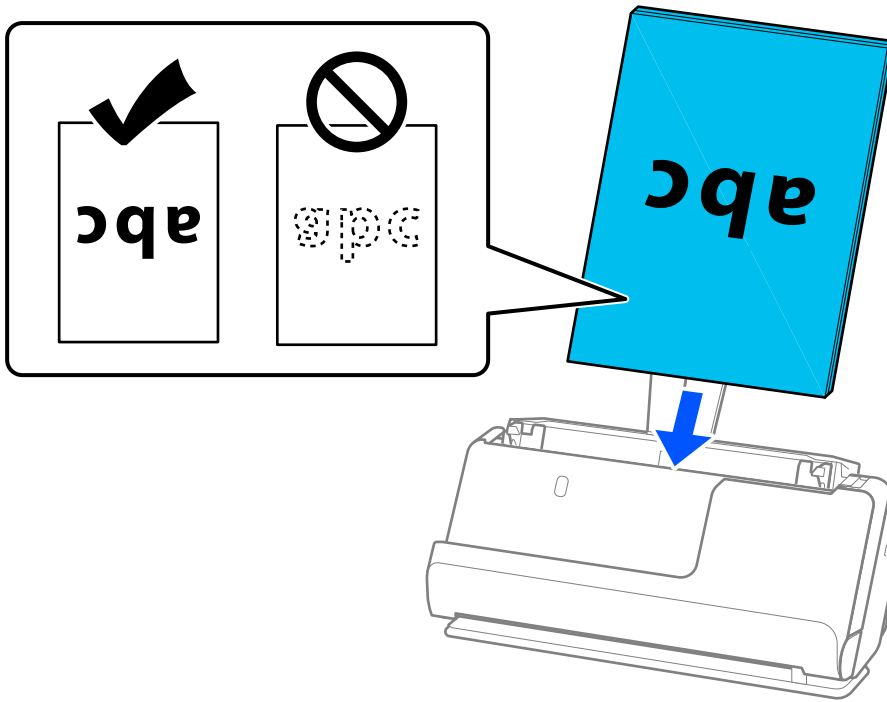

- When scanning originals with punch holes, such as loose leaf paper, load the originals with the holes facing to the left, right, or facing down. Place the originals so that there are no holes within a range of 15 mm (0.6 inches) to the left and right (30 mm (1.2 inches) in total) from the center of the originals. However, there can be holes within 30 mm (1.2 inches) from the leading edge of the originals. Make sure that the edges of the punch holes do not have burrs or curls.

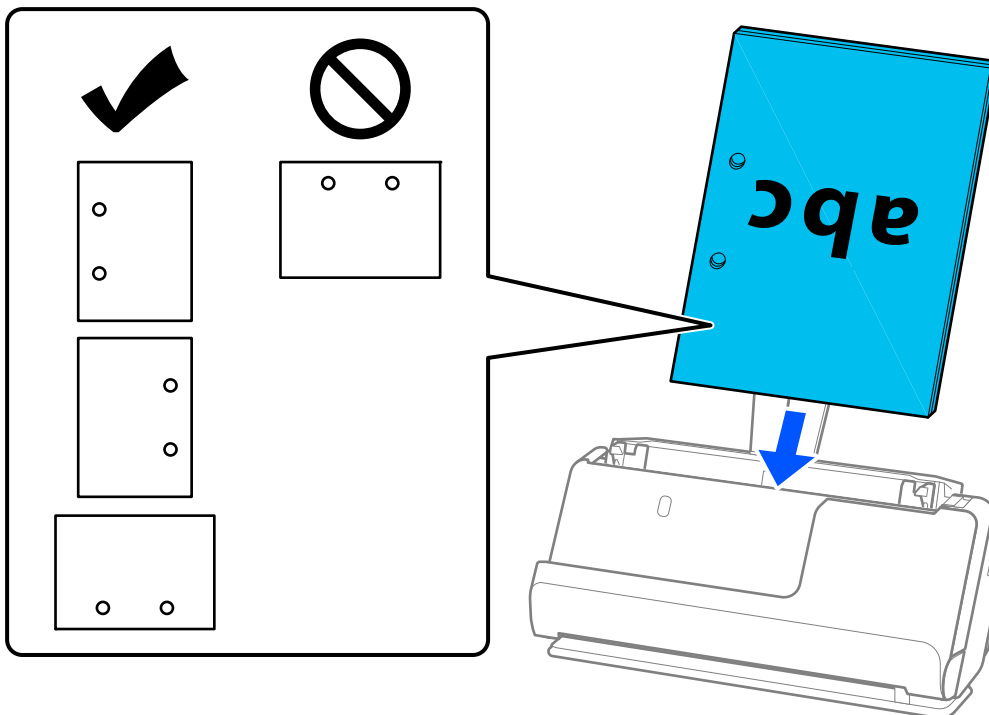

- ❑ Place folded originals so that the valley fold is at the front of the scanner and on the ADF side. You can load up to 10 sheets. Originals with a hard fold line may not be fed properly. For originals such as these, flatten them so that the height of the fold is 5 mm (0.2 inches) or less before loading it.

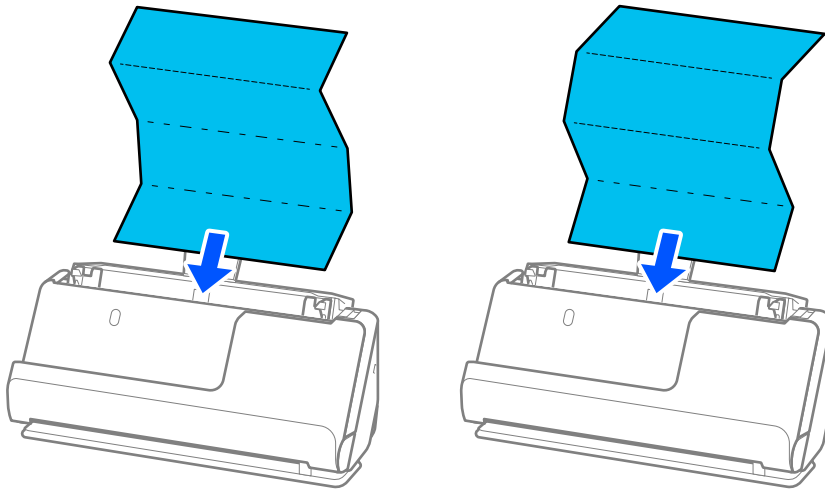

- ❑ When scanning award certificates and other thick originals (originals with a thickness of 127 g/m<sup>2</sup> or more), switch the scanner to the straight path position and load only one original at a time.

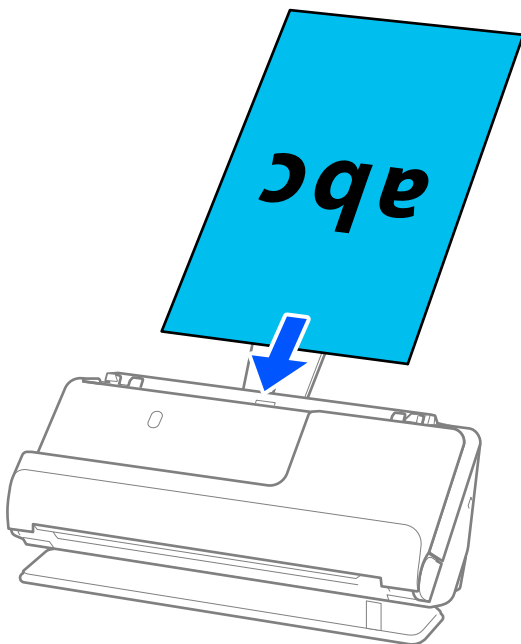

You can check the scanner position using the scanner position light (🔦). When the scanner position light is on, the scanner is in the straight path position. If the scanner position light is off (in the vertical path position), pull the lever on the back to tilt the scanner back.

When scanning in the straight path position, make sure there is enough space in front of the scanner for the ejected originals.

Also, if the ejected originals hit the surface of the table on which the scanner is placed and this affects the scanned image, move the scanner to the edge of the table so that the ejected originals can drop and catch them directly.

8. Adjust the edge guides to fit the edges of the original so that there are no gaps. Otherwise, the original may be fed skewed.

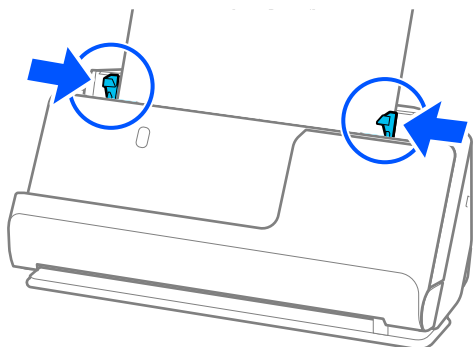

**Note:**

- ❑ If the edge guides are too far apart or too tight, the original may not be fed correctly. The edge guides should be aligned so that they lightly touch the edges of the original.
- ❑ If the document extends beyond the input tray extension, support the document with one hand to prevent it from falling from the ADF. Also, while scanning an original, support both ends of the original with your hands to prevent it from tilting.
- ❑ When scanning thin paper originals such as flyers or receipts, or when scanning originals that tend to curl after scanning, we recommend extending the paper output support in both places.  
After loading the original, press the buttons (two places) to raise the paper output support.

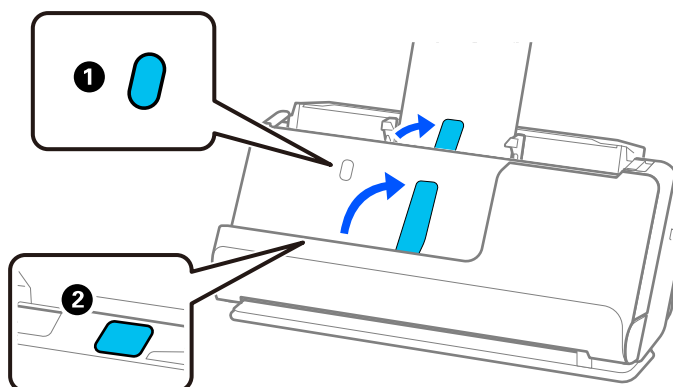

- ❑ When scanning originals such as business cards that tend to curl after scanning, we recommend scanning in the straight path position and only loading one original at a time.
- ❑ if you cancel scanning in the middle of scanning a batch of originals, the second original will be fed a little bit into the ADF and then scanning stops. Open the scanner cover to remove it, and then load the page again together with the first page and the rest of the originals.
- ❑ Depending on the type of paper and the environment in which the scanner is being used, the original may fall from the front of the scanner after scanning. In this situation, load fewer originals into the scanner than the specified number of originals that can be loaded.

## Placing Large Size Originals

**Note:**

Make sure there is enough space in front of the scanner for the ejected originals.

1. Make sure the scanner position light () is on.

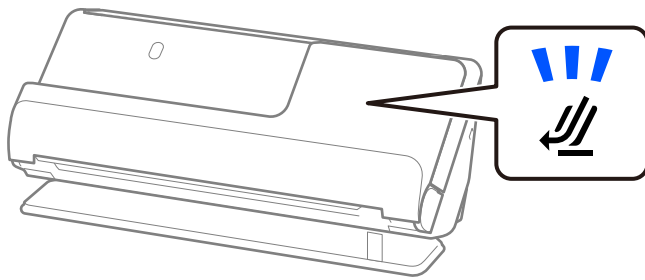

If the scanner position light () is off, pull the scanner position selector to tilt the scanner back.

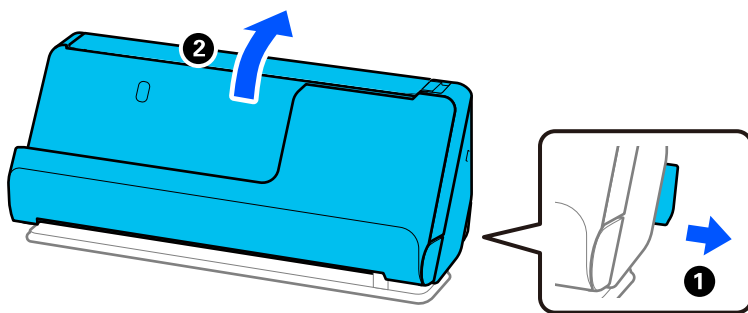

2. Open the input tray.

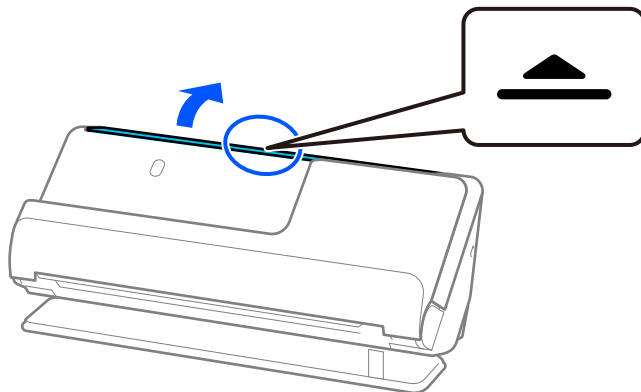

3. Raise the input tray extension.

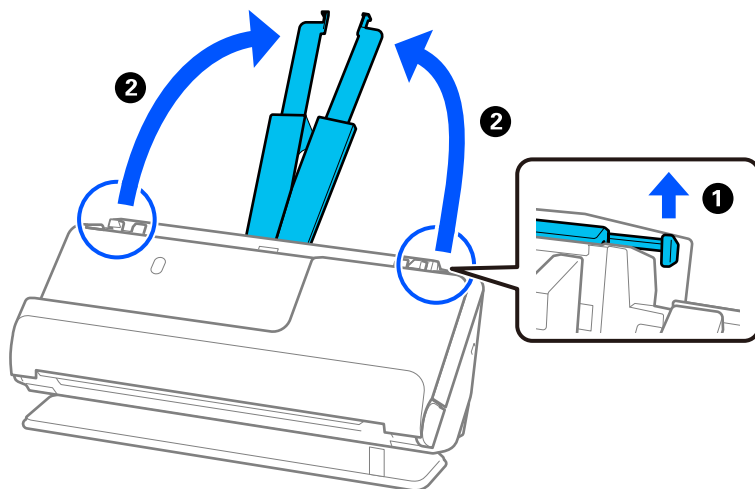

4. Move the edge guides to the edges of the input tray.

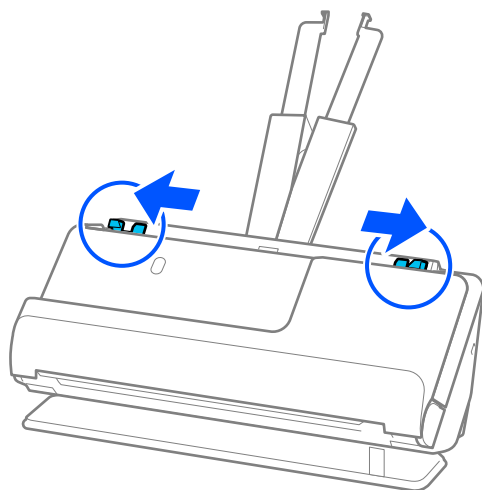

5. Fold the original in half so that the side to be scanned is facing out. Place your original with side "2" facing the side of the Carrier Sheet with the illustration and at the leading edge.

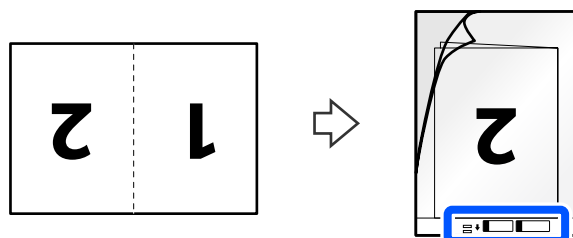

6. Turn over the Carrier Sheet.

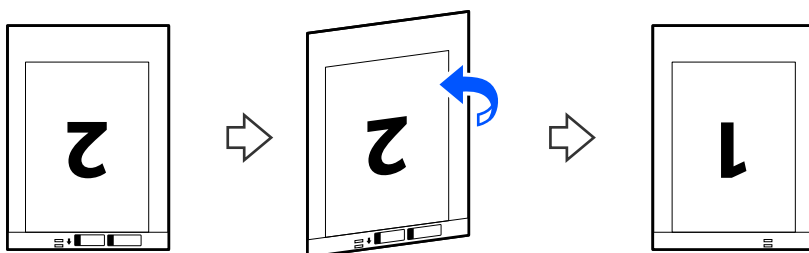

7. Load the Carrier Sheet into the input tray with the top edge facing into the ADF. Insert the paper into the ADF until it meets resistance.

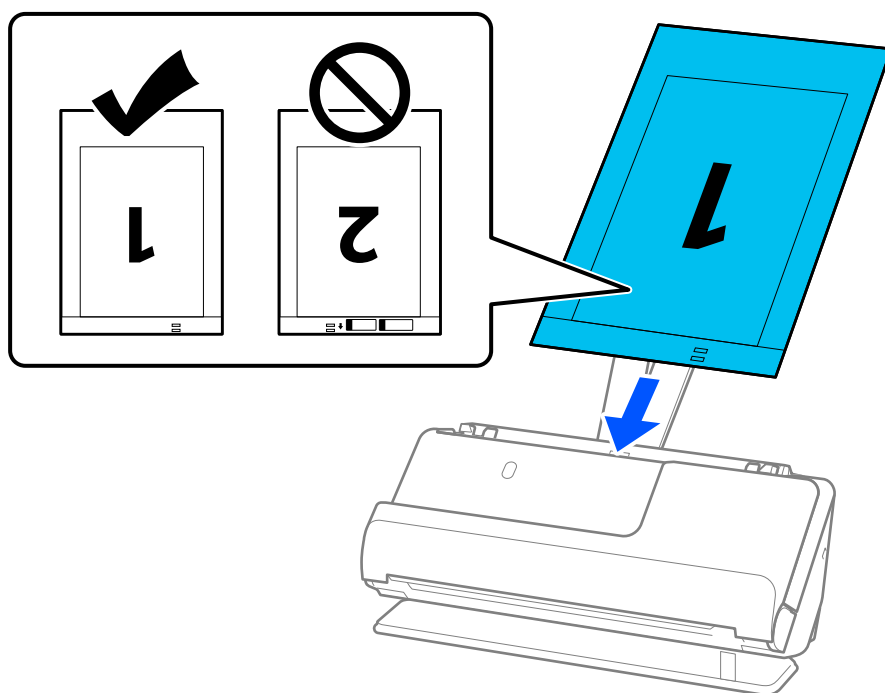

8. Align the edge guides with the Carrier Sheet so that there are no gaps. Otherwise, the Carrier Sheet may be fed skewed.

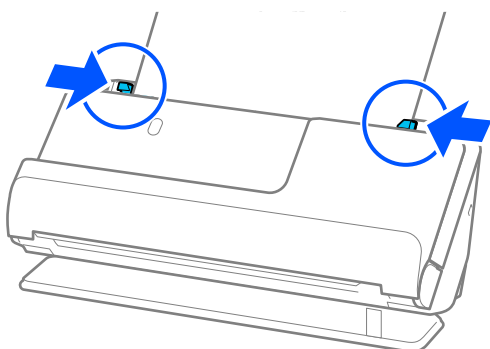

**Note:**

- ❑ If the edge guides are too far apart or too tight, the original may not be fed correctly. The edge guides should be aligned so that they lightly touch the edges of the original.
- ❑ Do not use a scratched Carrier Sheet or a Carrier Sheet that has been scanned more than 3,000 times.
- ❑ To scan both sizes and stitch them together, set the appropriate setting in the Epson Scan 2 window.  
When you are using Epson ScanSmart, you can open the Epson Scan 2 screen by clicking the **Settings** button > **Scanner Settings** tab > **Scan Settings**.  
Select **Double-Sided** from **Scanning Side** and select **Left & Right** from **Stitch Images** in the Epson Scan 2 window. See the Epson Scan 2 help for details.
- ❑ When scanning with a Carrier Sheet, select **Auto Detect** as the **Document Size** setting in Epson Scan 2 to automatically scan the image while applying **Paper Skew** as the **Correct Document Skew** setting.
- ❑ The leading edge of the original must be placed at the binding part of the Carrier Sheet when scanning an original approximately 297 mm (11.7 inches) long. Otherwise, the length of the scanned image may be longer than intended as the scanner scans to the end of the Carrier Sheet when you select **Auto Detect** as the **Document Size** setting in the Epson Scan 2 window.
- ❑ Only use a Carrier Sheet designed for your scanner. The Carrier Sheet is automatically recognized by the scanner by detecting two small rectangular holes on the leading edge. Keep the holes in the Carrier Sheet clean and uncovered.

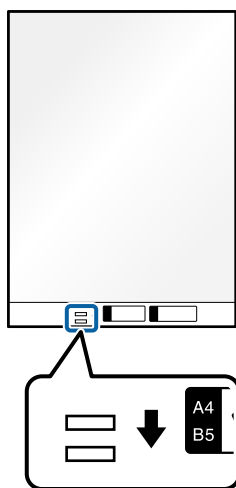

**Related Information**

➔ [“Carrier Sheet Codes” on page 34](#)

## Placing Long Paper

**Note:**

Make sure there is enough space in front of the scanner for the ejected originals.



1. Make sure the scanner position light () is on.

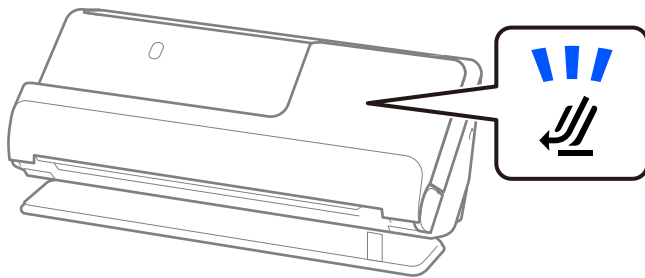

If the scanner position light () is off, pull the scanner position selector to tilt the scanner back.

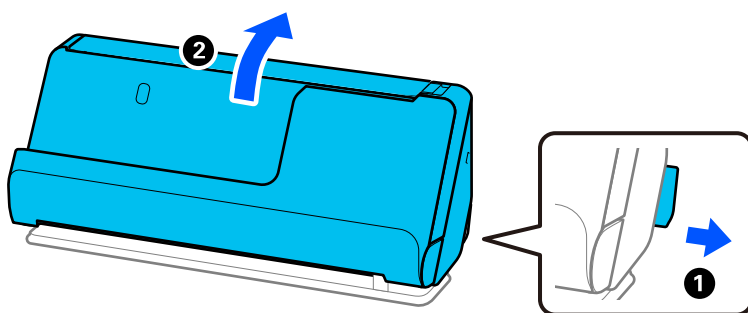

2. Open the input tray.

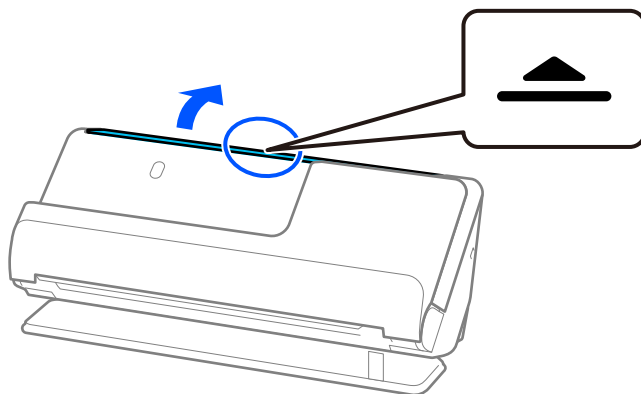

3. Raise the input tray extension.

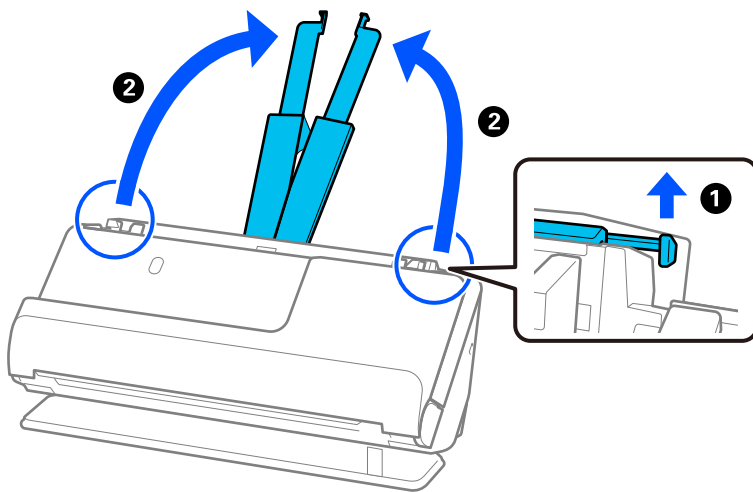

4. Move the edge guides to the edges of the input tray.

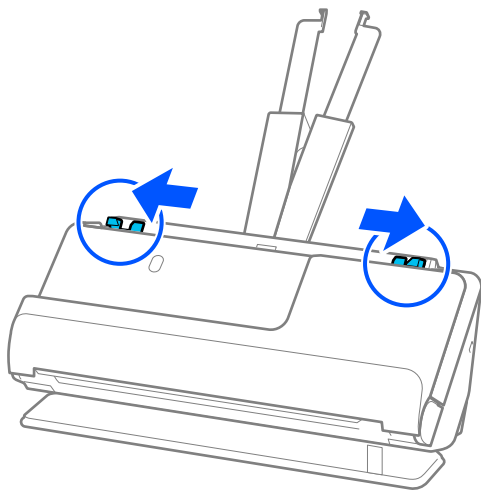

5. Load the original into the input tray straight, facing up and with the top edge facing into the ADF. Insert the paper into the ADF until it meets resistance.

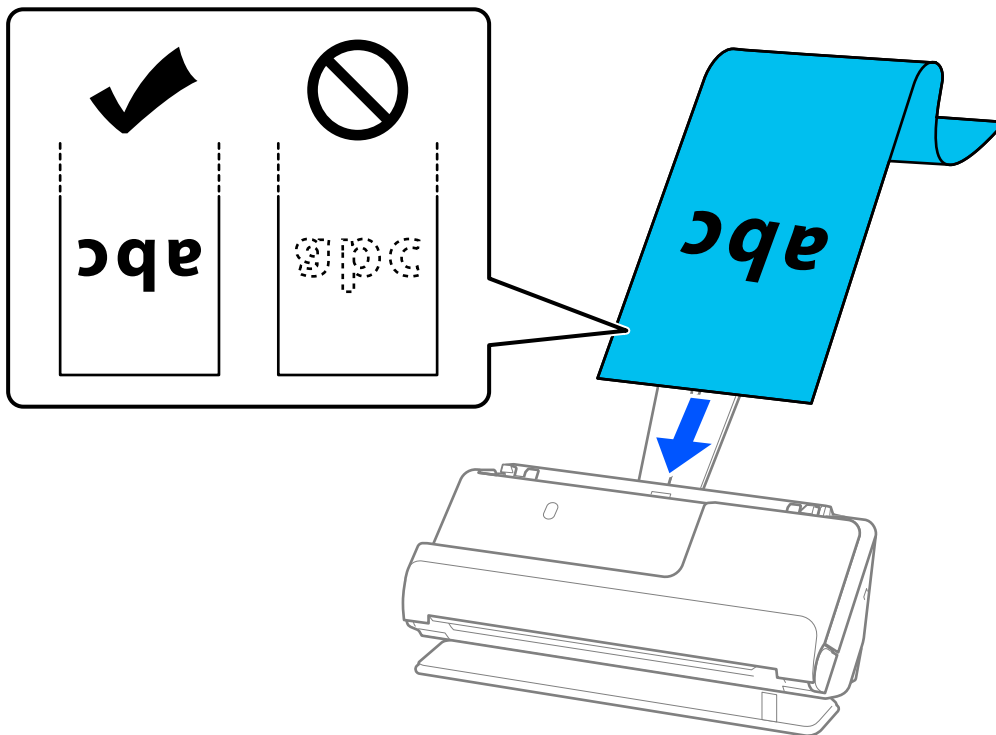

When loading long paper, support it at the input side so that it does not drop out of the ADF, and the output side so that the ejected paper does not get jammed or fall from the output tray.

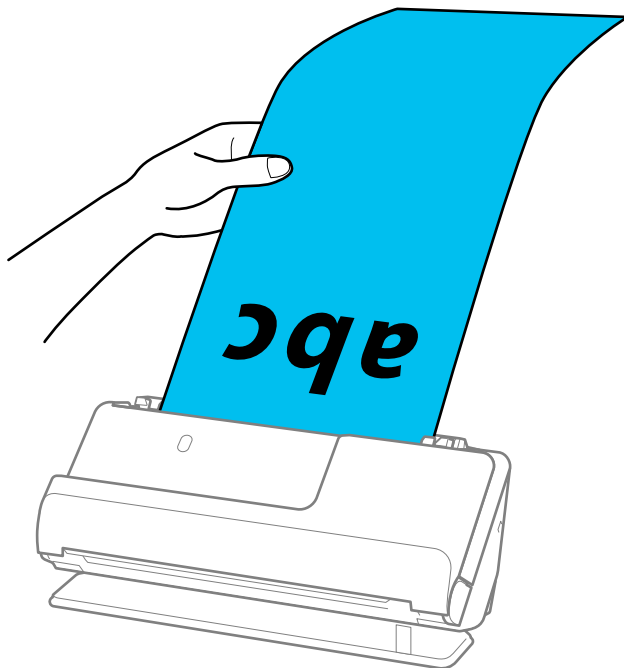

6. Adjust the edge guides to fit the edges of the original so that there are no gaps. If there are any gaps, the original may be fed skewed.

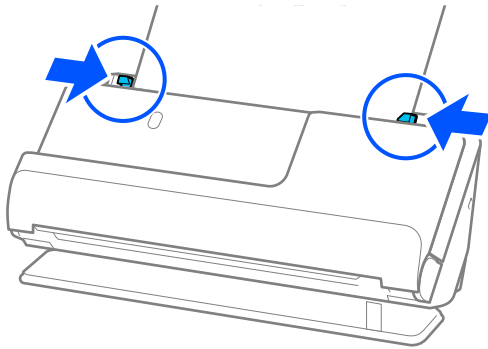

**Note:**

- ❑ If the edge guides are too far apart or too tight, the original may not be fed correctly. The edge guides should be aligned so that they lightly touch the edges of the original.
- ❑ Also, while scanning long paper, support both ends of the original with your hands to prevent it from tilting.

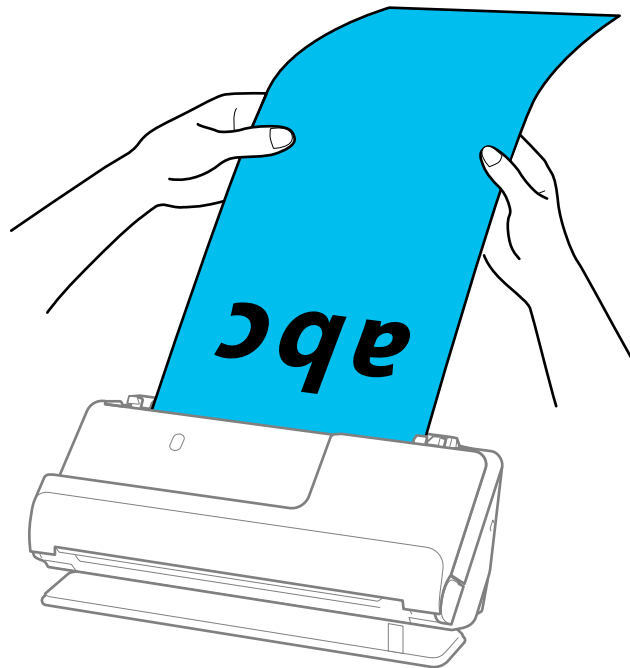

- ❑ You can scan long paper at the following resolutions.
  - Up to 393.7 mm: 600 dpi or less
  - 393.7 mm to 3,048 mm: 300 dpi or less
- ❑ You need to specify the paper size in the Epson Scan 2 window.

When you are using Epson ScanSmart, you can open the Epson Scan 2 screen by clicking the **Settings** button > **Scanner Settings** tab > **Scan Settings**.

On the **Main Settings** tab in Epson Scan 2, select **Auto Detect (Long Paper)** as the **Document Size**.

## Placing Plastic Cards

**Note:**

Make sure there is enough space in front of the scanner for the ejected originals.

1. Make sure the scanner position light () is on.

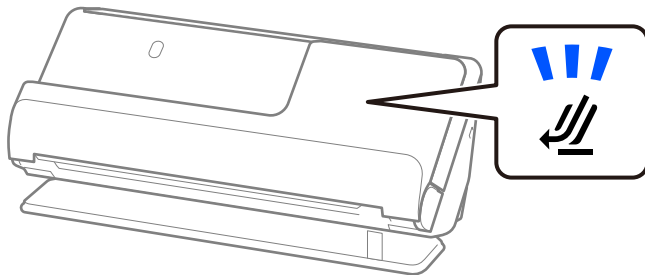

If the scanner position light () is off, pull the scanner position selector to tilt the scanner back.

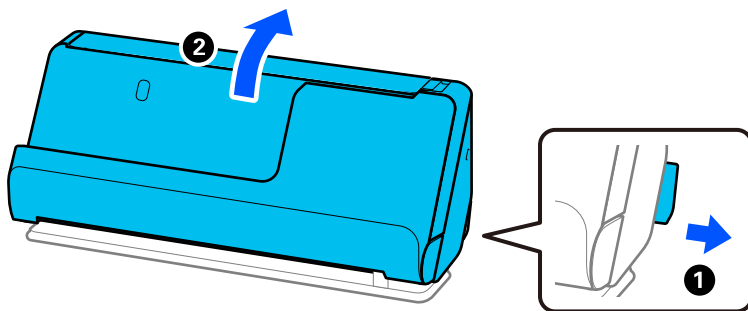

2. Open the input tray.

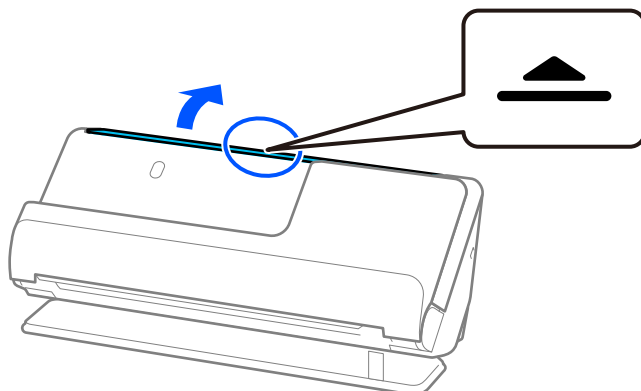

3. Raise the input tray extension.

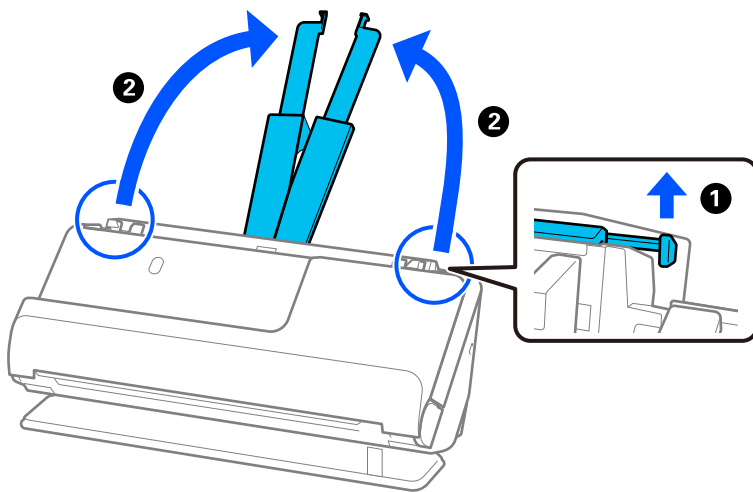

4. Move the edge guides to the edges of the input tray.

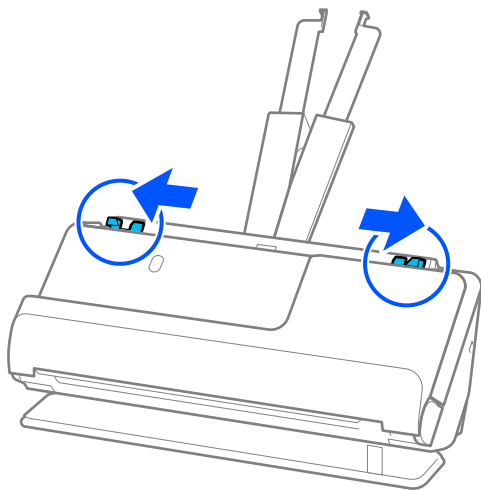

5. Load the plastic cards with the side to be scanned facing up with the top edge facing into the ADF. Insert the paper into the ADF until it meets resistance.

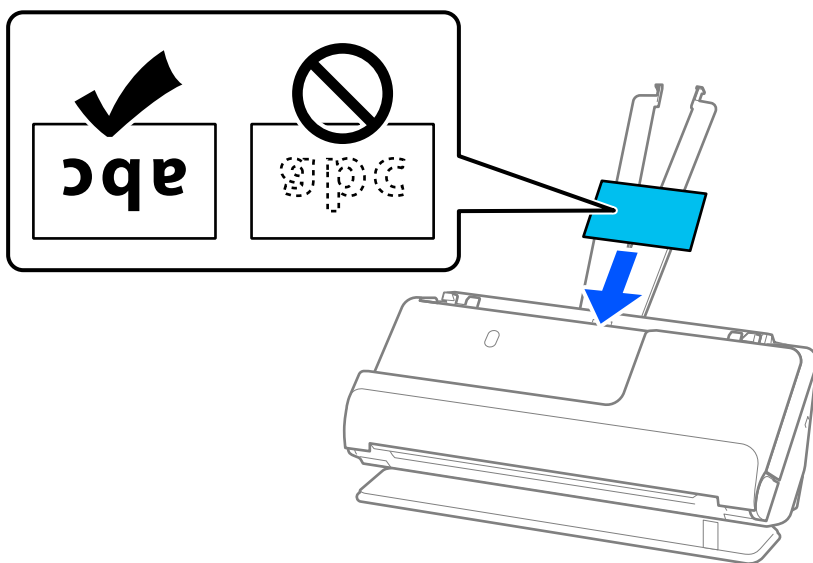

**!** *Important:*

*Do not load plastic cards vertically.*

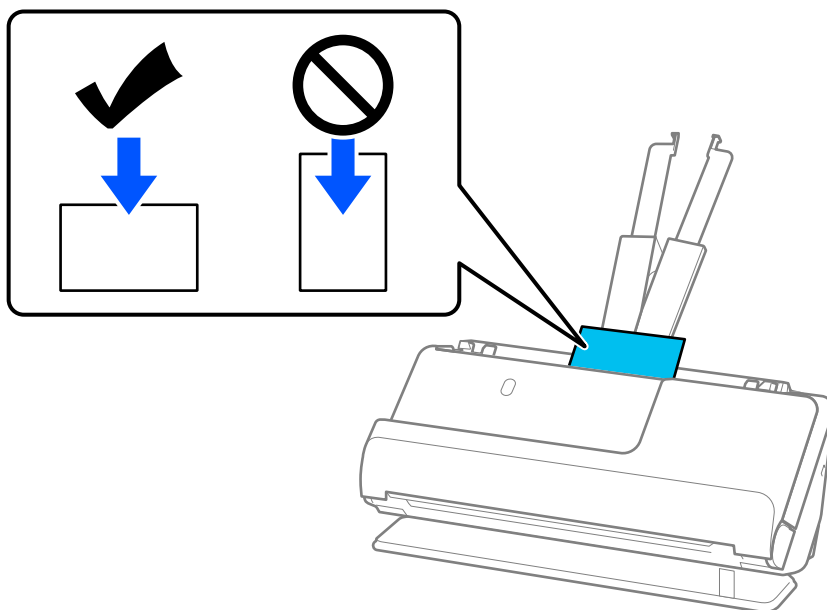

- Adjust the edge guides to fit the edges of the cards so that there are no gaps. Otherwise, the original may be fed skewed.

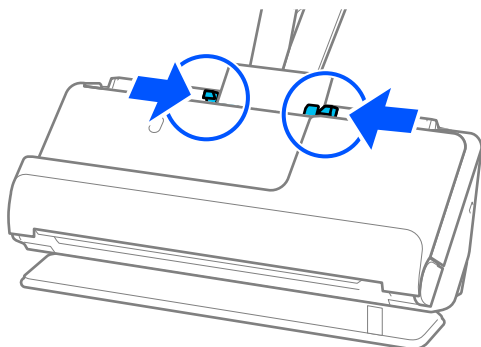

**Note:**

❑ If the edge guides are too far apart or too tight, the original may not be fed correctly. The edge guides should be aligned so that they lightly touch the edges of the original.

❑ To scan plastic cards, set the appropriate setting in the Epson Scan 2 window.

When you are using Epson ScanSmart, you can open the Epson Scan 2 window by pressing the **Settings** button > **Scanner Settings** tab > **Scan Settings**.

On the **Main Settings** tab in Epson Scan 2, select **Plastic Card** in **Document Size** or select **Off** in **Detect Double Feed**. See the Epson Scan 2 help for details.

If you have not disabled **Detect Double Feed** on the Epson Scan 2 screen and a double feed error occurs, remove the cards from the ADF and reload them.

**Related Information**

➔ [“Placing Laminated Cards” on page 64](#)

## Placing Laminated Cards

**Note:**

Make sure there is enough space in front of the scanner for the ejected originals.

- Make sure the scanner position light () is on.

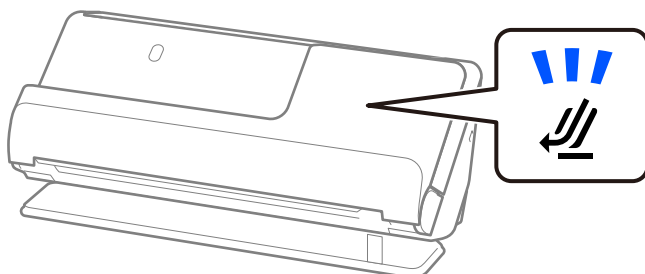



If the scanner position light () is off, pull the scanner position selector to tilt the scanner back.

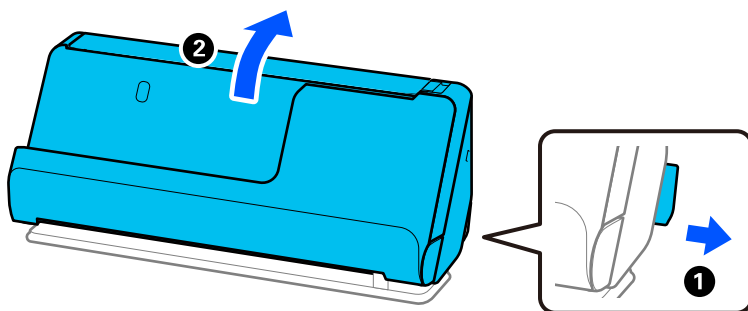

2. Open the input tray.

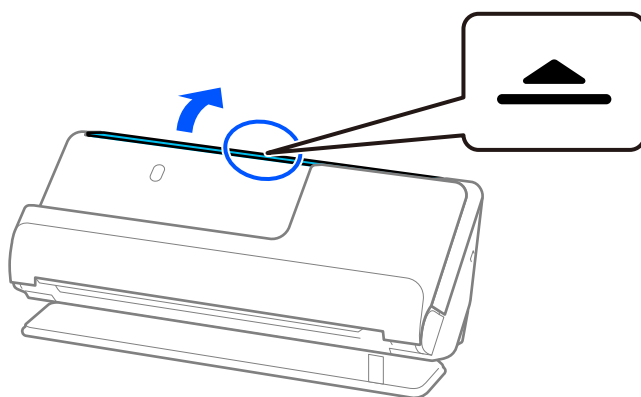

3. Raise the input tray extension.

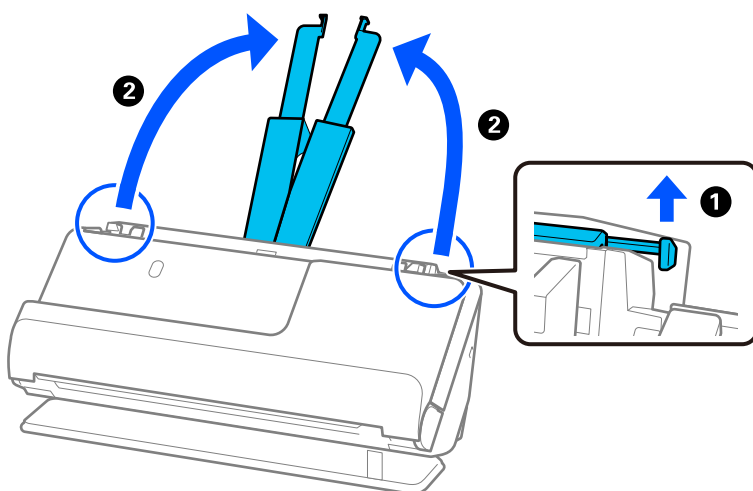

4. Move the edge guides to the edges of the input tray.

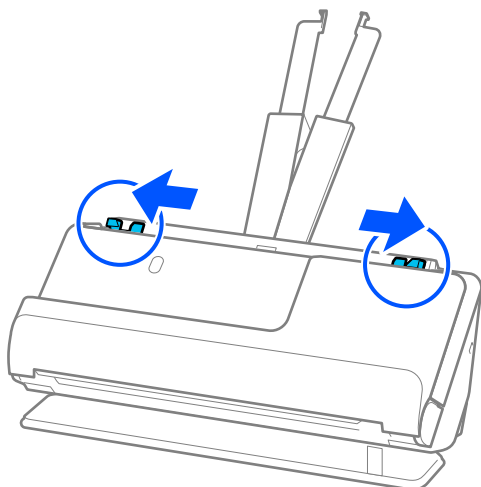

5. Load the plastic cards with the side to be scanned facing up with the top edge facing into the ADF. Insert the paper into the ADF until it meets resistance.

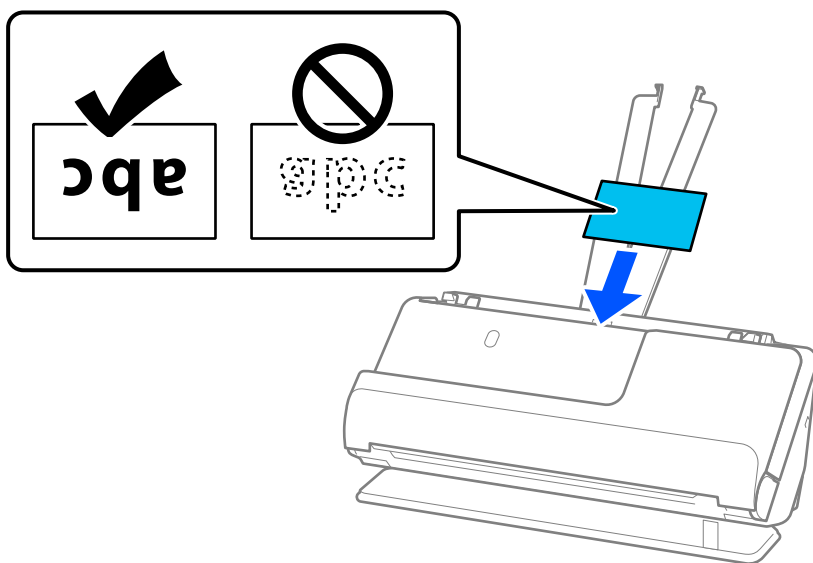

6. Adjust the edge guides to fit the edges of the cards so that there are no gaps. If there are any gaps, the original may be fed skewed.

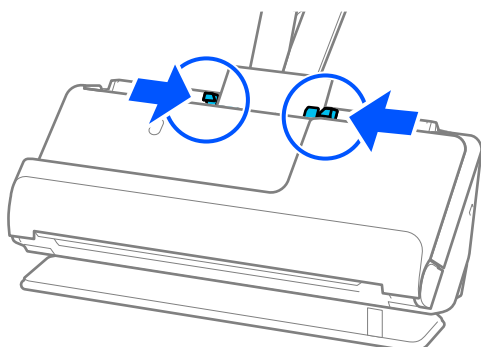

**Note:**

❑ If the edge guides are too far apart or too tight, the original may not be fed correctly. The edge guides should be aligned so that they lightly touch the edges of the original.

❑ To scan laminated cards, set the appropriate setting in the Epson Scan 2 window.

When you are using Epson ScanSmart, you can open the Epson Scan 2 screen by clicking the **Settings** button > **Scanner Settings** tab > **Scan Settings**.

· To increase the accuracy of auto size detection, select the **Main Settings** tab > **Document Size** > **Settings** > **Scan laminated card**. See the Epson Scan 2 help for details.

· Select the **Main Settings** tab > **Detect Double Feed** > **Off**. See the Epson Scan 2 help for details.

If you have not disabled **Detect Double Feed** on the Epson Scan 2 screen and a double feed error occurs, remove the cards from the ADF and reload them.

## Placing a Passport

**Note:**

Make sure there is enough space in front of the scanner for the ejected originals.

1. Make sure the scanner position light () is on.

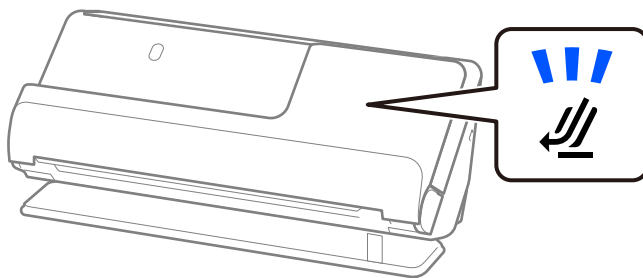

If the scanner position light () is off, pull the scanner position selector to tilt the scanner back.

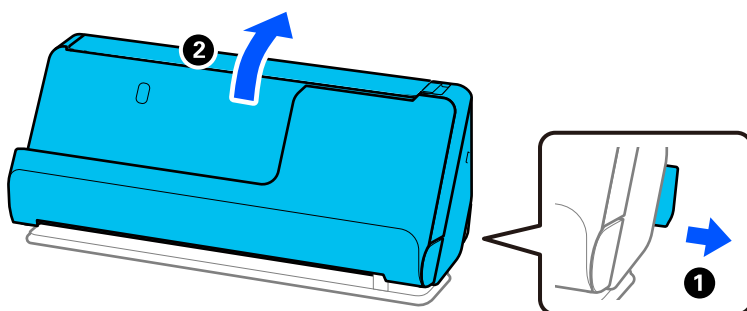

2. Open the input tray.

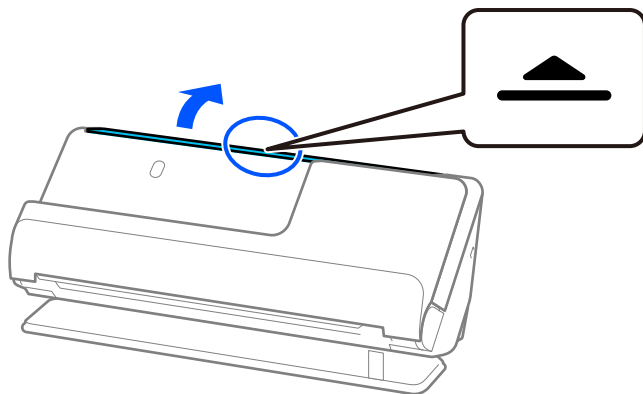

3. Raise the input tray extension.

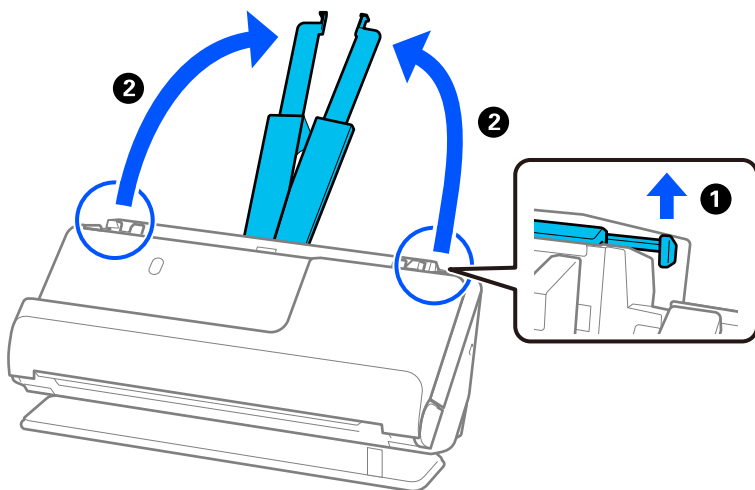

4. Move the edge guides to the edges of the input tray.

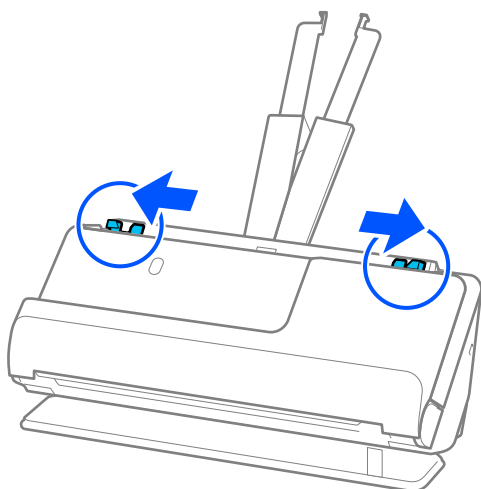

5. Place the passport in the Passport Carrier Sheet.

Place the passport in the Passport Carrier Sheet with the side to be scanned facing up and with the thicker side of the passport facing the leading edge.

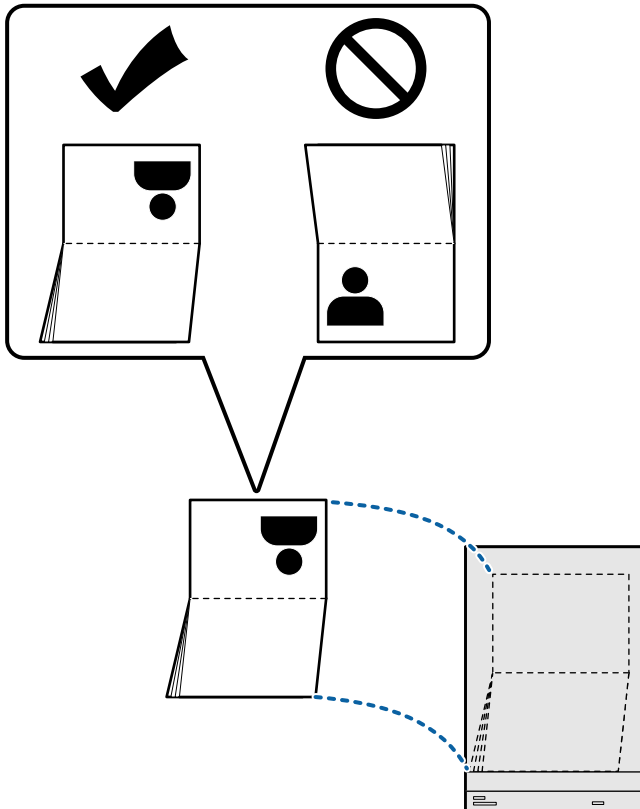

6. Place the Passport Carrier Sheet with the side to be scanned facing up and with the leading edge facing into the ADF.

Insert the paper into the ADF until it meets resistance.

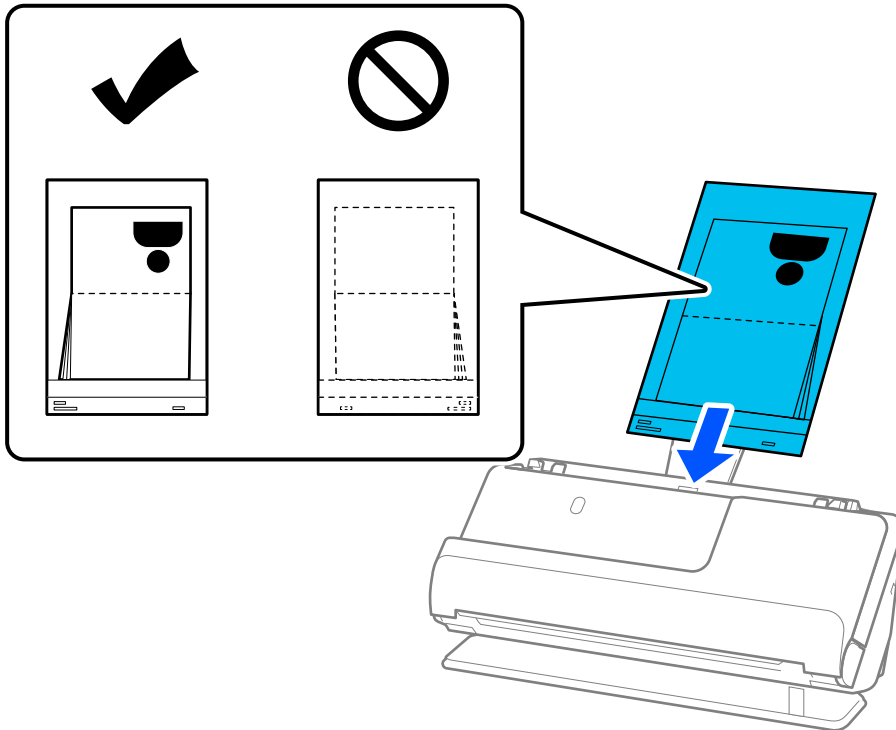

7. Align the edge guides with the Passport Carrier Sheet so that there are no gaps. Otherwise, the Passport Carrier Sheet may be fed skewed.

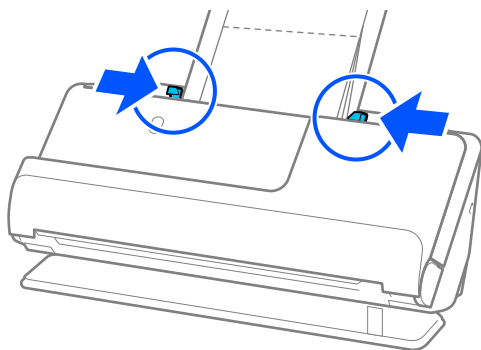

**Note:**

- ❑ If the edge guides are too far apart or too tight, the original may not be fed correctly. The edge guides should be aligned so that they lightly touch the edges of the original.
- ❑ When scanning a Passport Carrier Sheet, support the top by hand to prevent the Passport Carrier Sheet from falling out of the ADF.

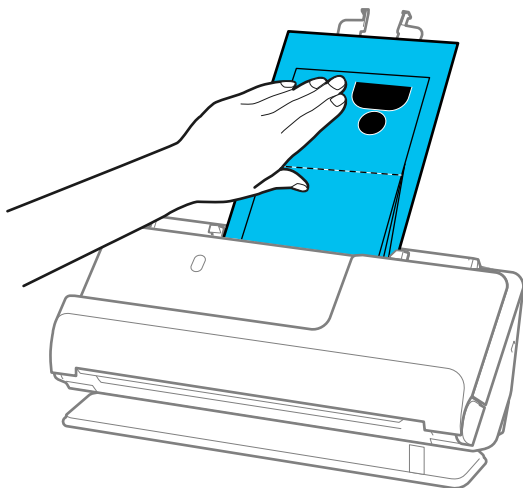

- ❑ If the ejected originals hit the surface of the table on which the scanner is placed and this affects the scanned image, move the scanner to the edge of the table so that the ejected originals can drop and catch them directly.
- ❑ When scanning a Passport Carrier Sheet, make the appropriate settings on the Epson Scan 2 screen.  
When you are using Epson ScanSmart, you can open the Epson Scan 2 screen by clicking the **Settings** button > **Scanner Settings** tab > **Scan Settings**.  
On the Epson Scan 2 screen, use one of the following methods to turn off **Detect Double Feed**.
  - Select **Passport** in **Scan Settings**
  - On the **Main Settings** tab, set **Detect Double Feed** to **Off**See the Epson Scan 2 help for details.
- ❑ Do not use a scratched Passport Carrier Sheet or a Passport Carrier Sheet that has been scanned more than 3,000 times.
- ❑ Only use a Passport Carrier Sheet designed for your scanner. The Passport Carrier Sheet is automatically recognized by the scanner by detecting three small rectangular holes on the leading edge. Keep the holes in the Passport Carrier Sheet clean and uncovered.

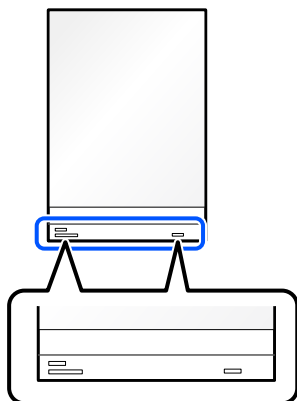

### Related Information

➔ “Carrier Sheet Codes” on page 34

## Placing Important Originals or Photos

Use a Carrier Sheet when scanning the following types of originals.

Large Size Originals

“Placing Large Size Originals” on page 52

Photos

Valuable originals

Wrinkled originals

Fragile originals

**Note:**

Make sure there is enough space in front of the scanner for the ejected originals.

1. Make sure the scanner position light () is on.

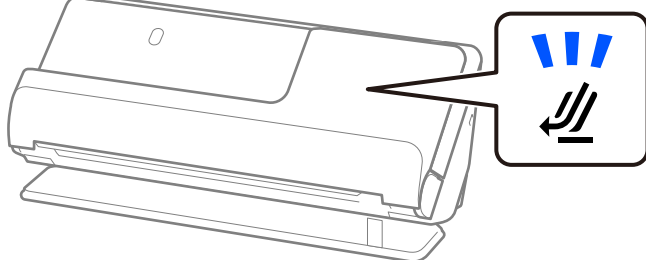

If the scanner position light () is off, pull the scanner position selector to tilt the scanner back.

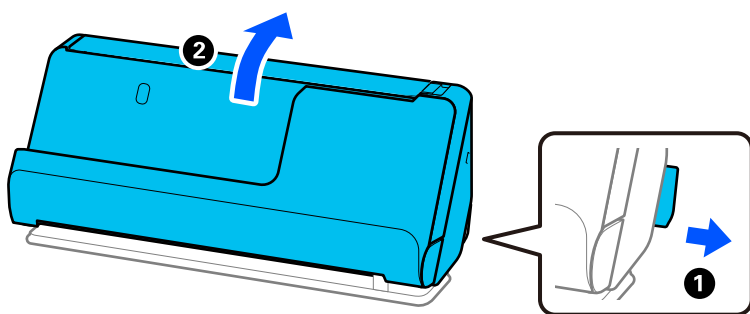



2. Open the input tray.

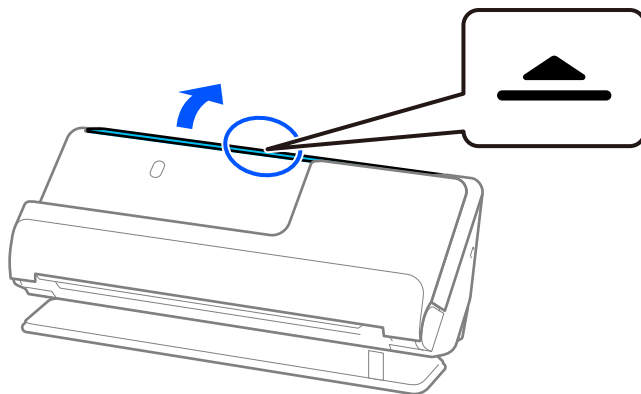

3. Raise the input tray extension.

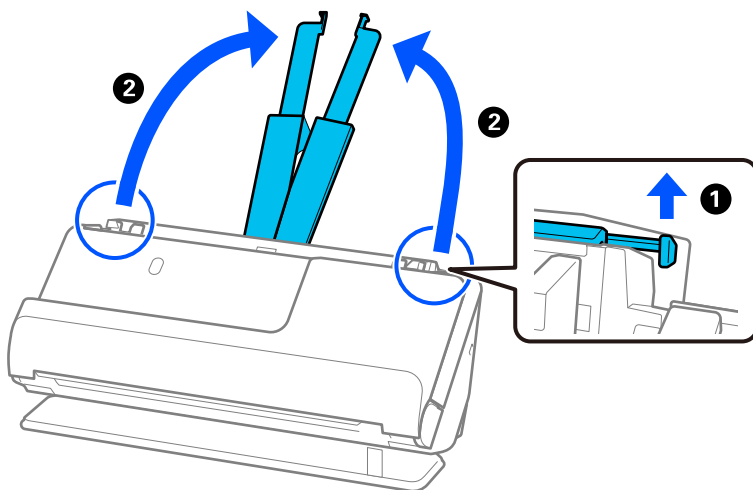

4. Move the edge guides to the edges of the input tray.

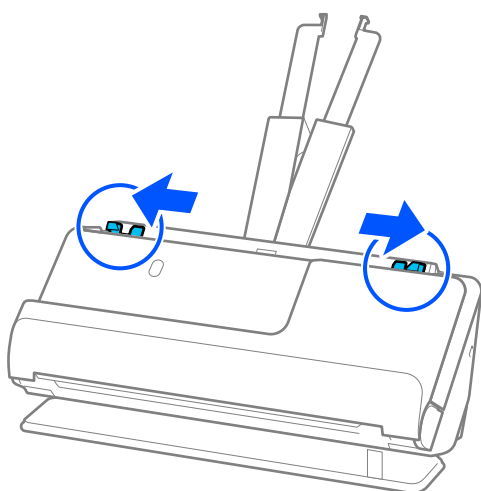

5. Place your original in the Carrier Sheet.

Place your original so that the back of the original is facing the side of the Carrier Sheet with the illustration.

❑ For originals

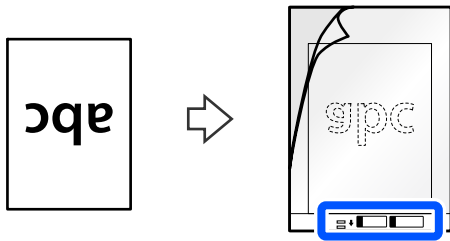

❑ For photos

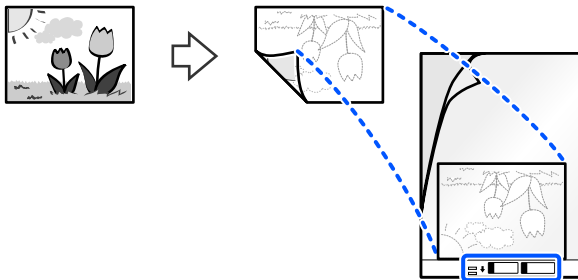

6. Turn over the Carrier Sheet.

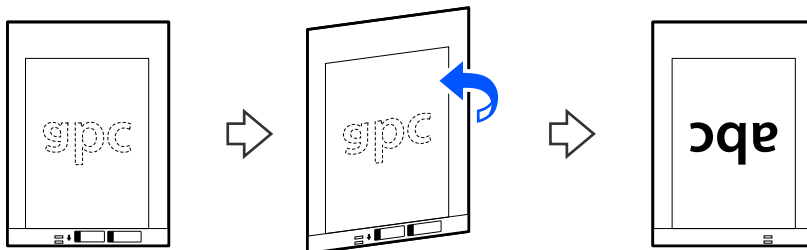

7. Load the Carrier Sheet into the input tray with the top edge facing into the ADF.  
Insert the paper into the ADF until it meets resistance.

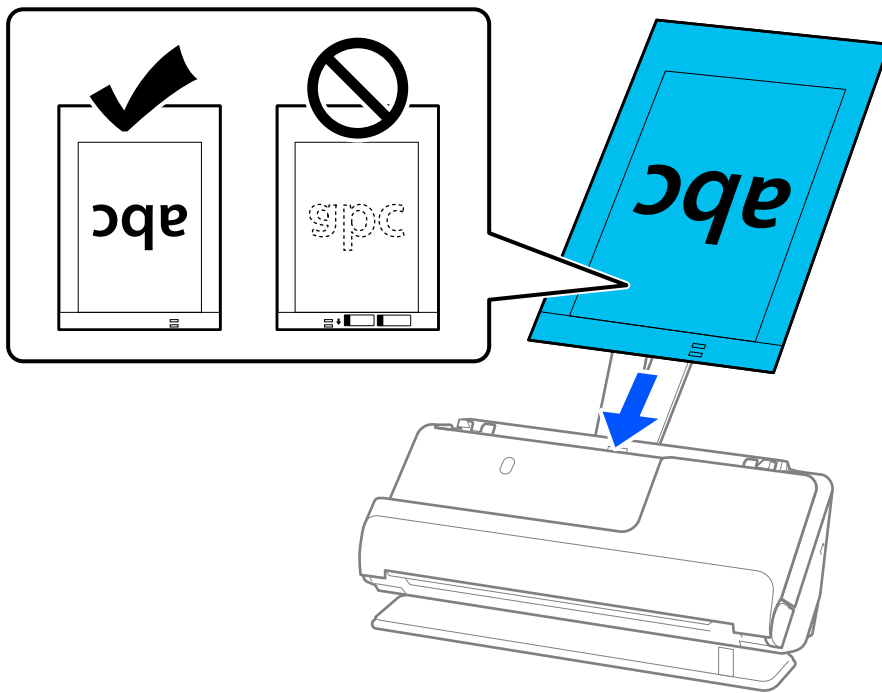

8. Align the edge guides with the Carrier Sheet so that there are no gaps. Otherwise, the Carrier Sheet may be fed skewed.

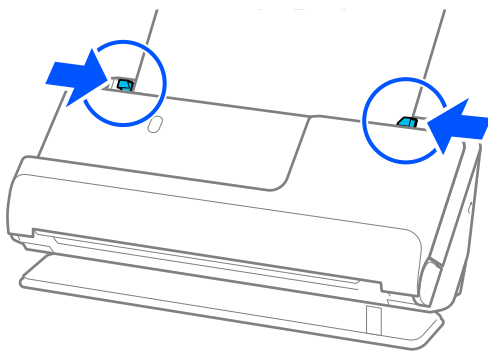

**Note:**

- ❑ If the edge guides are too far apart or too tight, the original may not be fed correctly. The edge guides should be aligned so that they lightly touch the edges of the original.
- ❑ Do not use a scratched Carrier Sheet or a Carrier Sheet that has been scanned more than 3,000 times.
- ❑ If you cannot find the size of the original to be scanned in the **Document Size** list in Epson Scan 2, select **Auto Detect**.
- ❑ When scanning with a Carrier Sheet, select **Auto Detect** as the **Document Size** to automatically scan the image while applying **Paper Skew** as the **Correct Document Skew** setting.
- ❑ The leading edge of the original must be placed at the binding part of the Carrier Sheet when scanning an original approximately 297 mm (11.7 inches) long. Otherwise, the entire length of the Carrier Sheet may be scanned when **Auto Detect** is selected as the **Document Size**.
- ❑ Only use a Carrier Sheet designed for your scanner. The Carrier Sheet is automatically recognized by the scanner by detecting two small rectangular holes on the leading edge. Keep the holes clean and not covered.

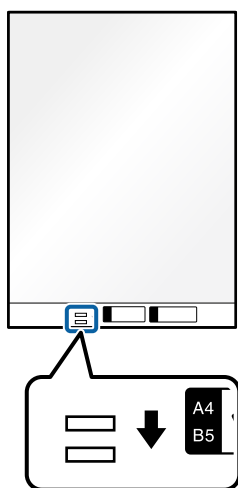

**Related Information**

➔ [“Carrier Sheet Codes” on page 34](#)

## Placing an Envelope

**Note:**

Make sure there is enough space in front of the scanner for the ejected originals.

1. Make sure the scanner position light () is on.

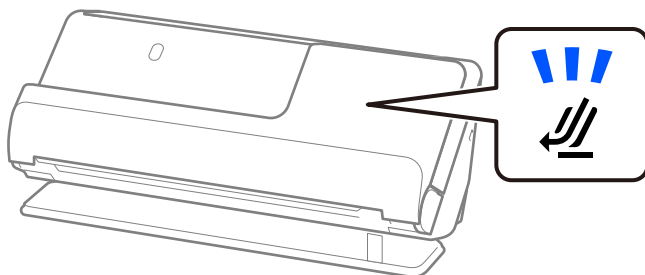

If the scanner position light () is off, pull the scanner position selector to tilt the scanner back.

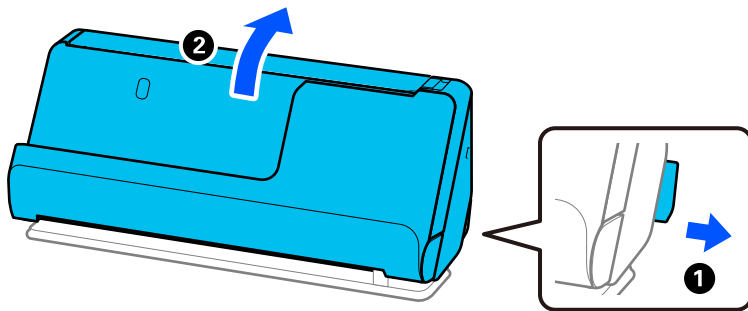

2. Open the input tray.

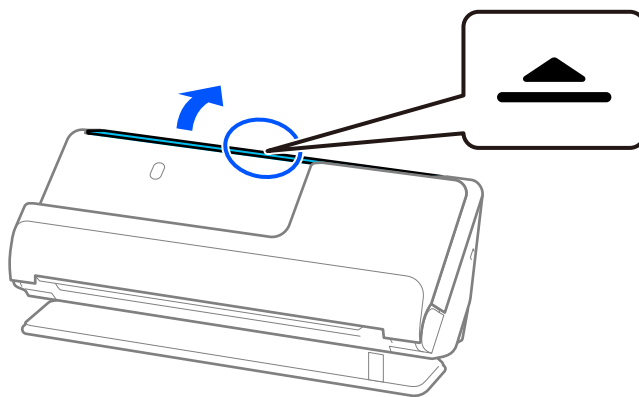

3. Raise the input tray extension.

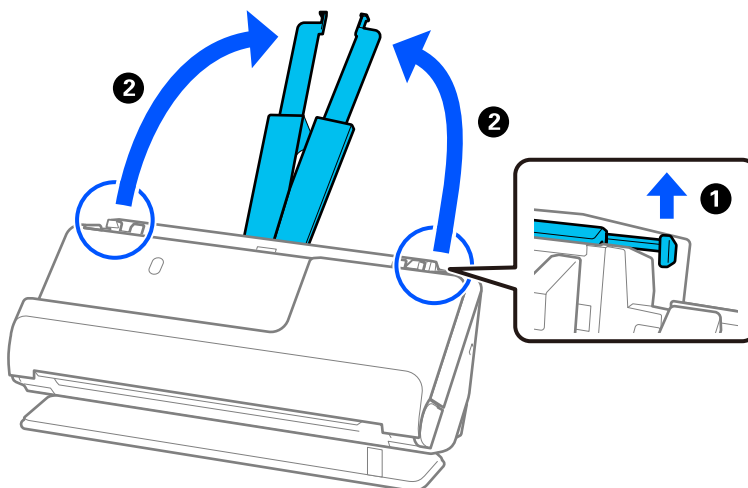

4. Move the edge guides to the edges of the input tray.

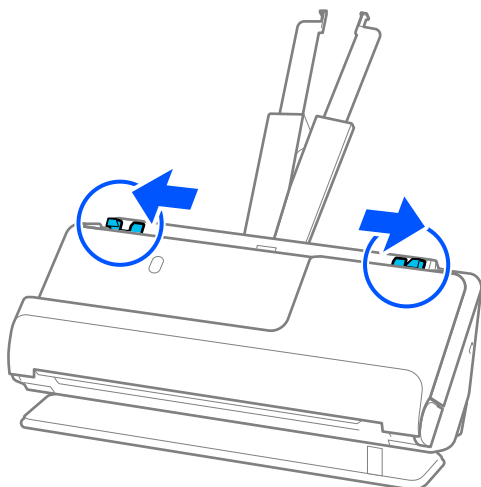

5. Load the envelope in a portrait orientation with the side to be scanned facing up. For envelopes with the opened edge (flap side) on the shorter side, you can load the envelope with the opened edge (flap side) facing up.

Insert the envelope into the ADF until it meets resistance.

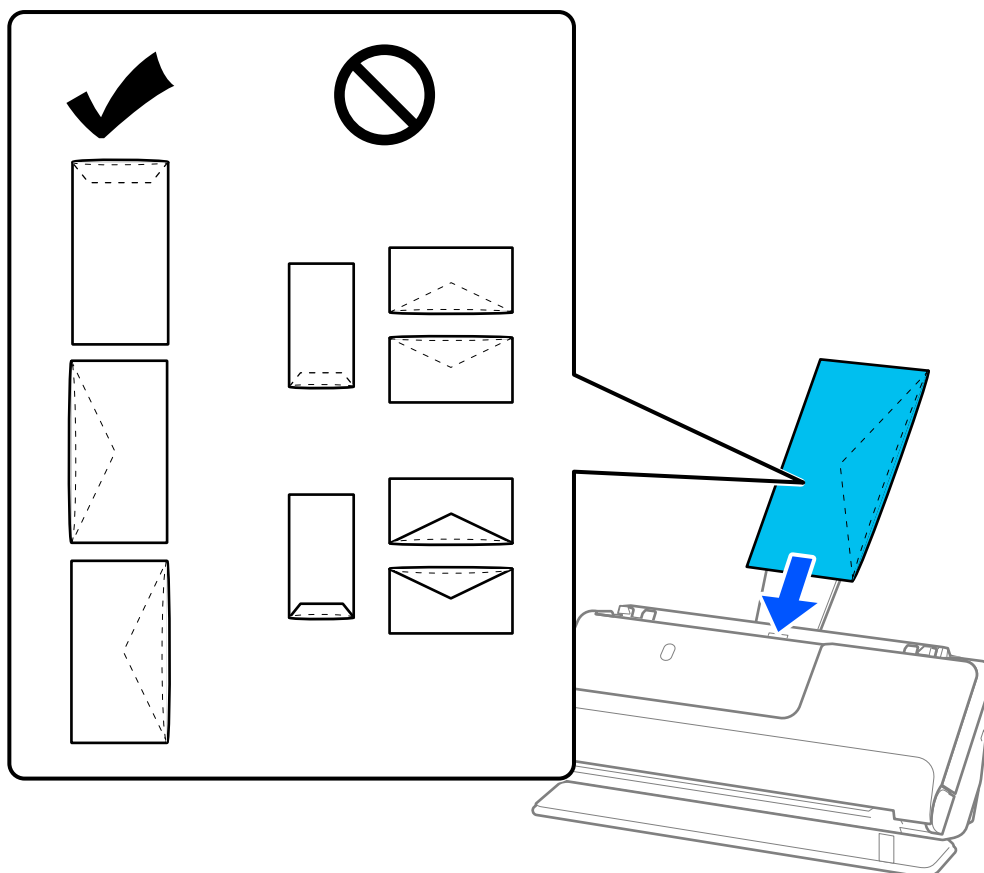

**Important:**

*Do not load envelopes with adhesives on them.*

**Note:**

- ❑ Envelopes that are not cut cleanly at the flap edge when they are opened may not be scanned correctly.
- ❑ Envelopes that have not yet been sealed can be loaded with the flap open and facing up.

6. Adjust the edge guides to fit the edges of the envelope so that there are no gaps. Otherwise, the envelope may be fed skewed.

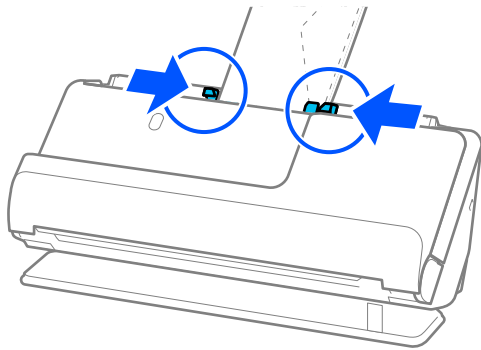

**Note:**

- ❑ If the edge guides are too far apart or too tight, the original may not be fed correctly. The edge guides should be aligned so that they lightly touch the edges of the original.
- ❑ We recommend selecting the appropriate rotation angle or **Auto** as the **Rotate** setting in the application.
- ❑ When scanning envelopes, make the appropriate settings on the Epson Scan 2 screen.

When you are using Epson ScanSmart, you can open the Epson Scan 2 screen by clicking the **Settings** button > **Scanner Settings** tab > **Scan Settings**.

Select **Main Settings** tab > **Detect Double Feed** > **Off**. See the Epson Scan 2 help for details.

If you have not disabled **Detect Double Feed** on the Epson Scan 2 screen and a double feed error occurs, remove the envelopes from the ADF and reload them.

## Placing Irregular Shaped Originals

**Note:**

Make sure there is enough space in front of the scanner for the ejected originals.

1. Make sure the scanner position light (  ) is on.

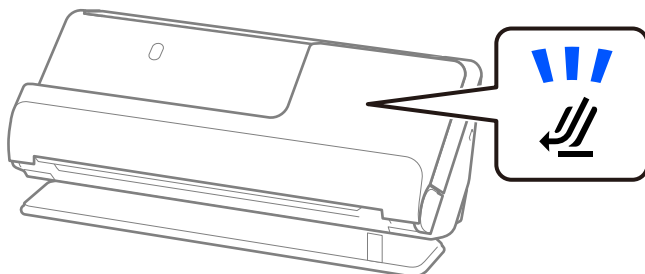

If the scanner position light () is off, pull the scanner position selector to tilt the scanner back.

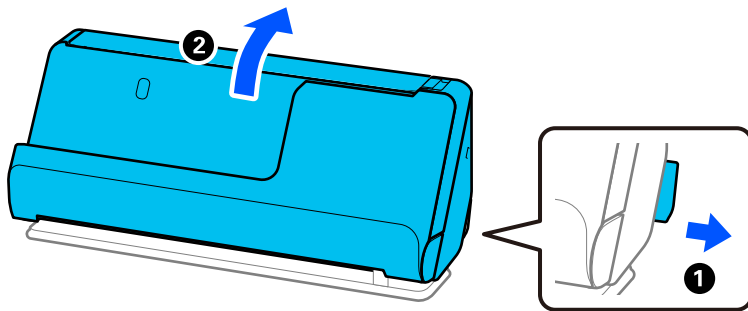

2. Open the input tray.

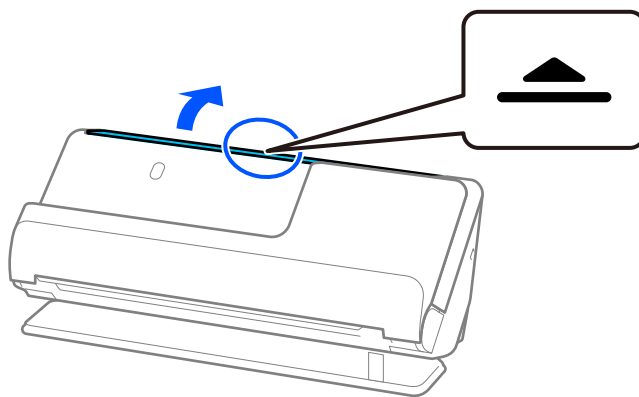

3. Raise the input tray extension.

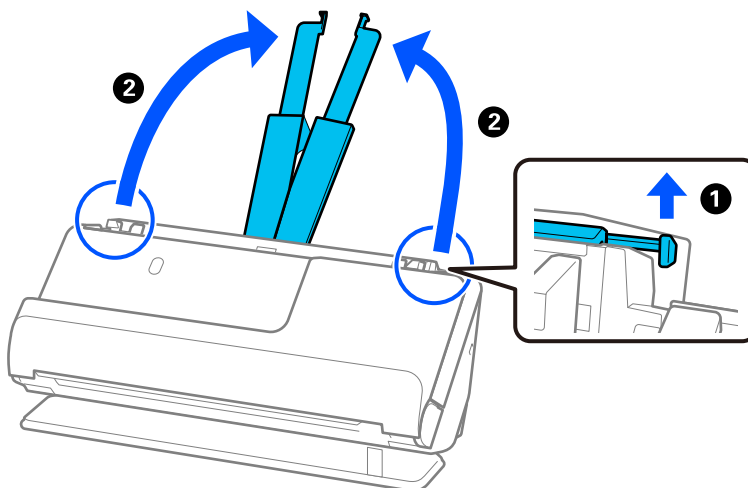



4. Move the edge guides to the edges of the input tray.

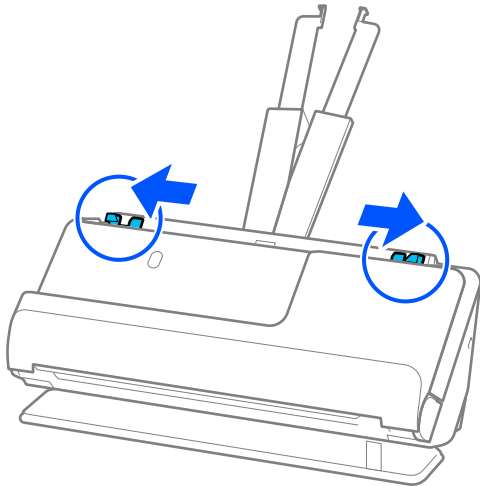

5. Place your original in the Carrier Sheet.  
Place your original so that the back of the original is facing the side of the Carrier Sheet with the illustration.

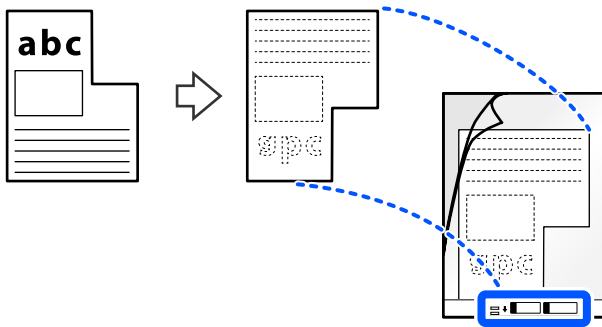

6. Turn over the Carrier Sheet.

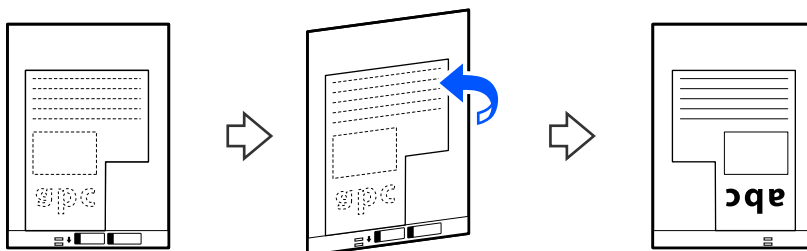

7. Load the Carrier Sheet into the input tray with the top edge facing into the ADF.  
Insert the Carrier Sheet into the ADF until it meets resistance.

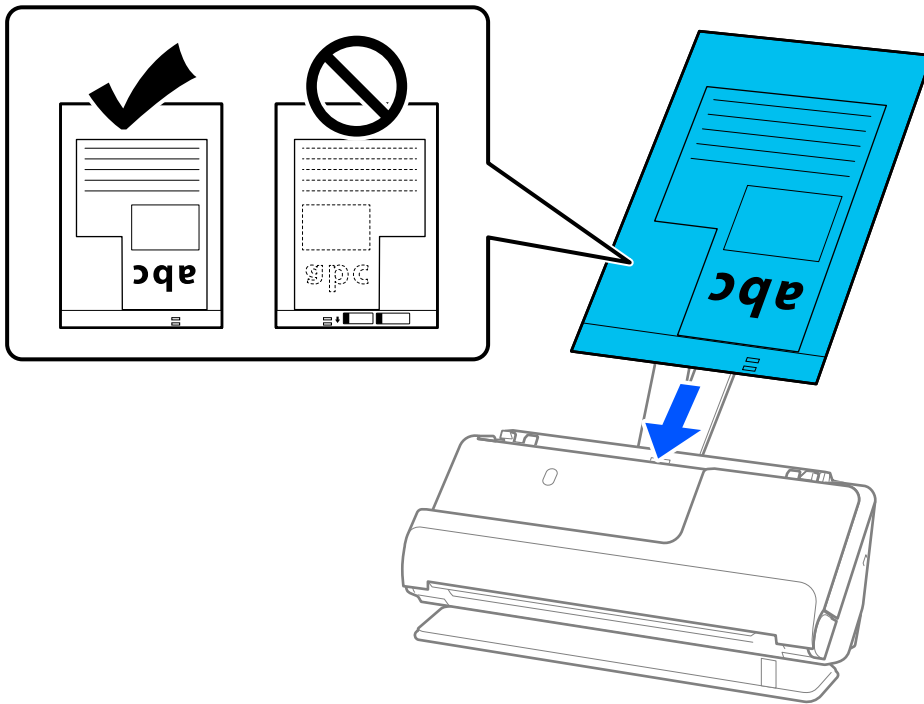

8. Align the edge guides with the Carrier Sheet so that there are no gaps. Otherwise, the Carrier Sheet may be fed skewed.

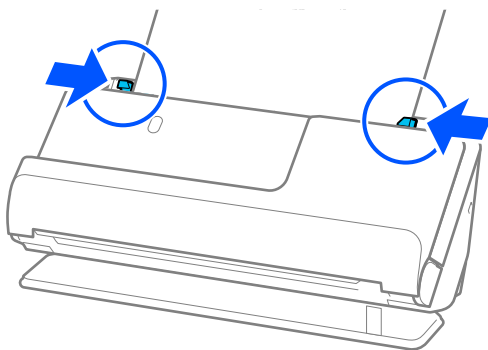

**Note:**

- ❑ If the edge guides are too far apart or too tight, the original may not be fed correctly. The edge guides should be aligned so that they lightly touch the edges of the original.
- ❑ Do not use a scratched Carrier Sheet or a Carrier Sheet that has been scanned more than 3,000 times.
- ❑ If you cannot find a **Document Size** that matches the original to be scanned, you need to make settings on the Epson Scan 2 screen.

When you are using Epson ScanSmart, you can open the Epson Scan 2 screen by clicking the **Settings** button > **Scanner Settings** tab > **Scan Settings**.

Select **Auto Detect** on the Epson Scan 2 screen, or select **Customize** to create a custom document size.

- ❑ When scanning with a Carrier Sheet, select **Auto Detect** as the **Document Size** setting in Epson Scan 2 to automatically scan the image while applying **Paper Skew** as the **Correct Document Skew** setting.
- ❑ Only use a Carrier Sheet designed for your scanner. The Carrier Sheet is automatically recognized by the scanner by detecting two small rectangular holes on the leading edge. Keep the holes in the Carrier Sheet clean and uncovered.

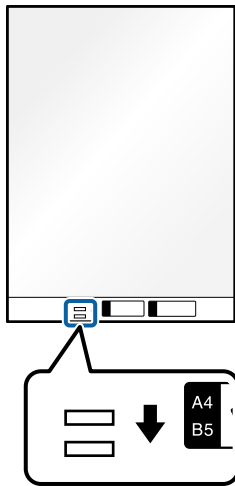

**Related Information**

➔ [“Carrier Sheet Codes” on page 34](#)

## Loading Batches of Originals with Different Paper Types and Sizes

You can place and scan batches of different size originals (50.8×50.8 mm (2.0×2.0 inches) to A4 or letter size) up to a total thickness of 2.4 mm (0.1 inches).

 **Caution:**

- ❑ When placing and scanning originals that are a mixture of different sizes, originals may be fed askew because not all of the originals are supported by the edge guides.
- ❑ Originals may be jammed or fed askew if you set different types or very different sizes of originals, such as in the following cases.
  - Thin paper and thick paper
  - A4 size paper and card size paper
  - Combinations of long, narrow paper that extend far beyond the input tray extension (example: long receipts and so on)
  - Combinations of folded or wrinkled paper

If originals are fed askew, check the scanned images. If the image is skewed, reduce the number of originals loaded and scan again.

**Note:**

- ❑ Alternatively, you can scan originals of different paper types and thickness by loading them one by one using **Automatic Feeding Mode**.

To use **Automatic Feeding Mode**, make the appropriate settings on the Epson Scan 2 screen.

When you are using Epson ScanSmart, you can open the Epson Scan 2 screen by clicking the **Settings** button > **Scanner Settings** tab > **Scan Settings**.

On the Epson Scan 2 screen, use **Automatic Feeding Mode** to scan while switching the position of the scanner according to the type of document.

1. Make sure the scanner position light () is off.

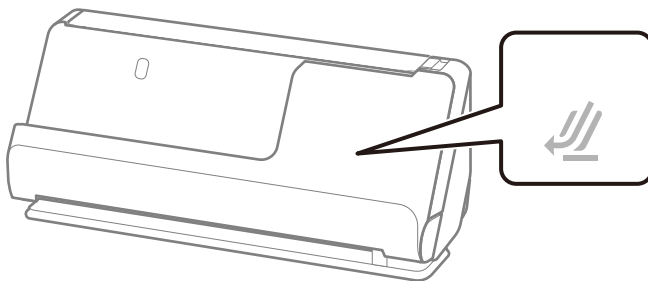

If the scanner position light () is on, pull the scanner position selector to tilt the scanner forward.

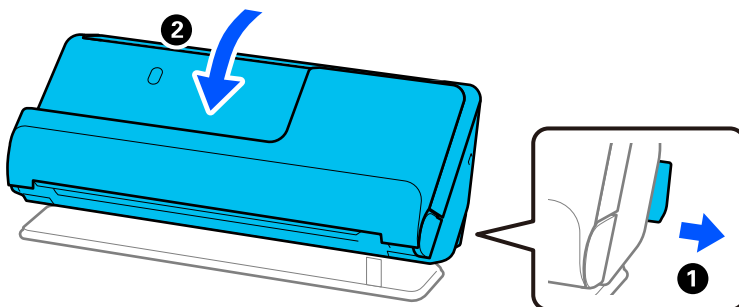

2. Open the input tray.

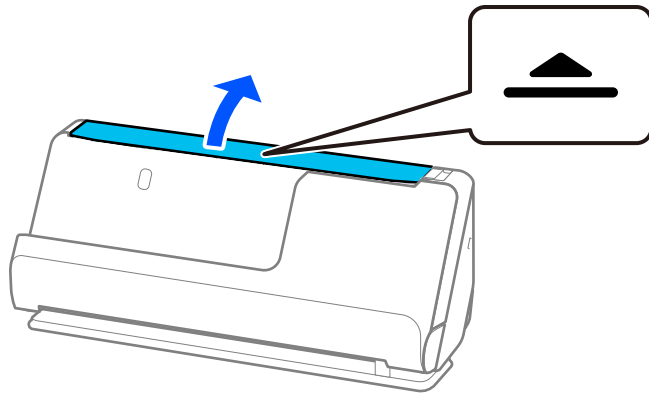

3. Raise the input tray extension.

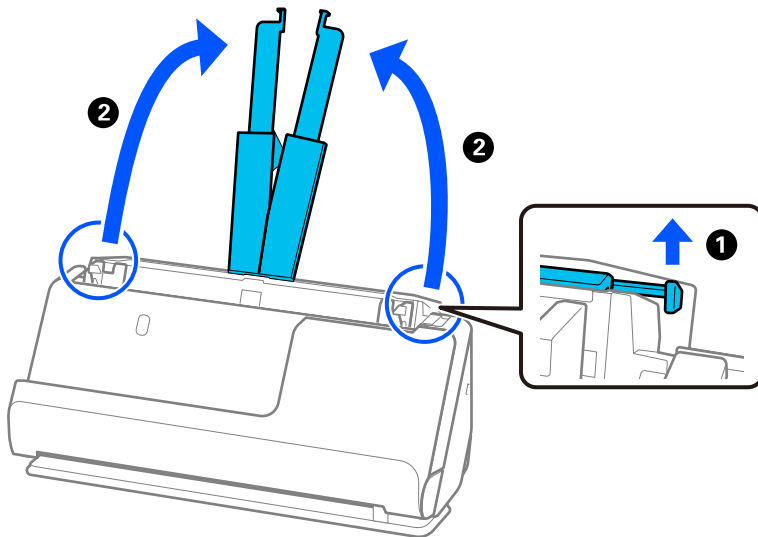

4. Move the edge guides to the edges of the input tray.

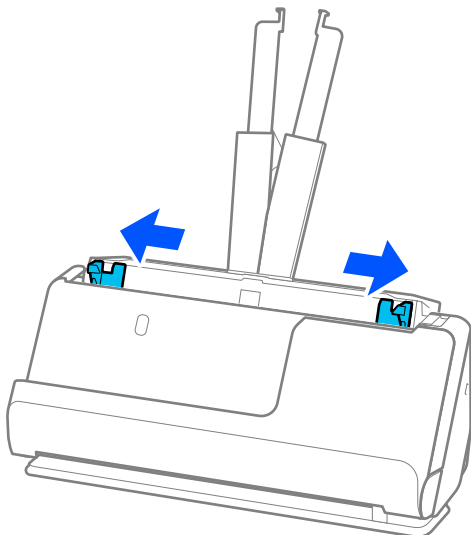

5. Load the originals with the side to be scanned facing up and in descending order of paper size with the widest at the back and the narrowest at the front of the input tray.

**!** *Important:*

*Check the following points when setting different sizes of originals.*

- Slide the originals with their leading edges aligned, until they meet resistance in the ADF.*
- Set the originals at the center of the input tray. Refer to the ▲ mark on the scanner as your guide.*
- Set the originals straight.*

*If not, originals may be fed askew or jammed.*

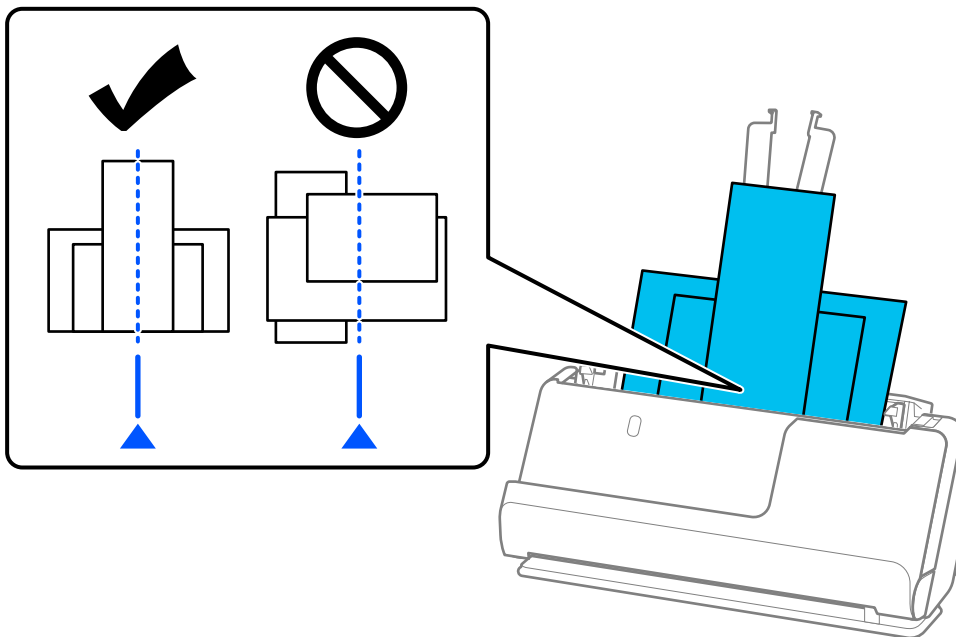

6. Align the edge guides with the widest original.

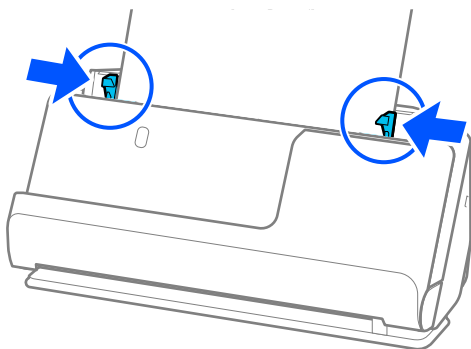

**Note:**

- ❑ *If the edge guides are too far apart or too tight, the original may not be fed correctly. The edge guides should be aligned so that they lightly touch the edges of the original.*
- ❑ *If you cancel scanning in the middle of scanning a batch of originals, the second original will be fed a little bit into the ADF and then scanning stops. Open the scanner cover to remove it, and then load the page again together with the first page and the rest of the originals.*
- ❑ *Depending on the type of paper and the environment in which the scanner is being used, the original may fall from the front of the scanner after scanning. In this situation, load fewer originals into the scanner than the specified number of originals that can be loaded.*

**Related Information**

- ➔ [“Scanning in Automatic Feeding Mode” on page 93](#)

---



# Scanning

Scanning Using a Scanner Button. . . . .	.89
Scanning from a Computer. . . . .	89
Scanning from a Smart Device. . . . .	.97



---

## Scanning Using a Scanner Button

You can scan using the button on your scanner.

**Note:**

- ❑ *Make sure that Epson ScanSmart is installed on your computer and the scanner is connected to your computer correctly.*
- ❑ *If a computer is connected to the scanner by USB while another computer is also connected to the scanner over a wireless connection, scanned images are saved to the USB connected computer when you press the scanner button.*

1. Place the originals on your scanner.
2. Press the  button on the scanner.  
Scanning starts and Epson ScanSmart opens.

---

## Scanning from a Computer

### Scanning Using Epson ScanSmart

Use the scanning application Epson ScanSmart to scan.

This application allows you to scan documents easily, and then save the scanned images in simple steps. See the Epson ScanSmart help for details on how to use the application. This section explains how to scan and save to a PDF file as a basic step.

1. Place the originals on your scanner.
2. Start Epson ScanSmart.
  - ❑ Windows 11  
Click the start button, and then select **All apps > Epson Software > Epson ScanSmart**.
  - ❑ Windows 10  
Click the start button, and then select **Epson Software > Epson ScanSmart**.
  - ❑ Windows 8.1/Windows 8  
Enter the application name in the search charm, and then select the displayed icon.
  - ❑ Windows 7  
Click the start button, and then select **All Programs > Epson Software > Epson ScanSmart**.
  - ❑ Mac OS  
Open the **Applications** folder and select **Epson ScanSmart**.

3. Click **Scan double-sided** or **Scan single-sided**.

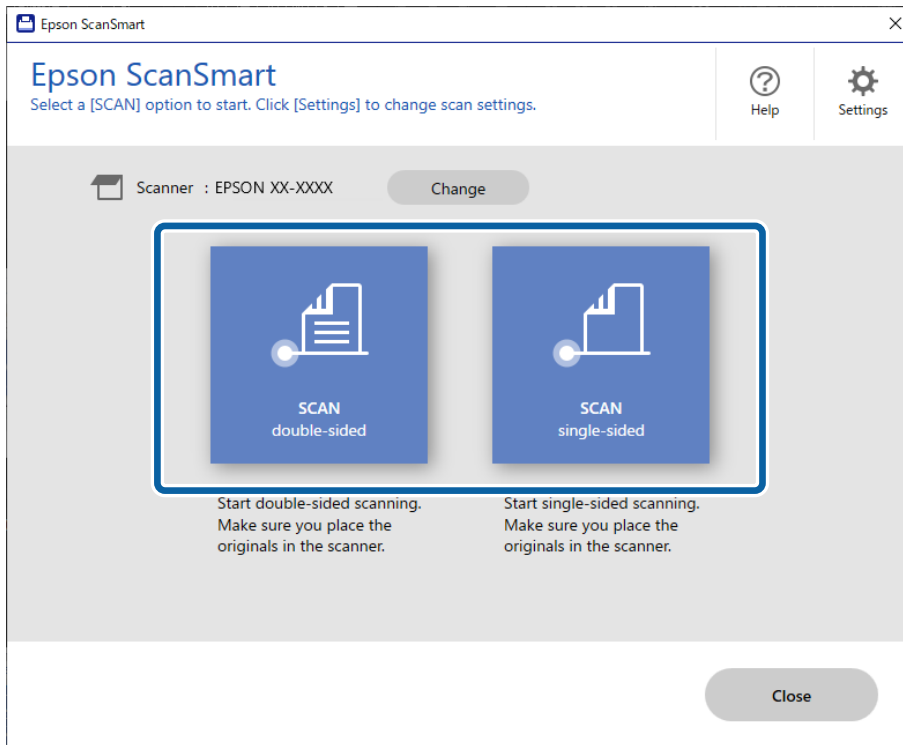

Scanning starts automatically.

4. Check the scanned images, and organize them if necessary.
  - 1 You can add originals and scan them by clicking **Scan**.
  - 2 You can use the buttons at the top of the screen to edit scanned images.
  - 3 You can choose to keep or discard the back sides of double-sided scanned images from **Include back sides**.
  - 4 If you do not want to check scanned images each time, select **Skip this screen next time**.

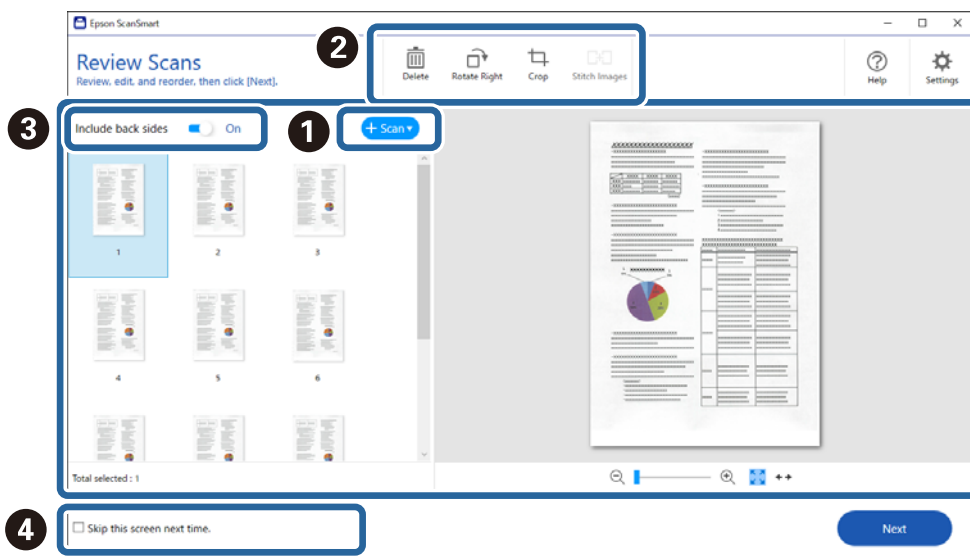

5. Click **Next**.

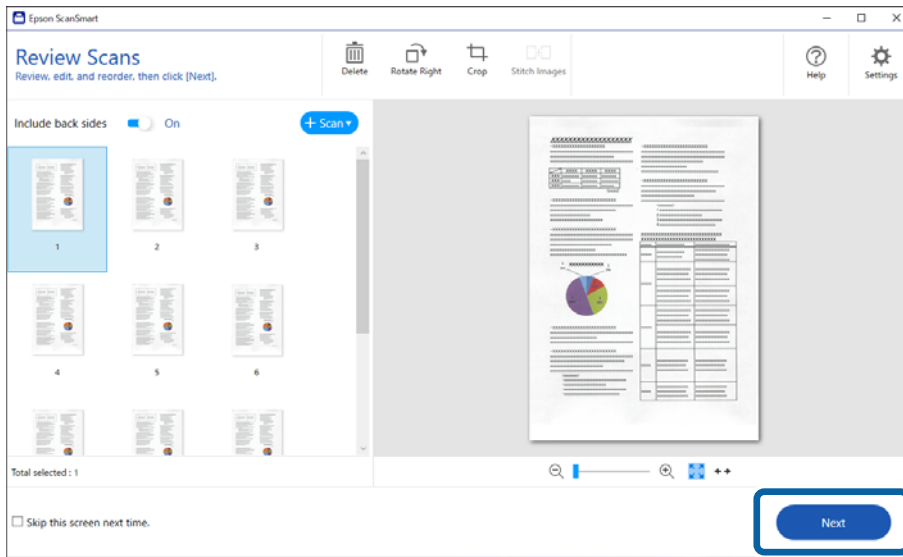

6. Click **Select Action** on the **Save** window.

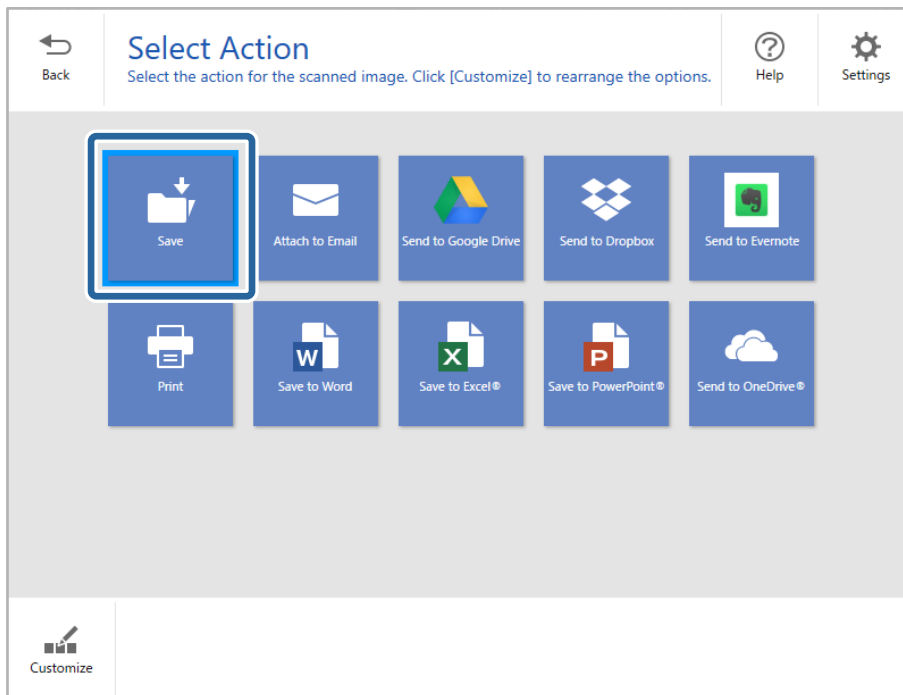

7. Check or change the save settings as necessary.

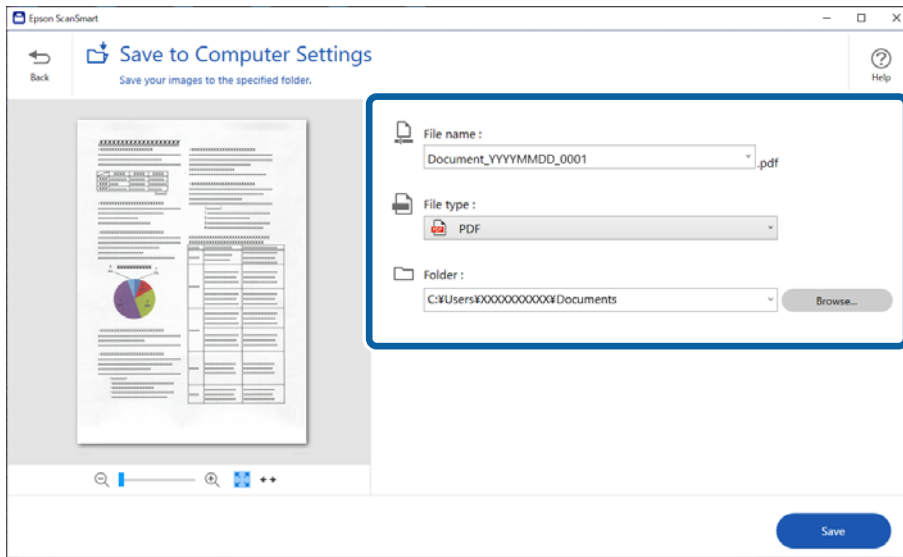

8. Click **Save**.

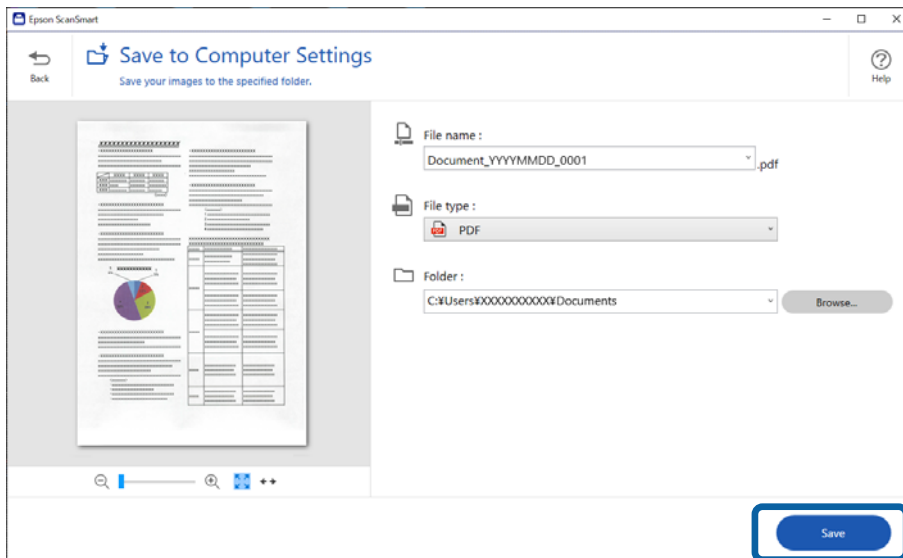

The scanned image is saved to the specified folder.

## Software Settings Required for Special Originals

To scan special originals, specify the necessary settings according to the originals. Press the  **Settings** button in Epson ScanSmart, and then select the **Scanner Settings** tab > **Scan Settings** to open the Settings screen.

Type of Original	Required Settings
Envelopes	Select <b>Off</b> in <b>Detect Double Feed</b> .
Plastic cards	Select <b>Plastic Card</b> in the <b>Document Size</b> list, or select <b>Off</b> in <b>Detect Double Feed</b> .

Type of Original	Required Settings
Carrier Sheet	<ul style="list-style-type: none"> <li><input type="checkbox"/> If you select <b>Auto Detect</b> from the <b>Document Size</b> list, skewing of the original is automatically corrected even if you select <b>Off</b> in <b>Correct Document Skew</b>.</li> <li><input type="checkbox"/> If you select any other size than <b>Auto Detect</b> from the <b>Document Size</b> list, you can only use <b>Contents Skew</b> when using <b>Correct Document Skew</b>. Selecting <b>Paper Skew</b> will not be applied. When you select <b>Paper and Contents Skew</b>, only contents skew is corrected.</li> </ul>
Passport Carrier Sheet	<p>Select <b>Auto Detect</b> from <b>Document Size</b>. Automatically detects and scans passports.</p> <p>You need to set this to save only the ID page of your passport. Select <b>Passport</b> in <b>Scan Settings</b>, and select <b>Settings</b> in <b>Document Size</b>. Select <b>Save ID page only when scanning passports</b> on the <b>Document Size Settings</b> screen.</p>
Large size originals	<p>If the size of the original you want to scan is not listed in <b>Document Size</b>, select <b>Customize</b>. Next, create the size manually on the window.</p>
Long paper	<p>If the size is not listed on the <b>Document Size</b> list, select <b>Auto Detect (Long Paper)</b> or select <b>Customize</b> to create a custom document size.</p>
Laminated cards	<p>To scan transparent areas around the document, select <b>Settings</b> in <b>Document Size</b> to open the <b>Document Size Settings</b> screen. Next, select <b>Scan laminated card</b> in the displayed window.</p> <p><b>Note:</b> <i>The appropriate effects may not be achieved depending on the original. If transparent areas around the document cannot be scanned, select <b>Customize</b> from the <b>Document Size</b> list, and then create the size manually.</i></p>

## Software Image Quality Adjustment Features

Press the  **Settings** button in Epson ScanSmart, and then select the **Scanner Settings** tab > **Scan Settings** to display the Scan Settings screen.

You can adjust the image quality of the scanned images using the features on the **Advanced Settings** tab. For more details on each feature, see the help on the screen displayed.

**Note:**

*Some items may not be available depending on other settings you made.*

## Scanning in Automatic Feeding Mode

In Automatic Feeding Mode, scanning starts automatically when originals are loaded into the ADF. This is useful when scanning originals one by one.

1. Start Epson ScanSmart.
2. Click  **Settings**.

3. Click **Scan Settings** on the **Scanner Settings** tab.

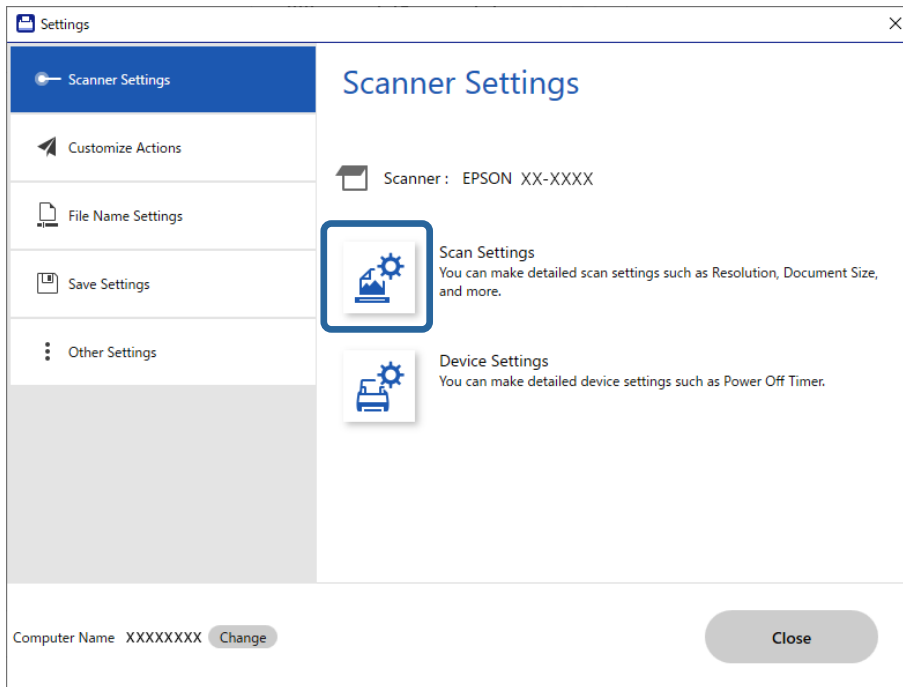

The Scan Settings screen is displayed.

- Click the **Main Settings** tab > **Automatic Feeding Mode**.

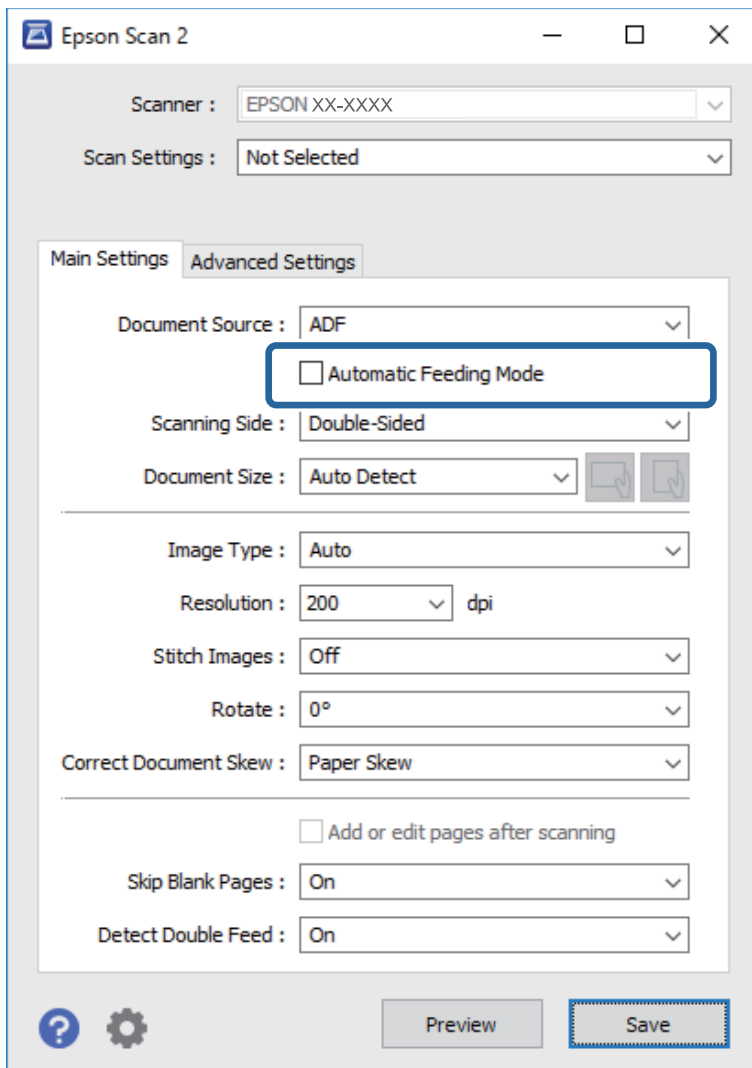

- Specify other settings for scanning on the settings screen.

**Note:**

You can make timeout settings to exit **Automatic Feeding Mode**.

Select **Settings** on the **Document Source** list to open the **Document Source Settings** window. Set **Automatic Feeding Mode Timeout (seconds)** on the screen displayed.

- Click **Save** to close the settings screen.
- Click **Close** to close the **Settings** window.
- Click **Scan double-sided** or **Scan single-sided**.  
Automatic Feeding Mode starts.
- Change the position of the scanner according to the type of original, adjust the edge guides, and then place the original in the ADF.  
Scanning starts automatically.

10. After scanning stops, place the next original in the ADF.

Repeat this procedure until you have scanned all originals.

11. After you have scanned all originals, exit Automatic Feeding Mode.

Press the  button on the scanner or press **Finish** on the **Automatic Feeding Mode** screen displayed on your computer.

Follow the instructions of the Epson ScanSmart to save the scanned image.

## Using AirPrint

AirPrint enables instant scanning from a Mac without the need to install drivers or download software.

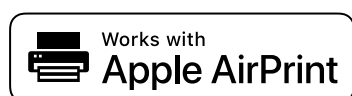

1. Load your originals.
2. Connect the product to the same network that your Mac is connected to, or connect the product to your Mac with a USB cable.
3. On the **System Preferences** screen on your Mac, click **Printers & Scanners**.
4. Select your scanner from the list, then click **Open Scanner**.
5. Select scan settings as needed, then start scanning.

**Note:**

For details, see the macOS User Guide.

## Scanning Using Chromebook

You can scan using a Chromebook.

1. Place the originals.
2. Connect the scanner to the network that your Chromebook is connected to, or connect the scanner to your Chromebook using a USB cable.
3. Open the Scan app on your Chromebook.  
Select the time in the bottom-right of the screen > **Settings** button > **Advanced** > **Print and scan** > **Scan**.
4. Select your scanner, and then set other items if necessary.
5. Scan from your Chromebook with your scanner.

**Note:**

For more details, check <https://www.google.com/chromebook/>.



## Scanning from a Smart Device

### Scanning Using Epson Smart Panel

To scan from your smart device, search for and install Epson Smart Panel from App Store or Google Play.

**Note:**

*Connect the scanner to the smart device before scanning.*

1. Place the original.
2. Start Epson Smart Panel.
3. Follow the on-screen instructions to scan.

**Note:**

*If the size of your original does not appear in the list, select **Auto**.*

The scanned image is saved to your smart device, send to cloud service, or send to email.

### Scanning Using Mopria Scan

Mopria Scan enables instant network scanning from Android smart phones or tablets.



1. Install Mopria Scan from Google Play.
2. Place the originals.
3. Set up your scanner for network scanning. See the link below.  
<https://epson.sn>
4. Connect your Android device over a wireless connection (Wi-Fi) to the same network that your scanner is using.
5. Scan from your device with your scanner.

**Note:**

*For more details, access the Mopria Web site at <https://mopria.org>.*

---

# Required Settings for Scanning

Connecting the Scanner to the Network. . . . .	99
Checking the Scanner's IP Address. . . . .	101
Setting Up AirPrint. . . . .	102

## Connecting the Scanner to the Network

If the scanner is not connected to the network, use the installer to connect the scanner to the network.

To start the installer, access the following website, and then enter the product name. Go to **Setup**, and then start setting up.

<https://epson.sn>

You can view the operating instructions in the Web Movie Manuals. Access the following URL.

<https://support.epson.net/publist/vlink.php?code=NPD7126>

### Related Information

- ➔ “Lights” on page 26
- ➔ “Error Indicators” on page 27
- ➔ “Connecting the Scanner to the Network” on page 169

## Connecting to the Wireless LAN (Wi-Fi)

You can connect the scanner to the wireless LAN (Wi-Fi) in several ways. Choose the connection method that matches the environment and conditions that you are using.

If the wireless router supports WPS, you can make settings by using push button setup.

After connecting the scanner to the network, connect to the scanner from the device that you want to use (computer, smart device, tablet, and so on.)

### Making Wi-Fi Settings by Push Button Setup (WPS)

You can automatically set up a connection by pressing a button on the access point. If the following conditions are met, you can set up by using this method.

- The access point is compatible with AOSS or WPS (Wi-Fi Protected Setup).
- The current Wi-Fi connection was established by pressing a button on the wireless router.



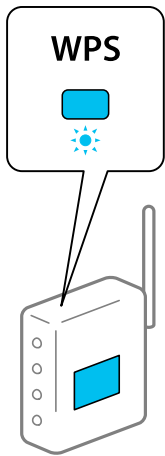

**Note:**

*If you cannot find the button or you are setting up using the software, see the documentation provided with the access point.*

1. Hold down the [WPS] button on the access point until the security light flashes.





If you do not know where the [WPS] button is, or there are no buttons on the access point, see the documentation provided with your access point for details.

2. Press the  button on the scanner's control panel until the  light flashes white (approximately 3 seconds).  
Connection setup begins. The  light and  light flash alternately.

The  is lit blue when connection is complete.

**Note:**



Connection fails when the  light turns on. After clearing the error by pressing the  button, restart the access point, move it closer to the scanner, and then try again.

### Related Information

➔ [“Checking the Network Connection Status” on page 165](#)

## Making Wi-Fi Settings by PIN Code Setup (WPS)

You can connect to an access point by using a PIN code. You can use this method to set up if an access point is capable of WPS (Wi-Fi Protected Setup). Use a computer to enter a PIN code into the access point.



1. Press the  button and the  button on the scanner's control panel simultaneously until  light flashes in white (approximately 3 seconds).
2. Use your computer to enter the PIN code (an eight-digit number) on the label stuck to the scanner into the access point within two minutes.

The connection setup begins. The  light and  light flash alternately.

The  is lit blue when connection is complete.

**Note:**

❑ See the documentation provided with the access point for details on entering a PIN code.

❑ Connection fails when the  light turns on. After clearing the error by pressing the  button, restart the access point, move it closer to the scanner, and then try again.

### Related Information

➔ [“Checking the Network Connection Status” on page 165](#)

## Making AP Mode Settings

This method allows you to connect the scanner directly to devices without an access point. The scanner acts as an access point.



### **Important:**

When you connect from a computer or smart device to the scanner using an AP mode connection, the scanner is connected to the same Wi-Fi network (SSID) as the computer or smart device and communication is established between them. Since the computer or smart device is automatically connected to other connectable Wi-Fi networks if the scanner is turned off, it is not connected to the previous Wi-Fi network again if the scanner is turned on. Connect to the scanner's SSID in AP mode from the computer or smart device again. If you do not want to connect every time you turn the scanner on or off, we recommend using a Wi-Fi network by connecting the scanner to an access point.

1. Press the  button on the scanner's control panel.

The  light is lit white when AP mode connection is enabled.

2. Connect from a computer or smart device using the scanner's SSID and password.

### **Note:**

- You can check the SSID and password on the label stuck to the scanner.
- See the documentation provided with your computer or smart device for the operating instructions.

### Related Information

➔ [“Checking the Network Connection Status” on page 165](#)

---

## Checking the Scanner's IP Address

You can check the scanner's IP address in the Epson Scan 2 Utility.

### **Note:**

You need to connect the computer to the same wireless router as the scanner before checking the IP address.

1. Start Epson Scan 2 Utility.

- Windows 11

Click the start button, and then select **All apps > EPSON > Epson Scan 2 Utility**.

- Windows 10

Click the start button, and then select **EPSON > Epson Scan 2 Utility**.

- Windows 8.1/Windows 8

Enter the application name in the search charm, and then select the displayed icon.

- Windows 7

Click the start button, and then select **All Programs (or Programs) > EPSON > Epson Scan 2 > Epson Scan 2 Utility**.

Mac OS

Select **Go > Applications > Epson Software > Epson Scan 2 Utility**.

2. Select the model for which you want to check the IP address from the **Scanner** list.

If the scanner is not displayed in the **Scanner** list, your scanner could not be detected.

Click **Settings** to open the **Scanner Settings** screen, and then click **Add** to add your scanner.

The IP address of the selected scanner is displayed next to the model name.

---

## Setting Up AirPrint

Access Web Config, select the **Network** tab, then select **AirPrint Setup**.

Items	Explanation
Bonjour Service Name	Enter a Bonjour service name, using ASCII text (0x20-0x7E) and up to 41 characters.
Bonjour Location	Enter a description of the scanner's location, using Unicode (UTF-8) text and up to 127 bytes.
Wide-Area Bonjour	Set whether or not to use Wide-Area Bonjour. If you use it, the scanner must be registered on the DNS server in order to search for the scanner over the segment.
Enable AirPrint	Bonjour and AirPrint (Scan service) are enabled.

---

# Useful Features

Setting the Glass Surface Stain Detection Feature. . . . .	104
Setting the Document Protection Feature. . . . .	105
Setting the Operation when a Double-feed is Detected. . . . .	106

## Setting the Glass Surface Stain Detection Feature

Vertical lines (streaks) may appear in the image due to dust or dirt on the glass surface inside the scanner.

When **Detect Glass Dirt** is set to On, the scanner detects any stains on the glass surface inside the scanner and displays a notification on your computer screen.

When this notification is displayed, clean the glass surface inside the scanner with the dedicated cleaning kit or a soft cloth.

The default setting is **Off**.

1. Start Epson Scan 2 Utility.

- Windows 11

Click the start button, and then select **All apps > EPSON > Epson Scan 2 Utility**.

- Windows 10

Click the start button, and then select **EPSON > Epson Scan 2 Utility**.

- Windows 8.1/Windows 8

Enter the application name in the search charm, and then select the displayed icon.

- Windows 7

Click the start button, and then select **All Programs (or Programs) > EPSON > Epson Scan 2 > Epson Scan 2 Utility**.

- Mac OS

Select **Go > Applications > Epson Software > Epson Scan 2 Utility**.

2. Make the following settings on the **Scanner Setting** tab.

Set **Detect Glass Dirt** to **On-Low** or **On-High**.

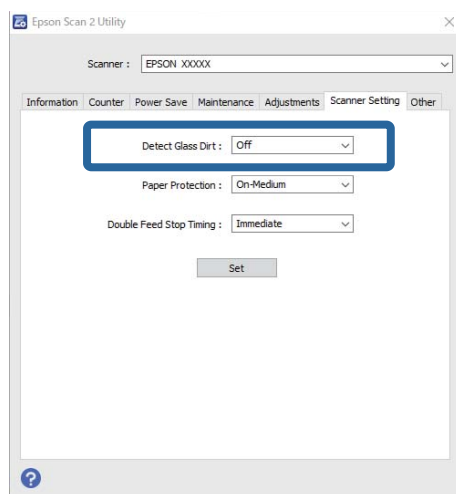

**Note:**

- Some stains may not be detected correctly.

- If detection does not work correctly, try changing the settings.

If no stains are detected, select **On-High**. If stains are detected incorrectly, select **On-Low** or **Off**.

3. Click **Set** to apply the settings to the scanner.



## Setting the Document Protection Feature

To reduce damage to the document, scanning stops immediately when the following conditions are detected.

- A paper feed error has occurred
- An original is fed at an angle
- The combination of the original and the scanner position does not match

The default setting is **On-Medium**.



**Important:**

- This feature does not prevent all originals from being damaged.
- Paper feed errors may not be detected depending on the condition of the originals being fed.

1. Start Epson Scan 2 Utility.

- Windows 11

Click the start button, and then select **All apps > EPSON > Epson Scan 2 Utility**.

- Windows 10

Click the start button, and then select **EPSON > Epson Scan 2 Utility**.

- Windows 8.1/Windows 8

Enter the application name in the search charm, and then select the displayed icon.

- Windows 7

Click the start button, and then select **All Programs (or Programs) > EPSON > Epson Scan 2 > Epson Scan 2 Utility**.

- Mac OS

Select **Go > Applications > Epson Software > Epson Scan 2 Utility**.

2. Make the following settings on the **Scanner Setting** tab.

Set **Paper Protection** to **On-Low**, **On-Medium** or **On-High**.

To enable this feature, select the level of detection you want to use. See the following table for details on each level.

Level	Explanations
On-Low	Lower the sensitivity to detect the skew of the originals.
On-Medium	Detect the skew of the stapled originals and the skew that <b>On-Low</b> could not detect.

Level	Explanations
On-High	Increase the sensitivity to detect the skew of the originals.

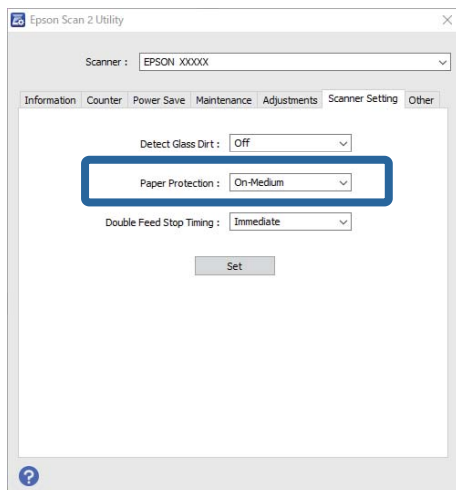

**Note:**

- This feature may not work correctly depending on the original, the paper feeding conditions, and the level set.
- If false positives occur frequently, try lowering the level.
- If the original is an irregular shape or is scanned at an angle, it may be mistakenly detected as a paper feed error.
- When loading multiple originals, make sure to align the leading edge of the originals. Originals may be misdetected as feeding errors if the edges of the originals are not aligned, even if they are scanned correctly.
- Make sure you align the edge guides with the original to avoid scanning it at an angle.

3. Click **Set** to apply the settings to the scanner.

## Setting the Operation when a Double-feed is Detected

Set the timing to stop operations when any double feed of originals is detected.

- Immediate:** Stops immediately after any double feed is detected.
- After Eject:** Scans documents for which a double feed is detected as they are, but scanning of the next document is stopped.

When you are satisfied that there are no problems in the scanned image, you can continue scanning.

The default setting is **Immediate**.

1. Start Epson Scan 2 Utility.
  - Windows 11  
Click the start button, and then select **All apps > EPSON > Epson Scan 2 Utility**.
  - Windows 10  
Click the start button, and then select **EPSON > Epson Scan 2 Utility**.
  - Windows 8.1/Windows 8  
Enter the application name in the search charm, and then select the displayed icon.

❑ Windows 7

Click the start button, and then select **All Programs** (or **Programs**) > **EPSON** > **Epson Scan 2** > **Epson Scan 2 Utility**.

❑ Mac OS

Select **Go** > **Applications** > **Epson Software** > **Epson Scan 2 Utility**.

2. Make the following settings on the **Scanner Setting** tab.

Set **Double Feed Stop Timing** to **Immediate** or **After Eject**.

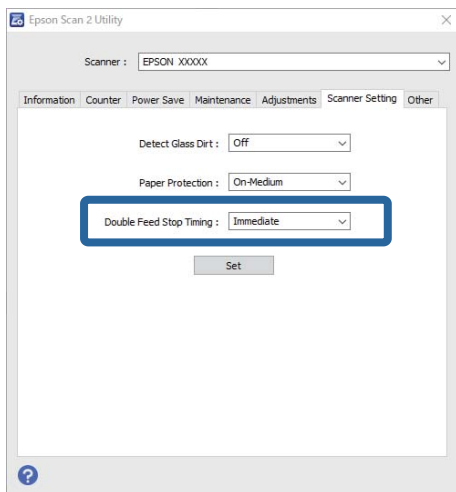

3. Click **Set** to apply the settings to the scanner.

---

# Maintenance

Cleaning Outside the Scanner. . . . .	109
Cleaning Inside the Scanner. . . . .	109
Replacing the Roller Assembly Kit. . . . .	119
Energy Saving. . . . .	127
Moving the Scanner. . . . .	128
Updating Applications and Firmware. . . . .	130

---

## Cleaning Outside the Scanner

Wipe off any stains on the outer case with a dry cloth or a cloth dampened with mild detergent and water.

 **Important:**

- Never use alcohol, thinner, or any corrosive solvent to clean the scanner. Deformation or discoloration may occur.
- Do not let water get inside the product. This could cause a malfunction to occur.
- Never open the scanner case.

1. Press the  button to turn off the scanner.
2. Unplug the AC adapter from the scanner.
3. Clean the outer case with a cloth dampened with mild detergent and water.

---

## Cleaning Inside the Scanner

After using the scanner for a while, paper and room dust on the roller or the glass part inside the scanner may cause paper feed or scanned image quality problems. Clean the inside of the scanner every 5,000 scans.

You can check the latest number of scans in the Epson Scan 2 Utility.

If a surface is stained with a hard-to-remove material, use a genuine Epson cleaning kit to remove stains. Use a small amount of cleaner on the cleaning cloth to remove the stains.

 **Caution:**

*Be careful not to get your hands or hair caught in the gears or rollers when cleaning the inside the scanner. This could cause an injury.*

 **Important:**

- Never use alcohol, thinner, or any corrosive solvent to clean the scanner. Doing so could cause deformation or discoloration to occur.
- Never spray any liquid or lubricant on the scanner. Damage to equipment or circuits may cause abnormal operations.
- Never open the scanner case.

**Note:**

- You can set cleaning time notifications and alerts after making a certain number of scans in the Epson Scan 2 Utility. By default, a notification is sent after every 5,000 scans.
- Clean inside the scanner while it is turned on.

1. **Wipe off any stains on the roller.** Open the vertical path cover.

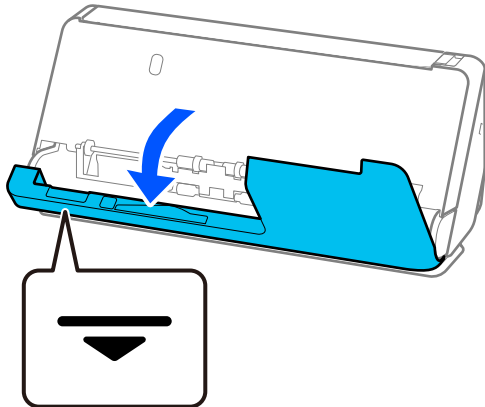

**! Important:**

*When opening the vertical path cover, hold the area indicated to avoid touching the antistatic brush. If the brush becomes bent it cannot eliminate static electricity, and this may cause the output originals to stick to each other.*

2. Wipe the rollers (4 locations) and the plastic rollers (4 locations). Wipe with a soft, lint-free cloth dampened with a small amount of dedicated cleaner or water.

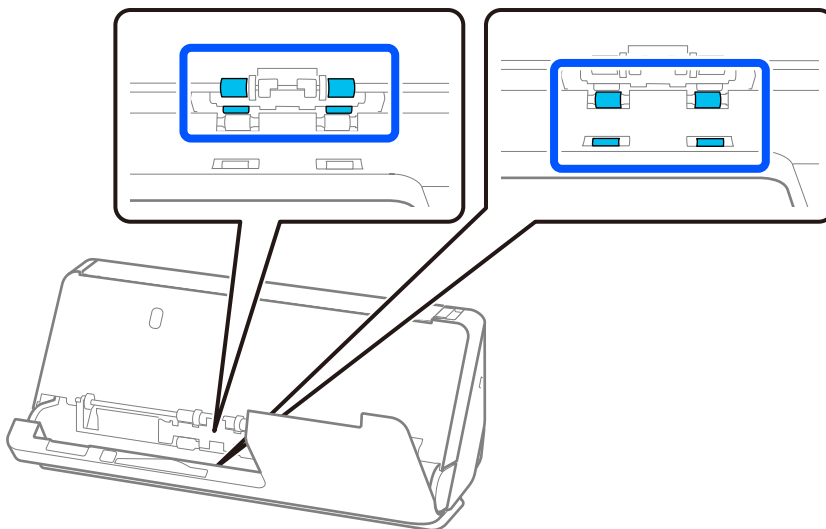

**! Important:**

*Be careful not to touch the antistatic brush when wiping the rollers. If the brush becomes bent it cannot eliminate static electricity, and this may cause the output originals to stick to each other.*

3. Open the input tray, and pull the lever to open the scanner cover.

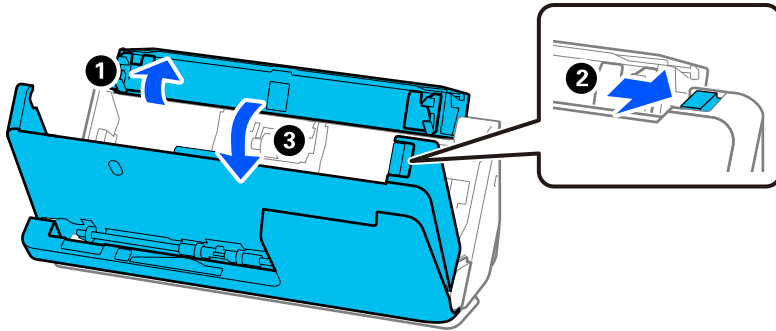

4. Wipe the rollers (8 locations). Wipe with a soft, lint-free cloth dampened with a small amount of dedicated cleaner or water.

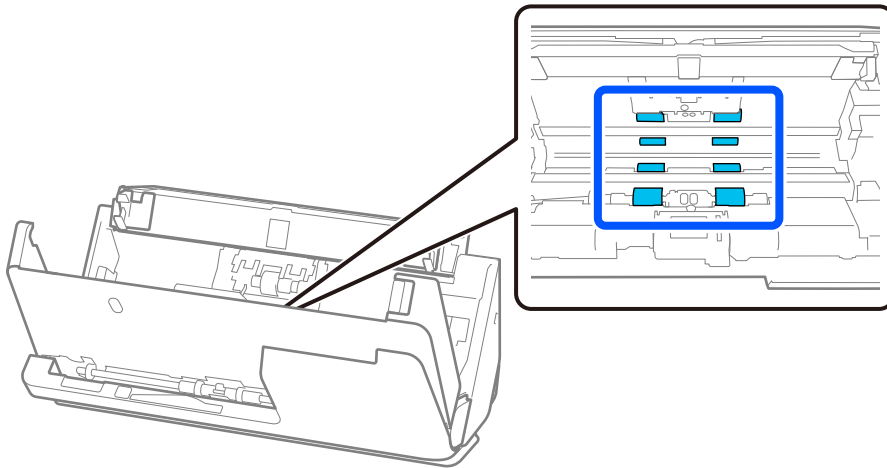

5. Close the scanner cover with both hands. Next, close the vertical path cover and then the input tray, in that order.

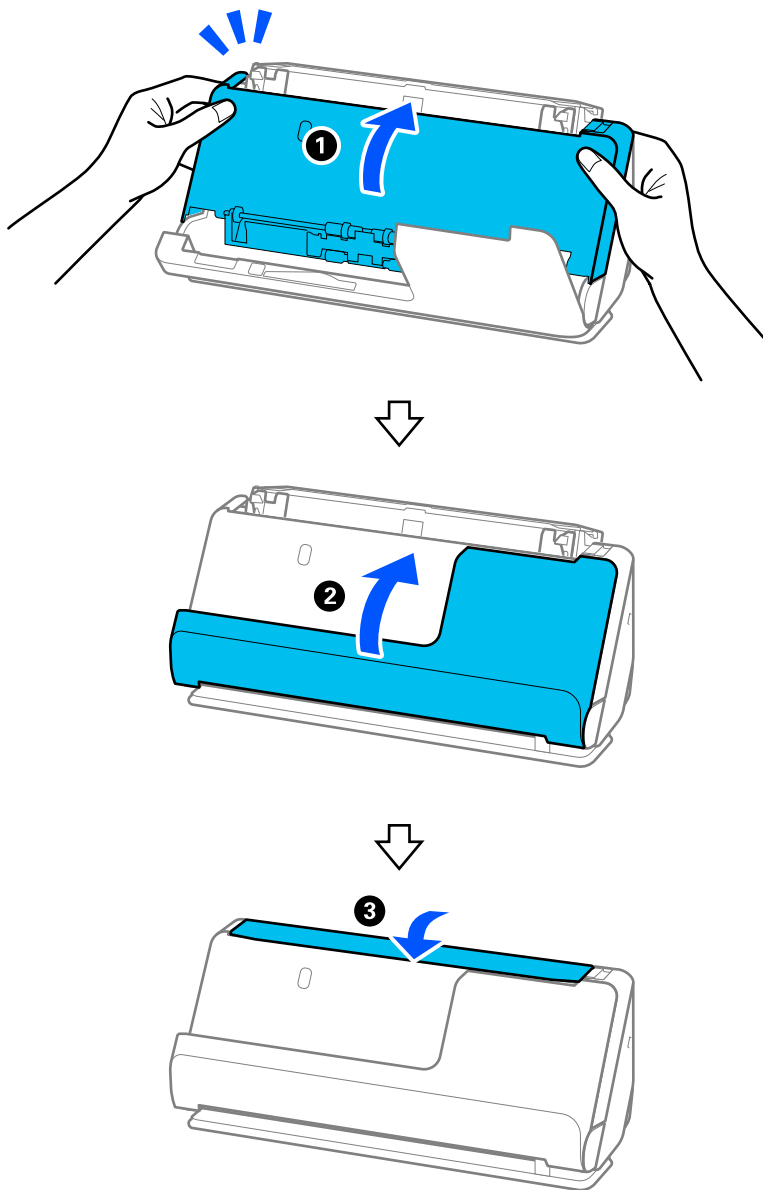

After closing the cover, wait for approximately four seconds before proceeding to the next step.

6. Repeat steps 1 to 5 four times.

The internal rollers rotate approximately one-quarter of a turn each time the cover is closed. Repeat this step until the entire roller is clean.



**Note:**

*If paper dust adheres to the inside of the vertical path cover, wipe it off with a soft, lint-free cloth.*

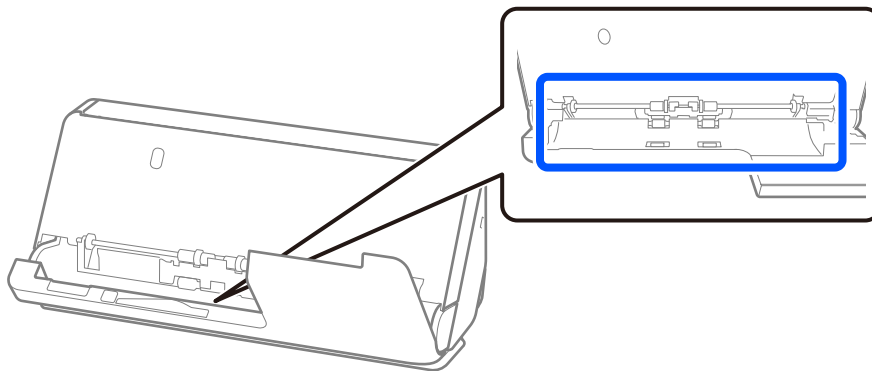

7. **Wipe off any stains inside the scanner.** Open the input tray, and pull the lever to open the scanner cover.

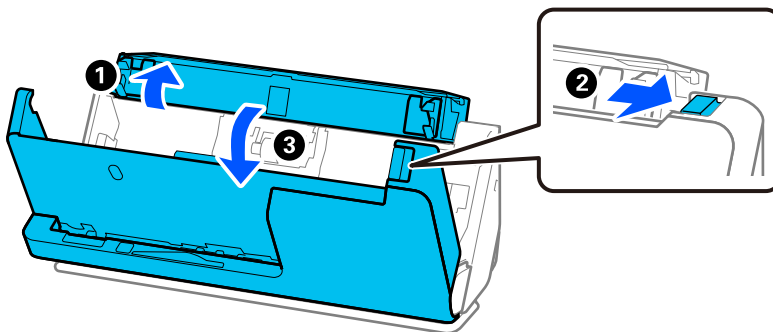

8. Wipe the glass surface inside the scanner cover. Wipe with a dedicated cleaning cloth or a soft, lint-free cloth. If the glass surface is very dirty, wipe with a soft, lint-free cloth dampened with a small amount of dedicated cleaner or water.



**Important:**

- ❑ Do not place too much force on the glass surface.
- ❑ Do not use a brush or a hard tool. Any scratches on the glass may affect the scan quality.
- ❑ Do not spray cleaner directly onto the glass surface.

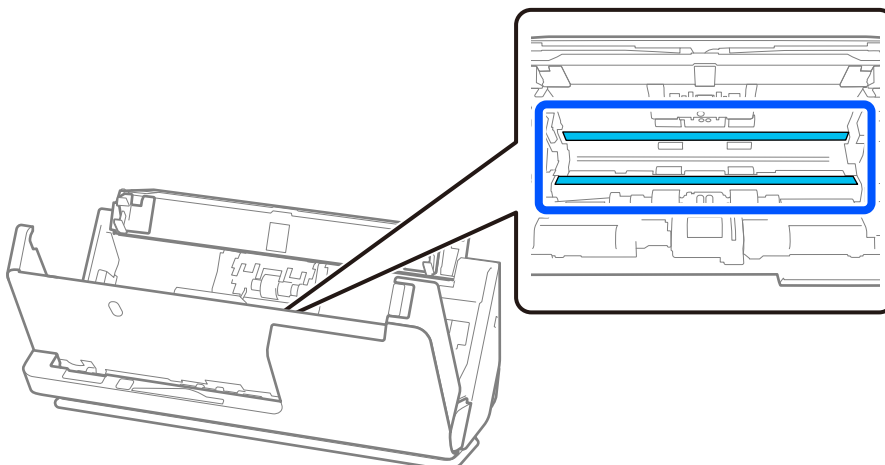

9. Wipe the sensors (4 locations) with a cotton swab.

**!** *Important:*

*Do not use liquid such as a cleaner on a cotton swab.*

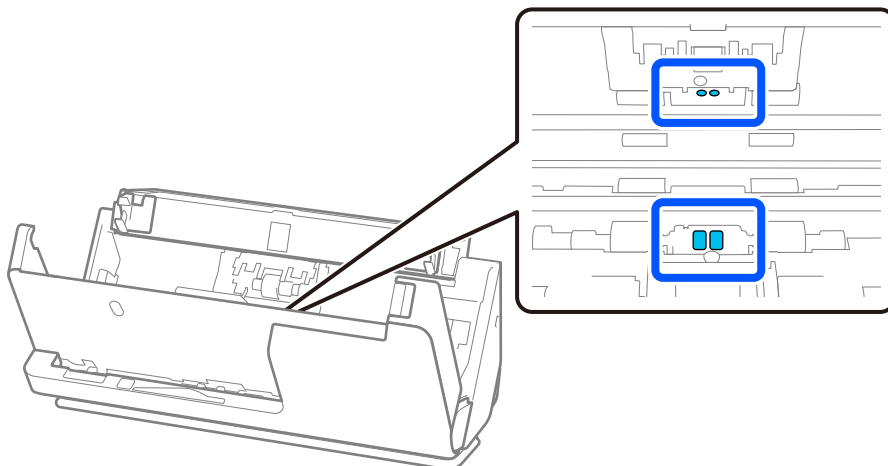

10. **Wipe off any stains on the separation roller.** Open the cover, and then remove the separation roller.

See “Replacing the Roller Assembly Kit” for more details.

[“Replacing the Roller Assembly Kit” on page 119](#)

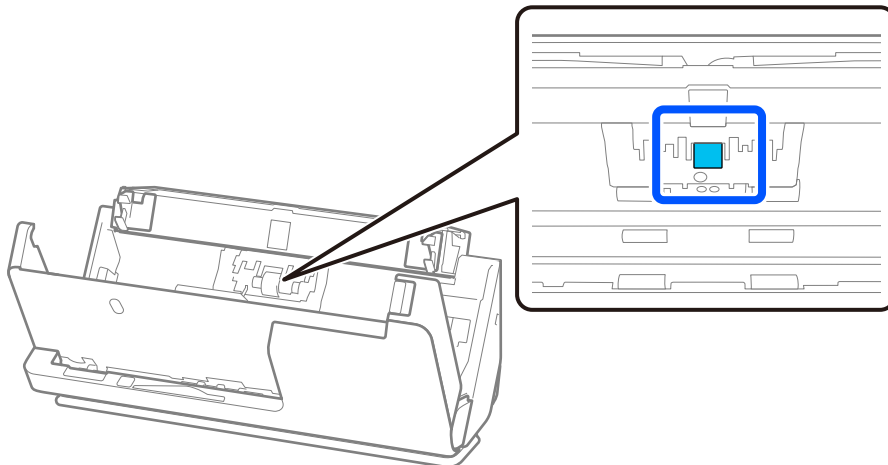

11. Wipe the separation roller. Wipe with a soft, lint-free cloth dampened with a small amount of dedicated cleaner or water.

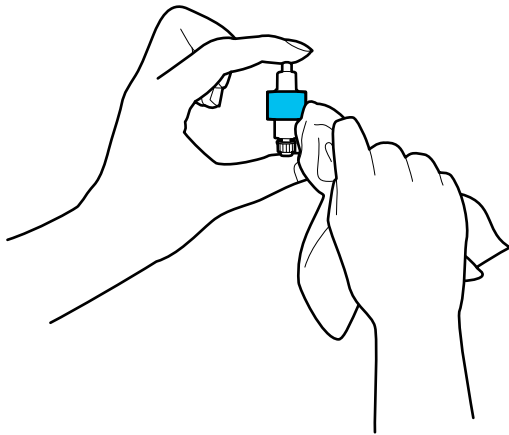

**Important:**

*Use only a moist cloth to clean the roller. Using a dry cloth may damage the surface of the roller.*

12. Install the separation roller.  
See “Replacing the Roller Assembly Kit” for more details on installing.
13. **Wipe off any stains on the pickup roller.** Open the cover, and then remove the pickup roller.  
See “Replacing the Roller Assembly Kit” for more details.  
[“Replacing the Roller Assembly Kit” on page 119](#)

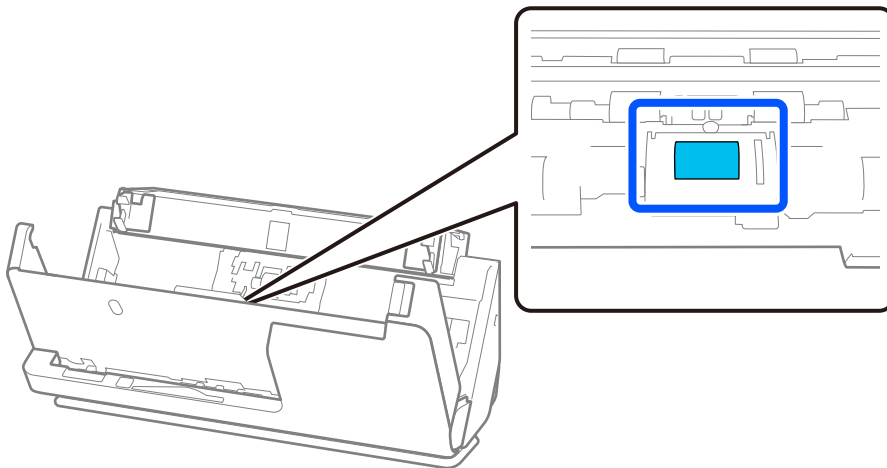

14. Wipe the pickup roller. Wipe with a soft, lint-free cloth dampened with a small amount of dedicated cleaner or water.

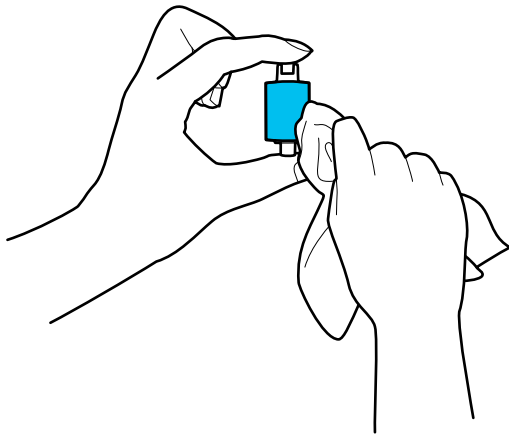

**!** *Important:*

*Use only a moist cloth to clean the roller. Using a dry cloth may damage the surface of the roller.*

15. Install the pickup roller.  
See “Replacing the Roller Assembly Kit” for more details on installing.
16. Close the scanner cover with both hands. Next, close the input tray.

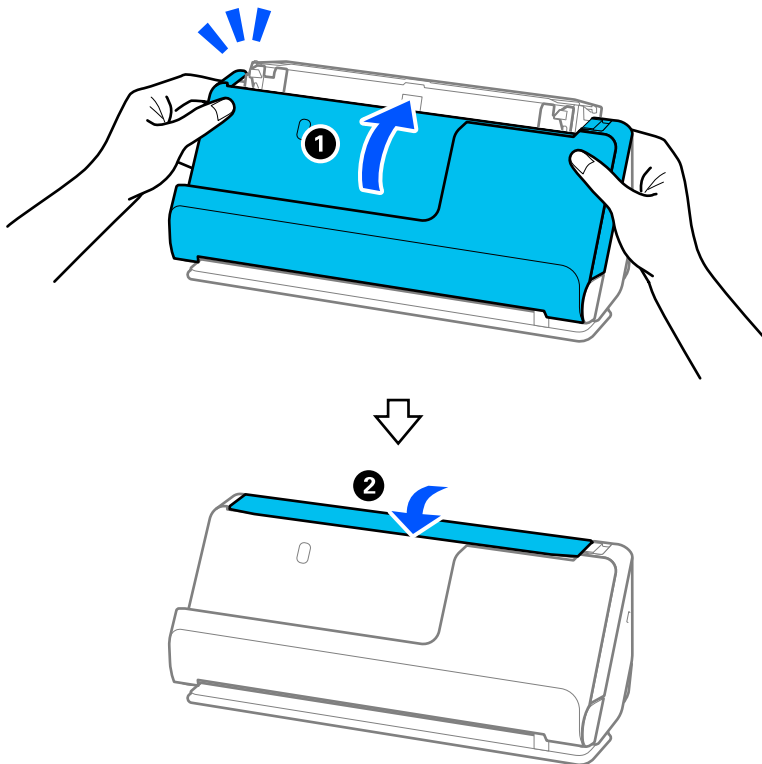

17. Reset the scan number by using the Epson Scan 2 Utility.

### Related Information

- ➔ [“Cleaning Kit Codes” on page 35](#)
- ➔ [“Replacing the Roller Assembly Kit” on page 119](#)

## Resetting the Number of Scans After Cleaning Inside the Scanner

After performing regular cleaning, reset the number of scans in the Epson Scan 2 Utility.

This section explains how to reset using the Epson Scan 2 Utility.

1. Turn on the scanner.
2. Start Epson Scan 2 Utility.
  - ❑ Windows 11  
Click the start button, and then select **All apps > EPSON > Epson Scan 2 Utility**.
  - ❑ Windows 10  
Click the start button, and then select **EPSON > Epson Scan 2 Utility**.
  - ❑ Windows 8.1/Windows 8  
**Start screen > Apps > Epson > Epson Scan 2 Utility**.
  - ❑ Windows 7/Windows Vista/Windows XP  
Click the start button, and then select **All Programs (or Programs) > EPSON > Epson Scan 2 > Epson Scan 2 Utility**.
  - ❑ Mac OS  
Select **Go > Applications > Epson Software > Epson Scan 2 Utility**.
3. Click the **Maintenance** tab.

4. Click **Reset** from **Regular Cleaning**.

**Note:**

You cannot reset when **Regular Cleaning Alert** is not selected.

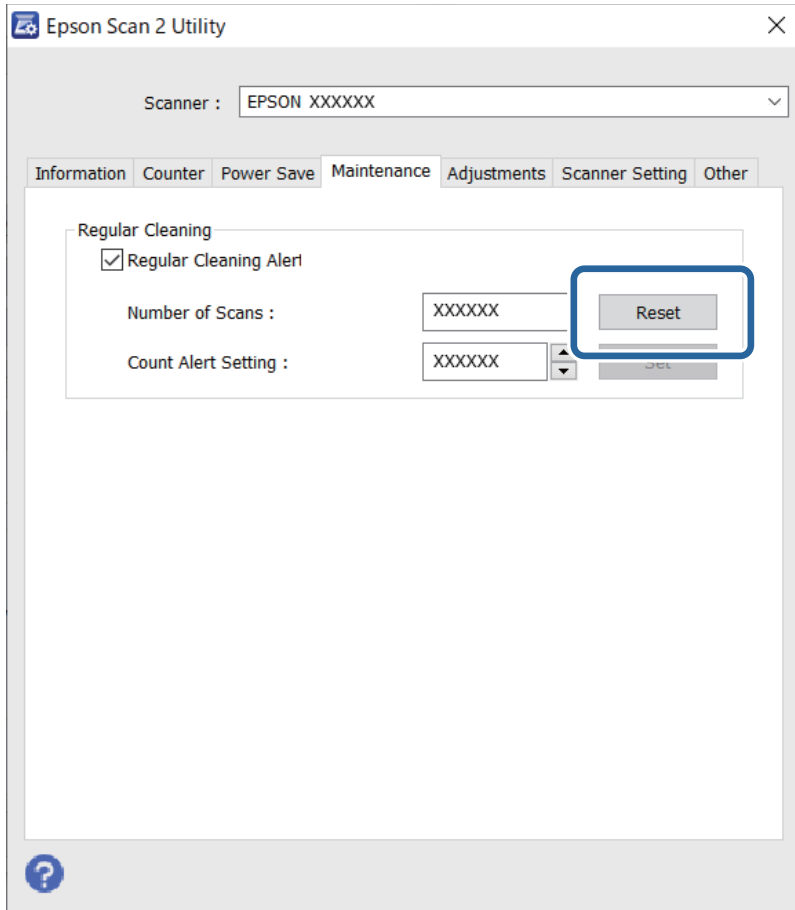

## Replacing the Roller Assembly Kit

The roller assembly kit (the pickup roller and the separation roller) needs to be replaced when the number of scans exceeds the life cycle of the rollers. When a replacement message is displayed on your computer screen, follow the steps below to replace it.

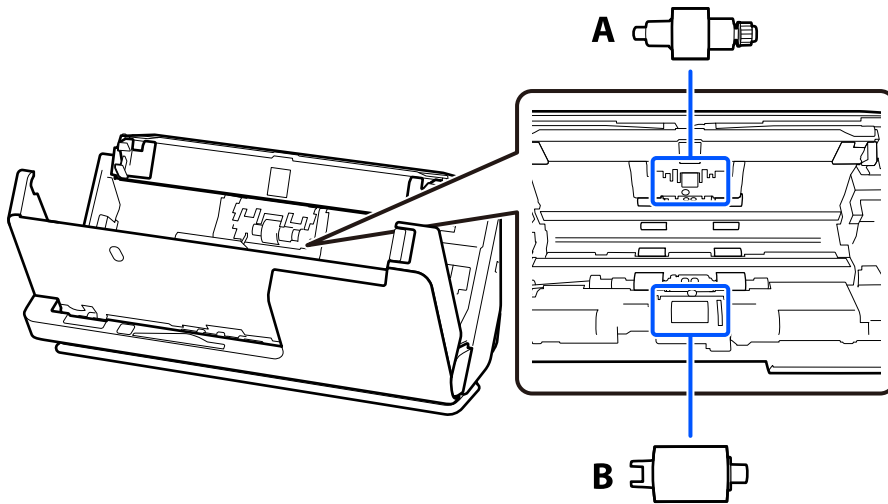

A: Separation Roller, B: Pickup roller

**Note:**

Replace the roller assembly kit while the scanner is turned on.

1. Open the input tray, and pull the lever to open the scanner cover.

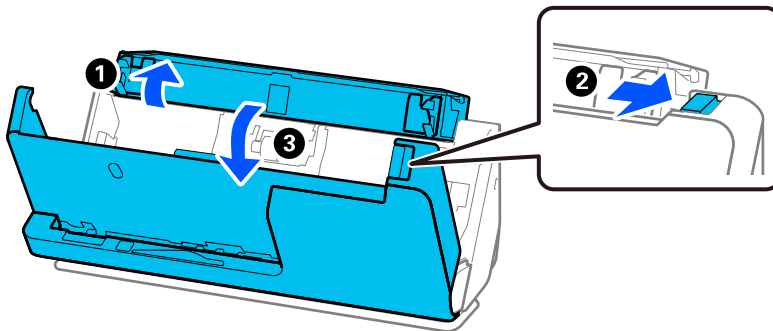

2. Remove the separation roller cover as shown.

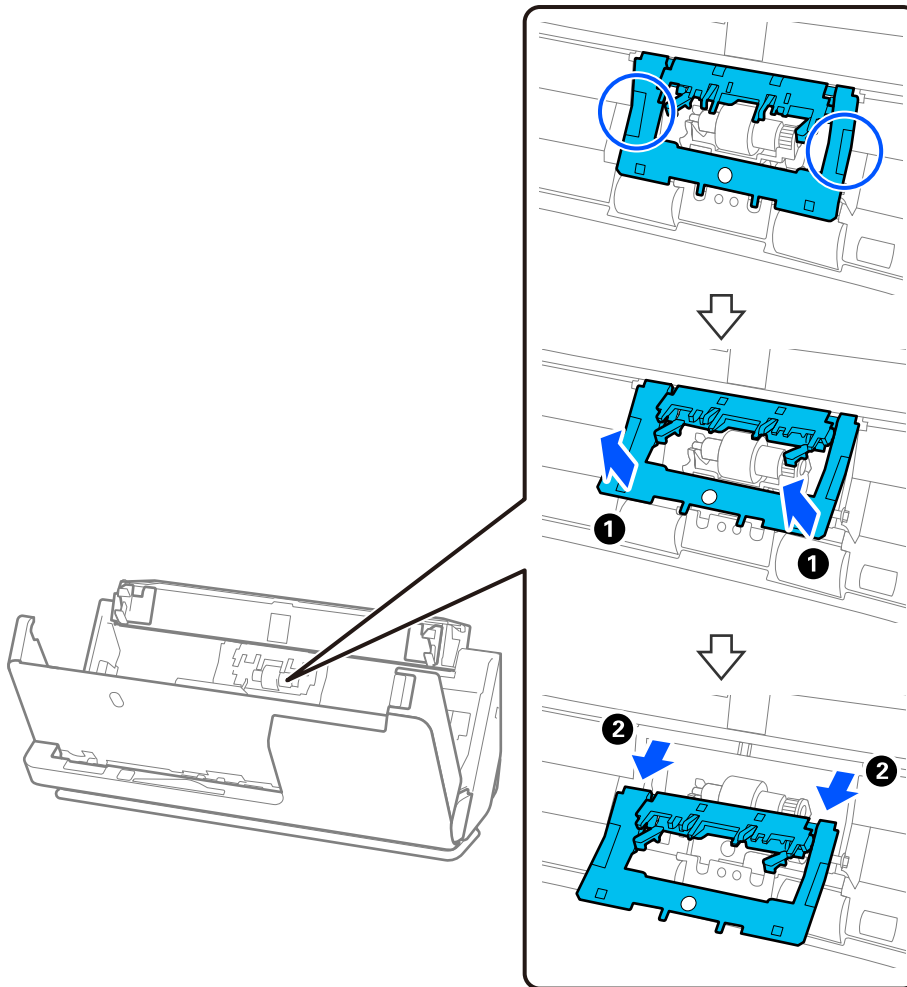

3. Remove the separation roller as shown.

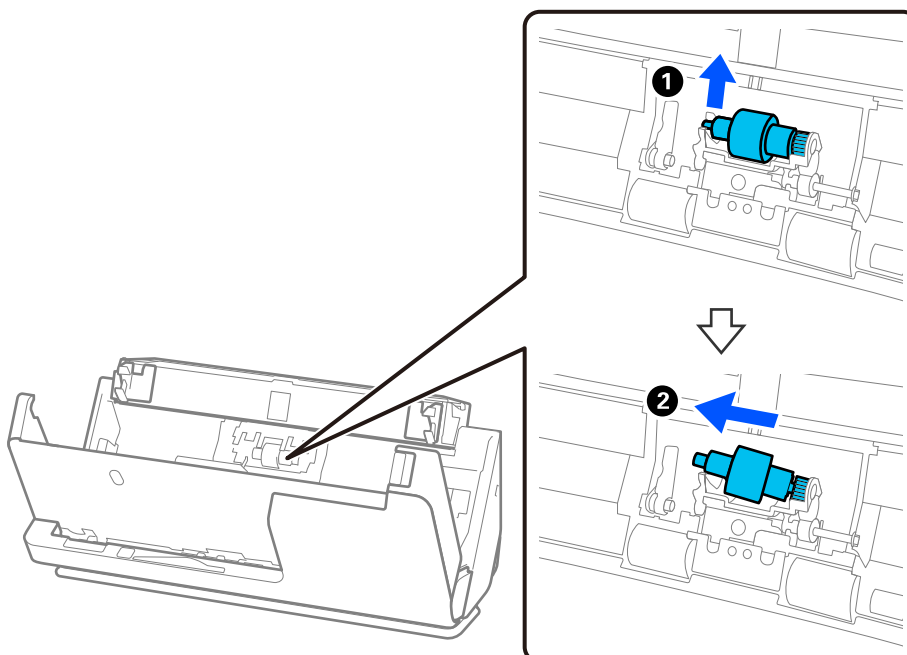



**!** *Important:*

*Do not pull out the separation roller forcibly. This could damage the inside of the scanner.*

4. Attach the new separation roller as shown. Insert the axis of the separation roller into the hole on the right side, and then lower the separation roller.

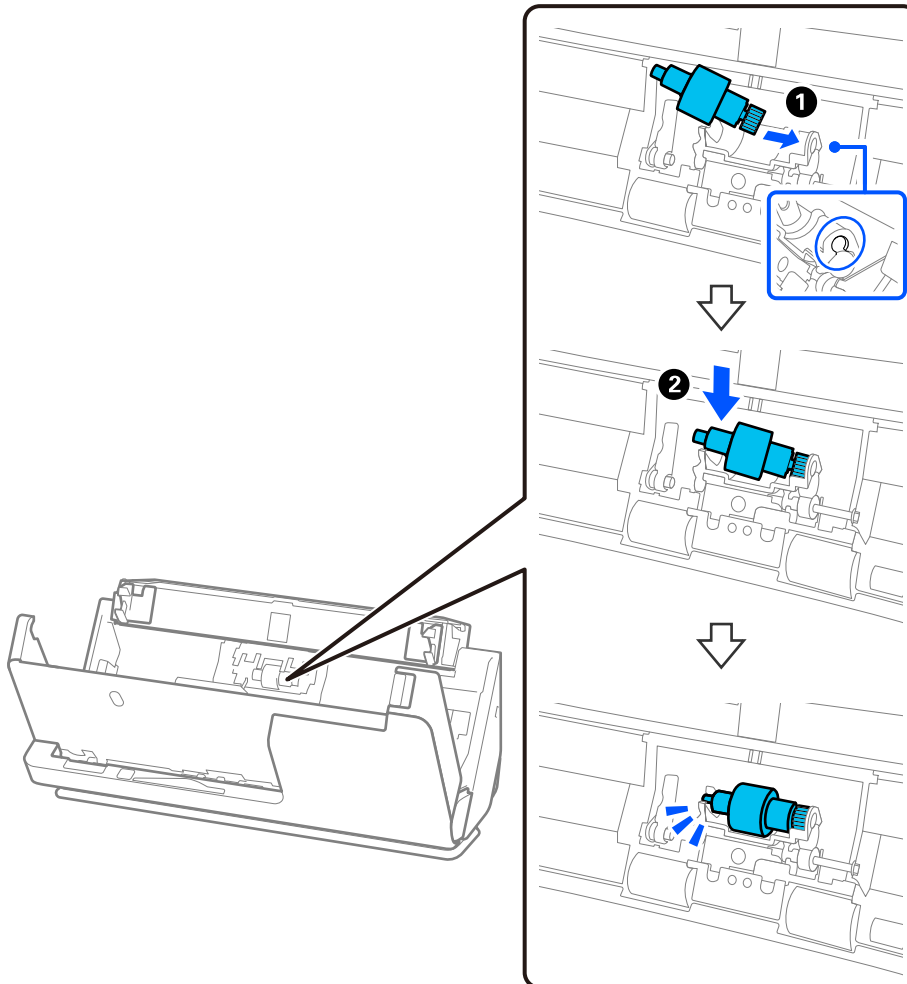

5. Attach the separation roller cover as shown. Insert the axis on the upper side of the cover into the grooves, and then close the cover firmly.

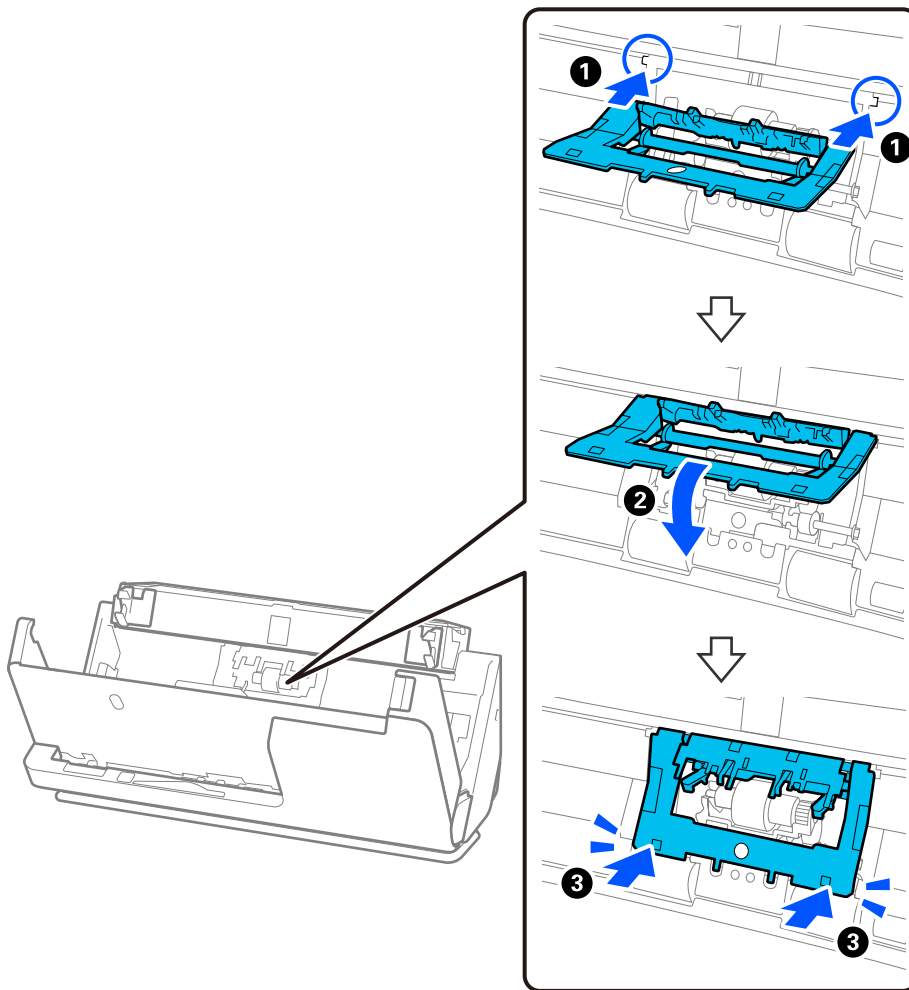

**!** *Important:*

- Make sure the cover is closed correctly.*
- If the cover is hard to close, make sure the separation rollers are installed correctly.*
- Do not install the cover while it is raised.*

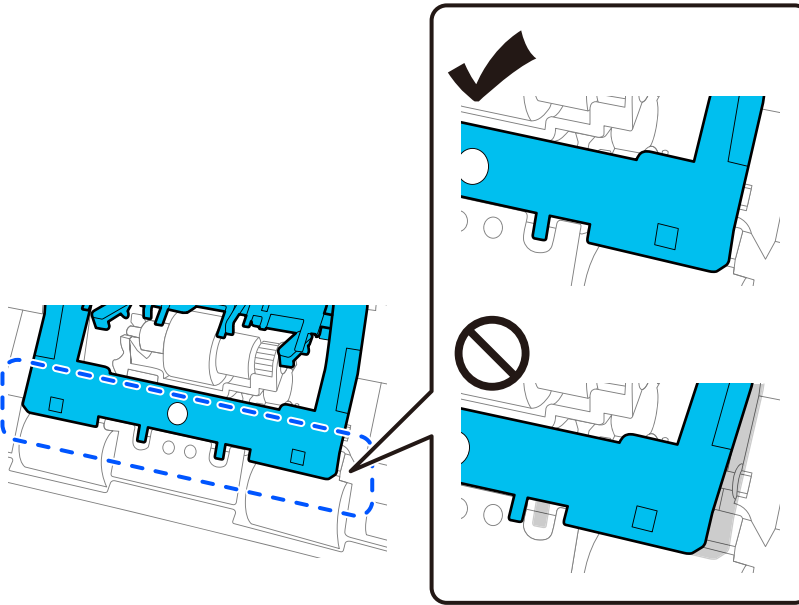

6. Open the cover of the pickup roller.

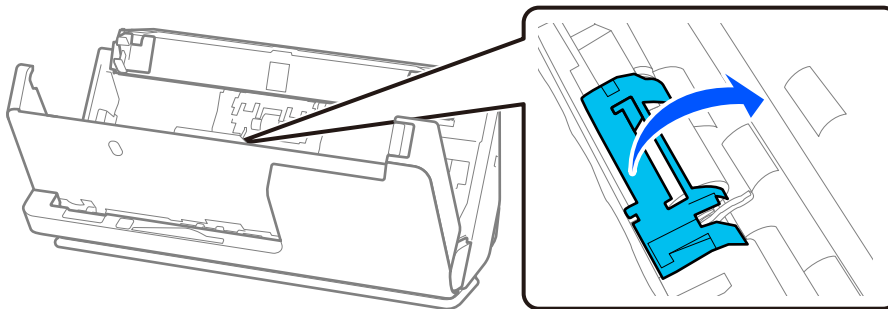

7. Remove the pickup roller as shown.

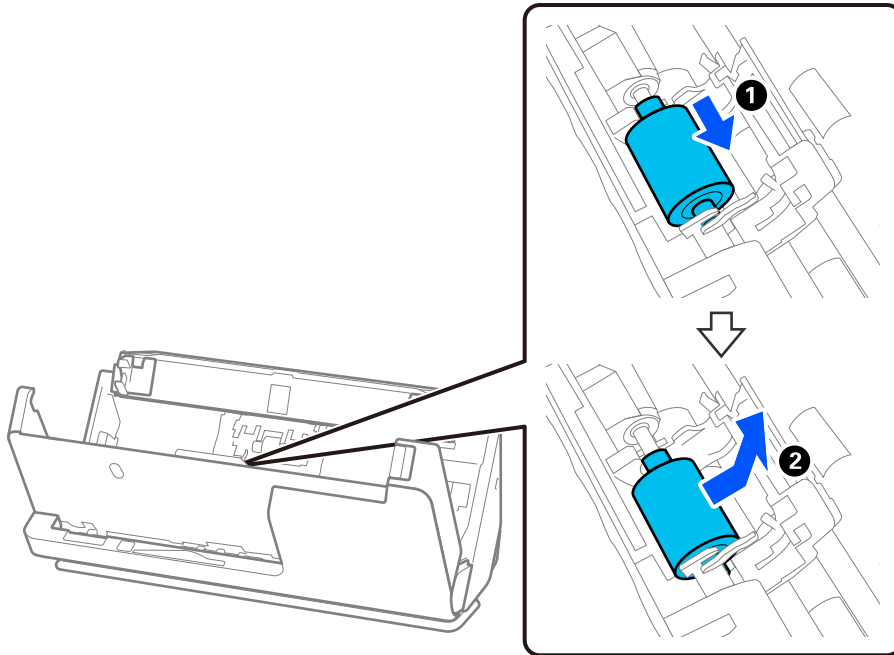

8. Attach the new pickup roller as shown. Insert the indentations at the ends of the pickup roller onto the axis on the scanner, lower the pickup roller, and then slide it to the back.

Make sure the indentations are aligned.

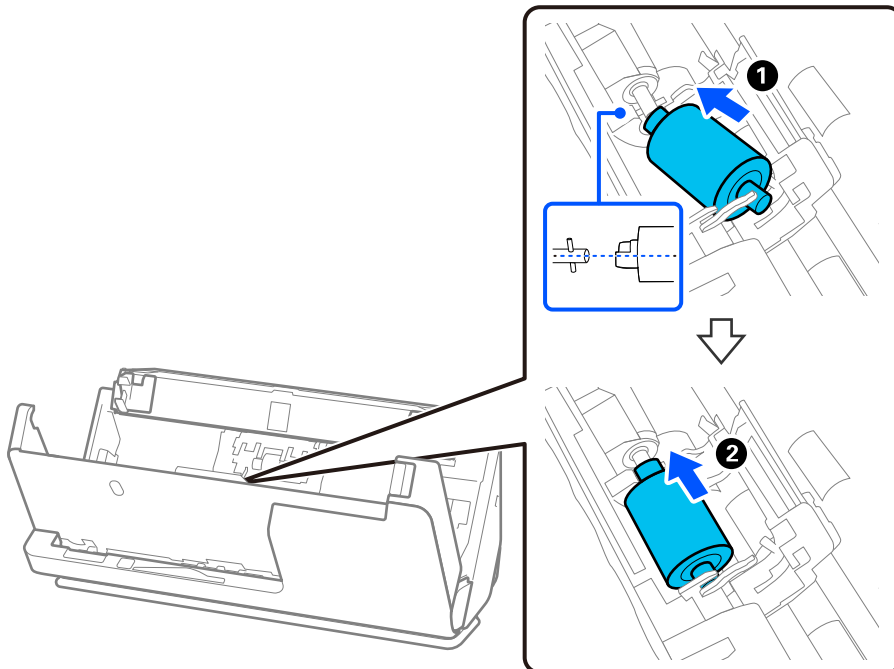

9. Close the pickup roller cover.

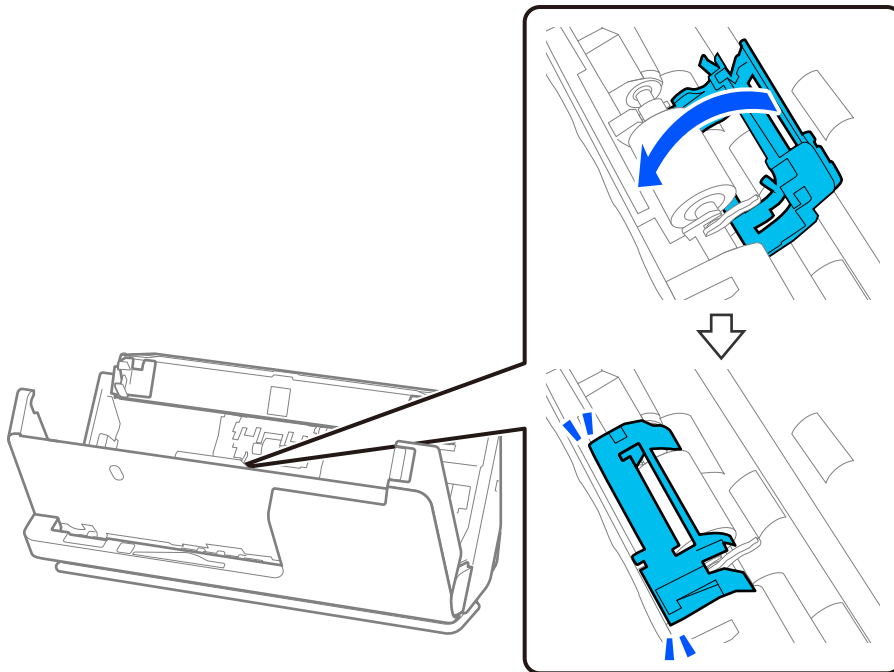

**!** *Important:*

*If the cover is hard to close, make sure the pickup rollers are installed correctly, and that the protruding parts are aligned.*

10. Close the scanner cover with both hands. Next, close the input tray.

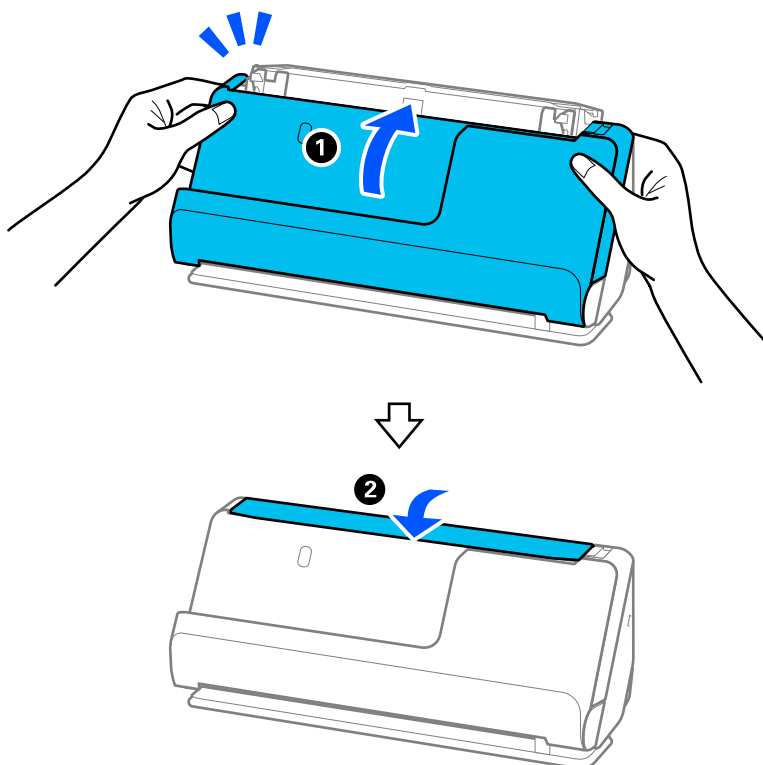

11. Reset the scan number by using the Epson Scan 2 Utility.

**Note:**

Dispose of the pickup roller and the separation roller following the rules and regulations of your local authority. Do not disassemble them.

**Related Information**

➔ [“Roller Assembly Kit Codes” on page 34](#)

## Resetting the Number of Scans After Replacing the Rollers

Reset the number of scans using Epson Scan 2 Utility after replacing the roller assembly kit.

This section explains how to reset using the Epson Scan 2 Utility.

1. Turn on the scanner.
2. Start Epson Scan 2 Utility.
  - ❑ Windows 11  
Click the start button, and then select **All apps > EPSON > Epson Scan 2 > Epson Scan 2 Utility**.
  - ❑ Windows 10  
Click the start button, and then select **EPSON > Epson Scan 2 Utility**.
  - ❑ Windows 8.1/Windows 8  
**Start screen > Apps > Epson > Epson Scan 2 Utility**.
  - ❑ Windows 7  
Click the start button, and then select **All Programs (or Programs) > EPSON > Epson Scan 2 > Epson Scan 2 Utility**.
  - ❑ Mac OS  
Select **Go > Applications > Epson Software > Epson Scan 2 Utility**.
3. Click the **Counter** tab.

4. Click **Reset** from **Roller Assembly Kit**.

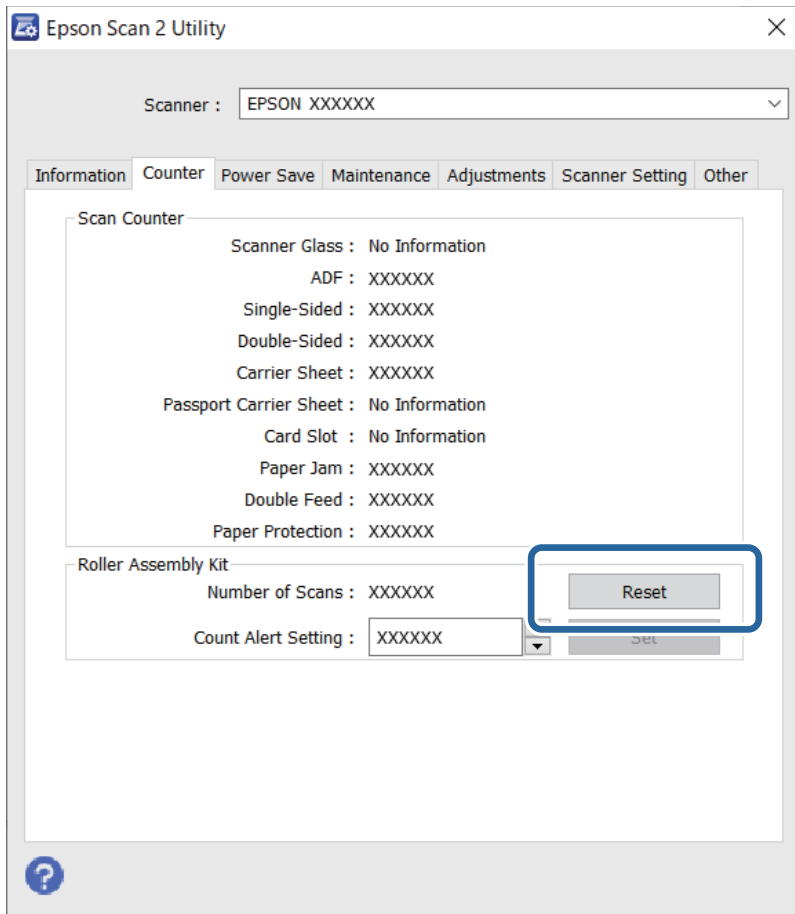

## Energy Saving

You can adjust the time before power management is applied. Any increase will affect the product's energy efficiency. Please consider the environment before making any changes.

1. Start Epson Scan 2 Utility.
  - Windows 11  
Click the start button, and then select **All apps > EPSON > Epson Scan 2 Utility**.
  - Windows 10  
Click the start button, and then select **EPSON > Epson Scan 2 Utility**.
  - Windows 8.1/Windows 8  
**Start screen > Apps > Epson > Epson Scan 2 Utility**.
  - Windows 7  
Click the start button, and then select **All Programs (or Programs) > EPSON > Epson Scan 2 > Epson Scan 2 Utility**.
  - Mac OS  
Select **Go > Applications > Epson Software > Epson Scan 2 Utility**.

2. Click the **Power Save** tab.
3. Set the **Power Off Timer (minutes)** or **Power Off If Disconnected**, and then click **Set**.

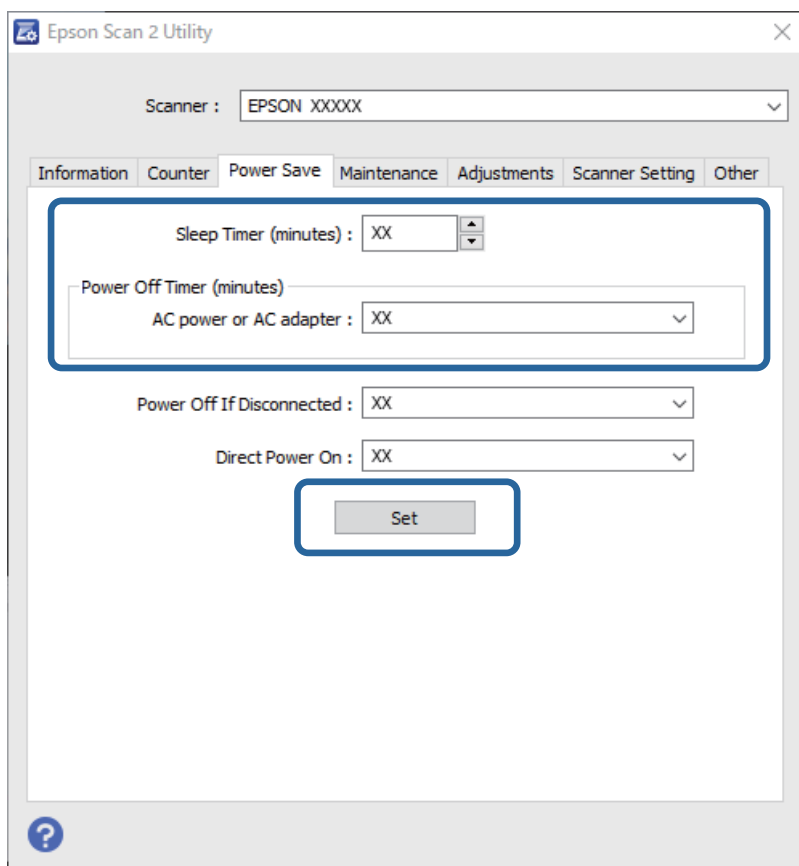

---

## Moving the Scanner

### Transporting the Scanner

When you need to transport the scanner, follow the steps below to pack the scanner.

1. Press the  button to turn off the scanner.
2. Unplug the AC adapter.
3. Remove the cables and the devices.



4. Store the input tray extension, and close the input tray.  
When the output support is extended, retract it completely.

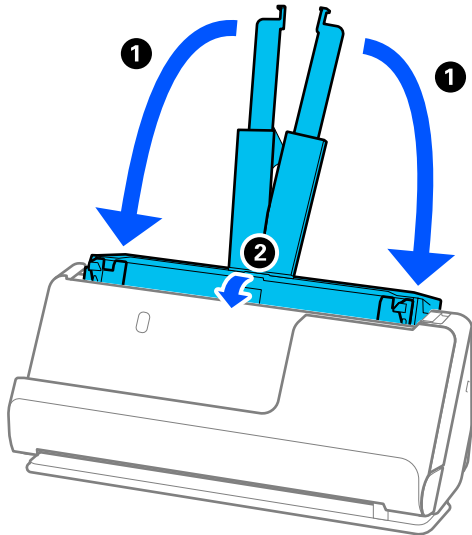

5. Set the scanner in the vertical path position.

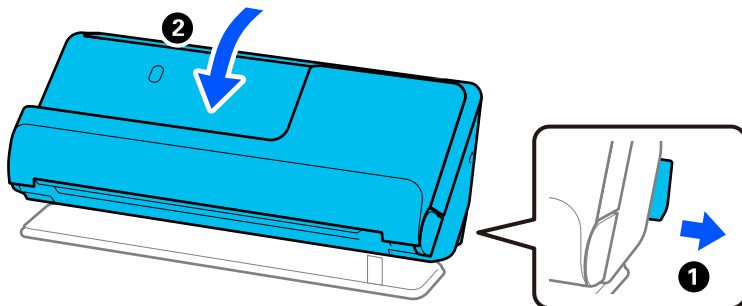

6. Attach the protective materials that came with the scanner, and then repack it in its original box or a similar sturdy box.

## How to Carry the Scanner

When carrying the scanner, hold it as shown in the following figure.

### When carrying with one hand

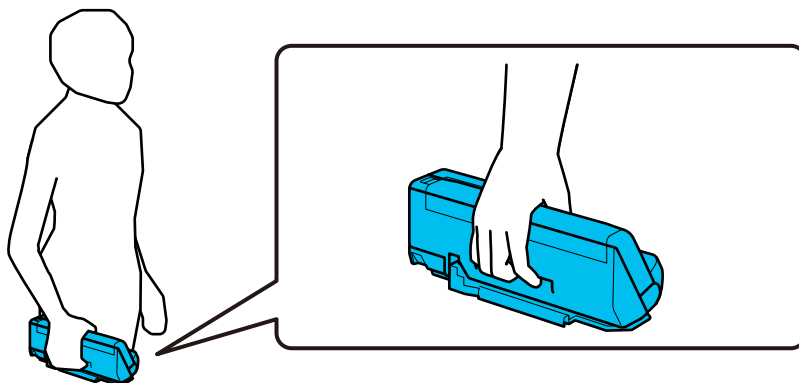

### When carrying with both hands

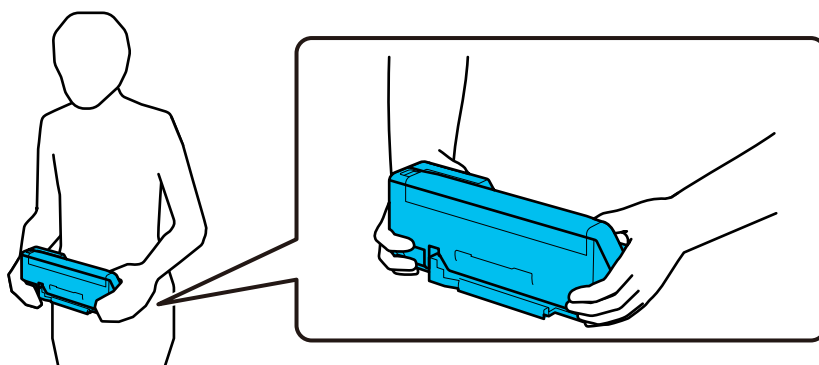

**Note:**

When carrying the scanner, disconnect all cables, stow the tray support, and place the scanner in the vertical path position.

[“Transporting the Scanner” on page 128](#)

---

## Updating Applications and Firmware

You may be able to clear certain problems and improve or add functions by updating the applications and the firmware. Make sure you use the latest version of the applications and firmware.

**! Important:**

- ❑ Do not turn off the computer or the scanner while updating.

**Note:**

When the scanner can connect to the Internet, you can update the firmware from Web Config. Select the **Device Management** tab > **Firmware Update**, check the displayed message, and then click **Start**.

1. Make sure that the scanner and the computer are connected, and the computer is connected to the internet.
2. Start EPSON Software Updater, and update the applications or the firmware.
  - ❑ Windows 11  
Click the start button, and then select **All apps > Epson Software > EPSON Software Updater**.

Windows 10

Click the start button, and then select **Epson Software > EPSON Software Updater**.

Windows 8.1/Windows 8

Enter the application name in the search charm, and then select the displayed icon.

Windows 7

Click the start button, and then select **All Programs** or **Programs > Epson Software > EPSON Software Updater**.

Mac OS

Select **Finder > Go > Applications > Epson Software > EPSON Software Updater**.

**Note:**

If you cannot find the application you want to update in the list, you cannot update using the EPSON Software Updater. Check for the latest versions of the applications on your local Epson website.

<http://www.epson.com>

## Updating Firmware Using Web Config

When the scanner can connect to the Internet, you can update the firmware from Web Config.

1. Access Web Config and select the **Device Management** tab > **Firmware Update**.
2. Click **Start**, and then follow the on-screen instructions.

The firmware confirmation starts, and the firmware information is displayed if the updated firmware exists.

**Note:**

You can also update the firmware using Epson Device Admin. You can visually confirm the firmware information on the device list. It is useful when you want to update multiple devices' firmware. See the Epson Device Admin guide or help for more details.

### Related Information

➔ [“Application for Configuring Scanner Operations \(Web Config\)” on page 30](#)

## Updating Firmware without Connecting to the Internet

You can download the device's firmware from Epson website on the computer, and then connect the device and the computer by USB cable to update the firmware. If you cannot update over the network, try this method.

**Note:**

Before updating, make sure that the scanner driver Epson Scan 2 is installed on your computer. If Epson Scan 2 is not installed, install it again.

1. Check the Epson website for the latest firmware update releases.

<http://www.epson.com>

- If there is the firmware for your scanner, download it and go to the next step.
- If there is no firmware information on the website, you are already using the latest firmware.

2. Connect the computer that contains the downloaded firmware to the scanner by USB cable.

3. Double-click the downloaded .exe file.  
Epson Firmware Updater starts.
4. Follow the on-screen instructions.

---

# Solving Problems

Problems with the Scanner. . . . .	134
Problems when Preparing Network Scanning. . . . .	135
Problems Starting Scanning. . . . .	137
Paper Feeding Problems. . . . .	143
Scanned Image Problems. . . . .	153
Uninstalling and Installing Applications. . . . .	158

## Problems with the Scanner

### Scanner Lights Indicate an Error

Check the following if the scanner lights indicate an error.

- Make sure there are no originals jammed in the scanner.
- If multiple originals are fed, open the scanner cover and remove the originals. Next, close the scanner cover.
- This product uses two different positions for scanning, depending on the original being scanned. Check the link to see which position is appropriate for your original.  
[“Combinations of Originals and Scanner Position” on page 46](#)
- Make sure the scanner cover is closed.
- Make sure the scanner is connected to your computer properly.  
If a Wi-Fi connection error has occurred, check the Wi-Fi connection settings.
- Make sure Epson Scan 2 is installed correctly.
- If the firmware update fails and the scanner enters recovery mode, update the firmware again using a USB connection.
- Restart the scanner. If the problem is not solved, the product may be malfunctioning. Also, the light source in the scanner unit may need to be replaced. Contact your dealer.

#### Related Information

- ➔ [“Error Indicators” on page 27](#)
- ➔ [“Paper Jams, Paper Feed Errors, and Document Protection Issues Occur Frequently” on page 151](#)

### The Scanner Does Not Turn On

- Make sure the AC adapter is securely connected to the scanner and an electrical outlet.
- Check that the electrical outlet is working. Plug another device into the electrical outlet and check that you can turn the power on.

### Forgot Your Administrator's Password

By resetting the network settings, you can restore the administrator password to its original setting at the time of purchase.

#### Related Information

- ➔ [“Initial Administrator Password” on page 12](#)
- ➔ [“Initializing the Network Settings from the Control Panel” on page 167](#)

## Problems when Preparing Network Scanning

### Hints to Solving Problems

Checking the error message

When trouble has occurred, first check whether there are any messages on the driver screen. If you have the notification email set when the events occur, you can promptly learn the status.

Checking the communication status

Check the communication status of server computer or client computer by using the command such as ping and ipconfig.

Connection test

For checking the connection between the scanner to the mail server, perform the connection test from the scanner. Also, check the connection from the client computer to the server to check the communication status.

Initializing the settings

If the settings and communication status show no problem, the problems may be solved by disabling or initializing the network settings of the scanner, and then setting up again.

### Related Information

➔ [“Error Indicators” on page 27](#)

➔ [“Receiving Email Notifications When Events Occur” on page 175](#)

### Cannot Access Web Config

#### ■ The IP address is not assigned to the scanner.

##### Solutions

A valid IP address may not be assigned to the scanner. Set a valid IP address using Epson Scan 2 Utility. You can confirm the current setting information from Epson Scan 2 Utility.

➔ [“Checking the Scanner's IP Address” on page 101](#)

#### ■ Web browser does not support the Encryption Strength for SSL/TLS.

##### Solutions

SSL/TLS has the Encryption Strength. You can open Web Config by using a web browser that supports bulk encryptions as indicated below. Check you are using the a supported browser.

80bit: AES256/AES128/3DES

112bit: AES256/AES128/3DES

128bit: AES256/AES128

192bit: AES256

256bit: AES256

### ■ CA-signed Certificate is expired.

#### Solutions

If there is a problem with the expiration date of the certificate, "The certificate has expired" is displayed when connecting to Web Config with SSL/TLS communication (https). If the message appears before its expiration date, make sure that the scanner's date is configured correctly.

### ■ The common name of the certificate and the scanner do not match.

#### Solutions

If the common name of the certificate and the scanner do not match, the message "The name of the security certificate does not match..." is displayed when accessing Web Config using SSL/TLS communication (https). This happens because the following IP addresses do not match.

- The scanner's IP address entered to common name for creating a Self-signed Certificate or CSR
- IP address entered to web browser when running Web Config

For Self-signed Certificate, update the certificate.

For CA-signed Certificate, take the certificate again for the scanner.

### ■ The proxy server setting of local address is not set to web browser.

#### Solutions

When the scanner is set to use a proxy server, configure the web browser not to connect to the local address via the proxy server.

- Windows:

Select **Control Panel > Network and Internet > Internet Options > Connections > LAN settings > Proxy server**, and then configure not to use the proxy server for LAN (local addresses).

- Mac OS:

Select **System Preferences > Network > Advanced > Proxies**, and then register the local address for **Bypass proxy settings for these Hosts & Domains**.

Example:

192.168.1.\*: Local address 192.168.1.XXX, subnet mask 255.255.255.0

192.168.\*.\*: Local address 192.168.XXX.XXX, subnet mask 255.255.0.0

### ■ DHCP is disabled in the computer's settings.

#### Solutions

If the DHCP for obtaining an IP address automatically is disabled on the computer, you may not be able to access Web Config. Enable DHCP.

Example for Windows 10:

Open the Control Panel and then click **Network and Internet > Network and Sharing Center > Change adapter settings**. Open the Properties screen of the connection you are using, and then open the properties screen for **Internet Protocol Version 4 (TCP/IPv4)** or **Internet Protocol Version 6 (TCP/IPv6)**. Check that **Obtain an IP address automatically** is selected on the displayed screen.



## Problems Starting Scanning

### Cannot Start Scanning from Computer

Make sure the computer and the scanner are connected correctly.

The cause and solution to the problem differ depending on whether or not they are connected.

#### Checking the Connection Status (Windows)

Use the Epson Scan 2 Utility to check the connection status.

**Note:**

*Epson Scan 2 Utility is an application supplied with the scanner software.*

1. Start the Epson Scan 2 Utility.
  - Windows 11  
Click the start button, and then select **All apps > EPSON > Epson Scan 2 Utility**.
  - Windows 10  
Click the start button, and then select **EPSON > Epson Scan 2 Utility**.
  - Windows 8.1/Windows 8  
Enter the application name in the search charm, and then select the displayed icon.
  - Windows 7  
Click the start button, and then select **All Programs or Programs > EPSON > Epson Scan 2 > Epson Scan 2 Utility**.
2. On the **Epson Scan 2 Utility** screen, open the **Scanner** list, and then click **Settings** to open the **Scanner Settings** screen.  
If the **Scanner Settings** screen is already displayed instead of the **Epson Scan 2 Utility** screen, go to the next.
3. If the scanner is not displayed on the **Scanner Settings** screen, your scanner is not detected.  
Click **Add**, and then add your scanner on the **Add Network Scanner** screen.

If you cannot search for the scanner or cannot scan even if the correct scanner is selected, see the related information.

#### Related Information



- ➔ [“Cannot connect to a Network” on page 138](#)
- ➔ [“The Scanner Cannot Connect by USB” on page 140](#)
- ➔ [“Cannot Scan Even Though a Connection has been Correctly Established” on page 140](#)

#### Checking the Connection Status (Mac OS)

Use Epson Scan 2 Utility to check the connection status.

**Note:**

*Epson Scan 2 Utility is an application supplied with the scanner software.*

1. Start the Epson Scan 2 Utility.  
Select **Go > Applications > Epson Software > Epson Scan 2 Utility**.
2. On the **Epson Scan 2 Utility** screen, open the **Scanner** list, and then click **Settings** to open the **Scanner Settings** screen.  
If the **Scanner Settings** screen is already displayed instead of the **Epson Scan 2 Utility** screen, go to the next
3. If the scanner is not displayed on the **Scanner Settings** screen, your scanner is not detected.  
Click the  icon, and then allow the software to make changes.
4. Click the  icon, and then add your scanner on the **Add Network Scanner** screen.

If you cannot search for the scanner or cannot scan even if the correct scanner is selected, see the related information.

**Related Information**

- ➔ [“Cannot connect to a Network” on page 138](#)
- ➔ [“The Scanner Cannot Connect by USB” on page 140](#)
- ➔ [“Cannot Scan Even Though a Connection has been Correctly Established” on page 140](#)

**Cannot connect to a Network**

The problem could be one of the following issues.

■ **Something is wrong with the network devices for Wi-Fi connection.**

**Solutions**

Turn off the devices you want to connect to the network. Wait for about 10 seconds, and then turn on the devices in the following order; wireless router, computer or smart device, and then scanner. Move the scanner and computer or smart device closer to the wireless router to help with radio wave communication, and then try to make network settings again.

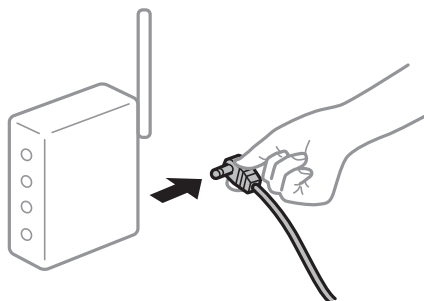

■ **Devices cannot receive signals from the wireless router because they are too far apart.**

**Solutions**

After moving the computer or the smart device and the scanner closer to the wireless router, turn off the wireless router, and then turn it back on.

**When changing the wireless router, the settings do not match the new router.**

**Solutions**

Make the connection settings again so that they match the new wireless router.

➔ [“When Replacing the Wireless Router” on page 163](#)

**The SSIDs connected from the computer or smart device and computer are different.**

**Solutions**

When you are using multiple wireless routers at the same time or the wireless router has multiple SSIDs and devices are connected to different SSIDs, you cannot connect to the wireless router.

Connect the computer or smart device to the same SSID as the scanner.

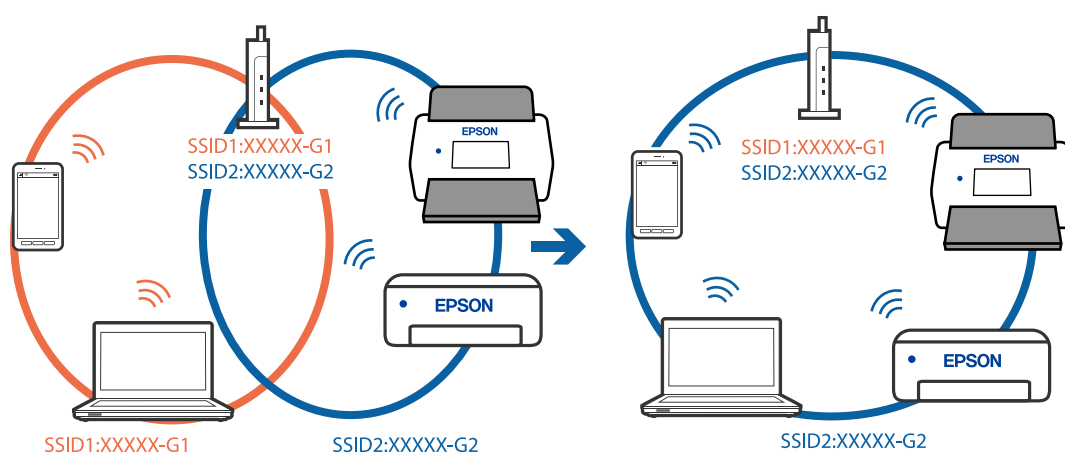

**A privacy separator on the wireless router is available.**

**Solutions**

Most wireless routers have a privacy separator feature that blocks communication between connected devices. If you cannot communicate between the scanner and the computer or smart device even if they are connected to the same network, disable the privacy separator on the wireless router. See the manual provided with the wireless router for details.

**The IP address is incorrectly assigned.**

**Solutions**

If the IP address assigned to the scanner is 169.254.XXX.XXX, and the subnet mask is 255.255.0.0, the IP address may not be assigned correctly.

Click **Add** on the **Scanner Settings** screen in Epson Scan 2 Utility. Select the model you are using, enter the IP address, and then click **OK**.

Restart the wireless router or reset the network settings for the scanner.

➔ [“Re-setting the Network Connection” on page 163](#)

**There is a problem with the network settings on the computer.**

**Solutions**

Try accessing any website from your computer to make sure that your computer's network settings are correct. If you cannot access any website, there is a problem on the computer.

Check the network connection of the computer. See the documentation provided with the computer for details.

■ **The scanner is off.**

**Solutions**

Make sure the scanner is turned on.

Also, wait until the status light stops flashing indicating that the scanner is ready to scan.

## **The Scanner Cannot Connect by USB**

The following causes can be considered.

■ **The USB cable is not plugged into the electrical outlet correctly.**

**Solutions**

Connect the USB cable securely to the scanner and the computer.

■ **There is a problem with the USB hub.**

**Solutions**

If you are using a USB hub, try to connect the scanner directly to the computer.

■ **There is a problem with the USB cable or the USB inlet.**

**Solutions**

If the USB cable cannot be recognized, change the port, or change the USB cable.

■ **The scanner is off.**

**Solutions**

Make sure the scanner is turned on.

Also, wait until the status light stops flashing indicating that the scanner is ready to scan.

## **Cannot Scan Even Though a Connection has been Correctly Established**

■ **Required applications are not installed on your computer.**

**Solutions**

Make sure the application Epson ScanSmart is installed.

If Epson ScanSmart is not installed, install it again.

➔ [“Installing Your Applications” on page 159](#)

■ **If you are using any TWAIN-compliant programs, the correct scanner is not selected as the source setting. (Windows)**

**Solutions**

Make sure that you select the correct scanner from your programs list.

## ■ Network Scanning Settings are Disabled

### Solutions

In Web Config, select the **Scan** tab > **Network Scan**, and then select **Enable scanning** in **EPSON Scan**.

## ■ AirPrint is disabled.

### Solutions

Enable the AirPrint setting in Web Config.

## Cannot Start Scanning from Smart Device

Make sure the smart device and the scanner are connected correctly.

The cause and solution to the problem differ depending on whether or not they are connected.

## Checking the Connection Status (Smart Device)

You can use Epson Smart Panel to check the connection status for the smart device and the scanner.

1. Start Epson Smart Panel on your smart device.
2. Check whether or not the scanner name is displayed in Epson Smart Panel.

If the scanner name is displayed, a connection has been successfully established between the smart device and the scanner.

If a message is displayed saying that the scanner is not selected, a connection has not been established between the smart device and the scanner. Follow the instructions on the Epson Smart Panel to connect to the scanner.

If you cannot connect to the scanner over a network, check the Related Information.

### Related Information

➔ [“Cannot connect to a Network” on page 141](#)

## Cannot connect to a Network

The problem could be one of the following issues.

## ■ Something is wrong with the network devices for Wi-Fi connection.

### Solutions

Turn off the devices you want to connect to the network. Wait for about 10 seconds, and then turn on the devices in the following order; wireless router, computer or smart device, and then scanner. Move the

scanner and computer or smart device closer to the wireless router to help with radio wave communication, and then try to make network settings again.

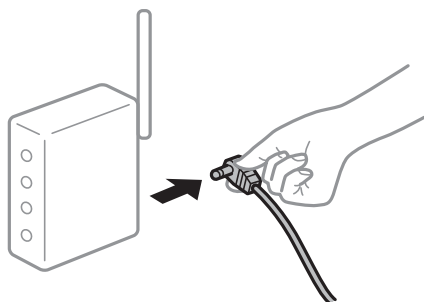

**Devices cannot receive signals from the wireless router because they are too far apart.**

**Solutions**

After moving the computer or the smart device and the scanner closer to the wireless router, turn off the wireless router, and then turn it back on.

**When changing the wireless router, the settings do not match the new router.**

**Solutions**

Make the connection settings again so that they match the new wireless router.

➔ [“When Replacing the Wireless Router” on page 163](#)

**The SSIDs connected from the computer or smart device and computer are different.**

**Solutions**

When you are using multiple wireless routers at the same time or the wireless router has multiple SSIDs and devices are connected to different SSIDs, you cannot connect to the wireless router.

Connect the computer or smart device to the same SSID as the scanner.

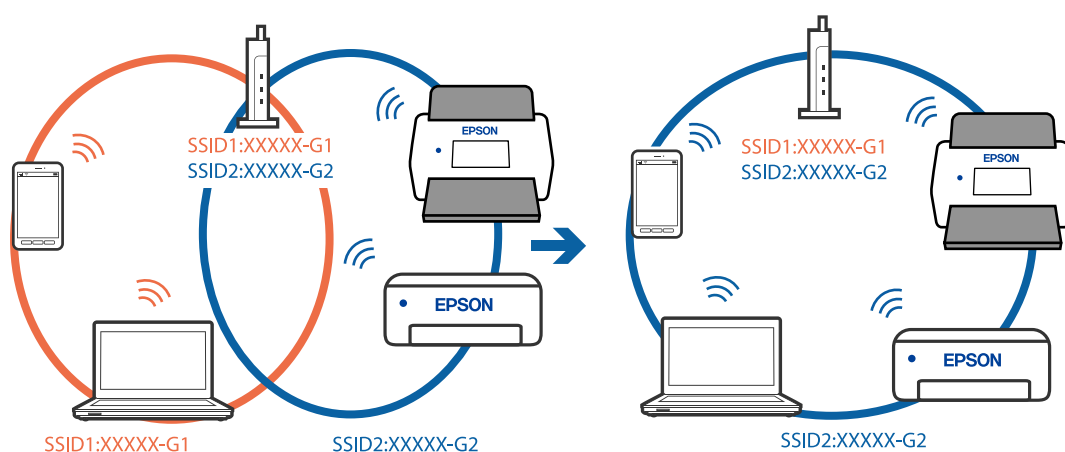

**A privacy separator on the wireless router is available.**

**Solutions**

Most wireless routers have a privacy separator feature that blocks communication between connected devices. If you cannot communicate between the scanner and the computer or smart device even if they

are connected to the same network, disable the privacy separator on the wireless router. See the manual provided with the wireless router for details.

### ■ **The IP address is incorrectly assigned.**

#### **Solutions**

If the IP address assigned to the scanner is 169.254.XXX.XXX, and the subnet mask is 255.255.0.0, the IP address may not be assigned correctly.

Click **Add** on the **Scanner Settings** screen in Epson Scan 2 Utility. Select the model you are using, enter the IP address, and then click **OK**.

Restart the wireless router or reset the network settings for the scanner.

➔ [“Re-setting the Network Connection” on page 163](#)

### ■ **There is a problem with the network settings on the smart device.**

#### **Solutions**

Try accessing any website from your smart device to make sure that your smart device's network settings are correct. If you cannot access any website, there is a problem on the smart device.

Check the network connection of the computer. See the documentation provided with the smart device for details.

### ■ **The scanner is off.**

#### **Solutions**

Make sure the scanner is turned on.

Also, wait until the status light stops flashing indicating that the scanner is ready to scan.

---

## **Paper Feeding Problems**

### **Multiple Originals Are Fed (Double Feed)**

Check the following when a double feed occurs.

- If the jammed original is inside the scanner, open the scanner cover or vertical path cover and remove the original.
- Check the scanned image, and then scan the originals again if necessary.

Make sure the scanner is in the correct scanner position for the original.

- This product uses two different positions for scanning, depending on the original being scanned. Check the link to see which position is appropriate for your original.

[“Combinations of Originals and Scanner Position” on page 46](#)

- ❑ When scanning multiple standard-size originals, scan in the vertical path position.

If the scanner is in the straight path position, pull the lever to tilt the scanner forward to place it in the vertical path position.

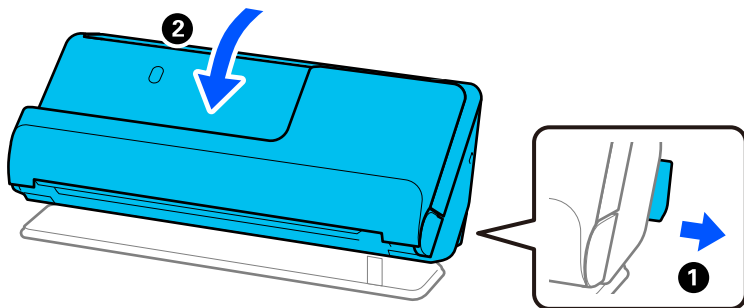

- ❑ When scanning in the straight path position, load only one original at a time.

If the scanner is in the vertical path position, pull the lever to tilt the scanner backward to the straight path position.

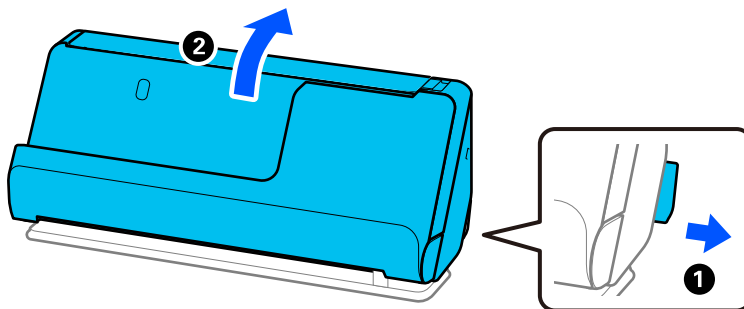

If multiple originals are fed frequently, try the following.

- ❑ If you load unsupported originals, the scanner may feed multiple originals at a time.
- ❑ Reduce the number of originals being placed at a time.
- ❑ Use **Automatic Feeding Mode**, and scan originals one by one.

When you are using Epson ScanSmart, you can open the Epson Scan 2 screen by clicking the **Settings** button > **Scanner Settings** tab > **Scan Settings**.

- ❑ Clean the rollers inside the scanner.

[“Cleaning Inside the Scanner” on page 109](#)

- ❑ Check the number of sheets scanned by the pickup roller. If the number of scans exceeds the pickup roller's service life (50,000 sheets), replace the roller assembly kit with a new one.

Even if the number of scans does not exceed the pickup roller's service life, we recommend replacing the roller assembly kit with a new one if the surface of the roller is worn out.

[“Replacing the Roller Assembly Kit” on page 119](#)

**Note:**

You can check the number of sheets scanned by the pickup roller in the Epson Scan 2 Utility. Start the Epson Scan 2 Utility, click on the **Counter** tab, and then check the **Number of Scans in Roller Assembly Kit**.

**Related Information**

➔ [“Scanning in Automatic Feeding Mode” on page 93](#)



- ➔ [“Cleaning Inside the Scanner” on page 109](#)
- ➔ [“Removing Jammed Originals from the Scanner” on page 145](#)

## Removing Jammed Originals from the Scanner

If an original is jammed in the scanner, clear the jam according to the procedure for the scanner position.

**Note:**

- If you change the scanner position while scanning, the original will get jammed. Do not change the scanner position while scanning.*
- Epson Smart Panel does not support scanning for long paper (393.7 mm (15.5 in.) or more).*

### Related Information

- ➔ [“Multiple Originals Are Fed \(Double Feed\)” on page 143](#)
- ➔ [“Paper Jams, Paper Feed Errors, and Document Protection Issues Occur Frequently” on page 151](#)
- ➔ [“Paper Protection Does not Work Correctly” on page 152](#)

### For the Vertical Path Position

1. Remove all originals remaining in the input tray.
2. Open the vertical path cover.

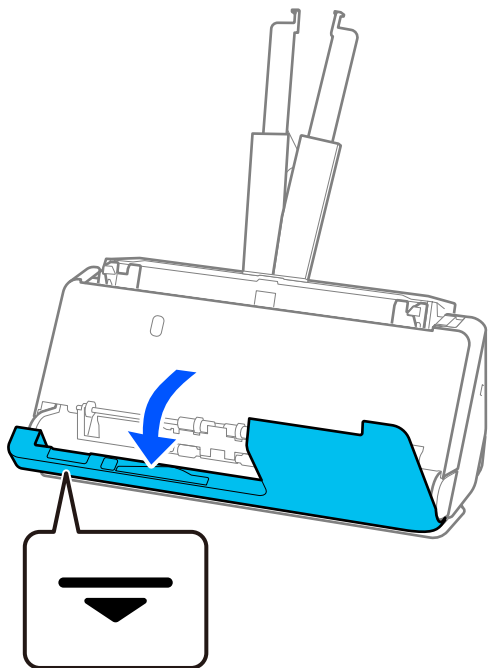

3. Pull the lever to open the scanner cover.

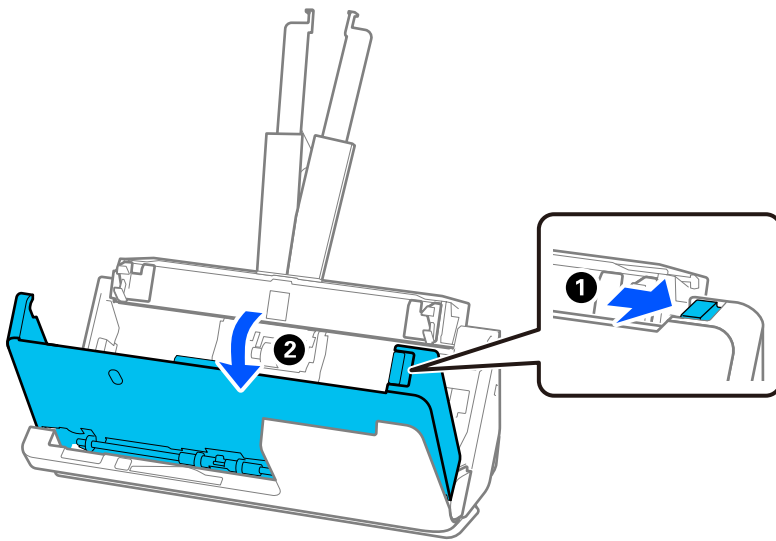

4. Carefully remove any jammed originals.

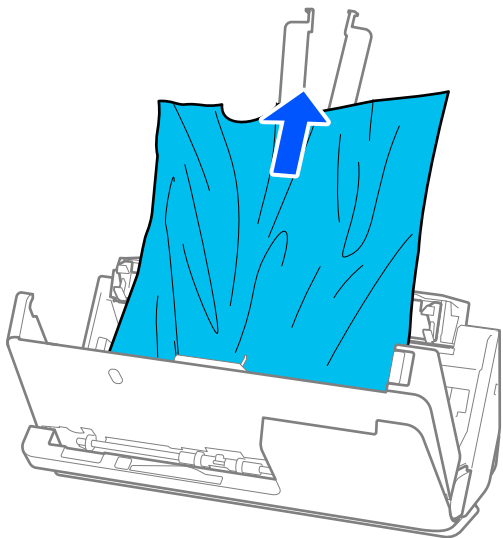

5. If you cannot pull originals straight up, carefully pull out any jammed originals from the output tray in the direction of the arrow.

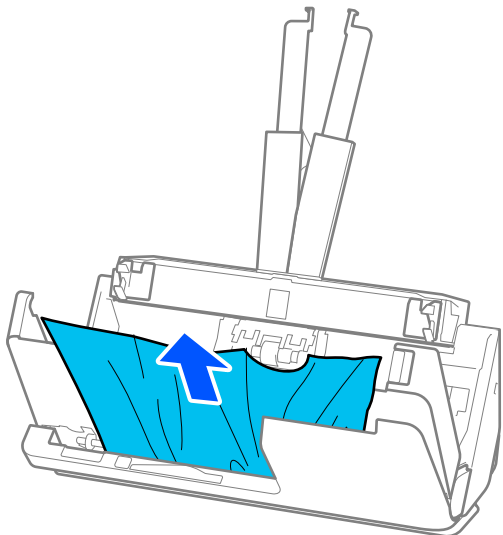

**Important:**

*Make sure there is no paper inside the scanner.*

6. Close the scanner cover with both hands. Next, close the vertical path cover.

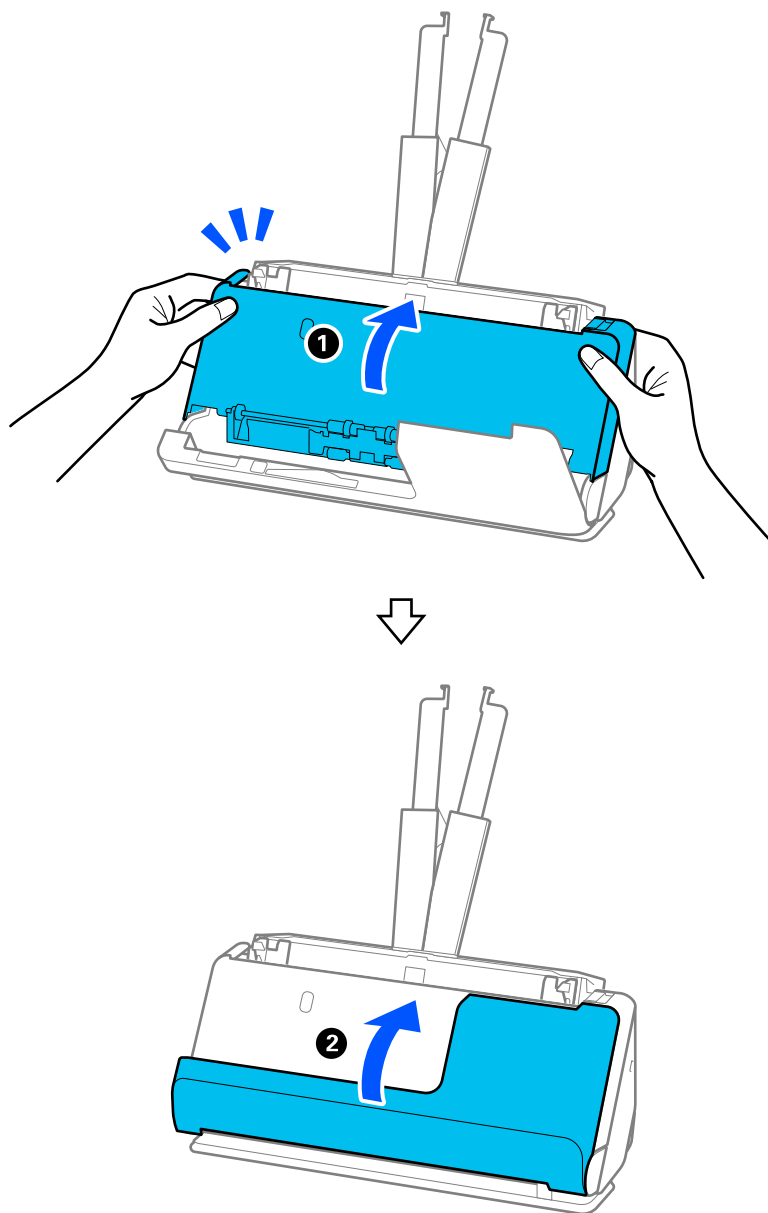

**Important:**

*Before restarting scanning, make sure that the scanner is stationary. If the scanner is not stationary, it could cause the original to jam.*

## For the Straight Path Position

1. Remove all originals remaining in the input tray.

2. Pull the lever to open the scanner cover.

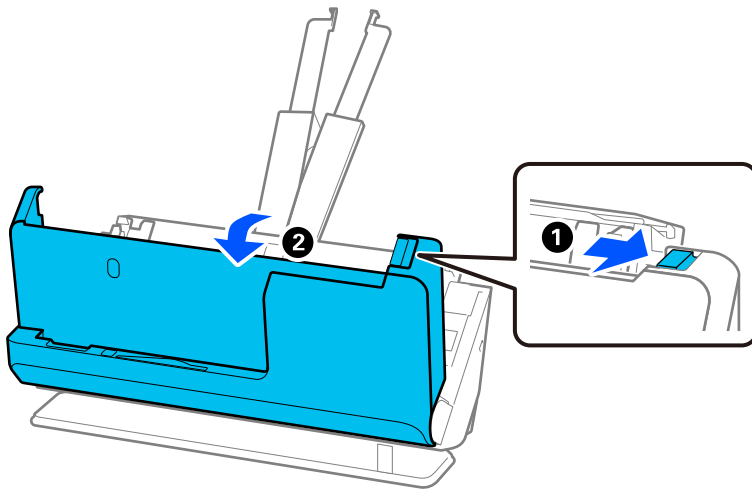

3. Carefully remove any jammed originals.

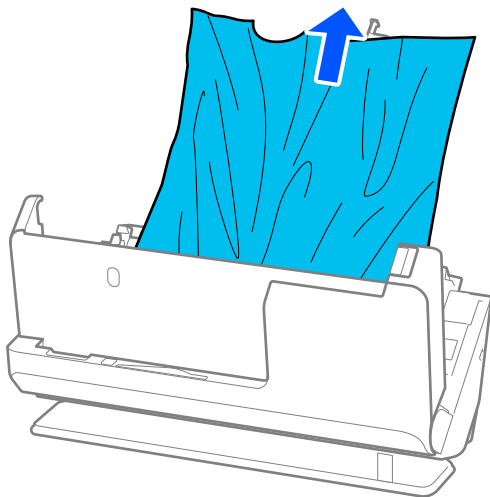

4. If you cannot pull originals straight up, carefully pull out any jammed originals from the output slot in the direction of the arrow.

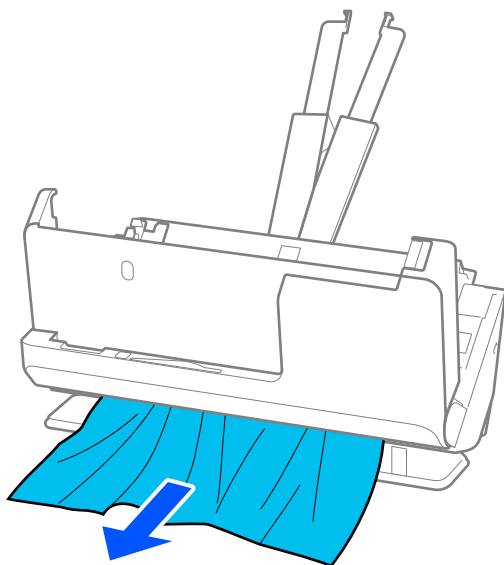

**Important:**

*Make sure there is no paper inside the scanner.*

5. Close the scanner cover with both hands.

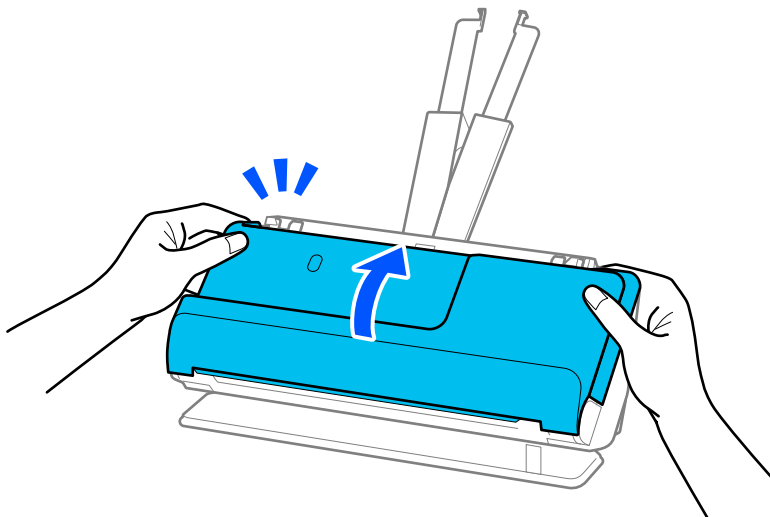

**Important:**

*Before restarting scanning, make sure that the scanner is stationary. If the scanner is not stationary, it could cause the original to jam.*

## Paper Jams, Paper Feed Errors, and Document Protection Issues Occur Frequently

If the following problems occur, check the original and the status of the scanner.

- Originals jam frequently
- Paper feed errors occur frequently
- Document protection issues occur frequently

### Points to check when loading originals

- For originals with folds or that are curled, flatten the original before loading.
- When loading originals with a mixture of different sizes, load the originals with the side to be scanned facing up and in descending order of paper size with the widest at the back and the narrowest at the center of the input tray. Next, slide the edge guides to align them with the widest originals.

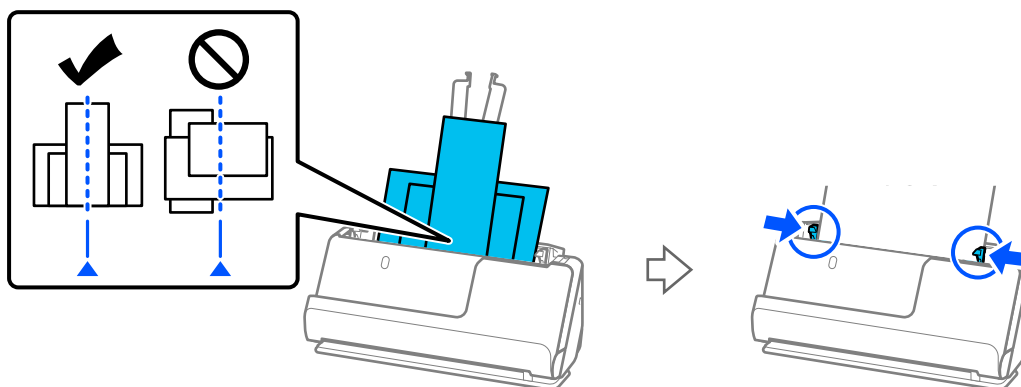

[“Loading Batches of Originals with Different Paper Types and Sizes” on page 83](#)

If the problem is not solved, try scanning the originals at each size separately, or scan the originals one by one. Align the edge guides to the width of the originals each time you load them.

### Note:

You can use the following methods to scan the originals multiple times separately and then save them to one file.

- You can use scanner software.  
See the *Epson ScanSmart* help for details on adding or editing the scanned pages after scanning in *Epson ScanSmart*.
- When you are using *Epson Smart Panel*, load the next original, and then tap **+Scan** after scanning the first page to display the *Edit* screen. You can rotate, move, and delete pages on the *Edit* screen.
- After scanning, remove the original from the output tray or the output slot.

### Points to check on the scanner

- Clean the rollers inside the scanner.  
[“Cleaning Inside the Scanner” on page 109](#)
- Check the number of sheets scanned by the pickup roller. If the number of scans exceeds the pickup roller's service life (50,000 sheets), replace the roller assembly kit with a new one.  
Even if the number of scans does not exceed the pickup roller's service life, we recommend replacing the roller assembly kit with a new one if the surface of the roller is worn out.

[“Replacing the Roller Assembly Kit” on page 119](#)

**Note:**

You can check the number of sheets scanned by the pickup roller in the Epson Scan 2 Utility. Start the Epson Scan 2 Utility, click on the **Counter** tab, and then check the **Number of Scans in Roller Assembly Kit**.

**Related Information**

- ➔ [“Types of Originals that Require Attention” on page 44](#)
- ➔ [“Loading Batches of Originals with Different Paper Types and Sizes” on page 83](#)
- ➔ [“Cleaning Inside the Scanner” on page 109](#)
- ➔ [“Multiple Originals Are Fed \(Double Feed\)” on page 143](#)
- ➔ [“Paper Protection Does not Work Correctly” on page 152](#)

## Paper Protection Does not Work Correctly

Depending on the original and the level you set, this feature may not work correctly.

- If false positives occur frequently, try lowering the level.
- If your original is damaged, check that this feature is enabled. If it is already enabled, increase the level of protection for the feature.

**Related Information**

- ➔ [“Removing Jammed Originals from the Scanner” on page 145](#)

## The Originals Get Dirty

Clean the inside of the scanner.

**Related Information**

- ➔ [“Cleaning Inside the Scanner” on page 109](#)

## Scanning Speed Slows Down when Scanning Continuously

When scanning continuously using the ADF, scanning slows down to prevent the scanner mechanism from overheating and being damaged. However, you can continue scanning.

To regain normal scanning speed, leave the scanner idle for at least 30 minutes. Scanning speed does not recover even if the power is off.

## Scanning Takes a Long Time

- The scanning speed may slow down depending on the scanning conditions, such as high resolution, image adjustment features, file format, communication mode, and so on.
- Computers with USB 3.0 (SuperSpeed) or USB 2.0 (Hi-Speed) ports can scan faster than those with USB 1.1 ports. If you are using a USB 3.0 or USB 2.0 port with the scanner, make sure it meets the system requirements.



- When using security software, exclude the TWAIN.log file from monitoring, or set the TWAIN.log as a read-only file. For more information on your security software's functions, see the help and so on supplied with the software. The TWAIN.log file is saved in the following locations.

C:\Users\user name\AppData\Local\Temp

---

## Scanned Image Problems

### Lines (Streaks) Appear when Scanning from ADF

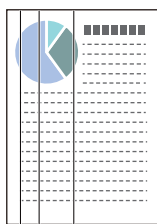

- Clean the ADF.

Straight lines (streaks) may appear in the image when debris or dirt gets into the ADF.

- Remove any debris or dirt that adheres to the original.

- Using **Glass Dirt Detection** feature, a notification is displayed when dirt is detected on the scanner glass inside the scanner.

Select **Scanner Setting** tab and then select **On-High** or **On-Low** from **Detect Glass Dirt** in Epson Scan 2 Utility .

When an alert is displayed, clean the glass surfaces inside your scanner using a genuine Epson cleaning kit or a soft cloth.

[“Cleaning Inside the Scanner” on page 109](#)

**Note:**

- Some stains may not be detected correctly.*

- If the detection does not work correctly, change the setting.*

*If no stains are detected, select **On-High**. If stains are detected incorrectly, select **On-Low** or **Off**.*

#### Related Information

➔ [“Cleaning Inside the Scanner” on page 109](#)

➔ [“Setting the Glass Surface Stain Detection Feature” on page 104](#)

### Alert About Stains Inside the Scanner Still Appears

If the alert screen appears after cleaning the inside of the scanner, glass part will be required to replace. Contact your local dealer to repair.

#### Related Information

➔ [“Cleaning Inside the Scanner” on page 109](#)

## Colors Are Uneven in the Scanned Image

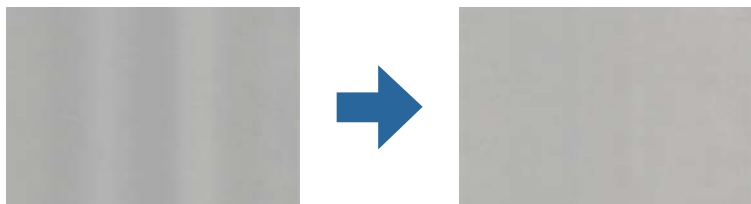

If the scanner is subject to strong light such as direct sunlight, the sensor inside the scanner misdetects the light and colors in the scanned image become uneven.

- Change the orientation of the scanner so that no strong light is falling on the front of the scanner.
- Move the scanner to a location where it will not be subjected to strong light.

## Expanding or Contracting the Scanned Image

When expanding or contracting the scanned image, you can adjust the expansion ratio by using the **Adjustments** feature in Epson Scan 2 Utility. This feature is only available for Windows.

**Note:**

*Epson Scan 2 Utility is one of the applications supplied with the scanner software.*

1. Start Epson Scan 2 Utility.
  - Windows 11  
Click the start button, and then select **All apps > EPSON > Epson Scan 2 Utility**.
  - Windows 10  
Click the start button, and then select **EPSON > Epson Scan 2 Utility**.
  - Windows 8.1/Windows 8  
Enter the application name in the search charm, and then select the displayed icon.
  - Windows 7  
Click the start button, and then select **All Programs or Programs > EPSON > Epson Scan 2 > Epson Scan 2 Utility**.
2. Select the **Adjustments** tab.
3. Use **Expansion/Contraction** to adjust the expansion ratio for scanned images.
4. Click **Set** to apply the settings to the scanner.

## An Image on the Back of Your Original Appears in Your Scanned Image

Images on the back of the original may appear in the scanned image.

- If **Auto**, **Color**, or **Grayscale** is selected as the **Image Type**:

- Check that **Remove Background** is selected.

Epson ScanSmart: On the **Epson ScanSmart**, **Review Scans**, or **Select Action** screen, click  **Settings** > **Scanner Settings** tab > **Scan Settings** button, select the **Advanced Settings** tab on the Epson Scan 2 screen displayed, and then enable **Remove Background**.

- Check that **Text Enhancement** is selected.

Epson ScanSmart: On the **Epson ScanSmart**, **Review Scans**, or **Select Action** screen, click  **Settings** > **Scanner Settings** tab > **Scan Settings** button, select the **Advanced Settings** tab on the Epson Scan 2 screen displayed, and then enable **Text Enhancement**.

- When **Black & White** is selected as the **Image Type**

- Check that **Text Enhancement** is selected.

Epson ScanSmart: On the **Epson ScanSmart**, **Review Scans**, or **Select Action** screen, click  **Settings** > **Scanner Settings** tab > **Scan Settings** button, select the **Advanced Settings** tab on the Epson Scan 2 screen displayed, and then enable **Text Enhancement**.

Depending on the condition of your scanned image, click **Settings**, and then move the slider towards **Remove background**.

## Scanned Text or Images are Missing or Blurred

You can adjust the appearance of the scanned image or text by increasing the resolution or adjusting the image quality.

- Change the resolution, and then scan again.

Set the appropriate resolution for the purpose of your scanned image.

Epson ScanSmart: On the **Epson ScanSmart**, **Review Scans**, or **Select Action** screen, click  **Settings** > **Scanner Settings** tab > **Scan Settings** button, select the **Main Settings** tab on the Epson Scan 2 screen displayed, and then set the **Resolution**.

- Check that **Text Enhancement** is selected.

Epson ScanSmart: On the **Epson ScanSmart**, **Review Scans**, or **Select Action** screen, click  **Settings** > **Scanner Settings** tab > **Scan Settings** button, select the **Advanced Settings** tab on the Epson Scan 2 screen displayed, and then enable **Text Enhancement**.

When you select **Black & White** as the **Image Type**, depending on the condition of the scanned image, click **Settings** and adjust the slider for **Emphasize light letters / Remove background**, turn off **Remove spot noise**, or set the level to **Low**.

- If you are scanning in JPEG format, try changing the compression level.

Epson ScanSmart: On the **Epson ScanSmart**, **Review Scans**, or **Select Action** screen, click  **Settings**, and then click the **Save Settings** tab > **Options** button.

## Moiré Patterns (Web-Like Shadows) Appear

If the original is a printed document, moiré patterns (web-like shadows) may appear in the scanned image.

- Check that **Descreening** is selected.

Click  **Settings** in **Epson ScanSmart, Review Scans** or on the **Select Action** window, and then click the **Scanner Settings** tab > **Scan Settings** button > **Advanced Settings** tab on the Epson Scan 2 window > **Descreening**.



- Change the resolution, and then scan again.

Click  **Settings** in **Epson ScanSmart, Review Scans** or on the **Select Action** window, and then click the **Scanner Settings** tab > **Scan Settings** button > **Main Settings** tab on the Epson Scan 2 window > **Resolution**.

## The Edge of the Original is Not Scanned when Automatically Detecting the Size of the Original

Depending on the original, the edge of the original may not be scanned when automatically detecting the size of the original.

- Click  **Settings** in **Epson ScanSmart, Review Scans** or on the **Select Action** window, and then click the **Scanner Settings** tab > **Scan Settings** button.

In Epson Scan 2, select the **Main Settings** tab, and then select **Document Size** > **Settings**. On the **Document Size Settings** window, adjust **Crop Margins for Size "Auto"**.

- Depending on the original, the area of the original may not be detected correctly when using the **Auto Detect** feature. Select the appropriate size of the original from the **Document Size** list.

Click  **Settings** in **Epson ScanSmart, Review Scans** or on the **Select Action** window, and then click the **Scanner Settings** tab > **Scan Settings** button.

In Epson Scan 2, click the **Main Settings** tab, and then click **Document Size**.

### **Note:**

*If the size of the original you want to scan is not on the list, select **Customize**, and then create the size manually.*

Click  **Settings** in **Epson ScanSmart, Review Scans** or on the **Select Action** window, and then click the **Scanner Settings** tab > **Scan Settings** button.

*In Epson Scan 2, click the **Main Settings** tab, and then click **Customize** in **Document Size**.*

## Character is not Recognized Correctly

Check the following to increase the recognition rate of OCR (Optical Character Recognition).

- Check that the original is placed straight.

- Use an original with clear text. Text recognition may decline for the following types of originals.
  - Originals that have been copied many times
  - Originals received by fax (at low resolutions)
  - Originals with tightly spaced characters or line spacing
  - Originals with ruled lines or underlined text
  - Originals with hand-written text
  - Originals with creases or wrinkles
- Paper type made of thermal paper such as receipts may deteriorate due to age or friction. Scan them as soon as possible.
- When saving to Microsoft® Office or **Searchable PDF** files, check that the correct languages are selected. Check the **Language** on the Save Settings screen.
- If you have set **Image Type** to **Color** or **Grayscale** in Epson Scan 2, try adjusting the **Text Enhancement** setting. In Epson ScanSmart, click the **Settings** button > **Scanner Settings** tab > **Scan Settings** to open the Epson Scan 2 screen. On the Epson Scan 2 screen, click the **Advanced Settings** tab > **Text Enhancement** > **Settings**, and then select **Emphasize light letters for OCR** as the **Mode**.

**Note:**

You need the EPSON Scan OCR component to save as a **Searchable PDF**. This is installed automatically when you set up the scanner using the installer.

## Cannot Solve Problems in the Scanned Image

If you have tried all of the solutions and have not solved the problem, initialize the scanner driver (Epson Scan 2) settings using Epson Scan 2 Utility.

**Note:**

*Epson Scan 2 Utility is one of the applications supplied with the scanner software.*

1. Start Epson Scan 2 Utility.
  - Windows 11  
Click the start button, and then select **All apps > EPSON > Epson Scan 2 Utility**.
  - Windows 10  
Click the start button, and then select **EPSON > Epson Scan 2 Utility**.
  - Windows 8.1/Windows 8  
Enter the application name in the search charm, and then select the displayed icon.
  - Windows 7  
Click the start button, and then select **All Programs or Programs > EPSON > Epson Scan 2 > Epson Scan 2 Utility**.
  - Mac OS  
Select **Go > Applications > Epson Software > Epson Scan 2 Utility**.
2. Select the **Other** tab.

3. Click **Reset**.

**Note:**

*If initialization does not solve the problem, uninstall and re-install the scanner driver (Epson Scan 2).*

---

## Uninstalling and Installing Applications

### Uninstalling Your Applications

You may need to uninstall and then reinstall your applications to solve certain problems or if you upgrade your operating system. Log on to your computer as an administrator. Enter the administrator password if the computer prompts you.

#### Uninstalling Your Applications for Windows

1. Quit all running applications.
2. Disconnect the scanner from your computer.
3. Open the Control Panel:
  - Windows 11  
Click the start button, and then select **All apps > Windows Tools > Control Panel**.
  - Windows 10  
Click the start button, and then select **Windows System > Control Panel**.
  - Windows 8.1/Windows 8  
Select **Desktop > Settings > Control Panel**.
  - Windows 7  
Click the start button, and then select **Control Panel**.
4. Select **Uninstall a program** in **Programs**.
5. Select the application you want to uninstall.
6. Click **Uninstall/Change** or **Uninstall**.

**Note:**  
*If the User Account Control window is displayed, click Continue.*
7. Follow the on-screen instructions.

**Note:**  
*A message may be displayed prompting you to restart your computer. If it is displayed, make sure **I want to restart my computer now** is selected, and then click **Finish**.*

#### Uninstalling Your Applications for Mac OS

**Note:**

*Make sure you installed EPSON Software Updater.*

1. Download the Uninstaller using EPSON Software Updater.  
Once you have downloaded the Uninstaller, you do not need to download it again each time you uninstall the application.
2. Disconnect the scanner from your computer.
3. To uninstall the scanner driver, select **System Preferences** from the Apple menu > **Printers & Scanners** (or **Print & Scan, Print & Fax**), and then remove the scanner from the enabled scanner list.
4. Quit all running applications.
5. Select **Go > Applications > Epson Software > Uninstaller**.
6. Select the application you want to uninstall, and then click Uninstall.

 **Important:**

*The Uninstaller removes all drivers for Epson scanners on the computer. If you use multiple Epson scanners and you only want to delete some of the drivers, delete all of them first, and then install the necessary scanner drivers again.*

**Note:**

*If you cannot find the application you want to uninstall in the application list, you cannot uninstall using the Uninstaller. In this situation, select **Go > Applications > Epson Software**, select the application you want to uninstall, and then drag it to the trash icon.*

## Installing Your Applications

Follow the steps below to install the necessary applications.

**Note:**

- Log on to your computer as an administrator. Enter the administrator password if the computer prompts you.
- When reinstalling applications, you need to uninstall them first.

1. Quit all running applications.
2. When installing scanner driver (Epson Scan 2), disconnect the scanner and the computer temporarily.

**Note:**

*Do not connect the scanner and the computer until you are instructed to do so.*

3. Install the application by following the instructions on the Website below.

<https://epson.sn>

---

# Adding or Replacing the Computer or Devices

Connecting to a Scanner that has been Connected to the Network. . . . .	161
Connecting a Smart Device and Scanner Directly (Wi-Fi Direct). . . . .	162
Re-setting the Network Connection. . . . .	163
Checking the Network Connection Status. . . . .	165



## Connecting to a Scanner that has been Connected to the Network

When the scanner has already been connected to the network, you can connect a computer or a smart device to the scanner over the network.

### Using a Network Scanner from a Second Computer

We recommend using the installer to connect the scanner to a computer.

To start the installer, access the following website, and then enter the product name. Go to **Setup**, and then start setting up.

<https://epson.sn>

You can view the operating instructions in the Web Movie Manuals. Access the following URL.

<https://support.epson.net/publist/vlink.php?code=NPD7126>

### Selecting the Scanner

Follow the on-screen instructions until the following screen is displayed, select the scanner name you want to connect to, and then click **Next**.

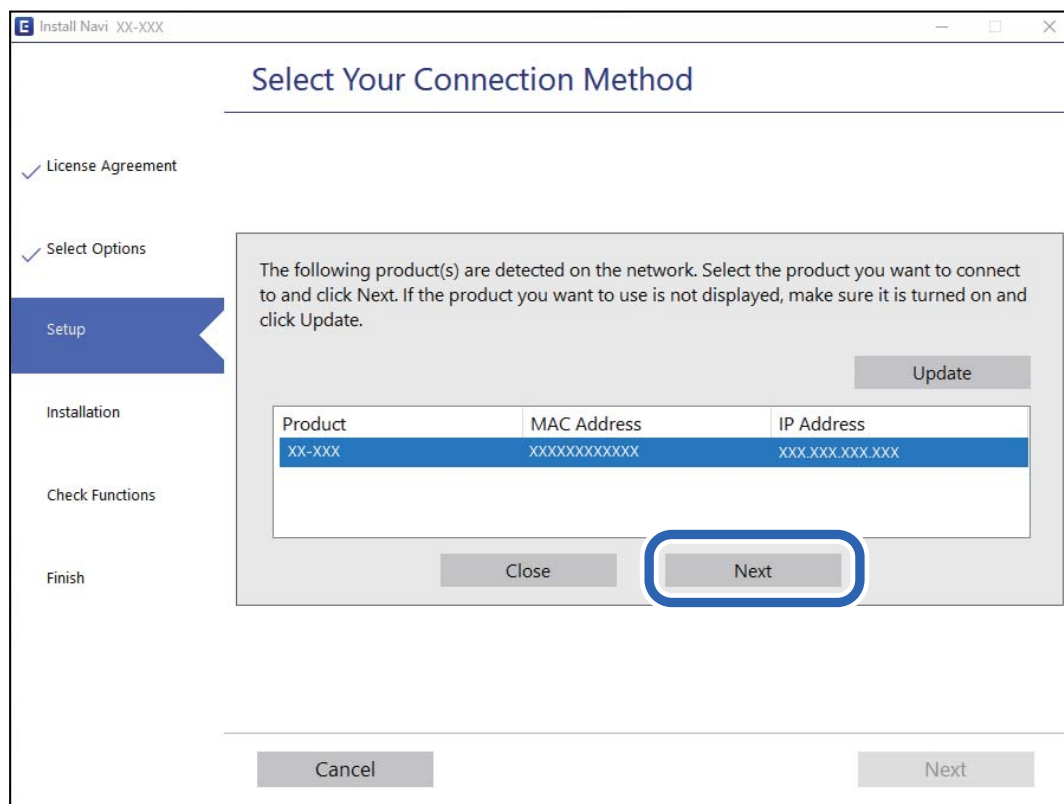

Follow the on-screen instructions.

## Using a Network Scanner from a Smart Device

You can connect a smart device to the scanner using one of the following methods.

### Connecting over a wireless router

Connect the smart device to the same Wi-Fi network (SSID) as the scanner.

See the following for more details.

[“Making Settings for Connecting to the Smart Device” on page 164](#)

### Connecting by Wi-Fi Direct

Connect the smart device to the scanner directly without a wireless router.

See the following for more details.

[“Connecting a Smart Device and Scanner Directly \(Wi-Fi Direct\)” on page 162](#)

---

## Connecting a Smart Device and Scanner Directly (Wi-Fi Direct)

Wi-Fi Direct (Simple AP) allows you to connect a smart device directly to the scanner without a wireless router and scan from the smart device.

### About Wi-Fi Direct

Use this connection method when you are not using Wi-Fi at home or at the office, or when you want to connect the scanner and the computer or smart device directly. In this mode, the scanner acts as an wireless router and you can connect up to 8 devices to the scanner without having to use a standard wireless router. However, devices directly connected to the scanner cannot communicate with each other through the scanner.

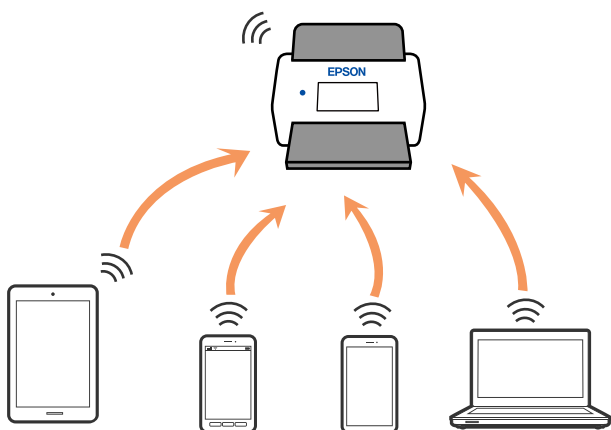

The scanner can be connected by Wi-Fi and Wi-Fi Direct (Simple AP) connection simultaneously. However, if you start a network connection in Wi-Fi Direct (Simple AP) connection when the scanner is connected by Wi-Fi, the Wi-Fi is temporarily disconnected.

## Making AP Mode Settings

This method allows you to connect the scanner directly to devices without an access point. The scanner acts as an access point.

 **Important:**

*When you connect from a computer or smart device to the scanner using an AP mode connection, the scanner is connected to the same Wi-Fi network (SSID) as the computer or smart device and communication is established between them. Since the computer or smart device is automatically connected to other connectable Wi-Fi networks if the scanner is turned off, it is not connected to the previous Wi-Fi network again if the scanner is turned on. Connect to the scanner's SSID in AP mode from the computer or smart device again. If you do not want to connect every time you turn the scanner on or off, we recommend using a Wi-Fi network by connecting the scanner to an access point.*

1. Press the  button on the scanner's control panel.

The  light is lit white when AP mode connection is enabled.

2. Connect from a computer or smart device using the scanner's SSID and password.

**Note:**

- You can check the SSID and password on the label stuck to the scanner.
- See the documentation provided with your computer or smart device for the operating instructions.

### Related Information

➔ [“Checking the Network Connection Status” on page 165](#)

---

## Re-setting the Network Connection

This section explains how to make the network connection settings and change the connection method when replacing the wireless router or the computer.

### When Replacing the Wireless Router

When you replace the wireless router, make settings for the connection between the computer or the smart device and the scanner.

You need to make these settings if you change your Internet service provider and so on.

### Making Settings for Connecting to the Computer

We recommend using the installer to connect the scanner to a computer.

To start the installer, access the following website, and then enter the product name. Go to **Setup**, and then start setting up.

<https://epson.sn>

You can view the operating instructions in the Web Movie Manuals. Access the following URL.

<https://support.epson.net/publist/vlink.php?code=NPD7126>

### **Selecting a Connection Method**

Follow the on-screen instructions. On the **Select Install Option** screen, select **Set up Scanner connection again (for new network router or changing USB to network, etc.)**, and then click **Next**.

Follow the on-screen instructions to finish setup.

If you cannot connect, see the following to try to solve the problem.

[“Cannot connect to a Network” on page 138](#)

### **Making Settings for Connecting to the Smart Device**

You can use the scanner from a smart device when you connect the scanner to the same Wi-Fi network (SSID) as the smart device. To use the scanner from a smart device, access the following website, and then enter the product name. Go to **Setup**, and then start setting up.

<https://epson.sn>

Access to the website from the smart device that you want to connect to the scanner.

### **When Changing the Computer**

When changing the computer, make connection settings between the computer and the scanner.

### **Making Settings for Connecting to the Computer**

We recommend using the installer to connect the scanner to a computer.

To start the installer, access the following website, and then enter the product name. Go to **Setup**, and then start setting up.

<https://epson.sn>

You can view the operating instructions in the Web Movie Manuals. Access the following URL.

<https://support.epson.net/publist/vlink.php?code=NPD7126>

Follow the on-screen instructions.

### **Changing the Connection Method to the Computer**

This section explains how to change the connection method when the computer and the scanner have been connected.

### **Changing from USB to a Network Connection**

Using the installer and re-set up in a different connection method.

Access the following website, and then enter the product name. Go to **Setup**, and then start setting up.

<https://epson.sn>

### **Selecting Change the Connection Methods**

Follow the instructions in each window. On the **Select Install Option** screen, select **Set up Scanner connection again (for new network router or changing USB to network, etc.)**, and then click **Next**.

Select **Connect via wireless network (Wi-Fi)**, and then click **Next**.

Follow the on-screen instructions to finish setup.

## **Making Wi-Fi Settings from the Control Panel**

You can make network settings from the scanner's control panel in several ways. Choose the connection method that matches the environment and conditions that you are using.

If the wireless router supports WPS, you can make settings by using push button setup.

After connecting the scanner to the network, connect to the scanner from the device that you want to use (computer, smart device, tablet, and so on.)

### **Related Information**

➔ [“Connecting the Scanner to the Network” on page 169](#)

---

## **Checking the Network Connection Status**

You can check the network connection status in the following way.

### **Checking the Network Status Using Network Light**

You can check the network connection status using the network light on the scanner's control panel.

### **Related Information**

➔ [“Lights” on page 26](#)

➔ [“Error Indicators” on page 27](#)

### **Checking the Network of the Computer (Windows only)**

By using the command prompt, check the connection status of the computer and the connection path to the scanner. This will lead you to solve the problems.

ipconfig command

Display the connection status of the network interface that is currently used by the computer.

By comparing the setting information with actual communication, you can check whether the connection is correct. In case there are multiple DHCP servers on the same network, you can find out the actual address assigned to the computer, the referred DNS server, etc.

Format : ipconfig /all

Examples :

```

Administrator: Command Prompt
c:\>ipconfig /all
Windows IP Configuration

Host Name . . . . . : WIN2012R2
Primary Dns Suffix . . . . . : pubs.net
Node Type . . . . . : Hybrid
IP Routing Enabled. . . . . : No
WINS Proxy Enabled. . . . . : No
DNS Suffix Search List. . . . . : pubs.net

Ethernet adapter Ethernet:

Connection-specific DNS Suffix . . . : 
Description . . . . . : Gigabit Network Connection
Physical Address. . . . . : XX-XX-XX-XX-XX-XX
DHCP Enabled. . . . . : No
Autoconfiguration Enabled . . . . . : Yes
Link-local IPv6 Address . . . . . : fe80::38fb:7546:18a8:d20e%14(Preferred)
IPv4 Address. . . . . : 192.168.111.10(Preferred)
Subnet Mask . . . . . : 255.255.255.0
Default Gateway . . . . . : 192.168.111.1
DHCPv6 IAID . . . . . : 283142549
DHCPv6 Client DUID. . . . . : 00-01-00-01-20-40-2F-45-00-1D-73-6A-44-08
DNS Servers . . . . . : 192.168.111.2
NetBIOS over Tcpip. . . . . : Enabled

Tunnel adapter isatap.{00000000-ABCD-EFGH-IJK-LMNOPQRSTUUV}:

Media State . . . . . : Media disconnected
Connection-specific DNS Suffix . . . : 
Description . . . . . : Microsoft ISATAP Adapter #2
Physical Address. . . . . : 00-00-00-00-00-00-E0
DHCP Enabled. . . . . : No
Autoconfiguration Enabled . . . . . : Yes

c:\>_
    
```

pathping command

You can confirm the list of routers passing through the destination host and the routing of communication.

Format : pathping xxx.xxx.xxx.xxx

Examples : pathping 192.0.2.222

```

Administrator: Command Prompt
c:\>pathping 192.168.111.20
Tracing route to EPSONAB12AB [192.168.111.20]
over a maximum of 30 hops:
 0  WIN2012R2.pubs.net [192.168.111.10]
 1  EPSONAB12AB [192.168.111.20]

Computing statistics for 25 seconds...
Hop  RTT      Source to Here   This Node/Link   Address
 0      0/ 100 = 0%      0/ 100 = 0%      WIN2012R2.pubs.net [192.168.111.10]
 1  38ms     0/ 100 = 0%      0/ 100 = 0%      EPSONAB12AB [192.168.111.20]



Trace complete.

c:\>_
    
```

## Disabling the Network Setting from the Control Panel

You can disable the network settings.

1. Press the  button for more than 3 seconds to disable a Wi-Fi and AP mode connection.

The  light and  light turn off when these are disabled.

**Note:**



Press the  button to re-connect Wi-Fi and AP mode.

## Initializing the Network Settings from the Control Panel

You can restore all network settings to their defaults.

The administrator password and user name will also be reset to their initial values at the time of purchase. If panel lock is set, the panel lock feature will be turned off.

1. Turn off the scanner.
2. While holding down the  button, press the  button until  light and  light turn on simultaneously.

The  light and  light flash alternately and then turn off when restoration is complete.

---

# Administrator Information

Connecting the Scanner to the Network. . . . .	169
Introduction of Product Security Features. . . . .	172
Administrator Settings. . . . .	172
Disabling Network Scanning from your Computer. . . . .	174
Disabling WSD Scan. . . . .	174
Monitoring a Remote Scanner. . . . .	174
Backing Up the Settings. . . . .	176
Advanced Security Settings. . . . .	177



## Connecting the Scanner to the Network

Connect the scanner to the network by using the scanner's control panel.

See Related Information for more details.

**Note:**

If your scanner and computer are in the same segment, you can also connect using the installer.

To start the installer, access the following website, and then enter the product name. Go to **Setup**, and then start setting up.

<https://epson.sn>

### Related Information

➔ [“Connecting to the Wireless LAN \(Wi-Fi\)” on page 99](#)

## Before Making Network Connection

To connect to the network, check the connection method and setting information for connection in advance.

### Gathering Information on the Connection Setting

Prepare the necessary setting information to connect. Check the following information in advance.

Divisions	Items	Note
Network connection information	<input type="checkbox"/> IP address <input type="checkbox"/> Subnet mask <input type="checkbox"/> Default gateway	Decide the IP address to assign to the scanner.  When you assign the IP address statically, all values are required.  When you assign the IP address dynamically using the DHCP function, this information is not required because it is set automatically.
Wi-Fi connection information	<input type="checkbox"/> SSID <input type="checkbox"/> Password	These are the SSID (network name) and the password of the access point that the scanner connects to.  If MAC address filtering has been set, register the MAC address of the scanner in advance to register the scanner.  See the following for the supported standards.  <a href="#">“Network Specifications” on page 209</a>
DNS server information	<input type="checkbox"/> IP address for primary DNS <input type="checkbox"/> IP address for secondary DNS	These are required when specifying DNS servers. The secondary DNS is set when the system has a redundant configuration and there is a secondary DNS server.  If you are in a small organization and do not set the DNS server, set the IP address of the router.

Divisions	Items	Note
Proxy server information	<input type="checkbox"/> Proxy server name	<p>Set this when your network environment uses the proxy server to access the internet from the intranet, and you use the function that the scanner directly accesses to the internet.</p> <p>For the following functions, the scanner directly connects to the internet .</p> <ul style="list-style-type: none"> <li><input type="checkbox"/> Epson Connect Services</li> <li><input type="checkbox"/> Cloud services of other companies</li> <li><input type="checkbox"/> Firmware updating</li> <li><input type="checkbox"/> Sending scanned images to SharePoint(WebDAV)</li> </ul>
Port number information	<input type="checkbox"/> Port number to release	<p>Check the port number used by the scanner and computer, then release the port that is blocked by a firewall, if necessary.</p> <p>See the following for the port number used by the scanner.</p> <p><a href="#">"Using Port for the Scanner" on page 211</a></p>

## IP Address Assignment

These are the following types of IP address assignment.

### Static IP address:

Assign the predetermined IP address to the scanner (host) manually.

The information to connect to the network (subnet mask, default gateway, DNS server and so on) need to be set manually.

The IP address does not change even when the device is turned off, so this is useful when you want to manage devices with an environment where you cannot change the IP address or you want to manage devices using the IP address. We recommend settings to the scanner, server, etc. that many computers access. Also, when using security features such as IPsec / IP filtering, assign a fixed IP address so that the IP address does not change.

### Automatic assignment by using DHCP function (dynamic IP address):

Assign the IP address automatically to the scanner (host) by using the DHCP function of the DHCP server or router.

The information to connect to the network (subnet mask, default gateway, DNS server and so on) is set automatically, so you can easily connect the device to the network.

If the device or the router is turned off, or depending on the DHCP server settings, IP address may change when re-connecting.

We recommend managing devices other than the IP address and communicating with protocols that can follow the IP address.

#### Note:

*When you use the IP address reservation function of the DHCP, you can assign the same IP address to the devices at any time.*

## DNS Server and Proxy Server

The DNS server has a host name, domain name of the email address, etc. in association with the IP address information.

Communication is impossible if the other party is described by host name, domain name, etc. when the computer or the scanner performs IP communication.

Queries the DNS server for that information and gets the IP address of the other party. This process is called name resolution.

Therefore, the devices such as computers and scanners can communicate using the IP address.

Name resolution is necessary for the scanner to communicate using the email function or Internet connection function.

When you use those functions, make the DNS server settings.

When you assign the scanner's IP address by using the DHCP function of the DHCP server or router, it is automatically set.

The proxy server is placed at the gateway between the network and the Internet, and it communicates to the computer, scanner, and Internet (opposite server) on behalf of each of them. The opposite server communicates only to the proxy server. Therefore, scanner information such as the IP address and port number cannot be read and increased security is expected.

When you connect to the Internet via a proxy server, configure the proxy server on the scanner.

## Connecting to the Network Using a Static IP Address

Selecting a static IP address using the software installer.

1. Start the software installer, and then follow the on-screen instructions.

**Note:**

To start the installer, access the following website, and then enter the product name. Go to **Setup**, and then start setting up.

<https://epson.sn>

2. On the **Select Your Connection Method** screen, select **Advanced configuration**, enter the static IP address, and then follow the on-screen instructions.

## Setting up the IEEE802.11k/v or IEEE802.11r Features

1. Access Web Config, and then select the **Network** tab > **Basic**.
2. Set **IEEE802.11k/v** or **IEEE802.11r** to enabled or disabled.
3. Click **Next**.  
The setting confirmation screen is displayed.
4. Click **OK**.

### Related Information

➡ [“How to Run Web Config in a Web Browser” on page 30](#)

## Introduction of Product Security Features

This section introduces the security function of the Epson Devices.

Feature name	Feature type	What to set	What to prevent
Configuring the Administrator Password	Locks the system settings, such as connection setup for network or USB.	An administrator sets a password to the device.  You can set or change from Web Config.	Prevent from illegally reading and changing the information stored in the device such as ID, password, network settings, and so on. Also, reduce a wide range of security risks such as leakage of information for the network environment or security policy.
Setup for external interface	Controls the interface that connects to the device.	Enable or disable USB connection with the computer.	USB connection of computer: Prevents unauthorized use of the device by prohibiting scanning without going through the network.

## Administrator Settings

### Configuring the Administrator Password

When you set an administrator password, you can prevent users from changing system management settings. The default values are set at the time of purchase. We recommend changing the initial administrator password from the default setting.

**Note:**

*The following provides the default values for the administrator information.*

User name (used for Web Config only): None (blank)

Password: Depends on the label attached to product.

*If there is a "PASSWORD" label attached to the back, enter the 8-digit number shown on the label.*

*If there is no "PASSWORD" label attached, enter the serial number on the label attached to the base of the product for the initial administrator password.*

*You can change the administrator password using either Web Config, the scanner's control panel, or Epson Device Admin. When using Epson Device Admin, see the Epson Device Admin guide or help.*

### Changing the Administrator Password Using Web Config

Change the administrator password in Web Config.

1. Access Web Config and select the **Product Security** tab > **Change Administrator Password**.

2. Enter the necessary information in **Current password**, **User Name**, **New Password**, and **Confirm New Password**.

The new password must be 8 to 20 characters long and only contain single-byte alphanumeric characters and symbols.

**Note:**

The following provides the default values for the administrator information.

*User name: none (blank)*

*Password: Depends on the label attached to product.*



*If there is a "PASSWORD" label attached to the back, enter the 8-digit number shown on the label. If there is no "PASSWORD" label attached, enter the serial number on the label attached to the base of the product for the initial administrator password.*

3. Select **OK**.

### Related Information

- ➔ [“Notes on the Administrator Password” on page 12](#)
- ➔ [“How to Run Web Config in a Web Browser” on page 30](#)

## Locking the Buttons on the Control Panel (Panel Lock)

You can lock the Wi-Fi connect button () and the Wi-Fi on/off button () so that network settings cannot be changed from the control panel.

You can set from the **Device Management** tab > **Control Panel** > **Panel Lock** in Web Config.

### Related Information

- ➔ [“How to Run Web Config in a Web Browser” on page 30](#)

## Logging on to the Scanner from a Computer

When you log in to Web Config as an administrator, you can operate items that are set in the Lock Setting.

1. Enter the scanner's IP address into a browser to run Web Config.
2. Click **Administrator Login**.
3. Enter the user name and administrator password in **User Name** and **Current password**.
4. Click **OK**.

The locked items and **Administrator Logout** are displayed when being authenticated.

Click **Administrator Logout** to log off.

### Related Information

- ➔ [“Notes on the Administrator Password” on page 12](#)
- ➔ [“How to Run Web Config in a Web Browser” on page 30](#)

---

## Disabling Network Scanning from your Computer

You can make the following settings in Web Config to disable network scanning using EPSON Scan from your computer.

1. Access Web Config, and then select the **Scan** tab > **Network Scan**.
2. In **EPSON Scan**, clear the **Enable scanning** check box.
3. Click **Next**.  
The setting confirmation screen is displayed.
4. Click **OK**.

### Related Information

➔ [“How to Run Web Config in a Web Browser” on page 30](#)

---

## Disabling WSD Scan

If you do not want your computer to configure the scanner as a WSD scanning device, follow the steps below to disable the WSD settings.

1. Access Web Config, and then select the **Network Security** tab > **Protocol**.
2. In **WSD Settings**, clear the **Enable WSD** check box.
3. Click **Next**.  
The setting confirmation screen is displayed.
4. Click **OK**.

### Related Information

➔ [“How to Run Web Config in a Web Browser” on page 30](#)

---

## Monitoring a Remote Scanner

### Checking Information for a Remote Scanner

You can check the following information of the operating scanner from **Status** by using Web Config.

Product Status

Check the status, product number, MAC address, etc.

Network Status

Check the information of the network connection status, IP address, DNS server, etc.

Usage Status

Check the first day of scanning, scanning count, and so on.

Hardware Status

Check the status of each function of the scanner.

## Receiving Email Notifications When Events Occur

### About Email Notifications

This is the notification function that, when events such as scanning stop and scanner error occur, send the email to the specified address.

You can register up to five destinations and set the notification settings for each destination.

To use this function, you need to set up the mail server before setting up notifications.

### Configuring Email Notification

Configure email notification by using Web Config.

1. Access Web Config and select the **Device Management** tab > **Email Notification**.

2. Set the subject of email notification.

Select the contents displayed on the subject from the two pull-down menus.

The selected contents are displayed next to **Subject**.

The same contents cannot be set on left and right.

When the number of characters in **Location** exceeds 32 bytes, characters exceeding 32 bytes are omitted.

3. Enter the email address for sending the notification email.

Use A-Z a-z 0-9 ! # \$ % & ' \* + - . / = ? ^ \_ { | } ~ @, and enter between 1 and 255 characters.

4. Select the language for the email notifications.

5. Select the check box on the event for which you want to receive a notification.

The number of **Notification Settings** is linked to the destination number of **Email Address Settings**.

Example :

If you want to send a notification to the email address set for number 1 in **Email Address Settings** when the admin password is changed, select the check box for column **1** on the line **Administrator password changed**.

6. Click **OK**.

Confirm that an email notification will be sent by causing an event.

Example : The administrator password has been changed.

### Related Information

➔ [“How to Run Web Config in a Web Browser” on page 30](#)

### Items for Email Notification

Items	Settings and Explanation
Administrator password changed	Notice when administrator password has been changed.
Scanner error	Notice when the scanner error has occurred.
Wi-Fi failure	Notice when the error of the wireless LAN interface has occurred.

## Backing Up the Settings

You can export the setting value set from Web Config to the file. You can use it for backing up the setting values, replacing the scanner, etc.

The exported file cannot be edited because it is exported as a binary file.

### Export the settings

Export the setting for the scanner.

1. Access Web Config, and then select the **Device Management** tab > **Export and Import Setting Value** > **Export**.

2. Select the settings that you want to export.

Select the settings you want to export. If you select the parent category, subcategories are also selected. However, subcategories that cause errors by duplicating within the same network (such as IP addresses and so on) cannot be selected.

3. Enter a password to encrypt the exported file.

You need the password to import the file. Leave this blank if you do not want to encrypt the file.

4. Click **Export**.



**Important:**

*If you want to export the scanner's network settings such as the device name and IPv6 address, select **Enable to select the individual settings of device** and select more items. Only use the selected values for the replacement scanner.*

### Related Information

➔ [“How to Run Web Config in a Web Browser” on page 30](#)

## Import the settings

Import the exported Web Config file to the scanner.



**!** **Important:**

*When importing values that include individual information such as a scanner name or IP address, make sure the same IP address does not exist on the same network.*

1. Access Web Config, and then select the **Device Management** tab > **Export and Import Setting Value** > **Import**.
2. Select the exported file, and then enter the encrypted password.
3. Click **Next**.
4. Select the settings that you want to import, and then click **Next**.
5. Click **OK**.

The settings are applied to the scanner.

**Related Information**

➔ [“How to Run Web Config in a Web Browser” on page 30](#)

## Advanced Security Settings

This section explains advanced security features.

### Security Settings and Prevention of Danger

When a scanner is connected to a network, you can access it from a remote location. In addition, many people can share the scanner, which is helpful in improving operational efficiency and convenience. However, risks such as illegal access, illegal use, and tampering with data are increased. If you use the scanner in an environment where you can access the Internet, the risks are even higher.

In order to avoid this risk, Epson scanners have a variety of security technologies.

Set the scanner as necessary according to the environmental conditions that have been built with the customer's environment information.

Name	Feature type	What to set	What to prevent
Control of protocol	Controls the protocols and services to be used for communication between scanners and computers, and it enables and disables features.	A protocol or service that is applied to features allowed or prohibited separately.	Reducing security risks that may occur through unintended use by preventing users from using unnecessary functions.

Name	Feature type	What to set	What to prevent
SSL/TLS communications	The communication content is encrypted with SSL/TLS communications when accessing to the Epson server on the Internet from the scanner, such as communicating to the computer via web browser and updating firmware.	Obtain a CA-signed certificate, and then import it to the scanner.	Clearing an identification of the scanner by the CA-signed certification prevents impersonation and unauthorized access. In addition, communication contents of SSL/TLS are protected, and it prevents the leakage of contents for scanning data and setup information.
IPsec/IP filtering	You can set to allow severing and cutting off of data that is from a certain client or is a particular type. Since IPsec protects the data by IP packet unit (encryption and authentication), you can safely communicate unsecured protocol.	Create a basic policy and individual policy to set the client or type of data that can access the scanner.	Protect unauthorized access, and tampering and interception of communication data to the scanner.
IEEE802.1X	Only allows authenticated users to connect to the network. Allows only a permitted user to use the scanner.	Authentication setting to the RADIUS server (authentication sever).	Protect unauthorized access and use to the scanner.

## Security Feature Settings

When setting IPsec/IP filtering or IEEE802.1X, it is recommended that you access Web Config using SSL/TLS to communicate settings information in order to reduce security risks such as tampering or interception.

Make sure you configure the administrator password before setting IPsec/IP filtering or IEEE802.1X.

## Controlling Using Protocols

You can scan using a variety of pathways and protocols. Also, you can use network scanning from an unspecified number of network computers.

You can lower unintended security risks by restricting scanning from specific pathways or by controlling the available functions.

### Controlling protocols

Configure the protocol settings supported by the scanner.

1. Access Web Config and then select the **Network Security** tab > **Protocol**.
2. Configure each item.
3. Click **Next**.

4. Click **OK**.

The settings are applied to the scanner.

**Related Information**

➔ [“How to Run Web Config in a Web Browser” on page 30](#)

**Protocols you can Enable or Disable**

Protocol	Description
Bonjour Settings	You can specify whether to use Bonjour. Bonjour is used to search for devices, scan, and so on.
SLP Settings	You can enable or disable the SLP function. SLP is used for push scanning and network searching in EpsonNet Config.
WSD Settings	You can enable or disable the WSD function. When this is enabled, you can add WSD devices, and scan from the WSD port.
LLTD Settings	You can enable or disable the LLTD function. When this is enabled, it is displayed on the Windows network map.
LLMNR Settings	You can enable or disable the LLMNR function. When this is enabled, you can use name resolution without NetBIOS even if you cannot use DNS.
SNMPv1/v2c Settings	You can specify whether or not to enable SNMPv1/v2c. This is used to set up devices, monitoring, and so on.
SNMPv3 Settings	You can specify whether or not to enable SNMPv3. This is used to set up encrypted devices, monitoring, etc.

**Protocol Setting Items**

Bonjour Settings

Item	Settings and Explanation
Use Bonjour	Select this to search for or use devices through Bonjour.
Bonjour Name	Displays the Bonjour name.
Bonjour Service Name	Displays the Bonjour service name.
Location	Displays the Bonjour location name.
Wide-Area Bonjour	Set whether to use Wide-Area Bonjour.

SLP Settings

Item	Settings and Explanation
Enable SLP	Select this to enable the SLP function. This is used with network searching in EpsonNet Config.

WSD Settings

Item	Settings and Explanation
Enable WSD	Select this to enable adding devices using WSD and scan from the WSD port.
Scanning Timeout (sec)	Enter the communication timeout value for WSD scanning between 3 to 3,600 seconds.
Device Name	Displays the WSD device name.
Location	Displays the WSD location name.

#### LLTD Settings

Item	Settings and Explanation
Enable LLTD	Select this to enable LLTD. The scanner is displayed in the Windows network map.
Device Name	Displays the LLTD device name.

#### LLMNR Settings

Item	Settings and Explanation
Enable LLMNR	Select this to enable LLMNR. When this is enabled, you can use name resolution without NetBIOS even if you cannot use DNS.

#### SNMPv1/v2c Settings

Item	Settings and Explanation
Enable SNMPv1/v2c	Select to enable SNMPv1/v2c.
Access Authority	Set the access authority when SNMPv1/v2c is enabled. Select <b>Read Only</b> or <b>Read/Write</b> .
Community Name (Read Only)	Enter within 32 characters in ASCII (0x20-0x7E). If you do not specify this, leave it blank.
Community Name (Read/Write)	Enter within 32 characters in ASCII (0x20-0x7E). If you do not specify this, leave it blank.
Allow access from Epson tools	Set whether to allow writing from Epson tools such as Epson Device Admin.

#### SNMPv3 Settings

Item	Settings and Explanation
Enable SNMPv3	SNMPv3 is enabled when the box is checked.
User Name	Enter between 1 and 32 characters using 1 byte characters.
Authentication Settings	

Item		Settings and Explanation
	Algorithm	Select an algorithm for an authentication for SNMPv3.
	Password	Enter the password for an authentication for SNMPv3. Enter between 8 and 32 characters in ASCII (0x20-0x7E). If you do not specify this, leave it blank.
	Confirm Password	Enter the password you configured for confirmation.
Encryption Settings		
	Algorithm	Select an algorithm for an encryption.
	Password	Enter the password for an encryption. Enter between 8 and 32 characters in ASCII (0x20-0x7E). If you do not specify this, leave it blank.
	Confirm Password	Enter the password you configured for confirmation.
Context Name		Enter within 32 characters in Unicode (UTF-8). If you do not specify this, leave it blank. The number of characters that can be entered varies depending on the language.

## Using a Digital Certificate

### About Digital Certification

#### CA-signed Certificate

This is a certificate signed by the CA (Certificate Authority.) You can obtain it to apply to the Certificate Authority. This certificate certifies the existence of the scanner is and used for SSL/TLS communication so that you can ensure the safety of data communication.

When it is used for SSL/TLS communication, it is used as a server certificate.

When it is set to IPsec/IP Filtering or IEEE802.1x communication, it is used as a client certificate.

#### CA Certificate

This is a certificate that is in chain of the CA-signed Certificate, also called the intermediate CA certificate. It is used by the web browser to validate the path of the scanner's certificate when accessing the server of the other party or Web Config.

For the CA Certificate, set when to validate the path of server certificate accessing from the scanner. For the scanner, set to certify the path of the CA-signed Certificate for SSL/TLS connection.

You can obtain the CA certificate of the scanner from the Certification Authority where the CA certificate is issued.

Also, you can obtain the CA certificate used to validate the server of the other party from the Certification Authority that issued the CA-signed Certificate of the other server.

Self-signed Certificate

This is a certificate that the scanner signs and issues itself. It is also called the root certificate. Because the issuer certifies itself, it is not reliable and cannot prevent impersonation.

Use it when making the security setting and performing simple SSL/TLS communication without the CA-signed Certificate.

If you use this certificate for an SSL/TLS communication, a security alert may be displayed on a web browser because the certificate is not registered on a web browser. You can use the Self-signed Certificate only for an SSL/TLS communication.

## Configuring a CA-signed Certificate

### Obtaining a CA-signed Certificate

To obtain a CA-signed certificate, create a CSR (Certificate Signing Request) and apply it to certificate authority. You can create a CSR using Web Config and a computer.

Follow the steps to create a CSR and obtain a CA-signed certificate using Web Config. When creating a CSR using Web Config, a certificate is the PEM/DER format.

1. Access Web Config, and then select the **Network Security** tab. Next, select **SSL/TLS > Certificate** or **IPsec/IP Filtering > Client Certificate** or **IEEE802.1X > Client Certificate**.

Whatever you choose, you can obtain the same certificate and use it in common.

2. Click **Generate** of **CSR**.

A CSR creating page is opened.

3. Enter a value for each item.

**Note:**

*Available key length and abbreviations vary by a certificate authority. Create a request according to rules of each certificate authority.*

4. Click **OK**.

A completion message is displayed.

5. Select the **Network Security** tab. Next, select **SSL/TLS > Certificate**, or **IPsec/IP Filtering > Client Certificate** or **IEEE802.1X > Client Certificate**.

6. Click one of the download buttons of **CSR** according to a specified format by each certificate authority to download a CSR to a computer.



**Important:**

*Do not generate a CSR again. If you do so, you may not be able to import an issued CA-signed Certificate.*

7. Send the CSR to a certificate authority and obtain a CA-signed Certificate.

Follow the rules of each certificate authority on sending method and form.

8. Save the issued CA-signed Certificate to a computer connected to the scanner.

Obtaining a CA-signed Certificate is complete when you save a certificate to a destination.

**Related Information**

➔ [“How to Run Web Config in a Web Browser” on page 30](#)

**CSR Setting Items**

Items	Settings and Explanation
Key Length	Select a key length for a CSR.
Common Name	<p>You can enter between 1 and 128 characters. If this is an IP address, it should be a static IP address. You can enter 1 to 5 IPv4 addresses, IPv6 addresses, host names, FQDNs by separating them with commas.</p> <p>The first element is stored to the common name, and other elements are stored to the alias field of the certificate subject.</p> <p>Example:                      Scanner's IP address : 192.0.2.123, Scanner name : EPSONA1B2C3                      Common Name : EPSONA1B2C3,EPSONA1B2C3.local,192.0.2.123</p>
Organization/ Organizational Unit/ Locality/ State/Province	You can enter between 0 and 64 characters in ASCII (0x20-0x7E). You can divide distinguished names with commas.
Country	Enter a country code in two-digit number specified by ISO-3166.
Sender's Email Address	You can enter the sender's email address for the mail server setting. Enter the same email address as the <b>Sender's Email Address</b> for the <b>Network</b> tab > <b>Email Server</b> > <b>Basic</b> .

**Importing a CA-signed Certificate**

Import the obtained CA-signed Certificate to the scanner.

 **Important:**

- Make sure that the scanner's date and time is set correctly. Certificate may be invalid.
- If you obtain a certificate using a CSR created from Web Config, you can import a certificate one time.

1. Access Web Config and then select the **Network Security** tab. Next, select **SSL/TLS > Certificate**, or **IPsec/IP Filtering > Client Certificate** or **IEEE802.1X > Client Certificate**.

2. Click **Import**

A certificate importing page is opened.

3. Enter a value for each item. Set **CA Certificate 1** and **CA Certificate 2** when verifying the path of the certificate on the web browser that accesses the scanner.

Depending on where you create a CSR and the file format of the certificate, required settings may vary. Enter values to required items according to the following.

- A certificate of the PEM/DER format obtained from Web Config
  - Private Key:** Do not configure because the scanner contains a private key.
  - Password:** Do not configure.
  - CA Certificate 1/CA Certificate 2:** Optional

- A certificate of the PEM/DER format obtained from a computer
  - Private Key:** You need to set.
  - Password:** Do not configure.
  - CA Certificate 1/CA Certificate 2:** Optional
- A certificate of the PKCS#12 format obtained from a computer
  - Private Key:** Do not configure.
  - Password:** Optional
  - CA Certificate 1/CA Certificate 2:** Do not configure.

4. Click **OK**.

A completion message is displayed.

**Note:**

Click **Confirm** to verify the certificate information.

**Related Information**

➔ [“How to Run Web Config in a Web Browser” on page 30](#)

**CA-signed Certificate Importing Setting Items**

Items	Settings and Explanation
Server Certificate or Client Certificate	Select a certificate's format. For SSL/TLS connection, the Server Certificate is displayed. For IPsec/IP Filtering or IEEE802.1x, the Client Certificate is displayed.
Private Key	If you obtain a certificate of the PEM/DER format by using a CSR created from a computer, specify a private key file that is match a certificate.
Password	If the file format is <b>Certificate with Private Key (PKCS#12)</b> , enter the password for encrypting the private key that is set when you obtain the certificate.
CA Certificate 1	If your certificate's format is <b>Certificate (PEM/DER)</b> , import a certificate of a certificate authority that issues a CA-signed Certificate used as server certificate. Specify a file if you need.
CA Certificate 2	If your certificate's format is <b>Certificate (PEM/DER)</b> , import a certificate of a certificate authority that issues CA Certificate 1. Specify a file if you need.

**Deleting a CA-signed Certificate**

You can delete an imported certificate when the certificate has expired or when an encrypted connection is no longer necessary.



**Important:**

*If you obtain a certificate using a CSR created from Web Config, you cannot import a deleted certificate again. In this case, create a CSR and obtain a certificate again.*



1. Access Web Config, and then select the **Network Security** tab. Next, select **SSL/TLS > Certificate** or **IPsec/IP Filtering > Client Certificate** or **IEEE802.1X > Client Certificate**.
2. Click **Delete**.
3. Confirm that you want to delete the certificate in the message displayed.

#### **Related Information**

➔ [“How to Run Web Config in a Web Browser” on page 30](#)

## **Updating a Self-signed Certificate**

Because the Self-signed Certificate is issued by the scanner, you can update it when it has expired or when the content described changes.

1. Access Web Config and select the **Network Security** tab > **SSL/TLS > Certificate**.
2. Click **Update**.
3. Enter **Common Name**.

You can enter up to 5 IPv4 addresses, IPv6 addresses, host names, FQDNs between 1 to 128 characters and separating them with commas. The first parameter is stored to the common name, and the others are stored to the alias field for the subject of the certificate.

Example:

Scanner's IP address : 192.0.2.123, Scanner name : EPSONA1B2C3

Common name : EPSONA1B2C3,EPSONA1B2C3.local,192.0.2.123

4. Specify a validity period for the certificate.
5. Click **Next**.

A confirmation message is displayed.

6. Click **OK**.

The scanner is updated.

#### **Note:**

*You can check the certificate information from **Network Security** tab > **SSL/TLS > Certificate > Self-signed Certificate** and click **Confirm**.*

#### **Related Information**

➔ [“How to Run Web Config in a Web Browser” on page 30](#)

## **Configuring a CA Certificate**

When you set the CA Certificate, you can validate the path to the CA certificate of the server that the scanner accesses. This can prevent impersonation.

You can obtain the CA Certificate from the Certification Authority where the CA-signed Certificate is issued.

### ***Importing a CA Certificate***

Import the CA Certificate to the scanner.

1. Access Web Config and then select the **Network Security** tab > **CA Certificate**.
2. Click **Import**.
3. Specify the CA Certificate you want to import.
4. Click **OK**.

When importing is complete, you are returned to the **CA Certificate** screen, and the imported CA Certificate is displayed.

### **Related Information**

➔ [“How to Run Web Config in a Web Browser” on page 30](#)

### ***Deleting a CA Certificate***

You can delete the imported CA Certificate.

1. Access Web Config and then select the **Network Security** tab > **CA Certificate**.
2. Click **Delete** next to the CA Certificate that you want to delete.
3. Confirm that you want to delete the certificate in the message displayed.
4. Click **Reboot Network**, and then check that the deleted CA Certificate is not listed on the updated screen.

### **Related Information**

➔ [“How to Run Web Config in a Web Browser” on page 30](#)

## **SSL/TLS Communication with the Scanner**

When the server certificate is set using SSL/TLS (Secure Sockets Layer/Transport Layer Security) communication to the scanner, you can encrypt the communication path between computers. Do this if you want to prevent remote and unauthorized access.

### **Configuring Basic SSL/TLS Settings**

If the scanner supports the HTTPS server feature, you can use an SSL/TLS communication to encrypt communications. You can configure and manage the scanner using Web Config while ensuring security.

Configure encryption strength and redirect feature.

1. Access Web Config and select the **Network Security** tab > **SSL/TLS** > **Basic**.

2. Select a value for each item.
  - Encryption Strength  
Select the level of encryption strength.
  - Redirect HTTP to HTTPS  
Redirect to HTTPS when HTTP is accessed.
3. Click **Next**.  
A confirmation message is displayed.
4. Click **OK**.  
The scanner is updated.

#### **Related Information**

➔ [“How to Run Web Config in a Web Browser” on page 30](#)

## **Configuring a Server Certificate for the Scanner**

1. Access Web Config and select the **Network Security** tab > **SSL/TLS** > **Certificate**.
2. Specify a certificate to use on **Server Certificate**.
  - Self-signed Certificate  
A self-signed certificate has been generated by the scanner. If you do not obtain a CA-signed certificate, select this.
  - CA-signed Certificate  
If you obtain and import a CA-signed certificate in advance, you can specify this.
3. Click **Next**.  
A confirmation message is displayed.
4. Click **OK**.  
The scanner is updated.

#### **Related Information**

➔ [“How to Run Web Config in a Web Browser” on page 30](#)

## **Encrypted Communication Using IPsec/IP Filtering**

### **About IPsec/IP Filtering**

You can filter traffic based on IP addresses, services, and port by using IPsec/IP Filtering function. By combining of the filtering, you can configure the scanner to accept or block specified clients and specified data. Additionally, you can improve security level by using an IPsec.

**Note:**

Computers that run Windows Vista or later or Windows Server 2008 or later support IPsec.

## Configuring Default Policy

To filter traffic, configure the default policy. The default policy applies to every user or group connecting to the scanner. For more fine-grained control over users and groups of users, configure group policies.

1. Access Web Config and then select the **Network Security** tab > **IPsec/IP Filtering** > **Basic**.
2. Enter a value for each item.
3. Click **Next**.  
A confirmation message is displayed.
4. Click **OK**.  
The scanner is updated.

### Related Information

➔ [“How to Run Web Config in a Web Browser” on page 30](#)

### Default Policy Setting Items

#### Default Policy

Items	Settings and Explanation
IPsec/IP Filtering	You can enable or disable an IPsec/IP Filtering feature.

#### Access Control

Configure a control method for traffic of IP packets.

Items	Settings and Explanation
Permit Access	Select this to permit configured IP packets to pass through.
Refuse Access	Select this to refuse configured IP packets to pass through.
IPsec	Select this to permit configured IPsec packets to pass through.

**IKE Version**

Select **IKEv1** or **IKEv2** for **IKE Version**. Select one of them according to the device that the scanner is connected to.

**IKEv1**

The following items are displayed when you select **IKEv1** for **IKE Version**.

Items	Settings and Explanation
Authentication Method	To select <b>Certificate</b> , you need to obtain and import a CA-signed certificate in advance.
Pre-Shared Key	If you select <b>Pre-Shared Key</b> for <b>Authentication Method</b> , enter a pre-shared key between 1 and 127 characters.
Confirm Pre-Shared Key	Enter the key you configured for confirmation.

**IKEv2**

The following items are displayed when you select **IKEv2** for **IKE Version**.

Items	Settings and Explanation	
Local	Authentication Method	To select <b>Certificate</b> , you need to obtain and import a CA-signed certificate in advance.
	ID Type	If you select <b>Pre-Shared Key</b> for <b>Authentication Method</b> , select the type of ID for the scanner.
	ID	Enter the scanner's ID that matches the type of ID. You cannot use "@", "#", and "=" for the first character. <b>Distinguished Name</b> : Enter 1 to 255 1-byte ASCII (0x20 to 0x7E) characters. You need to include "=". <b>IP Address</b> : Enter IPv4 or IPv6 format. <b>FQDN</b> : Enter a combination of between 1 and 255 characters using A-Z, a-z, 0-9, "-", and period (.). <b>Email Address</b> : Enter 1 to 255 1-byte ASCII (0x20 to 0x7E) characters. You need to include "@". <b>Key ID</b> : Enter 1 to 255 1-byte ASCII (0x20 to 0x7E) characters.
	Pre-Shared Key	If you select <b>Pre-Shared Key</b> for <b>Authentication Method</b> , enter a pre-shared key between 1 and 127 characters.
	Confirm Pre-Shared Key	Enter the key you configured for confirmation.

Items		Settings and Explanation
Remote	Authentication Method	To select <b>Certificate</b> , you need to obtain and import a CA-signed certificate in advance.
	ID Type	If you select <b>Pre-Shared Key</b> for <b>Authentication Method</b> , select the type of ID for the device that you want to authenticate.
	ID	Enter the scanner's ID that matches to the type of ID. You cannot use "@", "#", and "=" for the first character. <b>Distinguished Name</b> : Enter 1 to 255 1-byte ASCII (0x20 to 0x7E) characters. You need to include "=". <b>IP Address</b> : Enter IPv4 or IPv6 format. <b>FQDN</b> : Enter a combination of between 1 and 255 characters using A-Z, a-z, 0-9, "-", and period (.). <b>Email Address</b> : Enter 1 to 255 1-byte ASCII (0x20 to 0x7E) characters. You need to include "@". <b>Key ID</b> : Enter 1 to 255 1-byte ASCII (0x20 to 0x7E) characters.
	Pre-Shared Key	If you select <b>Pre-Shared Key</b> for <b>Authentication Method</b> , enter a pre-shared key between 1 and 127 characters.
	Confirm Pre-Shared Key	Enter the key you configured for confirmation.

**Encapsulation**

If you select **IPsec** for **Access Control**, you need to configure an encapsulation mode.

Items	Settings and Explanation
Transport Mode	If you only use the scanner on the same LAN, select this. IP packets of layer 4 or later are encrypted.
Tunnel Mode	If you use the scanner on the Internet-capable network such as IPsec-VPN, select this option. The header and data of the IP packets are encrypted. <b>Remote Gateway(Tunnel Mode)</b> : If you select <b>Tunnel Mode</b> for <b>Encapsulation</b> , enter a gateway address between 1 and 39 characters.

**Security Protocol**

If you select **IPsec** for **Access Control**, select an option.

Items	Settings and Explanation
ESP	Select this to ensure the integrity of an authentication and data, and encrypt data.
AH	Select this to ensure the integrity of an authentication and data. Even if encrypting data is prohibited, you can use IPsec.

**Algorithm Settings**

It is recommended that you select **Any** for all settings or select an item other than **Any** for each setting. If you select **Any** for some of the settings and select an item other than **Any** for the other settings, the device may not communicate depending on the other device that you want to authenticate.

Items		Settings and Explanation
IKE	Encryption	Select the encryption algorithm for IKE. The items vary depending on the version of IKE.
	Authentication	Select the authentication algorithm for IKE.
	Key Exchange	Select the key exchange algorithm for IKE. The items vary depending on the version of IKE.
ESP	Encryption	Select the encryption algorithm for ESP. This is available when <b>ESP</b> is selected for <b>Security Protocol</b> .
	Authentication	Select the authentication algorithm for ESP. This is available when <b>ESP</b> is selected for <b>Security Protocol</b> .
AH	Authentication	Select the encryption algorithm for AH. This is available when <b>AH</b> is selected for <b>Security Protocol</b> .

**Configuring Group Policy**

A group policy is one or more rules applied to a user or user group. The scanner controls IP packets that match with configured policies. IP packets are authenticated in the order of a group policy 1 to 10 then a default policy.

1. Access Web Config and then select the **Network Security** tab > **IPsec/IP Filtering** > **Basic**.
2. Click a numbered tab you want to configure.
3. Enter a value for each item.
4. Click **Next**.  
A confirmation message is displayed.
5. Click **OK**.  
The scanner is updated.

**Group Policy Setting Items**

Items	Settings and Explanation
Enable this Group Policy	You can enable or disable a group policy.

**Access Control**

Configure a control method for traffic of IP packets.

Items	Settings and Explanation
Permit Access	Select this to permit configured IP packets to pass through.
Refuse Access	Select this to refuse configured IP packets to pass through.
IPsec	Select this to permit configured IPsec packets to pass through.

### Local Address (Scanner)

Select an IPv4 address or IPv6 address that matches your network environment. If an IP address is assigned automatically, you can select **Use auto-obtained IPv4 address**.

**Note:**

*If an IPv6 address is assigned automatically, the connection may be unavailable. Configure a static IPv6 address.*

### Remote Address(Host)

Enter a device's IP address to control access. The IP address must be 43 characters or less. If you do not enter an IP address, all addresses are controlled.

**Note:**

*If an IP address is assigned automatically (e.g. assigned by DHCP), the connection may be unavailable. Configure a static IP address.*

### Method of Choosing Port

Select a method to specify ports.

- Service Name

If you select **Service Name** for **Method of Choosing Port**, select an option.

- Transport Protocol

If you select **Port Number** for **Method of Choosing Port**, you need to configure an encapsulation mode.

Items	Settings and Explanation
Any Protocol	Select this to control all protocol types.
TCP	Select this to control data for unicast.
UDP	Select this to control data for broadcast and multicast.
ICMPv4	Select this to control ping command.

- Local Port

If you select **Port Number** for **Method of Choosing Port** and if you select **TCP** or **UDP** for **Transport Protocol**, enter port numbers to control receiving packets, separating them with commas. You can enter 10 port numbers at the maximum.

Example: 20,80,119,5220

If you do not enter a port number, all ports are controlled.

- Remote Port

If you select **Port Number** for **Method of Choosing Port** and if you select **TCP** or **UDP** for **Transport Protocol**, enter port numbers to control sending packets, separating them with commas. You can enter 10 port numbers at the maximum.

Example: 25,80,143,5220

If you do not enter a port number, all ports are controlled.



### IKE Version

Select **IKEv1** or **IKEv2** for **IKE Version**. Select one of them according to the device that the scanner is connected to.

**IKEv1**

The following items are displayed when you select **IKEv1** for **IKE Version**.

Items	Settings and Explanation
Authentication Method	If you select <b>IPsec</b> for <b>Access Control</b> , select an option. Used certificate is common with a default policy.
Pre-Shared Key	If you select <b>Pre-Shared Key</b> for <b>Authentication Method</b> , enter a pre-shared key between 1 and 127 characters.
Confirm Pre-Shared Key	Enter the key you configured for confirmation.

❑ IKEv2

The following items are displayed when you select **IKEv2** for **IKE Version**.

Items		Settings and Explanation
Local	Authentication Method	If you select <b>IPsec</b> for <b>Access Control</b> , select an option. Used certificate is common with a default policy.
	ID Type	If you select <b>Pre-Shared Key</b> for <b>Authentication Method</b> , select the type of ID for the scanner.
	ID	Enter the scanner's ID that matches the type of ID. You cannot use "@", "#", and "=" for the first character. <b>Distinguished Name</b> : Enter 1 to 255 1-byte ASCII (0x20 to 0x7E) characters. You need to include "=". <b>IP Address</b> : Enter IPv4 or IPv6 format. <b>FQDN</b> : Enter a combination of between 1 and 255 characters using A-Z, a-z, 0-9, "-", and period (.). <b>Email Address</b> : Enter 1 to 255 1-byte ASCII (0x20 to 0x7E) characters. You need to include "@". <b>Key ID</b> : Enter 1 to 255 1-byte ASCII (0x20 to 0x7E) characters.
	Pre-Shared Key	If you select <b>Pre-Shared Key</b> for <b>Authentication Method</b> , enter a pre-shared key between 1 and 127 characters.
	Confirm Pre-Shared Key	Enter the key you configured for confirmation.
Remote	Authentication Method	If you select <b>IPsec</b> for <b>Access Control</b> , select an option. Used certificate is common with a default policy.
	ID Type	If you select <b>Pre-Shared Key</b> for <b>Authentication Method</b> , select the type of ID for the device that you want to authenticate.
	ID	Enter the scanner's ID that matches to the type of ID. You cannot use "@", "#", and "=" for the first character. <b>Distinguished Name</b> : Enter 1 to 255 1-byte ASCII (0x20 to 0x7E) characters. You need to include "=". <b>IP Address</b> : Enter IPv4 or IPv6 format. <b>FQDN</b> : Enter a combination of between 1 and 255 characters using A-Z, a-z, 0-9, "-", and period (.). <b>Email Address</b> : Enter 1 to 255 1-byte ASCII (0x20 to 0x7E) characters. You need to include "@". <b>Key ID</b> : Enter 1 to 255 1-byte ASCII (0x20 to 0x7E) characters.
	Pre-Shared Key	If you select <b>Pre-Shared Key</b> for <b>Authentication Method</b> , enter a pre-shared key between 1 and 127 characters.
	Confirm Pre-Shared Key	Enter the key you configured for confirmation.

**Encapsulation**

If you select **IPsec** for **Access Control**, you need to configure an encapsulation mode.

Items	Settings and Explanation
Transport Mode	If you only use the scanner on the same LAN, select this. IP packets of layer 4 or later are encrypted.
Tunnel Mode	If you use the scanner on the Internet-capable network such as IPsec-VPN, select this option. The header and data of the IP packets are encrypted.  <b>Remote Gateway(Tunnel Mode):</b> If you select <b>Tunnel Mode</b> for <b>Encapsulation</b> , enter a gateway address between 1 and 39 characters.

### Security Protocol

If you select **IPsec** for **Access Control**, select an option.

Items	Settings and Explanation
ESP	Select this to ensure the integrity of an authentication and data, and encrypt data.
AH	Select this to ensure the integrity of an authentication and data. Even if encrypting data is prohibited, you can use IPsec.

### Algorithm Settings

It is recommended that you select **Any** for all settings or select an item other than **Any** for each setting. If you select **Any** for some of the settings and select an item other than **Any** for the other settings, the device may not communicate depending on the other device that you want to authenticate.

Items	Settings and Explanation
IKE	Encryption Select the encryption algorithm for IKE. The items vary depending on the version of IKE.
	Authentication Select the authentication algorithm for IKE.
	Key Exchange Select the key exchange algorithm for IKE. The items vary depending on the version of IKE.
ESP	Encryption Select the encryption algorithm for ESP. This is available when <b>ESP</b> is selected for <b>Security Protocol</b> .
	Authentication Select the authentication algorithm for ESP. This is available when <b>ESP</b> is selected for <b>Security Protocol</b> .
AH	Authentication Select the encryption algorithm for AH. This is available when <b>AH</b> is selected for <b>Security Protocol</b> .

### Combination of Local Address (Scanner) and Remote Address(Host) on Group Policy

	Setting of Local Address (Scanner)		
	IPv4	IPv6* <sup>2</sup>	Any addresses* <sup>3</sup>

<b>Setting of Remote Address(Host)</b>	IPv4* <sup>1</sup>	✓	–	✓
	IPv6* <sup>1&amp;2</sup>	–	✓	✓
	Blank	✓	✓	✓

\*1If **IPsec** is selected for **Access Control**, you cannot specify in a prefix length.

\*2If **IPsec** is selected for **Access Control**, you can select a link-local address (fe80::) but group policy will be disabled.

\*3Except IPv6 link local addresses.

## Related Information

➔ [“How to Run Web Config in a Web Browser” on page 30](#)

## References of Service Name on Group Policy

### Note:

Unavailable services are displayed but cannot be selected.

Service Name	Protocol type	Local port number	Remote port number	Features controlled
Any	–	–	–	All services
ENPC	UDP	3289	Any port	Searching for a scanner from applications such as Epson Device Admin and the a scanner driver
SNMP	UDP	161	Any port	Acquiring and configuring of MIB from applications such as Epson Device Admin and the Epson scanner driver
WSD	TCP	Any port	5357	Controlling WSD
WS-Discovery	UDP	3702	Any port	Searching for a scanner from WSD
Network Scan	TCP	1865	Any port	Forwarding scan data from Epson ScanSmart
Network Push Scan Discovery	UDP	2968	Any port	Searching for a computer from scanner
Network Push Scan	TCP	Any port	2968	Acquiring job information of push scanning from Epson ScanSmart
HTTP (Local)	TCP	80	Any port	HTTP(S) server (forwarding data of Web Config and WSD)
HTTPS (Local)	TCP	443	Any port	
HTTP (Remote)	TCP	Any port	80	HTTP(S) client (firmware updating and root certificate updating)
HTTPS (Remote)	TCP	Any port	443	

## Configuration Examples of IPsec/IP Filtering

### Receiving IPsec packets only

This example is to configure a default policy only.

#### Default Policy:

- IPsec/IP Filtering: Enable**
- Access Control: IPsec**
- Authentication Method: Pre-Shared Key**
- Pre-Shared Key:** Enter up to 127 characters.

**Group Policy:** Do not configure.

### Receiving scanning data and scanner settings

This example allows communications of scanning data and scanner configuration from specified services.

#### Default Policy:

- IPsec/IP Filtering: Enable**
- Access Control: Refuse Access**

#### Group Policy:

- Enable this Group Policy:** Check the box.
- Access Control: Permit Access**
- Remote Address(Host):** IP address of a client
- Method of Choosing Port: Service Name**
- Service Name:** Check the box of ENPC, SNMP, HTTP (Local), HTTPS (Local) and Network Scan.

### Receiving access from a specified IP address only

This example allows a specified IP address to access the scanner.

#### Default Policy:

- IPsec/IP Filtering: Enable**
- Access Control: Refuse Access**

#### Group Policy:

- Enable this Group Policy:** Check the box.
- Access Control: Permit Access**
- Remote Address(Host):** IP address of an administrator's client

#### **Note:**

*Regardless of policy configuration, the client will be able to access and configure the scanner.*

## Configuring a Certificate for IPsec/IP Filtering

Configure the Client Certificate for IPsec/IP Filtering. When you set it, you can use the certificate as an authentication method for IPsec/IP Filtering. If you want to configure the certification authority, go to **CA Certificate**.

1. Access Web Config and then select the **Network Security** tab > **IPsec/IP Filtering** > **Client Certificate**.
2. Import the certificate in **Client Certificate**.

If you have already imported a certificate published by a Certification Authority, you can copy the certificate and use it in IPsec/IP Filtering. To copy, select the certificate from **Copy From**, and then click **Copy**.

### Related Information

➔ [“How to Run Web Config in a Web Browser” on page 30](#)

## Connecting the Scanner to an IEEE802.1X Network

### Configuring an IEEE802.1X Network

When you set IEEE802.1X to the scanner, you can use it on the network connected to a RADIUS server, a LAN switch with authentication function, or an access point.

1. Access Web Config and then select the **Network Security** tab > **IEEE802.1X** > **Basic**.

2. Enter a value for each item.

If you want to use the scanner on a Wi-Fi network, click **Wi-Fi Setup** and select or enter an SSID.

3. Click **Next**.

A confirmation message is displayed.

4. Click **OK**.

The scanner is updated.

### IEEE802.1X Network Setting Items

Items	Settings and Explanation	
IEEE802.1X (Wi-Fi)	The connection status of IEEE802.1X (Wi-Fi) is displayed.	
Connection Method	The connection method of a current network is displayed.	
EAP Type	Select an option for an authentication method between the scanner and a RADIUS server.	
	EAP-TLS	You need to obtain and import a CA-signed certificate.
	PEAP-TLS	
	PEAP/MSCHAPv2	You need to configure a password.
EAP-TTLS		

Items	Settings and Explanation	
User ID	Configure an ID to use for an authentication of a RADIUS server. Enter 1 to 128 1-byte ASCII (0x20 to 0x7E) characters.	
Password	Configure a password to authenticate the scanner. Enter 1 to 128 1-byte ASCII (0x20 to 0x7E) characters. If you are using a Windows server as a RADIUS server, you can enter up to 127 characters.	
Confirm Password	Enter the password you configured for confirmation.	
Server ID	You can configure a server ID to authenticate with a specified RADIUS server. Authenticator verifies whether a server ID is contained in the subject/subjectAltName field of a server certificate that is sent from a RADIUS server or not. Enter 0 to 128 1-byte ASCII (0x20 to 0x7E) characters.	
Certificate Validation	You can set certificate validation regardless of the authentication method. Import the certificate in <b>CA Certificate</b> .	
Anonymous Name	If you select <b>PEAP-TLS</b> or <b>PEAP/MSCHAPv2</b> for <b>EAP Type</b> , you can configure an anonymous name instead of a user ID for a phase 1 of a PEAP authentication. Enter 0 to 128 1-byte ASCII (0x20 to 0x7E) characters.	
Encryption Strength	You can select one of the followings.	
	High	AES256/3DES
	Middle	AES256/3DES/AES128/RC4

## Configuring a Certificate for IEEE802.1X

Configure the Client Certificate for IEEE802.1X. When you set it, you can use **EAP-TLS** and **PEAP-TLS** as an authentication method of IEEE802.1x. If you want to configure the certification authority certificate, go to **CA Certificate**.

1. Access Web Config and then select the **Network Security** tab > **IEEE802.1X** > **Client Certificate**.
2. Enter a certificate in the **Client Certificate**.

If you have already imported a certificate published by a Certification Authority, you can copy the certificate and use it in IEEE802.1X. To copy, select the certificate from **Copy From**, and then click **Copy**.

## Solving Problems for Advanced Security

### Hints to Solving Problems

- Checking the error message

When trouble has occurred, first check whether there are any messages on the driver screen. If you have the notification email set when the events occur, you can promptly learn the status.

- Checking the communication status

Check the communication status of server computer or client computer by using the command such as ping and ipconfig.

Connection test

For checking the connection between the scanner to the mail server, perform the connection test from the scanner. Also, check the connection from the client computer to the server to check the communication status.

Initializing the settings

If the settings and communication status show no problem, the problems may be solved by disabling or initializing the network settings of the scanner, and then setting up again.

### Related Information

➔ [“Error Indicators” on page 27](#)

➔ [“Receiving Email Notifications When Events Occur” on page 175](#)

## Cannot Access Web Config

### ■ The IP address is not assigned to the scanner.

#### Solutions

A valid IP address may not be assigned to the scanner. Set a valid IP address using Epson Scan 2 Utility. You can confirm the current setting information from Epson Scan 2 Utility.

➔ [“Checking the Scanner's IP Address” on page 101](#)

### ■ Web browser does not support the Encryption Strength for SSL/TLS.

#### Solutions

SSL/TLS has the Encryption Strength. You can open Web Config by using a web browser that supports bulk encryptions as indicated below. Check you are using the a supported browser.

80bit: AES256/AES128/3DES

112bit: AES256/AES128/3DES

128bit: AES256/AES128

192bit: AES256

256bit: AES256

### ■ CA-signed Certificate is expired.

#### Solutions

If there is a problem with the expiration date of the certificate, "The certificate has expired" is displayed when connecting to Web Config with SSL/TLS communication (https). If the message appears before its expiration date, make sure that the scanner's date is configured correctly.

### ■ The common name of the certificate and the scanner do not match.

#### Solutions

If the common name of the certificate and the scanner do not match, the message "The name of the security certificate does not match..." is displayed when accessing Web Config using SSL/TLS communication (https). This happens because the following IP addresses do not match.

The scanner's IP address entered to common name for creating a Self-signed Certificate or CSR

IP address entered to web browser when running Web Config



For Self-signed Certificate, update the certificate.

For CA-signed Certificate, take the certificate again for the scanner.

## **The proxy server setting of local address is not set to web browser.**

### **Solutions**

When the scanner is set to use a proxy server, configure the web browser not to connect to the local address via the proxy server.

#### Windows :

Select **Control Panel > Network and Internet > Internet Options > Connections > LAN settings > Proxy server**, and then configure not to use the proxy server for LAN (local addresses).

#### Mac OS :

Select **System Preferences > Network > Advanced > Proxies**, and then register the local address for **Bypass proxy settings for these Hosts & Domains**.

Example:

192.168.1.\*: Local address 192.168.1.XXX, subnet mask 255.255.255.0

192.168.\*.\*: Local address 192.168.XXX.XXX, subnet mask 255.255.0.0

## **Restoring the Security Settings**

When you establish a highly secure environment such as IPsec/IP Filtering or IEEE802.1X, you may not be able to communicate with devices because of incorrect settings or trouble with the device or server. In this case, restore the security settings in order to make settings for the device again or to allow you temporary use.

### ***Disabling the Security Function Using Web Config***

You can disable IPsec/IP Filtering using Web Config.

1. Access Web Config and select the **Network Security** tab > **IPsec/IP Filtering** > **Basic**.
2. Disable the **IPsec/IP Filtering**.

## **Problems Using Network Security Features**

### ***Forgot a Pre-shared Key***

#### **Re-configure a pre-shared key.**

To change the key, access Web Config and select the **Network Security** tab > **IPsec/IP Filtering** > **Basic** > **Default Policy** or **Group Policy**.

When you change the pre-shared key, configure the pre-shared key for computers.

### Cannot Communicate with IPsec Communication

#### Specify the algorithm that the scanner or the computer does not support.

The scanner supports the following algorithms. Check the settings of the computer.

Security Methods	Algorithms
IKE encryption algorithm	AES-CBC-128, AES-CBC-192, AES-CBC-256, AES-GCM-128*, AES-GCM-192*, AES-GCM-256*, 3DES
IKE authentication algorithm	SHA-1, SHA-256, SHA-384, SHA-512, MD5
IKE key exchange algorithm	DH Group1, DH Group2, DH Group5, DH Group14, DH Group15, DH Group16, DH Group17, DH Group18, DH Group19, DH Group20, DH Group21, DH Group22, DH Group23, DH Group24, DH Group25, DH Group26, DH Group27*, DH Group28*, DH Group29*, DH Group30*
ESP encryption algorithm	AES-CBC-128, AES-CBC-192, AES-CBC-256, AES-GCM-128, AES-GCM-192, AES-GCM-256, 3DES
ESP authentication algorithm	SHA-1, SHA-256, SHA-384, SHA-512, MD5
AH authentication algorithm	SHA-1, SHA-256, SHA-384, SHA-512, MD5

\*available for IKEv2 only

### Cannot Communicate Suddenly

#### There is an error in the certificate.

The scanner's date and time settings may be incorrect if power has not been supplied to the scanner for a long time.

When the scanner is connected using a client certificate for IPsec/IP filtering or IEEE802.1X, an error is indicated if a time lag occurs between the scanner's date and time and the validity period for the certificate. Because the scanner recognizes that the certificate is unavailable.

You can solve this problem by correcting the scanner's date and time settings. Connect the scanner and the computer using a USB cable, turn the scanner on, and then perform scanning over USB using Epson Scan 2. The scanner is synchronized with the computer and the date and time settings are corrected. The scanner indicates normal status.

If you cannot solve the problem, restore all network settings using the scanner's control panel. Connect the scanner and computer, make the network settings again, and then make the settings for client certification, IPsec/IP filtering, or IEEE802.1X.

#### The IP address of the scanner has been changed or cannot be used.

When the IP address registered to the local address on Group Policy has been changed or cannot be used, IPsec communication cannot be performed.

Restore all network settings using the scanner's control panel.

If the DHCP is out of date, rebooting or the IPv6 address is out of date or has not been obtained, then the IP address registered for the scanner's Web Config (**Network Security** tab > **IPsec/IP Filtering** > **Basic** > **Group Policy** > **Local Address (Scanner)**) may not be found.

Use a static IP address.

**The IP address of the computer has been changed or cannot be used.**

When the IP address registered to the remote address on Group Policy has been changed or cannot be used, IPsec communication cannot be performed.

Restore all network settings using the scanner's control panel.

If the DHCP is out of date, rebooting or the IPv6 address is out of date or has not been obtained, then the IP address registered for the scanner's Web Config (**Network Security** tab > **IPsec/IP Filtering** > **Basic** > **Group Policy** > **Remote Address(Host)**) may not be found.

Use a static IP address.

**Cannot Connect After Configuring IPsec/IP Filtering**

**The set value may be incorrect.**

Access the scanner according to its MAC address using EpsonNet Config or Epson Device Admin from another computer, such as administrator's. You can find the MAC address on the label pasted on the scanner.

If you can access, make the IPsec/IP filtering settings using EpsonNet Config or Epson Device Admin.

If you cannot access, restore all network settings using the scanner's control panel. Connect the scanner and computer, make the network settings again, and then make the IPsec/IP filtering settings.

**Cannot Access the Device after Configuring IEEE802.1X**

**The settings of IEEE802.1X are incorrect.**

Restore all network settings using the scanner's control panel. Connect the scanner and a computer, and then configure IEEE802.1X again.

**Problems on Using a Digital Certificate**

**Cannot Import a CA-signed Certificate**

**CA-signed Certificate and the information on the CSR do not match.**

If the CA-signed Certificate and CSR do not have the same information, the CSR cannot be imported. Check the following:

- Are you trying to import the certificate to a device that does not have the same information?  
Check the information of the CSR and then import the certificate to a device that has the same information.
- Did you overwrite the CSR saved into the scanner after sending the CSR to a certificate authority?  
Obtain the CA-signed certificate again with the CSR.

**CA-signed Certificate is more than 5KB.**

You cannot import a CA-signed Certificate that is more than 5KB.

**The password for importing the certificate is incorrect.**

Enter the correct password. If you forget the password, you cannot import the certificate. Re-obtain the CA-signed Certificate.

### **Cannot Update a Self-Signed Certificate**

#### **The Common Name has not been entered.**

**Common Name** must be entered.

#### **Unsupported characters have been entered to Common Name.**

Enter between 1 and 128 characters of either IPv4, IPv6, host name, or FQDN format in ASCII (0x20-0x7E).

#### **A comma or space is included in the common name.**

If a comma is entered, the **Common Name** is divided at that point. If only a space is entered before or after a comma, an error occurs.

### **Cannot Create a CSR**

#### **The Common Name has not been entered.**

The **Common Name** must be entered.

#### **Unsupported characters have been entered to Common Name, Organization, Organizational Unit, Locality, and State/Province.**

Enter characters of either IPv4, IPv6, host name, or FQDN format in ASCII (0x20-0x7E).

#### **A comma or space is included in the Common Name.**

If a comma is entered, the **Common Name** is divided at that point. If only a space is entered before or after a comma, an error occurs.

### **Warning Relating to a Digital Certificate Appears**

<b>Messages</b>	<b>Cause/What to do</b>
Enter a Server Certificate.	<p><b>Cause:</b> You have not selected a file to import.</p> <p><b>What to do:</b> Select a file and click <b>Import</b>.</p>
CA Certificate 1 is not entered.	<p><b>Cause:</b> CA certificate 1 is not entered and only CA certificate 2 is entered.</p> <p><b>What to do:</b> Import CA certificate 1 first.</p>
Invalid value below.	<p><b>Cause:</b> Unsupported characters are contained in the file path and/or password.</p> <p><b>What to do:</b> Make sure that the characters are entered correctly for the item.</p>

Messages	Cause/What to do
Invalid date and time.	<p><b>Cause:</b> Date and time for the scanner have not been set.</p> <p><b>What to do:</b> Set date and time using Web Config or EpsonNet Config.</p>
Invalid password.	<p><b>Cause:</b> The password set for CA certificate and entered password do not match.</p> <p><b>What to do:</b> Enter the correct password.</p>
Invalid file.	<p><b>Cause:</b> You are not importing a certificate file in X509 format.</p> <p><b>What to do:</b> Make sure that you are selecting the correct certificate sent by a trusted certificate authority.</p>
	<p><b>Cause:</b> The file you have imported is too large. The maximum file size is 5KB.</p> <p><b>What to do:</b> If you select the correct file, the certificate might be corrupted or fabricated.</p>
	<p><b>Cause:</b> The chain contained in the certificate is invalid.</p> <p><b>What to do:</b> For more information on the certificate, see the website of the certificate authority.</p>
Cannot use the Server Certificates that include more than three CA certificates.	<p><b>Cause:</b> The certificate file in PKCS#12 format contains more than 3 CA certificates.</p> <p><b>What to do:</b> Import each certificate as converting from PKCS#12 format to PEM format, or import the certificate file in PKCS#12 format that contains up to 2 CA certificates.</p>
The certificate has expired. Check if the certificate is valid, or check the date and time on the product.	<p><b>Cause:</b> The certificate is out of date.</p> <p><b>What to do:</b></p> <ul style="list-style-type: none"> <li><input type="checkbox"/> If the certificate is out of date, obtain and import the new certificate.</li> <li><input type="checkbox"/> If the certificate is not out of date, make sure the scanner's date and time are set correctly.</li> </ul>

Messages	Cause/What to do
Private key is required.	<p><b>Cause:</b></p> <p>There is no paired private key with the certificate.</p> <p><b>What to do:</b></p> <ul style="list-style-type: none"> <li><input type="checkbox"/> If the certificate is the PEM/DER format and it is obtained from a CSR using a computer, specify the private key file.</li> <li><input type="checkbox"/> If the certificate is the PKCS#12 format and it is obtained from a CSR using a computer, create a file that contains the private key.</li> </ul>
	<p><b>Cause:</b></p> <p>You have re-imported the PEM/DER certificate obtained from a CSR using Web Config.</p> <p><b>What to do:</b></p> <p>If the certificate is the PEM/DER format and it is obtained from a CSR using Web Config, you can only import it once.</p>
Setup failed.	<p><b>Cause:</b></p> <p>Cannot finish the configuration because the communication between the scanner and computer failed or the file cannot be read by some errors.</p> <p><b>What to do:</b></p> <p>After checking the specified file and communication, import the file again.</p>

**Delete a CA-signed Certificate by Mistake**

**There is no backup file for the CA-signed certificate.**

If you have the backup file, import the certificate again.

If you obtain a certificate using a CSR created from Web Config, you cannot import a deleted certificate again. Create a CSR and obtain a new certificate.

---

# Technical Specifications

General Scanner Specifications. . . . .	208
Network Specifications. . . . .	209
Supported Third Party Services. . . . .	211
Using Port for the Scanner. . . . .	211
Dimensions and Weight Specifications. . . . .	212
Electrical Specifications. . . . .	213
Environmental Specifications. . . . .	214
System Requirements. . . . .	214

## General Scanner Specifications

**Note:**

Specifications are subject to change without notice.

Scanner type	Sheet Feed, one pass duplex color scanner
Photoelectric device	CIS
Effective pixels	5,100×9,300 at 600 dpi 2,550×36,000 at 300 dpi
Light source	RGB LED
Scanning resolution	600 dpi (main scan) 600 dpi (sub scan)
Output resolution	50 to 1200 dpi (in 1 dpi increments) *1
Document Size	Max: 215.9×3048 (8.5×120 inches) Min: 50.8×50.8 mm (2×2 inches)
Paper input	Face-up loading
Paper output	Vertical path position: Face-down ejection Straight path position: Face-up ejection
Paper capacity	20 sheets of paper at 80 g/m <sup>2</sup>
Color Depth	<p>Color</p> <ul style="list-style-type: none"> <li><input type="checkbox"/> 30 bits per pixel internal (10 bits per pixel per color internal)</li> <li><input type="checkbox"/> 24 bits per pixel external (8 bits per pixel per color external)</li> </ul> <p>Grayscale</p> <ul style="list-style-type: none"> <li><input type="checkbox"/> 10 bits per pixel internal</li> <li><input type="checkbox"/> 8 bits per pixel external</li> </ul> <p>Black and white</p> <ul style="list-style-type: none"> <li><input type="checkbox"/> 10 bits per pixel internal</li> <li><input type="checkbox"/> 1 bit per pixel external</li> </ul>
Interface	Hi-Speed USB

\*1 This value is when scanning with a computer. Available resolutions may vary depending on the scanning method.



## Network Specifications

### Wi-Fi Specifications

See the following table for Wi-Fi specifications.

Countries or regions except for those listed below	Table A
Australia New Zealand China Taiwan South Korea	Table B

Table A

Standards	IEEE802.11b/g/n*1
Frequency Range	2400-2483.5 MHz
Maximum Radio-Frequency Power Transmitted	20 dBm (EIRP)
Channels	1/2/3/4/5/6/7/8/9/10/11/12/13
Connection Modes	Infrastructure, Wi-Fi Direct (Simple AP)*2*3
Security Protocols*4	WEP (64/128bit), WPA2-PSK (AES)*5, WPA3-SAE (AES), WPA2/WPA3-Enterprise

\*1 Only available for the HT20

\*2 Not supported for IEEE 802.11b

\*3 Infrastructure and Wi-Fi Direct modes can be used simultaneously.

\*4 Wi-Fi Direct supports WPA2-PSK (AES) only.

\*5 Complies with WPA2 standards with support for WPA/WPA2 Personal.

Table B

Standards	IEEE802.11a/b/g/n*1/ac
Frequency Ranges	IEEE802.11b/g/n: 2.4 GHz, IEEE802.11a/n/ac: 5 GHz

Channels	Wi-Fi	2.4 GHz	1/2/3/4/5/6/7/8/9/10/11/12* <sup>2</sup> /13* <sup>2</sup>
		5 GHz* <sup>3</sup>	W52 (36/40/44/48), W53 (52/56/60/64), W56 (100/104/108/112/116/120/124/128/132/136/140/144), W58 (149/153/157/161/165)
	Wi-Fi Direct	2.4 GHz	1/2/3/4/5/6/7/8/9/10/11/12* <sup>2</sup> /13* <sup>2</sup>
		5 GHz* <sup>3</sup>	W52 (36/40/44/48) W58 (149/153/157/161/165)
Connection Modes	Infrastructure, Wi-Fi Direct (Simple AP) * <sup>4</sup> * <sup>5</sup>		
Security Protocols* <sup>6</sup>	WEP (64/128bit), WPA2-PSK (AES)* <sup>7</sup> , WPA3-SAE (AES), WPA2/WPA3-Enterprise		

\*1 Only available for the HT20

\*2 Not available in Taiwan

\*3 The availability of these channels and use of the product outdoors over these channels varies by location. For more information, see <http://support.epson.net/wifi5ghz/>

\*4 Not supported for IEEE 802.11b

\*5 Infrastructure and Wi-Fi Direct modes can be used simultaneously.

\*6 Wi-Fi Direct only supports WPA2-PSK (AES) .

\*7 Complies with WPA2 standards with support for WPA/WPA2 Personal.

## Network Features and IPv4/IPv6 Support

Features	Supported
Epson ScanSmart	IPv4
AirPrint	IPv4, IPv6

## Security Protocol

IEEE802.1X*	
IPsec/IP Filtering	
SSL/TLS	HTTPS Server/Client
SMTPS (STARTTLS, SSL/TLS)	
SNMPv3	

\* You need to use a connection device that complies with IEEE802.1X.

## Supported Third Party Services

AirPrint	OS X Mavericks (10.9.5) or later
----------	----------------------------------

\* We recommend using the latest Mac OS.

## Using Port for the Scanner

The scanner uses the following port. These ports should be allowed to become available by the network administrator as necessary.

### When the Sender (Client) is the Scanner

Usage	Target (Server)	Protocol	Port Number
Controlling WSD	Client computer	WSD (TCP)	5357
Search the computer when push scanning from an application	Client computer	Network Push Scan Discovery	2968

### When the Sender (Client) is the Client Computer

Usage	Target (Server)	Protocol	Port Number
Discover the scanner from an application such as EpsonNet Config and scanner driver.	Scanner	ENPC (UDP)	3289
Collect and set up the MIB information from an application such as EpsonNet Config and scanner driver.	Scanner	SNMP (UDP)	161
Searching for WSD scanners	Scanner	WS-Discovery (UDP)	3702
Forwarding the scan data from an application	Scanner	Network Scan (TCP)	1865
Collecting the job information when push scanning from an application	Scanner	Network Push Scan	2968
Web Config	Scanner	HTTP(TCP)	80
		HTTPS(TCP)	443

## Dimensions and Weight Specifications

### Dimensions

Vertical path position (units: mm (inches))

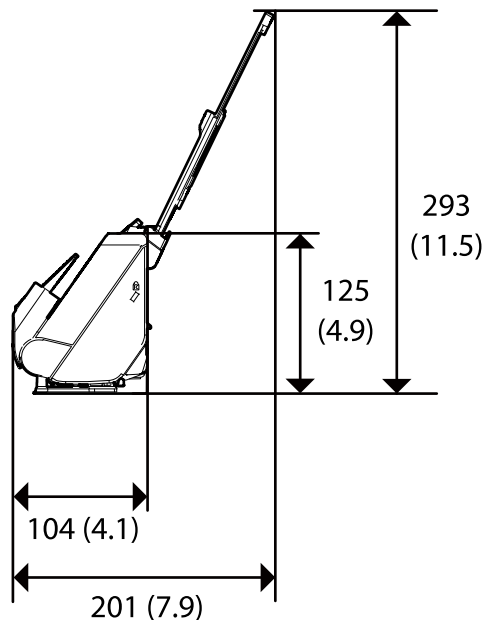
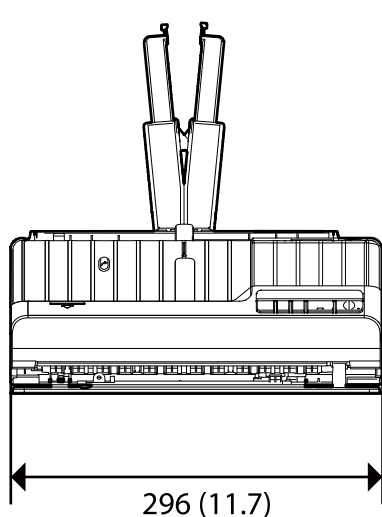

Straight path position (units: mm (inches))

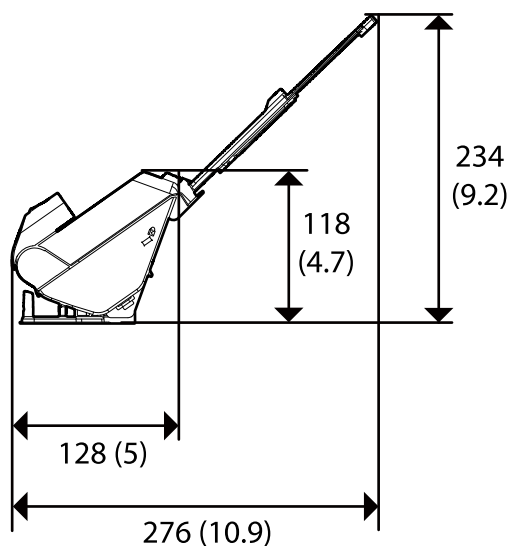
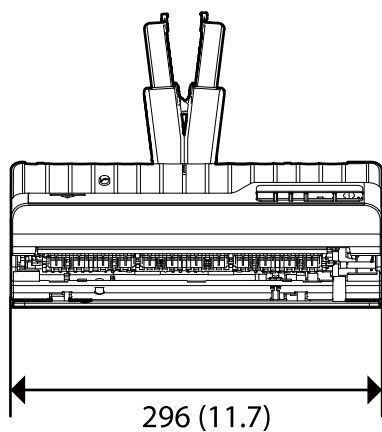

### Weight

Approx. 1.8 kg (4.0 lb)

## Electrical Specifications

### Scanner Electrical Specifications

Rated DC Input Power Supply Voltage	DC 24 V
Rated DC Input Current	1 A
Power Consumption	<p>USB Connection</p> <ul style="list-style-type: none"> <li><input type="checkbox"/> Operating: Approx. 10 W</li> <li><input type="checkbox"/> Ready mode: Approx. 3.3 W</li> <li><input type="checkbox"/> Sleep mode : Approx. 1.0 W</li> <li><input type="checkbox"/> Power off: Approx. 0.1 W</li> </ul> <p>Wi-Fi Connection</p> <ul style="list-style-type: none"> <li><input type="checkbox"/> Operating: Approx. 11 W</li> <li><input type="checkbox"/> Ready mode: Approx. 3.7 W</li> <li><input type="checkbox"/> Sleep mode : Approx. 1.4 W</li> <li><input type="checkbox"/> Power off: Approx. 0.1 W</li> </ul>

**Note:**

For European users, see the following Website for details on power consumption.

<http://www.epson.eu/energy-consumption>

### AC Adapter Electrical Specifications

Model	A461H (AC 100-240 V) A462E (AC 220-240 V)
Rated Input Current	1 A
Rated Frequency Range	50-60 Hz
Rated Output Power Supply Voltage	DC 24 V
Rated Output Current	1 A

**Note:**

For European users, see the following Website for details on power consumption.

<http://www.epson.eu/energy-consumption>

## Environmental Specifications

Temperature	When operating	5 to 35 °C (41 to 95 °F)
	When stored	-25 to 60 °C (-13 to 140 °F)
Humidity	When operating	15 to 80% (without condensation)
	When stored	15 to 85% (without condensation)
Operating conditions		Ordinary office or home conditions. Avoid operating the scanner in direct sunlight, near a strong light source, or in extremely dusty conditions.

## System Requirements

Supported operating systems may vary depending on the application.

Windows	Windows 11 or later Windows 10 Windows 8/8.1 Windows 7
Mac OS*1 *2	Mac OS X 10.11 or later, macOS 11 or later

\*1 Fast User Switching on Mac OS or later is not supported.

\*2 The UNIX File System (UFS) for Mac OS is not supported.

---



# Standards and Approvals

Standards and Approvals for European Models. . . . . 216

Standards and Approvals for Australian Models. . . . . 216

Standards and Approvals for U.S. Models. . . . . 216

---

## Standards and Approvals for European Models

### Product and AC adapter

For European users

Hereby, Seiko Epson Corporation declares that the following radio equipment models are in compliance with Directive 2014/53/EU. The full text of the EU declaration of conformity is available at the following website.

<http://www.epson.eu/conformity>

J441B

A461H, A462E

For use only in Ireland, UK, Austria, Germany, Liechtenstein, Switzerland, France, Belgium, Luxembourg, Netherlands, Italy, Portugal, Spain, Denmark, Finland, Norway, Sweden, Iceland, Croatia, Cyprus, Greece, Slovenia, Malta, Bulgaria, Czech, Estonia, Hungary, Latvia, Lithuania, Poland, Romania, and Slovakia.

Epson cannot accept responsibility for any failure to satisfy the protection requirements resulting from a non-recommended modification of the product.



---

## Standards and Approvals for Australian Models

### Product

EMC	AS/NZS CISPR32 Class B
-----	------------------------

Epson hereby declares that the following equipment Models are in compliance with the essential requirements and other relevant provisions of AS/NZS4268:

J441A

Epson cannot accept responsibility for any failure to satisfy the protection requirements resulting from a non-recommended modification of the product.

### AC adapter (A461H)

EMC	AS/NZS CISPR32 Class B
-----	------------------------

---

## Standards and Approvals for U.S. Models

### Product

EMC	FCC Part 15 Subpart B Class B CAN ICES-3 (B)/NMB-3 (B)
-----	-----------------------------------------------------------

This equipment contains the following wireless module.



Manufacturer: Seiko Epson Corporation

Type: J26H005

This product conforms to Part 15 of the FCC Rules and RSS-210 of the IC Rules. Epson cannot accept responsibility for any failure to satisfy the protection requirements resulting from a non-recommended modification of the product. Operation is subject to the following two conditions: (1) this device may not cause harmful interference, and (2) this device must accept any interference received, including interference that may cause undesired operation of the device.

To prevent radio interference to the licensed service, this device is intended to be operated indoors and away from windows to provide maximum shielding. Equipment (or its transmit antenna) that is installed outdoors is subject to licensing.

This equipment complies with FCC/IC radiation exposure limits set forth for an uncontrolled environment and meets the FCC radio frequency (RF) Exposure Guidelines in Supplement C to OET65 and RSS-102 of the IC radio frequency (RF) Exposure rules. This equipment should be installed and operated so that the radiator is kept at least 7.9 inches (20 cm) or more away from a person's body (excluding extremities: hands, wrists, feet and ankles).

**AC adapter (A461H)**

EMC	FCC Part 15 Subpart B Class B CAN ICES-3 (B)/NMB-3 (B)
-----	-----------------------------------------------------------

---

# Where to Get Help

Technical Support Web Site. . . . .	219
Contacting Epson Support. . . . .	219

---

## Technical Support Web Site

If you need further help, visit the Epson support website shown below. Select your country or region and go to the support section of your local Epson website. The latest drivers, FAQs, manuals, or other downloadables are also available from the site.

<http://support.epson.net/>

<http://www.epson.eu/support> (Europe)

If your Epson product is not operating properly and you cannot solve the problem, contact Epson support services for assistance.

---

## Contacting Epson Support

### Before Contacting Epson

If your Epson product is not operating properly and you cannot solve the problem using the troubleshooting information in your product manuals, contact Epson support services for assistance. If Epson support for your area is not listed below, contact the dealer where you purchased your product.

Epson support will be able to help you much more quickly if you give them the following information:

- Product serial number  
(The serial number label is usually on the back of the product.)
- Product model
- Product software version  
(Click **About**, **Version Info**, or a similar button in the product software.)
- Brand and model of your computer
- Your computer operating system name and version
- Names and versions of the software applications you normally use with your product

**Note:**

*Depending on the product, the dial list data for fax and/or network settings may be stored in the product's memory. Due to breakdown or repair of a product, data and/or settings may be lost. Epson shall not be responsible for the loss of any data, for backing up or recovering data and/or settings even during a warranty period. We recommend that you make your own backup data or take notes.*

### Help for Users in Europe

Check your Pan-European Warranty Document for information on how to contact Epson support.

### Help for Users in Taiwan

Contacts for information, support, and services are:

### **World Wide Web**

<http://www.epson.com.tw>

Information on product specifications, drivers for download, and products enquiry are available.

### **Epson HelpDesk**

Phone: +886-2-2165-3138

Our HelpDesk team can help you with the following over the phone:

- Sales enquiries and product information
- Product usage questions or problems
- Enquiries on repair service and warranty

### **Repair service center:**

<http://www.tekcare.com.tw/branchMap.page>

TekCare corporation is an authorized service center for Epson Taiwan Technology & Trading Ltd.

## **Help for Users in Australia**

Epson Australia wishes to provide you with a high level of customer service. In addition to your product manuals, we provide the following sources for obtaining information:

### **Internet URL**

<http://www.epson.com.au>

Access the Epson Australia World Wide Web pages. Worth taking your modem here for the occasional surf! The site provides a download area for drivers, Epson contact points, new product information and technical support (e-mail).

### **Epson Helpdesk**

Phone: 1300-361-054

Epson Helpdesk is provided as a final backup to make sure our clients have access to advice. Operators on the Helpdesk can aid you in installing, configuring and operating your Epson product. Our Pre-sales Helpdesk staff can provide literature on new Epson products and advise where the nearest dealer or service agent is located. Many types of queries are answered here.

We encourage you to have all the relevant information on hand when you ring. The more information you prepare, the faster we can help solve the problem. This information includes your Epson product manuals, type of computer, operating system, application programs, and any information you feel is required.

### **Transportation of Product**

Epson recommends retaining product packaging for future transportation.

## **Help for Users in Singapore**

Sources of information, support, and services available from Epson Singapore are:

### **World Wide Web**

<http://www.epson.com.sg>

Information on product specifications, drivers for download, Frequently Asked Questions (FAQ), Sales Enquiries, and Technical Support via e-mail are available.

### **Epson HelpDesk**

Toll Free: 800-120-5564

Our HelpDesk team can help you with the following over the phone:

- Sales enquiries and product information
- Product usage questions or problem troubleshooting
- Enquiries on repair service and warranty

## **Help for Users in Thailand**

Contacts for information, support, and services are:

### **World Wide Web**

<http://www.epson.co.th>

Information on product specifications, drivers for download, Frequently Asked Questions (FAQ), and e-mail are available.

### **Epson Call Centre**

Phone: 66-2460-9699

Email: [support@eth.epson.co.th](mailto:support@eth.epson.co.th)

Our Call Centre team can help you with the following over the phone:

- Sales enquiries and product information
- Product usage questions or problems
- Enquiries on repair service and warranty

## **Help for Users in Vietnam**

Contacts for information, support, and services are:

### **Epson Service Center**

27 Yen Lang, Trung Liet Ward, Dong Da District, Ha Noi City. Tel: +84 24 7300 0911

38 Le Dinh Ly, Thac Gian Ward, Thanh Khe District, Da Nang. Tel: +84 23 6356 2666

194/3 Nguyen Trong Tuyen, Ward 8, Phu Nhuan Dist., HCMC. Tel: +84 28 7300 0911

31 Phan Boi Chau, Ward 14, Binh Thanh District, HCMC. Tel: +84 28 35100818

## Help for Users in Indonesia

Contacts for information, support, and services are:

### World Wide Web

<http://www.epson.co.id>

- Information on product specifications, drivers for download
- Frequently Asked Questions (FAQ), Sales Enquiries, questions through e-mail

### Epson Hotline

Phone: 1500-766 (Indonesia Only)

Email: [customer.care@ein.epson.co.id](mailto:customer.care@ein.epson.co.id)

Our Hotline team can help you with the following over the phone or email:

- Sales enquiries and product information
- Technical support

## Help for Users in Hong Kong

To obtain technical support as well as other after-sales services, users are welcome to contact Epson Hong Kong Limited.

### Internet Home Page

<http://www.epson.com.hk>

Epson Hong Kong has established a local home page in both Chinese and English on the Internet to provide users with the following information:

- Product information
- Answers to Frequently Asked Questions (FAQs)
- Latest versions of Epson product drivers

### Technical Support Hotline

You can also contact our technical staff at the following telephone and fax numbers:

Phone: 852-2827-8911

Fax: 852-2827-4383

## Help for Users in Malaysia

Contacts for information, support, and services are:

### World Wide Web

<http://www.epson.com.my>

- Information on product specifications, drivers for download

Frequently Asked Questions (FAQ), Sales Enquiries, questions through e-mail

### **Epson Call Centre**

Phone: 1800-81-7349 (Toll Free)

Email: [websupport@emsb.epson.com.my](mailto:websupport@emsb.epson.com.my)

- Sales enquiries and product information
- Product usage questions or problems
- Enquiries on repair services and warranty

### **Epson Malaysia Sdn Bhd (Head Office)**

Phone: 603-56288288

Fax: 603-5628 8388/603-5621 2088

## **Help for Users in India**

Contacts for information, support, and services are:

### **World Wide Web**

<http://www.epson.co.in>

Information on product specifications, drivers for download, and products enquiry are available.

### **Toll Free Helpline**

For Service, Product information or to order consumables -

18004250011 / 186030001600 / 1800123001600 (9AM – 6PM)

### **Email**

[calllog@epson-india.in](mailto:calllog@epson-india.in)

### **WhatsApp**

+91 96400 00333

## **Help for Users in the Philippines**

To obtain technical support as well as other after sales services, users are welcome to contact the Epson Philippines Corporation at the telephone, fax numbers and e-mail address below:

### **World Wide Web**

<http://www.epson.com.ph>

Information on product specifications, drivers for download, Frequently Asked Questions (FAQ), and E-mail Enquiries are available.

**Epson Philippines Customer Care**

Toll Free: (PLDT) 1-800-1069-37766

Toll Free: (Digitel) 1-800-3-0037766

Metro Manila: +632-8441-9030

Web Site: <https://www.epson.com.ph/contact>

E-mail: [customercare@epc.epson.com.ph](mailto:customercare@epc.epson.com.ph)

Accessible 9am to 6pm, Monday through Saturday (Except public holidays)

Our Customer Care team can help you with the following over the phone:

- Sales enquiries and product information
- Product usage questions or problems
- Enquiries on repair service and warranty

**Epson Philippines Corporation**

Trunk Line: +632-8706-2609

Fax: +632-8706-2663 / +632-8706-2665