

SAMSUNG

USER GUIDE

SM-R530
SM-R630

English. 07/2024. Rev.1.1

www.samsung.com

Table of Contents

Getting started

- 3 About the Galaxy Buds3 / Galaxy Buds3 Pro
- 4 Device layout and functions
- 7 Replacing ear tips (Galaxy Buds3 Pro)
- 8 Charging the battery
- 15 Indicator lights identification

Using the earbuds

- 18 Connecting the earbuds to a mobile device
- 22 Wearing the earbuds
- 24 Using the earbud by gestures
- 27 Using the noise controls modes
- 29 Auto switching to ambient sound (Galaxy Buds3 Pro)
- 30 Listening to music
- 30 Using the equaliser
- 31 Using call features
- 31 Bixby

Galaxy Wearable app

- 33 Introduction
- 36 Configuring settings for the Galaxy Buds

Usage notices

- 44 Precautions for using the device
- 45 Notes on package contents and accessories
- 46 Maintaining water and dust resistance
- 47 Precautions for using the earbuds
- 48 Cleaning and managing the Galaxy Buds
- 50 Restarting the earbuds
- 50 Coupling the earbuds

Appendix

- 51 Troubleshooting
- 55 Removing the battery

Getting started

About the Galaxy Buds3 / Galaxy Buds3 Pro

Galaxy Buds3 / Galaxy Buds3 Pro (hereafter, Galaxy Buds) are wireless earbuds which allow you to listen to music or answer incoming calls after connecting them to your mobile device even while doing other activities, such as working out.

 Do not wear the earbuds in high-traffic areas, such as roads or crosswalks. Doing so may result in accidents because of slowed reaction times.

Device layout and functions

Earbud

► Galaxy Buds3:

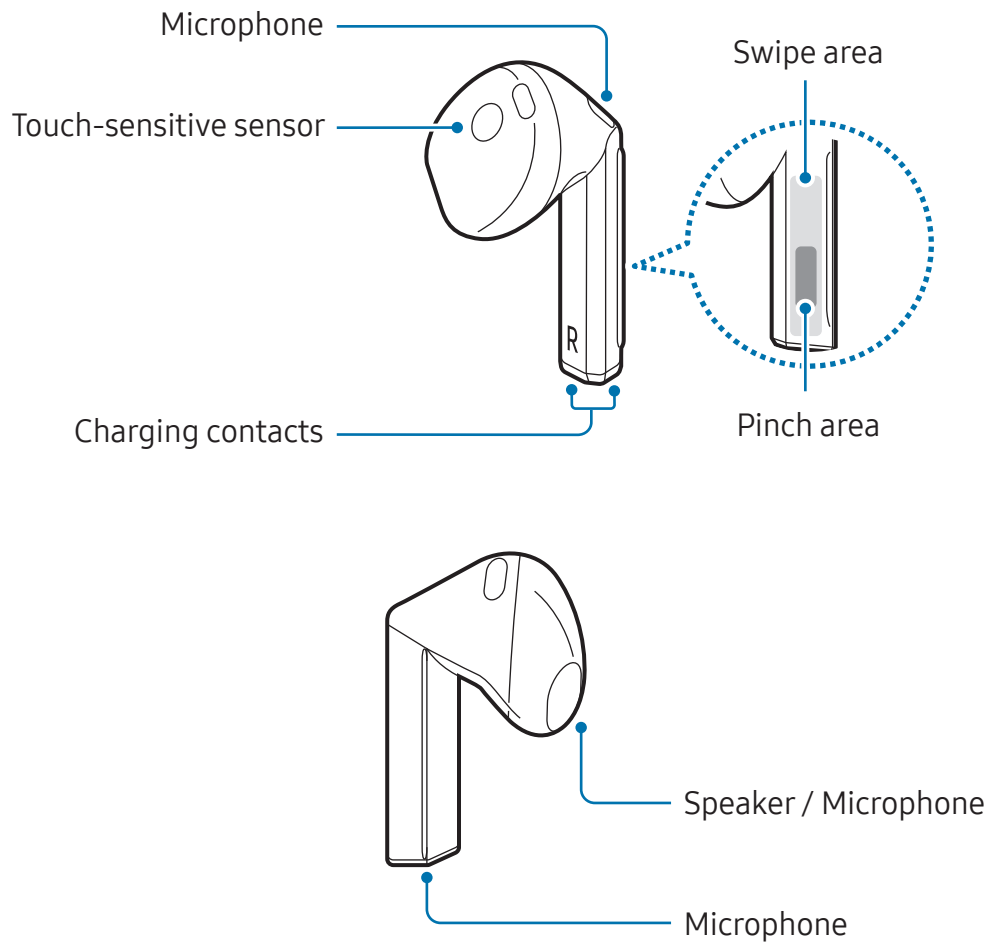

► Galaxy Buds3 Pro:

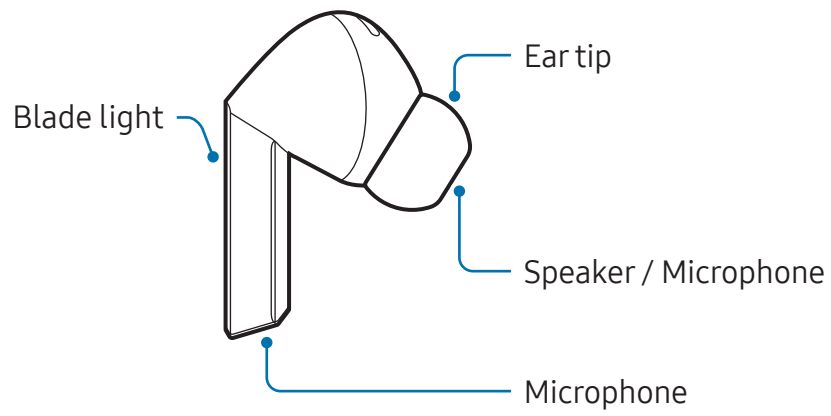
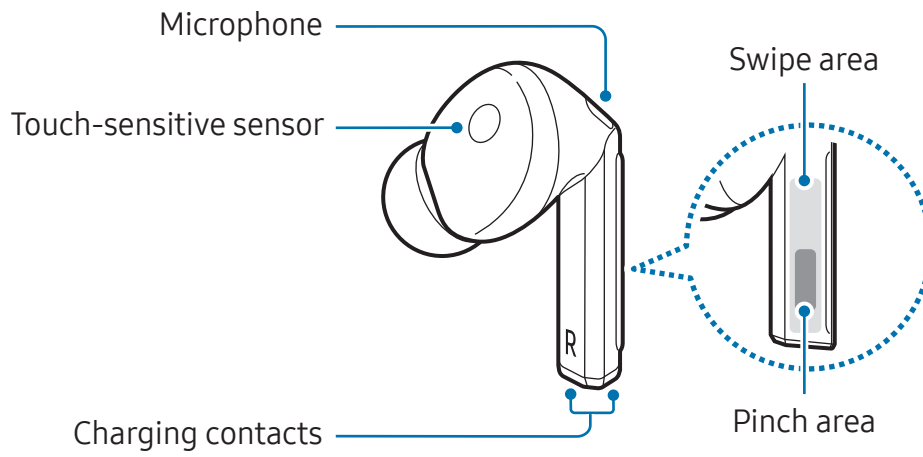

Charging case

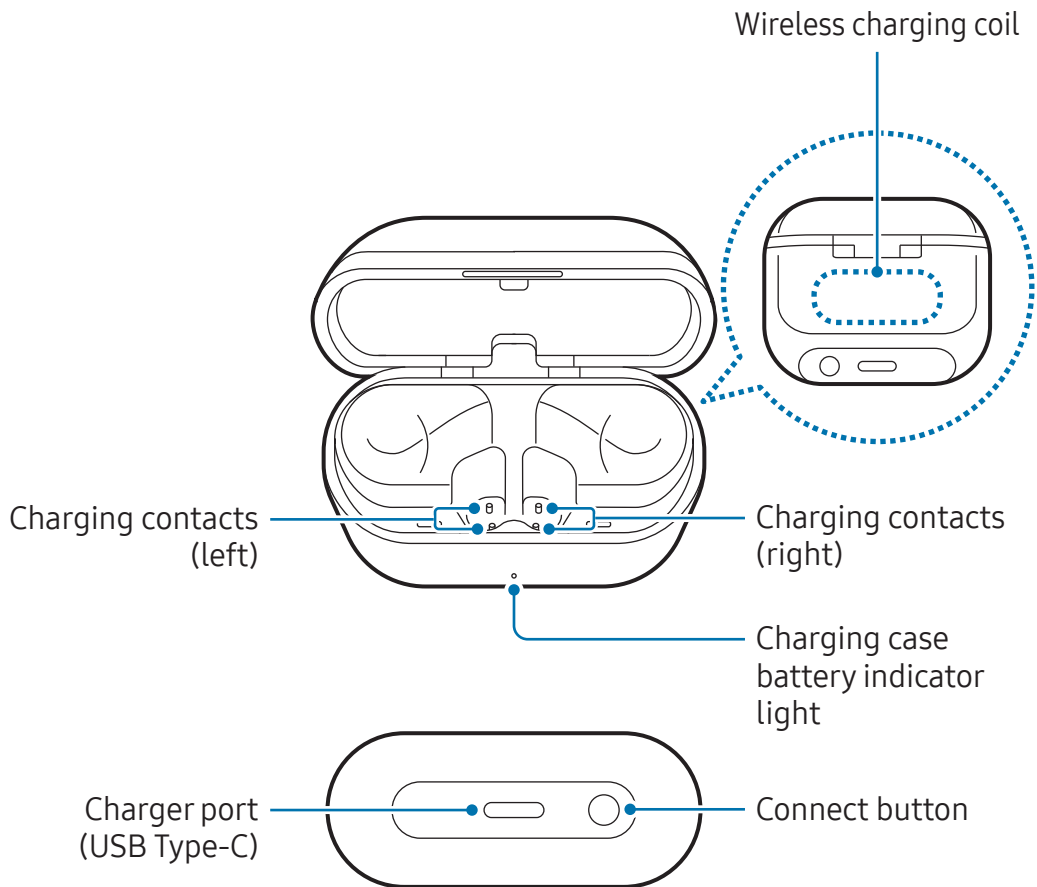

- Use the device in a place without magnetic interference for the device to operate normally.
- Your device and some accessories (sold separately) contain magnets. Keep it away from credit cards, implanted medical devices, and other devices that may be affected by magnets. In the case of medical devices, keep your device more than 15 cm apart. Stop using your device if you suspect any interference with your medical device and consult your physician or your medical device manufacturer.
- If you have a medical implant in your heart, do not place your device in a pocket close to your implanted device, such as your chest or inner jacket pocket.
- Keep a safe distance between objects that are affected by magnets, and your device and some accessories (sold separately) that contain magnets. Objects such as credit cards, passbooks, access cards, boarding passes, or parking passes may be damaged or disabled by the magnets in the device.

- ❗ If you use the earbuds when they are broken, there may be a risk of injury. Use the earbuds only after they have been repaired at a Samsung Service Centre or an authorised service centre.
- 🧼
 - If foreign materials are placed on the touch-sensitive sensor, they may cause the sensor to malfunction. Before wearing the earbuds, clean the sensor first.
 - If there is sweat or liquid on the charging contacts, corrosion may occur on the Galaxy Buds. When there is sweat or liquid on the charging contacts or earbuds, clean them before inserting the earbuds in the charging case.
 - The images in this guide are of a Galaxy Buds3 Pro.

Replacing ear tips (Galaxy Buds3 Pro)

- ❗
 - Do not put the earbuds in your ears without ear tips. Doing so may hurt your ears.
 - Do not pull the ear tip excessively when you attach or detach it. The ear tip may tear.
 - Do not press the ear tip excessively or twist it. The ear tip may be damaged.
 - When inserting the ear tip, the ear tip may get caught in the small gap that appears around the outside of the earbud. In this case, remove the ear tips and reinstall them.

- 1 Turn over the ear tip inserted into the earbud and vertically pull on the middle part of the ear tip to remove it.

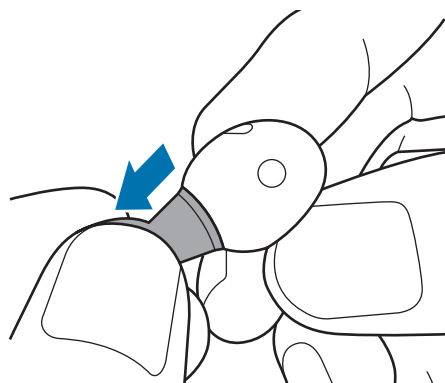

- 2 Select the ear tips that fit your ears.
- 3 Align the protruding part on the speaker of the earbud with the groove of the ear tip and push it in until it clicks into place.

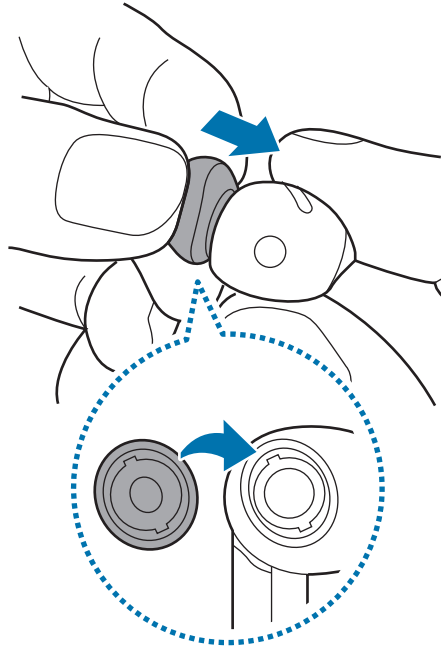

Charging the battery

Fully charge the battery before using the earbuds for the first time or when they have been unused for extended periods. The earbuds will start to work while charging. When you charge the battery for the first time or when the battery is completely discharged, it needs at least 10 minutes to start to work.

The charging case, which has a built-in battery, is charged along with the earbuds that are in the charging case when connected to the charger.

-  If you put the earbuds in a completely discharged charging case, they may emit a sound. Sufficiently charge the charging case before inserting the earbuds.

Wired charging

- 1 Open the charging case.
- 2 Check the direction of each earbud and correctly insert them into their corresponding slots in the charging case.

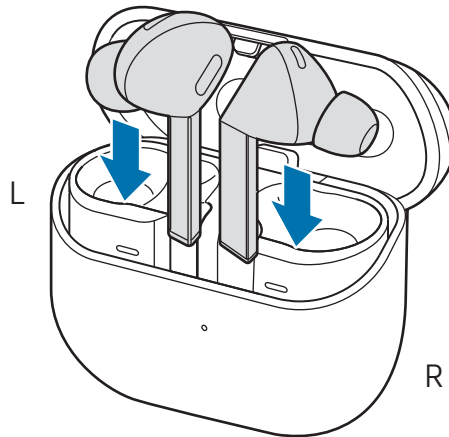

- 3 Close the charging case.

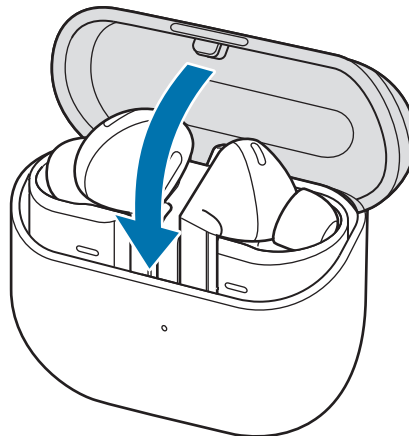

- 4 Connect the USB cable to the charger and then plug the USB cable into the charger port.

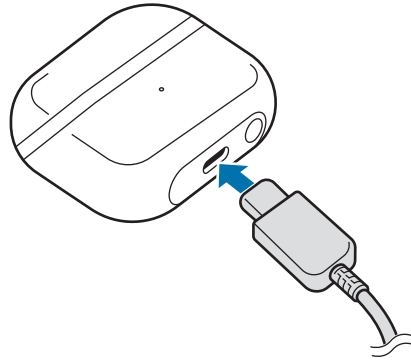

- 5 Plug the charger into an electric socket. The batteries of the earbuds and the charging case are charged simultaneously.
- 6 After fully charging, disconnect the charging case from the charger. First disconnect the USB cable from the charging case and then unplug the charger from the electric socket.

Wireless charging

The charging case has a built-in wireless charging coil. You can charge the battery by using a wireless charger (sold separately).

- 1 Open the charging case.
- 2 Check the direction of each earbud and correctly insert them into their corresponding slots in the charging case.
- 3 Close the charging case.

- 4 Place the centre of the wireless charging coil on the back of the charging case on the centre of the wireless charger. Wireless charging may not work smoothly depending on the type of accessory or cover. For stable wireless charging, it is recommended to separate the cover or accessory from the Galaxy Buds.

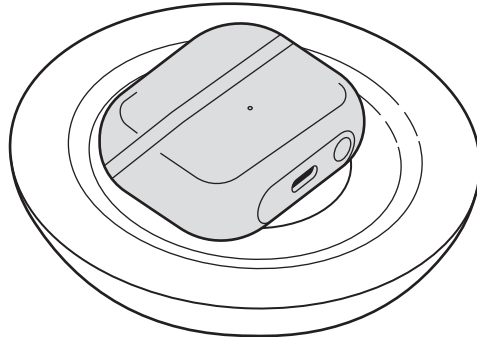

- 5 After fully charging, disconnect the charging case from the wireless charger.

Precautions for wireless charging

Do not place the charging case on the wireless charger when conductive materials, such as metal objects and magnets, are placed between the charging case and the wireless charger. The Galaxy Buds may not charge properly or may overheat, or the charging case may be damaged.

-  Use Samsung-approved wireless chargers. If you use other wireless chargers, the battery may not charge properly.

Charging by Wireless power sharing

You can charge your Galaxy Buds with the battery of the device that works as a wireless charger. You can still charge your Galaxy Buds even while charging the device that works as a wireless charger. Depending on the type of accessories or cover being used, the Wireless power sharing feature may not work properly. It is recommended to remove any cover being used from the device that works as a wireless charger and your Galaxy Buds before using this feature.

- 1 Open the charging case.
- 2 Check the direction of each earbud and correctly insert them into their corresponding slots in the charging case.

- 3 Close the charging case.
- 4 Turn on the Wireless power sharing feature on the device that functions as a wireless charger and place the centre of the wireless charging coil on the back of the charging case on the device that functions as a wireless charger.

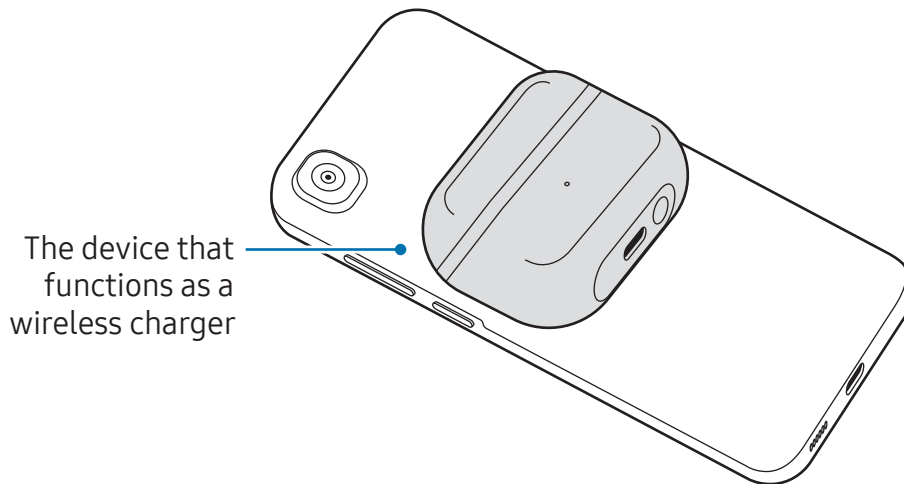

- 5 After fully charging, disconnect the charging case from the device that functions as a wireless charger.



- Only mobile devices that support the Wireless power sharing feature can charge the Galaxy Buds. To check mobile devices that support the Wireless power sharing feature, visit the Samsung website.
- The location of the wireless charging coil may vary by device. Adjust the device and the charging case to make a strong connection.
- To charge properly, do not move or use either the device that functions as a wireless charger or the charging case while charging.
- The power charged to the Galaxy Buds may be less than the amount shared to them by the device that functions as a wireless charger.
- If you charge the Galaxy Buds while charging the device that functions as a wireless charger, the charging speed may decrease or the Galaxy Buds may not charge properly, depending on the charger type.
- The charging speed or efficiency may vary depending on the device's condition or the surrounding environment.
- If the remaining battery power of the device that functions as a wireless charger drops below a certain level, power sharing will stop.

Checking the battery level

Connect the earbuds to your mobile device, open the **Galaxy Wearable** app on your mobile device, and check the battery status of the earbuds and the charging case. Refer to [Connecting the earbuds to a mobile device](#) for more information.





 When the remaining battery level is low, a notification will appear on your mobile device's notification panel.

Reducing the battery consumption

When you are not using the earbuds, store them in a charging case that has been charged. If not, the touch-sensitive sensor will continue to work, and it will affect the usage time and battery consumption.

Battery charging tips and precautions

-  Use only Samsung-approved charger and cable specifically designed for your Galaxy Buds. Incompatible charger and cable can cause serious injuries or damage to your device.
-  • Connecting the charger improperly may cause serious damage to the charging case. Any damage caused by misuse is not covered by the warranty.
- Use only USB Type-C cable supplied with the Galaxy Buds. The charging case may be damaged if you use Micro USB cable.
- If you charge the Galaxy Buds while the charger port is wet, the Galaxy Buds may be damaged. Thoroughly dry the charger port before charging the Galaxy Buds.



- Chargers are sold separately.
- To save energy, unplug the charger when not in use. The charger does not have a power switch, so you must unplug the charger from the electric socket when not in use to avoid wasting power.
- When using a charger, it is recommended to use an approved charger that guarantees the charging performance.
- Keep the charging case closed while you store or charge the earbuds, or when you charge the charging case.
- If you touch the charging contacts while charging the charging case, it may affect charging.
- If there is sweat or liquid on the charging contacts, corrosion may occur on the Galaxy Buds. When there is sweat or liquid on the charging contacts or earbuds, clean them before inserting the earbuds in the charging case.
- When you insert your earbuds in the charging case, the charging will start automatically, and it will stop automatically if earbuds are fully charged.
- Even if you do not remove your earbuds from the charging case after the earbuds are fully charged, it will likely not have a huge impact on the life of your Galaxy Buds.
- If you will not be using your Galaxy Buds for a long time, store them after they are charged.
- Using a power source other than the charger, such as a computer, may result in a slower charging speed because of a lower electric current.
- While charging, the Galaxy Buds and the charger may heat up. This is normal and should not affect the Galaxy Buds lifespan or performance. If the battery gets hotter than usual, the charger may stop charging.
- If the Galaxy Buds are not charging properly, take the Galaxy Buds and the charger to a Samsung Service Centre or an authorised service centre.
- Avoid bending the USB cable. Doing so may damage or reduce the lifespan of the USB cable. Never use a damaged USB cable.

Indicator lights identification

The blade lights and the charging case battery indicator light display the status of your earbuds and the charging case.

Blade lights (Galaxy Buds3 Pro)

Checking the status of the earbuds

You can check the status of the earbuds through the blade lights.

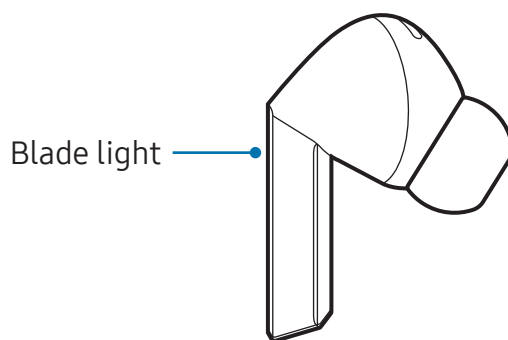

Action	Status
Flashes once	<ul style="list-style-type: none"> When opening the charging case, when putting earbuds into the charging case and closing it
Continuously on	<ul style="list-style-type: none"> When entering Bluetooth pairing mode, when finding the earbuds

 If you quickly open and close the charging case with fully charged earbuds inserted or slowly close the charging case with earbuds inserted, only the blade light of one earbud may turn on.

Using the blade lights

You can turn on the blade light and change the lighting style whenever you want.

-  This feature is only available when the battery levels in both earbuds are at least 30%.
- Using this feature will increase the earbuds' battery consumption.

1 Open the **Galaxy Wearable** app on your mobile device and tap **Earbud controls** → **Earbud lights controls**.

2 Select the desired lighting style of the blade lights under **Select lighting style**.

- **Blinking:** The blade lights will blink.
- **Fade in and out:** The blade lights will gradually turn on and dim.
- **Steady:** The blade lights will stay on.

If you pinch and hold both earbuds while not wearing them, the selected lighting style will continue to appear on the earbuds.

To turn off the blade lights, pinch and hold both earbuds while not wearing them or put them into the charging case. You can also open the notification panel on your mobile device, tap  on the **Earbud lights on** notification, and then tap **Turn off**.

Charging case battery indicator light

Check the charging status of the charging case through the colour of the charging case battery indicator light.

The charging case battery indicator light is displayed when you briefly press the Connect button on the bottom of the charging case or open or close the charging case.

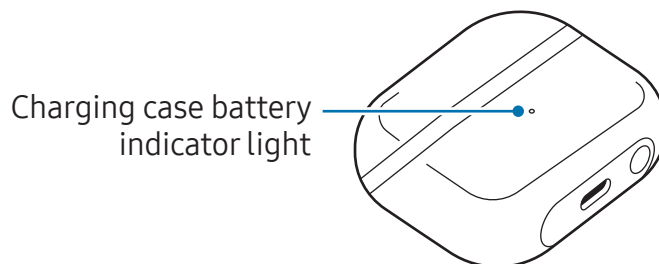

Colour	Status
Continuously red	<ul style="list-style-type: none"> • The earbuds (if inserted) and charging case are charging.
Continuously green	<ul style="list-style-type: none"> • The earbuds (if inserted) and charging case are fully charged.
Flashes red	<ul style="list-style-type: none"> • Charging blocked because of abnormal temperatures of the earbuds or charging case.
Flashes red (flashes after closing the charging case)	<ul style="list-style-type: none"> • The charging case's battery power is low (lower than 10%).

Colour	Status
Red (stays on for 5 seconds after closing the charging case)	<ul style="list-style-type: none">The charging case's battery power is low (between 10% and 29%), and the earbuds are charging.
Yellow (stays on for 5 seconds after closing the charging case)	<ul style="list-style-type: none">The charging case's battery power is moderate (between 30% and 59%).
Green (stays on for 5 seconds after closing the charging case)	<ul style="list-style-type: none">The charging case's battery power is high (more than 60%), and the earbuds are fully charged.



If the charging case battery indicator light does not work as described, disconnect the charger from the charging case and reconnect it.

Using the earbuds

Connecting the earbuds to a mobile device

Before the connection

- Charge the charging case sufficiently.
- The Galaxy Wearable app must be installed on your mobile device. If the app is not installed on your mobile device, download the app from **Galaxy Store** or **Play Store**.
 -  • You can download the Galaxy Wearable app only on mobile devices running Android OS version 10.0 (API 26), or later, and with 1.5 GB of memory or more.
 - You can change the language of the Galaxy Wearable app on your mobile device. Open **Settings** on your mobile device and tap **General management** → **Language**. English may appear by default if the selected language on Settings is not supported on the Galaxy Wearable app.

Connecting the earbuds to a Samsung mobile device for the first time

- 1 Check the direction of each earbud and correctly insert them into their corresponding slots in the charging case.

If the charging case battery indicator light does not flash, connect the charging case to the charger and charge them for more than 10 minutes.
- 2 Close the charging case and open it.

Alternatively, open the charging case and press and hold the Connect button on the bottom of the charging case for more than 3 seconds.

The earbuds will enter Bluetooth pairing mode automatically and a pop-up window will appear on your mobile device.

If the pop-up window does not appear or if you want to connect to a non-Samsung mobile device that also uses the Android OS, refer to [Connecting the earbuds to a non-Samsung mobile device that also uses the Android OS \(or, the connection pop-up window does not appear\)](#).

 When the charging case battery indicator light flashes in red, take out the earbuds from the charging case and insert them into the case again.

3 On your mobile device, tap **Connect** on the pop-up window and follow the on-screen instructions to complete the connection.

Once the connection has been set up, the earbuds will be automatically connected to your mobile device whenever you open the charging case while the earbuds are inside it.

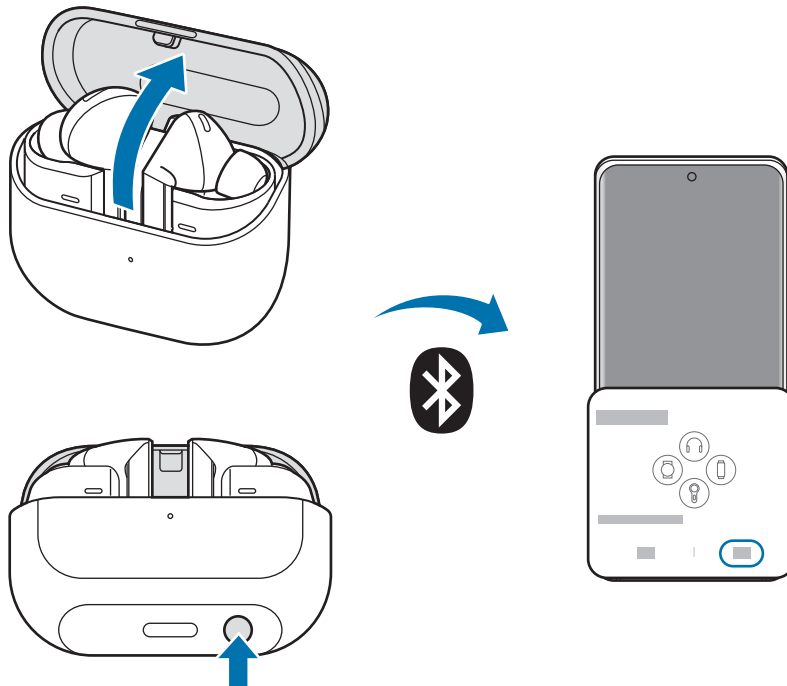

- 
- You can download the Galaxy Wearable app only on mobile devices running Android OS version 10.0 (API 26), or later, and with 1.5 GB of memory or more.
 - Connection methods may vary depending on your mobile device and software version.
 - The appearance of the pop-up window may vary depending on your connected mobile device.
 - If the earbuds do not connect to a mobile device within 3 minutes, Bluetooth pairing mode will be turned off. Close the charging case again and open it. The earbuds will enter Bluetooth pairing mode.
 - If you want to connect to another mobile device after a connection has been set up, refer to [Connecting with other devices after disconnecting from the previous mobile device](#).



- When connecting earbuds with a mobile device that has been signed in to a Samsung account, the earbuds pairing information will be synced on the other mobile devices that use the same Samsung account and you do not need to pair them at the beginning again. To connect the other devices that use the same Samsung account with the earbuds, on the mobile devices that you want to connect, open **Settings**, tap **Connections** → **Bluetooth**, and then select the earbuds synced through the Samsung account.
- If only a single earbud is connected to your mobile device, you will hear the sound in mono. It will automatically switch to Stereo mode when both earbuds are connected to your mobile device.
- If the earbuds do not connect to a mobile device, the connection pop-up window does not appear, or your mobile device cannot find the earbuds, store them in the charging case and press the Connect button for more than 3 seconds to enter Bluetooth pairing mode manually. When Bluetooth pairing mode has been entered, the charging case battery indicator light will flash red, green, and blue. Depending on the model, the blade lights may flash.

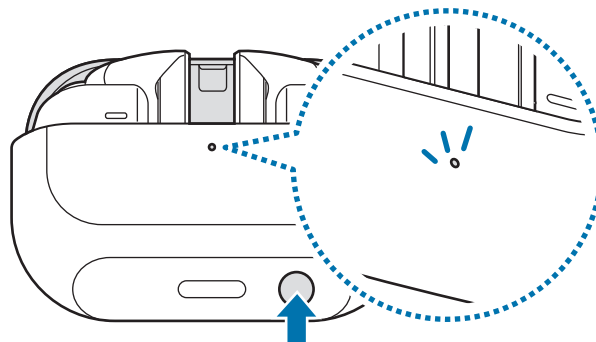

Connecting the earbuds to a non-Samsung mobile device that also uses the Android OS (or, the connection pop-up window does not appear)



If you connect to a non-Samsung mobile device that also uses the Android OS, some of the features of the earbuds may not be available and the earbuds may not work properly.

- 1 Check the direction of each earbud and correctly insert them into their corresponding slots in the charging case.
If the charging case battery indicator light does not flash, connect the charging case to the charger and charge them for more than 10 minutes.
- 2 Close the charging case and open it.
Alternatively, open the charging case and press and hold the Connect button on the bottom of the charging case for more than 3 seconds.
The earbuds will enter Bluetooth pairing mode.
- 3 On your mobile device, turn on the Bluetooth feature to connect the earbuds to your mobile device, open the **Galaxy Wearable** app, and then follow the on-screen instructions to complete the connection.

Precautions for using Bluetooth

- To avoid problems when connecting your earbuds to another device, place the devices close to each other.
- Ensure that your earbuds and the other Bluetooth device are within the maximum Bluetooth connection range (10 m). The distance may vary depending on the environment the devices are used in.
- Ensure that there are no obstacles between the earbuds and a connected device, including human bodies, walls, corners, or fences.
- Do not touch the Bluetooth antenna of a connected device.
- Bluetooth uses the same frequency as some industrial, scientific, medical, and low power products and interference may occur when making connections near these types of products.
- Some devices, especially those that are not tested or approved by the Bluetooth SIG, may be incompatible with the earbuds.
- Do not use the Bluetooth feature for illegal purposes (for example, pirating copies of files or illegally tapping communications for commercial purposes).

Wearing the earbuds

Adjust the earbuds to fit your ears.

-  • If the touch-sensitive sensor does not make contact with your ear, the earbud may not work. If you do not hear the sound informing you that the earbud is detected, remove the earbuds from your ears and put them in again or switch to ear tips that fit your ears.
- Because of the nature of the earbuds, they may feel loose or separate from your ears when worn. (Galaxy Buds3)
- If the earbuds are not positioned correctly in your ears, features like calling through the earbuds may not work. Use a pair of ear tips that fit your ears and wear the earbuds properly. (Galaxy Buds3 Pro)
- Follow all posted warnings and directions from authorised personnel in areas where the use of wireless devices is restricted, such as aeroplanes and hospitals.

- 1 Hold each earbud and remove them vertically from the charging case.

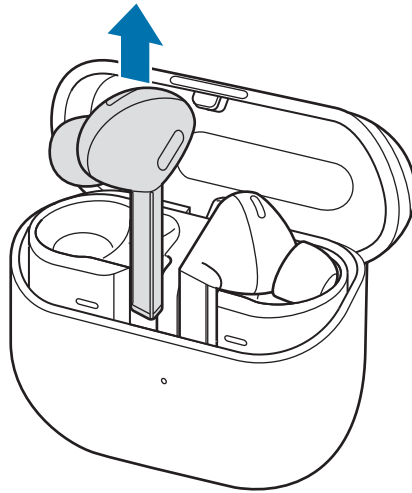

- 2 Check the direction of each earbud.
- 3 Insert the earbuds into your ears with the imprinted direction marks facing you, and orient the microphone on the bottom of the earbuds toward your mouth.
- 4 Adjust the earbuds by rotating them to the left and right so that they fit comfortably in your ears.

The touch-sensitive sensors will detect that you are wearing the earbuds when you put them on. Then, the earbud will emit a sound informing you that the earbud is detected.

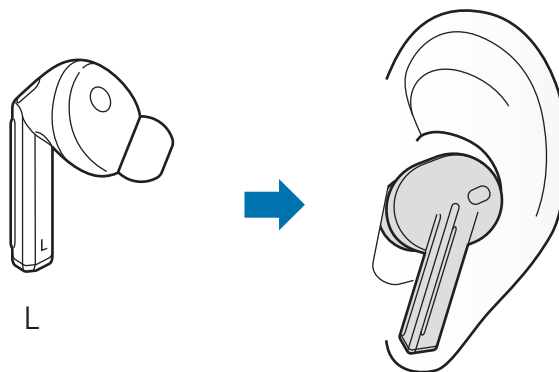



Using the earbud by gestures

Introduction

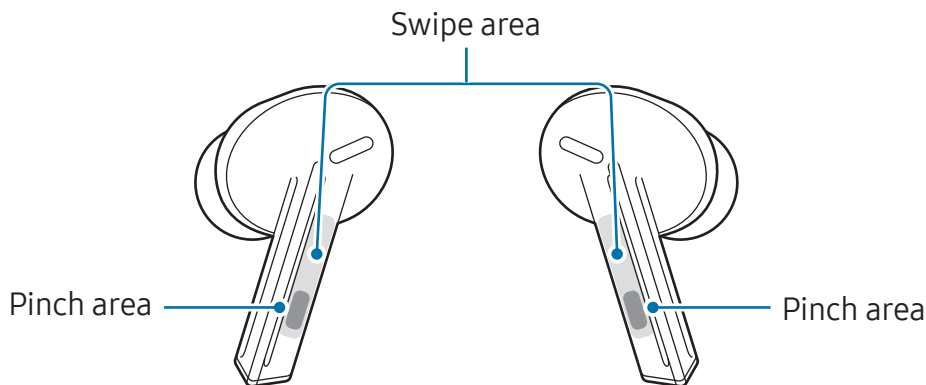
Pinch or swipe the earbuds to play or stop music or answer or decline calls. You can also set the earbuds to perform other actions by pinching or swiping them. The following term, gesture areas, includes both the pinch area and the swipe area.



-  To avoid hurting your ears, do not apply excessive pressure to the earbuds.
- To avoid damaging the gesture areas, do not pinch or swipe the earbuds with anything sharp.
-  If you have a metal object, such as a piercing in your ear, remove it. If a metal object comes into contact with the earbuds, the earbuds' gesture feature may malfunction or become unresponsive.
- If there is sweat or liquid on the earbuds, clean them. The earbuds' gesture feature may malfunction or become unresponsive because of sweat or liquid.
- When the earbuds are removed from your ears, be careful not to pinch or swipe their gesture areas. This could result in unintentionally launching features.

Understanding gestures

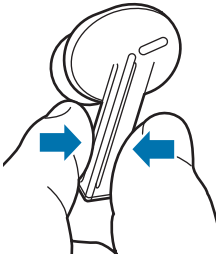

Single pinch

- Play or pause track.
- Answer or end a call.
- Stop using the Read notifications aloud feature.
- Stop using the Voice detect or Siren detect feature.



Double pinch

- Play next track.



Triple pinch

- Play previous track.
 - If you pinch the earbud three times 3 seconds after a track begins playing, it will start the track from beginning. Pinch the earbud three times within 3 seconds of when a track begins playing to play the previous track.



Pinch and hold

- Turn on the preset feature.
 - It is set by default to turn on the Noise controls mode. Refer to [Setting a pinch and hold feature](#) for more information about changing feature you want to turn on.
- Decline a call.
- When not wearing the earbuds, pinch and hold both earbuds to turn on the blade lights. (Galaxy Buds3 Pro)



Swipe upwards or downwards

- Adjust the volume.

-  If the earbuds do not connect to a mobile device, the connection pop-up window does not appear, or your mobile device cannot find the earbuds, store them in the charging case and press the Connect button for more than 3 seconds to enter Bluetooth pairing mode manually. When Bluetooth pairing mode has been entered, the charging case battery indicator light will flash red, green, and blue. Depending on the model, the blade lights may flash.

Setting a pinch and hold feature

You can set a pinch and hold feature of each earbud to turn on features.

- 1 Open the **Galaxy Wearable** app on your mobile device and tap **Earbud controls**.
 - 2 Tap the **Left** or **Right** switch under **Pinch and hold controls** to turn it on.
 - 3 Select the pinch and hold feature for each earbud.
 - **Switch noise controls:** Set to turn the following noise controls modes on or off: Ambient sound, Adaptive, and Active noise cancelling. Refer to [Activating the noise controls modes](#) for more information.
 - **Bixby:** Start a conversation with an intelligent voice assistant service. When using Bixby, refer to [Using Bixby](#) for more information.
 - **Interpreter:** Live translate spoken conversations and output it into speech or text.
 - **Mindfulness:** Play mindfulness music. You can also check the playlist in the Samsung Health app.
-  Available options may vary depending on the connected mobile device.

Using the noise controls modes

Introduction

▶ **Galaxy Buds3:** Turn on the Active noise cancelling feature to reduce the volume of sounds around you. Use it when you want to avoid distractions, such as when listening to music.

▶ **Galaxy Buds3 Pro:** There are three noise controls modes: Ambient sound, Adaptive, and Active noise cancelling.

Turn on Ambient sound mode to hear your surroundings clearly so you can detect any potentially dangerous situations or hear the other person's voice during a conversation. Turn on Adaptive mode to optimise the volume of the surrounding sounds or the strength of Active noise cancelling automatically according to the level of surrounding noise. Noise cancellation works in noisy places, but when it's quiet, the earbuds will let in ambient sounds. Turn on the Active noise cancelling feature to reduce the volume of the sounds around you. Use it when you want to avoid distractions, such as when listening to music.

 If the microphone (the outer microphone while wearing the earbuds) and its area are covered completely, feedback may occur when activating noise controls mode.

 You can only turn on the Adaptive mode and Active noise cancelling feature when wearing both earbuds in your ears.

Activating the noise controls modes

Activating from the earbuds

Make sure that the pinch and hold feature is set to **Switch noise controls** and then pinch and hold the earbud.

▶ **Galaxy Buds3:** The Active noise cancelling feature will be launched.

▶ **Galaxy Buds3 Pro:** The following noise controls modes will be launched: Ambient sound, Adaptive, and Active noise cancelling.

 If the pinch and hold feature is set to **Switch noise controls** and includes an option with Off, the noise controls modes may turn off. Tap **Switch noise controls** to check the option you selected.

Activating from the Galaxy Wearable app

- ▶ **Galaxy Buds3:** Open the **Galaxy Wearable** app on your mobile device and tap the **Active noise cancelling** switch to turn it on.
- ▶ **Galaxy Buds3 Pro:** Open the **Galaxy Wearable** app on your mobile device and tap **Ambient sound, Adaptive, or Active noise cancelling**.

Activating from Settings

-  • This feature is available only on mobile devices running the Android 11 One UI version 3.1 and later.
- Available options may vary depending on the connected mobile device.

- 1 Open **Settings** on your mobile device and tap **Connections** → **Bluetooth**.
- 2 Tap  next to the earbuds' name under **Paired devices**.
- 3 ▶ **Galaxy Buds3:** Tap the **Active noise cancelling** switch to turn it on.
▶ **Galaxy Buds3 Pro:** Tap **Ambient sound, Adaptive, or Active noise cancelling**.

Activating from the widget

- ▶ **Galaxy Buds3:** Add the Galaxy Buds controller widget to the mobile device and tap **Active noise cancelling**.
- ▶ **Galaxy Buds3 Pro:** Add the Galaxy Buds controller widget to the mobile device and tap the desired noise controls icon.

Adjusting noise control intensity (Galaxy Buds3 Pro)

When Ambient sound or Active noise cancelling is turned on as a noise controls mode, adjust the volume of surrounding sounds or the strength of Active noise cancelling to match your preferences.

- 1 Open the **Galaxy Wearable** app on your mobile device and tap **Ambient sound** or **Active noise cancelling**.
- 2 Drag the adjustment bar under the **Ambient sound volume** or **Active noise cancelling level**.

-  If you are using the Hearing enhancements for Ambient sound feature in the accessibility settings, tap **Hearing enhancements in use** to check the settings.

Auto switching to ambient sound (Galaxy Buds3 Pro)

In certain situations, such as when having a conversation or talking on the phone while wearing the earbuds, the earbuds will detect it and automatically turn on Ambient sound mode, which allows you to concentrate on the surrounding situation or conversation.

- 1 Open the **Galaxy Wearable** app on your mobile device and tap **Auto switch to ambient sound**.
- 2 Tap the switches of the situations you want the earbuds to turn on Ambient sound mode for automatically.
 - **Voice detect:** If you start speaking while wearing the earbuds, the earbuds will detect your voice in any situation and turn on Ambient sound mode. If no conversation is detected for a certain period of time, Ambient sound mode will be turned off.
 -  • The voice detection sensors of both earbuds detect your voice when they're in use. So, if you only wear an earbud in one ear, this feature may be unavailable.
 - When you are making noise, such as when you brush your teeth, cough, or hum, the earbuds may misinterpret it as speech.
 - When the Voice controls feature is turned on, even if the earbuds detect a voice, Ambient sound mode may react somewhat late because it will turn on only after discerning whether it is a voice control command.
 - **Siren detect:** The earbuds detect sirens above a certain level and turn on Ambient sound mode.
 - **Use Ambient sound during calls:** The earbuds will make your voice audible during calls, helping you to avoid unintentionally raising your voice and also making long calls more comfortable.

When Ambient sound mode is activated automatically, pinch the earbud once to turn it off.

Listening to music

Listen to music saved in your mobile device by connecting the earbuds to the mobile device. You can stream music played from the connected mobile device.

On your mobile device, open a music player app and play music.

Playing or pausing the track

Pinch the earbud to play or pause the track.

Playing the next track

Double pinch the earbud to play the next track.

Playing the previous track

Pinch the earbud three times to play the previous track.

-  If you pinch the earbud three times 3 seconds after a track begins playing, it will start the track from beginning. Pinch the earbud three times within 3 seconds of when a track begins playing to play the previous track.

Adjusting the volume

Swipe the earbud upwards to increase the volume, or swipe the earbud downwards to lower the volume.

-  • Adjust the volume through your connected mobile device if a sound is low in your earbuds while at full volume.
- If you connect the earbuds to your mobile device while listening to music, the volume may change.

Using the equaliser

You can select from several different equaliser options and enjoy the same music with a different and unique sound.

Open the **Galaxy Wearable** app on your mobile device, tap **Sound quality and effects** → **Equaliser**, and then select an option you want. Select **Custom** to adjust the equaliser as you wish.

Using call features

When wearing the earbuds while they are connected to a mobile device, you can answer and control calls from the connected mobile device.

-  If you are not notified of the incoming call's phone number or the name saved in your contacts through voice notification, open the **Phone** app on your mobile device and tap **⋮** → **Settings** → **Answering and ending calls**, and then tap the **Read caller names aloud** switch to turn it on.

Answering or declining a call

When a call comes in while you are wearing the earbuds, they will emit a sound and a voice notification will inform you of the incoming call's phone number or the name saved in your contacts.

To answer the call, pinch the earbud.

To decline the call, pinch and hold the earbud.

Ending a call

Pinch the earbud to end the current call.

Bixby

Introduction

Bixby is a user interface that helps you use your device more conveniently.

You can talk to Bixby or type text. Bixby will launch a feature you request or show the information you want on the connected mobile device. Visit www.samsung.com/bixby for more information.

-  • This feature is available only when a mobile device that supports Bixby is connected.
- Only some languages are available depending on Bixby set on your mobile device. Certain features may not be available depending on your region.

Starting Bixby

Make sure you set a pinch and hold feature for opening Bixby and pinch and hold the earbud.

Using Bixby

Pinch and hold the earbud and say what you want. Alternatively, say the wake-up phrase and say what you want.

For example, while pinching and holding the earbud, say “How’s the weather today?” The weather information will appear on your connected mobile device.

If Bixby asks you a question during a conversation, you can continue to talk to Bixby without pinching and holding the earbud or tapping .

Waking up Bixby using your voice

You can start a conversation with Bixby by saying the wake-up phrase (“Hi, Bixby” or “Bixby”) you have set on your mobile device while wearing the earbuds.

- 1 Open the **Galaxy Wearable** app on your mobile device and tap **Earbuds settings**.
- 2 Tap **Voice controls** and tap the **Bixby voice wake-up** switch to turn it on.

Communicating by typing text

If your voice is not recognised because of noisy environments or if you are in a situation where speaking is difficult, you can communicate with Bixby through text.

Pinch and hold the earbud, tap , and then type what you want.

During the communication, Bixby also will answer you through text instead of voice feedback.

Tips for better voice recognition

- Speak clearly.
- Speak in quiet places.
- Do not use offensive or slang words.
- Avoid speaking in dialectal accents.

The Galaxy Buds may not recognise what you say or may perform unwanted commands depending on your surroundings or how you speak.

Galaxy Wearable app

Introduction

You can check the Galaxy Buds' remaining battery and configure the settings with the Galaxy Wearable app.

Open the **Galaxy Wearable** app on your mobile device.

To search for settings by entering keywords, tap **Q**. You can also search for settings by selecting a tag under **Suggestions**.

To configure the settings of the Galaxy Wearable app, tap  →  and tap **Settings**.

-  • The earbuds must be connected to a mobile device to use the Galaxy Wearable app. Refer to [Connecting the earbuds to a mobile device](#) for more information.
- Some features may not be available depending on the type of connected mobile device or model.

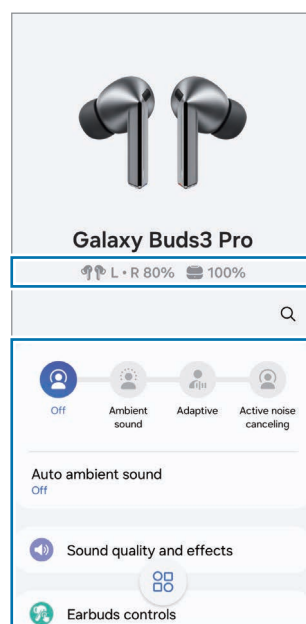

Galaxy Buds' remaining battery

Configure the Galaxy Buds settings and launch the features you want.



Managing devices connections

You can manage various device connections, such as checking your wearable devices connected to your mobile device or connecting a new device with the Galaxy Wearable app.



Managing connected devices

Tap  on the Galaxy Wearable screen of your mobile device.

Currently connected devices and previously connected devices will appear on the list.

-  • To disconnect the device from your mobile device, tap  next to the connected device in the list.
- To reconnect with a device you have previously connected, select the device you want to connect from the list.

Adding new devices and deleting devices

- 1 Tap  on the Galaxy Wearable screen of your mobile device.
- 2 Tap  and follow the on-screen instructions to connect a new wearable device. The new wearable device will be connected and added to the list.

To delete a wearable device from the list, tap  → **Remove devices**, select a device, and then tap **Remove**.

-  When you connect with new earbuds, the currently connected earbuds will temporarily be disconnected.

Connecting and disconnecting the earbuds

Disconnecting mobile devices from the earbuds

Insert the earbuds into the charging case and close it. The Bluetooth connection will end.

To manually disconnect the earbuds from your mobile device, open **Settings** on your mobile device, tap **Connections** → **Bluetooth**, and then disconnect the earbuds from your mobile device under **Paired devices**.

Reconnecting mobile devices with the earbuds that temporarily disconnected

To reconnect the earbuds that temporarily disconnected from a device, insert them into the charging case and close it. Then, open the charging case again. Alternatively, open the charging case and press and hold the Connect button on the bottom of the charging case for more than 3 seconds.

To manually reconnect the earbuds to your mobile device, tap **Connect** on the Galaxy Wearable screen of your mobile device.

Connecting with other devices after disconnecting from the previous mobile device

- 1 Open **Settings** on your mobile device, tap **Connections** → **Bluetooth**, and then unpair the earbuds from your mobile device under **Paired devices** to disconnect the earbuds from the previous mobile device.
- 2 Close the charging case and open it again to enter Bluetooth pairing mode. Alternatively, open the charging case and press and hold the Connect button on the bottom of the charging case to enter Bluetooth pairing mode.
- 3 Open the **Galaxy Wearable** app on your new mobile device and follow the on-screen instructions to complete the connection.

Switch the mobile devices connected with earbuds

When the earbuds are connected with two or more mobile devices, you can switch the mobile devices without disconnecting from the previous mobile device.

On the mobile device that you want to switch to, open **Settings**, tap **Connections** → **Bluetooth**, and then select earbuds under **Paired devices**.

-  The connections between your earbuds and the mobile devices can be switched automatically under the circumstances. For example, when your earbuds are registered on both a tablet and a phone that are logged in to the same Samsung account, you can receive an incoming call from the phone with your earbuds while watching a video on the tablet since the earbuds' connection is switched to the phone automatically.

Configuring settings for the Galaxy Buds

Introduction

Check the status of the Galaxy Buds that are connected to your mobile device and configure their settings.

Open the **Galaxy Wearable** app on your mobile device.

 Some features, such as the noise controls modes or Bixby voice wake-up, may affect the usage time of your earbuds.

Setting the noise controls modes

► **Galaxy Buds3**: Turn on or off the Active noise cancelling feature.

On the Galaxy Wearable screen of your mobile device, tap the **Active noise cancelling** switch to turn it on.

► **Galaxy Buds3 Pro**: Turn on or off the Ambient sound, Adaptive, or Active noise cancelling feature based on your situation or surroundings. Also, you can set the Ambient sound mode to turn on automatically.

On the Galaxy Wearable screen of your mobile device, select a feature and change its settings.

- **Off**: Turn off the noise controls mode.
- **Ambient sound**: Allows you to hear ambient sounds.
- **Adaptive**: Optimises the volume of surrounding sounds or the strength of Active noise cancelling automatically according to the level of surrounding noise.
- **Active noise cancelling**: Reduce external sounds.
- **Ambient sound volume / Active noise cancelling level**: Adjust the volume of surrounding sounds or the strength of Active noise cancelling to match your preferences while running the Ambient sound or Active noise cancelling feature.
- **Auto switch to ambient sound**: Auto ambient sound mode will automatically be turned on to help you be able to concentrate on the surrounding situation or conversation in certain situations, such as when the earbuds detect a conversation or siren, or during a call while the earbuds are worn.

Sound quality and effects

You can configure the sound quality and sound effects of the earbuds.

On the Galaxy Wearable screen on your mobile device, tap **Sound quality and effects**.

Sound effects

- **360 audio:** Provides 360-degree surround sound for an immersive environment while enjoying media. You can also set it to automatically adjust the direction of sound based on your head movement.
 -  This feature is available only on mobile devices running Android 11 One UI version 3.1 and later, and may not be available depending on the model of the mobile device.
 - You can enjoy better quality audio if you place the connected mobile device closer to you.
 - This feature may not be supported because of how the media is played.
 - When you are in areas with poor signal reception, the connection to the mobile device may be lost temporarily.
- **Equaliser:** Select from several different equaliser options and enjoy the same music with a different and unique sound. Refer to [Using the equaliser](#) for more information.
- **Boost dialogue:** Voices can be heard more clearly than the background sounds in videos.
- **Loudness normalisation:** Prevents the sound from suddenly becoming too loud or too quiet during media playback.
- **Adjust sound to fit:** When you wear the earbuds, the sound will be automatically adjusted to optimise the sound effect. Both earbuds must fit snugly in your ears.

- **Advanced quality options**

- **Ultra high quality (UHQ) audio:** Experience audio quality close to the original sound with a sample rate of up to 96 kHz.

 Some features may not be available when this feature is active.

- **Super wide band speech:** Provides clear call quality with 16 kHz bandwidth.

- **Earbud fit test:** Check the earbuds' fit to ensure better sound and Active noise cancelling. (Galaxy Buds3 Pro)

-  • Available options may vary depending on the connected mobile device.
- Using Advanced quality options feature will increase battery consumption.

Earbud controls

Configure settings for the gesture features of the earbuds.

On the Galaxy Wearable screen of your mobile device, tap **Earbud controls**.

- **Media controls:** During media playback, you can use the gesture feature of the earbuds to control music, such as playing or pausing it. Refer to [Understanding gestures](#) for more information.

Pinch and hold controls

- **Left:** Select the pinch and hold feature for the left earbud.
- **Right:** Select the pinch and hold feature for the right earbud.

 Refer to [Setting a pinch and hold feature](#) for more information.

Call controls

- **Answer call or end call:** Pinch to answer or end a call.
- **Decline call:** Pinch and hold to decline a call.
- **Earbud lights controls:** Change the lighting style of the blade lights and keep the blade lights visible on the earbuds. Refer to [Blade lights \(Galaxy Buds3 Pro\)](#) for more information. (Galaxy Buds3 Pro)

 Available options may vary depending on the connected mobile device.

Earbuds settings

Check information related to the earbuds and change various settings.

On the Galaxy Wearable screen of your mobile device, tap **Earbuds settings**.

Samsung account

Sign in to your Samsung account and manage it.

On the Galaxy Wearable screen of your mobile device, tap **Earbuds settings** → **Samsung account**.

Voice controls

Wake Bixby with your voice to start a conversation with an intelligent voice assistance service.

On the Galaxy Wearable screen of your mobile device, tap **Earbuds settings** → **Voice controls**, and tap the **Bixby voice wake-up** switch to turn it on.

If you tap the **Voice commands** switch to turn it on, you can also use set voice commands to perform desired actions without calling Bixby. This feature does not support some languages.

In-ear detection

You can set the earbuds to detect whether you are wearing them and to take calls on your mobile device or pause media playback.

On the Galaxy Wearable screen of your mobile device, tap **Earbuds settings** → **In-ear detection**, and then tap the switch you want to turn it on.

- **Switch calls to phone when both earbuds removed:** Set the earbuds or mobile device to take the call by detecting whether the earbuds are worn during the call. If this feature is turned off, the caller's voice is played on the earbuds even if the earbuds are not worn.
 - **Pause media when one earbud removed:** Set the earbuds to pause and resume media playback by detecting whether the earbuds are being worn. If this feature is turned off, media playback will only pause when both earbuds are not worn.
-  Even if you are not wearing the earbuds, the earbuds may be detected as being worn if you cover the touch-sensitive sensor with skin.

Read notifications aloud

You will receive notifications from the mobile device's apps through the earbuds.

On the Galaxy Wearable screen of your mobile device, tap **Earbuds settings** → **Read notifications aloud**.

- **Q** : You can search for apps to receive notifications from.
- **Read aloud while using phone**: Set the earbuds to receive notifications of the mobile device even when you are using the mobile device.
- **Allow all**: You can receive notifications from all apps through your earbuds and change notification settings for each app. To set whether or not to receive notifications differently for an app, tap the switch next to the app. You can also tap **All** to check the apps categorised by those set to read notifications or not read notifications.

Seamless earbud connection

You can change which mobile device to connect your earbuds with. You can turn on the feature to switch the connection from your current mobile device to a nearby mobile device logged in to the same Samsung account or a device that has previously connected with your earbuds.

On the Galaxy Wearable screen of your mobile device, tap **Earbuds settings** → **Seamless earbud connection**, and then tap the switch to turn it on.

 Be careful not to connect your earbuds to another person's mobile device.

Neck stretch reminders

When your earbuds detect that your head is bent downwards for more than 10 minutes, you will hear a sound and your mobile device will display a screen encouraging you to stretch that provides basic neck stretching exercises you can follow.

On the Galaxy Wearable screen of your mobile device, tap **Earbuds settings** → **Neck stretch reminders**, and then tap the switch to turn it on.

When launching this feature for the first time or after performing a data reset, you must calibrate the earbuds to set up the feature. Follow the on-screen instructions to complete the setup.



- Make sure to calibrate the earbuds so that they can accurately recognise your movements. Do not move your body, such as by sitting or standing during calibration.
- If someone else uses your earbuds, or if the earbuds' motion recognition feature is not accurate, calibrate them again.
- If you move, even if your head is bent downwards for more than 10 minutes, the sound will not emit.
- This feature works only when both earbuds are worn.

Labs

Use new earbud features.

On the Galaxy Wearable screen of your mobile device, tap **Earbuds settings** → **Labs**.

- **Gaming mode:** Minimise audio delay to remove the lag between the video and sound output, and hear properly synced audio whenever playing games.



This feature is available only when connecting with a Samsung mobile device that uses the Android OS.

Reset

You can reset all your earbuds settings.

On the Galaxy Wearable screen of your mobile device, and tap **Earbuds settings** → **Reset**.

Accessibility

Configure various settings to improve the accessibility of the earbuds.

On the Galaxy Wearable screen of your mobile device, tap **Earbuds settings** → **Accessibility**.

- **Left/right sound balance:** Adjust the left and right volume balance if you have a hearing impairment or if using a single earbud is more convenient. Drag the **Left/right sound balance** adjustment bar to adjust the balance. If you drag the bar to the left, the left earbud's volume will increase and vice versa.
- **Noise controls with one earbud:** Turn on noise controls modes even when only one earbud is worn.

- **Hearing enhancements for Ambient sound:** Set the sound to suit your hearing and preferences. (Galaxy Buds3 Pro)
 - **Ambient sound volume:** Adjust the left and right ambient sound volumes by dragging the left and right adjustment bars.
 - **Boost voices in front of you:** Makes voices coming from the front more audible. You can also adjust the amount of background noise reduction by dragging the **Background noise reduction level** adjustment bar.
- **Adapt ambient sound:** Adjust the Galaxy Buds to help people who have difficulty hearing surrounding sounds because of hearing loss. (Galaxy Buds3 Pro)

Earbuds software update

Update your earbuds' software through the firmware over-the-air (FOTA) service.

On the Galaxy Wearable screen of your mobile device, tap **Earbuds settings** → **Earbuds software update**.

- **Download and install:** Check for and install updates manually.
- **Auto update:** Set to install updates automatically when the earbuds are in the charging case.

Diagnostics

Test your Galaxy Buds using Samsung Members.

On the Galaxy Wearable screen of your mobile device, tap **Earbuds settings** → **Diagnostics**.

About earbuds

Access the information of the Galaxy Buds.

On the Galaxy Wearable screen of your mobile device, tap **Earbuds settings** → **About earbuds**.

To change your Galaxy Buds' name, tap **Rename**.

- **Legal information:** Check the legal information for the Galaxy Buds.
- **Software information:** Check the Galaxy Buds' software information.
- **Battery information:** Check the Galaxy Buds' battery information.

Find My Earbuds

If you misplace your earbuds, you can use the Samsung Find app installed on your connected mobile device to find it.

On the Galaxy Wearable screen of your mobile device, tap **Find My Earbuds**.

The Samsung Find app will be launched on your mobile device and you can check your misplaced earbuds' location on the map. Also, depending on your model, you can find your earbuds by following the sound emitted from them or by following the emitted sound and looking for the blinking blade lights.



- Samsung Find app support may vary depending on the software version of the connected mobile device.
- To find your earbuds using the Samsung Find app, Samsung Find's Lost mode must be turned on, and the features related to finding devices offline must also be turned on.
- If the earbuds you are trying to find are outside the charging case, it may take 4 minutes or more to search nearby to find the earbuds.



Usage notices

Precautions for using the device

Please read this guide when using the device to ensure safe and proper use.

- Descriptions are based on the device's default settings.
- Some content may differ from your device depending on the region, service provider, model specifications, or device's software.
- Before using other mobile devices, make sure they are compatible with the device. Visit the Samsung website to check the specifications of compatible mobile devices.
- Software, sound sources, wallpapers, images, and other media provided with this device are licensed for limited use. Extracting and using these materials for commercial or other purposes is an infringement of copyright laws. Users are entirely responsible for illegal use of media.
- Default apps that come with the device are subject to updates and may no longer be supported without prior notice.
- Modifying the device's operating system or installing software from unofficial sources may result in device malfunctions and data damage or loss. These actions are violations of your Samsung licence agreement and will void your warranty.
- Some functions may not work as described in this guide depending on the maker and model of the mobile device you connect to the device.
- This product includes certain free/open source software. The licence information of the open source software used in this product can be found at opensource.samsung.com.
- Your device contains magnets. Keep it away from credit cards, implanted medical devices, and other devices that may be affected by magnets. In the case of medical devices, keep your device more than 15 cm apart. Stop using your device if you suspect any interference with your medical device and consult your physician or your medical device manufacturer.
- This product operates using magnets. Do not store your device near magnetic fields. Doing so may cause malfunctions.

Instructional icons

-  **Warning:** situations that could cause injury to yourself or others
-  **Caution:** situations that could cause damage to your device or other equipment
-  **Notice:** notes, usage tips, or additional information

Notes on package contents and accessories

Refer to the quick start guide for package contents.

- The items supplied with the Galaxy Buds and any available accessories may vary depending on the region or carrier.
- The supplied items are designed only for this Galaxy Buds and may not be compatible with other devices.
- Appearances and specifications are subject to change without prior notice. Also, the size of the ear tips are subject to change to provide a better fit.
- You can purchase additional accessories from your local Samsung retailer. Make sure they are compatible with the Galaxy Buds before purchase.
- Use Samsung-approved accessories. Using unapproved accessories may cause the performance problems and malfunctions that are not covered by the warranty.
- Availability of all accessories is subject to change depending entirely on manufacturing companies. For more information about available accessories, refer to the Samsung website.

Maintaining water and dust resistance

Your device is water- and dust-resistant and meets the following international standards. The charging case is not water-resistant.

- IP57 water resistance rating certification: According to the requirements of the IEC 60529 standard, it was tested in 15–35 °C, 86–106 kPa, 1 m fresh water for 30 minutes without moving.

You must follow the guidelines to maintain the water- and dust-resistance of your device.

- Avoid exposing the devices to swimming pool water or seawater.
- Do not expose the devices to unclean water or other liquids, such as soapy water, oil, perfume, sunscreen, hand cleaner, chemical products such as cosmetics, or liquids that include alcohol.
- Do not let the devices come into contact with water moving with force or running water.
- Do not wear your devices while swimming, playing water sports, or taking a shower.
- Do not use the devices in places where the temperature is higher than the normal range or there is a lot of humidity, such as a sauna.
- Do not drop the devices or subject it to a heavy impact.
- Do not put the devices in a washing machine or dryer.

If the devices are exposed to water or contaminants, follow the guidelines below:

- If the devices are exposed to fresh water, dry them thoroughly by wiping them with a clean, soft cloth and shaking them to remove any water from the devices.
- If the devices are contaminated with or exposed to any liquid other than fresh water, use them only after they have been repaired at a Samsung Service Centre or an authorised service centre.

It is not recommended to use the devices under water.

Precautions for using the earbuds

- Excessive exposure to loud sounds can cause hearing damage.
- Using the earbuds while walking may distract your attention and cause an accident.
- Always turn the volume down before using the earbuds and use only the minimum volume setting necessary to hear your conversation or music.
- If your ears or earbuds are wet or have foreign materials on them, or if you have prolonged skin contact with the earbuds, it may result in skin irritation. Make sure that your ears and earbuds are clean and dry before wearing the earbuds.
- In dry environments, static electricity can build up in the earbuds. Avoid using earbuds in dry environments or touch a metal object to discharge static electricity before using the earbuds.
- Do not use earbuds while driving or riding. Doing so may distract your attention and cause an accident, or may be illegal depending on your region.
- Although the Galaxy Buds comply with international safety standards, inserting the earbuds forcefully or wearing them for a long time may cause pain or skin irritation.
- If you experience any skin irritation while you are wearing the earbuds, stop wearing them immediately and consult a specialist.
- Do not clean the earbuds with compressed air or use ultrasonic waves or external heat sources if dust, sweat, ink, oil, or chemicals (cosmetics, sunscreen, antibacterial spray, hand sanitiser, detergent, insecticide, etc.) come into contact with the earbuds and charging case. Discolouration or corrosion may cause damage to the Galaxy Buds.
- Remove the ear tips, wash the outside and the mesh part with clean water, and then dry them thoroughly after use. Wipe the earbuds with a soft, dry cloth if they are contaminated.

Cleaning and managing the Galaxy Buds

Basic maintenance

- Use a soft, dry cloth to clean the earbuds after use.
- Keep the earbuds dry. Prevent liquid from contacting or entering the earbuds.
- Clean the earbuds regularly to prevent earwax or debris from building up in the microphone hole, speaker, and air duct.

Cleaning the microphone hole, speaker, and air duct

If the volume is lower than it should be with the current setting, clean the microphone hole, speaker, and air duct. Before cleaning the speaker, detach the ear tip from the latch at the bottom of the earbud.

Remove any earwax or debris with a clean, dry, and soft brush, cotton swabs, or other tools.

► Galaxy Buds3:

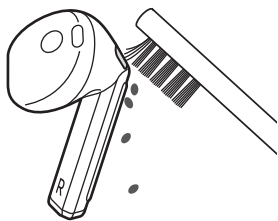

Microphone hole

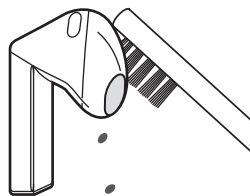

Speaker

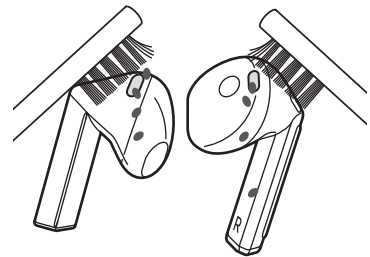

Air duct

► Galaxy Buds3 Pro:

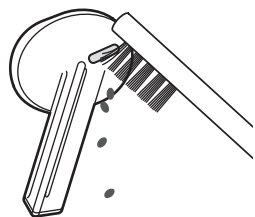

Microphone hole

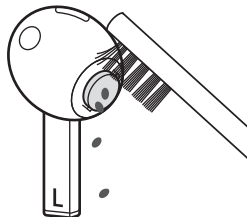

Speaker

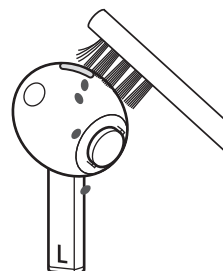

Air duct

❗ Do not use anything sharp or excessive force while removing earwax or debris. The microphone hole, speaker, and air duct may be damaged.

Cleaning the charging contacts

If the battery does not charge properly, wipe the charging contacts with a dry cloth.

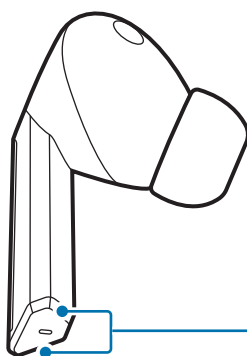

Charging contacts

Cleaning the earbuds and charging case

When the earbuds and charging case are exposed to foreign materials, such as dust, sand, or metal shavings, the Galaxy Buds may not charge properly or may be damaged. If the earbuds or the charging case were exposed to foreign materials, wipe them with a soft and dry cloth before inserting them into the charging case.

Restarting the earbuds

If the earbuds' gesture feature malfunctions or becomes unresponsive, and the earbuds do not work properly, restart the earbuds.

To restart the earbuds, insert the earbuds into their corresponding slots in the charging case, which is not discharged, close the charging case, and then remove them after 7 seconds or more.

 If the charging case has low battery, connect the charging case to the charger first.

Coupling the earbuds

When you lose one of the earbuds, you do not have to purchase a new set of earbuds because you can make a new set of earbuds with a newly purchased earbud and the other earbud that you already have.

- 1 Check the direction of each earbud, the newly purchased earbud and previously used earbud, and correctly insert them into their corresponding slots in the charging case.
- 2 Open the charging case and press and hold the Connect button at the bottom of the charging case for 7-20 seconds.

The charging case battery indicator light will flash blue and turn off. Then, the earbuds are coupled.

 The charging case battery indicator light will keep flashing red when the earbuds are not coupled properly. Remove the earbuds from the charging case and insert them again. Then, open the charging case and press and hold the Connect button at the bottom of the charging case for 7-20 seconds. If you press and hold the Connect button for more than 20 seconds, the earbuds may be reset.

- 3 Connect the earbuds to a mobile device. For more information, refer to [Connecting the earbuds to a mobile device](#).

Appendix

Troubleshooting

Before contacting a Samsung Service Centre or an authorised service centre, please attempt the following solutions. Some situations may not apply to your Galaxy Buds.

You can also use Samsung Members to solve any problems you might encounter while using your device.

Your earbuds do not work

- The battery may be completely discharged. Charge the battery completely before using the earbuds.
- If an earbud's touch-sensitive sensor does not make contact with your ear, the earbud may not work. If you do not hear a sound informing you that the earbuds are detected, remove the earbuds from your ears and put them in again.
- If the earbuds' gesture feature malfunctions or becomes unresponsive, and the earbuds do not work properly, insert the earbuds into their corresponding slots in the charging case, which is not discharged, close the charging case, and then remove them after 7 seconds or more.

Another Bluetooth device cannot locate your earbuds

- Close the charging case again and open it to enter the Bluetooth pairing mode.
- Ensure that your earbuds and the other Bluetooth device are within the maximum Bluetooth connection range (10 m). The distance may vary depending on the environment the devices are used in.

If the tips above do not solve the problem, contact a Samsung Service Centre or an authorised service centre.

A Bluetooth connection is not made or your earbuds and the mobile device are disconnected

- Ensure there are no obstacles, such as walls or electrical equipment, between the devices.
- Ensure that the latest version of the Galaxy Wearable app is installed on the mobile device. If the Galaxy Wearable app is not latest version, update the Galaxy Wearable app to the latest version.
- Ensure that your earbuds and the other Bluetooth device are within the maximum Bluetooth connection range (10 m). The distance may vary depending on the environment the devices are used in.
- Restart the mobile device and reopen the **Galaxy Wearable** app.
- If only a single earbud is connected to your mobile device, restart the earbuds to connect them both. To restart the earbuds, refer to [Restarting the earbuds](#) for more information.

The battery does not charge properly (For Samsung-approved chargers)

- Ensure that the charging contacts of the earbuds and the charging contacts of the charging case are in contact with each other.
- Ensure that the charger is connected properly to the charging case.
- If the charging contacts are dirty, the battery may not charge properly. Wipe the charging contacts with a dry cloth and try charging the battery again.

If the tips above do not solve the problem, contact a Samsung Service Centre or an authorised service centre.

The charging time and the battery life is different between the earbuds

- The charging time may differ between the two earbuds even if they started charging at the same time.
- The charging time and the remaining battery may differ between the two earbuds because of different inner components.

The battery depletes faster than when first purchased

- When you expose the Galaxy Buds to very cold or very hot temperatures, the useful charge may be reduced.
- The battery is consumable and the useful charge will get shorter over time.
- When you are not using the earbuds, store them in a charging case that has been charged. If not, the touch-sensitive sensor will continue to work, and it will affect the usage time and battery consumption.

You cannot hear others speaking

Adjust the volume on the connected mobile device.

Sound echoes during a call

Adjust the volume on the connected mobile device or move to another area.

Sound is emitted from the connected mobile device, not the earbuds, during a call

- Check if you are wearing the earbuds properly. If worn improperly, you will not be able to hear the call audio through the earbuds, even if the Bluetooth icon appears on the connected mobile device.
- Remove the earbuds from your ears and put them in again.

Audio quality is poor

- Wireless network services may be disabled because of issues with the carrier's network. Ensure to keep the earbuds away from electromagnetic waves.
- Ensure that your earbuds and the other Bluetooth device are within the maximum Bluetooth range (10 m). The distance may vary depending on the environment the devices are used in.
- You may experience drops in volume or noise depending on the connected device's volume. To avoid this, appropriately adjust the connected device's sound.

Your earbuds sound comes slower than the screen when playing videos and games

The earbuds may have a time lag between the video and sound output when playing videos or games when connected to a mobile device.

The noise controls modes do not work well

- Wear both earbuds in your ears and launch the Active noise cancelling feature, which is one of the noise controls modes. If you are unsure if the Active noise cancelling feature is turned on, check it on the Galaxy Wearable app.
- Check whether there is a buildup of foreign materials in the microphones located at the top and bottom of the earbuds, and clean them if required.
- Ensure that the latest software version is installed on the earbuds.

Your Galaxy Buds are hot to the touch

When you use the Galaxy Buds for an extended period of time, they may feel hot to the touch. This is normal and should not affect your Galaxy Buds' lifespan or performance.

If the Galaxy Buds overheat or feel hot for a prolonged period, do not use them for a while. If the Galaxy Buds continue to overheat, contact a Samsung Service Centre or an authorised service centre.

A small gap appears around the outside of the Galaxy Buds

- This gap is a necessary manufacturing feature and some minor rocking or vibration of parts may occur.
- Over time, friction between parts may cause this gap to expand slightly.

When the earbuds are removed from your ears, the ear tips are turned upside down (Galaxy Buds3 Pro)

Depending on how you wear the earbuds and the direction in which the earbuds are removed, the ear tips may turn over. In this case, turn them over in the original direction and use it again.

Removing the battery

- To remove the battery, contact an authorised service centre. To obtain battery removal instructions, please visit www.samsung.com/global/ecodesign_energy.
- For your safety, you **must not attempt to remove** the battery. If the battery is not properly removed, it may lead to damage to the battery and device, cause personal injury, and result in the device being unsafe.
- Samsung does not accept liability for any damage or loss (whether in contract or tort, including negligence) which may arise from failure to precisely follow these warnings and instructions, other than death or personal injury caused by Samsung's negligence.

Copyright

Copyright © 2024 Samsung Electronics Co., Ltd.

This guide is protected under international copyright laws.

No part of this guide may be reproduced, distributed, translated, or transmitted in any form or by any means, electronic or mechanical, including photocopying, recording, or storing in any information storage and retrieval system.

Trademarks

- SAMSUNG and the SAMSUNG logo are registered trademarks of Samsung Electronics Co., Ltd.
- Bluetooth® is a registered trademark of Bluetooth SIG, Inc. worldwide.
- All other trademarks and copyrights are the property of their respective owners.

Model: SM-R530 / SM-R630

Rated voltage/current:

5 V / 200 mA (earbuds)

5 V / 900 mA (charging case), 3.88 V (internal battery)

Made in Vietnam by Samsung

PO BOX 12987, DUBLIN. IE

